

SIREC DS Display Recorder

User Manual

Edition 01/2002

7ND4120-xxx

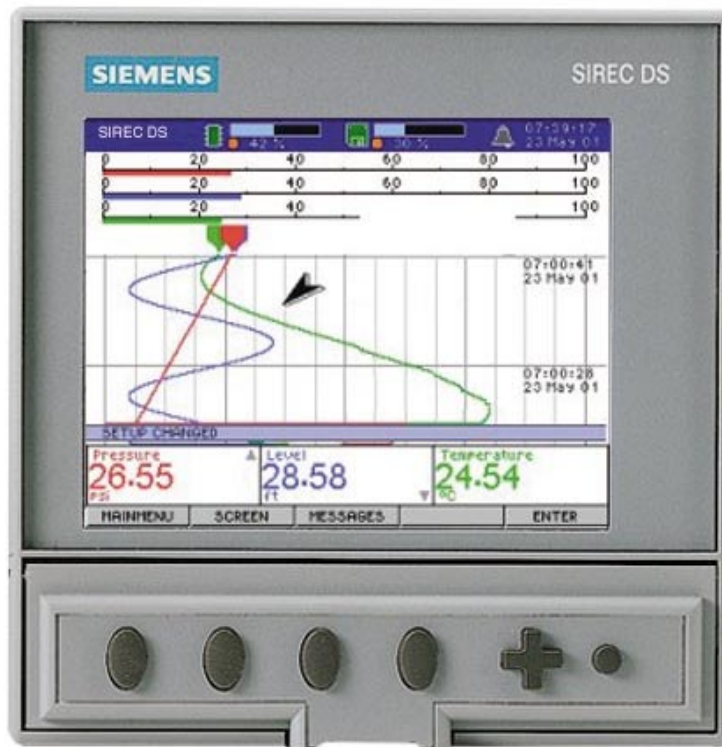

SIMATIC® , SIPART® , SIREC® , SITRANS®

are registered trademarks of Siemens.

All other products or system names are (registered) trademarks of their respective owners and must be treated accordingly.

The reproduction, transmission or use of this document or its contents is not permitted without express written authority. Offenders will be liable for damage.
All rights created by the granting of patents or registration of a design are reserved 2001.

Technical data is subject to change without notice.

Table of Contents

Table of Contents	iii
Safety	1
<i>Symbols</i>	1
<i>Static Electricity</i>	1
<i>Installation Category</i>	1
<i>Fuses</i>	1
<i>Cables</i>	2
WARNINGS AND SAFETY PRECAUTIONS	2
<i>Do's and Don'ts</i>	2
<i>Hazardous Voltage</i>	3
<i>Maintenance and Unit Repair</i>	3
Chapter 1:	
<i>Introduction</i>	5
SIREC DS	5
Description	5
Storage Media	5
Specifications	6
<i>Universal Input card</i>	7
<i>Universal Input card, performance</i>	7
<i>Universal card performance, RTDs</i>	8
Main Features	9
Default Start-up Condition Table	10
Real-time Visuals	10
<i>Status Bar</i>	10
<i>Bar</i>	11
<i>Digital</i>	11
<i>Alarm Indicators</i>	12
<i>Pen Pointers</i>	12
<i>Trend</i>	13
<i>Units and Scale</i>	13
<i>Scale</i>	13

Chapter 2:	<i>Installation</i>	15
	Unpacking	15
	Battery	15
	Mechanical	15
	<i>Panel Mounting</i>	16
	Electrical	17
	<i>Cables</i>	17
	<i>A.C. Power</i>	17
	Case	18
	<i>Display Trimpot Adjustments</i>	18
	<i>A - Brightness control</i>	18
	<i>B - Contrast control</i>	18
	<i>C - Battery switch</i>	18
	Universal Card	18
	<i>Current Inputs</i>	19
	<i>Thermocouple</i>	19
	Alarm Card (option)	19
	<i>Ethernet Interface</i>	20

Chapter 3:	<i>Quick Tour</i>	21
	The Keypad	21
	<i>Buttons</i>	21
	<i>Directional Key</i>	21
	The Screen	21
	<i>Status Bar</i>	22
	<i>Screen Layouts</i>	22
	<i>Screen Displays</i>	23
	<i>Replay Mode</i>	24
	<i>Messages</i>	25
	<i>Events List</i>	25
	Power Up	26
	Menu Selection	27
	Text Entry	27
	About	28

Chapter 4:	<i>General Setup</i>	29
	Setup	29
	Edit	29
	General	30
	<i>Language</i>	30
	<i>Name</i>	30
	<i>Description</i>	31
	<i>ID Number</i>	31
	<i>Default Drive</i>	31
	<i>Set Time</i>	31
	<i>Screen</i>	32
	<i>Option Codes</i>	32

Chapter 8:	<i>Setup Complete</i>	65
	Setup complete	65
	Load	66
	Save	66
Chapter 9:	<i>Recording</i>	67
	Recording	67
	<i>Enabled</i>	67
	<i>Log to Disk</i>	67
	<i>Save Data and Eject Disk</i>	67
	<i>Validate Disk</i>	68
Chapter 10:	<i>Totals</i>	69
	<i>Start All Totals</i>	69
	<i>Stop All Totals</i>	69
	<i>Reset All Totals</i>	69
Chapter 11:	<i>Change Password</i>	71
	Changing an Existing User Password	71
Chapter 12:	<i>Layout</i>	73
	Layout Configuration	73
	<i>Selecting and Re-naming Screens</i>	73
	<i>Data display evaluation</i>	74
	SIREC DS <i>chart speeds</i>	74
Chapter 13:	<i>Software</i>	75
	<i>Software License/Warranty</i>	75
	<i>Features</i>	75
	System Requirements	77
Chapter 14:	<i>Instrument Care</i>	79
	Battery Life	79
	Cleaning Instructions	79
	Disk Drive	79
	Disk Drive Cleaning	80
	<i>Cleaning Procedure</i>	80
	Backlights	81
	Operating Temperature	81
	Front Panel	81
	Calibration	81





Appendix A - Quality Approvals	83
CE Mark	83
 Appendix B - Battery Safety	
Data Sheet	85
Safety Guideline	85
<i>Identification</i>	85
<i>Composition/Information on Ingredients</i>	85
<i>Hazard Identification</i>	86
<i>First Aid Measures</i>	86
<i>Fire - fighting measures</i>	86
<i>Accidental release measures</i>	87
<i>Handling and Storage</i>	87
<i>Stability and Reactivity</i>	87
<i>Ecological information</i>	87
<i>Disposal Considerations</i>	87
 Appendix C -Thermocouple	
Connections	89
Internal Reference	89
External Reference @ 0°C	90
External Reference @ Specified Temperature	90
External Input Reference	91
 Appendix D- Maths Expressions	93
<i>Maths and Fail Safe</i>	95
 Appendix E - Ethernet & E-mail	97
Ethernet	97
E-mail	97
<i>General operation of the e-mail system</i>	97
 Appendix F- Fuzzy Logging	99
What is Fuzzy Logging?	99
OK. How does it work?	100
 Index	103

Safety

The product range of instruments is compliant with the requirements of BS EN 61010-1:1993 "Safety Requirements for Electrical Equipment for Measurement, Control and Laboratory Use". If the equipment is used in a manner NOT specified, the protection provided by the equipment may be impaired.

Symbols

One or more of the following symbols may appear on the recorder labelling:

Symbol	Meaning
	Caution - refer to manual for instructions
	Caution - risk of electric shock
	Direct Current
	Protective conductor terminal
	Earth terminal

Static Electricity

All circuit boards and electronic modules associated with this recorder contain components which are susceptible to damage caused by electrostatic discharge. Should it be necessary to handle such components, appropriate precautions in accordance with BS CECC 00015 "Basic specification: protection of electrostatic sensitive devices" should be observed.

Installation Category

- Installation category - Installation category II, Pollution degree 2

For voltage, frequency and power see "[Specifications](#)" on page 6.

Fuses

There is one fuse situated on the power supply that can not be replaced by the operator.

Cables

To fully comply with the requirements of the CE Mark, all cables connected to the rear of the unit should use screened cable terminated at both ends. Also a low impedance earth cable (<1 mΩ) should be connected to the earthing stud on the rear of the recorder.

WARNINGS AND SAFETY PRECAUTIONS

Do's and Don'ts

1. Before any other connections are made to the recorder, the protective earth terminal should be connected to a protective conductor.
- 2.



IMPROPER INTERRUPTION OF CONNECTIONS

Any interruption of the protective conductor outside the recorder, or disconnection of the protective earth terminal is likely to make the recorder dangerous under some fault conditions. Intentional interruption of the protective conductor is dangerous.

Failure to comply with these instructions will result in death or serious injury.

In order to comply with the requirements of safety standard EN61010, the recorder should have one of the following as a disconnecting device, located within easy reach of the operator, and be clearly labelled as the disconnecting safety device:

- A switch or circuit breaker which complies with the requirements of IEC947-1 and IEC947-3.
 - A separable coupler which can be disconnected without the use of a tool.
 - A separable plug, without a locking device, to mate with a socket outlet in the building.
3. Whenever it is likely that protection has been impaired, the recorder should be made inoperative and secured against operation. The manufacturer's service centre should be contacted.
 4. Any adjustment, maintenance, and repair of the opened recorder in a powered condition is hazardous and should never be attempted.
 5. Where conductive pollution such as condensation or conductive dust is present, adequate air conditioning, filtering and/or sealing must be installed.
 6. This recorder contains a battery which must be treated and disposed of with care. Batteries must not be short circuited. Batteries should be disposed of in accordance with local regulations, they must not be disposed of with normal refuse. *See "Appendix B - Battery Safety Data Sheet" on page 85.*

7.

 **WARNING**

IMPROPER SIGNAL AND SUPPLY WIRING

Signal and supply wiring should be kept separate. Where this is impractical, shielded cables should be used for the signal wiring. Where signal wiring is carrying, or could carry under fault conditions, hazardous voltage (defined as >30 V rms and 42.4 V peak, or >60 Vd.c.), double insulation must be used for all signal wiring.

Failure to comply with these instructions could result in death or serious injury.

8. If the equipment is used in a manner not specified by the manufacturer, the protection provided by the equipment may be inadequate.
9. In the case of portable equipment, the protective earth terminal must remain connected (even if the recorder is isolated from the mains supply) if any of the measuring, communications, or relay terminals are connected to hazardous voltages.
10. For transportation considerations, see ["Instrument Care" on page 79](#)

Hazardous Voltage

Hazardous Voltages are defined by EN61010-1 as follows:

 **WARNING**

HAZARDOUS VOLTAGE LEVELS

Voltage levels above 30V rms and 42.4V peak or 60V dc are deemed to be "**Hazardous Live**".

Refer to ["Appendix B - Battery Safety Data Sheet" on page 85](#) for further information

Failure to comply with these instructions could result in death or serious injury.

Maintenance and Unit Repair

[See "Instrument Care" on page 79.](#)

 **CAUTION**

CONTROL UNIT DAMAGE

In the event of a malfunction with the recorder contact your nearest Service Department (or authorised agent) to arrange for the return of the unit for repair.

Failure to comply with these instructions may result in property damage

Chapter 1: Introduction

SIREC DS

The **SIREC DS** paperless chart recorder, is the latest development of the solid-state replacement for traditional paper chart recorders.

The **SIREC DS** focuses on

- Ease 100 mm key recorder of use
- Low cost
- Reliability
- Strong visual design

Several options are available to meet a wide range of requirements within the pharmaceutical, water, process, gas and petrochemical industries, as well as power and environmental monitoring.

The **SIREC DS** uses a 5" passive colour STN QVGA display, with brightness and contrast adjustments. The displays shows combinations of horizontal and vertical chart trends, real time bars and digital panel readouts - each input channel can also have a number of alarms assigned to them, as an option.

The **SIREC DS** is available with up to 6 channels of Universal analogue inputs and with up to 32 alarms in any combination of any pen. Full Ethernet communications for direct connection of the recorder to a LAN or the Internet is available as standard.

SIREC DS can be fully programmed and re-configured locally via the integral keypad, or remotely from a PC. The configuration may be transferred from the PC to the recorder on a 3.5" 1.44 Mbyte floppy disk and stored in the internal flash memory.

Description

Model	Details
SIREC DS	2, 4 or 6 channel recorder with 5" diagonal colour STN QVGA.

Storage Media

Media	Capacity
3.5" Floppy Disk	1.4 Mbytes
Internal Flash Memory	2 Mbytes

Specifications

Panel depth measurements do not include the thickness of the panel.

	SIREC DS
Display Technology	5" passive colour STN QVGA Resolution 320 x 240 pixels
Dimensions (mm): Bezel Size (w x h) Panel Depth Panel cut out	144 x 144 mm 200 mm (minimum) 138 x 138 mm
Number of Channels	2, 4, or 6
Power Supply	100 - 240 Va.c. (50/60 Hz) 24 Vd.c. (option)
Storage Data Internal	2 Mbytes Internal Flash Memory 1.44 MByte standard floppy
Power Consumption (max)	20 VA (ac), 20 W (dc) Max.
Alarm card options	4 x relay outputs or 6 x relay outputs and 2 x volt free inputs (non inductive, internally suppressed)
Communications	Ethernet as standard.
DC Isolation	≤300 V d.c. (channel to channel, channel to earth)
Relative Humidity	10% to 90% RH
Storage Temp	-10 to 60 °C
Operating Temp	0 to 40 °C
Number of Inputs	2, 4 or 6 Universal Inputs
Input Types	EMF (mV, V, mA), Thermocouple, RTD
Input Sampling Rate	100 mSec for all inputs
Input Sampling Method	Sample, Average, Min-Max
Logging Method	Sample, Average, Min-Max
Logging Type	Continuous, Events, Fuzzy
Logging Rates	100 mSec to 4 days per log
Clock	Calendar function - adjustable for daylight saving via Ethernet
Event Markers	44 character messages activated by cause and events
Alarm Set Pointers	Up to 32 integral 'soft' alarm points set for out of limit conditions
Languages	English, French, German, Italian, Spanish

Universal Input card

Analogue Inputs	Details
Analogue input options	±70 mV, ±100 mV, ±200 mV, ±1 V, ±10 V, ±10 mA, ±20 mA Resistance thermometer, Thermocouple
Resolution of analogues	16 bit 0.0015%
Accuracy of analogues	
Voltage	±70 mV, ±100 mV (±0.04) ±200 mV (±0.04) ±1 V, ±10 V (±0.04)
Current	±10 mA, ±20 mA For current inputs, accuracy will depend on the resistor used, see " Current Inputs " on page 19
Source Resistance	-T/C mV 0.5°C/100 Ω (1000 Ω max) approx. -RTD 0.1°C/Ω (40 Ω max) approx.

Universal Input card, performance

Linear and Thermocouple

Input Actuation (Linear)	Range		Accuracy			Temp. Stability
Millivolts dc	-100 to 100		0.04%			0.04%/°C
Volts dc	-2200 to 200		0.04%			0.04%/°C
	-1.0 to 1.0		0.04%			0.04%/°C
	-10 to 10		0.04%			0.04%/°C
Input Actuation (Thermocouples)	Range		Accuracy			Temp. Stability ± Degrees Error per 1 degree
	°F	°C	±°F	±°C	±%Span	
B	32 to 3182	0 to 1820				
	32 to 1112	0 to 600	18	10	0.7%	0.15%/°C
	1182 to 3182	600 to 1750	7.2	4	0.3%	0.13%/°C
C(W5)	32 to 4172	0-2300	9	5.5	0.3%	0.06%/°C
E	32 to 4172	-200 to 1000	3.6	2	0.3%	0.06%/°C
J	-328 to 2174	-200 to 1190				
	-328 to 32	-200 to 0	5.4	3	0.25%	0.03%/°C
	32 to 2174	0 to 1190	2.7	1.5	0.15%	0.03%/°C
K	-328 to 2462	-200 to 1350				
	-328 to 32	-200 to 0	5.4	3	0.2%	0.03%/°C
	32 to 1832	0 to 1000	3.6	2	0.15%	0.03%/°C
	1832 to 2462	1000 to 1350	4.5	2.5	0.15%	0.03%/°C

Input Actuation (Linear)	Range		Accuracy			Temp. Stability
L	-328 to 1652	-200 to 900	5	2.75	0.3%	0.03%/°C 0.03%/°C
	-328 to 212 212 to 1652	-200 to 100 100 to 900	2.7	1.5	0.3%	
N (Nicrosil Nisil)	-328 to 2372	-200 to 1300	5.4	3	0.2%	0.05%/°C 0.04%/°C
	-328 to 32 32 to 2372	-200 to 0 0 to 1300	5	2.75	0.2%	
R	32 to 3092	0 to 1750	7.2	4	0.3%	0.01%/°C 0.01%/°C
	32 to 572 572 to 3092	0 to 300 300 to 1750	5.4	3	0.2%	
S	32 to 3092	0 to 1750	7.2	4	0.3%	0.01%/°C 0.01%/°C
	32 to 572 572 to 3092	0 to 300 300 to 1750	5.4	3	0.2%	
T	-328 to 752	-200 to 400	3.6	2	0.35%	0.08%/°C 0.08%/°C
	-328 to 32 32 to 752	-200 to 0 0 to 400	1.8	1	0.2%	
W	1832 to 4172	1000 to 2300	5.4	3	0.3%	0.15%/°C 0.15%/°C
	1832 to 3272 3272 to 4172	1000 to 1800 1800 to 2300	5.4	3	0.3%	
Cromel/Copel	-74 to 1110	-50 to 600	1.8	1	0.3%	0.05%/°C

Universal card performance, RTDs

Resistance Thermometer

Input Actuation (RTDs)	°F	°C	±°F	±°C	±%Span	Temp. Stability ± Degrees Error per 1 degree
PT100 100 ohms (To BS1904)	-328 to 1202	-200 to 650	2.7	1.5	0.2%	0.05%/°C
PT200 200 ohms	-328 to 356	-200 to 180	2.7	1.5	0.4%	0.05%/°C
CU53	32 to 300	0 to 150	2.7	1.5	0.9%	0.05%/°C
Ni120	-112 to 464	-80 to 240	2.7	1.5	0.5%	0.05%/°C

Reference Temperature 20°C
Reference Humidity 65% RH 15%
Reference Junction Accuracy ±1.0°C
CJC Temperature Effect ±0.05°C/°C
Long Term Stability 0.2%/year

Main Features

Recorder Function	Rationale
Ethernet comms	Access recorder data via an ethernet connection
Password protection	Allows restricted access to recorder menus at specific levels
Independent log rate on each pen.	Each input has specific logging response.
Adjustable chart speeds.	Data view and collection optimised to the process variables.
Independent logging criteria on each pen - Sample, Average, Max/Min, Fuzzy.	Data collection optimised to the process variable.
Programmable display of multicolour traces, digital instantaneous values and bars with 250mSec display update.	Process window customised to application and user preference.
Different pen colours for analog/waveforms.	Maximise user visibility.
Visual indication of process maximums and minimums on bargraph displays.	Prompt indication of process excursions.
Indication of alarm set-points and process over/under range on the bargraphs.	Timely indication of critical process deviations.
Programmable chart divisions.	Simulated "paper" background easily changed.
Programmable pen names, engineering units and tag descriptions (up to 20 characters).	Effective recorder and input identification.
Pen programmable maths expression.	Process input manipulated at the recorder.
Event marking and recording system using external switch inputs or keypad.	Specific event can be identified and recorded.
Self diagnostics within the recorder.	Distinct identification of unit failures.
Data replay in trend mode	Review of long term trends and data analysis.
Language sensitive firmware	Firmware available in 6 languages
Replay of historical and Realtime data	Stored and Realtime data can be graphed in the software.
Realtime data transfer	Stored data can be analysed in the software.
Comms Server	Manages the communication status of the recorder

Default Start-up Condition Table

Listed below are the recorder default settings for initial power up.

Menu	Function	Default
General Set up	Language	English (UK)
	Default Drive	Disk
	Password	Disabled
	Factory Drives	Disk 1.44 Mb floppy
Analogue In Set up	Inputs	Enabled
	Type	Volts
	Range	0-10V
	Sampling	500mS <2Hz>
	Pen	Enabled
Pens Set up	Scale	0-100% (Auto format/Auto Divs)
	Totaliser	Disabled
	Logging	Disabled
Recording Set up	Recording	Disabled
	Log to disk	Disabled
Layout	Screens 1 & 2	Enabled
	Screens 3 to 10	Disabled

Real-time Visuals

For a full display of the eight different screen layouts available on the **SIREC DS**, see [“Screen Layouts” on page 22](#). To select a screen layout see [“Selecting and Re-naming Screens” on page 73](#)

Status Bar

The Status bar depicts the various process states active in the recorder

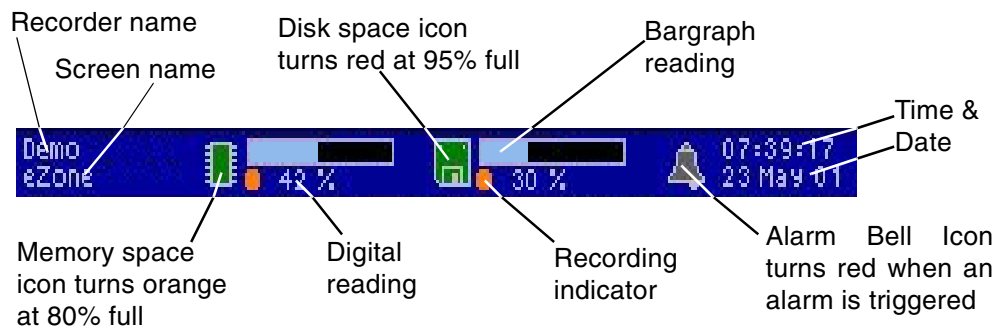

Bar

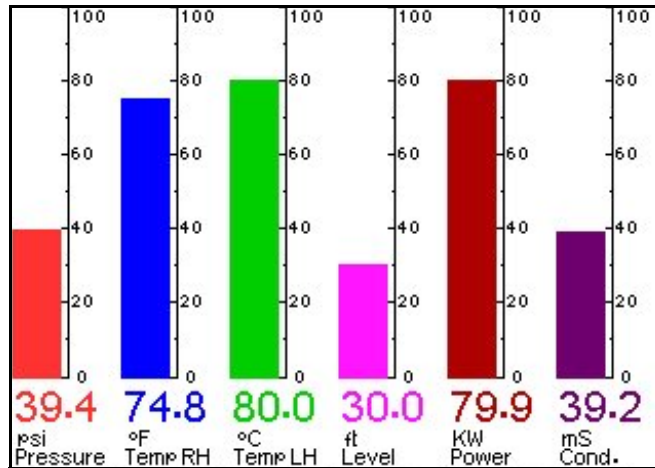

- Auto attach to trend.
- Major and Minor graduations.
- Over/under range indication.
- Variable screen position.
- Horizontal or vertical.

Digital

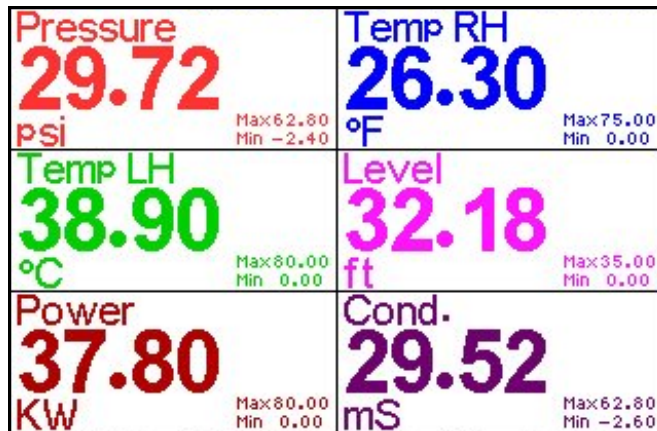

- Variable screen position.
- Max / Min. values.
- Over/under range indication.

Alarm Indicators



- High alarm icon is red



- Low alarm icon is red

Pen Pointers

- Provide pen pointers where bars are not required which move in real-time.
- Over/under range indication.

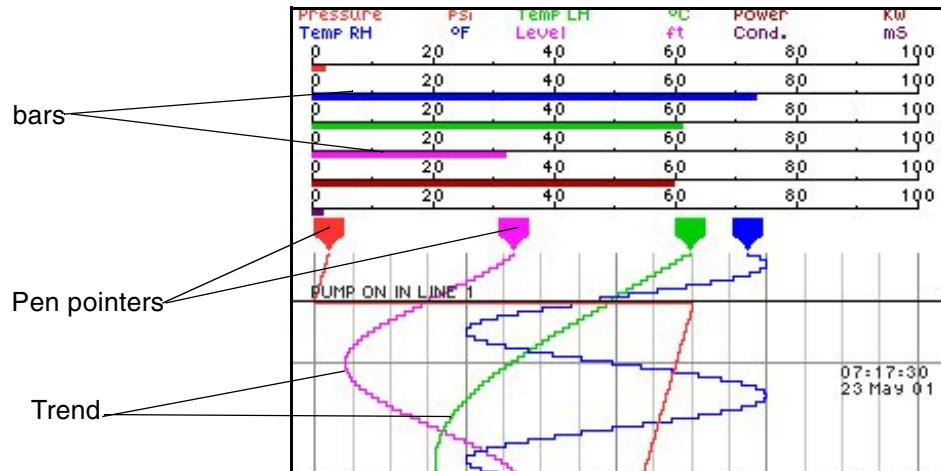

Trend

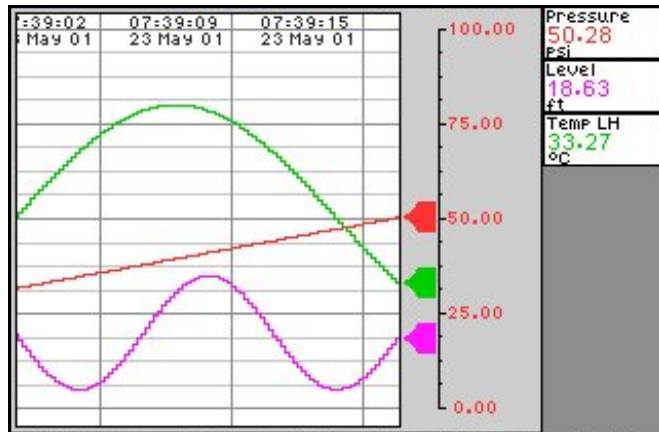

- Variable time per division.
- Text markers.
- Any combination of pens in tiled, conventional or waterfall mode.

Units and Scale

- Programmable text length up to 20 characters.



Scale

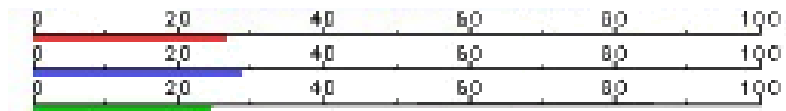

- Auto or definable scale.
- Horizontal or vertical.

Chapter 2: Installation

Unpacking

It is advisable to retain the packaging in which your **SIREC DS** recorder arrived, should the recorder need to be returned.

NB. Should the original packing be destroyed, then **ONLY** pack the recorder in polystyrene granules if the recorder is **FIRST** sealed in a strong plastic bag, failing to do this will invalidate your warranty.

For transportation information see [“Instrument Care” on page 79](#).

Battery

The **SIREC DS** battery does not require any charging prior to use. There is a battery switch located on the side of the unit, see [“Case” on page 18](#). With the battery switched on and the recorder power off, the battery will last for 6 months, with the battery and recorder power on, the battery should last for up to 10 years.

Mechanical

The **SIREC DS** units are panel mounted as shown below. The recorder slides into the panel cut-out from the front and is held in place by two mounting clamps pressed against the rear of the panel by two screws.

NB: For panel cutout size [See “Specifications” on page 6](#).

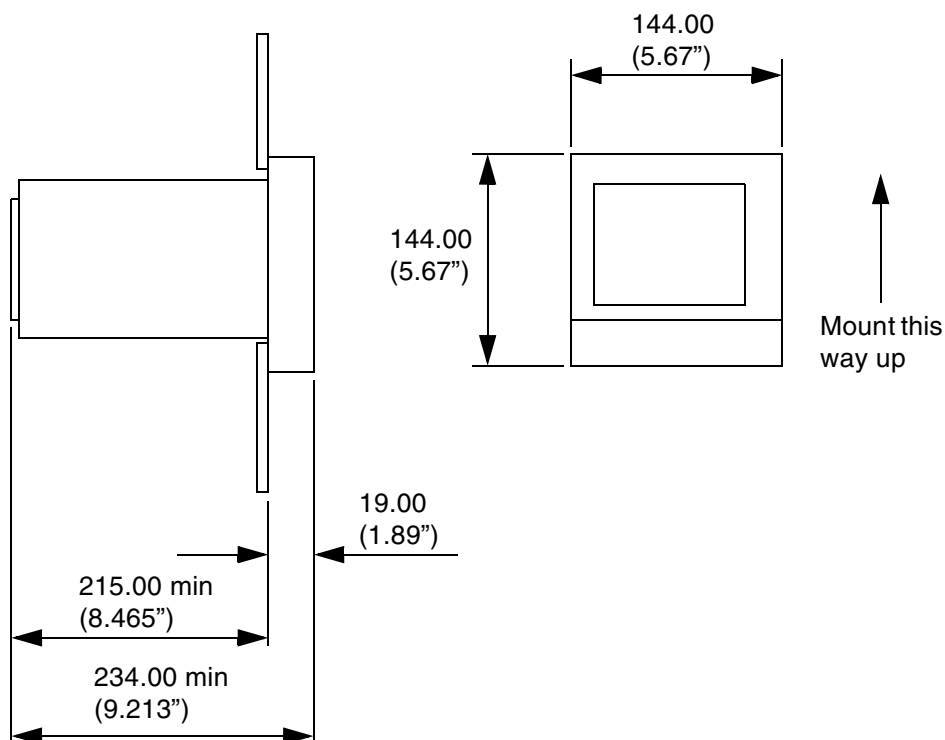

Panel Cut-out

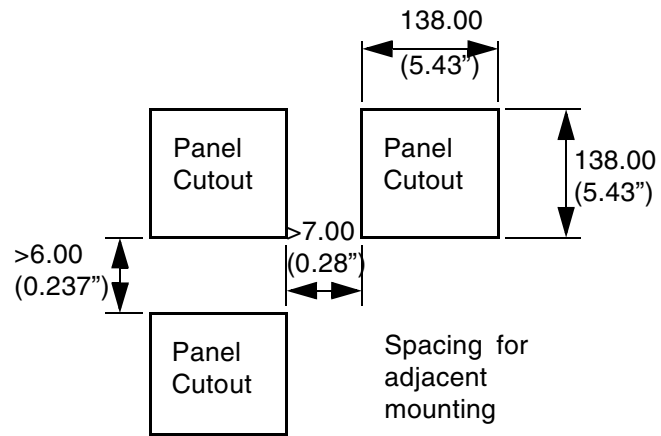

Panel Mounting

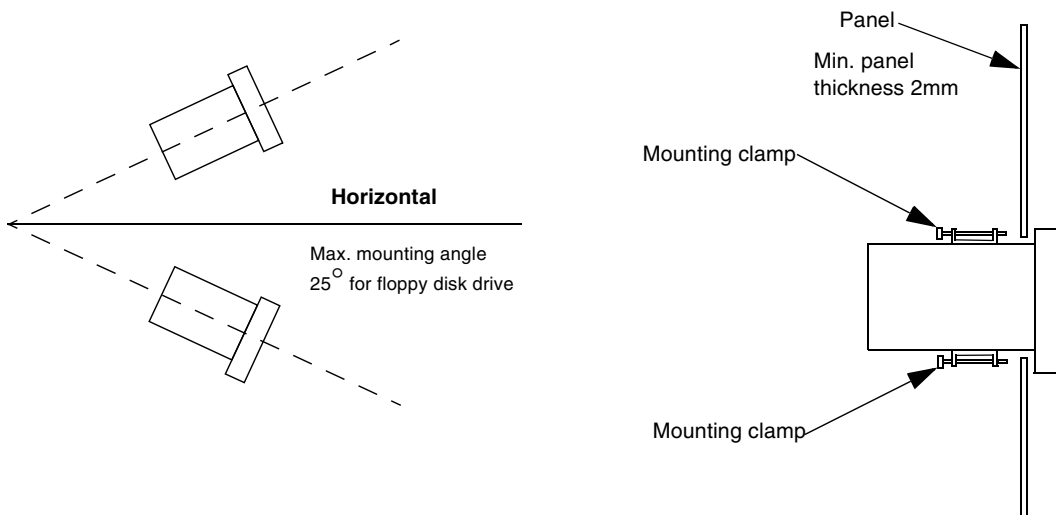

CAUTION

CONTROL UNIT DAMAGE

DO NOT OVERTIGHTEN MOUNTING CLAMP SCREWS
TORQUE SETTING 0.2 - 0.5 Nm/1.77 - 4.4 lbf-in

Electrical

All connections to the unit are made via the rear panel.

Cables

To comply with CE Mark, all cables connected to the rear of the unit should use screened cable terminated at both ends.

A.C. Power

A.C. supply is connected via the standard configuration IEC chassis plug on the rear panel.

NB: For the panel cut-out sizes, [See “Specifications” on page 6.](#)

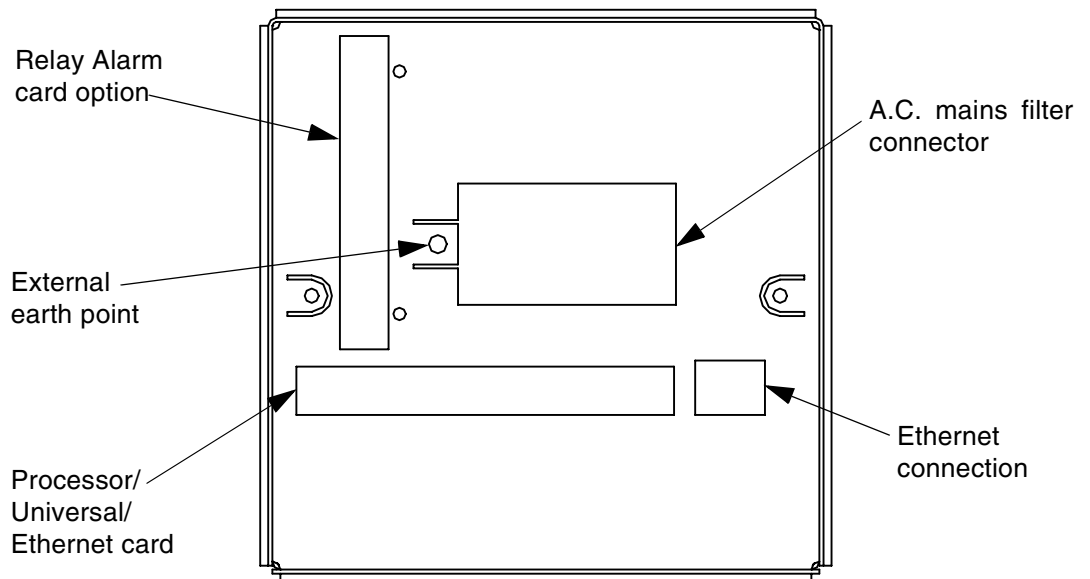

WARNING

ENSURE SAFETY EARTH CONNECTION

Always ensure the unit is connected to safety earth when connecting to a D.C. supply.

Failure to comply with these instructions could result in death or serious injury.

NB: The **SIREC DS** range is intended for panel-mount use and as such should be considered as permanently connected. Disconnection from the supply **MUST** be made possible by means of a switch, circuit breaker or other means of supply isolation. The disconnection device must be included in the panel installation, clearly marked, in close proximity to the equipment, and within easy reach of the operator. In the case of portable equipment, the protective earth terminal must remain connected (even if the recorder is isolated from the mains supply) if any of the analogue, communications, or relay terminals are connected to hazardous voltage.

Case

This view shows the right hand side of the case, the rectangular holes to the right are for the mounting clamps. The three round holes in the centre consist of two trimpots and a battery switch. The left hole is a trimpot adjustment that controls the **Brightness** of the screen. The centre hole is a trimpot adjustment that controls the **Contrast** of the screen. The third hole, to the right, is the **Battery Switch** his will be in the **Off** position by default. The unit will arrive with the battery switch in the off position to save battery life, place the switch into the **On** position, switched towards the front of the unit, to activate.

Display Trimpot Adjustments

A - Brightness control

B - Contrast control

C - Battery switch

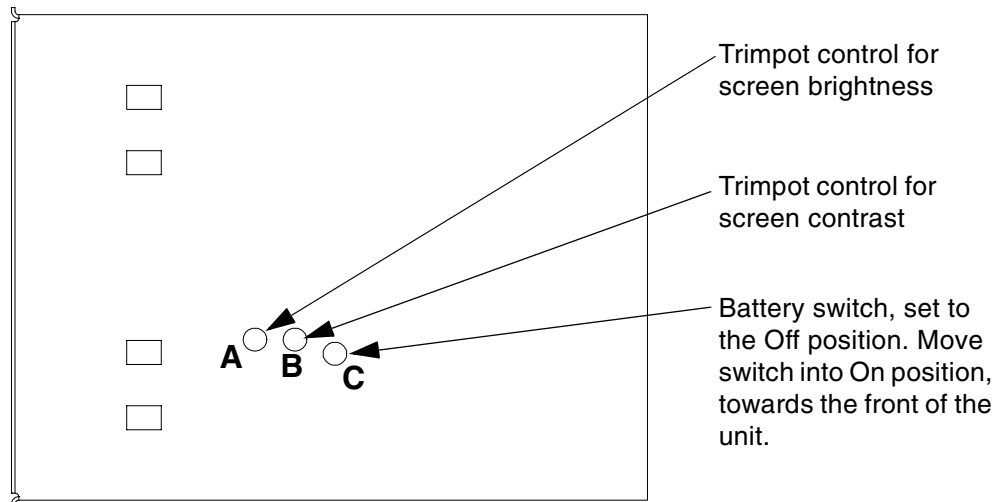

Universal Card

The **Universal input card** is used for connecting a range of input signals to a unit. These are connected as shown in the example below. For 18-way connector; torque setting 0.4Nm/3.5lbf-in. Do not over tighten.

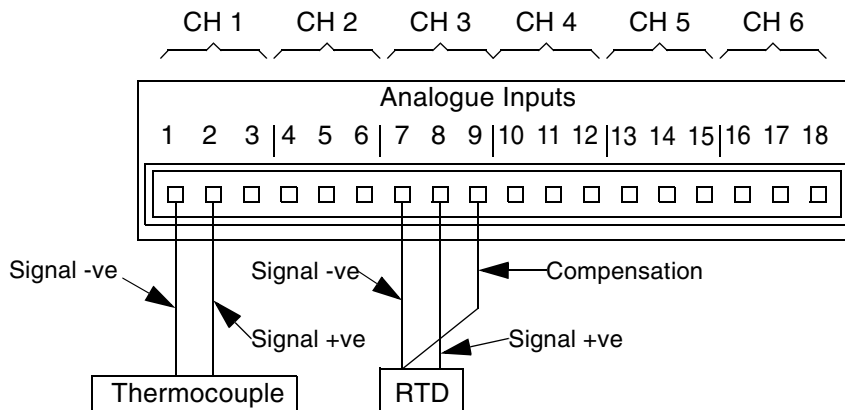

Current Inputs

For current inputs an external resistor is required to be fitted across pins 1 and 2, 1 per channel. The resistor value should be 10Ω and a high tolerance such as 0.1%.

The resistor should be connected as shown, on the mating half connector, across the relevant pins according to which channels are to be set up for current input.

See [“Analogue In Setup” on page 41.](#)

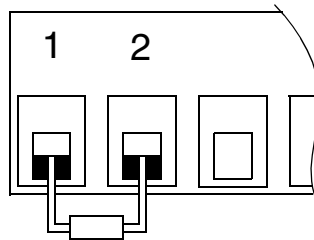

This resistor connection is an example for a current input on channel 1

Current input channel number	Pin numbers to connect
1	1&2
2	4&5
3	7&8
4	10&11
5	13&14
6	16&17

Thermocouple

The **Thermocouple** is connected for internal compensation - details on how to connect thermocouples using other forms of compensation are given in [“Appendix C -Thermocouple Connections” on page 89.](#)

Details on setting up thermocouple and resistance thermometer inputs See [“Thermocouple” on page 47.](#) Or see [“Calibrate Input” on page 38.](#)

Alarm Card (option)

For set up of Alarms, See [“Relay Alarm Cards” on page 63.](#)

There are two **Relay/Alarm Card** options available on the **SIREC DS**. There is a 4 x relay output card and a 6 x relay output with 2 volt free digital inputs. The relay outputs will be activated by

- Alarm or set points
- Disk full

The volt free contact inputs will be available to

- Activate alarms and set points
- Recording control
- Change log rates. (Pause logging)

The pin-outs for the relay alarm card are numbered from the bottom of the unit to top, pins 1 to 12, for the relay outputs, and pins 1 to 4 for the 2 digital input connector. Devices driven by the relays are connected to a 12-way screw terminal plug similar to the one used on the Universal analogue inputs. Available alarm outputs start from alarm channel 1 up to the maximum number of alarms allocated. For 12-way connector; torque setting 0.4 Nm/3.5 lbf-in. Do not over tighten

The Relay Card will be fitted with a link in the Normally Closed (NC) position on channels 1 to 6. The link can be moved manually to the Normally Open (NO) position if required.

The Alarm cards are mounted vertically in the unit and the rear connections for the alarm card are vertical. If the 6 relay output/2 input card is fitted the inputs are located in the 4 pin connector towards the top of the recorder.

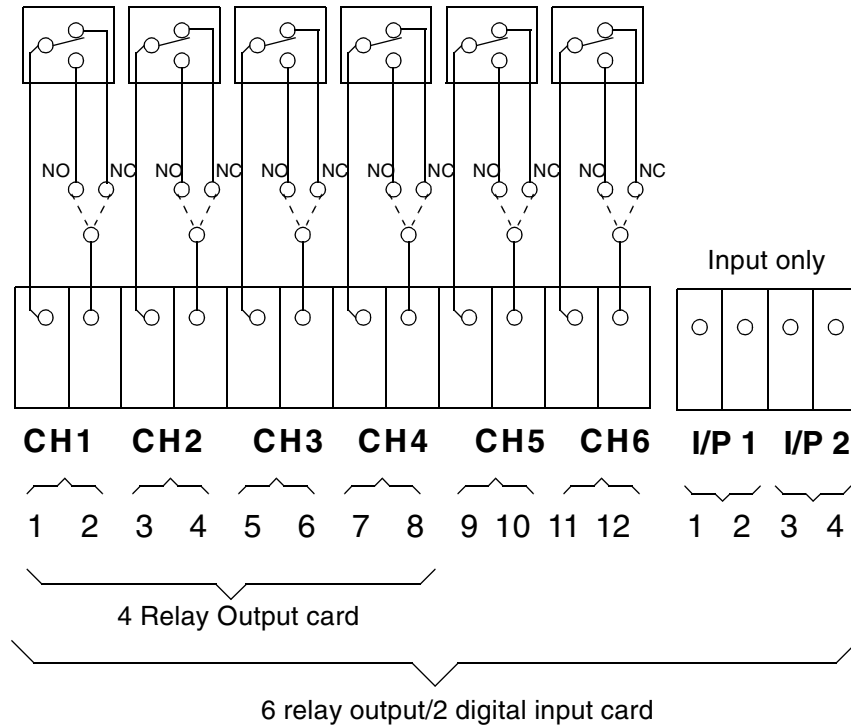

Ethernet Interface

The Ethernet connection is part of the main pcb. A separate socket is provided at the rear of the unit. This is an 8-way RJ45 socket Molex 95040-288" used for standard Ethernet connections.

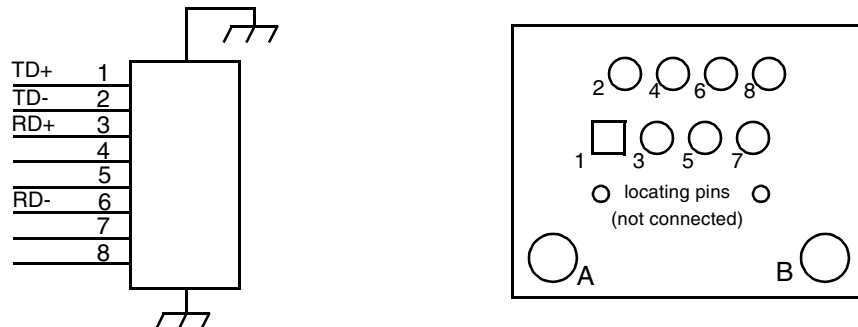

Chapter 3: Quick Tour

The Keypad

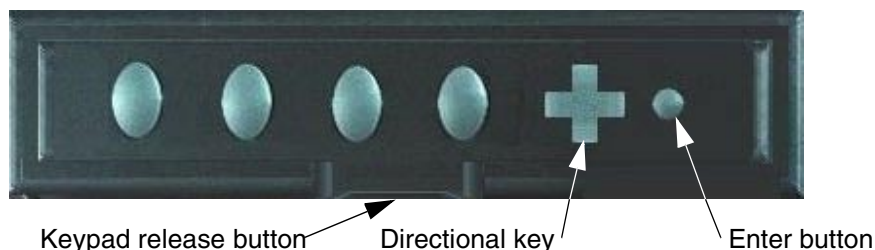

Buttons

To select an option as displayed along the bottom of the screen, press the button immediately below the required option. The options displayed above the buttons change dependent upon the facilities available at that given time.

Directional Key

The **Directional Key** has four orientations Up, Down, Left or Right. Down and Left produce the same movement as each other in horizontal or vertical plane. The Right and Up buttons produce the same action in vertical or horizontal planes. This will be determined by which menu or screen is being displayed. The directional button has three functions

1. To navigate through a list of menu options
2. To select a specific option
3. Activating replay mode (*See "Replay Mode" on page 24.*)

To choose an option from a drop down menu, use the directional button to navigate until the option required is highlighted and then press the enter button to select.

The Screen

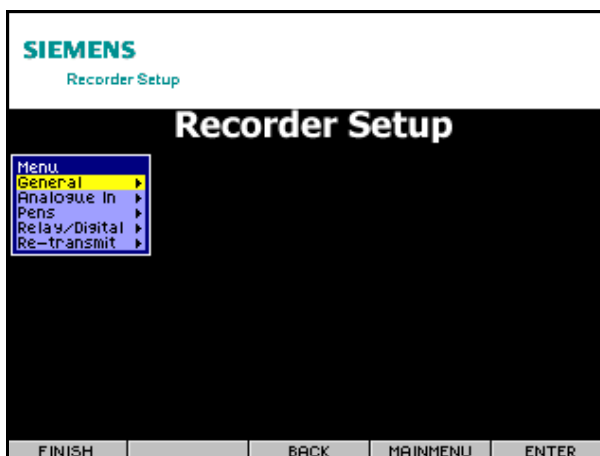

On the **SIREC DS** the data is displayed on a 5" diagonal passive colour STN Quarter VGA Industrial LCD. The display requires a warm up time of 60 minutes before any brightness or contrast adjustments should be made. *See "Display Trimpt Adjustments" on page 18.*

Status Bar

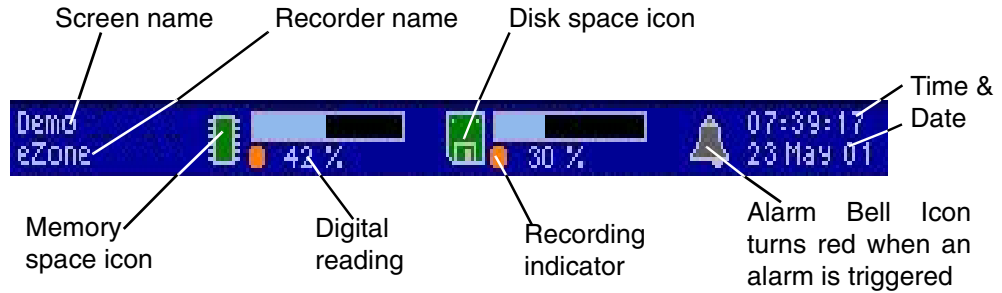

The icons for the **Chip** and **Floppy Disk** are green in normal operating conditions. The chip relates to the amount of memory space used and changes to orange when 80% full. The floppy disk icon represents the amount of space used on the floppy disk, which turns red when the disk is 95% full. The alarm bell icon which lights up red to indicate that an alarm has been triggered. Displayed on the left of the Status bar is the Recorder Name and the Screen number presently being displayed. On the far right, the Time and Date are displayed.

Screen Layouts

These are the display formats available for viewing data, 8 different layouts are available in varying combinations of trends, bars and digitals. All information specified in the set-up for a particular pen will be consistent in all screen displays. The screen can display 6 channels as chart trends, bars and or digitals. Selecting this item will cause all pens displayed on the screen in conventional mode to conform to the chart rate. If the directional key is operated whilst a chart is displayed a cursor arrow will appear. By depressing the directional key an on screen menu will appear and a chart rate can be selected. The yellow area of the chart indicates its in an alarm state.

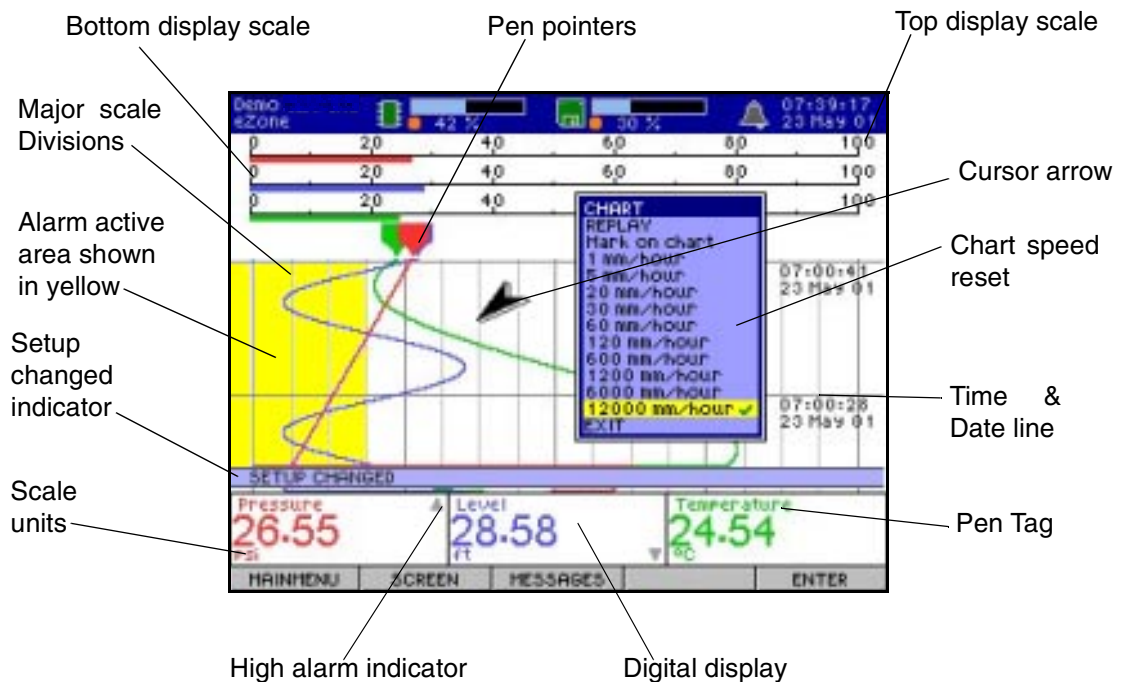

Screen Displays

There are eight different layouts available with the **SIREC DS**. To select a screen, see *“Selecting and Re-naming Screens” on page 73*

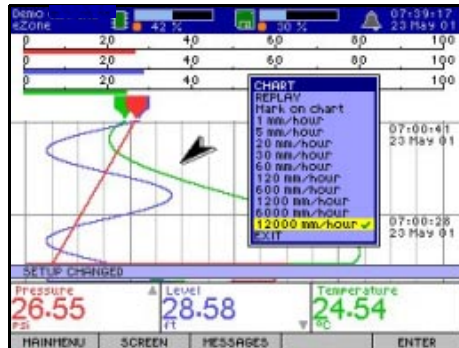

Chart V bars + digitals

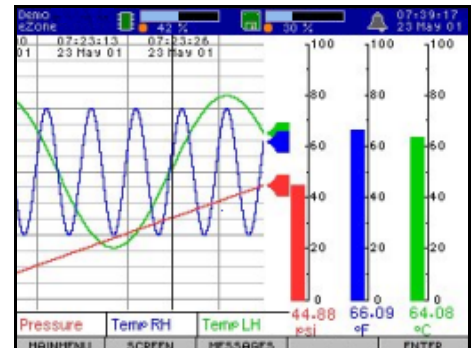
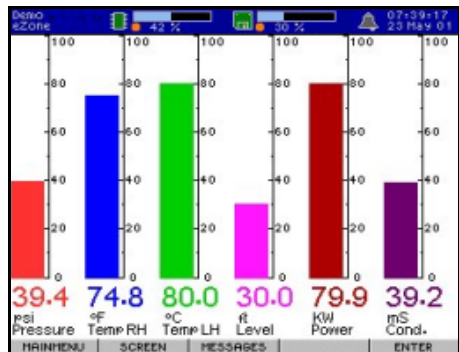
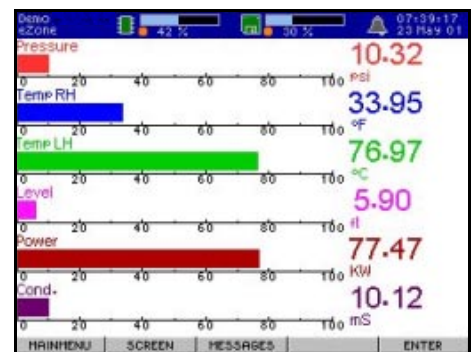

Chart H bars + digitals



Bars V (6 pens)



Bars H (6 pens)



Chart V (6 pens)

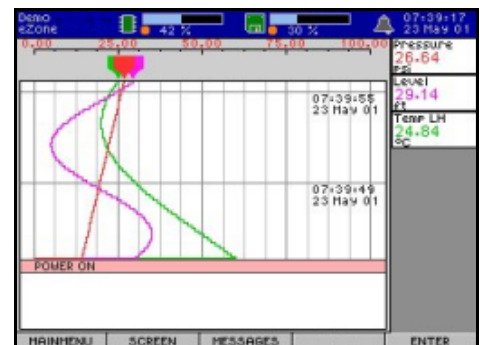
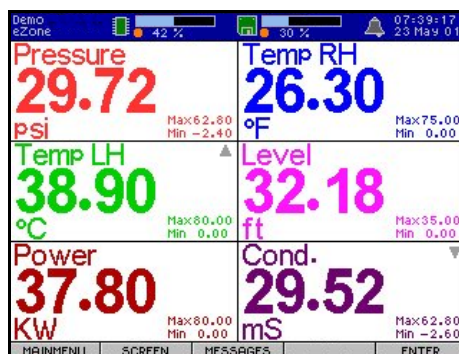

Chart & Digitals (V)



Digital Panel

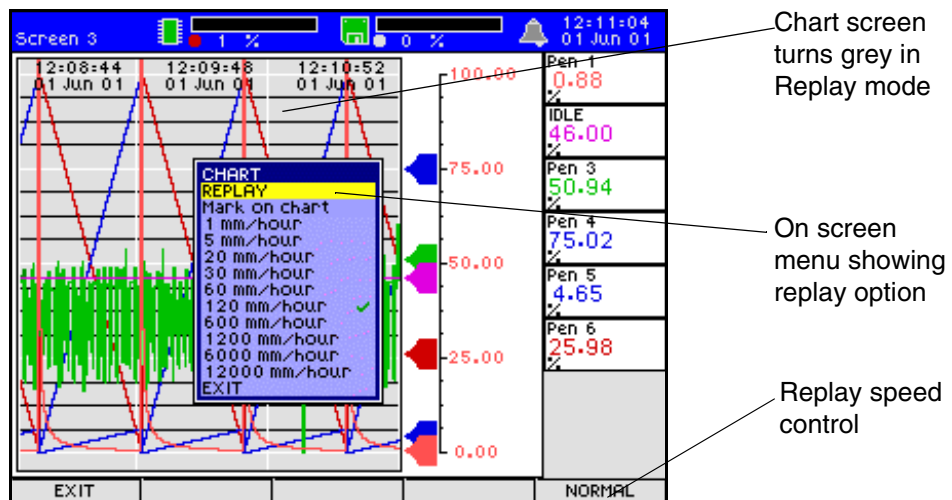

Chart & Digitals (H)

The screen display is *non volatile* which means the recorder will show the last screen displayed after a power down. The **SIREC DS** offers a selection of 8 display layouts. Combinations of trends, charts and digitals display are available in horizontal and vertical modes. See ["Layout" on page 73](#).

Replay Mode

Replay mode is only available when a chart is displayed on its own or with digitals or bars. This is activated by pressing the directional key to produce the cursor arrow and then press the enter button key to generate the on screen menu. Select **Replay**, the chart will change to a grey background and the menu bar at the bottom of the screen will change. The right hand button of the menu bar will read **Normal**, this is the speed at which the chart will travel when navigating using the directional key. Press the enter button to change between a **Fast** or **Normal** rate of travel. Use the left side of the directional key to go back in time and the right side to come forward to the present time. The chart pen pointers, bars and digitals stay in real time.



MaxMin: The minimum and maximum levels can be reset for bars and digitals. Use the directional key to navigate to the digitals or bars area of the screen and press to enter. The Bar Graph or Digitals menu will appear, select and press the directional key to reset using **Reset MaxMin** or by resetting all the channels using **Reset All Max Mins**.

Mark on chart: This will place a line across the full width of the chart with text identification, at the precise time and date of entry. Up to 80 characters can be entered, the **SIREC DS** can display the first 40 characters across the screen. The full text can be reviewed in the messages screen, shown as 2 lines of text.

Mark on chart can be used to indicate, for example, operator change over or for batch recognition. Mark on chart can also be used to notify when alarms are switched on or off, if an alarm card is fitted.

With a chart displayed, use the directional key to produce the cursor arrow in the chart area. Press the enter button to display the chart menu. Select **Mark on chart** and enter text required.

Preprogrammed markers can be composed in the **SIREC D - Software** and imported into the recorder as part of the setup. When mark on chart is selected a list of 20 preprogrammed markers will be displayed. Use the directional key to select a marker, these can be edited at any time. See ["Relay Alarm Cards" on page 63](#). All activity is recorded in the messages screen. See ["Messages" on page 25](#).

Messages



If a situation occurs where a warning message is indicated the MESSAGE button will flash amber. If an error occurs the MESSAGE button will flash red.

The messages screen records any setup activity that has been changed.

- Green - indicates normal status.
- Amber - indicates a warning message.
- Red - indicates an problem has occurred.
- Blue - indicates alarm on/digital on
- Magenta - indicates alarm off/digital off
- Dark Green - indicates user information e.g. mark on chart or password/user access

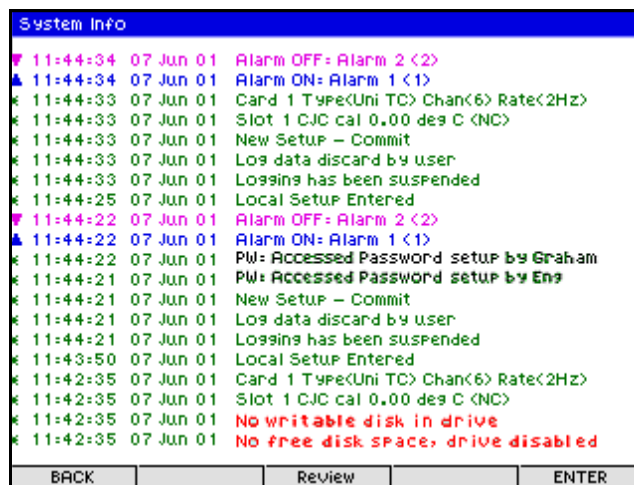

Press the **Review** button to reveal this menu bar



Press the **Back** button to return to the main screen. The **Review** button produces a different button bar at the bottom of the screen with the options of **Exit** which will return to the main messages screen and the **Date On/Off** facility which toggles on and off. **Up**, **Down** are for scrolling by **Page** or use the directional key to scroll by **Line** or **Page** which is determined by pressing the Enter button. The **Enter** button will only become active when the directional key is used and a cursor arrow appears, then press **Enter**. This activates the **Events list**.

Events List



The **Events list** is activated by entering the Messages screen, use the directional key to produce the cursor arrow. Then press the directional key to reveal the events list. From this list the **Date** option can be turned on or off and the **Review** menu bar can be activated. The **Filter** option allows specific event types only to be displayed such as indicating when an alarm has been triggered. **Reset** will clear all the messages that have been displayed up to that time and the **Exit** option will remove the events list menu.

Power Up

The first screen displayed is the 'power up screen' shown below. This only appears for a short time before changing to the last screen selected before the unit is switched off or, on first power up, it will default to the layout displaying horizontal chart trends with digits. To change screen layout press the **Screen** button and use the directional key to scroll up and down the selection menu. When the screen required is highlighted, press the enter button to select. Allow a warm up time for the display of 60 minutes before adjusting the brightness or contrast. See ["Display Trimpot Adjustments" on page 18](#).

NB: The flag displayed in the top right corner of the screen indicates the initial default language.

Power up screen



Non-Volatile Screen Display

The **SIREC DS** features a non-volatile screen display. This means the screen will display data continued from the last power down or reset. Below is an example demonstrating the non-volatile screen display. The first chart shows the data before the power is cut or the recorder is reset. The second chart shows what happens when the power is restored. No data has been lost, and the full chart history is retained, in the same format, during power interrupt. The recorder will always power up to the screen being displayed before any power interrupt.

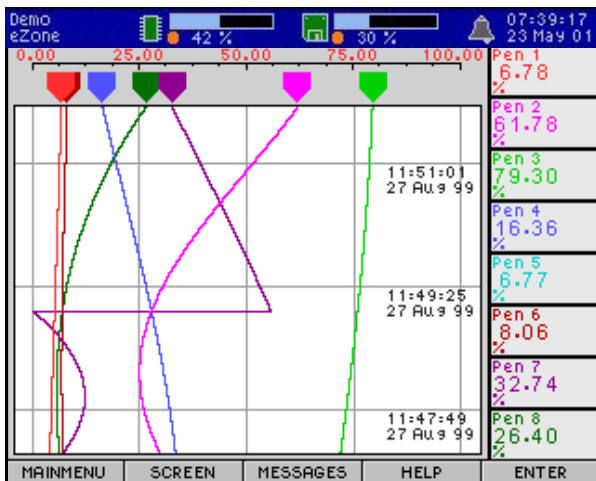

Before power down or reset

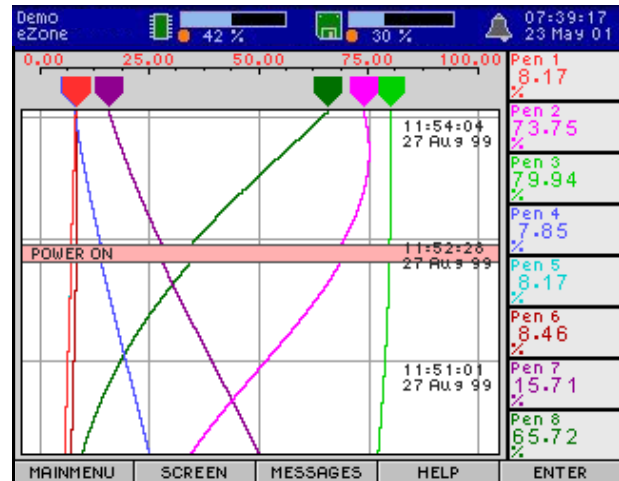

After power up or reset

Menu Selection

The four main buttons on the keypad apply to the on screen selection bar, press to activate. The **Directional Key** is operated in either Up and Down or Left and Right depending on the screen being displayed. Use the directional key to scroll through menus and highlight options. When an option is highlighted press the Enter button. The **Enter** button, is the small round button to the right of the keypad, press to activate. Pressing any of the buttons or the directional key will cause the display to change or another **Menu** to appear.

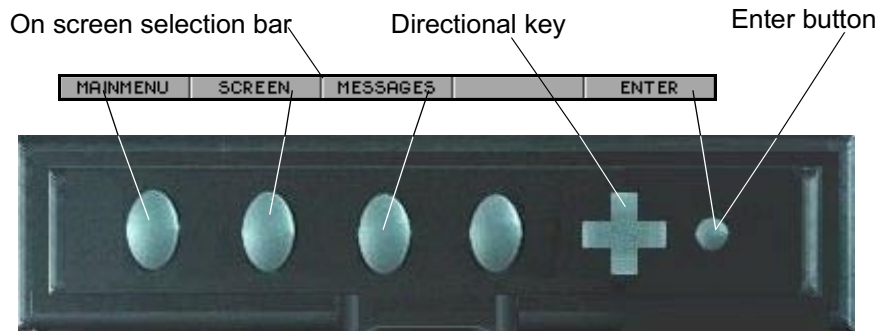

Text Entry

Text entry is required for configuring many of the options in the set-up menu. The principle for all text entry follows a similar format. Using the directional key, highlight the required option on the menu and then press the enter button to select. This will activate a character block at the bottom of the screen. Press enter again to display the character selection box. Using the directional key, once again, highlight the specific row required, press the enter button to select the character. Continue until all characters are entered. To enter a space, move the cursor to a blank area within the character selection block and select. Finally press **Accept** then **Finish** and **Apply** on the on-screen selection bar when complete. Follow the on screen instructions for the **Log Data History** screen which appears when any changes are made to the **Setup**.

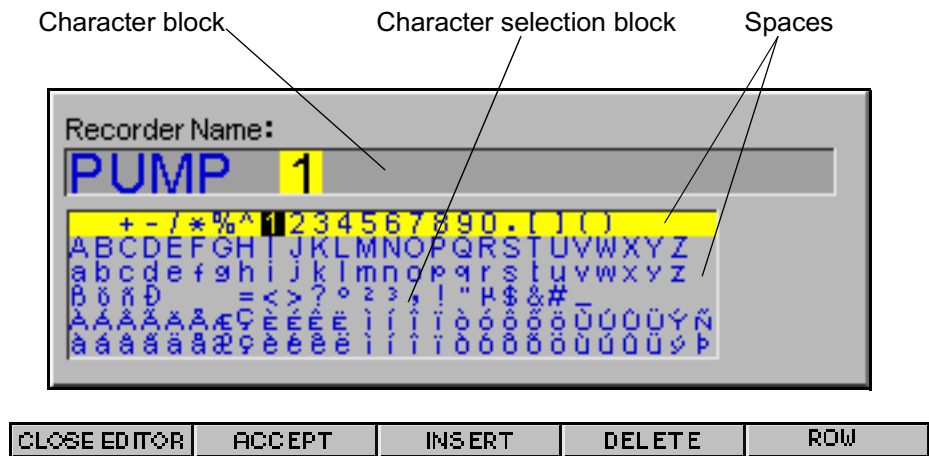

Notice the on screen selection bar has changed. These are active and enable you to **Cancel** and return to the menu, **Accept** the information entered, **Insert** characters into the text or numbers block, **Delete** any entry which may be incorrect and finally the directional key function which when depressed will **Select** the row or character highlighted.

About

Select the Main Menu button, use the directional key to select the **About** option then press the enter button. This will display the technical specifications relevant to your recorder which may include:

- Firmware version
- Serial number

Options available; such as

- Maths
- Totals
- Events
- TrendScript
- Web Server
- E-mail

Communications facilities appertaining to your recorder; such as

- Ethernet
- Trendbus

To remove the display from the screen press the button immediately below **OK**.

Chapter 4: General Setup

Setup

Use the on screen menu bar and the corresponding buttons below each item on the keypad, to select recorder options. Use the directional key to navigate through the recorder menus and highlight an option. Press the small round enter button to select an option.



To change the configuration of the recorder choose **MainMenu** from the on-screen selection bar displayed along the bottom of the screen by pressing the button immediately below. Use the directional key to highlight **Setup** then press the **Enter** button to select. The setup menu will appear showing three options. The **Edit** option is for configuring the setup of the recorder. The **Load** option is for importing setups from **SIREC D - Software** or another recorder. See [“Software” on page 75](#). To load a setup See [“Load” on page 66](#). The **Save** option will save imported setup. See [“Save” on page 66](#).

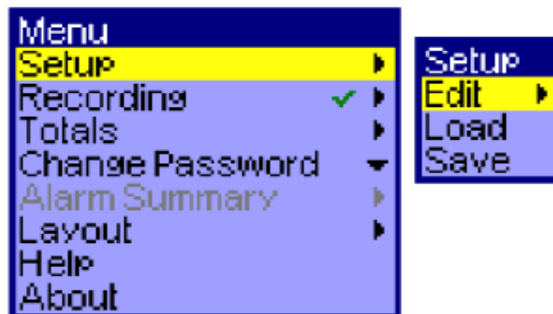

Edit

Select **Edit** for recorder configuration. The following **General** menu will appear showing the options available. These options are detailed on the pages indicated below. A small black arrow to the right indicates a further menu. Menu items shown in grey means this particular option is not available.

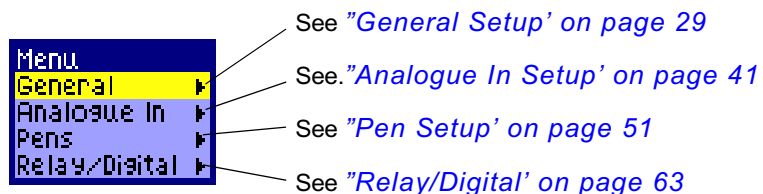

General

Language

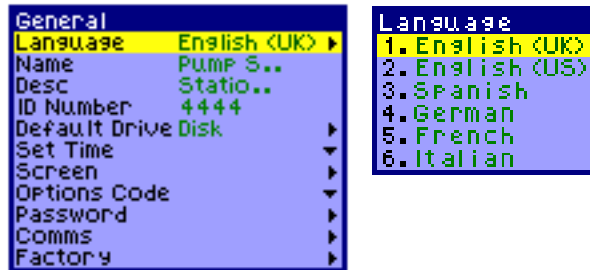

This is the first option on the **General** menu, select **Language** to activate the menu. Choose the language required and the reset window will appear, press the three buttons shown simultaneously to reset the recorder. The recorder will now display text in the chosen language.

Name

Function: Recorder name

Type: 20 Character alpha/numeric

Description: User programmable identification

The second selection on the **General** menu is **Name**, this is a user defined label. Highlight, using the directional key, and press the enter button to show the recorder name at the bottom of the screen, (the cursor will be on the first character) press enter again to display the character set available. To edit the text, navigate through the rows using the directional key and press enter when the row containing the letter required is highlighted. Use the directional key again to identify the specific character. Press enter to select the character. When the new name is complete, press the **Accept** button below the selection bar. See *“Setup Complete” on page 65.*

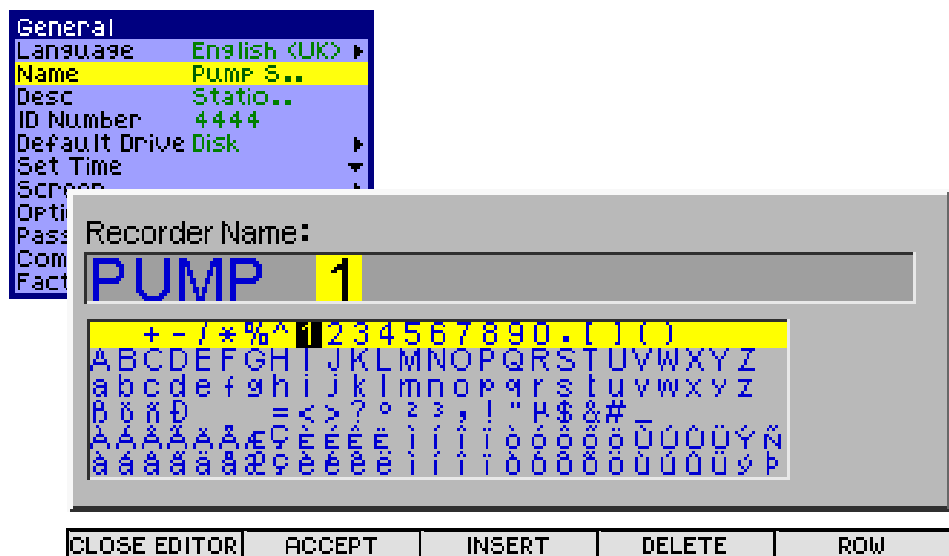

Description

Function: Recorder description

Type: 50 Character alpha/numeric

Description: User programmable identification

To display or change the description follow the instructions as for **Name** above.

ID Number

Function: Identification number of the recorder

Type: 4 Character numeric

Description: Address of recorder

Default: 0001

Essential that recorders on communication networks have different ID numbers. To display or change the **ID Number** follow the instructions as for **Name**.

Default Drive

This menu shows the logged data is going to the Floppy Disk Drive by default.



Set Time

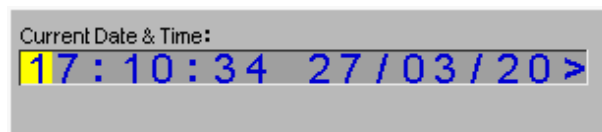

Function: Time and date display

Type: 6 Character numeric (time), 8 Character numeric (date)

Description: Time and date setup for the recorders real time clock.

Default: 00:00:00 01/01/2001

From the **Set Time** option on the **General** menu as shown in "[Setup](#)" on page 29, press the thumbwheel to show the current date and time as shown here. To change the **Time** and/or **Date** follow the instructions as for **Name**. The time is shown in hours, minutes, and seconds with a colon in between to separate each pair of digits. The date is shown by day, month and then year using a forward slash in between. Provide a space in-between to define the time and the date.

Screen

Function: Reduce wear on the screen, change the screen background appearance.

Type: Menu select, Time-out 1 to 255 minutes

Description: Blanks the screen when there has been no activity for a specified time period. black or white background option.

Default: Screen saver is disabled, chart defaults to a white background

The brightness and contrast of the screen can be controlled by a trimpot adjustment, see "[Display Trimpot Adjustments](#)" on page 18.

The **Saver** function helps to reduce screen wear, highlight and toggle this option On or Off using the Enter button. Set the screen saver **Timeout** from 1 to 255 minutes. Highlight and select to produce a text box and enter the time-out period required.

Chart paper - This feature gives the option of having a black or white chart background colour. Use the directional key to highlight and the enter button to select which chart background colour is preferred.

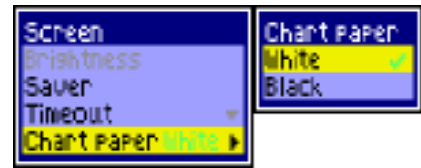

Option Codes

Function: Serial number Identification and option availability

Type: 2 part 15 Character alpha/numeric.

Description: 6 character serial number, factory programmed for unit identification. Plus a 9 character option code, fully upgradeable with option enhancements.

Default: Individual factory set code

This **Option Code** is a unique serial number specific to your recorder which contains information enabling certain options. It can ONLY be changed when and if you purchase further options for this recorder. The first six digits of the code depicts the serial number of the recorder. The other nine digits are the coded options available. The whole code is CRC checked, invalid entries will not be accepted.

Password

Function: Protects entry to the system at various levels

Type: Text entry

Description: Restricts access within the recorder, providing password protection at different levels.

Default: Disabled

Password protection restricts user entry to different levels within the recorder. Passwords will be disabled on start up and the recorder will default to a predetermined password, which is displayed. **'Eng', is the highest level of access to all screens.** From here the Engineer can allocate other users and their levels of access to screens within the recorder. Each user creates their own password when they initially log on. Each user, including 'Eng' is responsible for remembering their own password, 'Eng' level cannot access the passwords for other users.

NB. If the user does forget the password the user must be deleted from the recorder and start again. If 'Eng' user forgets their password and no access is available, contact us at **SIEMENS** and an override password can be issued.

This password system allows traceability by the users name, not the password.

The messages screen will keep a record of all entries made into each level, by user name, and if access has been accepted or denied.

There are four levels of user:

- Engineer - Highest access to all levels, Supervisor, Technician and Operator.
- Supervisor - 2nd highest level including Technician and Operator access
- Technician - 3rd level including Operator access
- Operator - 4th and lowest level of access

Eng Password Entry

From the **General** menu select **Password**, a **Select User** menu will appear. Initially only one 'Eng' will be available, enter a password in the text block, see [See "Text Entry" on page 27](#). For other user password entry see ["User Password entry" on page 35](#)

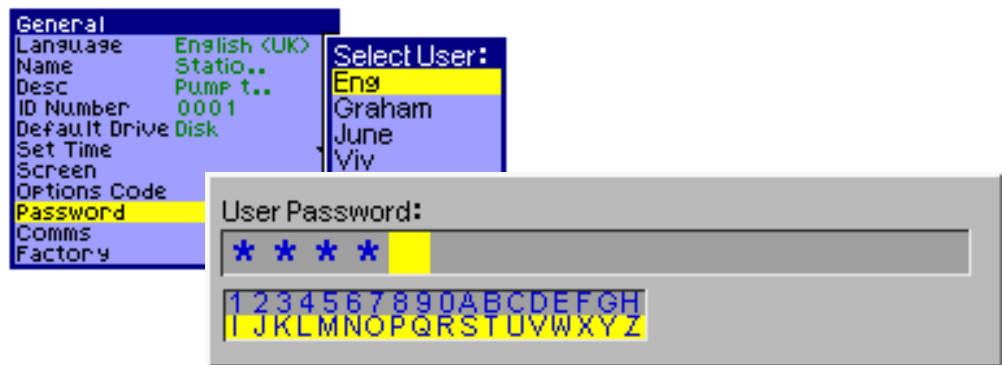

Enter the passwords carefully followed by the **ACCEPT** button from the on screen selection bar at the bottom of the screen.

Password Enable

When the 'Eng password is entered, the password menu will appear, press the enter button to **Enable**.

Password Protect

These menus are only available to 'Eng' level users.

There are six areas in the recorder which can be protected from users. Access to these areas can be assigned using the **Protect** and **Protect From** menus.

NB. Password protection is controlled by the highest user level defined as 'Eng'.

Select each of the six areas, **Setup, Record, Layout, Screen, Totals** and **Counters**. Decide at which user level each area is to be protected from, or not protected for all to access.

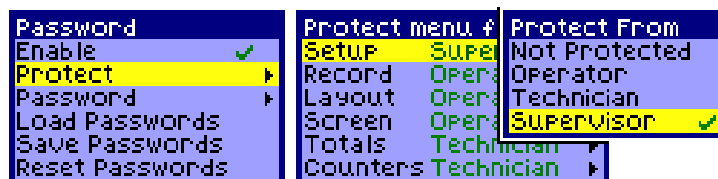

Notice the menu is labelled '**Protect From**', this table shows how to assign access. **Protect From** includes the highest user specified. i.e. if **Setup** is protected from the **Supervisor**, neither the **Supervisor's**, **Technician's** or the **Operator's** passwords will work, so only the **Engineer** has access.

The Operator is the default access to the recorder, this is the lowest level, anybody using the recorder will have this level of access. No password will be required until an operator signs on as a User.

The password system is based around the following priority hierarchy.

Priority table	
Top level	- Engineer
	- Supervisor
	- Technician
Bottom level	- Operator

Access only	Protect From enter	No access to
Engineer	Supervisor and below	Supervisor, Technician, Operator
Engineer and Supervisor	Technician and below	Technician and Operator
Eng, Super, Technician	Operator and below	Operator
Eng, Super, Tech, Operator	Not protected	Access to all users

Password Allocation

Only 'Eng' level has access to these menus to add up to 10 User Names in to the recorder and assign a level to that user, Technician, Supervisor or Engineer. 'Eng' can not enter a password, the User enters their own when they first enter the password menu.

The **User Name** is entered using the text and character box. Once entered, press the button below ACCEPT from the on screen menu bar at the bottom of the screen.

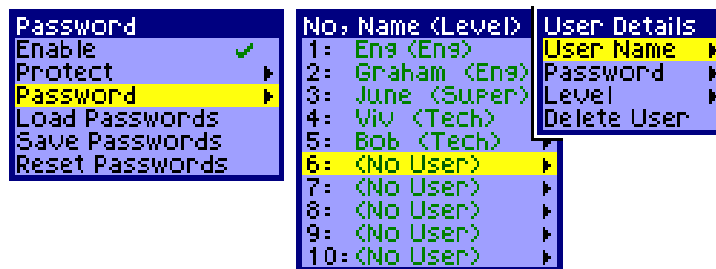

Also entered here is the **Level** of the user, this will restrict entry to the screens already setup in password protect.



User Password entry

Other users apart from the initial 'Eng' user will have to be entered on to the recorder, and their level set, by 'Eng'. See [“Eng Password Entry” on page 33](#).

When the user enters the password menu for the first time, they will be required to enter a new password. This must be re-entered to confirm. All users, apart from 'Eng' level, will not be able to proceed any further in to the password set up.

Once a users password is entered their level immediately applies and they will only be able to access the areas set up by the 'Eng' level user.

Each user, including 'Eng' is responsible for remembering their own password, 'Eng' level cannot access the passwords for other users. If the user does forget the password the user must be deleted and start again.

Change Password

To change a user password, go to the main menu and select **Change Password**. Select the user and enter the users current password. Enter the new password, then re-enter to confirm. This new password is now active.

Password User Traceability

Every time a **User**, entered into the recorder, enters any of the areas that are protected, it will be logged to the messages screen. The message will display the users name and which area they wish to access. It will show if the user **Accessed** or was **Denied** access according to their allocated user level. The messages screen will also show if a password setup **Failed**.

Load Passwords

Use this function to load the passwords setup's, including their levels, from a disk into other recorder setups.

Save Passwords

The save function saves all the password setups, including the allocated levels, onto disk. This is useful when setting up other recorders that require the same password setup.

Reset Passwords

Reset does exactly what it says. All passwords will be reset or cleared apart from the initial password for 'Eng' fixed into the recorder.

Comms for Ethernet

Refer to the **SIEMENS** Communications manual for full details on recorder setup, system configuration, connection and installation requirements.

Function: External communications facility

Type: Menu select

Description: Ethernet communications ports to allow information to be transmitted and received.

Default: Enabled

The Ethernet connection is fitted as standard into all **SIREC DSs**. To activate/de-activate the comms in the recorder go to the **Factory** option in the **General Set** up menu. Select **Comms Ports** and activate Ethernet in the menu. See *“Comms Ports” on page 40*. Go to the Comms option in the General menu to produce these sub menus to configure the Ethernet setup. See *“Appendix E - Ethernet & E-mail” on page 97*.

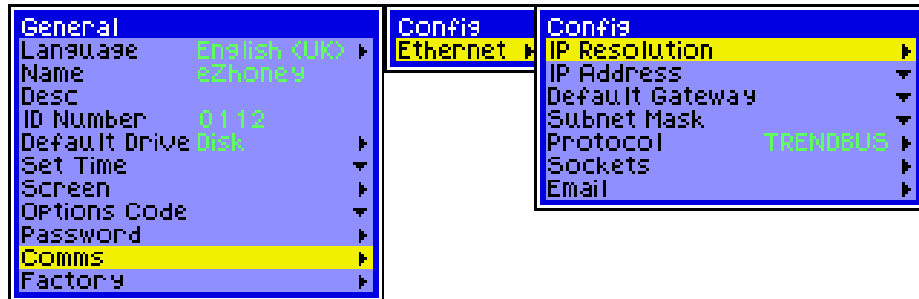

IP Resolution

IP Resolution is a mechanism which maps the IP Address to an Ethernet address. IP Resolution uses different types of protocol to translate the IP Address. The default is FIXED. Please see your IT systems administrator for selecting the type of resolution required.

IP Address

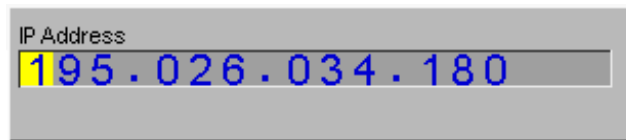

This is an identification address for communications between two peripherals. The IP Address identifies a specific recorder or device. Please see your IT systems administrator for allocating IP Addresses. Refer to the **SIEMENS** Communications manual for full details (43-TV-25-24).

Default Gateway

This is a configuration parameter transmitted to each network device. Where an IP Address cannot be found in a local network, the default gateway sorts out getting traffic from one subnet to another. Please see your IT systems administrator for information on Default Gateways.

Protocol

Protocols define the format in which the data is transferred from the recorder to a PC or transfer between other devices and peripherals. The protocol for the **SIREC DS** comms card using an **Ethernet** connection is **Trendbus**. Trendbus is designed to allow the user to receive data from remote recorders, without having to retrieve the disk from the unit. If Trendbus is not required select **None**. If None is selected, Ethernet can still be used for FTP download or HTTP web browser. The None option just de-selects Trendbus without disabling the default options.

Sockets

This is a term given to a software object that connects an application to a network. It works by using a program to open a socket and read and write data to and from the socket. It's a software object not a physical component.

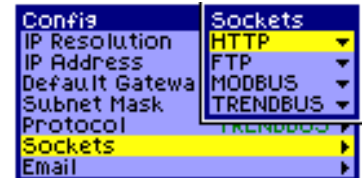

Socket number should not need to change. This must only be changed for networking by advanced users. The socket numbers are set according to each type of socket.

HTTP is used for web browsing using the **SIREC D - Servers** software via an Ethernet connection. **FTP** is used for importing data from the recorder using **SIREC D - Server** software via an Ethernet connection.

Subnet Mask

The Subnet mask acts as a filter when identifying IP Addresses. A single IP network can be divided into many subnets by using some of the bits of the host address portion of the IP address as a subnet. A mask is simply a screen of numbers that tells you which number to look at underneath. Please see your IT systems administrator for setting up the mask.

E-mail

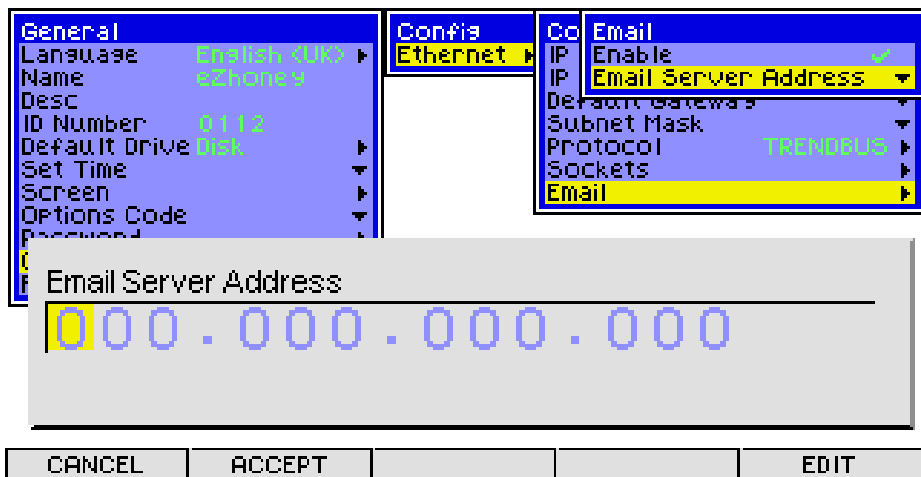

The E-mail facility is used in conjunction with the **SIREC D - Software**. Set up e-mails in the **SIREC D - Software** to send information to a specific recorder or device. Use this menu option to set up an **E-mail Server Address** so that information being transmitted to the recorder can be directed effectively. Tick to enable.

The recorder sends messages for distribution by a remote e-mail server. The e-mail server is located by its IP address as set-up in the communications set-up options. When the recorder sends an e-mail message, it locates the e-mail server you have configured and uses SMTP (Simple Message Transfer Protocol) to send the message to the e-mail server. SMTP allows the recorder to send messages to an e-mail server without having its own e-mail address; because of this the e-mail server will not be able to send any reply back to the recorder.

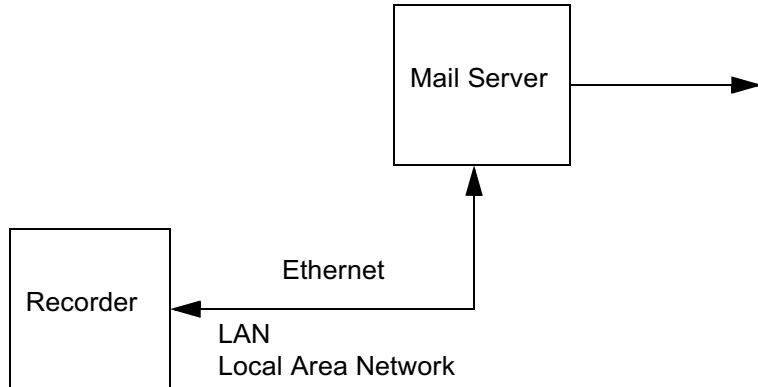

Factory

Function: Unit Calibration and Alarm card setup

Type: Menu selection

Description: Calibration of analogue input card and configuration of Relay/Digital.

Default: N/A

From the **Factory** option on the **General** menu use the directional key to select, as shown in "*Setup*" on page 29, press the enter button to generate the sub menus. Use this menu route to calibrate the analogue card for input or output of analogue signal. The **Drives** item is for the 1.4 Mbyte floppy drive disk only. **Reset Setup** will reset to the factory settings, highlight and press enter button. Follow on-screen instructions during this procedure.

Calibrate Input

The type of Universal analogue card fitted in the unit has the following menu screens, within the **Calibrate Input** option. Up to 6 analogue channels are available. Individual input channels can be switched on or off by selecting **Inputs** and entering a tick or a cross in the **Calibrate** option.

Select Analogue In 'All' to identify which channels require calibration using a ✓.

'F' indicates the input is calibrated to the factory setting. If any power loss should occur the unit will retain the calibration settings at the time of power loss.

Input channels can be calibrated individually, indicated by the disappearance of the 'F'. The other inputs are not effected and will calibrate to the factory settings.

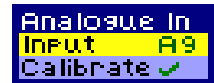
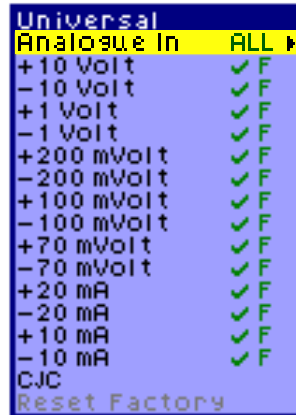
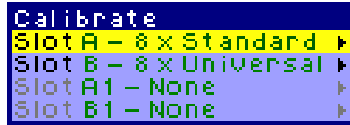

CJC Calibration

Function: CJC Calibration

Type: Menu selection

Description: Calibration of the Cold Junction Compensator on the analogue card

Default: N/A

Use a Resistance Thermometer sensor to measure the actual temperature of the Thermocouple connections at the rear of the unit. Deviation in temperature, between the measured T/C connections and the CJC, result in a calculated adjustment being made to the CJC temperature. Follow the on screen instructions for calibrating the CJC.

The diagram below shows how to wire an R/T across the first channel to measure the temperature of the terminal. This must be done on the first channel of each Analogue card fitted. For this calibration ensure channel 1 is enabled as an Resistance Thermometer and any other channel for the Type K Thermocouple.

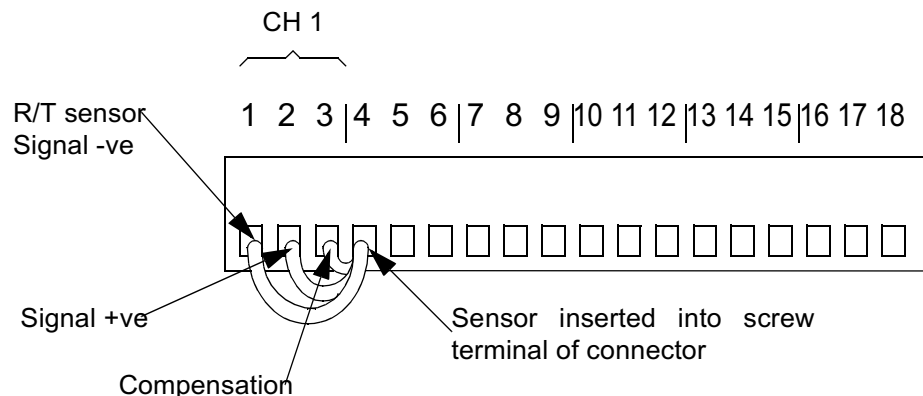

Drives

Set up before leaving the factory, this menu will identify the type of drives fitted to the unit. Only the floppy drive is available on the **SIREC DS**.

Comms Ports

The Ethernet card has the option to connect to Web and E-mail (TCP/IP). The default state is with the Ethernet option enabled. See [“Comms for Ethernet” on page 36](#).



The Ethernet card is required if the user wishes to import data using the **SIREC D - Server** software package. The Ethernet option will also give access to recorder data on the Internet by use of a web browser.

MAC address

Short for Media Access Control address, a hardware address that uniquely identifies each node of a network. No action is required, the MAC address is a factory setting.

Reset Setup

This will clear all user configuration from the recorder except layout.

Chapter 5: Analogue In Setup

Analogue In

Highlight the **Analogue In** option on the **Setup, Edit** menu, from the Main Menu, and press the Enter button to generate the menu shown.

The Analogue In menu deals with the processing of analogue input signals and their conversion into a digital form, suitable for the later stages of the logging process such as **Maths**. Depending on the options available on the unit, differing numbers of analogue channels can be selected. Channels can be set to the same configuration or set up with individual configurations.

We will now follow through the **Analogue In** menu.

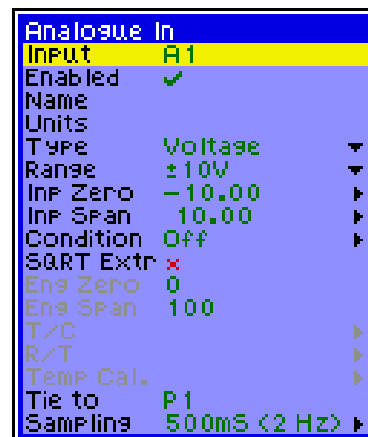

Input

Function: Input channel identification

Type: Preset choice

Description: Identify and setup input channel configurations

Default: A1 (analogue input channel 1)

The **Input** is selecting the analogue input. On the **SIREC DS** there are 2, 4 or 6 input channels available. The first input will be shown on the menu i.e. "A1" as indicated here. To set up the other inputs channels, press the enter button and use the directional key to navigate through to the required analogue channel. Press the enter button again to select when the relevant input is displayed.

Enabled

Function: To activate the analogue channels

Type: On/off switch

Description: Enables each analogue channel.

Default: Enabled

This enables the analogue input via a toggle switch, which shows as a **x** when off, or **✓** when active.

Name

Function: Analogue channel identifier

Type: 20 Character alpha/numeric

Description: User programmable identification

Default: N/A

This is the **Name** of the active analogue input channel. When this option is highlighted and the enter button is pressed for selection, the text box will be displayed along the bottom of the screen. Press enter again to reveal the character box. To edit the name follow the instructions in. [See “Text Entry” on page 27.](#)

Units

Function: Unit of measurement

Type: 11 Character alpha/numeric

Description: The measurement in units per input channel

Default: N/A

This is the unit of measurement for that particular input, e.g. **%** or **°C**. When this option is highlighted and the enter button pressed for selection, the text box will be displayed along the bottom of the screen. Press enter again to reveal the character box. To edit the **Units** follow the instructions in [See “Text Entry” on page 27.](#)

Type

Function: Type of Input signal

Type: Menu Selection

Description: Setting the type of input signal per channel

Default: Voltage

To choose an option, use the directional key to highlight the **Type** option and press the Enter button. Use the directional key again to select the required option and press enter.

For setting up instructions on Thermocouples and Resistance Thermometers [See “Thermocouple” on page 47.](#)

For further information on Thermocouple connections see, [“Appendix C -Thermocouple Connections” on page 89](#)

Range

Function: Specify the range for each input

Type: Menu Selection

Description: Selecting the value of the range

Default: $\pm 10V$

The **Range** is dependent on the type of input selected previously. Use the directional key and the enter button to select an option. For Thermocouple or Resistance thermometer input ranges [See “Thermocouple” on page 47.](#)

Input Zero

Function: Value at the bottom of the range.

Type: 10 Character numeric

Description: This is the input value that equates to the bottom of the scale.

Default: 0

When selecting **Input Zero** there are now two choices, either **Specify**, which will call up the relative prompt requiring a value to be entered see [See "Text Entry" on page 27](#). The other method of setting up an input is to apply **Sample** signals of known values to the input. These values are internally calibrated which means that the zero and span values selected are referenced to known values within the unit.

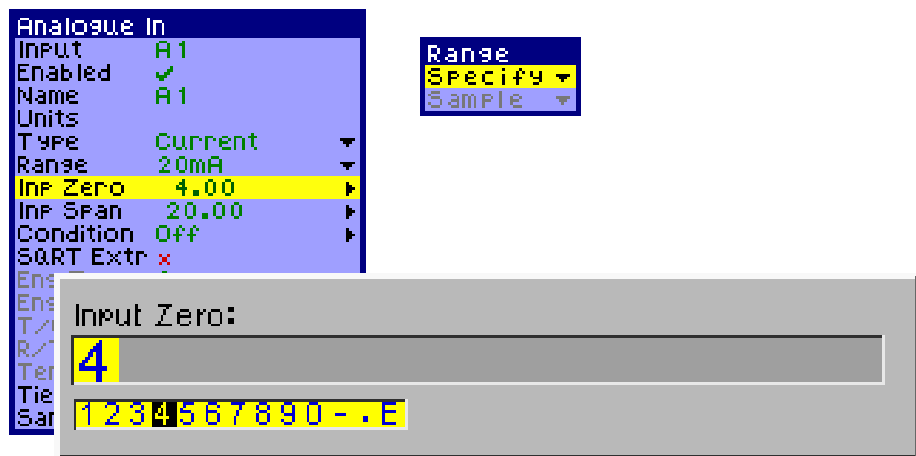

Input Span

Function: Value at the top of the range.

Type: 10 Character numeric

Description: Input value that equates to the top of the scale.

Default: 10.00

Refer to **Input Zero** for setting up instructions.

NB - The input zero and span must be within the selected range for correct operation

Conditioning

Function: Signal Conditioning

Type: Menu selection

Description: Damps noisy signals, filters transient anomalies

Default: Off

Damping

The damping option works by averaging sampled data over the allocated time. Signal damping can be set from 1 to 15 seconds irrespective of sample rate.

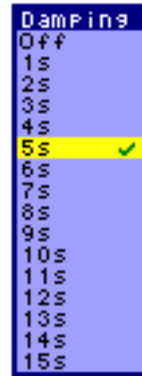

Transient Filter

Used to filter out any electrical interference from external influences.

The transient filter can be set up to ignore a momentary change in amplitude of a signal from its base line value to a higher or lower value, followed by a rapid return to the baseline value.

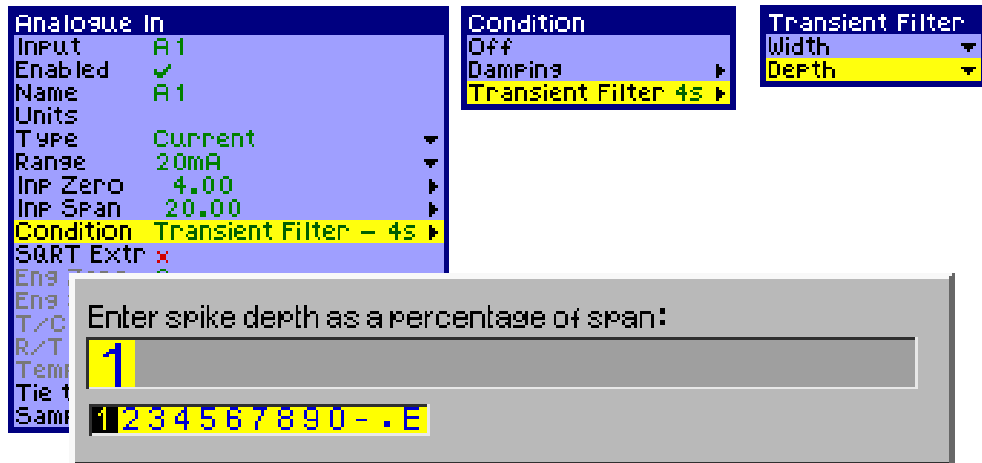

Set the **Transient filter** to disregard a specified type of pulse. The **Width** of the pulse, to be rejected, can be set from 1 to 15 seconds. The **Depth** of the pulse is entered as a percentage of the span. The span being defined by the Engineering span e.g. Eng Zero = -10, Eng Span = +10. Enter spike depth as a percentage of span = 20.

If the signal is within 20% of span, the point will be logged, if the signal is outside the 20% of span the signal will be logged as the previous point.

See ["Engineering Zero and Engineering Span" on page 46.](#)

Square Root Extraction

Function: To activate square root extraction

Type: On/off switch

Description: Enables square root extraction on a specific channel

Default: Disabled

This is a toggle switch which shows as a **x** when off, or a **✓** when active. It is a method for converting a non-linear signal into a linear scale.

The Square root extraction in the analogue input is used to linearise certain sensors that have a non linear output - for example in the calculation of flow. So when you check the Square root extraction in the Analogue input section it carries out the following calculation.

It ratios the analogue input range that you set, to 0 to 1.

So any sensor input is represented by a number from 0 to 1.

We then take the square root.

We then re ratio the result back to the user set range.

The resultant 'linearisation' carried out looks like this:

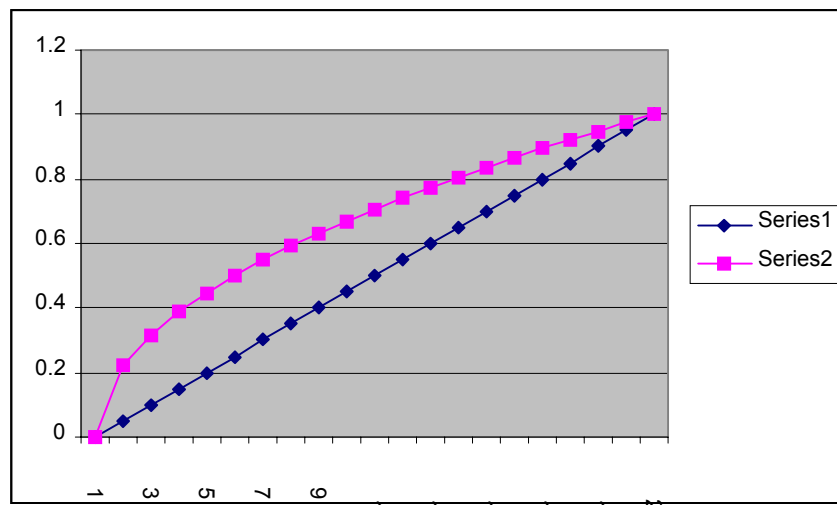

Engineering Zero and Engineering Span

Function: Setting of engineering units

Type: 10 Character numeric

Description: To allocate engineering units to the zero and span analogue inputs.

Default: Engineering zero = 0, Engineering span = 100

This facility can be best described by utilising the **Setup** window in **SIREC D - Software** as shown below.

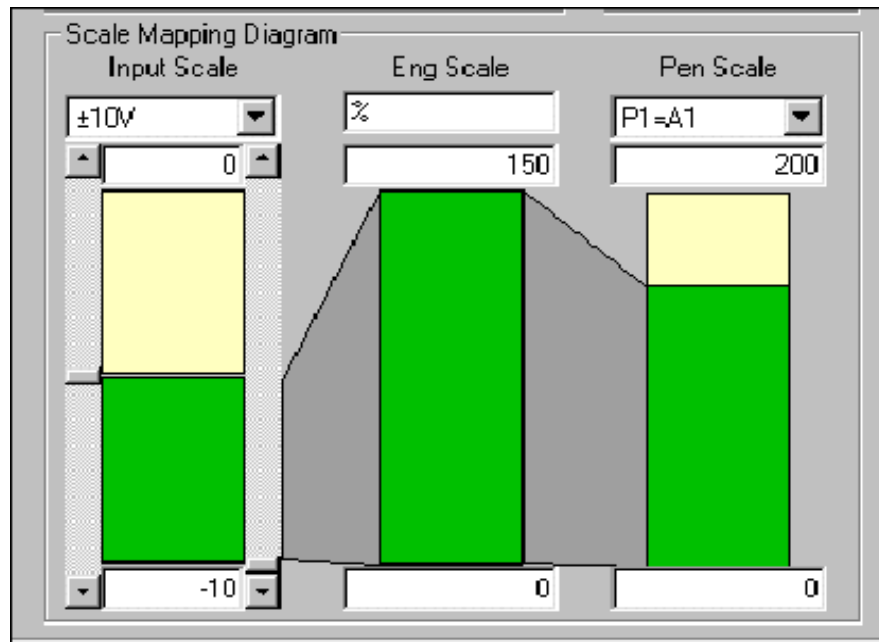

1. The input range is -10 to +10V. The sub-range is set to -10 to 0V

2. The input engineering scale is 0 to 150% but using span of -10 to 0 volts ie. 50% of input range

3. The pen scale is 0 to 200 but the input engineering scale is only 75% of that

The input range, left scale, is -10 to +10V, but data is only showing 50% of the scale. The engineering scale, in the middle, is 0-150% but only uses 50% of the data from the Input scale (-10 to 0). The effect is that of 'zooming in' on the signal i.e. the signal will appear bigger seeing 50% of the Input scale over the whole of the Engineering Input scale. The Pen scale, right scale, ranges from 0 to 200 but shows the Engineering Input scale reading only 75% of that. The effect will be 'zooming out' on the signal.

In this example -10V on the input will read zero on the pen scale, 0V on the input will read 150 on the pen scale. The top of the pen scale 150-200 will never be used

Thermocouple

Function: Temperature measurement

Type: Menu selection

Description: Selects thermocouple settings

Default: Type K

A **Thermocouple** is an electrical circuit comprising of two dissimilar materials. A voltage is generated which is dependent on the temperatures at the junctions forming the limits of the dissimilar materials.

Follow the on screen menus for each different type of input. For thermocouples enter the type, which reference junction is to be set for thermocouples, unit of measurement and finally specify upscale or downscale burn out.

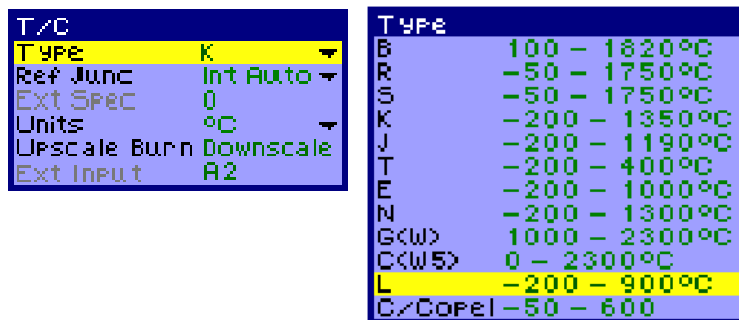

Type

Function: Type of thermocouple input

Type: Menu selection

Description: Setting the type of input signal per channel

Default: Type K

This is to specify the **Type** of thermocouple required. Different thermocouples are made from different materials which then measure over different ranges. Menu shown above.

Reference Junction

Function: Temperature reference

Type: Menu select

Description: Measures the temperature at the reference junction

Default: Int Auto

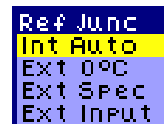

Int auto - Uses the cold junction sensor in the recorder as a variable reference temperature.

Ext 0°C - Assumes the cold junction is held at 0 °C to provide a 0mV reference, external to the recorder.

Ext Spec. - Uses a **Reference Junction** held at a constant temperature. Specify the temperature that the cold junction sensor is to be set at.

Ext Input - Use a thermocouple or resistance thermometer from another channel to measure as the cold junction sensor.

Units

Function: Unit of measurement

Type: Menu selection

Description: The measurement in units per input channel

Default: °C

Select from the menu box the units of measurement required for either thermocouple or resistance thermometer inputs.



Upscale Burn

Function: Takes the signal in a specified direction if there is a break in the T/C.

Type: Menu selection

Description: Should the thermocouple break contact the signal will be driven in a specified direction if activated.

Default: Downscale

This enables the signal to be directed **Upscale** in the event of a break in the thermocouple. These operate via a toggle switch, which shows as a **x** when off or a **✓** when active.

A **Downscale** function is also available which allows the signal to be directed downscale if there is a break in the thermocouple. There is also the **Off** option, to switch to no burn-out direction.

Resistance Thermometers

Function: Temperature measurement

Type: Menu selection

Description: Measurement of the resistance of the device produces its temperature

Default: Type - PT100, Units - °C

For the **R/T (Resistance Thermometer)** option, the **Analogue In** menu changes to allow the user to set up specific details. Follow the on screen menus for each different type of input. For resistance thermometer settings, just the unit of measure from this menu will be required. The resistance of an R/T increases with temperature.

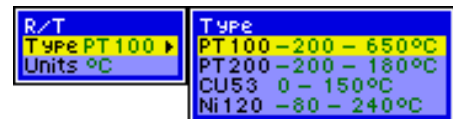

Temperature Calibration

Function: Remove T/C and R/T inaccuracies

Type: Menu selection

Description: To allow adjustment to T/C and R/T measurements

Default: No Cal

Both thermocouples and resistance thermometers may require additional **Temperature Calibration** to eliminate system measurement errors. A single point calibration can be set up for each input using **Set Cal Point**. From the Inputs menu highlight and select **Temp Cal**. To enable a calibration point to be set, highlight and select **Use Cal**. From here another menu will give the options available.

Select and highlight the option required. Return to the **Temp Cal** menu. If **Single or Dual point** has been selected then the calibration point needs to be set in either **Single Point Cal or Dual Point Cal**. Calibration can be in °C, °F, or Kelvin. Select **Set Cal Point**, by using the directional key to highlight the option and the enter button to select the option required. Press the directional key again to produce the character selection blocks. See “Text Entry” on page 27.

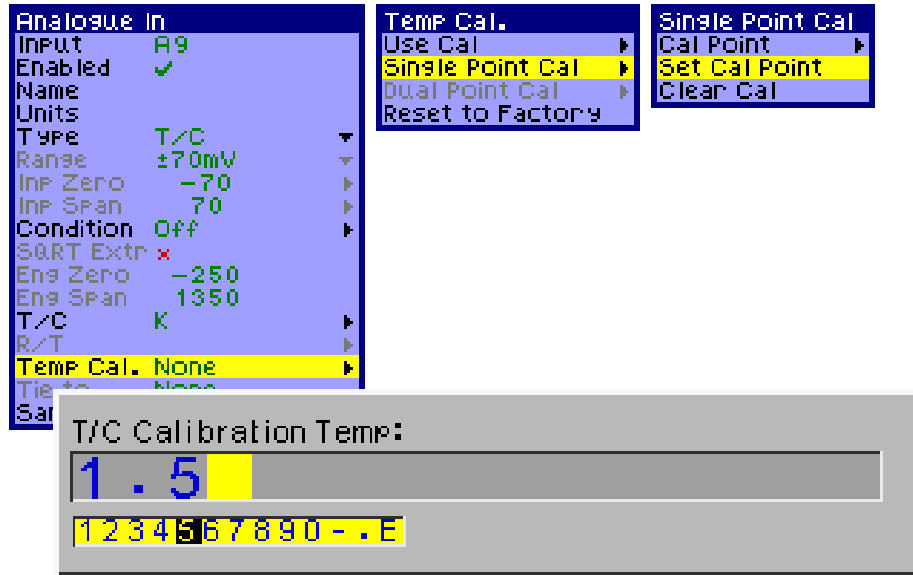

Tie To

Function: To tie the input engineering scale to pen scale

Type: Pen selection

Description: To allow the Pen scale and the Engineering scale to be independent of each other or to be linked together

Default: None

This is an option to connect the information on this input to a particular pen. The default is **Tie to**, so if you do not wish the input scales to change together this must be set to **None**. When active, a connection is made between the pen scale, engineering scale and the input scale. So if the pen scale is changed, the engineering and input scales will change too. To change or edit a tie to, highlight Tie to, press the directional key to select the option. navigate using the directional key until the required pen ID is displayed, press the enter button to select that pen. Press **Finish** on the on-screen selection bar, then press **Apply**.

Sampling

Function: Analogue input sample speed

Type: Menu selection

Description: Sets the sampling for the base input card

Default: Normal, Sampling speed defaults to 500ms(2Hz)

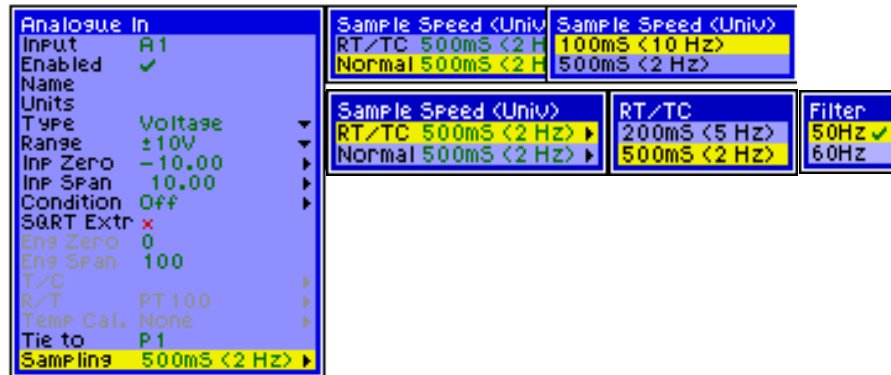

Normal sampling refers to the speed at which the card will run if voltage or current inputs are used. RT/TC sampling refers to the speed at which the card will run if any one or more of the inputs are set to RT/TC.

Normal input sample speed	RT/TC Sample speed
100 mS (10 Hz) 5 times per sec	200 mS (5 Hz) 5 times per sec
500 mS (2 Hz) twice per sec	500 mS (2 Hz) twice per sec

Pen speeds are not affected and the pen logging rate can be set higher than the sample speed for any input. The sample speed of 500 ms (2 Hz) will enable 50/60Hz **Digital filter** which will cut down external noise giving a more stable reading.

Chapter 6: Pen Setup

Pens

All available pens may be displayed as either a trend on a chart, a bargraph scale or as a digital panel meter or combinations of, see [“Screen Layouts” on page 22](#). Pens can be displayed in groups using the Layout menu and assigning pens to a screen. See [“Layout” on page 73](#). A pen can be assigned to show engineering units or display a maths expression. The **SIREC DS**, that has the Maths and Totalisers option fitted comes with 6 extra pens.

Highlight the **Pens** option on the **Setup** menu press the enter button to generate the menu shown opposite.

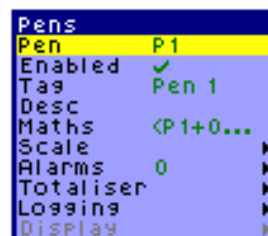

Pen

Function: Pen identification

Type: Preset choice

Description: Identify and setup pen configurations

Default: P1 (pen1)

The first pen will be shown on the menu ie. P1. To set up alternative pens, highlight the Pen option using the directional key and press the enter button to select. The available pens will scroll incrementally using the directional key. Press the enter button to select relevant pen.

Enabled

Function: Enables the pen

Type: Keypad activated on/off

Description: Activates each pen

Default: Enabled

This is a toggle switch which shows as a **x** when off, or a **✓** when active. Each pen can then be setup with information specific only to that pen.

Tag

Function: Active pen identifier

Type: 16 Character alpha/numeric

Description: A short name tag or identification for individual pens

Default: Pen 1

The **Tag** will be the identifier on any subsequent graph screens. Highlight this option using the directional key and then press the enter button for selection, the pen tag will be displayed along side the relevant bars or digital reading. To edit the tag follow the instructions in [“Text Entry” on page 27](#).

Description

Function: Pen function

Type: 32 Character alpha/numeric

Description: For additional Pen information

Default: N/A

Use the directional key to highlight an option and the enter button to select. The pen **Description** will be displayed along the bottom of the screen. To edit the name follow the instructions in [“Text Entry” on page 27](#).

Maths

Function: Maths calculations, available as an option

Type: 256 character alpha/numeric

Description: The maths expression allocated to this particular pen.

Default: A1 (for pen1)

Analogue signals may have a mathematical function performed on them before they are represented as a pen. Use the directional key to highlight an option and press the enter button for selection. The maths expression will be displayed along the bottom of the screen. For more information on maths [See “Appendix D- Maths Expressions” on page 93](#). To edit the maths expression follow the instructions in [“Text Entry” on page 27](#).

Scale

Function: Pen scale configuration

Type: Menu selection

Description: Information required to set up the pen scales

Default: N/A

Selecting **Scale** brings up a sub menu from which a further option menus appear, shown here. Highlight and select your entry using the directional key and the enter button. To edit the scale units follow the instructions in [“Text Entry” on page 27](#).

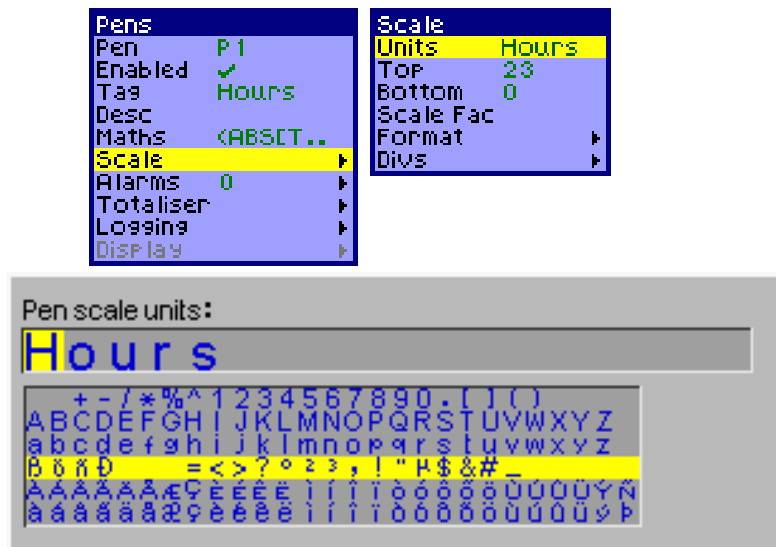

Units

Function: Scale measurement units

Type: 10 Characters alpha/numeric

Description: The units which the pen is measured in.

Default: %

Enter here the **Units** required for the scale measurement. Use the directional key to highlight an option and the enter button to select. The units will be displayed along the bottom of the screen. To edit the units follow the instructions for [“Text Entry” on page 27.](#)

Top

Function: Top scale value

Type: 10 Character alpha/numeric

Description: Reading shown at the top of the scale

Default: 100

The **Top** value allows the user to set the numerical value at the top of the graph display for a pen. To change or edit these values follow the instructions for [“Text Entry” on page 27.](#)

Bottom

Function: Bottom scale value

Type: 10 Character alpha/numeric

Description: Reading shown at the bottom of the scale

Default: 0

This value allows the user to set the numerical value at the **Bottom** of the graph display. To change or edit these values follow the instructions for [“Text Entry” on page 27.](#)

Scale Factor

Function: Scale value multiplier

Type: 8 Character alpha/numeric

Description: Reference scaling factor for representational use.

Default: None

Use this to avoid having large numbers displayed on the graph. A scale factor can be entered, by which the values on the scale can be multiplied to give the actual value being represented. This is shown at the bottom of the graph. The **Scale Factor** has no effect on the value being displayed- it is only for the user's reference. To change or edit these values follow the instructions for [“Text Entry” on page 27.](#)

Format

Function: Number of decimal places on the pen scale

Type: Single numeric character

Description: Pen scale format for up to 6 decimal places

Default: Auto = Automatic enabled

Automatic formatting for the pen scale defaults to 3 decimal places. Deselect **Automatic** to allow entry to manually set the number of decimal places. See table for automatic decimal place settings.

span of scale less than	Number of decimal places
10	4
100	3
1000	2
10,000	1

Divs

Function: Set up for chart major and minor divisions

Type: Major and minor 10 character numeric

Description: Allows the display to be divided into major and minor divisions

Default: Auto enabled

The chart background is divided in to major and minor divisions represented by thin blue lines. The major divisions are also marked numerically on the bargraph. To change or edit these values follow the instructions for *“Text Entry” on page 27.*

Alarms

This is an option initially purchased with the unit or can be added to the recorder at any time.

Function: Pen specific alarm setup

Type: Menu select

Description: Configures alarms to a specific pen

Default: 0

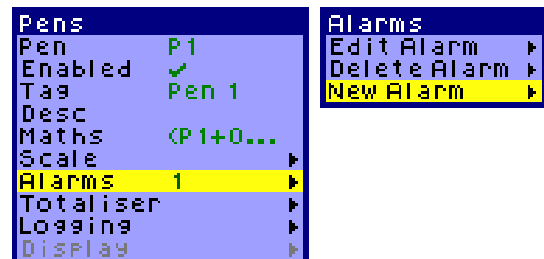

There are two relay alarm cards available to the **SIREC DS** either 4 relay output card or 6 relay output card with 2 volt free inputs. For connection details see *“Alarm Card (option)” on page 19.*

There are a total of up to 32 integral ‘soft’ alarms available in any combination for any pen to inform of selected out of limit conditions. So for example pen 1 could be allocated two alarms, pen 2 could have four alarms and pen 3 eight alarms, a total of 14 alarms out of a possible 32 alarms have been used. Pen 1 will use alarm numbers 1 & 2, pen 2 will use alarm numbers 3 to 6 and pen 3 will use alarm numbers 7 to 14. The procedure for setting each alarm is the same. Alarms can be configured to trigger at a specified levels and respond in various ways.

From the **Pens** menu, highlight and select **Alarms**, using the directional key and the Enter button, this will produce the **Alarms Menu**. An alarm can be allocated and configured to a pen using **New Alarm** See *“New Alarm” on page 55.* From here existing alarms can be edited by selecting **Edit Alarm** See *“Edit Alarm” on page 55.* Alarms can be deleted from specific pens using **Delete Alarm** See *“Delete Alarms” on page 55.*

New Alarm

Function: Create a new alarm

Type: Menu select

Description: To setup one or more new alarms per pen

Default: Alarm 1



- Alarm - The alarm number defaults to 1, of a possible 32.
- Create Alarm - Activates the complete menu for the setup of that alarm.
For full menu details [See "Edit Alarm" on page 55.](#)

Delete Alarms

Function: To delete an existing alarm

Type: Menu select

Description: Deletes existing alarm and setup

Default: First active alarm for that pen



- Alarm - select alarm for deletion by highlighting **Alarm**, using the directional key and pressing the enter button to select. Navigate the directional key to highlight the correct number of the alarm and press the enter button to select.
- Delete - Highlight and press to delete using the directional key and the enter button.

Edit Alarm

Function: Edit alarm features

Type: Menu select

Description: View and modify existing alarms

Default: First active alarm for that pen

Use this menu to configure the alarm specifications for each pen.

Alarm - Select alarm number by highlighting and selecting **Alarm**, use the directional key to scroll through the available alarms for that pen, press the enter button to select.

Enabled - The menu option is either **Always** or **Disabled** activated by navigating the directional key to highlight **Enabled**, press the enter button to select, from the next menu highlight the selection which will toggle from on (✓) or off (x).



Tag - Or name by which each alarm can be identified. Highlight this option and press the enter button twice to display the text and character boxes. To edit the **Tag** follow the instructions in ["Text Entry" on page 27.](#)

Type - Specify whether the alarm is to be set high or low. Highlight **Type** and select, from the next menu select either **High** or **Low**.

Level - The **Level** is the engineering units value and must be set within the **Scale** set for that particular pen. Highlight and select level, press the Enter button twice and follow the instructions. ["Text Entry" on page 27.](#)

Log Alarm - This is an on/off toggle ✓ to enable **x** to disable. When activated, alarm activity will be logged in the system events screen, which can be located by pressing MESSAGES, found on the main screen selection bar during normal recording.

Relay Enable - Depending on the type of alarm card fitted there may be from 4 to 6 relays available. This menu shows the **Relay** state, each relay can be individually enabled on (✓) or off (**x**). Select which relays are to be closed in the event of an alarm being triggered.

Relays - Only operative when **Relay Enable** is activated. This will show the relay number currently being edited, switch enable on or off using the toggle mode (✓) on or (**x**) off.

Hysteresis - This is effectively a tolerance level for an alarm level. When enabled, the **Adjust Level** can be set. This allows a specific percentage value of the engineering span to be added on to an alarm level.

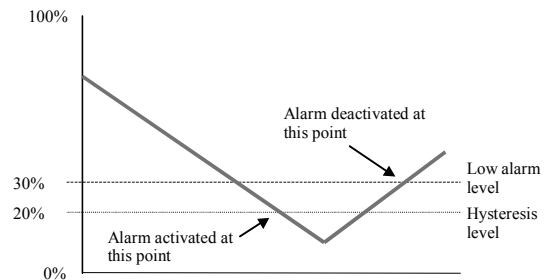

In this example, if a **Low** alarm is selected with a hysteresis value of 10%, a logged reading will have to be below the alarm level by at least 10% of the overall scale before an alarm is triggered.

Enable - this is a toggle on (✓) off (**x**) switch.

Symmetrical - The hysteresis value is divided on either side of an alarm level. In this example the adjust level is still the same, 10 %, but if hysteresis is selected as **Symmetrical** then the logged reading would only have to drop as much as 5% of the full scale value below the alarm level to trigger the alarm. For the alarm condition to cease the logged reading would have to rise to over 5 % of the full scale value above the alarm.

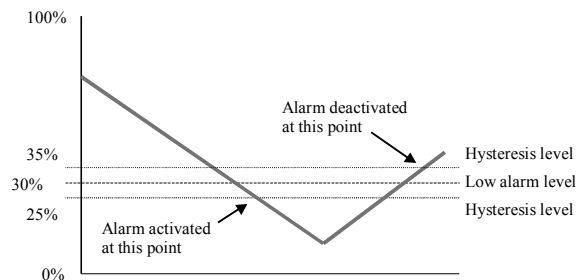

Low alarm - 10% Symmetrical hysteresis

- **Adjust Level** - Highlight and select this option using the directional key and the enter button, press the enter button twice more to display the numeric bars for entering the adjustment level. To enter a value see ["Text Entry" on page 27](#).

Damping - With this facility enabled, an alarm level must be breached for a specific period of time before an alarm is triggered.



For example, if a **High** alarm with **Damping** time of 3 minutes is set, the input signal must stay above the alarm level continuously for three minutes for the unit to activate an alarm. If the input signal drops below the alarm level before 3 minutes is up, the **Damping** timer will be reset and start again the next time the alarm level is breached.

Totaliser

Function: Totalises the value of a pen

Type: Menu selection

Description: A total value measured over a timed period

Default: Disabled

The **Totaliser** function is normally associated with flow monitoring applications, where the input to the recorder would be a measure of flow rate (ie. in litres per second) and the total amount that has flowed over a certain time period (ie.cubic metres). Totals can be assigned to individual pens. To setup the totals for a pen select **Totaliser** from the Pens setup menu, this will generate the totaliser sub-menu. Six extra pens are available with the Maths and Totaliser option.

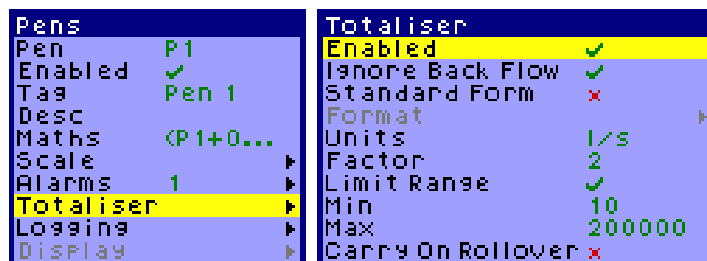

- **Enabled:** toggle switch on (✓) or off (x), enables the totaliser for that pen.
- **Ignore Back Flow:** If the flow reading should go into a negative value because the flow meter has been switched off, and the **Ignore Back Flow** option is non activate (x) the totaliser will start to subtract from the total value. When enabled (✓) any negative values are ignored and the total value will be held while the flow meter is off.
- **Standard Form:** With this function enabled the total values will always be displayed in standard form (eg.2.76823e+09) regardless of the length of the number.

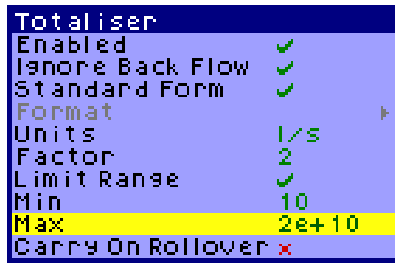

← Displaying Standard Form

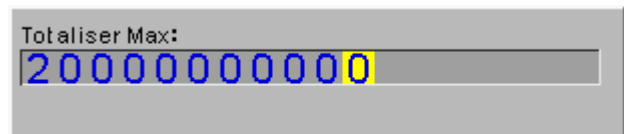

- **Units:** This is the units of measure for the totaliser.
- **Factor:** This is the totalising Factor for the conversion from pen input units to totaliser value.
- **Limit Range:** Toggle switch (✓) to activate the minimum and maximum ranges.
- **Min:** Activated by enabling the Limit Range. Set the minimum limit for the totals to range from.
- **Max:** Activated by enabling the Limit Range. Set the maximum limit for the totals to range to.
- **Carry On Rollover:** Activated by enabling the Limit range. When the total exceeds the maximum scale limit the total will reset to the minimum limit. When activated it will carry over any amount in excess of the maximum scale limit.

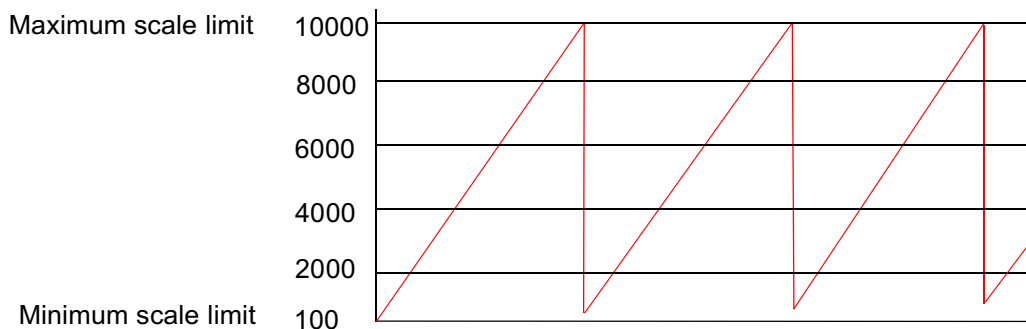

This example has a scale range set from 100 to 10000 with increments every 500. When the reading reaches the maximum scale of 10000 it will be over range by 100 (starting at 100, 20 increments of 500 will equal 10100), with Carry On Rollover activated the residual of 100 is added to the next minimum scale limit.

Displaying Totals

Six extra pens are available with the Maths and Totaliser option. Choose a spare pen to display the total of another pen using the Maths expression. See “Appendix D- Maths Expressions” on page 93.

In this example pen 1 (P1) is being used to display the **Total** of pen 2 (2). Pen 2 (2) is shown here being divided by 10 (10), this divisor may be necessary to divide the **Total** so that it does not exceed the pen scale limit of 1,000,000.

$$P1 = T[2,10]$$

NB: Do not omit the divider (10), a divisor must be added even if it is 1.

Logging

Function: Pen specific logging set up.

Type: Menu selection

Description: Storing data to disk by specifying relevant information

Default: Disabled



Selecting **logging** brings up sub menus from which further options appear. These will now be listed in detail.

Normal

Function: Normal log mode set up.

Type: Menu selection

Description: Specific pen during operation

Default: N/A

This takes you to further setup menus. When the unit has **logging** enabled it is then necessary to state the **Type**, **Method** and **Rate** of logging.

Enabled

Function: Activate logging

Type: Keypad activated on/off

Description: Enables logging for each pen

Default: Disabled

This is a toggle switch which shows as a **x** when off, or a **✓** when active. Each Pen can then be setup with individual logging information for that pen.

Type

Function: Type of logging

Type: Menu selection

Description: The format in which data is logged

Default: Continuous



Once enabled the **Type** of logging can be **Continuous**, only logging when an **Event** occurs or **Fuzzy**.

For Continuous logging, highlight and select, then go to [“Method” on page 60](#)

Fuzzy logging was developed as a secure data storage technique which has self teaching data storage algorithm so the recorder stores data at a variable rate to match the process being monitored. See [“Appendix F- Fuzzy Logging” on page 99](#).

Fuzzy logging has intelligent resources to enable the most effective and efficient way of using the Scan rate, Disk capacity and Recording time.

Select **Fuzzy** to produce this menu.

Enable Fuzzy logging with a ✓ and select the **Rate** option.



This will reveal two items, the **Value** and the **Units**, set these to the desired rate for logging.

AutoFit ensures that the last sampled data point is logged before the signal goes out of the tolerance set in Band A or Band B. When displayed on a graph, the input signal will automatically fit to this last logged point.

Band A% is where the tolerance is set for the input signal. Specify, as a percentage, the tolerance band allowed above and below the input signal.

Use Band B to enable a second tolerance to be set, ✓ to activate.

Band B% This is where a tighter tolerance can be specified which must be set within the limits of Band A. Specify, as a percentage, the tolerance band allowed above and below the input signal.

Method

Function: Style of logging

Type: Menu selection

Description: The way in which the logged data is collected.

Default: Sample



The **Continuous** logging option will require a **Method** of how the data is to be logged.

- **Sample** logs the last sampled reading.
- **Average** logs the average of all the samples taken since last log.
- **Max / Min** logs the highest and the lowest of the sampled readings since last log.

Rate

Function: Logging rate, speed

Type: Menu selection

Description: Set this to how often data is logged

Default: Value = 10, Units = Secs

Rate of logging is determined by first entering the **units** of measurement then setting their **value**. To change or edit these values follow the instructions in *“Text Entry” on page 27*.

If the units required are 'msec' the value screen will appear as shown here. This measures the value in Hertz (Hz), this measurement is then converted into the value in 'msec' i.e.: 5 Hz = 200 Msec.

NB. Hour and day logging rates are not available for Fuzzy logging.

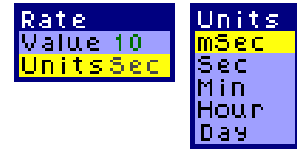

Device

Function: Store logged data

Type: Menu selection

Description: Down load logged data to Floppy disk

Default: Disk

The only **Device** available on the **SIREC DS** is 1.44 MByte floppy disk drive.

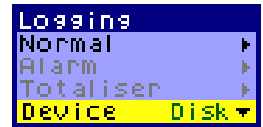

Chapter 7: Relay Alarm Cards

Relay/Digital can only be obtained on the recorder if the alarm card fitted is capable of both inputs and outputs. There are two different types of Relay/Alarm card available for the **SIREC DS** but only one has both inputs and outputs.

Relay Alarm Cards	Ratings
4 channel relay alarm card (Output only)	3A 240V a.c.
6 channel relay output/2 volt free digital inputs	3A 240V a.c.

Relay/Digital

Function: Specify relay/digital I/O

Type: Menu select

Description: To configure relay/digital input or output status

Default: Channel 1, Label D1,
On state On, Off state Off,
As Input x, As Output ✓,
Fail Safe x, Log digital Off.



Select each item required on the **Relay/Digital** menu:

Channel: Highlight and press the enter button, use the directional key to change the channel number. Select channel number required for configuration as a relay/digital input or output channel.

Label: 15 character alpha/numeric.

Highlight and press the enter button twice to activate the label block and the character display block. Allocate a name by which the relay/digital can be identified.

On State: 11 character alpha/numeric

Highlight and press the enter button twice to activate the Digital On State and character display block. This is what will be displayed in the messages list when an relay/digital is in its 'On State'.

Off State: 11 character alpha/numeric

Highlight and press the enter button twice to activate the Digital Off State and the character display block. This is what will be displayed in the messages list when an relay/digital is in its 'Off State'.

As Input: The first 6 channels are set to outputs. The 6 channel output/2 digital input card has two inputs available on channels 7 and 8 select these channels and enable as inputs. The 4 channel card will have this option greyed out as no inputs are available with this card.

As Output: The 4 channel relay output card will show this enabled for all 4 channels. The six channel output/2 digital input card will show this enable for channels 1 to 6 only, channels 7 & 8 are set to inputs.

Fail Safe: Toggle fail safe ✓ On or x Off.

A **Fail safe** operation can be activated on the **Output** on a channel by channel basis. Fail safe, when enabled, holds the relay in an energised state until triggered by an alarm when the relay is de-energised. Any power failure will cause the same result.

N.B. Fail Safe and Maths

However, when using output relays in a maths expression be aware the maths is reporting the literal state of the relay.

An example of this would be:-

If Pen 1 (P1) equals output channel 4 (O4) and Fail safe is On with no alarm triggered, the relay will be energised and P1 will return 1.

$$P1 = O4$$

Log Digital:

Setup each Digital individually. Default is set to **Off**, so no logging of any relay/digital events will be recorder on the Messages list or on any chart.



Use this box if digital activity is required to be logged to either **List**, which is the Messages list, or to **List & Chart** which is recorded on both the chart and in the messages list. Repeat for each channel. See [“Messages” on page 25](#).

Chapter 8: Setup Complete

Setup complete

Whilst making alterations to the recorder setup, the recorder has still been recording data with the previous setup. When the new setup is complete select **APPLY** and the recorder will ask if you wish to save the previously logged data and setup to disk. If the data logged whilst creating the new setup is not required select **DISCARD**.

When the setup is complete, select the **FINISH** button from the on screen selection bar at the bottom of the screen. The options are to **APPLY** the changes, **CANCEL** the changes and return to the main menu or go **BACK** to the previous menu.

APPLY - From here the options are to **SAVE** the log data, **DISCARD** the log data or **EJECT** the current disk for possible replacement. During **SAVE** an hourglass symbol will appear and the drive can be heard logging the data.

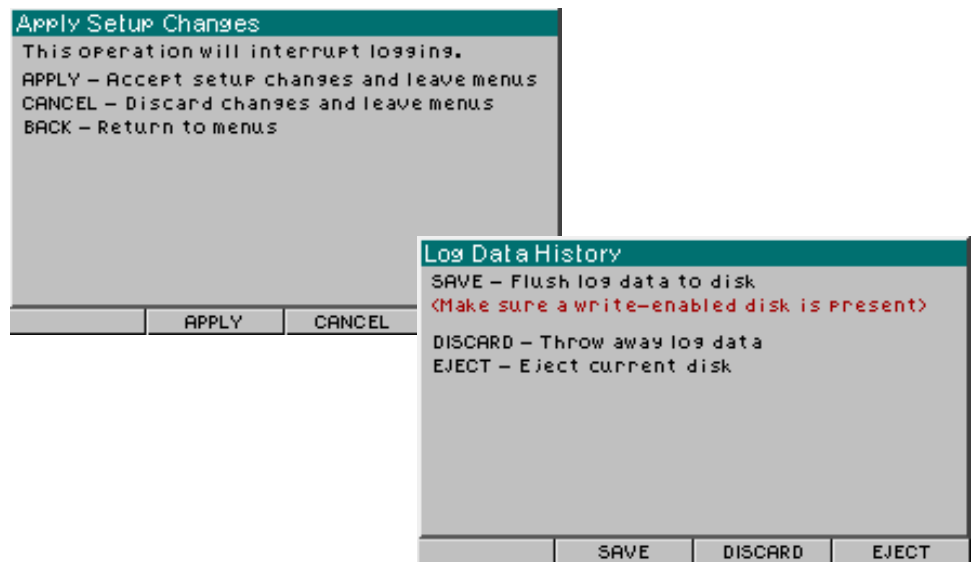

Load

Function: Import setup to the recorder

Type: Button activated

Description: To Import a setup from SIREC D - Software or other recorder

Default: N/A

Use this option to import data setups from disk when:

1. Setups have been exported to disk in **SIREC D - Software** previously.
2. Setup of one recorder is very similar to another, therefore only a minimal change would be required.
3. One recorder may be used to monitor several functions and may need more than one setup to do so.

Importing setups will interrupt logging and will cause the existing setup to be shut-down and saved, then the new setup will be executed.

Select setup from the **Main Menu**, use the directional key to highlight the **Load** option, press the enter button to select. The **Import** screen will appear, there are two options available. Follow the on screen instructions to complete importing or to cancel this operation.

Save

Function: Save setup only (no data)

Type: Menu Selection

Description: To save the recorder setup for transfer on disk to SIREC D - Software or to another recorder

Default: N/A

After completing a new setup either through editing the menus or importing one select **Save** to store. Use this option to export the setup only to disk under the same circumstances as importing setups. Use the directional key to navigate until **Save** is highlighted, press the enter button to execute the action. Always check there is a disk in the drive prior to using this function.

Chapter 9: Recording

Recording

NB. Validate disk before recording. [See “Validate Disk” on page 68.](#)

From the MainMenu, select **Recording** to produce this menu.



Enabled

Function: To activate recording

Type: On/off switch

Description: Enables the recording of data

Default: Disabled

This is a toggle switch which shows as a **x** when off, or a ✓ to activate recording.

Log to Disk

Function: To activate logging to disk

Type: On/off switch

Description: Enables logging to disk

Default: Disabled

This is a toggle switch which shows as a **x** when off, or a ✓ when the disk drive is accessible.

Save Data and Eject Disk

Function: Down load sampled data

Type: Thumbwheel activated

Description: Allows data to be stored to disk at any time.

Default: N/A

This option allows stored data and the recorder setup to be copied to disk at any time, you do not have to wait for the recorder to make a timed dump of recorded data to disk. It is only available when a disk is loaded in the recorder. When **Log To Disk** is not enabled **Save Data and Eject Disk** is displayed in grey text, thereby indicating the option is unavailable. Always check there is a disk in the drive prior to using this function and use the **Validate Disk** function before saving to disk. [See “Validate Disk” on page 68.](#) Use this option to store blocks of recorded data to disk which may be in a queue awaiting automatic transfer to disk.

Validate Disk

Function: Check disk

Type: Thumbwheel activated

Description: Initiates and verifies disk status

Default: N/A

Before saving to disk, use the **Validate Disk** function to instruct the recorder that a disk is present. The busy egg timer will appear while the function initiates the disk and checks for any corruption.

Chapter 10: Totals



Totals will not be active from this menu until the **Totaliser** is enabled.
See [“Totaliser” on page 57.](#), for setting up totalisers in the Pen Setup Menu.

Start All Totals

Select the **Start Totals** option by using the directional key to highlight and activate by pressing the enter button. This takes immediate effect.

Stop All Totals

Select the **Stop Totals** option by using the directional key to highlight and activate by pressing the enter button. This takes immediate effect.

Reset All Totals

Select the **Reset Totals** option by using the directional key highlight and activate by pressing the enter button. This takes immediate effect.

Chapter 11: Change Password

Changing an Existing User Password

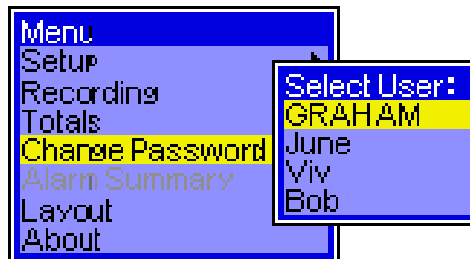

This is where the user can change their password, at any time.

The User must already be entered on to the recorder and have an existing password. Users can only be entered on to the recorder by someone at 'Eng' level. The 'Eng' level user enters all the users and assigns their user level of access. [See "Password" on page 32.](#)

Select **Change Password** followed by the **User** name. Enter the current password, then enter the new password. This has to be re-entered to confirm the new password.

The new password is now in the system and will be required when the user logs on.

Chapter 12: Layout

Layout Configuration

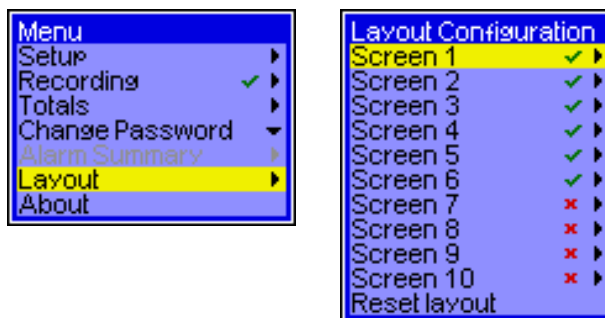

Selecting and Re-naming Screens

From the Layout configuration menu select a screen, e.g. **Screen 1**, and press the enter button. The screen must be **Enabled** by placing a ✓ against it. Up to ten screens can be set up individually with different pens allocated to specific channels.

The **Label** is the name given to a screen and can be renamed, by highlighting the option using the directional key and then press the enter button. Press the enter button once more to activate the character box. Using the directional key navigate up and down the rows then press enter to select. Use the directional key again to travel right and left along the rows to select a character, then press the enter button. See [“Text Entry” on page 27](#).

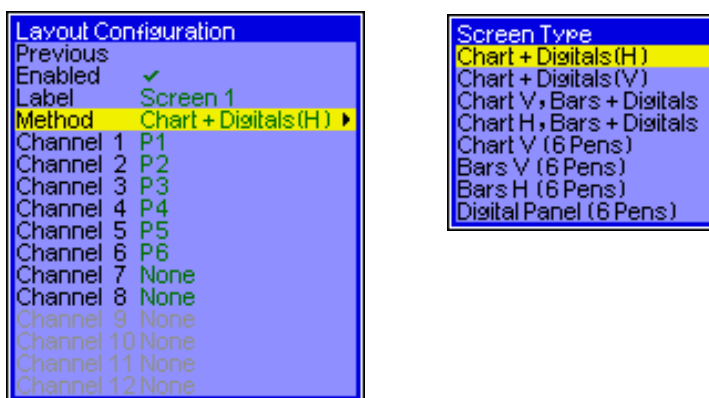

The **Method** in which the data on the screen is presented. The **SIREC DS** has eight variations of screen layouts to choose from. All the layouts are displayed on [“Screen Layouts” on page 22](#).

Scroll down to each channel on the Layout Configuration menu and assign the pen required to display each channel.

Data display evaluation

These charts shows the chart speed in millimetres per hour against the amount of time shown on the screen and the amount of time stored in the buffer.

SIREC DS chart speeds

SIREC DS					
Chart speed	<i>Screen display time</i>			<i>Buffered time available for replay</i>	
mm per hour	Days	Hours	Mins	Days	Hours
1	2.71	65.00	3900.00	59.29	1423.00
5	0.00	13.00	780.00	11.86	284.60
20		3.25	195.00	2.96	71.15
30		2.17	130.00	1.98	47.43
60		1.08	65.00	1.00	23.72
120			32.50		11.86
600			6.50		2.37
1200			3.25		1.19

A section of memory is allocated to 'Screen' data, this memory is in fixed areas. And can accurately relate the length of the 'chart' in time to the speed of the chart - shown in this table i.e. the faster the chart, the quicker the allocated memory is used up for that chart, the shorter the replay available.

Chapter 13: Software

The **SIREC DS** recorder can be used in conjunction with the **SIREC D - Software**. The software is Windows 95, 98SE, 2000 and NT compatible, integrated software solution to configure recorders, archive and analyse data and distribute data plant wide.

Software License/Warranty

Please refer to the Software manual 43-TV-25-18 for software licence and warranty information.

Features

1. Conflict free graphing of the same recorder or real-time data source by several users simultaneously.
2. **Time Bar** indicating the time of the data displayed in units of: year, month, day, hours, minutes, seconds, tenths, hundredths and milliseconds.
3. Data from recorders in a different database can be graphed on the same graph.
4. **Data Locator** now optionally displayed on the graph screen.
5. Seamless graphing of data on local and remote databases.
6. Full client server implementation.
7. FTP (File Transfer Protocol) - used for transferring data files over the Internet providing access to download and import data through remote Ethernet connection to one or many recorders.
8. Fuzzy logging - Self teaching storage rates recording data at a variable rate matching the process being monitored. 10:1 data compression, saving more data to disk and saving disk space.
9. Events system based on a 'cause' and 'effect' method with up to 9 possible causes triggering up to 8 different effects.
10. Windows™ 98SE, 2000 and NT compliant.
11. Password protection - protects screen entry, restricting access within the recorder and providing password protection at different level.
12. Web browse a recorder with an IP Address (network use).
13. Load up a setup from a PC to a recorder with an IP Address via Ethernet.
14. Event system now includes sending E-mails when an event is triggered.
15. Event View Filter allows the events displayed on the graph to be cut down to a specific type of event e.g. Alarm, Digital, System, User or Marker.
16. Audit Manager enables the user to setup an audit trail which records who's logging on and off, when and what they did.
17. Realtime data transfer to **SIREC D - Server** for display, graphing and logging.

18. A Communications Server to manage the communication status of the recorder on an Ethernet connection.

19. Remote Server and Database access via an Ethernet link.

Items 5, 6, 7, 8, 12, 13, 16, 17, 18 and 19 apply to **SIREC D - Server** only.

Features	SIREC D - Viewer	SIREC D - Manager	SIREC D Server
Full Configuration of any recorders on PC		✓	✓
Simulate any of our recorder on PC		✓	✓
Import data from disk	✓	✓	✓
Print all graph data and recorder configurations	✓	✓	✓
Archive data on integral secure database		✓	✓
E-mail recorder configurations and data on www		✓	✓
Export using CSV format files	✓	✓	✓
Export using OPC links			✓
On Ethernet using TCP/IP			✓
Distribute all recorder data over LAN plant-wide			✓
FTP/IP Ethernet connection			✓
Fuzzy logging		✓	✓
Events system		✓	✓
Operates in Windows 98SE, 2000 and NT	✓	✓	✓
Password protection			✓
Web browse a recorder			✓
Send setup to recorder via ethernet			✓
Audit trail manager			✓
Replay of historical and Realtime data using a split screen format			✓
Realtime data retrieval used for graphing and logging			✓
Comms Server to manage the communications status of each recorder			✓
Local and remote links via Ethernet to access other servers			✓

System Requirements

SIREC D - Viewer and **SIREC D - Manager** require the following minimum specification:



- 200 MHz Pentium processor
- 3.5" floppy disk drive
- LS120 super drive
- CD - ROM drive
- Monitor - recommended screen resolution 1024x768 minimum requirement, high colour.
- Windows™ 95, 98, 2000, NT ver. 4.0 with Service pack 3 (onwards)
- 32 Mbyte or more of RAM (64 Mbyte recommended)
- 10 Mbyte free hard disk space
- a Mouse

For **SIREC D - Server** the following minimum specifications apply:



- 450 MHz Pentium processor
- CD ROM
- LS120 super drive
- Monitor - recommended screen resolution 1024x768 minimum requirement, high colour.
- 2 Gbyte Hard-drive
- Windows™ 98SE, 2000, NT ver.4.0 with Service pack 3 (onwards)
- 128 Mbyte RAM (256 Mbyte recommended)
- TCP IP installed
- a mouse

TCP/IP = Transmission Control Protocol/Internet Protocol is the main transport protocol used on the Internet for connectivity and transmission of data across heterogeneous systems.

With all of the **SIREC D - Software** performance improves with more RAM, faster CPU's, and faster and larger hard disk drives.

NB: It is recommended that at least 100 Mbytes of free hard disk space is available for archiving data. Please note the more logging and data being stored, the more free space on the hard disk is required. This is not required with **SIREC D - Viewer**.

Chapter 14: Instrument Care



WARNING

PERSONAL INJURY

To avoid any personal injury or damage to the unit, ensure the recorder has the power turned off and mains has been disconnected before handling the unit.

Failure to comply with these instructions could result in death or serious injury.

Your recorder is designed and manufactured to ISO9000 quality procedures and will give a long and trouble free life.

In the event of a unit failure contact your nearest Service Department (or an authorised agent) to arrange for the return of the unit for repair.

Battery Life

Your **SIREC DS** will arrive with the battery switched off, to save battery life. The switch to turn on the battery is located on the right hand side of the case, see [“Display Trimpot Adjustments” on page 18](#). Set the battery to the On position before powering up the recorder. Powered up the battery will last up to 10 years, powered off the battery life is dramatically reduced to 6 or seven months.

Cleaning Instructions

Switch recorder off prior to cleaning.

Cleaning the unit should be done with a soft lint cloth and warm soapy water. Solvents and prolonged exposure to detergents can cause damage to the front panel. It is recommended that any cloth used for cleaning is damp but NOT wet, to avoid water collecting in the unit.

Disk Drive



CAUTION

AVOID DISK DAMAGE

To avoid damage to disk drive heads, ensure diskette is removed prior to transporting the recorder.

Failure to comply with these instructions may result in product damage.

DO NOT insert any object, other than a 3.5" floppy diskette, or force a diskette into the disk drive. Disks should be removed gently on a parallel plane to the opening of the disk drive. Avoid tilting the disk side to side during removal as it may damage the drive.

If the disk is impeded during ejection from the disk drive, it may jam. DO NOT pull the disk out if there is any resistance. To remove the disk, lift the key pad by

depressing a button located in a central position on the underside of the keypad. Pressing this button will release the keypad, lift the keypad flap to reveal the disk drive. The eject button can be found beneath the disk slot, press to eject the disk.

If the disk gets caught in the drive, DO NOT attempt to force it. Contact **SIEMENS** or an authorised agent.

Disk Drive Cleaning

The disk drive in your recorder is a highly reliable component that will give many years of trouble free operation if the following precautions are observed:-

1. Use only high quality diskettes. The recommended pre-formatted 1.44 MByte diskettes from Verbatim, Maxell, Fuji, and Sony.
2. **Never** use bulk supply “unbranded” diskettes, or diskettes “badged” by a component wholesale organization. Experience has shown that “unbranded” and “badged” diskettes, whilst often meeting ISO, ECMA, or ANSI standards, do not exhibit the longevity, or performance at temperature, available from diskettes sourced from reputable manufacturers.
3. Every six months (or more often in dusty or harsh environments), use a suitable cleaning diskette on the recording heads.
 - 1.44 Mbyte floppy disk drives - use a "dry" cleaning diskette



CAUTION

USE CORRECT DISK CLEANING MATERIALS

Refer to TEAC FD-235HF-7291 Micro Floppy Disk Drive Specification
Never use “wet” cleaning diskettes on these drives. These are not suitable.

Failure to comply with these instructions may result in product damage.

4. For critical applications, do not continually re-use the same diskette.
5. To minimise the risk of damaged or worn media, replace with new disks every 4 months.
6. Insert and remove diskette only when the “In Use” warning light is off.
7. Only touch the diskette on its cover - **NEVER** touch the recording media.
8. Do not place magnets near diskette.
9. Store diskette in a secure area, your data is valuable and you must protect the diskette from extremes of temperature, moisture and dust.
10. Never leave a diskette in the drive for a more than 2 months if not recording.

Cleaning Procedure

The disk drive should be regularly cleaned, at least every six months minimum. Use a suitable cleaning diskette on the recording heads, ie. for the 1.44 Mbyte floppy disk drive - use a ‘dry’ cleaning diskette. More frequent cleaning of the disk drive may be required for more dusty or harsh environments, and is left to the customers discretion.

Backlights

1. At room temperature and maximum brightness, the backlight MTTF is 15,000hrs. min.

MTTF is defined as the time at which 50 % of a batch of backlights remain in excess of half their original brightness i.e. a display has a greater than 50 % chance of being half its original brightness at 15,000 hours old.

2. At extended temperatures these times are reduced.
3. Brightness and contrast control is available on the **SIREC DS** adjusted by two trimpots which can be located on the right hand side of the unit, see [“Case” on page 18](#). The trimpot hole nearest the display is for the brightness control and the middle hole is for adjusting the contrast. Reducing backlight brightness will extend backlight life.

Operating Temperature

Operating temperatures are described in [“Specifications” on page 6](#). Prolonged operation at temperatures over 50 °C will cause degradation of the display and may lead to other damage.

If the unit has been moved from a cold environment into a warm one, ensure that the unit has reached a minimum temperature of 12 °C or is left to stand for 1 hour at room temperature before applying power, to ensure no condensation remains in the unit.

Front Panel

Care should be taken with the front panel when handling the unit. Sharp and hard objects may pierce the front panel and damage the display. Abrasive materials will damage the front panel.

Calibration

It is recommended that recorder calibration is checked at least every year, or in accordance with your industry regulations, to ensure maximum accuracy. See [“Calibrate Input” on page 38](#).

Appendix A - Quality Approvals

CE Mark

The **SIREC DS** is compliant with Low Voltage Directive 72/23/EEC and amended by 93/68/EEC, and the Electromagnetic Capability Directive 89/336/EEC and amended by 91/263/EEC, 92/31/EEC, 93/68/EEC and 93/97/EEC.

Appendix B - Battery Safety Data Sheet

Safety Guideline

Identification

Type	Inorganic Lithium Battery SL350PT
Typical Capacity (mAh)	1000 mAh
Weight (g)	9g
Chemical System	Li/SoCl ₂
Voltage	3.6V
Chemistry System	Lithium thionyl chloride
Anode	Lithium metal
Cathode	Liquid, thionyl chloride

Composition/Information on Ingredients

NOTICE

Handling Precautions

The material in this section may only represent a hazard if the integrity of the battery is compromised, or if the battery is physically or electrically abused

Substance	CAS No,	Approx. percent of total weight	Hazard symbol	R-phrases
Lithium metal	7439--93-2	2- 6	F, C	14/15-34
Thionyl Chloride	7719-09-7	18 - 47	C	14-34-37
Aluminium Chloride	7446-7--0	2 - 5		
Lithium Chloride	7447-41-8	1 - 2		
Carbon	7440-44-0	2 - 5		
Steel, Nickel plated	-	35 - 73		
Glass	-	0 - 2		
PVC	9002-86-2	0 - 1		
PMMA	9011-14-7	0 - 1		
PTFE	9002-84-0	0 - 1		

Hazard Identification



WARNING

Fire, explosion and severe burn hazard

Do not recharge, disassemble, heat above 100° C, incinerate, or expose contents to water

Failure to comply with these instructions could result in death or serious injury.

First Aid Measures

A) Electrolytic Contact

- Skin - Immediately wash with plenty of water for at least 15 minutes. If symptoms persist after washing, get medical attention.
- Eyes - Immediately flush with plenty of water for at least 15 minutes and get medical attention.
- Respiratory system: With large quantities and irritation of the respiratory tract medical surveillance for 48 hours. Immediately inhale Cortisone Spray.

B) Litium Metal Contact

- Skin Remove particles of lithium from the skin as rapidly as possible. Immediately wash with plenty of water for at least 15 minutes and get medical attention.
- Eyes Immediately flush with plenty of water for at least 15 minutes and get medical attention.

Fire - fighting measures

A) Extinguishing Media

- Copious amounts of cold water is an effective extinguishing medium for lithium batteries. Do not use warm or hot water.
- Lith-X (Class D extinguishing media) is effective on fires involving only a few lithium batteries.
- Do not use CO2 or Halon type extinguishers.
- Dry chemical type extinguishers have limited extinguishing potential.

B) Fire Fighting Procedure

- Use a positive self-contained breathing apparatus if batteries are involved in a fire.
- Full protective clothing is necessary
- During water application caution must be advised as burning pieces of lithium may be ejected from the fire.

Accidental release measures

When the battery housing is damaged, small amounts of electrolyte may leak. Seal battery airtight in a plastic bag, add some chalk (CaCO_3) or lime (CaO) powder or Vermiculite. Electrolyte traces may be wiped off dryly using household paper. Rinse with water afterwards.

Handling and Storage

Do not allow terminals to short-circuit

Store preferably in a cool (below 21°C), dry area that is subject to little temperature change.

Do not place near heating equipment, nor expose to direct sunlight for long periods. Elevated temperatures can result in reduced battery life.

Stability and Reactivity

May rupture violently when heated above 145°C or when charged.

Ecological information

The batteries do not contain mercury, cadmium or other heavy metals.

Disposal Considerations

- Dispose by incineration or burial at permitted waste treatment and/or disposal sites.
- Batteries do not contain hazardous materials according to EC directives 91/157/EEC and 98/86/EEC.
- For large quantities a disposal service is offered upon request.

Appendix C - Thermocouple Connections

The different methods for connecting thermocouples according to the type of reference are shown below.

Internal Reference

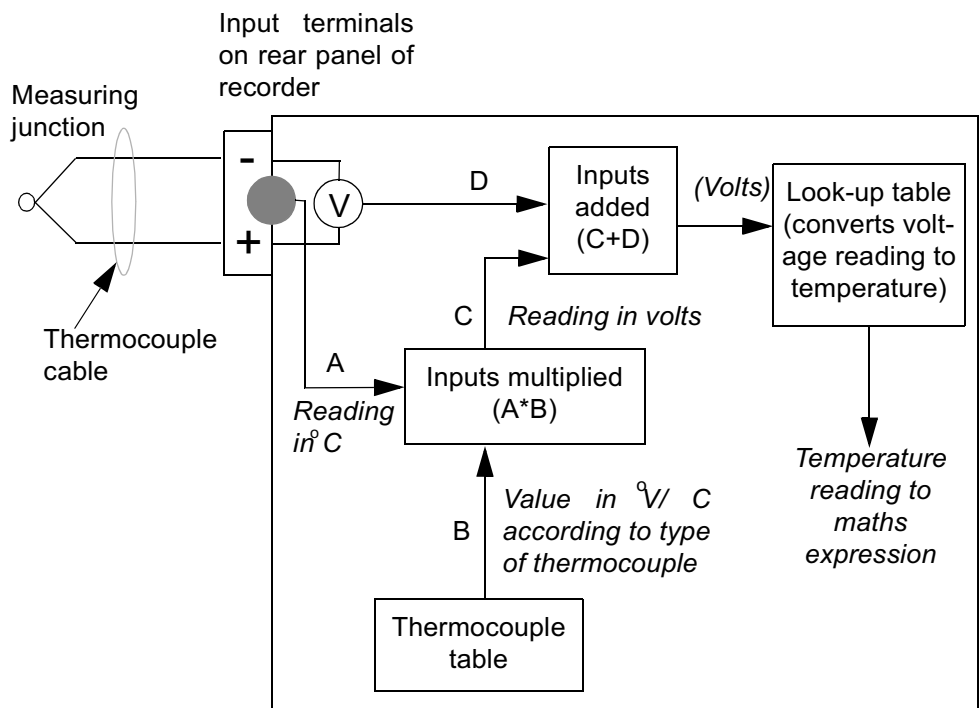

Internal Reference the reference junction is where the thermocouple is connected to the input terminals of the recorder, and the temperature at this junction is being measured by a temperature sensor on the rear panel of the recorder. The reading from this sensor is read off against a value taken from the thermocouple table, which corresponds to the type of thermocouple being used. The corresponding reading in volts for the temperature measured by the sensor is then used as a reference for the reading from the thermocouple.

External Reference @ 0°C

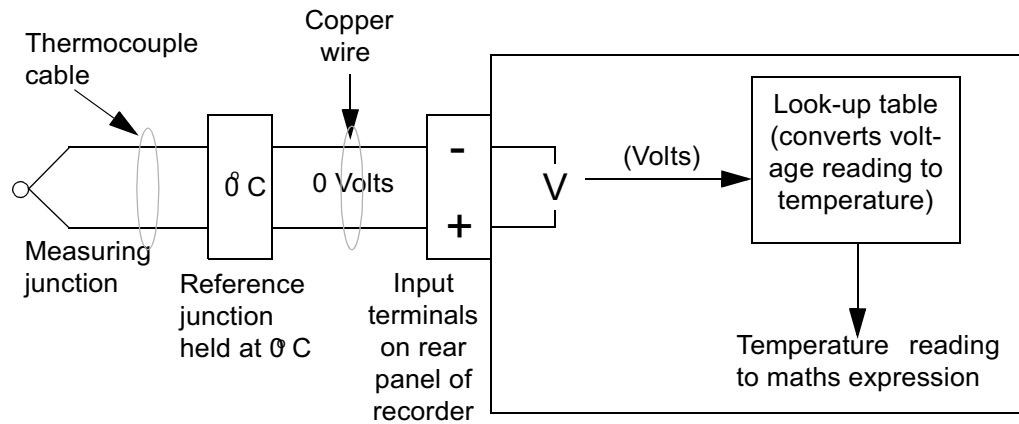

External Reference @ 0°C by keeping the reference junction at 0°C the negative input is acting as a 0 Volt reference so the voltage reading from the thermocouple can be passed directly to the polynomial where the corresponding temperature reading can be found.

External Reference @ Specified Temperature

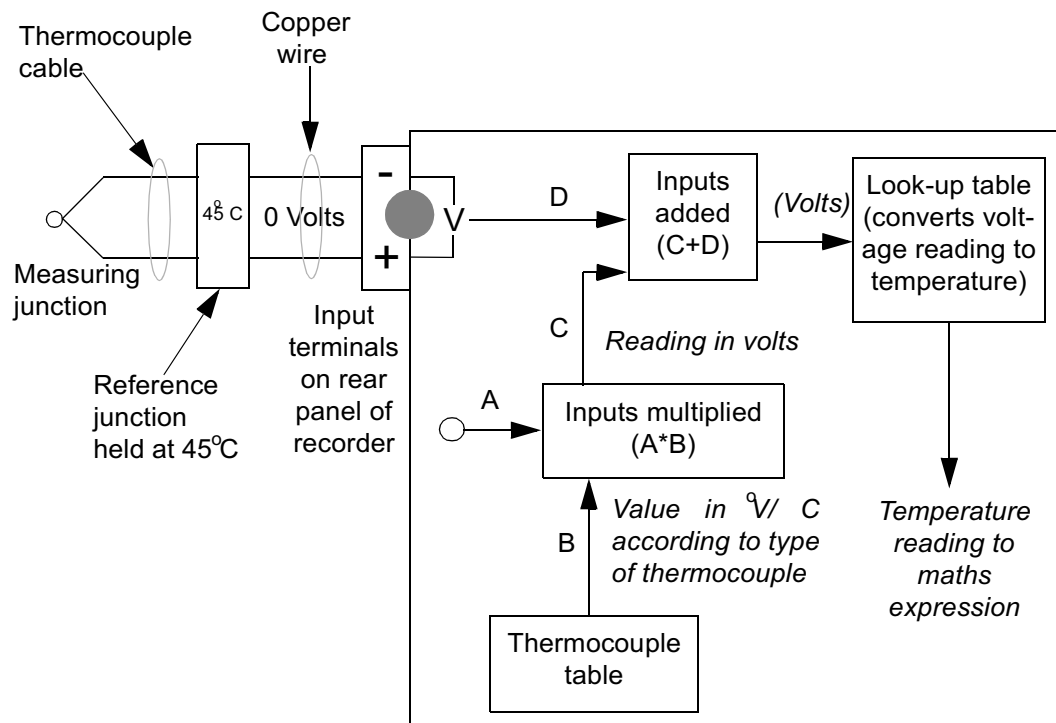

External Reference @ specified temperature if the reference junction can be kept at a constant known temperature other than 0°C this temperature can be specified in the setup menu. This reference temperature is then used in the same way as the reading from the temperature sensor using the **Internal Reference** method.

External Input Reference

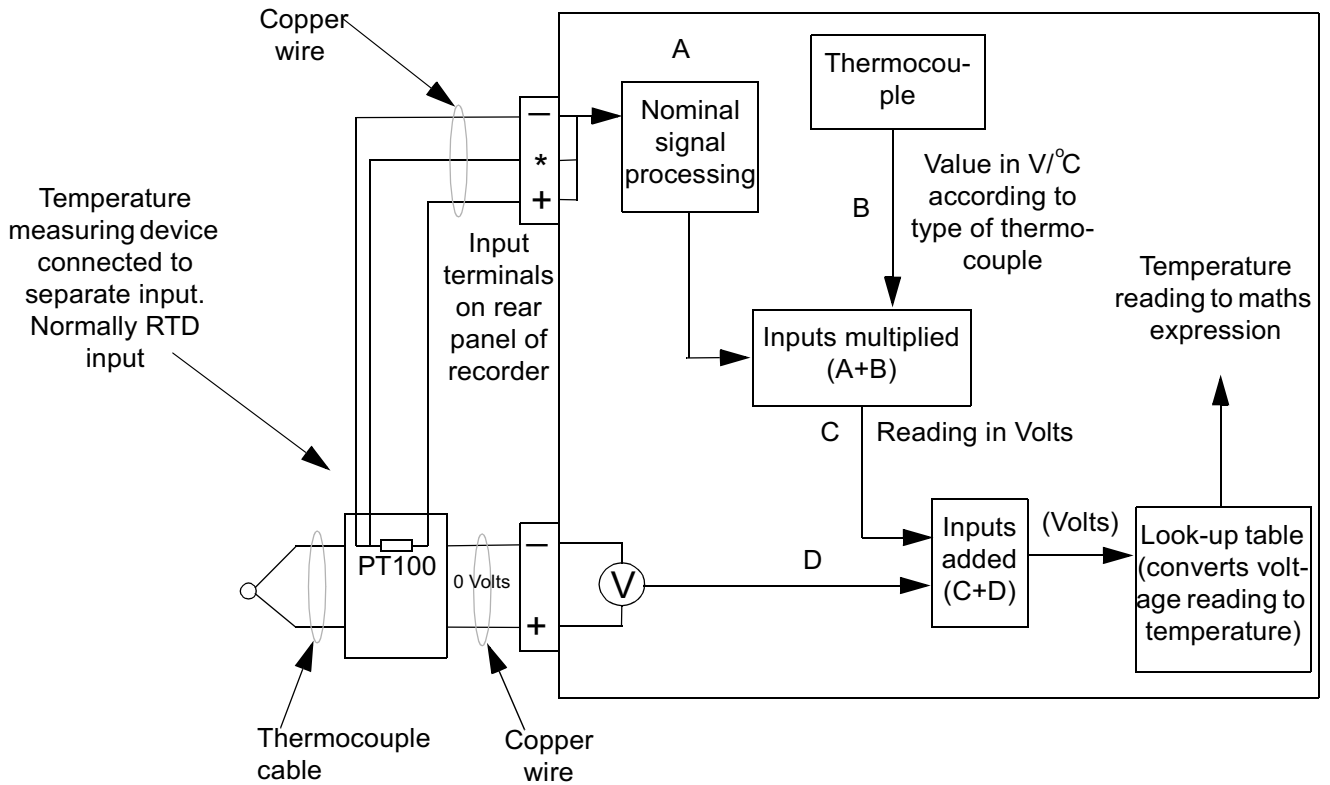

External Input Reference the reference temperature reading in this method is provided by a separate temperature measuring device connected to another input. This input is processed in the normal way and then passed back into the thermocouple signal processing system as a temperature reading.

Appendix D- Maths

Expressions

A maths expression is made up of a number of terms. A term is the smallest valid component in a maths expression and can be a variable, operator or function.

An operand may be a constant (i.e. a fixed number) or a **variable**. The variables that can be used are described below.

In the following examples P1 (Pen 1) equals the result of the maths expression shown in the shaded area. A pen number (P1) will be automatically entered when a pen is selected.

•**An** - The letter 'A' followed by a number causes the reading taken from an analogue input (denoted by the number) to be inserted in the maths expression. In this example, the readings from Analogue Input 1 are being displayed on Pen 1.

$$P1 = A1$$

•**In** - The letter 'I' followed by a number causes the reading taken from a digital input (denoted by the number) to be inserted in the maths expression. In this example, the result of digital input 1 multiplied by digital input 2 is displayed on Pen 9. As digital inputs are read as either 1 or 0, the result of this maths expression will effectively be an AND function (i.e. digital inputs 1 and 2 must both be 1 for the value displayed on Pen 9 to be 1).

$$P1 = I1 * I2$$

•**On** - The letter 'O' followed by a number causes the state of a Relay output (denoted by the number) to be inserted in the maths expression. A Relay output is read as 1 when active and 0 when inactive.

$$P1 = O1$$

•These two features on the **SIREC DS** are **MU** (Memory use) and **DU** (Disk use) gives a percentage reading of Memory space used or Disk space used.

$$P1 = MU$$

NB. When entering the MU and DU feature using SIREC D - Software, ensure the Complex Variables box is ticked.

The available functions and operators for maths expressions are described below. Where a function and operator have the same effect they are listed together. A **U** after the operator denotes a unary operator and a **B** denotes a binary operator.

+	Add Operator + (B)	Analogue Input 1 added to Analogue Input 4 displayed on Pen 1	$P1 = A1+A4$
-	Subtract. Operator - (B)	Analogue Input 1 subtracted from Analogue 2 displayed on Pen 1	$P1 = A2-A1$
*	Multiply. Operator * (B)	The value of Analogue Input 2 multiplied by two	$P1 = A2*2$
/	Divide. Operator: / (B)	Analogue Input 1 divided by Analogue Input 3	$P1 = A1/A3$
T	Assigns the Totalised value of a Pen	Pen 1 displays the Total of Pen 2 divided by 10 NB: Do not omit the divider (10), even if it is 1	$P1 = T[2,10]$
A	Indexed analogue	P1 is equal to the indexed analogue input 1+I1 (If I1 = 1, P1 = A2) (If I1= 0, P1 = A1)	$P1 = A[1+I1]$
I	Indexed digital input	P1 is equal to the indexed digital input of 1 + O1 (If O1 is 1, P1 = I2)	$P1 = I[1+O1]$
ABS	Absolute. Function ABS Operator: & (U)	The result of Input 4 subtracted from Input 1 is always considered as positive. If A1 = 2, and A4 = 3.5, the value displayed on Pen 1 would be 1.5 not -1.5.	$P1 = ABS[A1-A4]$ or $P1 = \& A1-A4$
O	Indexed relay output	P1 is equal to the indexed relay output of 1-A1 (If A1 = 0, P1 = O1)	$P1 = O[1-A1]$
MODULUS	Modulus Operator: % (B)	The value of Input 2 (A2) is divided by 20 and the remainder ONLY is displayed on Pen 1. The signal will be within 0-19.	$P1 = A2\%20$
OVER	Over	If the analogue input 'A1' is greater than '10' then P1 will return the value of A1.	$P1 = OVER[A1,10]$

UNDER	Under	If the analogue input 'A1' is less than '10' P1 will return the value of A1.	P1 = UNDER[A1,10]
HI	High value. Function: HI	Pen 1 displays the highest value out of Input 1 and Input 3.	P1 = HI[A1,A3]
LO	Low value. Function: LO	Pen 1 displays whichever is the lowest value out of Input 1 and Input 3. Note the inputs being compared are separated by a comma.	P1 = LO[A1,A3]
CJC	Cold Junction Compensator	P1 displays the value of the CJC 'x' is the board number from 1 to 4	P1 = CJC[x]

Maths and Fail Safe

When using output relays in a maths expression be aware the maths is reporting the literal state of the relay.

If Pen 1 (P1) equals output channel 4 (O4) and fail safe is On with no alarm triggered, the relay will be energised and P1 will return 1.

$$P1 = O4$$

Appendix E - Ethernet & E-mail

Ethernet

Ethernet is a local area network (LAN) technology that transmits information between computers and other devices, at speeds of 10 to 100 million bits per second (Mbps). Each Ethernet equipped device operates independently of all other devices on the network.

All devices attached to an Ethernet are connected to a shared signalling system. Ethernet signals are transmitted serially, one bit at a time, over the shared signal channel attached to each device.

It is up to the high-level protocol that is sending data over the network to make sure that the data is correctly received at the destination device.

Devices attached to an Ethernet can send application data to one another using high-level protocol software, such as TCP/IP protocol suite.

High-level protocols have their own system addresses, such as the 32-bit addresses used in the current version of IP. The high-level IP-based networking software in a device is aware of its own 32-bit IP address and can read the 48-bit Ethernet address of its own network interface, but it doesn't know the Ethernet addresses of the other devices on the network.

To discover the Ethernet addresses of other IP-based devices on the network another high-level protocol is used. For TCP/IP, this is done using a protocol called Address Resolution Protocol (ARP).

Example:

Device X has an IP address of 195.23.37.1 and sends data over the Ethernet channel to another IP-based device, Device Y with IP address 195.23.37.2. Device X sends the packets of information containing an ARP request. The ARP request is asking the device with the IP address of 195.23.37.2 to identify the address of the Ethernet Interface.

Only Device Y with the IP address of 195.23.37.2 will respond, sending a packet with the Ethernet address of device Y back to device X. Now device X and Y have each others Ethernet addresses to which data can be sent.

E-mail

General operation of the e-mail system

The recorder sends messages for distribution by an e-mail server. The e-mail server is located by its IP address as set-up in the communications set-up options. When the recorder sends an e-mail message, it locates the e-mail server and uses SMTP (Simple Message Transfer Protocol) to send the message to the e-mail server. SMTP allows the recorder to send messages to an e-mail server without

having its own e-mail address; because of this the e-mail server will not be able to send any reply back to the recorder.

When setting-up the e-mail address list, it is important to include the e-mail administrator address. The Administrator e-mail address is the e-mail address to where the e-mail server will respond in the event of any problems with the delivery of e-mail messages. The Administrator will also appear to be the source of any e-mail messages sent by the recorder. Most e-mail systems require a 'Reply To' address as part of an e-mail message, since the recorder does not have its own e-mail address; it uses the e-mail administrator as the 'Reply To' address.

Any e-mail message will consist of a delivery list (recipients), a subject, and an optional message body. The message body may be omitted for very short messages, or where the message is to be sent to a paging system.

The e-mail subject may be either one of the existing event markers, or one of the two e-mail subjects. The e-mail message body may be either one of the existing event markers, or one of the two e-mail message blocks. Event markers are restricted to 80 characters each. The two e-mail message blocks are restricted to just over 1000 characters each. Both the message subject and body may contain embedded marker tags as used in the event markers.

When the recorder sends an e-mail message that includes a message body, the recorder name, recorder number and the time/date will be appended to the end of the message body text. This is to allow easy identification of when the message was sent, and by which recorder.

Any e-mail message is sent as an action within the recorder events system, so anything that can be configured to act as an event cause, may be configured to send an e-mail message. Any e-mail message may be sent to up-to sixteen of the recipients. If the e-mail server supports named groups of e-mail addresses, an e-mail message may be sent to a combination of e-mail addresses and e-mail group.

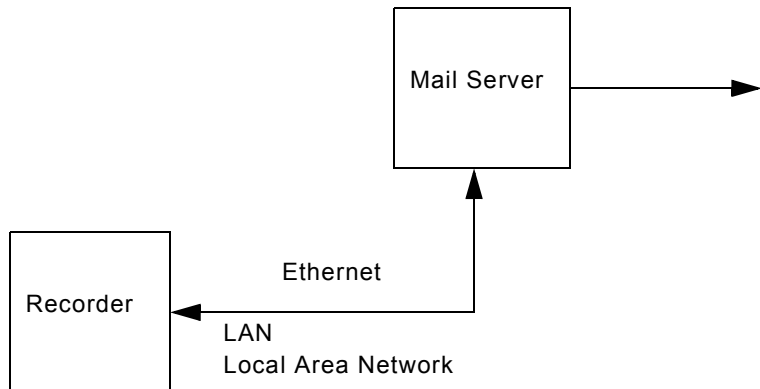

Appendix F- Fuzzy Logging

What is Fuzzy Logging?

Fuzzy Logging is a real time Data Compression technique, developed as an alternative to the more standard methods of recording data.

Paperless Recorders are primarily used for exception recording. They spend most of their life trending and recording straight lines. Fuzzy Logging has been developed to improve the efficiency of data storage, and is particularly effective in exception recording examples where normal operation consists of generally static inputs.

Fuzzy Logging looks for straight lines in the data stream, in real time, whether they are horizontal, climbing or descending. A straight line made up of say 10 points can be equally well represented by 2 points, one at either end, the other 8 points are redundant. Fuzzy logging works by creating straight lines in the data and discarding redundant points.

What's it for?

..... To help the user in the trade off between **Scan Rate**, **Disk capacity** and **Recording Time**, after all the 'Pie' is only so big.

Fuzzy Logging has been developed to help maximise all three sections, in effect increasing the size of the 'Pie'.

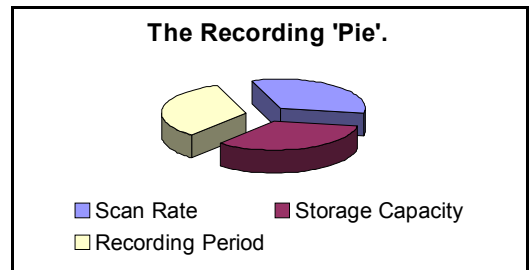

The result is a technique that delivers a host of real world benefits over the more traditional recording methods.

1. Disks take longer to fill – changed less frequently, less site visits.
2. Faster scan rates can be used for any given disk size – giving greater resolution on the process.
3. Recording time can be extended.
4. Less hard disk memory required for archiving on the PC.
5. Quicker graphing of data.
6. Smaller data files for remote collection.

OK. How does it work?

Fuzzy Logging does not log data points that form part of a straight line.

The technique is best illustrated by the diagram below:

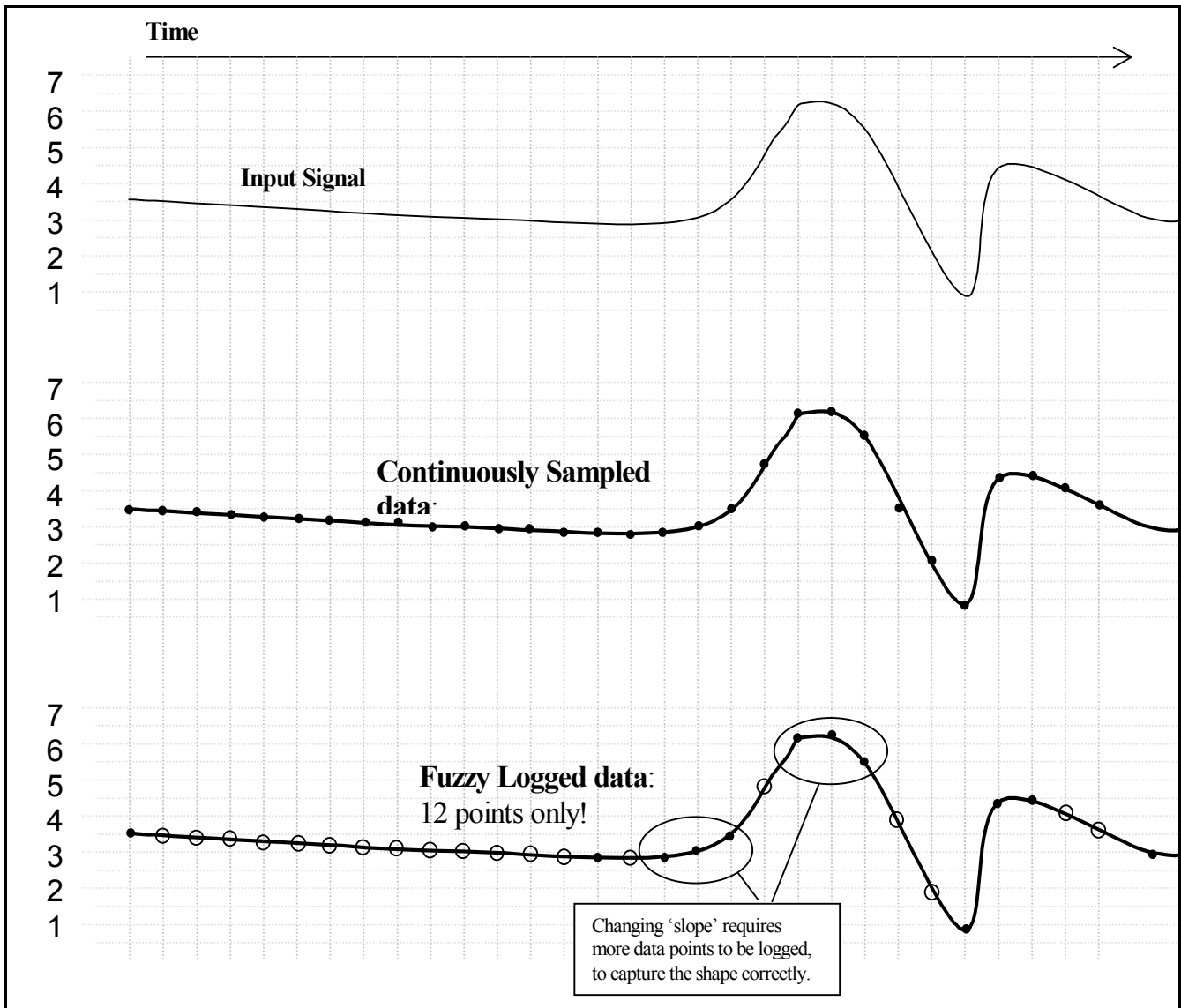

Diagram 1

Points marked: ○ are **NOT** logged, as they lie on an 'imaginary' straight line between points marked:

The graph of the Fuzzy Logged data, looks identical to the graph of the sampled data, but has taken **less than half the points** to build it.

Sounds Great! But what about ‘Spikes’ on my trend line? Won’t it miss them?

NO, you will not miss any ‘Spikes’, ‘Glitches’ or ‘Transients’ – these are what you need to see!

As Fuzzy Logging is an adaptive technique, it will log as fast as it needs to in order to capture everything.

Although not all points are logged, the base ‘Scan Rate’ of the input is the same as if you were using a standard logging technique.

OK, but what about slowly drifting inputs?

Again – **No Problem**. The algorithm is processed in ‘Real Time’, i.e. as the reading is taken. As it already knows the previous logged readings it can calculate where the next point should be (assuming it’s on a straight line) – if the measured value does not equal the predicted value, the point is logged as it no longer forms part of the straight line.

Fuzzy Logging, looks for straight lines – **at any angle**. Not just on the horizontal.

I’m convinced. Do you have any examples?

Example 1.) Flow & Pressure Measurement of Mains Water Pressure

A recorder was installed, to monitor the flow of a mains water supply. At peak demand the mains pressure had been subject to sharp drops in pressure and flow rate, and it was necessary to find the cause of the problem.

- The recorder had to have a fast scan rate, in order to capture the ‘glitches’.
- The recording period would be over many days if not weeks, so storage capacity was at a premium.

A fast scan rate using the standard sampling method would result in a disk life of about a day, which was not acceptable.

As this application consists of long periods of little activity (relatively constant flow rate), and short periods of high activity (rapidly changing flow rate), it is ideally suited to Fuzzy Logging.

During the hours of stable flow where the flow rate remained more or less constant, the Fuzzy Logging technique would give compression ratios up to 100 times. However, as soon as a glitch appeared the fast sampling rate was able to capture and store all the points.

Example 2.) Cold Storage Temperature Measurement

A recorder was required to help track random and rapid temperature changes within the cold storage rooms. Conventional sample recording had shown that temperature variations were present, but was not of high enough resolution to pinpoint the cause.

Again as in example 1), the measured inputs would show long periods of stable constant readings, interspersed with small sharp increases in temperature. In order to track the cause of these variations, it was necessary to maximise the time resolution of the data. This application was ideally suited to the Fuzzy Logging data storage technique, as the periods of inactivity would result in compression rates of over 50 times.

Example 3.) Logged Data Example

The diagram below is a sample of actual logged data in both the Fuzzy Logging method (top) and Sample Logging method (bottom), derived from the same analogue input.

It provides an excellent illustration of how less data points can be used to construct an identical trace.

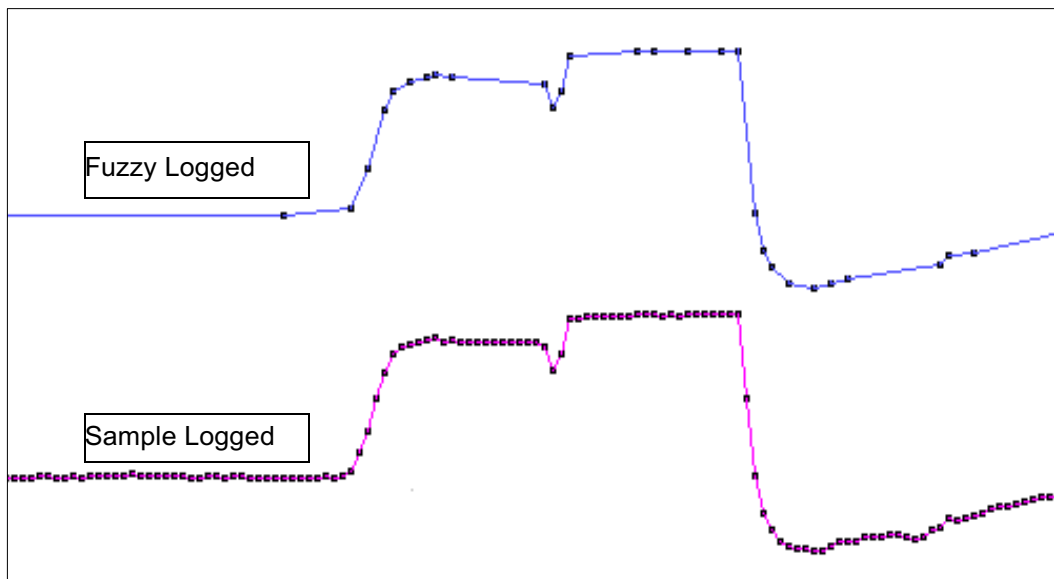

Diagram 2.

NB. This data extract was taken from a 56 hour temperature run, which resulted in approximately 1Mbyte of sample data, and approximately 40 Kbyte of Fuzzy Logged data.

A compression ratio of 25 times!!

Anything else it can do?

Yes! Fuzzy Logging can be used as a **'One Hit'** recording button.

In applications where the measured process is new or the ideal scan rate is unknown Fuzzy Logging is ideal, as it adapts the log rate to the input signal, and can therefore find the optimum logging rate for you.

Index

<i>4 channel relay O/P card</i>	19
<i>6 channel relay O/P+2 digital I/P</i>	19

A

<i>AC Power</i>	17
<i>About</i>	28
<i>Alarm Digital</i>	
Log Digital	64
<i>Alarm cards</i>	19
4 channel relay O/P card	19
6 channel relay O/P+2 digital I/P card	19
<i>Alarm channel As Input</i>	64
<i>Alarm channel As Output</i>	64
<i>Alarms</i>	54
Damping	57
Delete	55
Edit	55
Hysteresis	56
Log Alarm	56
New	55
Relay Enable	56
<i>Analogue In</i>	
Setup	41
<i>Appendix A, Quality Approvals</i>	83
<i>Appendix B</i>	
Battery Safety Data Sheet	85
<i>Appendix C</i>	
Thermocouple Connections	89
<i>Appendix D</i>	
Maths Expression	93
Maths and Fail Safe	94
<i>Appendix E</i>	
Ethernet & E-mail	97
<i>Appendix F</i>	
Fuzzy Logging	99

B

<i>Backlights</i>	
Maintenance	81
<i>Battery</i>	15
<i>Battery Life</i>	79
<i>Battery Safety</i>	
Guideline	85
<i>Battery Safety Data Sheet</i>	
Appendix B	85
<i>Battery switch</i>	18
<i>Brightness control</i>	18

C

<i>CE Mark</i>	83
<i>CJC Calibration</i>	39
<i>Cables</i>	2
<i>Calibrate Input</i>	38
<i>Calibration</i>	81
<i>Calibration check</i>	81
<i>Case</i>	18
Battery switch	18
Brightness control	18
Contrast control	18
<i>Change Password</i>	71
<i>Chart Colour</i>	32
<i>Cleaning Instructions</i>	79
<i>Comms</i>	
Default Gateway	36
E-mail	37
Ethernet	36
IP Address	36
IP Resolution	36
Protocol	37
Sockets	37
Subnet Mask	37
<i>Comms Ports</i>	
Ethernet	40
MAC address	40
<i>Contrast control</i>	18

D

<i>Damping, Alarms</i>	57
<i>Device, Log to</i>	61
<i>Digital filter</i>	50
<i>Directional Key</i>	21
<i>Disk Drive</i>	79
Cleaning	80
<i>Display Trimpot Adjustments</i>	18
<i>Displaying Totals</i>	59
<i>Downscale burnout</i>	48

E

<i>Edit, Setup</i>	29
<i>Electrical</i>	17
Cables	17
<i>Engineering Units</i>	
Tie to	49
<i>Engineering Zero and Span</i>	46
<i>Ethernet & E-mail</i>	
Appendix E	97
<i>Ethernet configuration</i>	36
<i>Ethernet interface</i>	20
<i>Events List</i>	25

F

<i>Factory</i>	
CJC Calibration	39
Calibrate Input	38
<i>Factory, Setup</i>	38
<i>Fail Safe and Maths</i>	64
<i>Front Panel</i>	
Handling	81
<i>Fuses</i>	1
<i>Fuzzy Logging</i>	
Appendix F	99
How does it work?	100
What's it for?	99

G

<i>General Menu</i>	30
---------------------------	----

H

<i>Hysteresis</i>	56
-------------------------	----

I

<i>ID Number</i>	
Recorder	31
<i>Input</i>	
Name	42
Range	42
Sampling	50
Span	43
Thermocouple	47
Type	42
Units	42
Zero	43
<i>Installation</i>	15
AC Power	17
Alarm Cards	19
Ethernet Interface	20
Universal card	18
<i>Instrument Care</i>	79
Backlights	81
Cleaning	79
Front Panel	81
Operating Temperature	81

K

<i>Keypad</i>	21
---------------------	----

L

<i>Layout</i>	
Data display evaluation	74
Screen	73
Selecting and Re-naming Screens	73
<i>Load setups from disk</i>	66
<i>Log Alarm</i>	56
<i>Log to Disk</i>	67
<i>Logging</i>	
Device	61
Method	60
Pens	59
Rate	61
Type	60

M

<i>MAC address</i>	40
<i>Main Features</i>	9
<i>Maintenance</i>	3
<i>Mark on chart</i>	24
<i>Maths Expression</i>	
<i>Maths and Fail Safe</i>	94
<i>Maths Expressions,</i>	
Appendix D	93
<i>Mechanical</i>	15
Panel Cut-out	16
Panel Mounting	16
<i>Menu Selection</i>	27
<i>Messages Screen</i>	25
<i>MinMax Reset</i>	24

N

<i>Name</i>	
Recorder	30
<i>New Alarm</i>	55
<i>Non-Volatile Screen Display</i>	26

O

<i>Operating Temperature</i>	81
<i>Options Code</i>	
Recorder	32

P

<i>Password</i>	32
Entry	33
Protect	33
Traceability	35
<i>Password, Change</i>	71

Pen

Description	52
Maths Expression	52
Scales	52
Tag	51
<i>Pen Setup</i>	
Alarms	54
<i>Pens Setup</i>	51
<i>Power Up</i>	26

Q

<i>Quality</i>	
CE Mark	83

R

<i>Real-time Visuals</i>	10
Alarm Indicators	12
Bar	11
Digital	11
Pen Pointers	12
Status bar	10
Trend	13
Units and Scale	13
<i>Recorder</i>	
ID Number	31
Name	30
Options Code	32
Set Time	31
<i>Recording</i>	67
Enabled	67
Log to Disk	67
Validate Disk	68
<i>Reference Junction</i>	47
<i>Relay Enable</i>	56
<i>Relay/Digital</i>	63
<i>Repairs</i>	3
<i>Replay Mode</i>	24
<i>Reset Passwords</i>	35
<i>Reset Setup</i>	40
<i>Resistance Thermometer</i>	48

S

<i>Safety</i>	1
<i>Sampling speeds</i>	50
<i>Save setups to disk</i>	66
<i>Scale</i>	52
Divisions	54
Factor	53
Format	53
Units	53
<i>Screen</i>	21
<i>Screen Displays</i>	23
<i>Screen Layouts</i>	22
<i>Screen Saver</i>	32
<i>Set Date</i>	31
<i>Set Time</i>	
Recorder	31
<i>Setup Complete</i>	65
<i>Setup recorder</i>	29
<i>Setups</i>	
Load	66
Save	66
<i>Signal conditioning</i>	44
Damping	44
Transient Filter	44
<i>Software</i>	75
System Requirements	77
<i>Software License/Warranty</i>	75
<i>Specifications</i>	6
Fast Universal card performance	7
<i>Square Root Extraction</i>	45
<i>Start-up Condition table</i>	10
<i>Status Bar layout</i>	22
<i>Storage Media</i>	5
<i>System Requirements</i>	
Software	77

T

<i>Temperature Calibration</i>	48
<i>Text Entry</i>	27
<i>Thermocouple Connections</i>	
Appendix C	89
External Input Reference	91
External Reference	90
Internal Reference	89
<i>Thermocouple Input</i>	47
<i>Tie to</i>	
Engineering Units	49

<i>Totaliser</i>	57
Displaying Totals	59
<i>Totals</i>	69
Reset All Totals	69
Start All Totals	69
Stop All Totals	69

U

<i>Universal card</i>	18
<i>Unpacking</i>	15
<i>Upscale Burn</i>	48

V,W,X,Y,Z

<i>Validate Disk</i>	68
<i>Warnings and Safety Precautions</i>	2

Siemens AG
Bereich Automatisierungs- und Antriebstechnik
Geschäftsgebiet A&D PI
D-76181 Karlsruhe

Siemens Aktiengesellschaft

©Siemens AG 2002
Subject to change without prior notice

Order No. A5E00117351-04
AG 0102 116 GB

