

SIEMENS

SIMATIC

PC Adapter USB

Manual

Preface,
Contents

Properties of the
PC Adapter USB **1**

Package Components **2**

Requirements for Operation **3**

Hardware Design of the
PC Adapter USB **4**

Working with the
PC Adapter USB **5**

PC Adapter USB on the
MPI/DP Network **6**

Firmware Update **7**

Error Diagnostics **8**

Technical Data **9**

Appendix **10**

Index

Safety Guidelines

This manual contains notices you have to observe in order to ensure your personal safety, as well as to prevent damage to property. The notices referring to your personal safety are highlighted in the manual by a safety alert symbol, notices referring to property damage only have no safety alert symbol. The notices shown below are graded according to the degree of danger.



Danger

indicates that death or severe personal injury **will** result if proper precautions are not taken.



Warning

indicates that death or severe personal injury **may** result if proper precautions are not taken.



Caution

with a safety alert symbol indicates that minor personal injury can result if proper precautions are not taken.

Caution

without a safety alert symbol indicates that property damage can result if proper precautions are not taken.

Notice

indicates that an unintended result or situation can occur if the corresponding notice is not taken into account.

If more than one degree of danger is present, the warning notice representing the highest degree of danger will be used. A notice warning of injury to persons with a safety alert symbol may also include a warning relating to property damage.

Qualified Personnel

The device/system may only be set up and used in conjunction with this documentation. Commissioning and operation of a device/system may only be performed by **qualified personnel**. Within the context of the safety notices in this documentation qualified persons are defined as persons who are authorized to commission, ground and label devices, systems and circuits in accordance with established safety practices and standards.

Prescribed Usage

Note the following:



Warning

This device and its components may only be used for the applications described in the catalog or the technical description, and only in connection with devices or components from other manufacturers which have been approved or recommended by Siemens.

Correct, reliable operation of the product requires proper transport, storage, positioning and assembly as well as careful operation and maintenance.

Trademarks

All names identified by ® are registered trademarks of the Siemens AG.

The remaining trademarks in this publication may be trademarks whose use by third parties for their own purposes could violate the rights of the owner.

Disclaimer of Liability

We have reviewed the contents of this publication to ensure consistency with the hardware and software described. Since variance cannot be precluded entirely, we cannot guarantee full consistency. However, the information in this publication is reviewed regularly and any necessary corrections are included in subsequent editions.

Preface

Purpose of the Manual

This manual gives you a complete overview of PC Adapter USB. It guides you when installing and commissioning the software and hardware. It also describes the operation and hardware installation requirements, as well as, the connection of the Adapter to MPI/DP networks.

This manual is intended for the programmers and for those responsible for configuring, commissioning, and servicing automation systems.

Required Basic Knowledge

You require a general knowledge in the field of automation engineering to be able to understand this manual.

In addition, you should know how to use computers or devices with similar functions (e.g. programming devices) under the Microsoft Windows operating systems.

Where is this Manual valid?

This manual is valid for the product PC Adapter USB with order number: 6ES7972-0CB20-0XA0.

Certification

PC Adapter USB have the following certification:

- Underwriters Laboratories, Inc.: UL 60950 registered and Canadian Standard C22.2 No. 60950 (Information Technology Equipment)

CE Labeling

PC Adapter USB fulfil the requirements and protection guidelines of the following EU directives:

- EC Directive 89/336/EEG "EMC directive"

CTick Mark

PC Adapter USB is compliant with requirements of the AS/NZS 3548 (Australian and New Zealand) standard.

Further Support

If you have any technical questions, please get in touch with your Siemens representative or agent responsible.

You will find your contact person at:

<http://www.siemens.com/automation/partner>

You will find the directory to offers on technical documentation for each SIMATIC products and systems under:

<http://www.siemens.de/simatic-tech-doku-portal>

You will find the Online catalog and the Online ordering system under:

<http://mall.automation.siemens.com/>

Training Centers

Siemens offers a number of training courses to familiarize you with the automation system SIMATIC S7 automation system. Please contact your regional training center or our central training center in D 90327 Nuremberg, Germany for details:

Telephone: +49 (911) 895-3200.

Internet: <http://www.sitrain.com>

Technical Support

You can get Technical Support for all A&D products

- Via the Web formula for the Support Request
<http://www.siemens.de/automation/support-request>
- Phone: + 49 180 5050 222
- Fax: + 49 180 5050 223

You can find more information on our Technical Support on the Internet under
<http://www.siemens.de/automation/service>

Service & Support on the Internet

In addition to our documentation, we offer our Know-how online on the internet at:

<http://www.siemens.com/automation/service&support>

where you will find the following:

- The newsletter, which constantly provides you with up-to-date information on your products.
- The right documents via our Search function in Service & Support.
- A forum, where users and experts from all over the world exchange their experiences.
- Your local representative for Automation & Drives.
- Information on field service, repairs, spare parts and more under "Services".

Contents

1	Properties of the PC Adapter USB	1-1
1.1	Function	1-1
1.2	Performance specifications.....	1-2
2	Package Components	2-1
3	Requirements for Operation	3-1
3.1	Software requirements.....	3-1
3.2	Hardware requirements	3-1
4	Hardware Design of the PC Adapter USB	4-1
4.1	Connections.....	4-1
4.2	LEDs on the PC Adapter USB.....	4-2
4.3	Power supply	4-3
4.4	MPI/DP interface.....	4-5
4.5	USB interface.....	4-6
5	Working with the PC Adapter USB	5-1
5.1	Technical safety notes	5-1
5.2	Installation of the software.....	5-1
5.3	Configuring the PG / PC interface	5-2
5.4	Connecting the PC Adapter USB	5-3
6	PC Adapter USB on the MPI/DP Network	6-1
6.1	General	6-1
6.2	Use as a stand-alone system	6-1
6.3	Use in a networked system	6-2
7	Firmware Update	7-1
8	Error Diagnostics	8-1
9	Technical Data	9-1
10	Appendix	10-1
10.1	Certificates, Directives and Declarations.....	10-1
10.2	Certification for the USA, Canada and Australia	10-3
Index		Index-1

1 Properties of the PC Adapter USB

The PC Adapter USB is compatible with USB V1.1 and satisfies the requirements for "Low-Powered" USB devices. The SIMATIC PC Adapter USB supports the energy saving mode (hibernate mode).

1.1 Function

The SIMATIC PC Adapter USB connects a PC to the MPI/DP interface of an S7/M7/C7 system via USB.

A slot is not required in the PC, which means that the adapter can also be used for non-expandable PCs such as notebooks.

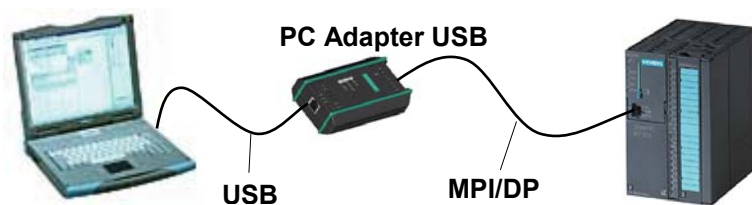

Fig. 1-1: Configuration with PC Adapter USB

Note

Only one PC Adapter USB can be used on a PC.

1.2 Performance specifications

The PC Adapter USB can be used on MPI and PROFIBUS networks. Starting at firmware V1.1, the PC Adapter USB can also be operated on homogeneous PPI networks.

The following table shows the transmission rates and network types supported by the PC Adapter USB.

Tabelle 1 : Busprofile und Übertragungsgeschwindigkeiten

Transmission rate	MPI	PPI	PROFIBUS			
			DP	Standard	Universal	User-defined
9.6 kbps	-	✓	✓	✓	✓	✓
19.2 kbps	✓	✓	✓	✓	✓	✓
45.45 kbps	-	-	✓	✓	-	✓
93.75 kbps	-	-	✓	✓	✓	✓
187.5 kbps	✓	✓	✓	✓	✓	✓
500 kbps	-	-	✓	✓	✓	✓
1.5 Mbps	✓	-	✓	✓	✓	✓

Other performance features

- Automatic bus profile detection
- Up to 16 communication connections, of those up to 4 slaves (DP/T connections)
- Routing support
- As of firmware V1.3, the PC Adapter USB DPV1 Standard slaves is supported through
 - Slave address assignment
 - Device diagnosis
 - Read/write data record

2 Package Components

The SIMATIC PC Adapter USB package includes:

- One "SIMATIC Software PC Adapter USB" CD containing the software and documentation
- One USB cable (5 m)
- One MPI cable (0.3 m)

The MPI cable can be used to connect the PC Adapter USB to MPI, homogeneous PPI or PROFIBUS (DP) networks.

Spare parts

Spare parts	Order number
USB cable (5 m)	A5E00276884
MPI cable (0.3 m)	A5E00164946

You can forward your spare parts orders to your local Siemens partner.

Supplies (not included in the PC Adapter USB)

To operate the PC Adapter USB to MPI/DP interfaces which do not have a 24V supply voltage, you can order an external power supply (order number: 6ES7 972-0CA00-0XA0).

3 Requirements for Operation

3.1 Software requirements

One of the following operating systems must be installed on the PC in order to be able to operate the SIMATIC PC Adapter USB:

- Windows 2000
- Windows XP Professional
- Windows XP Home
- Windows Server 2003 Standard Edition
- Windows Vista

and

- a SIMATIC software package that communicates via MPI (for example, STEP 7)

To operate the PC Adapter USB on a PPI network, you also need the STEP 7-Micro/Win32 SW package.

3.2 Hardware requirements

You require a PC with a USB interface and a CD ROM drive.

4 Hardware Design of the PC Adapter USB

4.1 Connections

Connections or displays on the PC Adapter USB:

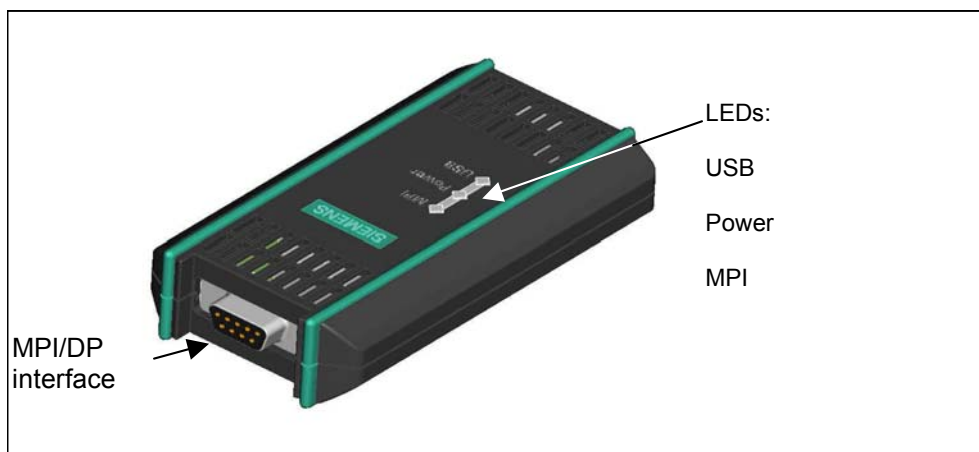

4.2 LEDs on the PC Adapter USB

The LEDs on the PC Adapter USB indicate the following:

Name	Color	Meaning
USB	green	Lights up when the PC Adapter USB is connected to the USB and the operating system of your PC is in normal operating mode. This LED is not lit when the PC is in standby or idle mode. The LED flickers when data are being transferred.
POWER	green	Lights up when the PC Adapter USB is supplied with the necessary power. Flashes when a hardware fault is detected.
MPI	green	Lights up when the PC Adapter USB is connected to the MPI/DP network and is operational. The LED flashes when data are transferred on the MPI/DP network. The LED is off when no firmware has been loaded in the PC Adapter USB.

The LED displays for error states are described in Chapter 8 Error Diagnostics.

4.3 Power supply

The PC Adapter USB is supplied with power by the automation system via the MPI cable or alternatively via the external power supply (see Section 2) included in the delivery.

It requires 24 V (see the technical data).



Caution

Always connect the PC Adapter USB to power supplies with limited power or NEC Class 2.

UL cable, AWM 2464, 80°C, 300 V, 28 AWG, VW-1



Fig. 1: MPI cable, 0.3 m with 9-pin sub-D connectors.



Warning

Always use the MPI cable included with your PC Adapter USB.

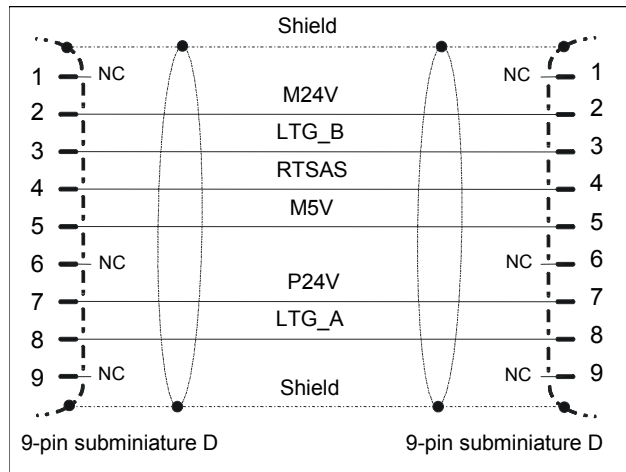

Fig. 2: MPI cable (0.3 m)

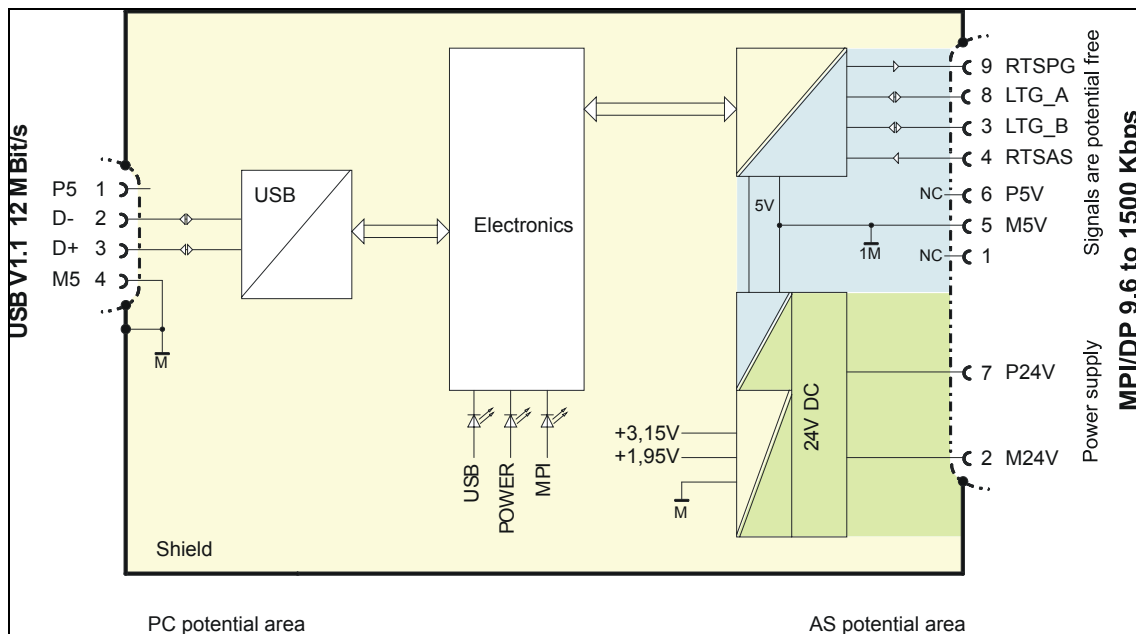

Fig. 3: Block diagram

The MPI/DP and USB interfaces of the PC Adapter USB are electrically isolated within a safety extra low-voltage circuit (SELV). It can therefore be operated directly on ungrounded S7/M7/C7 systems.

4.4 MPI/DP interface

Pin assignment

Pin assignment of the MPI/DP interface:

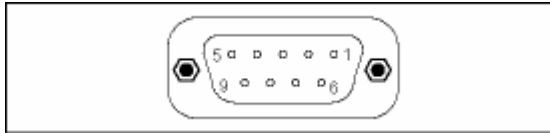

Description of signals

Pin no.	Short name	Meaning	Input / Output
1	NC	Not connected	–
2	M24V	Zero volt of the 24 V power supply, provided by the electronic DC/DC circuit of the adapter (AS potential range)	Input
3	LTG_B	Data line B	Input / Output
4	RTS_AS	RTSAS control signal for receive data current. The signal is active '1' when the directly connected AS is transmitting data.	Input
5	M5V	Reference potential of the MPI/DP interface for the RTS_AS and RTS_PG signals	Input
6	P5V	Not connected	
7	P24V	Zero volt of the +24 V power supply, provided by the electronic DC/DC circuit of the adapter (AS potential range)	Input
8	LTG_A	Data line A	Input / Output
9	RTS_PG	Adapter's RTS output signal. The signal is '1' when the adapter is transmitting data. The signal is not contained in the 0.3 m MPI cable!	Output
Shielding		on connector housing*	

* The shielding is interconnected with the USB interface via the adapter electronic module.

4.5 USB interface

Interface pin assignments

Top view of the USB socket:

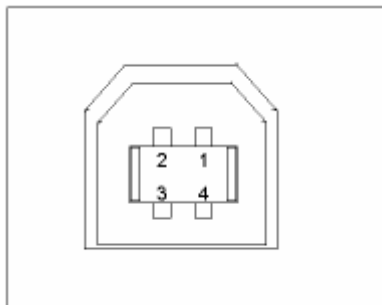

Description of signals

Pin no.	Signal	
1	+5V	Power supply
2	-Data	- Differential signal
3	+ Data	+ Differential signal
4	Ground	Ground



Caution

Operating several USB devices on your PC may effect the data transmission rates. To obtain optimum communication performance with the automation system, disconnect USB devices that are not required.

5 Working with the PC Adapter USB

5.1 Technical safety notes

Qualified personnel

The device should only be accessed by qualified personnel. Qualified personnel as referred to in safety guidelines in this documentation are persons who are authorized to commission, ground, and tag circuits, equipment, and systems in accordance with established safety practice.

Use as intended:



Warning

The equipment/system or the system components may only be used for the applications described in the catalog or the technical description, and only in combination with the equipment, components, and devices of other manufacturers as far as this is recommended or permitted by Siemens.

The product will function correctly and safely only if it is transported, stored, set up, and installed as intended, and operated and maintained with care.

5.2 Installation of the software

Setup runs the installation of the PC Adapter USB software automatically after you insert the CD.

If the autorun function is disabled, proceed as follows:

1. Insert the CD for your PC Adapter USB into the CD-ROM drive.
2. Open the root directory of this drive.
3. Double-click "setup.exe" to run Setup.

Setup is menu controlled. Please note the readme file in the root directory on the CD for information on the installation and use of your PC Adapter USB.

5.3 Configuring the PG / PC interface

You are prompted to configure the PG / PC interface during setup.

1. Check the PG / PC interface dialog box for the following interface settings.

The following items should be available in the selection list:

- PC Adapter (Auto) (only when STEP 7 is installed)
- PC Adapter (MPI)
- PC Adapter (PPI) (only if STEP 7-Micro/Win has been installed)
- PC Adapter (PROFIBUS)

If this is not so:

- Click "Select..." to add / remove interfaces. This opens a dialog box for installing / uninstalling interfaces.
- Select the PC Adapter module from the list and install it. Click "Close" to exit the dialog box.

2. Now select the interface configuration in the PG / PC interface dialog box with which you intend to communicate, for example, the PC Adapter (MPI). Click "Properties".
3. In the Properties dialog box of the PC Adapter (see table below), check if the parameter settings fit your system configuration, and change the settings if necessary:

Interface configuration	check in the tab
PC Adapter (Auto)	Auto-detection of the bus profile
PC Adapter (MPI)	MPI
PC Adapter (PPI)	PPI
PC Adapter (PROFIBUS)	PROFIBUS

4. The properties dialog box for the PC Adapter (MPI) appears. Select the local connection tab. Set USB in the COM port selection box (or connection to:).
5. Close this properties dialog box by clicking "OK".
6. Click OK to close the PG / PC interface dialog box.
7. A warning appears if you have changed an access path during the configuration. Acknowledge the message with OK to accept the changes.

5.4 Connecting the PC Adapter USB

Connecting to the PC

1. Insert the supplied USB cable into the USB port of your PC.
2. Plug the other end of the USB cable into PC Adapter USB.

Connecting to the PLC

1. Insert the supplied MPI cable into the PC Adapter USB and screw-tighten it.
2. Insert the other end of the MPI cable into the MPI port of your CPU and screw-tighten it.

Note

The adapter and the S7/M7/C7 system each represent a network node.

- In networks consisting of two nodes (adapter and S7/M7/C7 system), the adapter is connected directly to the socket of the S7/M7/C7 system.
 - When the network contains more than two nodes, the adapter should be connected to the "PG socket" of a PROFIBUS connector (SINEC L2 bus connector). You do not need to change the settings of the terminating resistors.
-

Caution

Do not connect the SIMATIC PC Adapter USB to the automation system with any other cable than the supplied MPI cable.

6 PC Adapter USB on the MPI/DP Network

6.1 General

A maximum of 32 nodes can be connected to an MPI/DP network segment. The total cable length may not exceed 50 meters. Several network segments can be connected together using RS485 repeaters, thus allowing a maximum number of 127 network nodes. The maximum data transmission rate in the MPI/DP network is 12 Mbps.

The PC Adapter USB supports transmission rates up to 1.5 Mbps.



Warning

An extension cord should not be interconnected between the adapter and the S7/M7/C7 system.

6.2 Use as a stand-alone system

The following illustration shows the connection to a stand-alone system (2 network nodes).

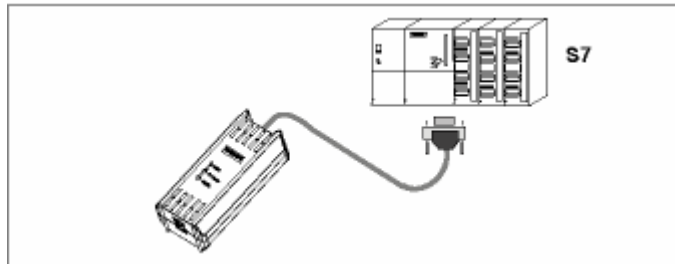

6.3 Use in a networked system

The following illustration shows the connection in a networked S7 system (MPI/DP network containing 2 or more network nodes).

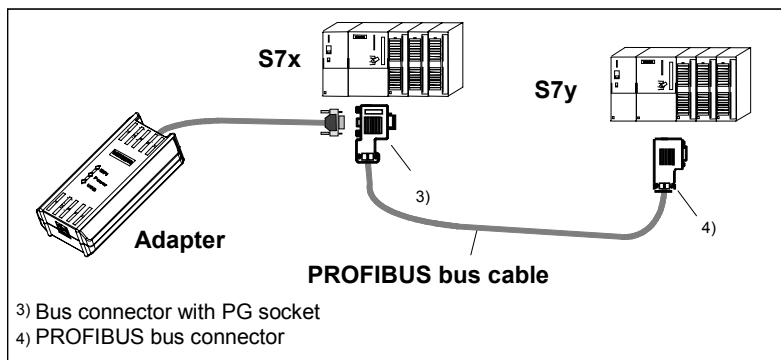

Once you have completed the installation and configuration of the PG / PC interface, you can communicate with the PLC using your SIMATIC software package..

7 Firmware Update

The firmware of the PC Adapter USB can be updated, for example, when new functions have been added.

How to update the firmware:

- Download the latest firmware and the firmware update utility from the Internet:
<http://www.siemens.com/automation/service&support>
- Search the product support area for the term "PC Adapter USB".
- Download the self-extracting EXE file containing the available firmware and the firmware update utility to your PC.
- Unzip the files to a local drive, then run the *.exe file to update your PC Adapter USB firmware. Follow the instructions on the screen.
- Please read the readme file in the "Firmware" folder of the firmware update utility. It contains notes about the installation and use of the latest firmware.

Note

The latest firmware and the firmware update utility is available on your "SIMATIC Software PC Adapter USB" CD in the "Firmware" folder at the time of delivery.

8 Error Diagnostics

The information in the following section offers support to help you locate and perhaps correct common errors by yourself.

Error / cause	To avoid or correct errors
The power LED is not lit	
<ul style="list-style-type: none"> • MPI cable not connected • The PLC is switched off • Hardware error 	<ul style="list-style-type: none"> • Connect the MPI cable • Switch on the PLC • Inform Customer Support
The USB LED is not lit	
<ul style="list-style-type: none"> • USB cable not connected • PC and PC Adapter USB are in energy saving mode (hibernate mode). • The PC can not find the PC Adapter USB 	<ul style="list-style-type: none"> • Connect the USB cable • permitted operating mode • Check your driver installation, and install it if necessary
The MPI LED is not lit	
<ul style="list-style-type: none"> • The MPI cable not connected • Firmware not loaded 	<ul style="list-style-type: none"> • Connect MPI cable • Start the supplied firmware update utility and check if the firmware is loaded.
None of the LEDs is lit	
<ul style="list-style-type: none"> • MPI cable not connected • The required 24 V DC are not wired to the MPI socket • Hardware error 	<ul style="list-style-type: none"> • Connect the MPI cable • Check the wiring • Inform Customer Support
The power LED flashes continuously	
<ul style="list-style-type: none"> • Hardware error 	<ul style="list-style-type: none"> • If the POWER LED of the device continues to flash continuously even after pulling and plugging the MPI cable several times, the device is defective and should be replaced.

9 Technical Data

PC Adapter USB	
Order no.	6ES7972-0CB20-0XA0
Dimensions	Approx. 105 x 58 x 26 mm
Weight	Approx. 250 g
Interfaces	
to S7 / M7 / C7 to PC	RS485 (max. 1.5 Mbps) USB (12 Mbps)
Power supply (via MPI interface)	24 V DC (SELV) (18V.. 30 V DC)
Power consumption	50 mA (typically) / 100 mA (max.)
Inrush current	I _{max.} 700 mA; 8µs
Safety	
Safety class	Safety class III conforming to IEC 60950
Safety requirements	IEC 60950 corresponds to DIN/EN 60950
Degree of protection	IP 20
Electromagnetic compatibility (EMC)	
Noise emission	Limit value class B according to EN 55022
Noise immunity on signal lines	2 kV (according to IEC 61000-4-4; burst; length > 3m)
Immunity to discharge of static electricity (ESD)	6 kV, contact discharge (according to IEC 61000-4-2) 8 kV, air gap discharge (according to IEC 61000-4-2)
RF immunity	10 V/m 80 - 1000 MHz, 80% AM (to IEC 61000-4-3) 10 V/m 900 MHz, 1.89 GHz, 50% ED (to IEC 61000-4-3)
RF conductance	10 V 9 kHz - 80 MHz (to IEC 61000-4-6)
Climatic conditions	
Temperature Operation Storage / shipping	Tested according to DIN EN 60068-2-2, DIN IEC 60068-2-1 +0 °C to +60°C, temperature change max. 10 K/h -20°C to +60°C, temperature change max. 20 K/h
Relative humidity Operation Storage / shipping	Tested according to DIN IEC 60068-2-3, DIN IEC 60068-2-30, DIN IEC 60068-2-14 5% to 80% at 25°C (no dewing) 5% to 95% at 25°C (no dewing)

PC Adapter USB	
Mechanical ambient conditions	
Vibration Operation	Tested according to DIN IEC 60068-2-6 10 to 58 Hz: amplitude 0.075 mm, 58 to 500 Hz: acceleration 9.8 m/s
Storage / shipping	5 to 9 Hz: amplitude 3.5 mm, 9 to 500 Hz: acceleration 9.8 m/s
Shockproof Operation	Tested according to DIN IEC 60068-2-27/29 150 m/s, 11 ms, 100 shocks
Storage / shipping	250 m/s, 6 ms, 1000 shocks

10 Appendix

10.1 Certificates, Directives and Declarations

Notes on the CE Label



The following applies to the SIMATIC product described in this documentation:

EMC directive

This product fulfills the requirements for the EC directive 89/336/EEC on “electromagnetic compatibility” and the following fields of application apply according to this CE label:

Fields of application	Requirement for	
	Noise emission	Noise Immunity
Residential and commercial areas and small businesses.	EN 61000-6-3: 2001	EN 61000-6-1: 2001
Industry	EN 61000-6-4: 2001	EN 61000-6-2: 2001

Declaration of Conformity

The EC declarations of conformity and the documentation relating to this are available to the authorities concerned, according to the above EC directive, from:

Siemens AG
Automation and Drives
A&D AS RD 4
PO Box 1963
D-92209 Amberg, Germany
Phone: +49 9621 80 3283
Fax: +49 9621 80 3278

Observing the installation guidelines



The installation guidelines and notes on safety given in the manual must be observed at startup and during operation.

Connecting I/O devices

Noise immunity when connected to industrial standard PC conforms with the requirements of EN 61000-6-2:2001.

10.2 Certification for the USA, Canada and Australia

One of the following markings on a device is indicative of the corresponding approval:

	Underwriters Laboratories (UL) according to the UL 60950 standard, and Canadian standard C22.2 No. 60950 (I.T.E) or to UL508 and C22.2 No. 142 (IND.CONT.EQ)
	UL Recognition Mark

EMC

Australia and New Zealand



This product meets the requirements of the AS/NZS 3548 Standard.

Index

B

Busprofile 1-2

C

Compatibility 1-1
Configuration with the PC Adapter USB 1-1
Connecting to the PC 5-3
Connecting to the PLC 5-3
Connections 4-1

D

Description of signals 4-5

E

Energy saving mode 1-1
Error diagnostics 8-1

F

Firmware Update 7-1

H

Hardware requirements 3-1

M

MPI 4-2

MPI cable 2-1
MPI/DP interface 4-5
MPI/DP network 6-1

O

Operating state LEDs 4-2

P

Package components 2-1
Performance specifications 1-2
POWER 4-2
Power supply 4-3

S

Software installation 5-1
Software requirements 3-1

T

Technical data 9-1
Technical safety notes 5-1
Transmission rate 1-2, 6-1

U

USB 4-2
USB cable 2-1
USB interface 4-6

