

SIEMENS

SIMATIC

Component based Automation Commissioning Systems

Tutorial

Preface, Contents	
Tutorial – Introduction	1
Part 1: Creating PROFINet Components	2
Part 2: Commissioning the System	3
Plant 1: CPU 315 with CP 343-1 PN	
Plant 2: IE/PB Link with PROFIBUS DP Slaves	
Plant 3: PC-Station WinLC PN with PROFIBUS-DP-Slaves	
Literature and Links	4
Index	

Safety Guidelines

This manual contains notices intended to ensure personal safety, as well as to protect the products and connected equipment against damage. These notices are highlighted by the symbols shown below and graded according to severity by the following texts:



Danger

indicates that death, severe personal injury or substantial property damage will result if proper precautions are not taken.



Warning

indicates that death, severe personal injury or substantial property damage can result if proper precautions are not taken.



Caution

indicates that minor personal injury can result if proper precautions are not taken.

Caution

indicates that property damage can result if proper precautions are not taken.

Notice

draws your attention to particularly important information on the product, handling the product, or to a particular part of the documentation.

Qualified Personnel

Only **qualified personnel** should be allowed to install and work on this equipment. Qualified persons are defined as persons who are authorized to commission, to ground and to tag circuits, equipment, and systems in accordance with established safety practices and standards.

Correct Usage

Note the following:



Warning

This device and its components may only be used for the applications described in the catalog or the technical description, and only in connection with devices or components from other manufacturers which have been approved or recommended by Siemens.

This product can only function correctly and safely if it is transported, stored, set up, and installed correctly, and operated and maintained as recommended.

Trademarks

SIMATIC®, SIMATIC HMI® and SIMATIC NET® are registered trademarks of SIEMENS AG.

Third parties using for their own purposes any other names in this document which refer to trademarks might infringe upon the rights of the trademark owners.

Copyright © Siemens AG 2002 All rights reserved

The reproduction, transmission or use of this document or its contents is not permitted without express written authority. Offenders will be liable for damages. All rights, including rights created by patent grant or registration of a utility model or design, are reserved.

Disclaimer of Liability

We have checked the contents of this manual for agreement with the hardware and software described. Since deviations cannot be precluded entirely, we cannot guarantee full agreement. However, the data in this manual are reviewed regularly and any necessary corrections included in subsequent editions. Suggestions for improvement are welcomed.

Siemens AG
Bereich Automation and Drives
Geschaeftsgebiet Industrial Automation Systems
Postfach 4848, D- 90327 Nuernberg

Siemens Aktiengesellschaft

©Siemens AG 2002
Technical data subject to change.

A5E00178020



Preface

Purpose of the Manual

The purpose of this tutorial is to enable you to commission the specimen plant described in this document.

Required Basic Knowledge

To understand the manual, you should have general experience of automation engineering.

You should also be familiar with working on computers or PC-type machines (for example, programming devices) with the Windows 2000 operating system. Since SIMATIC iMap uses the STEP 7 platform, you should also be familiar with working with the standard software described in the "Programming with STEP 7 V5.2" manual.

Where is this Manual valid?

The manual is valid for the SIMATIC iMap V1.2 software package.

Place of this Documentation in the Information Environment

This manual is part of the SIMATIC iMap documentation package. The documentation is installed with the software and includes the following electronic manuals in PDF format:

- Component Based Automation and SIMATIC iMap
- Getting Started with SIMATIC iMap
- Commissioning Systems, Tutorial

The entire documentation is available for you as HTML help.

Content of this tutorial

The tutorial contains

- A description of the overall plant
- Part 1- Instructions for creating the PROFINet components and
- Part 2 Instructions for commissioning the system.

Conventions

Menu commands are printed in bold print, for example, **Project > Save**.

Further Support

If you have any technical questions, please get in touch with your Siemens representative or agent responsible.

<http://www.siemens.com/automation/partner>

<http://www.ad.siemens.de/cba/>

Training Centers

Siemens offers a number of training courses to familiarize you with the SIMATIC S7 automation system. Please contact your regional training center or our central training center in D 90327 Nuremberg, Germany for details:

Telephone: +49 (911) 895-3200.

Internet: <http://www.sitrain.com>

A&D Technical Support

Worldwide, available 24 hours a day:



<p>Worldwide (Nuernberg) Technical Support</p> <p>24 hours a day, 365 days a year Phone: +49 (0) 180 5050-222 Fax: +49 (0) 180 5050-223 E-Mail: adsupport@siemens.com GMT: +1:00</p>		
<p>Europe / Africa (Nuernberg) Authorization</p> <p>Local time: Mon.-Fri. 8:00 to 17:00 Phone: +49 (0) 180 5050-222 Fax: +49 (0) 180 5050-223 E-Mail: adautorisierung@siemens.com GMT: +1:00</p>	<p>United States (Johnson City) Technical Support and Authorization</p> <p>Local time: Mon.-Fri. 8:00 to 17:00 Phone: +1 (0) 423 262 2522 Fax: +1 (0) 423 262 2289 E-Mail: simatic.hotline@sea.siemens.com GMT: -5:00</p>	<p>Asia / Australia (Beijing) Technical Support and Authorization</p> <p>Local time: Mon.-Fri. 8:30 to 17:30 Phone: +86 10 64 75 75 75 Fax: +86 10 64 74 74 74 E-Mail: adsupport.asia@siemens.com GMT: +8:00</p>
<p>The languages of the SIMATIC Hotlines and the authorization hotline are generally German and English.</p>		

Service & Support on the Internet

In addition to our documentation, we offer our Know-how online on the internet at:

<http://www.siemens.com/automation/service&support>

where you will find the following:

- The newsletter, which constantly provides you with up-to-date information on your products.
- The right documents via our Search function in Service & Support.
- A forum, where users and experts from all over the world exchange their experiences.
- Your local representative for Automation & Drives via our representatives database.
- Information on field service, repairs, spare parts and more under "Services".

Table of Contents

1	Tutorial - Introduction	1-1
1.1	Overview	1-1
1.2	Description of the plants	1-2
1.3	Examples supplied.....	1-3
2	Part 1: Creating PROFINet components	2-1
2.1	Overview - Creating PROFINet Components	2-1
1.2	Requirements - Creating PROFINet Components.....	2-2
1.3	Basic procedure - Creating PROFINet Components	2-3
1.4	Plant 1: Creating PROFINet Components	2-4
1.5	Plant 2: Creating PROFINet Components	2-13
1.5.1	Creating the PROFINet Component for ET 200S with IM151/CPU.....	2-14
1.5.2	Creating the PROFINet Component for ET 200X with BM147/CPU	2-21
1.6	Plant 3: Creating PROFINet Components	2-29
1.6.1	Creating the PROFINet Component for WinLC PN	2-30
1.6.2	Creating the PROFINet Component for ET 200S with IM151/CPU.....	2-38
1.6.3	Creating the PROFINet Component for ET 200M	2-45
3	Part 2: Commissioning the system	3-1
3.1	Requirements - Commissioning the system	3-1
3.2	Basic procedure: Commissioning the system	3-2
3.3	Plant 1: CPU 315 with CP 343-1 PN	3-3
3.3.1	Step 1: Set up hardware	3-4
3.3.2	Step 2: Configure Plant 1 in SIMATIC iMap	3-4
1.1.3	Step 3: Assign an IP address to the CP 343-1 PN for the first time.....	3-11
1.1.4	Step 4: Check the Necessary Settings on the Engineering Station for Plant 13-14	
1.1.5	Step 5: Commissioning Plant 1	3-16
1.1.6	Step 6: Monitor Plant 1 Online.....	3-18
1.4	Plant 2: IE/PB Link with PROFIBUS DP slaves	3-22
1.4.1	Step 1: Set up hardware	3-24
1.4.1.1	ET 200S with IM151/CPU Hardware Set-up	3-24
1.4.1.2	ET 200X with BM147/CPU Hardware Set-up	3-25
1.4.1.3	IE/PB Link Hardware Set-up	3-25
1.4.2	Step 2: Configure Plant 2 in SIMATIC iMap	3-26
1.4.3	Step 3: Assign addresses.....	3-36
1.4.3.1	Assigning an IP address to the IE/PB Link for the First Time.....	3-36
1.4.3.2	Assigning a PROFIBUS address to IM151/CPU for the First Time	3-39
1.4.4	Step 4: Check the Necessary Settings on the Engineering Station for Plant 23-42	
1.4.4.1	Set PG/PC Interface to TCP/IP	3-43
1.4.4.2	Assign PG/PC	3-44
1.4.5	Step 5: Commissioning Plant 2	3-50
1.4.6	Step 6: Monitor Plant 2 Online.....	3-52
1.5	Plant 3: PC-Station WinLC PN with PROFIBUS DP slaves	3-56
1.5.1	Step 1: Set up hardware	3-58
1.5.1.1	WinLC PN Hardware Set-up	3-59
1.5.1.2	ET 200M Hardware Set-up	3-59
1.5.1.3	ET 200S with IM151/CPU Hardware Set-up	3-60
1.5.2	Step 2: Configure Plant 3 in SIMATIC iMap	3-61

1.5.3	Step 3: Assigning a PROFIBUS address to the IM151/CPU for the First Time3-71	
1.5.4	Step 4: Check Settings Required for Download and Online Functions.....	3-75
1.5.4.1	Check Settings for Plant 3-1	3-75
1.5.4.2	Set PG/PC Interface to TCP/IP.....	3-76
1.5.4.3	Assign PG/PC.....	3-77
1.5.4.4	Set PG/PC Interface on the WinLC PN PC Station.....	3-82
1.5.5	Step 5: Commissioning Plant 3	3-86
1.5.6	Step 6: Monitor Plant 3 Online.....	3-88
1.6	Overall plant.....	3-93
1.6.1	Overall plant: Set up Hardware	3-93
1.6.2	Configure the Overall Plant.....	3-93
1.6.3	Check the Settings.....	3-96
1.6.4	Start the Overall Plant.....	3-97
1.6.5	Monitor the Overall Plant Online.....	3-100
2	Literature and Links	4-1

1 Tutorial - Introduction

1.1 Overview

Aim of the system commissioning tutorial

Commissioning a plant with PROFINet and PROFIBUS devices involves a number of different steps (in STEP 7, SIMATIC iMap and on the actual plant).

The aim of this tutorial is to enable you to commission the specimen plant described in this document.

Content of this tutorial

The tutorial contains

- A description of the overall plant
- Part 1 Instructions for creating the PROFINet components and
- Part 2 Instructions for commissioning the system.

Procedure

The examples described in this tutorial will guide you step-by-step through the process of commissioning a complex plant. You will use the projects and PROFINet components supplied to check your progress.

If you use the examples supplied as the basis for further steps, you can be sure that the commissioning will be carried out correctly.

If you prefer to use off-the-shelf PROFINet components in your SIMATIC iMap project, then you can start from **Part 2: Commissioning the system**.

1.2 Description of the plants

The overall plant is made up of three individual plants. Each plant consists of at least one PROFINet device with an Ethernet connection. If the PROFINet device is a PROFIBUS master, the plant may also contain PROFIBUS devices.

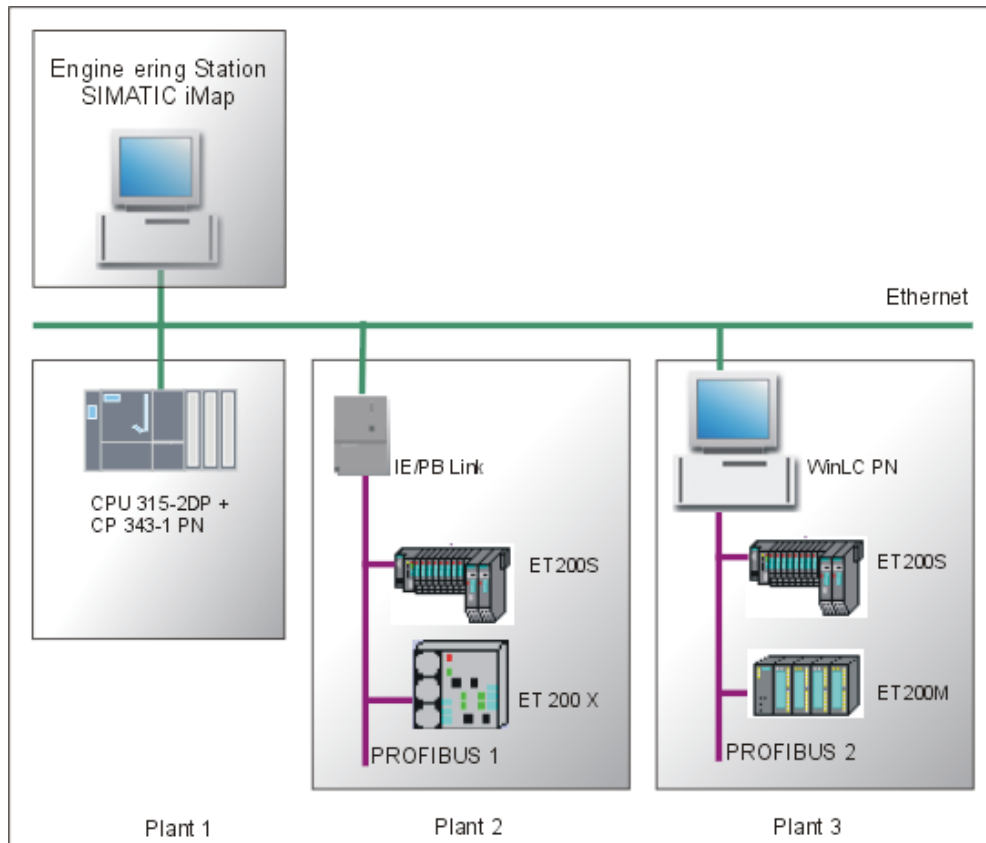

Structure of the plants

Plant	PROFINet device	PROFIBUS device	Function
Plant 1	CPU 315-2DP with a CP 343-1 PN		Processing station with conveyor belt
Plant 2	IE/PB Link	ET 200S with IM151/CPU ET 200X with BM147/CPU basic module	Conveyor station
Plant 3	PC station with WinLC PN	ET 200S with IM151/CPU ET 200M with IM153	Processing station

1.3 Examples supplied

Tutorial install directory

- Depending on the installation – the **CBA_Tutorial** install directory can be found
 - on any path if you download the tutorial to your PC from the Internet or
 - in the SIMATIC iMap install directory if you install it together with SIMATIC iMap version 1.2 or later.

If you download the tutorial from the Internet to your PC, you will find the following folders with the examples supplied in the tutorial install directory (**CBA_Tutorial**):

Folder	Content
S7_Projects	STEP7 component projects You can use these STEP7 projects to create PROFINet components for plants 1 to 3.
PROFINet_Components	Ready-to-use PROFINet components for plants 1 to 3. You can import these PROFINet components into a SIMATIC iMap library.

If you install the tutorial together with SIMATIC iMap, you will find the examples supplied in the following directories:

Folder	Content
Step7\examples\ ZEn27_04 to _08 (STEP 7 install directory)	STEP7 component projects You can use these STEP7 projects to create PROFINet components for plants 1 to 3.
\iMap\CBA_Tutorial\ Components (iMap install directory)	Ready-to-use PROFINet components for plants 1 to 3. You can import these PROFINet components into a SIMATIC iMap library.

Note

The PROFINet component for the IE/PB Link is already included with the SIMATIC iMap software.

Tip

We recommend that you first complete the individual commissioning steps and then use the sample projects and PROFINet components supplied as the basis for further steps to ensure that you complete the commissioning correctly.

2 Part 1: Creating PROFINet components

2.1 Overview - Creating PROFINet Components

You will need PROFINet components in order to configure a plant with SIMATIC iMap.

They can be created at any time – regardless of the physical hardware set-up. The PROFINet components for the plants described here are supplied with the software, however.

If you use off-the-shelf PROFINet components, you can skip this section and start directly with Part 2: System Commissioning.

Components for plants 1 to 3

Plant	PROFINet device	PROFIBUS device	PROFINet component
Plant 1	CPU 315-2DP with a CP 343-1 PN		Processing_B
Plant 2	IE/PB Link		IE-PB-Link1_5MB
		ET 200S with IM151/CPU ET 200X with BM147/CPU basic module	ET200S_Conveyor ET200X_Conveyor
Plant 3	PC station with WinLC PN		Processing_A
		ET 200S with IM151/CPU ET 200M with IM153	ET200S_Conveyor ET200M_IO

2.2 Requirements - Creating PROFINet Components

The following software must be installed in order to create PROFINet components for plants 1 to 3:

- Windows 2000 SP3 or later
- STEP 7 V5.2 or later
- SIMATIC iMap V1.2
- The WinLC PN V1.1 software package must be installed on the local engineering station (only for plant 3).

Note

You will need administrator rights in order to install SIMATIC iMap.

You will need at least primary user rights in order to use SIMATIC iMap.

2.3 Basic procedure - Creating PROFINet Components

The PROFINet components are created using STEP 7. The following steps must be carried out for each PROFINet component:

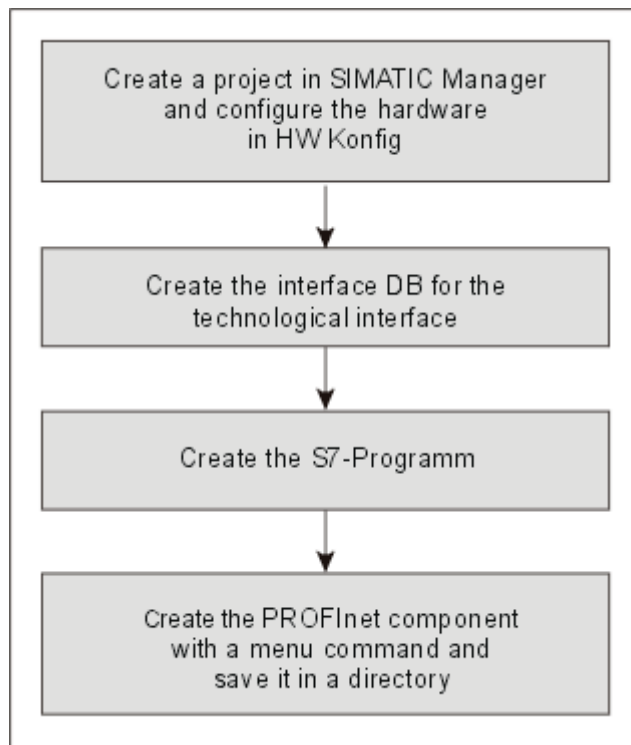

Tip

We recommend that you first complete the individual steps for creating the PROFINet components, and then use the S7 projects and PROFINet components supplied as the basis for further steps to ensure that you complete the commissioning correctly. The relevant points in the tutorial are indicated by the following note:

Note

The finished STEP7 component project can be found in the tutorial install directory under

\\CBA_Tutorial\S7_Projects or under Step7\examples\ZEn27_04 to _08

We recommend that you use the project supplied as the basis for further steps to ensure that you complete the commissioning correctly.

2.4 Plant 1: Creating PROFINet Components

For plant 1, create the PROFINet component called "Processing_B" from a CPU 315-2DP with CP 343-1PN as the controller for a machining station with conveyor belt.

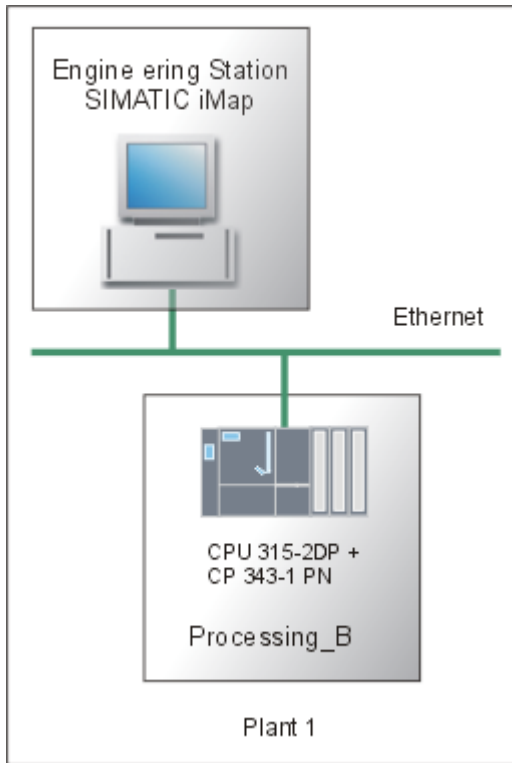

The PROFINet component contains:

PROFINet component	PROFINet device	Technological function
Processing_B	CPU 315-2DP with CP 343-1 PN	Processing station with conveyor belt (S7 program with the component interface)

Basic procedure

The PROFINet component is created using STEP 7, essentially by applying the following steps:

1. In SIMATIC Manager, create a project for a component and configure the station hardware in HWConfig.
2. Create the interface DB for the component interface.
3. Create the S7 program.
4. Create the PROFINet component using a menu command and save it to a directory.

Configure the hardware

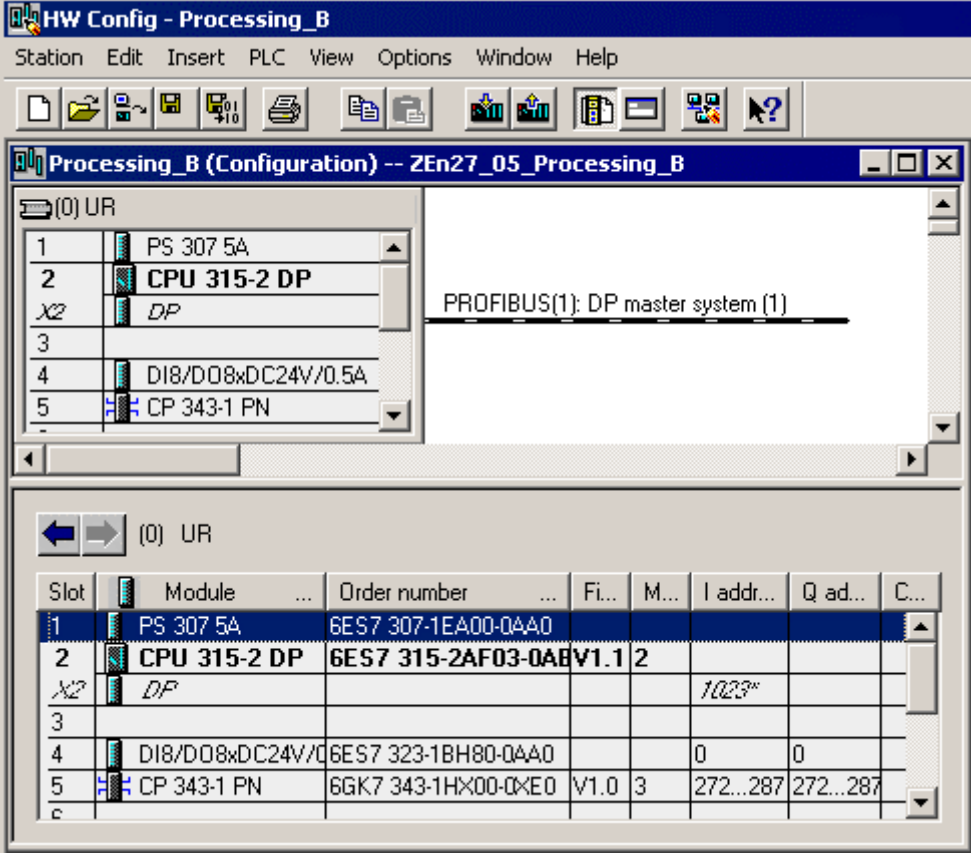
Step	Procedure																																																								
1.	Create a project in SIMATIC Manager and add a Simatic 300 station.																																																								
2.	<p>Configure the hardware as shown in the following diagram:</p>  <p>The screenshot shows the HW Config interface with the following rack configuration:</p> <table border="1"> <thead> <tr> <th>Slot</th> <th>Module</th> <th>Order number</th> <th>Fi...</th> <th>M...</th> <th>I addr...</th> <th>Q ad...</th> <th>C...</th> </tr> </thead> <tbody> <tr> <td>1</td> <td>PS 307 5A</td> <td>6ES7 307-1EA00-0AA0</td> <td></td> <td></td> <td></td> <td></td> <td></td> </tr> <tr> <td>2</td> <td>CPU 315-2 DP</td> <td>6ES7 315-2AF03-0ABV1.1</td> <td>2</td> <td></td> <td>1023"</td> <td></td> <td></td> </tr> <tr> <td>X2</td> <td>DP</td> <td></td> <td></td> <td></td> <td></td> <td></td> <td></td> </tr> <tr> <td>3</td> <td></td> <td></td> <td></td> <td></td> <td></td> <td></td> <td></td> </tr> <tr> <td>4</td> <td>DI8/DO8xDC24V/0.5A</td> <td>6ES7 323-1BH80-0AA0</td> <td></td> <td></td> <td>0</td> <td>0</td> <td></td> </tr> <tr> <td>5</td> <td>CP 343-1 PN</td> <td>6GK7 343-1HX00-0XE0</td> <td>V1.0</td> <td>3</td> <td>272...287</td> <td>272...287</td> <td></td> </tr> </tbody> </table>	Slot	Module	Order number	Fi...	M...	I addr...	Q ad...	C...	1	PS 307 5A	6ES7 307-1EA00-0AA0						2	CPU 315-2 DP	6ES7 315-2AF03-0ABV1.1	2		1023"			X2	DP							3								4	DI8/DO8xDC24V/0.5A	6ES7 323-1BH80-0AA0			0	0		5	CP 343-1 PN	6GK7 343-1HX00-0XE0	V1.0	3	272...287	272...287	
Slot	Module	Order number	Fi...	M...	I addr...	Q ad...	C...																																																		
1	PS 307 5A	6ES7 307-1EA00-0AA0																																																							
2	CPU 315-2 DP	6ES7 315-2AF03-0ABV1.1	2		1023"																																																				
X2	DP																																																								
3																																																									
4	DI8/DO8xDC24V/0.5A	6ES7 323-1BH80-0AA0			0	0																																																			
5	CP 343-1 PN	6GK7 343-1HX00-0XE0	V1.0	3	272...287	272...287																																																			

Create the Interface-DB

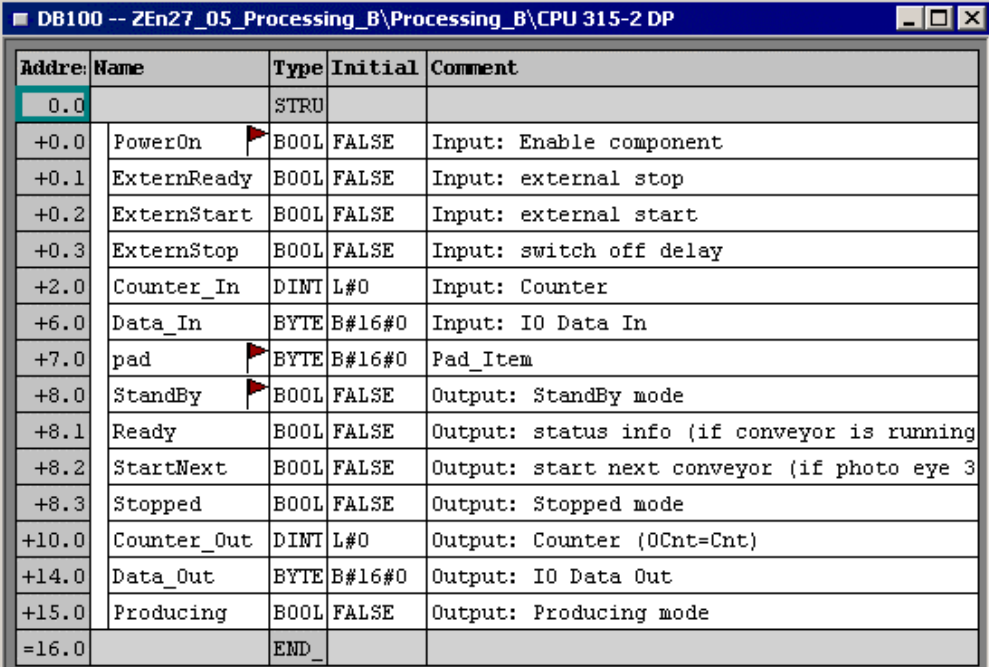
Step	Procedure																																																																																					
1.	From the <i>PROFINet System Library</i> , copy all the blocks from the "CP 300" block folder to the CPU block folder.																																																																																					
2.	In SIMATIC Manager, open the project block folder and then open DB100.																																																																																					
3.	<p>Use the DB100 as the template for the interface DB describing the component interface of the PROFINet component.</p> <p>Overwrite the variables and change the attributes as shown in the following diagram:</p>  <table border="1"> <caption>DB100 -- ZEn27_05_Processing_B\Processing_B\CPU 315-2 DP</caption> <thead> <tr> <th>Addr.</th> <th>Name</th> <th>Type</th> <th>Initial</th> <th>Comment</th> </tr> </thead> <tbody> <tr> <td>0.0</td> <td></td> <td>STRU</td> <td></td> <td></td> </tr> <tr> <td>+0.0</td> <td>PowerOn</td> <td>BOOL</td> <td>FALSE</td> <td>Input: Enable component</td> </tr> <tr> <td>+0.1</td> <td>ExternReady</td> <td>BOOL</td> <td>FALSE</td> <td>Input: external stop</td> </tr> <tr> <td>+0.2</td> <td>ExternStart</td> <td>BOOL</td> <td>FALSE</td> <td>Input: external start</td> </tr> <tr> <td>+0.3</td> <td>ExternStop</td> <td>BOOL</td> <td>FALSE</td> <td>Input: switch off delay</td> </tr> <tr> <td>+2.0</td> <td>Counter_In</td> <td>DINT</td> <td>L#0</td> <td>Input: Counter</td> </tr> <tr> <td>+6.0</td> <td>Data_In</td> <td>BYTE</td> <td>B#16#0</td> <td>Input: IO Data In</td> </tr> <tr> <td>+7.0</td> <td>pad</td> <td>BYTE</td> <td>B#16#0</td> <td>Pad_Item</td> </tr> <tr> <td>+8.0</td> <td>StandBy</td> <td>BOOL</td> <td>FALSE</td> <td>Output: StandBy mode</td> </tr> <tr> <td>+8.1</td> <td>Ready</td> <td>BOOL</td> <td>FALSE</td> <td>Output: status info (if conveyor is running</td> </tr> <tr> <td>+8.2</td> <td>StartNext</td> <td>BOOL</td> <td>FALSE</td> <td>Output: start next conveyor (if photo eye 3</td> </tr> <tr> <td>+8.3</td> <td>Stopped</td> <td>BOOL</td> <td>FALSE</td> <td>Output: Stopped mode</td> </tr> <tr> <td>+10.0</td> <td>Counter_Out</td> <td>DINT</td> <td>L#0</td> <td>Output: Counter (OCnt=Cnt)</td> </tr> <tr> <td>+14.0</td> <td>Data_Out</td> <td>BYTE</td> <td>B#16#0</td> <td>Output: IO Data Out</td> </tr> <tr> <td>+15.0</td> <td>Producing</td> <td>BOOL</td> <td>FALSE</td> <td>Output: Producing mode</td> </tr> <tr> <td>=16.0</td> <td></td> <td>END_</td> <td></td> <td></td> </tr> </tbody> </table>	Addr.	Name	Type	Initial	Comment	0.0		STRU			+0.0	PowerOn	BOOL	FALSE	Input: Enable component	+0.1	ExternReady	BOOL	FALSE	Input: external stop	+0.2	ExternStart	BOOL	FALSE	Input: external start	+0.3	ExternStop	BOOL	FALSE	Input: switch off delay	+2.0	Counter_In	DINT	L#0	Input: Counter	+6.0	Data_In	BYTE	B#16#0	Input: IO Data In	+7.0	pad	BYTE	B#16#0	Pad_Item	+8.0	StandBy	BOOL	FALSE	Output: StandBy mode	+8.1	Ready	BOOL	FALSE	Output: status info (if conveyor is running	+8.2	StartNext	BOOL	FALSE	Output: start next conveyor (if photo eye 3	+8.3	Stopped	BOOL	FALSE	Output: Stopped mode	+10.0	Counter_Out	DINT	L#0	Output: Counter (OCnt=Cnt)	+14.0	Data_Out	BYTE	B#16#0	Output: IO Data Out	+15.0	Producing	BOOL	FALSE	Output: Producing mode	=16.0		END_		
Addr.	Name	Type	Initial	Comment																																																																																		
0.0		STRU																																																																																				
+0.0	PowerOn	BOOL	FALSE	Input: Enable component																																																																																		
+0.1	ExternReady	BOOL	FALSE	Input: external stop																																																																																		
+0.2	ExternStart	BOOL	FALSE	Input: external start																																																																																		
+0.3	ExternStop	BOOL	FALSE	Input: switch off delay																																																																																		
+2.0	Counter_In	DINT	L#0	Input: Counter																																																																																		
+6.0	Data_In	BYTE	B#16#0	Input: IO Data In																																																																																		
+7.0	pad	BYTE	B#16#0	Pad_Item																																																																																		
+8.0	StandBy	BOOL	FALSE	Output: StandBy mode																																																																																		
+8.1	Ready	BOOL	FALSE	Output: status info (if conveyor is running																																																																																		
+8.2	StartNext	BOOL	FALSE	Output: start next conveyor (if photo eye 3																																																																																		
+8.3	Stopped	BOOL	FALSE	Output: Stopped mode																																																																																		
+10.0	Counter_Out	DINT	L#0	Output: Counter (OCnt=Cnt)																																																																																		
+14.0	Data_Out	BYTE	B#16#0	Output: IO Data Out																																																																																		
+15.0	Producing	BOOL	FALSE	Output: Producing mode																																																																																		
=16.0		END_																																																																																				

Step	Procedure																											
4.	<p>Check the user-defined attributes in the following declaration lines:</p> <p>PowerOn</p> <table border="1"> <thead> <tr> <th colspan="3">Properties - Parameters</th> </tr> <tr> <th></th> <th>Attribute</th> <th>Value</th> </tr> </thead> <tbody> <tr> <td>1</td> <td>CBA_direction</td> <td>in</td> </tr> </tbody> </table> <p>Pad</p> <table border="1"> <thead> <tr> <th colspan="3">Properties - Parameters</th> </tr> <tr> <th></th> <th>Attribute</th> <th>Value</th> </tr> </thead> <tbody> <tr> <td>1</td> <td>CBA_pad_item</td> <td>true</td> </tr> </tbody> </table> <p>StandBy</p> <table border="1"> <thead> <tr> <th colspan="3">Properties - Parameters</th> </tr> <tr> <th></th> <th>Attribute</th> <th>Value</th> </tr> </thead> <tbody> <tr> <td>1</td> <td>CBA_direction</td> <td>out</td> </tr> </tbody> </table> <p>The user-defined attributes are indicated by flags, and are already included in the DB100 template.</p>	Properties - Parameters				Attribute	Value	1	CBA_direction	in	Properties - Parameters				Attribute	Value	1	CBA_pad_item	true	Properties - Parameters				Attribute	Value	1	CBA_direction	out
Properties - Parameters																												
	Attribute	Value																										
1	CBA_direction	in																										
Properties - Parameters																												
	Attribute	Value																										
1	CBA_pad_item	true																										
Properties - Parameters																												
	Attribute	Value																										
1	CBA_direction	out																										

Further information...

on the interface DB and user-defined attributes can be found under "Interface DB properties" in the SIMATIC iMap Basic Help.

Creating the S7 program

Step	Procedure
1.	<p>Create the S7 program in OB1. The following section from the OB1 is given by way of example. The sources can be found in the finished STEP7 project.</p> <pre>//refreshing the interface db CALL "PN_InOut" , DB41 LADDR :=W#16#110 DONE :=M30.0 ERROR :=M30.1 STATUS:=MW32 //calling the technological function block "conveyor" CALL "CONVEYOR" , DB40 ExternStop :="PN_Interface_DB".PowerOn ExternStart :="PN_Interface_DB".ExternReady RunDelay := IOPhotoEye1 :="IO_PhotoEye1" IOPhotoEye2 :="IO_PhotoEye2" IOPhotoEye3 :="IO_PhotoEye3" IOEStop :=FALSE StartNext :="PN_Interface_DB".StandBy Running :="PN_Interface_DB".Ready IOConveyorStart:="IO_ConveyorStart" //optical signal A "IO_ConveyorStart" = "IO_Signal" //forwarding the counter value L "PN_Interface_DB".Counter_In T "PN_Interface_DB".Counter_Out</pre>
2.	Compile and test the S7 program.

Note

The finished STEP7 component project with all the necessary blocks of the S7 program can be found in the tutorial install directory under

\\CBA_Tutorial\S7_Projects\300pncp or under Step7\examples\ZEn27_05.

We recommend that you use the project supplied as the basis for further steps to ensure that you complete the commissioning correctly.

Create the PROFINET components

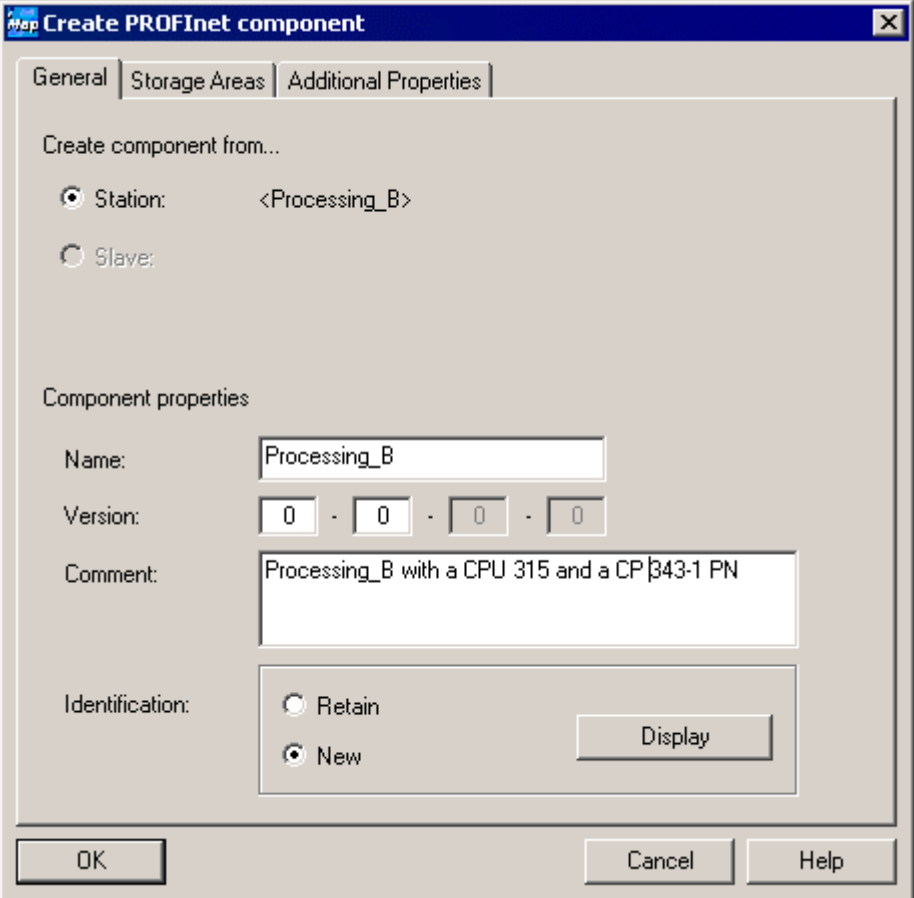
Step	Procedure
1.	In SIMATIC Manager, highlight the S7-300 station, and then select Create PROFINET Component from the context menu.
2.	On the "General" tab, highlight the "Identification" New option and enter the following name: "Processing_B". 

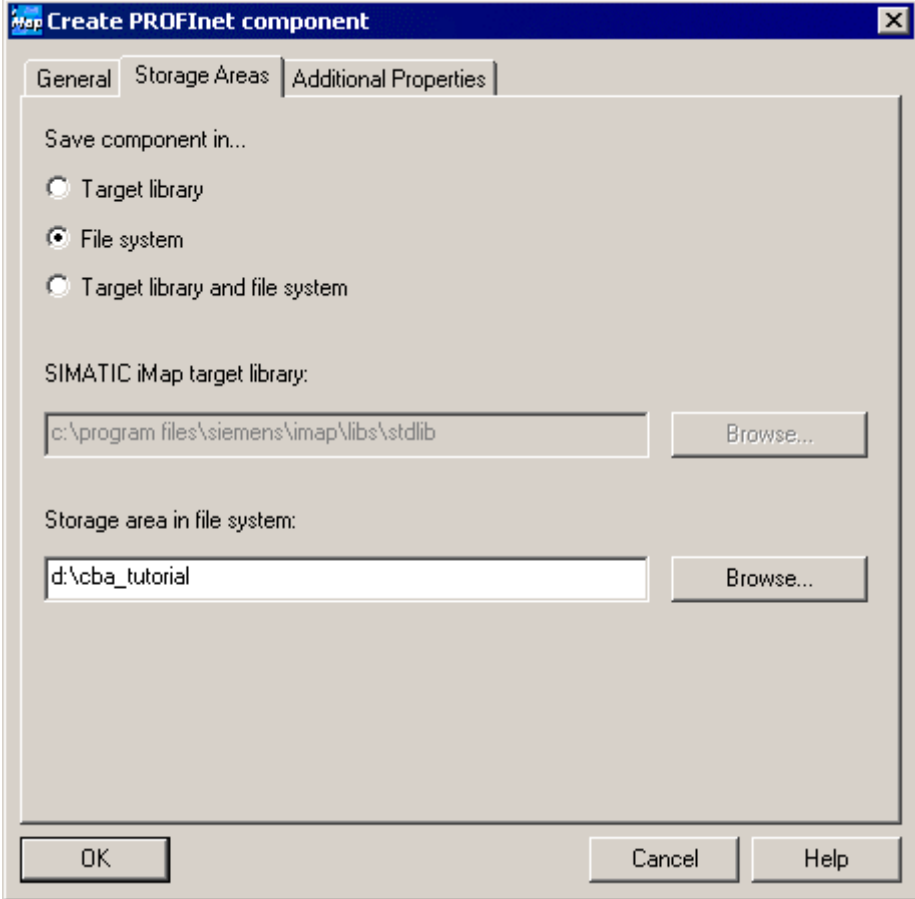
Step	Procedure
3.	<p data-bbox="322 347 1331 414">On the "Storage Areas" tab, enter the path D:\cba_tutorial (where D is any drive of your choice).</p>  <p data-bbox="322 421 1241 1317">The screenshot shows a dialog box titled "Create PROFINet component" with three tabs: "General", "Storage Areas", and "Additional Properties". The "Storage Areas" tab is active. Under "Save component in...", the "File system" radio button is selected. Below, the "SIMATIC IMap target library:" field contains the path "c:\program files\siemens\imap\libs\stdlib" with a "Browse..." button to its right. The "Storage area in file system:" field contains the path "d:\cba_tutorial" with a "Browse..." button to its right. At the bottom of the dialog are "OK", "Cancel", and "Help" buttons.</p>

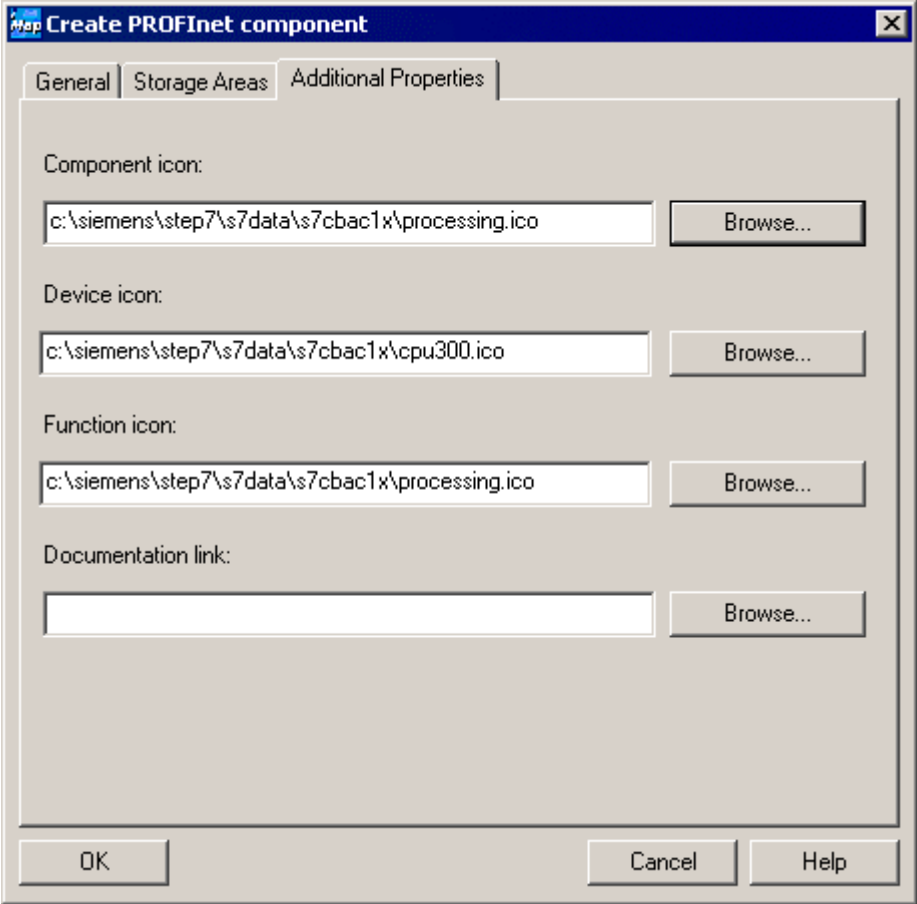
Step	Procedure
4.	<p>On the "Additional Properties" tab, enter the paths of the icon files and the path of the documentation link.</p> <p>Use the icons supplied if required (default path: Step7\s7data\s7cbac1x).</p> 

Result: The PROFInet component is saved as an XML file and the component project is saved at the specified storage location.

Note

The finished PROFInet component can be found in the tutorial install directory under

`\CBA_Tutorial\PROFInet_Components\processing_b-{...}`

We recommend that you use it as the basis for further steps to ensure that you complete the commissioning correctly.

Representation in SIMATIC iMap

In SIMATIC iMap, the PROFINET component as a technological function has the following appearance:

Processing_B	
PowerOn BOOL	BOOL StandBy
ExternReady BOOL	BOOL Ready
ExternStart BOOL	BOOL StartNext
ExternStop BOOL	BOOL Stopped
Counter_In I4	I4 Counter_Out
Data_In UI1	UI1 Data_Out
	BOOL Producing
	UI1 Lifestate

2.5 Plant 2: Creating PROFINet Components

For plant 2, create PROFINet components for the ET 200S and ET 200X devices.

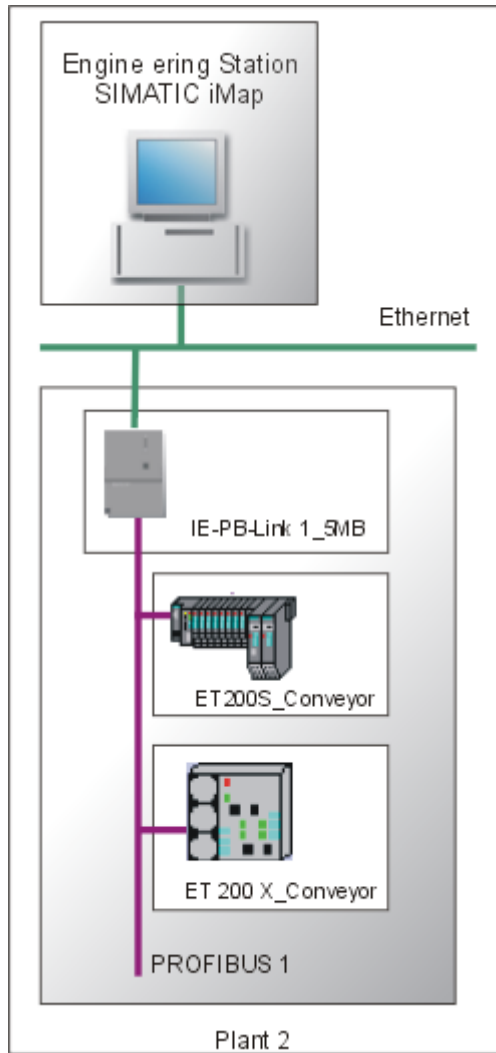

Each PROFINet component contains:

PROFINet component	PROFINet device	PROFIBUS device	Technological function
IE/PB Link	IE/PB Link		None
ET200S_Conveyor		ET 200S with IM151/CPU	Conveyor station (S7 program with the component interface)
ET200X_Conveyor		ET 200X with basic module BM147/CPU	Conveyor station (S7 program with the component interface)

Components supplied and reusability

- PROFINet components with various transmission speeds for the IE/PB Link are supplied with the SIMATIC iMap software.
- You can also use the PROFINet component "ET200S_Conveyor" for plant 3.
- In the example, "ET200S_Conveyor" and "ET200X_Conveyor" have the same S7 programs and the same component interfaces, i.e. the requirements and the procedure are the same for creating both PROFINet components.

2.5.1 Creating the PROFINet Component for ET 200S with IM151/CPU

For plant 2, create the PROFINet component "ET200S_Conveyor" as a controller for a conveyor belt with ET 200S.

Basic procedure

The PROFINet component is created using STEP 7, essentially by applying the following steps:

1. In SIMATIC Manager, create a project for a component and configure the station hardware in HW Config.
2. Create the interface DB for the component interface.
3. Create the S7 program.
4. Create the PROFINet component using a menu command and save it to a directory.

Configure the hardware

Step	Procedure																																																																																
1.	Create a project in SIMATIC Manager and add a Simatic 300 station.																																																																																
2.	Configure the hardware as shown in the following diagram: <div data-bbox="367 571 1372 1512" style="border: 1px solid black; padding: 5px;"> <table border="1" data-bbox="391 1131 1348 1444"> <thead> <tr> <th>St...</th> <th>Baugruppe</th> <th>Bestellnummer</th> <th>Firm...</th> <th>M...</th> <th>E-Adr...</th> <th>A-A...</th> <th>Ko...</th> </tr> </thead> <tbody> <tr> <td>1</td> <td></td> <td></td> <td></td> <td></td> <td></td> <td></td> <td></td> </tr> <tr> <td>2</td> <td>IM151 / CPU</td> <td></td> <td>V2.0</td> <td></td> <td></td> <td></td> <td></td> </tr> <tr> <td>X1</td> <td>MPI/DP</td> <td></td> <td></td> <td></td> <td>2047"</td> <td></td> <td></td> </tr> <tr> <td>3</td> <td></td> <td></td> <td></td> <td></td> <td></td> <td></td> <td></td> </tr> <tr> <td>4</td> <td>PM-E DC24V</td> <td>6ES7 138-4CA00-0AA0</td> <td></td> <td></td> <td></td> <td></td> <td></td> </tr> <tr> <td>5</td> <td>2 DI DC24V High Feature</td> <td>6ES7 131-4BB00-0AB0</td> <td></td> <td></td> <td>1.0...1.1</td> <td></td> <td></td> </tr> <tr> <td>6</td> <td>2 DI DC24V High Feature</td> <td>6ES7 131-4BB00-0AB0</td> <td></td> <td></td> <td>2.0...2.1</td> <td></td> <td></td> </tr> <tr> <td>7</td> <td>2 DO DC24V/0.5A High Fe</td> <td>6ES7 132-4BB00-0AB0</td> <td></td> <td></td> <td></td> <td>3.0...3.1</td> <td></td> </tr> <tr> <td>8</td> <td>2 DO DC24V/0.5A High Fe</td> <td>6ES7 132-4BB00-0AB0</td> <td></td> <td></td> <td></td> <td>4.0...4.1</td> <td></td> </tr> </tbody> </table> </div>	St...	Baugruppe	Bestellnummer	Firm...	M...	E-Adr...	A-A...	Ko...	1								2	IM151 / CPU		V2.0					X1	MPI/DP				2047"			3								4	PM-E DC24V	6ES7 138-4CA00-0AA0						5	2 DI DC24V High Feature	6ES7 131-4BB00-0AB0			1.0...1.1			6	2 DI DC24V High Feature	6ES7 131-4BB00-0AB0			2.0...2.1			7	2 DO DC24V/0.5A High Fe	6ES7 132-4BB00-0AB0				3.0...3.1		8	2 DO DC24V/0.5A High Fe	6ES7 132-4BB00-0AB0				4.0...4.1	
St...	Baugruppe	Bestellnummer	Firm...	M...	E-Adr...	A-A...	Ko...																																																																										
1																																																																																	
2	IM151 / CPU		V2.0																																																																														
X1	MPI/DP				2047"																																																																												
3																																																																																	
4	PM-E DC24V	6ES7 138-4CA00-0AA0																																																																															
5	2 DI DC24V High Feature	6ES7 131-4BB00-0AB0			1.0...1.1																																																																												
6	2 DI DC24V High Feature	6ES7 131-4BB00-0AB0			2.0...2.1																																																																												
7	2 DO DC24V/0.5A High Fe	6ES7 132-4BB00-0AB0				3.0...3.1																																																																											
8	2 DO DC24V/0.5A High Fe	6ES7 132-4BB00-0AB0				4.0...4.1																																																																											

Create the interface DB

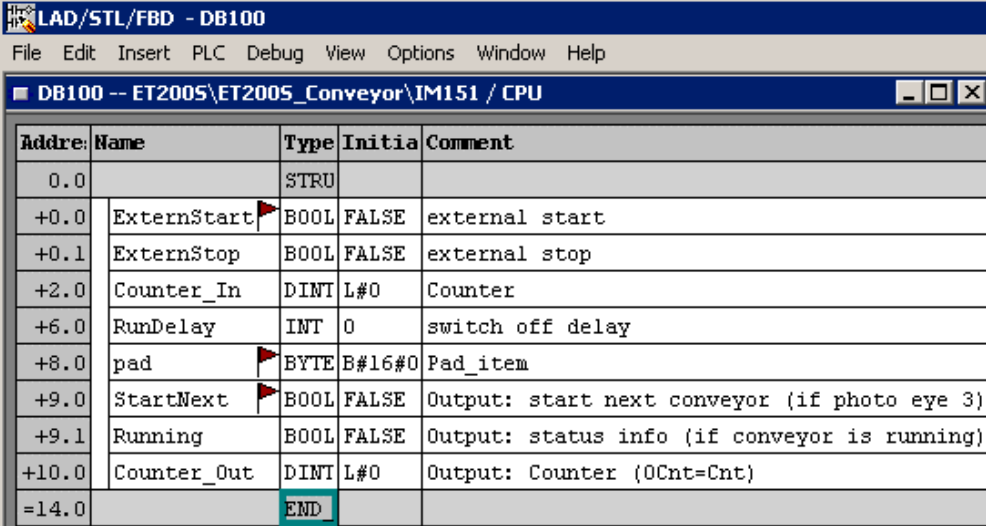
Step	Procedure																																																							
1.	From the <i>PROFINET System Library</i> , copy all the blocks from the "I-DP slave" block folder to the CPU block folder.																																																							
2.	In SIMATIC Manager, open the project block folder and then open DB100.																																																							
3.	<p>Use the DB100 as the template for the interface DB describing the component interface of the PROFINET component.</p> <p>Overwrite the variables and change the attributes as shown in the following diagram:</p>  <table border="1" data-bbox="331 645 1321 1169"> <thead> <tr> <th>Addr:</th> <th>Name</th> <th>Type</th> <th>Initia</th> <th>Comment</th> </tr> </thead> <tbody> <tr> <td>0.0</td> <td></td> <td>STRU</td> <td></td> <td></td> </tr> <tr> <td>+0.0</td> <td>ExternStart</td> <td>BOOL</td> <td>FALSE</td> <td>external start</td> </tr> <tr> <td>+0.1</td> <td>ExternStop</td> <td>BOOL</td> <td>FALSE</td> <td>external stop</td> </tr> <tr> <td>+2.0</td> <td>Counter_In</td> <td>DINT</td> <td>L#0</td> <td>Counter</td> </tr> <tr> <td>+6.0</td> <td>RunDelay</td> <td>INT</td> <td>0</td> <td>switch off delay</td> </tr> <tr> <td>+8.0</td> <td>pad</td> <td>BYTE</td> <td>B#16#0</td> <td>Pad_item</td> </tr> <tr> <td>+9.0</td> <td>StartNext</td> <td>BOOL</td> <td>FALSE</td> <td>Output: start next conveyor (if photo eye 3)</td> </tr> <tr> <td>+9.1</td> <td>Running</td> <td>BOOL</td> <td>FALSE</td> <td>Output: status info (if conveyor is running)</td> </tr> <tr> <td>+10.0</td> <td>Counter_Out</td> <td>DINT</td> <td>L#0</td> <td>Output: Counter (0Cnt=Cnt)</td> </tr> <tr> <td>=14.0</td> <td></td> <td>END</td> <td></td> <td></td> </tr> </tbody> </table>	Addr:	Name	Type	Initia	Comment	0.0		STRU			+0.0	ExternStart	BOOL	FALSE	external start	+0.1	ExternStop	BOOL	FALSE	external stop	+2.0	Counter_In	DINT	L#0	Counter	+6.0	RunDelay	INT	0	switch off delay	+8.0	pad	BYTE	B#16#0	Pad_item	+9.0	StartNext	BOOL	FALSE	Output: start next conveyor (if photo eye 3)	+9.1	Running	BOOL	FALSE	Output: status info (if conveyor is running)	+10.0	Counter_Out	DINT	L#0	Output: Counter (0Cnt=Cnt)	=14.0		END		
Addr:	Name	Type	Initia	Comment																																																				
0.0		STRU																																																						
+0.0	ExternStart	BOOL	FALSE	external start																																																				
+0.1	ExternStop	BOOL	FALSE	external stop																																																				
+2.0	Counter_In	DINT	L#0	Counter																																																				
+6.0	RunDelay	INT	0	switch off delay																																																				
+8.0	pad	BYTE	B#16#0	Pad_item																																																				
+9.0	StartNext	BOOL	FALSE	Output: start next conveyor (if photo eye 3)																																																				
+9.1	Running	BOOL	FALSE	Output: status info (if conveyor is running)																																																				
+10.0	Counter_Out	DINT	L#0	Output: Counter (0Cnt=Cnt)																																																				
=14.0		END																																																						
4.	<p>Check the user-defined attributes in the following declaration lines:</p> <p>ExternStart</p> <table border="1" data-bbox="331 1294 1082 1406"> <thead> <tr> <th colspan="3">Properties - Parameters</th> </tr> <tr> <th></th> <th>Attribute</th> <th>Value</th> </tr> </thead> <tbody> <tr> <td>1</td> <td>CBA_direction</td> <td>in</td> </tr> </tbody> </table> <p>Pad</p> <table border="1" data-bbox="331 1451 1082 1563"> <thead> <tr> <th colspan="3">Properties - Parameters</th> </tr> <tr> <th></th> <th>Attribute</th> <th>Value</th> </tr> </thead> <tbody> <tr> <td>1</td> <td>CBA_pad_item</td> <td>true</td> </tr> </tbody> </table> <p>StartNext</p> <table border="1" data-bbox="331 1608 1082 1720"> <thead> <tr> <th colspan="3">Properties - Parameters</th> </tr> <tr> <th></th> <th>Attribute</th> <th>Value</th> </tr> </thead> <tbody> <tr> <td>1</td> <td>CBA_direction</td> <td>out</td> </tr> </tbody> </table> <p>The user-defined attributes are indicated by flags, and are already included in the DB100 template.</p>	Properties - Parameters				Attribute	Value	1	CBA_direction	in	Properties - Parameters				Attribute	Value	1	CBA_pad_item	true	Properties - Parameters				Attribute	Value	1	CBA_direction	out																												
Properties - Parameters																																																								
	Attribute	Value																																																						
1	CBA_direction	in																																																						
Properties - Parameters																																																								
	Attribute	Value																																																						
1	CBA_pad_item	true																																																						
Properties - Parameters																																																								
	Attribute	Value																																																						
1	CBA_direction	out																																																						

Further information...

on the interface DB and user-defined attributes can be found under "Interface DB properties" in the SIMATIC iMap Basic Help.

Create the S7 program

Step	Procedure
1.	<p>Create the S7 program. The following section from the OB1 is given by way of example. The sources can be found in the finished STEP7 project.</p> <pre> //refreshing the input section of the interface db CALL "PN_IN" DB_NO := "PN_IO_DB" RET_VAL := MW20 //calling the technological function block "conveyor" CALL "CONVEYOR" , DB40 ExternStop := "PN_Interface_DB".ExternStart ExternStart := "PN_Interface_DB".ExternStop RunDelay := "PN_Interface_DB".RunDelay IOPhotoEye1 := "IO_PhotoEye1" IOPhotoEye2 := "IO_PhotoEye2" IOPhotoEye3 := "IO_PhotoEye3" IOEStop := FALSE StartNext := DB100.DBX8.0 Running := DB100.DBX8.1 IOConveyorStart := "IO_ConveyorStart" //forwarding the counter value L "PN_Interface_DB".Counter_In T "PN_Interface_DB".Counter_Out //optical signal U "IO_ConveyorStart" = "IO_Signal" //refreshing the output section of the interface db CALL "PN_OUT" DB_NO := "PN_IO_DB" RET_VAL := MW22 </pre>
2.	<p>Compile and test the S7 program.</p>

Attention

Please note that the PN_IN (FC10) block at the start of the OB1 and the PN_OUT (FC11) block at the end of the OB1 both have to be called.

Note

The finished STEP7 component project with all the necessary blocks of the S7 program can be found in the tutorial install directory under

\CBA_Tutorial\S7_Projects\Et200s or under Step7\examples\ZEn27_06.

We recommend that you use the project supplied as the basis for further steps to ensure that you complete the commissioning correctly.

Create the PROFINet component

Step	Procedure
1.	In SIMATIC Manager, highlight the Simatic 300 station, and then select Create PROFINet Component from the context menu.
2.	On the "General" tab, highlight the "Identification" New option and enter the following name: "ET200S_Conveyor".

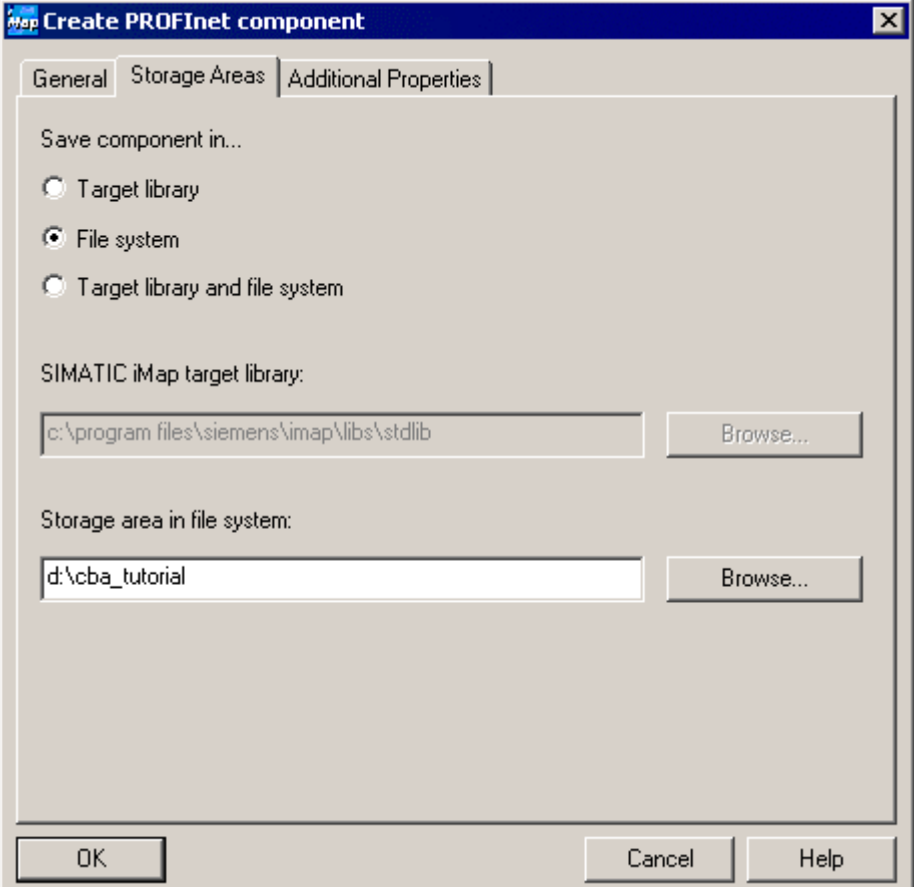
Step	Procedure
3.	<p>On the "Storage Areas" tab, enter the path D:\cba_tutorial (where D is any drive of your choice).</p>  <p>The screenshot shows a dialog box titled "Create PROFINet component" with three tabs: "General", "Storage Areas", and "Additional Properties". The "Storage Areas" tab is active. Under "Save component in...", the "File system" radio button is selected. Below, the "SIMATIC iMap target library:" field contains the path "c:\program files\siemens\imap\libs\stdlib" with a "Browse..." button to its right. The "Storage area in file system:" field contains the path "d:\cba_tutorial" with a "Browse..." button to its right. At the bottom are "OK", "Cancel", and "Help" buttons.</p>

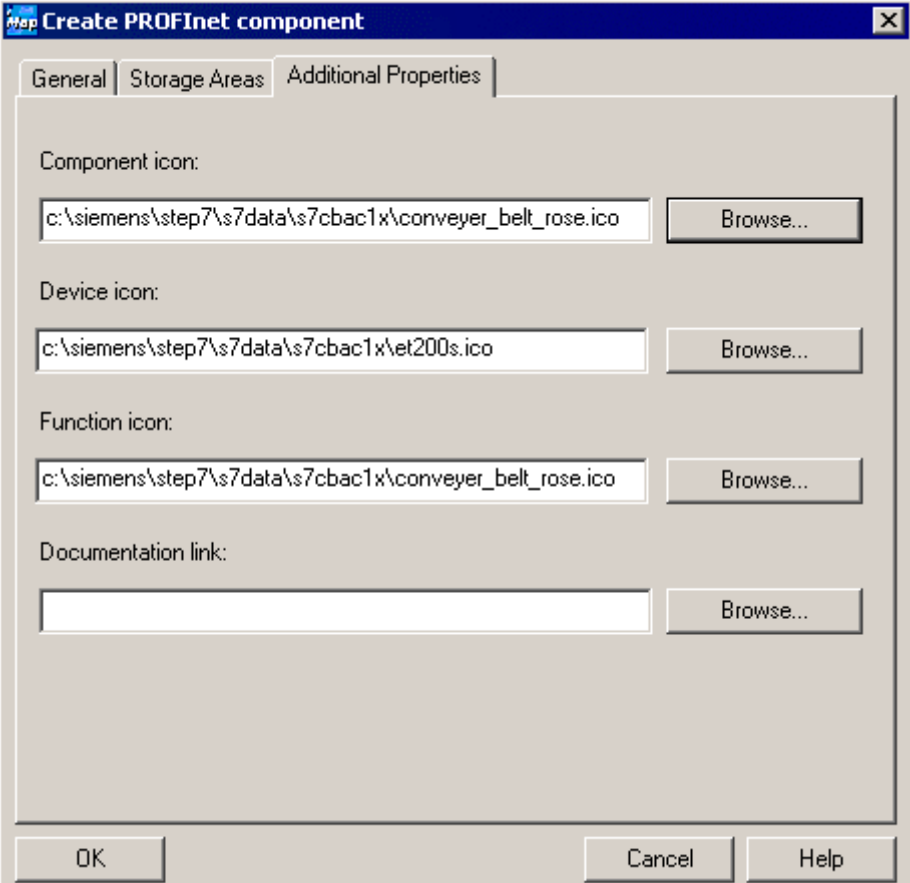
Step	Procedure
4.	<p>On the "Additional Properties" tab, enter the paths of the icon files and the path of the documentation link.</p> <p>Use the icons supplied if required (default path: Step7\s7data\s7cbac1x).</p> 

Result: The PROFINet component is saved as an XML file and the component project is saved at the specified storage location.

Note

The finished PROFINet component can be found in the tutorial install directory under

\CBA_Tutorial\S7_Projects\Et200s.

We recommend that you use it as the basis for further steps to ensure that you complete the commissioning correctly.

Representation in SIMATIC iMap

In SIMATIC iMap, the PROFINet component as a technological function has the following appearance:

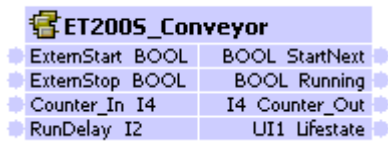

ET2005_Conveyor			
ExternStart	BOOL	BOOL	StartNext
ExternStop	BOOL	BOOL	Running
Counter_In	I4	I4	Counter_Out
RunDelay	I2	UI1	Lifestate

2.5.2 Creating the PROFINet Component for ET 200X with BM147/CPU

For plant 2, create the PROFINet component "ET200X_Conveyor" as a controller for a conveyor belt with ET 200X.

In the example, "ET200X_Conveyor" and "ET200X_Conveyor" have the same S7 programs and the same component interfaces, i.e. the requirement and procedure for creating the PROFINet component are the same as for ET 200S with IM151/CPU.

Basic procedure

The PROFINet component is created using STEP 7, essentially by applying the following steps:

1. In SIMATIC Manager, create a project for a component and configure the station hardware in HWConfig.
2. Create the interface DB for the component interface.
3. Create the S7 program.
4. Create the PROFINet component using a menu command and save it to a directory.

Configure the hardware

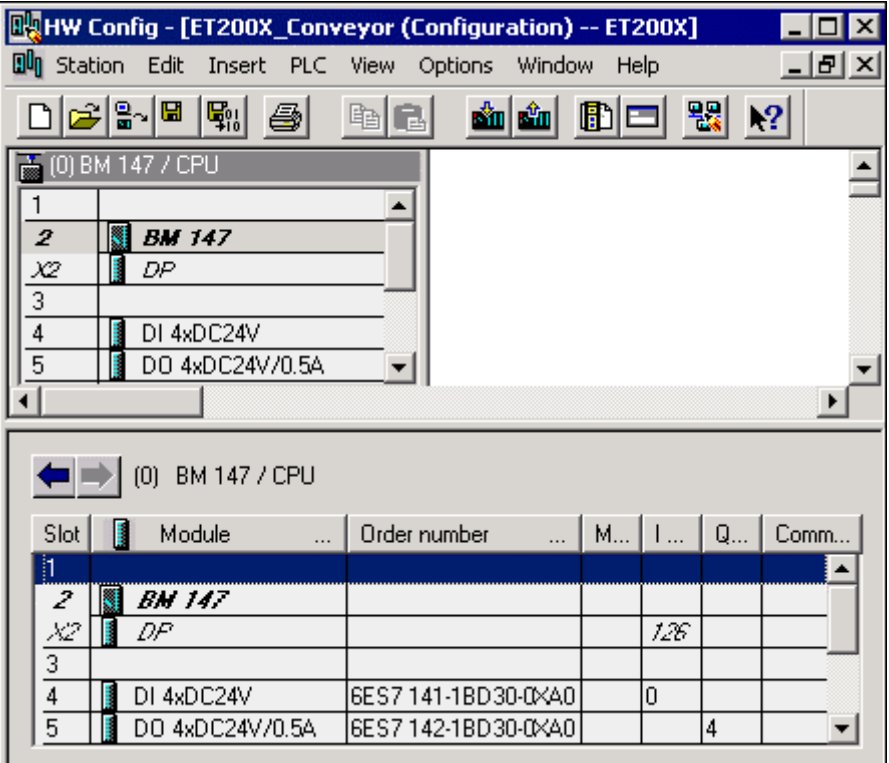
Step	Procedure																																																	
1.	Create a project in SIMATIC Manager and add a Simatic 300 station.																																																	
2.	<p>Configure the hardware as shown in the following diagram:</p>  <table border="1" data-bbox="359 1086 1189 1310"> <thead> <tr> <th>Slot</th> <th>Module</th> <th>Order number</th> <th>M...</th> <th>I ...</th> <th>Q...</th> <th>Comm...</th> </tr> </thead> <tbody> <tr> <td>1</td> <td></td> <td></td> <td></td> <td></td> <td></td> <td></td> </tr> <tr> <td>2</td> <td>BM 147</td> <td></td> <td></td> <td></td> <td></td> <td></td> </tr> <tr> <td>X2</td> <td>DP</td> <td></td> <td></td> <td>128</td> <td></td> <td></td> </tr> <tr> <td>3</td> <td></td> <td></td> <td></td> <td></td> <td></td> <td></td> </tr> <tr> <td>4</td> <td>DI 4xDC24V</td> <td>6ES7 141-1BD30-0xA0</td> <td></td> <td>0</td> <td></td> <td></td> </tr> <tr> <td>5</td> <td>DO 4xDC24V/0.5A</td> <td>6ES7 142-1BD30-0xA0</td> <td></td> <td></td> <td>4</td> <td></td> </tr> </tbody> </table>	Slot	Module	Order number	M...	I ...	Q...	Comm...	1							2	BM 147						X2	DP			128			3							4	DI 4xDC24V	6ES7 141-1BD30-0xA0		0			5	DO 4xDC24V/0.5A	6ES7 142-1BD30-0xA0			4	
Slot	Module	Order number	M...	I ...	Q...	Comm...																																												
1																																																		
2	BM 147																																																	
X2	DP			128																																														
3																																																		
4	DI 4xDC24V	6ES7 141-1BD30-0xA0		0																																														
5	DO 4xDC24V/0.5A	6ES7 142-1BD30-0xA0			4																																													

Creating the Interface DB

Step	Procedure																																																		
1.	From the <i>PROFINet System Library</i> , copy all the blocks from the "I-DP slave" block folder to the CPU block folder.																																																		
2.	In SIMATIC Manager, open the project block folder and then open DB100.																																																		
3.	<p>Use the DB100 as the template for the interface DB describing the component interface of the PROFINet component.</p> <p>Overwrite the variables and change the attributes as shown in the following diagram:</p> <table border="1"> <thead> <tr> <th>Addr</th> <th>Name</th> <th>Type</th> <th>Initia</th> <th>Comment</th> </tr> </thead> <tbody> <tr> <td>0.0</td> <td></td> <td>STRUCT</td> <td></td> <td></td> </tr> <tr> <td>+0.0</td> <td>ExternStart</td> <td>BOOL</td> <td>FALSE</td> <td>Input: external start</td> </tr> <tr> <td>+0.1</td> <td>ExternStop</td> <td>BOOL</td> <td>FALSE</td> <td>Input: external stop</td> </tr> <tr> <td>+2.0</td> <td>Counter_In</td> <td>DINT</td> <td>L#0</td> <td>Input: Counter</td> </tr> <tr> <td>+6.0</td> <td>RunDelay</td> <td>INT</td> <td>0</td> <td>Input: switch off delay</td> </tr> <tr> <td>+8.0</td> <td>StartNext</td> <td>BOOL</td> <td>FALSE</td> <td>Output: start next conveyor (if photo eye 3)</td> </tr> <tr> <td>+8.1</td> <td>Running</td> <td>BOOL</td> <td>FALSE</td> <td>Output: status info (if conveyor is running)</td> </tr> <tr> <td>+10.0</td> <td>Counter_Out</td> <td>DINT</td> <td>L#0</td> <td>Output: Counter (0Cnt=Cnt)</td> </tr> <tr> <td>=14.0</td> <td></td> <td>END_ST</td> <td></td> <td></td> </tr> </tbody> </table>	Addr	Name	Type	Initia	Comment	0.0		STRUCT			+0.0	ExternStart	BOOL	FALSE	Input: external start	+0.1	ExternStop	BOOL	FALSE	Input: external stop	+2.0	Counter_In	DINT	L#0	Input: Counter	+6.0	RunDelay	INT	0	Input: switch off delay	+8.0	StartNext	BOOL	FALSE	Output: start next conveyor (if photo eye 3)	+8.1	Running	BOOL	FALSE	Output: status info (if conveyor is running)	+10.0	Counter_Out	DINT	L#0	Output: Counter (0Cnt=Cnt)	=14.0		END_ST		
Addr	Name	Type	Initia	Comment																																															
0.0		STRUCT																																																	
+0.0	ExternStart	BOOL	FALSE	Input: external start																																															
+0.1	ExternStop	BOOL	FALSE	Input: external stop																																															
+2.0	Counter_In	DINT	L#0	Input: Counter																																															
+6.0	RunDelay	INT	0	Input: switch off delay																																															
+8.0	StartNext	BOOL	FALSE	Output: start next conveyor (if photo eye 3)																																															
+8.1	Running	BOOL	FALSE	Output: status info (if conveyor is running)																																															
+10.0	Counter_Out	DINT	L#0	Output: Counter (0Cnt=Cnt)																																															
=14.0		END_ST																																																	
4.	<p>Check the user-defined attributes in the following declaration lines:</p> <p>ExternStart</p> <table border="1"> <thead> <tr> <th colspan="3">Properties - Parameters</th> </tr> <tr> <th></th> <th>Attribute</th> <th>Value</th> </tr> </thead> <tbody> <tr> <td>1</td> <td>CBA_direction</td> <td>in</td> </tr> </tbody> </table> <p>Pad</p> <table border="1"> <thead> <tr> <th colspan="3">Properties - Parameters</th> </tr> <tr> <th></th> <th>Attribute</th> <th>Value</th> </tr> </thead> <tbody> <tr> <td>1</td> <td>CBA_pad_item</td> <td>true</td> </tr> </tbody> </table> <p>StartNext</p> <table border="1"> <thead> <tr> <th colspan="3">Properties - Parameters</th> </tr> <tr> <th></th> <th>Attribute</th> <th>Value</th> </tr> </thead> <tbody> <tr> <td>1</td> <td>CBA_direction</td> <td>out</td> </tr> </tbody> </table> <p>The user-defined attributes are indicated by flags, and are already included in the DB100 template.</p>	Properties - Parameters				Attribute	Value	1	CBA_direction	in	Properties - Parameters				Attribute	Value	1	CBA_pad_item	true	Properties - Parameters				Attribute	Value	1	CBA_direction	out																							
Properties - Parameters																																																			
	Attribute	Value																																																	
1	CBA_direction	in																																																	
Properties - Parameters																																																			
	Attribute	Value																																																	
1	CBA_pad_item	true																																																	
Properties - Parameters																																																			
	Attribute	Value																																																	
1	CBA_direction	out																																																	

Further information...

on the interface DB and user-defined attributes can be found under "Interface DB properties" in the SIMATIC iMap Basic Help.

Create the S7 program

Step	Procedure
1.	<p>Create the S7 program. The following section from the OB1 is given by way of example. The sources can be found in the finished STEP7 project.</p> <pre> //refreshing the input section of the interface db CALL "PN_IN" DB_NO :="PN_IO_DB" RET_VAL:=MW20 //calling the technological function block "conveyor" CALL "CONVEYOR" , DB40 ExternStop :="PN_Interface_DB".ExternStart ExternStart :="PN_Interface_DB".ExternStop RunDelay :="PN_Interface_DB".RunDelay IOPhotoEye1 :="IO_PhotoEye1" IOPhotoEye2 :="IO_PhotoEye2" IOPhotoEye3 :="IO_PhotoEye3" IOEStop :=FALSE StartNext :=DB100.DBX8.0 Running :=DB100.DBX8.1 IOConveyorStart:="IO_ConveyorStart" //forwarding the counter value L "PN_Interface_DB".Counter_In T "PN_Interface_DB".Counter_Out //optical signal U "IO_ConveyorStart" = "IO_Signal" //refreshing the output section of the interface db CALL "PN_OUT" DB_NO :="PN_IO_DB" RET_VAL:=MW22 </pre>
2.	Compile and test the S7 program.

Attention

Please note that the PN_IN (FC10) block at the start of the OB1 and the PN_OUT (FC11) block at the end of the OB1 both have to be called.

Note

The finished STEP7 component project with all the necessary blocks of the S7 program can be found in the tutorial install directory under

\CBA_Tutorial\S7_Projects\Et200x or under Step7\examples\ZEn27_07.

We recommend that you use the project supplied as the basis for further steps to ensure that you complete the commissioning correctly.

Create the PROFINet component

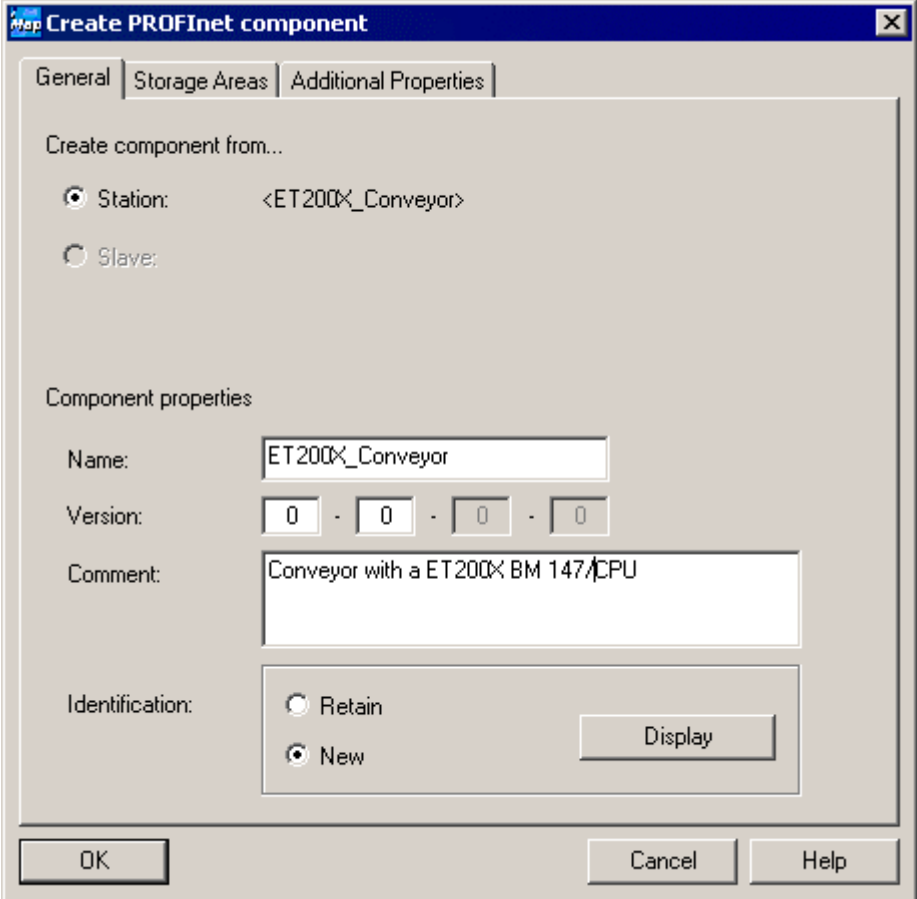
Step	Procedure
1.	In SIMATIC Manager, highlight the Simatic 300 station, and then select Create PROFINet Component from the context menu.
2.	<p>On the "General" tab, select the "Identification" New option and enter "ET200X_Conveyor" as the name.</p> 

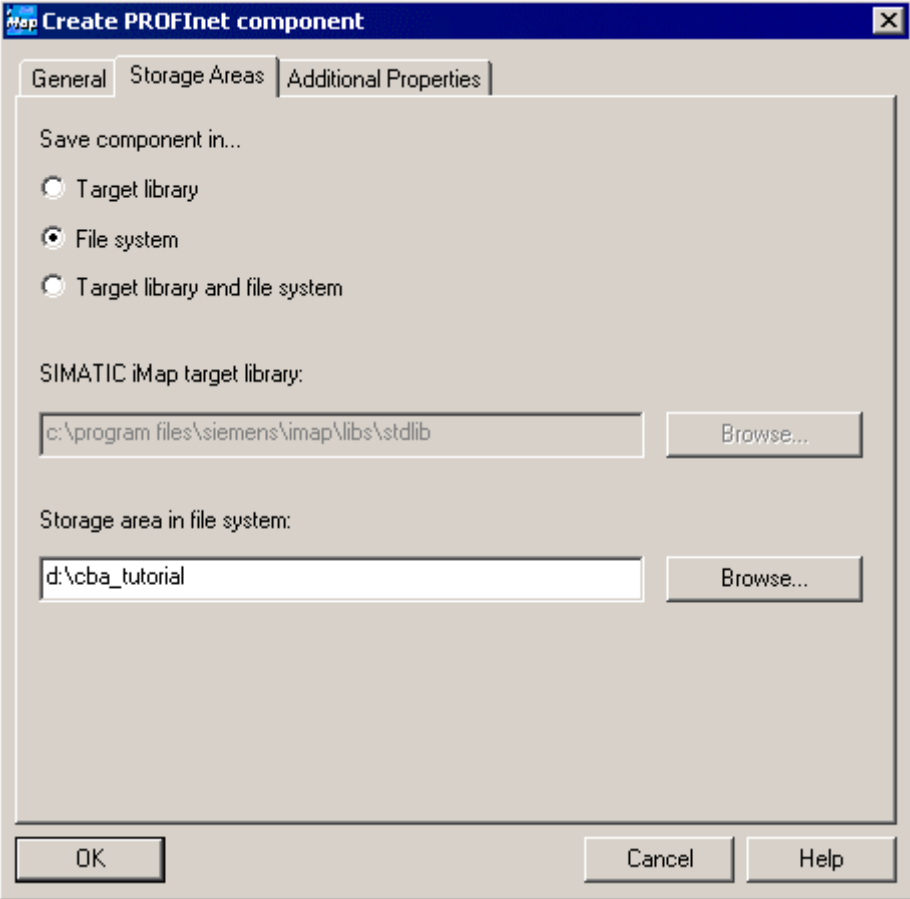
Step	Procedure
3.	<p>On the "Storage Areas" tab, enter the path D:\cba_tutorial (where D is any drive of your choice).</p>  <p>The screenshot shows a dialog box titled "Create PROFINet component" with three tabs: "General", "Storage Areas", and "Additional Properties". The "Storage Areas" tab is active. Under "Save component in...", the "File system" radio button is selected. Below this, there are two text input fields, each with a "Browse..." button to its right. The first field is labeled "SIMATIC IMap target library:" and contains the text "c:\program files\siemens\imap\libs\stdlib". The second field is labeled "Storage area in file system:" and contains the text "d:\cba_tutorial". At the bottom of the dialog are three buttons: "OK", "Cancel", and "Help".</p>

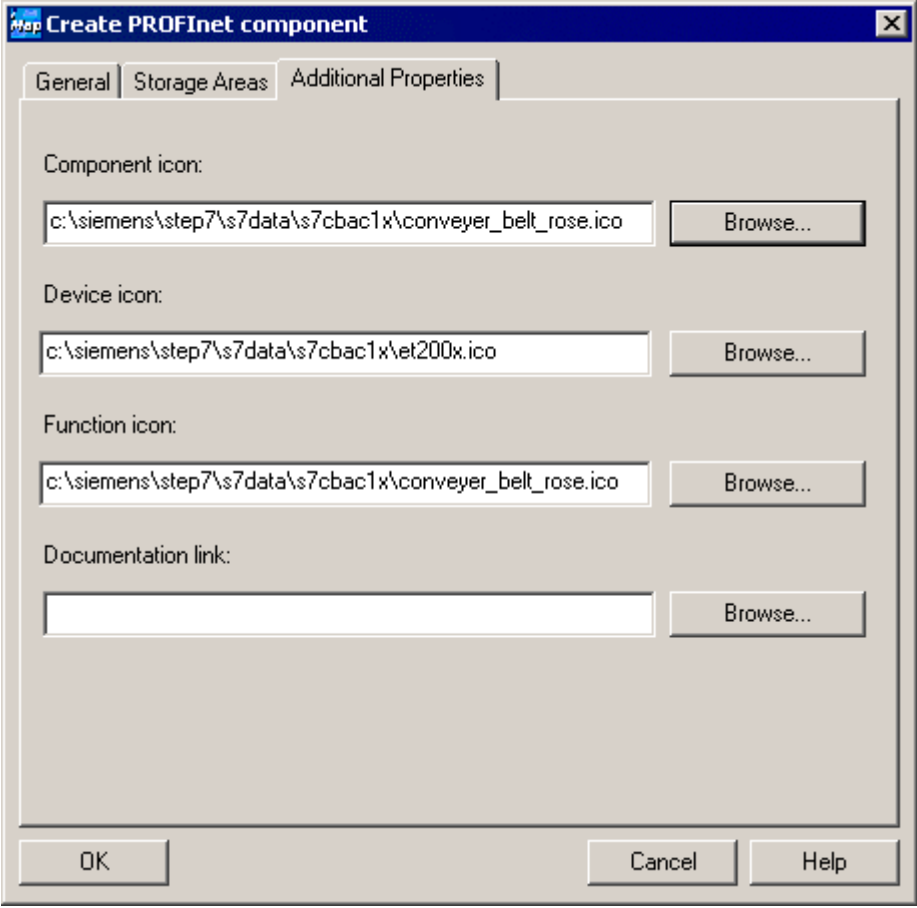
Step	Procedure
4.	<p>On the "Additional Properties" tab, enter the paths of the icon files and the path of the documentation link.</p> <p>Use the icons supplied if required (default path: Step7\s7data\s7cbac1x).</p> 

Result: The PROFInet component is saved as an XML file and the component project is saved at the specified storage location.

Note

The finished PROFInet component can be found in the tutorial install directory under

`\CBA_Tutorial\PROFInet_Components\et200x_conveyor-{...}`

We recommend that you use it as the basis for further steps to ensure that you complete the commissioning correctly.

Representation in SIMATIC iMap

In SIMATIC iMap, the PROFINet component as a technological function has the following appearance:

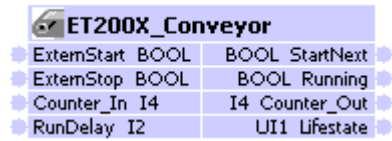

ET200X_Conveyor			
ExternStart	BOOL	BOOL	StartNext
ExternStop	BOOL	BOOL	Running
Counter_In	I4	I4	Counter_Out
RunDelay	I2	UI1	Lifestate

2.6 Plant 3: Creating PROFINet Components

For plant 3, create PROFINet components for the PC station with WinLC PN and for the ET 200S with IM151/CPU and ET 200M devices.

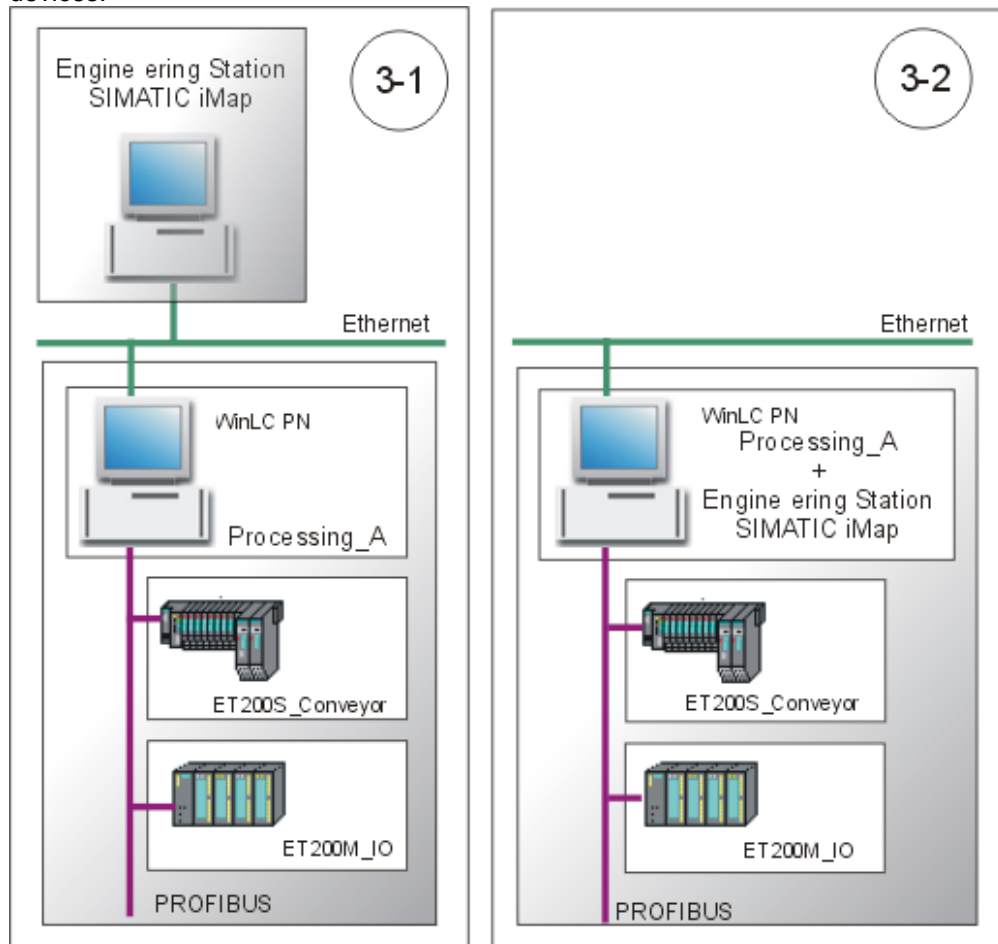

Plant 3

Each PROFINet component contains:

PROFINet component	PROFINet device	PROFIBUS device	Technological function
Processing_A	PC station with WinLC PN		Processing station (S7 program with the component interface)
ET200S_Conveyor		ET 200S with IM151/CPU	Conveyor station (S7 program with the component interface)
ET200M_IO		ET 200M with IM153	Component interface only (see below)

Note

You can use the PROFINet component "ET200S_Conveyor" from plant 2 for plant 3 as well.

2.6.1 Creating the PROFINet Component for WinLC PN

For plant 3, create the PROFINet component "Processing_A" as the coordinator for several conveyor systems.

Basic procedure

The PROFINet component is created using STEP 7, essentially by applying the following steps:

1. In SIMATIC Manager, create a project for a component and configure the station hardware in HWConfig.
2. Create the interface DB for the component interface.
3. Create the S7 program.
4. Create the PROFINet component using a menu command and save it to a directory.

Configure the hardware

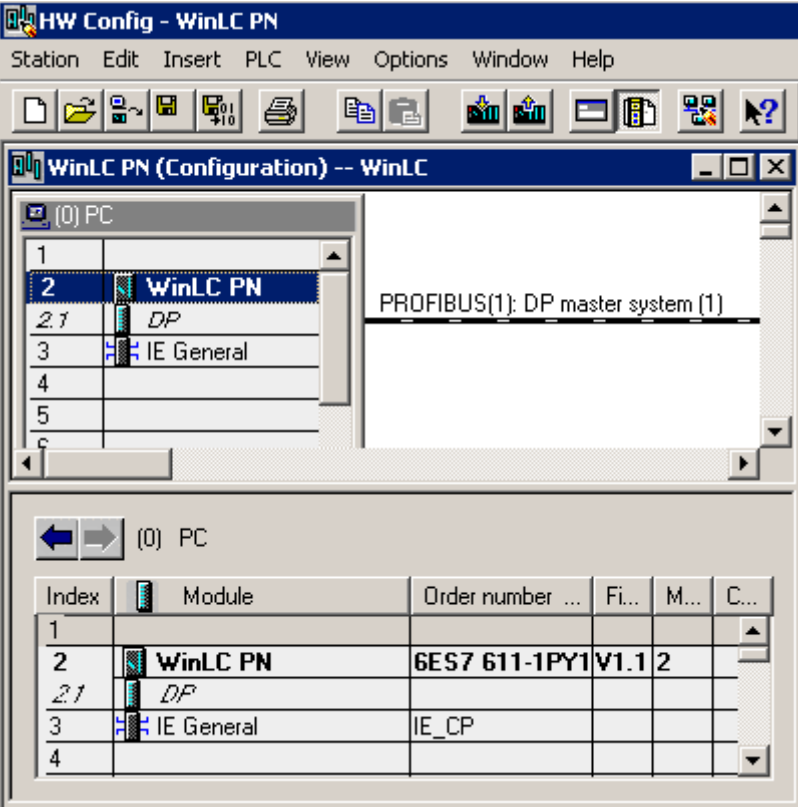
Step	Procedure																																				
1.	Create a project in SIMATIC Manager and add a Simatic PC station.																																				
2.	<p>Configure the hardware as shown in the following diagram:</p>  <p>The screenshot shows the 'HW Config - WinLC PN' application window. The main configuration area displays a rack with the following modules:</p> <ul style="list-style-type: none"> Index 1: (empty) Index 2: WinLC PN Index 2.1: DP Index 3: IE General Index 4: (empty) Index 5: (empty) Index 6: (empty) <p>The hardware catalog at the bottom shows the following table:</p> <table border="1" data-bbox="406 1142 1157 1355"> <thead> <tr> <th>Index</th> <th>Module</th> <th>Order number ...</th> <th>Fi...</th> <th>M...</th> <th>C...</th> </tr> </thead> <tbody> <tr> <td>1</td> <td></td> <td></td> <td></td> <td></td> <td></td> </tr> <tr> <td>2</td> <td>WinLC PN</td> <td>6ES7 611-1PY1V1.1 2</td> <td></td> <td></td> <td></td> </tr> <tr> <td>2.1</td> <td>DP</td> <td></td> <td></td> <td></td> <td></td> </tr> <tr> <td>3</td> <td>IE General</td> <td>IE_CP</td> <td></td> <td></td> <td></td> </tr> <tr> <td>4</td> <td></td> <td></td> <td></td> <td></td> <td></td> </tr> </tbody> </table>	Index	Module	Order number ...	Fi...	M...	C...	1						2	WinLC PN	6ES7 611-1PY1V1.1 2				2.1	DP					3	IE General	IE_CP				4					
Index	Module	Order number ...	Fi...	M...	C...																																
1																																					
2	WinLC PN	6ES7 611-1PY1V1.1 2																																			
2.1	DP																																				
3	IE General	IE_CP																																			
4																																					

Create the Interface DB

Step	Procedure
1.	From the <i>PROFINet System Library</i> , copy all the blocks from the "WinLC PN" block folder to the block folder for the WinLC PN.
2.	In SIMATIC Manager, open the project block folder and then open DB100.
3.	Use the DB100 as the template for the interface DB describing the component interface of the PROFINet component. Overwrite the variables and attributes as shown in the following diagram:

Adresse	Name	Type	Initial	Comment
0.0		STRUCT		
+0.0	PowerOn	BOOL	FALSE	Input: Enable component
+2.0	RunDelay	INT	0	Input: Delay for switch off (seconds)
+4.0	HMIStop	BOOL	FALSE	Input: HMIStop
+6.0	Counter_In	DINT	L#0	Input: Counter
+10.0	Data_In	BYTE	B#16#0	Input: IO Data In
+11.0	pad	BYTE	B#16#0	Pad_Item
+12.0	StandBy	BYTE	B#16#0	Output: StandBy modus
+14.0	RunDelay_Out	INT	0	Output: Delay for switch off
+16.0	HMIStop_Out	BOOL	FALSE	Output: HMIStop
+18.0	Counter_Out	DINT	L#0	Output: Counter (counts if Cnt==0Cnt)
+22.0	Data_Out	BYTE	B#16#0	Output: IO Data Out
+23.0	Producing	BOOL	FALSE	Output: Producing modus
=24.0		END_STRUCT		

Step	Procedure																											
4.	<p>Check the user-defined attributes in the following declaration lines:</p> <p>PowerOn</p> <table border="1"> <thead> <tr> <th colspan="3">Properties - Parameters</th> </tr> <tr> <th></th> <th>Attribute</th> <th>Value</th> </tr> </thead> <tbody> <tr> <td>1</td> <td>CBA_direction</td> <td>in</td> </tr> </tbody> </table> <p>Pad</p> <table border="1"> <thead> <tr> <th colspan="3">Properties - Parameters</th> </tr> <tr> <th></th> <th>Attribute</th> <th>Value</th> </tr> </thead> <tbody> <tr> <td>1</td> <td>CBA_pad_item</td> <td>true</td> </tr> </tbody> </table> <p>StandBy</p> <table border="1"> <thead> <tr> <th colspan="3">Properties - Parameters</th> </tr> <tr> <th></th> <th>Attribute</th> <th>Value</th> </tr> </thead> <tbody> <tr> <td>1</td> <td>CBA_direction</td> <td>out</td> </tr> </tbody> </table> <p>The user-defined attributes are indicated by flags, and are already included in the DB100 template.</p>	Properties - Parameters				Attribute	Value	1	CBA_direction	in	Properties - Parameters				Attribute	Value	1	CBA_pad_item	true	Properties - Parameters				Attribute	Value	1	CBA_direction	out
Properties - Parameters																												
	Attribute	Value																										
1	CBA_direction	in																										
Properties - Parameters																												
	Attribute	Value																										
1	CBA_pad_item	true																										
Properties - Parameters																												
	Attribute	Value																										
1	CBA_direction	out																										

Further information...

on the interface DB and user-defined attributes can be found under "Interface DB properties" in the SIMATIC iMap Basic Help.

Create the S7 program

Step	Procedure
1.	<p>Create the program. The following section from the OB1 is given by way of example. The sources can be found in the finished STEP7 project.</p> <pre> //forwards RunDelay to ORunDelay L "PN_Interface_DB".RunDelay T "PN_Interface_DB".RunDelay_Out //forwards EStop to OESop U "PN_Interface_DB".HMISop = "PN_Interface_DB".HMISop_Out //increments OCnt if Cnt==OCnt L "PN_Interface_DB".Counter_In L "PN_Interface_DB".Counter_Out <>D SPB GO L "PN_Interface_DB".Counter_Out L 1 +D T "PN_Interface_DB".Counter_Out GO: NOP 0 </pre>
2.	Compile and test the S7 program.

Note

The finished STEP7 component project with all the necessary blocks of the S7 program can be found in the tutorial install directory under

\CBA_Tutorial\S7_Projects\WinLC or under Step7\examples\ZEn27_04.

We recommend that you use the project supplied as the basis for further steps to ensure that you complete the commissioning correctly.

Create the PROFINet component

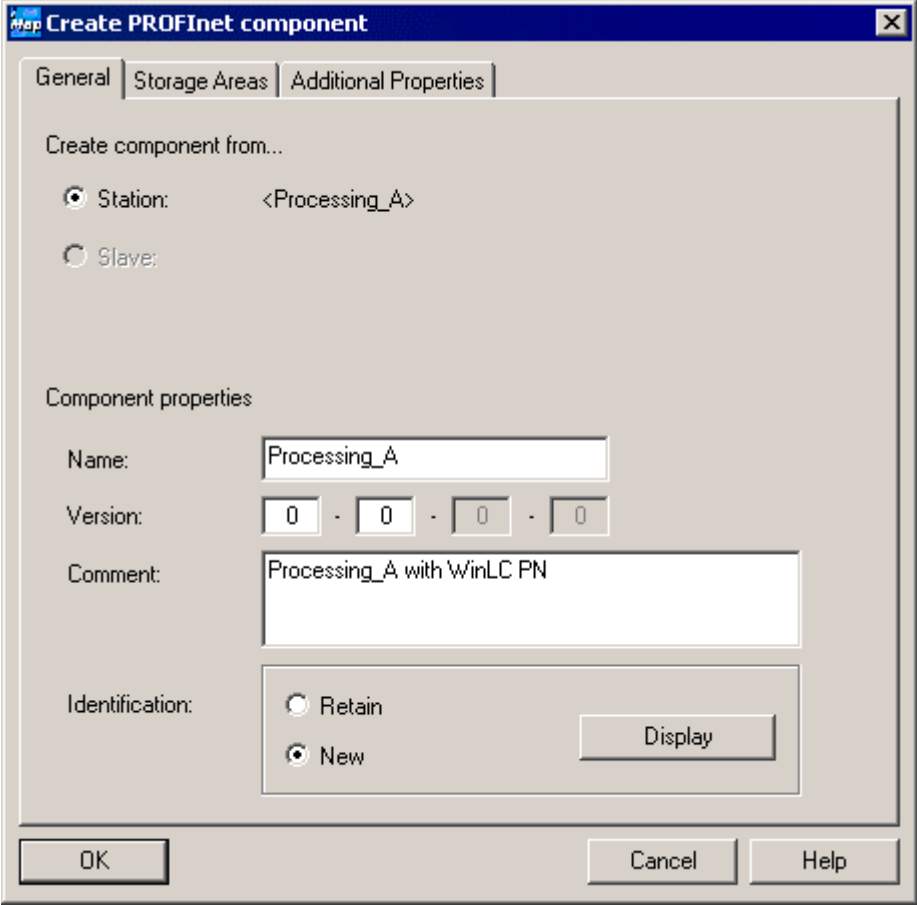
Step	Procedure
1.	In SIMATIC Manager, highlight the Simatic PC station, and then select Create PROFINet Component from the context menu.
2.	<p>On the "General" tab, highlight the "Identification" New option and enter the following name: "Processing_B".</p> 

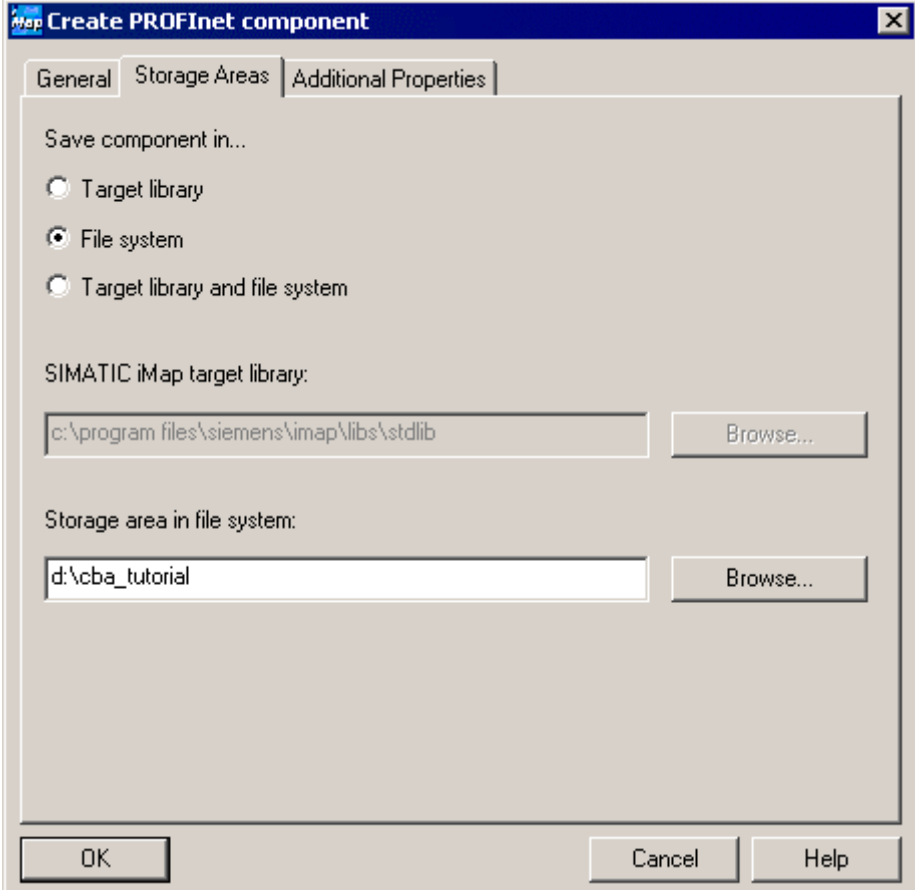
Step	Procedure
3.	<p data-bbox="322 347 1334 414">On the "Storage Areas" tab, enter the path D:\cba_tutorial (where D is any drive of your choice).</p>  <p>The screenshot shows a dialog box titled "Create PROFINet component" with three tabs: "General", "Storage Areas", and "Additional Properties". The "Storage Areas" tab is active. Under "Save component in...", the "File system" radio button is selected. Below this, there are two text input fields, each with a "Browse..." button to its right. The first field is labeled "SIMATIC IMap target library:" and contains the text "c:\program files\siemens\imap\libs\stdlibb". The second field is labeled "Storage area in file system:" and contains the text "d:\cba_tutorial". At the bottom of the dialog are three buttons: "OK", "Cancel", and "Help".</p>

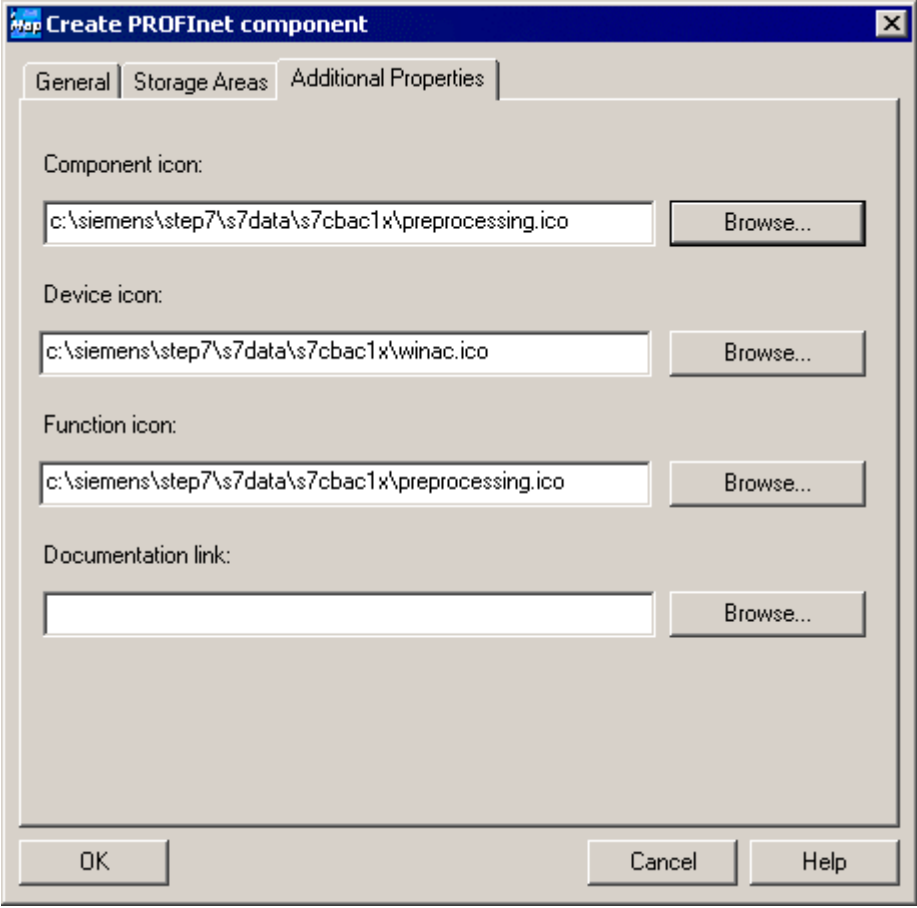
Step	Procedure
4.	<p>On the "Additional Properties" tab, enter the paths of the icon files and the path of the documentation link.</p> <p>Use the icons supplied if required (default path: Step7\s7data\s7cbac1x).</p> 

Result: The PROFInet component is saved as an XML file and the component project is saved at the specified storage location.

Note

The finished PROFInet component can be found in the tutorial install directory under

`\CBA_Tutorial\PROFInet_Components\processing_a-{...}`

We recommend that you use it as the basis for further steps to ensure that you complete the commissioning correctly.

Representation in SIMATIC iMap

In SIMATIC iMap, the PROFINet component as a technological function has the following appearance:

Processing_A	
PowerOn BOOL	UI1 StandBy
RunDelay I2	I2 RunDelay_Out
HMIStop BOOL	BOOL HMIStop_Out
Counter_In I4	I4 Counter_Out
Data_In UI1	UI1 Data_Out
	BOOL Producing
	UI1 Lifestate

2.6.2 Creating the PROFINet Component for ET 200S with IM151/CPU

For plant 2, create the PROFINet component "ET200S_Conveyor" as a controller for a conveyor belt with ET 200S.

Basic procedure

The PROFINet component is created using STEP 7, essentially by applying the following steps:

1. In SIMATIC Manager, create a project for a component and configure the station hardware in HW Config.
2. Create the interface DB for the component interface.
3. Create the S7 program.
4. Create the PROFINet component using a menu command and save it to a directory.

Configure the hardware

Step	Procedure																																																																																
1.	Create a project in SIMATIC Manager and add a Simatic 300 station.																																																																																
2.	Configure the hardware as shown in the following diagram: <div data-bbox="367 571 1364 1512" style="border: 1px solid black; padding: 5px;"> <table border="1" data-bbox="399 1131 1332 1444"> <thead> <tr> <th>St...</th> <th>Baugruppe</th> <th>Bestellnummer</th> <th>Firm...</th> <th>M...</th> <th>E-Adr...</th> <th>A-A...</th> <th>Ko...</th> </tr> </thead> <tbody> <tr> <td>1</td> <td></td> <td></td> <td></td> <td></td> <td></td> <td></td> <td></td> </tr> <tr> <td>2</td> <td>IM151 / CPU</td> <td></td> <td>V2.0</td> <td></td> <td></td> <td></td> <td></td> </tr> <tr> <td>X1</td> <td>MPI/DP</td> <td></td> <td></td> <td></td> <td>2047"</td> <td></td> <td></td> </tr> <tr> <td>3</td> <td></td> <td></td> <td></td> <td></td> <td></td> <td></td> <td></td> </tr> <tr> <td>4</td> <td>PM-E DC24V</td> <td>6ES7 138-4CA00-0AA0</td> <td></td> <td></td> <td></td> <td></td> <td></td> </tr> <tr> <td>5</td> <td>2 DI DC24V High Feature</td> <td>6ES7 131-4BB00-0AB0</td> <td></td> <td></td> <td>1.0...1.1</td> <td></td> <td></td> </tr> <tr> <td>6</td> <td>2 DI DC24V High Feature</td> <td>6ES7 131-4BB00-0AB0</td> <td></td> <td></td> <td>2.0...2.1</td> <td></td> <td></td> </tr> <tr> <td>7</td> <td>2 DO DC24V/0.5A High Fe</td> <td>6ES7 132-4BB00-0AB0</td> <td></td> <td></td> <td></td> <td>3.0...3.1</td> <td></td> </tr> <tr> <td>8</td> <td>2 DO DC24V/0.5A High Fe</td> <td>6ES7 132-4BB00-0AB0</td> <td></td> <td></td> <td></td> <td>4.0...4.1</td> <td></td> </tr> </tbody> </table> <p>Drücken Sie F1, um Hilfe zu erhalten.</p> </div>	St...	Baugruppe	Bestellnummer	Firm...	M...	E-Adr...	A-A...	Ko...	1								2	IM151 / CPU		V2.0					X1	MPI/DP				2047"			3								4	PM-E DC24V	6ES7 138-4CA00-0AA0						5	2 DI DC24V High Feature	6ES7 131-4BB00-0AB0			1.0...1.1			6	2 DI DC24V High Feature	6ES7 131-4BB00-0AB0			2.0...2.1			7	2 DO DC24V/0.5A High Fe	6ES7 132-4BB00-0AB0				3.0...3.1		8	2 DO DC24V/0.5A High Fe	6ES7 132-4BB00-0AB0				4.0...4.1	
St...	Baugruppe	Bestellnummer	Firm...	M...	E-Adr...	A-A...	Ko...																																																																										
1																																																																																	
2	IM151 / CPU		V2.0																																																																														
X1	MPI/DP				2047"																																																																												
3																																																																																	
4	PM-E DC24V	6ES7 138-4CA00-0AA0																																																																															
5	2 DI DC24V High Feature	6ES7 131-4BB00-0AB0			1.0...1.1																																																																												
6	2 DI DC24V High Feature	6ES7 131-4BB00-0AB0			2.0...2.1																																																																												
7	2 DO DC24V/0.5A High Fe	6ES7 132-4BB00-0AB0				3.0...3.1																																																																											
8	2 DO DC24V/0.5A High Fe	6ES7 132-4BB00-0AB0				4.0...4.1																																																																											

Create the interface DB

Step	Procedure																																																							
1.	From the <i>PROFINet System Library</i> , copy all the blocks from the "I-DP slave" block folder to the CPU block folder.																																																							
2.	In SIMATIC Manager, open the project block folder and then open DB100.																																																							
3.	<p>Use the DB100 as the template for the interface DB describing the component interface of the PROFINet component.</p> <p>Overwrite the variables and change the attributes as shown in the following diagram:</p> <table border="1"> <thead> <tr> <th>Addr:</th> <th>Name</th> <th>Type</th> <th>Initial</th> <th>Comment</th> </tr> </thead> <tbody> <tr> <td>0.0</td> <td></td> <td>STRU</td> <td></td> <td></td> </tr> <tr> <td>+0.0</td> <td>ExternStart</td> <td>BOOL</td> <td>FALSE</td> <td>external start</td> </tr> <tr> <td>+0.1</td> <td>ExternStop</td> <td>BOOL</td> <td>FALSE</td> <td>external stop</td> </tr> <tr> <td>+2.0</td> <td>Counter_In</td> <td>DINT</td> <td>L#0</td> <td>Counter</td> </tr> <tr> <td>+6.0</td> <td>RunDelay</td> <td>INT</td> <td>0</td> <td>switch off delay</td> </tr> <tr> <td>+8.0</td> <td>pad</td> <td>BYTE</td> <td>B#16#0</td> <td>Pad_item</td> </tr> <tr> <td>+9.0</td> <td>StartNext</td> <td>BOOL</td> <td>FALSE</td> <td>Output: start next conveyor (if photo eye 3)</td> </tr> <tr> <td>+9.1</td> <td>Running</td> <td>BOOL</td> <td>FALSE</td> <td>Output: status info (if conveyor is running)</td> </tr> <tr> <td>+10.0</td> <td>Counter_Out</td> <td>DINT</td> <td>L#0</td> <td>Output: Counter (OCnt=Cnt)</td> </tr> <tr> <td>=14.0</td> <td></td> <td>END</td> <td></td> <td></td> </tr> </tbody> </table>	Addr:	Name	Type	Initial	Comment	0.0		STRU			+0.0	ExternStart	BOOL	FALSE	external start	+0.1	ExternStop	BOOL	FALSE	external stop	+2.0	Counter_In	DINT	L#0	Counter	+6.0	RunDelay	INT	0	switch off delay	+8.0	pad	BYTE	B#16#0	Pad_item	+9.0	StartNext	BOOL	FALSE	Output: start next conveyor (if photo eye 3)	+9.1	Running	BOOL	FALSE	Output: status info (if conveyor is running)	+10.0	Counter_Out	DINT	L#0	Output: Counter (OCnt=Cnt)	=14.0		END		
Addr:	Name	Type	Initial	Comment																																																				
0.0		STRU																																																						
+0.0	ExternStart	BOOL	FALSE	external start																																																				
+0.1	ExternStop	BOOL	FALSE	external stop																																																				
+2.0	Counter_In	DINT	L#0	Counter																																																				
+6.0	RunDelay	INT	0	switch off delay																																																				
+8.0	pad	BYTE	B#16#0	Pad_item																																																				
+9.0	StartNext	BOOL	FALSE	Output: start next conveyor (if photo eye 3)																																																				
+9.1	Running	BOOL	FALSE	Output: status info (if conveyor is running)																																																				
+10.0	Counter_Out	DINT	L#0	Output: Counter (OCnt=Cnt)																																																				
=14.0		END																																																						
4.	<p>Check the user-defined attributes in the following declaration lines:</p> <p>ExternStart</p> <table border="1"> <thead> <tr> <th colspan="3">Properties - Parameters</th> </tr> <tr> <th></th> <th>Attribute</th> <th>Value</th> </tr> </thead> <tbody> <tr> <td>1</td> <td>CBA_direction</td> <td>in</td> </tr> </tbody> </table> <p>Pad</p> <table border="1"> <thead> <tr> <th colspan="3">Properties - Parameters</th> </tr> <tr> <th></th> <th>Attribute</th> <th>Value</th> </tr> </thead> <tbody> <tr> <td>1</td> <td>CBA_pad_item</td> <td>true</td> </tr> </tbody> </table> <p>StartNext</p> <table border="1"> <thead> <tr> <th colspan="3">Properties - Parameters</th> </tr> <tr> <th></th> <th>Attribute</th> <th>Value</th> </tr> </thead> <tbody> <tr> <td>1</td> <td>CBA_direction</td> <td>out</td> </tr> </tbody> </table> <p>The user-defined attributes are indicated by flags, and are already included in the DB100 template.</p>	Properties - Parameters				Attribute	Value	1	CBA_direction	in	Properties - Parameters				Attribute	Value	1	CBA_pad_item	true	Properties - Parameters				Attribute	Value	1	CBA_direction	out																												
Properties - Parameters																																																								
	Attribute	Value																																																						
1	CBA_direction	in																																																						
Properties - Parameters																																																								
	Attribute	Value																																																						
1	CBA_pad_item	true																																																						
Properties - Parameters																																																								
	Attribute	Value																																																						
1	CBA_direction	out																																																						

Further information...

on the interface DB and user-defined attributes can be found under "Interface DB properties" in the SIMATIC iMap Basic Help.

Create the S7 program

Step	Procedure
1.	<p>Create the S7 program. The following section from the OB1 is given by way of example. The sources can be found in the finished STEP7 project.</p> <pre> //refreshing the input section of the interface db CALL "PN_IN" DB_NO :="PN_IO_DB" RET_VAL:=MW20 //calling the technological function block "conveyor" CALL "CONVEYOR" , DB40 ExternStop :="PN_Interface_DB".ExternStart ExternStart :="PN_Interface_DB".ExternStop RunDelay :="PN_Interface_DB".RunDelay IOPhotoEye1 :="IO_PhotoEye1" IOPhotoEye2 :="IO_PhotoEye2" IOPhotoEye3 :="IO_PhotoEye3" IOEStop :=FALSE StartNext :=DB100.DBX8.0 Running :=DB100.DBX8.1 IOConveyorStart:="IO_ConveyorStart" //forwarding the counter value L "PN_Interface_DB".Counter_In T "PN_Interface_DB".Counter_Out //optical signal U "IO_ConveyorStart" = "IO_Signal" //refreshing the output section of the interface db CALL "PN_OUT" DB_NO :="PN_IO_DB" RET_VAL:=MW22 </pre>
2.	Compile and test the S7 program.

Attention

Please note that the PN_IN (FC10) block at the start of the OB1 and the PN_OUT (FC11) block at the end of the OB1 both have to be called.

Note

The finished STEP7 component project with all the necessary blocks of the S7 program can be found in the tutorial install directory under

\CBA_Tutorial\S7_Projects\Et200s or under Step7\examples\ZEn27_06.

We recommend that you use the project supplied as the basis for further steps to ensure that you complete the commissioning correctly.

Create the PROFINet component

Step	Procedure
1.	In SIMATIC Manager, highlight the Simatic 300 station, and then select Create PROFINet Component from the context menu.
2.	On the "General" tab, highlight the "Identification" New option and enter the following name: "ET200S_Conveyor".

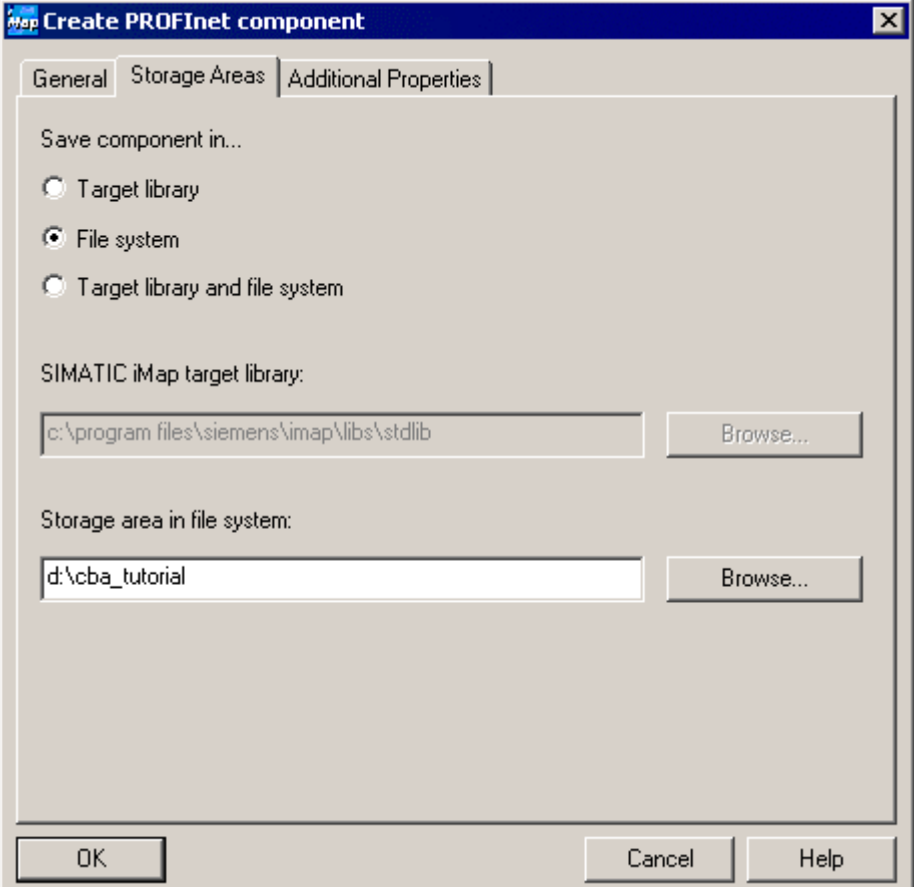
Step	Procedure
3.	<p>On the "Storage Areas" tab, enter the path D:\cba_tutorial (where D is any drive of your choice).</p>  <p>The screenshot shows a dialog box titled "Create PROFINet component" with three tabs: "General", "Storage Areas", and "Additional Properties". The "Storage Areas" tab is active. Under "Save component in...", the "File system" radio button is selected. Below, the "SIMATIC iMap target library:" field contains the path "c:\program files\siemens\imap\libs\stdlib" with a "Browse..." button to its right. The "Storage area in file system:" field contains the path "d:\cba_tutorial" with a "Browse..." button to its right. At the bottom are "OK", "Cancel", and "Help" buttons.</p>

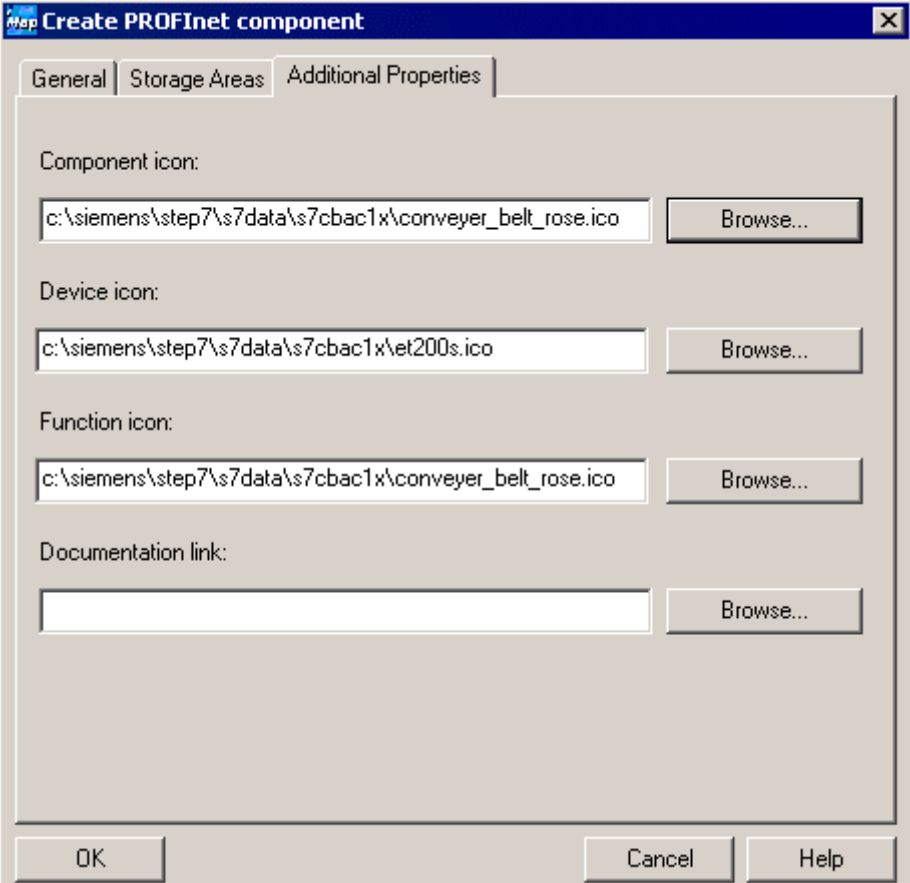
Step	Procedure
4.	<p>On the "Additional Properties" tab, enter the paths of the icon files and the path of the documentation link.</p> <p>Use the icons supplied if required (default path: Step7\s7data\s7cbac1x).</p> 

Result: The PROFINet component is saved as an XML file and the component project is saved at the specified storage location.

Note

The finished PROFINet component can be found in the tutorial install directory under

\CBA_Tutorial\S7_Projects\Et200s.

We recommend that you use it as the basis for further steps to ensure that you complete the commissioning correctly.

Representation in SIMATIC iMap

In SIMATIC iMap, the PROFINet component as a technological function has the following appearance:

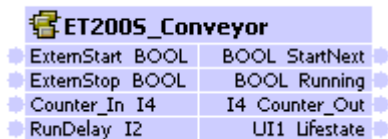

ET2005_Conveyor	
ExternStart BOOL	StartNext BOOL
ExternStop BOOL	Running BOOL
Counter_In I4	Counter_Out I4
RunDelay I2	Lifestate UI1

2.6.3 Creating the PROFINet Component for ET 200M

For plant 3, create the PROFINet component "ET200M_IO" as an I/O module.

Note

The PROFINet component ET200M_IO does not contain an S7 program. It only contains the component interface: the signal inputs are mapped directly onto the outputs of the technological function and the signal outputs onto the inputs of the technological function.

Basic procedure

The PROFINet component is created using STEP 7, essentially by applying the following steps:

1. In SIMATIC Manager, create a project for a component and configure the station hardware in HWConfig.
2. Create the interface DB for the component interface.
3. Create the S7 program.
4. Create the PROFINet component using a menu command and save it to a directory.

Configure the hardware

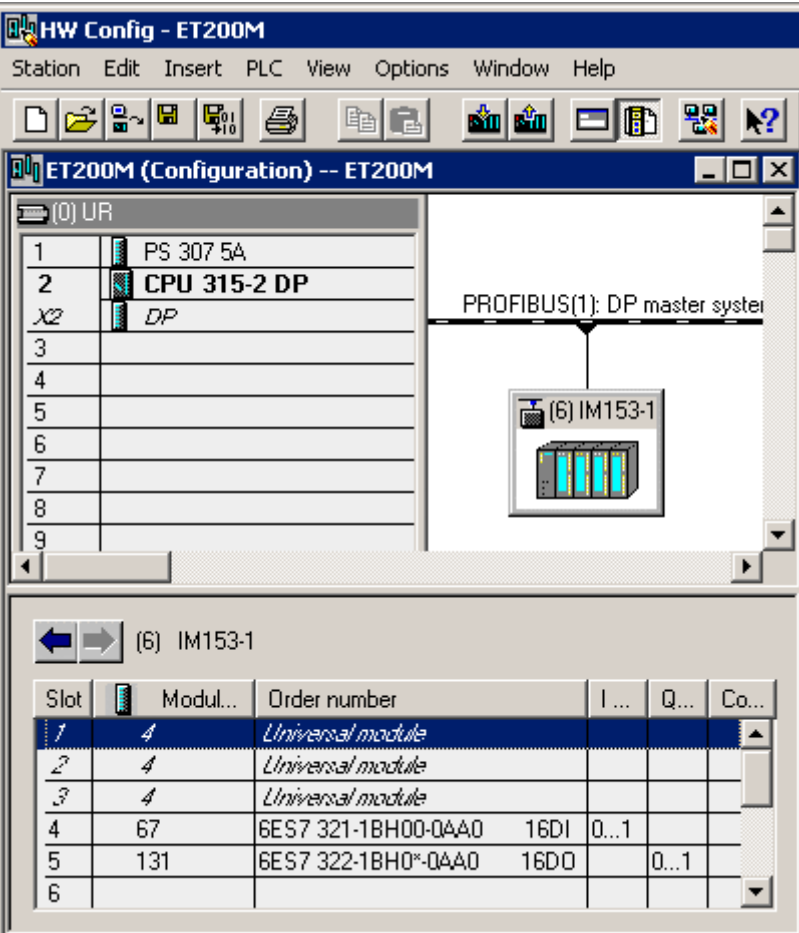
Step	Procedure																																										
1.	Create a project in SIMATIC Manager and add a Simatic 300 station.																																										
2.	Configure the hardware as shown in the following diagram: <div style="border: 1px solid black; padding: 5px; margin: 5px 0;">  <table border="1" style="width: 100%; border-collapse: collapse;"> <thead> <tr> <th>Slot</th> <th>Modul...</th> <th>Order number</th> <th>I ...</th> <th>Q...</th> <th>Co...</th> </tr> </thead> <tbody> <tr> <td>1</td> <td>4</td> <td>Universal module</td> <td></td> <td></td> <td></td> </tr> <tr> <td>2</td> <td>4</td> <td>Universal module</td> <td></td> <td></td> <td></td> </tr> <tr> <td>3</td> <td>4</td> <td>Universal module</td> <td></td> <td></td> <td></td> </tr> <tr> <td>4</td> <td>67</td> <td>6ES7 321-1BH00-0AA0</td> <td>16DI</td> <td>0...1</td> <td></td> </tr> <tr> <td>5</td> <td>131</td> <td>6ES7 322-1BH0*-0AA0</td> <td>16DO</td> <td></td> <td>0...1</td> </tr> <tr> <td>6</td> <td></td> <td></td> <td></td> <td></td> <td></td> </tr> </tbody> </table> </div> <p>The I/O modules of IM 153-2 are important.</p>	Slot	Modul...	Order number	I ...	Q...	Co...	1	4	Universal module				2	4	Universal module				3	4	Universal module				4	67	6ES7 321-1BH00-0AA0	16DI	0...1		5	131	6ES7 322-1BH0*-0AA0	16DO		0...1	6					
Slot	Modul...	Order number	I ...	Q...	Co...																																						
1	4	Universal module																																									
2	4	Universal module																																									
3	4	Universal module																																									
4	67	6ES7 321-1BH00-0AA0	16DI	0...1																																							
5	131	6ES7 322-1BH0*-0AA0	16DO		0...1																																						
6																																											

Note

The CPU (DP master) is not part of the PROFINet component to be created, so it is not displayed in SIMATIC iMap. It is needed in HW Config, however, for configuration purposes.

Create the Interface DB

Step	Procedure																																			
1.	From the <i>PROFINet System Library</i> , copy all the blocks from the "DP slave" block folder to the CPU 315-2DP block folder.																																			
2.	For the interface DB of the PROFINet component for ET 200M, note that: <ul style="list-style-type: none"> the inputs are mapped onto the addresses of the outputs, the outputs are mapped onto the addresses of the inputs. 																																			
3.	Use the DB100 as the template for the interface DB. Follow the rules for the interface DB (see Basic help for SIMATIC iMap, <i>Creating PROFINet components with STEP 7</i>). Overwrite the variables and change the attributes as shown in the following diagram: <div data-bbox="367 784 1388 1176" style="border: 1px solid black; padding: 5px; margin: 10px 0;"> <p>LAD/STL/FBD - [DB100 -- ET200M\ET200M\CPU 315-2 DP]</p> <p>File Edit Insert PLC Debug View Options Window Help</p> <table border="1" style="width: 100%; border-collapse: collapse;"> <thead> <tr> <th>Addr:</th> <th>Name</th> <th>Type</th> <th>Initial</th> <th>Comment</th> </tr> </thead> <tbody> <tr> <td>0.0</td> <td></td> <td>STRUCT</td> <td></td> <td></td> </tr> <tr> <td>+0.0</td> <td>Input1</td> <td>BYTE</td> <td>B#16#0</td> <td>Input Byte 1</td> </tr> <tr> <td>+1.0</td> <td>Input2</td> <td>BYTE</td> <td>B#16#0</td> <td>Input Byte 2</td> </tr> <tr> <td>+2.0</td> <td>Output1</td> <td>BYTE</td> <td>B#16#0</td> <td>Output Byte 1</td> </tr> <tr> <td>+3.0</td> <td>Output2</td> <td>BYTE</td> <td>B#16#0</td> <td>Output Byte 2</td> </tr> <tr> <td>=4.0</td> <td></td> <td>END_STRUCT</td> <td></td> <td></td> </tr> </tbody> </table> </div>	Addr:	Name	Type	Initial	Comment	0.0		STRUCT			+0.0	Input1	BYTE	B#16#0	Input Byte 1	+1.0	Input2	BYTE	B#16#0	Input Byte 2	+2.0	Output1	BYTE	B#16#0	Output Byte 1	+3.0	Output2	BYTE	B#16#0	Output Byte 2	=4.0		END_STRUCT		
Addr:	Name	Type	Initial	Comment																																
0.0		STRUCT																																		
+0.0	Input1	BYTE	B#16#0	Input Byte 1																																
+1.0	Input2	BYTE	B#16#0	Input Byte 2																																
+2.0	Output1	BYTE	B#16#0	Output Byte 1																																
+3.0	Output2	BYTE	B#16#0	Output Byte 2																																
=4.0		END_STRUCT																																		
4.	Check the user-defined attributes in the following declaration lines: <p>Input1</p> <div data-bbox="367 1321 1125 1444" style="border: 1px solid black; padding: 5px; margin: 10px 0;"> <p>Properties - Parameters</p> <table border="1" style="width: 100%; border-collapse: collapse;"> <thead> <tr> <th></th> <th>Attribute</th> <th>Value</th> </tr> </thead> <tbody> <tr> <td>1</td> <td>CBA_direction</td> <td>in</td> </tr> </tbody> </table> </div> <p>Output1</p> <div data-bbox="367 1478 1125 1601" style="border: 1px solid black; padding: 5px; margin: 10px 0;"> <p>Properties - Parameters</p> <table border="1" style="width: 100%; border-collapse: collapse;"> <thead> <tr> <th></th> <th>Attribute</th> <th>Value</th> </tr> </thead> <tbody> <tr> <td>1</td> <td>CBA_direction</td> <td>out</td> </tr> </tbody> </table> </div> <p>The user-defined attributes are indicated by flags, and are already included in the DB100 template.</p>		Attribute	Value	1	CBA_direction	in		Attribute	Value	1	CBA_direction	out																							
	Attribute	Value																																		
1	CBA_direction	in																																		
	Attribute	Value																																		
1	CBA_direction	out																																		

Further information...

on the interface DB and user-defined attributes can be found under "Interface DB properties" in the SIMATIC iMap Basic Help.

Create the S7 program

The ET 200M does **not** require a separate S7 program since it is a module without its own PLC (CPU).

Note

The finished STEP7 component project with all the necessary blocks of the S7 program can be found in the tutorial install directory under

\CBA_Tutorial\S7_Projects\Et200m or under Step7\examples\ZEn27_08.

We recommend that you use the project supplied as the basis for further steps to ensure that you complete the commissioning correctly.

Create the PROFINet component

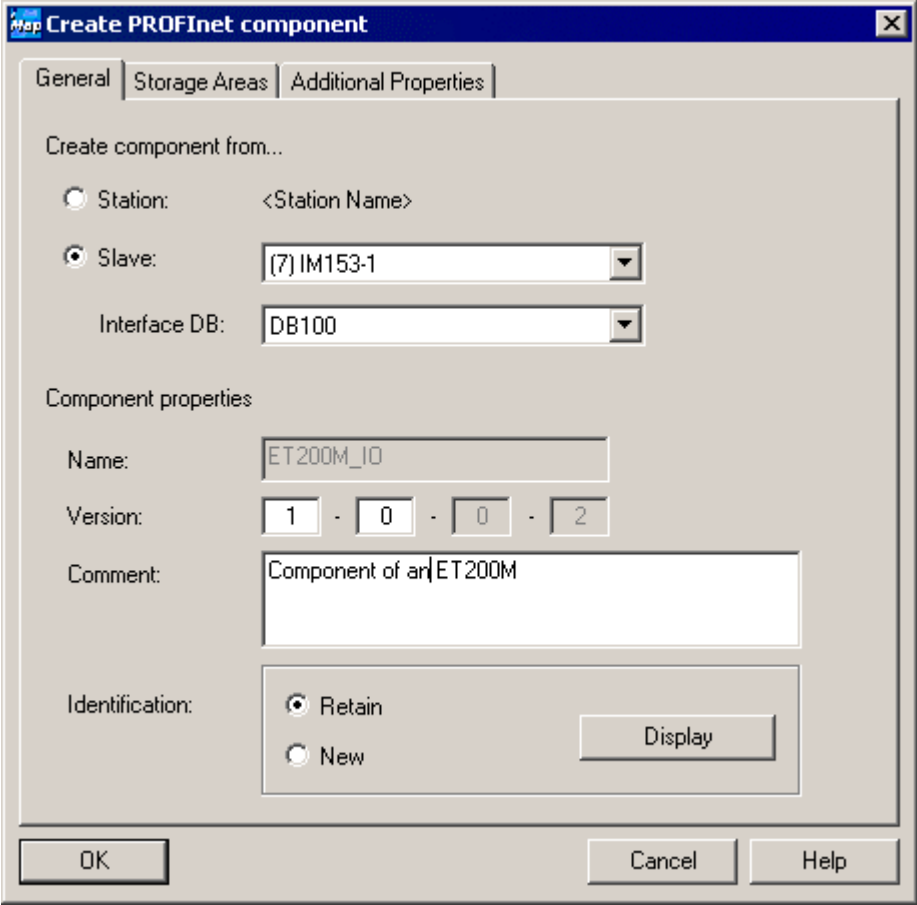
Step	Procedure
1.	In SIMATIC Manager, highlight the Simatic PC station, and then select Create PROFINet Component from the context menu.
2.	<p>On the "General" tab:</p> <ul style="list-style-type: none"> Highlight the "Create component from a slave" option and select the appropriate interface DB, e.g. DB100, from the drop-down list. Highlight the "Identification" New option and enter the following name: "ET200M_IO". 

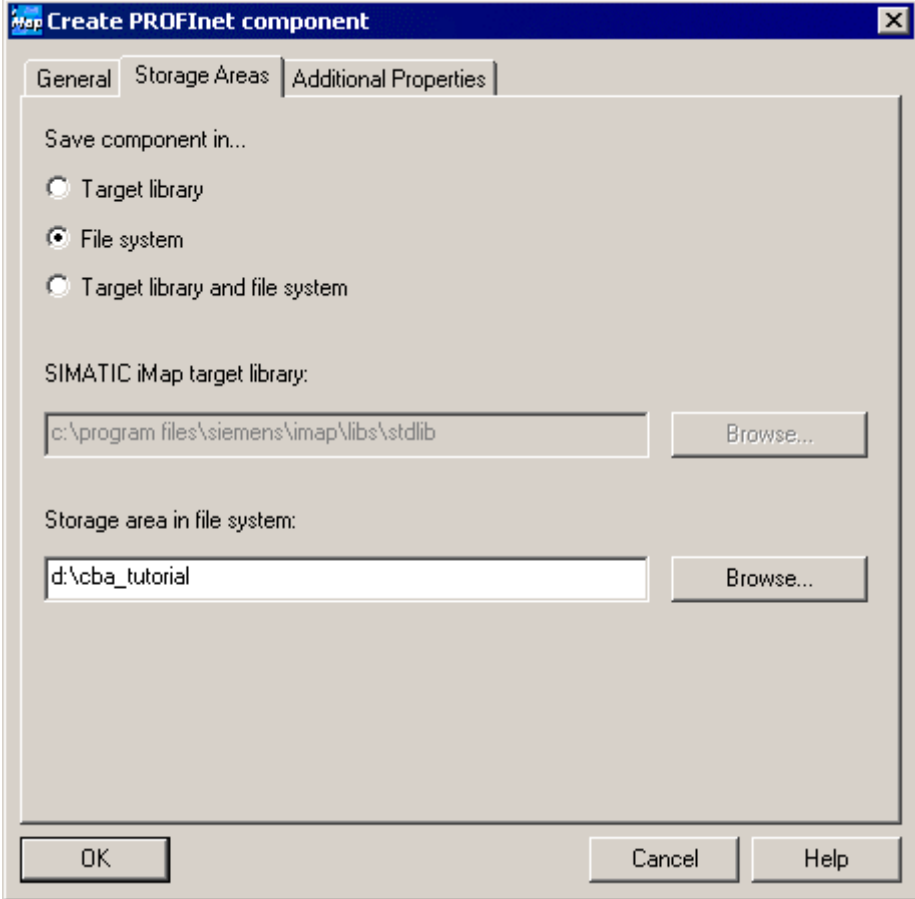
Step	Procedure
3.	<p data-bbox="322 347 1331 414">On the "Storage Areas" tab, enter the path D:\cba_tutorial (where D is any drive of your choice).</p> 

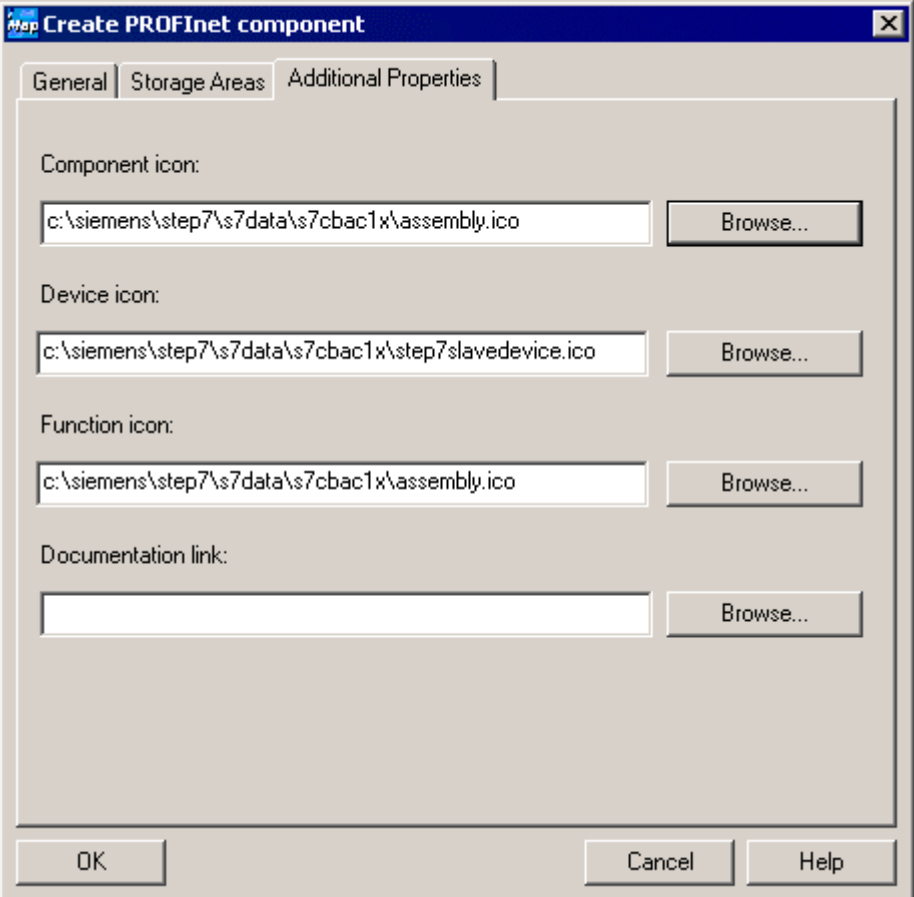
Step	Procedure
4.	<p>On the "Additional Properties" tab, enter the paths of the icon files and the path of the documentation link.</p> <p>Use the icons supplied if required (default path: Step7\s7data\s7cbac1x).</p> 

Result: The PROFInet component is saved as an XML file and the component project is saved at the specified storage location.

Note

The finished PROFInet component can be found in the tutorial install directory under

`\CBA_Tutorial\PROFInet_Components\et200m_io-{...}`

We recommend that you use it as the basis for further steps to ensure that you complete the commissioning correctly.

Representation in SIMATIC iMap

In SIMATIC iMap, the PROFINet component as a technological function has the following appearance:

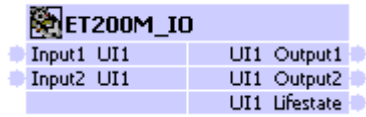

3 Part 2: Commissioning the system

Commissioning a complex plant with PROFINet and PROFIBUS devices involves a large number of tasks. The following description guides you step-by-step through the process of commissioning three typical configurations (plants 1 to 3).

3.1 Requirements - Commissioning the system

Hardware requirements

The devices must be in working order and have the latest firmware.

Tip

In the following descriptions, the devices are assigned fixed IP and PROFIBUS addresses. If commissioning is to be successful, we recommend that you use the same addresses since they are used throughout all the examples supplied.

For the plant described here, all the IP addresses must be in the same subnet.

Software requirements

The following software must be installed on the engineering station:

- Windows 2000 SP3 or later
- STEP 7 V5.2 or later
- SIMATIC iMap V1.2
- SIMATIC NET V6.0 SP6

Note

You will need administrator rights in order to install SIMATIC iMap.

You will need at least primary user rights in order to use SIMATIC iMap.

Requirement for configuring the plants in SIMATIC iMap

You must have created the PROFINet components and they must either be present in the file system or located in the tutorial install directory under

iMap\CBA_Tutorial\components

3.2 Basic procedure: Commissioning the system

The following commissioning tasks are carried out for every device in a plant:

- On the plant:
 - Set up the hardware
 - Set addresses on the PROFIBUS devices
 - Network the device and link to engineering PC
- In STEP 7:
 - Assign IP addresses for the first time, if necessary
 - Make the download, online monitoring and diagnostics settings
- In SIMATIC iMap:
 - Configure the plant
 - Start the plant
 - Monitor the plant online and diagnose

Next steps

Start up one of the following plants:

- Plant 1: A CPU 315-2DP with CP 343-1 PN
- Plant 2: An IE/PB Link with the PROFIBUS devices ET 200S with IM151/CPU and ET 200X with BM147/CPU
- Plant 3: A PC station WinLC PN with the PROFIBUS devices ET 200S with IM151/CPU and ET 200M
- Overall plant consisting of plants 1 to 3

3.3 Plant 1: CPU 315 with CP 343-1 PN

Plant 1 consists of one PROFINet component. In the following example, this PROFINet component is the controller for a processing station with conveyor belt.

The PROFINet component contains:

- the PROFINet device, consisting of a CPU 315-2 DP, a CP 343-1 PN and the associated I/O modules
- the technological function "Processing_B", consisting of the S7 program with the component interface.

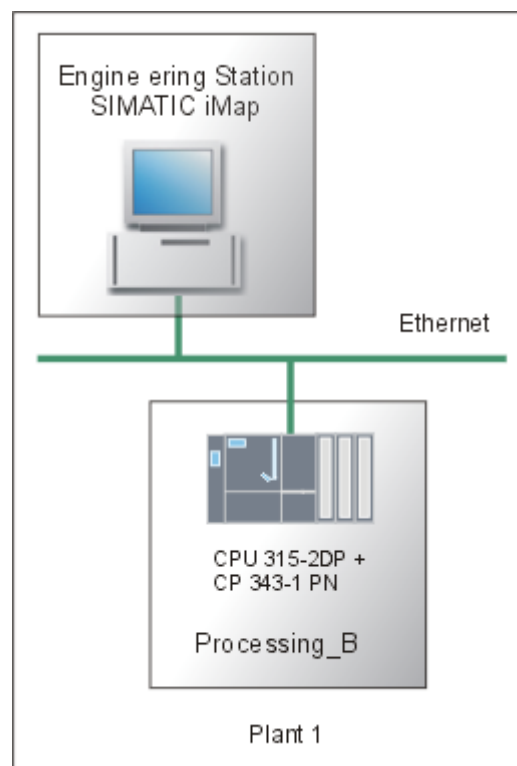

Basic procedure

The following tasks must be carried out:

1. Set up the plant hardware.
2. Configure the plant in SIMATIC iMap.
3. Assign an IP address to the device for the first time
4. Check your settings in STEP 7 in order to download the project data from SIMATIC iMap to the device and be able to monitor the plant online.
5. Start the plant
6. Monitor the plant online with SIMATIC iMap.

3.3.1 Step 1: Set up hardware

Hardware required

You will need the following S7-300 modules:

Quantity	Designation	Order no.
1 x	CPU 315-2DP	6ES7 315-2AF03-0AB0
1 x	Power supply unit PS 307 5A	6ES7 307-1EA00-0AA0
1 x	Communication processor CP 343-1 PN	6GK7 343-1HX00-0XE0
1 x	I/O modules DI8/DO8xDC24V/0.5A	6ES7 323-1BH01-0AA0

Step	Procedure
1.	Attach the modules to the rail Connect the CP 343-1 PN to the backplane bus via the bus connector.
2.	Connect the power supply.
3.	Wire up the I/O modules.
4.	Connect the Ethernet cable to the CP 343-1 PN.

3.3.2 Step 2: Configure Plant 1 in SIMATIC iMap

Requirements

You must have created the PROFINet components and they must either be present in the file system or located in the tutorial install directory under iMap\CBA_Tutorial\components.

Basic procedure

1. Create a library in SIMATIC iMap, if it does not exist.
2. Import the PROFINet component from the file system to the library.
3. Paste the PROFINet component from the library to the SIMATIC iMap project and assign addresses
4. Interconnect the technological functions, if necessary, and generate the SIMATIC iMap project.

Create a Library in SIMATIC iMap

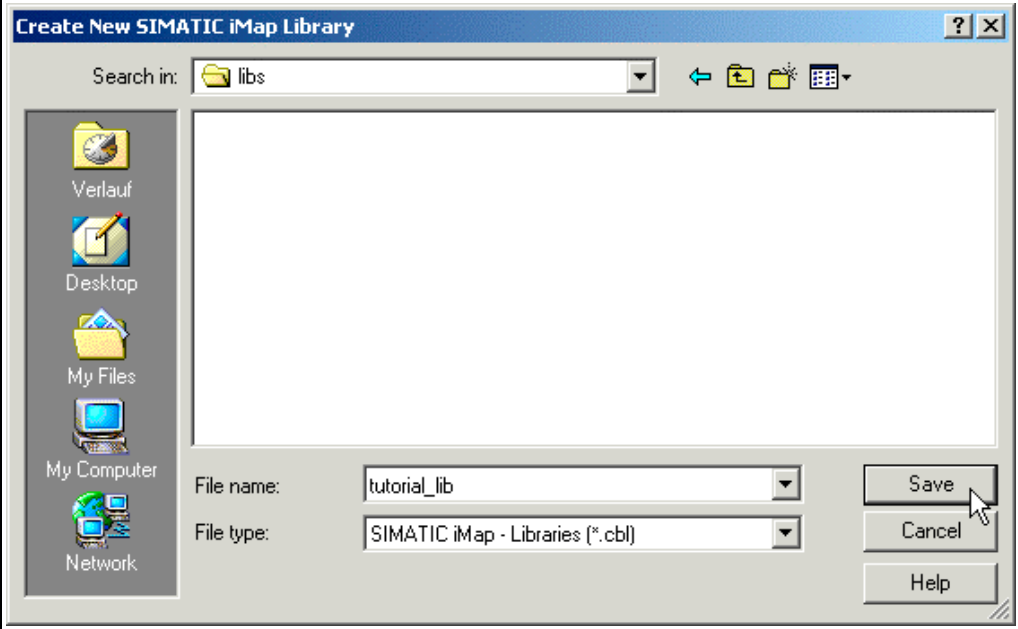
Step	Procedure
1.	Start SIMATIC iMap: <ul style="list-style-type: none">• by double-clicking the  icon or• by selecting Start > Programs > Component based Automation > SIMATIC iMap.
2.	Select the Library > New... menu command.
3.	Under "Search in", select the path Programs\Siemens\iMap\Tutorial .
4.	Create a new folder named "libs"
5.	In the "libs" folder, create a library with the file name "tutorial_lib". 

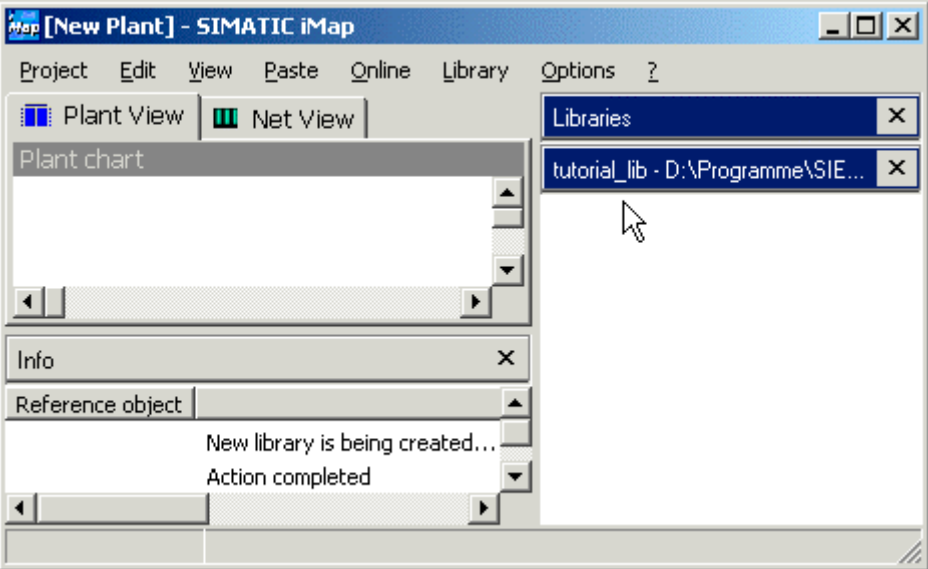
Step	Procedure
6.	<p>Click on the "Save" button to confirm your input. Result: The library called "tutorial_lib" is created and opened in SIMATIC iMap.</p>  <p>The screenshot shows the SIMATIC iMap interface. The title bar reads 'iMap [New Plant] - SIMATIC iMap'. The menu bar includes 'Project', 'Edit', 'View', 'Paste', 'Online', 'Library', and 'Options'. The 'View' menu is open, showing 'Plant View' and 'Net View'. The 'Libraries' window is open, displaying a list of libraries with 'tutorial_lib - D:\Programme\SIE...' selected. A mouse cursor is pointing at the selected library. Below the Libraries window, the 'Info' window shows the message 'New library is being created...' and 'Action completed'.</p>

Plant 1: Import PROFnet Component

Step	Procedure
1.	<p>In SIMATIC iMap, click in the "tutorial_lib" library window. If the "tutorial_lib" library is not open, open it by selecting Library > Open</p>
2.	<p>Import the PROFnet component from the file system to the library: Select Import Component from the context menu in the library window.</p>
3.	<p>Under "Search In", select the path Programs\Siemens\iMap\CBA_Tutorial\components.</p>

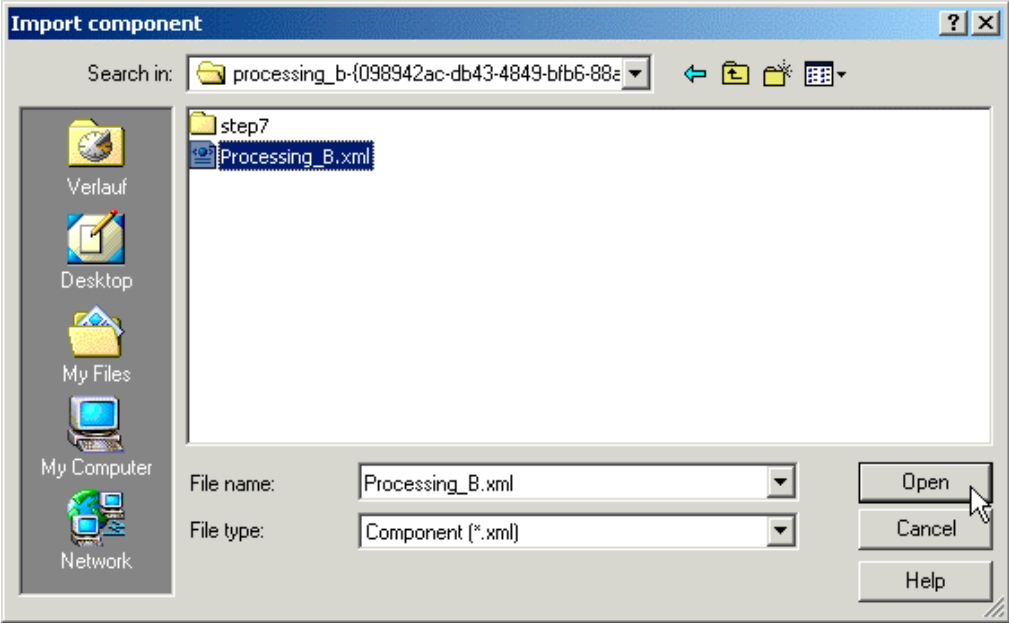
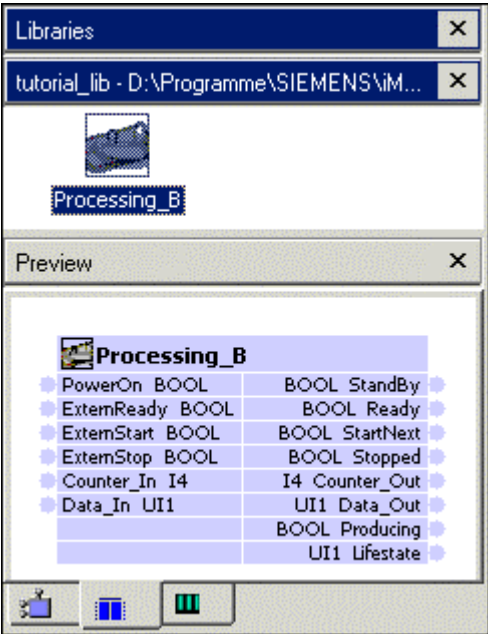
Step	Procedure
4.	<p>Select the "processing_b--{...}" folder.</p> 
5.	<p>Select the "Processing_B.xml" file from this folder and click on the "Open" button to confirm. Result: The PROFINet component "Processing_B" is added to the library.</p> 

Plant 1: Paste PROFINet Component into the Project and Assign Addresses

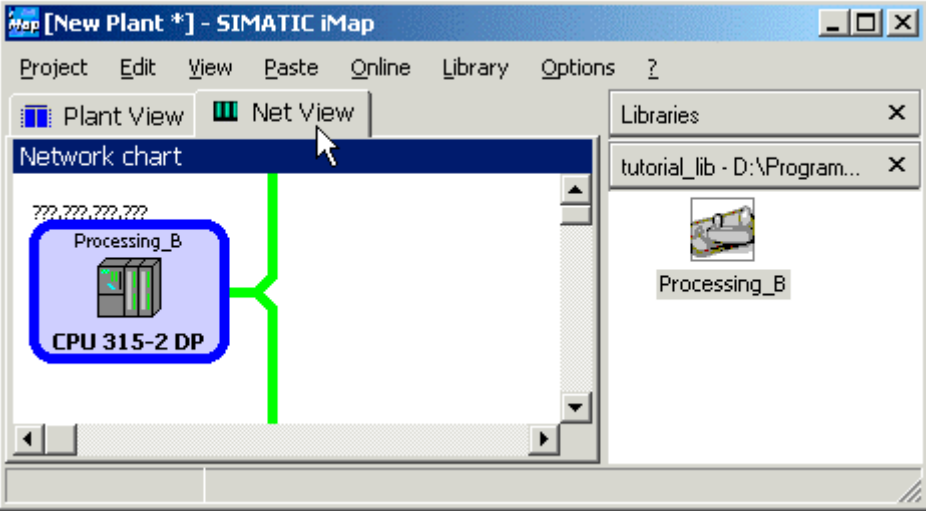
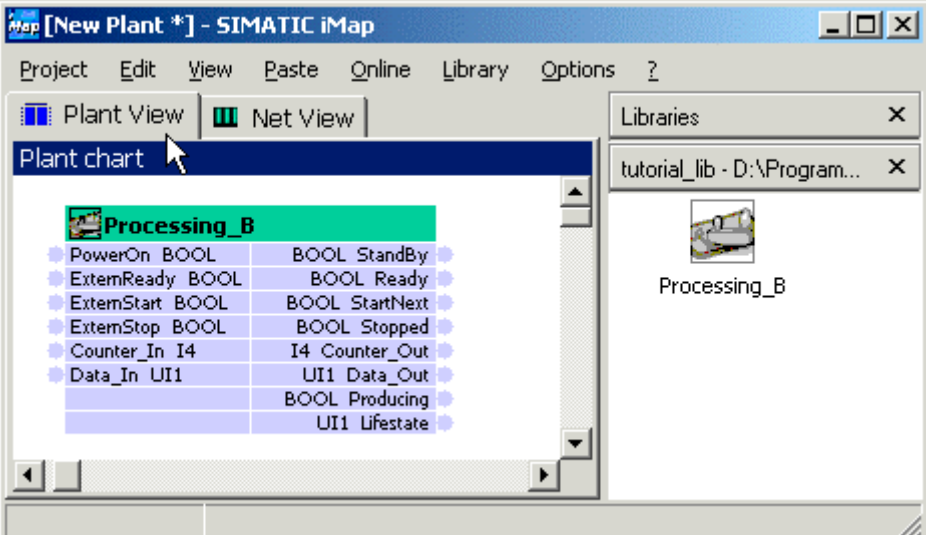
Step	Procedure
1.	<p>Insert the PROFINet component into the project: Select "Processing_B" from the library, then select Paste into Project from the context menu. The PROFINet device is automatically linked to the Ethernet in the network view.</p>  <p>The technological function is displayed in the plant view:</p> 
2.	Optional – Repeat step 1 for other PROFINet components, e.g. ET200X_Conveyor.

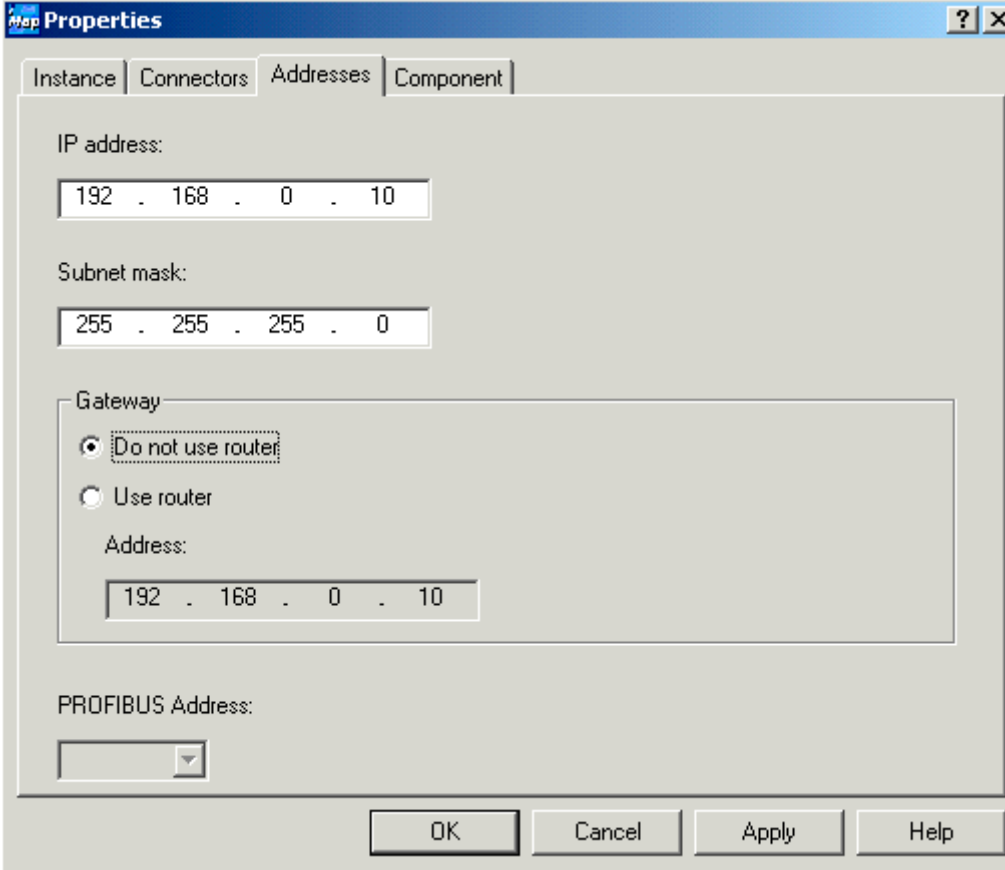
Step	Procedure
3.	<p>In the network view, select the CPU 315-2 DP device and select the Properties... context menu.</p> <p>Enter the IP address and subnet mask in the "Properties" dialog for the PROFINet device.</p> <p>Note: The IP address and subnet mask must be exactly the same as those that you entered for the device in STEP7.</p> 

Interconnect Technological Functions and Generate the Project

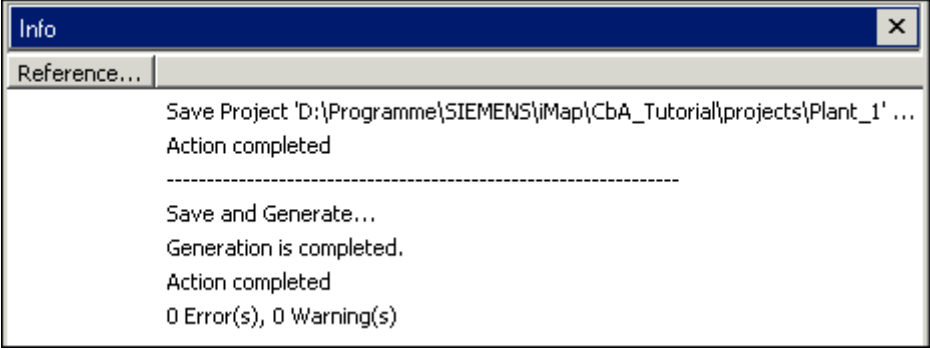
Step	Procedure
1.	Interconnection is not necessary for plant 1 since the project only contains one PROFInet component.
2.	<p>Make sure that the "tutorial_lib" library is open.</p> <p>Generate the project:</p> <ul style="list-style-type: none"> • using the Project > Generate > Changes Only menu command or • by clicking on the "Generate" icon . <p>If you have not yet saved the project, you will be prompted to enter a name for the project. In the "Save Simatic iMap Project As" dialog box, select a path and enter a name, e.g. "Plant_1".</p> <p>Result: The project is saved and generated.</p>
3.	<p>You can follow the generation progress in the information window.</p> 

Result: The plant is configured and can now be started.

3.3.3 Step 3: Assign an IP address to the CP 343-1 PN for the first time

Requirements

- The IP address of the CP 343-1PN must be known.
- The connection to the Ethernet LAN must be established; there must be no subnet transition (router) between the two.
- It must be possible to access the Ethernet interface of your PG/PC from STEP 7; the PG/PC interface must be set as follows:
S7ONLINE [STEP 7] > TCP/IP > <network module>
To set the PG/PC interface, select **Options > Set PG/PC interface...** in SIMATIC Manager or select **Start > Simatic > SIMATIC NET > Settings > Set PG-PC interface** from the Windows taskbar

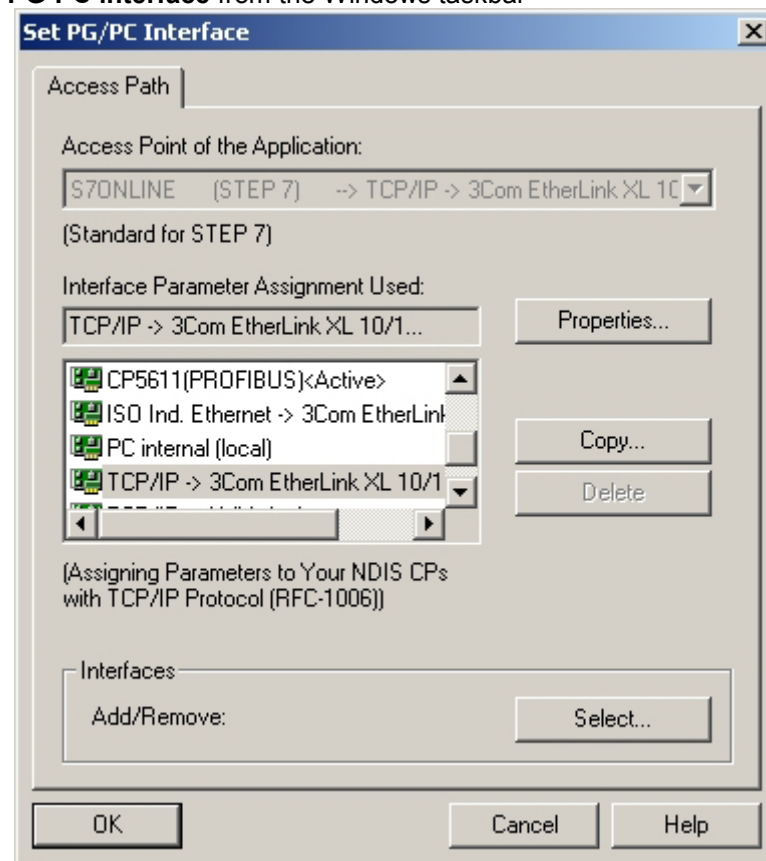

- The DLC protocol (Data Link Control) must be installed on the Ethernet interface. If the DLC protocol is not installed on your PG/PC, call up the network settings (via **Control Panel > Network > Protocols**) and install the DLC protocol for your Ethernet connection.

Procedure

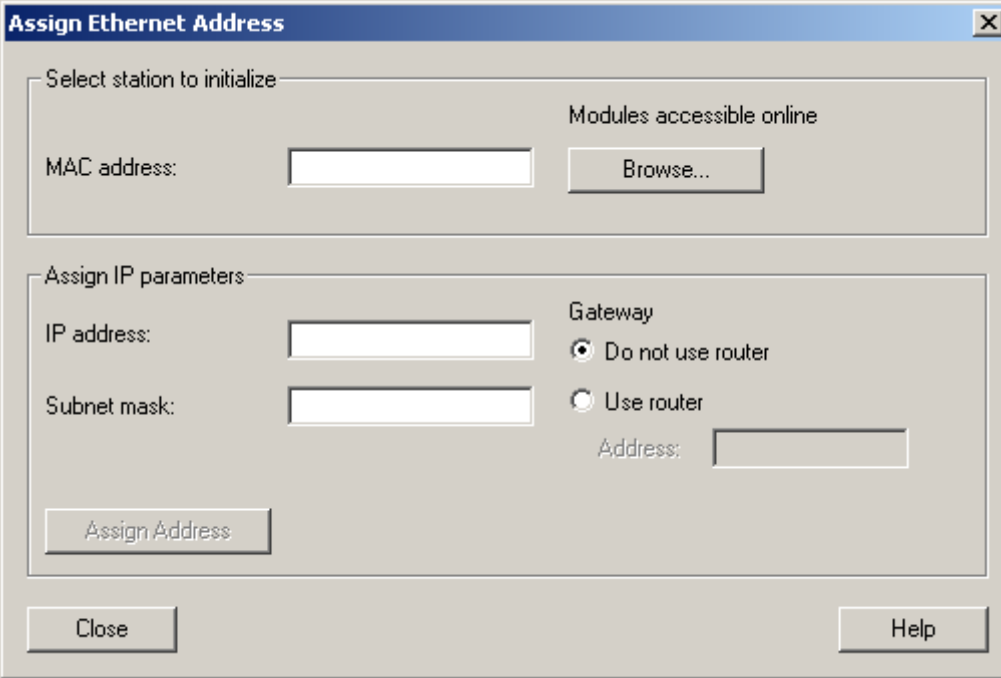
Step	Procedure
1.	Open SIMATIC Manager.
2.	<p>Select PLC > Assign Ethernet Address</p> 
3.	Click on the "Browse..." button to search the network for accessible modules. All accessible stations on the network are displayed.

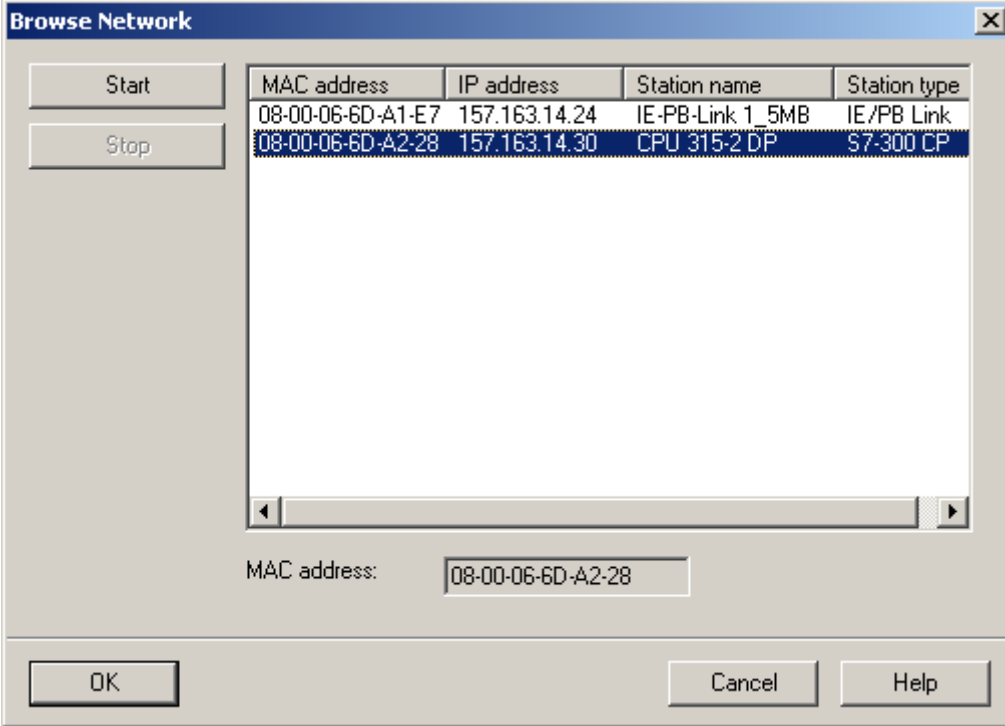
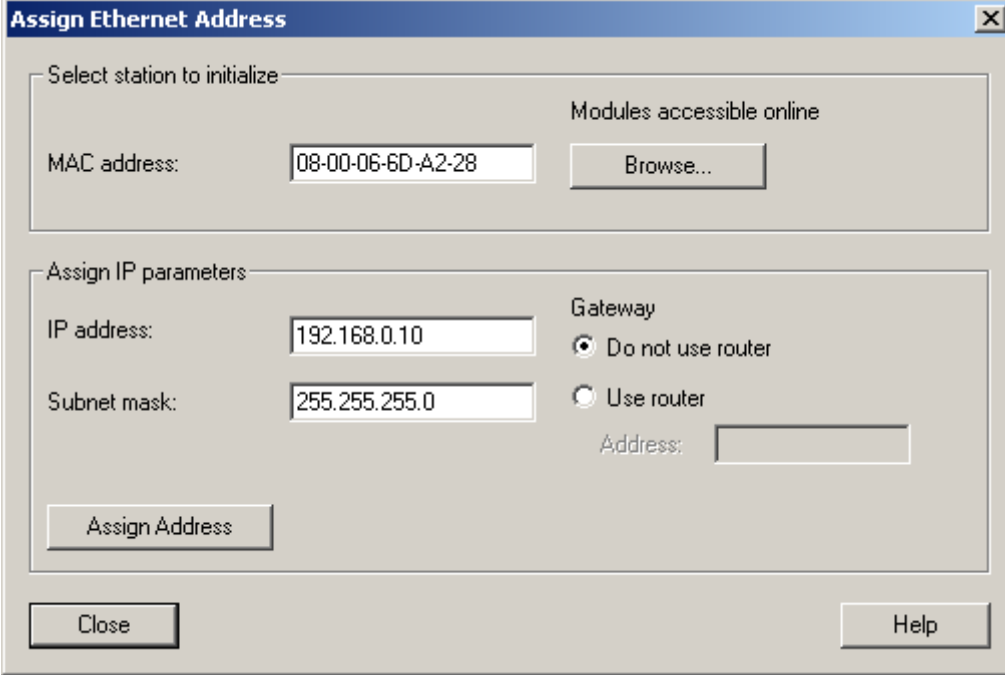
Step	Procedure												
4.	<p>Select the CP with the right MAC address from list of the suggested components.</p>  <p>Browse Network</p> <table border="1"> <thead> <tr> <th>MAC address</th> <th>IP address</th> <th>Station name</th> <th>Station type</th> </tr> </thead> <tbody> <tr> <td>08-00-06-6D-A1-E7</td> <td>157.163.14.24</td> <td>IE-PB-Link 1_5MB</td> <td>IE/PB Link</td> </tr> <tr style="background-color: #e0e0e0;"> <td>08-00-06-6D-A2-28</td> <td>157.163.14.30</td> <td>CPU 315-2 DP</td> <td>S7-300 CP</td> </tr> </tbody> </table> <p>MAC address: 08-00-06-6D-A2-28</p>	MAC address	IP address	Station name	Station type	08-00-06-6D-A1-E7	157.163.14.24	IE-PB-Link 1_5MB	IE/PB Link	08-00-06-6D-A2-28	157.163.14.30	CPU 315-2 DP	S7-300 CP
MAC address	IP address	Station name	Station type										
08-00-06-6D-A1-E7	157.163.14.24	IE-PB-Link 1_5MB	IE/PB Link										
08-00-06-6D-A2-28	157.163.14.30	CPU 315-2 DP	S7-300 CP										
5.	<p>Enter the IP parameters as shown in the following diagram, and assign them to the CP.</p>  <p>Assign Ethernet Address</p> <p>Select station to initialize</p> <p>MAC address: 08-00-06-6D-A2-28 Modules accessible online: Browse...</p> <p>Assign IP parameters</p> <p>IP address: 192.168.0.10 Gateway: <input checked="" type="radio"/> Do not use router</p> <p>Subnet mask: 255.255.255.0 <input type="radio"/> Use router</p> <p>Address: _____</p> <p>Assign Address</p> <p>Close Help</p>												

3.3.4 Step 4: Check the Necessary Settings on the Engineering Station for Plant 1

Requirements

- See chapter "Requirements - Commissioning the system"
- The PG/PC is linked to the CP 343-1 PN via the Ethernet.

Procedure

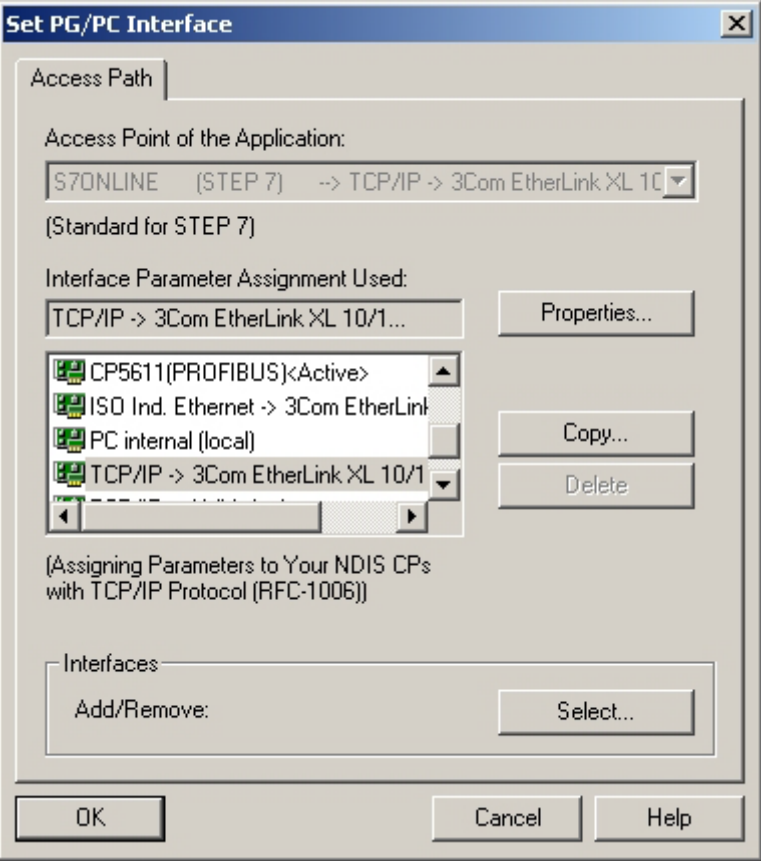
Step	Procedure
1.	<p>Select Start > Simatic > SIMATIC NET > Settings > PG/ PC Interface and check the following setting: "TCP/IP" is set as the access point for the "S7ONLINE (STEP 7)" application.</p> 
2.	<p>Select Start > Simatic > SIMATIC NET > Settings > Set PC Station. The configuration console opens.</p>

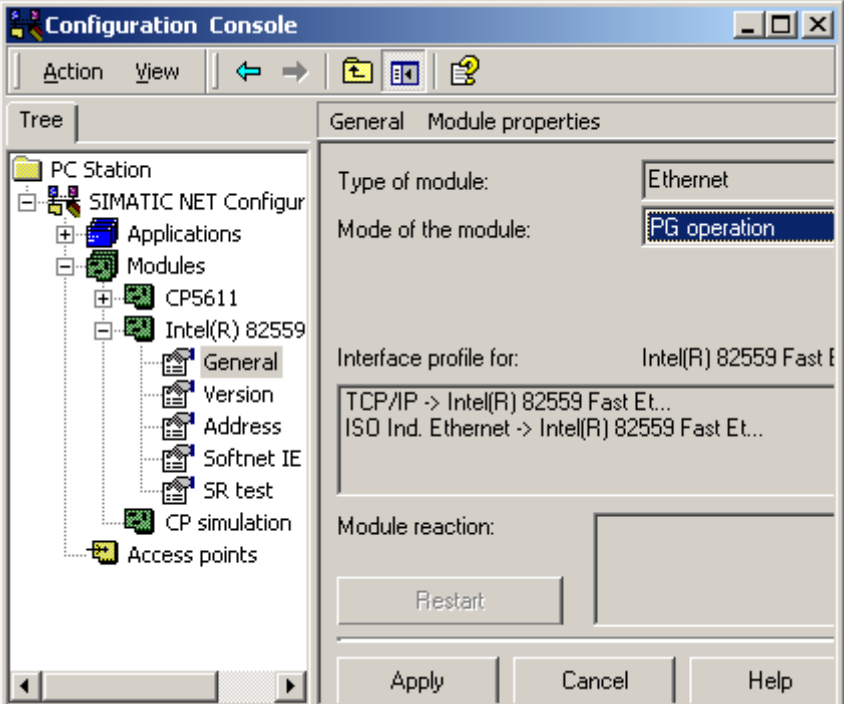
Step	Procedure
3.	<p>Select the computer's Ethernet module from the "Structure" window. "PG mode" must be set as the operating mode under "General".</p>  <p>The screenshot shows the 'Configuration Console' window. On the left is a 'Tree' view showing a hierarchy: PC Station > SIMATIC NET Configur > Applications > Modules > Intel(R) 82559 > General. The 'General' tab is selected in the right-hand pane. The 'Type of module' is 'Ethernet' and the 'Mode of the module' is 'PG operation'. Below this, there are sections for 'Interface profile for:' and 'Module reaction:'. The interface profile section lists 'TCP/IP -> Intel(R) 82559 Fast Et...' and 'ISO Ind. Ethernet -> Intel(R) 82559 Fast Et...'. At the bottom of the console are buttons for 'Restart', 'Apply', 'Cancel', and 'Help'.</p>
4.	Confirm any changes and close the configuration console.

For plants with WinLC PN

If you are using a WinLC PN, please note the following point:

If STEP 7, SIMATIC iMap and WinLC PN are on a computer - the local engineering station - then the settings for plant 3-2 apply, rather than those specified above.

3.3.5 Step 5: Commissioning Plant 1

Requirements

- See chapter "System commissioning requirements"
- The PG/PC is linked to the CP 343-1 PN via the Ethernet.
- You have checked the settings on the engineering station.
- You have generated the project in SIMATIC iMap.
- All the devices are switched on.

Tip: Check the generation status

To check the generation status of the device, open the properties

- of the device in the network view
- of the technological function in the plant view.

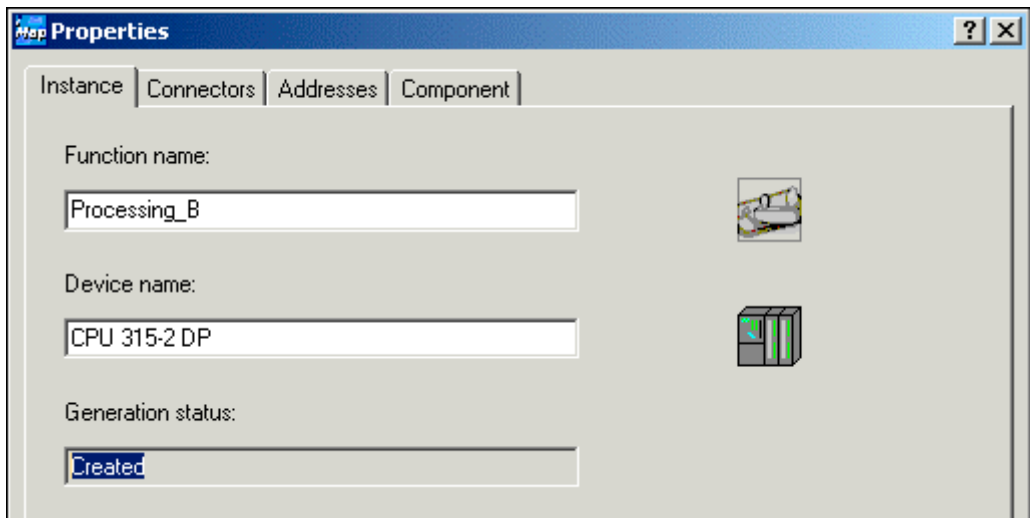

The generation status must be "Generated". If this is not the case, generate the project again using the **Project > Generate > Changes Only** menu command.

Procedure

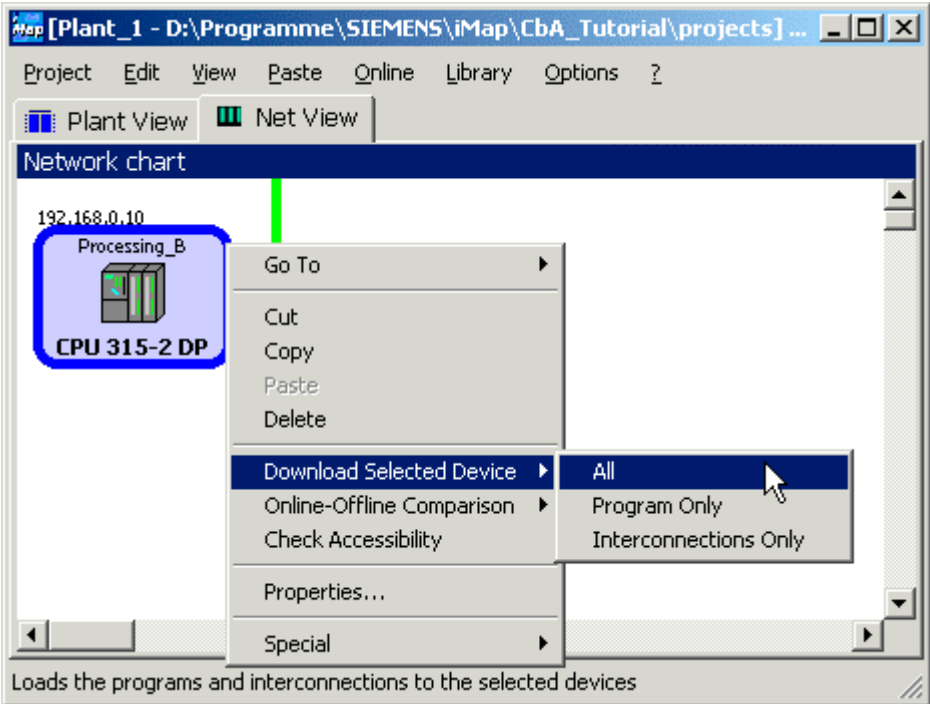
Step	Procedure
1.	<p>In SIMATIC iMap, select</p> <ul style="list-style-type: none"> the device from the network view or the technological function from the plant view <p>and download the data to the device: Select Download > Selected Devices > All from the context menu.</p> 
2.	<p>If the CP 343-1 PN is in RUN mode, you are asked whether you wish to stop the device. Click on "Yes" to confirm the message. Result: The device switches to STOP and the data is downloaded to the device. You are then asked whether you want to restart the device. Click on "Yes" to confirm the message.</p>

Result: The device is ready for use.

3.3.6 Step 6: Monitor Plant 1 Online

With SIMATIC iMap, you can



- monitor online and diagnose the devices of the plant.
- display and set online values.

Requirements

- See chapter "System commissioning requirements"
- The PG/ PC is linked to the PROFINet device or one of the PROFINet devices via the Ethernet.
- You have checked the settings in STEP 7.
- You have generated the project in SIMATIC iMap.
- You have downloaded the data to the device.
- The device is in RUN mode.

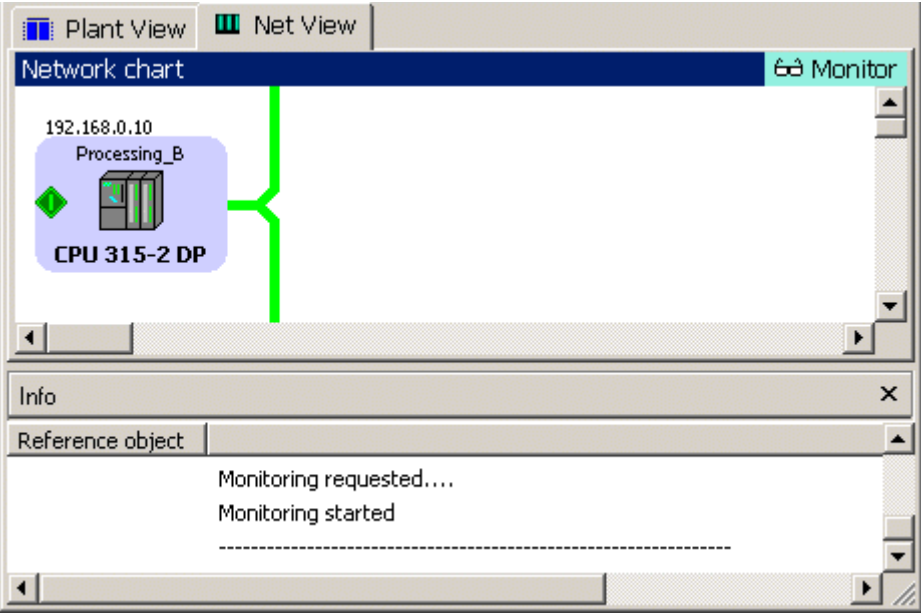
Procedure

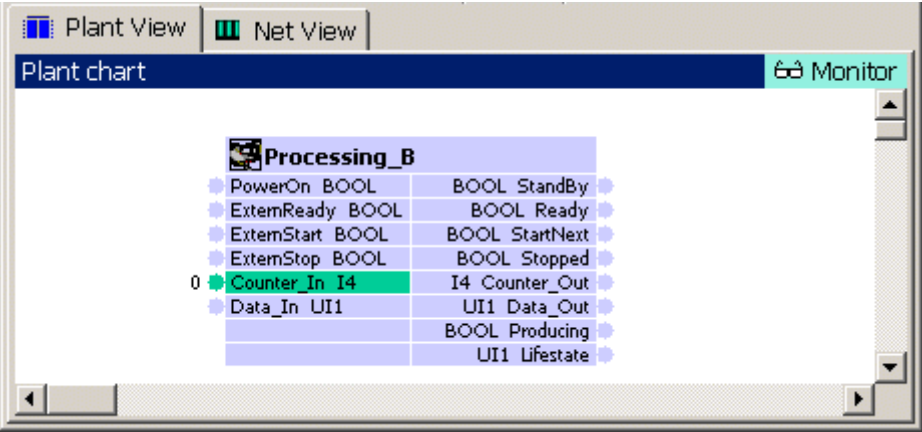
Step	Procedure
1.	<p>Switch the online view on/off</p> <p>In SIMATIC iMap, switch on the online view:</p> <ul style="list-style-type: none"> • click on the "Online Monitoring" icon  or • select Online > Monitor. <p>You are asked whether you want to compare the devices' online and offline program data. This comparison is optional. You can run it immediately or later.</p> <p>If you answer "Yes" to this question, the data is compared and the result is displayed in the information window.</p> <p>Result: The SIMATIC iMap online view is switched on and any diagnostic information is displayed directly at the devices and technological functions and in the diagnostic window.</p> 

Step	Procedure
2.	<p>Display Online Values</p> <p>In the project plant view, select the "CounterIn" input and then select the Display Online Values menu command from the context menu. The online value 0 is displayed since the connector is not interconnected.</p> 
3.	<p>Click again on the  icon or select the Online > Monitor option to switch off the online view.</p>

Display diagnostic information

In the event of an error, diagnostic information is displayed in SIMATIC iMap in both graphical and text format.

The diagnostic information for the technological functions can be found on the "Functions" tab in the diagnostic window.

Example: The interconnections have to be downloaded (**Online > Download Selected Device > Interconnection Only** menu command).

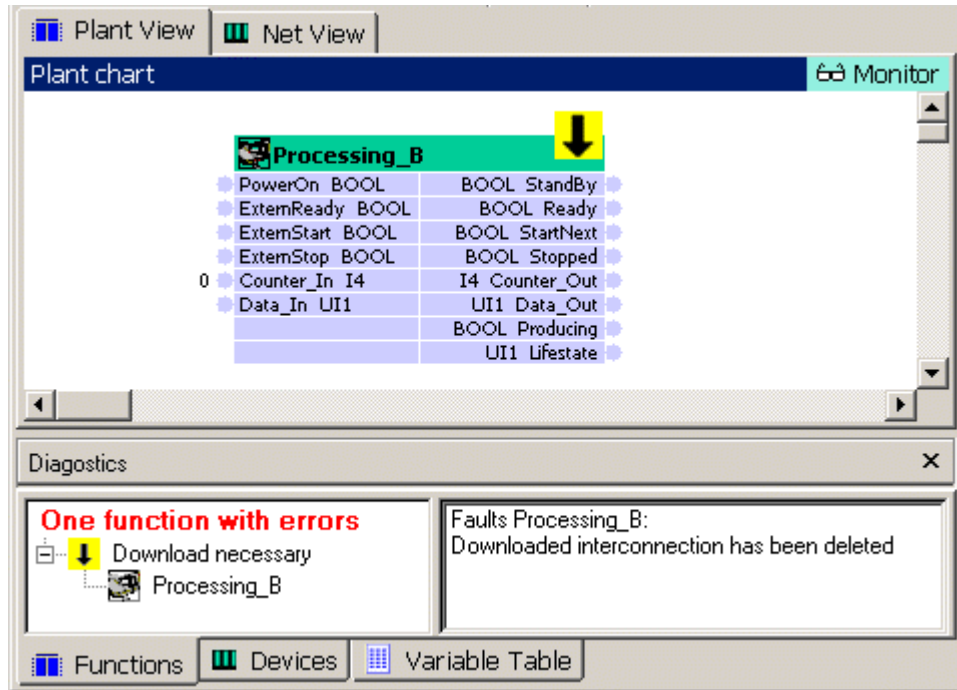

The diagnostic information for the devices can be found on the "Devices" tab in the diagnostic window.

Example: The device is not available. In this case, you will have to check the settings and the communication links.

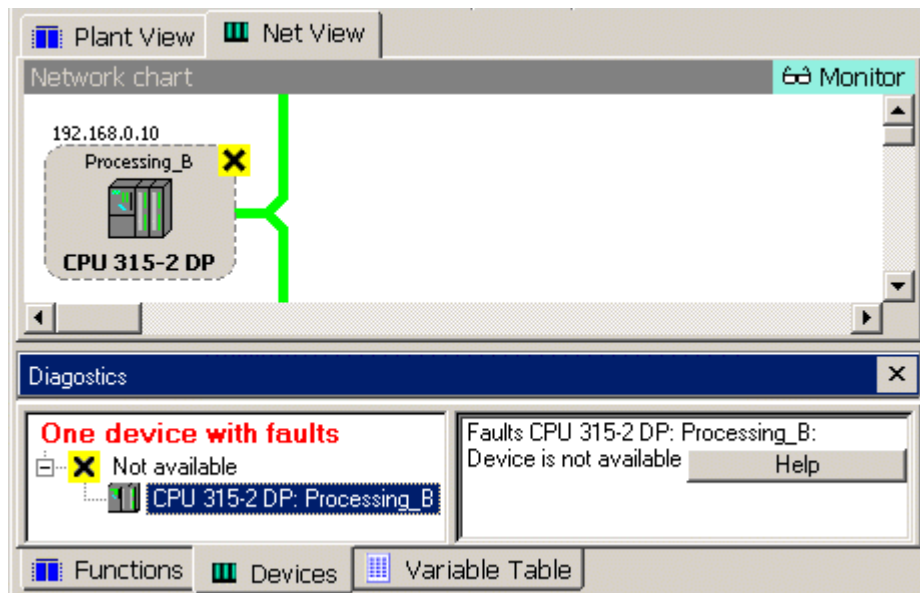

3.4 Plant 2: IE/PB Link with PROFIBUS DP slaves

Plant 2 consists of the following devices:

- An IE/PB Link PROFINet device as the DP master with proxy functionality for the following PROFIBUS devices:
- ET 200S with IM 151/CPU as the intelligent DP slave for controlling a conveyor belt "ET200S_Conveyor"
- ET 200X with BM147/CPU as an intelligent DP slave for controlling a conveyor belt "ET200X_Conveyor"

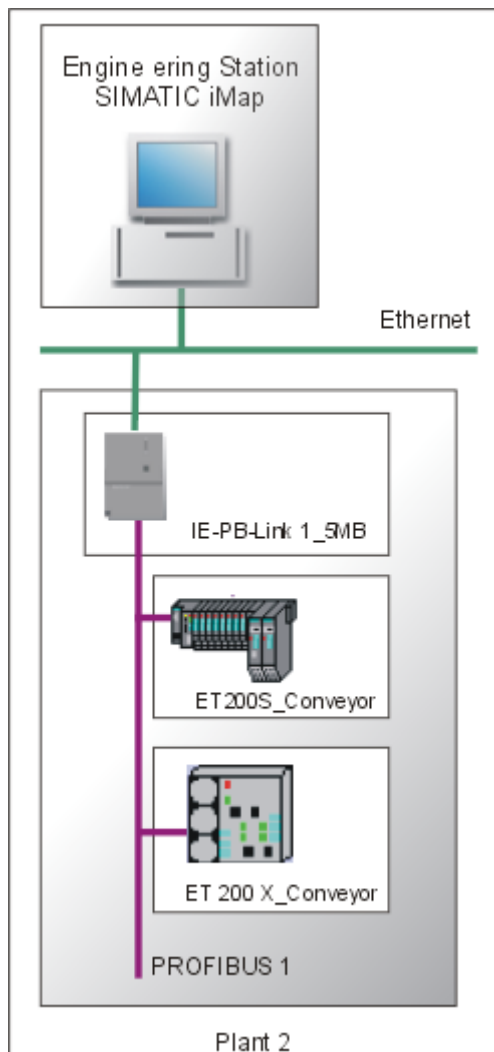

Basic procedure

The following tasks must be carried out:

1. Set up the plant hardware:
 - IE/PB Link
 - ET 200S with IM151/CPU
 - ET 200X with BM147/CPU
2. Configure the plant in SIMATIC iMap.
3. Assign addresses
 - Assign an IP address to the IE/PB Link for the first time.
 - Assign a PROFIBUS address to the IM151/CPU for the first time.
4. Check your settings in STEP 7 in order to download the project data from SIMATIC iMap to the devices of the plant and be able to monitor the plant online.
5. Start the plant
6. Monitor the plant online with SIMATIC iMap.

3.4.1 Step 1: Set up hardware

3.4.1.1 ET 200S with IM151/CPU Hardware Set-up

Hardware required

You will need the following modules:

Quantity	Designation	Order no.
1 x	Interface module IM 151 and terminating module, 1x	6ES7 151-7AA10-0AB0 / V2.0
2 x	Terminal module TM-P15S23-A1, 1x	6ES7 193-4CC30-0AA0
2 x	Terminal module TM-E15S24-A1, 5x	6ES7 193-4CA20-0AA0
2 x	Power module PM-E DC24 V, 1x	6ES7 138-4CA00-0AA0
1 x	2DI DC24V; high feature, 2x	6ES7 131-4BB00-0AB0
1 x	2DO DC24V; 0.5 A; high feature, 2x	6ES7 132-4BB00-0AB0
1 x	Bus connector	6ES7 972-0BA10-0XA0

Procedure

Step	Procedure
1.	Attach the modules to the rail
2.	Connect the power supply.
3.	Wire up the I/O modules.
4.	Connect the PG/PC to the IM151/CPU using the PG cable.
5.	Switch on the power supply to the IM151/CPU.

Note

When you **start up** the ET 200S for the first time (as-delivered state), the IM151/CPU can be accessed via MPI addresses 2, HSA 31 and 187.5 kBps. The PROFIBUS address is assigned to the IM 151/CPU via MPI after the project is generated in SIMATIC iMap.

3.4.1.2 ET 200X with BM147/CPU Hardware Set-up

Hardware required

You will need the following modules:

Quantity	Designation	Order no.
1 x	Basic module BM147/CPU	6ES7 147-1AA01-0XB0
1 x	Expansion module DI 4xDC24V	6ES7 141-1BD30 - 0XA0
1 x	Expansion module DO 4xDC24V/2A	6ES7 141-1BD40 - 0XA0

Procedure

Step	Procedure
1.	Attach the modules to the rail
2.	Set PROFIBUS address 18 on the BM 147/CPU basic module.
3.	Connect the power supply.
4.	Wire up the I/O modules.
5.	Connect the IE/PB Link to the BM 147/CPU using the PROFIBUS cable.
6.	Switch on the IE/PB Link if you have not already done so.

3.4.1.3 IE/PB Link Hardware Set-up

Hardware required

1 IE/PB Link network transition with the necessary accessories (see device manual).

Procedure

Step	Procedure
1.	Attach the modules to the rail
2.	Connect the power supply.
3.	Connect the IE/PB Link to the Ethernet and PROFIBUS.
4.	Switch on the power supply.

3.4.2 Step 2: Configure Plant 2 in SIMATIC iMap

Requirements

You must have created the PROFINet components and they must either be present in the file system or located in the tutorial install directory under iMap\CBA_Tutorial\components.

Basic procedure

1. Create a library in SIMATIC iMap, if it does not exist.
2. Import the PROFINet components from the file system to the library.
3. Paste the PROFINet components from the library into the SIMATIC iMap project.
4. Assign addresses in SIMATIC iMap .
5. Interconnect technological functions and generate SIMATIC iMap project.

Create a Library in SIMATIC iMap

Step	Procedure
1.	Start SIMATIC iMap: <ul style="list-style-type: none"> • by double-clicking the  icon or • by selecting Start > Programs > Component based Automation > SIMATIC iMap.
2.	Select the Library > New... menu command.
3.	Under "Search in", select the path Programs\Siemens\iMap\Tutorial.
4.	Crte a new folder named "libs"

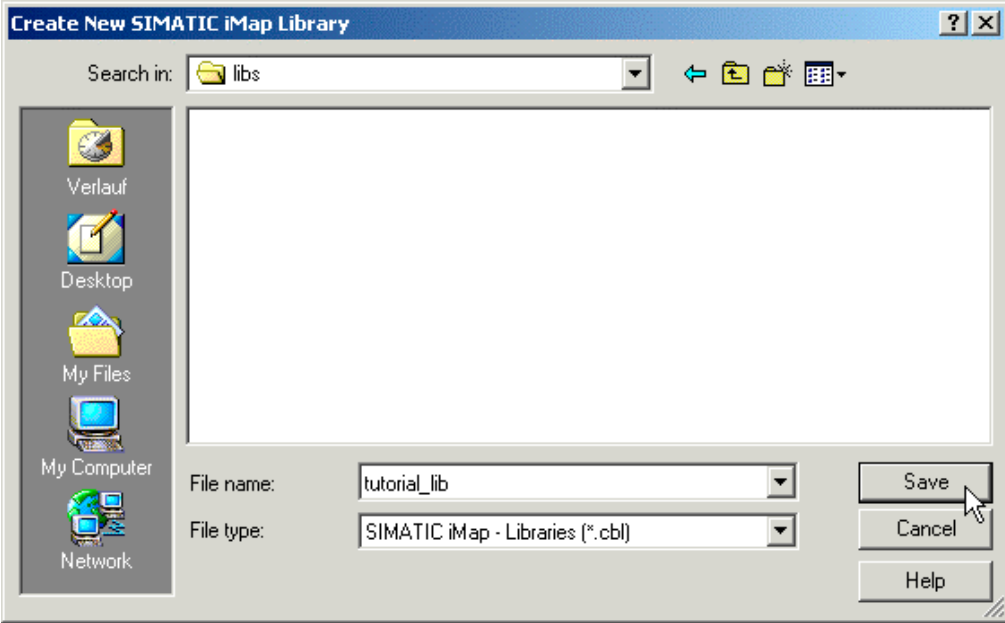
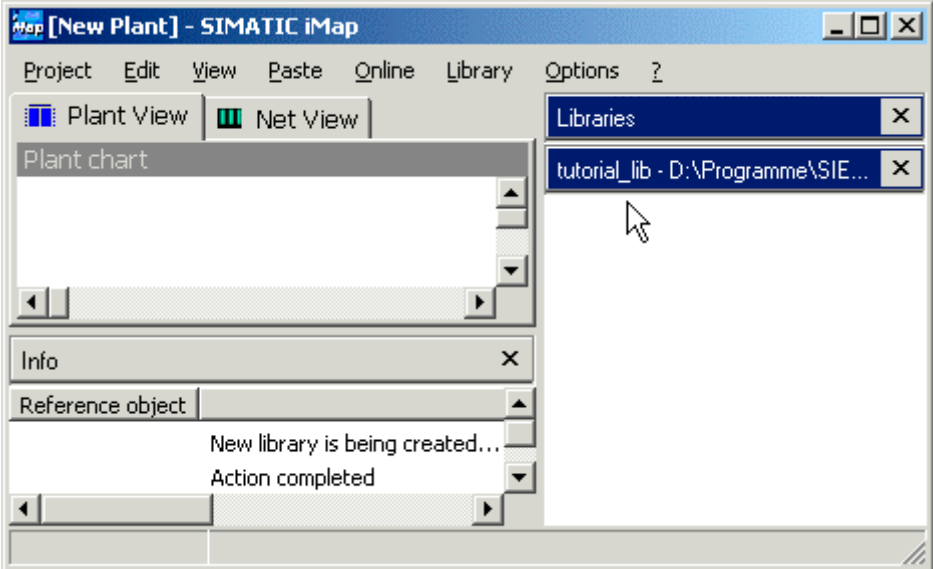
Step	Procedure
5.	<p>In the "libs" folder, create a library with the file name "tutorial_lib".</p> 
6.	<p>Click on the "Save" button to confirm your input. Result: The library called "tutorial_lib" is created and opened in SIMATIC iMap.</p> 

Import PROFINet Components

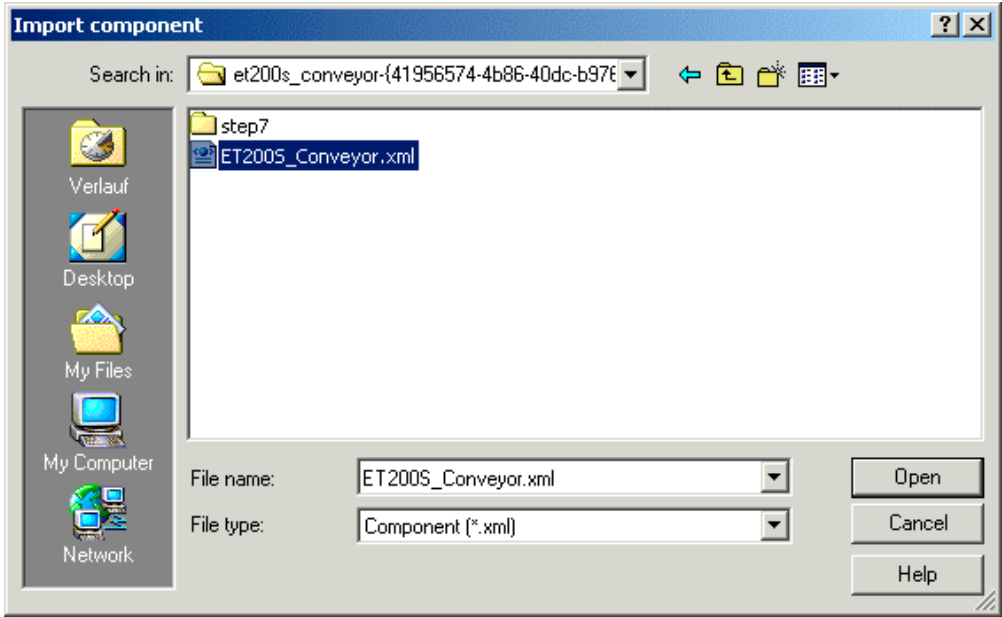
Step	Procedure
1.	In SIMATIC iMap, click in the "tutorial_lib" library window. If the "tutorial_lib" library is not open, open it by selecting Library > Open
2.	Import the PROFINet components from the file system to the library: Select Import Component from the context menu in the library window.
3.	Under "Search In", select the path Programs\Siemens\iMap\CBA_Tutorial\components .
4.	Select the "et200s_conveyor--{...}" folder. 
5.	From this folder, select the "ET200S_Conveyor.xml" file and click on the "Open" button to confirm your input. Result: The PROFINet component "ET200S_Conveyor" is added to the library.
6.	Repeat steps 2 to 5 for the PROFINet component "ET200X_Conveyor" ("et200x_conveyor--{...}" folder and "ET200X_Conveyor.xml" file). Result: The PROFINet component "ET200X_Conveyor" is added to the library.

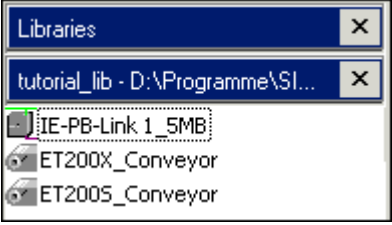
Step	Procedure
7.	<p>Repeat steps 2 to 5 for the off-the-shelf PROFInet component of the IE/PB Link, which can be found under imap\components\IE-PB-Link_PN_1,5MBaud-{} in the SIMATIC iMap install directory. Select the file called "IE-PB-Link PN 1_5MBaud.xml".</p> <p>Result: The PROFInet component "IE-PB-Link PN 1_5MBaud" is added to the library.</p> 

Paste PROFINet Components into the Project

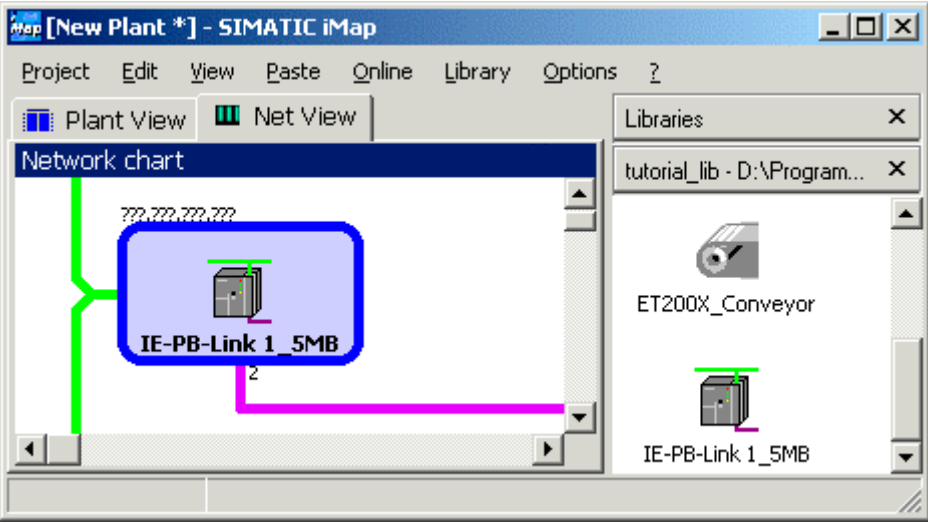
Step	Procedure
1.	<p>Paste the PROFINet component for the IE/PB Link into the project: Select the PROFINet component "IE-PB-Link 1_5MB" from the library and</p> <ul style="list-style-type: none"> • drag it into the network view or • select Paste Into Project from the context menu. <p>The PROFINet device is automatically linked to the Ethernet in the network view, and has a PROFIBUS connector as the DP master with proxy functionality.</p> 
2.	<p>Select the PROFINet component "ET200S_Conveyor" from the library, then use Drag&Drop to link it to the PROFIBUS of the IE/PB Link.</p>

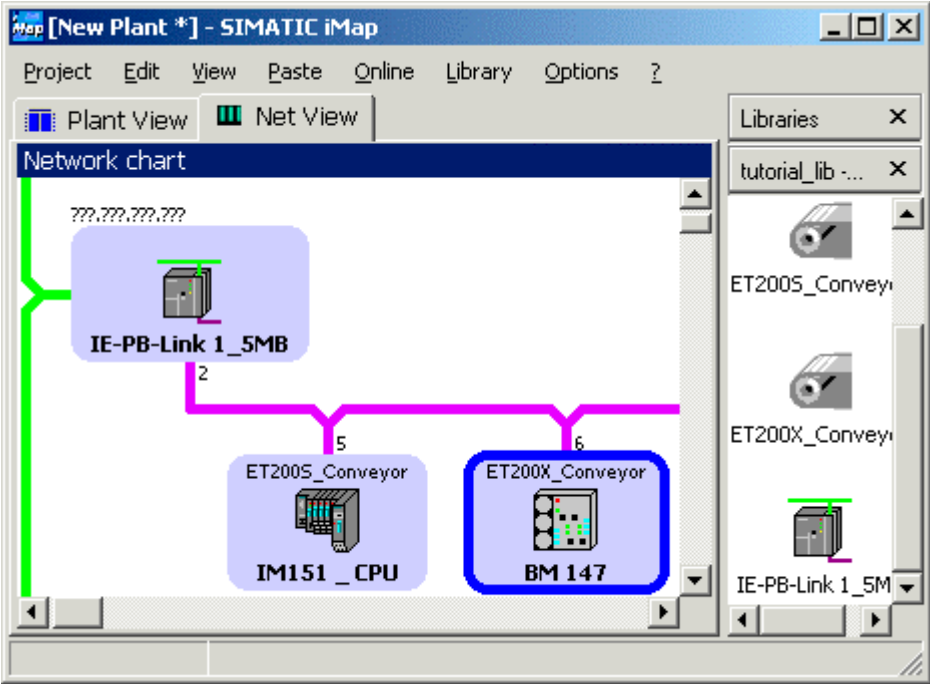
Step	Procedure
3.	<p>Repeat step 2 for the PROFINet component "ET200X_Conveyor".</p>  <p>The screenshot shows the SIMATIC iMap software interface. The main window displays a network chart with the following components and connections:</p> <ul style="list-style-type: none"> IE-PB-Link 1_5MB: Connected to the network via a green line. ET2005_Conveyor (IM151_CPU): Connected to the IE-PB-Link via a purple line labeled '2'. ET200X_Conveyor (BM 147): Connected to the IE-PB-Link via a purple line labeled '6'. <p>The ET200X_Conveyor component is highlighted with a blue border. The software interface includes a menu bar (Project, Edit, View, Paste, Online, Library, Options), a toolbar (Plant View, Net View), and a Libraries panel on the right.</p>

Assign Addresses

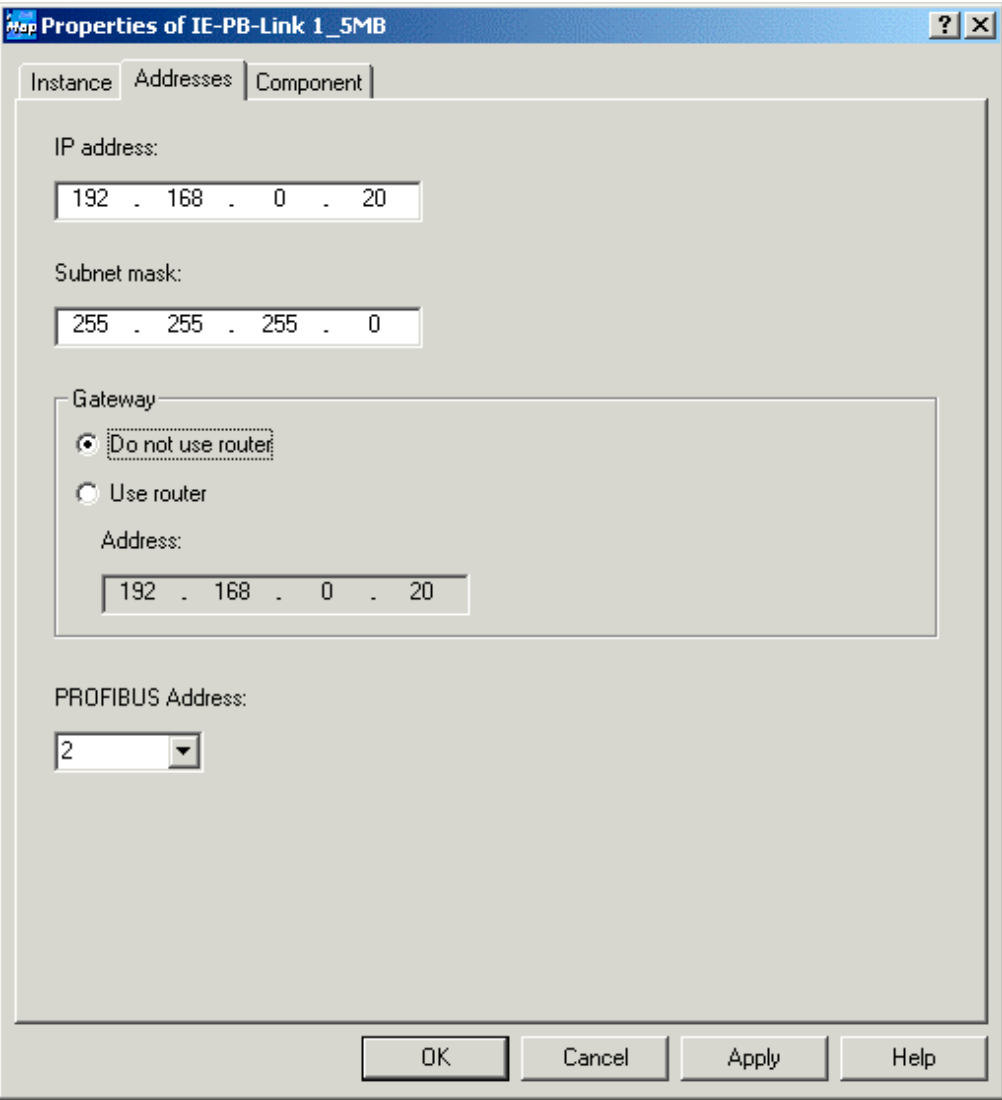

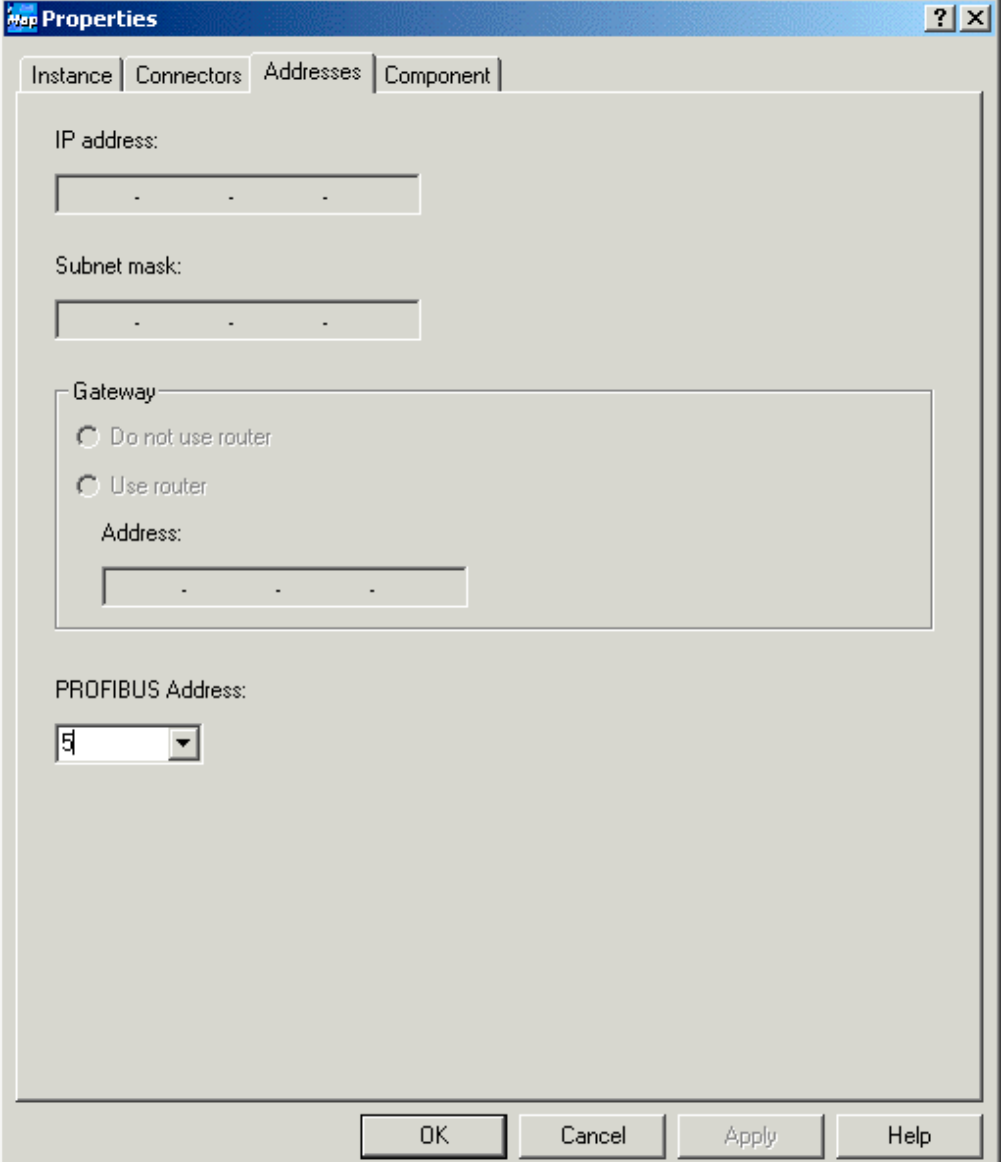
Step	Procedure
1.	<p>In the network view, open the IE/PB Link properties and enter the IP address and subnet mask, plus the PROFIBUS address of the device on the "Addresses" tab.</p> <p>Note: You assign exactly the same addresses to the device in step 3.</p>  <p>The screenshot shows a dialog box titled "Properties of IE-PB-Link 1_5MB" with three tabs: "Instance", "Addresses", and "Component". The "Addresses" tab is active. It contains the following fields:</p> <ul style="list-style-type: none"> IP address: 192 . 168 . 0 . 20 Subnet mask: 255 . 255 . 255 . 0 Gateway: <ul style="list-style-type: none"> <input checked="" type="radio"/> Do not use router <input type="radio"/> Use router Address: 192 . 168 . 0 . 20 PROFIBUS Address: 2 <p>Buttons at the bottom: OK, Cancel, Apply, Help.</p>

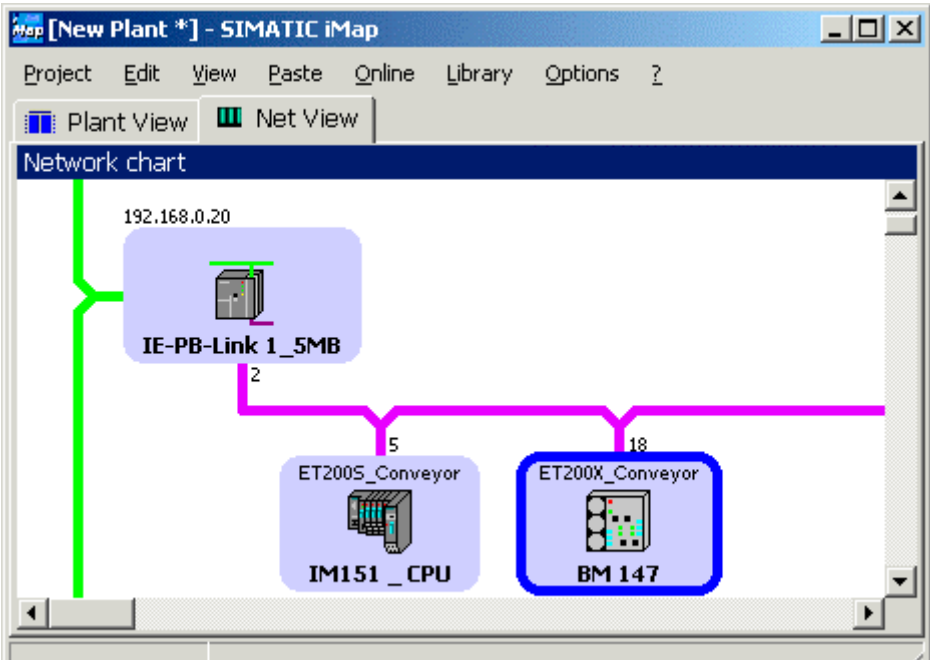
Step	Procedure
2.	<p>In the network view, open the properties of the PROFIBUS device "IM151_CPU" (ET 200S) and enter the device's PROFIBUS address on the "Addresses" tab.</p> <p>Note: You assign exactly the same address to the device via MPI (see Assign a PROFIBUS address to the IM 151/CPU for the first time).</p> 

Step	Procedure
3.	<p>Repeat step 2 for "BM147_CPU" and assign PROFIBUS address 18 to the device. This must be the address that is set on the device's DIL switch.</p> <p>The network view for plant 2 then has the following appearance:</p>  <p>The screenshot shows the SIMATIC iMap interface with the 'Net View' tab selected. The 'Network chart' displays a green vertical line representing the network backbone at IP address 192.168.0.20. A purple line branches off from this backbone, labeled with the number '2'. This line then splits into two branches: one labeled '5' connecting to the 'ET200S_Conveyor' (IM151_CPU) and another labeled '18' connecting to the 'ET200X_Conveyor' (BM 147). The BM 147 device is highlighted with a blue border.</p>

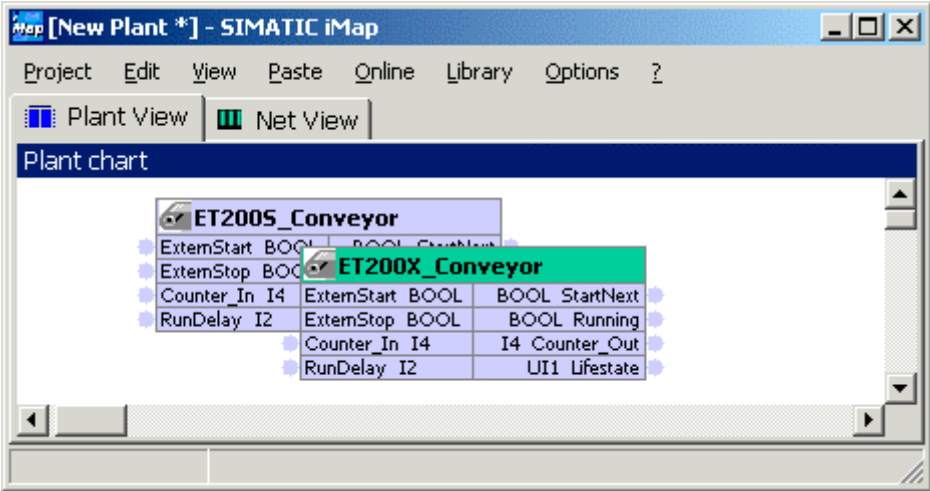
Interconnect Technological Functions and Generate Project

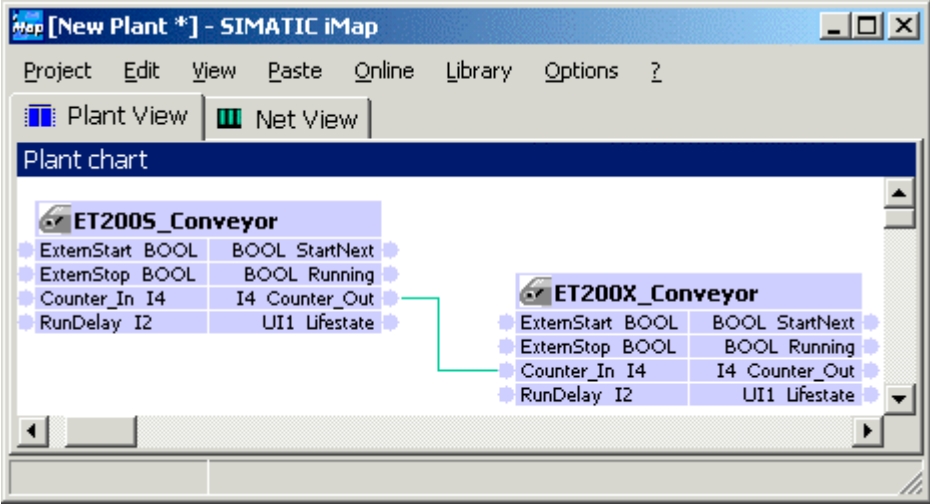
Step	Procedure
1.	<p>Open the plant view. At first, the technological functions are arranged one above the other.</p>  <p>The screenshot shows the SIMATIC iMap interface with the 'Plant View' tab selected. The 'Plant chart' displays two conveyor components: 'ET200S_Conveyor' and 'ET200X_Conveyor'. The ET200X_Conveyor is highlighted in green. Below the components, a list of variables is shown, including 'ExternStart', 'ExternStop', 'Counter_In', and 'RunDelay' for both conveyors, along with their data types (BOOL, I4, I2) and associated states or outputs like 'StartNext', 'Running', 'Counter_Out', and 'Lifestate'.</p>

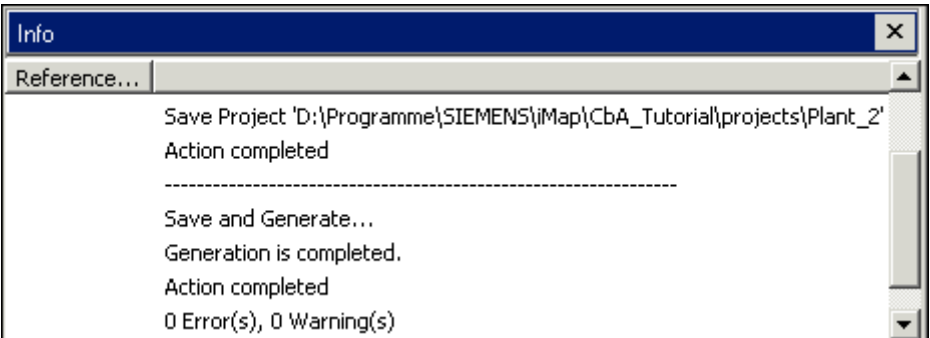
Step	Procedure
2.	<p>Arrange the technological functions and interconnect them as shown below:</p> 
3.	<p>Make sure that the "tutorial_lib" library is open. Generate the project:</p> <ul style="list-style-type: none"> • using the Project > Generate > Changes Only menu command or • by clicking on the "Generate" icon . <p>If you have not yet saved the project, you will be prompted to enter a name for the project. In the "Save Simatic iMap Project As" dialog box, select a path and enter a name, e.g. "Plant 2". Result: The project is saved and generated.</p>
4.	<p>You can follow the generation progress in the information window.</p> 

Result: The plant is configured and can now be started.

3.4.3 Step 3: Assign addresses

3.4.3.1 Assigning an IP address to the IE/PB Link for the First Time

Requirements

- The IP address of the IE/PB Link must be known.
- The connection to the Ethernet LAN must be established; there must be no subnet transition (router) between the two.
- It must be possible to access the Ethernet interface of your PG/PC from STEP 7; the PG/PC interface must be set as follows:
S7ONLINE [STEP 7] > TCP/IP > <network module>
To set the PG/PC interface, select **Options > Set PG/PC interface...** in SIMATIC Manager or select **Start > Simatic > SIMATIC NET > Settings > Set PG-PC interface** from the Windows taskbar

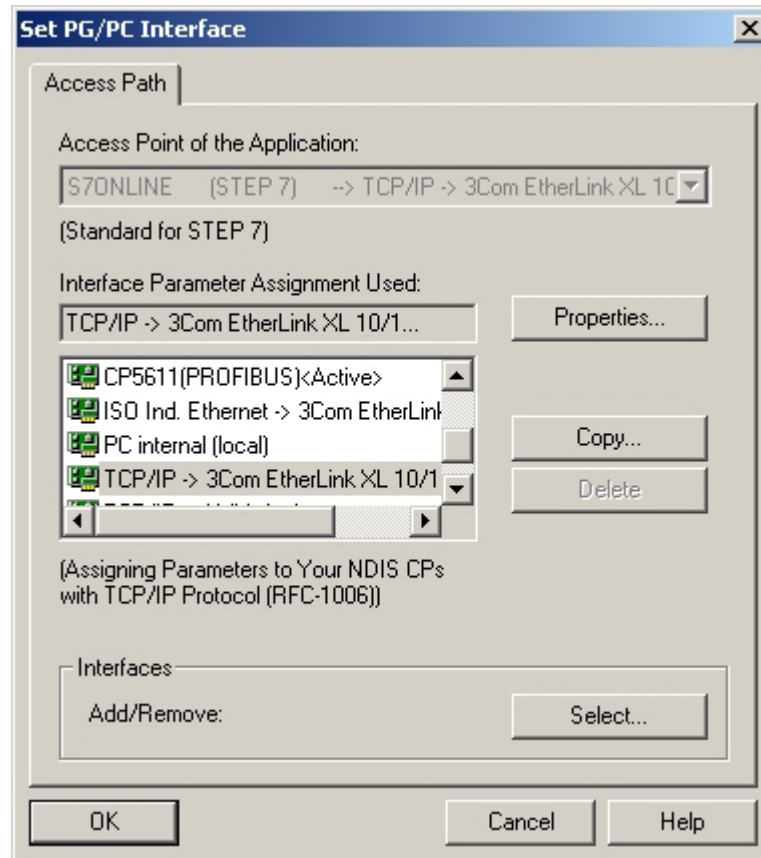

- The DLC protocol (Data Link Control) must be installed on the Ethernet interface. If the DLC protocol is not installed on your PG/PC, call up the network settings (via **Control Panel > Network > Protocols**) and install the DLC protocol for your Ethernet connection.

Procedure

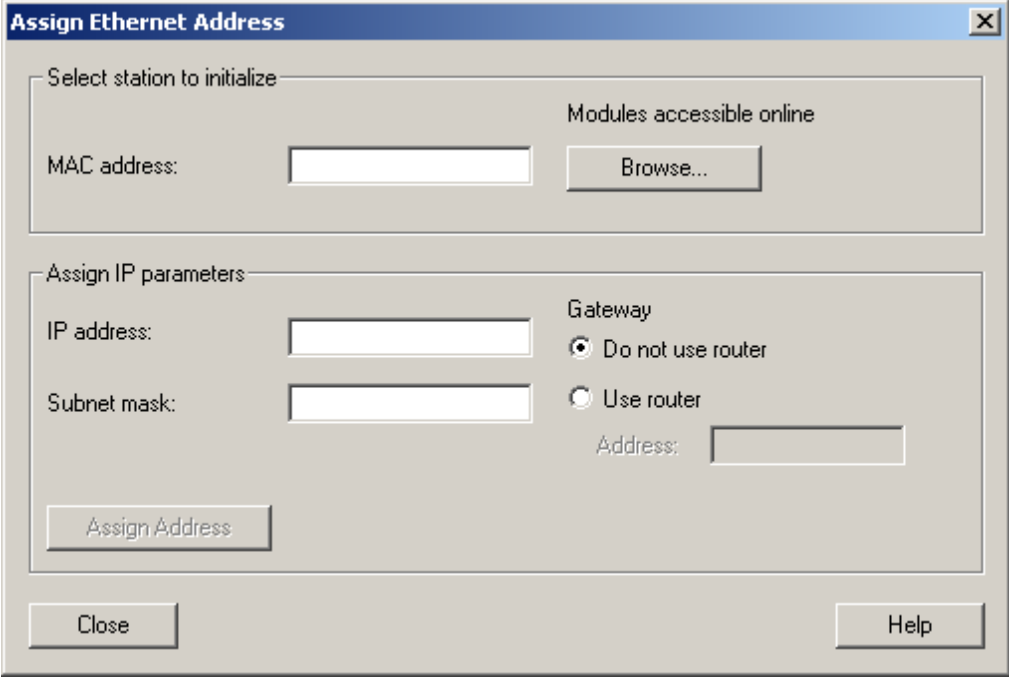
Step	Procedure
1.	Open SIMATIC Manager.
2.	<p>Select Target System > Assign Ethernet Address</p> 
3.	Click on the "Browse..." button to search the network for accessible modules. All accessible stations on the network are displayed.

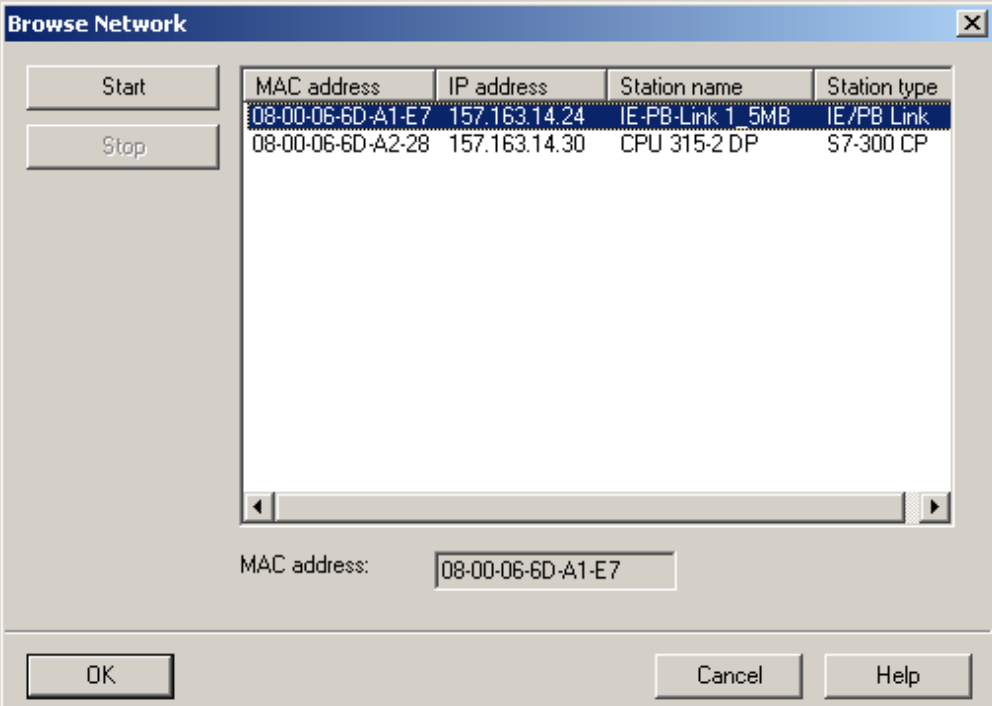
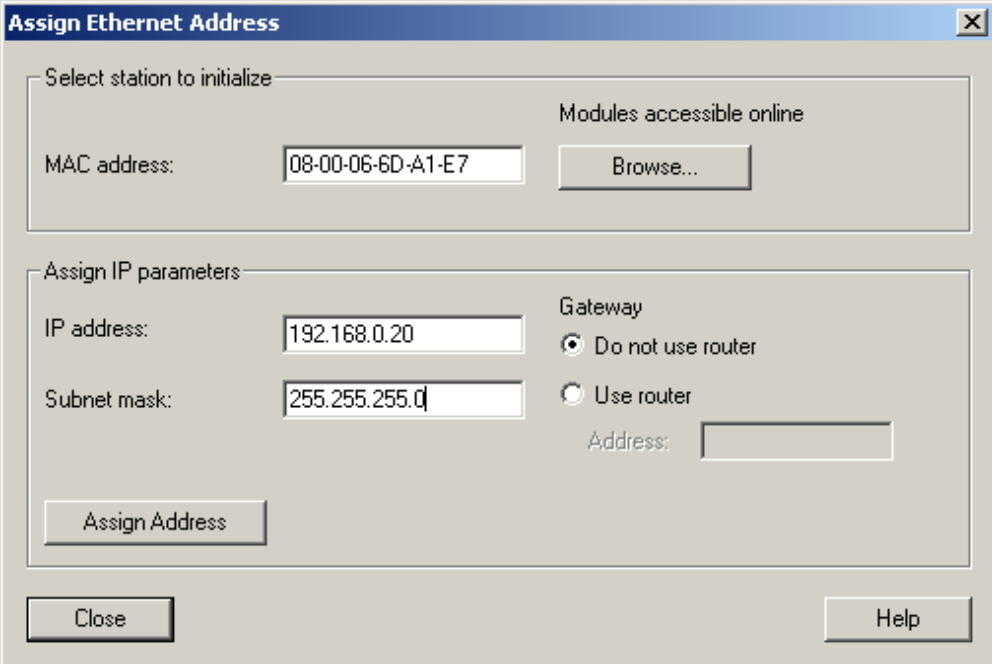
Step	Procedure												
4.	<p>Select the IE/PB Link with the right MAC address from list of the suggested components.</p>  <p>Browse Network</p> <table border="1"> <thead> <tr> <th>MAC address</th> <th>IP address</th> <th>Station name</th> <th>Station type</th> </tr> </thead> <tbody> <tr> <td>08-00-06-6D-A1-E7</td> <td>157.163.14.24</td> <td>IE-PB-Link 1_5MB</td> <td>IE/PB Link</td> </tr> <tr> <td>08-00-06-6D-A2-28</td> <td>157.163.14.30</td> <td>CPU 315-2 DP</td> <td>S7-300 CP</td> </tr> </tbody> </table> <p>MAC address: 08-00-06-6D-A1-E7</p>	MAC address	IP address	Station name	Station type	08-00-06-6D-A1-E7	157.163.14.24	IE-PB-Link 1_5MB	IE/PB Link	08-00-06-6D-A2-28	157.163.14.30	CPU 315-2 DP	S7-300 CP
MAC address	IP address	Station name	Station type										
08-00-06-6D-A1-E7	157.163.14.24	IE-PB-Link 1_5MB	IE/PB Link										
08-00-06-6D-A2-28	157.163.14.30	CPU 315-2 DP	S7-300 CP										
5.	<p>Enter the IP parameters as shown in the following diagram, and assign them to the IE/PB Link.</p>  <p>Assign Ethernet Address</p> <p>Select station to initialize</p> <p>MAC address: 08-00-06-6D-A1-E7</p> <p>Modules accessible online</p> <p>Assign IP parameters</p> <p>IP address: 192.168.0.20</p> <p>Subnet mask: 255.255.255.0</p> <p>Gateway</p> <p><input checked="" type="radio"/> Do not use router</p> <p><input type="radio"/> Use router</p> <p>Address: </p>												

3.4.3.2 Assigning a PROFIBUS address to IM151/CPU for the First Time

In step 2, you assigned a PROFIBUS address to the IM151_CPU device in SIMATIC iMap. You will have to download this PROFIBUS address from STEP 7 via MPI to the device yourself for the first time.

Requirements

- The IM151/CPU must be STOPped.
- The PG/PC must be connected to the IM151/CPU via MPI.
- The SIMATIC iMap project must have been generated. When you open the properties of the IM151_CPU device, the generation status "Generated" must appear on the "Instance" tab. Generate the project if this is not the case.

Procedure

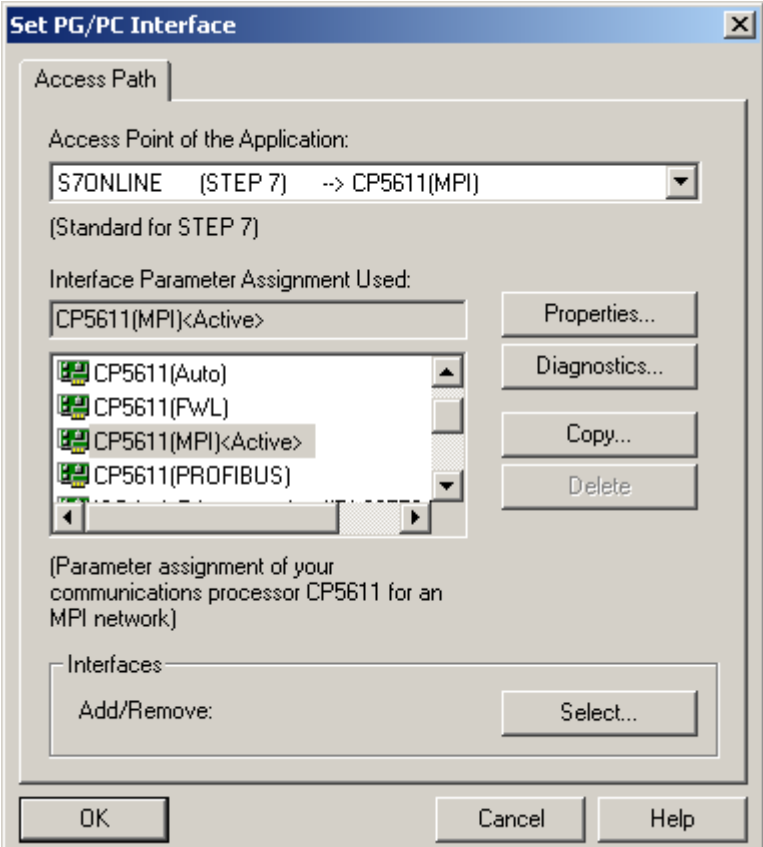
Step	Procedure
1.	<p>Set the PG/PC interface to MPI.</p> <p>From the taskbar, select Start > Simatic > SIMATIC NET > Settings > PG/ PC Interface. Configure the PG/PC interface as follows:</p> 

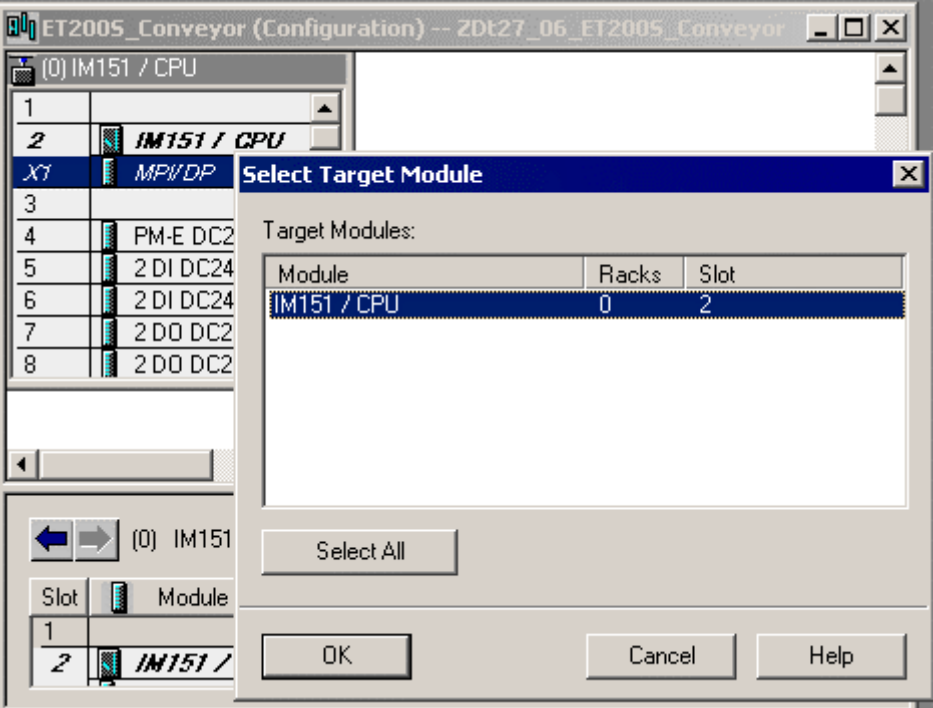
Step	Procedure
2.	<p>In the SIMATIC iMap network view, select the device IM151_CPU and then select Special > Configuration from the context menu.</p> <p>The station hardware configuration is opened in the shadow project.</p>
3.	<p>In HW Config, select PLC > Download to Module.</p>  <p>In the "Select Target Module" dialog box, select the IM151/ CPU and click on "OK" to confirm.</p>

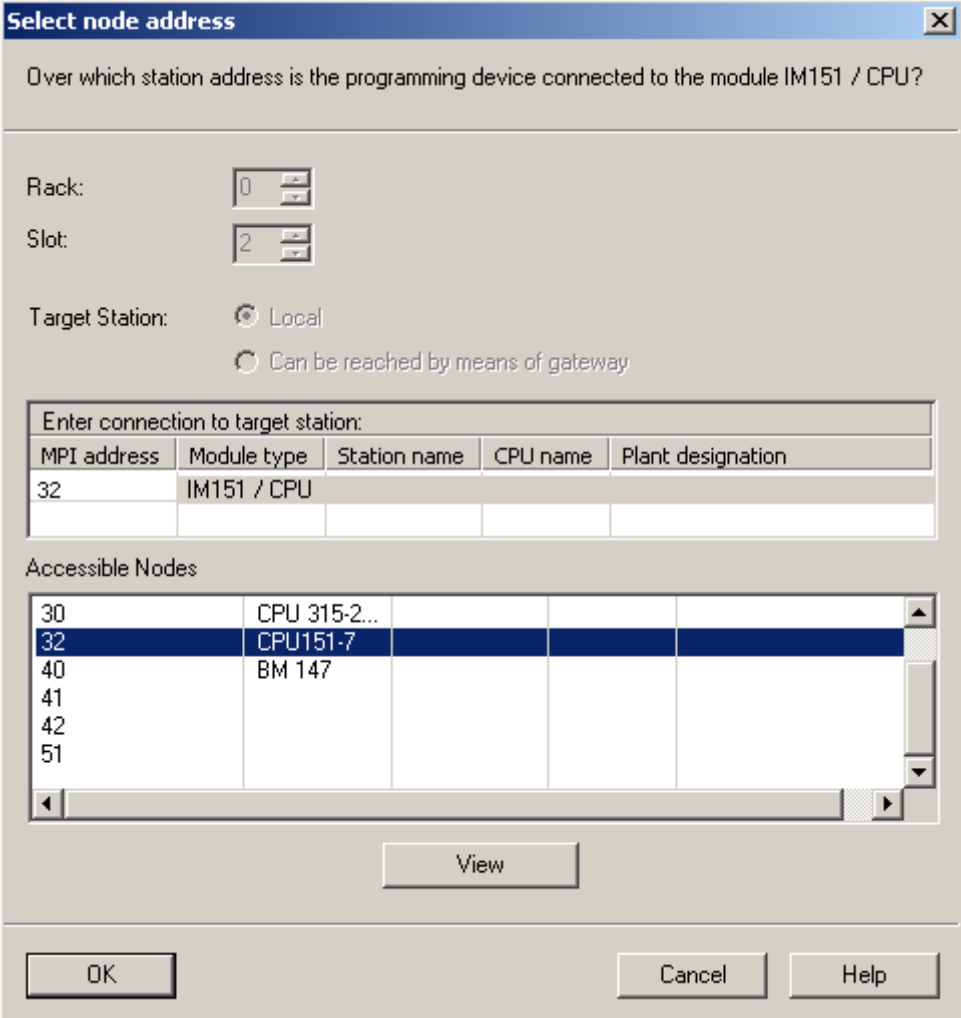
Step	Procedure
4.	<p>In the "Select Station Address" dialog, enter the MPI address of the CPU or click on "OK" to accept the displayed address, e.g:</p>  <p>Result: The system data, including the PROFIBUS address, are downloaded to the IM151/ CPU. The ET 200S can then communicate via the PROFIBUS.</p>
5.	Connect the ET 200S to the DP master using the PROFIBUS cable.

3.4.4 Step 4: Check the Necessary Settings on the Engineering Station for Plant 2

Requirements

- See chapter "System commissioning requirements"
- The PG/PC is linked to the IE/PB Link via the Ethernet.

Check the settings

Check the following settings:

- Set PG/PC interface to TCP/IP
- Assign PG/PC

Further information

Detailed information can be found in the online help for that dialog box or in the SIMATIC iMap help topics under "Assign PG/PC".

For combination plants...

If you are using a WinLC PN, we distinguish between the two alternative set-ups:

- STEP 7 and SIMATIC iMap are on the local engineering PC, while the WinLC PN is on a remote computer. In this case, the settings for plant 3-1 apply to the entire plant.
- STEP 7, SIMATIC iMap and WinLC PN are all on one computer, namely the local engineering PC. In this case, the settings for plant 3-2 apply to the entire plant.

3.4.4.1 Set PG/PC Interface to TCP/IP

Procedure

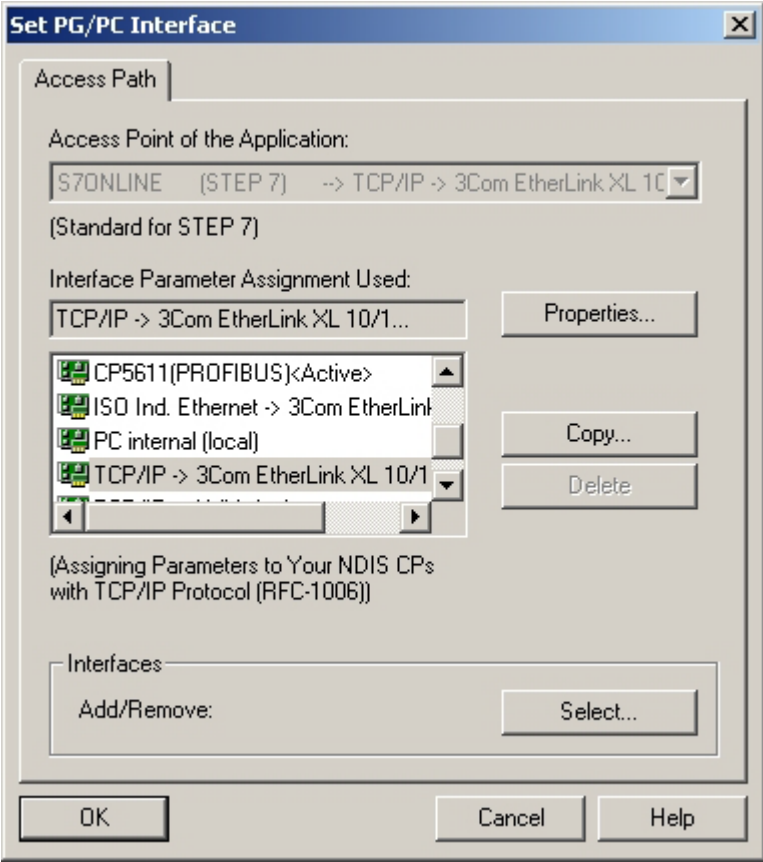
Step	Procedure
1.	<p>Select Start > Simatic > SIMATIC NET > Settings > PG/ PC Interface and check the following setting: "TCP/IP" is set as the access point for the "S7ONLINE (STEP 7)" application.</p> 
2.	<p>Select Start > Simatic > SIMATIC NET > Settings > Set PC Station. The configuration console opens.</p>

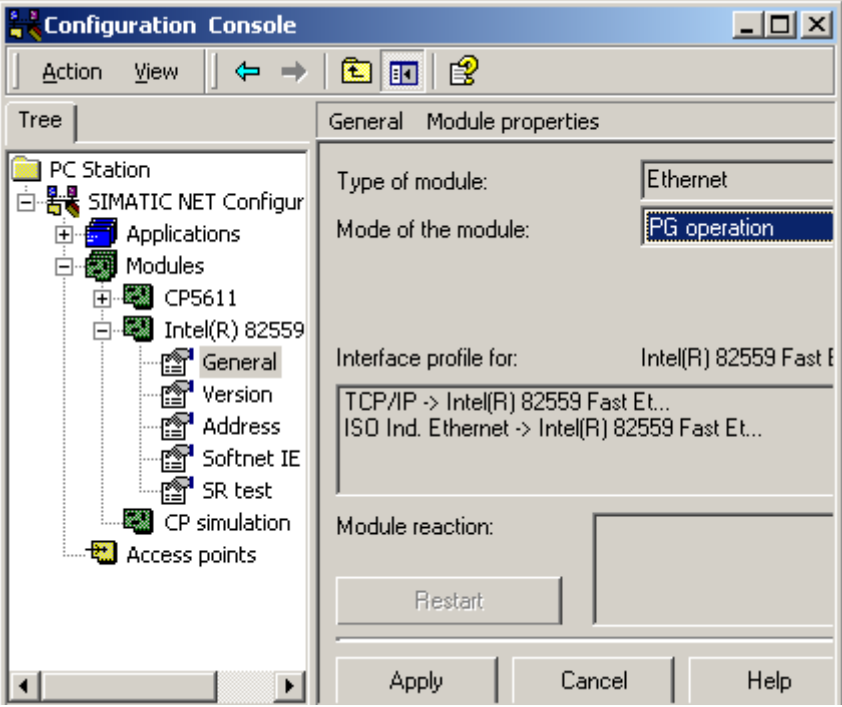
Step	Procedure
3.	<p>Select the computer's Ethernet module from the "Structure" window. "PG mode" must be set on the "General" tab since the PC does not have a WinLC.</p>  <p>The screenshot shows the 'Configuration Console' window. On the left is a 'Tree' view showing a hierarchy: PC Station > SIMATIC NET Configur > Applications > Modules > CP5611 > Intel(R) 82559. The 'General' tab is selected for the Intel(R) 82559 module. The 'Type of module' is 'Ethernet' and 'Mode of the module' is 'PG operation'. The 'Interface profile for:' is 'Intel(R) 82559 Fast Ethernet'. Below this, two profiles are listed: 'TCP/IP -> Intel(R) 82559 Fast Et...' and 'ISO Ind. Ethernet -> Intel(R) 82559 Fast Et...'. At the bottom are 'Restart', 'Apply', 'Cancel', and 'Help' buttons.</p>
4.	Confirm any changes and close the configuration console.

3.4.4.2 Assign PG/PC

Note

The PG/PC assignment is automatically carried out in SIMATIC iMap when the project is generated for the first time, and then whenever it is regenerated. In special cases, the PG/PC assignment cannot be carried out automatically, e.g.

- there are several network cards on the PG/PC or
- the PG/PC interface S7ONLINE (STEP 7) is not set to TCP/IP.

In these cases, an error is signalled in the information window during generation, and you will have to assign the PG/PC as described below.

The PG/PC assignment is not required if a local WinLC incorporating a network card is used.

Procedure

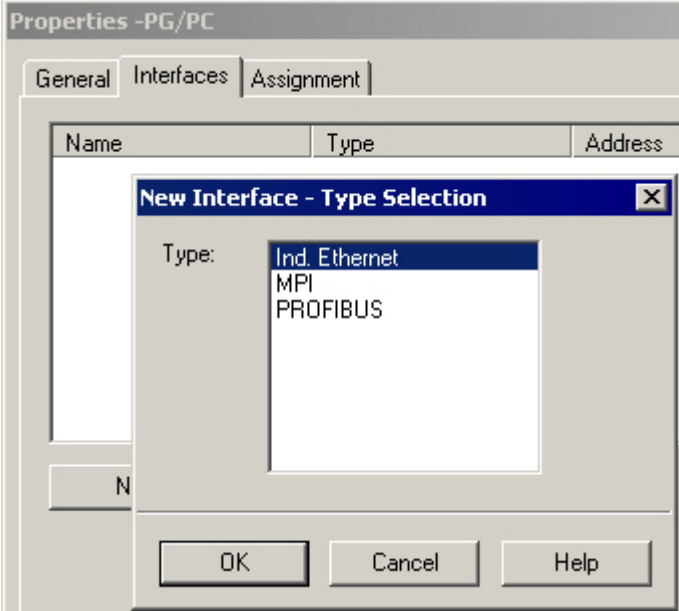
Step	Procedure
1.	Open the "Processing_A" project in SIMATIC iMap. In the network view, select any device and then select Special > Assign PG/PC . This is necessary in order to be able to download the program to intelligent PROFIBUS devices.
2.	<p>On the "Interfaces" tab in the "PG/PC interface" dialog box, click on the "New" button and select "Ind. Ethernet" from the drop-down list.</p>  <p>Click on "OK" to confirm your choice.</p>

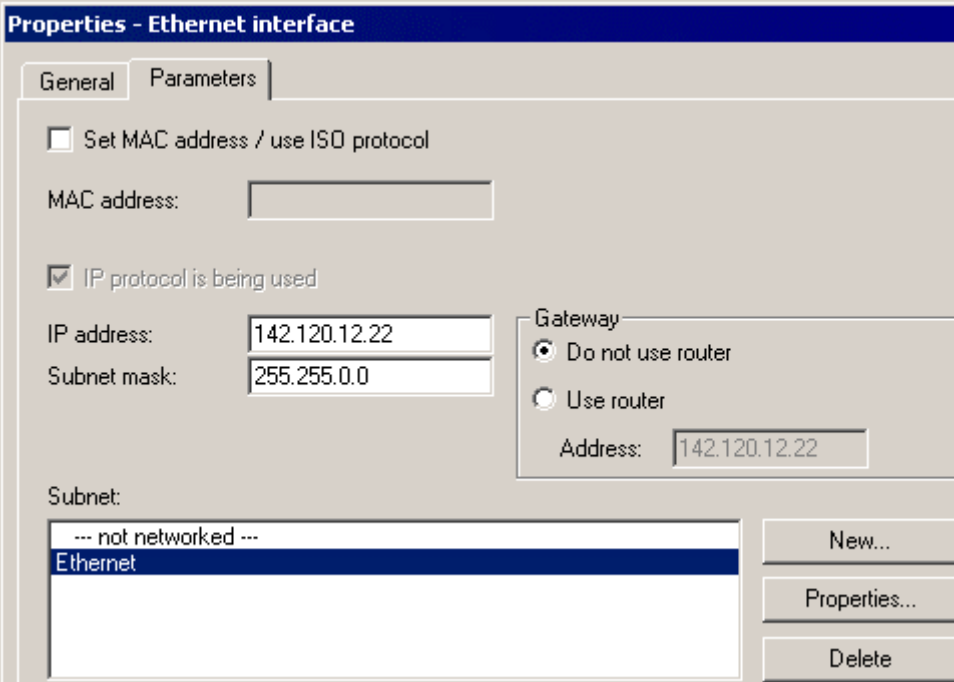
Step	Procedure
3.	<p>In the "Properties - Ethernet Interface" dialog box, enter the IP address and subnet mask of the local computer, then select the Ethernet subnet.</p> 

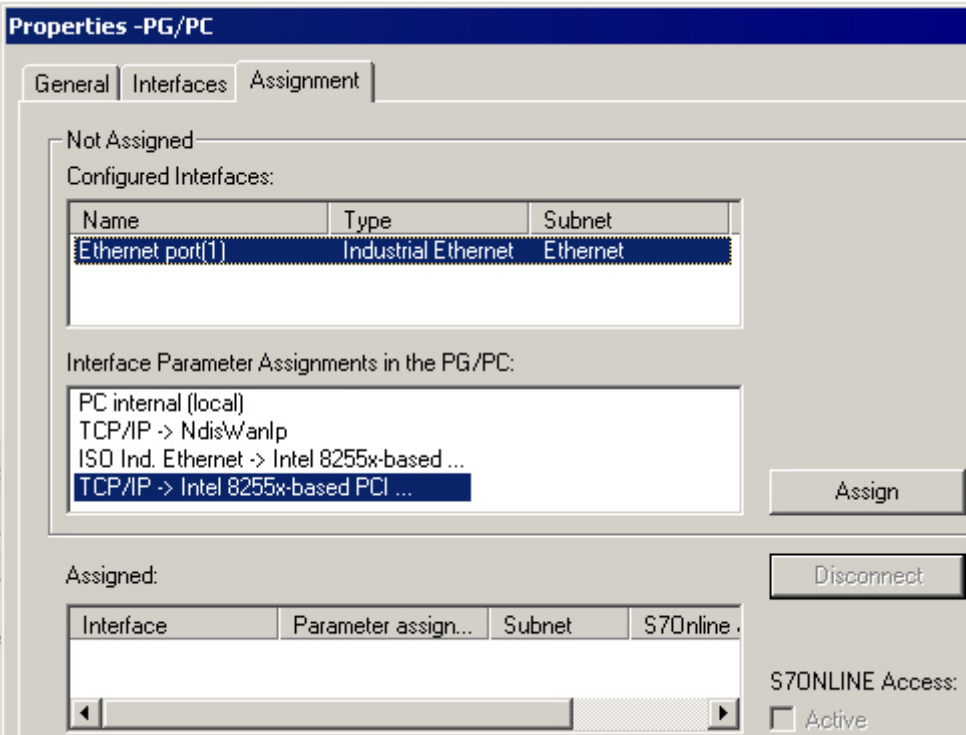
Step	Procedure														
4.	<p>Click on "OK" to confirm your input. Result: The interface you have just configured appears on the "Interfaces" tab.</p>  <p>Properties -PG/PC</p> <p>General Interfaces Assignment</p> <p>Not Assigned</p> <p>Configured Interfaces:</p> <table border="1" data-bbox="435 622 1114 750"> <thead> <tr> <th>Name</th> <th>Type</th> <th>Subnet</th> </tr> </thead> <tbody> <tr> <td>Ethernet port(1)</td> <td>Industrial Ethernet</td> <td>Ethernet</td> </tr> </tbody> </table> <p>Interface Parameter Assignments in the PG/PC:</p> <ul style="list-style-type: none"> PC internal (local) TCP/IP -> NdisWanIp ISO Ind. Ethernet -> Intel 8255x-based ... TCP/IP -> Intel 8255x-based PCI ... <p>Assign</p> <p>Disconnect</p> <p>Assigned:</p> <table border="1" data-bbox="435 1025 1114 1151"> <thead> <tr> <th>Interface</th> <th>Parameter assign...</th> <th>Subnet</th> <th>S7Online.</th> </tr> </thead> <tbody> <tr> <td></td> <td></td> <td></td> <td></td> </tr> </tbody> </table> <p>S7ONLINE Access: <input type="checkbox"/> Active</p>	Name	Type	Subnet	Ethernet port(1)	Industrial Ethernet	Ethernet	Interface	Parameter assign...	Subnet	S7Online.				
Name	Type	Subnet													
Ethernet port(1)	Industrial Ethernet	Ethernet													
Interface	Parameter assign...	Subnet	S7Online.												

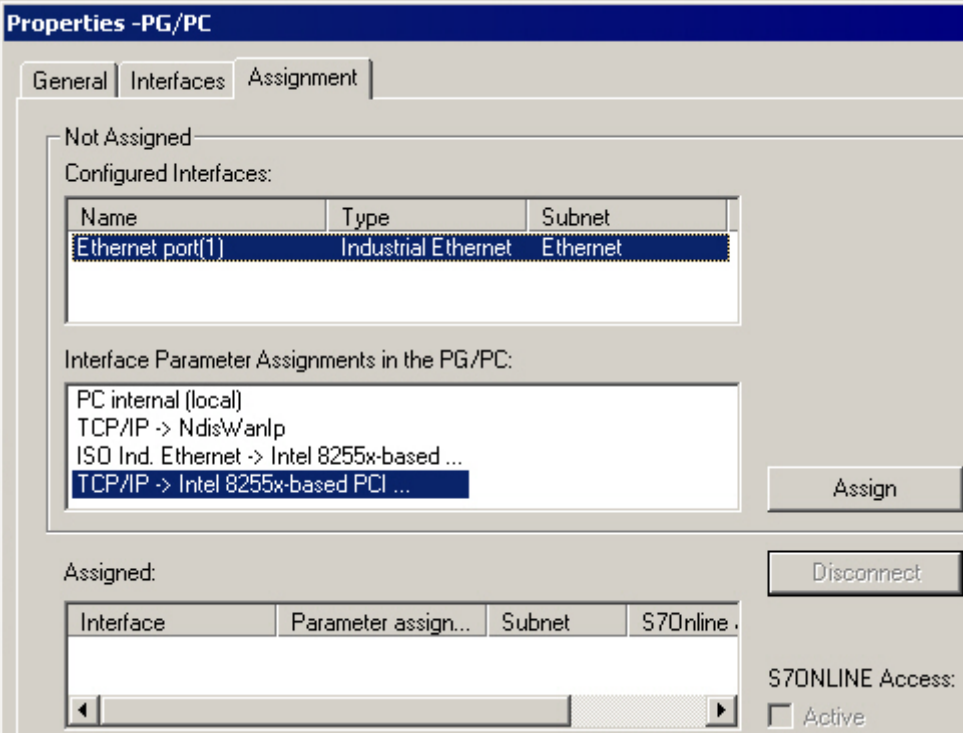
Step	Procedure						
5.	<p>On the "Assignment" tab, highlight the Ethernet interface you have just configured under "Not assigned" in the "Configured Interfaces" selection box, and in the "Interface parameter settings on the PG/PC:" box, select</p> <p>TCP/IP -> <Network card used></p>  <p>The screenshot shows the 'Properties -PG/PC' dialog box with the 'Assignment' tab selected. The 'Configured Interfaces' table has the following data:</p> <table border="1"> <thead> <tr> <th>Name</th> <th>Type</th> <th>Subnet</th> </tr> </thead> <tbody> <tr> <td>Ethernet port(1)</td> <td>Industrial Ethernet</td> <td>Ethernet</td> </tr> </tbody> </table> <p>The 'Interface Parameter Assignments in the PG/PC' list contains:</p> <ul style="list-style-type: none"> PC internal (local) TCP/IP -> NdisWanIp ISO Ind. Ethernet -> Intel 8255x-based ... TCP/IP -> Intel 8255x-based PCI ... (highlighted) <p>The 'Assigned' table is currently empty.</p>	Name	Type	Subnet	Ethernet port(1)	Industrial Ethernet	Ethernet
Name	Type	Subnet					
Ethernet port(1)	Industrial Ethernet	Ethernet					

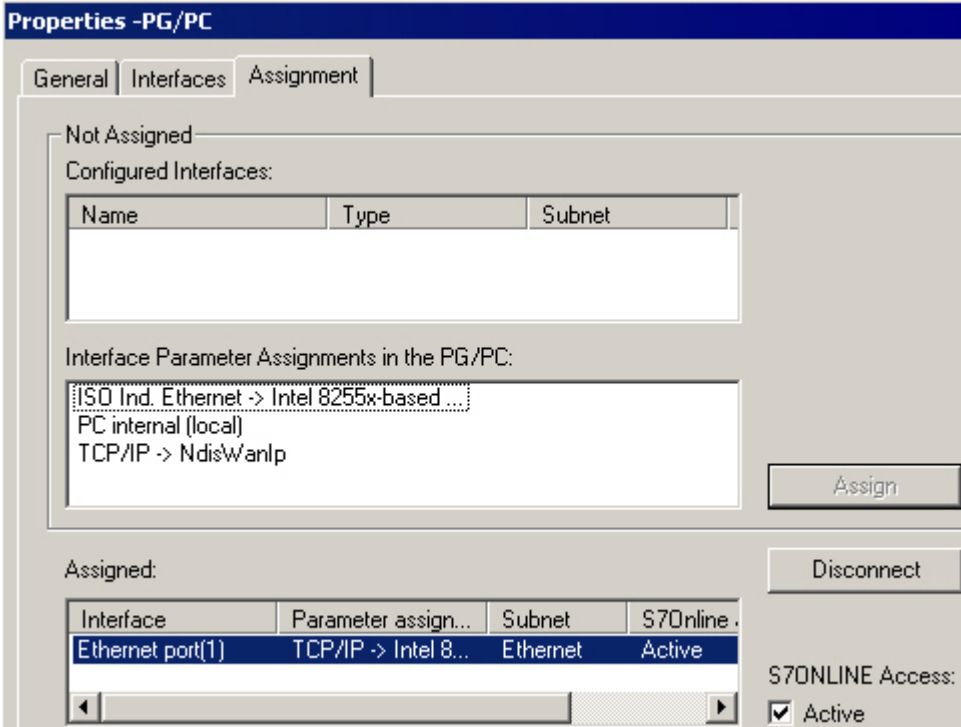
Step	Procedure								
6.	<p>Click on the "Assign" button. Result: The assigned interface appears in the "Assigned" selection box. Activate the "S7ONLINE access" option.</p>  <p>The screenshot shows the 'Properties -PG/PC' dialog box with the 'Assignment' tab selected. The 'Assigned' section contains a table with the following data:</p> <table border="1" data-bbox="432 1066 1110 1189"> <thead> <tr> <th>Interface</th> <th>Parameter assign...</th> <th>Subnet</th> <th>S7Online .</th> </tr> </thead> <tbody> <tr> <td>Ethernet port(1)</td> <td>TCP/IP -> Intel 8...</td> <td>Ethernet</td> <td>Active</td> </tr> </tbody> </table> <p>Below the table, the 'S7ONLINE Access:' checkbox is checked and labeled 'Active'.</p>	Interface	Parameter assign...	Subnet	S7Online .	Ethernet port(1)	TCP/IP -> Intel 8...	Ethernet	Active
Interface	Parameter assign...	Subnet	S7Online .						
Ethernet port(1)	TCP/IP -> Intel 8...	Ethernet	Active						

Click on "OK" to activate the assignment.

3.4.5 Step 5: Commissioning Plant 2

Requirements

- See Chapter "System commissioning requirements"
- The PG/PC is linked to the IE/PB Link via the Ethernet.
- The IE/PB Link is linked to the DP slaves via the PROFIBUS.
- You have checked the settings in STEP 7.
- You have generated the project in SIMATIC iMap.
- All the devices are switched on.

Tip: Check the generation status

To check the generation status of a device, open the properties

- of the device in the network view
- of the technological function in the plant view.

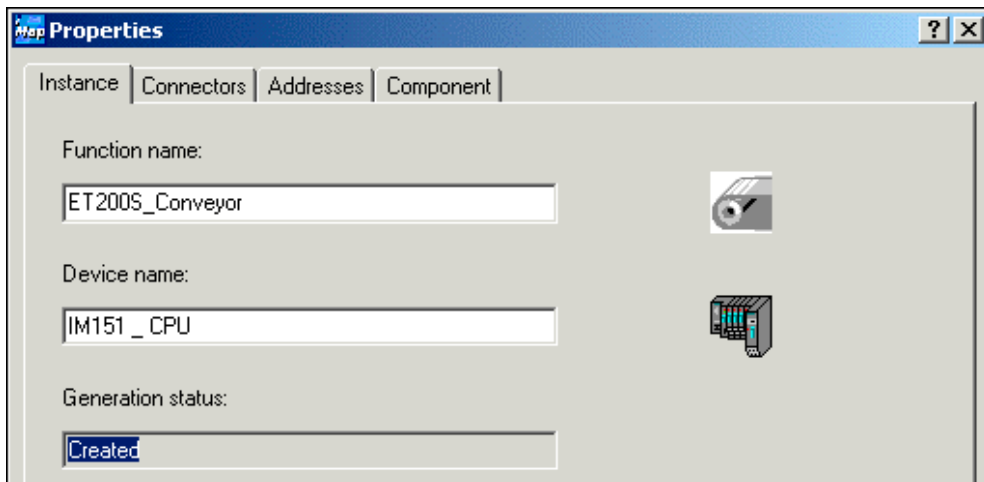

The generation status must be "Generated". If this is not the case, generate the project again using the **Project > Generate > Changes Only** menu command.

Procedure

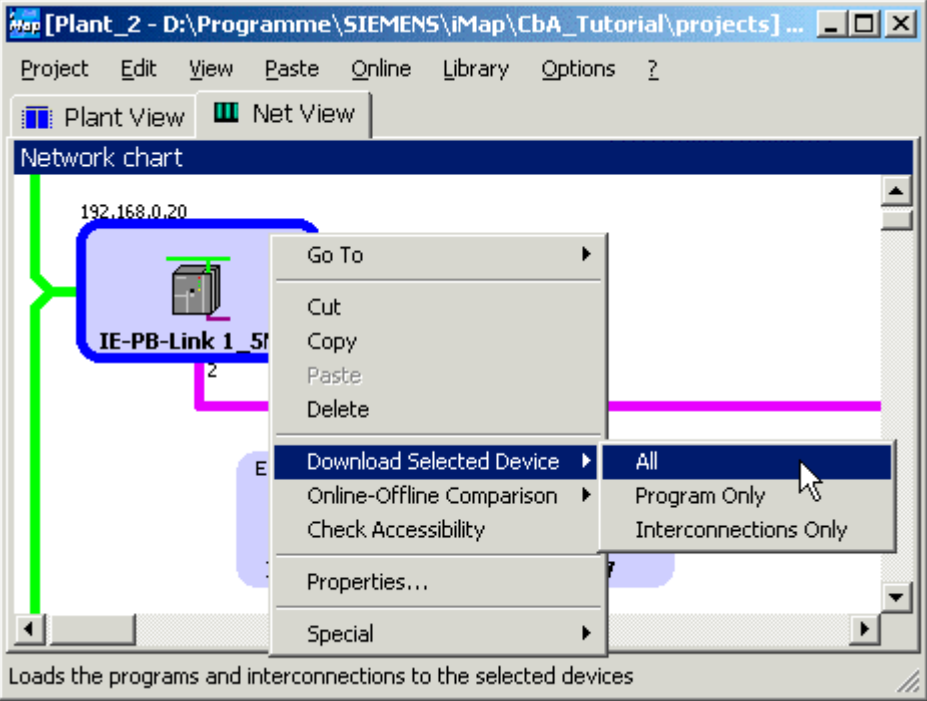
Step	Procedure
1.	<p>In SIMATIC iMap: Select the IE/PB Link from the network view. Download the data to the device: Select Download > Selected Devices > All from the context menu.</p>  <p>If the IE/PB Link is in RUN mode, you are asked whether you wish to stop the device. Click on "Yes" to confirm the message. Result: The device switches to STOP and the data is downloaded to the device. You are then asked whether you want to restart the device. Click on "Yes" to confirm this prompt. You can then download the data to the DP slaves.</p>
2.	<p>Select</p> <ul style="list-style-type: none"> • the devices from the network view or • the technological functions from the plant view <p>the two other PROFINet components, "ET200S_Conveyor" and "ET200X_Conveyor". Download the data to the devices: Select Download > Selected Devices > All from the context menu. You will receive the same prompt as in step 1 for each device. Answer "Yes" to each prompt.</p>

Result: The devices are ready for use.

Notes on downloading

Download the data to the DP master with proxy functionality (IE/PB Link) first, and then to the associated DP slaves.

When changes are made to the PROFIBUS within the project by removing or adding PROFIBUS devices, for example, then a download to both DP master and DP slaves is required.

The program download must be carried out first, using either:

- **Download > Selected Devices > All** or
- **Download > Selected Devices > Program Only.**

Interconnections can be downloaded later.

3.4.6 Step 6: Monitor Plant 2 Online

With SIMATIC iMap, you can



- monitor online and diagnose the devices of the plant.
- display and set online values.

Requirements

- See Chapter "System commissioning requirements"
- The PG/ PC is linked to the IE/PB Link or one of the PROFINet devices via the Ethernet.
- You have checked the settings in STEP 7.
- You have generated the project in SIMATIC iMap.
- You have downloaded the data to the devices.
- The devices are in RUN mode.

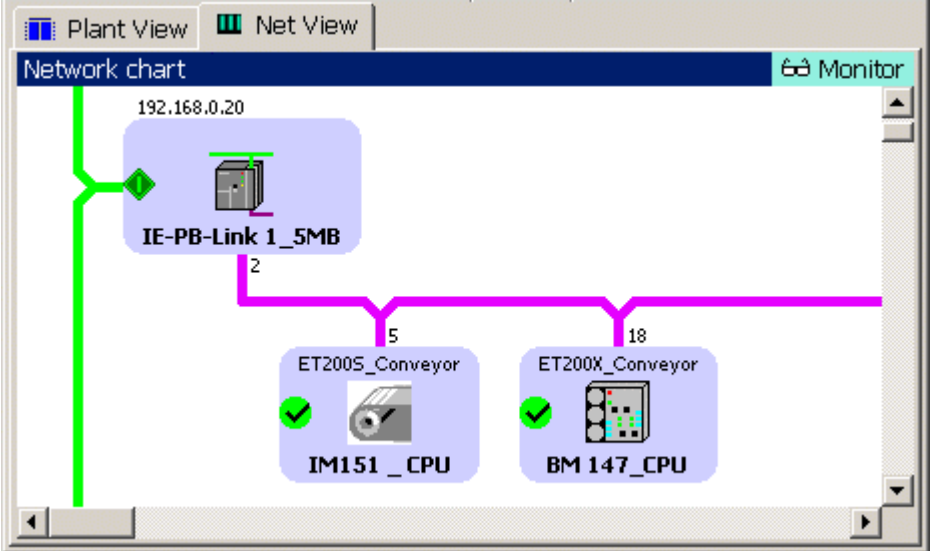
Procedure

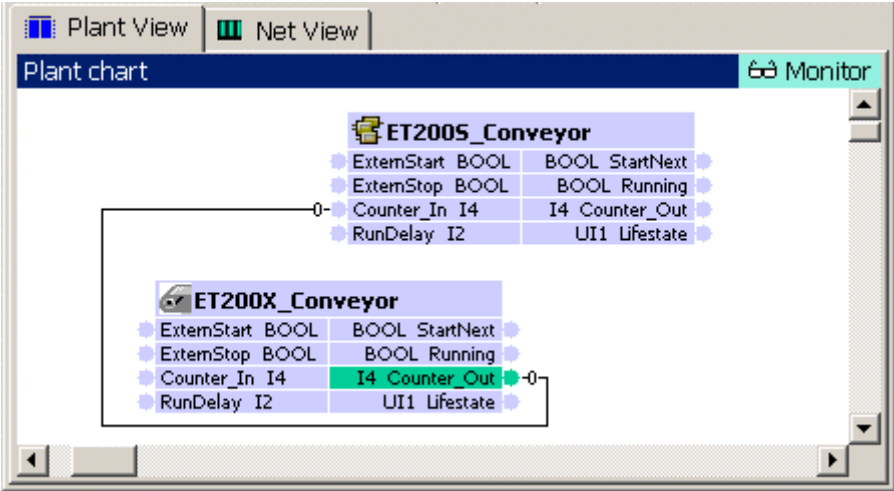
Step	Procedure
1.	<p>Switch the online view on/off</p> <p>In SIMATIC iMap, switch on the online view:</p> <ul style="list-style-type: none"> • click on the "Online Monitoring" icon  or • select Online > Monitor. <p>You are asked whether you want to compare the devices' online and offline program data. This comparison is optional. You can run it immediately or later.</p> <p>If you answer "Yes" to this question, the data is compared and the result is displayed in the information window.</p> <p>Result: The SIMATIC iMap online view is switched on and any diagnostic information is displayed directly at the devices and technological functions and in the diagnostic window.</p>  <p>The screenshot shows the SIMATIC iMap interface with the 'Net View' tab selected. The 'Network chart' displays a network topology. A green line represents the main network connection, leading to a device labeled 'IE-PB-Link 1_5MB' with IP address '192.168.0.20'. This device is connected to two other devices: 'ET200S_Conveyor' (IM151_CPU) and 'ET200X_Conveyor' (BM 147_CPU). The connections are labeled with the numbers 2, 5, and 18. Both conveyor devices have a green checkmark, indicating they are online. A 'Monitor' button is visible in the top right corner of the network chart window.</p>

Step	Procedure
2.	<p>Display Online Values</p> <p>In the project plant view, select the "Counter_In" input of "ET200X_Conveyor" and the "Counter_Out" output of "ET200S_Conveyor", then select the Online > Display Online Values menu command. The online value 0 is displayed at the connectors.</p> 
3.	<p>Click again on the  icon or select the Online > Monitor option to switch off the online view.</p>

Display diagnostic information

In the event of an error, diagnostic information is displayed in SIMATIC iMap in both graphical and text format.

The diagnostic information for the technological functions can be found on the "Functions" tab in the diagnostic window.

Example: The interconnections have to be downloaded (**Online > Download Selected Device > Interconnection Only** menu command).

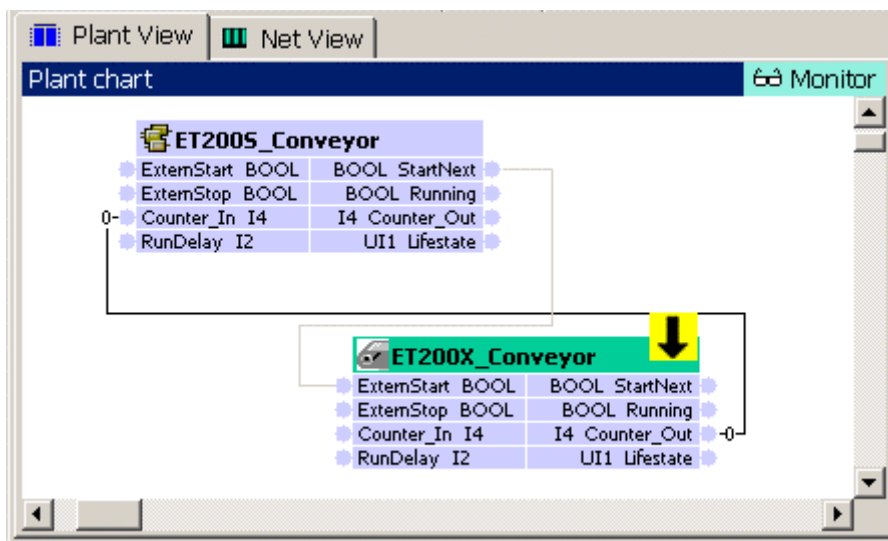

The diagnostic information for the devices can be found on the "Devices" tab in the diagnostic window.

Example: The device is not available. In this case, you will have to check the settings and the communication links.

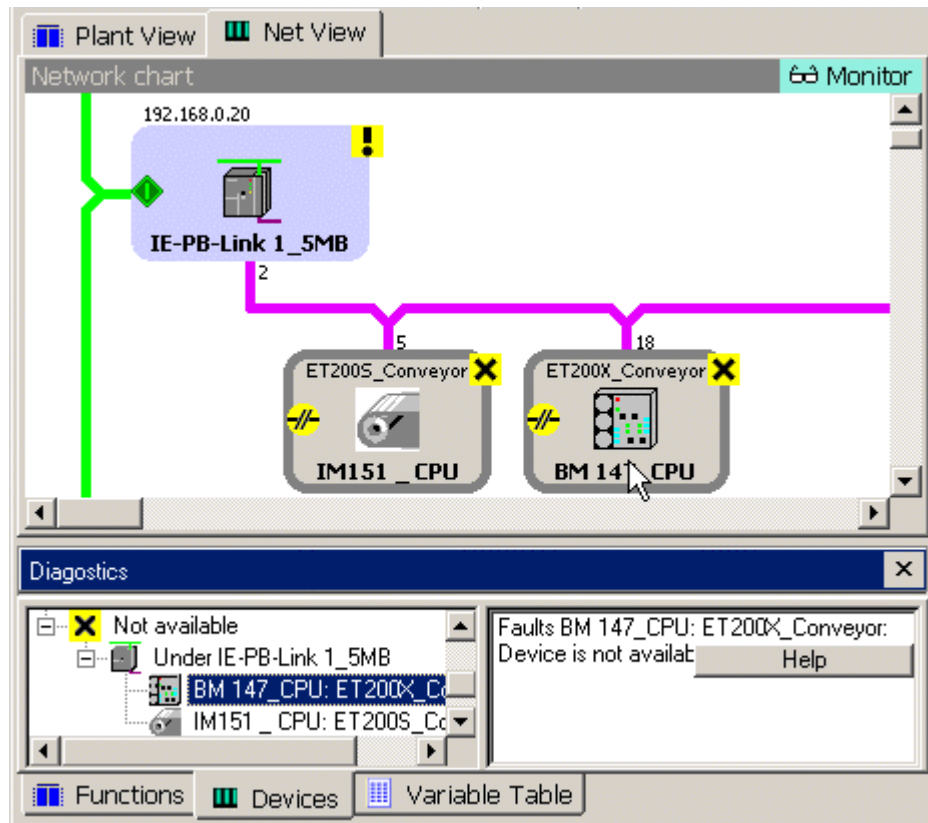

3.5 Plant 3: PC-Station WinLC PN with PROFIBUS DP slaves

Plant 3 contains a PC station WinLC PN "Processing_A" with the following PROFIBUS devices:

- ET 200S with IM151/CPU as the intelligent DP slave for controlling the conveyor belt "ET200S_Conveyor"
- ET 200M as a DP slave, I/O module "ET200M_IO" with 2 inputs and 2 outputs

The WinLC PN is a PROFINet device and a DP master with proxy functionality for the two DP slaves

Alternative set-up 3-1

STEP 7 and SIMATIC iMap are on the local engineering station, while the WinLC PN is on a remote computer.

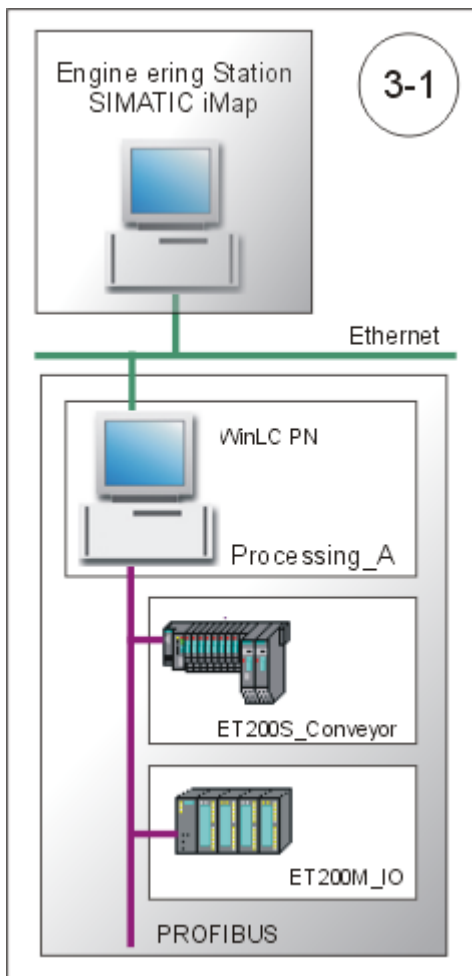

Alternative set-up 3-2

STEP 7, SIMATIC iMap and WinLC PN are all on one computer, namely the local engineering station.

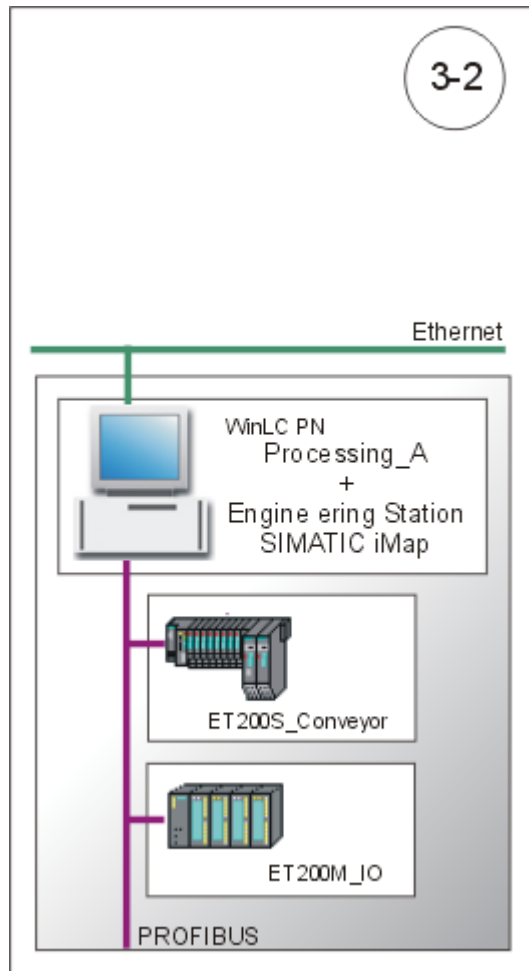

Basic procedure

The following tasks must be carried out:

1. Set up the plant hardware.
2. Set up the plant hardware:
 - IE/PB Link
 - ET 200 with IM151/CPU
 - ET 200X with BM147/CPU
3. Configure the plant in SIMATIC iMap.
4. Assign addresses
 - Assign an IP address to the IE/PB Link for the first time.
 - Assign a PROFIBUS address to the IM151/CPU for the first time.
5. Configure the plant in SIMATIC iMap.
6. Check your settings in STEP7 in order to download the project data from SIMATIC iMap to the plant and be able to monitor the plant online.
7. Start the plant
8. Monitor the plant online with SIMATIC iMap.

3.5.1 Step 1: Set up hardware

A PC station WinLC PN with the PROFIBUS devices ET 200S and ET 200M.

Set up the following hardware:

- WinLC PN

We distinguish between the two following situations:

- the WinLC PN is on a remote PC
 - the WinLC PN is on the local engineering station that is running SIMATIC iMap
- ET 200S with IM151/CPU
 - ET 200M with BM151/CPU

3.5.1.1 WinLC PN Hardware Set-up

Hardware required

- PC with Windows 2000 SP3 or later
- PROFIBUS connection via CP 5611, for example

Procedure

Step	Procedure
1.	Plant 3-1 only: Connect the PC to the local engineering station via the Ethernet.
2.	Connect the PC to the DP slaves using the PROFIBUS cable.

3.5.1.2 ET 200M Hardware Set-up

Hardware required

You will need the following modules:

Quantity	Designation	Order no.
1 x	Interface module IM 153 (from GSD file SI801DVD.200)	6ES7 153-1AA**-0XB0
1 x	Expansion module DI 4xDC24V (no power)	6ES7 321-1BH00-0AA0
1 x	Expansion module DO 4xDC24V/2A	6ES7 322-1BH00-0AA0

Procedure

Step	Procedure
1.	Attach the modules to the rail
2.	Set PROFIBUS address 3 on the interface module IM 153.
3.	Connect the power supply.
4.	Wire up the I/O modules.
5.	Connect the PROFIBUS cable to the IM153-2.

3.5.1.3 ET 200S with IM151/CPU Hardware Set-up

Hardware required

You will need the following modules:

Quantity	Designation	Order no.
1 x	Interface module IM 151 and terminating module, 1x	6ES7 151-7AA10-0AB0 / V2.0
2 x	Terminal module TM-P15S23-A1, 1x	6ES7 193-4CC30-0AA0
2 x	Terminal module TM-E15S24-A1, 5x	6ES7 193-4CA20-0AA0
2 x	Power module PM-E DC24 V, 1x	6ES7 138-4CA00-0AA0
1 x	2DI DC24V; high feature, 2x	6ES7 131-4BB00-0AB0
1 x	2DO DC24V; 0.5 A; high feature, 2x	6ES7 132-4BB00-0AB0
1 x	Bus connector	6ES7 972-0BA10-0XA0

Procedure

Step	Procedure
1.	Attach the modules to the rail
2.	Connect the power supply.
3.	Wire up the I/O modules.
4.	Connect the PG/PC to the IM151/CPU using the PG cable.
5.	Switch on the power supply to the IM151/CPU.

Note

When you **start up** the ET 200S for the first time (as-delivered state), the IM151/CPU can be accessed via MPI addresses 2, HSA 31 and 187.5 kBps. The PROFIBUS address is assigned to the IM 151/CPU via MPI after the project is generated in SIMATIC iMap.

3.5.2 Step 2: Configure Plant 3 in SIMATIC iMap

This task can be carried out regardless of the plant's hardware set-up.

Requirements

You must have created the PROFINet components and they must either be present in the file system or located in the tutorial install directory under iMap\CBA_Tutorial\components.

Basic procedure

1. Create a new library in SIMATIC iMap, if it does not exist.
2. Import the PROFINet components from the file system to the library.
3. Paste the PROFINet components from the library into the SIMATIC iMap project.
4. Assign addresses.
5. Interconnect technological functions and generate SIMATIC iMap project.

Create a Library in SIMATIC iMap

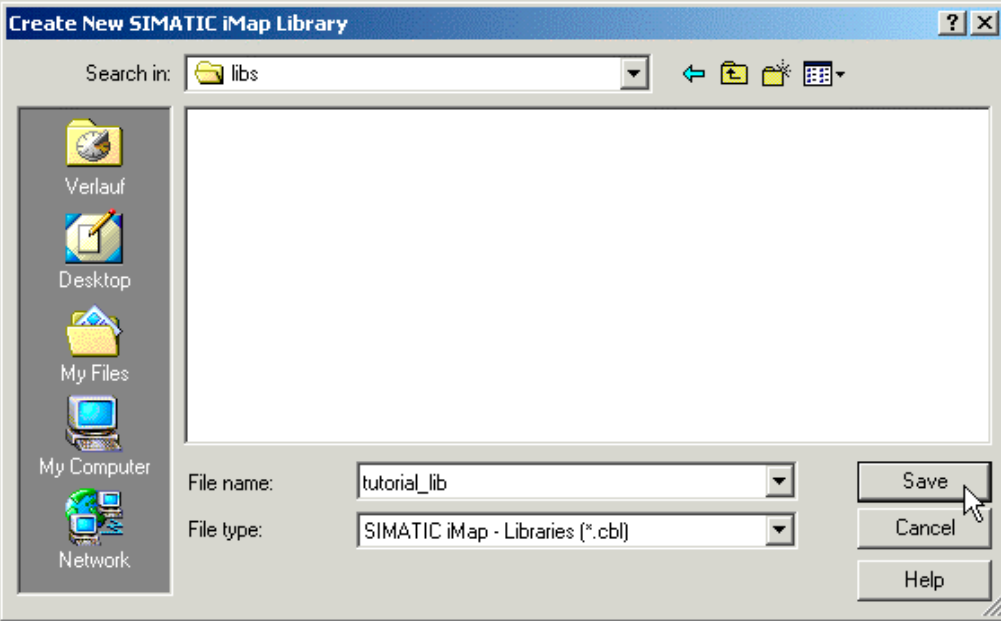
Step	Procedure
1.	Start SIMATIC iMap: <ul style="list-style-type: none"> • by double-clicking the  icon or • by selecting Start > Programs > Component based Automation > SIMATIC iMap.
2.	Select the Library > New... menu command.
3.	Under "Search in", select the path Programs\Siemens\iMap\Tutorial .
4.	Crate a new folder named "libs"
5.	In the "libs" folder, create a library with the file name "tutorial_lib". 

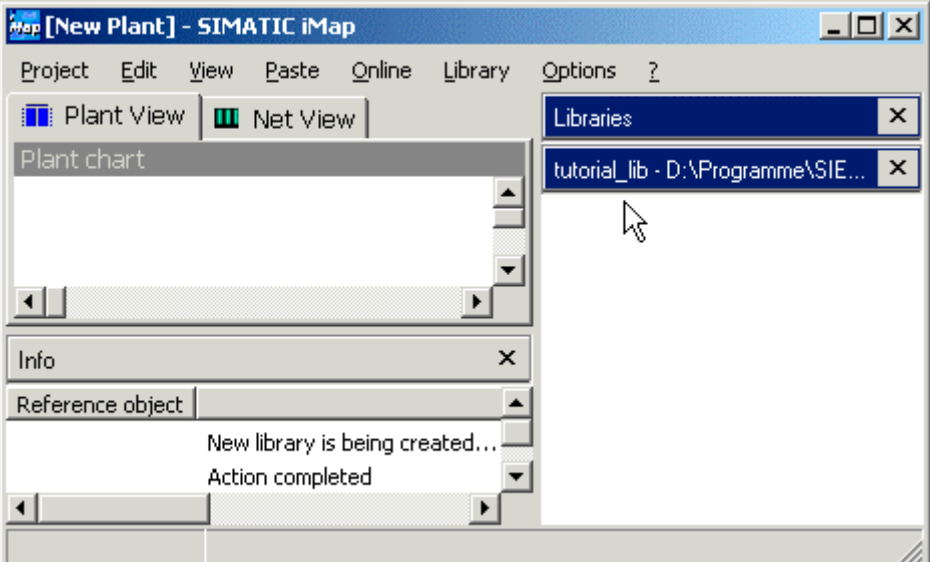
Step	Procedure
6.	<p>Click on the "Save" button to confirm your input. Result: The library called "tutorial_lib" is created and opened in SIMATIC iMap.</p> 

Import PROFINet Components

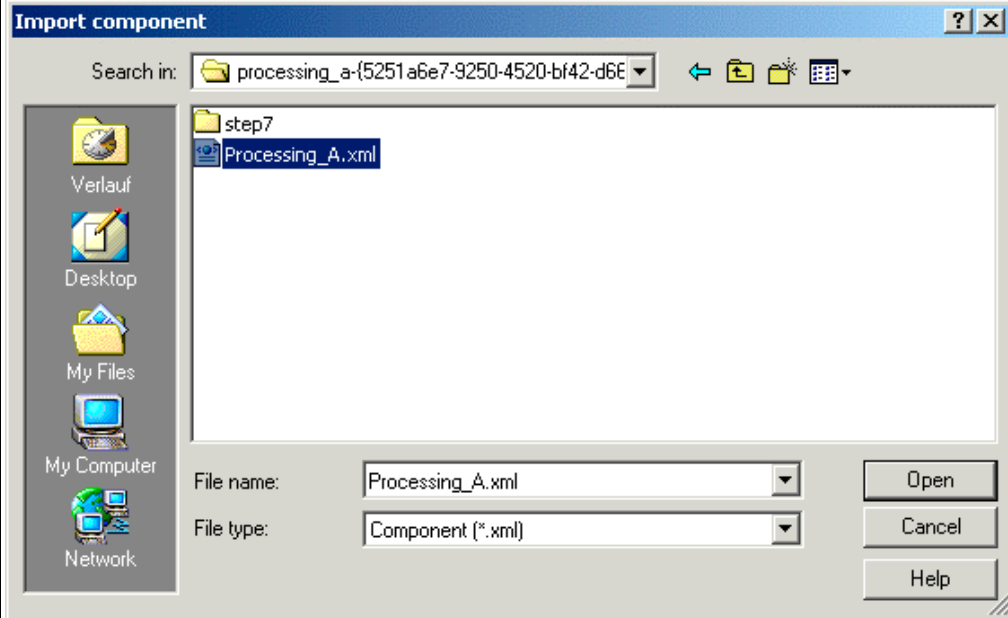
Step	Procedure
1.	In SIMATIC iMap, click in the "tutorial_lib" library window. If the "tutorial_lib" library is not open, open it by selecting Library > Open
2.	Import the PROFINet components from the file system to the library: Select Import Component from the context menu in the library window.
3.	Under "Search In", select the path Programs\Siemens\iMap\CBA_Tutorial\components .
4.	Select the "processing_a--{...}" folder. 
5.	From this folder, select the "Processing_A.xml" file and click on the "Open" button to confirm your input. Result: The PROFINet component "Processing_A" is added to the library.

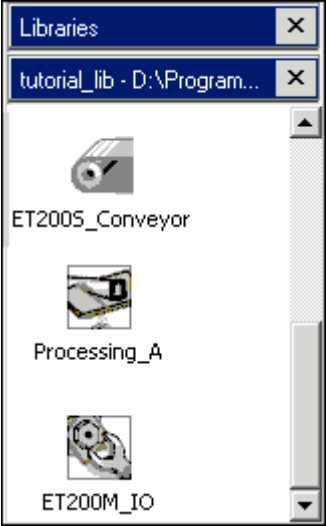
Step	Procedure
6.	<p>Repeat steps 3 to 5 for the following PROFINet components.</p> <ul style="list-style-type: none">• "ET200S_Conveyor" ("et200s_conveyor--{...}" folder and "ET200S_Conveyor.xml" file)• "ET200M_IO" ("et200m_io--{...}" folder and "ET200M_IO.xml" file). <p>Result: The two PROFINet components are added to the library.</p>  <p>The screenshot shows a software library window titled 'Libraries' with a sub-window 'tutorial_lib - D:\Program...'. The library contains three components: 'ET200S_Conveyor' (represented by a conveyor belt icon), 'Processing_A' (represented by a gear icon), and 'ET200M_IO' (represented by a gear icon).</p>

Paste PROFINet Components into the Project

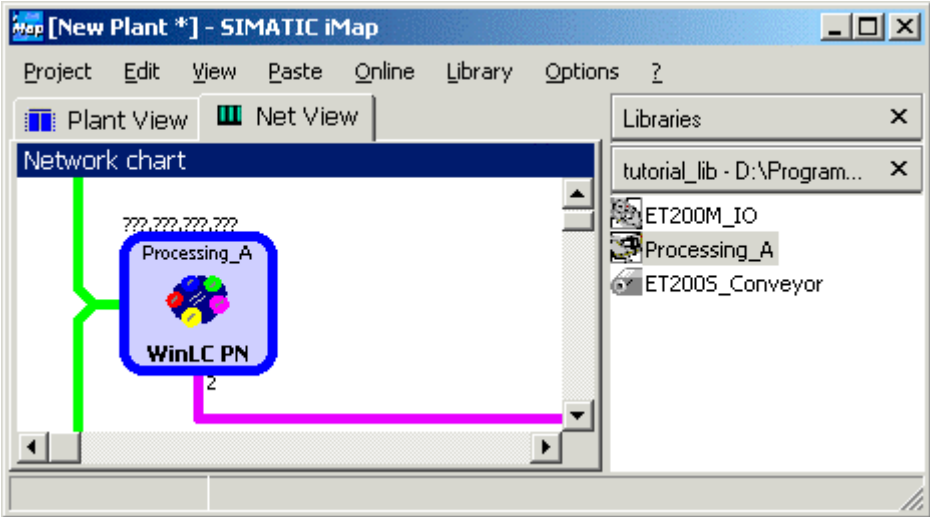
Step	Procedure
1.	<p>Paste the PROFINet component for the WinLC PN from the library and into the project: Select the PROFINet component "Processing_A" from the library and</p> <ul style="list-style-type: none"> • drag it into the network view or • select Paste Into Project from the context menu. <p>The PROFINet device is automatically linked to the Ethernet in the network view, and has a PROFIBUS connector as the DP master with proxy functionality.</p>  <p>The screenshot shows the SIMATIC Manager interface. The main window is titled 'iMap [New Plant *] - SIMATIC iMap'. It has a menu bar with 'Project', 'Edit', 'View', 'Paste', 'Online', 'Library', and 'Options'. Below the menu bar are two tabs: 'Plant View' and 'Net View', with 'Net View' selected. The main area is labeled 'Network chart' and shows a network diagram. A green line represents an Ethernet connection, and a purple line represents a PROFIBUS connection. A component labeled 'Processing_A' and 'WinLC PN' is connected to the network. The IP address '777.777.777.777' is visible above the component. A library pane on the right is titled 'Libraries' and shows a list of components: 'tutorial_lib - D:\Program...', 'ET200M_IO', 'Processing_A' (which is highlighted), and 'ET200S_Conveyor'.</p>
2.	<p>Select the PROFINet component "ET200S_Conveyor" from the library, then use Drag&Drop to link it to the PROFIBUS with the WinLC PN.</p>

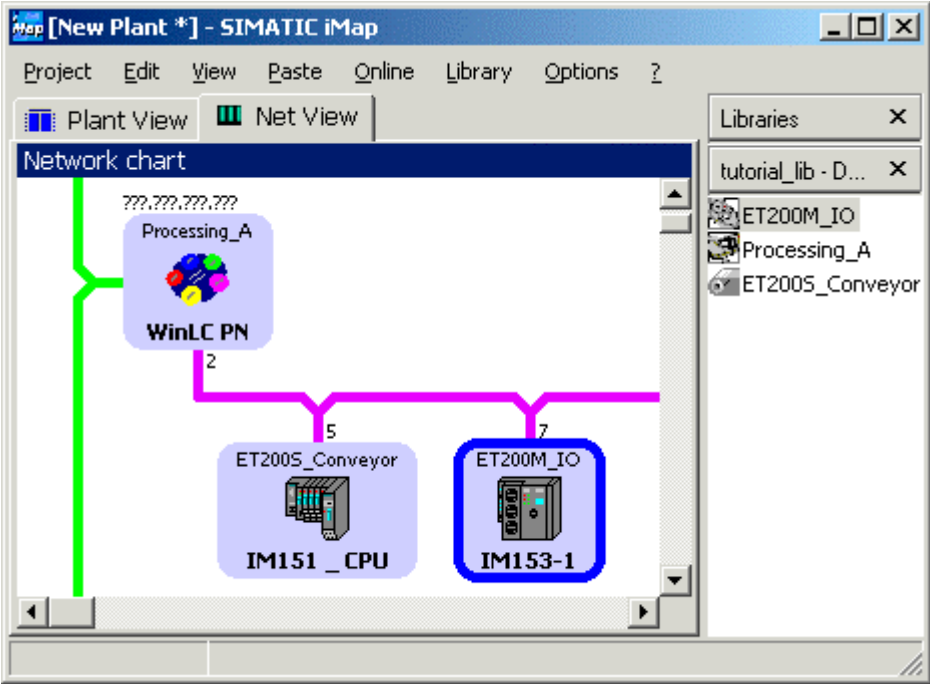
Step	Procedure
3.	<p>Repeat step 2 for the PROFINet component "ET200M_IO".</p>  <p>The screenshot shows the SIMATIC iMap software interface. The main window is titled "[New Plant *] - SIMATIC iMap" and has tabs for "Plant View" and "Net View". The "Net View" is active, displaying a "Network chart". A green line represents the backbone, leading to a "WinLC PN" node (IP address: ????.????). This node is connected via a purple line to two other nodes: "ET2005_Conveyor" (IM151_CPU) and "ET200M_IO" (IM153-1). The connection to the conveyor is labeled with the number '2', and the connection to the IO is labeled with '5' and '7'. A right-hand sidebar shows a "Libraries" pane with a tree view containing "ET200M_IO", "Processing_A", and "ET2005_Conveyor".</p>

Assign Addresses

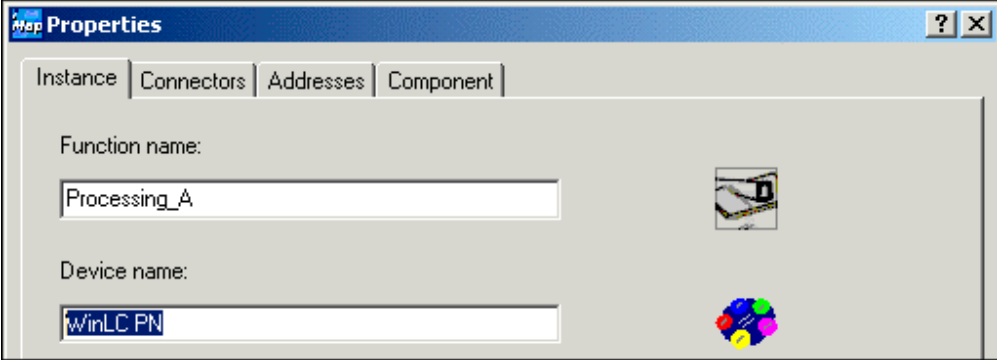

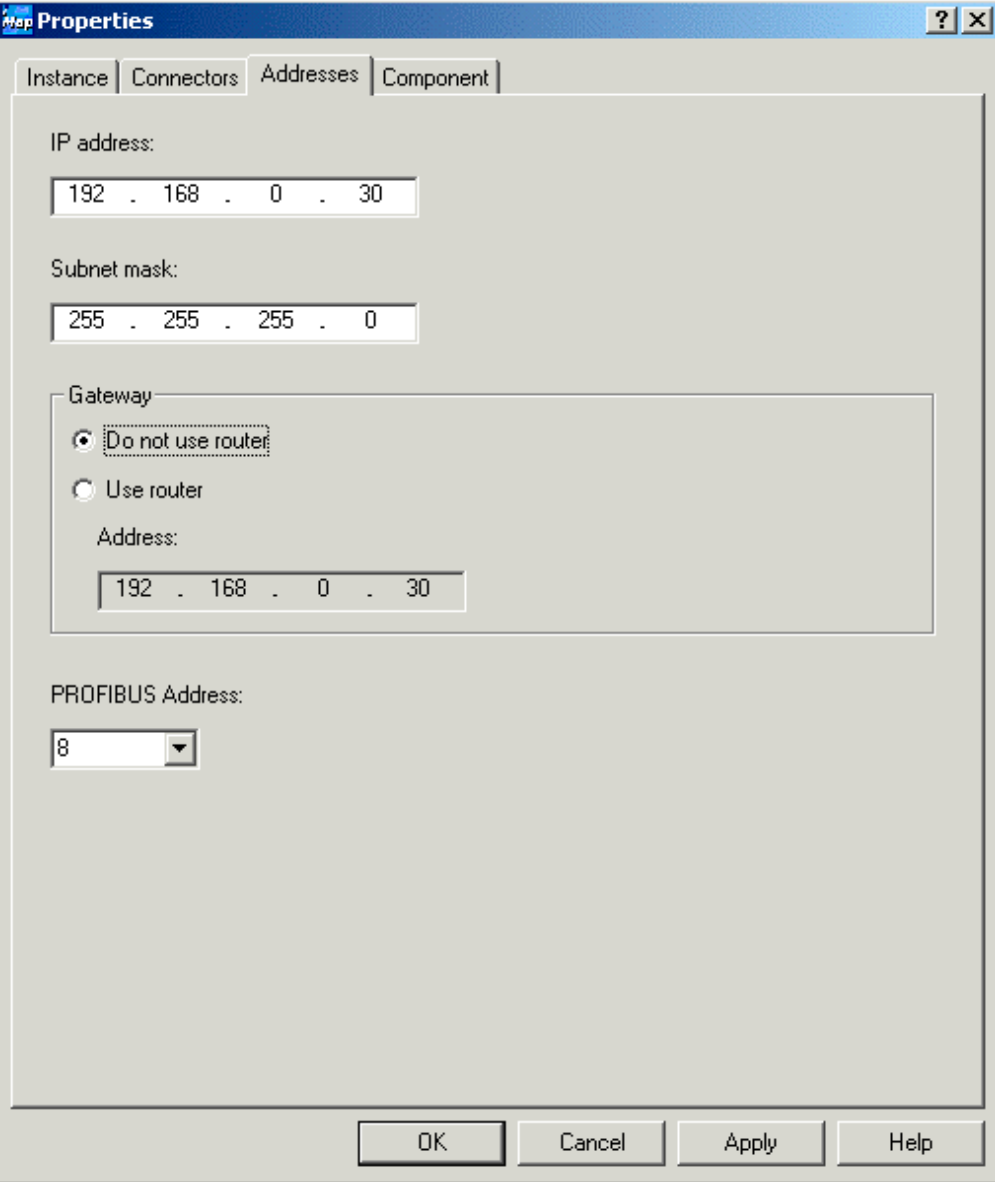
Step	Procedure
1.	<p>Open the WinLC PN properties in the network view. Enter the station name of the local PC station in the "Name" box on the "Instance" tab (only if the WinLC PN is on the local engineering station, e.g. "WinLC PN")</p>  <p>The screenshot shows the "Properties" dialog box for the WinLC PN component. The "Instance" tab is selected, showing fields for "Function name" (containing "Processing_A") and "Device name" (containing "WinLC PN"). There are also icons for the function and device. The "Connectors", "Addresses", and "Component" tabs are also visible.</p>

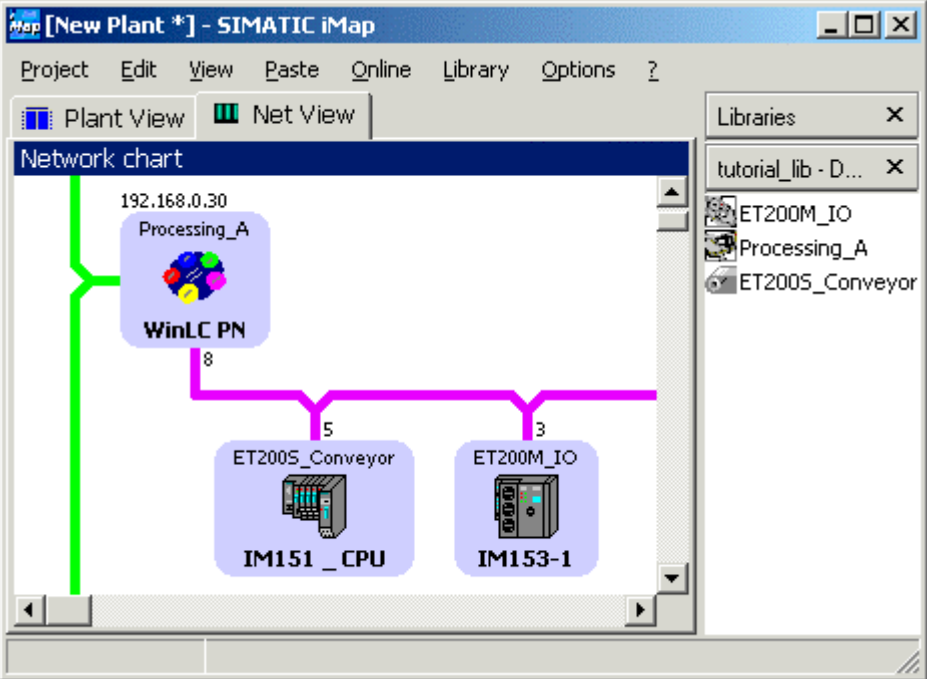
Step	Procedure
2.	<p>On the "Addresses" tab, enter the IP address and subnet mask, plus the PROFIBUS address of the device as illustrated below.</p>  <p>The screenshot shows a 'Properties' dialog box with four tabs: 'Instance', 'Connectors', 'Addresses', and 'Component'. The 'Addresses' tab is active. It contains the following fields:</p> <ul style="list-style-type: none"> IP address: 192 . 168 . 0 . 30 Subnet mask: 255 . 255 . 255 . 0 Gateway: <ul style="list-style-type: none"> <input checked="" type="radio"/> Do not use router <input type="radio"/> Use router Address: 192 . 168 . 0 . 30 PROFIBUS Address: 8 <p>Buttons at the bottom: OK, Cancel, Apply, Help.</p>
3.	<p>In the network view, open the properties of the PROFIBUS device "IM151_CPU" (ET 200S) and enter the device's PROFIBUS address on the "Addresses" tab, e. g. 5.</p> <p>Note: Exactly the same address must be assigned to the device via MPI (see Assign a PROFIBUS address to the IM 151/CPU for the first time).</p>

Step	Procedure
4.	<p>Repeat step 3 for "IM153-1" (ET 200M) and assign PROFIBUS address 3 to the device.</p> <p>The network view for plant 2 then has the following appearance:</p>  <p>The screenshot shows the 'Network chart' in SIMATIC iMap. A WinLC PN (IP: 192.168.0.30) is connected to a network. A purple line represents the network backbone, with a branch labeled '8' connecting to the WinLC PN. From this branch, two lines labeled '5' and '3' connect to ET2005_Conveyor (IM151_CPU) and ET200M_IO (IM153-1) respectively. The 'Libraries' pane on the right shows 'tutorial_lib - D...' with components ET200M_IO, Processing_A, and ET2005_Conveyor.</p>

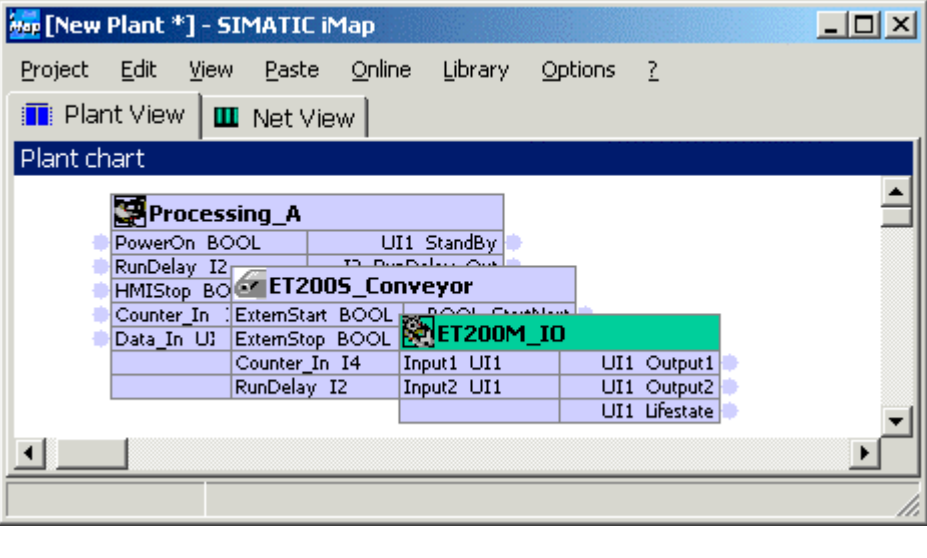
Interconnect Technological Functions and Generate Project

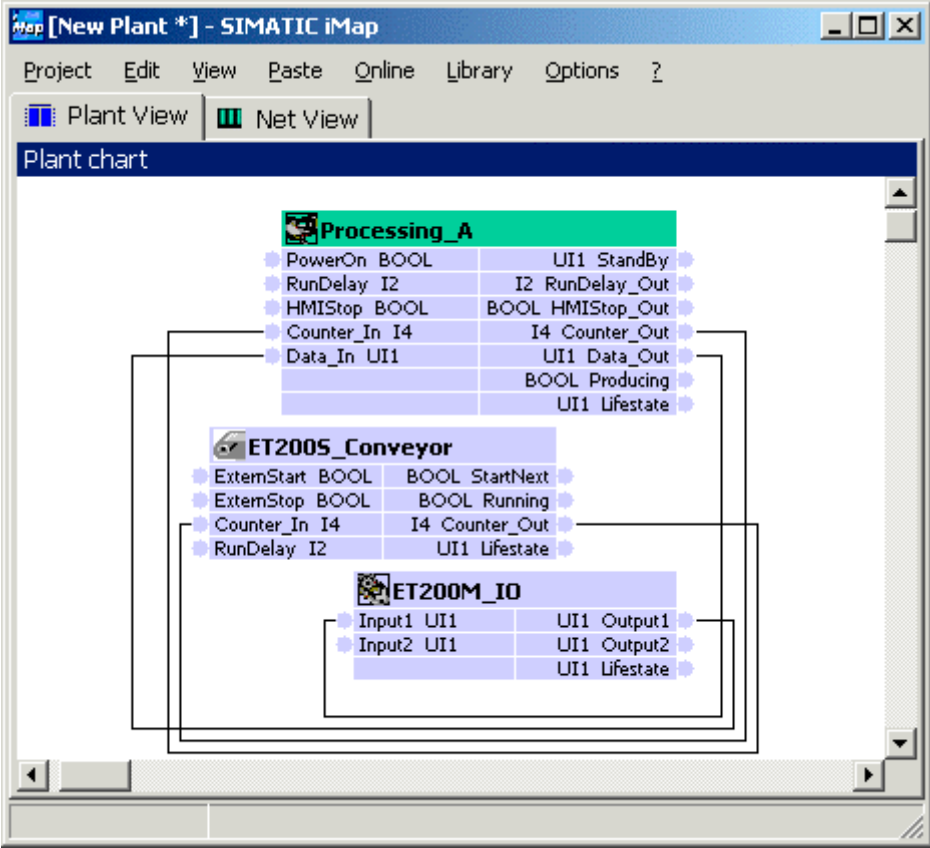
Step	Procedure
1.	<p>Open the plant view. At first, the technological functions are arranged one above the other.</p>  <p>The screenshot shows the 'Plant chart' in SIMATIC iMap. It displays three components: Processing_A, ET2005_Conveyor, and ET200M_IO. Processing_A has inputs: PowerOn (BOOL), RunDelay (I2), HMIStop (BO), Counter_In (U), and Data_In (U). It has outputs: UI1 StandBy, UI1 Output1, UI1 Output2, and UI1 Lifestate. ET2005_Conveyor has inputs: ExternStart (BOOL) and ExternStop (BOOL). ET200M_IO has inputs: Input1 (UI1) and Input2 (UI1). The connections between these components are shown as lines with arrows.</p>

Step	Procedure
2.	<p>Arrange the technological functions and interconnect them as shown below:</p>  <p>The screenshot shows the SIMATIC iMap interface with a 'Plant chart' view. It displays three components and their interconnections:</p> <ul style="list-style-type: none"> Processing_A (green header): <ul style="list-style-type: none"> Inputs: PowerOn (BOOL), RunDelay (I2), HMISstop (BOOL), Counter_In (I4), Data_In (UI1) Outputs: UI1 StandBy, I2 RunDelay_Out, BOOL HMISstop_Out, I4 Counter_Out, UI1 Data_Out, BOOL Producing, UI1 Lifestate ET2005_Conveyor (blue header): <ul style="list-style-type: none"> Inputs: ExtemStart (BOOL), ExtemStop (BOOL), Counter_In (I4), RunDelay (I2) Outputs: BOOL StartNext, BOOL Running, I4 Counter_Out, UI1 Lifestate ET200M_IO (blue header): <ul style="list-style-type: none"> Inputs: Input1 (UI1), Input2 (UI1) Outputs: UI1 Output1, UI1 Output2, UI1 Lifestate <p>Connections shown in the diagram:</p> <ul style="list-style-type: none"> Processing_A Counter_In (I4) connects to ET2005_Conveyor Counter_In (I4). ET2005_Conveyor RunDelay (I2) connects to Processing_A RunDelay (I2). ET2005_Conveyor Counter_Out (I4) connects to Processing_A Counter_Out (I4). ET2005_Conveyor UI1 Lifestate connects to Processing_A UI1 Lifestate. ET200M_IO Input1 (UI1) connects to ET2005_Conveyor ExtemStart (BOOL). ET200M_IO Input2 (UI1) connects to ET2005_Conveyor ExtemStop (BOOL). ET200M_IO UI1 Output1 connects to Processing_A UI1 StandBy. ET200M_IO UI1 Output2 connects to Processing_A UI1 Data_Out. ET200M_IO UI1 Lifestate connects to Processing_A UI1 Lifestate.
3.	<p>Make sure that the "tutorial_lib" library is open.</p> <p>Generate the project:</p> <ul style="list-style-type: none"> • using the Project > Generate > Changes Only menu command or • by clicking on the "Generate" icon . <p>If you have not yet saved the project, you will be prompted to enter a name for the project. In the "Save Simatic iMap Project As" dialog box, select a path and enter a name, e.g. "Plant_3".</p> <p>Result: The project is saved and generated.</p>

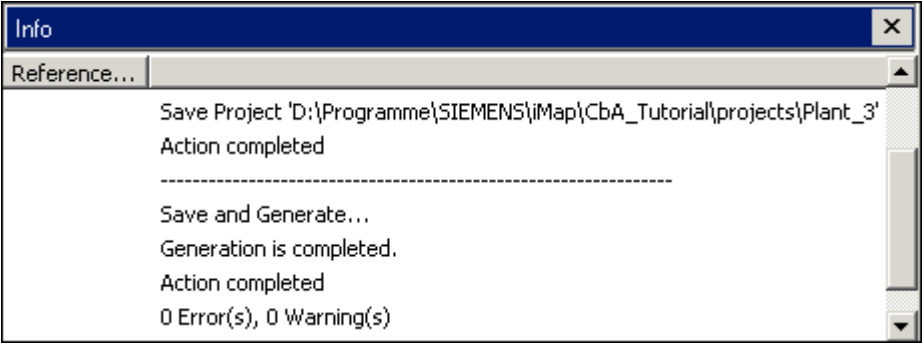
Step	Procedure
4.	<p>You can follow the generation progress in the information window.</p>  <p>The screenshot shows an 'Info' window with a 'Reference...' tab. The text inside the window reads: 'Save Project 'D:\Programme\SIEMENS\iMap\CbA_Tutorial\projects\Plant_3'', 'Action completed', a separator line, 'Save and Generate...', 'Generation is completed.', 'Action completed', and '0 Error(s), 0 Warning(s)'.</p>

Result: The plant is configured and can now be started.

3.5.3 Step 3: Assigning a PROFIBUS address to the IM151/CPU for the First Time

In step 2, you assigned a PROFIBUS address to the IM151_CPU device in SIMATIC iMap. You will have to download this PROFIBUS address from STEP 7 via MPI to the device yourself for the first time.

Requirements

- The IM151/CPU must be STOPped.
- The PG/PC must be connected to the IM151/CPU via MPI.
- The SIMATIC iMap project must have been generated. When you open the properties of the IM151_CPU device, the generation status "Generated" must appear on the "Instance" tab. Generate the project if this is not the case.

Procedure

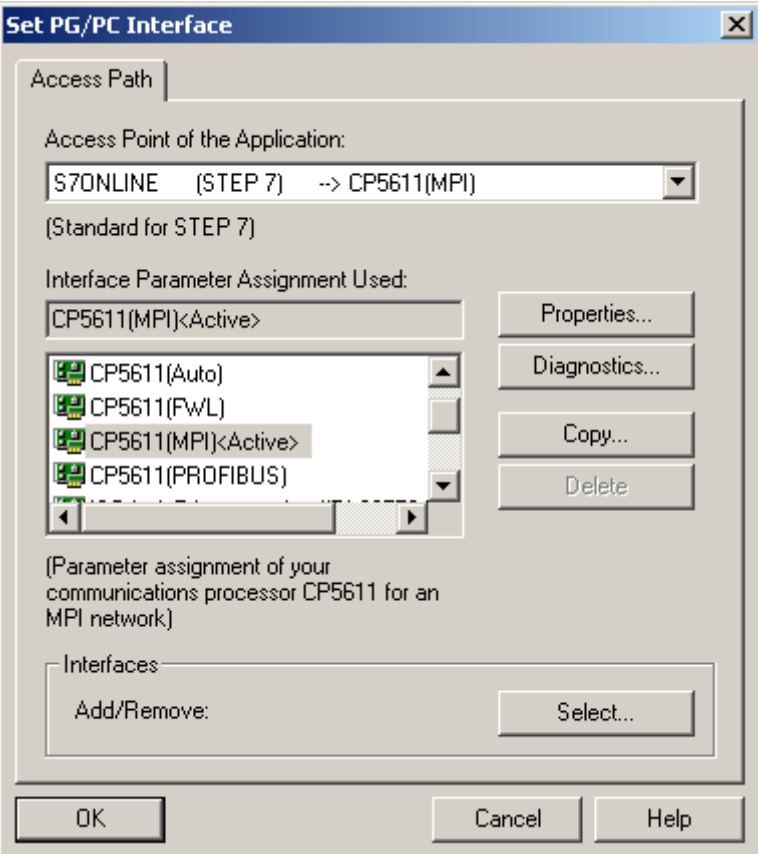
Step	Procedure
1.	<p>Set the PG/PC interface to MPI.</p> <p>From the taskbar, select Start > Simatic > SIMATIC NET > Settings > PG/ PC Interface. Configure the PG/PC interface as follows:</p> 
2.	<p>In the SIMATIC iMap network view, select the device IM151_CPU and then select Special > Configuration from the context menu.</p> <p>The station hardware configuration is opened in the shadow project.</p>

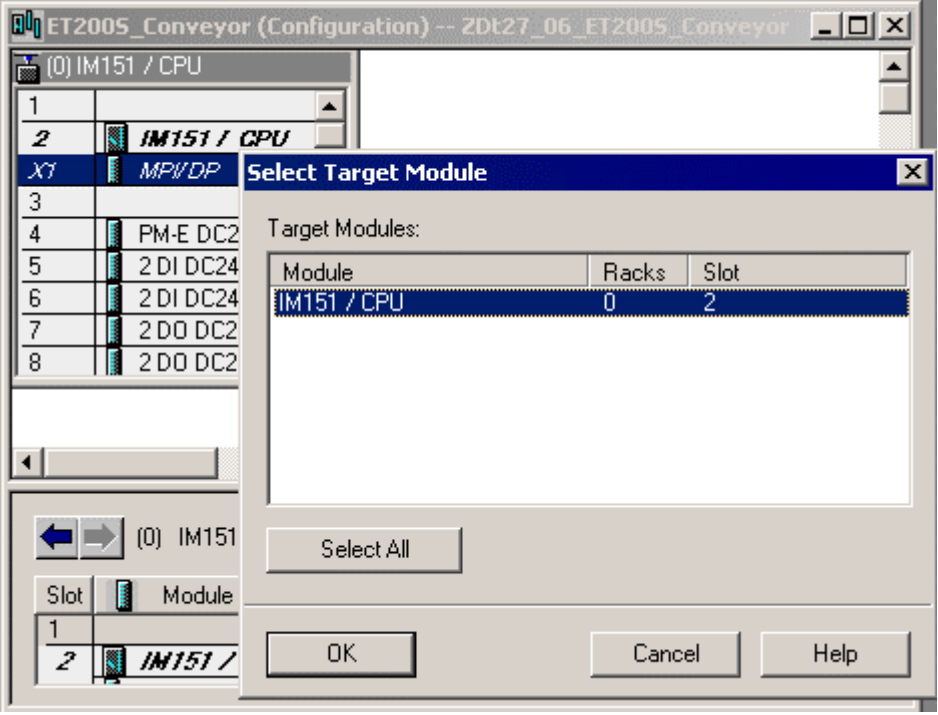
Step	Procedure
3.	<p>In HW Config, select PLC > Download to Module.</p>  <p>In the "Select Target Module" dialog box, select the IM151/ CPU and click on "OK" to confirm.</p>

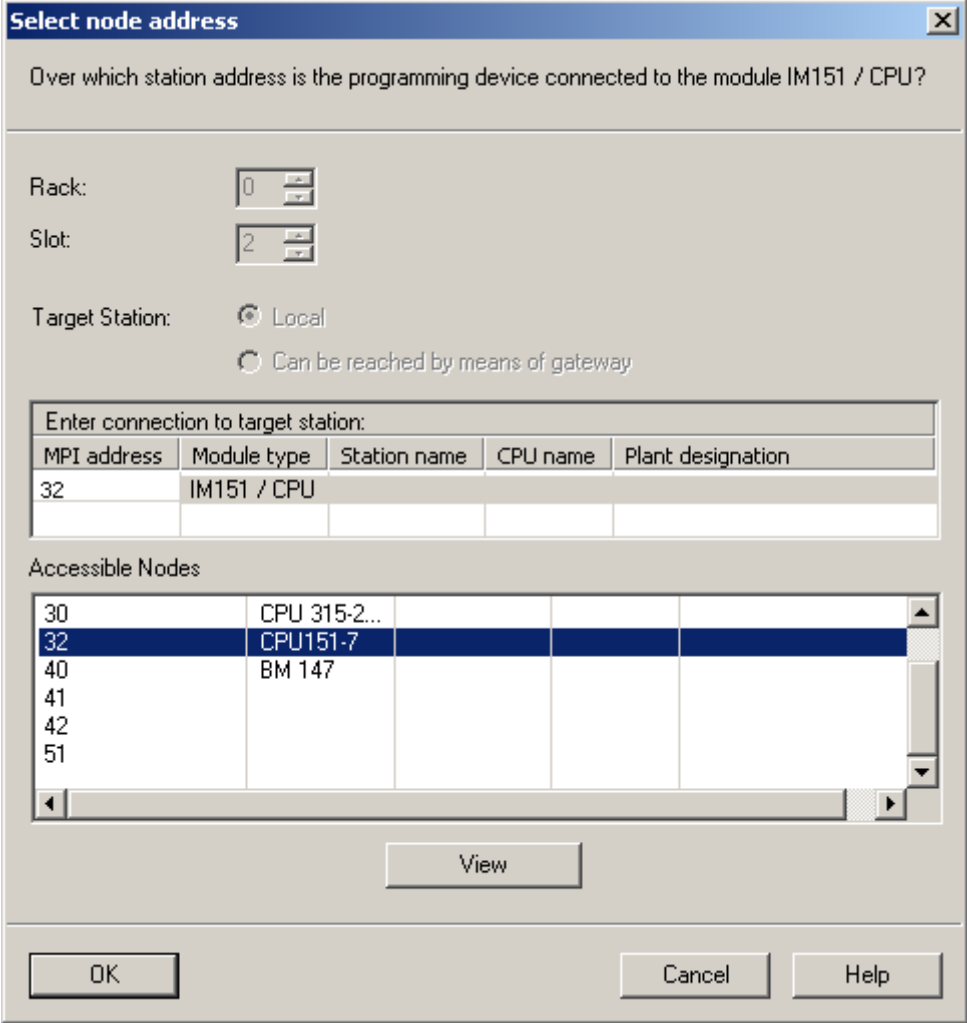
Step	Procedure
4.	<p>In the "Select Station Address" dialog, enter the MPI address of the CPU or click on "OK" to accept the displayed address, e.g:</p>  <p>Result: The system data, including the PROFIBUS address, are downloaded to the IM151/ CPU. The ET 200S can then communicate via the PROFIBUS.</p>
5.	Connect the ET 200S to the DP master using the PROFIBUS cable.

3.5.4 Step 4: Check Settings Required for Download and Online Functions

There are two different cases:

- Settings for plant 3-1: STEP 7 und SIMATIC iMap befinden sich auf dem lokalen Engineering-PC und die WinLC PN auf einem entfernten Rechner.
- Settings for plant 3-2: STEP 7, SIMATIC iMap and WinLC PN are all on the same computer - the local engineering station.

3.5.4.1 Check Settings for Plant 3-1

Requirements

- See Chapter "System commissioning requirements"
- The WinLC PN V1.1 software package must be installed on the remote PC.

Check the settings

Check the following settings:

- On the local engineering PG/PC,
Set the PG/PC interface to TCP/IP
- On the local engineering PG/PC, Assign PG/PC
- On the remote PC station with WinLC PN,
Set PG/PC interface to "PC internal". These settings are identical for Plant 3-1 and 3-2.

3.5.4.2 Set PG/PC Interface to TCP/IP

Procedure

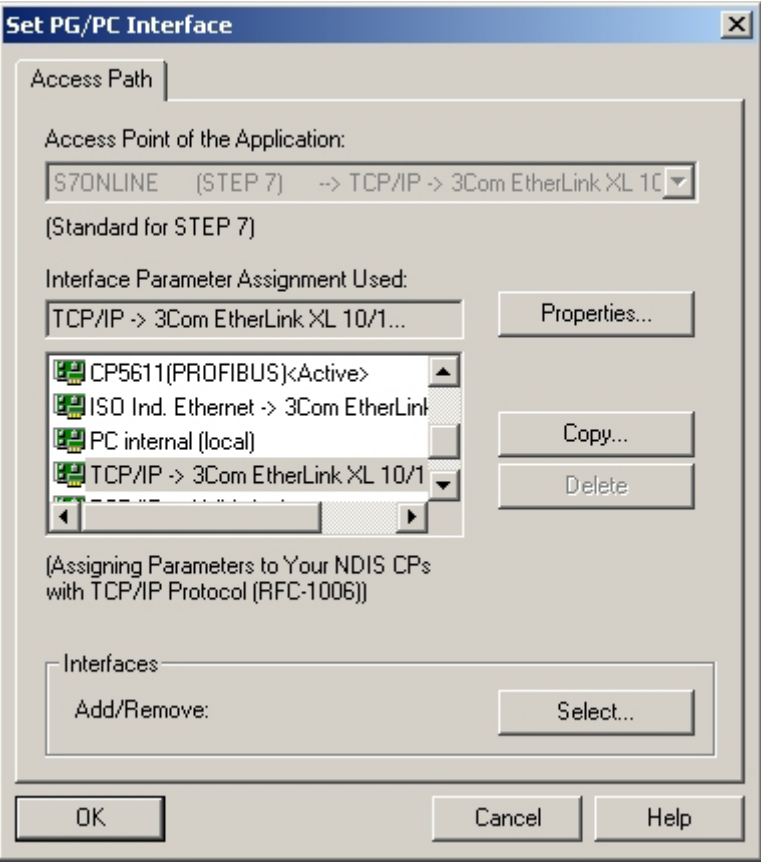
Step	Procedure
1.	<p>Select Start > Simatic > SIMATIC NET > Settings > PG/ PC Interface and check the following setting: "TCP/IP" is set as the access point for the "S7ONLINE (STEP 7)" application.</p> 
2.	<p>Select Start > Simatic > SIMATIC NET > Settings > Set PC Station. The configuration console opens.</p>

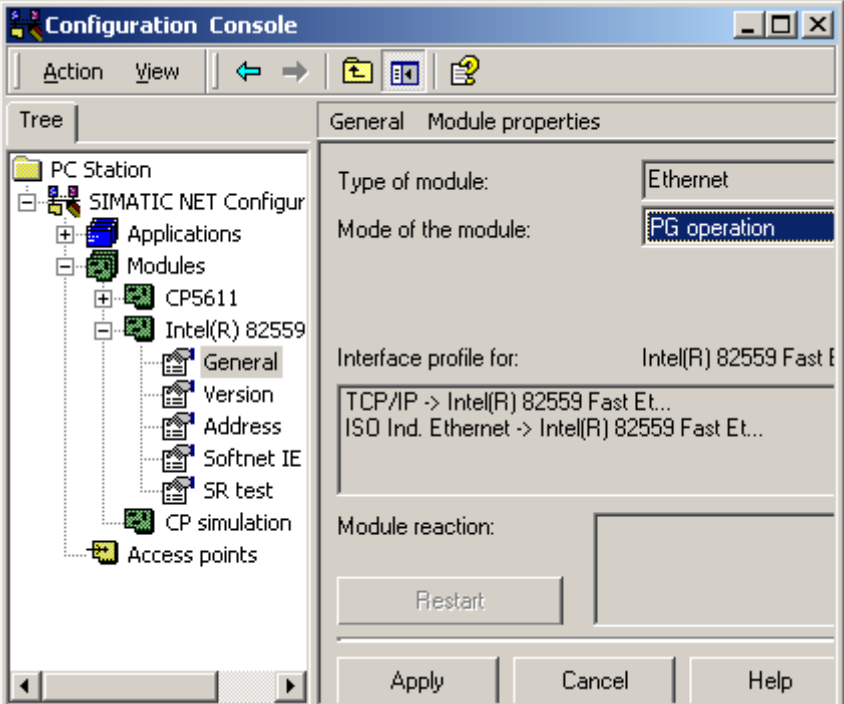
Step	Procedure
3.	<p>Select the computer's Ethernet module from the "Structure" window. "PG mode" must be set on the "General" tab since the PC does not have a WinLC.</p>  <p>The screenshot shows the 'Configuration Console' window. On the left, a tree view shows the project structure: PC Station > SIMATIC NET Configur > Applications > Modules > Intel(R) 82559 > General. The right pane shows the 'General' tab for the selected module. 'Type of module' is 'Ethernet', 'Mode of the module' is 'PG operation', and 'Interface profile for' is 'Intel(R) 82559 Fast Ethernet'. Below this, two profiles are listed: 'TCP/IP -> Intel(R) 82559 Fast Et...' and 'ISO Ind. Ethernet -> Intel(R) 82559 Fast Et...'. At the bottom, there are 'Restart', 'Apply', 'Cancel', and 'Help' buttons.</p>
4.	Confirm any changes and close the configuration console.

3.5.4.3 Assign PG/PC

Note

The PG/PC assignment is automatically carried out in SIMATIC iMap when the project is generated for the first time, and then whenever it is regenerated. In special cases, the PG/PC assignment cannot be carried out automatically, e.g.

- there are several network cards on the PG/PC or
- the PG/PC interface S7ONLINE (STEP 7) is not set to TCP/IP.

In these cases, an error is signalled in the information window during generation, and you will have to assign the PG/PC as described below.

The PG/PC assignment is not required if a local WinLC incorporating a network card is used.

Procedure

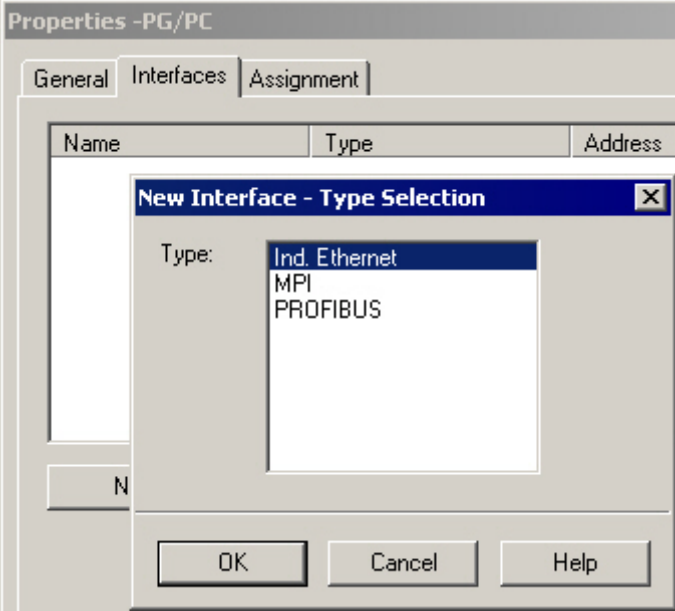
Step	Procedure
1.	Open the "Processing_A" project in SIMATIC iMap. In the network view, select any device and then select Special > Assign PG/PC . This is necessary in order to be able to download the program to intelligent PROFIBUS devices.
2.	<p>On the "Interfaces" tab in the "PG/PC interface" dialog box, click on the "New" button and select "Ind. Ethernet" from the drop-down list.</p>  <p>Click on "OK" to confirm your choice.</p>

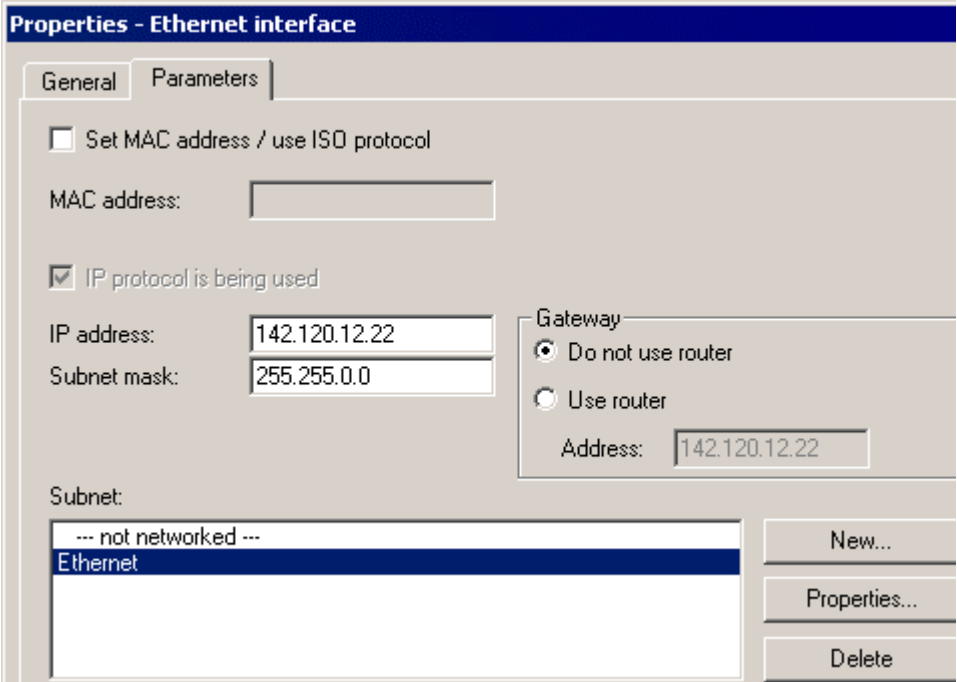
Step	Procedure
3.	<p>In the "Properties - Ethernet Interface" dialog box, enter the IP address and subnet mask of the local computer, then select the Ethernet subnet.</p> 

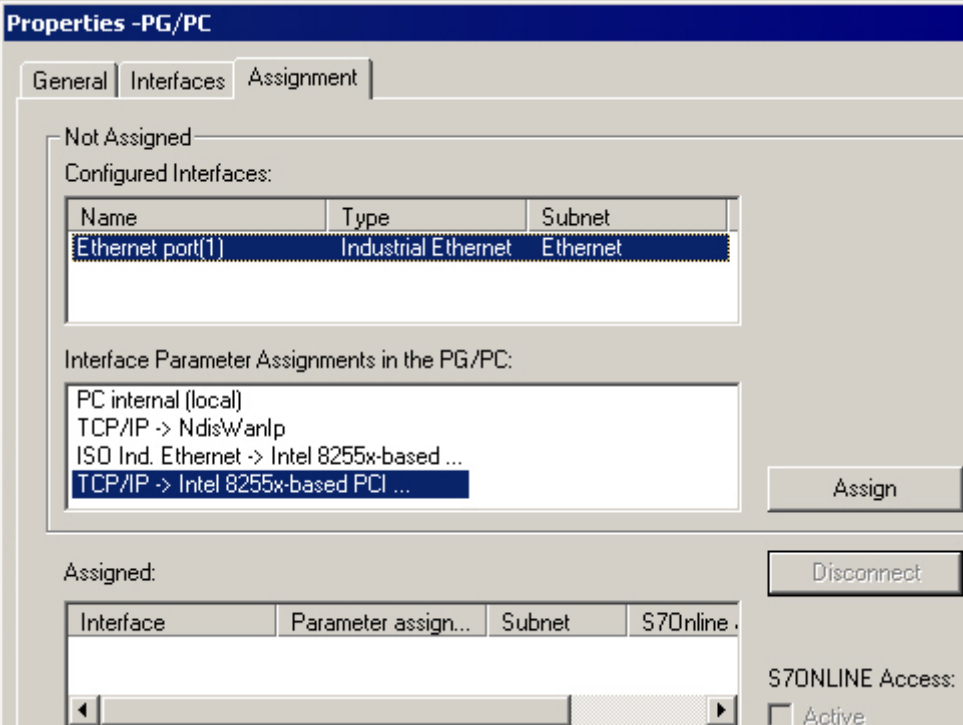
Step	Procedure														
4.	<p>Click on "OK" to confirm your input. Result: The interface you have just configured appears on the "Interfaces" tab.</p>  <p>Properties - PG/PC</p> <p>General Interfaces Assignment</p> <p>Not Assigned</p> <p>Configured Interfaces:</p> <table border="1" data-bbox="392 622 1066 748"> <thead> <tr> <th>Name</th> <th>Type</th> <th>Subnet</th> </tr> </thead> <tbody> <tr> <td>Ethernet port(1)</td> <td>Industrial Ethernet</td> <td>Ethernet</td> </tr> </tbody> </table> <p>Interface Parameter Assignments in the PG/PC:</p> <ul style="list-style-type: none"> PC internal (local) TCP/IP -> Ndisw/arp ISO Ind. Ethernet -> Intel 8255x-based ... TCP/IP -> Intel 8255x-based PCI ... <p>Assign</p> <p>Assigned:</p> <table border="1" data-bbox="392 1025 1066 1151"> <thead> <tr> <th>Interface</th> <th>Parameter assign...</th> <th>Subnet</th> <th>S7Online .</th> </tr> </thead> <tbody> <tr> <td></td> <td></td> <td></td> <td></td> </tr> </tbody> </table> <p>Disconnect</p> <p>S7ONLINE Access:</p> <p><input type="checkbox"/> Active</p>	Name	Type	Subnet	Ethernet port(1)	Industrial Ethernet	Ethernet	Interface	Parameter assign...	Subnet	S7Online .				
Name	Type	Subnet													
Ethernet port(1)	Industrial Ethernet	Ethernet													
Interface	Parameter assign...	Subnet	S7Online .												

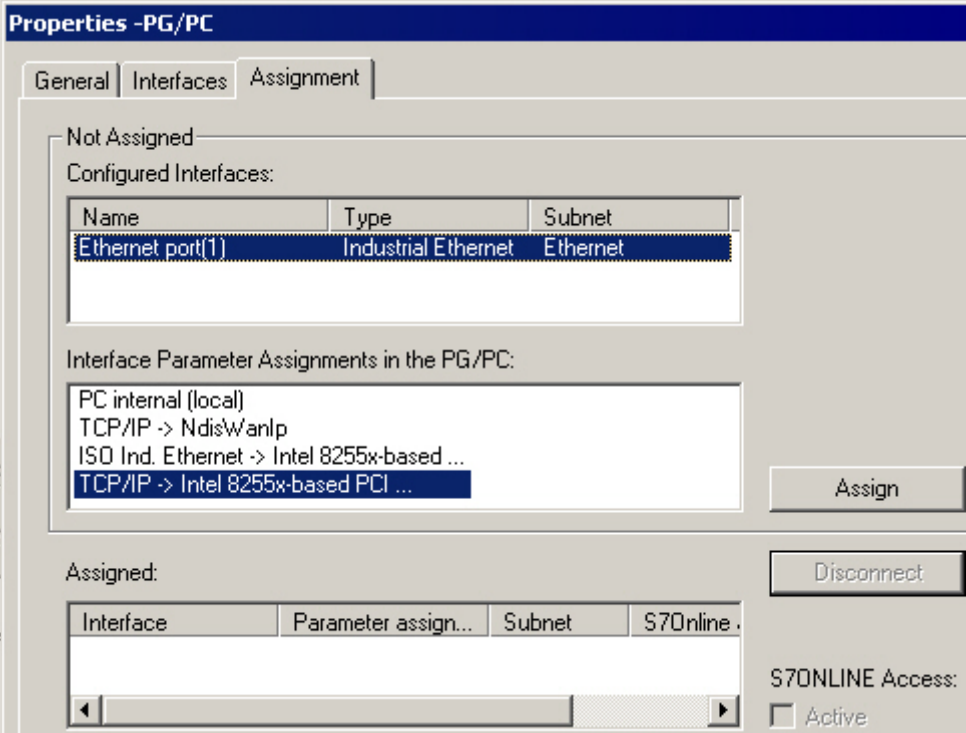
Step	Procedure
5.	<p>On the "Assignment" tab, highlight the Ethernet interface you have just configured under "Not assigned" in the "Configured Interfaces" selection box, and in the "Interface parameter settings on the PG/PC:" box, select</p> <p>TCP/IP -> <Network card used></p>  <p>The screenshot shows the 'Properties -PG/PC' dialog box with the 'Assignment' tab selected. Under 'Not Assigned', the 'Configured Interfaces' table contains one entry: 'Ethernet port(1)' of type 'Industrial Ethernet' and subnet 'Ethernet'. Below this, the 'Interface Parameter Assignments in the PG/PC' list shows several options, with 'TCP/IP -> Intel 8255x-based PCI ...' selected. To the right of this list is an 'Assign' button. Below the list is an 'Assigned:' section with an empty table with columns 'Interface', 'Parameter assign...', 'Subnet', and 'S7Online'. To the right of this table is a 'Disconnect' button. At the bottom right, there is a section for 'S7ONLINE Access' with an unchecked 'Active' checkbox.</p>

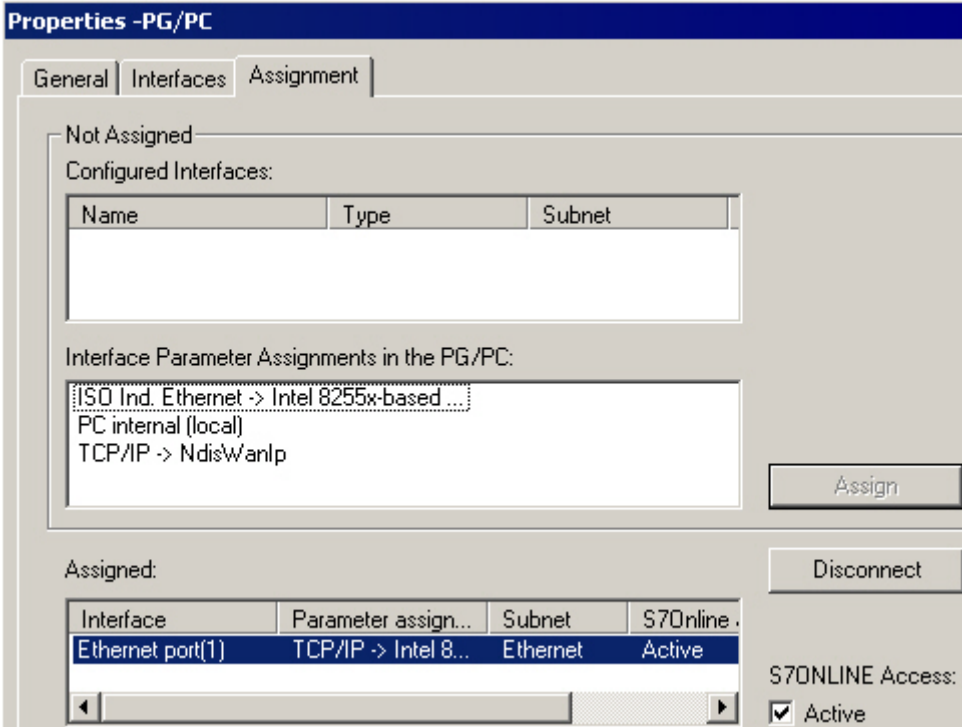
Step	Procedure
6.	<p>Click on the "Assign" button.</p> <p>Result: The assigned interface appears in the "Assigned" selection box.</p> <p>Activate the "S7ONLINE access" option.</p>  <p>The screenshot shows the 'Properties -PG/PC' dialog box with the 'Assignment' tab selected. It features two main sections: 'Not Assigned' and 'Assigned'. The 'Not Assigned' section contains a table for 'Configured Interfaces' (empty) and a list of 'Interface Parameter Assignments in the PG/PC' including 'ISO Ind. Ethernet -> Intel 8255x-based ...', 'PC internal (local)', and 'TCP/IP -> Ndiswanlp'. An 'Assign' button is located to the right of this list. The 'Assigned' section contains a table with columns 'Interface', 'Parameter assign...', 'Subnet', and 'S7Online'. The first row is 'Ethernet port(1)', 'TCP/IP -> Intel 8...', 'Ethernet', and 'Active'. A 'Disconnect' button is to the right of this table. Below the 'Assigned' table, there is a section for 'S7ONLINE Access:' with a checked checkbox for 'Active'.</p> <p>Click on "OK" to activate the assignment.</p>

3.5.4.4 Set PG/PC Interface on the WinLC PN PC Station

These settings are necessary on the WinLC PC Station of both plant 3-1 and 3-2.

Requirements

- See Chapter "System commissioning requirements"
- The WinLC PN V1.1 software package must be installed on the local engineering PC.

Note

If there is a WinLC PN on the local engineering station, the online connection between SIMATIC iMap and the devices of the plant is controlled via the station manager for the WinLC PN, so the local PC station must be configured accordingly.

Procedure

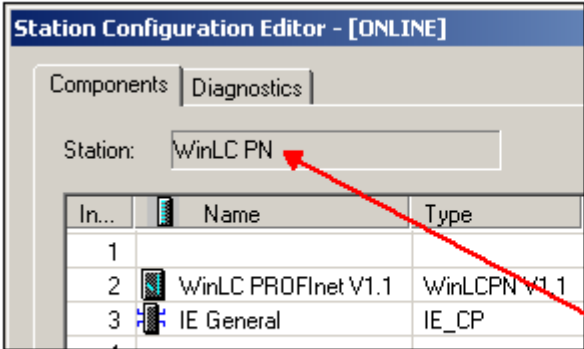
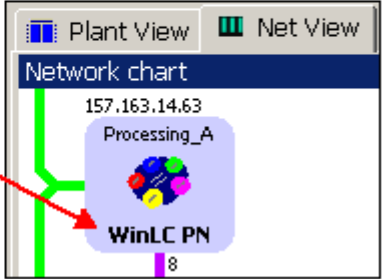
Step	Procedure
1.	<p>Open the Station Configuration Editor by</p> <ul style="list-style-type: none"> clicking on the  icon on the taskbar or by selecting Start > Programs > Startup > Station Configuration Editor.
2.	<p>Check</p> <ul style="list-style-type: none"> that the station name of the local engineering station with the WinLC PN is the same as the device name of the "Processing_A" component in the SIMATIC iMap network view and that the index of the IE_CP is the same as the CP "IE General" slot in the component project in STEP 7/HW Config. <div style="display: flex; justify-content: space-around; align-items: center;">   </div>

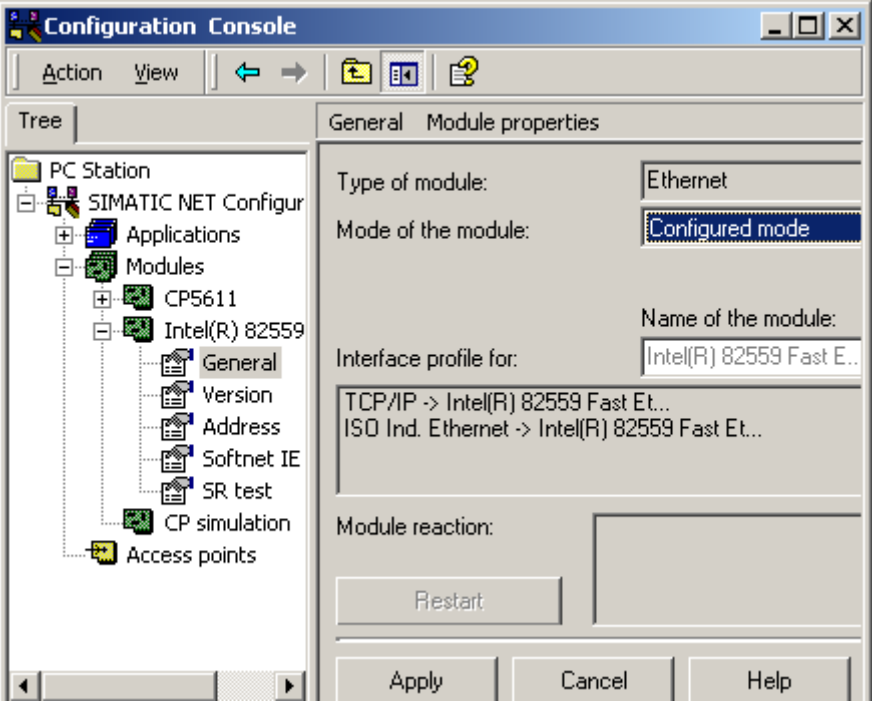
Step	Procedure
3.	<p>Select Start > Simatic > SIMATIC NET > Settings > Set PC Station. The configuration console opens.</p> 
4.	<p>Under "Modules" in the "Structure" window, select the Ethernet module of the computer. "Configured mode" is set as the operating mode under "General". The index must be the same as the CP "IE General" slot in the component project in STEP 7/HW Config.</p>

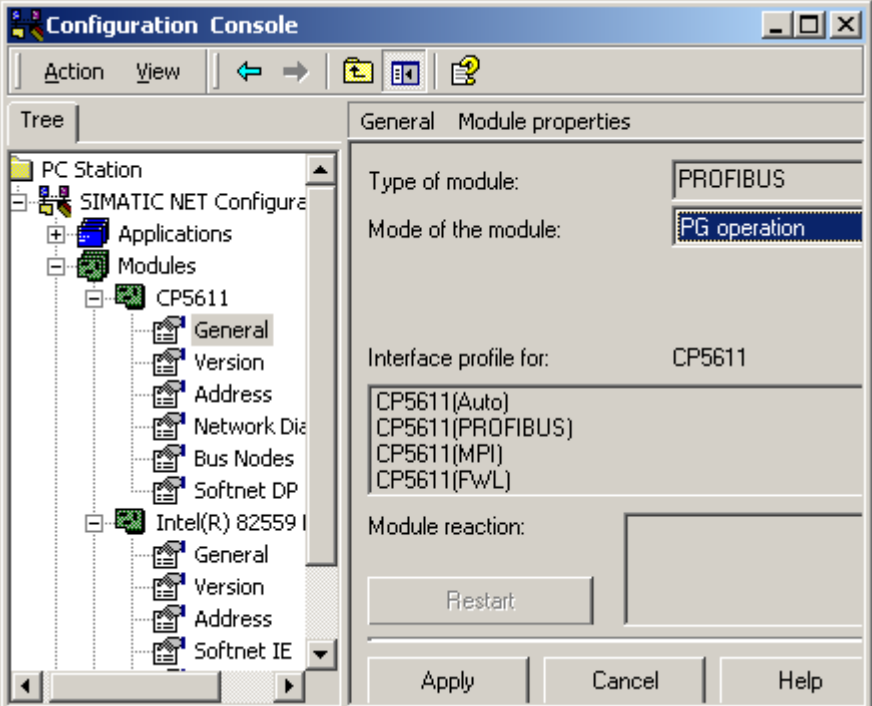
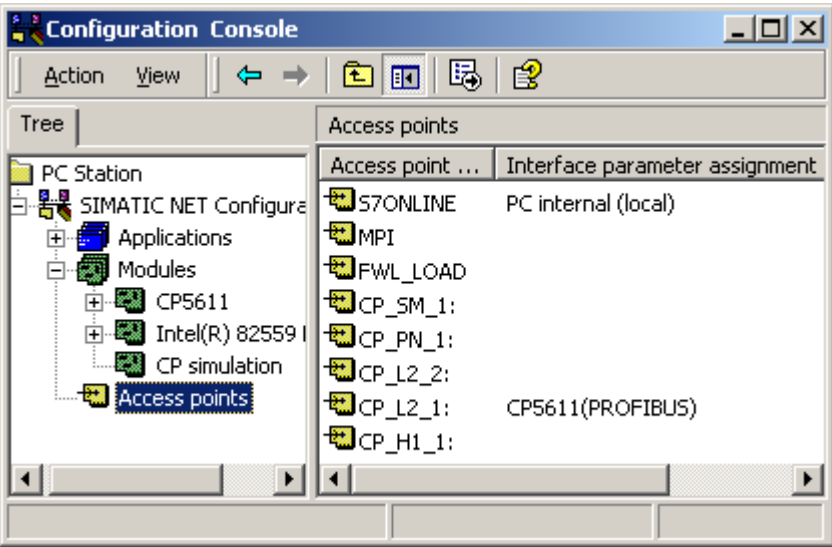
Step	Procedure
5.	<p>Select the PROFIBUS module of the computer. "PG mode" must be set as the operating mode under "General".</p> 
6.	<p>Select "Access Points" and check the following settings:</p> <ul style="list-style-type: none"> The local PROFIBUS module is set as the access point for the "CP_L2_1" application. "PC internal (local)" is set as the access point for the "S7ONLINE (STEP 7)" application. 
7.	<p>Confirm any changes and close the configuration console.</p>

Tip

You can also set or check the access points using **Start > Settings > Control Panel > Set PG/PC Interface**.

3.5.5 Step 5: Commissioning Plant 3**Requirements**

- See Chapter "System commissioning requirements"
- You have checked the settings in STEP 7.
- You have generated the project in SIMATIC iMap.
- **Plant 3-1 only:**
The local engineering station is linked to the remote PC (PC station with WinLC PN) via the Ethernet.
- The PC station with WinLC PN is linked to the DP slaves via the PROFIBUS.
- WinLC PN has been started.

Tip: Check the generation status

To check the generation status of a device, open the properties

- of the device in the network view
- of the technological function in the plant view.

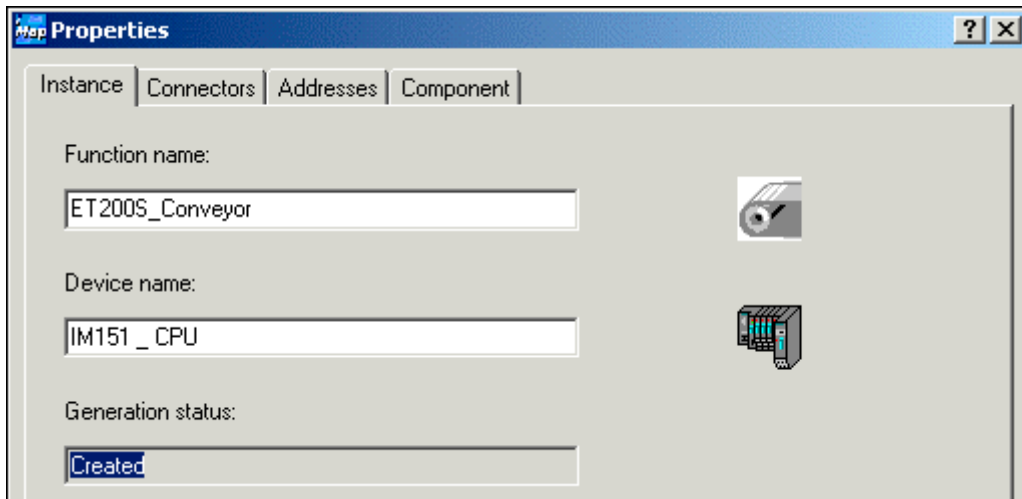

The generation status must be "Generated". If this is not the case, generate the project again using the **Project > Generate > Changes Only** menu command.

Procedure

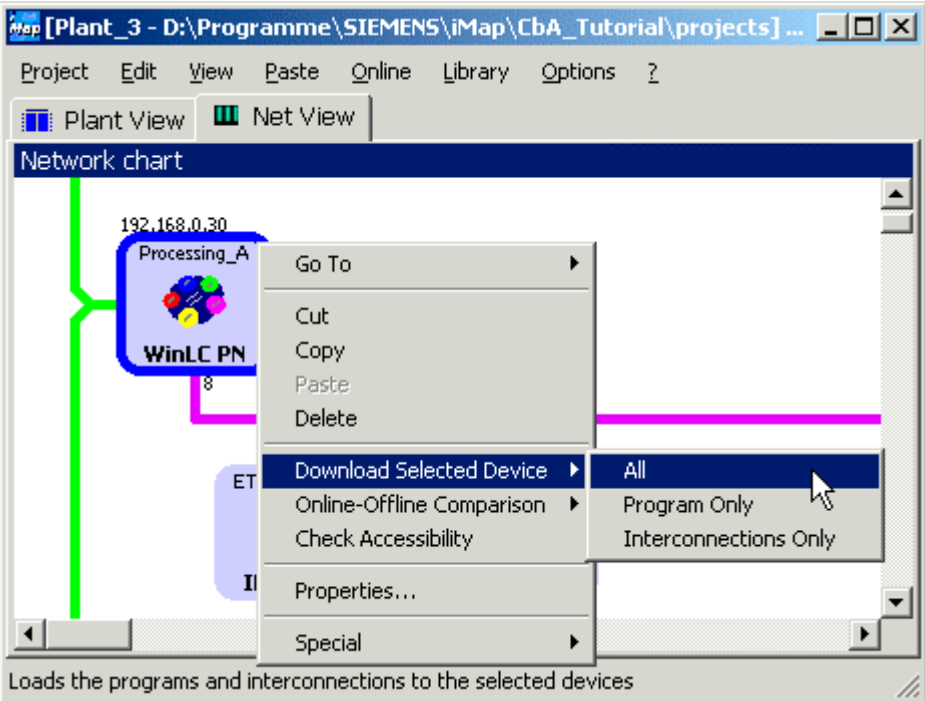
Step	Procedure
1.	<p>In SIMATIC iMap: Select the WinLC PN from the network view. Download the data to the device: Select Download > Selected Devices > All from the context menu.</p>  <p>The screenshot shows the SIMATIC iMap interface with a 'Network chart' view. A device labeled 'WinLC PN' is selected, and a context menu is open over it. The menu path 'Download Selected Device > All' is highlighted. The status bar at the bottom of the window reads 'Loads the programs and interconnections to the selected devices'.</p> <p>If the WinLC PN is in RUN mode, you are asked whether you wish to stop the device. Click on "Yes" to confirm the message. Result: The WinLC PN switches to STOP and the data is downloaded to the device. You are then asked whether you want to restart the device. Click on "Yes" to confirm this prompt. You can then download the data to the DP slaves.</p>
2.	<p>Select</p> <ul style="list-style-type: none"> • the devices from the network view or • the technological functions from the plant view <p>the two other PROFINet components, "ET200S_Conveyor" and "ET200M_IO". Download the data to the devices: Select Download > Selected Devices > All from the context menu. You will receive the same prompt as in step 2 for the IM151/CPU. Answer "Yes" to each prompt.</p>

Result: The devices are ready for use.

Notes on downloading

Download the data to the DP master with proxy functionality (WinLC PN) first, and then to the associated DP slaves.

When changes are made to the PROFIBUS within the project by removing or adding PROFIBUS devices, for example, then a download to both DP master and DP slaves is required.

The program download must be carried out first, using either:

- **Download > Selected Devices > All** or
- **Download > Selected Devices > Program Only.**

Interconnections can be downloaded later.



3.5.6 Step 6: Monitor Plant 3 Online

Requirements

- See Chapter "System commissioning requirements"
- The PG/ PC is linked to the PC station or one of the PROFINet devices via the Ethernet.
- You have checked the settings in STEP 7.
- You have generated the project in SIMATIC iMap.
- You have downloaded the data to the devices.
- The WinLC PN is in RUN or RUN-P mode, and the IM151/CPU is in RUN mode.

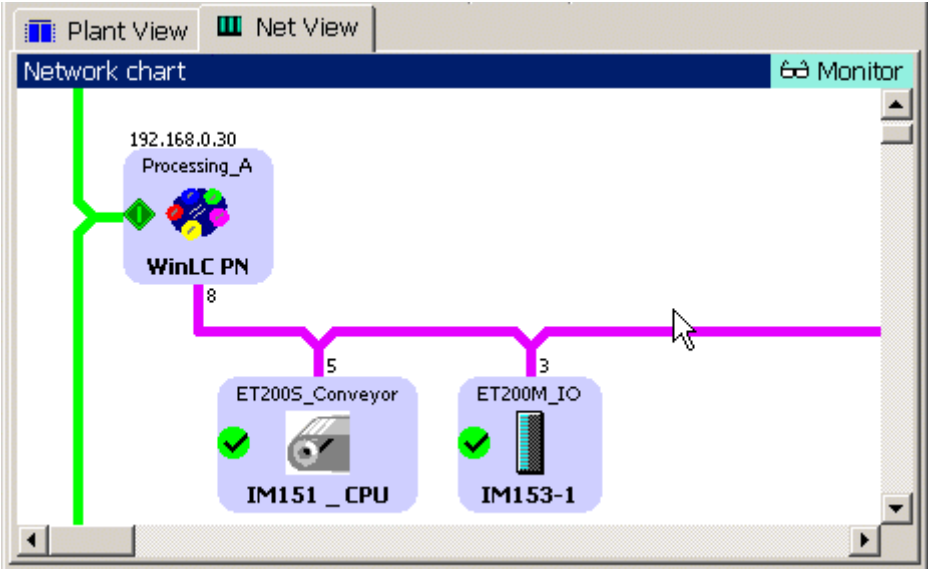
Procedure

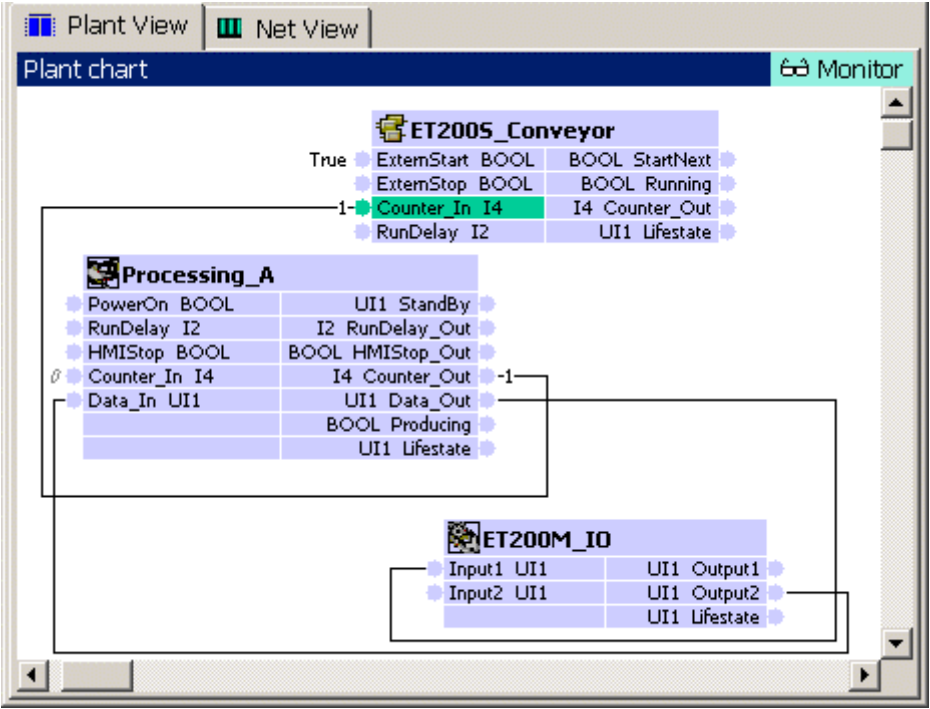
Step	Procedure
1.	<p>Switch the online view on/off</p> <p>In SIMATIC iMap, switch on the online view:</p> <ul style="list-style-type: none"> • click on the "Online Monitoring" icon  or • select Online > Monitor. <p>You are asked whether you want to compare the devices' online and offline program data. This comparison is optional. You can run it immediately or later.</p> <p>If you answer "Yes" to this question, the data is compared and the result is displayed in the information window.</p> <p>Result: The SIMATIC iMap online view is switched on and any diagnostic information is displayed directly at the devices and technological functions and in the diagnostic window.</p>  <p>The screenshot shows a 'Network chart' window with two tabs: 'Plant View' and 'Net View'. The 'Net View' tab is active. A green line represents the network backbone. A purple box labeled 'WinLC PN' with IP address '192.168.0.30' and 'Processing_A' is connected to the backbone. Below it, two purple boxes represent slave devices: 'ET200S_Conveyor' with 'IM151_CPU' and 'ET200M_IO' with 'IM153-1'. Both slave devices have a green checkmark icon. The connections are labeled with numbers: '8' for the WinLC PN connection, '5' for the ET200S_Conveyor connection, and '3' for the ET200M_IO connection. A mouse cursor is pointing at the right side of the network line.</p>

Step	Procedure
2.	<p>Display Online Values</p> <p>In the project plant view, select the "Counter_In" input of "ET200S_Conveyor" and the "Counter_Out" output of "Processing_A", then select the Online > Display Online Values menu command. The online value 1 is displayed at the connectors.</p>  <p>The screenshot shows a 'Plant chart' window with a 'Monitor' button. It displays three components: ET200S_Conveyor, Processing_A, and NET200M_IO. ET200S_Conveyor has inputs: ExternStart (BOOL), ExternStop (BOOL), Counter_In (I4), and RunDelay (I2). Processing_A has inputs: PowerOn (BOOL), RunDelay (I2), HMISStop (BOOL), Counter_In (I4), and Data_In (UI1). NET200M_IO has inputs: Input1 (UI1) and Input2 (UI1). The Counter_In I4 connector of ET200S_Conveyor is highlighted in green and shows the value '1'. The Counter_Out I4 connector of Processing_A is also highlighted in green and shows the value '-1'. The Monitor button is active, indicating the online view is currently displayed.</p>
3.	<p>Click again on the  icon or select the Online > Monitor option to switch off the online view.</p>

Display diagnostic information

In the event of an error, diagnostic information is displayed in SIMATIC iMap in both graphical and text format.

The diagnostic information for the technological functions can be found on the "Functions" tab in the diagnostic window.

Example: The interconnections have to be downloaded for the ET200M (**Online > Download Selected Device > Interconnection Only** menu command).

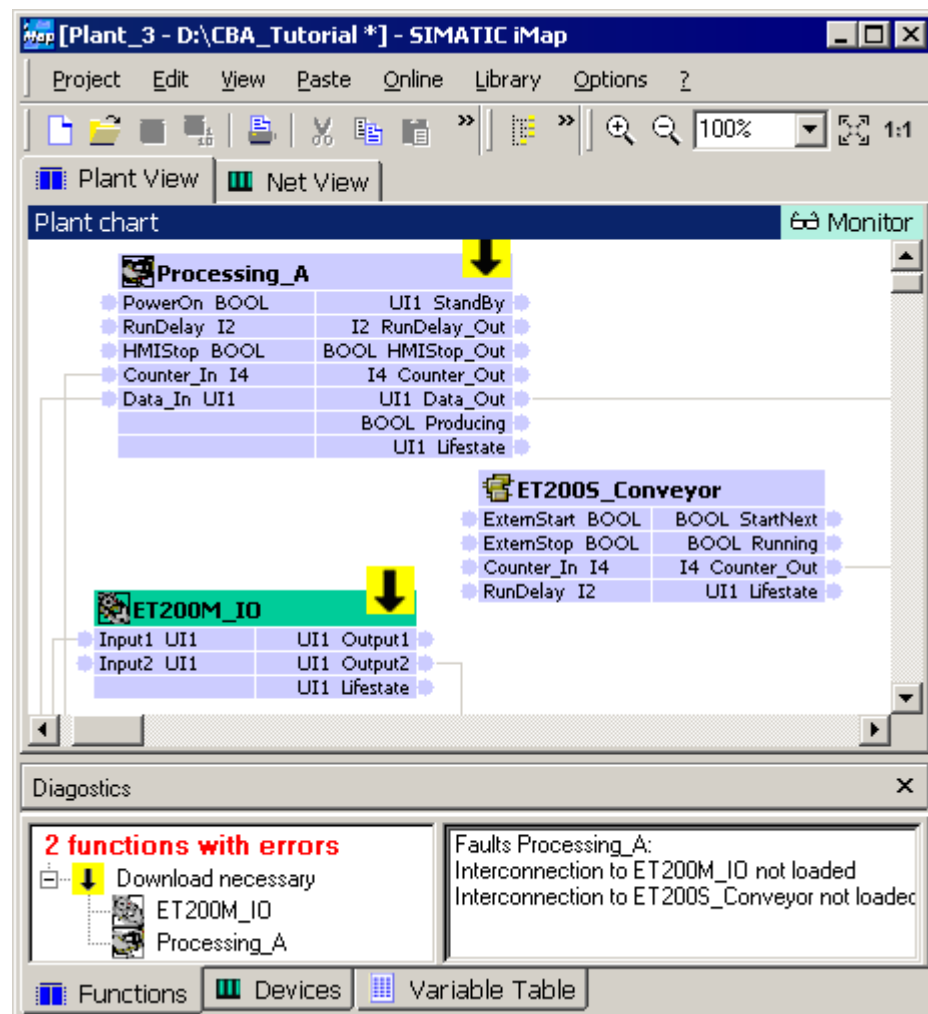

The diagnostic information for the devices can be found on the "Devices" tab in the diagnostic window.

Example: The device is not available. In this case, you will have to check the settings and the communication links.

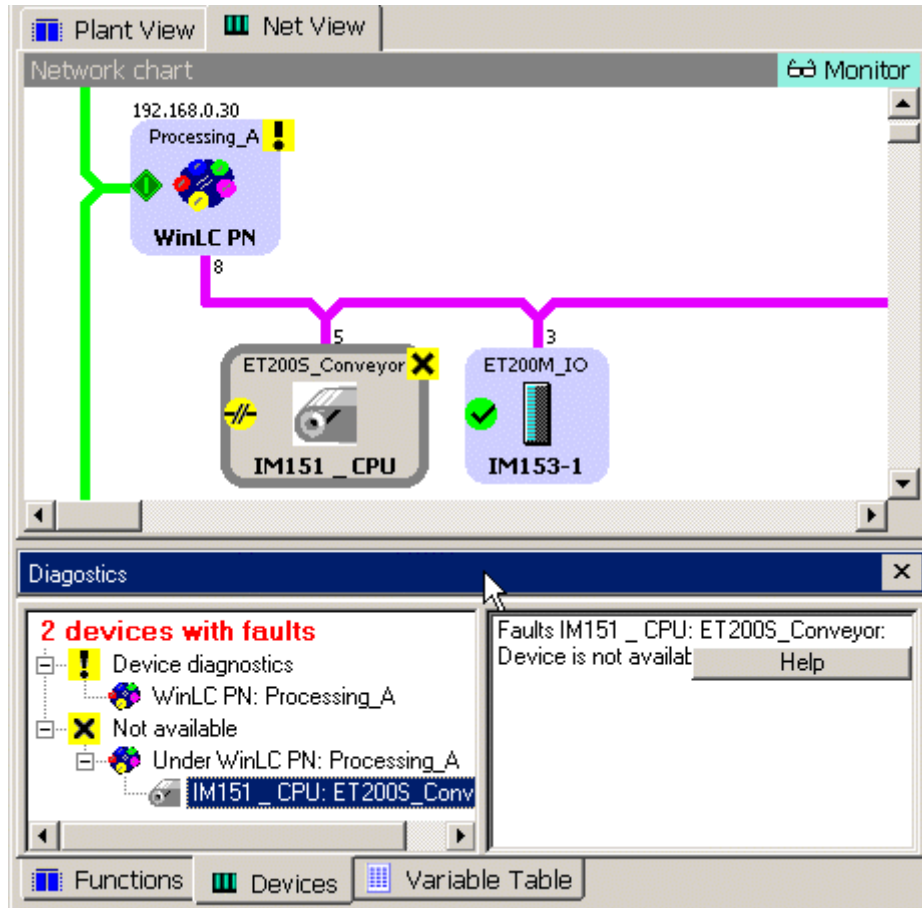

3.6 Overall plant

3.6.1 Overall plant: Set up Hardware

You can combine plants 1 to 3 to form an overall plant. The procedure is as follows:

Step	Procedure
1.	Set up all the devices as described for plants 1 to 3.
2.	Connect the CP 343-1 PN, the IE/PB Link and the PC station with the WinLC PN via the Ethernet.
3.	Connect the engineering PC (running SIMATIC iMap) with the above devices via the Ethernet.

3.6.2 Configure the Overall Plant

Configure the overall plant in SIMATIC iMap

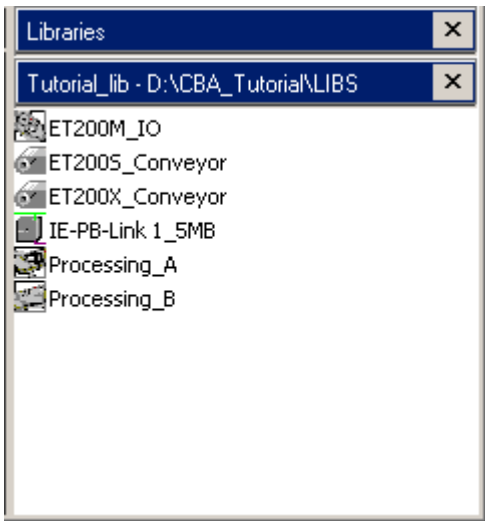
Step	Procedure
1.	<p>Start SIMATIC iMap and make sure that the library "tutorial_lib.cbl" is open and contains all the PROFINet components for the 3 plants.</p>  <p>If necessary, import the missing PROFINet components using Library > Import Component.</p>
2.	In SIMATIC iMap, select Project > New to open a new project.
3.	Select Project > Save to save the project with the name "Tutorial_Plant".

Step	Procedure
4.	<p>Drag the PROFINet components from the library and drop them into the project network view in the following order:</p> <ul style="list-style-type: none"> • Processing_B • IE-PB-Link 1_5MB • ET200S_Conveyor to the PROFIBUS with the IE/PB Link • ET200X_Conveyor to the PROFIBUS with the IE/PB Link • Processing_A • ET200S_Conveyor to the PROFIBUS with the WinLC PN • ET200M_IO to the PROFIBUS with the WinLC PN
5.	<p>Assign the IP or PROFIBUS addresses to the devices as described for plants 1 to 3. The project in the network view then has the following appearance:</p> <p>The screenshot shows a 'Network chart' with a central green vertical line representing the backbone. On the left, a device 'Processing_B CPU 315-2 DP' with IP 192.168.0.10 is connected. In the middle, 'IE-PB-Link 1_5MB' with IP 192.168.0.20 is connected. On the right, 'Processing_A WinLC PN' with IP 192.168.0.30 is connected. The IE-PB-Link is connected to two branches: one with 'ET200S_Conveyor IM151_CPU' (IP 5) and 'ET200X_Conveyor BM 147' (IP 18); the other with 'ET200S_Conveyo_1 IM151_CPU_1' (IP 5) and 'ET200M_IO IM153-1' (IP 3).</p>

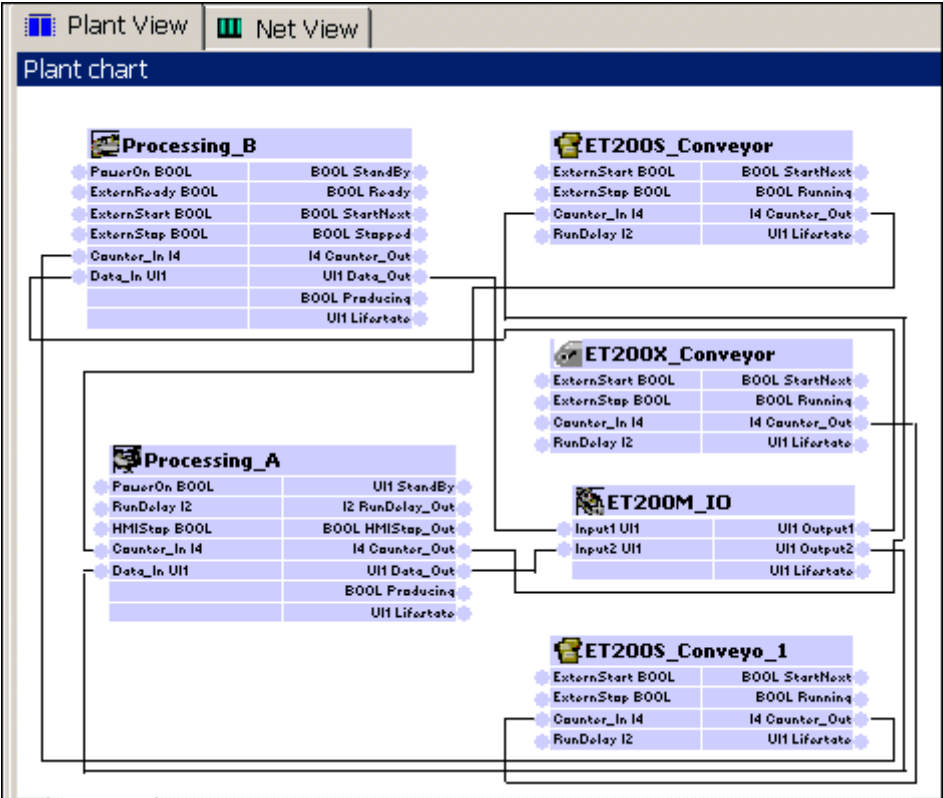
Step	Procedure
6.	<p>Switch to the plant view and interconnect the technological functions as shown below:</p>  <p>The interconnection lines on the plant are converted into communication links so that the data can be transferred via industrial Ethernet and PROFIBUS. The value of the Counter_Out output is sent to the Counter_In input, etc.</p>
7.	Select Project > Generate to generate the project.

Result: The overall plant is now configured in SIMATIC iMap.

3.6.3 Check the Settings

Requirement

For the overall plant, STEP 7 and SIMATIC iMap are on the local engineering station, while the WinLC PN is on a remote computer.

Check the settings

Check the following settings:

- On the local engineering PG/PC,
Set the PG/PC interface to TCP/IP
- On the local engineering PG/PC,
Assign PG/PC
- On the remote PC station with WinLC PN,
Set PG/PC interface to "PC internal".

3.6.4 Start the Overall Plant

Start the overall plant

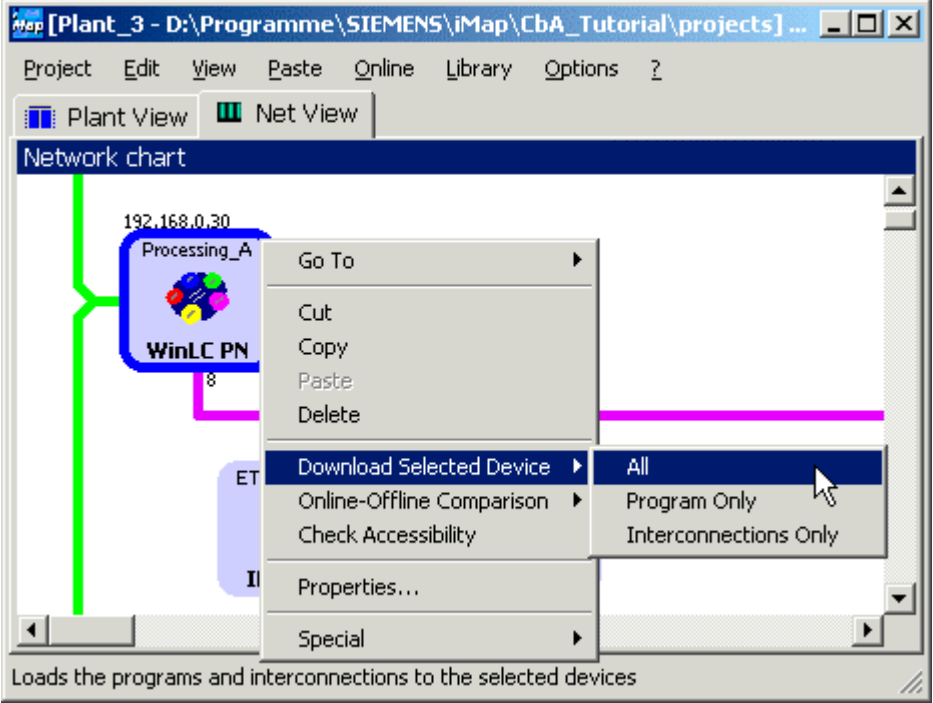
Step	Procedure
1.	<p>In SIMATIC iMap:</p> <p>Select the WinLC PN from the network view.</p> <p>Download the data to the device: Select Download > Selected Devices > All from the context menu.</p>  <p>The screenshot shows the SIMATIC iMap interface. The title bar reads 'iMap [Plant_3 - D:\Programme\SIEMENS\iMap\CbA_Tutorial\projects] ...'. The menu bar includes 'Project', 'Edit', 'View', 'Paste', 'Online', 'Library', and 'Options'. Below the menu bar are tabs for 'Plant View' and 'Net View'. The main area is titled 'Network chart' and displays a network diagram. A device labeled 'WinLC PN' with IP address '192.168.0.30' is selected. A context menu is open over this device, showing options: 'Go To', 'Cut', 'Copy', 'Paste', 'Delete', 'Download Selected Device', 'Online-Offline Comparison', 'Check Accessibility', 'Properties...', and 'Special'. The 'Download Selected Device' option is expanded, showing sub-options: 'All', 'Program Only', and 'Interconnections Only'. The 'All' option is selected. A status bar at the bottom of the window reads 'Loads the programs and interconnections to the selected devices'.</p> <p>If the WinLC PN is in RUN mode, you are asked whether you wish to stop the device. Click on "Yes" to confirm the message.</p> <p>Result: The WinLC PN switches to STOP and the data is downloaded to the device.</p> <p>You are then asked whether you want to restart the device. Click on "Yes" to confirm this prompt.</p>

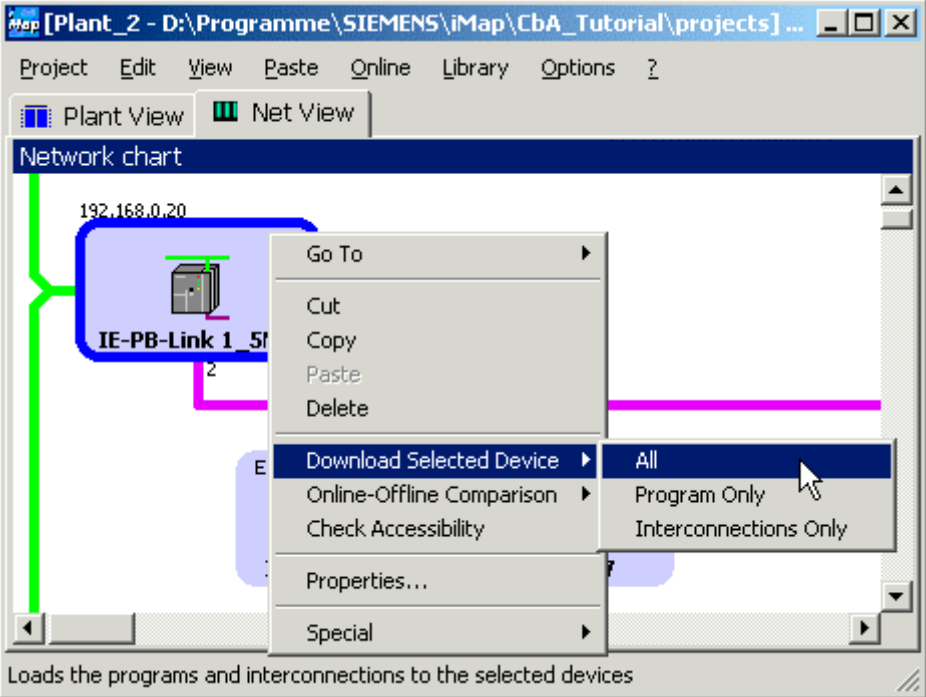
Step	Procedure
2.	<p>Select the IE/PB Link from the network view. Download the data to the device: Select Download > Selected Devices > All from the context menu.</p>  <p>If the IE/PB Link is in RUN mode, you are asked whether you wish to stop the device. Click on "Yes" to confirm the message. Result: The device switches to STOP and the data is downloaded to the device. You are then asked whether you want to restart the device. Click on "Yes" to confirm this prompt. You can then download the data to the other devices of the plant</p>
3.	<p>Select</p> <ul style="list-style-type: none"> • the devices from the network view or • the technological functions from the plant view <p>the other PROFINet components:</p> <ul style="list-style-type: none"> • Processing_B/CPU 315-2 DP • ET200S_Conveyor/IM151_CPU (twice) • ET200X_Conveyor/BM147_CPU • ET200_IO/IM 153-1 <p>Download the data to the devices: Select Download > Selected Devices > All from the context menu. For the IM151/CPU, BM147/CPU and CP343-1PN you will see the same prompts as for steps 1 and 2. Click on "Yes" to confirm all these prompts.</p>

Result: The devices are ready for use.

Notes on downloading

Download the data to the DP master(s) with proxy functionality (WinLC PN, IE/PB Link) first, and then to the associated DP slaves.

When changes are made to the PROFIBUS within the project by removing or adding PROFIBUS devices, for example, then a download to both DP master and DP slaves is required.

The program download must be carried out first, using either:

- **Download > Selected Devices > All** or
- **Download > Selected Devices > Program Only.**

Interconnections can be downloaded later.

3.6.5 Monitor the Overall Plant Online

Monitor the overall plant online

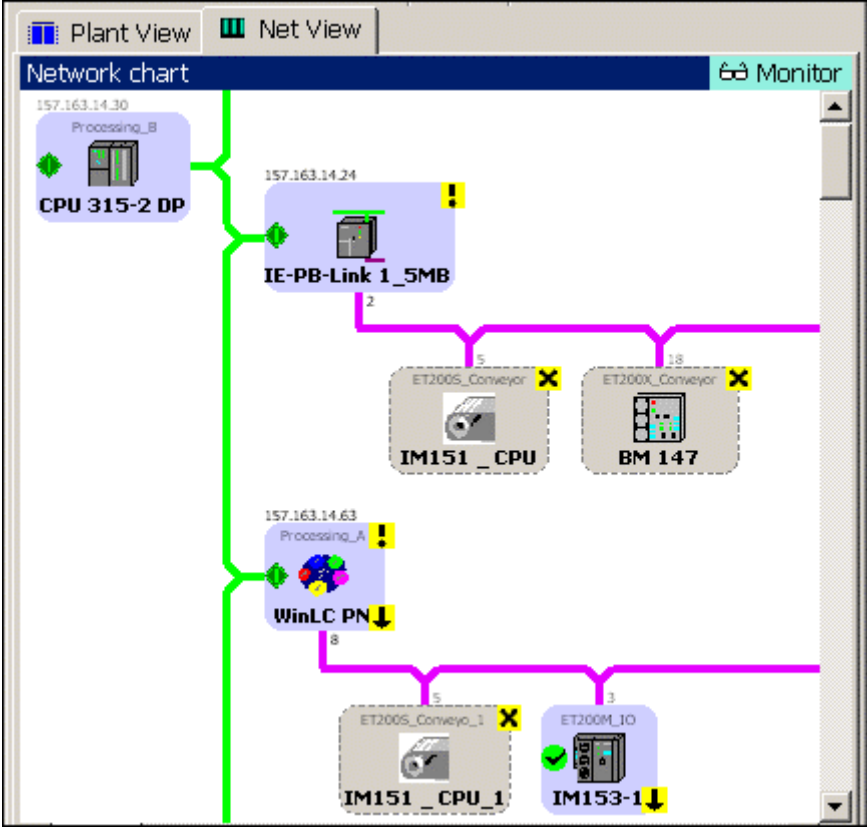
Step	Procedure
1.	<p>Switch the online view on/off</p> <p>In SIMATIC iMap, switch on the online view:</p> <ul style="list-style-type: none"> click on the "Online Monitoring" icon  or select Online > Monitor. <p>You are asked whether you want to compare the devices' online and offline program data. This comparison is optional. You can run it immediately or later.</p> <p>If you answer "Yes" to this question, the data is compared and the result is displayed in the information window.</p> <p>Result: The SIMATIC iMap online view is switched on and any diagnostic information is displayed directly at the devices and technological functions and in the diagnostic window.</p>  <p>The screenshot shows a network chart with the following components and their status:</p> <ul style="list-style-type: none"> Processing_B (CPU 315-2 DP): IP 157.163.14.30, status OK (green arrow). IE-PB-Link 1_5MB: IP 157.163.14.24, status Warning (yellow exclamation mark). ET2005_Conveyor (IM151_CPU): IP 157.163.14.24, port 5, status Error (red X). ET200X_Conveyor (BM 147): IP 157.163.14.24, port 18, status Error (red X). Processing_A (WinLC PN): IP 157.163.14.63, status Warning (yellow exclamation mark). ET2005_Conveyo_1 (IM151_CPU_1): IP 157.163.14.63, port 5, status Error (red X). ET200M_IO (IM153-1): IP 157.163.14.63, port 3, status OK (green checkmark).

4 Literature and Links

Requirement

- the SIMATIC Manual Collection, which contains all the current manuals, or
- an Internet connection. Here you will find constantly updated information in the form of FAQs and manuals and software for downloading.

Literature and links

Links to manuals containing further information about the devices and on working with SIMATIC iMap are given below.

Title	Link or download address
SIMATIC iMap manuals	SIMATIC iMap Manuals
S7-CPs Manual / Part B2 Description of the CP 343-1 PN Edition 04	Description of CP 343-1 PN
SIMATIC NET IE/PB Link Gateway Edition 11/2002	Description of IE/PB Link
SIMATIC Component based Automation - WinLC PN Addendum to WinAC Basis V3.0 Edition: 07/2001	Description of WinLC PN
SIMATIC Distributed I/O System ET 200S Edition 12/2001	Distributed I/O System ET 200S
SIMATIC ET 200S Interface Module IM 151-7 CPU Edition 09/2002	SIMATIC ET 200S Interface Module IM151/CPU
SIMATIC Distributed I/O System ET 200X Edition 05/2001	Distributed I/O System ET 200X
SIMATIC ET 200X Basic module BM147/CPU Edition 07/1999	SIMATIC ET 200X Basic Module BM147/CPU
SIMATIC Distributed I/O System ET 200M Edition 07/00	Distributed I/O System ET 200M
SIMATIC Manual Collection Edition 11/2002	SIMATIC Manual Collection
Information on Component based Automation	Component based Automation

Index

A

Addressing tips.....	3-1
assign IP addresses	
WinLC PN	3-68
Assign IP addresses	
CP 343-1 PN	3-11
IE/PB-Link	3-32
WinLC PN	3-68
Assign PG/PC	3-43, 3-45, 3-78
Assigning a PROFIBUS address to ET200S for the first time.....	3-39, 3-72
Attribute	2-14, 2-30
Attributes	2-7, 2-8

B

Basic procedure	
Comissioning the system	3-2
Basic procedure - Creating PROFINet components.....	2-3

C

CBA.....	4-1
Check settings	
Overall plant.....	3-97
Plant 1	3-43
Plant 2	3-43
Plant 3	3-76
Commissioning the system	
Plant 1	3-16
Plant 2	3-51
Plant 3	3-87
Component based Automation	4-1
Component project.....	2-10, 2-12
Configure plant in SIMATIC iMap	3-4
Overall plant.....	3-94, 3-96
Plant 2	3-26
Plant 3	3-62
Configure plant in SIMATIC iMap- Basic procedure	
plant 1	3-4
Create library.....	3-5, 3-26, 3-63
Creating PROFINet components	2-1
ET200S	2-15, 2-39
ET200X	2-22
Creating PROFINet Components	
CPU 315-2DP with CP 343-1PN	2-4
ET 200M.....	2-46

Requirements.....	2-2
WinLC PN	2-31

D

DB100.....	2-7, 2-8, 2-14, 2-30
Description of the plant	1-2
Documentation.....	4-1

E

ET 200M Hardware set-up.....	3-60
Examples	1-3
Examples supplied.....	1-1, 1-3

F

FAQs.....	4-1
-----------	-----

G

Generate project	3-10
generation status	3-16

H

Hardware set-up	
ET 200S.....	3-24, 3-61
ET 200X.....	3-25
Overall plant.....	3-94

I

IE/PBlink - Hardware set-up.....	3-25
Import PROFINet components	
Plant 1.....	3-6
Plant 2.....	3-28
Plant 3.....	3-65
Information.....	4-1
Install directory.....	1-1, 1-3
Interconnect technological functions and generate project.....	3-10, 3-34, 3-70
Plant 2.....	3-34
Plant 3.....	3-70
Interface DB	2-4, 2-7, 2-8
Interface-DB.....	2-14, 2-30
Internet.....	4-1

L

Links	4-1
Literature and Links	4-1
Internet.....	4-1

M

Manual Collection	4-1
Monitor online	
Overall plant	3-101
plant 1	3-18
Plant 2	3-53
Plant 3	3-89

O**Overview**

Creating PROFINet components	2-1
Overall plant	1-2
System Commissioning	3-1
Tutorial	1-1

P

Paste PROFINet components into the project and assign addresses	
IE-PB-Link 1_5MB	3-30
Processing_A	3-67
Processing_B	3-8

R

Requirements	2-2, 3-1
Software	3-1

S

Set PG/PC interface to TCP/IP	3-44, 3-77
SIMATIC Manual Collection	4-1
Software requirements	3-1
Start the overall plant	
Overall plant	3-98

T

Tips	1-1, 3-1, 3-16
On generation status	3-16
on using the tutorial	1-1

W

WinLC PN Hardware set up and address assignment	3-60
--	------