

SIEMENS



Manual

SIMATIC

S7-1500 / ET 200MP

Digital input/output module
DI 32x24VDC SNK/SRC/DQ 32x24VDC/0.3A SNK BA
(6ES7523-1BP50-0AA0)

Edition

07/2020

support.industry.siemens.com

SIEMENS

SIMATIC

**S7-1500/ET 200MP
Digital input/output module
DI 32x24VDC SNK/SRC/
DQ 32x24VDC/0.3A SNK BA
(6ES7523-1BP50-0AA0)**

Equipment Manual

Preface

**S7-1500 / ET 200MP
Documentation Guide**

1

Product overview

2

Wiring

3

Address space

4

Diagnostics alarms

5

Technical specifications

6



Dimensional drawing

A

Legal information

Warning notice system

This manual contains notices you have to observe in order to ensure your personal safety, as well as to prevent damage to property. The notices referring to your personal safety are highlighted in the manual by a safety alert symbol, notices referring only to property damage have no safety alert symbol. These notices shown below are graded according to the degree of danger.

 DANGER
indicates that death or severe personal injury will result if proper precautions are not taken.
 WARNING
indicates that death or severe personal injury may result if proper precautions are not taken.
 CAUTION
indicates that minor personal injury can result if proper precautions are not taken.
NOTICE
indicates that property damage can result if proper precautions are not taken.

If more than one degree of danger is present, the warning notice representing the highest degree of danger will be used. A notice warning of injury to persons with a safety alert symbol may also include a warning relating to property damage.

Qualified Personnel

The product/system described in this documentation may be operated only by **personnel qualified** for the specific task in accordance with the relevant documentation, in particular its warning notices and safety instructions. Qualified personnel are those who, based on their training and experience, are capable of identifying risks and avoiding potential hazards when working with these products/systems.

Proper use of Siemens products

Note the following:

 WARNING
Siemens products may only be used for the applications described in the catalog and in the relevant technical documentation. If products and components from other manufacturers are used, these must be recommended or approved by Siemens. Proper transport, storage, installation, assembly, commissioning, operation and maintenance are required to ensure that the products operate safely and without any problems. The permissible ambient conditions must be complied with. The information in the relevant documentation must be observed.

Trademarks

All names identified by ® are registered trademarks of Siemens AG. The remaining trademarks in this publication may be trademarks whose use by third parties for their own purposes could violate the rights of the owner.

Disclaimer of Liability

We have reviewed the contents of this publication to ensure consistency with the hardware and software described. Since variance cannot be precluded entirely, we cannot guarantee full consistency. However, the information in this publication is reviewed regularly and any necessary corrections are included in subsequent editions.

Preface

Purpose of the documentation

This manual supplements the S7-1500/ET 200MP (<https://support.industry.siemens.com/cs/ww/en/view/59191792>) system manual.

Functions that relate in general to the systems are described in this system manual.

The information provided in this manual and in the system/function manuals supports you in commissioning the systems.

Conventions

The term "CPU" is used in this manual both for the CPUs of the S7-1500 automation system and for interface modules of the ET 200MP distributed I/O system.

Please also observe notes marked as follows:

Note

A note contains important information on the product described in the documentation, on the handling of the product or on the section of the documentation to which particular attention should be paid.

Security information

Siemens provides products and solutions with industrial security functions that support the secure operation of plants, systems, machines and networks.

In order to protect plants, systems, machines and networks against cyber threats, it is necessary to implement – and continuously maintain – a holistic, state-of-the-art industrial security concept. Siemens' products and solutions constitute one element of such a concept.

Customers are responsible for preventing unauthorized access to their plants, systems, machines and networks. Such systems, machines and components should only be connected to an enterprise network or the internet if and to the extent such a connection is necessary and only when appropriate security measures (e.g. firewalls and/or network segmentation) are in place.

For additional information on industrial security measures that may be implemented, please visit (<https://www.siemens.com/industrialsecurity>).

Siemens' products and solutions undergo continuous development to make them more secure. Siemens strongly recommends that product updates are applied as soon as they are available and that the latest product versions are used. Use of product versions that are no longer supported, and failure to apply the latest updates may increase customers' exposure to cyber threats.

To stay informed about product updates, subscribe to the Siemens Industrial Security RSS Feed visit (<https://www.siemens.com/industrialsecurity>).

Open Source Software

Open-source software is used in the firmware of the I/O modules. Open Source Software is provided free of charge. We are liable for the product described, including the open-source software contained in it, pursuant to the conditions applicable to the product. Siemens accepts no liability for the use of the open source software over and above the intended program sequence, or for any faults caused by modifications to the software.

For legal reasons, we are obliged to publish the original text of the license conditions and copyright notices. Please read the information relating to this on the Internet (<https://support.industry.siemens.com/cs/ww/en/view/109757558>).

Table of contents

	Preface	3
1	S7-1500 / ET 200MP Documentation Guide	6
2	Product overview	8
	2.1 Properties	8
3	Wiring	11
	3.1 Wiring and block diagram	11
	3.2 Terminal assignment X10 and X11	12
	3.3 Connecting a module with a connection module	15
	3.4 Wiring of the module	17
	3.5 Fuse	19
4	Address space	21
5	Diagnostics alarms	29
	5.1 Status and error displays	29
6	Technical specifications	31
A	Dimensional drawing	36

S7-1500 / ET 200MP Documentation Guide

The documentation for the SIMATIC S7-1500 automation system and the SIMATIC ET 200MP distributed I/O system is arranged into three areas. This arrangement enables you to access the specific content you require.

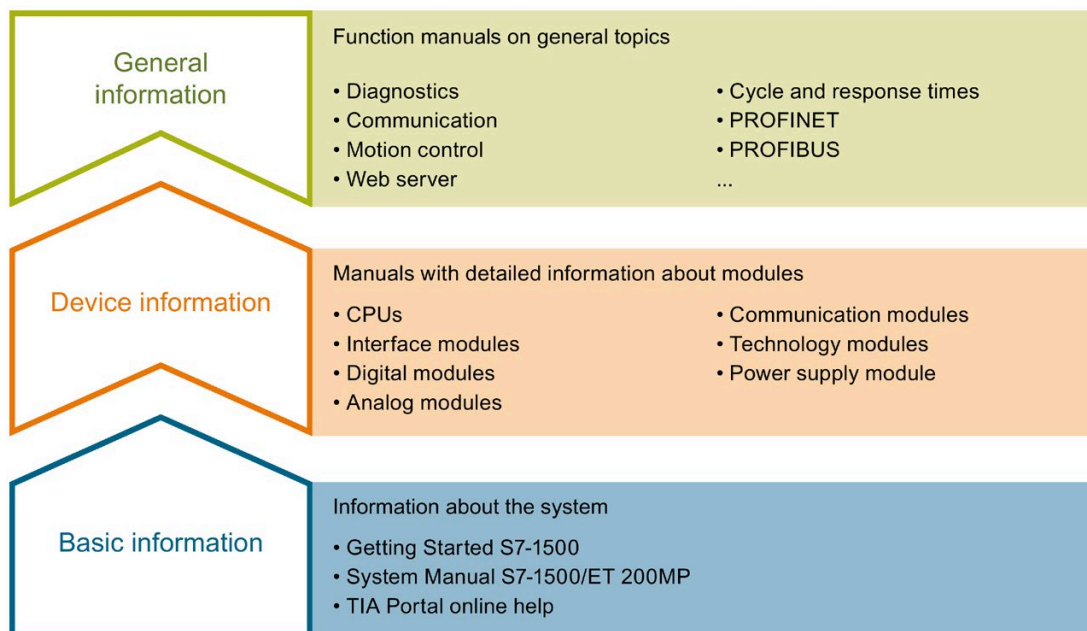

Basic information

The System Manual and Getting Started describe in detail the configuration, installation, wiring and commissioning of the SIMATIC S7-1500 and ET 200MP systems. The STEP 7 online help supports you in the configuration and programming.

Device information

Product manuals contain a compact description of the module-specific information, such as properties, wiring diagrams, characteristics and technical specifications.

General information

The function manuals contain detailed descriptions on general topics regarding the SIMATIC S7-1500 and ET 200MP systems, e.g. diagnostics, communication, motion control, Web server, OPC UA.

You can download the documentation free of charge from the Internet (<https://support.industry.siemens.com/cs/ww/en/view/109742691>).

Changes and supplements to the manuals are documented in a Product Information.

You can download the product information free of charge from the Internet (<https://support.industry.siemens.com/cs/us/en/view/68052815>).

Manual Collection S7-1500/ET 200MP

The Manual Collection contains the complete documentation on the SIMATIC S7-1500 automation system and the ET 200MP distributed I/O system gathered together in one file.

You can find the Manual Collection on the Internet (<https://support.industry.siemens.com/cs/ww/en/view/86140384>).

SIMATIC S7-1500 comparison list for programming languages

The comparison list contains an overview of which instructions and functions you can use for which controller families.

You can find the comparison list on the Internet (<https://support.industry.siemens.com/cs/ww/en/view/86630375>).

"mySupport"

With "mySupport", your personal workspace, you make the best out of your Industry Online Support.

In "mySupport", you can save filters, favorites and tags, request CAx data and compile your personal library in the Documentation area. In addition, your data is already filled out in support requests and you can get an overview of your current requests at any time.

You must register once to use the full functionality of "mySupport".

You can find "mySupport" on the Internet (<https://support.industry.siemens.com/My/ww/en>).

Application examples

The application examples support you with various tools and examples for solving your automation tasks. Solutions are shown in interplay with multiple components in the system - separated from the focus on individual products.

You will find the application examples on the Internet (<https://support.industry.siemens.com/sc/ww/en/sc/2054>).

Product overview

2.1 Properties

Part number:

6ES7523-1BP50-0AA0

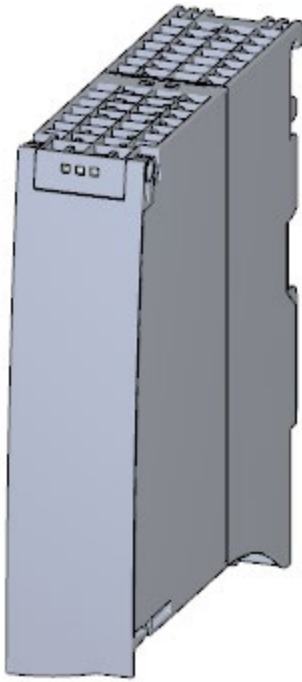

Figure 2-1 View of the module DI 32x24VDC SNK/SRC/DQ 32x24VDC/0.3A SNK BA

Properties

The module has the following technical properties:

- Digital inputs
 - 32 digital inputs; electrically isolated in 2 groups of 16
 - Sourcing input or sinking input, depending on wiring
 - Rated input voltage 24 VDC
 - Suitable for switches and 2-/3-/4-wire proximity switches
- Digital outputs
 - 32 digital outputs, electrically isolated in 2 groups of 16
 - Sinking output
 - Rated output voltage 24 VDC
 - Rated output current 0.3 A per channel
 - Suitable for solenoid valves, DC contactors, and indicator lights

The module supports the following functions:

Table 2- 1 Version dependencies of the module functions

Function	Firmware version of the module	Configuration software	
		STEP 7 (TIA Portal) as of V16 and HSP 0319	GSD file in STEP 7 (TIA Portal) V12 or higher, or STEP 7 V5.5 SP3 or higher
Firmware update	V1.0.0 or higher	X	--- / X
Identification data I&M0 to I&M3	V1.0.0 or higher	X	X
Module-internal Shared Input (MSI) / Shared Output (MSO)	V1.0.0 or higher	X (PROFINET IO only)	X (PROFINET IO only)
Configurable submodules / submodules for Shared Device	V1.0.0 or higher	X (PROFINET IO only)	X (PROFINET IO only)

You can configure the module with STEP 7 (TIA Portal) and with a GSD file.

Accessories

The following accessories are supplied with the module and can be ordered as spare parts:

- U connector
- Universal front door with the article number: 6ES7 591-8AA00-0AA0

You can find additional information in the system manual S7-1500/ET 200MP (<https://support.industry.siemens.com/cs/ww/en/view/59191792>).

Other components

The following must be ordered separately:

- SIMATIC TOP connect connection module
- Pre-fabricated connecting cable with IDC connectors

For additional information, see section Connecting a module with a connection module (Page 15)

Wiring

3.1 Wiring and block diagram

This section contains the block diagram of the module and the terminal assignment.

Wiring and block diagram

The following figure shows the terminal assignment and the assignment of the channels.

- Inputs: Channel 0 to 31 to connector X10.
- Outputs: Channel 0 to 31 to connector X11.

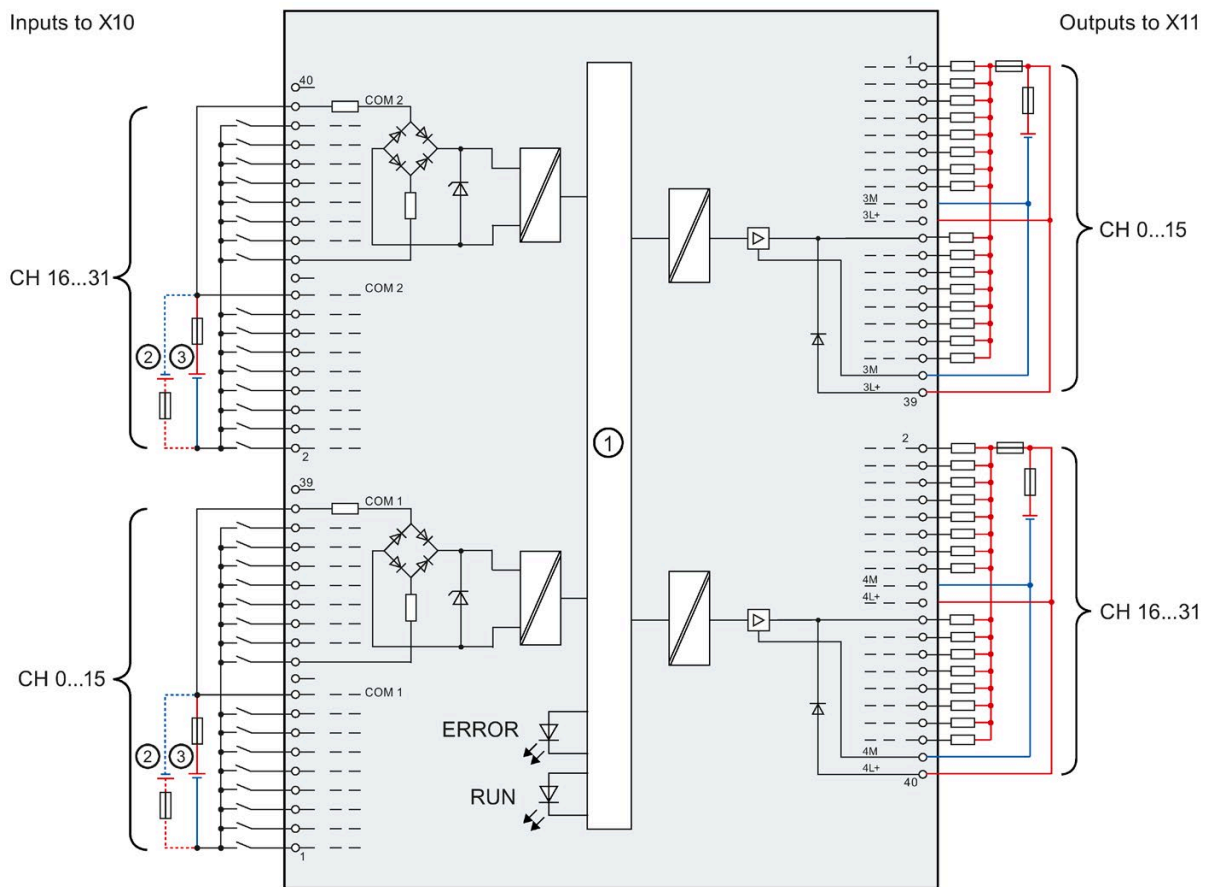

①	Backplane bus interface	CHx	Channel
②	Connection type sinking	RUN	Status display LED (green)
③	Connection type sourcing	ERROR	Error display LED (red)

Figure 3-1 Block diagram and terminal assignment

3.2 Terminal assignment X10 and X11

The following figure shows the assignment of the channels to the addresses.

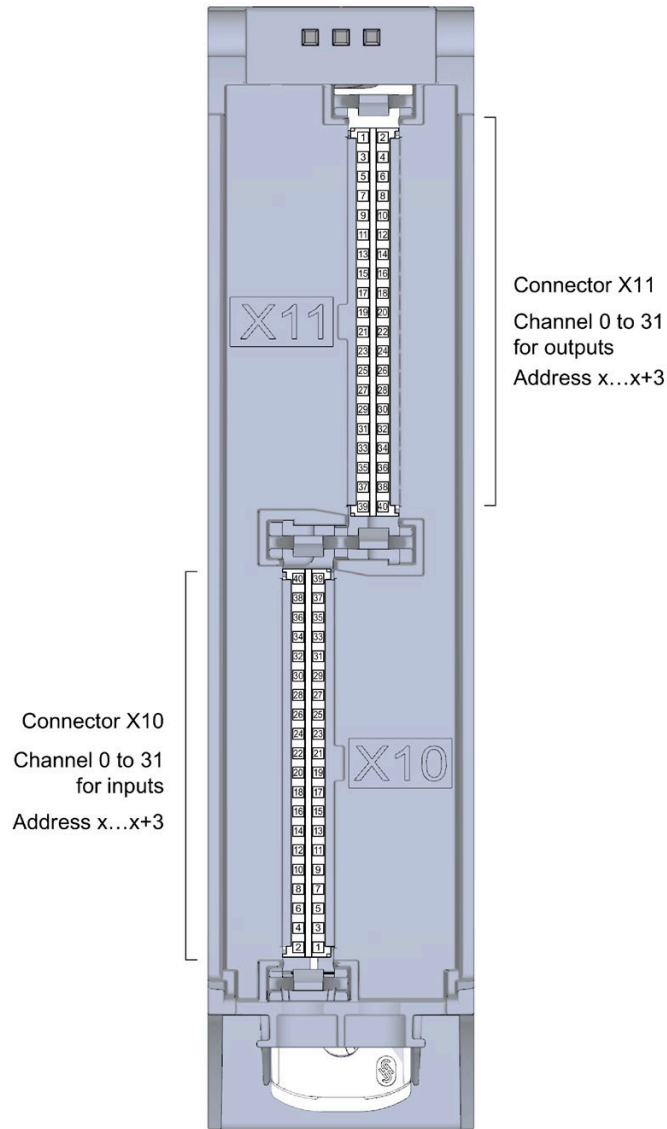

Figure 3-2 Front view of the module without front door

Terminal and address assignment

For connecting sensors or actuators, we recommend using the SIMATIC TOP connect pre-assembled connecting cables and the SIMATIC TOP connect connection modules. However, if you choose another wiring option, you will need the following tables.

Table 3- 1 Assignment for connector X10 of the module

Assignment for inputs to X10					
Terminal	Channel	Address	Terminal	Channel	Address
40	---	---	39	---	---
38	2COM *	---	37	1COM **	---
36	Channel 31	x+3.7	35	Channel 15	x+1.7
34	Channel 30	x+3.6	33	Channel 14	x+1.6
32	Channel 29	x+3.5	31	Channel 13	x+1.5
30	Channel 28	x+3.4	29	Channel 12	x+1.4
28	Channel 27	x+3.3	27	Channel 11	x+1.3
26	Channel 26	x+3.2	25	Channel 10	x+1.2
24	Channel 25	x+3.1	23	Channel 9	x+1.1
22	Channel 24	x+3.0	21	Channel 8	x+1.0
20	---	---	19	---	---
18	2COM *	---	17	1COM **	---
16	Channel 23	x+2.7	15	Channel 7	x.7
14	Channel 22	x+2.6	13	Channel 6	x.6
12	Channel 21	x+2.5	11	Channel 5	x.5
10	Channel 20	x+2.4	9	Channel 4	x.4
8	Channel 19	x+2.3	7	Channel 3	x.3
6	Channel 18	x+2.2	5	Channel 2	x.2
4	Channel 17	x+2.1	3	Channel 1	x.1
2	Channel 16	x+2.0	1	Channel 0	x.0

* 2M for Sinking (sinking input) connection type/ 2L+ for Sourcing (sourcing input) connection type

** 1M for Sinking (sinking input) connection type/ 1L+ for Sourcing (sourcing input) connection type

3.2 Terminal assignment X10 and X11

Table 3-2 Assignment for the connector X11 of the module

Assignment for outputs to X11					
Terminal	Channel	Address	Terminal	Channel	Address
1	Channel 0	x.0	2	Channel 16	x+2.0
3	Channel 1	x.1	4	Channel 17	x+2.1
5	Channel 2	x.2	6	Channel 18	x+2.2
7	Channel 3	x.3	8	Channel 19	x+2.3
9	Channel 4	x.4	10	Channel 20	x+2.4
11	Channel 5	x.5	12	Channel 21	x+2.5
13	Channel 6	x.6	14	Channel 22	x+2.6
15	Channel 7	x.7	16	Channel 23	x+2.7
17	3M	---	18	4M	---
19	3L+	---	20	4L+	---
21	Channel 8	x+1.0	22	Channel 24	x+3.0
23	Channel 9	x+1.1	24	Channel 25	x+3.1
25	Channel 10	x+1.2	26	Channel 26	x+3.2
27	Channel 11	x+1.3	28	Channel 27	x+3.3
29	Channel 12	x+1.4	30	Channel 28	x+3.4
31	Channel 13	x+1.5	32	Channel 29	x+3.5
33	Channel 14	x+1.6	34	Channel 30	x+3.6
35	Channel 15	x+1.7	36	Channel 31	x+3.7
37	3M	---	38	4M	---
39	3L+	---	40	4L+	---

3.3 Connecting a module with a connection module

Component for connecting

To connect actuators or sensors, you need 2 connection modules per module. The connection modules are connected to the module with pre-assembled connecting cables.

You can find additional information on the components of the SIMATIC TOP connect system cabling, e.g. for connecting connection modules, in the equipment manual SIMATIC TOP connect for S7-1500 and ET 200MP

(<https://support.industry.siemens.com/cs/ww/en/view/95924607>).

Note

Common supply

If you use the listed SIMATIC TOP connect connection modules, then all 32 channels of a connection module have a common supply. This means that 2 groups of 16 channels each are supplied by common potential.

You can find the required components in the tables below.

Table 3-3 SIMATIC TOP connect connection module

Components	Type	Description	Connection technology	Article number	Delivery quantity
Connection modules for digital inputs	TP1	1-wire connection, without LED (sinking input)	- Screw terminals - Push-in system	6ES7924-2AA20-0AA0 6ES7924-2AA20-0ACO	Pack of 1 Pack of 1
		1-wire connection, with LED (sinking input)	- Screw terminals - Push-in system	6ES7924-2AA20-0BA0 6ES7924-2AA20-0BC0	Pack of 1 Pack of 1
		1-wire connection, with LED (sourcing input)	- Screw terminals - Push-in system	6ES7924-2AK20-0BA0 6ES7924-2AK20-0BC0	Pack of 1 Pack of 1
	TP3	3-wire connection, without LED (sinking input)	- Screw terminals - Push-in system	6ES7924-2CA20-0AA0 6ES7924-2CA20-0ACO	Pack of 1 Pack of 1
		3-wire connection, with LED (sinking input)	- Screw terminals - Push-in system	6ES7924-2CA20-0BA0 6ES7924-2CA20-0BC0	Pack of 1 Pack of 1
Connection modules for digital outputs	TP1	1-wire connection, without LED (sinking output)	- Screw terminals - Push-in system	6ES7924-2AA20-0AA0 6ES7924-2AA20-0ACO	Pack of 1 Pack of 1
		1-wire connection, with LED (sinking output)	- Screw terminals - Push-in system	6ES7924-2AM20-0BA0 6ES7924-2AM20-0BC0	Pack of 1 Pack of 1
	TP3	3-wire connection, without LED (sinking output)	- Screw terminals - Push-in system	6ES7924-2CA20-0AA0 6ES7924-2CA20-0ACO	Pack of 1 Pack of 1

3.3 Connecting a module with a connection module

Table 3- 4 Connecting cables SIMATIC TOP connect

Components	Length	Article number	Delivery quantity
Pre-assembled connecting cable with IDC connector an both ends <ul style="list-style-type: none"> • IDC connector 40-pin for the I/O module • IDC connector 50-pin for the SIMATIC TOP connect connection module 	1.0 m	6ES7923-5BB00-0GB0	Pack of 1
	2.0 m	6ES7923-5BC00-0GB0	Pack of 1
	2.5 m	6ES7923-5BC50-0GB0	Pack of 1
	3.0 m	6ES7923-5BD00-0GB0	Pack of 1

Support for selecting hardware components

We recommend you use the TIA Selection Tool for planning your project. The TIA Selection Tool is available free of charge as a desktop version for download or as a cloud version, refer to the Internet (<https://new.siemens.com/global/en/products/automation/topic-areas/tia/tia-selection-tool.html>).

3.4 Wiring of the module

Requirement

- The I/O modules are installed on the mounting rail.
- The supply voltage of the station is switched off.

Procedure

1. Plug the two SIMATIC TOP connect connecting cables with the **40-pin IDC** connector into X10 and X11.

Note when plugging:

- ① The nob on the left edge of connector X11
- ② The nob on the right edge of connector X10

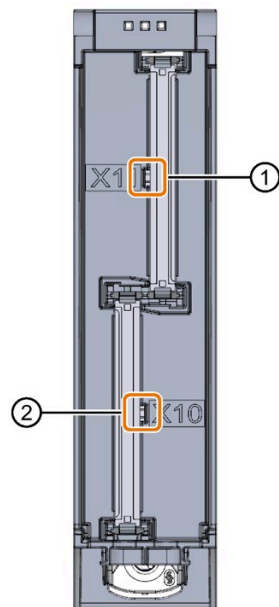

Figure 3-3 Connect the SIMATIC TOP connect 40-pin connecting cable to the module

2. Guide the SIMATIC TOP connect connecting cables down to the module.
3. Guide a cable tie around the module at the fixing points and connect the SIMATIC TOP connect cables.

4. Tighten the cable tie for the strain relief.

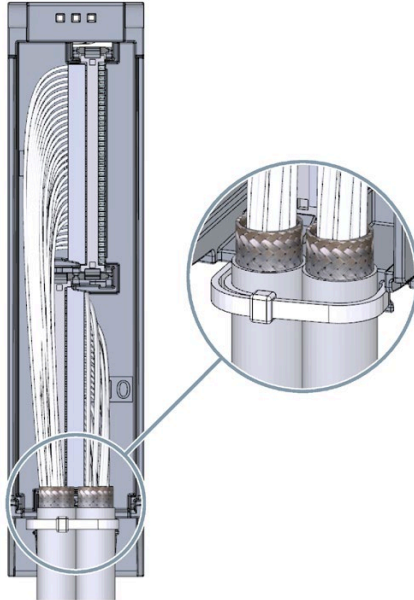

Figure 3-4 Fastening the cable tie for the strain relief

5. Plug the SIMATIC TOP connect connecting cables with the **50-pin** IDC connector into the SIMATIC TOP connect connection module.

Additional information

You can find out how to wire the SIMATIC TOP connect connection module in the equipment manual SIMATIC TOP connect for S7-1500 and ET 200MP (<https://support.industry.siemens.com/cs/ww/en/view/95924607>).

3.5 Fuse

Miniature circuit breaker

Inputs

The supply lines of groups are to be protected with a 4 A miniature circuit breaker with tripping characteristic C or B.

Below, you see the connection for "Sourcing" mode and for "Sinking" mode.

Outputs

The supply lines, max. 16 outputs of a group, are to be protected with a 4 A miniature circuit breaker with tripping characteristic B or C.

The connection module is to be protected with a 6 A miniature circuit breaker with tripping characteristic B.

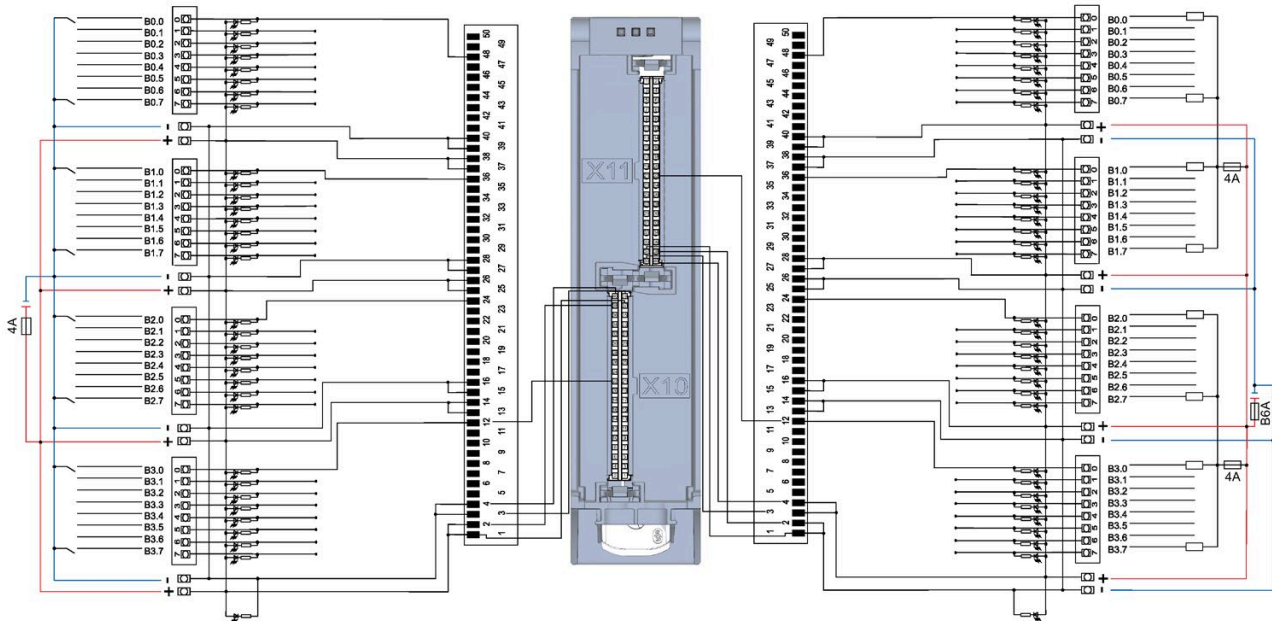

Figure 3-5 "Sourcing" mode for the inputs

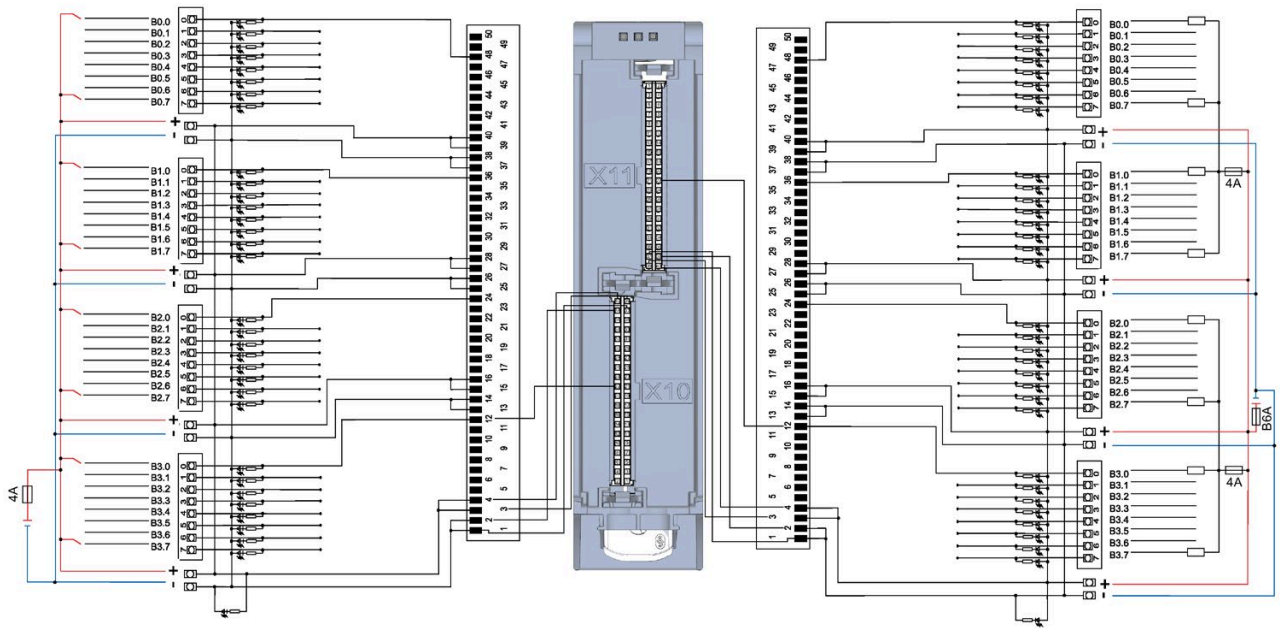

Figure 3-6 "Sinking" mode for the inputs

Address space

The module can be configured in various ways in STEP 7. Depending on the configuration, additional/different addresses are assigned in the process image input/output.

Configuration options of DI 32x24VDC SNK/SRC/DQ 32x24VDC/0.3A SNK BA

You can configure the module with STEP 7 (TIA Portal) or with a GSD file.

When you configure the module by means of the GSD file, the configurations are available under different abbreviations/module names.

The following configurations are possible:

Table 4-1 Configuration options

Configuration	Short designation/ module name in the GSD file	Configuration software, e.g., with STEP 7 (TIA Portal)	
		Integrated in the hardware catalog of STEP 7 (TIA Portal) as of V16 and HSP 0319	GSD file in STEP 7 (TIA Portal) V12 or higher or STEP 7 V5.5 SP3 or high- er
1 x 64-channel without value status (1 x 32 digital inputs and 1 x 32 digital outputs)	DI 32x24VDC SNK/SRC/DQ 32x24VDC/0.3A SNK BA	X	X
8 x 8-channel without value status (4 x 8 digital inputs and 4 x 8 digital outputs)	DI 32x24VDC SNK/SRC/DQ 32x24VDC/0.3A SNK BA S	X (PROFINET IO only)	X (PROFINET IO only)
1 x 64-channel with value status for up to 4 sub-modules (each 1 x 32 channels for module-internal Shared Input or module-internal Shared Output)	DI 32x24VDC SNK/SRC/DQ 32x24VDC/0.3A SNK BA MSI or MSO	X (PROFINET IO only)	X (PROFINET IO only)

**Address space for configuration as 1 x 64-channel
DI 32x24VDC SNK/SRC/DQ 32x24VDC/0.3A SNK BA**

The figure below shows the address space assignment for configuration as a 1 x 64-channel module (32 digital inputs / 32 digital outputs). You can freely assign the start address for the module. The addresses of the channels are derived from the start address.

"EB a (IB a)" stands for module start address input byte and "AB x (QB x)" stands for module start address output byte.

Assignment in the process image input (PII)

	7	6	5	4	3	2	1	0	Input value:
IB a	<input type="checkbox"/>	<input type="checkbox"/>	<input type="checkbox"/>	<input type="checkbox"/>	<input type="checkbox"/>	<input type="checkbox"/>	<input type="checkbox"/>	<input type="checkbox"/>	Channels 0 to 7 (input CH0 to CH7)
IB =a+1	<input type="checkbox"/>	<input type="checkbox"/>	<input type="checkbox"/>	<input type="checkbox"/>	<input type="checkbox"/>	<input type="checkbox"/>	<input type="checkbox"/>	<input type="checkbox"/>	Channels 8 to 15 (input CH8 to CH15)
IB =a+2	<input type="checkbox"/>	<input type="checkbox"/>	<input type="checkbox"/>	<input type="checkbox"/>	<input type="checkbox"/>	<input type="checkbox"/>	<input type="checkbox"/>	<input type="checkbox"/>	Channels 16 to 23 (input CH16 to CH23)
IB =a+2	<input type="checkbox"/>	<input type="checkbox"/>	<input type="checkbox"/>	<input type="checkbox"/>	<input type="checkbox"/>	<input type="checkbox"/>	<input type="checkbox"/>	<input type="checkbox"/>	Channels 24 to 31 (input CH24 to CH31)

Assignment in the process image output (PIQ)

	7	6	5	4	3	2	1	0	Output value
QB x	<input type="checkbox"/>	<input type="checkbox"/>	<input type="checkbox"/>	<input type="checkbox"/>	<input type="checkbox"/>	<input type="checkbox"/>	<input type="checkbox"/>	<input type="checkbox"/>	Channels 0 to 7 (output CH0 to CH7)
QB =x+1	<input type="checkbox"/>	<input type="checkbox"/>	<input type="checkbox"/>	<input type="checkbox"/>	<input type="checkbox"/>	<input type="checkbox"/>	<input type="checkbox"/>	<input type="checkbox"/>	Channels 8 to 15 (output CH8 to CH15)
QB =x+2	<input type="checkbox"/>	<input type="checkbox"/>	<input type="checkbox"/>	<input type="checkbox"/>	<input type="checkbox"/>	<input type="checkbox"/>	<input type="checkbox"/>	<input type="checkbox"/>	Channels 16 to 23 (output CH16 to CH23)
QB =x+3	<input type="checkbox"/>	<input type="checkbox"/>	<input type="checkbox"/>	<input type="checkbox"/>	<input type="checkbox"/>	<input type="checkbox"/>	<input type="checkbox"/>	<input type="checkbox"/>	Channels 24 to 31 (output CH24 to CH31)

Figure 4-1 Address space for configuration as 1 x 64-channel DI 32x24VDC SNK/SRC/DQ 32x24VDC/0.3A SNK BA

Address space for configuration as 8 x 8-channel DI 32x24VDC SNK/SRC/DQ 32x24VDC/0.3A SNK BA S

For the configuration as an 8 x 8-channel module, the channels of the module are divided into multiple submodules. The submodules can be assigned to different IO controllers when the module is used in a shared device.

The number of usable IO controllers depends on the interface module used. Please observe the information in the manual for the particular interface module.

Unlike the 1 x 64-channel module configuration, each of the eight submodules has a freely assignable start address.

Assignment in the process image input (PII)		Input value:	
IB a	7 6 5 4 3 2 1 0 □ □ □ □ □ □ □ □	Channels 0 to 7 (input CH0 to CH7)	1st submodule
IB b	□ □ □ □ □ □ □ □	Channels 8 to 15 (input CH8 to CH15)	2nd submodule
IB c	□ □ □ □ □ □ □ □	Channels 16 to 23 (input CH16 to CH23)	3rd submodule
IB d	□ □ □ □ □ □ □ □	Channels 24 to 31 (input CH24 to CH31)	4th submodule
Assignment in the process image output (PIQ)		Output value	
QB e	7 6 5 4 3 2 1 0 □ □ □ □ □ □ □ □	Channels 0 to 7 (output CH0 to CH7)	5th submodule
QB f	□ □ □ □ □ □ □ □	Channels 8 to 15 (output CH8 to CH15)	6th submodule
QB g	□ □ □ □ □ □ □ □	Channels 16 to 23 (output CH16 to CH23)	7th submodule
QB h	□ □ □ □ □ □ □ □	Channels 24 to 31 (output CH24 to CH31)	8th submodule

Figure 4-2 Address space for configuration as 8 x 8-channel DI 32x24VDC SNK/SRC/DQ 32x24VDC/0.3A SNK BA S

Address space for configuration as 1 x 64-channel DI 32x24VDC SNK/SRC/DQ 32x24VDC/0.3A SNK BA MSI/MSO

For configuration as a 1 x 64-channel module (module-internal Shared Input, MSI / module-internal Shared Output, MSO), the channels for inputs or outputs are copied to multiple submodules. Each of the channels are then available with identical values in various submodules. These submodules can be assigned to up to four IO controllers when the module is used in a Shared Device:

- The IO controller to which submodule 1 is assigned has write access to output channels 0 to 31 and read access to the input channels 0 to 31.
- The IO controllers to which submodule 2, 3 or 4 is assigned have read access to the input channels or output channels 0 to 31.

The number of usable IO controllers depends on the interface module used. Please observe the information in the manual for the particular interface module.

Value status (Quality Information, QI) for inputs

The meaning of the value status depends on the submodule involved.

For the 1st submodule (=basic submodule), the value status is not relevant.

For the 2nd to 4th submodule (=MSI submodule), the value status 0 indicates that the value is incorrect or the basic submodule has not yet been configured (not ready).

Value status (Quality Information, QI) for outputs

The meaning of the value status depends on the submodule involved.

For the 1st submodule (=basic submodule), the value status 1 indicates that the output value specified by the user program is actually output at the module terminal.

Possible causes for value status = 0: IO controller of the basic submodule is in STOP mode.

For the 2nd to 4th submodule (=MSO submodule), the value status 1 indicates that the output value specified by the user program is actually output at the module terminal.

Possible causes for value status = 0:

- IO controller of the basic submodule is in STOP mode.
- The basic submodule is not yet configured.

The figure below shows the assignment of the address space with submodule 1 and the value status.

Assignment in the process image input (PII) for 1st submodule

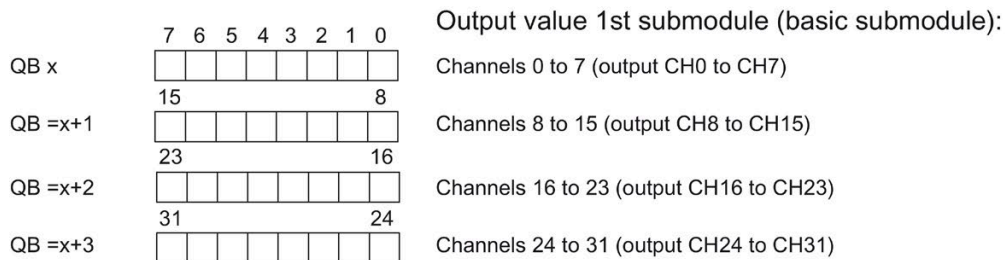
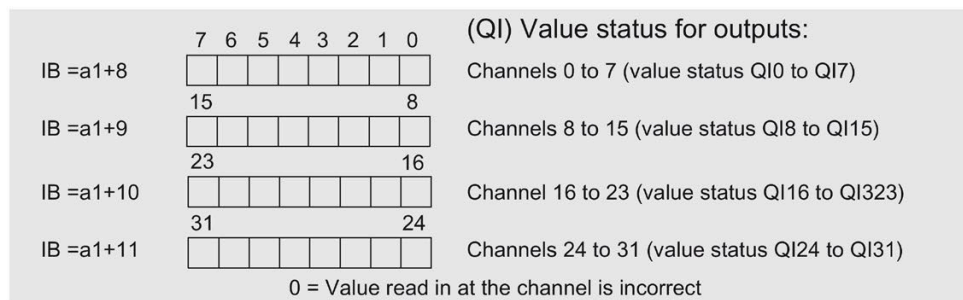
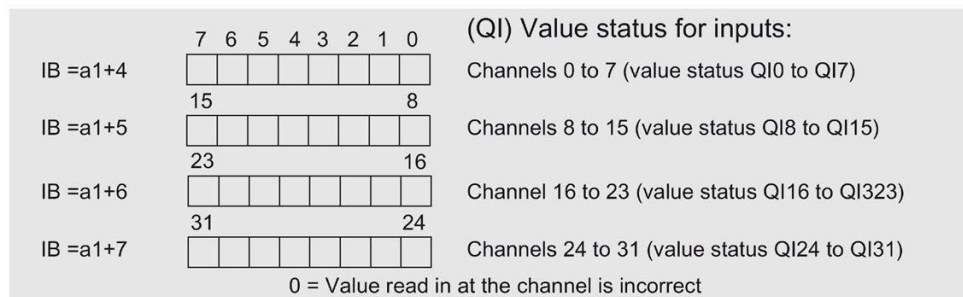
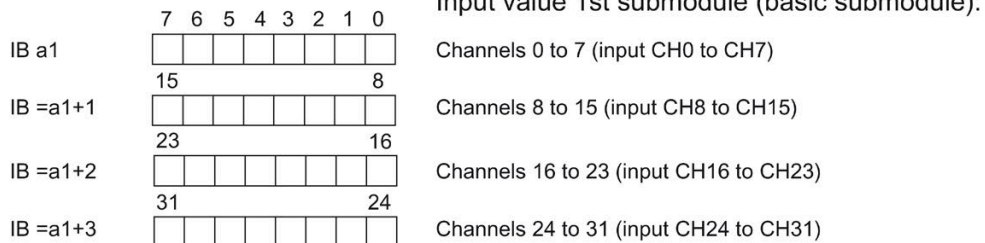

Figure 4-3 Address space for configuration as 1 x 64-channel DI 32x24VDC SNK/SRC/DQ 32x24VDC/0.3A SNK BA MSI/MSO

The figure below shows the assignment of the address space with submodule 2 and the value status.

Assignment in the process image input (PII) for 2nd submodule

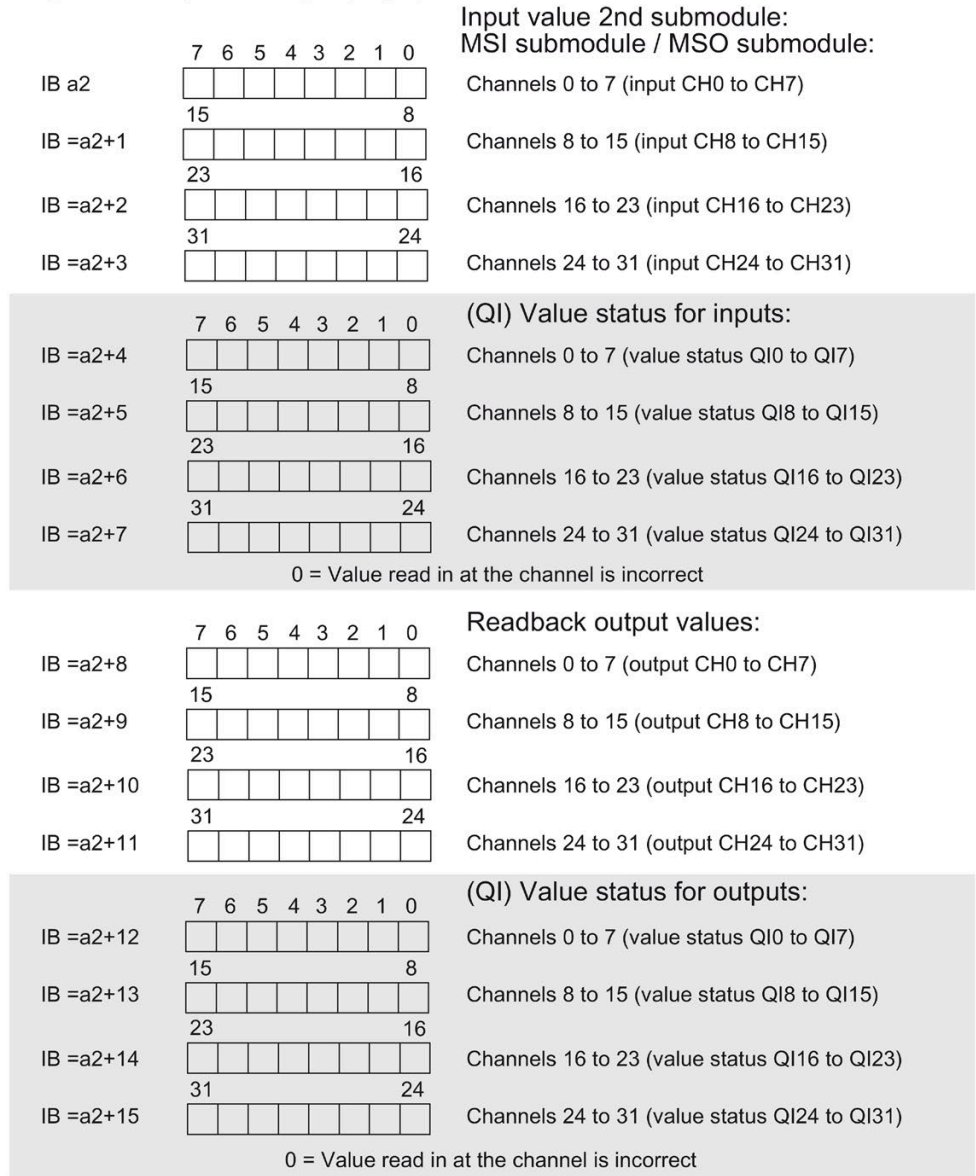

Figure 4-4 Address space for configuration as 1 x 64-channel DI 32x24VDC SNK/SRC/DQ 32x24VDC/0.3A SNK BA MSI/MSO

The figure below shows the assignment of the address space with submodule 4 and the value status.

Assignment in the process image input (PII) for 4th submodule

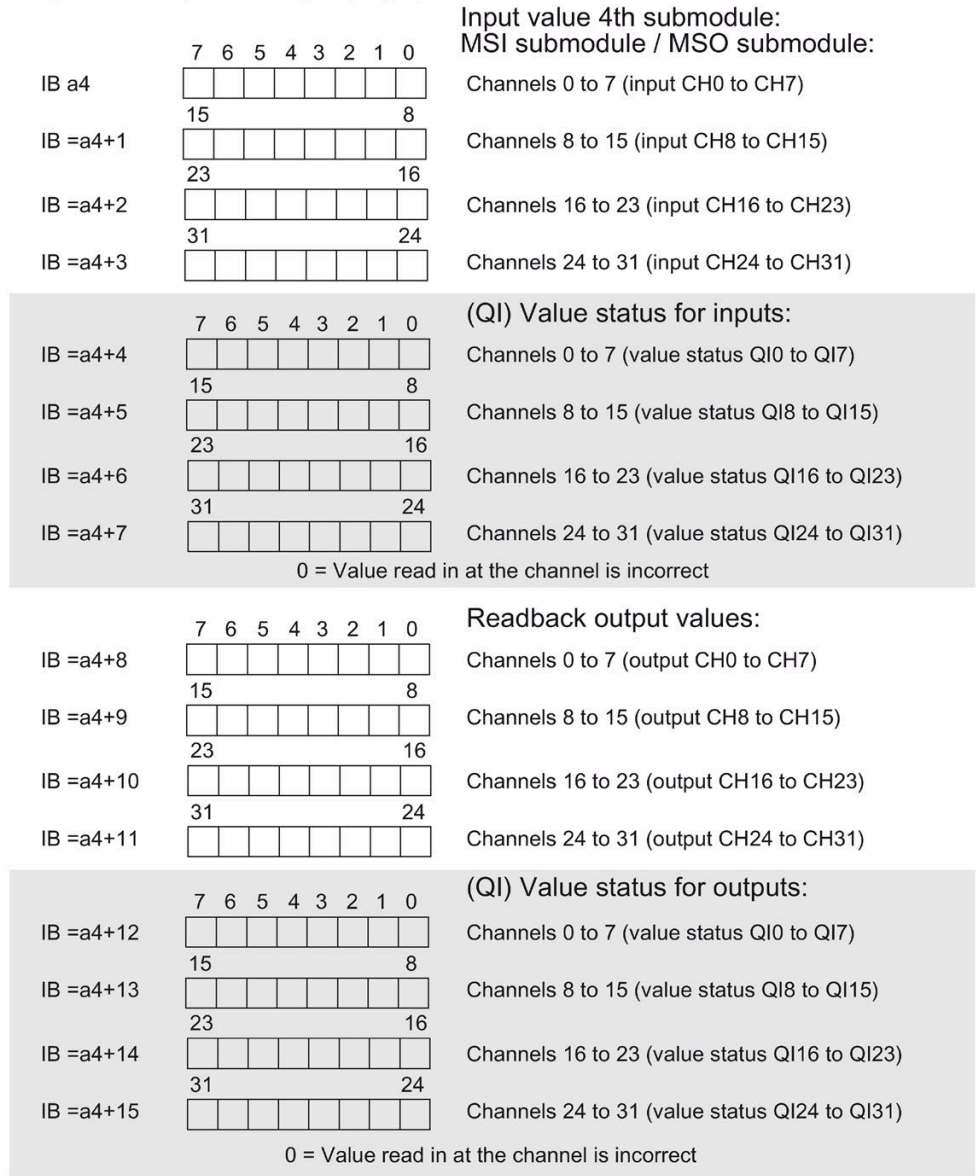

Figure 4-6 Address space for configuration as 1 x 64-channel DI 32x24VDC SNK/SRC/DQ 32x24VDC/0.3A SNK BA MSI/MSO

Reference

You can find information on the module-internal shared input/shared output (MSI/MSO) function in the section "Module-internal shared input / Module-internal shared output (MSI/MSO)" of the function manual PROFINET with STEP 7 V16 (<https://support.industry.siemens.com/cs/ww/en/view/49948856>).

Diagnostics alarms

The module has no selectable diagnostics. Diagnostics alarms, for example, cannot be output with STEP 7 (TIA Portal).

5.1 Status and error displays

LED displays

The figure below shows the LED displays (status and error displays) of DI 32x24VDC SNK/SRC/DQ 32x24VDC/0.3A SNK BA.

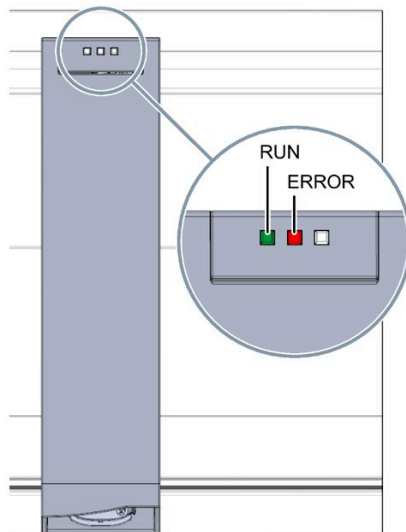









Figure 5-1 LED displays of the DI 32x24VDC SNK/SRC/DQ 32x24VDC/0.3A SNK BA module

Meaning of the LED displays

The tables below explain the meaning of the status and error displays.

LED RUN/ERROR

Table 5- 1 RUN/ERROR status and error displays

LED		Meaning	Remedy
RUN	ERROR		
 Off	 Off	Voltage missing or too low at backplane bus.	<ul style="list-style-type: none"> Switch on the CPU and/or the system power supply modules. Verify that the U connectors are inserted. Check whether too many modules are inserted.
 Flashes	 Off	Module is starting up.	---
 On	 Off	Module is ready.	
 Flashes	 Flashes	Hardware defective.	Replace the module.

Technical specifications

Technical specifications of the DI 32x24VDC SNK/SRC/DQ 32x24VDC/0.3A SNK BA

The following table shows the technical specifications as of 07/2020. You can find a data sheet including daily updated technical specifications on the Internet (<https://support.industry.siemens.com/cs/ww/en/ps/td>).

Enter the article number or the short designation of the module on the website.

Article number	6ES7523-1BP50-0AA0
General information	
Product type designation	DI 32 x 24 V DC / DQ 32 x 24 V DC/0.3A SNK BA
HW functional status	From FS01
Firmware version	V1.0.0
• FW update possible	Yes
Product function	
• I&M data	Yes; I&M0 to I&M3
• Isochronous mode	No
• Prioritized startup	No
Engineering with	
• STEP 7 TIA Portal configurable/integrated from version	V16 with HSP 0319 / V17
• STEP 7 configurable/integrated from version	V5.5 SP3 / -
• PROFIBUS from GSD version/GSD revision	V1.0 / V5.1
Operating mode	
• DI	Yes
• Counter	No
• DQ	Yes
• DQ with energy-saving function	No
• PWM	No
• Cam control (switching at comparison values)	No
• Oversampling	No
• MSI	Yes
• MSO	Yes
• Integrated operating cycle counter	No

Article number	6ES7523-1BP50-0AA0
Supply voltage	
Rated value (DC)	24 V
permissible range, lower limit (DC)	19.2 V
permissible range, upper limit (DC)	28.8 V
Reverse polarity protection	Yes; Through internal protection with 4 A per group
Input current	
Current consumption, max.	45 mA; without load
Output voltage	
Rated value (DC)	24 V
Power	
Power available from the backplane bus	0.6 W
Power loss	
Power loss, typ.	4.7 W
Digital inputs	
Number of digital inputs	32
Digital inputs, parameterizable	No
Source/sink input	Yes
Input characteristic curve in accordance with IEC 61131, type 3	Yes
Number of simultaneously controllable inputs	
• Number of simultaneously controllable inputs	32
horizontal installation	
– up to 60 °C, max.	32
vertical installation	
– up to 40 °C, max.	16
Input voltage	
• Rated value (DC)	24 V
• for signal "0"	-30 to +5 V
• for signal "1"	+11 to +30V
Input current	
• for signal "1", typ.	2.7 mA
Input delay (for rated value of input voltage) for standard inputs	
– parameterizable	No
– at "0" to "1", min.	3 ms
– at "0" to "1", max.	4 ms
– at "1" to "0", min.	3 ms
– at "1" to "0", max.	4 ms
for interrupt inputs	
– parameterizable	No

Article number	6ES7523-1BP50-0AA0
for technological functions	
– parameterizable	No
Cable length	
• shielded, max.	1 000 m
• unshielded, max.	600 m
Digital outputs	
Type of digital output	Transistor
Number of digital outputs	32
Current-sinking	Yes
Current-sourcing	No
Digital outputs, parameterizable	No
Short-circuit protection	No; external fusing necessary, max. 4 A per group, tripping characteristic type B or C
Limitation of inductive shutdown voltage to	L+ (-53 V)
Controlling a digital input	Yes
Switching capacity of the outputs	
• with resistive load, max.	0.3 A
• on lamp load, max.	5 W
Load resistance range	
• lower limit	80 Ω
• upper limit	10 kΩ
Output voltage	
• for signal "1", min.	M+ (0.5 V)
Output current	
• for signal "1" rated value	0.3 A
• for signal "1" permissible range, max.	0.3 A
• for signal "0" residual current, max.	0.5 mA
Output delay with resistive load	
• "0" to "1", max.	100 μs
• "1" to "0", max.	500 μs
Parallel switching of two outputs	
• for logic links	Yes
• for uprating	No
• for redundant control of a load	Yes
Switching frequency	
• with resistive load, max.	100 Hz
• with inductive load, max.	0.5 Hz; According to IEC 60947-5-1, DC-13
• on lamp load, max.	10 Hz

Article number	6ES7523-1BP50-0AA0
Total current of the outputs	
• Current per channel, max.	0.3 A
• Current per group, max.	2 A
• Current per module, max.	4 A
Total current of the outputs (per module)	
horizontal installation	
– up to 60 °C, max.	4 A
vertical installation	
– up to 40 °C, max.	4 A
Cable length	
• shielded, max.	1 000 m
• unshielded, max.	600 m
Encoder	
Connectable encoders	
• 2-wire sensor	Yes
– permissible quiescent current (2-wire sensor), max.	1.5 mA
Interrupts/diagnostics/status information	
Diagnostics function	No
Substitute values connectable	No
Alarms	
• Diagnostic alarm	No
• Maintenance interrupt	No
• Hardware interrupt	No
Diagnostic messages	
• Monitoring the supply voltage	No
• Wire-break	No
• Short-circuit	No
• Group error	No
Diagnostics indication LED	
• RUN LED	Yes; green LED
• ERROR LED	Yes; red LED
• MAINT LED	No
• Monitoring of the supply voltage (PWR-LED)	Yes; via SIMATIC TOP connect connection module
• Channel status display	Yes; via SIMATIC TOP connect connection module
• for channel diagnostics	No
• for module diagnostics	No

Article number	6ES7523-1BP50-0AA0
Potential separation	
Potential separation channels	
<ul style="list-style-type: none"> • between the channels • between the channels, in groups of • between the channels and backplane bus 	<p>No</p> <p>16; 32 when using SIMATIC TOP connect connection module</p> <p>Yes</p>
Isolation	
Isolation tested with	707 V DC (type test)
Ambient conditions	
Ambient temperature during operation	
<ul style="list-style-type: none"> • horizontal installation, min. • horizontal installation, max. • vertical installation, min. • vertical installation, max. 	<p>-30 °C</p> <p>60 °C</p> <p>-30 °C</p> <p>40 °C</p>
Altitude during operation relating to sea level	
<ul style="list-style-type: none"> • Installation altitude above sea level, max. 	5 000 m
Dimensions	
Width	35 mm
Height	147 mm
Depth	129 mm
Weights	
Weight, approx.	250 g
Other	
Note:	Please order cable and connection modules separately

Dimensional drawing

The dimensional drawing of the module on the mounting rail, as well as a dimensional drawing with open front cover, are provided in this appendix. Always observe the specified dimensions for installation in cabinets, control rooms, etc.

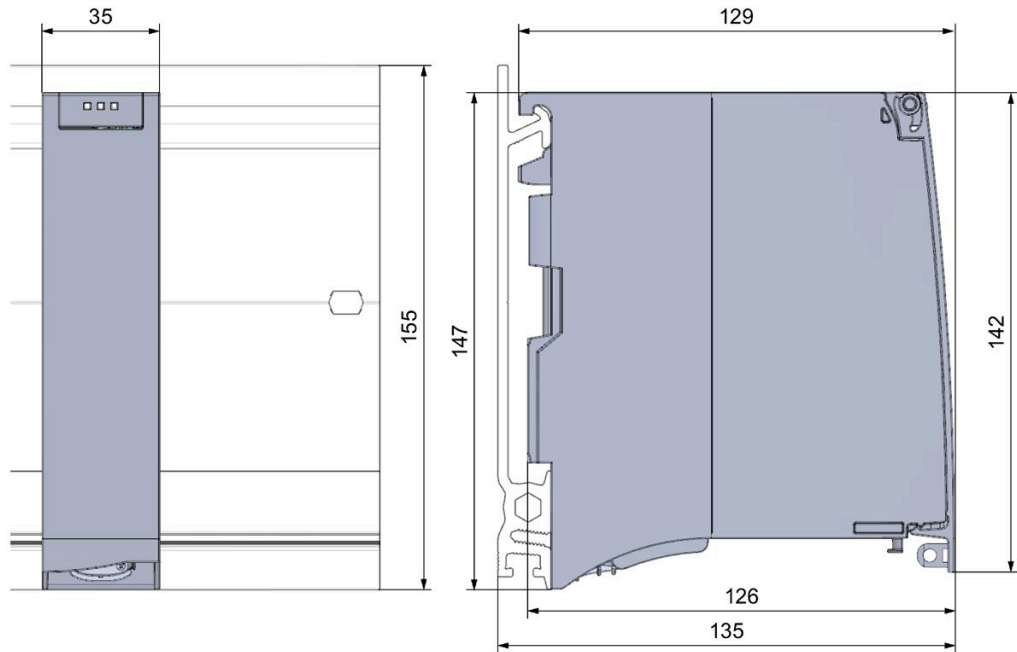

Figure A-1 Dimensional drawing of the DI 32x24VDC SNK/SRC/DQ 32x24VDC/0.3A SNK BA module

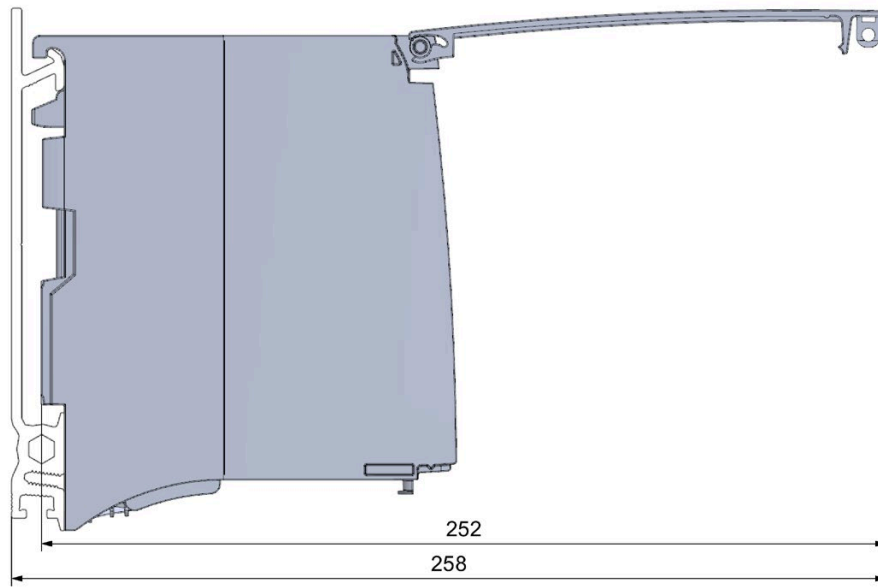

Figure A-2 Dimension drawing of the DI 32x24VDC SNK/SRC/DQ 32x24VDC/0.3A SNK BA module, side view with open front cover