

Industrial controls

Monitoring and control devices 3RP25 Time Relays



Manual

<u>Introduction</u>	1
<u>Safety notes</u>	2
<u>Description</u>	3
<u>Mounting</u>	4
<u>Connection</u>	5
<u>Single function devices</u>	6
<u>Multifunction units</u>	7
<u>Technical data</u>	8
<u>Dimension drawings</u>	9
<u>Spare parts/accessories</u>	10

Legal information

Warning notice system

This manual contains notices you have to observe in order to ensure your personal safety, as well as to prevent damage to property. The notices referring to your personal safety are highlighted in the manual by a safety alert symbol, notices referring only to property damage have no safety alert symbol. These notices shown below are graded according to the degree of danger.

 DANGER
indicates that death or severe personal injury will result if proper precautions are not taken.
 WARNING
indicates that death or severe personal injury may result if proper precautions are not taken.
 CAUTION
indicates that minor personal injury can result if proper precautions are not taken.
NOTICE
indicates that property damage can result if proper precautions are not taken.

If more than one degree of danger is present, the warning notice representing the highest degree of danger will be used. A notice warning of injury to persons with a safety alert symbol may also include a warning relating to property damage.

Qualified Personnel

The product/system described in this documentation may be operated only by **personnel qualified** for the specific task in accordance with the relevant documentation, in particular its warning notices and safety instructions. Qualified personnel are those who, based on their training and experience, are capable of identifying risks and avoiding potential hazards when working with these products/systems.

Proper use of Siemens products

Note the following:

 WARNING
Siemens products may only be used for the applications described in the catalog and in the relevant technical documentation. If products and components from other manufacturers are used, these must be recommended or approved by Siemens. Proper transport, storage, installation, assembly, commissioning, operation and maintenance are required to ensure that the products operate safely and without any problems. The permissible ambient conditions must be complied with. The information in the relevant documentation must be observed.

Trademarks

All names identified by ® are registered trademarks of Siemens AG. The remaining trademarks in this publication may be trademarks whose use by third parties for their own purposes could violate the rights of the owner.

Disclaimer of Liability

We have reviewed the contents of this publication to ensure consistency with the hardware and software described. Since variance cannot be precluded entirely, we cannot guarantee full consistency. However, the information in this publication is reviewed regularly and any necessary corrections are included in subsequent editions.

Table of contents

1	Introduction.....	5
1.1	Required basic knowledge.....	5
1.2	Service&Support.....	5
1.3	DataMatrix code.....	7
1.4	Standards/Regulations/Approvals	8
1.5	Declaration of conformity	8
1.6	Article No. scheme.....	8
2	Safety notes.....	11
2.1	General safety notes.....	11
2.2	Intended use	12
2.3	Current information about operational safety	12
3	Description.....	13
3.1	Device overview.....	13
3.2	Device description.....	14
3.3	Device versions.....	15
3.4	Special features	17
3.5	Notes on configuration.....	19
3.6	Area of application	20
3.7	Overview of 3RP25 components and accessories	22
4	Mounting.....	23
4.1	Warning notices	23
4.2	Terminal coding	24
4.3	Mounting the devices on a standard mounting rail	25
4.4	Removing devices from a standard mounting rail	26
4.5	Mounting the devices on a level surface	27
4.6	Disassembling the devices from a level surface.....	28
4.7	Mounting the sealable cover.....	29
4.8	Attaching set of labels (multifunction).....	30

5	Connection	31
5.1	Terminal assignment.....	31
5.2	Position of the connecting terminals	35
5.3	Connection data for terminals	38
5.4	Connecting the screw-type terminals.....	39
5.5	Disconnecting the screw-type terminals	40
5.6	Wiring rules for spring-loaded terminals (with push-in technology)	41
5.7	Connect the spring-loaded terminal (push-in).....	42
5.8	Disconnect the spring-loaded terminal (push-in)	44
5.9	Attaching the terminals	45
5.10	Removing the terminals	46
6	Single function devices	49
6.1	Structure.....	49
6.2	Time setting single function unit.....	50
6.3	ON-delay	51
6.4	OFF-delay	54
6.5	Flasher relay asymmetrical (clock generator).....	58
6.6	Star-delta (wye-delta) function	59
6.7	Star-delta (wye-delta) function with coasting time (idling)	60
7	Multifunction units	65
7.1	Structure.....	65
7.2	Time setting multifunction unit	66
7.3	Function table multifunction (3RP2505).....	69
8	Technical data	83
8.1	Technical data in Siemens Industry Online Support.....	83
9	Dimension drawings	85
9.1	Dimension drawings 3RP25 devices	85
10	Spare parts/accessories	89
10.1	Accessories for 3RP25	89

Introduction

1.1 Required basic knowledge

Basic knowledge of low-voltage industrial controls is required to understand this manual.

1.2 Service&Support

Online Support

The Online Support in the Service&Support portal is an extensive information system for all questions relating to Siemens products and solutions. This service enables direct and central access to in-depth information concerning the products, systems and applications for industry and to a large number of programming, configuration and application examples. Its content is available via a mobile app.

The Technical Forum of the Online Support provides the opportunity for users to swap information. Support Request allows contact to be established with Siemens experts in Technical Support.

Siemens Industry Online Support ensures that users in industry are always kept up-to-date with news, software updates and announcements by means of newsletters and Twitter.

Links: Service&Support Portal (<http://support.automation.siemens.com>), Online Support (<http://support.automation.siemens.com/WW/view/de/16605022>)

Product Support

Are you looking for product information such as technical data, updates or FAQs? Here, the "Product Support" section of the Service & Support Portal offers an extensive collection of all information about the Siemens Industry Automation and Drive Technologies products and solutions:

- Answers to frequently asked questions (FAQs)
- Updates/upgrades, service packs and support tools for downloading
- Manuals and operating instructions
- Technical data/CAx data
- Approvals and certificates
- Test certificates and characteristic curves

All Product Support information is at your disposal free of charge and around the clock, and you always get the current version.

Link: Product Support (<http://support.automation.siemens.com/WW/view/de/4000024>)

CAx data

The CAx Download Manager provides you with a simple means of gaining access to up-to-date product data for your CAx or CAe system.

You configure your own download package with just a few clicks. You can choose from the following information for products

- Product images
- 2D dimensional drawings
- 3D models
- Internal circuit diagrams
- EPLAN macro files
- Manuals
- Characteristics
- Operating instructions
- Certificates
- Product master data

Link: CAx Download Manager

(<http://support.automation.siemens.com/WW/view/de/42455541>)

Applications & Tools

Applications & Tools supports you with various tools and examples when it comes to solving your automation tasks. Solutions are presented in interaction with several components in the system, without focusing on individual products.

- Application examples
- Function blocks & tools
- Background and system descriptions
- Performance statements
- Demonstration systems/videos

Link: Applications & Tools (<http://support.automation.siemens.com/WW/view/de/20208582>)

My Documentation Manager

My Documentation Manager enables you to compile your own documentation from our standard documents (manuals), which are located in the Product Support section. Under mySupport, you have the opportunity to create and manage your own compilations in a structure of their own.

Link:

MyDocumentationManager (<http://support.automation.siemens.com/WW/view/de/38715968>)

Reference

You can find further information on structure and navigation in Online Support here (<http://support.automation.siemens.com/WW/view/de/11774658>).

1.3 DataMatrix code

A DataMatrix code is lasered onto the lower terminal cover of all devices of this series.

DataMatrix codes are standardized in ISO/IEC 16022. The DataMatrix codes on Siemens devices use ECC200 coding.

The following device information is encoded in the DataMatrix codes as a bit stream:

- Article number
- Serial number

This information is stored in the following format in the DataMatrix code:

1P	Article number	+	S	Serial number
Data identifier	Net content	Separator	Data identifier	Net content

Note

The information content is displayed without spaces.

This machine-readable information simplifies and accelerates handling of the respective devices.

As well as fast access to the serial numbers of the respective devices for unique identification, the DataMatrix codes simplify communication with Siemens Technical Support.

SIEMENS Industry Support App

DataMatrix codes primarily enable extremely fast and convenient access to all device-specific information relating to an article number in the SIEMENS Service&Support Portal (<http://support.automation.siemens.com>), such as operating instructions, manuals, data sheets, FAQs, etc.

We provide the SIEMENS Industry Support app free for this purpose and it can be used on most commercially available smartphones and tablets.

The SIEMENS Industry Support app is available for iOS and Android-based devices and can be accessed via the following links:



Link for Android



Link for iOS



Link for Windows Phone

1.4 Standards/Regulations/Approvals

Standards

The time relays comply with the following standards:

- EN 61812-1/DIN VDE 0435 Part 2021 "Electrical relays, time relays"
- EN 60947-5-1; (VDE 0660 Part 200) "Low-Voltage Switchgear and Controlgear"
- EN 61000-6-2 and EN 61000-6-4 "Electromagnetic compatibility"

UL/CSA/Shipbuilding approval

(applied for, for the current status see the Product Data Sheet in the Siemens Industry Mall)

SIRIUS time relays have UL and CSA approval for use all over the world. They have also been prototype-tested by the GL, LRS, and DNV shipbuilding companies.

1.5 Declaration of conformity

The manufacturer declares that the time relays of the SIRIUS 3RP25 series in the designs marketed by us comply with the applicable basic health and safety requirements of the EC Directives* stated (including amendments) and that the stated standards* were applied in their design and construction.

* You can download the complete EC Declaration of Conformity from the Service Portal (<https://support.industry.siemens.com/cs/ww/en/ps/cert>) as a PDF.

1.6 Article No. scheme

Note

The Article No. scheme is presented here merely for information purposes and for better understanding of the logic behind the article numbers.

For your orders, please use the article numbers quoted in the catalog in the Selection and ordering data.

Digit of the Article No.	1st - 5th	6th	7th	8th	9th	10th	11h	12th		
SIRIUS timing relay	3 R P 2 5	<input type="checkbox"/>	<input type="checkbox"/>	-	<input type="checkbox"/>	<input type="checkbox"/>	<input type="checkbox"/>	<input type="checkbox"/>	0	
Functional variant		<input type="checkbox"/>								0 Multifunction 1 ON-delay with a time range 2 ON-delay > 1 time range 3 OFF-delay with control signal 4 OFF-delay without control signal and Non-volatile (positive passing make contact) 5 Flasher relays asymmetrical (clock-pulse) 6 Start-delta (wye-delta) function (SD) with coasting time 7 Star-delta (wye-delta) function (SD)
Time ranges			<input type="checkbox"/>							0 0.05 ... 600 s, 1... 20 s, (SD, 30 ... 600 s coasting time) 1 0.5 ... 10 s 2 1 ... 30 s 3 5 ... 100 s 4 1 ... 20 s (SD) 5 7 time ranges 0.05 s... 100 h 6 3 ... 60 s (SD) 7 4 time ranges 0.05 ... 240 s
Connection system				<input type="checkbox"/>						1 Screw terminal 2 Spring-loaded terminal (push-in)
Output type					<input type="checkbox"/>					A 1 CO relay B 2 CO relay C 1 NO semiconductor contact (AC/DC) E 1 NO semiconductor contact (AC/DC), two-wire N 2 NO contacts R 1 relay, 2 CO contacts, positively-driven and hard gold-plated contacts S 3 NO contacts
Supply voltage						<input type="checkbox"/>				T 400 ... 440 V AC W 12 ... 240 V AC/DC M (GND) 200 ... 240 V / 380 ... 440 V AC B 24 V AC/DC
Frequency range							<input type="checkbox"/>			2 50/60 Hz AC 3 50/60 Hz AC/DC
Example	3 R P 2 5	0	5	-	1	A	W	3	0	Multifunction relays with 7 time ranges; screw-type terminals; 1 CO relay contact; 12 ... 240 V AC/DC; 50/60 Hz

Safety notes

2.1 General safety notes

Note**Recycling and disposal**

Dispose of existing packing material in accordance with applicable regulations or recycle it.

3RP25 time relays are able to be recycled thanks to a low-pollutant manufacturing process. For environmentally-friendly recycling and disposal of your electronic waste, please contact a company certified for the disposal of electronic waste.

 WARNING**Protection against electrically conductive contamination!**

The devices must be protected against conductive contamination while taking account of the ambient conditions. One way you can do this is to install the devices in a control cabinet with the appropriate degree of protection.

You will find more detailed information in IEC 60529, for example.

 CAUTION**Protection against electrostatic charge**

When handling and installing 3RP25 time relays, ensure that the components are protected from being electrostatically charged. Changes to the system configuration and wiring are only permissible while the supply voltage is switched off.

Connection of 3RP25 time relays is only permissible when the power supply is switched off.

2.2 Intended use

 WARNING
Hazardous Voltage Can Cause Death, Serious Injury, or Property Damage. Intended Use of Hardware Products
<p>This equipment is only allowed to be used for the applications described in the catalog and in the technical description, and only in conjunction with non-Siemens equipment and components recommended by Siemens.</p> <p>Correct transport, storage, installation and assembly, as well as careful operation and maintenance, are required to ensure that the product operates safely and without faults.</p>

2.3 Current information about operational safety

Important note for maintaining operational safety of your system

 WARNING
Hazardous voltage Can Cause Death, Serious Injury, or Property Damage. Please take note of our latest information
<p>Systems with safety-related characteristics are subject to special operational safety requirements on the part of the operator. The supplier is also obliged to comply with special product monitoring measures. For this reason, we publish a special newsletter containing information on product developments and features that are (or could be) relevant to operation of safety-related systems. By subscribing to the appropriate newsletter, you will ensure that you are always up-to-date and able to make changes to your system, when necessary:</p> <p>SIEMENS Newsletter (http://www.industry.siemens.com/newsletter) Subscribe to the following newsletter under "Products & Solutions":</p> <ul style="list-style-type: none">• Control Components and System Engineering News

Description

3.1 Device overview

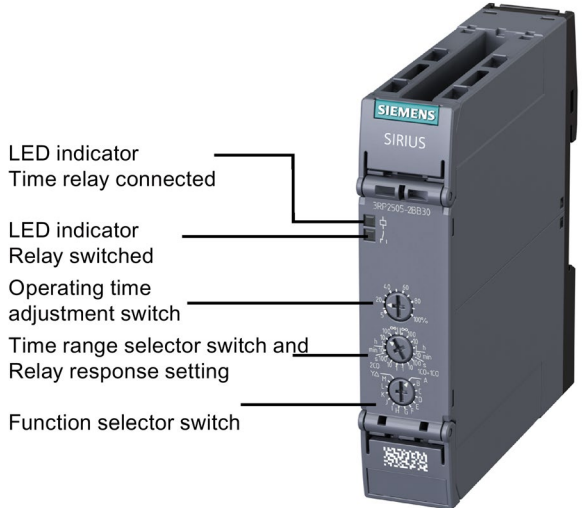

3.2 Device description

Electronic timing relays are used in control, starting, and protective circuits for all switching operations involving time delays. Their fully developed concept and space-saving, compact design make the SIRIUS 3RP timing relays ideal modules for control cabinet, switchgear and control manufacturers in the industry.

Thanks to their slim-line, space-saving design from 17.5 mm, 3RP25 timing relays are especially suitable for use in smaller control boxes, such as heating, ventilation and air-conditioning systems, and in compressors. All 3RP25 timing relays in this enclosure version are suitable for snapping onto TH35 mounting rails in accordance with IEC60175.

Benefit

- Transparent program with seven basic units for the 3RP timing relay
- Logistical advantages provided by versions with wide voltage range and wide setting range
- No tools required for assembly or disassembly on standard mounting rails
- Cadmium-free relay contacts
- Recyclable, halogen-free enclosure
- Optimum price/performance ratio
- Timing relays in 17.5 mm width offer more space in the control cabinet
- Environmentally friendly laser inscription instead of printing containing solvents
- Hard gold-plated relay contacts for optimum interaction with electronic controls
- Versions with screw-type connection or alternatively with spring-loaded/push-in technology

3.3 Device versions

SIRIUS 3RP25 timing relays are available in the following versions:

- Single function units, e.g. "ON-delay" function
- Multifunction units

Sizes

The overall height of 100 mm has been standardized with the other system components, and the overall depth has been standardized for all widths to 90 mm. Refer to Section "Dimension drawings 3RP25 devices (Page 85)" for the precise dimensions. The timing relays are designed in two widths:

- 17.5 mm
This width is used predominantly for relays with one contact element (e.g. 1 CO contact) and 8 possible connecting terminals.
- 22.5 mm
This width is used predominantly for relays with several contact elements (e.g. 2 CO contacts) and 12 possible connecting terminals.

Characteristics

The features of the 3RP25 timing relay are:

- 1 CO contact (single function and multifunction with 13 functions)
- 1 NO semiconductor contact (two-wire timing relay, multifunction with 13 functions)
- 1 relay, 2 CO contacts, positively-driven (multifunction with 13 functions)
- 2 CO contacts (multifunction with 27 functions)
- 7 switchable time ranges
- Adjustable operating time from 0.05 s to 100 h
- Wide voltage range version 12 ... 240 V AC/DC
- Single function unit for the following functions:
 - ON-delay with 1 or 2 CO contacts
 - OFF-delay with control signal and 1 CO contact
 - OFF-delay without control signal and 1 or 2 CO contacts
 - Asymmetrical flasher relay (clock-pulse; pulse and interval separately adjustable) with 1 CO contact
 - Star-delta (wye-delta) with 2 or 3 NO contacts, with and without overtravel function
 - 2-wire ON-delay with semiconductor output

3.3 Device versions

- Two-wire timing relays

In conjunction with contactors, they have the following advantages compared to conventional timing relays:

- Reduced wiring
- Bounce-free control
- The solid-state output enables increased service life as there is no mechanical wear

- Multifunction timing relay with 1 CO contact and 13 functions (A-M) or 2 CO contacts and 27 functions (A-M + YD). The unit can be set as a 2 CO contact unit (2CO) or 1 CO contact + 1 CO contact unit (1CO+1CO):

Function	- 1CO: 1 CO contact - 1NO: 1 NO contact - 2CO: 2 CO contacts, parallel contacts	- 1CO+1CO: 1 CO contact delayed + 1 instantaneous CO contact - Star-delta (wye-delta) function
A	ON-delay	ON-delay <i>and instantaneous contact</i>
B	OFF-delay with control signal	OFF-delay with control signal <i>and instantaneous contact</i>
C	ON-delay and OFF-delay with control signal	ON-delay and OFF-delay with control signal <i>and instantaneous contact</i>
D	Flasher relay, symmetrical, starting with interval	Flasher relay, symmetrical, starting with interval <i>and instantaneous contact</i>
E	Passing make contact, interval relay	Passing make contact, interval relay <i>and instantaneous contact</i>
F	Retriggerable interval relay with deactivated control signal (passing break contact with control signal)	Retriggerable interval relay with deactivated control signal (passing break contact with control signal) <i>and instantaneous contact</i>
G	Passing make contact with control signal, not retriggerable, (pulse-forming with control signal)	Passing make contact with control signal, not retriggerable, (pulse-forming with control signal) <i>and instantaneous contact</i>
H	Additive ON-delay, instantaneous OFF with control signal	Additive ON-delay, instantaneous OFF with control signal <i>and instantaneous contact</i>
I	Additive ON-delay with control signal	Additive ON-delay with control signal <i>and instantaneous contact</i>
J	Flasher relay, symmetrical, starting with pulse	Flasher relay, symmetrical, starting with pulse <i>and instantaneous contact</i>
K	Pulse-delayed (pulse and pulse delay adjustable)	Pulse-delayed (pulse and pulse delay adjustable) <i>and instantaneous contact</i>
L	Pulse-delayed with control signal (pulse and pulse delay adjustable)	Pulse-delayed with control signal (pulse and pulse delay adjustable) <i>and instantaneous contact</i>
M (GND)	Retriggerable interval relay with activated control signal (watchdog)	Retriggerable interval relay with activated control signal <i>and instantaneous contact</i> (watchdog)
YD		Star-delta (wye-delta) function

3.4 Special features

Operating temperature

For operation from -25 °C to +60 °C, there are no restrictions for the control supply, switching current, or ON time.

Time ranges

Up to 7 time ranges are available from 0.05 s to 100 h. These are as follows:

- 0.05 s - 1 s
- 0.5 s - 10 s
- 5 s - 100 s
- 0.5 min - 10 min
- 0.05 h - 1 h
- 0.5 h - 10 h
- 5 h - 100 h

Wide voltage range

All functions can be operated with a wide voltage range 12 ... 240 V AC/DC.

Electrical service life

The electrical service life with contactor load (e.g. 3RT1016 contactor) is 10 million operating cycles.

The electrical service life at 230 V AC voltage, utilization category AC-15/3 A is 100 000 operating cycles.

Start/control contact

With functions requiring a continuously active supply voltage at terminals A1/A2, the timer function is started by a control signal at terminal B1.

3.4 Special features

Special functions

- Function "flashing, asymmetrical": Pulse and interval can be adjusted separately. (clock-pulse)
- Function "flashing, symmetrical": the pulse/interval ratio is 1:1. (flashing)
- With the "OFF-delay without control signal" function, timing is started when the time relay is disconnected from the supply voltage.
- On the 3RP25 time relay with 7 switchable time ranges, there is a switch position ∞ . This means "continuous (unlimited) time". If this setting is selected with the "ON-delay" function, the output relay never connects after the supply voltage is applied (OFF function). With the function "passing make contact", the output relay always remains on (ON function). This can be used for test purposes.
- If the control signal is interrupted when the "additive ON-delay with control signal" function has been selected, timing stops and continues when the control signal is closed again.
This function is not non-volatile and requires a continuous control signal supply.
- With the function "pulse-forming with control signal", an activated control signal triggers an adjustable timing period. The control signal can be shorter or longer than the desired operating time.

3.5 Notes on configuration

Prerequisites

NOTICE

Potential property damage.

Only change the time setting range or function in the de-energized state.

Start input

The control signal at B1 may only be applied when the supply voltage is already present at A1 / A2.

Same potential

The same potential must be applied at terminals A1 and B1. This means the supply voltage and the control signal must be identical.

Combination voltage

With combination voltage versions, only one voltage range must ever be connected at one time. Never apply both control voltages simultaneously.

Parallel load at the start contact

A circuit with parallel load is permissible with AC and DC on the 3RP25 timing relays.

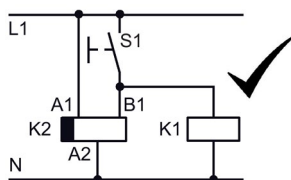

Positively-driven contacts

When using positively driven contacts with 3RP2502-xRW30, the same power supply / voltage must be used for both changeover contacts.

3.6 Area of application

Functions

Time relays with ON-delay

- Interference pulse suppression (gating of interference pulses)
- Gradual startup of motors so as not to overload the power supply

Time relays with OFF-delay

- Generation of overtravel functions following removal of voltage
- Gradual, delayed shutdown, e.g. of motors or fans to allow a plant to be shut down selectively

Star-delta (wye-delta) time relay

- Motor changeover from star (wye) to delta with a changeover delay of 50 ms to prevent interphase short-circuit

Multifunction time relays

- Maximum flexibility, with a device for every application

Additive ON-delay, instantaneous OFF with control signal

- e.g. for the control of cyclical machine lubrication operations dependent on operating hours

Flasher relay, symmetrical, starting with pulse

- Gradual adjustability of longitudinal feed on punching/embossing machines

Pulse-delayed relay

- Time relay with which the timing period starts when the control supply voltage is applied and the output briefly switches to the working position after expiry of the set time delay

Pulse-delayed relay with control signal

- Time relay with which the timing period starts when the supply voltage and the control signal are applied, and the output briefly switches to the working position after expiry of the set time delay

Retriggerable interval relay with activated control signal and instantaneous contact (watchdog relay)

- Cyclic monitoring of a start contact (dead man's circuit)

Supply voltage present at A1/A2. When the control signal is applied, the relay switches immediately to the working position. The relay switches to idle after the set time independently of the presence of the control signal (watchdog function). The time delay is restarted each time the control signal is applied.

Retriggerable interval relay with deactivated control signal

- Time relay for which the output switches immediately to the working position when the supply voltage is applied and the control signal is deactivated. The time starts and the output switches to the idle position after the set delay has expired. The time function is restarted each time the control signal is switched off.

ON and OFF-delay

- Closed-loop control (pre-travel and overtravel) of heating or cooling systems

Passing make contact

- Forced ventilation of rooms
- Stairwell lighting and elevator lighting

Passing break contact

- Emptying a conveyor belt / chip conveyor at end of process

3.7 Overview of 3RP25 components and accessories

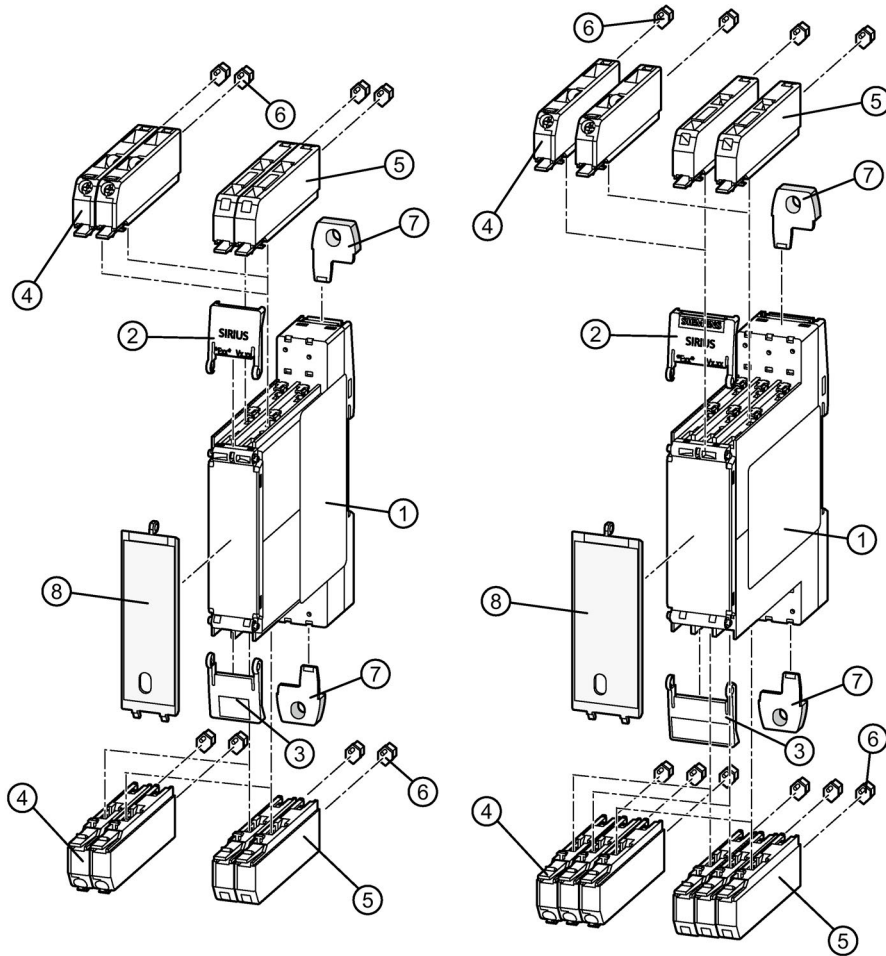

- ① Basic unit
- ② Top cover flap
- ③ Bottom cover flap
- ④ Spring-loaded terminals (push-in) 2-pole 1 x 2.5 mm²
- ⑤ Screw-type terminals 2-pole 1 x 2.5 mm²
- ⑥ Coding pins (accessories, to be ordered separately)
- ⑦ Push-in lugs for wall mounting (accessories, to be ordered separately)
- ⑧ Sealable covers (accessories, to be ordered separately)

You can find details and article numbers for the accessories in the Section Accessories (Page 89).

Mounting

4.1 Warning notices

Warning notices before installation, wiring, and commissioning

 WARNING
Hazardous voltage!
Causes electric shock and burns when touched.
Turn off and lock out all power supplying this device before working on this device.

Note**Following figures similar!**The figures shown below (size, accessories, add-ons, etc.) are similar.

4.2 Terminal coding

You can provide the terminals with coding pins (3ZY1440-1AA00). This helps you to avoid errors when replacing the terminals.

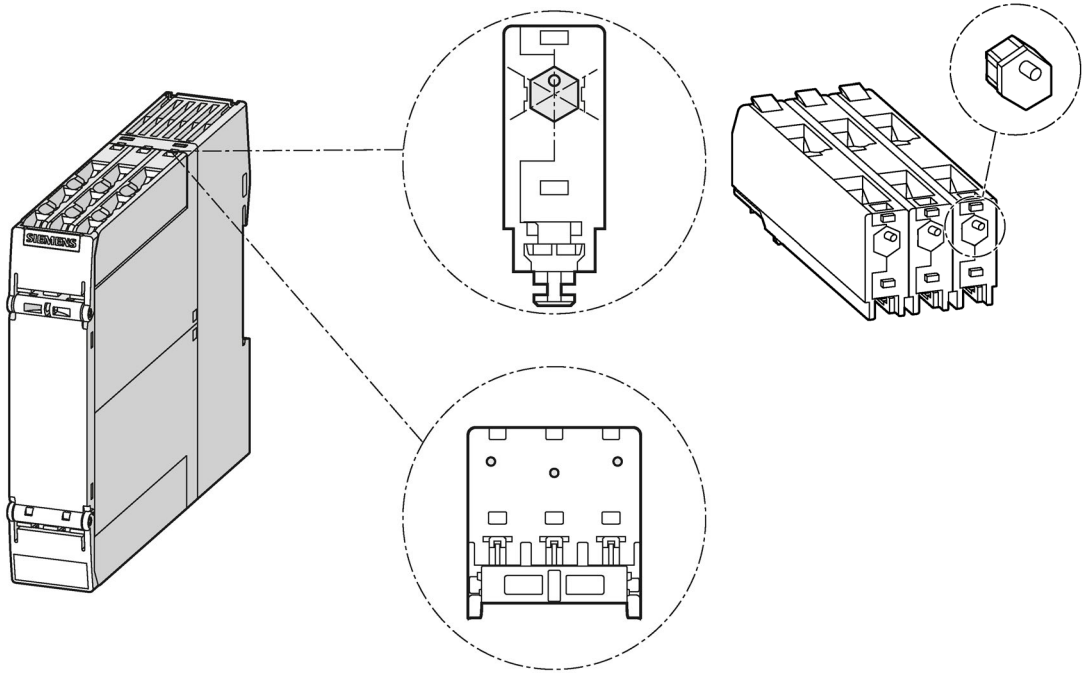

4.3 Mounting the devices on a standard mounting rail

Requirements

- A horizontal 35-mm wide mounting rail in accordance with DIN EN 60715 has been properly secured at the installation location.

Procedure

The figures show 22.5 mm devices. The 17.5 mm devices are mounted correspondingly.

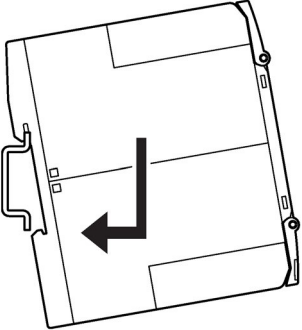
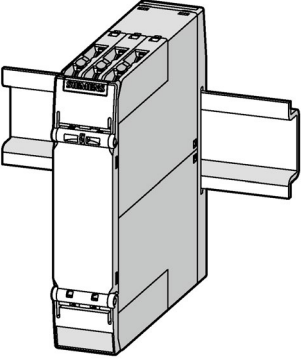
Step	Instructions	Figure
1	Hang the back of the device onto the upper edge of the standard mounting rail	 
2	Press the lower half of the device against the rail until the device engages	

4.4 Removing devices from a standard mounting rail

⚠ WARNING
Hazardous Voltage Can Cause Death, Serious Injury, or Property Damage.
Before starting work, therefore, disconnect the system and devices from the power supply.

Requirements

- The terminals have been removed or disconnected.

Procedure

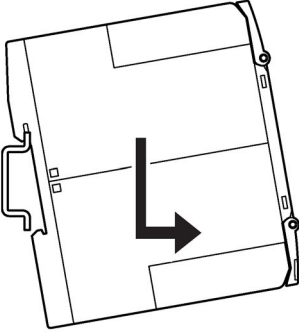
Step	Instructions	Figure
1	Press the device downwards.	
2	Pull the lower half of the device away from the standard mounting rail.	
3	Lift the device from the upper edge of the standard mounting rail.	

4.5 Mounting the devices on a level surface

Requirements

Please note the following requirements for mounting on a level surface:

- A vertical mounting surface is recommended for the time relay.
- Two properly executed drill holes with thread or plug on the level surface. For details of the distances between the drilled holes, please refer to the relevant dimension drawings in the chapter "Dimension drawings 3RP25 devices (Page 85)".
- Two screws to fit the M4 x 12 holes in accordance with DIN 784.
- Two fixing lugs in accordance with the article number in the accessories list in the Section "Accessories for 3RP25 (Page 89)".

Procedure

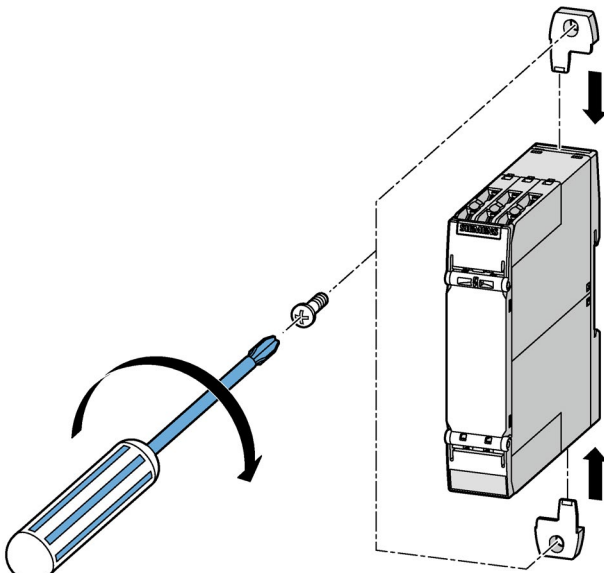
Step	Instructions	Figure
1	Insert the securing brackets into the openings provided on the device until they engage.	
2	Hold the device up to the level surface prepared for screw fastening.	
3	Insert the head screws through the corresponding elongated holes in the fixing lugs.	
4	Screw the device securely onto the level surface. Tightening torque: 1 Nm	

4.6 Disassembling the devices from a level surface

⚠ WARNING
Hazardous Voltage
Can Cause Death, Serious Injury, or Property Damage.
Before starting work, therefore, disconnect the system and devices from the power supply.

Requirements

- The terminals have been removed or disconnected.

Procedure

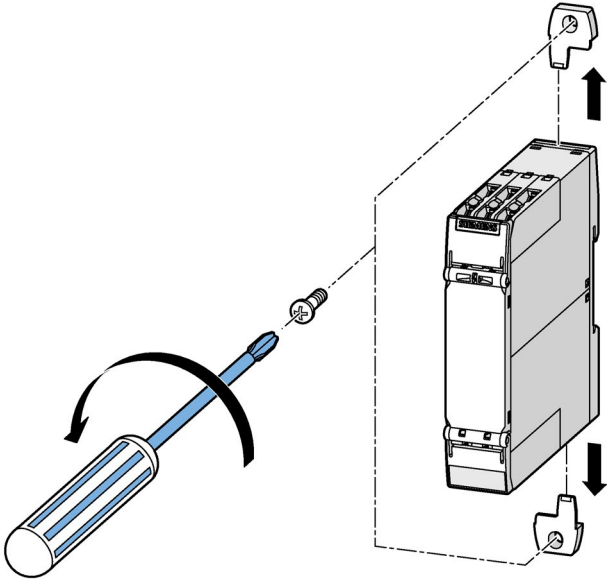
Step	Instructions	Figure
1	Hold the device firmly.	
2	Unscrew the cap screws.	
3	Lift the device from the level surface.	
4	Remove the securing brackets from the device.	

4.7 Mounting the sealable cover

The sealable cover (3ZY1321-1AA00 for 17.5 mm devices, 3ZY1321-2AA00 for 22.5 mm devices) can be used to secure the time range switch and the function selector switch as well as the operating time adjustment switch against unauthorized or unintended readjustment.

Mounting the sealable cover

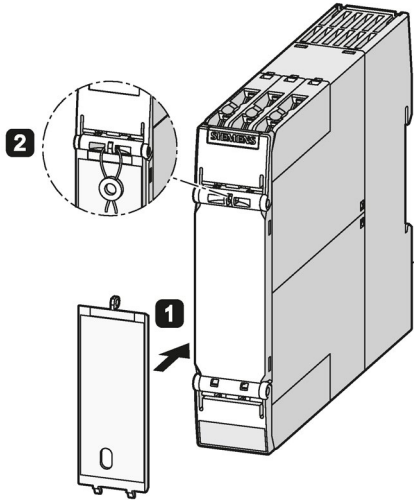
Step	Instructions	Figure
1	Attach the hooks on the cover to the openings on the device and fold the cover up	
2	Seal the cover to secure it against unauthorized removal. Sealing wire diameter, max.: 2 mm	

4.8 Attaching set of labels (multifunction)

A set of stickers is available for labeling the functions set on the 3RP2505 solid-state time relay, multifunction unit, depending on the version (with 1 CO contact, 13 functions, with 1 NO contact/semiconductor output, 13 functions, with 2 CO contacts, 27 functions).

Attaching the set of stickers (only for multifunctionality)

Step	Instructions	Figure
1	Set the desired function on the time range and function selector switch using a screwdriver.	
2	Take the corresponding sticker for labeling the function from the set of stickers, and stick it directly above the function selector switch (A-M). Function, see Function table multifunction (3RP2505) (Page 69)	

Connection

5.1 Terminal assignment

Location of the connections

The inside faces of the terminal covers are labeled with the designations of the relevant terminals. The position of the label corresponds to the position of the respective terminal.

NOTICE

Risk of property damage

When using the terminal blocks, you must observe the correct position of the blocks (see inside of cover).

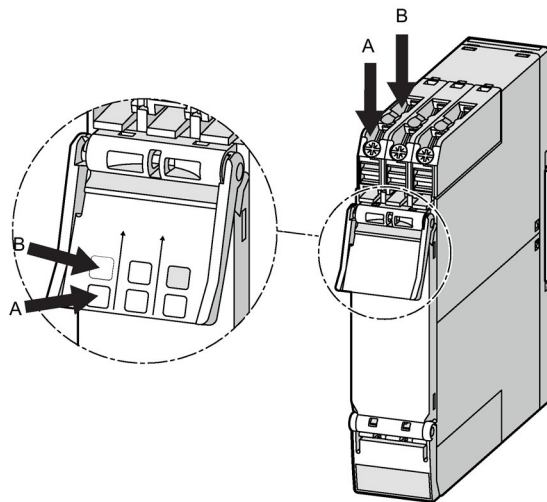

Figure 5-1 Upper terminal cover

5.1 Terminal assignment

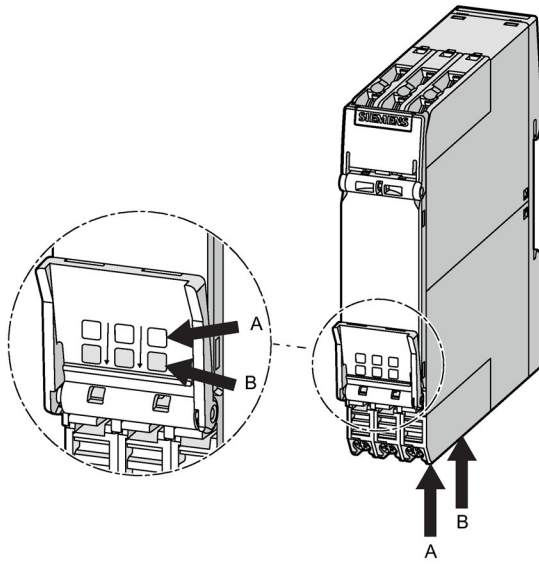

Figure 5-2 Lower terminal cover

Terminal cover

Depending on the version of the 3RP25 time relay, the device will have the following connections:

Time relay version	Inscription of the terminal cover		
Control circuit/control circuit supply (at the top of the device)			
Single function <ul style="list-style-type: none"> • 24 V AC/DC • (3RP25...B..) 		<p>3RP25xx-xB30</p> <p>A2(-) 24V AC/DC A1(+)</p> <p>A2(-)</p>	
	<ul style="list-style-type: none"> • 12 ... 240 V AC/DC • (3RP25...W...) 	<p>3RP25xx-xW30</p> <p>A2(-) 12...240V AC/DC A1(+)</p> <p>A2(-)</p>	<p>3RP257x-xNW30</p> <p>A2 12...240V AC/DC A1</p> <p>A2 12...240V AC/DC A1</p>
	<ul style="list-style-type: none"> • 200 ... 240 V / 380 ... 440 V AC • (3RP25...M..) 		<p>3RP257x-xM20</p> <p>A2 380...440V A1</p> <p>A2 200...240V A3</p>
Multifunction <ul style="list-style-type: none"> • 24 V AC/DC • (3RP250...B..) 		<p>3RP2505-xB30</p> <p>A2(-) 24V AC/DC A1(+)</p> <p>B1(+)</p>	<p>3RP2505-xBB30</p> <p>A2(-) 24V AC/DC A1(+)</p> <p>B1(+)</p>
	<ul style="list-style-type: none"> • 12 ... 240 V AC/DC • (3RP250...W..) 	<p>3RP2505-xW30</p> <p>A2(-) 12...240V AC/DC A1(+)</p> <p>B1(+)</p>	<p>3RP2505-xW30</p> <p>A2(-) 12...240V AC/DC A1(+)</p> <p>B1(+)</p>
	<ul style="list-style-type: none"> • 400 to 440 V AC • (3RP250...T..) 		<p>3RP2505-xB120</p> <p>A2 400-440 V AC A1</p> <p>A2 B1</p>

5.1 Terminal assignment

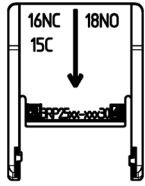
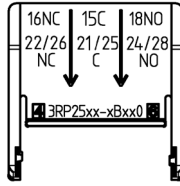
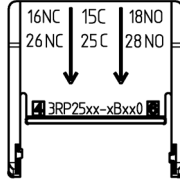
Time relay version	Inscription of the terminal cover	
Output contacts/output relays (at the bottom of the device)		
Single and multifunction		
		

5.2 Position of the connecting terminals

Note

The terminals A2 are connected internally. This means A2 can simply be looped on from device to device.

①	②	③	④	⑤
<p>Diagram 1 shows a terminal block with two rows of terminals. The top row has two terminals labeled A2. The second row has two terminals labeled A1 and B1. Below this is a vertical slot with two small rectangular components. Further down are three circular components. At the bottom, there are two rows of terminals: the first row has 16NC and 18NO, and the second row has 15C.</p>	<p>Diagram 2 shows a terminal block with two rows of terminals. The top row has two terminals labeled A2. The second row has two terminals labeled A1 and B1. Below this is a vertical slot with two small rectangular components. Further down are two circular components. At the bottom, there are two rows of terminals: the first row has 16NC and 18NO, and the second row has 15C.</p>	<p>Diagram 3 shows a terminal block with two rows of terminals. The top row has two terminals labeled A2. The second row has one terminal labeled A1. Below this is a vertical slot with two small rectangular components. Further down are two circular components. At the bottom, there are two rows of terminals: the first row has 16NC and 18NO, and the second row has 15C.</p>	<p>Diagram 4 shows a terminal block with two rows of terminals. The top row has one terminal labeled A2. The second row has one terminal labeled A1. Below this is a vertical slot with two small rectangular components. Further down are two circular components. At the bottom, there are two rows of empty terminal slots.</p>	<p>Diagram 5 shows a terminal block with two rows of terminals. The top row has two terminals labeled A2, with a shaded rectangular area between them. The second row has two terminals labeled A1 and B1. Below this is a vertical slot with two small rectangular components. Further down are two circular components. At the bottom, there are two rows of terminals: the first row has 18NO, 28NO, and 38NO, and the second row has 17C.</p>
<p>3RP2505 - .AB30 3RP2505 - .AW30</p>	<p>3RP2535 - .AW30</p>	<p>3RP2511 - .AW30 3RP2512 - .AW30 3RP2513 - .AW30 3RP2525 - .AW30</p>	<p>3RP2527 - .EW30</p>	<p>3RP2560 - .SW30</p>

5.2 Position of the connecting terminals

⑥	⑦	⑧	⑨	⑩
<p>3RP2574 - .NW30 3RP2576 - .NW30</p>	<p>3RP2540 - .AB30 3RP2540 - .AW30</p>	<p>3RP2540 - .BB30 3RP2540 - .BW30</p>	<p>3RP2505 - .BB30 3RP2505 - .BW30</p>	<p>3RP2525 - .BB30 3RP2525 - .BW30</p>

5.2 Position of the connecting terminals

<p>⑪</p>	<p>⑫</p>	<p>⑬</p>	<p>⑭</p>	<p>⑮</p>
<p>3RP2574 - .NM20 3RP2576 - .NM20</p>	<p>3RP2555 - .AW30</p>	<p>3RP2505 - .CW30</p>	<p>3RP2505 - .BT20</p>	<p>3RP2505-.RW30</p>

5.3 Connection data for terminals

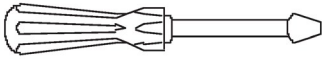
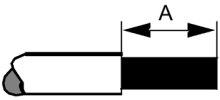
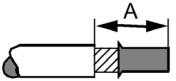
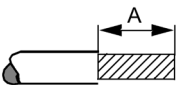
	Specification and value in the case of removable terminals with screw-type terminals	Specification and value in the case of removable terminals with spring-loaded terminals (push-in terminals)
Screwdriver 	Cross-tip screwdriver Size: PZ 1x80 (ø 4.5 mm) Torque: 0.6 ... 0.8 Nm (5.2 ... 7.0 lb/inch)	Screwdriver (3RA2908-1A) Size: 3 mm for operating the springs DIN 5264-A; 0.5 x 3
Rigid cable 	A = 10 mm 1 x 0.5 ... 4.0 mm ² 2 x 0.5 ... 2.5 mm ²	A = 10 mm 1 x 0.5 ... 4.0 mm ²
Flexible conductor with end sleeve 	A = 10 mm 1 x 0.5 ... 4.0 mm ² 2 x 0.5 ... 1.5 mm ² ¹⁾	A = 10 mm 1 x 0.5 ... 2.5 mm ²
Flexible cable 	Not permissible	A = 10 mm 1 x 0.5 ... 4.0 mm ²
AWG	1 x 20 ... 12 2 x 20 ... 14	1 x 20 ... 12

¹⁾ When 2 x 1.0 mm² end sleeves with a plastic sleeve are used, space problems may arise with the sleeves; as an alternative, you are advised to use end sleeves without plastic sleeves

5.4 Connecting the screw-type terminals

<p>⚠ WARNING</p> <p>Hazardous voltage</p> <p>Can Cause Death, Serious Injury, or Property Damage.</p> <p>Before starting work, therefore, disconnect the system and devices from the power supply.</p>

Requirements

- Cross-tip screwdriver size PZ 1 x 80.
- For suitable connection cross-sections of the cables, see the chapter "Connection data for terminals (Page 38)".

Procedure

Step	Instructions	Figure
1	Insert the relevant cable into square on the screw-type terminal until it engages.	
2	Hold the cable in the screw-type terminal.	
3	Tighten the screw with a torque of 0.8 to 1.2 N.	
4	Pull on the cable to ensure it is screwed tight.	

5.5 Disconnecting the screw-type terminals

⚠ WARNING

**Hazardous Voltage
Can Cause Death, Serious Injury, or Property Damage.**

Before starting work, therefore, disconnect the system and devices from the power supply.

Requirements

- Cross-tip screwdriver size PZ 1 x 80

Procedure

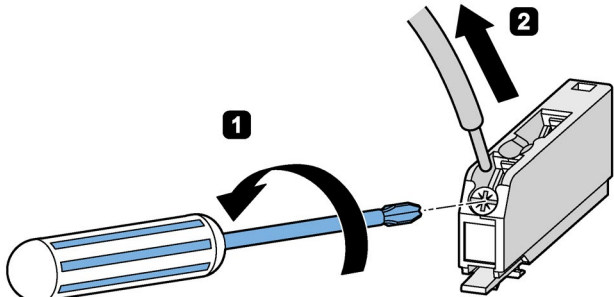
Step	Instructions	Figure
1	Unscrew the screw of the screw-type terminal.	
2	Remove the cable from the unscrewed screw-type terminal.	

5.6 Wiring rules for spring-loaded terminals (with push-in technology)

Notes on handling spring-loaded terminals with push-in technology

The terminal area of the spring-loaded terminals is rectangular, and the maximum overall dimensions of the conductor to be wired must not exceed 2.4 x 2.8 mm.

Attention must be paid to the orientation of the terminal area, which may call for vertical fitting of rectangularly crimped cables.

To make optimum use of available terminal area, you are advised to choose a form of crimping that creates a corresponding rectangular contour. Trapezoidal crimping is generally very highly suitable in this case.

When use is made of a cable that utilizes the full overall height, the terminal's spring is deflected to the maximum. Therefore, removal of this cable may become a problem because it requires further deflection of the spring.

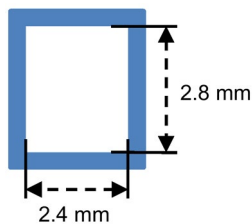

5.7 Connect the spring-loaded terminal (push-in)

⚠ WARNING

Hazardous voltage

Can Cause Death, Serious Injury, or Property Damage.

Before starting work, therefore, disconnect the system and devices from the power supply.

The spring-type (push-in) terminals allow wiring without tools for rigid conductors or conductors equipped with end sleeves.

For wiring finely stranded or stranded conductors without end sleeves on spring-type (push-in) terminals, a screwdriver is required to open the spring-type terminals.

Requirements

- 0.5 x 3 mm screwdriver DIN 5264 (for finely-stranded conductors only).
- For suitable connection cross-sections of the cables, see the chapter "Connection data for terminals (Page 38)".

Procedure

Table 5- 1 Rigid conductors or conductors equipped with end sleeves

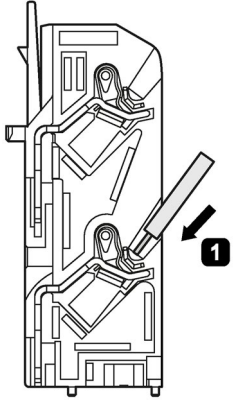
Step	Instructions	Figure
1	Insert the cable into the oval opening as far as it will go.	
2	Pull on the cable to ensure it is tight.	

5.7 Connect the spring-loaded terminal (push-in)

Table 5- 2 Finely stranded cables without end sleeve

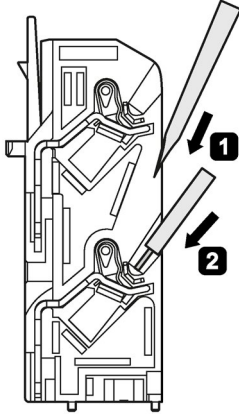
Step	Instructions	Figure
1	Insert the screwdriver in the rectangular opening to open the terminal (oval opening).	 The diagram shows a vertical terminal block with two terminals. A screwdriver is shown in the top terminal, with an arrow labeled '1' pointing to its tip. A cable is shown being inserted into the terminal, with an arrow labeled '2' pointing to the cable's end. The terminal block has a rectangular opening on top and an oval opening on the side.
2	Insert the cable as far as it will go into the oval opening and remove the screwdriver.	
3	Pull on the cable to ensure it is tight.	

5.8 Disconnect the spring-loaded terminal (push-in)

⚠ WARNING

Hazardous voltage

Can Cause Death, Serious Injury, or Property Damage.

Before starting work, therefore, disconnect the system and devices from the power supply.

Requirements

- Screwdriver DIN 5264 of the size 0.5 x 3 mm

Procedure

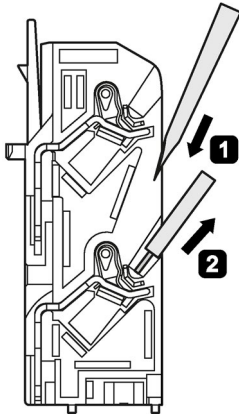
Step	Instructions	Figure
1	Insert the screwdriver into the rectangular opening of the spring-loaded terminal until it engages.	
2	Remove the cable from the oval opening.	
3	Remove the screwdriver.	

5.9 Attaching the terminals

⚠ WARNING
<p>Hazardous voltage</p> <p>Can Cause Death, Serious Injury, or Property Damage.</p> <p>Before starting work, therefore, disconnect the system and devices from the power supply.</p>

Requirements

You must have removed the terminals, for the purpose of replacing a device, for example.

Procedure when plugging in the terminals

Step	Instructions	Figure
1	Insert the detachable terminals into the guide rail of the device.	
2	Slide the detachable terminals back until they audibly engage.	

5.10 Removing the terminals

⚠ WARNING

Hazardous voltage

Can Cause Death, Serious Injury, or Property Damage.

Before starting work, therefore, disconnect the system and devices from the power supply.

Removing terminals from the device

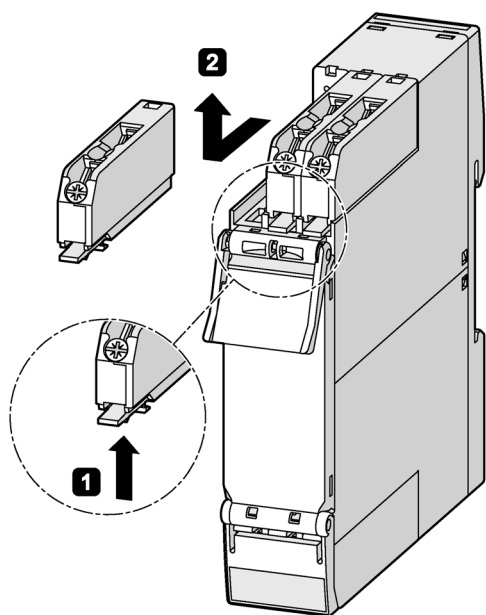
Step	Instructions	Figure
1	Press the clip of the terminals upwards.	
2	Pull the terminals out to the front.	
3	Lift the terminals out of the guide rail of the device.	

Screw terminals: Disconnecting the conductor

Step	Instructions	Figure
1	Unscrew the screw of the screw-type terminal.	
2	Remove the cable from the unscrewed screw-type terminal.	

Spring-loaded terminal (push-in): Disconnecting the conductor

Step	Instructions	Figure
1	Insert the screwdriver into the rectangular opening of the push-in terminal until it engages. Please observe a 10° horizontal angular deviation of the screwdriver to the oval opening.	
2	Remove the cable from the oval opening.	
3	Remove the screwdriver.	

Single function devices

6.1 Structure

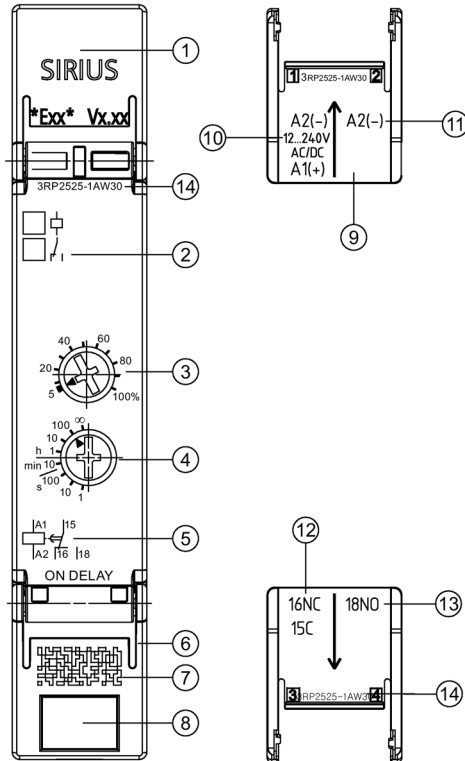

- ① Top cover flap
- ② LED statuses
- ③ Operating time adjustment switch for fine adjustment
- ④ Time range selector switch
- ⑤ Function circuit diagram lasered on enclosure
- ⑥ Terminal cover at bottom
- ⑦ DataMatrix code
- ⑧ Device identification label
- ⑨ Terminal cover top, inscription on inside
- ⑩ Control supply voltage specification
- ⑪ Terminal labeling of the control supply voltage
- ⑫ Terminal cover top, inscription on inside
- ⑬ Terminal labeling of the output contacts
- ⑭ Time relay article number (MLFB)

6.2 Time setting single function unit

Relay with single function

Operating time setting

The desired time range is set with the time range selector switch.

The desired operating time is set precisely with the operating time adjustment switch.

Note

Changes to the set time (time range and operating time) do not become effective until the supply voltage is applied again.

Procedure

Let us suppose you wish to set a duration of 50 seconds:

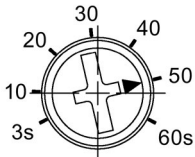
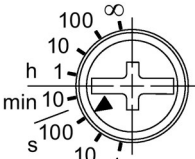
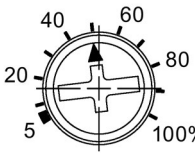
Work step	Setting graphic	Process description
One time range		
①	 <p>Operating time adjustment switch</p>	Turn the operating time adjustment switch to the setting value 50s with a screwdriver.
Several time ranges		
①	 <p>Time range selector switch</p>	Turn the time range selector switch to 100s with a screwdriver. This means that operating times up to 100 seconds can be set.
②	 <p>Operating time adjustment switch</p>	Turn the operating time adjustment switch for fine adjustment to 50 %. This means 50 % of the maximum value (50 % of 100 seconds = 50 seconds) is set.

6.3 ON-delay

3RP2511 / 3RP2512 / 3RP2513 time relay

The time relay contains 1 CO contact.

Each relay has a fixed time range:

- 0.5 s - 10 s (3RP2511)
- 1.5 s - 30 s (3RP2512)
- 5 s - 100 s (3RP2513)

Function table

Function	Function chart	Circuit diagram	Time relay
1 CO contact			
ON-delay			3RP2511-.AW30 3RP2512-.AW30 3RP2513-.AW30

3RP2525 time relay

The time relay is optionally available with 1 or 2 CO contacts.

7 time ranges can be set with the time range selector switch:

- 0.05 s - 1 s
- 0.5 s - 10 s
- 5 s - 100 s
- 0.5 min - 10 min
- 0.05 h - 1 h
- 0.5 h - 10 h
- 5 h - 100 h

Note

The desired operating time is set precisely with the operating time adjustment switch.

Note

Changes to the time range (time range and operating time) only take effect if made in the deenergized state.

Function table

Function	Function chart	Circuit diagram	Time relay
1 CO contact			
ON-delay			3RP2525-1AW30 3RP2525-2AW30
2 CO contacts			
ON-delay			3RP2525-1BB30 3RP2525-1BW30 3RP2525-2BB30 3RP2525-2BW30

3RP2527 time relay - two-wire time relay

The two-wire time relay is connected in series with the load. Timing begins after application of the control supply voltage. The semiconductor output then becomes conducting, and the load is under power.

4 time ranges can be set with the time range selector switch:

- 0.05 s - 1 s
- 0.2 s - 4 s
- 1.5 s - 30 s
- 12 s - 240 s

Note

The desired operating time is set precisely with the operating time adjustment switch.

Note

Rated operational current, residual current in the case of a non-switched output, and voltage drop in the case of a switched output must be taken into account. You can find the values in the technical specifications (Page 83).

Function table

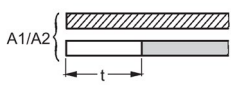
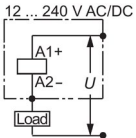
Function	Function chart	Circuit diagram	Time relay
1 NO semiconductor contact (two-wire time relay)			
ON-delay			3RP2527-1EW30 3RP2527-2EW30

6.4 OFF-delay

3RP2535 time relay - OFF-delay with control signal

The time relay contains 1 CO contact.

A continuous supply voltage (A1/A2) is present on the time relay. If a control signal is applied to B1, the output relay switches over. The set operating time starts when the control signal is switched off. A minimum ON duration of ≥ 35 ms must be observed. If the control signal is applied again after the time has started, the time is reset. If the control signal is withdrawn, the time starts again (retriggerable).

7 time ranges can be set with the time range selector switch:

- 0.05 s - 1 s
- 0.5 s - 10 s
- 5 s - 100 s
- 0.5 min - 10 min
- 0.05 h - 1 h
- 0.5 h - 10 h
- 5 h - 100 h

Note

The desired operating time is set precisely with the operating time adjustment switch.

Function table

Function	Function chart	Circuit diagram	Time relay
1 CO contact			
OFF-delay with control signal			3RP2535-1AW30 3RP2535-2AW30

3RP2540 time relay - OFF-delay/positive passing make contact without control signal

The time relay is optionally available with 1 or 2 CO contacts.

The time relay switches over when the control supply voltage is applied. The operating time t starts when the control supply voltage is disconnected. The relay switches back to the idle state when t has elapsed. It is ensured that if the minimum ON duration is not observed either timing will not start or, if the time has started, it will always be completed in an orderly fashion. Users can rely on intermediate states of the functional sequence, such as "no relay dropout", being detected. If the control supply voltage is applied again after the time has started, the time is reset. When the control supply voltage is withdrawn, the time starts again (retriggerable).

7 time ranges can be set using a time range and function selector switch:

- 0.05 s - 1 s
- 0.15 s - 3 s
- 0.5 s - 10 s
- 1.5 s - 30 s
- 0.05 min (3 s) - 1 min (60 s)
- 5 s - 100 s
- 0.5 min (30 s) - 10 min (600 s)

Note

The desired operating time is set precisely with the operating time adjustment switch.

Note

Changes to the time range (time range and operating time) only take effect if made in the deenergized state.

Function setting

2 functions can be selected for time relays of this type. Depending on the function required, the left or right display must be pre-selected.

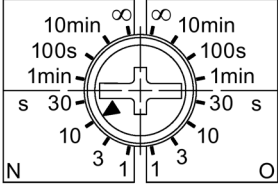
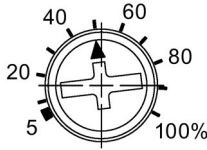
Work step	Setting graphic	Process description
①	 <p>N - power-off-delay O - maintained impuls on</p>	<p>Turn the time range and function selector switch to the desired time range with a screwdriver. Due to the choice of the two functions, the time ranges are arranged to the left and right respectively.</p> <p>left (function N) = OFF-delay without control signal right (function O) = positive passing make contact without control signal</p>
②		<p>Turn the operating time adjustment switch for fine adjustment to the required value.</p>

Function table

Function	Function chart	Circuit diagram	Time relay
1 CO contact			
OFF-delay without control signal - Function N			3RP2540-1AB30 3RP2540-2AB30 3RP2540-1AW30 3RP2540-2AW30
positive passing make contact without control signal - Function O			
2 CO contacts			
OFF-delay without control signal - Function N			3RP2540-1BB30 3RP2540-2BB30 3RP2540-1BW30 3RP2540-2BW30
positive passing make contact without control signal - Function O			

6.5 Flasher relay asymmetrical (clock generator)

3RP2555 time relay with control signal

The time relay contains 1 CO contact.

The interval and the pulse time of the clock generator and time ranges can each be adjustable separately. The clock pulse function starts with the interval.

7 time ranges can be set with the time range selector switch:

- 0.05 s - 1 s
- 0.5 s - 10 s
- 5 s - 100 s
- 0.5 min - 10 min
- 0.05 h - 1 h
- 0.5 h - 10 h
- 5 h - 100 h

Note

The desired operating time is set precisely with the operating time adjustment switch.

Note

Changes to the time range (time range and operating time) only take effect if made in the deenergized state.

Function table

Function	Function chart	Circuit diagram	Time relay
1 CO contact			
Flasher relay asymmetrical, starting with interval (interval, pulse time, and time ranges each separately adjustable)			3RP2555-1AW30 3RP2555-2AW30

6.6 Star-delta (wye-delta) function

3RP2574 / 3RP2576 time relay

The time relay contains 2 NO contacts.

The instantaneous star contact and the time-delayed delta contact share the same contact root. To avoid interphase short circuits, the changeover delay from star (wye) to delta is 50 ms.

Time ranges

Each relay has a fixed time range:

- 1 s - 20 s (3RP2574)
- 3 s - 60 s (3RP2576)

Note

Changes to the time range (time range and operating time) only take effect if made in the deenergized state.

Function table

Function	Function chart	Circuit diagram	Time relay
2 NO contacts			
Star-delta (wye-delta) function		12 ... 240 V AC/DC 	3RP2574-.NW30 3RP2576-.NW30
		380 ... 440 V AC 200 ... 240 V AC 	3RP2574-.NM20 3RP2576-.NM20

6.7 Star-delta (wye-delta) function with coasting time (idling)

3RP2560 time relay

The time relay contains 3 NO contacts.

Star-delta (wye-delta) time:

- 1 s - 20 s

Coasting time:

- 30 s - 600 s

Note

Changes to the time range (time range and operating time) only take effect if made in the deenergized state.

Function table

Function	Function chart	Circuit diagram	Time relay
3 NO contacts			
Star-delta (wye-delta) function with overtravel function ²⁾ (idling)			3RP2560-1SW30 3RP2560-2SW30

²⁾ Function charts for the different operation options of the 3RP2560 - .SW30

Operation options of the time relay

Operation 1

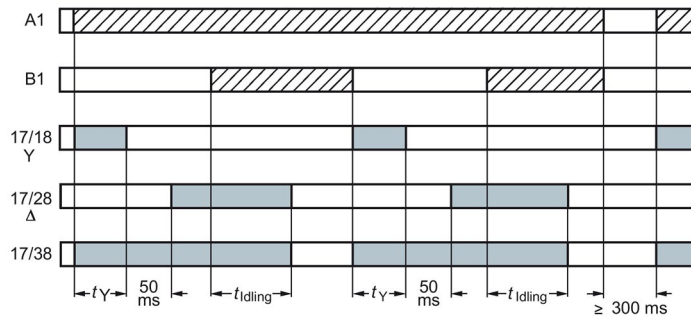

Control signal B1 is open when supply voltage A1 is applied.

The supply voltage is applied to A1/A2 and there is no control signal on B1. This starts the star-delta (we-delta) (YΔ) time. The idling time (coasting time) is started by applying a control signal to B1. When the set time (30 ... 600 s) has elapsed, the output relays (17/38 and 17/28) are reset. If the control signal on B1 is switched off (minimum OFF period 270 ms), a new timing is started.

Remarks:

Observe response time (dead period) of 400 ms on energizing the supply voltage until contacts 17/18 and 17/38 close.

Operation 2

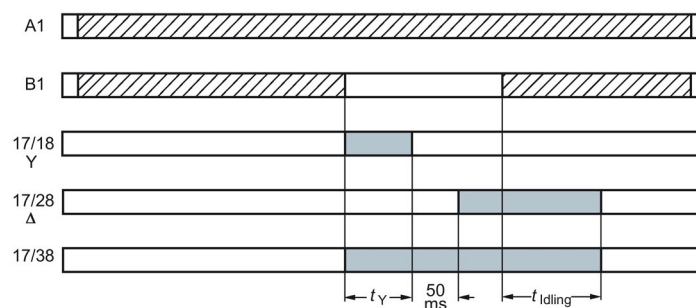

Control signal B1 is closed when supply voltage A1 is applied.

If the control signal is already present at B1 when the supply voltage is applied to A1, no timing takes place. The timing is only started when the control signal at B1 is switched off.

Operation 3

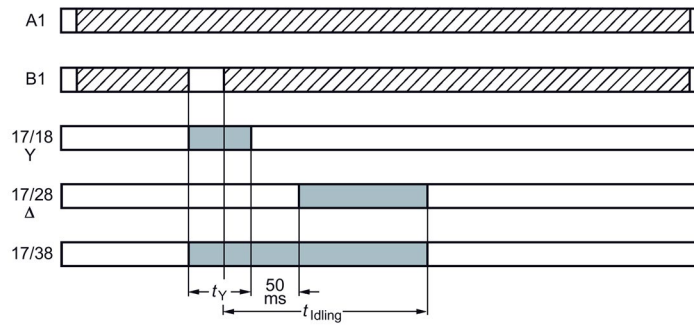

Start contact B1 closes while the star time runs.

If the control signal B1 is applied again during the star time, idling time starts and the timing is terminated normally.

Operation 4

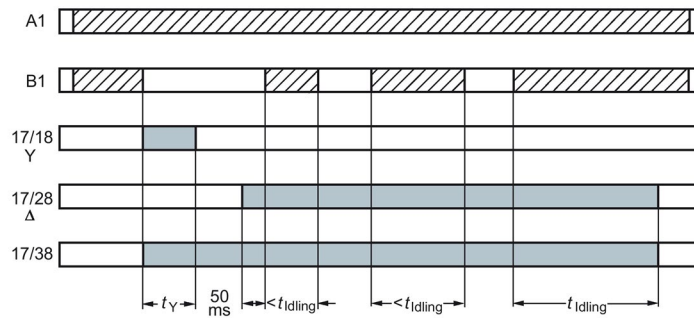

Start contact B1 opens while delta time is running and is applied again.

If the control signal on B1 is applied again during delta time and switched off again although the idling time has not yet elapsed, the idling time (coasting time) is reset to zero. If the control signal is reapplied to B1, the idling time is restarted.

Application example based on standard operation (operation 1): For example, use of 3RP2560 for compressor control

Frequent starting of compressors strains the network and the machine, and increases costs for operators. The new time relay prevents frequent starting at times when there is high demand for compressed air. A special control circuit prevents the compressor from being switched off immediately when the required air pressure in the tank has been reached. Instead, the valve in the intake tube is closed and the compressor runs in "Idling" mode, that is, in no-load operation, for a specific time which can be set from 30 ... 600 s.

If the pressure falls within this time, the motor does not have to be restarted again, but can return to nominal load operation from no-load operation.

If the pressure does not fall within this idling time, the motor is switched off.

The pressure switch controls the timing via B1.

The supply voltage is applied at A1 and start contact B1 is open, i.e. there is no control signal at B1 when applying the supply voltage. The pressure switch signals "too little pressure in system" and starts the timing via terminal B1. The compressor is started, enters star-delta ($Y\Delta$) operation, and fills the pressure tank.

When the pressure switch signals "sufficient pressure", the control signal B1 is applied, the idling time (coasting time) is started, and the compressor enters no-load operation for the set period of time from 30 ... 600 s. The compressor is then switched off. The compressor is only restarted if the pressure switch responds again (low pressure).

Note

The following applies to all operations: The pressure switch controls the timing via B1.

6.7 Star-delta (wye-delta) function with coasting time (idling)

Multifunction units

7.1 Structure

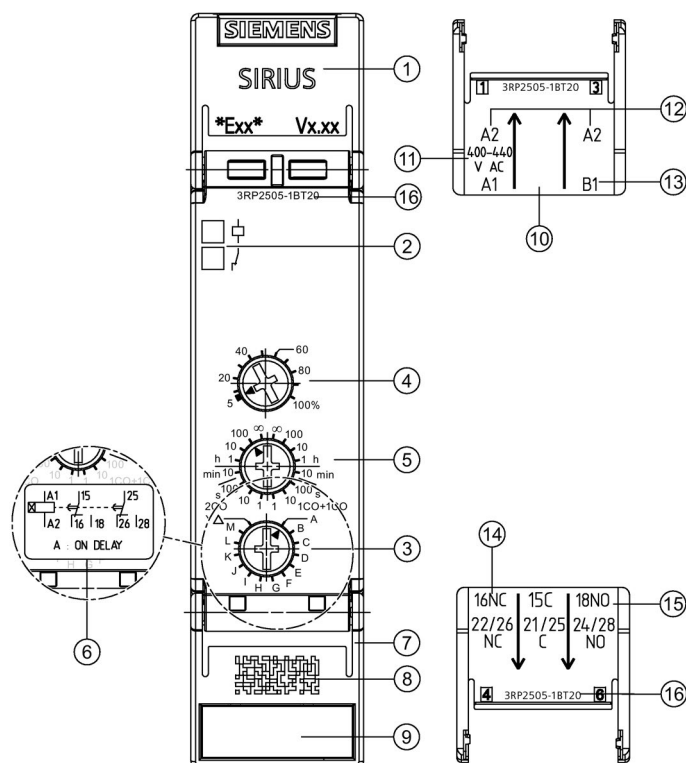

- ① Top cover flap
- ② LED display
- ③ Function selector switch (multifunction)
- ④ Operating time adjustment switch for fine adjustment of the time range
- ⑤ Time range and function selector switch, selection delayed/parallel contacts
- ⑥ Function diagram (sticker)
- ⑦ Terminal cover at bottom
- ⑧ DataMatrix code
- ⑨ Device identification label
- ⑩ Terminal cover top, inscription on inside
- ⑪ Control supply voltage specification
- ⑫ Terminal labeling of the control supply voltage
- ⑬ Terminal labeling control signal
- ⑭ Terminal cover top, inscription on inside
- ⑮ Terminal labeling of the output contacts
- ⑯ Time relay article number (MLFB)

7.2 Time setting multifunction unit

3RP2505 time relay

The time relay contains 1 or 2 CO contacts.

Time ranges

7 time ranges can be set with the time range selector switch:

- 0.05 s - 1 s
- 0.5 s - 10 s
- 5 s - 100 s
- 0.5 min - 10 min
- 0.05 h - 1 h
- 0.5 h - 10 h
- 5 h - 100 h

Operating time setting

The available time ranges are set using the time range selector switch, ensuring extremely high setting accuracy. The set time range is indicated on the rotary switch. The desired operating time is set precisely using an operating time adjustment switch. In the time range "continuous" (∞), the function is implemented with an unlimited time setting. In the case of "ON-delay" and applied supply voltage, the output relay never connects, for example, or with "passing make contact", the output relay remains switched on continuously.

The selected function can be indicated legibly on the multifunction relay using the appropriate stickers. You can find these stickers for labeling the set function in Section "Attaching set of labels (multifunction) (Page 30)".

Note

Changes to the time range (time range and operating time) only take effect if made in the deenergized state.

Procedure

Let us suppose you wish to set a duration of 90 seconds:

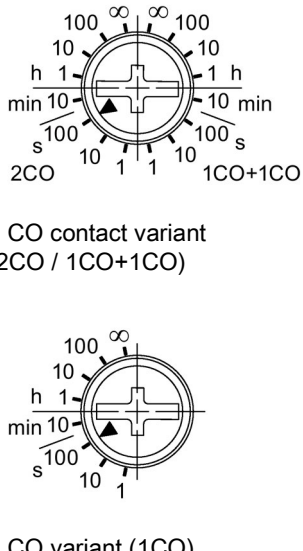
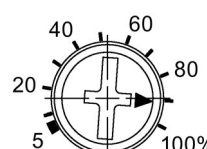
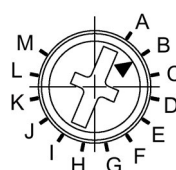
Work step	Setting graphic	Process description
<p>①</p>	 <p>2 CO contact variant (2CO / 1CO+1CO)</p> <p>1 CO variant (1CO)</p>	<p>Turn the time range selector switch to the time range 100 s with a screwdriver. This means that operating times up to 100 seconds can be set. As the relay response can be optionally selected on the 2-CO-contact variant, the time ranges are arranged on the left and right.</p> <p>Left (2CO) = 2 parallel contacts Right (1CO+1CO) = 1 instantaneous contact, 1 delayed contact</p> <p>With the 1-CO-contact variant, the time range is given only once on the left.</p>
<p>②</p>		<p>Turn the operating time adjustment switch for fine adjustment to 90%. This means 90% of the maximum value (90 % of 100 seconds = 90 seconds) is set.</p>
<p>③</p>		<p>The function is set via a function selector switch, and displayed in the adjacent window by an identification letter.</p> <p>The set function is indicated unmistakably on the unit by a sticker with the corresponding function diagram. A set of stickers with the function diagrams for all functions that can be set for the time relay is included in the scope of supply.</p>

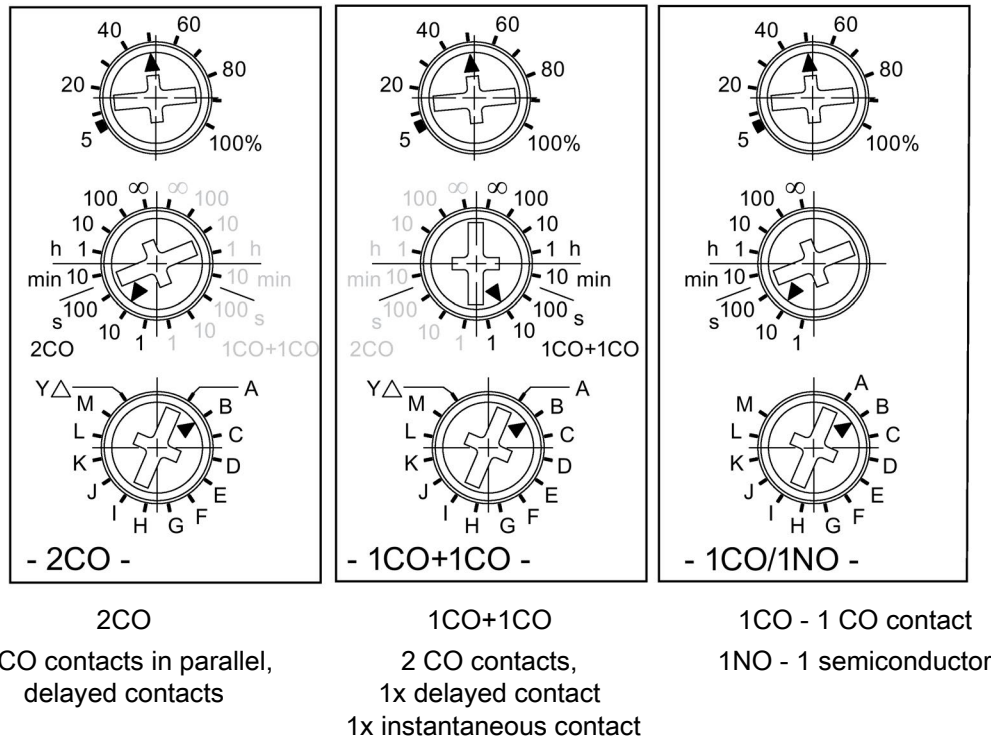

Functions

These are set as follows using a function selector switch:

- Time relay with 1 CO contact: 13 functions (A - M)
- Time relay with 2 CO contacts: 27 functions (for both 2CO and 1CO+1CO A - M as well as star-delta YD)

Selection of the respective function is described in the following Section (see Section "Function table multifunction (3RP2505) (Page 69)").

Note

Unless otherwise specified, the ON duration is always at least 35 ms for all subsequently described functions with control signal.

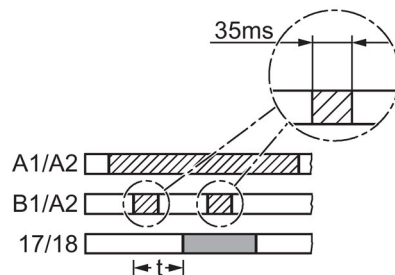

7.3 Function table multifunction (3RP2505)

Function	Output type	Function chart	Circuit diagram	Time relay	Identification letter
ON-delay	1 CO contact		<p>12 ... 240 V AC/DC 24 V AC/DC</p>	<p>3RP2505 - 1A.30 3RP2505 - 2A.30</p>	A
	1 NO contact / semiconductor		<p>12 ... 240 V AC/DC</p>	<p>3RP2505 - 1CW30 3RP2505 - 2CW30</p>	
	1 relay, 2 CO contacts, positively driven		<p>12 ... 240 V AC/DC</p>	<p>3RP2505 - 1RW30 3RP2505 - 2RW30</p>	
	2 CO contacts (2CO)		<p>12 ... 240 V AC/DC</p>	<p>3RP2505 - 1B..0 3RP2505 - 2B..0</p>	
ON-delay and instantaneous contact	2 CO contacts (1CO+1CO)		<p>12 ... 240 V AC/DC 400 ... 440 V AC 24 V AC/DC</p>	<p>3RP2505 - 1B..0 3RP2505 - 2B..0</p>	

7.3 Function table multifunction (3RP2505)

Function	Output type	Function chart	Circuit diagram	Time relay	Identification letter
OFF-delay with control signal	1 CO contact		<p>12 ... 240 V AC/DC 24 V AC/DC</p>	<p>3RP2505 - 1A.30 3RP2505 - 2A.30</p>	B
	1 NO contact / semiconductor		<p>12 ... 240 V AC/DC</p>	<p>3RP2505 - 1CW30 3RP2505 - 2CW30</p>	
	1 relay, 2 CO contacts, positively driven		<p>12 ... 240 V AC/DC</p>	<p>3RP2505 - 1RW30 3RP2505 - 2RW30</p>	
	2 CO contacts (2CO)		<p>12 ... 240 V AC/DC 400 ... 440 V AC 24 V AC/DC</p>	<p>3RP2505 - 1B..0 3RP2505 - 2B..0</p>	
OFF-delay with control signal and instantaneous contact	2 CO contacts (1CO+1CO)		<p>12 ... 240 V AC/DC 400 ... 440 V AC 24 V AC/DC</p>	<p>3RP2505 - 1B..0 3RP2505 - 2B..0</p>	

Function	Output type	Function chart	Circuit diagram	Time relay	Identification letter
ON-delay and OFF-delay with control signal ($t = t_{on} = t_{off}$)	1 CO contact			3RP2505 - 1A.30 3RP2505 - 2A.30	C
	1 NO contact / semiconductor			3RP2505 - 1CW30 3RP2505 - 2CW30	
	1 relay, 2 CO contacts, positively driven			3RP2505 - 1RW30 3RP2505 - 2RW30	
	2 CO contacts (2CO)			3RP2505 - 1B..0 3RP2505 - 2B..0	
ON-delay and OFF-delay with control signal and instantaneous contact ($t = t_{on} = t_{off}$)	2 CO contacts (1CO+1CO)			3RP2505 - 1B..0 3RP2505 - 2B..0	

7.3 Function table multifunction (3RP2505)

Function	Output type	Function chart	Circuit diagram	Time relay	Identification letter
Flasher relay, symmetrical, starting with interval (pulse/interval 1:1)	1 CO contact			3RP2505 - 1A.30 3RP2505 - 2A.30	D
	1 NO contact / semiconductor			3RP2505 - 1CW30 3RP2505 - 2CW30	
	1 relay, 2 CO contacts, positively driven			3RP2505 - 1RW30 3RP2505 - 2RW30	
	2 CO contacts (2CO)			3RP2505 - 1B..0 3RP2505 - 2B..0	
Flasher relay, symmetrical, starting with interval and instantaneous contact (pulse/interval 1:1)	2 CO contacts (1CO+1CO)			3RP2505 - 1B..0 3RP2505 - 2B..0	

Function	Output type	Function chart	Circuit diagram	Time relay	Identification letter
Passing make contact, interval relay	1 CO contact			3RP2505 - 1A.30 3RP2505 - 2A.30	E
	1 NO contact / semiconductor			3RP2505 - 1CW30 3RP2505 - 2CW30	
	1 relay, 2 CO contacts, positively driven			3RP2505 - 1RW30 3RP2505 - 2RW30	
	2 CO contacts (2CO)			3RP2505 - 1B..0 3RP2505 - 2B..0	
Passing make contact, interval relay and instantaneous contact	2 CO contacts (1CO+1CO)			3RP2505 - 1B..0 3RP2505 - 2B..0	

7.3 Function table multifunction (3RP2505)

Function	Output type	Function chart	Circuit diagram	Time relay	Identification letter
Retriggerable interval relay with deactivated control signal (passing break contact with control signal)	1 CO contact			3RP2505 - 1A.30 3RP2505 - 2A.30	F
	1 NO contact / semiconductor			3RP2505 - 1CW30 3RP2505 - 2CW30	
	1 relay, 2 CO contacts, positively driven			3RP2505 - 1RW30 3RP2505 - 2RW30	
	2 CO contacts (2CO)			3RP2505 - 1B..0 3RP2505 - 2B..0	
Retriggerable interval relay with deactivated control signal (passing break contact with control signal) and instantaneous contact	2 CO contacts (1CO+1CO)			3RP2505 - 1B..0 3RP2505 - 2B..0	
On function with start contact: A new control signal at terminal B, after the operating time has started, restarts the operating time. The time is then extended correspondingly (retriggerable).					

7.3 Function table multifunction (3RP2505)

Function	Output type	Function chart	Circuit diagram	Time relay	Identifi- cation letter
Passing make contact with control signal, not retriggerable, (pulse-forming with control signal)	1 CO contact			3RP2505 - 1A.30 3RP2505 - 2A.30	G
	1 NO contact / semiconductor			3RP2505 - 1CW30 3RP2505 - 2CW30	
	1 relay, 2 CO contacts, positively driven			3RP2505 - 1RW30 3RP2505 - 2RW30	
	2 CO contacts (2CO)			3RP2505 - 1B..0 3RP2505 - 2B..0	
Passing make contact with control signal, not retriggerable, (pulse-forming with control signal) and instantaneous contact	2 CO contacts (1CO+1CO)			3RP2505 - 1B..0 3RP2505 - 2B..0	

7.3 Function table multifunction (3RP2505)

Function	Output type	Function chart	Circuit diagram	Time relay	Identification letter
Additive ON-delay, not retriggerable, instantaneous OFF with control signal	1 CO contact			3RP2505 - 1A.30 3RP2505 - 2A.30	H
	1 NO contact / semiconductor			3RP2505 - 1CW30 3RP2505 - 2CW30	
	1 relay, 2 CO contacts, positively driven			3RP2505 - 1RW30 3RP2505 - 2RW30	
	2 CO contacts (2CO)			3RP2505 - 1B..0 3RP2505 - 2B..0	
Additive ON-delay, not retriggerable, instantaneous OFF with control signal and instantaneous contact	2 CO contacts (1CO+1CO)			3RP2505 - 1B..0 3RP2505 - 2B..0	

7.3 Function table multifunction (3RP2505)

Function	Output type	Function chart	Circuit diagram	Time relay	Identification letter
Additive ON-delay, not retriggerable, with control signal	1 CO contact			3RP2505 - 1A.30 3RP2505 - 2A.30	I
	1 NO contact / semiconductor			3RP2505 - 1CW30 3RP2505 - 2CW30	
	1 relay, 2 CO contacts, positively driven			3RP2505 - 1RW30 3RP2505 - 2RW30	
	2 CO contacts (2CO)			3RP2505 - 1B..0 3RP2505 - 2B..0	
Additive ON-delay, not retriggerable, with control signal and instantaneous contact	2 CO contacts (1CO+1CO)			3RP2505 - 1B..0 3RP2505 - 2B..0	

7.3 Function table multifunction (3RP2505)

Function	Output type	Function chart	Circuit diagram	Time relay	Identification letter
Flasher relay, symmetrical, starting with pulse	1 CO contact		<p>12 ... 240 V AC/DC 24 V AC/DC</p>	<p>3RP2505 - 1A.30 3RP2505 - 2A.30</p>	J
	1 NO contact / semiconductor		<p>12 ... 240 V AC/DC</p>	<p>3RP2505 - 1CW30 3RP2505 - 2CW30</p>	
	1 relay, 2 CO contacts, positively driven		<p>12 ... 240 V AC/DC</p>	<p>3RP2505 - 1RW30 3RP2505 - 2RW30</p>	
	2 CO contacts (2CO)		<p>12 ... 240 V AC/DC 400 ... 440 V AC 24 V AC/DC</p>	<p>3RP2505 - 1B..0 3RP2505 - 2B..0</p>	
Flasher relay, symmetrical, starting with pulse and instantaneous contact	2 CO contacts (1CO+1CO)		<p>12 ... 240 V AC/DC 400 ... 440 V AC 24 V AC/DC</p>	<p>3RP2505 - 1B..0 3RP2505 - 2B..0</p>	

Function	Output type	Function chart	Circuit diagram	Time relay	Identification letter
Pulse-delay relay, fixed pulse (1 s) and settable pulse delay	1 CO contact			3RP2505 - 1A.30 3RP2505 - 2A.30	K
	1 NO contact / semiconductor			3RP2505 - 1CW30 3RP2505 - 2CW30	
	1 relay, 2 CO contacts, positively driven			3RP2505 - 1RW30 3RP2505 - 2RW30	
	2 CO contacts (2CO)			3RP2505 - 1B..0 3RP2505 - 2B..0	
Pulse-delay relay, fixed pulse (1 s) and settable pulse delay, and instantaneous contact	2 CO contacts (1CO+1CO)			3RP2505 - 1B..0 3RP2505 - 2B..0	

7.3 Function table multifunction (3RP2505)

Function	Output type	Function chart	Circuit diagram	Time relay	Identification letter
Pulse-delay relay with control signal (fixed pulse (1 s) and settable pulse delay)	1 CO contact			3RP2505 - 1A.30 3RP2505 - 2A.30	L
	1 NO contact / semiconductor			3RP2505 - 1CW30 3RP2505 - 2CW30	
	1 relay, 2 CO contacts, positively driven			3RP2505 - 1RW30 3RP2505 - 2RW30	
	2 CO contacts (2CO)			3RP2505 - 1B..0 3RP2505 - 2B..0	
Pulse-delay relay with control signal (fixed pulse and settable pulse delay) and instantaneous contact	2 CO contacts (1CO+1CO)			3RP2505 - 1B..0 3RP2505 - 2B..0	

7.3 Function table multifunction (3RP2505)

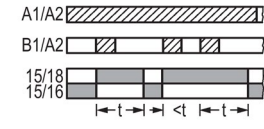
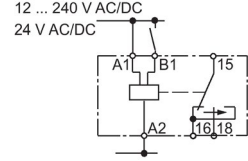
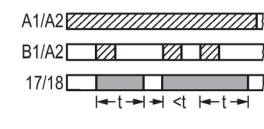
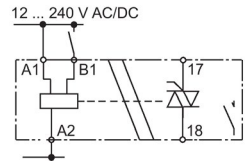
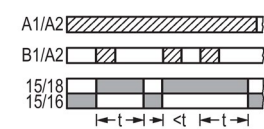
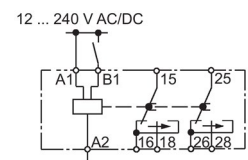
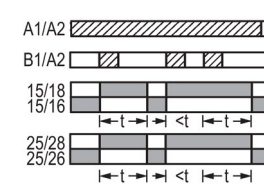
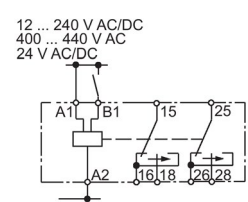
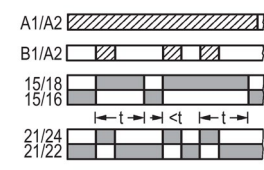
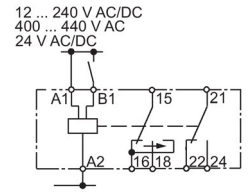
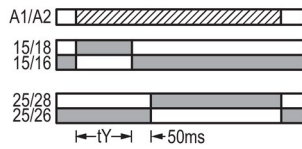
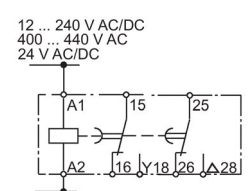
Function	Output type	Function chart	Circuit diagram	Time relay	Identifi- cation letter
Retriggerable interval relay with activated control signal (watchdog)	1 CO contact			3RP2505 - 1A.30 3RP2505 - 2A.30	M (GND)
	1 NO contact / semiconductor			3RP2505 - 1CW30 3RP2505 - 2CW30	
	1 relay, 2 CO contacts, positively driven			3RP2505 - 1RW30 3RP2505 - 2RW30	
	2 CO contacts (2CO)			3RP2505 - 1B..0 3RP2505 - 2B..0	
Retriggerable interval relay with activated control signal and instantaneous contact (watchdog)	2 CO contacts (1CO+1CO)			3RP2505 - 1B..0 3RP2505 - 2B..0	
Star-delta (YΔ) function	2 CO contacts (2CO)			3RP2505 - 1B..0 3RP2505 - 2B..0	YΔ

Technical data

8.1 Technical data in Siemens Industry Online Support

Technical data sheet

You can also find the technical data of the product at Siemens Industry Online Support (<https://support.industry.siemens.com/cs/ww/en/ps/>).

1. Enter the full article number of the desired device in the "Product" field, and confirm with the Enter key.
2. Click the "Technical data" link.

The screenshot shows the Siemens Industry Online Support search interface. At the top, there is a search bar with the text "Enter keyword...". Below the search bar, there are three input fields: "Product", "Entry type", and "Date". The "Product" field contains the article number "3RV2031-4BA10" and is highlighted with a red box. The "Entry type" field contains "Technical data (1)" and is also highlighted with a red box. The "Date" field is empty. Below the search bar, there is a "Search product" button. The search results are displayed in a table with one row. The first column contains a placeholder image. The second column contains the product name "3RV2031-4BA10" and its description: "CIRCUIT BREAKER, SCREW TYPE, 20 A CIRCUIT BREAKER SIZE S2, FOR MOTOR PROTECTION, CLASS 10, A-RELEASE 14... 20A, N-RELEASE 20DA, SCREW TERMINAL, STANDARD BREAKING CAPACITY". Below the description, there are three links: "Product details", "Technical data" (highlighted with a red box), and "CAx data".

Dimension drawings

9.1 Dimension drawings 3RP25 devices

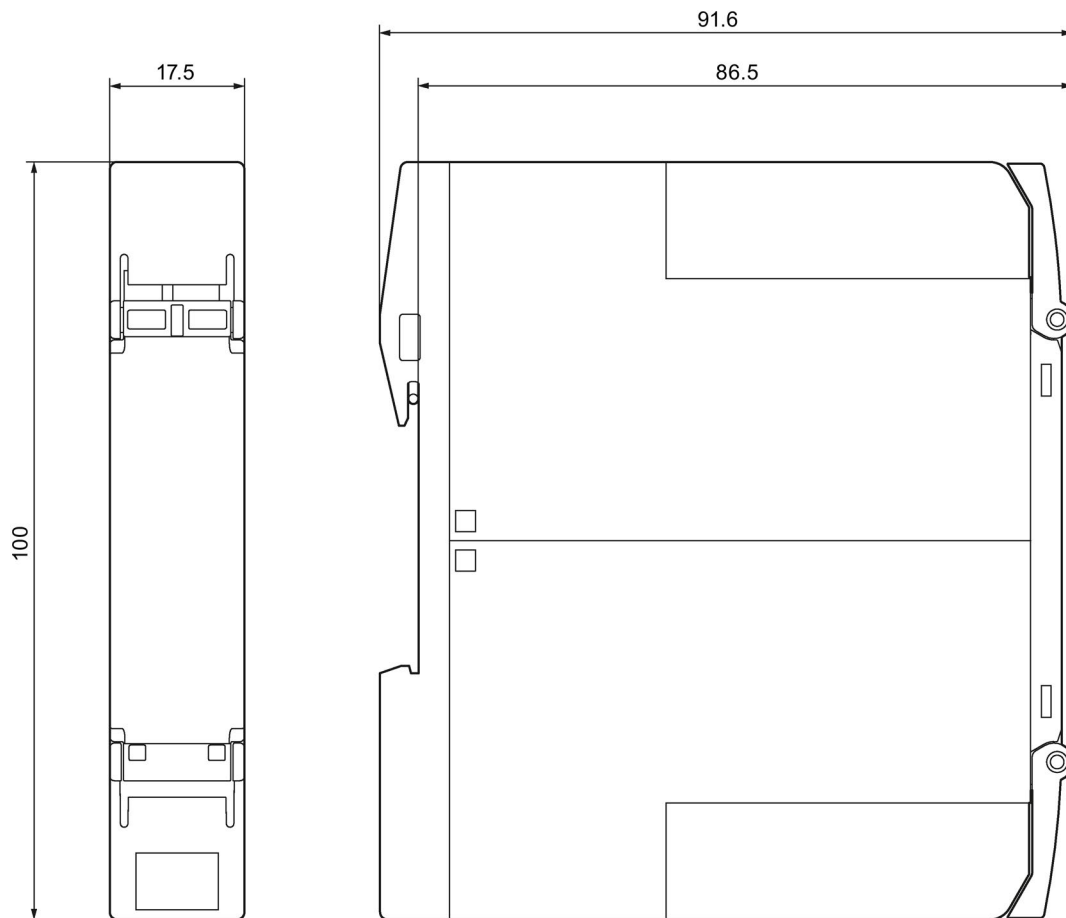

Enclosure 17.5 mm for timing relay:

- 3RP2505 - .A.30
- 3RP2505 - .CW30
- 3RP251. - .AW30
- 3RP252. - ..W30
- 3RP253. - .AW30
- 3RP255. - .AW30

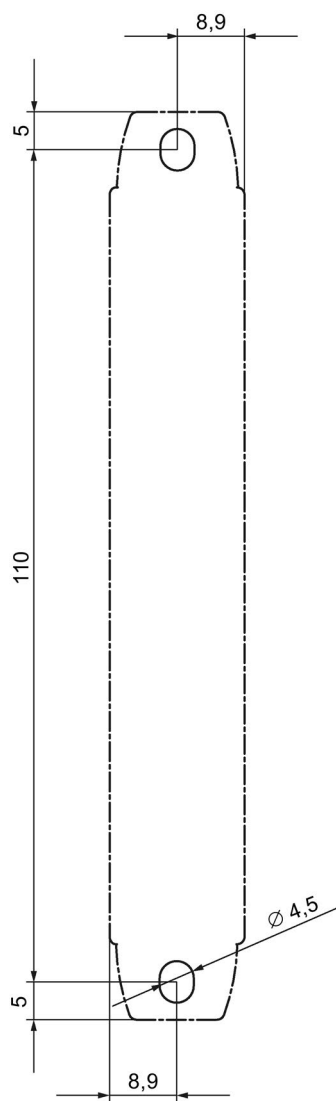

Drilling diagram, enclosure 17.5 mm

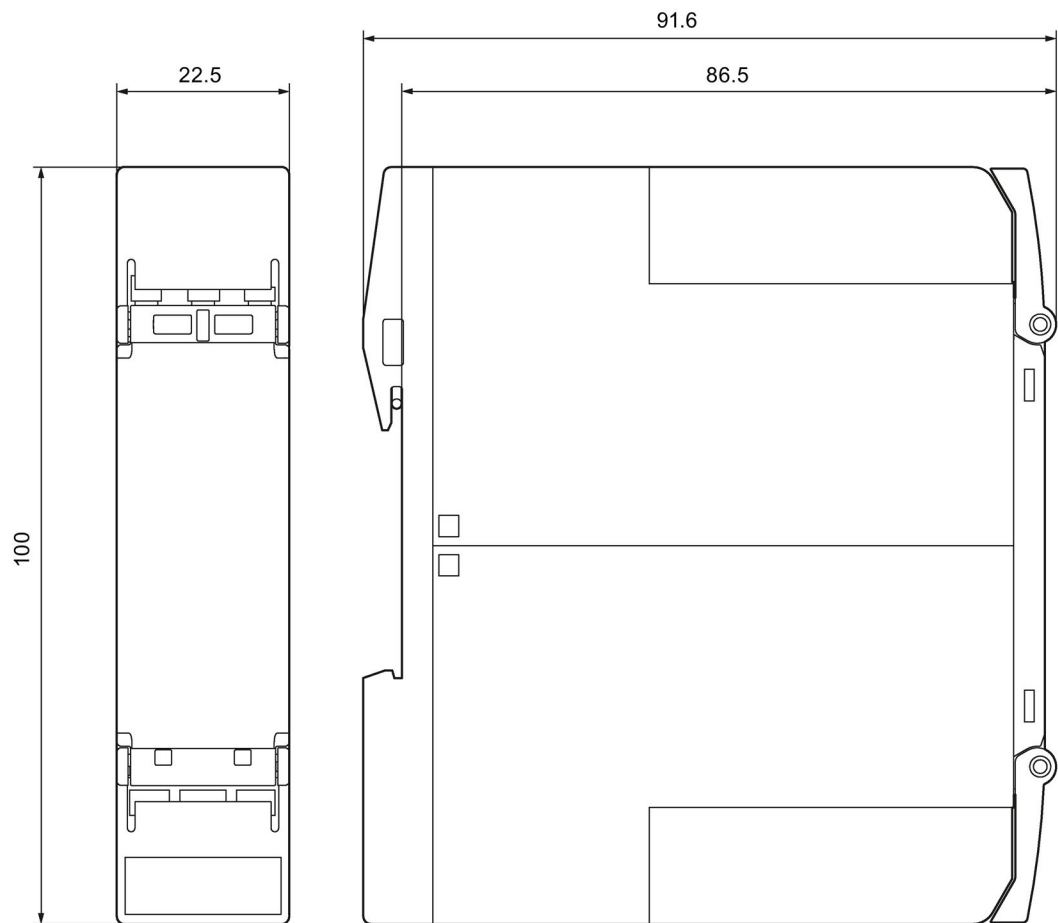

Enclosure 22.5 mm (short) for timing relay:

- 3RP2505 - .B.30
- 3RP2505 - .RW30
- 3RP2505 - .BT20
- 3RP2525 - .B.30
- 3RP2540 - .A.30
- 3RP2540 - .B.30
- 3RP2560 - .SW30
- 3RP257 . - .NW30
- 3RP257 . - .NM20

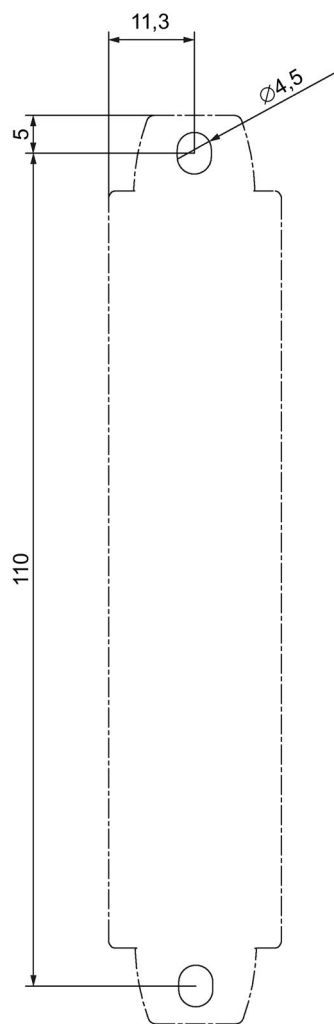



Drilling diagram, enclosure 22.5 mm





Spare parts/accessories

10.1 Accessories for 3RP25

The following accessories are available for the 3RP25 time relay.

Designation	Graphic	Article number
SIRIUS terminal, 2-pole, screw-type, 1 x 2.5 mm ²		3ZY1122-1BA00
SIRIUS terminal, 2-pole, push-in, 1 x 2.5 mm ²		3ZY1122-2BA00
SIRIUS push-in lugs for wall mounting (Contents: 12 units)		3ZY1311-0AA00

10.1 Accessories for 3RP25

Designation	Graphic	Article number
SIRIUS sealable cover, 17.5 mm		3ZY1321-1AA00
SIRIUS sealable cover, 22.5 mm		3ZY1321-2AA00
Coding pins for SIRIUS terminals		3ZY1440-1AA00
<p>Hinged cover</p> <ul style="list-style-type: none"> • Width 17.5 mm - titanium gray for SC17.5 • Width 22.5 mm - titanium gray for SC22.5 		<p>3ZY1450-1AA00</p> <p>3ZY1450-1AB00</p>