

599 Series Zone Valves SSA81U Electronic Zone Valve Actuator 24 Vac Floating Control Fail-in-Place

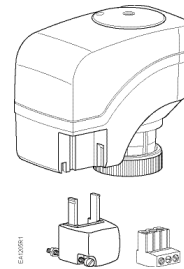

Product Description

The SSA81U actuator requires 24 Vac, Class 2 power, and a floating control signal to control 599 Series Zone Valves with 1/10-inch (2.5 mm) stroke.

Warning/Caution Notations

WARNING:		Personal injury/loss of life may occur if you do not follow a procedure as specified.
CAUTION:		Equipment damage, or loss of data may occur if you do not follow the procedures as specified.

Product Number

Description		Actuator Code
SSA81U	Normally Closed Floating	244

Contents: One actuator

Required Tools

- Small flat-blade screwdriver
- Wire stripper

Estimated Installation Time

20 minutes

Prerequisites



WARNING:

If mounting the actuator to a valve already in line:

- Close the shut-off valves in the piping (upstream first, then downstream);
- Or
- Switch off the pump to allow the differential pressure in the valve to drop.

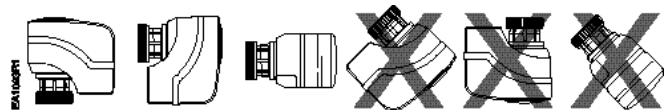

Figure 1. Acceptable Mounting Positions. *

*The vertical position is recommended for mounting.



WARNING:

Disconnect the controller power before replacing the actuator.

Installation

Mounting an Actuator to a Valve



CAUTIONS:

- The black actuator attachment support ring must be in place on top of the valve bonnet before installing the actuator.
 If the support ring is not in place, damage to the actuator connection may result.
- SSA61/81: Using the 3mm hex wrench, rotate the manual override to the 1 position before installing on a valve assembly.

- Place the actuator on the valve and firmly hand-tighten the coupling piece.
- Connect the wires per the *Wiring* section.

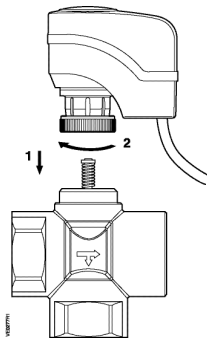

Figure 2. Mounting an Actuator to a Valve

The installation is now complete.

Removing an Actuator from a Valve

- Disconnect the wiring.

- Unscrew the actuator-coupling piece from the valve body threads.
- Remove the actuator from the valve.

Wiring

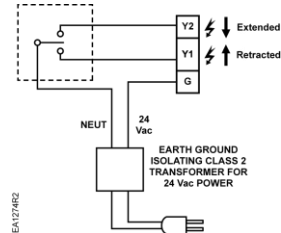

Figure 3. SSA81U Actuator Wiring Diagram.



CAUTION:

G must be properly wired for correct function and full life of the actuator.

- All wiring must conform to NEC and local codes and regulations.
- Use earth ground isolating step-down Class 2 transformers.
- Do not use autotransformers.
- Determine the supply transformer rating by summing the total VA of all actuators used.
- The maximum rating for a Class 2 step-down transformer is 100 VA.
- It is recommended that one transformer power no more than 10 actuators.

Start-up

Check the wiring and the position indication. See Figure 4 for referred positions **0** and **1** on the position indicator disc.

SSA81U Normally Closed

When the position indicator disc is at the **0** position the output shaft is extended (two-way valve closed).

When the position indicator disc rotates to position **1**, the output shaft is retracted (two-way valve open).

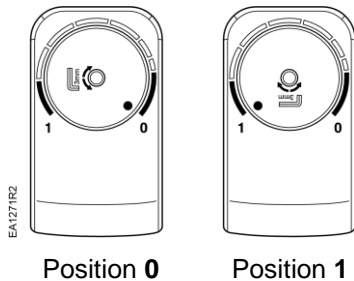

Position **0**

Position **1**

Figure 4. Visual Position Indication.

Note:
 The **0** and **1** position markings are intended for reference only and not for stroke measurement.

Manual Override

The actuators can be driven manually to any position between **0** and **1** with a 3 mm hex wrench.

See Figure 5. A control signal from the controller, however, will take priority over any manual position.

NOTE:

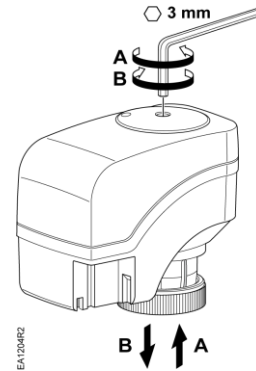

- (A) Turn hex wrench counterclockwise to retract the spindle.
- (B) Turn hex wrench clockwise to extend the spindle.

Figure 5.
 SSA81U Normally Closed.

Troubleshooting

Check the wiring for the proper connections.

References

Technical Instructions	Document Number
SSA81U Electronic Valve Actuator 24 Vac 3-Position Control	155-710
Technical Bulletin TB254 599 Series Zone Valves Electric Actuator Assembly Selection	155-291

Service Envelope

Minimum access space recommended: 8-inches
(200 mm) above the actuator.

Dimensions

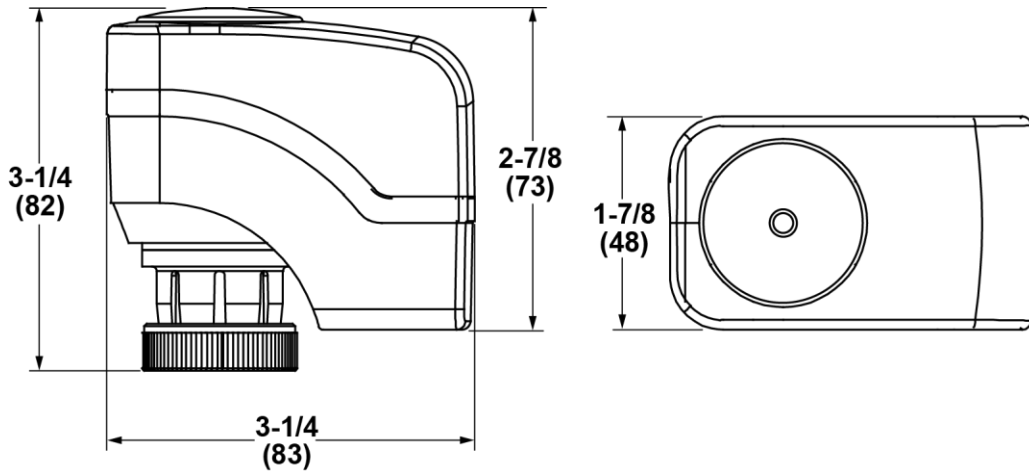

EA1207R1

Figure 6. Dimensions of the SSA81U Actuator in Inches (mm).

Information in this publication is based on current specifications. The company reserves the right to make changes in specifications and models as design improvements are introduced. Product or company names mentioned herein may be the trademarks of their respective owners.
© 2009-2023 Siemens Industry, Inc.