

SIEMENS

Configuration Manual

SENTRON

8US Busbar Systems

Edition

10/2019

www.siemens.com/lowvoltage

SIEMENS

SENTRON

8US Busbar Systems

Configuration Manual

<u>Overview of busbar systems</u>	1
<u>Introduction to busbar systems</u>	2
<u>8US 60 mm Compact Busbar Systems up to 360 A</u>	3
<u>8US 60 mm Busbar Systems up to 1600 A</u>	4

Legal information

Warning notice system

This manual contains notices you have to observe in order to ensure your personal safety, as well as to prevent damage to property. The notices referring to your personal safety are highlighted in the manual by a safety alert symbol, notices referring only to property damage have no safety alert symbol. These notices shown below are graded according to the degree of danger.

 DANGER
indicates that death or severe personal injury will result if proper precautions are not taken.

 WARNING
indicates that death or severe personal injury may result if proper precautions are not taken.

 CAUTION
indicates that minor personal injury can result if proper precautions are not taken.

NOTICE
indicates that property damage can result if proper precautions are not taken.

If more than one degree of danger is present, the warning notice representing the highest degree of danger will be used. A notice warning of injury to persons with a safety alert symbol may also include a warning relating to property damage.

Qualified Personnel

The product/system described in this documentation may be operated only by **personnel qualified** for the specific task in accordance with the relevant documentation, in particular its warning notices and safety instructions. Qualified personnel are those who, based on their training and experience, are capable of identifying risks and avoiding potential hazards when working with these products/systems.

Proper use of Siemens products

Note the following:

 WARNING
Siemens products may only be used for the applications described in the catalog and in the relevant technical documentation. If products and components from other manufacturers are used, these must be recommended or approved by Siemens. Proper transport, storage, installation, assembly, commissioning, operation and maintenance are required to ensure that the products operate safely and without any problems. The permissible ambient conditions must be complied with. The information in the relevant documentation must be observed.

Trademarks

All names identified by ® are registered trademarks of Siemens AG. The remaining trademarks in this publication may be trademarks whose use by third parties for their own purposes could violate the rights of the owner.







Disclaimer of Liability



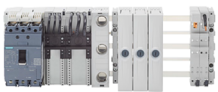



We have reviewed the contents of this publication to ensure consistency with the hardware and software described. Since variance cannot be precluded entirely, we cannot guarantee full consistency. However, the information in this publication is reviewed regularly and any necessary corrections are included in subsequent editions.

Table of contents

1	Overview of busbar systems	5
2	Introduction to busbar systems	7
2.1	Technical specifications	9
2.1.1	Continuous current for busbars	9
2.1.2	General technical specifications	10
2.1.3	Technical specifications of the system components.....	11
2.2	Characteristic curves	12
2.3	Current-carrying capacity values for flat bars acc. to DIN 43671	14
2.4	UL applications	15
3	8US 60 mm Compact Busbar Systems up to 360 A	17
3.1	Product description	17
3.2	3-pole and 5-pole installation with a busbar support	18
3.3	Infeeds and connection methods.....	18
3.4	Built-in components	19
3.5	Device adapters and device holders.....	20
4	8US 60 mm Busbar Systems up to 1600 A	21
4.1	Product description	21
4.2	Basic assemblies up to 630 A.....	22
4.3	Basic assemblies up to 1600 A.....	23
4.4	Infeeds and connection methods.....	23
4.5	Built-in components	24
4.6	Device adapters and device holders.....	30
	Index	31

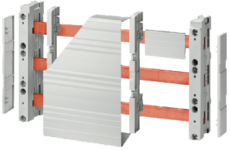
Overview of busbar systems

Devices		Applications	Standards	Used in		
				Non-residential buildings	Residential buildings	Industry
	60 mm compact busbar systems up to 360 A		EN 13601 IEC 61439-1, IEC 61439-2 UL 508 A	✓	--	✓
	Basic assemblies	Basic assemblies up to 360 A, busbar supports, busbars, touch protection covers	EN 13601 IEC 61439-1, IEC 61439-2 UL 508 A	✓	--	✓
	3-pole: Infeeds and connection methods	Infeed for busbar systems, terminals	EN 13601 IEC 61439-1 UL 508 A	✓	--	✓
	3-pole: Built-in components	3-pole NEOZED bus-mounting bases	IEC 60947-3, EN 60947-3 (VDE 0660) IEC 60269, EN 60269 (VDE 0636)	✓	--	✓
	3-pole: Device adapters and device holders	Busbar device adapters and device holders for the assembly of 3RV2/3RT2 load feeders	EN 13601 IEC 61439-1 UL 508 A	✓	--	✓
	5-pole: Infeeds and connection methods	Infeed for busbar systems, terminals	EN 13601 IEC 61439-1 UL 508 A	✓	--	✓

Devices	Applications	Standards	Used in			
			Non-residential buildings	Residential buildings	Industry	
	5-pole: Device adapters and device holders	Busbar device adapters and device holders for the assembly of 3RV2/3RT2 load feeders	EN 13601 IEC 61439-1 UL 508 A	✓	--	✓
	8US 60 mm busbar systems up to 1600 A		EN 13601 IEC 61439-1 UL 508 A	✓	--	✓
	Basic assemblies up to 630 A	Basic assemblies up to 630 A, busbar supports, busbars, touch protection covers	EN 13601 IEC 61439-1 UL 508 A	✓	--	✓
	Basic assemblies up to 1600 A	Basic assemblies up to 1600 A, busbar supports, busbars, touch protection covers	EN 13601 IEC 61439-1 UL 508 A	✓	--	✓
	Infeeds and connection methods	Infeed for busbar systems, terminals ...	EN 13601 IEC 61439-1 UL 508 A	✓	--	✓
	Built-in components	3-pole NEOZED bus-mounting bases or DIAZED bus-mounting bases, NEOZED bus-mounting switch disconnectors, fuse switch disconnectors and busbar device adapters	IEC 60947-3, EN 60947-3 (VDE 0660) IEC 60269, EN 60269 (VDE 0636)	✓	--	✓
	Device adapters and device holders	Busbar device adapters and device holders for the assembly of 3RV2/3RT2 load feeders	EN 13601 IEC 61439-1 UL 508 A	✓	--	✓

Introduction to busbar systems

The use of busbar systems with their versatile rail-adaptable connection, switching and installation devices is an ideal and cost-effective electrotechnical enhancement of modern distribution boards thanks to their small footprint, compact design and quick assembly contacts. Mounting is implemented on longitudinal stays. The standard busbar spacing is 60 mm. However, 40 mm, 100 mm and 185 mm systems are also in use.

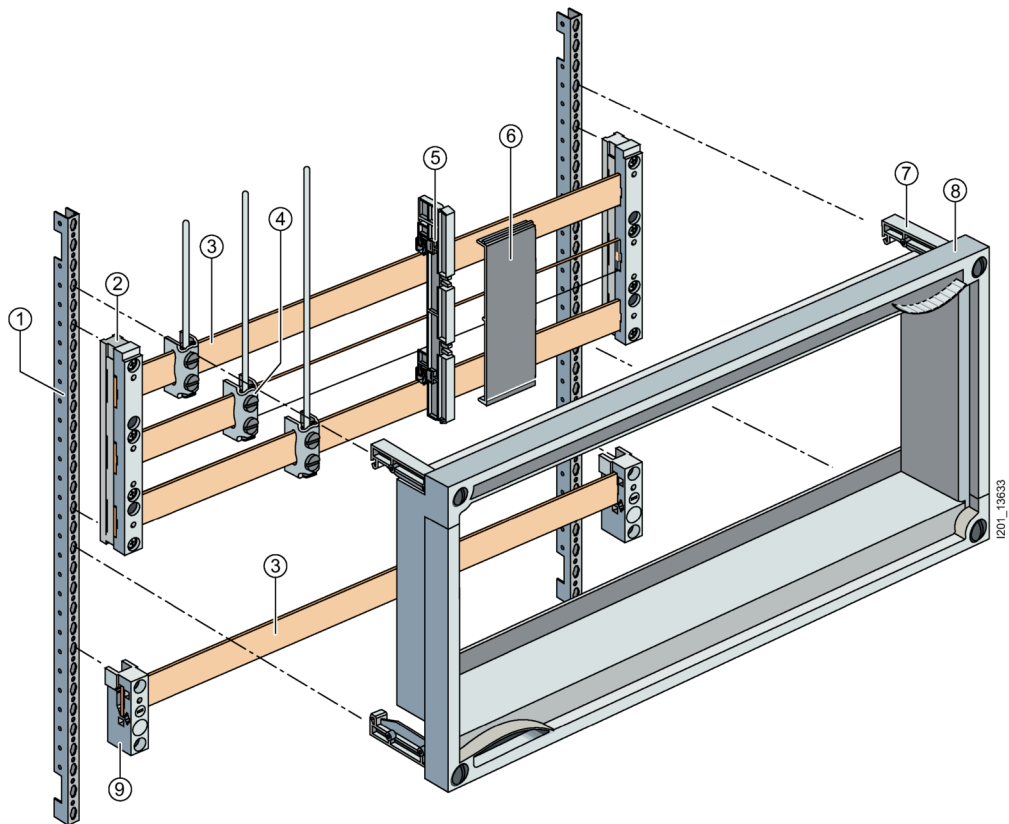

- ① Longitudinal stays
- ② Busbar support, three-phase
- ③ Cu busbars
- ④ Connecting terminals
- ⑤ Supports for blanking covers
- ⑥ Blanking cover
- ⑦ Supports
- ⑧ Touch protection cover
- ⑨ Busbar support, single-phase

Benefits

Notable cost reduction compared to conventional installation in switchgear and control cabinets due to the following reasons:

- Mechanical fixing and electrical contacting in a single step
- No access wiring and fewer busbar terminals used
- Double use of the busbar space
- Clear arrangement
- Straightforward replacement of individual devices or whole combinations
- High operational safety through finger-safe cover of the adapters and device holders

The above advantages are felt especially in cases where many tap-off units of the same performance range are required.

Design

8US busbar systems with 60 mm busbar center-to-center spacing as well as flat copper profiles have become firmly established on the world market.

The permissible busbar temperature is decisive when dimensioning the busbars. The busbar temperature is dependent on the current and the current distribution, on the busbar cross-section and the busbar surface, on the position of the busbars, convection and the ambient temperature. The values stated in the following table can only be considered as guide values because the conditions vary with each location. The values are based on continuous current over the whole busbar length.

The busbar runs prove most advantageous when the infeed is centrally located and the load is distributed symmetrically on both sides.

Applications

8US busbar systems are used for mounting current-limiting devices (protective devices), such as fuse switch disconnectors, circuit breakers and complete load feeders, directly onto busbars. 8US busbar systems are designed for horizontal mounting of the busbars.

Function

Short-circuit strength

The short-circuit strength of the busbar system is dependent on the spacing of the busbar supports and on the busbar cross-section.

The short-circuit strength of the whole system is dependent on the short-circuit strength of the busbars and of the adapters with circuit breakers or switch disconnectors. If one of these values is lower than the prospective short-circuit current at the installation site, a current-limiting protective device has to be mounted upstream of the 8US busbar system. This may also be mounted as a feeder circuit breaker on the busbar system itself.

2.1 Technical specifications

2.1.1 Continuous current for busbars

E-Cu bare, at 35 °C ambient temperature according to DIN 43671

Busbar dimensions	System	Continuous current at a busbar temperature of		
		65 °C	85 °C	105 °C
mm	mm	A	A	A
12 × 5	40 + 60	188	248	295
12 × 5	40 + 60	222	293	349
20 × 5	60	274	362	430
25 × 5	60	327	432	513
30 × 5	60	379	500	595
12 × 10	40 + 60	302	398	474
20 × 10	60	427	564	670
30 × 10	60	573	756	900
Special profile up to 1600 A	60	1020	1020	1600

2.1.2 General technical specifications

Rated insulation voltage U_i	V AC	1000
Short-circuit strength		
Of 8US1 busbar device adapter	Current limitation due to associated motor starter protectors/circuit breakers/load feeders up to 50 kA	
Of the busbar systems	6	
Material of the 8US1 busbar supports, busbar device adapters and device holders	Glass-fiber reinforced polyamide	
Color	RAL 7035, light gray	
Thermal stability (minimum values)		
Busbar supports, busbar device adapters, device holders, infeed and caps	°C	120
AWG connecting cables	°C	105 / 150
Cover profile	°C	110
Bases, partitions, edge profiles and blanking covers	°C	70
Machining of plastic profiles	<p>Take care when machining that no cracks are formed. A cross-cut circular saw with the following characteristic values has proven successful in cutting cover profiles for busbars:</p> <ul style="list-style-type: none"> <input type="checkbox"/> D = 300 mm, B = 2.2 mm, <input type="checkbox"/> T = 120 R (5° negative replaceable tooth at a cutting rate of 50 ... 60 m/s) <input type="checkbox"/> Tooth feed 0.05 ... 0.1 mm <p>The plastic parts have to be secured so that vibration is ruled out.</p>	
Approvals		
Busbar supports, busbar device adapters, device holders and terminals	UR, CSA,  -listed	

2.1.3 Technical specifications of the system components

Infeed, connection module, three-phase		5SH3538	5SH3535	8US1921-1BA00	8US1921-1AA00
Busbar center-to-center spacing	mm	60	60	60	60
Current-carrying capacity of the terminal points The specified current-carrying capacities reflect the thermal load capability of the terminal points under favorable conditions (with the largest conductors it is possible to connect). This does not invalidate the assignment of conductor cross-sections and current-carrying capacities as defined in national and international specifications.	A	80	560	300	440
Tightening torque	Nm	--	30	8 ... 10	12 ... 15
Clamping space W × H	mm	--	--	10 x 75	15 x 15
Conductors that can be used	mm ²	1.5 ... 16 Cu, re, rm, f, f+AE (reduction of the maximum conductor cross-sections may be required)	150 ... 300 Cu, Al (connections with aluminum conductors are not maintenance free), rm, sm, f	6 ... 50 (70) Cu, rm, f, f+AE (reduction of the maximum conductor cross-sections may be required), Cu 6 × 9 × 0.8	35 ... 120 Cu, rm, f, f+AE (reduction of the maximum conductor cross-sections may be required), Cu 6/10 × 15.5 × 0.8

2.2 Characteristic curves

60 mm busbar systems

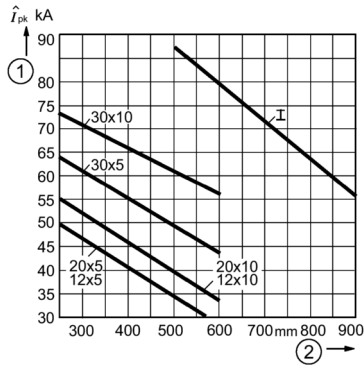

- ① Peak current i_{pk}
- ② Spacing of busbar supports

100 mm busbar system for 3NJ4/3NJ5

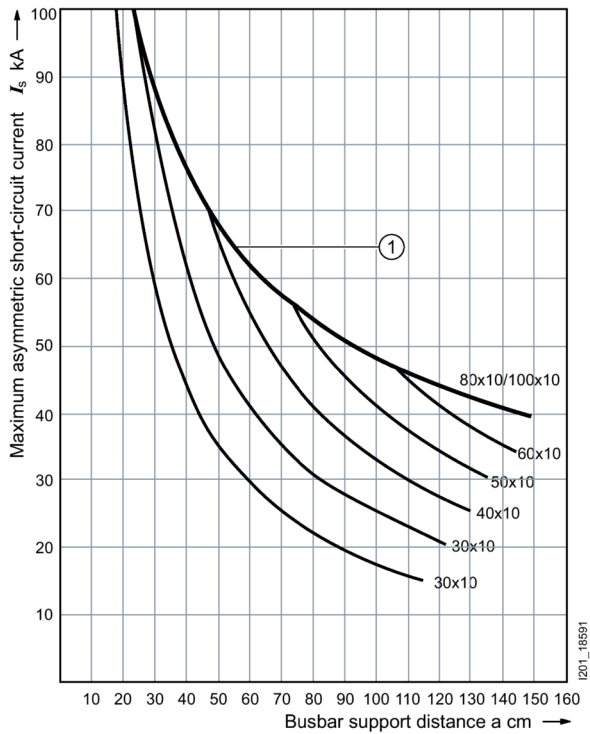

- ① Maximum limit load on busbar system

185 mm busbar system for 3NJ4/3NJ5

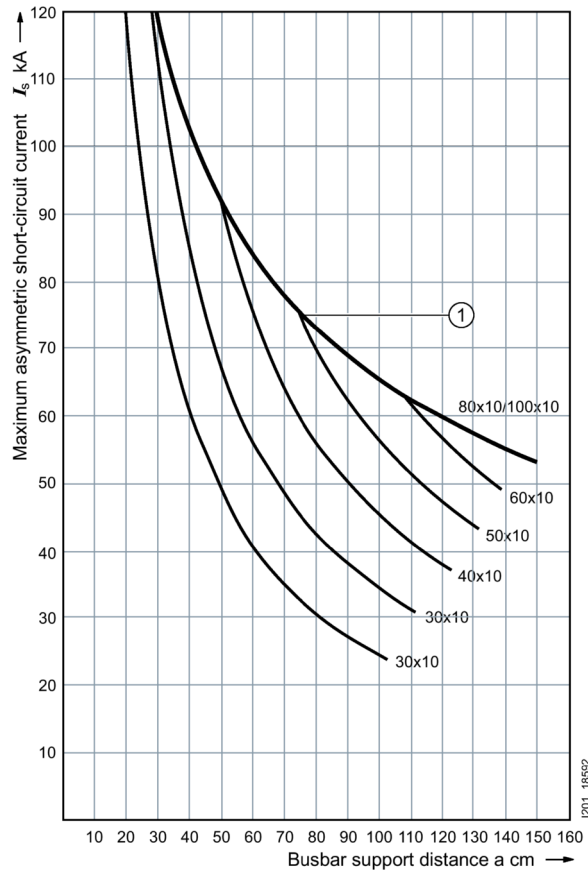

① Maximum limit load on busbar system

2.3 Current-carrying capacity values for flat bars acc. to DIN 43671

According to DIN 43671, current-carrying capacity values for flat bars are defined at 35 °C ambient temperature and 65 °C busbar temperature.

If a higher busbar temperature than 65 °C is possible, the busbars can be operated with higher current values according to the following formula: $I = I_n \cdot k_2$

Example

Under normal operating conditions (35 °C ambient temperature and 65 °C busbar temperature), a 30 x 10 mm busbar can handle loads up to 630 A. However, you want the busbar to handle a higher current, at the expense of an increased busbar temperature of max. 85 °C.

The following applies:

- Bar type: Busbar
- Busbar size: 30 x 10 mm
- Max. bar temperature: 85 °C
- Ambient temperature: 35 °C

The figure below shows the correction factor $k_2 = 1.3$ for the current-carrying capacity.

This results in a higher value of $630 \text{ A} \cdot 1.3 = 819 \text{ A}$.

If the 30 x 10 mm busbar is to be operated with a bar temperature of 85 °C, it may be loaded with maximum 819 A.

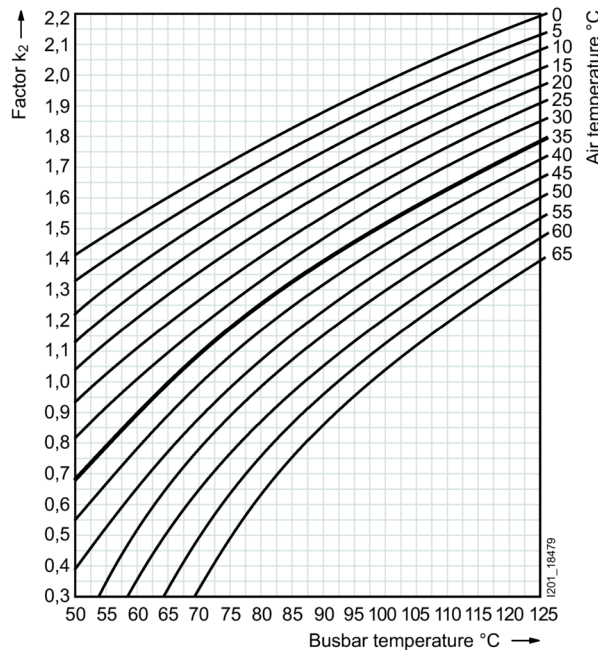

Figure 2-1 Current-carrying capacity values for 30 x 10 mm flat bars acc. to DIN 43671, depending on ambient and bar temperature

2.4 UL applications

Short-circuit strength

The short-circuit strength of the busbar system is dependent on the spacing of the busbar supports and on the busbar cross-section.

The short-circuit strength of the whole system is dependent on the short-circuit strength of the busbars and of the adapters with circuit breakers or switch disconnectors. If one of these values is lower than the prospective short-circuit current at the installation site, a current-limiting protective device has to be mounted upstream of the 8US busbar system. This may also be mounted as a feeder circuit breaker on the busbar system itself.

Selection aid for UL applications

An updated summary of all the busbar adapters can be found at
www.siemens.com/lowvoltage/8US-UL
(<https://support.industry.siemens.com/cs/ww/en/view/109762817>)

8US 60 mm Compact Busbar Systems up to 360 A

3.1 Product description

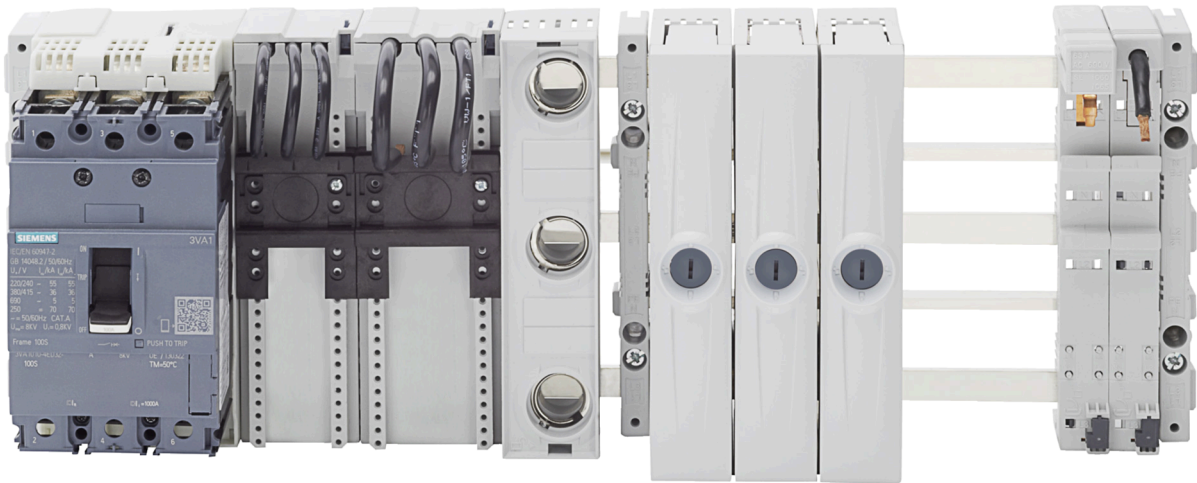

Figure 3-1 The 60 mm compact busbar system for the lower performance range up to 360 A

The 60 mm compact busbar system is especially useful for space-saving solutions in distribution boards with a 12 x 5 or 12 x 10 mm busbar up to 360 A.

Thanks to its maximum height of 160 mm, it offers significant space benefits over other assemblies and with dimensions comparable to a 40 mm busbar system, it offers an ideal alternative with the benefits of a 60 mm busbar system.

Another important benefit is provided by the option of combining with adapters from the basic assemblies up to 400 A.

In addition, most components of the system in the 3-pole version meet the requirement regarding clearances in accordance with UL 508.

Another benefit is expansion to a 5-pole system with the same mounting height of 160 mm. The N and PE conductors are each arranged between the phases. The busbar supports are already prepared for a 5-pole system.

The 5-pole compact system is approved for 12 x 5 mm busbars and for applications according to IEC up to a maximum of 200 A.

Benefits

- Significant space advantage compared to other assemblies
- Combination option with adapters from the basic assemblies up to 400 A
- Compliance with the clearances stipulated by UL 508 in the 3-pole version
- Expansion to a 5-pole system up to 200 A possible in accordance with IEC

3.2 3-pole and 5-pole installation with a busbar support



Figure 3-2 The 3-/5-pole 60 mm compact busbar system for the lower performance range up to 360 A; the 5-pole element is only designed for up to 200 A

3.3 Infeeds and connection methods

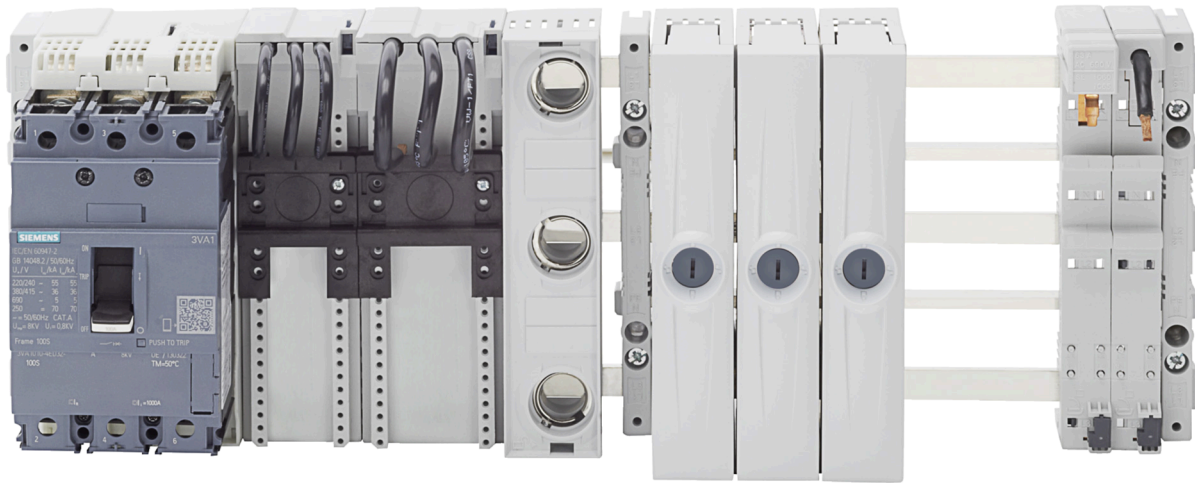

Figure 3-3 The 3-/5-pole 60 mm compact busbar system for the lower performance range up to 200/360 A: Infeeds and connection methods

3.4 Built-in components



Figure 3-4 Bus-mounting base for 3-pole compact busbar systems

Melting fuses are capable of safely switching off faulty circuits. NEOZED fuses have a high short-circuit breaking capacity of 50 kA and a high short-circuit current limitation.

The NEOZED bus-mounting fuse bases in size D02 enable the direct use of 20 A to 63 A NEOZED fuse links. Adapter sleeves and a special retaining spring (5SH5400) are available for use with smaller rated currents up to 16 A. Thanks to their 36-mm-wide design, NEOZED bus-mounting fuse bases are highly thermally emissive, thus enabling high operating currents under continuous load.

Technical specifications of bus-mounting bases

		NEOZED bus-mounting bases for 5SG6208 60 mm compact busbar systems
Size		D02
Standards		IEC 60269-3, DIN VDE 0636-3
Rated voltage	V AC	400
	V DC	250
Rated frequency	Hz	50
Rated current	A	63
Rated conditional short-circuit current	kA AC	50
	kA DC	8
For fuse links with power losses per phase	W	5.5
Busbar center-to-center spacing	mm	60
Box terminals for wire connection	mm ²	Cu 1.5 ... 10 (re)
	mm ²	Cu 1.5 ... 25 (f)
	mm ²	Cu 1.5 ... 25 (f+AE)
Tightening torque	Nm	3
Material		Temperature-resistant up to min. 120 °C, self-extinguishing acc. to UL 94, min. creepage resistance CTI 200

3.5 Device adapters and device holders

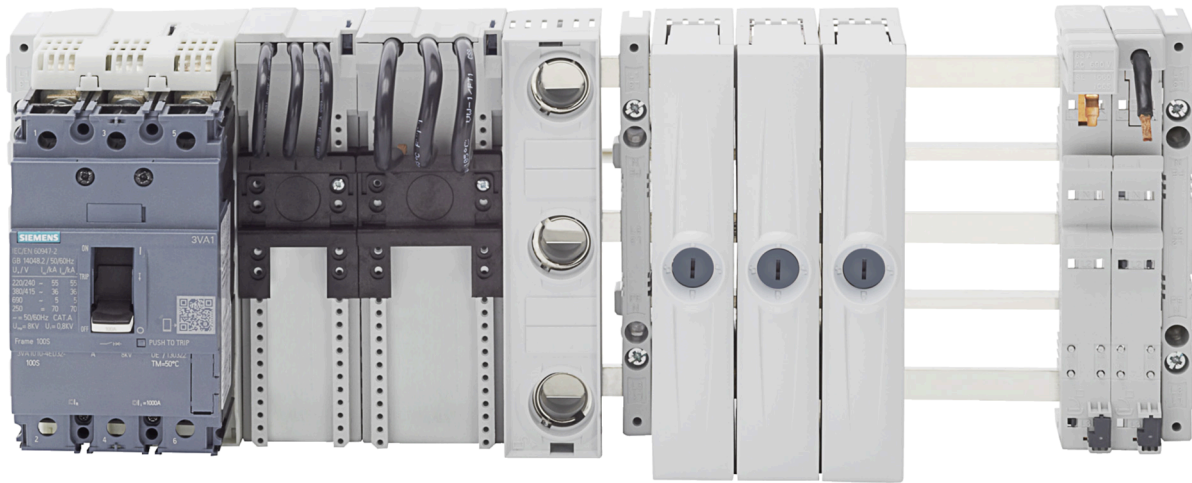

Figure 3-5 The 3-/5-pole 60 mm compact busbar system for the lower performance range up to 360 A: Device adapters and device holders

Universal adapters for SIRIUS 3RM1 motor starters and for relays

Maximum continuous load current of fuses to be used

The universal adapters for SIRIUS 3RM1 motor starters and for relays can be equipped with the following fuses:

aM fuses			gG fuses			SITOR semiconductor fuses			Class CC UL fuses		
Article No.	I_n (A)	I_{max} (A)	Article No.	I_n (A)	I_{max} (A)	Article No.	I_n (A)	I_{max} (A)	Article No.	I_n (A)	I_{max} (A)
3NW8000-1	0.5	0.5	3NW6000-1	0.5	0.5	3NC1006-0MK	6	6	3NW1006-0HG	6	6
3NW8011-1	1	1	3NW6011-1	1	1	3NC1010-0MK	10	9.5	3NW1008-0HG	8	8
3NW8002-1	2	2	3NW6002-1	2	2	3NC1012-0MK	12	10.4	3NW1010-0HG	10	10
3NW8004-1	4	4	3NW6004-1	4	4	3NC1003	3	3	3NW1015-0HG	15	12
3NW8001-1	6	6	3NW6001-1	6	6	3NC1006	6	6	3NW1020-0HG	20	12.5
3NW8008-1	8	8	3NW6008-1	8	8	3NC1008	8	8			
3NW8003-1	10	10	3NW6003-1	10	10	3NC1010	10	10			
3NW8006-1	12	12	3NW6006-1	12	12	3NC1012	12	12			
3NW8005-1	16	16	3NW6005-1	16	16	3NC1016	16	14.8			
						3NC1020	20	15.8			

8US 60 mm Busbar Systems up to 1600 A

4.1 Product description



Figure 4-1 The 60 mm busbar system for the medium and top performance range up to 1600 A, here for example with the 3NP1 switch disconnect, size 3

The 60 mm busbar system is mainly used in control cabinet installations, motor control centers and power distribution systems in the medium (630 A) and top performance ranges (1600 A, special profile).

The 60 mm busbar system can be configured as a basic system without covers. The busbar cross-sections are available in the sizes 12 x 5 mm to 30 x 10 mm and as a special profile. Busbar device adapters for SIRIUS devices, 3VA circuit breakers, 3KA and 3KL switch disconnectors, and 3NP1 fuse switch disconnectors offer numerous options for configuring this busbar system. Infeed units, terminals and other accessories open up a large range of applications.

Busbars with a special profile are suitable for applications up to 1600 A. All components of the 60 mm busbar system can be fitted.

SIRIUS motor starter combinations

SIRIUS motor starter combinations can be configured with and without fuses.

The compact 3NW7...-1 cylindrical fuse holders for IEC fuses, size 10 x 38 mm, or 3NW7...-1HG UL for Class CC fuses are suitable for use with fused motor starter combinations.

With a width of 45 mm, SIRIUS motor starter combinations are the same width as the majority of contactors.

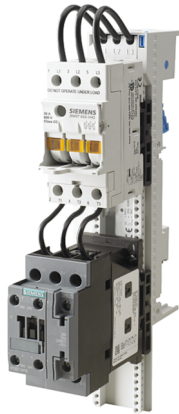
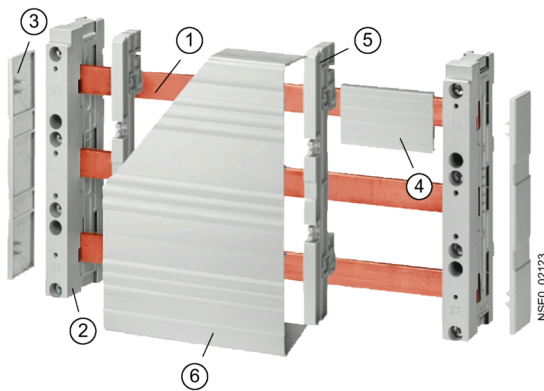

Figure 4-2 Installation configuration of a cylindrical fuse holder and a SIRIUS contactor on busbar device adapter for the 60 mm busbar system

4.2 Basic assemblies up to 630 A



- ① Flat copper profile
- ② Busbar support
- ③ End cover
- ④ Cover profile
- ⑤ Supports for blanking covers
- ⑥ Blanking cover

Figure 4-3 60 mm busbar system: Basic assemblies up to 630 A

4.3 Basic assemblies up to 1600 A

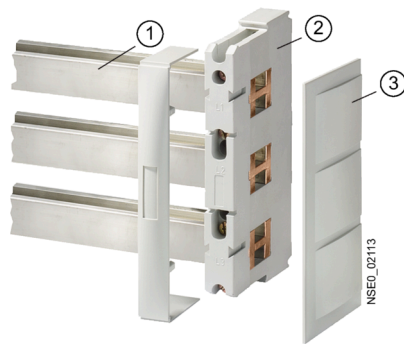

- ① Flat copper profile
- ② Busbar support
- ③ End cover

Figure 4-4 60 mm busbar system: Basic assembly up to 1600 A

4.4 Infeeds and connection methods

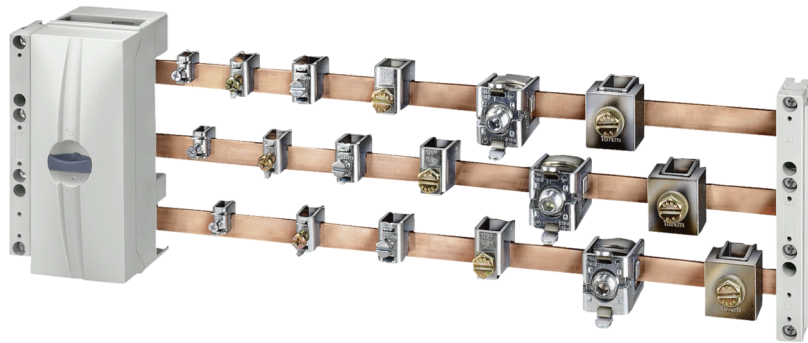
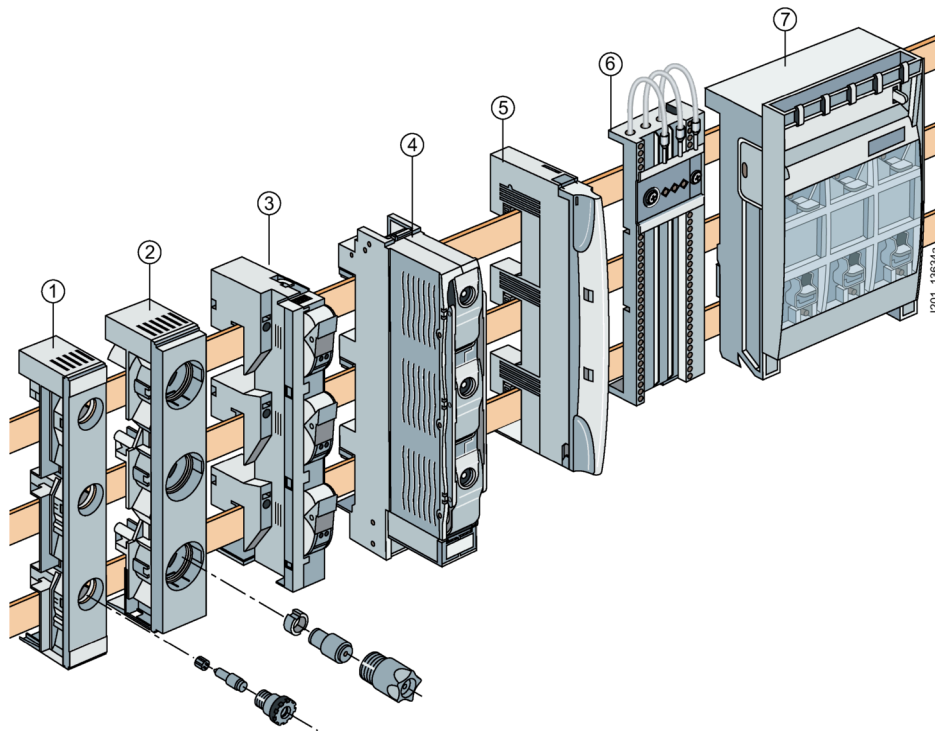

Figure 4-5 60 mm busbar system: Terminals and covers for infeed and connection methods

4.5 Built-in components



- ① NEOZED bus-mounting base, 3-pole
- ② DIAZED bus-mounting base, 3-pole
- ③ SR60 bus-mounting fuse holder, 3-pole
- ④ NEOZED bus-mounting switch disconnecter, 3-pole
- ⑤ Connection module, three-phase
- ⑥ Adapter for modular installation devices according to DIN 43880
- ⑦ LV HRC fuse switch disconnecter

NEOZED and DIAZED built-in components

Rail-adaptable built-in components, such as NEOZED and DIAZED bus-mounting bases, adapters for modular installation devices, fuse switch disconnectors and NEOZED bus-mounting fuse switch disconnectors are made of glass-fiber reinforced, thermoplastic polyester. The material ensures the required mechanical, chemical and electrical properties.

Efficient power distribution up to 630 A. Users have several options for mounting the SR60 busbar system:

1. Mounting in distribution boards

The busbar supports are mounted on longitudinal stays. Once the built-in components are mounted and connected, the touch protection cover (section cover) protects against accidental contact with live parts.

2. Mounting in industrial control panels

The demand for comprehensive touch protection has generated new solutions: Built-in components such as busbar fuse bases have integrated reach-through guards, enabling the implementation of cost-effective overall solutions.

Previously two optional solutions were provided, which can now be replaced using new technology: touch protection via base and edge profiles or touch protection via partitions.

Higher overall efficiency and cost savings for the plant constructor.

Fuse holders, fuse switch disconnectors, switch disconnectors with fuse and 16 mm² connection modules with screwless terminals are available; this offers users maximum safety and comfort.

Class CC and Class J fuse systems

Class CC and Class J fuse links according to the UL and CSA standards are used for "branch circuit protection" and in the "feeder circuit". Different characteristics are available for different applications.

The Class CC and Class J 30 A and 60 A fuse holders are modular installation devices for mounting on a DIN rail (standard mounting rail) and are available in 1-, 2- and 3-pole versions. A 3-pole device for mounting Class CC fuses on a 60 mm busbar system is also available.

The Class J 100 A, 200 A and 400 A fuse holders are available as versions either for screwing onto a mounting plate or for directly mounting on the 60 mm busbar system.

The fuse holders for cylindrical fuses, size 10 x 38 and for American fuses, Class CC and Class J, can be used in the international plant engineering industry. In addition, Siemens offers a broad range of UL-approved components for the design of switchboards according to UL 508 A.

Advantages:

- For manufacturers of switchboard assemblies and machinery who export their switchboards to the USA or Canada.
- Easier export due to UL and CSA approvals.
- Modern fuse holder design with touch protection to BGV A3 ensures safe installation.
- Fuse holders up to 200 A enable fuses to be changed in the de-energized state.
- Efficient power distribution thanks to mounting the devices on 60 mm busbar system.

Planning dimensions

	Width	Width
	mm	MW
NEOZED bus-mounting bases D02		
<input type="checkbox"/> Cover	27	1.5
<input type="checkbox"/> Cover, extra wide	36	2.0
<input type="checkbox"/> Cover, double width	54	3.0
DIAZED bus-mounting bases DII		
<input type="checkbox"/> Cover	42	2.3
DIAZED bus-mounting bases DIII		
<input type="checkbox"/> Cover	57	3.2
NEOZED bus-mounting switch disconnectors	27	1.5
LV HRC fuse switch disconnectors size 00	108	6
Bus-mounting fuse holders	27	1.5
Class J bus-mounting fuse holders		
<input type="checkbox"/> 100 A	106	5.9
<input type="checkbox"/> 200 A	184	10.2
<input type="checkbox"/> 400 A	256	14.2

Benefits

- Direct contacting of the rail-adaptable switching and installation devices on the Cu busbars reduces distribution panels and mounting times.
- Compared to conventional installation, the transfer resistance of the connections is drastically reduced. This prevents unnecessary temperature rise.
- New built-in components with touch protection ensure comprehensive touch protection without the previously required partitions.
- International application due to UL-approved components
- Enhanced effectiveness and increased safety due to screwless terminals

Technical specifications of bus-mounting bases

		NEOZED SR60 bus-mounting bases		DIAZED SR60 bus-mounting bases		
		5SG6202		5SF6014	5SF6214	
		5SG6206		5SF6015	5SF6215	
		5SG6207		5SF6020	5SF6220	
		D01	D02	DII	DIII	
Standards		IEC 60269-3, DIN VDE 0636-3				
Rated voltage	V AC	400		500	690	
	V DC	250		--	600	
Rated frequency	Hz	50				
Rated current	A	16 (with 5SH5400 retaining spring)	63	25	63	
Rated conditional short-circuit current	kA AC	50		50		
	kA DC	8		8		
For fuse links with power losses per phase	W	2.5	5.5	4	7	
Busbar center-to-center spacing	mm	60		60		
Box terminals for wire connection	mm ²	1.5 ... 10 (re)		1.5 ... 10 (re)		
	mm ²	1.5 ... 25 (f)		1.5 ... 35 (f)		
	mm ²	1.5 ... 25 (f+AE)		1.5 ... 35 (f+AE)		
Tightening torque	Nm	3		4		
Material		Temperature-resistant up to min. 125 °C, self-extinguishing acc. to UL 94, CTI 600 creepage resistance		Temperature-resistant up to min. 125 °C, self-extinguishing acc. to UL 94, min. creepage resistance CTI 225		

Technical specifications of bus-mounting fuse holders

		3NW7431	3NW7431-0HG
Standards		IEC 60269-2, IEC 60947-3 UL 512, CSA C22.2	UL 512, CSA C22.2
Approvals		 , CSA	UL, CSA
Size		10 x 38	Class CC
Rated frequency	Hz	50 / 60	
Max. rated voltage U_e			
<input type="checkbox"/> IEC / EN	V AC	690	--
<input type="checkbox"/> UL / CSA	V AC	600	600
Max. rated current I_e (When several devices are used next to each other, it is essential to comply with the rated load factor according to EN 60439-1 (VDE 0660-500), Table 1.)			
<input type="checkbox"/> IEC / EN	A	32	--
<input type="checkbox"/> UL / CSA	A	30	30
Utilization categories			
<input type="checkbox"/> IEC / EN	AC-22B (500 V) AC-21B (690 V, 30 A) Can only be used as fuse holder		
<input type="checkbox"/> UL / CSA			
Rated conditional short-circuit current (Type-tested with fuse links, operational class gG)			
<input type="checkbox"/> IEC / EN	kA	100 (400 V, 500 V, 690 V)	--
<input type="checkbox"/> UL / CSA	kA	50 (600 V)	200
For fuse links with power losses per phase	W	3	--
Screwless wire connections			
<input type="checkbox"/> IEC / EN	mm ²	Cu 1.5 ... 6 (f)	
<input type="checkbox"/> UL / CSA	AWG	16 ... 10 (str)	

Technical specifications of bus-mounting switch disconnectors with fuses

		5SG7230	5SG7234-1 5SG7234-2
Standards		HD 60269-3 (VDE 0636-3), IEC 60269-3, EN 60947-3 (VDE 0660-107), IEC 60947-3	
Approvals		VDE, EAC	
Size		D02 (D01)	D02
Rated frequency	Hz	50 / 60	
Rated voltage U_e			
	V AC	400	400
	V DC	110	--
Rated insulation voltage U_i	V	800	500
Rated impulse withstand voltage U_{imp}	kV	6	6
Rated current I_e	A	63 ¹⁾	63 ²⁾
Utilization categories			
(Type-tested with 3-pole, switchable version)		AC-23A (400 V)	AC-22 B (400 V)
		DC-21B (48 V), 1-pole	
		DC-21B (110 V), 2-pole	
Box terminals for wire connection			
	mm ²	Cu 1.5 ... 6 (re)	Cu 1.5 ... 6 (re)
	mm ²	Cu 1.5 ... 16 (f)	Cu 1.5 ... 16 (f)
	mm ²	Cu 1.5 ... 16 (f+AE)	Cu 1.5 ... 16 (f+AE)
Signaling switches for the display of switching positions		1 CO contact	LED signal detector (5SG7234-2)
Cable terminals		Bottom	On side (right)
Busbar thickness	mm	Through combination foot for 5, 10 mm	
Rated conditional short-circuit current (Type-tested with fuse links of operational class gG)			
	kA AC	50	50
	kA DC	8	--
Permissible power loss of fuse links per phase			
For stand-alone operation without lateral modules or for group operation with lateral modules	W	5.5	5.5
Material		Temperature-resistant up to min. 125 °C, self-extinguishing acc. to UL 94, min. creepage resistance CTI 125	Temperature-resistant up to min. 120 °C, self-extinguishing acc. to UL 94, min. creepage resistance CTI 200

1) In the case of permanent load over 35 A, we recommend the use of 5SH5526 lateral modules. Please observe EN 60439-1, Table 1.

2) In the case of permanent load over 35 A, we recommend the use of 5SH5533 lateral modules. Please observe EN 60439-1, Table 1.

4.6 Device adapters and device holders

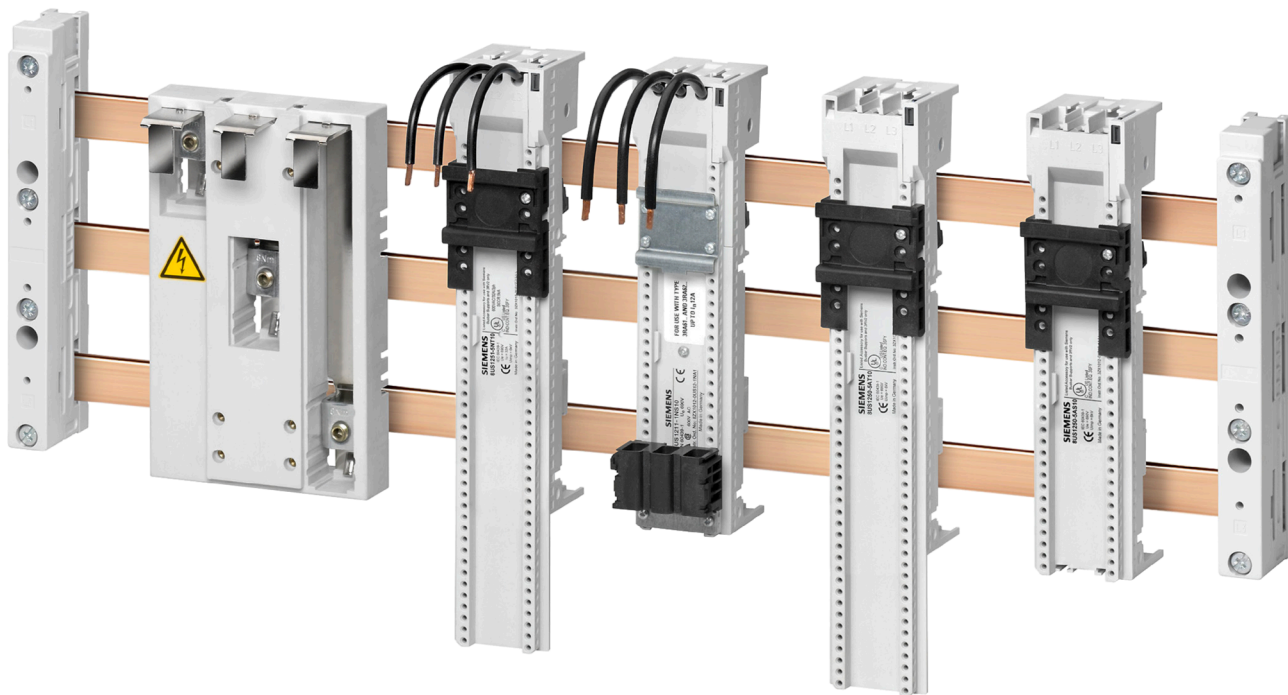

Figure 4-6 60 mm busbar system: Busbar device adapters and device holders

All busbar device adapters and device holders are designed for copper busbars according to DIN 46433, width 12 to 30 mm, thickness 5 mm and 10 mm, and special profiles up to 1600 A.

Index

1

- 100 mm busbar system
 - Characteristic curve, 12
- 185 mm busbar system
 - Characteristic curve, 13

6

- 60 mm busbar systems
 - Characteristic curve, 12
- 60 mm compact busbar system
 - Benefits, 17

A

- Applications
 - Busbar systems, 8

B

- Benefits
 - 60 mm compact busbar system, 17
 - Busbar systems, 8
- Busbar systems
 - Applications, 8
 - Benefits, 8
 - Design, 8
 - Function, 8
- Bus-mounting bases
 - Technical specifications, 19, 27
- Bus-mounting fuse holders
 - Technical specifications, 28
- Bus-mounting switch disconnectors with fuses
 - Technical specifications, 29

C

- Characteristic curve
 - 100 mm busbar system, 12
 - 185 mm busbar system, 13
 - 60 mm busbar systems, 12

D

- Design
 - Busbar systems, 8

F

- Function
 - Busbar systems, 8
- Fuses
 - Permanent load, 20

P

- Permanent load
 - Fuses, 20
- Planning dimensions, 26

S

- Short-circuit strength, 8
 - UL applications, 15
- SIRIUS
 - Motor starter combinations, 22

T

- Technical specifications
 - Bus-mounting bases, 19, 27
 - Bus-mounting fuse holders, 28
 - Bus-mounting switch disconnectors with fuses, 29

U

- UL applications
 - Short-circuit strength, 15

Further Information

Always at your disposal: our extensive support
www.siemens.com/online-support

Siemens AG
Smart Infrastructure
Low Voltage Products
Postfach 10 09 53
93009 REGENSBURG
Germany

Subject to change.

© Siemens AG 2019

