

SIEMENS

SIWAREX[®] CF

Device Manual

Status 06/2008



Warning and Safety Terms

This manual contains notices that are for your personal safety and to prevent damage to devices or surroundings. These notices are indicated by a warning triangle and are presented as follows depending on the degree of danger:



Danger

Means that failure to take the necessary safety precautions **will** result in death, serious injury and/or considerable property damage.



Warning

Means that death, severe injury or serious material damage **can** result if the corresponding safety precautions are not followed carefully.



Caution

Means that material damage or minor injuries can result if the corresponding safety precautions are not followed carefully.

Caution

Means that material damage can result if the corresponding safety precautions are not followed carefully.

Attention

Refers to important information on the product, handling of a product or a corresponding segment of the documentation to which special attention should be given.

Qualified Personnel

Commissioning and operation of a device may only be performed by **qualified personnel**. Qualified personnel as indicated in the safety information in this manual are people that have the authorization to install, ground and label devices, systems and power circuits.

Intended Utilization



Warning

The device may only be utilized for the applications described in the catalog and the technical description and only in conjunction with external devices and components that are approved or recommended by Siemens.

Fault-free and safe operation of the product depend on proper transport, proper storage, assembly, installation, operation and maintenance.

Brand names / Trademarks

SIWAREX®, SIMATIC®, SIMATIC HMI® are registered trade marks of Siemens AG. The other designations in this info may be trade marks the use of which by third persons for their own purposes might infringe proprietor rights.

Copyright © Siemens AG 2005 All rights reserved

Circulation or duplication of this document, utilization and disclosure of its contents are not permitted unless explicitly approved. Offenders will be liable for damages. All rights reserved, including rights created by granting of patents or registration of a utility model or design.

Siemens AG
Automation & Drives Dept.
SIWAREX Weighing Systems
A&D PI 14
Östliche Rheinbrückenstr. 50
D-76187 Karlsruhe

Disclaimer

We have tested the contents of this document for compatibility with the hardware and software described. This does not exclude the possibility of discrepancies, in which case we do not guarantee the complete compatibility of this document. The information in this document is assessed regularly and any necessary corrections are included in the next revision. We are grateful for any suggestions for improvement.

© Siemens AG 2005
Subject to change without notice.

SIWAREX CF

Force measurement module for ET 200S

Device Manual

Issue 06/2008

<u>Safety Instructions</u>	
<u>Table of Contents</u>	
Preface	1
Scope of Delivery	2
Product Overview	3
Hardware Configuration and Assembly	4
Measuring Function	5
Programming in SIMATIC STEP 7	6
Accessories	7
Technical Data	8
Index	9
Abbreviations	10

Contents

1 Preface	1-1
1.1 PURPOSE OF MANUAL	1-1
1.2 BASIC KNOWLEDGE REQUIRED	1-1
1.3 SCOPE OF MANUAL	1-1
1.4 FURTHER SUPPORT	1-2
2 Scope of Delivery	2-3
2.1 SCOPE OF DELIVERY	2-3
2.2 RELEASED HEAD MODULES	2-3
3 Product Overview	3-4
3.1 GENERAL	3-4
3.2 AREA OF APPLICATION	3-4
3.3 STRUCTURE	3-4
3.4 FUNCTION	3-5
3.5 SYSTEM INTEGRATION IN SIMATIC	3-5
4 Hardware Configuration and Assembly	4-7
4.1 INSTALLATION IN SIMATIC	4-8
4.2 STRUCTURE TO EMC GUIDELINES	4-8
4.2.1 Definition: EMC	4-8
4.2.2 Introduction	4-8
4.2.3 Possible Effects of Interference	4-8
4.2.4 Coupling Mechanisms	4-9
4.2.5 Five Basic Rules for Guaranteeing EMC	4-9
4.3 ASSEMBLY	4-10
4.4 CONNECTION AND WIRING	4-11
4.4.1 Connection areas for SIWAREX CF	4-11
4.4.2 Shielding connection	4-11
4.4.3 Connection of 24 V Power Supply	4-12
4.4.4 Connecting the FORCE Sensor	4-12
4.4.5 LED Display Elements	4-14
4.5 PREPARING FOR OPERATION	4-15
4.6 USE FOR POTENTIALLY EXPLOSIVE AREA	4-16
5 Measuring Function	5-18
5.1 GENERAL	5-18
5.2 SIGNAL PATH	5-18
5.2.1 Signal processing	5-18
5.2.2 Characteristic value range	5-18
5.2.3 Low-pass filter	5-19
5.2.4 Status display	5-19
5.2.5 Group diagnosis in the SIMATIC-CPU	5-19
5.3 MESSAGES VIA LEDs	5-19
6 Programming in SIMATIC STEP 7	6-20
6.1 GENERAL	6-20
6.2 SIWAREX CF IN HW-CONFIG	6-20
6.3 SIWAREX CF IS CYCLIC STEP 7 – PROGRAM	6-20
7 Accessories	7-22
8 Technical Data	8-23
8.1 24 V POWER SUPPLY	8-23
8.2 POWER SUPPLY FROM THE ET 200S BACKPLANE BUS	8-23
8.3 STRAIN GAUGE MEASUREMENT INPUT	8-23
8.4 DIMENSIONS AND WEIGHT	8-24
8.5 ENVIRONMENTAL CONDITIONS	8-24
8.6 MECHANICAL REQUIREMENTS AND DATA	8-24
8.7 ELECTRICAL-, EMC AND CLIMATIC REQUIREMENTS	8-25
8.7.1 Electrical protection and safety requirements	8-25

8.7.2	<i>Electromagnetic Compatibility</i>	8-26
8.7.3	<i>Climatic Requirements</i>	8-27
9	Index	9-28
10	Abbreviations	10-29

Images

FIGURE 3-1	SYSTEM OVERVIEW	3-5
FIGURE 3-2	TYPICAL CONFIGURATION OF SIMATIC S7 WITH SIWAREX CF.....	3-6
FIGURE 4-1	SIWAREX CF CONNECTION AREAS	4-11
FIGURE 4-2	ASSEMBLY OF SHIELD CLAMPS.....	4-12
FIGURE 4-3	SENSOR CONNECTIONS (4-WIRE SYSTEM).....	4-14
FIGURE 5-1	CHARACTERISTIC CURVE FOR SIGNAL CONVERSION.....	5-18
FIGURE 6-1	MEASURING VALUE DISPLAY IN TP 270	6-21

Tables

TABLE 1-1	SCOPE OF MANUAL	1-1
TABLE 1-2	OVERVIEW OF CHAPTER.....	1-2
TABLE 4-1	CONNECTING THE FORCE SENSOR TO SIWAREX CF	4-13
TABLE 4-2	DISPLAY ELEMENTS (LED)	4-14
TABLE 5-1	STATUS INFORMATION	5-19
TABLE 5-2	LIST OF LED MESSAGES	5-19
TABLE 6-1	PERIPHERAL AREA OCCUPATION.....	6-20
TABLE 8-1	DATA: POWER SUPPLY 24 V	8-23
TABLE 8-2	DATA: POWER SUPPLY FROM THE ET 200S BACKPLANE BUS.....	8-23
TABLE 8-3	DATA: SENSOR CONNECTION.....	8-23
TABLE 8-4	DATA: DIMENSIONS AND WEIGHT	8-24
TABLE 8-5	DATA: AMBIENT CONDITIONS.....	8-24
TABLE 8-6	DATA: MECHANICAL REQUIREMENTS.....	8-24
TABLE 8-7	DATA: ELECTR. PROT.- AND SAFETY REQUIREMENTS	8-26
TABLE 8-8	DATA: ELECTROMAGNETIC COMPATIBILITY	8-27
TABLE 8-9	DATA: CLIMATIC REQUIREMENTS	8-27

1 Preface

1.1 Purpose of Manual

All of the information for assembling and operating the SIWAREX CF Force module is contained in this manual.

1.2 Basic Knowledge Required

To understand this manual, a general knowledge of SIMATIC automation technology is required. Knowledge of measuring technology is also of advantage.

1.3 Scope of Manual

This manual applies to the SIWAREX CF - Module:

Type	Name	Order number	From product revision (Version)	
SIWAREX CF	SIWAREX Compact Force Measurement	7MH4920-0AA01	HW V. 2	FW V. 1.0

Table 1-1 Scope of Manual

Note

The manual describes the SIWAREX CF Force module as a part of the SIMATIC ET 200S system and is to be used along with the manual for the ET 200S.

Note

This manual contains the description of the module that is valid at the time of release.

We reserve the right to supply new modules or newer versions of modules with product information containing current information about the module.

Preface

The layout of this manual is based on activities that must be performed as part of configuration, commissioning, operation and service / maintenance.

Chapter	Description of Content
<i>1 Preface</i>	Notes on using this manual
<i>2 Scope of Delivery</i>	Description of the SIWAREX CF delivery contents.
<i>3 Preface</i>	Overview of -Structure - Functionality - System integration of SIWAREX CF.
<i>4 Hardware Configuration and Assembly</i>	Description - of individual hardware components - of structure and installation - of connections - of preparations for operation.
<i>5 Measuring Function</i>	Measuring Function descriptions.
<i>6 Programming in SIMATIC STEP 7</i>	Description of data exchange with the SIMATIC CPU.
<i>7 Accessories</i>	Order information for optional components.
<i>8 Technical Data</i>	Technical Data
<i>9 Index</i>	Index
<i>10 Abbreviations</i>	List of Abbreviations

Table 1-2 Overview of Chapter

1.4 Further Support

Do you still have questions concerning the use of the SIWAREX CF? Then please contact your Siemens representative in the office or business location that is responsible for your area or technical support for SIWAREX
Tel.: +49 (0)721 595 2811.

Current information concerning SIWAREX force measurement can be found on the Internet site.

<http://www.siwarex.com>

2 Scope of Delivery

2.1 Scope of Delivery

Included in the scope of delivery of the SIWAREX CF is the declaration of conformity from the manufacturer and a supplementary sheet containing up-to-date information on the product.

For the first steps of programming, the “Getting Started” software is very useful. The device manual and the example software “SIWAREX CF Getting started” can be obtained free of charge via the Internet www.siwarex.com (support).

Any necessary or optional accessories are detailed in chapter [7 Accessories](#).

2.2 Released head modules

SIWAREX CF can be operated with the following head modules:

- IM 151-1 HF Order number 6ES7 151-1BA00-0AB0 onward
- IM 151-1 BASIC Order number 6ES7 151-1CA00-0AB0 onward
- IM 151-1 STANDARD Order number 6ES7 151-1AA02-0AB0 onward

3 Product Overview

3.1 General

SIWAREX CF (Compact Force) is a measuring module for the FORCE sensors (e.g. force measurement), which can be used anywhere that measurements should be made in the ET 200S automation system.

The function module (FM) SIWAREX CF can be used in SIMATIC ET 200S and puts all features of the modern automation system, such as the peripheral communication, the diagnostics system and the configuration tools to good use.

Customer benefits:

SIWAREX CF is characterized by a few clear advantages:

- Standardized connection technology and integrated communication due to use in SIMATIC ET 200S
- Uniform configuration with the SIMATIC Manager
- Use in a decentralized system concept through connection to PROFIBUS DP via ET 200S
- Bi-directional force measurement with a resolution of 14 bits plus the sign
- Accuracy 0.15 %
- High measuring rate of 50 Hz
- Flexible adaptation to different requirements with SIMATIC control
- Diagnostic functions

3.2 Area of Application

SIWAREX CF is the optimal solution wherever signals need to be detected from FORCE sensors.

SIWAREX CF is suitable for the following applications:

- Measurement of crane and cable loads and other force measurements
- Load measurements in industrial lifts or rolling mills
- Belt tensioning measuring equipment
- More applications with STRAIN GAUGE full bridge as sensor

3.3 Structure

SIWAREX CF is a function module (FM) of SIMATIC ET 200S and can be directly attached in a terminal module. The installation and cabling for the 30 mm wide module is minimal. Sensor connections are made through the terminal module.

Product Overview

Force measurement can be completely integrated into the automation system with SIWAREX CF operation in SIMATIC.

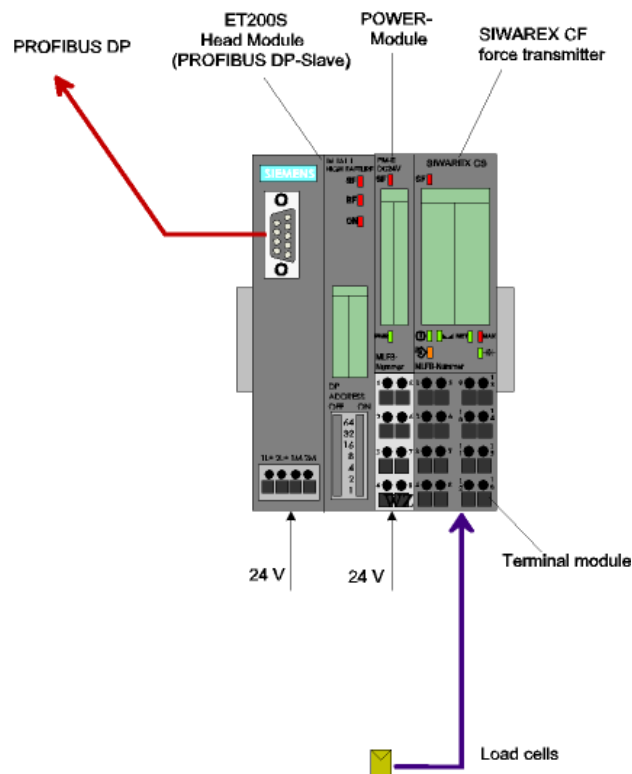

Figure 3-1 System Overview

3.4 Function

The primary task of the SIWAREX CF consists of measuring the actual sensor signals. Integration into SIMATIC enables the processing of converted measurement values directly in the PLC. The actual measurement value is read through the peripheral area.

3.5 System Integration in SIMATIC

SIWAREX CF is a component of the SIMATIC ET 200S. You are therefore completely free in the automation solution configuration. Respective combinations of SIMATIC components enables optimal solutions in different systems. The following figure shows a typical setup for a medium sized system.

Product Overview

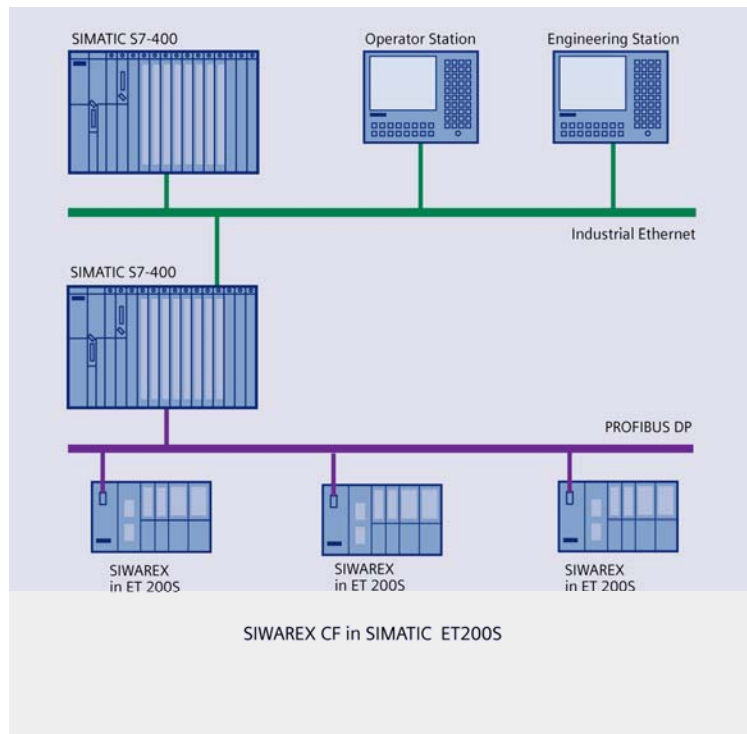

Figure 3-2 Typical configuration of SIMATIC S7 with SIWAREX CF

4 Hardware Configuration and Assembly



Warning Notes

During planning, assembly and commissioning, the specifications defined in the manual for the ET 200S decentralized peripherals system apply. This chapter contains additional information on hardware configuration, assembly and preparations for operating the SIWAREX CF.

The technical safety information is to be strictly adhered to.



Warning

Unqualified intervention in the device/system or not adhering to the warning notices can result in serious injury or damage to equipment. Only qualified personnel are permitted to access the operational components of this device / system.



Warning

The unit has been developed, manufactured, tested and documented in accordance with the corresponding safety standards. The device itself will not cause any danger to equipment or personal health under normal circumstances.



Danger

Commissioning is not permitted until it is guaranteed that the machine in which these components are to be integrated meets with the guidelines in 89/392/EWG.

4.1 Installation in SIMATIC

SIWAREX CF is a 30 mm wide function module (FM) in the ET 200S decentralized peripheral automation system. It can be plugged into terminal modules that are designed for double-wide function modules (see chapter [7 Accessories](#)).

Every SIWAREX CF requires 8 bytes from the peripheral area of the head module. Maximum expansion can be determined with this information and using the manual for the ET 200S decentralized peripherals system. Depending on the head station, the maximum expansion for SIWAREX CF can be from 11 to 30 SIWAREX CF per head station.

The selection of the suitable head station ET 200S, the SIMATIC master CPU, the SIMATIC HMI (Human Machine Interface) is determined according to the overall assignment of the automation system.

4.2 Structure to EMC Guidelines

SIWAREX CF is a measuring device which is to dependably measure the slightest signal. Because of this, proper assembly and wiring are absolutely essential for fault-free operation.

4.2.1 Definition: EMC

EMC (Electromagnetic Compatibility) describes the ability of an electrical device to function without faults in a defined electromagnetic environment without being influenced by its surroundings and without negatively influencing the surroundings.

4.2.2 Introduction

Although SIWAREX CF was developed for use in industrial environments and meets high EMC specifications, you should carry out EMC planning before installing your controller to determine and take into account any possible interference sources.

4.2.3 Possible Effects of Interference

Electromagnetic interference can influence the automation system and the SIWAREX CF in various ways:

- Electromagnetic fields that have a direct influence on the system
- Interference that infiltrates the environment through bus signals (PROFIBUS DP etc.)
- Interference through process cabling (e.g. measurement lines)
- Interference infiltrating the system through the power supply and/or protective ground

Interference can impair the fault-free functioning of the SIWAREX CF.

4.2.4 Coupling Mechanisms

Depending on the means of distribution (conductive or non-conductive bound) and the distance between the interference source and the device, interference can be introduced into the automation system through four different coupling mechanisms.

Galvanic coupling

Capacitive coupling

Inductive coupling

Radiation coupling

4.2.5 Five Basic Rules for Guaranteeing EMC

If you follow these five basic rules, EMC can be guaranteed in most cases!

Rule 1: Large surface area grounding connection

Ensure that while installing the automation devices, a well-made large surface area ground connection is made between the inactive metal components (see following sections).

Connect all inactive metal components and low-impedance components with ground (broad cross-section).

Use screwed connections on painted or anodized metal surfaces either with special contact washers or remove the insulated protective surface at the contact points.

Do not use aluminum components for ground connections if at all possible. Aluminum oxidizes easily and is therefore less suitable for grounding connections.

Find a central location for connections between the grounding point and the ground wiring system.

Rule 2: Proper wiring

Separate the cabling into groups (high-voltage lines, power supply lines, signal lines, ground wiring, data lines etc.).

Run the high-voltage lines and ground wiring or data cables in separate channels or bundles.

Run measurement lines as close to grounding surfaces as possible (e. g. support beams, metal rails, cabinet panels).

Rule 3: Fixed cable shielding

Ensure that the cable shielding is connected properly.

The shielding of measurement lines must also be connected to ground at both ends.

The shielding should continue right up to the terminal connection. Unshielded cable ends should be kept as short as possible. Run cable shielding directly under the SIWAREX CF on the shielding channeling. The connection between the shielding rail and the cabinet/housing must be low impedance.

Rule 4: Special EMC measures

All inductivity to be controlled should be connected with suppressors.

To light up the cabinets and housings in the immediate area around your controller, incandescent lamps or suppressed fluorescent lighting should be used.

Rule 5: Uniform reference potential

Create a uniform reference potential and ground all electrical operational elements.

Run sufficiently dimensioned potential equalizing cabling if potential differences exist or are to be expected between system components in the system.

4.3 Assembly

When assembling the SIMATIC components and the SIWAREX CF, the installation, assembly and wiring guidelines for the SIMATIC ET 200S must be followed (see manual for ET 200S decentralized peripheral system).

This manual describes supplementary aspects of assembly and wiring that are specific to the SIWAREX CF.

4.4 Connection and Wiring

4.4.1 Connection areas for SIWAREX CF

All external connections are run through the terminal block.

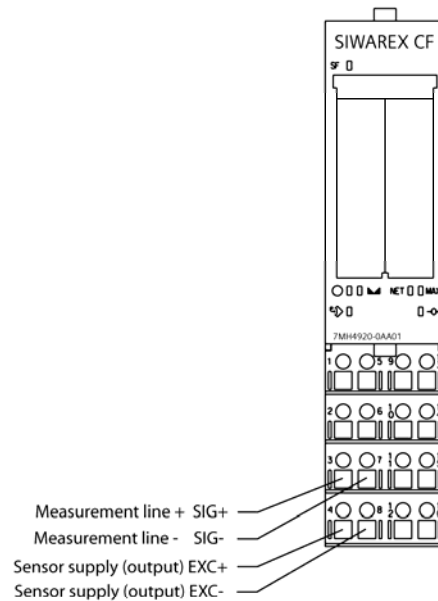

Figure 4-1 SIWAREX CF Connection areas

4.4.2 Shielding connection

Special attention must be given to the shield strip for the shielded lines. Only correct installation guarantees that the system will be immune to interference. A cable is shielded to decrease the affects of magnetic, electrical and electromagnetic interference on this line. Interference on cable shielding is routed to ground through shielding rails that are conductively connected with the housing. To ensure that this interference does not become a source of interference, a low impedance connection to ground is especially important.

Use only wires with braided shielding (see recommended cycle types in chapter [7 Accessories](#)).

To fasten the braided shielding, use only the proper metal cable clamps. The clamps must cover as much shielding as possible and ensure a good contact. Shield clamps must be ordered separately from the grounding elements. Approximately 1.5 cm of the cable insulation must be exposed in the area of the

cable to be fastened to the shielding clamp. The exposed shielding is then pressed firmly against the grounding element with the shielding clamp. The insulated cable shielding can then continue up to the terminal connection.

The following figure shows the assembly of the shield clamps.

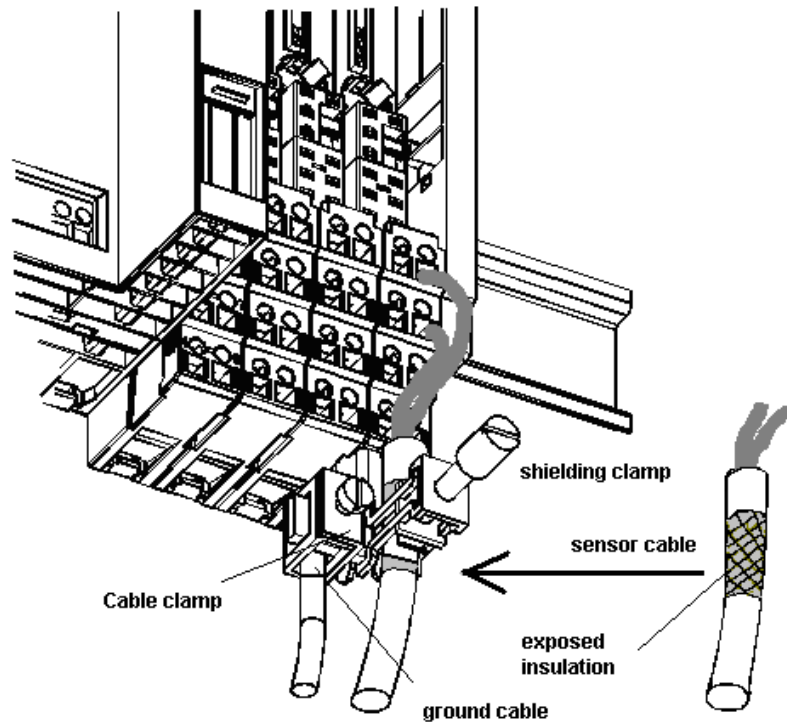

Figure 4-2 Assembly of Shield Clamps

The shielding should be pressed against the shielding rail by the screw in the shielding clamp.

4.4.3 Connection of 24 V Power Supply

The 24 V power supply is not connected directly to the terminal module for the SIWAREX CF module. The 24V connection runs from the power module. The power module supplies the SIWAREX CF via the power supply rail.

4.4.4 Connecting the FORCE Sensor

Measuring sensors can be connected to the SIWAREX CF fitted with strain gauges full bridge and meeting the following conditions (see also Technical Data – chapter [8.3](#)):

- Characteristic value 1.... 4 mV/V
- Permissible supply voltage of 6 V

Hardware Configuration and Assembly

The following rules are to be followed when connecting force sensors:

1. The cable shielding is always run to the cable gland on the extension box.

If there is a risk of potential equalization currents on the cable shielding, a potential equalization conductor should be run in parallel to the sensor cable.

3. Twisted pair cables should be used for the specified lines and should also be shielded:

- Measuring voltage lines (+) and (-)
- Supply voltage lines (+) and (-)

We recommend that the cables specified in chapter [7 Accessories](#) are used.

4. The shielding is to be attached to the shielding strip on the SIWAREX CF.

The maximum distance between the SIWAREX CF and the force sensor applies if using the recommended cable and shielded sensor e.g. from the SIWAREX R product series.

The power supply (6 V) for the force sensor is taken from the SIWAREX CF (terminals 4 and 8).

The connection should be made using the cable described in chapter [7 Accessories](#).

Connection in terminal block	Signal	Comment
3	SIG+	Measurement line +
7	SIG-	Measurement line -
4	EXC+	Output STRAIN GAUGE supply +
8	EXC-	Output STRAIN GAUGE supply -

Table 4-1 Connecting the FORCE sensor to SIWAREX CF

Caution

Means that material damage can result if the corresponding safety precautions are not followed carefully.

The connections that are not defined for connection on the terminal module of SIWAREX CF are not to be used.

The following figure shows the sensor connections (4-wire system).

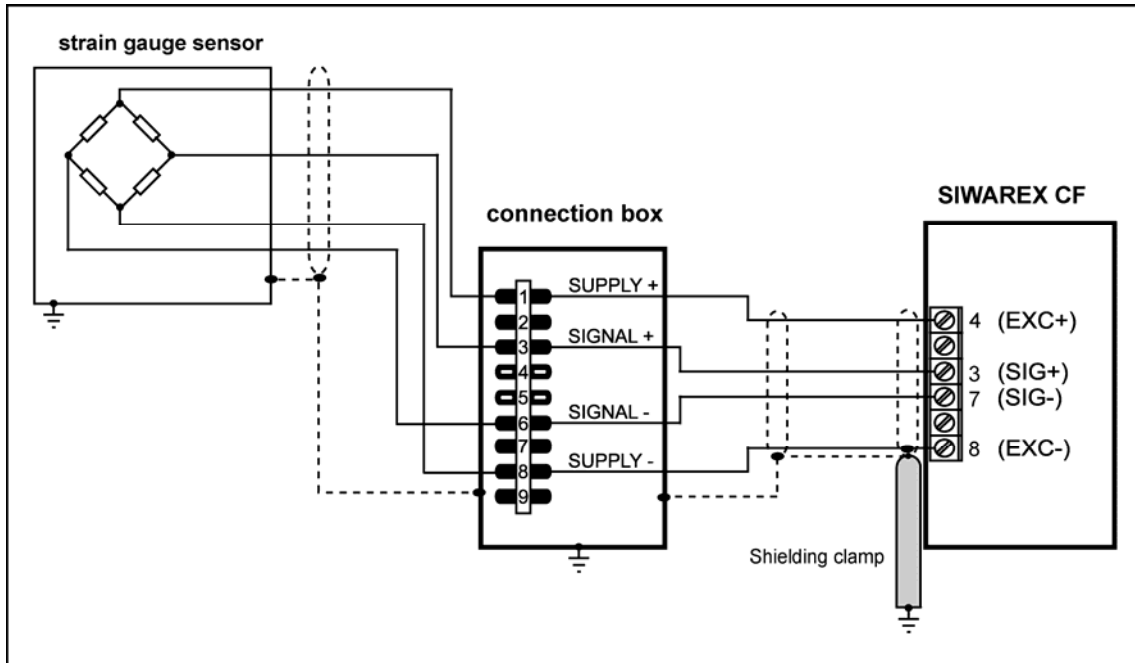

Figure 4-3 Sensor connections (4-wire system)

4.4.5 LED Display Elements

Label	LED color	LED	Description
SF	Red	LED 1	System Fault Hardware fault
ⓘ	Green	LED 2	RUN

Table 4-2 Display Elements (LED)

For further information about the LEDs, see chapter [5.3](#).

4.5 Preparing for Operation

Introduction

At this point in the commissioning procedure, after assembling the module group and making all connections, you should perform a partial functionality test for the SIWAREX CF and all connected components. The individual steps for partial testing are to be performed in the following sequence:

Visual check

Check all previously performed steps for proper execution:

- Does the SIWAREX CF have any external damage?
- Is the SIWAREX CF in the correct installation position?
- Are all connecting cables properly connected and fastened tightly?
- Is all shielding in place?
- Is the ground busbar connected to the ground bus?
- Is the U profile rail connected to the ground bus?
- Have all tools, materials or components that do not belong to the S7 or SIWAREX CF components removed from the modules?

Turn on 24 V

Turn on power supply on.

LED check on SIWAREX CF

After switching the 24V supply voltage on and a short initialization phase (internal tests), the SIWAREX CF goes into operational status. The following LEDs must have the status that is indicated below if the unit is running correctly:

LED (System Fault) --> OFF status
LED (RUN) --> ON status

For further information about the LEDs, see chapter [5.3](#).

4.6 Use for potentially explosive area



Danger

DANGER EXPLOSION

Exists when the installation and setup regulations are not adhered to.



For using the SIWAREX CF in areas with a risk of explosion, the important information in the „SIMATIC Automation Systems - Basics of Explosion protection (Doc.No. A5E00206200)“ must be observed!

Below you will find important information on the installation of the SIWAREX CF in a hazardous area.

SIWAREX CF may only be used under the conditions, which are specified in the appropriate certificates.

The SIWAREX CF can be used in Ex zone 2 (acc. to IEC/CENELEC, directive 94/9/EG).

In the following you find some details about the certificates ATEX (Europe) and UL (USA, Canada).

Certificate: ATEX:

Type Examination Certificate Number: ATEX Nr. KEMA 08ATEX0002 X



Please always observe the relevant safety instructions. These can be accessed on the Internet at

<http://support.automation.siemens.com/WW/view/en/29443327>

Certificate: c-UL-us haz. loc.

UL file number. USA: NRAG.E239877

UL file number Canada: NRAG7.E239877

Note to c-UL-us haz.loc:

Warning – Explosion Hazard – Do not disconnect while circuit is live unless area is known to be non-hazardous.

Hardware Configuration and Assembly

Warning – Explosion Hazard – Substitution of components may impair suitability for Class I, Division 2.

This equipment is suitable for use in Class I, Division 2, Groups A, B, C, D or non-hazardous locations only.

Connection from load cells to SIWAREX CF:

The SIWAREX CS can be connected with load cells in zone 1 or zone 2.

For a connection of load cells in zone 2 it is sufficient, that the load cells also have an approval for zone 2 and all associated directives as well as the installation instructions are respected.

For a connection of load cells in zone 1 load cells with the adequate approvals are needed and appropriate provisions according to the guidelines must ensure explosion protected operation. For example SIWAREX R load cells can be connected intrinsically safe via the Ex-Interface SIWAREX IS. The instructions for the Ex-Interface, the load cells and the ATEX as well as the c-UL-CSA directives have to be respected.

Installation and Maintenance:

Required connection and installation work must be performed by qualified personnel.

Repairs can only be carried out at the production location.

5 Measuring Function

5.1 General

The SIWAREX CF can be used as a measurement transmitter for force measurement. Converting the signal into a value is done in the module, further conversions can be performed by the SIMATIC software in the controller program.

5.2 Signal Path

5.2.1 Signal processing

The module provides the sensor with a voltage of 6 V DC. The measuring voltages generated in the sensor are transferred to the module. The analog signal is converted in the module to a value between $\pm 16,383$. Corresponding with the force characteristic-curve of the sensor, each value represents a force value from the range mentioned above. The user can perform respective conversions to physical units in the SIMATIC software and can then display the converted value.

5.2.2 Characteristic value range

SIWAREX CF can work with sensors having a characteristic value range up to 4 mV/V. Since the SIWAREX CF supplies the sensor with approx. 6 V, the sensor voltage is respectively up to approx. ± 24 mV.

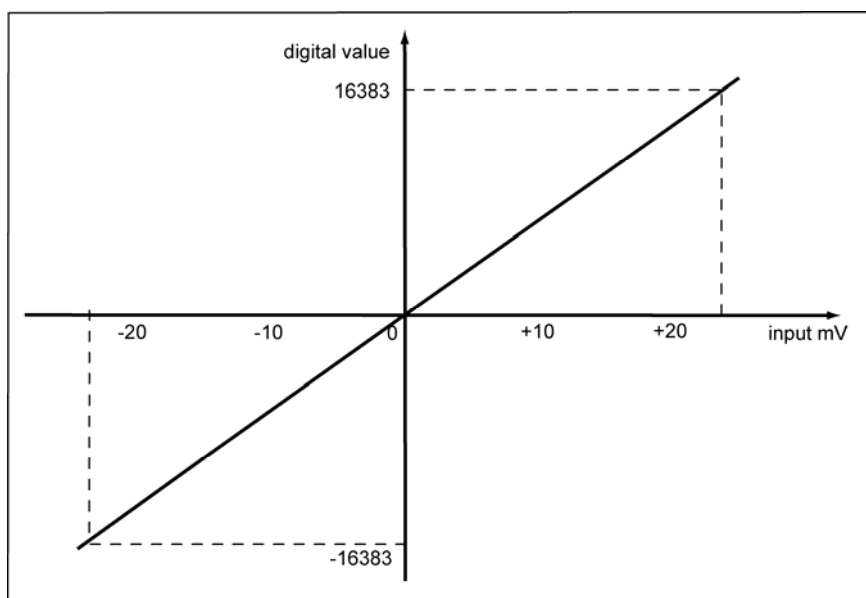

Figure 5-1 Characteristic curve for signal conversion

Measuring Function

5.2.3 Low-pass filter

A critically energized low-pass filter with a limit frequency of 2 Hz is provided for interference suppression. The value of the unfiltered and filtered signal are both provided to the peripheral interfaces of the module at the same time.

5.2.4 Status display

Besides the measuring value, the SIWAREX CF also has a status display. The status display provides information about possible faults.

Bit_No	Name	Range of Values / Meaning
0	RAM error	RAM memory is faulty
1	Watchdog Error	A reset was performed by the watchdog
2	ROM error	ROM memory is faulty
3	Operating error	General info operating error
4	Reserved	
5	Control limits exceeded	The voltages on the measuring input lies outside the permitted measuring range.
6	Reserved	
7	ADC error	The Analog Digital Converter delivers no plausible measuring value.

Table 5-1 Status Information

5.2.5 Group diagnosis in the SIMATIC-CPU

With particular head modules, operating messages (hardware faults) are detected in the SIMATIC CPU using diagnostic alarms.

5.3 Messages via LEDs

The LEDs on the front of the SIWAREX CF are used to signal the following status and error messages.

Label	LED color	LED	Description	State display during operation
SF	Red	LED 1	Error display System Fault (hardware fault, operating error)	OFF: No operating error ON: Operating error
	Green	LED 2	Status and error display RUN	OFF: Fatal error / defect ON: Module in cycle

Table 5-2 List of LED Messages

6 Programming in SIMATIC STEP 7

6.1 General

The SIWAREX CF was designed especially for operation in the SIMATIC ET 200S. The hardware setup is described in detail in chapter 4 Hardware Configuration.

The current GSD file for ET 200S can also be used for the configuration. It can be obtained from Customer Support via the Internet

<http://support.automation.siemens.com>.

An S7 example program – “Getting Started” is also available. The example program shows how application software can be created. We recommend using the example program and expanding it for different applications.

6.2 SIWAREX CF in HW-Config

Planning of the hardware configuration in SIMATIC Manager involves definition of the basic properties of the module:

- Peripheral address of the module
- Release of alarms

SIWAREX CF takes up 8 bytes in the input and output areas.

6.3 SIWAREX CF is cyclic STEP 7 – Program

The current values can also be read directly from the peripheral area. The following table shows the meaning of individual bytes.

Byte	Peripheral inputs	Peripheral outputs
0	unused	unused
1	Update counter	
2	Firmware version	
3	Status byte (s. Table 5-1 Status Information)	
4	Current measuring value 14 bits+sign filtered	
5	Current measuring value 14 bits+sign filtered	
6	Current measuring value 14 bits+sign unfiltered	
7	Current measuring value 14 bits+sign unfiltered	

Table 6-1 Peripheral area occupation

Programming in SIMATIC STEP 7

For cyclic operation, a single function module is used. It reads the current values from the peripheral area of the module (8 bytes) and puts them in a data module. Operation&Observation is performed very well with the TP 270.

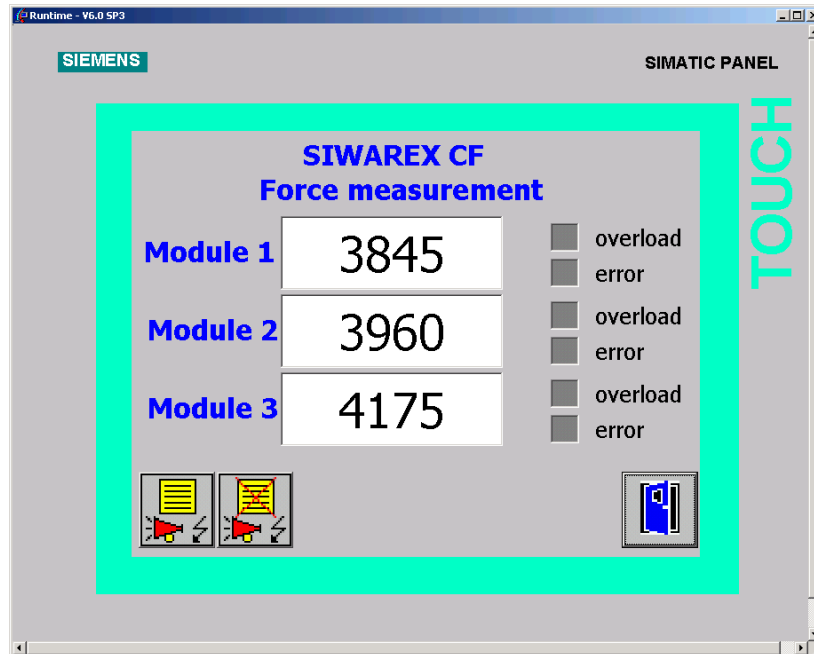

Figure 6-1 Measuring value display in TP 270

Warning

If a processing error occurs for the FC, you can assume that the measuring values that have been output do not correspond with the actual status in the module.

7 Accessories

There are necessary and optional accessories for the SIWAREX CF.

SIWAREX CF Force measurement module for SIMATIC ET 200S	7MH4 920-0AA01
SIWAREX CF Device Manual German, English	Free download from Internet*
SIWAREX CF “Getting Started” for STEP 7	Free download from Internet*
Installation material (necessary)	
Terminal module or similar TM-E 30mm wide (necessary for each module)	6ES7 193-4CG20-0AA0
Shielding contact rail Content 5 units	6ES7 193-4GA00-0AA0
Shielding connection clamp Content: 5 units	6ES7 193-4GB00-0AA0
N busbar, tin plated 3x10 mm 1.5 m long	8WA2842
Feed terminal for N busbar Other components for the ET200S decentralized peripheral system are listed in the CA01 catalog	8WA2868
Optional accessories	
SIWAREX EB expansion box for extending the sensor cable	7MH4 710-2AA
Cable Li2Y 1 x 2 x 0.75 ST + 2 x (2 x 0.34 ST) - CY for connecting a SIWAREX CF, extending box (EB) for stationary installation, occasional bending is possible 10.8 mm outer diameter for environmental temperatures –20 to +70°C	7MH4 702-8AG

*) <http://support.automation.siemens.com>.

8 Technical Data

8.1 24 V Power Supply

An isolated function low voltage (in accordance with EN60204-1) is to be ensured by the system power supply.

Rated voltage	DC 24 V feed from PM-E power module
Static upper / lower limits	DC 20.4 V/28.8V
Dynamic upper / lower limits	DC 18.5 V/30.2 V
Non-periodic over-voltages	DC 35 V for 500 msec with a recovery time of 50 sec.
Max. current consumption	100 mA
Typical module power loss	2.5 W

Table 8-1 Data: Power Supply 24 V

8.2 Power supply from the ET 200S backplane bus

Power consumption from ET 200S backplane bus	Typical < 10 mA
--	-----------------

Table 8-2 Data: Power supply from the ET 200S backplane bus

8.3 Strain Gauge measurement input

Error limit conforming to DIN1319-1 from measurement range end value at 20 °C ±10 K	≤ 0.15 %
Refresh rate	50 Hz
Resolution	+/- 16383 parts
Measuring range	0 to 4 mV/V
max. distance to sensor	300 m*
Sensor supply Voltage, Short-circuit proof	Typical DC 6 V *
Permitted sensor resistance	> 250 Ω < 4500 Ω
Common mode rejection CMRR @50 Hz	Typical 120 dB
Low pass filter limit frequency	2 Hz
Isolation	500 V (DC)

*If using the recommended cable (accessory) and sensor shielding

Table 8-3 Data: Sensor connection

8.4 Dimensions and Weight

Dimensions W x H x D	30 x 80 x 50 mm ³
Weight	75 g

Table 8-4 Data: Dimensions and Weight

8.5 Environmental conditions

The SIWAREX CF is designed to be used in SIMATIC ET 200S systems under the following conditions.

Usage conditions in accordance with IEC 60721:

Operation: IEC60721-3-3
Stationary use, weatherproof
Class 3M3, 3K3

Storage/Transport: IEC 60721-3-2
Transport packaged, no condensation
Class 2M2, 2K4

For use in extreme operating conditions (e. g. heavy dust, acidic vapors or gasses etc.), additional measures are to be taken such as e.g. Encapsulation

Table 8-5 Data: Ambient Conditions

8.6 Mechanical requirements and data

Testing	Standards	Test values
Vibration in operation	IEC 60068-2-6	<u>Testing Fc</u> 10 ... 58 Hz: 0.075 mm movement 58 ...150 Hz: 9.8 m/s ² 10 cycles per axis 1 octave / min.
Shock in operation	IEC 60068-2-27	<u>Test Ea</u> 150 m/s ² , Half sinus Duration: 11 ms Number: 3 per axis each in neg. and pos. direction
Vibration during transport	IEC 60068-2-6	<u>Testing Fc</u> 5 ... 9 Hz: 3.5 mm movement 9 ...500 Hz: 9.8 m/s ² 10 cycles per axis 1 octave / min.
Shock during transport	IEC 60068-2-29	<u>Testing Eb</u> 250 m/s ² , Half sinus Duration: 6 ms Number: 1000 per axis each
Free fall	IEC 68000-2-32	<u>Testing Ed</u> Height of fall 1m





Table 8-6 Data: Mechanical Requirements

8.7 Electrical-, EMC and climatic requirements

8.7.1 Electrical protection and safety requirements

Note:

The currently valid approvals for SIWAREX CS can be found on the SIWAREX CF rating plate.

	<p>Directives: 89/336/EEC "Electromagnetic Compatibility" 94/9/EC "Explosion protection" Note: Further information on EC directives can be found in the product documentation accompanying every SIWAREX CF.</p>
	<p>Underwriters Laboratories Inc. to UL 508 (Industrial Control Equipment) CSA C22.2 No. 142 (Process Control Equipment)</p>
	<p>Factory Mutual Research (FM) to Approval Standard Class Number 3611, 3600, 3810 APPROVED for use in Class I, Division 2, Group A, B, C, D T4; Class I, Zone 2, Group IIC T4</p>
	<p>Explosion protection to EN 60079-15: 2005 (Electrical apparatus for potentially explosive atmospheres; Type of protection "n") Class II 3 G EEx nA II T4 Note: For use of the SIWAREX CF in areas with a risk of explosion, the important information in the "ET 200S Decentralized Peripheral System" manual must be adhered to!</p>

The SIWAREX CF meets the following requirements:

Requirement met	Standards	Comments
Safety regulations	EN60204; DIN VDE 0113; IEC 61131-2; IEC61010-1, UL 508; CSA C22.2 No.142; FM class I, Div.2; UL/CSA	UL-/CSA-/FM
Protection class	Class I to IEC 60536	
IP protection	IP 20 to IEC 60529	<ul style="list-style-type: none"> • Protection against contact with standard test fingers • Protection against foreign bodies with diameters above

Technical Data

Requirement met	Standards	Comments
		12.5 mm • No special protection against water
Air and creepage distances	IEC 61131-2	Surge category II Pollution degree 2 Circuit board material IIIa Circuit track spacing 0.5 mm
Insulation resistance	IEC 61131-2:	The insulation resistance was demonstrated with a test voltage of 500V in the type test.
Material	SN 36350 (3.93)	

Table 8-7 Data: Electr. Prot.- and safety requirements

8.7.2 Electromagnetic Compatibility

Spurious transmission (industrial use): EN 61000-6-4		
Comments	Standard	Limit values
Emission of radio interference (electromagnetic fields)	IEC 61131-2	EN 55011 Class A, Group 1 30 – 230 MHz: < 40dB(μ V/m) Q 230-1000MHz: < 47dB(μ V/m) Q
Emission on power supply lines	IEC 61131-2	EN 55011 Class A, Group 1 EN 55014

Interference immunity (industrial use): EN 61000-6-2		
Comments	Standard	Degree of severity
Burst pulses on power supply lines:	IEC 61000-4-4 IEC 61131-2 NAMUR NE 21	2 kV
Burst pulses on data and signal lines:	IEC 61000-4-4 IEC 61131-2 NAMUR NE 21	2 kV Signal lines
Electrostatic discharge (ESD)	IEC 61000-4-2 NAMUR NE 21	6 kV
Electrostatic air discharge (ESD)	IEC 61000-4-2 NAMUR NE 21	8 kV
Surge on power supply lines	IEC 61000-4-5 NAMUR NE 21 IEC 61131-2	\pm 2 kV unsym.* \pm 1 kV sym.*
Surge on data and signal lines :	IEC 61000-4-5 NAMUR NE 21 IEC 61131-2	\pm 1 kV unsym. (to cable shielding)
HF irradiation (electromagnetic fields)	IEC 61000-4-3 IEC 61131-2 NAMUR NE 21	26 MHz to 1000 MHz: Up to 10 V/m (80% AM at 1 kHz) 900 MHz and 1.89 GHz Up to 10 V/m (50% PM)

Technical Data

Interference immunity (industrial use): EN 61000-6-2		
Comments	Standard	Degree of severity
		2.0 GHz – 2,7 GHz : 1V/m
HF current feed Data, signal and power supply lines	IEC 61000-4-3 IEC 61131-2 NAMUR NE 21	9 kHz – 80 MHz 10V (80% AM 1 kHz)

Table 8-8 Data: Electromagnetic Compatibility

* An external protection element should be fitted to meet the requirement (e. g.: Blitzductor VT AD24V, from Dehn&Söhne)

Attention

This is a class A device. In residential areas, this device can cause radio interference. In such areas, users must take suitable measures (e.g.: use in 8MC cabinets).

8.7.3 Climatic Requirements

Climatic requirements		
Comments	Environmental conditions	Application range
Operating temperature: Horizontal installation in ET 200S Other installation positions in ET 200S	0 to +60 °C 0 to +40 °C	
Storage and transport temperature	-40 to +70 °C	
Relative humidity	15 to 95 %	Without condensation, corresponds to relative humidity (RH) exposure level 2 in accordance with DIN IEC 61131- 2
Air pressure	from 1080 to 660 hPa	corresponds to an altitude of -1000 to 3500 m above sea level
Pollutant concentration	SO ₂ : < 0.5 ppm; Rel. humidity < 60 %, H ₂ S: < 0.1 ppm; Rel. humidity < 60 %,	No condensation

Table 8-9 Data: Climatic Requirements

9 Index

24 V Power Supply.....	4-12	LED.....	4-15
24 V supply	4-15	LED color	4-14, 5-19
4-wire system	4-14	LED Display Elements.....	4-14
Accessories.....	7-22	LED message list.....	5-19
Area of Application.....	3-4	Low Pass Filter	5-19
Assembly.....	4-7, 4-10	Measuring functions	5-18
Basic Knowledge.....	1-1	Message list.....	5-19
Benefits	3-4	Potential equalization conductor	4-13
Cable shielding.....	4-10	Power supply	4-15
Characteristic Value	5-18	Preface	1-1
Climatic requirements	8-27	Preparing for Operation	4-15
Commissioning, Preparation.....	4-15	Product Overview	3-4
Configuring.....	4-8	Programming in SIMATIC STEP 7	6-20
Connection	4-11	Scope of Delivery	2-3
Connection Areas.....	4-11	Shielding connection	4-11
Diagnostic alarms.....	5-19	Standards	8-25
Effects of Interference	4-8	Structure	3-4
Environmental conditions	8-27	Structure to EMC Guidelines.....	4-8
Example software.....	2-3	System Integration in SIMATIC	3-5
Function.....	3-5	Technical Data.....	8-23
Further Support	1-2	Test values	8-24
Hardware Configuration	v, 1-2, 4-7	Visual check.....	4-15
HW Config.....	6-20	Wiring.....	4-11
Internet Site.....	1-2		

10 Abbreviations

ADC	Analog-Digital-Converter
CPU	Central processing unit
DB	Data block
FC	STEP7 function call
FB	Function block (S7)
FM	Function module (for S7-300)
GSD	Device data file (for Profibus)
HMI	Human machine interface (SIMATIC Operator Panel)
HW	Hardware
LED	Light-emitting diode
MPI	Multi-Point-Interface
OD	Output Disable (S7)
OM	Object manager for STEP 7 objects
O&O	Operating and Observing
OP	Operator Panel (SIMATIC)
PC	Personal Computer
RAM	Random- access-memory (read-write memory)
ROM	Read Only Memory
S7-300	Siemens Automation System for the mid-performance-range
S7-400	Siemens Automation System for the high-level performance range
SFC	System Function Call (S7)
SG	Strain gauge
STEP 7	Programming device software for SIMATIC S7
TP	Touch Panel (SIMATIC)
UDT	Universal Data Table (S7)