

# SIEMENS



## Measuring Devices and Power Monitoring

SENTRON

Configu-  
ration  
Manual

Edition  
10/2015

[siemens.com/lowvoltage](http://siemens.com/lowvoltage)



## Measuring Devices and Power Monitoring



<sup>1)</sup> Manuals and other technical product information are available from Siemens Industry Online Support, directly at <https://support.industry.siemens.com/cs/de/en/view/109477872>

	<b>Power monitoring</b>
2	Energy management in accordance with ISO 50001
5	Hardware and software components
LV 10	powermanager
7	PC-based power monitoring system
9	SIMATIC-based power data management system
	<b>Measuring devices</b>
11	Introduction
	<b>7KM PAC measuring devices</b>
14	Introduction
15	Technical specifications and project planning aids
	7KM PAC expansion modules
34	- Expansion module SWITCHED ETHERNET PROFINET
35	- Expansion module 7KM PAC PROFIBUS DP
36	- Expansion module 7KM PAC RS 485
37	- Expansion module 7KM PAC 4DI/2DO
SIOS <sup>1)</sup>	7KM PAC5100 measuring devices
SIOS <sup>1)</sup>	7KM PAC5200 measuring devices
	<b>7KT PAC measuring devices</b>
38	7KT PAC1500 three-phase measuring devices
41	7KT PAC1500 single-phase measuring devices
44	7KT PAC expansion modules
45	7KT PAC3000 measuring device
48	7KT LAN couplers
	<b>Other measuring devices</b>
51	Digital voltmeters and ammeters
53	Time and pulse counters for standard rail mounting
55	Time counters for front-panel mounting
	<b>Accessories</b>
56	4NC current transformers
58	7KT12 current transformers
59	7KT90 measuring selector switches

### For further technical product information:

Siemens Industry Online Support:  
[www.siemens.com/lowvoltage/product-support](http://www.siemens.com/lowvoltage/product-support)

→ Entry type:  
 Application example  
 Certificate  
 Characteristic  
 Download  
 FAQ  
 Manual  
 Product note  
 Software archive  
 Technical data

# Measuring Devices and Power Monitoring

## Power Monitoring

### Energy management in accordance with ISO 50001

#### Overview

##### **A systematic approach to energy efficiency**

The standard ISO 50001 supports companies with a specific process description for introducing a corporate energy management system. Standard-compliant energy management optimizes energy utilization, while continuously enhancing energy efficiency.

##### **Defining energy policy objectives**

A central management task is the formulation of an in-house energy policy. It defines relevant strategic and operational objectives. Ongoing planning will include the identification of additional optimization potential for the business areas under scrutiny, and the development of relevant improvement measures.

##### **Introducing process optimization**

As a first step, an energy manager must be identified and nominated. He will then evaluate captured data, and derive and implement appropriate optimization measures. He will report the achieved results to corporate management.

##### **Making energy flows transparent**

As a second step, basic energy consumption and cost data, as well as information on in-house energy production, must be collected and documented clearly and verifiably. This requires the development of a reliable and precise system for the capture and analysis of consumption data. The objective is to recognize sustainable savings potential, to derive appropriate measures for that potential, and to implement these measures systematically.

##### **Periodic controlling**

Periodic checks will ensure that your energy management system functions correctly, and that objectives are reached. Corrective and preventative measures can then be implemented as needed.

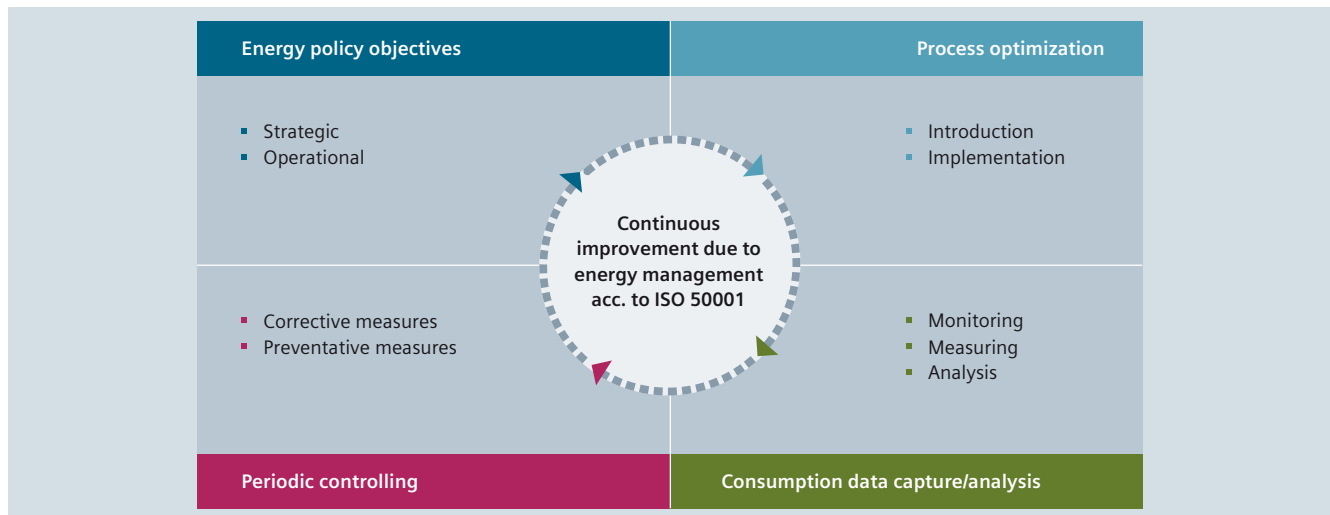

Introduction of a corporate energy management system in accordance with ISO 50001 for continuous improvement of energy efficiency by reducing energy consumption and costs.

### Providing the basis with power monitoring

The power monitoring system from the SENTRON portfolio is suitable for infrastructure, industrial applications, and buildings. The 7KT/7KM PAC measuring devices record the data of outgoing feeders or individual loads.

The 3WL/3VA/3VL circuit breakers supply measured values and important information for diagnostics, fault detection, and maintenance via standardized bus systems.

With the powermanager power monitoring software, the recorded measured values can be easily visualized, analyzed, archived, and monitored.

Recording of generated energy using measuring devices in MID version

Derivation of optimization measures through transparency of the energy flows

Increased availability of energy through monitoring of critical states in the power supply

Increased system availability through continuous monitoring of switching states

Increased productivity through optimization of energy consumption and energy costs

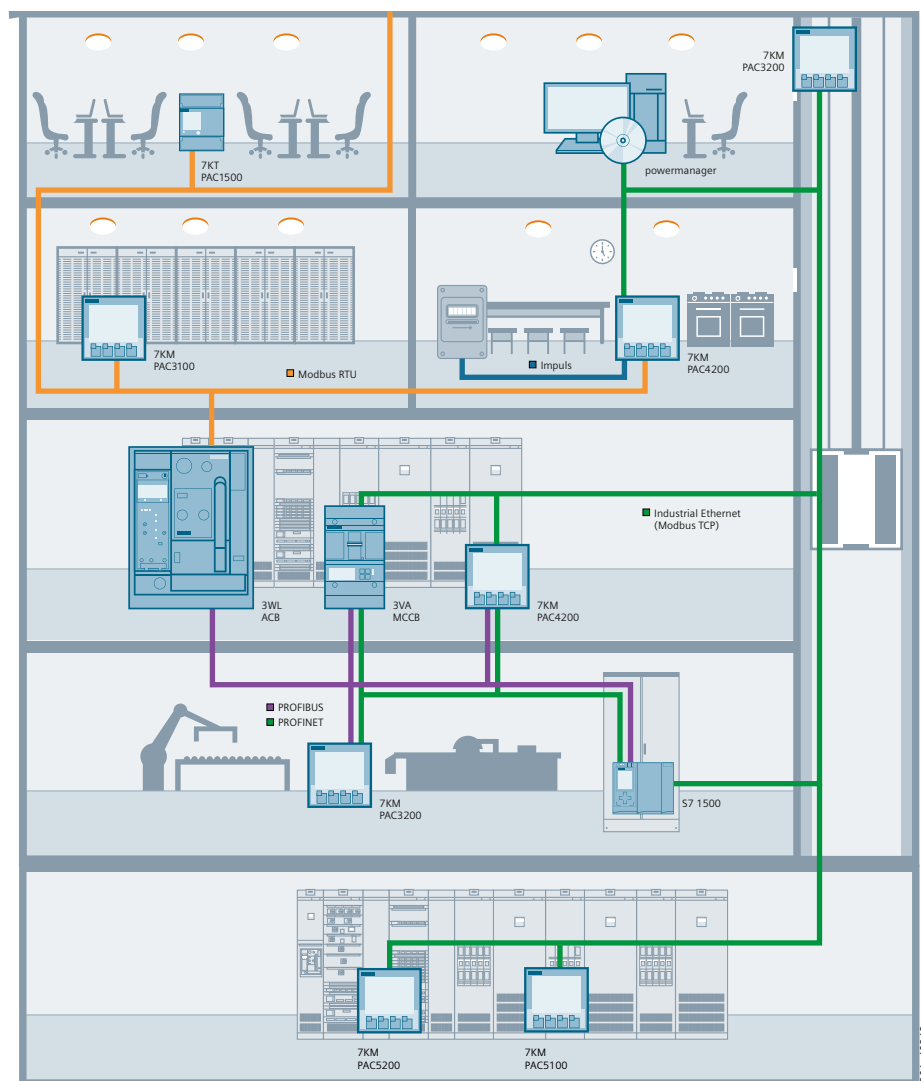

## Measuring Devices and Power Monitoring

### Power Monitoring

#### Energy management in accordance with ISO 5001

##### *Continuously increasing energy efficiency*

###### Precise cost center accounting for consumers



- Precise allocation of energy costs to cost centers
- Benchmarking between different cost centers
- Increased energy awareness

###### Detection of energy guzzlers, reduction of load peaks



- Detection of energy-intensive processes and loads
- Cost savings created by amending the power supply agreement
- Tax savings by seamless documentation of application-specific consumption

###### Protection of sensitive areas for high plant safety



- Avoidance of equipment failures due to overload
- Protection of sensitive devices against harmonics
- Early intervention possible by means of notifications

###### Monitoring of protective devices for high system availability



- Increased system availability
- Optimization of maintenance
- Fast response to service call-outs







###### Multi-site power monitoring



- Centralized, multi-site power monitoring via standard IT networks
- Benchmarking of various corporate units increases energy awareness
- Improvement of power supply conditions by bundling supply volumes

### Overview

#### 7KT PAC and 7KM PAC measuring devices and 3VA molded case circuit breakers with ETUs of the 8-series

	7KT PAC1500	7KM PAC3100	7KM PAC3200	7KM PAC4200	7KM PAC5100	7KM PAC5200	3VA ETU8..
							
	The entry-level solution when it comes to energy measurement	The cost-effective solution for digital measurement	The specialist solution for precise energy measurement	The professional solution for communication/monitoring	The specialist solution for measured value recording	The expert solution for power supply quality	The specialist solution for protection and energy measurement
<b>Measuring range/connection</b>							
Max. input voltage L-L/L-N	400 V/230 V	480 V/276 V	690 V/400 V <sup>1)</sup>	690 V/400 V <sup>1)</sup>	690 V/400 V	690 V/400 V	690 V/400 V <sup>1)</sup>
Transformer connection version	x/5 A	x/5 A	x/1 A/x/5 A	x/1 A/x/5 A	x/1 A/x/5 A	x/1 A/x/5 A	Integrated
Direct connection version	80 A/125 A	–	–	–	–	–	–
DC power supply unit with extra-low voltage version	–	–	22 ... 65 V	22 ... 65 V	–	–	24 V
Single-phase counter version	✓	–	–	–	–	–	–
Electrically isolated voltage inputs	–	–	–	–	✓	✓	–
Version without display (with web server)	–	–	–	–	✓	✓	–
<b>Measured quantities</b>							
Voltage, current, power, frequency, power factor	✓ <sup>2)</sup>	✓	✓	✓	✓	✓	✓
<b>Energy measurement</b>							
• Apparent, active, reactive energy	–   ✓   ✓	–   ✓   ✓	✓   ✓   ✓	✓   ✓   ✓	✓   ✓   ✓	✓   ✓   ✓	✓   ✓   ✓
<b>Extended measured quantities</b>							
• Distortion factor THD (voltage, current)	–	–	✓ <sup>3)</sup>	✓	✓	✓	✓
• Harmonics (voltage, current)	–	–	–	3 ... 31.	2 ... 40.	2 ... 40.	–
• Phase angle/phase chart	–	–	–	✓	✓	✓	–
• Load profile record with time stamp for min/max values	–	–	–	✓	–	✓	✓
• Flicker acc. to IEC 61000-4-15	–	–	–	–	–	✓	–
<b>Monitoring functions</b>							
Operating hours counter	–	–	✓	✓	–	–	✓
Limit monitoring	–	–	✓	✓	✓	✓	✓
Logic functions	–	–	✓	✓	✓	✓	–
Event log	–	–	–	> 4000 events	✓	✓	✓
Gateway function	–	–	–	✓	✓	✓	–
Reporting acc. to EN 50160	–	–	–	–	–	✓	–
Integrated fault recorder	–	–	–	–	–	✓	–
<b>System integration and communication</b>							
Digital inputs (DI)/digital outputs (DO)	–	2/2	1/1	2/2	0/2	0/2	–
S0 interface	✓	✓	✓	✓	–	–	✓
4DI/2DO expansion module	–	–	–	Optional	–	–	Optional
M-Bus	Optional	–	–	–	–	–	–
Instabus KNX	Optional	–	–	–	–	–	–
Modbus RTU	Optional	✓	Optional	Optional	–	–	Optional
Ethernet with Modbus TCP	–	–	✓	✓	✓	✓	✓
PROFIBUS DPV1	–	–	Optional	Optional	–	–	Optional
PROFINET IO/ PROFIenergy	–	–	Optional	Optional	–	–	Optional
Parameterization software	✓	powerconfig	powerconfig	powerconfig	–	–	powerconfig
Integration of power monitoring system	powermanager	–	–	–	–	–	powermanager
Web servers	–	–	–	–	✓	✓	–
<b>General data</b>							
Measuring accuracy, active energy, reactive energy	1   2	1   3	0.5 S   2	0.2 S   2	0.5 S   2	0.5 S   2	2 S   2
MID version	✓	–	–	–	–	–	–
Installation	Standard mounting rail	Front mounting	Front mounting	Front mounting	Front mounting/standard mounting rail	–	See 3VA
Dimensions in MW (1 MW = 18 mm) or in mm	2 / 4 / 6 MW	96 × 96 × 56	96 × 96 × 56	96 × 96 × 82	96 × 96 × 100	96 × 96 × 100	96 × 96 × 82 <sup>4)</sup>

<sup>1)</sup> With the exception of devices with power supply units with extra-low voltage  
<sup>2)</sup> On the display – energy and power values only. Additional measured quantities are transmitted via the optional 7KT Modbus and 7KT M-Bus expansion modules.

<sup>3)</sup> THD indication

<sup>4)</sup> For display via DSP800; see manual





✓ Available/possible -- not available/not possible

# Measuring Devices and Power Monitoring



## Power Monitoring

### Hardware and software components

#### Accessories for 7KT PAC measuring devices

					
	<b>7KT PAC expansion modules</b>				<b>7KT LAN couplers</b>
	M-Bus	Modbus RTU	RS 485	KNX	Web servers
Specification	Up to 9,600 bit/s	Up to 115,200 bit/s	For connection to the 7KT LAN coupler	Up to 19,200 bit/s	For up to 30 7KT PAC1500 measuring devices

#### Accessories for 7KM PAC measuring devices

					
	<b>7KM PAC expansion modules</b>				<b>Standard mounting rail adapters</b>
	Switched Ethernet for 7KM PAC3200, 7KM PAC4200 and 3VA COM100/COM800	PROFIBUS DP for 7KM PAC3200, 7KM PAC4200 and 3VA COM100/COM800	RS 485 for 7KM PAC3200, 7KM PAC4200 and 3VA COM100/COM800	4DI/2DO for 7KM PAC4200 (number of digital inputs/outputs per module 4/2)	7KM PAC TMP2 for 7KM PAC3100 / 3200/4200 for mounting on a standard mounting rail
Protocol	PROFINET IO PROFenergy Modbus TCP	DPV1	Modbus RTU	S0 interface	--
Maximum number of connectable expansion modules of the same type	1	1	1	2	--

#### The powerconfig software for commissioning

	Software tool for the efficient commissioning and diagnosis of communication-capable SENTRON components
License	Free use
Supported devices	7KM PAC3100/3200/4200 measuring devices, incl. expansion modules 3WL/3VL/3VA/ATC5300 circuit breakers
General range of functions	The PC-based tool facilitates parameterization of the devices, resulting in substantial time savings, particularly when several devices have to be set up. The device settings can be stored in the PC and printed out. The tool enables monitoring of instantaneous measured quantities, which can be printed out if required. Execution of specific device functions, such as resetting of devices and setting of energy counters.
Supported languages	German, English, Chinese, Spanish, Portuguese
Service functions	Firmware updates and switching of language packs for 7KM PAC measuring devices
Functional scope with 7KM PAC4200 and 3VA	Readout of data stored in the device (events; load profile history; daily energy counters), which are saved in csv format

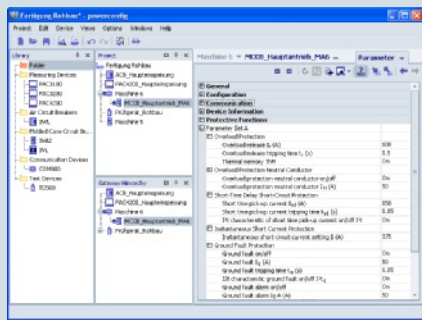

Setting parameter values

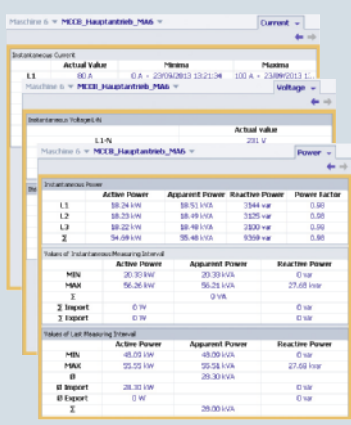

Display of current measured variables

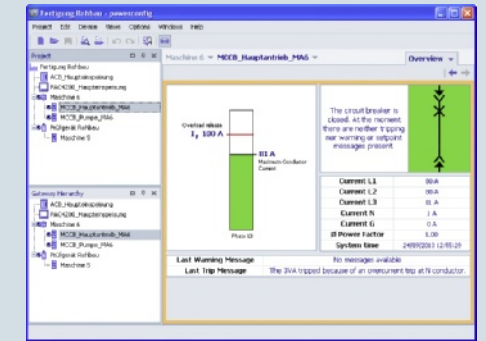

Display of the circuit breaker state

For more information about powerconfig, see chapter "Software".



### Overview



Hardware components of the PC-based power monitoring system

#### **Power monitoring system with SENTRON components**

The TÜV-certified power monitoring system from the SENTRON portfolio consists of the 7KT/7KM PAC measuring devices, the 3WL/3VA/3VL circuit breakers, and the powermanager power monitoring software. This forms the technical basis for supporting a corporate energy management system as specified by ISO 50001.

The hardware and software components are optimally coordinated with each other. For example, special drivers for the SENTRON devices are integrated in the powermanager power monitoring software. They enable energy data to be captured without any great configuration effort and they indicate the key measured values or the status by means of predefined views.

This reduces the engineering overhead. The device functions are optimally supported in the software.



Software component of the power monitoring software: powermanager

#### **Features of the powermanager power monitoring software**

The powermanager power monitoring software constitutes the optimum technical basis for supporting a corporate power monitoring system as specified by ISO 50001:

- Independent power monitoring software
- Can be operated using a Windows PC and measuring devices with Ethernet connection
- Easy getting started with basic license, can be extended with flexible licensing concept according to customer requirements
- Fully scalable, relative to number of devices and software functions
- Ensures optimum integration of 7KT/7KM PAC measuring devices, as well as 3WL/3VA/3VL circuit breakers and other Modbus devices
- Support of the various device and communication interfaces (Modbus RTU, Modbus TCP)
- Status display of devices
- Available languages: German, English, Spanish, Portuguese, Italian, French, Turkish, Chinese

## Measuring Devices and Power Monitoring

### Power Monitoring

#### PC-based power monitoring system

##### Application

###### Industries

An energy-efficient production system enhances both the image and the productivity of the company, and thus its competitiveness.

Power monitoring as the technical basis for energy management for increasing a company's energy efficiency is thus of interest to all areas, from industrial applications to infrastructure, and buildings in the service sector.

###### System configuration

- Integration of measuring devices by means of predefined device templates for the 7KT/7KM PAC measuring devices and the 3WL/3VA/3VL circuit breakers
- Easy integration of existing Modbus-capable measuring devices
- Communication through Standard Ethernet
- Integration of devices with RS485 interface (ModbusRTU) through Modbus gateway, e.g. the 7KM PAC4200 measuring device can be used as the gateway

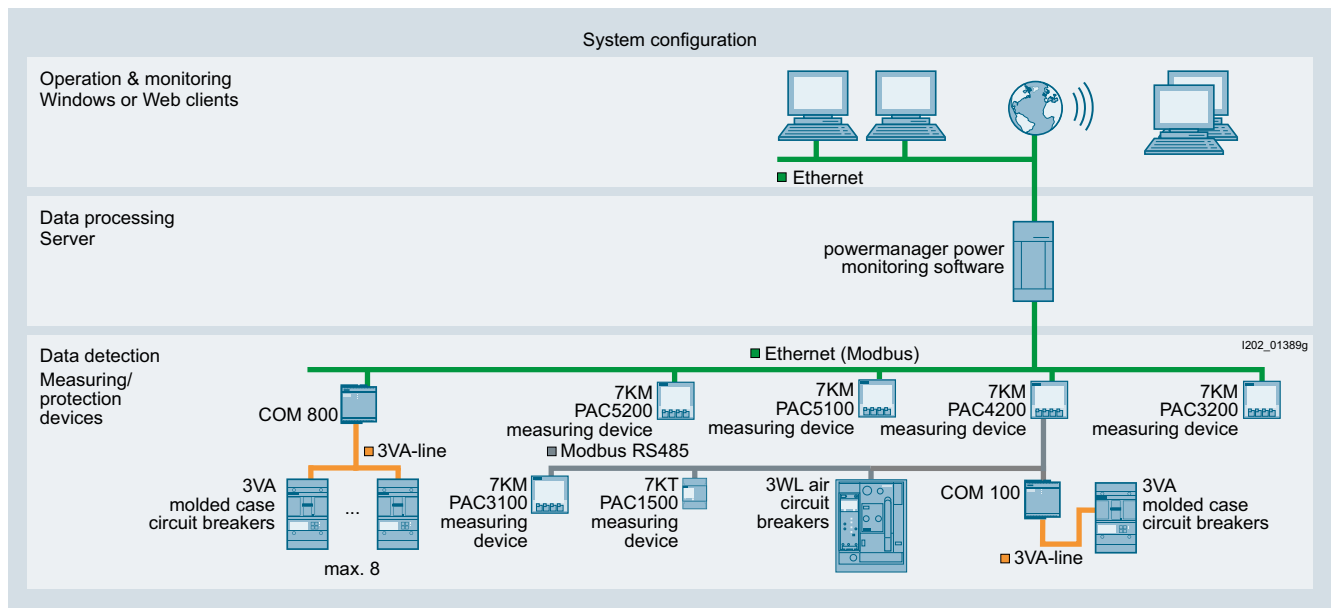

Typical topology of a power monitoring system

##### More information

###### TÜV certification



The TÜV certificate is available from

[www.siemens.com/tuev-certificate-of-conformity](http://www.siemens.com/tuev-certificate-of-conformity)

###### Hardware of the PC-based power monitoring system

The hardware components of the PC-based power monitoring system are

- 7KM PAC measuring devices
- 3WL air circuit breakers
- 3VL molded case circuit breakers
- 3VA molded case circuit breakers
- Software of the PC-based power monitoring system

The software of the PC-based power monitoring system is powermanager.

Powermanager system packages with software and hardware are an easy and low-cost way to get started in a power monitoring system.

###### Internet

You can find more information on the Internet at:  
[www.siemens.com/powermonitoring](http://www.siemens.com/powermonitoring)

### Overview

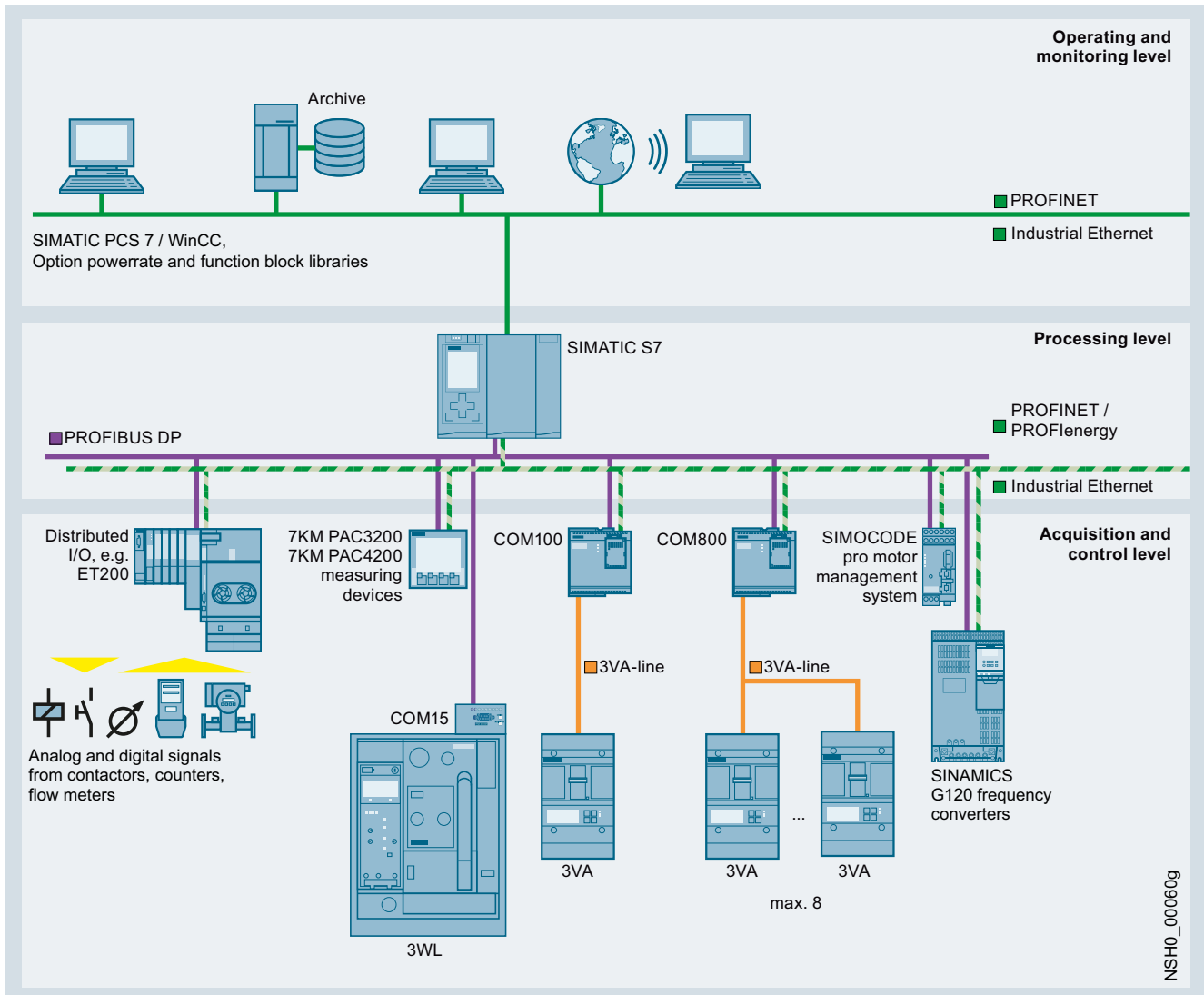

### SIMATIC-based solutions for the process and manufacturing industries

A key feature of the process and manufacturing industry is frequently high energy consumption. It therefore makes sense to integrate a power data management system in existing systems.

#### Communication via PROFIBUS DP

PROFIBUS DP enables integration of a wide range of devices:

- For the protection of distribution boards and loads: Protective devices, such as circuit breakers
- For open-loop and closed-loop control: Frequency converters, motor management systems and soft starters
- For detection
  - Electrical measured quantities: Via the 7KM PAC3200/4200 measuring devices
  - Non-electrical measured quantities: Via analog/digital converters

### PROFINET and PROFINergy

An increasing number of devices in automation technology offer PROFINET. The 7KM PAC Switched Ethernet PROFINET expansion module enables the 7KM PAC3200/PAC4200 measuring devices and 3VA circuit breakers to be connected to the automation systems.

PROFINergy is a "Common Application Profile" from PROFIBUS International. Thanks to PROFINergy it is possible to create a power data management system with standardized device interfaces.

#### Function block libraries for SIMATIC PCS 7 and WinCC

The function block library for SIMATIC PCS 7 and WinCC ensures device integration as follows:

- Measured quantities and states can be connected via CFC
- Structured display of measured quantities and protection parameters for the 3WL/3VA/3VL circuit breakers
- Limit value violations are displayed, archived and acknowledged in the relevant communications system in the usual way
- Circuit breakers can be program-controlled or manually operated with the appropriate user authorization

## Measuring Devices and Power Monitoring

### Power Monitoring

#### SIMATIC-based power data management system

##### Benefits

- Increased energy efficiency due to precise knowledge of the load profile
- Optimization of power supply agreements
- Allocation of power costs to cost centers
- Optimization of plant maintenance
- Identification of critical plant conditions
- Reliable monitoring of the power limit through automatic load management

##### Application

The SIMATIC-based power data management system is used in all industries in which PCS 7 and WinCC are used, and the transparency and monitoring of power flows is crucial.

##### More information

###### **Hardware components**

The hardware components of the SIMATIC-based power data management system are

- 7KM PAC measuring devices
- 3WL air circuit breakers
- 3VL molded case circuit breakers
- 3VA molded case circuit breakers

###### **Software components**

The software components of the SIMATIC-based power data management system are





- Library 7KM PAC3200 for SIMATIC PCS 7
- Library 7KM PAC3200 for SIMATIC WinCC

Information about all the software components

###### **Internet**

You can find more information on the Internet at:  
[www.siemens.com/powermonitoring](http://www.siemens.com/powermonitoring)

### Overview

Devices	Page	Application	Standards	Used in		
				Non-residential buildings	Residential buildings	Industry
<b>7KM PAC measuring devices</b>						
 <p><b>7KM PAC3100 measuring device</b> AC/DC wide-range power supply unit, screw connection</p>	15	<p>Control panel instrument with graphics display, integrated digital inputs and outputs and an RS 485 interface for the transmission of measured values and configurations.</p> <p>Display of 30 electrical measured values and consumption values in switchgear assemblies, infeeds or outgoing feeders.</p> <p>International standards and multi-lingual displays for worldwide use.</p>	Measuring accuracy for energy acc. to IEC 61557-12	✓	--	✓
 <p><b>7KM PAC3200 measuring device</b> 3 versions:</p> <ul style="list-style-type: none"> <li>AC/DC wide-range power supply unit, screw connection</li> <li>DC power supply unit with extra-low voltage, screw connection</li> <li>AC/DC wide-range power supply unit, ring cable lug connection</li> </ul>	15	<p>Control panel instrument with graphics display, integrated digital inputs and outputs and an integrated Ethernet interface for the transfer of measured values and configurations.</p> <p>Display of over 50 electrical measured values for switchgear assemblies, infeeds or outgoing feeders.</p> <p>Dual-tariff measuring devices for precise energy measurement for power import and feedback.</p> <p>The following components are available:</p> <ul style="list-style-type: none"> <li>7KM PAC Switched Ethernet PROFINET</li> <li>7KM PAC RS 485</li> <li>7KM PAC PROFIBUS DP</li> </ul>	Measuring accuracy for energy acc. to IEC 62053-22/23 and IEC 61557-12	✓	--	✓
 <p><b>7KM PAC4200 measuring device</b> 3 versions:</p> <ul style="list-style-type: none"> <li>AC/DC wide-range power supply unit, screw connection</li> <li>DC power supply unit with extra-low voltage, screw connection</li> <li>AC/DC wide-range power supply unit, ring cable lug connection</li> </ul>	15	<p>Control panel instrument with graphics display, user-defined displays, memory, clock and calendar function, digital inputs and outputs and an integrated Ethernet interface with gateway function to transfer measured values and configurations.</p> <p>Display of over 200 electrical measured values for switchgear assemblies, infeeds or outgoing feeders.</p> <p>Extensive functions for precise energy measurement for power import and feedback and assessment of the system quality.</p> <p>The following components are available:</p> <ul style="list-style-type: none"> <li>7KM PAC Switched Ethernet PROFINET</li> <li>7KM PAC RS 485</li> <li>7KM PAC PROFIBUS DP</li> <li>7KM PAC 4DI/2DO</li> </ul>	Measuring accuracy for energy acc. to IEC 62053-22/23 and IEC 61557-12	✓	--	✓
 <p><b>7KM PAC5100 measuring device</b> 2 versions:</p> <ul style="list-style-type: none"> <li>Control panel instrument with graphics display</li> <li>Standard rail instrument without display</li> </ul>	SIOS <sup>1)</sup>	<p>Control panel instrument with graphics display and user-defined displays, or instrument for standard rail mounting in accordance with EN 60750, web server for parameterization, visualization and data management, 2 binary outputs, electrically isolated voltage inputs, synchronization via internal RTC clock or externally via NTP, 4 freely parameterizable LEDs for device status or limit violations, as well as integrated RJ45 Ethernet interface.</p> <p>Acquisition of over 250 electrical measurements for switchboard assemblies, infeeds or outgoing feeders, extensive functions for precise energy measurement for power import and feedback and assessment of the system quality.</p>	Measuring accuracy for energy acc. to IEC 62053-22/23 and IEC 61557-12	✓	--	✓
 <p><b>7KM PAC5200 measuring device</b> 2 versions:</p> <ul style="list-style-type: none"> <li>Control panel instrument with graphics display</li> <li>Standard rail instrument without display</li> </ul>	SIOS <sup>1)</sup>	<p>Control panel instrument with graphics display and user-defined displays or instrument for standard rail mounting in accordance with EN 60750, web server for parameterization, visualization and data management, 2 binary outputs, electrically isolated voltage inputs, flicker in accordance with IEC 61000-4-15, synchronization via internal RTC clock or externally via NTP, 4 freely parameterizable LEDs for device status or limit violations, 2 GB memory, integrated fault recorder, reporting in accordance with EN 50160, rms recorder, as well as integrated RJ45 Ethernet interface.</p> <p>Acquisition of over 250 electrical measurements for switchboard assemblies, infeeds or outgoing feeders. Extensive functions for precise energy measurement for power import and feedback and assessment of the system quality.</p>	Measuring accuracy for energy acc. to IEC 62053-22/23 and IEC 61557-12	✓	--	✓







<sup>1)</sup> Manuals and other technical product information are available from Siemens Industry Online Support, directly at <https://support.industry.siemens.com/cs/de/en/view/10947782>

# Measuring Devices and Power Monitoring

## Measuring Devices

### Introduction

Devices	Page	Application	Standards	Used in		
				Non-residential buildings	Residential buildings	Industry
 <p><b>7KM PAC expansion modules</b></p>	32	<ul style="list-style-type: none"> <li>The expansion module 7KM PAC Switched Ethernet PROFINET is used to connect the 7KM PAC3200 and 7KM PAC4200 measuring devices and 3VA molded case circuit breakers to Switched Ethernet PROFINET (PROFenergy).</li> <li>The 7KM PAC PROFIBUS DP expansion module is used to connect the 7KM PAC3200 and 7KM PAC4200 measuring devices and 3VA molded case circuit breakers to PROFIBUS DPV1.</li> <li>The 7KM PAC RS 485 expansion module is used to connect simple devices with RS 485 interface, such as the 7KM PAC3200 and 3VA molded case circuit breaker, and supports the Modbus RTU protocol.</li> <li>The 7KM PAC 4DI/2DO expansion module is used to expand the 7KM PAC4200 measuring device to up to 10 digital inputs and 6 digital outputs.</li> </ul>	IEC 62053-31	✓	-	✓
 <p><b>7KT PAC1500 three-phase measuring device</b> 7KT154</p>	38	Measurement of consumption data in three-phase systems of plant sections, offices or holiday apartments.	EN 50470-1, EN 50470-3 EN 62052-23, EN 62053-31	✓	✓	✓
 <p><b>7KT PAC1500 single-phase measuring device</b> 7KT153</p>	41	For the measurement of consumption data in single-phase systems, e.g. in industrial plants, offices and apartments in apartment blocks.	EN 50740-1, EN 50470-3, EN 62053-31	✓	✓	✓
 <p><b>Expansion modules 7KT PAC</b> 7KT19</p>	44	<p>Communication interfaces with IrDA infrared interface for 7KT PAC1500 measuring devices. Modules are available for the following bus systems:</p> <ul style="list-style-type: none"> <li>M-Bus</li> <li>Modbus RTU</li> <li>RS 485 (7KT1391 LAN coupler connection)</li> <li>KNX/EIB</li> </ul>	EN 13321-1, EN 13757 ISO/IEC 14543-3 EN 50090	✓	✓	✓
 <p><b>7KT LAN couplers</b></p>	48	<p>Web server with 2 GB internal storage, for up to 30 7KT15.. measuring devices.</p> <p>Global view and Excel export of actual consumption data via LAN or Internet using a web browser such as Firefox</p>	IEEE 802	✓	--	✓

Devices	Page	Application	Standards	Used in			
				Non-residential buildings	Residential buildings	Industry	
<b>Other measuring devices</b>							
	<b>Digital measuring devices</b> 7KT111, 7KT112	51	Voltage and current measurement with large 3-digit LEDs for monitoring incoming/outgoing currents and device currents in order to prevent plant overload.	DIN 43751-1, DIN 43751-2	✓	--	✓
	<b>Time and pulse counters for standard rail mounting</b> 7KT58	51	For monitoring operating hours and starting operations for the planning of preventative maintenance tasks and preventing sudden shutdowns.	IEC 60255-6, EN 60255-6 (VDE 0435-301) UL 94	✓	✓	✓
	<b>Time counters for front-panel mounting</b> 7KT55, 7KT56	55	For monitoring operating hours and starting operations for planning preventative maintenance tasks and preventing sudden shutdowns.	IEC 60255-6, EN 60255-6 (VDE 0435-301)	✓	✓	✓
<b>Accessories</b>							
	<b>4NC current transformers</b>	56	Window-type current transformers/pin-wound transformers, particularly suitable for long measuring leads, low cable losses	EN 60044-1, VDE 0414-44-1	✓	--	✓
	<b>7KT12 current transformers</b>	58	Straight-through transformers for installation in distribution boards and non-contact measuring of primary currents. Ideal for combination with switch disconnectors, measuring devices and counters.	IEC 60044-1, EN 60044-1 (VDE 0414 T 44-1)	✓	--	✓
	<b>7KT90 measuring selector switches</b>	59	For switching over the phases for voltmeters and ammeters.		✓	--	✓

## Measuring Devices and Power Monitoring

### 7KM PAC Measuring Devices

#### Introduction

#### Overview

#### Measuring precisely with 7KM PAC3100/3200/4200



The 7KM PAC measuring devices:  
PAC3200 (left), PAC3100 (center) and PAC4200 (right)

The 7KM PAC measuring devices are used to measure and display all relevant system parameters in low-voltage power distribution. They can be used for both single-phase and multi-phase measurements in 3 and 4-conductor power supply systems (TN, TT, IT).

They record energy values for main distribution boards, electrical branches or individual loads precisely and reliably, and also supply key measured values for assessment of the state of the plant and the quality of the power supply.

#### Features

##### 7KM PAC measuring devices, general

The measuring devices of the 7KM PAC series offer the following key features:

- Simple mounting and commissioning
- High IP65 degree of protection (front side, when installed) permits usage in extremely dusty and wet environments
- Intuitive operation using 4 function buttons and multilingual plain text displays
- Easy adaptation to different systems using integrated and optional
  - Digital inputs and outputs
  - Communication interfaces
- Worldwide use
  - At least 8 languages
  - International approvals
  - Developed and tested to European and international standards
- Low mounting depth

##### 7KM PAC3200 and 7KM PAC4200 measuring devices

Additional performance characteristics of the 7KM PAC3200 and 7KM PAC4200:

- Precise energy measurement
- Versatile system integration
  - Integrated Ethernet interface
  - Optional communication modules available
  - Multifunctional digital inputs and outputs
  - Limit monitoring
- Can be connected directly to power supply networks up to 690 V AC (UL-L), CATIII without voltage transformers
- Easy-to-use configuration software included in the scope of delivery

##### 7KM PAC4200 measuring device

Additional performance characteristics of the 7KM PAC4200:

- Monitoring the plant status and the power supply quality
  - Basic information for evaluating the power supply quality
  - Logging of plant history in the form of operation, control and system-related events
- Recording of the power range through power averaging (load profile)
- Daily energy meters for apparent, active and reactive energy across 365 days for cut-off date assessment
- Detection of gas, water, compressed air or other energy sources via pulse counter to the digital inputs
- Can be expanded using modules to up to 10 digital inputs and 6 digital outputs
- Counters for apparent, active and reactive energy for the precise detection of the power consumption of a partial process or manufacturing process
- 10/100 Mbit/s Ethernet interface with gateway function for the easy connection of devices with serial RS 485 interface via expansion module 7KM PAC RS 485 to an Ethernet network
- Comprehensive user-friendly indicators, such as user-defined displays, bar and status indicators, phase diagram and list and histogram graphics
- Satisfies the accuracy requirements of class 0.2S high-precision meters used by power supply companies according to IEC 62053-22, which are normally reserved for exacting industrial applications



### Application

Three-phase measuring devices are used to measure and display all relevant network parameters of an electrical installation and they monitor these parameters permanently.

### Applications

Wherever power has to be distributed, be it in industrial or infra-structural buildings, the 7KM PAC measuring device supplies important information to the building services system or the power controlling system.

The many different communication options offered by the 7KM PAC make it an indispensable supplier of data for power management systems and for plant and building automation.

### Industries

Power distribution systems for the power supply are needed in all areas of industry. The 7KM PAC measuring devices are used accordingly in all areas where power consumption and electrical parameters are to be measured.

### Integration of 7KM PAC3200 and 7KM PAC4200

When the 7KM PAC3200 and 7KM PAC4200 measuring devices are fully integrated into a power monitoring system, they monitor the power consumption and help to monitor the operating state of the plant. Measured values, limit value violations, operating hours of a connected load or power flows are supplied by the instruments quickly and reliably.

Using the optionally available interface modules, it is possible to integrate both instruments in every control system or every SIMATIC S7 environment.

### System integration using function block libraries

Optionally available function block libraries make it easy to integrate the measuring devices in the SIMATIC PCS 7 process control system and the SIMATIC WinCC SCADA system. Together with the faceplates as user interface for the 7KM PAC3200, the driver blocks and diagnostics blocks in the control system enable the display and monitoring of technologically important values and functions of the measuring devices in the respective target system.

### System integration of RS 485 fieldbus devices through Ethernet

A special feature is the integrated gateway function of the 7KM PAC4200. It enables a cost-effective and simple connection of devices with a serial RS 485 interface to an Ethernet network.

Everything required is provided by the 7KM PAC RS 485 expansion module, to which a maximum of 31 lower-level devices can be connected without a repeater and as many as 247 with a repeater.

The gateway function of the 7KM PAC4200 supports the Modbus protocol and can be parameterized using powerconfig.

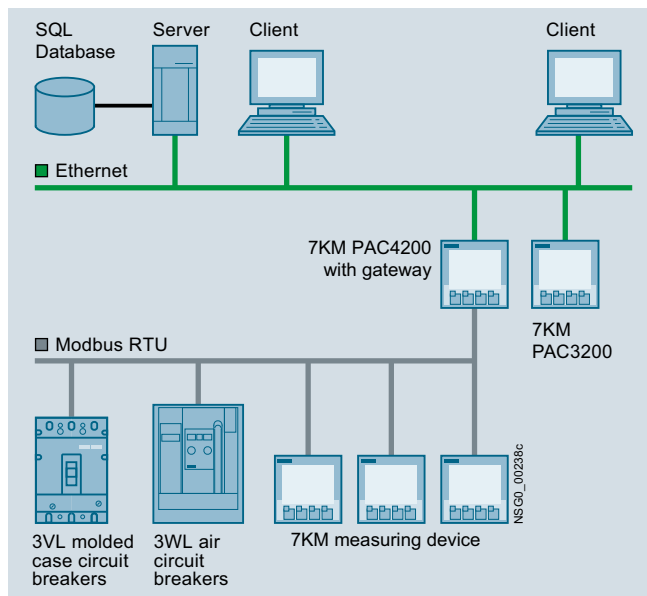

Connecting Modbus RTU devices to a power monitoring system through 7KM PAC4200

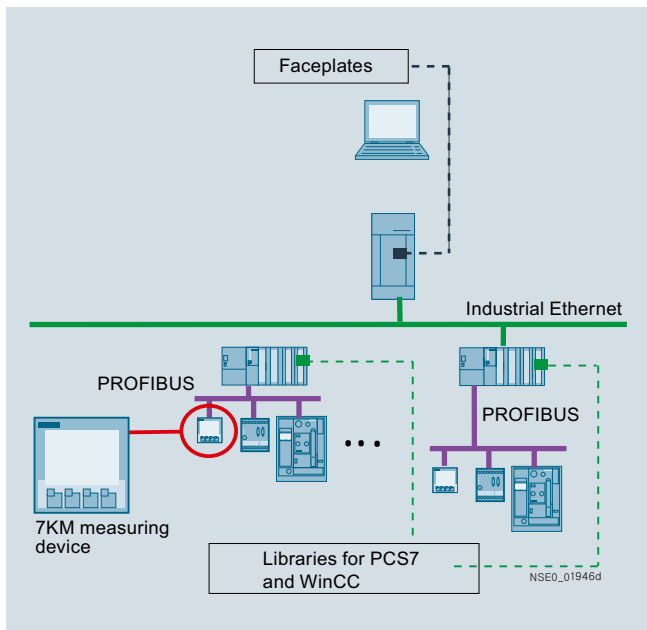

Integration of the 7KM PAC3200 in SIMATIC PCS 7/WinCC

## Measuring Devices and Power Monitoring

### 7KM PAC Measuring Devices

#### Technical specifications and project planning aids

#### Design

##### Installation

The 7KM PAC3100/3200/PAC4200 measuring devices come with a plastic enclosure for installation in control panels. It is fastened by one holder on the right side of the device and one on the left side.

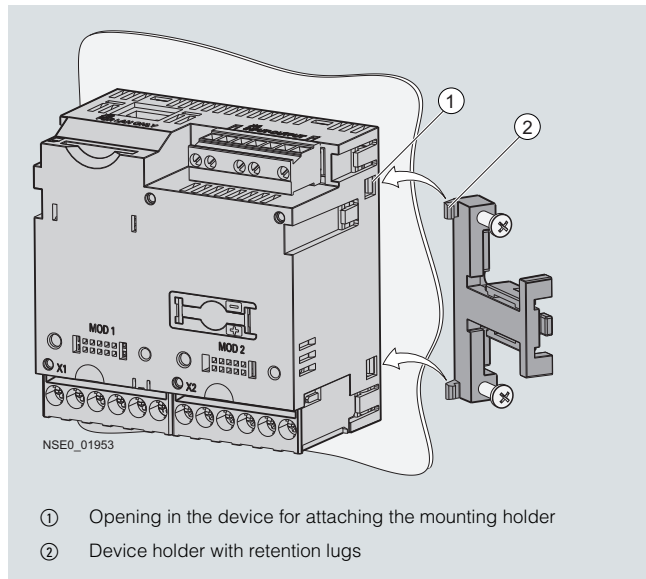

Mounting of the 7KM PAC3100, 7KM PAC3200 and 7KM PAC4200

To mount the devices they are inserted from the front through the square cutout in the control cabinet door and secured with the supplied combination latching holders.

The pair of combination latching holders performs two functions:

- Thanks to the latching mechanism the fitter can fasten the device in the control panel quickly and without the use of any tools.
- If greater protection is required, the four latching holder screws can be used to increase contact pressure evenly on all sides so that the control panel cutout is completely sealed by the integrally molded gasket, which is a standard feature. It is no longer necessary to insert an accessory gasket in addition.

From the front, i.e. in the installed state, the device thus complies with safety class II with degree of protection IP65.

As the result of the easy-to-use combination latching holders and the small mounting depth it is easy to mount several devices side by side.

The following illustration of the rear view of the 7KM PAC3200 and top view of the expansion module (in this case: 7KM PROFIBUS DP) shows by way of example how the 7KM PAC3200 and the expansion module are joined together. An expansion module is mounted on a 7KM PAC4200 in similar manner.

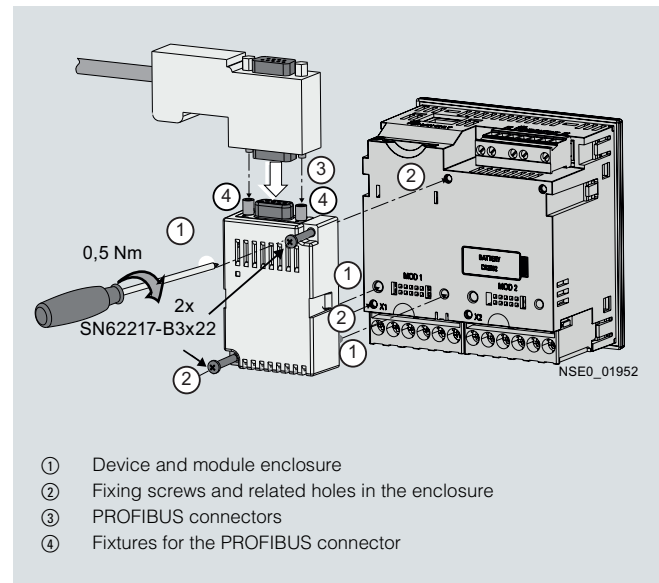

Mounting the expansion module, for example the PAC PROFIBUS DP on the 7KM PAC3200 and 7KM PAC4200

##### Operator controls and displays

The following picture shows the device from the front, divided into the function blocks provided for operation and monitoring, including a description.

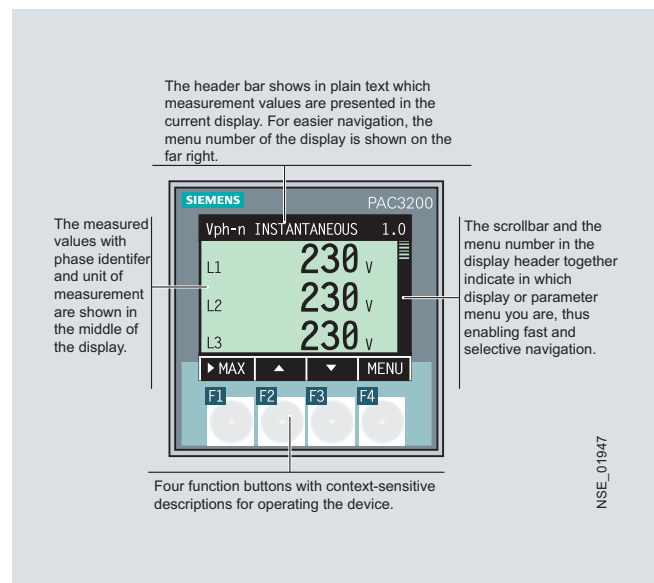

Device front of the 7KM PAC 3100, 7KM PAC3200 and 7KM PAC4200 measuring devices (here for example the 7KM PAC3200)

The devices are operated using 4 function keys, which correspond to the 4 text fields situated above them. The key are each assigned with several functions; their function at any time depends on the menu then displayed. Which function a key has in the respective menu is indicated by the text in the related display.

## Function

### Precise measurement of variables

#### 7KM PAC3100 measuring device

The 7KM PAC3100 measuring device provides Class 1 measuring accuracy for voltages, currents, active power, apparent power, and active energy (in accordance with IEC 61557-12).

#### 7KM PAC3200 measuring device

With its high accuracy, the 7KM PAC3200 meets the increasing demand for precise power measurement. It satisfies the accuracy requirements of Class 0.5S according to IEC 62053-22 for electronic active consumption meters.

#### 7KM PAC4200 measuring device

The 7KM PAC4200 measuring device supplies measurement data of far greater accuracy for determining and processing power data and for assessing the quality of the network:

- For voltage, current, active power and active energy the device achieves for example Class 0.2 according to IEC 61557-12.
- For active energy this corresponds to Class 0.2S according to the international meter standard IEC 62053-22.

The 7KM PAC4200 thus meets the accuracy requirements of the high-precision meters used by the power supply companies, which are normally reserved for exacting industrial applications.

### Transparency in power matters

Altogether 10 power meters for active, reactive and apparent energy monitor the power import and power feedback continuously and separately according to high tariff and low tariff.

In addition to the continuous counters for apparent, active and reactive energy, the 7KM PAC4200 saves the power consumption levels per day for a period of 365 days. A cut-off date assessment accurate to the day is possible by entering the required calculation period. The power consumption for a preselected period can be called up either directly on the device or by using the communication interface.

The image shows a monochrome LCD display of a 7KM PAC4200 measuring device. The display is divided into several sections. At the top, it shows 'WIRKENERGIE BEZUG Ø 19.2'. Below this, it displays 'VON: 09.12.2007' and 'BIS: 08.12.2008'. A horizontal line separates these from the main data area, which shows 'HT 492.98 kWh' and 'NT 0.00 Wh'. At the bottom, there is a menu bar with the following options: 'BEZ.', 'ABGØ', 'EDIT', and 'MENÜ'.

Daily counter indicator of the 7KM PAC4200

The 7KM PAC3200 and 7KM PAC4200 measuring devices supply the required power demands for active and reactive power for load profile recording and serve as reliable suppliers of data for a higher-level power management system.

### Load profile recording with the 7KM PAC4200

As soon as the power draw conditions per demand period or also reactive energy components affect the power costs it is important to obtain an exact picture of your own plant's load profile.

With its generously sized memory, the 7KM PAC4200 is ideal for this purpose. With a set demand period of 15 minutes it records the load profile for apparent, active and reactive power with minimum and maximum values for import and feedback over a period of 40 days. The recording duration can be increased or decreased depending on the demand period selected.

The demand period can be synchronized to the period of the power supply company so that the measured data can be compared with the power supply company's records. This can be done using either one of the digital inputs or a synchronization command via the communication interface. If no synchronization option is available, the device synchronizes itself with its internal clock.

For load profile recording the 7KM PAC4200 supports the fixed block method (only one demand period) or the rolling block method (division of the demand period into several sub-periods). In addition it is possible to choose between arithmetic or cumulated power demand calculation.

Load profile recording can be individually adapted with the powerconfig configuration software.

### Powerful communication

#### 7KM PAC3100 measuring device

The 7KM PAC3100 measuring device has an integrated RS 485 port and can be operated with the Modbus RTU protocol.

#### Ethernet interface (7KM PAC3200/4200 measuring devices)

The 7KM PAC3200/4200 measuring devices have an Ethernet interface as a standard feature which can be used not only for configuration purposes using powerconfig but also for system communication in a higher-level power management system. This makes additional hardware superfluous.

The 10 Mbit/s Ethernet interface of the 7KM PAC3200 permits one communication connection while the 10/100 Mbit/s Ethernet interface of the 7KM PAC4200 permits three such connections simultaneously. Both devices support the Modbus TCP protocol.

The Ethernet interface of the 7KM PAC4200 offers not only a higher data transmission rate but also additional functions:

- Auto MDI(X) (auto crossover) and auto negotiation
- Serial gateway for connecting devices with an RS 485 interface to an Ethernet network

#### PROFIBUS DP interface (7KM PAC3200/4200 measuring devices)

Use of the power monitoring devices in PROFIBUS DP is made possible by the optionally available 7KM PAC PROFIBUS DP expansion module.

Integration in PROFIBUS DP takes place using a standardized text file, the device master data file (GSD). This GSD file is read into the master with the help of the PROFIBUS configuration tool. The master thus receives the slave-specific communication framework of the PAC3200 or PAC4200 and can start cyclic operation immediately. With DP V1 the PAC PROFIBUS DP expansion module also supports acyclic data traffic.

#### Modbus RTU interface

Use of the power monitoring devices in Modbus RTU fieldbuses is made possible by the optionally available PAC RS 485 expansion module.

Integration in Modbus RTU systems takes place through parameterization of the device address and baud rate using the device keyboard or via powerconfig.

## Measuring Devices and Power Monitoring

### 7KM PAC Measuring Devices

#### Technical specifications and project planning aids

##### **The 7KM PAC4200 provides comprehensive information about events**

Voltage failures, limit value violations, switching operations, device configuration changes, counter resets or deleting of the memory are just some of the possible events which the 7KM PAC4200 records and saves to the events list.

The integrated memory has space for more than 4000 operation, control and system-related events, which the user can organize according to his requirements.

For example, in addition to the three selectable alert levels for information, warning or alarm it is possible to choose the priority of each event independently of each other. And it is also possible of course to choose whether an event is to be recorded at all and in which order the events are to be shown on the display.

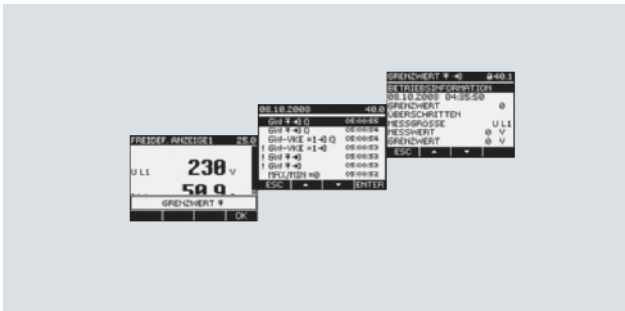

Three-level event displays on the 7KM PAC4200

Events are displayed in three levels:

- Popup window for signaling important events, e.g. in the case of alarm messages. Mandatory acknowledgment is selectable for particularly important events
- Events list for clear representation of the individual events with symbols indicating the alert level
- Detail window with particulars of the event, e.g. event class, date and time of occurrence, reason for triggering the event and, where applicable, the measurement variable in question with its measured value and limit value

Event recording can be configured with the powerconfig configuration software.

##### **Plain-text displays**

A large, fully graphic LCD display enables easy reading even from great distances. To make sure that this is also the case in poor light conditions, the backlighting can be individually adapted to the actual requirements.

In addition to the standard displays of the 7KM PAC3100/3200, the 7KM PAC4200 measuring device offers up to four user-definable displays. These displays can be used for individual arrangement of the desired measured variables and for their representation as bar or digital displays.

##### **Operation, also multilingual**

Operation is quick to learn thanks to the intuitive user guidance using the four function keys in conjunction with multilingual plain text displays. The experienced operator can also use direct navigation for quicker selection of the desired display menu.

Following languages can be selected: English, Chinese, French, German, Italian, Portuguese, Russian, Spanish and Turkish.

The product documentation is also available in 9 languages.

##### **Multifunctional digital inputs and outputs**

The 7KM PAC3200 measuring device is equipped with one digital input and output each, and the 7KM PAC3100 and 7KM PAC4200 measuring devices with two multifunctional digital inputs and outputs, to each of which various functions can be assigned.

Functions of the digital inputs:

7KM PAC measuring device	3100	3200	4200
Number of integrated digital inputs	2	1	2
Count input for energy pulses (kWh, kvarh) from third-party devices	--	✓	✓ + any energy form
Status monitoring of a switching device	✓	✓	✓
Tariff switching between high tariff and low tariff	--	✓	✓
Signal input for synchronization of the demand period	--	✓	✓
Time synchronization of the internal clock to a master clock	--	--	✓

Functions of the digital outputs:

7KM PAC measuring device	3100	3200	4200
Number of integrated digital outputs	2	1	2
Pulse output for sending energy pulses (kWh, kvarh)	✓	✓	✓
Alarm output for signaling limit value violations	--	✓	✓
Operating status display	--	✓	✓
Direction of rotation indicator	--	✓	✓
Switching output for remote control via system software	✓	✓	✓
Synchronization of third-party devices to own demand period	--	--	✓

✓ Available

-- Not available

##### **Monitoring of measured variables for limit value violation (7KM PAC3200 and 7KM PAC4200 only)**

The 7KM PAC3200 has a function for monitoring up to 6 measured variables, and the 7KM PAC4200 up to 12 measured variables, for violation of an adjustable upper or lower limit value.

The following variables can be monitored: Voltage, current, power, power factors, THD for voltage and current, frequency, unbalance of voltage and current.

In addition it is possible with the 7KM PAC4200 to monitor the phase angle, distortion current strength, individual line harmonics from the 3rd to the 31st harmonic, and sliding window demand values.

The following can be assigned to each limit value:

- A measured variable
- The monitoring mode (overshooting or undershooting)
- A limit value
- A delay time and
- A hysteresis

It is possible to select the action to be triggered by violation of a limit value.

For example, a signal can be sent through the digital output or the communication interface. The integrated universal counter can be used to total the number of limit value violations. Whether a limit value has been violated is indicated on the device.

#### Interconnected with logic operations ...

The 7KM PAC3200 and 7KM PAC4200 measuring devices have a function for interconnecting limit values using logic operations as follows:

- 7KM PAC3200: AND/OR
- 7KM PAC4200: AND/OR/NAND/NOR/XOR/XNOR

Like the individual limit values, the result of the logic operation can also trigger selective actions, which were previously described in the section "Monitoring of measured variables for limit value violations".

#### ... and conveniently programmed with the 7KM PAC4200

In addition to the interconnection of limit values it is also possible with the 7KM PAC4200 to include the digital inputs in the logic operation.

On the 7KM PAC4200 the logic operations are configured in user-friendly manner using a graphic programming interface. To each of the 5 logic gates it is possible to assign 4 random inputs (limit value or digital input) and one logic function (AND, OR, NAND, ...).

From the small black bar at the inputs of the gates the user can see the state of the input at a glance.

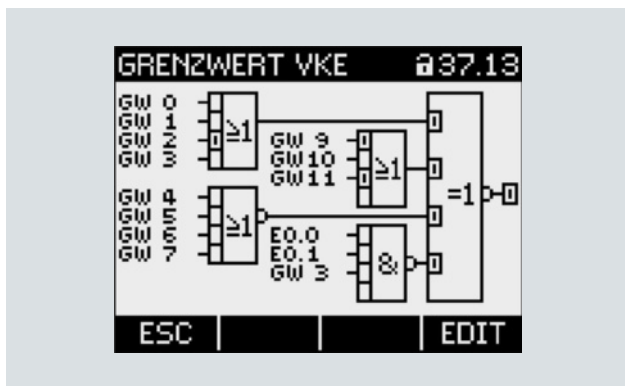

Logic operations with limit value events on the 7KM PAC4200 measuring device

#### Monitoring of voltage and current for unbalance (7KM PAC4200 only)

The 7KM PAC4200 measuring device measures, among other things, the unbalance of voltage and current in the line. Now that a limit value can also be assigned to these two parameters, problems due to unsymmetrical loads in the installation can be detected early on and avoided.

#### Operating hours counter (7KM PAC3200 and PAC4200 measuring devices)

An important service function is performed by the integrated operating hours counter, which can be used to monitor e.g. pumps, motors or machines. The counter measures the runtime of a connected load, helping to ensure that important maintenance intervals are observed.

The count can be read out and evaluated by a PC. A higher-level power management system is thus able to generate relevant maintenance information.

#### Universal in use

The 7KM PAC3100, 7KM PAC3200 and 7KM PAC4200 can all be used for measuring in two, three and four-wire networks. Single-phase, two-phase and three-phase measurements are possible.

Thanks to their large measured voltage range, the devices can be directly connected in every low-voltage system up to a rated line voltage of 690 V ( $U_{L-L}$ )<sup>1)</sup>. Higher voltages can be measured using voltage transformers.

For measuring currents it is possible to use both x/1A and x/5A current transformers (for 7KM PAC3100 only x/5A x/5A current transformers). Transformer ratios and current direction can be programmed on the device for adaptation to local conditions.

#### Protection against unauthorized access

The 7KM PAC3100, 7KM PAC3200 and 7KM PAC4200 come with integrated password protection so that the energy and parameter data are safe from unauthorized access. Changes to the parameterization can be traced using a configuration counter which can be read out through the communication interface.

<sup>1)</sup> Max. 500 V (UL-L) for version with DC power supply unit with extra-low voltage (7KM2111-1BA00-3AA0)

# Measuring Devices and Power Monitoring

## 7KM PAC Measuring Devices

### Technical specifications and project planning aids

#### Technical specifications

Device			7KM PAC3100	7KM PAC3200	7KM PAC4200
<b>Measurement</b>					
<b>Systems</b>					
Voltage types			Only for alternating voltage systems	Only for alternating voltage systems	Only for alternating voltage systems
Number of phases			Single-, two- or three-phase	Single-, two- or three-phase	Single-, two- or three-phase
Number of conductors			3 or 4 conductors	3 or 4 conductors	3 or 4 conductors
Load type			Same or any load	Same or any load	Same or any load
Quadrants			4 quadrants (import and export)		
<b>Frequency of the relative fundamental</b>	Hz		50/60	50/60	50/60
<b>Signal detection</b>	For <i>E, U, I</i>		Seamless	Seamless	Seamless
<b>Waveform</b>					
			Sine or distorted	Sine or distorted	Sine or distorted
<b>Measuring inputs for voltage</b>					
<b>Rated voltage 3 AC <math>U_e</math> (max.)</b>					
Device with AC/DC wide-voltage power supply unit			7KM3133-0BA00-3AA0	7KM2112-0BA00-3AA0 -0BA00-2AA0	7KM4212-0BA00-3AA0 -0BA00-2AA0
	Phase/N	V AC	277 (max. 347 for UL) +20 %	400 (max. 347 for UL) +20 %	400 (max. 347 for UL) +20 %
	Phase/phase	V AC	480 (max. 600 for UL) +20 %	690 (max. 600 for UL) +20 %	690 (max. 600 for UL) +20 %
Device with DC power supply unit with extra-low voltage			--	7KM2111-1BA00-3AA0	7KM4211-1BA00-3AA0
	Phase/N	V AC	--	289 +20 %	289 +20 %
	Phase/phase	V AC	--	500 +20 %	500 +20 %
Minimum measurable voltage	Phase/N	V AC	11.6	40	11.5
	Phase/phase	V AC	20	69.3	20
<b>Surge strength</b>	1.2/50 $\mu$ s	kV	6.5	9.5	9.5
<b>Input resistance</b>	Phase/N	M $\Omega$	0.84	1.05	1.05
<b>Power consumption</b>	Per phase	mW	131	220	220
<b>Measuring category</b>					
			CAT III	CAT III	CAT III
<b>Measuring of voltages &gt; 690 or 500 V AC using a voltage transformer</b>					
<b>Measuring inputs for current</b>					
Rated current 3 AC $I_b$ per phase	Adjustable	A AC	5	1 or 5	1 or 5
Permanent load capacity	Permanent	A AC	10	10	10
Surge withstand capability	For 1 second	A AC	100	100	100
Power consumption	Per phase	mVA	500 at 6 A	4 at 1 A, 115 at 5 A	4 at 1 A, 115 at 5 A
<b>Measuring category</b>					
			CAT III	CAT III	CAT III
Zero point suppression level	Adjustable		10 mA in the phases, 45 mA in the neutral conductor	0 ... 10 %	0 ... 10 %
<b>Measuring of currents using current transformer</b>					
			x/5 A	x/1 A or x/5 A	x/1 A or x/5 A
<b>Supply voltage</b>					
<b>AC/DC wide-voltage power supply unit</b>					
			7KM3133-0BA00-3AA0	7KM2112-0BA00-3AA0 -0BA00-2AA0	7KM4212-0BA00-3AA0 -0BA00-2AA0
<b>Primary operating range</b>		V AC	100 ... 240 $\pm$ 10 %	95 ... 240 $\pm$ 10 %	95 ... 240 $\pm$ 10 %
		V DC	110 ... 250 $\pm$ 10 %	110 ... 340 $\pm$ 10 %	110 ... 340 $\pm$ 10 %
Rated frequency of the AC operating range		Hz	50/60	50/60	50/60
<b>DC extra-low voltage power supply unit</b>					
<b>Primary operating range</b>		V DC	--	7KM2111-1BA00-3AA0	7KM4211-1BA00-3AA0
			--	22 ... 65 $\pm$ 10 %	22 ... 65 $\pm$ 10 %
<b>Power consumption (max.)</b>					
Without optional expansion module		AC VA	10	6	11
		DC W	5	3	5.5
Including optional expansion module		AC VA	--	8	32
		DC W	--	3.5	11
<b>Overvoltage category</b>					
			CAT III	CAT III	CAT III

## Measuring Devices and Power Monitoring

### 7KM PAC Measuring Devices

#### Technical specifications and project planning aids

Device			7KM PAC3100	7KM PAC3200	7KM PAC4200
<b>Error limits</b>					
<b>Accuracy class according to IEC 61557-12:2007</b>			Yes	No	Yes
The accuracy class according to IEC 61557-12 is the value in % relative to the measured value under reference conditions.					
<b>Voltage</b>	Phase/N		1	±0.3 %	0.2
	Phase/phase		1	±0.3 %	0.2
<b>Current</b>			1	±0.2 %	0.2
<b>Apparent power</b>			1	±0.5 %	0.5
<b>Active power</b>			1	±0.5 %	0.2
<b>Reactive power</b>			3	±2 %	1.0
<b>Frequency</b>			0.1	±0.05 %	0.1
<b>p.f.</b>			--	--	0.2 % <sup>1)</sup>
<b>Power factor</b>			2	±0.5 %	2.0
<b>Phase angle</b>			--	--	±1° <sup>1)</sup>
<b>Apparent energy</b>			--	±0.5 %	0.5
<b>Active energy</b>			1	Class 0.5S according to IEC 62053-22	0.2
<b>Reactive energy</b>			3	Class 2 according to IEC 62053-23	2
When measuring on external current transformers or voltage transformers, the accuracy of the measurement depends on the quality of the transformer.					
<b>Digital inputs</b>					
<b>Number</b>			2	1	2
<b>Rated value</b>	V DC		24	24	24
<b>Max. input voltage</b>	V DC		30 (SELV or PELV supply)	30 (SELV or PELV supply)	30 (SELV or PELV supply)
<b>Input threshold</b>	Signal "1"	V DC	> 13	> 13	> 19
	Signal "0"	V DC	< 8	< 8	< 10
<b>Input current</b>	Signal "1"	mA DC	2.5 ... 10	7	4
<b>Max. input delay</b>	From "0" to "1"	ms	5	5	5
	From "1" to "0"	ms	5	5	5
<b>Digital outputs</b>					
<b>Number</b>			2	1	2
<b>Function</b>			Switching or pulse output	Switching or pulse output	Switching or pulse output
<b>Required operational voltage</b>	V DC		12 ... 24	12 ... 24	12 ... 24
<b>Max. switched output voltage</b>	V DC		30 (SELV or PELV supply)	30 (SELV or PELV supply)	30 (SELV or PELV supply)
<b>Output current signal "1"</b>					
Typical		mA DC	10 ... 27	10 ... 27	10 ... 27
Permanent	Max.	mA DC	50 (thermal overload protection)	100	100 (thermal overload protection)
Short-time overload for max. 100 ms		mA DC	130	300	300
Resistive load		mA DC	100	100	100
<b>Switching frequency</b>	Max.	Hz	17	17	17
<b>Max. output delay</b>	From "0" to "1"	ms	5	5	5
	From "1" to "0"	ms	5	5	5
<b>Pulse output function</b>			Signal characteristics in accordance with IEC 62053-31	Signal characteristics in accordance with IEC 62053-31	Signal characteristics in accordance with IEC 62053-31
<b>Adjustable pulse duration</b>		ms	30 ... 500	30 ... 500	30 ... 500
<b>Minimum adjustable time frame</b>		ms	10	10	10
<b>Short-circuit protection</b>			Yes	Yes	Yes

# Measuring Devices and Power Monitoring

## 7KM PAC Measuring Devices

### Technical specifications and project planning aids





Device	7KM PAC3100	7KM PAC3200	7KM PAC4200
<b>Communication</b>			
<b>Ethernet</b>			
Version	--	RJ45 (8P8C)	RJ45 (8P8C)
Usable cable types (ground necessary)	--	Twisted pair (CAT 5)	Twisted pair (CAT 5)
Protocol	--	Modbus TCP	Modbus TCP
Transmission rate max. MBit/s	--	10	10/100
Supported functions	--	--	Auto negotiation and auto MDI(X)
TCP/IP ports	--	1	2
Max. number of simultaneous connections	--	1	3
Max. refresh time at the interface for instantaneous values ms	--	200	200
<b>Serial gateway</b>			
Protocol (Ethernet)	--	--	Modbus TCP
Protocol (lower-level devices)	--	--	Modbus RTU
Use requirement	--	--	Expansion module 7KM PAC RS 485
Max. number of lower-level devices	--	--	Without repeater: 31 With repeater: 247
<b>PROFIBUS DP</b>			
Through the 7KM PAC PROFIBUS DP V1 expansion module	--	Yes	Yes
Transmission rate max. MBit/s	--	12	12
Measured variables to be transferred	--	Definable using GSD file	Definable using GSD file
<b>RS 485</b>			
Through expansion module 7KM PAC RS 485	No, integrated	Yes	Yes
Transfer rates kBd	Optionally 4.8/9.6/19.2/38.4	Optionally 4.8/9.6/19.2/38.4	Optionally 4.8/9.6/19.2/38.4
Protocol	Modbus RTU	Modbus RTU	Modbus RTU
<b>Display and operator control</b>			
<b>Display type</b>	LCD, monochrome	LCD, monochrome	LCD, monochrome
<b>Displays/indicators</b>	Alphanumeric and text	Alphanumeric and text	Full graphics
<b>Resolution</b> Dots	128 x 96	128 x 96	128 x 96
<b>Size</b> mm	72 x 54	72 x 54	72 x 54
<b>Contrast</b>	Adjustable	Adjustable	Adjustable
<b>Representation</b>	Display invertible, pos/neg mode	Display invertible, pos/neg mode	Display invertible, pos/neg mode
<b>Backlighting</b>			
Background color	White	White	White
Lighting intensity	Adjustable	Adjustable	Adjustable
Lighting intensity reduced	Adjustable	Adjustable	Adjustable
Time until reduction of lighting intensity min	0 ... 99	0 ... 99	0 ... 99
<b>Refresh time</b> s	0.33 ... 3, adjustable		
<b>Keyboard</b>	4 function keys F1 to F4 on the front		



## Measuring Devices and Power Monitoring

### 7KM PAC Measuring Devices

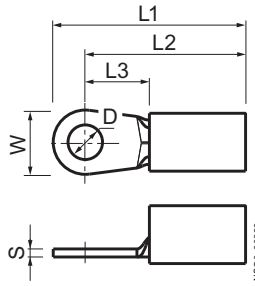
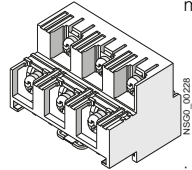
#### Technical specifications and project planning aids

Device			7KM PAC3100	7KM PAC3200	7KM PAC4200
<b>Connection elements and terminals</b>					
<b>Measuring inputs and supply voltage</b>					
			 <b>Screw connection</b>		
			<b>7KM3133-0BA00-3AA0</b>	<b>7KM2112-0BA00-3AA0 7KM2112-1BA00-3AA0</b>	<b>7KM4212-0BA00-3AA0 7KM4212-1BA00-3AA0</b>
Conductor cross-sections	Solid	mm <sup>2</sup>	1 x 0.5 ... 4 AWG 1 x 20 ... 12	1 x 0.5 ... 4 AWG 1 x 20 ... 12	1 x 0.5 ... 4 AWG 1 x 20 ... 12
		mm <sup>2</sup>	2 x 0.5 ... 2.5 AWG 2 x 20 ... 14	2 x 0.5 ... 2.5 AWG 2 x 20 ... 14	2 x 0.5 ... 2.5 AWG 2 x 20 ... 14
		Finely stranded with end sleeve	mm <sup>2</sup>	1 x 0.5 ... 2.5 AWG 1 x 20 ... 14	1 x 0.5 ... 2.5 AWG 1 x 20 ... 12
	mm <sup>2</sup>		2 x 0.5 ... 1.5 AWG 2 x 20 ... 16	2 x 0.5 ... 1.5 AWG 2 x 20 ... 16	2 x 0.5 ... 1.5 AWG 2 x 20 ... 16
	mm <sup>2</sup>		2 x 0.5 ... 1.5 AWG 2 x 20 ... 16	2 x 0.5 ... 1.5 AWG 2 x 20 ... 16	2 x 0.5 ... 1.5 AWG 2 x 20 ... 16
	Tool size	± Screw, Pozidriv		2	2
<b>Measuring inputs and supply voltage</b>					
			 <b>Ring cable lug connection</b>		
Conductor cross-sections	Dependent on ring cable lug used	mm <sup>2</sup>	--	<b>7KM2112-0BA00-2AA0</b>	<b>7KM4212-0BA00-2AA0</b>
		mm	--	1 x 1.0...6.0 AWG 1 x 18...10 D: 3...4 S: 0.75 ... 1.0 W: ≤ 8 L1: ≤ 24 L2: ≤ 20 L3: ≥ 8	1 x 1.0...6.0 AWG 1 x 18...10 D: 3...4 S: 0.75 ... 1.0 W: ≤ 8 L1: ≤ 24 L2: ≤ 20 L3: ≥ 8
		inch	--	D: 0.118 ... 0.157 S: 0.029 ... 0.039 W: ≤ 0.314 L1: ≤ 0.944 L2: ≤ 0.787 L3: ≥ 0.314	D: 0.118 ... 0.157 S: 0.029 ... 0.039 W: ≤ 0.314 L1: ≤ 0.944 L2: ≤ 0.787 L3: ≥ 0.314
		inch	--	--	--
Tool size	± Screw, Pozidriv		--	2	2
Required tool			--	Crimping or fitting tool for ring terminal lugs	
<b>Digital output, digital input</b>					
			 <b>Screw connection (for all measuring device versions)</b>		
Conductor cross-sections	Solid	mm <sup>2</sup>	1 x 0.2 ... 2.5	1 x 0.2 ... 2.5	1 x 0.2 ... 2.5
		mm <sup>2</sup>	2 x 0.2 ... 1.0 AWG 1 x 24 ... 12	2 x 0.2 ... 1.0 AWG 1 x 24 ... 12	2 x 0.2 ... 1.0 AWG 1 x 24 ... 12
		Finely stranded with end sleeve	mm <sup>2</sup>	1 x 0.25 ... 2.5	1 x 0.25 ... 2.5
	mm <sup>2</sup>		2 x 0.25 ... 1.0 AWG 1 x 24 ... 12	2 x 0.25 ... 1.0 AWG 1 x 24 ... 12	2 x 0.25 ... 1.0 AWG 1 x 24 ... 12
	mm <sup>2</sup>		2 x 0.25 ... 1.0 AWG 1 x 24 ... 12	2 x 0.25 ... 1.0 AWG 1 x 24 ... 12	2 x 0.25 ... 1.0 AWG 1 x 24 ... 12
	Tool size	± Screw, Pozidriv		1	1
<b>RS 485 connection</b>					
			 <b>Screw connection</b> <b>(RS485 connection using 7KM PAC RS485 expansion module)</b>		
Connection designations			Com, +/B, -/A	--	--
Conductor cross-sections	Solid	mm <sup>2</sup>	1 x 0.2 ... 2.5	--	--
		mm <sup>2</sup>	2 x 0.2 ... 1.0 AWG 1 x 24 ... 12	--	--
		mm <sup>2</sup>	1 x 0.25 ... 2.5	--	--
	Finely stranded with end sleeve	mm <sup>2</sup>	2 x 0.25 ... 1.0 AWG 1 x 24 ... 12	--	--
		mm <sup>2</sup>	2 x 0.25 ... 1.0 AWG 1 x 24 ... 12	--	--
Tool size	± Screw, Pozidriv		1	--	--

# Measuring Devices and Power Monitoring

## 7KM PAC Measuring Devices

### Technical specifications and project planning aids

Device			7KM PAC3100	7KM PAC3200	7KM PAC4200
<b>Dimensions and weights</b>					
<b>Enclosure dimensions (W x H x D)</b>					
Without expansion module	mm		96 x 96 x 56	96 x 96 x 56	96 x 96 x 82
With expansion module	mm		--	96 x 96 x 78	96 x 96 x 104
<b>Mounting depth</b>					
Without expansion module	mm		51	51	77
With expansion module	mm		--	73	99
<b>Weight</b>					
Without expansion module	Approx.	g	325	325	450
With expansion module	Approx.	g	--	370	540
<b>Switchboard cutout</b>					
	mm		92 <sup>+0.8</sup> x 92 <sup>+0.8</sup>	92 <sup>+0.8</sup> x 92 <sup>+0.8</sup>	92 <sup>+0.8</sup> x 92 <sup>+0.8</sup>
<b>Enclosure for panel mounting</b>					
			Acc. to IEC 61554	Acc. to IEC 61554	Acc. to IEC 61554
<b>Control panel thickness</b>					
	mm		0.5 ... 4	0.5 ... 4	0.5 ... 4
<b>Mounting position</b>					
			Vertical	Vertical	Vertical
<b>Degree of protection and safety class</b>					
<b>Safety class acc. to EN 61010-1</b>					
From the front when installed			II	II	II
<b>Degree of protection acc. to EN 60529</b>					
All devices	Front		IP65	IP65	IP65
Device with screw terminals	Rear		IP20	IP20	IP20
Device with ring cable lug terminals	Rear		--	IP10	IP10
<b>Ambient conditions</b>					
<b>Temperature range</b>					
Operating temperature		°C	-10 ... + 55	-10 ... + 55	-10 ... + 55
Storage and transport temperature		°C	-25 ... + 70	-25 ... + 70	-25 ... + 70
<b>Relative humidity</b>					
At 25 °C without condensation		%	95	95	95
<b>Altitude</b>					
Above sea level up to max.		m	2000	2000	2000
<b>Pollution degree</b>					
			2	2	2
<b>Battery for buffering measured variables</b>					
<b>Recommended battery types</b>	Non-rechargeable types		--	--	BR2032 or CR2032
<b>Approval</b>					
			--	--	Acc. to UL1642
<b>Nominal voltage/nominal discharge current</b>					
		V/mA	--	--	3/0.2
<b>Minimum permissible reverse current</b>					
		mA	--	--	5
<b>Suitable for ambient temperatures up to at least</b>					
		°C	--	--	70
<b>Access protection</b>					
<b>Password protection</b>					
Password protection prevents the following:			4-digit numerical code	4-digit numerical code	4-digit numerical code
Effective through:			Effective through:	Effective through:	Effective through:
<ul style="list-style-type: none"> <li>Changing of device settings, including password</li> <li>Changing and deleting of values</li> <li>Deleting of data and memory content</li> <li>Setting and resetting of counts</li> </ul>			<ul style="list-style-type: none"> <li>Direct input on the device</li> </ul>	<ul style="list-style-type: none"> <li>Direct input on the device</li> </ul>	<ul style="list-style-type: none"> <li>Direct input on the device</li> <li>Via the Ethernet interface</li> <li>Via the 7KM PAC RS 485 expansion module</li> </ul>
Reading out of measured values and memory content			Possible without restriction	Possible without restriction	Possible without restriction
<b>Standards and approvals</b>					
<b>CE</b>	EU		Acc. to the CE Declaration of Conformity	Acc. to the CE Declaration of Conformity	Acc. to the CE Declaration of Conformity
<b>cULus</b>	USA/Canada		Acc. to UL File E314880	Acc. to UL File E314880	Acc. to UL File E314880
<b>UL50</b>			Type enclosure 5	Type enclosure 5	Type enclosure 5
<b>FCC</b>			Class A, Part 15 Subpart B	Class A, Part 15 Subpart B	Class A, Part 15 Subpart B
<b>Environmental tests</b>					
			IEC 60068	IEC 60068	IEC 60068

<sup>1)</sup> The IEC 61557-12 standard does not specify any accuracy class for these variables. The specifications refer to the maximum deviation from the actual value.

#### Dimensional drawings

##### Dimensions of the 7KM PAC3100

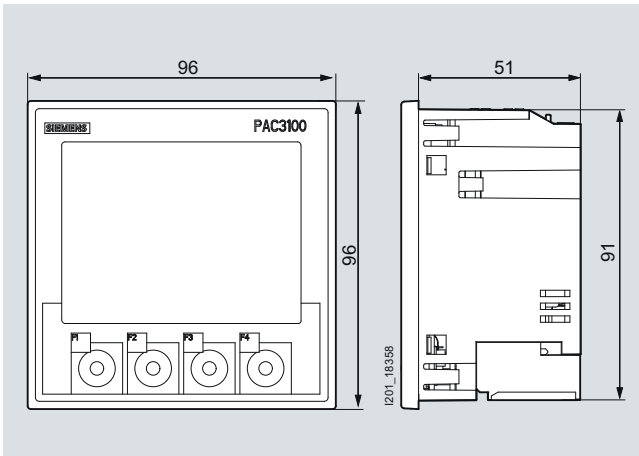

Left: Front view with screw terminals;  
Right: Side view with screw terminals

##### Dimensions of the 7KM PAC3200

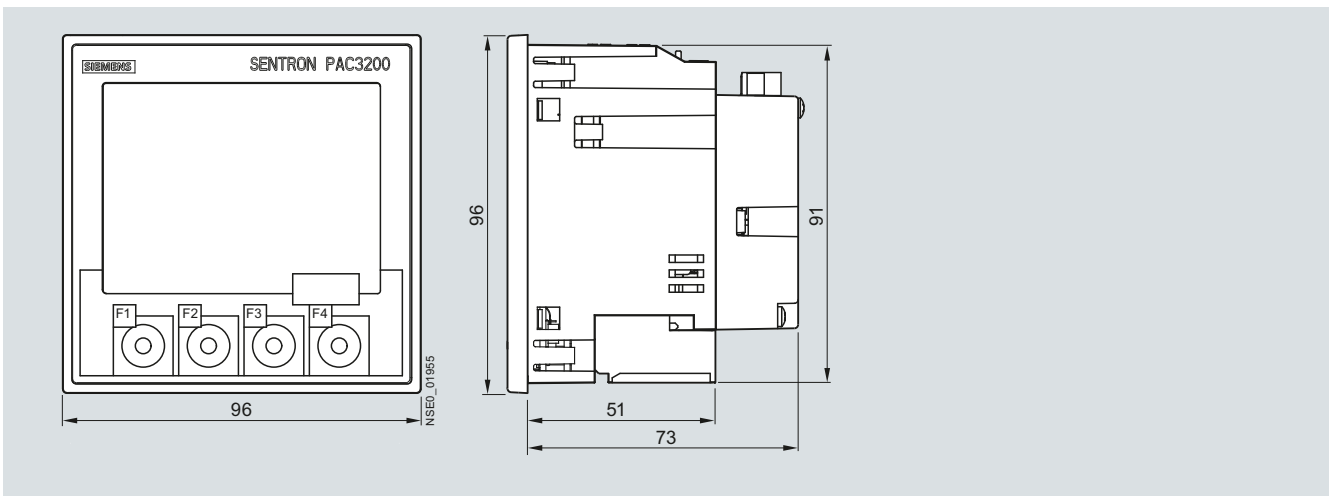

Left: Front view with screw terminals; Center: Side view with screw terminals; Right: Side view with ring cable lug terminals

##### Dimensions of the 7KM PAC4200

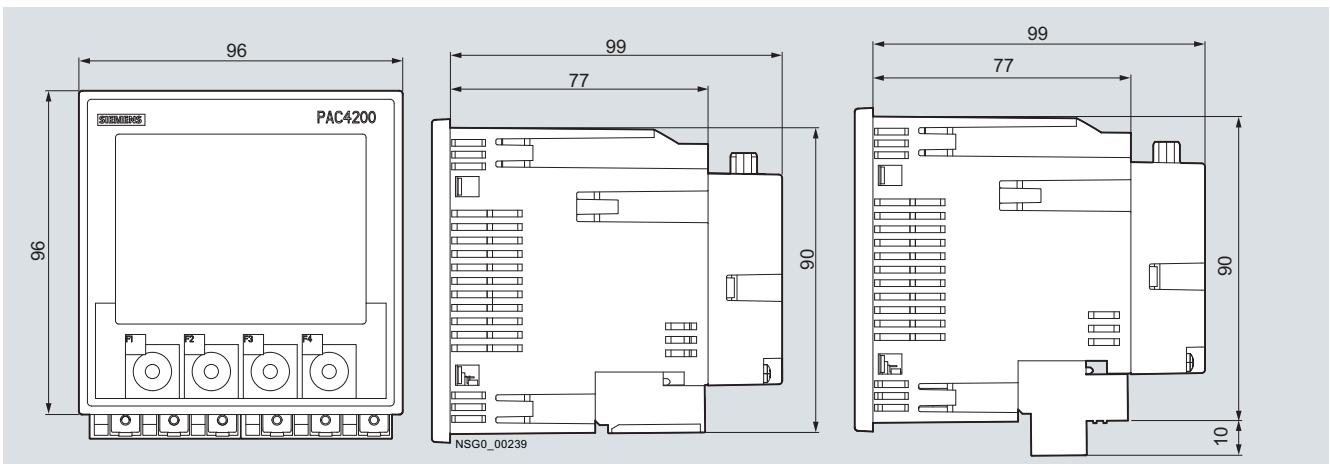

Left: Front view with ring cable lug terminals; Center: Side view with screw terminals; Right: Side view with ring cable lug terminals

## Measuring Devices and Power Monitoring

### 7KM PAC Measuring Devices

#### Technical specifications and project planning aids

#### Control panel cutout on the 7KM PAC4200, side

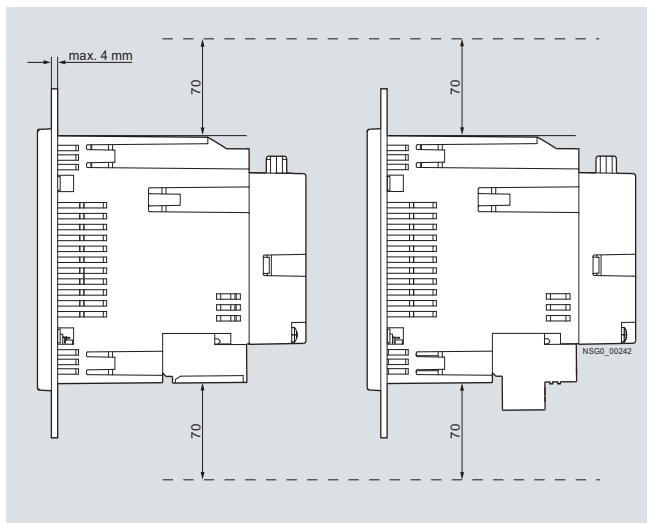

Left: 7KM PAC3200 with screw terminals  
Right: 7KM PAC3200 with ring cable lug terminals

#### Control panel cutout and mounting clearances for 7KM PAC3100, PAC3200 and 7KM PAC4200

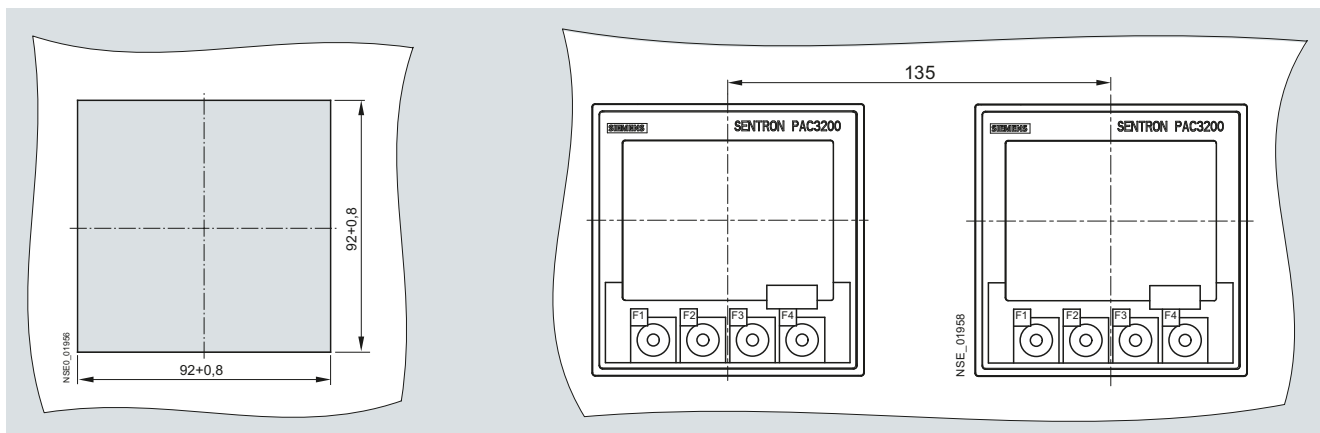

Left: Control panel cutout from the front (here for example the 7KM PAC3200)  
Right: Mounting clearances of two devices

## Circuit diagrams

### Connection examples

Following connection examples apply for the measuring devices 7KM PAC3200, 7KM PAC4200 and partly for the 7KM PAC3100. More information can be found in the respective manuals.

#### Note

In the examples, some elements are shown with one asterisk (\*) and/or two asterisks (\*\*). Their meanings are as follows:

\* Fuses must be provided by the user

\*\* Connection of supply voltage

#### Fuses

Protection of the supply voltage input:

Fuse holders	Cylindrical fuse links
3NW7-5130HG	3NW1006-0HG (0.6A)

#### Connection example 1:

Three-phase measurement, four conductors, unbalanced load, without voltage transformer, with three current transformers

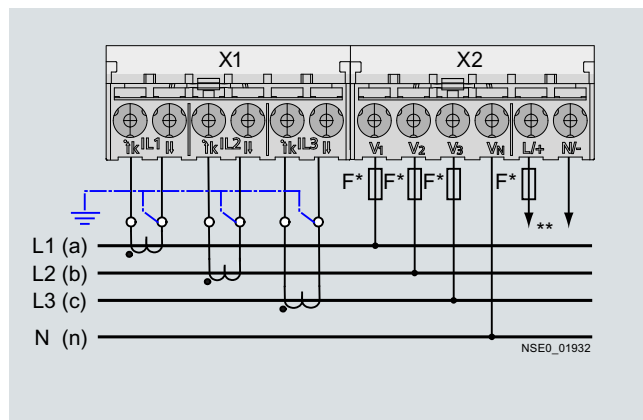

## Measuring Devices and Power Monitoring 7KM PAC Measuring Devices

### Technical specifications and project planning aids

#### Connection example 2:

Three-phase measuring, four conductors, unbalanced load, with voltage transformer, with three current transformers

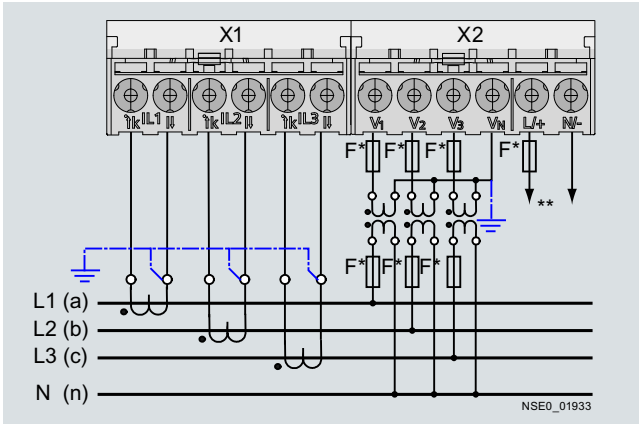

#### Connection example 5:

Three-phase measuring, three conductors, unbalanced load, without voltage transformers, with three current transformers

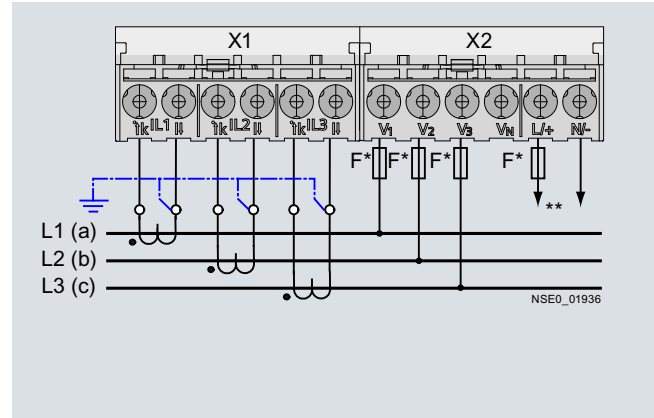

#### Connection example 3:

Three-phase measuring, four conductors, balanced load, without voltage transformers, with one current transformer

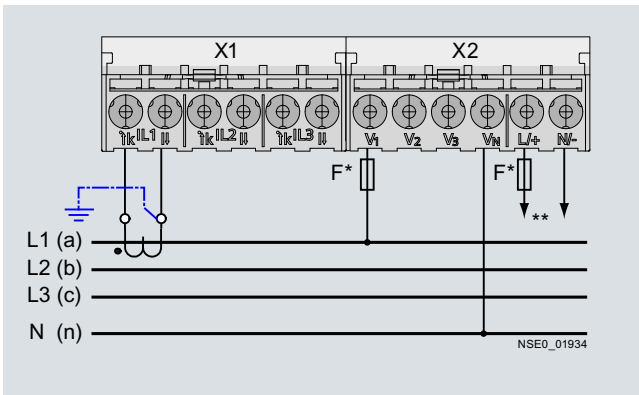

#### Connection example 6:

Three-phase measuring, three conductors, unbalanced load, with voltage transformers, with three current transformers

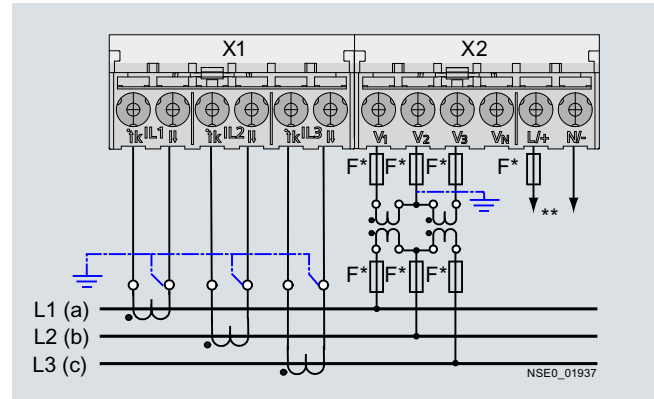

#### Connection example 4:

Three-phase measuring, four conductors, balanced load, with voltage transformers, with one current transformer

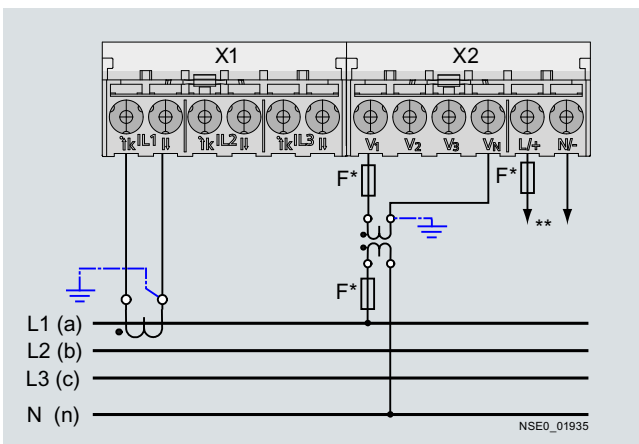

#### Connection example 7:

Three-phase measuring, three conductors, unbalanced load, without voltage transformers, with two current transformers

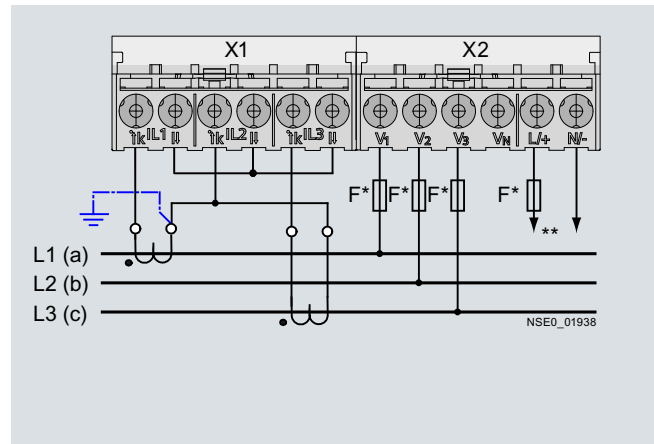

# Measuring Devices and Power Monitoring

## 7KM PAC Measuring Devices

### Technical specifications and project planning aids

#### Connection example 8:

Three-phase measuring, three conductors, unbalanced load, with voltage transformers, with two current transformers

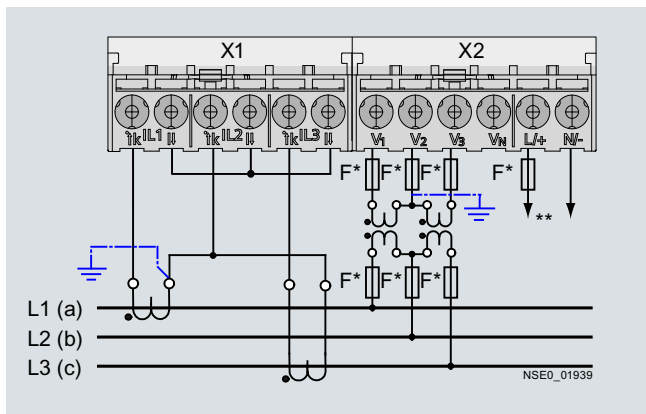

#### Connection example 11:

Two-phase measuring, three conductors, unbalanced load, without voltage transformers, with two current transformers

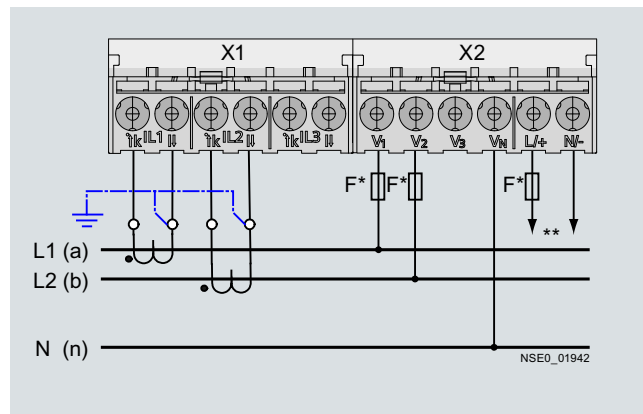

#### Connection example 9:

Three-phase measuring, three conductors, balanced load, without voltage transformers, with one current transformer

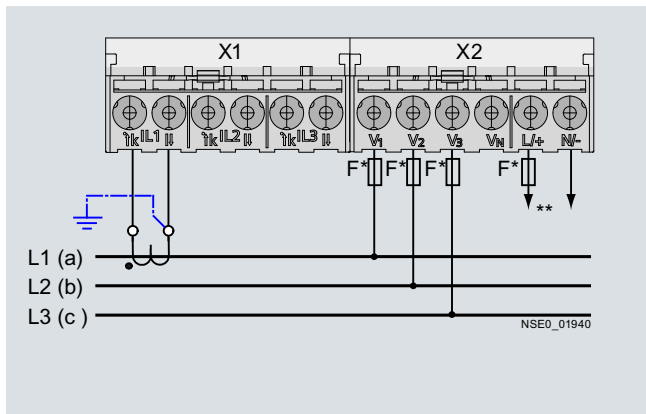

#### Connection example 12:

Single-phase measuring, two conductors, without voltage transformers, with one current transformer

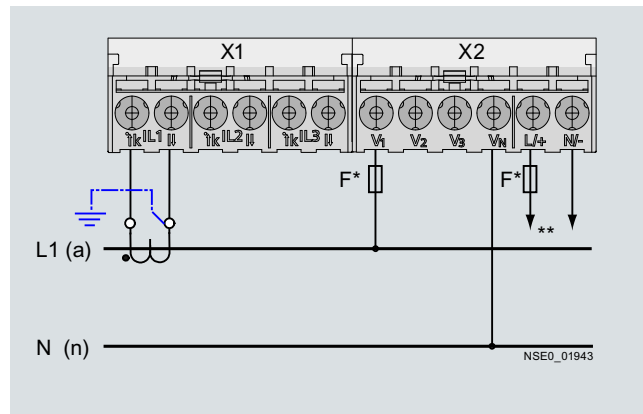

#### Connection example 10:

Three-phase measuring, three conductors, balanced load, with voltage transformers, with one current transformer

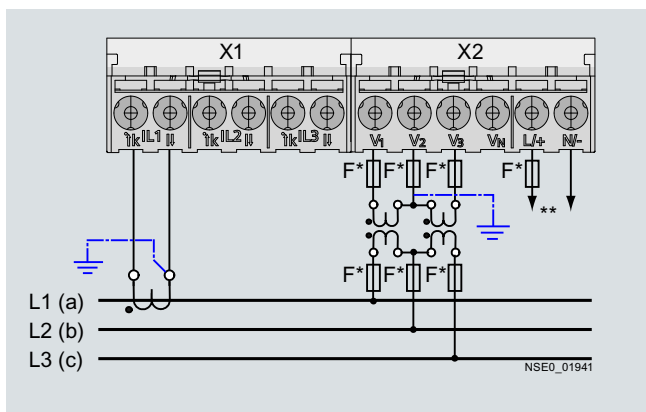

#### Connection example 13:

Three-phase measuring, four conductors, unbalanced load, with voltage transformer, with three current transformers

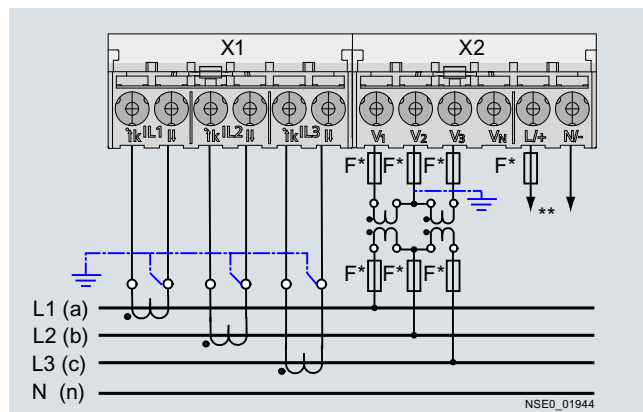

#### Connection graphics

Connection graphics for 7KM PAC3100

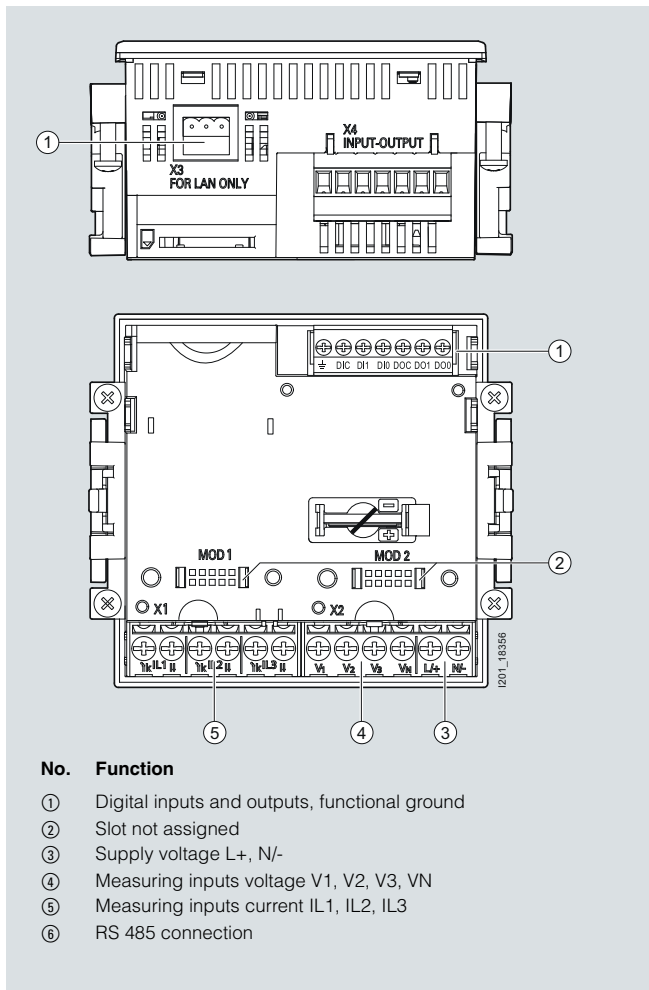

Overview of 7KM PAC3100 terminal assignments  
 Top: Top side, Bottom: Rear  
 Device with screw terminals

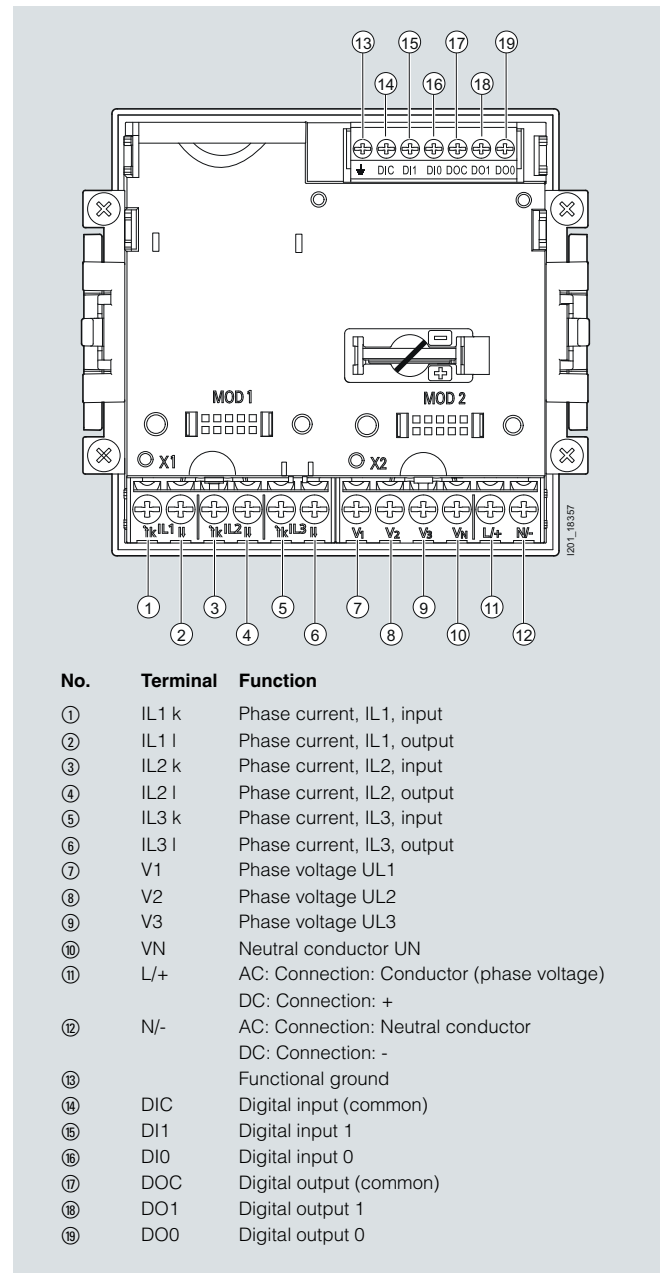

7KM PAC3100 terminal assignments in detail (rear)  
 Device with screw terminals

## Measuring Devices and Power Monitoring

### 7KM PAC Measuring Devices

#### Technical specifications and project planning aids

##### Connection graphics for 7KM PAC3200

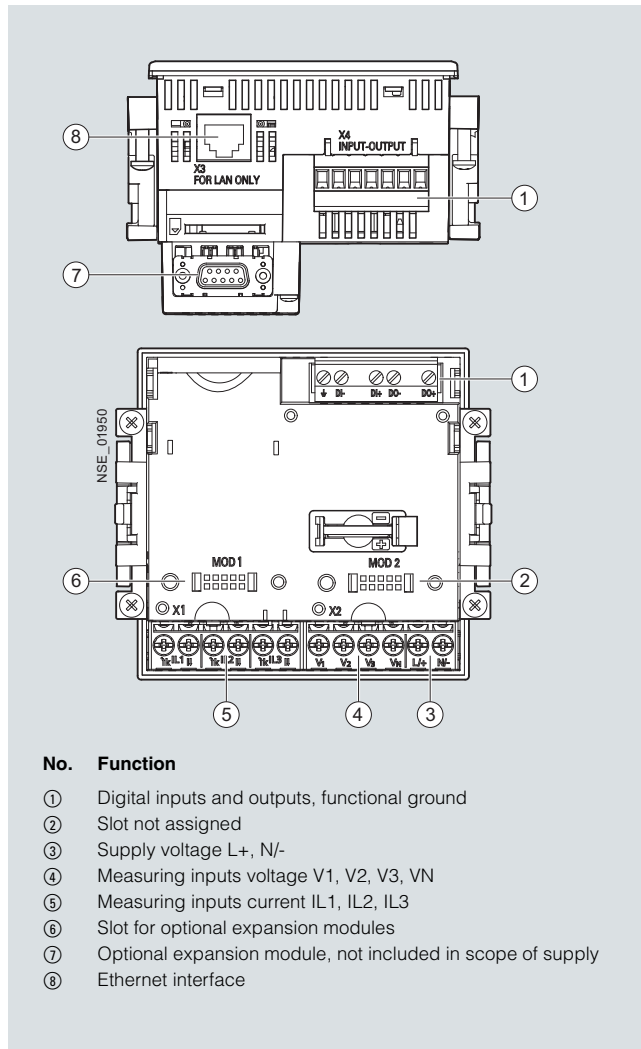

Overview of 7KM PAC3200 terminal assignments  
Top: Top side, Bottom: Rear  
Device with screw terminals

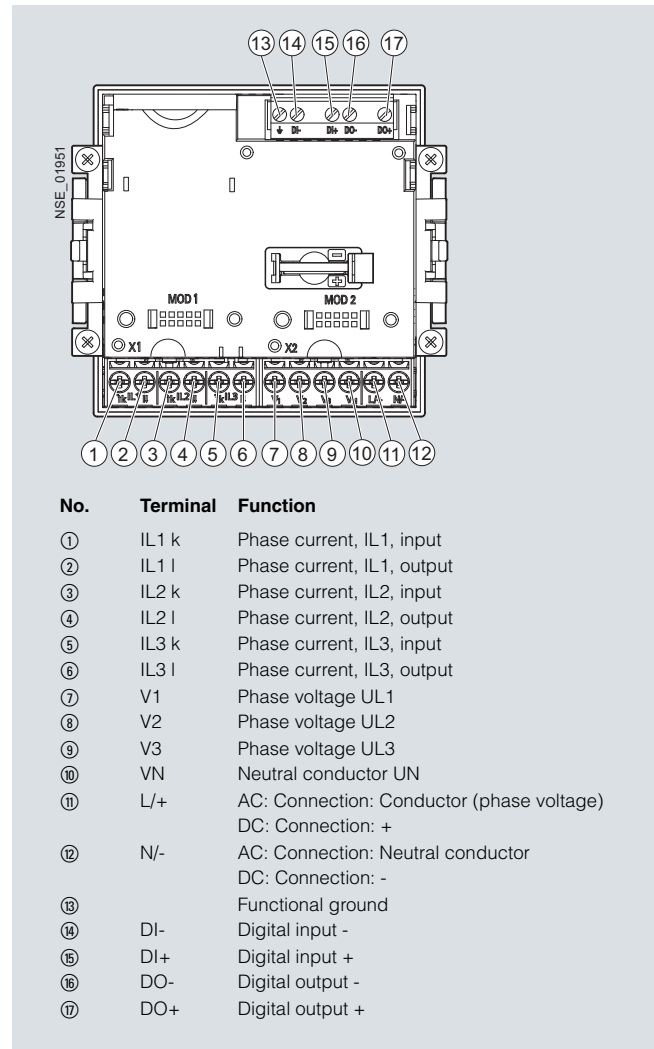

7KM PAC3200 terminal assignments in detail (rear)  
Device with screw terminals



## Measuring Devices and Power Monitoring

### 7KM PAC Measuring Devices

#### Technical specifications and project planning aids

#### Connection graphics for 7KM PAC4200

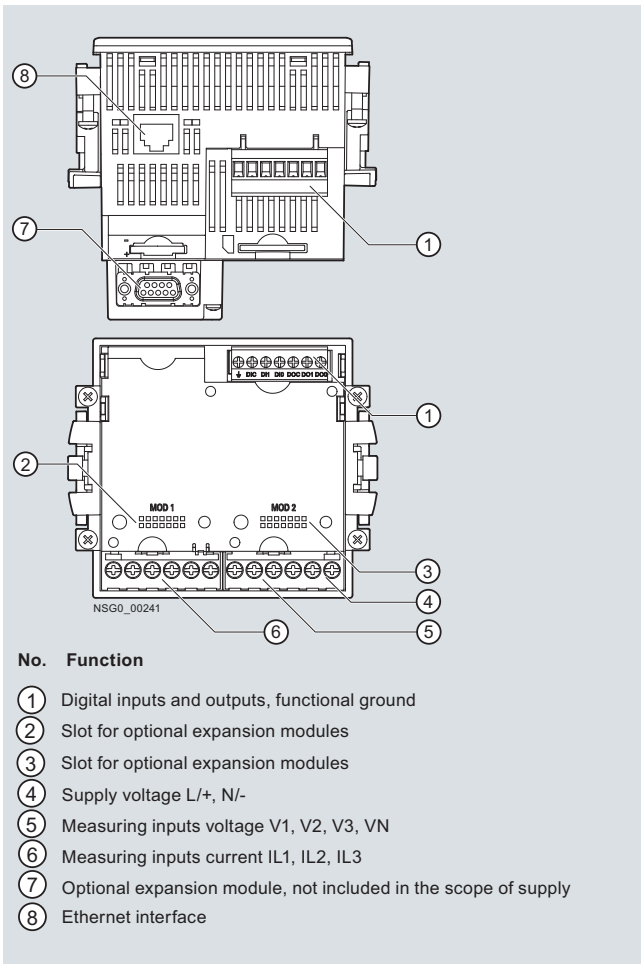

Overview of 7KM PAC4200 terminal assignments  
Top: Top side, Bottom: Rear  
Device with screw terminals

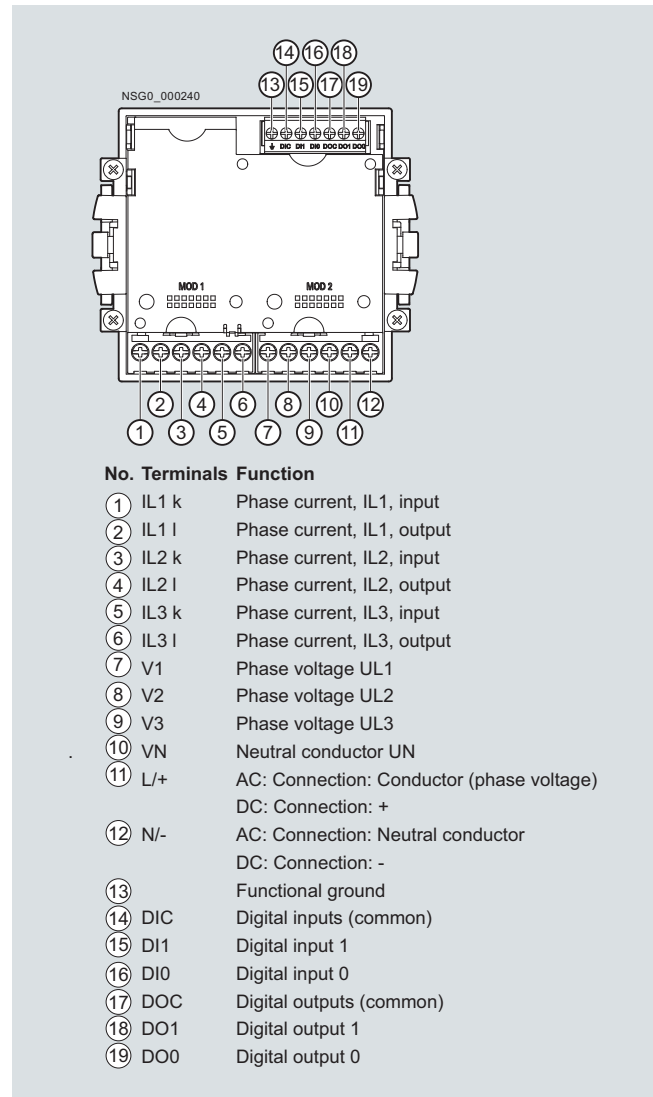

7KM PAC4200 terminal assignments in detail (rear)  
Device with screw terminals

## Measuring Devices and Power Monitoring

### 7KM PAC Measuring Devices

#### 7KM PAC expansion modules

##### Overview



Expansion modules are used as communication interfaces and for expanding the digital inputs/outputs for 7KM PAC measuring devices.

The expansion modules are plugged in at the back of the measuring device. The device identifies the module automatically and presents the relevant parameters for this module for selection in the parameterization menu.

The following expansion modules are available (shown from left to right in the figure on the left):

- 7KM PAC Switched Ethernet PROFINET expansion module
- 7KM PAC PROFIBUS DP expansion module
- 7KM PAC RS 485 expansion module
- 7KM PAC 4DI/2DO expansion module

##### Connection for 3VA molded case circuit breakers

The following expansion modules can be mounted on the front of the COM800/COM100 data concentrators of the 3VA molded case circuit breaker:

- 7KM PAC Switched Ethernet PROFINET and
- 7KM PAC PROFIBUS DP

For further details, see [Catalog LV 10, chapter "Molded case circuit breakers"](#) or the manual at <http://support.automation.siemens.com/DE/view/en/90318775>

##### More information

For more information about the software components see [Catalog LV 10, chapter "Software"](#), and on the Internet at [www.siemens.com/lowvoltage/powermonitoring](http://www.siemens.com/lowvoltage/powermonitoring)

##### Version

##### Use in

##### 7KM PAC

PAC3100

PAC3200

PAC4200

PAC5100

PAC5200

3VA  
COM800/  
COM100

#### 7KM PAC expansion modules



##### 7KM PAC Switched Ethernet PROFINET expansion module

The 7KM PAC Switched Ethernet PROFINET expansion module is a plug-in communication module for 7KM PAC3200 and 7KM PAC4200 measuring devices and 3VA molded case circuit breakers.



It provides the following features:

- Standardized PROFINET interface to the measured quantities
- The measured quantities can be individually selected using a GSDML file. This permits use of cost-effective S7 CPUs
- Easy parameter assignment using the device display and STEP 7
- Integrated Ethernet switching allows networking with short cables without additional switches
- Direct integration in production machine networks using IRT (IRT = Isochronous-Real-Time)
- Full support of PROFINET IO (DHC, DNS, SNMP, SNTIP)
- Device replacement without PG in the PROFINET assembly using LLDP
- Deterministic reversing time through ring redundancy (MRP)
- Modbus TCP communication
- Communication with powermanager or powerconfig
- 2 x Ethernet (RJ45) sockets
- Transmission rates 10 and 100 Mbit/s
- Protocols PROFINET IO, PROFINET and Modbus TCP
- No external auxiliary power necessary
- Status display via the device display and via LEDs on the module

All measured variables from 7KM PAC3200 and 7KM PAC4200 can be individually selected and cyclically transmitted by means of the GSDML file. This enables optimum use of the process image of the PROFINET controller, e.g. CPU 315-2 PN/DP of SIMATIC S7.

The measured variables can be read out in acyclic mode using PROFINET, a PNO protocol profile. Thanks to PROFINET, it is possible to assemble a power monitoring system with devices from various manufacturers using PROFINET.

	7KM PAC					3VA
	PAC3100	PAC3200	PAC4200	PAC5100	PAC5200	COM800/ COM100
7KM PAC Switched Ethernet PROFINET expansion module	--	✓	✓	--	--	✓

Version	Use in	7KM PAC					
		PAC3100	PAC3200	PAC4200	PAC5100	PAC5200	3VA COM800/ COM100
 <p><b>7KM PAC PROFIBUS DP expansion module</b></p> <p>The 7KM PAC PROFIBUS DP expansion module is a plug-in communication module for 7KM PAC3200 and 7KM PAC4200 measuring devices and 3VA molded case circuit breakers.</p> <p>The 7KM PAC PROFIBUS DP expansion module has the following features:</p> <ul style="list-style-type: none"> <li>• Plug-in communication module for measuring devices for connection to PROFIBUS DPV1</li> <li>• 7KM PAC3200 and 7KM PAC4200</li> <li>• Parameterizable via device front or using parameterization software</li> <li>• Data can be transferred both cyclically and acyclically via PROFIBUS DPV1</li> <li>• Easy engineering thanks to integration in SIMATIC STEP 7 and/or simple integration via GSD file for other programming systems</li> <li>• Optimum use of process image of a control system for selection of individual measured quantities for cyclical transfer</li> <li>• Supports all baud rates from 9.6 kbit/s up to 12 Mbit/s</li> <li>• Connection through 9-pole Sub-D connector according to IEC 61158</li> <li>• No external auxiliary power necessary</li> <li>• Status display via the device display and via LEDs on the module</li> </ul>	--	✓	✓	--	--	✓	
 <p><b>7KM PAC RS 485 expansion module</b></p> <p>The 7KM PAC RS 485 expansion module has the following features:</p> <ul style="list-style-type: none"> <li>• 7KM PAC RS 485 plug-in communication module for 7KM PAC3200 and 7KM PAC4200 measuring devices and 3VA molded case circuit breakers</li> <li>• Parameterizable via device front or using parameterization software</li> <li>• Support for the Modbus RTU protocol</li> <li>• Plug and play</li> <li>• Supports transmission rates of 4.8/9.6/19.2 and 38.4 kbit/s</li> <li>• Connection by means of 6-pole screw terminals</li> <li>• No external auxiliary power necessary</li> <li>• Status indication by LED on the module</li> <li>• The 7KM PAC RS 485 expansion module is required for the gateway function of the 7KM PAC4200 for communication with simple devices with an RS 485 interface, such as the 7KM PAC3100, via Ethernet (Modbus TCP).</li> </ul>	--	✓	✓	--	--	--	
 <p><b>7KM PAC 4DI/2DO expansion module</b></p> <p>The 7KM PAC 4DI/2DO expansion module is used to expand the 7KM PAC4200 measuring device to up to 10 digital inputs and 6 digital outputs and offers the following features:</p> <ul style="list-style-type: none"> <li>• Up to two 7KM PAC 4DI/2DO modules can be plugged onto a 7KM PAC4200</li> <li>• The 7KM PAC 4DI/2DO expansion modules mean that the internal digital inputs and outputs can be expanded by up to 8 inputs and 4 outputs</li> <li>• The 7KM PAC 4DI/2DO expansion modules can be configured locally at the front of the device or via the powerconfig parameterization software</li> <li>• The digital inputs can be used without the need for an external power supply as they are self-powered. This is particularly useful for the integration of non-electric measuring devices, such as water or compressed-air counters</li> <li>• All functions of the integrated multifunctional inputs/outputs on the 7KM PAC4200 are also available in the 7KM PAC 4DI/2DO expansion module</li> <li>• Inputs and outputs can be used as an S0 interface conforming to IEC 62053-31</li> <li>• The connection is made via a 9-pole screw terminal</li> <li>• No external auxiliary power supply is required</li> </ul>	--	--	✓	--	--	--	

## Measuring Devices and Power Monitoring

### 7KM PAC Measuring Devices

#### 7KM PAC expansion modules – Switched Ethernet PROFINET expansion module

##### Technical specifications

<b>Communication</b>		
Industrial Ethernet		10/100 Mbit/s
Integrated IRT-enabled switch		Auto crossover
With 2 x 8-pole RJ45 sockets		Auto negotiation
<b>Power supply</b>		
		From 7KM PAC measuring device
<b>Dimensions and weights</b>		
<b>Enclosure dimensions (W x H x D)</b>		
Module enclosure for plug-in mounting	mm	43 x 63 x 22
<b>Weight approx.</b>	g	36
<b>Degree of protection</b>		
<b>Degree of protection acc. to EN 60529</b>		IP20
<b>Ambient conditions</b>		
<b>Temperature range</b>		
Operating temperature	°C	-10 ... + 55
Storage and transport temperature	°C	-25 ... + 70
<b>Relative humidity</b>		
At 25 °C without condensation	%	95
<b>Altitude</b>		
Above sea level up to max.	m	2000
<b>Pollution degree</b>		
		2

##### Dimensional drawings

Dimensions of Switched Ethernet PROFINET expansion module at the side and from above

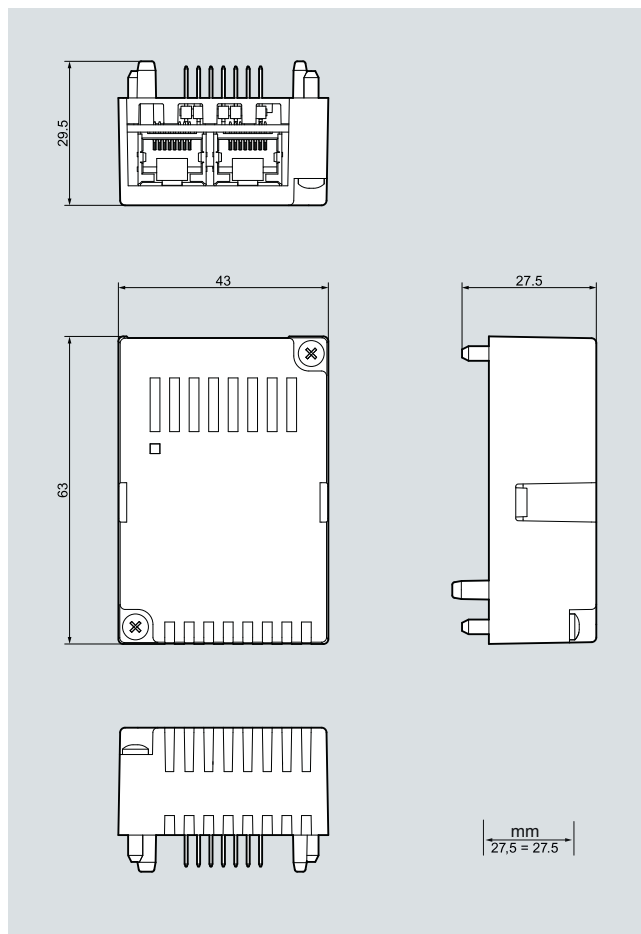

#### Technical specifications

Communication		
<b>PROFIBUS DP</b>		
Transmission rate max.	Mbit/s	12
Protocol		PROFIBUS DPV1
Measured variables to be transferred		Definable using GSD file
Dimensions and weights		
<b>Enclosure dimensions (W x H x D)</b>		
Module enclosure for plug-in mounting	mm	43 x 63 x 22
<b>Weight approx.</b>	g	45
Degree of protection		
<b>Degree of protection acc. to EN 60529</b>		IP20
Ambient conditions		
<b>Temperature range</b>		
Operating temperature	°C	-10 ... + 55
Storage and transport temperature	°C	-25 ... + 70
<b>Relative humidity</b>		
At 25 °C without condensation	%	95
<b>Altitude</b>		
Above sea level up to max.	m	2000
<b>Pollution degree</b>		2

#### Dimensional drawings

Dimensions of 7KM PAC PROFIBUS DP expansion module at the side and from above

Dimensions of the plug connector between the 7KM PAC PROFIBUS DP expansion module and the 7KM PAC measuring device

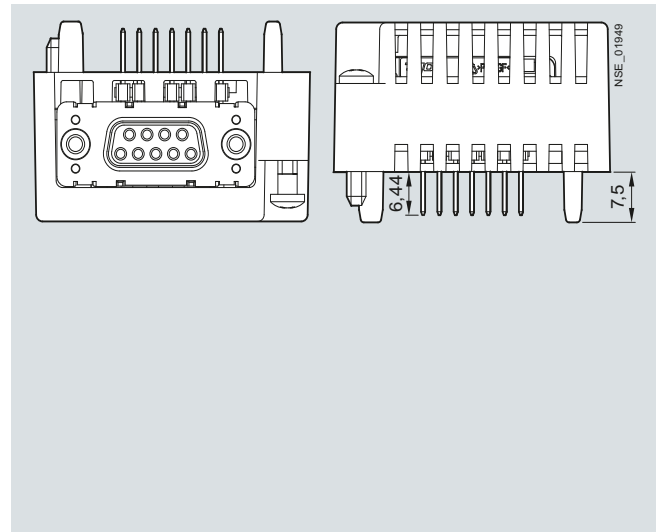
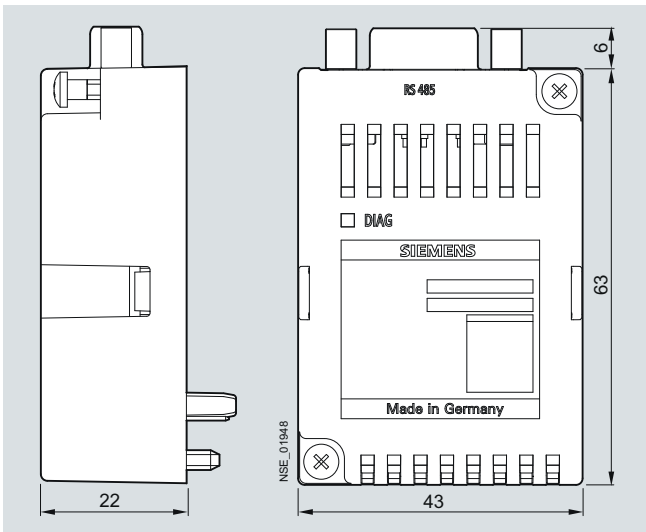

#### More information

##### Software components

For more information about the software components, see Catalog LV 10, chapter "Software", and on the Internet at [www.siemens.com/lowvoltage/powermonitoring](http://www.siemens.com/lowvoltage/powermonitoring)

## Measuring Devices and Power Monitoring

### 7KM PAC Measuring Devices

#### 7KM PAC expansion modules – 7KM PAC RS 485 expansion module

##### Technical specifications

Communication		
<b>RS 485</b>		
Transfer rates	kBd	Optionally 4.8/9.6/19.2/38.4
Protocol		Modbus RTU
Dimensions and weights		
<b>Enclosure dimensions (W x H x D)</b>		
Module enclosure for plug-in mounting	mm	43 x 63 x 22
<b>Weight approx.</b>	g	41
Degree of protection		
<b>Degree of protection acc. to EN 60529</b>		IP20
Ambient conditions		
<b>Temperature range</b>		
Operating temperature	°C	-10 ... + 55
Storage and transport temperature	°C	-25 ... + 70
<b>Relative humidity</b>		
At 25 °C without condensation	%	95
<b>Altitude</b>		
Above sea level up to max.	m	2000
<b>Pollution degree</b>		2

##### Dimensional drawings

Dimensions of 7KM PAC RS 485 expansion module at the side and from above

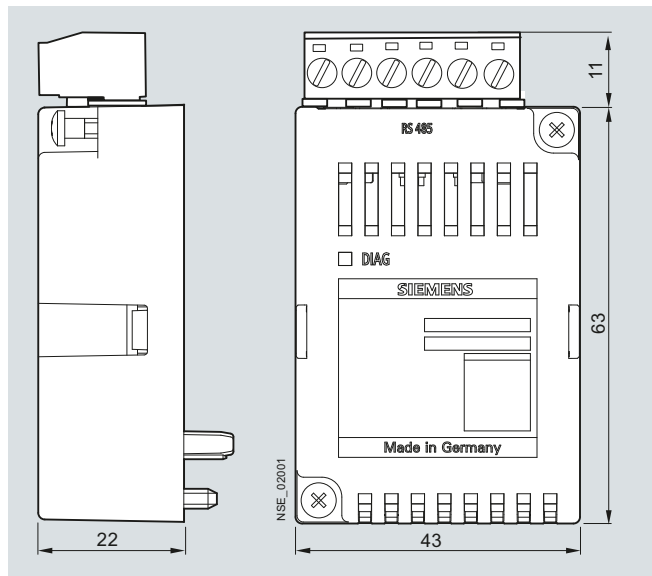

Dimensions of the plug connector between the 7KM PAC RS 485 expansion module and the 7KM PAC measuring device

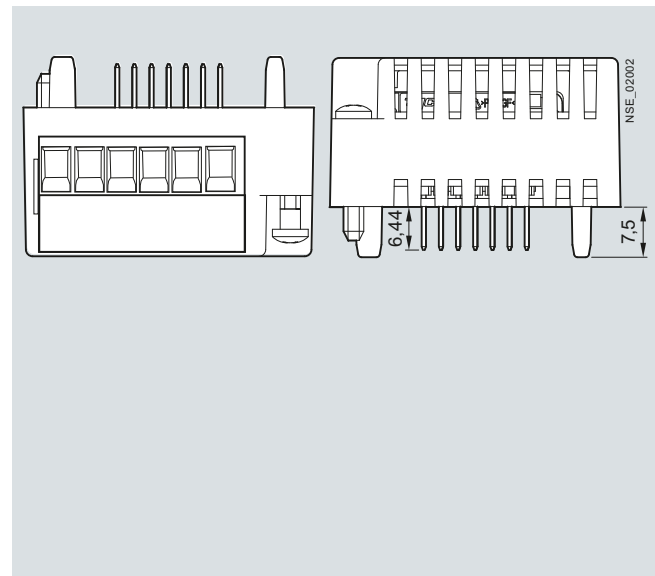

##### More information

###### Software components

For more information about the software components, see Catalog LV 10, chapter "Software", and on the Internet at [www.siemens.com/lowvoltage/powermonitoring](http://www.siemens.com/lowvoltage/powermonitoring)

### Technical specifications

#### Inputs/outputs

##### Digital outputs

Number	4
Type	Internal power supply
Design/function	Switching output or pulse output according to IEC 62053-31 Class B
External operating voltage	0 ... 30 V DC, (optional)
Input resistance	
• "1" signal detection	≤ 1 kΩ
• "0" signal detection	≥ 100 kΩ
Input resistance	
• "1" signal detection	≥ 2.5 mA
• "0" signal detection	≤ 0.5 mA

##### Digital outputs

Number	2
Type	Bidirectional
Design/function	Switching output or pulse output according to IEC 62053-31 Class B
Rated voltage	0 ... 30 V DC, typical 24 V DC (SELV or PELV supply)
Output current for "1" signal	
• Continuous load	≤ 50 mA (internal resistance 55 Ω)
• Transient overload	≤ 130 mA for 100 ms
Output current for "0" signal	
• Continuous load	≤ 0.2 mA
• Transient overload	≤ 130 mA for 100 ms

#### Dimensions and weights

##### Enclosure dimensions (W x H x D)

Module enclosure for plug-in mounting	mm	43 x 63 x 22
---------------------------------------	----	--------------

Weight approx.	g	38
----------------	---	----

#### Degree of protection

Degree of protection acc. to EN 60529	IP20
---------------------------------------	------

#### Ambient conditions

##### Temperature range

Operating temperature	°C	-10 ... + 55
Storage and transport temperature	°C	-25 ... + 70

##### Relative humidity

At 25 °C without condensation	%	95
-------------------------------	---	----

##### Altitude

Above sea level up to max.	m	2000
----------------------------	---	------

Pollution degree	2
------------------	---

### Dimensional drawings

Dimensions of 7KM PAC 4DI/2DO expansion module at the side and from above

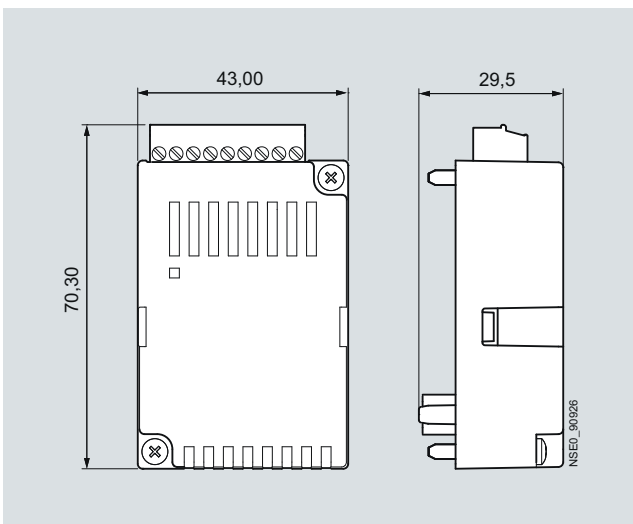

## Measuring Devices and Power Monitoring

### 7KT PAC Measuring Devices

#### 7KT PAC1500 three-phase measuring devices

##### Overview



7KT PAC1500 measuring devices, three-phase, for direct connection up to 80 A / 125 A

The measuring devices (power meters) are used to record the amount of electrical energy and power exported and imported. Siemens compact measuring devices are designed as modular devices for alternating current and can be mounted on standard mounting rails. They comply with the metering equipment standard EN 50470 (Part 1 and 3) and come with an LCD display.

The three-phase measuring devices for direct connection are available up to 125 A and in versions with transformer connections (.../5 A to 10000/5 A).

The measuring devices store active and reactive energy and all comply with accuracy class 1 (for active energy).

All measuring devices have a pulse output (S0) and are designed for 2-tariff measurements. The MID versions comply with the new Measuring Instruments Directive 2004/22/EC. The measuring devices also have an integrated optical interface (IrDA) for connecting communication modules, which enables their integration in a range of other systems, such as power management systems.

##### Technical specifications

7KT PAC1500 three-phase measuring device			7KT1540 7KT1542	7KT1543 7KT1545	7KT1546 7KT1548
<b>Standards</b>			EN 50470-1, EN 50470-3, EN 62053-23, EN 62053-31		
<b>Connection</b>					
• Direct connection			--	80 A	125 A
• Transformer current connection			.../5 A	--	--
<b>General data</b>					
• Enclosures	Acc. to DIN 43880	MW (1 MW = 18 mm)	4	4	6
• Mounting	Acc. to EN 60715		35 mm		
• Mounting height		mm	70		
<b>Function</b>					
• Connection	Single-phase or three-phase	No. of conductors	4	2 ... 4	2 ... 4
• Storage of setting and counter reading	Via (EEPROM)		Yes	Yes	Yes
• Tariffs	For active and reactive energy		T1/T2	T1/T2	T1/T2
<b>Supply (through measuring terminals)</b>					
• Rated control supply voltage $U_n$		V AC	230		
• Voltage range		V	110... 276		
• Rated frequency $f_n$		Hz	50		
<b>Measuring accuracy (at 23 ± 1 °C)</b>					
• Active energy and active power	Based on nominal value		Class B		
• Reactive energy and reactive power	Acc. to EN 50470-3		Class 2		
<b>Measuring inputs</b>					
• Connection type			Transformer TA-TC .../5 A	Direct	Direct
• Terminal capacitance, operational and main current paths	Rigid, min. (max.)	mm <sup>2</sup>	1.5 (6)	1.5 (35)	5 (50)
	Flexible min. (max.)	mm <sup>2</sup>	1.5 (6)	1.5 (35)	5 (50)
• Voltage $U_n$	Phase/phase	V	400		
	Phase/N	V	230		
• Operating range voltage	Phase/phase	V	190 ... 480		
	Phase/N	V	110 ... 276		
• Current $I_{ref}$		A	--	5	5
• Current $I_n$		A	5	--	--
• Current $I_{min}$		A	0.05	0.25	0.25
• Current operating range ( $I_{st} ... I_{max}$ )	Direct connection	A	--	0.015 ... 80	0.020 ... 125
	Transformer connection	A	0.003 ... 6	--	--
• Transformer current	Primary current of the transformer	A	5 ... 10000	--	--
	Smallest input step	A	5	--	--
• Input ripple form			Sinusoidal		
• Operating starting current $I_{st}$		mA	3	15	20
<b>S0 interface</b>					
• Pulse outputs for absorbed active and reactive energy T1 + T2	Acc. to EN 62053-31		Yes		
• Pulse count	For input current $I_{max}$	Pulses/kWh	--	500	500
	Automatic for transformers	Pulses/kWh	100 - 10 - 1	--	--
<b>IR interface</b>					
• At the side for connecting communication modules				M-Bus/Modbus RTU/RS 485/KNX	



**Dimensional drawings**

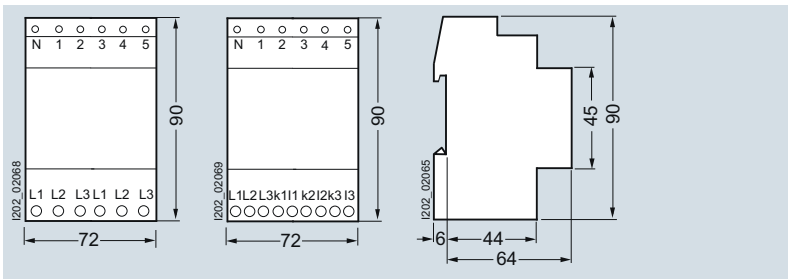

7KT1543  
7KT1545

7KT1540

7KT1543, 7KT1545, 7KT1540,  
view from the left

**Circuit diagrams**

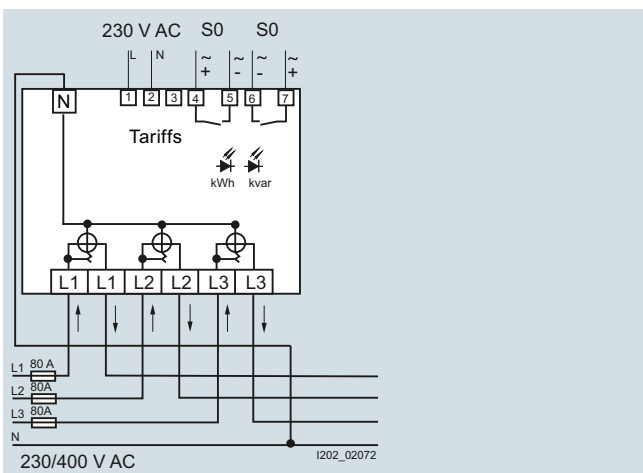

7KT1543, 7KT1545, three-phase connection

To achieve the specified accuracy, the N conductor must be connected to the counter.

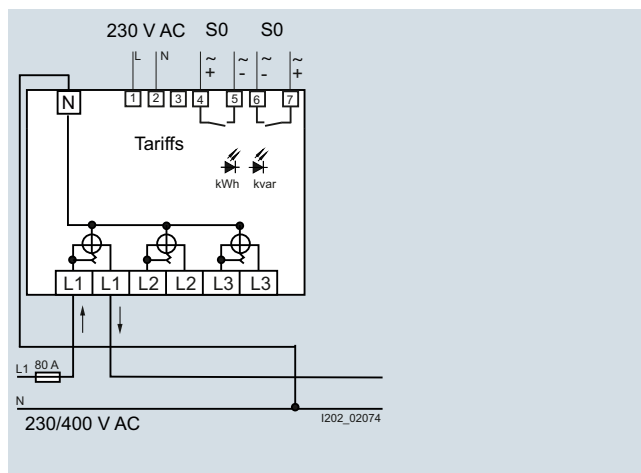

7KT1543, 7KT1545, single-phase connection

With single-phase connection the display lighting cannot be activated.

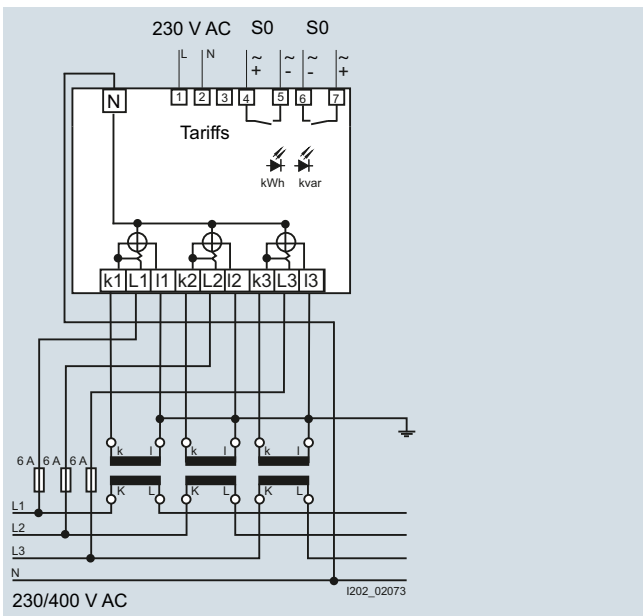

7KT1540

## Measuring Devices and Power Monitoring

### 7KT PAC Measuring Devices

#### 7KT PAC1500 three-phase measuring devices

##### More information

##### Display representation

- Green, backlit LCD
- The control button is used to select the different display levels.

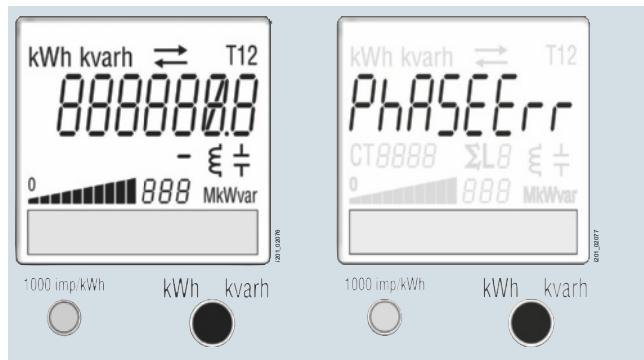

Connection error and phase failure

kWh kvarh	kWh display kvarh display
↔	Power import display Power export display
T12	Selected/active tariff
LB	Phase value of energy display (L1-2-3) and SL
ΣL	Phase total value of energy display
⌚	Display for inductive power
⊥	Display for capacitive power
888	Display for active and reactive power
CT8888	Display for the current transformer ratio, primary side
▬▬▬▬▬	Bar diagram (as a percent of $I_{max}$ )
▭	Device name and approval data
○	LED accuracy check display
●	Control button

##### Operation

The large number of measured variables makes it necessary to present the data in 2 display levels:

- Default and
- Energy counter states

##### A) Default display level

- The default display level shows the sum of the active and reactive energy:
  - Sum of active energy (E1-E2+E5-E6)
  - Sum of reactive energy (E3-E4+E7-E8)
  - Software version
  - Checksum
- The various measured variables can be called up by briefly pressing the control button.
- A 3-digit display indicates the instantaneous power. A bar display indicates the instantaneous current in steps of 10 % in relation to the maximum load rating ( $I_{max}$ ) (transformer connection in relation to  $I_{secondary}$ ). The bar display is refreshed every 2 s.
- Note:  
In this display level the symbol indicator (import/export) refers to the actual power and not to the energy consumption value.

##### Display test control button

- If the control button is pressed and held for longer than 10 s, a display test will be activated.
- This test takes 30 s to complete. The DEFAULT display level then appears.

##### B) E-counter states display level

- This display level presents the energy values E1 to E8.
- To switch to the E1 to E8 energy values, press and hold the control button until the red LED lights up (approx. 4 s). The power indicators go out and the display shows the energy values E1 to E8.
- A brief press of the control button enables these measured values to be shown in a loop.
- To return to the default display level, press and hold the control button for approx. 4 s or wait approx. 30 s for automatic switchover to the initial display.
- To view all the energy registers per phase (active and reactive energy for consumed and supplied energy for T1 and T2) in a loop, press the control button for 2 s.
- The display lighting is switched off automatically after 40 s of inactivity.

##### Resetting all energy registers

- If the control button is pressed and held for longer than 20 s, the word "rESEt" will appear.
- After the control button is pressed again for at least another 4 seconds, all the energy registers are set to ZERO.

## Measuring Devices and Power Monitoring

### 7KT PAC Measuring Devices

#### 7KT PAC1500 single-phase measuring devices

#### Overview



The 7KT PAC1500 single-phase measuring devices (power meters) are used to record the amount of electrical energy and power exported and imported. They comply with the metering equipment standard EN 50470 (Part 1 and 3) and come with an LCD display.

The 7KT PAC1500 single-phase measuring devices for direct connection are available up to 80 A. They store active and reactive energy, and all comply with accuracy class 1 (for active energy).

All measuring devices have a pulse output (S0) and are designed for 1-tariff or 2-tariff measurements, depending on the version.

The MID versions comply with the new Measuring Instruments Directive 2004/22/EC. The measuring devices (with the exception of 7KT1530) also have an integrated optical interface (IrDA) for connecting communication modules.

#### Technical specifications

7KT PAC1500 single-phase measuring device Direct connection up to 80 A			7KT530	7KT531 7KT533
<b>Standards</b>			EN 50470-1, EN 50470-3, EN 62053-23, EN 62053-31	
<b>General data</b>				
• Enclosures	Acc. to DIN 43880	MW	2	
• Mounting	Acc. to EN 60715		35 mm	
• Mounting height		mm	70	
<b>Function</b>				
• Operating mode	Single-phase loads	Conductors	2	
• Storage of setting and counter reading	Via (EEPROM)		Yes	
• Tariff	For active energy		T1	T1 + T2
	For reactive energy		T1	T1 + T2
<b>Supply (through measuring terminals)</b>				
• Rated control supply voltage $U_n$		V AC	230	
• Voltage range		V	184 ... 276	
• Rated frequency $f_n$		Hz	50	
<b>Measuring accuracy (at 23 ± 1 °C)</b>				
• Active energy and active power	Acc. to EN 50470-3		Class B	
• Reactive energy and reactive power	Acc. to EN 62053-23		Class 2	
<b>Measuring inputs</b>				
• Connection type	Phase/N		Direct	
• Terminal capacitance, operational and main current paths	Rigid, min. (max.)	mm <sup>2</sup>	1.5 (35)	1.5 (35)
	Flexible min. (max.)	mm <sup>2</sup>	1.5 (35)	1.5 (35)
• Operating range voltage	Phase/N	V AC	184 ... 276	
• Current $I_{ref}$		A	15	
• Current $I_{min}$		A	0.75	
• Current operating range ( $I_{st} \dots I_{max}$ )	Direct connection	A	0.025 ... 80	
• Current waveform			Sinusoidal	
• Operating starting current $I_{st}$		mA	25	
<b>S0 interface</b>			Acc. to EN 62053-31	
• Pulse outputs for consumed active and reactive energy			Yes	
• Pulse count		Pulses/kWh	1000	
<b>IR interface</b>				
• At the side for connecting communication modules (M-Bus/Modbus RTU/RS 485/KNX)			--	Yes

# Measuring Devices and Power Monitoring

## 7KT PAC Measuring Devices

### 7KT PAC1500 single-phase measuring devices

#### Dimensional drawings

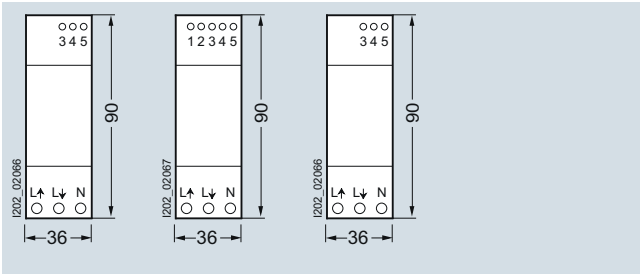

7KT530

7KT531,  
7KT533

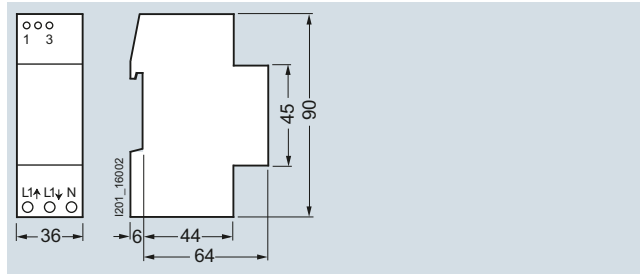

7KT140

#### Circuit diagrams

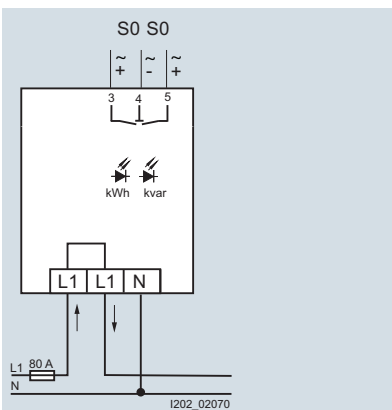

7KT530

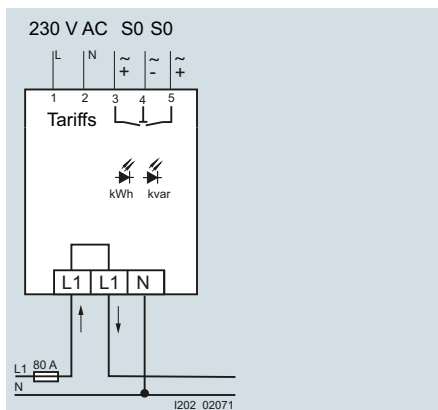

7KT531,  
7KT533

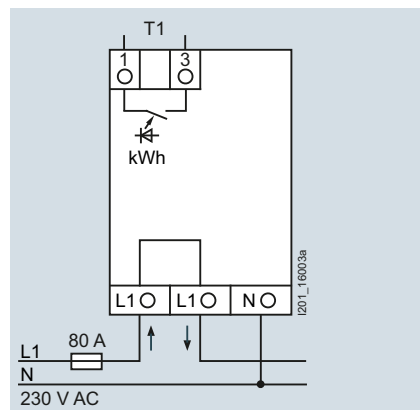

7KT140

### More information

#### Digital 7KT53. single-phase E-counters, display representation

- Green, backlit LCD
- The control button is used to select the different display levels.

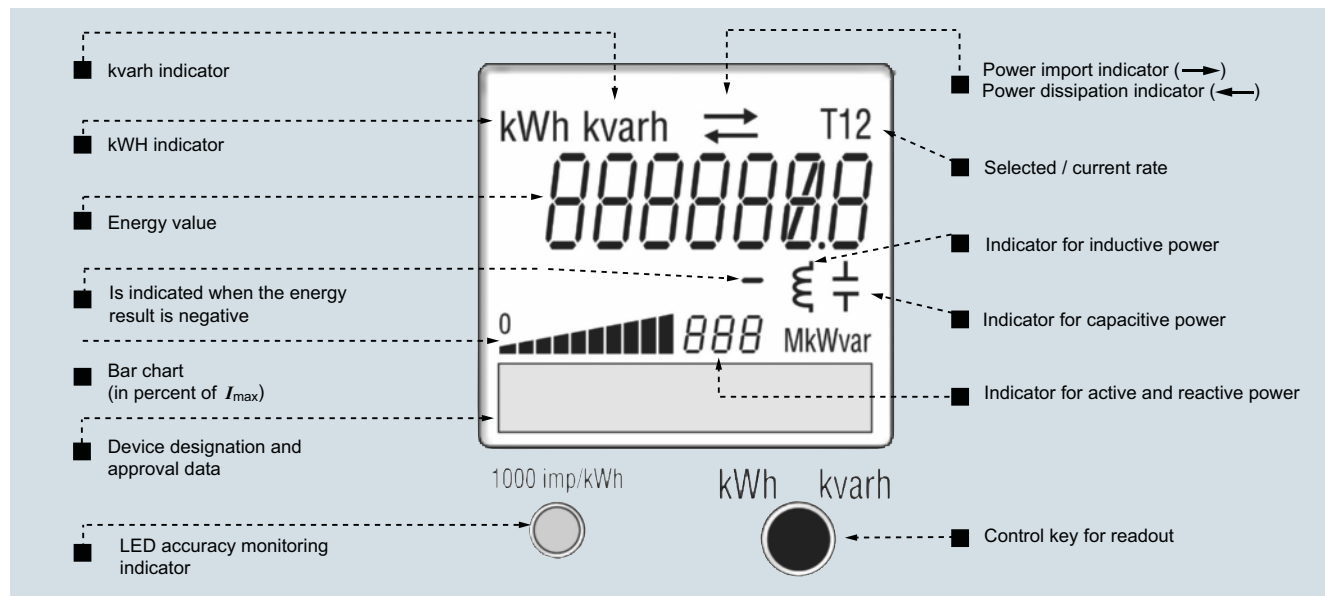

### Operation

The large number of measured variables makes it necessary to present the data in 2 display levels:

- Default
- Energy counter states

#### A) Default display level

- The default display level shows the sum of the active and reactive energy:
  - Sum of active energy (E1-E2 for 7KT1530 and E1-E2+E5-E6 for 7KT1531, 7KT1533)
  - Sum of reactive energy (E3-E4 for 7KT1530 and E3-E4+E7-E8 for 7KT1531, 7KT1533)
  - Software version
  - Checksum
- The various measured variables can be called up by briefly pressing the control button.
- A 3-digit display indicates the instantaneous power. A bar display indicates the instantaneous current in steps of 10 % in relation to the maximum load rating ( $I_{max}$ ). The bar display is refreshed every second.
- Note:  
In this display level the symbol indicator (import/export) refers to the actual power and not to the energy consumption value.

#### Display test control button

If the control button is pressed and held for longer than 10 s, a display test will be activated.

This test takes 30 s to complete. The DEFAULT display level then appears.

#### B) E-counter states display level

- This display level presents the energy values E1 to E8.
- To switch to this display level, press and hold the control button until the red LED lights up (approx. 4 s). The power indicators disappear and the display shows the energy values E1-E8.
- A brief press of the control button enables the loop display of these measured values.
- To return to the default display level, press and hold the control button for 4 seconds.
- The display lighting is switched off automatically after 40 s of inactivity.

#### Resetting of all energy registers (except for 7KT1533)

If the control button is pressed and held for longer than 20 s, the word "rESEt" will appear.

Pressing the control button again for at least another 4 seconds, resets all the energy registers to ZERO.

## Measuring Devices and Power Monitoring

### 7KT PAC Measuring Devices

#### 7KT PAC expansion modules

##### Overview



7KT PAC expansion modules, from left to right:  
Expansion modules for M-Bus, Modbus RTU, RS 485, Instabus KNX

The 7KT PAC expansion modules are used as communication interfaces for 7KT PAC1500 measuring devices. They have the following features:

- The expansion modules can be selected independently of the measuring device. This means they can also be retrofitted in already installed measuring devices.
- Data transmission between the measuring devices and expansion modules is executed via the IrDA infrared interface.
- The expansion modules are placed alongside the measuring devices in the installation direction so that their IrDA interfaces are exactly opposite each other.

##### **M-Bus expansion module (7KT1908)**

- Power supply through bus cable
- Baud rates: 300 to 9,600 kbit/s
- Status indication by LED on the module
- Can be parameterized using M-Bus Master software

##### **Modbus RTU expansion module (7KT1907)**

- Power supply: 230 V AC
- Baud rates: 4.8 / 9.6 / 19.2 and 38.4 kbit/s are supported
- Status indication by LED on the module
- Configurable via RS 485 master software

##### **RS 485 expansion module (7KZ1903)**

- Power supply: 230 V AC
- Status indication by LED on the module

##### **7KNX/EIB expansion module (7KT1900)**

- Power supply through the KNX/EIB bus cable
- Status indication by LED on the module

##### Dimensional drawings

###### **M-Bus expansion module**

For dimensional drawings, see  
<http://support.automation.siemens.com/WW/view/en/39963313/td>

###### **Modbus RTU expansion module**

For dimensional drawings, see  
<http://support.automation.siemens.com/WW/view/en/42261531/td>

###### **RS 485 expansion module**

For dimensional drawings, see  
<http://support.automation.siemens.com/WW/view/en/45510722/td>

###### **7KNX/EIB expansion module**

For dimensional drawings, see  
<http://support.automation.siemens.com/WW/view/en/46373272/td>

### Overview



7KT PAC3000 measuring device

### Features

- Measuring devices with LED display
- For direct connection (80A) and transformer connection (/5A)
- Indication of 38 measured values possible
- 9 display levels, each with 6 display blocks (one level is freely configurable)
- Password-protected menu setting
- S0 pulse output
- Integrated RS 485 interface (for connection to the 7KT1391 LAN coupler or for communication using Modbus RTU)

### Technical specifications

7KT PAC3000 measuring device without communication	7KT310	7KT311		
7KT PAC3000 measuring device with RS 485 interface (Modbus RTU/LAN coupler)	7KT340	7KT341		
<b>Standards</b>	EN 50470-1, EN 50470-3, EN 62053-23, EN 62053-31, IEC 61010-1			
<b>General data</b>				
• Enclosures	Acc. to DIN 43880	6 modules		
• Mounting	Acc. to EN 60715	35 mm		
• Mounting height	mm	70		
<b>Supply</b>				
• Rated control supply voltage $U_C$	V AC	230		
• Primary operating range	$\times U_C$	0.8 ... 1.2		
• Rated frequency	Hz	50		
• Rated power loss $P_V$	VA	< 5		
<b>Measuring accuracy</b>				
• Voltage	%	$\pm 1$		
• Current	%	$\pm 2$		
• Services	%	$\pm 1$		
• Active energy	Acc. to EN 50470-3	Class B		
• Reactive energy	Acc. to IEC 62053-23	Class 2		
• p.f.	%	$\pm 2$		
• Frequency	%	$\pm 0.2$		
<b>Measuring inputs</b>				
• Connection type		Direct	Transformer /5 A	
• Voltage $U_n$	Phase/phase Phase/N	V V	400 230	
• Operating range voltage	Phase/phase Phase/N	V V	87 ... 480 50 ... 276	
• Current $I_n/I_{ref}$		A	5	1 or 5
• Operating range current		A	0.0015 ... 80	0.003 ... 6
• Transformer current	Primary current of the transformer Smallest input step	A A	-- --	5 ... 10000 1 or 5
• Frequency		Hz	50	
<b>S0 interface</b>	Acc. to IEC 62053-31	Class A		
• Pulse outputs	For active and reactive energy T1 and T2	Yes	Yes	
• Pulse count	At 80 A, max. Depending on the transformer factor, adjustable, max.	Pulses/kWh Pulses/kWh	500 --	-- 10000
<b>Modbus RTU interface (for 7KT1340 - 7KT1341 only)</b>				
• Transmission rate		kbit/s	9.6-19.2	9.6-19.2
<b>Ambient conditions</b>				
• Mechanical environment			M1	
• Electromagnetic environment			E2	
• Operating temperature		°C	-10 ... +55	
• Temperature limits for storage and transport		°C	-25 ... +70	
• Relative humidity (without condensation)		%	< 80	
• Vibrations	Sine amplitude at 50 Hz	mm	$\pm 0.075$	
• Degree of protection	Installed device front side/terminals		IP51 <sup>1)</sup> /IP20	

<sup>1)</sup> For installation in a distribution board with at least IP51 degree of protection.

# Measuring Devices and Power Monitoring

## 7KT PAC Measuring Devices

### 7KT PAC3000 measuring devices

#### Dimensional drawings

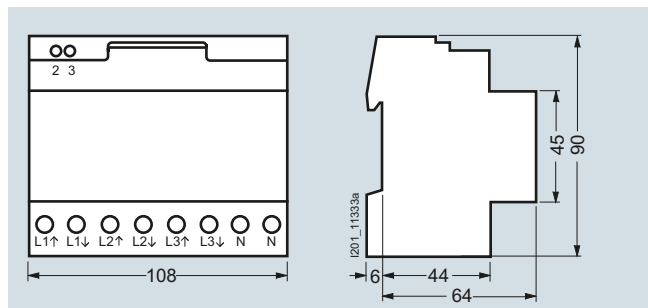

7KT300

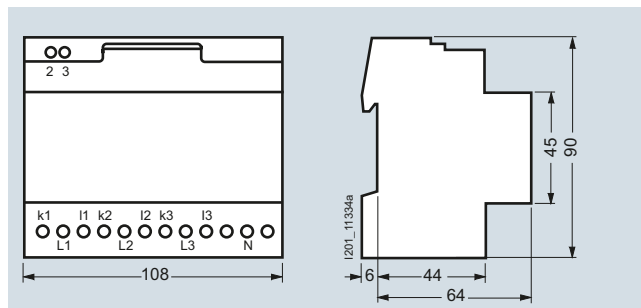

7KT301

#### Circuit diagrams

Information on the connection of transformer counters:

In the case of cross-section reduction, a short-circuit resistant cable is required for the power supply of terminal 2, depending on the fusing for phases L1, L2, L3. A fuse of 6 A is recommended for line protection.

Current transformers must not be operated with open terminals as this can result in dangerously high voltages, which may cause personal injury and/or property damage. It can also lead to a thermal overload of the transformers.

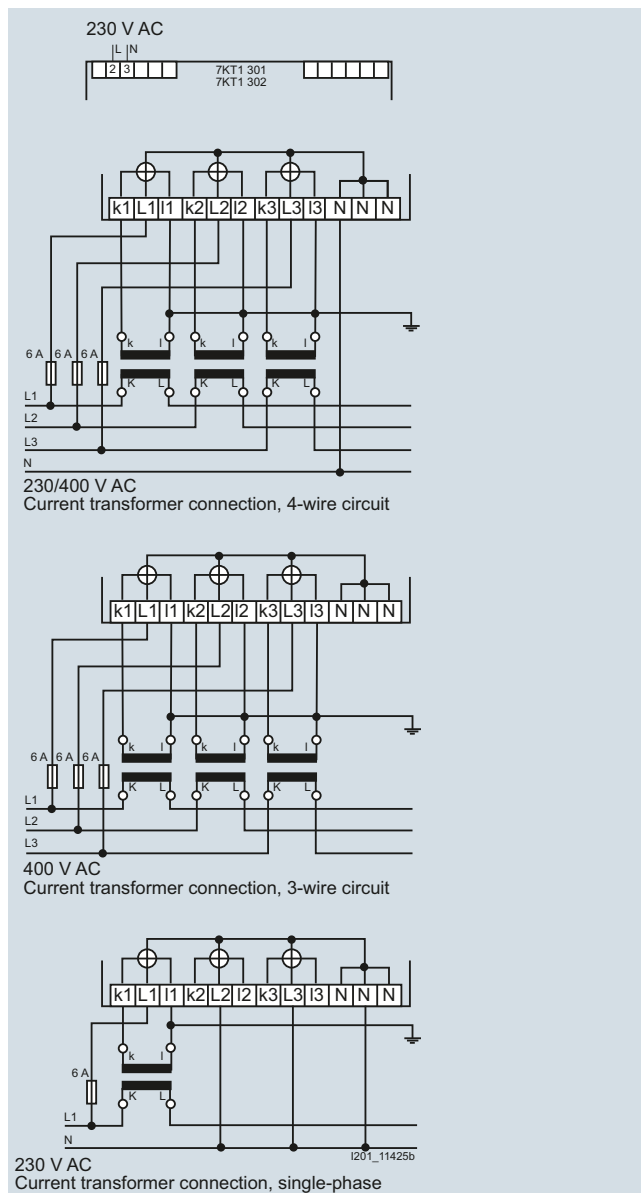
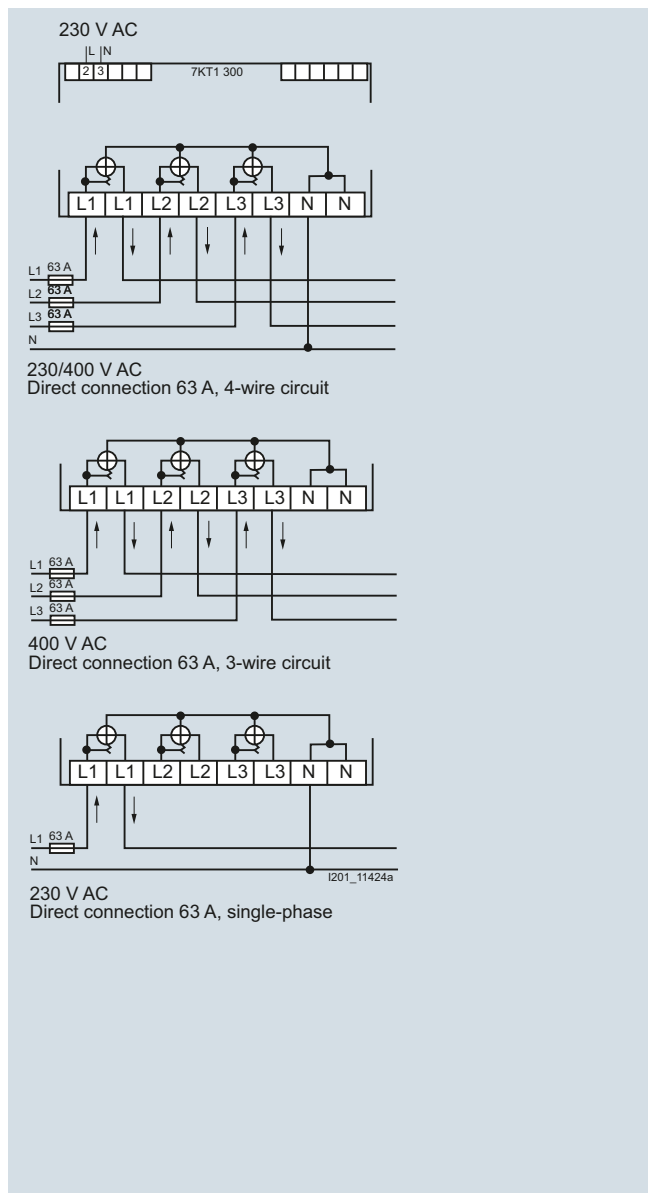



### More information

#### Voltage measurement

The multimeter measures the delta voltages L1 to L2; L2 to L3 and L3 to L1 or the star voltages L1, L2, L3 to N.

#### $\Sigma L$ symbol for the three-phase system

This indicates that all physical units shown under this symbol are always 3-phase.

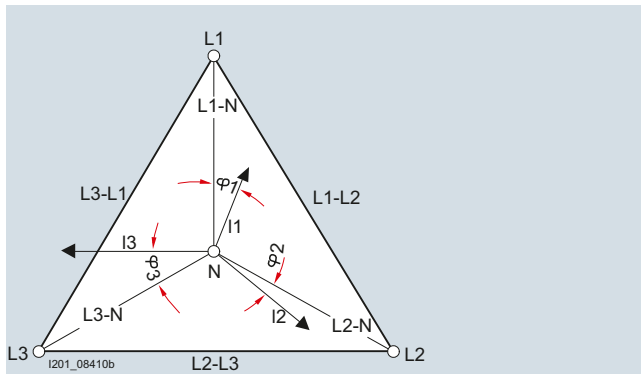

#### Display values

You can continuously display 5 measured variables from the following 23 options:

No.	Measured value	Display	Unit	Assignment
1	Active power	D1	W	L1
2	Voltage	D1	V	L1
3	Current	D1	A	L1
4	Apparent power	D1	VA	L1
5	p.f.	D1	p.f.	L1
6	Voltage	D1	V	L1 – L2
7	Active power	D2	W	L2
8	Voltage	D2	V	L2
9	Current	D2	A	L2
10	Apparent power	D2	VA	L2
11	p.f.	D2	p.f.	L2
12	Voltage	D2	V	L2 – L3
13	Active power	D3	W	L3
14	Voltage	D3	V	L3
15	Current	D3	A	L3
16	Apparent power	D3	VA	L3
17	p.f.	D3	p.f.	L3
18	Voltage	D3	V	L3 – L1
19	Active power	D1, D2, D3, D5	W	$\Sigma L$
20	Apparent power	D1, D2, D3, D5	VA	$\Sigma L$
21	Reactive power	D5	var	$\Sigma L$
22	Frequency	D4	Hz	$\Sigma L$
23	p.f.	D1, D2, D3, D4	p.f.	$\Sigma L$

2 set values are also displayed:

24	Transformer setting	D5	CT/A	/5
25	Transformer setting		CT/A	5 ... 5000

#### Display

The multimeters have a covered, brightly lit LED display. The measured values are indicated on an 11-mm high, green 7-segment LED, the physical units are indicated by orange text abbreviations. Both colors are easier to recognize than the red LEDs used for conventional displays. Capacitive loads are automatically indicated by a capacitor symbol, inductive loads by a coil symbol – also in orange.

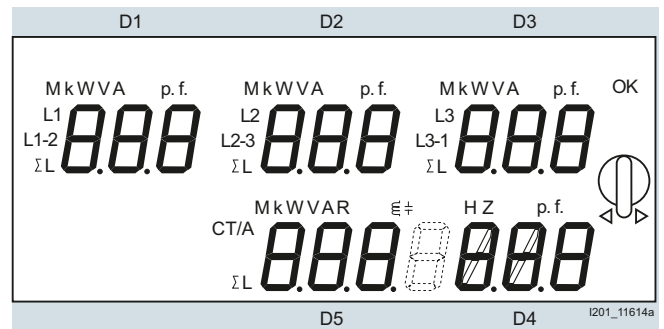

#### Matrix selection

Conventional measuring instruments display voltages, currents, powers, etc. in a rigid sequence on several "screens". These multimeters allow users to define their own standard for measured variables per display field, so that they can be implemented far more universally and flexibly.

A special feature is the analysis of the different loads on the phases. Phase displacement and unsymmetrical or unbalanced loads can cause partial overloads. These multimeters offer a range of different options for combining and assessing measured values.

The display fields are selected using rotary pushbuttons and the desired indications confirmed with OK. By making the horizontal selection e.g. W, V, A or p.f., and the vertical selection, e.g. L1, L1-L2 or  $\Sigma L$ , users can then define the desired measured variables for this display field.

The vertical data on the display can be assigned to any measured value in the horizontal data. The letters M(ega) and k(ilo) are automatically assigned according to measuring range, i.e. measured value, e.g. kW or MW. Capacitive loads are automatically indicated by a capacitor symbol, inductive loads by a coil.

The following diagram shows an example of what your matrix selection might look like.

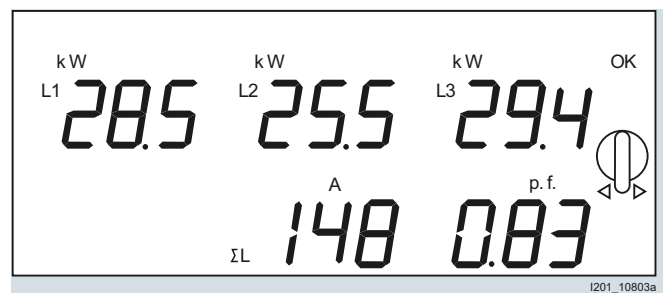

## Measuring Devices and Power Monitoring

### 7KT PAC Measuring Devices

#### 7KT LAN couplers

##### Overview



7KT 391 LAN coupler

A LAN coupler supports worldwide data retrieval from 7KT PAC measuring devices, as long as there is a LAN link to the Internet.

Up to 30 devices can be connected to a LAN coupler via a web browser, such as Firefox. In turn, the LAN coupler is connected to a LAN.

Data communication between the LAN coupler and the PC takes place using the TCP/IP protocol.

##### Application

###### **Suitable 7KT PAC measuring devices**

The following measuring devices can be connected to the LAN coupler:

	Order No.
<b>Energy measuring devices</b>	
7KT PAC1500 digital three-phase counters	
• For direct connection 80 A, double tariff	7KT1543
• For direct connection 80 A, double tariff calibrated version	7KT1545
• For transformer connection .../5 A, double tariff	7KT1540
• For transformer connection .../5 A, double tariff calibrated version	7KT1542
• For direct connection 125 A, double tariff	7KT1546
• For direct connection 125 A, double tariff, calibrated version	7KT1548
• For direct connection 63 A, double tariff	7KT1520
• For transformer connection .../5 A, double tariff	7KT1521
• Digital 1-phase counters	
• For direct connection 80 A, double tariff	7KT1531
• For direct connection 80 A, double tariff calibrated version	7KT1533
<b>7KT PAC3000 measuring devices</b>	
• 7KT PAC3000, for direct connection	7KT1340
• 7KT PAC3000, for transformer connection .../5 A	7KT1341

### Technical specifications

				7KT1391 LAN couplers
<b>Standards</b>				IEEE 802.3 AS, IEC 60950, EN 61000-6-2, EN 61000-6-3
<b>General data</b>				
• Enclosures	Acc. to DIN 43880			4 modules
• Mounting	Acc. to EN 60715			Mounting on standard mounting rail (35 mm)
• Mounting height		mm		70
<b>Supply</b>				
• Rated power loss $P_v$		VA		≤ 10
• Rated control supply voltage $U_c$		V AC		230
• Primary operating range		× $U_c$		0.9 ... 1.10
• Rated frequency		Hz		50
• Frequency ranges		Hz		45 ... 65
<b>Function</b>				
• System start				Automatic upon switching on
• LAN server identification				Over the IP address of the PC
• Transmission rate	Limitation by LAN	Mbit/s		100
• Operating system				Windows XP/Vista/7
• Browser				IE 7,8; Mozilla Firefox 3.09 / 3.5.3 / 3.6; Opera 9.64 / 10 / 10.5; Safari 3.2.2 / 4.0.5; Google Chrome 3.0.195.27.
<b>LAN interface</b>				
• HW interface				Connection RJ 45
• SW interface				TCP/IP
<b>Interface to measuring devices</b>				
• HW interface	RS 485 terminals	Number		3 (+/-/shielded twisted pair)
• Line	Version			STP (shielded twisted pair)
	Minimum cross-section	mm <sup>2</sup>		2 × 0.2 or 2 × AWG 24
	Maximum line capacitance	pF/m		< 50
	Impedance	W		100
	Maximum overall cable length	m		≤ 1200
	Type of installation			Serial
Measuring devices can be connected directly				Number 30
<b>Environmental conditions</b>				
• Temperatures	In operation	°C		-10 ... +55
	Storage and transport	°C		-25 ... +70
• Relative humidity	In operation	%		≤ 80
• Vibrations	Sine amplitude at 50 Hz	mm		± 0.25
• Safety class	Acc. to IEC 60950			III
• Degree of protection	Installed device front side (terminals)			IP20

## Measuring Devices and Power Monitoring

### 7KT PAC Measuring Devices

#### 7KT LAN couplers

##### Dimensional drawings

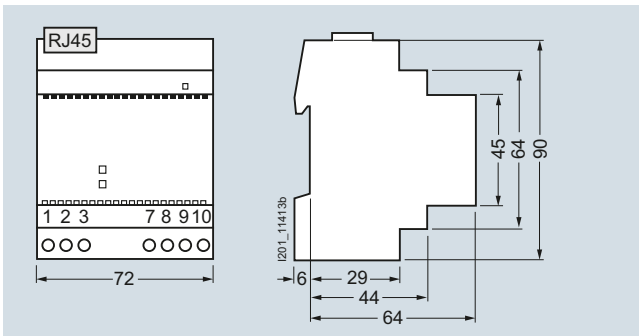

7KT391

##### Circuit diagrams

###### Graphic symbols

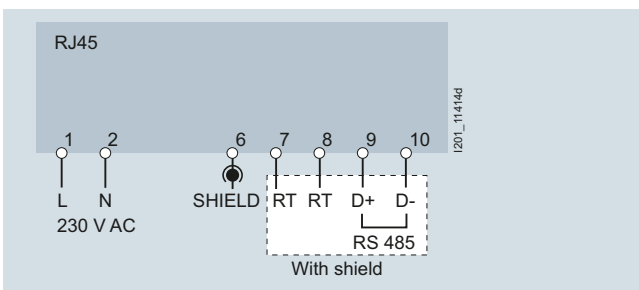

###### Grounding potential

Both the LAN cable with the RJ45 connector and the shielded cable of the RS 485 bus system must be grounded. This also applies to the devices connected to the LAN coupler.

###### Connecting the devices to the LAN coupler

All the devices are connected in parallel with a shielded two-wire cable. Point-to-point installations, junctions or ring installations are not possible.

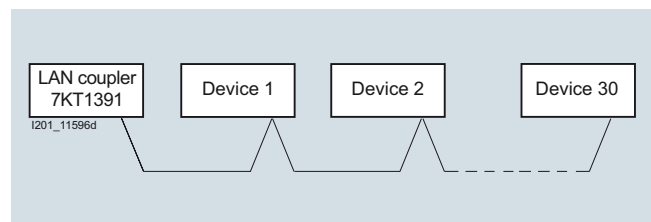

### Overview



Digital measuring devices: Left: 7KT1 voltmeter, Right: 7KT1 ammeter

These devices for measuring voltages and currents can be used for monitoring incoming and outgoing currents or device currents in electric plants.

They are suitable for direct connection in a single-phase system or with measuring transducers in three-phase systems.

The measuring ranges of the ammeter are set locally at the device using a coding switch.

### Technical specifications

		7KT1110	7KT1120
<b>Standards</b>		DIN 43751-1, -2	
<b>Rated operational voltage <math>U_e</math></b>	V AC	230	
<b>Primary operating range</b>	$\times U_e$	0.9 ... 1.15	
<b>Rated frequency</b>	Hz	50/60	
<b>Rated operational power <math>P_S</math></b>	VA	<2	
<b>7+1-segment display</b>		3-digit	
<b>Measuring range</b>			
• Voltage	Direct measurement	V AC	12 ... 600 ( $U_n$ )
• Current	Direct measurement	A AC	--
	Transformer measurement	A AC	0.4 ... 20 ( $I_n$ )
			25, 40, 50, ... 1000/5
<b>Lower display value</b>	Of the scale-end value	%	2
<b>Measuring shunt</b>			
• Current	Direct measurement 20 A	m $\Omega$	--
	Transformer measurement	m $\Omega$	5
• Voltage	Direct measurement 600 V	M $\Omega$	10
			--
<b>Measuring frequency</b>		Hz	45 ... 65
<b>Measurement cycle</b>		/s	4
<b>Measuring accuracy</b>	at 23 °C $\pm$ 1 °C	%	$\pm$ 0.5 $\pm$ 1 digit
<b>Temperature influence</b>		%/°C	$\pm$ 0.03
<b>Overload capability</b>			
• Voltage	Continuous	V	$1.2 \times U_n$
	Short-time for 1 s	V	$1.3 \times U_n$
• Current	Continuous, direct	A	--
	Short-time for 1 s, direct	A	$1.1 \times I_n$
			$10 \times I_n$
<b>Terminals</b>			
• Stripped length	$\pm$ Screw (Pozidriv)	mm	1
		mm	7
<b>Conductor cross-sections</b>			
	Rigid, max.	mm <sup>2</sup>	$1 \times 6/2 \times 4$
	Flexible, with end sleeve, min.	mm <sup>2</sup>	0.75
<b>Degree of protection</b>		IP20, with connected conductors	
<b>Permissible ambient temperature</b>		IP20, with connected conductors	
• Operation		°C	-10 ... +55
• Storage		°C	-40 ... +70

# Measuring Devices and Power Monitoring

## Other Measuring Devices

### Digital voltmeters and ammeters

#### Dimensional drawings

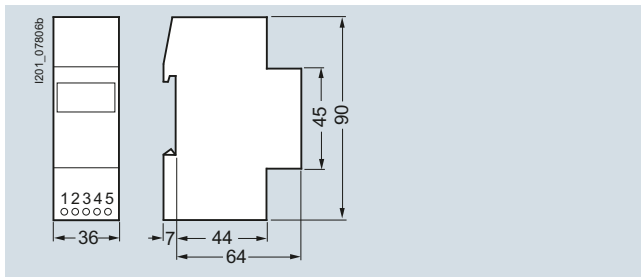

7KT110, 7KT120

#### Circuit diagrams

##### Typical circuit diagrams

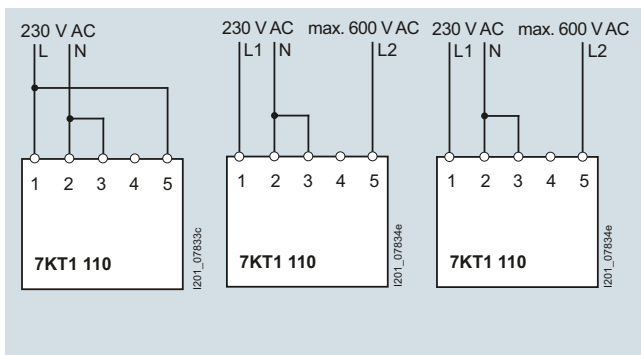

Digital voltmeters

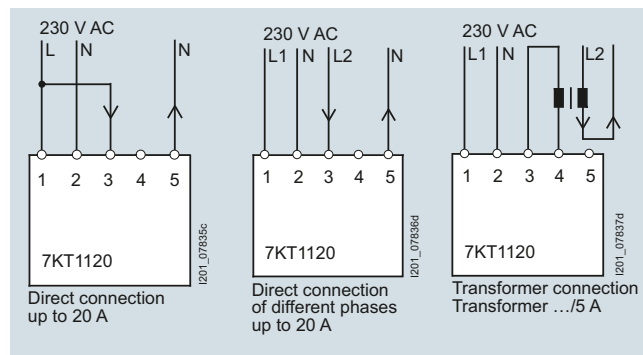

Digital ammeters

#### More information

##### Range selector switch for 7KT120 digital ammeter

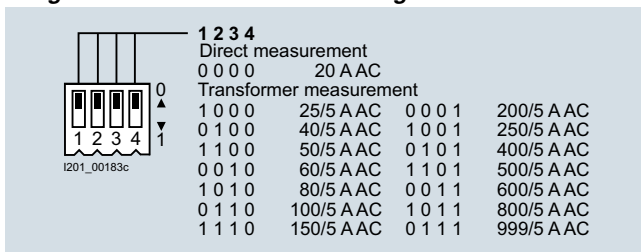

#### Overview

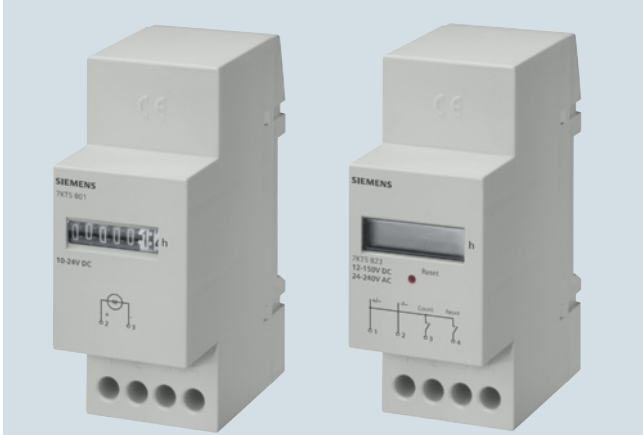

Time counters: Left: Electromechanical, Right: Electronic

Time and pulse counters are used for the reliable monitoring of production and service times, which enables the exact planning and monitoring of production sequences, maintenance cycles and warranty times.

As well as the proven electromechanical time and pulse counters for mounting in distribution boards, we also supply digital time and pulse counters.

The fields of application for both counter types are very diverse, such as the recording of operating hours of machines, systems or building management systems, as well as pulse counting for general volume flow counting, registration of starting frequencies, starting cycles or production quantities in systems and machines.

#### Technical specifications

		7KT5801	7KT5802	7KT5803	7KT5804	7KT5806	7KT5807	
<b>Standards Approvals</b>		DIN VDE 0435-110; EN 60255-6; UL 863 UL 863, UL File No. E300537, CSA C22.2 No. 6 and 55						
<b>Rated control supply voltage <math>U_c</math></b>	V AC V DC	-- 12 ... 24	24 --	115	230	115	230	
<b>Primary operating range</b>	At 50/60 Hz	$\times U_c$ 0.9 ... 1.1						
<b>Rated frequency</b>	Hz	--	50			60		
<b>Rated power loss <math>P_v</math></b>	VA	< 1		< 2				
<b>Method of operation</b>	Counting of	Hours						
<b>Display</b>	Drum-type register	h 00000.00						
<b>Terminals</b>	$\pm$ Screw (Phillips)	1						
<b>Conductor cross-sections</b>	Rigid Flexible, with end sleeve, min.	mm <sup>2</sup> mm <sup>2</sup>		1.5 0.75				
<b>Permissible ambient temperature</b>	°C	-10 ... +70						
<b>Degree of protection</b>	Acc. to EN 60529	IP20, with connected conductors						
<b>Safety class</b>	Acc. to EN 61140/VDE 0140-1	II						
<b>Permissible humidity</b>	%	< 80						
		7KT5811	7KT5812	7KT5814	7KT5821	7KT5822	7KT5823	7KT5833
<b>Standards Approvals</b>		DIN VDE 0435-110; EN 60255-6; UL 863 UL 863, UL File No. E300537, CSA C22.2 No. 6 and 55						
<b>Rated control supply voltage <math>U_c</math></b>	V AC V DC	-- 12 ... 24	24 --	230 --	24 ... 240 12 ... 150			
<b>Primary operating range</b>	At 50/60 Hz	$\times U_c$ 0.9 ... 1.1						
<b>Rated frequency</b>	Hz	--	50/60					
<b>Rated power loss <math>P_v</math></b>	VA	< 1		< 2	< 1			
<b>Method of operation</b>	Counting of	Pulses			Hours		Pulses	
<b>Display</b>	Drum-type register LCD	h 		0000000		000000.0		-- -- 0000000
<b>Counting frequency</b>	Hz	10		--		10		
<b>Pulse duration</b>	ms	50		--		50		
<b>Resetting</b>	Electrical Mechanical	--			Yes		Yes	
<b>Terminals</b>	$\pm$ Screw (Phillips)	1						
<b>Conductor cross-sections</b>	Rigid Flexible, with end sleeve, min.	mm <sup>2</sup> mm <sup>2</sup>		1.5 0.75				
<b>Permissible ambient temperature</b>	°C	-10 ... +70						
<b>Degree of protection</b>	Acc. to EN 60529	IP20, with connected conductors						
<b>Safety class</b>	Acc. to EN 61140/VDE 0140-1	II						
<b>Permissible humidity</b>	%	< 80						

## Measuring Devices and Power Monitoring

### Other Measuring Devices

#### Time and pulse counters for standard rail mounting

##### Dimensional drawings

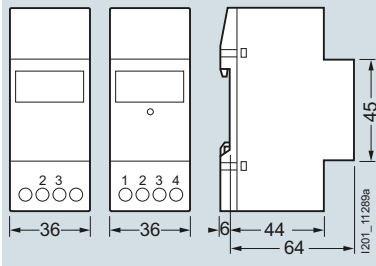

7KT580. 7KT582.  
7KT581. 7KT5833

##### More information

Time counters count the time in hours with an accuracy of two decimal places (hundredths of hours). The pulse counter adds the number of pulses, e.g. the making operations of devices.

A power supply is required at terminals 1 and 2 of the electronic counters so that the device can constantly display the measured values. Once terminal 3 is supplied with voltage (for DC "+"), the counting procedure starts. If terminal 4 is supplied short-time with voltage (for DC "+"), the counter is reset.

In the case of electronic counters, the counting result is saved indefinitely in the event of a power failure (EEPROM). On recovery of the power, the counting is continued from the saved value. As well as a modern design, the electronic counter has a 7-digit LCD, which can be reset electrically or manually.

##### Circuit diagrams

###### Connections

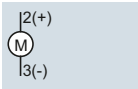

7KT5801

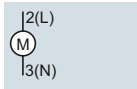

7KT5802  
7KT5803  
7KT5804  
7KT5806  
7KT5807

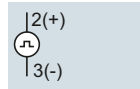

7KT5811

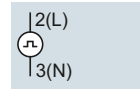

7KT5812  
7KT5814

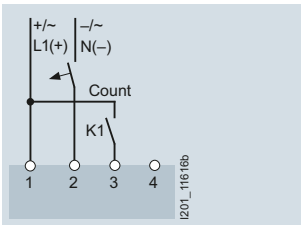

7KT5821

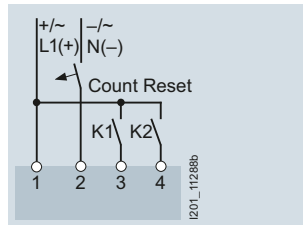

7KT5822, 7KT5823, 7KT5833



#### Overview



Time counters: Left: Counting mechanism, Right: Counting mechanism with front frame

Time and pulse counters for control cabinets, control systems and mechanical engineering are used, e.g. in boilers, machine tools or compressors. The pulse counters count the starting frequencies. This supports planning for preventative maintenance.

In-time and regular maintenance is the best protection against unexpected shutdowns.

#### Technical specifications

		7KT5500	7KT5501	7KT5502	7KT5503	7KT5504	7KT5505
<b>Standards</b>		DIN VDE 0435-110; EN 60255-6					
<b>Rated control supply voltage <math>U_c</math></b>	V AC V DC	-- 10 ... 80	115 --	230	115	230	24
<b>Rated frequency</b>	Hz	--	50		60		50
<b>Front-panel mounting</b>	Switchboard cutout	mm × mm 45.2 × 45.2 <sup>+0.3</sup> Ø mm 50.2 <sup>+0.3</sup>					
• Without masking frame 55 × 55 mm	mm × mm						
• With masking frame 55 × 55 mm	Ø mm						
		7KT5600	7KT5601	7KT5602	7KT5603	7KT5604	
<b>Standards</b>		DIN VDE 0435-110; EN 60255-6					
<b>Rated control supply voltage <math>U_c</math></b>	V AC V DC	-- 10 ... 50	115 --	230	115	230	
<b>Rated frequency</b>	Hz	--	50		60		
<b>Front-panel mounting</b>	Switchboard cutout	mm × mm 68 <sup>+0.5</sup> × 68 <sup>+0.5</sup>					

#### Dimensional drawings

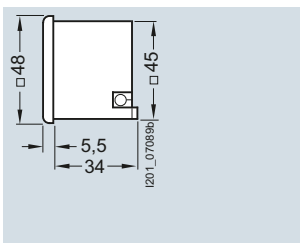

7KT55

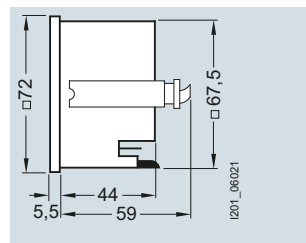

7KT56

#### Circuit diagrams

##### Connections

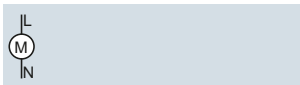

7KT55, 7KT56

## Measuring Devices and Power Monitoring

### Accessories

#### 4NC current transformers

##### Overview



4NC53 current transformers

##### Technical specifications

#### 4NC current transformers for measuring purposes

<b>Standards</b>	EN 60044-1, VDE 0414-44-1
<b>Window-type current transformers</b>	The conductor to be measured (busbar or cable) is passed through the window opening and constitutes the primary circuit of the window-type current transformer. Pin-wound transformers: An economical solution especially for small primary currents of 5 ... 75 A are window-type current transformers when the conductor to be measured is pin-wound several times.
<b>Primary rated operational current <math>I_{pn}</math></b>	Current transformers can be continuously loaded with 1.3 times the primary rated current ( $I_{pn}$ ).
<b>Secondary rated operational current <math>I_{sn}</math></b> 1 A 5 A	Particularly suitable for longer measuring leads. Cable losses of only 4 % in contrast to 5 A current transformers. 5 A current transformers generate 25 times the power losses on measuring leads as compared with 1 A current transformers. These stray losses result in higher power in the case of long cables. Only recommended for use with short measuring leads.
<b>Accuracy class</b> Class 1  Class 3	Operation measurement, internal metering Current error $\pm 1\%$ at $1 \times I_{pn}$ and $1.2 \times I_{pn}$  Coarse measurement Current error $\pm 3\%$ at $0.5 \times I_{pn}$ and $1.2 \times I_{pn}$
<b>Rated power <math>P_n</math></b>	The rated power of transformers is specified in VA. The actual load rating should be similar to the rated power; a lower actual load rating (underburden) increases the overcurrent factor and measuring devices are not sufficiently protected in case of a short-circuit, a higher actual load rating (overburden) has a negative effect on the accuracy. With a frequency of 60 Hz the rated power increases to 1.2 times. With $16^{2/3}$ Hz the output power decreases to $1/3$ of the rated power.
<b>Maximum voltage for equipment <math>U_m</math></b>	This is the rms value of the maximum voltage between the conductors of a system. For this voltage the insulation must be rated at normal operating conditions. 4NC5 current transformers are suitable for 720 V.
<b>Overcurrent limiting factor FS</b>	The overcurrent limiting factor is expressed using the characters FS and a factor, e.g. FS5 or FS10. When a short-circuit current flows through the primary winding of a current transformer, the stress on the measuring devices connected to the current transformer is the lower the smaller the overcurrent limiting factor is.
<b>Thermal rated short-time current <math>I_{th}</math></b>	The thermal rated short-time current $I_{th}$ is the rms value of the primary current with a duration of one second, whose heat effect the current transformer can resist without being damaged in the event of a short-circuited secondary winding.
<b>Rated impulse current <math>I_{dyn}</math></b>	The rated impulse current $I_{dyn}$ is the highest instantaneous value of the current after a short-circuit whose force the current transformer can resist without being damaged. The rated impulse current is specified as peak value.

### 4NC51 window-type current transformers, used as pin-wound transformers, Classes 1 and 3, from 5 A to 75 A

Pin-winding increases the primary current of the current transformer. Consequently, window-type current transformers can also be used for low primary currents.

Basic type		4NC5112	4NC5113	4NC5115	4NC5117	4NC5121	4NC5122	4NC5123	
Rated primary current	A	50	60	75	100	150	200	250	
Power	VA	2.5	2.5	2.5	2.5	2.5	5	5	
Primary current to be measured	Number of required pin windings								
	A	Class 3			Class 1				
	5	10	--	--	--	--	--	--	
	10	5	6	--	10	--	--	--	
	15	--	4	5	--	10	--	--	
	20	--	3	--	5	--	10	--	
	25	2	--	3	4	6	8	10	
	30	--	2	--	--	5	--	--	
	40	--	--	--	--	--	5	--	
	50	--	--	--	2	3	4	5	
75	--	--	--	--	2	--	--		



4NC51 used as pin-wound transformer

## Measuring Devices and Power Monitoring

### Accessories

#### 7KT12 current transformers

##### Overview

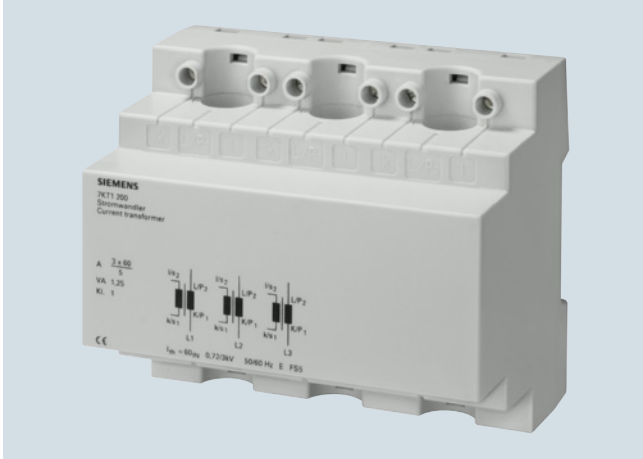

7KT12 current transformers

The three-phase 7KT12 current transformer can be used in distribution boards according to DIN 43880. The measuring leads are routed vertically through to the standard mounting rail.

This type of current transformer is suitable for infeeds or outgoing lines in connection with the installation of a 5TE8 switch or a 5TE1 disconnecter, as the primary connecting leads do not have to be interrupted.

The current transformer is designed for cables of up to 13 mm in diameter, e.g. H07V-R with 50 mm<sup>2</sup> conductor cross-section.

##### Technical specifications

	7KT1200	7KT1201	7KT1202	
<b>Standards</b>	EN 60044-1			
<b>Secondary rated current strength</b>	A	5		
<b>Accuracy class</b>	Cl.	1		
<b>Rated power</b>	VA	1.25	2.5	3.75
<b>Rated frequency <math>f_n</math></b>	Hz	50/60		
<b>Thermal current limit <math>I_{th}</math></b>	Short-time	A $60 \times I_e$		
<b>Thermal continuous current</b>	A	$1 \times I_e$		
<b>Overcurrent limit factor</b>	FS	5		
<b>Rated impulse withstand voltage <math>U_{imp}</math></b>	kV	> 3		
<b>Creepage distances and clearances</b>	mm	> 3		
<b>Rated operational voltage <math>U_e</math></b>	V AC	720		
<b>Rated operational current <math>I_e</math></b>	A AC	$3 \times 60$	$3 \times 100$	$3 \times 150$
<b>Terminals ± Screw (Pozidriv)</b>		PZ 1		
<b>Conductor cross-sections</b>				
- Rigid	mm <sup>2</sup>	0.5 ... 4		
- Flexible, with end sleeve	mm <sup>2</sup>	0.5 ... 2.5		
<b>Permissible ambient temperature</b>	°C	-5 ... +60		
<b>Resistance to climate</b>	Acc. to EN 60068-1	20/60/4		

##### Dimensional drawings

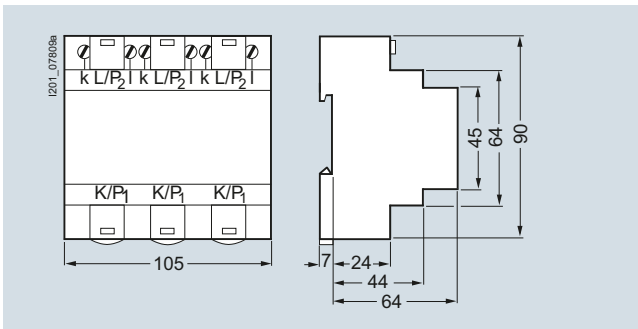
7KT200  
7KT201  
7KT202

##### Circuit diagrams

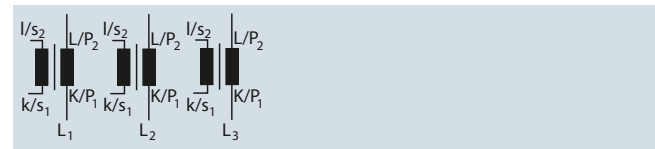
7KT200  
7KT201  
7KT202

##### Note:

Current transformers must not be operated with open terminals, as this can result in dangerously high voltages, which may cause personal injury and/or property damage. It also exposes the transformer to thermal overload.

Overview



Measuring selector switch (voltmeter selector switch)

Measuring selector switches are used as CO contacts of the phases for voltages and currents in three-phase systems for voltmeters and ammeters.

The design of these switches is adapted to match the modular installation devices. They support use in compliance with EN 60947-3.

Dimensional drawings

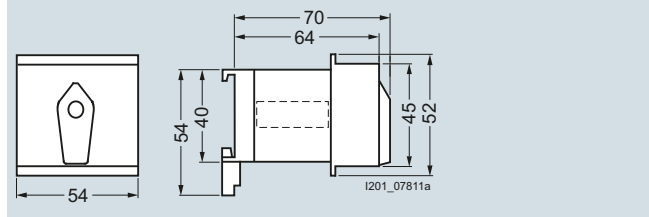

7KT9010  
7KT9011

Circuit diagrams

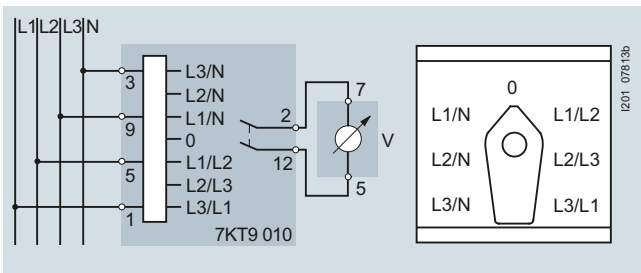

Voltmeter switching

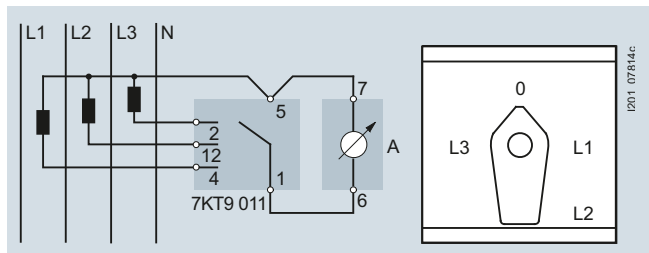

Ammeter switching

Internal interconnection of the phases in the ammeter selector switch for the prevention of glitches at the connections of the current transformers:

Switch position	Short-circuited phases		
	L1	L2	L3
0	✓	✓	✓
L1	--	✓	✓
L2	✓	--	✓
L3	✓	✓	--

## Measuring Devices and Power Monitoring

### Accessories

#### Notes



Siemens AG  
Energy Management  
Low Voltage & Products  
Postfach 10 09 53  
93009 REGENSBURG  
GERMANY

Subject to change without prior notice  
PDF (3ZW1012-7KM42-0AC1)  
PH 0216 60 En  
Produced in Germany  
© Siemens AG 2016

The information provided in this brochure contains merely general descriptions or characteristics of performance which in case of actual use do not always apply as described or which may change as a result of further development of the products. An obligation to provide the respective characteristics shall only exist if expressly agreed in the terms of contract. Availability and technical specifications are subject to change without notice.

All product designations may be trademarks or product names of Siemens AG or supplier companies whose use by third parties for their own purposes could violate the rights of the owners.