

Valuable information for those interested in CNC



We are part of the  
workshop team

**SIEMENS**



---

2<sup>nd</sup> and revised edition

This brochure was created as a joint effort between

SIEMENS AG  
Automation and Drive Technology  
Motion Control Systems

Erlangen

You can obtain additional information under:

<http://www.siemens.de/SINUMERIK>

<http://www.siemens.de/jobshop>

and

R. & S. KELLER GmbH

Didaktik + Technik

Wuppertal

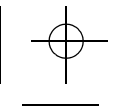
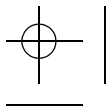

---

## Foreword

This brochure is intended for everybody who is interested in modern production techniques. It supports the Siemens workshop initiative called JobShop, whose goal is to make it easier to work on lathes and milling machines.

For the layman, this brochure should motivate him to look into this extremely diversified future-oriented industry sector. Professionals will enjoy reading about subjects which they know about in-depth in a somewhat lighter vein.

Laymen and professionals will be able to get to know the new SINUMERIK 810D control system with ShopMill and ShopTurn. Its graphic HMI makes it very easy to familiarize yourself with and productively work with CNC machines.

With this brochure, entitled "We belong to the workshop", enter into a partnership with Siemens in the sense of creating an attractive, future-oriented and cost-effective workshop.

Erlangen / Wuppertal, January 2001

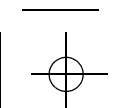
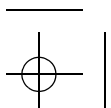

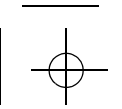
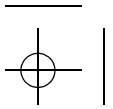
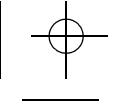
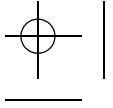

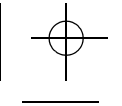
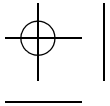

---

## We are part of the workshop team

### 1 Technology for the benefit of the human race

Siemens technology worldwide .....	7
Technology around us .....	8
Production technology .....	9
Ideas ... ..	10

### 2 Machines make state-of-the-art technology possible

A glance back into history .....	12
On the way to perfection .....	13
The operator and his machine .....	14
The wide range of CNC turning and milling machines .....	15
SINUMERIK controls yesterday and today .....	16
The axes - no cutting without motion .....	18
The drive - no power without strong muscles .....	19

### 3 Work must be planned

The NC program - how do I tell my machine? .....	20
Thoughts in motion .....	21
Where it all happens: Room for motion .....	22
Straight to the point .....	23
When it has to be fast .....	24

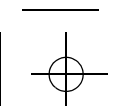
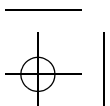

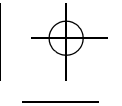
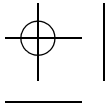

---

## **4** How workpieces are formed ...

Contours consist of straight lines and arcs . . . . .	25
How straight lines are programmed according to DIN . . . . .	26
Basics when programming arcs . . . . .	28
How arcs are programmed according to DIN . . . . .	30
Graphic programming . . . . .	32
Contours and tool paths . . . . .	34

## **5** ... and how they are produced

Tools today . . . . .	36
Tools in use* . . . . .	40
When something turns* . . . . .	42
Speed and time . . . . .	43
The circumferential speed at different diameters . . . . .	44
The circumferential speed at various rotational speeds . . . . .	45
The cutting speed: when a tool cuts . . . . .	46
Feed and surface quality . . . . .	47
Constant cutting speed manually controlled . . . . .	48

## **6** The optimum technology is important

Milling with ShopMill . . . . .	50
Turning with ShopTurn . . . . .	64
Detailed quality for the perfect fit . . . . .	78

### **Index**

. . . . .	82
-----------	----

### **Diagrams/Photographs**

. . . . .	85
-----------	----

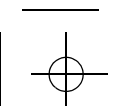
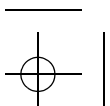

---

# 1 Technology for the benefit of the human race

## 1.1 Siemens technology worldwide

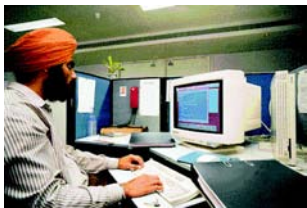

PLC



Control technology



Relay technology



Communications



High-tech for racing cars



Micro-electronics



Domestic appliances



ICE 3



Power utility technology

**Siemens, leading-edge solutions - on all continents**

---

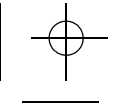
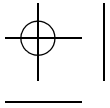

---

## 1.2 Technology around us

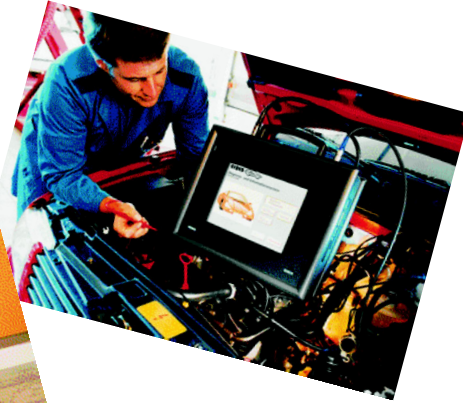

The things around us comprise the widest range of components.

Not only are different materials used, but they also come in all shapes and sizes.

The most important techniques for producing these "round" and "square" shapes will be discussed.

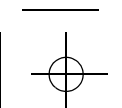
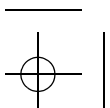



---

### 1.3 Production technology

The most important production techniques required to machine these parts are:

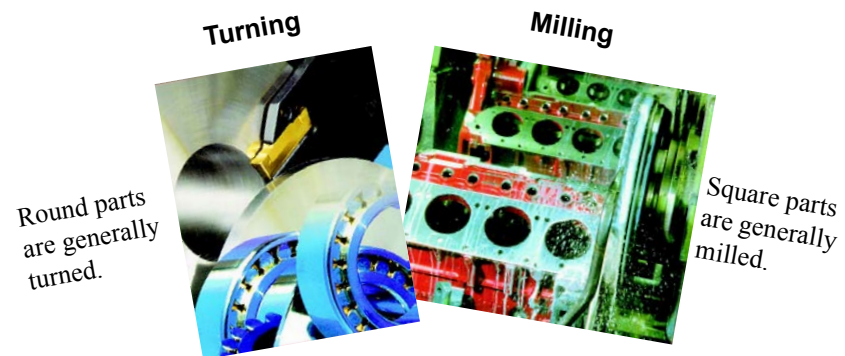

Workpieces can be produced according to the various requirements by turning and milling.

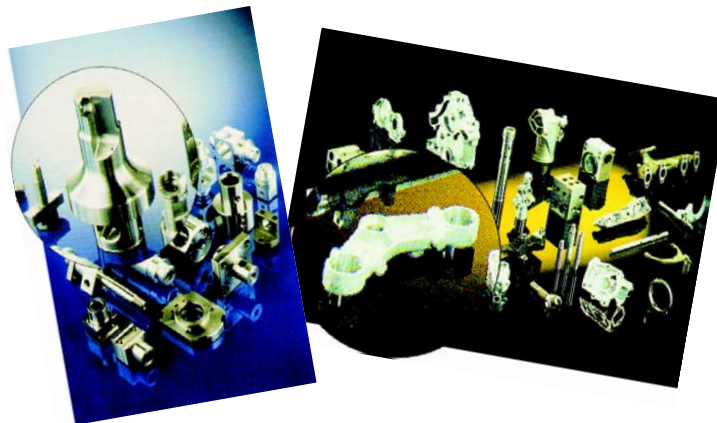

Workpieces can be produced on lathes and milling machines with a repeat accuracy of just a few micrometers and with mirror surfaces. The precision is several times better than the thickness of a human hair (0.05 mm).



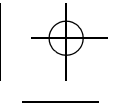
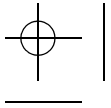

## 1.4 Ideas ...

The mechanical design engineer specifies the dimensions and the surface quality of the workpiece.

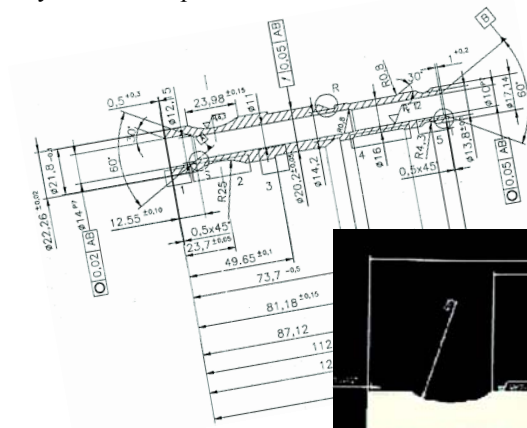

Damper of a steering assembly

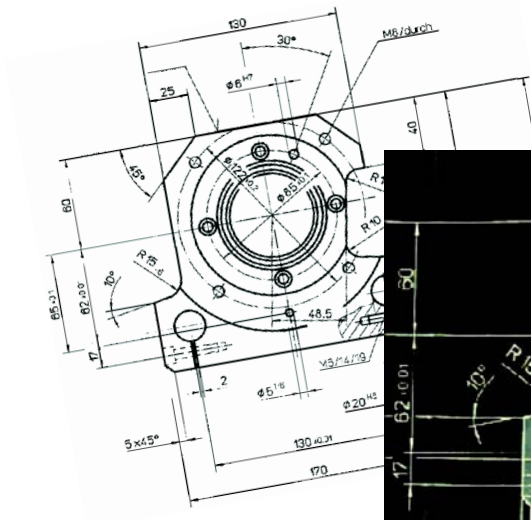
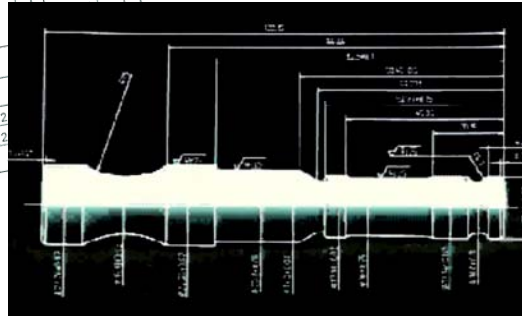

Sealing plate of a grinding machine

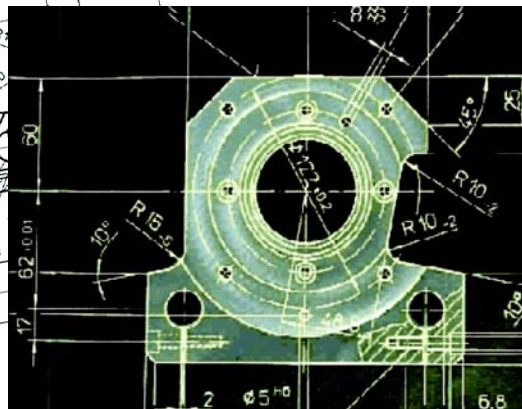

From this the technical draftsman generates the technical drawing as a basis for production.

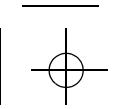
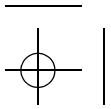

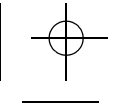
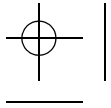

---

**... implemented with technology**

Before production starts, the program must first be written.

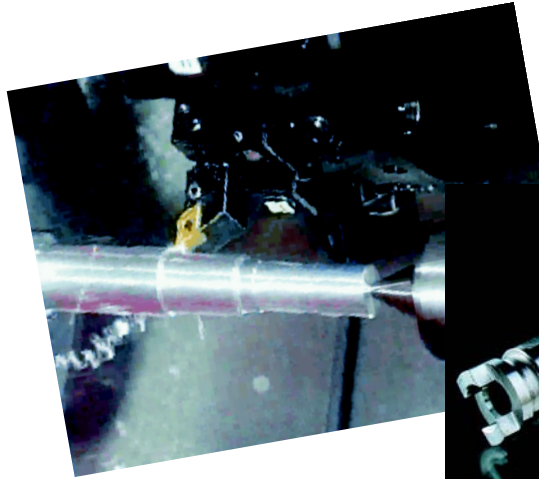

The program is then directly converted into chips.

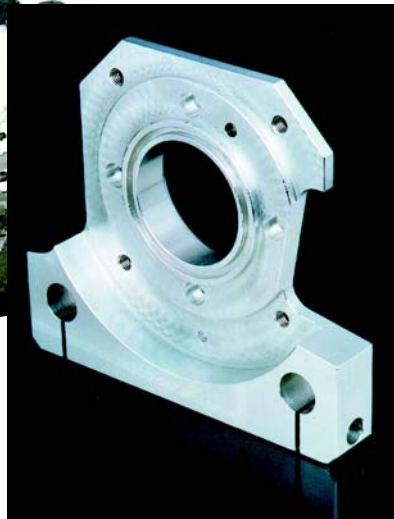
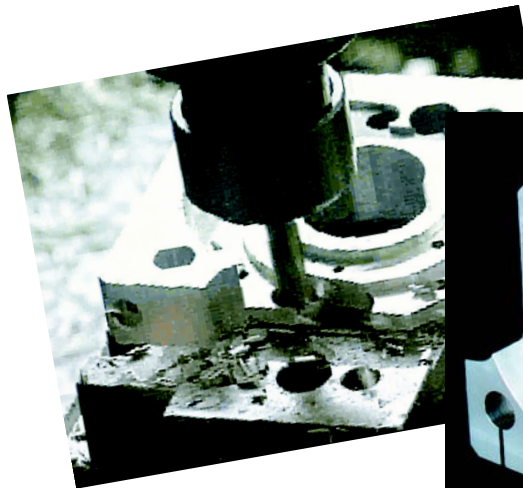

For these cutting technologies, skill and experience play an extremely important role.

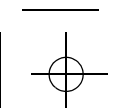
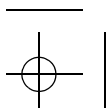

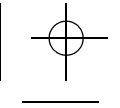
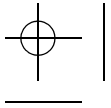

## 2 Machines make state-of-the-art technology possible

### 2.1 A glance back into history

As soon as man started to work with stones and to manufacture tools to help him do this, he had to construct devices for drilling.

This can be considered as the start of machine tool development.

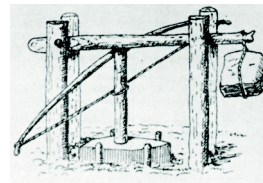

*Drilling device with bow-type drive (5000 B. C.)*



*Operator on the lathe (approx. 1425)*

The Middle Ages with the turning and drilling equipment of the trades represented the first major milestone. Either people or water were used as the prime movers.

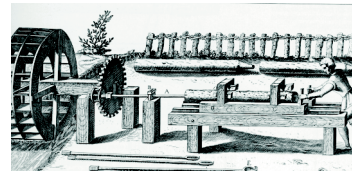

*Drilling machine with water-powered drive (approx. 1615)*



*James Watt (1766 to 1819), inventor of the steam engine*

The Industrial Revolution in the 18th/19th centuries was the next major milestone: The advent of the steam engine as a "powerful drive" and the cross-slide are important events in the history of machine tools.



*Henry Maudslay (1771 to 1831), inventor of the cross-slide*

This picture illustrates the tedious work with the chisel and the more comfortable way of working with the cross-slide. Conservative operators looked down on it and called it "going car".

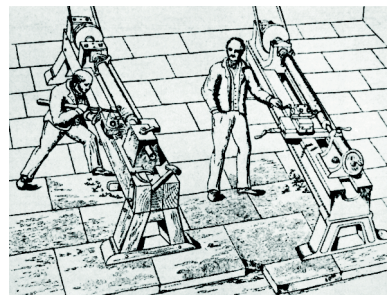

*Old lathe and spindle lathe*

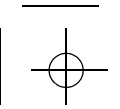
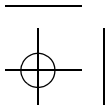

## 2.2 On the way to perfection

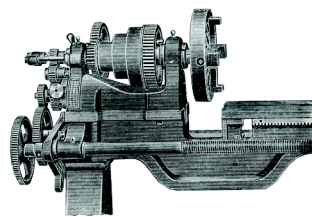

*Cone-pulley drive with back gears*

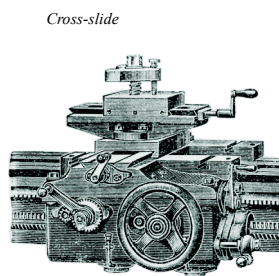

*Cross-slide*

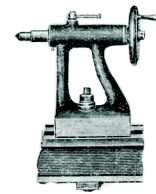

*Tailstock*

Well-conceived mechanical designs for all of the modules used in machine tools were distinctive features of progress in the 19th century.

Initially, the machines were driven from a central drive through transmission belts.

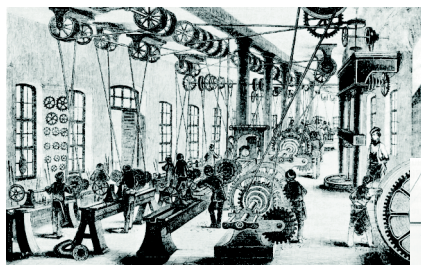

*Lathe shop (approx. 1850)*

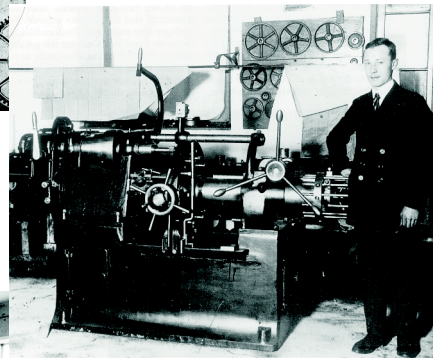

*Lathe (approx. 1916)*

Later, machine tools had their own individual drives, which resulted in higher productivity in the man/machine combination.



*Lathe shop (approx. 1950)*

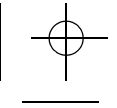
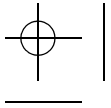

---

## 2.3 The operator and his machine



*Conventional turning (approx. 1950)*

Anybody visiting exhibitions today, might think that only CNC-type machines\* are in use. But that's not true.

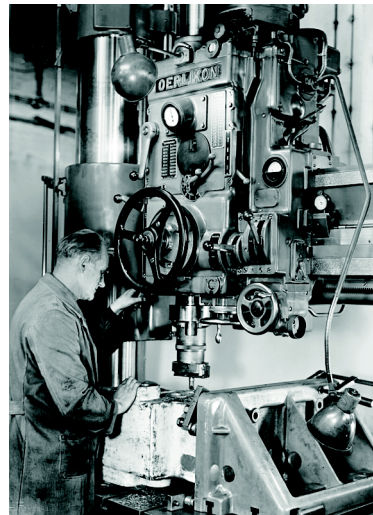

*Conventional drilling (approx. 1950)*

Today, more conventional machines than CNC machines are still being built worldwide.

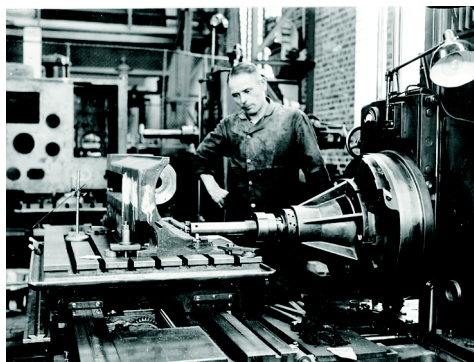

*Conventional milling (approx. 1950)*

Conventional machines are still used for simple workpieces due to their lower price.

\* CNC stands for "Computer Numerical Control", i.e. a machine with a computer that controls the machine with numerical data.

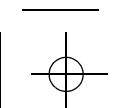
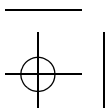

---

2.4 The wide range of CNC turning and milling machines



... with a central solution for all.



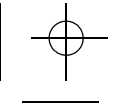
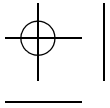

---

## 2.5 SINUMERIK controls yesterday and today

### 1952 Massachusetts Institute of Technology (MIT)

The first NC-controlled machine tool was built here (the control still used tubes). It was used to simplify production of increasingly more complex parts and components for the aircraft industry.



### 1960 Siemens NC control

In 1960, the first numerical control was built using relay technology.

### 1967 SINUMERIK System 200

The first point-to-point and path control for turning and milling.

### 1976 SINUMERIK System 7

The first path control using microprocessors and semiconductor memories instead of relays is introduced.

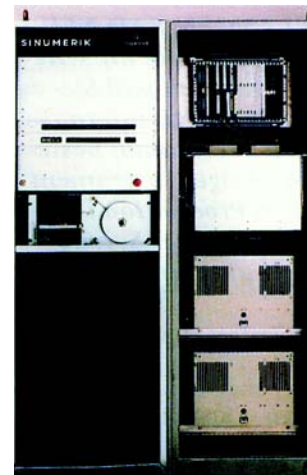

### 1977 SINUMERIK Sprint T

Workshop programming first establishes itself in turning in the world of CNC path controls.

### 1981 SINUMERIK System 3

A modular CNC path control for turning, drilling and milling up to four axes is developed, a control system with a wide range of applications.

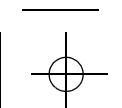
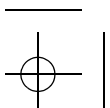
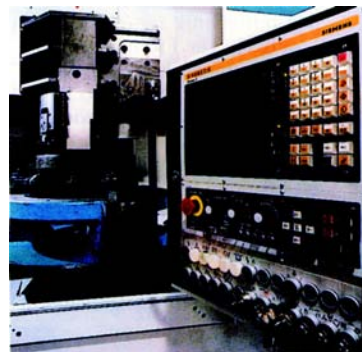



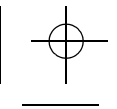
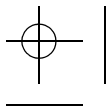

**1984 SINUMERIK 810**

A compact CNC path control for four axes and one spindle is developed for turning and milling.

**1986 SINUMERIK 880**

This modular CNC path control, with up to 24 axes and 6 spindles (16 channels) is developed for the upper performance range.

**1994 SINUMERIK 840D**

This modular control concept was conceived for even more flexible and favorably-priced production. It was integrated in the same packaging design as the drive. It includes both hardware-independent software as well as interfaces to the digital drives. Siemens was the first to develop and implement Nurbs interpolation for CNC technology.



**1996 SINUMERIK 810D**

The NC controls and drives were consistently further developed and combined to form a single module in this control. The control software is based on SINUMERIK 840D.



**1998 ShopMill**

**2000 ShopTurn**

Production of components on lathe and milling machines is made extremely simple using a modern programming HMI in line with the requirements of operators and workshops. This concept, based on the 810D, is implemented for milling with ShopMill, and for turning with ShopTurn.

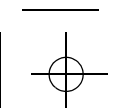
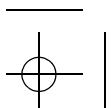

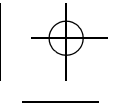
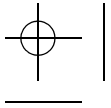

---

## 2.6 The axes - no cutting without motion

Modern production on turning and milling machines requires that workpieces and tools are moved. Thus, today's machine tools with a main drive (shown in blue) and with axis drives (shown in red) are equipped for motion in different directions:

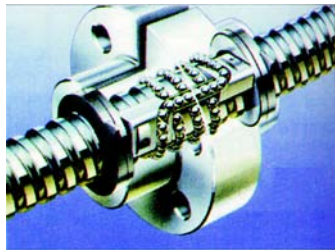
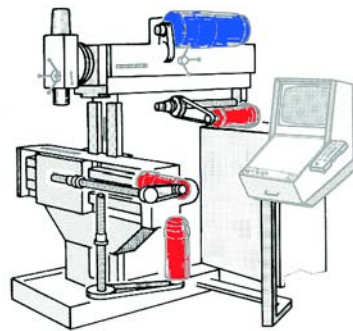
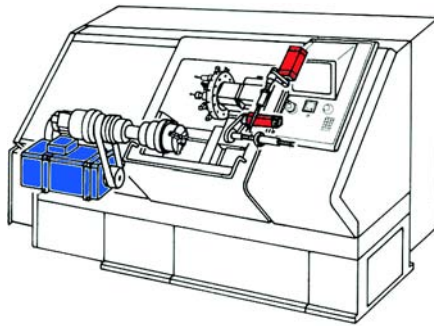

Ball screws, drive motors ...

... and the measuring system, are the essential components of a control circuit for high-precision production.

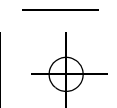
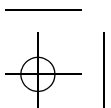
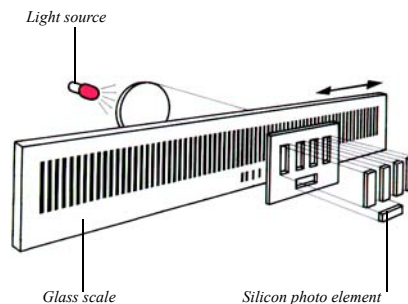

## 2.7 The drive - no power without strong muscles

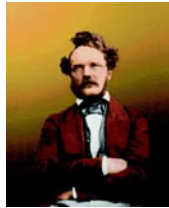

Werner von Siemens (1816 to 1892) is the father of drives. A new era of energy conversion began with his invention of the dynamo machine back in 1866.

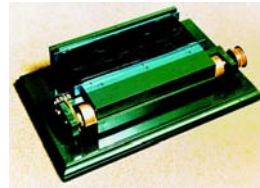

For fast and precise production, powerful, variable-speed motors are required for the main drive...

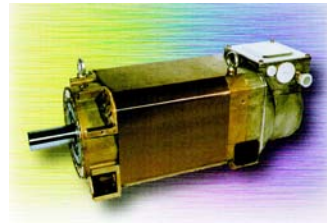

*Siemens main spindle motor with a rated output of up to 37 kW*

... and feed motors.

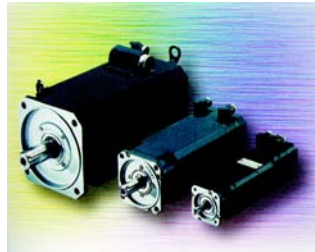

*Siemens axis drive motors with acceleration rates up to 450 m/s<sup>2</sup>*

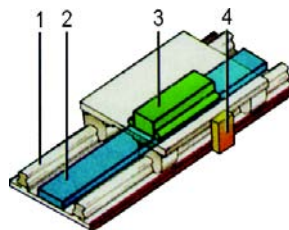

- 1 Guide system
- 2 Secondary section
- 3 Primary section
- 4 Linear position measuring system

*Principle of operation of a linear motor*

The linear motor is considered to be the innovative drive of the future. Higher acceleration levels and velocities (up to 120 m/min for machine tools) can be achieved by eliminating mechanical transmission elements.



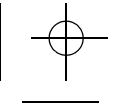
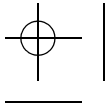

---

### 3 Work must be planned

#### 3.1 The NC program - how do I tell my machine?

Whether yesterday's punched tape ...



... or tomorrow's voice instructions ...

...even today, nothing moves without clear instructions which the control system understands.

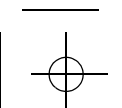
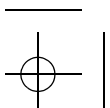

### 3.2 Thoughts in motion

Consider the following task: The milling tool has to rotate clockwise with a speed of 1650 revolutions per minute.

Initially it should travel vertically downwards to a depth of 10 mm and the tool should then mill the complete right-hand longitudinal side to produce a smooth, shiny workpiece surface.

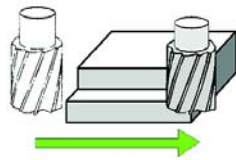

This is achieved using a feed velocity of 100 millimeters per minute. The tool should then retract quickly to the initial position. Ready!

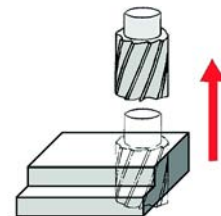
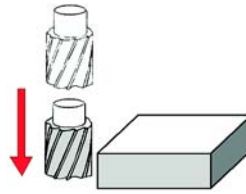

As usual, there are various ways of achieving this goal: One of the shortest ways is a "special" language which the machine tool specialist calls **DIN 66025**.

The task mentioned above is defined as follows in this language:

```
N1 F100 S1650 T24 M3
N2 G0 Z-10
N3 G42
N4 G1 X0 Y15
N5 G1 X74,3
N5 G40
N6 G0 Z100 M30
```

This widely established language is really very abstract. Furthermore, for workpieces with complex shapes its limits are quickly reached and points must be calculated. Today, it is far faster and simpler to use

**graphic programming.**

You will clearly see this on

the following pages with the Siemens control operator interfaces ShopMill and ShopTurn.

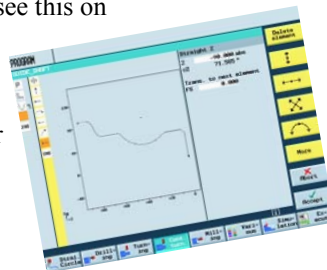
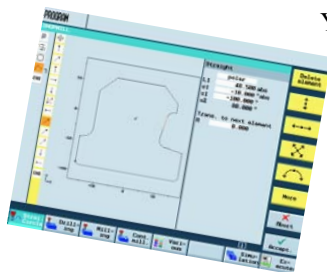

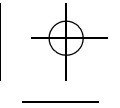
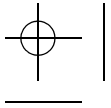

### 3.3 Where it all happens: Room for motion

Not every workpiece fits every machine.

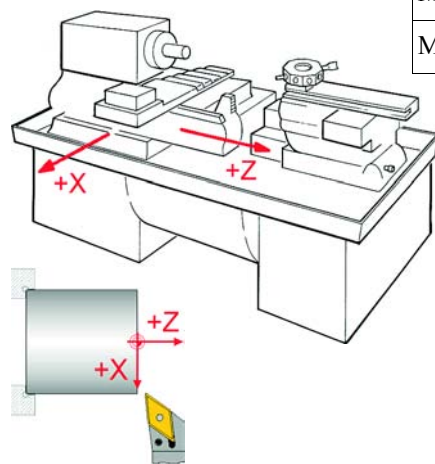

Max. turning diameter	Axis X
Max. turning length	Axis Z

#### Flatbed machine

(all the following displays refer to this machine type)

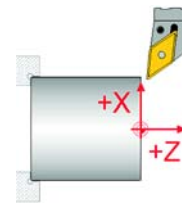

#### Inclined bed machine

(ShopTurn is used on most of these machine types)

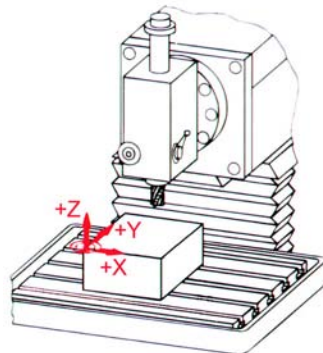

Max. workpiece length	Axis X
Max. workpiece width	Axis Y
Max. workpiece height	Axis Z

The maximum workpiece dimensions correspond to the possible traversing path of the tool in the particular axis.

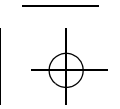
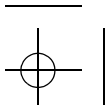

### 3.4 Straight to the point

There are several reference points on every CNC machine which are extremely important for program execution.

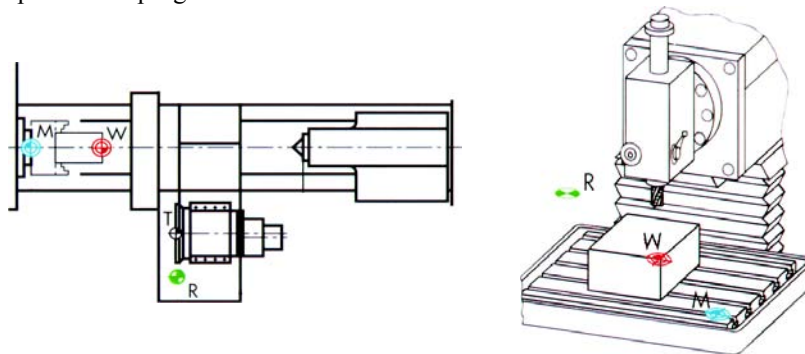

**Machine zero M**

The manufacturer defines the machine zero M and this cannot be changed. It is located at the origin of the machine coordinate system.



**Workpiece zero W**

The workpiece zero W (also known as program zero) is at the origin of the workpiece coordinate system. It can be freely selected, and should be located at the point where most of the dimensions originate in the drawing.



**Reference point R**

The reference point R is approached to set the measuring system to zero, as the machine zero point can generally not be approached. The control starts to count in its incremental position measuring system.

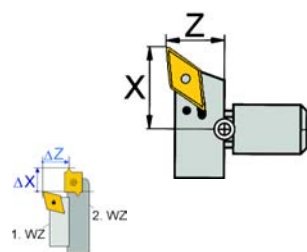

After they have been installed, all tools have a fixed measured reference point. The control system must know dimensions X and Z, and R and L so that each of these different dimensions can be taken into account when positioning.



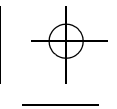
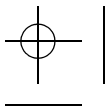

### 3.5 When it has to be fast

"Time is money" is also true for CNC machines. The tool has to travel quickly from the starting point to the workpiece.

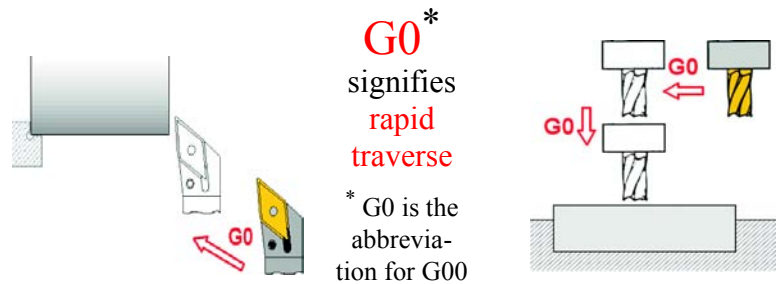

Today's CNC machine tools achieve extremely high traversing rates. Although these only correspond to the velocity of a pedestrian, for a machine tool they are quite adequate as generally only short travel paths are used: The target is reached in seconds and, without a visible braking distance. Traversing the tool is similar to driving to work and you need to watch out for obstructions.

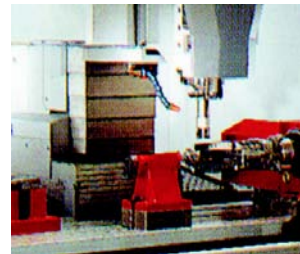

In order to save time, the tool is moved as close as possible to the workpiece. When experienced at close quarters, this operation is highly impressive and even for professionals.

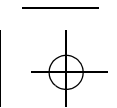
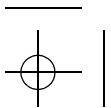



---

## 4 How workpieces are formed ...

### 4.1 Contours consist of straight lines and arcs

Turned and milled workpieces and therefore their contours can generally be defined using straight lines and arcs.

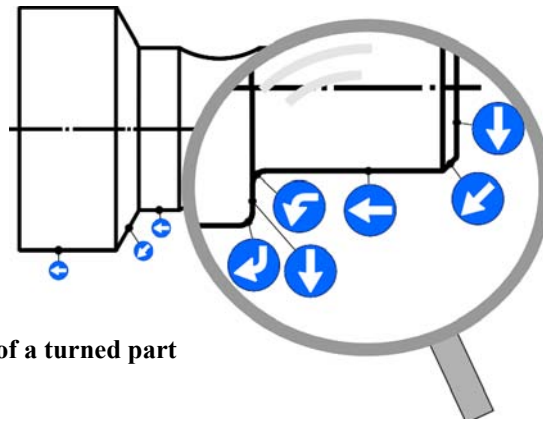

Contour of a turned part

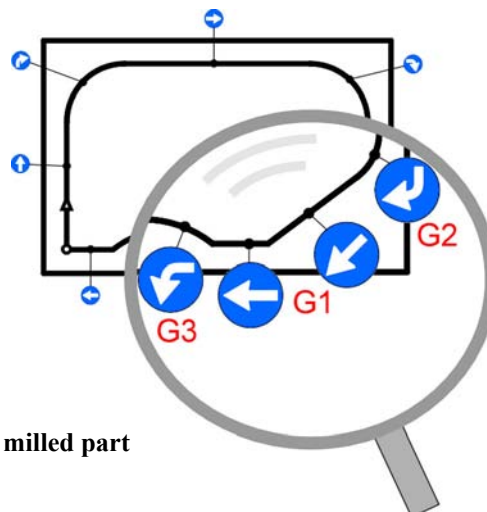

Contour of a milled part

Each arc can be produced from the left or from the right, similar to a curve in traffic, which, depending on the direction of travel, is either a right-hand or left-hand arc.

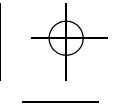
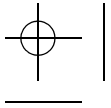

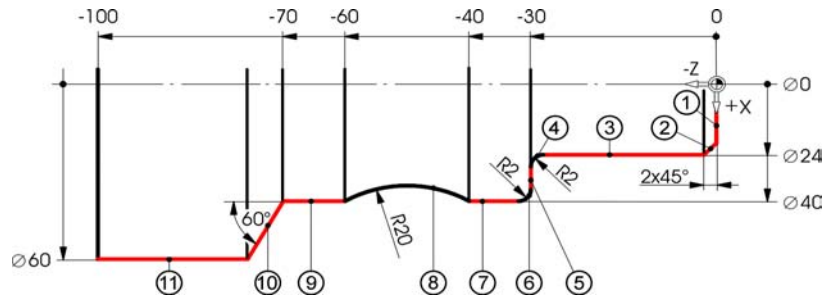

## 4.2 How straight lines are programmed according to DIN

According to DIN 66025, all straight lines are programmed using function G1 (short form of G01). In this case, the end point in X and Z is generally specified using absolute coordinates.



The starting point of the contour is X0 / Z0.



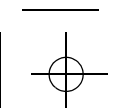
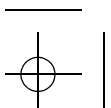

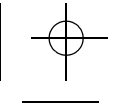
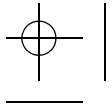
①	<b>G1</b>	<b>X20</b>		Start of the chamfer (24-2*2)
②	<b>G1</b>	<b>X24</b>	<b>Z-2</b>	
③	<b>G1</b>		<b>Z-28</b>	Start of the arc (30-2)
④	<b>Arc</b>			
⑤	<b>G1</b>	<b>X36</b>		Start of the arc (40-2*2)
⑥	<b>Arc</b>			
⑦	<b>G1</b>		<b>Z-40</b>	
⑧	<b>Arc</b>			
⑨	<b>G1</b> or <b>G91 G1</b>		<b>Z-70</b> <b>Z-10</b>	Absolute ("ABS") G91 stands for incremental ("INC")
⑩	<b>(G90)G1</b>	<b>X60</b>	<b>Z-75,774</b>	Value U can be determined using the tangent function as DIN does not permit any angles to be entered.
⑪	<b>G1</b>		<b>Z-100</b>	



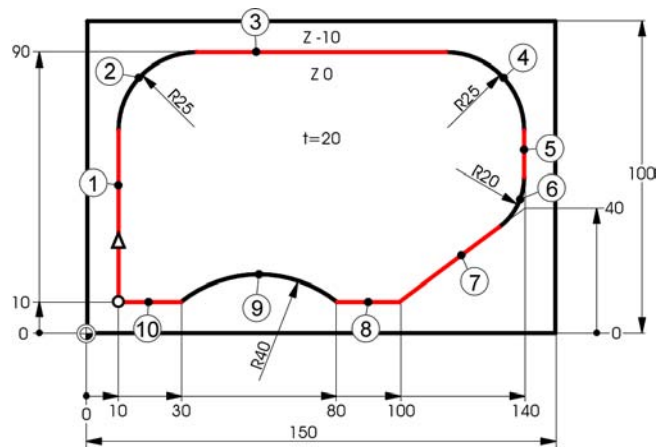

When milling, axes X and Y are programmed with function G1 (and for depth infeed, also the Z axis).



- |   |               |   |   |  |
|---|---------------|---|---|--|
| ① | <b>G1</b>     |   | <b>Y65</b>  | Start of the arc (90-25)                                     |
| ② | Arc           |  |   |  |
| ③ | <b>G1</b>     |   | <b>X115</b>   | Start of the arc (140-25)                                    |
| ④ | Arc           |   |   |  |
| ⑤ | <b>G1</b>     |  | <b>Y50</b>  | This value can be determined using trigonometrical functions |
| ⑥ | Arc           |  |   |  |
| ⑦ | <b>G1</b>     |   | <b>X100 Y10</b>   |  |
| ⑧ | <b>G1</b>     |   | <b>X80</b>  | Absolute ("ABS")   |
|   | or            |   |   |  |
|   | <b>G91 G1</b> |   | <b>X20</b>  | G91 stands for incremental ("INC")                           |
| ⑨ | <b>(G90)</b>  | Arc   |  |  |
| ⑩ | <b>G1</b>     |   | <b>X10</b>  |  |

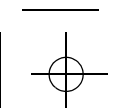
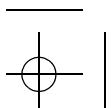

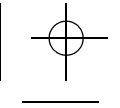
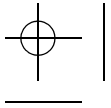

### 4.3 Basics when programming arcs

If an arc is to be programmed, the direction of rotation must first be defined. The following is valid according to DIN:

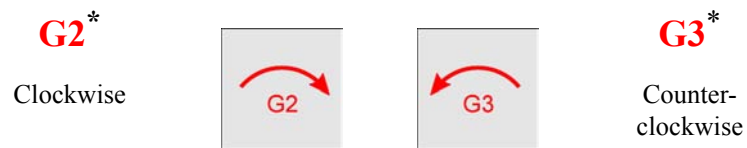

\*Abbreviations for G02 / G03

While this definition is easy to understand for CNC milling machines, there is a "problem" for all CNC-controlled lathes due to the various machine types, i.e. flat-bed or inclined-bed machines:

**What is G2, what is G3?**

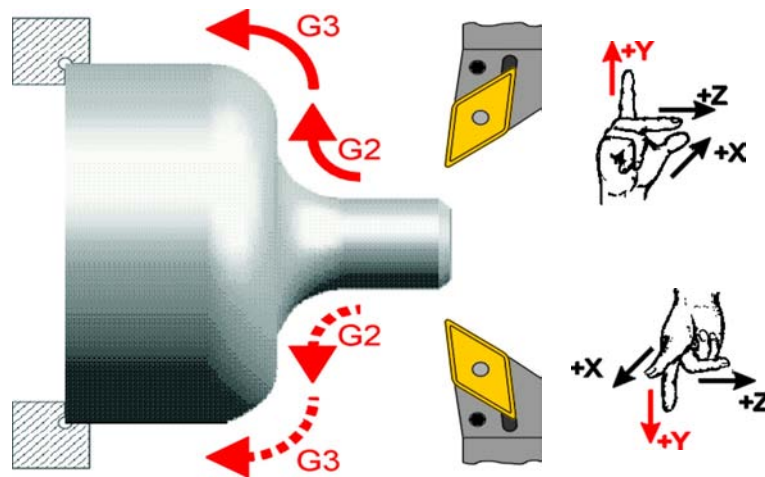

Due to the quite complicated "three-finger rule", derived from the DIN standard, G2 and G3 can also be defined as follows:

- **G2** is an **inner** arc,
- **G3** is an **outer** arc.

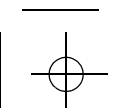
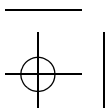



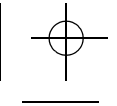
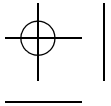

---

#### 4.4 How arcs are programmed according to DIN

##### Turned part

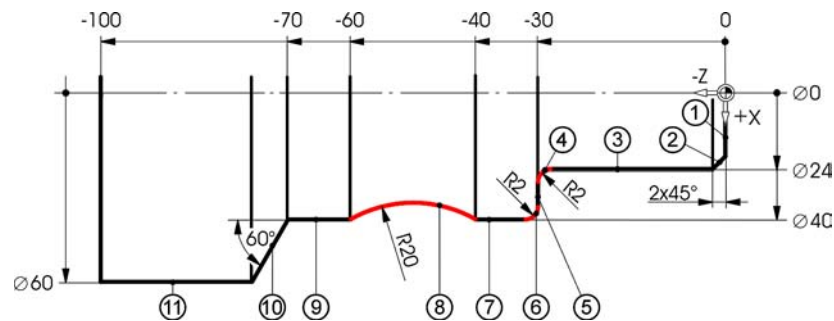

Up until now, the individual contour sections were designated in the program with a, s, d etc. However, according to DIN, **N1, N2, N3** etc. must be written.

The NC program for the contour above:

**N1 G1 X20**

**N2 G1 X24 Z-2**

**N3 G1 Z-28**

**N4 G2 X25 Z-30 I2 K0** K is 0, as the starting and center point have the same Z value.

**N5 G1 X36**

**N6 G3 X40 Z-32 I0 K-2** I is 0, as the starting and center point have the same X value.

**N7 G1 Z-40**

**N8 G2 X40 Z-60 I17,321 K-10** The I value can be calculated using the Pythagorean theorem.

**N9 G1 Z-70**

**N10 G1 X60 Z-75,774** (refer to page 26)

**N11 G1 Z-100**

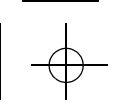
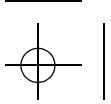

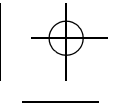
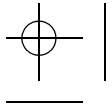

### Milled part

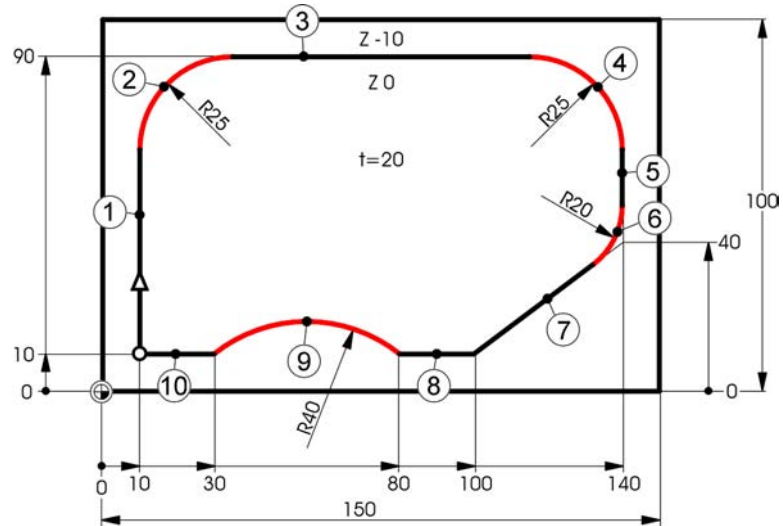

The NC program for the contour above:

**N1 G1 Y65**

**N2 G2 X35 Y90 I25 J0**

J is 0, as the starting and center point have the same Y value.

**N3 G1**

**N4 G2 X115 Y65 I0 J-25**

I is 0, as the starting and center point have the same X value.

**N5 G1 Y50**

(refer to page 27)

**N6 G2 X132 Y34 I-20 J0**

The values for X and Y can be determined using trigonometrical functions.

**N7 G1 X100 Y10**

**N8 G1 X80**

**N9 G3 X30 Y10 I-25 J-31,225**

The value for J can be calculated using the Pythagorean theorem.

**N10 G1 X10**

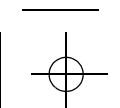
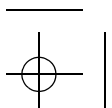

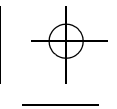
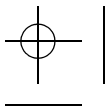

## 4.5 Graphic programming

On the previous pages, you have seen how difficult it can be to program a contour according to DIN.

On the following pages you will see, how simple it is to graphically program contours by way of an example of ShopTurn and ShopMill.

### Graphically programming a turning contour with ShopTurn

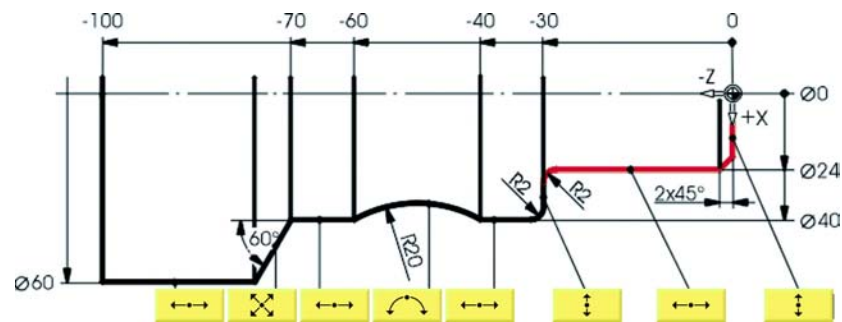

**Straight X**

X

Trans. to next element  
FS

**Straight Z**

Z

$\alpha 2$

Trans. to next element  
R

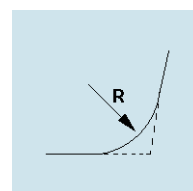
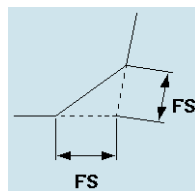

The chamfer 2\*45° is simply "attached" to the path.

The rounding R2 is simply "attached" to the path.

Graphic programming using ShopTurn is not only simpler, but it is also far faster, especially for complex contours.

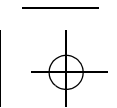
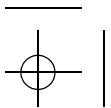



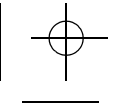
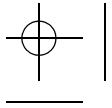

### Graphically programming a milling contour using ShopMill

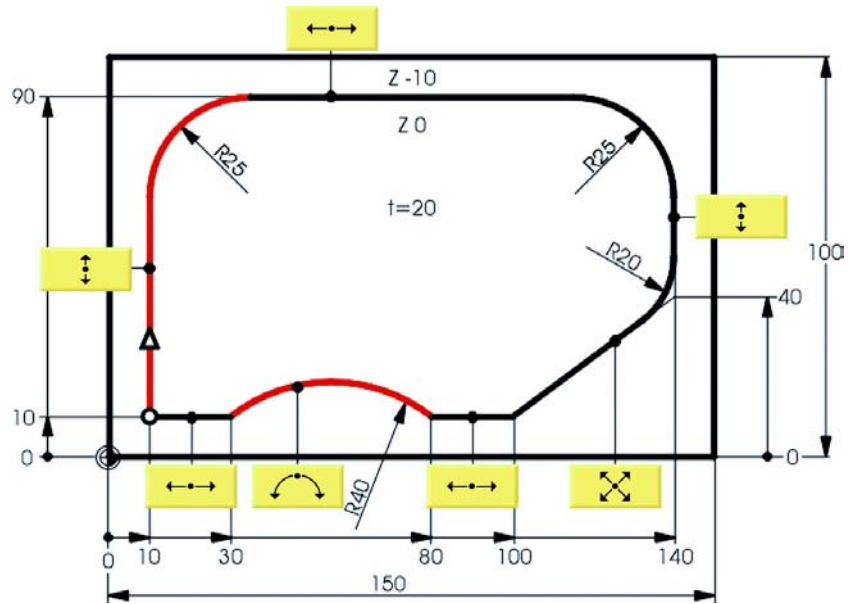

**Straight Y**

Y

Trans. to next element  
R

**Circle**

Dir. of rot.:

R

X

Y

I

J

α2

Trans. to next element  
R

Rounding R25 is simply "attached" to the path.

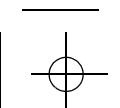
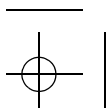

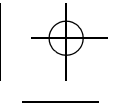
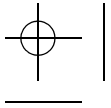

## 4.6 Contours and tool paths

To obtain a precisely dimensioned workpiece, the tool geometries must be observed, both when turning and when milling.

### Turning tool

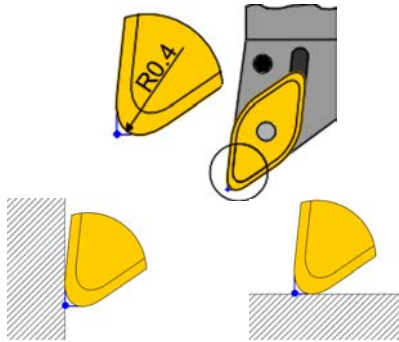

Turning longitudinally and face turning, **no dimension deviations** occur, in spite of a rounded cutting surface.

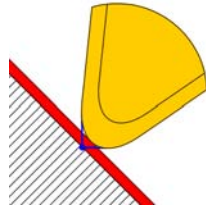

Tool path **NOT corrected**

For taper and also radius turning, **dimension deviations** occur if the tool path is not corrected.

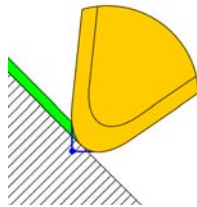

Tool path **corrected**.

### Milling tool

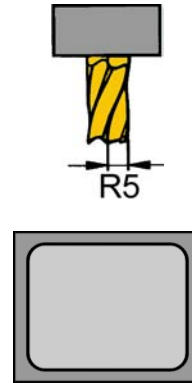

However, imagine the milling cutter were to move along the contour with its center point.

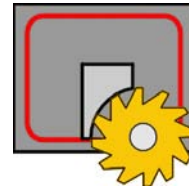

Tool path **NOT corrected**

The larger the radius, the smaller the remaining volume which has to be removed.

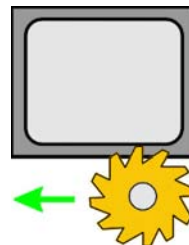

Tool path **corrected**.

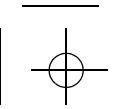
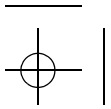

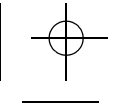
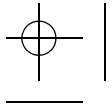

---

If the tool is corrected using the control system's "intelligence" (instead of the tedious tool path calculation in the path in parallel to the contour), then the specialist talks about

**Tool nose radius compensation**

and

**Cutter radius correction**

Compensation or offset correction is implemented using the two functions **G41** and **G42** :

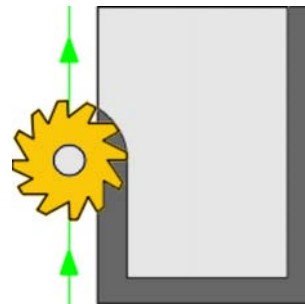
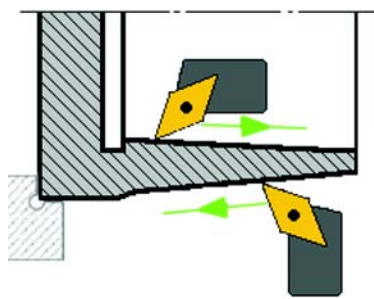

**G41**

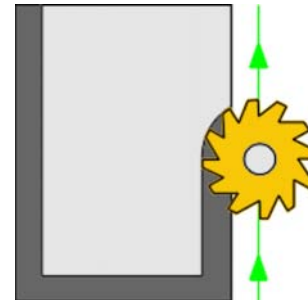
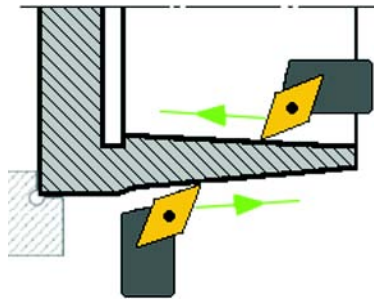

**G42**

Direction of motion = direction of view

**G41** The tool is located to the **left** of the contour.

**G42** The tool is located to the **right** of the contour.

**G40** cancels **G41** and **G42**.

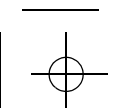
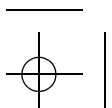

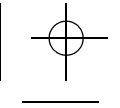
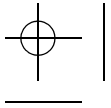

## 5 ... and how they are produced

### 5.1 Tools today

When turning and milling, as is true for any cutting operation, the cutting materials and their resistance to wear are especially important. .

Whereas previously alloyed and non-alloyed tool steels dominated, in the summer of 1998, the distribution is as follows:

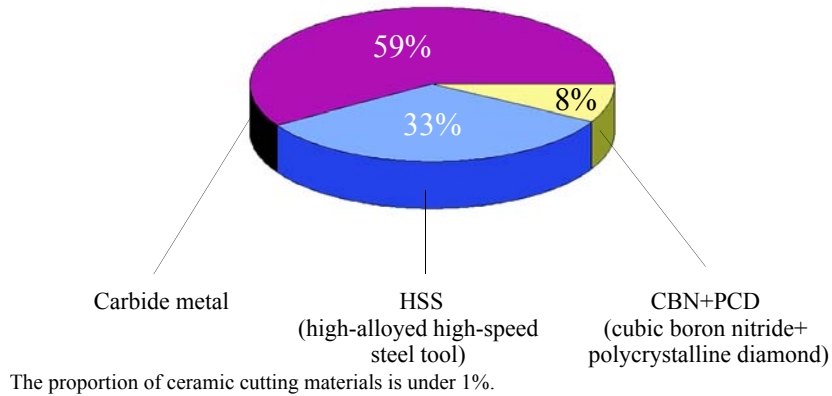

Carbide metal

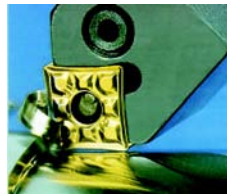

The increasing use of this coated sintered material means that machining can be performed at extremely high cutting speeds

HSS



Spiral drill, sinker, reamer, ...  
Machining is performed at low cutting speeds.

CBN

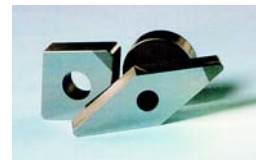

Suitable for roughing and finishing hardened steel and also for cast iron.

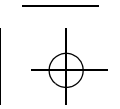
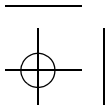

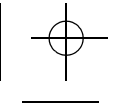
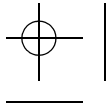

---

### Productivity using state-of-the-art tools

Under the title "Costs reduced - how you can save when cutting", Edition 24 of the PRODUKTION trade periodical of 10.6.98 reported on some insider information from a machine tool OEM.

The report included statements which appeared unbelievable for the "standard" operator:

**"Trials at SECO have shown that when finishing cast iron brake disks, ceramic cutting tools had a lifetime of approximately 40 brake disks at a cutting speed of 500 m/min.**

**With the same cutting speed, CBN-30 cutting tools had a lifetime equivalent to 500 brake disks; if the cutting speed is doubled, the tool lifetime was a factor of 6 higher, i.e. 3000 brake disks."**

SECO were contacted for an explanation, this is what they said:

*"These values come from our experience in the field. We cannot give any detailed explanation."*

One thing is quite correct, the wear properties when machining grade 25 cast iron with CBN improve the higher the cutting speed.

These "unbelievable" statements can be compared with the "contradictions" of carbide metals:

Individual materials with their particular properties are combined so that a new carbide metal material is formed which only has the required properties of the individual materials.

<b>Titanium/tungsten carbide</b>	<b>+</b>	<b>Cobalt</b>	<b>→</b>	<b>Carbide metal</b>
<b>hard</b>		<b>soft</b>		<b>hard</b>
<b>brittle</b>		<b>tough</b>		<b>tough</b>

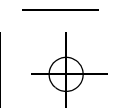
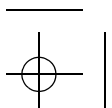

The carbide metal inserts are produced for the widest range of materials (steel, cast iron, aluminium) and with a wide range of different geometries. The machining type (coarse or fine machining) also determines the carbide metal type selected.



Comprehensive cutting data catalogs from all of the tool manufacturers are available to select the optimal inserts.

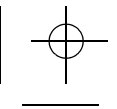
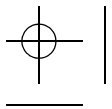

The clamping system and clamp type depend on the machining situation, the properties of the workpiece and the insert type.

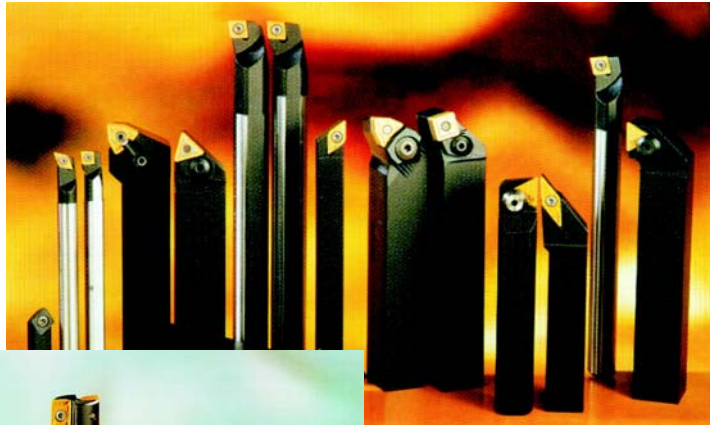

The name reversible insert comes from the fact that these inserts can be re-clamped in the clamp when one of the cutting edges is worn so that a new cutting edge is available.

You will find general nominal values for machining using carbide metal inserts in the various books of tables.



Drehen						
Richtwerte für das Drehen mit Hartmetall-Wendeschneidplatten						
Werkstoffe	Einstell- höhe mm	Vorschub f mm	Schneidgeschwindigkeit v <sub>c</sub> in m/min bei einem Hartmetall- Zähneumkehrabstand Z <sub>0</sub> = 0,1 mm			
			PM60 K10C	PM60 K15C	PM60 K20C	Hartmetall PM60 P10
<b>Allgemeine Baustähle</b> z.B. St 37, St 45, St 50, St 60, St 80, St 100, St 120, St 150, St 170, St 200, St 235, St 270, St 300, St 355, St 400, St 450, St 500, St 550, St 600, St 635, St 670, St 700, St 735, St 770, St 800, St 835, St 870, St 900, St 935, St 970, St 1000	90-230	0,1 - 0,25 0,3 - 0,5 0,6 - 1,5	290 230 180	280 220 170	270 210 160	160 140 120
<b>Einroststähle</b> z.B. Cr 12, Cr 13, Cr 15, Cr 17, Cr 18, Cr 19, Cr 20, Cr 22, Cr 24, Cr 26, Cr 28, Cr 30, Cr 32, Cr 34, Cr 36, Cr 38, Cr 40, Cr 42, Cr 44, Cr 46, Cr 48, Cr 50, Cr 52, Cr 54, Cr 56, Cr 58, Cr 60, Cr 62, Cr 64, Cr 66, Cr 68, Cr 70, Cr 72, Cr 74, Cr 76, Cr 78, Cr 80, Cr 82, Cr 84, Cr 86, Cr 88, Cr 90, Cr 92, Cr 94, Cr 96, Cr 98, Cr 100	140-370	0,1 - 0,25 0,3 - 0,5 0,6 - 1,5	270 210 160	260 200 150	250 190 140	150 130 110
<b>Vergütungsstähle</b> z.B. C 45, C 50, C 60, C 70, C 80, C 90, C 100, C 110, C 120, C 130, C 140, C 150, C 160, C 170, C 180, C 190, C 200, C 210, C 220, C 230, C 240, C 250, C 260, C 270, C 280, C 290, C 300, C 310, C 320, C 330, C 340, C 350, C 360, C 370, C 380, C 390, C 400, C 410, C 420, C 430, C 440, C 450, C 460, C 470, C 480, C 490, C 500	160-390	0,1 - 0,25 0,3 - 0,5 0,6 - 1,5	260 200 150	250 190 140	240 180 130	140 120 100
<b>Niwerkstoffe</b> z.B. Ni 10, Ni 20, Ni 30, Ni 40, Ni 50, Ni 60, Ni 70, Ni 80, Ni 90, Ni 100, Ni 110, Ni 120, Ni 130, Ni 140, Ni 150, Ni 160, Ni 170, Ni 180, Ni 190, Ni 200, Ni 210, Ni 220, Ni 230, Ni 240, Ni 250, Ni 260, Ni 270, Ni 280, Ni 290, Ni 300, Ni 310, Ni 320, Ni 330, Ni 340, Ni 350, Ni 360, Ni 370, Ni 380, Ni 390, Ni 400	230-370	0,1 - 0,25 0,3 - 0,5 0,6 - 1,5	180 140 100	170 130 90	160 120 80	100 80 60
<b>Aluminiumlegierungen</b> z.B. Al 10, Al 20, Al 30, Al 40, Al 50, Al 60, Al 70, Al 80, Al 90, Al 100, Al 110, Al 120, Al 130, Al 140, Al 150, Al 160, Al 170, Al 180, Al 190, Al 200, Al 210, Al 220, Al 230, Al 240, Al 250, Al 260, Al 270, Al 280, Al 290, Al 300, Al 310, Al 320, Al 330, Al 340, Al 350, Al 360, Al 370, Al 380, Al 390, Al 400	230-420	0,1 - 0,25 0,3 - 0,5 0,6 - 1,5	160 120 90	150 110 80	140 100 70	110 90 70
<b>Kupferlegierungen</b> z.B. Cu 10, Cu 20, Cu 30, Cu 40, Cu 50, Cu 60, Cu 70, Cu 80, Cu 90, Cu 100, Cu 110, Cu 120, Cu 130, Cu 140, Cu 150, Cu 160, Cu 170, Cu 180, Cu 190, Cu 200, Cu 210, Cu 220, Cu 230, Cu 240, Cu 250, Cu 260, Cu 270, Cu 280, Cu 290, Cu 300, Cu 310, Cu 320, Cu 330, Cu 340, Cu 350, Cu 360, Cu 370, Cu 380, Cu 390, Cu 400	230-250	0,1 - 0,25 0,3 - 0,5 0,6 - 1,5	170 130 90	160 120 80	150 110 70	100 80 60
<b>Werkstofflegierungen</b> z.B. Ti 10, Ti 20, Ti 30, Ti 40, Ti 50, Ti 60, Ti 70, Ti 80, Ti 90, Ti 100, Ti 110, Ti 120, Ti 130, Ti 140, Ti 150, Ti 160, Ti 170, Ti 180, Ti 190, Ti 200, Ti 210, Ti 220, Ti 230, Ti 240, Ti 250, Ti 260, Ti 270, Ti 280, Ti 290, Ti 300, Ti 310, Ti 320, Ti 330, Ti 340, Ti 350, Ti 360, Ti 370, Ti 380, Ti 390, Ti 400	150-230	0,1 - 0,25 0,3 - 0,5 0,6 - 1,5	140 100 70	130 90 60	120 80 50	80 60 40
<b>Stahlguß</b> z.B. GG 10, GG 15, GG 20, GG 25, GG 30, GG 35, GG 40, GG 45, GG 50, GG 55, GG 60, GG 65, GG 70, GG 75, GG 80, GG 85, GG 90, GG 95, GG 100, GG 105, GG 110, GG 115, GG 120, GG 125, GG 130, GG 135, GG 140, GG 145, GG 150, GG 155, GG 160, GG 165, GG 170, GG 175, GG 180, GG 185, GG 190, GG 195, GG 200	140-230	0,1 - 0,25 0,3 - 0,5 0,6 - 1,5	200 150 100	190 140 90	180 130 80	110 90 70
<b>AluGuß</b> z.B. GG 10, GG 15, GG 20, GG 25, GG 30, GG 35, GG 40, GG 45, GG 50, GG 55, GG 60, GG 65, GG 70, GG 75, GG 80, GG 85, GG 90, GG 95, GG 100, GG 105, GG 110, GG 115, GG 120, GG 125, GG 130, GG 135, GG 140, GG 145, GG 150, GG 155, GG 160, GG 165, GG 170, GG 175, GG 180, GG 185, GG 190, GG 195, GG 200	140-230	0,1 - 0,25 0,3 - 0,5 0,6 - 1,5	180 140 100	170 130 90	160 120 80	100 80 60

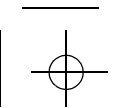
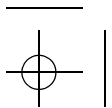

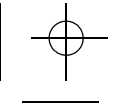
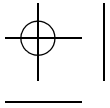

---

## 5.2 Tools in use\*

**Plunge cutting**  
with a 3 mm wide  
grooving tool

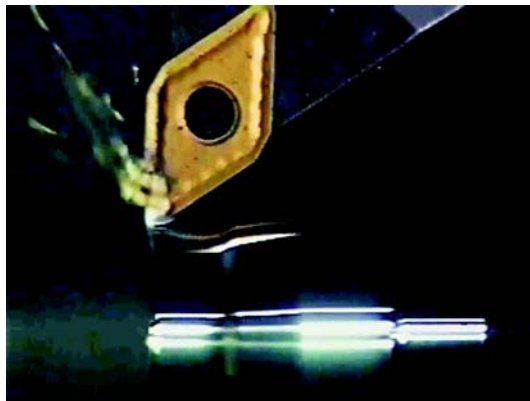
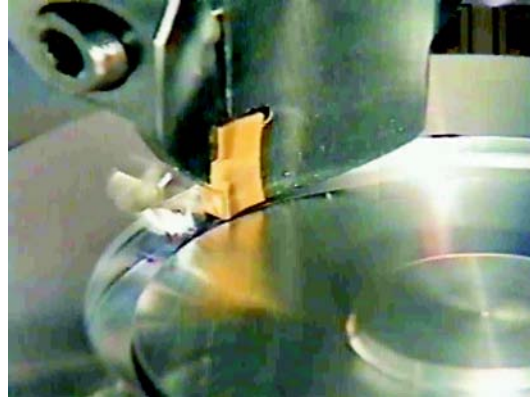

**Longitudinal  
roughing**  
with a 55° insert

**Inner face turning**

\* The diagrams on this and the next pages are video sequences from the Siemens CD "We belong to the workshop".

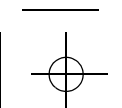
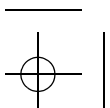
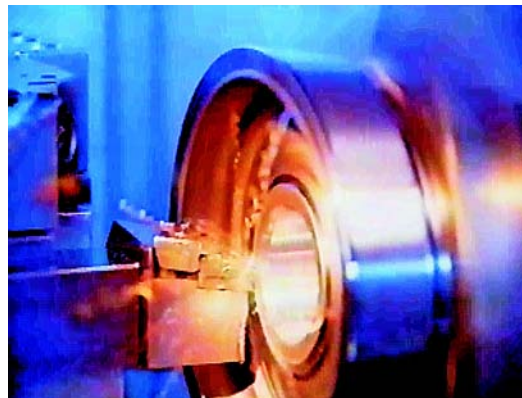



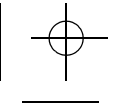
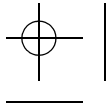

**Roughing**  
an external contour

**Horizontal machining**  
with NC rotary table

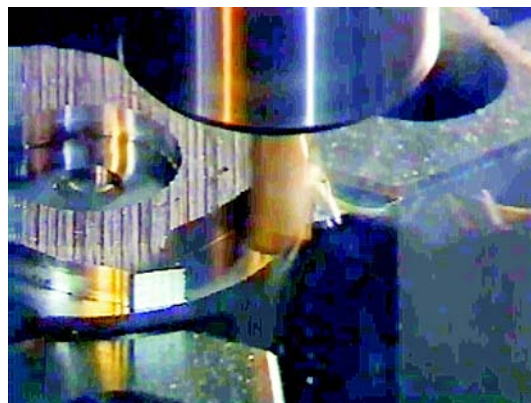

**Finishing**  
high alloyed steel

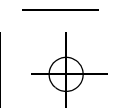
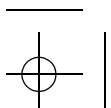

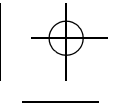
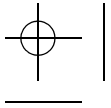

---

### 5.3 When something turns\*

The **workpiece** speed when turning ...



Das Werkstück dreht sich in einer Minute 120 mal:

Drehzahl  $n = 120 \frac{U}{min}^*$

Eingabe:

\*Umgangssprachliche Einheit:  
Richtig ist:  $\frac{1}{min}$  bzw.  $min^{-1}$

S  
180  
120  
60  
0

S 120

... and the **tool** speed when milling ...



Das Werkzeug dreht sich in einer Minute 180 mal:

Drehzahl  $n = 180 \frac{U}{min}^*$

Eingabe:

\*Umgangssprachliche Einheit:  
Richtig ist:  $\frac{1}{min}$  bzw.  $min^{-1}$

S  
180  
120  
60  
0

S 180

... are prerequisites for machining.

\* The diagrams on this and the next pages are video sequences from the Siemens CD "We belong to the workshop team"

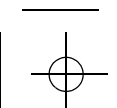
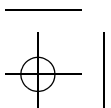

---

## 5.4 Speed and time

The higher the speed the shorter the time in which the workpiece turns through one complete revolution.

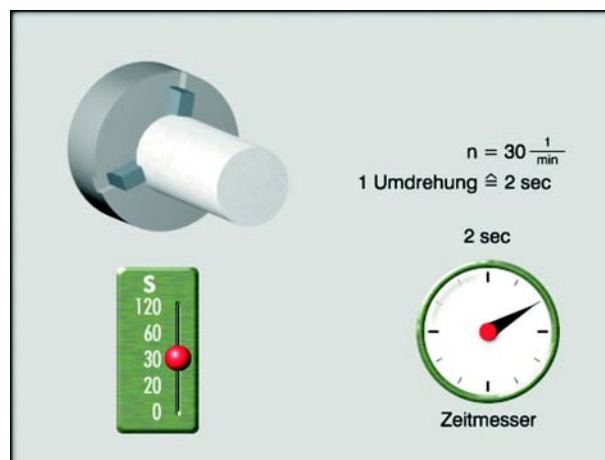

For a speed of  $n = 30$  RPM, one revolution takes 2 seconds.

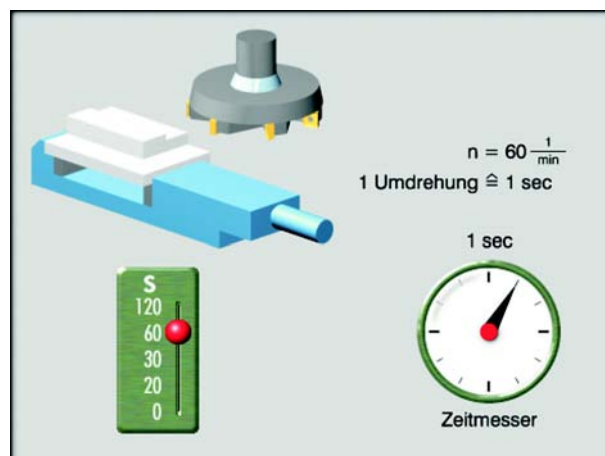

For a speed of  $n = 60$  RPM, one revolution takes 1 second.

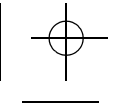
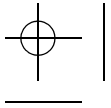

---

## 5.5 The circumferential speed at different diameters

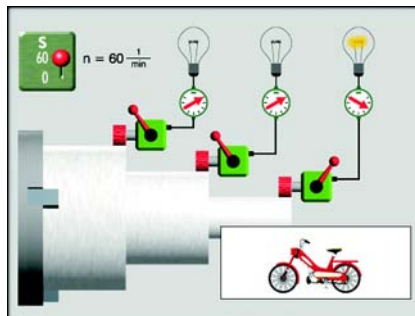

For a **small diameter** (and constant speed), the circumferential speed is **low**.

The circumferential speed can be calculated using the following formula.

$$v = d * \pi * n$$

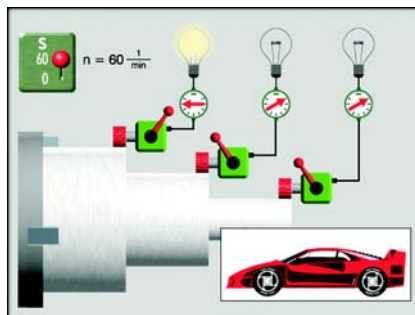
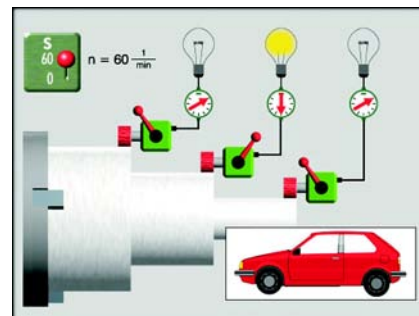

For a **large diameter** (and constant speed), the circumferential speed is **high**.

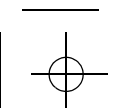
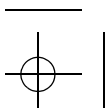

---

## 5.6 The circumferential speed at various rotational speeds

With increasing speed (and constant diameter), the circumferential speed increases.

The circumferential speed is generally specified in m/min.

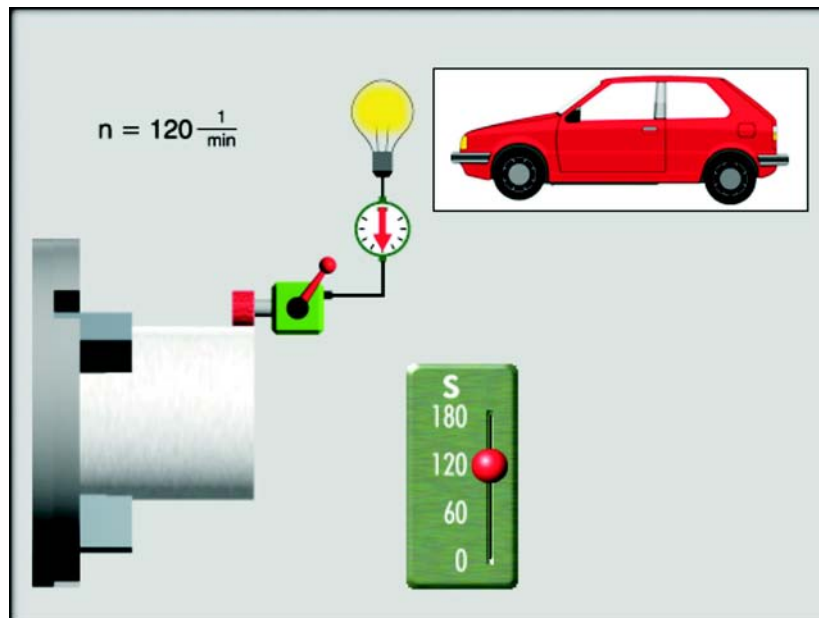

For an assumed diameter  $d = 60 \text{ mm}$  ( $0.06 \text{ m}$ ), and a speed  $n = 120 \text{ RPM}$ , the following is obtained:

$$\begin{aligned}v &= d * \pi * n \\v &= 0,06\text{m} * 3,14 * 120 \frac{1}{\text{min}} \\v &= 22,6 \frac{\text{m}}{\text{min}}\end{aligned}$$

---

---

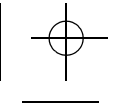
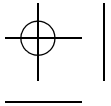

---

## 5.7 The cutting speed: when a tool cuts

The cutting speed, unlike the circumferential speed, measures the speed of the tool relative to the workpiece when cutting.

At the same speed  $n=750$  RPM, the cutting speed can be different, depending on the workpiece diameters.

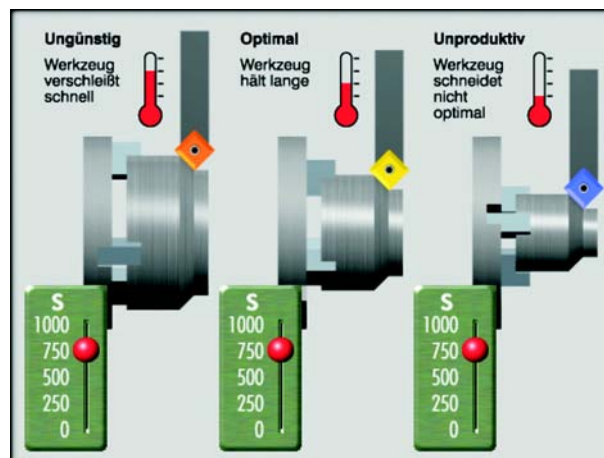

In order to achieve optimum tool use, it must be possible to select various speeds:

Larger diameter = lower speed etc.

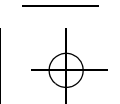
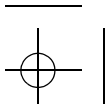
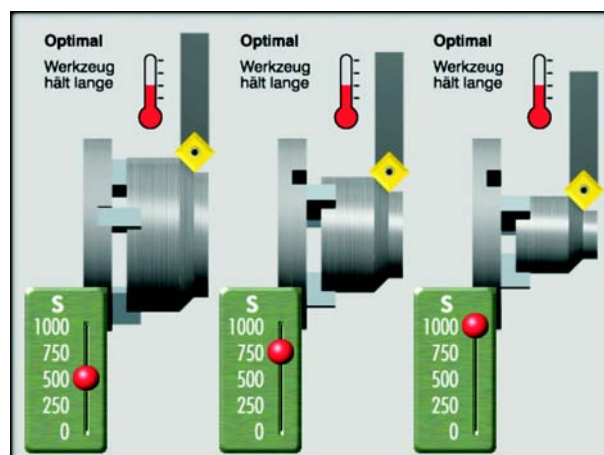

## 5.8 Feed and surface quality

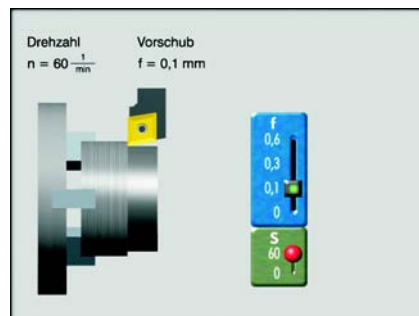

In addition to the cutting speed (and the tool nose radius), the feed especially influences the surface quality.

Generally, the following is valid:  
The lower the feedrate, the better the surface.

When turning,  
the **feed**  
is specified in mm:

$$f = 0,3 \text{ mm}$$

Input when programming:

**F 0.3**

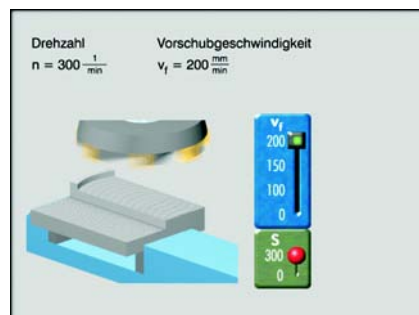
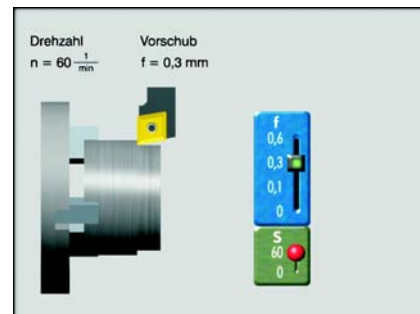

When milling, the **feedrate** is  
specified in  $\frac{\text{mm}}{\text{min}}$ :

$$v_f = 200 \frac{\text{mm}}{\text{min}}$$

Input when programming:

**F 200**

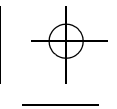
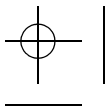

## 5.9 Constant cutting speed manually controlled

When face turning, it is tedious to keep adjusting the speed to maintain an optimum cutting speed.

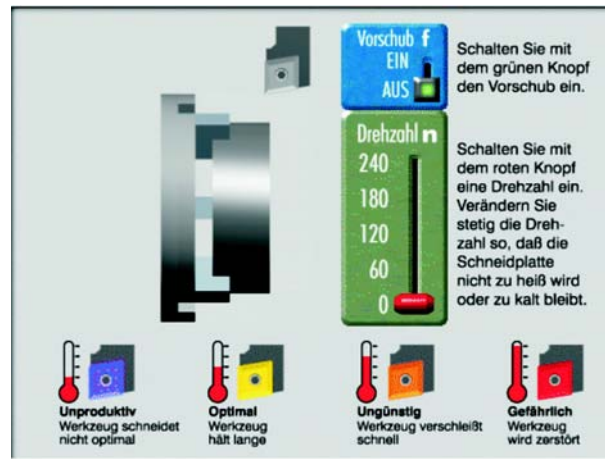

At an excessive speed ( $n = 240$  RPM), the tool will be destroyed, at a speed which is too low ( $n = 60$  RPM), the tool will not cut optimally.

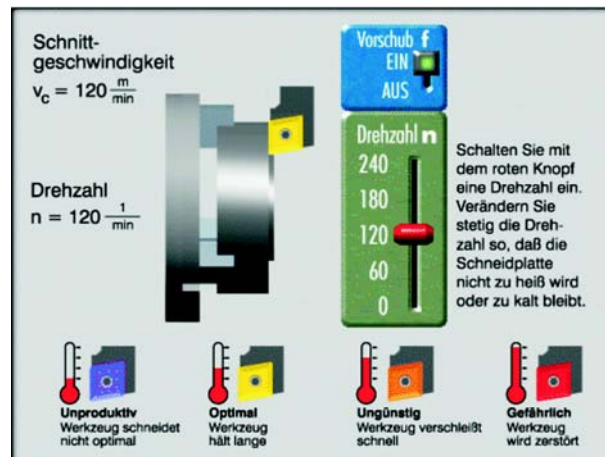

For those who are interested:

$$v = d \cdot \pi \cdot n$$

$$d = \frac{v}{\pi \cdot n}$$

$$d = \frac{12000 \frac{mm}{min}}{3,14 \cdot 120 \frac{1}{min}}$$

$$d = \underline{\underline{318mm}}$$

would be the instantaneous diameter at which the tool is cutting.

At a speed of  $n = 120$  RPM, the tool cuts optimally which means that higher speeds must be selected at an ever increasing rate.

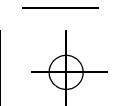
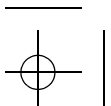



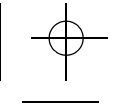
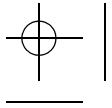

---

## Constant cutting speed controlled by the control system

For all CNC lathes, a constant cutting speed can be selected:

The control system calculates the appropriate speed as a function of the particular (actual) diameter.

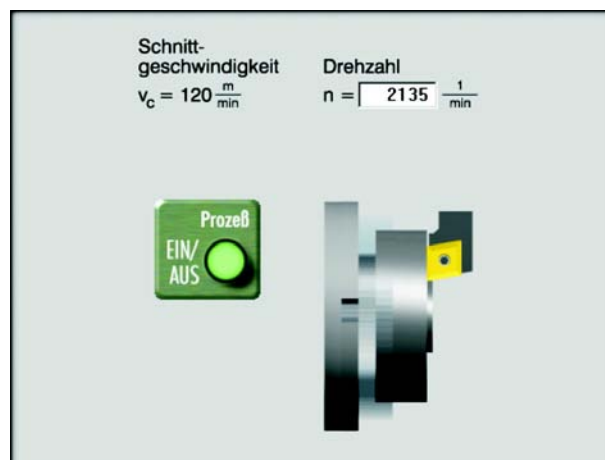

The operator only has to specify the required cutting speed, in this case,

$$v_c = 120 \text{ m/min.}$$

In the specialist's language, this is known as

**G96 S120**

The cutting speed (an empirical value or from the book of tables), depends on many parameters, e.g.:

- Tool material
- Workpiece material
- Required surface quality
- Coolant
- Machine (stability, ...)
- Clamping (projection, ...)

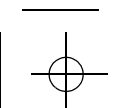
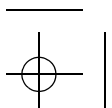



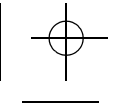
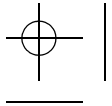

---

## Before we get going

To start off with the exercise has to be given a name

That is also true for ShopMill programs.

But, just like a child, the program isn't given a run-of-the-mill number, but a real name. Just like everything else in ShopMill.

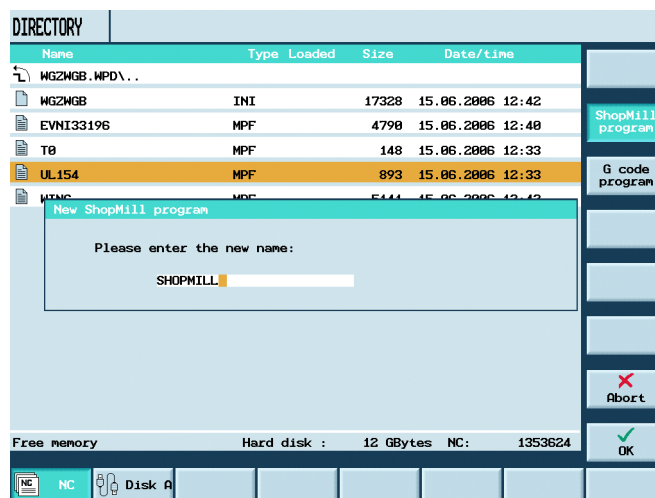

First, you define the unmachined dimensions, the retraction plane, the safety clearances and the main spindle axis.

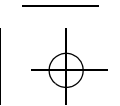
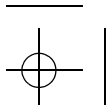
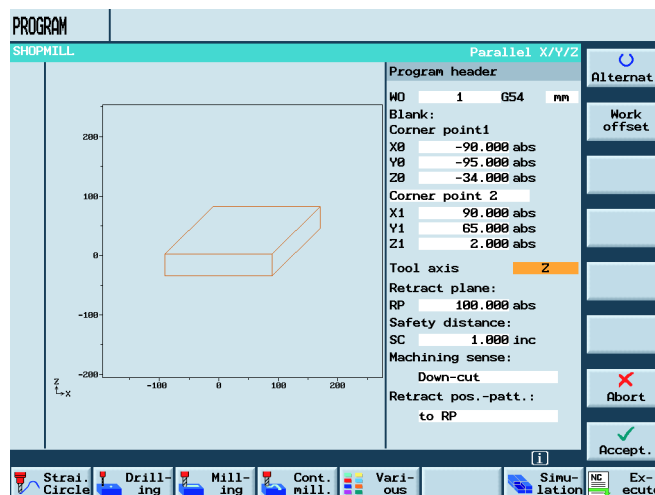

## Facing

The workpiece is to be face machined in the first working step. In this case, a milling cutter has already been recommended for the facing ...

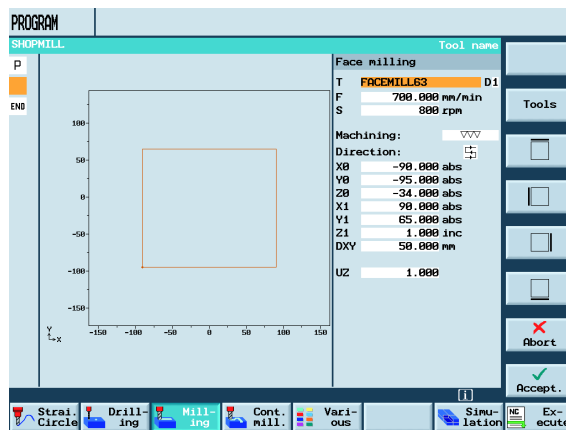

... Of course you can select any other tool from the list. You will find all of the parameters which you require next to the tool names: geometrical and technological values, coolant, compressed air ... The tool usage time is also monitored - the so-called tool life monitoring.



Even so-called replacement tools and flexibly-coded tool magazines can be administered. For oversized tools, the adjacent positions are also automatically taken into account.

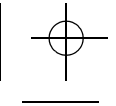
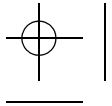

## Help graphics for every data entry

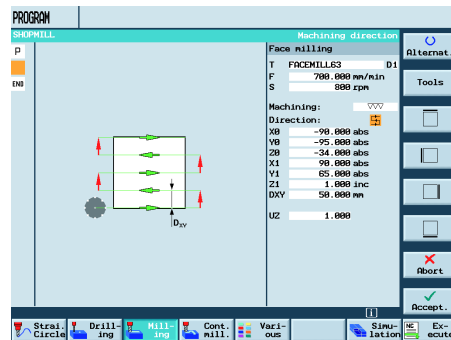

Let's stay with the selected size 63 milling cutter

The cutting data for the facing must now be specified. There is a plain text display for each input field, and if required, a help screen.

This means that you can quickly get to learn ShopMill without any long training period. There is no coding or programming to learn. All of the inputs are made using input masks with graphic support.

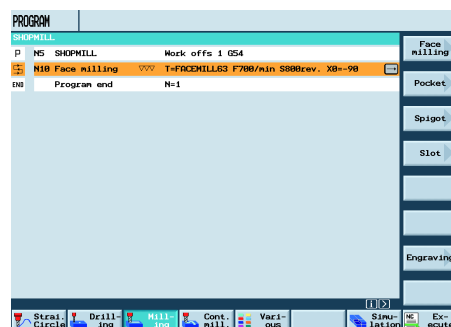
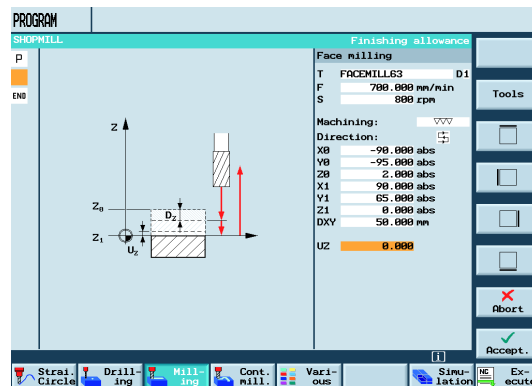

The first machining step has, in the meantime, been transferred into the machining step list. The facing is symbolized using a pictogram. The most important data of particular machining step is always displayed at the side - well arranged and to be read at a glance.

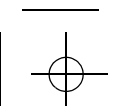
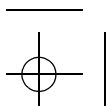

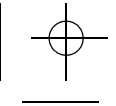
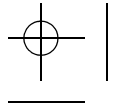

## Circular pocket

The continuous circular pocket is now to be milled at the center.

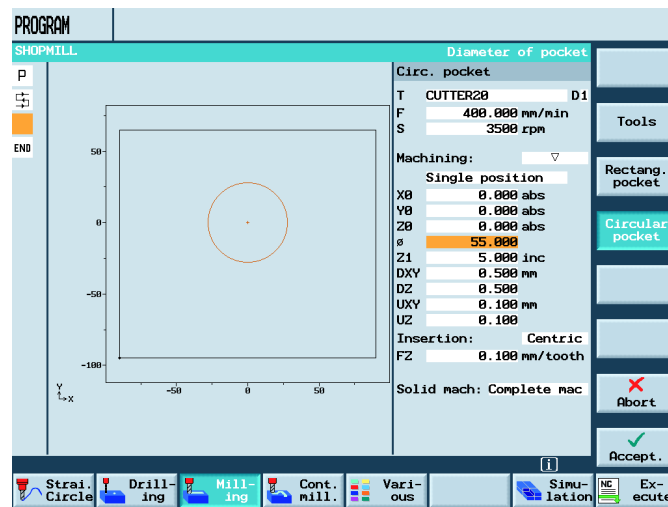

You have access to a wide range of plunge strategies. Depending on what your tool can best handle, it can be fed centered, oscillating or in a spiral. You can check your inputs using a simulation graphic.

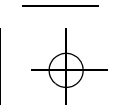
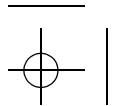
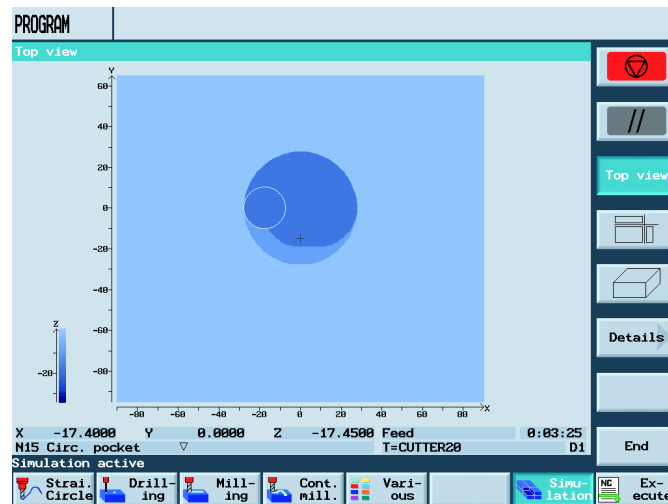

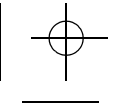
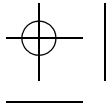

## Creating complex contours

So you reckon this is going to be somewhat more difficult with a complex outer contour? Wrong! Even if your drawing is not dimensioned for NC machining, ShopMill's contour computer and the graphic display are there to support you. Rounding-off and chamfers are absolutely no problem. They are simply "attached" to the previous element.

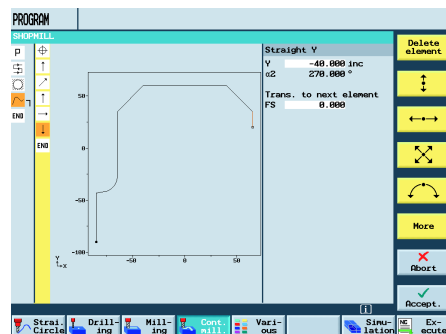
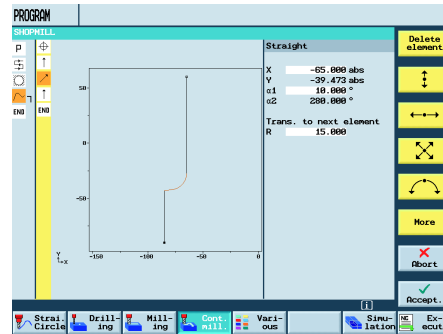

It doesn't make any difference if dimension in the drawing is specified in absolute or incremental terms. You can toggle between them simply by clicking. Furthermore, an integrated calculator can be called up from every input field.

If a contour element is not fully dimensioned, it can be defined using the subsequent elements. As soon as all of the dimensions are known, the graphic is updated. The contour is completely defined in just minutes - without any mathematical operations.

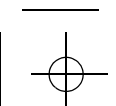
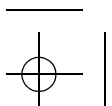
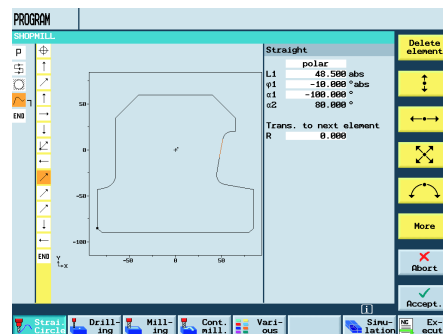

## Roughing along a contour

Using a size 30 cutter, the workpiece will now be roughed along its contour.

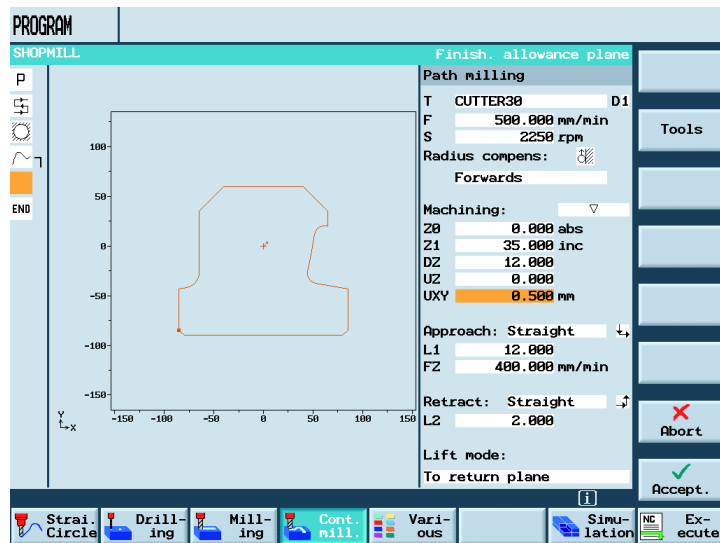

The machining step is simulated.

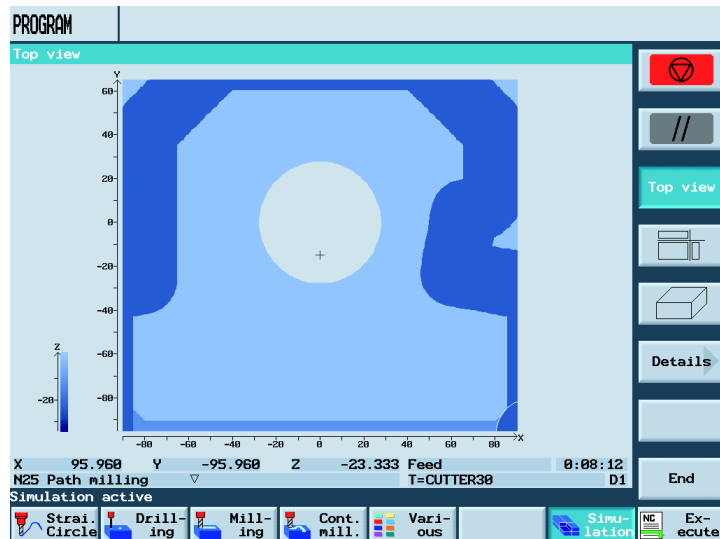



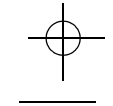
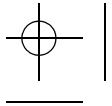

## Finishing along a contour

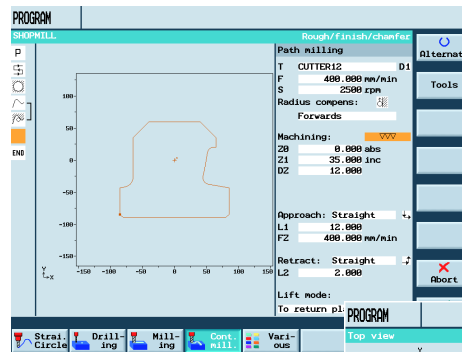

Then the contour is finished using a size 12 milling cutter.

The screen shows the finishing operation at an "obvious" position of the workpiece - zoomed-in.

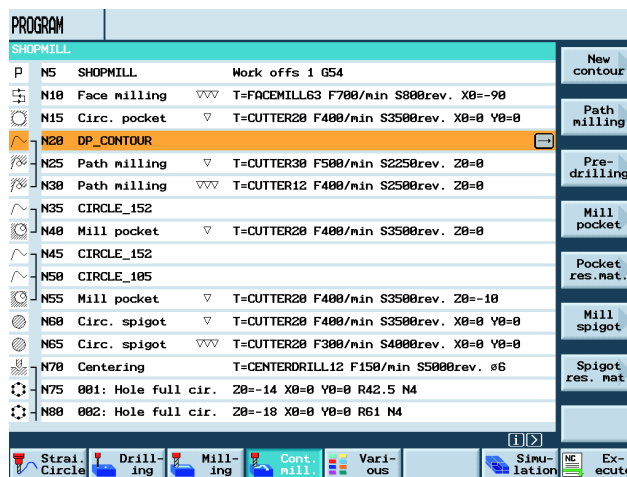
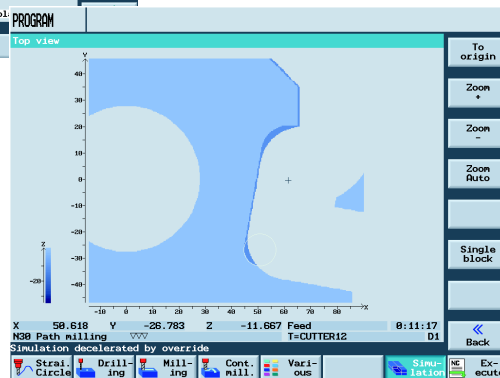

A bracket symbolizes the link between the contour and the machining steps.

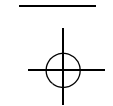
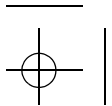

## Pocket with islands

In this case, it is the other way around, two contours are linked by one machining operation. The first contour defines a pocket, and the second, an island within this pocket.

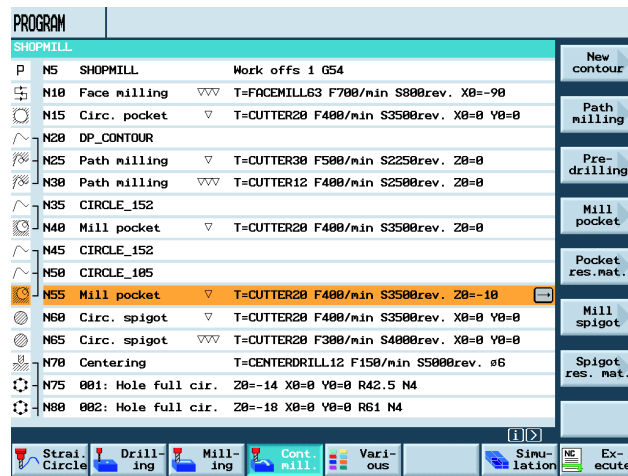

Pockets, with up to twelve complex islands can be solid machined parallel with the contour using ShopMill. This includes identifying and removing the residual material, if a large milling cutter was used for roughing. The benefit - you save time!

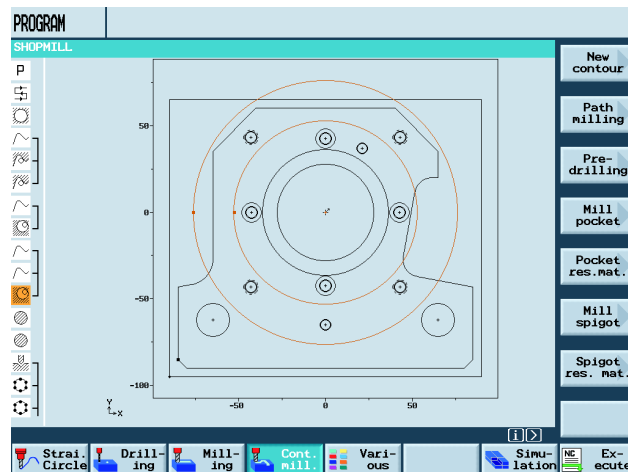

You can always toggle between the operating steps and the graphics with a simple click.

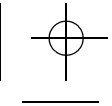
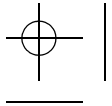

## Linking drilling patterns

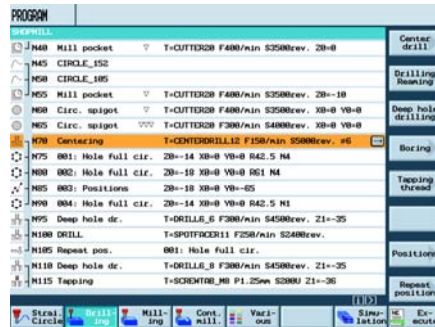

Once all the milling operations have been completed, it is time to drill.

In order to avoid having to change the tool early on, initially, all of the drilling patterns and individual holes are centered. You can also clearly see the linking in this list of machining steps.

The screen shows the input mask for defining a "circle" drilling pattern with help screen.

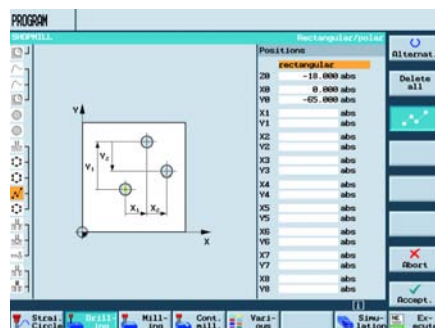
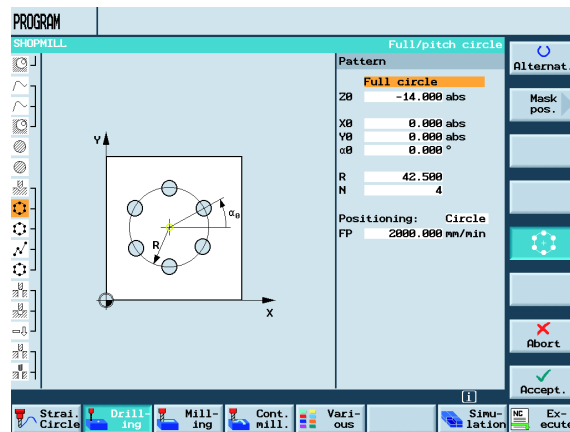

You can quickly, simply and individually enter the positions of the holes, pockets, grooves etc., using this mask.

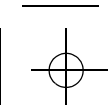
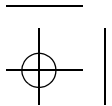

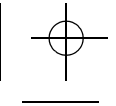
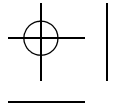

## Linking drilling operations

A position pattern can be linked with various machining operations.

The two technological elements (drilling and thread cutting) not only can be shown as top view to optically check the data entries ...

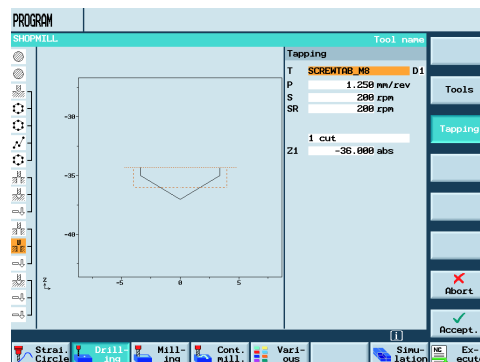
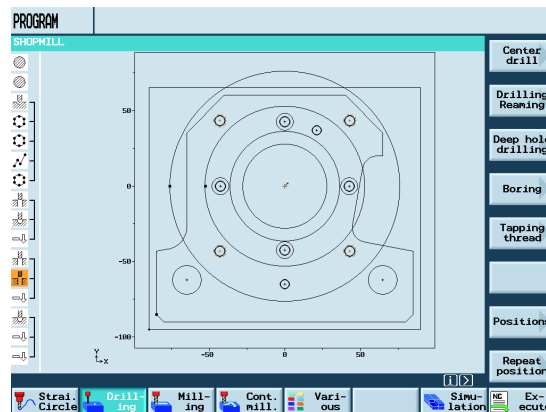

... but they can also be displayed as a side view.

This allows you to immediately see whether you entered the correct drilling diameter and drilling depths.

All good things come in three's:  
In addition to the top view and side view, there is also a help screen for this input mask.

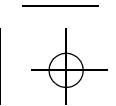
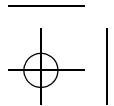
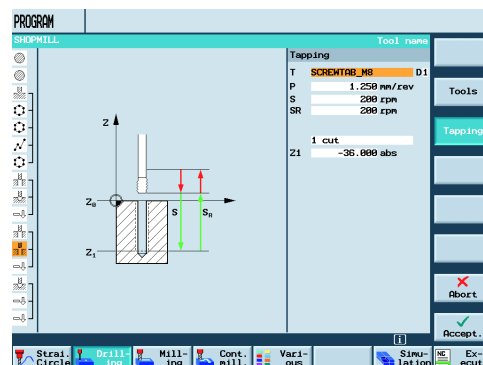

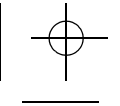
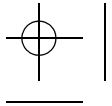

## Simulation

After the last machining step, you can simulate everything once again to check:

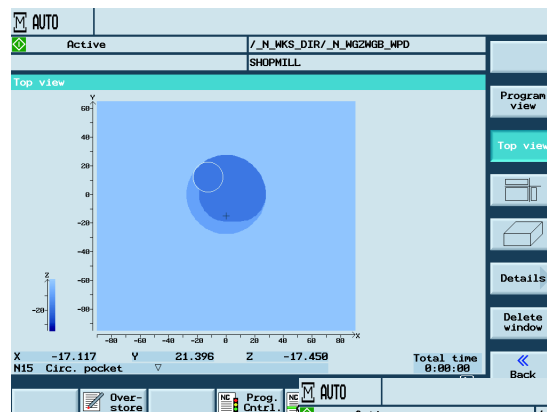

Firstly the circular pocket ...

... then rough the outer contour with a size 30 milling cutter ...

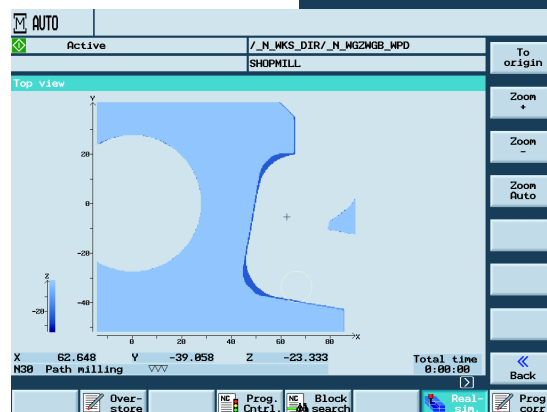
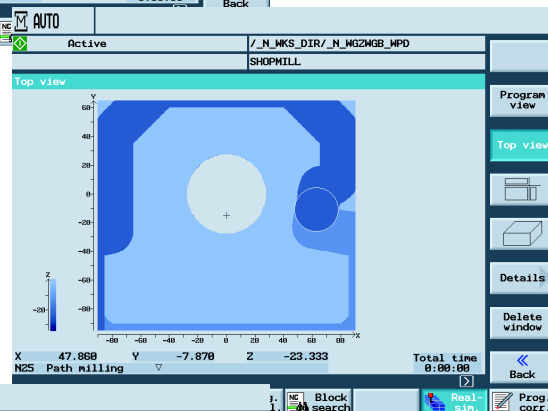

... and then finish this contour with a size 12 milling cutter etc.

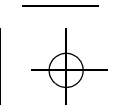
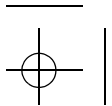

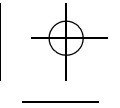
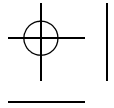

## The finished workpiece in 2D

The screen shows a top view of the part after the machining has been completed ...

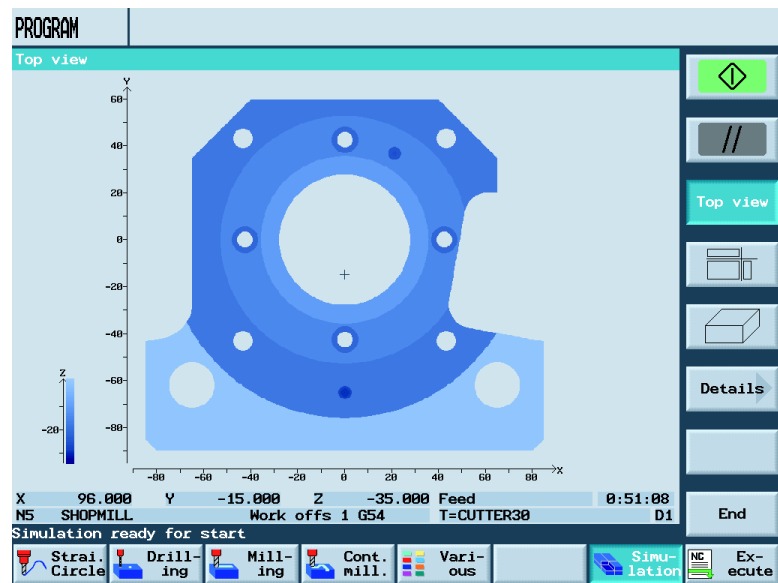

... or a view from three sides.

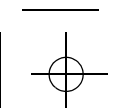
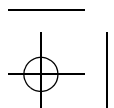
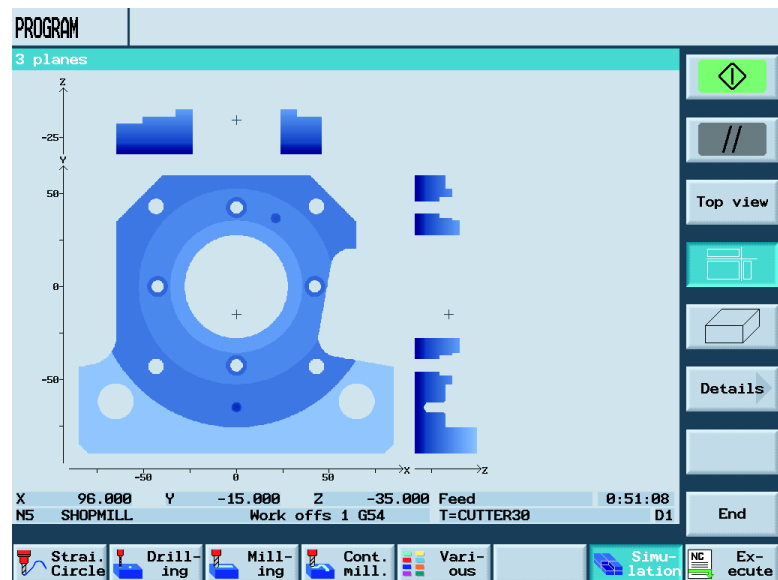

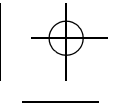
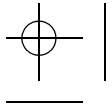

---

## The finished workpiece in 3D

The 3D screen is especially transparent. Here, you can view the workpiece from various sides, and the cross section.

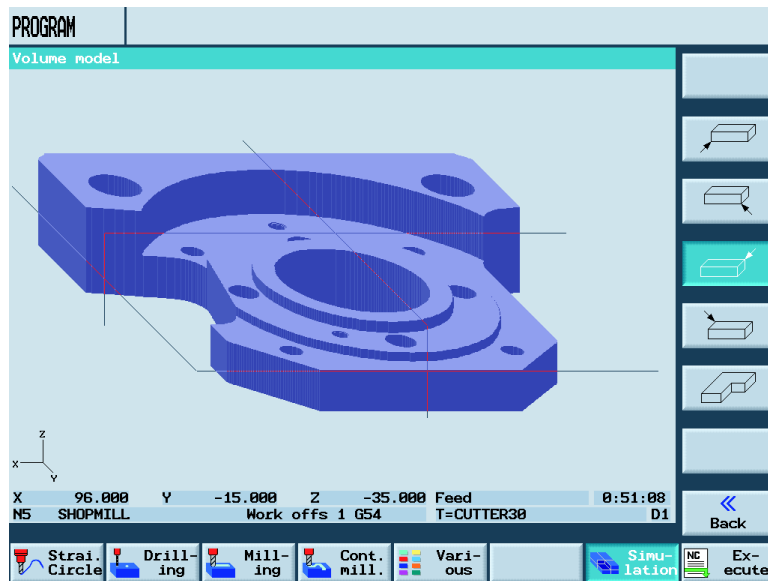

And as always: After theory, it's time for practice!

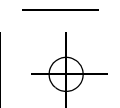
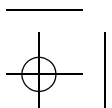
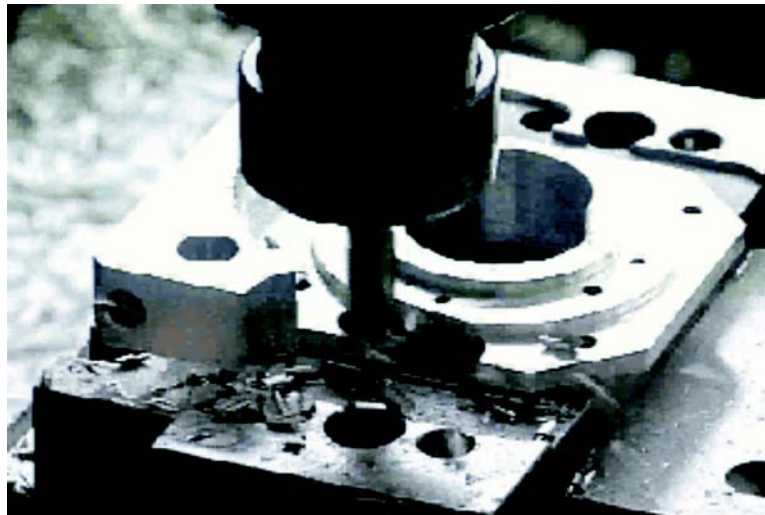

## 6.2 Turning with ShopTurn

In the following, you will see, using a swivel damper from a steering system, as example how you can use ShopTurn to quickly obtain a turned part from the drawing - graphically supported and without any programming know-how.

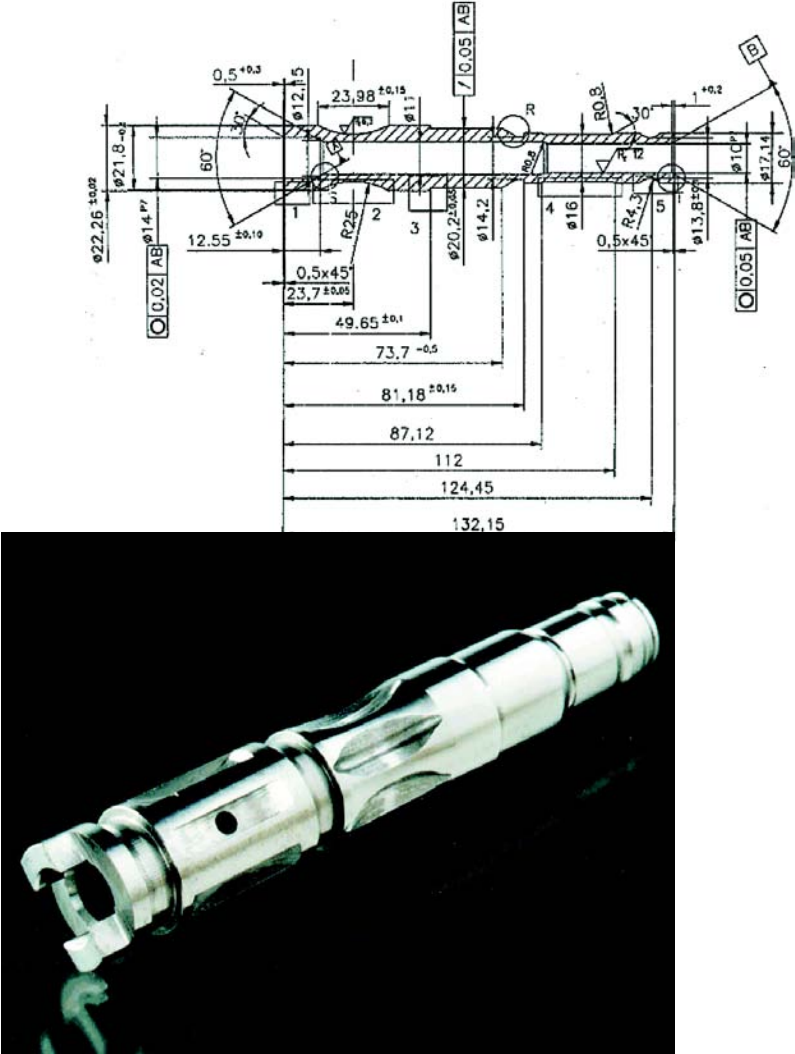



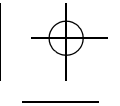
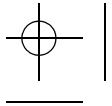

## Before we get going

In the first step, you define the unmachined part type, unmachined part dimension, the retraction plane and the tool change point. Furthermore, you can define the speed limits for up to three spindles.

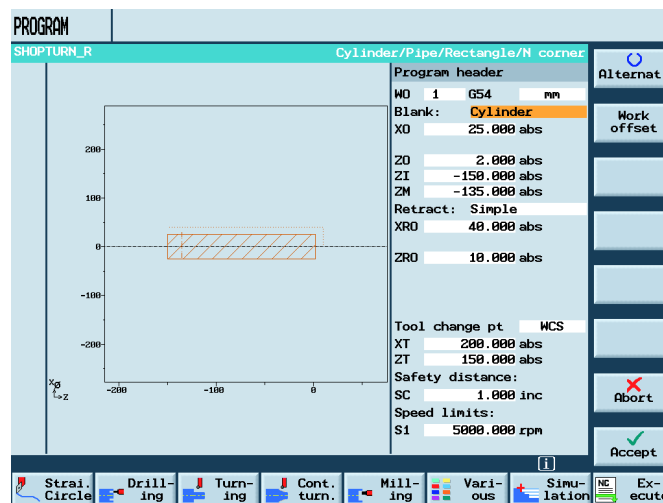

Initially, the workpiece should be faced. In this case, an 80° lathe tool is already offered for the facing ...

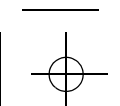
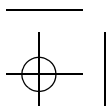
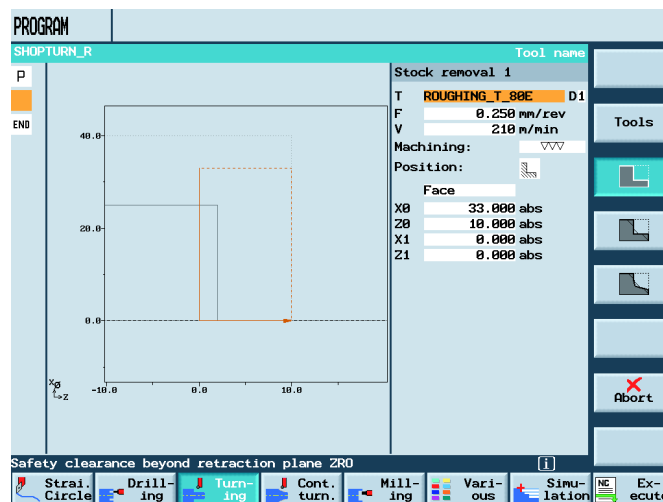

## Tool list

... It goes without saying that you could also select any other tool from the list. All of the geometry and technological values which are required are available after the tool name ...

Tool list										
Loc	Typ	Tool name	DP.1st cutting edge				Insr length	12		
			Lngh X	Lngh Z	Radius					
1		ROUGHING_T_80E	55.848	39.124	0.800	95.080	12.000	X		
2		DRILL_32	0.000	185.124	32.000	180.0		X		
3		FINISHING_T_35E	123.976	57.370	0.400	93.035	12.000	X		
4		ROUGHING_T_80I	-8.950	122.457	0.800	95.080	10.000	X		
5		PLUNGE-CUTTER_4E	85.124	44.124	0.200	4.000	8.000	X		
6		FINISHING_T_35I	-12.658	121.807	0.400	95.035	8.000	X		
7		THREADING_T_1.5	66.326	33.333	0.100			X		
8		CUTTER_8	87.833	74.621	8.000		3	X		
9		PLUNGE-CUTTER_3I	-11.736	135.124	0.100	3.000	4.000	X		
10		DRILL_9.8	0.000	185.124	9.800	118.0		X		
11		FINISHING_T35VE	67.561	30.245	0.400	72.535	12.000	X		
12		TAP_M6	0.000	145.132	6.000	1.000		X		
13										
14										

... Naturally, you can compensate the tool wear using the fine offsets, and you can monitor the tool lifetime as well as the number of times that the tool is used.

Tool wear										
Loc	Typ	Tool name	DP.1st cutting edge				T C			
			ΔLngh X	ΔLngh Z	ΔRadius					
1		ROUGHING_T_80E	0.000	0.000	0.000					
2		DRILL_32	0.000	0.000	0.000					
3		FINISHING_T_35E	0.000	0.000	0.000					
4		ROUGHING_T_80I	0.000	0.000	0.000					
5		PLUNGE-CUTTER_4E	0.000	0.000	0.000					
6		FINISHING_T_35I	0.000	0.000	0.000					
7		THREADING_T_1.5	0.000	0.000	0.000					
8		CUTTER_8	0.000	0.000	0.000					
9		PLUNGE-CUTTER_3I	0.000	0.000	0.000					
10		DRILL_9.8	0.000	0.000	0.000					
11		FINISHING_T35VE	0.000	0.000	0.000					
12		TAP_M6	0.000	0.000	0.000					
13										
14										

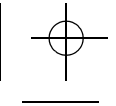
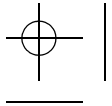

## Facing

After the tool has been selected, the technology and geometry data must be entered. In this case, when required, there is a clear help display for each display.

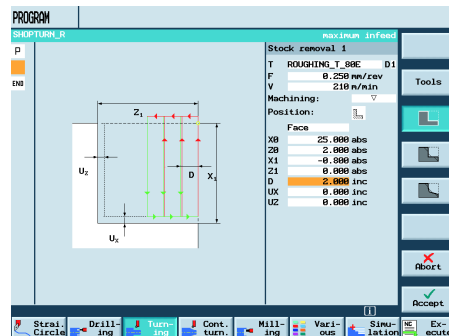

Neither coding nor programming is required.

You can start to use ShopTurn with almost any training.

The first machining step has in the meantime, already been included in the working step list.

A pictogram symbolizes stock removal with the data for facing. The most important technological data of the working step are provided next to it - always precise and transparent.

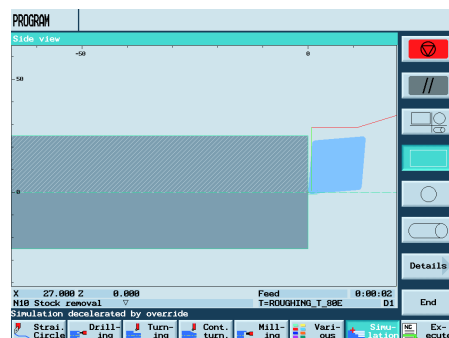
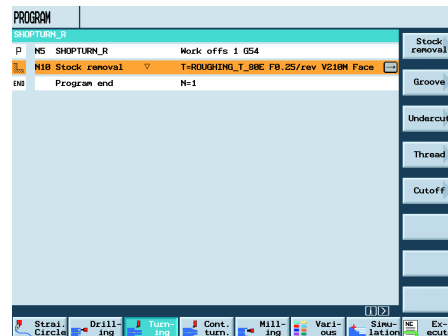

You can check your entries using the simulation graphics. Here, you can also read the total production time.

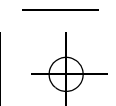
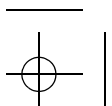

## Creating complex contours

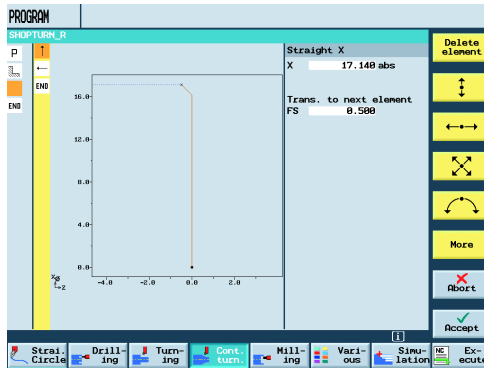

And you think that it will be more difficult with the complex outer contour? Wrong! If the drawing isn't provided with dimensions for NC machining, then the ShopTurn contour computer comes to your aid..

If the dimension system of your drawing allows various geometrical solutions, ...

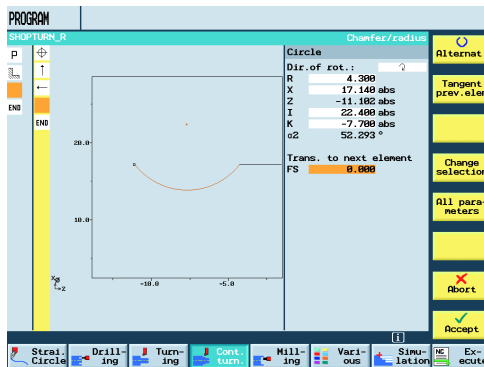
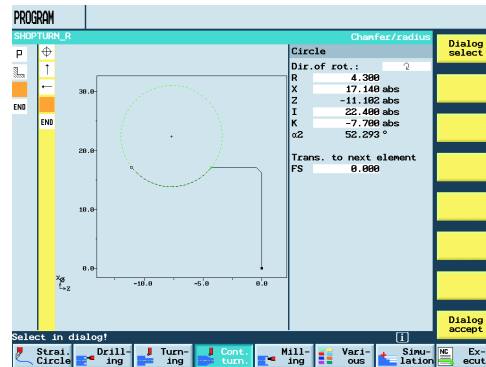

... then simply graphically select the optimum solution.

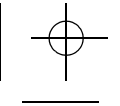
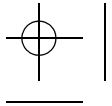

This means that even complex geometries are quickly created using clear, transparent symbols and easy to understand inputs.

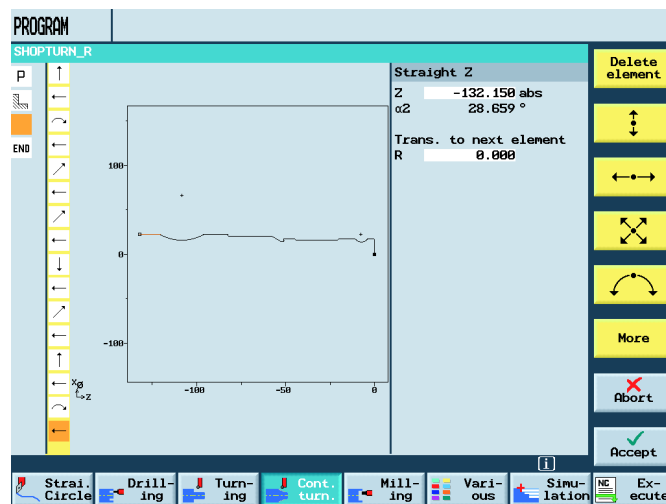

### Stock removal against contour

The workpiece is now to be roughed against the contour using the 80° lathe tool.

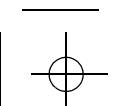
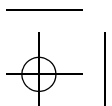
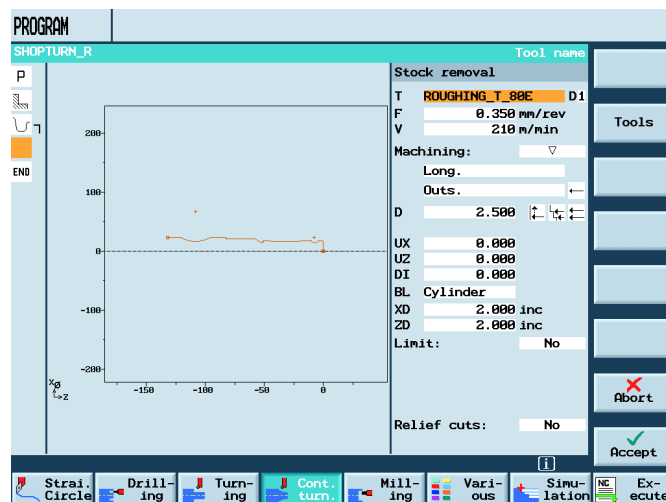

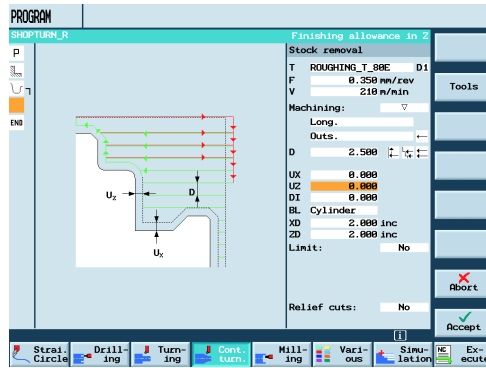
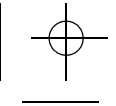
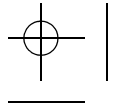

The finishing allowance is set to zero because the contour isn't to be finished.

As the negative gradient contours cannot be machined using the 80° tool, the relief cut field is set to no.

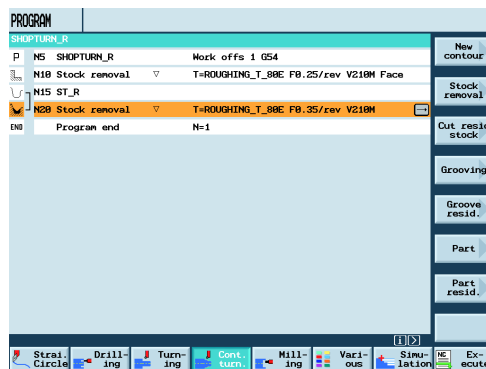
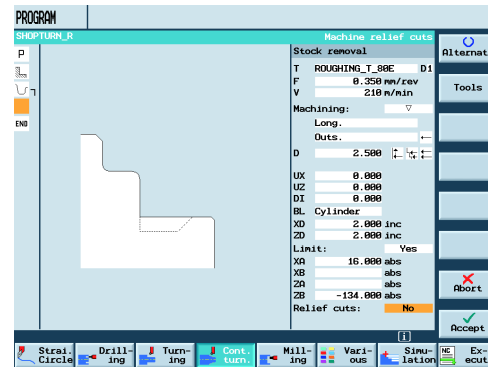

A bracket symbolizes the logic operation between the contour, entered in line N15 and the machining step.

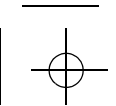
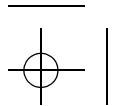

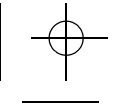
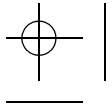

---

## Simulation

Just like always, the simulation displays the result of your entry ...

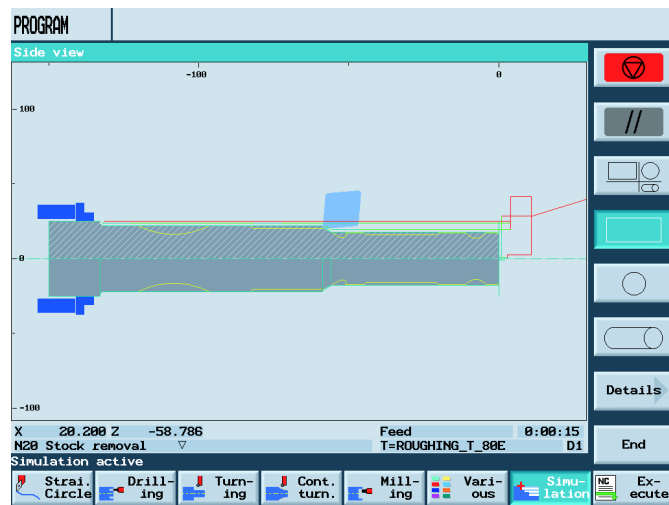

... and you can clearly see the current workpiece condition in the 3D view.

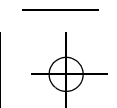
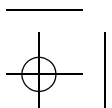
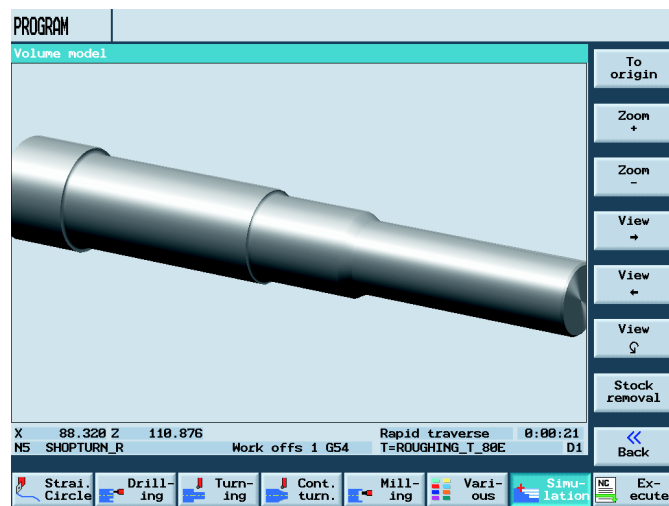

## Machining residual material

Now, the negative gradient contours should be machined using the 35° V chisel, because only this tool can remove residual material.

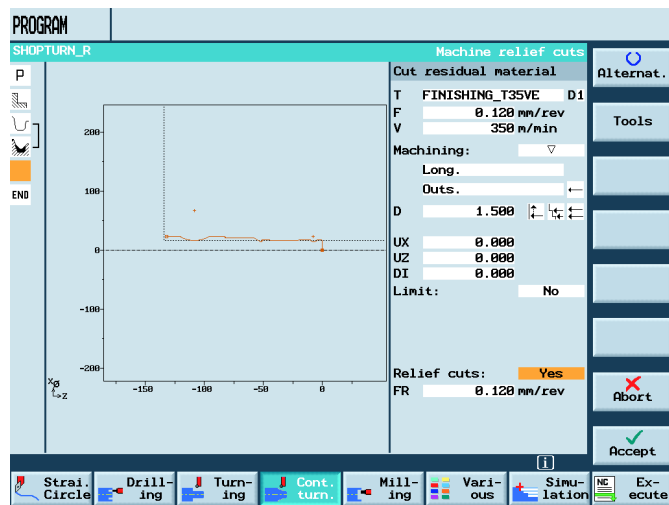

This working step is automatically linked with the contour entered in line N15.

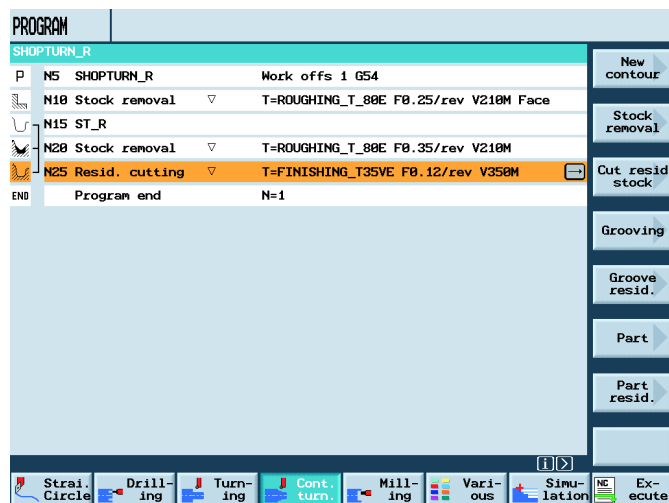



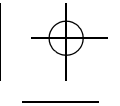
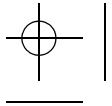

## Different workpiece views

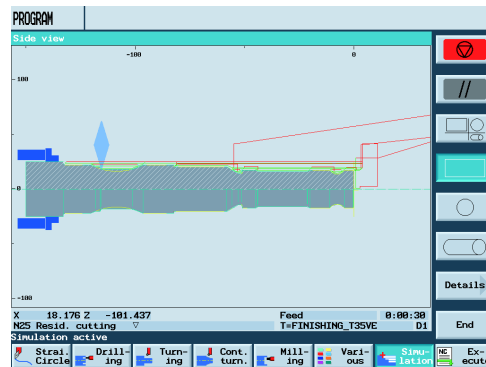

And, to be on the safe side, simulation...

... with the final 3D display for checking.

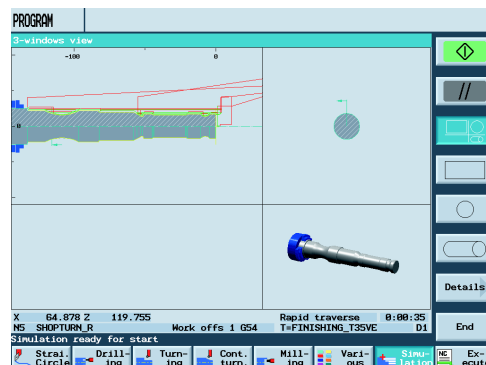
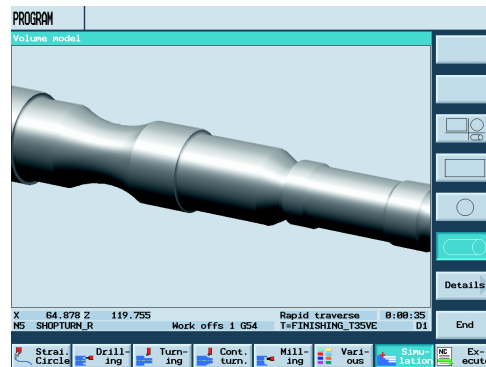

You can then obtain a complete overview of your production situation in the 3-window view which is also provided.

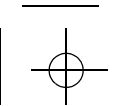
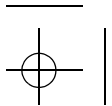

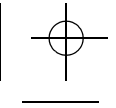
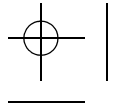

## Rechucking

In addition to a hole and the grooves, two spigots have to be milled on the lefthand side of the workpiece. This is the reason that a new machining plan with a short unmachined part is created.

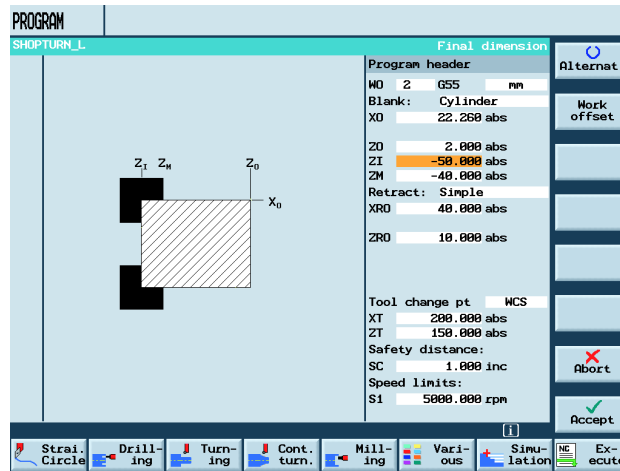

## Making grooves

If you wish to create several, similar grooves, then this does not present a problem. Simply enter the number of grooves and the clearance between them and ShopTurn does the rest for you.

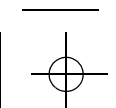
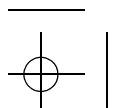
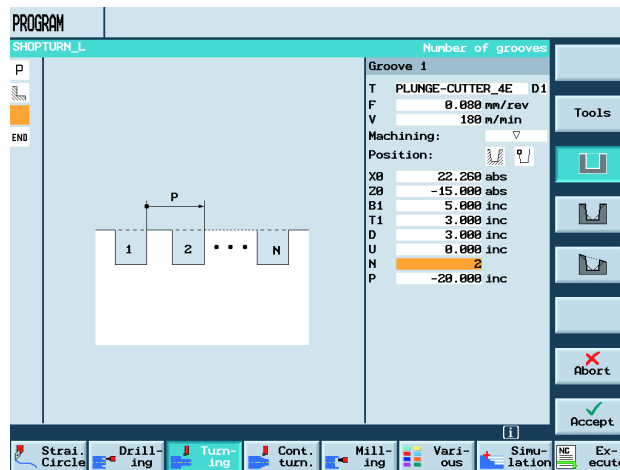

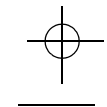
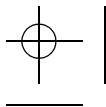

## Drilling

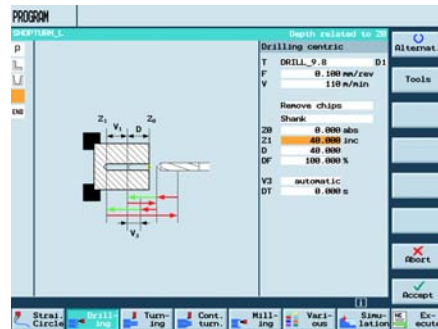

Also when drilling, for each input field, a help text is displayed at the top next to a help display.

## Milling operations on the lathe

No need to worry about milling on a lathe!

Using ShopTurn, it is also quite simple and straight forward. In addition to the simple square spigots shown here, derived from ShopMill, it is also possible to machine complex pockets and islands - both for face as well as the peripheral surfaces!

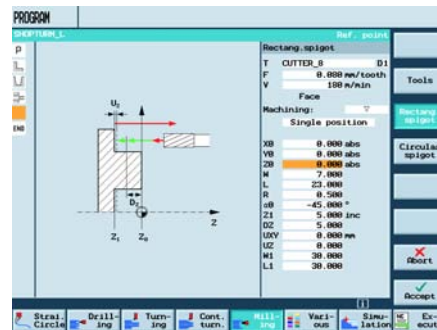

## The process plan with complete machining

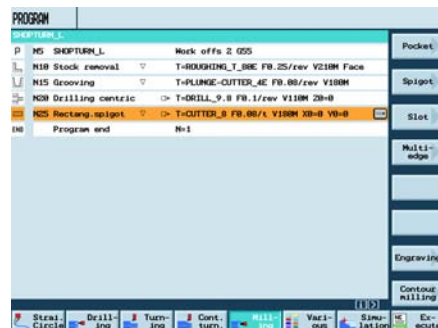

This is the work plan ...

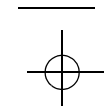
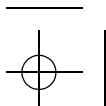

... with the grooving ...

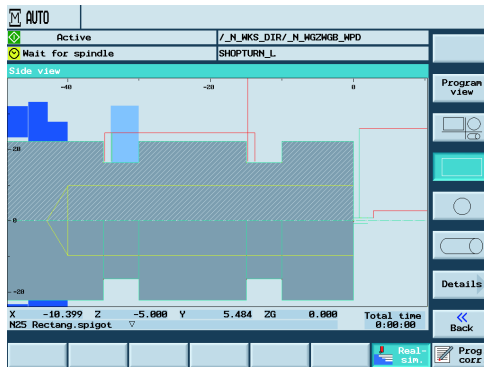

... and the hole ...

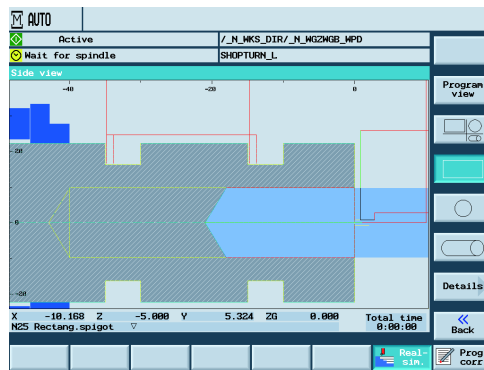

... and with face milling!

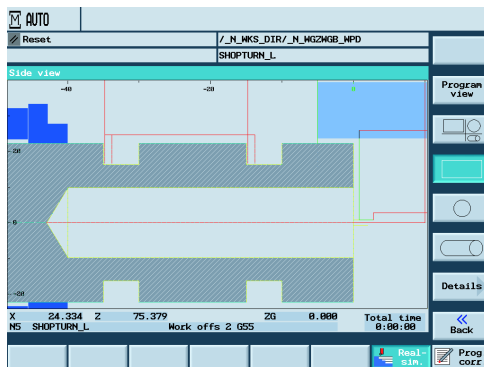

The work plan which can be simply created even for complex workpieces, in conjunction with such transparent 3D graphics, allows you to even integrate one-chuck machining simply and easily into your production environment.

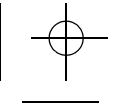
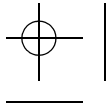

---

## And the chips keep going!

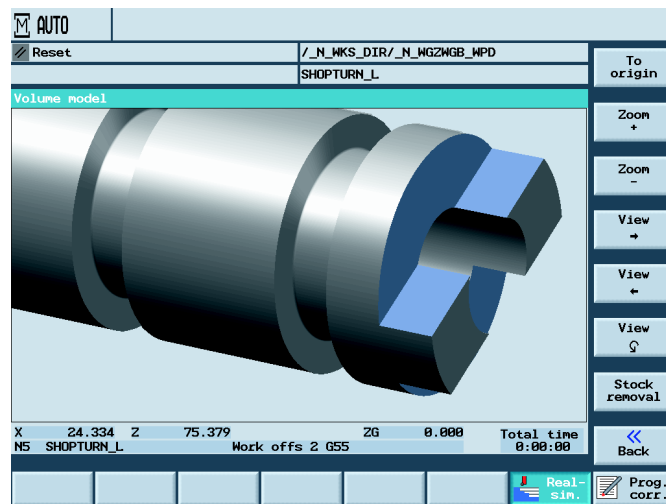

Practice always follows theory ...

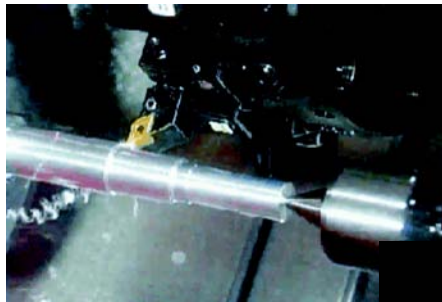

... practice, which with ShopTurn, is fun - lots of fun!

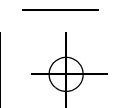
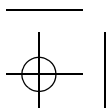

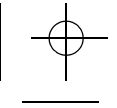
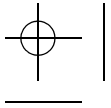

---

### 6.3 Detailed quality for the perfect fit

In spite of state-of-the-art production technology, incorrectly dimensioned workpieces can occur due to, for example, worn tools, vibrations etc.

Personnel must check (at least randomly) whether the workpiece corresponds to the specifications in the technical drawing

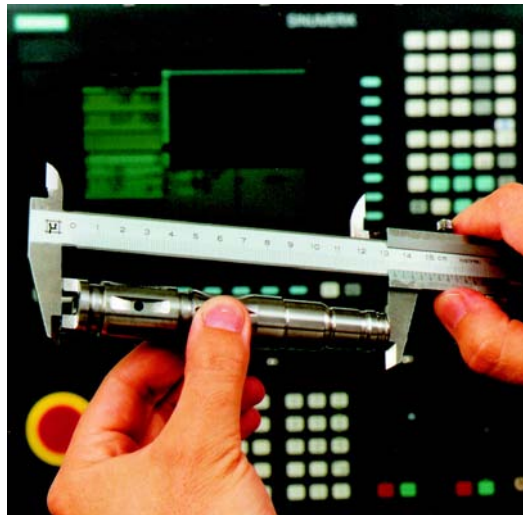

**Measuring**  
the complete length of  
132.15 mm of the work-  
piece using a  
**caliper**

**Checking**  
the diameter  
 $20,2^{+0,03}$  mm with a  
**limit gauge**

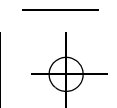
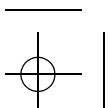

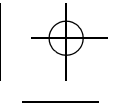
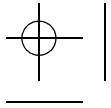

---

In a photo-montage, the mounting location of the damper assembly can be seen within the steering assembly.

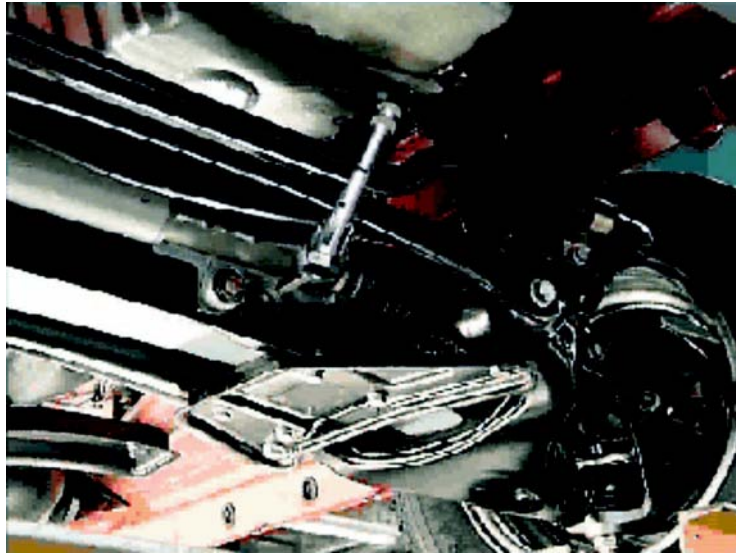

The steering assembly shown above is used for this commercial vehicle.

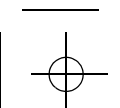
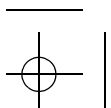

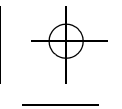
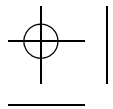

**Measuring**  
the plate thickness using  
an **external micrometer**

When **measuring**, a specific dimension is determined. The measuring accuracy depends on the measuring device (caliper, external micrometer, ...).

**Checking**  
the bore with a  
**tolerance-plug gauge**



When **checking**, a specific dimension is not determined. It is determined whether the workpiece is "GOOD" or "WASTE" at the checked location.

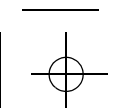
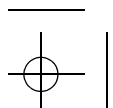



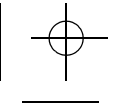
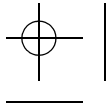

---

Installed sealing plate on the drive motor of the grinding disk

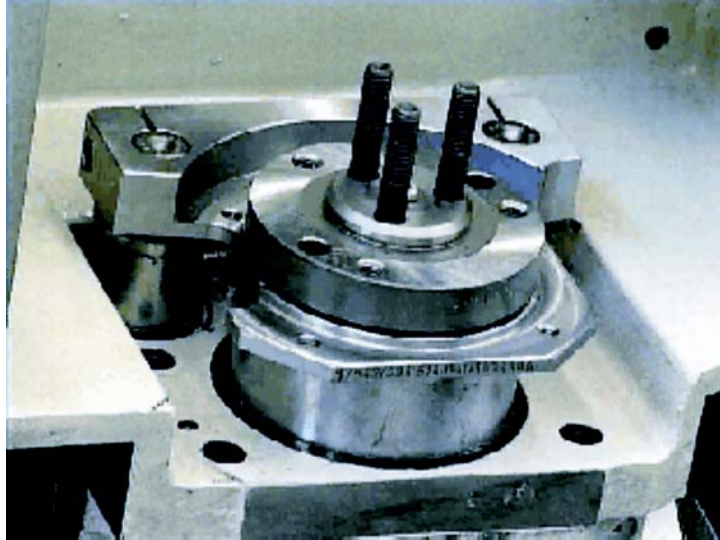

Overall view of the tool grinding machine showing the drive motor

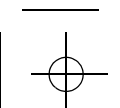
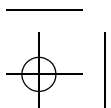

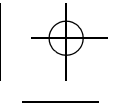
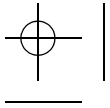

---

## Index

### A

Absolute dimensioning	26
Arc	28
Axes	18
Axis drive	18

### B

Book of tables	39
----------------	----

### C

Calculator	55
Caliper	78
Carbide metal	36
Carbide metals	37
CBN	36
Chamfer	26, 32
Checking	78, 80
Circle center point	29
Circle end point	29
Circular pocket	54
Circumferential speed	44, 45
Clamping holder	39
CNC lathes	15
CNC milling machines	15
CNC path control	17
Cobalt	37
Commands	20
Contour	25
Contour computer	55
Contour milling	40
Control loop	18
Conventional machines	14
Coolant	49
Cross slide	12

Cut	34
Cutting data	53
Cutting edge	39
Cutting material	36
Cutting radius compensation	35
Cutting speed	37, 46, 47
Cutting speed, constant	48, 49

### D

Dimension deviation	34
Dimension reference point	23
Dimensions	10
Dimensions of unmachined parts	51
DIN 66025	21, 26, 27, 28
Direction of rotation	28
Drilling	60, 75
Drilling device	12
Drilling patterns	59
Dynamo machine	19

### E

EASYSSTEP (mode)	50
Electron tubes	16
Experience know-how	11
External micrometer	80

### F

F address	21, 47
Face grooving	40
Face turning	40
Feed	47
Feed motor	19
Finishing	41
Finishing allowance	70
Flatbed machine	22, 28

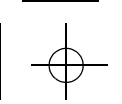
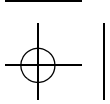



---

## G

G0	24
G1	26, 27
G2, G3	28
G40, G41, G42	35
G90, G91	26
G96	49
Geometrical functions	26, 27
Graphically programming	32, 33
Groove milling	41
Grooves	74

## H

Help screen	59, 60
HSS	36

## I

Inclined bed machine	22, 22, 28
Incremental dimensioning	26
Incremental position measuring system	23
Individual drive	13
Inner arc	28
Inner turning	40
Islands	58

## L

Language input	20
Lathe	12
Leadscrew drive	18
Limit gauge	78
Linear motor	19
Linking	59, 60
Linking drilling patterns	59
Logic operation	57
Longitudinal roughing	40

## M

M3	21
----	----

M30	21
Machine tools	12, 13, 13, 14
Machine zero	23
Machining step	52
Main drive	18, 19
Maudsley, Henry	12
Measuring	78, 80
Measuring system	18
Microprocessor	16
Milled part	25, 26, 27
Milling	41
Milling radius control	35
Milling tool	34
MIT	16
Modules	13
Motors	19

## N

NC program	11, 19, 30
Nurbs interpolation	17

## O

Outer arc	28
-----------	----

## P

PCD	36
Plunge strategies	54
Pockets	58
Point-to-point and path control	16
Programming interface	17
Punched tape	20
Pythagoras	30

## R

Rapid traverse	24
Reference point	23
Reference points	23
Relay technology	16

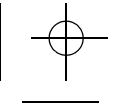
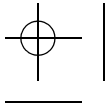

---

Repeat accuracy	8
Replacement tools	52
Residual material	59, 72
Rotation	42, 43
Roughing	40, 41
Rounding-off	32, 33

## S

S address	21, 42
Semiconductor memory	16
ShopMill	17, 33, 50, 51, 52
ShopTurn	17, 32, 32, 64
Siemens, Werner von	19
Simulation	56, 57, 58, 61
Sinter materials	36
SINUMERIK	16, 17
Speed	19, 42, 42, 43
Spindle lathe	12
Steam engine	12
Straight lines	26, 27
Surface quality	10, 47

## T

T address	21
Tangential function	26
Technical drawing	10
Technological values	52
Titanium carbide	37
Tolerance-plug gauge	80
Tool grinding machine	81
Tool life monitoring	52
Tool list	52, 66
Tool manufacturer	37
Tool paths	34, 35
Tool steels	36
Tools	36, 37
Transmission belts	13
Tungsten carbide	37
Turned part	25, 26, 27
Turning	40

---

Turning tool	34
Turnplates	37, 39

## W

Waste	80
Watt, James	12
Work plan	57
Workpiece programming	16
Workpiece zero	23

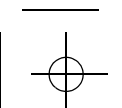
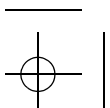

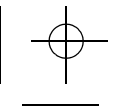
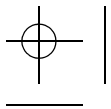

---

## Diagrams/Photographs

We would like to thank the following companies and institutions, who provided us with the photographs on the following pages.

Boehringer, Göppingen	15
Bridgeport, Weiterstadt	15
Deutsches Museum, München	12, 13, 14
Deutsches Werkzeugmuseum/Historisches Zentrum, Remscheid	12, 13, 14
DMG, Bielefeld	15
Hanser-Verlag, München	9
Hochschuldidaktisches Zentrum der RWTH Aachen	10
Index, Esslingen	15
Iscar, Ettlingen	36, 38, 39, 40, 41
Klingelnberg, Hückeswagen	10, 11, 81
Konradin-Verlag / INDUSTRIE Anzeiger, Leinfelden-Echterdingen	19
Laboratorium für Werkzeugmaschinen und Betriebslehre der RWTH Aachen	7, 20
Mercedes-Benz Lenkungen GmbH, Düsseldorf	10, 11, 81
NC-Verlag, Hannover	9
Sandvik, Düsseldorf	36, 38, 39, 40, 41
Seco, Düsseldorf	36, 38, 39, 40, 41
Verlag Europa-Lehrmittel, Haan-Grutten	39

