

SIEMENS

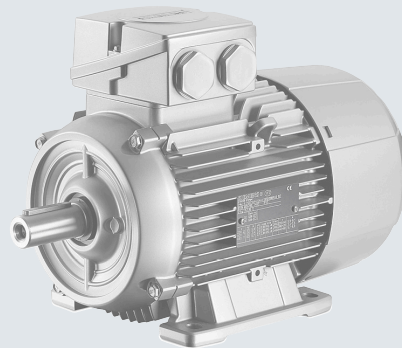
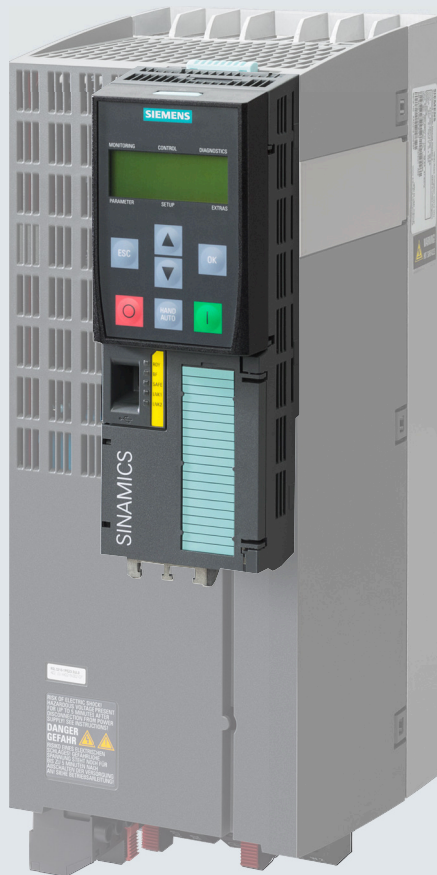

Operating Instructions

SINAMICS

SINAMICS G120

Low voltage converters
Built-in units with CU240B-2 and CU240E-2
Control Units

Edition

02/2023

www.siemens.com/drives

SINAMICS

SINAMICS G120 Converters with the CU240B-2 and CU240E-2 Control Units

Operating Instructions

Changes in the current edition

Fundamental safety instructions	1
Introduction	2
Description	3
Installing	4
Commissioning	5
Uploading the converter settings	6
Protecting the converter settings	7
Advanced commissioning	8
Alarms, faults and system messages	9
Corrective maintenance	10
Technical data	11
Appendix	A

Edition 02/2023, Firmware V4.7 SP14

Legal information

Warning notice system

This manual contains notices you have to observe in order to ensure your personal safety, as well as to prevent damage to property. The notices referring to your personal safety are highlighted in the manual by a safety alert symbol, notices referring only to property damage have no safety alert symbol. These notices shown below are graded according to the degree of danger.

 DANGER
indicates that death or severe personal injury will result if proper precautions are not taken.

 WARNING
indicates that death or severe personal injury may result if proper precautions are not taken.

 CAUTION
indicates that minor personal injury can result if proper precautions are not taken.

NOTICE
indicates that property damage can result if proper precautions are not taken.

If more than one degree of danger is present, the warning notice representing the highest degree of danger will be used. A notice warning of injury to persons with a safety alert symbol may also include a warning relating to property damage.

Qualified Personnel

The product/system described in this documentation may be operated only by **personnel qualified** for the specific task in accordance with the relevant documentation, in particular its warning notices and safety instructions. Qualified personnel are those who, based on their training and experience, are capable of identifying risks and avoiding potential hazards when working with these products/systems.

Proper use of Siemens products

Note the following:

 WARNING
Siemens products may only be used for the applications described in the catalog and in the relevant technical documentation. If products and components from other manufacturers are used, these must be recommended or approved by Siemens. Proper transport, storage, installation, assembly, commissioning, operation and maintenance are required to ensure that the products operate safely and without any problems. The permissible ambient conditions must be complied with. The information in the relevant documentation must be observed.

Trademarks

All names identified by ® are registered trademarks of Siemens AG. The remaining trademarks in this publication may be trademarks whose use by third parties for their own purposes could violate the rights of the owner.

Disclaimer of Liability

We have reviewed the contents of this publication to ensure consistency with the hardware and software described. Since variance cannot be precluded entirely, we cannot guarantee full consistency. However, the information in this publication is reviewed regularly and any necessary corrections are included in subsequent editions.

Changes in the current edition

Essential changes with respect to Edition 10/2020

New functions

SINAMICS G115D converter now supports the extended function 'Safety Limited Speed (SLS)' with the firmware version V4.7 SP14.

Overview of new and modified function in firmware V4.7 SP14:

 Firmware version 4.7 SP14 (Page 547)

Table of contents

	Changes in the current edition	3
1	Fundamental safety instructions	13
1.1	General safety instructions	13
1.2	Equipment damage due to electric fields or electrostatic discharge	20
1.3	Warranty and liability for application examples	21
1.4	Security information	22
1.5	Residual risks of power drive systems	23
2	Introduction	25
2.1	About the Manual	25
2.2	Guide through the manual	26
3	Description	29
3.1	Intended use	29
3.2	OpenSSL	30
3.3	Transferring OpenOSS license terms to a PC	31
3.4	Identifying the converter	32
3.5	Directives and standards	33
3.6	Overview of Control Units	35
3.7	Power Module	37
3.7.1	Power Module with IP20 degree of protection	38
3.7.2	Power Module with Push-Through technology	40
3.7.3	Power Module in IP55 degree of protection / UL Type 12	41
3.8	Components for the Power Modules	42
3.8.1	Accessories for shielding	42
3.8.2	Line filter	43
3.8.3	Line reactor	44
3.8.4	Output reactor	46
3.8.5	((dv/dt filter plus VPL_PM240-2))	50
3.8.6	Sine-wave filter	52
3.8.7	Braking resistor	54
3.8.8	Brake Relay	56
3.8.9	Safe Brake Relay	56
3.8.10	Control Unit Adapter Kit CUA20	57
3.9	Motors and multi-motor drives that can be operated	58
4	Installing	59
4.1	Installing the label for the North American market	59

4.2	EMC-compliant setup of the machine or plant	60
4.2.1	Control cabinet	61
4.2.2	Cables	62
4.2.3	Electromechanical components.....	65
4.3	Installing reactors, filters and braking resistors.....	66
4.4	Installing Power Modules	67
4.4.1	Basic installation rules.....	67
4.4.2	Dimensioned drawings, drilling dimensions for the PM240-2 Power Module, IP20.....	68
4.4.3	Dimension drawings, drilling dimensions for PM240P-2 Power Modules, IP20	71
4.4.4	Dimension drawings, drilling dimensions for the PM230 Power Module, IP20.....	73
4.4.5	Dimension drawings, drilling dimensions for PM230 and PM240-2 Power Modules utilizing push-through technology.....	76
4.4.6	Dimensioned drawings, drilling dimensions for the PM250 Power Module	80
4.5	Connecting the line supply and motor	83
4.5.1	Permissible line supplies.....	83
4.5.1.1	TN line system	84
4.5.1.2	TT line system.....	86
4.5.1.3	IT system	87
4.5.2	Requirements for the protective conductor	88
4.5.3	Connecting a converter with the PM240-2 Power Module.....	90
4.5.4	Connecting the converter with the PM230 Power Module.....	96
4.5.5	Connecting the converter with the PM240P-2 Power Module.....	98
4.5.6	Connecting the converter with the PM250 Power Module.....	100
4.5.7	Connecting the motor to the converter in a star or delta connection	102
4.6	Connecting the interfaces for the converter control	103
4.6.1	Overview of the interfaces	105
4.6.2	Fieldbus interface allocation.....	106
4.6.3	Terminal strips on CU240B-2 Control Units	107
4.6.4	Factory setting of the CU240B-2 interfaces	109
4.6.5	Default settings of the CU240B-2 interfaces	111
4.6.6	Terminal strips on CU240E-2 Control Units	114
4.6.7	Factory setting of the CU240E-2 interfaces	117
4.6.8	Default settings of the CU240E-2 interfaces.....	119
4.6.9	Failsafe digital input of CU240E-2.....	129
4.6.10	Connecting a failsafe digital input	131
4.6.11	Wiring the terminal strip	133
4.6.12	Fieldbus interfaces.....	135
4.6.13	Connecting the converter to PROFINET	135
4.6.13.1	Communication via PROFINET IO and Ethernet	135
4.6.13.2	Connecting the PROFINET cable to the converter	137
4.6.13.3	What do you have to set for communication via PROFINET?.....	137
4.6.13.4	Installing GSDML	138
4.6.14	Connecting the converter to PROFIBUS	138
4.6.14.1	Connecting the PROFIBUS cable to the converter	139
4.6.14.2	What do you have to set for communication via PROFIBUS?	139
4.6.14.3	Installing the GSD	140
4.6.14.4	Set the PROFIBUS address.....	140
4.7	Connecting a motor holding brake	142
4.7.1	Installing a Brake Relay - PM250 Power Module	144

4.7.2	Mounting and connecting the brake relay.....	145
4.8	Monitoring the temperature of the braking resistor	146
5	Commissioning	147
5.1	Commissioning guidelines	147
5.2	Tools to commission the converter	148
5.3	Preparing for commissioning.....	150
5.3.1	Collecting motor data	150
5.3.2	Forming DC link capacitors.....	151
5.3.3	Converter factory setting.....	153
5.4	Quick commissioning using the BOP-2 operator panel	155
5.4.1	Inserting the BOP-2	155
5.4.2	Overview	156
5.4.3	Starting quick commissioning	157
5.4.4	Selecting an application class	157
5.4.5	Standard Drive Control.....	160
5.4.6	Dynamic Drive Control	162
5.4.7	Expert.....	165
5.4.8	Identifying the motor data and optimizing the closed-loop control.....	169
5.5	Quick commissioning with a PC.....	171
5.5.1	Creating a project	171
5.5.2	Transfer converters connected via USB into the project	172
5.5.3	Go online and start the commissioning Wizard	173
5.5.4	Overview of quick commissioning	174
5.5.5	Commissioning wizard.....	175
5.5.6	Standard Drive Control.....	178
5.5.7	Dynamic Drive Control	180
5.5.8	Expert.....	182
5.5.9	Identify motor data	185
5.6	Restoring the factory setting	187
5.6.1	Resetting the safety functions to the factory setting.....	188
5.6.2	Restore the factory settings (without safety functions).....	190
5.7	Series commissioning	191
5.8	Handling the BOP 2 operator panel.....	192
5.8.1	Switching the motor on and off	193
5.8.2	Changing parameter values.....	194
5.8.3	Changing indexed parameters.....	195
5.8.4	Entering the parameter number directly	196
5.8.5	Entering the parameter value directly	197
5.8.6	Why can a parameter value not be changed?	198
6	Uploading the converter settings	199
6.1	Uploading to the memory card.....	200
6.1.1	Recommended memory cards	200
6.1.2	Automatic upload	201
6.1.3	Message for a memory card that is not inserted.....	202
6.1.4	Manual upload with Startdrive	202
6.1.5	Manual upload with BOP-2.....	203

6.1.6	Safely removing a memory card using the BOP-2	204
6.1.7	Safely remove the memory card with Startdrive	205
6.2	Uploading to the BOP-2	207
6.3	Upload to a PC using Startdrive	208
6.4	More options for the upload	209
7	Protecting the converter settings	211
7.1	Write protection	211
7.2	Know-how protection	213
7.2.1	Extending the exception list for know-how protection	217
7.2.2	Activating and deactivating know-how protection	218
8	Advanced commissioning	221
8.1	Overview of the converter functions	221
8.2	Brief description of the parameters	224
8.3	Sequence control when switching the motor on and off	225
8.4	Adapt the default setting of the terminal strip	228
8.4.1	Digital inputs	229
8.4.2	Analog inputs as digital inputs	230
8.4.3	Failsafe digital inputs	231
8.4.4	Digital outputs	232
8.4.5	Analog inputs	234
8.4.6	Adjusting characteristics for analog input	236
8.4.7	Setting the deadband	237
8.4.8	Analog outputs	238
8.4.9	Adjusting characteristics for analog output	239
8.5	Controlling clockwise and counter-clockwise rotation via digital inputs	241
8.5.1	Two-wire control, ON/reverse	243
8.5.2	Two-wire control, clockwise/counterclockwise rotation 1	245
8.5.3	Two-wire control, clockwise/counterclockwise rotation 2	247
8.5.4	Three-wire control, enable/clockwise/counterclockwise rotation	249
8.5.5	Three-wire control, enable/ON/reverse	251
8.6	Drive control via PROFIBUS or PROFINET	253
8.6.1	Receive data and send data	253
8.6.2	Telegrams	254
8.6.3	Parameter channel	260
8.6.4	Expanding or freely interconnecting telegrams	265
8.6.5	Device-to-device communication	268
8.6.6	Acyclically reading and writing converter parameters	268
8.7	Drive control via Modbus RTU	269
8.8	Drive control via USS	272
8.9	Drive control via Ethernet/IP	275
8.10	Jogging	277
8.11	Limit position control	279
8.12	Switching over the drive control (command data set)	281

8.13	Motor holding brake	283
8.14	Free function blocks.....	288
8.14.1	Overview	288
8.14.2	Further information	289
8.15	Selecting physical units	290
8.15.1	Motor standard	290
8.15.2	Unit system	290
8.15.3	Technological unit of the technology controller	292
8.15.4	Setting the system of units and technology unit	293
8.16	Safe Torque Off (STO) safety function	294
8.16.1	Where are the safety functions described?	294
8.16.2	Principle of operation.....	294
8.16.3	EMERGENCY SWITCHING OFF and EMERGENCY STOP	296
8.16.4	Functional restrictions as a result of the Power Modules	297
8.16.5	Commissioning STO	298
8.16.5.1	Commissioning tools.....	298
8.16.5.2	Password	298
8.16.5.3	Configuring a safety function	299
8.16.5.4	Interconnecting the "STO active" signal.....	300
8.16.5.5	Signal filter for STO selection	301
8.16.5.6	Setting the signal filter for STO selection.....	303
8.16.5.7	Forced checking procedure	303
8.16.5.8	Setting forced checking procedure	304
8.16.5.9	Complete commissioning.....	306
8.16.5.10	Checking the assignment of the digital inputs	307
8.16.5.11	Acceptance test	308
8.17	Setpoints	310
8.17.1	Overview	310
8.17.2	Analog input as setpoint source	311
8.17.3	Specifying the setpoint via the fieldbus.....	312
8.17.4	Motorized potentiometer as setpoint source	313
8.17.5	Fixed speed setpoint as setpoint source	315
8.18	Setpoint processing.....	320
8.18.1	Overview	320
8.18.2	Invert setpoint	321
8.18.3	Inhibit direction of rotation	322
8.18.4	Skip frequency bands and minimum speed.....	323
8.18.5	Speed limitation	325
8.18.6	Ramp-function generator	326
8.19	PID technology controller.....	331
8.19.1	PID technology controller.....	331
8.19.2	Autotuning the PID technology controller	338
8.19.3	Adapting Kp and Tn	341
8.20	Reactor, filter and cable resistance at the converter output.....	343
8.21	Motor control.....	344
8.21.1	U/f control	344
8.21.1.1	U/f control	344
8.21.1.2	Optimizing motor starting.....	348

8.21.1.3	U/f control with Standard Drive Control	349
8.21.1.4	Optimizing motor starting using Standard Drive Control	352
8.21.2	Sensorless vector control with speed controller.....	354
8.21.2.1	Structure of vector control without encoder (sensorless).....	354
8.21.2.2	Default setting as a result of the application class Dynamic Drive Control	356
8.21.2.3	Optimizing the speed controller	356
8.21.2.4	Advanced settings.....	358
8.21.2.5	Friction characteristic	361
8.21.2.6	Moment of inertia estimator	364
8.21.3	Torque control	369
8.21.4	Application examples for closed-loop motor control.....	371
8.22	Electrically braking the motor	372
8.22.1	DC braking.....	374
8.22.2	Compound braking	379
8.22.3	Dynamic braking.....	381
8.22.4	Braking with regenerative feedback to the line	385
8.23	Overcurrent protection.....	386
8.24	Converter protection using temperature monitoring	387
8.25	Motor protection with temperature sensor	390
8.26	Motor protection by calculating the temperature	392
8.27	How do I achieve a motor overload protection in accordance with IEC/UL 61800-5-1?.....	394
8.28	Motor and converter protection by limiting the voltage.....	395
8.29	Monitoring the driven load.....	397
8.29.1	Stall protection	398
8.29.2	No-load monitoring	398
8.29.3	Blocking protection	399
8.29.4	Torque monitoring	400
8.29.5	Blocking protection, leakage protection and dry-running protection.....	402
8.29.6	Rotation monitoring.....	405
8.29.7	Speed deviation monitoring	406
8.30	Flying restart – switching on while the motor is running.....	408
8.31	Automatic restart.....	410
8.32	Kinetic buffering (Vdc min control).....	413
8.33	Efficiency optimization	415
8.34	Line contactor control	418
8.35	Calculating the energy saving for fluid flow machines.....	420
8.36	Switchover between different settings.....	422
9	Alarms, faults and system messages.....	425
9.1	LED.....	426
9.1.1	Operating states indicated via LEDs	426
9.2	System runtime	429
9.3	Identification & maintenance data (I&M)	430

9.4	Alarms, alarm buffer, and alarm history	431
9.5	Faults, alarm buffer and alarm history.....	434
9.6	List of alarms and faults	437
10	Corrective maintenance	445
10.1	Replace Control Unit	447
10.2	Downloading the converter settings	449
10.2.1	Converter without enabled safety functions	449
10.2.1.1	Automatic download from the memory card	449
10.2.1.2	Manual downloading from the memory card with the BOP-2	449
10.2.1.3	Manual download from the memory card using Startdrive	450
10.2.1.4	Download from BOP-2 operator panel	451
10.2.1.5	Download from IOP-2 operator panel	453
10.2.1.6	Download from Smart Access.....	454
10.2.1.7	Download from the PC using Startdrive	456
10.2.2	Converter with enabled safety functions.....	457
10.2.2.1	Automatic download from the memory card	457
10.2.2.2	Manual downloading from the memory card with the BOP-2	458
10.2.2.3	Download from BOP-2 operator panel	460
10.2.2.4	Download from IOP-2 operator panel	462
10.2.2.5	Download from Smart Access.....	464
10.2.2.6	Download from the PC using Startdrive	467
10.2.3	Download with active know-how protection with copy protection.....	468
10.3	Replacing a Power Module	471
10.4	PROFINET device name	473
10.5	Firmware upgrade and downgrade.....	474
10.5.1	Overview	474
10.5.2	Preparing the memory card.....	475
10.5.3	Upgrading the firmware	476
10.5.4	Firmware downgrade.....	478
10.5.5	Correcting an unsuccessful firmware upgrade or downgrade	480
10.6	Reduced acceptance test after component replacement and firmware change	481
10.7	If the converter no longer responds.....	482
11	Technical data.....	485
11.1	Technical data, CU240B-2 Control Unit	485
11.2	Technical data, CU240E-2 Control Unit	487
11.3	Overload capability of the converter	490
11.4	Technical data, PM240-2 Power Module	491
11.4.1	High overload - low overload PM240-2	491
11.4.2	General technical data, 200 V converters.....	493
11.4.3	Specific technical data, 200 V converters	494
11.4.4	Current derating depending on the pulse frequency, 200 V converters.....	501
11.4.5	General technical data, 400 V converters.....	502
11.4.6	Specific technical data, 400 V converters	503
11.4.7	Current derating depending on the pulse frequency, 400 V converters.....	511

11.4.8	General technical data, 690 V converters.....	512
11.4.9	Specific technical data, 690 V converters	513
11.4.10	Current derating depending on the pulse frequency, 690 V converters.....	516
11.5	Technical Data, PM240P-2 Power Module	517
11.5.1	Ambient conditions.....	517
11.5.2	General technical data, 400 V converters.....	519
11.5.3	Specific technical data, 400 V converters	520
11.5.4	Current derating depending on the pulse frequency, 400 V converters.....	522
11.5.5	General technical data, 690 V converters.....	523
11.5.6	Specific technical data, 690 V converters	524
11.5.7	Current derating depending on the pulse frequency, 690 V converters.....	527
11.6	Technical data, PM230 Power Module	528
11.6.1	Ambient conditions.....	528
11.6.2	General technical data, PM230.....	530
11.6.3	Detailed technical data, PM230	531
11.6.4	Current reduction depending on pulse frequency	536
11.7	Technical data, PM250 Power Module	537
11.7.1	High overload – low overload.....	537
11.7.2	Ambient conditions.....	537
11.7.3	General technical data, PM250.....	539
11.7.4	Specific technical specifications	540
11.7.5	Current reduction depending upon pulse frequency	542
11.8	Data regarding the power loss in partial load operation	543
11.9	Restrictions for special ambient conditions	544
11.10	Protecting persons from electromagnetic fields.....	545
A	Appendix.....	547
A.1	New and extended functions.....	547
A.1.1	Firmware version 4.7 SP14.....	547
A.1.2	Firmware version 4.7 SP13.....	547
A.1.3	Firmware version 4.7 SP10.....	549
A.1.4	Firmware version 4.7 SP9.....	551
A.1.5	Firmware version 4.7 SP6.....	553
A.1.6	Firmware version 4.7 SP3.....	554
A.1.7	Firmware version 4.7	556
A.1.8	Firmware version 4.6 SP6.....	557
A.1.9	Firmware version 4.6	558
A.1.10	Firmware version 4.5	559
A.2	Interconnecting signals in the converter	560
A.2.1	Fundamentals.....	560
A.2.2	Application example	562
A.3	Manuals and technical support.....	564
A.3.1	Overview of the manuals	564
A.3.2	Configuring support.....	566
A.3.3	Product Support.....	567
	Index.....	569

Fundamental safety instructions

1.1 General safety instructions



! WARNING

Electric shock and danger to life due to other energy sources

Touching live components can result in death or severe injury.

- Only work on electrical devices when you are qualified for this job.
- Always observe the country-specific safety rules.

Generally, the following steps apply when establishing safety:

1. Prepare for disconnection. Notify all those who will be affected by the procedure.
2. Isolate the drive system from the power supply and take measures to prevent it being switched back on again.
3. Wait until the discharge time specified on the warning labels has elapsed.
4. Check that there is no voltage between any of the power connections, and between any of the power connections and the protective conductor connection.
5. Check whether the existing auxiliary supply circuits are de-energized.
6. Ensure that the motors cannot move.
7. Identify all other dangerous energy sources, e.g. compressed air, hydraulic systems, or water. Switch the energy sources to a safe state.
8. Check that the correct drive system is completely locked.

After you have completed the work, restore the operational readiness in the inverse sequence.



! WARNING

Risk of electric shock and fire from supply networks with an excessively high impedance

Excessively low short-circuit currents can lead to the protective devices not tripping or tripping too late, and thus causing electric shock or a fire.

- In the case of a conductor-conductor or conductor-ground short-circuit, ensure that the short-circuit current at the point where the converter is connected to the line supply at least meets the minimum requirements for the response of the protective device used.
- You must use an additional residual-current device (RCD) if a conductor-ground short circuit does not reach the short-circuit current required for the protective device to respond. The required short-circuit current can be too low, especially for TT supply systems.



⚠ WARNING

Risk of electric shock and fire from supply networks with an excessively low impedance

Excessively high short-circuit currents can lead to the protective devices not being able to interrupt these short-circuit currents and being destroyed, and thus causing electric shock or a fire.

- Ensure that the prospective short-circuit current at the line terminal of the converter does not exceed the breaking capacity (SCCR or Icc) of the protective device used.



⚠ WARNING

Electric shock if there is no ground connection

For missing or incorrectly implemented protective conductor connection for devices with protection class I, high voltages can be present at open, exposed parts, which when touched, can result in death or severe injury.

- Ground the device in compliance with the applicable regulations.



⚠ WARNING

Electric shock due to connection to an unsuitable power supply

When equipment is connected to an unsuitable power supply, exposed components may carry a hazardous voltage. Contact with hazardous voltage can result in severe injury or death.

- Only use power supplies that provide SELV (Safety Extra Low Voltage) or PELV- (Protective Extra Low Voltage) output voltages for all connections and terminals of the electronics modules.



⚠ WARNING

Electric shock due to equipment damage

Improper handling may cause damage to equipment. For damaged devices, hazardous voltages can be present at the enclosure or at exposed components; if touched, this can result in death or severe injury.

- Ensure compliance with the limit values specified in the technical data during transport, storage and operation.
- Do not use any damaged devices.



⚠ WARNING

Electric shock due to unconnected cable shield

Hazardous touch voltages can occur through capacitive cross-coupling due to unconnected cable shields.

- As a minimum, connect cable shields and the conductors of power cables that are not used (e.g. brake cores) at one end at the grounded housing potential.



⚠ WARNING

Arcing when a plug connection is opened during operation

Opening a plug connection when a system is operation can result in arcing that may cause serious injury or death.

- Only open plug connections when the equipment is in a voltage-free state, unless it has been explicitly stated that they can be opened in operation.



⚠ WARNING

Electric shock due to residual charges in power components

Because of the capacitors, a hazardous voltage is present for up to 5 minutes after the power supply has been switched off. Contact with live parts can result in death or serious injury.

- Wait for 5 minutes before you check that the unit really is in a no-voltage condition and start work.

NOTICE

Damage to equipment due to unsuitable tightening tools.

Unsuitable tightening tools or fastening methods can damage the screws of the equipment.

- Only use screw inserts that exactly match the screw head.
- Tighten the screws with the torque specified in the technical documentation.
- Use a torque wrench or a mechanical precision nut runner with a dynamic torque sensor and speed limitation system.
- Adjust the tools used regularly.

NOTICE

Property damage due to loose power connections

Insufficient tightening torques or vibration can result in loose power connections. This can result in damage due to fire, device defects or malfunctions.

- Tighten all power connections to the prescribed torque.
- Check all power connections at regular intervals, particularly after equipment has been transported.

 **WARNING**

Electromagnetic interference due to inadequate shield support

A lack of adequate shield support for the power cables can cause malfunctions and impermissibly high levels of interference.

- Use the shield connection plates supplied or recommended.
- Use the shield connection clips recommended.

 **WARNING**

Spread of fire from built-in devices

Built-in devices can cause a fire and a pressure wave in the event of a fault. Fire and smoke can escape from the control cabinet and cause serious personal injury and property damage.

- Install built-in appliances in a robust metal control cabinet that is suitable for protecting people from fire and smoke.
- Only operate built-in devices with the control cabinet doors closed.
- Ensure that smoke can only escape via controlled and monitored paths.

 **WARNING**

Active implant malfunctions due to electromagnetic fields

Converters generate electromagnetic fields (EMF) in operation. Electromagnetic fields may interfere with active implants, e.g. pacemakers. People with active implants in the immediate vicinity of a converter are at risk.

- As the operator of an EMF-emitting installation, assess the individual risks of persons with active implants.
- Observe the data on EMF emission provided in the product documentation.

 **CAUTION**

Symptomatic respiratory and skin reaction to chemicals

A newly purchased product might contain traces of substances that are identified as sensitizers. Sensitizers are substances which can cause sensitization in the lungs and skin after exposure to them.

Once sensitized, individuals can have severe reactions to further exposure, even in small amounts. In the most extreme cases, individuals might develop asthma or dermatitis respectively.

- If the product has a strong smell, keep it in a well-ventilated area for 14 days.

 WARNING**Unexpected machine movement caused by radio devices or mobile phones**

Using radio devices, cellphones, or mobile WLAN devices in the immediate vicinity of the components can result in equipment malfunction. Malfunctions may impair the functional safety of machines and can therefore put people in danger or lead to property damage.

- Therefore, if you move closer than 20 cm to the components, be sure to switch off radio devices, cellphones or WLAN devices.
- Use the "SIEMENS Industry Online Support app" only on equipment that has already been switched off.

NOTICE**Damage to motor insulation due to excessive voltages**

When operated on systems with grounded line conductors or in the event of a ground fault in the IT system, the motor insulation can be damaged by the higher voltage against ground. If you use motors that have insulation that is not designed for operation with grounded line conductors, you must perform the following measures:

- IT system: Use a ground fault monitor and eliminate the fault as quickly as possible.
- TN or TT systems with grounded line conductor: Use an isolating transformer on the line side.

 WARNING**Fire due to inadequate ventilation clearances**

Inadequate ventilation clearances can cause overheating of components with subsequent fire and smoke. This can cause severe injury or even death. This can also result in increased downtime and reduced service lives for devices/systems.

- Ensure compliance with the specified minimum clearance as ventilation clearance for the respective component.

NOTICE**Overheating due to inadmissible mounting position**

The device may overheat and therefore be damaged if mounted in an inadmissible position.

- Only operate the device in admissible mounting positions.

 **WARNING**

Unrecognized dangers due to missing or illegible warning labels

Dangers might not be recognized if warning labels are missing or illegible. Unrecognized dangers may cause accidents resulting in serious injury or death.

- Check that the warning labels are complete based on the documentation.
- Attach any missing warning labels to the components, where necessary in the national language.
- Replace illegible warning labels.

NOTICE

Device damage caused by incorrect voltage/insulation tests

Incorrect voltage/insulation tests can damage the device.

- Before carrying out a voltage/insulation check of the system/machine, disconnect the devices as all converters and motors have been subject to a high voltage test by the manufacturer, and therefore it is not necessary to perform an additional test within the system/machine.

 **WARNING**

Unexpected movement of machines caused by inactive safety functions

Inactive or non-adapted safety functions can trigger unexpected machine movements that may result in serious injury or death.

- Observe the information in the appropriate product documentation before commissioning.
- Carry out a safety inspection for functions relevant to safety on the entire system, including all safety-related components.
- Ensure that the safety functions used in your drives and automation tasks are adjusted and activated through appropriate parameterizing.
- Perform a function test.
- Only put your plant into live operation once you have guaranteed that the functions relevant to safety are running correctly.

Note

Important Safety instructions for Safety Integrated

If you want to use Safety Integrated functions, you must observe the Safety instructions in the Safety Integrated documentation.

 **WARNING**

Malfunctions of the machine as a result of incorrect or changed parameter settings

As a result of incorrect or changed parameterization, machines can malfunction, which in turn can lead to injuries or death.

- Protect the parameterization against unauthorized access.
- Handle possible malfunctions by taking suitable measures, e.g. emergency stop or emergency off.

1.2 Equipment damage due to electric fields or electrostatic discharge

Electrostatic sensitive devices (ESD) are individual components, integrated circuits, modules or devices that may be damaged by either electric fields or electrostatic discharge.



NOTICE

Equipment damage due to electric fields or electrostatic discharge

Electric fields or electrostatic discharge can cause malfunctions through damaged individual components, integrated circuits, modules or devices.

- Only pack, store, transport and send electronic components, modules or devices in their original packaging or in other suitable materials, e.g. conductive foam rubber or aluminum foil.
- Only touch components, modules and devices when you are grounded by one of the following methods:
 - Wearing an ESD wrist strap
 - Wearing ESD shoes or ESD grounding straps in ESD areas with conductive flooring
- Only place electronic components, modules or devices on conductive surfaces (table with ESD surface, conductive ESD foam, ESD packaging, ESD transport container).

1.3 Warranty and liability for application examples

Application examples are not binding and do not claim to be complete regarding configuration, equipment or any eventuality which may arise. Application examples do not represent specific customer solutions, but are only intended to provide support for typical tasks.

As the user you yourself are responsible for ensuring that the products described are operated correctly. Application examples do not relieve you of your responsibility for safe handling when using, installing, operating and maintaining the equipment.

1.4 Security information

Siemens provides products and solutions with industrial security functions that support the secure operation of plants, systems, machines and networks.

In order to protect plants, systems, machines and networks against cyber threats, it is necessary to implement – and continuously maintain – a holistic, state-of-the-art industrial security concept. Siemens' products and solutions constitute one element of such a concept.

Customers are responsible for preventing unauthorized access to their plants, systems, machines and networks. Such systems, machines and components should only be connected to an enterprise network or the internet if and to the extent such a connection is necessary and only when appropriate security measures (e.g. firewalls and/or network segmentation) are in place.

For additional information on industrial security measures that may be implemented, please visit

<https://www.siemens.com/industrialsecurity>.

Siemens' products and solutions undergo continuous development to make them more secure. Siemens strongly recommends that product updates are applied as soon as they are available and that the latest product versions are used. Use of product versions that are no longer supported, and failure to apply the latest updates may increase customer's exposure to cyber threats.

To stay informed about product updates, subscribe to the Siemens Industrial Security RSS Feed under

<https://www.siemens.com/cert>.

Further information is provided on the Internet:

Industrial Security Configuration Manual (<https://support.industry.siemens.com/cs/ww/en/view/108862708>)



WARNING

Unsafe operating states resulting from software manipulation

Software manipulations, e.g. viruses, Trojans, or worms, can cause unsafe operating states in your system that may lead to death, serious injury, and property damage.

- Keep the software up to date.
- Incorporate the automation and drive components into a holistic, state-of-the-art industrial security concept for the installation or machine.
- Make sure that you include all installed products into the holistic industrial security concept.
- Protect files stored on exchangeable storage media from malicious software by with suitable protection measures, e.g. virus scanners.
- On completion of commissioning, check all security-related settings.

1.5 Residual risks of power drive systems

When assessing the machine or system-related risk in accordance with the respective local regulations (e.g. EC Machinery Directive), the machine manufacturer or system integrator must take into account the following residual risks emanating from the control and drive components of a drive system:

1. Unintentional movements of driven machine or system components during commissioning, operation, maintenance, and repairs caused by, for example,
 - Hardware faults and/or software errors in the sensors, control system, actuators, and connections
 - Response times of the control system and of the drive
 - Operation and/or environmental conditions outside the specification
 - Condensation/conductive contamination
 - Parameterization, programming, cabling, and installation errors
 - Use of wireless devices/mobile phones in the immediate vicinity of electronic components
 - External influences/damage
 - X-ray, ionizing radiation and cosmic radiation
2. Unusually high temperatures, including open flames, as well as emissions of light, noise, particles, gases, etc., can occur inside and outside the components under fault conditions caused by, for example:
 - Component failure
 - Software errors
 - Operation and/or environmental conditions outside the specification
 - External influences/damage
3. Hazardous shock voltages caused by, for example:
 - Component failure
 - Influence during electrostatic charging
 - Induction of voltages in moving motors
 - Operation and/or environmental conditions outside the specification
 - Condensation/conductive contamination
 - External influences/damage
4. Electrical, magnetic and electromagnetic fields generated in operation that can pose a risk to people with a pacemaker, implants or metal replacement joints, etc., if they are too close
5. Release of environmental pollutants or emissions as a result of improper operation of the system and/or failure to dispose of components safely and correctly

1.5 Residual risks of power drive systems

6. Influence of network-connected communication systems, e.g. ripple-control transmitters or data communication via the network
7. Motors for use in potentially explosive areas:
When moving components such as bearings become worn, this can cause enclosure components to exhibit unexpectedly high temperatures during operation, creating a hazard in areas with a potentially explosive atmosphere.

For more information about the residual risks of the drive system components, see the relevant sections in the technical user documentation.

Introduction

2.1 About the Manual

Who requires the operating instructions and what for?

These operating instructions primarily address fitters, commissioning engineers and machine operators. The operating instructions describe the devices and device components and enable the target groups being addressed to install, connect-up, set, and commission the converters safely and in the correct manner.

What is described in the operating instructions?

These operating instructions provide a summary of all of the information required to operate the converter under normal, safe conditions.

The information provided in the operating instructions has been compiled in such a way that it is sufficient for all standard applications and enables drives to be commissioned as efficiently as possible. Where it appears useful, additional information for entry level personnel has been added.

The operating instructions also contain information about special applications. Since it is assumed that readers already have a sound technical knowledge of how to configure and parameterize these applications, the relevant information is summarized accordingly. This relates, e.g. to operation with fieldbus systems.

What is the meaning of the symbols in the manual?



 Reference to further information in the manual

 Download from the Internet







 DVD that can be ordered



End of a handling instruction.



  Examples of converter function symbols

2.2 Guide through the manual

Chapter	In this section you will find answers to the following questions:
 Description (Page 29)	<ul style="list-style-type: none"> • How is the converter marked? • Which components make up the converter? • Which optional components are available for the converter? • What is the purpose of the optional components? • Which motors can be fed from the converter? • Which commissioning tools are there?
 Installing (Page 59)	<ul style="list-style-type: none"> • Which sequence is recommended when installing the converter? • What does EMC-compliant installation actually mean? • Which options are available to install optional components below the converter? • What are the converter dimensions? • Which mounting and installation materials are required when installing the converter? • To which line supplies can the converter be connected? • How is the converter connected to the line supply? • How is the braking resistor connected to the converter? • Which terminals and fieldbus interfaces does the converter have? • What are the interface functions?
 Commissioning (Page 147)	<ul style="list-style-type: none"> • Which motor data is required for commissioning • How is the converter set in the factory? • What is the commissioning procedure? • How do you restore the converter factory settings?
 Uploading the converter settings (Page 199)	<ul style="list-style-type: none"> • Why is it necessary to back up the converter settings? • Which options are available to back up the settings? • How does the data backup function? • How do you prevent the converter settings from being changed? • How do you prevent the converter settings from being read out?
 Protecting the converter settings (Page 211)	<ul style="list-style-type: none"> • How do I protect the converter settings against manipulation? • How do I protect my know-how, which is embedded in the converter settings, so that it cannot be copied by unauthorized persons?
 Advanced commissioning (Page 221)	<ul style="list-style-type: none"> • Which functions are included in the converter firmware? • How are the functions set?
 Corrective maintenance (Page 445)	<ul style="list-style-type: none"> • What is the meaning of the LEDs provided on the converter? • How does the system runtime respond? • How does the converter save alarms and faults? • What do the converter alarms and faults mean? • How are converter faults resolved? • Which I&M data is saved in the converter?

Chapter	In this section you will find answers to the following questions:
 Alarms, faults and system messages (Page 425)	<ul style="list-style-type: none"> • How are converter components replaced? • How is the firmware version of the converter changed? • What must be done after a converter replacement if the safety functions of the converter are active?
 Technical data (Page 485)	<ul style="list-style-type: none"> • What is the converter technical data? • What do "High Overload" and "Low Overload" mean? • What effect do the installation altitude or ambient temperature have on the converter, for example?
 Appendix (Page 547)	<ul style="list-style-type: none"> • What are the new functions of the current firmware? • How is the converter operated using the BOP-2 Operator Panel? • How can signal interconnections be changed in the converter firmware? • What does "BiCo technology" mean? • Where can I find additional information about the converter?

Description

3.1 Intended use

Use for the intended purpose

The converter described in this manual is a device to control a three-phase motor. The converter is designed for installation in electrical installations or machines.

It has been approved for industrial and commercial use on industrial networks. Additional measures have to be taken when connected to public grids.

The technical specifications and information about connection conditions are indicated on the rating plate and in the operating instructions.

Use of third-party products

This document contains recommendations relating to third-party products. Siemens accepts the fundamental suitability of these third-party products.

You can use equivalent products from other manufacturers.

Siemens does not accept any warranty for the properties of third-party products.

3.2 OpenSSL

Use of OpenSSL

This product contains software developed in the OpenSSL project for use within the OpenSSL toolkit.

This product contains cryptographic software created by Eric Young.

This product contains software developed by Eric Young.

Further information is provided on the Internet:

 OpenSSL (<https://www.openssl.org/>)

 Cryptsoft (<mailto:eay@cryptsoft.com>)

3.3 Transferring OpenOSS license terms to a PC

Requirement

You have an empty memory card and a reader for the memory card.

Procedure

Procedure

To transfer OpenOSS license terms to a PC, proceed as follows:

1. Switch off the converter power supply.
2. Insert an empty memory card into the card slot of the converter.
 Overview of the interfaces (Page 105)
3. Switch on the converter power supply.
4. The converter writes file "Read_OSS.ZIP" to the memory card within approximately 30 seconds.
5. Switch off the converter power supply.
6. Withdraw the memory card from the converter.
7. Insert the memory card into the card reader of a PC.
8. Please read the license terms.

3.4 Identifying the converter

Main components of the converter

Each SINAMICS G120 converter comprises a Control Unit and a Power Module.

- The Control Unit controls and monitors the connected motor.
- The Power Module provides the connections for line supply and motor.

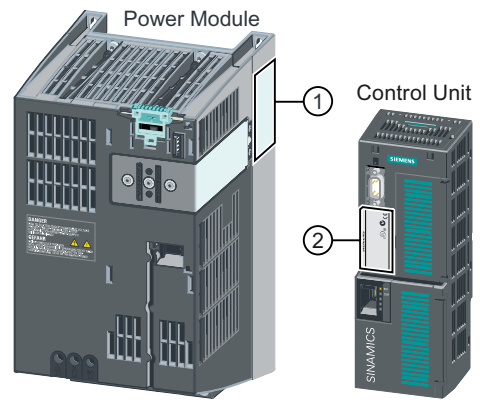

The following data is provided on the Power Module type plate (①):







- Designation, e.g. PM240-2 Power Module
- Technical specifications: voltage and current
- Article number, e.g. 6SL3210-1PE21-1UL0
- Version, e.g. A02

The following data can be found on the Control Unit type plate (②):

- Designation, e.g. Control Unit CU240E-2 DP-F
- Article number, e.g. 6SL3244-0BB13-1PA0
- Version, e.g. A02 (hardware), 4.7 (firmware)

Further converter components

The following components are available so that you can adapt the converter to different applications and ambient conditions:

-  Line filter (Page 43)
-  Line reactor (Page 44)
-  Output reactor (Page 46)
-  Sine-wave filter (Page 52)
-  Braking resistor (Page 54)
-  Brake relay to control a motor holding brake (Page 56)
-  Control Unit Adapter Kit CUA20 (Page 57)

3.5 Directives and standards

Description

The following directives and standards are relevant for the converters:



European Low Voltage Directive

The converters fulfill the requirements stipulated in the Low-Voltage Directive 2014/35/EU, if they are covered by the application area of this directive.

European Machinery Directive

The converters fulfill the requirements stipulated in the Machinery Directive 2006/42/EC, if they are covered by the application area of this directive.

However, the use of the converters in a typical machine application has been fully assessed for compliance with the main regulations in this directive concerning health and safety.

Directive 2011/65/EU

The converter fulfills the requirements of Directive 2011/65/EU relating to the restriction of the use of certain hazardous substances in electrical and electronic devices (RoHS).

European EMC Directive

The compliance of the converter with the regulations of the Directive 2014/30/EU has been verified through full compliance with IEC/EN 61800-3.

Underwriters Laboratories (North American market)

Converters provided with one of the test symbols displayed fulfill the requirements stipulated for the North American market as a component of drive applications, and are appropriately listed.



EMC requirements for South Korea

The converters with the KC marking on the rating plate satisfy the EMC requirements for South Korea.

Eurasian conformity

The converters comply with the requirements of the Russia/Belarus/Kazakhstan customs union (EAC).



Australia and New Zealand (RCM formerly C-Tick)

The converters showing the test symbols fulfill the EMC requirements for Australia and New Zealand.

Immunity to voltage drop of semiconductor process equipment.

The converters comply with the requirements of standard SEMI F47-0706.

DNV-GL

The SINAMICS CUA20 Control Unit Adapter Kit facilitates DNV-GL-certified cabinet designs.

China RoHS

The converters comply with the China-RoHS directive. Further information is provided on the Internet:





 China RoHS (<https://support.industry.siemens.com/cs/ww/en/view/109738656>)

Quality systems

Siemens AG employs a quality management system that meets the requirements of ISO 9001 and ISO 14001.

Further information

Certificates for download

-  EC Declaration of Conformity: (<https://support.industry.siemens.com/cs/ww/en/view/58275445>)
-  Certificates for the relevant directives, prototype test certificates, manufacturers declarations and test certificates for functions relating to functional safety ("Safety Integrated"): (<http://support.automation.siemens.com/WW/view/en/22339653/134200>)
-  Certificates for products that were certified by UL: (<http://database.ul.com/cgi-bin/XYV/template/LISEXT/1FRAME/index.html>)
-  Certificates for products that were certified by TÜV SÜD: (https://www.tuev-sued.de/industrie_konsumprodukte/zertifikatsdatenbank)

Standards that are not relevant

The converters do not fall in the area of validity of the China Compulsory Certification (CCC).



3.6 Overview of Control Units

Table 3-1 Control Units CU240B-2 ...



	The CU240B-2 Control Units differ with regard to the type of fieldbus.		
	Designation	CU240B-2	CU240B-2 DP
	Article number	6SL3244-0BB00-1BA1	6SL3244-0BB00-1PA1
	Fieldbus	USS, Modbus RTU	PROFIBUS DP

Table 3-2 Control Units CU240E-2 ...

	The CU240E-2 Control Units have, in comparison to the CU240B-2, an extended terminal strip with integrated safety functions.		
	The CU240E-2 Control Units differ with regard to the type of fieldbus and the scope of the integrated safety functions.		
Designation	CU240E-2	CU240E-2 DP	CU240E-2 PN
Article number	6SL3244-0BB12-1BA1	6SL3244-0BB12-1PA1	6SL3244-0BB12-1FA0
Fieldbus	USS, Modbus RTU	PROFIBUS DP	PROFINET IO, EtherNet/IP
Safety Integrated	Basic functions		
Designation	CU240E-2 F	CU240E-2 DP-F	CU240E-2 PN-F
Article number	6SL3244-0BB13-1BA1	6SL3244-0BB13-1PA1	6SL3244-0BB13-1FA0
Fieldbus	USS, Modbus RTU	PROFIBUS DP	PROFINET IO, EtherNet/IP
Safety Integrated	Extended functions		

Shield connection kit for the Control Unit

The shield connection kit is an optional component. The shield connection kit comprises the following components:

- Shield plate
- Elements for optimum shield support and strain relief of the signal and communication cables

Table 3-3 Article Nos.

Shield connection kit 2 for CU240B-2 and CU240E-2 Control Units with all fieldbus interfaces with the exception of PROFINET.	6SL3264-1EA00-0HA0
Shield connection kit 3 for the CU230P-2 and CU240E-2 Control Units with PROFINET interface.	6SL3264-1EA00-0HB0

Adapter for operating a PM230 IP55 Power Module



For operating the Control Unit with a PM230 IP55 Power Module, FSA ... FSC, an adapter is required between the Control Unit and operator panel (BOP-2 or IOP).

The adapter, which is included in the scope of delivery of the Power Module, is too short for the CU240E-2 Control Unit. The matching adapter for the CU240E-2 Control Unit can be ordered through the KnorrTec company.

Article number 10055500

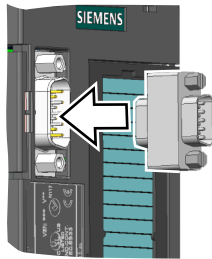



Figure 3-1 Insert the KnorrTec adapter on the interface for the operator panel

3.7 Power Module

Important data on the Power Modules is provided in this section. Further information is contained in the Hardware Installation Manual of the Power Module.

 Overview of the manuals (Page 564)

All power data refers to rated values or to power for operation with low overload (LO).

Which Power Module can I use with the Control Unit?

Table 3-4 Permitted combinations of Control Unit and Power Module

Control Unit	Power Module				
	PM230		PM240-2	PM240P-2	PM250
	IP20 and Push-Through technology	IP55			
CU240B-2...	✓	---	✓	✓	✓
CU240E-2...	✓	✓	✓	✓	✓

3.7.1 Power Module with IP20 degree of protection



Figure 3-2 Examples of Power Modules with IP20 degree of protection

PM240-2 for standard applications

The PM240-2 Power Module is available without a filter or with an integrated class A line filter. The PM240-2 permits dynamic braking via an external braking resistor.

Table 3-5 1-phase/3-phase 200 VAC ... 240 VAC, article number 6SL3210-1PB... and 6SL3210-1PC...

Frame size	FSA	FSB	FSC	FSD	FSE	FSF
Power (kW)	0.55 ... 0.75	1.1 ... 2.2	3.0 ... 4.0	11 ... 18.5	22 ... 30	37 ... 55

Table 3-6 3-phase 380 VAC ... 480 VAC, article number 6SL3210-1PE...

Frame size	FSA	FSB	FSC	FSD	FSE	FSF	FSG
Power (kW)	0.55 ... 3.0	4.0 ... 7.5	11 ... 15	18.5 ... 37	45 ... 55	75 ... 132	160 ... 250

Table 3-7 3-phase 500 VAC ... 690 VAC, article number 6SL3210-1PH...

Frame size	FSD	FSE	FSF	FSG
Power (kW)	11 ... 37	45 ... 55	75 ... 132	160 ... 250

PM240P-2 for pump and fan applications

The PM240P-2 Power Module is available without a filter or with an integrated class A line filter.

Table 3-8 3-phase 380 VAC ... 480 VAC, article number 6SL3210-1RE...

Frame size	FSD	FSE	FSF
Power (kW)	22 ... 37	45 ... 55	75 ... 132

Table 3-9 3-phase 500 VAC ... 690 VAC, article number 6SL3210-1RH...

Frame size	FSD	FSE	FSE
Power (kW)	11 ... 37	45 ... 55	75 ... 132

PM230, 3-phase 400 VAC in IP20 degree of protection for pump and fan applications

The PM230 Power Module in IP20 degree of protection is available without a filter or with an integrated class A line filter.

Table 3-10 3-phase 380 VAC ... 480 VAC, article numbers: 6SL3210-1NE...

Frame size	FSA	FSB	FSC	FSD	FSE	FSF
Power (kW)	0.37 ... 3	4 ... 7.5	11 ... 18.5	22 ... 37	45 ... 55	75 ... 90

PM250 for standard applications with energy recovery

The PM250 Power Module is available without a filter or with integrated class A line filter. The PM250 permits dynamic braking with energy recovery into the line supply.

Table 3-11 3-phase 380 VAC ... 480 VAC, article number 6SL3225-0BE...

Frame size	FSC	FSD	FSE	FSF
Power (kW)	7.5 ... 15	18.5 ... 30	37 ... 45	55 ... 90

3.7.2 Power Module with Push-Through technology



Figure 3-3 Examples of Power Modules with Push-Through technology FSA ... FSC

PM240-2 with Push-Through technology for standard applications

The PM240-2 Power Module is available with Push-Through technology without a filter or with an integrated class A line filter. The PM240-2 allows dynamic braking using an external braking resistor.

Table 3-12 1-phase/3-phase 200 VAC ... 240 VAC, article number 6SL3211-1PB...

Frame size	FSA	FSB	FSC	FSD	FSE	FSF
Power (kW)	0.75	2.2	4.0	18.5	30	55

Table 3-13 3-phase 380 VAC ... 480 VAC, article number 6SL3211-1PE...

Frame size	FSA	FSB	FSC	FSD	FSE	FSF
Power (kW)	3.0	7.5	15	37	55	132

Table 3-14 3 AC 500 V ... 690 V, Article No. 6SL3211-1PH...

Frame size	FSD	FSE	FSF
Power (kW)	37	55	132

PM230 in Push-Through technology for pump and fan applications

The PM230 Power Module is available without a filter or with integrated class A line filter.

Table 3-15 3-phase 380 VAC ... 480 VAC, article number 6SL3211-1NE...

Frame size	FSA	FSB	FSC
Power (kW)	3	7.5	18.5

3.7.3 Power Module in IP55 degree of protection / UL Type 12



Figure 3-4 PM230, 3-phase 400 VAC, degree of protection IP55 / UL Type 12

PM230 for pumps and fan applications

The PM230 Power Module is suitable for cabinet-free installation.

Table 3-16 3-phase 380 VAC ... 480 VAC, article number 6SL3223-0DE...

Frame size		FSA	FSB	FSC	FSD	FSE	FSF
Power (kW)	Filter Class A	0.37 ... 3	4 ... 7.5	11 ... 18.5	22 ... 30	37 ... 45	55 ... 90
	Filter Class B	0.37 ... 3	4 ... 7.5	11 ... 15	18.5 ... 30	37 ... 45	55 ... 90

3.8 Components for the Power Modules

3.8.1 Accessories for shielding

Shield connection kit

Establish the shield and strain relief for the power connections using the shield connection kit.

The shield connection kit comprises a shield plate and serrated strips with screws.

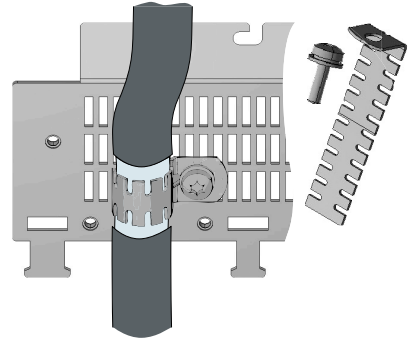

Table 3-17 Article numbers for the shield connection kit

Frame size	PM250 Power Module	PM230, PM240-2	PM240P-2
FSA	6SL3262-1AA00-0BA0	The shield connection kit is included in the scope of delivery	---
FSB	6SL3262-1AB00-0DA0		
FSC	6SL3262-1AC00-0DA0		
FSD	6SL3262-1AD00-0DA0		The lower shield connection kit is included in the scope of delivery
FSE	6SL3262-1AD00-0DA0		
FSF	6SL3262-1AF00-0DA0		

3.8.2 Line filter

With a line filter, the converter can achieve a higher radio interference class.

NOTICE
<p>Overloading the line filter when connected to line supplies that are not permissible</p> <p>The line filter is only suitable for operation on TN or TT line supplies with a grounded neutral point. If operated on other line supplies, the line filter will be thermally overloaded and will be damaged.</p> <ul style="list-style-type: none"> For converters equipped with line filter, only connect to TN or TT line supplies with a grounded neutral point.

External line filters for PM250

Power Module		Power	Class B line filter according to EN55011: 2009
FSC	6SL3225-0BE25-5AA0, 6SL3225-0BE27-5AA0, 6SL3225-0BE31-1AA0	7.5 kW ... 15.0 kW	6SL3203-0BD23-8SA0

3.8.3 Line reactor

The line reactor supports the overvoltage protection, smoothes the harmonics in the line supply and bridges commutation dips. For the Power Modules subsequently listed, a line reactor is suitable in order to dampen the specified effects.

The figure on the right-hand side shows as example the line reactors for the PM240-2 Power Modules, FSB.

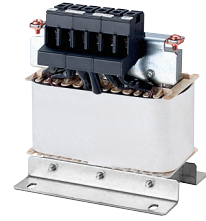

The line requirements for deployment of a line reactor depends on the Power Module:

 Technical data (Page 485)

NOTICE
Damage to the converter as a result of a missing line reactor
Depending on the Power Module and line supply, if a line reactors is not used, this can result in damage to the converter and other components in the electrical plant or system.
<ul style="list-style-type: none"> Install a line reactor if the relative short-circuit voltage of the line supply is below 1%

Line reactors for PM240-2, 380 V ... 480 V

Power Module		Power	Line reactor
FSA	6SL3210-1PE11-8 . L1, 6SL3210-1PE12-3 . L1, 6SL3210-1PE13-2 . L1	0.55 kW ... 1.1 kW	6SL3203-OCE13-2AA0
FSB	6SL3210-1PE14-3 . L1, 6SL321 . -1PE16-1 . L1, 6SL321 . -1PE18-0 . L1	1.5 kW ... 3 kW	6SL3203-OCE21-0AA0
FSC	6SL3210-1PE21-1 . LO, 6SL3210-1PE21-4 . LO, 6SL321 . -1PE21-8 . LO	4 kW ... 7.5 kW	6SL3203-OCE21-8AA0
	6SL3210-1PE22-7 . LO, 6SL321 . -1PE23-3 . LO	11 kW ... 15 kW	6SL3203-OCE23-8AA0

FSD ... FSG: A line reactor is not required.

Line reactors for PM240-2 Power Module, 500 V ... 690 V

A line reactor is not required.

Line reactors for PM240-2, 200 V ... 240 V

Power Module		Power	Line reactor
FSA	6SL3210-1PB13-0 . LO, 6SL3210-1PB13-8 . LO	0.55 kW ... 0.75 kW	6SL3203-OCE13-2AA0
FSB	6SL3210-1PB15-5 . LO, 6SL3210-1PB17-4 . LO, 6SL321 . -1PB21-0 . LO	1.1 kW ... 2.2 kW	6SL3203-OCE21-0AA0
FSC	6SL3210-1PB21-4 . LO, 6SL321 . -1PB21-8 . LO	3 kW ... 4 kW	6SL3203-OCE21-8AA0
	6SL321 . -1PC22-2 . LO, 6SL3210-1PC22-8 . LO	5.5 kW ... 7.5 kW	6SL3203-OCE23-8AA0

FSD ... FSF: A line reactor is not required.

Line reactors for PM240-2 Power Modules

A line reactor is not required.

3.8.4 Output reactor

Output reactors reduce the voltage stress on the motor windings and the load placed on the converter as a result of capacitive recharging currents in the cables. One or two output reactors are required for longer motor cables.

You will find more information about permissible motor cable lengths in the Hardware Installation Manual for the Power Module.

 Overview of the manuals (Page 564)

The figure on the right-hand side shows as example the output reactors for PM240-2 Power Modules, FSB and FSC.

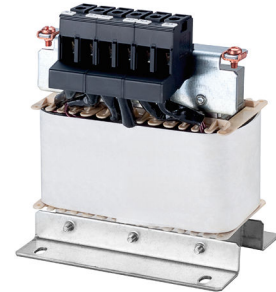

NOTICE

Overheating of the output reactor if the pulse frequency is too high

The output reactor is dimensioned for the converter pulse frequency set in the factory. Converter operation with pulse frequencies higher than the factory setting can result in thermal overload of the output reactor. Excessively high temperatures damage the output reactor.

- Operate the converter with an output reactor with a maximum pulse frequency \leq factory setting.

Output reactors for PM240-2 Power Modules, 380 V ... 480 V

Power Module		Power	Output reactor
FSA	6SL3210-1PE11-8 . L1, 6SL3210-1PE12-3 . L1, 6SL3210-1PE13-2 . L1, 6SL3210-1PE14-3 . L1, 6SL3210-1PE16-1 . L1	0.55 kW ... 2.2 kW	6SL3202-0AE16-1CA0
	6SL321 . -1PE18-0 . L1	3 kW	6SL3202-0AE18-8CA0
FSB	6SL3210-1PE21-1 . L0, 6SL3210-1PE21-4 . L0, 6SL321 . -1PE21-8 . L0	4 kW ... 7.5 kW	6SL3202-0AE21-8CA0
FSC	6SL3210-1PE22-7 . L0, 6SL321 . -1PE23-3 . L0	11 kW ... 15 kW	6SL3202-0AE23-8CA0
FSD	6SL3210-1PE23-8 . L0 6SL3210-1PE24-5 . L0 6SL3210-1PE26-0 . L0 6SL321 . -1PE27-5 . L0	18.5 kW ... 37 kW	6SE6400-3TC07-5ED0
FSE	6SL3210-1PE28-8 . L0, 6SL321 . -1PE31-1 . L0	45 kW ... 55 kW	6SE6400-3TC14-5FD0
FSF	6SL3210-1PE31-5 . L0	75 kW	6SL3000-2BE32-1AA0
	6SL3210-1PE31-8 . L0	90 kW	
	6SL3210-1PE32-1 . L0	110 kW	6SL3000-2BE32-1AA0
	6SL321 . -1PE32-5 . L0	132 kW	6SL3000-2BE32-6AA0

Power Module		Power	Output reactor
FSG	6SL3210-1PE33-0 . LO	160 kW	6SL3000-2BE33-2AA0
	6SL3210-1PE33-7 . LO	200 kW	6SL3000-2BE33-8AA0
	6SL3210-1PE34-8 . LO	250 kW	6SL3000-2BE35-0AA0

Output reactors for PM240-2 Power Modules, 500 V ... 690 V

Power Module		Power	Output reactor
FSF	6SL3210-1PH28-0 . LO, 6SL3210-1PH31-0 . LO	75 kW ... 90 kW	6SL3000-2AH31-0AA0
	6SL3210-1PH31-2 . LO, 6SL3210-1PH31-4 . LO	110 kW ... 132 kW	6SL3000-2AH31-5AA0
FSG	6SL3210-1PH31-7CLO	160 kW	6SL3000-2AH31-8AA0
	6SL3210-1PH32-1CLO	200 kW	6SL3000-2AH32-4AA0
	6SL3210-1PH32-5CLO	250 kW	6SL3000-2AH32-6AA0

Output reactors for PM240-2 Power Modules, 200 V ... 240 V

Power Module		Power	Output reactor
FSA	6SL3210-1PB13-0 . LO, 6SL321 . -1PB13-8 . LO	0.55 kW ... 0.75 kW	6SL3202-0AE16-1CA0
FSB	6SL3210-1PB15-5 . LO	1.1 kW	
	6SL3210-1PB17-4 . LO	1.5 kW	6SL3202-0AE18-8CA0
FSB	6SL321 . -1PB21-0 . LO	2.2 kW	6SL3202-0AE21-8CA0
FSC	6SL3210-1PB21-4 . LO, 6SL321 . -1PB21-8 . LO	3 kW ... 4 kW	
	6SL321 . -1PC22-2 . LO, 6SL3210-1PC22-8 . LO	5.5 kw ... 7.5 kW	6SL3202-0AE23-8CA0
FSD	6SL3210-1PC24-2ULO, 6SL3210-1PC25-4ULO, 6SL3210-1PC26-8ULO	11 kW ... 18.5 kW	6SE6400-3TC07-5ED0
FSE	6SL3210-1PC28-0ULO, 6SL3210-1PC31-1ULO	22 kW ... 55 kW	6SE6400-3TC14-5FD0
FSF	6SL3210-1PC31-3ULO, 6SL3210-1PC31-6ULO, 6SL3210-1PC31-8ULO		

Output reactors for PM240P-2 Power Modules, 380 V ... 480 V

Power Module		Power	Output reactor
FSD	6SL3210-1RE24-5 . L0	22 kW	6SE6400-3TC03-8DD0
	6SL3210-1RE26-0 . L0	30 kW	6SE6400-3TC07-5ED0
	6SL3210-1RE27-5 . L0	37 kW	
FSE	6SL3210-1RE28-8 . L0	45 kW	6SE6400-3TC14-5FD0
	6SL3210-1RE31-1 . L0	55 kW	
FSF	6SL3210-1RE31-5 . L0	75 kW	
	6SL3210-1RE31-8 . L0	90 kW	
	6SL3210-1RE32-1 . L0	110 kW	6SL3000-2BE32-1AA0
	6SL3210-1RE32-5 . L0	132 kW	6SL3000-2BE32-6AA0

Output reactors for PM250 Power Module

Power Module		Power	Output reactor
FSC	6SL3225-0BE25-5 . A0, 6SL3225-0BE27-5 . A0, 6SL3225-0BE31-1 . A0	7.5 kW ... 15.0 kW	6SL3202-0AJ23-2CA0
FSD	6SL3225-0BE31-5 . A0	18.5 kW	6SE6400-3TC05-4DD0
	6SL3225-0BE31-8 . A0	22 kW	6SE6400-3TC03-8DD0
	6SL3225-0BE32-2 . A0	30 kW	6SE6400-3TC05-4DD0
FSE	6SL3225-0BE33-0 . A0	37 kW	6SE6400-3TC08-0ED0
	6SL3225-0BE33-7 . A0	45 kW	6SE6400-3TC07-5ED0
FSF	6SL3225-0BE34-5 . A0	55 kW	6SE6400-3TC14-5FD0
	6SL3225-0BE35-5 . A0	75 kW	6SE6400-3TC15-4FD0
	6SL3225-0BE37-5 . A0	90 kW	6SE6400-3TC14-5FD0

Output reactors for PM230 Power Modules (IP20)

Power Module		Power	Output reactor
FSA	6SL3210-1NE11-3 . G1 6SL3210-1NE11-7 . G1 6SL3210-1NE12-2 . G1 6SL3210-1NE13-1 . G1 6SL3210-1NE14-1 . G1 6SL3210-1NE15-8 . G1	0.37 kW ... 2.2 kW	6SL3202-0AE16-1CA0
	6SL3210-1NE17-7 . G1	3.0 kW	6SL3202-0AE18-8CA0
FSB	6SL3210-1NE21-0 . G1 6SL3210-1NE21-3 . G1 6SL3210-1NE21-8 . G1	4.0 kW ... 7.5 kW	6SL3202-0AE21-8CA0
	6SL3210-1NE22-6 . G1 6SL3210-1NE23-2 . G1 6SL3210-1NE23-8 . G1	11.0 kW ... 18.5 kW	6SL3202-0AE23-8CA0
	FSD	6SL3210-1NE24-5 . L0	22 kW
6SL3210-1NE26-0 . L0		30 kW	6SE6400-3TC05-4DD0

Power Module		Power	Output reactor
FSE	6SL3210-1NE27-5 . LO	37 kW	6SE6400-3TC08-0ED0
	6SL3210-1NE28-8 . LO	45 kW	6SE6400-3TC07-5ED0
FSF	6SL3210-1NE31-1 . LO	55 kW	6SE6400-3TC14-5FD0
	6SL3210-1NE31-5 . LO	75 kW	6SE6400-3TC15-4FD0

Output reactors for PM230 push-through Power Modules

Power Module		Power	Output reactor
FSA	6SL3211-1NE17-7 . G1	3.0 kW	6SL3202-0AE18-8CA0
FSB	6SL3211-1NE21-8 . G1	7.5 kW	6SL3202-0AE21-8CA0
FSC	6SL3211-1NE23-8 . G1	18.5 kW	6SL3202-0AE23-8CA0

3.8.5 ((dv/dt filter plus VPL_PM240-2))

A combination of dv/dt filter and a voltage peak limiter (VPL) – dv/dt filter plus VPL – is available to suppress voltage peaks.

When using a dv/dt filter plus VPL, observe the following restrictions:

- The output frequency must not exceed 150 Hz.
- The pulse frequency must not exceed 4 kHz.

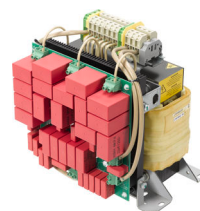

NOTICE

Damage to the dv/dt filter plus VPL if it is not activated during commissioning

The dv/dt filter plus VPL may be damaged if it is not activated during commissioning.

- Activate the dv/dt filter plus VPL during commissioning via parameter p0230.
- Activate the dv/dt filter plus VPL during commissioning according to the electric specifications.

NOTICE

Damage to the dv/dt filter plus VPL if the connection to the capacitor is not removed

The dv/dt filter plus VPL may be damaged if the connection to the capacitor of the common mode filter is not removed when the dv/dt filter plus VPL operates in the IT line system.

Further information is provided on the Internet:

-  FAQ of dv/dt filter plus VPL (<https://support.industry.siemens.com/cs/ww/en/ps/13224/faq>)

For applications in the USA and Canada, you can also use the dv/dt filters plus VPL recommended by Siemens Product Partner for Drive Options. For more information, see the link below:

-  Voltage limiter and dv/dt filter (https://www.mdexx.com/wp-content/uploads/2019/11/BAF-18-001-76_Instruction_manual.pdf)

dv/dt filters plus VPL for PM240-2 Power Modules, 3 AC 400 V

Power Module		Power	dv/dt filter plus VPL Manufacturer: mdexx Mag- netronic Devices s.r.o
FSD	6SL3210-1PE23-8 .LO	18.5 kW	JTA:TEF1203-OHB
	6SL3210-1PE24-5 .LO	22 kW	JTA:TEF1203-OJB
	6SL3210-1PE26-0 .LO	30 kW	
FSD	6SL321 .-1PE27-5 .LO	37 kW	JTA:TEF1203-OKB
FSE	6SL3210-1PE28-8 .LO	45 kW	

Power Module		Power	dv/dt filter plus VPL Manufacturer: mdexx Mag- netronic Devices s.r.o
FSE	6SL321 .-1PE31-1 .LO	55 kW	JTA:TEF1203-OLB
FSF	6SL3210-1PE31-5 .LO	75 kW	
FSF	6SL3210-1PE31-8 .LO	90 kW	JTA:TEF1203-OMB
	6SL3210-1PE32-1 .LO	110 kW	
	6SL321 .-1PE32-5 .LO	132 kW	

dv/dt filters plus VPL for PM240-2 Power Modules, 3 AC 690 V

Power Module		Power	dv/dt filter plus VPL Manufacturer: mdexx Mag- netronic Devices s.r.o
FSD	6SL3210-1PH21-4 .LO	11 kW	JTA:TEF1203-0GB
	6SL3210-1PH22-0 .LO	15 kW	
	6SL3210-1PH22-3 .LO	18.5 kW	
	6SL3210-1PH22-7 .LO	22 kW	JTA:TEF1203-0HB
	6SL3210-1PH23-5 .LO	30 kW	
	6SL3210-1PH24-2 .LO	37 kW	
FSE	6SL3210-1PH25-2 .LO	45 kW	JTA:TEF1203-0JB
	6SL3210-1PH26-2 .LO	55 kW	
FSF	6SL3210-1PH28-0 .LO	75 kW	JTA:TEF1203-0KB
	6SL3210-1PH31-0 .LO	90 kW	
	6SL3210-1PH31-2 .LO	110 kW	JTA:TEF1203-OLB
	6SL3210-1PH31-4 .LO	132 kW	
FSG	6SL3210-1PH31-7CLO	160 kW	JTA:TEF1203-OMB
	6SL3210-1PH32-1CLO	200 kW	
	6SL3210-1PH32-5CLO	250 kW	

3.8.6 Sine-wave filter

The sine-wave filter at the converter output limits the voltage rate-of-rise and the peak voltages at the motor winding. The maximum permissible length of motor feeder cables is increased to 300 m.

The following applies when using a sine-wave filter:

- Operation is only permissible with pulse frequencies from 4 kHz to 8 kHz.
From 110 kW power rating of the Power Modules (according to the type plate) only 4 kHz is permissible.
- The converter power is reduced by 5%.
- The maximum output frequency of the converter is 150 Hz at 380 V to 480 V.
- Operation and commissioning may only be performed with the motor connected, as the sine-wave filter is not no-load proof.
- An output reactor is superfluous.

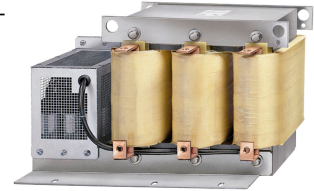

Sine-wave filter for PM240-2 Power Module, 380 V ... 480 V

Power Module		Power	Sine-wave filter
FSD	6SL3210-1PE23-8 . LO, 6SL3210-1PE24-5 . LO	18.5 kW ... 22 kW	6SL3202-0AE24-6SA0
	6SL3210-1PE26-0 . LO	30 kW	6SL3202-0AE26-2SA0
	6SL321 . -1PE27-5 . LO	37 kW	6SL3202-0AE28-8SA0
FSE	6SL3210-1PE28-8 . LO	45 kW	6SL3202-0AE31-5SA0
	6SL321 . -1PE31-1 . LO	55 kW	
FSF	6SL3210-1PE31-5 . LO	75 kW	6SL3202-0AE31-8SA0
	6SL3210-1PE31-8 . LO	90 kW	
	6SL3210-1PE32-1 . LO, 6SL321 . -1PE32-5 . LO	110 kW ... 132 kW	
FSG	6SL3210-1PE33-0 . LO	160 kW	6SL3000-2CE32-8AA0
	6SL3210-1PE33-7 . LO	200 kW	6SL3000-2CE33-3AA0
	6SL3210-1PE34-8 . LO	250 kW	6SL3000-2CE34-1AA0

Sine-wave filter for PM240-2 Power Module, 200 V ... 240 V

Power Module		Power	Sine-wave filter
FSD	6SL3210-1PC24-2UL0	11 kW	6SL3202-0AE24-6SA0
	6SL3210-1PC25-4UL0	15 kW	6SL3202-0AE26-2SA0
	6SL321 . -1PC26-8UL0	18.5 kW	6SL3202-0AE28-8SA0
FSE	6SL3210-1PC28-0UL0	22 kW	6SL3202-0AE31-5SA0
	6SL321 . -1PC31-1UL0	30 kW	
FSF	6SL3210-1PC31-3UL0	37 kW	6SL3202-0AE31-8SA0
	6SL3210-1PC31-6UL0, 6SL321 . -1PC31-8UL0	45 kW ... 55 kW	

Sine-wave filter for PM250 Power Module

Power Module		Power	Sine-wave filter
FSC	6SL3225-0BE25-5 . A0	7.5 kW	6SL3202-0AE22-0SA0
	6SL3225-0BE27-5 . A0, 6SL3225-0BE31-1 . A0	11.0 kW ... 15.0 kW	6SL3202-0AE23-3SA0
	6SL3225-0BE31-5 . A0, 6SL3225-0BE31-8 . A0	18.5 kW ... 22 kW	6SL3202-0AE24-6SA0
FSD	6SL3225-0BE32-2 . A0	30 kW	6SL3202-0AE26-2SA0
	6SL3225-0BE33-0 . A0, 6SL3225-0BE33-7 . A0	37 kW ... 45 kW	6SL3202-0AE28-8SA0
FSE	6SL3225-0BE34-5 . A0, 6SL3225-0BE35-5 . A0	55 kW ... 75 kW	6SL3202-0AE31-5SA0
	6SL3225-0BE37-5 . A0	90 kW	6SL3202-0AE31-8SA0

Sine-wave filter for PM240P-2 Power Module, 380 V ... 480 V

Power Module		Power	Sine-wave filter
FSD	6SL3210-1RE24-5 . L0	22 kW	6SL3202-0AE26-2SA0
	6SL3210-1RE26-0 . L0	30 kW	6SL3202-0AE28-8SA0
	6SL3210-1RE27-5 . L0	37 kW	
FSE	6SL3210-1RE28-8 . L0	45 kW	6SL3202-0AE31-5SA0
	6SL3210-1RE31-1 . L0	55 kW	
FSF	6SL3210-1RE31-5 . L0	75 kW	6SL3202-0AE31-8SA0
	6SL3210-1RE31-8 . L0	90 kW	6SL3000-2CE32-3AA0
	6SL3210-1RE32-1 . L0	110 kW	
	6SL3210-1RE32-5 . L0	132 kW	6SL3000-2CE32-8AA0

3.8.7 Braking resistor

The braking resistor allows loads with a high moment of inertia to be quickly braked.

The Power Module controls the braking resistor via its integrated braking module. The figure shown on the right-hand side shows as example the braking resistor for a PM240-2 Power Module, FSB.



Braking resistors for PM240-2, 380 V ... 480 V

Power Module		Power	Braking resistor
FSA	6SL3210-1PE11-8 . L1, 6SL3210-1PE12-3 . L1, 6SL3210-1PE13-2 . L1, 6SL3210-1PE14-3 . L1	0.55 kW ... 1.5 kW	6SL3201-0BE14-3AA0
	6SL321 . -1PE16-1 . L1, 6SL321 . -1PE18-0 . L1	2.2 kW ... 3.0 kW	6SL3201-0BE21-0AA0
FSB	6SL3210-1PE21-1 . L0, 6SL3210-1PE21-4 . L0, 6SL321 . -1PE21-8 . L0	4 kW ... 7.5 kW	6SL3201-0BE21-8AA0
FSC	6SL3210-1PE22-7 . L0, 6SL321 . -1PE23-3 . L0	11 kW ... 15 kW	6SL3201-0BE23-8AA0
FSD	6SL3210-1PE23-8 . L0, 6SL3210-1PE24-5 . L0	18.5 kW ... 22 kW	JJY:023422620001
	6SL3210-1PE26-0 . L0, 6SL3210-1PE27-5 . L0	30 kW ... 37 kW	JJY:023424020001
FSE	6SL3210-1PE28-8 . L0, 6SL3210-1PE31-1 . L0	45 kW ... 55 kW	JJY:023434020001
FSF	6SL3210-1PE31-5 . L0, 6SL3210-1PE31-8 . L0,	75 kW ... 90 kW	JJY:023454020001
	6SL3210-1PE32-1 . L0, 6SL3210-1PE32-5 . L0	90 kW ... 132 kW	JJY:023464020001
FSG	6SL3210-1PE33-0ALO, 6SL3210-1PE33-7ALO, 6SL3210-1PE34-8ALO	160 kW ... 250 kW	6SL3000-1BE32-5AA0

Braking resistors for PM240-2, 500 V ... 690 V

Power Module		Power	Braking resistor
FSD	6SL3210-1PH21-4 . LO, 6SL3210-1PH22-0 . LO, 6SL3210-1PH22-3 . LO, 6SL3210-1PH22-7 . LO, 6SL3210-1PH23-5 . LO, 6SL3210-1PH24-2 . LO	11 kW ... 37 kW	JJY:023424020002
FSE	6SL3210-1PH25-2 . LO, 6SL3210-1PH26-2 . LO	45 kW ... 55 kW	JJY:023434020002
FSF	6SL3210-1PH28-0 . LO, 6SL3210-1PH31-0 . LO,	75 kW ... 90 kW	JJY:023464020002
	6SL3210-1PH31-2 . LO, 6SL3210-1PH31-4 . LO	110 kW ... 132 kW	JJY:023464020002
FSG	6SL3210-1PH31-7CLO, 6SL3210-1PH32-1CLO, 6SL3210-1PH32-5CLO	160 kW ... 250 kW	6SL3000-1BH32-5AA0

Braking resistors for PM240-2, 200 V ... 240 V

Power Module		Power	Braking resistor
FSA	6SL3210-1PB13-0 . LO, 6SL321 . -1PB13-8 . LO	0.55 kW ... 0.75 kW	JJY:023146720008
FSB	6SL3210-1PB15-5 . LO, 6SL3210-1PB17-4 . LO, 6SL321 . -1PB21-0 . LO	1.1 kW ... 2.2 kW	JJY:023151720007
FSC	6SL3210-1PB21-4 . LO, 6SL321 . -1PB21-8 . LO	3 kW ... 4 kW	JJY:02 3163720018
	6SL3210-1PC22-2 . LO, 6SL3210-1PC22-8 . LO	5.5 kW ... 7.5 kW	JJY:023433720001
FSD	6SL3210-1PC24-2ULO, 6SL3210-1PC25-4ULO, 6SL3210-1PC26-8ULO	11 kW ... 18.5 kW	JJY:023422620002
FSE	6SL3210-1PC28-0ULO, 6SL3210-1PC31-1ULO	22 kW ... 30 kW	JJY:023423320001
FSF	6SL3210-1PC31-3ULO, 6SL3210-1PC31-6ULO, 6SL3210-1PC31-8ULO	37 kW ... 55 kW	JJY:023434020003

3.8.8 Brake Relay



The Brake Relay has a switch contact (NO contact) for controlling a motor holding brake.

Article number: 6SL3252-0BB00-0AA0

The following Power Modules have a connection possibility for the Brake Relay:

- PM240-2
- PM240P-2
- PM250

3.8.9 Safe Brake Relay



The Safe Brake Relay controls a 24 V motor brake and monitors the brake control for a short-circuit or interrupted cable.

Article number: 6SL3252-0BB01-0AA0

The following Power Modules have a connection possibility for the Brake Relay:

- PM240-2
- PM240P-2
- PM250

3.8.10 Control Unit Adapter Kit CUA20

Overview

When using the CUA20 Control Unit Adapter Kit, the Control Unit can be installed next to the PM240-2 Power Module.

Article No: 6SL3255-0BW01-0NA0

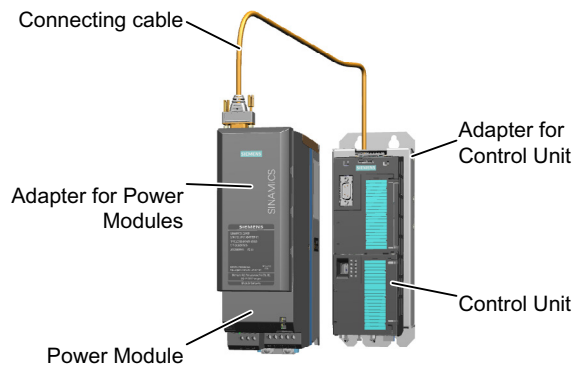

Figure 3-5 Control Unit Adapter Kit CUA20

The SINAMICS CUA20 Control Unit Adapter Kit comprises the following components:

- Adapter which is snapped onto the Power Module
- Adapter for the Control Unit
- Prefabricated cable to connect the two adapters

3.9 Motors and multi-motor drives that can be operated

Siemens motors that can be operated

You can connect standard induction motors to the converter.

You can find information on further motors on the Internet:

 Motors that can be operated (<https://support.industry.siemens.com/cs/ww/en/view/100426622>)

Third-party motors that can be operated

You can operate standard asynchronous motors from other manufacturers with the converter:

NOTICE
Insulation failure due to unsuitable third-party motor
A higher load occurs on the motor insulation in converter mode than with line operation. Damage to the motor winding may occur as a result.
<ul style="list-style-type: none">• Please observe the notes in the System Manual "Requirements for third-party motors"

Further information is provided on the Internet:

 Requirements for third-party motors (<https://support.industry.siemens.com/cs/ww/en/view/79690594>)

Multi-motor operation

Multi-motor operation involves simultaneously operating several identical motors on one converter. For standard induction motors, multi-motor operation is generally permissible.

Additional preconditions and restrictions relating to multi-motor operation are available on the Internet:

 Multi-motor drive (<http://support.automation.siemens.com/WW/view/en/84049346>)

Installing

4.1 Installing the label for the North American market

Description

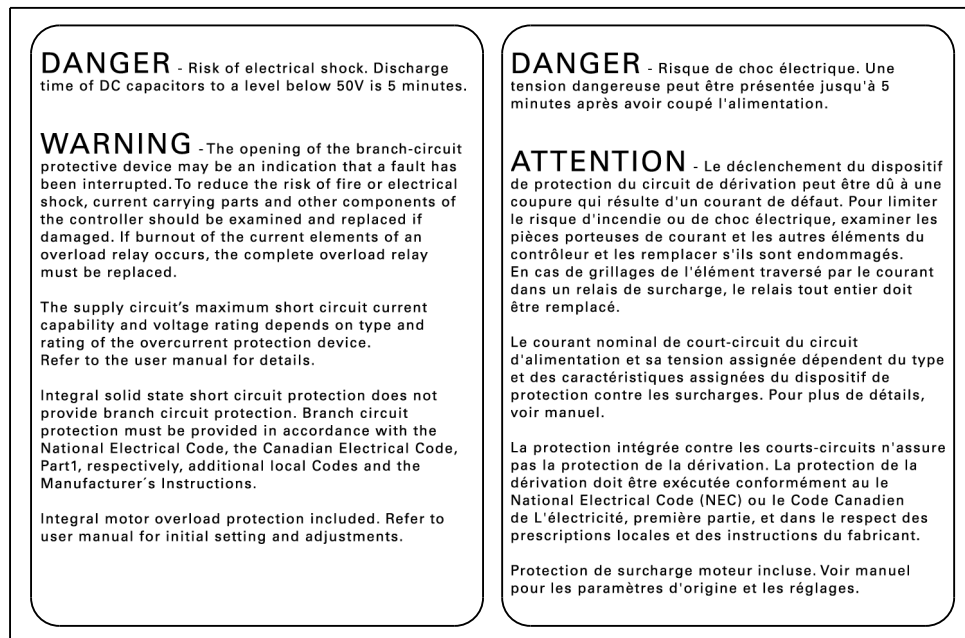

Figure 4-1 Adhesive label with danger and warning notes for North America

The converter is supplied with an adhesive label with danger and warning notes for the North American market.

Attach the adhesive label in the required language to the inside of the control cabinet where it is clearly visible at all times.

4.2 EMC-compliant setup of the machine or plant

The converter is designed for operation in industrial environments where strong electromagnetic fields are to be expected.

Reliable and disturbance-free operation is only ensured for EMC-compliant installation.

To achieve this, subdivide the control cabinet and the machine or system into EMC zones:

EMC zones

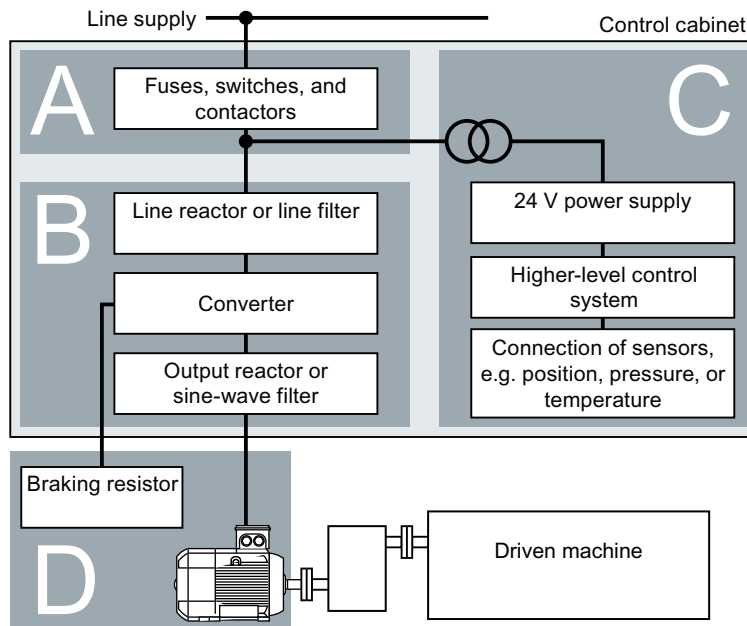

Figure 4-2 Example of the EMC zones of a plant or machine

Inside the control cabinet

- Zone A: Line supply connection
- Zone B: Power electronics
Devices in Zone B generate energy-rich electromagnetic fields.
- Zone C: Control and sensors
Devices in Zone C do not generate any energy-rich electromagnetic fields themselves, but their functions can be impaired by electromagnetic fields.

Outside the control cabinet

- Zone D: Motors, braking resistors
Devices in Zone D generate electromagnetic fields with a significant amount of energy

4.2.1 Control cabinet

- Assign the various devices to zones in the control cabinet.
- Electromagnetically uncouple the zones from each other by means of one of the following actions:
 - Side clearance ≥ 25 cm
 - Separate metal enclosure
 - Large-area partition plates
- Route cables of various zones in separate cable harnesses or cable ducts.
- Install filters or isolation amplifiers at the interfaces of the zones.

Control cabinet assembly

- Connect the door, side panels, top and base plate of the control cabinet with the control cabinet frame using one of the following methods:
 - Electrical contact surface of several cm^2 for each contact location
 - Several screw connections
 - Short, finely stranded, braided copper wires with cross-sections $\geq 95 \text{ mm}^2 / 000 (3/0) (-2) \text{ AWG}$
- Install a shield support for shielded cables that are routed out of the control cabinet.
- Connect the PE bar and the shield support to the control cabinet frame through a large surface area to establish a good electrical connection.
- Mount the control cabinet components on a bare metal mounting plate.
- Connect the mounting plate to the control cabinet frame and PE bar and shield support through a large surface area to establish a good electrical connection.
- For screw connections onto painted or anodized surfaces, establish a good conductive contact using one of the following methods:
 - Use special (serrated) contact washers that cut through the painted or anodized surface.
 - Remove the insulating coating at the contact locations.

Measures required for several control cabinets

- Install equipotential bonding for all control cabinets.
- Screw the frames of the control cabinets together at several locations through a large surface area using serrated washers to establish a good electrical connection.
- In plants and systems where the control cabinets are lined up next to one another, and which are installed in two groups back to back, connect the PE bars of the two cabinet groups at as many locations as possible.

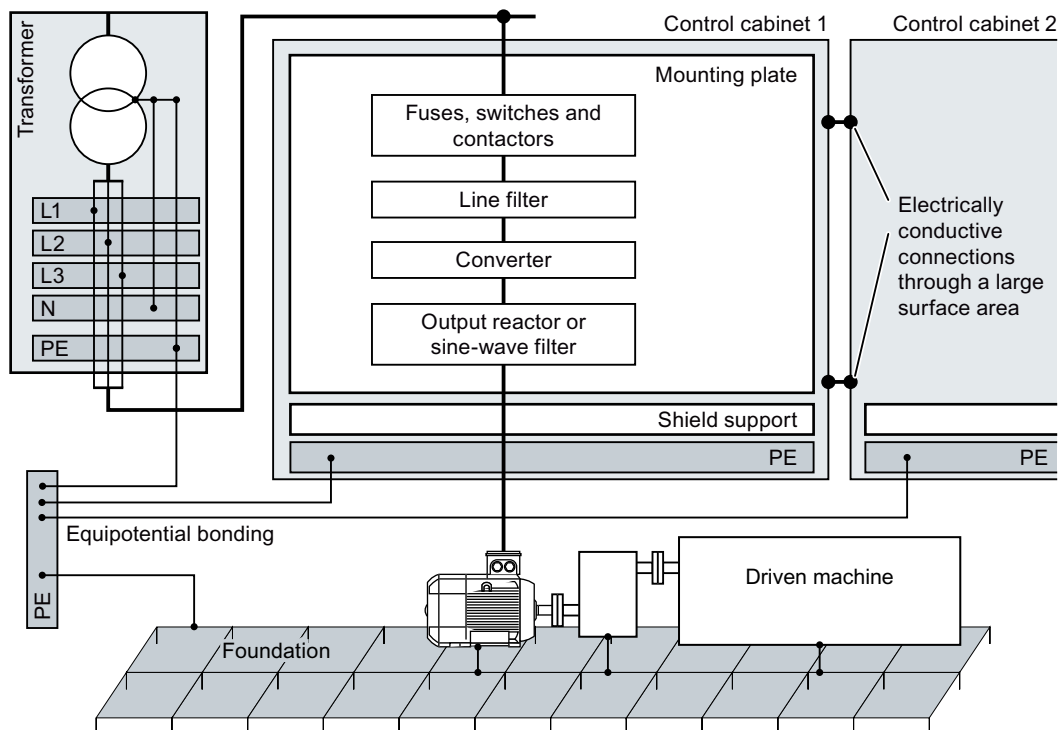

Figure 4-3 Grounding and high-frequency equipotential bonding measures in the control cabinet and in the plant/system

Further information

Additional information about EMC-compliant installation is available in the Internet:

 EMC installation guideline (<http://support.automation.siemens.com/WW/view/en/60612658>)

4.2.2 Cables

Cables with a high level of interference and cables with a low level of interference are connected to the converter:

- Cables with a high level of interference:
 - Cable between the line filter and converter
 - Motor cable
 - Cable at the converter DC link connection
 - Cable between the converter and braking resistor
- Cables with a low level of interference:
 - Cable between the line and line filter
 - Signal and data cables

Cable routing inside the cabinet

- Route the power cables with a high level of interference so that there is a minimum clearance of 25 cm to cables with a low level of interference.
If the minimum clearance of 25 cm is not possible, insert separating metal sheets between the cables with a high level of interference and cables with a low level of interference.
Connect these separating metal sheets to the mounting plate to establish a good electrical connection.
- Cables with a high level of interference and cables with a low level of interference may only cross over at right angles:
- Keep all of the cables as short as possible.
- Route all of the cables close to the mounting plates or cabinet frames.
- Route signal and data cables - as well as the associated equipotential bonding cables - parallel and close to one another.
- Twist incoming and outgoing unshielded individual conductors.
Alternatively, you can route incoming and outgoing conductors in parallel, but close to one another.
- Ground any unused conductors of signal and data cables at both ends.
- Signal and data cables must only enter the cabinet from one side, e.g. from below.
- Use shielded cables for the following connections:
 - Cable between the converter and line filter
 - Cable between the converter and output reactor or sine-wave filter

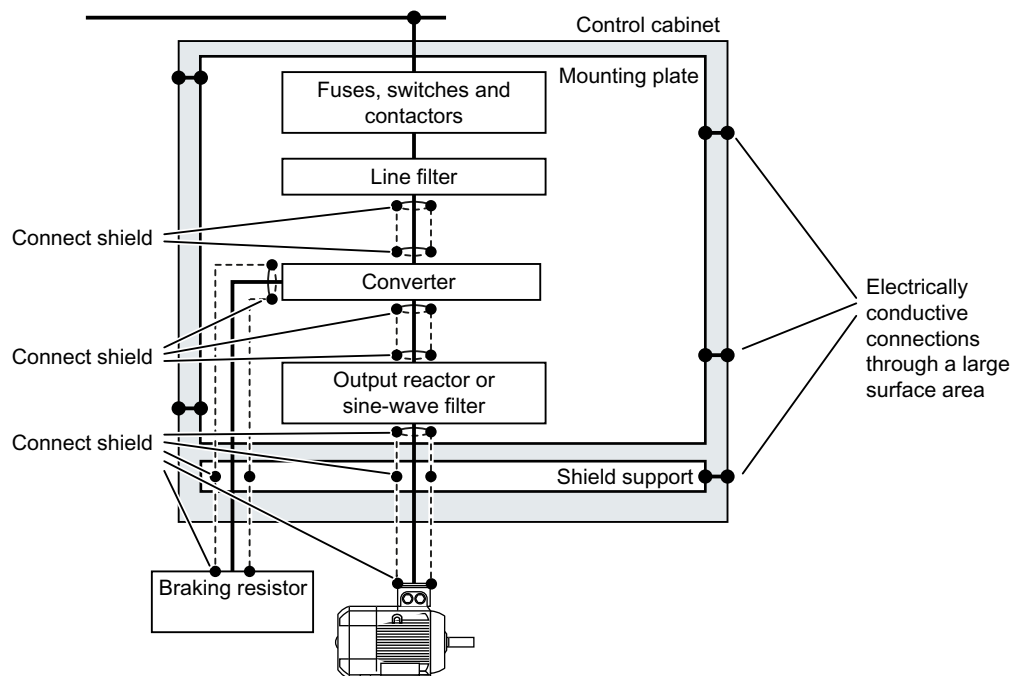

Figure 4-4 Routing converter cables inside and outside a control cabinet

Routing cables outside the control cabinet

- Maintain a minimum clearance of 25 cm between cables with a high level of interference and cables with a low level of interference.
- Use shielded cables for the following connections:
 - Converter motor cable
 - Cable between the converter and braking resistor
 - Signal and data cables
- Connect the motor cable shield to the motor enclosure using a PG gland that establishes a good electrical connection.

Requirements relating to shielded cables

- Use cables with finely-stranded, braided shields.
- Connect the shield to at least one end of the cable.

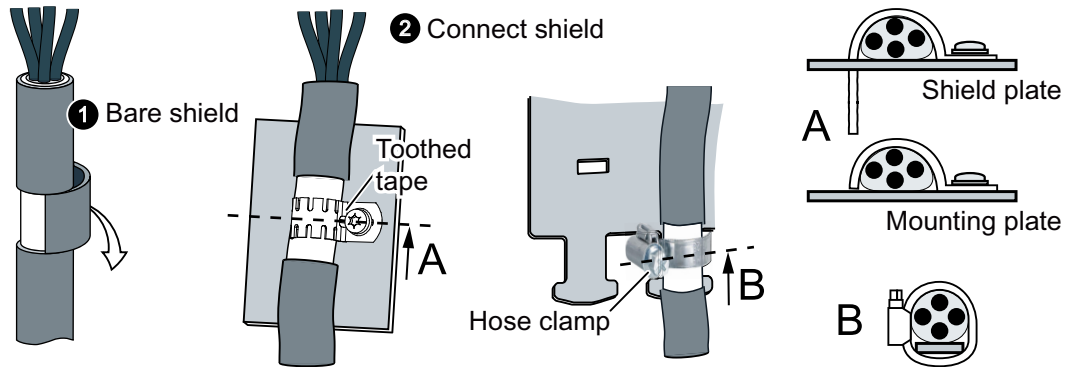

Figure 4-5 Examples for EMC-compliant shield support

- Attach the shield to the shield support directly after the cable enters the cabinet.
- Do not interrupt the shield.
- Only use metallic or metallized plug connectors for shielded data cables.

4.2.3 Electromechanical components

Surge voltage protection circuit

- Connect surge voltage protection circuits to the following components:
 - Coils of contactors
 - Relays
 - Solenoid valves
 - Motor holding brakes
- Connect the surge voltage protection circuit directly at the coil.
- Use RC elements or varistors for AC-operated coils and freewheeling diodes or varistors for DC-operated coils.

4.3 Installing reactors, filters and braking resistors

Installing reactors, filters and braking resistors

The following supplementary components may be required depending on the Power Modules and the particular application:

- Line reactors
- Filter
- Braking resistors
- Brake Relay

Installing these components is described in the documentation provided.

4.4 Installing Power Modules

4.4.1 Basic installation rules

Protection against the spread of fire

The built-in units may be operated only in closed housings or in higher-level control cabinets with closed protective covers, and when all of the protective devices are used. The installation of the built-in units in a metal control cabinet or protection with another equivalent measure must prevent the spread of fire and emissions outside the control cabinet.

Wall mounting units may be operated outside the control cabinet.

Protection against condensation or electrically conductive contamination

Protect the converter, e.g. by installing it in a control cabinet with degree of protection IP54 according to IEC 60529 or NEMA 12. Further measures may be necessary for particularly critical operating conditions.

If condensation or conductive pollution can be excluded at the installation site, a lower degree of control cabinet protection may be permitted.

Installing

Rules for admissible mounting:

- Only mount the Power Module in a vertical position with the motor connectors at the bottom.

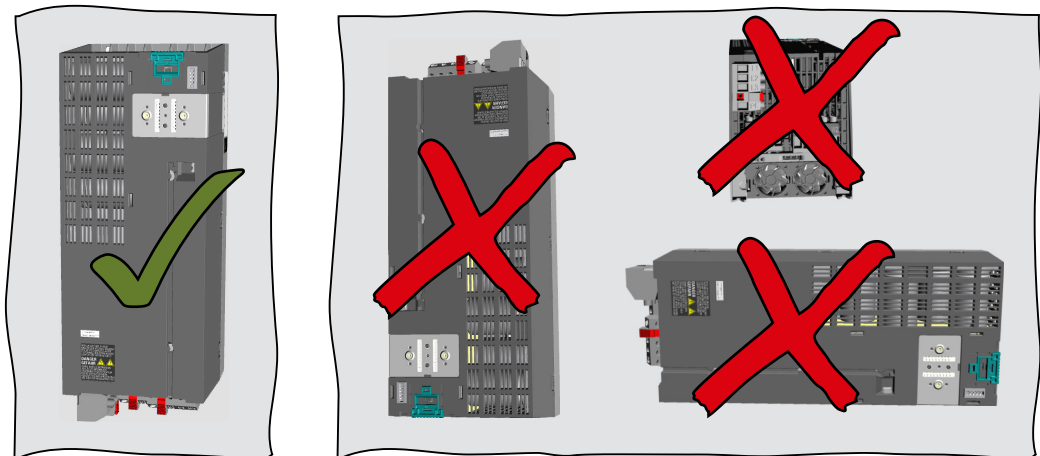

- Maintain the minimum clearances to other components.
- Use the specified installation parts and components.
- Comply with the specified torques.

4.4.2 Dimensioned drawings, drilling dimensions for the PM240-2 Power Module, IP20

The following dimension drawings and drilling patterns are not to scale.

Frame sizes FSA ... FSC

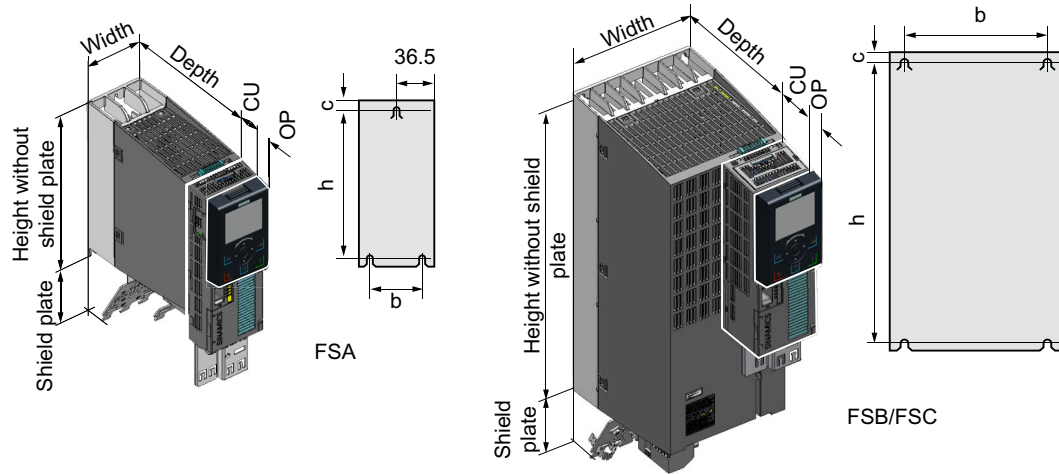

Table 4-1 Dimensions

Frame size	Width [mm]	Height [mm]		Mounting depth in the cabinet with Control Unit (CU) [mm] ³⁾		Mounting depth with CUA20 ²⁾ [mm]
		without shield plate	with shield plate	without OP	with OP ¹⁾	
FSA	73	196	276	206	217	194
FSB	100	292	370	206	217	194
FSC	140	355	432	206	217	194

- 1) BOP-2, IOP-2 or blanking cover
- 2) Control Unit Adapter Kit CUA20
- 3) Depth of Power Module without Control Unit: 165 mm

Table 4-2 Drilling dimensions, cooling clearances and fixing

Frame size	Drilling dimensions [mm]			Cooling air clearances [mm] ¹⁾			Fixing/torque [Nm]
	h	b	c	Top	Bottom	Front	
FSA	186	62.3	6	80	100	100	3 x M4 / 2.5
FSB	281	80	6	80	100	100	4 x M4 / 2.5
FSC	343	120	6	80	100	100	4 x M5 / 3.5

- 1) The Power Module is designed for mounting without any lateral cooling air clearance. For tolerance reasons, we recommend a lateral clearance of approx. 1 mm

Frame sizes FSD ... FSF

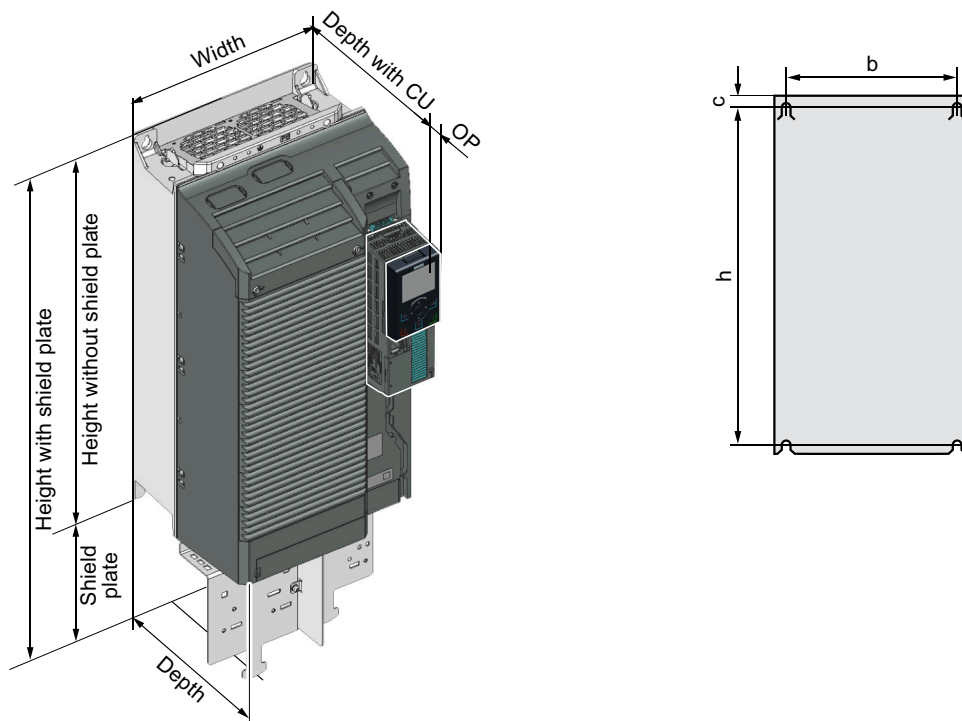

Table 4-3 Dimensions

Frame size	Width [mm]	Height [mm]		Mounting depth in the cabinet with Control Unit (CU) [mm] ³⁾		Mounting depth with CUA20 ²⁾ [mm]
		without shield plate	with shield plate	without OP	with OP ¹⁾	
FSD	200	472	624	237	246	237
FSE	275	551	728	237	246	237
FSF	305	709	965	357	366	357
FSG	305	1000	1286	357	366	357

1) BOP-2, IOP-2 or blanking cover

2) Control Unit Adapter Kit CUA20

3) Depth of Power Module without Control Unit: FSD, FSE 237 mm, FSF, FSG 357 mm

Table 4-4 Drilling dimensions, cooling clearances and fixing

Frame size	Drilling dimensions [mm]			Cooling air clearances [mm] ¹⁾			Fixing/torque [Nm]
	h	b	c	Top ²⁾	Bottom ²⁾	Front	
FSD	430	170	7	300	350	100	4 x M5 / 6.0
FSE	509	230	8.5	300	350	100	4 x M6 / 10

Frame size	Drilling dimensions [mm]			Cooling air clearances [mm] ¹⁾			Fixing/torque [Nm]
	h	b	c	Top ²⁾	Bottom ²⁾	Front	
FSF	680	270	13	300	350	100	4 x M8 / 25
FSG	970.5	265	15	300	350	100	4 x M8 / 25

- 1) The Power Module is designed for mounting without any lateral cooling air clearance. For tolerance reasons, we recommend a lateral clearance of approx. 1 mm
- 2) The top and bottom cooling air clearances refer to the Power Module without shield plate

4.4.3 Dimension drawings, drilling dimensions for PM240P-2 Power Modules, IP20

The following dimension drawings and drilling patterns are not to scale.

Frame sizes FSD ... FSF

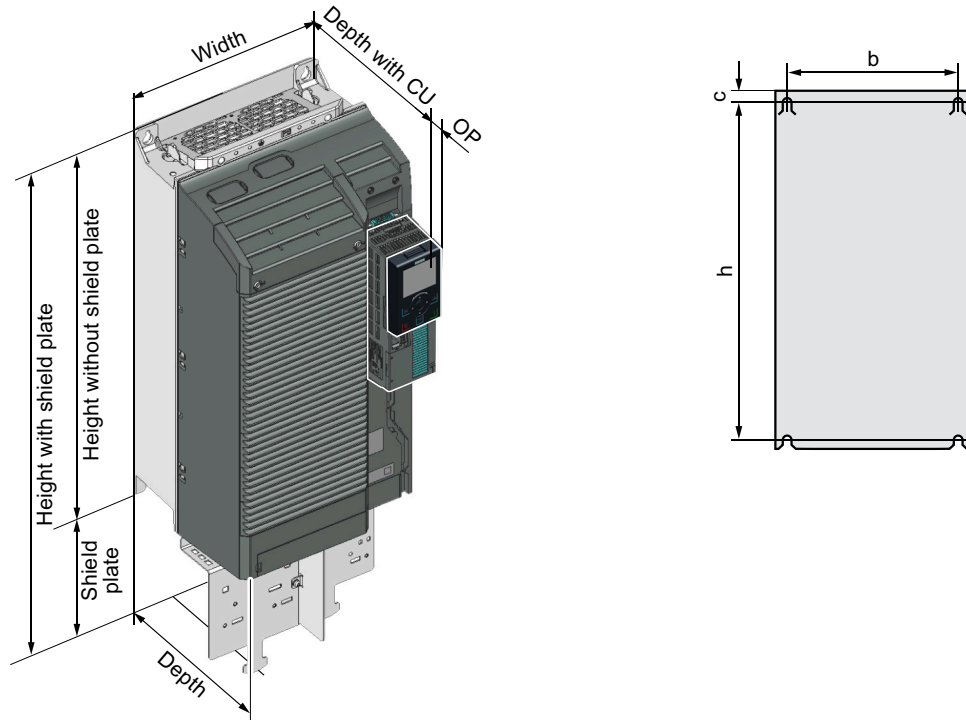

Table 4-5 Dimensions depend on the operator panel (OP) that is inserted¹⁾

Frame size	Width [mm]	Height [mm]		Mounting depth in the cabinet with Control Unit (CU) [mm] ²⁾	
		without shield plate	with shield plate	without OP	with OP ¹⁾
FSD	200	472	624	237	246
FSE	275	551	728	237	246
FSF	305	709	965	357	366

¹⁾ BOP-2, IOP-2 or blanking cover

²⁾ Power Module depth without Control Unit: FSD, FSE 237 mm, FSF 357 mm

Table 4-6 Drilling dimensions, cooling clearances and fixing

Frame size	Drilling dimensions [mm]			Cooling air clearances [mm] ¹⁾			Fixing/torque [Nm]
	h	b	c	Top	Bottom	Front	
FSD	430	170	7	300	350	100	4 x M5 / 6.0
FSE	509	230	8.5	300	350	100	4 x M6 / 10
FSF	680	270	13	300	350	100	4 x M8 / 25

¹⁾ The Power Module is designed for mounting without any lateral cooling air clearance. For tolerance reasons, we recommend a lateral clearance of approx. 1 mm

4.4.4 Dimension drawings, drilling dimensions for the PM230 Power Module, IP20

The following dimension drawings and drilling patterns are not to scale.

Frame sizes FSA ... FSC

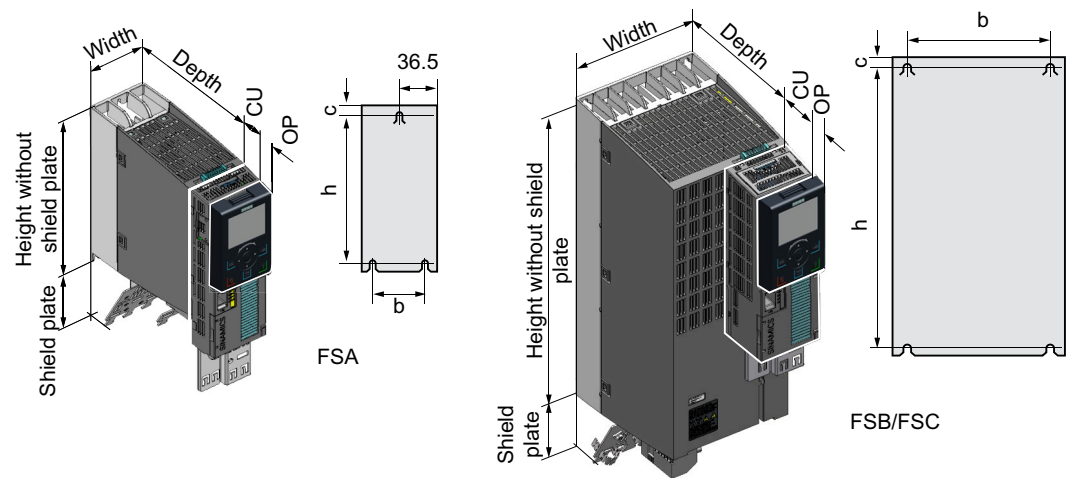

Table 4-7 Dimensions depend on the operator panel (OP) that is inserted

Frame size	Width [mm]	Height [mm]		Mounting depth in the cabinet with Control Unit (CU) [mm] ²⁾	
		without shield plate	with shield plate	without OP	with OP ¹⁾
FSA	73	196	276	224	235
FSB	100	292	370	224	235
FSC	140	355	432	224	235

¹⁾ BOP-2, IOP-2 or blanking cover

²⁾ Power Module depth without Control Unit: 165 mm

Table 4-8 Drilling dimensions, cooling clearances and fixing

Frame size	Drilling dimensions [mm]			Cooling air clearances [mm] ¹⁾			Fixing/torque [Nm]
	b	h	c	Top	Bottom	Front	
FSA	62.3	186	6	80	100	---	2 x M4 / 2.5
FSB	80	281	6	80	100	---	4 x M4 / 2.5
FSC	120	343	6	80	100	---	4 x M5 / 3.0

¹⁾ You can mount the Power Modules without any lateral cooling air clearance. For tolerance reasons, we recommend a lateral clearance of approx. 1 mm

Frame sizes FSD ... FSF

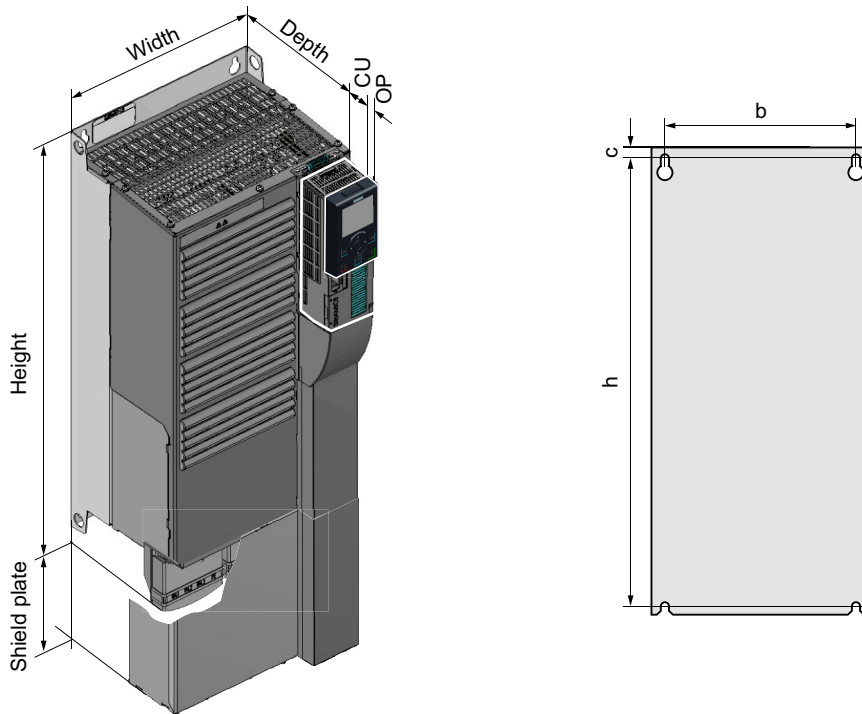

Table 4-9 Dimensions depend on the operator panel (OP) that is inserted ¹⁾

Frame size	Width [mm]	Height [mm]		Mounting depth in the cabinet with Control Unit (CU) [mm] ²⁾	
		without shield plate	with shield plate	without OP	with OP ¹⁾
FSD without filter	275	419	542	263	274
FSD with filter	275	512	635	263	274
FSE without filter	275	499	622	263	274
FSE with filter	275	635	758	263	274
FSF without filter	350	634	792	375	386
FSF with filter	350	934	1092	375	386

¹⁾ BOP-2, IOP-2 or blanking cover

²⁾ Power Module depth without Control Unit: FSD, FSE 237 mm, FSF 357 mm

Table 4-10 Drilling dimensions, cooling clearances and fixing

Frame size	Drilling dimensions [mm]			Cooling air clearances [mm] ¹⁾			Fixing/torque [Nm]
	b	h	c	Top	Bottom	Front	
FSD without filter	235	325	11	300	300	100	4 x M6 / 6.0
FSD with filter	235	419	11	300	300	100	4 x M6 / 6.0
FSE without filter	235	405	11	300	300	100	4 x M6 / 10
FSE with filter	235	451	11	300	300	100	4 x M6 / 10
FSF without filter	300	598	11	350	350	100	4 x M8 / 13
FSF with filter	300	899	11	350	350	100	4 x M8 / 13

¹⁾ You can mount the Power Modules without any lateral cooling air clearance. For tolerance reasons, we recommend a lateral clearance of approx. 1 mm

4.4.5 Dimension drawings, drilling dimensions for PM230 and PM240-2 Power Modules utilizing push-through technology

The following dimension drawings and drilling patterns are not to scale.

Frame sizes FSA ... FSC

Panel thickness of the control cabinet ≤ 3.5 mm

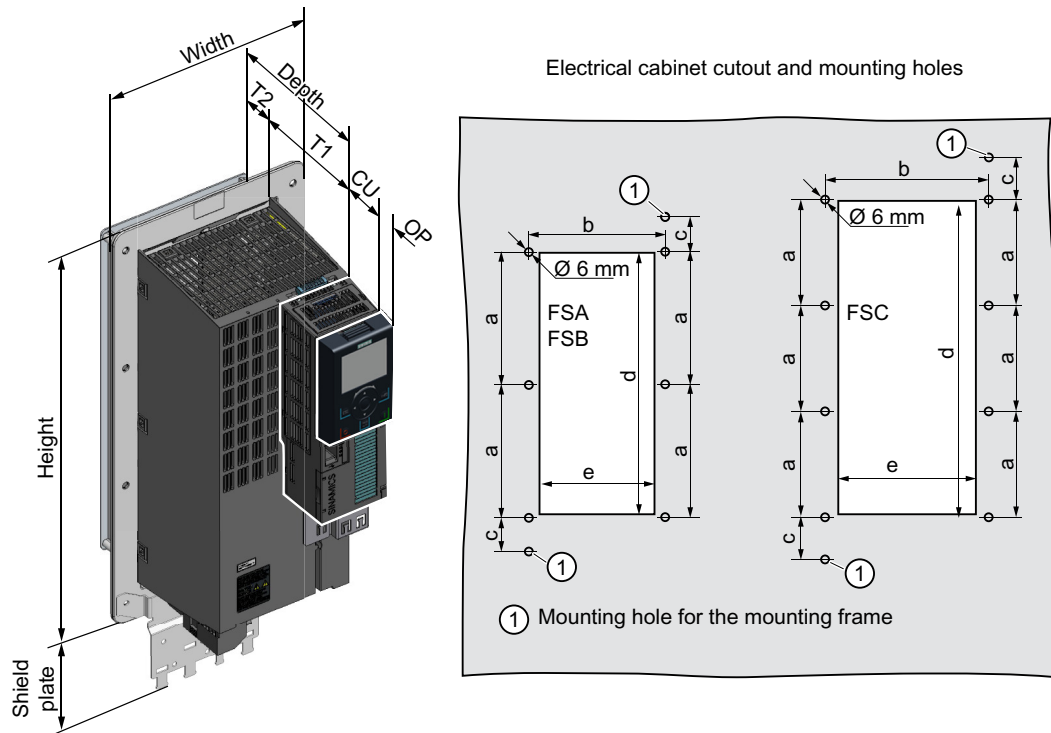

Figure 4-6 Dimension drawing and drilling dimensions for frame sizes FSA ... FSC

Table 4-11 Dimensions depend on the operator panel (OP) that is inserted

Frame size	Width [mm]	Height [mm]		Mounting depth in the cabinet with Control Unit (CU) [mm]	
		without shield plate	with shield plate	without OP	with OP ¹⁾
FSA	126	238	322	159	170
FSB	154	345	430	159	170
FSC	200	411	500	159	170

¹⁾ BOP-2, IOP-2 or blanking cover

Table 4-12 Cooling air clearances and additional dimensions

Frame size	Power Module depth [mm]	T1	T2	Cooling air clearances [mm] ¹⁾		
				Top	Bottom	Front
FSA ... FSC	171	118	53	80	100	100

¹⁾ The Power Module is designed for mounting without any lateral cooling air clearance. For tolerance reasons, we recommend a lateral clearance of 1 mm

Table 4-13 Electrical cabinet cutout and mounting holes

Frame size	Control cabinet cutout [mm]					Fixing/torque [Nm]
	a	b	c	d	e	
FSA	103	106	27	198	88	8 × M5 / 3.5
FSB	148	134	34.5	304	116	8 × M5 / 3.5
FSC	123	174	30.5	365	156	10 × M5 / 3.5

Frame sizes FSD ... FSF

Panel thickness of the control cabinet ≤ 3.5 mm

Cutouts of the control cabinet and mounting holes

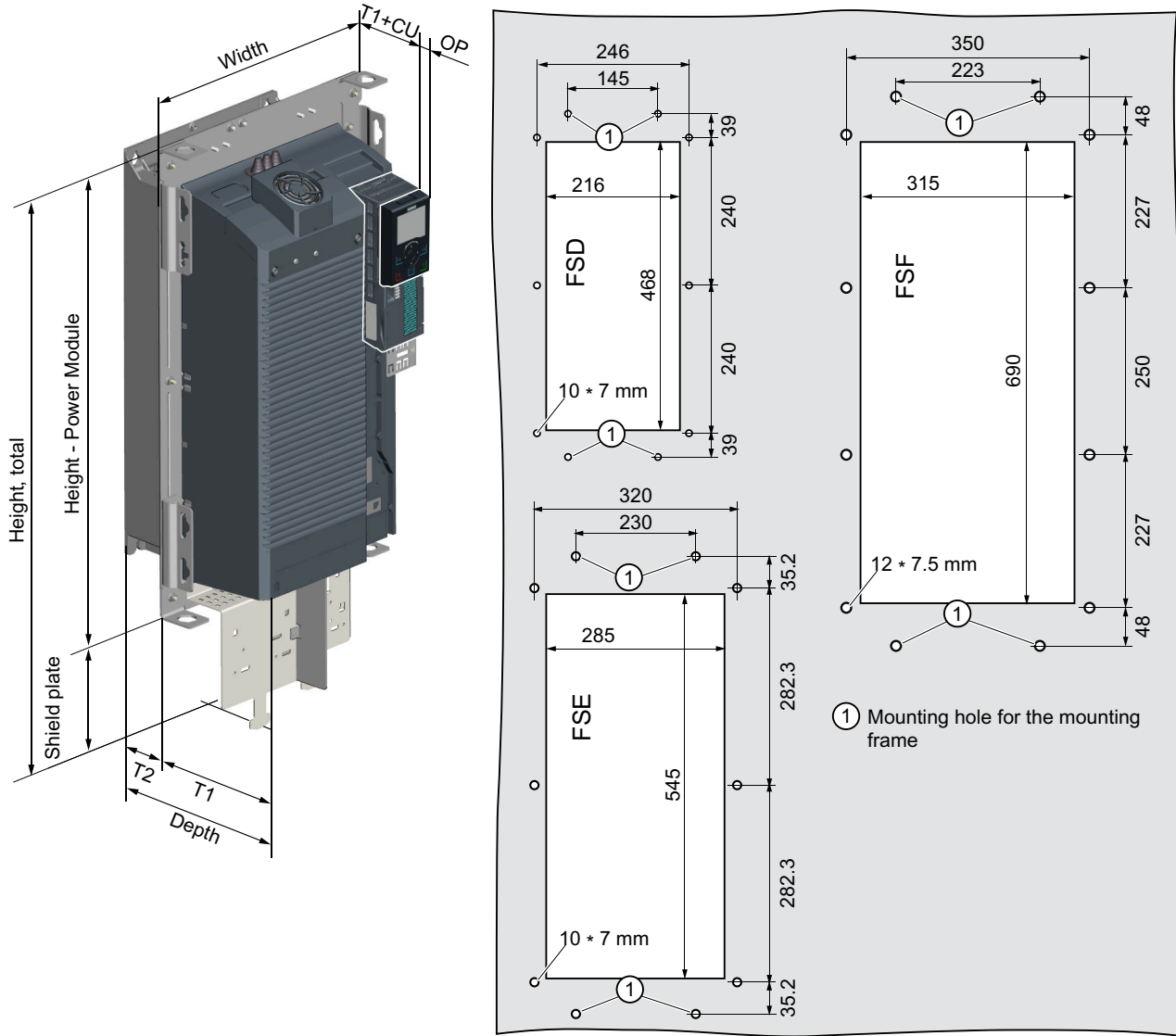

Figure 4-7 Dimension drawing and drilling dimensions for frame sizes FSD ... FSF

Table 4-14 Dimensions depend on the operator panel (OP) that is inserted¹⁾

Frame size	Width [mm]	Height [mm]		Mounting depth in the cabinet with Control Unit (CU) [mm]	
		without shield plate	with shield plate	without OP	with OP ¹⁾
FSD	275	517	650	141	148
FSE	354	615	772	141	148
FSF	384	785	1021	177.5	186

¹⁾ BOP-2, IOP-2 or blanking cover

Table 4-15 Cooling air clearances and additional dimensions

Frame size	Power Module depth [mm]	T1	T2	Cooling air clearances [mm]		
				Top	Bottom	Front
FSD, FSE	237	141	97.5	350	350	29
FSF	358	177.5	180.5	80	100	100

Table 4-16 Mounting

Frame size	Fixing/torque [Nm]
FSD, FSE	10 × M5 / 3.5
FSF	12 × M6 / 5.9

4.4.6 Dimensioned drawings, drilling dimensions for the PM250 Power Module

The following dimension drawings and drilling patterns are not to scale.

Frame size FSC

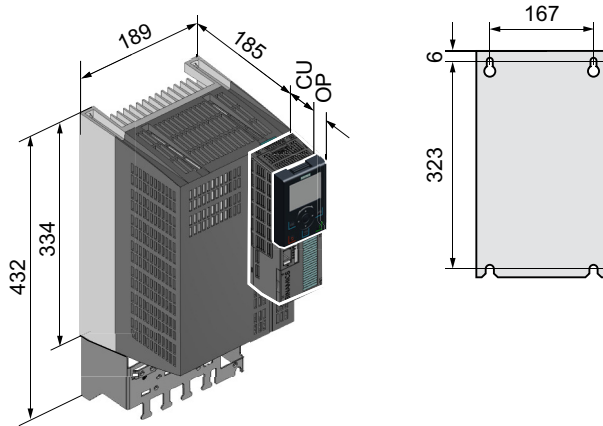

Table 4-17 Dimensions depend on the operator panel (OP) that is inserted

Frame size	Mounting depth in the cabinet with Control Unit (CU) [mm]	
	without OP	with OP ¹⁾
FSC	206	217

¹⁾ BOP-2, IOP-2 or blanking cover

Table 4-18 Cooling air clearances and fastening

Frame size	Cooling air clearances [mm] ¹⁾			Fixing/torque [Nm]
	Top	Bottom	Front	
FSC	125	125	65	4 x M5 / 3

¹⁾ You can mount the Power Modules without any lateral cooling air clearance. For tolerance reasons, we recommend a lateral clearance of approx. 1 mm

Frame sizes FSD ... FSF

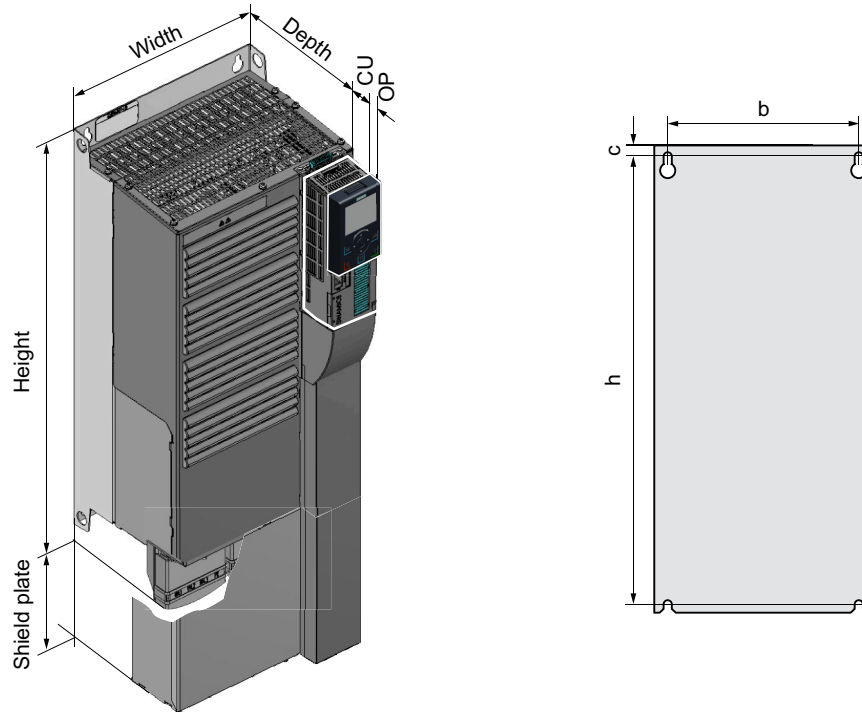
Table 4-19 Dimensions depend on the operator panel (OP) that is inserted¹⁾

Frame size	Width [mm]	Height [mm]		Mounting depth in the cabinet with Control Unit (CU) [mm] ²⁾	
		without shield plate	with shield plate	without OP	with OP ¹⁾
FSD without filter	275	419	542	245	256
FSD with filter	275	512	635	245	256
FSE without filter	275	499	622	245	256
FSE with filter	275	635	758	245	256
FSF without filter	350	634	792	357	368
FSF with filter	350	934	1092	357	368

¹⁾ BOP-2, IOP-2 or blanking cover

²⁾ Power Module depth without Control Unit: FSD, FSE 204 mm, FSF 316 mm

Table 4-20 Drilling dimensions, cooling clearances and fixing

Frame size	Drilling dimensions [mm]			Cooling air clearances [mm] ¹⁾			Fixing/torque [Nm]
	b	h	c	Top	Bottom	Front	
FSD without filter	235	325	11	300	300	65	4 x M6 / 6
FSD with filter	235	419	11	300	300	65	4 x M6 / 6
FSE without filter	235	405	11	300	300	65	4 x M6 / 6
FSE with filter	235	541	11	300	300	65	4 x M6 / 6
FSF without filter	300	598	11	350	350	65	4 x M8 / 13
FSF with filter	300	898	11	350	350	65	4 x M8 / 13

¹⁾ You can mount the Power Modules without any lateral cooling air clearance. For tolerance reasons, we recommend a lateral clearance of approx. 1 mm

4.5 Connecting the line supply and motor



WARNING

Electric shock when the motor terminal box is open

As soon as the converter is connected to the line supply, the motor connections of the converter may carry dangerous voltages. When the motor is connected to the converter, there is danger to life through contact with the motor terminals if the motor terminal box is open.

- Close the motor terminal box before connecting the converter to the line supply.

Note

Fault protection when insulation fails in the motor circuit at the output side

In case of insulation failure in the motor circuit, the overcurrent trip of the converter meets the requirements of IEC 60364-4-41:2005/AMD1:2017 Section 411 and Annex D for protection against electric shock.

- Observe the installation specifications for this converter.
- Ensure the continuity of the protective conductor.
- Observe the applicable installation standards.

4.5.1 Permissible line supplies

Restrictions for installation altitudes above 2000 m

Above an installation altitude of 2000 m, the permissible line supplies are restricted.



Restrictions for special ambient conditions (Page 544)

Screw for functional grounding on the converter, frame size FSG

If you wish to use the converters with integrated C3 line filter, please note the information in the sections "TN line system", "TT line system" and "IT system" below.

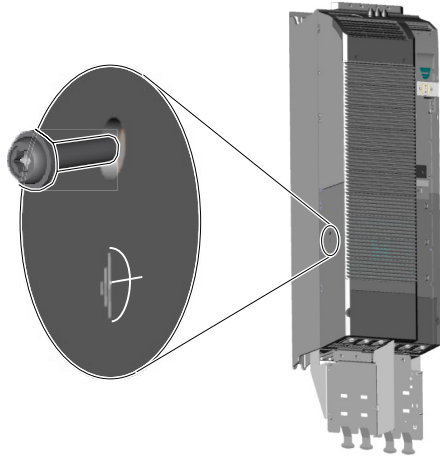

Figure 4-8 Remove screw for functional grounding

4.5.1.1 TN line system

A TN system transfers the PE protective conductor to the installed plant or system using a cable.

Generally, in a TN system the neutral point is grounded. There are versions of a TN system with a grounded line conductor, e.g. with grounded L1.

A TN system can transfer the neutral conductor N and the PE protective conductor either separately or combined.

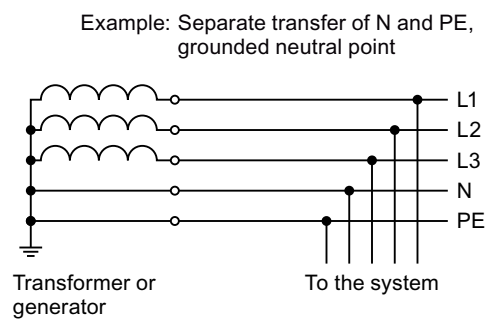

Converter connected to a TN system

- Converters with integrated line filter:
 - Operation on TN line systems with grounded neutral point permissible.
 - Operation on TN line systems with grounded line conductor not permissible.

Note

Special feature of FSG converters

FSG converters with integrated C3 line filter can be operated in TN line systems ≤ 600 V with a grounded line conductor if you remove the screw for functional grounding.



Figure 4-8 Remove screw for functional grounding (Page 84)

If you remove the screw for functional grounding, the EMC properties deteriorate and the requirements of Class C3 are no longer met.

- Converters with external line filter:
 - Operation on TN line systems with grounded neutral point permissible.
 - Operation on TN line systems with grounded line conductor not permissible.
- Converters without line filter:
 - Operation on all TN line systems ≤ 600 V permissible
 - Operation on TN line systems > 600 V and grounded neutral point permissible.
 - Operation on TN line systems > 600 V and grounded line conductor not permissible.

4.5.1.2 TT line system

In a TT line system, the transformer grounding and the installation grounding are independent of one another.

There are TT line supplies where the neutral conductor N is either transferred – or not.

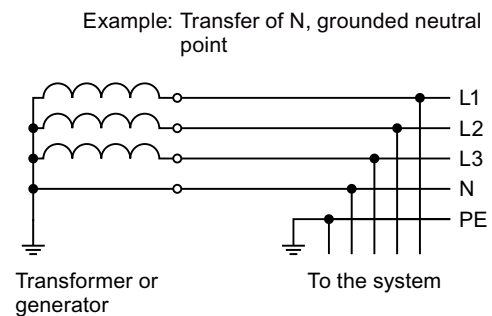

Note

Operation in IEC or UL systems

For installations in compliance with IEC, operation on TT line systems is permissible. For installations in compliance with UL, operation on TT line systems is not permissible.

Converters connected to a TT system

- Converters with integrated line filter:
 - Operation on TT line systems with grounded neutral point permissible.
 - Operation on TT line systems without grounded neutral point not permissible.

Note

Special feature of FSG converters

FSG converters with integrated C3 line filter can be operated in TT line systems without a grounded neutral point if you remove the screw for functional grounding.

 Figure 4-8 Remove screw for functional grounding (Page 84)

If you remove the screw for functional grounding, the EMC properties deteriorate and the requirements of Class C3 are no longer met.

- Converters with external line filter:
 - Operation on TT line systems with grounded neutral point permissible.
 - Operation on TT line systems without grounded neutral point not permissible.
- Converters without line filter:
 - Operation on all TT line systems permissible.

4.5.1.3 IT system

In an IT line system, all of the conductors are insulated with respect to the PE protective conductor – or connected to the PE protective conductor through an impedance.

There are IT systems with and without transfer of the neutral conductor N.

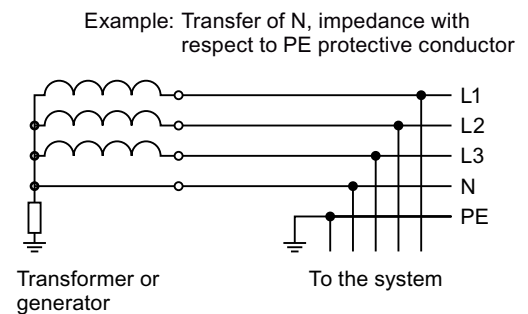

Note

Behavior of the converter when a ground fault occurs

If the converter is to remain operable even when a ground fault occurs at the converter output, you must install an output reactor. This prevents an overcurrent trip or damage to the drive.

Converters connected to an IT system

- Converters with integrated line filter:
 - Operation on IT line systems not permissible.

Note

Special feature of FSG converters

FSG converters with integrated C3 line filter can be operated in IT line systems if you remove the screw for functional grounding.

 Figure 4-8 Remove screw for functional grounding (Page 84)

If you remove the screw for functional grounding, the EMC properties deteriorate and the requirements of Class C3 are no longer met.

- Converters without line filter:
 - Operation on all IT line systems permissible.

Note

690 V converters: Output reactors for frame sizes FSD and FSE

An output reactor is required for 690 V reactors in frame sizes FSD and FSE.

4.5.2 Requirements for the protective conductor

Overview

A high leakage current flows through the protective conductor in converter operation. The protective conductor of the converter must not be interrupted for safe touch protection in converter operation.

This primarily results in requirements for the minimum conductor cross-section of the protective conductor.

No restriction applies to the length of the protective conductor for touch protection. However, short protective conductors are advantageous for EMC-compliant installation.

Description



! WARNING

Electric shock due to interrupted protective conductor

The drive components conduct a high leakage current via the protective conductor. Touching conductive parts when the protective conductor is interrupted can result in death or serious injury.

- Comply with the requirements for the protective conductor.

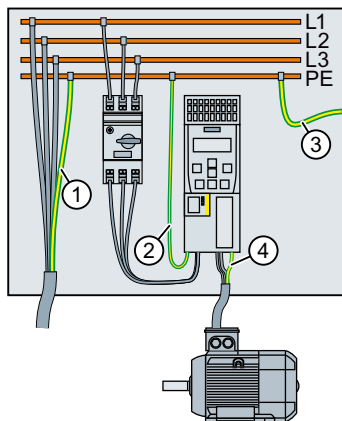

- ① Protective conductor for line feeder cables
- ② Protective conductor for converter line feeder cables
- ③ Protective conductor between PE and the control cabinet
- ④ Protective conductor for motor feeder cables

The minimum cross-section of the protective conductor ① ... ④ depends on the cross-section of the line or motor feeder cable:

- Line or motor feeder cable $\leq 16 \text{ mm}^2$
⇒ Minimum cross-section of the protective conductor = cross-section of the line or motor feeder cable
- $16 \text{ mm}^2 < \text{line or motor feeder cable} \leq 35 \text{ mm}^2$
⇒ Minimum cross-section of the protective conductor = 16 mm^2
- Line or motor feeder cable $> 35 \text{ mm}^2$
⇒ Minimum cross-section of the protective conductor = $\frac{1}{2}$ cross-section of the line or motor feeder cable

Additional requirements placed on the protective conductor ① according to IEC 60204-1:

- For permanent connection, the protective conductor must fulfill at least one of the following conditions:
 - The protective conductor is routed so that it is protected against damage along its complete length.
Cables routed inside switch cabinets or enclosed machine housings are considered to be adequately protected against mechanical damage.
 - As a conductor of a multi-conductor cable, the protective conductor has a cross-section $\geq 2.5 \text{ mm}^2 \text{ Cu}$.
 - For an individual conductor, the protective conductor has a cross-section $\geq 10 \text{ mm}^2 \text{ Cu}$.
 - The protective conductor consists of 2 individual conductors with the same cross-section.
- When connecting a multi-core cable using an industrial plug connector according to EN 60309, the protective conductor must have a cross-section of $\geq 2.5 \text{ mm}^2 \text{ Cu}$.
- Observe the local regulations for protective conductors subject to a high leakage current at the installation site.

4.5.3 Connecting a converter with the PM240-2 Power Module

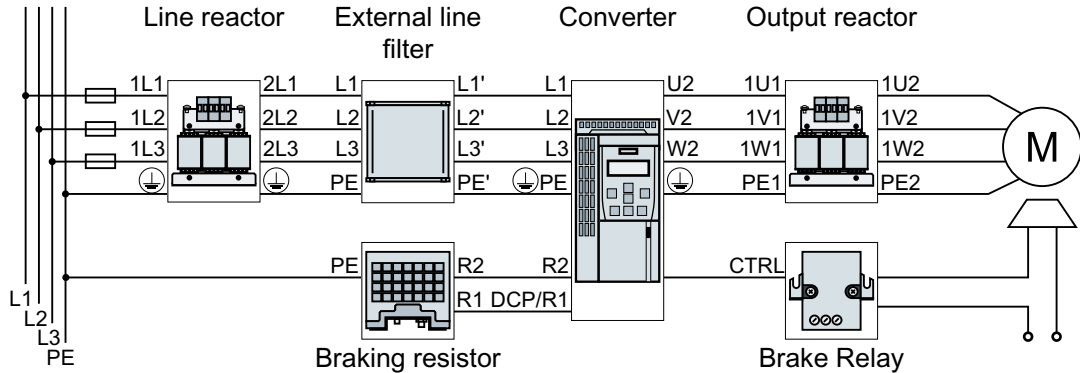

Figure 4-9 Connection of the PM240-2 Power Module, 3 AC, FSA ... FSC

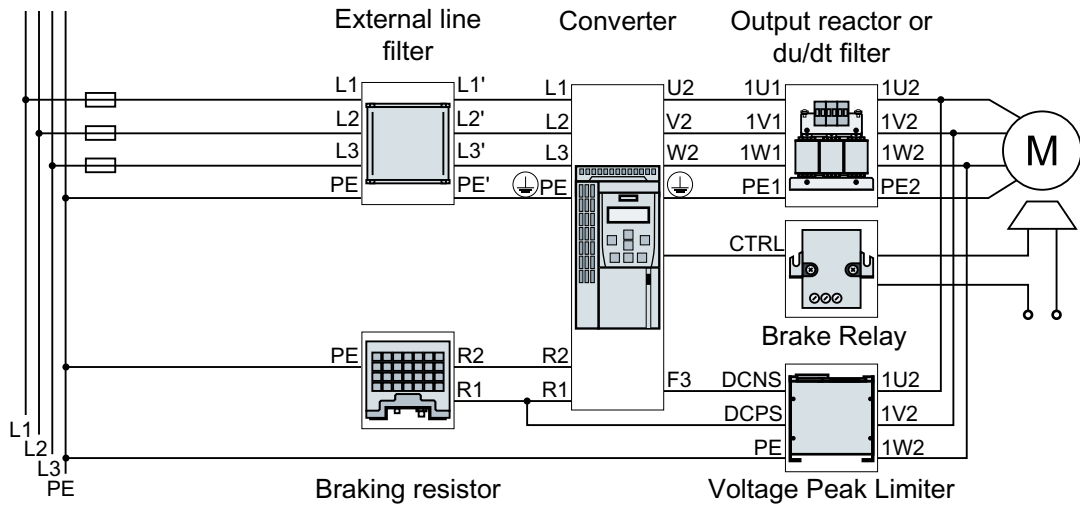

Figure 4-10 Connection of the PM240-2 Power Module, 3 AC, FSD ... FSF

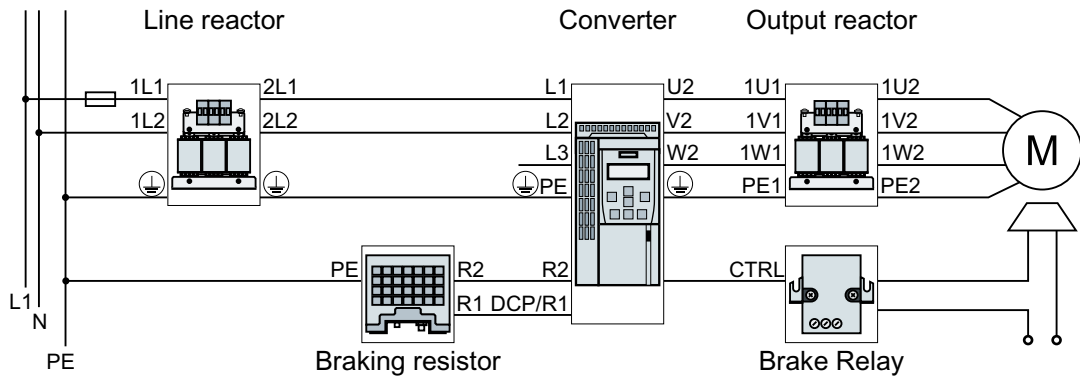

Figure 4-11 Connection of the PM240-2 Power Module, 1 AC 200 V, FSA ... FSC

4.5 Connecting the line supply and motor

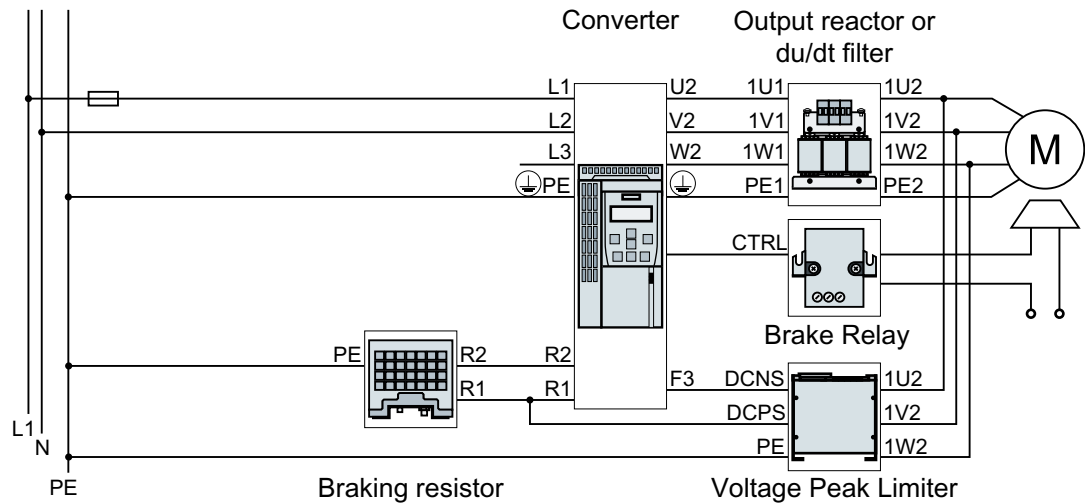





Figure 4-12 Connection of the PM240-2 Power Module, 1 AC 200 V, FSD ... FSF

Table 4-21 Connection, cross-section and tightening torque for PM240-2 Power Modules

Converter	Connection		Cross-section and tightening torque		Stripped insulation length
			Metric	Imperial	
FSA	Line system, motor and braking resistor		1.5 ... 2.5 mm ² , 0.5 Nm	16 ... 14 AWG, 4.5 lbf in	8 mm
FSB			1.5 ... 6 mm ² , 0.6 Nm	16 ... 10 AWG, 5.5 lbf in	8 mm
FSC			6 ... 16 mm ² , 1.3 Nm	10 ... 6 AWG, 12 lbf in	10 mm
FSD	Line and motor	Screw-type terminal	10 ... 35 mm ² , 2.5 ... 4.5 Nm	8 ... 2 AWG, 22 ... 40 lbf in	18 mm
	Braking resistor		2.5 ... 16 mm ² , 1.2 ... 1.5 Nm	20 ... 6 AWG, 10.5 ... 13 lbf in	10 mm
FSE	Line and motor	Screw-type terminal	25 ... 70 mm ² , 8 ... 10 Nm	6 ... 3/0 AWG, 71 ... 88.5 lbf in	25 mm
	Braking resistor		10 ... 35 mm ² , 2.5 ... 4.5 Nm	8 ... 2 AWG, 22 ... 40 lbf in	18 mm
FSF	Line and motor		35 ... 2 × 120 mm ² , 22 ... 25 Nm	1 AWG ... 2 × 4/0 AWG, 195 ... 221 lbf.in	/
	Braking resistor	Screw-type terminal	25 ¹⁾ ... 70 mm ² , 8 ... 10 Nm	6 ... 3/0 AWG, 71 ... 88.5 lbf in	25 mm
FSG	Line and motor		35 ... 2 × 185 mm ² , 22 ... 25 Nm	1 AWG ... 2 × 350 MCM, 195 ... 221 lbf.in	/
	Braking resistor	Screw-type terminal	25 ... 70 mm ² , 8 ... 10 Nm	6 ... 3/0 AWG, 71 ... 88.5 lbf in	25 mm

¹⁾ 16 mm² allowed during short-time duty

Connections for frame sizes FSA ... FSC

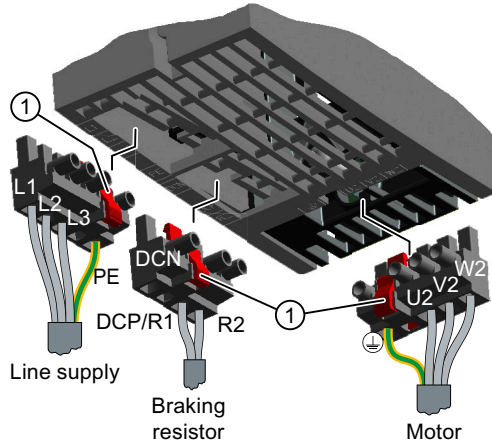

The Power Modules are equipped with withdrawable plug connectors that cannot be inadvertently interchanged.

To remove a plug connector, you must release it by pressing on the red lever.

① Release lever

Connections for frame sizes FSD ... FSG

You must remove the covers from the connections in order to connect the line supply, braking resistor and motor to the converter. In addition, for frame sizes FSD and FSE, release the two terminal screws on the connections for the motor and braking resistor, and remove the dummy plug.

For frame sizes FSF and FSG, you must breakout the openings from the connection cover for the power connections. Use side cutters or a fine saw blade.

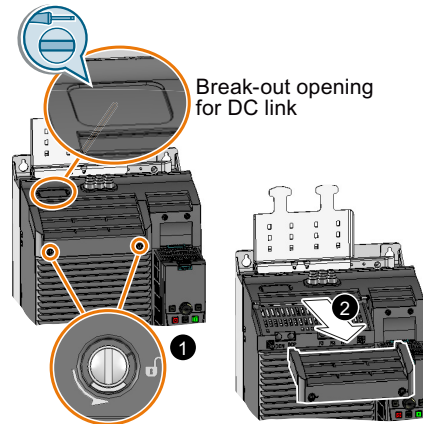

FSD ... FSG: Remove the top covers

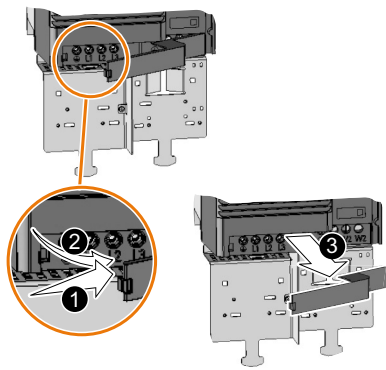

FSD, FSE: Remove the lower cover

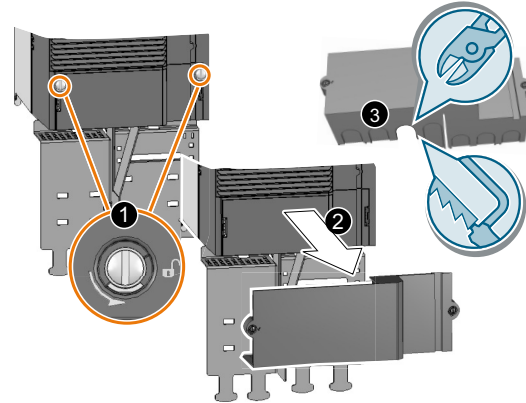

FSF, FSG: Remove the lower cover

4.5 Connecting the line supply and motor

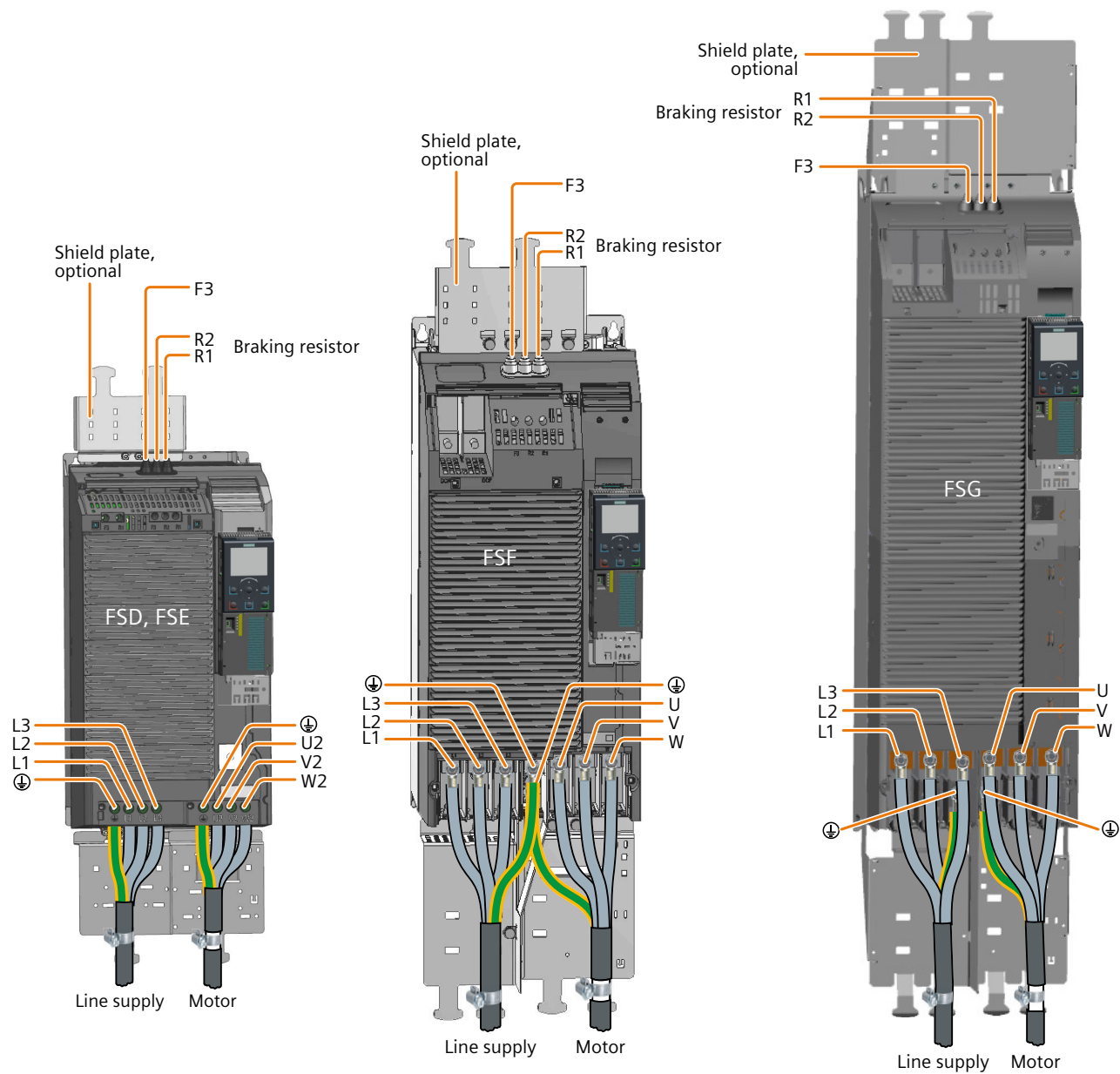

Figure 4-13 Connections for the line supply, motor and braking resistor

You must re-attach the connection covers in order to re-establish the touch protection of the converter after it has been connected up.

Additional information when connecting FSG converters

Note

Conductor cross-section 240 mm²

Cable lugs for M10 bolts according to SN71322 are suitable for cables with cross-sections of 35 mm² ... 185 mm² (1 AWG ... 2 × 350 MCM).

If you wish to establish connections with cables of 240 mm² (500 MCM), you must use narrow cable lugs, e.g. Klauke 12SG10. Other cable lugs are not suitable due to the narrow design of the converter.

The maximum permissible width of the cable lugs is 37 mm (1.45 inches).

Remove the plastic insulating plate as shown below to gain better access to the terminals for the power connections.

WARNING

Damage to converter as a result of operation without insulating plates

Without the insulating plates, voltage flashovers may occur between the phases.

- Replace the insulating plates after connecting the cables.

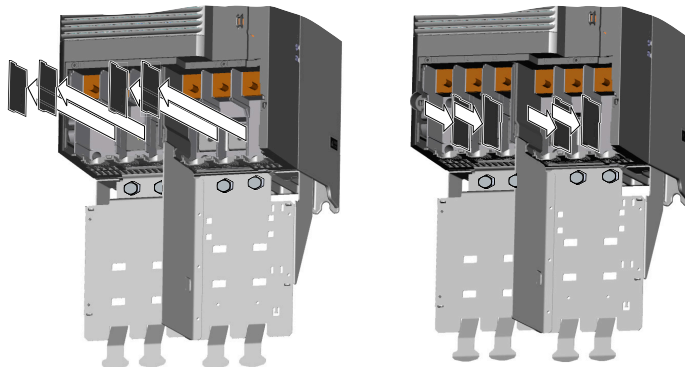

4.5.4 Connecting the converter with the PM230 Power Module

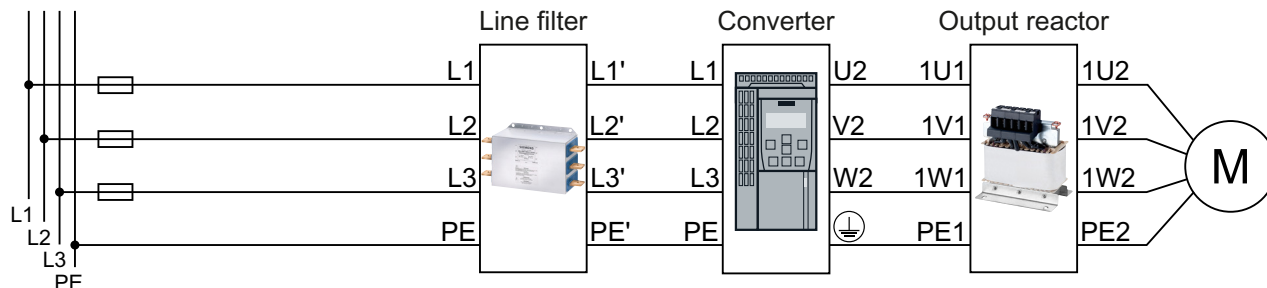

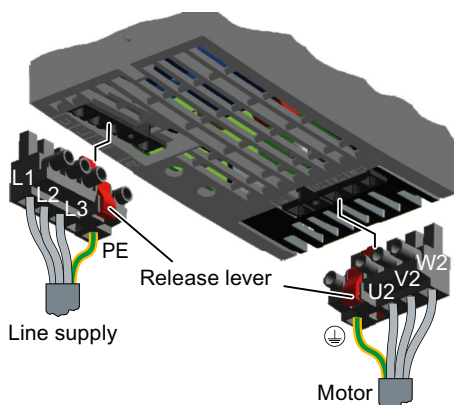

Figure 4-14 PM230 Power Module connection overview

Table 4-22 Connection, cross-section and tightening torque for PM230 Power Modules

Converter	Connection		Cross-section, tightening torque		Stripped insulation length
			Metric	Imperial	
FSA	Line supply, motor		1 ... 2.5 mm ² , 0.5 Nm	16 ... 14 AWG, 4.5 lbf in	8 mm
FSB			1.5 ... 6 mm ² , 0.6 Nm	16 ... 10 AWG, 5.5 lbf in	8 mm
FSC			6 ... 16 mm ² , 1.3 Nm	10 ... 6 AWG, 12 lbf in	10 mm
FSD	Line supply, motor		10 ... 35 mm ² , 6 Nm	7 ... 2 AWG, 53 lbf in	--
FSE			25 ... 50 mm ² , 6 Nm	3 ... 1 AWG, 53 lbf in	--
FSF			35 ... 120 mm ² , 13 Nm	2 ... 4/0 AWG, 115 lbf in	--

Connections for frame sizes FSA ... FSC



The Power Modules are equipped with withdrawable plug connectors that cannot be inadvertently interchanged.

To remove a plug connector, you must release it by pressing on the red lever.

Connections for frame sizes FSD ... FSF

The line and motor connections have covers to prevent them from being touched.

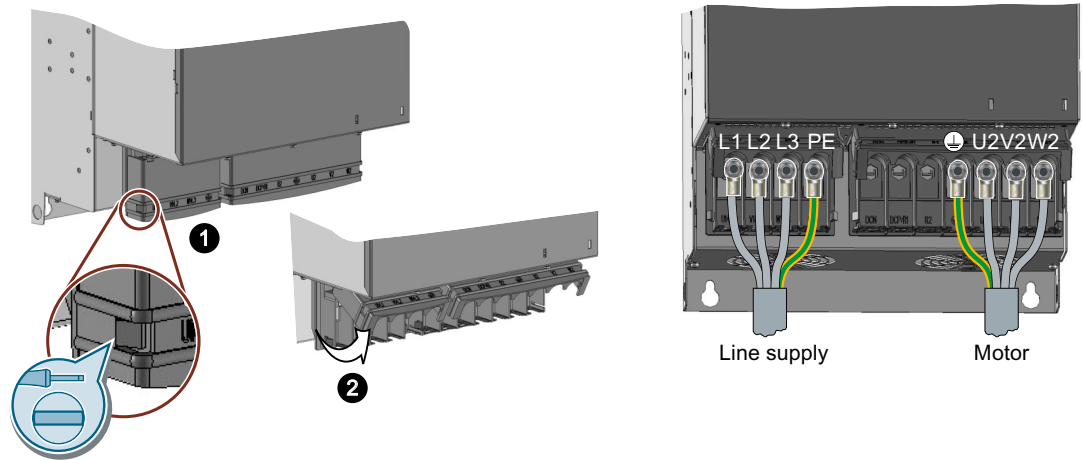

You must open the cover to connect the line and motor:

1. Release the catches on both sides of the covers using a screwdriver.
2. Swivel the covers upwards.

Close the covers once you have connected the line and motor.

4.5.5 Connecting the converter with the PM240P-2 Power Module

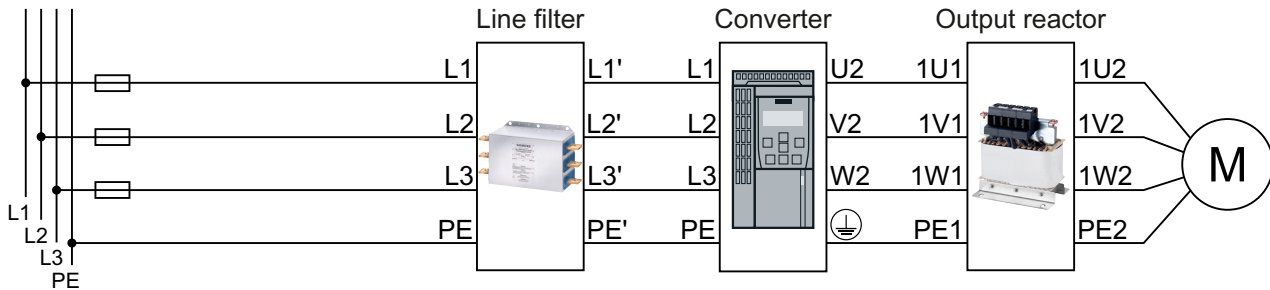



Figure 4-15 PM240P-2 Power Module connection overview

Table 4-23 Connection, cross-section and tightening torque for PM240P-2 Power Modules

Converter	Connection		Cross-section, tightening torque		Stripped insulation length
			Metric	Imperial	
FSD	Line supply, motor	Screw-type terminal	10 ... 35 mm ² , 2.5 ... 4.5 Nm	20 ... 10 AWG, 22 lbf in 8 ... 2 AWG, 40 lbf in	18 mm
FSE			25 ... 70 mm ² , 8 ... 10 Nm	6 ... 3/0 AWG, 88.5 lbf in	25 mm
FSF	Line supply, motor	 Cable lug according to SN71322	35 ... 2 × 120 mm ² , 22 ... 25 Nm	1 ... 2 × 4/0 AWG, 210 lbf in	--

Connections, frame sizes FSD ... FSF

You must remove the covers from the connections in order to connect the line supply and motor cables to the converter.

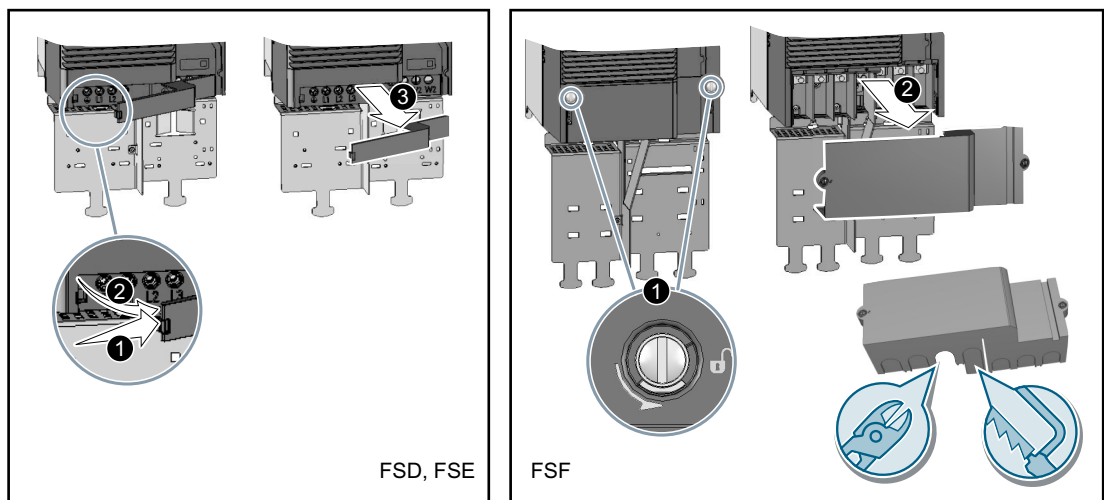

Figure 4-16 Remove the connection covers

In addition, for frame sizes FSD and FSE, release the two terminal screws on the connections for the motor and remove the dummy plug.

For frame size FSF you must breakout the openings from the connection cover for the power connections. Use side cutters or a fine saw blade.

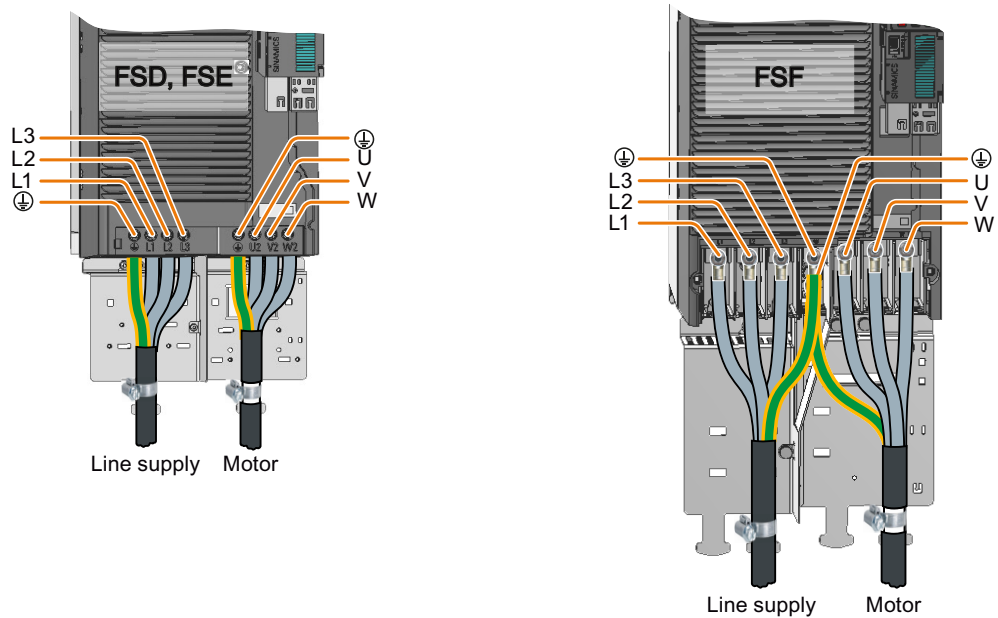

Figure 4-17 Line and motor connections

You must re-attach the connection covers in order to re-establish the touch protection of the converter after it has been connected up.

4.5.6 Connecting the converter with the PM250 Power Module

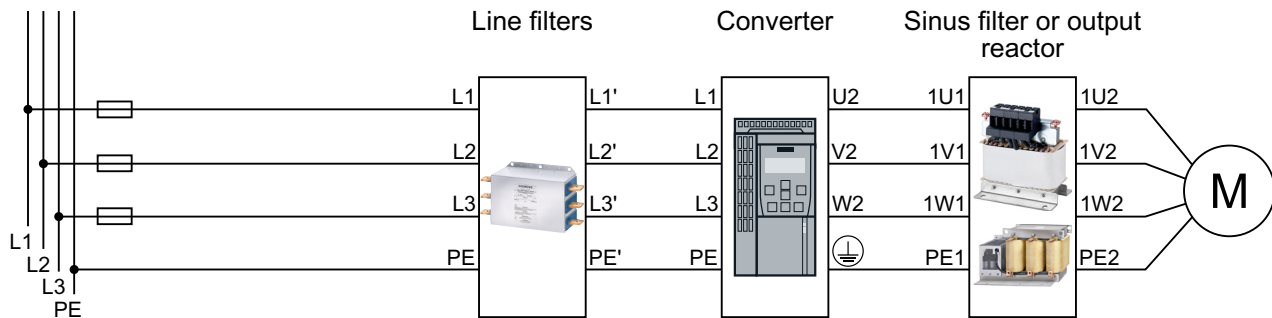

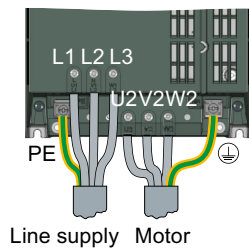

Figure 4-18 Connecting the PM250 Power Module

Table 4-24 Connection, cross-section and tightening torque for PM250 Power Modules

Converter	Line supply and motor connection	Cross-section and tightening torque		Stripped insulation length
		Metric	Imperial	
FSC	Screw-type terminal	4 ... 10 mm ² , 2.3 Nm	12 ... 8 AWG, 20 lbf in	10 mm
FSD	 Cable lug	10 ... 35 mm ² , 6 Nm	7 ... 2 AWG, 53 lbf in	--
FSE		25 ... 50 mm ² , 6 Nm	3 ... 1/0 AWG, 53 lbf in	--
FSF		35 ... 120 mm ² , 13 Nm	2 ... 4/0 AWG, 115 lbf in	--

Connections for frame size FSC



Connections for frame sizes FSD ... FSF

The line and motor connections have covers to prevent them from being touched.

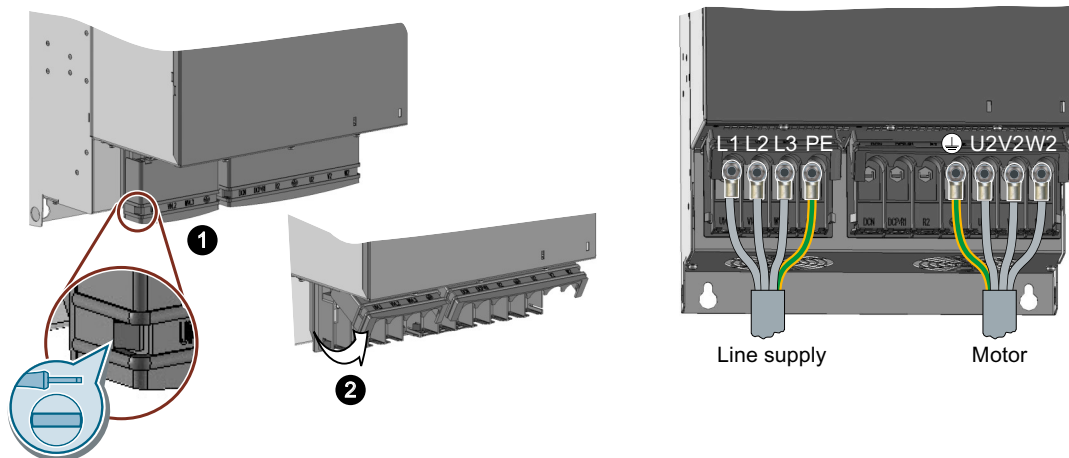

You must open the cover to connect the line and motor:

1. Release the catches on both sides of the covers using a screwdriver.
2. Swivel the covers upwards.

Close the covers once you have connected the line and motor.

4.5.7 Connecting the motor to the converter in a star or delta connection

Overview

Standard induction motors up to a rated power of approximately 3 kW are usually connected in star/delta connection (Y/ Δ) at 400 V/230 V. For a 400-V line supply, you can connect the motor to the converter either in a star or in a delta connection.

Function description

Operating the motor in a star connection

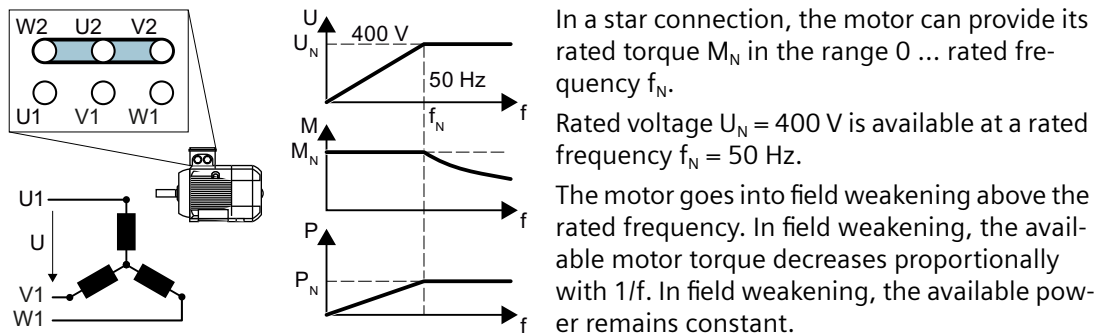

Operating the motor in a delta connection with 87 Hz characteristic

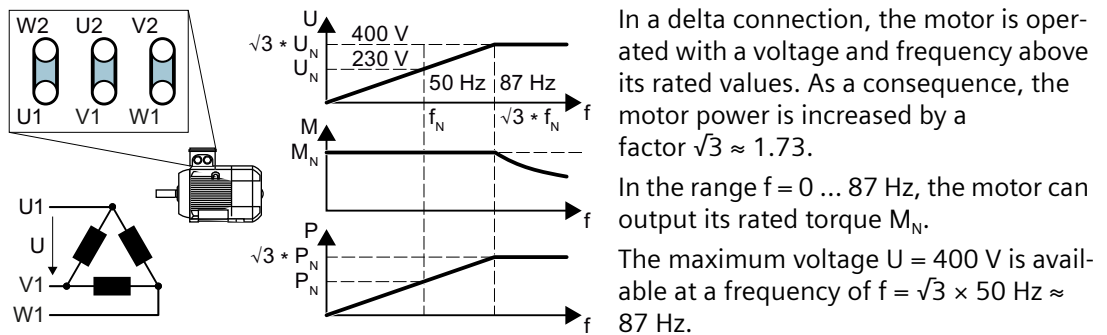

The motor only goes into field weakening above 87 Hz.

The higher motor power when operated with an 87 Hz characteristic has the following disadvantages:

- The converter must supply approximately 1.73x current. Select a converter based on its rated current - and not its rated power.
- The motor temperature increases more significantly than when operated with $f \leq 50$ Hz.
- The motor must have windings that are approved for a voltage > rated voltage U_N .
- As the fan impeller rotates faster, the motor has a higher noise level than operation with $f \leq 50$ Hz.

4.6 Connecting the interfaces for the converter control

The Power Module has a holder for the Control Unit and a release mechanism. There are different release mechanisms depending on the particular Power Module.

Inserting the Control Unit

Procedure

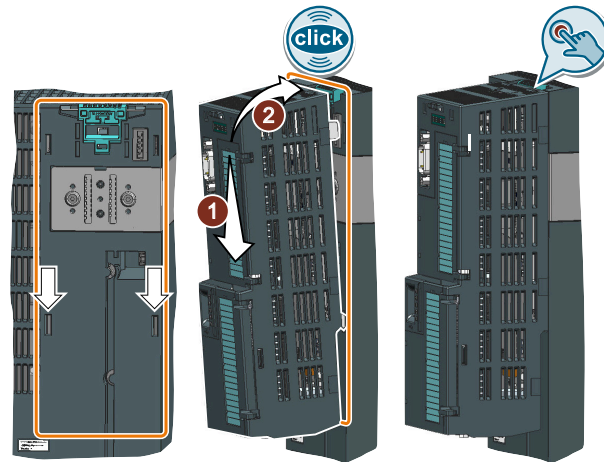

1. Place the two catches of the Control Unit in the matching grooves of the Power Module.
2. Press the Control Unit onto the Power Module until you hear that it latches.

The Control Unit is plugged onto the Power Module.



Removing the Control Unit

Procedure

Remove the Control Unit from the Power Module by pressing the release mechanism.

Special features for the PM230 Power Module IP55, FSA ... FSC

To insert or detach the Control Unit, you must release eight or ten fixing screws of the cover and then remove the cover.

The Power Module release mechanism is shown in the diagram.

Attach the cover again before you commission the converter. Do not damage the seal of the cover when attaching it.

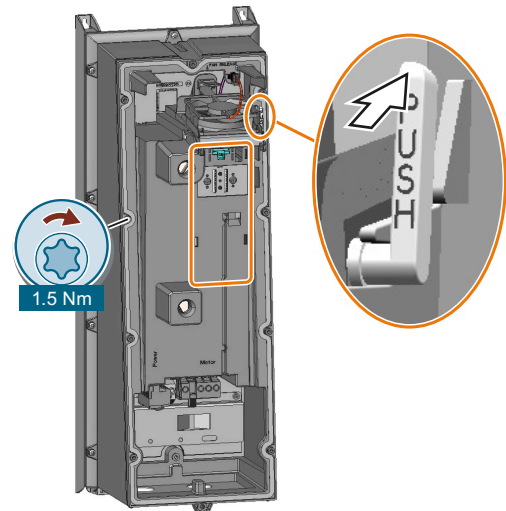

4.6.1 Overview of the interfaces

Interfaces on the Control Unit

To access the interfaces at the front of the Control Unit, you must lift the Operator Panel (if one is being used) and open the front doors.

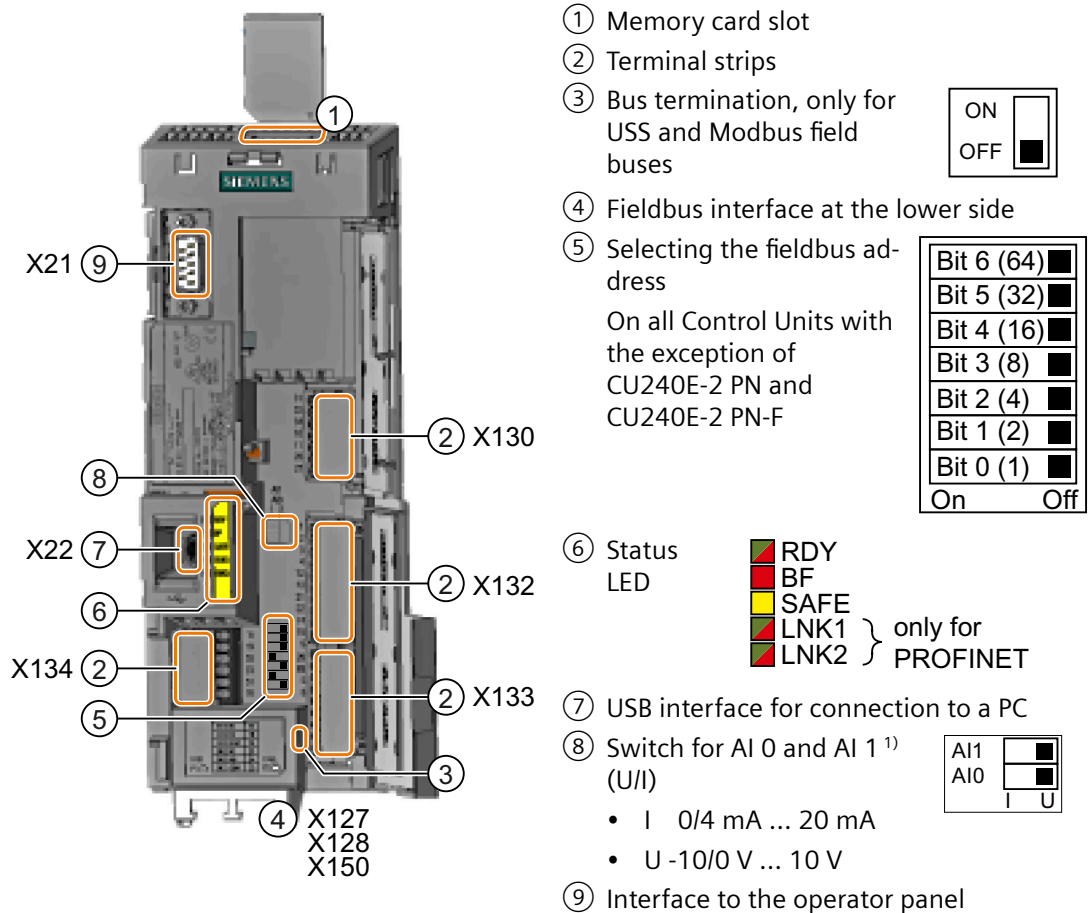

¹⁾ AI 1 is not available on the CU240B-2 Control Unit

Table 4-25 Number of inputs and outputs

	Digital in-puts DI	Digital out-puts DO	Analog in-puts AI	Analog outputs AO	Failsafe digital inputs F-DI ¹⁾
CU240B-2, CU240B-2 DP	4	1	1	1	0
CU240E-2, CU240E-2 DP, CU240E-2 PN	6	3	2	2	1
CU240E-2 F, CU240E-2 DP-F, CU240E-2 PN-F	6	3	2	2	3

¹⁾ Each failsafe digital input F-DI used takes up two digital inputs DI

Protection against unauthorized access via the USB interface

 WARNING
Unsafe operating states resulting from manipulation of the converter software
Manipulation of the converter software can cause unsafe operating states in your system that may lead to death, serious injury, and property damage.
<ul style="list-style-type: none">• Prevent unauthorized persons from accessing the converter's USB interface:<ul style="list-style-type: none">– Do not route the USB interface outside the control cabinet.– Lock the control cabinet or the control room in which the converter is installed.

4.6.2 Fieldbus interface allocation

Interfaces at the lower side of the CU240B-2 and CU240E-2 Control Units

RS485 plug for USS and Modbus RTU (X128)

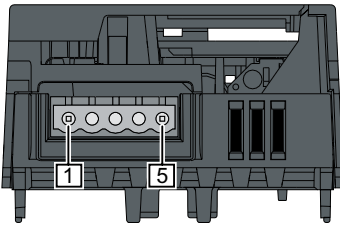

- Pin
- 1 0 V, reference potential
 - 2 RS485P, receive and transmit (+)
 - 3 RS485N, receive and transmit (-)
 - 4 Cable shield
 - 5 Not connected

RJ45 connector socket for PROFINET IO (X150 P1, X150 P2)

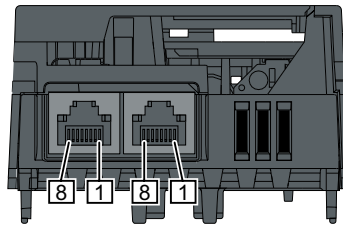

- Pin
- 1 RX+, receive data +
 - 2 RX-, receive data -
 - 3 TX+, Transmit data +
 - 4 Not assigned
 - 5 Not assigned
 - 6 TX-, transmit data -
 - 7 Not assigned
 - 8 Not assigned

SUB-D socket for PROFIBUS DP (X126)

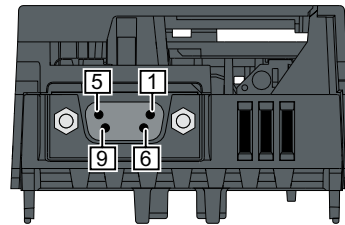

- Pin
- 1 Shield, grounding connection
 - 2 Not assigned
 - 3 RxD/TxD-P, receive and transmit (B/B')
 - 4 CNTR-P, control signal
 - 5 DGND, reference potential for data (C/C')
 - 6 VP, supply voltage
 - 7 Not assigned
 - 8 RxD/TxD-N, receive and transmit (A/A')
 - 9 Not assigned

4.6.3 Terminal strips on CU240B-2 Control Units

Terminal strips with wiring example

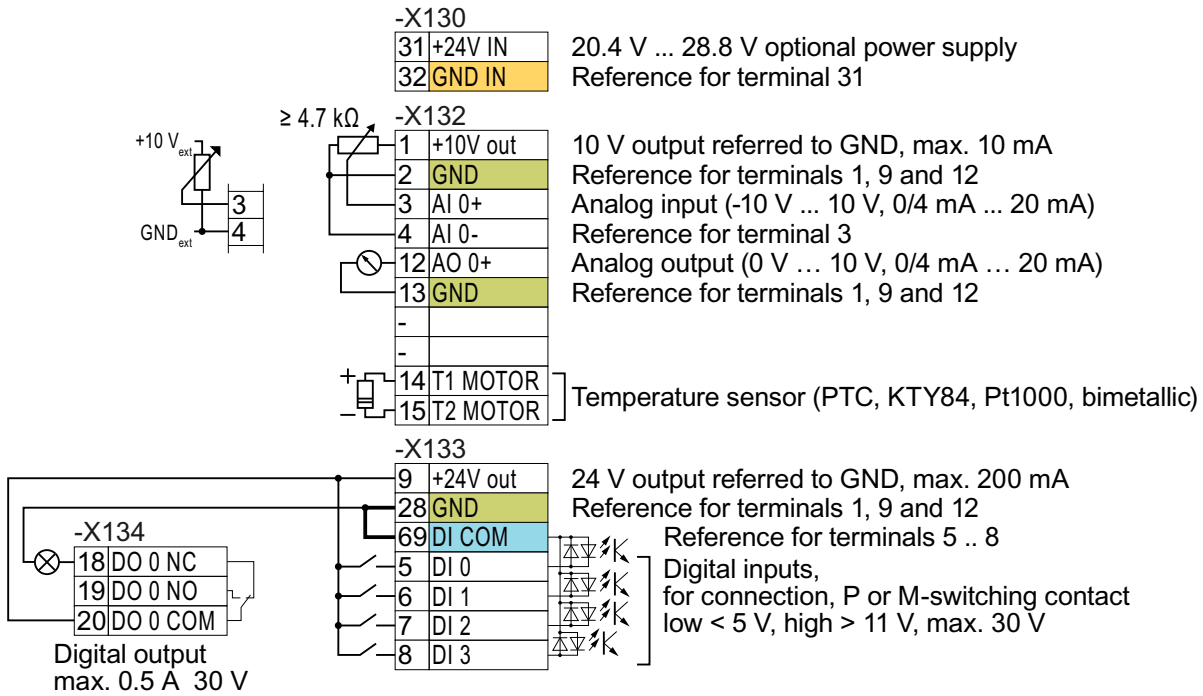

Figure 4-19 Wiring example of the digital inputs with the internal converter 24 V power supply

GND All terminals with reference potential "GND" are connected with one another in the converter.

DI COM Reference potential "DI COM" is electrically isolated from "GND".

→ if, as described above, you use the 24-V power supply from terminal 9 to supply the digital inputs, then you must connect "GND" with "DI COM" at the terminals.

31+24 V IN
32GND IN When an optional 24-V power supply is connected to terminals 31, 32, the Control Unit remains in operation even after the Power Module has been disconnected from the line supply. The Control Unit thus maintains the fieldbus communication, for example.

→ for terminals 31, 32 only use a 24 VDC power supply with SELV (Safety Extra Low Voltage).

→ for applications in the USA and Canada: Use a 24 VDC power supply, NEC Class 2.

→ connect the 0 V of the power supply with the protective conductor.

→ if you also wish to use the power supply at terminals 31, 32 for the digital inputs, then you must connect "DI COM" and "GND IN" with one another at the terminals.

3 AI 0+
4 AI 0- You may use the internal 10V power supply or an external power supply for the analog input.

4.6 Connecting the interfaces for the converter control

→ If you use the internal 10 V power supply, you must connect AI 0- to GND.

Note

Protection against overload and short circuit

All outputs such as 10V and 24V are protected against overload and short circuit using either ITS4140N or a monitored current shunt in the control system.

Additional options for wiring the digital inputs

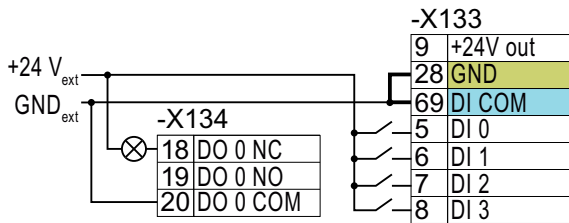

You must remove the jumper between terminals 28 and 69 if it is necessary to have electrical isolation between the external power supply and the internal converter power supply.

Connecting P-switching contacts with an external power supply

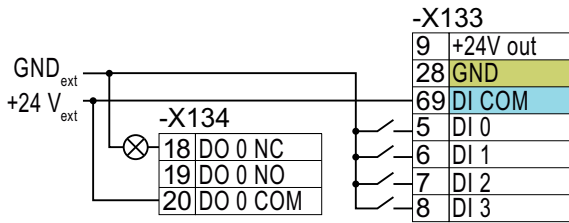

It is not permissible that terminals 28 and 69 are connected with one another.

Connecting M-switching contacts with an external power supply

4.6.4 Factory setting of the CU240B-2 interfaces

The factory setting of the terminals depends on which fieldbus the Control Unit supports.

Control Units with PROFIBUS interface

The function of the fieldbus interface and digital inputs DI 0, DI 1 depends on DI 3.

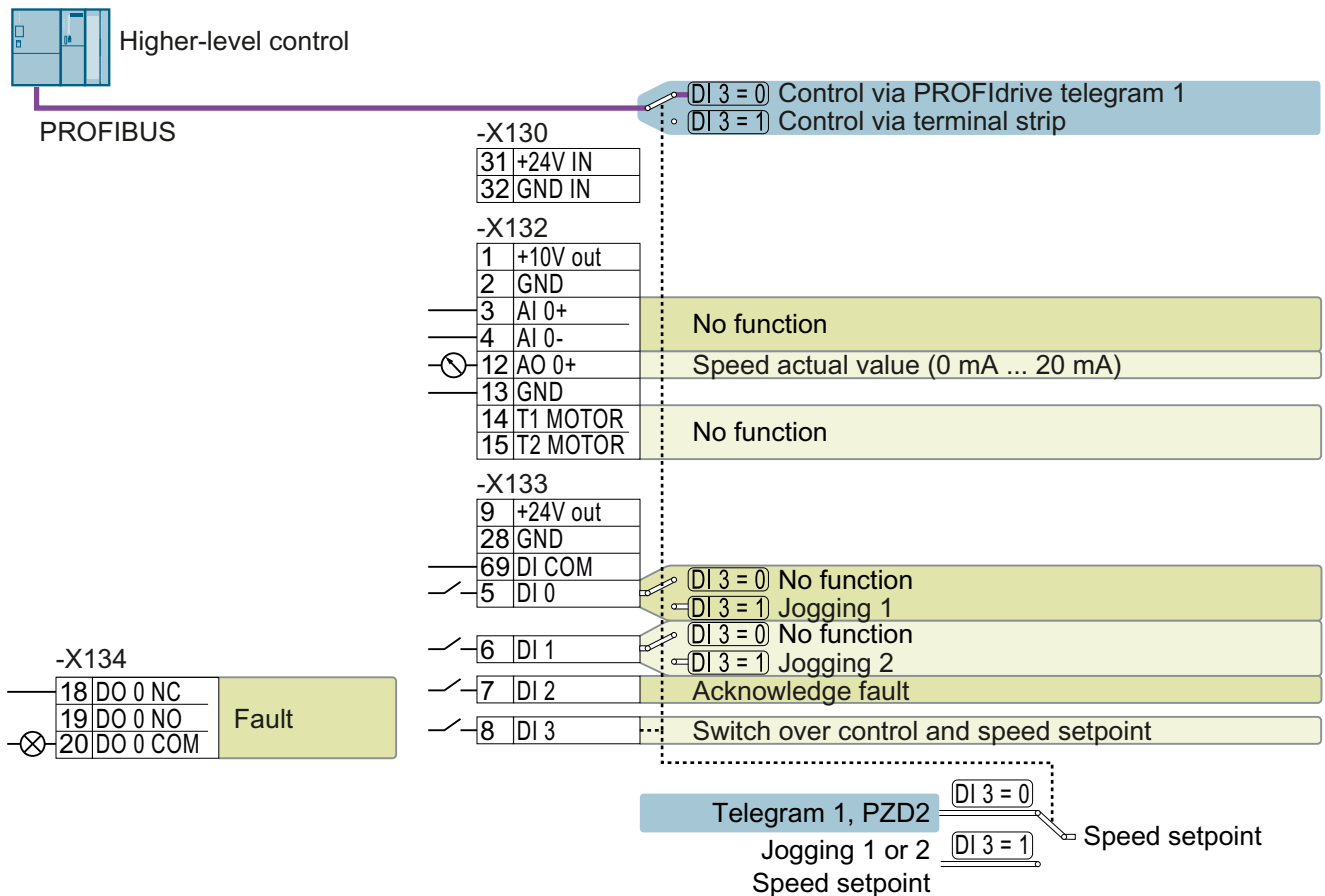

DO 0: p0730

AO 0: p0771[0]

DI x: r0722.x

Speed setpoint (main setpoint): p1070[0] = 2050[1]

Figure 4-20 Factory setting of the CU240B-2 DP Control Unit

Control Units with USS interface

The fieldbus interface is not active.

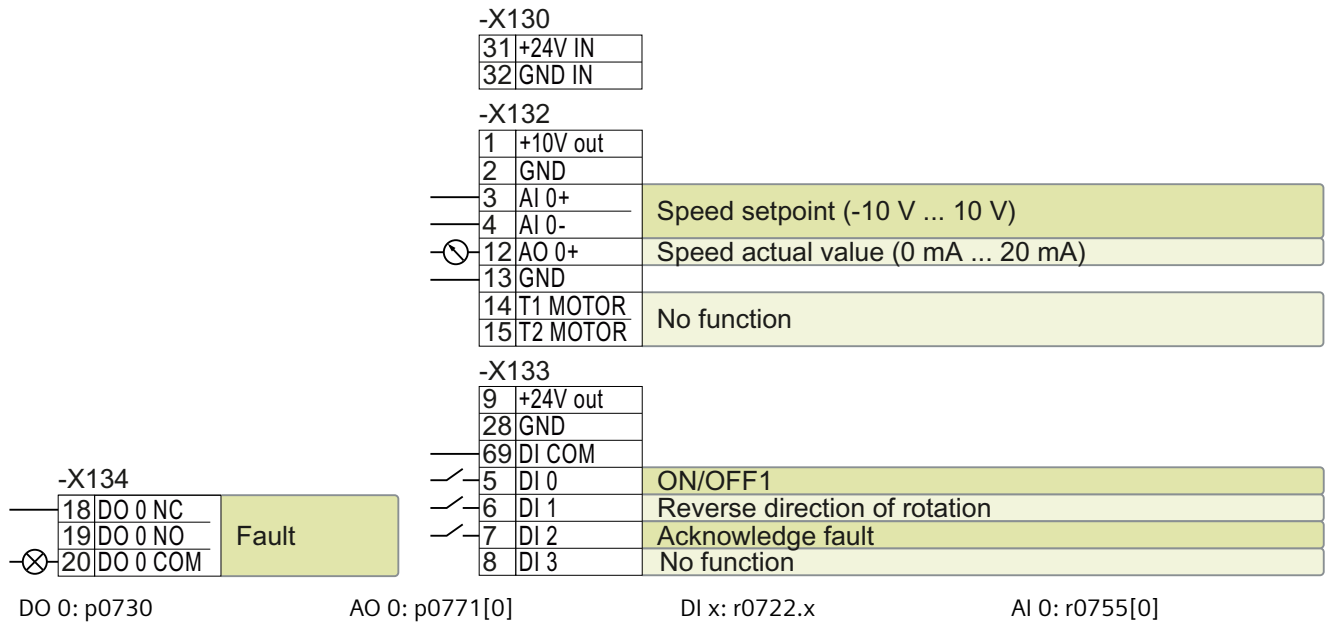

DO 0: p0730

AO 0: p0771[0]

DI x: r0722.x

AI 0: r0755[0]

Speed setpoint (main setpoint): p1070[0] = 755[0]

Figure 4-21 Factory setting of the CU240B-2 Control Unit

4.6.5 Default settings of the CU240B-2 interfaces

Default setting 7: "Fieldbus with data set switchover"

Factory setting for converters with PROFIBUS interface

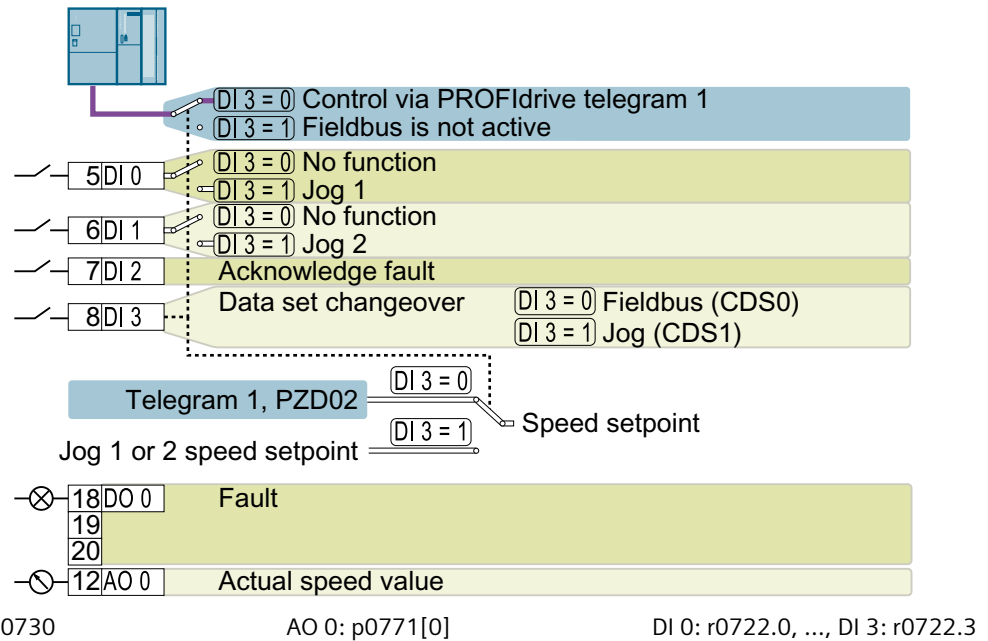

Speed setpoint (main setpoint): p1070[0] = 2050[1]
 Jog 1 speed setpoint: p1058, factory setting: 150 rpm
 Jog 2 speed setpoint: p1059, factory setting: -150 rpm
 Designation in the BOP-2: FB cdS

Default setting 9: "Standard I/O with MOP"

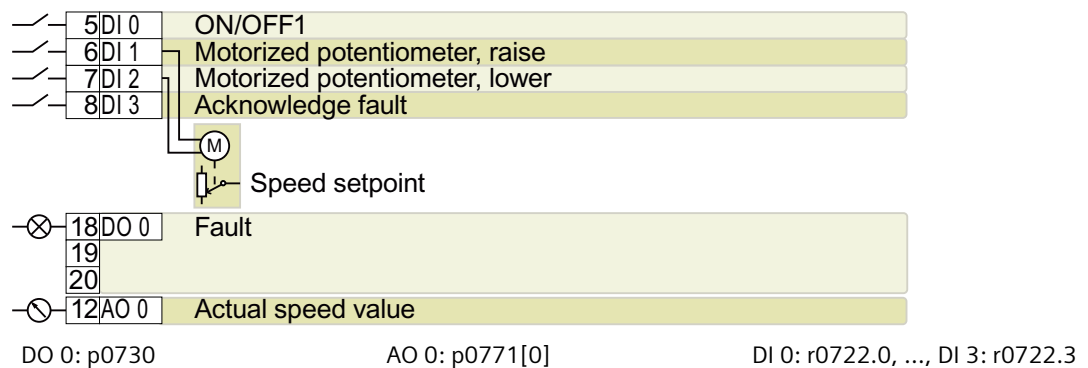

Motorized potentiometer setpoint after ramp-function generator: r1050
 Speed setpoint (main setpoint): p1070[0] = 1050
 Designation in the BOP-2: Std MoP

Default setting 12: "Standard I/O with analog setpoint"

Factory setting for converters with USS interface

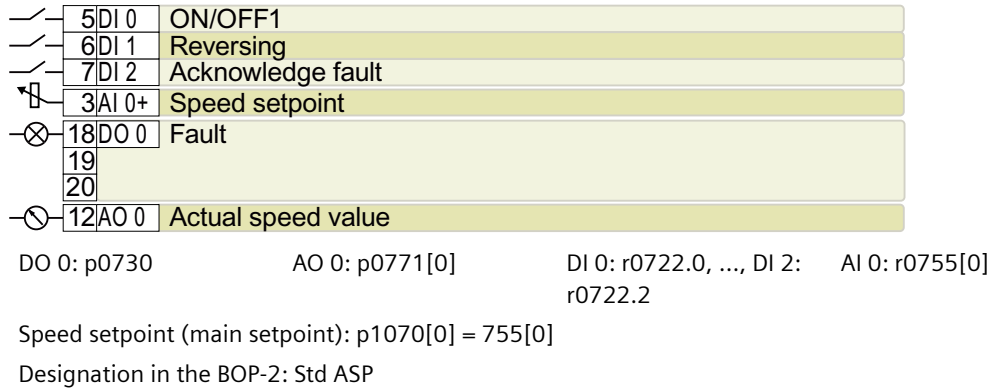

Default setting 17: "2-wire (forw/backw1)"

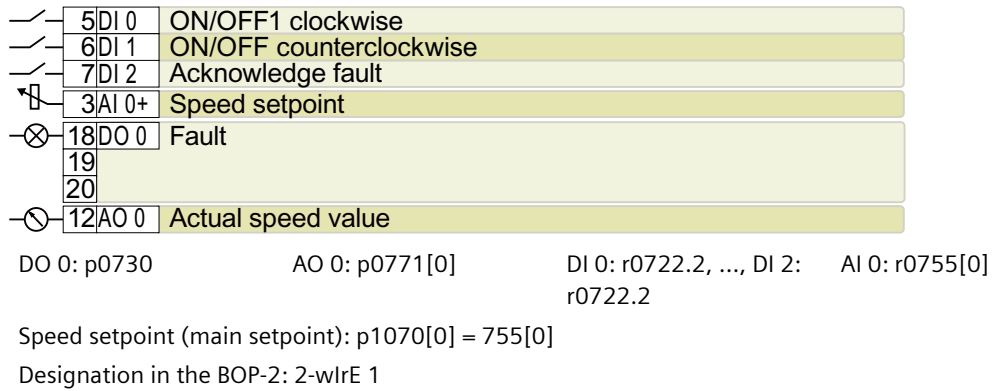

Default setting 18: "2-wire (forw/backw2)"

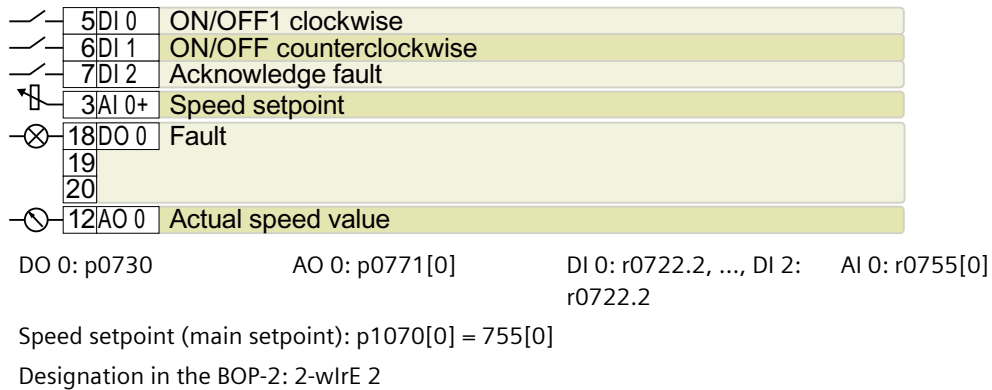

Default setting 19: "3-wire (enable/forw/backw)"

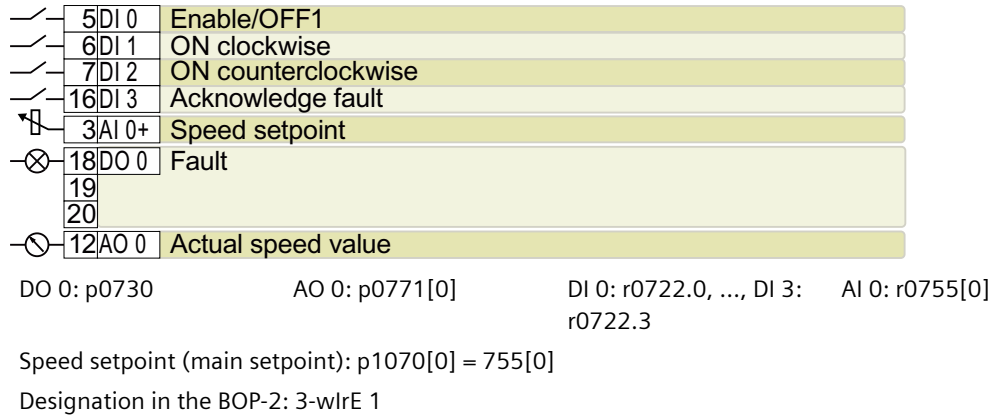

Default setting 20: "3-wire (enable/on/reverse)"

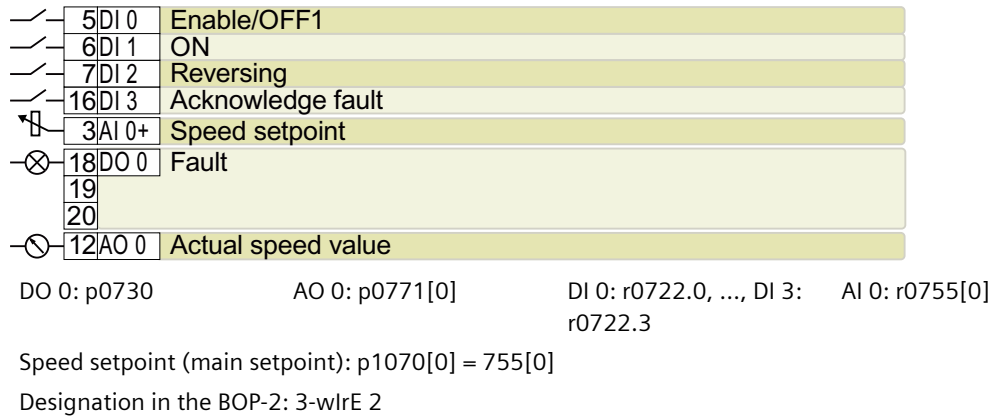

Default setting 21: "USS fieldbus"

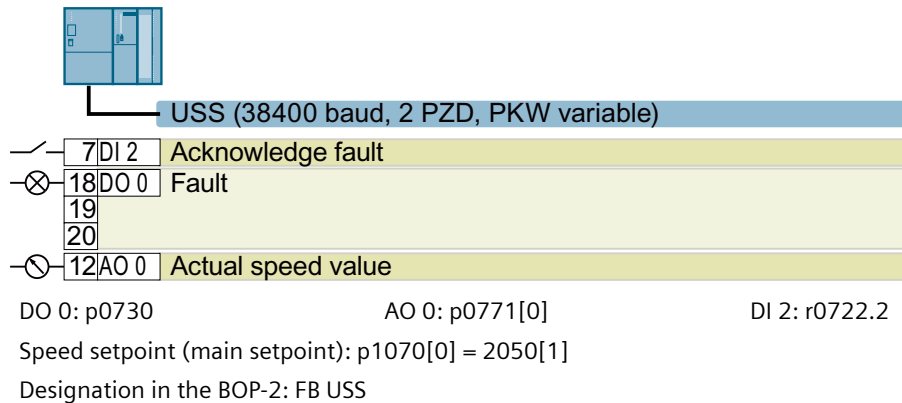

4.6.6 Terminal strips on CU240E-2 Control Units

Terminal strips with wiring example

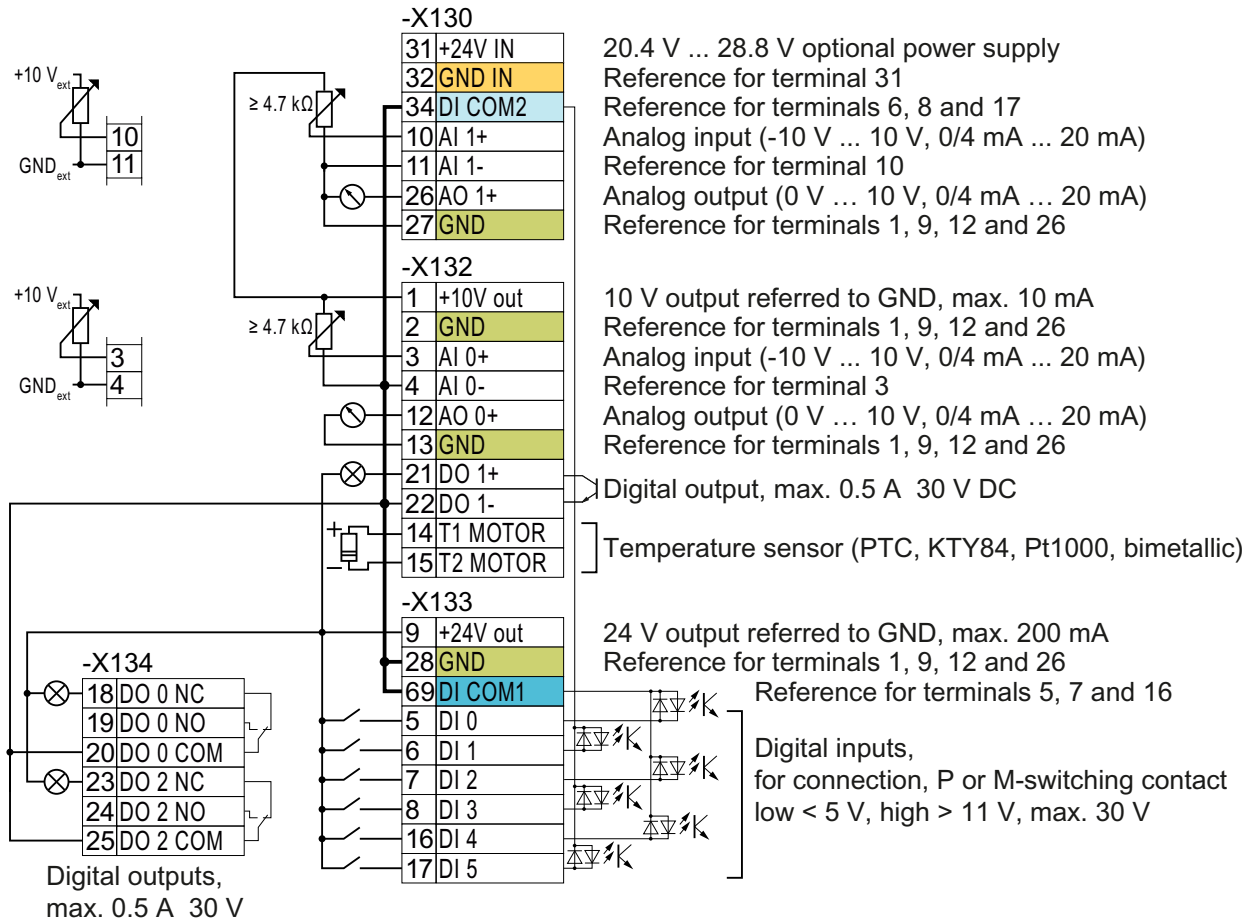

Figure 4-22 Wiring example of the digital inputs with the internal converter 24 V power supply

- GND** All terminals with reference potential "GND" are connected with one another in the converter.
- DI COM1** Reference potentials "DI COM1" and "DI COM2" are electrically isolated from "GND".
- DI COM2** → if, as described above, you use the 24-V power supply from terminal 9 to supply the digital inputs, then you must connect "GND" with "DI COM1" and "DI COM2" at the terminals.
- 31/+24 V IN**
32/GND IN When an optional 24-V power supply is connected to terminals 31, 32, the Control Unit remains in operation even after the Power Module has been disconnected from the line supply. The Control Unit thus maintains the fieldbus communication, for example.
 - for terminals 31, 32 only use a 24 VDC power supply with SELV (Safety Extra Low Voltage).
 - for applications in the USA and Canada: Use a 24 VDC power supply, NEC Class 2.
 - connect the 0 V of the power supply with the protective conductor.
 - if you also wish to use the power supply at terminals 31, 32 for the digital inputs, then you must connect "DI COM1/2" and "GND IN" with one another at the terminals.

10	AI 1+
11	AI 1-
3	AI 0+
4	AI 0-

You may use the internal 10V power supply or an external power supply for the analog inputs.
 → If you use the internal 10 V power supply, you must connect AI 0- or AI 1- to GND.

Note

Protection against overload and short circuit

All outputs such as 10V and 24V are protected against overload and short circuit using either ITS4140N or a monitored current shunt in the control system.

Additional options for wiring the digital inputs

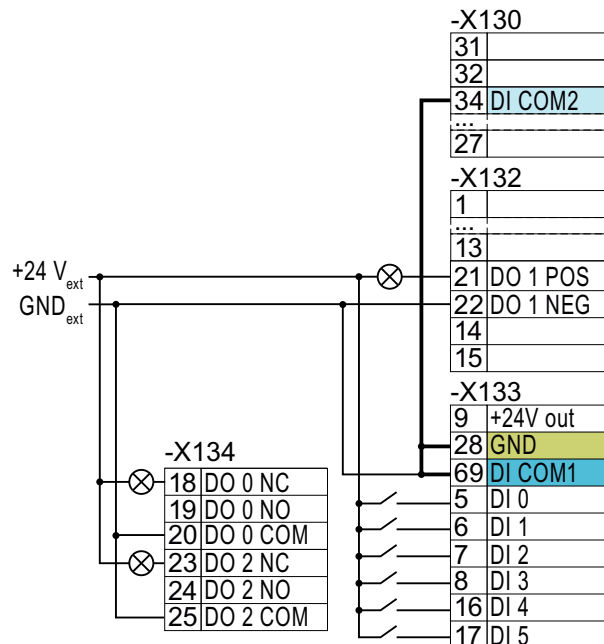

If you wish to connect the external and the internal converter power supply voltages with one another, then you must connect "GND" with terminals 34 and 69 at the terminals.

Connecting P-switching contacts with an external power supply

4.6 Connecting the interfaces for the converter control

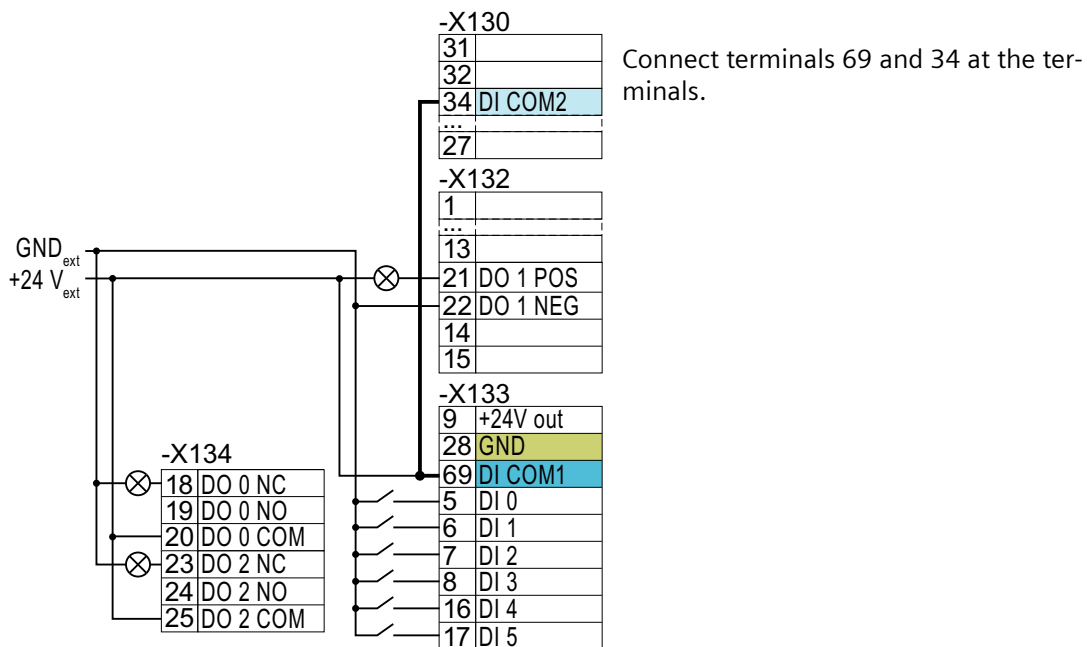

Connecting M-switching contacts with an external power supply

NOTICE

Damage when the 24V output voltage is short-circuited

If the following conditions occur simultaneously, the Control Unit with PROFINET interface can be damaged:

1. The converter is operational.
2. The 24V output voltage develops a short-circuit at terminal 9.
3. The ambient temperature reaches the maximum permissible value.
4. The external 24V power supply voltage at terminals 31 and 32 reaches the maximum permissible value.

- Ensure that not all of these conditions are simultaneously satisfied.

4.6.7 Factory setting of the CU240E-2 interfaces

The factory setting of the terminal strip depends on the Control Unit.

Control Units with PROFIBUS or PROFINET interface

The function of the fieldbus interface and digital inputs DI 0, DI 1 depends on DI 3.

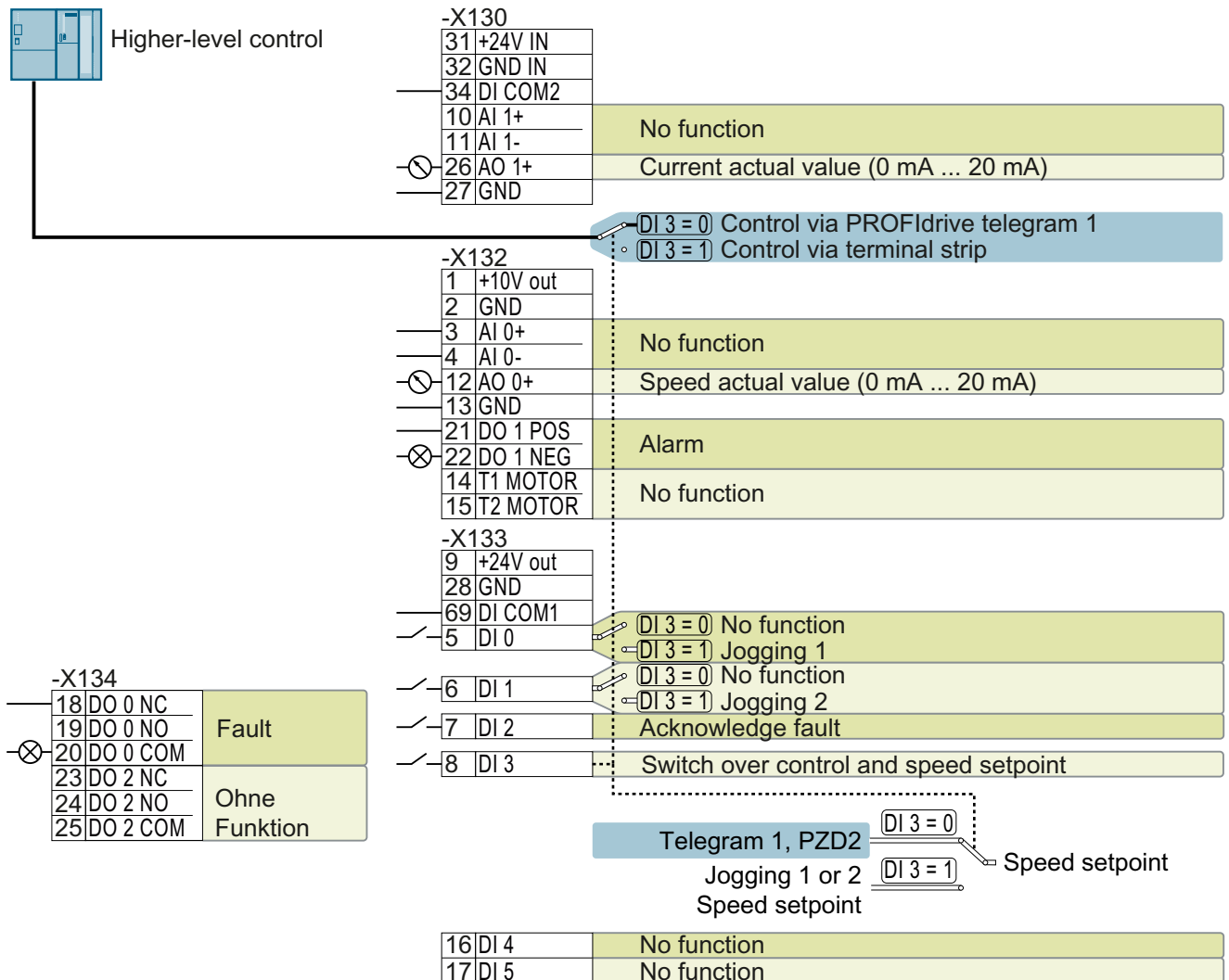

DO x: p073x

AO 0: p0771[0]

DI x: r0722.x

Speed setpoint (main setpoint): p1070[0] = 2050[1]

Figure 4-23 Factory setting of CU240E-2 DP(-F) and CU240E-2 PN(-F) Control Units

Control Units with USS interface

The fieldbus interface is not active.

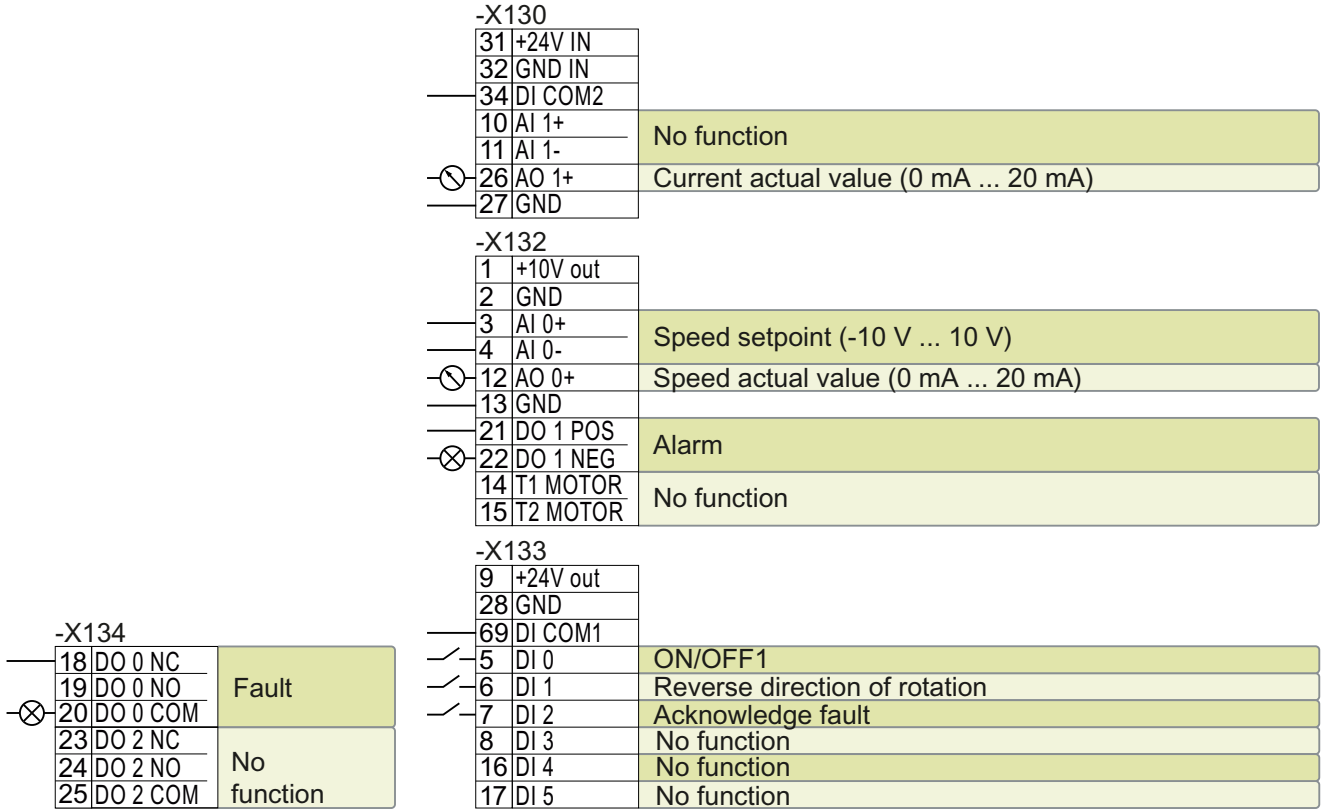

DO x: p073x

AO 0: p0771[0]

DI x: r0722.x

AI 0: r0755[0]

Speed setpoint (main setpoint): p1070[0] = 755[0]

Figure 4-24 Factory setting of the CU240E-2 and CU240E-2 F Control Units

4.6.8 Default settings of the CU240E-2 interfaces

Default setting 1: "Conveyor technology with 2 fixed frequencies"

—	5	DI 0	ON/OFF1 clockwise
—	6	DI 1	ON/OFF1 counterclockwise
—	7	DI 2	Acknowledge fault
—	16	DI 4	Fixed speed setpoint 3:
—	17	DI 5	Fixed speed setpoint 4
⊗	18	DO 0	Fault
	19		
	20		
⊗	21	DO 1	Warning
	22		
⊖	12	AO 0	Actual speed value
⊖	26	AO 1	Actual current value

DO 0: p0730, DO 1: p0731 AO 0: p0771[0], AO 1: p0771[1] DI 0: r0722.0, ..., DI 5: r0722.5

Fixed speed setpoint 3: p1003, fixed speed setpoint 4: p1004, fixed speed setpoint active: r1024

Speed setpoint (main setpoint): p1070[0] = 1024

DI 4 and DI 5 = high: The converter adds both fixed speed setpoints

Designation in the BOP-2: coN 2 SP

Default setting 2: "Conveyor systems with Basic Safety"

—	5	DI 0	ON/OFF1 with fixed speed setpoint 1
—	6	DI 1	Fixed speed setpoint 2:
—	7	DI 2	Acknowledge fault
—	16	DI 4	} Reserved für a safety function
—	17	DI 5	
⊗	18	DO 0	Fault
	19		
	20		
⊗	21	DO 1	Warning
	22		
⊖	12	AO 0	Actual speed value
⊖	26	AO 1	Actual current value

DO 0: p0730, DO 1: p0731 AO 0: p0771[0], AO 1: p0771[1] DI 0: r0722.0, ..., DI 5: r0722.5

Fixed speed setpoint 1: p1001, fixed speed setpoint 2: p1002, fixed speed setpoint active: r1024

Speed setpoint (main setpoint): p1070[0] = 1024

DI 0 and DI 1 = high: The converter adds both fixed speed setpoints.

Designation in the BOP-2: coN SAFE

Default setting 3: "Conveyor systems with 4 fixed frequencies"

✓	5	DI 0	ON/OFF1 with fixed speed setpoint 1
✓	6	DI 1	Fixed speed setpoint 2
✓	7	DI 2	Acknowledge fault
✓	16	DI 4	Fixed speed setpoint 3
✓	17	DI 5	Fixed speed setpoint 4
⊗	18	DO 0	Fault
	19		
	20		
⊗	21	DO 1	Warning
	22		
⊗	12	AO 0	Actual speed value
⊗	26	AO 1	Actual current value

DO 0: p0730, DO 1: p0731 AO 0: p0771[0], AO 1: p0771[1] DI 0: r0722.0, ..., DI 5: r0722.5
 Fixed speed setpoint 1: p1001, ... fixed speed setpoint 4: p1004, fixed speed setpoint active: r1024
 Speed setpoint (main setpoint): p1070[0] = 1024
 Several of the DI 0, DI 1, DI 4, and DI 5 = high: the converter adds the corresponding fixed speed setpoints.
 Designation in the BOP-2: coN 4 SP

Default setting 4: "Conveyor system with fieldbus"

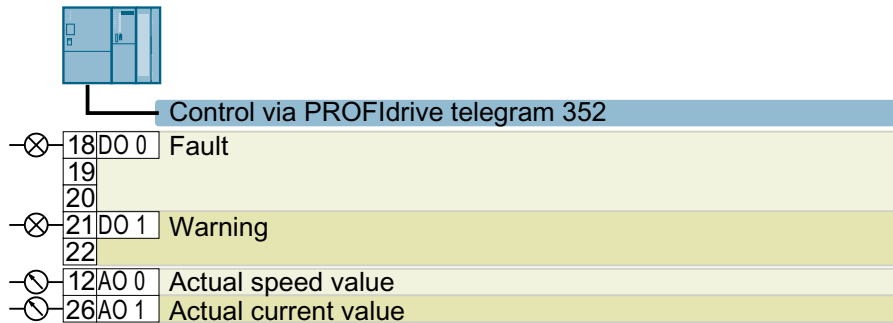

DO 0: p0730, DO 1: p0731 AO 0: p0771[0], AO 1: p0771[1]
 Speed setpoint (main setpoint): p1070[0] = 2050[1]
 Designation in the BOP-2: coN Fb

Default setting 5: "Conveyor systems with fieldbus and Basic Safety"

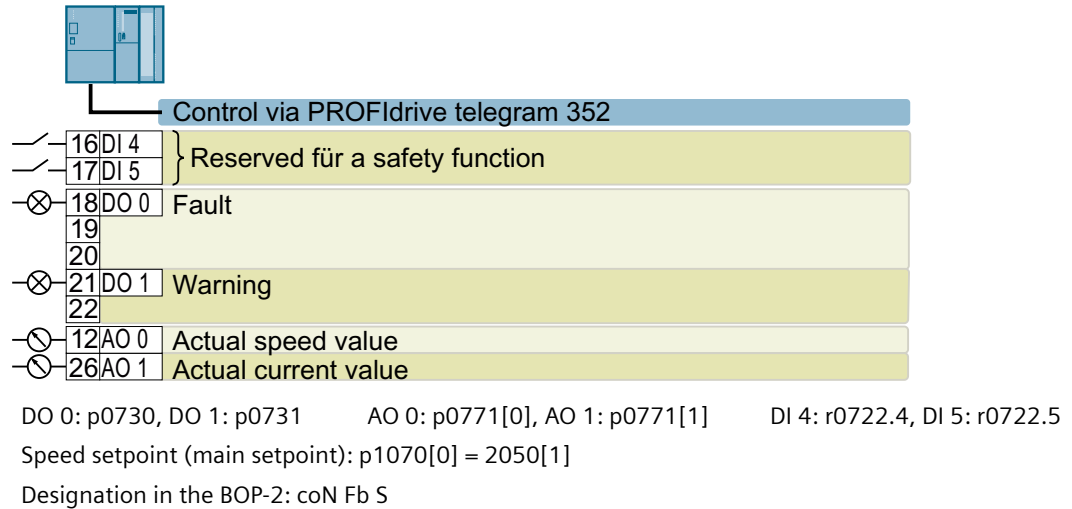

Default setting 6: "Fieldbus with Extended Safety"

Only with Control Units CU240E-2 F, CU240E-2 DP-F, and CU240E-2 PN-F.

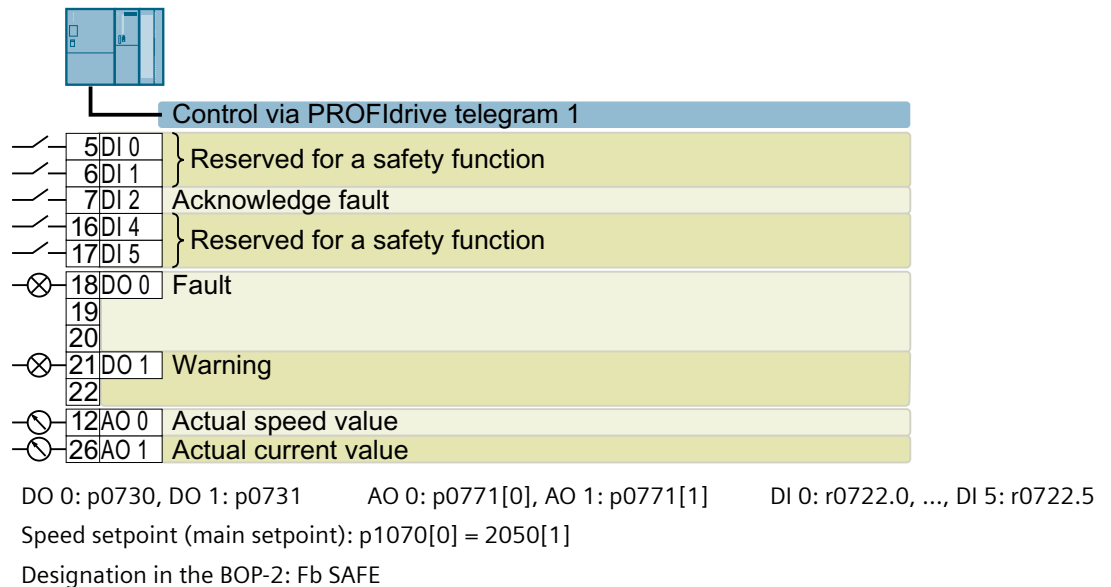

Default setting 7: "Fieldbus with data set switchover"

Factory setting for converters with PROFIBUS or PROFINET interface

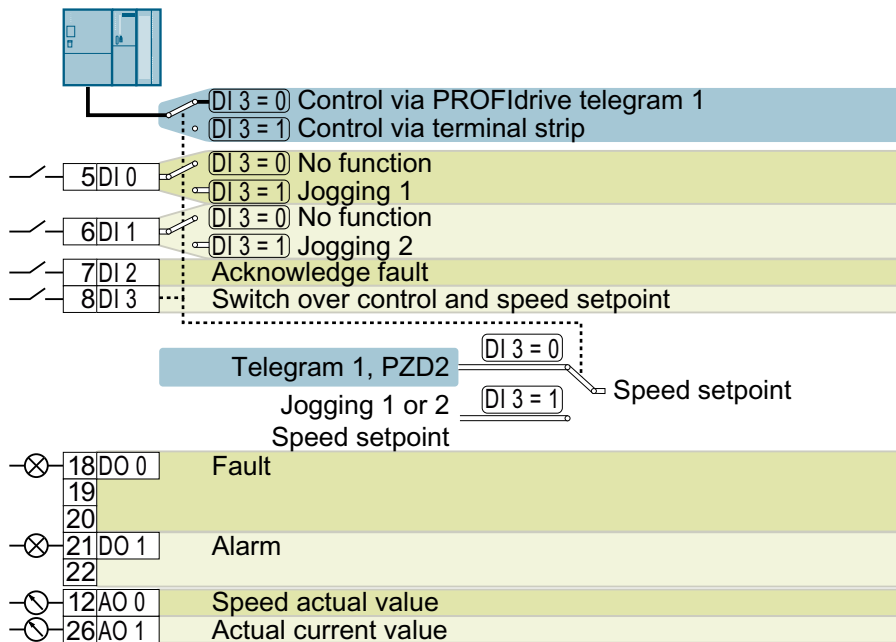

DO 0: p0730, DO 1: p0731 AO 0: p0771[0], AO 1: p0771[1] DI 0: r0722.0, ..., DI 3: r0722.3

Speed setpoint (main setpoint): p1070[0] = 2050[1]

Jog 1 speed setpoint: p1058, factory setting: 150 rpm

Jog 2 speed setpoint: p1059, factory setting: -150 rpm

Designation in the BOP-2: FB cdS

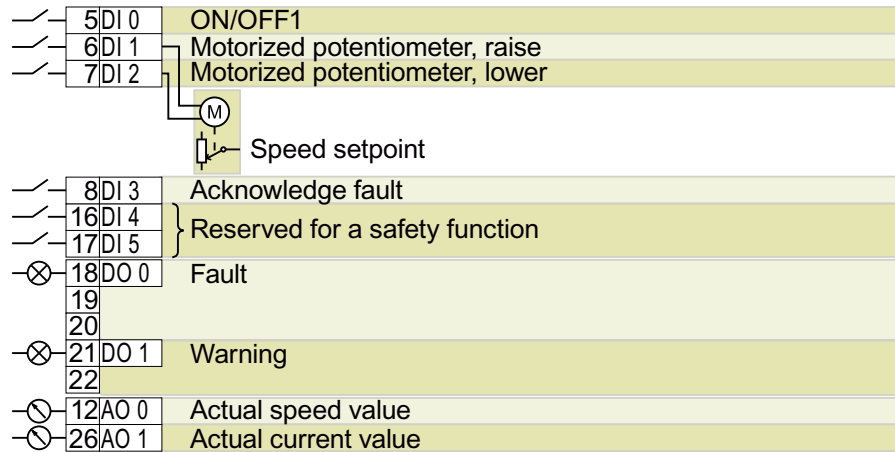
Default setting 8: "MOP with Basic Safety"

DO 0: p0730, DO 1: p0731 AO 0: p0771[0], AO 1: p0771[1] DI 0: r0722.0, ..., DI 5: r0722.5

Motorized potentiometer setpoint after ramp-function generator: r1050

Speed setpoint (main setpoint): p1070[0] = 1050

Designation in the BOP-2: MoP SAFE

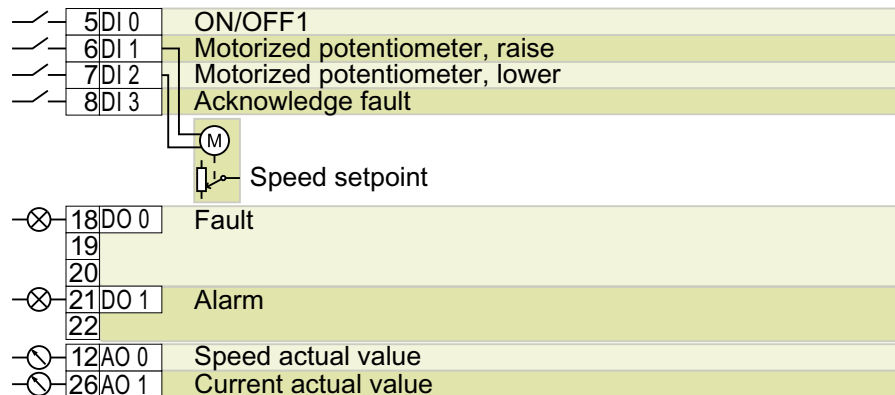
Default setting 9: "Standard I/O with MOP"

DO 0: p0730, DO 1: p0731 AO 0: p0771[0], AO 1: p0771[1] DI 0: r0722.0, ..., DI 3: r0722.3

Motorized potentiometer setpoint after ramp-function generator: r1050

Speed setpoint (main setpoint): p1070[0] = 1050

Designation in the BOP-2: Std MoP

Default setting 12: "Standard I/O with analog setpoint"

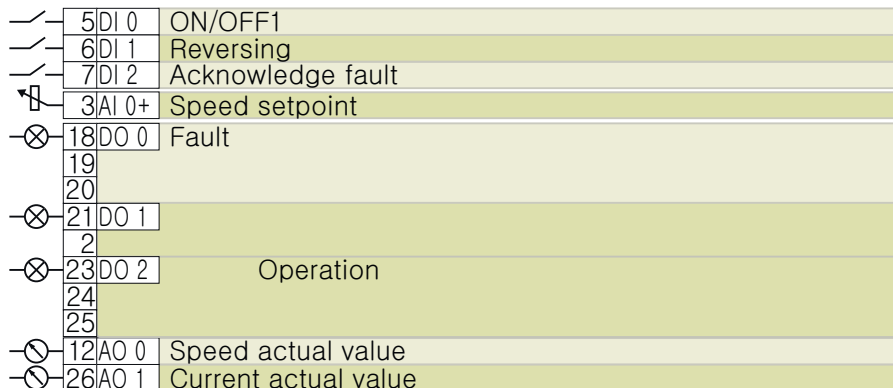

DO 0: p0730, DO 1: p0731, AO 0: p0771[0], AO 1: p0771[1], DI 0: r0722.0, ..., DI 2: r0722.2, AI 0: r0755[0]

Speed setpoint (main setpoint): p1070[0] = 755[0]

Designation in the BOP-2: Std ASP

Default setting 13: "Standard I/O with analog setpoint and safety"

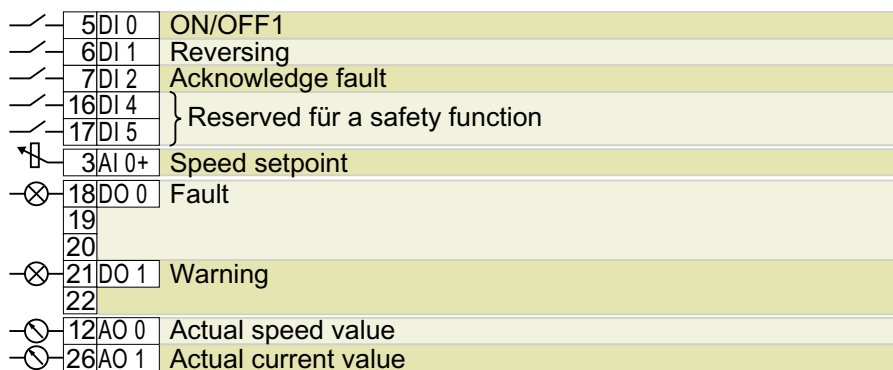

DO 0: p0730, DO 1: p0731, AO 0: p0771[0], AO 1: p0771[1], DI 0: r0722.0, ..., DI 5: r0722.5, AI 0: r0755[0]

Speed setpoint (main setpoint): p1070[0] = 755[0]

Designation in the BOP-2: ASPS

Default setting 14: "Process industry with fieldbus"

PROFdrive telegram 20

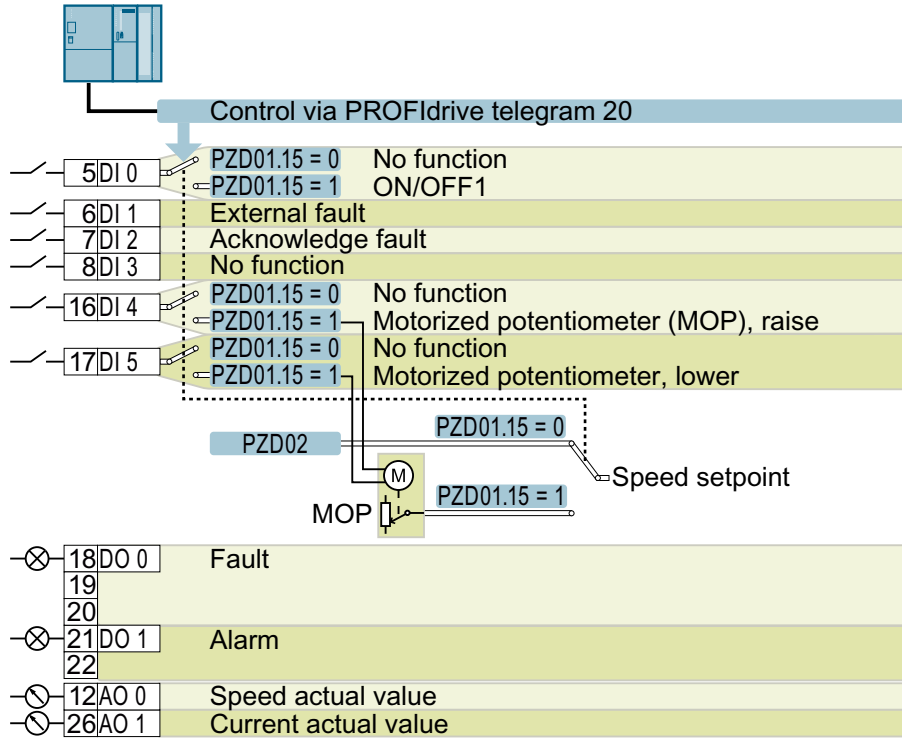

MOP = motorized potentiometer

DO 0: p0730, DO 1: p0731 AO 0: p0771[0], AO 1: p0771[1] DI 0: r0722.0, ..., DI 5: r0722.5

Motorized potentiometer setpoint after ramp-function generator: r1050

Speed setpoint (main setpoint): p1070[0] = 2050[1], p1070[1] = 1050

Switch controller via PZD01, bit 15: p0810 = r2090.15

Designation in the BOP-2: Proc Fb

Default setting 15: "Process industry"

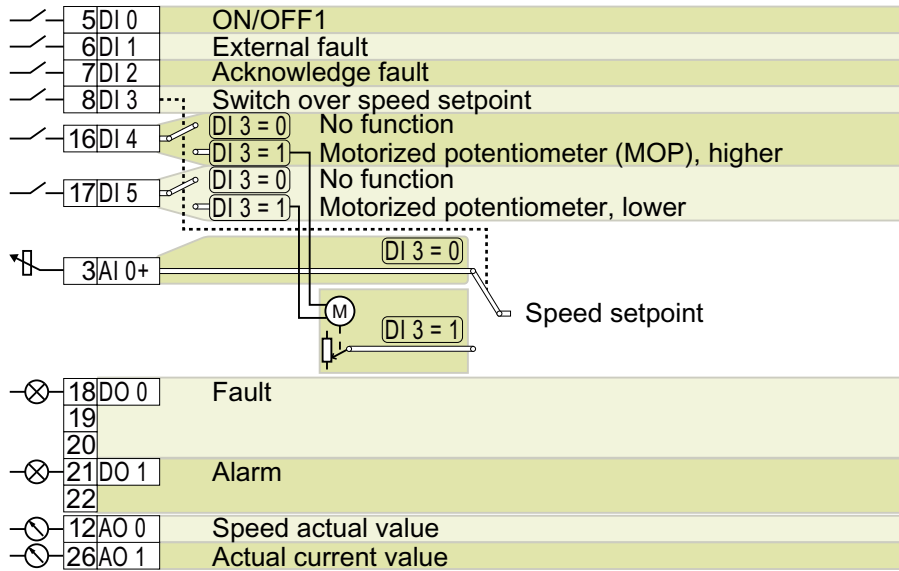

DO 0: p0730, DO 1: AO 0: p0771[0], DI 0: r0722.5, ..., DI 4: r0722.5 AI 0: r0755[0]
 p0731 AO 1: p0771[1]

Motorized potentiometer setpoint after ramp-function generator: r1050

Speed setpoint (main setpoint): p1070[0] = 755[0], p1070[1] = 1050

Designation in the BOP-2: Proc

Default setting 17: "2-wire (forw/backw1)"

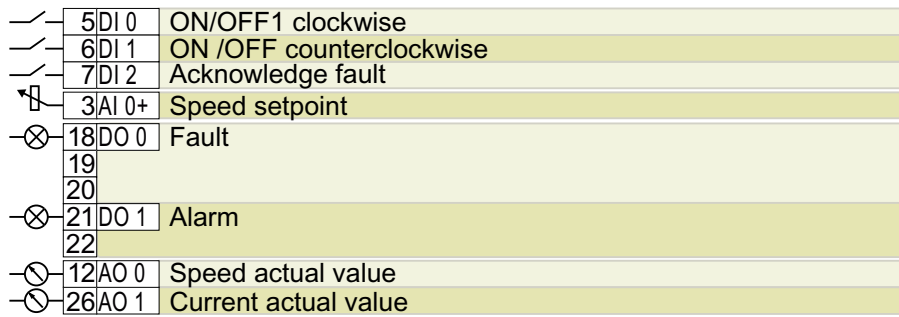

DO 0: p0730, DO 1: AO 0: p0771[0], DI 0: r0722.2, ..., DI 2: r0722.2 AI 0: r0755[0]
 p0731 AO 1: p0771[1]

Speed setpoint (main setpoint): p1070[0] = 755[0]

Designation in the BOP-2: 2-wlrE 1

Default setting 18: "2-wire (forw/backw2)"

5	DI 0	ON/OFF1 clockwise
6	DI 1	ON /OFF counterclockwise
7	DI 2	Acknowledge fault
3	AI 0+	Speed setpoint
18	DO 0	Fault
19		
20		
21	DO 1	Alarm
22		
12	AO 0	Speed actual value
26	AO 1	Current actual value

DO 0: p0730, DO 1: AO 0: p0771[0], DI 0: r0722.0, ..., DI 2: r0722.2 AI 0: r0755[0]
 p0731 AO 1: p0771[1]

Speed setpoint (main setpoint): p1070[0] = 755[0]

Designation in the BOP-2: 2-wlrE 2

Default setting 19: "3-wire (enable/forw/backw)"

5	DI 0	Enable / OFF1
6	DI 1	ON clockwise
7	DI 2	ON counterclockwise
16	DI 4	Acknowledge fault
3	AI 0+	Speed setpoint
18	DO 0	Fault
19		
20		
21	DO 1	Alarm
22		
12	AO 0	Speed actual value
26	AO 1	Current actual value

DO 0: p0730, DO 1: AO 0: p0771[0], DI 0: r0722.0, ..., DI 4: r0722.4 AI 0: r0755[0]
 p0731 AO 1: p0771[1]

Speed setpoint (main setpoint): p1070[0] = 755[0]

Designation in the BOP-2: 3-wlrE 1

Default setting 20: "3-wire (enable/on/reverse)"

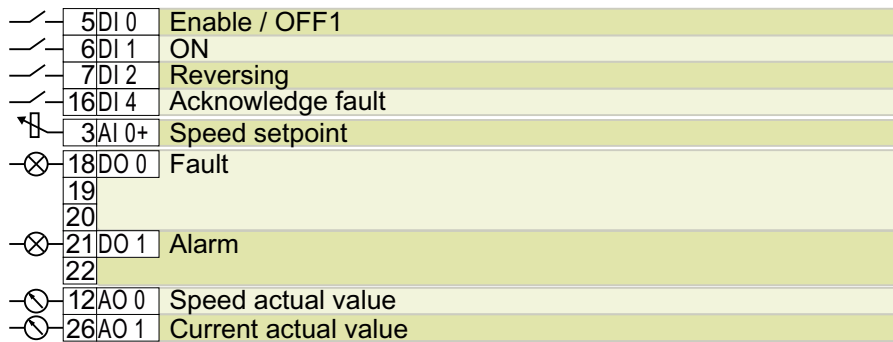

DO 0: p0730, DO 1: AO 0: p0771[0], DI 0: r0722.0, ..., DI 4: r0722.4 AI 0: r0755[0]
 p0731 AO 1: p0771[1]
 Speed setpoint (main setpoint): p1070[0] = 755[0]
 Designation in the BOP-2: 3-wlrE 2

Default setting 21: "USS fieldbus"

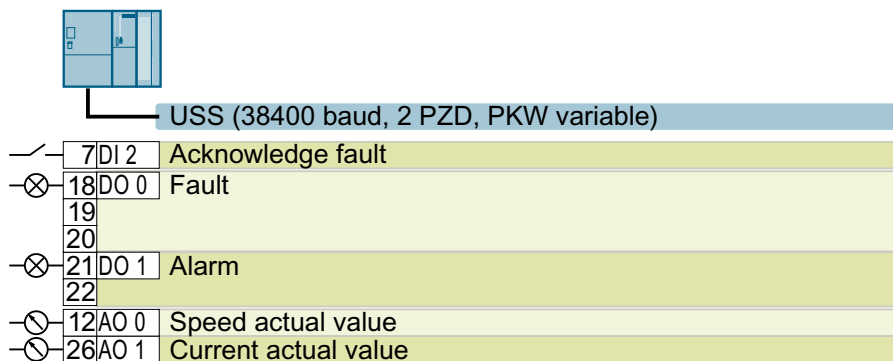

DO 0: p0730, DO 1: p0731 AO 0: p0771[0], AO 1: p0771[1] DI 2: r0722.2
 Speed setpoint (main setpoint): p1070[0] = 2050[1]
 Designation in the BOP-2: FB USS

4.6.9 Failsafe digital input of CU240E-2

To enable a safety function via the terminal strip of the converter, you need a failsafe digital input.

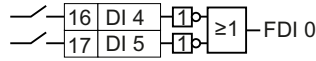

For specific default settings of the terminal strip, e.g. default setting 2, the converter combines two digital inputs to form one failsafe digital input FDI 0.

Which devices are you allowed to connect?

The failsafe digital input is designed for the following devices:

- Connection of safety sensors, e.g. emergency stop command devices or light curtains.
- Connection of pre-processing devices, e.g. failsafe control systems and safety relays.

Signal state

The converter expects signals with the same state at its failsafe digital input:

- High signal: The safety function is deselected.
- Low signal: The safety function is selected.

Connecting P/P and P/M-switching fail-safe digital outputs

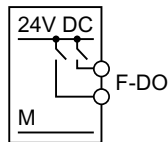

PP-switching digital output

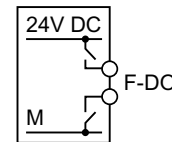

PM-switching digital output

It is permissible to connect PP and PM-switching safe outputs to a fail-safe digital input.

Fault detection

The converter compares the two signals of the failsafe digital input. The converter thus detects, for example the following faults:

- Cable break
- Defective sensor

The converter cannot detect the following faults:

- Cross-circuit of the two cables
- Short-circuit between signal cable and 24 V power supply

Special measures to prevent cross-circuits and short-circuits

The routing of cables over longer distances, e.g. between remote control cabinets, increases the risk of damaging cables. Damaged cables raise the risk of an undetected cross-circuit with power-conducting cables laid in parallel. A cross-circuit can cause interruption to the transfer of safety-related signals.

To avoid cross circuit faults and short-circuits, you must protect the cables between a sensor and the converter; this can be done by routing the cables separately or in a steel pipe/duct

On and off test

The converter filters signal changes using on and off tests at the failsafe digital input using an adjustable software filter.

4.6.10 Connecting a failsafe digital input

Overview

The converter has the following connection options for failsafe digital inputs:

- Sensor output
- PM-switching failsafe digital output
- PP-switching failsafe digital output

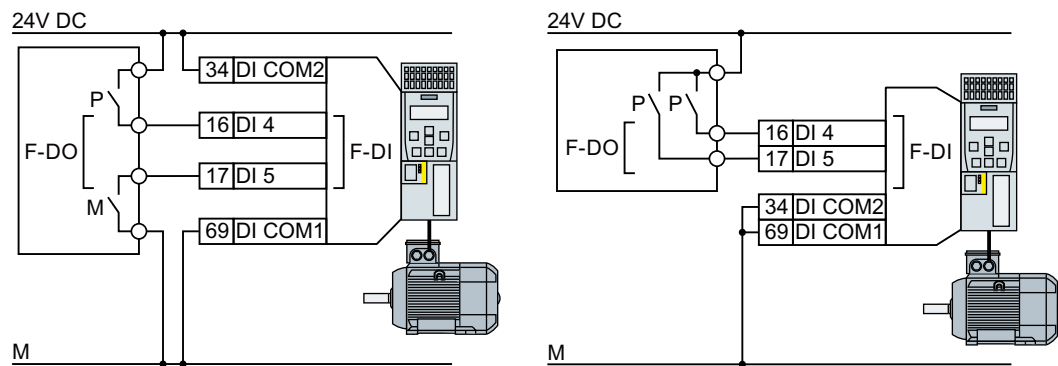

Figure 4-25 Connecting a PM-switching and PP-switching failsafe digital output

Function description

The following examples comply with PL d according to EN 13849-1 and SIL2 according to IEC 61508 for the case that all components are installed within one control cabinet.

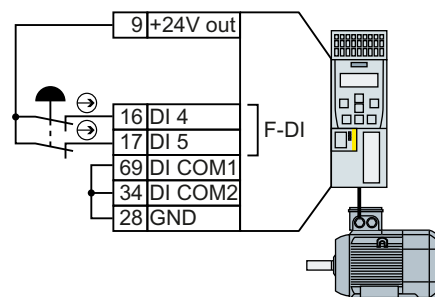

Figure 4-26 Connecting a sensor, e.g. Emergency Stop mushroom pushbutton or limit switch

4.6 Connecting the interfaces for the converter control

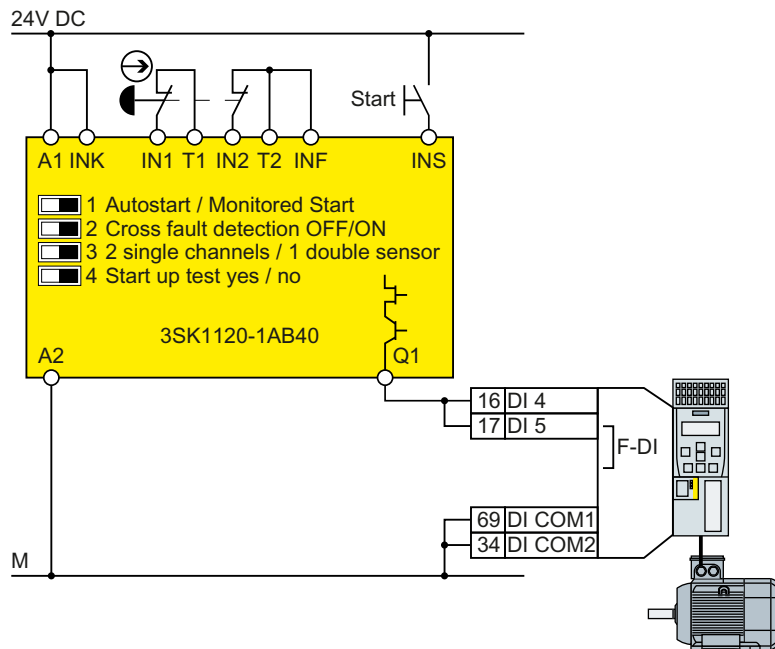

Figure 4-27 Connecting a safety relay, e.g. SIRIUS 3SK11

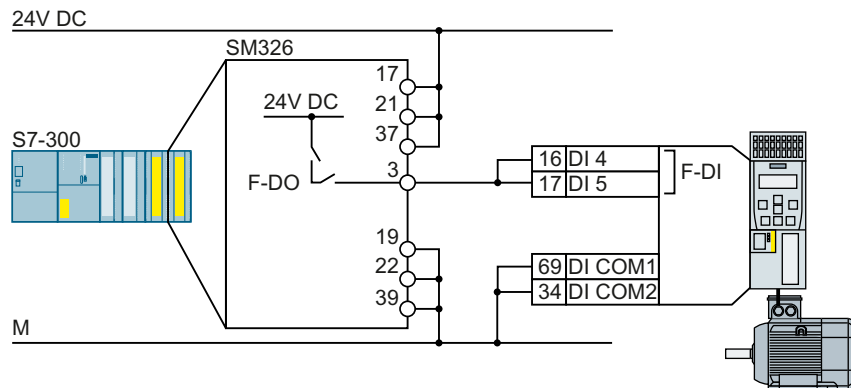



Figure 4-28 Connecting an F digital output module, e.g. SIMATIC F digital output module

Further information

 Overview of the manuals (Page 564)

The Safety Integrated Function Manual provides additional connection options and connections in separate control cabinets.

4.6.11 Wiring the terminal strip



! WARNING

Electric shock due to unsuitable power supply

Death or serious injury can result when live parts are touched in the event of a fault.

- For all connections and terminals of the electronic boards, only use power supplies that provide PELV (Protective Extra Low Voltage) or SELV (Safety Extra Low Voltage) output voltages.



! WARNING

Electric shock due to unsuitable motor temperature evaluation system

Voltage flashovers to the electronics of the converter can occur in motors without safe electrical separation of the temperature sensors in accordance with IEC 61800-5-1 when the motor develops a fault.

- Install a temperature monitoring relay 3RS1... or 3RS2...
- Evaluate the temperature monitoring relay output using a digital input of the converter, e.g. using the "External fault" function.

You can find additional information about the temperature monitoring relay on the Internet:



Manual 3RS1 / 3RS2 temperature monitoring relays (<https://support.industry.siemens.com/cs/ww/en/view/54999309>)

Note

Malfunction caused by incorrect switching states as the result of diagnostic flows in the off state (logical state "0")

In contrast to mechanical switching contacts, e.g. emergency stop switches, diagnostic flows can also flow with semiconductor switches in the off state. If interconnection with digital inputs is faulty, the diagnostic flows can lead to incorrect switching states and thus to a malfunction of the drive.

- Observe the conditions for digital inputs and digital outputs specified in the relevant manufacturers documentation.
- Check the conditions of the digital inputs and digital outputs in regard to the flows in off state. If applicable, connect the digital inputs with suitably dimensioned, external resistors to protect against the reference potential of the digital inputs.

Note

If your application requires UL certification, please note that the power supply of the digital output must comply with specific specifications.



Technical data (Page 485)

NOTICE**Overvoltages for long signal cables**

Using > 30 m long cables at the converter's digital inputs and 24 V power supply or inductive circuits at the digital inputs can lead to overvoltage. Overvoltages can damage the converter.

- Connect an overvoltage protection device between the terminal and the associated reference potential.

We recommend using the Weidmüller overvoltage protection terminal with designation MCZ OVP TAZ DIODE 24VDC.

Table 4-26 Permissible cable and wiring options

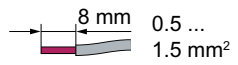
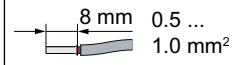
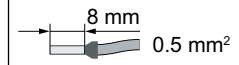
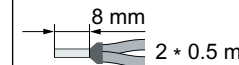
Solid or finely-stranded conductor	Finely stranded conductor with non-insulated end sleeve	Finely stranded conductor with partially insulated end sleeve	Two finely-stranded conductors with the same cross-section with partially insulated twin end sleeves
 8 mm 0.5 ... 1.5 mm ²	 8 mm 0.5 ... 1.0 mm ²	 8 mm 0.5 mm ²	 8 mm 2 * 0.5 mm ²

Wiring the terminal strip in compliance with EMC

If you use shielded cables, then you must connect the shield to the mounting plate of the control cabinet or with the shield support of the converter through a good electrical connection and a large surface area.

Use the shield connection plate of the Control Unit as strain relief.



Overview of Control Units (Page 35)

EMC-compliant wiring of failsafe inputs

Use shielded signal lines. Connect the shield at both cable ends.

In order to connect two or more converter terminals, use the shortest possible jumpers directly at the terminals themselves.

Further information

Further information about EMC-compliant wiring is available on the Internet:



EMC installation guideline (<http://support.automation.siemens.com/WW/view/en/60612658>)

4.6.12 Fieldbus interfaces

Overview

The Control Units are available in different versions for communication with higher-level controls with the subsequently listed fieldbus interfaces:

Fieldbus	Profiles			S7 communication ²⁾	Control Unit
	PROFIdrive	PROFIsafe ¹⁾	PROFIenergy ²⁾		
PROFINET	✓	✓	✓	✓	CU240E-2 PN CU240E-2 PN-F
EtherNet/IP ²⁾	---			---	
PROFIBUS	✓	✓	---	✓	CU240B-2 DP CU240E-2 DP CU240E-2 DP-F
USS ²⁾	---			---	CU240B-2 CU240E-2 CU240E-2 F
Modbus RTU ²⁾	---			---	

¹⁾ Information on PROFIsafe can be found in the "Safety Integrated" Function Manual.

²⁾ Information about these fieldbuses, profiles and communication types can be found in the "Fieldbus" Function Manual.

 Overview of the manuals (Page 564)

4.6.13 Connecting the converter to PROFINET

4.6.13.1 Communication via PROFINET IO and Ethernet

You can either integrate the converter in a PROFINET network or communicate with the converter via Ethernet.

The converter in PROFINET IO operation

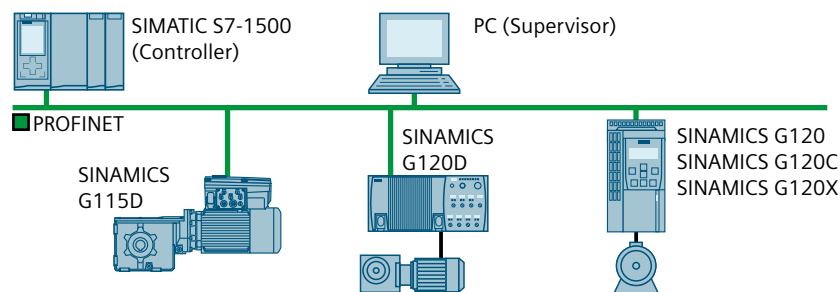

Figure 4-29 The converter in PROFINET IO operation (examples)

The converter supports the following functions:

- RT
- IRT: The converter forwards the clock synchronism, but does not support clock synchronism.

- MRP: Media redundancy, impulsed with 200 ms. Precondition: Ring topology
With MRP, you get an uninterrupted switchover if you set the failure monitoring time to a value > 200 ms.
- MRPD: Media redundancy, bumpless. Precondition: IRT and the ring topology created in the control
- Diagnostic alarms in accordance with the error classes specified in the PROFIdrive profile.
- Device replacement without removable data storage medium: The replacement converter is assigned the device name from the IO controller, not from its memory card or from the programming device.
- Shared Device for converters that support PROFI-safe.

The converter as Ethernet node

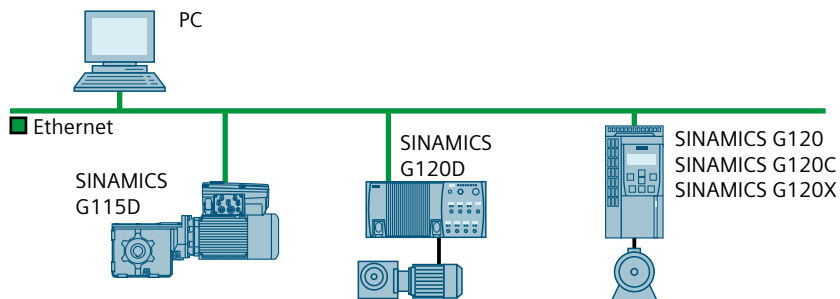





Figure 4-30 The converter as Ethernet node (examples)

Further information on the operation as Ethernet nodes can be found in the Function Manual "Fieldbuses".

 Overview of the manuals (Page 564)

Further information on PROFINET

Further information on PROFINET can be found on the Internet:

-  PROFINET – the Ethernet standard for automation (<http://w3.siemens.com/mcms/automation/en/industrial-communications/profinet/Pages/Default.aspx>)
-  PROFINET system description (<https://support.industry.siemens.com/cs/ww/en/view/19292127>)

4.6.13.2 Connecting the PROFINET cable to the converter

Procedure

1. Integrate the converter in the bus system (e.g. ring topology) of the control using PROFINET cables and the two PROFINET sockets X150-P1 and X150-P2.
 Fieldbus interface allocation (Page 106)
The maximum permitted cable length from the previous station and to the next one is 100 m.
2. Externally supply the converter with 24 VDC through terminals 31 and 32.
The external 24 V supply is only required if communications with the control should also run when the line voltage is switched off.

You have connected the converter to the control system via PROFINET.



Communication with the control system even if the line voltage is switched off

You must supply the converter with 24 V DC at terminals 31 and 32 if you wish to maintain communication with the control system when the line voltage is switched off.

In the case of brief interruptions of the 24 V power supply, the converter may signal a fault without communications with the control system being interrupted.

4.6.13.3 What do you have to set for communication via PROFINET?

Configuring PROFINET communication in the I/O controller

You require the appropriate engineering system to configure PROFINET communication in the IO controller.

If required, load the GSDML file of the converter into the engineering system.



Installing GSDML (Page 138)

Device name

In addition to the MAC address and IP address, PROFINET also uses the device name to identify PROFINET devices (Device name). The device name must be unique across the PROFINET network.

To assign the device name, you need an engineering software, e.g. HW-Config.

The converter saves the device name on the inserted memory card.

IP address

In addition to the device name, PROFINET also uses an IP address.

You have the following options to specify the IP address of the converter:

- You specify the IP address using engineering software, e.g. via HW Config.
- The IO Controller assigns an IP address to the converter.

Telegram

Set the same telegram in the converter as in the IO Controller. Interconnect the telegrams in the control program of the IO Controller with the signals of your choosing.

 Drive control via PROFIBUS or PROFINET (Page 253)

Application examples

You can find application examples for PROFINET communication on the Internet:

 Controlling the speed of a SINAMICS G110M/G120/G120C/G120D with S7-300/400F via PROFIBUS or PROFIBUS, with Safety Integrated (via terminal) and HMI (<https://support.industry.siemens.com/cs/ww/en/view/60441457>)

 Controlling the speed of a SINAMICS G110M / G120 (Startdrive) with S7-1500 (TO) via PROFIBUS or PROFIBUS, with Safety Integrated (via terminal) and HMI (<https://support.industry.siemens.com/cs/ww/en/view/78788716>)

4.6.13.4 Installing GSDML

Procedure

1. Save the GSDML to your PC.
 - With Internet access:
 -  GSDML (<https://support.industry.siemens.com/cs/ww/en/view/26641490>)
 - Without Internet access:
 - Insert a memory card into the converter.
 - Set p0804 = 12.
 - The converter writes the GSDML as a zipped file (*.zip) into directory /SIEMENS/SINAMICS/DATA/CFG on the memory card.
2. Unzip the GSDML file on your computer.
3. Import the GSDML into the engineering system of the controller.

You have now installed the GSDML in the engineering system of the controller.

4.6.14 Connecting the converter to PROFIBUS

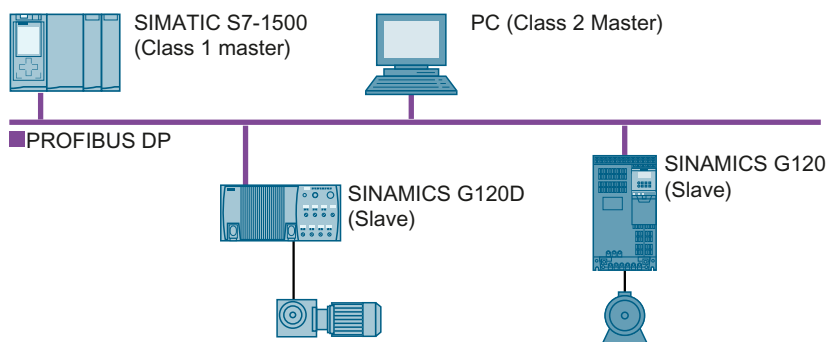

The PROFIBUS DP interface has the following functions:

- Cyclic communication
- Acyclic communication
- Diagnostic alarms

General information on PROFIBUS DP can be found in the Internet:

-  PROFIBUS user organization (<http://www.profibus.com/downloads/installation-guide/>)
-  Information about PROFIBUS DP (www.siemens.com/profibus)

4.6.14.1 Connecting the PROFIBUS cable to the converter

Procedure

1. Connect the converter to socket X126 via a PROFIBUS cable with the higher-level control.
 Overview of the interfaces (Page 105)
The maximum permitted cable length to the previous station or the subsequent one is 100 m at a baud rate of 12 Mbit/s.
2. If necessary, connect a 24 V supply voltage to terminals 31 and 32.
The external 24 V supply is only required if communication with the control may not be interrupted even if the line voltage is switched off.

You connected the converter with the control via PROFIBUS.



4.6.14.2 What do you have to set for communication via PROFIBUS?

Configuring PROFIBUS communication

You require the appropriate engineering system to configure PROFIBUS communication in the PROFIBUS master.

If required, load the GSD file of the converter into the engineering system.



Installing the GSD (Page 140)

Setting the address

Set the address of the PROFIBUS device.



Set the PROFIBUS address (Page 140)

Setting the telegram

Set the same telegram in the converter as in the PROFIBUS master. Interconnect the telegrams in the control program of the PROFIBUS master with the signals of your choosing.



Drive control via PROFIBUS or PROFINET (Page 253)

Application examples

You can find application examples for PROFIBUS communication on the Internet:



Controlling the speed of a SINAMICS G110M/G120/G120C/G120D with S7-300/400F via PROFINET or PROFIBUS, with Safety Integrated (via terminal) and HMI (<https://support.industry.siemens.com/cs/ww/en/view/60441457>)



Controlling the speed of a SINAMICS G110M / G120 (Startdrive) with S7-1500 (TO) via PROFINET or PROFIBUS, with Safety Integrated (via terminal) and HMI (<https://support.industry.siemens.com/cs/ww/en/view/78788716>)

Communication with the control system even if the line voltage is switched off

You must supply the converter with 24 V DC at terminals 31 and 32 if you wish to maintain communication with the control system when the line voltage is switched off.

In the case of brief interruptions of the 24 V power supply, the converter may signal a fault without communications with the control system being interrupted.

4.6.14.3 Installing the GSD

Procedure

1. Save the GSD on your PC using one of the following methods.
 - With Internet access:
 -  GSD (<http://support.automation.siemens.com/WW/view/en/22339653/133100>)
 - Without Internet access:
 - Insert a memory card into the converter.
 - Set p0804 = 12.
 - The converter writes the GSD as zipped file (*.zip) into directory /SIEMENS/SINAMICS/DATA/CFG on the memory card.
2. Unzip the GSD file on your computer.
3. Import the GSD in the engineering system of the controller.

You have now installed the GSD file in the engineering system of the controller.

4.6.14.4 Set the PROFIBUS address

Valid address area: 1 ... 125

You have the following options for setting the address:

- Using the address switch on the Control Unit:

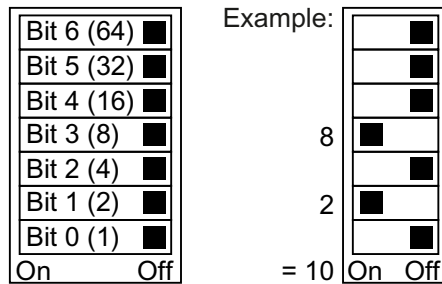



Figure 4-31 Address switch with example for bus address 10

The address switch has priority over the other settings.

- With a commissioning tool, e.g. an operator panel, via parameter p0918 (factory setting: p0918 = 126).
It is only possible to change p0918 if an invalid address is set in the address switch.

 Overview of the interfaces (Page 105)

Setting the bus address

Procedure

1. Set the address using one of the subsequently listed options:
 - Via the address switch
 - With a commissioning tool via p0918
2. Switch off the converter power supply.
3. Wait until all LEDs on the converter are dark.
4. Switch on the converter power supply again.
Your settings become effective after switching on.

The PROFIBUS address is set.



4.7 Connecting a motor holding brake

The converter uses the Brake Relay to control the motor holding brake. Two types of Brake Relay exist:

- The Brake Relay controls the motor holding brake
- The Safe Brake Relay controls a 24 V motor holding brake and monitors the brake control for short-circuit or cable breakage.

Note

Brake Relay and Safe Brake Relay

There are no differences between the Brake Relay and the Safe Brake Relay in terms of installation and connection to the converter.

Connection to the converter

To ensure that you have the correct cable for connecting the Brake Relay irrespective of the converter size, you are supplied with two preassembled cables with different lengths. Connect the appropriate cable to the Brake Module and to the converter as shown below.

If you are using your own cable, ensure that the cable is insulated and rated for 600 V.

Connecting the motor holding brake via a PELV circuit

The Brake Relay must be connected to the protective conductor if the motor brake is supplied from a PELV circuit.

Brake Relay

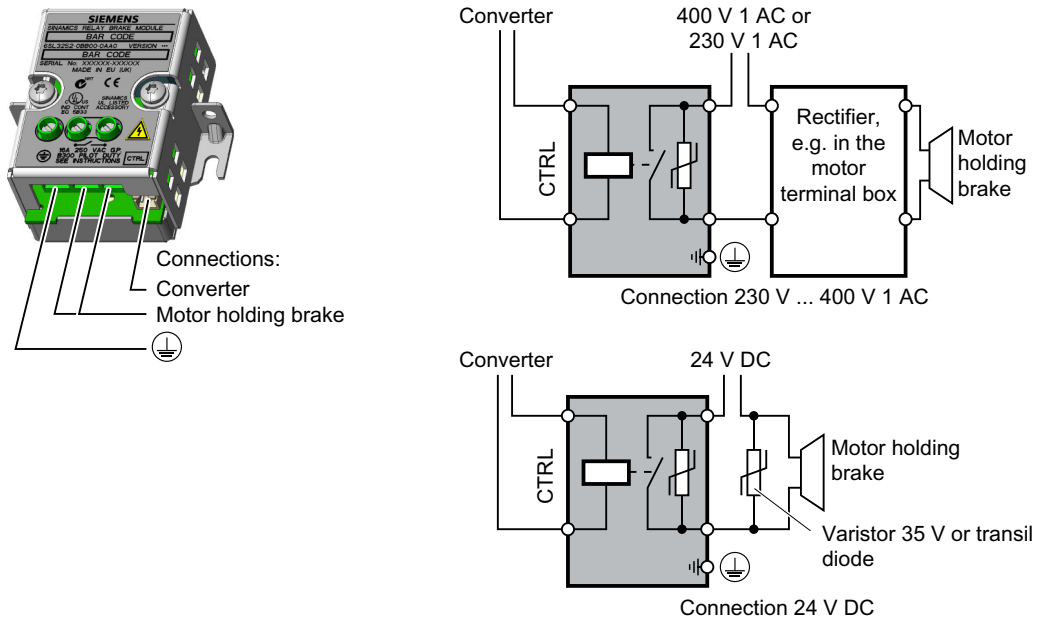

Safe Brake Relay

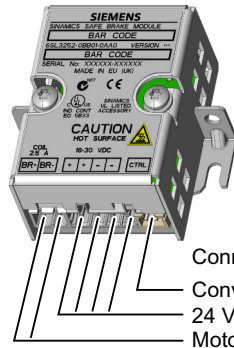

Connections:
 Converter
 24 V DC
 Motor holding brake

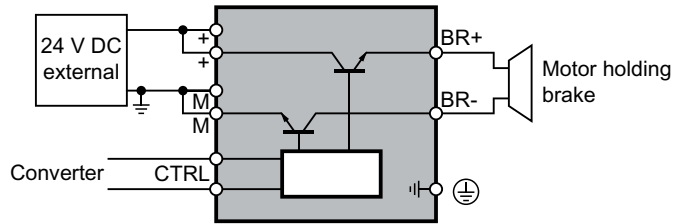

4.7.1 Installing a Brake Relay - PM250 Power Module

Installing the Brake Relay

If you use the optional shield plate, install the Brake Relay on the shield plate of the Power Module.

If you do not use the shield plate, install the Brake Relay as close as possible to the Power Module.

Connecting the Brake Relay to the converter

The connector for the Brake relay is located at the front of the Power Module for the FSA ... FSC frame sizes. These Power Modules have a cable entry for the connecting cable to the Brake Relay.

The connector for the Brake Relay is located at the bottom of the Power Module for the FSD ... FSF frame sizes.

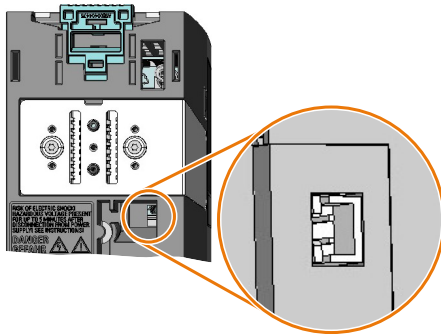

Brake relay connector for FSA ... FSC Power Modules

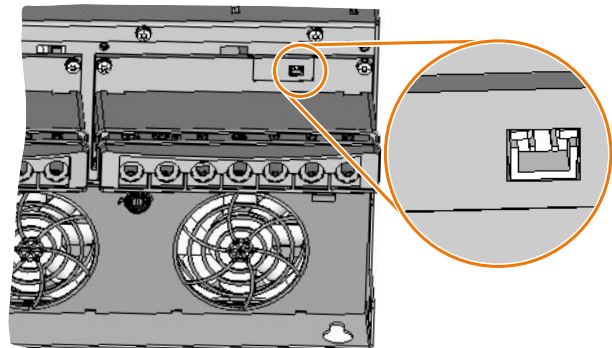

Brake relay connector for FSD ... FSF Power Modules

4.7.2 Mounting and connecting the brake relay

Installing the Brake Relay

- **FSA ... FSC:** Install the Brake Relay next to the Power Module.
- **FSD ... FSG:** Install the Brake Relay at the rear of the lower shield plate. Attach the Brake Relay before you install the shield plate.

Connecting the Brake Relay to the converter

The connector for the Brake Relay is located at the front of the Power Module. Lay the cable harness for the Brake Relay in the cable routing.

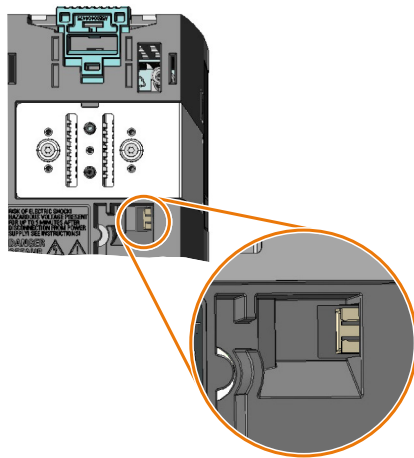

Brake relay connector for FSA ... FSC Power Modules without STO terminals

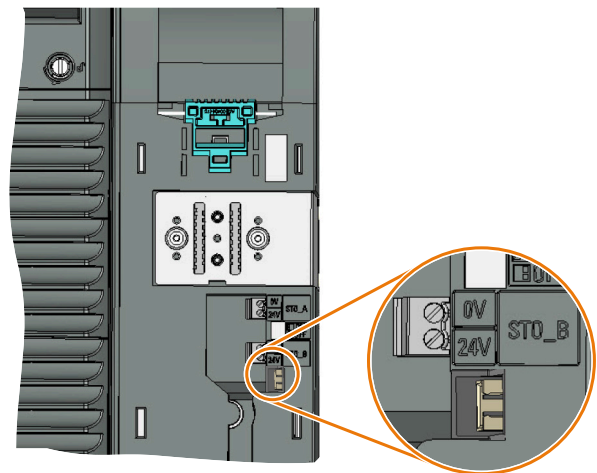

Brake relay connector for FSD ... FSF Power Modules with STO terminals

4.8 Monitoring the temperature of the braking resistor



WARNING

Fire caused by an unsuitable or incorrectly installed braking resistor

Using an unsuitable or improperly installed braking resistor can cause fires and smoke to develop. Fire and smoke development can cause severe personal injury or material damage.

- Only use braking resistors that are approved for the converter.
- Install the braking resistor in accordance with regulations.
- Monitor the temperature of the braking resistor.

Procedure

1. Connect the temperature monitoring system of the braking resistor (terminals T1 and T2 on the braking resistor) to a free digital input on the converter.

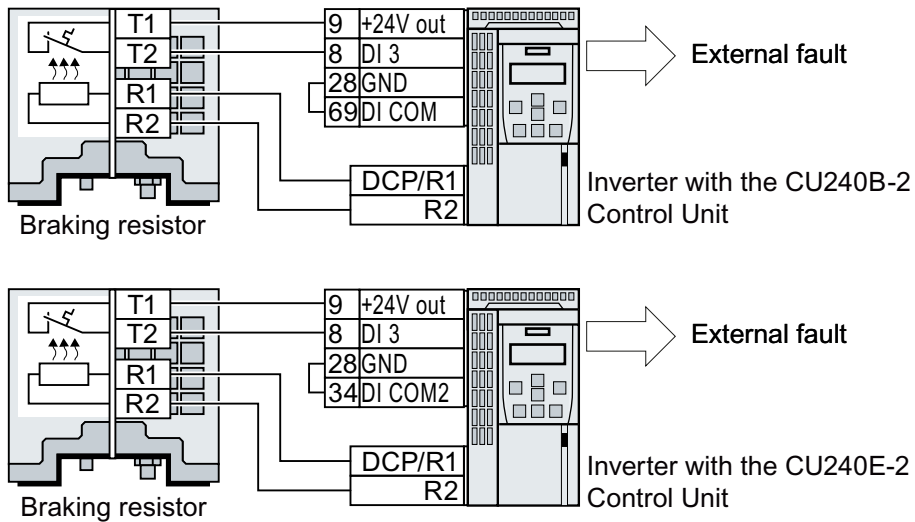

Figure 4-32 Example: Temperature monitoring of the braking resistor via digital input DI 3 on the Control Unit

2. Define the function of the digital input used as an external fault with p2106.
As an example with temperature monitoring via digital input DI 3: p2106 = 722.3.

You have ensured that the temperature is monitored.







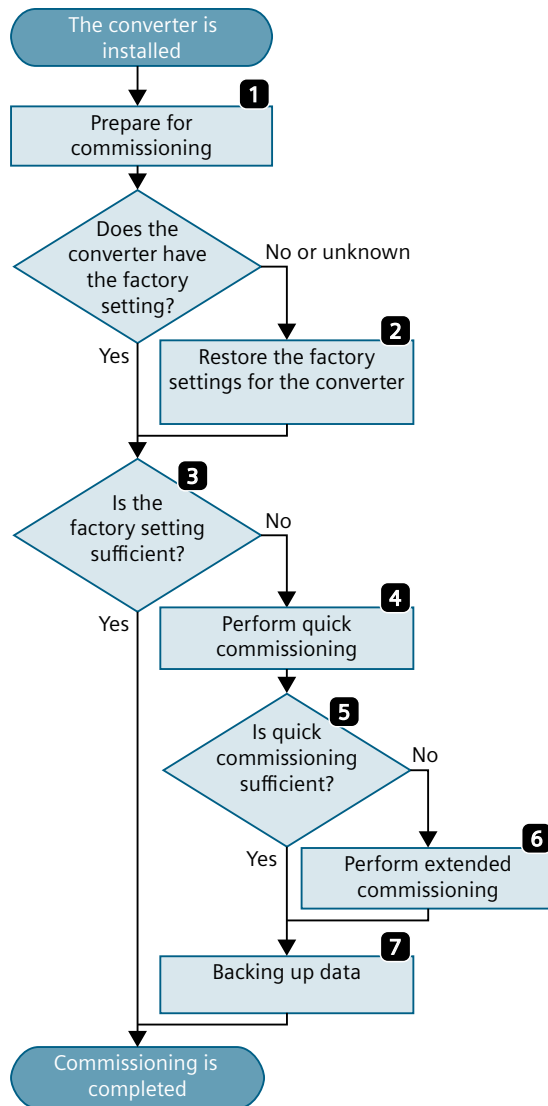

Commissioning

5.1 Commissioning guidelines

Overview



1. Define the requirements to be met by the drive for your application.
 (Page 150)
2. Restore the factory settings of the converter if necessary.
 (Page 187)
3. Check if the factory setting of the converter is sufficient for your application.
 (Page 153)
4. Set the following for quick commissioning of the drive:
 - The closed-loop motor control
 - The inputs and outputs
 - The fieldbus interface (Page 155)
5. Check if additional converter functions are required for the application.
 (Page 221)
6. If necessary, adapt the drive.
 (Page 221)
7. Save your settings.
 (Page 199)

5.2 Tools to commission the converter

Operator panel

An operator panel is used to commission, troubleshoot and control the converter, as well as to back up and transfer the converter settings.



The **Intelligent Operator Panel (IOP-2)** can either be snapped onto a converter, or is available as handheld device with a connecting cable to the converter. The graphics-capable plain text display of the IOP-2 enables intuitive converter operation.

Additional information on the IOP-2 is available in the Internet:

 SINAMICS IOP-2 release for sale (<https://support.industry.siemens.com/cs/ww/en/view/109747625>)



The **Operator Panel BOP-2** for snapping onto the converter has a two-line display for diagnostics and operating the converter.

Operating Instructions of the BOP-2 and IOP-2 operator panels:

 Overview of the manuals (Page 564)

Smart Access



Smart Access is snapped onto a converter, and is a web server-based operating unit with wireless connection to a PC, tablet or smartphone. Smart Access is used to commission and maintain the converter.

You can find additional information about Smart Access on the Internet:

 SINAMICS G120 Smart Access Operating Instructions (<https://support.industry.siemens.com/cs/ww/en/view/109758122>)

PC tools

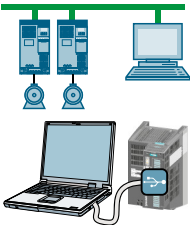

STARTER and **Startdrive** are PC tools that are used to commission, troubleshoot and control the converter, as well as to back up and transfer the converter settings. You can connect the PC with the converter via USB or via the PROFIBUS / PROFINET fieldbus.

Connecting cable (3 m) between PC and converter: Article number 6SL3255-0AA00-2CA0

 Startdrive DVD: Article number 6SL3072-4CA02-1XG0

 Startdrive, system requirements and download (<https://support.industry.siemens.com/cs/ww/en/view/109760844>)

 Startdrive tutorial (<http://support.automation.siemens.com/WW/view/en/73598459>)

 STARTER, system requirements and download (<http://support.automation.siemens.com/WW/view/en/26233208>)

Compliance with the General Data Protection Regulation

Siemens respects the principles of data protection, in particular the data minimization rules (privacy by design).

For this product, this means:

The product does not process neither store any person-related data, only technical function data (e.g. time stamps). If the user links these data with other data (e.g. shift plans) or if he stores person-related data on the same data medium (e.g. hard disk), thus personalizing these data, he has to ensure compliance with the applicable data protection stipulations.

5.3 Preparing for commissioning

5.3.1 Collecting motor data

Data for a standard induction motor

Before starting commissioning, you must know the following data:

- **Which motor is connected to the converter?**
Note down the Article No. of the motor and the motor’s nameplate data. If available, note down the motor code on the motor’s nameplate.

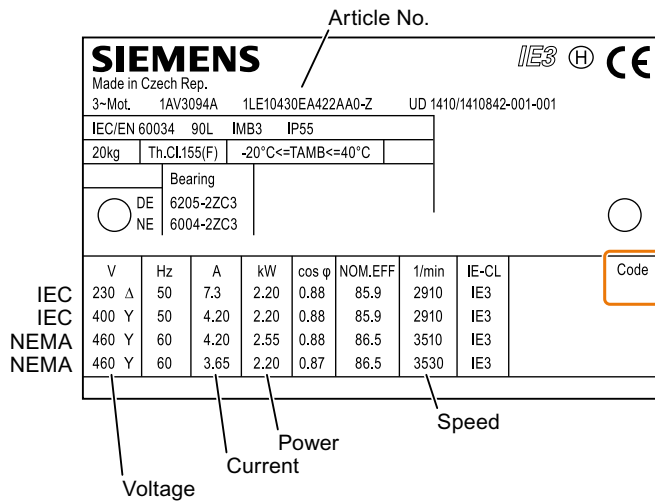

Figure 5-1 Example of the rating plate for a standard induction motor

- **In which region of the world is the motor to be used?**
- Europe IEC: 50 Hz [kW]
- North America NEMA: 60 Hz [hp] or 60 Hz [kW]
- **How is the motor connected?**
Pay attention to the connection of the motor (star connection [Y] or delta connection [Δ]). Note the appropriate motor data for connecting.

5.3.2 Forming DC link capacitors

Description

You may have to reform the DC link capacitors if the Power Module has been stored for more than one year. When the converter is operational, DC link capacitors that have not been formed can be damaged.

Table 5-1 The forming duration depends on how long the converter was stored for

Storage time from the date of manufacture	Recommended forming duration
1 – 2 years	1 hour
2 – 3 years	2 hours
> 3 years	8 hours

The production date of the Power Module is coded in the 3rd and 4th digit of the serial number on the rating plate: "S X -- ③ ④ X X X..."

Table 5-2 Production year and month

Digit ③	Year of manufacture	Digit ④	Month of manufacture
D	2013	1 ... 9	January ... September
E	2014	0	October
F	2015	N	November
H	2016	D	December
J	2017		
K	2018		
L	2019		
M	2020		

Forming the DC link of PM240-2 and PM240P-2 Power Modules

You form the DC link capacitors by supplying the converter with a line voltage of $\leq 100\%$ of the rated voltage for a defined time.

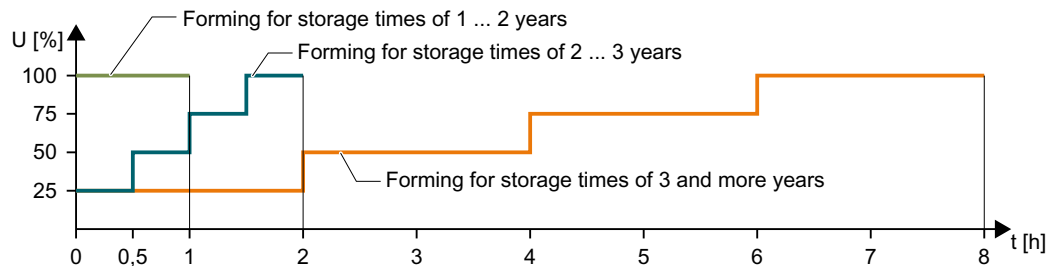

Figure 5-2 Forming the DC-link capacitors

Form DC Link of other power modules

Formation of the DC link capacitors is not required for the following power modules even after a lengthy period of storage.

- PM230
- PM250

5.3.3 Converter factory setting

Motor



In the factory, the converter is set for an induction motor matching the rated power of the Power Module.

Converter control

You can find the factory settings for the converter control in the following Chapters:

Converter interfaces

The inputs and outputs and the fieldbus interface of the converter have specific functions when set to the factory settings.

-  Factory setting of the CU240B-2 interfaces (Page 109)
-  Factory setting of the CU240E-2 interfaces (Page 117)

Switching the motor on and off

The converter is set in the factory as follows:

- After the ON command, the motor accelerates with a ramp-up time of 10 s (referred to 1500 rpm) to its speed setpoint.
- After the OFF1 command, the motor brakes down to standstill with the ramp-down time.
- The motor direction of rotation reverses with the reversing command.

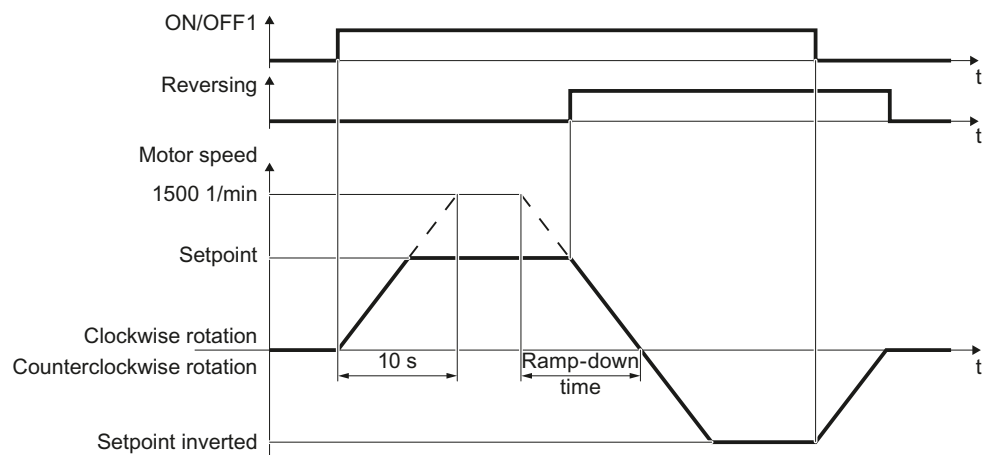

- Ramp-down time:
- With the PM230 Power Module: 30 s
 - For all other Power Modules: 10 s

Figure 5-3 Switching on, switching off and reversing the motor in the factory setting

The ramp-up and ramp-down times define the maximum motor acceleration when the speed setpoint changes. The ramp-up and ramp-down times are derived from the time between

motor standstill and the maximum speed, or between the maximum speed and motor standstill.

Traverse the motor in the jog mode

For a converter with PROFIBUS or PROFINET interface, operation can be switched over using digital input DI 3. The motor is either switched on and off via the fieldbus – or operated in the jog mode via its digital inputs.

For a control command at the respective digital input, the motor rotates with ± 150 rpm. The same ramp-up and ramp-down times as described above apply.

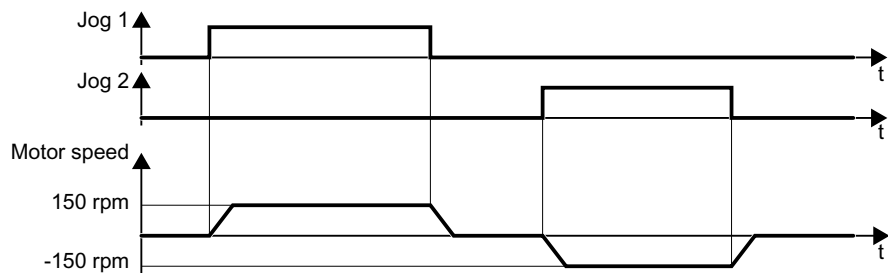

Figure 5-4 Jogging the motor in the factory setting

Minimum and maximum speed

- Minimum speed - factory setting 0 [rpm]
The minimum speed is the lowest speed of the motor independent of the speed setpoint. A minimum speed > 0 is, for example, useful for fans or pumps.
- Maximum speed - factory setting 1500 [rpm]
The converter limits the motor speed to the maximum speed.

Operate the converter with the factory setting

We recommend that you execute quick commissioning. For quick commissioning, you must adapt the converter to the connected motor by setting the motor data in the converter.

In basic applications with a standard induction motor, you can attempt to operate the drive with a rated power of < 18.5 kW without carry out an additional commissioning steps. Check whether the control quality of the drive without commissioning is adequate for the requirements of the application.

5.4 Quick commissioning using the BOP-2 operator panel

5.4.1 Inserting the BOP-2

Plugging on an operator panel

Procedure

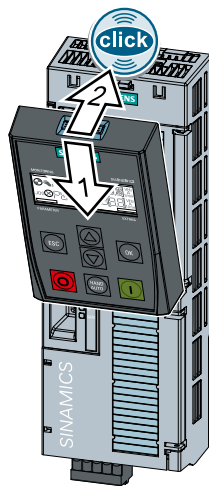

1. Locate the lower edge of the Operator Panel into the matching recess of the Control Unit.
2. Plug the Operator Panel onto the converter until the latch audibly engages.

The operator panel is plugged onto the Control Unit.



The operator panel is ready for operation when you connect the converter to the power supply.

5.4.2 Overview

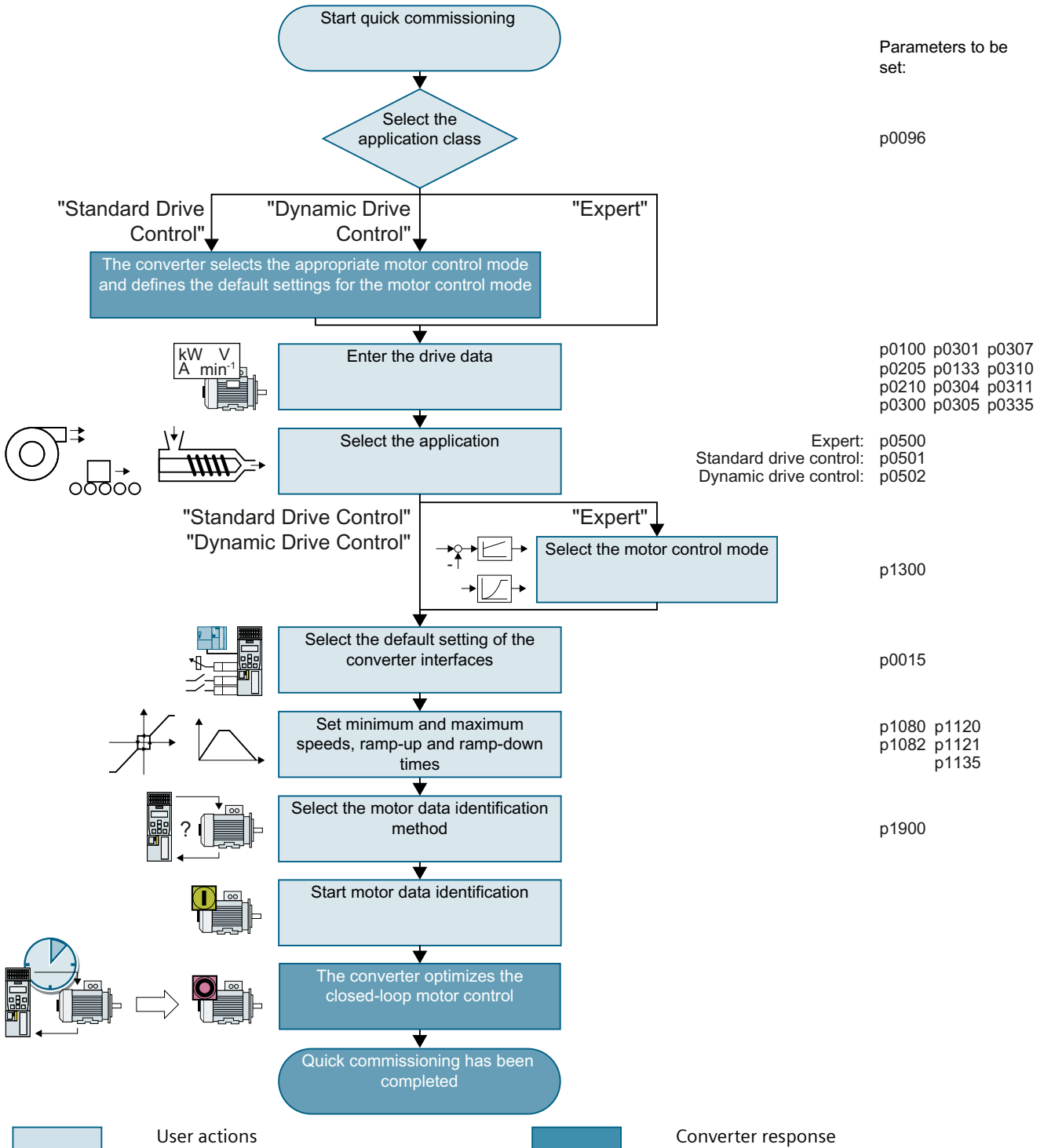

Figure 5-5 Quick commissioning using the BOP-2 operator panel

5.4.3 Starting quick commissioning

Requirement



The following requirements apply:

- The power supply is switched on.
- The operator panel displays setpoints and actual values.

Function description

Procedure



Press the ESC key.



Press one of the arrow keys until the BOP-2 displays menu **SETUP**.



To start quick commissioning, press the OK key in menu **SETUP**.



We recommend resetting the converter to the factory setting before commencing quick commissioning.

Should you wish to change the default setting of the interfaces, the converter must be reset to the factory settings now.

Proceed as follows:

1. Press the OK key.
2. Switch over the display using an arrow key: **n0** → **YES**
3. Press the OK key.



Selecting an application class (Page 157)

5.4.4 Selecting an application class

Overview

When selecting an application class, the converter assigns the appropriate settings to the motor control.

If you do not set the application class, but instead setting "Expert", then you must define the appropriate closed-loop motor control setting.

Requirement

You are using one of the following Power Modules:

- PM240-2
- PM240P-2



If you are using a different Power Module, then BOP-2 does not show step *DRV APPL*. Continue commissioning as described under "Expert".

 Expert (Page 165)

Function description



Select one of the application classes or setting "Expert":

- *STANDARD*  Standard Drive Control (Page 160)
- *DYNAMIC*  Dynamic Drive Control (Page 162)
- *EXPERT*  Expert (Page 165)

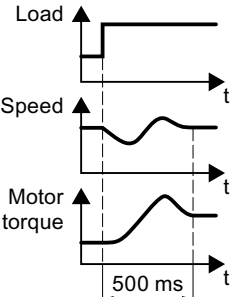
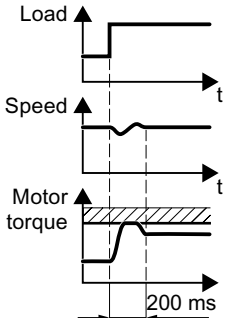
Application class	Standard Drive Control	Dynamic Drive Control
Properties	<ul style="list-style-type: none"> • Typical settling time after a speed change: 100 ms ... 200 ms • Typical settling time after a load surge: 500 ms  <ul style="list-style-type: none"> • Standard Drive Control is suitable for the following requirements: <ul style="list-style-type: none"> – Motor power ratings < 45 kW – Ramp-up time 0 → rated speed (depending on the motor power rating): 1 s (0.1 kW) ... 10 s (45 kW) – Applications with steady load torque without load surges • Standard Drive Control is insensitive with respect to imprecise setting of the motor data 	<ul style="list-style-type: none"> • Typical settling time after a speed change: < 100 ms • Typical settling time after a load surge: 200 ms  <ul style="list-style-type: none"> • Dynamic Drive Control controls and limits the motor torque • Torque accuracy that can be achieved: $\pm 5\%$ for 15 % ... 100 % of the rated speed • We recommend Dynamic Drive Control for the following applications: <ul style="list-style-type: none"> – Motor power ratings > 11 kW – For load surges of 10 % ... >100% of the rated motor torque • Dynamic Drive Control is necessary for a ramp-up time 0 → rated speed (dependent on the rated motor power): < 1 s (0.1 kW) ... < 10 s (132 kW).
Application examples	<ul style="list-style-type: none"> • Pumps, fans, and compressors with flow characteristic • Wet or dry blasting technology • Mills, mixers, kneaders, crushers, agitators • Horizontal conveyor technology (conveyor belts, roller conveyors, chain conveyors) • Basic spindles 	<ul style="list-style-type: none"> • Pumps and compressors with displacement machines • Rotary furnaces • Extruder • Centrifuges
Motors that can be operated	Induction motors	Induction and synchronous motors
Power Modules that can be operated	PM240-2, PM240P-2	
Max. output frequency	550 Hz	240 Hz

5.4 Quick commissioning using the BOP-2 operator panel

Application class	Standard Drive Control	Dynamic Drive Control
Torque control	Without torque control	Speed control with lower-level torque control
Commissioning	<ul style="list-style-type: none"> • Unlike "Dynamic Drive Control," no speed controller needs to be set • Compared with the "EXPERT" setting: <ul style="list-style-type: none"> – Simplified commissioning using predefined motor data – Reduced number of parameters • Standard Drive Control is preset for Power Modules, frame size A ... frame size C 	<ul style="list-style-type: none"> • Fewer parameters compared with the "EXPERT" setting • Dynamic Drive Control is preset for Power Modules, frame size D ... frame size F

5.4.5 Standard Drive Control

Function description



Select the motor standard:

- KW 50HZ IEC
- HP 60HZ NEMA, US units
- KW 60HZ NEMA, SI units



Set the converter supply voltage.



Select the motor type. If a 5-digit motor code is stamped on the motor rating plate, select the corresponding motor type with motor code.

Motors without motor code stamped on the rating plate:

- INDUCT Third-party induction motor
- IL IND 1LE1, 1LG6, 1LA7, 1LA9 induction motors

Motors with motor code stamped on the rating plate:

- 1LE1 IND 100 1LE1 induction motor . 9
- 1PC1 IND 1PC1 induction motor
- 1PH8 IND 1PH8 induction motor

Depending on the converter, the motor list in BOP-2 can deviate from the list shown above.



If you have selected a motor type with motor code, you must now enter the motor code. The converter assigns the following motor data corresponding to the motor code.

If you do not know the motor code, then you must set the motor code = 0, and enter motor data from p0304 and higher from the rating plate.



87 Hz motor operation The BOP-2 only indicates this step if you selected IEC as the motor standard (P100 = KW 50HZ).

MOT VOLT
P304

Rated motor voltage

MOT CURR
P305

Rated motor current

MOT POW
P307

Rated motor power

MOT FREQ
P310

Rated motor frequency

MOT RPM
P311

Rated motor speed

MOT COOL
P335

Motor cooling:

- *SELF* Natural cooling
- *FORCED* Forced-air cooling
- *LIQUID* Liquid cooling
- *NO FAN* Without fan



TEC APPL
P501

Select the basic setting for the motor control:

- *VEC STD* Constant load
- *PUMP FAN* Speed-dependent load

MRc PRr
P15

Select the default setting for the interfaces of the converter that is suitable for your application.

-  Default settings of the CU240B-2 interfaces (Page 111)
-  Default settings of the CU240E-2 interfaces (Page 119)

M: n RPM
P1080

MR: n RPM
P1082

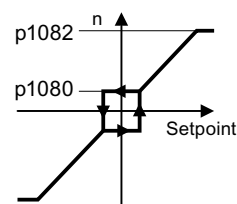

Figure 5-6 Minimum and maximum motor speed

RAMP UP
P1120

RAMP DWN
P1121

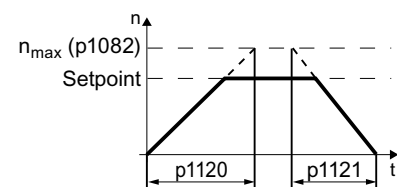

Figure 5-7 Ramp-up and ramp-down time of the motor

OFF3 RP
P1135

Ramp-down time after the OFF3 command

5.4 Quick commissioning using the BOP-2 operator panel



Motor data identification. Select the method which the converter uses to measure the data of the connected motor:

- *OFF* No motor data identification
- *STIL ROT* Measure the motor data at standstill and with the motor rotating. The converter switches off the motor after the motor data identification has been completed.
- *STILL* Recommended setting: Measure the motor data at standstill. The converter switches off the motor after the motor data identification has been completed. Select this setting if the motor cannot rotate freely.
- *ROT* Measure the motor data while the motor is rotating. The converter switches off the motor after the motor data identification has been completed.
- *ST RT OP* Setting the same as *STIL ROT*. After the motor data identification, the motor accelerates to the current setpoint.
- *STILL OP* Setting the same as *STILL*. After the motor data identification, the motor accelerates to the current setpoint.



Complete the data entry for quick commissioning as follows:

1. Switch over the display using an arrow key: *n0* → *YES*
2. Press the OK key.

You have entered all of the data that is necessary for the quick commissioning of the converter.



5.4.6 Dynamic Drive Control

Function description



Select the motor standard:

- *KW 50HZ* IEC
- *HP 60HZ* NEMA, US units
- *KW 60HZ* NEMA, SI units



Set the converter supply voltage.

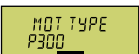

Select the motor type. If a 5-digit motor code is stamped on the motor rating plate, select the corresponding motor type with motor code.

Motors without motor code stamped on the rating plate:

- *INDUCT* Third-party induction motor
- *IL IND* 1LE1, 1LG6, 1LA7, 1LA9 induction motors

Motors with motor code stamped on the rating plate:

- `1LE1 IND 100` 1LE1 induction motor . 9
- `1PC1 IND` 1PC1 induction motor
- `1PH8 IND` 1PH8 induction motor

Depending on the converter, the motor list in BOP-2 can deviate from the list shown above.

MOT CODE
P301

If you have selected a motor type with motor code, you must now enter the motor code. The converter assigns the following motor data corresponding to the motor code.

If you do not know the motor code, then you must set the motor code = 0, and enter motor data from p0304 and higher from the rating plate.

87 HZ

87 Hz motor operation The BOP-2 only indicates this step if you selected IEC as the motor standard (P100 = `4W 50HZ`).

MOT VOLT
P304

Rated motor voltage

MOT CURR
P305

Rated motor current

MOT POW
P307

Rated motor power

MOT FREQ
P310

Rated motor frequency

MOT RPM
P311

Rated motor speed

MOT COOL
P335

Motor cooling:

- `SELF` Natural cooling
- `FORCED` Forced-air cooling
- `LIQUID` Liquid cooling
- `NO FAN` Without fan

TEC APPL
P502

Select the basic setting for the motor control:

- `OP LOOP` Recommended setting for standard applications
- `CL LOOP` Recommended setting for applications with short ramp-up and ramp-down times
- `HVY LOAD` Recommended setting for applications with a high break loose torque.

HA_c PR
P15

Select the default setting for the interfaces of the converter that is suitable for your application.

 Default settings of the CU240B-2 interfaces (Page 111)

 Default settings of the CU240E-2 interfaces (Page 119)

5.4 Quick commissioning using the BOP-2 operator panel

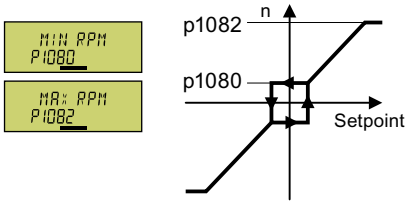

Figure 5-8 Minimum and maximum motor speed

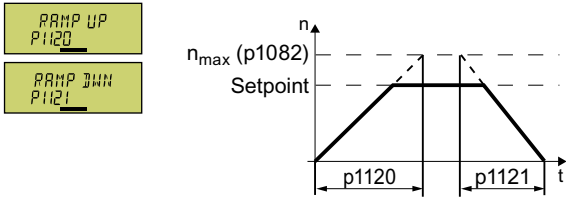
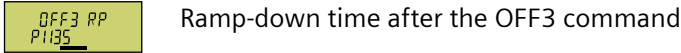

Figure 5-9 Ramp-up and ramp-down time of the motor



Ramp-down time after the OFF3 command

Motor data identification: Select the method which the converter uses to measure the data of the connected motor:

- **OFF** No motor data identification
- **STIL ROT** Recommended setting: Measure the motor data at standstill and with the motor rotating. The converter switches off the motor after the motor data identification has been completed.
- **STILL** Default setting: Measure the motor data at standstill. The converter switches off the motor after the motor data identification has been completed. Select this setting if the motor cannot rotate freely.
- **ROT** Measure the motor data while the motor is rotating. The converter switches off the motor after the motor data identification has been completed.
- **ST RT OP** Setting the same as **STIL ROT**. After the motor data identification, the motor accelerates to the current setpoint.
- **STILL OP** Setting the same as **STILL**. After the motor data identification, the motor accelerates to the current setpoint.

FINISH Complete the data entry for quick commissioning as follows:

1. Switch over the display using an arrow key: $n0 \rightarrow 4ES$
2. Press the OK key.

You have entered all of the data that is necessary for the quick commissioning of the converter.



5.4.7 Expert

Function description

EUR/USA
P100

Select the motor standard:

- KW 50HZ IEC
- HP 60HZ NEMA, US units
- KW 60HZ NEMA, SI units

LOAD TYP
P205

Specify the overload capability of the converter:

- HIGH OVL Duty cycle with "high overload"
- LOW OVL Duty cycle with "low overload"

 Overload capability of the converter (Page 490)

INV VOLT
P210

Set the converter supply voltage.

MOT TYPE
P300

Select the motor type. If a 5-digit motor code is stamped on the motor rating plate, select the corresponding motor type with motor code.

Motors without motor code stamped on the rating plate:

- INDUCT Third-party induction motor
- IL IND 1LE1, 1LG6, 1LA7, 1LA9 induction motors

Motors with motor code stamped on the rating plate:

- ILE1 IND 100 1LE1 induction motor . 9
- IPC1 IND 1PC1 induction motor
- IPH8 IND 1PH8 induction motor

Depending on the converter, the motor list in BOP-2 can deviate from the list shown above.

MOT CODE
P301

If you have selected a motor type with motor code, you must now enter the motor code. The converter assigns the following motor data corresponding to the motor code.

If you do not know the motor code, then you must set the motor code = 0, and enter motor data from p0304 and higher from the rating plate.

87 HZ

87 Hz motor operation The BOP-2 only indicates this step if you selected IEC as the motor standard (P100 = KW 50HZ).

MOT VOLT
P304

Rated motor voltage

MOT CURR
P305

Rated motor current

MOT POW
P307

Rated motor power

MOT FREQ
P310

Rated motor frequency

MOT RPM
P311

Rated motor speed

MOT COOL
P335

Motor cooling:

- **SELF** Natural cooling
- **FORCED** Forced-air cooling
- **LIQUID** Liquid cooling
- **NO FAN** Without fan

TEC APPL
P500

Select the appropriate application:

- **VEC STD** In all applications that do not fit the other setting options.
- **PUMP FAN** Applications involving pumps and fans
- **SLVC OHZ** Applications with short ramp-up and ramp-down times.
- **PUMP OHZ** Applications involving pumps and fans with optimized efficiency. The setting only makes sense for steady-state operation with slow speed changes. We recommend setting **VEC STD** if load surges during operation cannot be ruled out.

CTRL MOD
P1300

Select the control mode:

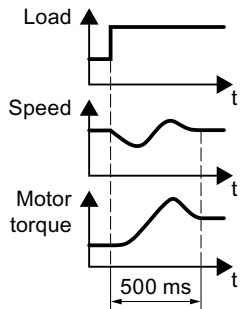
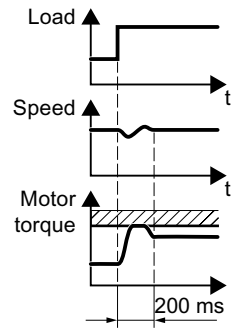

- **VF LIN** U/f control with linear characteristic
- **VF LIN F** Flux current control (FCC)
- **VF QUAD** U/f control with square-law characteristic
- **SPD N EN** Sensorless vector control

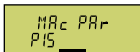
Control mode	U/f control or flux current control (FCC)	Sensorless vector control
Properties	<ul style="list-style-type: none"> • Typical settling time after a speed change: 100 ms ... 200 ms • Typical settling time after a load surge: 500 ms  <ul style="list-style-type: none"> • The control mode is suitable to address the following requirements: <ul style="list-style-type: none"> – Motor power ratings < 45 kW – Ramp-up time 0 → rated speed (depending on the motor power rating): 1 s (0.1 kW) ... 10 s (45 kW) – Applications with steady load torque without load surges • The control mode is insensitive with respect to imprecise setting of the motor data 	<ul style="list-style-type: none"> • Typical settling time after a speed change: < 100 ms • Typical settling time after a load surge: 200 ms  <ul style="list-style-type: none"> • The control mode controls and limits the motor torque • Torque accuracy that can be achieved: $\pm 5\%$ for 15 % ... 100 % of the rated speed • We recommend the control mode for the following applications: <ul style="list-style-type: none"> – Motor power ratings > 11 kW – For load surges of 10 % ... >100 % of the rated motor torque • The control mode is necessary for a ramp-up time 0 → Rated speed (dependent on the rated motor power): < 1 s (0.1 kW) ... < 10 s (250 kW).
Application examples	<ul style="list-style-type: none"> • Pumps, fans, and compressors with flow characteristic • Wet or dry blasting technology • Mills, mixers, kneaders, crushers, agitators • Horizontal conveyor technology (conveyor belts, roller conveyors, chain conveyors) • Basic spindles 	<ul style="list-style-type: none"> • Pumps and compressors with displacement machines • Rotary furnaces • Extruder • Centrifuges
Motors that can be operated	Induction motors	Induction and synchronous motors
Power Modules that can be operated	No restrictions	
Max. output frequency	550 Hz	240 Hz
Torque control	Without torque control	Torque control with and without higher-level speed control
Commissioning	<ul style="list-style-type: none"> • In contrast to sensorless vector control, the speed controller does not have to be set 	



Select the default setting for the interfaces of the converter that is suitable for your application.

5.4 Quick commissioning using the BOP-2 operator panel

-  Default settings of the CU240B-2 interfaces (Page 111)
-  Default settings of the CU240E-2 interfaces (Page 119)

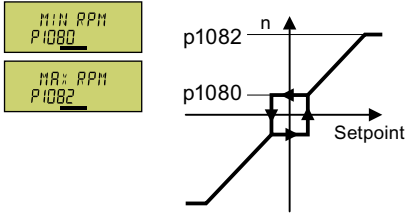

Figure 5-10 Minimum and maximum motor speed

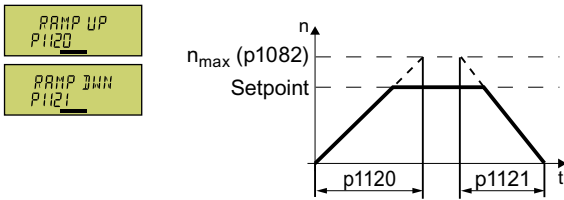

Figure 5-11 Ramp-up and ramp-down time of the motor

OFF3 RP
P1135

Ramp-down time for the OFF3 command

MOT ID
P1900

Motor data identification: Select the method which the converter uses to measure the data of the connected motor:

- **OFF** Motor data is not measured.
- **STIL ROT** Recommended setting: Measure the motor data at standstill and with the motor rotating. The converter switches off the motor after the motor data identification has been completed.
- **STILL** Measure the motor data at standstill. The converter switches off the motor after the motor data identification has been completed.
Select this setting if one of the following cases is applicable:
 - You have selected control mode "SPD N EN"; however, the motor cannot rotate freely.
 - You have selected U/f control as control mode, e.g. **VF LIN** or **VF QUA**
- **ROT** Measure the motor data while the motor is rotating. The converter switches off the motor after the motor data identification has been completed.
- **ST RT OP** Setting the same as **STIL ROT**
After the motor data identification, the motor accelerates to the current setpoint.
- **STILL OP** Setting the same as **STILL**
After the motor data identification, the motor accelerates to the current setpoint.

FINISH

Complete quick commissioning as follows:

1. Switch over the display using an arrow key: $n0 \rightarrow 4E5$
2. Press the OK key.

You have entered all of the data that is necessary for the quick commissioning of the converter.



5.4.8 Identifying the motor data and optimizing the closed-loop control

Overview

Using the motor data identification, the converter measures the data of the stationary motor. In addition, based on the response of the rotating motor, the converter can determine a suitable setting for the vector control.

To start the motor data identification routine, you must switch-on the motor via the terminal strip, fieldbus or from the operator panel.

Identifying the motor data and optimizing the closed-loop control

Requirements

- You have selected a method of motor data identification during quick commissioning, e.g. measuring motor data while the motor is stationary.
When quick commissioning is complete, the converter issues alarm A07991.
- The motor has cooled down to the ambient temperature.
An excessively high motor temperature falsifies the motor data identification results.



WARNING

Unexpected machine motion while the motor data identification is in progress

For the stationary measurement, the motor can make several rotations. The rotating measurement accelerates the motor up to the rated speed. Secure dangerous machine parts before starting motor data identification:

- Before switching on, ensure that nobody is working on the machine or located within its working area.
- Secure the machine's work area against unintended access.
- Lower suspended loads to the floor.

Procedure



Enable the control priority via the operator panel.



The BOP-2 displays the symbol indicating manual operation.



Switch on the motor.



During motor data identification **MOT - 1** flashes on the BOP-2.



If the converter again outputs alarm A07991, then it waits for a new ON command to start the rotating measurement.

5.4 Quick commissioning using the BOP-2 operator panel

If the converter does not output alarm A07991, switch off the motor as described below, and switch over the converter control from HAND to AUTO.



Switch on the motor to start the rotating measurement.



During motor data identification **MOT - 1** flashes on the BOP-2.

The motor data identification can take up to 2 minutes depending on the rated motor power.



Depending on the setting, after motor data identification has been completed, the converter switches off the motor - or it accelerates it to the setpoint.

If required, switch off the motor.



Disable the control priority via the operator panel.

You have completed the motor data identification.



Quick commissioning has been completed once the motor data identification has been successfully completed.

5.5 Quick commissioning with a PC.

The screen forms that are shown in this manual show generally valid examples. The number of setting options available in screen forms depends on the particular converter type.

5.5.1 Creating a project

Creating a new project

Procedure

1. Start the Startdrive commissioning software.
2. In the menu, select "Project" → "New...".
3. Specify a name of your choice for the project.

You have created a new project.



5.5.2 Transfer converters connected via USB into the project

Integrating the converter into the project

Procedure

1. Switch on the converter power supply.
2. First insert a USB cable into your PC and then into the converter.
3. The PC operating system installs the USB driver when you are connecting the converter and PC together for the first time.
4. Press the "Accessible nodes" button.

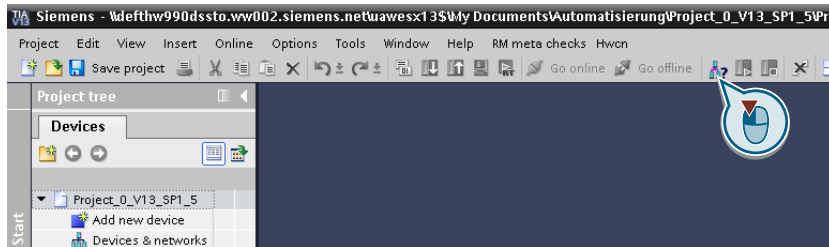

5. When the USB interface is appropriately set, then the "Accessible nodes" screen form shows the converters that can be accessed.

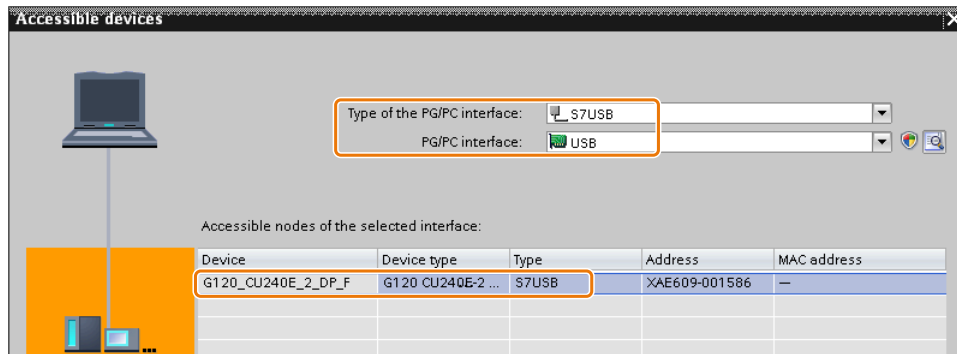

If you have not correctly set the USB interface, then the following "No additional nodes found" message is displayed. In this case, follow the description below.

6. Transfer the converter into the project using the menu: "Online - Upload device as new station (hardware and software)".

You have transferred a converter accessible via the USB interface into your project.



5.5.3 Go online and start the commissioning Wizard

Procedure

1. Select your project and go online: 
2. In the following screen form, select the converter with which you wish to go online.
3. Once you are online, select "Commissioning" → "Commissioning Wizard":

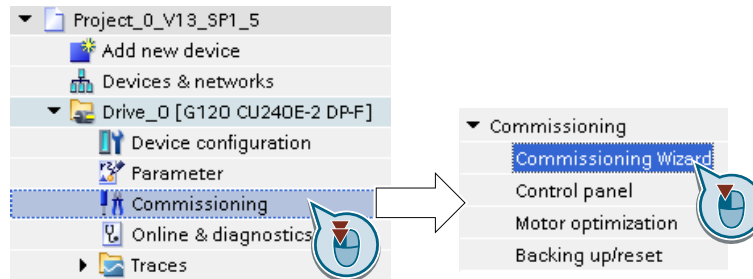

You have started the commissioning Wizard of the converter.



5.5.4 Overview of quick commissioning

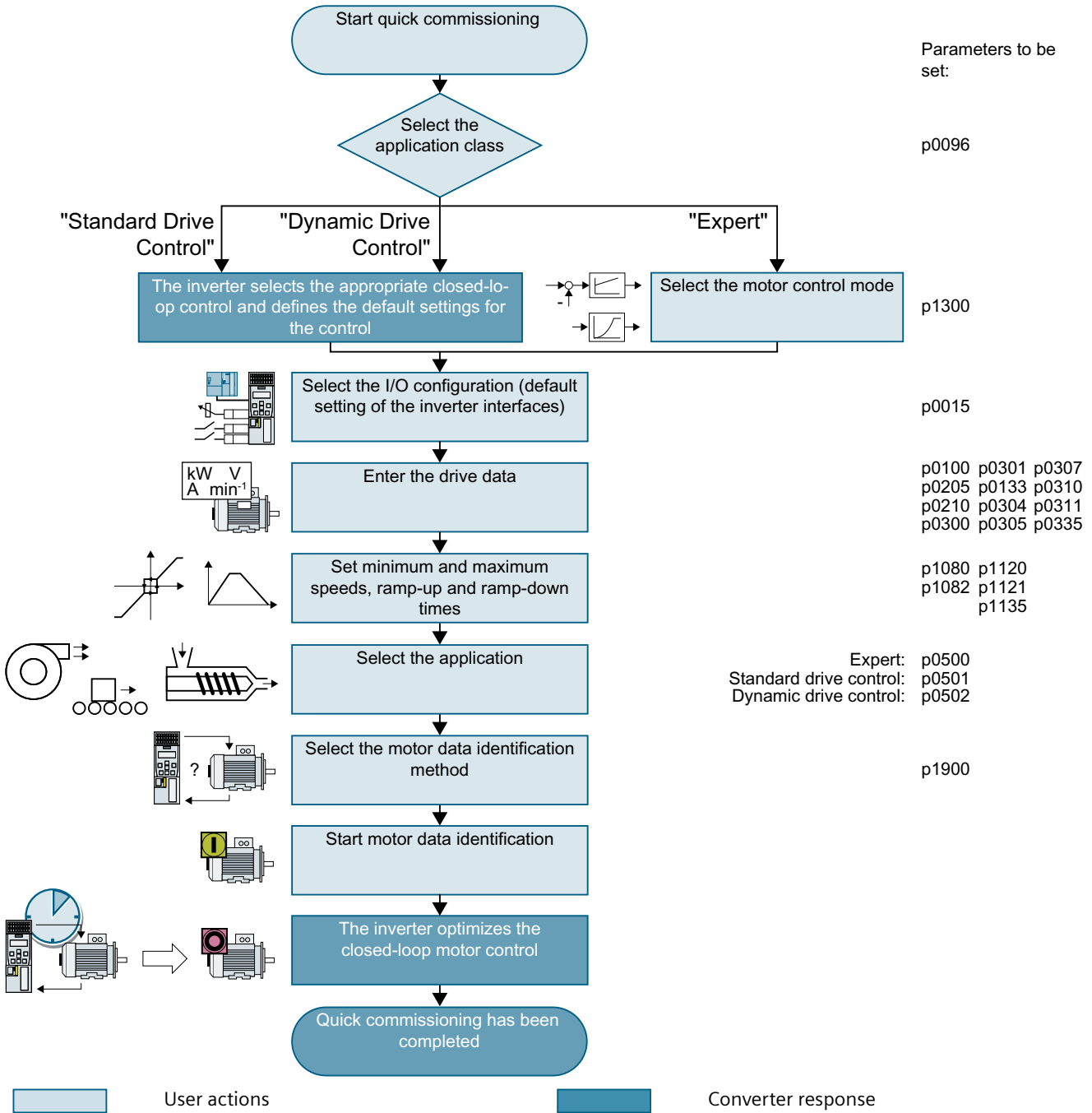



Figure 5-12 Quick commissioning with a PC



5.5.5 Commissioning wizard

Select the application class

Procedure

 Application class

When selecting an application class, the converter assigns the motor control with the appropriate default settings:

- [1]  Standard Drive Control (Page 178)
- [2]  Dynamic Drive Control (Page 180)
- [0] Expert - or if no application class is listed:
 Expert (Page 182)

5.5 Quick commissioning with a PC.

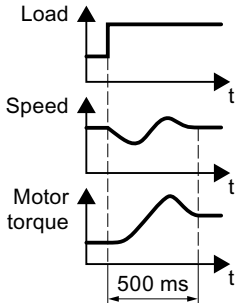
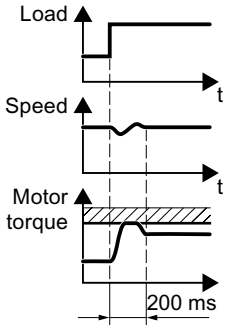
Application class	Standard Drive Control	Dynamic Drive Control
<p>Properties</p>	<ul style="list-style-type: none"> • Typical settling time after a speed change: 100 ms ... 200 ms • Typical settling time after a load surge: 500 ms  <ul style="list-style-type: none"> • Standard Drive Control is suitable for the following requirements: <ul style="list-style-type: none"> – Motor power ratings < 45 kW – Ramp-up time 0 → rated speed (depending on the motor power rating): 1 s (0.1 kW) ... 10 s (45 kW) – Applications with increasing load torque without load surges • Standard Drive Control is insensitive with respect to imprecise setting of the motor data 	<ul style="list-style-type: none"> • Typical settling time after a speed change: < 100 ms • Typical settling time after a load surge: 200 ms  <ul style="list-style-type: none"> • Dynamic Drive Control controls and limits the motor torque • Torque accuracy that can be achieved: ± 5% for 15 % ... 100 % of the rated speed • We recommend Dynamic Drive Control for the following applications: <ul style="list-style-type: none"> – Motor power ratings > 11 kW – For load surges of 10 % ... >100 % of the rated motor torque • Dynamic Drive Control is necessary for a ramp-up time 0 → rated speed (dependent on the rated motor power): < 1 s (0.1 kW) ... < 10 s (132 kW).
<p>Application examples</p>	<ul style="list-style-type: none"> • Pumps, fans, and compressors with flow characteristic • Wet or dry blasting technology • Mills, mixers, kneaders, crushers, agitators • Horizontal conveyor technology (conveyor belts, roller conveyors, chain conveyors) • Basic spindles 	<ul style="list-style-type: none"> • Pumps and compressors with displacement machines • Rotary furnaces • Extruder • Centrifuges
<p>Motors that can be operated</p>	<p>Induction motors</p>	<p>Induction and synchronous motors</p>
<p>Power Modules that can be operated</p>	<p>PM240-2, PM240P-2</p>	
<p>Max. output frequency</p>	<p>550 Hz</p>	<p>240 Hz</p>

Application class	Standard Drive Control	Dynamic Drive Control
Torque control	Without torque control	Speed control with lower-level torque control
Commissioning	<ul style="list-style-type: none"> • Unlike "Dynamic Drive Control," no speed controller needs to be set • Compared with the "EXPERT" setting: <ul style="list-style-type: none"> – Simplified commissioning using predefined motor data – Reduced number of parameters • Standard Drive Control is preset for Power Modules, frame size A ... frame size C 	<ul style="list-style-type: none"> • Fewer parameters compared with the "EXPERT" setting • Dynamic Drive Control is preset for Power Modules, frame size D ... frame size F

5.5.6 Standard Drive Control

Procedure for application class [1]: Standard Drive Control

Setpoint specification

The wizard only displays the "setpoint input" if you configured a converter with PROFINET or PROFIBUS interface.

Select whether the converter is connected to a higher-level control via the fieldbus.

Select whether the ramp-function generator for the speed setpoint is implemented in the higher-level control or in the converter.

Defaults of the setpoi...

Select the I/O configuration to preassign the converter interfaces.

 Default settings of the CU240B-2 interfaces (Page 111)

 Default settings of the CU240E-2 interfaces (Page 119)

Drive setting

Set the applicable motor standard and the converter supply voltage.

Drive options

If an optional component is installed between converter and motor, the corresponding setting must be performed.

If a braking resistor is installed, you set the maximum braking power to which the braking resistor will be subjected.

Motor

Select your motor.

Enter the motor data according to the rating plate of your motor.

If you have selected a motor based on its article number, the data has already been entered.

Select the temperature sensor for monitoring of the motor temperature.

Motor holding brake

Define whether the converter actuates a motor holding brake.

Important parameters

Set the most important parameters to suit your application.

Drive functions

Select the technological application:

- [0] Constant load: Typical applications include conveyor drives
- [1] Speed-dependent load: Typical applications include pumps and fans

Motor data identification (not all the following settings may be visible in Startdrive):

- [0]: No motor data identification
- [2]: Recommended setting. Measure the motor data at standstill. The converter switches off the motor after the motor data identification has been completed.
Select this setting if the motor cannot freely rotate, e.g. for a mechanically limited traversing range.
- [12]: The same setting as [2]. The motor accelerates to the currently set setpoint after the motor data identification.

Calculating the motor parameters: Select "Complete calculation".

Summary

Set the check mark for "RAM data to EEPROM (save data in the drive)" to save your data in the converter so that it is not lost if the power fails.

Press the "Finish" button.

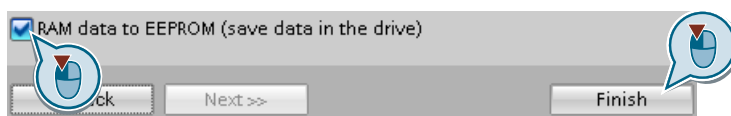

You have entered all of the data that is necessary for the quick commissioning of the converter.



5.5.7 Dynamic Drive Control

Procedure for application class [2]: Dynamic Drive Control

Setpoint specification

The wizard only displays the "setpoint input" if you configured a converter with PROFINET or PROFIBUS interface.

Select whether the converter is connected to a higher-level control via the fieldbus.

Select whether the ramp-function generator for the speed setpoint is implemented in the higher-level control or in the converter.

Defaults of the setpoi...

Select the I/O configuration to preassign the converter interfaces.



Default settings of the CU240B-2 interfaces (Page 111)



Default settings of the CU240E-2 interfaces (Page 119)

Drive setting

Set the applicable motor standard and the converter supply voltage.

Drive options

If an optional component is installed between converter and motor, the corresponding setting must be performed.

If a braking resistor is installed, you set the maximum braking power to which the braking resistor will be subjected.

Motor

Select your motor.

Enter the motor data according to the rating plate of your motor.

If you have selected a motor based on its article number, the data has already been entered.

Motor holding brake

Define whether the converter actuates a motor holding brake.

Important parameters

Set the most important parameters to suit your application.

Drive functions

Application:

- [0]: Recommended setting for standard applications.
- [1]: Recommended setting for applications with ramp-up and ramp-down times < 10 s. This setting is not suitable for hoisting gear and cranes.
- [5] Recommended setting for applications with a high break loose torque.

Motor data identification:

- [0]: No motor data identification
- [1]: Recommended setting. Measure the motor data at standstill and with the motor rotating. The converter switches off the motor after the motor data identification has been completed.
- [2]: Default setting: Measure the motor data at standstill. The converter switches off the motor after the motor data identification has been completed.
Select this setting if the motor cannot freely rotate, e.g. for a mechanically limited traversing range.
- [3]: Measure the motor data while the motor is rotating. The converter switches off the motor after the motor data identification has been completed.

- [11]: The same setting as [1]. The motor accelerates to the currently set setpoint after the motor data identification.
- [12]: The same setting as [2]. The motor accelerates to the currently set setpoint after the motor data identification.

Calculating the motor parameters: Select "Complete calculation".

Summary

Set the check mark for "RAM data to EEPROM (save data in the drive)" to save your data in the converter so that it is not lost if the power fails.

Select "Finish".

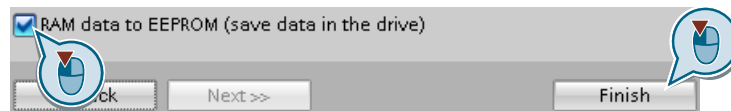

You have entered all of the data that is necessary for the quick commissioning of the converter.



5.5.8 Expert

Procedure without application class or for the application class [0]: Expert

Setpoint specification

The wizard only displays the "setpoint input" if you configured a converter with PROFINET or PROFIBUS interface.

Select whether the converter is connected to a higher-level control via the fieldbus.

Select whether the ramp-function generator for the speed setpoint is implemented in the higher-level control or in the converter.

Open-loop/closed-loop ...

Select the control mode.

Further information is provided at the end of the section.

Defaults of the setpoi...

Select the I/O configuration to preassign the converter interfaces.

 Default settings of the CU240B-2 interfaces (Page 111)

 Default settings of the CU240E-2 interfaces (Page 119)

Drive setting

Set the applicable motor standard and the converter supply voltage.

Application:

- "[0] Load cycle with high overload ..." for applications requiring a high dynamic performance, e.g. conveyor systems.
- "[1] Load cycle with low overload ..." for applications that do not require a high dynamic performance, e.g. pumps or fans.

Drive options

If an optional component is installed between converter and motor, the corresponding setting must be performed.

If a braking resistor is installed, you set the maximum braking power to which the braking resistor will be subjected.

Motor

Select your motor.

Enter the motor data according to the rating plate of your motor.

If you have selected a motor based on its article number, the data has already been entered.

Motor holding brake

Define whether the converter actuates a motor holding brake.

Important parameters

Set the most important parameters to suit your application.

Drive functions

Application:

- [0]: In all applications that do not fall under [1] ... [3]
- [1]: Applications involving pumps and fans
- [2]: Applications with short ramp-up and ramp-down times. However, this setting is not suitable for hoisting gear and cranes/lifting gear.
- [3]: Applications involving pumps and fans with optimized efficiency. The setting only makes sense for steady-state operation with slow speed changes. We recommend setting [1] if load surges in operation cannot be ruled out.
- [5]: Applications with high breakaway torques, e.g. extruders, mills and mixers

Motor identification:

- [1]: Recommended setting. Measure the motor data at standstill and with the motor rotating. The converter switches off the motor after the motor data identification has been completed.
- [2]: Measure the motor data at standstill. The converter switches off the motor after the motor data identification has been completed.
Recommended setting for the following cases:
 - You have selected "Speed control" as control mode, however the motor cannot freely rotate, e.g. for mechanically limited traversing sections.
 - You have set "U/f control" as control mode.
- [3]: Measure the motor data while the motor is rotating. The converter switches off the motor after the motor data identification has been completed.
- [11]: The same setting as [1]. The motor accelerates to the currently set setpoint after the motor data identification.
- [12]: The same setting as [2]. The motor accelerates to the currently set setpoint after the motor data identification.

Calculating the motor parameters: Select "Complete calculation".

Summary

Set the check mark for "RAM data to EEPROM (save data in the drive)" to save your data in the converter so that it is not lost if the power fails.

Select "Finish".

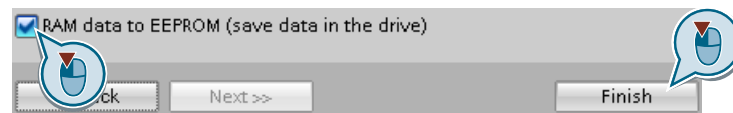

You have entered all of the data that is necessary for the quick commissioning of the converter.

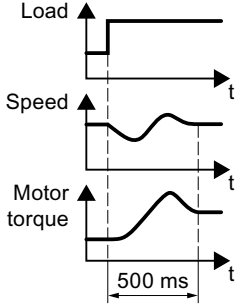
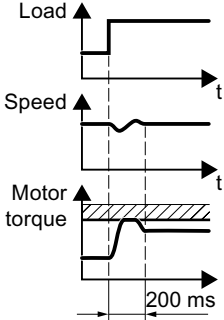

Select a suitable control mode

Control mode	U/f control or flux current control (FCC)	Encoderless vector control
Properties	<ul style="list-style-type: none"> • Typical settling time after a speed change: 100 ms ... 200 ms • Typical settling time after a load surge: 500 ms  <ul style="list-style-type: none"> • The control mode is suitable to address the following requirements: <ul style="list-style-type: none"> – Motor power ratings < 45 kW – Ramp-up time 0 → rated speed (depending on the motor power rating): 1 s (0.1 kW) ... 10 s (45 kW) – Applications with increasing load torque without load surges • The control mode is insensitive with respect to imprecise setting of the motor data 	<ul style="list-style-type: none"> • Typical settling time after a speed change: < 100 ms • Typical settling time after a load surge: 200 ms  <ul style="list-style-type: none"> • The control mode controls and limits the motor torque • Torque accuracy that can be achieved: ± 5% for 15 % ... 100 % of the rated speed • We recommend the control mode for the following applications: <ul style="list-style-type: none"> – Motor power ratings > 11 kW – For load surges of 10 % ... >100 % of the rated motor torque • The control mode is necessary for a ramp-up time 0 → Rated speed (dependent on the rated motor power): < 1 s (0.1 kW) ... < 10 s (250 kW).
Application examples	<ul style="list-style-type: none"> • Pumps, fans, and compressors with flow characteristic • Wet or dry blasting technology • Mills, mixers, kneaders, crushers, agitators • Horizontal conveyor technology (conveyor belts, roller conveyors, chain conveyors) • Basic spindles 	<ul style="list-style-type: none"> • Pumps and compressors with displacement machines • Rotary furnaces • Extruder • Centrifuges
Motors that can be operated	Induction motors	Induction and synchronous motors
Power Modules that can be operated	No restrictions	
Max. output frequency	550 Hz	240 Hz
Torque control	Without torque control	Torque control with and without higher-level speed control
Commissioning	<ul style="list-style-type: none"> • Contrary to encoderless vector control, the speed controller does not have to be set 	

5.5.9 Identify motor data

Overview

Using the motor data identification, the converter measures the data of the stationary motor. In addition, based on the response of the rotating motor, the converter can determine a suitable setting for the vector control.

To start the motor data identification routine, you must switch on the motor.

Identifying the motor data and optimizing the closed-loop control

Requirements

- You have selected a method of motor data identification during quick commissioning, e.g. measurement of the motor data while the motor is stationary.
When quick commissioning is complete, the converter issues alarm A07991.
- The motor has cooled down to the ambient temperature.
An excessively high motor temperature falsifies the motor data identification results.
- The PC and converter are connected to each other online.

⚠ WARNING

Unexpected machine motion while the motor data identification is in progress

For the stationary measurement, the motor can make several rotations. The rotating measurement accelerates the motor up to the rated speed. Secure dangerous machine parts before starting motor data identification:

- Before switching on, ensure that nobody is working on the machine or located within its working area.
- Secure the machine's work area against unintended access.
- Lower suspended loads to the floor.

Procedure

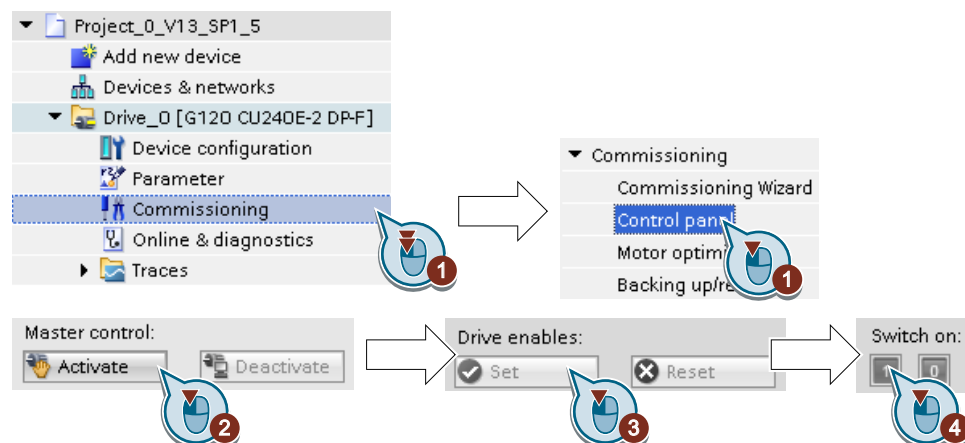

1. Open the control panel.
2. Assume master control for the converter.
3. Set the "Drive enables"
4. Switch on the motor.
The converter starts the motor data identification. This measurement can take several minutes.
Depending on the setting, after motor data identification has been completed, the converter switches off the motor - or it accelerates it to the currently set setpoint.
5. If required, switch off the motor.
6. Relinquish the master control after the motor data identification.
7. Save the settings in the converter (RAM → EEPROM):

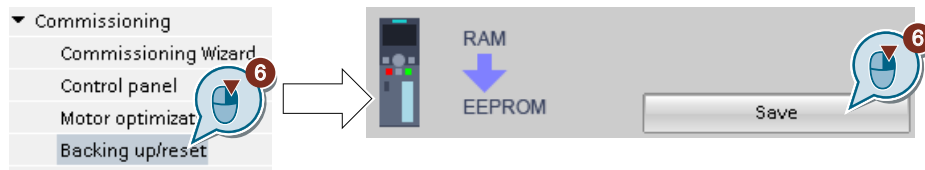

You have completed the motor data identification.
□

Self-optimization of the speed control

If you have not only selected motor data identification with the motor stationary, but also rotating measurement with self-optimization of the speed control, you must switch on the motor again as described above and wait for the optimization run to finish.

Quick commissioning has been completed once the motor data identification has been successfully completed.

Recommendations

- Induction motors
When commissioning induction machines, you are advised to proceed as follows:
 - Before connecting the load, a complete "rotating measurement" (p1900 = 3 or without encoder: p1960 = 1; with encoder: p1960 = 2) should be carried out. Since the induction machine is idling, you can expect highly accurate results for the saturation characteristic and the rated magnetizing current.
 - When the load is connected, speed controller tuning should be repeated because the total moment of inertia has changed. This is realized by selecting parameter p1960 (without encoder: p1960 = 3; with encoder: p1960 = 4). During the speed optimization, the saturation characteristic recording is automatically deactivated in parameter p1959.
- Permanent-magnet synchronous motors
When permanent-magnet synchronous motors are commissioned, the speed controller should be tuned (p1900 = 3 or p1960 > 0) when the load is connected.

5.6 Restoring the factory setting

When must you reset the converter to the factory settings?

Reset the converter to the factory settings in the following cases:

- The line voltage was interrupted during commissioning and you were not able to complete commissioning.
- You can no longer trace the settings that you made during commissioning.
- You do not know whether the converter was already operational.

Restoring the factory settings when the safety functions are enabled

If you are using the integrated safety functions of the converter, e.g. "Safe Torque Off", you must reset the safety functions separately from the remaining converter settings.

The settings of the safety functions are protected by a password.

Settings that are not changed when restoring the factory setting

The communication settings and the settings of the motor standard (IEC/NEMA) are kept when restoring the factory setting.

5.6.1 Resetting the safety functions to the factory setting

Procedure

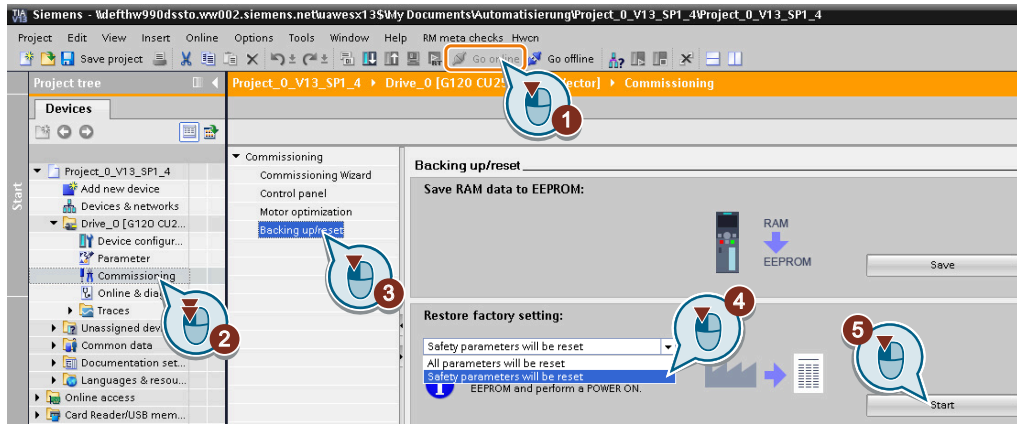

1. Go online.
2. Select "Commissioning".
3. Select "Backing up/reset".
4. Select "Safety parameters are reset".
5. Press the "Start" button.
6. Enter the password for the safety functions.
7. Confirm that the parameters have been saved (RAM to ROM).
8. Go offline.
9. Switch off the converter power supply.
10. Wait until all LEDs on the converter are dark.
11. Switch on the converter power supply again.

You have restored the safety functions in the converter to the factory settings.



Exception: The password for the safety functions is not reset.

 Password (Page 298)

Procedure with an operator panel

1. Set p0010 = 30
Activate reset settings.
2. p9761 = ...
Enter the password for the safety functions
3. Start the reset with p0970 = 5.
4. Wait until the converter sets p0970 = 0.
5. Set p0971 = 1.
6. Wait until the converter sets p0971 = 0.

7. Switch off the converter power supply.
8. Wait until all LEDs on the converter are dark.
9. Switch on the converter power supply again.

You have restored the safety function settings of your converter to the factory settings.



5.6.2 Restore the factory settings (without safety functions)

Resetting to factory settings with Startdrive

Procedure

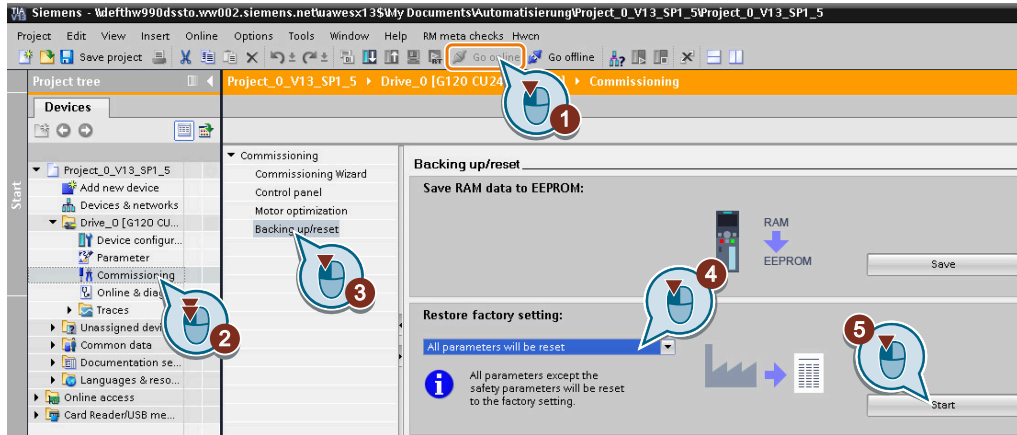

1. Go online.
2. Select "Commissioning".
3. Select "Back up/reset".
4. Select "All parameters will be reset".
5. Press the "Start" button.
6. Wait until the converter has been reset to the factory settings.

You have reset the converter to the factory settings.



Resetting to factory setting with the BOP-2 operator panel

Procedure

1. Select "Reset to factory settings"



2. Start the reset.

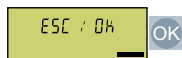

3. Wait until the converter has been reset to the factory setting.



You have reset the converter to the factory settings.



5.7 Series commissioning

Overview

Series commissioning is the commissioning of several identical converters. During series commissioning, it is sufficient to commission one of the converters and then transfer the settings of the first converter to additional converters.



Precondition

The following preconditions apply to the converters regarding series commissioning:

- All converters have the same article number
- The converters to which the settings are transferred have the same or a higher firmware version as the source converter with the original settings.

Function description

Procedure

1. Commission the first converter.
2. Back up the settings of the first converter to an external storage medium.
 Uploading the converter settings (Page 199)
3. Transfer the settings from the first converter to another converter via the data storage medium.
 Downloading the converter settings (Page 449)

5.8 Handling the BOP 2 operator panel

Overview

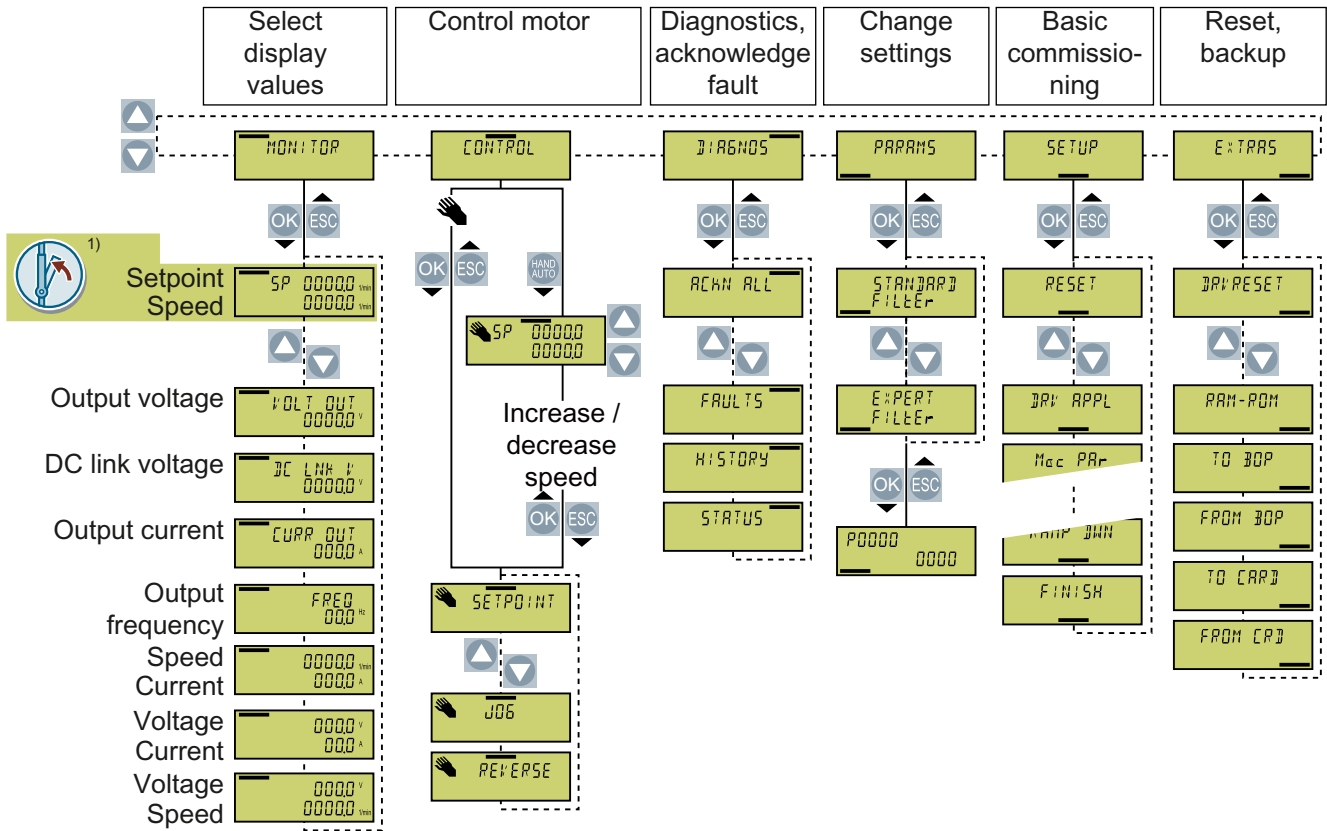

1) Status display once the power supply for the converter has been switched on.

Figure 5-13 Menu of the BOP-2





-  The motor is switched on
-  Jog is active
-  An alarm is active
-  Flashing symbol: A fault is active
-  Master control of the inverter is released via the BOP-2

Figure 5-14 Additional symbols of the BOP-2

5.8.1 Switching the motor on and off

Overview

The BOP-2 offers the option of switching the motor on and off using the control keys.

Function description

Procedure

1. Enable the control priority via the operator panel.

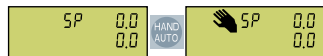

2. Switch on the motor.



3. Switch off the motor.

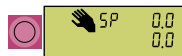

4. Disable the control priority via the operator panel.

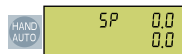

You switched the motor on and off again.



5.8.2 Changing parameter values

Overview

You can modify the settings of the converter by changing the parameter values in the converter.

Precondition

The converter only permits changes to write parameters. Write parameters begin with a "P", e.g. P45.

The value of a read-only parameter cannot be changed. Read-only parameters begin with an "r", for example: r2.

Function description

Procedure

1. Select the menu to display and change parameter values.



2. Select the parameter filter.



- The converter only displays the most important parameters:



- The converter displays all of the parameters to you:



3. When the parameter number flashes, select the desired parameter number.



4. When the parameter value flashes, change the parameter value.



You changed a parameter value.



Additional information

The converter immediately saves any changes so that they are protected against power failure.

5.8.3 Changing indexed parameters

Overview

For indexed parameters, several parameter values are assigned to a parameter number. Each of the parameter values has its own index.

Precondition

You are in the menu for displaying and changing parameter values.

The number of an indexed parameter flashes in the BOP-2 display.

Function description

Procedure

1. Set the parameter index.



2. Set the parameter value for the selected index.



You have now changed an indexed parameter.



5.8.4 Entering the parameter number directly

Overview

The BOP-2 offers the possibility of setting the parameter number digit by digit.

Precondition

You are in the menu for displaying and changing parameter values.

The number of a given parameter flashes in the BOP-2 display.

Function description

Procedure

1. Press the OK button until the first digit of the parameter number flashes.



2. Change the parameter number digit-by-digit.
If you press the OK button, the BOP-2 jumps to the next digit.

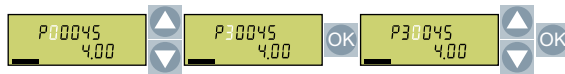

3. After you have entered all of the digits of the parameter number, press the OK button.

You set the parameter number directly.



5.8.5 Entering the parameter value directly

Overview

The BOP-2 offers the option of setting the parameter value digit by digit.

Precondition

You are in the menu for displaying and changing parameter values.

The parameter value flashes in the BOP-2 display.

Function description

Procedure

1. Press the OK button until the first digit of the parameter value flashes.



2. Change the parameter value digit-by-digit.

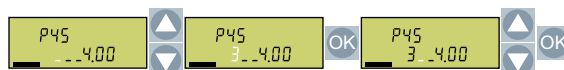

You set the parameter value directly.





5.8.6 Why can a parameter value not be changed?

Overview

Whether or not a parameter value can be changed depends on the type of parameter and the operating mode of the converter.

Function description

The converter indicates why it currently does not permit a parameter to be changed:

Read parameters cannot be adjusted	
The parameter can only be adjusted during quick commissioning.	
A parameter can only be adjusted when the motor is switched off	

Further information

For each parameter, the parameter list contains the operating state in which the parameter can be changed.

Uploading the converter settings

Overview

After commissioning, your settings are permanently saved in the converter.

We recommend that you additionally back up the converter settings on an external storage medium by means of an upload. Without a backup, your settings could be lost should the converter develop a fault.

The following storage media options are available:

- Memory card
- Operator panel BOP-2
- Operator panel IOP-2
- SINAMICS G120 Smart Access
- PG/PC

6.1 Uploading to the memory card

6.1.1 Recommended memory cards

Function description



Table 6-1 Memory cards to back up converter settings

Scope of delivery	Article number
Memory card without firmware	6SL3054-4AG00-2AA0
Memory card with firmware V4.7	6SL3054-7EH00-2BA0
Memory card with firmware V4.7 SP3	6SL3054-7TB00-2BA0
Memory card with firmware V4.7 SP6	6SL3054-7TD00-2BA0
Memory card with firmware V4.7 SP9	6SL3054-7TE00-2BA0
Memory card with firmware V4.7 SP10	6SL3054-7TF00-2BA0
Memory card with firmware V4.7 SP14	6SL3054-7TG00-2BA0

Further information

Using memory cards from other manufacturers

The converter only supports memory cards up to 2 GB. SDHC cards (SD High Capacity) and SDXC cards (SD Extended Capacity) are not permitted.

If you use a different SD memory card, then you must format it as follows:

- Insert the card into your PC's card reader.
- Command to format the card:
format x: /fs:fat or format x: /fs:fat32 (x: Drive code of the memory card on your PC.)

Functional restrictions with memory cards from other manufacturers

The following functions are either not possible – or only with some restrictions – when using memory cards from other manufacturers:

- Licensing functions is only possible using the recommended memory cards.
- Know-how protection is only possible with one of the recommended memory cards.
- In certain circumstances, memory cards from other manufacturers do not support writing or reading data from/to the converter.

6.1.2 Automatic upload

Overview

We recommend that you insert the memory card before switching on the converter. The converter automatically backs up its settings on the inserted memory card and always keeps it up to date.

Precondition

The converter power supply has been switched off.

Function description

Procedure

1. Insert an empty memory card into the converter.

Note

Accidental overwrite of the converter settings

When the supply voltage is switched on, the converter automatically accepts the settings already backed up on the memory card. If you use a memory card on which settings are already backed up, you will overwrite the settings of the converter.

- Use an empty memory card for the first automatic back-up of your settings.

Note

Unintentional firmware update

If the memory card contains a converter firmware, the converter may perform a firmware update after the supply voltage has been switched on.

- Before inserting the memory card, ensure that it is empty.

 [Firmware upgrade and downgrade \(Page 474\)](#)

2. Switch on the power supply for the converter.

After the power supply has been switched on, the converter copies its changed settings to the memory card.



6.1.3 Message for a memory card that is not inserted

Function description

The converter identifies that a memory card is not inserted, and signals this state. The message is deactivated in the converter factory setting.

Activate message

Procedure

1. Set $p2118[x] = 1101$, $x = 0, 1, \dots 19$
2. Set $p2119[x] = 2$

Message A01101 for a memory card that is not inserted is activated.



To cyclically signal to the higher-level control that a memory card is not inserted, connect parameter r9401 to the send data of the fieldbus interface.

Deactivate message

Procedure

1. Set $p2118[x] = 1101$, $x = 0, 1, \dots 19$
2. Set $p2119[x] = 3$

Message A01101 for a memory card that is not inserted is deactivated.



Parameter

Parameter	Explanation	Factory setting
p2118[0...19]	Change message type, message number	0
p2119[0 ... 19]	Change message type, type	0
r9401	Safely remove memory card status	-

6.1.4 Manual upload with Startdrive

Overview

If you insert the memory card into a converter that is already supplied with power, you must start the upload manually using a commissioning tool.

Requirement

The following preconditions apply:

- The converter power supply has been switched on.
- The PC and converter are connected with one another via a USB cable or via the fieldbus.
- A memory card is inserted in the converter.

Function description

Procedure

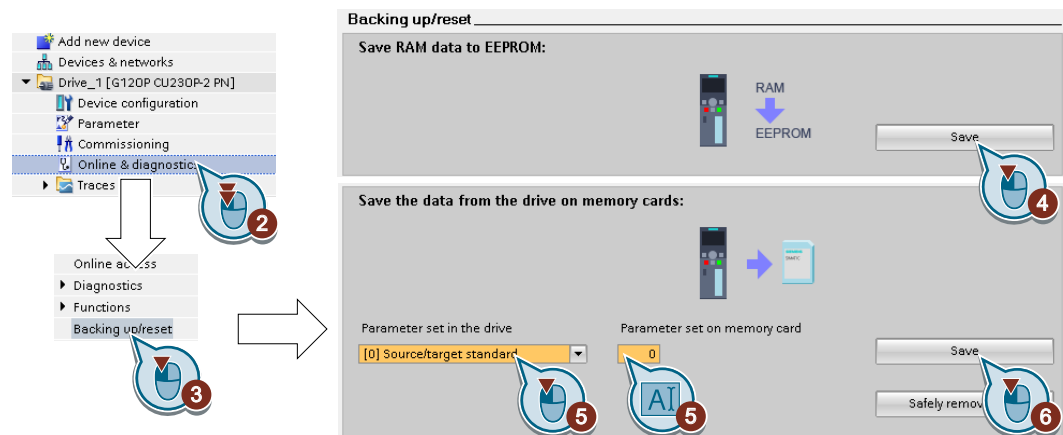

1. Go online.
2. Select "Online & diagnostics".
3. Select "Back up/reset".
4. Back up the settings to the EEPROM of the converter.
5. Set the number of your data backup. You can back up 99 different settings on the memory card.
6. Start data transfer
7. Wait until Startdrive signals that data backup has been completed.

You have backed up the converter settings to a memory card.



6.1.5 Manual upload with BOP-2

Overview

If you insert the memory card into a converter that is already supplied with power, you must start the upload manually using a commissioning tool.

6.1 Uploading to the memory card

Precondition

The converter power supply has been switched on.
A memory card is inserted in the converter.

Function description

Procedure

- 1. Select the upload.



- 2. Set the number of your data backup. You can back up 99 different settings on the memory card.



- 3. Start the upload.



- 4. Wait until the converter has backed up the settings to the memory card.



You have backed up the settings of the converter to the memory card.
□

6.1.6 Safely removing a memory card using the BOP-2

Function description

NOTICE
Data loss from improper handling of the memory card
If you remove the memory card when the converter is switched on without implementing the "safe removal" function you may destroy the file system on the memory card. The data on the memory card are lost. The memory card will only function again after formatting.
<ul style="list-style-type: none"> Only remove the memory card using the "safe removal" function.

Procedure

1. Select the menu for changing parameter values.



2. If a memory card is inserted, p9400 = 1.
Set p9400 = 2.



3. The converter indicates whether it is currently writing data to the memory card:

- The converter sets p9400 = 100:



You must not remove the memory card. Wait for several seconds and then set p9400 = 2 again.

- The converter sets p9400 = 3:



Remove the memory card.

4. After removing the memory card, the converter sets p9400 = 0.



You have safely removed the memory card.



6.1.7 Safely remove the memory card with Startdrive

Function description

NOTICE
Data loss from improper handling of the memory card
If you remove the memory card when the converter is switched on without implementing the "safe removal" function you may destroy the file system on the memory card. The data on the memory card are lost. The memory card will only function again after formatting.
<ul style="list-style-type: none">• Only remove the memory card using the "safe removal" function.

Procedure

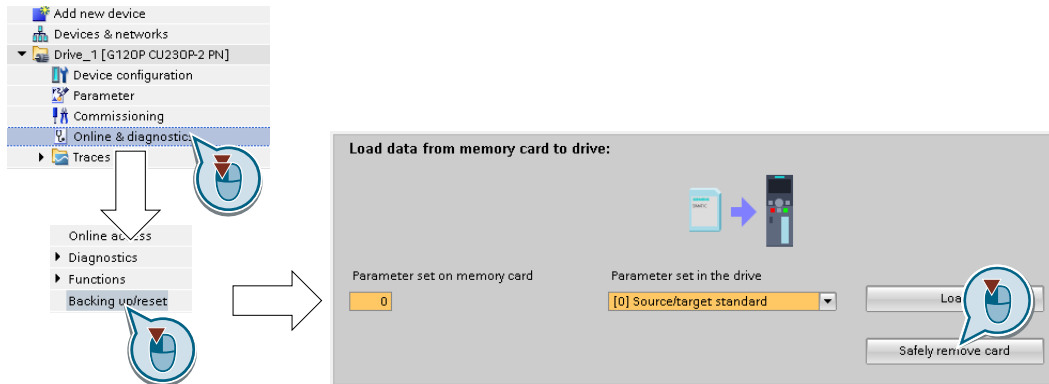

1. In the Drive Navigator select the following screen form:
2. Click on the button to safely remove the memory card.
Startdrive will tell you whether you can remove the memory card from the converter.

You have now safely removed the memory card from the converter.



6.2 Uploading to the BOP-2

Overview

You can back up the converter settings on the BOP-2 operator panel.

Precondition

The converter power supply has been switched on.

Function description

Procedure

1. Select the upload to the operator panel.



2. Start the upload.

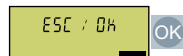

3. Wait until the upload is completed.



The upload from the converter to the BOP-2 is completed.



6.3 Upload to a PC using Startdrive

Overview

You can backup the converter settings to a PC.

Requirement

The following preconditions apply:

- The converter power supply has been switched on.
- The PC and converter are connected with one another via a USB cable or via the fieldbus.

Function description

Procedure

1. Go online.
2. Select "Online" > "Upload device to PG/PC."
3. Back up the project with "Project" > "Save."
4. Wait until Startdrive signals that data backup has been completed.
5. Go offline.

You have backed up the settings.



6.4 More options for the upload

Function description

In addition to the default setting, the converter has an internal memory for backing up three other settings.

On the memory card, you can back up 99 other settings in addition to the default setting.

Further information is provided on the Internet:

 Memory options (<http://support.automation.siemens.com/WW/view/en/43512514>)

Protecting the converter settings

7.1 Write protection

Overview

The write protection prevents unauthorized changing of the converter settings.

Function description

Write protection is applicable for all user interfaces:

- Commissioning tool, e.g. operator panel or PC
- Parameter changes via fieldbus

No password is required for write protection.

Activate and deactivate write protection

Parameter		
r7760	Write protection/know-how protection status	
	.00	1 signal: Write protection active
p7761	Write protection (factory setting: 0)	
	0:	Deactivate write protection
	1:	Activate write protection

Parameter

Table 7-1 Parameters that can be changed with active write protection

Number	Name
p0003	Access level / Acc_level
p0010	Drive commissioning parameter filter / Drv comm par_filt
p0124[0...n]	CU detection using LED / CU detect LED
p0970	Reset drive parameters / Drive par reset
p0971	Save parameters / Sav par
p0972	Drive unit reset / Drv_unit reset
p2111	Alarm counter / Alarm counter
p3950	Service parameter / Serv par
p3981	Acknowledge drive object faults / Ackn DO faults
p3985	Master control mode selection / PcCtrl mode select
p7761	Write protection / Write protection
p8805	Identification and Maintenance 4 Configuration / I&M 4 Config

7.1 Write protection

Number	Name
p8806[0...53]	Identification and Maintenance 1 / I&M 1
p8807[0...15]	Identification and Maintenance 2 / I&M 2
p8808[0...53]	Identification and Maintenance 3 / I&M 3
p8809[0...53]	Identification and Maintenance 4 / I&M 4
p9400	Safely remove memory card / Mem_card rem
p9484	BICO interconnections search signal source / BICO S_src srch

Note

Write protection for multimaster fieldbus systems

Via multimaster fieldbus systems, e.g. BACnet or Modbus RTU, in spite of write protection being activated, parameters can still be changed. So that write protection is also active when accessing via these fieldbuses, you must additionally set p7762 to 1.

7.2 Know-how protection



Overview

Know-how protection prevents unauthorized reading of the converter settings.

To protect your converter settings against unauthorized copying, in addition to know-how protection, you can also activate copy protection.

Requirement

Know-how protection requires a password.

Combination of know-how protection and copy protection	Is a memory card necessary?
Know-how protection without copy protection	The converter can be operated with or without memory card.
Know-how protection with basic copy protection	 The converter can only be operated with a SIEMENS memory card  Recommended memory cards (Page 200)
Know-how protection with extended copy protection	

Function description

The active know-how protection provides the following:

- With just a few exceptions, the values of all adjustable parameters p ... are invisible.
 - Several adjustable parameters can be read and changed when know-how protection is active.
In addition, you can define an exception list of adjustable parameters, which end users may change.
 - Several adjustable parameters can be read but not changed when know-how protection is active.
- The values of monitoring parameters r ... remain visible.

7.2 Know-how protection

- Locked functions:
 - Downloading converter settings using a PC
 - Automatic controller optimization
 - Stationary or rotating measurement of the motor data identification
 - Deleting the alarm history and the fault history
 - Generating acceptance documents for safety functions
- Executable functions:
 - Restoring factory settings
 - Acknowledging faults
 - Displaying faults, alarms, fault history, and alarm history
 - Reading out the diagnostic buffer
 - Controlling a converter using a PC
 - Uploading adjustable parameters that can be changed or read when know-how protection is active.
 - Displaying acceptance documents for safety functions

When know-how protection is active, support can only be provided (from Technical Support) after prior agreement from the machine manufacturer (OEM).

Know-how protection without copy protection

You can transfer the converter settings to another converter, e.g. using a memory card or an operator panel.



Know-how protection with basic copy protection

After replacing a converter, to be able to operate the new converter with the settings of the replaced converter without knowing the password, the memory card must be inserted in the new converter.

Know-how protection with extended copy protection

It is not possible to insert and use the memory card in another converter without knowing the password.

Commissioning know-how protection

1. Check as to whether you must extend the exception list.
 List of exceptions (Page 217)
2. Activate the know-how protection.
 Know-how protection (Page 218)

Parameter

Table 7-2 Parameters that can be changed with active know-how protection

Number	Name
p0003	Access level / Acc_level
p0010	Drive commissioning parameter filter / Drv comm par_filt
p0124[0...n]	CU detection using LED / CU detect LED
p0791[0...1]	CO: Fieldbus analog outputs / Fieldbus AO
p0970	Reset drive parameters / Drive par reset
p0971	Save parameters / Sav par
p0972	Drive unit reset / Drv_unit reset
p2040	Fieldbus interface monitoring time / Fieldbus t_monit
p2111	Alarm counter / Alarm counter
p3950	Service parameter / Serv par
p3981	Acknowledge drive object faults / Ackn DO faults
p3985	Master control mode selection / PcCtrl mode select
p7761	Write protection / Write protection
p8402[0...8]	RTC daylight saving time setting / RTC DST
p8805	Identification and Maintenance 4 Configuration / I&M 4 Config
p8806[0...53]	Identification and Maintenance 1 / I&M 1
p8807[0...15]	Identification and Maintenance 2 / I&M 2
p8808[0...53]	Identification and Maintenance 3 / I&M 3
p8809[0...53]	Identification and Maintenance 4 / I&M 4
p8980	EtherNet/IP profile / Eth/IP profile
p8981	EtherNet/IP ODVA STOP mode / Eth/IP ODVA STOP
p8982	EtherNet/IP ODVA speed scaling / Eth/IP ODVA n scal
p8983	EtherNet/IP ODVA torque scaling / Eth/IP ODVA M scal
p9400	Safely remove memory card / Mem_card rem
p9484	BICO interconnections search signal source / BICO S_src srch

Table 7-3 Parameters that can be read with active know-how protection

Number	Name
p0015	Macro drive unit / Macro drv unit
p0100	IEC/NEMA Standards / IEC/NEMA Standards
p0170	Number of Command Data Sets (CDS) / CDS count
p0180	Number of Drive Data Sets (DDS) / DDS count
p0300[0...n]	Motor type selection / Mot type sel
p0304[0...n]	Rated motor voltage / Mot U_rated
p0305[0...n]	Rated motor current / Mot I_rated
p0505	Selecting the system of units / Unit sys select
p0595	Technological unit selection / Tech unit select
p0730	BI: CU signal source for terminal DO 0 / CU S_src DO 0

Number	Name
p0731	BI: CU signal source for terminal DO 1 / CU S_src DO 1
p0732	BI: CU signal source for terminal DO 2 / CU S_src DO 2
p0806	BI: Inhibit master control / Inhibit PcCtrl
p0870	BI: Close main contactor / Close main cont
p0922	PROFIdrive PZD telegram selection / PZD telegr_sel
p1080[0...n]	Minimum velocity / v_min
p1082[0...n]	Maximum velocity / v_max
p1520[0...n]	CO: Torque limit upper / M_max upper
p2000	Reference speed reference frequency / n_ref f_ref
p2001	Reference voltage / Reference voltage
p2002	Reference current / I_ref
p2003	Reference torque / M_ref
p2006	Reference temperature / Ref temp
p2030	Fieldbus interface protocol selection / Fieldbus protocol
p2038	PROFIdrive STW/ZSW interface mode / PD STW/ZSW IF mode
p2079	PROFIdrive PZD telegram selection extended / PZD telegr ext
p7763	KHP OEM exception list number of indices for p7764 / KHP OEM qty p7765
p7764[0...n]	KHP OEM exception list / KHP OEM excep list

7.2.1 Extending the exception list for know-how protection

In the factory setting, the exception list only includes the password for know-how protection.

Before activating know-how protection, you can additionally enter the adjustable parameters in the exception list, which must still be able to be read and changed by end users – even if know-how protection has been activated.

You do not need to change the exception list, if, with exception of the password, you do not require additional adjustable parameters in the exception list.

Absolute know-how protection

If you remove password p7766 from the exception list, it is no longer possible to enter or change the password for know-how protection.

You must reset the converter to the factory settings in order to be able to gain access to the converter adjustable parameters. When restoring the factory settings, you lose what you have configured in the converter, and you must recommission the converter.

Parameter

Parameter	Description	Factory setting
p7763	KHP OEM exception list, number of indices for p7764	1
p7764[0...p7763]	KHP OEM exception list p7766 is the password for know-how protection	[0] 7766 [1...499] 0

7.2.2 Activating and deactivating know-how protection

Requirements

- The converter has now been commissioned.
- You have generated the exception list for know-how protection.
- To guarantee know-how protection, you must ensure that the project does not remain at the end user as a file.

Function description

Activating know-how protection

1. Enter a password of your choice in p7767.
Each index of p7767 corresponds with a character in the ASCII format.
2. Complete entry of the password with p7767[29] = 0.
3. Enter the same password in p7768 as that for p7767.
4. Complete entry of the password with p7768[29] = 0.

The know-how protection for the converter is activated.



Deactivating know-how protection

1. Enter the password for the know-how protection in p7766.
Each index of p7766 corresponds with a character in the ASCII format.
2. Complete entry of the password with p7766[29] = 0.

The know-how protection for the converter is deactivated.



Parameter

Parameter	Description	Factory setting
r7758[0...19]	KHP Control Unit serial number	---
p7759[0...19]	KHP Control Unit reference serial number	---
r7760	Write protection/know-how protection status	---
p7765	KHP configuration	0000 bin
p7766[0...29]	KHP password, input	---
p7767[0...29]	KHP password, new	---
p7768[0...29]	KHP password, confirmation	---
p7769[0...20]	KHP memory card reference serial number	---
r7843[0...20]	Memory card serial number	---

Further information

Preventing data reconstruction from the memory card

As soon as know-how protection has been activated, the converter only backs up encrypted data to the memory card.

In order to guarantee know-how protection, after activating know-how protection, we recommend that you insert a new, empty memory card. For memory cards that have already been written to, previously backed up data that was not encrypted can be reconstructed.

Advanced commissioning

8.1 Overview of the converter functions

Overview

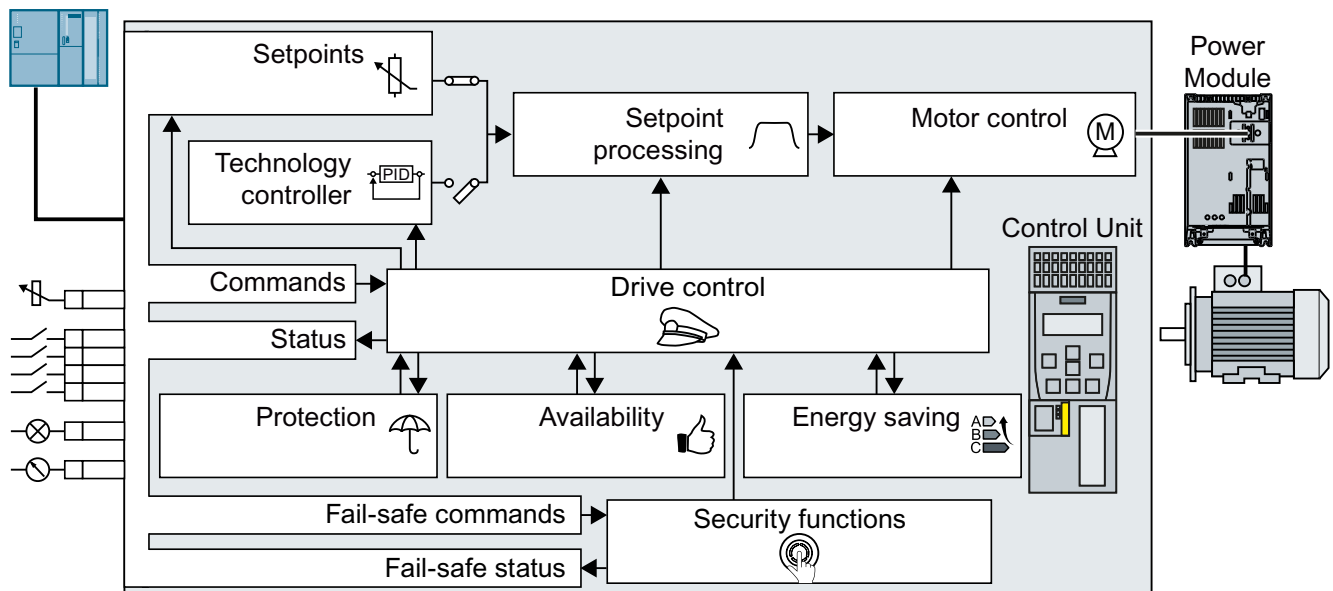











Figure 8-1 Overview of converter functions

Drive control



The converter receives its commands from the higher-level control via the terminal strip or the fieldbus interface of the Control Unit. The drive control defines how the converter responds to the commands.

-  Sequence control when switching the motor on and off (Page 225)
-  Adapt the default setting of the terminal strip (Page 228)
-  Controlling clockwise and counter-clockwise rotation via digital inputs (Page 241)
-  Drive control via PROFIBUS or PROFINET (Page 253)
-  Drive control via Modbus RTU (Page 269)
-  Drive control via USS (Page 272)
-  Drive control via Ethernet/IP (Page 275)
-  Jogging (Page 277)
-  Limit position control (Page 279)

The converter can switch between different settings of the drive control.

-  Switching over the drive control (command data set) (Page 281)

The converter provides the control for a motor holding brake. The motor holding brake holds the motor in position when it is switched off.

 Motor holding brake (Page 283)

The free function blocks permit configurable signal processing within the converter.

 Free function blocks (Page 288)

You can select in which physical units the converter represents its associated values.

 Selecting physical units (Page 290)

Safety functions



The safety functions fulfill increased requirements regarding the functional safety of the drive.

 Safe Torque Off (STO) safety function (Page 294)

The extended safety functions monitor the drive speed.

The extended safety functions are described in the "Safety Integrated" function manual.

 Overview of the manuals (Page 564)

Setpoints and setpoint processing



The setpoint generally determines the motor speed.

 Setpoints (Page 310)



The setpoint processing uses a ramp-function generator to prevent speed steps occurring and to limit the speed to a permissible maximum value.

 Setpoint processing (Page 320)

Technology controller



The technology controller controls process variables, e.g. pressure, temperature, level or flow. The closed-loop motor control receives the setpoint either from the higher-level control or from the technology controller.

 PID technology controller (Page 331)

Motor control



The closed-loop motor control ensures that the motor follows the speed setpoint. You can choose between various control modes.

 Motor control (Page 344)

The converter provides several methods to brake the motor electrically. During electrical braking, the motor develops a torque that reduces the speed down to standstill.

 Electrically braking the motor (Page 372)

Protection of the drive and the driven load





The protection functions prevent damage to the motor, converter and driven load.

 Overcurrent protection (Page 386)

 Converter protection using temperature monitoring (Page 387)

 Motor protection with temperature sensor (Page 390)

 Motor protection by calculating the temperature (Page 392)

 Motor and converter protection by limiting the voltage (Page 395)

The monitoring of the driven load prevents impermissible operating modes, e.g. dry-running of a pump.

 Monitoring the driven load (Page 397)

Increasing the drive availability



The kinetic buffering converts the kinetic energy of the load into electrical energy to buffer short-term power failures.

 Kinetic buffering (Vdc min control) (Page 413)

The "Flying restart" function permits the fault-free switching on of the motor while it is still turning.

 Flying restart – switching on while the motor is running (Page 408)

For active automatic restart, after a power failure, the converter attempts to automatically restart the motor and to acknowledge any faults that occur.

 Automatic restart (Page 410)

Energy saving



For standard induction motors, the efficiency optimization reduces the motor losses in the partial load range.

 Efficiency optimization (Page 415)

If necessary, the main contactor control disconnects the converter from the power system and so reduces the converter losses.

 Line contactor control (Page 418)

The converter calculates how much energy controlled converter operation saves when compared to mechanical flow control (e.g. throttle).

 Calculating the energy saving for fluid flow machines (Page 420)

8.2 Brief description of the parameters

Overview

The brief parameter description provides the most important information for all of the parameters that are assigned to a certain converter function.

If the number of parameter indices depends on the data sets, then the parameter index is shown in an abbreviated form.

Number	Name	Factory setting
p1234[C]		
p1234[D]		
p1234[M]		
p1234[0...3]		
p1234.0...15		

Figure 8-2 Brief parameter description

8.3 Sequence control when switching the motor on and off

Overview



The sequence control defines the rules for switching the motor on and off.

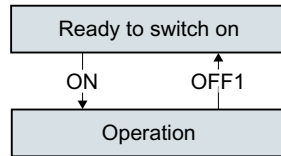

Figure 8-3 Simplified representation of the sequence control

After switching the supply voltage on, the converter normally goes into the "ready to start" state. In this state, the converter waits for the command to switch on the motor.

The converter switches on the motor with the ON command. The converter changes to the "Operation" state.

After the OFF1 command, the converter brakes the motor down to standstill. The converter switches off the motor once standstill has been reached. The converter is again "ready to start".

Function description

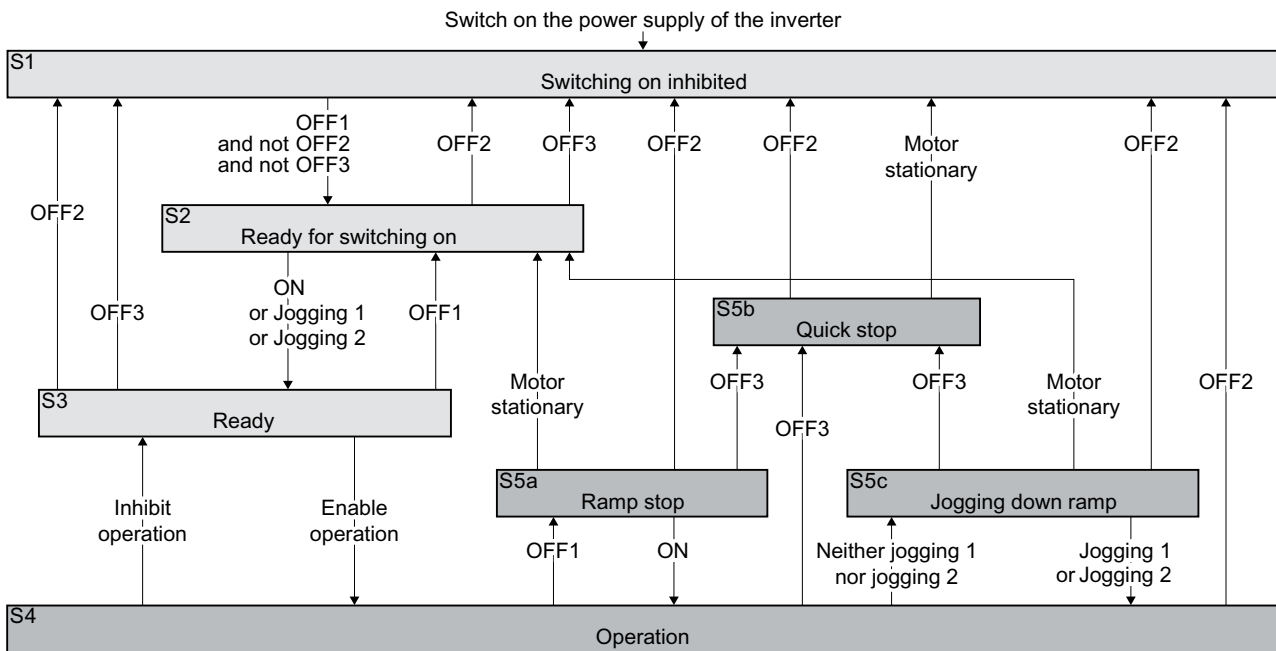

Figure 8-4 Sequence control of the converter when the motor is switched on and off

8.3 Sequence control when switching the motor on and off

Converter states S1 ... S5c are defined in the PROFIdrive profile. The sequence control defines the transition from one state to another.

Table 8-1 Converter states

The motor is switched off		The motor is switched on	
Current does not flow in the motor and the motor does not generate any torque		Current flows in the motor and the motor generates a torque	
S1	The ON command and an OFF command are active at the same time. In order for the converter to exit the state, you must deactivate OFF2 and OFF3 and activate the ON command again.	S4	The motor is switched on.
S2	The converter waits for a new command to switch on the motor.	S5a, S5c	The motor is still switched on. The converter brakes the motor with the ramp-down time of the ramp-function generator.
S3	The converter waits for "Enable operation". The "Enable operation" command is always active in the converter factory setting.	S5b	The motor is still switched on. The converter brakes the motor with the OFF3 ramp-down time.

Table 8-2 Commands for switching the motor on and off

ON Jogging 1 Jogging 2 Enable operation	The converter switches the motor on.
OFF1, OFF3	1. The converter brakes the motor. 2. The converter switches off the motor once it comes to a standstill. The converter identifies that the motor is at a standstill when at least one of the following conditions is satisfied: <ul style="list-style-type: none"> The speed actual value falls below the threshold in p1226, and the time started in p1228 has expired. The speed setpoint falls below the threshold in p1226, and the time subsequently started in p1227 has expired.
OFF2 Inhibit operation	The converter switches off the motor immediately without first braking it.

Parameters

Number	Name	Factory setting
r0046.0...31	CO/BO: Missing enable signals	-
p0857	Power unit monitoring time	10000 ms
p0858[C]	Bl: Unconditionally close holding brake	0
p0860	Bl: Line contactor feedback signal	863.1

8.3 Sequence control when switching the motor on and off

Number	Name	Factory setting
p0861	Line contactor monitoring time	100 ms
p1226[D]	Speed threshold for standstill detection	20 rpm
p1227	Standstill detection monitoring time	300 s
p1228	Pulse suppression delay time	0.01 s

8.4 Adapt the default setting of the terminal strip

Overview



In the converter, the input and output signals are interconnected with specific converter functions using special parameters. The following parameters are available to interconnect signals:

- Binectors BI and BO are parameters to interconnect binary signals.
- Connectors CI and CO are parameters to interconnect analog signals.

The following chapters describe how you adapt the function of individual converter inputs and outputs using binectors and connectors.

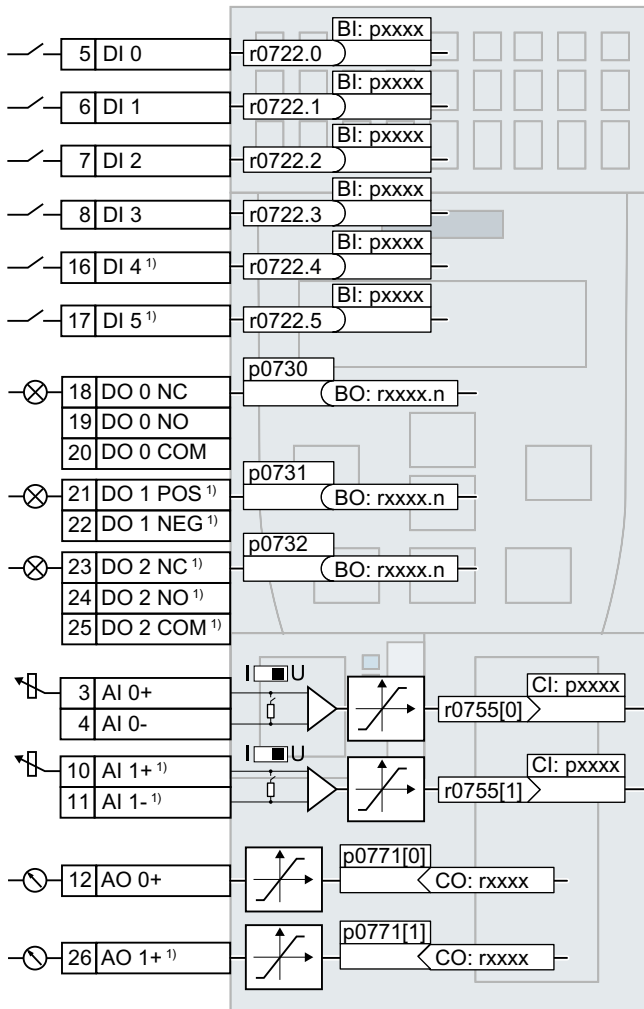

¹⁾ Not available with Control Units CU240B-2 and CU240B-2 DP

8.4.1 Digital inputs

Function description

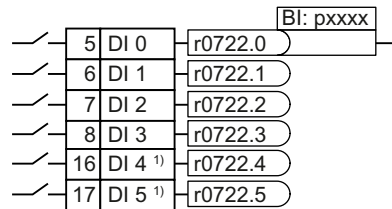

¹⁾ Not available with Control Units CU240B-2 and CU240B-2 DP

To change the function of a digital input, you must interconnect the status parameter of the digital input with a binector input of your choice.

Binector inputs are designated in the parameter list with the "BI".

Example



To acknowledge converter fault messages using digital input DI 1, you must interconnect DI 1 with the command to acknowledge faults (p2103).

Set p2103 = 722.1.

Parameter

Parameter	Description	Factory setting
r0721	CU digital inputs, terminal actual value	-
r0722	CO/BO: CU digital inputs, status	-
r0723	CO/BO: CU digital inputs, status inverted	--
p0724	CU digital inputs debounce time	4 ms
p0810	BI: Command data set selection CDS bit 0	0
p0840[C]	BI: ON/OFF (OFF1)	Dependent on the converter
p0844[C]	BI: No coast down/coast down (OFF2) signal source 1	Dependent on the converter
p0848[C]	BI: No quick stop/quick stop (OFF3) signal source 1	1
p0852[C]	BI: Enable operation/inhibit operation	Dependent on the converter
p1020[C]	BI: Fixed speed setpoint selection, bit 0	0
p1021[C]	BI: Fixed speed setpoint selection, bit 1	0
p1022[C]	BI: Fixed speed setpoint selection, bit 2	0
p1023[C]	BI: Fixed speed setpoint selection, bit 3	0
p1035[C]	BI: Motorized potentiometer setpoint higher	Dependent on the converter
p1036[C]	BI: Motorized potentiometer setpoint lower	Dependent on the converter

8.4 Adapt the default setting of the terminal strip

Parameter	Description	Factory setting
p1055[C]	Bl: Jogging bit 0	Dependent on the converter
p1056[C]	Bl: Jogging bit 1	Dependent on the converter
p1113[C]	Bl: Setpoint inversion	Dependent on the converter
p2103[C]	Bl: 1. Acknowledge faults	Dependent on the converter
p2106[C]	Bl: External fault 1	1
p2112[C]	Bl: External alarm 1	1

For additional binector inputs and additional information on parameters, please refer to the parameter list.

 Overview of the manuals (Page 564)

8.4.2 Analog inputs as digital inputs

Function description

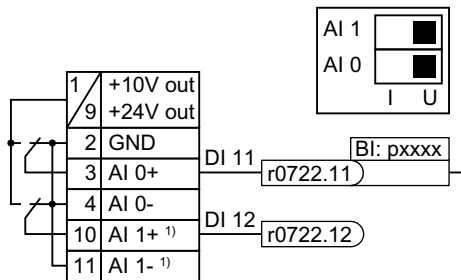

¹ Not available with CU240B-2 and CU240B-2 DP Control Units

To use an analog input as additional digital input, you must interconnect the corresponding status parameter r0722.11 or r0722.12 with a binector input of your choice.

You may operate the analog input as a digital input with 10 V or with 24 V.

NOTICE

Defective analog input due to overcurrent

If the analog input switch is set to "Current input" (I), a 10 V or 24 V voltage source results in an overcurrent at the analog input. An overcurrent condition destroys the analog input.

- If you use an analog input as a digital input, then you must set the analog input switch to "Voltage" (U).

8.4.3 Failsafe digital inputs

Function description

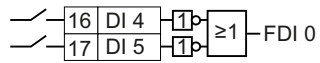

The converter combines two digital inputs into one failsafe digital input.

Additional information on failsafe digital inputs is provided in the description of the STO safety function.

 Safe Torque Off (STO) safety function (Page 294)

8.4.4 Digital outputs

Function description

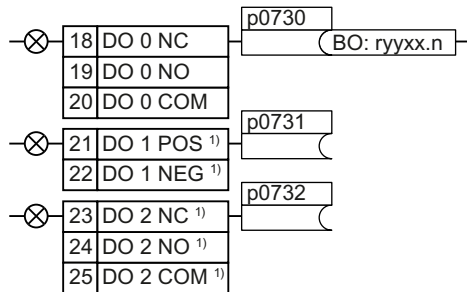

¹⁾ Not available with Control Units CU240B-2 and CU240B-2 DP

To change the function of a digital output, you must interconnect the digital output with a binector output of your choice.

Binector outputs are designated in the parameter list with "BO".

Example

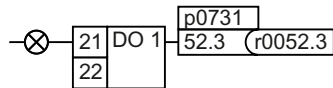

To output converter fault messages via digital output DO 1, you must interconnect DO 1 with these fault messages.

Set p0731 = 52.3

Parameter

Table 8-3 Frequently used binector outputs (BO) of the converter

Parameter	Description	Factory setting	
r0052[0...15]	CO/BO: Status word 1		-
	.00	1 signal: Ready for switching on	
	.01	1 signal: Ready for operation	
	.02	1 signal: Operation enabled	
	.03	1 signal: Fault active	
	.04	0 signal: OFF2 active	
	.05	0 signal: OFF3 active	
	.06	1 signal: Switching on inhibited active	
	.07	1 signal: Alarm active	
	.08	0 signal: Deviation, setpoint/actual speed	
	.09	1 signal: Control request	
	.10	1 signal: Maximum speed (p1082) reached	
	.11	0 signal: I, M, P limit reached	
	.13	0 signal: Alarm, motor overtemperature	
	.14	1 signal: Motor clockwise rotation	
.15	0 signal: Alarm, converter overload		
r0053[0...11]	CO/BO: Status word 2		-
	.00	1 signal: DC braking active	
	.02	1 signal: Speed > minimum speed (p1080)	
	.06	1 signal: Speed ≥ setpoint speed (r1119)	

You can find additional binector outputs in the parameter list.

 [Overview of the manuals \(Page 564\)](#)

8.4.5 Analog inputs

Function description

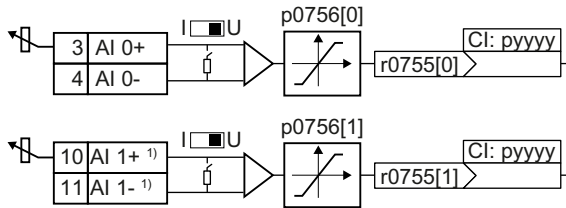

1) Not available with Control Units CU240B-2 and CU240B-2 DP

Defining the analog input type

The converter offers a series of default settings, which you can select using parameter p0756:

AI 0	Unipolar voltage input	0 V ... +10 V	p0756[0] =	0
	Unipolar voltage input monitored	+2 V ... +10 V		1
	Unipolar current input	0 mA ... +20 mA		2
	Unipolar current input monitored	+4 mA ... +20 mA		3
	Bipolar voltage input	-10 V ... +10 V		4
	No sensor connected	---		8
AI 1	Unipolar voltage input	0 V ... +10 V	p0756[1] =	0
	Unipolar voltage input monitored	+2 V ... +10 V		1
	Unipolar current input	0 mA ... +20 mA		2
	Unipolar current input monitored	+4 mA ... +20 mA		3
	Bipolar voltage input	-10 V ... +10 V		4
	No sensor connected	---		8

In addition, you must also set the switch associated with the analog input. You can find the switch on the Control Unit behind the lower front door.

- Voltage input: Switch position U (factory setting)
- Current input: Switch position I

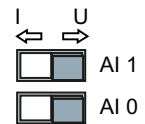

Defining the function of an analog input

You define the analog input function by interconnecting a connector input of your choice with parameter p0755. Parameter p0755 is assigned to the particular analog input via its index, e.g. parameter p0755[0] is assigned to analog input 0.

Connector inputs are designated in the parameter list with "CI".

Example

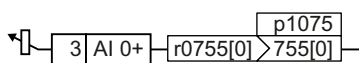

In order to enter the supplementary setpoint via analog input AI 0, you must interconnect AI 0 with the signal source for the supplementary setpoint.

Set p1075 = 755[0].

Parameter

Table 8-4 Frequently used connector inputs (CI) of the converter

Parameter	Description	Factory setting
p1070[C]	CI: Main setpoint	0
p1075[C]	CI: Supplementary setpoint	0
p2253[C]	CI: Technology controller setpoint 1	0
p2264[C]	CI: Technology controller actual value	0

You can find additional connector inputs in the parameter list.

 Overview of the manuals (Page 564)

Further information

Signal smoothing

When required, you can smooth the signal, which you read-in via an analog input, using parameter p0753.

Additional information is provided in the parameter list and in function diagram 2251 of the List Manual.

 Overview of the manuals (Page 564)

Using an analog input as a digital input

An analog input can also be used as a digital input.

 Digital inputs (Page 229)

8.4.6 Adjusting characteristics for analog input

Function description

If you change the analog input type using p0756, then the converter automatically selects the appropriate scaling of the analog input. The linear scaling characteristic is defined using two points (p0757, p0758) and (p0759, p0760). Parameters p0757 ... p0760 are assigned to an analog input via their index, e.g. parameters p0757[0] ... p0760[0] belong to analog input 0.

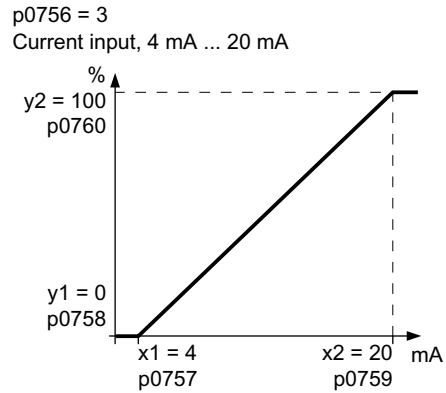
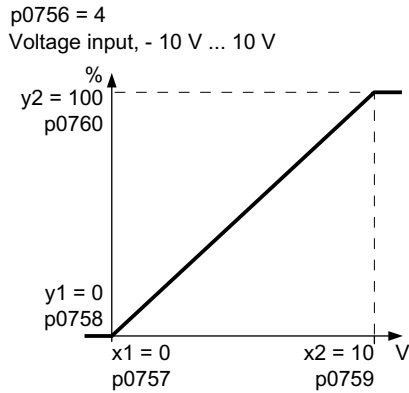

You must define your own characteristic if none of the default types match your particular application.

Example

The converter should convert a 6 mA ... 12 mA signal into the value range -100% ... 100% via analog input 0. The wire-break monitoring of the converter should respond when 6 mA is fallen below.

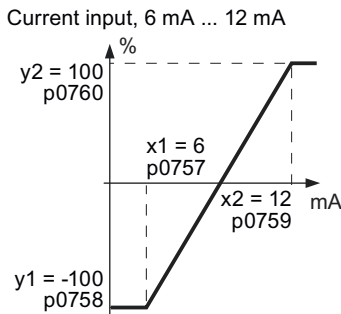

Procedure

1. Set the DIP switch for analog input 0 on the Control Unit to current input ("I").



2. set p0756[0] = 3
You have defined analog input 0 as a current input with wire-break monitoring.
3. Set p0757[0] = 6.0 (x1)

4. Set p0758[0] = -100.0 (y1)
5. Set p0759[0] = 12.0 (x2)
6. Set p0760[0] = 100.0 (y2)
7. Set p0761[0] = 6
An input current < 6 mA results in fault F03505.

The characteristic for the application example is set.



Parameters

Parameter	Description	Factory setting
p0757[0...n]	CU analog inputs characteristic value x1	0
p0758[0...n]	CU analog inputs characteristic value y1	0%
p0759[0...n]	CU analog inputs characteristic value x2	10
p0760[0...n]	CU analog inputs characteristic value y2	100%
p0761[0...n]	CU analog inputs wire-break monitoring, response threshold	2
p0762[0...n]	CU analog inputs wire breakage monitoring time	100 ms

8.4.7 Setting the deadband

Function description

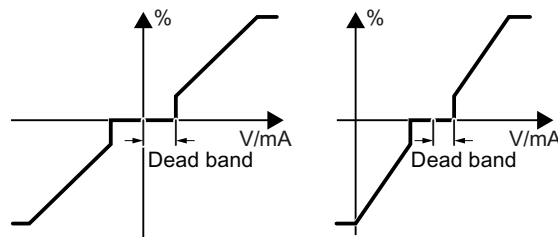

With the control enabled, electromagnetic interference on the signal cable can cause the motor to slowly rotate in one direction in spite of a speed setpoint = 0.

The deadband acts on the zero crossover of the analog input characteristic. Internally, the converter sets its speed setpoint = 0, even if the signal at the analog input terminals is slightly positive or negative. This prevents the converter from rotating the motor when the speed setpoint = 0.

Parameters

Parameter	Description	Factory setting
p0764[0]	Analog inputs deadband, AI 0	0
p0764[1]	Analog inputs deadband, AI 1	0

8.4.8 Analog outputs

Function description

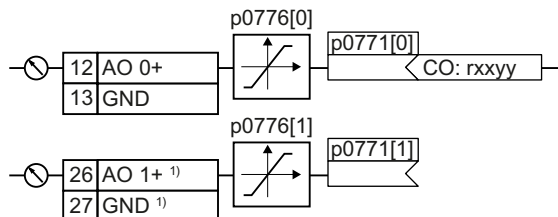

¹⁾ Not available with Control Units CU240B-2 and CU240B-2 DP

Defining the analog output type

Define the analog output type using parameter p0776.

AO 0	Current output (factory setting)	0 mA ... +20 mA	p0776[0] =	0
	Voltage output	0 V ... +10 V		1
	Current output	+4 mA ... +20 mA		2
AO 1	Current output (factory setting)	0 mA ... +20 mA	p0776[1] =	0
	Voltage output	0 V ... +10 V		1
	Current output	+4 mA ... +20 mA		2

Defining the function of an analog output

You define the analog output function by interconnecting parameter p0771 with a connector output of your choice. Parameter p0771 is assigned to the specific analog output via its index, e.g. parameter p0771[0] is assigned to analog output 0.

Connector outputs are designated in the parameter list with "CO".

 Overview of the manuals (Page 564)

Example

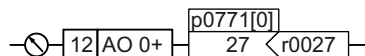

To output the converter output current via analog output 0, you must interconnect AO 0 with the signal for the output current.

Set p0771 = 27.

Parameter

Table 8-5 Frequently used connector outputs (CO) of the converter

Parameter	Description	Factory setting
r0021	CO: Speed actual value, smoothed	- rpm
r0025	CO: Output voltage, smoothed	- Vrms
r0026	CO: DC link voltage, smoothed	- V
r0027	CO: Absolute actual current, smoothed	- Arms
r0063	CO: Speed actual value	- rpm

You can find additional connector outputs in the parameter list.

 Overview of the manuals (Page 564)

8.4.9 Adjusting characteristics for analog output

Function description

If you change the analog output type, then the converter automatically selects the appropriate scaling of the analog output. The linear scaling characteristic is defined using two points (p0777, p0778) and (p0779, p0780).

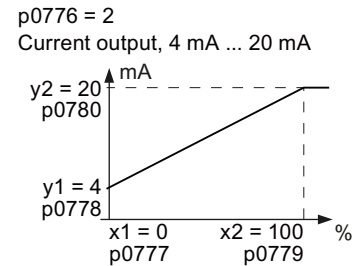
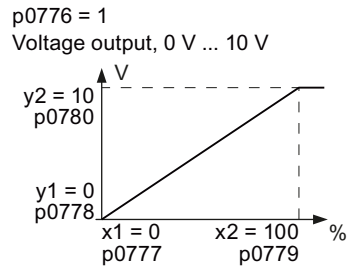

Parameters p0777 ... p0780 are assigned to an analog output via their index, e.g. parameters p0777[0] ... p0770[0] belong to analog output 0.

You must define your own characteristic if none of the default types match your particular application.

Example

Via analog output 0, the converter should convert a signal in the value range 0% ... 100% into an output signal 6 mA ... 12 mA.

Current output, 6 mA ... 12 mA

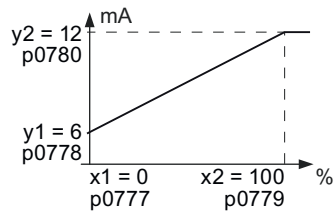
**Procedure**

1. Set p0776[0] = 2
This defines analog output 0 as a current output.
2. Set p0777[0] = 0.0 (x1)
3. Set p0778[0] = 6.0 (y1)
4. Set p0779[0] = 100.0 (x2)
5. Set p0780[0] = 12.0 (y2)

The characteristic for the application example is set.

□

Parameters

Table 8-6 Parameters for the scaling characteristic

Parameter	Description	Factory setting
p0777[0...1]	CU analog outputs characteristic value x1	-
p0778[0...1]	CU analog outputs characteristic value y1	0 V
p0779[0...1]	CU analog outputs characteristic value x2	100%
p0780[0...1]	CU analog outputs characteristic value y2	20 V

8.5 Controlling clockwise and counter-clockwise rotation via digital inputs

Overview



The converter offers various methods to start and stop the motor and reverse its direction.

Two-wire control, ON/reverse

ON/OFF1:

Switches the motor on or off

Reversing:

Reverses the motor direction of rotation

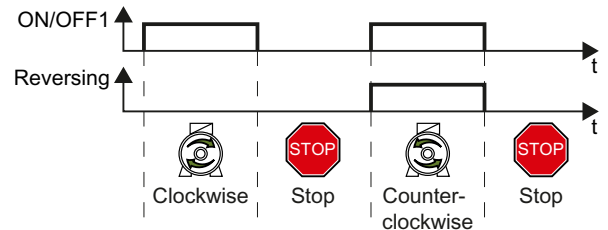

Two-wire control, clockwise/counter-clockwise rotation 1 and clockwise/counter-clockwise rotation 2

ON/OFF1 clockwise rotation:

Switches the motor on or off, clockwise rotation

ON/OFF1 counter-clockwise rotation:

Switches the motor on or off, counter-clockwise rotation

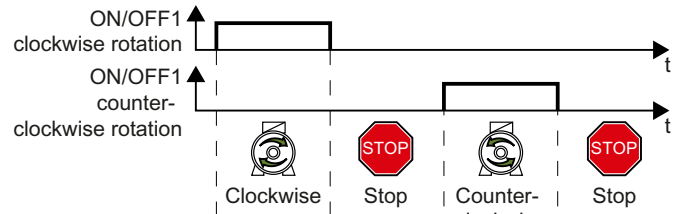

Three-wire control, enable/clockwise/counter-clockwise rotation

Enable/OFF1:

Enables the motor to be switched on or switched off

ON clockwise rotation:

Switches on the motor, clockwise rotation

ON counter-clockwise rotation:

Switches on the motor, counter-clockwise rotation

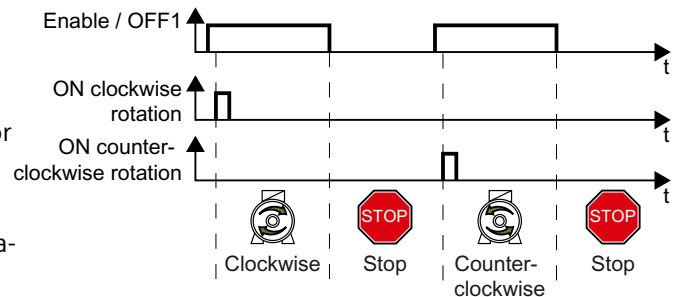

8.5 Controlling clockwise and counter-clockwise rotation via digital inputs

Three-wire control, enable/ON/ reverse

Enable/OFF1:

Enables the motor to be switched on or switched off

ON:

Switches on the motor

Reversing:

Reverses the motor direction of rotation

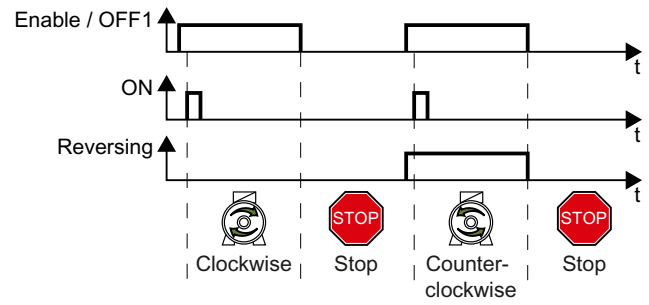

8.5.1 Two-wire control, ON/reverse

Function description

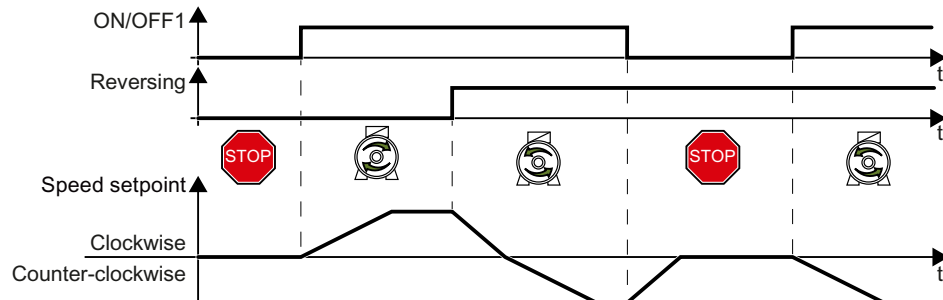

Figure 8-5 Two-wire control, ON/reverse

Command "ON/OFF1" switches the motor on and off. The "Reversing" command inverts the motor direction of rotation.

Table 8-7 Function table

ON/OFF1	Reversing	Function
0	0	The motor stops
0	1	
1	0	Clockwise motor rotation
1	1	Counter-clockwise motor rotation

Examples

Table 8-8 Two-wire control and setting the assignment of the digital inputs

Parameter	Description
p3334 = 0	2/3 wire control selection 0: Two-wire control, ON/reverse
p0840[C] = 722.0	BI: ON/OFF (OFF1) Command is received via digital input 0
p1113[C] = 722.1	BI: Setpoint inversion (reversing) Command is received via digital input 1

8.5 Controlling clockwise and counter-clockwise rotation via digital inputs

Table 8-9 Set two-wire control, ON/reverse in quick commissioning

Parameter	Description
p0015 = 12	Macro drive unit Assigning digital inputs to the commands: <ul style="list-style-type: none"> Digital input 0: ON/OFF1 Digital input 1: Reversing  Default settings of the CU240B-2 interfaces (Page 111)

Parameter

Parameter	Description	Factory setting
p0840[C]	BI: ON/OFF (OFF1)	0
p1113[C]	BI: Setpoint inversion	0
r0722.0...n	CO/BO: CU digital inputs, status	-
p3334	2/3 wire control selection 0: Two-wire control, ON/reverse	0

8.5.2 Two-wire control, clockwise/counterclockwise rotation 1

Function description

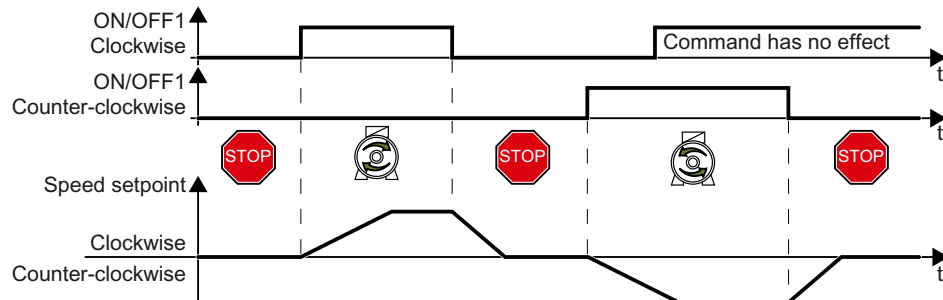

Figure 8-6 Two-wire control, clockwise/counterclockwise rotation 1

Commands "ON/OFF1 clockwise rotation" and "ON/OFF1 counter-clockwise rotation" switch on the motor - and simultaneously select a direction of rotation. The converter only accepts a new command when the motor is at a standstill.

Table 8-10 Function table

ON/OFF1 clockwise rotation	ON/OFF1 counter-clockwise rotation	Function
0	0	The motor stops.
1	0	Clockwise motor rotation.
0	1	Counter-clockwise motor rotation.
1	1	The motor direction of rotation is defined by the command that first reaches state "1".

Examples

Table 8-11 Two-wire control and setting the assignment of the digital inputs

Parameter	Description
p3334 = 1	2/3 wire control selection 1: Two-wire control, clockwise/counterclockwise rotation 1
p3330[C] = 722.0	BI: 2/3 wire control command 1 (ON/OFF1 clockwise rotation) Command is received via digital input 0
p3331[C] = 722.1	BI: 2/3 wire control command 2 (ON/OFF1 counter-clockwise rotation) Command is received via digital input 1

8.5 Controlling clockwise and counter-clockwise rotation via digital inputs

Table 8-12 Set two-wire control, clockwise/counterclockwise rotation 1 in quick commissioning

Parameter	Description
p0015 = 17	Macro drive unit Assigning digital inputs to the commands: <ul style="list-style-type: none"> • Digital input 0: ON/OFF1 clockwise rotation • Digital input 1: ON/OFF1 counter-clockwise rotation  Default settings of the CU240E-2 interfaces (Page 119)

Parameter

Parameter	Description	Factory setting
r0722.0...n	CO/BO: CU digital inputs, status	-
p0840[C]	Bl: ON/OFF (OFF1)	0
p1113[C]	Bl: Setpoint inversion	0
p3330[C]	Bl: 2/3 wire control command 1	0
p3331[C]	Bl: 2/3 wire control command 2	0
r3333.0...n	CO/BO: 2/3 wire control control word	-
p3334	2/3 wire control selection 1: Two-wire control, clockwise/counterclockwise rotation 1	0

8.5.3 Two-wire control, clockwise/counterclockwise rotation 2

Function description

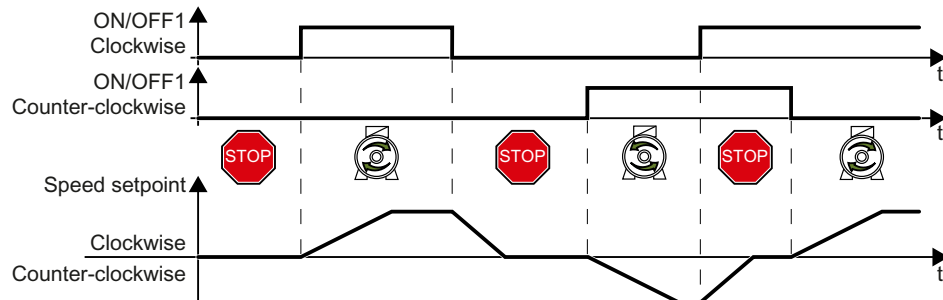

Figure 8-7 Two-wire control, clockwise/counterclockwise rotation 2

Commands "ON/OFF1 clockwise rotation" and "ON/OFF1 counter-clockwise rotation" switch on the motor - and simultaneously select a direction of rotation. The converter accepts a new command at any time, independent of the motor speed.

Table 8-13 Function table

ON/OFF1 clockwise rotation	ON/OFF1 counter-clockwise rotation	Function
0	0	The motor stops.
1	0	Clockwise motor rotation.
0	1	Counter-clockwise motor rotation.
1	1	The motor stops.

Examples

Table 8-14 Two-wire control and setting the assignment of the digital inputs

Parameter	Description
p3334 = 2	2/3 wire control selection 2: Two-wire control, clockwise/counterclockwise rotation 2
p3330[C] = 722.0	BI: 2/3 wire control command 1 (ON/OFF1 clockwise rotation) Command is received via digital input 0 (DI 0)
p3331[C] = 722.1	BI: 2/3 wire control command 2 (ON/OFF1 counter-clockwise rotation) Command is received via digital input 1 (DI 1)

8.5 Controlling clockwise and counter-clockwise rotation via digital inputs

Table 8-15 Set two-wire control, clockwise/counterclockwise rotation 2 in quick commissioning

Parameter	Description
p0015 = 18	Macro drive unit Assigning digital inputs to the commands: <ul style="list-style-type: none"> Digital input 0: ON/OFF1 clockwise rotation Digital input 1: ON/OFF1 counter-clockwise rotation  Default settings of the CU240B-2 interfaces (Page 111)

Parameter

Parameter	Description	Factory setting
r0722.0...n	CO/BO: CU digital inputs, status	-
p0840[C]	BI: ON/OFF (OFF1)	0
p1113[C]	BI: Setpoint inversion	0
p3330[C]	BI: 2/3 wire control command 1	0
p3331[C]	BI: 2/3 wire control command 2	0
r3333.0...n	CO/BO: 2/3 wire control control word	-
p3334	2/3 wire control selection 2: Two-wire control, clockwise/counterclockwise rotation 2	0

8.5.4 Three-wire control, enable/clockwise/counterclockwise rotation

Function description

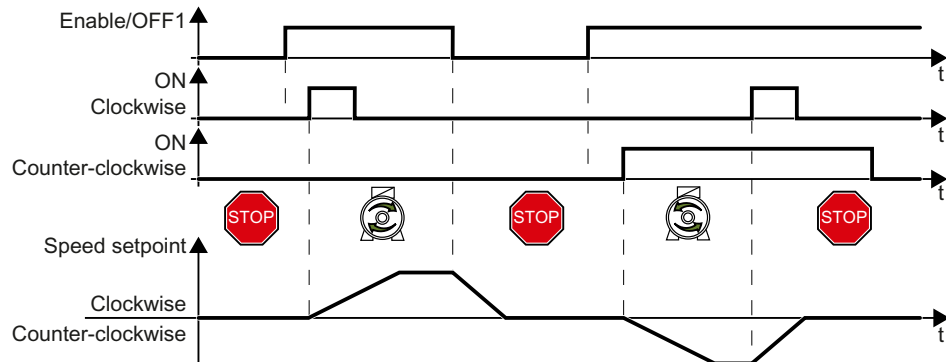

Figure 8-8 Three-wire control, enable/clockwise/counterclockwise rotation

The "Enable" command is a precondition for switching on the motor. Commands "ON clockwise rotation" and "ON counter-clockwise rotation" switch on the motor - and simultaneously select a direction of rotation. Removing the enable switches the motor off (OFF1).

Table 8-16 Function table

Enable / OFF1	ON clockwise rotation	ON counter-clockwise rotation	Function
0	0 or 1	0 or 1	The motor stops.
1	0→1	0	Clockwise motor rotation.
1	0	0→1	Counter-clockwise motor rotation.
1	1	1	The motor stops.

Examples

Table 8-17 Three-wire control and setting the assignment of the digital inputs

Parameter	Description
p3334 = 3	2/3 wire control selection 3: Three-wire control enable/clockwise/counterclockwise rotation
p3330[C] = 722.0	BI: 2/3 wire control command 1 (enable/OFF1) Command is received via digital input 0
p3331[C] = 722.1	BI: 2/3 wire control command 2 (ON clockwise rotation) Command is received via digital input 0
p3332[C] = 722.2	BI: 2/3 wire control command 3 (ON counter-clockwise rotation) Command is received via digital input 0

8.5 Controlling clockwise and counter-clockwise rotation via digital inputs

Table 8-18 Set three-wire control, enable/clockwise/counterclockwise rotation in quick commissioning

Parameter	Description
p0015 = 19	Macro drive unit Assigning digital inputs to the commands: <ul style="list-style-type: none"> • Digital input 0: Enable/OFF1 • Digital input 1: ON clockwise rotation • Digital input 2: ON counter-clockwise rotation  Default settings of the CU240B-2 interfaces (Page 111)

Parameter

Parameter	Description	Factory setting
r0722.0...n	CO/BO: CU digital inputs, status	-
p0840[C]	BI: ON/OFF (OFF1)	0
p1113[C]	BI: Setpoint inversion	0
p3330[C]	BI: 2/3 wire control command 1	0
p3331[C]	BI: 2/3 wire control command 2	0
p3332[C]	BI: 2/3 wire control command 3	0
r3333.0...n	CO/BO: 2/3 wire control control word	-
p3334	2/3 wire control selection 3: Three-wire control enable/clockwise/counterclockwise rotation	0

8.5.5 Three-wire control, enable/ON/reverse

Function description

The "Enable" command is a precondition for switching on the motor. The "ON" command switches the motor on. The "Reversing" command inverts the motor direction of rotation. Removing the enable switches the motor off (OFF1).

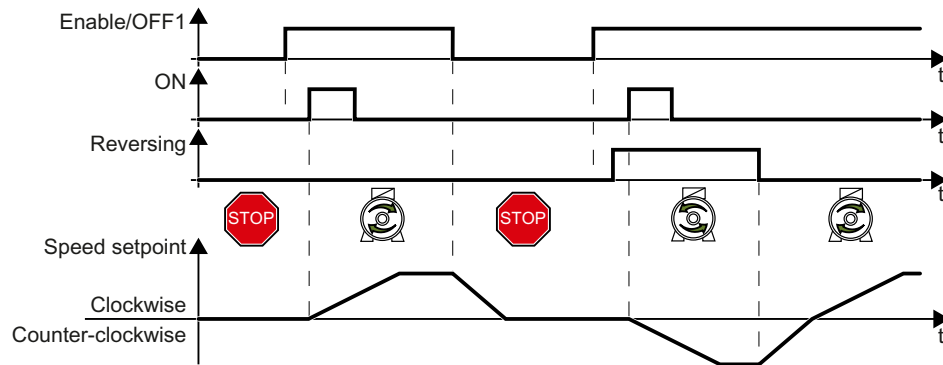

Figure 8-9 Three-wire control, enable/ON/reverse

Table 8-19 Function table

Enable / OFF1	ON	Reversing	Function
0	0 or 1	0 or 1	The motor stops.
1	0→1	0	Clockwise motor rotation.
1	0→1	1	Counter-clockwise motor rotation.

Examples

Table 8-20 Changing the assignment of the digital inputs

Parameter	Description
p3334 = 4	2/3 wire control selection 4: Three-wire control enable/clockwise/counterclockwise rotation
p3330[C] = 722.0	BI: 2/3 wire control command 1 (enable/OFF1) Command is received via digital input 0
p3331[C] = 722.1	BI: 2/3 wire control command 2 (ON) Command is received via digital input 0
p3332[C] = 722.2	BI: 2/3 wire control command 3 (reversing) Command is received via digital input 0

8.5 Controlling clockwise and counter-clockwise rotation via digital inputs

Table 8-21 Set three-wire control, enable/ON/reverse in quick commissioning

Parameter	Description
p0015 = 20	Macro drive unit Assigning digital inputs to the commands: <ul style="list-style-type: none"> • Digital input 0: Enable/OFF1 • Digital input 1: ON • Digital input 2: Reversing  Default settings of the CU240B-2 interfaces (Page 111)

Parameter

Parameter	Description	Factory setting
r0722.0...n	CO/BO: CU digital inputs, status	-
p0840[C]	Bl: ON/OFF (OFF1)	0
p1113[C]	Bl: Setpoint inversion	0
p3330[C]	Bl: 2/3 wire control command 1	0
p3331[C]	Bl: 2/3 wire control command 2	0
p3332[C]	Bl: 2/3 wire control command 3	0
r3333.0...n	CO/BO: 2/3 wire control control word	-
p3334	2/3 wire control selection 4: Three-wire control enable/ON/reverse	0

8.6 Drive control via PROFIBUS or PROFINET

8.6.1 Receive data and send data

Overview

Cyclic data exchange



The converter receives cyclic data from the higher-level control - and returns cyclic data to the control.

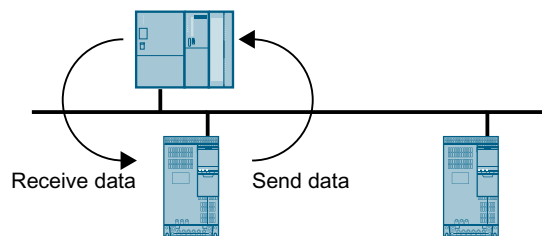

Figure 8-10 Cyclic data exchange

Converter and higher-level control system package their data in the form of telegrams.

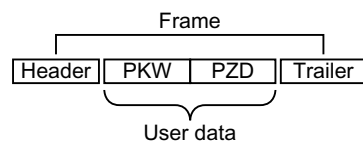

Figure 8-11 Telegram structure

A telegram has the following structure:

- Header and trailer form the protocol frame.
- User data is located within the frame:
 - PKW: The control system can read or change the parameters in the converter via "PKW data".
Not every telegram has a "PKW range".
 - PZD: The converter receives control commands and setpoints from the higher-level control - and sends status messages and actual values via "PZD data".

PROFIdrive and telegram numbers

For typical applications, certain telegrams are defined in the PROFIdrive profile and are assigned a fixed PROFIdrive telegram number. As a consequence, behind a PROFIdrive telegram number, there is a defined signal composition. As a consequence, a telegram number uniquely describes cyclic data exchange.

The telegrams are identical for PROFIBUS and PROFINET.

8.6.2 Telegrams

Overview

The user data of the telegrams that are available are described in the following.

Telegram 1

PZD01	PZD02	
STW1	NSOLL_A	
ZSW1	NIST_A	

16-bit speed setpoint

Telegram 20

PZD01	PZD02	PZD03	PZD04	PZD05	PZD06
STW1	NSOLL_A				
ZSW1	NIST_A GLATT	IAIST_ GLATT	MIST_ GLATT	PIST_ GLATT	MELD_ NAMUR

16-bit speed setpoint for VIK-Namur

Telegram 350

PZD01	PZD02	PZD03	PZD04
STW1	NSOLL_A	M_LIM	STW3
ZSW1	NIST_A GLATT	IAIST_ GLATT	ZSW3

16-bit speed setpoint with torque limiting

Telegram 352

PZD01	PZD02	PZD03	PZD04	PZD05	PZD06
STW1	NSOLL_A	Freely assignable			
ZSW1	NIST_A GLATT	IAIST_ GLATT	MIST_ GLATT	WARN_ CODE	FAULT_ CODE

16-bit speed setpoint for PCS7

Telegram 353

	PZD01	PZD02
PKW	STW1	NSOLL_A
	ZSW1	NIST_A GLATT

16-bit speed setpoint with reading and writing to parameters

Telegram 354

	PZD01	PZD02	PZD03	PZD04	PZD05	PZD06
PKW	STW1	NSOLL_A	Freely assignable			
	ZSW1	NIST_A GLATT	IAIST_ GLATT	MIST_ GLATT	WARN_ CODE	FAULT_ CODE

16-bit speed setpoint for PCS7 with reading and writing to parameters

Telegram 999

PZD01	PZD02	PZD03	PZD04	PZD05	PZD06	PZD07	PZD08	PZD09	PZD10	PZD11	PZD12	PZD13 ... PZD17
STW1	Telegram length for the receive data											
ZSW1	Telegram length for the transmit data											

Unassigned interconnection and length

Table 8-22 Abbreviations

Abbreviation	Explanation	Abbreviation	Explanation
PZD	Process data	PKW	Parameter channel
STW	Control word	MIST_GLATT	Actual smoothed torque
ZSW	Status word	PIST_GLATT	Actual smoothed active power
NSOLL_A	Speed setpoint	M_LIM	Torque limit value
NIST_A	Speed actual value	FAULT_CODE	Fault code
NIST_A_GLATT	Smoothed actual speed value	WARN_CODE	Alarm code
IAIST_GLATT	Smoothed current actual value	MELD_NAMUR	Message according to the VIK-NAMUR definition

Function description

Control word 1 (STW1)

Bit	Significance		Explanation	Signal interconnection in the converter
	Telegram 20	All other telegrams		
0	0 = OFF1		The motor brakes with the ramp-down time p1121 of the ramp-function generator. The converter switches off the motor at standstill.	p0840[0] = r2090.0
	0 → 1 = ON		The converter goes into the "ready" state. If, in addition bit 3 = 1, then the converter switches on the motor.	
1	0 = OFF2		Switch off the motor immediately, the motor then coasts down to a standstill.	p0844[0] = r2090.1
	1 = No OFF2		The motor can be switched on (ON command).	
2	0 = Quick stop (OFF3)		Quick stop: The motor brakes to a standstill with the OFF3 ramp-down time p1135.	p0848[0] = r2090.2
	1 = No quick stop (OFF3)		The motor can be switched on (ON command).	
3	0 = Inhibit operation		Immediately switch-off motor (cancel pulses).	p0852[0] = r2090.3
	1 = Enable operation		Switch-on motor (pulses can be enabled).	
4	0 = Disable RFG		The converter immediately sets its ramp-function generator output to 0.	p1140[0] = r2090.4
	1 = Do not disable RFG		The ramp-function generator can be enabled.	

Bit	Significance		Explanation	Signal inter-connection in the converter
	Telegram 20	All other telegrams		
5	0 = Stop RFG		The output of the ramp-function generator stops at the actual value.	p1141[0] = r2090.5
	1 = Enable RFG		The output of the ramp-function generator follows the setpoint.	
6	0 = Inhibit setpoint		The converter brakes the motor with the ramp-down time p1121 of the ramp-function generator.	p1142[0] = r2090.6
	1 = Enable setpoint		Motor accelerates to the setpoint with the ramp-up time p1120.	
7	0 → 1 = Acknowledge faults		Acknowledge fault. If the ON command is still active, the converter switches to the "switching on inhibited" state.	p2103[0] = r2090.7
8, 9	Reserved			
10	0 = No control via PLC		Converter ignores the process data from the fieldbus.	p0854[0] = r2090.10
	1 = Control via PLC		Control via fieldbus, converter accepts the process data from the fieldbus.	
11	1 = Direction reversal		Invert setpoint in the converter.	p1113[0] = r2090.11
12	Not used			
13	--- ¹⁾	1 = MOP up	Increase the setpoint saved in the motorized potentiometer.	p1035[0] = r2090.13
14	--- ¹⁾	1 = MOP down	Reduce the setpoint saved in the motorized potentiometer.	p1036[0] = r2090.14
15	CDS bit 0	Reserved	Changes over between settings for different operation interfaces (command data sets).	p0810 = r2090.15

¹⁾ If you change over from another telegram to telegram 20, then the assignment of the previous telegram is kept.

Status word 1 (ZSW1)

Bit	Significance		Remarks	Signal inter-connection in the converter
	Telegram 20	All other telegrams		
0	1 = Ready for switching on		Power supply switched on; electronics initialized; pulses locked.	p2080[0] = r0899.0
1	1 = Ready		Motor is switched on (ON/OFF1 = 1), no fault is active. With the command "Enable operation" (STW1.3), the converter switches on the motor.	p2080[1] = r0899.1
2	1 = Operation enabled		Motor follows setpoint. See control word 1, bit 3.	p2080[2] = r0899.2
3	1 = Fault active		The converter has a fault. Acknowledge fault using STW1.7.	p2080[3] = r2139.3
4	1 = OFF2 inactive		Coast down to standstill is not active.	p2080[4] = r0899.4

Bit	Significance		Remarks	Signal interconnection in the converter
	Telegram 20	All other telegrams		
5	1 = OFF3 inactive		Quick stop is not active.	p2080[5] = r0899.5
6	1 = Switching on inhibited active		It is only possible to switch on the motor after an OFF1 followed by ON.	p2080[6] = r0899.6
7	1 = Alarm active		Motor remains switched on; no acknowledgement is necessary.	p2080[7] = r2139.7
8	1 = Speed deviation within the tolerance range		Setpoint / actual value deviation within the tolerance range.	p2080[8] = r2197.7
9	1 = Master control requested		The automation system is requested to accept the converter control.	p2080[9] = r0899.9
10	1 = Comparison speed reached or exceeded		Speed is greater than or equal to the corresponding maximum speed.	p2080[10] = r2199.1
11	1 = current or torque limit reached	1 = torque limit reached	Comparison value for current or torque has been reached or exceeded.	p2080[11] = r0056.13 / r1407.7
12	--- ¹⁾	1 = Holding brake open	Signal to open and close a motor holding brake.	p2080[12] = r0899.12
13	0 = Alarm, motor overtemperature		--	p2080[13] = r2135.14
14	1 = Motor rotates clockwise		Internal converter actual value > 0.	p2080[14] = r2197.3
	0 = Motor rotates counter-clockwise		Internal converter actual value < 0.	
15	1 = CDS display	0 = Alarm, converter thermal overload		p2080[15] = r0836.0 / r2135.15

¹⁾ If you change over from another telegram to telegram 20, then the assignment of the previous telegram is kept.

Control word 3 (STW3)

Bit	Significance		Explanation	Signal interconnection in the converter ¹⁾
	Telegram 350			
0	1 = fixed setpoint bit 0		Selects up to 16 different fixed setpoints.	p1020[0] = r2093.0
1	1 = fixed setpoint bit 1			p1021[0] = r2093.1
2	1 = fixed setpoint bit 2			p1022[0] = r2093.2
3	1 = fixed setpoint bit 3			p1023[0] = r2093.3
4	1 = DDS selection bit 0		Changes over between settings for different motors (drive data sets).	p0820 = r2093.4
5	1 = DDS selection bit 1			p0821 = r2093.5
6	Not used			
7	Not used			
8	1 = technology controller enable		--	p2200[0] = r2093.8
9	1 = enable DC braking		--	p1230[0] = r2093.9
10	Not used			

Bit	Significance	Explanation	Signal interconnection in the converter ¹⁾
	Telegram 350		
11	1 = Enable droop	Enable or inhibit speed controller droop.	p1492[0] = r2093.11
12	1 = torque control active 0 = speed control active	Changes over the control mode for vector control.	p1501[0] = r2093.12
13	1 = no external fault 0 = external fault is active (F07860)	--	p2106[0] = r2093.13
14	Not used		
15	1 = CDS bit 1	Changes over between settings for different operation interfaces (command data sets).	p0811[0] = r2093.15

¹⁾ If you switch from telegram 350 to a different one, then the converter sets all interconnections p1020, ... to "0". Exception: p2106 = 1.

Status word 3 (ZSW3)

Bit	Significance	Description	Signal interconnection in the converter
0	1 = DC braking active	--	p2051[3] = r0053
1	1 = $ n_{act} > p1226$	Absolute current speed > stationary state detection	
2	1 = $ n_{act} > p1080$	Absolute actual speed > minimum speed	
3	1 = $i_{act} \geq p2170$	Actual current \geq current threshold value	
4	1 = $ n_{act} > p2155$	Absolute actual speed > speed threshold value 2	
5	1 = $ n_{act} \leq p2155$	Absolute actual speed < speed threshold value 2	
6	1 = $ n_{act} \geq r1119$	Speed setpoint reached	
7	1 = DC link voltage $\leq p2172$	Actual DC link voltage \leq threshold value	
8	1 = DC link voltage > p2172	Actual DC link voltage > threshold value	
9	1 = ramp-up or ramp-down completed	Ramp-function generator is not active.	
10	1 = technology controller output at the lower limit	Technology controller output $\leq p2292$	
11	1 = technology controller output at the upper limit	Technology controller output > p2291	
12	Not used		
13	Not used		
14	Not used		
15	Not used		

Fault word according to the VIK-NAMUR definition (MELD_NAMUR)

Bit	Significance	P no.
0	1 = Control Unit signals a fault	p2051[5] = r3113
1	1 = line fault: Phase failure or inadmissible voltage	
2	1 = DC link overvoltage	
3	1 = Power Module fault, e.g. overcurrent or overtemperature	
4	1 = converter overtemperature	
5	1 = ground fault/phase fault in the motor cable or in the motor	
6	1 = motor overload	
7	1 = communication error to the higher-level control system	
8	1 = fault in a safety-relevant monitoring channel	
10	1 = fault in the internal converter communication	
11	1 = line fault	
15	1 = other fault	

8.6.3 Parameter channel

Overview

The parameter channel allows parameter values to be cyclically read and written to.

Parameter channel					
PKE (1st word)		IND (2nd word)		PWE (3rd and 4th words)	
15...12;11;	10...0	15...8	7...0	15...0	15...0
AK	S; P M	PNU	Subindex	Page index	PWE 1 PWE 2

Structure of the parameter channel:

- PKE (1st word)
 - Type of task (read or write).
 - Bit 11 is reserved and is always assigned 0.
 - Parameter number
- IND (2nd word)
 - Parameter index
- PWE (3rd and 4th word)
 - Parameter value

Function description

AK: Request and response ID

Table 8-23 Request identifiers, control → converter

AK	Description	Response identifier	
		positive	negative
0	No request	0	7 / 8
1	Request parameter value	1 / 2	7 / 8
2	Change parameter value (word)	1	7 / 8
3	Change parameter value (double word)	2	7 / 8
4	Request descriptive element ¹⁾	3	7 / 8
6 ²⁾	Request parameter value (field) ¹⁾	4 / 5	7 / 8
7 ²⁾	Change parameter value (field, word) ¹⁾	4	7 / 8
8 ²⁾	Change parameter value (field, double word) ¹⁾	5	7 / 8
9	Request number of field elements	6	7 / 8

¹⁾ The required element of the parameter is specified in IND (2nd word).

²⁾ The following request IDs are identical: 1 ≡ 6, 2 ≡ 7 and 3 ≡ 8.
We recommend that you use identifiers 6, 7 and 8.

Table 8-24 Response identifiers, converter → control

AK	Description
0	No response
1	Transfer parameter value (word)
2	Transfer parameter value (double word)
3	Transfer descriptive element ¹⁾
4	Transfer parameter value (field, word) ²⁾
5	Transfer parameter value (field, double word) ²⁾
6	Transfer number of field elements
7	Converter cannot process the request. In the most significant word of the parameter channel, the converter sends an error number to the control, refer to the following table.
8	No master controller status / no authorization to change parameters of the parameter channel interface

¹⁾ The required element of the parameter is specified in IND (2nd word).

²⁾ The required element of the indexed parameter is specified in IND (2nd word).

Table 8-25 Error numbers for response identifier 7

No.	Description
00 hex	Illegal parameter number (access to a parameter that does not exist)
01 hex	Parameter value cannot be changed (change request for a parameter value that cannot be changed)
02 hex	Lower or upper value limit exceeded (change request with a value outside the value limits)
03 hex	Incorrect subindex (access to a subindex that does not exist)
04 hex	No array (access with a subindex to non-indexed parameters)
05 hex	Incorrect data type (change request with a value that does not match the data type of the parameter)
06 hex	Setting not permitted, only resetting (change request with a value not equal to 0 without permission)
07 hex	Descriptive element cannot be changed (change request to a descriptive element error value that cannot be changed)
0B hex	No master control (change request but with no master control, see also p0927)
0C hex	Keyword missing
11 hex	Request cannot be executed due to the operating state (access is not possible for temporary reasons that are not specified)
14 hex	Inadmissible value (change request with a value that is within the limits but which is illegal for other permanent reasons, i.e. a parameter with defined individual values)
65 hex	Parameter number is currently deactivated (depending on the mode of the converter)
66 hex	Channel width is insufficient (communication channel is too small for response)
68 hex	Illegal parameter value (parameter can only assume certain values)
6A hex	Request not included / task is not supported (the valid request identifications can be found in table "Request identifications controller → converter")
6B hex	No change access for a controller that is enabled. (The operating state of the converter prevents a parameter change)

No.	Description
86 hex	Write access only for commissioning (p0010 = 15) (operating state of the converter prevents a parameter change)
87 hex	Know-how protection active, access locked
C8 hex	Change request below the currently valid limit (change request to a value that lies within the "absolute" limits, but is however below the currently valid lower limit)
C9 hex	Change request above the currently valid limit (example: a parameter value is too large for the converter power)
CC hex	Change request not permitted (change is not permitted as the access code is not available)

PNU (parameter number) and page index

Parameter number	PNU	Page index
0000 ... 1999	0000 ... 1999	0 hex
2000 ... 3999	0000 ... 1999	80 hex
6000 ... 7999	0000 ... 1999	90 hex
8000 ... 9999	0000 ... 1999	20 hex
10000 ... 11999	0000 ... 1999	A0 hex
20000 ... 21999	0000 ... 1999	50 hex
30000 ... 31999	0000 ... 1999	F0 hex
60000 ... 61999	0000 ... 1999	74 hex

Subindex

For indexed parameters, the parameter index is located in subindex as hexadecimal value.

PWE: Parameter value or connector

Parameter values or connectors can be located in the PWE.

Table 8-26 Parameter value or connector

	PWE 1	PWE 2	
Parameter value	Bit 15 ... 0	Bit 15 ... 8	Bit 7 ... 0
	0	0	8-bit value
	0	16-bit value	
	32-bit value		
Connector	Bit 15 ... 0	Bit 15 ... 10	Bit 9 ... 0
	Number of the connector	3F hex	The index or bit field number of the connector

8.6 Drive control via PROFIBUS or PROFINET

- **IND, bit 8 ... 15 (subindex): = 1 hex** (CDS1 = Index 1)
- **IND, bit 0 ... 7 (page index): = 0 hex** (offset 0 corresponds to 0 hex)
- **PWE1, Bit 0 ... 15: = 2D2 hex** (722 = 2D2 hex)
- **PWE2, Bit 10 ... 15: = 3F hex** (drive object - for SINAMICS G120, always 63 = 3f hex)
- **PWE2, Bit 0 ... 9: = 2 hex** (Index of Parameter (DI 2 = 2))

Parameter channel																																																											
PKE, 1st word				IND, 2nd word				PWE1 - high, 3rd word				PWE2 - low, 4th word																																															
15...12	11	10 ... 0		15 ... 8	7 ... 0			15 ... 0				15 ... 10	9 ... 0																																														
AK	Parameter number			Subindex	Page index			Parameter value				Drive Object	Index																																														
0	1	1	1	0	0	1	1	0	1	0	1	0	0	1	0	0	0	0	0	0	0	0	0	0	1	0	0	0	0	0	0	0	0	0	0	1	0	1	1	0	1	0	0	1	0	1	1	1	1	1	1	0	0	0	0	0	0	1	0

Figure 8-14 Parameter channel to assign digital input 2 with ON/OFF1

8.6.4 Expanding or freely interconnecting telegrams

Overview

When you have selected a telegram, the converter interconnects the corresponding signals with the fieldbus interface. Generally, these interconnections are locked so that they cannot be changed. However, with the appropriate setting in the converter, the telegram can be extended or even freely interconnected.

Function description

Interconnection of send data and receive data

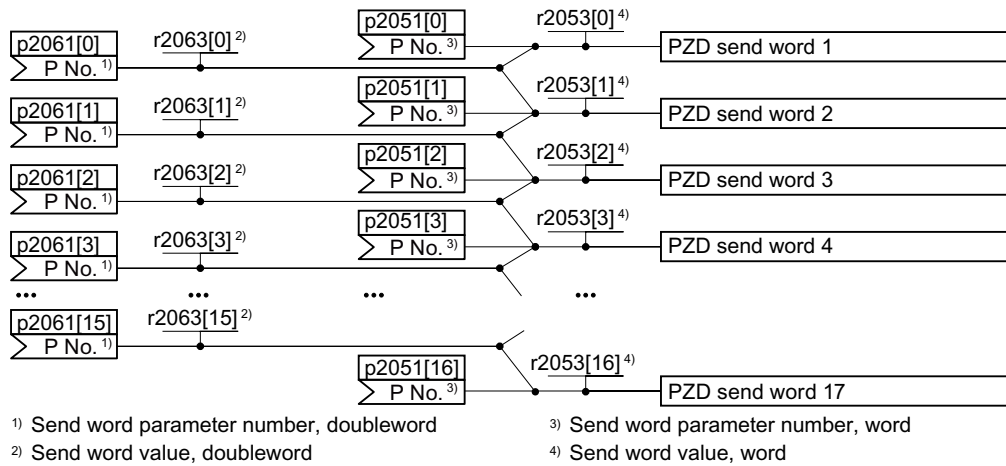

Figure 8-15 Interconnection of the send data

In the converter, the send data are available in the "Word" format (p2051) - and in the "Double word" format (p2061). If you set a specific telegram, or you change the telegram, the converter automatically interconnects parameters p2051 and p2061 with the appropriate signals.

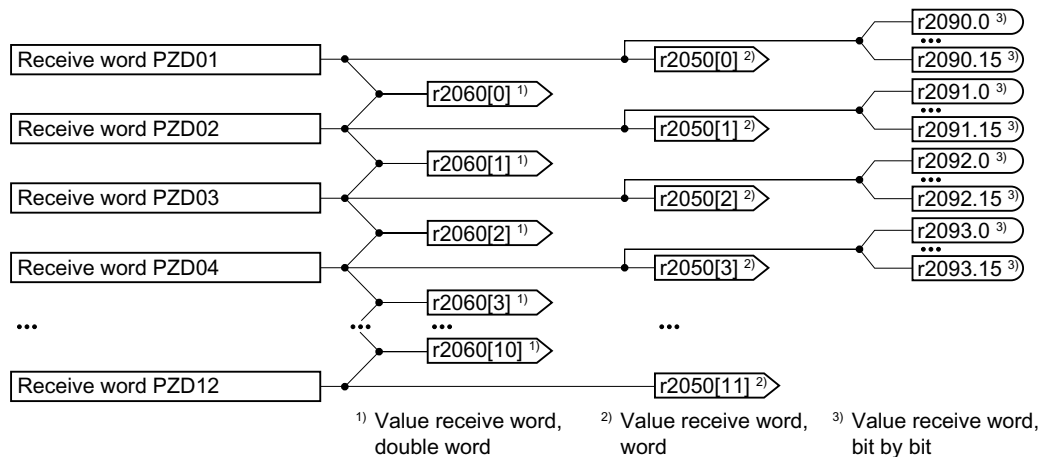

Figure 8-16 Interconnection of the receive data

The converter saves the receive data as follows:

- "Word" format in r2050
- "Double word" format in r2060
- Bit-by-bit in r2090 ... r2093

Extending a telegram: Procedure

1. Set p0922 = 999.
2. Set parameter p2079 to the value of the corresponding telegram.
3. Interconnect additional send words and receive words with signals of your choice via parameters r2050 and p2051.

You have extended a telegram.



Freely interconnecting signals in the telegram: Procedure

1. Set p0922 = 999.
2. Set p2079 = 999.
3. Interconnect additional send words and receive words with signals of your choice via parameters r2050 and p2051.

You have freely interconnected a telegram.



Example

You wish to extend telegram 1 to 6 send words and 6 receive words. You want to test the extension by initiating that the converter returns each receive word back to the higher-level control system.

Procedure

1. p0922 = 999
2. p2079 = 1
3. p2051[2] = r2050[2]
4. ...
5. p2051[5] = r2050[5]
6. Test the telegram length for received and sent words:
 - r2067[0] = 6
 - r2067[1] = 6

You wish to extend telegram 1 to 6 send words and 6 receive words.



Parameter

Number	Name	Factory setting
p0922	PROFIdrive PZD telegram selection	1
r2050[0...11]	CO: PROFIdrive PZD receive word	-
p2051[0...16]	CI: PROFIdrive PZD send word	0 or dependent on the converter
r2053[0...16]	PROFIdrive diagnostics send PZD word	-
r2060[0...10]	CO: PROFIdrive PZD receive double word	-
p2061[0...15]	CI: PROFIdrive PZD send double word	0
r2063[0...15]	PROFIdrive diagnostics PZD send double word	-
r2067	PZD maximum interconnected [0] Receive (r2050, r2060) [1] Send (p2051, p2061)	-
p2079	PROFIdrive PZD telegram selection extended	1
p2080[0...15]	BI: Binector-connector converter, status word 1	[0] 899 [1] 899.1 [2] 899.2 [3] 2139.3 [4] 899.4 [5] 899.5 [6] 899.6 [7] 2139.7 [8] 2197.7 [9] 899.9 [10] 2199.1 [11] 1407.7 [12] 0 [13] 2135.14 [14] 2197.3 [15] 2135.15
r2090.0...15	BO: PROFIdrive receive PZD1 bit by bit	-
r2091.0...15	BO: PROFIdrive PZD2 receive bit-serial	-
r2092.0...15	BO: PROFIdrive PZD3 receive bit-serial	-
r2093.0...15	BO: PROFIdrive PZD4 receive bit-serial	-

8.6.5 Device-to-device communication

Overview

"Direct data exchange" is sometimes called "device-to-device communication" or "data exchange broadcast". With direct data exchange, devices exchange data without any direct involvement of the master.

Additional information

Further information about the "Direct data exchange" function is provided in the Fieldbus function manual.

 Overview of the manuals (Page 564)

8.6.6 Acyclically reading and writing converter parameters

Overview

The converter supports the writing and reading of parameters via acyclic communication:

- For PROFIBUS: Up to 240 bytes per write or read request via data set 47
- For PROFINET: Write or read requests via B02E hex and B02F hex

Example

Application example, "Read and write to parameters"

Further information is provided on the Internet:

 Application examples (<https://support.industry.siemens.com/cs/ww/en/view/29157692>)

Further information

Further information about acyclic communication is provided in the Fieldbus function manual.

 Overview of the manuals (Page 564)

8.7 Drive control via Modbus RTU

Overview



Modbus RTU is used to transfer cyclic process data and acyclic parameter data between precisely one master and up to 247 slaves. The converter is always the slave, and sends data when requested to do so by the master. Slave-to-slave communication is not possible.

Function description

Control word 1 (STW1)

Bit	Meaning	Explanation	Signal inter-connection in the converter
0	0 = OFF1	The motor brakes with the ramp-down time p1121 of the ramp-function generator. The converter switches off the motor at standstill.	p0840[0] = r2090.0
	0 → 1 = ON	The converter goes into the "ready" state. If, in addition, bit 3 = 1, the converter switches on the motor.	
1	0 = OFF2	Switch off the motor immediately, the motor then coasts down to a standstill.	p0844[0] = r2090.1
	1 = No OFF2	The motor can be switched on (ON command).	
2	0 = Quick stop (OFF3)	Quick stop: The motor brakes with the OFF3 ramp-down time p1135 down to standstill.	p0848[0] = r2090.2
	1 = No quick stop (OFF3)	The motor can be switched on (ON command).	
3	0 = Inhibit operation	Immediately switch-off motor (cancel pulses).	p0852[0] = r2090.3
	1 = Enable operation	Switch-on motor (pulses can be enabled).	
4	0 = Disable RFG	The converter immediately sets its ramp-function generator output to 0.	p1140[0] = r2090.4
	1 = Do not disable RFG	The ramp-function generator can be enabled.	
5	0 = Stop RFG	The output of the ramp-function generator stops at the actual value.	p1141[0] = r2090.5
	1 = Enable RFG	The output of the ramp-function generator follows the setpoint.	
6	0 = Inhibit setpoint	The converter brakes the motor with the ramp-down time p1121 of the ramp-function generator.	p1142[0] = r2090.6
	1 = Enable setpoint	Motor accelerates with the ramp-up time p1120 to the setpoint.	
7	0 → 1 = Acknowledge faults	Acknowledge fault. If the ON command is still active, the converter switches to the "switching on inhibited" state.	p2103[0] = r2090.7
8, 9	Reserved		
10	0 = No control via PLC	Converter ignores the process data from the fieldbus.	p0854[0] = r2090.10
	1 = Control via PLC	Control via fieldbus, converter accepts the process data from the fieldbus.	

Bit	Meaning	Explanation	Signal interconnection in the converter
11	1 = Direction reversal	Invert setpoint in the converter.	p1113[0] = r2090.11
12	Reserved		
13	1 = MOP up	Increase the setpoint saved in the motorized potentiometer.	p1035[0] = r2090.13
14	1 = MOP down	Reduce the setpoint saved in the motorized potentiometer.	p1036[0] = r2090.14
15	Reserved		

Status word 1 (ZSW1)

Bit	Meaning	Remarks	Signal interconnection in the converter
0	1 = Ready for switching on	Power supply switched on; electronics initialized; pulses locked.	p2080[0] = r0899.0
1	1 = Ready	Motor is switched on (ON/OFF1 = 1), no fault is active. With the command "Enable operation" (STW1.3), the converter switches on the motor.	p2080[1] = r0899.1
2	1 = Operation enabled	Motor follows setpoint. See control word 1, bit 3.	p2080[2] = r0899.2
3	1 = Fault active	The converter has a fault. Acknowledge fault using STW1.7.	p2080[3] = r2139.3
4	1 = OFF2 inactive	Coast down to standstill is not active.	p2080[4] = r0899.4
5	1 = OFF3 inactive	Quick stop is not active.	p2080[5] = r0899.5
6	1 = Switching on inhibited active	It is only possible to switch on the motor after an OFF1 followed by ON.	p2080[6] = r0899.6
7	1 = Alarm active	Motor remains switched on; no acknowledgement is necessary.	p2080[7] = r2139.7
8	1 = Speed deviation within the tolerance range	Setpoint / actual value deviation within the tolerance range.	p2080[8] = r2197.7
9	1 = Master control requested	The automation system is requested to accept the converter control.	p2080[9] = r0899.9
10	1 = Comparison speed reached or exceeded	Speed is greater than or equal to the corresponding maximum speed.	p2080[10] = r2199.1
11	1 = Torque limit not reached	Comparison value for current or torque has been fallen below.	p2080[11] = r0056.13 / r1407.7
12	Reserved		p2080[12] = r0899.12
13	0 = Alarm, motor overtemperature	--	p2080[13] = r2135.14

Bit	Meaning	Remarks	Signal interconnection in the converter
14	1 = Motor rotates clockwise	Internal converter actual value > 0	p2080[14] = r2197.3
	0 = Motor rotates counter-clockwise	Internal converter actual value < 0	
15	0 = Alarm, converter thermal overload		p2080[15] = r2135.15

¹⁾ If you change over from another telegram to telegram 20, then the assignment of the previous telegram is kept.

Parameter

Table 8-27 Settings for Modbus RTU

Parameter	Description	Factory setting
p2020	Fieldbus interface baud rate	8
p2021	Fieldbus interface address	0
p2024	Fieldbus interface times	[0] 1000 ms [1] 0 ms [2] 0 ms
r2029	Fieldbus interface error statistics	-
p2030	Fieldbus interface protocol selection	0
p2031	Fieldbus interface Modbus parity	2
p2040	Fieldbus interface monitoring time	100 ms

Further information

Further information Additional information about Modbus RTU is provided in the "Fieldbus" function manual.



Overview of the manuals (Page 564)

8.8 Drive control via USS

Overview



USS is used to transfer cyclic process data and acyclic parameter data between precisely one master and up to 31 devices. The converter is always the device, and sends data when requested to do so by the master. Device-to-device communication is not possible.

Function description

Control word 1 (STW1)

Bit	Meaning	Explanation	Signal inter-connection in the converter
0	0 = OFF1	The motor brakes with the ramp-down time p1121 of the ramp-function generator. The converter switches off the motor at standstill.	p0840[0] = r2090.0
	0 → 1 = ON	The converter goes into the "ready" state. If, in addition, bit 3 = 1, the converter switches on the motor.	
1	0 = OFF2	Switch off the motor immediately, the motor then coasts down to a standstill.	p0844[0] = r2090.1
	1 = No OFF2	The motor can be switched on (ON command).	
2	0 = Quick stop (OFF3)	Quick stop: The motor brakes with the OFF3 ramp-down time p1135 down to standstill.	p0848[0] = r2090.2
	1 = No quick stop (OFF3)	The motor can be switched on (ON command).	
3	0 = Inhibit operation	Immediately switch-off motor (cancel pulses).	p0852[0] = r2090.3
	1 = Enable operation	Switch-on motor (pulses can be enabled).	
4	0 = Disable RFG	The converter immediately sets its ramp-function generator output to 0.	p1140[0] = r2090.4
	1 = Do not disable RFG	The ramp-function generator can be enabled.	
5	0 = Stop RFG	The output of the ramp-function generator stops at the actual value.	p1141[0] = r2090.5
	1 = Enable RFG	The output of the ramp-function generator follows the setpoint.	
6	0 = Inhibit setpoint	The converter brakes the motor with the ramp-down time p1121 of the ramp-function generator.	p1142[0] = r2090.6
	1 = Enable setpoint	Motor accelerates with the ramp-up time p1120 to the setpoint.	
7	0 → 1 = Acknowledge faults	Acknowledge fault. If the ON command is still active, the converter switches to the "switching on inhibited" state.	p2103[0] = r2090.7
8, 9	Reserved		
10	0 = No control via PLC	Converter ignores the process data from the fieldbus.	p0854[0] = r2090.10
	1 = Control via PLC	Control via fieldbus, converter accepts the process data from the fieldbus.	

Bit	Meaning	Explanation	Signal inter-connection in the converter
11	1 = Direction reversal	Invert setpoint in the converter.	p1113[0] = r2090.11
12	Reserved		
13	1 = MOP up	Increase the setpoint saved in the motorized potentiometer.	p1035[0] = r2090.13
14	1 = MOP down	Reduce the setpoint saved in the motorized potentiometer.	p1036[0] = r2090.14
15	Reserved		

Status word 1 (ZSW1)

Bit	Meaning	Remarks	Signal inter-connection in the converter
0	1 = Ready for switching on	Power supply switched on; electronics initialized; pulses locked.	p2080[0] = r0899.0
1	1 = Ready	Motor is switched on (ON/OFF1 = 1), no fault is active. With the command "Enable operation" (STW1.3), the converter switches on the motor.	p2080[1] = r0899.1
2	1 = Operation enabled	Motor follows setpoint. See control word 1, bit 3.	p2080[2] = r0899.2
3	1 = Fault active	The converter has a fault. Acknowledge fault using STW1.7.	p2080[3] = r2139.3
4	1 = OFF2 inactive	Coast down to standstill is not active.	p2080[4] = r0899.4
5	1 = OFF3 inactive	Quick stop is not active.	p2080[5] = r0899.5
6	1 = Switching on inhibited active	It is only possible to switch on the motor after an OFF1 followed by ON.	p2080[6] = r0899.6
7	1 = Alarm active	Motor remains switched on; no acknowledgement is necessary.	p2080[7] = r2139.7
8	1 = Speed deviation within the tolerance range	Setpoint / actual value deviation within the tolerance range.	p2080[8] = r2197.7
9	1 = Master control requested	The automation system is requested to accept the converter control.	p2080[9] = r0899.9
10	1 = Comparison speed reached or exceeded	Speed is greater than or equal to the corresponding maximum speed.	p2080[10] = r2199.1
11	1 = Torque limit not reached	Comparison value for current or torque has been fallen below.	p2080[11] = r0056.13 / r1407.7
12	Reserved		p2080[12] = r0899.12
13	0 = Alarm, motor over-temperature	--	p2080[13] = r2135.14

Bit	Meaning	Remarks	Signal inter-connection in the converter
14	1 = Motor rotates clockwise	Internal converter actual value > 0	p2080[14] = r2197.3
	0 = Motor rotates counter-clockwise	Internal converter actual value < 0	
15	0 = Alarm, converter thermal overload		p2080[15] = r2135.15

Parameter

Parameter	Description	Factory setting
p2020	Fieldbus interface baud rate	8
p2021	Fieldbus interface address	0
p2022	Fieldbus interface USS PZD number	2
p2023	Fieldbus interface USS PKW number	127
p2024	Fieldbus interface times	[0] 1000 ms [1] 0 ms [2] 0 ms
r2029	Fieldbus interface error statistics	-
p2030	Fieldbus interface protocol selection	0
p2031	Fieldbus interface Modbus parity	2
p2040	Fieldbus interface monitoring time	100 ms

Further information

Additional information about USS is provided in the "Fieldbus" function manual.

 Overview of the manuals (Page 564)

8.9 Drive control via Ethernet/IP

Overview



EtherNet/IP is an Ethernet-based fieldbus. EtherNet/IP is used to transfer cyclic process data as well as acyclic parameter data.

Function description

Parameter	Description		
p2030 = 10	Fieldbus interface protocol selection: Ethernet/IP		
p8924	PN DHCP mode	0: DHCP off 2: DHCP on, identification based on MAC address 3: DHCP on, identification based on Name of Station	
p8925	PN interfaces configuration	0: No function 1: Reserved 2: Save the configuration and activate 3: Delete configuration	
p8980	Ethernet/IP profile A change only becomes active after the converter power supply is switched off and switched on again.	0: SINAMICS 1: ODVA AC/DC	
p8982	Ethernet/IP ODVA speed scaling A change only becomes active after the converter power supply is switched off and switched on again.		
	123: 32 124: 16 125: 8 126: 4	127: 2 128: 1 129: 0.5 130: 0.25	131: 0.125 132: 0.0625 133: 0.03125

Parameter

Settings for Ethernet/IP

Parameter	Description	Factory setting
p2030	Fieldbus interface protocol selection	0
p8920	PN Name of Station	-
p8921[0...3]	PN IP Address	0
p8922[0...3]	PN Default Gateway	0
p8923[0...3]	PN Subnet Mask	0
p8924	PN DHCP mode	0
p8925	Activate PN interface configuration	0
p8980	EtherNet/IP profile	0
p8982	EtherNet/IP ODVA speed scaling	128

Further information

Additional information about USS is provided in the "Fieldbus" function manual.



Overview of the manuals (Page 564)

8.10 Jogging

Overview



The "Jog" function is typically used to temporarily move a motor using local control commands.

Requirement

The OFF1 command must be active. With an active ON command, the converter ignores the commands "Jogging 1" and "Jogging 2".

Function description

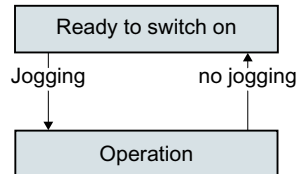

Commands "Jog 1" or "Jog 2" switch the motor on and off.

The commands are only active when the converter is in the "Ready for switching on" state.

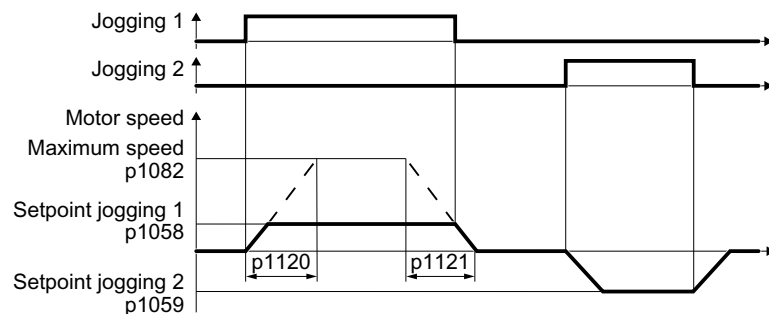

Figure 8-17 Behavior of the motor when "jogging"

After switching on, the motor accelerates to the setpoint, jog 1 or setpoint, jog 2. The two different setpoints can, for example, be assigned to motor clockwise and counter-clockwise rotation.

When jogging, the same ramp-function generator is active as for the ON/OFF1 command.

Example

Parameter	Description
p1055 = 722.0	Jogging bit 0: Select jogging 1 via digital input 0
p1056 = 722.1	Jogging bit 1: Select jogging 2 via digital input 1

Parameter

Number	Name	Factory setting
p1055[C]	Bl: Jogging bit 0	Depending on the converter
p1056[C]	Bl: Jogging bit 1	Depending on the converter
p1058[D]	Jogging 1 speed setpoint	150 rpm
p1059[D]	Jogging 2 speed setpoint	-150 rpm
p1082[D]	Maximum speed	1500 rpm
p1110[C]	Bl: Inhibit negative direction	Depending on the converter
p1111[C]	Bl: Inhibit positive direction	0
p1113[C]	Bl: Setpoint inversion	0
p1120[D]	Ramp-function generator ramp-up time	Depending on the converter
p1121[D]	Ramp-function generator ramp-down time	Depending on the converter

8.11 Limit position control

Overview

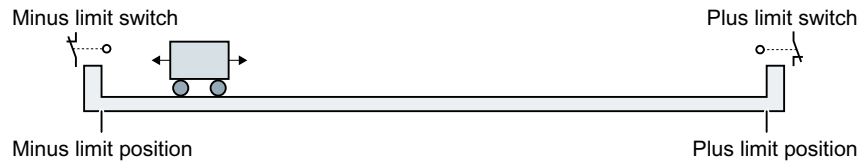

An end position is a position in the direction of motion of a machine component where motion stops as a result of the inherent mechanical design. A limit switch is a sensor that signals that the end position has been reached.

The end position control of the converter controls the motor depending on 2 limit switch signals:

- When an end position is reached, the converter stops the motor.
- At end position, the converter prevents the motor from moving the machine component further in the direction of this end position.

Function description

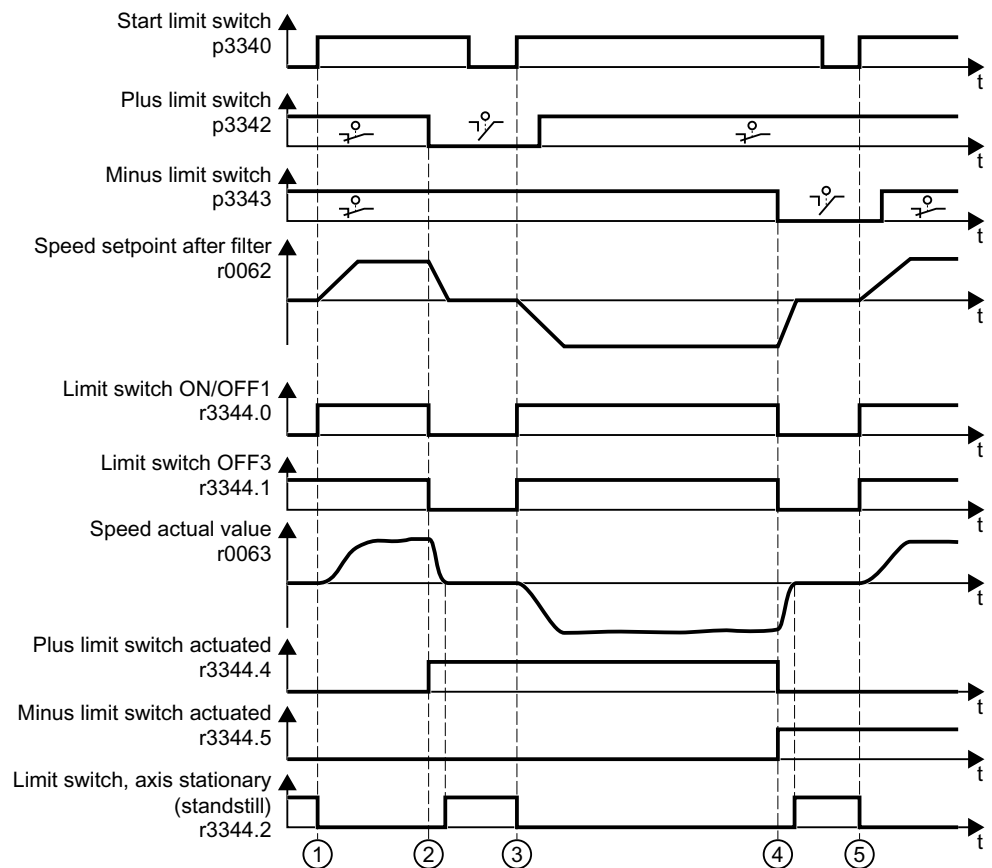

Figure 8-18 End position control of the converter

Table 8-28 Explanation

①	The higher-level control system issues a positive setpoint. The motor moves the machine component in the direction of the positive end position.
②	The positive end position has been reached. The motor stops with the OFF3 ramp-down time.
③	The higher-level control system issues a negative setpoint. With a signal change 0 → 1 at p3340, the motor moves the machine component in the direction of "Limit switch minus".
④	The negative end position has been reached. The motor stops with the OFF3 ramp-down time.
⑤	The higher-level control system issues a positive setpoint. With a signal change 0 → 1 at p3340, the motor moves the machine component in the direction of "Limit switch plus".

Parameter

Parameter	Description	Factory setting
p3340[C]	BI: Start limit switch	0
p3342[C]	BI: Plus limit switch	1
p3343[C]	BI: Minus limit switch	1
r3344	CO/BO: Limit switch status word	-

8.12 Switching over the drive control (command data set)

Overview



Several applications require the option of switching over the master control to operate the converter.

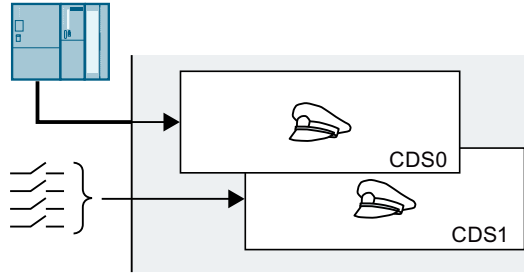

Figure 8-19 Converter control either via fieldbus or via terminal strip

Function description

Command data set (CDS)

You can set the converter control in various ways and toggle between the settings.

The settings in the converter, which are assigned to a specific master control, are called the command data set.

You select the command data set using parameters p0810 and p0811. To do this, you must interconnect parameters p0810 and p0811 with control commands of your choice, e.g. a digital input.

Changing the number of command data sets

Up to 4 command data sets are possible.

1. Set p0010 = 15.
2. The number of command data sets is configured with p0170.
3. Set p0010 = 0.

You have changed the number of command data sets.



Copying command data sets

1. Set p0809[0] to the number of the command data set whose settings you wish to copy (source).
2. Set p0809[1] to the number of the command data set into which you wish to copy the settings.
3. Set p0809[2] = 1
4. The converter sets p0809[2] = 0.

You have copied the settings of a command data set into another command data set.



Example

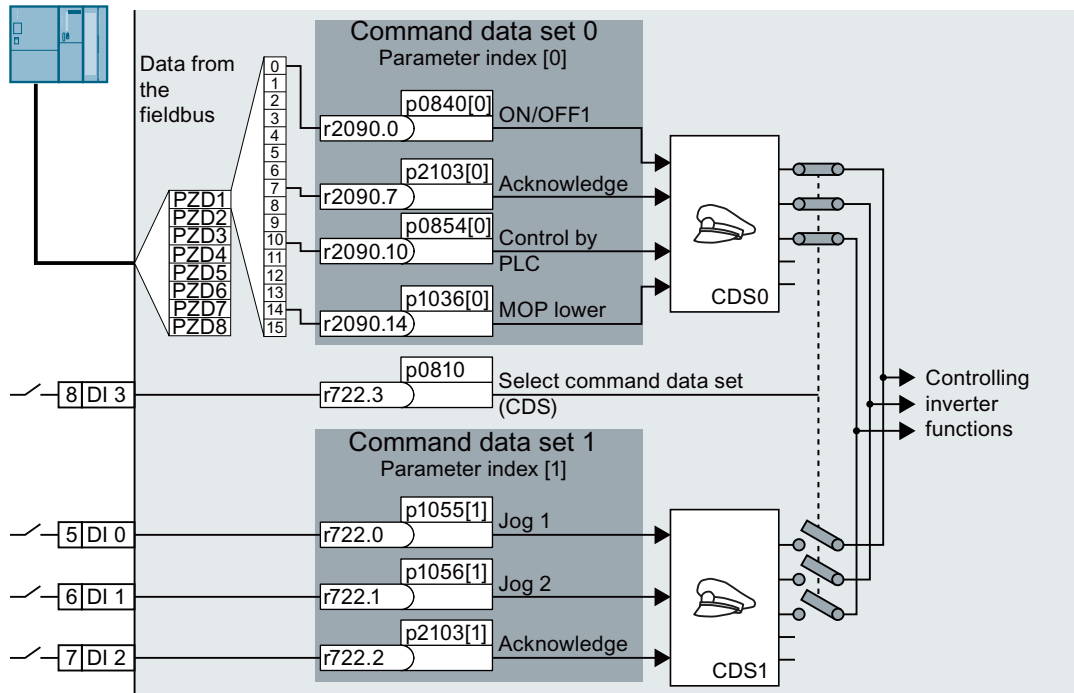

The converter evaluates its control commands depending on digital input DI 3:

- Via a fieldbus from a central control system
- Via the converter digital inputs at the installation.

Note

The converter requires approx. 4 ms to switch over the command data set.

Parameters

Number	Name	Factory setting
p0010	Drive commissioning parameter filter	1
r0050	CO/BO: Command data set CDS effective	-
p0170	Number of command data sets (CDS)	2
p0809[0 ... 2]	Copy command data set CDS	0
p0810	Bl: Command data set selection CDS bit 0	Dependent on the converter
p0811	Bl: Command data set selection CDS bit 1	0

8.13 Motor holding brake

Overview



The motor holding brake holds the motor in position when it is switched off.

When the "Motor holding brake" function is correctly set, the motor remains switched on as long as the motor holding brake is open. The converter only switches the motor off when the motor holding brake is closed.

Function description

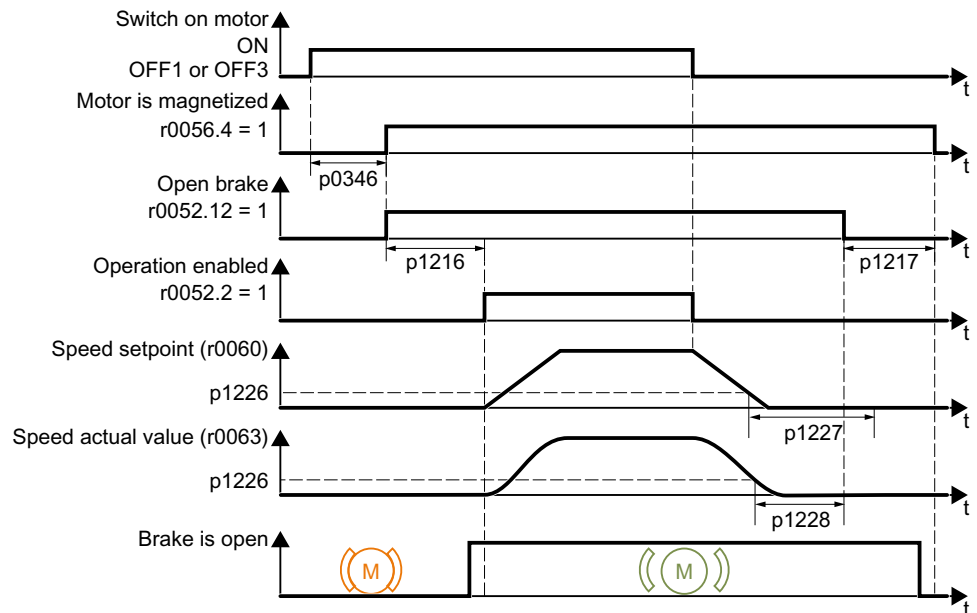

Figure 8-20 Motor holding brake function

After the ON command:

1. The converter switches on the motor with the ON command.
2. At the end of the "motor excitation build-up time" (p0346), the converter issues the command to open the brake.
3. The converter keeps the motor at a standstill until the "motor holding brake opening time" p1216 has ended.
The motor holding brake must be opened within time p1216.
4. The converter accelerates the motor to the speed setpoint.

After the OFF1 or OFF3 command:

1. The converter brakes the motor down to a standstill using the OFF1 or OFF3 command.
2. When braking, the converter compares the speed setpoint and the actual speed with the "standstill detection speed threshold" p1226:
 - Speed setpoint < p1226: The "standstill detection monitoring time" p1227 starts
 - Current speed < p1226: The "pulse cancellation deceleration time" p1228 starts
3. When the first of the two times (p1227 or p1228) has elapsed, the converter issues the command to close the brake.
4. After the "motor holding brake closing time" p1217, the converter switches off the motor. The motor holding brake must close within the time p1217.

After the OFF2 command

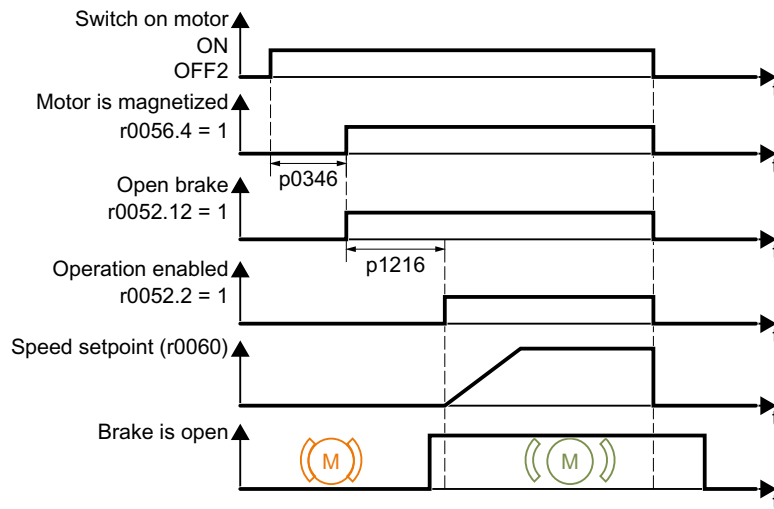

Figure 8-21 Controlling the motor holding brake after OFF2

After the OFF2 command, the converter issues the signal to immediately close the motor holding brake, irrespective of the motor speed.

Commissioning a motor holding brake

 WARNING**Load can fall if the "Motor holding brake" function is incorrectly set**

For applications with a suspended load, such as cranes and elevators, there is a danger to life if the "Motor holding brake" function is not completely set or is incorrectly set.

- When commissioning the "Motor holding brake" function, secure any suspended loads, e.g. by applying the following measures:
 - Lower the load down to the floor.
 - Secure the dangerous area so that nobody can inadvertently enter it.
- Set the "Motor holding brake" function according to the following description.
- After commissioning, check that the motor holding brake and the motor control function reliably.
- For applications involving suspended loads, we recommend that you use vector control with an encoder.

Requirement

The motor holding brake is connected to the converter.

Procedure

1. Set $p1215 = 1$.
The "Motor holding brake" function is enabled.
2. Check the magnetizing time $p0346$.
The magnetizing time must be greater than zero. The converter assigns the magnetizing time when it is being commissioned.
3. Find out the mechanical opening and closing times from the technical data of the motor holding brake.
 - Depending on the brake size, brake opening times lie between 25 ms and 500 ms.
 - Depending on the brake size, brake closing times lie between 15 ms and 300 ms.
4. Set the following parameters in the converter suitably for the mechanical opening and closing times of the motor holding brake:
 - $p1216 \geq$ mechanical opening time of the motor holding brake
 - $p1217 >$ mechanical closing time of the motor holding brake
5. Switch on the motor.

6. Check the acceleration behavior of the drive immediately after the motor has been switched on:
 - If the motor holding brake opens too late, the converter will accelerate the motor suddenly against the closed motor holding brake.
Set p1216 larger.
 - If the motor waits too long before accelerating after the motor holding brake has opened, reduce p1216.
For applications involving a pulling load, e.g. lifting gear/crane, if p1216 is too long, then the load can briefly sag/sink after the motor holding brake is opened. If you reduce p1216, then the amount that the load sags/sinks is reduced.
7. If the load sags after switching on the motor, then you must increase the motor torque when opening the motor holding brake. Depending on the control mode, you must set different parameters:
 - U/f control (p1300 = 0 to 3):
Increase p1310 in small steps.
Increase p1351 in small steps.
 - Vector control (p1300 ≥ 20):
Increase p1475 in small steps.
8. Switch off the motor.
9. Check the behavior of the drive immediately after the motor has been switched off:
 - If the motor holding brake closes too late, the load briefly sags before the motor holding brake closes.
Set a larger value for p1217.
 - If the motor waits too long before switching off after the motor holding brake has closed, reduce p1217.

The "Motor holding brake" function has been commissioned.



Parameter

Table 8-29 Setting the control logic of the motor holding brake

Parameter	Description	Factory setting
r0052.0...15	CO/BO: Status word 1	-
p1215	Motor holding brake configuration	0
p1216	Motor holding brake opening time	100 ms
p1217	Motor holding brake closing time	100 ms

Table 8-30 Advanced settings

Parameter	Description	Factory setting
p0346[M]	Motor excitation build-up time	0 s
p0855[C]	BI: Unconditionally open holding brake	0

Parameter	Description	Factory setting
p0858[C]	BI: Unconditionally close holding brake	0
p1226[D]	Speed threshold for standstill detection	20 rpm
p1227	Standstill detection monitoring time	300 s
p1228	Pulse suppression delay time	0.01 s
p1351[D]	CO: Motor holding brake start frequency	0
p1352[C]	CI: Motor holding brake start frequency signal source	1351
p1475[C]	CI: Speed controller torque setting value for motor holding brake	0

8.14 Free function blocks

8.14.1 Overview

Overview



The free function blocks permit configurable signal processing in the converter.

Function description

The following free function blocks are available:

Table 8-31 Free function blocks

Logic blocks	AND 0	OR 0	XOR 0	NOT 0			
	AND 1	OR 1	XOR 1	NOT 1			
	AND 2	OR 2	XOR 2	NOT 2			
	AND 3	OR 3	XOR 3	NOT 3			
				NOT 4			
				NOT 5			
Calculation blocks	Adder	Subtractor	Multiplier	Divider	Comparator	Absolute value	Polyline
	ADD 0	SUB 0	MUL 0	DIV 0	NCM 0	AVA 0	PLI 0
	ADD 1	SUB 1	MUL 1	DIV 1	NCM 1	AVA 1	PLI 1
	ADD 2						
Timer blocks	Pulse generator	Pulse shortening	ON delay	OFF delay	Pulse stretching		
	MFP 0	PCL 0	PDE 0	PDF 0	PST 0		
	MFP 1	PCL 1	PDE 1	PDF 1	PST 1		
	MFP 2		PDE 2	PDF 2			
	MFP 3		PDE 3	PDF 3			
Memory block	RS flip-flop	D flip-flop					
	RSR 0	DFR 0					
	RSR 1	DFR 1					
	RSR 2	DFR 2					
Breaker block	Analog switch	Binary switch					
	NSW 0	BSW 0					
	NSW 1	BSW 1					
Control block	Limiter	Smoothing	Integrator	Differentiator			
	LIM 0	PT1 0	INT 0	DIF 0			
	LIM 1	PT1 1					

Complex block	Limit monitor
	LVM 0 LVM 1

You can only use a function block once. The converter has 3 adders for instance, ADD 0, ADD 1, and ADD 2. If you have already configured 3 adders, then no other adders are available.

8.14.2 Further information

Application description for the free function blocks

Further information is provided on the Internet:



FAQ (<http://support.automation.siemens.com/WW/view/en/85168215>)

8.15 Selecting physical units

8.15.1 Motor standard

Selection options and parameters involved



The converter represents the motor data corresponding to motor standard IEC or NEMA in different system units: SI units or US units.

Table 8-32 Parameters involved when selecting the motor standard

Parameter	Designation	Motor standard IEC/NEMA, p0100 =		
		0 ¹⁾ IEC motor 50 Hz, SI units	1 NEMA motor 60 Hz, US units	2 NEMA motor 60 Hz, SI units
r0206	Power Module rated power	kW	hp	kW
p0219	Braking resistor braking power	kW	hp	kW
p0307	Rated motor power	kW	hp	kW
p0316	Motor torque constant	Nm/A	lbf ft/A	Nm/A
r0333	Rated motor torque	Nm	lbf ft	Nm
p0341	Motor moment of inertia	kgm ²	lb ft ²	kgm ²
p0344	Motor weight	kg	Lb	kg
r0394	Rated motor power	kW	hp	kW
r1493	Total moment of inertia, scaled	kgm ²	lb ft ²	kgm ²

¹⁾ Factory setting

It is only possible to change the motor standard during quick commissioning.

8.15.2 Unit system

Some physical units depend on the system of units selected (SI or US), for example the power [kW or hp] or the torque [Nm or lbf ft]. You can select in which system of units the converter represents its physical values.

Options when selecting the system of units

The following options apply when selecting the system of units:

- p0505 = 1: System of units SI (factory setting)
Torque [Nm], power [kW], temperature [°C or K]
- p0505 = 2: Referred system of units/SI
Represented as [%]

- p0505 = 3: US system of units
Torque [lbf ft], power [hp], temperature [°F]
- p0505 = 4: System of units, referred/US
Represented as [%]

Special features

The values for p0505 = 2 and for p0505 = 4 - represented in the converter - are identical. However, the reference to SI or US units is required for internal calculations and to output physical variables.

For variables, which cannot be represented as [%], then the following applies:

- p0505 = 1 corresponds to setting p0505 = 2
- p0505 = 3 corresponds to setting p0505 = 4

In the case of variables whose units are identical in the SI system and US system, and which can be displayed as a percentage, the following applies:

- p0505 = 1 corresponds to setting p0505 = 3
- p0505 = 2 corresponds to setting p0505 = 4

Reference variables

There is a reference variable in the converter for most parameters with physical units. When the referred representation [%] is set, then the converter scales the physical variables based on the particular reference variable.

When the reference variable changes, then the significance of the scaled value also changes. Example:

- Reference speed = 1500 rpm → fixed speed = 80 % corresponds to the speed = 1200 rpm
- Reference speed = 3000 rpm → fixed speed = 80 % corresponds to the speed = 2400 rpm

For each parameter you can find the associated reference variable for scaling in the parameter list. Example: r0065 is scaled with reference variable p2000.

If scaling is not specified in the parameter list, then the converter always shows/displays the parameter unscaled.

Groups of units

In the parameter list you will find the following information for parameters with changeable units:

- Unit group
Designates the group to which the parameter belongs
- Unit selection
Designates the parameter that changes over the unit

Example:

Unit group: 7_1, unit selection: p0505

The parameter belongs to the unit group 7_1 and p0505 changes over the unit.

Table 8-33 Unit group (p0100)

Unit group	Unit selection for p0100 =		
	0	1	2
7_4	Nm	lbf ft	Nm
14_6	kW	hp	kW
25_1	kg m ²	lbf ft ²	kg m ²
27_1	kg	lb	kg
28_1	Nm/A	lbf ft/A	Nm/A

Table 8-34 Unit group (p0505)

Unit group	Unit selection for p0505 =				Reference value for %
	1	2	3	4	
2_1	Hz	%	Hz	%	p2000
3_1	rpm	%	rpm	%	p2000
5_1	Vrms	%	Vrms	%	P2001
5_2	V	%	V	%	p2001
5_3	V	%	V	%	p2001
6_2	Arms	%	Arms	%	p2002
6_5	A	%	A	%	p2002
7_1	Nm	%	lbf ft	%	p2003
7_2	Nm	Nm	lbf ft	lbf ft	-
14_5	kW	%	hp	%	r2004
14_10	kW	kW	hp	hp	-
21_1	°C	°C	°F	°F	-
21_2	K	K	°F	°F	-
39_1	1/s ²	%	1/s ²	%	p2007

8.15.3 Technological unit of the technology controller

Options when selecting the technological unit

p0595 defines in which technological unit the input and output variables of the technology controller are calculated, e.g. [bar], [m³/min] or [kg/h].

Reference variable

p0596 defines the reference variable of the technological unit for the technology controller.

Unit group

Parameters involved with p0595 belong to unit group 9_1.

The values that can be set and the technological units are shown in p0595.

Special features

You must optimize the technology controller after changing p0595 or p0596.

8.15.4 Setting the system of units and technology unit

Setting using Startdrive

Requirement

You are offline with Startdrive.

Procedure

1. In the project, select "Parameter".
2. Select "Units".

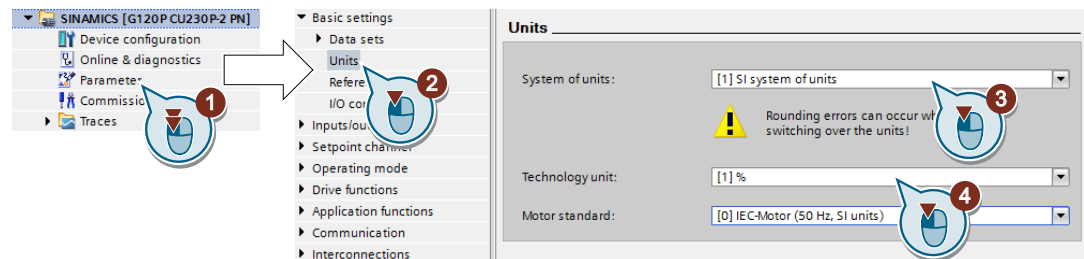

3. Select the system of units.
4. Select the technological unit of the technology controller.
5. Save your settings.
6. Go online.
The converter signals that offline, other units and process variables are set than in the converter itself.
7. Accept these settings in the converter.

You have selected the motor standard and system of units.



8.16 Safe Torque Off (STO) safety function

8.16.1 Where are the safety functions described?

Overview

The operating instructions describe how to commission the STO safety function as basic function for control via a failsafe digital input.

A description of all the safety functions is provided in the "Safety Integrated" Function Manual:

- The basic functions and the extended functions
- Controlling safety functions via PROFIsafe

 Overview of the manuals (Page 564)

8.16.2 Principle of operation

Overview

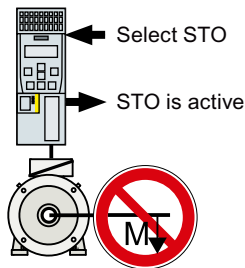

An active STO function prevents energy from being fed to the motor. The motor can no longer generate torque on the motor shaft.

Consequently, the STO function prevents the starting of an electrically-driven machine component.

Requirement

The machine manufacturer has already performed a risk assessment, e.g. in compliance with EN ISO 1050, "Safety of machinery - Principles of risk assessment". The risk assessment must confirm that it is permissible to use the STO safety function.

Function description

Table 8-35 Principle of operation of STO

	Safe Torque Off (STO)	Standard converter functions linked with STO
1.	The converter identifies when STO is selected via a failsafe digital input or via PROFIsafe.	---
2.	The converter interrupts the energy supply to the motor.	If you use a motor holding brake, the converter closes the motor holding brake. If you use a line contactor, the converter opens the line contactor.
3.	The converter signals "STO is active" via a failsafe digital output or via PROFIsafe.	---

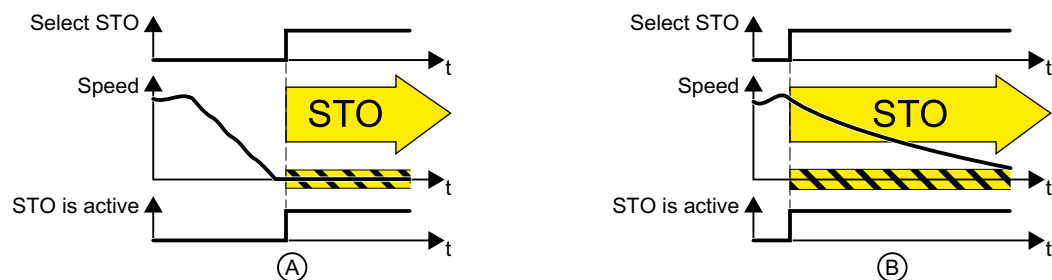

Figure 8-22 STO when the motor is at standstill (A), and rotating (B)

(A): When selecting STO, if the motor is already stationary (zero speed), then STO prevents the motor from starting.

(B): If the motor is still rotating (B) when STO is selected, it coasts down to standstill.

The STO safety function is standardized

The STO function is defined in IEC/EN 61800-5-2:

"[...] [The converter] does not supply any energy to the motor which can generate a torque (or for a linear motor, a force)".

⇒ The STO converter function conforms to IEC/EN 61800-5-2.

Example

The STO function is suitable for applications where the motor is already at a standstill or will come to a standstill in a short, safe period of time through friction. STO does not shorten the run-on time of machine components.

Application	Possible solution
When the EMERGENCY STOP button is pressed, it is not permissible for a stationary motor to inadvertently accelerate.	<ul style="list-style-type: none"> Connect the EMERGENCY STOP pushbutton with a failsafe converter digital input. Select STO via the failsafe digital input.
A central EMERGENCY STOP button must prevent the unintentional acceleration of several motors that are at a standstill.	<ul style="list-style-type: none"> Evaluate the EMERGENCY STOP button in a central control. Select STO via PROFIsafe.

8.16.3 EMERGENCY SWITCHING OFF and EMERGENCY STOP

Overview



In plants, systems and machines a distinction must be made between "EMERGENCY OFF" and "EMERGENCY STOP". The STO safety function is only suitable for implementing an "EMERGENCY STOP".

Function description

EN 60204-1 defines "EMERGENCY OFF" and "EMERGENCY STOP":

- "EMERGENCY OFF" and "EMERGENCY STOP" are functions that are used in an emergency.
- "EMERGENCY OFF" and "EMERGENCY STOP" minimize different risks in the system or machine.
 - "EMERGENCY OFF" minimizes the risk of electric shock.
 - "EMERGENCY STOP" minimizes the risk of unexpected motion.
- Stop Categories 0, 1 and 2 are available for EMERGENCY STOP.

Table 8-36 The distinction between "EMERGENCY OFF" and "EMERGENCY STOP"

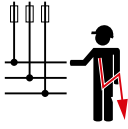
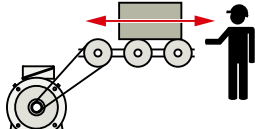
Action:	EMERGENCY OFF	EMERGENCY STOP Stop Category 0 according to EN 60204-1
Risk:	 Electric shock	 Unexpected movement
Measure to minimize risk:	Switch off the power supply Either completely or partially switch off hazardous voltages	Prevent movement Prevent any hazardous movement

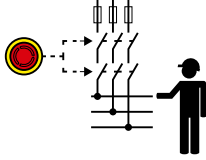
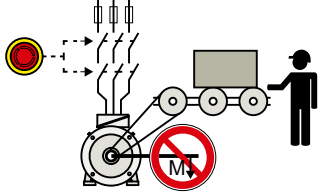
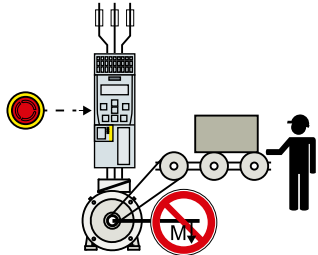
Action:	EMERGENCY OFF	EMERGENCY STOP
		Stop Category 0 according to EN 60204-1
Classic solution:	Switch off the power supply: 	Switch-off the drive power supply: 
Solution with the STO safety function integrated in the drive:	STO is not suitable for switching off a voltage.	Select STO:  It is permissible that you also switch off the converter supply voltage. However, switching off the voltage is not required as a risk reduction measure.

8.16.4 Functional restrictions as a result of the Power Modules

Overview

The use of the STO safety function is possible with almost every Power Module. For some Power Modules restrictions apply?

Function description

Power Module	Article number	Constraint
PM230 in degree of protection IP55	6SL3223-0DE A .	Safety functions cannot be used.
	6SL3223-0DE G .	The STO basic function can be used.
PM230 in degree of protection IP20 and Push Through	6SL321 . -1NE L .	Safety functions cannot be used.
	6SL321 . -1NE G .	The STO basic function can be used.

8.16.5 Commissioning STO

8.16.5.1 Commissioning tools

Overview

We recommend that you commission the safety functions using the Startdrive PC tool.



Tools to commission the converter (Page 148)

8.16.5.2 Password

Overview

The password protects the settings of the safety functions from being changed by unauthorized persons.

Function description

Do you have to assign a password?

The probabilities of failure (PFH) and certification of the safety functions also apply without password.

The machine manufacturer decides whether or not a password is required.

Further information

What do I do if I lose the password?

You have forgotten the password, however, you would nevertheless like to change the setting of the safety functions.

Procedure

1. Create a new project for the converter using Startdrive.
Leave all the settings in the project on those set in the factory.
2. Load the project in the converter.
After loading, the converter has the factory settings.
3. If a memory card inserted in the converter, remove it.
4. Recommission the converter.

You can obtain additional information or learn about alternative procedures from Product Support.



Product Support (Page 567)

8.16.5.3 Configuring a safety function

Overview

You must enable the STO safety function and define how STO is selected.

Function description

Procedure

1. Select "Select safety functionality".

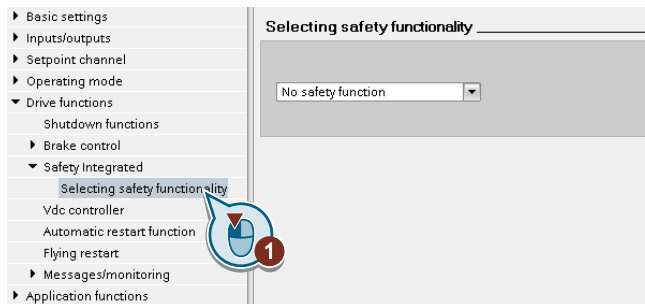

2. Select "Basic Functions".

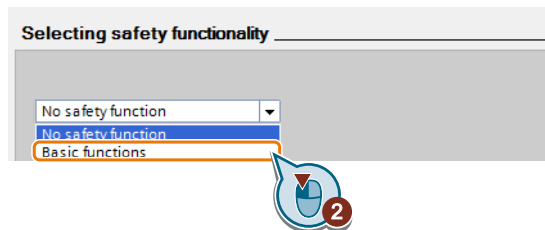

3. Select "Control type/safety functions".

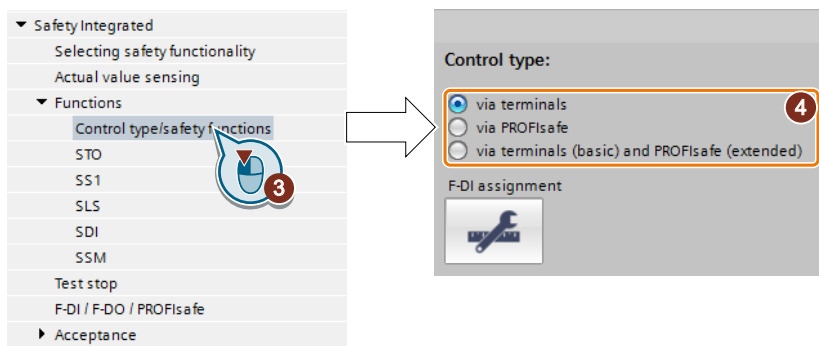

4. Select "Via terminals" as control type for the safety functions.

You have configured the safety functions.



Additional safety function configurations are described in the "Safety Integrated" Function Manual.



Overview of the manuals (Page 564)

Parameter

Parameter	Description	Factory setting
p0010	Drive commissioning parameter filter	1
p9601	SI enable, functions integrated in the drive (processor 1)	0000 0000 bin
p9761	SI password input	0000 hex
p9762	SI password new	0000 hex
p9763	SI password acknowledgment	0000 hex

8.16.5.4 Interconnecting the "STO active" signal

Overview

If you require the feedback signal "STO active" of the converter in your higher-level control system, then you must appropriately interconnect the signal.

Requirement

You are online with Startdrive.

Function description

Procedure

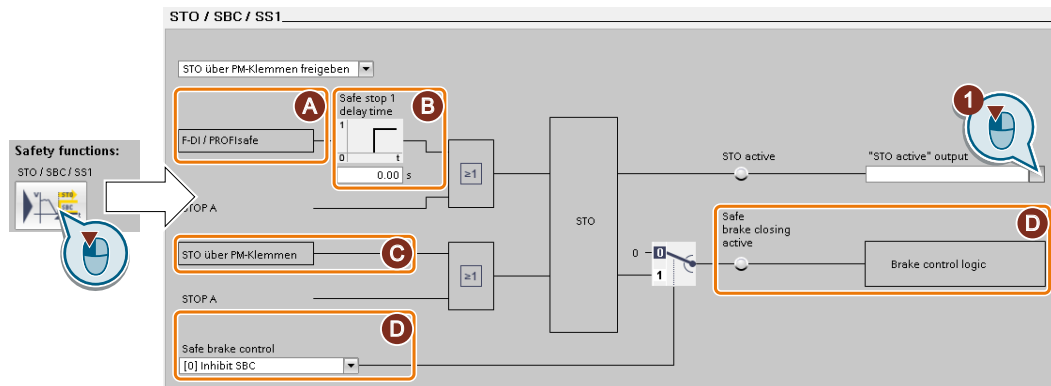

The screen form varies depending on the converter and the interface that has been selected.

- (A) Control type
- (B) Delay time for SS1 and enable SBC for a converter with CU250S-2 Control Unit
- (C) STO via the Power Module terminals for a PM240-2 or PM240P-2, FSD ... FSF Power Module
- (D) Enable SBC for a converter with CU250S-2 Control Unit

1. Select the button for the feedback signal.
2. Select the signal that matches your particular application.

You have interconnected the "STO active" checkback signal.



After STO has been selected, the converter signals "STO active" to the higher-level control.

Parameter

Parameter	Description		Factory setting
r9773[0...31]	CO/BO: SI status (processor 1 + processor 2)		-
	.01	1 signal: STO is active in the drive	

8.16.5.5 Signal filter for STO selection

Overview

Two filters are available for a failsafe digital input:

- When the discrepancy time is active, the converter tolerates input signals that briefly differ.
- When the debounce time is active, the converter suppresses brief signal changes.

Function description

Discrepancy time

The converter checks that the two input signals of the failsafe digital input always have the same signal state (high or low).

With electromechanical sensors (e.g. emergency stop buttons or door switches), the two sensor contacts switch, but never at exactly the same time, and are therefore temporarily inconsistent (discrepancy).

Only a permanent discrepancy signifies a fault in the failsafe digital input circuit, e.g. wire breakage.

You must set the discrepancy time to ignore signals that are briefly inconsistent.

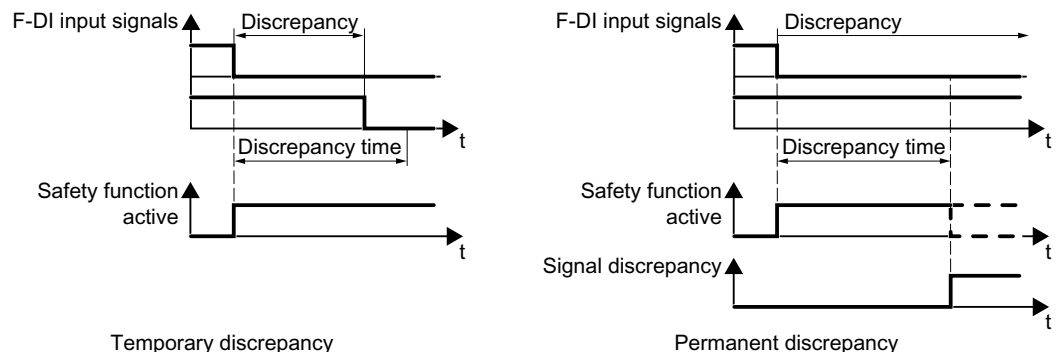

Figure 8-23 Discrepancy time

The discrepancy time does not extend the converter response time. The converter activates the safety functions as soon as one of the two F-DI signals changes its state from high to low.

Debounce time

In the following cases, an immediate converter response to signal changes of the failsafe digital inputs is not desirable:

- If a failsafe digital input of the converter is interconnected with an electromechanical sensor, brief signal changes can occur due to contact bounce.
- In order to identify faults due to short-circuit or cross faults, several control modules test their failsafe digital outputs with "bit pattern tests" (on/off test). If a failsafe digital input of the converter is interconnected with a failsafe digital output of an open-loop control module, then the converter responds with a bit pattern test.

The typical duration of the signal change within a bit pattern test:

- On test: 1 ms
- Off test: 4 ms

Too many signal changes within a specific time result in a converter fault.

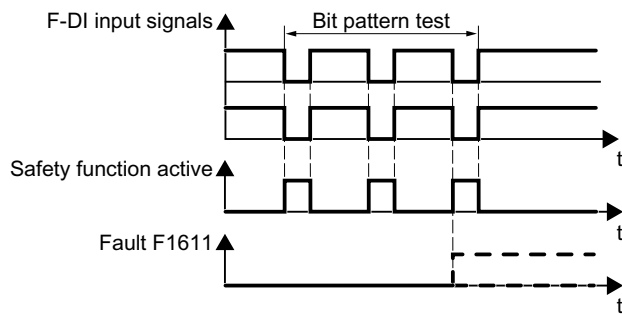

Figure 8-24 Converter response to a bit pattern test

You must set the debounce time to ignore temporary signal changes.

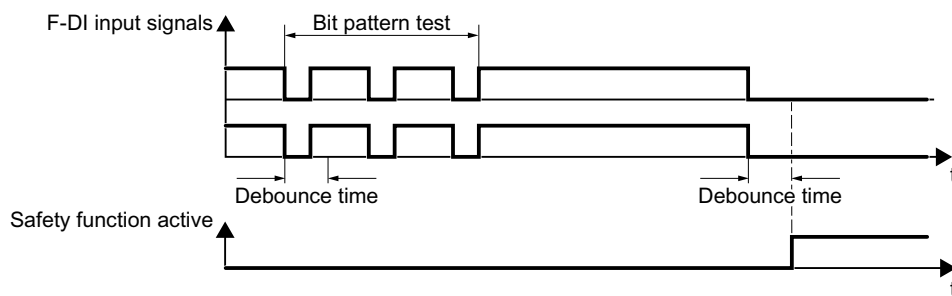

Figure 8-25 Filter to suppress brief signals

The debounce time extends the response time of the safety function.

Further information

Debounce times for standard and safety functions

The debounce time p0724 for "standard" digital inputs has no influence over the failsafe input signals. Conversely, the same applies: The F-DI debounce time does not affect the signals of the "standard" inputs.

If you use an input as a standard input, set the debounce time using parameter p0724 .

If you use an input as a failsafe input, set the debounce time as described above.

8.16.5.6 Setting the signal filter for STO selection

Overview

If required, you must set the signal filter for selecting the STO safety function.

Requirement

You are online with Startdrive.

Function description

Procedure

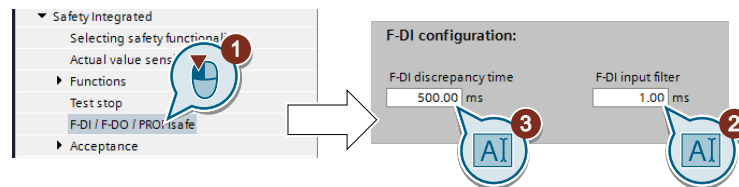

1. Navigate to the filter settings.
2. Set the debounce time for the F-DI input filter.
3. Set the discrepancy time for the simultaneity monitoring.

You have set the signal filter of the failsafe digital input.



Parameter

Parameter	Description	Factory setting
p9650	SI F-DI switchover discrepancy time (CPU 1)	500 ms
p9651	SI STO debounce time (processor 1)	1 ms

8.16.5.7 Forced checking procedure

Overview

The forced checking procedure (test stop) is a converter self test, which is necessary when you have enabled at least one safety function.

Function description

Each time the forced checking procedure starts, the converter checks its circuits to switch off the torque.

You start the forced checking procedure each time that the STO function is selected.

Using a timer block, the converter monitors as to whether the forced checking procedure is regularly started.

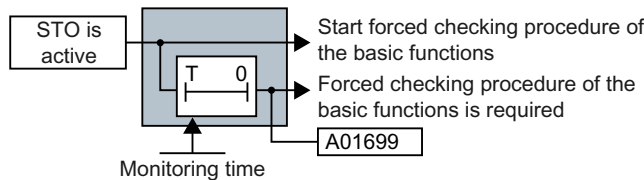

Figure 8-26 Starting and monitoring the forced checking procedure (test stop)

8.16.5.8 Setting forced checking procedure

Overview

You must set the time interval in which, as a minimum, you must start the forced checking procedure at least once.

Requirement

You are online with Startdrive.

Function description

Procedure

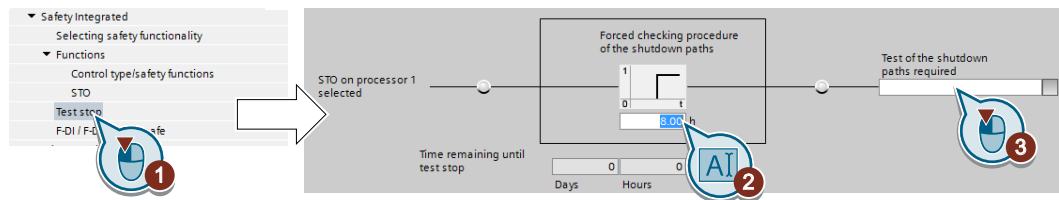

1. Select the screen form for setting the forced checking procedure.
2. Set the monitoring time to a value to match your application.
3. Using this signal, the converter signals that a forced checking procedure (test stop) is required.
Interconnect this signal with a converter signal of your choice.

You have set the forced checking procedure (test stop) for the Basic Functions.



Parameter

Parameter	Description	Factory setting
p9659	SI forced checking procedure timer	8 h
r9660	SI forced checking procedure remaining time	- h
r9773.0...31	CO/BO: SI status (processor 1 + processor 2)	-

8.16.5.9 Complete commissioning

Overview

You must exit commissioning the safety functions and save the settings.

Requirement

You are online with Startdrive.

Function description

Procedure

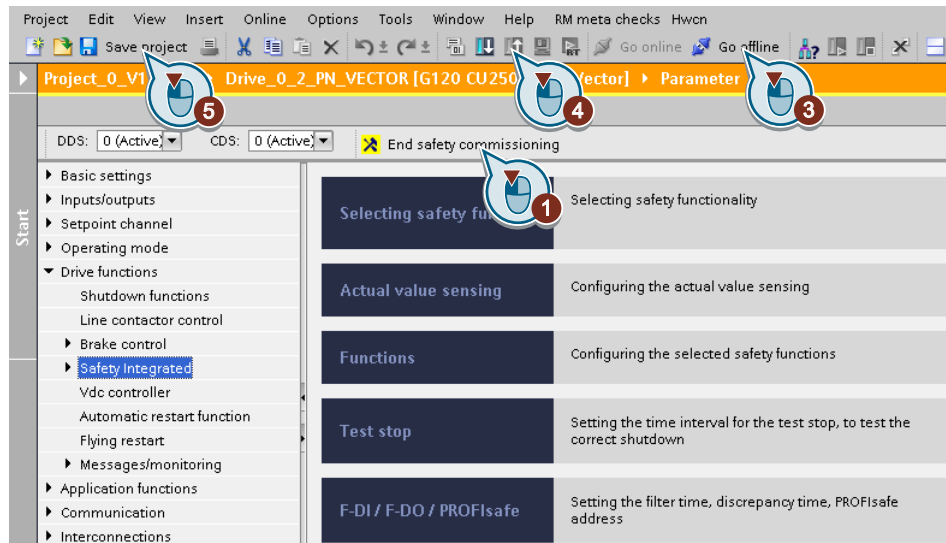

1. Press the "End safety commissioning" button.
2. Confirm the prompt for saving your settings (copy RAM to ROM).
3. Disconnect the online connection.
4. Select the "Load from device (software)" button.
5. Save the project.
6. Switch off the converter power supply.
7. Wait until all LEDs on the converter go dark (no voltage condition).
8. Switch on the converter power supply again.

Your settings are now active.



Parameter

Parameter	Description	Factory setting
p0010	Drive commissioning parameter filter	1
p0971	Save parameters	0
p9700	SI copy function	0000 hex
p9701	Acknowledge SI data change	0000 hex

8.16.5.10 Checking the assignment of the digital inputs

Overview

The simultaneous connection of digital inputs with a safety function and a "standard" function may lead to the drive behaving in unexpected ways.

If you control the safety functions in the converter via failsafe digital inputs, then you must check as to whether the failsafe digital inputs are in some instances interconnected with a "standard" function.

Function description

Procedure

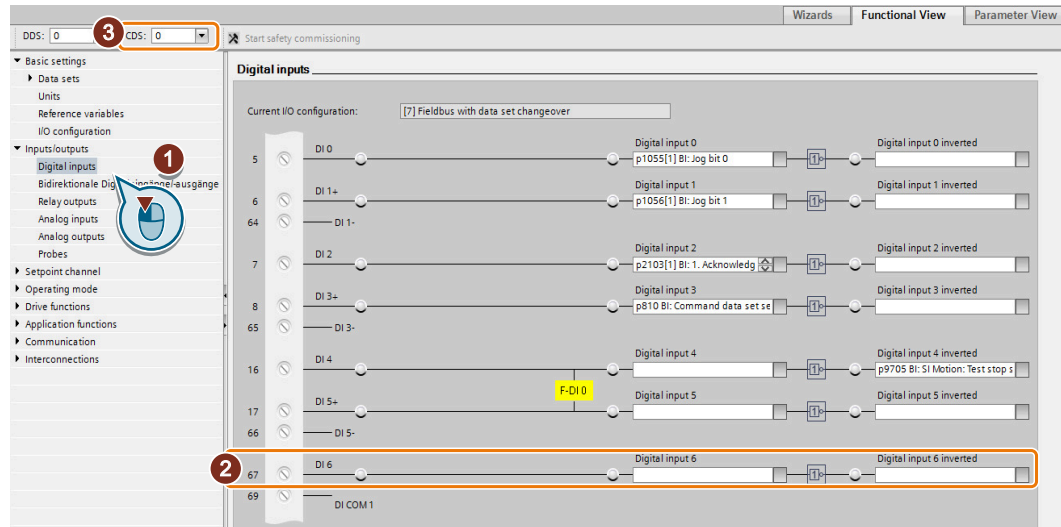

1. Select the screen for the digital inputs.
2. Remove all interconnections of the digital inputs that you use as failsafe digital input F-DI:
3. You must delete the digital input connections for all CDS if you use the switchover of the command data sets (CDS).

You can find a description of the CDS switchover in the operating instructions.

You have ensured that the failsafe digital inputs only control the safety functions in the converter.



8.16.5.11 Acceptance test

Overview

The machine manufacturer is responsible in ensuring that his plant or machine functions perfectly. As a consequence, after commissioning, the machine manufacturer must check those functions or have them checked by specialist personnel, which represent an increased risk of injury or material damage. This acceptance or validation is, for example, also specified in the European machinery directive and essentially comprises two parts:

- Checking the safety-relevant functions and machine parts.
→ **Acceptance test.**
- Generate an "Acceptance report" that describes the test results.
→ **Documentation.**

Supply information for the validation, e.g. the harmonized European standards EN ISO 13849-1 and EN ISO 13849-2.

Function description

Acceptance test of the machine or plant

The acceptance test checks whether the safety-relevant functions in the plant or machine function correctly. The documentation of the components used in the safety functions can also provide information about the necessary tests.

Testing the safety-related functions includes, e.g. the following:

- Are all safety equipment such as protective door monitoring devices, light barriers or emergency-off switches connected and ready for operation?
- Does the higher-level control respond as expected to the safety-relevant feedback signals of the converter?
- Do the converter settings match the configured safety-relevant function in the machine?

Acceptance test of the converter

The acceptance test of the converter is a part of the acceptance test of the entire machine or plant.

The acceptance test of the converter checks whether the integrated drive safety functions are set up correctly for the planned safety function of the machine.

Documentation of the converter

The following must be documented for the converter:

- The results of the acceptance test.
- The settings of the integrated drive safety functions.

The documentation must be signed.

Who may perform the acceptance test of the converter?

The following are authorized to perform a converter acceptance test: Only personnel from the machine manufacturer, who, on account of their technical qualifications and knowledge

of the safety functions, are in a position to perform the acceptance test in the correct and appropriate manner.

Wizard for the acceptance test

The "Startdrive Advanced" commissioning tool (requires an appropriate license) includes a wizard for the acceptance test of the safety functions integrated in the drive.

"Startdrive Advanced" guides you through the acceptance test, generates the appropriate traces to analyze the machine response – and generates an acceptance report as Excel file.

Further information is provided on the Internet:

 Startdrive, system requirements and download (<https://support.industry.siemens.com/cs/ww/en/view/109760844>)

Reduced acceptance test after function expansions

A full acceptance test is necessary only after first commissioning. A reduced acceptance test is sufficient when safety functions are expanded.

Measure	Acceptance test	
	Acceptance test	Documentation
Functional expansion of the machine (additional drive).	Yes. Only check the safety functions of the new drive.	<ul style="list-style-type: none"> • Supplement machine overview • Supplement converter data • Add function table • Log the new checksums • Countersignature
Transfer of converter settings to other identical machines by means of series commissioning.	No. Only check the control of all of the safety functions.	<ul style="list-style-type: none"> • Add machine description • Check checksums • Checking the firmware versions

8.17 Setpoints

8.17.1 Overview

Overview



The converter receives its main setpoint from the setpoint source. The main setpoint generally specifies the motor speed.

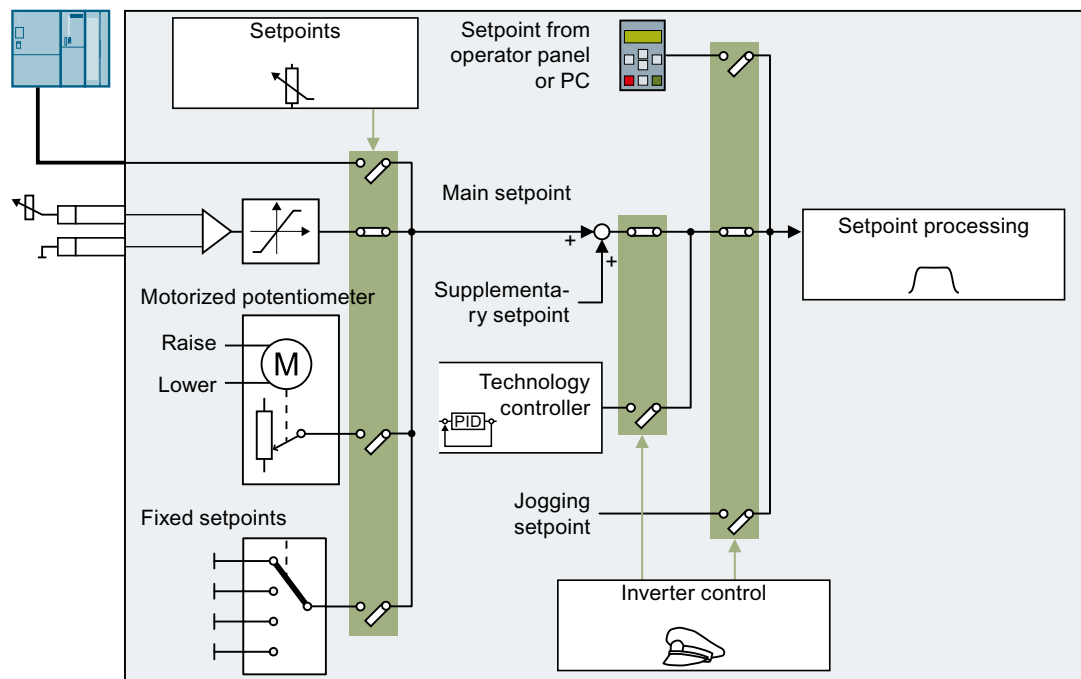

Figure 8-27 Setpoint sources for the converter

You have the following options when selecting the source of the main setpoint:

- Converter fieldbus interface
- Analog input of the converter
- Motorized potentiometer emulated in the converter
- Fixed setpoints saved in the converter

You have the same selection options when selecting the source of the supplementary setpoint.

Under the following conditions, the converter switches from the main setpoint to other setpoints:

- When the technology controller is active and appropriately interconnected, its output specifies the motor speed.
- When jogging is active
- When controlled from an operator panel or a PC

8.17.2 Analog input as setpoint source

Function description

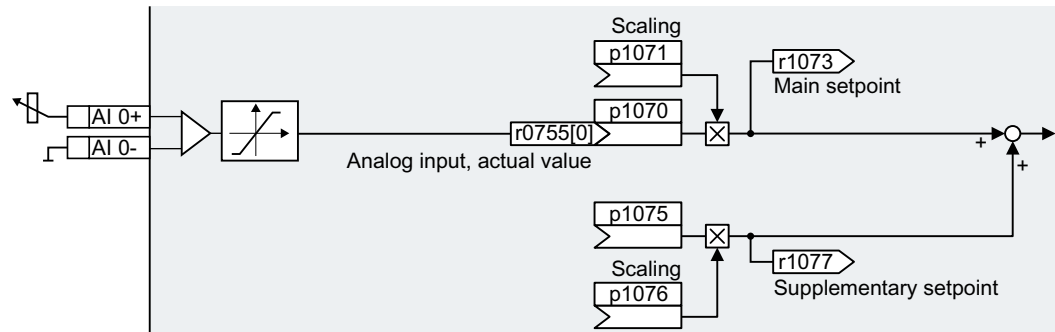

Figure 8-28 Example: Analog input 0 as setpoint source

In the quick commissioning, you define the preassignment for the converter interfaces. Depending on what has been preassigned, after quick commissioning, the analog input can be interconnected with the main setpoint.

Example

Setting with analog input 0 as setpoint source:

Parameter	Description
p1070 = 755[0]	Interconnects main setpoint with analog input 0
p1075 = 755[0]	Interconnects supplementary setpoint with analog input 0

Parameters

Number	Name	Factory setting
r0755[0 ... 1]	CO: CU analog inputs, actual value in percent	- %
p1070[C]	CI: Main setpoint	Dependent on the converter
p1071[C]	CI: Main setpoint scaling	1
r1073	CO: Main setpoint active	- rpm
p1075[C]	CI: Supplementary setpoint	0
p1076[C]	CI: Supplementary setpoint scaling	1
r1077	CO: Supplementary setpoint effective	- rpm

8.17.3 Specifying the setpoint via the fieldbus

Function description

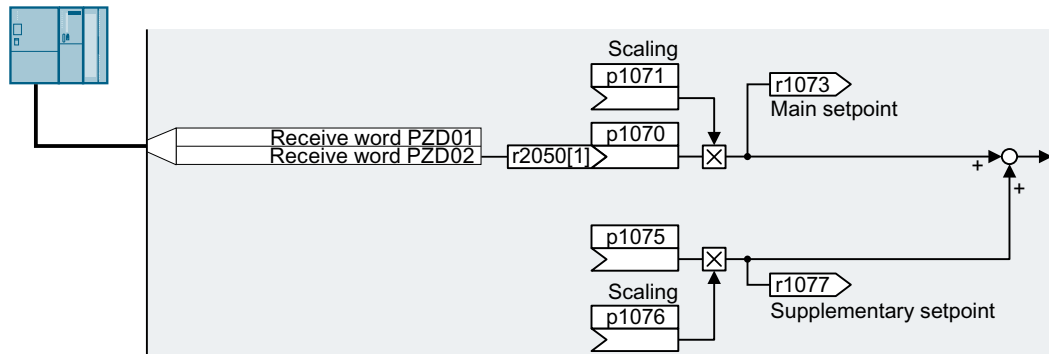

Figure 8-29 Fieldbus as setpoint source

In the quick commissioning, you define the preassignment for the converter interfaces. Depending on what has been preassigned, after quick commissioning, the receive word PZD02 can be interconnected with the main setpoint.

Example

Setting with receive word PZD02 as setpoint source:

Parameter	Description
p1070 = 2050[1]	Interconnects the main setpoint with the receive word PZD02 from the fieldbus.
p1075 = 2050[1]	Interconnects the supplementary setpoint with receive word PZD02 from the fieldbus.

Parameters

Number	Name	Factory setting
p1070[C]	CI: Main setpoint	Dependent on the converter
p1071[C]	CI: Main setpoint scaling	1
r1073	CO: Main setpoint active	- rpm
p1075[C]	CI: Supplementary setpoint	0
p1076[C]	CI: Supplementary setpoint scaling	1
r1077	CO: Supplementary setpoint effective	- rpm
r2050[0...11]	CO: PROFIdrive PZD receive word	-

8.17.4 Motorized potentiometer as setpoint source

Function description

The "Motorized potentiometer" function emulates an electromechanical potentiometer. The output value of the motorized potentiometer can be set with the "higher" and "lower" control signals.

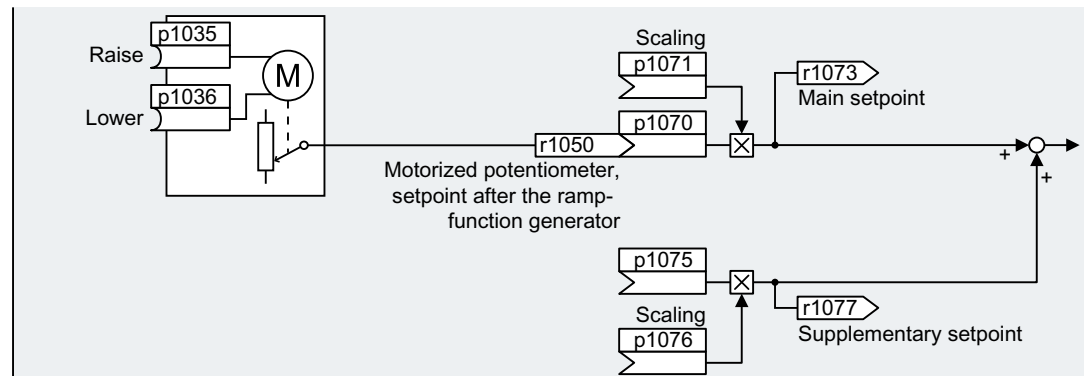

Figure 8-30 Motorized potentiometer as setpoint source

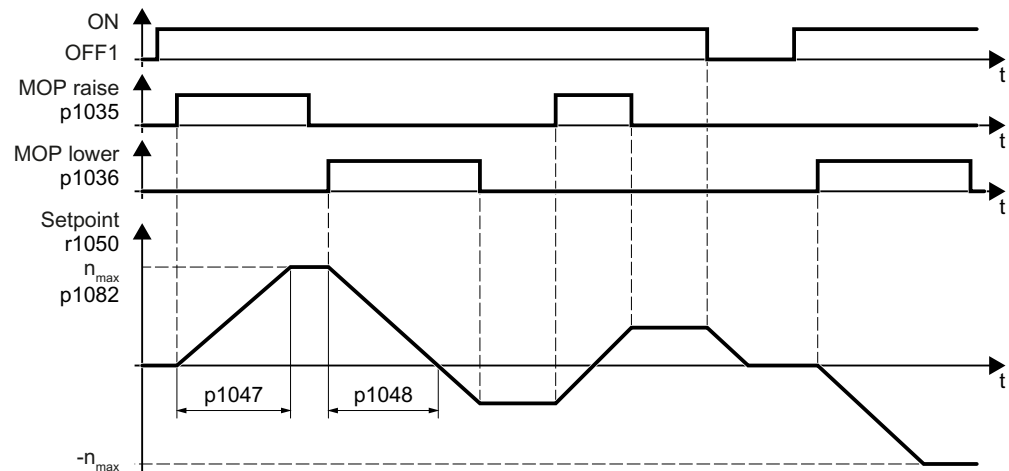

Figure 8-31 Function chart of the motorized potentiometer

Example

Setting with the motorized potentiometer as setpoint source:

Parameter	Description
p1070 = 1050	Interconnects the main setpoint with the motorized potentiometer output.

Parameter

Table 8-37 Basic setup of motorized potentiometer

Number	Name	Factory setting
p1035[C]	Bl: Motorized potentiometer setpoint higher	0
p1036[C]	Bl: Motorized potentiometer setpoint lower	Dependent on the converter
p1040[D]	Motorized potentiometer start value	0 rpm
p1047[D]	Motorized potentiometer, ramp-up time	10 s
p1048[D]	Motorized potentiometer, ramp-down time	10 s
r1050	Motorized potentiometer, setpoint after the ramp-function generator	- rpm
p1070[C]	Cl: Main setpoint	Dependent on the converter
p1071[C]	Cl: Main setpoint scaling	1
r1073	CO: Main setpoint active	- rpm
p1075[C]	Cl: Supplementary setpoint	0
p1076[C]	Cl: Supplementary setpoint scaling	1

Table 8-38 Extended setup of motorized potentiometer

Number	Name	Factory setting
p1030[D]	Motorized potentiometer configuration	0000 0110 bin
p1037[D]	Motorized potentiometer, maximum speed	0 rpm
p1038[D]	Motorized potentiometer, minimum speed	0 rpm
p1043[C]	Bl: Motorized potentiometer, accept setting value	0
p1044[C]	Cl: Motorized potentiometer, setting value	0

8.17.5 Fixed speed setpoint as setpoint source

Function description

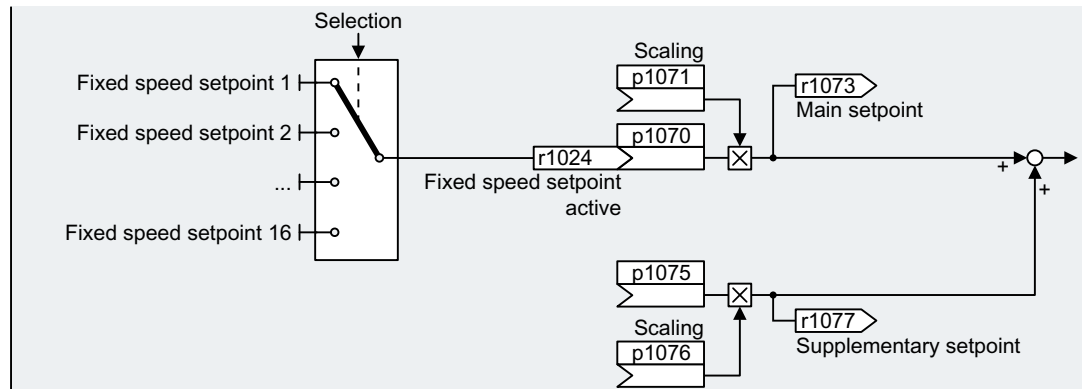

Figure 8-32 Fixed speed setpoint as setpoint source

The converter makes a distinction between two methods when selecting the fixed speed setpoints:

Directly selecting a fixed speed setpoint

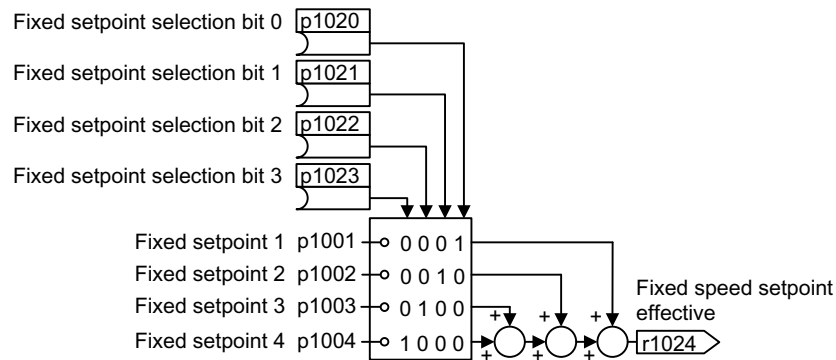

Figure 8-33 Direct selection of the fixed speed setpoint

Table 8-39 Resulting setpoint

p1020	p1021	p1022	p1023	Resulting setpoint
0	0	0	0	0
1	0	0	0	p1001
0	1	0	0	p1002
1	1	0	0	p1001 + p1002
0	0	1	0	p1003
1	0	1	0	p1001 + p1003
0	1	1	0	p1002 + p1003
1	1	1	0	p1001 + p1002 + p1003
0	0	0	1	p1004

p1020	p1021	p1022	p1023	Resulting setpoint
1	0	0	1	p1001 + p1004
0	1	0	1	p1002 + p1004
1	1	0	1	p1001 + p1002 + p1004
0	0	1	1	p1003 + p1004
1	0	1	1	p1001 + p1003 + p1004
0	1	1	1	p1002 + p1003 + p1004
1	1	1	1	p1001 + p1002 + p1003 + p1004

Selecting the fixed speed setpoint, binary

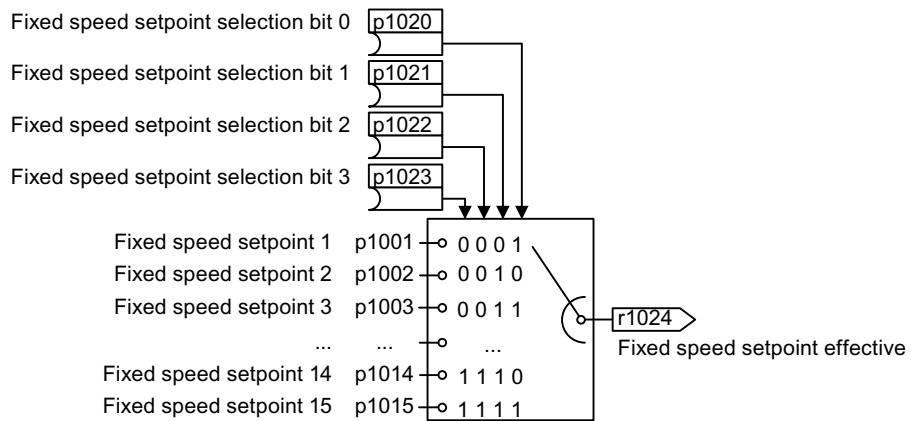

Figure 8-34 Binary selection of the fixed speed setpoint

Table 8-40 Resulting setpoint

p1020	p1021	p1022	p1023	Resulting setpoint
0	0	0	0	0
1	0	0	0	p1001
0	1	0	0	p1002
1	1	0	0	p1003
0	0	1	0	p1004
1	0	1	0	p1005
0	1	1	0	p1006
1	1	1	0	p1007
0	0	0	1	p1008
1	0	0	1	p1009
0	1	0	1	p1010
1	1	0	1	p1011
0	0	1	1	p1012
1	0	1	1	p1013
0	1	1	1	p1014
1	1	1	1	p1015

Example

After it has been switched on, a conveyor belt only runs with two different velocities. The motor should now operate with the following corresponding speeds:

- The signal at digital input 0 switches the motor on and accelerates it up to 300 rpm.
- The signal at digital input 1 accelerates the motor up to 2000 rpm.
- With signals at both digital inputs, the motor accelerates up to 2300 rpm.

Table 8-41 Settings for the application example

Parameter	Description
p1001[0] = 300.000	Fixed speed setpoint 1
p1002[0] = 2000.000	Fixed speed setpoint 2
p0840[0] = 722.0	ON/OFF1: Switches on the motor with digital input 0
p1070[0] = 1024	Main setpoint: Interconnects the main setpoint with a fixed speed setpoint.
p1020[0] = 722.0	Fixed speed setpoint selection bit 0: Interconnects fixed speed setpoint 1 with digital input 0 (DI 0).
p1021[0] = 722.1	Fixed speed setpoint selection bit 1: Interconnects fixed speed setpoint 2 with digital input 1 (DI 1).
p1016 = 1	Fixed speed setpoint mode: Directly selects fixed speed setpoints.

Table 8-42 Resulting fixed speed setpoints for the application example

Fixed speed setpoint selected via	Resulting setpoint
DI 0 = 0	Motor stops
DI 0 = 1 and DI 1 = 0	300 rpm
DI 0 = 1 and DI 1 = 1	2300 rpm

Parameter

Parameter	Description	Factory setting
p1001[D]	CO: Fixed speed setpoint 1	0 rpm
p1002[D]	CO: Fixed speed setpoint 2	0 rpm
p1003[D]	CO: Fixed speed setpoint 3	0 rpm
p1004[D]	CO: Fixed speed setpoint 4	0 rpm
p1005[D]	CO: Fixed speed setpoint 5	0 rpm
p1006[D]	CO: Fixed speed setpoint 6	0 rpm
p1007[D]	CO: Fixed speed setpoint 7	0 rpm
p1008[D]	CO: Fixed speed setpoint 8	0 rpm
p1009[D]	CO: Fixed speed setpoint 9	0 rpm
p1010[D]	CO: Fixed speed setpoint 10	0 rpm
p1011[D]	CO: Fixed speed setpoint 11	0 rpm
p1012[D]	CO: Fixed speed setpoint 12	0 rpm

Parameter	Description	Factory setting
p1013[D]	CO: Fixed speed setpoint 13	0 rpm
p1014[D]	CO: Fixed speed setpoint 14	0 rpm
p1015[D]	CO: Fixed speed setpoint 15	0 rpm
p1016	Fixed speed setpoint selection mode	1
p1020[C]	Fixed speed setpoint selection, bit 0	0
p1021[C]	Fixed speed setpoint selection, bit 1	0
p1022[C]	Fixed speed setpoint selection, bit 2	0
p1023[C]	Fixed speed setpoint selection, bit 3	0
r1024	Fixed speed setpoint active	- rpm
r1025.0	Fixed speed setpoint status	-
p1070[C]	CI: Main setpoint	Dependent on the converter
p1071[C]	CI: Main setpoint scaling	1
r1073	CO: Main setpoint active	- rpm
p1075[C]	CI: Supplementary setpoint	0
p1076	CI: Supplementary setpoint scaling	1
r1077	CO: Supplementary setpoint effective	- rpm

Example

Directly selecting two fixed speed setpoints

The motor should operate at different speeds as follows:

- The signal on digital input 0 switches the motor on and accelerates it to 300 rpm.
- The signal at digital input 1 accelerates the motor to 2000 rpm.
- With signals at both digital inputs, the motor accelerates up to 2300 rpm.

Table 8-43 Settings for the application example

Parameter	Description
p1001 = 300.000	Fixed speed setpoint 1
p1002 = 2000.000	Fixed speed setpoint 2
p0840 = 722.0	ON/OFF1: Switches on the motor with digital input 0
p1070 = 1024	Main setpoint: Interconnects the main setpoint with a fixed speed setpoint.
p1020 = 722.0	Fixed speed setpoint selection bit 0: Interconnects fixed speed setpoint 1 with digital input 0 (DI 0).
p1021 = 722.1	Fixed speed setpoint selection bit 1: Interconnects fixed speed setpoint 2 with digital input 1 (DI 1).
p1016 = 1	Fixed speed setpoint mode: Directly selects fixed speed setpoints.

Table 8-44 Resulting fixed speed setpoints for the application example

Fixed speed setpoint selected via	Resulting setpoint
DI 0 = 0	Motor stops
DI 0 = 1 and DI 1 = 0	300 rpm
DI 0 = 1 and DI 1 = 1	2300 rpm

Parameter

Parameter	Description	Factory setting
p0840[C]	BI: ON/OFF (OFF1)	[0] 2090.0 [1] 0 [2] 0 [3] 0
p1001	CO: Fixed speed setpoint 1	0 rpm
p1002	CO: Fixed speed setpoint 2	0 rpm
p1016	Fixed speed setpoint selection mode	1
p1020[C]	BI: Fixed speed setpoint selection, bit 0	0
p1021[C]	BI: Fixed speed setpoint selection, bit 1	0
p1070[C]	CI: Main setpoint	[0] 755[0] [1] 0 [2] 0 [3] 0

8.18 Setpoint processing

8.18.1 Overview

Overview



Setpoint processing influences the setpoint using the following functions:

- "Invert" inverts the motor direction of rotation.
- The "Inhibit direction of rotation" function prevents the motor from rotating in the incorrect direction; this function can make sense for conveyor belts, extruders, pumps and fans, for example.
- The "Skip frequency bands" prevent the motor from being continuously operated within these skip bands. This function avoids mechanical resonance effects by only permitting the motor to operate briefly at specific speeds.
- The "Speed limitation" function protects the motor and the driven load against excessively high speeds.
- The "Ramp-function generator" function prevents the setpoint from suddenly changing. As a consequence, the motor accelerates and brakes with a reduced torque.

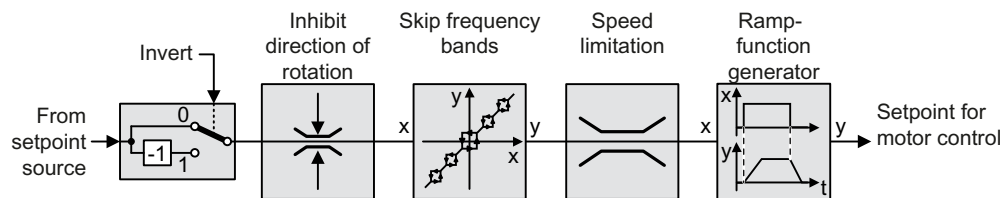
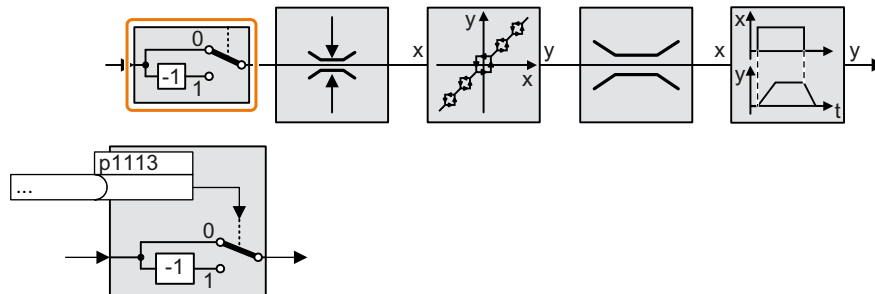

Figure 8-35 Setpoint processing in the converter

8.18.2 Invert setpoint

Function description



The function inverts the sign of the setpoint using a binary signal.

Example

To invert the setpoint via an external signal, interconnect parameter p1113 with a binary signal of your choice.

Table 8-45 Application examples showing how a setpoint is inverted

Parameter	Description
p1113 = 722.1	Digital input 1 = 0: Setpoint remains unchanged. Digital input 1 = 1: Converter inverts the setpoint.
p1113 = 2090.11	Inverts the setpoint via the fieldbus (control word 1, bit 11).

Parameter

Number	Name	Factory setting
p1113[C]	BI: Setpoint inversion	Dependent on the converter

8.18.3 Inhibit direction of rotation

Function description

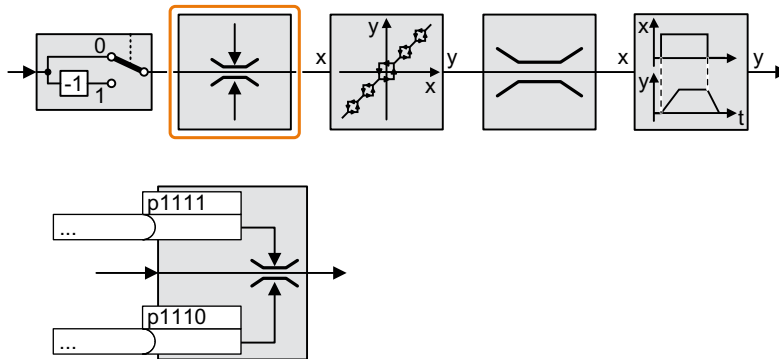

In the factory setting of the converter, both motor directions of rotation are enabled.
Set the corresponding parameter to a value = 1 to permanently block directions of rotation.

Example

Table 8-46 Application examples for inhibiting and enabling a direction of rotation

Parameter	Description
p1110[0] = 1	Negative direction of rotation is permanently inhibited.
p1110[0] = 722.3	Digital input 3 = 0: Negative direction of rotation is enabled. Digital input 3 = 1: Negative direction of rotation is inhibited.

Parameter

Parameter	Description	Factory setting
p1110[C]	Bl: Inhibit negative direction	0
p1111[C]	Bl: Inhibit positive direction	0

8.18.4 Skip frequency bands and minimum speed

Overview

The converter has a minimum speed and four skip frequency bands:

- The minimum speed prevents continuous motor operation at speeds less than the minimum speed.
- Each skip frequency band prevents continuous motor operation within a specific speed range.

Function description

Minimum speed

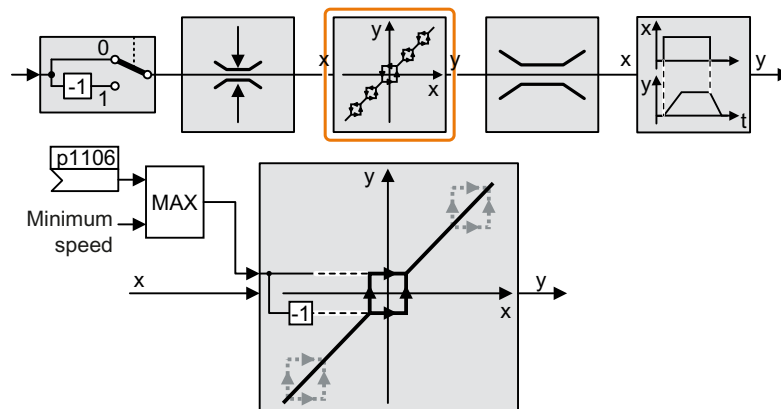

Speeds where the absolute value is less than the minimum speed are only possible when the motor is accelerating or braking.

Skip frequency bands

Additional information on the skip frequency bands is provided in the function diagram.

Parameter

Table 8-47 Minimum speed

Number	Name	Factory setting
p1051[C]	CI: Speed limit of ramp-function generator, positive direction of rotation	9733
p1052[C]	CI: Speed limit of ramp-function generator, negative direction of rotation	1086
p1080[D]	Minimum speed	0 rpm
p1083[D]	CO: Speed limit in positive direction of rotation	210000 rpm
r1084	CO: Speed limit positive active	- rpm
p1085[C]	CI: Speed limit in positive direction of rotation	1083

Number	Name	Factory setting
p1091[D]	Skip speed 1	0 rpm
p1092[D]	Skip speed 2	0 rpm
p1093[D]	Skip speed 3	0 rpm
p1094[D]	Skip speed 4	0 rpm
p1098[C]	CI: Skip speed scaling	1
r1099	CO/BO: Skip frequency band of status word	-
p1101	Skip speed bandwidth	0 rpm
p1106	CI: Minimum speed signal source	0
r1112	CO: Speed setpoint according to minimum limit	- rpm
r1114	CO: Setpoint after direction limiting	- rpm
r1119	CO: Ramp-function generator setpoint at the input	- rpm
r1170	CO: Speed controller setpoint sum	- rpm

Note

In order that a stationary motor – after all of the enable signals have been switched on, can operate at the minimum speed/minimum velocity once all of the enable signals are available, the direction must be entered using one of the following options:

- direction input via small setpoint.
- direction input by inhibiting the negative or positive direction (p1110, p1111).

NOTICE**Incorrect direction of motor rotation if the parameterization is not suitable**

If you are using an analog input as speed setpoint source, then for a setpoint = 0 V, noise voltages can be superimposed on the analog input signal. After the on command, the motor accelerates up to the minimum frequency in the direction of the random polarity of the noise voltage. A motor rotating in the wrong direction can cause significant material damage to the machine or system.

- Inhibit the motor direction of rotation that is not permissible.

8.18.5 Speed limitation

The maximum speed limits the speed setpoint range for both directions of rotation.

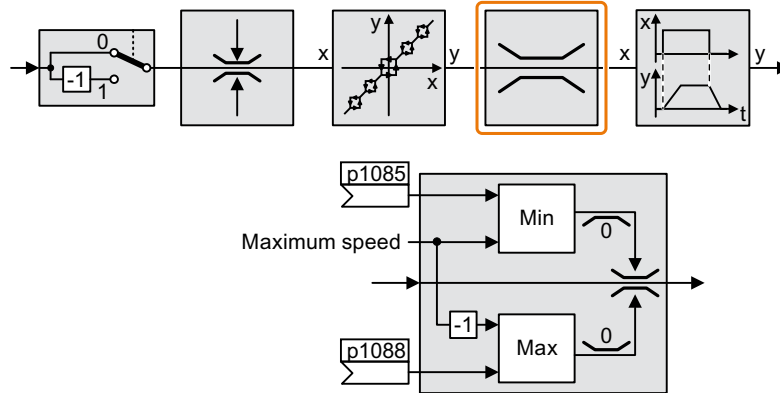

The converter generates a message (fault or alarm) when the maximum speed is exceeded.

If you must limit the speed depending on the direction of rotation, then you can define speed limits for each direction.

Parameters

Table 8-48 Parameters for the speed limitation

Number	Name	Factory setting
p1082[D]	Maximum speed	1500 rpm
p1083[D]	CO: Speed limit in positive direction of rotation	210000 rpm
p1085[C]	CI: Speed limit in positive direction of rotation	1083
p1086[D]	CO: Speed limit in negative direction of rotation	-210000 rpm
p1088[C]	CI: Speed limit in negative direction of rotation	1086

8.18.6 Ramp-function generator

The ramp-function generator in the setpoint channel limits the rate change of the speed setpoint (acceleration). A reduced acceleration reduces the accelerating torque of the motor. In this case, the motor reduces the load on the mechanical system of the driven machine.

You can select between two different ramp-function generator types:

- Extended ramp-function generator
The expanded ramp-function generator limits not only the acceleration but also the change in acceleration (jerk) by rounding the setpoint. In this case, the torque does not rise suddenly in the motor.
- Basic ramp-function generator
The basic ramp-function generator limits the acceleration, however not the rate the acceleration changes (jerk).

Extended ramp-function generator

The ramp-up and ramp-down times of the extended ramp-function generator can be set independently of each other. The optimal times depend on the application, and can lie in the range from a few 100 ms to several minutes.

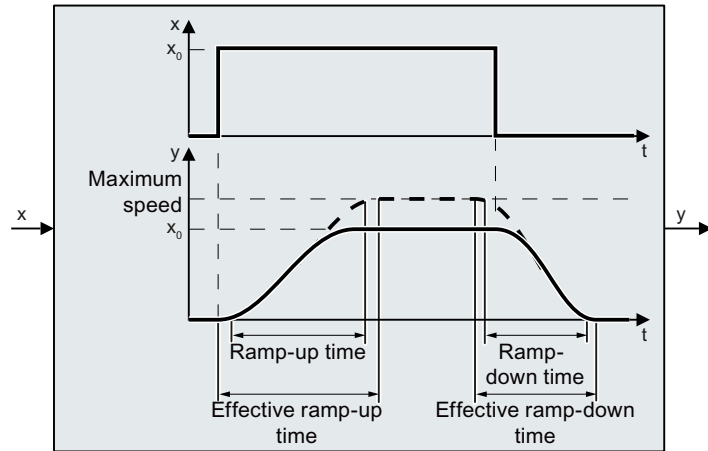
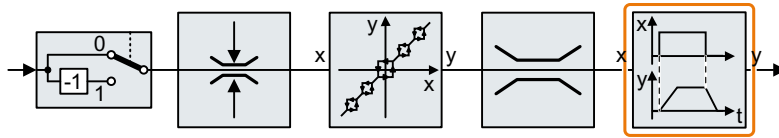

Initial and final rounding permit smooth, jerk-free acceleration and braking.

The ramp-up and ramp-down times of the motor are increased by the rounding times:

- Effective ramp-up time = $p1120 + 0.5 \times (p1130 + p1131)$.
- Effective ramp-down time = $p1121 + 0.5 \times (p1130 + p1131)$.

Parameter

Table 8-49 Additional parameters to set the extended ramp-function generator

Parameter	Description	Factory setting
p1115	Ramp-function generator selection	1
p1120[D]	Ramp-function generator ramp-up time	10 s
p1121[D]	Ramp-function generator ramp-down time	30 s
p1130[D]	Ramp-function generator initial rounding time	0 s
p1131[D]	Ramp-function generator final rounding time	2 s
p1134[D]	Ramp-function generator rounding type 0: Continuous smoothing 1: Discontinuous smoothing	0
p1135[D]	OFF3 ramp-down time	30 s / 0 s
p1136[D]	OFF3 initial rounding time	2 s / 0 s
p1137[D]	OFF3 final rounding time	0 s

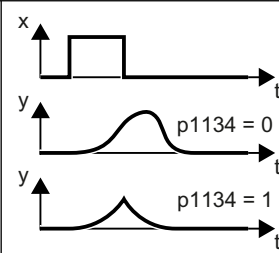

Additional information is provided in the parameter list of the List Manual.

Setting the extended ramp-function generator

Procedure

1. Enter the highest possible speed setpoint.
2. Switch on the motor.
3. Evaluate your drive response.
 - If the motor accelerates too slowly, then reduce the ramp-up time.
An excessively short ramp-up time means that the motor will reach its current limiting when accelerating, and will temporarily not be able to follow the speed setpoint. In this case, the drive exceeds the set time.
 - If the motor accelerates too fast, then extend the ramp-up time.
 - Increase the initial rounding if the acceleration is jerky.
 - In most applications, it is sufficient when the final rounding is set to the same value as the initial rounding.
4. Switch off the motor.

5. Evaluate your drive response.
 - If the motor decelerates too slowly, then reduce the ramp-down time. The minimum ramp-down time that makes sense depends on your particular application. Depending on the Power Module used, for an excessively short ramp-down time, the converter either reaches the motor current, or the DC link voltage in the converter becomes too high.
 - Extend the ramp-down time if the motor is braked too quickly or the converter goes into a fault condition when braking.
 6. Repeat steps 1 ... 5 until the drive behavior meets the requirements of the machine or plant.
- You have set the extended ramp-function generator.



Basic ramp-function generator

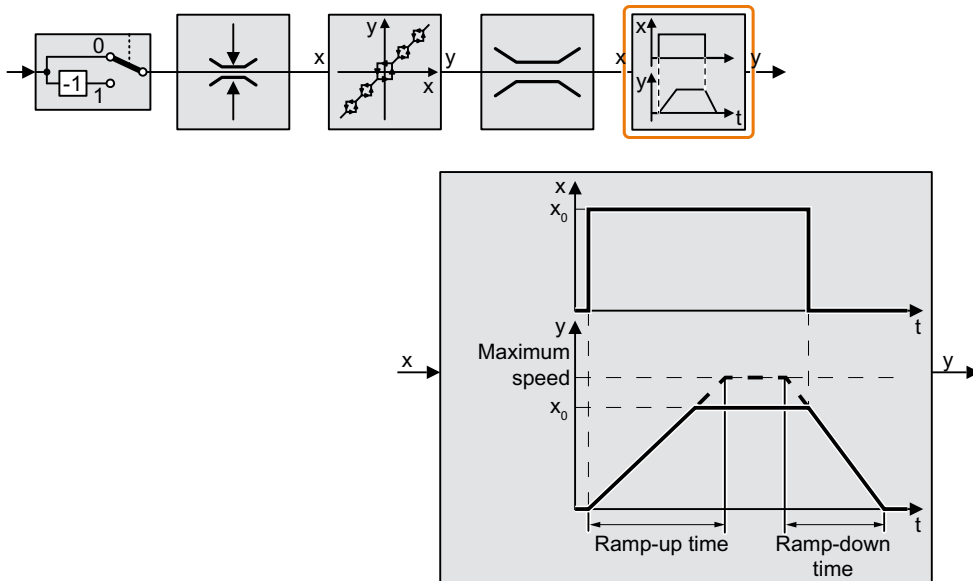

When compared to the extended ramp-function generator, the basic ramp-function generator has no rounding times.

Parameter

Table 8-50 Parameters for setting the ramp-function generator

Parameter	Description	Factory setting
p1082[D]	Maximum speed	1500 rpm
p1115	Ramp-function generator selection	1
p1120[D]	Ramp-function generator ramp-up time	10 s
p1121[D]	Ramp-function generator ramp-down time	10 s
p1135[D]	OFF3 ramp-down time	30 s

Changing the ramp-up and ramp-down times in operation

The ramping up and down time of the ramp-function generator can be changed during operation. The scaling value can come, e.g. from the fieldbus.

Requirements

- You have commissioned the communication between the converter and the control system.
- Free telegram 999 has been set in the converter and in your higher-level control system.
 Expanding or freely interconnecting telegrams (Page 265)
- The control sends the scaling value to the converter in PZD 3.

Procedure

1. Set $p1138 = 2050[2]$.
This means that you have interconnected the scaling factor for the ramp-up time with PZD receive word 3.
2. Set $p1139 = 2050[2]$.
This means that you have interconnected the scaling factor for the ramp-down time with PZD receive word 3.

The converter receives the value for scaling the ramp-up and ramp-down times via PZD receive word 3.



Further information is provided on the Internet:

 FAQ (<https://support.industry.siemens.com/cs/ww/en/view/82604741>)

Application example

In the following application example, the higher-level control sets the ramp-up and ramp-down times of the converter via PROFIBUS.

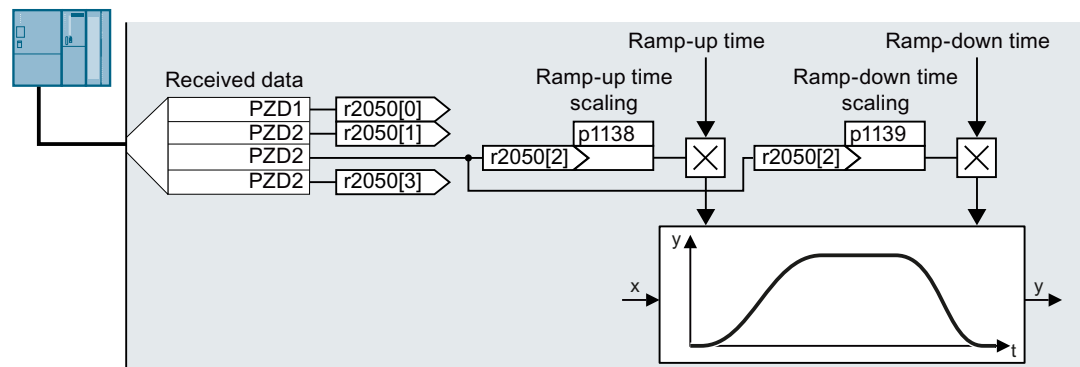

Figure 8-36 Application example for changing the ramp-function generator times in operation

Parameter

Table 8-51 Parameters for setting the scaling

Parameter	Description	Factory setting
p1138[C]	CI: Ramp-function generator ramp-up time scaling	1
p1139[C]	Down ramp scaling	1
r2050	CO: PROFIdrive PZD receive word	-

8.19 PID technology controller

8.19.1 PID technology controller

Overview



The technology controller controls process variables, e.g. pressure, temperature, level or flow.

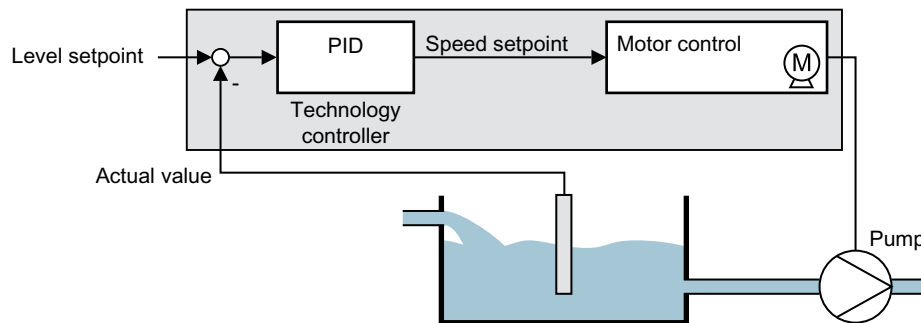

Figure 8-37 Example: Technology controller as a level controller

Requirement

The U/f control or the vector control have been set.

Function description

Function diagram

The technology controller is implemented as a PID controller (controller with proportional, integral, and derivative action).

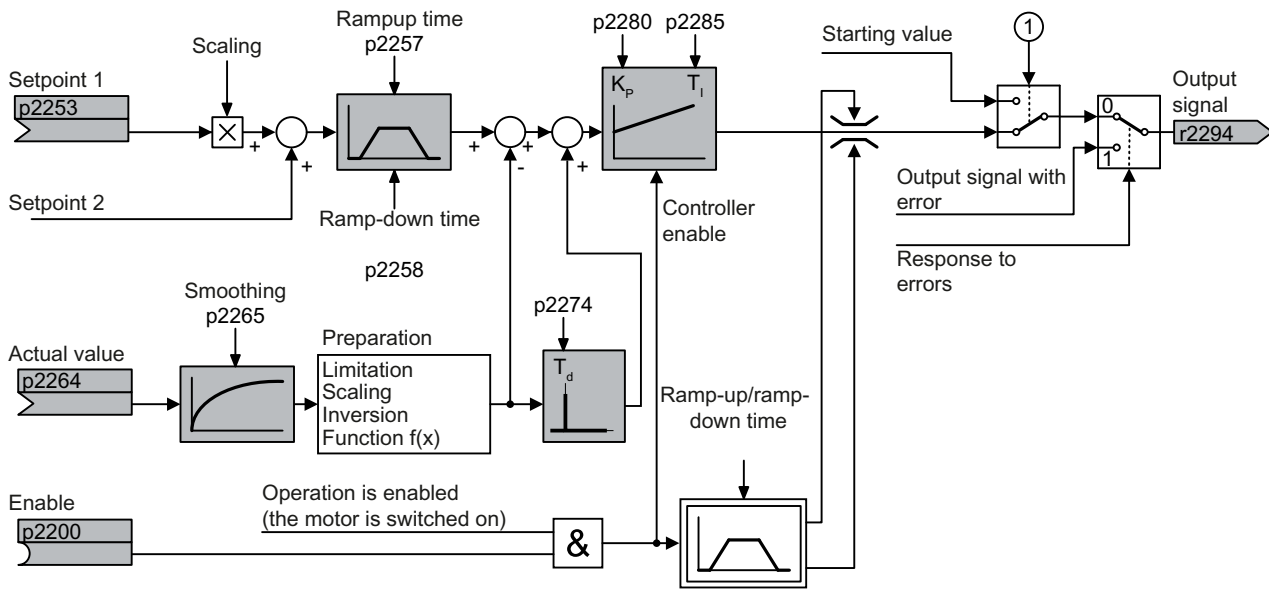

- ① The converter uses the start value when all the following conditions are simultaneously satisfied:
- The technology controller supplies the main setpoint (p2251 = 0).
 - The ramp-function generator output of the technology controller has not yet reached the start value.

Figure 8-38 Simplified representation of the technology controller

Basic settings

The settings required as a minimum are marked in gray in the function diagram:

- Interconnect setpoint and actual values with signals of your choice
- Set ramp-function generator and controller parameters K_p , T_i and T_d .

Set controller parameters K_p , T_i and T_d .**Procedure**

1. Temporarily set the ramp-up and ramp-down times of the ramp-function generator (p2257 and p2258) to zero.
2. Enter a setpoint step and monitor the associated actual value.
The slower the response of the process to be controlled, the longer you must monitor the controller response. Under certain circumstances (e.g. for a temperature control), you need to wait several minutes until you can evaluate the controller response.

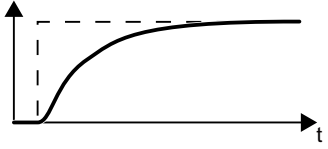
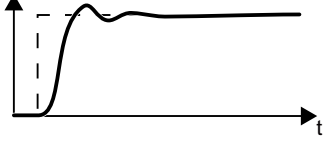
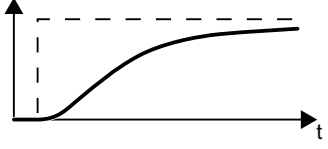
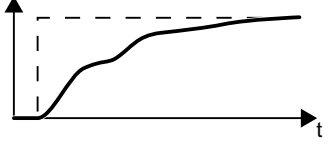
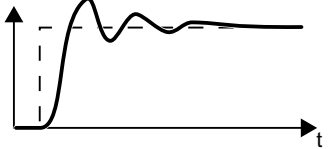
	<p>Optimum controller response for applications that do not permit any overshoot.</p> <p>The actual value approaches the setpoint without any significant overshoot.</p>
	<p>Optimum controller behavior for fast correction and quick compensation of disturbance components.</p> <p>The actual value approaches the setpoint and slightly overshoots, maximum 10 % of the setpoint step.</p>
	<p>The actual value only slowly approaches the setpoint.</p> <ul style="list-style-type: none"> • Increase the proportional component K_p (p2280) and reduce the integration time T_i (p2285).
	<p>The actual value only slowly approaches the setpoint with slight oscillation.</p> <ul style="list-style-type: none"> • Increase the proportional component K_p (p2280) and reduce the rate time T_d (p2274)
	<p>The actual value quickly approaches the setpoint, but overshoots too much.</p> <ul style="list-style-type: none"> • Decrease the proportional component K_p (p2280) and increase the integration time T_i (p2285).

3. Set the ramp-up and ramp-down times of the ramp-function generator back to their original value.

You have manually set the technology controller.

**Limiting the output of the technology controller**

In the factory setting, the output of the technology controller is limited to \pm maximum speed. You must change this limit, depending on your particular application.

Example: The output of the technology controller supplies the speed setpoint for a pump. The pump should only run in the positive direction.

Parameter

Table 8-52 Basic settings

Number	Name	Factory setting
r0046[0...31]	CO/BO: Missing enable signals	-
r0052[0...15]	CO/BO: Status word 1	-
r0056[0...15]	CO/BO: Status word, closed-loop control	-
r1084	CO: Speed limit positive active	-
r1087	CO: Speed limit negative active	- rpm
p2200[C]	BI: Technology controller enable	0
p2252	Technology controller configuration	See parameter list
p2253[C]	CI: Technology controller setpoint 1	0
p2254[C]	CI: Technology controller setpoint 2	0
p2255	Technology controller setpoint 1 scaling	100%
p2256	Technology controller setpoint 2 scaling	100%
p2257	Technology controller ramp-up time	1 s
p2258	Technology controller ramp-down time	1 s
r2260	CO: Technology controller setpoint after ramp-function generator	- %
p2261	Technology controller setpoint filter time constant	0 s
r2262	CO: Technology controller setpoint after filter	- %
p2263	Technology controller type	0
r2273	CO: Technology controller system deviation	- %
p2274	Technology controller differentiation time constant	0 s
p2280	Technology controller proportional gain	See parameter list
p2285	Technology controller integral time	See parameter list
p2286	BI: Hold technology controller integrator	56.13
p2289[C]	CI: Technology controller precontrol signal	0
p2306	Technology controller system deviation inversion	0
p2339	Technology controller threshold value for I proportion stop at skip speed	- s
r2344	CO: Technology controller last speed setpoint (smoothed)	- %
p2345	Technology controller fault response	0
r2349[0...13]	CO/BO: Technology controller status word	-
r3889[0...10]	CO/BO: ESM status word	-

Table 8-53 Limiting the output of the technology controller

Number	Name	Factory setting
p2290[C]	BI: Technology controller limitation enable	1
p2291	CO: Technology controller maximum limiting	100%
p2292	CO: Technology controller minimum limiting	0%
p2293	Technology controller ramp-up/ramp-down time	1 s

Number	Name	Factory setting
r2294	CO: Technology controller output signal	- %
p2295	CO: Technology controller output scaling	100%
p2296[C]	CI: Technology controller output scaling	2295
p2297[C]	CI: Technology controller maximum limiting signal source	1084
p2298[C]	CI: Technology controller minimum limiting signal source	1087
p2299[C]	CI: Technology controller limitation offset	0
p2302	Technology controller output signal start value	0%

Table 8-54 Adapting the actual value of the technology controller

Number	Name	Factory setting
p2264[C]	CI: Technology controller actual value	0
p2265	Technology controller actual value filter time constant	0 s
p2266	CO: Technology controller actual value after filter	- %
p2267	Technology controller upper limit actual value	100%
p2268	Technology controller lower limit actual value	-100%
p2269	Technology controller gain actual value	100%
p2270	Technology controller actual value function	0
p2271	Technology controller actual value inversion	0
r2272	CO: Technology controller actual value scaled	- %

Table 8-55 PID technology controller, fixed values (binary selection)

Number	Name	Factory setting
p2201[D]	CO: Technology controller fixed value 1	10%
p2202[D]	CO: Technology controller fixed value 2	20%
p2203[D]	CO: Technology controller fixed value 3	30%
p2204[D]	CO: Technology controller fixed value 4	40%
p2205[D]	CO: Technology controller fixed value 5	50%
p2206[D]	CO: Technology controller fixed value 6	60%
p2207[D]	CO: Technology controller fixed value 7	70%
p2208[D]	CO: Technology controller fixed value 8	80%
p2209[D]	CO: Technology controller fixed value 9	90%
p2210[D]	CO: Technology controller fixed value 10	100%
p2211[D]	CO: Technology controller fixed value 11	110%
p2212[D]	CO: Technology controller fixed value 12	120%
p2213[D]	CO: Technology controller fixed value 13	130%
p2214[D]	CO: Technology controller fixed value 14	140%
p2215[D]	CO: Technology controller fixed value 15	150%
p2216[D]	Technology controller fixed value selection method	1
r2224	CO: Technology controller fixed value active	- %

8.19 PID technology controller

Number	Name	Factory setting
r2225	CO/BO: Technology controller fixed value selection status word	- %
r2229	Technology controller number actual	-

Table 8-56 PID technology controller, fixed values (direct selection)

Number	Name	Factory setting
p2216[D]	Technology controller fixed value selection method	1
p2220[C]	BI: Technology controller fixed value selection bit 0	0
p2221[C]	BI: Technology controller fixed value selection bit 1	0
p2222[C]	BI: Technology controller fixed value selection bit 2	0
p2223[C]	BI: Technology controller fixed value selection bit 3	0
r2224	CO: Technology controller fixed value active	- %
r2225	CO/BO: Technology controller fixed value selection status word	- %
r2229	Technology controller number actual	-

Table 8-57 PID technology controller, motorized potentiometer

Number	Name	Factory setting
r2231	Technology controller motorized potentiometer setpoint memory	- %
p2235[C]	BI: Technology controller motorized potentiometer, setpoint, raise	0
p2236[C]	BI: Technology controller motorized potentiometer, setpoint, lower	0
p2237[D]	Technology controller motorized potentiometer maximum value	100%
p2238[D]	Technology controller motorized potentiometer minimum value	-100%
p2240[D]	Technology controller motorized potentiometer start value	0%
r2245	CO: Technology controller motorized potentiometer, setpoint before RFG	- %
p2247[D]	Technology controller motorized potentiometer ramp-up time	10 s
p2248[D]	Technology controller motorized potentiometer ramp-down time	10 s
r2250	CO: Technology controller motorized potentiometer, setpoint after RFG	- %

Further information

You will find additional information on the following PID controller components on the Internet at:

- Setpoint input: Analog value or fixed setpoint
- Setpoint channel: Scaling, ramp-function generator and filter
- Actual value channel: Filter, limiting and signal processing
- PID controller: Principle of operation of the D component, inhibiting the I component and the control sense
- Enable, limiting the controller output and fault response



FAQ (<http://support.automation.siemens.com/WW/view/en/92556266>)

8.19.2 Autotuning the PID technology controller

Overview

Autotuning is a converter function for the automatic optimization of the PID technology controller.

Requirement

The following requirements apply:

- The motor closed-loop control is set
- The PID technology controller must be set the same as when used in subsequent operation:
 - The actual value is interconnected.
 - Scalings, filter and ramp-function generator have been set.
 - The PID technology controller is enabled (p2200 = 1 signal).

Function description

For active autotuning, the converter interrupts the connection between the PID technology controller and the speed controller. Instead of the PID technology controller output, the autotuning function specifies the speed setpoint.

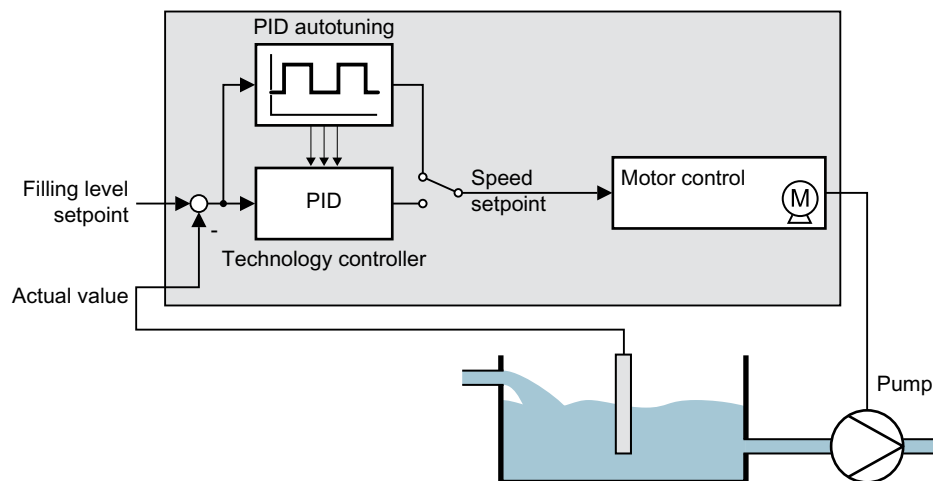

Figure 8-39 Autotuning using closed-loop level control as example

The speed setpoint results from the technology setpoint and a superimposed rectangular signal with amplitude p2355. If actual value = technology setpoint \pm p2355, the autotuning function switches the polarity of the superimposed signal. This causes the converter to excite the process variable for an oscillation.

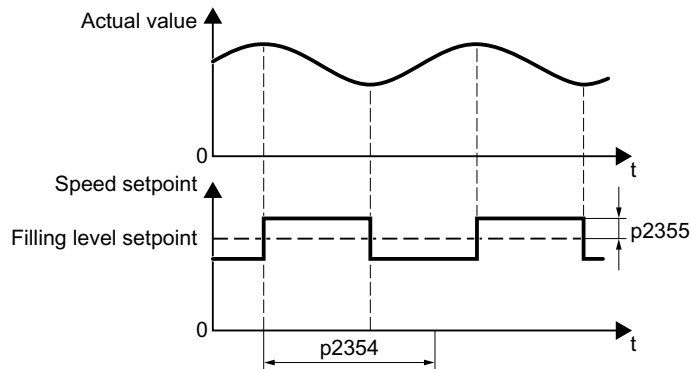

Figure 8-40 Example for speed setpoint and actual process value for autotuning

The converter calculates the parameters of the PID controller from the determined oscillation frequency.

Executing autotuning



1. Select with p2350 the appropriate controller setting.
2. Switch on the motor.
The converter signals Alarm A07444.
3. Wait until alarm A07444 goes away.
The converter has recalculated parameters p2280, p2274 and p2285.
If the converter signals fault F07445:
 - If possible, double p2354 and p2355.
 - Repeat the autotuning with the changed parameters.
4. Back up the calculated values so that they are protected against power failure, e.g. using the BOP-2: OPTIONS → RAM-ROM.

You have auto tuned the PID controller.

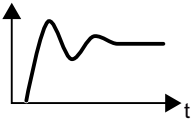
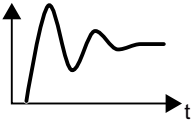

Parameter

Number	Name	Factory setting
p2274	Technology controller differentiation time constant	0.0 s
p2280	Technology controller proportional gain	See parameter list
p2285	Technology controller integral time	See parameter list

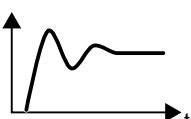
Number	Name	Factory setting
p2350	<p>Enable PID autotuning</p> <p>Automatic controller setting based on the "Ziegler Nichols" method.</p> <p>After completion of the autotuning, the converter sets p2350 = 0.</p> <p>0: No function</p> <p>1: The process variable follows the setpoint after a sudden setpoint change (step function) relatively quickly, however with an overshoot.</p>  <p>2: Faster controller setting than for p2350 = 1 with larger overshoot of the controlled variable.</p>  <p>3: Slower controller setting than for p2350 = 1. Overshoot of the controlled variable is, to a large extent, avoided.</p>  <p>4: Controller setting after completion of the autotuning as for p2350 = 1. Optimize only the P and I action of the PID controller.</p> 	0
p2354	PID autotuning monitoring time	240 s
p2355	PID autotuning offset	5%

8.19.3 Adapting Kp and Tn

Overview

This function adapts the PID technology controller to the process, e.g. depending on the control deviation of the technology controller.

Function description

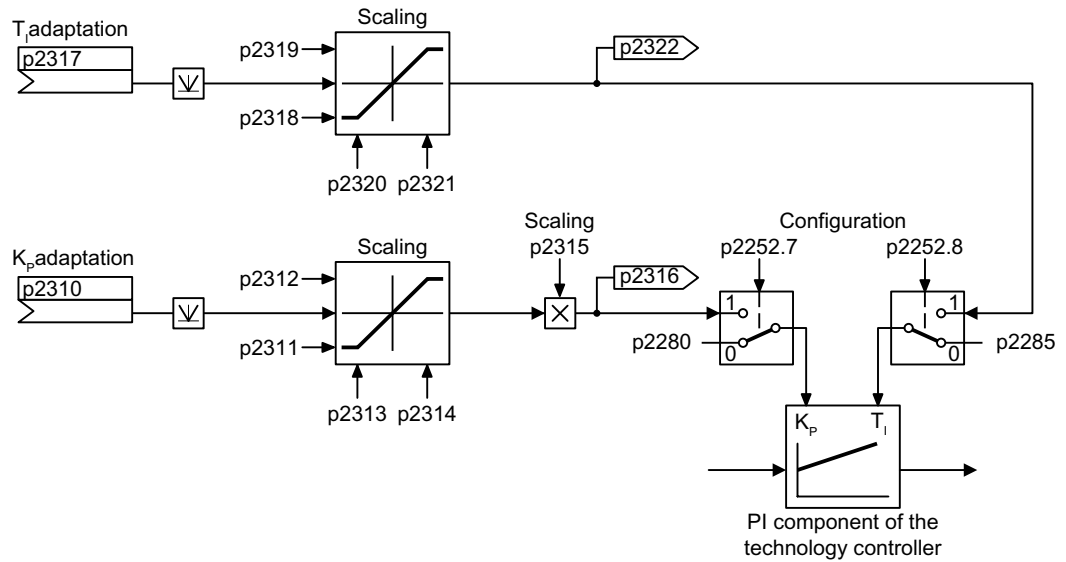

Figure 8-41 Controller adaptation

Parameter

Number	Name	Factory setting
p2252	Technology controller configuration	0000 0000 0000 0000 bin
p2280	Technology controller proportional gain	see parameter list
p2285	Technology controller integral time	see parameter list
p2310	CI: Technology controller Kp adaptation input value signal source	0
p2311	Technology controller, lower Kp adaptation value	1
p2312	Technology controller, upper Kp adaptation value	10
p2313	Technology controller lower Kp adaptation transition point	0%
p2314	Technology controller upper Kp adaptation transition point	100%
p2315	CI: Technology controller Kp adaptation scaling signal source	1
r2316	CO: Technology controller Kp adaptation output	-
p2317	CI: Technology controller Tn adaptation input value signal source	0
p2318	Technology controller, lower Tn adaptation value	3 s

Number	Name	Factory setting
p2319	Technology controller, upper Tn adaptation value	10 s
p2320	Technology controller lower Tn adaptation transition point	0%
p2321	Technology controller upper Tn adaptation transition point	100%
r2322	CO: Technology controller Tn adaptation output	- s

8.20 Reactor, filter and cable resistance at the converter output

Overview

Components between the converter and the motor influence the closed-loop control quality of the converter:

- Output reactor or sine-wave filter
In the factory setting, for the motor data identification, the converter assumes that neither output reactor nor sine wave filter are connected at the converter output.
- Motor cable with unusually high cable resistance.
For the motor data identification, the converter assumes a cable resistance = 20 % of the stator resistance of the cold motor.

Function description

You must correctly set the components between the converter and motor to achieve an optimum closed-loop control quality

Procedure

1. Set p0010 = 2.
2. Set the cable resistance in p0352.
3. Set p0230 to the appropriate value.
4. Set p0235 to the appropriate value.
5. Set p0010 = 0.
6. Carry out the quick commissioning and the motor identification again.



Commissioning (Page 147)

You have set the reactor, filter and cable resistance between the converter and motor.



Parameter

Number	Name	Factory setting
p0010	Drive commissioning parameter filter	1
p0230	Drive filter type, motor side	0
p0235	Number of motor reactors in series	1
p0350[M]	Motor stator resistance, cold	0 Ω
p0352[M]	Cable resistance	0 Ω

For further information on parameters, please refer to the parameter list.

8.21 Motor control

Overview



The converter has two alternative methods to ensure the motor speed follows the configured speed setpoint:

- U/f control
- Vector control

8.21.1 U/f control

8.21.1.1 U/f control

Overview

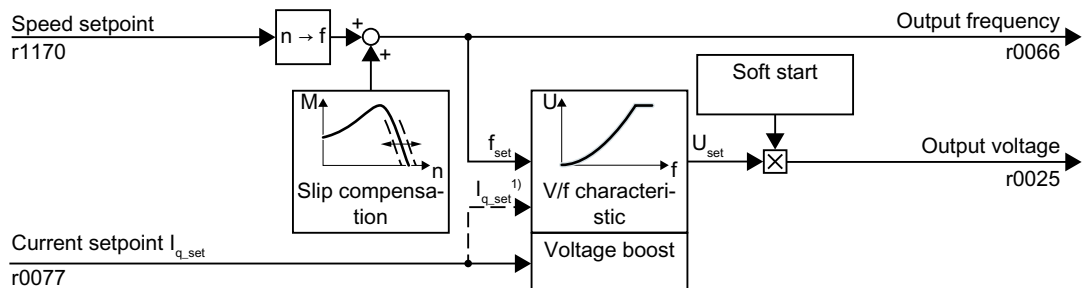

- ¹⁾ In the "Flux Current Control (FCC)" U/f version, the converter controls the motor current (starting current) at low speeds.

Figure 8-42 Simplified function diagram of the U/f control

The U/f control is a speed feedforward control with the following properties:

- The converter sets the output voltage on the basis of the U/f characteristic.
- The output frequency is essentially calculated from the speed setpoint and the number of pole pairs of the motor.
- The slip compensation corrects the output frequency depending on the load and thus increases the speed accuracy.
- The omission of a control loop means that the U/f control is stable in all cases.
- In applications with higher speed accuracy requirements, a load-dependent voltage boost can be selected (flux current control, FCC)

For operation of the motor with U/f control, you must set at least the following subfunctions appropriate for your application:

- U/f characteristic
- Voltage boost

Function description

The converter has different U/f characteristics.

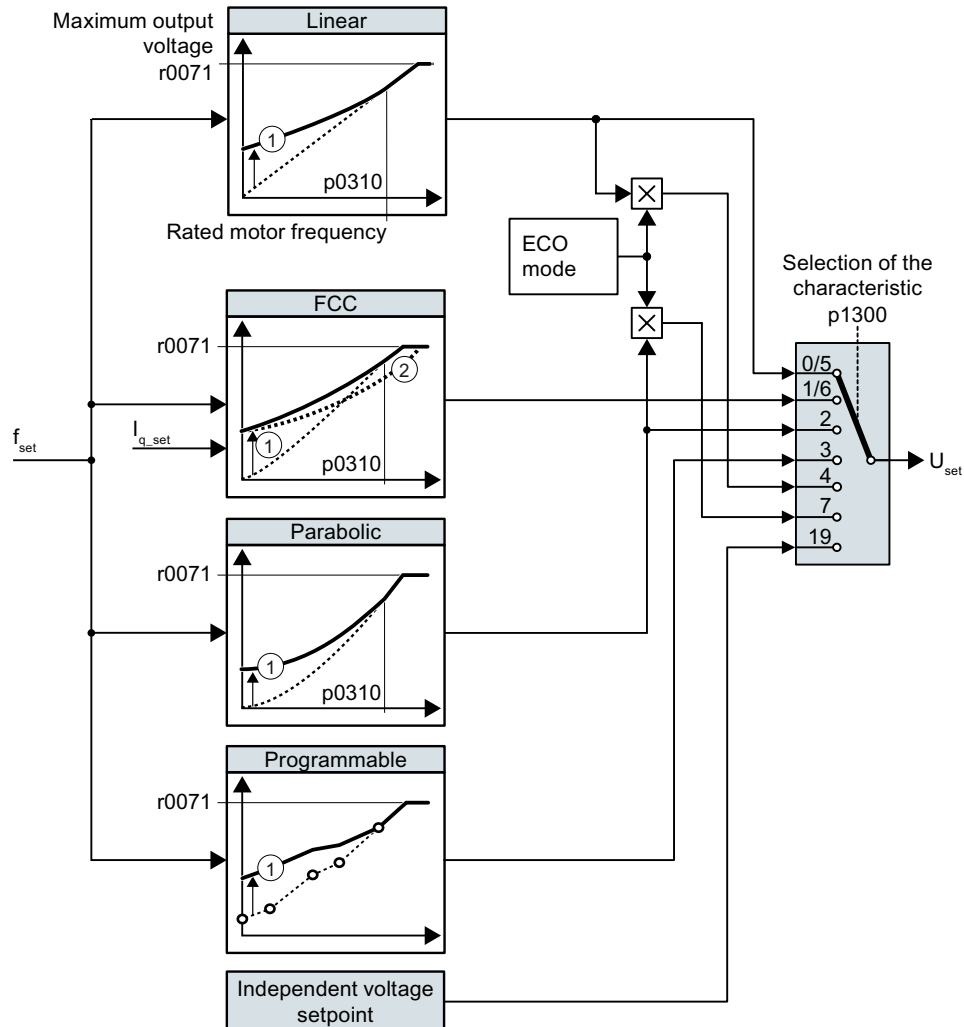

- ① The voltage boost of the characteristic improves speed control at low speeds
- ② With the flux current control (FCC), the converter compensates for the voltage drop in the stator resistor of the motor

Figure 8-43 Characteristics of U/f control

With increasing speed or output frequency, the converter increases its output voltage U . The maximum possible output voltage of the converter depends on the line voltage.

The converter can increase the output frequency even at the maximum output voltage. The motor is then operated with field weakening.

The value of the output voltage at the rated motor frequency $p0310$ also depends on the following variables:

- Ratio between the converter size and the motor size
- Line voltage

- Line impedance
- Actual motor torque

The maximum possible output voltage as a function of the input voltage is provided in the technical data.

 Technical data (Page 485)

Table 8-58 The characteristic that matches the application

Requirement	Application examples	Remark	Characteristic	Parameter
The required torque is independent of the speed	Conveyor belts, roller conveyors, chain conveyors, eccentric worm pumps, compressors, extruders, centrifuges, agitators, mixers	-	Linear	p1300 = 0
		The converter compensates for the voltage drops across the stator resistance. Recommended for motors less than 7.5 kW. Precondition: You have set the motor data according to the rating plate and have performed the motor identification after quick commissioning.	Linear with Flux Current Control (FCC)	p1300 = 1
The required torque increases with the speed	Centrifugal pumps, radial fans, axial fans	Lower losses in the motor and converter than for a linear characteristic.	Parabolic	p1300 = 2

Table 8-59 Characteristics for special applications

Requirement	Application examples	Remark	Characteristic	Parameter
Applications with a low dynamic response and constant speed	Centrifugal pumps, radial fans, axial fans	If the speed setpoint is reached and remains unchanged for 5 seconds, then the converter reduces its output voltage. As a consequence, the ECO mode saves energy with respect to the parabolic characteristic.	ECO mode	p1300 = 4 or p1300 = 7
The converter must maintain the motor speed constant for the longest possible time.	Drives in the textile sector	When reaching the maximum current limit, the converter only reduces the output voltage, but not the frequency.	Precise frequency characteristic	p1300 = 5 or p1300 = 6
Freely adjustable U/f characteristic	-	-	Adjustable characteristic	p1300 = 3
U/f characteristic with independent voltage setpoint	-	The interrelationship between the frequency and voltage is not calculated in the converter, but is specified by the user.	Independent voltage setpoint	p1300 = 19

Parameter

Parameter	Description	Factory setting
r0025	CO: Output voltage, smoothed	- Vrms
r0066	CO: Output frequency	- Hz
r0071	Output voltage, maximum	- Vrms
p0304[M]	Rated motor voltage	0 Vrms
p0310[M]	Rated motor frequency	0 Hz
p1300[D]	Open-loop/closed-loop control operating mode	0
p1333[D]	U/f control FCC starting frequency	0 Hz
p1334[D]	U/f control slip compensation starting frequency	0 Hz
p1335[D]	Slip compensation scaling	0%
p1338[D]	U/f mode resonance damping gain	0

8.21.1.2 Optimizing motor starting

Overview

After selection of the U/f characteristic, no further settings are required in most applications.

In the following circumstances, the motor cannot accelerate to its speed setpoint after it has been switched on:

- Load moment of inertia too high
- Load torque too large
- Ramp-up time p1120 too short

To improve the starting behavior of the motor, a voltage boost can be set for the U/f characteristic at low speeds.

Requirement

The ramp-up time of the ramp-function generator is, depending on the motor rated power, 1 s (< 1 kW) ... 10 s (> 10 kW).

Function description

Setting the voltage boost for U/f control

The converter boosts the voltage corresponding to the starting currents p1310 ... p1312.

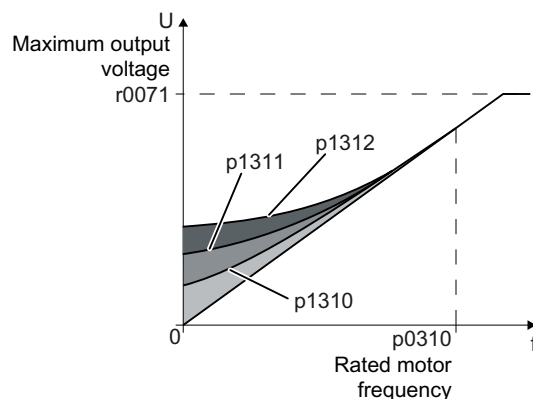

Figure 8-44 The resulting voltage boost using a linear characteristic as example

Increase parameter values p1310 ... p1312 in steps of $\leq 5\%$. Excessively high values in p1310 ... p1312 can cause the motor to overheat and switch off (trip) the converter due to overcurrent.

If message A07409 appears, it is not permissible that you further increase the value of any of the parameters.

Procedure

1. Switch on the motor with a setpoint of a few revolutions per minute.
2. Check whether the motor rotates smoothly.

3. If the motor does not rotate smoothly, or even remains stationary, increase the voltage boost p1310 until the motor runs smoothly.
4. Accelerate the motor to the maximum speed with maximum load.
5. Check that the motor follows the setpoint.
6. If necessary, increase the voltage boost p1311 until the motor accelerates without problem.

In applications with a high break loose torque, you must also increase parameter p1312 in order to achieve a satisfactory motor response.

You have set the voltage boost.



Parameter

Number	Name	Factory setting
r0071	Output voltage, maximum	Vrms
p0310[M]	Rated motor frequency	0 Hz
p1310[D]	Starting current (voltage boost) permanent	50%
p1311[D]	Starting current (voltage boost) when accelerating	0%
p1312[D]	Starting current (voltage boost) when starting	0%

8.21.1.3 U/f control with Standard Drive Control

Overview

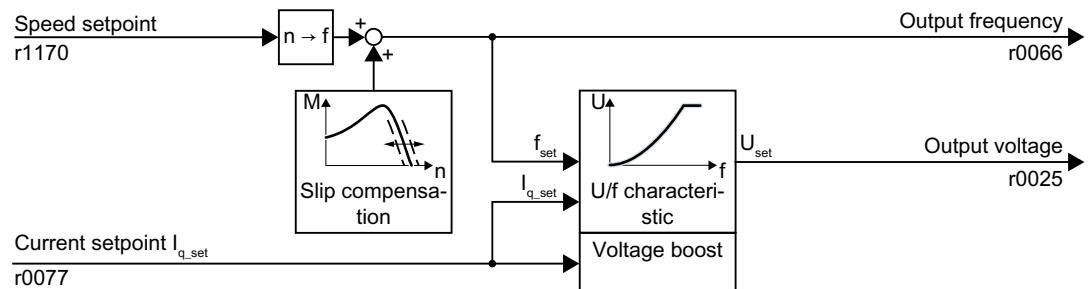

Figure 8-45 Default setting of the U/f control after selecting Standard Drive Control

Selecting application class Standard Drive Control in the quick commissioning adapts the structure and the setting options of the U/f control as follows:

- Starting current closed-loop control: At low speeds, a controlled motor current reduces the tendency of the motor to oscillate.
- With increasing speed, the converter changes from closed-loop starting current control to U/f control with load-dependent voltage boost.
- The slip compensation is activated.
- Soft starting is not possible.
- Reduced setting options

Function description

Characteristics after selecting the application class Standard Drive Control

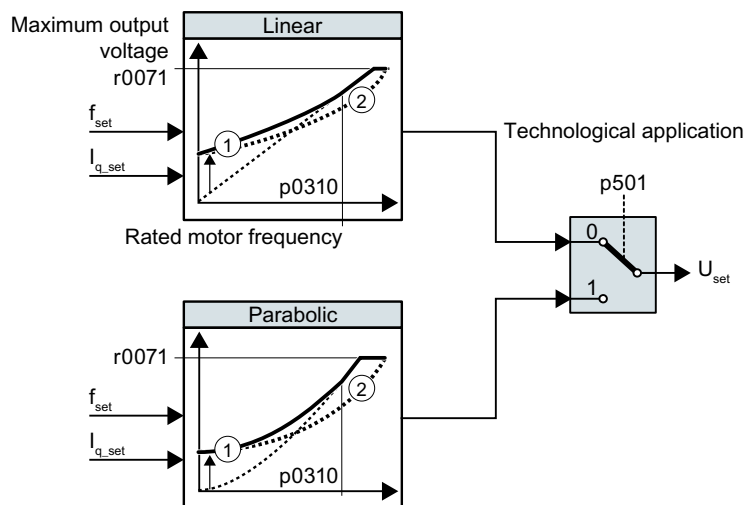

- ① The closed-loop starting current control optimizes the speed control at low speeds
- ② The converter compensates the voltage drop across the motor stator resistance

Figure 8-46 Characteristics after selecting Standard Drive Control

The application class Standard Drive Control reduces the number of characteristics and setting options:

- A linear and a parabolic characteristic are available.
- Selecting a technological application defines the characteristics.

Table 8-60 Linear and parabolic characteristics

Requirement	Application examples	Remark	Characteristic	Parameter
The required torque is independent of the speed	Conveyor belts, roller conveyors, chain conveyors, eccentric worm pumps, compressors, extruders, centrifuges, agitators, mixers	-	Linear	p0501 = 0
The required torque increases with the speed	Centrifugal pumps, radial fans, axial fans	Lower losses in the motor and converter than for a linear characteristic.	Parabolic	p0501 = 1

Parameter

Parameter	Description	Factory setting
r0025	CO: Output voltage, smoothed	- Vrms
r0066	CO: Output frequency	- Hz
r0071	Output voltage, maximum	- Vrms
p0310[M]	Rated motor frequency	0 Hz
p501	Technology application	0

8.21.1.4 Optimizing motor starting using Standard Drive Control

Overview

After selecting application class Standard Drive Control, in most applications no additional settings need to be made.

At standstill, the converter ensures that at least the rated motor magnetizing current flows. Magnetizing current p0320 approximately corresponds to the no-load current at 50 % ... 80 % of the rated motor speed.

In the following circumstances, the motor cannot accelerate to its speed setpoint after it has been switched on:

- Load moment of inertia too high
- Load torque too large
- Ramp-up time p1120 too short

The current can be increased at low speeds to improve the starting behavior of the motor.

Requirement

The ramp-up time of the ramp-function generator is, depending on the motor rated power, 1 s (< 1 kW) ... 10 s (> 10 kW).

Function description

Starting current (boost) after selecting the application class Standard Drive Control

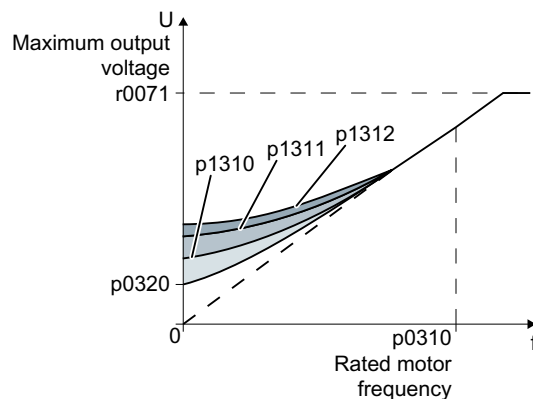

Figure 8-47 The resulting voltage boost using a linear characteristic as example

The converter boosts the voltage corresponding to the starting currents p1310 ... p1312.

Increase parameter values p1310 ... p1312 in steps of $\leq 5\%$. Excessively high values in p1310 ... p1312 can cause the motor to overheat and switch off (trip) the converter due to overcurrent.

If message A07409 appears, it is not permissible that you further increase the value of any of the parameters.

Procedure

1. Switch on the motor with a setpoint of a few revolutions per minute.
2. Check whether the motor rotates smoothly.
3. If the motor does not rotate smoothly, or even remains stationary, increase the voltage boost p1310 until the motor runs smoothly.
4. Accelerate the motor with the maximum load.
5. Check that the motor follows the setpoint.
6. If necessary, increase the voltage boost p1311 until the motor accelerates without problem.

In applications with a high break loose torque, you must also increase parameter p1312 in order to achieve a satisfactory motor response.

You have set the voltage boost.

**Parameter**

Number	Name	Factory setting
r0071	Output voltage, maximum	Vrms
p0310[M]	Rated motor frequency	0 Hz
p0320[M]	Rated motor magnetizing current / short-circuit current	0 Arms
p1310[D]	Starting current (voltage boost) permanent	50%
p1311[D]	Starting current (voltage boost) when accelerating	0%
p1312[D]	Starting current (voltage boost) when starting	0%

8.21.2 Sensorless vector control with speed controller

8.21.2.1 Structure of vector control without encoder (sensorless)

Overview

The vector control comprises closed-loop current control and a higher-level closed-loop speed control.

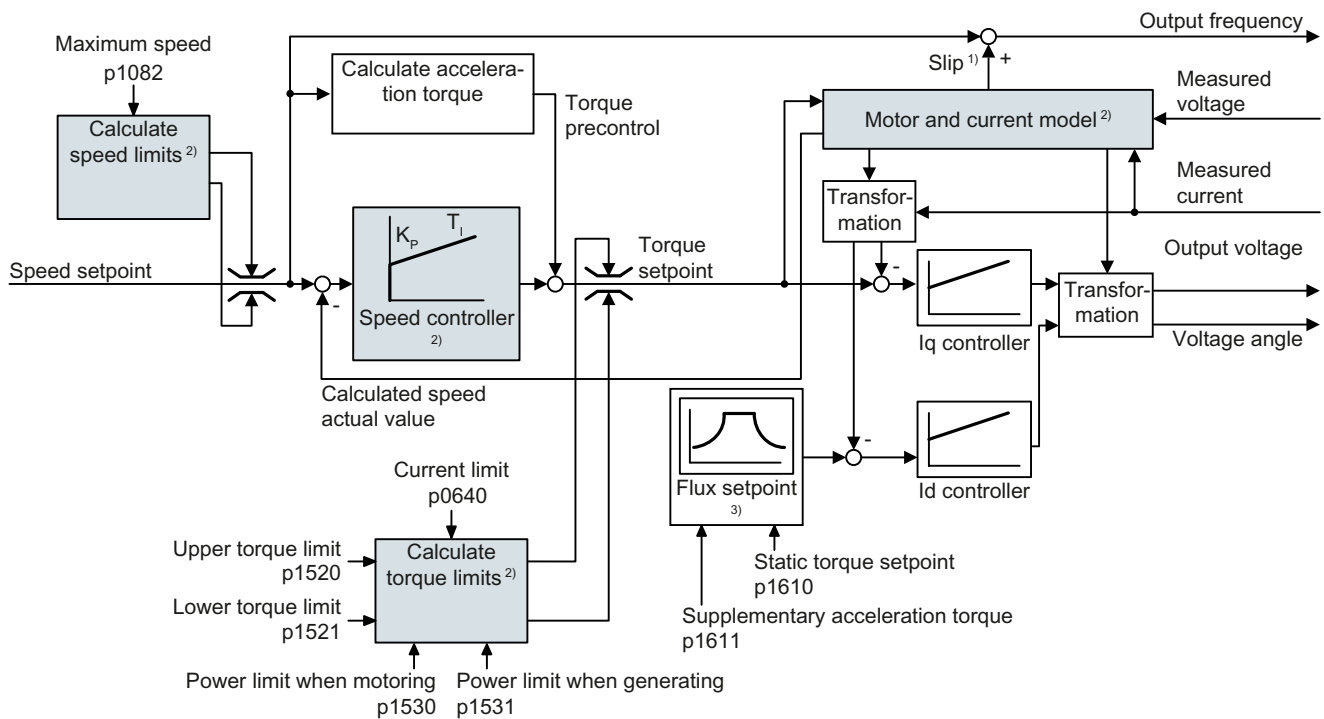

¹⁾ for induction motors

²⁾ Settings that are required

Figure 8-48 Simplified function diagram for sensorless vector control with speed controller

Using the motor model, the converter calculates the following closed-loop control signals from the measured phase currents and the output voltage:

- Current component I_q
- Current component I_d
- Speed actual value

The setpoint of the current component I_d (flux setpoint) is obtained from the motor data. For speeds above the rated speed, the converter reduces the flux setpoint along the field weakening characteristic.

When the speed setpoint is increased, the speed controller responds with a higher setpoint for current component I_q (torque setpoint). The closed-loop control responds to a higher torque setpoint by adding a higher slip frequency to the output frequency. The higher output frequency also results in a higher motor slip, which is proportional to the accelerating torque.

I_q and I_d controllers keep the motor flux constant using the output voltage, and adjust the matching current component I_q in the motor.

Settings that are required

Restart quick commissioning and select the vector control in quick commissioning.



Commissioning (Page 147)

In order to achieve a satisfactory control response, as a minimum you must set the partial functions – shown with gray background in the diagram above – to match your particular application:



- **Motor and current model:** In the quick commissioning, correctly set the motor data on the rating plate corresponding to the connection type (Y/Δ), and carry out the motor data identification routine at standstill.
- **Speed limits and torque limits:** In the quick commissioning, set the maximum speed (p1082) and current limit (p0640) to match your particular application. When exiting quick commissioning, the converter calculates the torque and power limits corresponding to the current limit. The actual torque limits are obtained from the converted current and power limits and the set torque limits.
- **Speed controller:** Start the rotating measurement of the motor data identification. You must manually optimize the controller if the rotating measurement is not possible.



WARNING

The load falls due to incorrect closed-loop control settings

For encoderless vector control, the converter calculates the actual speed based on an electric motor model. In applications with pulling loads - e.g. hoisting gear, lifting tables or vertical conveyors - an incorrectly set motor model or other incorrect settings can mean that the load falls. A falling load can result in death or serious injury.

- Correctly set the motor data during the quick commissioning.
- Carry out the motor data identification.
- Correctly set the "Motor holding brake" function.
 -  Motor holding brake (Page 283)
- For pulling loads, carefully comply with the recommended settings for vector control.
 -  Advanced settings (Page 358)

8.21.2.2 Default setting as a result of the application class Dynamic Drive Control

Selecting application class Dynamic Drive Control in the quick commissioning adapts the structure of the vector control, and reduces the setting options:

	Vector control after selecting the application class Dynamic Drive Control	Vector control without selecting an application class
Closed-loop torque control without higher-level speed controller	Not possible	Possible
Droop	Not possible	Possible
K_p - and T_i adaptation	Simplified	Advanced
Hold or set the integral component of the speed controller	Not possible	Possible
Acceleration model for pre-control	Default setting	Can be activated
Motor data identification at standstill or with rotating measurement	Shortened, with optional transition into operation	Complete

8.21.2.3 Optimizing the speed controller

Optimum control response - post optimization not required

Preconditions for assessing the controller response:

- The moment of inertia of the load is constant and does not depend on the speed
- The converter does not reach the set torque limits during acceleration
- You operate the motor in the range 40 % ... 60 % of its rated speed

If the motor exhibits the following response, the speed control is well set and you do not have to adapt the speed controller manually:

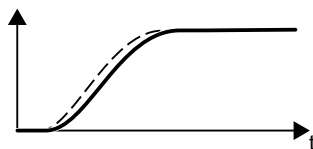

The speed setpoint (broken line) increases with the set ramp-up time and rounding.
The speed actual value follows the setpoint without any overshoot.

Control optimization required

In some cases, the self optimization result is not satisfactory, or self optimization is not possible as the motor cannot freely rotate.

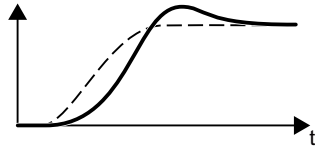

Initially, the speed actual value follows the speed setpoint with some delay, and then overshoots the speed setpoint.

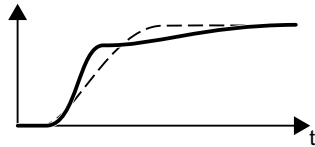

First, the actual speed value increases faster than the speed setpoint. Before the setpoint reaches its final value, it passes the actual value. Finally, the actual value approaches the setpoint without any significant overshoot.

In the two cases describe above, we recommend that you manually optimize the speed control.

Optimizing the speed controller

Requirements

- Torque precontrol is active: p1496 = 100 %.
- The load moment of inertia is constant and independent of the speed.
- The converter requires 10 % ... 50 % of the rated torque to accelerate.
When necessary, adapt the ramp-up and ramp-down times of the ramp-function generator (p1120 and p1121).

Procedure

1. Switch on the motor.
2. Enter a speed setpoint of approximately 40 % of the rated speed.
3. Wait until the actual speed has stabilized.
4. Increase the setpoint up to a maximum of 60% of the rated speed.
5. Monitor the associated characteristic of the setpoint and actual speed.
6. Optimize the controller by adapting the ratio of the moments of inertia of the load and motor (p0342):

	<p>Initially, the speed actual value follows the speed setpoint with some delay, and then overshoots the speed setpoint.</p> <ul style="list-style-type: none"> • Increase p0342
	<p>Initially, the speed actual value increases faster than the speed setpoint. The setpoint passes the actual value before reaching its final value. Finally, the actual value approaches the setpoint without any overshoot.</p> <ul style="list-style-type: none"> • Reduce p0342

7. Switch off the motor.
8. Set p0340 = 4. The converter again calculates the speed controller parameters.
9. Switch on the motor.
10. Over the complete speed range check as to whether the speed control operates satisfactorily with the optimized settings.

You have optimized the speed controller.



When necessary, set the ramp-up and ramp-down times of the ramp-function generator (p1120 and p1121) back to the value before optimization.

Mastering critical applications

The drive control can become unstable for drives with a high load moment of inertia and gearbox backlash or a coupling between the motor and load that can possibly oscillate. In this case, we recommend the following settings:

- Increase p1452 (smoothing the speed actual value).
- Increase p1472 (integral time T_i): $T_i \geq 4 \cdot p1452$
- If, after these measures, the speed controller does not operate with an adequate dynamic performance, then increase p1470 (gain K_p) step-by-step.

Parameters

Table 8-61 Encoderless speed control

Number	Name	Factory setting
p0342[M]	Ratio between the total and motor moments of inertia	1
p1452	Speed controller actual speed value smoothing time (encoderless)	10 ms
p1470[D]	Speed controller encoderless operation P gain	0.3
p1472[D]	Speed controller encoderless operation integral time	20 ms
p1496[D]	Acceleration precontrol scaling	0%

8.21.2.4 Advanced settings

K_p - and T_i adaptation

K_p and T_i adaptation suppress speed control oscillations that may occur. The "rotating measurement" of the motor data identification optimizes the speed controller. If you have performed the rotating measurement, then the K_p - and T_i adaptation has been set.

Additional information is provided in the List Manual:

- Vector control with speed controller: Function diagram 6050
- Vector control after presetting the application class Dynamic Drive Control: Function diagram 6824

Function description

For mechanically coupled drives, there is the risk that the drives oppose one another: Small deviations in the speed setpoint or actual value of the coupled drives can mean that the drives are operated with significantly different torques.

The droop function ensures even torque distribution between several mechanically coupled drives.

The droop function reduces the speed setpoint as a function of the torque setpoint.

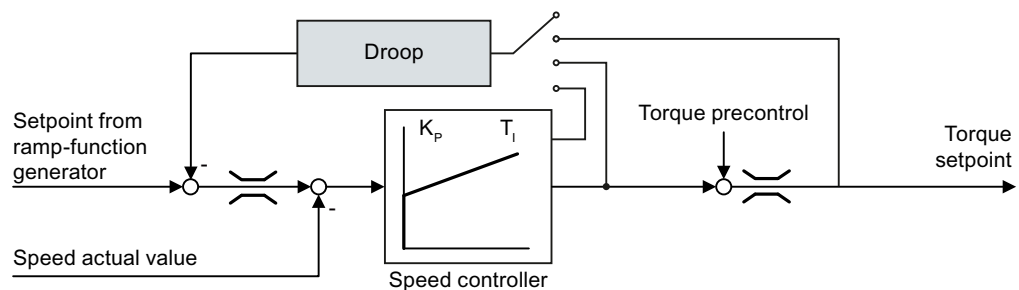

Figure 8-49 Effect of droop in the speed controller

Parameter

Parameter	Description	Factory setting
r1482	CO: Speed controller I torque output	- Nm
p1486	Droop compensation torque	0
p1487	Droop compensation torque scaling	100.0%
p1488[D]	Droop input source	0
p1489[D]	Droop feedback scaling	0.05
r1490	CO: Droop feedback speed reduction	- rpm
p1492[C]	BI: Droop feedback enable	0

When droop is active, the ramp-function generators of all of the coupled drives must be set to have identical ramp-up and ramp-down times as well as rounding-off.

After selecting application class "Dynamic Drive Control", droop is no longer possible.

Additional information is provided in the List Manual, function diagram 6030.

Overview

Special settings for a pulling load

For a pulling load, e.g. a hoisting gear, a permanent force is exerted on the motor, even when the motor is stationary.

For a pulling load, we recommend that you use vector control with an encoder.

Function description

If you use sensorless vector control with a pulling load, then the following settings are required:

- Set the following parameters:
- When opening the motor holding brake, enter a speed setpoint > 0 .
For speed setpoint = 0, and with the motor holding brake open, the load drops because the induction motor rotates with the slip frequency as a result of the pulling load.
- Set the ramp-up and ramp-down times ≤ 10 s in the ramp-function generator.
- If, in quick commissioning, you have selected application class Dynamic Drive Control then set $p0502 = 1$ (technological application: dynamic starting or reversing).

Parameter

Parameter	Description	Factory setting
p1610[D]	Torque setpoint static (without encoder)	50%
p1750[D]	Motor model configuration	0000 0000 0000 1100 bin

8.21.2.5 Friction characteristic

Overview

In many applications, e.g. applications with geared motors or belt conveyors, the frictional torque of the load is not negligible.

The converter provides the possibility of precontrolling the torque setpoint, bypassing the speed controller. The precontrol reduces overshooting of the speed after speed changes.

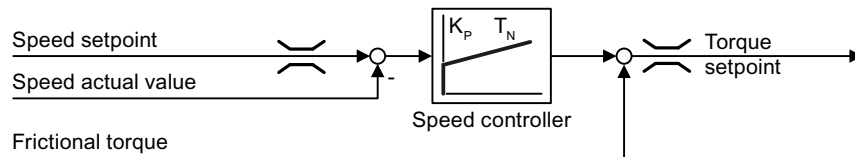

Figure 8-50 Precontrol of the speed controller with frictional torque

The converter calculates the current frictional torque from a friction characteristic with 10 intermediate points.

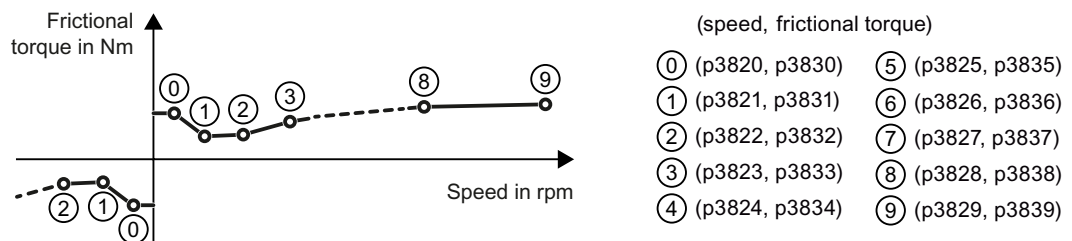

Figure 8-51 Friction characteristic

The intermediate points of the friction characteristic are defined for positive speeds. In the negative direction of rotation, the converter uses the intermediate points with a negative sign.

Function description

Recording a friction characteristic

After quick commissioning, the converter sets the speeds of the intermediate points to values suitable for the rated speed of the motor. The frictional torque of all intermediate points is still equal to zero. On request, the converter records the friction characteristic: The converter accelerates the motor step by step up to the rated speed, measures the frictional torque and writes the frictional torque into the intermediate points of the friction characteristic.

Requirement

The motor is permitted to accelerate up to the rated speed without endangering persons or property.

Procedure

1. Set P3845 = 1: The converter accelerates the motor successively in both directions of rotation and averages the measurement results of the positive and negative directions.
2. Switch on the motor (ON/OFF1 = 1).
3. The converter accelerates the motor.
During measurement, the converter signals the alarm A07961.
When the converter has determined all the intermediate points of the friction characteristic without fault code F07963, the converter stops the motor.

You have recorded the friction characteristic.

**Adding friction characteristic for the torque setpoint**

If you enable the friction characteristic (p3842 = 1), the converter adds the output of the friction characteristic r3841 to the torque setpoint.

Parameter

Parameter	Description	Factory setting
p3820[D]	Friction characteristic, value n0	15 rpm
p3821[D]	Friction characteristic, value n1	30 rpm
p3822[D]	Friction characteristic, value n2	60 rpm
p3823[D]	Friction characteristic, value n3	120 rpm
p3824[D]	Friction characteristic, value n4	150 rpm
p3825[D]	Friction characteristic, value n5	300 rpm
p3826[D]	Friction characteristic, value n6	600 rpm
p3827[D]	Friction characteristic, value n7	1200 rpm
p3828[D]	Friction characteristic, value n8	1500 rpm
p3829[D]	Friction characteristic, value n9	3000 rpm
p3830[D]	Friction characteristic, value M0	0 Nm
p3831[D]	Friction characteristic, value M1	0 Nm
p3832[D]	Friction characteristic, value M2	0 Nm
p3833[D]	Friction characteristic, value M3	0 Nm
p3834[D]	Friction characteristic, value M4	0 Nm
p3835[D]	Friction characteristic, value M5	0 Nm
p3836[D]	Friction characteristic, value M6	0 Nm
p3837[D]	Friction characteristic, value M7	0 Nm
p3838[D]	Friction characteristic, value M8	0 Nm
p3839[D]	Friction characteristic, value M9	0 Nm
r3840.0...8	CO/BO: Friction characteristic status word	-
r3841	CO: Friction characteristic, output	- Nm
p3842	Activate friction characteristic	0
p3845	Activate friction characteristic plot	0
p3846[D]	Friction characteristic plot ramp-up/ramp-down time	10 s
p3847[D]	Friction characteristic plot warm-up period	0 s

Further information on this topic is provided in the List Manual.

8.21.2.6 Moment of inertia estimator

Overview

From the load moment of inertia and the speed setpoint change, the converter calculates the accelerating torque required for the motor. Via the speed controller precontrol, the accelerating torque specifies the main percentage of the torque setpoint. The speed controller corrects inaccuracies in the precontrol (feed-forward control).

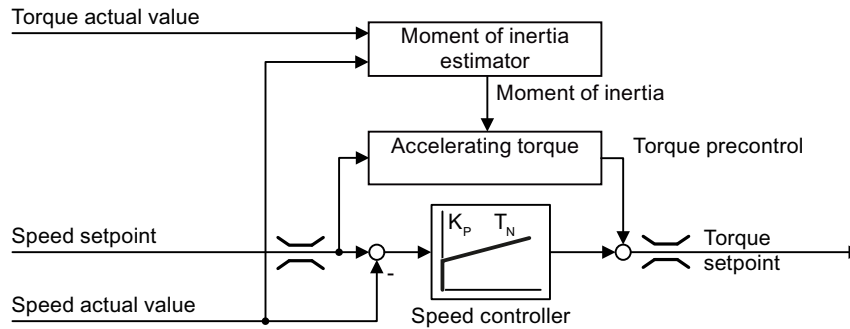

Figure 8-52 Influence of the moment of inertia estimator on the speed control

The more precise the value of the moment of inertia in the converter, the lower the overshoot after speed changes.

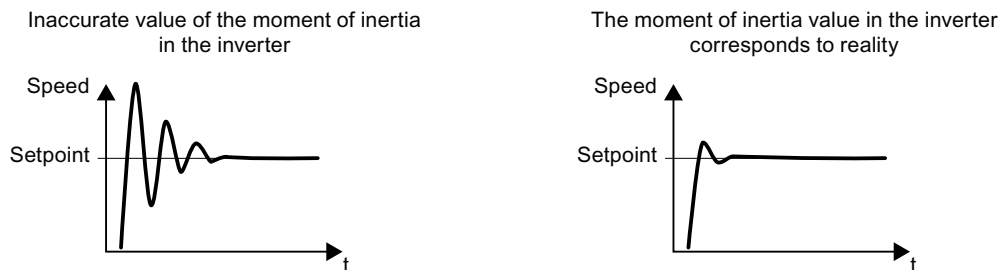

Figure 8-53 Influence of the moment of inertia on the speed

Function description

The converter calculates the total moment of inertia of the load and motor. The calculation comprises the following components:

- Current speed
- Actual motor torque
- Reduce the load

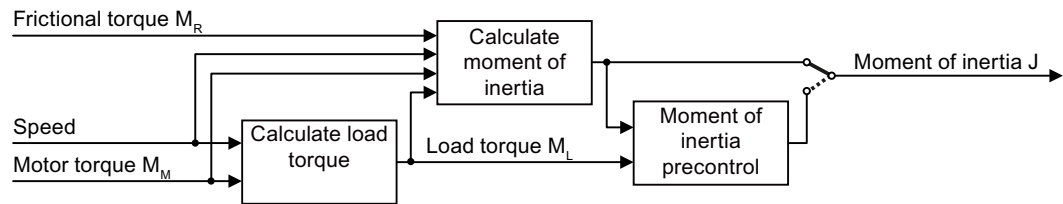

Figure 8-54 Overview of the function of the moment of inertia estimator

When using the moment of inertia estimator, we recommend that you also activate the friction characteristic.



Friction characteristic (Page 361)

How does the converter calculate the load torque?

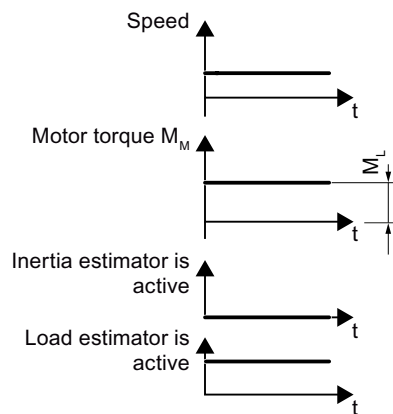

Figure 8-55 Calculating the load torque

At low speeds, the converter calculates the load torque M_L from the actual motor torque.

The calculation takes place under the following conditions:

- Speed $\geq p1226$
- Acceleration setpoint $< 8 \text{ 1/s}^2$ (Δ speed change 480 rpm per s)
- Acceleration \times moment of inertia (r1493) $< 0.9 \times p1560$

How does the converter calculate the moment of inertia?

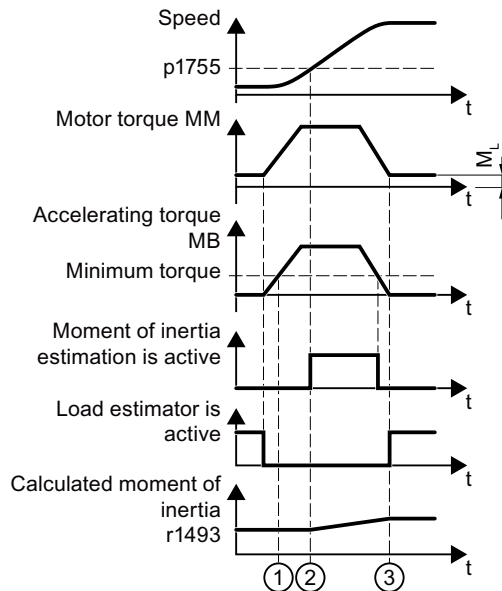

Figure 8-56 Calculating the moment of inertia

For higher speed changes, the converter initially calculates the accelerating torque M_B as difference between the motor torque M_M , load torque M_L and frictional torque M_R :

$$M_B = M_M - M_L - M_R$$

Moment of inertia J of the motor and load is obtained from the accelerating torque M_B and angular acceleration α (α = rate at which the speed changes):

$$J = M_B / \alpha$$

If all of the following conditions are met, the converter calculates the moment of inertia:

- ① The rated accelerating torque M_B must satisfy the following two conditions:
 - The sign of M_B is the same as the direction of the actual acceleration
 - $M_B > p1560 \times$ rated motor torque (r0333)
- ② speed > p1755
- The converter has calculated the load torque in at least one direction of rotation.
- Acceleration setpoint > 8 1/s^2 (\triangleq speed change 480 rpm per s)
- ③ The converter calculates the load torque again after acceleration.

Moment of inertia precontrol

In applications where the motor predominantly operates with a constant speed, the converter can only infrequently calculate the moment of inertia using the function described above. Moment of inertia precontrol is available for situations such as these. The moment of inertia precontrol assumes that there is an approximately linear relationship between the moment of inertia and the load torque.

Example: For a horizontal conveyor, in a first approximation, the moment of inertia depends on the load.

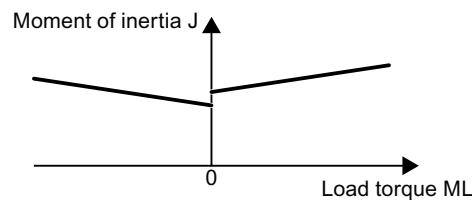

Figure 8-57 Moment of inertia precontrol

The relationship between load torque and torque is saved in the converter as linear characteristic.

- In a positive direction of rotation:
Moment of inertia $J = p5312 \times \text{load torque } M_L + p5313$
- In a negative direction of rotation:
Moment of inertia $J = p5314 \times \text{load torque } M_L + p5315$

You have the following options to determine the characteristic:

- You already know the characteristic from other measurements. In this case, you must set the parameters to known values when commissioning the system.
- The converter iteratively determines the characteristic by performing measurements while the motor is operational.

Activating the moment of inertia estimator

The moment of inertia estimator is deactivated in the factory setting. $p1400.18 = 0$, $p1400.20 = 0$, $p1400.22 = 0$.

If you performed the rotating measurement for the motor identification during quick commissioning, we recommend leaving the moment of inertia estimator deactivated.

Requirements

- You have selected sensorless vector control.
- The load torque must be constant whilst the motor accelerates or brakes.
Typical of a constant load torque are conveyor applications and centrifuges, for example. Fan applications, for example, are not permitted.
- The speed setpoint is free from superimposed unwanted signals.
- The motor and load are connected to each other with an interference fit.
Drives with slip between the motor shaft and load are not permitted, e.g. as a result of loose or worn belts.

If the preconditions are not met, you must not activate the moment of inertia estimator.

Procedure

1. Set $p1400.18 = 1$
2. Check: $p1496 \neq 0$
3. Activate the acceleration model of the speed controller pre-control: $p1400.20 = 1$.

You have activated the moment of inertia estimator.



Parameter

The most important settings

Parameter	Description	Factory setting
r0333[M]	Rated motor torque	- Nm
p0341[M]	Motor moment of inertia	0 kgm ²
p0342[M]	Ratio between the total and motor moments of inertia	1
p1400[D]	Speed control configuration	0000 0000 0000 0000 1000 0000 0010 0001 bin
r1407.0...27	CO/BO: Status word, speed controller	-
r1493	CO: Total moment of inertia, scaled	- kgm ²
p1496[D]	Acceleration precontrol scaling	0%
p1498[D]	Load moment of inertia	0 kgm ²
p1502[C]	BI: Freezing the moment of inertia estimator	0
p1755[D]	Motor model changeover speed encoderless operation	210000 rpm

Advanced settings

Parameter	Description	Factory setting
p1226[D]	Speed threshold for standstill detection	20 rpm
p1560[D]	Moment of inertia estimator accelerating torque threshold value	10%
p1561[D]	Moment of inertia estimator change time moment of inertia	500 ms
p1562[D]	Inertia estimator, change time, load	10 ms
p1563[D]	CO: Moment of inertia estimator load torque positive direction of rotation	0 Nm
p1564[D]	CO: Moment of inertia estimator load torque negative direction of rotation	0 Nm
p5310[D]	Moment of inertia precontrol configuration	0000 bin
r5311[D]	Moment of inertia precontrol status word	-
p5312[D]	Moment of inertia precontrol linear positive	0 s ²
p5313[D]	Moment of inertia precontrol constant positive	0 kgm ²
p5314[D]	Moment of inertia precontrol linear negative	0 s ²
p5315[D]	Moment of inertia precontrol constant negative	0 kgm ²

8.21.3 Torque control

Overview

Torque control is part of the vector control and normally receives its setpoint from the speed controller output. By deactivating the speed controller and directly entering the torque setpoint, the closed-loop speed control becomes closed-loop torque control. The converter then no longer controls the motor speed, but the torque that the motor generates.

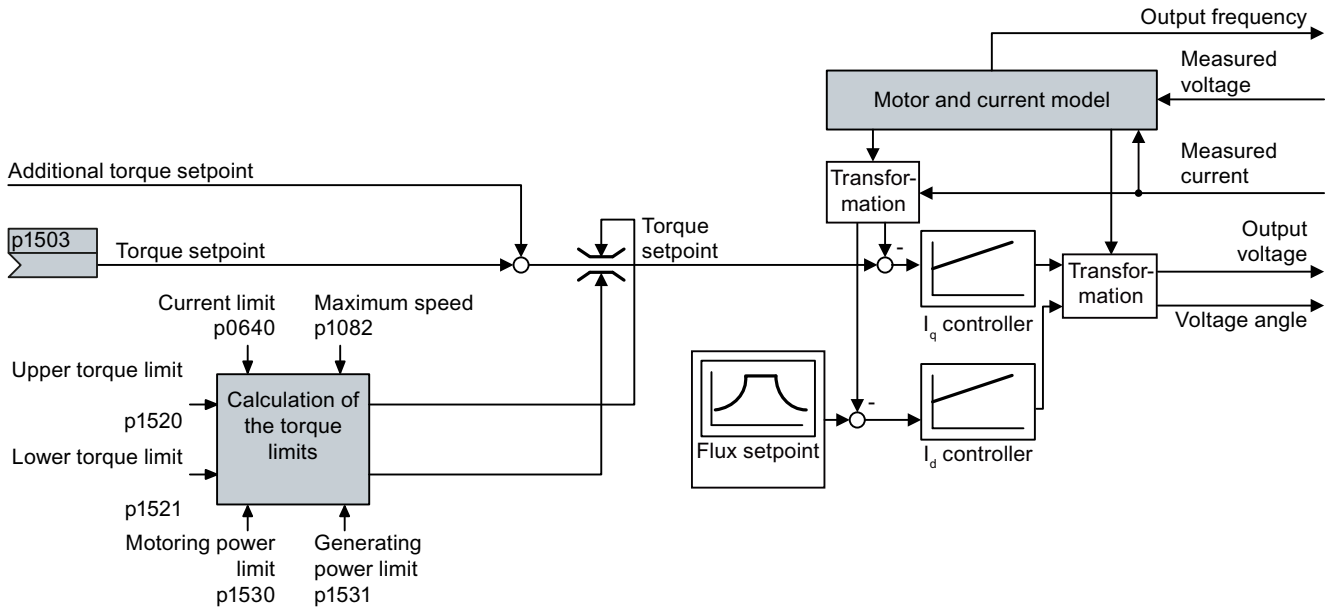

Figure 8-58 Simplified function diagram of the closed-loop torque control

Function description

Typical applications for torque control

The torque control is used in applications where the motor speed is specified by the connected driven load. Examples of such applications include:

- Load distribution between master and follower drives:
The master drive is speed controlled, the follower drive is torque controlled.
- Winding machines

The most important settings

Preconditions for the correct functioning of the torque control:

- You have set the motor data correctly during the quick commissioning  Commissioning (Page 147)
- You have performed a motor data identification on the cold motor



Parameter

Parameter	Description	Factory setting
p0300 ... p0360	Motor data is transferred from the motor type plate during quick commissioning and calculated with the motor data identification	-
p1300[D]	Open-loop/closed-loop control operating mode	0
p1511[C]	CI: Supplementary torque 1	0
p1520[D]	CO: Torque limit, upper	0 Nm
p1521[D]	CO: Torque limit, lower	0 Nm
p1530[D]	Power limit, motoring	0 kW
p1531[D]	Power limit, generating	-0.01 kW

Additional information about this function is provided in the parameter list and in function diagrams 6030 ff in the List Manual.

8.21.4 Application examples for closed-loop motor control

Additional information for setting the closed-loop motor control in certain applications is provided in the Internet:

-  Engineering and commissioning series lifting equipment/cranes (<https://support.industry.siemens.com/cs/de/en/view/103156155>)
-  Commissioning a compressor with closed-loop pressure control (<https://support.industry.siemens.com/cs/ww/en/view/77491582>)

8.22 Electrically braking the motor

Overview



Braking with the motor in generating mode

If the motor brakes the connected load electrically, it converts the kinetic energy of the motor into electrical energy. The electrical energy E released when braking the load is proportional to the moment of inertia J of the motor and load and to the square of the speed n . The motor attempts to transfer the energy on to the converter.

Main features of the braking functions

DC braking

DC braking prevents the motor from transferring braking energy to the converter. The converter impresses a DC current into the motor, therefore braking the motor. The motor converts braking energy E of the load into heat.

- *Advantage:* The motor brakes the load without the converter having to process regenerative power.
- *Disadvantages:* Significant increase in the motor temperature; no defined braking characteristics; no constant braking torque; no braking torque at standstill; braking energy E is lost as heat; does not function when the power fails

Compound braking

One version of DC braking. The converter brakes the motor with a defined ramp-down time and superimposes a DC current on the output current.

Dynamic braking

Using a braking resistor, the converter converts the electrical energy into heat.

- *Advantages:* Defined braking response; motor temperature does not increase any further; constant braking torque
- *Disadvantages:* Braking resistor required; braking energy E is lost in the form of heat

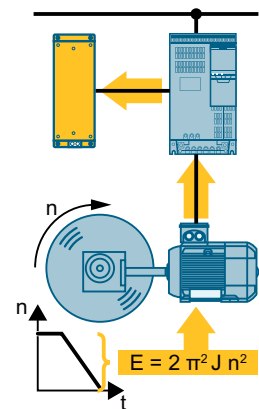
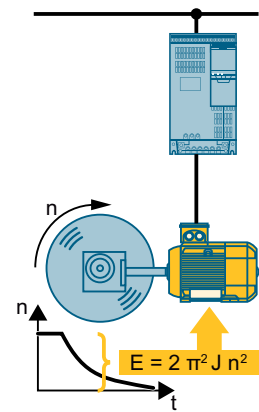

Braking with energy recovery into the line supply

The converter feeds electrical energy back into the line supply (energy recovery).

- *Advantages:* Constant braking torque; the braking energy E is not completely converted into heat, but regenerated back into the line supply; suitable for all applications; continuous regenerative operation is possible - e.g. when lowering a suspended load
- *Disadvantage:* Does not function with a power failure

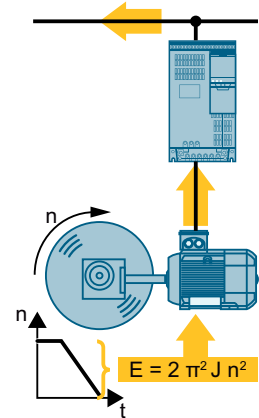
**Which Power Module permits which braking method?**

Electrical braking method	Power Modules that can be used
DC braking, compound braking	PM240-2, PM240P-2
Dynamic braking	PM240-2
Braking with energy recovery into the line supply	PM250

8.22.1 DC braking

Overview

DC braking is used for applications where the motor must be actively braked, but where the converter is neither capable of energy recovery nor does it have a braking resistor.

Typical applications for DC braking include:

- Centrifuges
- Saws
- Grinding machines
- Conveyor belts

DC braking is not permissible in applications involving suspended loads, e.g. lifting equipment/cranes and vertical conveyors.

Requirement

The DC braking function is possible only for induction motors.

NOTICE
Motor overheating as a result of DC braking
The motor will overheat if you use DC braking too frequently or use it for too long. This may damage the motor.
<ul style="list-style-type: none">• Monitor the motor temperature.• Allow the motor to adequately cool down between braking operations.• If necessary, select another motor braking method.

Function description

With DC braking, a constant braking current flows through the motor. As long as the motor is rotating, the DC current generates a braking torque.

The following configurations are available for DC braking:

- DC braking initiated by a control command
- DC braking when falling below a starting speed
- DC braking when the motor is switched off

Regardless of the configuration, you also can define the DC braking as a reaction to certain converter faults.

⚠ WARNING

Unexpected motor acceleration

In the following configurations, the converter can accelerate the motor to the set speed without requiring a further ON command:

- DC braking initiated by a control command
- DC braking when falling below a starting speed

An unexpected acceleration of the motor can cause serious injury or material damage.

- Consider the behavior of the drive in the higher-level controller.

DC braking initiated by a control command

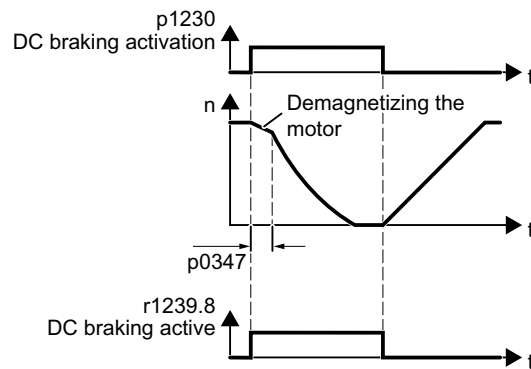

Figure 8-59 Activating DC braking via a control command

Set p1231 = 4 and p1230 = control command.

The control command "DC braking activation" activates and deactivates the DC braking:

- 1 signal:
 - The converter de-energizes the motor for the motor de-excitation time p0347 in order to demagnetize the motor.
 - The converter activates the DC braking.
- 0 signal: The drive switches back to normal operation.

DC braking when falling below a starting speed

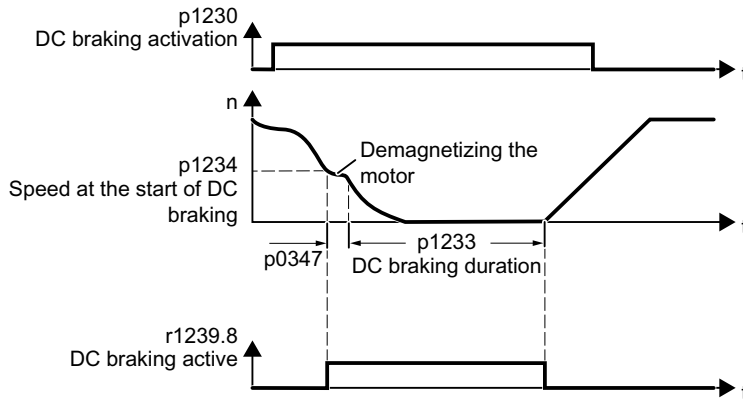

Figure 8-60 DC braking when falling below a starting speed

Set p1231 = 14 and p1230 = control command.

With an active DC braking command (p1230 = 1 signal), the following occurs:

1. If motor speed < starting speed p1234:
The converter de-energizes the motor for the motor de-excitation time p0347 in order to demagnetize the motor.
2. The converter activates the DC braking.
3. The drive switches back to normal operation if at least one of the following conditions has been fulfilled:
 - "DC braking duration" p1233 has expired.
 - The DC braking command is inactive (p1230 = 0 signal).

DC braking when the motor is switched off

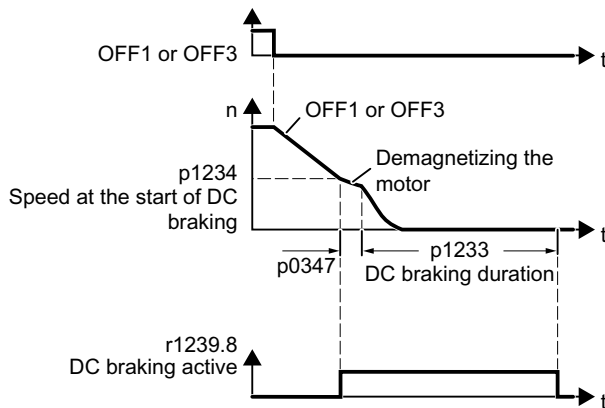

Figure 8-61 DC braking when the motor is switched off

Set p1231 = 5.

The following occurs after an OFF1 or OFF3 command:

1. The motor brakes along the OFF1 or OFF3 deceleration ramp to starting speed p1234.
2. The converter de-energizes the motor for the motor de-excitation time p0347 in order to demagnetize the motor.
3. The converter activates the DC braking.
4. After "DC braking duration" p1233 expires, the converter de-energizes the motor.

If the OFF1 command is deactivated before "DC braking duration" p1233 expires, the converter terminates the DC braking and switches to normal operation.

DC braking as reaction to a fault

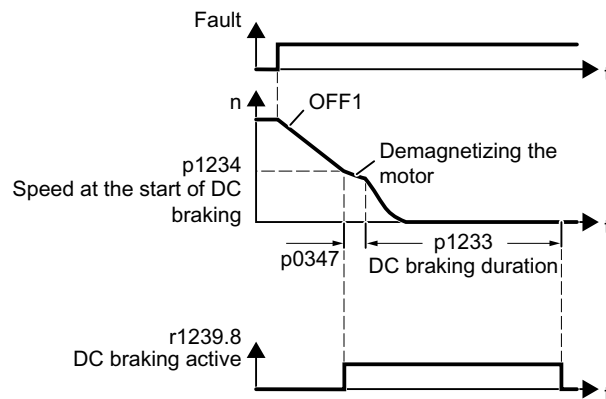

Figure 8-62 DC braking as a fault reaction

Set p2101[x] = 6 and p2100[x] to the corresponding fault code.

If you have defined the DC braking as a reaction to a fault, then the following will occur:

1. The converter brakes the motor with OFF1.
2. The converter de-energizes the motor for the motor de-excitation time p0347 in order to demagnetize the motor.
3. The converter activates the DC braking.
4. After "DC braking duration" p1233 expires, the converter de-energizes the motor.

Parameter

Settings for DC braking

Parameter	Description	Factory setting
p0347[M]	Motor de-excitation time	0 s
p1230[C]	BI: DC braking activation	0
p1231[M]	Configuring DC braking	0
p1232[M]	DC braking, braking current	0 Arms
p1233[M]	DC braking duration	1 s
p1234[M]	Speed at the start of DC braking	210000 rpm
r1239[8...13]	CO/BO: DC braking status word	-

Table 8-62 Configuring DC braking as a response to faults

Parameter	Description	Factory setting
p2100[0...19]	Changing the fault reaction, fault code	0
p2101[0...19]	Changing the fault reaction, reaction	0

8.22.2 Compound braking

Overview

Compound braking is suitable for applications in which the motor is normally operated at a constant speed and is only braked down to standstill in longer time intervals.

Typically, the following applications are suitable for compound braking:

- Centrifuges
- Saws
- Grinding machines
- Horizontal conveyors

Compound braking is not permissible for applications with suspended loads, e.g. lifting equipment/cranes all vertical conveyors.

Function description

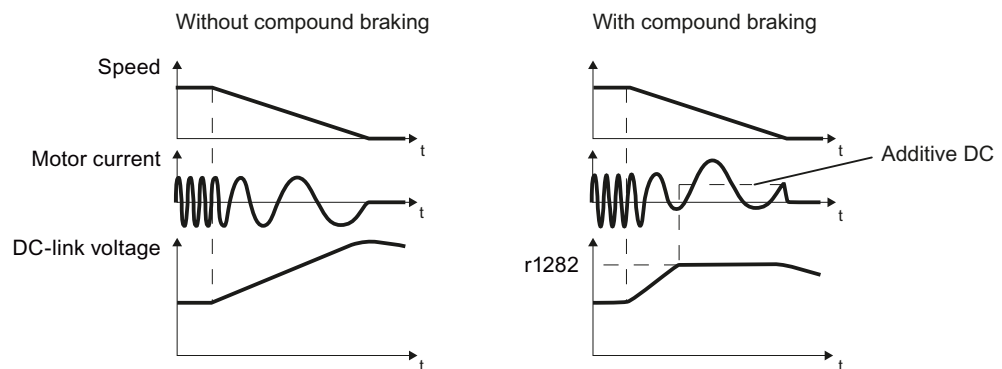

Figure 8-63 Motor brakes with and without active compound braking

Compound braking prevents the DC-link voltage increasing above a critical value. The converter activates compound braking depending on the DC-link voltage. Above a DC-link voltage threshold (r1282), the converter adds a DC current to the motor current. The DC current brakes the motor and prevents an excessive increase in the DC-link voltage.

Note

Compound braking is possible only with the U/f control.

Compound braking does not operate in the following cases:

- The "flying restart" function is active
- DC braking is active
- Vector control is selected

NOTICE
<p>Overheating of the motor due to compound braking</p> <p>The motor will overheat if you use compound braking too frequently or for too long. This may damage the motor.</p> <ul style="list-style-type: none"> • Monitor the motor temperature. • Allow the motor to adequately cool down between braking operations. • If necessary, select another motor braking method.

Parameter

Table 8-63 Setting and enabling compound braking

Parameter	Description	Factory setting
r1282	Vdc_max controller switch-on level (U/f)	- V
p3856[D]	Compound braking current (%)	0%
r3859.0	CO/BO: Compound braking/equal quantity control status word	-

8.22.3 Dynamic braking

Overview

Dynamic braking processes the regenerative power that occurs during braking of the motor. In this way, the converter can accelerate and brake the motor with the same dynamic response.

The following are typical applications for dynamic braking:

- Centrifuge
- Horizontal conveyors
- Vertical and inclined conveyors
- Hoisting gear

Requirement

You are using a PM240-2 power module and a braking resistor.

Function description

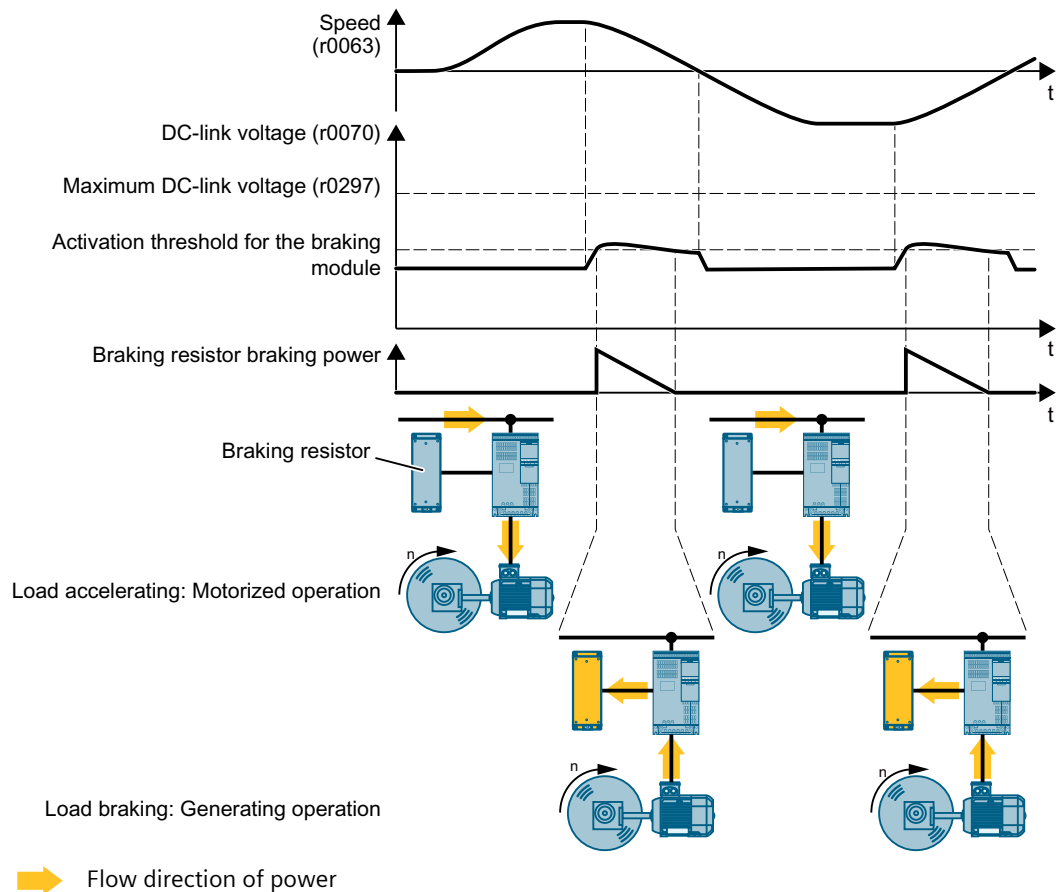

Figure 8-64 Simplified representation of dynamic braking when a motor is reversed

The motor supplies regenerative power to the converter when braking. The regenerative power means that the DC-link voltage in the converter increases. Above the activation threshold for the braking module, the converter forwards the regenerative power to the braking resistor. The braking resistor converts the regenerative power into heat, thereby preventing converter faults due to excessive DC-link voltage.

Factory setting for the activation threshold for the braking module:

- 690 V converter: 1120 V
- 400 V converters: 760 V
- 200 V converter: 385 V

NOTICE
Overload of motor insulation during braking
When the motor brakes, the DC-link voltage, and thus also the voltage load of the motor, increases. Particularly when you operate a 500 V motor on a 690 V converter, the converter can overload the motor insulation and damage the motor.
<ul style="list-style-type: none">• Reduce the activation threshold for the braking module

Procedure

1. Setting the braking power

Using p0219, you define the maximum braking power that the braking resistor must absorb.

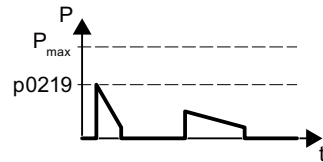

P_{max} Maximum braking power of the braking resistor

p021 Maximum braking power of the application

9

Figure 8-65 Example of maximum braking power in an application

p0219 > 0 activates dynamic braking.

Boundary conditions for p0219:

- p0219 is too low:
The converter cannot fully convert the generated braking power into heat. The converter extends the ramp-down time of the motor in order to reduce the braking power.
- p0219 > maximum braking power of the braking resistor:
The temperature monitoring of the braking resistor can trigger a converter fault.
 Monitoring the temperature of the braking resistor (Page 146)

You can find the maximum braking power of the braking resistor in the Hardware Installation Manual of the power module.

 Overview of the manuals (Page 564)

The SIZER PC tool supports you when calculating the maximum braking power.

 Configuring support (Page 566)

2. If necessary: Reduce the activation threshold for the braking module

You can reduce the activation threshold for the braking module for the following converters:

- 690 V converter
- 400 V converter

We recommend the following settings, particularly when using a 500 V motor:

- Set p0212.8 = 1
- Enter the rated value of the converter supply voltage in p0210.
Enter the voltage value at the intended place of use of the converter, if known, in p0210.

You have now set the dynamic braking.



Example

You can find an example for configuring and commissioning a drive with braking resistor on the Internet:

 Engineering and commissioning series lifting equipment/cranes (<https://support.industry.siemens.com/cs/de/en/view/103156155>)

Parameters

Parameter	Description	Factory setting
r0063	CO: Actual speed value	- rpm
r0070	CO: Actual DC link voltage value	- V
p0210	Device supply voltage	400 V
p0212	Power unit configuration	0000 0000 bin
p0219	Braking resistor braking power	0 kW
r0297	DC-link voltage overvoltage threshold	- V

Further information

Interaction with other functions

When you set the braking power of the braking resistor ($p0219 > 0$), the converter disables the V_{dc_max} control.

 Motor and converter protection by limiting the voltage (Page 395)

At the same time, $p0219$ defines the regenerative power limit $p1531$ for vector control.

 Structure of vector control without encoder (sensorless) (Page 354)

8.22.4 Braking with regenerative feedback to the line

Overview

The typical applications for braking with energy recovery (regenerative feedback into the line supply) are as follows:

- Hoist drives
- Centrifuges
- Unwinders

For these applications, the motor must brake for longer periods of time.

The converter can feed back up to 100% of its rated power into the line supply (referred to "High Overload" base load).

 Technical data, PM250 Power Module (Page 537)

Parameter

Setting the braking with regenerative feedback to the line

Parameter	Description	Factory setting
Limiting the regenerative feedback for U/f control (p1300 < 20)		
p0640[D]	Current limit	0 Arms
Limiting feedback with vector control (p1300 ≥ 20)		
p1531[D]	Power limit, generating	-0.01 kW

8.23 Overcurrent protection

Overview



The *U/f* control prevents too high a motor current by influencing the output frequency and the motor voltage (I-max controller).

Requirement

You have selected *U/f* control.

The application must allow the motor torque to decrease at a lower speed.

Function description

The I-max controller influences the output frequency and the motor voltage.

If the motor current reaches the current limit during acceleration, the I-max controller extends the acceleration operation.

If the motor load is so high during steady-state operation that the motor current reaches the current limit, then the I-max controller reduces the speed and the motor voltage until the motor current returns to the permissible range again.

If the motor current reaches the current limit during deceleration, the I-max controller extends the deceleration operation.

Changing the settings

The factory setting for proportional gain and the integral time of the I-max controller ensures faultless operation in the vast majority of cases.

The factory setting of the I-max controller must only be changed in the following exceptional cases:

- Speed or torque of the motor tend to cause vibrations upon reaching the current limit.
- The converter goes into the fault state with an overcurrent message.

Parameter

Number	Name	Factory setting
r0056.0 ... 13	CO/BO: Status word, closed-loop control	-
p0305[M]	Rated motor current	0 Arms
p0640[D]	Current limit	0 Arms
p1340[D]	I_max frequency controller proportional gain	0
p1341[D]	I_max frequency controller integral time	0.300 s
r1343	CO: I_max controller frequency output	- rpm

8.24 Converter protection using temperature monitoring

Overview



The converter temperature is essentially defined by the following effects:

- The ambient temperature
- The ohmic losses increasing with the output current
- Switching losses increasing with the pulse frequency

Monitoring types

The converter monitors its temperature using the following monitoring types:

- I²t monitoring (alarm A07805, fault F30005)
- Measuring the chip temperature of the Power Module (alarm A05006, fault F30024)
- Measuring the heat sink temperature of the Power Module (alarm A05000, fault F30004)

Function description

Overload response for p0290 = 0

The converter responds depending on the control mode that has been set:

- In vector control, the converter reduces the output current.
- In *U/f* control, the converter reduces the speed.

Once the overload condition has been removed, the converter re-enables the output current or speed.

If the measure cannot prevent a converter thermal overload, then the converter switches off the motor with fault F30024.

Overload response for p0290 = 1

The converter immediately switches off the motor with fault F30024.

Overload response for p0290 = 2

We recommend this setting for drives with square-law torque characteristic, e.g. fans.

The converter responds in 2 stages:

1. If you operate the converter with increased pulse frequency setpoint p1800, then the converter reduces its pulse frequency starting at p1800. In spite of the temporarily reduced pulse frequency, the base-load output current remains unchanged at the value that is assigned to parameter p1800.

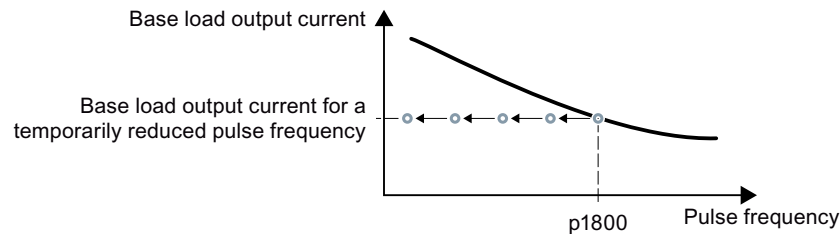

Figure 8-66 Derating characteristic and base load output current for overload

Once the overload condition has been removed, the converter increases the pulse frequency back to the pulse frequency setpoint p1800.

2. If it is not possible to temporarily reduce the pulse frequency, or the risk of thermal overload cannot be prevented, then stage 2 follows:
 - In vector control, the converter reduces its output current.
 - In U/f control, the converter reduces the speed.

Once the overload condition has been removed, the converter re-enables the output current or speed.

If both measures cannot prevent a power unit thermal overload, then the converter switches off the motor with fault F30024.

Overload response for p0290 = 3

If you operate the converter with increased pulse frequency, then the converter reduces its pulse frequency starting at the pulse frequency setpoint p1800.

In spite of the temporarily reduced pulse frequency, the maximum output current remains unchanged at the value that is assigned to the pulse frequency setpoint. Also see p0290 = 2.

Once the overload condition has been removed, the converter increases the pulse frequency back to the pulse frequency setpoint p1800.

If it is not possible to temporarily reduce the pulse frequency, or the measure cannot prevent a power unit thermal overload, then the converter switches off the motor with fault F30024.

Overload response for p0290 = 12

The converter responds in 2 stages:

1. If you operate the converter with increased pulse frequency setpoint p1800, then the converter reduces its pulse frequency starting at p1800.
There is no current derating as a result of the higher pulse frequency setpoint.
Once the overload condition has been removed, the converter increases the pulse frequency back to the pulse frequency setpoint p1800.
2. If it is not possible to temporarily reduce the pulse frequency, or the risk of converter thermal overload cannot be prevented, then stage 2 follows:
 - In vector control, the converter reduces the output current.
 - In U/f control, the converter reduces the speed.
 Once the overload condition has been removed, the converter re-enables the output current or speed.

If both measures cannot prevent a power unit thermal overload, then the converter switches off the motor with fault F30024.

Overload response for p0290 = 13

We recommend this setting for drives with a high starting torque.

If you operate the converter with increased pulse frequency, then the converter reduces its pulse frequency starting at the pulse frequency setpoint p1800.

There is no current derating as a result of the higher pulse frequency setpoint.

Once the overload condition has been removed, the converter increases the pulse frequency back to the pulse frequency setpoint p1800.

If it is not possible to temporarily reduce the pulse frequency, or the measure cannot prevent a power unit thermal overload, then the converter switches off the motor with fault F30024.

Parameters





Number	Name	Factory setting
r0036	CO: Power unit overload I2t	%
r0037[0...19]	Power unit temperatures	°C
p0290	Power unit overload response	2
p0292[0...1]	Power unit temperature alarm threshold	[0] 5 °C, [1] 15 °C
p0294	Power Module alarm for I2t overload	95%

8.25 Motor protection with temperature sensor

Overview



The converter can evaluate one of the following sensors to protect the motor against overtemperature:

- | | | |
|---|----------------------------|---|
|  | 14 T1 MOTOR
15 T2 MOTOR | • KTY84 sensor |
|  | 14 T1 MOTOR
15 T2 MOTOR | • Temperature switch (e.g. bimetallic switch) |
|  | 14 T1 MOTOR
15 T2 MOTOR | • PTC sensor |
|  | 14 T1 MOTOR
15 T2 MOTOR | • Pt1000 sensor |

Function description

KTY84 sensor

NOTICE

Overheating of the motor due to KTY sensor connected with the incorrect polarity

If a KTY sensor is connected with incorrect polarity, the motor can be damaged by overheating, as the converter cannot detect a motor overtemperature condition.

- Connect the KTY sensor with the correct polarity.



Using a KTY sensor, the converter monitors the motor temperature and the sensor itself for wire-break or short-circuit:

- Temperature monitoring:
The converter uses a KTY sensor to evaluate the motor temperature in the range from $-48\text{ °C} \dots +248\text{ °C}$.
Set the temperature for the alarm and fault thresholds with parameter p0604 or p0605.
 - Overtemperature alarm (A07910):
- motor temperature > p0604 and p0610 = 0
 - Overtemperature fault (F07011):
The converter responds with a fault in the following cases:
 - motor temperature > p0605
 - motor temperature > p0604 and p0610 > 0
- Sensor monitoring (A07015 or F07016):
 - Wire-break:
The converter interprets a resistance > 2120 Ω as a wire-break and outputs the alarm A07015. After 100 milliseconds, the converter changes to the fault state with F07016.
 - Short-circuit:
The converter interprets a resistance < 50 Ω as a short-circuit and outputs the alarm A07015. After 100 milliseconds, the converter changes to the fault state with F07016.

Temperature switch



The converter interprets a resistance $\geq 100 \Omega$ as an opened bimetallic switch and responds according to the setting for p0610.

PTC sensor



The converter interprets a resistance $> 1650 \Omega$ as being an overtemperature condition and responds according to the setting of p0610.

The converter interprets a resistance $< 20 \Omega$ as being a short-circuit and responds with alarm A07015. If the alarm is present for longer than 100 milliseconds, the converter shuts down with fault F07016.

Pt1000 sensor



Using a Pt1000 sensor, the converter monitors the motor temperature and the sensor itself for wire breakage and/or short-circuit:

- Temperature monitoring:
 - Using a Pt1000 sensor, the converter evaluates the motor temperature in the range from $-48 \text{ }^\circ\text{C}$... $+248 \text{ }^\circ\text{C}$.
 - Set the temperature for the alarm and fault thresholds with parameter p0604 or p0605.
 - Overtemperature alarm (A07910):
 - motor temperature $> p0604$ and $p0610 = 0$
 - Overtemperature fault (F07011):
 - The converter responds with a fault in the following cases:
 - motor temperature $> p0605$
 - motor temperature $> p0604$ and $p0610 > 0$
- Sensor monitoring (A07015 or F07016):
 - Wire-break:
 - The converter interprets a resistance $> 2120 \Omega$ as a wire-break and outputs the alarm A07015. After 100 milliseconds, the converter changes to the fault state with F07016.
 - Short-circuit:
 - The converter interprets a resistance $< 603 \Omega$ as a short-circuit and outputs the alarm A07015. After 100 milliseconds, the converter changes to the fault state with F07016.

Parameters

Number	Name	Factory setting
p0335[M]	Type of motor cooling	0
p0601[M]	Motor temperature sensor type	0
p0604[M]	Mot_temp_mod 2/sensor alarm threshold	130 °C
p0605[M]	Mot_temp_mod 1/2/sensor threshold and temperature value	145 °C
p0610[M]	Motor overtemperature response	12
p0640[D]	Current limit	0 Arms

8.26 Motor protection by calculating the temperature

Overview



The converter calculates the motor temperature based on a thermal motor model. After commissioning, the converter sets the thermal motor type to match the motor.

The thermal motor model responds far faster to temperature increases than a temperature sensor.

If the thermal motor model is used together with a temperature sensor, e.g. a Pt1000, then the converter corrects the model according to the measured temperature.

Function description

Thermal motor model 2 for induction motors

The thermal motor model 2 for induction motors is a thermal 3-mass model, consisting of stator core, stator winding and rotor. Thermal motor model 2 calculates the temperatures - both in the rotor as well as in the stator winding.

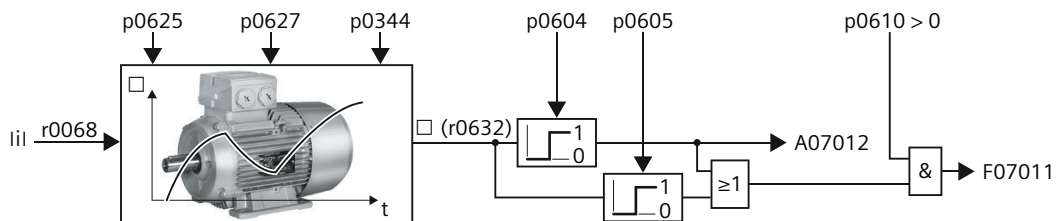

Figure 8-67 Thermal motor model 2 for induction motors

Parameter

Table 8-64 Thermal motor model 2 for induction motors

Number	Name	Factory setting
r0068[0 ... 1]	CO: Absolute actual current value	- Arms
p0344[M]	Motor weight (for thermal motor model)	0 kg
p0604[M]	Mot_temp_mod 2/KTY alarm threshold	130 °C
p0605[M]	Mot_temp_mod 1/2/sensor threshold and temperature value	145 °C
p0610[M]	Motor overtemperature response	12
p0612[M]	Mot_temp_mod activation	0000 0010 0000 0010 bin
p0625[M]	Motor ambient temperature during commissioning	20 °C
p0627[M]	Motor overtemperature, stator winding	80 K
r0632[M]	Mot_temp_mod stator winding temperature	- °C
p0640[D]	Current limit	0 Arms

Thermal motor model 1 for synchronous motors

Further information about thermal motor model 1 for synchronous motors is provided in the function charts 8016 and 8017 of the List Manual.

8.27 How do I achieve a motor overload protection in accordance with IEC/UL 61800-5-1?

Overview

The thermal motor model of the converter fulfills motor overload protection according to IEC/UL 61800-5-1.

For motor overload protection according to IEC/UL 61800-5-1, some parameters of the thermal motor model may also need to be adjusted.

Requirement

You have correctly entered the motor data during quick commissioning.

NOTICE

Thermal overload of third-party motors due to a trip threshold that is too high

With a Siemens motor, the converter sets the trip threshold of the thermal motor model to match the motor. With a third-party motor, the converter cannot ensure in every case that the trip threshold is exactly right for the motor. A trip threshold that is set too high can lead to a thermal overload, thus causing damage to the motor.

- If required for a third-party motor, reduce the corresponding trip threshold p0605, p0615, or p5391.

Procedure

1. Set p0610 = 12.
2. Set the following parameters depending on the motor:
 - Induction motor:
 - p0612.1 = 1
 - p0612.9 = 1
 - For a motor without temperature sensor: p0625 = 40 °C
 - Synchronous motor
 - p0612.0 = 1
 - p0612.8 = 1
 - For a motor without temperature sensor: p0613 = 40 °C

The trip threshold p0605, p0615 or p5391 parameterized in the motor data set may not be increased.

Changing additional parameters of the thermal motor model can lead to the converter no longer satisfying the motor overload protection in accordance with IEC/UL 61800-5-1.

8.28 Motor and converter protection by limiting the voltage

Overview



An electric motor converts electrical energy into mechanical energy to drive the load. If the motor is driven by its load, e.g. by the inertia of the load during braking, the energy flow reverses: The motor operates temporarily as a generator, and converts mechanical energy into electrical energy. The electrical energy flows from the motor to the converter. If the converter cannot output the electrical energy supplied by the motor, e.g. to a braking resistor, then the converter stores the energy in its DC link capacitance. As a consequence, the DC link voltage V_{dc} in the converter is higher.

An excessively high DC link voltage damages both the converter and the motor. The converter therefore monitors its DC-link voltage and, when necessary, switches off the connected motor and outputs the fault "DC-link overvoltage".

Function description

Protecting the motor and converter against overvoltage

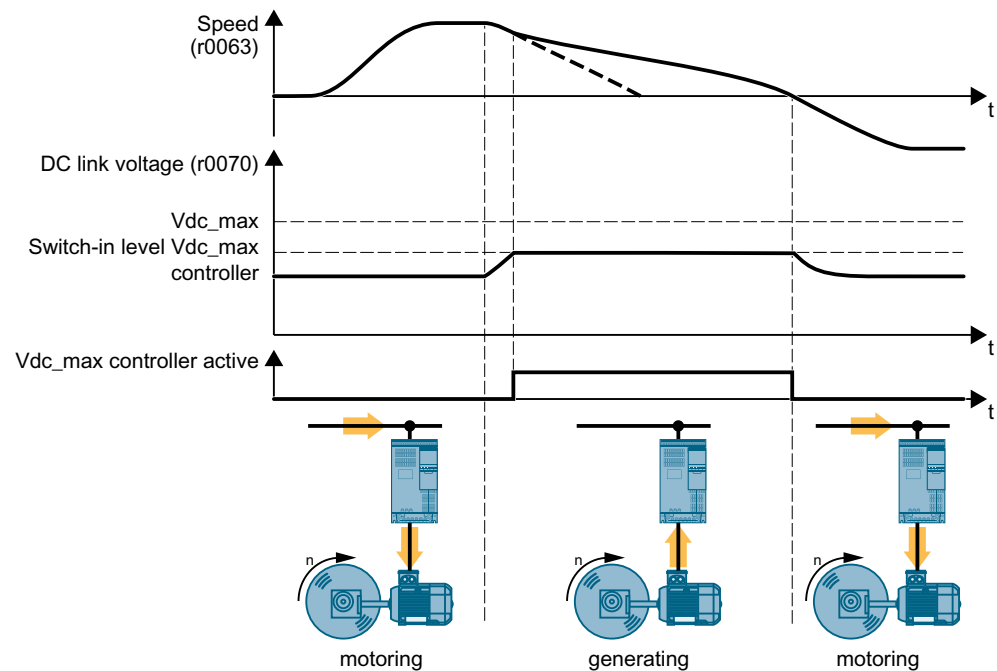

Figure 8-68 Simplified representation of the V_{dc_max} control

The V_{dc_max} control lengthens the motor ramp-down time when braking. Consequently, the motor feeds only so much energy back into the converter to cover the losses in the converter. The DC link voltage remains within the permissible range.

The V_{dc_max} control is not suitable for applications where the motor is in continuous regenerative operation, e.g. as is the case for cranes and centrifuges.



Electrically braking the motor (Page 372)

8.28 Motor and converter protection by limiting the voltage

The Vdc_max control can be used only with the PM230, PM240-2 and PM240P-2 Power Modules. The Vdc_max control is not required if you use a braking resistor.

PM250 Power Modules feed back regenerative energy into the line supply. Therefore, the Vdc_max control is not required for a PM250 Power Module.

Parameter

The parameters differ depending on the motor control mode.

Table 8-65 Parameters for U/f control

Parameter	Description	Factory setting
p0210	Device supply voltage	400 V
p1280[D]	Vdc controller configuration (U/f)	1
r1282	Vdc_max controller switch-on level (U/f)	- V
p1283[D]	Vdc_max controller, dynamic factor (U/f)	100%
p1284[D]	Vdc_max controller time threshold (U/f)	4 s
p1290[D]	Vdc controller proportional gain (U/f)	1
p1291[D]	Vdc controller integral time (U/f)	40 ms
p1292[D]	Vdc controller derivative-action time (U/f)	10 ms
p1294	Vdc_max controller automatic ON level detection (U/f)	0

Table 8-66 Parameters for vector control

Parameter	Description	Factory setting
p0210	Device supply voltage	400 V
p1240[D]	Vdc controller configuration (vector control)	1
r1242	Vdc_max controller switch-in level	- V
p1243[D]	Vdc_max controller, dynamic factor	100%
p1250[D]	Vdc controller proportional gain	1
p1251[D]	Vdc controller integral time	0 ms
p1252[D]	Vdc controller derivative-action time	0 ms
p1254	Vdc_max controller automatic ON level detection	0

For further information about this function, see function diagram in the List Manual.

8.29 Monitoring the driven load



In many applications, the speed and the torque of the motor can be used to determine whether the driven load is in an impermissible operating state. The use of an appropriate monitoring function in the converter prevents failures and damage to the machine or plant.

Examples:

- For fans or conveyor belts, an excessively low torque can mean a broken drive belt.
- For pumps, insufficient torque can indicate a leakage or dry-running.
- For extruders and mixers, an excessive torque together with low speed can indicate machine blockage.

Functions for monitoring the driven load

The converter provides the following options to monitor the driven load based on the output current:

	<p>The stall protection recognizes a stalled asynchronous motor.</p>
	<p>The no-load monitoring evaluates the motor current. An insufficient current can mean that the motor cable is disconnected.</p>
	<p>The blocking protection triggers for a motor current that corresponds to the set current limit coupled with motor standstill.</p>
	<p>The torque monitoring assumes that a specific torque is associated with each speed for pumps and fans. Insufficient torque indicates that the motor and the load are no longer mechanically connected. An excessive torque can indicate problems in the mechanical system of the driven load, e.g. a mechanically blocked load.</p>
	<p>Blocking protection, leakage protection and dry-running protection are a monitoring method for pumps or fans. The monitoring combines a torque monitoring with a blocking protection.</p>

Monitoring the driven load using a binary signal:

	<p>The speed monitoring evaluates a periodic binary signal. A signal failure indicates that the motor and the load are no longer mechanically connected with each other.</p>
--	--

8.29.1 Stall protection

Function description

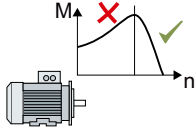

If the load of a standard induction motor exceeds the stall torque of the motor, the motor can also stall during operation on the converter. A stalled motor is stationary and does not develop sufficient torque to accelerate the load.

If the "Motor model fault signal stall detection" r1746 for the time p2178 is present via the "Motor model error threshold stall detection" p1745, the converter signals "Motor stalled" and fault F07902.

Parameter

Number	Name	Factory setting
r1408[0 ... 14]	CO/BO: Status word, current controller	-
p1745[D]	Motor model error threshold stall detection	5%
r1746	Motor model fault signal stall detection	- %
p2178[D]	Motor stalled delay time	0.01 s
r2198	CO/BO: Status word monitoring functions 2	-

See also

Blocking protection (Page 399)

8.29.2 No-load monitoring

Function description



An insufficient motor current indicates that the motor cable is disconnected.

If the motor current for the time p2180 lies below the current level p2179, the converter signals the alarm A07929.

Parameters

Number	Name	Factory setting
r0068[0 ... 1]	CO: Absolute actual current value	- Arms
p2179[D]	Output load detection current limit	0 Arms
p2180[D]	Output load detection delay time	2000 ms
r2197[0 ... 13]	CO/BO: Status word monitoring functions 1	-

8.29.3 Blocking protection

Function description



If the mechanical load is too high, the motor may block. For a blocked motor, the motor current corresponds to the set current limit without the speed reaching the specified setpoint.

If the speed lies below the speed threshold p2175 for the time p2177 while the motor current reaches the current limit, the converter signals "Motor blocked" and fault F07900.

Parameter

Number	Name	Factory settings
p0045	Display values of smoothing time constant	4 ms
r0063	CO: Speed actual value	- rpm
p2175[D]	Motor blocked speed threshold	120 rpm
p2177[D]	Motor blocked delay time	3 s
r2198	Status word monitoring functions 2	-

8.29.4 Torque monitoring

Function description

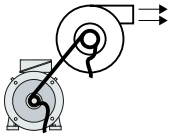

In applications with fans, pumps or compressors with the flow characteristic, the torque follows the speed according to a specific characteristic. An insufficient torque for fans indicates that the power transmission from the motor to the load is interrupted. For pumps, insufficient torque can indicate a leakage or dry-running.

The converter monitors the torque based on the envelope curve depending on the speed against a lower and upper torque.

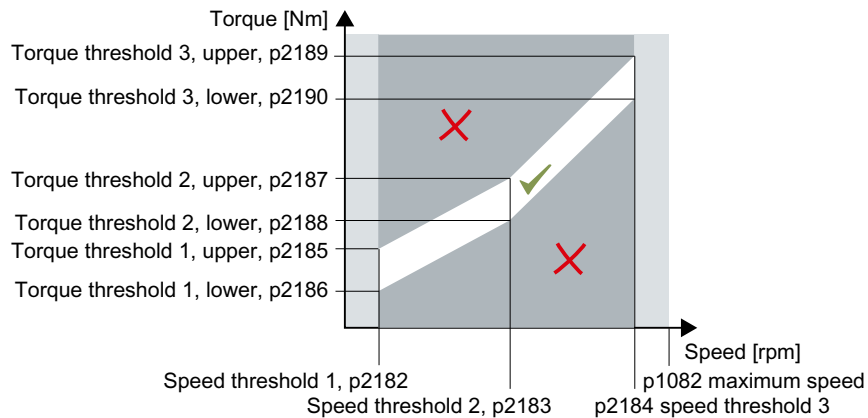

If the torque lies in the impermissible range longer than time p2192, the converter reacts as specified in p2181.

The monitoring is not active below speed threshold 1 and above speed threshold 3.

Setting monitoring

1. Operate the drive at three different speeds in succession.
2. Set the speed thresholds p2182 ... p2184 to the respective values.
3. Set the torque thresholds for each speed.
The converter displays the current torque in r0031.
4. Set p2193 = 1.

You have now set monitoring.



Parameter

Number	Name	Factory setting
r0031	Torque actual value, smoothed	-
p2181[D]	Load monitoring, response	0
p2182[D]	Load monitoring, speed threshold 1	150 rpm
p2183[D]	Load monitoring, speed threshold 2	900 rpm
p2184[D]	Load monitoring, speed threshold 3	1500 rpm

Number	Name	Factory setting
p2185[D]	Load monitoring, torque threshold 1, upper	10000000 Nm
p2186[D]	Load monitoring torque threshold 1, lower	0 Nm
p2187[D]	Load monitoring torque threshold 2, upper	10000000 Nm
p2188[D]	Load monitoring torque threshold 2, lower	0 Nm
p2189[D]	Load monitoring torque threshold 3, upper	10000000 Nm
p2190[D]	Load monitoring torque threshold 3, lower	0 Nm
p2191[D]	Load monitoring torque threshold, no load	0 Nm
p2192[D]	Load monitoring, delay time	10 s
p2193[D]	Load monitoring configuration	1

8.29.5 Blocking protection, leakage protection and dry-running protection

Overview

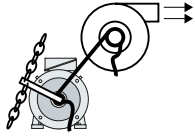

In applications with fans, pumps or compressors with the flow characteristic, the torque follows the speed according to a specific characteristic. An insufficient torque for fans indicates that the power transmission from the motor to the load is interrupted. For pumps, insufficient torque can indicate a leakage or dry-running.

Function description

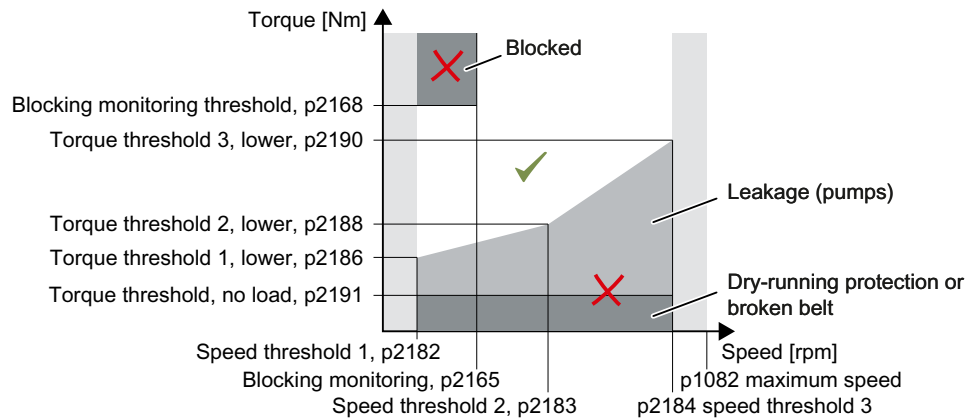

If the torque and speed lie in the impermissible range longer than time p2192, the converter reacts as specified in p2181.

For applications with pumps, the converter detects the following states of the driven load:

- Blocked
- Leakage
- Dry running

For applications with fans or compressors, the converter detects the following states of the driven load:

- Blocked
- Torn belt

The monitoring is not active below speed threshold 1 and above speed threshold 3.

When using the control mode "U/f control" ($p1300 < 10$), the "Blocking protection" function becomes active when the current limit is reached.



No-load monitoring (Page 398)

Setting pump monitoring

1. Set p2193 = 4.
2. The converter sets the monitoring as shown.

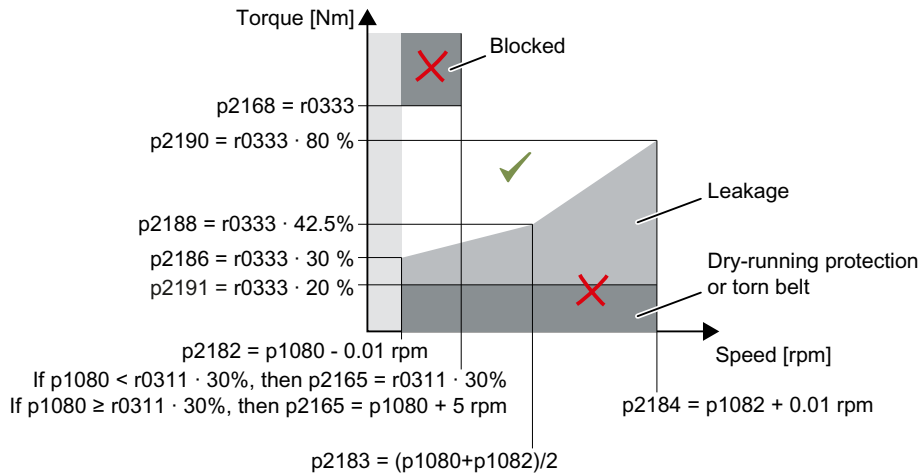

Figure 8-69 Default settings for pumps

3. The converter sets monitoring response p2181 = 7
4. If necessary, adjust the speed thresholds p2182 ... p2184.
5. If necessary, adjust the torque threshold for each speed. The converter displays the current torque in r0031.

You have now set monitoring.



Setting fan and compressor monitoring

1. Set p2193 = 5.
2. The converter sets the monitoring as shown.

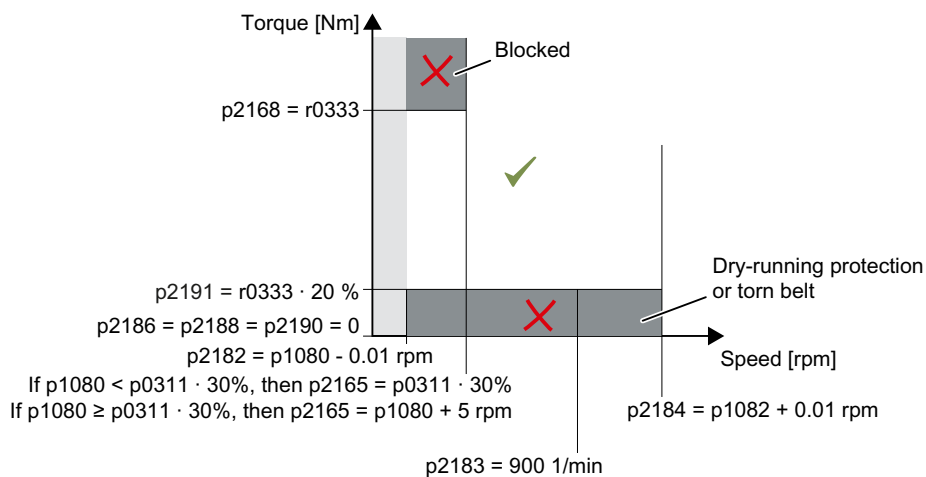

Figure 8-70 Default settings for fans and compressors

3. The converter sets monitoring response p2181 = 7

4. If necessary, adjust the speed thresholds p2182 ... p2184.
5. Set the torque threshold for each speed.
The converter displays the current torque in r0031.

You have now set monitoring.



Parameter

Number	Name	Factory setting
r0031	Torque actual value, smoothed	-
p0311[M]	Rated motor speed	0 rpm
r0333[M]	Rated motor torque	-
p1080[D]	Minimum speed	0 rpm
p1082[D]	Maximum speed	1500 rpm
p1300[D]	Open-loop/closed-loop control operating mode	See parameter list
p2165[D]	Load monitoring blocking monitoring threshold, upper	0 rpm
p2168[D]	Load monitoring blocking monitoring torque threshold	10000000 Nm
p2181[D]	Load monitoring, response	0
p2182[D]	Load monitoring, speed threshold 1	150 rpm
p2183[D]	Load monitoring, speed threshold 2	900 rpm
p2184[D]	Load monitoring, speed threshold 3	1500 rpm
p2186[D]	Load monitoring torque threshold 1, lower	0 Nm
p2188[D]	Load monitoring torque threshold 2, lower	0 Nm
p2190[D]	Load monitoring torque threshold 3, lower	0 Nm
p2191[D]	Load monitoring torque threshold, no load	0 Nm
p2192[D]	Load monitoring, delay time	10 s
p2193[D]	Load monitoring configuration	1

Further information

If you deselect monitoring with p2193 < 4, the converter then resets the load monitoring parameters to factory settings.

See also

Torque monitoring (Page 400)

8.29.6 Rotation monitoring

Function description

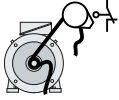

The converter monitors the speed or velocity of a machine component via an electromechanic or electronic encoder, e.g. a proximity switch. Examples of how the function can be used:

- Gearbox monitoring for traction drives and hoisting gear
- Drive belt monitoring for fans and conveyor belts
- Blocking protection for pumps and conveyor belts

The converter checks whether the encoder consistently supplies a 24 V signal during motor operation. If the encoder signal fails for time p2192, the converter signals fault F07936.

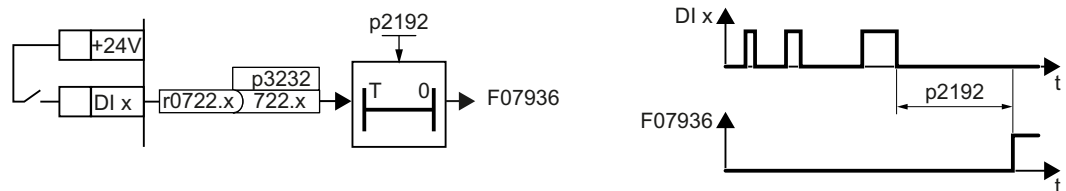

Figure 8-71 Function plan and time response of the speed monitoring

Parameter

Parameter	Description	Factory setting
r0722	CO/BO: CU digital inputs, status	-
p2192[D]	Load monitoring, delay time	10 s
p2193[D]	Load monitoring configuration	1
p3232[C]	BI: Load monitoring, failure detection	1

Additional information is provided in the List Manual (the parameter list and function diagram 8013).

Function diagrams

Torque monitoring (Page 400)

8.29.7 Speed deviation monitoring

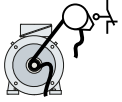

The converter calculates and monitors the speed or velocity of a machine component.

Examples of how the function can be used:

- Gearbox monitoring for traction drives and hoisting gear
- Drive belt monitoring for fans and conveyor belts
- Blocking protection for conveyor belts

You need an electronic sensor, e.g. a proximity switch, for the "Speed monitoring" function. The converter analyzes an encoder signal at max. 32 kHz.

The function is only available with the CU240E-2 Control Unit via digital input DI 3.

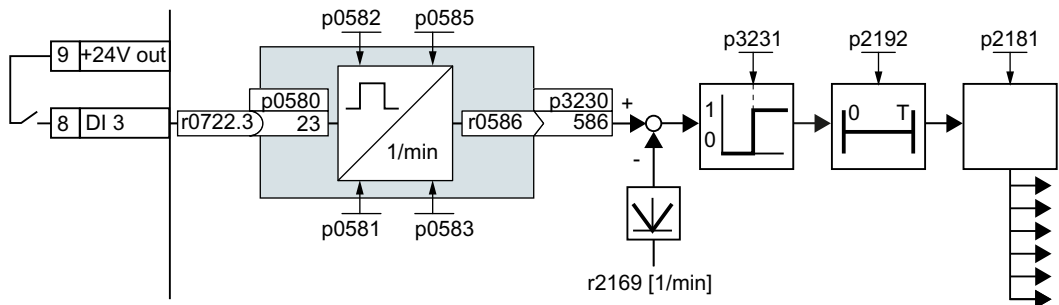

Figure 8-72 Speed deviation monitoring

Function description

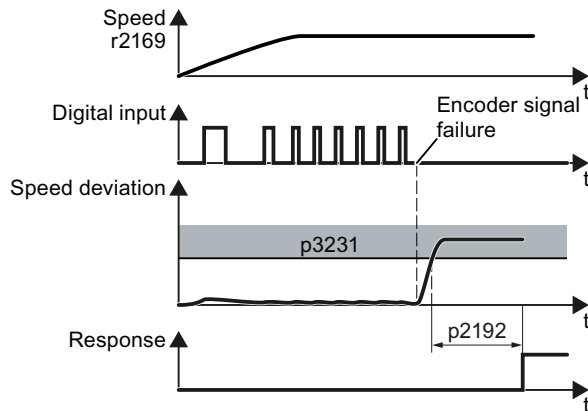

Figure 8-73 Time response of the speed monitoring

The converter compares speed r0586 with the actual speed value r2169 and signals an excessive deviation between the encoder signal and the motor speed. p2181 specifies the converter response for an excessive deviation.

¹⁾The "Probe" subfunction calculates the speed from the pulse signal of the digital input.

Additional information is provided in the List Manual (the parameter list and function diagram 8013).

Parameter

Parameter	Description	Factory setting
p0490	Invert measuring probe ¹⁾	0000 bin
p0580	Measuring probe input terminal ¹⁾	0
p0581	Measuring probe signal edge ¹⁾	0
p0582	Measuring probe pulses per revolution ¹⁾	1
p0583	Maximum measuring probe measurement time ¹⁾	10 s
p0585	Measuring probe gear ratio ¹⁾	1
r0586	CO: Measuring probe speed actual value ¹⁾	- rpm
r2169	CO: Actual speed value smoothed messages	- rpm
p2181[D]	Load monitoring, response	0
p2192	Load monitoring, delay time	10 s
p2193[D]	Load monitoring configuration	1
p3230[C]	CI: Load monitoring, speed actual value	0
p3231[D]	Load monitoring speed deviation	150 rpm

8.30 Flying restart – switching on while the motor is running

Overview



If you switch on the motor while it is still rotating, without the "Flying restart" function, there is a high probability that a fault will occur as a result of overcurrent (F30001 or F07801). Examples of applications involving an unintentionally rotating motor directly before switching on:

- The motor rotates after a brief line interruption.
- A flow of air turns the fan impeller.
- A load with a high moment of inertia drives the motor.

Function description

The "Flying restart" function comprises the following steps:

1. After the on command, the converter impresses the search current in the motor and increases the output frequency.
2. When the output frequency reaches the actual motor speed, the converter waits for the motor excitation build up time.
3. The converter accelerates the motor to the actual speed setpoint.

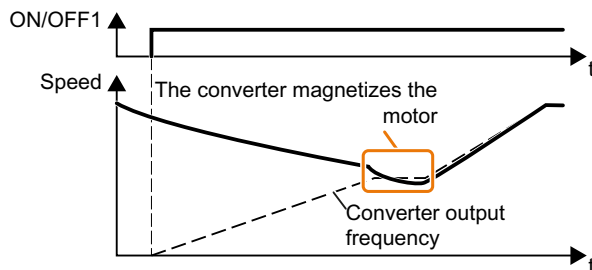

Figure 8-74 Principle of operation of the "flying restart" function

Parameter

Setting "flying restart" function

Parameter	Description	Factory setting
p1200[D]	Flying restart operating mode	0
	0 = flying restart is inhibited	
	1 = Flying restart is enabled, search for the motor in both directions, start in the direction of the setpoint	
	4 = Flying restart is enabled, search for the motor only in the direction of the setpoint	

No "Flying restart" function for group drives

It is not permissible that you enable the "Flying restart" function if the converter is simultaneously driving several motors.

Exception: A mechanical coupling ensures that all of the motors always operate with the same speed.

Table 8-67 Advanced settings

Parameter	Description	Factory setting
p0346[M]	Motor excitation build-up time	0 s
p0347[M]	Motor de-excitation time	0 s
p1201[C]	BI: Flying restart enable signal source	1
p1202[D]	Flying restart detection current	Factory setting dependent on the Power Module
p1203[D]	Flying restart search rate factor	Factory setting dependent on the Power Module

8.31 Automatic restart

Overview



The automatic restart includes two different functions:

- The converter automatically acknowledges faults.
- After a fault occurs or after a power failure, the converter automatically switches-on the motor again.

The converter interprets the following events as power failure:

- The converter signals fault F30003 (undervoltage in the DC link), after the converter line voltage has been briefly interrupted.
- All the converter power supplies have been interrupted and all the energy storage devices in the converter have discharged to such a level that the converter electronics fail.

Function description

Setting the automatic restart function

⚠ WARNING

Unexpected machine motion caused by the active automatic restart function

When the "automatic restart" function is active ($p1210 > 1$), the motor automatically starts after a line supply phase. Unexpected movement of machine parts can result in serious injury and material damage.

- Block off hazardous areas within the machine to prevent inadvertent access.

If it is possible that the motor is still rotating for a longer period of time after a power failure or after a fault, then you must also activate the "flying restart" function.



Flying restart – switching on while the motor is running (Page 408)

Using p1210, select the automatic restart mode that best suits your application.

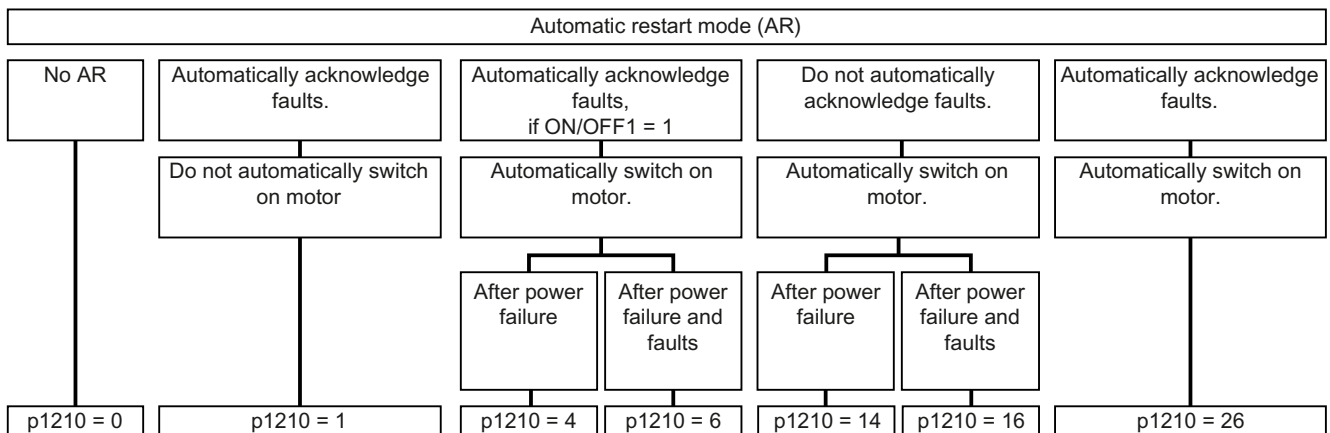
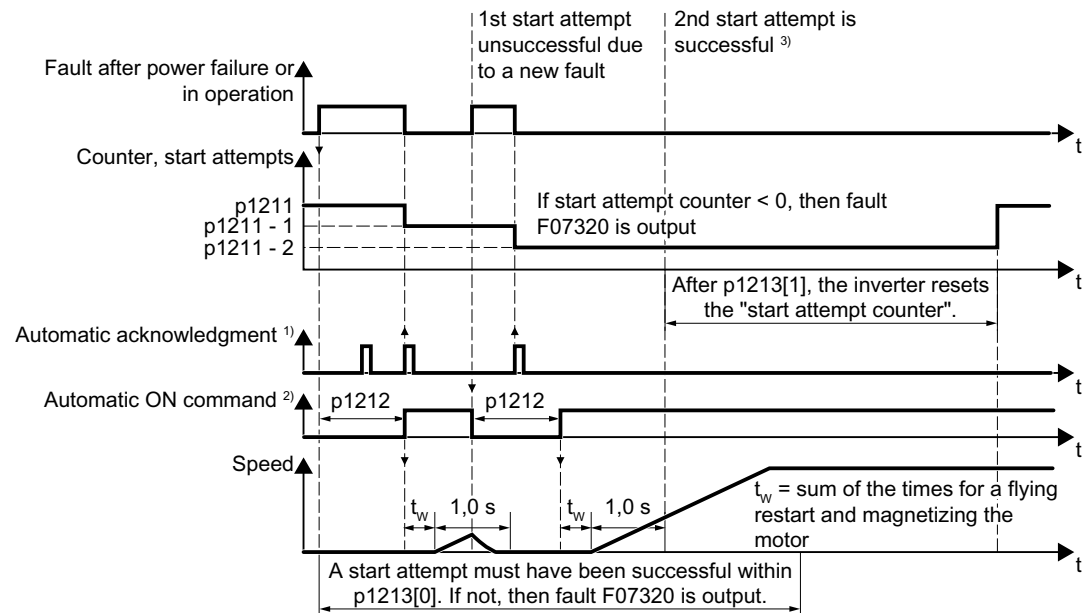

Figure 8-75 Automatic restart modes

The principle of operation of the other parameters is explained in the following diagram and in the table below.



¹⁾ The converter automatically acknowledges faults under the following conditions:

- p1210 = 1 or 26: Always.
- p1210 = 4 or 6: If the command to switch-on the motor is available at a digital input or via the fieldbus (ON/OFF1 = 1).
- p1210 = 14 or 16: Never.

²⁾ The converter attempts to automatically switch the motor on under the following conditions:

- p1210 = 1: Never.
- p1210 = 4, 6, 14, 16, or 26: If the command to switch-on the motor is available at a digital input or via the fieldbus (ON/OFF1 = 1).

³⁾ If, after a flying restart and magnetization (r0056.4 = 1) no fault occurs within one second, then the start attempt was successful.

Figure 8-76 Time response of the automatic restart

Further information is provided in the parameter list.

Advanced settings

If you wish to suppress the automatic restart function for certain faults, then you must enter the appropriate fault numbers in p1206[0 ... 9].

Example: p1206[0] = 07331 ⇒ No restart for fault F07331.

Suppressing the automatic restart only functions for the setting p1210 = 6, 16 or 26.

Note
Motor starts in spite of an OFF command via the fieldbus

The converter responds with a fault if fieldbus communication is interrupted. For one of the settings p1210 = 6, 16 or 26, the converter automatically acknowledges the fault and the motor restarts, even if the higher-level control attempts to send an OFF command to the converter.

- In order to prevent the motor automatically starting when the fieldbus communication fails, you must enter the fault number of the communication error in parameter p1206.
-

Parameter

Number	Name	Factory setting
p1206	Automatic restart faults not active	0
p1210	Automatic restart mode	0
p1211	Automatic restart, start attempts	3
p1212	Automatic restart, wait time start attempts	1 s
p1213[0]	Automatic restart monitoring time for restart	60 s
p1213[1]	Reset automatic restart monitoring time for startup counter	0 s

8.32 Kinetic buffering (Vdc min control)

Overview



Kinetic buffering increases the drive availability. The kinetic buffering utilizes the kinetic energy of the load to buffer line dips and failures. During a line dip, the converter keeps the motor in the switched-on state for as long as possible. One second is a typical maximum buffer time.

Requirement

The following requirements must be fulfilled to practically use the "kinetic buffering" function:

- The driven machine has a sufficiently high inertia.
- The application allows a motor to be braked when the line supply fails.

The Vdc_min control is possible only with the PM240-2 and PM240P-2 Power Modules.

Function description

When the line supply dips, the DC-link voltage in the converter decreases. The kinetic buffering (V_{DCmin} control) intervenes at an adjustable threshold. The V_{DCmin} control forces the load to go into slightly regenerative operation. As a consequence, the converter covers its power loss and the losses in the motor with the kinetic energy of the load. The load speed decreases, but the DC-link voltage remains constant during the kinetic buffering. After the line supply returns, the converter immediately resumes normal operation.

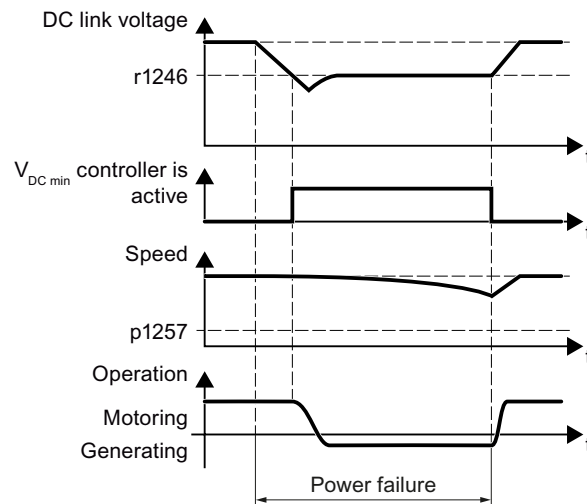

Figure 8-77 Principle mode of operation of kinetic buffering

Parameter

Parameter	Description	Factory setting
r0056[0...15]	CO/BO: Status word, closed-loop control	-
p0210	Device supply voltage	400 V

Parameter	Description	Factory setting
p1240[D]	Vdc controller configuration (vector control)	1
p1245[D]	Vdc_min controller switch-in level (kinetic buffering)	73 % or 76 %
r1246	Vdc_min controller switch-in level (kinetic buffering)	- V
p1247[D]	Vdc_min controller dynamic factor (kinetic buffering)	300%
p1255[D]	Vdc_min controller, time threshold	0 s
p1257[D]	Vdc_min controller, speed threshold	50 rpm

8.33 Efficiency optimization

Overview



The efficiency optimization reduces the motor losses as far as possible.

Active efficiency optimization has the following advantages:

- Lower energy costs
- Lower motor temperature rise
- Lower motor noise levels

Active efficiency optimization has the following disadvantage:

- Longer acceleration times and more significant speed dips during torque surges.

The disadvantage is only relevant when the motor must satisfy high requirements relating to the dynamic performance. Even when efficiency optimization is active, the converter closed-loop motor control prevents the motor from stalling.

Requirement

Efficiency optimization functions under the following preconditions:

- Operation with an induction motor
- Vector control is set in the converter.

Function description

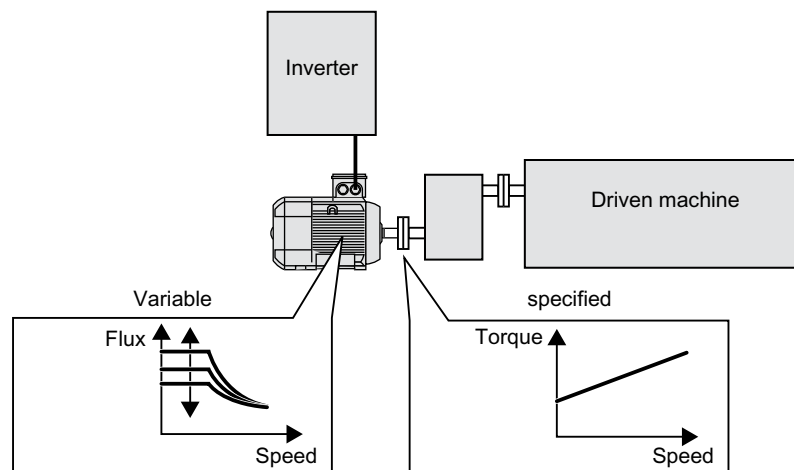

Figure 8-78 Efficiency optimization by changing the motor flux

The three variables that the converter can directly set, which define efficiency of an induction motor, are speed, torque and flux.

However, in all applications, speed and torque are specified by the driven machine. As a consequence, the remaining variable for the efficiency optimization is the flux.

The converter has two different methods of optimizing the efficiency.

Efficiency optimization, method 2

Generally, energy efficiency optimization method 2 achieves a better efficiency than method 1.

We recommend that you set method 2.

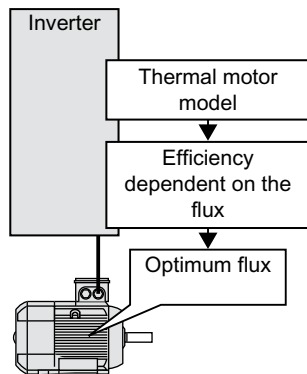

Figure 8-79 Determining the optimum flux from the motor thermal model

Based on its thermal motor model, the converter continually determines - for the actual operating point of the motor - the interdependency between efficiency and flux. The converter then sets the flux to achieve the optimum efficiency.

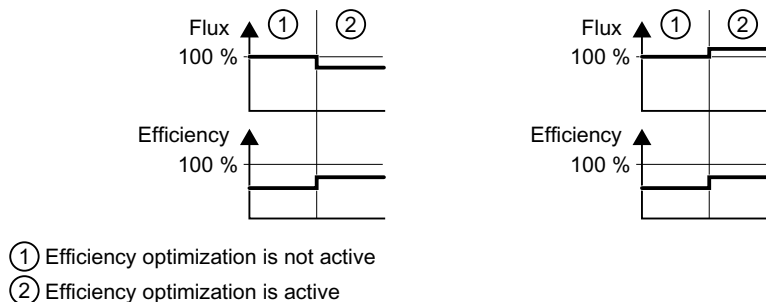

Figure 8-80 Qualitative result of efficiency optimization, method 2

Depending on the motor operating point, the converter either decreases or increases the flux in partial load operation of the motor.

Efficiency optimization, method 1

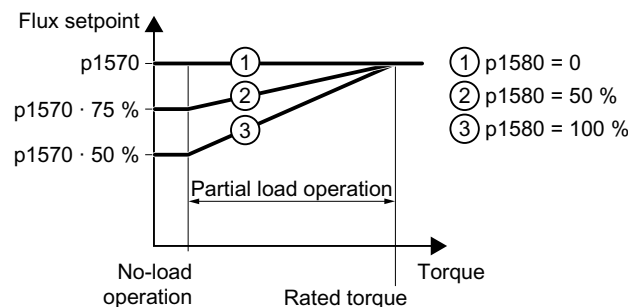

Figure 8-81 Reduce the flux setpoint in the partial load range of the motor

The motor operates in partial load mode between no-load operation and the rated motor torque. Depending on p1580, in the partial load range, the converter reduces the flux setpoint linearly with the torque.

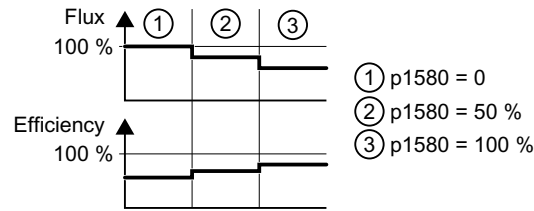

Figure 8-82 Qualitative result of efficiency optimization, method 1

The reduced flux in the motor partial load range results in higher efficiency.

Parameters

Table 8-68 Efficiency optimization, method 2

Number	Name	Factory setting
p1401[D]	Flux control configuration	0000 0000 0000 0110 bin
p1570[D]	CO: Flux setpoint	100%
p3315[D]	Efficiency optimization 2 minimum flux limit value	50%
p3316[D]	Efficiency optimization 2 maximum flux limit value	110 %

Table 8-69 Efficiency optimization, method 1

Number	Name	Factory setting
p1570[D]	CO: Flux setpoint	100%
p1580[D]	Efficiency optimization	80%

8.34 Line contactor control

Overview



A line contactor disconnects the converter from the line supply, and therefore reduces the converter losses when the motor is not operational.

Requirement

The line contactor control requires a 24 V power supply from the converter. The 24 V power supply must be maintained, even when the line contactor is open.

Function description

The converter controls its own line contactor using a digital output.

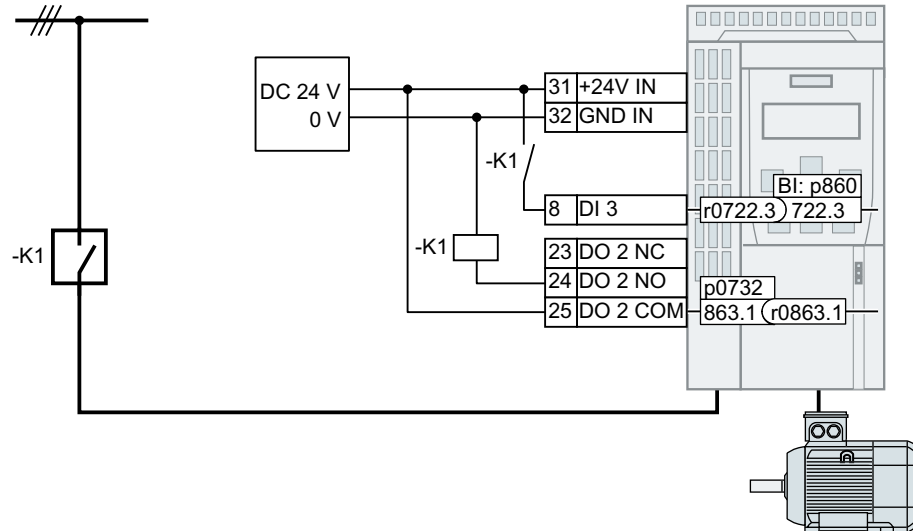

Figure 8-83 Line contactor control via DO 2 with feedback signal via DI 3

Activating the line contactor control

Connect the digital output that controls the line contactor with signal r0863.1.

Example for DO 2: p0732 = 863.1.

Line contactor control with feedback signal

Interconnect p0860 with the signal of the corresponding digital input:

- p0860 = 722.x: Feedback signal of an NO contact via DIx
- p0860 = 723.x: Feedback signal of an NC contact via DIx

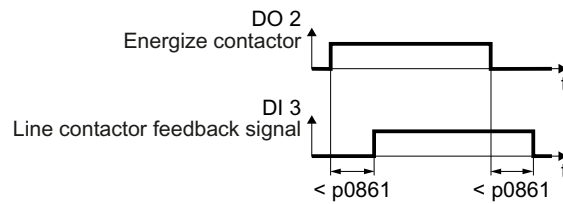

Figure 8-84 Line contactor control via DO 2 with feedback signal via DI 3

If the line contactor feedback signal is not available for longer than the time set in p0861, then the converter issues fault F07300.

Parameter

Number	Name	Factory setting
r0046.0...n	CO/BO: Missing enable signals	-
p0860	BI: Line contactor feedback signal	863.1
p0861	Line contactor monitoring time	100 ms
r0863.0...1	CO/BO: Drive coupling status word / control word	-
p0867	Power unit main contactor holding time after OFF1	50 ms
p0869	Configuration sequence control	0000 bin
p0870	BI: close main contactor	0

Further information is provided in the parameter list.

8.35 Calculating the energy saving for fluid flow machines

Overview



Fluid flow machines, which mechanically control the flow rate using valves or throttle flaps, operate with a constant speed corresponding to the line frequency.



Figure 8-85 Flow control with pump and throttle connected to a 50 Hz line supply

The lower the flow rate, the poorer the efficiency of the fluid flow machine (pump). The fluid flow machine (pump) has the poorest efficiency when the throttle or valve is completely closed. Further, undesirable effects can occur, for example the formation of vapor bubbles in liquids (cavitation) or the temperature of the medium being pumped can increase.

The converter controls the flow rate by appropriately varying the speed of the fluid flow machine. By controlling the flow rate, the fluid flow machine operates at the optimum efficiency for each flow rate. This situation means that in the partial load range less electric power is required than when controlling the flow rate using valves and throttles.

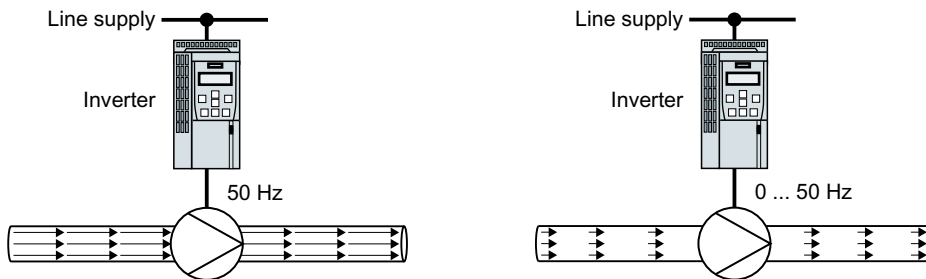
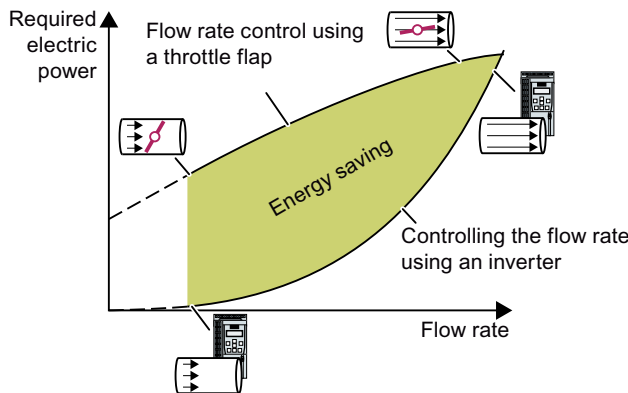

Figure 8-86 Flow control with pump and converter

Function description



The converter calculates the energy saving from the flow characteristic associated with a mechanical flow control and the measured electric power that is drawn. The calculation is suitable for centrifugal pumps, fans, radial and axial compressors, for instance.

Flow characteristic

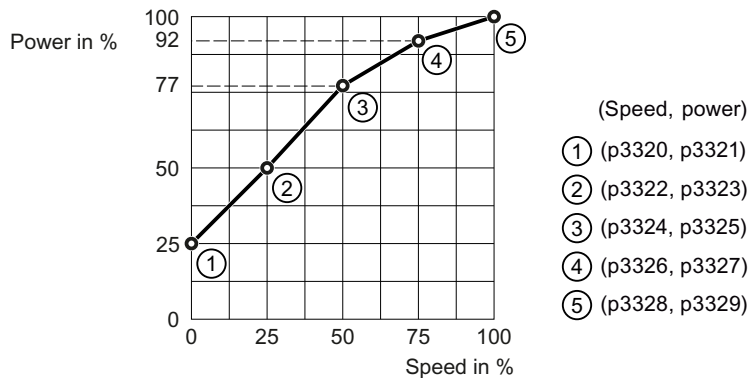

Figure 8-87 Factory setting of the flow characteristic

To set the characteristic, you require the following data from the machine manufacturer for each speed interpolation point:

- The flow rate of the fluid-flow machine associated with the 5 selected converter speeds
- At constant speed, the power drawn which is associated with the 5 flow rates corresponds to the line frequency and mechanical throttling of the flow rate.

Parameters

Number	Name	Factory setting
r0039[0...n]	CO: Energy display	-
p0040	Reset energy consumption display	0
r0041	Energy saved	-
r0042[0...n]	CO: Process energy display	-
p0043	BI: Energy consumption display enabled.	0
p3320[0...n]	Fluid flow machine power, point 1	25
p3321[0...n]	Fluid flow machine speed, point 1	0
p3322[0...n]	Fluid flow machine power, point 2	50
p3323[0...n]	Fluid flow machine speed, point 2	25
p3324[0...n]	Fluid flow machine power, point 3	77
p3325[0...n]	Fluid flow machine speed, point 3	50
p3326[0...n]	Fluid flow machine power, point 4	92
p3327[0...n]	Fluid flow machine speed, point 4	75
p3328[0...n]	Fluid flow machine power, point 5	100
p3329[0...n]	Fluid flow machine speed, point 5	100

8.36 Switchover between different settings

Overview

There are applications that require different converter settings.

Example:

Different motors are operated on one converter. Depending on the particular motor, the converter must operate with the associated motor data and the appropriate ramp-function generator.

Function description

Drive Data Sets (DDS)

You can set several converter functions differently and then switch over between the different settings.

Note

You can only switch over the motor data of the drive data sets in the "ready" state with the motor switched off. The switchover time is approx. 50 ms.

If you do not switch over the motor data together with the drive data sets (i.e. same motor number in p0826), then the drive data sets can also be switched over in operation.

The associated parameters are indexed (index 0, 1, 2, or 3). Using control commands select one of the four indexes and therefore one of the four saved settings.

The settings in the converter with the same index are called the drive data set.

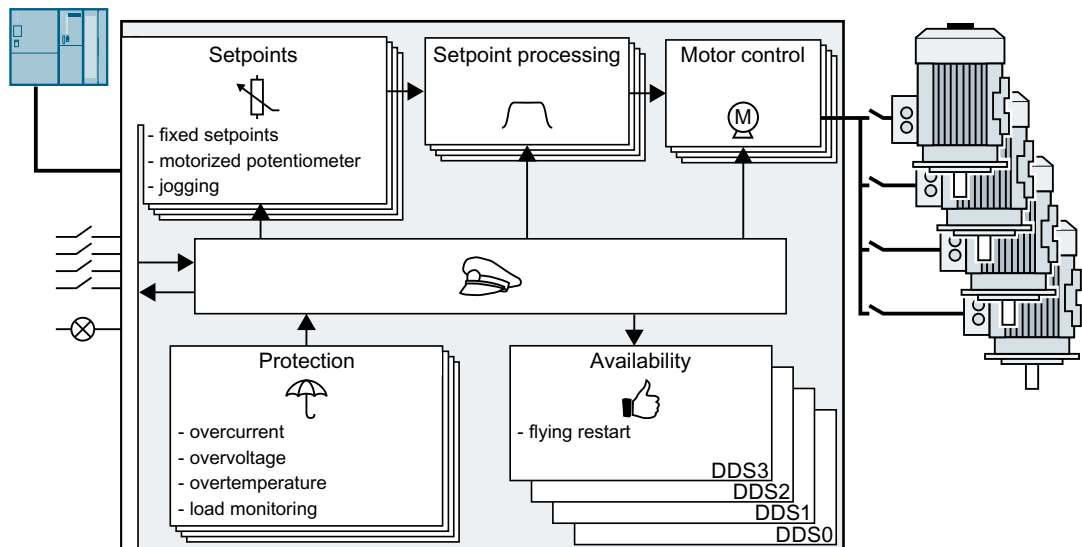

Selecting the number of drive data sets

The number of drive data sets (1 ... 4) is defined by parameter p0180.

Parameter	Description
p0010 = 0	Drive commissioning: Ready
p0010 = 15	Drive commissioning: Data sets
p0180	Number of Drive Data Sets (DDS)

Copying the drive data sets

Parameter	Description
p0819[0]	Source drive data set
p0819[1]	Target drive data set
p0819[2] = 1	Starts the copy operation

Parameter

Parameter	Description	Factory setting
p0010	Drive commissioning parameter filter	1
r0051	CO/BO: Drive data set DDS effective	-
p0180	Number of Drive Data Sets (DDS)	1
p0819[0 ... 2]	Copy drive data set DDS	0
p0820[C]	BI: Drive data set DDS selection, bit 0	0
p0821[C]	BI: Drive data set DDS selection, bit 1	0
p0826[M]	Motor changeover, motor number	0

Further information

The converter switches the motor data set (MDS) and the power unit data set (PDS) together with the drive data set (DDS).

Alarms, faults and system messages





The converter has the following diagnostic types:

- LED
The LEDs at the front of the converter immediately inform you about the most important converter states.
- System runtime
The system run time is the total time that the converter has been supplied with power since the initial commissioning.
- Alarms and faults
The converter signals alarms and faults via the following interfaces:
 - Fieldbus
 - Terminal strip with the appropriate setting
 - Interface for an operator panel
 - Interface for a PC
- Identification & maintenance data (I&M)
If requested, the converter sends data to the higher-level control via PROFIBUS or PROFINET:
 - Converter-specific data
 - Plant-specific data

9.1 LED

9.1.1 Operating states indicated via LEDs

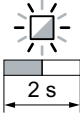
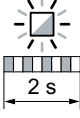
Table 9-1 Explanation of symbols for the following tables

	LED is ON
	LED is OFF
	LED flashes slowly
	LED flashes quickly
	LED flashes with variable frequency

Please contact Technical Support for LED states that are not described in the following.

Table 9-2 Basic states







RDY	Explanation
	Temporary state after the supply voltage is switched on.
	The converter is free of faults
	Commissioning or reset to factory settings
	A fault is active
	Firmware update is active
	Converter waits until the power supply is switched off and switched on again after a firmware update

Table 9-3 Integrated safety functions



SAFE	Explanation
	One or more safety functions are enabled, but not active.
	One or more safety functions are active and error-free.
	The converter has detected a safety function fault and initiated a stop response.

Table 9-4 PROFINET fieldbus











LNK	Explanation
	Communication via PROFINET is error-free
	Device naming is active
	No communication via PROFINET

Table 9-5 Fieldbuses via RS 485 interface

BF	Explanation
	Data exchange between the converter and control system is active
	The fieldbus is active, however, the converter is not receiving any process data RDY When LED RDY flashes simultaneously: Converter waits until the power supply is switched off and switched on again after a firmware update 
	No fieldbus connection available RDY When LED RDY flashes simultaneously: Incorrect memory card 
	Firmware update failed
	Firmware update is active

Communication via Modbus or USS:

If the fieldbus monitoring is deactivated with p2040 = 0, the BF-LED remains dark, independent of the communication state.

9.1 LED

Table 9-6 PROFINET fieldbus















BF	Explanation
	Data exchange between the converter and control system is active
	The fieldbus is improperly configured.
	RDY In conjunction with a synchronously flashing LED RDY: Converter waits until the power supply is switched off and switched on again after a firmware update
	No communication with higher-level controller
	RDY In conjunction with an asynchronously flashing LED RDY: Incorrect memory card
	Firmware update failed
	Firmware update is active

Table 9-7 PROFIBUS fieldbus

BF	Explanation
	Data exchange between the converter and control system is active
	Fieldbus interface is not being used
	The fieldbus is improperly configured.
	RDY In conjunction with a synchronously flashing LED RDY: Converter waits until the power supply is switched off and switched on again after a firmware update
	No communication with higher-level controller
	RDY In conjunction with an asynchronously flashing LED RDY: Incorrect memory card
	Firmware update failed
	Firmware update is active

9.2 System runtime

Overview

By evaluating the system runtime of the converter, you can decide whether you must replace components subject to wear such as fans, motors and gear units.

Function description

The converter starts the system runtime as soon as it is supplied with power. The system runtime stops when the converter is switched off.

The system runtime comprises r2114[0] (milliseconds) and r2114[1] (days):

System runtime = r2114[1] × days + r2114[0] × milliseconds

If r2114[0] has reached a value of 86,400,000 ms (24 hours), the converter sets r2114[0] the value 0 and increases the value of r2114[1] by 1.

Using system runtime, you can track the chronological sequence of faults and alarms over time. When a corresponding message is triggered, the converter transfers the parameter values r2114 to the corresponding parameters of the alarm or fault buffer.

Example

Parameter	Description
r2114[0]	System runtime (ms)
r2114[1]	System runtime (days)

You cannot reset the system runtime.

Parameter

Parameter	Description	Factory setting
r2114[0 ... 1]	Total system runtime	-

9.3 Identification & maintenance data (I&M)

I&M data

The converter supports the following identification and maintenance (I&M) data.

I&M data	Format	Explanation	Associated parameters	Example for the content
I&M0	u8[64] PROFIBUS u8[54] PROFINET	Converter-specific data, read only	-	See below
I&M1	Visible String [32]	Plant/system identifier	p8806[0 ... 31]	"ak12-ne.bo2=fu1"
	Visible String [22]	Location code	p8806[32 ... 53]	"sc2+or45"
I&M2	Visible String [16]	Date	p8807[0 ... 15]	"2013-01-21 16:15"
I&M3	Visible String [54]	Any comment	p8808[0 ... 53]	-
I&M4	Octet String[54]	Check signature to track changes for Safety Integrated. This value can be changed by the user. The test signature is reset to the value generated by the machine if p8805 = 0 is used.	p8809[0 ... 53]	Values of r9781[0] and r9782[0]

When requested, the converter transfers its I&M data to a higher-level control or to a PC/PG with installed STEP 7 or TIA Portal.

I&M0

Designation	Format	Example for the content	Valid for PROFINET	Valid for PROFIBUS
Manufacturer-specific	u8[10]	00 ... 00 hex	---	✓
MANUFACTURER_ID	u16	42d hex (=Siemens)	✓	✓
ORDER_ID	Visible String [20]	"6SL3246-0BA22-1FA0"	✓	✓
SERIAL_NUMBER	Visible String [16]	"T-R32015957"	✓	✓
HARDWARE_REVISION	u16	0001 hex	✓	✓
SOFTWARE_REVISION	char, u8[3]	"V" 04.70.19	✓	✓
REVISION_COUNTER	u16	0000 hex	✓	✓
PROFILE_ID	u16	3A00 hex	✓	✓
PROFILE_SPECIFIC_TYPE	u16	0000 hex	✓	✓
IM_VERSION	u8[2]	01.02	✓	✓
IM_SUPPORTED	bit[16]	001E hex	✓	✓

9.4 Alarms, alarm buffer, and alarm history

Overview

An alarm generally indicates that the converter may no longer be able to maintain the operation of the motor in future.

The extended diagnostics have an alarm buffer and an alarm history, in which the converter stores the most recent alarms.

Function description

Alarms have the following properties:

- Incoming alarms have no direct influence on the converter.
- A warning disappears as soon as its cause is eliminated.
- Alarms do not have to be acknowledged.

Alarm code or alarm value describe the cause of the alarm.

Alarm buffer

Alarm code		Alarm value		Alarm time received		Alarm time removed		
		I32	float	Days	ms			
r2122[0]	r2124[0]	r2134[0]		r2145[0]	r2123[0]	old	r2146[0]	r2125[0]
[1]	[1]	[1]		[1]	[1]	↓ new	[1]	[1]
[2]	[2]	[2]		[2]	[2]		[2]	[2]
[3]	[3]	[3]		[3]	[3]		[3]	[3]
[4]	[4]	[4]		[4]	[4]		[4]	[4]
[5]	[5]	[5]		[5]	[5]		[5]	[5]
[6]	[6]	[6]		[6]	[6]		[6]	[6]
[7]	[7]	[7]		[7]	[7]		[7]	[7]

Figure 9-1 Alarm buffer

The converter saves incoming alarms in the alarm buffer. An alarm includes an alarm code, an alarm value, and two alarm times:

- Alarm code: r2122
- Alarm value: r2124 in fixed-point format "I32", r2134 in floating-point format "Float"
- Alarm time received = r2145 + r2123
- Alarm time removed = r2146 + r2125

The converter takes its internal time calculation to save the alarm times.

 System runtime (Page 429)

Up to 8 alarms can be saved in the alarm buffer.

In the alarm buffer, the alarms are sorted according to "Alarm time received". If the alarm buffer is completely filled and an additional alarm occurs, then the converter overwrites the values with Index [7].

Alarm history

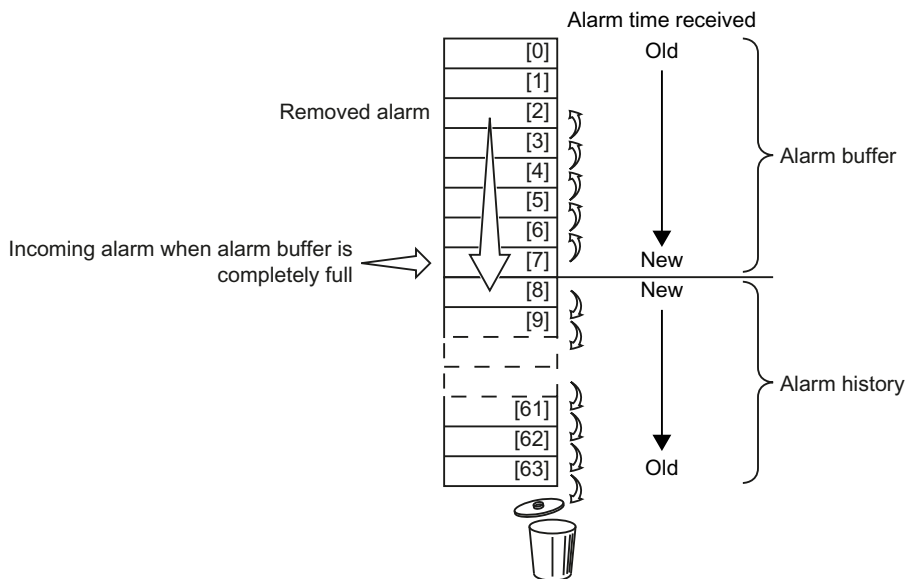

Figure 9-2 Shifting removed alarms into the alarm history

If the alarm buffer is completely filled and an additional alarm occurs, the converter shifts all removed alarms into the alarm history. The following occurs in detail:

1. To create space after position [8] in the alarm history, the converter shifts the alarms already stored in the alarm history "down" by one or more positions.
If the alarm history is completely full, the converter will delete the oldest alarms.
2. The converter moves the removed alarms from the alarm buffer to the now freed up positions of the alarm history.
Alarms that have not been removed remain in the alarm buffer.
3. The converter closes gaps in the alarm buffer that occurred when the removed alarms were shifted in the alarm history by shifting the alarms that have not been removed "up".
4. The converter saves the received alarm as the latest alarm in the alarm buffer.

The alarm history saves up to 56 alarms.

In the alarm history, alarms are sorted according to the "alarm time removed". The latest alarm to be removed has Index [8].

Parameter

Table 9-8 Parameters of the alarm buffer and the alarm history

Parameter	Description	Factory setting
p2111	Alarm counter	0
r2122[0 ... 63]	Alarm code	-
r2123[0 ... 63]	Alarm time received in milliseconds	- ms
r2124[0 ... 63]	Alarm value	-
r2125[0 ... 63]	Alarm time removed in milliseconds	- ms

Parameter	Description	Factory setting
r2132	CO: Actual alarm code	-
r2134[0 ... 63]	Alarm value for float values	-
r2145[0 ... 63]	Alarm time received in days	-
r2146[0 ... 63]	Alarm time removed in days	-

Table 9-9 Extended settings for alarms

Parameter	Description	Factory setting
You can change up to 20 different alarms into a fault or suppress alarms:		
p2118[0...19]	Change message type, message number	0
p2119[0 ... 19]	Change message type, type	1

Further information is provided in the parameter list.

9.5 Faults, alarm buffer and alarm history

Overview

A fault generally indicates that the converter can no longer maintain the operation of the motor. The extended diagnostics have a fault buffer and a fault history, in which the converter stores the most recent faults.

Function description

Faults have the following properties:

- In general, a fault leads to the motor being switched off.
- A fault must be acknowledged.

Fault buffer

Fault code	Fault value		Fault time received			Fault time removed	
	I32	float	Days	ms		Days	ms
r0945[0]	r0949[0]	r2133[0]	r2130[0]	r0948[0]	Old ↓ New	r2136[0]	r2109[0]
[1]	[1]	[1]	[1]	[1]		[1]	[1]
[2]	[2]	[2]	[2]	[2]		[2]	[2]
[3]	[3]	[3]	[3]	[3]		[3]	[3]
[4]	[4]	[4]	[4]	[4]		[4]	[4]
[5]	[5]	[5]	[5]	[5]		[5]	[5]
[6]	[6]	[6]	[6]	[6]		[6]	[6]
[7]	[7]	[7]	[7]	[7]		[7]	[7]

Figure 9-3 Fault buffer

The converter saves incoming faults in the fault buffer. A fault includes a fault code, a fault value, and two fault times:

- Fault code: r0945
The fault code and fault value describe the cause of the fault.
- Fault value: r0949 in fixed-point format "I32", r2133 in floating-point format "Float"
- Fault time received = r2130 + r0948
- Fault time removed = r2136 + r2109

The converter takes its internal time calculation to save the fault times.

 System runtime (Page 429)

Up to 8 faults can be saved in the fault buffer.

In the fault buffer, the faults are sorted according to "Fault time received". If the fault buffer is completely full, and an additional fault is received in the fault buffer, then the converter overwrites the values with Index [7].

Acknowledge fault

To acknowledge a fault, you have the following options:

- PROFIdrive control word 1, bit 7 (r2090.7)
- Acknowledge via a digital input
- Acknowledge via the Operator Panel
- Switch off the converter power supply and switch on again

Faults detected during the converter-internal monitoring of hardware and firmware can be acknowledged only by switching the supply voltage off and on again. In the list of faults in the List Manual, at the corresponding fault codes you may find the information on limitations when acknowledging.

Fault history

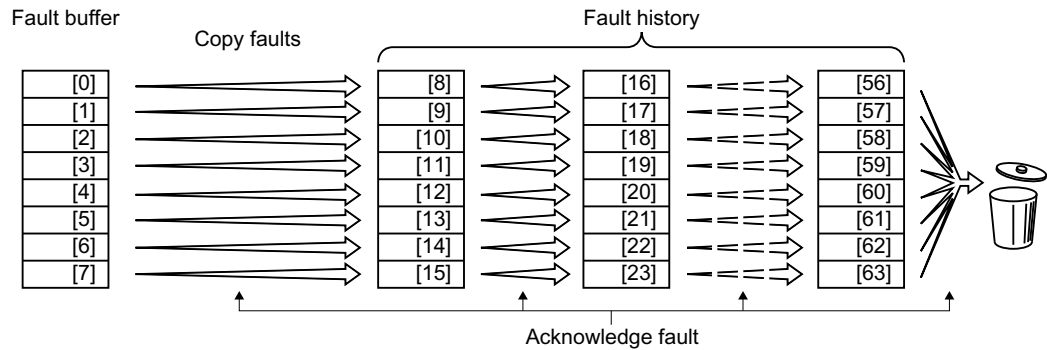

Figure 9-4 Fault history after acknowledging the faults

If at least one of the fault causes in the fault buffer has been removed and you acknowledge the faults, the following takes place:

1. The converter shifts the values previously saved in the fault history each by eight indices. The converter deletes the faults that were saved in the indexes [56 ... 63] before the acknowledgement.
2. The converter copies the contents of the fault buffer to the memory locations [8 ... 15] in the fault history.
3. The converter deletes the faults that have been removed from the fault buffer. The faults that have not been removed are now saved both in the fault buffer and in the fault history.
4. The converter writes the time of acknowledgement of the removed faults to "Fault time removed". The "Fault time removed" of the faults that have not been removed retains the value = 0.

The fault history can contain up to 56 faults.

Deleting the fault history

To delete all faults from the fault history, set parameter p0952 = 0.

Parameter

Table 9-10 Parameters of the fault buffer and the fault history

Parameter	Description	Factory setting
r0945[0 ... 63]	Fault code	-
r0948[0 ... 63]	Fault time received in milliseconds	- ms
r0949[0...63]	Fault value	-
p0952	Fault cases counter	0
r2109[0 ... 63]	Fault time removed in milliseconds	- ms
r2130[0 ... 63]	Fault time received in days	-
r2131	CO: Actual fault code	-
r2133[0 ... 63]	Fault value for float values	-
r2136[0 ... 63]	Fault time removed in days	-

Extended settings for faults

Parameter	Description	Factory setting
p2100[0...19]	Changing the fault reaction, fault number	0
p2101[0...19]	Changing the fault reaction, reaction	0
p2118[0...19]	Change message type, message number	0
p2119[0 ... 19]	Change message type, type	1
p2126[0 ... 19]	Changing the acknowledge mode, fault number	0
p2127[0 ... 19]	Changing the acknowledge mode	1

Further information is provided in the parameter list.

9.6 List of alarms and faults

Axxxxx Alarm

Fyyyyy: Fault

Table 9-11 The most important alarms and faults

Number	Cause	Remedy
F01000	Software error in the CU	Replacing the Control Unit.
F01001	Floating point exception	Switch the Control Unit off and on again.
F01015	Software error in the CU	Upgrade firmware or contact technical support.
F01018	Power-up aborted more than once	<ol style="list-style-type: none"> 1. Switch the module off and on again. 2. After this fault has been output, the module is powered up with the factory settings. 3. Recommission the converter.
A01028	Configuration error	<p>Explanation: Parameterization on the memory card has been created with a different type of module (Article number, MLFB).</p> <p>Check the module parameters and recommission if necessary.</p>
F01033	Switching over units: Reference parameter value invalid	Set the value of the reference parameter not equal to 0.0 (p0304, p0305, p0310, p0596, p2000, p2001, p2002, p2003, r2004).
F01034	Switching over units: Calculation of the parameter values after reference value change unsuccessful	Select the value of the reference parameter so that the parameters involved can be calculated in the per unit notation (p0304, p0305, p0310, p0596, p2000, p2001, p2002, p2003, r2004).
F01040	Parameters must be saved	<p>Save parameters (p0971).</p> <p>Switch the Control Unit off and on again.</p>
F01044	Error loading data from memory card	Replace the memory card or the Control Unit.
A01053	System overload measured	<p>The maximum computing power of the Control Unit was exceeded. The following measures reduce the load on the Control Unit:</p> <ul style="list-style-type: none"> • Use only one data record (CDS and DDS) • Only use the safety features of the basic functions • Deactivate the technology controller • Use the simple ramp-function generator rather than the extended ramp-function generator • Do not use any free function components • Reduce the sampling time of the free function blocks
F01054	System limit exceeded	
A01101	Memory card not available	<p>Insert a memory card or deactivate alarm A01101.</p> <p> Message for a memory card that is not inserted (Page 202)</p>
F01105	CU: Insufficient memory	Reduce number of data sets.
F01122	Frequency at the probe input too high	Reduce the frequency of the pulses at the probe input.
F01205	CU: Time slice overflow	Contact technical support.
F01250	CU hardware fault	Replacing the Control Unit.
F01512	An attempt has been made to establish a conversion factor for scaling which does not exist	Create scaling or check transfer value.
A01590	Motor maintenance interval expired	Carry out maintenance and reset the maintenance interval (p0651).

9.6 List of alarms and faults

Number	Cause	Remedy						
F01600	STOP A initiated	Select the STO safety function and then deselect again.						
F01625	Sign-of-life error in the Safety data	<ul style="list-style-type: none"> • Check the electrical cabinet design and cable routing for EMC compliance. • Check whether an impermissible voltage is connected at one of the digital outputs. • Check whether a digital output is loaded with an impermissible current. • Check whether additional faults exist and perform diagnostics if applicable. • Select STO safety function and then deselect again. • Switch off the converter power supply and switch it on again. 						
F01650	Acceptance test required	<p>Perform an acceptance test for the safety functions and create the acceptance certificate.</p> <p>To confirm the fault, switch the Control Unit off and on again.</p>						
F01659	Write task for parameter rejected	<p>Cause: The converter should be reset to the factory setting. However, it is not permissible to reset the safety functions as the safety functions are currently enabled.</p> <p>Remedy with operator panel:</p>						
		<table border="1"> <tr> <td>p0010 = 30</td> <td>Parameter reset</td> </tr> <tr> <td>p9761 = ...</td> <td>If required, enter the password for the safety functions.</td> </tr> <tr> <td>p0970 = 5</td> <td>Reset start safety parameter. The converter sets p0970 = 5 once it has reset the parameters.</td> </tr> </table>	p0010 = 30	Parameter reset	p9761 = ...	If required, enter the password for the safety functions.	p0970 = 5	Reset start safety parameter. The converter sets p0970 = 5 once it has reset the parameters.
		p0010 = 30	Parameter reset					
		p9761 = ...	If required, enter the password for the safety functions.					
p0970 = 5	Reset start safety parameter. The converter sets p0970 = 5 once it has reset the parameters.							
Then reset the converter to the factory setting again.								
F01662	Error, internal communications	<ul style="list-style-type: none"> • Check the electrical cabinet design and cable routing for EMC compliance. • Check whether an impermissible voltage is connected at one of the digital outputs. • Check whether a digital output is loaded with an impermissible current. <p>If the checks are unsuccessful:</p> <ul style="list-style-type: none"> • Switch off the converter power supply and switch it on again • Upgrade the firmware • Contact technical support 						
A01666	Static 1 signal at the F-DI for safe acknowledgment	Set failsafe digital input F-DI to a logical 0 signal.						
A01698	Commissioning mode active for safety functions	The converter revokes the alarm after completion of the safety commissioning.						
A01699	Switch-off signal path test required	After the next deselection of the STO safety function, the converter revokes the message.						
A01900	PROFIBUS: Configuration telegram faulty	<p>Explanation: A PROFIBUS master is attempting to establish a connection with a faulty configuration telegram.</p> <p>Check the bus configuration on the master and device side.</p>						

Number	Cause	Remedy
A01910 F01910	Setpoint timeout	The alarm is generated when p2040 \neq 0 ms and one of the following causes is present: <ul style="list-style-type: none"> The bus connection is interrupted The Modbus master is switched off Communications error (CRC, parity bit, logical error) An excessively low value for the fieldbus monitoring time (p2040)
A01920	PROFIBUS: Cyclic connection interrupt	Explanation: The cyclic connection to PROFIBUS master is interrupted. Establish the PROFIBUS connection and activate the PROFIBUS master with cyclic operation.
F03505	Analog input, wire break	Check the wiring for interruptions. Check the level of the injected signal. The input current measured by the analog input can be read out in r0752.
A03520	Temperature sensor fault	Check that the sensor is connected correctly.
A05000 A05001 A05002 A05004 A05006	Power Module overtemperature	Check the following: <ul style="list-style-type: none"> - Is the ambient temperature within the defined limit values? - Are the load conditions and duty cycle configured accordingly? - Has the cooling failed?
F06310	Supply voltage (p0210) incorrectly set	Check the set supply voltage and if required change (p0210). Check the line voltage.
F07011	Motor overtemperature	Reduce the motor load. Check ambient temperature. Check the wiring and connection of the sensor.
A07012	I2t motor model overtemperature	Check and if necessary reduce the motor load. Check the motor's ambient temperature. Check the thermal time constant p0611. Check overtemperature fault threshold p0605.
A07015	Motor temperature sensor alarm	Check that the sensor is connected correctly. Check the parameter assignment (p0601).
F07016	Motor temperature sensor fault	Make sure that the sensor is connected correctly. Check the parameterization (p0601). Deactivate the motor temperature sensor fault evaluation (p0607 = 0).
F07086 F07088	Switching over units: Parameter limit violation	Check the adapted parameter values and if required correct.
F07320	Automatic restart aborted	Increase the number of restart attempts (p1211). The current number of start attempts is shown in r1214. Increase the wait time in p1212 and/or monitoring time in p1213. Connect an ON command (p0840). Increase the monitoring time of the power unit or switch off (p0857). Reduce the wait time for resetting the fault counter p1213[1] so that fewer faults are registered in the time interval.
A07321	Automatic restart active	Explanation: The automatic restart (AR) is active. During voltage recovery and/or when remedying the causes of pending faults, the drive is automatically switched back on.
F07330	Search current measured too low	Increase the search current (p1202), check the motor connection.

9.6 List of alarms and faults

Number	Cause	Remedy
A07400	DC-link voltage maximum controller active	If the controller is not to intervene: <ul style="list-style-type: none"> • Increase the ramp-down times. • Deactivate the Vdc_max control (p1240 = 0 for vector control, p1280 = 0 for U/f control).
A07409	U/f control, current limiting controller active	The alarm automatically disappears after one of the following measures: <ul style="list-style-type: none"> • Increase the current limit (p0640). • Reduce the load. • Slow down the ramp up to the setpoint speed.
F07426	Technology controller actual value limited	<ul style="list-style-type: none"> • Adapt the limits to the signal level (p2267, p2268). • Check the actual value scaling (p2264).
A07444	PID autotuning is activated	Automatic setting of the PID controller (autotuning) is active (p2350 > 0). The alarm disappears automatically after completion of the autotuning.
F07445	PID autotuning canceled	The converter has canceled the automatic setting of the PID controller (autotuning) because of a fault. Remedy: Increase p2355 and restart autotuning.
F07801	Motor overcurrent	Check current limits (p0640). Vector control: Check current controller (p1715, p1717). U/f control: Check the current limiting controller (p1340 ... p1346). Increase the acceleration ramp (p1120) or reduce the load. Check the motor and motor cables for short-circuit and ground fault. Check the motor regarding the star/delta connection and rating plate parameterization. Check power unit / motor combination. Select the flying restart function (p1200) if switched to rotating motor.
A07805	Drive: Power unit overload I2t	<ul style="list-style-type: none"> • Reduce the continuous load. • Adapt the load cycle. • Check the assignment of rated currents of the motor and power unit.
F07806	Regenerative power limit exceeded	Increase the deceleration ramp. Reduce the driving load. Use a power unit with higher energy recovery capability. For vector control, the regenerative power limit in p1531 can be reduced until the fault is no longer activated.
F07807	Short circuit detected	<ul style="list-style-type: none"> • Check the converter connection on the motor side for any phase-phase short-circuit. • Rule out that line and motor cables have been interchanged.
A07850 A07851 A07852	External alarm 1 ... 3	The signal for "external alarm 1" has been triggered. Parameters p2112, p2116 and p2117 determine the signal sources for the external alarm 1... 3. Remedy: Remove the causes of these alarms.
F07860 F07861 F07862	External fault 1 ... 3	Remove the external causes for this fault.

Number	Cause	Remedy
A07891	Load monitoring, pump/fan blocked	<ul style="list-style-type: none"> Check the pump/fan for blockage and rectify if necessary. Check the fan for sluggishness and rectify if necessary. Adapt the parameterization depending on the load (p2165, p2168).
A07892	Load monitoring, pump/fan without load	<ul style="list-style-type: none"> For a pump, check the conveyor medium and provide if necessary. For a fan, check the belt and replace if necessary If necessary, increase the torque threshold for detection (p2191).
A07893	Load monitoring, pump leakage	<ul style="list-style-type: none"> Rectify the leakage in the pump circuit. For a false tripping, reduce the torque thresholds of the leakage characteristic (p2186, p2188, p2190).
F07894	Load monitoring, pump/fan blocked	<ul style="list-style-type: none"> Check the pump/fan for blockage and rectify if necessary. Check the fan for sluggishness and rectify if necessary. Adapt the parameterization depending on the load (p2165, p2168).
F07895	Load monitoring, pump/fan without load	<ul style="list-style-type: none"> For a pump, check the conveyor medium and provide if necessary. For a fan, check the belt and replace if necessary If necessary, increase the torque threshold for detection (p2191).
F07896	Load monitoring, pump leakage	<ul style="list-style-type: none"> Rectify the leakage in the pump circuit. For a false tripping, reduce the torque thresholds of the leakage characteristic (p2186, p2188, p2190).
F07900	Motor blocked	<p>Check that the motor can run freely.</p> <p>Check the torque limits (r1538 and r1539).</p> <p>Check the parameters of the "Motor blocked" message (p2175, p2177).</p>
F07901	Motor overspeed	<p>Activate the precontrol for the speed limiting controller (p1401 bit 7 = 1).</p> <p>Increase the hysteresis for overspeed signal p2162.</p>
F07902	Motor stalled	<p>Check whether the motor data has been set correctly and perform a motor identification.</p> <p>Check the current limits (p0640, r0067, r0289). If the current limits are too low, the drive cannot be magnetized.</p> <p>Check whether motor cables are disconnected during operation.</p>
A07903	Motor speed deviation	<p>Increase p2163 and/or p2166.</p> <p>Increase the torque, current and power limits.</p>
A07910	Motor overtemperature	<p>Check the motor load.</p> <p>Check the motor's ambient temperature.</p> <p>Check the KTY84 or PT1000 sensor.</p> <p>Check the overtemperatures of the thermal model (p0626 ... p0628).</p>
A07920	Torque/speed too low	The torque deviates from the torque/speed envelope curve.
A07921	Torque/speed too high	<ul style="list-style-type: none"> Check the connection between the motor and the load.
A07922	Torque/speed out of tolerance	<ul style="list-style-type: none"> Adapt the parameterization corresponding to the load.
F07923	Torque/speed too low	<ul style="list-style-type: none"> Check the connection between the motor and the load.
F07924	Torque/speed too high	<ul style="list-style-type: none"> Adapt the parameterization corresponding to the load.
A07927	DC braking active	Not required
A07980	Rotary measurement activated	Not required
A07981	No enabling for rotary measurement	<p>Acknowledge pending faults.</p> <p>Establish missing enables (see r00002, r0046).</p>

9.6 List of alarms and faults

Number	Cause	Remedy
A07991	Motor identification activated	Switch on the motor and identify the motor data.
F08501	Setpoint timeout	<ul style="list-style-type: none"> • Check the PROFINET connection. • Set the controller to RUN mode. • If the fault occurs repeatedly, check the monitoring time set p2044.
F08502	Monitoring time, sign-of-life expired	<ul style="list-style-type: none"> • Check the PROFINET connection.
F08510	Send configuration data not valid	<ul style="list-style-type: none"> • Check the PROFINET configuration
A08511	Receive configuration data not valid	
A08526	No cyclic connection	<ul style="list-style-type: none"> • Activate the control with cyclic operation. • Check the parameters "Name of Station" and "IP of Station" (r61000, r61001).
A08565	Consistency error affecting adjustable parameters	<p>Check the following:</p> <ul style="list-style-type: none"> • IP address, subnet mask or default gateway is not correct. • IP address or station name used twice in the network. • Station name contains invalid characters.
F08700	Communications error	<p>A CAN communications error has occurred. Check the following:</p> <ul style="list-style-type: none"> • Bus cable • Baud rate (p8622) • Bit timing (p8623) • Manager <p>Start the CAN controller manually with p8608 = 1 after the cause of the fault has been resolved!</p>
F13100	Know-how protection: Copy protection error	<p>The know-how protection and the copy protection for the memory card are active. An error occurred when checking the memory card.</p> <ul style="list-style-type: none"> • Insert a suitable memory card and switch the converter supply voltage temporarily off and then on again (POWER ON). • Deactivate the copy protection (p7765).
F13101	Know-how protection: Copy protection cannot be activated	Insert a valid memory card.
F30001	Overcurrent	<p>Check the following:</p> <ul style="list-style-type: none"> • Motor data, if required, carry out commissioning • Motor connection method (Y / Δ) • U/f operation: Assignment of rated currents of motor and Power Module • Line quality • Make sure that the line commutating reactor is connected properly • Power cable connections • Power cables for short-circuit or ground fault • Power cable length • Line phases <p>If this doesn't help:</p> <ul style="list-style-type: none"> • U/f operation: Increase the acceleration ramp • Reduce the load • Replace the power unit

Number	Cause	Remedy
F30002	DC-link voltage overvoltage	Increase the ramp-down time (p1121). Set the rounding times (p1130, p1136). Activate the DC-link voltage controller (p1240, p1280). Check the line voltage (p0210). Check the line phases.
F30003	DC-link voltage undervoltage	Check the line voltage (p0210).
F30004	Converter overtemperature	Check whether the converter fan is running. Check whether the ambient temperature is in the permissible range. Check whether the motor is overloaded. Reduce the pulse frequency.
F30005	I2t converter overload	Check the rated currents of the motor and Power Module. Reduce the current limit p0640. When operating with U/f characteristic: Reduce p1341.
F30011	Line phase failure	Check the converter's input fuses. Check the motor feeder cables.
F30015	Motor cable phase failure	Check the motor cables. Increase the ramp-up or ramp-down time (p1120).
F30021	Ground fault	<ul style="list-style-type: none"> • Check the power cable connections. • Check the motor. • Check the current transformer. • Check the cables and contacts of the brake connection (a wire might be broken).
F30022	Power Module: Monitoring U_{CE}	Check or replace Power Module.
F30027	Time monitoring for DC link pre-charging	Check the line voltage at the input terminals. Check the line voltage setting (p0210).
F30035	Overtemperature, intake air	<ul style="list-style-type: none"> • Check whether the fan is running.
F30036	Overtemperature, inside area	<ul style="list-style-type: none"> • Check the fan filter elements. • Check whether the ambient temperature is in the permissible range.
F30037	Rectifier overtemperature	See F30035 and, in addition: <ul style="list-style-type: none"> • Check the motor load. • Check the line phases
A30049	Internal fan defective	Check the internal fan and if required replace.
F30052	Incorrect Power Module data	Replace the Power Module or upgrade the Control Unit firmware.
F30053	Error in FPGA data	Replace the Power Module.
F30059	Internal fan defective	Check the internal fan and if required replace.
F30074	Communications error between Control Unit and Power Module	There is a communications fault between the Control Unit and the Power Module. Possible causes: <ul style="list-style-type: none"> • The Control Unit may have been removed or inserted incorrectly. • The external 24 V Control Unit power supply has dipped to $\leq 95\%$ of the rated voltage for ≤ 3 ms
A30502	DC link overvoltage	<ul style="list-style-type: none"> • Check the device supply voltage (p0210). • Check the line reactor dimensioning
F30600	STOP A triggered	Select STO safety function and then deselect again.

9.6 List of alarms and faults

Number	Cause	Remedy
F30662	CU hardware fault	Switch the Control Unit off and on again, upgrade the firmware or contact technical support.
F30664	CU power up aborted	Switch the Control Unit off and on again, upgrade the firmware or contact technical support.
F30850	Software fault in the Power Module	Replace Power Module or contact technical support.
A30920	Temperature sensor fault	Check that the sensor is connected correctly.
A50001	PROFINET configuration error	A PROFINET control is attempting to establish a connection with an incorrect configuration telegram. Check whether "Shared Device" is activated (p8929 = 2).
A50010	PROFINET name of station invalid	Correct the name of station (p8920) and activate (p8925 = 2).
A50020	PROFINET: Second control missing	"Shared Device" is activated (p8929 = 2). However, only the connection to a PROFINET control is available.

Further information on this topic is provided in the List Manual.

 Overview of the manuals (Page 564)

Corrective maintenance

WARNING

Fire or electric shock due to defective components

If an overcurrent protection device is triggered, the converter may be defective. A defective converter can cause a fire or electric shock.

- Have the converter and the overcurrent protection device checked by a specialist.

Repair

WARNING

Fire or electric shock due to improper repair

Improper repair of the converter may cause malfunctions or result in consequential damage such as fire or electric shock.

- Only commission the following persons to repair the converter:
 - Siemens customer service
 - A repair center that has been authorized by Siemens
 - Specialist personnel who are thoroughly acquainted with all the warnings and operating procedures contained in this manual.
- Only use original spare parts when carrying out repairs.

Recycling and disposal



For environmentally-friendly recycling and disposal of your old device, please contact a company certified for the disposal of waste electrical and electronic equipment, and dispose of the old device as prescribed in the respective country of use.

Continuous development within the scope of product maintenance

Converter components are being continuously developed within the scope of product maintenance. Product maintenance includes, for example, measures to increase the ruggedness or hardware changes which become necessary as components are discontinued.

These further developments are "spare parts-compatible" and do not change the article number.

In the scope of such spare parts-compatible ongoing development, plug connector or connection positions are sometimes slightly modified. This does not cause any problems when the components are properly used. Please take this fact into consideration in special installation situations (e.g. allow sufficient reserve regarding the cable length).

10.1 Replace Control Unit

Overview

You are only permitted to replace a Control Unit with a different Control Unit under certain preconditions. After the replacement, you must transfer the settings of the Control Unit that was replaced to the new Control Unit.

Requirement

The following preconditions apply for making a replacement:

- The new Control Unit is the same type as the Control Unit that was replaced.
- The new Control Unit has the same or more recent firmware version than that of the Control Unit that was replaced.

Description

 WARNING
Unexpected machine motion caused when using an inappropriate Control Unit
Replacing Control Units of different types can result in incomplete or inappropriate/incorrect converter settings. As a consequence, machines can unexpectedly move, e.g. speed oscillation, overspeed or incorrect direction of rotation. Unexpected machine motion can result in death, injury and/or material damage.
<ul style="list-style-type: none">• In all cases not permitted according to the above precondition, you must recommission the drive after replacing the Control Unit.

 WARNING
Unexpected machine motion caused by inappropriate/incorrect converter settings
Missing or incorrect converter settings can lead to unexpected operating states or machine movements, e.g. a non-functioning EMERGENCY STOP or an incorrect direction of rotation. As a consequence, machine components or devices can become damaged or death or bodily injury may result.
<ul style="list-style-type: none">• If possible, back up the settings of the Control Unit to be replaced by uploading them to an external storage medium, e.g. a memory card.• Transfer the settings of the Control Unit that was replaced per download to the new Control Unit.• If you do not have a backup of the converter settings, commission the converter as new converter.• After replacing the Control Unit, you must check the function of the converter.

Procedure

1. Switch off the line voltage to the Power Module.
2. If being used, switch off the supply voltage for the digital outputs on the Control Unit.

10.1 Replace Control Unit

3. If being used, switch off the external 24 V supply of the Control Unit.
4. Carefully check that the Control Unit terminals have a no voltage condition.
5. Remove the signal cables from the Control Unit.
6. Remove the defective Control Unit.
7. Mount the new Control Unit on the Power Module.
8. Reconnect the signal cables of the Control Unit.
9. Switch on all of the converter power supplies again.
10. Set the new converter to suit the application:
 - If the settings of the replaced Control Unit are backed up on an external storage medium, transfer the settings using a download.
 Downloading the converter settings (Page 449)
 - If there is no data backup of the replaced Control Unit, commission the converter as new converter.

You have replaced the Control Unit.



10.2 Downloading the converter settings

10.2.1 Converter without enabled safety functions

10.2.1.1 Automatic download from the memory card

Overview

We recommend that you insert the memory card before switching on the converter. The converter automatically imports its settings from the inserted memory card.

Precondition

The following requirements apply:

- The converter power supply has been switched off.
- The converter settings are not protected against copying.
 Download with active know-how protection with copy protection (Page 468)

Function description

Procedure

1. Insert the memory card into the converter.
2. Switch on the power supply for the converter.
3. The converter loads the settings from the memory card.
4. After loading, check whether the converter outputs Alarm A01028.
 - Alarm A01028:
The loaded settings are not compatible with the converter.
Delete the alarm with p0971 = 1.
Recommission the drive.
 - No alarm A01028:
The converter accepts the settings that have been loaded.

You have transferred the settings to the converter.



10.2.1.2 Manual downloading from the memory card with the BOP-2

Overview

If you have backed up the settings of several converters on the memory card, the settings download must be started manually.

Precondition

The following requirements apply:

- The converter power supply has been switched on.
- The converter settings are not protected against copying.
 Download with active know-how protection with copy protection (Page 468)

Function description

Procedure

1. Insert the memory card into the converter.
2. Select the download.



3. Set the number of your data backup. You can back up 99 different settings on the memory card.



4. Start the data transfer.

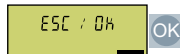

5. Wait until the converter has transferred the settings from the memory card.



6. Back up the settings so that they are protected against power failure.

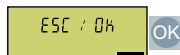

You have transferred the settings from the memory card to the converter.



10.2.1.3 Manual download from the memory card using Startdrive

Overview

If you have backed up the settings of several converters on the memory card, the settings download must be started manually.

Requirement

The following preconditions apply:

- The converter power supply has been switched on.
- The PC and converter are connected with one another via a USB cable or via the fieldbus.
- The converter settings are not protected against copying.
 Download with active know-how protection with copy protection (Page 468)

Function description

Procedure

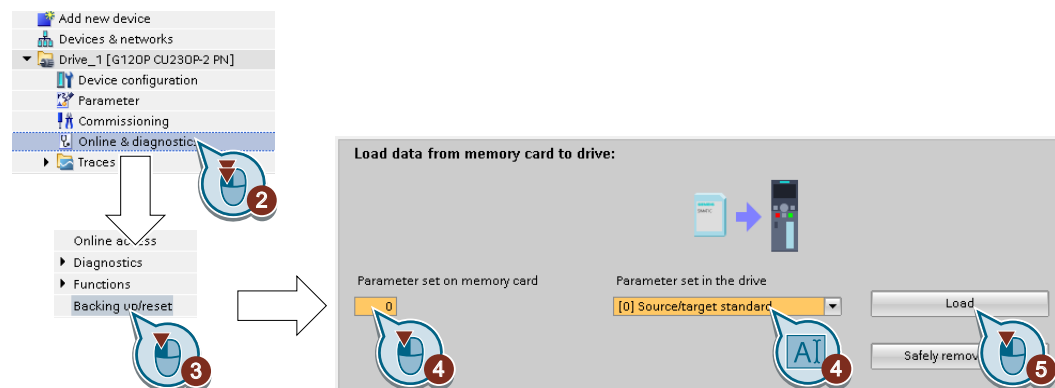

1. Go online.
2. Select "Online & diagnostics".
3. Select "Back up/reset".
4. Set the number of your data backup. You can back up 99 different settings on the memory card.
5. Start the data transfer.
6. Wait until Startdrive has signaled that the data transfer has been completed.
7. Go offline.

You have transferred your settings from a memory card to the converter.



10.2.1.4 Download from BOP-2 operator panel

Overview

You can transfer the converter settings that are backed up on the BOP-2 operator panel back into the converter.

Precondition

The following requirements apply:

- The converter power supply has been switched on.
- The converter settings are not protected against copying.
 Download with active know-how protection with copy protection (Page 468)

Function description

Procedure

1. Attach the Operator Panel to the converter.
2. Select the download from the operator panel to the converter.



3. Start the download.

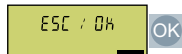

4. Wait until the download is completed.



5. After loading, check whether the converter outputs Alarm A01028.



- Alarm A01028:
The loaded settings are not compatible with the converter.
Delete the alarm with p0971 = 1.
Recommission the drive.
- No alarm A01028: Proceed with the next step.

6. Back up the settings so that they are protected against power failure.

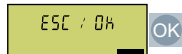

You have transferred the settings to the converter.



10.2.1.5 Download from IOP-2 operator panel

Overview

You can transfer the converter settings that are backed up on the IOP-2 operator panel back into the converter.

Precondition

The following requirements apply:

- The converter power supply has been switched on.
- The converter settings are not protected against copying.
 Download with active know-how protection with copy protection (Page 468)

Function description

Procedure

1. Connect the operator panel to the converter.
2. Start the download.

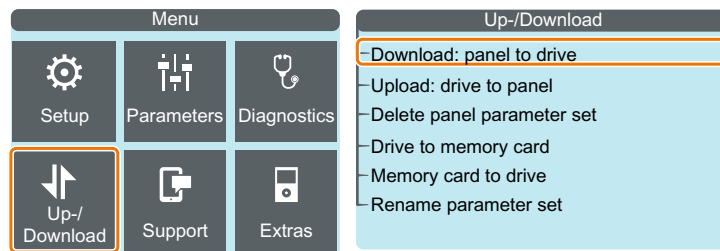

3. Wait until the download is completed.

10.2 Downloading the converter settings

4. After loading, check whether the converter outputs Alarm A01028.

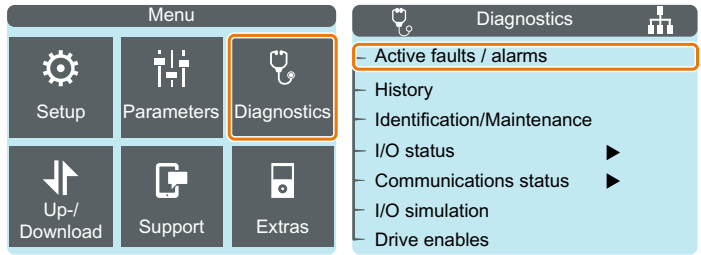

- Alarm A01028:
The loaded settings are not compatible with the converter.
Delete the alarm with p0971 = 1.
Recommission the drive.
- No alarm A01028: Proceed with the next step.

5. Back up the settings so that they are protected against power failure.

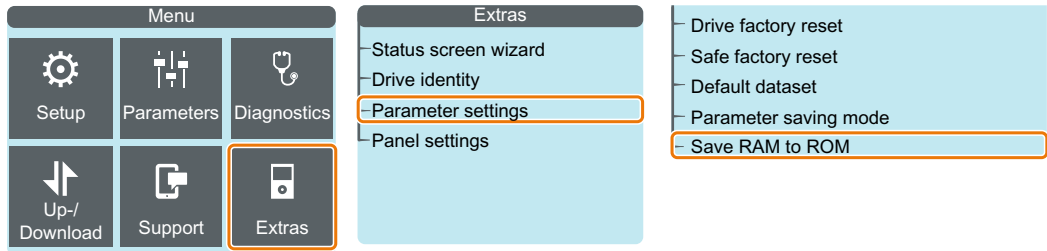

You transferred the settings to the converter.

10.2.1.6 Download from Smart Access

Overview

You can transfer the converter settings that are backed up on the digital terminal device back into the converter.

Precondition

The following requirements apply:

- The converter power supply has been switched on.
- The converter settings are not protected against copying.
 Download with active know-how protection with copy protection (Page 468)

Function description

Procedure

1. Attach the Smart Access to the converter.
2. Connect your terminal device with the Smart Access.
3. Select the file for restoring the converter settings.

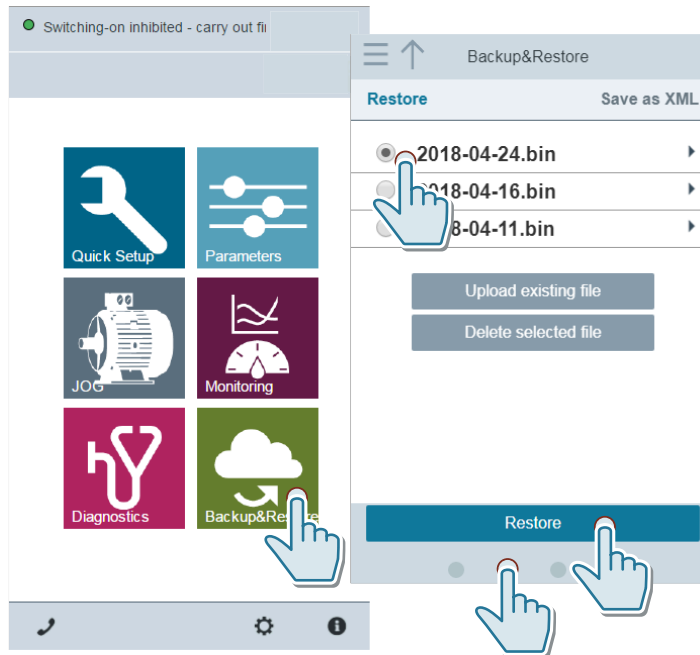

10.2 Downloading the converter settings

- 4. Back up the settings so that they are protected against power failure.

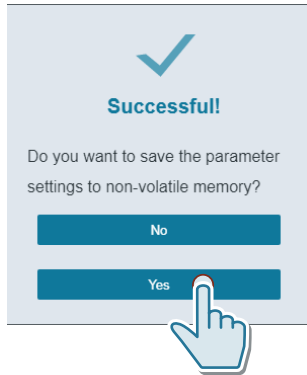

- 5. After loading, check whether the converter outputs Alarm A01028.

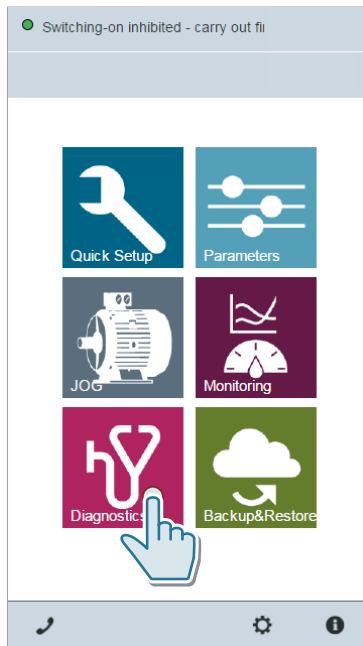

- Alarm A01028:
The loaded settings are not compatible with the converter.
Delete the alarm with p0971 = 1.
Recommission the drive.
- No alarm A01028: Proceed with the next step.

You transferred the settings from the Smart Access to the new converter.



10.2.1.7 Download from the PC using Startdrive

Overview

You can transfer the converter settings that have been backed up to a PC back to the converter.

Requirement

The following preconditions apply:

- The PC and converter are connected with one another.
- The converter settings are not protected against copying.
 Download with active know-how protection with copy protection (Page 468)

Function description

Procedure

1. Open the Startdrive project that matches the drive.
2. Select "Load to device".
3. Confirm the prompt for saving your settings (copy RAM to ROM).

You transferred the settings from the PC to the new converter.



10.2.2 Converter with enabled safety functions

10.2.2.1 Automatic download from the memory card

Overview

We recommend that you insert the memory card before switching on the converter. The converter automatically imports its settings from the inserted memory card.

Requirement

The following preconditions apply:

- The converter power supply has been switched off.
- The converter settings are not protected against copying.
 Download with active know-how protection with copy protection (Page 468)

Function description

Procedure

1. Insert the memory card into the converter.
2. Switch on the power supply for the converter.

10.2 Downloading the converter settings

3. The converter loads the settings from the memory card.
4. After loading, check whether the converter outputs Alarm A01028.
 - Alarm A01028:
The loaded settings are not compatible with the converter.
Set p0971 = 1 to delete the alarm. Check the converter settings. We recommend that you recommission the drive.
 - No alarm A01028:
Perform a **reduced** acceptance test.
 Reduced acceptance test after component replacement and firmware change (Page 481)

You have transferred the settings to the converter.



10.2.2.2 Manual downloading from the memory card with the BOP-2

Overview

If you have backed up the settings of several converters on the memory card, the settings download must be started manually.

Requirement

The following preconditions apply:

- You know the password for the converter safety functions.
- The converter power supply has been switched on.
- The converter settings are not protected against copying.
-  Download with active know-how protection with copy protection (Page 468)

Function description

Procedure

1. Insert a memory card into the converter.
2. Select the download.



3. Set the number of your data backup. You can back up 99 different settings on the memory card.



4. Start the data transfer.

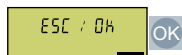

- Wait until the converter has transferred the settings from the memory card.



- Back up the settings so that they are protected against power failure.

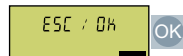

- Start to commission the safety functions.

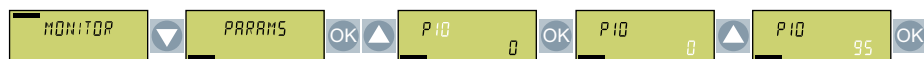

- Enter the password for the safety functions.



- Confirm the setting of the safety functions.

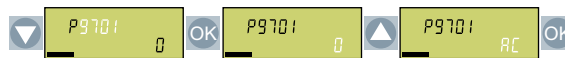

- Exit commissioning of the safety functions.

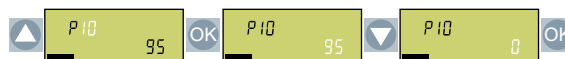

- Back up the settings so that they are protected against power failure.

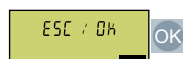

- Switch off the converter power supply.

- Wait until all LEDs on the converter are dark.

- Switch on the converter power supply again.

- Perform a **reduced** acceptance test.

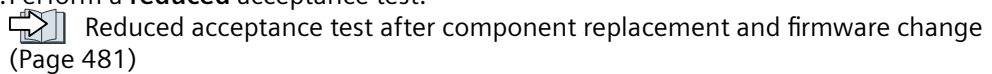

You have transferred the settings from the memory card to the converter.



10.2.2.3 Download from BOP-2 operator panel

Overview

You can transfer the converter settings that are backed up on the BOP-2 operator panel back into the converter.

Requirement

The following preconditions apply:

- You know the password for the converter safety functions.
- The converter power supply has been switched on.
- The converter settings are not protected against copying.
 Download with active know-how protection with copy protection (Page 468)

Function description

Procedure

1. Attach the Operator Panel to the converter.
2. Select the download from the operator panel to the converter.



3. Start the download.

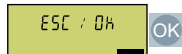

4. Wait until the download is completed.



5. After loading, check whether the converter outputs Alarm A01028.



- Alarm A01028:
The loaded settings are not compatible with the converter.
Delete the alarm with p0971 = 1.
Recommission the drive.
- No alarm A01028: Proceed with the next step.

6. Back up the settings so that they are protected against power failure.

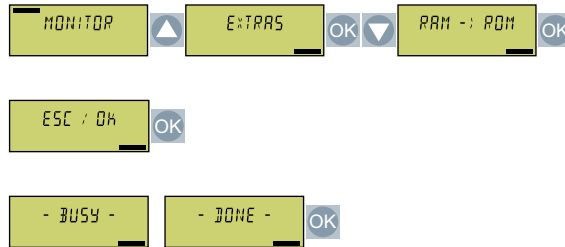

7. Start to commission the safety functions.



8. Enter the password for the safety functions.



9. Confirm the setting of the safety functions.

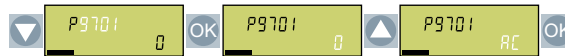

10. Exit commissioning of the safety functions.

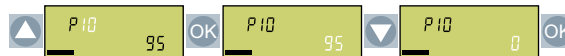

11. Back up the settings so that they are protected against power failure.

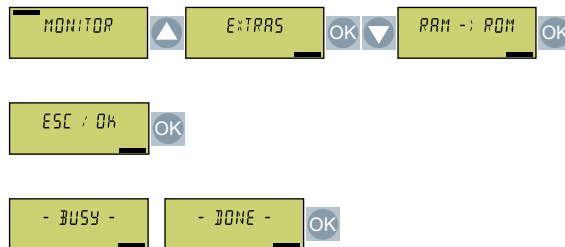

12. Switch off the converter power supply.

13. Wait until all LEDs on the converter are dark.

14. Switch on the converter power supply again.

15. Perform a **reduced** acceptance test.

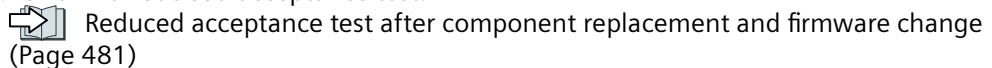

You have transferred the settings to the converter.



10.2.2.4 Download from IOP-2 operator panel

Overview

You can transfer the converter settings that are backed up on the IOP-2 operator panel back into the converter.

Requirement

The following preconditions apply:

- You know the password for the converter safety functions.
- The converter power supply has been switched on.
- The converter settings are not protected against copying.
 Download with active know-how protection with copy protection (Page 468)

Function description

Procedure

1. Attach the Operator Panel to the converter.
2. Start the download.

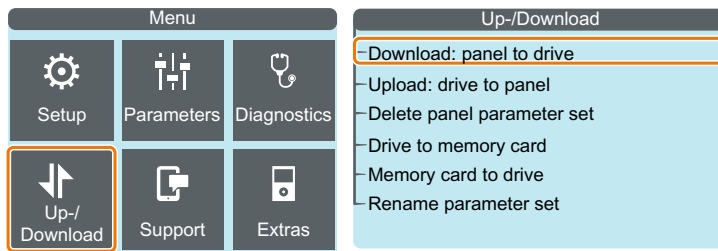

3. Wait until the transfer is complete.
4. After loading, check whether the converter outputs Alarm A01028.

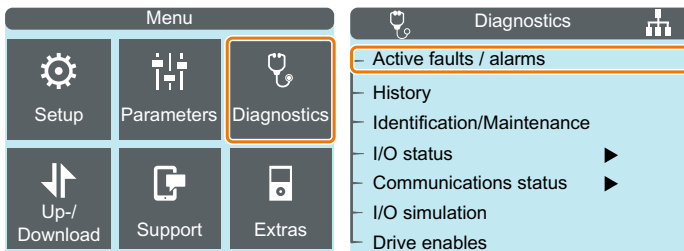

- Alarm A01028:
The loaded settings are not compatible with the converter.
Delete the alarm with p0971 = 1.
Recommission the drive.
- No alarm A01028: Proceed with the next step.

- Back up the settings so that they are protected against power failure.

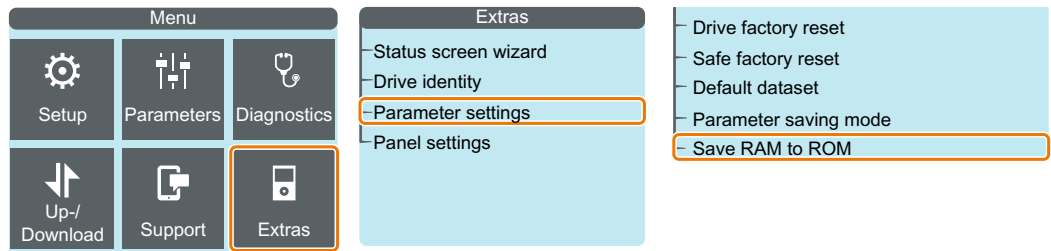

- Select menu "Parameter".

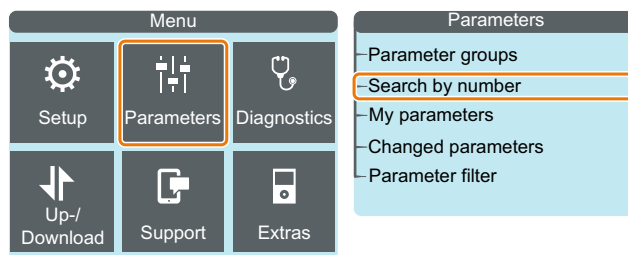

- To start commissioning of the safety functions, set p10 = 95.
- Enter the password for the safety functions in p9761.
- To confirm the settings of the safety functions, set p9701 = AC.
- To exit commissioning of the safety functions, set p10 = 0.
- Back up the settings so that they are protected against power failure.

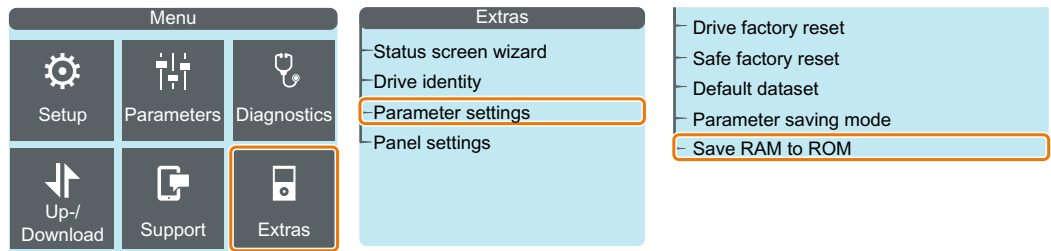

- Switch off the converter power supply.
- Wait until all LEDs on the converter are dark.
- Switch on the converter power supply again.
- Perform a **reduced** acceptance test.
 - ➡ Reduced acceptance test after component replacement and firmware change (Page 481)

You have replaced the converter and transferred the safety function settings from the operator panel to the new converter.

□

10.2.2.5 Download from Smart Access

Overview

You can transfer the converter settings that are backed up on the digital terminal device back into the converter.

Requirement

The following preconditions apply:

- You know the password for the converter safety functions.
- The converter power supply has been switched on.
- The converter settings are not protected against copying.
 Download with active know-how protection with copy protection (Page 468)

Function description

Procedure

1. Attach the Smart Access to the converter.
2. Connect your terminal device with the Smart Access.
3. Select the file for restoring the converter settings.

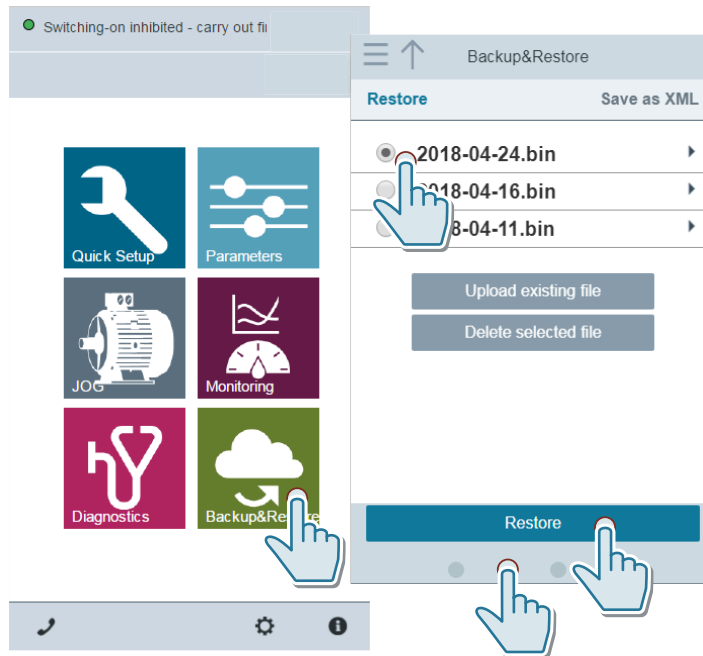

4. Back up the settings so that they are protected against power failure.

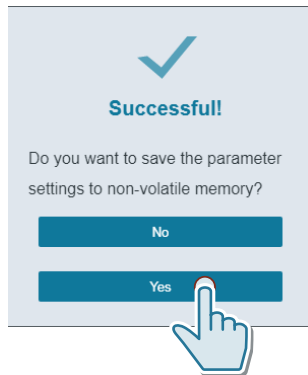

5. After loading, check whether the converter outputs Alarm A01028.



- Alarm A01028:
The loaded settings are not compatible with the converter.
Delete the alarm with p0971 = 1.
Recommission the drive.
- No alarm A01028: Proceed with the next step.

10.2 Downloading the converter settings

6. Select menu "Parameter".

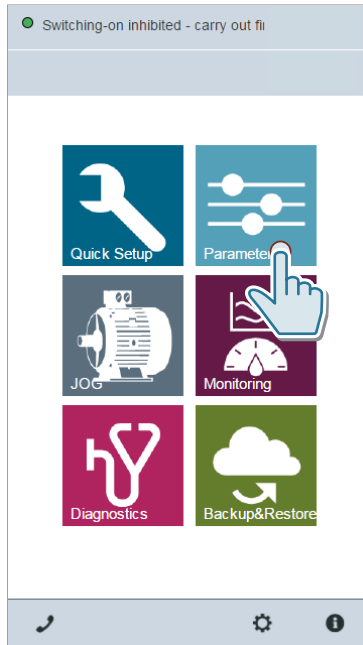

7. To start commissioning of the safety functions, set p10 = 95.

8. Enter the password for the safety functions in p9761.

9. To confirm the settings of the safety functions, set p9701 = AC.

10. To exit commissioning of the safety functions, set p10 = 0.

11. Back up the settings so that they are protected against power failure.

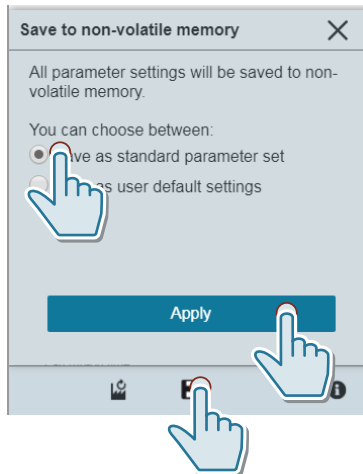

12. Switch off the converter power supply.

13. Wait until all LEDs on the converter are dark.

14. Switch on the converter power supply again.

15. Perform a **reduced** acceptance test.

 Reduced acceptance test after component replacement and firmware change (Page 481)

You transferred the settings from the Smart Access to the new converter.



10.2.2.6 Download from the PC using Startdrive

Overview

You can transfer the converter settings that have been backed up to a PC back to the converter.

Requirement

The following preconditions apply:

- The converter power supply has been switched on.
- The PC and converter are connected with one another via a USB cable or via the fieldbus.
- The converter settings are not protected against copying.



Download with active know-how protection with copy protection (Page 468)

Function description

Procedure

1. In Startdrive, open the project that matches the drive.
2. Select "Load to device".
3. Connect Startdrive online with the drive.
The converter signals faults after the download. Ignore these faults, as they will be automatically acknowledged by the following steps.
4. Press the "Start safety commissioning" button.

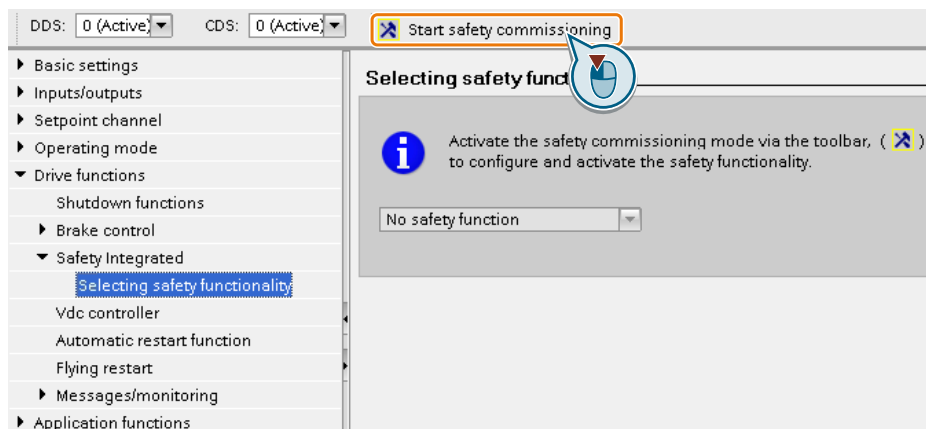

5. Enter the password for the safety functions.

10.2 Downloading the converter settings

6. Press the "End safety commissioning" button.

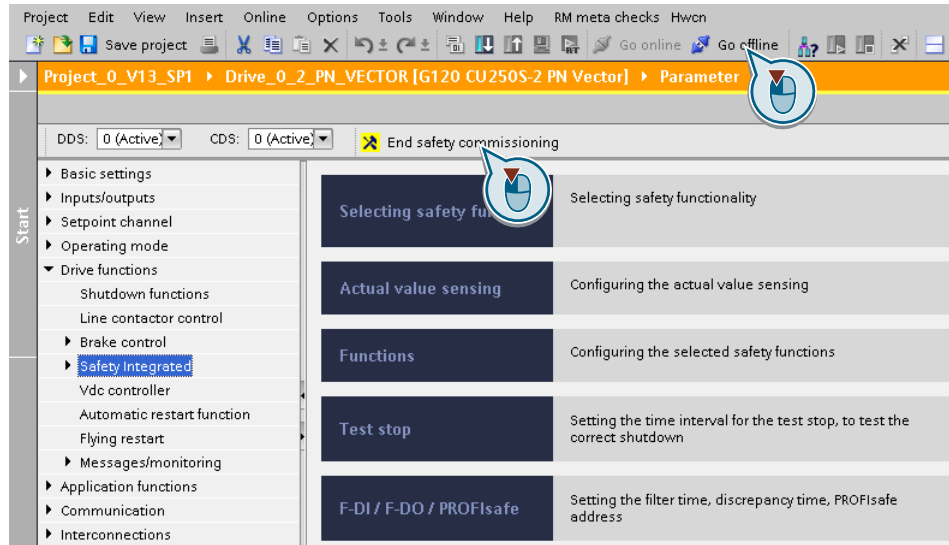

- 7. Confirm the prompt for saving your settings (copy RAM to ROM).
- 8. Disconnect the online connection.
- 9. Switch off the converter power supply.
- 10. Wait until all LEDs on the converter are dark.
- 11. Switch on the converter power supply again.
- 12. Perform a **reduced** acceptance test.
 Reduced acceptance test after component replacement and firmware change (Page 481)

You transferred the settings from the PC to the new converter.

10.2.3 Download with active know-how protection with copy protection

Overview

The know-how protection function prevents converter settings from being copied. There are two options to avoid recommissioning after a converter has been replaced.

Requirement

- The following preconditions apply:
- The end user uses a SIEMENS memory card.
 - The machine manufacturer (OEM) has an identical machine.

Function description

Procedure 1: The machine manufacturer only knows the serial number of the new converter

1. The end customer provides the machine manufacturer with the following information:
 - For which machine must the converter be replaced?
 - What is the serial number (r7758) of the new converter?
2. The machine manufacturer performs the following steps online on the prototype machine:
 - Deactivating know-how protection
 -  Activating and deactivating know-how protection (Page 218)
 - Enter the serial number of the new converter in p7759.
 - Enter the serial number of the inserted memory card as reference serial number in p7769.
 - Activate know-how protection with copy protection. "Copy RAM to ROM" must be activated.
 - Write the configuration with p0971 = 1 to the memory card.
 - Send the memory card to the end customer.
3. The end user inserts the memory card.
4. The end user switches on the converter power supply.
5. The converter checks the serial numbers of the card and the converter, and when there is a match the converter goes into the "Ready for switching on" state.
If the numbers do not match, then the converter signals fault F13100 (no valid memory card).

The settings have been transferred to the converter.



Procedure 2: The machine manufacturer knows the serial number of the new converter and the serial number of the memory card

1. The end customer provides the machine manufacturer with the following information:
 - For which machine must the converter be replaced?
 - What is the serial number (r7758) of the new converter?
 - What is the serial number of the memory card?
2. The machine manufacturer performs the following steps online on the prototype machine:
 - Deactivating know-how protection
 -  Activating and deactivating know-how protection (Page 218)
 - Enter the serial number of the new converter in p7759.
 - Enter the serial number of the customer's memory card as reference serial number in p7769.
 - Activate know-how protection with copy protection. "Copy RAM to ROM" must be activated.
 - Write the configuration with p0971 = 1 to the memory card.
 - Copy the encrypted project from the card to the associated PC.
 - Send the encrypted project to the end customer, e.g. via e-mail.
3. The end user copies the project to the Siemens memory card that belongs to the machine.
4. The end user inserts the Siemens memory card into the converter.
5. The end user switches on the converter power supply.
6. The converter checks the serial numbers of the card and the converter, and when there is a match the converter goes into the "Ready for switching on" state.
If the numbers do not match, then the converter signals fault F13100 (no valid memory card).

The settings have been transferred to the converter.



10.3 Replacing a Power Module

Overview

You are only permitted to replace the Power Module by another Power Module under certain specific preconditions.

Requirement

The following preconditions apply when making a replacement:

- The new and replaced Power Modules have the same power rating.
- The new Power Module has a different power rating than the replaced Power Module, however still the same frame size.
In this case, the rated power of the Power Module and the rated power of the motor must not differ too much.
The following values are permissible for the quotients (rated motor power)/(rated Power Module power):
 - 200 V Power Modules and 400 V Power Modules: 0.25 ... 1.5
 - 690 V Power Modules: 0.5 ... 1.5

Description

Procedure

1. Switch off the line voltage to the Power Module.
You do not have to switch off an external 24 V power supply for the Control Unit if one is being used.
2. Remove the connecting cables of the Power Module.
3. Remove the Control Unit from the Power Module.
4. Replace the previous Power Module with the new Power Module.
5. Mount the Control Unit onto the new Power Module.
6. Connect up the new Power Module using the connecting cables.

NOTICE

Motor damage due to interchanged motor connecting cables

The direction in which the motor rotates switches if you exchange the two phases of the motor line. A motor with an incorrect direction of rotation can damage the machine or installation. Driven loads with only one permissible direction of rotation include certain compressors, saws and pumps, for example.

- Connect the 3 phases of the motor lines in the correct sequence.
- After replacing the Power Module, check the direction of motor rotation.

10.3 Replacing a Power Module

7. Switch on the line supply and, if necessary, the 24 V supply of the Control Unit.
8. Perform a reduced acceptance test if the converter outputs fault F01641.
 Reduced acceptance test after component replacement and firmware change
(Page 481)

You have successfully replaced the Power Module.



10.4 PROFINET device name

Overview

Converters with PROFINET interface support "Device replacement without removable data storage medium".

Requirement

The topology of the PROFINET IO system with the IO device involved is configured in the higher-level control system.

Function description

The converter can be replaced without having to insert a removable data storage medium (e.g. a memory card) with the saved device names in the converter – or having to reassign the device names using a PG.

Further information

Details of the device replacement without removable storage medium can be found on the Internet:

 PROFINET system description (<http://support.automation.siemens.com/WW/view/en/19292127>)

10.5 Firmware upgrade and downgrade

10.5.1 Overview

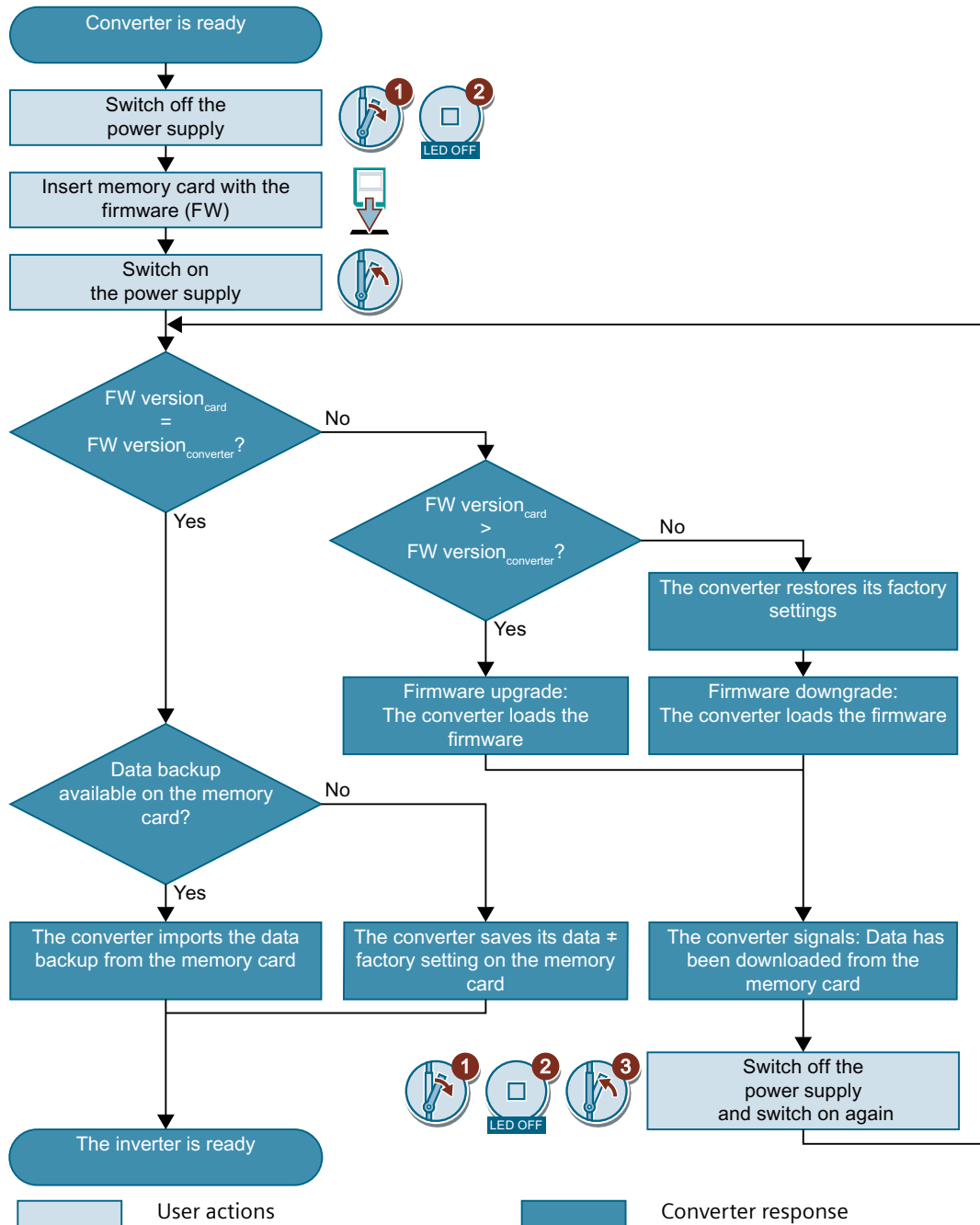

Figure 10-1 Overview of the firmware upgrade and firmware downgrade

10.5.2 Preparing the memory card

Overview

You can load the converter firmware from the Internet to a memory card.

Precondition

You have the appropriate memory card.

 Recommended memory cards (Page 200)

Function description

Procedure

1. Download the required firmware to your PC from the Internet.
 Download (<https://support.industry.siemens.com/cs/ww/en/view/67364620>)
2. Extract the files to a directory of your choice on your PC.
3. Transfer the unzipped files into the root directory of the memory card.



Figure 10-2 Example of memory card contents after the file transfer

Depending on the firmware, the filenames and the number of files may differ from the display above.

The "USER" directory does not exist on unused memory cards. After the memory card is plugged in for the first time, the converter creates a new "USER" directory.

You have prepared the memory card for the firmware upgrade or downgrade.



10.5.3 Upgrading the firmware

Introduction

When upgrading the firmware, you replace the converter firmware by a later version.

Requirements

- Your converter's firmware is at least version V4.5.
- Converter and memory card have different firmware versions.

Function Description

Procedure

1. Switch off the converter power supply.
2. Wait until all LEDs on the converter are dark.
3. Insert the card with the matching firmware into the converter slot until it latches into place.

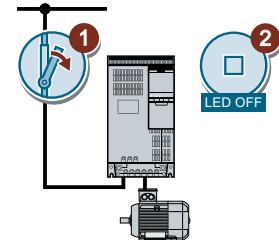

4. Switch on the converter power supply again.
5. The converter transfers the firmware from the memory card into its memory.
The transfer takes between 5 and 10 minutes.
While data is being transferred, the LED RDY stays red. The BF LED flashes orange with a variable frequency.

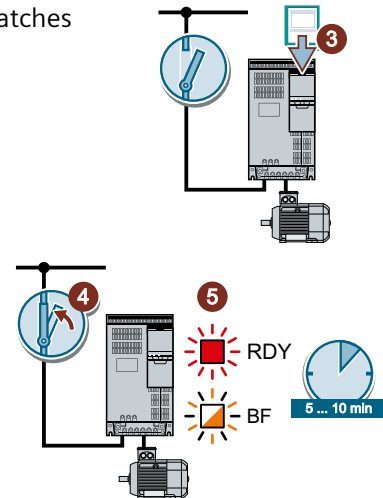

6. At the end of the transfer, the LED RDY and BF slowly flash red (0.5 Hz).

Power supply failure during transfer

The converter firmware will be incomplete if the power supply fails during the transfer.

- Start again with step 1 of the instructions.

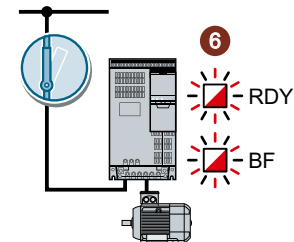

7. Switch off the converter power supply.
8. Wait until all LEDs on the converter are dark.

Decide whether you want to withdraw the memory card from the converter:

- You remove the memory card:
⇒ The converter keeps its settings.

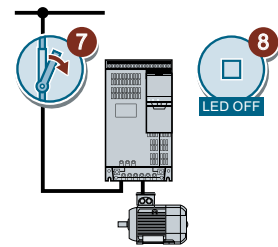

- You leave the memory card in the converter:
⇒ If the memory card still does not have a data backup of the converter settings, in step 9 the converter writes its settings to the memory card.
⇒ If the memory card already includes a data backup, the converter imports the settings from the memory card in step 9.

9. Switch on the converter power supply again.
10. If the firmware upgrade was successful, the converter LED RDY turns green after several seconds.

If the memory card is still inserted, depending on the previous content of the memory card, one of the two following cases has occurred:

- The memory card contains a data backup:
⇒ The converter has taken the settings from the memory card.
- There was no data backup on the memory card:
⇒ The converter has written its settings to the memory card.

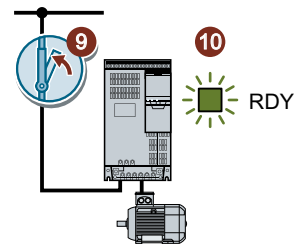

You have upgraded the converter firmware.

10.5.4 Firmware downgrade

Overview

When downgrading the firmware, you replace the converter firmware by an older version.

Requirement

- Your converter's firmware is at least version V4.6.
- Converter and memory card have different firmware versions.
- You have backed up your settings on the memory card, in an Operator Panel or in a PC.

Function Description

Procedure

1. Switch off the converter power supply.
2. Wait until all LEDs on the converter are dark.
3. Insert the card with the matching firmware into the converter slot until it latches into place.

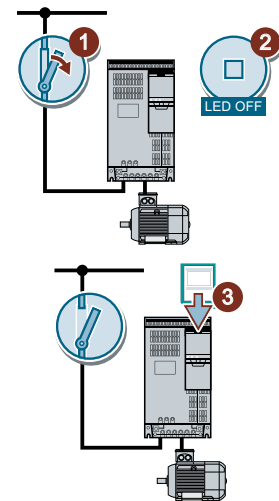

4. Switch on the converter power supply again.
5. The converter transfers the firmware from the memory card into its memory.
The transfer takes between 5 and 10 minutes.
While data is being transferred, the LED RDY on the converter stays red.
The BF LED flashes orange with a variable frequency.

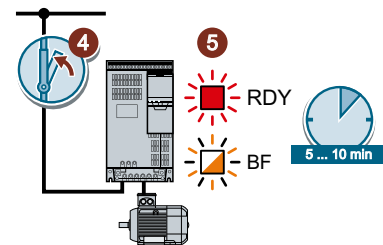

6. At the end of the transfer, the LED RDY and BF slowly flash red (0.5 Hz).
Power supply failure during transfer
The converter firmware will be incomplete if the power supply fails during the transfer.
 - Start again with Step 1 of these instructions.

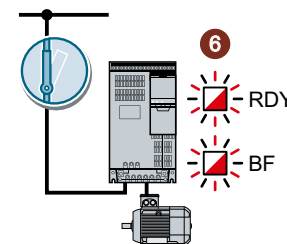

7. Switch off the converter power supply.
8. Wait until all LEDs on the converter are dark.

Decide whether you want to withdraw the memory card from the converter:

- The memory card contains a data backup:
⇒ The converter has taken the settings from the memory card.
- There was no data backup on the memory card:
⇒ The converter has the factory setting.

9. Switch on the converter power supply again.

10. If the firmware downgrade was successful, after several seconds the converter LED RDY turns green.

If the memory card is still inserted, depending on the previous content of the memory card, one of the two following cases has occurred:

- The memory card contains a data backup:
⇒ The converter has taken the settings from the memory card.
- There was no data backup on the memory card:
⇒ The converter has the factory setting.

11. If the memory card did not contain a data backup of the converter settings, then you must transfer your settings to the converter from another data backup.

 Downloading the converter settings (Page 449)

You have replaced the converter firmware by an older version.

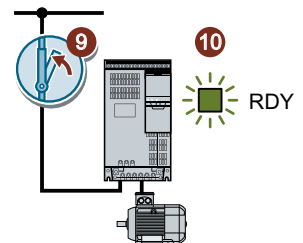
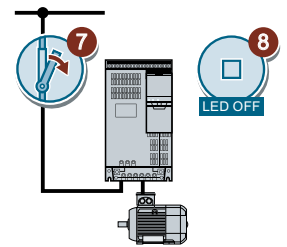

10.5.5 Correcting an unsuccessful firmware upgrade or downgrade

Requirements

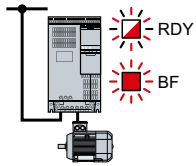

- When upgrading, the converter has firmware version V4.5 as a minimum.
- When downgrading, as a minimum the converter has firmware version V4.6.

Function Description

To correct a failed firmware upgrade or downgrade you can check the following:

- Have you inserted the card properly?
- Does the card contain the correct firmware?

Repeat the firmware upgrade or downgrade

10.6 Reduced acceptance test after component replacement and firmware change

After a component has been replaced or the firmware updated, a reduced acceptance test of the safety functions must be performed.

Measure	Acceptance test	
	Acceptance test	Documentation
Replacing the Control Unit.	No. Only check the direction of rotation of the motor.	<ul style="list-style-type: none"> • Supplement the converter data • Log the new checksums • Countersignature
Replacing the Power Module.		Supplement the hardware version in the converter data
Replacing the motor with an identical pole pair number		No change.
Replace the gearbox with an identical ratio		
Replacing safety-related I/O devices (e.g. Emergency Stop switch).	No. Only check the control of the safety functions that are influenced by the components that have been replaced.	No change.
Converter firmware update.	No.	<ul style="list-style-type: none"> • Supplement firmware version in the converter data • Log the new checksums • Countersignature.

10.7 If the converter no longer responds

If the converter no longer responds

For example, when loading an incorrect file from the memory card, the converter can go into a state where it can no longer respond to commands from the operator panel or from a higher-level control system. In this case, you must reset the converter to its factory setting and recommission it. This converter state is manifested in two different ways:

Case 1

- The motor is switched off.
- You cannot communicate with the converter, either via the operator panel or other interfaces.
- The LEDs flicker and after 3 minutes the converter has still not powered up.

Procedure

1. Remove the memory card if one is inserted in the converter.
2. Switch off the converter power supply.
3. Wait until all LEDs on the converter are dark. Then switch on the converter power supply again.
4. Repeat steps 2 and 3 as often as required until the converter outputs fault F01018.
5. Set p0971 = 1.
6. Switch off the converter power supply.
7. Wait until all LEDs on the converter are dark. Then switch on the converter power supply again.
The converter now powers up with the factory settings.
8. Recommission the converter.

You have restored the converter factory settings.



Case 2

- The motor is switched off.
- You cannot communicate with the converter, either via the operator panel or other interfaces.
- The LEDs flash and are dark - this process is continually repeated.

Procedure

1. Remove the memory card if one is inserted in the converter.
2. Switch off the converter power supply.
3. Wait until all LEDs on the converter are dark. Then switch on the converter power supply again.
4. Wait until the LEDs flash orange.

5. Repeat steps 2 and 3 as often as required until the converter outputs fault F01018.
6. Now set $p0971 = 1$.
7. Switch off the converter power supply.
8. Wait until all LEDs on the converter are dark. Then switch on the converter power supply again.
The converter now powers up with the factory settings.
9. Recommission the converter.

You have restored the converter factory settings.



The motor cannot be switched-on

If the motor cannot be switched-on, then check the following:

- Is a fault present?
If there is, then remove the fault cause and acknowledge the fault.
- Has the converter been completely commissioned $p0010 = 0$?
If not, the converter is e.g. still in a commissioning state.
- Is the converter reporting the "ready to start" status ($r0052.0 = 1$)?
- Is the converter missing some enable signals ($r0046$)?
- How does the converter receive its setpoint and commands?
Digital inputs, analog inputs or fieldbus?

10.7 If the converter no longer responds

Technical data

11.1 Technical data, CU240B-2 Control Unit

Feature	Data
Fieldbus interface	CU240B-2
	CU240B-2 DP
	<p>With RS485 interface for the following protocols:</p> <ul style="list-style-type: none"> • USS • Modbus RTU <p>With PROFIBUS interface</p>
	<p>Article numbers:  Overview of Control Units (Page 35)</p>
Operating voltage	<p>You have two options for the Control Unit power supply:</p> <ul style="list-style-type: none"> • Supply from the Power Module • External 20.4 V ... 28.8 V DC supply via terminals 31 and 32. <p>The power supply is electrically isolated from the control terminals.</p>
Current consumption	≤ 1.5 A
Power loss	5.0 W
	Plus power loss of the output voltages.
Output voltages	<p>+24 V out (terminal 9), 18 V ... 28.8 V, max. 200 mA</p> <p>+10 V out (terminals 1 and 35), 9.5 V ... 10.5 V, max. 10 mA</p>
Setpoint resolution	0.01 Hz
Digital inputs	<p>4 (DI 0 ... DI 3)</p> <ul style="list-style-type: none"> • Electrically isolated • Voltage: ≤ 30 V • Voltage for "low" state: < 5 V • Voltage for "high" state: > 11 V • Current for 24 V input voltage: 2.7 mA ... 4.7 mA • Minimum current for the "high" state: 1.8 mA ... 3.9 mA • Compatible to SIMATIC outputs • Response time for debounce time p0724 = 0: 5 ms
Analog input	<p>1 (AI 0)</p> <ul style="list-style-type: none"> • Differential input • 12-bit resolution • 13 ms ± 1 ms response time • Switchable: <ul style="list-style-type: none"> – 0 V ... 10 V or -10 V ... +10 V (typical power consumption: 0.1 mA, voltage < 35 V) – 0 mA ... 20 mA (120 Ω input resistance, voltage < 10 V, current < 80 mA) • If AI 0 has been configured as additional digital input: Voltage < 35 V, low < 1.6 V, high > 4.0 V, 13 ms ± 1 ms response time for debounce time p0724 = 0.
Digital output	<p>1 (DO 0)</p> <ul style="list-style-type: none"> • Relay output, 30 V DC / max. 0.5 A for ohmic loads • Update time 2 ms

Technical data



11.1 Technical data, CU240B-2 Control Unit

Feature	Data	
Analog output	1 (AO 0)	<ul style="list-style-type: none"> • 0 V ... 10 V or 0 mA ... 20 mA • 16-bit resolution • 4 ms update time • <400 mV offset at 0 %
Temperature sensor	PTC	<ul style="list-style-type: none"> • Short-circuit monitoring < 20 Ω • Overtemperature 1650 Ω
	KTY84	<ul style="list-style-type: none"> • Short-circuit monitoring < 50 Ω • Wire-break: > 2120 Ω
	Pt1000	<ul style="list-style-type: none"> • Short-circuit monitoring < 603 Ω • Wire-break > 2120 Ω
	Temperature switch with NC contact	
USB interface	Mini-B	
Dimensions (WxHxD)	73 mm × 199 mm × 39 mm	The depth specification is valid when mounting on the Power Module.
Weight	0.49 kg	
Memory cards	Slot for SD or MMC memory cards  Recommended memory cards (Page 200)	
Operating temperature	-10 °C ... 55 °C	Without inserted Operator Panel
	0 °C ... 50 °C	With inserted BOP-2 or IOP-2 operator panel
	Observe any possible restrictions regarding the operating temperature as a result of the Power Module.	
Storage temperature	- 40 °C ... 70 °C	
Relative humidity	< 95 %	Condensation is not permissible.

11.2 Technical data, CU240E-2 Control Unit

Feature	Data
Fieldbus interface	<p>CU240E-2, CU240E-2 F With RS485 interface for the following protocols:</p> <ul style="list-style-type: none"> • USS • Modbus RTU <p>CU240E-2 DP, CU240E-2 DP-F With PROFIBUS interface</p> <p>CU240E-2 PN, CU240E-2 PN-F With PROFINET interface</p>
	<p>Article numbers:  Overview of Control Units (Page 35)</p>
Operating voltage	<p>You have two options for the Control Unit power supply:</p> <ul style="list-style-type: none"> • Supply from the Power Module • External 20.4 V ... 28.8 V DC supply via terminals 31 and 32. <p>The power supply is electrically isolated from the control terminals.</p>
Current consumption	≤ 1.5 A
Power loss	5.0 W Plus power loss of the output voltages.
Output voltages	<p>+24 V out (terminal 9), 18 V ... 28.8 V, max. 200 mA</p> <p>+10 V out (terminals 1 and 35), 9.5 V ... 10.5 V, max. 10 mA</p>
Setpoint resolution	0.01 Hz
Digital inputs	<p>6 (DI 0 ... DI 5)</p> <ul style="list-style-type: none"> • Electrically isolated • Voltage: ≤ 30 V • Voltage for "low" state: < 5 V • Voltage for "high" state: > 11 V • Current for 24 V input voltage: 2.7 mA ... 4.7 mA • Minimum current for the "high" state: 1.8 mA ... 3.9 mA • Compatible to SIMATIC outputs • Response time for debounce time p0724 = 0: 5 ms
Pulse input	<p>1 (DI 3) Maximum frequency 32 kHz</p>
Analog inputs	<p>2 (AI 0, AI 1)</p> <ul style="list-style-type: none"> • Differential input • 12-bit resolution • 13 ms ± 1 ms response time • AI 0 and AI 1 can be switched over: <ul style="list-style-type: none"> – 0 V ... 10 V or -10 V ... +10 V (typical power consumption: 0.1 mA, voltage < 35 V) – 0 mA ... 20 mA (120 Ω input resistance, voltage < 10 V, current < 80 mA) • If AI 0 and AI 1 are configured as supplementary digital inputs: Voltage < 35 V, low < 1.6 V, high > 4.0 V, 13 ms ± 1 ms response time for debounce time p0724 = 0.

11.2 Technical data, CU240E-2 Control Unit

Feature	Data	
Digital outputs	3 (DO 0 ... DO 2)	<ul style="list-style-type: none"> DO 0: Relay output, 30 V DC / max. 0.5 A with resistive load DO 1: Transistor output, 30 VDC / max. 0.5 A with resistive load, protection against incorrect voltage polarity. Output current from DO1 for "low" state: ≤ 0.5 mA DO 2: Relay output, 30 V DC / max. 0.5 A with resistive load. 2 ms update time
For applications which require UL certification, the voltage at DO 0 must not exceed 30 VDC referred to ground potential and must be supplied via a grounded class 2 power supply.		
Analog outputs	2 (AO 0, AO 1)	<ul style="list-style-type: none"> 0 V ... 10 V or 0 mA ... 20 mA 16-bit resolution 4 ms update time <400 mV offset at 0 %
Temperature sensor	PTC	<ul style="list-style-type: none"> Short-circuit monitoring < 20 Ω Overtemperature 1650 Ω
	KTY84	<ul style="list-style-type: none"> Short-circuit monitoring < 50 Ω Wire-break: > 2120 Ω
	Pt1000	<ul style="list-style-type: none"> Short-circuit monitoring < 603 Ω Wire-break > 2120 Ω
Temperature switch with NC contact		
Failsafe digital input	1 (DI 4 and DI 5)	<ul style="list-style-type: none"> If you enable safety function STO, then the failsafe digital input comprises the two digital inputs DI 4 and DI 5. Maximum input voltage 30 V, 5.5 mA Response time: <ul style="list-style-type: none"> Typical: 5 ms + debounce time p9651 Typical, if debounce time = 0: 6 ms Worst-case scenario: 15 ms + debounce time Worst case, if debounce time = 0: 16 ms
Extended safety function data can be found in the "Safety Integrated" function manual.		
 Overview of the manuals (Page 564)		
PFH	5 × 10E-8	Probability of failure of the safety functions (Probability of Failure per Hour)
USB interface	Mini-B	
Dimensions (WxHxD)	73 mm × 199 mm × 39 mm	The depth specification is valid when mounting on the Power Module.
Weight	0.49 kg	
Memory cards	Slot for SD or MMC memory cards.	
 Recommended memory cards (Page 200)		

Feature	Data
Operating temperature	-10 °C ... 55 °C CU240E-2, CU240E-2 F, CU240E-2 DP, CU240E-2 DP-F Without inserted Operator Panel
	-10 °C ... 53 °C CU240E-2 PN, CU240E-2 PN-F Without inserted Operator Panel
	0 °C ... 50 °C With inserted BOP-2 or IOP-2 operator panel
	Observe any possible restrictions regarding the operating temperature as a result of the Power Module.
Storage temperature	- 40 °C ... 70 °C
Relative humidity	< 95 % Condensation is not permissible.

11.3 Overload capability of the converter

Overload capability is the property of the converter to temporarily supply a current that is higher than the rated current to accelerate a load. Two typical load cycles are defined to clearly demonstrate the overload capability: "Low Overload" and "High Overload"

Definitions

Base load

Constant load between the accelerating phases of the drive

Low Overload

- **LO base load input current**
Permissible input current for a "Low Overload" load cycle
- **LO base load output current**
Permissible output current for a "Low Overload" load cycle
- **LO base load power**
Rated power based on the LO base load output current

High Overload

- **HO base load input current**
Permissible input current for a "High Overload" load cycle
- **HO base load output current**
Permissible output current for a "High Overload" load cycle
- **HO base load power**
Rated power based on the HO base load output current

If not specified otherwise, the power and current data in the technical data always refer to a load cycle according to Low Overload.

We recommend using the "SIZER" engineering software to select the converter.

You can find additional information about SIZER on the Internet:

 Download SIZER (<http://support.automation.siemens.com/WW/view/en/10804987/130000>)

Load cycles and typical applications:

"Low Overload" load cycle

The "Low Overload" load cycle assumes a uniform base load with low requirements placed on brief accelerating phases. Typical applications when designing according to "Low Overload" include:

- Pumps, fans and compressors
- Wet or dry blasting technology
- Mills, mixers, kneaders, crushers, agitators
- Basic spindles
- Rotary furnaces
- Extruders

"High Overload" load cycle

The "High Overload" load cycle permits dynamic accelerating phases at a reduced base load. Typical applications when designing according to "High Overload" include:

- Horizontal and vertical conveyor technology (conveyor belts, roller conveyors, chain conveyors)
- Centrifuges
- Escalators/moving stairways
- Lifters/Lowerers
- Elevators
- Gantry cranes
- Cable railways
- Storage and retrieval machines

11.4 Technical data, PM240-2 Power Module

Protective devices for the Power Module

The fuses listed in the following tables are examples of suitable fuses.

Additional components for branch protection are available in the Internet:

 Branch protection and short-circuit strength according to UL and IEC (<https://support.industry.siemens.com/cs/ww/en/view/109486009>)

11.4.1 High overload - low overload PM240-2

Typical converter load cycles

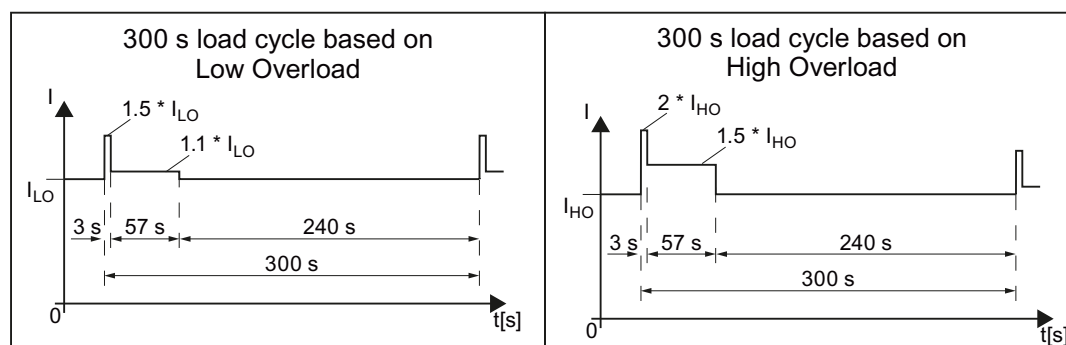





Figure 11-1 "Low Overload" and "High Overload" load cycles





Property	Version
Ambient conditions for transport in the transport packaging	
Air-conditioning	- 40 °C ... + 70 °C, according to Class 2K4 to EN 60721-3-2:1997 maximum humidity 95% at 40 °C
Mechanical system	Shocks and vibrations permissible according to 2M3 to IEC 60721-3-2:1997
Chemical substances	Protected according to Class 2C2 to IEC 60721-3-2:1997
Biological ambient conditions	Suitable according to Class 2B1 to IEC 60721-3-2:1997
Ambient conditions for long-term storage in the product packaging or in transport packaging	
Air-conditioning	- 25 °C ... + 55 °C, according to Class 1K3 to IEC 60721-3-1:1997
Chemical substances	Protected according to Class 1C2 to IEC 60721-3-1:1997
Biological ambient conditions	Suitable according to Class 1B1 to IEC 60721-3-1:1997
Ambient conditions in operation	
Installation altitude	Up to 1000 m above sea level without limitations  Restrictions for special ambient conditions (Page 544)

Property	Version
Air-conditioning ¹⁾	<ul style="list-style-type: none"> • FSA ... FSC ambient operating temperature ²⁾ <ul style="list-style-type: none"> – For operation according to Low Overload: -10 °C ... +40 °C – For operation according to High Overload: -10 °C ... +50 °C –  Restrictions for special ambient conditions (Page 544) • FSD ... FSG ambient operating temperature ²⁾ <ul style="list-style-type: none"> – For operation according to Low Overload: -20 °C ... +40 °C – For operation according to High Overload: -20 °C ... +50 °C –  Restrictions for special ambient conditions (Page 544) • Relative humidity: 5 ... 95%, condensation not permitted • Oil mist, ice formation, condensation, dripping water, spraying water, splashing water and water jets are not permitted
Mechanical system	<p>Vibration test during operation according to IEC 60068-2-6 Test Fc (sinusoidal)</p> <ul style="list-style-type: none"> • 0 ... 57 Hz: 0.075 mm deflection amplitude • 57 ... 150 Hz: 1 g acceleration amplitude • 10 frequency cycles per axis <p>Shock test according to IEC 60068-2-27 Test Ea (half-sine)</p> <ul style="list-style-type: none"> • 5 g peak acceleration • 30 ms duration • 3 shocks in all three axes in both directions
Chemical substances	Protected according to 3C2 to IEC 60721-3-3:2002
Biological ambient conditions	Suitable according to 3B1 to IEC 60721-3-3: 2002
Pollution	Suitable for environments with degree of pollution 2 according to EN 61800-5-1
Cooling	Forced air cooling AF, according to EN 60146
Cooling air	Clean and dry air
Noise emission	Maximum 75 db(A)

¹⁾ Increased ruggedness regarding temperature range and relative humidity; therefore better than 3K3 according to IEC 60721-3-3: 2002

²⁾ Observe the permissible ambient operating temperatures for the Control Unit and the Operator Panel (IOP-2 or BOP-2).

11.4.2 General technical data, 200 V converters

Property	Version	
Line voltage	FSA ... FSC	200 V ... 240 V 1 AC ± 10% 0.55 kW ... 4 kW - LO 0.37 kW ... 3 kW - HO
		200 V ... 240 V 3 AC ± 10% 0.55 kW ... 7.5 kW - LO 0.37 kW ... 5.5 kW - HO
	FSD ... FSF	200 V ... 240 V 3 AC ± 10% (in operation -20% < 1 min) 11 kW ... 55 kW - LO 7.5 kW ... 45 kW - HO
Line supply configurations	 Grounded TN/TT line supplies or non-grounded IT line supplies Connecting the line supply and motor (Page 83)	
Line impedance	FSA ... FSC	2% ≤ Uk < 4%. For Uk < 2%, we recommend a line reactor, or a Power Module with the next higher power rating.
	FSD ... FSF	No restrictions
Power factor λ	FSA ... FSC	0.7 without line reactor for Uk ≥ 2% 0.85 with line reactor for Uk < 2%
	FSD ... FSF	> 0.9
Output voltage	0 V 3 AC ... 0.95 × input voltage	
Input frequency	50 Hz ... 60 Hz, ± 3 Hz	
Output frequency	0 ... 550 Hz, depending on the control mode	
Inrush current	< LO base load input current	
Overvoltage category according to EN 61800-5-1	III for line supplies	
Pulse frequency	4 kHz (factory setting), Adjustable in steps of 2 kHz.	
	 Current reduction as a function of the pulse frequency (Page 501) If you increase the pulse frequency, the converter reduces the maximum output current.	
Short-circuit current (SCCR) and branch protection	Maximum permissible line short-circuit current ≤ 100 kA rms	
	 Branch protection and short-circuit strength according to UL and IEC (https://support.industry.siemens.com/cs/ww/en/view/109479152)	
Degree of protection according to EN 60529	IP20	
	IP55 PT devices outside the control cabinet	
Protection class according to EN 61800-5-1	The converters are devices with protection class I	
Touch protection according to EN 50274	DGVU regulation 3 when used for the intended purpose	
Cooling in compliance with EN 60146	Forced air cooling AF	
Safety Integrated	See function manual "Safety Integrated"  "Safety Integrated" function manual (https://support.industry.siemens.com/cs/ww/en/view/109751320)	

11.4.3 Specific technical data, 200 V converters

Table 11-1 PM240-2, IP20, frame size A, 200 V ... 240 V 1 AC / 3 AC

Article No. without filter Article No. with filter	6SL3210-1PB13-0UL0 6SL3210-1PB13-0AL0	6SL3210-1PB13-8UL0 6SL3210-1PB13-8AL0
LO base load power	0.55 kW	0.75 kW
1 AC LO base load input current	7.5 A	9.6 A
3 AC LO base load input current	4.2 A	5.5 A
LO base load output current	3.2 A	4.2 A
HO base load power	0.37 kW	0.55 kW
1 AC HO base load input current	6.6 A	8.4 A
3 AC HO base load input current	3.0 A	4.2 A
HO base load output current	2.3 A	3.2 A
Fuse according to IEC	3NA3805 (16 A)	3NA3805 (16 A)
Fuse according to UL, class J	15 A	15 A
Power loss	0.04 kW	0.04 kW
Required cooling air flow	5 l/s	5 l/s
Weight without filter	1.4 kg	1.4 kg
Weight with filter	1.6 kg	1.6 kg

Table 11-2 PM240-2, PT, frame size A, 200 V ... 240 V 1 AC / 3 AC

Article No. without filter Article No. with filter	6SL3211-1PB13-8UL0 6SL3211-1PB13-8AL0
LO base load power	0.75 kW
1 AC LO base load input current	9.6 A
3 AC LO base load input current	5.5 A
LO base load output current	4.2 A
HO base load power	0.55 kW
1 AC HO base load input current	8.4 A
3 AC HO base load input current	4.2 A
HO base load output current	3.2 A
Fuse according to IEC	3NA3 805 (16 A)
Fuse according to UL, class J	15 A
Power loss	0.04 kW
Required cooling air flow	5 l/s
Weight without filter	1.8 kg
Weight with filter	2.0 kg

Table 11-3 PM240-2, IP20, frame size B, 200 V ... 240 V 1 AC / 3 AC

Article No. without filter	6SL3210-1PB15-5ULO	6SL3210-1PB17-4ULO	6SL3210-1PB21-0ULO
Article No. with filter	6SL3210-1PB15-5ALO	6SL3210-1PB17-4ALO	6SL3210-1PB21-0ALO
LO base load power	1.1 kW	1.5 kW	2.2 kW
1 AC LO base load input current	13.5 A	18.1 A	24.0 A
3 AC LO base load input current	7.8 A	9.7 A	13.6 A
LO base load output current	6 A	7.4 A	10.4 A
HO base load power	0.75 kW	1.1 kW	1.5 kW
1 AC HO base load input current	11.8 A	15.8 A	20.9 A
3 AC HO base load input current	5.5 A	7.8 A	9.7 A
HO base load output current	4.2 A	6 A	7.4 A
Fuse according to IEC	3NA3812 (32 A)	3NA3812 (32 A)	3NA3812 (32 A)
Fuse according to UL, class J	35 A	35 A	35 A
Power loss	0.05 kW	0.07 kW	0.12 kW
Required cooling air flow	9.2 l/s	9.2 l/s	9.2 l/s
Weight without filter	2.8 kg	2.8 kg	2.8 kg
Weight with filter	3.1 kg	3.1 kg	3.1 kg

Table 11-4 PM240-2, PT, frame size B, 200 V ... 240 V 1 AC / 3 AC

Article No. without filter	6SL3211-1PB21-0ULO
Article No. with filter	6SL3211-1PB21-0ALO
LO base load power	2.2 kW
1 AC LO base load input current	24.0 A
3 AC LO base load input current	13.6 A
LO base load output current	10.4 A
HO base load power	1.5 kW
1 AC HO base load input current	20.9 A
3 AC HO base load input current	9.7 A
HO base load output current	7.4 A
Fuse according to IEC	3NA3812 (32 A)
Fuse according to UL, class J	35 A
Power loss	0.12 kW ¹⁾
Required cooling air flow	9.2 l/s
Weight without filter	3.4 kg
Weight with filter	3.7 kg

¹⁾ approx. 0.08 kW through the heat sink

Technical data

11.4 Technical data, PM240-2 Power Module

Table 11-5 PM240-2, IP 20, frame size C, 200 V ... 240 V 1 AC / 3 AC

Article No. without filter Article No. with filter	6SL3210-1PB21-4UL0 6SL3210-1PB21-4AL0	6SL3210-1PB21-8UL0 6SL3210-1PB21-8AL0
LO base load power	3 kW	4 kW
1 AC LO base load input current	35.9 A	43.0 A
3 AC LO base load input current	17.7 A	22.8 A
LO base load output current	13.6 A	17.5 A
HO base load power	2.2 kW	3 kW
1 AC HO base load input current	31.3 A	37.5 A
3 AC HO base load input current	13.6 A	17.7 A
HO base load output current	10.4 A	13.6 A
Fuse according to IEC Fuse according to UL, class J	3NA3820 (50 A) 50 A	3NA3820 (50 A) 50 A
Power loss	0.14 kW	0.18 kW
Required cooling air flow	18.5 l/s	18.5 l/s
Weight without filter	5.0 kg	5.0 kg
Weight with filter	5.2 kg	5.2 kg

Table 11-6 PM240-2, PT, frame size C, 200 V ... 240 V 1 AC / 3 AC

Article No. without filter Article No. with filter	6SL3211-1PB21-8UL0 6SL3211-1PB21-8AL0
LO base load power	4 kW
1 AC LO base load input current	43.0 A
3 AC LO base load input current	22.8 A
LO base load output current	17.5 A
HO base load power	3 kW
1 AC HO base load input current	37.5 A
3 AC HO base load input current	17.7 A
HO base load output current	13.6 A
Fuse according to IEC Fuse according to UL, class J	3NA3820 (50 A) 50 A
Power loss	0.18 kW ¹⁾
Required cooling air flow	18.5 l/s
Weight without filter	5.9 kg
Weight with filter	6.2 kg

¹⁾ approx. 0.09 kW through the heat sink

Table 11-7 PM240-2, IP 20, frame size C, 200 V ... 240 V 3 AC

Article No. without filter Article No. with filter	6SL3210-1PC22-2ULO 6SL3210-1PC22-2ALO	6SL3210-1PC22-8ULO 6SL3210-1PC22-8ALO
LO base load power	5.5 kW	7.5 kW
LO base load input current	28.6 A	36.4 A
LO base load output current	22.0 A	28.0 A
HO base load power	4 kW	5.5 kW
HO base load input current	22.8 A	28.6 A
HO base load output current	17.5 A	22.0 A
Fuse according to IEC Fuse according to UL, class J	3NA3820 (50 A) 50 A	3NA3820 (50 A) 50 A
Power loss	0.2 kW	0.26 kW
Required cooling air flow	18.5 l/s	18.5 l/s
Weight without filter	5.0 kg	5.0 kg
Weight with filter	5.2 kg	5.2 kg

Table 11-8 PM240-2, PT, frame size C, 200 V ... 240 V 3 AC

Article No. without filter Article No. with filter	6SL3211-1PC22-2ULO 6SL3211-1PC22-2ALO	6SL3211-1PC22-8ULO 6SL3211-1PC22-8ALO
LO base load power	5.5 kW	7.5 kW
LO base load input current	28.6 A	36.4 A
LO base load output current	22.0 A	28.0 A
HO base load power	4 kW	5.5 kW
HO base load input current	22.8 A	28.6 A
HO base load output current	17.5 A	22.0 A
Fuse according to IEC Fuse according to UL, class J	3NA3820 (50 A) 50 A	3NA3820 (50 A) 50 A
Power loss	0.2 kW ¹⁾	0.26 kW ²⁾
Required cooling air flow	18.5 l/s	18.5 l/s
Weight without filter	5.9 kg	5.9 kg
Weight with filter	6.2 kg	6.2 kg

¹⁾ approx. 0.2 kW through the heatsink

²⁾ approx. 0.25 kW through the heatsink

Table 11-9 PM240-2, IP20, frame size D, 200 V ... 240 V 3 AC

Article No. without filter	6SL3210-1PC24-2ULO	6SL3210-1PC25-4ULO	6SL3210-1PC26-8ULO
LO base load power	11 kW	15 kW	18.5 kW
LO base load input current	40 A	51 A	64 A

Technical data

11.4 Technical data, PM240-2 Power Module

Article No. without filter	6SL3210-1PC24-2UL0	6SL3210-1PC25-4UL0	6SL3210-1PC26-8UL0
LO base load output current	42 A	54 A	68 A
HO base load power	7.5 kW	11 kW	15 kW
HO base load input current	36 A	43 A	56 A
HO base load output current	35 A	42 A	54 A
Fuse according to IEC	3NA3822 (63 A)	3NA3824 (80 A)	3NA3830 (100 A)
Fuse according to UL, class J	60 A	70 A	90 A
Power loss	0.45 kW	0.61 kW	0.82 kW
Required cooling air flow	55 l/s	55 l/s	55 l/s
Weight	18.3 kg	18.3 kg	18.3 kg

Table 11-10 PM240-2, PT, frame size D, 200 V ... 240 V 3 AC

Article No. without filter	6SL3211-1PC26-8UL0
LO base load power	18.5 kW
LO base load input current	64 A
LO base load output current	68 A
HO base load power	15 kW
HO base load input current	56 A
HO base load output current	54 A
Fuse according to IEC	3NA3830 (100 A)
Fuse according to UL, class J	90 A
Power loss	0.82 kW ¹⁾
Required cooling air flow	55 l/s
Weight	19.5 kg

¹⁾ approx. 0.72 kW through the heatsink

Table 11-11 PM240-2, IP20, frame size E, 200 V ... 240 V 3 AC

Article No. without filter	6SL3210-1PC28-0UL0	6SL3210-1PC31-1UL0
LO base load power	22 kW	30 kW
LO base load input current	76 A	98 A
LO base load output current	80 A	104 A
HO base load power	18.5 kW	22 kW
HO base load input current	71 A	83 A
HO base load output current	68 A	80 A
Fuse according to IEC	3NA3830 (100 A)	3NA3836 (160 A)
Fuse according to UL, class J	100 A	150 A
Power loss	0.92 kW	1.28 kW

Article No. without filter	6SL3210-1PC28-0U0	6SL3210-1PC31-1U0
Required cooling air flow	83 l/s	83 l/s
Weight	26.8 kg	26.8 kg

Table 11-12 PM240-2, PT, frame size E, 200 V to 240 V 3 AC

Article No. without filter	6SL3211-1PC31-1U0
LO base load power	30 kW
LO base load input current	98 A
LO base load output current	104 A
HO base load power	22 kW
HO base load input current	83 A
HO base load output current	80 A
Fuse according to IEC	3NA3836 (160 A)
Fuse according to UL, class J	150 A
Power loss	1.28 kW ¹⁾
Required cooling air flow	83 l/s
Weight	29.5 kg

¹⁾ approx. 1.1 kW through the heatsink

Table 11-13 PM240-2, IP20, frame size F, 200 V ... 240 V 3 AC

Article No. without filter	6SL3210-1PC31-3U0	6SL3210-1PC31-6U0	6SL3210-1PC31-8U0
LO base load power	37 kW	45 kW	55 kW
LO base load input current	126 A	149 A	172 A
LO base load output current	130 A	154 A	178 A
HO base load power	30 kW	37 kW	45 kW
HO base load input current	110 A	138 A	164 A
HO base load output current	104 A	130 A	154 A
Fuse according to IEC	3NA3140 (200 A)	3NA3140 (200 A)	3NA3142 (224 A)
Fuse according to UL, class J	175 A	200 A	250 A
Power loss	1.38 kW	1.72 kW	2.09 kW
Required cooling air flow	153 l/s	153 l/s	153 l/s
Weight	58 kg	58 kg	58 kg

Technical data

11.4 Technical data, PM240-2 Power Module

Table 11-14 PM240-2, PT, frame size F, 200 V to 240 V 3 AC

Article No. without filter	6SL3211-1PC31-8UL0
LO base load power	55 kW
LO base load input current	172 A
LO base load output current	178 A
HO base load power	45 kW
HO base load input current	164 A
HO base load output current	154 A
Fuse according to IEC	3NA3142 (224 A)
Fuse according to UL, class J	250 A
Power loss	2.09 kW ¹⁾
Required cooling air flow	153 l/s
Weight	60.5 kg

¹⁾ approx. 1.9 kW through the heatsink

11.4.4 Current derating depending on the pulse frequency, 200 V converters





LO base load

Article number	LO power [kW]	Pulse frequency [kHz]							
		2	4 *)	6	8	10	12	14	16
		LO base load output current [A]							
6SL3210-1PB13-0 . LO	0.55	3.2	3.2	2.7	2.2	1.9	1.6	1.4	1.3
6SL321 . -1PB13-8 . LO	0.75	4.2	4.2	3.6	2.9	2.5	2.1	1.9	1.7
6SL3210-1PB15-5 . LO	1.1	6	6	5.1	4.2	3.6	3	2.7	2.4
6SL3210-1PB17-4 . LO	1.5	7.4	7.4	6.3	5.2	4.4	3.7	3.3	3
6SL321 . -1PB21-0 . LO	2.2	10.4	10.4	8.8	7.3	6.2	5.2	4.7	4.2
6SL3210-1PB21-4 . LO	3	13.6	13.6	11.6	9.5	8.2	6.8	6.1	5.4
6SL321 . -1PB21-8 . LO	4	17.5	17.5	14.9	12.3	10.5	8.8	7.9	7
6SL3210-1PC22-2 . LO	5.5	22	22	18.7	15.4	13.2	11	9.9	8.8
6SL3210-1PC22-8 . LO	7.5	28	28	23.8	19.6	16.8	14	12.6	11.2
6SL3210-1PC24-2UL0	11	42	42	35.7	29.4	25.2	21	18.9	16.8
6SL3210-1PC25-4UL0	15	54	54	45.9	37.8	32.4	27	24.3	21.6
6SL321 . -1PC26-8UL0	18.5	68	68	57.8	47.6	40.8	34	30.6	27.2
6SL3210-1PC28-0UL0	22	80	80	68	56	48	40	36	32
6SL321 . -1PC31-1UL0	30	104	104	88.4	72.8	62.4	52	46.8	41.6
6SL3210-1PC31-3UL0	37	130	130	110.5	91	---	---	---	---
6SL3210-1PC31-6UL0	45	154	154	130.9	107.8	---	---	---	---
6SL321 . -1PC31-8UL0	55	178	178	151.3	124.6	---	---	---	---

*) Factory setting

The permissible motor cable length depends on the particular cable type and the pulse frequency that has been selected.

11.4.5 General technical data, 400 V converters

Property	Version
Line voltage	FSA ... FSC 380 V ... 480 V 3 AC ± 10%
	FSD ... FSG 380 V (-20 %) ... 480 V 3 AC + 10%
Line supply configurations	 Grounded TN/TT line supplies or non-grounded IT line supplies  Connecting the line supply and motor (Page 83)
Line impedance	FSA ... FSC 1% ≤ Uk < 4%, for values smaller than 1%, we recommend a line reactor, or a Power Module with the next higher power rating.
	FSD ... FSG No restrictions
Power factor λ	FSA ... FSC 0.7 without line reactor for Uk ≥ 1% 0.85 with line reactor for Uk < 1%
	FSD ... FSG > 0.9
Output voltage	0 V 3 AC ... 0.95 x input voltage (max.)
Input frequency	50 Hz ... 60 Hz, ± 3 Hz
Output frequency	0 ... 550 Hz, depending on the control mode
Inrush current	< LO base load input current
Overvoltage category according to EN 61800-5-1	III for line supplies
Pulse frequency	Factory setting
	<ul style="list-style-type: none"> • 4 kHz for devices with an LO base load power < 110 kW • 2 kHz for devices with an LO base load power ≥ 110 kW Can be adjusted in 2 kHz steps as follows: <ul style="list-style-type: none"> • 2 kHz ... 16 kHz for devices with an LO base load power < 55 kW • 2 kHz ... 8 kHz for devices with an LO base load output of 55 kW ... 250 kW If you increase the pulse frequency, the converter reduces the maximum output current.  Current reduction as a function of the pulse frequency (Page 511)
Short-circuit current (SCCR) and branch protection	Maximum permissible line short-circuit current ≤ 100 kA rms
	 Branch protection and short-circuit strength according to UL and IEC (https://support.industry.siemens.com/cs/ww/en/view/109801083)
Braking methods	DC braking, compound braking, dynamic braking with integrated braking chopper
Degree of protection according to EN 60529	IP20
	IP55 PT devices outside the control cabinet
Protection class according to EN 61800-5-1	The converters are devices with protection class I
Touch protection according to EN 50274	DGUV regulation 3 when used for the intended purpose
Cooling in compliance with EN 60146	Forced air cooling AF
Safety Integrated	See function manual "Safety Integrated"  "Safety Integrated" function manual (https://support.industry.siemens.com/cs/ww/en/view/109751320)

11.4.6 Specific technical data, 400 V converters

Table 11-15 PM240-2, IP20, frame size A, 380 V ... 480 V 3 AC

Article No. without filter Article No. with filter	6SL3210-1PE11-8UL1 6SL3210-1PE11-8AL1	6SL3210-1PE12-3UL1 6SL3210-1PE12-3AL1	6SL3210-1PE13-2UL1 6SL3210-1PE13-2AL1
LO base load power	0.55 kW	0.75 kW	1.1 kW
LO base load input current	2.3 A	2.9 A	4.1 A
LO base load output current	1.7 A	2.2 A	3.1 A
HO base load power	0.37 kW	0.55 kW	0.75 kW
HO base load input current	2.0 A	2.6 A	3.3 A
HO base load output current	1.3 A	1.7 A	2.2 A
Fuse according to IEC	3NA3803 (10 A)	3NA3803 (10 A)	3NA3805 (16 A)
Fuse according to UL, class J	10 A	10 A	15 A
Power loss	0.04 kW	0.04 kW	0.04 kW
Required cooling air flow	5 l/s	5 l/s	5 l/s
Weight without filter	1.3 kg	1.3 kg	1.3 kg
Weight with filter	1.5 kg	1.5 kg	1.5 kg

Table 11-16 PM240-2, IP20, frame size A, 380 V ... 480 V 3 AC

Article No. without filter Article No. with filter	6SL3210-1PE14-3UL1 6SL3210-1PE14-3AL1	6SL3210-1PE16-1UL1 6SL3210-1PE16-1AL1	6SL3210-1PE18-0UL1 6SL3210-1PE18-0AL1
LO base load power	1.5 kW	2.2 kW	3.0 kW
LO base load input current	5.5 A	7.7 A	10.1 A
LO base load output current	4.1 A	5.9 A	7.7 A
HO base load power	1.1 kW	1.5 kW	2.2 kW
HO base load input current	4.7 A	6.1 A	8.8 A
HO base load output current	3.1 A	4.1 A	5.9 A
Fuse according to IEC	3NA3805 (16 A)	3NA3805 (16 A)	3NA3805 (16 A)
Fuse according to UL, class J	15 A	15 A	15 A
Power loss	0.07 kW	0.1 kW	0.12 kW
Required cooling air flow	5 l/s	5 l/s	5 l/s
Weight without filter	1.4 kg	1.4 kg	1.4 kg
Weight with filter	1.6 kg	1.6 kg	1.6 kg

Technical data

11.4 Technical data, PM240-2 Power Module

Table 11-17 PM240-2, PT, frame size A, 380 V ... 480 V 3 AC

Article No. without filter	6SL3211-1PE18-OUL1
Article No. with filter	6SL3211-1PE18-OAL1
LO base load power	3.0 kW
LO base load input current	10.1 A
LO base load output current	7.7 A
HO base load power	2.2 kW
HO base load input current	8.8 A
HO base load output current	5.9 A
Fuse according to IEC	3NA3805 (16 A)
Fuse according to UL, class J	15 A
Power loss without filter	0.12 kW ¹⁾
Required cooling air flow	7 l/s
Weight without filter	1.8 kg
Weight with filter	2.0 kg

1) approx. 0.1 kW through the heatsink

Table 11-18 PM240-2, IP20, frame size B, 380 V ... 480 V 3 AC

Article No. without filter	6SL3210-1PE21-1UL0	6SL3210-1PE21-4UL0	6SL3210-1PE21-8UL0
Article No. with filter	6SL3210-1PE21-1AL0	6SL3210-1PE21-4AL0	6SL3210-1PE21-8AL0
LO base load power	4.0 kW	5.5 kW	7.5 kW
LO base load input current	13.3 A	17.2 A	22.2 A
LO base load output current	10.2 A	13.2 A	18.0 A
HO base load power	3.0 kW	4.0 kW	5.5 kW
HO base load input current	11.6 A	15.3 A	19.8 A
HO base load output current	7.7 A	10.2 A	13.2 A
Fuse according to IEC	3NA3812 (32 A)	3NA3812 (32 A)	3NA3812 (32 A)
Fuse according to UL, class J	35 A	35 A	35 A
Power loss	0.11 kW	0.15 kW	0.2 kW
Required cooling air flow	9.2 l/s	9.2 l/s	9.2 l/s
Weight without filter	2.9 kg	2.9 kg	3.0 kg
Weight with filter	3.1 kg	3.1 kg	3.2 kg

Table 11-19 PM240-2, PT, frame size B, 380 V ... 480 V 3 AC

Article No. without filter	6SL3211-1PE21-8UL0
Article No. with filter	6SL3211-1PE21-8AL0
LO base load power	7.5 kW
LO base load input current	22.2 A
LO base load output current	18.0 A

Article No. without filter	6SL3211-1PE21-8ULO
Article No. with filter	6SL3211-1PE21-8ALO
HO base load power	5.5 kW
HO base load input current	19.8 A
HO base load output current	13.7 A
Fuse according to IEC	3NA3812 (32 A)
Fuse according to UL, class J	35 A
Power loss	0.2 kW ¹⁾
Required cooling air flow	9.2 l/s
Weight without filter	3.6 kg
Weight with filter	3.9 kg

1) approx. 0.16 kW through the heatsink

Table 11-20 PM240-2, IP20, frame size C, 380 V ... 480 V 3 AC

Article No. without filter	6SL3210-1PE22-7ULO	6SL3210-1PE23-3ULO
Article No. with filter	6SL3210-1PE22-7ALO	6SL3210-1PE23-3ALO
LO base load power	11.0 kW	15.0 kW
LO base load input current	32.6 A	39.9 A
LO base load output current	26.0 A	32.0 A
HO base load power	7.5 kW	11.0 kW
HO base load input current	27.0 A	36.0 A
HO base load output current	18.0 A	26.0 A
Fuse according to IEC	3NA3820 (50 A)	3NA3820 (50 A)
Fuse according to UL, class J	50 A	50 A
Power loss	0.3 kW	0.37 kW
Required cooling air flow	18.5 l/s	18.5 l/s
Weight without filter	4.7 kg	4.8 kg
Weight with filter	5.3 kg	5.4 kg

Table 11-21 PM240-2, PT, frame size C, 380 V ... 480 V 3 AC

Article No. without filter	6SL3211-1PE23-3ULO
Article No. with filter	6SL3211-1PE23-3ALO
LO base load power	15.0 kW
LO base load input current	39.9 A
LO base load output current	32.0 A
HO base load power	11.0 kW
HO base load input current	36.0 A
HO base load output current	26.0 A

Technical data

11.4 Technical data, PM240-2 Power Module

Article No. without filter	6SL3211-1PE23-3UL0
Article No. with filter	6SL3211-1PE23-3AL0
Fuse according to IEC	3NA3820 (50 A)
Fuse according to UL, class J	50 A
Power loss	0.37 kW ¹⁾
Required cooling air flow	18.5 l/s
Weight without filter	5.8 kg
Weight with filter	6.3 kg

1) approx. 0.3 kW through the heatsink

Table 11-22 PM240-2, IP20, frame size D, 380 V ... 480 V 3 AC

Article No. without filter	6SL3210-1PE23-8UL0	6SL3210-1PE24-5UL0	6SL3210-1PE26-0UL0
Article No. with filter	6SL3210-1PE23-8AL0	6SL3210-1PE24-5AL0	6SL3210-1PE26-0AL0
LO base load power	18.5 kW	22 kW	30 kW
LO base load input current	36 A	42 A	57 A
LO base load output current	38 A	45 A	60 A
HO base load power	15 kW	18.5 kW	22 kW
HO base load input current	33 A	38 A	47 A
HO base load output current	32 A	38 A	45 A
Fuse according to IEC	3NA3822 (63 A)	3NA3824 (80 A)	3NA3830 (100 A)
Fuse according to UL, class J	60 A	70 A	90 A
Power loss without filter	0.57 kW	0.70 kW	0.82 kW
Power loss with filter	0.58 kW	0.71 kW	0.83 kW
Required cooling air flow	55 l/s	55 l/s	55 l/s
Weight without filter	16.6 kg	16.6 kg	18.3 kg
Weight with filter	18.3 kg	18.3 kg	19 kg

Table 11-23 PM240-2, IP20, frame size D, 380 V ... 480 V 3 AC

Article No. without filter	6SL3210-1PE27-5UL0
Article No. with filter	6SL3210-1PE27-5AL0
LO base load power	37 kW
LO base load input current	70 A
LO base load output current	75 A
HO base load power	30 kW
HO base load input current	62 A
HO base load output current	60 A
Fuse according to IEC	3NA3830 (100 A)
Fuse according to UL, class J	100 A
Power loss without filter	1.09 kW

Article No. without filter	6SL3210-1PE27-5ULO
Article No. with filter	6SL3210-1PE27-5ALO
Power loss with filter	1.10 kW
Required cooling air flow	55 l/s
Weight without filter	18.3 kg
Weight with filter	19 kg

Table 11-24 PM240-2, PT, frame size D, 380 V ... 480 V 3 AC

Article No. without filter	6SL3211-1PE27-5ULO
Article No. with filter	6SL3211-1PE27-5ALO
LO base load power	37 kW
LO base load input current	70 A
LO base load output current	75 A
HO base load power	30 kW
HO base load input current	62 A
HO base load output current	60 A
Fuse according to IEC	3NA3830 (100 A)
Fuse according to UL, class J	100 A
Power loss without filter	1.09 kW ¹⁾
Power loss with filter	1.10 kW ¹⁾
Required cooling air flow	55 l/s
Weight without filter	20 kg
Weight with filter	22 kg

¹⁾ Approx. 1 kW through the heatsink

Table 11-25 PM240-2, IP20, frame size E, 380 V ... 480 V 3 AC

Article No. without filter	6SL3210-1PE28-8ULO	6SL3210-1PE31-1ULO
Article No. with filter	6SL3210-1PE28-8ALO	6SL3210-1PE31-1ALO
LO base load power	45 kW	55 kW
LO base load input current	86 A	104 A
LO base load output current	90 A	110 A
HO base load power	37 kW	45 kW
HO base load input current	78 A	94 A
HO base load output current	75 A	90 A
Fuse according to IEC	3NA3832 (125 A)	3NA3836 (160 A)
Fuse according to UL, class J	125 A	150 A
Power loss without filter	1.29 kW	1.65 kW
Power loss with filter	1.30 kW	1.67 kW
Required cooling air flow	83 l/s	83 l/s

Technical data

11.4 Technical data, PM240-2 Power Module

Article No. without filter	6SL3210-1PE28-8UL0	6SL3210-1PE31-1UL0
Article No. with filter	6SL3210-1PE28-8AL0	6SL3210-1PE31-1AL0
Weight without filter	26.4 kg	26.4 kg
Weight with filter	28.4 kg	28.4 kg

Table 11-26 PM240-2, PT, frame size E, 380 V ... 480 V 3 AC

Article No. without filter	6SL3211-1PE31-1UL0
Article No. with filter	6SL3211-1PE31-1AL0
LO base load power	55 kW
LO base load input current	104 A
LO base load output current	110 A
HO base load power	45 kW
HO base load input current	94 A
HO base load output current	90 A
Fuse according to IEC	3NA3836 (160 A)
Fuse according to UL, class J	150 A
Power loss without filter	1.65 kW ¹⁾
Power loss with filter	1.67 kW ¹⁾
Required cooling air flow	83 l/s
Weight without filter	30.5 kg
Weight with filter	32 kg

¹⁾ Approx. 1.4 kW through the heatsink

Table 11-27 PM240-2, IP20, frame size F, 380 V ... 480 V 3 AC

Article No. without filter	6SL3210-1PE31-5UL0	6SL3210-1PE31-8UL0	6SL3210-1PE32-1UL0
Article No. with filter	6SL3210-1PE31-5AL0	6SL3210-1PE31-8AL0	6SL3210-1PE32-1AL0
LO base load power	75 kW	90 kW	110 kW
LO base load input current	140 A	172 A	198 A
LO base load output current	145 A	178 A	205 A
HO base load power	55 kW	75 kW	90 kW
HO base load input current	117 A	154 A	189 A
HO base load output current	110 A	145 A	178 A
Fuse according to IEC	3NA3140 (200 A)	3NA3142 (224 A)	3NA3250 (300 A)
Fuse according to UL, class J	200 A	250 A	300 A
Power loss without filter	1.91 kW	2.46 kW	2.28 kW
Power loss with filter	1.93 kW	2.48 kW	2.30 kW
Required cooling air flow	153 l/s	153 l/s	153 l/s

Article No. without filter	6SL3210-1PE31-5ULO	6SL3210-1PE31-8ULO	6SL3210-1PE32-1ULO
Article No. with filter	6SL3210-1PE31-5ALO	6SL3210-1PE31-8ALO	6SL3210-1PE32-1ALO
Weight without filter	58 kg	58 kg	62 kg
Weight with filter	64 kg	64 kg	66 kg

Table 11-28 PM240-2, IP20, frame size F, 380 V ... 480 V 3 AC

Article No. without filter	6SL3210-1PE32-5ULO
Article No. with filter	6SL3210-1PE32-5ALO
LO base load power	132 kW
LO base load input current	242 A
LO base load output current	250 A
HO base load power	110 kW
HO base load input current	218 A
HO base load output current	205 A
Fuse according to IEC	3NA3252 (315 A)
Fuse according to UL, class J	350 A
Power loss without filter	2.98 kW
Power loss with filter	3.02 kW
Required cooling air flow	153 l/s
Weight without filter	62 kg
Weight with filter	66 kg

Table 11-29 PM240-2, PT, frame size F, 380 V ... 480 V 3 AC

Article No. without filter	6SL3211-1PE32-5ULO
Article No. with filter	6SL3211-1PE32-5ALO
LO base load power	132 kW
LO base load input current	242 A
LO base load output current	250 A
HO base load power	110 kW
HO base load input current	218 A
HO base load output current	205 A
Fuse according to IEC	3NA3252 (315 A)
Fuse according to UL, class J	350 A
Power loss without filter	2.98 kW ¹⁾
Power loss with filter	3.02 kW ¹⁾
Required cooling air flow	153 l/s

Technical data

11.4 Technical data, PM240-2 Power Module

Article No. without filter	6SL3211-1PE32-5UL0
Article No. with filter	6SL3211-1PE32-5AL0
Weight without filter	63.5 kg
Weight with filter	68.5 kg

¹⁾ Approx. 2.6 kW through the heatsink

Table 11-30 PM240-2, frame size G, 380 V ... 480 V 3 AC

Article No. with filter class C3	6SL3210-1PE33-0CLO	6SL3210-1PE33-7CLO	6SL3210-1PE34-8CLO
Article No. with filter class C2	6SL3210-1PE33-0ALO	6SL3210-1PE33-7ALO	6SL3210-1PE34-8ALO
LO base load power	160 kW	200 kW	250 kW
LO base load input current	300 A	365 A	470 A
LO base load output current	302 A	370 A	477 A
HO base load power	132 kW	160 kW	200 kW
HO base load input current	275 A	330 A	400 A
HO base load output current	250 A	302 A	370 A
Fuse according to IEC	3NA3254 (355 A)	3NA3260 (400 A)	3NA3372 (630 A)
Fuse according to UL, class J	400 A	500 A	600 A
Fuse according to IEC/UL	3NE1334-2 (500A)	3NE1334-2 (500A)	3NE1436-2 (630A)
Power loss with filter class C3	3.67 kW	4.62 kW	6.18 kW
Power loss with filter class C2	3.67 kW	4.62 kW	6.18 kW
Required cooling air flow	210 l/s	210 l/s	210 l/s
Weight with filter class C3	105 kg	113 kg	120 kg
Weight with filter class C2	107 kg	114 kg	122 kg

11.4.7 Current derating depending on the pulse frequency, 400 V converters

LO base load





Article number	LO power [kW]	Pulse frequency [kHz]							
		2	4 *)	6	8	10	12	14	16
		LO base load output current [A]							
6SL3210-1PE11-8 . L1	0.55	1.7	1.7	1.4	1.2	1	0.9	0.8	0.7
6SL3210-1PE12-3 . L1	0.75	2.2	2.2	1.9	1.5	1.3	1.1	1	0.9
6SL3210-1PE13-2 . L1	1.1	3.1	3.1	2.6	2.2	1.9	1.6	1.4	1.2
6SL3210-1PE14-3 . L1	1.5	4.1	4.1	3.5	2.9	2.5	2.1	1.8	1.6
6SL3210-1PE16-1 . L1	2.2	5.9	5.9	5	4.1	3.5	3	2.7	2.4
6SL321 . -1PE18-0 . L1	3	7.7	7.7	6.5	5.4	4.6	3.9	3.5	3.1
6SL3210-1PE21-1 . LO	4	10.2	10.2	8.7	7.1	6.1	5.1	4.6	4.1
6SL3210-1PE21-4 . LO	5.5	13.2	13.2	11.2	9.2	7.9	6.6	5.9	5.3
6SL321 . -1PE21-8 . LO	7.5	18	18	15.3	12.6	10.8	9	8.1	7.2
6SL3210-1PE22-7 . LO	11	26	26	22.1	18.2	15.6	13	11.7	10.4
6SL321 . -1PE23-3 . LO	15	32	32	27.2	22.4	19.2	16	14.4	12.8
6SL3210-1PE23-8 . LO	18.5	38	38	32.3	26.6	22.8	19	17.1	15.2
6SL3210-1PE24-5 . LO	22	45	45	38.3	31.5	27	22.5	20.3	18
6SL3210-1PE26-0 . LO	30	60	60	51	42	36	30	27	24
6SL321 . -1PE27-5 . LO	37	75	75	63.8	52.5	45	37.5	33.8	30
6SL3210-1PE28-8 . LO	45	90	90	76.5	63	54	45	40.5	36
6SL321 . -1PE31-1 . LO	55	110	110	93.5	77	---	---	---	---
6SL3210-1PE31-5 . LO	75	145	145	123.3	101.5	---	---	---	---
6SL3210-1PE31-8 . LO	90	178	178	151.3	124.6	---	---	---	---
Article number		Pulse frequency [kHz]							
		2 *)	4	6 **)	8 **)	10	12	14	16
		LO base load output current [A]							
6SL3210-1PE32-1 . LO	110	205	143.5	102.5	82	---	---	---	---
6SL321 .-1PE32-5 . LO	132	250	175	125	100	---	---	---	---
6SL3210-1PE33-0 .LO	160	302	211.4	151	120.8	---	---	---	---
6SL3210-1PE33-7 .LO	200	370	259	185	148	---	---	---	---
6SL3210-1PE34-8 .LO	250	477	333.9	238.5	190.8	---	---	---	---

*) Factory setting

**) Available from Functional State (FS) 12

The permissible motor cable length depends on the particular cable type and the pulse frequency that has been selected.

11.4.8 General technical data, 690 V converters

Property	Version
Line voltage	<ul style="list-style-type: none"> for systems according to IEC: 500 V ... 690 V 3 AC \pm 10% (in operation -20% < 1 min) for systems according to UL 500 V ... 600 V 3 AC \pm 10% (in operation -20% < 1 min) filtered devices only with Slash Rating (600Y/347V AC)
Line supply configurations	Grounded TN/TT line supplies or non-grounded IT line supplies  Connecting the line supply and motor (Page 83)
Line impedance	No restrictions
Power factor λ	> 0.9
Output voltage	0 V 3 AC ... 0.95 x input voltage (max.)
Input frequency	50 Hz ... 60 Hz, \pm 3 Hz
Output frequency	0 ... 550 Hz, depending on the control mode
Inrush current	< LO base load input current
Overvoltage category according to EN 61800-5-1	III for line supplies
Pulse frequency	2 kHz (factory setting), can be adjusted to 4 kHz Adjustable in steps of 2 kHz.  Current reduction as a function of the pulse frequency (Page 516) If you increase the pulse frequency, the converter reduces the maximum output current.
Short-circuit current (SCCR) and branch protection	Maximum permissible line short-circuit current \leq 100 kA rms  Branch protection and short-circuit strength according to UL and IEC https://support.industry.siemens.com/cs/ww/en/view/109801083
Braking methods	DC braking, compound braking, dynamic braking with integrated braking chopper
Degree of protection according to EN 60529	IP20; must be installed in a control cabinet
Protection class according to EN 61800-5-1	The converters are devices with protection class I
Touch protection according to EN 50274	DGUV regulation 3 when used for the intended purpose
Cooling in compliance with EN 60146	Forced air cooling AF
Safety Integrated	See function manual "Safety Integrated"  "Safety Integrated" function manual (https://support.industry.siemens.com/cs/ww/en/view/109751320)

11.4.9 Specific technical data, 690 V converters

Table 11-31 PM240-2, IP20, frame size D, 500 V ... 690 V 3 AC

Article No. - without filter	6SL3210-1PH21-4ULO	6SL3210-1PH22-0ULO	6SL3210-1PH22-3ULO
Article No. - with filter	6SL3210-1PH21-4ALO	6SL3210-1PH22-0ALO	6SL3210-1PH22-3ALO
LO base load power	11 kW	15 kW	18.5 kW
LO base load input current	14 A	18 A	22 A
LO base load output current	14 A	19 A	23 A
HO base load power	7.5 kW	11 kW	15 kW
HO base load input current	11 A	14 A	20 A
HO base load output current	11 A	14 A	19 A
Fuse according to IEC	3NA3807-6 (20 A)	3NA3810-6 (25 A)	3NA3812-6 (32 A)
Fuse according to UL, class J	20 A	25 A	30 A
Power loss without filter	0.35 kW	0.44 kW	0.52 kW
Power loss with filter	0.35 kW	0.45 kW	0.52 kW
Required cooling air flow	55 l/s	55 l/s	55 l/s
Weight without filter	17.4 kg	17.4 kg	17.4 kg
Weight with filter	18.9 kg	18.9 kg	18.9 kg

Table 11-32 PM240-2, IP20, frame size D, 500 V ... 690 V 3 AC

Article No. - without filter	6SL3210-1PH22-7ULO	6SL3210-1PH23-5ULO	6SL3210-1PH24-2ULO
Article No. - with filter	6SL3210-1PH22-7ALO	6SL3210-1PH23-5ALO	6SL3210-1PH24-2ALO
LO base load power	22 kW	30 kW	37 kW
LO base load input current	25 A	33 A	40 A
LO base load output current	27 A	35 A	42 A
HO base load power	18.5 kW	22 kW	30 kW
HO base load input current	24 A	28 A	36 A
HO base load output current	23 A	27 A	35 A
Siemens fuse according to IEC	3NA3817-6KJ (40 A)	3NA3820-6KJ (50 A)	3NA3822-6 (63 A)
Fuse according to UL, class J	35 A	45 A	60 A
Power loss without filter	0.60 kW	0.77 kW	0.93 kW
Power loss with filter	0.60 kW	0.78 kW	0.94 kW
Required cooling air flow	55 l/s	55 l/s	55 l/s
Weight without filter	17.4 kg	17.4 kg	17.4 kg
Weight with filter	18.9 kg	18.9 kg	18.9 kg

Technical data

11.4 Technical data, PM240-2 Power Module

Table 11-33 PM240-2, IP20, frame size E, 500 V ... 690 V 3 AC

Article No. - without filter	6SL3210-1PH25-2UL0	6SL3210-1PH26-2UL0
Article No. - with filter	6SL3210-1PH25-2AL0	6SL3210-1PH26-2AL0
LO base load power	45 kW	55 kW
LO base load input current	50 A	59 A
LO base load output current	52 A	62 A
HO base load power	37 kW	45 kW
HO base load input current	44 A	54 A
HO base load output current	42 A	52 A
Siemens fuse according to IEC	3NA3824-6 (80A)	3NA3824-6 (80A)
Fuse according to UL, class J	80 A	80 A
Power loss without filter	1.07 kW	1.30 kW
Power loss with filter	1.08 kW	1.31 kW
Required cooling air flow	83 l/s	83 l/s
Weight without filter	27.1 kg	27.1 kg
Weight with filter	28.5 kg	28.5 kg

Table 11-34 PM240-2, IP20, frame size F, 500 V ... 690 V 3 AC

Article No. - without filter	6SL3210-1PH28-OULO	6SL3210-1PH31-OULO	6SL3210-1PH31-2ULO
Article No. - with filter	6SL3210-1PH28-OALO	6SL3210-1PH31-OALO	6SL3210-1PH31-2ALO
LO base load power	75 kW	90 kW	110 kW
LO base load input current	78 A	97 A	111 A
LO base load output current	80 A	100 A	115 A
HO base load power	55 kW	75 kW	90 kW
HO base load input current	66 A	85 A	106 A
HO base load output current	62 A	80 A	100 A
Siemens fuse according to IEC	3NA3830-6 (100 A)	3NA3132-6 (125 A)	3NA3136-6 (160 A)
Fuse according to UL, class J	100 A	125 A	150 A
Power loss without filter	1.37 kW	1.74 kW	1.95 kW
Power loss with filter	1.38 kW	1.76 kW	1.97 kW
Required cooling air flow	153 l/s	153 l/s	153 l/s
Weight without filter	61 kg	61 kg	61 kg
Weight with filter	65 kg	65 kg	65 kg

Table 11-35 PM240-2, IP20, frame size F, 500 V ... 690 V 3 AC

Article No. - without filter	6SL3210-1PH31-4ULO
Article No. - with filter	6SL3210-1PH31-4ALO
LO base load power	132 kW
LO base load input current	137 A

Article No. - without filter	6SL3210-1PH31-4ULO
Article No. - with filter	6SL3210-1PH31-4ALO
LO base load output current	142 A
HO base load power	110 kW
HO base load input current	122 A
HO base load output current	115 A
Siemens fuse according to IEC	3NA3140-6 (200 A)
Fuse according to UL, class J	200 A
Power loss without filter	2.48 kW
Power loss with filter	2.51 kW
Required cooling air flow	153 l/s
Weight without filter	61 kg
Weight with filter	65 kg

Table 11-36 PM240-2, frame size G, 500 V ... 690 V 3 AC

Article No. with filter	6SL3210-1PH31-7CLO	6SL3210-1PH32-1CLO	6SL3210-1PH32-5CLO
LO base load power	160 kW	200 kW	250 kW
LO base load input current	170 A	205 A	250 A
LO base load output current	171 A	208 A	250 A
HO base load power	132 kW	160 kW	200 kW
HO base load input current	160 A	185 A	225 A
HO base load output current	144 A	171 A	208 A
Fuse according to the IEC/UL	3NE1227-0 (250A)	3NE1230-0 (315A)	3NE1331-0 (350A)
Power loss	2.94 kW	3.70 kW	4.64 kW
Required cooling air flow	210 l/s	210 l/s	210 l/s
Weight	114 kg	114 kg	114 kg

11.4.10 Current derating depending on the pulse frequency, 690 V converters

LO base load

Article number	LO power [kW]	Pulse frequency [kHz]	
		2 *)	4
		LO base load output current [A]	
6SL3210-1PH21-4 . LO	11	14	8.4
6SL3210-1PH22-0 . LO	15	19	11.4
6SL3210-1PH22-3 . LO	18.5	23	13.8
6SL3210-1PH22-7 . LO	22	27	16.2
6SL3210-1PH23-5 . LO	30	35	21
6SL321 . -1PH24-2 . LO	37	42	25.2
6SL3210-1PH25-2 . LO	45	52	31.2
6SL321 . -1PH26-2 . LO	55	62	37.2
6SL3210-1PH28-0 . LO	75	80	48
6SL3210-1PH31-0 . LO	90	100	60
6SL3210-1PH31-2 . LO	110	115	69
6SL3210-1PH31-4 . LO	132	142	85.2
6SL3210-1PH31-7CLO	160	171	102.6
6SL3210-1PH32-1CLO	200	208	124.8
6SL3210-1PH32-5CLO	250	250	150

*) Factory setting

The permissible motor cable length depends on the particular cable type and the pulse frequency that has been selected

11.5 Technical Data, PM240P-2 Power Module

Protective devices for the Power Module

The fuses listed in the following tables are examples of suitable fuses.

Additional components for branch protection are available in the Internet:

 Branch protection and short-circuit strength according to UL and IEC (<https://support.industry.siemens.com/cs/ww/en/view/109479152>)

Typical converter load cycles

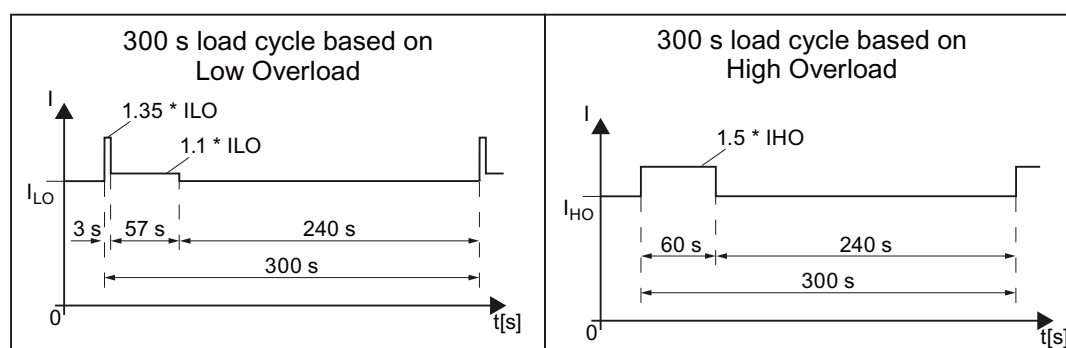



Figure 11-2 "Low Overload" and "High Overload" load cycles

11.5.1 Ambient conditions

Property	Version
Ambient conditions for transport in the transport packaging	
Climatic ambient conditions	- 40 °C ... + 70 °C, according to Class 2K4 to EN 60721-3-2:1997 maximum humidity 95% at 40 °C
Mechanical ambient conditions	Shocks and vibrations permissible according to 2M3 to IEC 60721-3-2:1997
Protection against chemical substances	Protected according to Class 2C2 to IEC 60721-3-2:1997
Biological environmental conditions	Suitable according to Class 2B1 to IEC 60721-3-2:1997
Ambient conditions for long-term storage in the product packaging	
Climatic ambient conditions	- 25 °C ... + 55 °C, according to Class 1K3 to IEC 60721-3-1:1997
Protection against chemical substances	Protected according to Class 1C2 to IEC 60721-3-1:1997
Biological environmental conditions	Suitable according to Class 1B1 to IEC 60721-3-1:1997
Ambient conditions in operation	

Property	Version
Installation altitude	Up to 1000 m above sea level without derating, > 1000 m  Restrictions for special ambient conditions (Page 544)
Climatic ambient conditions ¹⁾	<ul style="list-style-type: none"> • Frame sizes FSD ... FSF temperature range ²⁾ <ul style="list-style-type: none"> – in operation acc. to LO: -20 °C ... +40 °C – in operation acc. to HO: -20 °C ... +50 °C – for higher temperatures  Restrictions for special ambient conditions (Page 544) • Relative humidity: 5 ... 95%, condensation not permitted • Oil mist, ice formation, condensation, dripping water, spraying water, splashing water and water jets are not permitted
Mechanical ambient conditions	<ul style="list-style-type: none"> • Vibration levels permissible according to Class 3M1 to EN 60721-3-3:2002 • Shocks permissible according to Class 3M1 to EN 60721-3-3:2002
Protection against chemical substances	Protected according to 3C2 to IEC 60721-3-3:2002
Biological environmental conditions	Suitable according to 3B1 to IEC 60721-3-3: 2002
Pollution	Suitable for environments with degree of pollution 2 according to EN 61800-5-1
Cooling	Forced air cooling AF, according to EN 60146
Cooling air	Clean and dry air

¹⁾ Increased ruggedness regarding temperature range and relative humidity; therefore better than 3K3 according to IEC 60721-3-3: 2002

²⁾ Observe the permissible ambient temperatures for the Control Unit and possibly the operator panel (IOP-2 or BOP-2).

11.5.2 General technical data, 400 V converters

Property	Version
Line voltage	3 AC 380 V ... 480 V \pm 10% (in operation -20% < 1 min)
Line system configurations	Grounded TN/TT line systems or non-grounded IT line systems
Line impedance	$U_k < 4\%$, line reactor is not required
Power factor λ	> 0.9
Output voltage	3 AC 0 V ... 0.95 x input voltage (max.)
Input frequency	50 Hz ... 60 Hz, \pm 3 Hz
Output frequency	0 ... 550 Hz, depending on the control mode
Inrush current	$< LO$ base load input current
Overvoltage category according to EN 61800-5-1	III for line supplies
Pulse frequency	<p>Factory setting</p> <ul style="list-style-type: none"> • 4 kHz for devices with an LO base load power < 75 kW • 2 kHz for devices with an LO base load power ≥ 75 kW <p>Can be adjusted in 2 kHz steps as follows:</p> <ul style="list-style-type: none"> • 2 kHz ... 16 kHz for devices with an LO base load power < 55 kW • 2 kHz ... 8 kHz for devices with an LO base load power ≥ 55 kW • 2 kHz ... 4 kHz for devices with an LO base load power ≥ 110 kW <p>If you increase the pulse frequency, the converter reduces the maximum output current.</p>
Short-circuit current rating (SCCR) and branch protection	<p>≤ 100 kA rms</p> <p> Branch protection and short-circuit strength according to UL and IEC (https://support.industry.siemens.com/cs/ww/en/view/109479152)</p>
Braking methods	DC braking, compound braking
Degree of protection according to EN 60529	IP20 Must be installed in a control cabinet
Protection class according to EN 61800-5-1	The converters are devices with protection class I
Touch protection according to EN 50274	DGUV regulation 3 when used for the intended purpose
Cooling in compliance with EN 60146	Forced air cooling AF

11.5.3 Specific technical data, 400 V converters

The fuses listed in the following tables are examples of suitable fuses.

You can find additional suitable fuses in the Internet:

 Branch protection and short-circuit strength according to UL and IEC (<https://support.industry.siemens.com/cs/ww/en/view/109479152>)

Table 11-37 PM240P-2, IP20, Frame Size D, 3-ph. AC 380 V ... 480 V

Article number without filter	6SL3210-1RE24-5UL0	6SL3210-1RE26-0UL0	6SL3210-1RE27-5UL0
Article number with filter	6SL3210-1RE24-5AL0	6SL3210-1RE26-0AL0	6SL3210-1RE27-5AL0
LO base load power	22 kW	30 kW	37 kW
LO base load input current	42 A	57 A	70 A
LO base load output current	45 A	60 A	75 A
HO base load power	18.5 kW	22 kW	30 kW
HO base load input current	38 A	47 A	62 A
HO base load output current	38 A	45 A	60 A
Siemens fuse according to IEC/UL	3NE1820-0 / 80 A	3NE1021-0 / 100 A	3NE1021-0 / 100 A
Fuse according to IEC/UL, Class J	70 A	90 A	100 A
Power loss without filter	0.68 kW	0.76 kW	1.01 kW
Power loss with filter	0.68 kW	0.77 kW	1.02 kW
Required cooling air flow	55 l/s	55 l/s	55 l/s
Weight without filter	16 kg	17 kg	17 kg
Weight with filter	17.5 kg	18.5 kg	18.5 kg

Table 11-38 PM240P-2, IP20, Frame Size E, 3-ph. AC 380 V ... 480 V

Article number without filter	6SL3210-1RE28-8UL0	6SL3210-1RE31-1UL0
Article number with filter	6SL3210-1RE28-8AL0	6SL3210-1RE31-1AL0
LO base load power	45 kW	55 kW
LO base load input current	86 A	104 A
LO base load output current	90 A	110 A
HO base load power	37 kW	45 kW
HO base load input current	78 A	94 A
HO base load output current	75 A	90 A
Siemens fuse according to IEC/UL	3NE1022-0 / 125 A	3NE1224-0 / 160 A
Fuse according to IEC/UL, Class J	125 A	150 A
Power loss without filter	1.19 kW	1.54 kW
Power loss with filter	1.2 kW	1.55 kW
Required cooling air flow	83 l/s	83 l/s
Weight without filter	26 kg	26 kg
Weight with filter	28 kg	28 kg

Table 11-39 PM240P-2, IP20, Frame Size F, 3-ph. AC 380 V ... 480 V

Article number without filter	6SL3210-1RE31-5ULO	6SL3210-1RE31-8ULO	6SL3210-1RE32-1ULO
Article number with filter	6SL3210-1RE31-5ALO	6SL3210-1RE31-8ALO	6SL3210-1RE32-1ALO
LO base load power	75 kW	90 kW	110 kW
LO base load input current	140 A	172 A	198 A
LO base load output current	145 A	178 A	205 A
HO base load power	55 kW	75 kW	90 kW
HO base load input current	117 A	154 A	189 A
HO base load output current	110 A	145 A	178 A
Siemens fuse according to IEC/UL	3NE1225-0 / 200 A	3NE1227-0 / 250 A	3NE1230-0 / 315 A
Fuse according to IEC/UL, Class J	200 A	250 A	300 A
Power loss without filter	1.95 kW	2.54 kW	2.36 kW
Power loss with filter	1.97 kW	2.56 kW	2.38 kW
Required cooling air flow	153 l/s	153 l/s	153 l/s
Weight without filter	57 kg	57 kg	61 kg
Weight with filter	63 kg	63 kg	65 kg

Table 11-40 PM240P-2, IP20, Frame Size F, 3-ph. AC 380 V ... 480 V

Article number without filter	6SL3210-1RE32-5ULO
Article number with filter	6SL3210-1RE32-5ALO
LO base load power	132 kW
LO base load input current	242 A
LO base load output current	250 A
HO base load power	110 kW
HO base load input current	218 A
HO base load output current	205 A
Siemens fuse according to IEC/UL	3NE1331-0 / 350 A
Fuse according to IEC/UL, Class J	350 A
Power loss without filter	3.09 kW
Power loss with filter	3.12 kW
Required cooling air flow	153 l/s
Weight without filter	61 kg
Weight with filter	65 kg

11.5.4 Current derating depending on the pulse frequency, 400 V converters

Article number	LO power [kW]	LO base load output current [A]							
		2	4 *)	6	8	10	12	14	16
Pulse frequency [kHz]		2	4 *)	6	8	10	12	14	16
6SL3210-1RE24-5 . LO	22	45	45	38.3	31.5	27	22.5	20.3	18
6SL3210-1RE26-0 . LO	30	60	60	51	42	36	30	27	24
6SL3210-1RE27-5 . LO	37	75	75	63.8	52.5	45	37.5	33.8	30
6SL3210-1RE28-8 . LO	45	90	90	76.5	63	54	45	40.5	36
6SL3210-1RE31-1 . LO	55	110	110	93.5	77	---	---	---	---
Pulse frequency [kHz]		2 *)	4	6	8	10	12	14	16
6SL3210-1RE31-5 . LO	75	145	145	123.3	101.5	---	---	---	---
6SL3210-1RE31-8 . LO	90	178	178	151.3	124.6	---	---	---	---
6SL3210-1RE32-1 . LO	110	205	143.5	---	---	---	---	---	---
6SL3210-1RE32-5 . LO	132	250	175	---	---	---	---	---	---

*) Factory setting

The permissible motor cable length depends on the particular cable type and the pulse frequency that has been selected

11.5.5 General technical data, 690 V converters

Property	Version
Line voltage	3 AC 500 V ... 690 V \pm 10% (in operation -20% < 1 min) with Class J fuses, maximum 600 V
Line system configurations	Grounded TN/TT line systems or non-grounded IT line systems
Line impedance	$U_k < 4\%$, line reactor is not required
Power factor λ	> 0.9
Output voltage	3 AC 0 V ... $0.95 \times$ input voltage (max.)
Input frequency	50 Hz ... 60 Hz, ± 3 Hz
Output frequency	0 ... 550 Hz, depending on the control mode
Inrush current	$<$ LO base load input current
Overvoltage category according to EN 61800-5-1	III for line supplies
Pulse frequency	2 kHz (factory setting), can be adjusted to 4 kHz If you increase the pulse frequency, the converter reduces the maximum output current.
Short-circuit current rating (SCCR) and branch protection	≤ 100 kA rms  Branch protection and short-circuit strength according to UL and IEC (https://support.industry.siemens.com/cs/ww/en/view/109479152)
Braking methods	DC braking, compound braking
Degree of protection according to EN 60529	IP20; must be installed in a control cabinet
Protection class according to EN 61800-5-1	The converters are devices with protection class I
Touch protection according to EN 50274	DGUV regulation 3 when used for the intended purpose
Cooling in compliance with EN 60146	Forced air cooling AF

11.5.6 Specific technical data, 690 V converters

The fuses listed in the following tables are examples of suitable fuses.

You can find additional suitable fuses in the Internet:

 Branch protection and short-circuit strength according to UL and IEC (<https://support.industry.siemens.com/cs/ww/en/view/109479152>)

Table 11-41 PM240P-2, IP20, frame size D, 3 AC 500 V ... 690 V

Article number without filter	6SL3210-1RH21-4UL0	6SL3210-1RH22-0UL0	6SL3210-1RH22-3UL0
Article number with filter	6SL3210-1RH21-4AL0	6SL3210-1RH22-0AL0	6SL3210-1RH22-3AL0
LO base load power	11 kW	15 kW	18.5 kW
LO base load input current	14 A	18 A	22 A
LO base load output current	14 A	19 A	23 A
HO base load power	7.5 kW	11 kW	15 kW
HO base load input current	11 A	14 A	20 A
HO base load output current	11 A	14 A	19 A
Siemens fuse according to IEC/UL	3NE1815-0 / 25 A	3NE1815-0 / 25 A	3NE1803-0 / 35 A
Fuse according to IEC/UL, Class J	20 A	25 A	30 A
Power loss	0.32 kW	0.41 kW	0.48 kW
Required cooling air flow	55 l/s	55 l/s	55 l/s
Weight without filter	17 kg	17 kg	17 kg
Weight with filter	18.5 kg	18.5 kg	18.5 kg

Table 11-42 PM240P-2, IP20, frame size D, 3 AC 500 V ... 690 V

Article number without filter	6SL3210-1RH22-7UL0	6SL3210-1RH23-5UL0	6SL3210-1RH24-2UL0
Article number with filter	6SL3210-1RH22-7AL0	6SL3210-1RH23-5AL0	6SL3210-1RH24-2AL0
LO base load power	22 kW	30 kW	37 kW
LO base load input current	25 A	33 A	40 A
LO base load output current	27 A	35 A	42 A
HO base load power	18.5 kW	22 kW	30 kW
HO base load input current	24 A	28 A	36 A
HO base load output current	23 A	27 A	35 A
Siemens fuse according to IEC/UL	3NE1803-0 / 35 A	3NE1817-0 / 50 A	3NE1818-0 / 63 A
Fuse according to IEC/UL, Class J	35 A	50 A	60 A
Power loss without filter	0.56 kW	0.72 kW	0.88 kW
Power loss with filter	0.56 kW	0.73 kW	0.88 kW
Required cooling air flow	55 l/s	55 l/s	55 l/s
Weight without filter	17 kg	17 kg	17 kg
Weight with filter	18.5 kg	18.5 kg	18.5 kg

Table 11-43 PM240P-2, IP20, frame sizes E, 3 AC 500 V ... 690 V

Article number without filter	6SL3210-1RH25-2ULO	6SL3210-1RH26-2ULO
Article number with filter	6SL3210-1RH25-2ALO	6SL3210-1RH26-2ALO
LO base load power	45 kW	55 kW
LO base load input current	50 A	59 A
LO base load output current	52 A	62 A
HO base load power	37 kW	45 kW
HO base load input current	44 A	54 A
HO base load output current	42 A	52 A
Siemens fuse according to IEC/UL	3NA1820-0 / 80 A	3NE1820-0 / 80 A
Fuse according to IEC/UL, Class J	80 A	80 A
Power loss without filter	1.00 kW	1.21 kW
Power loss with filter	1.00 kW	1.22 kW
Required cooling air flow	83 l/s	83 l/s
Weight without filter	26 kg	26 kg
Weight with filter	28 kg	28 kg

Table 11-44 PM240-2, IP20, frame size F, 3 AC 500 V ... 690 V

Article number without filter	6SL3210-1RH28-0ULO	6SL3210-1RH31-0ULO	6SL3210-1RH31-2ULO
Article number with filter	6SL3210-1RH28-0ALO	6SL3210-1RH31-0ALO	6SL3210-1RH31-2ALO
LO base load power	75 kW	90 kW	110 kW
LO base load input current	78 A	97 A	111 A
LO base load output current	80 A	100 A	115 A
HO base load power	55 kW	75 kW	90 kW
HO base load input current	66 A	85 A	106 A
HO base load output current	62 A	80 A	100 A
Siemens fuse according to IEC/UL	3NE1021-0 / 100 A	3NE1022-0 / 125 A	3NE1224-0 / 160 A
Fuse according to IEC/UL, Class J	110 A	150 A	150 A
Power loss without filter	1.34 kW	1.71 kW	2 kW
Power loss with filter	1.35 kW	1.72 kW	2.02 kW
Required cooling air flow	153 l/s	153 l/s	153 l/s
Weight without filter	60 kg	60 kg	60 kg
Weight with filter	64 kg	64 kg	64 kg

Table 11-45 PM240-2, IP20, frame size F, 3 AC 500 V ... 690 V

Article number without filter	6SL3210-1RH31-4ULO
Article number with filter	6SL3210-1RH31-4ALO
LO base load power	132 kW
LO base load input current	137 A
LO base load output current	142 A
HO base load power	110 kW

Technical data

11.5 Technical Data, PM240P-2 Power Module

Article number without filter	6SL3210-1RH31-4UL0
Article number with filter	6SL3210-1RH31-4AL0
HO base load input current	122 A
HO base load output current	115 A
Siemens fuse according to IEC/UL	3NE1225-0 / 200 A
Fuse according to IEC/UL, Class J	200 A
Power loss without filter	2.56 kW
Power loss with filter	2.59 kW
Required cooling air flow	153 l/s
Weight without filter	60 kg
Weight with filter	64 kg

11.5.7 Current derating depending on the pulse frequency, 690 V converters

Article number	LO power [kW]	LO base load output current [A]	
		2	4
6SL3210-1RH21-4 . LO		14	8.4
6SL3210-1RH22-0 . LO		19	11.4
6SL3210-1RH22-3 . LO		23	13.8
6SL3210-1RH22-7 . LO		27	16.2
6SL3210-1RH23-5 . LO		35	21
6SL3210-1RH24-2 . LO		42	25.2
6SL3210-1RH25-2 . LO		52	31.2
6SL3210-1RH26-2 . LO		62	37.2
6SL3210-1RH28-0 . LO		80	48
6SL3210-1RH31-0 . LO		100	60
6SL3210-1RH31-2 . LO		115	69
6SL3210-1RH31-4 . LO		142	85.2

The permissible motor cable length depends on the cable type and the selected pulse frequency.

11.6 Technical data, PM230 Power Module

Typical converter load cycles

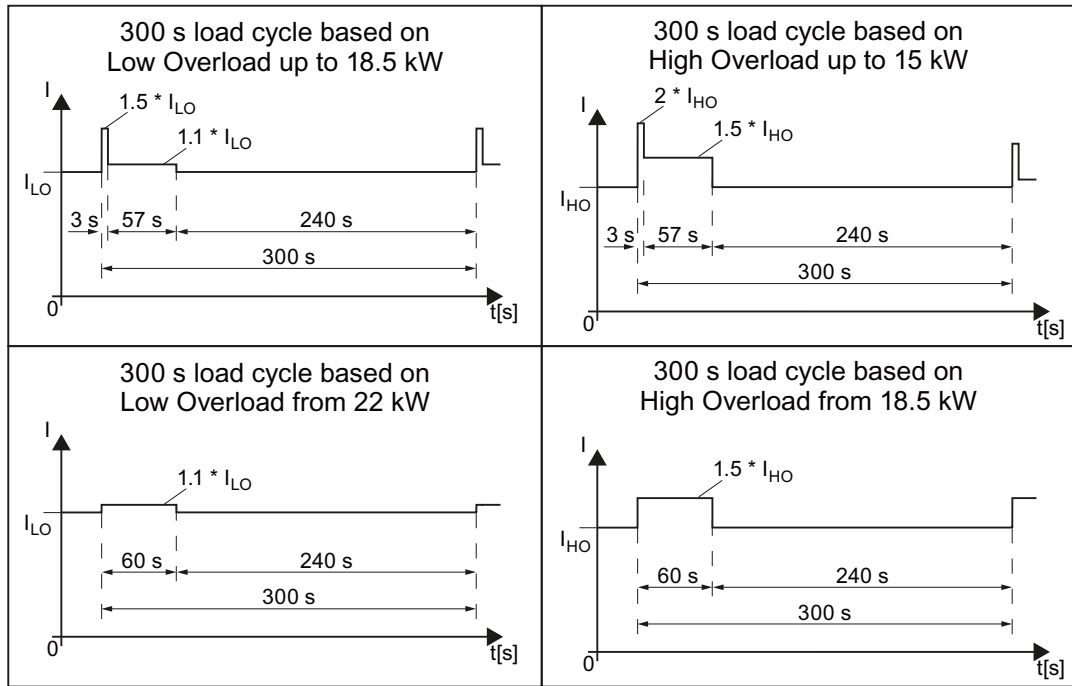



Figure 11-3 Duty cycles, "High Overload" and "Low Overload"

11.6.1 Ambient conditions



Property	Version
Ambient conditions for transport in the transport packaging	
Climatic ambient conditions	- 40 °C ... + 70 °C, according to Class 2K4 to EN 60721-3-2 maximum humidity 95 % at 40 °C
Mechanical ambient conditions	FSA ... FSC: Shock and vibration permissible according to 1M2 to EN 60721-3-2 FSD ... FSF: Shock and vibration permissible according to 2M3 to EN 60721-3-2
Protection against chemical substances	Protected according to Class 2C2 to EN 60721-3-2
Biological ambient conditions	Suitable according to Class 2B1 to EN 60721-3-2
Ambient conditions for long-term storage in the product packaging	
Climatic ambient conditions	- 25 °C ... + 55 °C, according to Class 1K3 to EN 60721-3-1
Protection against chemical substances	Protected according to Class 1C2 to EN 60721-3-1
Biological ambient conditions	Suitable according to Class 1B1 according to EN 60721-3-1

Property	Version
Ambient conditions in operation	
Installation altitude	Up to 1000 m above sea level without derating, > 1000 m  Restrictions for special ambient conditions (Page 544)
Climatic ambient conditions ¹⁾	<ul style="list-style-type: none"> • Temperature range without derating ²⁾ <ul style="list-style-type: none"> – LO base load power: 0 °C...40 °C – HO base load power: 0 °C...50 °C <p>For higher temperatures.  Restrictions for special ambient conditions (Page 544)</p> <ul style="list-style-type: none"> • Relative humidity: 5 ... 95%, condensation not permitted • Oil mist, salt mist, ice formation, condensation, dripping water, spraying water, splashing water and water jets are not permitted
Mechanical ambient conditions	FSA ... FSF: Vibration levels permissible according to Class 3M1 to EN 60721-3-3 FSA ... FSC: Shock, permissible according to Class 3M2 to EN 60721-3-3 FSD ... FSF: Shock permissible according to Class 3M1 to EN 60721-3-3
Protection against chemical substances	Protected according to 3C2 to EN 60721-3-3
Biological ambient conditions	Suitable according to 3B1 to EN 60721-3-3
Pollution	Suitable for environments with degree of pollution 2 according to EN 61800-5-1
Cooling	Forced air cooling AF, according to EN 60146
Cooling air	clean and dry air

¹⁾ Increased ruggedness regarding temperature range and relative humidity; therefore better than Class 3K3 to EN 60721-3-3

²⁾ Observe the permissible ambient temperatures for the Control Unit and possibly the operator panel (IOP-2 or BOP-2).

11.6.2 General technical data, PM230

Property	Version	
Line voltage	380 ... 480 V 3 AC ± 10%	
Output voltage	3-phase 0 VAC ... input voltage x 0.95 (max.)	
Input frequency	50 Hz ... 60 Hz, ± 3 Hz	
Output frequency	0 Hz ... 550 Hz, depending on the control mode	
Power factor λ	0.9	
Line impedance	U _k ≤ 1%, line reactor not permissible	
Inrush current	< LO base load input current	
Pulse frequency (factory setting)	4 kHz The pulse frequency can be increased in 2 kHz steps up to 16 kHz (up to 8 kHz for 55 kW and 75 kW). An increase in the pulse frequency results in a lower output current.	
Electromagnetic compatibility	Devices with filters in compliance with EN 61800-3: 2004 are suitable for Category C2 environments.	
Braking methods	DC braking	
Degree of protection	IP20 built-in units PT devices	IP20 when mounted in a control cabinet IP54 on the control cabinet wall
Operating temperature at	LO base load power without derating	0° C ... +40° C
	HO base load power without derating	0° C ... +50° C
	LO/HO base load power with derating:	Up to 60° C
	 Restrictions for special ambient conditions (Page 544)	
Storage temperature	-40° C ... +70° C	
Relative humidity	< 95% - condensation not permissible	
Pollution	Protected according to pollution degree 2 according to EN 61800-5-1: 2007	
Ambient conditions	Protected against damaging chemical substances according to environmental class 3C2 according to EN 60721-3-3: 1995	
Shock and vibration	<ul style="list-style-type: none"> • Long-term storage in the transport packaging according to Class 1M2 according to EN 60721-3-1: 1997 • Transport in the transport packaging according to Class 2M3 according to EN 60721-3-2: 1997 • Vibration during operation according to Class 3M2 according to EN 60721-3-3: 1995 	
Installation altitude	without derating:	up to 1000 m above sea level
	with derating:	up to 4000 m above sea level
	 Restrictions for special ambient conditions (Page 544)	
Permissible short-circuit current	Frame size D ... F: 65 kA ¹⁾	
Overvoltage category	Supply circuits:	Overvoltage category III
	Non-supply circuits:	Overvoltage category II
Standards	UL ^{1),2)} , CE, C-tick The drive only satisfies the UL requirements when UL-certified fuses are used.	

¹⁾ If fuse-protected with a listed Class J or 3NE1 fuse, rated voltage 600 VAC with the rated current of the specific converter.

²⁾ UL available soon for frame sizes D ... F

11.6.3 Detailed technical data, PM230

Table 11-46 PM230, IP20, frame size A, 3 AC 380 V ... 480 V

Article number without filter Article number with filter	6SL3210-1NE11-3UG1 6SL3210-1NE11-3AG1	6SL3210-1NE11-7UG1 6SL3210-1NE11-7AG1	6SL3210-1NE12-2UG1 6SL3210-1NE12-2AG1
LO base load power	0.37 kW	0.55 kW	0.75 kW
LO base load input current	1.3 A	1.8 A	2.3 A
LO base load output current	1.3 A	1.7 A	2.2 A
HO base load power	0.25 kW	0.37 kW	0.55 kW
HO base load input current	0.9 A	1.3 A	1.8 A
HO base load output current	0.9 A	1.3 A	1.7 A
Fuse according to IEC / UL Fuse according to UL, Class J	3NE1813-0 2 A	3NE1813-0 4 A	3NE1813-0 4 A
Circuit breaker 3RV2711-1KD10	12.5 A	12.5 A	12.5 A
Power loss	0.04 kW	0.04 kW	0.05 kW
Required cooling air flow	1.5 l/s	1.5 l/s	4.5 l/s
Weight without filter	1.4 kg	1.4 kg	1.4 kg
Weight with filter	1.6 kg	1.6 kg	1.6 kg

Table 11-47 PM230, IP20, frame size A, 3 AC 380 V ... 480 V

Article number without filter Article number with filter	6SL3210-1NE13-1UG1 6SL3210-1NE13-1AG1	6SL3210-1NE14-1UG1 6SL3210-1NE14-1AG1	6SL3210-1NE15-8UG1 6SL3210-1NE15-8AG1
LO base load power	1.1 kW	1.5 kW	2.2 kW
LO base load input current	3.2 A	4.2 A	6.1 A
LO base load output current	3.1 A	4.1 A	5.9 A
HO base load power	0.75 kW	1.1 kW	1.5 kW
HO base load input current	2.3 A	3.2 A	4.2 A
HO base load output current	2.2 A	3.1 A	4.1 A
Fuse according to IEC / UL Fuse according to UL, Class J	3NE1813-0 6 A	3NE1813-0 6 A	3NE1813-0 10 A
Power loss	0.06 kW	0.07 kW	0.08 kW
Circuit breaker N3RV2711-1KD10	12.5 A	12.5 A	12.5 A
Required cooling air flow	4.5 l/s	4.5 l/s	4.5 l/s
Weight without filter	1.4 kg	1.4 kg	1.4 kg
Weight with filter	1.6 kg	1.6 kg	1.6 kg

Table 11-48 PM230, IP20, frame size A, 3 AC 380 V ... 480 V

Article number without filter Article number with filter	6SL3210-1NE17-7UG1 6SL3210-1NE17-7AG1
LO base load power	3 kW
LO base load input current	8.0 A

11.6 Technical data, PM230 Power Module

Article number without filter	6SL3210-1NE17-7UG1
Article number with filter	6SL3210-1NE17-7AG1
LO base load output current	7.7 A
HO base load power	2.2 kW
HO base load input current	6.1 A
HO base load output current	5.9 A
Fuse according to IEC / UL	3NE1813-0
Fuse according to UL, Class J	10 A
Circuit breaker N3RV2711-1KD10	12.5 A
Power loss	0.11 kW
Required cooling air flow	4.5 l/s
Weight without filter	1.4 kg
Weight with filter	1.6 kg

Table 11-49 PM230, PT, frame size A, 3 AC 380 V ... 480 V

Article number without filter	6SL3211-1NE17-7UG1
Article number with filter	6SL3211-1NE17-7AG1
LO base load power	3 kW
LO base load input current	8.0 A
LO base load output current	7.7 A
HO base load power	2.2 kW
HO base load input current	6.1 A
HO base load output current	5.9 A
Fuse according to IEC / UL	3NE1813-0
Fuse according to UL, Class J	10 A
Power loss	0.11 kW
Required cooling air flow	4.5 l/s
Weight without filter	1.7 kg
Weight with filter	1.9 kg

Table 11-50 PM230, IP20, frame size B, 3-phase 380 ... 480 VAC

Article number without filter	6SL3210-1NE21-0UG1	6SL3210-1NE21-3UG1	6SL3210-1NE21-8UG1
Article number with filter	6SL3210-1NE21-0AG1	6SL3210-1NE21-3AG1	6SL3210-1NE21-8AG1
LO base load power	4 kW	5.5 kW	7.5 kW
LO base load input current	10.5 A	13.6 A	18.6 A
LO base load output current	10.2 A	13.2 A	18 A
HO base load power	3 kW	4 kW	5.5 kW
HO base load input current	8.0 A	10.5 A	13.6 A
HO base load output current	7.7 A	10.2 A	13.2 A
Fuse according to IEC / UL	3NE1813-0	3NE1814-0	3NE1815-0
Fuse according to UL, Class J	15 A	20 A	25 A

Article number without filter	6SL3210-1NE21-0UG1	6SL3210-1NE21-3UG1	6SL3210-1NE21-8UG1
Article number with filter	6SL3210-1NE21-0AG1	6SL3210-1NE21-3AG1	6SL3210-1NE21-8AG1
Power loss	0.12 kW	0.15 kW	0.22 kW
Required cooling air flow	9.2 l/s	9.2 l/s	9.2 l/s
Weight without filter	2.8 kg	2.8 kg	2.8 kg
Weight with filter	3 kg	3 kg	3 kg

Table 11-51 PM230, PT, frame size B, 3 AC 380 V ... 480 V

Article number without filter	6SL3211-1NE21-8UG1
Article number with filter	6SL3211-1NE21-8AG1
LO base load power	7.5 kW
LO base load input current	18.6 A
LO base load output current	18 A
HO base load power	5.5 kW
HO base load input current	13.6 A
HO base load output current	13.2 A
Fuse according to IEC / UL	3NE1815-0
Fuse according to UL, Class J	25 A
Power loss	0.22 kW
Required cooling air flow	9.2 l/s
Weight without filter	3.4 kg
Weight with filter	3.6 kg

Table 11-52 PM230, IP20, frame size C, 3 AC 380 V ... 480 V

Article number without filter	6SL3210-1NE22-6UG1	6SL3210-1NE23-2UG1	6SL3210-1NE23-8UG1
Article number with filter	6SL3210-1NE22-6AG1	6SL3210-1NE23-2AG1	6SL3210-1NE23-8AG1
LO base load power	11 kW	15 kW	18.5 kW
LO base load input current	26.9 A	33.1 A	39.2 A
LO base load output current	26 A	32 A	38 A
HO base load power	7.5 kW	11 kW	15 kW
HO base load input current	18.6 A	26.9 A	33.1 A
HO base load output current	18 A	26 A	32 A
Fuse according to IEC / UL	3NE1803-0	3NE1817-0	3NE1817-0
Fuse according to UL, Class J	35 A	45 A	50 A
Power loss	0.3 kW	0.35 kW	0.45 kW
Required cooling air flow	18.5 l/s	18.5 l/s	18.5 l/s
Weight without filter	4.5 kg	4.5 kg	4.5 kg
Weight with filter	5.1 kg	5.1 kg	5.1 kg

11.6 Technical data, PM230 Power Module

Table 11-53 PM230, PT, frame size C, 3 AC 380 V ... 480 V

Article number without filter	6SL3211-1NE23-8UG1
Article number with filter	6SL3211-1NE23-8AG1
LO base load power	18.5 kW
LO base load input current	39.2 A
LO base load output current	38 A
HO base load power	15 kW
HO base load input current	33.1 A
HO base load output current	32 A
Fuse according to IEC / UL	3NE1817-0
Fuse according to UL, Class J	50 A
Power loss	0.45 kW
Required cooling air flow	18.5 l/s
Weight without filter	5.4 kg
Weight with filter	6 kg

Table 11-54 PM230, IP20, frame size D, 3 AC 380 V ... 480 V

Article number without filter	6SL3210-1NE24-5UL0	6SL3210-1NE26-0UL0
Article number with filter	6SL3210-1NE24-5AL0	6SL3210-1NE26-0AL0
LO base load power	22 kW	30 kW
LO base load input current	42 A	56 A
LO base load output current	45 A	60 A
HO base load power	18.5 kW	22 kW
HO base load input current	36 A	42 A
HO base load output current	38 A	45 A
Fuse according to IEC / UL	3NE1818-0	3NE1820-0
Power loss	0.52 kW	0.68 kW
Required cooling air flow	80 l/s	80 l/s
Weight without filter	11 kg	11 kg
Weight with filter	14 kg	14 kg

Table 11-55 PM230, IP20, frame size E, 3 AC 380 V ... 480 V

Article number without filter	6SL3210-1NE27-5UL0	6SL3210-1NE28-8UL0
Article number with filter	6SL3210-1NE27-5AL0	6SL3210-1NE28-8AL0
LO base load power	37 kW	45 kW
LO base load input current	70 A	84 A
LO base load output current	75 A	90 A
HO base load power	30 kW	37 kW
HO base load input current	56 A	70 A
HO base load output current	60 A	75 A
Fuse according to IEC / UL	3NE1021-0	3NE1022-0

Article number without filter	6SL3210-1NE27-5ULO	6SL3210-1NE28-8ULO
Article number with filter	6SL3210-1NE27-5ALO	6SL3210-1NE28-8ALO
Power loss	0.99 kW	1.2 kW
Required cooling air flow	80 l/s	80 l/s
Weight without filter	15 kg	15 kg
Weight with filter	22 kg	22 kg

Table 11-56 PM230, IP20, frame size F, 3 AC 380 V ... 480 V

Article number without filter	6SL3210-1NE31-1ULO	6SL3210-1NE31-5ULO
Article number with filter	6SL3210-1NE31-1ALO	6SL3210-1NE31-5ALO
LO base load power	55 kW	75 kW
LO base load input current	102 A	135 A
LO base load output current	110 A	145 A
HO base load power	45 kW	55 kW
HO base load input current	84 A	102 A
HO base load output current	90 A	110 A
Fuse according to IEC / UL	3NE1224-0	3NE1225-0
Power loss	1.4 kW	1.9 kW
Required cooling air flow	150 l/s	150 l/s
Weight without filter	33 kg	33 kg
Weight with filter	48 kg	48 kg

11.6.4 Current reduction depending on pulse frequency

Current derating depending on the pulse frequency

LO base load	Output base-load current at a pulse frequency of							
	2 kHz	4 kHz	6 kHz	8 kHz	10 kHz	12 kHz	14 kHz	16 kHz
kW	A	A	A	A	A	A	A	A
0.37	--	1.3	1.11	0.91	0.78	0.65	0.59	0.52
0.55	--	1.7	1.45	1.19	1.02	0.85	0.77	0.68
0.75	--	2.2	1.87	1.54	1.32	1.10	0.99	0.88
1.1	--	3.1	2.64	2.17	1.86	1.55	1.4	1.24
1.5	--	4.1	3.49	2.87	2.46	2.05	1.85	1.64
2.2	--	5.9	5.02	4.13	3.54	2.95	2.66	2.36
3.0	--	7.7	6.55	5.39	4.62	3.85	3.47	3.08
4.0	--	10.2	8.67	7.14	6.12	5.1	4.59	4.08
5.5	--	13.2	11.22	9.24	7.92	6.6	5.94	5.28
7.5	--	18	15.3	12.6	10.8	9	8.1	7.2
11.0	--	26	22.1	18.2	15.6	13	11.7	10.4
15.0	--	32	27.2	22.4	19.2	16	14.4	12.8
18.5	--	38	32.3	26.6	22.8	19	17.1	15.2
22	--	45	38.25	31.5	27	22.5	20.25	18
30	--	60	51	42	36	30	27	24
37	--	75	63.75	52.5	45	37.5	33.75	30
45	--	90	76.5	63	54	45	40.5	36
55	--	110	93.5	77	66	55	49.5	44
75	--	145	123.3	101.5	--	--	--	--
90	--	178	151.3	124.6	--	--	--	--

The permissible cable length to the motor also depends on the cable type and the selected pulse frequency.

11.7 Technical data, PM250 Power Module

11.7.1 High overload – low overload

Typical converter load cycles

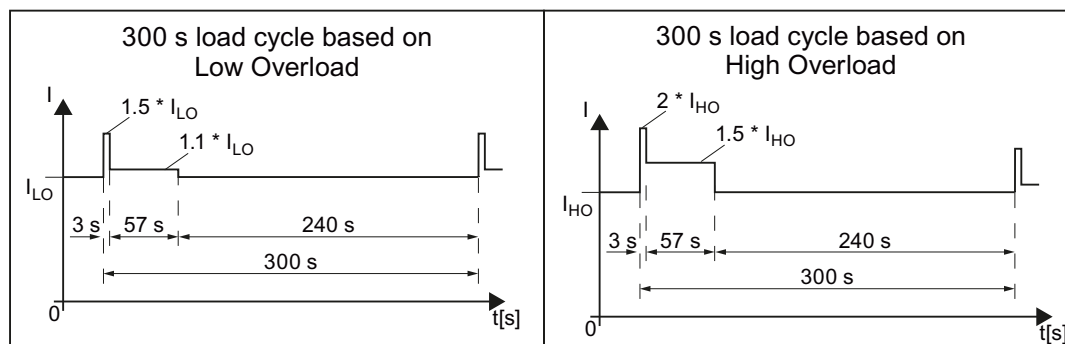

11.7.2 Ambient conditions

Ambient conditions during operation

Property	Version
Ambient conditions for transport in the transport packaging	
Climatic ambient conditions	- 40° C ... + 70° C, according to Class 2K4 to EN 60721-3-2 maximum humidity 95% at 40 °C
Mechanical ambient conditions	FSC: Shock and vibration permissible according to 1M2 to EN 60721-3-2 FSD ... FSF: Shock and vibration permissible according to 2M3 to EN 60721-3-2
Protection against chemical substances	Protected according to Class 2C2 to EN 60721-3-2
Biological ambient conditions	Suitable according to Class 2B1 to EN 60721-3-2
Ambient conditions for long-term storage in the product packaging	
Climatic ambient conditions	- 25 °C ... + 55 °C, according to Class 1K3 to EN 60721-3-1
Protection against chemical substances	Protected according to Class 1C2 to EN 60721-3-1
Biological ambient conditions	Suitable according to class 1B1 to EN 60721-3-1
Ambient conditions in operation	
Installation altitude	Up to 1000 m above sea level without limitations  Restrictions for special ambient conditions (Page 544)

Property	Version
Climatic ambient conditions ¹⁾	<ul style="list-style-type: none"> • Ambient operating temperature ²⁾ <ul style="list-style-type: none"> – For operation according to Low Overload: 0° C ... +40° C – For operation according to High Overload: 0° C ... +50° C –  Restrictions for special ambient conditions (Page 544) • Relative humidity: 5 ... 95%, condensation not permitted • Oil mist, salt mist, ice formation, condensation, dripping water, spraying water, splashing water and water jets are not permitted
Mechanical ambient conditions	<ul style="list-style-type: none"> • FSC ... FSF: Vibration levels permissible according to Class 3M1 to EN 60721-3-3 • FSC: Shock, permissible according to Class 3M2 to EN 60721-3-3 • FSD ... FSF: Shock permissible according to Class 3M1 to EN 60721-3-3
Protection against chemical substances	Protected according to 3C2 to EN 60721-3-3
Biological ambient conditions	Suitable according to 3C2 to EN 60721-3-3
Pollution	Suitable for environments with degree of pollution 2 according to EN 61800-5-1, condensation not permitted
Cooling	Forced air cooling AF, according to EN 60146
Cooling air	Clean and dry air

¹⁾ Increased ruggedness regarding temperature range and relative humidity; therefore better than 3K3 according to EN 60721-3-3

²⁾ Observe the permissible ambient temperatures for the Control Unit and possibly the operator panel (IOP-2 or BOP-2).

11.7.3 General technical data, PM250

Property	Version
Line voltage	380 ... 480 V 3 AC \pm 10%
Line impedance	$U_k < 1\%$ ($RSC > 100$), a line reactor is not permitted
Output voltage	3-phase 0 VAC ... input voltage x 0.87 (max.)
Input frequency	50 Hz ... 60 Hz, \pm 3 Hz
Output frequency	0 ... 550 Hz, depending on the control mode
Power factor λ	0.9
Inrush current	< LO base load input current
Pulse frequency (factory setting)	4 kHz The pulse frequency can be adjusted up to 16 kHz in 2 kHz steps. The higher the pulse frequency, the lower the available output current.  Current reduction depending upon pulse frequency (Page 542)
Electromagnetic compatibility	The devices comply with EN 61800-3: 2004 suitable for Category C2 and C3 environments.
Braking methods	<ul style="list-style-type: none"> • DC braking • Regenerative feedback (energy recovery) max. with rated power based on high overload (HO)
Degree of protection	IP20 chassis units

11.7.4 Specific technical specifications

Note

The values for Low Overload (LO) are identical with those of the rated values.

Table 11-57 PM250, IP20, Frame Size C, 3-ph. AC 380 V ... 480 V

Article No.	6SL3225-0BE25-5AA1	6SL3225-0BE27-5AA1	6SL3225-0BE31-1AA1
LO base load output	7.5 kW	11 kW	15 kW
LO base load input current	18 A	25 A	32 A
LO base load output current	18 A	25 A	32 A
HO base load output	5.5 kW	7.5 kW	11 kW
HO base load input current	13.2 A	19 A	26 A
HO base load output current	13.2 A	19 A	26 A
Fuse	20 A, Class J	32 A, Class J	35 A, Class J
Power loss	0.24 kW	0.30 kW	0.31 kW
Required cooling air flow	38 l/s	38 l/s	38 l/s
Sound pressure level L_{pA} (1 m)	< 60 dB	< 60 dB	< 60 dB
Weight	7.5 kg	7.5 kg	7.5 kg

Table 11-58 PM250, IP20, Frame Size D, 3-ph. AC 380 V ... 480 V

Article No.	6SL3225-0BE31-5 . A0	6SL3225-0BE31-8 . A0	6SL3225-0BE32-2 . A0
LO base load output	18.5 kW	22 kW	30 kW
LO base load input current	36 A	42 A	56 A
LO base load output current	38 A	45 A	60 A
HO base load output	15 kW	18.5 kW	22 kW
HO base load input current	30 A	36 A	42 A
HO base load output current	32 A	38 A	45 A
Fuse according to IEC	3NA3820	3NA3822	3NA3824
Fuse according to UL	50 A, Class J 3NE1817-0	63 A, Class J 3NE1818-0	80 A, Class J 3NE1820-0
Power loss	0.44 kW	0.55 kW	0.72 kW
Required cooling air flow	22 l/s	22 l/s	39 l/s
Sound pressure level L_{pA} (1 m)	< 60 dB	< 60 dB	< 61 dB
Weight	15 kg	15 kg	16 kg

Table 11-59 PM250, IP20, Frame Size E, 3-ph. AC 380 V ... 480 V

Article No.	6SL3225-0BE33-0 . A0	6SL3225-0BE33-7 . A0
LO base load output	37 kW	45 kW
LO base load input current	70 A	84 A
LO base load output current	75 A	90 A
HO base load output	30 kW	37 kW
HO base load input current	56 A	70 A
HO base load output current	60 A	75 A
Fuse according to IEC	3NA3830	3NA3832
Fuse according to UL	100 A, Class J 3NE1821-0	125 A, Class J 3NE1822-0
Power loss	1.04 kW	1.2 kW
Required cooling air flow	22 l/s	39 l/s
Sound pressure level L_{pA} (1 m)	< 60 dB	< 62 dB
Weight	21 kg	21 kg

Table 11-60 PM250, IP20, Frame size F, 3-ph. AC 380 V ... 480 V

Article No.	6SL3225-0BE34-5 . A0	6SL3225-0BE35-5 . A0	6SL3225-0BE37-5 . A0
LO base load output	55 kW	75 kW	90 kW
LO base load input current	102 A	135 A	166 A
LO base load output current	110 A	145 A	178 A
HO base load output	45 kW	55 kW	75 kW
HO base load input current	84 A	102 A	135 A
HO base load output current	90 A	110 A	145 A
Fuse according to IEC	3NA3836	3NA3140	3NA3144
Fuse according to UL	160 A, Class J 3NE1824-0	200 A, Class J 3NE1825-0	250 A, Class J 3NE1827-0
Power loss	1.5 kW	2.0 kW	2.4 kW
Required cooling air flow	94 l/s	94 l/s	117 l/s
Sound pressure level L_{pA} (1 m)	< 60 dB	< 60 dB	< 65 dB
Weight	51 kg	51 kg	51 kg

11.7.5 Current reduction depending upon pulse frequency

Relationship between pulse frequency and current reduction

Table 11-61 Current reduction depending on pulse frequency

Rated Power (LO)	Base load current (LO)	Base load current (LO) at pulse frequency of						
		4 kHz	6 kHz	8 kHz	10 kHz	12 kHz	14 kHz	16 kHz
kW	A	A	A	A	A	A	A	
0,55	1,7							
0,75	2,2							
1,1	3,1							
1,5	4,1							
2,2	5,9							
3	7,7							
4	10.2							
5,5	13.2							
7.5	18.0	12.5	11.9	10.6	9.20	7.90	6.60	
11	25.0	18.1	17.1	15.2	13.3	11.4	9.50	
15	32.0	24.7	23.4	20.8	18.2	15.6	12.8	
18.5	38.0	32.3	26.6	22.8	19.0	17.1	15.2	
22	45.0	38.3	31.5	27.0	22.5	20.3	18.0	
30	60.0	51.0	42.0	36.0	30.0	27.0	24.0	
37	75.0	63.8	52.5	45.0	37.5	33.8	30.0	
45	90.0	76.5	63.0	54.0	45.0	40.5	36.0	
55	110	93.5	77.0	--	--	--	--	
75	145	123	102	--	--	--	--	
90	178	151	125	--	--	--	--	

11.8 Data regarding the power loss in partial load operation

You can find data regarding power loss in partial load operation in the Internet:

 Partial load operation (<http://support.automation.siemens.com/WW/view/en/94059311>)

11.9 Restrictions for special ambient conditions

Permissible line supplies dependent on the installation altitude

- For installation altitudes ≤ 2000 m above sea level, it is permissible to connect the converter to any of the line supplies that are specified for it.
- For installation altitudes 2000 m ... 4000 m above sea level, the following applies:
 - Connection to a TN line system with grounded neutral point is permissible.
 - TN systems with grounded line conductor are not permitted.
 - The TN line system with grounded neutral point can also be supplied using an isolation transformer.
 - The phase-to-phase voltage does not have to be reduced.

Note

Using Power Modules connected to TN line supplies with voltages ≥ 600 V for installation altitudes 2000 m ... 4000 m

For voltages ≥ 600 V, the TN line supply must have a grounded neutral point established using an isolating transformer.

Current derating as a function of the installation altitude

The permissible converter output current is reduced above an installation altitude of 1000 m.

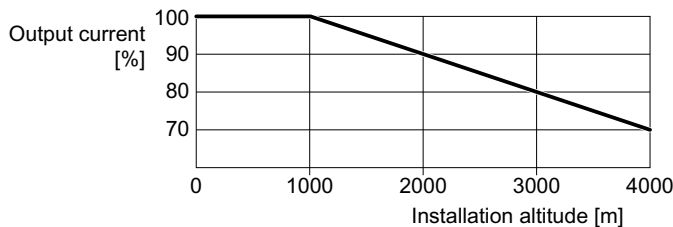

Figure 11-4 Characteristic for PM240-2 Power Modules and PM240P-2 Power Modules

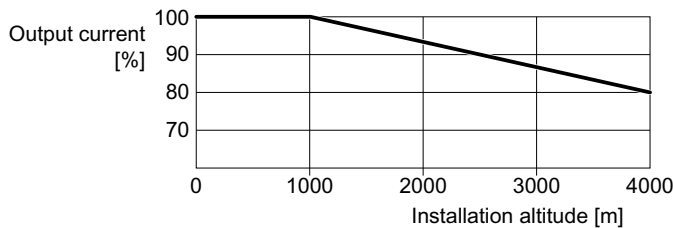

Figure 11-5 Characteristic for PM230 Power Modules and PM250 Power Modules

11.10 Protecting persons from electromagnetic fields

Overview

Protection of workers from electromagnetic fields is specified in the European EMF Directive 2013/35/EU. This directive is implemented in national law in the European Economic Area (EEA). Employers are obligated to design workplaces in such a way that workers are protected from impermissibly strong electromagnetic fields.

To this end, assessments and/or measurements must be performed for workplaces.

General conditions

The following general conditions apply for the evaluations and measurements:

1. The laws for protection from electromagnetic fields in force in individual EU member states can go beyond the minimum requirements of the EMF Directive 2013/35/EU and always take precedence.
2. The ICNIRP 2010 limits for the workplace are the basis for the assessment.
3. The 26th BImSchV (German Federal Emission Protection Regulation) defines 100 μT (RMS) for the assessment of active implants.
According to Directive 2013/35/EU, 500 μT (RMS) at 50 Hz is applicable here.
4. The routing of power cables has a significant impact on the electromagnetic fields that occur. Install and operate the components inside metallic cabinets in compliance with the documentation and use shielded motor cables.
 EMC-compliant setup of the machine or plant (Page 60)

Evaluation of the converter

The converters are normally used in machines. The assessment and testing is based on DIN EN 12198.

Compliance with the limit values was assessed for the following frequencies:

- Line frequency 47 ... 63 Hz
- Pulse frequency, for example 4/8/16 kHz and multiples thereof, assessed up to a maximum of 100 kHz

The indicated minimum distances apply to the head and complete torso of the human body. Shorter distances are possible for extremities.

Table 11-62 Minimum distances to the converter

Individuals without active implants		Individuals with active implants	
Control cabinet closed	Control cabinet open	Control cabinet closed	Control cabinet open
0 cm	Forearm length (approx. 35 cm)	Must be separately assessed depending on the active implant.	

Appendix

A.1 New and extended functions

A.1.1 Firmware version 4.7 SP14



Table A-1 New functions and function changes in firmware 4.7 SP14

	Function	SINAMICS							
		G120						G120D	
		G115D	G120C	CU230P-2	CU240B-2	CU240E-2	CU250S-2	CU240D-2	CU250D-2
1	The G115D converter now supports the extended safety function 'Safety Limited Speed (SLS)' when using motors from SIEMENS and third-party manufacturers.	✓	-	-	-	✓	-	✓	-

A.1.2 Firmware version 4.7 SP13

Table A-2 New functions and function changes in firmware 4.7 SP13

	Function	SINAMICS								
		G120							G120D	
		G115D	G110M	G120C	CU230P-2	CU240B-2	CU240E-2	CU250S-2	CU240D-2	CU250D-2
1	SIMOTICS 1FP1 and 1FP3 synchronous-reluctance motors have also been approved for operation with SINAMICS G120C.	-	✓	✓	✓	✓	✓	-	✓	-
2	The extended safety functions SS1, SLS, SSM and SDI are approved when using synchronous-reluctance motors from Siemens and third-party manufacturers.	-	-	-	-	-	✓	-	✓	-
3	The converter transmits the state of the fail-safe digital input F-DI 0 via PROFIsafe when using the basic functions. You can find more information in the "Safety Integrated" Function Manual.  "Safety Integrated" function manual (https://support.industry.siemens.com/cs/ww/en/view/109751320)	✓	✓	✓	-	-	✓	✓	✓	✓



	Function	SINAMICS								
					G120			G120D		
4	Modbus RTU: The converter supports the combination "1 stop bit" and "no parity".	-	-	✓	✓	✓	✓	✓	-	-
5	EtherNet/IP: When selecting the ODVA AC/DC drive profile, although telegram 1 is pre-defined, it can be extended to include additional process data. The EDS file has been extended accordingly by a telegram with a length of 6 words. More information is provided in the "Fieldbuses" Function Manual.  "Fieldbus" function manual (https://support.industry.siemens.com/cs/ww/en/view/109751350)  EDS (https://support.industry.siemens.com/cs/ww/de/view/78026217)	✓	✓	✓	✓	-	✓	✓	✓	✓

A.1.3 Firmware version 4.7 SP10

Table A-3 New functions and function changes in firmware 4.7 SP10

	Function	SINAMICS								
		G120				G120D				
		G110M	G120C	CU230P-2	CU240B-2	CU240E-2	CU250S-2	CU240D-2	CU250D-2	ET 200pro FC-2
1	New parameter r7844 [1] for displaying the firmware version in plain text. "04070901" is equivalent to firmware version V4.7 SP9 HF1, for example	✓	✓	✓	✓	✓	✓	✓	✓	✓
2	Modbus RTU: <ul style="list-style-type: none"> The factory setting of parameter p2040 was increased to provide more robust converter operation. Monitoring time for data failure at the Modbus interface: p2040 = 10 s r2057 indicates how the address switch on the converter is set 	✓	✓	✓	✓	✓	✓	-	-	-
3	BACnet MS/TP: <ul style="list-style-type: none"> New factory setting for more robust converter operation: <ul style="list-style-type: none"> Baud rate p2020 = 38.4 kBd Monitoring time for data failure at the BACnet interface was increased: p2040 = 10 s Factory setting for the maximum number of info frames p2025 [1] = 5 Factory setting for the maximum number of manager addresses p2025 [3] = 32 r2057 indicates how the address switch on the converter is set 	-	-	✓	-	-	-	-	-	-
4	Further technological unit kg/cm ² for unit switchover	✓	✓	✓	✓	✓	✓	✓	✓	✓
5	Further technological unit kg/cm ² for additional technology controllers	-	-	✓	-	-	-	-	-	-

A.1 New and extended functions

	Function	SINAMICS								
		G120				G120D				
6	<p>Commissioning with predefined motor data for SIMOTICS GP/SD synchronous-reluctance motors:</p> <ul style="list-style-type: none"> • Second generation: 1FP1 . 04 → 1FP1 . 14 • Further frame sizes: <ul style="list-style-type: none"> – 1.1 kW ... 3 kW, 1500 1/min, 1800 1/min, 2810 1/min – 0.75 kW ... 4 kW, 3000 1/min, 3600 1/min • In planning: <ul style="list-style-type: none"> – 37 kW ... 45 kW, 1500 1/min, 1800 1/min, 2810 1/min – 5.5 kW ... 18.5 kW, 3000 1/min, 3600 1/min – 45 kW, 3000 1/min, 3600 1/min – The predefined motor data is already included in the firmware 	✓	-	✓	-	✓ ¹⁾	-	✓	-	-
7	<p>Extended setting option for evaluating the STOP cam in the "basic positioner" function</p> <p>Two different functions to evaluate STOP cams can be set:</p> <ul style="list-style-type: none"> • Edge-triggered evaluation (factory setting) • Level-triggered evaluation <p>For more information, refer to the "Basic Positioner" Function Manual or the operating instructions for "SINAMICS G120D Converter with CU250D-2 Control Units".</p> <p> "Basic positioner" function manual (https://support.industry.siemens.com/cs/ww/en/view/109477922)</p> <p> Operating instructions SINAMICS G120D with CU250D-2 (https://support.industry.siemens.com/cs/ww/en/view/109477365)</p>	-	-	-	-	-	✓	-	✓	-

¹⁾ Installation with PM240-2 or PM240P-2 Power Modules

A.1.4 Firmware version 4.7 SP9

Table A-4 New functions and function changes in firmware 4.7 SP9

	Function	SINAMICS								
		G120				G120D				
		G110M	G120C	CU230P-2	CU240B-2	CU240E-2	CU250S-2	CU240D-2	CU250D-2	ET 200pro FC-2
1	Support of PM240-2 FSG Power Modules	-	-	✓	✓	✓	✓	-	-	-
2	Support of PM240-2 Power Modules in push-through technology, frame sizes FSD ... FSF, for the following voltages: <ul style="list-style-type: none"> • 3 AC 200 V ... 240 V • 3 AC 380 V ... 480 V • 3 AC 500 V ... 690 V 	-	-	✓	✓	✓	✓	-	-	-
3	Shortened switch-on time for PM330 Power Modules	-	-	✓	-	-	-	-	-	-
4	Expansion of the support for 1FP1 synchronous-reluctance motor with the following converters: <ul style="list-style-type: none"> • SINAMICS G110M • SINAMICS G120D • SINAMICS G120 with CU240B-2 or CU240E-2 Control Unit A PM240-2 Power Module is required to operate a 1FP1 synchronous-reluctance motor with SINAMICS G120	✓	-	✓	✓	✓	-	✓	-	-
5	Support of 1FP3 synchronous-reluctance motors A PM240-2 Power Module is required to operate a 1FP3 synchronous-reluctance motor along with a selective release from SIEMENS	-	-	✓	-	-	-	-	-	-
6	Support of 1LE5 induction motors	-	✓	✓	✓	✓	✓	-	-	-
7	The converter supports forming of the PM330 Power Module DC link capacitors	-	-	✓	-	-	-	-	-	-
8	Setting option for two output reactors using parameter p0235 at the SINAMICS G120C and SINAMICS G120 with PM240-2 FSD ... FSF Power Module	-	✓	✓	✓	✓	✓	-	-	-
9	Efficiency-optimized operation of induction motors Improved method "Efficiency optimization 2"	✓	✓	✓	✓	✓	✓	✓	✓	✓
10	New setting option for the "Technology application" p0500 = 5 during quick commissioning	✓	✓	✓	✓	✓	✓	✓	✓	✓
11	Expansion of the available PROFIdrive telegrams in the SINAMICS G120C to include telegram 350	-	✓	✓	✓	✓	✓	-	-	-
12	An SSI encoder can be parameterized as motor encoder	-	-	-	-	-	✓	-	✓	-
13	Expansion of the "Basic positioner" function to include the feedback signal from traversing blocks to the higher-level control system	-	-	-	-	-	✓	-	✓	-
14	Feedback signal supplemented to indicate that a memory card is not inserted in the converter: <ul style="list-style-type: none"> • Parameter r9401 as BiCo parameter for the optional feedback signal to the higher-level control system. • New alarm A01101 	✓	✓	✓	✓	✓	✓	✓	✓	✓

	Function	SINAMICS								
		G120				G120D				
15	Expansion of the "End stop control" function on the following converters: <ul style="list-style-type: none"> • SINAMICS G120 • SINAMICS G120C • SINAMICS G120D 	✓	✓	✓	✓	✓	✓	✓	✓	-
16	Expansion of the technology controller to include the following functions: <ul style="list-style-type: none"> • Gain K_p and integral time T_N can be adapted. • The system deviation can be used as adaptation signal 	-	-	✓	-	✓	-	-	-	-
17	Expansion to the torque limiting for SINAMICS G120 converters with CU230P-2 Control Unit	✓	✓	✓	✓	✓	✓	✓	✓	✓
18	The converter displays the state "PROFenergy pause" as follows: <ul style="list-style-type: none"> • LED RDY "green on": 0.5 s • LED RDY off: 3 s 	✓	✓	✓	✓	✓	✓	✓	✓	✓

A.1.5 Firmware version 4.7 SP6

Table A-5 New functions and function changes in firmware 4.7 SP6

	Function	SINAMICS								
		G120						G120D		
		G110M	G120C	CU230P-2	CU240B-2	CU240E-2	CU250S-2	CU240D-2	CU250D-2	ET 200pro FC-2
1	Support for the Power Module PM240-2, FSF frame sizes	-	-	✓	✓	✓	✓	-	-	-
	Support of PM240P-2 Power Modules frame sizes FSD ... FSF	-	-	✓	✓	✓	-	-	-	-
	Support of safety function Safe Torque Off (STO) via the terminals of the PM240-2 Power Module, frame size FSF and PM240P-2 Power Module FSD ... FSF	-	-	-	-	✓	✓	-	-	-
2	Support for Power Module PM330 JX frame size	-	-	✓	-	-	-	-	-	-
3	Support for 1PC1 induction motors	✓	✓	✓	✓	✓	✓	✓	✓	✓
4	The control of synchronous reluctance takes into account the inductance of the output reactor.	-	-	✓	-	-	-	-	-	-
5	Support of motor temperature sensor Pt1000	✓	✓	✓	✓	✓	✓	✓	✓	✓
6	New p4621 parameter for disabling PTC short-circuit monitoring	-	-	-	-	-	-	✓	✓	✓
7	Revision of the thermal motor model for protecting the motor against damage due to overheating in the stator or rotor	✓	✓	✓	✓	✓	✓	✓	✓	✓
8	Changing the quick commissioning in the "Standard Drive Control" application class: The motor data identification is no longer permanently set to p1900 = 12; instead, users select the appropriate motor data identification. Factory setting: p1900 = 2.	-	✓	✓	✓	✓	✓	-	-	-
9	The free function blocks are also available in the SINAMICS G120C.	✓	✓	✓	✓	✓	✓	✓	-	-

A.1.6 Firmware version 4.7 SP3

Table A-6 New functions and function changes in firmware 4.7 SP3

	Function	SINAMICS								
		G120						G120D		
		G110M	G120C	CU230P-2	CU240B-2	CU240E-2	CU250S-2	CU240D-2	CU250D-2	ET 200pro FC-2
1	PM240-2 Power Modules, frame sizes FSD and FSE are supported	-	-	✓	✓	✓	✓	-	-	-
	The Safety Integrated Basic Function Safe Torque Off (STO) is supported via the terminals of the PM240-2 Power Module, frame sizes FSD and FSE	-	-	-	-	✓	✓	-	-	-
2	Revised PM230 Power Module with new article numbers supported: • IP55 degree of protection: 6SL3223-0DE G . • IP20 degree of protection and Push Through: 6SL321 . -1NE G .	-	-	✓	✓	✓	-	-	-	-
	The Safety Integrated Basic Function Safe Torque Off (STO) is supported with the revised PM230 Power Module	-	-	-	-	✓	-	-	-	-
3	PM330 Power Module, frame size HX is supported	-	-	✓	-	-	-	-	-	-
4	Support of 1FP1 synchronous-reluctance motors	-	-	✓	-	-	-	-	-	-
5	Encoderless 1FG1 geared synchronous motors are supported	-	-	-	-	-	-	✓	-	-
6	Selection list for 1PH8 induction motors in the STARTER and Startdrive commissioning wizard	-	✓	✓	✓	✓	✓	-	-	-
7	Updated selection list for 1LE1 induction motors in the STARTER and Startdrive commissioning wizard	✓	✓	✓	✓	✓	✓	✓	✓	✓
8	Motor support expanded with 1LE1, 1LG6, 1LA7 and 1LA9 induction motors	✓	-	-	-	-	-	-	-	-
9	Speed and position control obtain their respective actual value from an SSI encoder with incremental tracks. The output signals of the encoder are available as encoder 2 for position control and timer 1 for speed control.	-	-	-	-	-	✓	-	✓	-
10	Power Module with temperature-controlled fan	✓	-	-	-	-	-	-	-	-
11	SINAMICS "Standard Drive Control" and "Dynamic Drive Control" application classes to simplify commissioning and increase the degree of ruggedness of the closed-loop motor control. The SINAMICS application classes are available with the following converters: • SINAMICS G120C • SINAMICS G120 with PM240, PM240-2 and PM330 Power Modules	-	✓	✓	✓	✓	✓	-	-	-
12	Moment of inertia estimator with moment of inertia precontrol to optimize the speed controller in operation	✓	✓	-	✓	✓	✓	✓	✓	✓
13	Friction torque characteristic with automatic plotting to optimize the speed controller	✓	✓	-	✓	✓	✓	✓	✓	✓
14	Automatic optimization of the technology controller	-	-	✓	✓	✓	-	-	-	-
15	The sign of the system deviation for the additional, free technology controller can be switched over. A new parameter defines the sign of the system deviation matching the particular application, e.g. for cooling or heating applications.	-	-	✓	-	-	-	-	-	-

	Function	SINAMICS								
				G120			G120D			
16	The technology controller output can be enabled and disabled during operation	-	✓	✓	✓	✓	✓	-	-	-
17	Ramp-function generator remains active with enabled technology controller	-	-	✓	-	-	-	-	-	-
18	Line contactor control using a digital output of the converter to save energy when the motor is switched off	✓	✓	✓	✓	✓	✓	✓	✓	-
19	Fast flying restart for PM330 Power Modules: The "Flying restart" function does not have to wait for the motor demagnetization time, and identifies the motor speed without requiring a search operation.	-	-	✓	-	-	-	-	-	-
20	Load torque monitoring extended to include the following functions: • Protection against blocking, leakage and dry running operation in pump applications • Protection against blocking and broken belts in fan applications	✓	-	✓	✓	✓	-	-	-	-
21	Automatic switchover of the real time clock from daylight saving time (summer time) to standard time (winter time).	-	-	✓	-	-	-	-	-	-
22	New or revised default settings of the interfaces: p0015 macros 110, 112 and 120	-	-	✓	-	-	-	-	-	-
23	Expansion of the temperature sensors to include DIN-Ni1000 for analog inputs AI 2 and AI 3	-	-	✓	-	-	-	-	-	-
24	Communication via AS-Interface. Default setting of the communication via AS-i: p0015 macros 30, 31, 32 and 34	✓	-	-	-	-	-	-	-	-
25	Communication expansion via Modbus: Adjustable parity bit, access to parameters and analog inputs	✓	✓	✓	✓	✓	✓	-	-	-
26	Extending communication via BACnet: Access to parameters and analog inputs	-	-	✓	-	-	-	-	-	-
27	The bus error LED for communication via USS and Modbus can be switched off	✓	✓	✓	✓	✓	✓	-	-	-
28	Default of the minimum speed to 20 % of the rated motor speed	-	-	✓	-	-	-	-	-	-
29	For commissioning with an operator panel, the converter automatically backs up the measured data retentively in the ROM after identification of the motor data.	✓	✓	✓	✓	✓	✓	✓	✓	✓
30	The result of the energy savings calculation for flow machines is available as a connector	✓	✓	✓	✓	✓	✓	✓	✓	✓
31	New "ppm" unit (parts per million) for unit switching	✓	✓	✓	✓	✓	✓	✓	✓	✓
32	Displaying speeds during commissioning via operator panel in units of Hz instead of rpm. Conversion from Hz to rpm via p8552	-	-	✓	-	-	-	-	-	-
33	Voltage-dependent current limit for 600V devices of Power Module PM330 and PM240-2	-	-	✓	✓	✓	✓	-	-	-

A.1.7 Firmware version 4.7

Table A-7 New functions and function changes in Firmware 4.7

	Function	SINAMICS							
		G120					G120D		
		G110M	G120C	CU230P-2	CU240B-2	CU240E-2	CU250S-2	CU240D-2	CU250D-2
1	Supporting the identification & maintenance datasets (I&M1 ... 4)	✓	✓	✓	✓	✓	✓	✓	✓
2	Fall in pulse rate with increased drive power required by the motor <ul style="list-style-type: none"> The converter temporarily lowers the pulse frequency if required when the motor is started up, and simultaneously increases the current limit. 	✓	✓	✓	✓	✓	✓	✓	✓
3	S7 communication <ul style="list-style-type: none"> Direct data exchange between the converter and human-machine interface (HMI). Increase in communication performance with the engineering tools and support of the S7 routing 	✓	✓	✓	✓	✓	✓	✓	✓
4	The basic functions of Safety Integrated are unrestrictedly available in all control types with 1FK7 encoderless permanent-field synchronous motors	-	-	-	-	-	-	✓	-
5	Encoderless 1FK7 synchronous motors are supported <ul style="list-style-type: none"> Direct motor selection based on the article number with associated code number It is not necessary to input individual motor data 	-	-	-	-	-	-	✓	-
6	Pulse input as source of setpoint value <ul style="list-style-type: none"> The converter calculates its speed setpoint from a sequence of pulses at the digital input. 	-	-	-	-	-	✓	-	-
7	Dynamic IP address assignment (DHCP) and temporary device names for PROFINET	✓	✓	✓	-	✓	✓	✓	✓
8	PROFInergy device profile 2 and 3	✓	✓	✓	-	✓	✓	✓	✓
9	Uniform behavior for component replacement <ul style="list-style-type: none"> After a component is replaced, a converter with activated Safety Integrated will report what type of component has been replaced using a unique code. 	✓	✓	-	-	✓	✓	✓	✓
10	Improved direct-component control in PM230 <ul style="list-style-type: none"> Optimized efficiency for pump and fan applications 	-	-	✓	-	-	-	-	-
11	Rounding down of BACnet and macros	-	-	✓	-	-	-	-	-

A.1.8 Firmware version 4.6 SP6

Table A-8 New functions and function changes in firmware 4.6 SP6

	Function	SINAMICS						
			G120			G120D		
		G120C	CU230P-2	CU240B-2	CU240E-2	CU250S-2	CU240D-2	CU250D-2
1	Support for the new Power Modules <ul style="list-style-type: none"> PM330 IP20 GX 	-	✓	-	-	-	-	-

A.1.9 Firmware version 4.6

Table A-9 New functions and function changes in Firmware 4.6

	Function	SINAMICS						
		G120				G120D		
		G120C	CU230P-2	CU240B-2	CU240E-2	CU250S-2	CU240D-2	CU250D-2
1	Support for the new Power Modules <ul style="list-style-type: none"> PM240-2 IP20 FSB ... FSC PM240-2 in through-hole technology FSB ... FSC 	-	✓	✓	✓	✓	-	-
2	Support for the new Power Modules <ul style="list-style-type: none"> PM230 in through-hole technology FSD ... FSF 	-	✓	✓	✓	-	-	-
3	Motor data preassignment for the 1LA/1LE motors via code number <ul style="list-style-type: none"> During quick commissioning with the operator panel, set the motor data using a code number 	✓	✓	✓	✓	✓	✓	✓
4	Extension to communication via CANopen <ul style="list-style-type: none"> CAN velocity, ProfilTorque, SDO channel for each axis, system test with CodeSys, suppression of ErrorPassiv alarm 	✓	✓	-	-	✓	-	-
5	Extension to communication via BACnet <ul style="list-style-type: none"> Multistate value objects for alarms, commandable AO objects, objects for configuring the PID controller 	-	✓	-	-	-	-	-
6	Communication via EtherNet/IP	✓	✓	-	✓	✓	✓	✓
7	Skip frequency band for analog input <ul style="list-style-type: none"> A symmetrical skip frequency band can be set for each analog input around the 0 V range. 	✓	✓	✓	✓	✓	✓	-
8	Changing the control of the motor holding brake	✓	-	✓	✓	✓	✓	-
9	Safety function SBC (Safe Brake Control) <ul style="list-style-type: none"> Secure control of a motor holding brake when using the "Safe Brake Module" option 	-	-	-	-	✓	-	-
10	Safety function SS1 (Safe Stop 1) without speed monitoring	-	-	-	-	✓	-	-
11	Straightforward selection of standard motors <ul style="list-style-type: none"> Selection of 1LA... and 1LE... motors with an operator panel using a list containing code numbers 	✓	✓	✓	✓	✓	✓	✓
12	Firmware update via memory card	✓	✓	✓	✓	✓	✓	✓
13	Safety info channel <ul style="list-style-type: none"> BICO source r9734.0...14 for the status bits of the extended safety functions 	-	-	-	✓	✓	✓	✓
14	Diagnostic alarms for PROFIBUS	✓	✓	✓	✓	✓	✓	✓

A.1.10 Firmware version 4.5

Table A-10 New functions and function changes in Firmware 4.5

	Function	SINAMICS					
		G120				G120D	
		G120C	CU230P-2	CU240B-2	CU240E-2	CU240D-2	CU250D-2
1	Support for the new Power Modules: <ul style="list-style-type: none"> PM230 IP20 FSA ... FSF PM230 in a push-through FSA ... FSC 	-	✓	✓	✓	-	-
2	Support for the new Power Modules: <ul style="list-style-type: none"> PM240-2 IP20 FSA PM240-2 in push-through FSA 	-	✓	✓	✓	-	-
3	New Control Units with PROFINET support	✓	✓	-	✓	✓	✓
4	Support of the PROFlenergy profile	✓	✓	-	✓	✓	✓
5	Shared device support via PROFINET	✓	✓	-	✓	✓	✓
6	Write protection	✓	✓	✓	✓	✓	✓
7	Know-how protection	✓	✓	✓	✓	✓	✓
8	Adding a second command data set (CDS0 → CDS0 ... CDS1) (All other converters have four command data sets)	✓	-	-	-	-	-
9	Position control and basic positioner	-	-	-	-	-	✓
10	Support of an HTL encoder	-	-	-	-	✓	✓
11	Support of an SSI encoder	-	-	-	-	-	✓
12	Failsafe digital output	-	-	-	-	✓	✓

A.2 Interconnecting signals in the converter

A.2.1 Fundamentals

The following functions are implemented in the converter:

- Open-loop and closed-loop control functions
- Communication functions
- Diagnosis and operating functions

Every function comprises one or several blocks that are interconnected with one another.

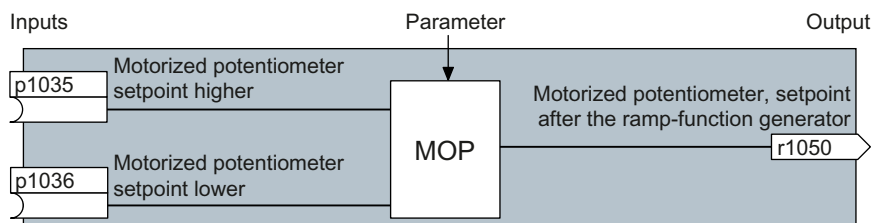

Figure A-1 Example of a block: Motorized potentiometer (MOP)

Most of the blocks can be adapted to specific applications using parameters.

You cannot change the signal interconnection within the block. However, the interconnection between blocks can be changed by interconnecting the inputs of a block with the appropriate outputs of another block.

The signal interconnection of the blocks is realized, contrary to electric circuitry, not using cables, but in the software.

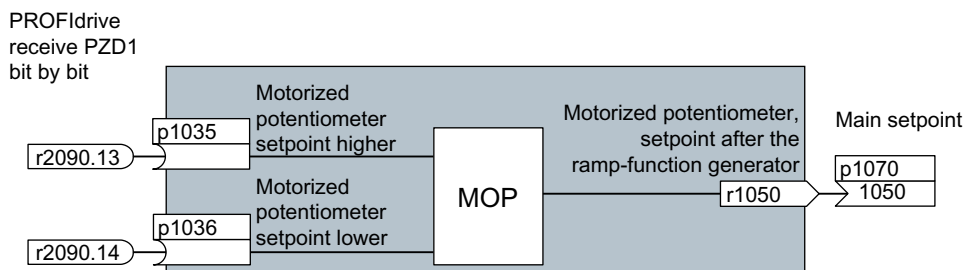

Figure A-2 Example: Signal interconnection of two blocks for digital input 0

Binectors and connectors

Connectors and binectors are used to exchange signals between the individual blocks:

- Connectors are used to interconnect "analog" signals (e.g. MOP output speed)
- Binectors are used to interconnect digital signals (e.g. "Enable MOP up" command)

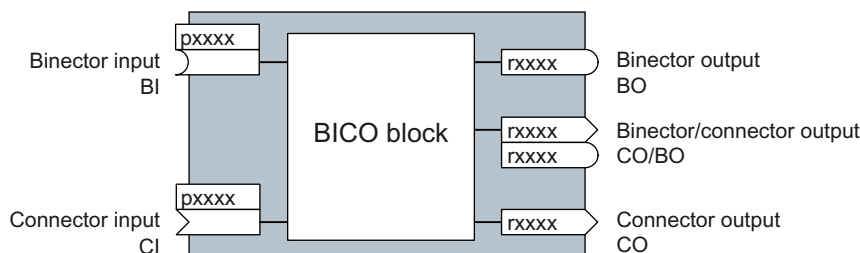

Figure A-3 Symbols for binector and connector inputs and outputs

Binector/connector outputs (CO/BO) are parameters that combine more than one binector output in a single word (e.g. r0052 CO/BO: status word 1). Each bit in the word represents a digital (binary) signal. This summary reduces the number of parameters and simplifies parameter assignment.

Binector or connector outputs (CO, BO or CO/BO) can be used more than once.

Interconnecting signals

When must you interconnect signals in the converter?

If you change the signal interconnection in the converter, you can adapt the converter to a wide range of requirements. This does not necessarily have to involve highly complex functions.

Example 1: Assign a different function to a digital input.

Example 2: Switch the speed setpoint from the fixed speed to the analog input.

Principle when connecting BICO blocks using BICO technology

When interconnecting the signal, the following principle applies: **Where does the signal come from?**

An interconnection between two BICO blocks consists of a connector or a binector and a BICO parameter. The input of a block must be assigned the output of a different block: In the BICO parameters, enter the parameter numbers of the connector/binector that should supply its output signal to the BICO parameter.

How much care is required when you change the signal interconnection?

Note which changes you make. A subsequent analysis of the set signal interconnections is possible only by evaluating the parameter list.

Where can you find additional information?

- All the binectors and connectors are located in the Parameter list.
- The function diagrams provide a complete overview of the factory setting for the signal interconnections and the setting options.

A.2.2 Application example

Shift the control logic into the converter

It is only permissible that a conveyor system starts when two signals are present simultaneously. These could be the following signals, for example:

- The oil pump is running (the required pressure level is not reached, however, until after 5 seconds)
- The protective door is closed

To implement this task, you must insert free function blocks between digital input 0 and the command to switch on the motor (ON/OFF1).

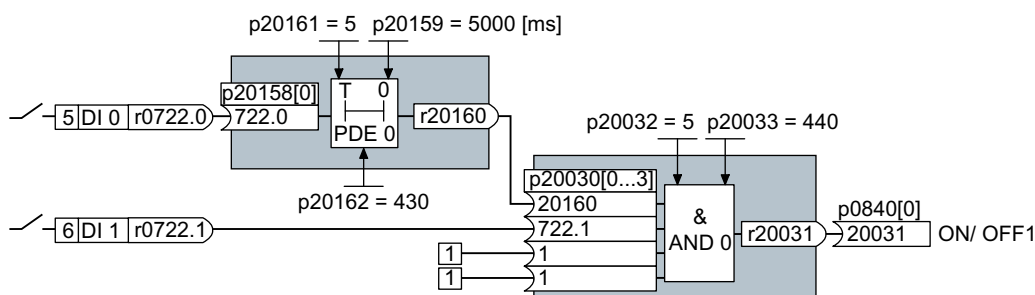

Figure A-4 Signal interconnection for control logic

The signal of digital input 0 (DI 0) is fed through a time block (PDE 0) and is interconnected with the input of a logic block (AND 0). The signal of digital input 1 (DI 1) is interconnected to the second input of the logic block. The logic block output issues the ON/OFF1 command to switch-on the motor.

Setting the control logic

Parameter	Description
p20161 = 5	The time block is enabled by assigning to runtime group 5 (time slice of 128 ms)
p20162 = 430	Run sequence of the time block within runtime group 5 (processing before the AND logic block)
p20032 = 5	The AND logic block is enabled by assigning to runtime group 5 (time slice of 128 ms)
p20033 = 440	Run sequence of the AND logic block within runtime group 5 (processing after the time block)
p20159 = 5000.00	Setting the delay time [ms] of the time module: 5 seconds
p20158 = 722.0	Connect the status of DI 0 to the input of the time block r0722.0 = Parameter that displays the status of digital input 0.
p20030[0] = 20160	Interconnecting the time block to the 1st AND input
p20030[1] = 722.1	Interconnecting the status of DI 1 to the 2nd AND input r0722.1 = Parameter that displays the status of digital input 1.
p0840 = 20031	Interconnect the AND output to ON/OFF1

Explanation of the application example using the ON/OFF1 command

Parameter p0840[0] is the input of the "ON/OFF1" block of the converter. Parameter r20031 is the output of the AND block. To interconnect ON/OFF1 with the output of the AND block, set p0840 = 20031.

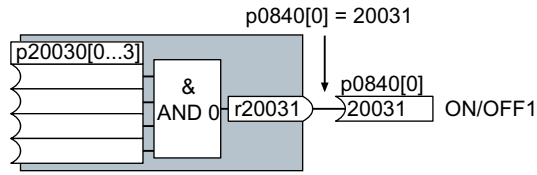





Figure A-5 Interconnecting blocks by setting p0840[0] = 20031







A.3 Manuals and technical support

A.3.1 Overview of the manuals



Converter Manuals



-  CU240B/E-2 List Manual (<https://support.industry.siemens.com/cs/ww/en/view/109782301>)
Parameter list, alarms and faults. Graphic function diagrams

-  CU240B/E-2 operating instructions (<https://support.industry.siemens.com/cs/ww/en/view/109782865>)
Installing, commissioning and maintaining the converter. Advanced commissioning (this manual)

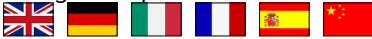
Supplementary manuals for converter

-  "Fieldbus" function manual (<https://support.industry.siemens.com/cs/ww/en/view/109751350>)
Configuring fieldbuses.

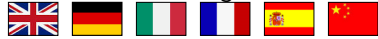
-  "Safety Integrated" function manual (<https://support.industry.siemens.com/cs/ww/en/view/109751320>)
Configuring PROFIsafe. Installing, commissioning and operating failsafe functions of the converter.

-  Power Module Installation Manual (<https://support.industry.siemens.com/cs/ww/en/ps/13224/man>)
Installing Power Modules, reactors and filters. Technical data, maintenance

Converter accessory manuals

-  BOP-2 operating instructions (<https://support.industry.siemens.com/cs/ww/en/view/109483379>)
Using the Operator Panel.

-  Operating instructions IOP-2 (<https://support.industry.siemens.com/cs/ww/en/view/109808456>)
Using the Operator Panel. Mounting the door mounting kit for IOP.

-  Application manual IOP (<https://support.industry.siemens.com/cs/ww/en/view/109483443>)
 The commissioning wizards in the IOP

-  Accessories manual (<https://support.industry.siemens.com/cs/ww/en/ps/13225/man>)
 Installation descriptions for converter components, e.g. line reactors and line filters. The printed installation descriptions are supplied together with the components.

Additional information

-  EMC installation guideline (<http://support.automation.siemens.com/WW/view/en/60612658>)

EMC-compliant control cabinet design, equipotential bonding and cable routing



Finding the most recent edition of a manual

If there are multiple editions of a manual, select the latest edition:

> Manual Fieldbus systems: PROFINET, PROFIBUS, EtherNet/IP, CANopen, USS, Bacnet, Modbus, P1
 04/2014, FW V4.7.3 Function manual, A5E34229197B AA
 For products: 6SL3544-0MB02-1PA0, 6SL3244-0BB13-1FA0, ... > All products
 View of this manual

08/11/2014
ID: 99685159
★★★★☆ (3)

04/2015, FW V4.7.3

04/2015, FW V4.7.3

04/2014, FW V4.7.3

Configuring a manual

Further information about the configurability of manuals is available in the Internet:

-  MyDocumentationManager (<https://www.industry.siemens.com/topics/global/en/planning-efficiency/documentation/Pages/default.aspx>).

Select "Display and configure" and add the manual to your "mySupport-documentation":

Function manual
 Function Manual
Article number of the documentation: A5E34229197B AA
Description / topic 04/2014, FW V4.7,
 Show and configure
 Download (5644 KB)

mySupport Cockpit

Add to mySupport favorites
 Add to mySupport documentation
 Favorite

Not all manuals can be configured.

The configured manual can be exported in RTF, PDF or XML format.

A.3.2 Configuring support

Catalog

Ordering data and technical information for the converters SINAMICS G.



Catalogs for download or online catalog (Industry Mall):

 Everything about SINAMICS G120 (www.siemens.com/sinamics-g120)

SIZER

The configuration tool for SINAMICS, MICROMASTER and DYNAVERT T drives, motor starters, as well as SINUMERIK, SIMOTION controllers and SIMATIC technology



 SIZER on DVD:

Article number: 6SL3070-0AA00-0AG0

 Download SIZER (<http://support.automation.siemens.com/WW/view/en/10804987/130000>)

EMC (electromagnetic compatibility) technical overview

Standards and guidelines, EMC-compliant control cabinet design



 EMC overview (<https://support.industry.siemens.com/cs/ww/en/view/103704610>)

EMC Guidelines configuration manual

EMC-compliant control cabinet design, potential equalization and cable routing



 EMC installation guideline (<http://support.automation.siemens.com/WW/view/en/60612658>)

See also

Safety Integrated for novices (<https://support.industry.siemens.com/cs/ww/en/view/80561520>)

A.3.3 Product Support

Overview

You can find additional information about the product on the Internet:

 Product support (<https://support.industry.siemens.com/cs/ww/en/>)

This URL provides the following:

- Up-to-date product information (product announcements)
- FAQs
- Downloads
- The Newsletter contains the latest information on the products you use.
- The Knowledge Manager (Intelligent Search) helps you find the documents you need.
- Users and specialists from around the world share their experience and knowledge in the Forum.
- You can find your local representative for Automation & Drives via our contact database under "Contact & Partner".
- Information about local service, repair, spare parts and much more can be found under "Services".

If you have any technical questions, use the online form in the "Support Request" menu:

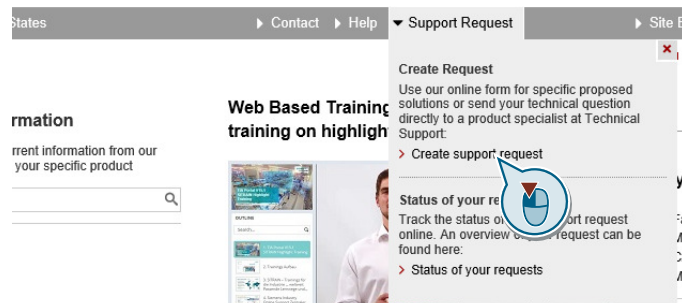

Index

8

87 Hz characteristic, 102
87 Hz characteristic, 102

A

Acceptance test, 308
 Complete, 308
 Reduced scope, 309
 Reduced scope of, 481
 Test scope, 309, 481
Acceptance test record, 308
Acyclic communication, 268
Agitators, 159, 167, 176, 184
Alarm, 425, 431
Alarm buffer, 431
Alarm code, 431
Alarm history, 432
Alarm time, 431
Alarm value, 431
Ambient temperature, 392
Analog input, 109, 117
 Function, 234
Analog output, 109, 117
Application example, 138, 140, 229, 238, 268, 317, 318, 321, 322, 562
 Application example, 232, 236
 Reading and writing parameters cyclically via PROFIBUS, 268
Article number, 32
Automatic mode, 282
Automatic restart, 410

B

Base load, 490
Base load input current, 490
Base load output current, 490
Base load power, 490
BF (Bus Fault), 426, 427, 428
BICO block, 560
Bimetallic switch, 390
Binector input, 229
Binectors, 561
Bit pattern test, 302
Block, 560

BOP-2

 Menu, 192
 Symbols, 192
Brake Relay, 142
Braking
 Regenerative, 385
Braking functions, 372
Braking method, 372
Braking module, 381
Braking resistor, 54, 381
Bus termination, 105

C

Cable resistance, 343
Catalog, 566
CDS (Command Data Set), 281, 307
Centrifuge, 159, 167, 176, 184, 374, 379, 381, 385
Chain conveyor, 159, 167
Chain conveyors, 176, 184
Characteristic
 Additional, 346
 Linear, 346, 350
 parabolic, 346, 350
 square-law, 346, 350
Clockwise rotation, 241
Closed-loop torque control, 369
Command data set, 281
Commissioning
 Guidelines, 147
Communication
 Acyclic, 268
Compound braking, 379, 380
Compressor, 159, 167, 176, 184
Configuring support, 566
Connectors, 561
Consistency, 301
Consistent signals, 301
Contact bounce, 302
Control terminals, 109, 117
Control Units, 32, 35
Control word
 Control word 1, 272
 Control word 3, 257
 Control word 1, 255
Control word 3 (STW3), 257
Control word";"Control word 1, 269
Controlling the motor, 241

Converter

- does not respond, 482
- Update, 481
- Converter components, 32
- Conveyor belt, 159, 167, 176, 184, 374
- Conveyor systems, 182
- Copy
 - Series commissioning, 309
- Copy parameters (series commissioning), 309
- Counter-clockwise rotation, 241
- Crane, 285
- Crushers, 159, 167, 176, 184
- Current input, 234
- Current reduction, 536, 542
- Cyclic communication, 265

D

- Data backup, 199, 208
 - Data transfer, 207
- Data set 47 (DS), 268
- Data set changeover, 307
- DC braking, 257, 374, 375, 376, 377
- DC link overvoltage, 395
- DC link voltage, 395
- Deadband, 237
- Delta connection, 102
- Delta connection (Δ), 150
- Derating
 - Installation altitude, 544
- Digital input, 109, 117, 229, 241
- Digital inputs
 - Multiple assignment, 307
- Digital output, 109, 117
 - Function, 233, 235, 239
- DIP switch
 - Analog input, 234
- Direct data exchange, 268
- Direction of rotation, 320
- Direction reversal, 241
- Discrepancy, 301
 - Filter, 301
 - Tolerance time, 301
- Distance connector, 36
- Drive control, 221
- Drive Data Set, DDS, 422
- Drive Data Sets, 422
- Droop, 359
- Dynamic braking, 381

E

- Electromechanical sensor, 131
- Elevator, 285
- EMC, 60
- EMERGENCY OFF, 296
- EMERGENCY STOP, 296
- Emergency Stop button, 295
- EN 60204-1, 296
- EN 61800-5-2, 295
- End position, 279
- End position control, 279
- Energy recovery, 39
- Energy recovery option, 385
- Energy-saving display, 420
- Extending the telegram, 266
- Extruder, 159, 167, 176, 184

F

- Factory assignment, 109, 117
- Factory settings, 187
 - Restoring the, 187, 188, 190
- Failsafe digital input, 231
- Fan, 39, 40, 159, 167, 176, 182, 184
- Fans, 387
- Fault, 425
 - Acknowledge, 435
 - Motor, 483
- Fault buffer, 434
- Fault case, 436
- Fault code, 434
- Fault history, 435
- Fault time, 434
 - Received, 434
 - Removed, 434
- Fault value, 434
- FCC, 344
- FCC (Flux Current Control), 346
- F-DI (Failsafe Digital Input), 231
- F-digital output module, 132
- Field weakening, 102
- Fieldbus interfaces, 105, 106, 135
- Filter
 - Contact bounce, 302
 - Discrepancy, 301
 - On/off test, 302
- Firmware, 32
 - Update, 481
- Firmware downgrade, 478

Firmware version, 547, 548, 549, 550, 551, 552, 553, 554, 555, 556, 557, 558

Flow control, 331

Flux current control, 344

Flying restart, 408

Forced checking procedure, 304
Setting, 304

Formatting, 200

Forming the DC-link capacitors, 151

Free function blocks, 288

Function Manual, 564

Functional expansions, 309

Functions

BOP-2, 192

Overview, 221

G

Grinding machine, 374, 379

H

High Overload, 490

Hoist drive, 385

Hoisting gear, 285, 381

Horizontal conveyors, 379, 381

Hotline, 567

I

I_{max} controller, 386

i2t monitoring, 389

Inclined conveyors, 381

IND (page index), 262

Industry Mall, 566

Installation altitude, 544

Installing, 67

Interfaces, 105

Interlock, 562

J

JOG function, 277

K

Kinetic buffering, 413

Kneaders, 159, 167, 176, 184

Know-how protection, 200, 214

KTY84 sensor, 390

L

LED

BF, 426, 427, 428

LNK, 427

RDY, 426

SAFE, 427

LED (light emitting diode), 425

Level control, 331

License, 200

Limit switch, 279

Line and motor connection, frame sizes

FSD ... FSF, 97, 101

Line contactor, 295

Line dip, 413

Line filter, 43

Linear characteristic, 346, 350

List Manual, 564

LNK (PROFINET Link), 427

Load failure, 406

Low Overload, 490

M

Main screen form (basic functions), 300

Manual mode, 282

Maximum cable length

PROFIBUS, 139

PROFINET, 137

Maximum current controller, 386

Maximum speed, 154, 320

Memory cards, 200

Menu

BOP-2, 192

Operator panel, 192

Mills, 159, 167, 176, 184

Minimum speed, 154, 320, 323

Mixers, 159, 167, 176, 184

Moment of inertia estimator, 364

MOP (motorized potentiometer), 313

MotID (motor data identification), 162, 164, 168

Motor control, 222

Motor data, 150

Identify, 162, 164, 168, 357, 369

Measure, 162, 164, 168

Motor data set, 423

Motor Data Set, MDS, 423

Motor fault, 483

Motor holding brake, 283, 284, 285, 295

Motor standard, 290

Motor temperature sensor, 109, 117
Motorized potentiometer, 313
Multiple assignment
 Digital inputs, 307

O

OFF1 command, 241
OFF3 ramp-down time, 327
ON command, 241
On/off test, 302
Operating instruction, 25
Operating Instructions, 564
Operation, 226
Operator panel
 BOP-2, 192
 Menu, 192
Optimizing the closed-loop speed controller, 357
Output reactor, 343
Overload, 386
Overview
 Chapter, 26, 27
Overview of the functions, 221
Overvoltage, 395
Overvoltage protection, 134

P

Parabolic characteristic, 346, 350
Parameter channel, 260
 IND, 262
Parameter index, 262
Parameter list, 564
Parameter number, 196, 262
Parameter value, 197
Parameters
 Overview, 224
Partial load operation, 543
PFH (Probability of failure per hour), 488
PID controller, 331
PKW (parameter, ID value), 253
PLC functionality, 562
Power failure, 410
Power Module, 32
Power unit data set, 423
Power Unit Data Set, PDS, 423
Pre-control, 367
Pressure control, 331
Probe, 406
Procedure, 25
PROFIBUS, 139

PROFIdrive, 135
PROFIenergy, 135
PROFI-safe, 135
Protection functions, 222
Pt1000 sensor, 390
PTC sensor, 390
Pulse cancellation, 255, 269, 272
Pulse enable, 255, 269, 272
Pulse frequency, 388, 389, 536, 542
Pump, 39, 40, 159, 167, 176, 182, 184
PZD (process data), 253

Q

Questions, 567

R

Ramp-down time, 327, 328
 Scaling, 330
Ramp-function generator, 320, 326
Ramp-up time, 327, 328
 Scaling, 330
RDY (Ready), 426
Ready, 226
Ready for switching on, 226
Regenerative feedback, 385
Regenerative operation, 372
Replacing
 Control Unit, 481
 Gear unit, 481
 Hardware, 481
 Motor, 481
 Power Module, 481
Reset
 Parameter, 187, 188, 190
Reversing, 320
Roller conveyor, 159, 167
Roller conveyors, 176, 184
Rotary furnace, 159, 167, 176, 184
Rounding, 327
Rounding OFF3, 327

S

S7 communication, 135
SAFE, 427
Safe Brake Relay, 56, 142, 303
Safety function, 222
Safety relay, 132
Saw, 374, 379

- Scaling
 - Analog input, 236
 - Analog output, 239
 - SD (memory card), 200
 - Formatting, 200
 - Self-test, 304
 - Sensor (electromechanical), 131
 - Sequence control, 225
 - Series commissioning, 191, 309
 - Setpoint processing, 222, 320
 - Setpoint source, 222
 - Selecting, 311, 312, 313
 - Settling time, 159, 167, 176, 184
 - Shield connection kit, 35
 - Short-circuit monitoring, 390, 391
 - Signal interconnection, 560
 - Sine-wave filter, 52, 343
 - SIZER, 566
 - Skip frequency band, 320
 - Slip compensation, 344
 - Smart Access, 148
 - Speed
 - change with BOP-2, 192
 - Limiting, 320
 - Speed control, 354
 - Speed monitoring, 406
 - Spindle, 159, 167, 176, 184
 - Square-law characteristic, 346, 350
 - Standards
 - EN 61800-3, 33
 - Star connection (Y), 102
 - Startdrive, 298
 - Download, 148
 - Startdrive PC tool, 298
 - STARTER
 - Download, 148
 - STARTER PC tool, 298
 - Starting behavior
 - Optimization, 352
 - Starting behavior"; "Optimization, 348
 - Starting current, 349
 - State overview, 225
 - Status word
 - Status word 1, 255, 256, 270, 273
 - Status word 3, 258
 - STO (Safe Torque Off), 294, 295
 - select, 295
 - Storage medium, 199
 - STW1 (control word 1), 255, 269, 272
 - Subindex, 262
 - Support, 567
 - Switch off
 - Motor, 226
 - OFF1 command, 226
 - OFF2 command, 226
 - OFF3 command, 226
 - Switch on
 - Motor, 226
 - ON command, 226
 - Switching on inhibited, 226, 256, 269, 272
 - Switch-off signal paths, 304
 - Symbols, 25
 - System runtime, 429
- T**
- Technical data
 - Control Unit, 485, 486, 487, 488, 489
 - Technology controller, 257, 292, 331
 - Temperature calculation, 392
 - Temperature monitoring, 389, 392
 - Temperature sensor, 109, 117
 - Temperature switch, 390
 - Terminal block, 228
 - Terminal strip, 134
 - Factory setting, 109, 117
 - Test signals, 302
 - Three-wire control, 241
 - Torque accuracy, 159, 167, 176, 184
 - Two-wire control, 241
 - Type plate
 - Control Unit, 32
 - Power Module, 32
- U**
- U/f characteristic, 344
 - Unit system, 290
 - Unwinders, 385
 - Update (firmware), 481
 - Upgrading the firmware, 476
 - Upload
 - Data transfer, 208
 - Download, 207
 - Use for the intended purpose, 29
 - User interfaces, 105
- V**
- Vdc_min controller, 413
 - Vector control, 357, 369
 - Sensorless, 354

Version

- Control Unit, 32
- Power Module, 32
- Vertical conveyors, 381
- Voltage boost, 344, 348, 349, 352
- Voltage input, 234

W

- Winders, 385
- Wire breakage, 301
- Wire-break monitoring, 237, 390, 391
- Write protection, 211

Z

- Ziegler Nichols, 340
- ZSW 1 (status word 1)", 256
- ZSW1 (status word 1), 255, 270
- ZWS3 (status word 3), 258
- ZWST1 (status word 1), 273

Further information

SINAMICS converters:
www.siemens.com/sinamics

Safety Integrated
www.siemens.com/safety-integrated

PROFINET
www.siemens.com/profinet

Siemens AG
Digital Factory
Motion Control
Postfach 3180
91050 ERLANGEN
Germany

Scan the QR code for
additional
information about
SINAMICS G120.

