



sinamics

G110

SINAMICS G110

SIEMENS

SINAMICS G110 Documentation

Getting Started Guide

The Getting Started Guide is designed to give the user quick access to all the basic information required to install and set-up the SINAMICS G110 for operation.



Operating Instructions

Gives information regarding the features of SINAMICS G110 including Installation, Commissioning, Control modes, System Parameter structure, Troubleshooting, Specifications and available options for the inverter.



Parameter List

The Parameter List contains a detailed description of all Parameters relating to the SINAMICS G110 and is structured in numerical order.



Catalogues

In the catalogue you will find all the necessary information to select an appropriate inverter, as well as the Basic Operator Panel and Communication Options for the SINAMICS G110 series.

English

Changes to the motor thermal protection feature of the MICROMASTER, SIMATIC & SINAMICS inverters

On 9th November 2010 Underwriters Laboratories Inc.(UL) revised the standard for “safety of power conversion equipment” which covers Siemens inverters. These changes in the standard become effective from the 9th of May 2013.

The changes relate to the performance of the software motor protection offered by the inverter, in that when the inverter is power-cycled it must now retain the motor temperature data for use when power is reapplied.

The following products have had a software update to comply with the new requirements.

- MICROMASTER 420 software V1.3 or above. (Order No. 6SE6420.....)
- MICROMASTER 430 software V2.2 or above. (Order No. 6SE6430.....)
- MICROMASTER 440 software V2.2 or above. (Order No. 6SE6440.....)
- SINAMICS G110 software V1.2 or above. (Order No. 6SL3211.....)
- SINAMICS G110D software V3.6 or above. (Order No. 6SL3511.....)
- SINAMICS Pool CU-2 software V4.6 or above *)
(CU230P-2, CU240E-2, CU240B-2, G120C, CU240D-2, CU250D-2).
- SIMATIC ET200pro FC-2 software V4.7 or above *)

These products now, by default, store the motor temperature (r0034 for SINAMICS G110 and MICROMASTER 420; r0035 for SINAMICS G110D and MICROMASTER 430/440) and re-use this value when power is reapplied:

Parameter P0610 has been changed to reflect this new requirement as follows:

The default value of parameter P0610 is now 6 and the following settings have been added:

- Value 4 = Warning Only, no reaction, no trip, save temperature on power down.
- Value 5 = Warning, I_{max} reduction, trip F0011, save temperature on power down.
- Value 6 = Warning, no reaction, trip F0011, save temperature on power down.

*) Those units have other settings and default values. Please refer to the relevant parameter lists.

The following products will not have the software update to support the new requirements.

- All MICROMASTER 3 variants (Order No. 6SE32.....)
- All MICROMASTER 410 (Order No. 6SE6410.....)
- All MICROMASTER 411 (Order No. 6SE6411.....)
- All MICROMASTER 436 (Order No. 6SE6436.....)
- All MICROMASTER MMI / CM2 (Order No. 6SE96.....)

These products are unchanged from their original design, but this is no longer compliant with the new requirements.

These products may still bear the UL symbol but it is now the end users responsibility to provide listed motor overload protection external to the inverter.

We suggest the end user consider devices such as the Siemens overload relay 3RU series on the motor side of the inverter in order to provide the motor protection, details of which can be found at the link below:

<http://www.automation.siemens.com/mcms/industrial-controls/en/protection-equipment/overload-relays/pages/default.aspx>



A 5 E 3 1 6 7 4 1 4 5 A

Deutsch

Änderung zum thermischen Motorschutz bei Frequenzumrichtern MICROMASTER, SIMATIC und SINAMICS

Ab 9. November 2010 hat "Underwriters Laboratories Inc.(UL)" den Standard "Safety of power conversion equipment" geändert. Davon sind auch Siemens-Frequenzumrichter betroffen. Die Änderung trat am 9. Mai 2013 in Kraft.

Die Änderung bezieht sich auf die Leistungsfähigkeit der Software für den Motorschutz, den der Frequenzumrichter bietet. Wenn bei dem Frequenzumrichter ein "Power-Cycle" durchgeführt wird, muss der Wert der Motortemperatur beim Wiedereinschalten beibehalten werden.

Folgende Produkte erfüllen die neue Anforderung zum thermischen Motorschutz:

- MICROMASTER 420, ab Software V1.3 (Bestell- Nr. 6SE6420.....)
- MICROMASTER 430, ab Software V2.2 (Bestell- Nr. 6SE6430.....)
- MICROMASTER 440, Software V2.2. (Bestell- Nr. 6SE6440.....)
- SINAMICS G110, ab Software V1.2 (Bestell- Nr. 6SL3211.....)
- SINAMICS G110D , ab Software v3.6 (Bestell- Nr. 6SL3511.....)
- SINAMICS Pool CU-2 , ab Software V4.6 *)
(CU230P-2, CU240E-2, CU240B-2, G120C, CU240D-2, CU250D-2).
- SIMATIC ET200pro FC-2 , ab Software V4.7 *)

Dabei wird in der Werkseinstellung die Motortemperatur gespeichert (r0034 für SINAMICS G110 und MICROMASTER 420; r0035 für SINAMICS G110D und MICROMASTER 430/440) und beim Zuschalten der Spannung, also nach einem Power Cycle, für die Berechnung der Motortemperatur verwendet.

Die Änderung wird über folgende Erweiterung des Parameters P0610 realisiert.

Neue Einstellmöglichkeiten:

- Wert 4 = nur Warnung, keine Reaktion, Temperaturwert beim Ausschalten speichern.
- Wert 5 = Warnung, I_{max} reduzieren, Abschaltung mit F0011, Temperaturwert beim Ausschalten speichern.
- Wert 6 = Warnung , keine Reaktion, Abschaltung mit F0011, Temperaturwert beim Ausschalten speichern (**neue Werkseinstellung**)

*) Bei diesen Geräten gibt es andere Einstellmöglichkeiten und Werkseinstellungen. Beachten Sie die entsprechenden Listenhandbücher!

Die folgenden Produkte erfüllen die neue Anforderung zum thermischen Motorschutz nicht:

- Alle MICROMASTER 3 Varianten (Bestell- Nr. 6SE32.....)
- Alle MICROMASTER 410 (Bestell- Nr. 6SE6410.....)
- Alle MICROMASTER 411 (Bestell- Nr. 6SE6411.....)
- Alle MICROMASTER 436 (Bestell- Nr. 6SE6436.....)
- Alle MICROMASTER MMI / CM2 (Bestell- Nr. 6SE96.....)

Am Original Design dieser Produkte hat sich nichts geändert, aber sie erfüllen nicht mehr die neuen UL Vorschriften.

Diese Produkte dürfen am Typenschild ein UL Symbol zeigen, aber es ist in der Verantwortung des Endkunden einen gelisteten externen Motorüberlastschutz einzubauen.

Wir empfehlen dem Endkunden ein Siemens-Überlastrelais der Serie 3RU motorseitig am Frequenzumrichter zu installieren, um den Motorschutz zu gewährleisten.

Weitere Informationen zu den Sirius 3RU-Überlastrelais finden Sie unter folgendem Link:

<http://www.automation.siemens.com/mcms/industrial-controls/de/schutzgeraete/ueberlastrelais/Seiten/default.aspx>



Français

Changement de la fonction de protection thermique du moteur des variateurs de vitesse MICROMASTER & SINAMICS

Le 09 Novembre 2010 Underwriters Laboratories Inc.(UL) ont révisé les standards sur la "sécurité des convertisseurs de puissance" ("safety of power conversion equipment") qui s'appliquent aux variateurs de vitesse Siemens . Ces changements des standards sont effectifs à partir du 09 Mai 2013.

Les changements se rapportent à la performance de la fonction protection thermique du moteur des variateurs de vitesse, en ceci que lorsque le variateur de vitesse est mis hors tension, les données thermiques du moteur doivent désormais être conservées jusqu'à la prochaine mise sous tension et utilisation du produit.

Une mise à jour du software sur les produits suivants a été implémentée afin de se conformer aux nouveaux standards.

- MICROMASTER 420 software V1.3 ou supérieur (Order No. 6SE6420.....)
- MICROMASTER 430 software V2.2 ou supérieur (Order No. 6SE6430.....)
- MICROMASTER 440 software V2.2 ou supérieur (Order No. 6SE6440.....)
- SINAMICS G110 software V1.12 ou supérieur (Order No. 6SL3211.....)
- SINAMICS G110D software V1.3 ou supérieur (Order No. 6SL3511.....)
- SINAMICS Pool CU-2 software V4.6 ou supérieur *)
(CU230P-2, CU240E-2, CU240B-2, G120C, CU240D-2, CU250D-2).
- SIMATIC ET200pro FC-2 software V4.7 ou supérieur *)

Désormais, les produits enregistrent par défaut la température du moteur (r0034 pour SINAMICS G110 et MICROMASTER 420 ; r0035 pour SINAMICS G110D et MICROMASTER 430/440) et réutilisent cette valeur dès que la puissance est rétablie sur l'équipement.

Le paramètre P0610 a été modifié afin de refléter ces changements, comme indiqué ci-dessous :

La valeur par défaut du paramètre P0610 est désormais 6, et les réglages suivants ont été ajoutés :

- Value 4 = Avertissement uniquement, température enregistrée lors de la mise hors tension.
- Value 5 = Avertissement et réduction I_{max}, arrêt F0011, température enregistrée lors de la mise hors tension.
- Value 6 = Avertissement, pas réaction, arrêt F0011, température enregistrée lors de la mise hors tension.

*) Ces appareils ont d'autres possibilités de réglage et d'autres réglages usine. Tenir compte des tables de paramètres !

Les versions de software des produits suivants n'intègrent pas les modifications pour répondre aux nouveaux standards UL.

- tous les MICROMASTER 3 variants (N° de réf. 6SE32.....)
- tous les MICROMASTER 410 (N° de réf. 6SE6410.....)
- tous les MICROMASTER 411 (N° de réf. 6SE6411.....)
- tous les MICROMASTER 436 (N° de réf. 6SE6436.....)
- tous les MICROMASTER MMI / CM2 (N° de réf. 6SE96.....)

Ces produits restent inchangés de leur conception d'origine et ne sont pas conforme à ce nouveau standards UL.

Bien que ces produits aient toujours le marquage UL, les utilisateurs finaux sont maintenant responsables de la mise en place sur le variateur d'équipement externe de protection thermique moteur listés.

Nous recommandons aux utilisateurs externes d'utiliser des relais de protection thermique côté moteur de type Siemens Sirius 3RU.

Plus d'informations sur ces relais sont disponibles sous le lien suivant :

<http://www.automation.siemens.com/mcms/industrial-controls/en/protection-equipment/overload-relays/pages/default.aspx>



A 5 E 3 1 6 7 4 1 4 5 A

Italiano

Modifiche della funzione di protezione termica del motore dei convertitori di frequenza MICROMASTER, SIMATIC e SINAMICS

In data 9 novembre 2010 Underwriters Laboratories Inc.(UL) ha rivisto lo standard per la "sicurezza delle apparecchiature di conversione di potenza" (*safety of power conversion equipment*) che si applica ai convertitori di frequenza Siemens. Queste modifiche della norma sono entrate in vigore il 9 maggio 2013.

Le variazioni riguardano le caratteristiche della protezione software del motore offerte dal convertitore di frequenza: quando quest'ultimo viene spento e riacceso deve ora memorizzare i dati termici del motore per riutilizzarli al momento della riaccensione.

I prodotti seguenti hanno implementato un aggiornamento del software per conformarsi ai nuovi requisiti normativi.

- MICROMASTER 420 software V1.3 o successiva. (n. di ordinazione 6SE6420.....)
- MICROMASTER 430 software V2.2 o successiva. (n. di ordinazione 6SE6430.....)
- MICROMASTER 440 software V2.2 o successiva. (n. di ordinazione 6SE6440.....)
- SINAMICS G110 software V1.2 o successiva. (n. di ordinazione 6SL3211.....)
- SINAMICS G110D software V3.6 o successiva. (n. di ordinazione 6SL3511.....)
- SINAMICS Pool CU-2 software V4.6 o successiva *)
(CU230P-2, CU240E-2, CU240B-2, G120C, CU240D-2, CU250D-2).
- SIMATIC ET200pro FC-2 software V4.7 o successiva *)

Tali prodotti memorizzano adesso sistematicamente la temperatura del motore (r0034 per SINAMICS G110 e MICROMASTER 420; r0035 per SINAMICS G110D e MICROMASTER 430/440) e riutilizzano questo valore alla riaccensione:

Il parametro P0610 è stato modificato come segue per tenere conto di questo nuovo requisito:
Il valore predefinito del parametro P0610 è diventato 6 e sono state aggiunte le seguenti impostazioni:

- Valore 4 = solo avviso, nessuna reazione, nessuna disinserzione, memorizzazione della temperatura allo spegnimento.
- Valore 5 = solo avviso, riduzione I_{max}, disinserzione F0011, memorizzazione della temperatura allo spegnimento.
- Valore 6 = solo avviso, nessuna reazione, disinserzione F0011, memorizzazione della temperatura allo spegnimento.

*) Queste unità presentano impostazioni e valori predefiniti differenti. Fare riferimento alla lista parametri corrispondente.

I prodotti seguenti non implementeranno l'aggiornamento software e di conseguenza non supporteranno i nuovi requisiti.

- Tutte le varianti MICROMASTER 3 (n. di ordinazione 6SE32.....)
- Tutti i MICROMASTER 410 (n. di ordinazione 6SE6410.....)
- Tutti i MICROMASTER 411 (n. di ordinazione 6SE6411.....)
- Tutti i MICROMASTER 436 (n. di ordinazione 6SE6436.....)
- Tutti i MICROMASTER MMI / CM2 (n. di ordinazione 6SE96.....)

Questi prodotti restano invariati rispetto alla loro progettazione originale, ma non sono più compatibili con i nuovi requisiti.

Questi prodotti possono mantenere il simbolo UL, ma compete all'utente finale assicurare la protezione esterna contro i sovraccarichi del motore richiesta dalla norma per il convertitore di frequenza.

Per assicurare la protezione del motore si consiglia all'utente finale di ricorrere a dispositivi come i relè di sovraccarico Siemens della serie 3RU sul lato motore del convertitore di frequenza. Per i dettagli fare riferimento al link seguente:

<http://www.automation.siemens.com/mcms/industrial-controls/en/protection-equipment/overload-relays/pages/default.aspx>



A 5 E 3 1 6 7 4 1 4 5 A

Cambios en la función de protección térmica del motor de los convertidores MICROMASTER, SIMATIC y SINAMICS

El 9 de noviembre de 2010, Underwriters Laboratories Inc. (UL) revisó el estándar de "seguridad de los equipos convertidores de energía", que afecta a los convertidores de Siemens. Estos cambios en el estándar entraron en vigor el 9 de mayo de 2013.

Los cambios están relacionados con el rendimiento de la protección del motor por software ofrecida por el convertidor, por la cual, cuando el convertidor se apaga y se vuelve a encender, debe conservar los datos sobre la temperatura del motor para utilizarlos al volver a arrancar.

Para cumplir con los nuevos requisitos, se ha actualizado el software de los productos siguientes.

- Software MICROMASTER 420 V1.3 o superior. (Ref. 6SE6420.....)
- Software MICROMASTER 430 V2.2 o superior. (Ref. 6SE6430.....)
- Software MICROMASTER 440 V2.2 o superior. (Ref. 6SE6440.....)
- Software SINAMICS G110 V1.2 o superior. (Ref. 6SL3211.....)
- Software SINAMICS G110D V3.6 o superior. (Ref. 6SL3511.....)
- Software SINAMICS Pool CU-2 V4.6 o superior (*)
(CU230P-2, CU240E-2, CU240B-2, G120C, CU240D-2, CU250D-2).
- Software SIMATIC ET200pro FC-2 V4.7 o superior. (*)

De forma predeterminada, estos productos almacenan la temperatura del motor (r0034 para SINAMICS G110 y MICROMASTER 420; r0035 para SINAMICS G110D y MICROMASTER 430/440) y reutilizan ese valor al volver a arrancar:

El parámetro P0610 se ha modificado para reflejar este nuevo requisito de la forma siguiente:

El valor predeterminado del parámetro P0610 ahora es 6, y se han añadido los siguientes ajustes:

- Valor 4 = Solo aviso, sin reacción, sin disparo, guardar temperatura al apagar.
- Valor 5 = Aviso, reducción $I_{m\acute{a}x}$, disparo F0011, guardar temperatura al apagar.
- Valor 6 = Aviso, sin reacción, disparo F0011, guardar temperatura al apagar.

*) Estas unidades tienen otros ajustes y valores predeterminados. Consulte las listas de parámetros pertinentes.

Los productos siguientes no dispondrán de la actualización de software para cumplir los nuevos requisitos.

- Todas las variantes de MICROMASTER 3 (Ref. 6SE32.....)
- Todos los MICROMASTER 410 (Ref. 6SE6410.....)
- Todos los MICROMASTER 411 (Ref. 6SE6411.....)
- Todos los MICROMASTER 436 (Ref. 6SE6436.....)
- Todos los MICROMASTER MMI/CM2 (Ref. 6SE96.....)

Estos productos no han sufrido cambios respecto a su diseño original, pero ya no cumplen los nuevos requisitos.

Estos productos todavía pueden llevar el símbolo UL, pero ahora es responsabilidad de los usuarios finales proporcionar una protección homologada contra sobrecarga del motor externa al convertidor.

Para la protección del motor, recomendamos al usuario final dispositivos como el relé de sobrecarga de la serie 3RU de Siemens en el lado del motor del convertidor. Puede encontrar información detallada en el enlace siguiente:

<http://www.automation.siemens.com/mcms/industrial-controls/en/protection-equipment/overload-relays/pages/default.aspx>



A 5 E 3 1 6 7 4 1 4 5 A

SIEMENS

SINAMICS G110 120 W - 3 kW

Parameter List
User Documentation

Inverter Type
SINAMICS G110

Firmware Version
1.0 & 1.1
(on page 4)

Issue 11/2004

Parameters 1

Faults and Alarms 2

Appendix 3

Important Information

This Parameter List must only be used in conjunction with the Operating Instructions of the SINAMICS G110.



WARNING

Please pay special attention to the Warnings, Cautions, Notices and Notes contained in the Operating Instructions.

You will find the Operating Instructions on the Docu CD which can be ordered via your local Siemens department under the Order No. 6SL3271-0CA00-0AG0 or downloaded from our website <http://www.siemens.com/sinamics-g110>.

Summary of amendments

Edition	Valid for firmware version	Status/Changes	Order no of the inverter 6SL3211-0xxxx-xxxx
04/2003	1.0	First issue	Last digit "0" 6SL3211-0xxxx-xxx0
11/2004	1.0 1.1	New features inserted: P0727: 2-wire / 3-wire control method P1234: DC braking start frequency P1236: Compound braking P1334: Slip compensation activation range P2172: Threshold DC link voltage P1215-P1217: Motor holding brake optimized	Last digit "0" 6SL3211-0xxxx-xxx0 Last digit "1" 6SL3211-0xxxx-xxx1

Approved Siemens Quality for Software and Training is to DIN ISO 9001, Reg. No. 2160-01

The reproduction, transmission or use of this document, or its contents is not permitted unless authorized in writing. Offenders will be liable for damages. All rights including rights created by patent grant or registration of a utility model or design are reserved.

© Siemens AG 2004. All Rights Reserved.

SINAMICS® is a registered trademark of Siemens

Other functions not described in this document may be available. However, this fact shall not constitute an obligation to supply such functions with a new control, or when servicing.

We have checked that the contents of this document correspond to the hardware and software described. There may be discrepancies nevertheless, and no guarantee can be given that they are completely identical. The information contained in this document is reviewed regularly and any necessary changes will be included in the next edition. We welcome suggestions for improvement.

Siemens handbooks are printed on chlorine-free paper that has been produced from managed sustainable forests. No solvents have been used in the printing or binding process.

Document subject to change without prior notice.

Table of Contents

1	Parameters	7
1.1	Introduction to SINAMICS G110 System Parameters	7
1.2	Quick commissioning (P0010=1).....	10
1.3	Parameter Description	12
2	Faults and Alarms	91
2.1	Fault messages.....	91
2.2	Alarm Messages	95
3	Appendix	97
3.1	List of Abbreviations.....	97

1 Parameters

1.1 Introduction to SINAMICS G110 System Parameters

The layout of the parameter description is as follows.

1 Par number [index]	2 Parameter name 3 CStat: 4 P-Group:	5 Datatype: 6 Active:	7 Unit: 8 QuickComm.:	9 Min: 10 Def: 11 Max:	12 Level: 2
-------------------------	--	--------------------------	--------------------------	------------------------------	-----------------------

13 Description:

1. Parameter number

Indicates the relevant parameter number. The numbers used are 4-digit numbers in the range 0000 to 9999. Numbers prefixed with an "r" indicate that the parameter is a "read-only" parameter, which displays a particular value but cannot be changed directly by specifying a different value via this parameter number (in such cases, dashes "-" are entered at the points "Unit", "Min", "Def" and "Max" in the header of the parameter description.

All other parameters are prefixed with a "P". The values of these parameters can be changed directly in the range indicated by the "Min" and "Max" settings in the header.

[index] indicates that the parameter is an indexed parameter and specifies the number of indices available.

2. Parameter name

Indicates the name of the relevant parameter.

The BICO system is not available with the SINAMICS G110 inverter. To allow the parameter names to be used across a variety of inverter types, the names of parameter have not been changed.

3. Cstat

Commissioning status of the parameter. Three states are possible:

- ◆ Commissioning C
- ◆ Run U
- ◆ Ready to run T

This indicates when the parameter can be changed. One, two or all three states may be specified. If all three states are specified, this means that it is possible to change this parameter setting in all three inverter states.

4. P-Group

Indicates the functional group of the particular.

Note

Parameter P0004 (parameter filter) acts as a filter and focuses access to parameters according to the functional group selected.

5. Datatype

The data types available are shown in the table below.

Notation	Meaning
U16	16-bit unsigned
U32	32-bit unsigned
I16	16-bit integer
I32	32-bit integer
Float	Floating point

6. Active

Indicates whether

- ◆ Immediately changes to the parameter values take effective immediately after they have been entered, or
- ◆ first confirm the "P" button on the basic operator panel (BOP) must be pressed before the changes take effect.

7. Unit

Indicates the unit of measure applicable to the parameter values

8. QuickComm

Indicates whether or not (Yes or No) a parameter can only be changed during quick commissioning, i.e. when P0010 (parameter groups for commissioning) is set to 1 (quick commissioning).

9. Min

Indicates the minimum value to which the parameter can be set.

10. Def

Indicates the default value, i.e. the value which applies if the user does not specify a particular value for the parameter.

11. Max

Indicates the maximum value to which the parameter can be set.

12. Level

Indicates the level of user access. There are three access levels: Standard, Extended and Expert. The number of parameters that appear in each functional group depends on the access level set in P0003 (user access level).

13. Description

The parameter description consists of the sections and contents listed below. Some of these sections and contents are optional and will be omitted on a case-to-case basis if not applicable.

- Description:** Brief explanation of the parameter function.
- Diagram:** Where applicable, diagram to illustrate the effects of parameters on a characteristic curve, for example
- Settings:** List of applicable settings. These include
Possible settings, Most common settings, Index and Bitfields
- Example:** Optional example of the effects of a particular parameter setting.
- Dependency:** Any conditions that must be satisfied in connection with this parameter. Also any particular effects, which this parameter has on other parameter(s) or which other parameters have on this one.
- Warning / Caution / Notice / Note:**
Important information which must be observed to prevent personal injury or damage to equipment / specific information which should be observed in order to avoid problems / information which may be helpful to the user
- More details:** Any sources of more detailed information concerning the particular parameter.

1.2 Quick commissioning (P0010=1)

The following parameters are necessary for quick commissioning (P0010=1).

No	Name	Access level	Cstat
P0100	Europe / North America	1	C
P0304	Motor voltage rating	1	C
P0305	Motor current rating	1	C
P0307	Motor power rating	1	C
P0308	Motor cosPhi rating	3	C
P0309	Motor efficiency rating	3	C
P0310	Motor frequency rating	1	C
P0311	Motor speed rating	1	C
P0335	Motor cooling	3	CT
P0640	Motor overload factor [%]	3	CUT
P0700	Selection of command source	1	CT
P1000	Selection of frequency setpoint	1	CT
P1080	Min. frequency	1	CUT
P1082	Max. frequency	1	CT
P1120	Ramp-up time	1	CUT
P1121	Ramp-down time	1	CUT
P1135	OFF3 ramp-down time	3	CUT
P1300	Control mode	2	CT
P3900	End of quick commissioning	1	C

When P0010 = 1 is chosen, P0003 (user access level) can be used to select the parameters to be accessed. This parameter also allows selection of a user-defined parameter list for quick commissioning.

At the end of the quick commissioning sequence, set P3900 = 1 to carry out the necessary motor calculations and clear all other parameters (not included in P0010=1) to their default settings.

NOTE

This applies only in Quick Commissioning mode.

Reset to Factory default

To reset all parameters to the factory default settings; the following parameters should be set as follows:

Set P0010 = 30

Set P0970 = 1

NOTE

The reset process takes approximately 10 seconds to complete.

Seven-segment display

The seven-segment display is structured as follows:

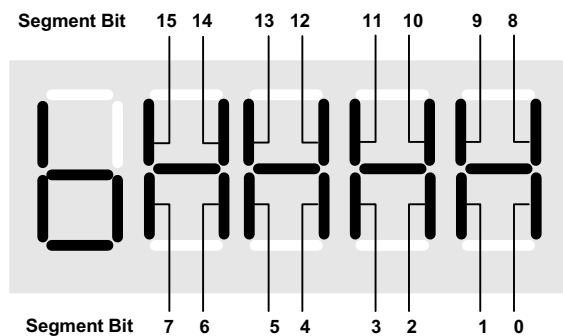

The significance of the relevant bits in the display are described in the status and control word parameters.

1.3 Parameter Description

r0000	Drive display	Datatype: U16	Unit: -	Min: - Def: - Max: -	Level 1
	P-Group: ALWAYS				

Displays the user selected output as defined in P0005.

Note:

Pressing the "Fn" button for 2 seconds allows the user to view the values of DC link voltage, output frequency, output voltage and chosen r0000 setting (defined in P0005).

r0002	Drive state	Datatype: U16	Unit: -	Min: - Def: - Max: -	Level 3
	P-Group: COMMANDS				

Displays actual drive state.

Possible Settings:

- 0 Commissioning mode (P0010 != 0)
- 1 Drive ready
- 2 Drive fault active
- 3 Drive starting (DC-link precharging)
- 4 Drive running
- 5 Stopping (ramping down)

Dependency:

State 3 visible only while precharging DC link.

P0003	User access level			Min: 1 Def: 1 Max: 4	Level 1
	CStat: CUT	Datatype: U16	Unit: -		
	P-Group: ALWAYS	Active: first confirm	QuickComm.: No		

Defines user access level to parameter sets. The default setting (standard) is sufficient for most simple applications.

Possible Settings:

- 1 Standard: Allows access into most frequently used parameters.
- 2 Extended: Allows extended access e.g. to inverter I/O functions.
- 3 Expert: For expert use only.
- 4 reserved

P0004	Parameter filter			Min: 0 Def: 0 Max: 21	Level 3
	CStat: CUT	Datatype: U16	Unit: -		
	P-Group: ALWAYS	Active: first confirm	QuickComm.: No		

Filters available parameters according to functionality to enable a more focused approach to commissioning.

Possible Settings:

- 0 All parameters
- 2 Inverter
- 3 Motor
- 7 Commands, binary I/O
- 8 ADC
- 10 Setpoint channel / RFG
- 12 Drive features
- 13 Motor control
- 20 Communication
- 21 Alarms / warnings / monitoring

Example:

P0004 = 8 specifies that only ADC parameters will be visible.

Dependency:

The parameters are sub-divided into groups (P-Group) according to their functionality. This increases the transparency and allows a parameter to be quickly searched for. Furthermore, parameter P0004 can be used to control the ability to be visualized for the operator panel.

Value	P-Group	Group	Parameter area
0	ALWAYS	All parameters	
2	INVERTER	Drive inverter parameters	0200 0299
3	MOTOR	Motor parameters	0300 ... 0399 + 0600 0699
7	COMMANDS	Control commands, digital I/O	0700 0749 + 0800 ... 0899
8	TERMINAL	Analog inputs/outputs	0750 0799
10	SETPOINT	Setpoint channel and ramp-function gen.	1000 1199
12	FUNC	Drive inverter functions	1200 1299
13	CONTROL	Motor open-loop/closed-loop control	1300 1799
20	COMM	Communications	2000 2099
21	ALARMS	Faults, warnings, monitoring functions	2100 2199

P0005	Display selection			Min: 2	Level 2
	CStat: CUT	Datatype: U16	Unit: -	Def: 21	
	P-Group: FUNC	Active: first confirm	QuickComm.: No	Max: 4000	

Selects display for parameter r0000 (drive display).

Common Settings:

- 21 Actual frequency
- 25 Output voltage
- 26 DC link voltage
- 27 Output current

Notice:

These settings refer to read only parameter numbers ("rxxxx").

Details:

See relevant "rxxxx" parameter descriptions.

P0010	Commissioning parameter			Min: 0	Level 1
	CStat: CT	Datatype: U16	Unit: -	Def: 0	
	P-Group: ALWAYS	Active: first confirm	QuickComm.: No	Max: 30	

Filters parameters so that only those related to a particular functional group are selected.

Possible Settings:

- 0 Ready
- 1 Quick commissioning
- 2 Inverter
- 29 Download
- 30 Factory setting

Dependency:

- Reset to 0 for inverter to run.
- P0003 (user access level) also determines access to parameters.

Note:

P0010 = 1

The inverter can be commissioned very quickly and easily by setting P0010 = 1. After that only the important parameters (e.g.: P0304, P0305, etc.) are visible. The value of these parameters must be entered one after the other. The end of quick commissioning and the start of internal calculation will be done by setting P3900 = 1 - 3. Afterward parameter P0010 and P3900 will be reset to zero automatically.

P0010 = 2

For service purposes only.

P0010 = 29

To transfer a parameter file via PC tool (e.g.: STARTER) parameter P0010 will be set to 29 by the PC tool. When download has been finished PC tool resets parameter P0010 to zero.

P0010 = 30

When resetting the parameters of inverter P0010 must be set to 30. Resetting of the parameters will be started by setting parameter P0970 = 1. The inverter will automatically reset all its parameters to their default settings. This can prove beneficial if you experience problems during parameter setup and wish to start again.

P0014[3]	Store mode	Min: 0	Level 3	
	CStat: UT	Datatype: U16		Unit: -
	P-Group: -	Active: first confirm		QuickComm.: No
		Def: 0		
		Max: 1		

Sets the store mode for parameters. The store mode can be configured for all interfaces listed under "Index".

Possible Settings:

- 0 Volatile (RAM)
- 1 Nonvolatile (EEPROM)

Index:

P0014[0] : USS
P0014[1] : reserved
P0014[2] : reserved

Note:

An independent store request may be part of the serial communications (e.g. PKE bits 15-12 of USS protocol), set by a PLC or PC tools like STARTER. See the table below for an influence on the settings of P0014.

1. With the BOP the parameter will always be stored in the EEPROM.
2. P0014 itself will always be stored in the EEPROM.
3. P0014 will not be changed by performing a factory reset (P0010 = 30 and P0971 = 1).
4. P0014 can be transferred during a DOWNLOAD (P0010 = 29).
5. If "Store request via USS = volatile (RAM)" and "P0014[x] = volatile (RAM)", you can make a transfer of all parameter values into the nonvolatile memory via P0971.
6. If "Store request via USS" and P0014[x] are not consistent, the setting of P0014[x] = "store nonvolatile (EEPROM)" has always higher priority.

Store request via USS	Value of P0014[x]	Result
EEPROM	RAM	EEPROM
EEPROM	EEPROM	EEPROM
RAM	RAM	RAM
RAM	EEPROM	EEPROM

r0018	Firmware version	Min: -	Level 3	
	Datatype: U32	Unit: -		Def: -
	P-Group: INVERTER			Max: -

Displays version number of installed firmware.

r0019	CO/BO: BOP control word	Min: -	Level 3	
	Datatype: U16	Unit: -		Def: -
	P-Group: COMMANDS			Max: -

Displays status of operator panel commands.

Bitfields:

Bit00	ON/OFF1	0	NO	1	YES
Bit01	OFF2: Electrical stop	0	YES	1	NO
Bit08	JOG right	0	NO	1	YES
Bit11	Reverse (setpoint inversion)	0	NO	1	YES
Bit13	Motor potentiometer MOP up	0	NO	1	YES
Bit14	Motor potentiometer MOP down	0	NO	1	YES

Note:

The following functions can be "connected" to individual buttons:

- ON/OFF1,
- OFF2,
- JOG,
- REVERSE,
- INCREASE,
- DECREASE

Details:

The 7-segment display of the bit-parameters (binary parameters) is explained in the Introduction of the Parameter List.

r0020	CO: Freq. setpoint before RFG	Datatype: Float	Unit: Hz	Min: - Def: - Max: -	Level 2
P-Group: CONTROL					

Displays actual frequency setpoint (input for ramp function generator).

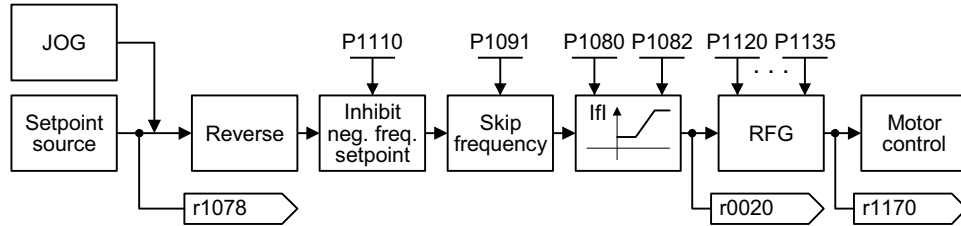

r0021	CO: Act. frequency	Datatype: Float	Unit: Hz	Min: - Def: - Max: -	Level 2
P-Group: CONTROL					

Displays actual inverter output frequency (r0024) without slip compensation and frequency limitation.

r0024	CO: Act. output frequency	Datatype: Float	Unit: Hz	Min: - Def: - Max: -	Level 3
P-Group: CONTROL					

Displays actual output frequency (slip compensation and frequency limitation are included).

r0025	CO: Act. output voltage	Datatype: Float	Unit: V	Min: - Def: - Max: -	Level 3
P-Group: CONTROL					

Displays [rms] voltage applied to motor.

r0026	CO: Act. DC-link voltage	Datatype: Float	Unit: V	Min: - Def: - Max: -	Level 2
P-Group: INVERTER					

Displays DC-link voltage.

r0027	CO: Act. output current	Datatype: Float	Unit: A	Min: - Def: - Max: -	Level 3
P-Group: CONTROL					

Displays estimated rms value of motor current [A].

r0034	CO: Motor temperature (i2t)	Datatype: Float	Unit: %	Min: - Def: - Max: -	Level 3
P-Group: MOTOR					

Displays actual motor i2t temperature (I2t model), see parameter P0611, P0614) as [%].

Note:

The maximum permissible operating temperature (i2t) of the motor is given, if the parameter r0034 has reached the value of P0614. In this case, the motor will attempt to reduce the motor loading as defined in P0610 (motor I2t temperature reaction). A value of 110% means that the motor has reached its maximum permissible operating temperature.

r0052	CO/BO: Act. status word 1	Min: -	Level 2
	P-Group: COMMANDS	Datatype: U16 Unit: -	

Displays first active status word of inverter (bit format) and can be used to diagnose inverter status.

Bitfields:

Bit00	Drive ready	0	NO	1	YES
Bit01	Drive ready to run	0	NO	1	YES
Bit02	Drive running	0	NO	1	YES
Bit03	Drive fault active	0	NO	1	YES
Bit04	OFF2 active	0	YES	1	NO
Bit05	OFF3 active	0	YES	1	NO
Bit06	ON inhibit active	0	NO	1	YES
Bit07	Drive warning active	0	NO	1	YES
Bit08	Deviation setpoint / act. value	0	YES	1	NO
Bit09	PZD control	0	NO	1	YES
Bit10	f_act >= P1082 (f_max)	0	NO	1	YES
Bit11	Warning: Motor current limit	0	YES	1	NO
Bit12	Motor holding brake active	0	NO	1	YES
Bit13	Motor overload	0	YES	1	NO
Bit14	Motor runs right	0	NO	1	YES
Bit15	Inverter overload	0	YES	1	NO

Dependency:

r0052 Bit00 - Bit02:

State-sequence diagram after Power On or ON/OFF1 respectively: ==> see below

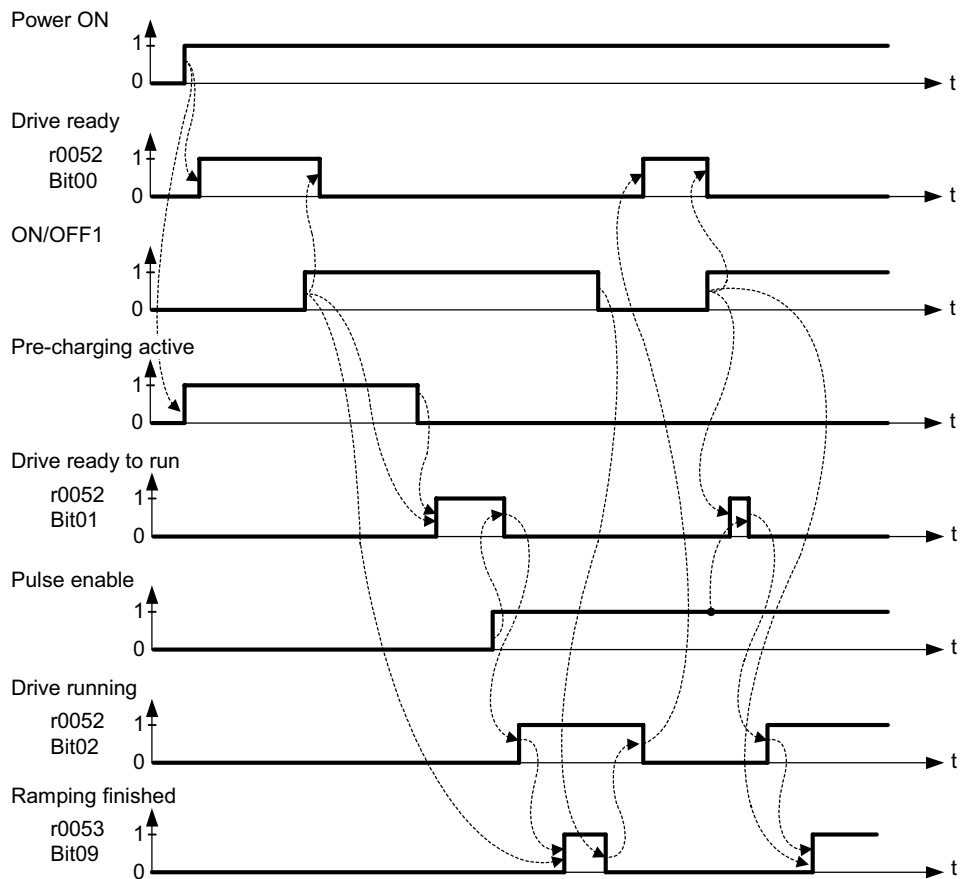

r0052 Bit03 "Drive fault active":

Output of Bit3 (Fault) will be inverted on digital output (Low = Fault, High = No Fault).

r0052 Bit08 "Deviation setpoint/act. value": ==> see below

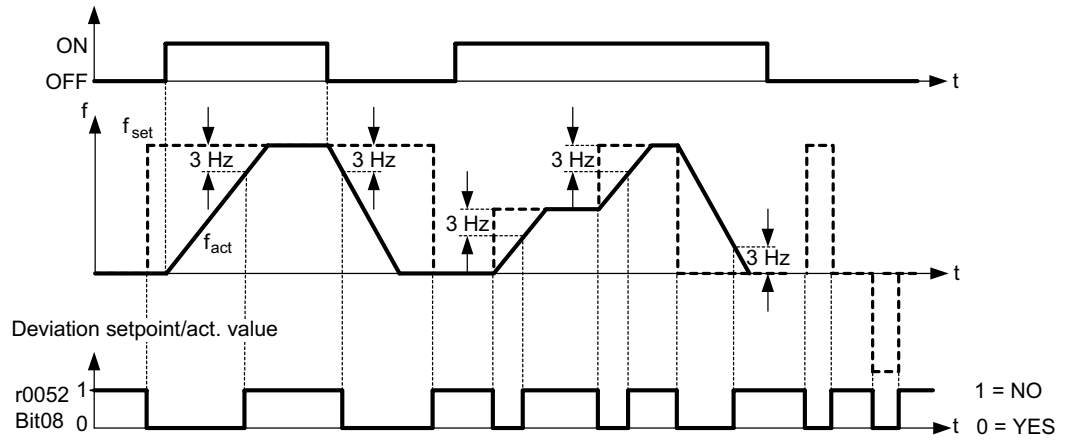

r0052 Bit10 " $f_{act} \geq P1082 (f_{max})$ " ==> see parameter P1082

r0052 Bit12 "Motor holding brake active" ==> see parameter P1215

r0052 Bit14 "Motor runs right" ==> see below

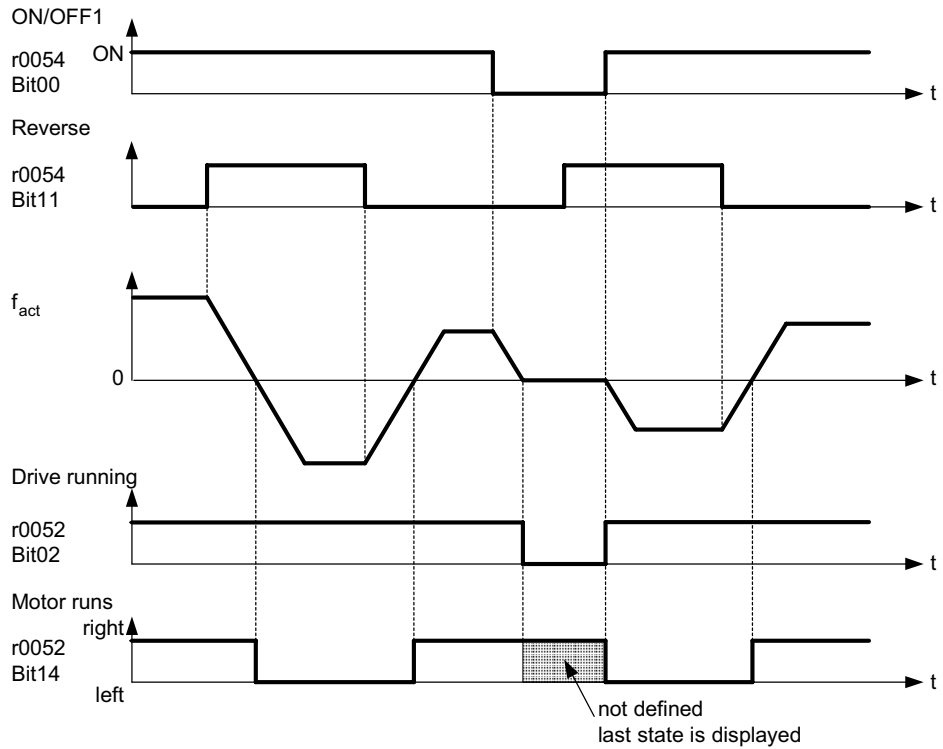

Details:

The 7-segment display of the bit-parameters (binary parameters) is explained in the Introduction of the Parameter List.

r0053	CO/BO: Act. status word 2	Datatype: U16	Unit: -	Min: -	Level 2
	P-Group: COMMANDS			Def: - Max: -	

Displays second status word of inverter (in bit format).

Bitfields:

Bit00	DC brake active	0	NO	1	YES
Bit01	$f_{act} > P2167 (f_{off})$	0	NO	1	YES
Bit02	$f_{act} \leq P1080 (f_{min})$	0	NO	1	YES
Bit06	$f_{act} \geq \text{setpoint} (f_{set})$	0	NO	1	YES
Bit07	$V_{dc_act} r0026 < P2172$	0	NO	1	YES
Bit08	$V_{dc_act} r0026 > P2172$	0	NO	1	YES
Bit09	Ramping finished	0	NO	1	YES

Notice:

r0053 Bit00 "DC brake active" ==> see parameter P1233

r0053 Bit01 " $f_{act} > P2167 (f_{off})$ " ==> see parameter P2167

r0053 Bit02 " $f_{act} \leq P1080 (f_{min})$ " ==> see parameter P1080

r0053 Bit06 " $f_{act} \geq \text{setpoint} (f_{set})$ " ==> see below

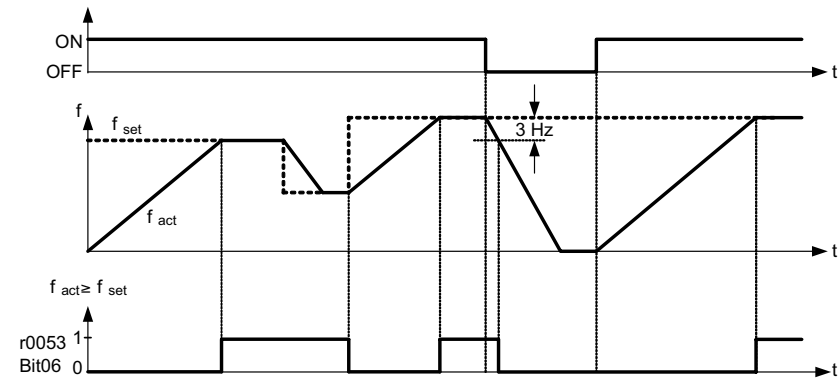

r0053 Bit07 " $V_{dc_act} r0026 < P2172$ " ==> see parameter P2172

r0053 Bit08 " $V_{dc_act} r0026 > P2172$ " ==> see parameter P2172

r0053 Bit09 "Ramping finished" ==> see below

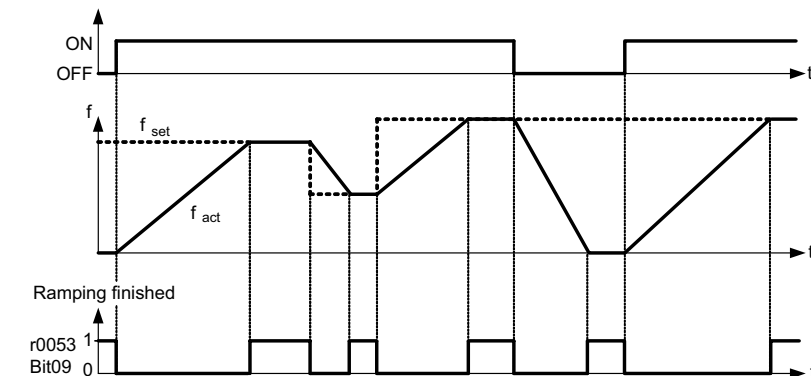
**Details:**

The 7-segment display of the bit-parameters (binary parameters) is explained in the Introduction of the Parameter List.

r0054	CO/BO: Act. control word 1	Datatype: U16	Unit: -	Min: -	Level 3
	P-Group: COMMANDS			Def: - Max: -	

Displays first control word of inverter (in bit format) and can be used to diagnose which commands are active.

Bitfields:

Bit00	ON/OFF1	0	NO	1	YES
Bit01	OFF2: Electrical stop	0	YES	1	NO
Bit02	OFF3: Fast stop	0	YES	1	NO
Bit03	Pulse enable	0	NO	1	YES
Bit04	RFG enable	0	NO	1	YES
Bit05	RFG start	0	NO	1	YES
Bit06	Setpoint enable	0	NO	1	YES
Bit07	Fault acknowledge	0	NO	1	YES
Bit08	JOG right	0	NO	1	YES
Bit09	JOG left	0	NO	1	YES
Bit10	Control from PLC	0	NO	1	YES
Bit11	Reverse (setpoint inversion)	0	NO	1	YES
Bit13	Motor potentiometer MOP up	0	NO	1	YES
Bit14	Motor potentiometer MOP down	0	NO	1	YES
Bit15	Hand/Auto	0	NO	1	YES

Notice:

Identical to r2036 if USS is selected as command source via P0700 or P0719.

Details:

The 7-segment display of the bit-parameters (binary parameters) is explained in the Introduction of the Parameter List.

r0055	CO/BO: Act. control word 2	Datatype: U16	Unit: -	Min: -	Level 3
	P-Group: COMMANDS			Def: - Max: -	

Displays additional control word of inverter (in bit format) and can be used to diagnose which commands are active.

Bitfields:

Bit00	Fixed frequency Bit 0	0	NO	1	YES
Bit01	Fixed frequency Bit 1	0	NO	1	YES
Bit02	Fixed frequency Bit 2	0	NO	1	YES
Bit09	Enable DC brake	0	NO	1	YES
Bit13	External fault 1	0	YES	1	NO

Notice:

Identical to r2037 if USS is selected as command source via P0700 or P0719.

Details:

The 7-segment display of the bit-parameters (binary parameters) is explained in the Introduction of the Parameter List.

r0056	CO/BO: Status of motor control	Datatype: U16	Unit: -	Min: -	Level 2
	P-Group: CONTROL			Def: - Max: -	

Displays status of motor control (in bit format), which can be used to diagnose inverter status.

Bitfields:

Bit00	Init. control finished	0	NO	1	YES
Bit01	Motor demagnetizing finished	0	NO	1	YES
Bit02	Pulses enabled	0	NO	1	YES
Bit04	Motor excitation finished	0	NO	1	YES
Bit05	Starting boost active	0	NO	1	YES
Bit06	Acceleration boost active	0	NO	1	YES
Bit07	Frequency is negative	0	NO	1	YES
Bit08	Field weakening active	0	NO	1	YES
Bit09	Volts setpoint limited	0	NO	1	YES
Bit10	Slip frequency limited	0	NO	1	YES
Bit13	I-max controller active	0	NO	1	YES
Bit14	Vdc-max controller active	0	NO	1	YES

Notice:

The I-max controller (r0056 Bit13) will be activated when the actual output current (r0027) exceeds the current limit in r0067.

Details:

See description of seven-segment display given in the introduction.

r0067	CO: Act. output current limit	Min: -	Level 3
	P-Group: CONTROL	Datatype: Float Unit: A Def: - Max: -	

Displays valid maximum output current of inverter.

Parameter r0067 is influenced/determined by the following factors:

- Rated motor current P0305
- Motor overload factor P0640
- Motor protection in dependency of P0610
- r0067 is less than or equal to maximum inverter current r0209
- Inverter protection in dependency of P0290

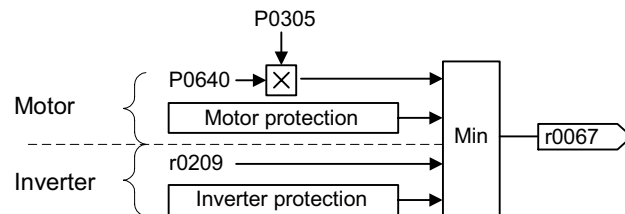

Note:

A reduction of r0067 may indicate an inverter overload or a motor overload.

P0100	Europe / North America	Min: 0	Level 1	
	CStat: C	Datatype: U16		Unit: -
	P-Group: QUICK	Active: first confirm		QuickComm.: Yes

Determines whether power settings are expressed in [kW] or [hp] (e.g. Rated motor power P0307).

The default settings for the rated motor frequency P0310 and maximum frequency P1082 are also set automatically here, in addition to reference frequency P2000.

Possible Settings:

- 0 Europe [kW], motor base frequency is 50 Hz
- 1 North America [hp], motor base frequency is 60 Hz
- 2 North America [kW], motor base frequency is 60 Hz

Dependency:

Where:

- Stop drive first (i.e. disable all pulses) before you change this parameter.
- Changing P0100 resets all rated motor parameters as well as other parameters that depend on the rated motor parameters (see P0340 - calculation of motor parameters).

Changing P0100 overwrites the settings of the DIP50/60 switch (location shown in the diagram below):

1. Parameter P0100 has a higher priority than the DIP50/60 switch.
2. However, after the inverter is powered-on again and P0100 < 2, the DIP50/60 setting will take priority and overwrite P0100.
3. The DIP50/60 switch does not have any effect, if P0100 = 2.

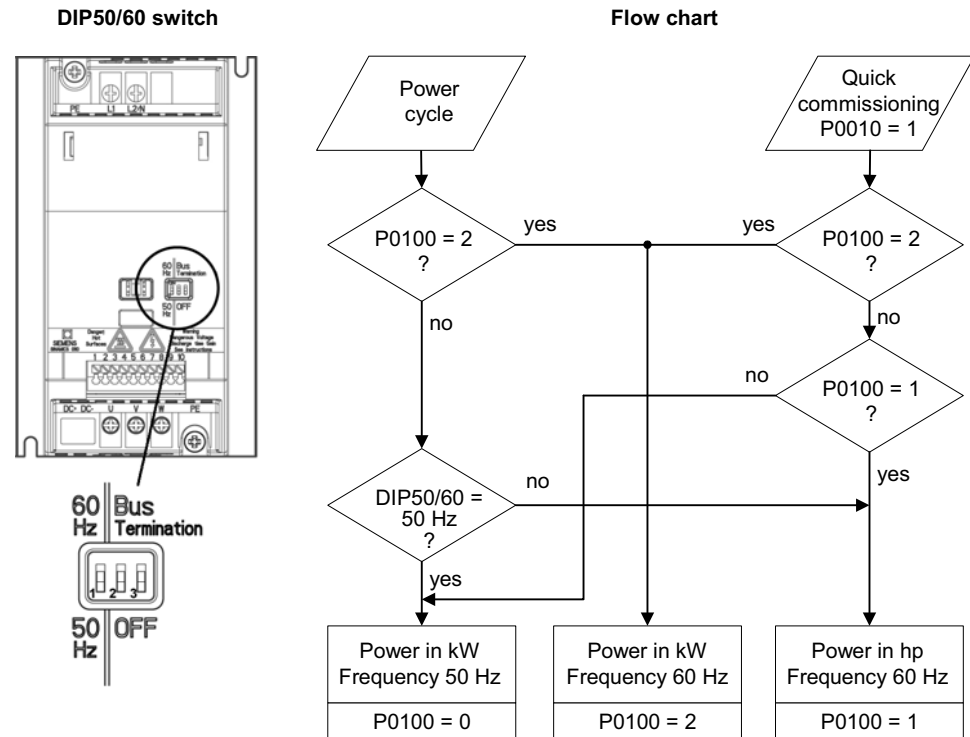

Notice:

P0100 setting 2 (==> [kW], frequency default 60 [Hz]) is not overwritten by the setting of DIP50/60 switch (see diagram above).

r0127	Analogue / USS Variant	Min: -	Level 2	
		Datatype: U16		Unit: -
	P-Group: INVERTER			Def: -

Displays the Control Board Variant Type.

Possible Settings:

- 0 Analogue
- 1 USS

r0200	Act. power stack code number	Min: -	Level 3
	Datatype: U32	Unit: -	
	P-Group: INVERTER	Def: - Max: -	

Identifies hardware variant as shown in table below.

Code- No.	G110 Type	G110 Type	Input Voltage & Frequency	Power kW	Internal Filter	Heat sink	Frame Size
4001	6SL3211-0AB11-2UAx	AIN	1AC230V 47-63Hz	0,12	no	Y	A
4002	6SL3211-0AB12-5UAx	AIN	1AC230V 47-63Hz	0,25	no	Y	A
4003	6SL3211-0AB13-7UAx	AIN	1AC230V 47-63Hz	0,37	no	Y	A
4004	6SL3211-0AB15-5UAx	AIN	1AC230V 47-63Hz	0,55	no	Y	A
4005	6SL3211-0AB17-5UAx	AIN	1AC230V 47-63Hz	0,75	no	Y	A
4006	6SL3211-0KB11-2UAx	AIN	1AC230V 47-63Hz	0,12	no	N	A
4007	6SL3211-0KB12-5UAx	AIN	1AC230V 47-63Hz	0,25	no	N	A
4008	6SL3211-0KB13-7UAx	AIN	1AC230V 47-63Hz	0,37	no	N	A
4009	6SL3211-0KB15-5UAx	AIN	1AC230V 47-63Hz	0,55	no	N	A
4010	6SL3211-0KB17-5UAx	AIN	1AC230V 47-63Hz	0,75	no	N	A
4011	6SL3211-0AB21-1UAx	AIN	1AC230V 47-63Hz	1,10	no	Y	B
4012	6SL3211-0AB21-5UAx	AIN	1AC230V 47-63Hz	1,50	no	Y	B
4013	6SL3211-0AB22-2UAx	AIN	1AC230V 47-63Hz	2,20	no	Y	C
4014	6SL3211-0AB23-0UAx	AIN	1AC230V 47-63Hz	3,00	no	Y	C
4015	6SL3211-0AB11-2BAx	AIN	1AC230V 47-63Hz	0,12	Cl. A	Y	A
4016	6SL3211-0AB12-5BAx	AIN	1AC230V 47-63Hz	0,25	Cl. A	Y	A
4017	6SL3211-0AB13-7BAx	AIN	1AC230V 47-63Hz	0,37	Cl. A	Y	A
4018	6SL3211-0AB15-5BAx	AIN	1AC230V 47-63Hz	0,55	Cl. A	Y	A
4019	6SL3211-0AB17-5BAx	AIN	1AC230V 47-63Hz	0,75	Cl. A	Y	A
4020	6SL3211-0KB11-2BAx	AIN	1AC230V 47-63Hz	0,12	Cl. A	N	A
4021	6SL3211-0KB12-5BAx	AIN	1AC230V 47-63Hz	0,25	Cl. A	N	A
4022	6SL3211-0KB13-7BAx	AIN	1AC230V 47-63Hz	0,37	Cl. A	N	A
4023	6SL3211-0KB15-5BAx	AIN	1AC230V 47-63Hz	0,55	Cl. A	N	A
4024	6SL3211-0KB17-5BAx	AIN	1AC230V 47-63Hz	0,75	Cl. A	N	A
4025	6SL3211-0AB21-1AAx	AIN	1AC230V 47-63Hz	1,10	Cl. A	Y	B
4026	6SL3211-0AB21-5AAx	AIN	1AC230V 47-63Hz	1,50	Cl. A	Y	B
4027	6SL3211-0AB22-2AAx	AIN	1AC230V 47-63Hz	2,20	Cl. A	Y	C
4028	6SL3211-0AB23-0AAx	AIN	1AC230V 47-63Hz	3,00	Cl. A	Y	C

Code-No.	G110 MLFB	G110 Type	Input Voltage & Frequency	Power kW	Internal Filter	Heat sink	Frame Size
4029	6SL3211-0AB11-2UBx	USS	1AC230V 47-63Hz	0,12	no	Y	A
4030	6SL3211-0AB12-5UBx	USS	1AC230V 47-63Hz	0,25	no	Y	A
4031	6SL3211-0AB13-7UBx	USS	1AC230V 47-63Hz	0,37	no	Y	A
4032	6SL3211-0AB15-5UBx	USS	1AC230V 47-63Hz	0,55	no	Y	A
4033	6SL3211-0AB17-5UBx	USS	1AC230V 47-63Hz	0,75	no	Y	A
4034	6SL3211-0KB11-2UBx	USS	1AC230V 47-63Hz	0,12	no	N	A
4035	6SL3211-0KB12-5UBx	USS	1AC230V 47-63Hz	0,25	no	N	A
4036	6SL3211-0KB13-7UBx	USS	1AC230V 47-63Hz	0,37	no	N	A
4037	6SL3211-0KB15-5UBx	USS	1AC230V 47-63Hz	0,55	no	N	A
4038	6SL3211-0KB17-5UBx	USS	1AC230V 47-63Hz	0,75	no	N	A
4039	6SL3211-0AB21-1UBx	USS	1AC230V 47-63Hz	1,10	no	Y	B
4040	6SL3211-0AB21-5UBx	USS	1AC230V 47-63Hz	1,50	no	Y	B
4041	6SL3211-0AB22-2UBx	USS	1AC230V 47-63Hz	2,20	no	Y	C
4042	6SL3211-0AB23-0UBx	USS	1AC230V 47-63Hz	3,00	no	Y	C
4043	6SL3211-0AB11-2BBx	USS	1AC230V 47-63Hz	0,12	Cl. A	Y	A
4044	6SL3211-0AB12-5BBx	USS	1AC230V 47-63Hz	0,25	Cl. A	Y	A
4045	6SL3211-0AB13-7BBx	USS	1AC230V 47-63Hz	0,37	Cl. A	Y	A
4046	6SL3211-0AB15-5BBx	USS	1AC230V 47-63Hz	0,55	Cl. A	Y	A
4047	6SL3211-0AB17-5BBx	USS	1AC230V 47-63Hz	0,75	Cl. A	Y	A
4048	6SL3211-0KB11-2BBx	USS	1AC230V 47-63Hz	0,12	Cl. A	N	A
4049	6SL3211-0KB12-5BBx	USS	1AC230V 47-63Hz	0,25	Cl. A	N	A
4050	6SL3211-0KB13-7BBx	USS	1AC230V 47-63Hz	0,37	Cl. A	N	A
4051	6SL3211-0KB15-5BBx	USS	1AC230V 47-63Hz	0,55	Cl. A	N	A
4052	6SL3211-0KB17-5BBx	USS	1AC230V 47-63Hz	0,75	Cl. A	N	A
4053	6SL3211-0AB21-1ABx	USS	1AC230V 47-63Hz	1,10	Cl. A	Y	B
4054	6SL3211-0AB21-5ABx	USS	1AC230V 47-63Hz	1,50	Cl. A	Y	B
4055	6SL3211-0AB22-2ABx	USS	1AC230V 47-63Hz	2,20	Cl. A	Y	C
4056	6SL3211-0AB23-0ABx	USS	1AC230V 47-63Hz	3,00	Cl. A	Y	C

Notice:

Parameter r0200 = 0 indicates that no power stack has been identified.

P0201	Power stack code number	Min: 0	Level 3	
	CStat: C	Datatype: U16		Unit: -
	P-Group: INVERTER	Active: first confirm		QuickComm.: No
		Def: 0		
		Max: 65535		

Confirms actual power stack identified.

r0206	Rated inverter power [kW] / [hp]	Min: -	Level 3	
		Datatype: Float		Unit: -
	P-Group: INVERTER			Def: -
		Max: -		

Displays nominal rated motor power from inverter.

Dependency:

Value is displayed in [kW] or [hp] depending on setting for P0100 (operation for Europe / North America).

$$r0206 \text{ [hp]} = 0.75 \cdot r0206 \text{ [kW]}$$

r0207[3]	Rated inverter current	Datatype: Float	Unit: A	Min: -	Level 3
	P-Group: INVERTER			Def: - Max: -	

Indicates the rated inverter current.

Index:

r0207[0] : Rated inverter current
r0207[1] : Rated VT current
r0207[2] : Rated CT current

Notes:

VT (variable torque) and CT (constant torque) specify the overload capability (CT/VT application) of the inverter. The definition of the rated as well as the overload and base load values depend on the inverter type and inverter power. The different values can be taken from the appropriate Catalog or are saved in the inverter.

The VT rated current r0207[1] or CT rated current r0207[2] represent the matching 4-pole Siemens IEC standard motor for the selected load duty cycle (refer to the diagram). Parameters r0207[1] or r0207[2] are used as default values for P0305 as a function of the CT/VT application (load duty cycle). If r0207[1] = r0207[2], then it is not possible to make a differentiation between a CT/VT application.

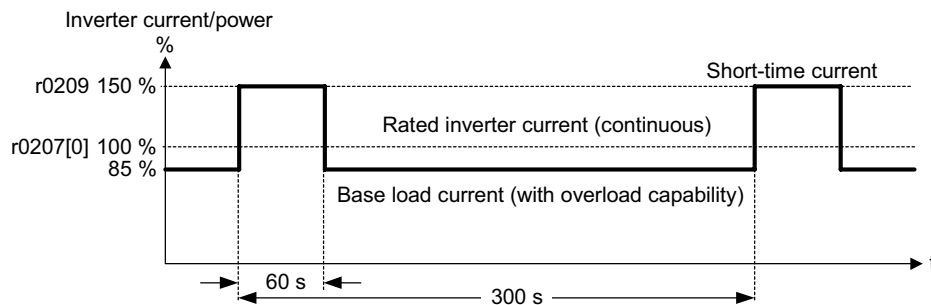

Overload in operation is only possible if, before the overload condition, the load current was less than the rated current. For drives, which must be able to handle overload conditions, it is first necessary to define a base load current for the required load.

If the full overload capability is used, then this is detected using an I^2t monitoring and the power module is protected as a function of parameter P0290.

The above diagram refers to the inverter current. Since the motor rated current of a matching 4-pole Siemens standard motor is smaller as the inverter current motor overheating will occur when this inverter load cycle is applied to the matching motor.

r0209	Maximum inverter current	Datatype: Float	Unit: A	Min: -	Level 3
	P-Group: INVERTER			Def: - Max: -	

Displays maximum output current of inverter.

Dependency:

Parameter r0209 depends on the derating which is affected by pulse frequency P1800, ambient temperature and altitude. The data of deration is given in the OPERATING INSTRUCTION.

P0290	Inverter overload reaction	Min: 0	Level 3	
	CStat: CT	Datatype: U16		Unit: -
	P-Group: INVERTER	Active: first confirm		QuickComm.: No
		Def: 0		
		Max: 1		

Selects reaction of inverter to an internal over-temperature.

Possible Settings:

- 0 Reduce output frequency
- 1 Trip (F0004 / F0005)

Dependency:

- Following physical values influence the inverter overload protection (see diagram):
- heat sink temperature
 - inverter I²t

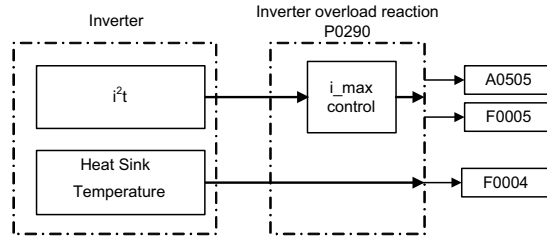

Notice:

- P0290 = 0:
- Reduction of output frequency is only effective if the load is also reduced. This is for example valid for variable torque applications with a quadratic torque characteristic as pumps or fans.
 - In settings P0290 = 0, the I-max controller will act upon the output current limit (r0067) in case of overtemperature.

A trip will always result, if the action taken does not sufficiently reduce internal temperature.

P0295	Inverter fan off delay time	Min: 0	Level 3	
	CStat: CUT	Datatype: U16		Unit: s
	P-Group: TERMINAL	Active: first confirm		QuickComm.: No
		Def: 0		
		Max: 3600		

Defines inverter fan switch off delay time in seconds after drive has stopped.

Note:

- Setting to 0, inverter fan will switch off when the drive stops, that is no delay.
- SINAMICS G110 FS A has no fan.

P0304	Rated motor voltage	Min: 10	Level 1	
	CStat: C	Datatype: U16		Unit: V
	P-Group: MOTOR	Active: first confirm		QuickComm.: Yes
		Def: 230		
		Max: 2000		

Nominal motor voltage [V] from rating plate.

Following diagram shows a typical rating plate with the locations of the relevant motor data.

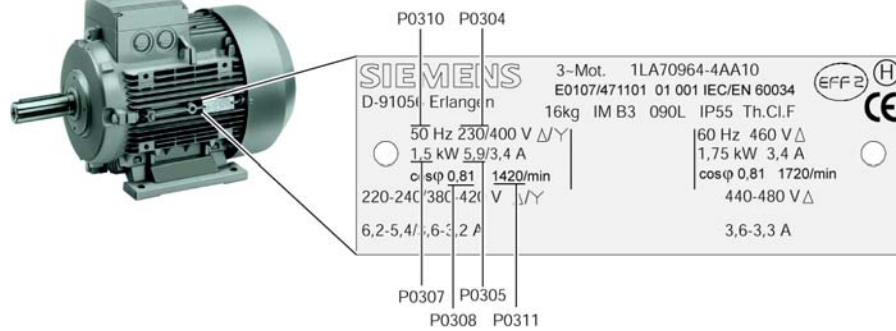

Line supply voltage	1 AC 230 V	3 AC 230 V	3 AC 400 V	3 AC 560 V
SINAMICS G110	X	-	-	-

Dependency:

Changeable only when P0010 = 1 (quick commissioning).



Caution:

The input of rating plate data must correspond with the wiring of the motor (star / delta). This means, if delta wiring is used for the motor, delta rating plate data has to be entered.

IEC Motor

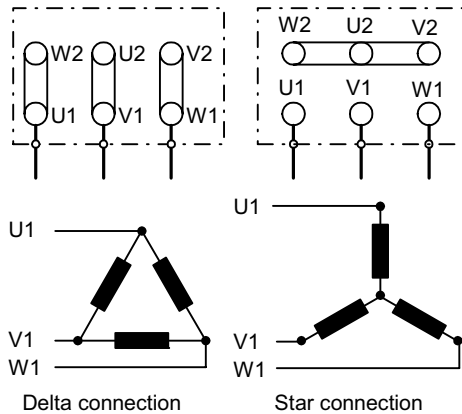

e.g.: Volts 230 V (Delta connection) / 400 V (Star connection)

Note:

Default value is depending on inverter type and its rating data.

P0305	Rated motor current	Min: 0.01	Level 1	
	CStat: C	Datatype: Float		Unit: A
	P-Group: MOTOR	Active: first confirm		QuickComm.: Yes

Def: (x)
Max: 10000.00

Nominal motor current [A] from rating plate - see diagram in P0304.

Dependency:

- Changeable only when P0010 = 1 (quick commissioning).

Note:

The maximum value of P0305 depends on the maximum inverter current r0209 and the motor type:

Asynchronous motor : $P0305_{max, asyn} = 2 \cdot r0209$

It is recommended that the ratio of P0305 (rated motor current) and r0207 (rated inverter current) should not be lower than:

$$V/f: \frac{1}{8} \leq \frac{P0305}{r0207}$$

When the relation of the nominal motor current P0305 and half of the maximal inverter current (r0209) exceeds 1,5 an additional current derating is applied. This is necessary to protect the inverter from harmonic current waves.

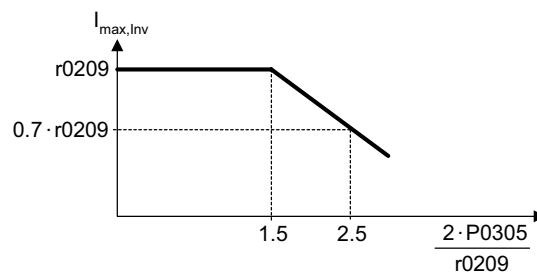

(x) Default value is depending on inverter type and its rating data and the matching 4 pole Siemens standard motor.

P0307	Rated motor power	Min: 0.01	Level 1	
	CStat: C	Datatype: Float		Unit: -
	P-Group: MOTOR	Active: first confirm		QuickComm.: Yes

Def: (x)
Max: 2000.00

Nominal motor power [kW/hp] from rating plate.

Dependency:

- If P0100 = 1, values will be in [hp] - see diagram P0304 (rating plate).
- Changeable only when P0010 = 1 (quick commissioning).
- (x) Default value is depending on inverter type and its rating data and the matching 4 pole Siemens standard motor.

P0308	Rated motor cosPhi	Min: 0.000	Level 3	
	CStat: C	Datatype: Float		Unit: -
	P-Group: MOTOR	Active: first confirm		QuickComm.: Yes

Def: 0.000
Max: 1.000

Nominal motor power factor (cosPhi) from rating plate - see diagram P0304.

Dependency:

- Changeable only when P0010 = 1 (quick commissioning).
- Visible only when P0003 = 3.
- Applicable only if the motor power is entered in [kW]) i.e. P0100= 0 or 2
In this case P0309 is not relevant.
- Setting 0 causes internal calculation of value.

P0309	Rated motor efficiency	Min: 0.0	Level 3	
	CStat: C	Datatype: Float		Unit: %
	P-Group: MOTOR	Active: first confirm		QuickComm.: Yes

Nominal motor efficiency in [%] from rating plate.

Dependency:

- Changeable only when P0010 = 1 (quick commissioning).
- Visible only when P0003 = 3.
- Applicable only if the motor power is entered in [hp] i.e. P0100 = 1
In this case P0308 is not relevant.
- Setting 0 causes internal calculation of value.

Note:

P0309 = 100 % corresponds to superconducting.

Details:

See diagram in P0304 (rating plate).

P0310	Rated motor frequency	Min: 12.00	Level 1	
	CStat: C	Datatype: Float		Unit: Hz
	P-Group: MOTOR	Active: first confirm		QuickComm.: Yes

Nominal motor frequency [Hz] from rating plate.

Dependency:

- Changeable only when P0010 = 1 (quick commissioning).
- Pole pair number recalculated automatically if parameter is changed.

Details:

See diagram in P0304 (rating plate)

P0311	Rated motor speed	Min: 0	Level 1	
	CStat: C	Datatype: U16		Unit: 1/min
	P-Group: MOTOR	Active: first confirm		QuickComm.: Yes

Nominal motor speed [rpm] from rating plate.

Dependency:

- Changeable only when P0010 = 1 (quick commissioning).
- Setting 0 causes internal calculation of value.
- Slip compensation in V/f control requires rated motor speed for correct operation.
- Pole pair number recalculated automatically if parameter is changed.

(x) Default value depends on the inverter type and its rating data and the matching 4 pole Siemens standard motor.

Details:

See diagram in P0304 (rating plate)

r0330	Rated motor slip	Min: -	Level 3	
		Datatype: Float		Unit: %
	P-Group: MOTOR	Active: first confirm		QuickComm.: Yes

Displays nominal motor slip in [%] relative to P0310 (rated motor frequency) and P0311 (rated motor speed).

P0335	Motor cooling	Min: 0	Level 3	
	CStat: CT	Datatype: U16		Unit: -
	P-Group: MOTOR	Active: first confirm		QuickComm.: Yes

Selects motor cooling system used.

Possible Settings:

- 0 Self-cooled: Using shaft mounted fan attached to motor
- 1 Force-cooled: Using separately powered cooling fan

P0340	Calculation of motor parameters	Min: 0	Level 3	
	CStat: CT	Datatype: U16		Unit: -
	P-Group: MOTOR	Active: first confirm		QuickComm.: No

Calculates various motor parameters (see table below). This parameter is required during commissioning to optimize inverter performance.

Possible Settings:

- 0 No calculation
- 1 Complete parameterization

Note:

- P0340 = 1 :
- P0346 Magnetization time
 - P0347 Demagnetization time
 - P0350 Stator resistance (line-to-line)
 - P1316 Boost end frequency
 - P2000 Reference frequency

P0346	Magnetization time	Min: 0.000	Level 3	
	CStat: CUT	Datatype: Float		Unit: s
	P-Group: MOTOR	Active: Immediately		QuickComm.: No
		Def: (x)		
		Max: 20.000		

Sets magnetization time [s], i.e. waiting time between pulse enable and start of ramp-up. Motor magnetization builds up during this time.

Magnetization time is normally calculated automatically from the motor data and corresponds to the rotor time constant.

Note:

- If boost settings are higher than 100 %, magnetization time may be reduced.
- An excessive reduction of this time can result in insufficient motor magnetization.

(x) Default value depends on the inverter type and its rating data and the matching 4 pole Siemens standard motor.

P0347	Demagnetization time	Min: 0.000	Level 3	
	CStat: CUT	Datatype: Float		Unit: s
	P-Group: MOTOR	Active: Immediately		QuickComm.: No
		Def: (x)		
		Max: 20.000		

Changes time allowed after OFF2 / fault condition, before pulses can be re-enabled.

Note:

- The demagnetization time is approximately 2.5 x rotor time constant in seconds.
- Not active following a normally completed ramp-down, e.g. after OFF1, OFF3 or JOG.
- Overcurrent trips will occur if the time is decreased excessively.

(x) Default value depends on the inverter type and its rating data and the matching 4 pole Siemens standard motor.

P0350	Stator resistance (line-to-line)	Min: 0.00001	Level 3	
	CStat: CUT	Datatype: Float		Unit: Ohm
	P-Group: MOTOR	Active: Immediately		QuickComm.: No
		Def: (x)		
		Max: 2000.00000		

Stator resistance value in [Ohms] for connected motor (from line-to-line). The parameter value includes the cable resistance.

$$P0350 = 2 \cdot (R_{\text{Cable}} + R_{\text{S}})$$

There are two ways to determine the value for this parameter:

1. Calculate using
 - P0340 = 1 (data entered from rating plate) or
 - P0010 = 1, P3900 = 1,2 or 3 (end of quick commissioning).
2. Measure manually using an Ohmmeter.

Note:

- Since measured line-to-line, this value may appear to be higher (up to 2 times higher) than expected.
- The value entered in P0350 (stator resistance) is the one obtained by the method last used.

(x) Default value depends on the inverter type and its rating data and the matching 4 pole Siemens standard motor.

P0610	Motor I²t reaction			Min: 0	Level 3
	CStat: CT	Datatype: U16	Unit: -	Def: 2	
	P-Group: MOTOR	Active: first confirm	QuickComm.: No	Max: 2	

Defines reaction when motor I²t reaches warning threshold.

Possible Settings:

- 0 Warning, no reaction, no trip
- 1 Warning, I_{max} reduction
- 2 Warning, no I_{max} reduction, trip F0011

Dependency:

P0614 = Motor I²t overload warning level

$$i_{trip}^2 [\%] = i_{warn}^2 [\%] \cdot 1.1 = P0614 \cdot 1.1$$

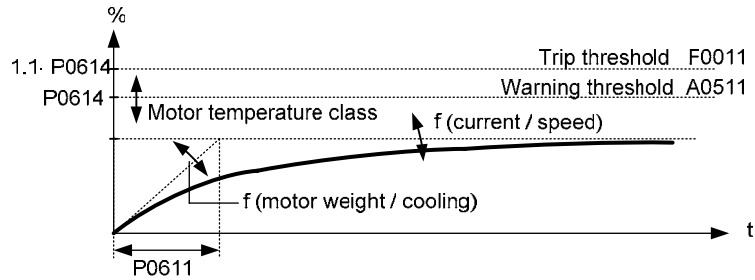

Note:

P0610 = 1:

If the max. permissible current I_{max} is reduced, this results in a lower output frequency.

The motor I²t monitoring function is used to protect the motor against overheating. The motor temperature will be dependent on many factors, including the size of the motor, the ambient temperature, the previous history of the motor's loading, and of course, the load current. (The square of the current actually determines the heating of the motor and the temperature rises with time - hence I²t).

Because most motors are cooled by fans integrated in the motor and running at the motor speed, the speed of the motor is also important. Clearly a motor running with a high current (maybe due to boost) and a low speed, will overheat more quickly than one running at 50 or 60 Hz, full load. The SINAMICS take account of these factors.

P0611	Motor I2t time constant				Min: 0	Level 3
	CStat: CT	Datatype: U16	Unit: s	Def: 100		
	P-Group: MOTOR	Active: Immediately	QuickComm.: No	Max: 16000		

Thermal Time constant for the motor.

The time until the thermal limit of a motor is reached, is calculated via the thermal time constant. A higher value increases the time at which the motor thermal limit is reached.

The value of P0611 is estimated according to the motor data during quick commissioning or is calculated using P0340 (Calculating of the motor parameters). When the calculation of motor parameters during quick commission is complete the stored value can be replaced by the value given by the motor manufacturer.

Example:

For a 2 pole 1LA7063 motor the value is 8 min (see table). The value for P0611 is calculated as follows:

$$P0611 = 8 \text{ min} \cdot 60 \frac{\text{s}}{\text{min}} = 480 \text{ s}$$

For Siemens standard motors 1LA7 the thermal time constant values are given in minutes (see following table):

Type	2 pole	4 pole	6 pole	8 pole
1LA7050	13	13	-	-
1LA7053	13	13	-	-
1LA7060	8	11	-	-
1LA7063	8	13	12	-
1LA7070	8	10	12	12
1LA7073	8	10	12	12
1LA7080	8	10	12	12
1LA7083	10	10	12	12
1LA7090	5	9	12	12
1LA7096	6	11	12	14
1LA7106	8	12	12	16
1LA7107	-	12	-	16
1LA7113	14	11	13	12
1LA7130	11	10	13	10
1LA7131	11	-	-	-
1LA7133	-	10	14	10
1LA7134	-	-	16	-
1LA7163	15	19	20	12
1LA7164	15	-	-	14
1LA7166	15	19	20	14

Dependency:

P0611 < 99 s (I2t-calculation inactive):

To activate I2t calculation set P0611 to a value > 99 s.

Note:

Mode of operation of I²t:

The square of the normalized motor current (measured motor current r0027 divided by the rated motor current P0305) weighted with the thermal motor time constant results in the I²t value of the motor. In addition, the output frequency (motor speed) is incorporated in the calculation to take into consideration the cooling effect of the motor fan. If parameter P0335 is changed to a force-ventilated motor, then the calculation is appropriately modified. The I²t value represents a dimension for the temperature rise / temperature of the motor.

If users do not enter parameters then a value, based on a Siemens motor is used. When required, the motor time constant can be changed using P0611, which is the same as overwriting the calculated value.

The I²t value that is obtained is displayed in r0034. If this value reaches the value defined in P0614 (default: 110%), an alarm message A0511 is output and, depending on P0610 a response is initiated or, when a shutdown threshold is reached, a fault is output.

Parameter r0034 is particularly useful to monitor if the calculated motor temperature is rising excessively.

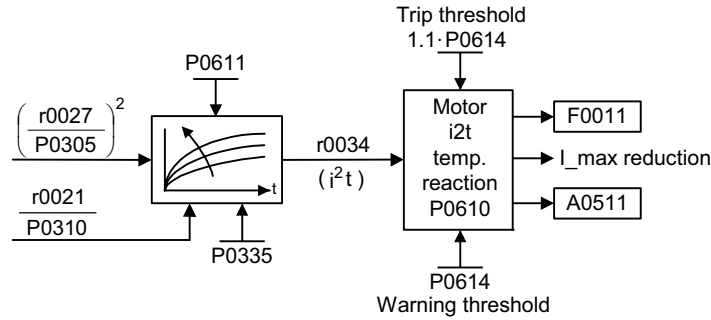

P0614	Motor I2t overload warning level				Level 3
	CStat: CUT	Datatype: Float	Unit: %	Min: 0.0	
	P-Group: MOTOR	Active: first confirm	QuickComm.: No	Def: 110.0 Max: 400.0	

Defines the [%] value at which alarm A0511 (motor overtemperature) is generated.

The motor temperature will be dependent on many factors, including the size of the motor, the ambient temperature, the previous history of the loading of the motor, and of course, the load current. (The square of the current actually determines the heating of the motor and the temperature rises with time - hence I²t). A motor-I²t-value of P0614 means that the motor has reached its maximum permissible operating temperature. The actual I²t-value is displayed in parameter r0034.

Dependency:

A motor over-temperature trip (F0011) is produced at 110 % of this level.

$$i^2t_{\text{trip}} [\%] = i^2t_{\text{warn}} [\%] \cdot 1.1 = P0614 \cdot 1.1$$

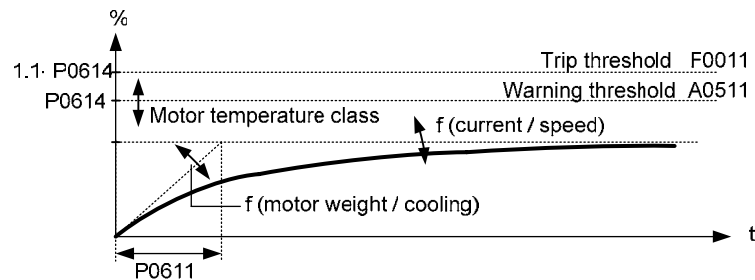

P0640	Motor overload factor [%]				Level 3
	CStat: CUT	Datatype: Float	Unit: %	Min: 10.0	
	P-Group: MOTOR	Active: Immediately	QuickComm.: Yes	Def: 150.0 Max: 400.0	

Defines motor overload current limit in [%] relative to P0305 (rated motor current).

Dependency:

Limited to maximum inverter current or to 400 % of rated motor current (P0305), whichever is the lower.

$$P0640_{\text{max}} = \frac{\min(r0209, 4 \cdot P0305)}{P0305} \cdot 100$$

P0700	Selection of command source				Min: 0	Level 1
	CStat: CT	Datatype: U16	Unit: -	Def: 2		
	P-Group: COMMANDS	Active: first confirm	QuickComm.: Yes	Max: 5		

Selects digital command source.

Possible Settings:

- 0 Factory default setting
- 1 BOP (keypad)
- 2 Terminal
- 5 USS

Example:

SINAMICS G110 CPM110 AIN (Default: P0700 = 2)

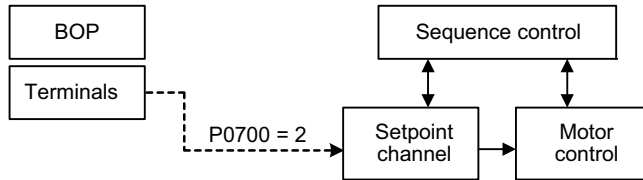

SINAMICS G110 CPM110 USS (Default: P0700 = 5)

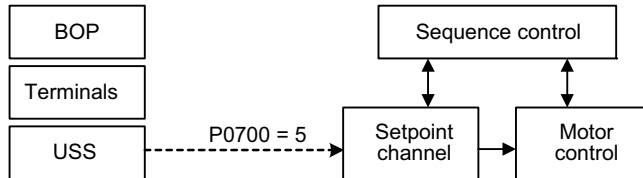

Dependency:

Parameter P0719 has higher priority than P0700.
 Changing parameter P0700 resets functional settings of the digital inputs (P0701, ...) to default. After changing the settings of the digital inputs they must be checked.

Note:

The start and direction signals ON / OFF / REV to be submitted via USS bus (P0700=5) are only possible in Siemens standard control mode P0727=0
 Note for the USS variant:
 A combination of two different command sources (USS P0700=5 and digital inputs P0701 – P0703) will be possible when using P0727 control methods.

P0701	Function of digital input 0				Min: 0	Level 2
	CStat: CT	Datatype: U16	Unit: -	Def: 1		
	P-Group: COMMANDS	Active: first confirm	QuickComm.: No	Max: 29		

Selects function of digital input 0.

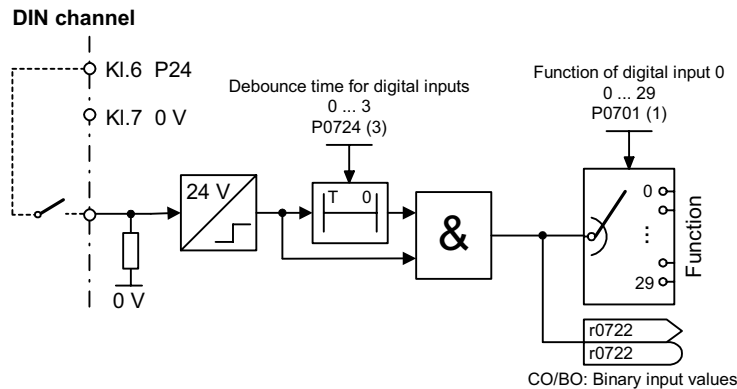

Possible Settings:

- 0 Digital input disabled
- 1 ON/OFF1
- 2 ON reverse /OFF1
- 3 OFF2 - coast to standstill
- 4 OFF3 - quick ramp-down
- 9 Fault acknowledge
- 10 JOG right
- 11 JOG left
- 12 Reverse
- 13 MOP up (increase frequency)
- 14 MOP down (decrease frequency)
- 15 Fixed frequency (Direct selection)
- 16 Fixed frequency (Direct selection + ON)
- 21 Local/Remote
- 25 DC brake enable
- 29 External trip

Dependency:

See P0727 for redefinition of settings 1, 2, 12.

Following settings of parameter P0701 inclusive remain effective and are not affected by the settings of P0719:

- OFF2 3
- OFF3 4
- Fault acknowledge 9
- Fixed setpoint (direct selection) 15
- Local/Remote 21
- External trip 29

Note:

"ON/OFF1" can only be selected for one digital input (e.g. P0700 = 2 and P0701 = 1). Configuring DIN1 with P0702 = 1 will disable DIN0 by setting P0701 = 0. "ON/OFF1" on a digital input can be combined with "ON reverse/OFF1" on another digital input. Only the first activated digital input serves as a command source.

Different sources of "OFF2", "OFF3" are independently selectable. For example, "OFF2" from digital input or from BOP or from USS can be issued at the same time.

Details:

- JOG ==> see parameter P1058
- MOP ==> see parameter r1050
- Fixed frequency ==> see parameter P1001
- DC brake ==> see parameter P1232

P0702	Function of digital input 1				Min: 0	Level 2
	CStat: CT	Datatype: U16	Unit: -	Def: 12		
	P-Group: COMMANDS	Active: first confirm	QuickComm.: No	Max: 29		

Selects function of digital input 1.

Possible Settings:

- 0 Digital input disabled
- 1 ON/OFF1
- 2 ON reverse /OFF1
- 3 OFF2 - coast to standstill
- 4 OFF3 - quick ramp-down
- 9 Fault acknowledge
- 10 JOG right
- 11 JOG left
- 12 Reverse
- 13 MOP up (increase frequency)
- 14 MOP down (decrease frequency)
- 15 Fixed frequency (Direct selection)
- 16 Fixed frequency (Direct selection + ON)
- 21 Local / Remote
- 25 DC brake enable
- 29 External trip

Details:

See P0701 (function of digital input0).

See P0727 for redefinition of settings 1, 2, 12

P0703	Function of digital input 2				Min: 0	Level 2
	CStat: CT	Datatype: U16	Unit: -	Def: 9		
	P-Group: COMMANDS	Active: first confirm	QuickComm.: No	Max: 29		

Selects function of digital input 2.

Possible Settings:

- 0 Digital input disabled
- 1 ON/OFF1
- 2 ON reverse /OFF1
- 3 OFF2 - coast to standstill
- 4 OFF3 - quick ramp-down
- 9 Fault acknowledge
- 10 JOG right
- 11 JOG left
- 12 Reverse
- 13 MOP up (increase frequency)
- 14 MOP down (decrease frequency)
- 15 Fixed frequency (Direct selection)
- 16 Fixed frequency (Direct selection + ON)
- 21 Local / Remote
- 25 DC brake enable
- 29 External trip

Details:

See P0701 (function of digital input 0).

See P0727 for redefinition of settings 1, 2, 12

P0704	Function of digital input 3				Min: 0	Level 2
	CStat: CT	Datatype: U16	Unit: -	Def: 0		
	P-Group: COMMANDS	Active: first confirm	QuickComm.: No	Max: 29		

Selects function of digital input 3 (via analog input).

Possible Settings:

- 0 Digital input disabled
- 1 ON/OFF1
- 2 ON reverse /OFF1
- 3 OFF2 - coast to standstill
- 4 OFF3 - quick ramp-down
- 9 Fault acknowledge
- 10 JOG right
- 11 JOG left
- 12 Reverse
- 13 MOP up (increase freq.)
- 14 MOP down (decrease freq.)
- 21 Local / Remote
- 25 DC brake enable
- 29 External trip

Details:

See P0701 (function of digital input 0).

See P0727 for redefinition of settings 1, 2, 12

P0719[2]	Selection of cmd. & freq. setp.			Min: 0	Level 3
	CStat: CT	Datatype: U16	Unit: -	Def: 0	
	P-Group: COMMANDS	Active: first confirm	QuickComm.: No	Max: 55	

Central switch to select control command source for inverter.

Possible Settings:

0	Cmd = P0700	Setpoint = P1000
1	Cmd = P0700	Setpoint = MOP setpoint
2	Cmd = P0700	Setpoint = Analog setpoint
3	Cmd = P0700	Setpoint = Fixed frequency
5	Cmd = P0700	Setpoint = USS
10	Cmd = BOP	Setpoint = P1000
11	Cmd = BOP	Setpoint = MOP setpoint
12	Cmd = BOP	Setpoint = Analog setpoint
13	Cmd = BOP	Setpoint = Fixed frequency
15	Cmd = BOP	Setpoint = USS
50	Cmd = USS	Setpoint = P1000
51	Cmd = USS	Setpoint = MOP setpoint
52	Cmd = USS	Setpoint = Analog setpoint
53	Cmd = USS	Setpoint = Fixed frequency
55	Cmd = USS	Setpoint = USS

Index:

P0719[0] : 1st Control source (Remote)
P0719[1] : 2nd Control source (Local)

Dependency:

P0719 has higher priority than P0700 and P1000.

Note:

Command and setpoint sources can be changed independently.

The tens digit chooses the command source and the units digit chooses the setpoint source.

The two indices of this parameter are used for local/remote switching. The local/remote signal switches between these settings.

The default setting is 0 for the first index (i.e. normal parameterization is active).

The second index is for control via BOP (i.e. activating the local/remote signal will then switch to BOP).

Example:

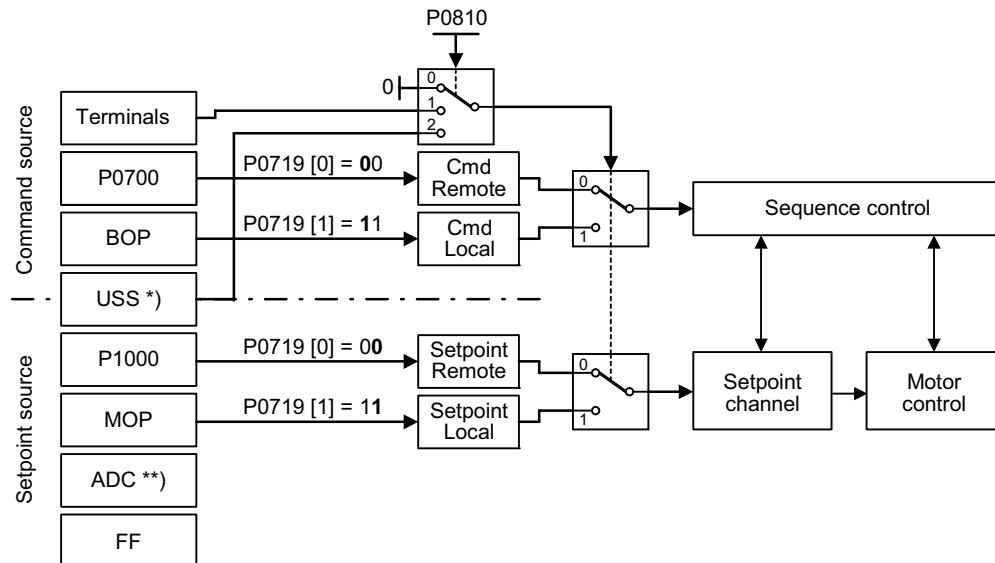

*) SINAMICS G110 CPM110 USS only

**) SINAMICS G110 CPM110 AIN only

Particularly useful when e.g. changing command source temporarily from P0700 = 2. Functional setting of digital inputs is not reset to default.

r0722	CO/BO: Binary input values	Datatype: U16	Unit: -	Min: -	Level 3
	P-Group: COMMANDS			Def: - Max: -	

Displays status of digital inputs.

Bitfields:

Bit00	Digital input 0	0	OFF	1	ON
Bit01	Digital input 1	0	OFF	1	ON
Bit02	Digital input 2	0	OFF	1	ON
Bit03	Digital input 3 (via ADC)	0	OFF	1	ON

Note:

Segment is lit when signal is active.

P0724	Debounce time for digital inputs	Datatype: U16	Unit: -	Min: 0	Level 3
	CStat: CT	Active: Immediately	QuickComm.: No	Def: 3 Max: 3	

Defines debounce time (filtering time) used for digital inputs.

Possible Settings:

- 0 No debounce time
- 1 2.5 ms debounce time
- 2 8.2 ms debounce time
- 3 12.3 ms debounce time

P0727	2-wire / 3-wire control method	Datatype: U16	Unit: -	Min: 0	Level 2
	CStat: CT	Active: first confirm	QuickComm.: No	Def: 0 Max: 3	

Determines the control method using the terminals

Possible Settings:

- 0 Siemens Standard (Start / Direction)
- 1 2-wire (FWD / REV)
- 2 3-wire (FWD P / REV P)
- 3 3-wire (Start P / Direction)

“P” denotes “Pulse”; “FWD” denotes “FORWARD”; “REV” denotes “REVERSE”

When any of the control functions are selected using P0727, the setting for the digital inputs (P0701 to P0704) are redefined as follows:

Redefined Digital Inputs

Settings P0701 – P0704	P0727=0 (Siemens standard control)	P0727=1 (2-wire control)	P0727=2 (3-wire control)	P0727=3 (3-wire control)
1	ON/OFF1	ON_FWD	STOP	ON_PULSE
2	ON_REV/OFF1	ON_REV	FWDP	OFF1/HOLD
12	REV	REV	REVP	REV

Note:

Regarding the use of fixed frequencies see P1000 and P1001.

The function of the different control methods is described as follows:

Siemens standard control using ON/OFF1 and REV

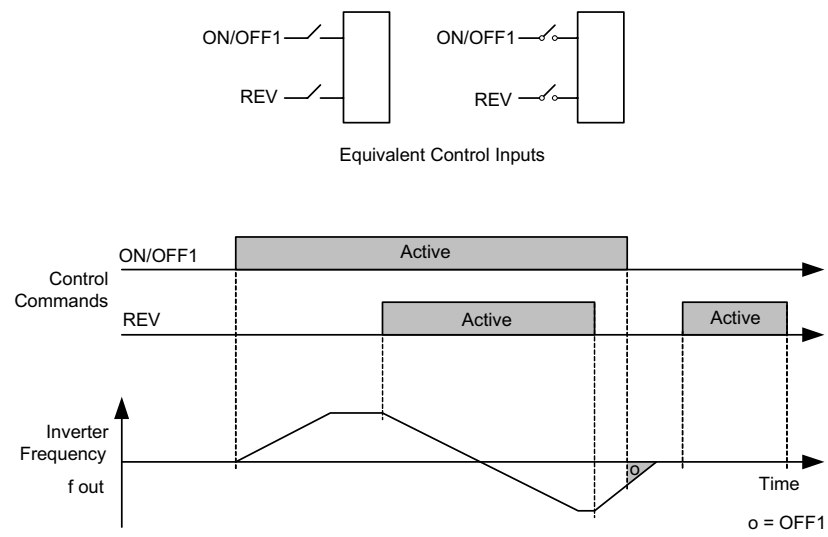

Siemens standard control using ON/OFF1 and ON_REV/OFF1

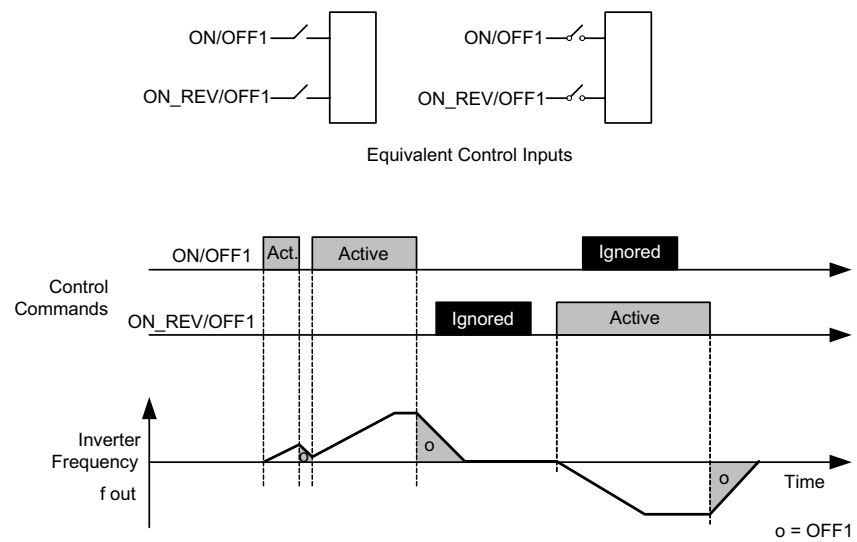

2-wire control using ON_FWD and ON_REV

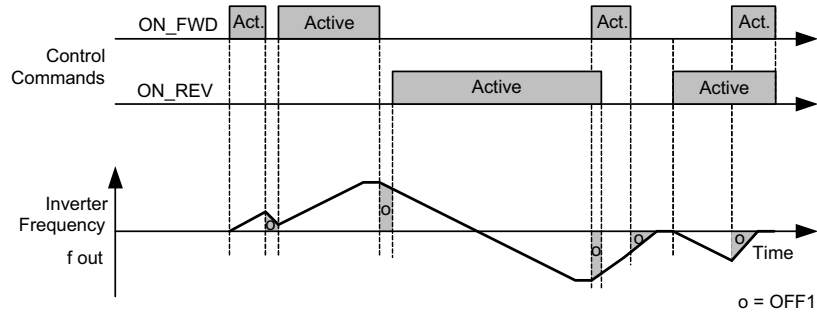
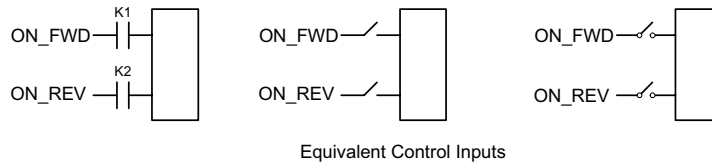

3-wire control using FWDP, REVP and STOP

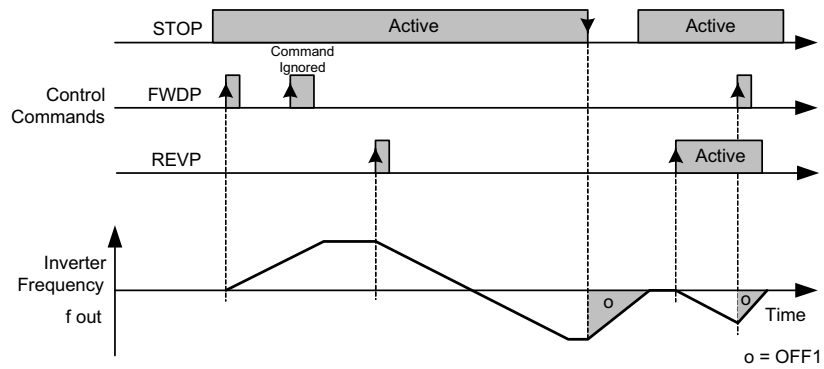
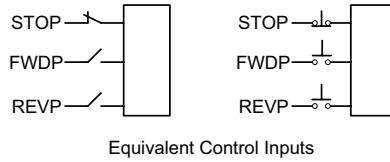

3-wire control using ON_PULSE, OFF1/HOLD and REV

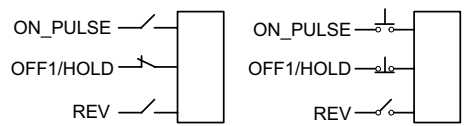

Equivalent Control Inputs

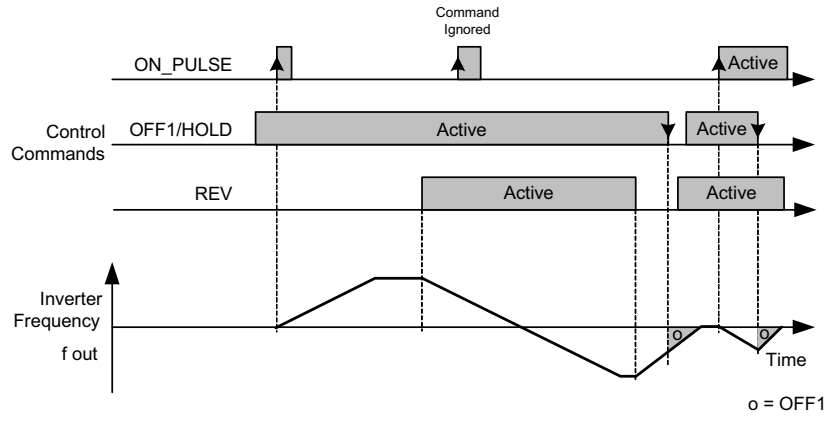

P0731	Function of digital output 0	Min: 0	Level 3	
	CStat: CUT	Datatype: U16		Unit: -
	P-Group: COMMANDS	Active: first confirm		QuickComm.: No
		Def: 5		
		Max: 23		

Defines source of digital output 0.

Canale DOUT

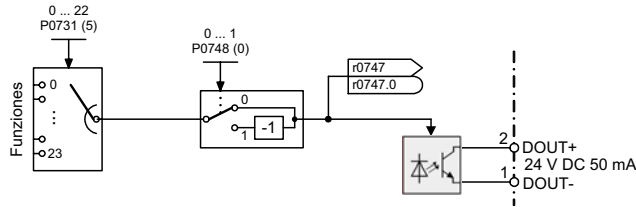

Possible Settings:

Status of Digital Output at logically active signal (0 = open 1 = closed)			
Possible settings		Active	Status
0	Not Active	----	0 (always)
1	Active	----	1 (always)
2	Drive ready	High	1
3	Drive ready to run	High	1
4	Drive running	High	1
5	Drive fault active	High	0
6	OFF2 active	Low	0
7	OFF3 active	Low	0
8	Switch on inhibit active	High	1
9	Drive warning active	High	1
10	Deviation between f_{set} and f_{act} (r0021) < 3 Hz	High	1
11	PZD control (P700=5)	High	1
12	Act. freq \geq P1082 (f_{max})	High	1
13	Warning: Motor current limit	High	0
14	Motor holding brake active (means: the brake is open)	High	1
15	Motor overload	High	0
16	Motor running direction right	High	1
17	Inverter overload	High	0
18	DC brake active	High	1
19	Act. freq > P2167	High	1
20	Act. freq \leq P1080 (f_{min})	High	0
21	Act. freq \geq setpoint	High	1
22	Ramping finish	High	1
23	Vdc_act r0026 > P2172	High	1

Note:

Output of fault bit 52.3 is inverted on digital output.

Details:

- Monitor functions ==> see parameter r0052, r0053
- Motor holding brake ==> see parameter P1215
- DC-Brake ==> see parameter P1232, P1233, P1234

r0747	CO/BO: State of digital outputs	Min: -	Level 3	
		Datatype: U16		Unit: -
	P-Group: COMMANDS			Def: -
		Max: -		

Displays status of digital outputs (also includes inversion of digital outputs via P0748).

Bitfields:

Bit00 Digital output 0 energized 0 NO 1 YES

Dependency:

Bit 0 = 0 :
Optocoupler contacts open

Bit 0 = 1 :
Optocoupler contacts closed

P0748	Invert digital outputs	Min: 0	Level
	CStat: CUT	Datatype: U16	Def: 0
	P-Group: COMMANDS	Active: first confirm	QuickComm.: No
		Max: 1	3

Defines high and low states of relay for a given function.

Bitfields:

Bit00 Invert digital output 0 0 NO 1 YES

r0752	Act. input of ADC	Min: -	Level
	Datatype: Float	Unit: V	Def: -
	P-Group: TERMINAL	QuickComm.: No	Max: -
			3

Displays smoothed analog input value in volts before the characteristic block.

ADC channel

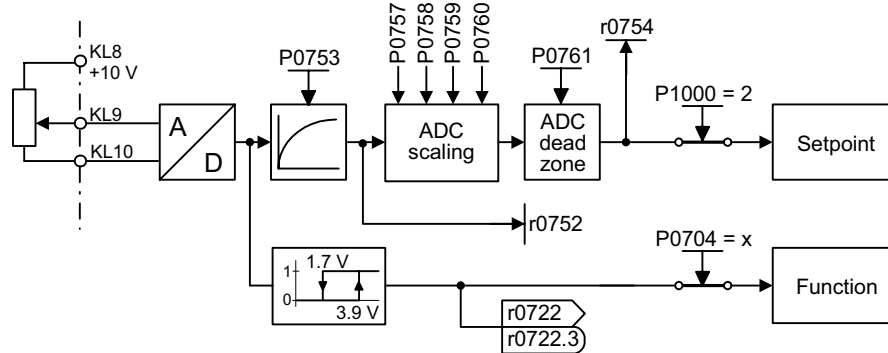

P0753	Smooth time ADC	Min: 0	Level
	CStat: CUT	Datatype: U16	Unit: ms
	P-Group: TERMINAL	Active: first confirm	QuickComm.: No
		Def: 3	3
		Max: 10000	

Defines filter time (PT1 filter) in [ms] for analog input.

Note:

Increasing this time (smooth) reduces jitter but slows down response to the analog input. Only when 5 times of P0753 have been passed then approx. 100% of the setpoint will be reached. P0753 = 0 : No filtering

r0754	Act. ADC value after scaling [%]	Min: -	Level
	Datatype: Float	Unit: %	Def: -
	P-Group: TERMINAL	QuickComm.: No	Max: -
			2

Shows smoothed value of analog input in [%] after scaling block.

Dependency:

P0757 to P0760 define range (ADC scaling).

P0757	Value x1 of ADC scaling	Min: 0	Level 3	
	CStat: CUT	Datatype: Float		Unit: V
	P-Group: TERMINAL	Active: first confirm		QuickComm.: No
		Def: 0		
		Max: 10		

Parameters P0757 - P0760 configure the input scaling as shown in the diagram:

P0761 = 0

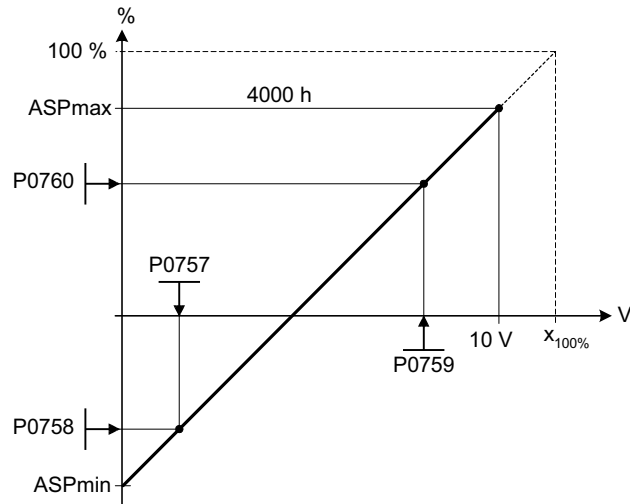

Where:

- Analog setpoints represent a [%] of the normalized frequency in P2000.
- Analog setpoints may be larger than 100 %.
- ASPmax represents highest analog setpoint (this may be at 10 V).
- ASPmin represents lowest analog setpoint (this may be at 0 V).
- Default values provide a scaling of 0 V = 0 %, and 10 V = 100 %.

Note:

The ADC-linear characteristic is described by 4 coordinates, based on a two-point equation:

$$\frac{y - P0758}{x - P0757} = \frac{P0760 - P0758}{P0759 - P0757}$$

For calculations the point-gradient form (offset and gradient) is more advantageous:

$$y = m \cdot x + y_0$$

The transformation between these two forms is given by:

$$m = \frac{P0760 - P0758}{P0759 - P0757} \quad y_0 = \frac{P0758 \cdot P0759 - P0757 \cdot P0760}{P0759 - P0757}$$

For scaling of the input the value of y_max and x_min has to be determined. This is done by the following equations:

$$x_{min} = \frac{P0760 \cdot P0757 - P0758 \cdot P0759}{P0760 - P0758}$$

$$y_{max} = (x_{max} - x_{min}) \cdot \frac{P0760 - P0758}{P0759 - P0757}$$

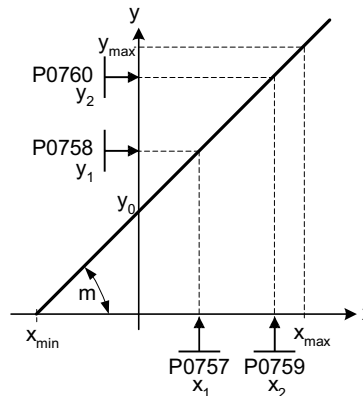

Notice:

The value x2 of ADC scaling P0759 must be greater than the value x1 of ADC scaling P0757.

P0758	Value y1 of ADC scaling	Min: -99999.9	Level
	CStat: CUT	Datatype: Float	Def: 0.0
	P-Group: TERMINAL	Active: first confirm	QuickComm.: No

Sets value of Y1 in [%] as described in P0757 (ADC scaling)

Dependency:

Affects P2000 (reference frequency).

P0759	Value x2 of ADC scaling	Min: 0	Level
	CStat: CUT	Datatype: Float	Def: 10
	P-Group: TERMINAL	Active: first confirm	QuickComm.: No

Sets value of X2 as described in P0757 (ADC scaling).

Notice:

The value x2 of ADC scaling P0759 must be greater than the value x1 of ADC scaling P0757.

P0760	Value y2 of ADC scaling	Min: -99999.9	Level
	CStat: CUT	Datatype: Float	Def: 100.0
	P-Group: TERMINAL	Active: first confirm	QuickComm.: No

Sets value of Y2 in [%] as described in P0757 (ADC scaling).

Dependency:

Affects P2000 (reference frequency).

P0761	Width of ADC deadband	Min: 0	Level
	CStat: CUT	Datatype: Float	Def: 0
	P-Group: TERMINAL	Active: first confirm	QuickComm.: No

Defines width of deadband on analog input. The diagrams below explain its use.

Example:

The below example produces a 2 to 10 V, 0 to 50 Hz analog input (ADC value 2 to 10 V, 0 to 50 Hz):

- P2000 = 50 Hz
- P0759 = 8 V P0760 = 75 %
- P0757 = 2 V P0758 = 0 %
- P0761 = 2 V

P0761 > 0 and (0 < P0758 < P0760 or 0 > P0758 > P0760)

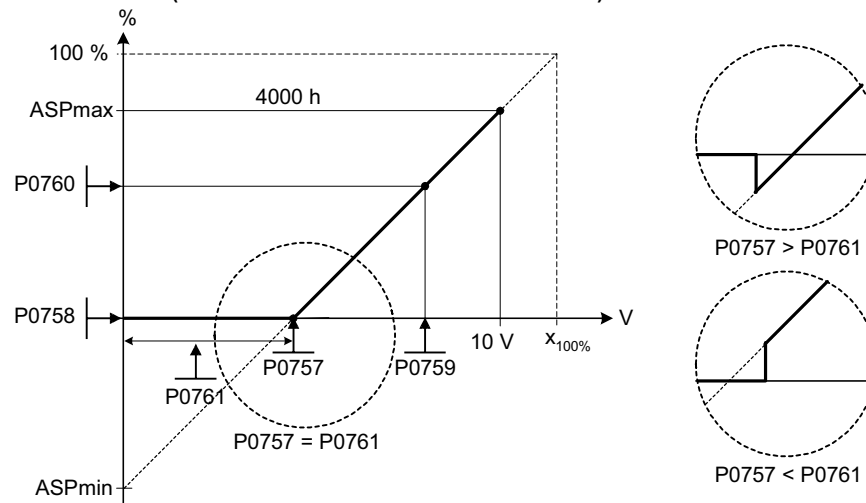

The below example produces a 0 to 10 V analog input (-50 to +50 Hz) with center zero and a "holding point" 0.2 V wide (0.1 V to each side of center, ADC value 0 to 10 V, -50 to +50 Hz):

- P2000 = 50 Hz
- P0759 = 8 V P0760 = 75 %
- P0757 = 2 V P0758 = -75 %
- P0761 = 0.1 V

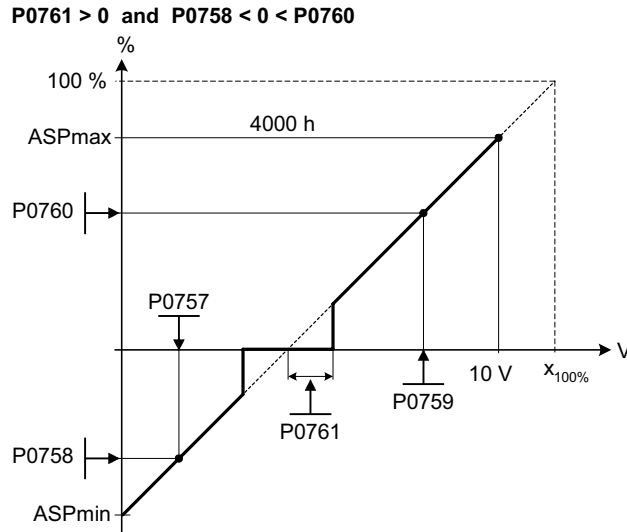

Note:

P0761[x] = 0 : No deadband active.

Deadband starts from 0 V to value of P0761, if both values of P0758 and P0760 (y coordinates of ADC scaling) are positive or negative respectively. However, deadband is active in both directions from point of intersection (x axis with ADC scaling curve), if sign of P0758 and P0760 are opposite.

Min. frequency P1080 should be zero when using center zero setup. There is no hysteresis at the end of the deadband.

P0802	Transfer data to BOP	Min: 0	Level
	CStat: C Datatype: U16 Unit: -	Def: 0	3
	P-Group: PAR_RESET Active: first confirm QuickComm.: No	Max: 1	

Transfers values from drive to BOP when set to 1. Parameter P0010 must be set to 30 for this to be possible.

Possible Settings:

- 0 Disabled
- 1 Start transfer

Note:

Parameter is automatically reset to 0 (default) after transfer. P0010 will be reset to 0 on successful completion.

P0803	Transfer data from BOP	Min: 0	Level
	CStat: C Datatype: U16 Unit: -	Def: 0	3
	P-Group: PAR_RESET Active: first confirm QuickComm.: No	Max: 1	

Transfers values from BOP to drive when set to 1. Parameter P0010 must be set to 30 for this to be possible.

Possible Settings:

- 0 Disabled
- 1 Start transfer

Note:

Parameter is automatically reset to 0 (default) after transfer. P0010 will be reset to 0 on successful completion.

P0810	Source of Local / Remote				Min: 0	Level 3
	CStat: CUT	Datatype: U16	Unit: -	Def: 0		
	P-Group: COMMANDS	Active: first confirm	QuickComm.: No	Max: 2		

Source of Local / Remote.

Possible Settings:

- 0 Disabled
- 1 DIN
- 2 USS

Example:

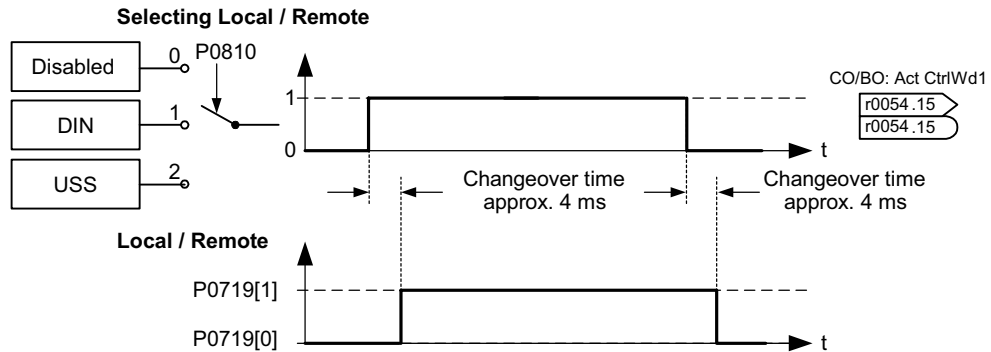

Dependency:

The following dependencies exist by use of the Local / Remote functionality:

- 1) If Local / Remote is selected via DIN the following parameters have to set:
 - P0810 = 1
 - One of P0701 to P0704 = 21
- 2) If P0810 is changed from 1 to 0 or 2, the parameter P0701 to P0704 = 21 are reset to 0.
- 3) If P0701 to P0704 are changed to 21, parameter P0810 is set to 1 automatically.
- 4) If P0701 to P0704 are changed from 21 to any value, P0810 is reset to 0.

P0927	Parameter changeable via				Min: 0	Level 3
	CStat: CUT	Datatype: U16	Unit: -	Def: 15		
	P-Group: COMM	Active: first confirm	QuickComm.: No	Max: 15		

Specifies the interfaces which can be used to change parameters.

This parameter allows the user to easily protect the inverter from unauthorized modification of parameters.
Annotation: Parameter P0927 is not password protected.

Bitfields:

Bit00	Not used	0	NO	1	YES
Bit01	BOP	0	NO	1	YES
Bit02	Not used	0	NO	1	YES
Bit03	USS	0	NO	1	YES

Example:

Bits 0, 1, 2 and 3 set:

The default setting allows parameters to be changed via any interface. If all bits are set, the parameter is displayed on BOP as follows:

BOP:

Bits 0, 1, 2 and 3 reset:

This setting allows no parameters to be modified via any interface with the exception of P0003 and P0927. If all bits are reset, the parameter is displayed on BOP as follows:

BOP:

Details:

The 7-segment display of the bit-parameters (binary parameters) is explained in the Introduction of the Parameter List.

r0947[8]	Last fault code	Datatype: U16	Unit: -	Min: - Def: - Max: -	Level 2
	P-Group: ALARMS				

Displays fault history according to the diagram below

where:

- "F1" is the first active fault (not yet acknowledged).
- "F2" is the second active fault (not yet acknowledged).
- "F1e" is the occurrence of the fault acknowledgement for F1 & F2.

This moves the value in the 2 indices down to the next pair of indices, where they are stored. Indices 0 & 1 contain the active faults. When faults are acknowledged, indices 0 & 1 are reset to 0.

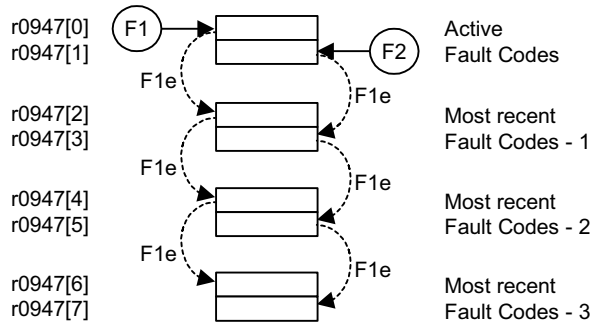

Index:

- r0947[0] : Recent fault trip --, fault 1
- r0947[1] : Recent fault trip --, fault 2
- r0947[2] : Recent fault trip -1, fault 3
- r0947[3] : Recent fault trip -1, fault 4
- r0947[4] : Recent fault trip -2, fault 5
- r0947[5] : Recent fault trip -2, fault 6
- r0947[6] : Recent fault trip -3, fault 7
- r0947[7] : Recent fault trip -3, fault 8

Example:

If the inverter trips on undervoltage and then receives an external trip before the undervoltage is acknowledged, you will obtain:

- r0947[0] = 3 Undervoltage (F0003)
- r0947[1] = 85 External trip (F0085)

Whenever a fault in index 0 is acknowledged (F1e), the fault history shifts as indicated in the diagram above.

Dependency:

Index 1 used only if second fault occurs before first fault is acknowledged.

Details:

See "Faults and Warnings"

r0949[8]	Fault value	Datatype: U16	Unit: -	Min: - Def: - Max: -	Level 3
	P-Group: ALARMS				

Displays drive fault values. It is for service purposes and indicate the type of fault reported. The values are listed in the code where faults are reported.

Index:

- r0949[0] : Recent fault trip --, fault value 1
- r0949[1] : Recent fault trip --, fault value 2
- r0949[2] : Recent fault trip -1, fault value 3
- r0949[3] : Recent fault trip -1, fault value 4
- r0949[4] : Recent fault trip -2, fault value 5
- r0949[5] : Recent fault trip -2, fault value 6
- r0949[6] : Recent fault trip -3, fault value 7
- r0949[7] : Recent fault trip -3, fault value 8

Note:

Detailed fault values are shown in the list "Fault Messages"

r0964[7]	Firmware version data	Datatype: U16	Unit: -	Min: - Def: - Max: -	Level 3
P-Group: COMM					

Firmware version data.

Index:

r0964[0] : Company (Siemens = 42)
 r0964[1] : Product type
 r0964[2] : Firmware version
 r0964[3] : Firmware date (year)
 r0964[4] : Firmware date (day/month)
 r0964[5] : Number of drive objects
 r0964[6] : Firmware version (patch)

Example:

No.	Value	Meaning
r0964[0]	42	SIEMENS
r0964[1]	1001	MICROMASTER 420
	1002	MICROMASTER 440
	1003	MICRO- / COMBIMASTER 411
	1004	MICROMASTER 410
	1005	reserved
	1006	MICROMASTER 440 PX
	1007	MICROMASTER 430
	5301	SINAMICS G110
r0964[2]	105	Firmware V1.05.cc.dd.
r0964[3]	2001	27.10.2001
r0964[4]	2710	
r0964[5]	1	Drive objects
r0964[6]	200	Firmware Vaa.bb.02.00

P0970	Factory reset	Datatype: U16	Unit: -	Min: 0 Def: 0 Max: 1	Level 1
CStat: C					
P-Group: PAR_RESET					
Active: first confirm					
QuickComm.: No					

P0970 = 1 resets all parameters to their default values.

Possible Settings:

0 Disabled
 1 Parameter reset

Dependency:

First set P0010 = 30 (factory settings).

Stop drive (i.e. disable all pulses) before you can reset parameters to default values.

Note:

The following parameters retain their values after a factory reset:

- P0014 Store mode
- P0100 Europe / North America
- P2010 USS baud rate
- P2011 USS address

P0971	Transfer data from RAM to EEPROM	Min: 0	Level 3	
	CStat: CUT	Datatype: U16		Unit: -
	P-Group: COMM	Active: first confirm		QuickComm.: No
		Def: 0		
		Max: 1		

Transfers values from RAM to EEPROM when set to 1.

Possible Settings:

- 0 Disabled
- 1 Start transfer

Note:

All values in RAM are transferred to EEPROM.

Parameter is automatically reset to 0 (default) after successful transfer.

The storage from RAM to EEPROM is accomplished via P0971. The communications are reset, if the transfer was successful. During the reset process communications will be interrupted. This creates the following conditions:

- PLC (e.g. SIMATIC S7) enters Stop mode
- Starter automatically recovers communications once they are re-established.
- BOP displays "busy"

After completion of the transfer process, the communication between the inverter and the PC-tools (e.g. Starter) or BOP is automatically re-established.

P1000	Selection of frequency setpoint	Min: 0	Level 1	
	CStat: CT	Datatype: U16		Unit: -
	P-Group: SETPOINT	Active: first confirm		QuickComm.: Yes
		Def: 2		
		Max: 5		

Selects frequency setpoint source.

Possible Settings:

- 0 No main setpoint
- 1 MOP setpoint
- 2 Analog setpoint
- 3 Fixed frequency
- 5 USS

Example:

SINAMICS G110 CPM110 AIN (Default: P1000 = 2)

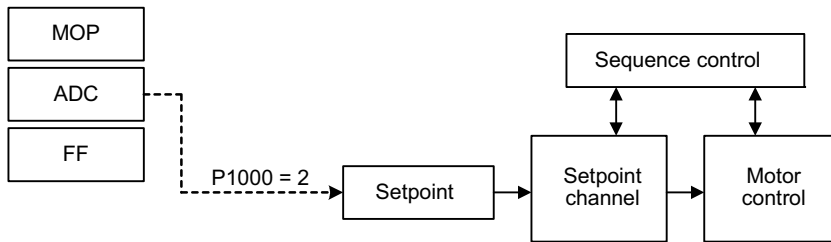

SINAMICS G110 CPM110 USS (Default: P1000 = 5)

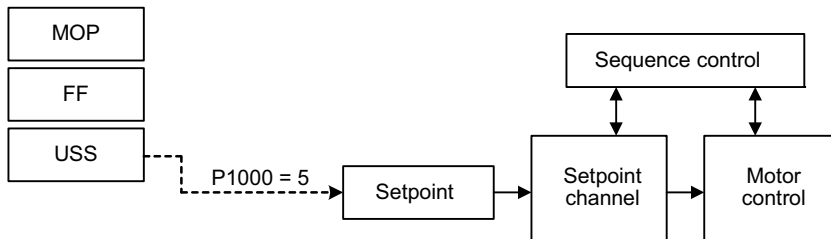

Dependency:

Parameter P0719 has higher priority than P1000.

Details:

- MOP ==> see parameter r1050
- ADC ==> see parameter r0752
- Fixed frequency ==> see parameter P1001

P1001	Fixed frequency 1			Min: -650.00	Level 2
	CStat: CUT	Datatype: Float	Unit: Hz	Def: 0.00	
	P-Group: SETPOINT	Active: Immediately	QuickComm.: No	Max: 650.00	

Defines fixed frequency setpoint 1.

There are 2 types of fixed frequencies:

1. Direct selection
 2. Direct selection + ON command
1. Direct selection (P0701 - P0703 = 15):
 - In this mode of operation, 1 digital input selects 1 fixed frequency (e.g. if P0700 = 2 and P0701 = 15, the value of P1001 is selected when the status of digital input 0 (DIN0) is ON, see also r0722).
 - If several inputs are active together, the selected frequencies are summed.
 - E.g.: r1024 = FF1 + FF3 (the status of DIN0 and DIN2 is ON and that of DIN1 is OFF)
 2. Direct selection + ON command (P0701 - P0703 = 16):
 - The fixed frequency selection combines the fixed frequencies with an ON command.
 - In this mode of operation 1 digital input selects 1 fixed frequency.
 - If several inputs are active together, the selected frequencies are summed.
 - E.g.: r1024 = FF1 + FF2 + FF3 (the status of DIN0, DIN1 and DIN2 is ON)
 - For 3 wire control P0727 = 2, 3 the following applies: if more than one setting '16' is used, each time the digital input (set to 16) receives a pulse, it will delatch the previously assigned fixed frequency thus "overwriting the previously fixed frequency".
 - For control methods P0727 = 1, 2, 3 at least one of the digital inputs is requested to be assigned 'setting 16' to allow an ON command to be issued.
 - In case of 3 wire control the STOP signal (P0727=2) resp. the OFF1/HOLD signal (P0727=3) is necessary to stop the drive. To achieve a maximum number of fixed frequencies it is recommended to parameterize the stop signal to digital input 3 (P0704=1 resp. P0704=2; only for analog variant)

Summary of fixed frequencies and digital inputs capabilities

Parameter	P0727=0	P0727=1	P0727=2	P0727=3
Control method	Siemens Standard	2-wire	3-wire	3-wire
P0701 ... P0703=15	Direct selection FF	Direct selection FF	Direct selection FF	Direct selection FF
P0701 ... P0703=16	Direct selection FF + ON	Direct selection FF + ON_FWD	Direct selection FF + FWDP	Direct selection FF + ON_PULSE
Opposite direction of rotation can be accomplished with the following:				
REV signal	Yes	No	No	Yes
Negative fixed frequency	Yes	Yes	Yes	Yes
Summation of fixed frequencies (at least one negative FF)	Yes	Yes	Yes	Yes
Summation	At least one digital input must be set to 16. Other FF with setting 16 and 15 can be summed.	At least one digital input must be set to 16. Other FF with setting 16 and 15 can be summed.	Each pulse on a digital input set to 16 will overwrite an previously selected FF with setting 16. Other FF with setting 15 can be summed.	Each pulse on a digital input set to 16 will overwrite a previously selected FF with setting 16. Other FF with setting 15 can be summed.

Possible parameter settings for the selection of FF:

	Selection	P1003 (FF3)	P1002 (FF2)	P1001 (FF1)	ON
DIN	P0719=0, P0700=2, P1000=3 or P0719=3, P0700=2	P0703=15	P0702=15	P0701=15	P070x=1 or 2
		P0703=16	P0702=16	P0701=16	P070x=16
BOP	P0719=0, P0700=1, P1000=3 or P0719=3, P0700=1 or P0719=13	P0703=15	P0702=15	P0701=15	ON button of BOP
USS *)	P0719=0, P0700=5, P1000=3 or P0719=3, P0700=5 or P0719=53	P0703=15	P0702=15	P0701=15	ON via USS Ctrl. wd. 1 r0054 Bit00
		Ctrl. wd. 2**) r0055 Bit02	Ctrl. wd. 2**) r0055 Bit01	Ctrl. wd. 2**) r0055 Bit00	

*) SINAMICS G110 CPM110 USS only

**) P2012 = 4

Example:

Direct selection of FF via DIN:

		DIN2	DIN1	DIN0
0 Hz	FF0	0	0	0
P1001	FF1	0	0	1
P1002	FF2	0	1	0
P1003	FF3	1	0	0
P1001+P1002	FF1+FF2	0	1	1
:	:	:	:	:
P1001+P1002+P1003	FF1+FF2+FF3	1	1	1

Dependency:

Select fixed frequency operation (using P1000).

Inverter requires ON command to start in the case of direct selection (P0701 - P0703 = 15).

Note:

Fixed frequencies can be selected using the digital inputs, and can also be combined with an ON command.

P1002	Fixed frequency 2	Min: -650.00	Level 2	
	CStat: CUT	Datatype: Float		Unit: Hz
	P-Group: SETPOINT	Active: Immediately		QuickComm.: No
		Def: 5.00		
		Max: 650.00		

Defines fixed frequency setpoint 2.

Details:

See parameter P1001 (fixed frequency 1).

P1003	Fixed frequency 3	Min: -650.00	Level 2	
	CStat: CUT	Datatype: Float		Unit: Hz
	P-Group: SETPOINT	Active: Immediately		QuickComm.: No
		Def: 10.00		
		Max: 650.00		

Defines fixed frequency setpoint 3.

Details:

See parameter P1001 (fixed frequency 1).

r1024	CO: Act. fixed frequency	Min: -	Level 3	
		Datatype: Float		Unit: Hz
	P-Group: SETPOINT			Max: -
		Def: -		
		Max: -		

Displays sum total of selected fixed frequencies.

P1031	Setpoint memory of the MOP	Min: 0	Level 2	
	CStat: CUT	Datatype: U16		Unit: -
	P-Group: SETPOINT	Active: Immediately		QuickComm.: No
		Def: 0		
		Max: 1		

Saves last motor potentiometer setpoint (MOP) that was active before OFF command or power down.

Possible Settings:

- 0 MOP setpoint will not be stored
- 1 MOP setpoint will be stored (P1040 is updated)

Note:

On next ON command, motor potentiometer setpoint will be the saved value in parameter P1040 (setpoint of the MOP).

P1032	Inhibit negative MOP setpoints				Min: 0	Level 3
	CStat: CT	Datatype: U16	Unit: -	Def: 1		
	P-Group: SETPOINT	Active: first confirm	QuickComm.: No	Max: 1		

This parameter suppresses negative setpoints of the MOP output r1050.

Possible Settings:

0 Neg. MOP setpoint is allowed
1 Neg. MOP setpoint inhibited

Note:

It is possible to change motor direction using the motor potentiometer setpoint (increase / decrease frequency) either by using digital inputs or BOP keypad (up / down). The reversing functions (e.g. BOP-Reverse button if P0700 = 1) are not affected by the settings of P1032. Use P1110 to fully prevent change of direction in setpoint channel.

P1040	Setpoint of the MOP				Min: -650.00	Level 3
	CStat: CUT	Datatype: Float	Unit: Hz	Def: 5.00		
	P-Group: SETPOINT	Active: Immediately	QuickComm.: No	Max: 650.00		

Determines setpoint for motor potentiometer control (P1000 = 1).

Dependency:

Motor potentiometer setpoint (P1040) must be chosen as setpoint via P1000 or P0719.

Note:

If motor potentiometer setpoint is selected, the reverse direction will be inhibited by default of P1032 (inhibit reverse direction of MOP).

To re-enable reverse direction, set P1032 = 0.

A short press of the 'up' or 'down' keys (e.g.: BOP) will change the frequency setpoint in steps of 0.1Hz. A longer press will cause an accelerated frequency setpoint change.

r1050	CO: Act. Output freq. of the MOP	Min: -	Level 3
	Datatype: Float Unit: Hz	Def: -	
P-Group: SETPOINT		Max: -	

Displays output frequency of motor potentiometer setpoint ([Hz]).

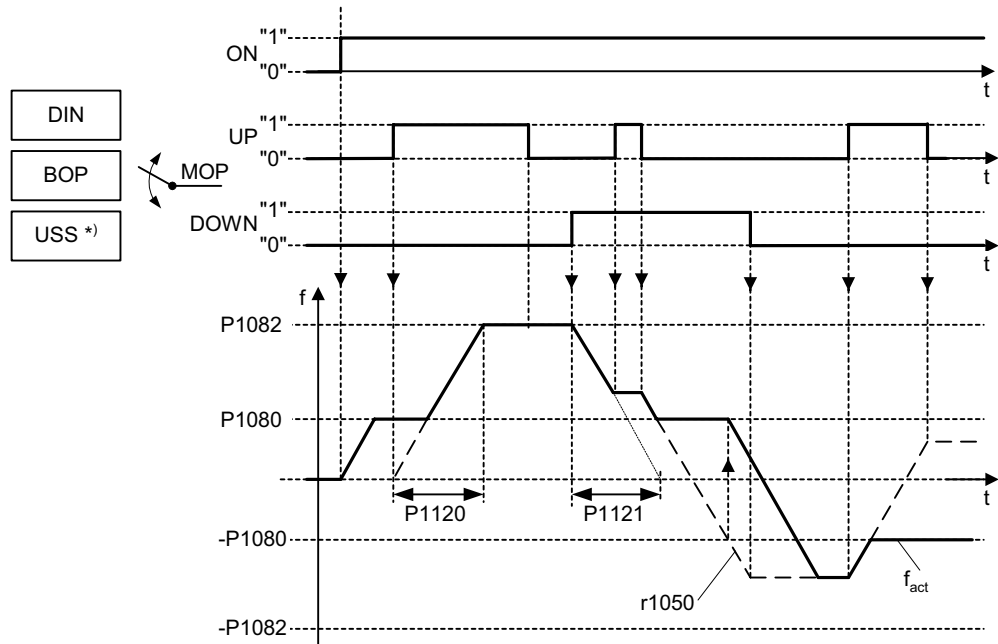

Possible parameter settings for the selection of MOP:

	Selection	MOP up	MOP down
DIN	P0719 = 0, P0700 = 2, P1000 = 1 or P0719 = 1, P0700 = 2	P0702 = 13 (DIN1)	P0703 = 14 (DIN2)
BOP	P0719 = 0, P0700 = 1, P1000 = 1 or P0719 = 1, P0700 = 1 or P0719 = 11	UP button	DOWN button
USS *)	P0719 = 0, P0700 = 5, P1000 = 1 or P0719 = 1, P0700 = 5 or P0719 = 51	USS control word r2036 Bit13	USS control word r2036 Bit14

*) SINAMICS G110 CPM110 USS only

Notice:

If the MOP is enabled by short pulses of less than 1 second, the frequency is changed in steps of 0.1 Hz.

P1058	JOG frequency			Min: 0.00	Level 3
	CStat: CUT	Datatype: Float	Unit: Hz	Def: 5.00	
	P-Group: SETPOINT	Active: Immediately	QuickComm.: No	Max: 650.00	

Jogging increases the motor speed by small amounts. The JOG buttons use a non-latching switch on one of the digital inputs to control the motor speed. While the JOG button is pressed, parameter P1058 determines the frequency at which the inverter will run. The JOG mode allows the operator to perform a specific number of revolutions and position the rotor manually.

The motor speed is increased as long as 'JOG left' or 'JOG right' are selected and until the JOG frequency (P1058) is reached.

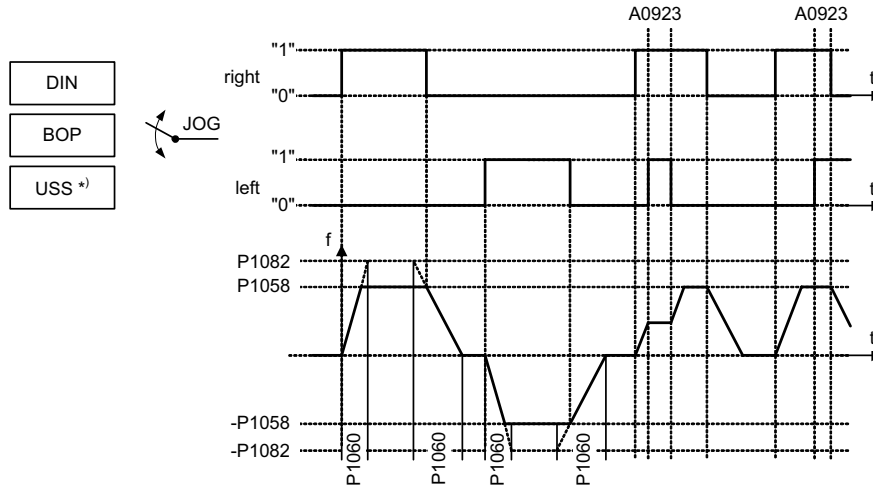

Possible parameter settings for the selection of JOG:

	Selection	JOG right	JOG left
DIN	P0719 = 0, P0700 = 2	P0702 = 10	P0703 = 11
BOP	P0719 = 0, P0700 = 1 or P0719 = 10 ... 15	JOG button	Rev button JOG button
USS *)	P0719 = 0, P0700 = 5 or P0719 = 50 ... 55	USS control word r2036 Bit08	USS control word r2036 Bit09

*) SINAMICS G110 CPM110 USS only

Dependency:

P1060 sets up ramp and down ramp times for jogging.

Rounding time (P1130), rounding type (P1134) and P2167 will also have influence on the JOG ramp.

P1060	JOG ramp-up/down time	Min: 0.00	Level 3	
	CStat: CUT	Datatype: Float		Unit: s
	P-Group: SETPOINT	Active: first confirm		QuickComm.: No
		Def: 10.00		
		Max: 650.00		

Sets jog ramp-up and ramp-down time. This is the ramping time used while jogging is active.

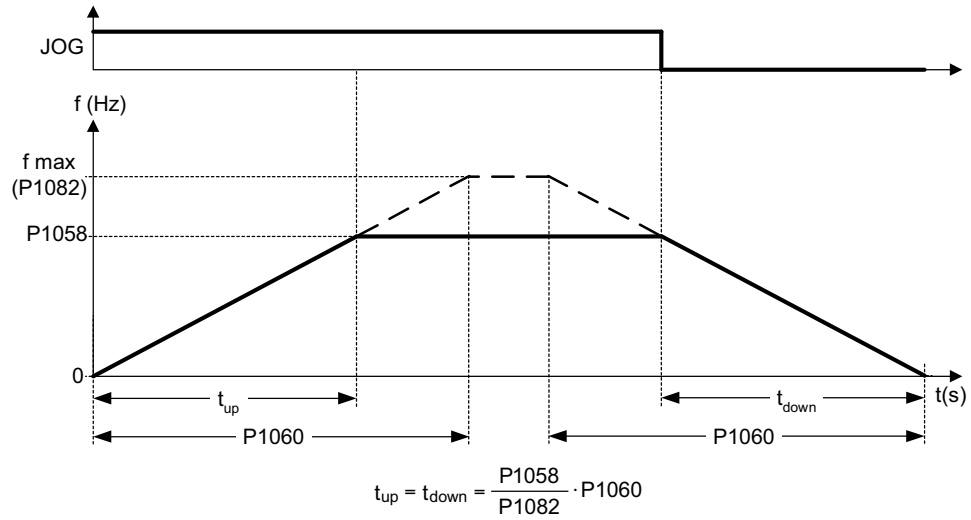

Notice:

- Ramp times will be used as follows:
- P1060 : JOG mode is active
 - P1120 / P1121 : Normal mode (ON/OFF) is active

The rounding of P1130 also applies to the JOG ramping.

r1078	CO: Total frequency setpoint	Min: -	Level 3	
		Datatype: Float		Unit: Hz
	P-Group: SETPOINT			Def: -
		Max: -		

Displays setpoints in [Hz].

P1080	Min. frequency			Min: 0.00	Level 1
	CStat: CUT	Datatype: Float	Unit: Hz	Def: 0.00	
	P-Group: SETPOINT	Active: Immediately	QuickComm.: Yes	Max: 650.00	

Sets minimum motor frequency [Hz] at which motor will run irrespective of frequency setpoint.

The minimum frequency P1080 represents a masking frequency of 0 Hz for all frequency target value sources (e.g. ADC, MOP, FF, USS), with the exception of the JOG target value source (analogous to P1091). Thus the frequency band +/- P1080 is run through in optimum time by means of the acceleration/deceleration ramps. Dwelling in the frequency band is not possible (see example).

Furthermore, an overshoot of the actual frequency f_{act} upper min. frequency P1080 is output by the signal function ($|f_{act}| > f_{min}$, see below).

Example:

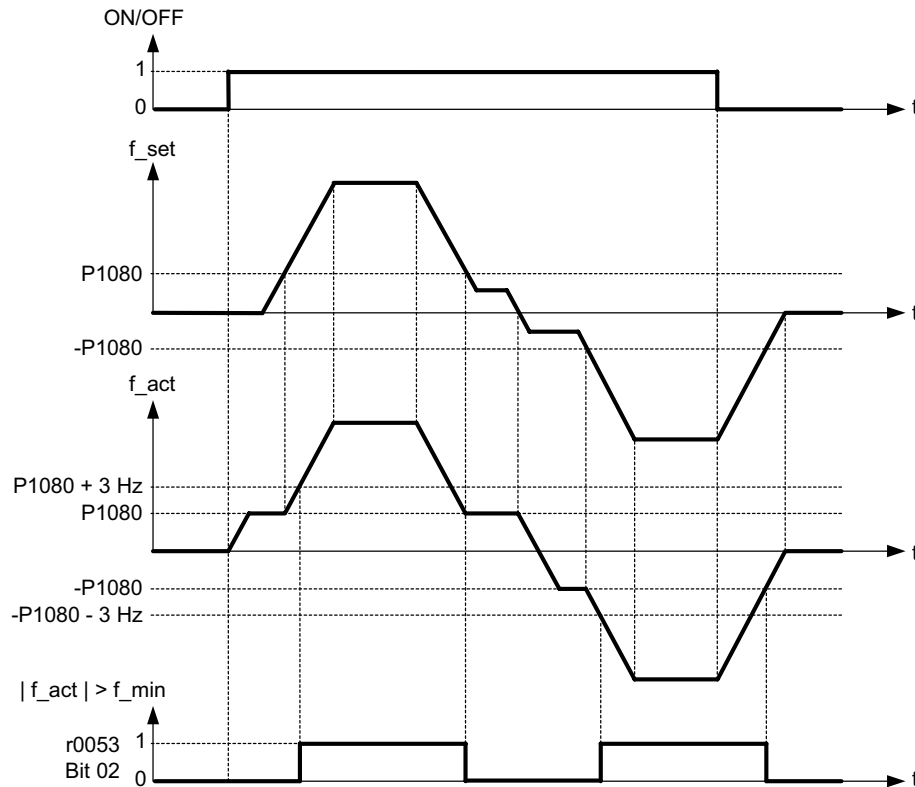

Note:

Value set here is valid both for clockwise and for anticlockwise rotation.

Under certain conditions (e.g. ramping, current limiting), motor can run below minimum frequency.

P1082	Max. frequency			Min: 0.00	Level 1
	CStat: CT	Datatype: Float	Unit: Hz	Def: 50.00	
	P-Group: SETPOINT	Active: first confirm	QuickComm.: Yes	Max: 650.00	

Sets maximum motor frequency [Hz] at which motor will run irrespective of the frequency setpoint. The value set here is valid for both clockwise and anticlockwise rotation.

Furthermore, the monitoring function $|f_act| \geq P1082$ (r0052 Bit10, see example below) is affected by this parameter.

Example:

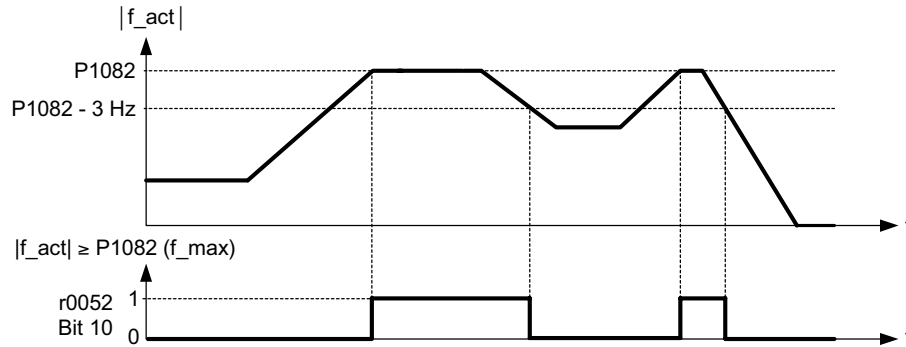

Dependency:

The maximal value of motor frequency P1082 is limited to pulse frequency P1800. P1082 is dependent on the derating characteristic as followed:

		P1800			
		2 kHz	4 kHz	6 kHz	8 - 16 kHz
f_{max}	P1082	0 - 133.3 Hz	0 - 266.6 Hz	0 - 400 Hz	0 - 650 Hz

The maximum output frequency of inverter can be exceeded if one of the following is active:

- P1335 \neq 0 (Slip compensation active) :

$$f_{max}(P1335) = f_{max} + f_{slip,max} = P1082 + 2.5 \cdot \frac{r0330}{100} \cdot P0310$$

- P1200 \neq 0 (Flying restart active) :

$$f_{max}(P1200) = f_{max} + 2 \cdot f_{slip,nom} = P1082 + 2 \cdot \frac{r0330}{100} \cdot P0310$$

Note:

When using the setpoint source

- Analog Input
- USS

The setpoint frequency (in Hz) is cyclically calculated using a percentage value (e.g. for the analog input r0754) or a hexadecimal value (e.g. for the USS r2018[1]) and the reference frequency P2000. If for example P1082 = 80 Hz, P2000 = 50 Hz and the analog input is parameterized with P0757 = 0 V, P0758 = 0 %, P0759 = 10 V, P0760 = 100 %, a setpoint frequency of 50 Hz will be applied at 10 V of the analog input.

P1091	Skip frequency	Datatype: Float	Unit: Hz	Min: 0.00	Level 3
	CStat: CUT	Active: Immediately	QuickComm.: No	Def: 0.00	
	P-Group: SETPOINT			Max: 650.00	

Defines skip frequency which avoids effects of mechanical resonance and suppresses frequencies within +/- 2 Hz (skip frequency bandwidth).

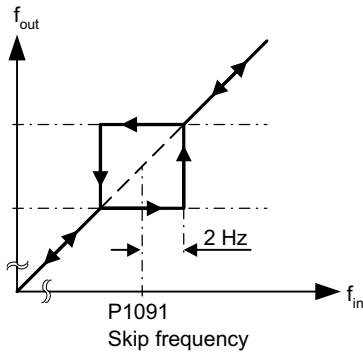

Note: The function is disabled if P1091 = 0.

Notice: Stationary operation is not possible within the suppressed frequency range; the range is merely passed through (on the ramp).

For example, if P1091 = 10 Hz it is not possible to operate continuously between 10 Hz +/- 2 Hz (i.e. between 8 and 12 Hz).

P1110	Inhibit neg. freq. setpoint	Datatype: U16	Unit: -	Min: 0	Level 3
	CStat: CT	Active: first confirm	QuickComm.: No	Def: 0	
	P-Group: COMMANDS			Max: 1	

This parameter suppresses negative setpoints. Therefore, modification of the motor direction is inhibited to the setpoint channel.

Possible Settings:
 0 Disable
 1 Enable

Notice: Where

- If a min. frequency (P1080) and a negative setpoint are given, the motor is accelerated by a positive value in relationship to the min. frequency.
- This function does not disable the "reverse command functions" (e.g. Reverse, ON left); rather, a reverse command causes motor to run in the positive direction only, as described above.

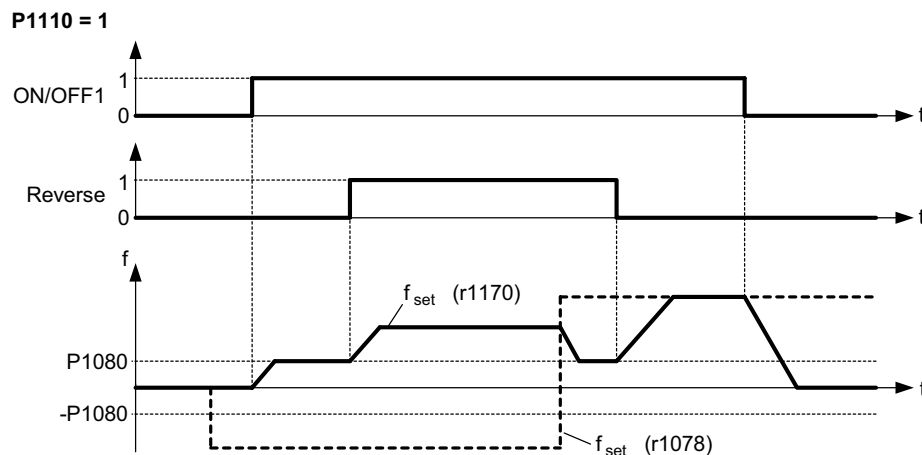

P1120	Ramp-up time	Min: 0.00	Level 1	
	CStat: CUT	Datatype: Float		Unit: s
	P-Group: SETPOINT	Active: first confirm		QuickComm.: Yes
		Def: 10.00		
		Max: 650.00		

Time taken for motor to accelerate from standstill up to maximum motor frequency (P1082) when no rounding is used.

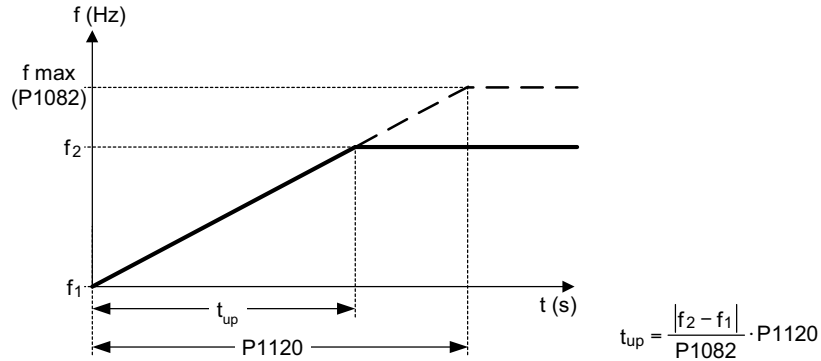

Setting the ramp-up time too short can cause the inverter to trip (overcurrent F0001).

Dependency:

Rounding time (P1130) and rounding type (P1134) will also have influence on the ramp.

Note:

If an external frequency setpoint with set ramp rates is used (e.g. from a PLC). The best way to achieve optimum drive performance is to set ramp times in P1120 and P1121 slightly shorter than those of the PLC.

Notice:

- Ramp times will be used as follows:
- P1060 : JOG mode is active
 - P1120 / P1121 : Normal mode (ON/OFF) is active

P1121	Ramp-down time	Min: 0.00	Level 1	
	CStat: CUT	Datatype: Float		Unit: s
	P-Group: SETPOINT	Active: first confirm		QuickComm.: Yes
		Def: 10.00		
		Max: 650.00		

Time taken for motor to decelerate from maximum motor frequency (P1082) down to standstill when no rounding is used.

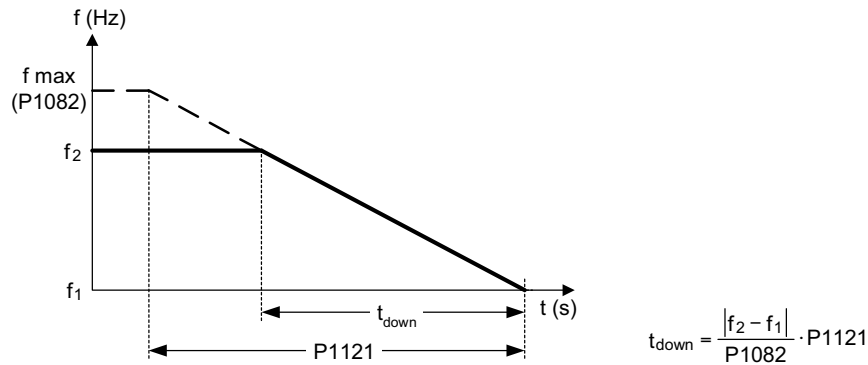

Notice:

Setting the ramp-down time too short can cause the inverter to trip (overcurrent F0001 / overvoltage F0002).

- Ramp times will be used as follows:
- P1060 : JOG mode is active
 - P1120 / P1121 : Normal mode (ON/OFF) is active

P1130	Ramp rounding time	Min: 0.00	Level 3	
	CStat: CUT	Datatype: Float		Unit: s
	P-Group: SETPOINT	Active: first confirm		QuickComm.: No
		Def: 0.00		
		Max: 40.00		

Defines rounding time in seconds as shown on the diagram below.

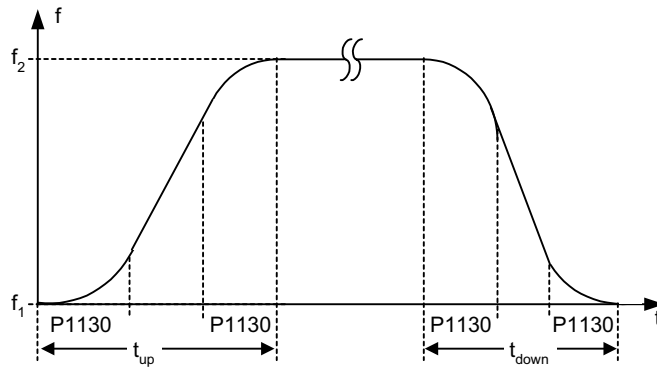

where:

Dependency	Ramp-up time	Ramp-down time
always for $ f_2 - f_1 = p1082$	$t_{up} = P1130 + P1120$	$t_{down} = P1130 + P1121$
for $P1130 > P1120$	$t_{up} = (P1130 + P1120) \cdot \sqrt{\frac{ f_2 - f_1 }{p1082}}$	$t_{down} = (P1130 + P1121) \cdot \sqrt{\frac{ f_2 - f_1 }{p1082}}$
for $P1130 \leq P1120$	$t_{up} = P1130 + P1120 \cdot \frac{ f_2 - f_1 }{P1082}$	$t_{down} = P1130 + P1121 \cdot \frac{ f_2 - f_1 }{P1082}$

Note:

If short or zero ramp times (with $P1120, P1121 < P1130$) are set and $(f_2 - f_1) < P1082$, the total ramp up time (t_{up}) or total ramp down time (t_{down}) will be a nonlinear function of $P1130$. See equations above for valid conditions to calculate t_{up} and t_{down} .

Notice:

Rounding times are recommended, since they prevent an abrupt response, thus avoiding detrimental effects on the mechanics.

Rounding times are not recommended when analog inputs are used, since they would result in overshoot/undershoot in the inverter response.

P1134	Rounding type	Min: 0	Level 3	
	CStat: CUT	Datatype: U16		Unit: -
	P-Group: SETPOINT	Active: Immediately		QuickComm.: No
		Def: 0		
		Max: 1		

Defines the smoothing which is active by setpoint modifications during acceleration or deceleration (e.g. new setpoint, OFF1, OFF3, REV).

This smoothing is applied, if the motor is ramped-up or ramped-down and

- $P1134 = 0$,
- $P1130 > 0$ and
- the setpoint is not yet reached.

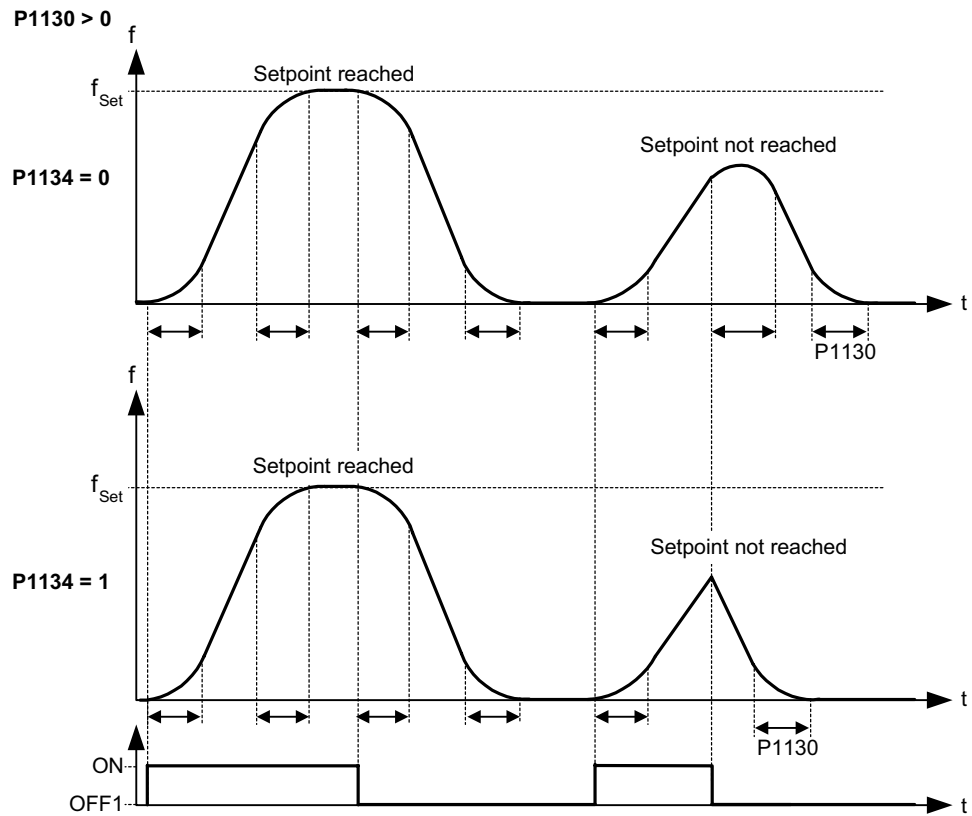
**Possible Settings:**

- 0 Continuous smoothing
- 1 Discontinuous smoothing

Dependency:

This parameter has no effect unless the value set in P1130 is greater than 0.

P1135	OFF3 ramp-down time	Min: 0.00	Level
	CStat: CUT	Datatype: Float	Unit: s
	P-Group: SETPOINT	Active: first confirm	QuickComm.: Yes
		Def: 5.00	3
		Max: 650.00	

Defines ramp-down time from maximum frequency to standstill for OFF3 command.

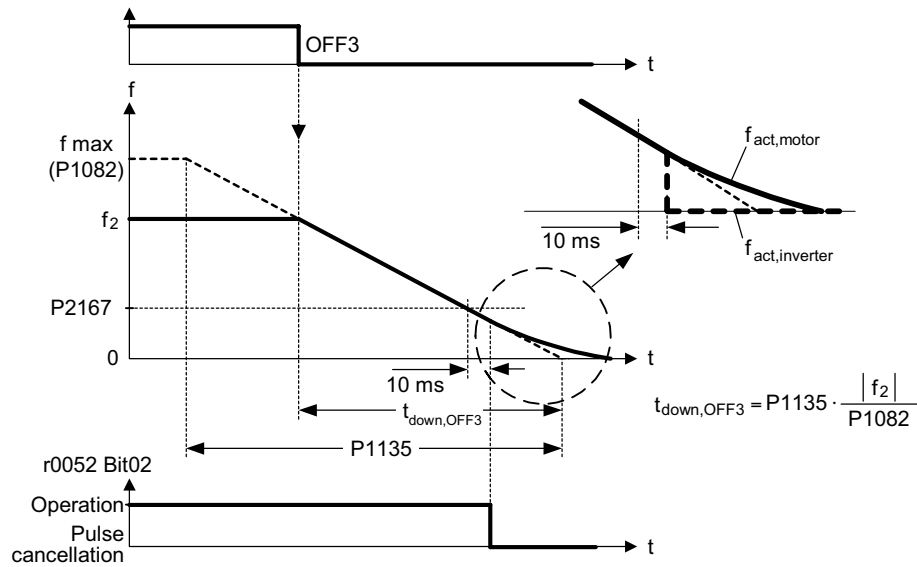

Settings in P1130 have no effect on OFF3 braking. OFF3 braking operations are influenced by P1134 (refer to the parameter description of P1134). The complete OFF3 ramp-down time is approximately given by:

$$t_{down,OFF3} = f(P1134) = 1.1 \cdot P1135 \cdot \frac{|f_2|}{P1082}$$

Note:

This time may be exceeded if the VDC_max. level is reached.

r1170	CO: Frequency setpoint after RFG	Min: -	Level
		Datatype: Float	Unit: Hz
	P-Group: SETPOINT	Def: -	3
		Max: -	

Displays overall frequency setpoint after ramp generator.

P1200	Flying start			Min: 0	Level 3
	CStat: CUT	Datatype: U16	Unit: -	Def: 0	
	P-Group: FUNC	Active: first confirm	QuickComm.: No	Max: 6	

Starts inverter onto a spinning motor by rapidly changing the output frequency of the inverter until the actual motor speed has been found. Then, the motor runs up to setpoint using the normal ramp time.

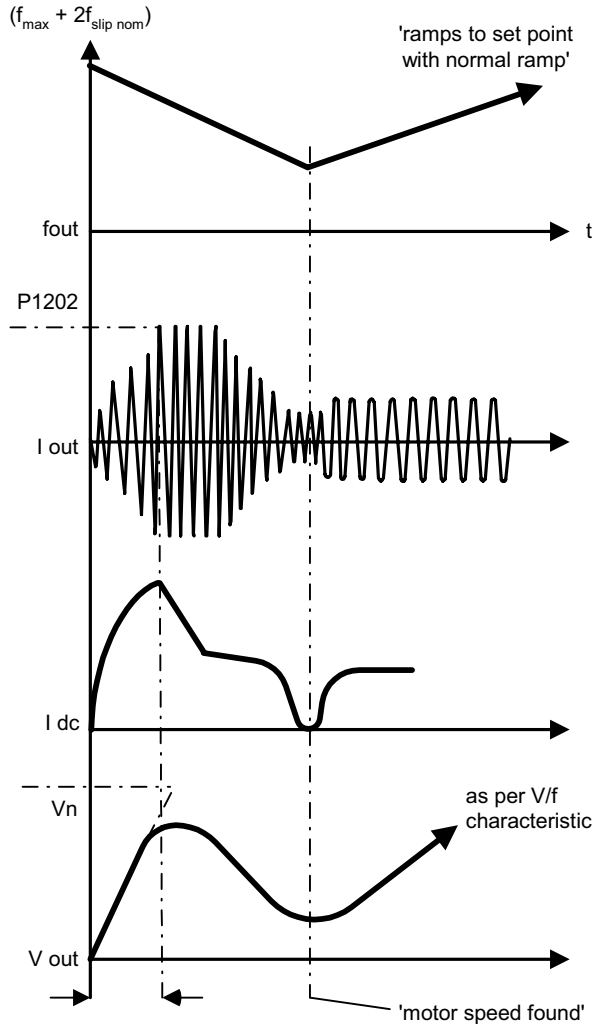

Possible Settings:

- 0 Flying start disabled
- 1 Flying start is always active, start in direction of setpoint
- 2 Flying start is active if power on, fault, OFF2, start in direction of setpoint
- 3 Flying start is active if fault, OFF2, start in direction of setpoint
- 4 Flying start is always active, only in direction of setpoint
- 5 Flying start is active if power on, fault, OFF2, only in direction of setpoint
- 6 Flying start is active if fault, OFF2, only in direction of setpoint

Note:

Useful for motors with high inertia loads.

Settings 1 to 3 search in both directions.
Settings 4 to 6 search only in direction of setpoint.

Notice:

Flying start must be used in cases where the motor may still be turning (e.g. after a short mains break) or can be driven by the load. Otherwise, overcurrent trips will occur.
Flying Start cannot be used in combination with the Motor Holding Brake P1215.

P1202	Motor-current: Flying start			Min: 10	Level 3
	CStat: CUT	Datatype: U16	Unit: %	Def: 100	
	P-Group: FUNC	Active: first confirm	QuickComm.: No	Max: 200	

Defines search current used for flying start. Value is in [%] based on rated motor current (P0305).

Note:

Reducing the search current may improve performance for flying start if the inertia of the system is not very high.

P1203	Search rate: Flying start	Min: 10	Level 3	
	CStat: CUT	Datatype: U16		Unit: %
	P-Group: FUNC	Active: first confirm		QuickComm.: No
		Def: 100		
		Max: 200		

Sets factor by which the output frequency changes during flying start to synchronize with turning motor. This value is entered in [%] defines the reciprocal initial gradient in the search sequence (see curve below). Parameter P1203 influences the time taken to search for the motor frequency.

The search time is the time taken to search through all frequencies between max. frequency $P1082 + 2 \times f_{slip}$ to 0 Hz.

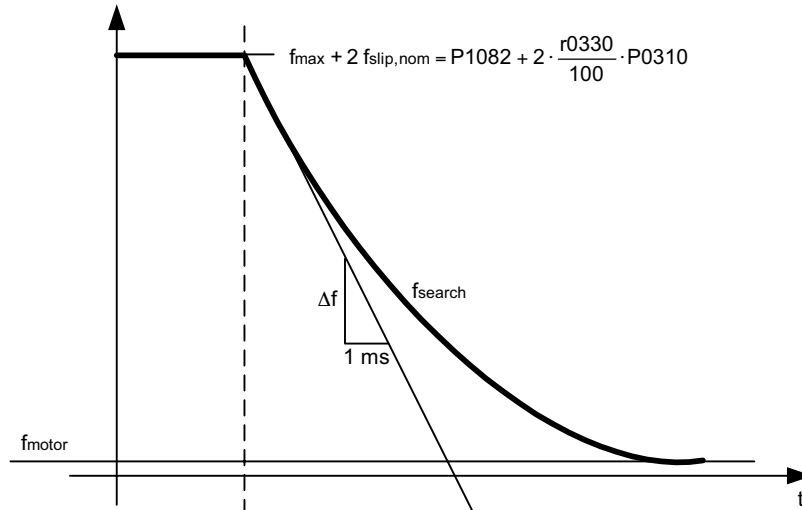

$$P1203 [\%] = \frac{\Delta t [\text{ms}]}{\Delta f [\text{Hz}]} \cdot \frac{f_{slip,nom} [\text{Hz}]}{1[\text{ms}]} \cdot 2 [\%] \Rightarrow \Delta f = \frac{2 [\%]}{P1203 [\%]} \cdot \frac{r0330}{100} \cdot P0310$$

P1203 = 100 % is defined as giving a rate of 2 % of $f_{slip,nom}$ / [ms].

P1203 = 200 % would result in a rate of frequency change of 1 % of $f_{slip,nom}$ / [ms].

Example:

For a motor with 50 Hz, 1350 rpm, 100 % would produce a maximum search time of 600 ms.

Note:

- A higher value produces a flatter gradient and thus a longer search time.
- A lower value has the opposite effect.

P1210	Automatic restart			Min: 0	Level 2
	CStat: CUT	Datatype: U16	Unit: -	Def: 1	
	P-Group: FUNC	Active: first confirm	QuickComm.: No	Max: 6	

Configures automatic restart function

Possible Settings:

- 0 Disabled
- 1 Trip reset after power on
- 2 Restart after mains blackout
- 3 Restart after mains brownout or fault
- 4 Restart after mains brownout
- 5 Restart after mains blackout and fault
- 6 Restart after mains brown- /blackout or fault

Dependency:

Automatic restart requires constant ON command via a digital input wire link.



Caution:

P1210 >= 2 can cause the motor to restart automatically without toggling the ON command !

Notice:

A "mains brownout" is where the power is interrupted and re-applied before the display on the BOP (if one is fitted to the inverter) has gone dark (a very short mains break where the DC link has not fully collapsed).

A "mains blackout" is where the display has gone dark (a long mains break where the DC link has fully collapsed) before the power is re-applied.

Setting 3 and 4 provides a limited number of restart attempts (maximum 3) in conjunction with a delay time between the restart attempts defined as follows:

"Delay Time" is the time between attempts of acknowledging fault. The "Delay Time" of first attempt is 1 second, then it will be double every next attempt.

"Number of Restart Attempts" is the number of restarts the inverter will try to acknowledge the fault. The default for "Number of Restart Attempts" is 3 times.

When faults are acknowledged and after 4 seconds of no fault condition, "Number of Restart Attempts" will be reset to default and "Delay Time" will be reset to 1 second.

After three restart attempts being unsuccessfully carried out (i.e. 7 seconds) there will be no further restart attempt. The drive must then be started manually.

Setting 2, 5 and 6 provide an unlimited number of restart attempts (without any delay time between the attempts).

P1210 = 0:
Automatic restart is disabled.

P1210 = 1:
The inverter will acknowledge (reset) faults i.e. the inverter will reset a fault when the power is re-applied. This means the inverter must be fully powered down, a brownout is not sufficient. The inverter will not run until the ON command has been toggled.

P1210 = 2:
The inverter will acknowledge the fault F0003 at power on after blackout and restarts the drive. It is necessary that the ON command is wired via a digital input (DIN).

P1210 = 3:
For this setting it is fundamental that the drive only restarts if it has been in a RUN state at the time of the faults (F0003, etc.). The inverter will acknowledge the fault and restarts the drive after a blackout or brownout. It is necessary that the ON command is wired via a digital input (DIN).

P1210 = 4:
For this setting it is fundamental that the drive only restarts if it has been in a RUN state at the time of the fault (F0003). The inverter will acknowledge the fault and restarts the drive after a blackout or brownout. It is necessary that the ON command is wired via a digital input (DIN).

P1210 = 5:
The inverter will acknowledge the faults F0003 etc. at power on after blackout and restarts the drive. It is necessary that the ON command is wired via a digital input (DIN).

P1210 = 6:
The inverter will acknowledge the faults (F0003 etc.) at power on after blackout or brownout and restarts the drive. It is necessary that the ON command is wired via a digital input (DIN).
Note for the USS variant: if the communication goes lost during restart attempt, an unexpected restart could happen which can only be interrupted by power cycle or after the communication functions again. Hence it is recommended to implement the automatic restart within the higher level control.
Following table presents an overview of parameter P1210 and its functionality.

P1210	ON command always active				ON command enabled during Power Off	
	Blackout F0003	Brownout F0003	All other faults with power cycle	All other faults without power cycle	All other faults with power cycle	No faults by power off
0	No Fault acknowledge No restart	No Fault acknowledge No restart	No Fault acknowledge No restart	No Fault acknowledge No restart	No Fault acknowledge No restart	No Fault acknowledge No restart
1	Fault acknowledge No restart	No Fault acknowledge No restart	Fault acknowledge No restart	No Fault acknowledge No restart	Fault acknowledge No restart	Fault acknowledge No restart
2	Fault acknowledge + Restart	No Fault acknowledge No restart	No Fault acknowledge No restart	No Fault acknowledge No restart	No Fault acknowledge No restart	Fault acknowledge Restart
3	Fault acknowledge + Restart	Fault acknowledge + Restart	Fault acknowledge + Restart	Fault acknowledge + Restart	Fault acknowledge + Restart	Fault acknowledge No restart
4	Fault acknowledge + Restart	Fault acknowledge + Restart	No Fault acknowledge No restart	No Fault acknowledge No restart	No Fault acknowledge No restart	Fault acknowledge No restart
5	Fault acknowledge + Restart	No Fault acknowledge No restart	Fault acknowledge + Restart	No Fault acknowledge No restart	Fault acknowledge + Restart	Fault acknowledge + Restart
6	Fault acknowledge + Restart	Fault acknowledge + Restart	Fault acknowledge + Restart	Fault acknowledge + Restart	Fault acknowledge + Restart	Fault acknowledge + Restart

Flying start must be used in cases where the motor may still be turning (e.g. after a short mains break) or can be driven by the load (P1200).

During automatic restart being active (settings >=2) the BOP display shows "0010".

Note:

The 3-wire control (P0727 = 2, 3) will normally not be used in conjunction with automatic restart. However, if the automatic restart feature will be used, the digital input with setting 1 (STOP) resp. setting 2 (OFF1/HOLD) must be re-set and set again for motor start.

P1215	Holding brake enable	Datatype: U16	Unit: -	Min: 0	Level 3
	CStat: T	Active: first confirm	QuickComm.: No	Def: 0	
	P-Group: FUNC			Max: 1	

Enables/disables holding brake function.

The mechanical motor holding brake (MHB) is controlled via the signal of status word 1 r0052 Bit12 "motor holding brake active". This signal can be issued via:

- digital output (e.g. DOUT 0: ==> P0731 = 14)
- status word of the serial interface (e.g. USS)

In firmware version 1.0 the signal of status word 1 r0052 Bit12 "motor holding brake active" will be set when the holding brake release delay time P1216 has been passed.

ON / OFF1/OFF3:

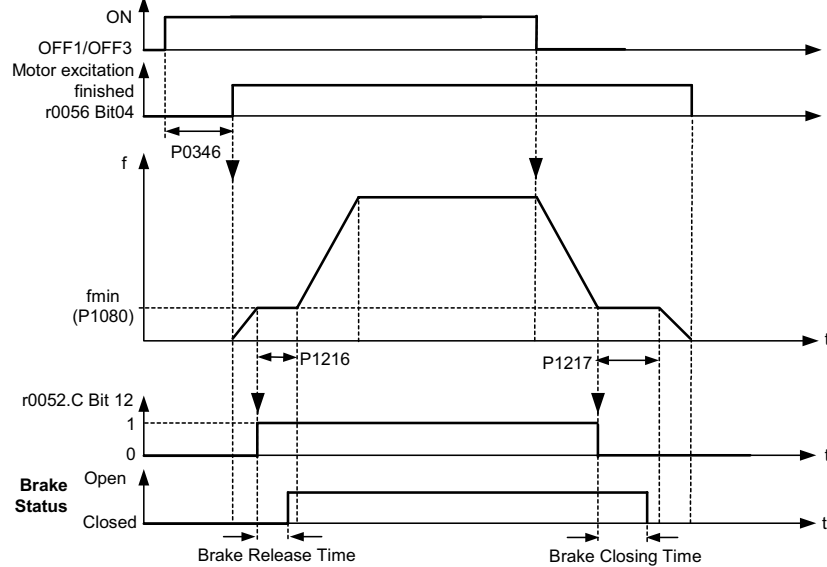

ON/OFF2:

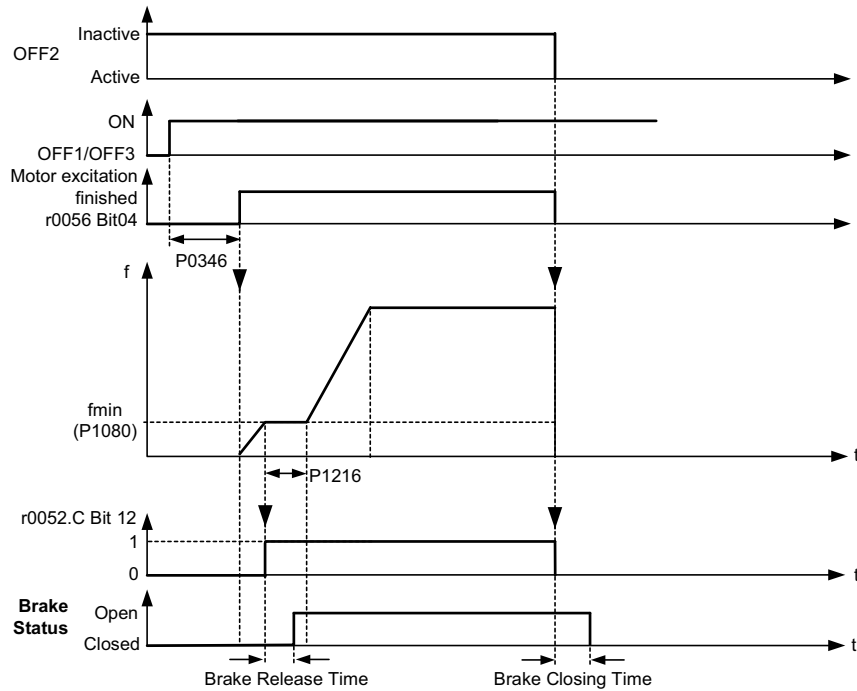

Possible Settings:

- 0 Motor holding brake disabled
- 1 Motor holding brake enabled

**Caution:**

It is not permissible to use the motor holding brake as working brake, as it is generally only designed for a limited number of emergency braking operations.

If the inverter controls the Motor Holding Brake, then series commissioning, for example, by using the cloning mode of BOP or parameter download with Starter commissioning tool, must not be carried-out for potentially hazardous loads such as suspended loads for crane applications, unless the load has been secured. Potentially hazardous loads can be secured as follows before series commissioning is started:

-lower the load to the floor or

-clamp the load using the motor holding brake. Before and during series commissioning, the motor holding brake may not be activated by the inverter.

Note:

A typical value of min. frequency P1080 for motor holding brake is the slip frequency of the motor r0330.

Note for P0727=1, 2, 3 : When the Motor Holding Brake is enabled (P1215=1) the drive will ramp down to f_{min} following an OFF1/OFF3 command. The sign of f_{min} depends on the last setpoint selected.

The Motor Holding Brake cannot be used in combination with Flying Start P1200.

P1216	Holding brake release delay	Min: 0.0	Level 3	
	CStat: T	Datatype: Float		Unit: s
	P-Group: FUNC	Active: first confirm		QuickComm.: No
	Def: 1.0	Max: 20.0		

Defines period during which inverter runs at min. frequency P1080 before ramping up (as shown in P1215 - holding brake enable). Inverter starts at min. frequency P1080 on this profile.

Note:

A typical value of min. frequency P1080 for this type of application is the slip frequency of the motor.

You can calculate the rated slip frequency by using the following formula:

$$f_{slip}[\text{Hz}] = \frac{r0330}{100} \cdot P0310 = \frac{n_{syn} - n_n}{n_{syn}} \cdot f_n$$

Details:

See diagram P1215 (holding brake enable).

P1217	Holding time after ramp down	Min: 0.0	Level 3	
	CStat: T	Datatype: Float		Unit: s
	P-Group: FUNC	Active: first confirm		QuickComm.: No
	Def: 1.0	Max: 20.0		

Defines time for which inverter runs at minimum frequency (P1080) after ramping down.

Details:

See diagram P1215 (holding brake enable).

Caution:

If P1217 is still active and an ON command is present, P1216 will be ignored and the motor could run against the closed brake !!

P1232	DC braking current	Datatype: U16	Unit: %	Min: 0	Level 3
	CStat: CUT	Active: Immediately	QuickComm.: No	Def: 100	
	P-Group: FUNC			Max: 250	

Defines level of DC current in [%] relative to rated motor current (P0305).

$$r0027_{DC-Brake} [A] \approx \frac{1}{\sqrt{2}} \cdot P0305 \cdot \frac{P1232}{100\%}$$

The current of the DC-braking is limited by r0067.

The DC Brake (DC Injection Brake) can be issued observing the following dependencies:

- OFF1 or OFF3 ==> see P1233
- DIN or USS ==> see below

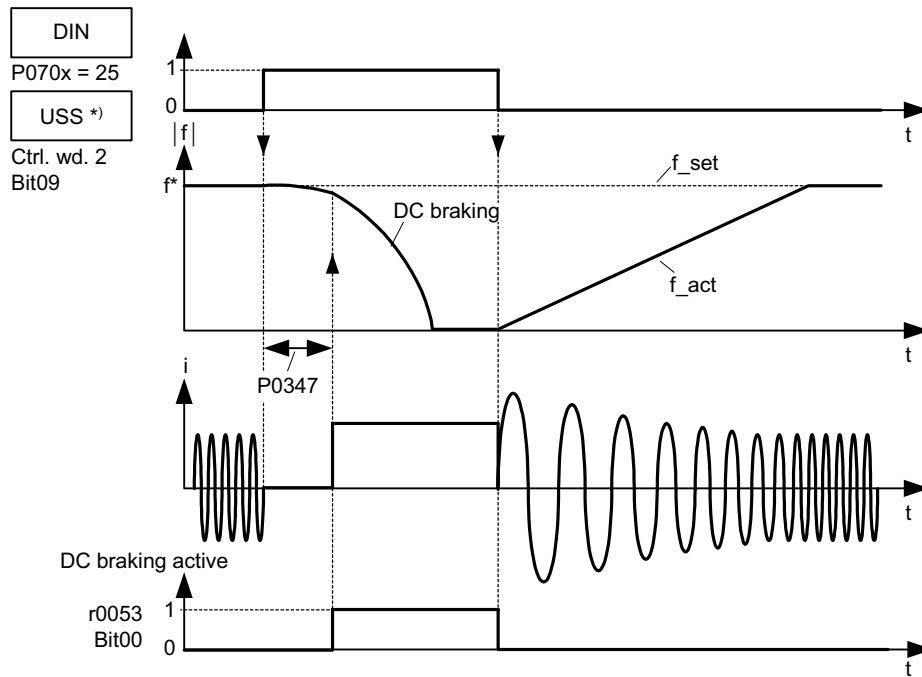

Note: DC brake can be applied in drive states r0002 = 1, 4, 5

*) SINAMICS G110 CPM110 USS only

P1233	Duration of DC braking	Datatype: U16	Unit: s	Min: 0	Level 3
	CStat: CUT	Active: Immediately	QuickComm.: No	Def: 0	
	P-Group: FUNC			Max: 250	

Defines duration for which DC injection braking is to be active following an OFF1 or OFF3 command. When an OFF1 or OFF3 command is received by the drive, the output frequency starts to ramp to 0 Hz. When the output frequency reaches the value set in P1234, the inverter pulses are inhibited for the duration of the demagnetizing time P0347. Then the drive injects a DC braking current P1232 for the time duration set in P1233.

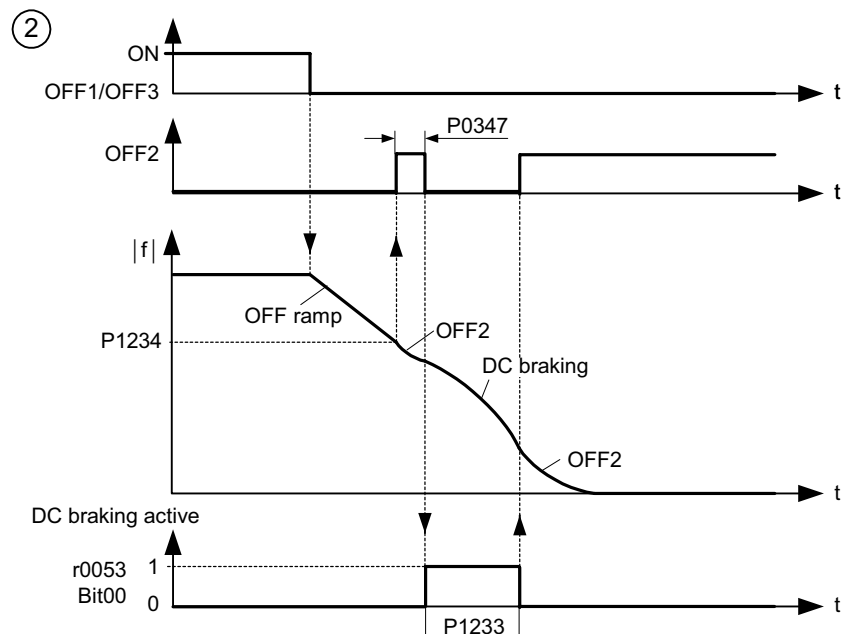
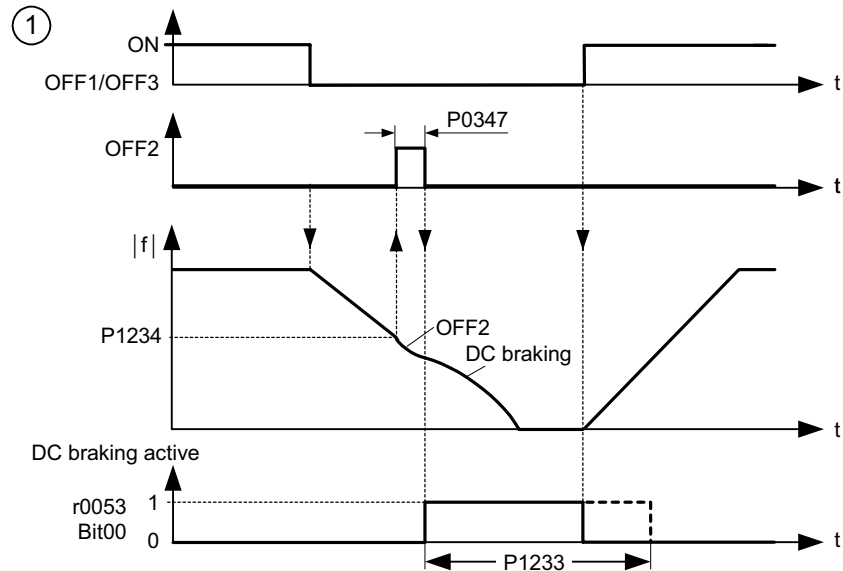

Parameter P1232 still controls the level of DC injection.

Value:

P1233 = 0 :
Not active.

P1233 = 1 - 250 :
Active for the specified duration.



Caution:

With the DC braking, the kinetic energy of the motor is converted into heat in the motor. The drive could overheat if the motor remains in this status for an excessive period of time !

Notice:

The DC braking function causes the motor to stop rapidly by applying a DC braking current. During DC braking being active the BOP display shows "dc".

P1234	DC braking start frequency	Min: 0.00	Level 2	
	CStat: CUT	Datatype: Float		Unit: Hz
	P-Group: FUNC	Active: Immediately		QuickComm.: No

Sets start frequency for DC braking.

When an OFF1 or OFF3 command is received by the drive, the output frequency starts to ramp to 0 Hz. When the output frequency reaches the value set in start frequency of DC braking P1234, the inverter pulses are inhibited for the duration of the de-magnetizing time P0347. Then the drive injects a DC braking current P1232 for the time duration set in P1233.

Details:

See P1232 (DC braking current) and P1233 (duration of DC braking)

P1236	Compound braking current	Min: 0	Level 3	
	CStat: CUT	Datatype: U16		Unit: %
	P-Group: FUNC	Active: Immediately		QuickComm.: No

Defines DC level superimposed on AC waveform after exceeding DC-link voltage threshold of compound braking. The value is entered in [%] relative to rated motor current (P0305).

Compound braking switch-on level : $V_{DC_Comp} = 380,6\text{ V}$

The Compound Brake is an overlay of the DC brake function with regenerative braking (effective braking at the ramp) after OFF1 or OFF3. This enables braking with controlled motor frequency and a minimum of energy returned to the motor. Through optimization of the ramp-down time and the compound braking an efficient braking without additional HW components is possible.

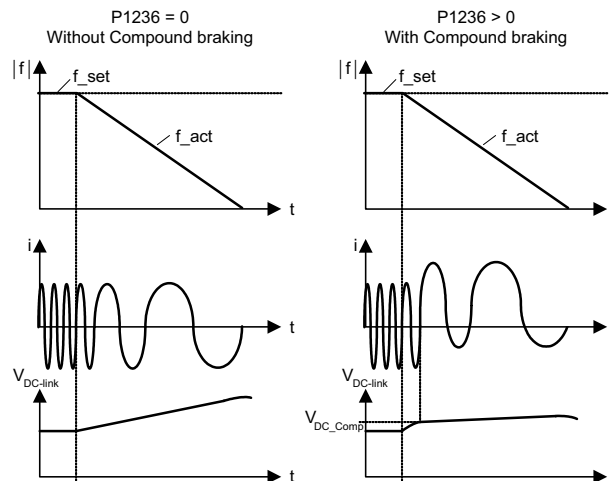

Value:

P1236 = 0 :
Compound braking disabled.

P1236 = 1 - 250 :
Level of DC braking current defined as a [%] of rated motor current (P0305).

Dependency:

Compound braking depends on the DC link voltage only.

It is disabled, when:

- DC braking is active
- Flying start is active

Notice:

Increasing the value will generally improve braking performance; however, if you set the value too high, an overcurrent trip may result.

If used with the Vdc max controller enabled the drive behaviour whilst braking may be worsened particularly with high values of compound braking.

P1240	Configuration of Vdc controller				Min: 0	Level 3
	CStat: CT	Datatype: U16	Unit: -	Def: 1		
	P-Group: FUNC	Active: Immediately	QuickComm.: No	Max: 1		

Enables / disables Vdc controller.

The Vdc controller dynamically controls the DC link voltage to prevent overvoltage trips on high inertia systems.

Possible Settings:

- 0 Vdc controller disabled
- 1 Vdc-max controller enabled

Note:

Vdc max controller automatically increases ramp-down times to keep the DC-link voltage (r0026) within limits.

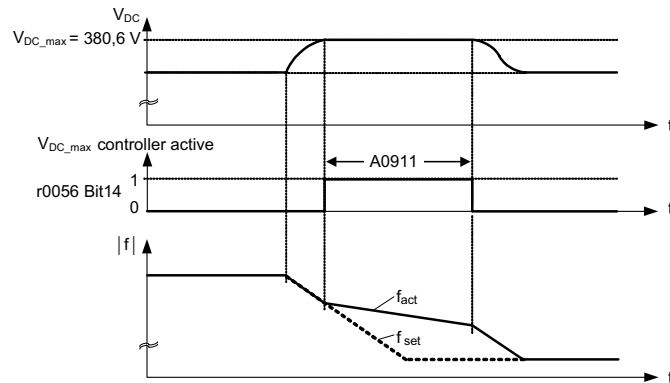

P1300	Control mode	Min: 0	Level 2	
	CStat: CT	Datatype: U16		Def: 0
	P-Group: CONTROL	Active: first confirm		QuickComm.: Yes Max: 3

Controls relationship between speed of motor and voltage supplied by inverter as illustrated in the diagram below.

Possible Settings:

- 0 V/f with linear characteristic
- 2 V/f with quadratic characteristic
- 3 V/f with programmable characteristic

Note:

P1300 = 0	Linear characteristic	Standard	
P1300 = 2	Quadratic characteristic	Characteristics which cover the torque properties of the production machine (for example, pumps and fans). a) The voltage to frequency relationship suited for variable torque applications such as some pumps and fans. b) By utilizing lower voltages at lower output frequencies there can be significant energy savings.	
P1300 = 3	Programmable characteristic	The freely programmable characteristics enables the best V to f relationship to be selected the motor or production machine.	

The following table presents an overview of control parameters (V/f) that can be modified in relationship to P1300 dependencies:

ParNo.	Parameter name	Level	V/f		
			P1300 =		
			0	2	3
P1300	Control mode	2	x	x	x
P1310	Continuous boost	2	x	x	x
P1311	Acceleration boost	2	x	x	x
P1312	Starting boost	2	x	x	x
P1316	Boost end frequency	3	x	x	x
P1320	Programmable V/f freq. coord. 1	3	-	-	x
P1321	Programmable V/f volt. coord. 1	3	-	-	x
P1322	Programmable V/f freq. coord. 2	3	-	-	x
P1323	Programmable V/f volt. coord. 2	3	-	-	x
P1324	Programmable V/f freq. coord. 3	3	-	-	x
P1325	Programmable V/f volt. coord. 3	3	-	-	x
P1335	Slip compensation	2	x	x	x

P1310	Continuous boost			Min: 0.0	Level 2
	CStat: CUT	Datatype: Float	Unit: %	Def: 50.0	
	P-Group: CONTROL	Active: Immediately	QuickComm.: No	Max: 250.0	

At low output frequencies the output voltage is low to keep the flux level constant. However, the output voltage may be too low

- for magnetization the asynchronous motor
- to hold the load
- to overcome losses in the system. The output voltage can be increased using parameter P1310.

The inverter output voltage can be increased via P1310 for the compensation of losses, hold loads at 0 Hz or maintain the magnetization.

Defines boost level in [%] relative to P0305 (rated motor current) applicable to both linear and quadratic V/f curves according to the diagram below:

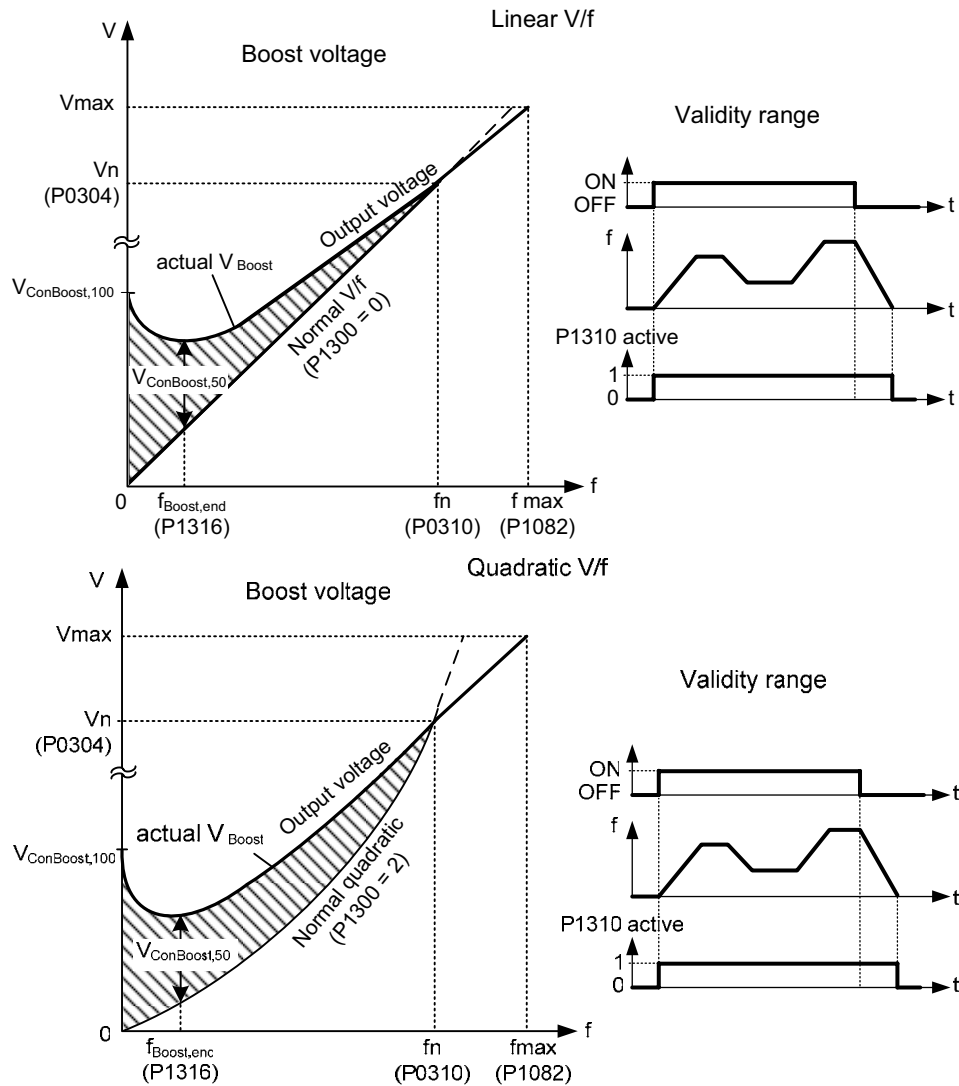

where voltage values are given

$$V_{ConBoost,100} = P0305 \cdot P0350 \cdot \frac{P1310}{100}$$

$$V_{ConBoost,50} = \frac{V_{ConBoost,100}}{2}$$

Note:

Increasing the boost levels increases motor heating (especially at standstill).

The boost values are combined when continuous boost (P1310) used in conjunction with other boost parameters (acceleration boost P1311 and starting boost P1312).

However priorities are allocated to these parameters as follows:
 P1310 > P1311 > P1312

The total boost is limited by following equation:

$$\sum V_{Boost} \leq 3 \cdot R_s \cdot I_{Mot} = 3 \cdot P0305 \cdot P0350$$

Setting in P0640 (motor overload factor [%]) limits the boost:

$$\frac{\sum V_{Boost}}{P0305 \cdot P0350} \leq \frac{P0640}{100}$$

P1311	Acceleration boost	Min: 0.0	Level 3	
	CStat: CUT	Datatype: Float		Unit: %
	P-Group: CONTROL	Active: Immediately		QuickComm.: No
		Def: 0.0		
		Max: 250.0		

P1311 will only produce boost during ramping, and is therefore useful for additional torque during acceleration and deceleration. As opposed to parameter P1312, which is only active on the first acceleration issued after the ON command, parameter P1311 is always effect during an acceleration and deceleration when issued, if the condition below is not violated.

Applies boost in [%] relative to P0305 (rated motor current) following a positive setpoint change and drops back out once the setpoint is reached.

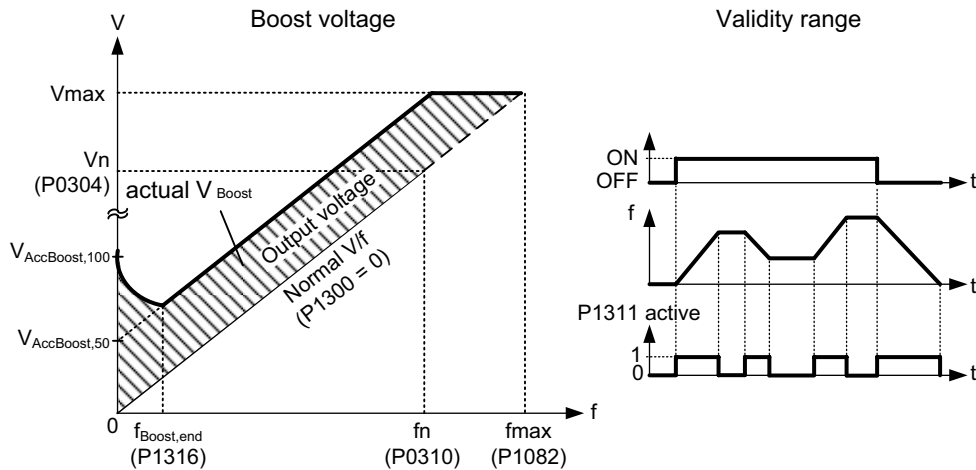

where voltage values are given

$$V_{AccBoost,100} = P0305 \cdot P0350 \cdot \frac{P1311}{100}$$

$$V_{AccBoost,50} = \frac{V_{AccBoost,100}}{2}$$

Note:

See parameter P1310

P1312	Starting boost			Min: 0.0	Level 2
	CStat: CUT	Datatype: Float	Unit: %	Def: 0.0	
	P-Group: CONTROL	Active: Immediately	QuickComm.: No	Max: 250.0	

Applies a constant linear offset (in [%] relative to P0305 (rated motor current)) to active V/f curve (either linear or quadratic) after an ON command and is active until
 1) ramp output reaches setpoint for the first time respectively
 2) setpoint is reduced to less than present ramp output

This is useful for starting loads with high inertia.

Setting the starting boost (P1312) too high will cause the inverter to limit the current, which will in turn restrict the output frequency to below the setpoint frequency.

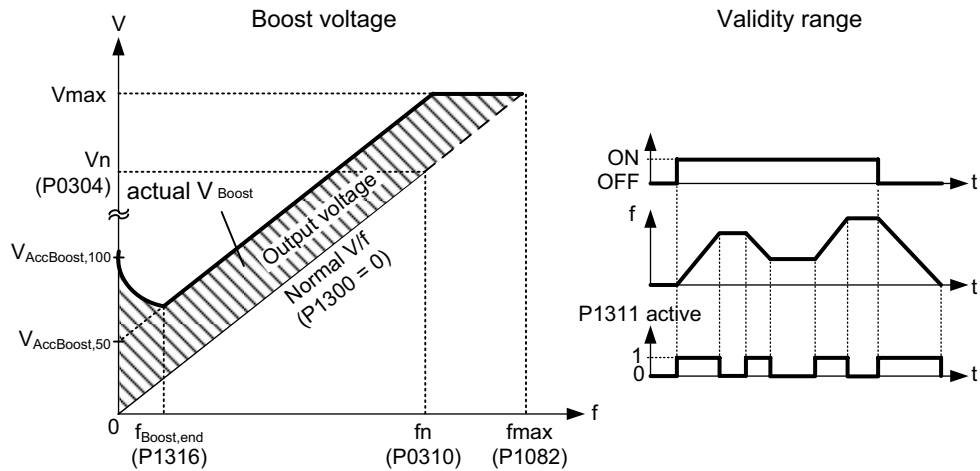

where voltage values are given

$$V_{\text{StartBoost},100} = P0305 \cdot P0350 \cdot \frac{P1312}{100}$$

$$V_{\text{StartBoost},50} = \frac{V_{\text{StartBoost},100}}{2}$$

Example:

Setpoint = 50Hz. Ramping up with starting boost. During ramp up, setpoint changed to 20Hz. As soon as setpoint changed, starting boost removed because setpoint smaller than present ramp output.

Note:

See parameter P1310

P1316	Boost end frequency			Min: 0.0	Level 3
	CStat: CUT	Datatype: Float	Unit: %	Def: 20.0	
	P-Group: CONTROL	Active: Immediately	QuickComm.: No	Max: 100.0	

Defines point at which programmed boost reaches 50 % of its value. This value is expressed in [%] relative to P0310 (rated motor frequency).

The default frequency is defined as follows:

$$f_{\text{Boost min}} = 2 \cdot \left(\frac{153}{\sqrt{P_{\text{motor}}}} + 3 \right)$$

Note:

- The expert user may change this value to alter the shape of the curve, e.g. to increase torque at a particular frequency.
- Default value is depending on inverter type and its rating data.

Details:

See diagram in P1310 (continuous boost).

P1320	Programmable V/f freq. coord. 1				Min: 0.00	Level 3
	CStat: CT	Datatype: Float	Unit: Hz	Def: 0.00		
	P-Group: CONTROL	Active: Immediately	QuickComm.: No	Max: 650.00		

Sets V/f coordinates (P1320/1321 to P1324/1325) to define V/f characteristic.

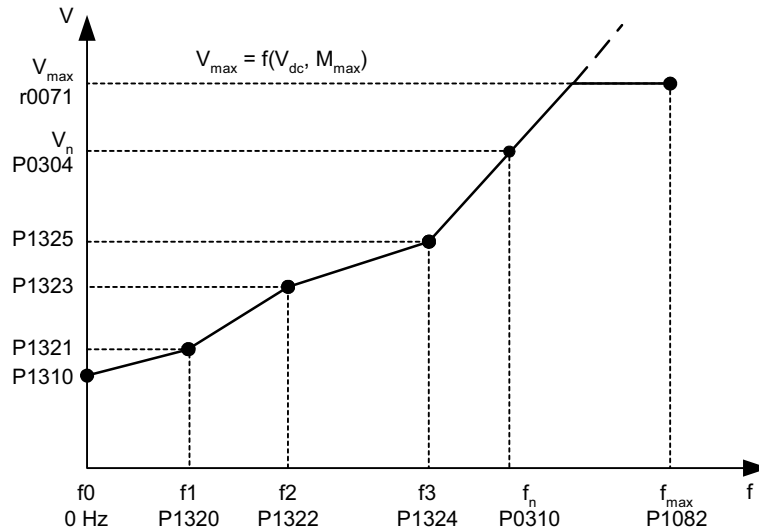

$$P1310[V] = \frac{P1310[\%]}{100[\%]} \cdot P0350 \cdot \sqrt{3} \cdot P0305$$

Dependency:

To set parameter, select P1300 = 3 (V/f with programmable characteristic).

Note:

Linear interpolation will be applied between the individual data points.

V/f with programmable characteristic (P1300 = 3) has 3 programmable points. The two non-programmable points are:

- Continuous boost P1310 at zero 0 Hz
- Rated motor voltage P0304 at rated motor frequency P0310

The acceleration boost and starting boost defined in P1311 and P1312 are applied to V/f with programmable characteristic.

P1321	Programmable V/f volt. coord. 1				Min: 0.0	Level 3
	CStat: CUT	Datatype: Float	Unit: V	Def: 0.0		
	P-Group: CONTROL	Active: Immediately	QuickComm.: No	Max: 3000.0		

See P1320 (programmable V/f freq. coord. 1).

P1322	Programmable V/f freq. coord. 2				Min: 0.00	Level 3
	CStat: CT	Datatype: Float	Unit: Hz	Def: 0.00		
	P-Group: CONTROL	Active: Immediately	QuickComm.: No	Max: 650.00		

See P1320 (programmable V/f freq. coord. 1).

P1323	Programmable V/f volt. coord. 2				Min: 0.0	Level 3
	CStat: CUT	Datatype: Float	Unit: V	Def: 0.0		
	P-Group: CONTROL	Active: Immediately	QuickComm.: No	Max: 3000.0		

See P1320 (programmable V/f freq. coord. 1).

P1324	Programmable V/f freq. coord. 3				Min: 0.00	Level 3
	CStat: CT	Datatype: Float	Unit: Hz	Def: 0.00		
	P-Group: CONTROL	Active: Immediately	QuickComm.: No	Max: 650.00		

See P1320 (programmable V/f freq. coord. 1).

P1325	Programmable V/f volt. coord. 3				Min: 0.0	Level 3
	CStat: CUT	Datatype: Float	Unit: V	Def: 0.0		
	P-Group: CONTROL	Active: Immediately	QuickComm.: No	Max: 3000.0		

See P1320 (programmable V/f freq. coord. 1).

P1334	Slip compens. activation range				Min: 1.0	Level 3
	CStat: CUT	Datatype: Float	Unit: %	Def: 6.0		
	P-Group: CONTROL	Active: Immediately	QuickComm.: No	Max: 20.0		

To set the frequency activation range for slip compensation. The percentage value of P1334 refers to the motor rated frequency P0310. The upper threshold will always stay 4% above P1334.

Notice:

Use: more flexible approach to critical applications that need a slip compensation also at lower frequencies (e.g. start under load with small values of r0021).

Range of slip compensation :

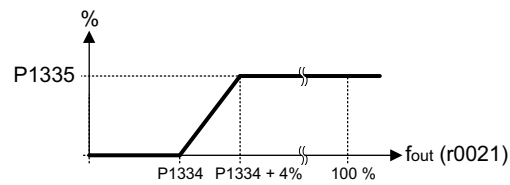

Note: the starting point for the slip compensation is $P1334 \times P0310$

P1335	Slip compensation			Min: 0.0	Level 3
	CStat: CUT	Datatype: Float	Unit: %	Def: 0.0	
	P-Group: CONTROL	Active: Immediately	QuickComm.: No	Max: 600.0	

Dynamically adjusts output frequency of inverter so that motor speed is kept constant independent of motor load.

In the V/f-control, the motor speed will always be less than the command speed due to the slip speed. For a given speed command, the speed will drop as load is increased. The speed regulation of drive can be improved by the technique known as slip compensation.

Increasing the load from M1 to M2 (see diagram) will decrease the motor speed from f1 to f2, due to the slip. The inverter can compensate for this by increasing the output frequency slightly as the load increases. An increase of the output frequency from f_out_M1 to f_out_M2 will result in a motor speed at f1 for load M2. The inverter measures the current and increases the output frequency to compensate for the expected slip. P1335 can be used to enable and fine-tune the slip compensation.

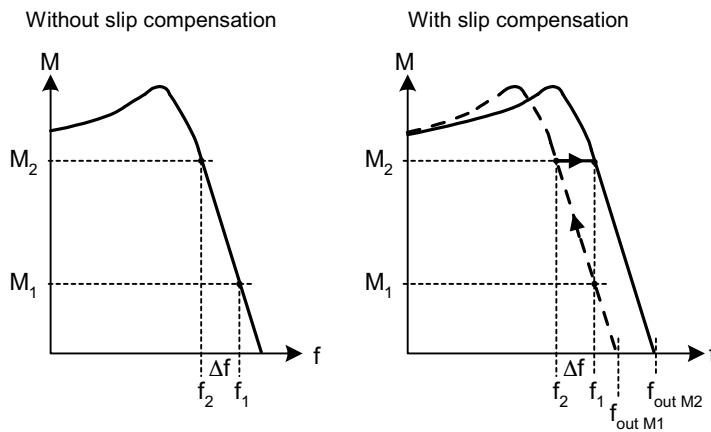

Value:

P1335 = 0 % :
Slip compensation disabled.

P1335 = 50 % - 70 % :
Full slip compensation at cold motor (partial load).

P1335 = 100 % :
Full slip compensation at warm motor (full load).

Range of slip compensation :

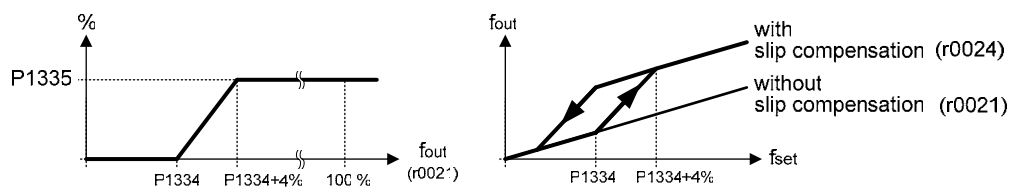

Notice:

The internal starting frequency f_{slip_start} will be calculated as follows:

$$f_{slip_start} = P1334 \times P0310$$

The applied value of the slip compensation (scaled by P1335) is limited by following equation:

$$f_{slip_comp\ max} = 2,5 \times r0330$$

P1340	I_{max} controller prop. gain	Min: 0.000	Level 3	
	CStat: CUT	Datatype: Float		Unit: -
	P-Group: CONTROL	Active: Immediately		QuickComm.: No

Proportional gain of the I_{max} controller.

Dynamically controls the inverter if the output current exceeds the maximum motor current (r0067). It does this by first limiting the inverter output frequency (to a possible minimum of the nominal slip frequency). If this action does not successfully remove the overcurrent condition, the inverter output voltage is reduced. When the overcurrent condition has been removed successfully, frequency limiting is removed using the ramp-up time set in P1120.

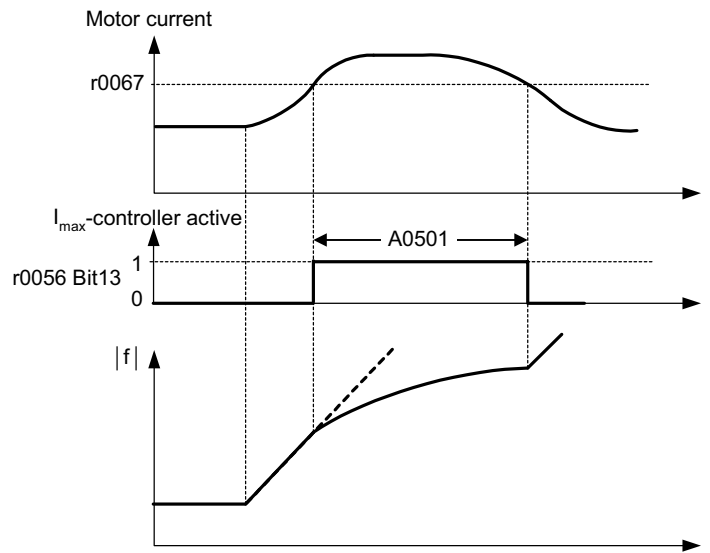

P1800	Pulse frequency	Min: 2	Level 3	
	CStat: CUT	Datatype: U16		Unit: kHz
	P-Group: INVERTER	Active: Immediately		QuickComm.: No

Sets pulse frequency of power switches in inverter. The frequency can be changed in steps of 2 kHz.

Dependency:

Minimum pulse frequency depends on P1082 (maximum frequency) and P0310 (rated motor frequency).

The maximal frequency P1082 is limited to pulse frequency P1800 (see P1082).

Note:

If the pulse frequency is increased, max. inverter current r0209 can be reduced (derating). The derating characteristic depends on the type and power of the inverter (see OPERATING INSTRUCTIONS).

If silent operation is not absolutely necessary, lower pulse frequencies may be selected to reduce inverter losses and radio-frequency emissions.

r1801	CO: Act. pulse frequency	Min: -	Level 3	
		Datatype: U16		Unit: kHz
	P-Group: INVERTER	Active: -		QuickComm.: -

Actual pulse frequency of power switches in inverter.

Notice:

Under certain conditions, the inverter changes the switching frequency from the value selected in P1800. At start-up, the pulse frequency is set to the minimum value; below an operating frequency of 2 Hz, the pulse frequency is halved.

P2000	Reference frequency	Min: 1.00	Level 3	
	CStat: CT	Datatype: Float		Unit: Hz
	P-Group: COMM	Active: first confirm		QuickComm.: No
		Def: 50.00		
		Max: 650.00		

Parameter P2000 represents the reference frequency for frequency values which are displayed/transferred as a percentage or a hexadecimal value. Where:

- hexadecimal 4000 H ==> P2000 (e.g.: USS-PZD)
- percentage 100 % ==> P2000 (e.g.: ADC)

Example:

The signal of the analog input (ADC) is connected to the frequency setpoint (e.g. P1000 = 2). The actual percentage input value is cyclically converted into the absolute frequency setpoint (in Hz) via the reference frequency P2000.

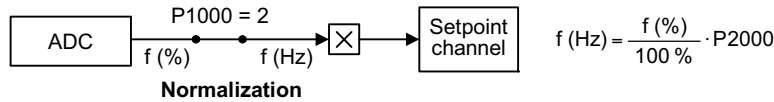

Caution:

Parameter P2000 represents the reference frequency of the above mentioned interfaces. A maximum frequency setpoint of 2*P2000 can be applied via the corresponding interface. Unlike parameter P1082 (Max. Frequency) this limits the inverter frequency internally independent of the reference frequency. By modification of P2000 it will also adapt the parameter to the new settings.

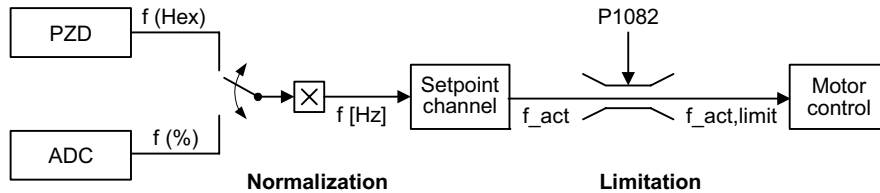

$$f[\text{Hz}] = \frac{f(\text{Hex})}{4000(\text{Hex})} \cdot P2000 = \frac{f(\%)}{100\%} \cdot P2000$$

$$f_{\text{act,limit}} = \min(P1082, f_{\text{act}})$$

Notice:

Reference parameters are intended as an aid to presenting setpoint and actual value signals in a uniform manner. This also applies to fixed settings entered as a percentage. A value of 100 % corresponds to a process data value of 4000H, or 4000 0000H in the case of double values.

P2010	USS baudrate	Min: 3	Level 3	
	CStat: CUT	Datatype: U16		Unit: -
	P-Group: COMM	Active: first confirm		QuickComm.: No
		Def: 6		
		Max: 9		

Sets baud rate for USS communication.

Possible Settings:

- 3 1200 baud
- 4 2400 baud
- 5 4800 baud
- 6 9600 baud
- 7 19200 baud
- 8 38400 baud
- 9 57600 baud

P2011	USS address	Min: 0	Level 3	
	CStat: CUT	Datatype: U16		Unit: -
	P-Group: COMM	Active: first confirm		QuickComm.: No
		Def: 0		
		Max: 31		

Sets unique address for inverter.

Note:

You can connect up to a further 30 inverters via the serial link (i.e. 31 inverters in total) and control them with the USS serial bus protocol.

P2012	USS PZD length			Min: 0	Level 3
	CStat: CUT	Datatype: U16	Unit: -	Def: 2	
	P-Group: COMM	Active: first confirm	QuickComm.: No	Max: 4	

Defines the number of 16-bit words in PZD part of USS telegram.

In this area, process data (PZD) are continually exchanged between the master and slaves. The PZD part of the USS telegram is used for the main setpoint, and to control the inverter.

Notice:

USS protocol consists of PZD and PKW which can be changed by the user via parameters P2012 and P2013 respectively.

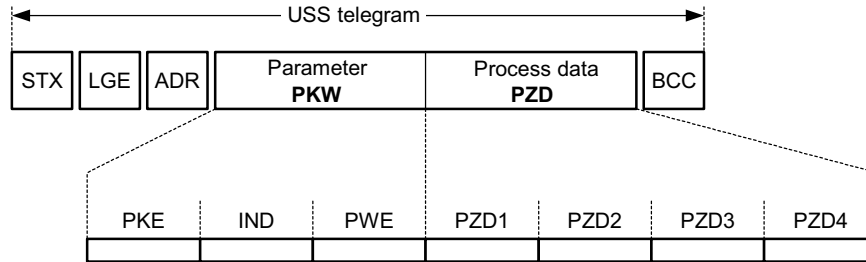

STX	Start of text	PKE	Parameter ID
LGE	Length	IND	Sub-index
ADR	Address	PWE	Parameter value
PKW	Parameter ID value		
PZD	Process data		
BCC	Block check character		

PZD transmits a control word and setpoint or status word and actual values. The number of PZD-words in a USS-telegram are determined by parameter P2012, where the first two words are either:

- control word and main setpoint or
- status data and actual value.

When P2012 is equal to 4 the additional control word is transferred as the 4th PZD-word (default setting).

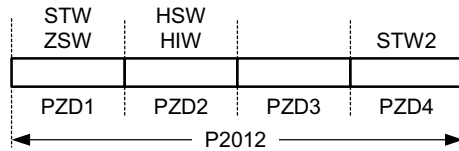

STW	Control word	HSW	Main setpoint
ZSW	Status word	HIW	Main actual value
PZD	Process data		

P2013	USS PKW length			Min: 0	Level 3
	CStat: CUT	Datatype: U16	Unit: -	Def: 127	
	P-Group: COMM	Active: first confirm	QuickComm.: No	Max: 127	

Defines the number of 16-bit words in PKW part of USS telegram. The PKW area can be varied. Depending on the particular requirement, 3-word, 4-word or variable word lengths can be parameterized. The PKW part of the USS telegram is used to read and write individual parameter values.

Possible Settings:

- 0 No words
- 3 3 words
- 4 4 words
- 127 Variable

Example:

	Data type		
	U16 (16 Bit)	U32 (32 Bit)	Float (32 Bit)
P2013 = 3	X	Parameter access fault	Parameter access fault
P2013 = 4	X	X	X
P2013 = 127	X	X	X

Notice:

USS protocol consists of PZD and PKW which can be changed by the user via parameters P2012 and P2013 respectively. Parameter P2013 determines the number of PKW-words in a USS-telegram.

Setting P2013 to 3 or 4 determines the length of the PKW words (3 = three words and 4 = four words). When P2013 set to 127 automatically adjusts the length of the PKW words are required.

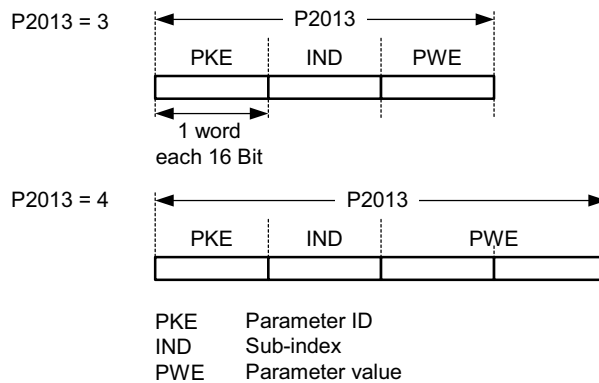

If a fixed PKW length is selected only one parameter value can be transferred. In the case of indexed parameter, you must use the variable PKW length if you wish to have the values of all indices transferred in a single telegram. In selecting the fixed PKW length, it is important to ensure the value in question can be transferred using this PKW length.

P2013 = 3, fixes PKW length, but does not allow access to many parameter values. A parameter fault is generated when an out-of-range value is used, the value will not be accepted but the inverter state will not be affected. Useful for applications where parameters are not changed, but MM3s are also used. Broadcast mode is not possible with this setting.

P2013 = 4, fixes PKW length. Allows access to all parameters, but indexed parameters can only be read one index at a time. Word order for single word values are different to setting 3 or 127, see example below.

P2013 = 127, most useful setting. PKW reply length varies depending on the amount of information needed. Can read fault information and all indices of a parameter with a single telegram with this setting.

Example:

Set P0700 to value 5 (0700 = 2BC (hex))

	P2013 = 3	P2013 = 4	P2013 = 127
Master → SINAMICS	22BC 0000 0005	22BC 0000 0000 0005	22BC 0000 0005 0000
SINAMICS → Master	12BC 0000 0005	12BC 0000 0000 0005	12BC 0000 0005

P2014	USS telegram off time	Min: 0	Level
	CStat: CT	Datatype: U16	Unit: ms
	P-Group: COMM	Active: Immediately	QuickComm.: No
		Def: 0	3
		Max: 65535	

Defines a time T_off after which a fault will be generated (F0070) if no telegram is received via the USS channels.

Notice:

By default (time set to 0), no fault is generated (i.e. watchdog disabled).

r2018[4]	CO: PZD from USS	Min: -	Level
	Datatype: U16	Unit: -	3
	P-Group: COMM	Def: -	Max: -

Displays process data received via USS interface.

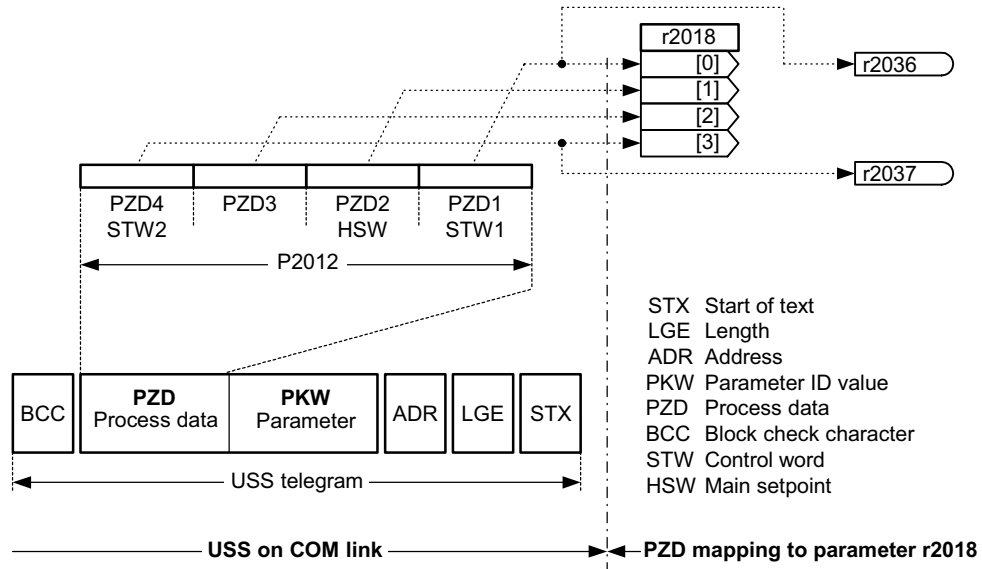

Index:

- r2018[0] : Received word 0
- r2018[1] : Received word 1
- r2018[2] : Received word 2
- r2018[3] : Received word 3

Note:

The control words can be viewed as bit parameters r2036 and r2037.

Restrictions:

- If the above serial interface controls the inverter (P0700 or P0719) then the 1st control word must be transferred in the 1st PZD-word.
- If the setpoint source is selected via P1000 or P0719, then the main setpoint must be transferred in the 2nd PZD-word,
- When P2012 is equal to 4 the additional control word (2nd control word) must transferred in the 4th PZD-word, if the above serial interface controls the inverter (P0700 or P0719).

r2024	USS error-free telegrams	Min: -	Level
	Datatype: U16	Unit: -	3
	P-Group: COMM	Def: -	Max: -

Displays number of error-free USS telegrams received.

r2025	USS rejected telegrams	Min: -	Level
	Datatype: U16	Unit: -	3
	P-Group: COMM	Def: -	Max: -

Displays number of USS telegrams rejected.

r2026	USS character frame error	Min: -	Level
	Datatype: U16	Unit: -	3
	P-Group: COMM	Def: -	Max: -

Displays number of USS character frame errors.

r2027	USS overrun error	Min: -	Level
	Datatype: U16	Unit: -	3
	P-Group: COMM	Def: -	Max: -

Displays number of USS telegrams with overrun error.

r2028	USS parity error	Datatype: U16	Unit: -	Min: - Def: - Max: -	Level 3
	P-Group: COMM				
	Displays number of USS telegrams with parity error.				
r2029	USS start not identified	Datatype: U16	Unit: -	Min: - Def: - Max: -	Level 3
	P-Group: COMM				
	Displays number of USS telegrams with unidentified start.				
r2030	USS BCC error	Datatype: U16	Unit: -	Min: - Def: - Max: -	Level 3
	P-Group: COMM				
	Displays number of USS telegrams with BCC error.				
r2031	USS length error	Datatype: U16	Unit: -	Min: - Def: - Max: -	Level 3
	P-Group: COMM				
	Displays number of USS telegrams with incorrect length.				
r2036	BO: CtrlWrd1 from USS	Datatype: U16	Unit: -	Min: - Def: - Max: -	Level 3
	P-Group: COMM				
	Displays control word 1 from USS (i.e. word 1 within USS = PZD1).				
	Bitfields:				
	Bit00	ON/OFF1	0 NO	1 YES	
	Bit01	OFF2: Electrical stop	0 YES	1 NO	
	Bit02	OFF3: Fast stop	0 YES	1 NO	
	Bit03	Pulse enable	0 NO	1 YES	
	Bit04	RFG enable	0 NO	1 YES	
	Bit05	RFG start	0 NO	1 YES	
	Bit06	Setpoint enable	0 NO	1 YES	
	Bit07	Fault acknowledge	0 NO	1 YES	
	Bit08	JOG right	0 NO	1 YES	
	Bit09	JOG left	0 NO	1 YES	
	Bit10	Control from PLC	0 NO	1 YES	
	Bit11	Reverse (setpoint inversion)	0 NO	1 YES	
	Bit13	Motor potentiometer MOP up	0 NO	1 YES	
	Bit14	Motor potentiometer MOP down	0 NO	1 YES	
	Bit15	Local/Remote	0 NO	1 YES	
	Dependency:				
	See parameter P2012				
	Note:				
	Sets control word r0054, if USS is selected as command source (see P0700).				
	To activate the bit Local/Remote we have to set parameter P0810.				
	Details:				
	The 7-segment display of the bit-parameters (binary parameters) is explained in the Introduction of the Parameter List.				
r2037	BO: CtrlWrd2 from USS	Datatype: U16	Unit: -	Min: - Def: - Max: -	Level 3
	P-Group: COMM				
	Displays control word 2 from USS (i.e. word 4 within USS = PZD4).				
	Bitfields:				
	Bit00	Fixed frequency Bit 0	0 NO	1 YES	
	Bit01	Fixed frequency Bit 1	0 NO	1 YES	
	Bit02	Fixed frequency Bit 2	0 NO	1 YES	
	Bit09	Enable DC brake	0 NO	1 YES	
	Bit13	External fault 1	0 YES	1 NO	
	Dependency:				
	See parameter P2012				
	Note:				
	Sets control word r0055, if USS is selected as command source (see P0700).				
	To enable the external fault (r2037 Bit 13) facility via USS, the following parameters must be set:				
	- P2012 = 4				
	- P2106 = 1				
	Details:				
	The 7-segment display of the bit-parameters (binary parameters) is explained in the Introduction of the Parameter List.				

P2106	External fault via USS	Min: 0	Level 3	
	CStat: CUT	Datatype: U16		Unit: -
	P-Group: COMMANDS	Active: first confirm		QuickComm.: No

External fault from USS Link (r2037 Bit13)

Possible Settings:

0 Disable
1 Enable

Dependency:

External fault from USS Link if PZD length is larger than 3 (P2012 > 3).

Note:

The source of external fault can be from digital input or from USS link.

r2110[4]	Warning number	Min: -	Level 3
	Datatype: U16	Unit: -	
	P-Group: ALARMS	Def: -	

Displays warning information.

A maximum of 2 active warnings (indices 0 and 1) and 2 historical warnings (indices 2 and 3) may be viewed.

Index:

r2110[0] : Recent Warnings --, warning 1
r2110[1] : Recent Warnings --, warning 2
r2110[2] : Recent Warnings -1, warning 3
r2110[3] : Recent Warnings -1, warning 4

Note:

- Indices 0 and 1 are not stored.
- The keypad will flash while a warning is active. The LED indicates the warning status in this case.

r2114[2]	Run time counter	Min: -	Level 3
	Datatype: U16	Unit: -	
	P-Group: ALARMS	Def: -	

Displays run time counter.

It is the total time the drive has been powered up. When power goes value is saved, then restored on power up. The run time counter r2114 will be calculate as followed:

- Multiply the value in r2114[0], by 65536 and then add it to the value in r2114[1] (Total power up time = 65536 * r2114[0] + r2114[1] seconds).
- The resultant answer will be in seconds.

Index:

r2114[0] : System Time, Seconds, Upper Word
r2114[1] : System Time, Seconds, Lower Word

Example:

If r2114[0] = 1 & r2114[1] = 20864
We get 1 * 65536 + 20864 = 86400 seconds which equals 1 day.

P2167	Switch-off frequency f_off	Min: 0.00	Level 3	
	CStat: CUT	Datatype: Float		Unit: Hz
	P-Group: ALARMS	Active: Immediately		QuickComm.: No

Defines the threshold of the monitoring function $|f_{act}| > P2167 (f_{off})$.

P2167 influences following functions:

- If the actual frequency falls below this threshold and the time delay has expired, bit 1 in status word 2 (r0053) is reset.
- If a OFF1 or OFF3 was applied and bit 1 is reset the inverter will disable the pulse (OFF2).

Restriction:

- The monitoring function $|f_{act}| > P2167 (f_{off})$ is not updated and pulses are not inhibited, if motor holding brake (MHB, P1215 = 1) is enabled.

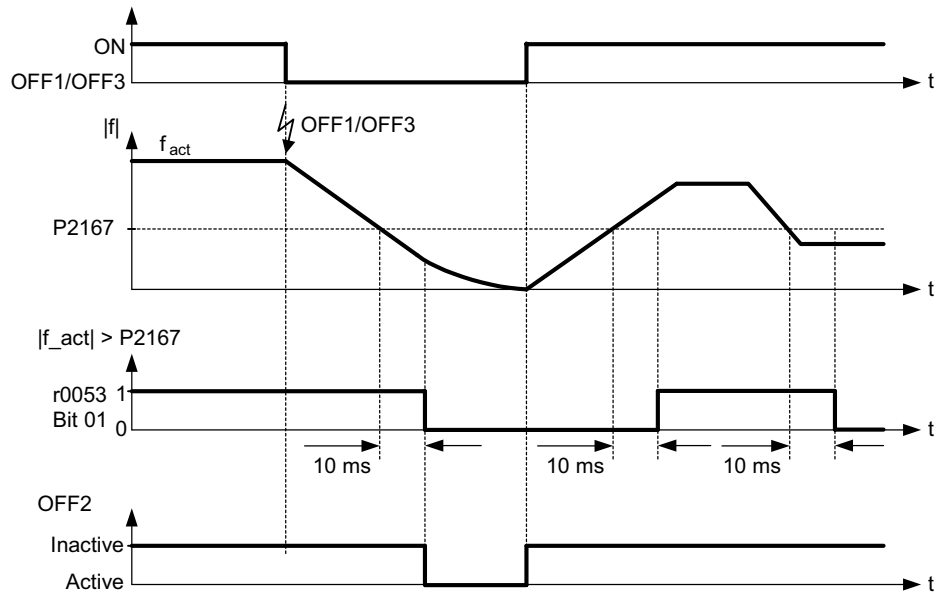

P2172	Threshold DC-link voltage	Min: 0	Level
	CStat: CUT	Datatype: U16	Def: 0
	P-Group: ALARMS	Active: Immediately	QuickComm.: No
			3

Defines the DC link voltage threshold below which the drive automatically performs an OFF3. A drive switch-off (emergency stop) can be activated for the case of mains failure (browns out or black out). The drive is controlled to zero Hz and a coast-to-stop can be prevented. The OFF3 ramp (see P1335) needs to be set accordingly. The emergency stop is disabled when P2172 = 0.

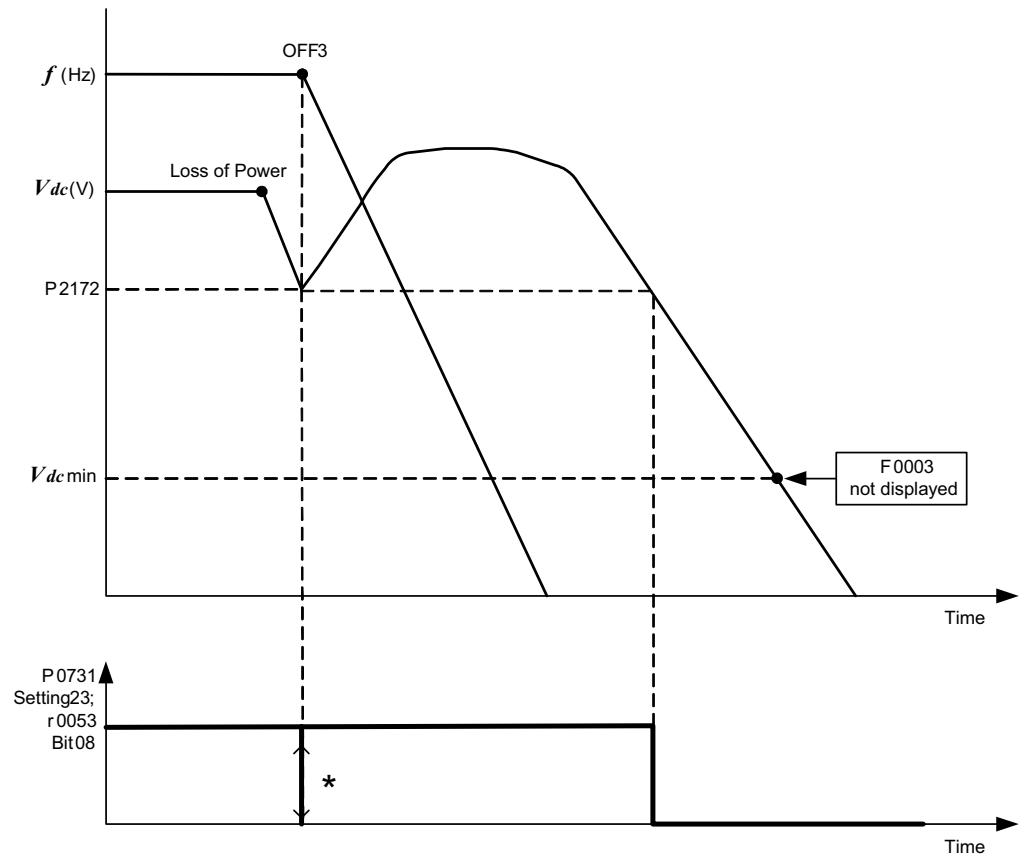

* Signal edge recognition required for monitor function with the digital output

Note:

This voltage controls bits 7 and 8 in status word 2 (r0053). The V_{dc} controller dynamically controls the DC link voltage to prevent overvoltage trips on high inertia systems during regenerative braking. By default this function is enabled (see P1240) and may attempt to

extend the ramp-down time set in P1135 to prevent an overvoltage trip. If the OFF3 ramp-down time P1135 is set too short, F0002 (overvoltage) can occur even with the V_{dc} controller being enabled. If the threshold level in P2172 is set too high, then any voltage fluctuation or sudden load change will cause an OFF3 command.

If the threshold level in P2172 is set too low, it is possible that there will be insufficient energy within the DC link capacitors to allow the inverter to slow the motor to 0 Hz in a controlled manner. As a consequence F0003 (undervoltage) will be displayed.

To adjust P2172 it is recommended to observe r0026 under load condition. P2172 must be set lower than this value.

P3900	End of quick commissioning				Min: 0	Level 1
	CStat: C	Datatype: U16	Unit: -	Def: 0		
	P-Group: QUICK	Active: first confirm	QuickComm.: Yes	Max: 3		

Performs calculations necessary for optimized motor operation.

After completion of calculation, P3900 and P0010 (parameter groups for commissioning) are automatically reset to their original value 0.

Possible Settings:

- 0 No quick commissioning (no motor calculation)
- 1 End quick commissioning, with factory reset of all other settings
- 2 End quick commissioning, with factory reset of I/O settings
- 3 End quick commissioning, without reset of all other settings

Dependency:

Changeable only when P0010 = 1 (quick commissioning)

Notes:

The following settings calculate a variety of motor parameters, overwriting previous values (see parameter P0340, setting P0340 = 1).

P3900 = 1 :

When setting 1 is selected, only the parameter settings carried out via the commissioning menu "Quick commissioning", are retained; all other parameter changes, including the I/O settings, are lost. Motor calculations are also performed.

P3900 = 2 :

When setting 2 is selected, only those parameters, which depend on the parameters in the commissioning menu "Quick commissioning" (P0010 = 1) are calculated. The I/O settings are also reset to default and the motor calculations performed.

P3900 = 3 :

When setting 3 is selected, only the motor and controller calculations are performed. Exiting quick commissioning with this setting saves time (for example, if only motor rating plate data have been changed).

2 Faults and Alarms

2.1 Fault messages

In the event of a failure, the inverter switches off and a fault code appears on the display.

NOTE

To reset the fault code, one of three methods listed below can be used:

1. Cycle the power to the drive
 2. Press the **FN** button on the BOP
 3. Via Digital Input 2 (default setting)
-

Fault messages are stored in parameter r0947 under their code number (e.g. F0003 = 3). The associated error value is found in parameter r0949. The value 0 is entered if a fault has no error value.

F0001 Overcurrent

STOP II

Quit

reset fault memory / Stop

Cause

- Motor power (P0307) does not correspond to the inverter power (r0206)
- Motor lead short circuit
- Earth faults

Diagnosis & Remedy

Check the following:

- Motor power (P0307) must correspond to inverter power (r0206).
- Cable length limits must not be exceeded.
- Motor cable and motor must have no short-circuits or earth faults
- Motor parameters must match the motor in use
- Value of stator resistance (P0350) must be correct
- Motor must not be obstructed or overloaded
- Increase Ramp-up time (P1120)
- Reduce Starting boost level (P1312)
- Check fault value r0949:
 - 0 = hardware generated trip
 - 1 = software generated trip

F0002 Overvoltage

STOP II

Quit

reset fault memory / Stop

Cause

- Main supply voltage too high
- Motor is in regenerative mode

NOTE

Regenerative mode can be caused by fast ramp downs or if the motor is driven by an active load.

Diagnosis & Remedy

Check the following:

- Supply voltage must lie within limits indicated on rating plate.
 - Vdc controller must be enabled (P1240) and parameterized properly.
 - Ramp-down time (P1121) must match inertia of load.
 - Required braking power must lie within specified limits.
 - Check fault value r0949:
 - 0 = hardware generated trip
 - 1 = software generated trip at inverter's internal nominal state
-

NOTE

Higher inertia requires longer ramp times.

<p>F0003 Undervoltage</p> <p>Quit reset fault memory / Stop</p> <p>Cause</p> <ul style="list-style-type: none"> - Main supply failed. - Shock load outside specified limits. <p>Diagnosis & Remedy</p> <ul style="list-style-type: none"> - Check Supply voltage. - Check fault value r0949: 0 = hardware generated trip 1 = software generated trip at undervoltage state 2 = software generated trip at inverter's internal nominal state 	<p>STOP II</p>
<p>F0004 Inverter Over Temperature</p> <p>Quit reset fault memory / Stop</p> <p>Cause</p> <ul style="list-style-type: none"> - Inverter overloaded - Ventilation inadequate - Pulse frequency too high - Ambient temperature too high <p>Diagnosis & Remedy Check the following:</p> <ul style="list-style-type: none"> - Load or load duty cycle too high? - Motor power (P0307) must match inverter power (r0206) - Pulse frequency must be set to default value - Ambient temperature too high? 	<p>STOP II</p>
<p>F0005 Inverter I2T</p> <p>Quit reset fault memory / Stop</p> <p>Cause</p> <ul style="list-style-type: none"> - Inverter overloaded. - Duty cycle too demanding. - Motor power (P0307) exceeds inverter power capability (r0206). <p>Diagnosis & Remedy Check the following:</p> <ul style="list-style-type: none"> - Load duty cycle must lie within specified limits. - Motor power (P0307) must match inverter power (r0206) 	<p>STOP II</p>
<p>F0011 Motor Over Temperature I2T</p> <p>Quit reset fault memory / Stop</p> <p>Cause Motor overloaded</p> <p>Diagnosis & Remedy Check the following:</p> <ul style="list-style-type: none"> - Load or load duty cycle too high? - Motor thermal time constant (P0611) must be correct - Motor I2t warning level (P0614) must match 	<p>STOP II</p>
<p>F0051 Parameter EEPROM Fault</p> <p>Quit reset fault memory / Stop</p> <p>Cause Read or write failure while access to EEPROM.</p> <p>Diagnosis & Remedy</p> <ul style="list-style-type: none"> - Factory Reset and new parameterization - Change drive 	<p>STOP II</p>
<p>F0052 Power Stack Fault</p> <p>Quit reset fault memory / Stop</p> <p>Cause Read failure for power stack information or invalid data.</p> <p>Diagnosis & Remedy Change drive</p>	<p>STOP II</p>

F0055	BOP-EEPROM Fault	STOP II
	Quit reset fault memory / Stop	
	Cause Read or write failure while saving non-volatile parameter to EEPROM on BOP whilst parameter cloning.	
	Diagnosis & Remedy - Factory Reset and new parameterization - Change BOP	
F0056	BOP not fitted	STOP II
	Quit reset fault memory / Stop	
	Cause Trying to initiate parameter cloning without BOP fitted.	
	Diagnosis & Remedy Fit BOP and try again.	
F0057	BOP fault	STOP II
	Quit reset fault memory / Stop	
	Cause - Parameter cloning with empty BOP. - Parameter cloning with invalid BOP.	
	Diagnosis & Remedy Download to BOP or replace BOP.	
F0058	BOP contents incompatible	STOP II
	Quit reset fault memory / Stop	
	Cause Trying to initiate parameter cloning with BOP created on another type of drive.	
	Diagnosis & Remedy Download to BOP from this type of drive.	
F0060	Asic Timeout	STOP II
	Quit reset fault memory / Stop	
	Cause Internal communications failure	
	Diagnosis & Remedy - If fault persists, change inverter. - Contact Service Department - Check fault value r0949: 0 = generated by ASIC 1 = software generated trip	
F0072	USS Setpoint Fault	STOP II
	Quit reset fault memory / Stop	
	Cause No setpoint values from USS during telegram off time	
	Diagnosis & Remedy Check USS master	
F0085	External Fault	STOP II
	Quit reset fault memory / Stop	
	Cause External fault triggered via terminal inputs	
	Diagnosis & Remedy Disable terminal input for fault trigger.	

F0100 Watchdog Reset **STOP II****Quit**

reset fault memory / Stop

Cause

Short power dip or Software Error

Diagnosis & Remedy

F0100 trips may happen after a short power dip. In this case there is no problem with the inverter itself. However if an F0100 is experienced without a loss of power in the case of normal operation then the Service Department should be contacted.

F0101 Stack Overflow **STOP II****Quit**

reset fault memory / Stop

Cause

Software error or processor failure

Diagnosis & Remedy

Run self test routines

2.2 Alarm Messages

Alarm messages are stored in parameter r2110 under their code number (e.g. A0503 = 503) and can be read out from there.

NOTE

- Alarm messages are displayed as long as the alarm condition exists. If the alarm condition ceases, the alarm message will disappear.
- It is not possible to stop alarm messages.

A0501 Current Limit

Cause

- Motor power does not correspond to the inverter power
- Motor leads are too long
- Earth faults

Diagnosis & Remedy

Check the following:

- Motor power (P0307) must correspond to inverter power (r0206).
- Cable length limits must not be exceeded.
- Motor cable and motor must have no short-circuits or earth faults
- Motor parameters must match the motor in use
- Value of stator resistance (P0350) must be correct
- Motor must not be obstructed or overloaded
- Increase Ramp-up time (P1120)
- Reduce Starting boost level (P1312)

A0502 Overvoltage Limit

Cause

Overvoltage limit is reached. This warning can occur during ramp down, if the Vdc controller is disabled (P1240 = 0).

Diagnosis & Remedy

If this warning is displayed permanently, check drive input voltage.

A0503 Undervoltage Limit

Cause

- Main supply failed
- Main supply and consequently DC-link voltage (r0026) below specified limit.

Diagnosis & Remedy

Check main supply voltage.

A0505 Inverter I2T

Cause

Warning level exceeded, current will be reduced if parameterized (P0610 = 1)

Diagnosis & Remedy

Check that duty cycle lies within specified limits.

A0511 Motor Over Temperature I2T

Cause

- Motor overloaded.
- Load duty cycle too high.

Diagnosis & Remedy

Check the following:

- P0611 (motor I2t time constant) should be set to appropriate value
- P0614 (Motor I2t overload warning level) should be set to suitable level

A0910 Vdc-max Controller de-activated

Cause

Occurs

- if main supply voltage is permanently too high.
- if motor is driven by an active load, causing motor to go into regenerative mode.
- at very high load inertias, when ramping down.

Diagnosis & Remedy

Check the following:

- Input voltage must lie within range.
- Load must be match.

A0911 Vdc-max Controller active**Cause**

Vdc max controller is active; so ramp-down times will be increased automatically to keep DC-link voltage (r0026) within limits.

Diagnosis & Remedy

Check the following:

- Supply voltage must lie within limits indicated on rating plate.
- Ramp-down time (P1121) must match inertia of load.

NOTE

Higher inertia requires longer ramp times.

A0920 ADC parameters not set properly**Cause**

ADC parameters should not be set to identical values, since this would produce illogical results

Diagnosis & Remedy

Check P0757, P0758, P0759, P0760

A0923 Both JOG Left and JOG Right are requested**Cause**

Both JOG right and JOG left have been requested. This freezes the RFG output frequency at its current value.

Diagnosis & Remedy

Do not press JOG right and left simultaneously.

3 Appendix

3.1 List of Abbreviations

AC	Alternating current	FB	Function block
AD	Analog digital converter	FCC	Flux current control
ADC	Analog digital converter	FCL	Fast current limit
ADR	Address	FF	Fixed frequency
AFM	Additional frequency modification	FFB	Free function block
AG	Automation unit	FOC	Field orientated control
AIN	Analog input	FSA	Frame size A
AOP	Advanced operator panel	GSG	Getting started guide
AOUT	Analog output	GUI ID	Global unique identifier
ASP	Analog setpoint	HIW	Main actual value
ASVM	Asymmetric space vector modulation	HSW	Main setpoint
BCC	Block check character	HTL	High-threshold logic
BCD	Binary-coded decimal code	I/O	Input and output
BI	Binector input	IBN	Commissioning
BICO	Binector / connector	IGBT	Insulated gate bipolar transistor
BO	Binector output	IND	Sub-index
BOP	Basic operator panel	JOG	Jog
C	Commissioning	KIB	Kinetic buffering
CB	Communication board	LCD	Liquid crystal display
CCW	Counter-clockwise	LED	Light emitting diode
CDS	Command data set	LGE	Length
CI	Connector input	MHB	Motor holding brake
CM	Configuration management	MM4	MICROMASTER 4th. Generation
CMD	Commando	MOP	Motor potentiometer
CMM	Combimaster	NC	Normally closed
CO	Connector output	NO	Normally open
CO/BO	Connector output / Binector output	OPI	Operating instructions
COM	Common (terminal that is connected to NO or NC)	PDS	Power drive system
COM-Link	Communication link	PID	PID controller (proportional, integral, derivative)
CT	Commissioning, ready to run	PKE	Parameter ID
CT	Constant torque	PKW	Parameter ID value
CUT	Commissioning, run, ready to run	PLC	Programmable logic controller
CW	Clockwise	PLI	Parameter list
DA	Digital analog converter	POT	Potentiometer
DAC	Digital analog converter	PPO	Parameter process data object
DC	Direct current	PTC	Positive temperature coefficient
DDS	Drive data set	PWE	Parameter value
DIN	Digital input	PWM	Pulse-width modulation
DIP	DIP switch	PX	Power extension
DOUT	Digital output	PZD	Process data
DS	Drive state	QC	Quick commissioning
EEC	European Economic Community	RAM	Random-access memory
EEPROM	Electrical erasable programmable read-only memory	RCCB	Residual current circuit breaker
ELCB	Earth leakage circuit breaker	RCD	Residual current device
EMC	Electro-magnetic compatibility	RFG	Ramp function generator
EMF	Electromotive force	RFI	Radio-frequency interference
EMI	Electro-magnetic interference	RPM	Revolutions per minute
ESB	Equivalent circuit	SCL	Scaling
FAQ	Frequently asked questions	SDP	Status display panel
		SLVC	Sensorless vector control

STW	Control word	VC	Vector control
STX	Start of text	VT	Variable torque
SVM	Space vector modulation	ZSW	Status word
TTL	Transistor-transistor logic	ZUSW	Additional setpoint
USS	Universal serial interface		

Suggestions and / or Corrections

To: Siemens AG Automation & Drives Group SD SM 5 P.O. Box 3269 D-91050 Erlangen Federal Republic of Germany	Suggestions Corrections For Publication/Manual: SINAMICS G110 Parameter List
Email: documentation.sd@siemens.com	User Documentation
From	Parameter List
Name:	Order Number:
Company/Service Department	6SL3298-0BA11-0BP0
Address:	Date of Issue: 11/2004
	Should you come across any printing errors when reading this publication, please notify us on this sheet.
Telephone:	Suggestions for improvement are also welcome.
Telefax:	

Siemens AG
Automation & Drives
Standard Drives
Postfach 3269, D – 91050 Erlangen
Germany

www.siemens.com

© Siemens AG 2004
Subject to change without prior notice
6SL3298-0BA11-0BP0

Printed in Germany