

SIEMENS

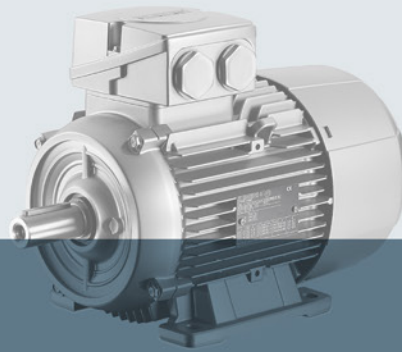

SINAMICS

Low-voltage SINAMICS G120C converters

Built-in devices, frame sizes A ... C

Getting Started

Edition

04/2014

Answers for industry.

SIEMENS

SINAMICS

SINAMICS G120C SINAMICS G120C converter

Getting Started

<u>Fundamental safety instructions</u>	1
<u>Product overview</u>	2
<u>Installing</u>	3
<u>Commissioning</u>	4
<u>Fault rectification</u>	5

Edition 04/2014, Firmware V4.7



04/2014, FW V4.7

A5E34264105B AA

Legal information

Warning notice system

This manual contains notices you have to observe in order to ensure your personal safety, as well as to prevent damage to property. The notices referring to your personal safety are highlighted in the manual by a safety alert symbol, notices referring only to property damage have no safety alert symbol. These notices shown below are graded according to the degree of danger.

 DANGER
indicates that death or severe personal injury will result if proper precautions are not taken.
 WARNING
indicates that death or severe personal injury may result if proper precautions are not taken.
 CAUTION
indicates that minor personal injury can result if proper precautions are not taken.
NOTICE
indicates that property damage can result if proper precautions are not taken.

If more than one degree of danger is present, the warning notice representing the highest degree of danger will be used. A notice warning of injury to persons with a safety alert symbol may also include a warning relating to property damage.

Qualified Personnel

The product/system described in this documentation may be operated only by **personnel qualified** for the specific task in accordance with the relevant documentation, in particular its warning notices and safety instructions. Qualified personnel are those who, based on their training and experience, are capable of identifying risks and avoiding potential hazards when working with these products/systems.

Proper use of Siemens products

Note the following:

 WARNING
Siemens products may only be used for the applications described in the catalog and in the relevant technical documentation. If products and components from other manufacturers are used, these must be recommended or approved by Siemens. Proper transport, storage, installation, assembly, commissioning, operation and maintenance are required to ensure that the products operate safely and without any problems. The permissible ambient conditions must be complied with. The information in the relevant documentation must be observed.

Trademarks

All names identified by ® are registered trademarks of Siemens AG. The remaining trademarks in this publication may be trademarks whose use by third parties for their own purposes could violate the rights of the owner.

Disclaimer of Liability

We have reviewed the contents of this publication to ensure consistency with the hardware and software described. Since variance cannot be precluded entirely, we cannot guarantee full consistency. However, the information in this publication is reviewed regularly and any necessary corrections are included in subsequent editions.

Table of contents

1	Fundamental safety instructions	7
1.1	General safety instructions	7
1.2	Safety instructions for electromagnetic fields (EMF)	11
1.3	Handling electrostatic sensitive devices (ESD)	11
1.4	Industrial security	12
1.5	Residual risks of power drive systems	13
2	Product overview	15
2.1	Type plate and technical data	15
2.2	Components, which you require depending on your application	16
3	Installing	17
3.1	Mounting	17
3.2	Connecting	19
3.2.1	Connecting the line supply, motor, and other components	19
3.2.2	Installing the converter in compliance with EMC rules	21
3.2.3	Overview of the interfaces	22
3.2.4	Terminal strips	23
3.2.5	Default settings of the terminals	25
3.2.6	Wiring the terminal strip	28
3.2.7	Fieldbus interface assignment	28
4	Commissioning	29
4.1	Overview of the commissioning tool	29
4.2	Commissioning with BOP-2 operator panel	30
4.2.1	Basic commissioning with BOP-2	31
4.2.2	Selecting the control mode	35
4.2.3	Additional settings	36
4.2.3.1	Operating the inverter with the BOP-2	36
4.2.3.2	Changing the function of individual terminals	39
4.2.3.3	Releasing the failsafe function "Safe Torque Off" (STO)	41
4.2.3.4	Parameter list	42
5	Fault rectification	59
5.1	List of alarms and faults	59
5.2	Product support	65
5.3	Spare parts	65

This Getting Started Guide describes how you install and commission the SINAMICS G120C converter.

What is the meaning of the symbols in the manual?

 1 An operating instruction starts here.
2

 This concludes the operating instruction.

Firmware upgrade and downgrade

Options for upgrading and downgrading the firmware can be found on the Internet at <http://support.automation.siemens.com/WW/view/de/67364620> (<http://support.automation.siemens.com/WW/news/en/67364620>).

Transferring license terms of the OSS code to a PC

 1
2

Procedure

To transfer the OSS license terms from the inverter to a PC, proceed as follows:

1. Switch off the inverter power supply.
2. Insert an empty memory card into the card slot of the inverter. Also see Section: Overview of the interfaces (Page 22)
3. Switch on the inverter power supply.
4. When you have switched on the power supply, wait 30 seconds.
During this time, the inverter writes the "Read_OSS.ZIP" file onto the memory card.
5. Switch off the inverter power supply.
6. Remove the card from the inverter.
7. Use a card reader and load the file to a PC.

 You have then transferred the OSS license terms from the inverter to a PC.

Fundamental safety instructions

1.1 General safety instructions



DANGER

Danger to life due to live parts and other energy sources

Death or serious injury can result when live parts are touched.

- Only work on electrical devices when you are qualified for this job.
- Always observe the country-specific safety rules.

Generally, six steps apply when establishing safety:

1. Prepare for shutdown and notify all those who will be affected by the procedure.
2. Disconnect the machine from the supply.
 - Switch off the machine.
 - Wait until the discharge time specified on the warning labels has elapsed.
 - Check that it really is in a no-voltage condition, from phase conductor to phase conductor and phase conductor to protective conductor.
 - Check whether the existing auxiliary supply circuits are de-energized.
 - Ensure that the motors cannot move.
3. Identify all other dangerous energy sources, e.g. compressed air, hydraulic systems, or water.
4. Isolate or neutralize all hazardous energy sources by closing switches, grounding or short-circuiting or closing valves, for example.
5. Secure the energy sources against switching on again.
6. Ensure that the correct machine is completely interlocked.

After you have completed the work, restore the operational readiness in the inverse sequence.



WARNING

Danger to life through a hazardous voltage when connecting an unsuitable power supply

Touching live components can result in death or severe injury.

- Only use power supplies that provide SELV (Safety Extra Low Voltage) or PELV- (Protective Extra Low Voltage) output voltages for all connections and terminals of the electronics modules.



! WARNING

Danger to life when live parts are touched on damaged devices

Improper handling of devices can cause damage.

For damaged devices, hazardous voltages can be present at the enclosure or at exposed components; if touched, this can result in death or severe injury.

- Ensure compliance with the limit values specified in the technical data during transport, storage and operation.
- Do not use any damaged devices.



! WARNING

Danger to life through electric shock due to unconnected cable shields

Hazardous touch voltages can occur through capacitive cross-coupling due to unconnected cable shields.

- As a minimum, connect cable shields and the conductors of power cables that are not used (e.g. brake cores) at one end at the grounded housing potential.



! WARNING

Danger to life due to electric shock when not grounded

For missing or incorrectly implemented protective conductor connection for devices with protection class I, high voltages can be present at open, exposed parts, which when touched, can result in death or severe injury.

- Ground the device in compliance with the applicable regulations.



! WARNING

Danger to life due to electric shock when opening plug connections in operation

When opening plug connections in operation, arcs can result in severe injury or death.

- Only open plug connections when the equipment is in a no-voltage state, unless it has been explicitly stated that they can be opened in operation.

! WARNING

Danger to life due to fire spreading if housing is inadequate

Fire and smoke development can cause severe personal injury or material damage.

- Install devices without a protective housing in a metal control cabinet (or protect the device by another equivalent measure) in such a way that contact with fire is prevented.
- Ensure that smoke can only escape via controlled and monitored paths.

 **WARNING****Danger to life through unexpected movement of machines when using mobile wireless devices or mobile phones**

Using mobile wireless devices or mobile phones with a transmit power > 1 W closer than approx. 2 m to the components may cause the devices to malfunction, influence the functional safety of machines therefore putting people at risk or causing material damage.

- Switch the wireless devices or mobile phones off in the immediate vicinity of the components.

 **WARNING****Danger to life due to the motor catching fire in the event of insulation overload**

There is higher stress on the motor insulation through a ground fault in an IT system. If the insulation fails, it is possible that death or severe injury can occur as a result of smoke and fire.

- Use a monitoring device that signals an insulation fault.
- Correct the fault as quickly as possible so the motor insulation is not overloaded.

 **WARNING****Danger to life due to fire if overheating occurs because of insufficient ventilation clearances**

Inadequate ventilation clearances can cause overheating of components with subsequent fire and smoke. This can cause severe injury or even death. This can also result in increased downtime and reduced service lives for devices/systems.

- Ensure compliance with the specified minimum clearance as ventilation clearance for the respective component.

 **WARNING****Danger of an accident occurring due to missing or illegible warning labels**

Missing or illegible warning labels can result in accidents involving death or serious injury.

- Check that the warning labels are complete based on the documentation.
- Attach any missing warning labels to the components, in the national language if necessary.
- Replace illegible warning labels.

NOTICE
Device damage caused by incorrect voltage/insulation tests Incorrect voltage/insulation tests can damage the device. <ul style="list-style-type: none">• Before carrying out a voltage/insulation check of the system/machine, disconnect the devices as all converters and motors have been subject to a high voltage test by the manufacturer, and therefore it is not necessary to perform an additional test within the system/machine.

 WARNING
Danger to life when safety functions are inactive Safety functions that are inactive or that have not been adjusted accordingly can cause operational faults on machines that could lead to serious injury or death. <ul style="list-style-type: none">• Observe the information in the appropriate product documentation before commissioning.• Carry out a safety inspection for functions relevant to safety on the entire system, including all safety-related components.• Ensure that the safety functions used in your drives and automation tasks are adjusted and activated through appropriate parameterizing.• Perform a function test.• Only put your plant into live operation once you have guaranteed that the functions relevant to safety are running correctly.

Note

Important safety notices for Safety Integrated functions

If you want to use Safety Integrated functions, you must observe the safety notices in the Safety Integrated manuals.

 WARNING
Danger to life or malfunctions of the machine as a result of incorrect or changed parameterization As a result of incorrect or changed parameterization, machines can malfunction, which in turn can lead to injuries or death. <ul style="list-style-type: none">• Protect the parameterization (parameter assignments) against unauthorized access.• Respond to possible malfunctions by applying suitable measures (e.g. EMERGENCY STOP or EMERGENCY OFF).

1.2 Safety instructions for electromagnetic fields (EMF)



WARNING

Danger to life from electromagnetic fields

Electromagnetic fields (EMF) are generated by the operation of electrical power equipment such as transformers, converters or motors.

People with pacemakers or implants are at a special risk in the immediate vicinity of these devices/systems.

- Ensure that the persons involved are the necessary distance away (minimum 2 m).

1.3 Handling electrostatic sensitive devices (ESD)

Electrostatic sensitive devices (ESD) are individual components, integrated circuits, modules or devices that may be damaged by either electric fields or electrostatic discharge.



NOTICE

Damage through electric fields or electrostatic discharge

Electric fields or electrostatic discharge can cause malfunctions through damaged individual components, integrated circuits, modules or devices.

- Only pack, store, transport and send electronic components, modules or devices in their original packaging or in other suitable materials, e.g. conductive foam rubber or aluminum foil.
- Only touch components, modules and devices when you are grounded by one of the following methods:
 - Wearing an ESD wrist strap
 - Wearing ESD shoes or ESD grounding straps in ESD areas with conductive flooring
- Only place electronic components, modules or devices on conductive surfaces (table with ESD surface, conductive ESD foam, ESD packaging, ESD transport container).

1.4 Industrial security

Note

Industrial security

Siemens provides products and solutions with industrial security functions that support the secure operation of plants, solutions, machines, equipment and/or networks. They are important components in a holistic industrial security concept. With this in mind, Siemens' products and solutions undergo continuous development. Siemens recommends strongly that you regularly check for product updates.

For the secure operation of Siemens products and solutions, it is necessary to take suitable preventive action (e.g. cell protection concept) and integrate each component into a holistic, state-of-the-art industrial security concept. Third-party products that may be in use should also be considered. For more information about industrial security, visit Hotspot-Text (<http://www.siemens.com/industrialsecurity>).

To stay informed about product updates as they occur, sign up for a product-specific newsletter. For more information, visit Hotspot-Text (<http://support.automation.siemens.com>).

WARNING

Danger as a result of unsafe operating states resulting from software manipulation

Software manipulation (e.g. by viruses, Trojan horses, malware, worms) can cause unsafe operating states to develop in your installation which can result in death, severe injuries and/or material damage.

- Keep the software up to date.
You will find relevant information and newsletters at this address (<http://support.automation.siemens.com>).
- Incorporate the automation and drive components into a holistic, state-of-the-art industrial security concept for the installation or machine.
You will find further information at this address (<http://www.siemens.com/industrialsecurity>).
- Make sure that you include all installed products into the holistic industrial security concept.

1.5 Residual risks of power drive systems

The control and drive components of a drive system are approved for industrial and commercial use in industrial line supplies. Their use in public line supplies requires a different configuration and/or additional measures.

These components may only be operated in closed housings or in higher-level control cabinets with protective covers that are closed, and when all of the protective devices are used.

These components may only be handled by qualified and trained technical personnel who are knowledgeable and observe all of the safety instructions on the components and in the associated technical user documentation.

When assessing the machine's risk in accordance with the respective local regulations (e.g., EC Machinery Directive), the machine manufacturer must take into account the following residual risks emanating from the control and drive components of a drive system:

1. Unintentional movements of driven machine components during commissioning, operation, maintenance, and repairs caused by, for example,
 - Hardware and/or software errors in the sensors, control system, actuators, and cables and connections
 - Response times of the control system and of the drive
 - Operation and/or environmental conditions outside the specification
 - Condensation/conductive contamination
 - Parameterization, programming, cabling, and installation errors
 - Use of wireless devices/mobile phones in the immediate vicinity of the control system
 - External influences/damage
2. In the event of a fault, exceptionally high temperatures, including an open fire, as well as emissions of light, noise, particles, gases, etc. can occur inside and outside the inverter, e.g.:
 - Component failure
 - Software errors
 - Operation and/or environmental conditions outside the specification
 - External influences/damage

Inverters of the Open Type/IP20 degree of protection must be installed in a metal control cabinet (or protected by another equivalent measure) such that contact with fire inside and outside the inverter is not possible.

1.5 Residual risks of power drive systems

3. Hazardous shock voltages caused by, for example,
 - Component failure
 - Influence during electrostatic charging
 - Induction of voltages in moving motors
 - Operation and/or environmental conditions outside the specification
 - Condensation/conductive contamination
 - External influences/damage
4. Electrical, magnetic and electromagnetic fields generated in operation that can pose a risk to people with a pacemaker, implants or metal replacement joints, etc., if they are too close
5. Release of environmental pollutants or emissions as a result of improper operation of the system and/or failure to dispose of components safely and correctly

Note

The components must be protected against conductive contamination (e.g. by installing them in a control cabinet with degree of protection IP54 according to IEC 60529 or NEMA 12).

Assuming that conductive contamination at the installation site can definitely be excluded, a lower degree of cabinet protection may be permitted.

For more information about residual risks of the components in a drive system, see the relevant sections in the technical user documentation.

Product overview

2.1 Type plate and technical data

The inverter type plate contains the most important technical data and the order number. A type plate is provided at the following locations of an inverter:

- At the front after removing the dummy cover for the operator panel.
- At the side of the heat sink.



	Rated output power	Rated output current	Order number			
	based on Low Overload		Unfiltered		Filtered	
 Frame Size A	0.55 kW	1.7 A	6SL3210-1KE11-8U	1	6SL3210-1KE11-8A	1
	0.75 kW	2.2 A	6SL3210-1KE12-3U	1	6SL3210-1KE12-3A	1
	1.1 kW	3.1 A	6SL3210-1KE13-2U	1	6SL3210-1KE13-2A	1
	1.5 kW	4.1 A	6SL3210-1KE14-3U	1	6SL3210-1KE14-3A	1
	2.2 kW	5.6 A	6SL3210-1KE15-8U	1	6SL3210-1KE15-8A	1
	3.0 kW	7.3 A	6SL3210-1KE17-5U	1	6SL3210-1KE17-5A	1
	4.0 kW	8.8 A	6SL3210-1KE18-8U	1	6SL3210-1KE18-8A	1
 Frame Size B	5.5 kW	12.5 A	6SL3210-1KE21-3U	1	6SL3210-1KE21-3A	1
	7.5 kW	16.5 A	6SL3210-1KE21-7U	1	6SL3210-1KE21-7A	1
 Frame Size C	11.0 kW	25.0 A	6SL3210-1KE22-6U	1	6SL3210-1KE22-6A	1
	15.0 kW	31.0 A	6SL3210-1KE23-2U	1	6SL3210-1KE23-2A	1
	18.5 kW	37.0 A	6SL3210-1KE23-8U	1	6SL3210-1KE23-8A	1
SINAMICS G120C USS/MB (USS, Modbus RTU)				B		B
SINAMICS G120C DP (PROFIBUS)				P		P
SINAMICS G120C PN (PROFINET, EtherNet/IP)				F		F
SINAMICS G120C CANopen				C		C

Figure 2-1 Identifying the converter

Use for the intended purpose

The inverter described in this manual is a device for controlling an induction motor. The inverter is designed for installation in electrical installations or machines.

It has been approved for industrial and commercial use on industrial networks. Additional measures have to be taken when connected to public grids.

The technical specifications and information about connection conditions are indicated on the rating plate and in the operating instructions.

2.2 Components, which you require depending on your application

Line reactor

A line reactor protects the converter from the rough characteristics of an industrial grid. A line reactor supports the overvoltage protection, smoothes harmonics and bridges commutation notches.

Note

If the relative short-circuit voltage u_k of the line transformer is smaller than 1 %, you have to install a line reactor in order to ensure the optimal lifetime of your converter.

Output reactor

An output reactor allows longer cables between converter and motor.

Braking resistor

The braking resistor enables loads with a large moment of inertia to be braked quickly.

Converter 6SL3210-...			Braking resistor	Line reactor	Output reactor
Frame Size A	0.55 kW ... 1.1 kW	...1KE11-8□□1, ...1KE12-3□□1, ...1KE13-2□□1	6SL3201-0BE14-3AA0	6SL3203-0CE13-2AA0	6SL3202-0AE16-1CA0
	1.5 kW	...1KE14-3□□1		6SL3203-0CE21-0AA0	
	2.2 kW	...1KE15-8□□1	6SL3201-0BE21-0AA0		6SL3202-0AE18-8CA0
	3.0 kW ... 4.0 kW	...1KE17-5□□1, ...1KE18-8□□1			
Frame Size B	5.5 kW ... 7.5 kW	...1KE21-3□□1, ...1KE21-7□□1	6SL3201-0BE21-8AA0	6SL3203-0CE21-8AA0	6SL3202-0AE21-8CA0
Frame Size C	11.0 kW ... 18.5 kW	...1KE22-6□□1, ...1KE23-2□□1, ...1KE23-8□□1	6SL3201-0BE23-8AA0	6SL3203-0CE23-8AA0	6SL3202-0AE23-8CA0

Installing

3.1 Mounting

Dimensions

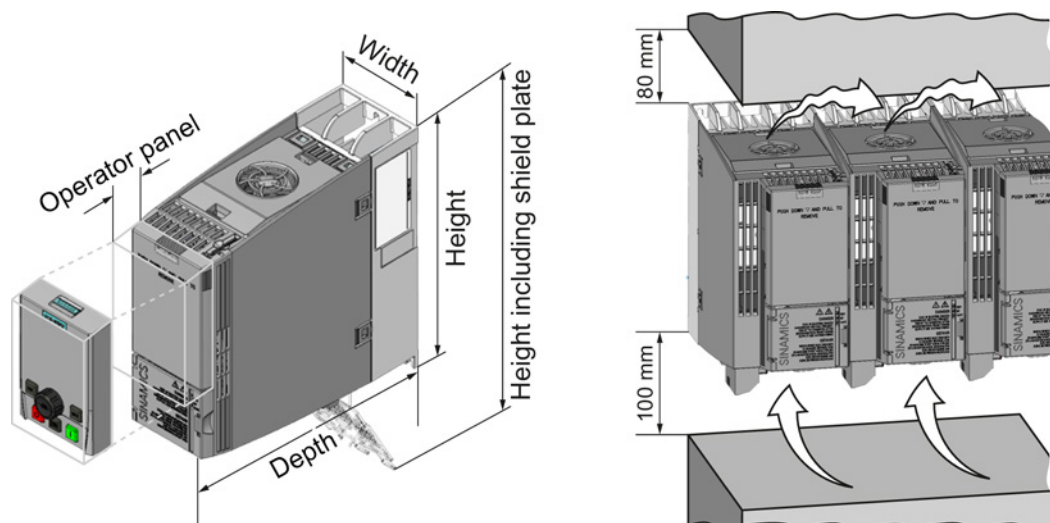

Figure 3-1 Dimensions and minimum spacing to other devices

Table 3- 1 Dimensions

	Frame Size A 0.55 kW ... 4.0 kW	Frame Size B 5.5 kW ... 7.5 kW	Frame Size C 11 kW ... 18.5 kW
Height	196 mm	196 mm	295 mm
Height including shield plate	276 mm	276 mm	375 mm
Width	73 mm	100 mm	140 mm
Depth of the inverter with PROFINET interface	225.4 mm	225.4 mm	225.4 mm
Depth of the inverter with USS/MB, CANopen, or PROFIBUS interface	203 mm	203 mm	203 mm
Additional depth when the Operator Panel is attached	+ 21 mm when Operator Panel IOP (Intelligent Operator Panel) is attached		
	+ 6 mm when Operator Panel BOP-2 (Basic Operator Panel) is attached		

Mounting

Table 3-2 Drilling patterns and mounting equipment

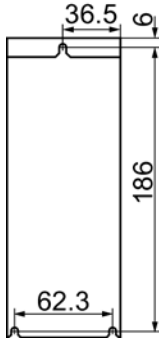
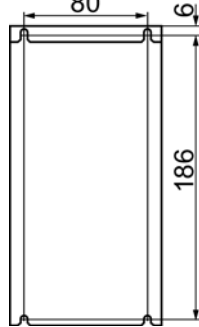
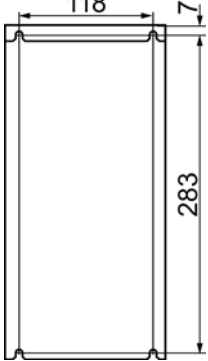
	Frame Size A 0.55 kW ... 4.0 kW	Frame Size B 5.5 kW ... 7.5 kW	Frame Size C 11 kW ... 18.5 kW
Drilling pattern			
Fixing elements	3 x M4 studs, 3 x M4 nuts, 3 x M4 washers	4 x M4 studs, 4 x M4 nuts, 4 x M4 washers	4 x M5 studs, 4 x M5 nuts, 4 x M5 washers
Locked-rotor (starting) torque	2.5 Nm	2.5 Nm	2.5 Nm

Mounting the shield plate

We recommend that you mount the shield plates provided. The shield plates make it simpler to install the inverter in compliance with EMC regulations and to provide strength relief for the connected cables.

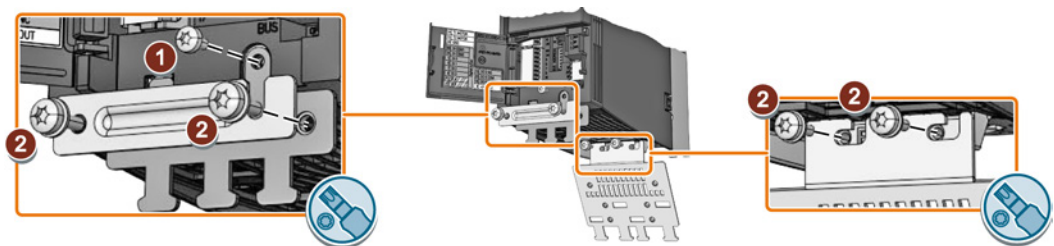

- ① M3 - 0.8 Nm
- ② M4 - 2.5 Nm

Figure 3-2 Mounting a shield plate using as example a frame size A inverter

3.2 Connecting

3.2.1 Connecting the line supply, motor, and other components

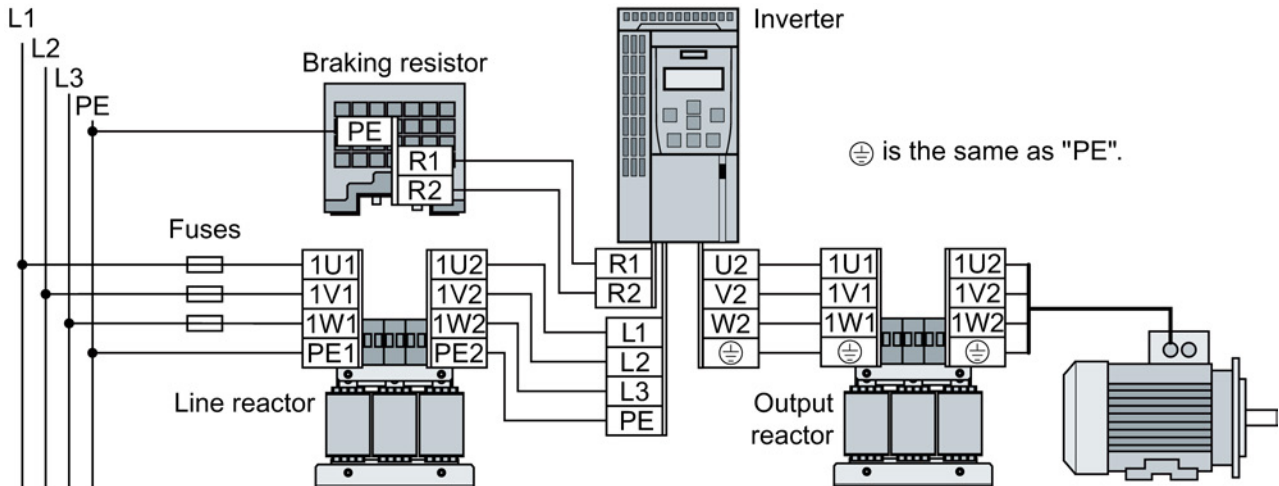

Inverter		Connection cross-section (tightening torque)		Line reactor, output reactor			Braking resistor	
FSA	0.55 kW ... 4 kW	2.5 mm ² (0.5 Nm)	14 AWG (4.5 lbf in)	4 mm ² (0.8 Nm)	12 AWG (7 lbf in)	PE M4 (3 Nm 26.5 lbf in)	2.5 mm ² (0.5 Nm)	14 AWG (4.5 lbf in)
FSB	5.5 kW ... 7.5 kW	6 mm ² (0.6 Nm)	10 AWG (5.5 lbf in)	10 mm ² (1.8 Nm)	8 AWG (16 lbf in)	PE M5 (5 Nm 44 lbf in)		
FSC	11 kW ... 18.5 kW	16 mm ² (1.5 Nm)	5 AWG (13.5 lbf in)	16 mm ² (4 Nm)	5 AWG (35 lbf in)		6 mm ² (0.6 Nm)	10 AWG (5.5 lbf in)

Procedure



To connect the inverter and its components, proceed as follows:

1. Install the appropriate fuses:

Inverter	Fuse	UL/cUL fuse
FSA	0.55 kW ... 1.1 kW	3NA3801 (6 A)
	1.5 kW ... 2.2 kW	3NA3803 (10 A)
	3.0 kW ... 4.0 kW	3NA3805 (16 A)
FSB	5.5 kW	3NA3807 (20 A)
	7.5 kW	3NA3810 (25 A)
FSC	11 kW	3NA3817 (40 A)
	15 kW	3NA3820 (50 A)
	18.5 kW	3NA3822 (63 A)

2. Connect the inverter and its components.
The plugs for connecting the line supply, motor, and braking resistor can be found on the lower side of the inverter.
3. If an EMC-compliant installation is required, you must use shielded cables. See also section: Installing the converter in compliance with EMC rules (Page 21).

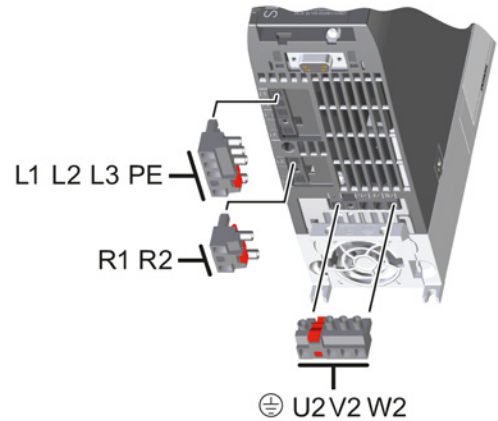

■ You have now connected the inverter and its components.

Components for United States / Canadian installations (UL/CSA)

This equipment is capable of providing internal motor overload protection according to UL508C. Take the following actions in order to comply with UL508C:

- Use UL/CSA-certified J-type fuses, overload circuit-breakers or intrinsically safe motor protection devices.
- For each frame size A to C use class 1 75° C copper wire only.
- Install the converter with any external recommended suppressor with the following features:
 - Surge-protective devices; device shall be a Listed Surge-protective device (Category code VZCA and VZCA7).
 - Rated nominal voltage 480/277 V_{AC}, 50/60 Hz, 3-phase.
 - Clamping voltage V_{PR} = 2000 V, I_N = 3 kA min, MCOV = 508 V_{AC}, SCCR = 40 kA.
 - Suitable for Type 1 or Type 2 SPD application.
 - Clamping shall be provided between phases and also between phase and ground.
- Do not change the parameter p0610 (factory setting of p0610 = 12 means: the drive reacts on a motor overtemperature with an immediate alarm and after a certain time with a fault).

3.2.2 Installing the converter in compliance with EMC rules

Rules for EMC-compliant cable routing

Preconditions

- The inverter is mounted on a metal mounting plate. The mounting plate is unpainted and has good electrical conductivity.
- Use shielded cables for the following connections:
 - Motor and motor temperature sensor
 - Braking resistor
 - Fieldbus
 - Inputs and outputs of the terminal strip

Procedure

To install the inverter cables in compliance with EMC rules, proceed as follows:

1. Expose the shields of the shielded cables.
2. Place the shields on the mounting plate or on the inverter shield plate using EMC clamps.

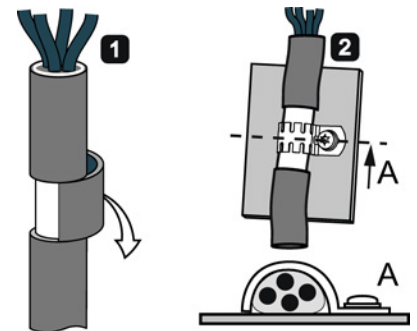

You have wired the inverter in an EMC-compliant fashion.

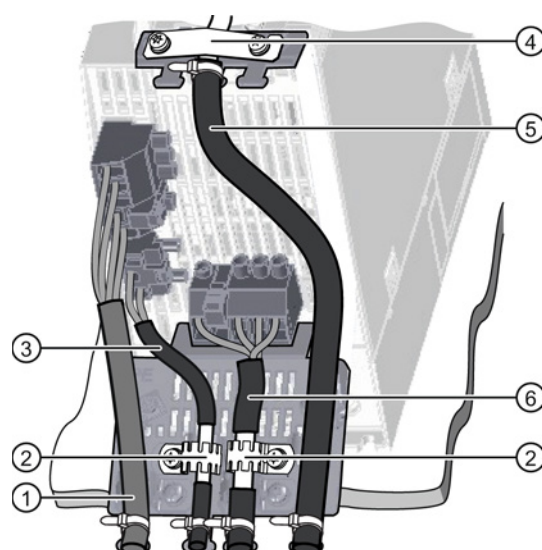

EMC-compliant wiring shown using the example of a frame size A inverter

- ① Unshielded line supply cable
- ② EMC clamps (serrated rails) on the shield plate of the Power Module
- ③ Shielded cable to the braking resistor
- ④ EMC clamp for the cable to the terminal strip on the shield plate of the CU
- ⑤ Shielded cable to the terminal strip
- ⑥ Shielded motor cable

3.2.3 Overview of the interfaces

Interfaces at the front of the Control Unit

To access the interfaces at the front of the Control Unit, you must unplug the Operator Panel (if one is being used) and open the front doors.

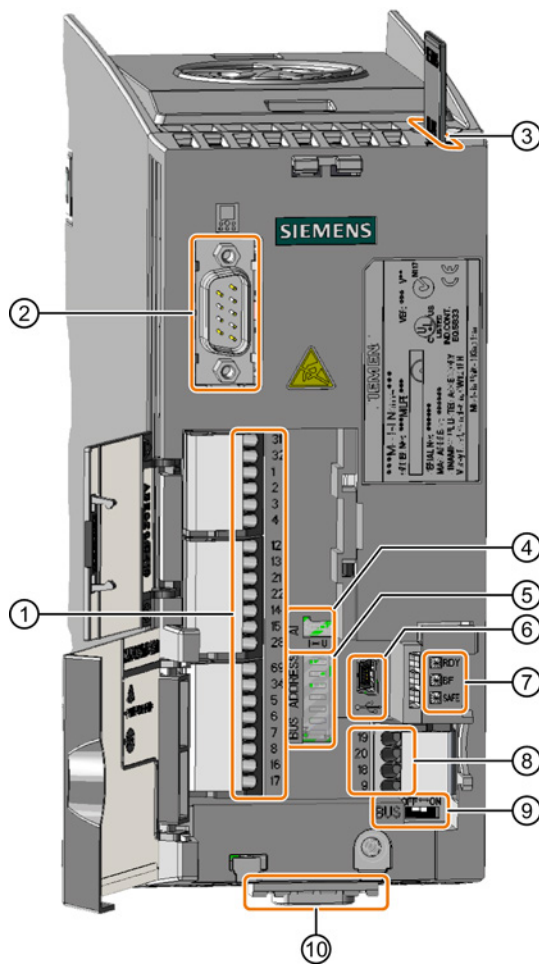

- ① Terminal strip
- ② Connection to the operator panel
- ③ Memory card slot
- ④ Switch for analog input

I 0/4 mA ... 20 mA
 U -10/0 V ... 10 V

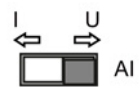

- ⑤ Selecting the fieldbus address:

- PROFIBUS
- USS
- Modbus RTU
- CanOpen

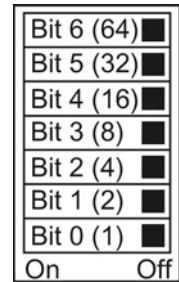

- ⑥ USB interface for connection to a PC

- ⑦ Status LED

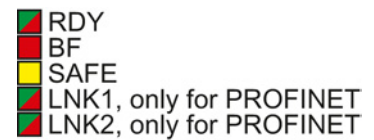

- ⑧ Terminal strip

- ⑨ Depending on the fieldbus OFF ON

- PROFIBUS, PROFINET: No function
- USS, Modbus, CANopen: Bus termination

- ⑩ Fieldbus interface

3.2.4 Terminal strips

Wiring variations of the terminal strips

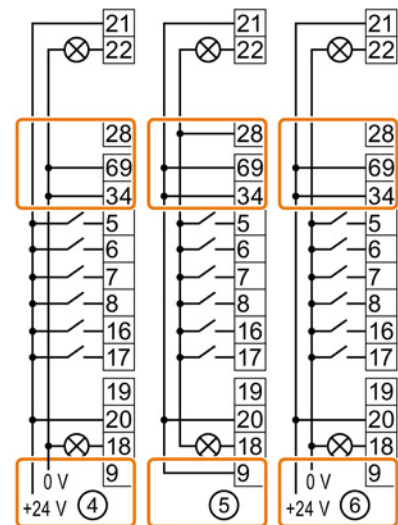
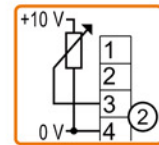
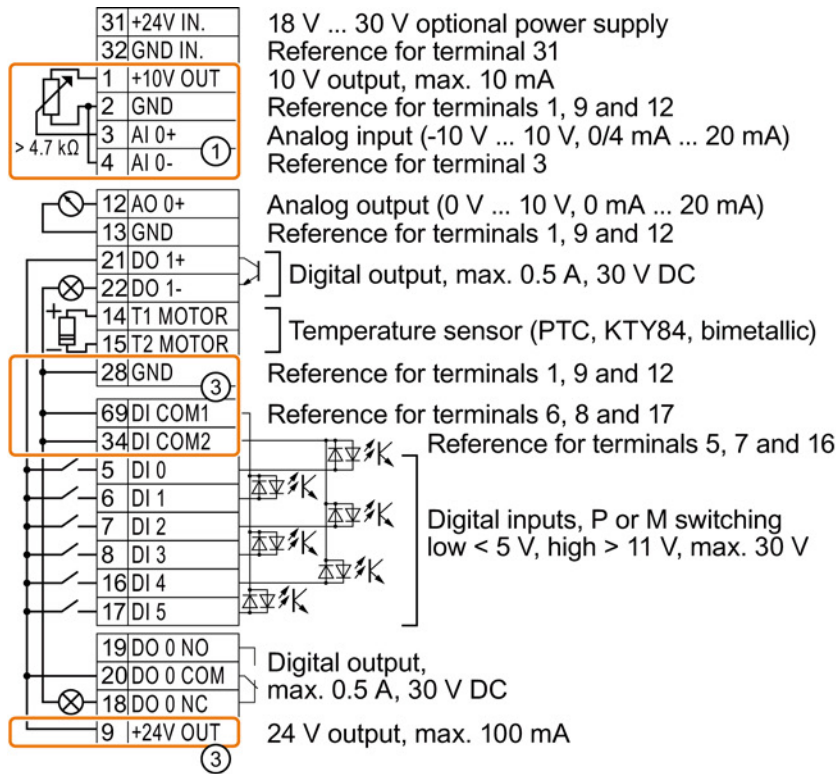

- ① The analog input is supplied from the internal 10 V voltage.
- ② The analog input is supplied from an external 10 V source.
- ③ Wiring when using the internal power supplies. Connecting a contact that switches to P potential.
- ④ Wiring when using external power supplies. Connecting a contact that switches to P potential.
- ⑤ Wiring when using the internal power supplies. Connecting a contact that switches to M potential.
- ⑥ Wiring when using external power supplies. Connecting a contact that switches to M potential.

Factory setting of the terminals

The factory setting of the terminals depends on whether the inverter has a PROFIBUS / PROFINET interface.

Factory setting of the terminals for G120C USS and G120C CAN	Factory setting of the terminals for G120C DP and G120C PN
<p>Fieldbus interface is not active.</p>	<p>The function of the fieldbus interface depends on DI 3.</p> <p style="text-align: center;"> <input checked="" type="checkbox"/> 8 <input type="checkbox"/> 8 Inverter receives control signals via PROFIdrive telegram 1 Fieldbus interface is not active </p>

Changing the function of terminals

The function of every color-coded terminal can be set.

In order that you do not have to successively change terminal for terminal, several terminals can be jointly set using default settings.

The factory settings described above for USS and PROFIBUS/PROFINET terminals correspond to default setting 12 (two-wire control using method 1) or default setting 7 (switchover between fieldbus and jog using DI 3).

See also: Default settings of the terminals (Page 25).

3.2.5 Default settings of the terminals

Available settings of the terminals

<p>Default setting 1: Two fixed speeds Selected with</p> <ul style="list-style-type: none"> STARTER: Conveyor technology with 2 fixed frequencies BOP-2: coN 2 SP 	<p>Default setting 2: Two fixed speeds with safety function Selected with</p> <ul style="list-style-type: none"> STARTER: Conveyor systems with Basic Safety BOP-2: coN SAFE 	<p>Default setting 3: Four fixed speeds Selected with</p> <ul style="list-style-type: none"> STARTER: Conveyor technology with 4 fixed frequencies BOP-2: coN 4 SP 																																																																							
<p>Fieldbus interface is not active.</p> <table border="1" style="width: 100%; border-collapse: collapse;"> <tr><td style="width: 20px; text-align: center;">3</td><td style="width: 40px;">AI 0</td><td style="width: 40px;">---</td></tr> <tr><td style="text-align: center;">4</td><td></td><td></td></tr> <tr><td style="text-align: center;">5</td><td>DI 0</td><td>ON/OFF1 clockwise</td></tr> <tr><td style="text-align: center;">6</td><td>DI 1</td><td>ON / OFF1 counter-clockwise</td></tr> <tr><td style="text-align: center;">7</td><td>DI 2</td><td>Acknowledge</td></tr> <tr><td style="text-align: center;">8</td><td>DI 3</td><td>---</td></tr> <tr><td style="text-align: center;">16</td><td>DI 4</td><td>Fixed speed 3</td></tr> <tr><td style="text-align: center;">17</td><td>DI 5</td><td>Fixed speed 4</td></tr> </table> <p>DI 4 and DI 5 = high: The inverter adds both fixed speeds.</p>	3	AI 0	---	4			5	DI 0	ON/OFF1 clockwise	6	DI 1	ON / OFF1 counter-clockwise	7	DI 2	Acknowledge	8	DI 3	---	16	DI 4	Fixed speed 3	17	DI 5	Fixed speed 4	<p>Fieldbus interface is not active.</p> <table border="1" style="width: 100%; border-collapse: collapse;"> <tr><td style="width: 20px; text-align: center;">3</td><td style="width: 40px;">AI 0</td><td style="width: 40px;">---</td></tr> <tr><td style="text-align: center;">4</td><td></td><td></td></tr> <tr><td style="text-align: center;">5</td><td>DI 0</td><td>ON / OFF1 fixed speed 1</td></tr> <tr><td style="text-align: center;">6</td><td>DI 1</td><td>Fixed speed 2</td></tr> <tr><td style="text-align: center;">7</td><td>DI 2</td><td>Acknowledge</td></tr> <tr><td style="text-align: center;">8</td><td>DI 3</td><td>---</td></tr> <tr><td style="text-align: center;">16</td><td>DI 4</td><td rowspan="2">] Reserved for safety function</td></tr> <tr><td style="text-align: center;">17</td><td>DI 5</td></tr> </table> <p>DI 0 and DI 1 = high: The inverter adds both fixed speeds.</p>	3	AI 0	---	4			5	DI 0	ON / OFF1 fixed speed 1	6	DI 1	Fixed speed 2	7	DI 2	Acknowledge	8	DI 3	---	16	DI 4] Reserved for safety function	17	DI 5	<p>Fieldbus interface is not active.</p> <table border="1" style="width: 100%; border-collapse: collapse;"> <tr><td style="width: 20px; text-align: center;">3</td><td style="width: 40px;">AI 0</td><td style="width: 40px;">---</td></tr> <tr><td style="text-align: center;">4</td><td></td><td></td></tr> <tr><td style="text-align: center;">5</td><td>DI 0</td><td>ON / OFF1 fixed speed 1</td></tr> <tr><td style="text-align: center;">6</td><td>DI 1</td><td>Fixed speed 2</td></tr> <tr><td style="text-align: center;">7</td><td>DI 2</td><td>Acknowledge</td></tr> <tr><td style="text-align: center;">8</td><td>DI 3</td><td>---</td></tr> <tr><td style="text-align: center;">16</td><td>DI 4</td><td>Fixed speed 3</td></tr> <tr><td style="text-align: center;">17</td><td>DI 5</td><td>Fixed speed 4</td></tr> </table> <p>Multiple DIs = high: The inverter adds the corresponding fixed speeds.</p>	3	AI 0	---	4			5	DI 0	ON / OFF1 fixed speed 1	6	DI 1	Fixed speed 2	7	DI 2	Acknowledge	8	DI 3	---	16	DI 4	Fixed speed 3	17	DI 5	Fixed speed 4
3	AI 0	---																																																																							
4																																																																									
5	DI 0	ON/OFF1 clockwise																																																																							
6	DI 1	ON / OFF1 counter-clockwise																																																																							
7	DI 2	Acknowledge																																																																							
8	DI 3	---																																																																							
16	DI 4	Fixed speed 3																																																																							
17	DI 5	Fixed speed 4																																																																							
3	AI 0	---																																																																							
4																																																																									
5	DI 0	ON / OFF1 fixed speed 1																																																																							
6	DI 1	Fixed speed 2																																																																							
7	DI 2	Acknowledge																																																																							
8	DI 3	---																																																																							
16	DI 4] Reserved for safety function																																																																							
17	DI 5																																																																								
3	AI 0	---																																																																							
4																																																																									
5	DI 0	ON / OFF1 fixed speed 1																																																																							
6	DI 1	Fixed speed 2																																																																							
7	DI 2	Acknowledge																																																																							
8	DI 3	---																																																																							
16	DI 4	Fixed speed 3																																																																							
17	DI 5	Fixed speed 4																																																																							
<p>Default setting 4: PROFIBUS or PROFINET Selected with</p> <ul style="list-style-type: none"> STARTER: Conveyor systems with fieldbus BOP2: coN Fb 	<p>Default setting 5: PROFIBUS or PROFINET with safety function Selected with</p> <ul style="list-style-type: none"> STARTER: Conveyor systems with fieldbus and Basic Safety BOP-2: coN Fb S 																																																																								
<p>PROFIdrive telegram 352</p> <table border="1" style="width: 100%; border-collapse: collapse;"> <tr><td style="width: 20px; text-align: center;">3</td><td style="width: 40px;">AI 0</td><td style="width: 40px;">---</td></tr> <tr><td style="text-align: center;">4</td><td></td><td></td></tr> <tr><td style="text-align: center;">5</td><td>DI 0</td><td>---</td></tr> <tr><td style="text-align: center;">6</td><td>DI 1</td><td>---</td></tr> <tr><td style="text-align: center;">7</td><td>DI 2</td><td>Acknowledge</td></tr> <tr><td style="text-align: center;">8</td><td>DI 3</td><td>---</td></tr> <tr><td style="text-align: center;">16</td><td>DI 4</td><td>---</td></tr> <tr><td style="text-align: center;">17</td><td>DI 5</td><td>---</td></tr> </table>	3	AI 0	---	4			5	DI 0	---	6	DI 1	---	7	DI 2	Acknowledge	8	DI 3	---	16	DI 4	---	17	DI 5	---	<p>PROFIdrive telegram 352</p> <table border="1" style="width: 100%; border-collapse: collapse;"> <tr><td style="width: 20px; text-align: center;">3</td><td style="width: 40px;">AI 0</td><td style="width: 40px;">---</td></tr> <tr><td style="text-align: center;">4</td><td></td><td></td></tr> <tr><td style="text-align: center;">5</td><td>DI 0</td><td>---</td></tr> <tr><td style="text-align: center;">6</td><td>DI 1</td><td>---</td></tr> <tr><td style="text-align: center;">7</td><td>DI 2</td><td>Acknowledge</td></tr> <tr><td style="text-align: center;">8</td><td>DI 3</td><td>---</td></tr> <tr><td style="text-align: center;">16</td><td>DI 4</td><td rowspan="2">] Reserved for safety function</td></tr> <tr><td style="text-align: center;">17</td><td>DI 5</td></tr> </table>	3	AI 0	---	4			5	DI 0	---	6	DI 1	---	7	DI 2	Acknowledge	8	DI 3	---	16	DI 4] Reserved for safety function	17	DI 5																									
3	AI 0	---																																																																							
4																																																																									
5	DI 0	---																																																																							
6	DI 1	---																																																																							
7	DI 2	Acknowledge																																																																							
8	DI 3	---																																																																							
16	DI 4	---																																																																							
17	DI 5	---																																																																							
3	AI 0	---																																																																							
4																																																																									
5	DI 0	---																																																																							
6	DI 1	---																																																																							
7	DI 2	Acknowledge																																																																							
8	DI 3	---																																																																							
16	DI 4] Reserved for safety function																																																																							
17	DI 5																																																																								

<p>Default setting 7: Switch over between fieldbus and jogging using DI 3 Selected with</p> <ul style="list-style-type: none"> STARTER: Fieldbus with data set switchover BOP-2: FB cdS <p>Factory setting for inverters with PROFIBUS interface</p>		<p>Default setting 8: Motorized potentiometer (MOP) with safety function Selected with</p> <ul style="list-style-type: none"> STARTER: MOP with Basic Safety BOP-2: MoP SAFE 																																																																							
<p>PROFIdrive telegram 1</p> <table border="1"> <tr><td>3</td><td>AI 0</td><td>---</td></tr> <tr><td>4</td><td></td><td></td></tr> <tr><td>5</td><td>DI 0</td><td>---</td></tr> <tr><td>6</td><td>DI 1</td><td>---</td></tr> <tr><td>7</td><td>DI 2</td><td>Acknowledge</td></tr> <tr><td>8</td><td>DI 3</td><td>Low</td></tr> <tr><td>16</td><td>DI 4</td><td>---</td></tr> <tr><td>17</td><td>DI 5</td><td>---</td></tr> </table>	3	AI 0	---	4			5	DI 0	---	6	DI 1	---	7	DI 2	Acknowledge	8	DI 3	Low	16	DI 4	---	17	DI 5	---	<p>Fieldbus interface is not active.</p> <table border="1"> <tr><td>3</td><td>AI 0</td><td>---</td></tr> <tr><td>4</td><td></td><td></td></tr> <tr><td>5</td><td>DI 0</td><td>Jog 1</td></tr> <tr><td>6</td><td>DI 1</td><td>Jog 2</td></tr> <tr><td>7</td><td>DI 2</td><td>Acknowledge</td></tr> <tr><td>8</td><td>DI 3</td><td>High</td></tr> <tr><td>16</td><td>DI 4</td><td>---</td></tr> <tr><td>17</td><td>DI 5</td><td>---</td></tr> </table>	3	AI 0	---	4			5	DI 0	Jog 1	6	DI 1	Jog 2	7	DI 2	Acknowledge	8	DI 3	High	16	DI 4	---	17	DI 5	---	<p>Fieldbus interface is not active.</p> <table border="1"> <tr><td>3</td><td>AI 0</td><td>---</td></tr> <tr><td>4</td><td></td><td></td></tr> <tr><td>5</td><td>DI 0</td><td>ON / OFF1</td></tr> <tr><td>6</td><td>DI 1</td><td>MOP raise</td></tr> <tr><td>7</td><td>DI 2</td><td>MOP lower</td></tr> <tr><td>8</td><td>DI 3</td><td>Acknowledge</td></tr> <tr><td>16</td><td>DI 4</td><td rowspan="2">Reserved for safety function</td></tr> <tr><td>17</td><td>DI 5</td></tr> </table>	3	AI 0	---	4			5	DI 0	ON / OFF1	6	DI 1	MOP raise	7	DI 2	MOP lower	8	DI 3	Acknowledge	16	DI 4	Reserved for safety function	17	DI 5
3	AI 0	---																																																																							
4																																																																									
5	DI 0	---																																																																							
6	DI 1	---																																																																							
7	DI 2	Acknowledge																																																																							
8	DI 3	Low																																																																							
16	DI 4	---																																																																							
17	DI 5	---																																																																							
3	AI 0	---																																																																							
4																																																																									
5	DI 0	Jog 1																																																																							
6	DI 1	Jog 2																																																																							
7	DI 2	Acknowledge																																																																							
8	DI 3	High																																																																							
16	DI 4	---																																																																							
17	DI 5	---																																																																							
3	AI 0	---																																																																							
4																																																																									
5	DI 0	ON / OFF1																																																																							
6	DI 1	MOP raise																																																																							
7	DI 2	MOP lower																																																																							
8	DI 3	Acknowledge																																																																							
16	DI 4	Reserved for safety function																																																																							
17	DI 5																																																																								
<p>Default setting 9: Motorized potentiometer (MOP) Selected with</p> <ul style="list-style-type: none"> STARTER: standard I/O with MOP BOP-2: Std MoP 	<p>Default setting 12: Two-wire control with method 1 Selected with</p> <ul style="list-style-type: none"> STARTER: Standard I/O with analog setpoint BOP-2: Std ASP <p>Factory setting for inverters with USS interface</p>	<p>Default setting 13: Setpoint via analog input with safety function Selected with</p> <ul style="list-style-type: none"> STARTER: Standard I/O with analog setpoint and safety BOP-2: ASPS 																																																																							
<p>Fieldbus interface is not active.</p> <table border="1"> <tr><td>3</td><td>AI 0</td><td>---</td></tr> <tr><td>4</td><td></td><td></td></tr> <tr><td>5</td><td>DI 0</td><td>ON / OFF1</td></tr> <tr><td>6</td><td>DI 1</td><td>MOP raise</td></tr> <tr><td>7</td><td>DI 2</td><td>MOP lower</td></tr> <tr><td>8</td><td>DI 3</td><td>Acknowledge</td></tr> <tr><td>16</td><td>DI 4</td><td>---</td></tr> <tr><td>17</td><td>DI 5</td><td>---</td></tr> </table>	3	AI 0	---	4			5	DI 0	ON / OFF1	6	DI 1	MOP raise	7	DI 2	MOP lower	8	DI 3	Acknowledge	16	DI 4	---	17	DI 5	---	<p>Fieldbus interface is not active.</p> <table border="1"> <tr><td>3</td><td>AI 0</td><td>Setpoint</td></tr> <tr><td>4</td><td></td><td>I <input type="checkbox"/> U -10 V ... 10 V</td></tr> <tr><td>5</td><td>DI 0</td><td>ON / OFF1</td></tr> <tr><td>6</td><td>DI 1</td><td>Reversing</td></tr> <tr><td>7</td><td>DI 2</td><td>Acknowledge</td></tr> <tr><td>8</td><td>DI 3</td><td>---</td></tr> <tr><td>16</td><td>DI 4</td><td>---</td></tr> <tr><td>17</td><td>DI 5</td><td>---</td></tr> </table>	3	AI 0	Setpoint	4		I <input type="checkbox"/> U -10 V ... 10 V	5	DI 0	ON / OFF1	6	DI 1	Reversing	7	DI 2	Acknowledge	8	DI 3	---	16	DI 4	---	17	DI 5	---	<p>Fieldbus interface is not active.</p> <table border="1"> <tr><td>3</td><td>AI 0</td><td>Setpoint</td></tr> <tr><td>4</td><td></td><td>I <input type="checkbox"/> U -10 V ... 10 V</td></tr> <tr><td>5</td><td>DI 0</td><td>ON / OFF1</td></tr> <tr><td>6</td><td>DI 1</td><td>Reversing</td></tr> <tr><td>7</td><td>DI 2</td><td>Acknowledge</td></tr> <tr><td>8</td><td>DI 3</td><td>---</td></tr> <tr><td>16</td><td>DI 4</td><td rowspan="2">Reserved for safety function</td></tr> <tr><td>17</td><td>DI 5</td></tr> </table>	3	AI 0	Setpoint	4		I <input type="checkbox"/> U -10 V ... 10 V	5	DI 0	ON / OFF1	6	DI 1	Reversing	7	DI 2	Acknowledge	8	DI 3	---	16	DI 4	Reserved for safety function	17	DI 5
3	AI 0	---																																																																							
4																																																																									
5	DI 0	ON / OFF1																																																																							
6	DI 1	MOP raise																																																																							
7	DI 2	MOP lower																																																																							
8	DI 3	Acknowledge																																																																							
16	DI 4	---																																																																							
17	DI 5	---																																																																							
3	AI 0	Setpoint																																																																							
4		I <input type="checkbox"/> U -10 V ... 10 V																																																																							
5	DI 0	ON / OFF1																																																																							
6	DI 1	Reversing																																																																							
7	DI 2	Acknowledge																																																																							
8	DI 3	---																																																																							
16	DI 4	---																																																																							
17	DI 5	---																																																																							
3	AI 0	Setpoint																																																																							
4		I <input type="checkbox"/> U -10 V ... 10 V																																																																							
5	DI 0	ON / OFF1																																																																							
6	DI 1	Reversing																																																																							
7	DI 2	Acknowledge																																																																							
8	DI 3	---																																																																							
16	DI 4	Reserved for safety function																																																																							
17	DI 5																																																																								
<p>Default setting 14: Switch over between fieldbus and motorized potentiometer (MOP) using DI 3 Selected with</p> <ul style="list-style-type: none"> STARTER: Process industry with fieldbus BOP-2: Proc Fb 																																																																									
<p>PROFIdrive telegram 20</p> <table border="1"> <tr><td>3</td><td>AI 0</td><td>---</td></tr> <tr><td>4</td><td></td><td></td></tr> <tr><td>5</td><td>DI 0</td><td>---</td></tr> <tr><td>6</td><td>DI 1</td><td>External fault</td></tr> <tr><td>7</td><td>DI 2</td><td>Acknowledge</td></tr> <tr><td>8</td><td>DI 3</td><td>Low</td></tr> <tr><td>16</td><td>DI 4</td><td>---</td></tr> <tr><td>17</td><td>DI 5</td><td>---</td></tr> </table>	3	AI 0	---	4			5	DI 0	---	6	DI 1	External fault	7	DI 2	Acknowledge	8	DI 3	Low	16	DI 4	---	17	DI 5	---	<p>Fieldbus interface is not active.</p> <table border="1"> <tr><td>3</td><td>AI 0</td><td>---</td></tr> <tr><td>4</td><td></td><td></td></tr> <tr><td>5</td><td>DI 0</td><td>ON / OFF1</td></tr> <tr><td>6</td><td>DI 1</td><td>External fault</td></tr> <tr><td>7</td><td>DI 2</td><td>Acknowledge</td></tr> <tr><td>8</td><td>DI 3</td><td>High</td></tr> <tr><td>16</td><td>DI 4</td><td>MOP raise</td></tr> <tr><td>17</td><td>DI 5</td><td>MOP lower</td></tr> </table>	3	AI 0	---	4			5	DI 0	ON / OFF1	6	DI 1	External fault	7	DI 2	Acknowledge	8	DI 3	High	16	DI 4	MOP raise	17	DI 5	MOP lower																								
3	AI 0	---																																																																							
4																																																																									
5	DI 0	---																																																																							
6	DI 1	External fault																																																																							
7	DI 2	Acknowledge																																																																							
8	DI 3	Low																																																																							
16	DI 4	---																																																																							
17	DI 5	---																																																																							
3	AI 0	---																																																																							
4																																																																									
5	DI 0	ON / OFF1																																																																							
6	DI 1	External fault																																																																							
7	DI 2	Acknowledge																																																																							
8	DI 3	High																																																																							
16	DI 4	MOP raise																																																																							
17	DI 5	MOP lower																																																																							

<p>Default setting 15: Switch over between analog setpoint and motorized potentiometer (MOP) using DI 3 Selected with</p> <ul style="list-style-type: none"> STARTER: Process industry BOP-2: Proc 		<p>Default setting 17: Two-wire control with method 2 Selected with</p> <ul style="list-style-type: none"> STARTER: 2-wire (forward/backward 1) BOP-2: 2-wlrE 1 <p>Default setting 18: Two-wire control with method 3 Selected with</p> <ul style="list-style-type: none"> STARTER: 2-wire (forward/backward 2) BOP-2: 2-wlrE 2 																																																																									
Fieldbus interface is not active.	Fieldbus interface is not active.	Fieldbus interface is not active.	Fieldbus interface is not active.																																																																								
<table border="1"> <tr><td>3</td><td>AI 0</td><td>Setpoint</td></tr> <tr><td>4</td><td></td><td>I □ U -10 V ... 10 V</td></tr> <tr><td>5</td><td>DI 0</td><td>ON / OFF1</td></tr> <tr><td>6</td><td>DI 1</td><td>External fault</td></tr> <tr><td>7</td><td>DI 2</td><td>Acknowledge</td></tr> <tr><td>8</td><td>DI 3</td><td>Low</td></tr> <tr><td>16</td><td>DI 4</td><td>---</td></tr> <tr><td>17</td><td>DI 5</td><td>---</td></tr> </table>	3	AI 0	Setpoint	4		I □ U -10 V ... 10 V	5	DI 0	ON / OFF1	6	DI 1	External fault	7	DI 2	Acknowledge	8	DI 3	Low	16	DI 4	---	17	DI 5	---	<table border="1"> <tr><td>3</td><td>AI 0</td><td>---</td></tr> <tr><td>4</td><td></td><td></td></tr> <tr><td>5</td><td>DI 0</td><td>ON / OFF1</td></tr> <tr><td>6</td><td>DI 1</td><td>External fault</td></tr> <tr><td>7</td><td>DI 2</td><td>Acknowledge</td></tr> <tr><td>8</td><td>DI 3</td><td>High</td></tr> <tr><td>16</td><td>DI 4</td><td>MOP raise</td></tr> <tr><td>17</td><td>DI 5</td><td>MOP lower</td></tr> </table>	3	AI 0	---	4			5	DI 0	ON / OFF1	6	DI 1	External fault	7	DI 2	Acknowledge	8	DI 3	High	16	DI 4	MOP raise	17	DI 5	MOP lower	<table border="1"> <tr><td>3</td><td>AI 0</td><td>Setpoint</td></tr> <tr><td>4</td><td></td><td>I □ U -10 V ... 10 V</td></tr> <tr><td>5</td><td>DI 0</td><td>ON/OFF1 clockwise</td></tr> <tr><td>6</td><td>DI 1</td><td>ON / OFF1 counter-clockwise</td></tr> <tr><td>7</td><td>DI 2</td><td>Acknowledge</td></tr> <tr><td>8</td><td>DI 3</td><td>---</td></tr> <tr><td>16</td><td>DI 4</td><td>---</td></tr> <tr><td>17</td><td>DI 5</td><td>---</td></tr> </table>	3	AI 0	Setpoint	4		I □ U -10 V ... 10 V	5	DI 0	ON/OFF1 clockwise	6	DI 1	ON / OFF1 counter-clockwise	7	DI 2	Acknowledge	8	DI 3	---	16	DI 4	---	17	DI 5	---	
3	AI 0	Setpoint																																																																									
4		I □ U -10 V ... 10 V																																																																									
5	DI 0	ON / OFF1																																																																									
6	DI 1	External fault																																																																									
7	DI 2	Acknowledge																																																																									
8	DI 3	Low																																																																									
16	DI 4	---																																																																									
17	DI 5	---																																																																									
3	AI 0	---																																																																									
4																																																																											
5	DI 0	ON / OFF1																																																																									
6	DI 1	External fault																																																																									
7	DI 2	Acknowledge																																																																									
8	DI 3	High																																																																									
16	DI 4	MOP raise																																																																									
17	DI 5	MOP lower																																																																									
3	AI 0	Setpoint																																																																									
4		I □ U -10 V ... 10 V																																																																									
5	DI 0	ON/OFF1 clockwise																																																																									
6	DI 1	ON / OFF1 counter-clockwise																																																																									
7	DI 2	Acknowledge																																																																									
8	DI 3	---																																																																									
16	DI 4	---																																																																									
17	DI 5	---																																																																									
<p>Default setting 19: Three-wire control with method 1 Selected with</p> <ul style="list-style-type: none"> STARTER: 3-wire (enable/forward/backward) BOP-2: 3-wlrE 1 	<p>Default setting 20: Three-wire control with method 2 Selected with</p> <ul style="list-style-type: none"> STARTER: 3-wire (enable/on/reverse) BOP-2: 3-wlrE 2 	<p>Default setting 21: Fieldbus USS Selected with</p> <ul style="list-style-type: none"> STARTER: USS fieldbus BOP-2: FB USS <p>Default setting 22: Fieldbus CANopen Selected with</p> <ul style="list-style-type: none"> STARTER: CAN fieldbus BOP-2: FB CAN 																																																																									
Fieldbus interface is not active.	Fieldbus interface is not active.	USS setting: 38400 baud, 2 PZD, PKW variable	CANopen setting: 20 kBaud																																																																								
<table border="1"> <tr><td>3</td><td>AI 0</td><td>Setpoint</td></tr> <tr><td>4</td><td></td><td>I □ U -10 V ... 10 V</td></tr> <tr><td>5</td><td>DI 0</td><td>Enable / OFF1</td></tr> <tr><td>6</td><td>DI 1</td><td>ON clockwise</td></tr> <tr><td>7</td><td>DI 2</td><td>ON counter-clockwise</td></tr> <tr><td>8</td><td>DI 3</td><td>---</td></tr> <tr><td>16</td><td>DI 4</td><td>Acknowledge</td></tr> <tr><td>17</td><td>DI 5</td><td>---</td></tr> </table>	3	AI 0	Setpoint	4		I □ U -10 V ... 10 V	5	DI 0	Enable / OFF1	6	DI 1	ON clockwise	7	DI 2	ON counter-clockwise	8	DI 3	---	16	DI 4	Acknowledge	17	DI 5	---	<table border="1"> <tr><td>3</td><td>AI 0</td><td>Setpoint</td></tr> <tr><td>4</td><td></td><td>I □ U -10 V ... 10 V</td></tr> <tr><td>5</td><td>DI 0</td><td>Enable / OFF1</td></tr> <tr><td>6</td><td>DI 1</td><td>ON</td></tr> <tr><td>7</td><td>DI 2</td><td>Reversing</td></tr> <tr><td>8</td><td>DI 3</td><td>---</td></tr> <tr><td>16</td><td>DI 4</td><td>Acknowledge</td></tr> <tr><td>17</td><td>DI 5</td><td>---</td></tr> </table>	3	AI 0	Setpoint	4		I □ U -10 V ... 10 V	5	DI 0	Enable / OFF1	6	DI 1	ON	7	DI 2	Reversing	8	DI 3	---	16	DI 4	Acknowledge	17	DI 5	---	<table border="1"> <tr><td>3</td><td>AI 0</td><td>---</td></tr> <tr><td>4</td><td></td><td></td></tr> <tr><td>5</td><td>DI 0</td><td>---</td></tr> <tr><td>6</td><td>DI 1</td><td>---</td></tr> <tr><td>7</td><td>DI 2</td><td>Acknowledge</td></tr> <tr><td>8</td><td>DI 3</td><td>---</td></tr> <tr><td>16</td><td>DI 4</td><td>---</td></tr> <tr><td>17</td><td>DI 5</td><td>---</td></tr> </table>	3	AI 0	---	4			5	DI 0	---	6	DI 1	---	7	DI 2	Acknowledge	8	DI 3	---	16	DI 4	---	17	DI 5	---	
3	AI 0	Setpoint																																																																									
4		I □ U -10 V ... 10 V																																																																									
5	DI 0	Enable / OFF1																																																																									
6	DI 1	ON clockwise																																																																									
7	DI 2	ON counter-clockwise																																																																									
8	DI 3	---																																																																									
16	DI 4	Acknowledge																																																																									
17	DI 5	---																																																																									
3	AI 0	Setpoint																																																																									
4		I □ U -10 V ... 10 V																																																																									
5	DI 0	Enable / OFF1																																																																									
6	DI 1	ON																																																																									
7	DI 2	Reversing																																																																									
8	DI 3	---																																																																									
16	DI 4	Acknowledge																																																																									
17	DI 5	---																																																																									
3	AI 0	---																																																																									
4																																																																											
5	DI 0	---																																																																									
6	DI 1	---																																																																									
7	DI 2	Acknowledge																																																																									
8	DI 3	---																																																																									
16	DI 4	---																																																																									
17	DI 5	---																																																																									

3.2.6 Wiring the terminal strip

1. Use a cable with the recommended cross-section, which has been appropriately prepared for use:

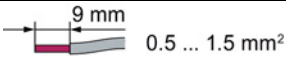
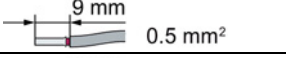
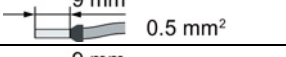
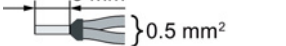
Solid or flexible cable	
Flexible conductor with non-insulated end sleeve	
Flexible conductor with partially-insulated end sleeve	
Two flexible cables with the same cross-section with partially insulated twin end sleeves	

2. If you use shielded cables, then you must connect the shield to the mounting plate of the control cabinet or with the shield support of the inverter through a good electrical connection and a large surface area.
See also: EMC installation guideline
(<http://support.automation.siemens.com/WW/view/en/60612658>)

3. Use the shield connection plate of the inverter as strain relief.

3.2.7 Fieldbus interface assignment

The fieldbus interface is on the underside of the converter.

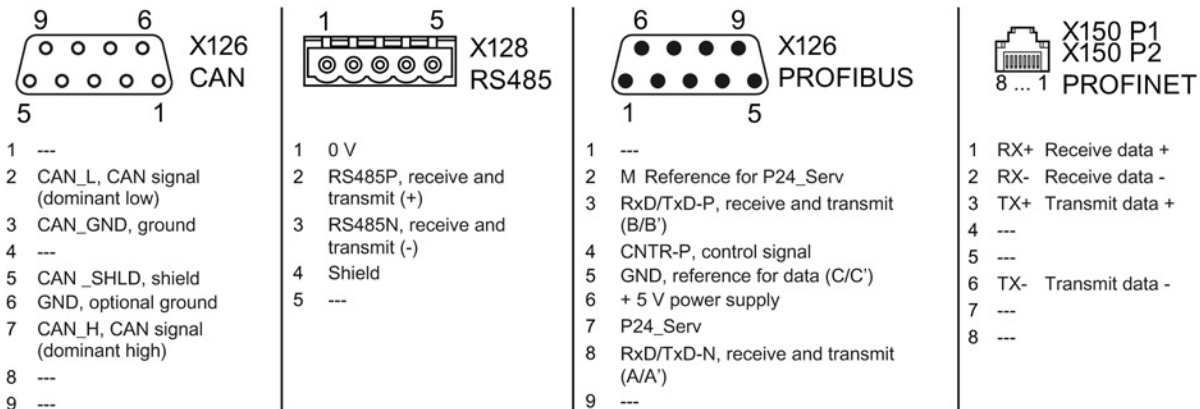





The description files contain the information required to configure and operate the inverter on a fieldbus under a higher-level control.

Description file	Download	Alternative to download
GSD for PROFIBUS	Internet: (http://support.automation.siemens.com/WW/view/en/23450835)	GSD and GSDML are saved in the inverter. The inverter writes its GSD or GSDML to the memory card once you insert this card in the inverter and set p0804 to 12. You can then transfer the file to your programming device or PC using the memory card.
GSDML for PROFINET	Internet: (http://support.automation.siemens.com/WW/view/en/26641490)	
EDS for CANopen	Internet: (http://support.automation.siemens.com/WW/view/en/48351511)	---
EDS for Ethernet/IP	---	Further information can be found in the operating instructions

Commissioning

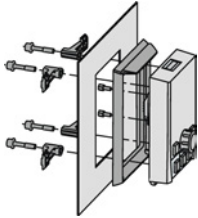
4.1 Overview of the commissioning tool

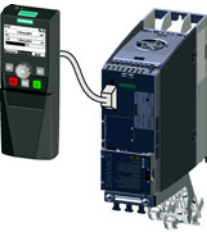
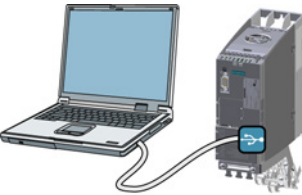
The following tools are used to commission, troubleshoot and control the inverter, as well as to backup and transfer the inverter settings.

Operator panels		Order number
 <p>BOP-2 (Basic Operator Panel) - for snapping onto the inverter</p> <ul style="list-style-type: none"> Two-line display Guided basic commissioning 	 <p>Door mounting kit for IOP/BOP-2</p> <ul style="list-style-type: none"> For installation of the BOP-2 or IOP in a control cabinet door. Degree of protection with IOP: IP54 or UL Type 12 Degree of protection with BOP-2: IP55 	BOP-2: 6SL3255-0AA00-4CA1 IOP: 6SL3255-0AA00-4JA0 Door mounting kit: 6SL3256-0AP00-0JA0
 <p>IOP (Intelligent Operator Panel) - for snapping onto the inverter</p> <ul style="list-style-type: none"> Plain text display Menu-based operation and application wizards 		
	<p>For mobile use of the IOP: IOP handheld with power supply unit and rechargeable batteries as well as RS232 connection cable If you are using your own connection cable, carefully note the maximum permissible length of 5 m.</p>	6SL3255-0AA00-4HA0
PC tools		
 	<p>STARTER Connected to the inverter via USB port, PROFIBUS or PROFINET Download: STARTER (http://support.automation.siemens.com/WW/view/en/10804985/130000)</p>	STARTER on DVD: 6SL3072-0AA00-0AG0
	<p>Startdrive Connected to the inverter via USB port, PROFIBUS or PROFINET Download: Startdrive (http://support.automation.siemens.com/WW/view/en/68034568)</p>	Startdrive on DVD: 6SL3072-4CA02-1XG0
	<p>SINAMICS PC Inverter Connection Kit 2 Contains the correct USB cable (3 m) to connect a PC to the inverter.</p>	6SL3255-0AA00-2CA0

If you intend to commission the converter with IOP operator panel

The IOP offers commissioning wizards and help texts for an intuitive commissioning. For further information refer to the IOP operating instructions.

If you intend to commission the converter with PC tool STARTER

Overview of the most important steps:

1. Connect the PC to the converter via USB and start the STARTER tool.
2. Choose the project wizard (menu "Project / New with assistant").
 - In the project wizard choose "Find drive units online".
 - Select USB as interface (Access point of the application: "DEVICE ...", interface parameter assignment used: "S7USB").
 - Finish the project wizard.
3. STARTER has now created your project and inserted a new drive.
 - Select the drive in your project and go online .
 - In your drive open the "Configuration" mask (double click).
 - Start commissioning with the "Assistent" button.

For further information refer to converter operating instructions.

4.2 Commissioning with BOP-2 operator panel

Installing the basic operator panel BOP-2

Procedure



For installing the BOP-2 operator panel you have to proceed as follows:

1. Remove the blind cover from the converter.
2. Place the bottom edge of the BOP-2 casing into the lower recess of the converter housing.
3. Push the BOP-2 towards the converter until the release-catch clicks into place on the converter housing.

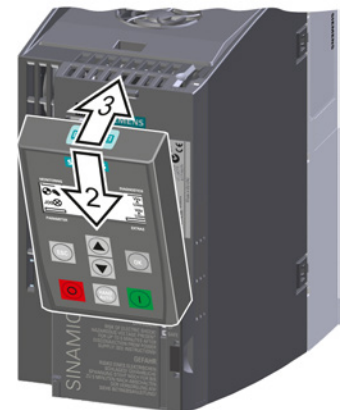

The BOP-2 is installed. When you supply the voltage to the converter, the operator panel BOP-2 is ready to operate.

4.2.1 Basic commissioning with BOP-2

Setting the basic commissioning data

Basic commissioning is the first step of the commissioning procedure. The BOP-2 Operator Panel guides you through the basic commissioning process and prompts you to enter the most important data for your inverter.





Precondition

 You have inserted the BOP-2 Operator Panel on the inverter and connected the inverter to a power supply.
The Operator Panel has powered up and displays setpoints and actual values.

Procedure

To enter the data for basic commissioning, proceed as follows:



1.  Press the ESC key.
2.  Press one of the arrow keys until the BOP-2 displays the "SETUP" menu.
3.  In the "SETUP" menu, press the OK key to start basic commissioning.
4.  If you wish to restore all of the parameters to the factory setting before the basic commissioning:
 - 4.1. Switch over the display using an arrow key: nO → YES
 - 4.2. Press the OK key.
5. 

VF LIN	V/f control with a linear characteristic for basic applications, e.g. horizontal conveyors.
VF QUAD	V/f control with a square-law characteristic for basic pump and fan applications.
SPD N EN	We recommend that you use vector control.

Further information on the control types can be found in Section Selecting the control mode (Page 35)

6. Transfer the data from the motor rating plate to the inverter:

- 6.1. EUR/USA
P100 OK Motor standard
KW 50HZ IEC
HP 60HZ NEMA
KW 60HZ IEC 60 Hz
- 6.2. MOT VOLT
P304 OK Rated voltage
- 6.3. MOT CURR
P305 OK Rated current
- 6.4. MOT POW
P307 OK IEC power (kW)
NEMA (HP)
- 6.5. MOT RPM
P311 OK Rated speed

SIEMENS (H) (EFF I)						
D-91056 Erlangen						
3-Mot. 1LE10011AC434AA0			E0807/0496382			
IEC/EN 60034 100L		IMB3	IP55			
25 kg	Th.Cl. 155(F)		-20°C Tamb 40°C			
Bearing		UNIREX-N3				
○	DE	6206-2ZC3	15g	Intervall: 4000hrs		
	NE	6206-2ZC3	11g			
60Hz: SF 1.15 CONT NEMA MG1-12						
V	Hz	A	kW	PF	NOM.EFF	rpm
400 Δ	50	3.5	1.5	0.73	84.5%	970
690 Y	50	2.05	1.5	0.73	84.5%	970
460 Δ	60	3.15	1.5	0.69	86.5%	1175
(2)	(1)	(3)	(4)	(5)		

7. MOT ID
P1900 OK Motor data identification

Select the method which the inverter uses to measure the data of the connected motor:

OFF No measurement of motor data.

STIL ROT Recommended setting: Measure the motor data at standstill and with the motor rotating.

STILL Measure the motor data at standstill.

Select this setting if one of the following cases is applicable:

- You have selected the control mode "SPD N EN". However, the motor cannot rotate freely – for example, if the traversing range is mechanically limited.
- You have selected V/f control as a control mode, e.g. "VF LIN" or "VF QUAD".

ROT Measuring the motor data while it is rotating.

8. MAc PAr
P15 OK Select the default setting for the interfaces of the inverter that is suitable for your application. You will find the default settings in Section: Default settings of the terminals (Page 25).

9. MIN RPM
P1080 OK Set the minimum speed of the motor.

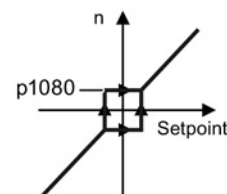

10. **RAMP UP**
P1120 OK Set the ramp-up time of the motor.

11. **RAMP DWN**
P1121 OK Set the ramp-down time of the motor.

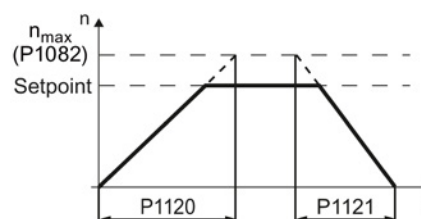

12. **FINISH** OK Complete the basic commissioning:

12.1. Switch over the display using an arrow key: nO → YES

12.2. Press the OK key.



You have entered all of the data that is necessary for the basic commissioning of your inverter.

Identifying the motor data and optimizing the closed-loop control

Following basic commissioning, the inverter generally has to measure other motor data and optimize its current and speed controllers.

To start motor data identification, you must switch on the motor. It does not matter whether you use the terminal strip, fieldbus, or operator panel to enter the ON command.

WARNING

Risk of fatal injury as a result of machine movements when switching on the motor

Switching on the motor for identification purposes may result in hazardous machine movements.

Secure dangerous machine parts before starting motor data identification:

- Before switching on, check that no parts are loose on the machine or can be spun out.
- Before switching on, ensure that nobody is working on the machine or located within its working area.
- Secure the machine's work area against unintended access.
- Lower hanging/suspended loads to the floor.

Preconditions

- In the basic commissioning, you have selected the motor identification (MOT ID). In this case, after the basic commissioning has been completed, the inverter issues the alarm A07991.









	You can recognize an active alarm from the corresponding symbol on the BOP-2.
---	---

- The motor has cooled down to the ambient temperature.
If the motor is too hot, the motor data identification will provide incorrect values and the vector control can become unstable.

Procedure

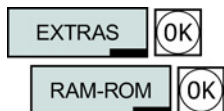

To initiate motor data identification and optimization of the vector control, proceed as follows:

1.  =>  Press the HAND/AUTO key. The BOP-2 displays the HAND symbol.
2.  Switch on the motor.
3.  Wait until the inverter switches off the motor after completion of the motor data identification. The measurement takes several seconds.
4.  Save the measurements so that they are protected against power failure.
5.  If you have also selected a rotating measurement in addition to the motor data identification, then the inverter again issues the alarm A07991.
6.  Switch the motor on again in order to optimize the vector control.
7.  Wait until the inverter switches off the motor after completion of the optimization. The optimization can take up to one minute.
8.  Switch the inverter control from HAND to AUTO.
9.  Save the measurements so that they are protected against power failure.

 You have now completed motor data identification and the vector control has been optimized.

4.2.2 Selecting the control mode

Criteria for selecting either V/f control or vector control

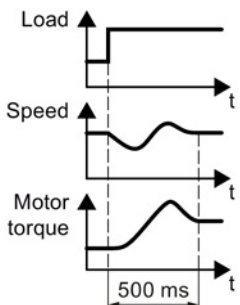
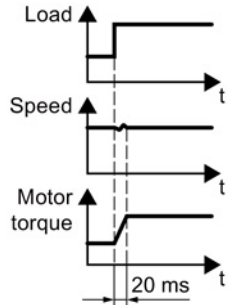
	U/f control or FCC (flux current control)	Vector control without an encoder
Application examples	<ul style="list-style-type: none"> • Pumps, fans, and compressors with flow characteristic • Wet or dry blasting technology • Mills, mixers, kneaders, crushers, agitators • Horizontal conveyor technology (conveyor belts, roller conveyors, chain conveyors) • Basic spindles 	<ul style="list-style-type: none"> • Pumps and compressors with displacement machines • Rotary furnaces • Extruder • Centrifuge
Motors that can be operated	The rated current of the motor must lie in the range of 13 % ... 100 % of the rated current of the inverter.	
Properties of closed-loop motor control	<ul style="list-style-type: none"> • The closed-loop control is insensitive to inaccurate motor data settings, e.g. the motor temperature • Can be commissioned with just a few settings. • Responds to speed changes with a typical settling time of 100 ms ... 200 ms • Responds to load surges with a typical settling time of 500 ms  <ul style="list-style-type: none"> • U/f and FCC are suitable for the following cases: <ul style="list-style-type: none"> – For power-up times $0 \rightarrow$ rated speed > 2 s – For applications with increasing load torque without load impulses 	<ul style="list-style-type: none"> • The vector control makes highly efficient use of the power module, the motor and the mechanical system (95% of the line voltage). • The vector control responds to speed changes with a typical settling time of < 100 ms. • The vector control responds to load impulses with a typical settling time of 20 ms.  <ul style="list-style-type: none"> • The vector control is required in the following cases: <ul style="list-style-type: none"> – For power-up times $0 \rightarrow$ rated speed < 2 s – For applications with fast and high load impulses – For heavy duty starting using ≤ 90 % of the stall torque of the motor • Vector control typically achieves a torque accuracy of ± 5 % for 10 % ... 100 % of the rated speed
Max. output frequency	240 Hz	200 Hz

4.2.3 Additional settings

4.2.3.1 Operating the inverter with the BOP-2

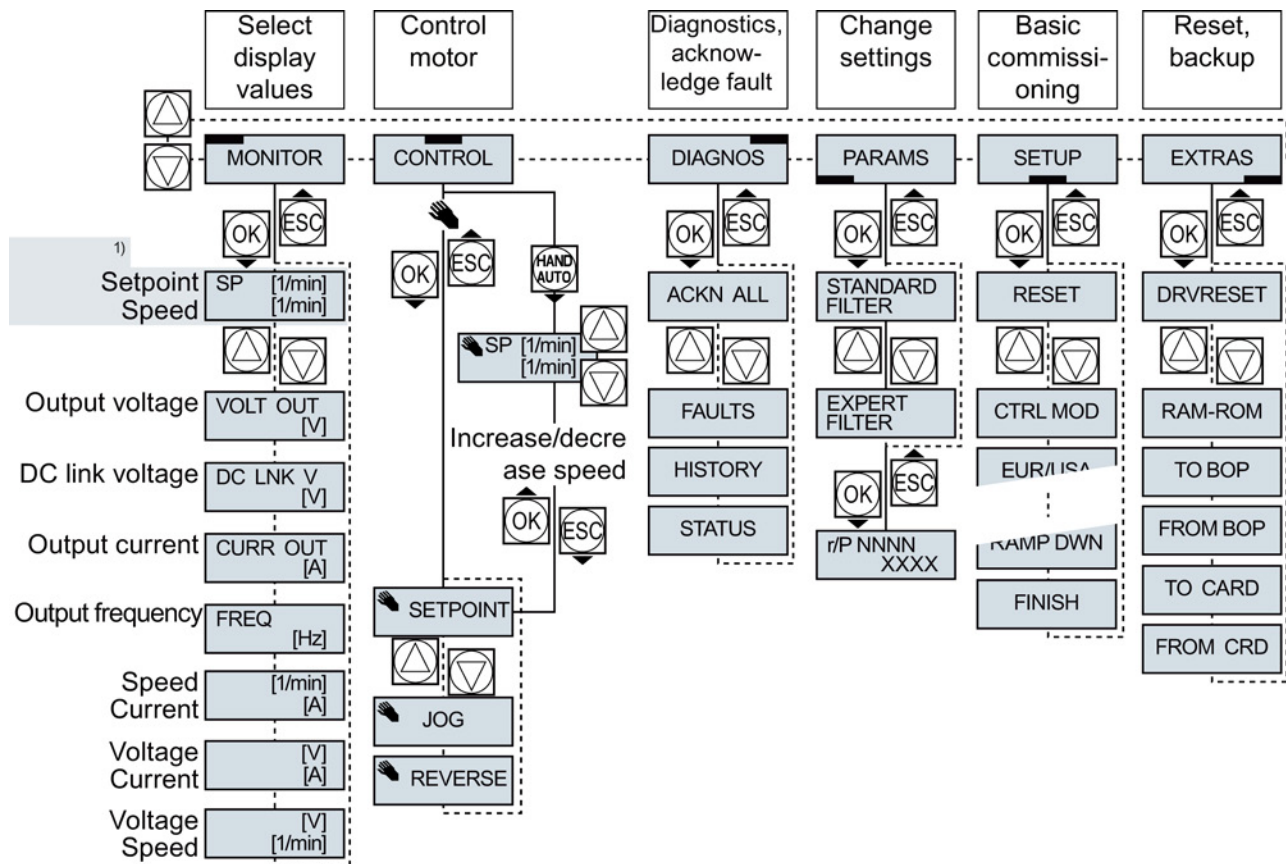

1) Status display once the power supply for the inverter has been switched on.

Figure 4-1 Menu of the BOP-2

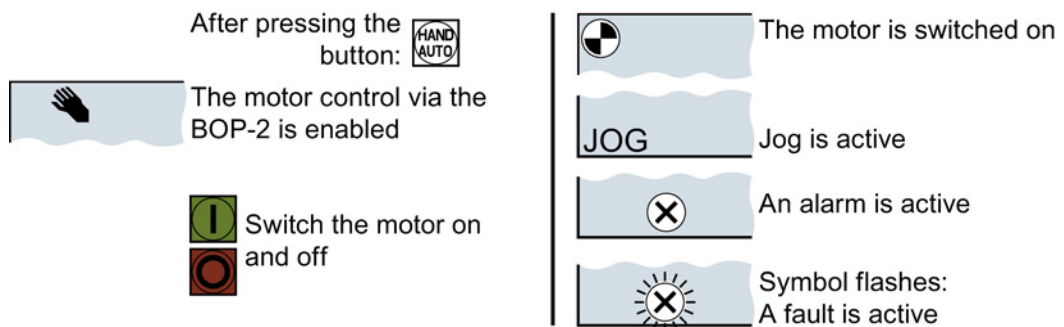

Figure 4-2 Other keys and symbols of the BOP-2

Changing settings using BOP-2

You can modify the settings of your inverter by changing the values of the its parameters. The inverter only permits changes to "write" parameters. Write parameters begin with a "P", e.g. P45.

The value of a read-only parameter cannot be changed. Read-only parameters begin with an "r", for example: r2.

Procedure

To change write parameters using the BOP-2, proceed as follows:

1. Select the menu to display and change parameters.
Press the OK key.
2. Select the parameter filter using the arrow keys.
Press the OK key.
 - STANDARD: The inverter only displays the most important parameters.
 - EXPERT: The inverter displays all of the parameters.
3. Select the required number of a write parameter using the arrow keys.
Press the OK key.
4. Select the value of the write parameter using the arrow keys.
Accept the value with the OK key.

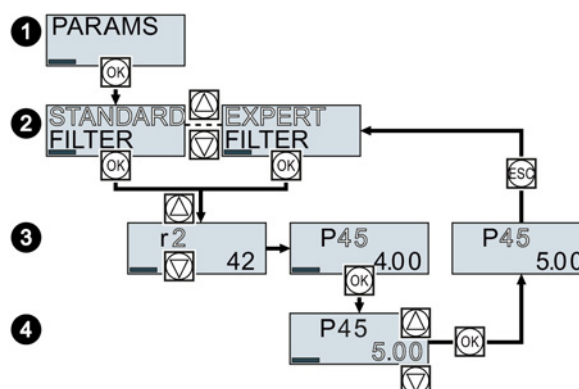

You have now changed a write parameter using the BOP-2.

The converter saves all the changes made using the BOP-2 so that they are protected against power failure.

Changing indexed parameters

For indexed parameters, several parameter values are assigned to a parameter number. Each of the parameter values has its own index.

Procedure

To change an indexed parameter, proceed as follows:

1. Select the parameter number.
2. Press the OK key.
3. Set the parameter index.
4. Press the OK key.
5. Set the parameter value for the selected index.

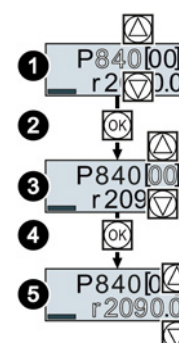

You have now changed an indexed parameter.

Directly select the parameter number

The BOP-2 offers the possibility of setting the parameter number digit by digit.

Precondition

The parameter number is flashing in the BOP-2 display.

Procedure



To select the parameter number directly, proceed as follows:

1. Press the OK button for longer than five seconds.
2. Change the parameter number digit-by-digit.
If you press the OK button then the BOP-2 jumps to the next digit.
3. If you have entered all of the digits of the parameter number, press the OK button.

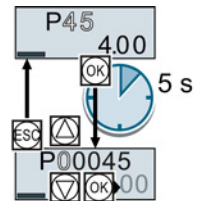

You have now entered the parameter number directly.

Entering the parameter value directly

The BOP-2 offers the option of setting the parameter value digit by digit.

Precondition

The parameter value flashes in the BOP-2 display.

Procedure



To select the parameter value directly, proceed as follows:

1. Press the OK button for longer than five seconds.
2. Change the parameter value digit-by-digit.
If you press the OK button then the BOP-2 jumps to the next digit.
3. If you have entered all of the digits of the parameter value, press the OK button.

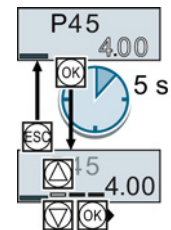

You have now entered the parameter value directly.

When must you not change a parameter?

The converter indicates why it currently does not permit a parameter to be changed:

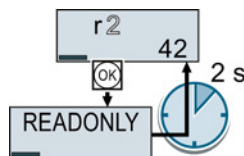

You have attempted to change a read-only parameter.

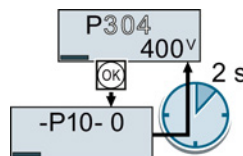

You must change to basic commissioning to set this parameter.

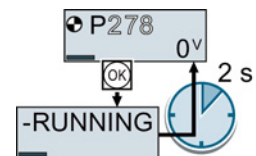

You must turn the motor off to set this parameter.

The operating state in which you can change a parameter is provided in the List Manual for each parameter.

4.2.3.2 Changing the function of individual terminals

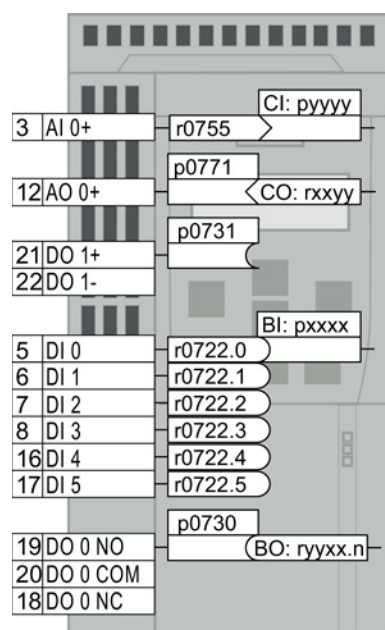

The function of the terminal is defined through a signal interconnection in the inverter:

- The inverter writes every input signal into a readable parameter. Parameter r0755 makes the signal of the analog input available, for example.

To define the function of the input, the appropriate parameter (connector CI or BI) must be set to the parameter number of the input.

- Every inverter output is represented by a parameter that can be written to. The value of parameter p0771 defines the analog output signal, for example.

To define the output function, you must set the parameter number of the output to the parameter number of the matching signal (binector CO or BO).

In the parameter list, the abbreviation CI, CO, BI or BO as prefix indicates as to whether the parameter is available as signal for the function of the terminal.

Defining the function of a digital input

Procedure



To define the function of a digital input, proceed as follows:

1. Select the function marked using a BI parameter.
2. Enter the parameter number of the required digital input 722.x into the BI parameter.



You have defined the digital input function.

Example: You want to switch on the motor using DI 2.	Setting in BOP-2:

Advanced settings

When switching over the master control of the inverter (for example, if you select default setting 7), you must select the correct index of the parameter:

- Index 0 (e.g., P840[00]) applies for the interface assignment on the left side of the macro illustration.
- Index 1 (e.g., P840[01]) applies for the interface assignment on the right side of the macro illustration.

Defining the function of an analog input



Procedure

To define the function of an analog input, proceed as follows:

1. Select the function marked using a CI parameter.
2. Enter the parameter number of analog input 755[00] into the CI parameter.
3. Determine whether the analog input is a current or a voltage input:
 - Set the I/U switch at the front of the inverter to the correct position.
 - Set the p0756[00] parameter to the corresponding value.



You have now defined the analog input function.

Example: You want to enter the supplementary setpoint via AI 0.	Setting in BOP-2:

Advanced settings

When switching over the master control of the inverter (for example, if you select default setting 7), you must select the correct index of the parameter:

- Index 0 (e.g. p1075[00]) applies to the assignment for the interface on the left-hand side of the macro representation.
- Index 1 (e.g. P1075[01]) applies to the assignment for the interface on the right-hand side of the macro representation.

Defining the function of a digital output



Procedure

To define the function of a digital output, proceed as follows:

1. Select the function marked using a BO parameter.
2. Enter the number of the BO parameter into parameter p073x of the digital output.



You have defined the digital output function.

Example: You want to report a "fault" signal via the DO 1.	Setting in BOP-2:

Defining the function of an analog output



Procedure

To define the function of an analog output, proceed as follows:

1. Select the function marked using a CO parameter.
2. Enter the number of the CO parameter into parameter p0771 of the analog output.
3. Use p0776[0] to determine whether the analog output is a current or voltage input.



You have now defined the analog output function.

Example: You want to output the signal for the actual current via AO 0.	Setting in BOP-2:

4.2.3.3 Releasing the failsafe function "Safe Torque Off" (STO)

Precondition

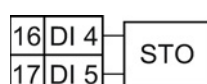

You selected an interface assignment with terminals reserved for a failsafe function. See also Default settings of the terminals (Page 25).



Procedure

For releasing the STO function you have to set the following parameters:

1. p0010 = 95 - Enter commissioning of fail-safe functions.
2. p9761 = ... - Enter password for fail-safe function (factory setting = 0).
3. p9762 = ... - Enter new password, if required (0 ... FFFF FFFF).
4. p9763 = ... - Confirm new password.
5. p9601.0 = 1 - Select STO via terminal strip.
6. p9659 = ... - Set the forced checking procedure timer.
7. p9700 = D0 - Copy fail-safe parameters.
8. p9701 = DC - Confirm fail-safe parameters.
9. p0010 = 0 - Finish commissioning of fail-safe functions
10. p0971 = 1 - Save the parameters in a non-volatile memory
11. Wait until p0971 = 0
12. Bring the converter into a completely no-voltage condition (400V and 24V) and switch on again.



You have released the STO function.

4.2.3.4 Parameter list

The following list contains the basic parameter information with access level 1 ... 3. The complete parameter list is provided in the list manual, see Product support (Page 65).

No.	Description
Operation and visualization	
r0002	Drive operating display
p0003	Access level
p0010	Drive, commissioning parameter filter
p0015	Macro drive unit See also Default settings of the terminals (Page 25)
r0018	Control Unit firmware version
r0020	Speed setpoint smoothed [100 % \pm p2000]
r0021	CO: Actual speed smoothed [100 % \pm p2000]
r0022	Speed actual value rpm smoothed [rpm]
r0024	Output frequency smoothed [100 % \pm p2000]
r0025	CO: Output voltage smoothed [100 % \pm p2001]
r0026	CO: DC link voltage smoothed [100 % \pm p2001]
r0027	CO: Absolute actual current smoothed [100 % \pm p2002]
r0031	Actual torque smoothed [100 % \pm p2003]
r0032	CO: Active power actual value smoothed [100 % \pm r2004]
r0034	Motor utilization [100 \pm 100%]
r0035	CO: Motor temperature [100°C \pm p2006]
r0036	CO: Power unit overload I ² t [100 \pm 100%]
r0039	Energy consumption [kWh]
	[0] Energy balance (total) [1] Energy drawn
	[2] Energy fed back
p0040	0 \rightarrow 1 Reset the energy consumption display
r0041	Energy usage saved/energy saved
p0045	Smoothing time constant, display values [ms]
r0046	CO/BO: Missing enable signals
r0047	Motor data identification routine and speed controller optimization
r0050	CO/BO: Command Data Set CDS effective
r0051	CO/BO: Drive Data Set DDS effective
r0052	CO/BO: Status word 1
	.00 Ready to start .01 Ready

No.	Description
	.02 Operation enabled
	.03 Fault active
	.04 Coast down active (OFF2)
	.05 Quick stop active (OFF3)
	.06 Closing lockout active
	.07 Alarm active
	.08 Deviation, setpoint/actual speed
	.09 Control requested
	.10 Maximum speed reached
	.11 I,M,P limit reached
	.12 Motor holding brake open
	.13 Alarm overtemperature motor
	.14 Motor rotates forwards
	.15 Alarm inverter overload
	r0053
r0054	CO/BO: Control word 1
	.00 ON/OFF1
	.01 OFF2
	.02 OFF3
	.03 Enable ramp-function generator
	.04 Enable ramp-function generator
	.05 Continue ramp-function generator
	.06 Enable speed setpoint
	.07 Acknowledge fault
	.08 Jog bit 0
	.09 Jog bit 1
	.10 Master control by PLC
	.11 Direction reversal (setpoint)
	.13 Motorized potentiometer, raise
	.14 Motorized potentiometer, lower
.15 CDS bit 0	
r0055	CO/BO: Supplementary control word
	.00 Fixed setpoint, bit 0
	.01 Fixed setpoint, bit 1
	.02 Fixed setpoint, bit 2
	.03 Fixed setpoint, bit 3
	.04 DDS selection, bit 0
	.05 DDS selection, bit 1
	.08 Technology controller enable
	.09 DC braking enable
	.11 Droop enable
	.12 Closed-loop torque control active

No.	Description			
	.13	External fault 1 (F07860)		
	.15	CDS bit 1		
r0056	CO/BO: Status word, closed-loop control			
r0060	CO: Speed setpoint before setpoint filter [100 % \pm p2000]			
r0062	CO: Speed setpoint after filter [100 % \pm p2000]			
r0063	CO: Speed actual value unsmoothed [100 % \pm p2000]			
r0064	CO: Speed controller system deviation [100 % \pm p2000]			
r0065	Slip frequency [100 % \pm p2000]			
r0066	CO: Output frequency [100 % \pm p2000]			
r0067	CO: Output current, maximum [100 % \pm p2002]			
r0068	CO: Absolute current actual value unsmoothed [100 % \pm p2002]			
r0070	CO: Actual DC link voltage [100 % \pm p2001]			
r0071	Maximum output voltage [100 % \pm p2001]			
r0072	CO: Output voltage [100 % \pm p2001]			
r0075	CO: Current setpoint field-generating [100 % \pm p2002]			
r0076	CO: Current actual value field-generating [100 % \pm p2002]			
r0077	CO: Current setpoint torque-generating [100 % \pm p2002]			
r0078	CO: Current actual value torque-generating [100 % \pm p2002]			
r0079	CO: Torque setpoint, total [100 % \pm p2003]			
r0080	CO: Actual torque value			
	[0]	unsmoothed	[1]	smoothed
r0082	CO: Active power actual value			
	[0]	unsmoothed	[1]	smoothed with p0045
	[2]	Electric power		
Commissioning				
p0100	IEC/NEMA motor standard			
	0	IEC motor (50 Hz, SI units)		
	1	NEMA motor (60 Hz, US units)		
	2	NEMA motor (60 Hz, SI units)		
p0124	CU Identification via LED			
p0133	Motor configuration			
	.00	1: Delta 0: Star	.01	1: 87 Hz 0: No 87 Hz
p0170	Number of Command Data Sets (CDS)			
p0180	Number of Drive Data Sets (DDS)			
No.	Description			
Power Module				
p0201	Power unit code number			
r0204	Power unit, hardware properties			
p0205	Power unit application			
	0	Load cycle with high overload		
	1	Load cycle with light overload		
r0206	Rated power unit power [kw/hp]			
r0207	Rated power unit current			
r0208	Rated power unit line supply voltage [V]			
r0209	Power unit, maximum current			
p0210	Drive unit line supply voltage [V]			
p0219	Braking resistor braking power [kW]			
p0230	Drive filter type, motor side			
	0	No filter		
	1	Motor reactor		
	2	dv/dt filter		
	3	Siemens sine-wave filter		
	4	Sine wave filter, third-party manufacturer		
p0233	Power unit motor reactor [mH]			
p0234	Power unit sine-wave filter capacitance [μ F]			
r0238	Internal power unit resistance			
p0287	Ground fault monitoring thresholds [100 % \pm r0209]			
r0289	CO: Maximum power unit output current [100 % \pm p2002]			
p0290	Power unit overload response			
	0	Reduce output current or output frequency		
	1	No reduction, shutdown when overload threshold is reached		
	2	Reduce I_output or f_output and f_pulse (not using I2t).		
	3	Reduce the pulse frequency (not using I2t)		
	12	I_output or f_output and automatic pulse frequency reduction		
	13	Automatic pulse frequency reduction		
p0292	Power unit temperature alarm threshold [$^{\circ}$ C]			
p0295	Fan run-on time [s]			
Motor				
p0300	Motor type selection			
	0	No motor		
	1	Induction motor		
	2	Synchronous motor		

No.	Description
	10 1LE1 standard induction motor
	13 1LG6 standard induction motor
	17 1LA7 standard induction motor
	19 1LA9 standard induction motor
	100 1LE1 standard induction motor
p0301	Motor code number selection
p0304	Rated motor voltage [V]
p0305	Rated motor current [A]
p0306	Number of motors connected in parallel
p0307	Rated motor power [kW]
p0308	Rated motor power factor
p0309	Rated motor efficiency [%]
p0310	Rated motor frequency [Hz]
p0311	Rated motor speed [rpm]
p0312	Rated motor torque [Nm]
p0320	Motor rated magnetizing current/short-circuit current [A]
p0322	Maximum motor speed [rpm]
p0323	Maximum motor current [A]
p0325	Motor pole position identification current 1st phase [A]
p0329	Motor pole position identification current [A]
r0330	Rated motor slip
r0331	Actual motor magnetizing current/short-circuit current
r0333	Rated motor torque [Nm]
p0335	Motor cooling type
p0340	Automatic calculation of motor/control parameters
p0341	Motor moment of inertia [kgm ²]
p0342	Ratio between the total and motor moment of inertia [kgm ²]
r0345	Nominal motor starting time
p0346	Motor excitation build-up time [s]
p0347	Motor de-excitation time [s]
p0350	Motor stator resistance, cold [Ω]
p0352	Cable resistance [Ω]
r0395	Actual stator resistance
r0396	Actual rotor resistance
Technology and units	
p0500	Technology application
p0505	Selecting the system of units
	1 System of units SI

No.	Description
	2 Referred system of units/SI
	3 US system of units
	4 System of units, referred/US
p0573	Inhibit automatic reference value calculation
p0595	Selecting technological units
	1 % 2 1 referred, no dimensions
	3 bar 4 °C 5 Pa
	6 ltr/s 7 m ³ /s 8 ltr/min
	9 m ³ /min 10 ltr/h 11 m ³ /h
	12 kg/s 13 kg/min 14 kg/h
	15 t/min 16 t/h 17 N
	18 kN 19 Nm 20 psi
	21 °F 22 gallon/s 23 inch ³ /s
	24 gallon/min 25 inch ³ /min 26 gallon/h
	27 inch ³ /h 28 lb/s 29 lb/min
	30 lb/h 31 lbf 32 lbf ft
	33 K 34 rpm 35 parts/min
	36 m/s 37 ft ³ /s 38 ft ³ /min
	39 BTU/min 40 BTU/h 41 mbar
	42 inch wg 43 ft wg 44 m wg
	45 % r.h. 46 g/kg
p0596	Reference quantity, technological units
Thermal motor monitoring and motor model, maximum current	
p0601	Motor temperature sensor type
	0 No sensor
	1 PTC warning & timer
	2 KTY84
	4 Bimetallic NC contact warning & timer
p0604	Motor temperature alarm threshold [°C]
p0605	Motor temperature fault threshold [°C]
p0610	Motor overtemperature response
	0 No response, alarm only, no reduction of I _{max}
	1 Alarm with reduction of I _{max} and fault
	2 Alarm and fault, no reduction of I _{max}
	12 Messages, no reduction of I _{max} , temperature is saved
p0611	I ² t motor model thermal time constant [s]
p0612	Motor temperature model activation
	00 Activate motor temperature model 1 (I ² t) 01 Activate motor temperature model 2

No.	Description		No.	Description	
	09	Activate motor temperature model 2 expansions			
p0614	Thermal resistor adaptation reduction factor		p0757	CU analog input characteristic value x1	
p0615	I ² t motor model fault threshold [°C]		p0758	CU analog input characteristic value y1 [%]	
p0625	Motor ambient temperature [°C]		p0759	CU analog input characteristic value x2	
p0637	Q flux, flux gradient saturated [mH]		p0760	CU analog input characteristic value y2 [%]	
p0640	Current limit [A]		p0761	CU analog input wire break monitoring response threshold	
Command sources and terminals on the Control Unit			p0764	CU analog inputs deadband [V]	
r0720	CU number of inputs and outputs		p0771	CI: CU analog output signal source, AO 0 (terminals 12, 13) [100 ± 100%]	
r0722	CO/BO: CU digital inputs, status		r0772	CU analog output, output value currently referred	
	.00	DI 0 (terminal 5)	r0774	CU analog output, output voltage/current actual [100% ± p2001]	
	.01	DI 1 (terminal 6)	p0775	CU analog output activate absolute value generation	
	.02	DI 2 (terminal 7)		p0776	CU analog output type
	.03	DI 3 (terminal 8)	0		Current output (0 mA ... +20 mA)
	.04	DI 4 (terminal 16)	1		Voltage output (0 V... +10 V)
	.05	DI 5 (terminal 17)	2	Current output (+4 mA ... +20 mA)	
	.11	DI 11 (terminals 3, 4) AI 0			
r0723	CO/BO: CU digital inputs, status inverted		p0777	CU analog output characteristic value x1 [%]	
p0730	BI: CU signal source for terminal DO 0		p0778	CU analog output characteristic value y1 [V]	
	NO: Terminal 19 / NC: Terminal 18		p0779	CU analog output characteristic value x2 [%]	
p0731	BI: CU signal source for terminal DO 1		p0780	CU analog output characteristic value y2 [V]	
	NO: Terminal 21		p0782	BI: CU analog output invert signal source, AO 0 (terminals 12,13)	
r0747	CU, digital outputs status		r0785	BO: CU analog outputs status word	
p0748	CU, invert digital outputs			.00	1 = AO 0 negative
r0751	BO: CU analog inputs status word		p0795	CU digital inputs, simulation mode	
r0752	CO: CU analog inputs input voltage/current actual AI0 (terminals 3/4)		p0796	CU digital inputs, simulation mode setpoint	
r0755	CO: CU analog inputs actual value in percent, AI0 (terminals 3/4) [100 ± 100%]				
p0756	CU analog input type (terminals 3, 4)				
	0	Unipolar voltage input (0 V ... +10 V)			
	1	Unipolar voltage input monitored (+2 V... +10 V)			
	2	Unipolar current input (0 mA ... +20 mA)			
	3	Unipolar current input monitored (+4 mA ... +20 mA)			
	4	Bipolar voltage input (-10 V...+10 V)			
8	No sensor connected				

No.	Description
p0797	CU analog inputs, simulation mode
p0798	CU analog inputs, simulation mode setpoint
Change over and copy data sets	
p0802	Data transfer with memory card as source/target
p0803	Data transfer with device memory as source/target
p0804	Data transfer start
	12 Start transfer of the GSD for PROFIBUS master on the memory card
p0806	BI: Inhibit master control
r0807	BO: Master control active
p0809	Copy Command Data Set CDS
p0810	BI: Command data set selection CDS bit 0
p0819	Copy drive data set DDS
p0820	BI: Drive data set selection DDS, bit 0
p0826	Motor changeover, motor number
r0835	CO/BO: Data set changeover status word
r0836	CO/BO: Command data set CDS selected
r0837	CO/BO: Drive data set DDS selected
Sequence control (e.g. ON/OFF1)	
p0840	BI: ON/OFF (OFF1)
p0844	BI: No coast down/coast down (OFF2) signal source 1
p0845	BI: No coast down/coast down (OFF2) signal source 2
p0848	BI: No quick stop/quick stop (OFF3) signal source 1
p0849	BI: No quick stop/quick stop (OFF3) signal source 1
p0852	BI: Enable operation
p0854	BI: Master control by PLC
p0855	BI: Unconditionally release holding brake
p0856	BI: Enable speed controller
p0858	BI: Unconditionally close holding brake
p0867	Power unit main contactor hold time after OFF1 [ms]
	.00 1 = keep main contactor closed for STO
p0869	Configuration sequence control
r0898	CO/BO: Control word sequence control
r0899	CO/BO: Status word sequence control

PROFIBUS, PROFIdrive	
p0918	PROFIBUS address
p0922	PROFIdrive telegram selection
	1 Standard telegram 1, PZD-2/2
	20 Standard telegram 20, PZD-2/6
	352 SIEMENS telegram 352, PZD-6/6
	353 SIEMENS telegram 353, PZD-2/2, PKW-4/4
	354 SIEMENS telegram 354, PZD-6/6, PKW-4/4
999	Free telegram configuration with BICO
Faults (Part 1)	
r0944	CO: Counter for fault buffer changes
r0945	Fault code
r0946	Fault code list
r0947	Fault number
r0948	Fault time received in milliseconds [ms]
r0949	Fault value
p0952	Fault cases, counter
r0963	PROFIBUS baud rate
r0964	Device identification
p0965	PROFIdrive profile number
p0969	System runtime relative [ms]
Restoring the factory setting Saving parameters	
p0970	Reset drive parameters
	0 Inactive
	1 Reset start parameters
	5 Starts a safety parameter reset
	10 Starts to download setting 10
	11 Starts to download setting 11
	12 Starts to download setting 12
	100 Starts a BICO interconnection reset
	p0971
0 Inactive	
1 Save drive object	
10 Save in a non-volatile memory as setting 10	
11 Save in a non-volatile memory as setting 11	
12 Save in a non-volatile memory as setting 12	
p0972	Drive unit reset

Setpoint channel				
p1000	Speed setpoint selection		p1047	Motorized potentiometer ramp-up time [s]
p1001	CO: Fixed speed setpoint 1 [rpm]		p1048	Motorized potentiometer ramp-down time [s]
p1002	CO: Fixed speed setpoint 2 [rpm]		r1050	CO: Motorized potentiometer setpoint after the ramp-function generator [100 % \pm p2000]
p1003	CO: Fixed speed setpoint 3 [rpm]		p1055	BI: Jog bit 0
p1004	CO: Fixed speed setpoint 4 [rpm]		p1056	BI: Jog bit 1
p1005	CO: Fixed speed setpoint 5 [rpm]		p1058	Jog 1 speed setpoint [rpm]
p1006	CO: Fixed speed setpoint 6 [rpm]		p1059	Jog 2 speed setpoint [rpm]
p1007	CO: Fixed speed setpoint 7 [rpm]		p1070	CI: Main setpoint [100 % \pm p2000]
p1008	CO: Fixed speed setpoint 8 [rpm]		p1071	CI: Main setpoint scaling [100 \pm 100%]
p1009	CO: Fixed speed setpoint 9 [rpm]		r1073	CO: Main setpoint effective [100 % \pm p2000]
p1010	CO: Fixed speed setpoint 10 [rpm]		p1075	CI: Supplementary setpoint [100 % \pm p2000]
p1011	CO: Fixed speed setpoint 11 [rpm]		p1076	CI: Supplementary setpoint scaling [100 \pm 100%]
p1012	CO: Fixed speed setpoint 12 [rpm]		r1077	CO: Supplementary setpoint effective [100 % \pm p2000]
p1013	CO: Fixed speed setpoint 13 [rpm]		r1078	CO: Total setpoint effective [100 % \pm p2000]
p1014	CO: Fixed speed setpoint 14 [rpm]		p1080	Minimum speed [rpm]
p1015	CO: Fixed speed setpoint 15 [rpm]		p1081	Maximum speed scaling [%]
p1016	Fixed speed setpoint mode		p1082	Maximum speed [rpm]
	1	Direct selection	p1083	CO: Speed limit in positive direction of rotation [rpm]
	2	Selection, binary coded	r1084	CO: Speed limit positive effective [100 % \pm p2000]
p1020	BI: Fixed speed setpoint selection bit 0		p1086	CO: Speed limit in negative direction of rotation [rpm]
p1021	BI: Fixed speed setpoint selection bit 1		r1087	CO: Speed limit negative effective [100 % \pm p2000]
p1022	BI: Fixed speed setpoint selection bit 2		p1091	Skip speed 1 [rpm]
p1023	BI: Fixed speed setpoint selection bit 3		p1092	Skip speed 2 [rpm]
r1024	CO: Fixed speed setpoint effective [100 % \pm p2000]		p1101	Skip speed bandwidth [rpm]
r1025	BO: Fixed speed setpoint status		p1106	CI: Minimum speed signal source
p1030	Motorized potentiometer configuration		p1110	BI: Inhibit negative direction
	00	Storage active	p1111	BI: Inhibit positive direction
	01	Automatic operation, ramp-function generator active	p1113	BI: Setpoint inversion
	02	Initial rounding active	r1114	CO: Setpoint after the direction limiting [100 % \pm p2000]
p1035	BI: Motorized potentiometer setpoint raise		r1119	CO: Ramp-function generator setpoint at the input [100 % \pm p2000]
p1036	BI: Motorized potentiometer setpoint lower			
p1037	Motorized potentiometer maximum speed [rpm]			
p1038	Motorized potentiometer minimum speed [rpm]			
p1040	Motorized potentiometer start value [rpm]			
p1043	BI: Motorized potentiometer, accept setting value			
p1044	CI: Motorized potentiometer setting value [100 % \pm p2000]			
r1045	CO: Motorized potentiometer, setpoint in front of the ramp-function generator [rpm]			
p1120	Ramp-function generator ramp-up time [s]			

p1121	Ramp-function generator ramp-down time [s]
p1130	Ramp-function generator initial rounding-off time [s]
p1131	Ramp-function generator final rounding-off time [s]
p1134	Ramp-function generator rounding-off type
	0 Continuous smoothing
	1 Discontinuous smoothing
p1135	OFF3 ramp-down time [s]
p1136	OFF3 initial rounding-off time [s]
p1137	OFF3 final rounding-off time [s]
p1138	CI: Acceleration ramp scaling [100 ± 100%]
p1139	CI: Ramp down scaling [100 ± 100%]
p1140	BI: Enable ramp-function generator
p1141	BI: Continue ramp-function generator
p1142	BI: Enable speed setpoint
r1149	CO: Ramp-function generator acceleration [100 % ± p2007]
r1170	CO: Speed controller setpoint sum [100 % ± p2000]
r1198	CO/BO: Control word, setpoint channel
Functions (e.g. motor holding brake)	
p1200	Flying restart operating mode
	0 Flying restart inactive
	1 Flying restart always active (start in setpoint direction)
	4 Flying restart always active (start only in setpoint direction)
p1201	BI: Flying restart enable signal source
p1202	Flying restart search current [100 % ± r0331]
p1203	Flying restart search rate factor [%]
	A higher value results in a longer search time.
p1206	Set fault number without automatic restart
p1210	Automatic restart mode
	0 Inhibit automatic restart
	1 Acknowledge all faults without restarting
	4 Restart after line supply failure, without additional start attempts
	6 Restart after fault with additional start attempts
	14 Restart after line supply failure following manual acknowledgement
16 Restart after fault following manual acknowledgement	

	26	Acknowledging all faults and restarting for an ON command
p1211	Automatic restart, start attempts	
p1212	Automatic restart, delay time start attempts [s]	
p1213	Automatic restart, monitoring time [s]	
	[0]	Restart [1] Reset start counter
p1215	Motor holding brake configuration	
	0	No motor holding brake being used
	3	Motor holding brake like sequential control, connection via BICO
p1216	Motor holding brake, opening time [ms]	
p1217	Motor holding brake, closing time [ms]	
p1230	BI: DC braking activation	
p1231	DC braking configuration	
	0	No function
	4	DC braking
	5	DC braking OFF1/OFF3
	14	DC braking below starting speed
p1232	DC braking, braking current [A]	
p1233	DC braking time [s]	
p1234	Speed at the start of DC braking [rpm]	
r1239	CO/BO: DC braking status word	
p1240	V _{DC} controller or V _{DC} monitoring configuration (vector control)	
	0	Inhibit V _{DC} controller
	1	Enable V _{DC_max} controller
	2	Enable V _{DC_min} controller (kinetic buffering)
	3	Enable V _{DC_min} controller and V _{DC_max} controller
r1242	V _{DC_max} controller switch-in level [100 % ± p2001]	
p1243	V _{DC_max} controller dynamic factor [%]	
p1245	V _{DC_min} controller switch-in level (kinetic buffering) [%]	
r1246	V _{DC_min} controller switch-in level (kinetic buffering) [100 % ± p2001]	
p1247	V _{DC_min} controller dynamic factor (kinetic buffering) [%]	
p1249	V _{DC_max} controller speed threshold [rpm]	
p1254	V _{DC_max} controller automatic ON level detection	
	0	Automatic detection inhibited
	1	Automatic detection enabled
p1255	V _{DC_min} controller time threshold [s]	
p1256	V _{DC_min} controller response (kinetic buffering)	
	0	Buffer V _{DC} until undervoltage, n<p1257 → F07405

	1	Buffer V_{DC} until undervoltage, $n < p1257 \rightarrow F07405$, $t > p1255 \rightarrow F07406$	r1315	Voltage boost, total [100 % \pm p2001]
p1257		V_{DC_min} controller speed threshold [rpm]		
p1271		Flying restart maximum frequency for the inhibited direction [Hz]	p1320	V/f control programmable characteristic frequency 1 [Hz]
p1280		V_{DC} controller or V_{DC} monitoring configuration (V/f)	p1321	V/f control programmable characteristic voltage 1 [V]
	0	Inhibit V_{DC} controller	p1322	Characteristic frequency 2 [Hz]
	1	Enable V_{DC_max} controller	p1323	Characteristic voltage 2 [V]
r1282		V_{DC_max} controller switch-in level (V/f) [100 % \pm p2001]	p1324	Characteristic frequency 3 [Hz]
p1283		V_{DC_max} controller dynamic factor (V/f) [%]	p1325	Characteristic voltage 3 [V]
p1284		V_{DC_max} controller time threshold (U/f) [s]	p1326	Characteristic frequency 4 [Hz]
V/f control			p1327	Characteristic voltage 4 [V]
p1300		Open-loop/closed-loop control operating mode	p1330	CI: V/f control independent voltage setpoint [100 % \pm p2001]
	0	V/f control with linear characteristic	p1331	Voltage limiting [V]
	1	V/f control with linear characteristic and FCC	p1334	V/f control slip compensation starting frequency [Hz]
	2	V/f control with parabolic characteristic	p1335	Slip compensation, scaling [100 % \pm r0330]
	3	V/f control with parameterizable characteristic	p1336	Slip compensation limit value [100 % \pm r0330]
	4	V/f control with linear characteristic and ECO	r1337	CO: Actual slip compensation [100 \pm 100%]
	5	V/f control for drive requiring a precise frequency (e.g. textiles)	p1338	V/f mode resonance damping gain
	6	V/f control for drive requiring a precise frequency and FCC	p1340	I_{max} frequency controller proportional gain
	7	V/f control for parabolic characteristic and ECO	r1343	CO: I_{max} controller frequency output [100 % \pm p2000]
	19	V/f control with independent voltage setpoint	p1349	U/f mode resonance damping maximum frequency [Hz]
	20	Speed control (without encoder)	p1351	CO: Motor holding brake starting frequency [100 \pm 100%]
			p1352	CI: Motor holding brake starting frequency [100 \pm 100%]
p1302		V/f control configuration	Vector control	
	.03	Motor holding brake with constant stop frequency	r1438	CO: Speed controller speed setpoint [100 % \pm p2000]
p1310		Voltage boost permanent [100 % \pm p0305]	p1452	Speed controller speed actual value smoothing time (SLVC) [ms]
p1311		Voltage boost when accelerating [%]		
p1312		Voltage boost when starting [%]		

p1470	Speed controller encoderless operation P gain
p1472	Speed controller sensorless operation integral time [ms]
p1475	CI: Speed controller torque setting value for motor holding brake [100 % \pm p2003]
r1482	CO: Speed controller I torque output [100 % \pm p2003]
r1493	CO: Total moment of inertia [kgm ²]
p1496	Acceleration pre-control scaling [%]
p1498	Load moment of inertia [kgm ²]
p1502	BI: Freezing the moment of inertia estimator
	0 Moment of inertia estimator active 1 Determined moment of inertia frozen
p1511	CI: Supplementary torque 1 [100 % \pm p2003]
r1516	CO: Supplementary torque and acceleration torque [100 % \pm p2003]
p1520	CO: Torque limit upper [Nm]
p1521	CO: Torque limit lower [Nm]
p1522	CI: Torque limit upper [100 % \pm p2003]
p1523	CI: Torque limit lower [100 % \pm p2003]
p1524	CO: Torque limit upper/motoring scaling [100 \pm 100%]
p1525	CO: Torque limit lower scaling [100 \pm 100%]
r1526	CO: Torque limit upper without offset [100 % \pm p2003]
r1527	CO: Torque limit lower without offset [100 % \pm p2003]
p1530	Power limit motoring [kW]
p1531	Power limit regenerative [kW]
r1538	CO: Upper effective torque limit [100 % \pm p2003]
r1539	CO: Lower effective torque limit [100 % \pm p2003]
r1547	CO: Torque limit for speed controller output
	[0] Upper limit [100 % \pm p2003]
	[1] Lower limit [100 % \pm p2003]
p1552	CI: Torque limit upper scaling without offset [100 \pm 100%]
p1554	CI: Torque limit lower scaling without offset [100 \pm 100%]
p1560	Moment of inertia estimator, accelerating torque threshold value [100% \pm r0333]
p1561	Moment of inertia estimator change time inertia [ms]
p1562	Moment of inertia estimator change time load [ms]
p1563	CO: Moment of inertia estimator load torque positive direction of rotation [Nm]

p1564	CO: Moment of inertia estimator load torque negative direction of rotation [Nm]
p1570	CO: Flux setpoint [100 \pm 100%]
p1580	Efficiency optimization [%]
r1598	CO: Flux setpoint total [100 \pm 100%]
p1610	Torque setpoint static (SLVC) [100 % \pm r0333]
p1611	Supplementary accelerating torque (SLVC) [100 % \pm r0333]
r1732	CO: Direct-axis voltage setpoint [100 % \pm p2001]
r1733	CO: Quadrature-axis voltage setpoint [100 % \pm p2001]
p1745	Motor model error threshold stall detection [%]
p1780	Motor model adaptation configuration
Gating unit	
p1800	Pulse frequency setpoint [kHz]
r1801	CO: Pulse frequency [100 % \pm p2000]
p1806	Filter time constant V _{DC} correction [ms]
p1820	Reverse the output phase sequence
	0 Off 1 On
r1838	CO/BO: Gating unit status word 1
Motor identification	
p1900	Motor data identification and rotating measurement
	0 Inhibited
	1 Identify the motor data at standstill and with the motor rotating
	2 Identify motor data at standstill
p1901	Test pulse evaluation configuration
	.00 Phase short-circuit test pulse active
	.01 Ground fault detection test pulse active
	.02 Test pulse for every pulse enable
p1909	Motor data identification control word
p1910	Motor data identification selection
p1959	Rotating measurement configuration
p1960	Rotating measurement selection
	0 Inhibited
	1 Rotating measurement in encoderless operation
p1961	3 Speed controller optimization in encoderless operation
	Saturation characteristic speed to determine [%]
p1965	Speed_ctrl_opt speed [100 % \pm p0310]

p1967	Speed_ctrl_opt dynamic factor [%]			
p1980	PolID procedure			
	1	Voltage pulsing, 1st harmonic		
	4	Voltage pulsing, 2-phase		
	6	Voltage pulsing, 2-phase inverse		
	8	Voltage pulsing, 2nd harmonic, inverse		
	10	Impressing DC current		
Reference values				
p2000	Reference speed reference frequency [rpm]			
p2001	Reference voltage [V]			
p2002	Reference current [A]			
p2003	Reference torque [Nm]			
r2004	Reference power			
p2006	Reference temperature [°C]			
p2010	Commissioning interface baud rate			
p2011	Commissioning interface address			
p2016	CI: Comm IF USS PZD send word			
USS or Modbus RTU				
p2020	Fieldbus interface baud rate			
	4	2400 baud	5	4800 baud
	6	9600 baud	7	19200 baud
	8	38400 baud	9	57600 baud
	10	76800 baud	11	93750 baud
	12	115200 baud	13	187500 baud
	p2021	Fieldbus interface address		
p2022	Fieldbus interface USS PZD number			
p2023	Fieldbus interface USS PKW number			
	0	PKW 0 words	3	PKW 3 words
	4	PKW 4 words	127	PKW variable
p2024	Fieldbus interface times [ms]			
	[0]	Maximum processing time		
	[1]	Character delay time		
	[2]	Telegram pause time		
r2029	Fieldbus interface error statistics			
	[0]	Number of error-free telegrams		
	[1]	Number of rejected telegrams		
	[2]	Number of framing errors		
	[3]	Number of overrun errors		
	[4]	Number of parity errors		
	[5]	Number of starting character errors		
	[6]	Number of checksum errors		
[7]	Number of length errors			
p2030	Fieldbus interface protocol selection			
	0	No protocol		
	1	USS		
	2	MODBUS		
	3	PROFIBUS		
4	CAN			
r2032	Master control, control word effective			
	.00	ON / OFF1		
	.01	OFF2 inactive		
	.02	OFF3 inactive		
	.03	Enable operation		
	.04	Enable ramp-function generator		
	.05	Start ramp-function generator		
	.06	Enable speed setpoint		
	.07	Acknowledge fault		
	.08	Jog bit 0		
.09	Jog bit 1			
.10	Master control by PLC			
p2037	PROFIdrive STW1.10 = 0 mode			
	0	Freeze setpoints and further process sign-of-life		
	1	Freeze setpoints and sign-of-life		
2	Setpoints are not frozen			
p2038	PROFIdrive STW/ZSW interface mode			
	0	SINAMICS		
2	VIK-NAMUR			
p2040	Fieldbus interface monitoring time [ms]			
PROFIBUS, PROFIdrive				
p2042	PROFIBUS ID Number			
	0	SINAMICS		
	2	VIK-NAMUR		
r2043	BO: PROFIdrive PZD state			
	.00	Setpoint failure		
	.02	Fieldbus operational		
p2044	PROFIdrive fault delay [s]			
p2047	PROFIBUS additional monitoring time [ms]			
r2050	CO: PROFIdrive PZD receive word			
	[0]	PZD 1	...	[7] PZD 8
p2051	CI: PROFIdrive PZD send word			
	[0]	PZD 1	...	[7] PZD 8

r2053	PROFdrive diagnostics send PZD word			
	[0]	PZD 1	...	[7] PZD 8
r2054	PROFIBUS status			
	0	Off		
	1	No connection (search for baud rate)		
	2	Connection OK (baud rate found)		
	3	Cyclic connection with master (data exchange)		
r2055	PROFIBUS diagnosis standard			
	[0]	Master bus address		
	[1]	Master input total length bytes		
	[2]	Master output total length bytes		
r2057	PROFIBUS address switch diagnostics			
r2060	CO: IF1 PROFdrive PZD receive double word			
	[0]	PZD 1 + 2	...	[10] PZD 11 + 12
r2061	CI: IF1 PROFdrive PZD send double word			
	[0]	PZD 1 + 2	...	[10] PZD 11 + 12
r2063	IF1 PROFdrive diagnostics PZD send double word			
	[0]	PZD 1 + 2	...	[10] PZD 11 + 12
r2067	IF1 PZD maximum interconnected			
	[0]	Receiving		
	[1]	Sending		
p2072	Response, receive value after PZD failure			
	.00	Unconditionally open holding brake (p0855)	1 = freeze value	0 = zero value
r2074	PROFdrive diagnostics bus address PZD receive			
	[0]	PZD 1	...	[7] PZD 8
r2075	PROFdrive diagnostics telegram offset PZD receive			
	[0]	PZD 1	...	[7] PZD 8
r2076	PROFdrive diagnostics telegram offset PZD send			
	[0]	PZD 1	...	[7] PZD 8
r2077	PROFIBUS diagnostics peer-to-peer data transfer addresses			
p2079	PROFdrive PZD telegram selection extended See p0922			
p2080	BI: Binector-connector converter, status word 1			
	The individual bits are combined to form status word 1.			
p2088	Binector-connector converter, invert status word			

r2089	CO: Send binector-connector converter status word			
	[0]	Status word 1		
	[1]	Status word 2		
	[2]	Free status word 3		
	[3]	Free status word 4		
	[4]	Free status word 5		
r2090	BO: PROFdrive PZD1 receive bit-serial			
r2091	BO: PROFdrive PZD2 receive bit-serial			
r2092	BO: PROFdrive PZD3 receive bit-serial			
r2093	BO: PROFdrive PZD4 receive bit-serial			
r2094	BO: Connector-binector converter binector output			
r2095	BO: Connector-binector converter binector output			
p2098	Invert connector-binector converter binector output			
p2099	CI: Connector-binector converter signal source			
Faults (Part 2) and alarms				
p2100	Setting the fault number for fault response			
p2101	Setting the fault response			
	0	None	1	OFF1
	2	OFF2	3	OFF3
	5	STOP2	6	DC braking
p2103	BI: 1. Acknowledge faults			
p2104	BI: 2. Acknowledge faults			
p2106	BI: External fault 1			
r2110	Alarm number			
p2111	Alarm counter			
p2112	BI: External alarm 1			
r2122	Alarm code			
r2123	Alarm time received [ms]			
r2124	Alarm value			
r2125	Alarm time removed [ms]			
p2126	Setting fault number for acknowledge mode			
p2127	Sets acknowledgement mode			
p2128	Selecting fault/alarm code for trigger			
r2129	CO/BO: Trigger word for faults and alarms			
r2130	Fault time received in days			
r2131	CO: Actual fault code			
r2132	CO: Actual alarm code			
r2133	Fault value for float values			
r2134	Alarm value for float values			
r2135	CO/BO: Status word, faults/alarms 2			
r2136	Fault time removed in days			

r2138	CO/BO: Control word, faults/alarms
r2139	CO/BO: Status word, faults/alarms 1
p2141	Speed threshold value 1 [rpm]
p2153	Speed actual value filter time constant [ms]
p2156	Switch-on delay comparison value reached [ms]
r2169	CO: Speed actual value smoothed signals [rpm]
p2170	Current threshold value [A]
p2171	Current threshold value reached delay time [ms]
p2174	Torque threshold value 1 [Nm]
p2194	Torque threshold value 2 [%]
p2195	Torque utilization switch-off delay [ms]
r2197	CO/BO: Status word monitoring functions 1
r2198	CO/BO: Status word monitoring 2
r2199	CO/BO: Status word monitoring 3
Technology controller	
p2200	BI: Technology controller enable
p2201	CO: Techn. controller fixed value 1 [100 ± 100%]
p2202	CO: Techn. controller fixed value 2 [100 ± 100%]
p2203	CO: Techn. controller fixed value 3 [100 ± 100%]
p2204	CO: Techn. controller fixed value 4 [100 ± 100%]
p2205	CO: Techn. controller fixed value 5 [100 ± 100%]
p2206	CO: Techn. controller fixed value 6 [100 ± 100%]
p2207	CO: Techn. controller fixed value 7 [100 ± 100%]
p2208	CO: Techn. controller fixed value 8 [100 ± 100%]
p2209	CO: Techn. controller fixed value 9 [100 ± 100%]
p2210	CO: Techn. controller fixed value 10 [100 ± 100%]
p2211	CO: Techn. controller fixed value 11 [100 ± 100%]
p2212	CO: Techn. controller fixed value 12 [100 ± 100%]
p2213	CO: Techn. controller fixed value 13 [100 ± 100%]
p2214	CO: Techn. controller fixed value 14 [100 ± 100%]
p2215	CO: Techn. controller fixed value 15 [100 ± 100%]
p2216	Techn. controller fixed value selection method
	0 Fixed value selection direct
	1 Fixed value selection binary
p2220	BI: Techn. controller fixed value selection bit 0
p2221	BI: Techn. controller fixed value selection bit 1
p2222	BI: Techn. controller fixed value selection bit 2
p2223	BI: Techn. controller fixed value selection bit 3
r2224	CO: Techn. controller fixed value active [100 ± 100%]
r2225	CO/BO: Techn. controller fixed value selection status word
r2229	Techn. controller number currently
p2230	Techn. controller motorized potentiometer configuration
	.00 Storage active
	.02 Initial rounding active
	.03 Non-volatile data save active for p2230.0 = 1
.04 Ramp-function generator always active	
r2231	Techn. controller motorized potentiometer setpoint memory
p2235	BI: Techn. controller motorized potentiometer setpoint up
p2236	BI: Techn. controller motorized potentiometer setpoint down
p2237	Techn. controller motorized potentiometer maximum value [%]
p2238	Techn. controller motorized potentiometer minimum value [%]
p2240	Techn. controller motorized potentiometer start value [%]
r2245	CO: Techn. controller motorized potentiometer setpoint before RFG [100 ± 100%]
p2247	Techn. controller motorized potentiometer ramp-up time [s]
p2248	Techn. controller motorized potentiometer ramp-down time [s]
r2250	CO: Techn. controller motorized potentiometer setpoint after RFG [100 ± 100%]
p2251	Techn. controller mode
	0 Techn. controller as main speed setpoint 1 Techn. controller as additional speed setpoint
p2253	CI: Techn. controller setpoint 1 [100 ± 100%]
p2254	CI: Techn. controller setpoint 2 [100 ± 100%]
p2255	Techn. controller setpoint 1 scaling [100 ± 100%]
p2256	Techn. controller setpoint 2 scaling [100 ± 100%]
p2257	Techn. controller ramp-up time [s]
p2258	Techn. controller ramp-down time [s]
r2260	CO: Techn. controller setpoint after ramp function generator [100 ± 100%]
p2261	Techn. controller setpoint filter time constant [s]
p2263	Techn. controller type
	0 D component in the actual value signal 1 D component in the fault signal
p2264	CI: Techn. controller actual value [100 ± 100%]
p2265	Techn. controller actual value filter time constant [s]
r2266	CO: Techn. controller actual value after filter [100 ± 100%]

p2267	Techn. controller upper limit actual value [100 ± 100%]		
p2268	Techn. controller lower limit actual value [100 ± 100%]		
p2269	Techn. controller gain actual value [%]		
p2270	Techn. controller actual value function selection		
	0	No function	1 √x
	2	x ²	3 x ³
p2271	Techn. controller actual value inversion (sensor type)		
	0	No inversion	
	1	Inversion of the technology controller actual value signal	
r2272	CO: Techn. controller actual value scaled [100 ± 100%]		
r2273	CO: Techn. controller error [100 ± 100%]		
p2274	Techn. controller actual differentiation time constant [s]		
p2280	Techn. controller proportional gain		
p2285	Techn. controller integral time [s]		
p2286	BI: Hold techn. controller integrator		
p2289	CI: Techn. controller pre-control signal [100 ± 100%]		
p2291	CO: Techn. controller maximum limit [100 ± 100%]		
p2292	CO: Techn. controller minimum limit [100 ± 100%]		
p2293	Techn. controller ramp-up/ramp-down time [s]		
r2294	CO: Techn. controller output signal [100 ± 100%]		
p2295	CO: Techn. controller output scaling [100 ± 100%]		
p2296	CI: Techn. controller output scaling [100 ± 100%]		
p2297	CI: Techn. controller maximum limit signal source [100 ± 100%]		
p2298	CI: Techn. controller minimum limit signal source [100 ± 100%]		
p2299	CI: Techn. controller limit offset [100 ± 100%]		
p2302	Techn. controller output signal start value [%]		
p2306	Techn. controller fault signal inversion		
	0	No inversion	
	1	Inversion of the techn. controller fault signal	
r2344	CO: Techn. controller last speed setpoint (smoothed) [100 ± 100%]		
p2345	Techn. controller fault response		
	0	Function inhibited	
	1	For a fault: change over to r2344 (or p2302)	
	2	For a fault: Change over to p2215	
r2349	CO/BO: Techn. controller status word		

p2900	CO: Fixed value 1 [100 ± 100%]		
p2901	CO: Fixed value 2 [100 ± 100%]		
r2902	CO: Fixed values [100 ± 100%]		
p2930	CO: Fixed value M [Nm]		
r2969	Direct axis flux model display		
Messages			
r3113	CO/BO: NAMUR message bit bar		
p3117	Change safety message type		
	0	Safety messages are not reparameterized	
	1	Safety messages are reparameterized	
r3120	Component fault		
	0	No assignment	1 Control Unit
	2	Power Module	3 Motor
r3121	Component alarm		
	0	No assignment	1 Control Unit
	2	Power Module	3 Motor
r3122	Diagnostic attribute fault		
r3123	Diagnostic attribute alarm		
p3233	Torque actual value filter time constant [ms]		
Motor characteristic			
p3320	Fluid flow machine P = f(n), Y coordinate: P flow 1%, point 1		
p3321	Fluid flow machine P = f(n), X coordinate: n flow 1%, point 1		
p3322	P = f(n), Y coordinate: P flow 2%, point 2		
p3323	P = f(n), X coordinate: n flow 2%, point 2		
p3324	P = f(n), Y coordinate: P flow 3%, point 3		
p3325	P = f(n), X coordinate: n flow 3%, point 3		
p3326	P = f(n), Y coordinate: P flow 4%, point 4		
p3327	P = f(n), X coordinate: n flow 4%, point 4		
p3328	P = f(n), Y coordinate: P flow 5%, point 5		
p3329	P = f(n), X coordinate: n flow 5%, point 5		
Two/three wire control			
p3330	BI: 2-3 wire control 1		
p3331	BI: 2-3 wire control 2		
p3332	BI: 2-3 wire control 3		
r3333	CO/BO: 2-3 wire output		
	.00	2-3 wire ON	
	.01	2-3 wire reverse	
	.02	2-3 wire ON / invert	
	.03	2-3 wire reverse/invert	

Compound braking						
p3856	Compound braking current [100 ± 100%]					
r3859	CO/BO: Compound braking status word					
Administration parameters						
p3900	Completion of quick commissioning					
r3925	Identification final display					
p3950	Service parameters					
p3981	Faults, acknowledge drive object					
p3985	Master control mode selection					
r3996	Parameter write inhibit status					
r5398	Motor temperature model 3 alarm threshold image [°C]					
r5399	Motor temperature model 3 fault threshold image [°C]					
r5600	Pe hibernation ID					
	0:	POWER OFF	2: Hibernation 2			
	255:	Ready				
p5602	Pe hibernation pause time, minimum [s]					
	[0]	Reserved	[1] Mode 2			
p5606	Pe hibernation duration, maximum [ms]					
	[0]	Reserved	[1] Mode 2			
p5611	Pe energy-saving properties, general					
	.00	Inhibit PROFenergy	.01 Drive triggers OFF1			
	.02	Transition to hibernation from PROFdrive state 4 possible				
p5612	Pe energy-saving properties, mode-dependent					
	[0]	Reserved	[1] Mode 2			
r5613	CO/BO: Pe energy-saving active/inactive					
	.00	Pe active	.01 Pe inactive			
p5614	BI: Set Pe Switching On Inhibited signal source					
r7758	Know-how protection Control Unit serial number					
r7759	Know-how protection Control Unit reference serial number					
p7760	Write protection/know-how protection status					
	.00	1 = Write protection active				
	.01	1 = Know-how protection active				
	.02	1 = Know-how protection temporarily unlocked				
	.03	1 = Know-how protection cannot be deactivated				
	.04	1 = Memory card copy protection active				
.05	1 = basis copy protection active					
	.06	1 = trace and measuring functions for diagnostic purposes active				
p7761	Write protection					
	0	Deactivate write protection				
	1	Activate write protection				
p7762	Write access for control using multi-master third-party bus system					
	0	Free write access independent of p7761				
	1	No free write access (p7761 is active)				
p7763	Know-how protection OEM exception list number of parameters					
p7764	Know-how protection OEM exception list					
p7765	Know-how protection memory card copy protection					
	0	Memory card deactivate copy protection				
	1	Memory card activate copy protection				
p7766	Know-how protection password input					
p7767	Know-how protection password new					
p7768	Know-how protection password confirmation					
p7769	Know-how protection memory card setpoint serial number					
p7775	NVRAM data action					
r7843	Memory card serial number					
r8570	Macro Drive object					
	Display of the macro files stored in the inverter. See also p0015.					
CANopen						
r8600	CAN Device Type					
r8601	CAN Error Register					
p8602	CAN SYNC-Object					
p8603	CAN COB-ID Emergency Message [hex]					
p8604	CAN Node Guarding					
p8606	CAN Producer Heartbeat Time [ms]					
r8607	CAN Identity Object					
p8608	CAN Clear Bus Off Error					
p8609	CAN Error Behavior					
r8610	CAN First Server SDO					
p8611	CAN Pre-defined Error Field [hex]					
p8620	CAN Node-ID					
r8621	CAN Node-ID effective					
p8622	CAN bit rate [kBit/s]					
	0	1000	1	800	2	500
	3	250	4	125	5	50
	6	20	7	10		

p8623	CAN Bit Timing selection [hex]			
p8630	CAN virtual objects			
p8641	CAN Abort Connection Option Code			
	0	No response	1	OFF1
	2	OFF2	3	OFF3
r8680	CAN Diagnosis Hardware			
p8684	CAN NMT state after booting			
p8685	CAN NMT state			
p8699	CAN RPDO monitoring time [ms]			
p8700	CAN Receive PDO 1 [hex]			
p8701	CAN Receive PDO 2 [hex]			
p8702	CAN Receive PDO 3 [hex]			
p8703	CAN Receive PDO 4 [hex]			
p8704	CAN Receive PDO 5 [hex]			
p8705	CAN Receive PDO 6 [hex]			
p8706	CAN Receive PDO 7 [hex]			
p8707	CAN Receive PDO 8 [hex]			
p8710	CAN Receive Mapping for RPDO 1 [hex]			
p8711	CAN Receive Mapping for RPDO 2 [hex]			
p8712	CAN Receive Mapping for RPDO 3 [hex]			
p8713	CAN Receive Mapping for RPDO 4 [hex]			
p8714	CAN Receive Mapping for RPDO 5 [hex]			
p8715	CAN Receive Mapping for RPDO 6 [hex]			
p8716	CAN Receive Mapping for RPDO 7 [hex]			
p8717	CAN Receive Mapping for RPDO 8 [hex]			
p8720	CAN Transmit PDO 1 [hex]			
p8721	CAN Transmit PDO 2 [hex]			
p8722	CAN Transmit PDO 3 [hex]			
p8723	CAN Transmit PDO 4 [hex]			
p8724	CAN Transmit PDO 5 [hex]			
p8725	CAN Transmit PDO 6 [hex]			
p8726	CAN Transmit PDO 7 [hex]			
p8727	CAN Transmit PDO 8 [hex]			
p8730	CAN Transmit Mapping for TPDO 1 [hex]			
p8731	CAN Transmit Mapping for TPDO 2 [hex]			
p8732	CAN Transmit Mapping for TPDO 3 [hex]			
p8733	CAN Transmit Mapping for TPDO 4 [hex]			
p8734	CAN Transmit Mapping for TPDO 5 [hex]			
p8735	CAN Transmit Mapping for TPDO 6 [hex]			
p8736	CAN Transmit Mapping for TPDO 7 [hex]			
p8737	CAN Transmit Mapping for TPDO 8 [hex]			
p8744	CAN PDO Mapping Configuration			
	1:	Predefined connection set		

	2:	Free PDO mapping	
r8745	CO: CAN free PZD receive objects 16 bit		
p8746	CI: CAN free PZD send objects 16 bit		
r8747	CO: CAN free PZD receive objects 32 bit		
p8748	CI: CAN free PZD send objects 32 bit		
r8750	CAN mapped receive objects 16 bit		
r8751	CAN mapped receive objects 16 bit		
r8760	CAN mapped receive objects 32 bit		
r8761	CAN mapped transmit objects 32 bit		
r8762	CO: CAN operating mode display		
r8784	CO: CAN status word		
p8785	BI: CAN status word bit 8		
p8786	BI: CAN status word bit 14		
p8787	BI: CAN status word bit 15		
p8790	CAN control word - auto interconnection		
p8791	CAN holding option code		
r8792	CO: CAN Velocity Mode I16 setpoint		
r8795	CAN control word		
r8796	CO: CAN Profile Velocity Mode I32 setpoints		
r8797	CAN Target Torque		
p8798	CAN speed conversion factor		
	[0]	Counters	[1] Denominator
Identification & maintenance data (I&M)			
p8805	Identification and Maintenance 4 configuration		
	0:	Standard value for I&M 4 (p8809)	
	1:	User value for I&M 4 (p8809)	
p8806	Identification and Maintenance 1		
	[0...31]	Plant ID (PID)	
	[32...53]	Location ID (LID)	
p8807	Identification and Maintenance 2		
	[0...15]	YYY-MM-DD hh.mm	
p8808	Identification and Maintenance 3		
	[0...53]	Arbitrary supplementary information and remarks (ASCII)	
p8809	Identification and Maintenance 4 (signature)		
PROFIdrive			
r8859	PROFINET identification data		
r8909	PN Device ID		
p8920	PN Name of station		
p8921	PN IP Address of Station		
p8922	PN Default Gateway of Station		
p8923	PN Subnet Mask of Station		

p8924	PN DHCP mode		r9485	BICO interconnections, search signal source number	
p8925	PN interfaces configuration		r9486	BICO interconnections, search signal source first index	
	0:	No function		Safety Integrated	
	1:	Activate the configuration			
	2:	Activate the configuration and save			
3:	Delete configuration				
p8929	PN Remote Controller number		p9601	SI enable, functions integrated in the drive (processor 1)	
	0:	Automation or Safety	p9610	SI PROFIsafe address (processor 1)	
	1:	Automation and Safety	p9650	SI F-DI changeover, tolerance time (processor 1) [ms]	
r8930	PN Name of Station active		p9651	SI STO debounce time (processor 1) [ms]	
r8931	PN IP Address of Station active		p9659	SI forced checking procedure timer [h]	
r8932	PN Default Gateway of Station active		r9660	SI forced checking procedure remaining time [h]	
r8933	PN Subnet Mask of Station active		r9670	SI module identifier, Control Unit	
r8934	PN DHCP mode active		r9672	SI module identifier, Power Module	
r8935	PN MAC Address of Station		p9700	SI copy function	
r8939	PN DAP ID		p9701	Acknowledge SI data change	
r8960	PN Subslot assignment		p9761	SI password input [hex]	
r8961	PN IP Addr Remote Controller 1		p9762	SI password new [hex]	
r8962	PN IP Addr Remote Controller 2		p9763	SI password acknowledgment [hex]	
p8980	Ethernet/IP profile		r9768	SI PROFIsafe control words received (processor 1)	
	0:	SINAMICS		1:	ODVA / AC/DC
p8981	Ethernet/IP ODVA STOP mode		[0]	PZD 1	... [7] PZD 8
	0:	OFF1	1:	OFF2	
p8982 p8983	Ethernet/IP ODVA speed (p8982) or torque (p8983) scaling		r9769	SI PROFIsafe status words send (processor 1)	
	123:	32	124:	16	[0] PZD 1 ... [7] PZD 8
	125:	8	126:	4	
	127:	2	128:	1	
	129:	0,5	130:	0,25	
	131:	0,125	132:	0,0625	
	133:	0,03128			
p8991	USB memory access		r9770	SI version, safety functions integrated in the drive (processor 1)	
Parameter consistency and storage			r9771	SI common functions (processor 1)	
p9400	Safely remove memory card		r9772	CO/BO: SI status (processor 1)	
	0	No memory card inserted	r9773	CO/BO: SI status (processor 1 + processor 2)	
	1	Memory card inserted	r9776	SI diagnostics	
	2	Request "safe removal" of the memory card		.00	1 = safety parameters changed, POWER ON required
	3	"Safe removal" possible		.01	1 = safety functions enabled
100	"Safe removal" not possible due to access	.02	1 = safety components exchanged and save necessary		
r9401	Safely remove memory card status		r9780	SI monitoring clock cycle (processor 1) [ms]	
r9463	Set valid macro		r9781	SI checksum to check changes (processor 1)	
p9484	BICO interconnections, search signal source		r9782	SI time stamp to check changes (processor 1) [h]	
			r9794	SI crosswise comparison list (processor 1)	
			r9795	SI diagnostics, STOP F (processor 1)	
			r9798	SI actual checksum SI parameters (processor 1)	
			p9799	SI reference checksum SI parameters (processor 1)	

p9801	SI enable, functions integrated in the drive (processor 2)
p9810	SI PROFIsafe address (processor 2)
p9850	SI F-DI changeover, tolerance time (processor 2)
p9851	SI STO debounce time (processor 2) [µs]
r9871	SI common functions (processor 2)
r9872	CO/BO: SI status (Power Module)
r9898	SI actual checksum SI parameters (processor 2)
p9899	SI reference checksum SI parameters (processor 2)

Diagnostics (internal)	
r9976	System utilization [%]
[1]	Computation time utilization
[5]	Highest gross utilization
p60022	Selecting a PROFIsafe telegram
r61000	PROFINET Name of Station
r61001	PROFINET IP of Station

Fault rectification

5.1 List of alarms and faults

Axxxxx Alarm

Fyyyyy: Fault

Table 5- 1 The most important alarms and faults of the safety functions

Number	Cause	Remedy
F01600	STOP A Triggered	STO Select and then deselect again.
F01650	Acceptance test required	Carry out acceptance test and create test certificate. Switch the Control Unit off and then on again.
F01659	Write task for parameter rejected	Cause: The converter should be reset to the factory setting. The resetting of the safety functions is, however, not allowed, because the safety functions are currently enabled.
		Remedy with operator panel:
		p0010 = 30 Parameter reset
		p9761 = ... Enter password for the safety functions.
		p0970 = 5 Reset Start Safety Parameter. The converter sets p0970 = 5 if it has reset the parameters.
Then reset the converter to the factory setting again.		
A01666	Static 1 signal at F-DI for safe acknowledgment	F-DI to a logical 0 signal.
A01698	Commissioning mode active for safety functions	This message is withdrawn after the Safety commissioning has ended.
A01699	Shutdown path test required	After the next time that the "STO" function is deselected, the message is withdrawn and the monitoring time is reset.
F30600	STOP A Triggered	STO Select and then deselect again.

Table 5- 2 The most important alarms and faults

Number	Cause	Remedy
F01018	Power-up aborted more than once	1. Switch off the converter power supply and switch it on again. 2. After this fault, the converter powers up with the factory settings. 3. Recommission the converter.
A01028	Configuration error	Explanation: Parameterization on the memory card has been created with a different type of module (order number, MLFB) Check the module parameters and recommission if necessary.
F01033	Unit switchover: Reference parameter value invalid	Set the value of the reference parameter to a value other than 0.0 (p0304, p0305, p0310, p0596, p2000, p2001, p2002, p2003, r2004).

5.1 List of alarms and faults

Number	Cause	Remedy
F01034	Unit switchover: Calculation of the parameter values after reference value change unsuccessful	Select the value of the reference parameter so that the parameters involved can be calculated in the per unit notation (p0304, p0305, p0310, p0596, p2000, p2001, p2002, p2003, r2004).
F01122	Frequency at the probe input too high	Reduce the frequency of the pulses at the probe input.
A01590	Motor maintenance interval lapsed	Carry out the maintenance.
A01900	PROFIBUS: Configuration telegram faulty	Explanation: A PROFIBUS master is attempting to establish a connection with a faulty configuration telegram. Check the bus configuration on the master and slave side.
A01910 F01910	Fieldbus SS setpoint timeout	The alarm is generated when p2040 ≠ 0 ms and one of the following causes is present: <ul style="list-style-type: none"> • The bus connection is interrupted • The MODBUS master is switched off • Communications error (CRC, parity bit, logical error) An excessively low value for the fieldbus monitoring time (p2040)
A01920	PROFIBUS: Cyclic connection interrupt	Explanation: The cyclic connection to PROFIBUS master is interrupted. Establish the PROFIBUS connection and activate the PROFIBUS master with cyclic operation.
F03505	Analog input, wire break	Check the connection to the signal source for interrupts. Check the level of the signal supplied. The input current measured by the analog input can be read out in r0752.
A03520	Temperature sensor fault	Check that the sensor is connected correctly.
A05000 A05001 A05002 A05004 A05006	Power Module overtemperature	Check the following: <ul style="list-style-type: none"> - Is the ambient temperature within the defined limit values? - Are the load conditions and duty cycle configured accordingly? - Has the cooling failed?
F06310	Supply voltage (p0210) incorrectly parameterized	Check the parameterized supply voltage and if required change (p0210). Check the line voltage.
F07011	Motor overtemperature	Reduce the motor load. Check ambient temperature. Check sensor's wiring and connection.
A07012	I2t Motor Module overtemperature	Check and if necessary reduce the motor load. Check the motor's ambient temperature. Check thermal time constant p0611. Check overtemperature fault threshold p0605.
A07015	Motor temperature sensor alarm	Check that the sensor is connected correctly. Check the parameter assignment (p0601).
F07016	Motor temperature sensor fault	Make sure that the sensor is connected correctly. Check the parameterization (p0601).
F07086 F07088	Unit switchover: Parameter limit violation	Check the adapted parameter values and if required correct.

Number	Cause	Remedy
F07320	Automatic restart aborted	Increase the number of restart attempts (p1211). The current number of start attempts is shown in r1214. Increase the wait time in p1212 and/or monitoring time in p1213. Create ON command (p0840). Increase the monitoring time of the power unit or switch off (p0857). Reduce the wait time for resetting the fault counter p1213[1] so that fewer faults are registered in the time interval.
A07321	Automatic restart active	Explanation: The automatic restart (AR) is active. During voltage recovery and/or when remedying the causes of pending faults, the drive is automatically switched back on.
F07330	Search current measured too low	Increase search current (P1202), check motor connection.
A07400	V _{DC_max} controller active	If the controller is not to intervene: <ul style="list-style-type: none"> • Increase the ramp-down times. • Deactivate the V_{DC_max} controller (p1240 = 0 for vector control, p1280 = 0 for V/f control).
A07409	V/f control current limiting controller active	The alarm automatically disappears after one of the following measures: <ul style="list-style-type: none"> • Increase the current limit (p0640). • Reduce load. • Increase the ramp-up time to the speed setpoint.
F07426	Technology controller actual value limited	<ul style="list-style-type: none"> • Adapt the limits to the signal level (p2267, p2268). • Check the actual value scaling (p2264).
F07801	Motor overcurrent	Check current limits (p0640). U/f control: Check the current limiting controller (p1340 ... p1346). Increase acceleration ramp (p1120) or reduce load. Check motor and motor cables for short circuit and ground fault. Check motor for star-delta connection and rating plate parameterization. Check power unit / motor combination. Select flying restart function (p1200) if switched to rotating motor.
A07805	Drive: Power unit overload I2t	<ul style="list-style-type: none"> • Reduce the continuous load. • Adapt the load cycle. • Check the assignment of rated currents of the motor and power unit.
F07807	Short circuit detected	<ul style="list-style-type: none"> • Check the converter connection on the motor side for any phase-phase short-circuit. • Rule out that line and motor cables have been interchanged.
A07850	External alarm 1	The signal for "external alarm 1" has been triggered. Parameter p2112 defines the signal source of the external alarm. Remedy: Rectify the cause of this alarm.
F07860	External fault 1	Remove the external causes for this fault.
F07900	Motor blocked	<ul style="list-style-type: none"> • Make sure that the motor can rotate freely. • Check the torque limit: r1538 for a positive direction of rotation; r1539 for a negative direction of rotation.

5.1 List of alarms and faults

Number	Cause	Remedy
F07901	Motor overspeed	Activate precontrol of the speed limiting controller (p1401 bit 7 = 1).
F07902	Motor stalled	Check whether the motor data has been parameterized correctly and perform motor identification. Check the current limits (p0640, r0067, r0289). If the current limits are too low, the drive cannot be magnetized. Check whether motor cables are disconnected during operation.
A07903	Motor speed deviation	Increase p2163 and/or p2166. Increase the torque, current and power limits.
A07910	Motor overtemperature	Check the motor load. Check the motor's ambient temperature. Check the KTY84 sensor.
A07920	Torque/speed too low	The torque deviates from the torque/speed envelope curve.
A07921	Torque/speed too high	<ul style="list-style-type: none"> • Check the connection between the motor and the load. • Adapt the parameterization corresponding to the load.
A07922	Torque/speed out of tolerance	
F07923	Torque/speed too low	<ul style="list-style-type: none"> • Check the connection between the motor and the load. • Adapt the parameterization corresponding to the load.
F07924	Torque/speed too high	
A07927	DC braking active	Not required
A07980	Rotary measurement activated	Not required
A07981	No enabling for rotary measurement	Acknowledge pending faults. Establish missing enables (see r00002, r0046).
A07991	Motor data identification activated	Switch on the motor and identify the motor data.
F08501	Setpoint timeout	<ul style="list-style-type: none"> • Check the PROFINET connection. • Set the controller to RUN mode. • If the error occurs repeatedly, check the monitoring time set (p2044).
F08502	Monitoring time, sign-of-life expired	<ul style="list-style-type: none"> • Check the PROFINET connection.
F08510	Send configuration data not valid	<ul style="list-style-type: none"> • Check the PROFINET configuration
A08511	Receive configuration data not valid	
A08526	No cyclic connection	<ul style="list-style-type: none"> • Activate the controller with cyclic operation. • Check the parameters "Name of Station" and "IP of Station" (r61000, r61001).
A08565	Consistency error affecting adjustable parameters	Check the following: <ul style="list-style-type: none"> • IP address, subnet mask or default gateway is not correct. • IP address or station name used twice in the network. • Station name contains invalid characters.

Number	Cause	Remedy
F08700	Communications error	<p>A CAN communications error has occurred. Check the following:</p> <ul style="list-style-type: none"> • Bus cable • Baud rate (p8622) • Bit timing (p8623) • Master <p>Start the CAN controller manually with p8608 = 1 after the cause of the fault has been resolved!</p>
F13100	Know-how protection: Copy protection error	<p>The know-how protection and the copy protection for the memory card are active. An error occurred during checking of the memory card.</p> <ul style="list-style-type: none"> • Insert a suitable memory card and switch the converter supply voltage temporarily off and then on again (POWER ON). • Deactivate the copy protection (p7765).
F13101	Know-how protection: Copy protection cannot be activated	Insert a valid memory card.
F30001	Overcurrent	<p>Check the following:</p> <ul style="list-style-type: none"> • Motor data, if required, carry out commissioning • Motor's connection method (Y / Δ) • U/f operation: Assignment of rated currents of motor and Power Module • Line quality • Make sure that the line commutating reactor is connected properly • Power cable connections • Power cables for short-circuit or ground fault • Power cable length • Line phases <p>If this doesn't help:</p> <ul style="list-style-type: none"> • U/f operation: Increase the acceleration ramp • Reduce the load • Replace the power unit
F30002	DC-link voltage overvoltage	<p>Increase the ramp-down time (p1121). Set the rounding times (p1130, p1136). Activate the DC link voltage controller (p1240, p1280). Check the line voltage (p0210). Check the line phases.</p>
F30003	DC-link voltage undervoltage	Check the line voltage (p0210).
F30004	Converter overtemperature	<p>Check whether the converter fan is running. Check whether the ambient temperature is in the permissible range. Check whether the motor is overloaded. Reduce the pulse frequency.</p>
F30005	I _{2t} converter overload	<p>Check the rated currents of the motor and Power Module. Reduce current limit p0640. When operating with U/f characteristic: Reduce p1341.</p>

Number	Cause	Remedy
F30011	Line phase failure	Check the converter's input fuses. Check the motor cables.
F30015	Motor cable phase failure	Check the motor cables. Increase the ramp-up or ramp-down time (p1120).
F30021	Ground fault	<ul style="list-style-type: none"> • Check the power cable connections. • Check the motor. • Check the current transformer. • Check the cables and contacts of the brake connection (a wire might be broken).
F30027	Time monitoring for DC link pre-charging	Check the line voltage. Check the line voltage setting (p0210).
F30035	Overtemperature, intake air	<ul style="list-style-type: none"> • Check whether the fan is running. • Check the fan filter elements. • Check whether the ambient temperature is in the permissible range.
F30036	Overtemperature, inside area	
F30037	Rectifier overtemperature	See F30035 and, in addition: <ul style="list-style-type: none"> • Check the motor load. • Check the line phases
A30049	Internal fan defective	Check the internal fan and if required replace.
F30059	Internal fan defective	Check the internal fan and if required replace.
F30074	Communications fault between Control Unit and Power Module	The 24V voltage supply of the converter (terminals 31 and 32) was interrupted briefly. Please check the voltage supply and the wiring.
A30502	DC link overvoltage	<ul style="list-style-type: none"> • Check the device supply voltage (p0210). • Check the line reactor dimensioning
A30920	Temperature sensor fault	Check that the sensor is connected correctly.
A50001	PROFINET configuration error	A PROFINET controller is attempting to establish a connection with a faulty configuration telegram. Check to see whether "Shared Device" is activated (p8929 = 2).
A50010	PROFINET name of station invalid	Correct name of station (p8920) and activate (p8925 = 2).
A50020	PROFINET: Second controller missing	"Shared Device" is activated (p8929 = 2). However, only the connection to a PROFINET controller is present.

For further information, please refer to the List Manual.

5.2 Product support

Table 5-3 Technical Support

France	Germany	Italy	Spain	United Kingdom
+33 (0) 821 801 122	+49 (0)911 895 7222	+39 (02) 24362000	+34 902 237 238	+44 161 446 5545
Further service telephone numbers: Product support (http://www.siemens.com/automation/service&support)				

Table 5-4 Manuals with further information

Information level	Manual	Content	Available languages	Download or order number
+	Getting Started	(this manual)	English, German, Italian, French, Spanish, Chinese	Download manuals (http://support.automation.siemens.com/WW/view/en/30563628/133300) SINAMICS Manual Collection Documentation on DVD Order number: 6SL3097-4CA00-0YGO
++	Operating instructions - converter	Installing, commissioning and operating the converter. Description of converter functions. Technical data.		
+++	Function Manual Safety Integrated	Configuring PROFIsafe. Installing, commissioning and operating the integrated fail-safe function.	English, German	
+++	List manual	Complete list of parameters, alarms and faults. Graphic function block diagrams.	English, German, Chinese	
+++	Operating instructions - BOP-2, IOP	Description of operator panel	English, German	

5.3 Spare parts

		Order number
Spare part kit including 5 sets I/O terminals, 2 door sets and 1 blind cover		6SL3200-0SK41-0AA0
Screening plates	Frame size A	6SL3266-1EA00-0KA0
	Frame size B	6SL3266-1EB00-0KA0
	Frame size C	6SL3266-1EC00-0KA0
1 set of connector plugs (mains, motor and breaking resistor)	Frame size A	6SL3200-0ST05-0AA0
	Frame size B	6SL3200-0ST06-0AA0
	Frame size C	6SL3200-0ST07-0AA0
Fan units	Frame size A	6SL3200-0SF12-0AA0
	Frame size B	6SL3200-0SF13-0AA0
	Frame size C	6SL3200-0SF14-0AA0
Top cover with built in fan	Frame size A	6SL3200-0SF40-0AA0
	Frame size B	6SL3200-0SF41-0AA0
	Frame size C	6SL3200-0SF42-0AA0

Further information

SINAMICS inverters:
www.siemens.com/sinamics

Safety Integrated:
www.siemens.com/safety-integrated

PROFINET:
www.siemens.com/profinet

Siemens AG
Industry Sector
Drive Technologies
Motion Control Systems
Postfach 3180
91050 ERLANGEN
GERMANY

Subject to change without prior notice
© Siemens AG 2011-2014

Scan the QR code for
additional information
on SINAMICS G120C.



www.siemens.com/drives