

SIEMENS

SINUMERIK

SINUMERIK 840D sl Operator Components and Networking

Manual

Preface

General information and
networking

1

Operator panels

2

Handheld units

3

Machine control panels

4

Keyboards and additional
components

5

Appendix

A

Valid for: SINUMERIK 840D sl / 840DE sl control

03/2013

Legal information

Warning notice system

This manual contains notices you have to observe in order to ensure your personal safety, as well as to prevent damage to property. The notices referring to your personal safety are highlighted in the manual by a safety alert symbol, notices referring only to property damage have no safety alert symbol. These notices shown below are graded according to the degree of danger.

 DANGER
indicates that death or severe personal injury will result if proper precautions are not taken.

 WARNING
indicates that death or severe personal injury may result if proper precautions are not taken.

 CAUTION
indicates that minor personal injury can result if proper precautions are not taken.

NOTICE
indicates that property damage can result if proper precautions are not taken.

If more than one degree of danger is present, the warning notice representing the highest degree of danger will be used. A notice warning of injury to persons with a safety alert symbol may also include a warning relating to property damage.

Qualified Personnel

The product/system described in this documentation may be operated only by **personnel qualified** for the specific task in accordance with the relevant documentation, in particular its warning notices and safety instructions. Qualified personnel are those who, based on their training and experience, are capable of identifying risks and avoiding potential hazards when working with these products/systems.

Proper use of Siemens products

Note the following:

 WARNING
Siemens products may only be used for the applications described in the catalog and in the relevant technical documentation. If products and components from other manufacturers are used, these must be recommended or approved by Siemens. Proper transport, storage, installation, assembly, commissioning, operation and maintenance are required to ensure that the products operate safely and without any problems. The permissible ambient conditions must be complied with. The information in the relevant documentation must be observed.

Trademarks

All names identified by ® are registered trademarks of Siemens AG. The remaining trademarks in this publication may be trademarks whose use by third parties for their own purposes could violate the rights of the owner.

Disclaimer of Liability

We have reviewed the contents of this publication to ensure consistency with the hardware and software described. Since variance cannot be precluded entirely, we cannot guarantee full consistency. However, the information in this publication is reviewed regularly and any necessary corrections are included in subsequent editions.

Preface

SINUMERIK documentation

The SINUMERIK documentation is organized in the following categories:

- General documentation
- User documentation
- Manufacturer/service documentation

Additional information

You can find information on the following topics at <http://www.siemens.com/motioncontrol/docu>:

- Ordering documentation / documentation overview
- Additional links to download documents
- Using documentation online (find and search in manuals/information)

For any questions about the technical documentation (e.g. suggestions for improvement, corrections), please send an e-mail to the following address:
<mailto:docu.motioncontrol@siemens.com>

My Documentation Manager (MDM)

Under the following link you will find information on how to compile OEM-specific machine documentation based on the Siemens content:
<http://www.siemens.com/mdm>

Training

Information about training courses can be found at:

- <http://www.siemens.com/sitrain>
SITRAIN - Siemens training for products, systems and solutions in automation technology
- <http://www.siemens.com/sinutrain>
SinuTrain - training software for SINUMERIK

FAQs

You can find Frequently Asked Questions in the Service&Support pages under Product Support. <http://support.automation.siemens.com>

SINUMERIK

You can find information about SINUMERIK at the following link:
<http://www.siemens.com/sinumerik>

Target group

This documentation is intended for:

- Project engineers, electricians and installers
- Maintenance and service personnel

Benefits

The manual provides information on the components and functions of devices so that the target group is capable of installing, setting up, testing, operating, and troubleshooting the devices correctly and in absolute safety.

Standard scope

This documentation only describes the functionality of the standard version. Additions or revisions made by the machine manufacturer are documented by the machine manufacturer.

Other functions not described in this documentation might be executable in the controller. This does not, however, represent an obligation to supply such functions with a new controller or when servicing.

For the sake of simplicity, this documentation does not contain all detailed information about all types of the product and cannot cover every conceivable installation, operation, or maintenance situation.

Technical Support

You will find telephone numbers for other countries for technical support in the Internet under <http://www.siemens.com/automation/service&support>

EC Declaration of Conformity

The EC Declaration of Conformity for the EMC Directive can be found on the Internet at:

<http://support.automation.siemens.com>

Here, enter the number **15257461** as the search term or contact your local Siemens office.

SIEMENS

SINUMERIK

SINUMERIK 840D sl General information and networking

Manual

Safety information

1

System overview

2

Application planning

3

Connecting

4

Networking

5

Valid for:
Control
SINUMERIK 840D sl / 840DE sl



03/2013

6FC5397-1AP40-3BA0

Legal information

Warning notice system

This manual contains notices you have to observe in order to ensure your personal safety, as well as to prevent damage to property. The notices referring to your personal safety are highlighted in the manual by a safety alert symbol, notices referring only to property damage have no safety alert symbol. These notices shown below are graded according to the degree of danger.

 DANGER
indicates that death or severe personal injury will result if proper precautions are not taken.
 WARNING
indicates that death or severe personal injury may result if proper precautions are not taken.
 CAUTION
indicates that minor personal injury can result if proper precautions are not taken.
NOTICE
indicates that property damage can result if proper precautions are not taken.

If more than one degree of danger is present, the warning notice representing the highest degree of danger will be used. A notice warning of injury to persons with a safety alert symbol may also include a warning relating to property damage.

Qualified Personnel

The product/system described in this documentation may be operated only by **personnel qualified** for the specific task in accordance with the relevant documentation, in particular its warning notices and safety instructions. Qualified personnel are those who, based on their training and experience, are capable of identifying risks and avoiding potential hazards when working with these products/systems.

Proper use of Siemens products

Note the following:

 WARNING
Siemens products may only be used for the applications described in the catalog and in the relevant technical documentation. If products and components from other manufacturers are used, these must be recommended or approved by Siemens. Proper transport, storage, installation, assembly, commissioning, operation and maintenance are required to ensure that the products operate safely and without any problems. The permissible ambient conditions must be complied with. The information in the relevant documentation must be observed.

Trademarks

All names identified by ® are registered trademarks of Siemens AG. The remaining trademarks in this publication may be trademarks whose use by third parties for their own purposes could violate the rights of the owner.

Disclaimer of Liability

We have reviewed the contents of this publication to ensure consistency with the hardware and software described. Since variance cannot be precluded entirely, we cannot guarantee full consistency. However, the information in this publication is reviewed regularly and any necessary corrections are included in subsequent editions.

Table of contents

1	Safety information	5
1.1	General safety notes.....	5
1.2	Safety functions	8
1.3	Fault-free operation.....	11
1.4	Handling components that can be destroyed by electrostatic discharge	12
1.5	Residual risks of power drive systems.....	13
2	System overview	15
2.1	Application.....	15
2.2	System configuration	16
2.3	Overview of operator components.....	17
3	Application planning	19
3.1	Secondary electrical conditions	19
3.1.1	Power supply.....	19
3.1.2	Grounding concept.....	20
3.1.3	RI suppression measures	20
3.2	Ambient climatic and mechanical conditions	22
3.2.1	Transport and storage conditions	22
3.2.2	Operating conditions	25
3.2.3	Cooling	26
3.3	Recycling and disposal	28
4	Connecting	29
4.1	Pin assignment of the interfaces.....	29
4.2	Handling membrane connectors.....	44
5	Networking	45
5.1	System settings.....	45
5.1.1	Settings for SINUMERIK solution line.....	45
5.1.2	Thin Client Unit (TCU).....	47
5.1.3	Factory default settings.....	48
5.2	Commissioning TCU	50
5.2.1	Using the TCU's main menu	50
5.2.2	Using additional TCU menus	54
5.2.3	How to register a TCU on the system network	64
5.2.4	How to calibrate a touch panel.....	68
5.2.5	Connecting-up the SIMATIC Thin Client Touch Panel	70
5.2.6	This is how you configure the SIMATIC Thin Client Touch Panel.....	72
5.2.7	Settings in the "config.ini" file.....	74
5.2.8	Settings in the "TCU.ini" file	76

5.2.9	Displacement mechanism for TCUs	83
5.2.10	Disable switchover between TCU via PLC	84
5.2.11	Example: How to select the behavior of the TCUs during boot up	87
5.3	Configure the system network	88
5.3.1	System boot with system network.....	88
5.3.2	System Network Center (SNC)	89
5.3.2.1	Function overview of the System Network Center.....	89
5.3.2.2	SNC: "Adapter" tab	92
5.3.2.3	SNC: "OPs" tab	93
5.3.2.4	How to configure an OP	95
5.3.2.5	How to configure VNC connections	96
5.3.2.6	SNC: Configuring TCU support services	99
5.3.2.7	SNC: Configuring "TCU mode"	101
5.3.2.8	SNC: Configuring the X120 interface (System network).....	103
5.3.2.9	SNC: Configuring the X130 interface (Company network)	105
5.3.2.10	SNC: Configuring parameters on the "System basics" tab.....	106
5.3.2.11	SNC: "Scanned devices" tab.....	106
5.4	Network configuration	111
5.4.1	Permissible network topologies	111
5.4.2	Networks without connection to the company network.....	112
5.4.2.1	Configuration 1: NCU and TCU	112
5.4.2.2	Configuration 2: NCU and PCU with direct OP.....	113
5.4.3	Networks with NCU connection to the company network.....	114
5.4.3.1	Configuration 3: NCU and TCU	114
5.4.3.2	Configuration 4: NCU and PCU with direct OP.....	115
5.4.3.3	Configuration 5: PCU with TCU on NCU	116
5.4.3.4	Connecting the programming device (PG) to the NCU.....	117
5.4.4	Application example	118
5.5	Service and diagnostics	120
5.5.1	Booting of the TCU.....	120
Index		123

Safety information

1.1 General safety notes

The following notices are intended to ensure both your personal safety and to prevent damage occurring to the products described or any connected devices and machines.



! WARNING

Danger to life as a result of hazardous voltages when connecting an unsuitable power supply

Death or serious injury can result when live parts are touched in the event of a fault.

For all connections and terminals of the electronic boards, only use power supplies that provide SELV (Safety Extra Low Voltage) or PELV (Protective Extra Low Voltage) output voltages.

Should it be necessary to test or take measurements on live equipment, then the specifications and procedures defined in Accident Prevention Regulation VBG 4.0 must be adhered to, in particular § 8 "Permissible deviations when working on live components". Suitable electric tools should be used.



! WARNING

Danger of death when devices opened by unqualified personnel

Repairs to SIEMENS equipment may only be carried out by SIEMENS customer service or by repair centers authorized by SIEMENS. When replacing parts or components, only use those parts that are included in the spare parts list.

- Before opening the device, always disconnect the power supply.
- Emergency stop/off devices *) complying with EN 60204 / IEC 60204 (VDE 0113-1) must remain effective in all automation equipment operating modes. The act of releasing the emergency stop/off device must not cause an uncontrolled or undefined hot restart.

*) The term "Emergency stop" is used for both "Emergency stop" and "Emergency off" in the rest of the document, as this function is normally implemented by the machine manufacturer in the SINUMERIK environment.



 **WARNING**

Danger to life as a result of touching live parts on damaged equipment

Incorrectly handling equipment with backlighting can damage it.

With damaged equipment, dangerous voltages can be present at the housing or at exposed components.

- When transporting, storing and operating, maintain the limit value specified in the technical data.
- Do not use any damaged equipment.
- Protect the components against conductive pollution, e.g. by installing them in a cabinet with IP54 degree of protection according to EN 60529. Provided conductive pollution can be prevented at the installation site, the degree of protection for the cabinet can be decreased accordingly.

 **WARNING**

Danger to life as a result of unexpected movement of machines when using mobile wireless devices or cellular phones

Using mobile radios or cellular phones with a transmit power > 1 W closer than approx. 2 m to the components may cause the devices to malfunction, influence the functional safety of machines therefore putting people at risk or causing material damage.

When close to components, switch off all mobile radios and cellular phones.

NOTICE

Ensure the EMC-compatible installation

The components provided by Siemens meet CE requirements. The customer is responsible for ensuring that the components continue to meet the requirements once installed.

Connecting cables and signal lines should be installed so that inductive and capacitive interference do not in any way impair the automation functions.

Machinery directive (2006/42/EC)

When the European common market was launched, a decision was made that the domestic standards and regulations of all of the EU Member States relating to the technical implementation of machines would be harmonized. This meant that, as an internal market directive, the content of the machinery directive had to be implemented by the individual member states as national legislation. For the machinery directive, this was realized with the objective to achieve standard protective goals thus removing trade barriers resulting from technical differences. In accordance with the definition of a machine ("an assembly of linked parts or components, at least one of which moves"), this directive is extremely extensive.

The basic safety and health requirements specified in Annex I of the machinery directive must be fulfilled for the safety of machines.

The protective goals must be implemented responsibly to ensure compliance with the directive.

Manufacturers of a machine must verify that their machine complies with the basic requirements. This proof is made more simple by applying harmonized standards.

General Information

Note

Denotes an important item of information about the product, handling of the product or a section of the documentation which requires particular attention.

Machine manufacturer



This pictorial symbol always appears in this document to indicate that the machine manufacturer can affect or modify the function described. Observe the machine manufacturer's specifications.

1.2 Safety functions

Explanation of terms

This documentation conforms to Machinery Directive 2006/42/EC and EN 60204--1:2006.

EN 60204-1:1997	EN 60204-1:2006
Enabling device	Device for enable control

To avoid confusing users, terms used in the past will continue to be used in future editions of this documentation.

The operator panels can be part of the emergency off or emergency stop and enable control safety functions corresponding to EN 60204-1. The term emergency stop is used for both the emergency stop and emergency off safety functions in this document, the term enabling function will continue to be used for the enable control function (from EN 60204-1:1997).

Safety functions

Note

All safety functions of the operator panels are designed with double-circuits and enable Category 3 PL d according to EN ISO 13849-1:2008.

WARNING

Danger of death by moving machine parts

- The emergency stop button and enabling button must be checked periodically for proper functioning.
- The hazardous location must be visible from the operating position taken by the personnel.

Emergency Stop button

The emergency stop button on the operator panels causes a safety-related stop of the system to be monitored in accordance with EN 60204-1:2006, Section 9.2.5.4. You have the option of implementing a Category 0 or 1 stop function in accordance with EN 60204-1:2006, Section 9.2.2. The stop function category must be selected on the basis of a risk assessment.

WARNING

Category 0 or 1 stop

The emergency stop circuit must be implemented as a stop of Category 0 or 1 and must be effective irrespective of the operating mode. A Category 0 stop must have precedence. Unlocking the emergency stop button should not cause a hazardous situation (see also EN 60204-1, Section 9.2.5.4).

Enabling button

WARNING

Danger of death by the improper use of the enabling button

- The enabling button is only suitable as a protective function if the person activating it promptly recognizes a danger to personnel and can immediately take steps to avoid the danger! Reduced speed of the motion may also be required as an additional measure. The permissible speed must be determined on the basis of a risk assessment.
- Commands for unsafe conditions are not permitted to be issued with one enabling button alone. A second deliberate start command is required for this (button on the handheld unit).
- Prohibited fixation of the enabling button in the "Enable" position by mechanical means is considered foreseeable misuse, which can be prevented. We recommend the following measures for this, which result in bringing the machine to a standstill in manual mode:
 - Query the enabling button when switching-on the system to be monitored and for changing the operating mode from "Automatic" to "Manual operation". In both cases, the enabling function may not be used.
 - The enabling button must be released within a specified time frame appropriate for the task and returned to the "Enable" position.

Standards and approvals

CE approval



The operator panels and the safety-relevant accessories satisfy the requirements and protection objectives of the following EC directives. The operator panels and the safety-relevant accessories comply with the harmonized European standards (EN), promulgated in the Official Journals of the European Community:

- 2004/108/EC "Electromagnetic Compatibility" (EMC directive)
- Directive 2006/42/EC of the European Parliament and Council of May 17, 2006, on machinery, and Directive 95/16/EC (amendment)

SIBE Switzerland Certification Service

For the HT 2 and HT 8 units.



The operator panels and the safety-relevant accessories (is identified in the "Accessories" section for the respective devices) satisfy Category 3, PL d according to EN ISO 13849-1:2008. The safety function Enabling device for special mode control and the emergency stop button satisfy the following requirements:

- Category 3, PL d according to EN ISO 13849-1:2008
- Requirements of EN 60204-1:2006, under compliance with the safety instructions in the relevant chapters of this documentation

Risk assessment

The following standards must be used to perform the risk assessment:

- EN ISO 12100-1:2003 and EN ISO 12100-2:2003, General Design Guidelines for Machines
- EN ISO 14121-1:2007, Risk Assessment for Machinery
- EN ISO 13849-1:2008, Safety-related Parts of Machines

These considerations result in a category (B, 1, 2, 3, 4) and a performance level (PL a to e) in accordance with EN ISO 13849-1:2008 that ultimately dictate how the safety-related parts of the system to be monitored must be constructed.

The connection examples with different monitoring units in "Handheld units", Section: "HT 2", Section: "Connections" → "Connection examples for enabling button and emergency stop button" can also be used for other operator panels and demonstrate how Category 3, PL d according to EN ISO 13849-1:2008 can be attained with the safety-related parts of the operator panels. Note that the overall concept of the installation must be designed with this in mind.

1.3 Fault-free operation

Compliance with the connection conditions

The control is tested for compliance with the environmental conditions specified below. Trouble-free operation is ensured only if:

- These environmental conditions are maintained when storing, transporting and operating the equipment.
- Original components and spare parts are used. This applies in particular to the use of the specified cables and connectors.
- The equipment is correctly installed and commissioned.

Additional Information

Literature: EMC Design Guidelines

Assistance and support

The connection conditions must be maintained when installing the complete system. Please contact your local Siemens office or representative for any assistance.

Note

Please refer to the documentation for the respective operator components for information on deviations to the standard connection conditions.

1.4 Handling components that can be destroyed by electrostatic discharge

Electrostatic sensitive devices (ESDs) are individual components, integrated circuits, modules or devices that may be damaged by either electrostatic fields or electrostatic discharge.



NOTICE

Damage caused by electric fields or electrostatic discharge

Electric fields or electrostatic discharge can result in malfunctions as a result of damaged individual parts, integrated circuits, modules or devices.

- Only pack, store, transport and send electronic components, modules or devices in the original product packaging or in other suitable materials, e.g. conductive foam rubber or aluminum foil.
- Only touch components, modules and devices if you are first grounded by applying one of the following measures:
 - Wearing an ESD wrist strap
 - Wearing ESD shoes or ESD grounding straps in ESD areas with conductive flooring
- Only place electronic components, modules and devices on conductive surfaces (table with ESD surface, conductive ESD foam, ESD packaging, ESD transport container).

1.5 Residual risks of power drive systems

Residual risks of power drive systems

The control and drive components of a drive system are approved for industrial and commercial use in industrial line supplies. Their use in public line supplies requires a different configuration and/or additional measures.

These components may only be operated in closed housings or in higher-level control cabinets with protective covers that are closed, and when all of the protective devices are used.

These components may only be handled by qualified and trained technical personnel who are knowledgeable and observe all of the safety instructions on the components and in the associated technical user documentation.

When assessing the machine's risk in accordance with the EC Machinery Directive, the machine manufacturer must take into account the following residual risks emanating from the control and drive components of a drive system:

1. Unintentional movements of driven machine components during commissioning, operation, maintenance, and repairs caused by, for example:
 - Hardware defects and/or software errors in the sensors, controllers, actuators, and connection technology
 - Response times of the controller and drive
 - Operating and/or ambient conditions outside of the specification
 - Condensation / conductive contamination
 - Parameterization, programming, cabling, and installation errors
 - Use of radio devices / cellular phones in the immediate vicinity of the controller
 - External influences / damage
2. In the event of a fault, exceptionally high temperatures, including an open fire, as well as emissions of light, noise, particles, gases, etc. can occur inside and outside the inverter, e.g.:
 - Component malfunctions
 - Software errors
 - Operating and/or ambient conditions outside of the specification
 - External influences / damage

Inverters of the Open Type / IP20 degree of protection must be installed in a metal control cabinet (or protected by another equivalent measure) such that the contact with fire inside and outside the inverter is not possible.

1.5 Residual risks of power drive systems

3. Hazardous shock voltages caused by, for example:
 - Component malfunctions
 - Influence of electrostatic charging
 - Induction of voltages in moving motors
 - Operating and/or ambient conditions outside of the specification
 - Condensation / conductive contamination
 - External influences / damage
4. Electrical, magnetic and electromagnetic fields generated in operation that can pose a risk to people with a pacemaker, implants or metal replacement joints, etc. if they are too close.
5. Release of environmental pollutants or emissions as a result of improper operation of the system and/or failure to dispose of components safely and correctly.

Note

The components must be protected against conductive contamination (e.g. by installing them in a control cabinet with degree of protection IP54 according to IEC 60529 or NEMA 12).

Assuming that conductive contamination at the installation site can definitely be excluded, a lower degree of cabinet protection may be permitted.

For more information about residual risks of the components in a drive system, see the relevant sections in the technical user documentation of the SINAMICS S120.

System overview

2.1 Application

Overview

SINUMERIK 840D sl offers modularity, openness, flexibility and uniform structures for operation, programming, and visualization. It provides a system platform with trend-setting functions for almost all technologies.

Integrated into the SINAMICS S120 drive system and complemented by the SIMATIC S7-300 automation system, the SINUMERIK 840D sl forms a complete digital system that is ideally suited for the mid to upper performance range.

SINUMERIK 840D sl is characterized by:

- A high degree of flexibility
- Excellent dynamic response and precision
- Optimum integration into networks

Benefits

- Outstanding performance and flexibility for multi-axis systems of average to high complexity thanks to scalable hardware and software.
- Universal openness of the user interface, the PLC and the NC kernel to allow integration of your specialist know-how.
- Integrated safety functions for man and machine: SINUMERIK Safety Integrated
- Comprehensive range of products for integrating machine tools into communication, engineering and production processes: SINUMERIK Integrate

Field of application

The SINUMERIK 840D sl can be used worldwide in tool and mold making, for high-speed cutting applications, for wood and glass processing, for handling operations, in transfer lines and rotary indexing machines, for mass production and JobShop production.

The SINUMERIK 840DE sl is available as an export version for use in countries where approval is required.

2.2 System configuration

SINUMERIK 840D sl combines CNC, HMI, PLC, closed-loop control, and communication tasks within a single NCU (Numerical Control Unit).

Components

For operating, programming and visualization, the corresponding operator software is already integrated in the CNC software. For increased operating performance, the SINUMERIK PCU 50.5 industrial PC can be used.

Up to four distributed OPs can be operated on one NCU / PCU. The operator panel can be installed as a Thin Client at a distance of up to 100 m.

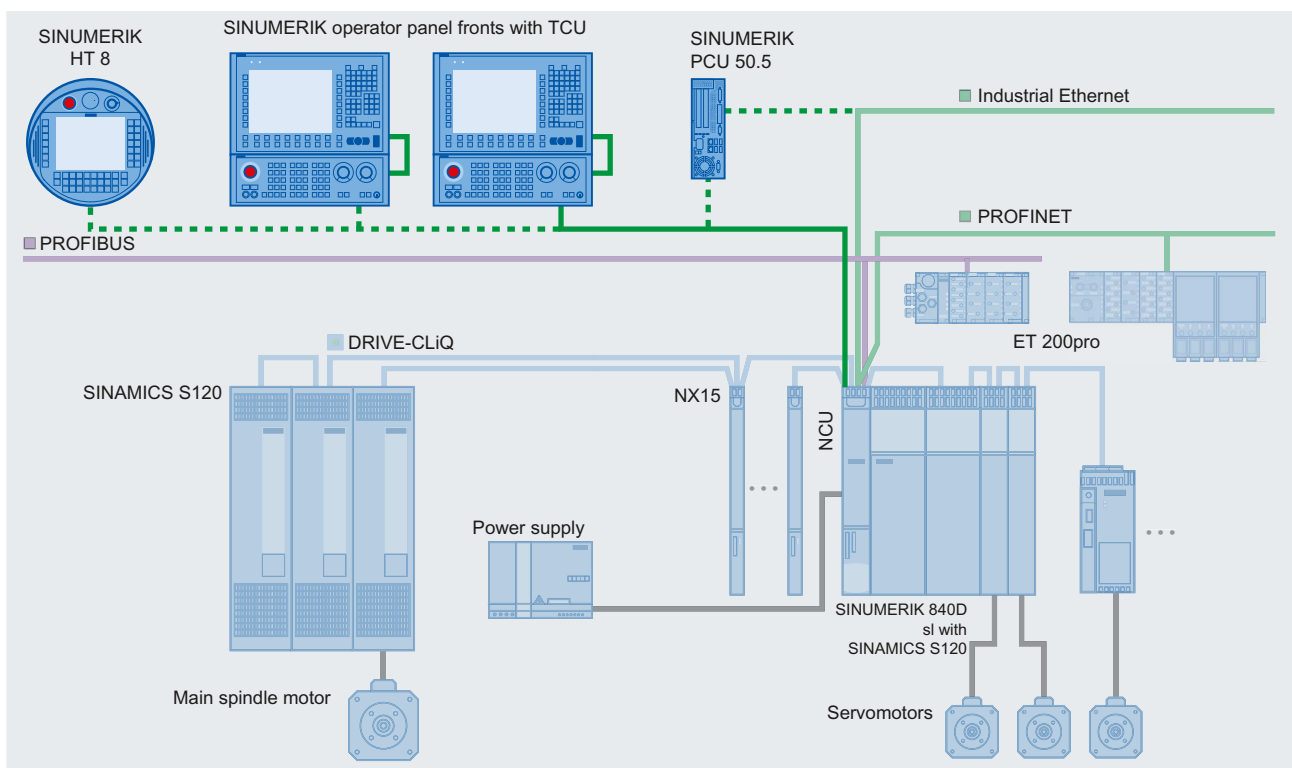

Figure 2-1 Typical topology of the SINUMERIK 840D sl complete system

The following components can be connected to the SINUMERIK 840D sl:

- SINUMERIK operator panel front with PCU/TCU
- SINUMERIK machine control panel MCP/MPP
- SINUMERIK handheld units
- SIMATIC CE panel
- SIMATIC thin client (as of firmware V1.4)
- Distributed PLC I/O via PROFIBUS DP or PROFINET IO
- SINUMERIK PP 72/48 I/O module

- SINUMERIK ADI 4 analog drive interface for four axes
- SINAMICS S120 drive system
- Feed and main spindle motors

2.3 Overview of operator components

Overview of the operator components



SINUMERIK OP 08T



SINUMERIK OP 010

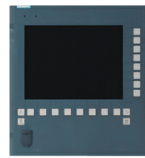

SINUMERIK OP 010S

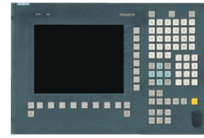

SINUMERIK OP 010C



SINUMERIK OP 012



SINUMERIK OP 015

SINUMERIK OP 015A/
OP 015AT/TP 015A/TP 015AT

SINUMERIK OP 019



SINUMERIK TCU 20.2



SINUMERIK TCU 30.2



SINUMERIK PCU 50.3



SINUMERIK PCU 50.5

Figure 2-2 Operator panels

2.3 Overview of operator components

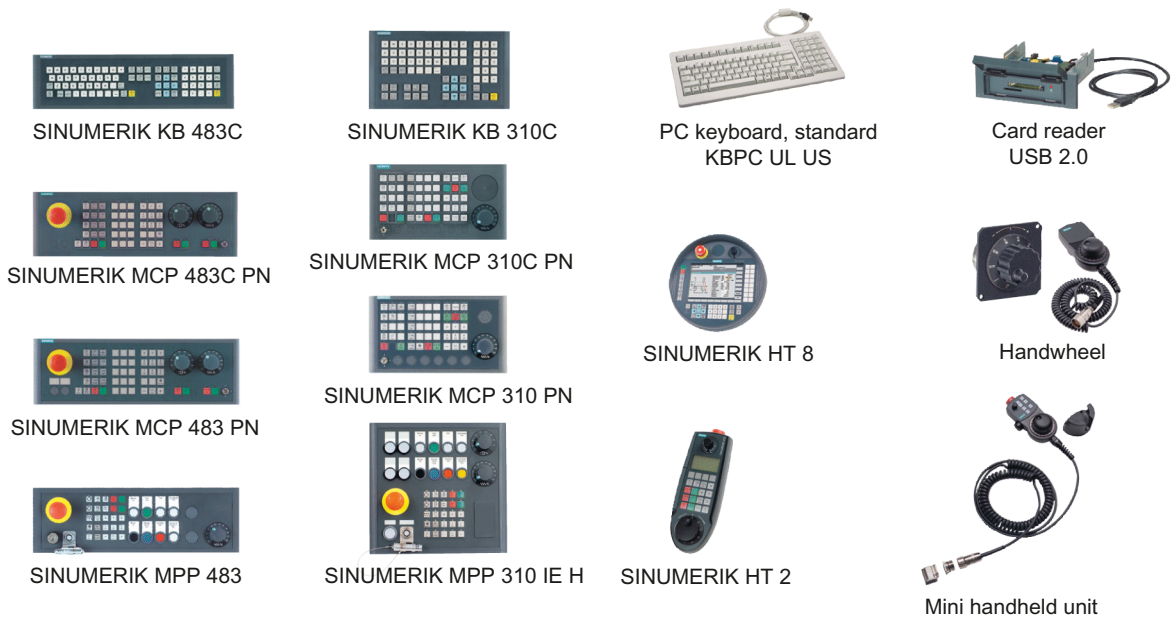

Figure 2-3 Machine control panels, handheld units, keyboards and additional components (selection)

Application planning

3.1 Secondary electrical conditions

3.1.1 Power supply

Requirements for DC power supplies



 DANGER
<p>Danger of death caused by unsafe power supply</p> <p>The DC power supply must be implemented as a circuit of Category PELV/DVC A according to EN 61800-5-1.</p>
 WARNING
<p>Inadequately fused supply cables can be life-threatening</p> <p>In the case of supply lines > 10 m, protectors must be installed at the device input in order to protect against lightning (surge).</p> <p>The DC power supply must be connected to the ground/shield of the NC for EMC and/or functional reasons. For EMC reasons, this connection should only be made at one point. As a rule, the connection is provided as standard in the S7-300 I/Os. In exceptional circumstances when this is not the case, the ground connection should be made on the grounding rail of the NC cabinet (also refer to /EMC/EMC Installation Guide.)</p>

Table 3- 1 Requirements of the DC power supply

Rated voltage	According to EN 61131-2 Voltage range (mean value) Voltage ripple, peak/peak Powering up time when switched on	24 VDC 20.4 VDC to 28.8 VDC 5% (unsmoothed 6-pulse rectification) any
Non-periodic overvoltages	Period of overvoltage Recover time Events per hour	≤ 35 V ≤ 500 ms ≥ 50 s ≤ 10
Transient voltage interruptions	Downtime Recovery time Events per hour	≤ 3 ms ≥ 10 s ≤ 10

3.1.2 Grounding concept

Components

The SINUMERIK 840D sl system consists of a number of individual components which have been designed so that the system complies with the appropriate EMC and safety standards. The individual system components are:

- Numerical Control Unit (NCU)
- Machine Control Panel (MCP), Machine Pushbutton Panel (MPP)
- Keyboard
- Operator panels (operator panel front + TCU/PCU)
- Distributor box and handheld unit
- S7-300 I/O with IM 153 interface module

Grounding measures

The individual modules are attached to a metal cabinet panel. Insulating paints on the mounting points (e.g. tension jacks) must be removed.

It is permissible to cluster the operator control components regarding connection/potential bonding.

Example: The control panel on the swivel arm.

It is sufficient in this instance to connect the ground connections of, for example, the PCU, TCU, and operator panel front using a cable and to route a shared grounding conductor to the central ground connection in the control cabinet.

Additional references

EMC Design Guidelines

3.1.3 RI suppression measures

In addition to the protective grounding of system components, special precautions must be taken to guarantee safe, trouble-free operation of the system. These measures include shielded signal lines, special equipotential bonding connections, and isolation and shielding measures.

Shielded signal cables

- For safe and fault-free operation of the system, the specified cables must be used.
- For digital signal transmission, the shield must have a conductive connection at both sides of the housing.

Cable definition

Definition:

- Signal cables (example)
 - Data cables (Ethernet, PROFIBUS, sensor cables, etc.)
 - Digital I/Os
 - Cables for safety functions (emergency stop, enabling)
- Power cables (example)
 - Low-voltage supply lines (230 VAC, +24 VDC, etc.)
 - Motor cables

Rules for routing cables

In order to achieve the best-possible noise immunity for the complete system (control, power section, machine) the following EMC measures must be observed:

- A minimum distance of 200 mm must be observed between the signal lines and power cables.
- If necessary, signal and power cables may cross one another (if possible at an angle of 90°), but must never be laid close or parallel to one another.
- Only use cables approved by SIEMENS for the signal lines from and to the Control Unit.
- Signal cables must not be routed close to strong external magnetic fields (e.g. motors and transformers).
- If signal lines cannot be routed a sufficient distance away from other cables, they must be installed in grounded cable ducts (metal).

Note

For further information on interference suppression measures and the connection of shielded cables, please refer to the EMC Installation Guide.

EMC limit values in South Korea

이 기기는 업무용(A급) 전자파적합기기로서 판매자 또는 사용자는 이 점을 주의하시기 바라며, 가정외의 지역에서 사용하는 것을 목적으로 합니다.
For sellers or other user, please keep in mind that this device is an A-grade electromagnetic wave device.
This device is intended to be used in areas other than home.

The EMC limit values to be complied with for South Korea correspond to the limit values of the EMC product standard for variable-speed electric drives EN 61800-3, Category C2, or limit value class A, Group 1 according to EN 55011. By applying suitable supplementary measures, the limit values according to Category C2 or according to limit value class A, Group 1, are maintained. Further, additional measures may be required, for instance, using an additional radio interference suppression filter (EMC filter).

The measures for EMC-compliant design of the system are described in detail in this manual respectively in the Installation Guideline EMC.

Please note that the final statement on compliance with the standard is given by the respective label attached to the individual unit.

3.2 Ambient climatic and mechanical conditions

3.2.1 Transport and storage conditions

The components of the SINUMERIK 840D sl system exceed the requirements according to EN 61800-2 with regard to shipping and storage conditions.

The following data applies under the following conditions:

- Long-term storage in the transport and product packaging:
At weather-protected locations that have continuous contact with outside air through openings.
- Transport in the transport packaging:
 - In unventilated containers under conditions not protected from weather effects.
 - In the "cold" in accordance with outside air.
 - Air transport in the air-conditioned cargo hold.

Table 3- 2 Ambient conditions during storage and transport

Type of condition	Permissible range/class		
	Transport	Storage	
Classification	EN 60721-3-2	EN 60721-3-1	
Climate class	2K4	1K4	
Ambient temperature ¹⁾	-40° C ... +70° C	-25° C ... +55° C	
Biological environmental conditions	2B1 ²⁾	1B1 ²⁾	
Chemically active environmental conditions	2C2 ³⁾	1C2 ³⁾	
Maximum permissible temperature change	Direct interaction in air/air: -40°/+30° C at 95% relative humidity	30 k/h	
Relative atmospheric humidity	5 to 95%		
Precipitation, rain	6 mm/min ²⁾	Not permitted	
Water other than rain	1 m/s and wet loading surfaces ⁴⁾	Not permissible ⁵⁾	1 m/s and wet loading surfaces ⁴⁾
Height	Max. 4,000 m above sea level		
Condensation, splash water, icing, salt spray	Permissible	Not permissible ⁵⁾	Permissible ⁴⁾

¹⁾ Transport and storage of operator panel fronts and diskette drives: -20° C to +55° C.

²⁾ Mold growth, slime, rodents, termites and other animal vermin are not permissible.

³⁾ In marine- and weather-resistant transport packaging (container).

⁴⁾ For storage in the transport packaging.

⁵⁾ For storage in the product packaging.

Note

Remove the transport protective foil and packaging material before installing the components.

Shipping backup batteries

Backup batteries must only be shipped in the original packaging. No special authorization is required to ship backup batteries. The lithium content is approximately 300 mg.

Note

The backup battery is classified as a hazardous substance, Class 9 in accordance with the relevant air-freight transportation regulations.

Storage of backup batteries

Always store backup batteries in a cool and dry place. The batteries have a maximum shelf life of 10 years.

Rules for handling backup batteries



WARNING

Incorrect handling of backup batteries can lead to a risk of ignition, explosion and combustion

The stipulations of DIN EN 60086-4, in particular regarding avoidance of mechanical or electrical tampering of any kind, must be complied with.

- Do not open a battery. Replace a faulty battery only with the same type.
- Obtain replacement batteries only from Siemens.
- Always try to return low batteries to the manufacturer or deliver these to a registered recycling company.

Rules for handling hard disks

The PCU 50.3 hard disk unit is provided with shock absorbers. However, the following rules must still be observed when handling this unit.

Hard disk unit

- Should always be transported in its original packaging
- Should not be thrown or dropped
- Should not be dismantled from the mechanical components with which it was supplied
- Should not be handled by its springs

3.2.2 Operating conditions

The components of the SINUMERIK 840D sl system are intended for a weatherproof, fixed location. The documented environmental conditions apply to the climate in the immediate vicinity of the units and to the entry of the cooling air. They exceed the requirements according to EN 60204-1, EN 61800-2, EN 61131-2 and IEC 62477-1.

NOTICE
<p>Damage to components by coolants and lubricants</p> <p>The SINUMERIK operator components have been designed for industrial use, particularly on machine tools and production machines. This also takes into account the use of commercially available coolants and lubricants. The use of aggressive compounds and additives can damage components and result in their failure.</p> <p>Contact between the operator components and coolants and lubricants should be avoided as far as possible, as resistance to all coolants and lubricants cannot be guaranteed.</p>

Table 3- 3 Ambient conditions for operation

Environmental conditions	Application areas	Remarks
Climatic environmental conditions		
Climate class	3K3	According to EN 60721-3-3
Limit temperatures at 100% load	0° C ... 55° C	Everything except components with drives; front-side for OP, MCP/MPP and CNC standard keyboards KB.
	0 ... 45° C	Rear-side for OP, MCP/MPP and CNC standard keyboards KB.
	5° C... 55° C	Components with drives.
Relative atmospheric humidity	5% to 95% (60% when corrosive gases and/or dusts are present)	
Condensation, icing, drip, spray and splash water	Not permitted	All components, except for ...
	Permissible	For operator panel fronts, handheld units and machine control panels
Max. installation altitude	1000 m above sea level	Without thermal derating
	2000 m above sea level	With insulation
	> 2000 m to 5000 m above sea level	Clearances for a working voltage of 50 V at 5000 m.
Biological, chemical and mechanical influences, pollutants		
Biological environmental conditions	Class 3B1 according to EN 60 721-3-3: Mold, mold growth, slime, rodents, termite and other animal vermin are not permissible.	
Chemically active environmental conditions	Class 3C1 according to EN 60721-3-3	
Mechanically active environmental conditions	Class 3S1 according to EN 60721-3-3: Conductive dust not permitted.	

Environmental conditions	Application areas	Remarks
Classification of the mechanical environment		3M3 for components on the machine 3M1/3M2 for components in the control cabinet
Degree of contamination		2
EMC conducted / radiation		Class C3 according to EN 61800-3

Note

The user must consider radio interference for the complete system. Particular attention should be paid to cabling. Please contact your sales representative for assistance and support.

If compliance with limit value class C2 is required, please contact your local sales representative.

3.2.3 Cooling

To calculate the heat dissipation, the total power loss P_{Vtotal} of all heat-generating components in a housing must be taken into account.

$$Total\ power\ loss\ P_{Vtotal} = P_{V1} + P_{V2} + P_{V3} + \dots [W]$$

Convection surface area $A [m^2]$:

The surface areas of the front and bottom sides are not included in the convection surface area calculation.

Note

A recommended value for the power loss of the operator control components is contained in the "Technical data" section of the associated component (see "Power consumption").

Means of heat dissipation

Heat dissipation can take place as follows:

- Heat dissipation by natural convection
- Heat dissipation by natural convection and internal air turbulence
- Heat dissipation by open-circuit cooling
- Heat dissipation by open-circuit ventilation

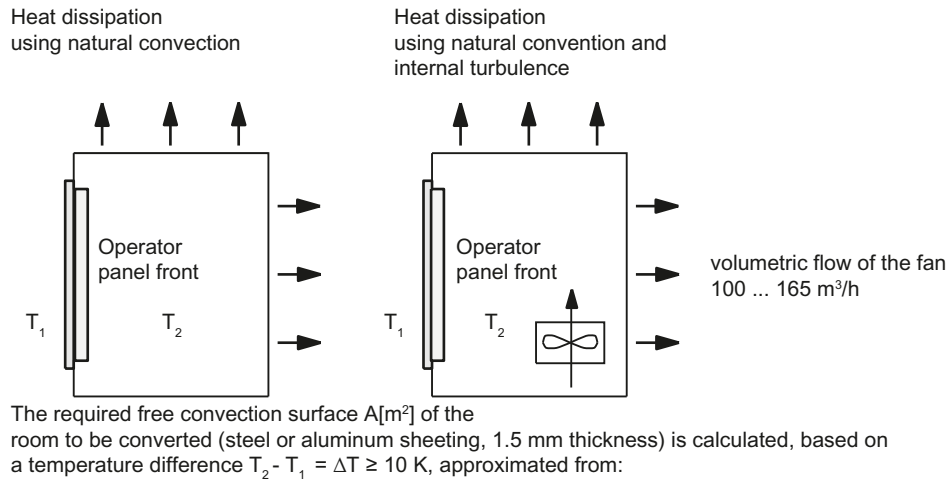

$$A \text{ [m}^2\text{]} = \frac{PV_{\text{ges}} \text{ [W]}}{5 * \Delta T \text{ [K]}}$$

$$A \text{ [m}^2\text{]} = \frac{PV_{\text{ges}} \text{ [W]}}{10 * \Delta T \text{ [K]}}$$

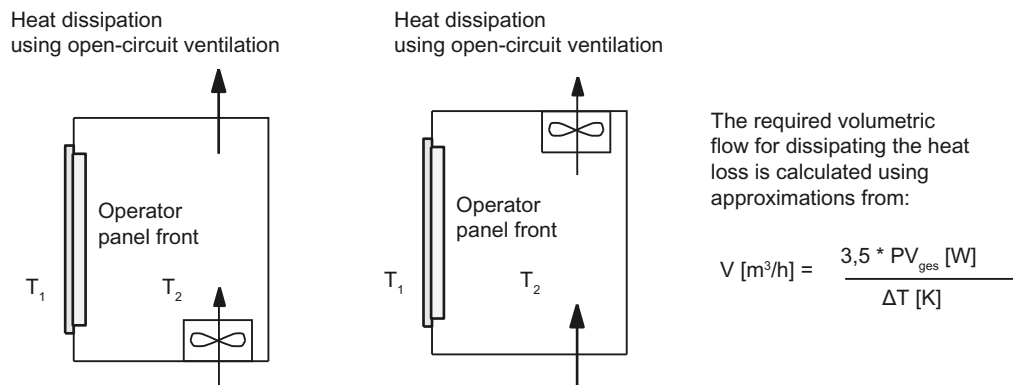

$$V \text{ [m}^3\text{/h]} = \frac{3,5 * PV_{\text{ges}} \text{ [W]}}{\Delta T \text{ [K]}}$$

Figure 3-1 Means of heat dissipation

Fan design

- The fan must be positioned to produce an optimum heat dissipation. A clearance of 10 mm must be maintained in front of the fan.
- The inlet and outlet slots must remain free for the open-circuit ventilation.
- Air filters must be provided to maintain the permitted environmental conditions.

NOTICE

Damage to the operating components caused by temperatures that are too high or too low

Contaminated air filters impair the desired heat dissipation. For handling the air filters, pay attention to:

- Proper handling
- Regular replacement
- Correct disposal

Guidelines

If the convection area A [m²] does not suffice for the "heat dissipation using natural convection", then use:

- "Heat dissipation using natural convection and internal turbulence" for hot spots and heat concentrations in housings subject to space constraints. The total power loss P_{Ltot} for thermally critical applications can be determined as follows:
 - Current measurement for a 24 V supply voltage
 - Power loss P_{Ltot} [W] = U (24 V) * |measured value in ampères|
- Heat dissipation using open-circuit ventilation

Calculation of the volumetric flow

The power loss (thermal) dissipated by the components in an operator unit is to be dissipated using open-circuit ventilation. The volumetric flow V required for this should be calculated at a difference in temperature of T₂ - T₁ = ΔT ≥ 10K.

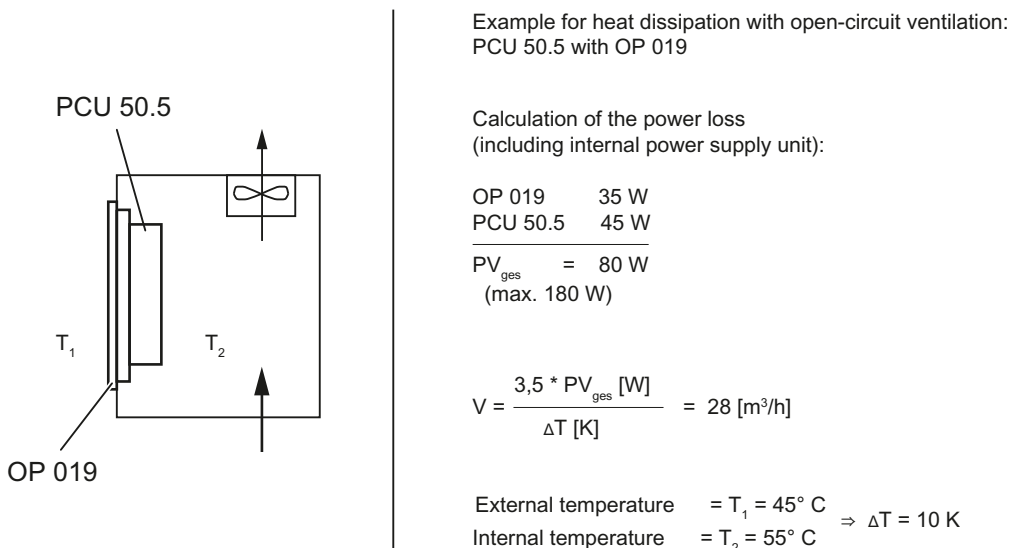

Figure 3-2 Calculating heat dissipation for PCU 50.5 with OP 019

3.3 Recycling and disposal

Products should be disposed of corresponding to the relevant national regulations. The products described in this manual can be mostly recycled due to the fact that they contain very few damaging substances. To recycle and dispose of your old device in an environmentally friendly way, please contact an appropriate disposal company.

Connecting

4.1 Pin assignment of the interfaces

The pins of the component interfaces are assigned as specified in the tables below. Any deviations are indicated at the relevant point.

Signal type:

I	Input
O	Output
B	Bidirectional (inputs/outputs)
V	Power supply
-	Ground (reference potential) or N.C. (not connected)

Power supply interface

Connector type:	Terminal block, 3-pin plug connector
Max. cable length:	10 m

Table 4- 1 Assignment of the power supply interface

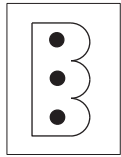
	Pin	Name	Type	Meaning
	1	P24 (+)	-	24 VDC potential
	2	M24 (-)	VI	Ground 24 V
	3	SHIELD (PE)		Shield potential

Serial interface COM1

9-pin sub-D connector

Table 4- 2 Assignment of the serial interface COM1 (V.24/RS232)

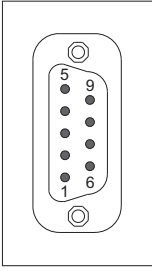
Connector	Pin	Name	Type	Remark
	1	DCD (M5)	I	Receive signal level (carrier)
	2	RxD (D2)		Serial receive data
	3	TxD (D1)	O	Serial transmit data
	4	DTR (S1)		Data terminal ready
	5	GND (E2)	-	Ground (reference potential)
	6	DSR (M1)	I	Data Set Ready
	7	RTS (S2)	O	Request To Send
	8	CTS (M2)	I	Clear To Send
	9	RI (M3)		Incoming call

USB interfaces

The USB interfaces are implemented as sockets and comply with the generally valid standard. The version information (1.1, 2.0 etc.) and the socket type (A or B) are documented in the individual sections for the associated devices.

In principle, USB interfaces have the following characteristics:

- Integrated power supply up to 500 mA for each socket.
- Maximum cable length 3 m (Length including the supply cable to the hub and the connected terminal; only 1 hub at maximum is allowed. It should be noted that some keyboards already have a hub.)

<p>NOTICE</p> <p>Cables that are too long can cause the screen to freeze</p> <p>Observe the following restrictions for the USB front interface for connecting operator panels to the keyboard, mouse or USB FlashDrive:</p> <ul style="list-style-type: none"> • Maximum cable length: 1.8 m • Extension cables are not permissible

- Hot-plugging-capable devices are connected during operation and are identified automatically.

Note

Correct identification is only guaranteed for USB I/Os that comply to 100% with the USB specification.

Table 4- 3 Assignment of the USB interface

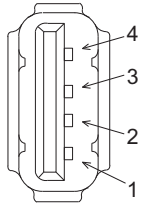
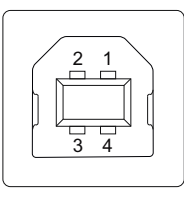
Type A socket	Type B socket	Pin	Name	Type	Remark
		1	P5V_fused	V	+ 5 V (fused)
		2	Data-	B	Data -
		3	Data+		Data +
		4	GND	V	Ground (reference potential)

PROFIBUS DP / MPI interface

Connector type:	9-pin sub-D socket
Max. data transmission rate:	12 Mbit/s
Max. cable length:	100 m

Table 4- 4 Assignment of the PROFIBUS DP / MPI interface

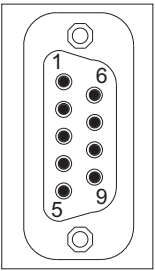
Connector	Pin	Name	Type	Remark
	1,2	N.C.	-	Not connected
	3	LTG_B	B	Signal line B of MPI module
	4	RTS_AS	I	Control signal for receive data current. Signal 1 active if directly connected control is sending.
	5	M5EXT	V	Return line (GND) of 5 V supply. Current load from a load of 90 mA max. connected between P5EXT and M5EXT.
	6	P5EXT	V	5 V supply (current load see M5EXT)
	7	N.C.	-	Not connected
	8	LTG_A	B	Signal line A of MPI module
	9	RTS_PG	O	RTS signal of MPI module; signal is "1", when PG is sending
	Shielding			-

4.1 Pin assignment of the interfaces

PROFIBUS DP interface

Connector type: 9-pin sub-D socket
 Max. data transmission rate: 12 Mbit/s
 Max. cable length: 100 m

Table 4- 5 Assignment of the PROFIBUS DP interface

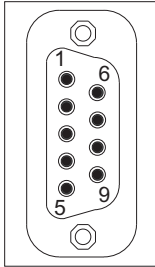
Connector	Pin	Name	Type	Remark
	1,2	N.C.	-	Not connected
	3	RS_DP	B	RS-485 differential signal
	4	RTS_DP	O	Request To Send
	5	M5EXT	V	5 V external ground
	6	P5EXT	V	5 V external potential
	7	N.C.	-	Not connected
	8	XRS_DP	B	RS-485 differential signal
	9	N.C.	-	Not connected

Ethernet RJ45 interface

Connector type: Standard RJ45 socket
 Max. data transmission rate: 10/100/1000 Mbit/s
 Max. cable length: 100 m

Table 4- 6 Assignment of the Ethernet RJ45 interface 10/100 Mbit/s

Connector	Pin	Name	Type	Remark
	1	TxD+	O	Send data
	2	TxD-		
	3	RxD+	I	Receive data
	4/5	GND	-	(terminated internally with 75 Ω; not required for data transmission)
	6	RD-	I	Receive data
	7/8	GND	-	(terminated internally with 75 Ω; not required for data transmission)
	Shielding	-	-	On connector housing
	-	Green LED (on right)	-	Lit: 10 or 100 Mbit/s Off: No or faulty connection
	-	Orange LED (left)	-	Lit: Data exchange Off: No data exchange

Table 4- 7 Assignment of the Ethernet RJ45 interface 1000 Mbit/s

Connector	Pin	Name	Type	Remark	
	1	DA+	B	Bidirectional pair A+	
	2	DA-		Bidirectional pair A-	
	3	DB+		Bidirectional pair B+	
	4	DC+		Bidirectional pair C+	
	5	DC-		Bidirectional pair C-	
	6	DB-		Bidirectional pair B-	
	7	DD+		Bidirectional pair D+	
	8	DD-		Bidirectional pair D-	
	Shielding	-		-	On connector housing
	-	Green LED (on right)		-	Illuminated orange: 1000 Mbit/s Off: No or faulty connection
-	Orange LED (left)	-	Lit: Data exchange Off: No data exchange		

Note

Connection only on LAN, not on telecommunication networks!

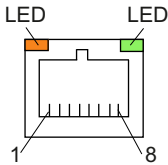
DVI-I interface

Table 4- 8 Assignment of DVI-I interface

Connector	Pin	Name	Type	Remark
	S	GND	-	Ground
	S1	GND	-	Ground
	C1	R	O	Red
	C2	G		Green
	C3	B		Blue
	C4	HSYNC	O	Horizontal synchronizing pulse
	C5	GND	-	Ground
	CSA	GND	-	Ground
	1	TX2N	O	TDMS data 2-
	2	TX2P		TDMS data 2+
	3	GND	-	Ground
	4	N.C.	-	Not connected
	5	N.C.	-	Not connected
	6	DDC CLK	B	DDC clock
	7	DDC CLK		DDC data
	8	VSYNC	O	Vertical synchronizing pulse
	9	TX1N	O	TDMS data 1-
	10	TX1P		TDMS data 1+
	11	GND	-	Ground
	12	N.C.	-	Not connected
	13	N.C.	-	Not connected
	14	+ 5 V	VO	+ 5 V
	15	GND	VO	Ground
	16	MONDET	I	Hot plug detect
17	TX0N	O	TDMS data 0-	
18	TXoP		TDMS data 0+	
19	GND	-	Ground	
20	N.C.	-	Not connected	
21	N.C.	-	Not connected	
22	GND	-	Ground	
23	TXCP	O	TDMS clock +	
24	TXCN		TDMS clock -	

I/O USB interface

All signals required for connecting operator panel fronts, with the exception of the display interface, are assigned to this interface.

Associated interface cable: K1
 Connector type: 2 x 13-pin socket connector

Table 4- 9 Allocation of the I/O USB interface

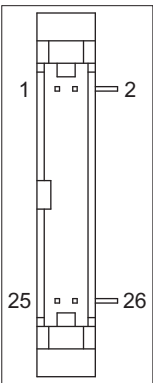
Connector	Pin	Name	Type	Meaning	
	1	GND		Ground	
	2	P12C	VO	+power supply for backlight inverter	
	3	BL_ON	O	Backlight On	
	4	P5V_fused	VO	+5 V VCC (fused in PCU/TCU)	
	5	GND	VO	Ground	
	6	P3V3_fused	VO	+3.3 V VCC (fused in PCU/TCU)	
	7 - 10	N.C.	-	Not connected	
	11	P5V_fused	VO	+5 V VCC (fused in PCU/TCU)	
	12	USB_D1M	B	USB data- Channel 1	
	13	USB_D1P		USB data+ Channel 1	
	14	GND	VO	Ground	
	15	LCD_SEL0	I	Display type select signal	1
	16	LCD_SEL1			2
	17	LCD_SEL2			3
	18	LCD_SEL3			4
	19	RESET_N		Reset signal (low active)	
	20	reserved	-	Reserved	
	21	HD_LED	O	HD LED, anode with 1 kΩ in series on the motherboard	
	22	DP_LED	O	MPI/DP LED, anode with 1 kΩ in series on the motherboard	
	23	Ethernet_LED	O	Ethernet LED, anode with 1 kΩ in series on the motherboard	
	24	TEMP_ERR	O	LED temperature sensor; anode with 1 kΩ in series on the board	
	25	RUN_R *)	O	Watchdog error LED, anode with 1 kΩ in series on the motherboard	
	26	RUN_G	O	Watchdog OK LED, anode with 1 kΩ in series on the motherboard	

LVDS display interface channel 1

Used to connect operator panel fronts with TFT displays with 640 x 480 pixels (VGA), 800 x 600 pixels (SVGA) or 1024 x 768 pixels (XGA).

Associated interface cable: K2, max. length: 0.5 m
 Connector type: 2 x 10-pin socket connector

Table 4- 10 Allocation of the LVDS display interface

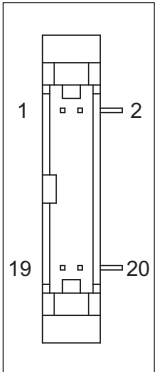
Connector	Pin	Name	Type	Meaning	
	1/2	P5V_D_fused	VO	+5 V display supply voltage (fused in PCU/TCU)	
	3	RXIN0-	I	LVDS input signal	Bit 0 (-)
	4	RXIN0+			Bit 0 (+)
	5/6	P3V3_D_fused	VO	+3.3 V display supply voltage (fused in PCU/TCU)	
	7	RXIN1-	I	LVDS input signal	Bit 1 (-)
	8	RXIN1+			Bit 1 (+)
	9/10	GND	-	System ground (reference potential)	
	11	RXIN2-	I	LVDS input signal	Bit 2 (-)
	12	RXIN2+			Bit 2 (+)
	13/14	GND	-	System ground (reference potential)	
	15	RXCLKIN-	O	LVDS cycle clock signal	(-)
	16	RXCLKIN+			(+)
	17/18	GND	-	System ground (reference potential)	
	19/20	N.C.	-	Not connected	

LVDS display interface channel 2

Used for expanding the LVDS display interface channel 1 to control TFT displays with 1280 x 1024 pixels (SXGA).

Associated interface cable: K3

Connector type: 2 x 10-pin socket connector

Table 4- 11 Allocation of the LVDS display interface

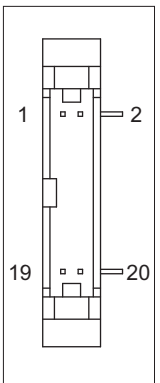
Connector	Pin	Name	Type	Meaning	
	1/2	GND	-	System ground (reference potential)	
	3	RXIN10-	I	LVDS input signal	Bit 0 (-)
	4	RXIN10+			Bit 0 (+)
	5/6	GND	-	System ground (reference potential)	
	7	RXIN1-	I	LVDS input signal	Bit 1 (-)
	8	RXIN1+			Bit 1 (+)
	9/10	GND	-	System ground (reference potential)	
	11	RXIN2-	I	LVDS input signal	Bit 2 (-)
	12	RXIN2+			Bit 2 (+)
	13/14	GND	V	Ground	
	15	RXCLKIN-	O	LVDS cycle clock signal	(-)
	16	RXCLKIN+			(+)
	17	GND	V	Ground	
	18-20	P12VF	VO	+12 V fused	

Rotary switch: Feed override X30

Connector designation: X30

Connector type: 2 x 5-pin plug connector, according to EN 60603-13 with coding

Table 4- 12 Assignment of X30 connector (on delivery)

Pin	Name	Type	Meaning
1	N.C.	-	Not connected
2	N.C.	-	Not connected
3	M	V	Ground
4	N.C.	-	Not connected
5	P5	V	5 V supply
6	OV_VS16	I	Override rotary switch value 16
7	OV_VS8		Override rotary switch value 8
8	OV_VS4		Override rotary switch value 4
9	OV_VS2		Override rotary switch value 2
10	OV_VS1		Override rotary switch value 1

Rotary switch: Spindle override X31

Connector designation: **X31**

Connector type: 2 x 5-pin plug connector, according to EN 60603-13 with coding

Table 4- 13 Assignment of X31 connector (on delivery)

Pin	Name	Type	Meaning
1	N.C.	-	Not connected
2	N.C.	-	Not connected
3	M	V	Ground
4	N.C.	-	Not connected
5	P5	V	5 V supply
6	OV_SP16	I	Override rotary switch value 16
7	OV_SP8		Override rotary switch value 8
8	OV_SP4		Override rotary switch value 4
9	OV_SP2		Override rotary switch value 2
10	OV_SP1		Override rotary switch value 1

Optional customer buttons IN (X51 / X52 / X55)

Only switches (passive inputs) may be connected via the X51, X52 and X55 connectors. X51 and X52 are typically used for connecting illuminated pushbuttons. The lamps in the buttons are activated via X53 and X54. X55 has no corresponding outputs.

Note

Connection miniature handheld unit

Alternatively, at the inputs X51, X52 and X55, one miniature handheld unit may be operated. For details, please refer to the corresponding section.

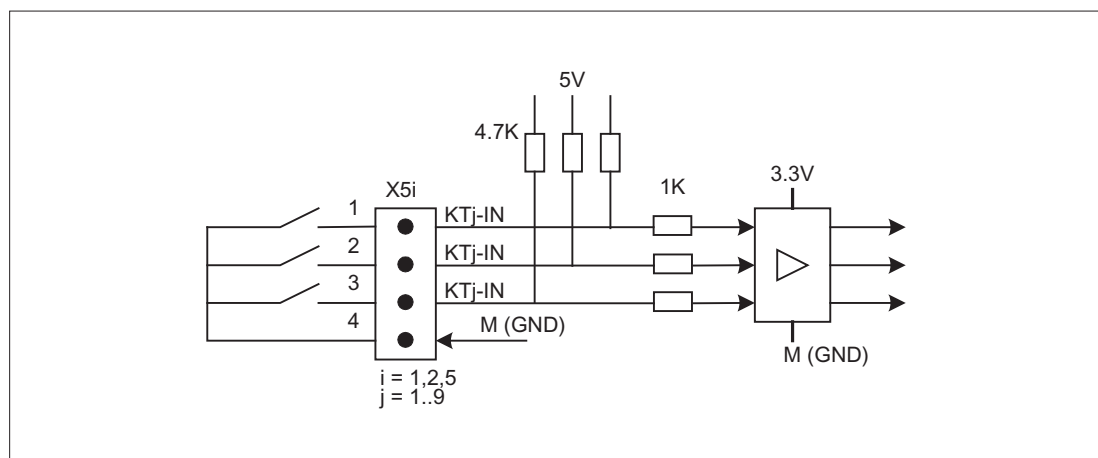

Figure 4-1 Main circuit diagram for input circuit for X51, X52 and X55

Connector designation: **X51 / X52 / X55**
 Connector type: 4-pin plug connector

Table 4- 14 Assignment of connector X51

Pin	Name	Type	Meaning
1	KT-IN1	I	Customer key 1
2	KT-IN2		Customer key 2
3	KT-IN3		Customer key 3
4	M	V	Ground

Table 4- 15 Assignment of connector X52

Pin	Name	Type	Meaning
1	KT-IN4	I	Customer key 4
2	KT-IN5		Customer key 5
3	KT-IN6		Customer key 6
4	M	V	Ground

Table 4- 16 Assignment of connector X55

Pin	Name	Type	Meaning
1	KT-IN7	I	Customer key 7
2	KT-IN8		Customer key 8
3	KT-IN9		Customer key 9
4	M	V	Ground

Optional customer buttons OUT (X53 / X54)

The short-circuit-proof outputs X53/X54 are provided to control lamps in the keys. Lamps with 24 V and 2.4 W per output are recommended.

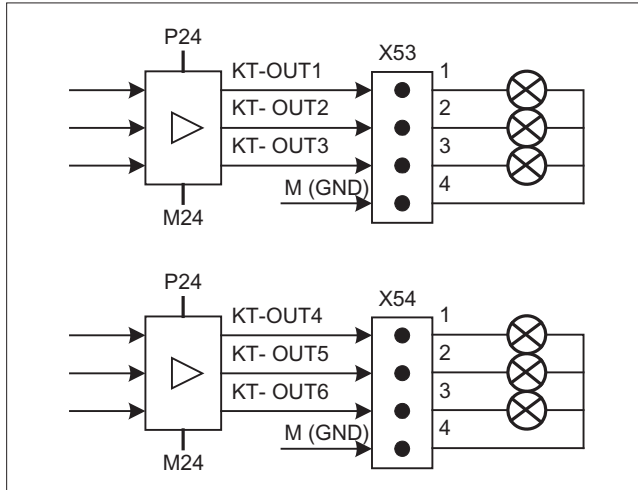

Figure 4-2 Main circuit diagram for input circuit for X53 and X54

NOTICE

Damage to the electronics

Do not connect any relays, valves or other inductive loads.

Connector designation: **X53 / X54**
 Connector type: 4-pin plug connector

Table 4- 17 Assignment of connector X53

Pin	Name	Type	Meaning
1	KT-OUT1	O	Output 1 lamp
2	KT-OUT2		Output 2 lamp
3	KT-OUT3		Output 3 lamp
4	M	V	Ground

Table 4- 18 Assignment of connector X54

Pin	Name	Type	Meaning
1	KT-OUT4	O	Output 4 lamp
2	KT-OUT5		Output 5 lamp
3	KT-OUT6		Output 6 lamp
4	M	V	Ground

Interfaces for two handwheels X60 / X 61

Interface:	Handwheel 1	Handwheel 2
Connector designation:	X60	X61
Connector type:	15-pin Sub-D socket	
Max. cable length:	5 m	

Table 4- 19 Pin assignment for connectors X60 / X61

Pin	Name	Type	Meaning
1	P5HW	V	5 V power supply
2	M	V	Ground
3	HW1_A / HW2_A	I	Handwheel pulses track A
4	HW1_XA / HW2_XA	I	Handwheel pulses track A (negated)
5	N.C.	-	Not connected
6	HW1_B / HW2_B	I	Handwheel pulses track B
7	HW1_XB / HW2_XB	I	Handwheel pulses track B (negated)
8	N.C.	-	Not connected
9	P5HW	V	5 V power supply
10	N.C.	-	Not connected
11	M	V	Ground
12	N.C.	-	Not connected
13	N.C.	-	Not connected
14	N.C.	-	Not connected
15	N.C.	-	Not connected

Note

The handwheels can either be operated with TTL or differential signals. You set the signal type using S1 (wire bridge) on the COM board.

The handwheels are supplied with 5 V ± 5% and 100 mA via the interface.

Contour and velocity specification via handwheel are not supported.

Interfaces for direct keys

X11 on the operator panel (OP) fronts can be used to fetch the state of the direct keys. The connection of a 20-pin ribbon cable allows the direct keys to evaluate the following components:

- Direct key module (DTM)
- X70 in the machine control panels (MCP, MPP) and the handwheel connection module (HAM)
- X205 on the Thin Client Unit (TCU)

The signals are then forwarded to the control over the various communications networks. Note that DTM and HAM can be operated only with PROFIBUS DP.

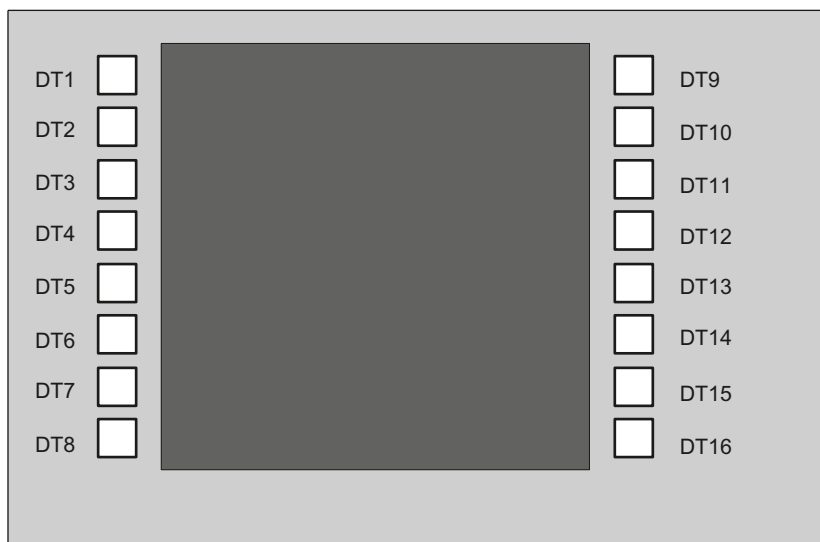

Figure 4-3 Assignment of the direct keys to the vertical softkeys of an operator panel front

16 digital inputs (5 V) can be fetched via the X11 connector.

Connector designation: **X11**
 Connector type: 20-pin plug connector
 Max. cable length: 0.85 m

Table 4- 20 Pin assignment of the X11 connector

Pin	Name	Type	Meaning
1	DT1	O	Direct key 1
...
16	DT16		Direct key 16
17	P5V	V	+ 5 V (fused)
18	P5V		+ 5 V (fused)
19	GND		Ground
20	GND		Ground

16 digital inputs can be polled by the X70/X205/DTM connector.

Connector designation: **X70/X205/DTM**
 Connector type: 20-pin plug connector
 Max. cable length: 0.85 m

Table 4- 21 Pin assignment of the X70 connector (MCP, MPP, HAM) / X205 (TCU) / DTM

Pin	Name	Type	Meaning
1	DT1	I ¹⁾	Direct key 1
...
16	DT16		Direct key 16
17	P5V / CON1 ²⁾	V	+ 5 V input voltage ³⁾
18	P5V / CON2 ²⁾		+ 5 V input voltage ³⁾
19	GND		Ground
20	GND		Ground

¹⁾ The inputs are electrically isolated for MCP / MPP / HAM and DTM.

²⁾ For the TCU, it is evaluated whether the direct keys have been connected.

³⁾ Power consumption: 100 mA for MCP / MPP / HAM; 500 mA for DTM

Table 4- 22 Signal level

HIGH level:	5 V or open
Low level	<= 0.8 V

4.2 Handling membrane connectors

When replacing parts it can sometimes be necessary to disconnect membrane connectors from the boards and reconnect them again.

This should be done as follows:

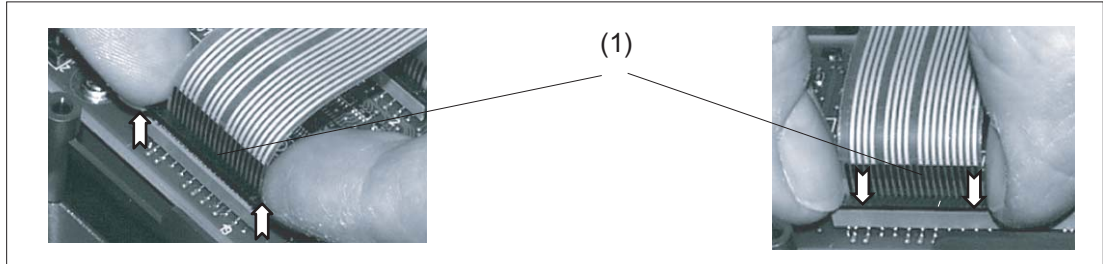

(1) Clamping frame of socket

Figure 4-4 Removing (left) and attaching (right) a membrane connector

Unplugging the membrane connector

1. Loosen the dark clamping frame of the socket by pushing it up with your fingernails until it engages in its upper, unlocked position (Fig. left).
2. Carefully pull off the membrane connector upward.

Plugging in the membrane connector

1. With the clamping frame in the upper position, carefully plug the membrane connector into the socket.
2. Lock it in place by pushing down the clamping frame (Figure right).

Networking

5.1 System settings

5.1.1 Settings for SINUMERIK solution line

Area of application

This description is valid for:

- NCU 7x0.3 PN with CNC software V4.6
- PCU 50.3 with PCU Base software V8.6 SP3
- PCU 50.5 with PCU Base software V5XP 1.3
- PCU 50.5 with PCU Base software V5W7 1.0?

Introduction

This manual describes the structure and commissioning of the system network with SINUMERIK solution line control and operator components with Ethernet-based communication. The fundamentals of the system network are described first, details and special cases are described in subsequent chapters.

Fundamentals

The system network for SINUMERIK solution line is structured as a star topology with a central Ethernet switch, to which all Ethernet-based components of the system are connected.

For an NCU the connection is executed via the X120 Ethernet socket, for PCU 50 it is executed via the "Ethernet 2" connection. There is no default for all other components with two Ethernet connections. These components have an internal 2-port switch and may be used to connect an additional operator component. Thus in this case there can be deviation from the strict star topology.

System network

In the system network the IP address 192.168.214.xxx with subnet mask 255.255.255.0 is pre-selected. Here, there is precisely one DHCP server with DNS that can run on one NCU or one PCU 50. The server ensures assignment of IP addresses to the Ethernet components in the system network (DHCP clients) from a specified address band.

The following rules apply for assignment of IP addresses in the system network:

- For all NCUs and PCUs the commissioning engineer assigns fixed IP addresses in the associated address bands, as well as appropriate computer names (host names). All other (operator) components are automatically assigned an IP address from the DHCP server. Its name is generated automatically (for MCP, MPP, HT 8), or is entered at commissioning (TCU).
- If there are multiple NCUs and/or PCUs in the system network the system automatically (depending on the start-up sequence) specifies the DHCP server and automatically ensures synchronization of all necessary data so that the next time the system boots any other NCU or PCU could take on the role of DHCP server. However it is a good idea to specify a DHCP master. This is an NCU or PCU in the system network that is available at each system boot and which regularly takes over the task of the DHCP server and DNS server.

Synchronization of data takes place in any event so that any other NCU or PCU can take over this task. All non-master NCUs / PCUs wait in the system boot an adjustable length of time for availability of the master.

Note

In a system network, on a boot server respectively - i.e. the NCU or PCU which accommodates the active DHCP server - a maximum of 30 operator stations may be operated simultaneously with a TCU.

A maximum of 10 operator stations with a TCU may connect up simultaneously with the same HMI application when powering up.

Connection to a company network

Each NCU can be connected via X130, and each PCU can be connected via "Ethernet 1" to the company network. The company network is used to exchange operating software with servers or to execute part-programs directly from servers in the company network. Company network and system network should always be logically and also physically separated.

Service interface X127

The service interface X127 of the NCU is used for direct connection of a PG/PC for service purposes. Here access with STEP 7 to the PLC, and with NCU 7x0.3 PN also to PROFINET is possible.

With direct connection (peer-to-peer) of a PG/PC to X127 it is absolutely necessary that the PG is operated as a DHCP client.

5.1.2 Thin Client Unit (TCU)

TCU overview

The Thin Client Unit (TCU) for the distributed configuration permits spatial separation of the SINUMERIK operator panel front (OP/TP) and the SINUMERIK PCU or NCU. On the SINUMERIK solution line, the TCU is used to display the user interface of the PCU 50 or the NCU.

It is possible to connect one TCU to several PCUs/NCUs. All TCUs and PCUs/NCUs that are connected to one another via a switch form the "system network". The user interface of a PCU/NCU is copied to several OPs with one TCU each. In other words, all of the TCUs display the same screen. Operator actions can only be performed on one TCU at a time. This TCU then has user authorization. The PCU can also have its own OP connected directly to it.

The following diagram shows a **configuration example** for a distributed topology:

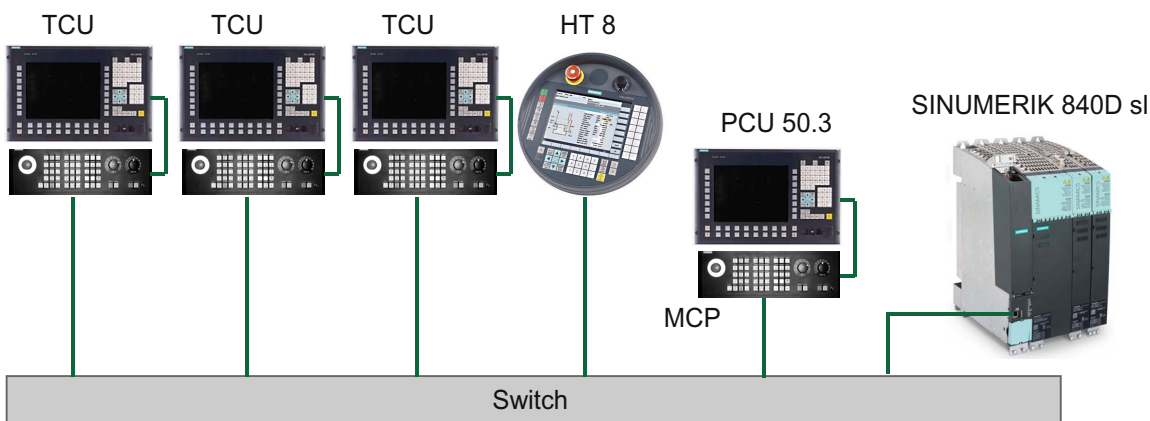

The mobile SINUMERIK HT 8 handheld terminal works on the thin client principle and combines the functions of an operator panel with a machine control panel.

The configuration and cabling of the whole plant system based on a permissible configuration is described in the chapter "Network configurations".

Supplementary conditions

For operation of a TCU:

- In the system network, the number of **active** TCUs is limited:
 - a maximum of 2 TCUs: NCU 710.3 PN
 - a maximum of 4 TCUs: NCU 720.3 PN or NCU 730.3 PN
 - a maximum of 4 TCUs: PCU

Any number of TCUs can be operated in the system network.

- CompactFlash Cards cannot be used on the TCU.
- A 16 bit or 32 bit depth of color setting may be selected.

- If a PC keyboard is connected to the TCU, it is not possible to ensure that all special keys, e.g., multi-media keys, will be transferred to the software of the NCU / PCU.
- Machine control panels connected via a PROFIBUS network are not supported for switchover.
- Distributed memory media that are connected to the TCU via USB can be used.

5.1.3 Factory default settings

Meaning of the symbols:

- Eth 1 as a DHCP client
- Eth 2 as a DHCP server
- Eth 2 with a fixed IP address

Preconfiguration of the TCU

The TCU is configured as a DHCP client and primarily accepts IP addresses from SINUMERIK components, from the DHCP server of such components that are inherent to SINUMERIK, for example, an NCU at X120 or a PCU on the system network or from a default DHCP server. The behavior of the TCU cannot be modified here.

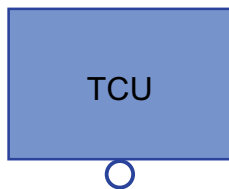

A TCU is a SINUMERIK DHCP client.
The TCU has a single Ethernet connection.

A TCU executes a boot via the network. The boot server is the computer node from which the TCU also obtains its IP address.

Pre-configuration of the PCU

A PCU has two Ethernet interfaces with default settings suitable for use with SINUMERIK solution line:

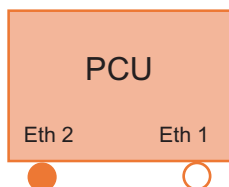

Eth 1 is pre-selected as a default DHCP client for connection to a company network.

Eth 2 is pre-selected as a SINUMERIK DHCP server for connection to a system network. On Eth 2 the fixed IP address 192.168.214.241 is pre-selected.

Preconfiguration of the NCU

On the X120, the NCU is preconfigured for the SINUMERIK DHCP protocol. The NCU is pre-selected here as a SINUMERIK DHCP server. On X120, the NCU occupies the fixed IP address 192.168.214.1 with the subnet mask 255.255.255.0 in its capacity as a DHCP server. The DHCP server of the NCU assigns IP addresses from the range 192.168.214.10 – 192.168.214.239 to the DHCP clients. The behavior of the NCU on X120 cannot be modified.

Restricting the available address band that is managed by the DHCP server of the NCU frees up IP addresses 192.168.214.2 to 192.168.214.9 as well as addresses 192.168.214.241 to 192.168.214.254 for network nodes with fixed IP addresses.

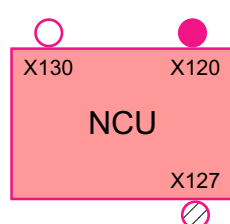

The NCU has three Ethernet connections:

- X120 to connect to the system network with an active DHCP server (Eth 0)
- X130 to connect to the company network as a default DHCP client (Eth 1)
- X127 as a service connection with an active DHCP server (Ibn 0)

On X130, the NCU is set as a default DHCP client for the address reference from a company network. The IP address received here is specified by the DHCP server from the company network.

On X127, an NCU is a standard DHCP server (in contrast to the SINUMERIK DHCP server). On X127, the NCU has the fixed IP address 192.168.215.1 with the subnet mask 255.255.255.224). The IP addresses 192.168.215.2 – 192.168.215.23 are dynamically assigned to the DHCP clients. The range 192.168.215.24 - 192.168.215.30 is reserved, and can be used by stations on the network with a fixed IP address, e.g. by a modem.

Reserved IP addresses for NCU and PCU

The following defaults apply on delivery:

- Connection to the system network with subnet mask 255.255.255.0:

IP address	Network station	Remark
192.168.214.1	NCU on X120	Default
192.168.214.2 – 9	For additional NCUs with a fixed IP address on the system network	Unassigned
192.168.214.10 – 239	For additional TCUs, subsequently for additional PCUs, NCUs, MCPs, MPPs	DHCP clients
192.168.214.240	Reserved for EKS (Electronic Key System)	Default
192.168.214.241	Fixed IP address of the PCU on Eth 2	Default
192.168.214.242 – 249	For additional PCUs with a fixed IP address	Unassigned
192.168.214.250 – 254	For PGs with a fixed IP address (service connection)	Unassigned

- Service connection with subnet mask 255.255.255.224:









IP address	Network station	Remark
192.168.215.1	NCU on X127	Default
192.168.215.2 – 23	for service purposes with PG, PC	DHCP clients
192.168.215.24 – 30	fixed IP address, for example for a modem	Unassigned

5.2 Commissioning TCU

5.2.1 Using the TCU's main menu

Key assignment

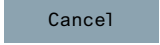
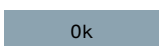
Functions of the keys and softkeys in the "Operator panel service system":

Softkey	Key on OP	External keyboard	Description
	HSK1	<F1>	Moves the cursor down a row
	HSK2	<F2>	Moves the cursor up a row
	HSK3	<F3>	Moves the cursor down a page
	HSK4	<F4>	Moves the cursor up a page
	HSK5	<F5>	Inserts text or digits
	HSK6	<F6>	Inserts text or digits
	VSK7	←	Cancel / Return
	VSK8	→	OK / Confirm
---		Pos1	Moves the cursor to the top row
---		End	Moves the cursor to the bottom row

Exceptions to the above are mainly the result of input fields. Where these are present, the left/right cursor keys move the input cursor rather than performing an OK/cancel function. The Return key takes you to the next field (like the "down" key) rather than closing the entire dialog with OK. There are also Backspace (deletes character to the left) and Delete (deletes character to the right) keys for editing text and numbers. The F5, F6, Backspace, Delete, and Select keys (between the cursor keys on the panel) can be used to switch between Yes/No fields.

With a touch screen, you can activate all the softkeys and even select rows in a menu simply by touching them.

Touch panels without any additional keys still have a special function which allows you to edit letters and numbers with HSK5/HSK6 by moving characters forwards or backwards.

See also: How to calibrate a touch panel (Page 68)

"Main menu"



The dialog "Main menu (TCU1)" is started with the menu back key and the key <MENU SELECT>:

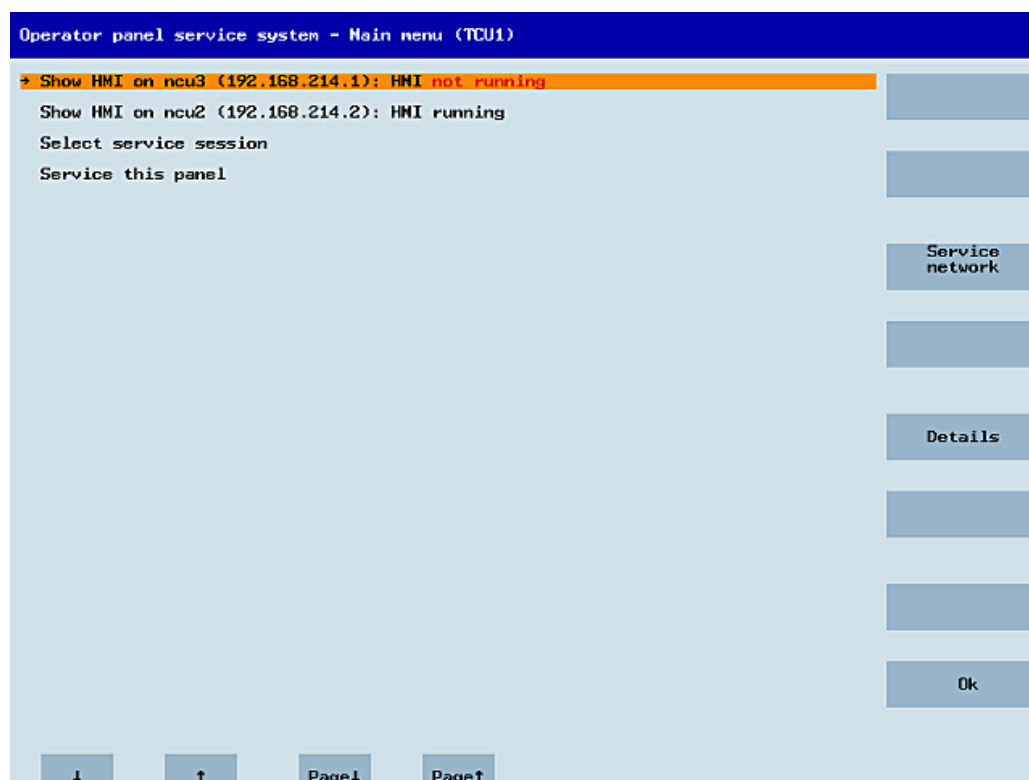

Figure 5-1 TCU menu: Main menu

The main menu contains:

- A "Main menu" title followed by the TCU name in brackets
- A central area listing the servers from config.ini. This is followed by two more fixed items, "Select service session" and "Service this panel".
 - The penultimate menu item, "Select service session", triggers a server scan which detects all the VNC servers in the local (system) network. These are then displayed in a session menu which largely reflects the main menu.
 - The last menu item on the main menu, "Service this panel", opens the "Service menu for operator panel" submenu.
- The right-hand side of the menu has a column containing 8 softkeys for use on a context-specific basis.
- The lower section of the menu has a row of 4 softkeys for navigating with the cursor.
- There is an error line for displaying error messages directly above the row of softkeys. Transient status messages also occasionally appear in this line.
- There is a further message line above this error line. The contents of this line can be set from the servers using HWS commands.

"Service Network" softkey

The System Network Center (SNC) (Page 89) opens when the "Service network" softkey is pressed.

The following message only appears if an error has occurred:

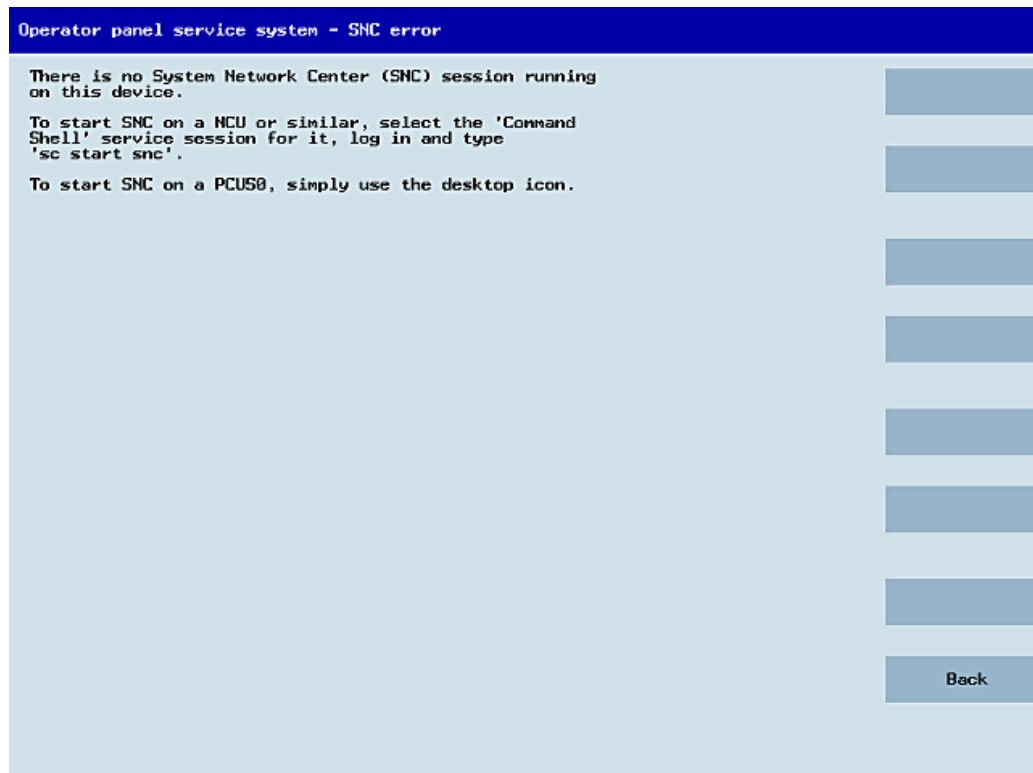

Figure 5-2 TCU menu: Fault signal

"Details" softkey

The following connection data for the selected device appears when the "Details" softkey is pressed:

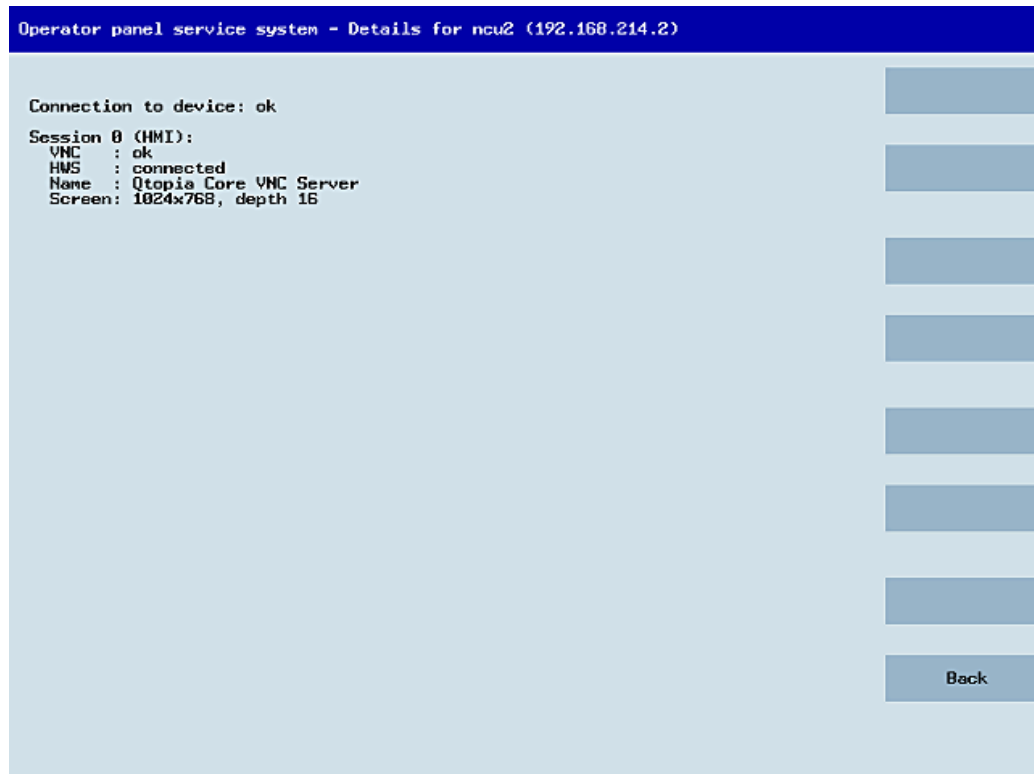

Figure 5-3 TCU menu: Connection data

5.2.2 Using additional TCU menus

"Service sessions" dialog

When "Select service session" is selected from the main menu, the resulting process begins by triggering a server scan:

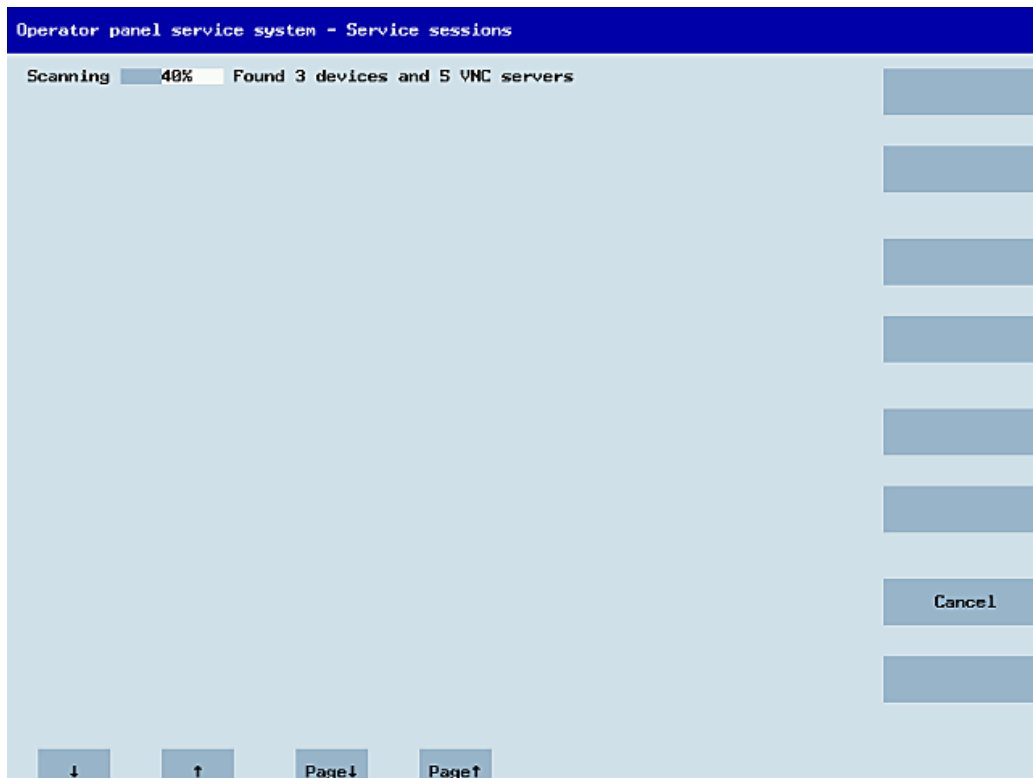

Figure 5-4 TCU menu: Scanning

After this, the following dialog appears:

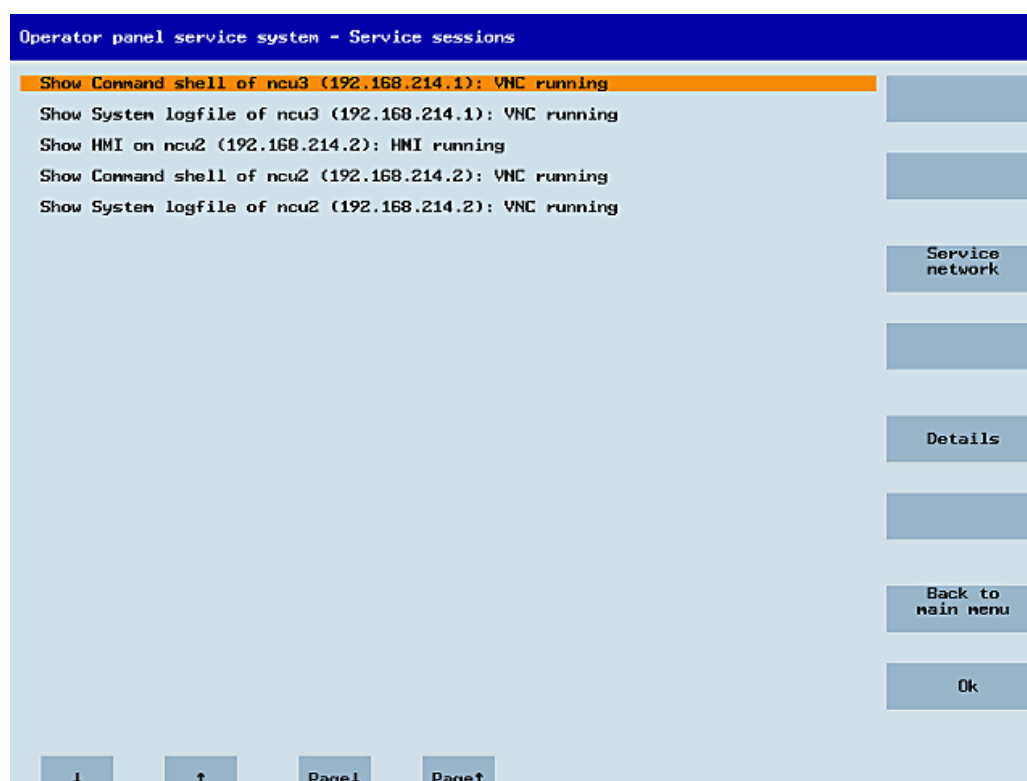

Figure 5-5 TCU menu: Active sessions

Central area with the server list:

The individual server lines contain either "Show WHAT on NAME (IP)" or the IP address only where the name is unknown.

Session number	VNC server
Session 0	HMI
Session 4	Command shell
Session 5	System logfile
Session 6	System Network Center (SNC)
...	
Session <N>	other server

These details are followed by a status message regarding the accessibility of the VNC server. "Connection not ok" appears if it is already impossible to access the VNC server from the IP side (if switched off, for example). If it can be accessed, a message shows whether an HMI-VNC server is also accessible ("HMI running/not running").

The VSK8, Return or right cursor keys can be used to launch a VNC viewer for the selected server.

Connection status:

Further details on the connection status can be called with the "Details" softkey. In the next dialog, "not ok" or "not running" are accompanied by an additional error message with more precise details on the reason for the loss of function. With more favorable scenarios, the session name for the VNC server will also be specified along with its resolution.

The connection and HMI status are monitored on a regular basis in the background. This may mean that these details change spontaneously if a change is made on the relevant server (for example, it may be switched off, the HMI may become available, etc.).

"Service menu for operator panel (TCU)" dialog

The following dialog appears when "Service this panel" is selected from the main menu:

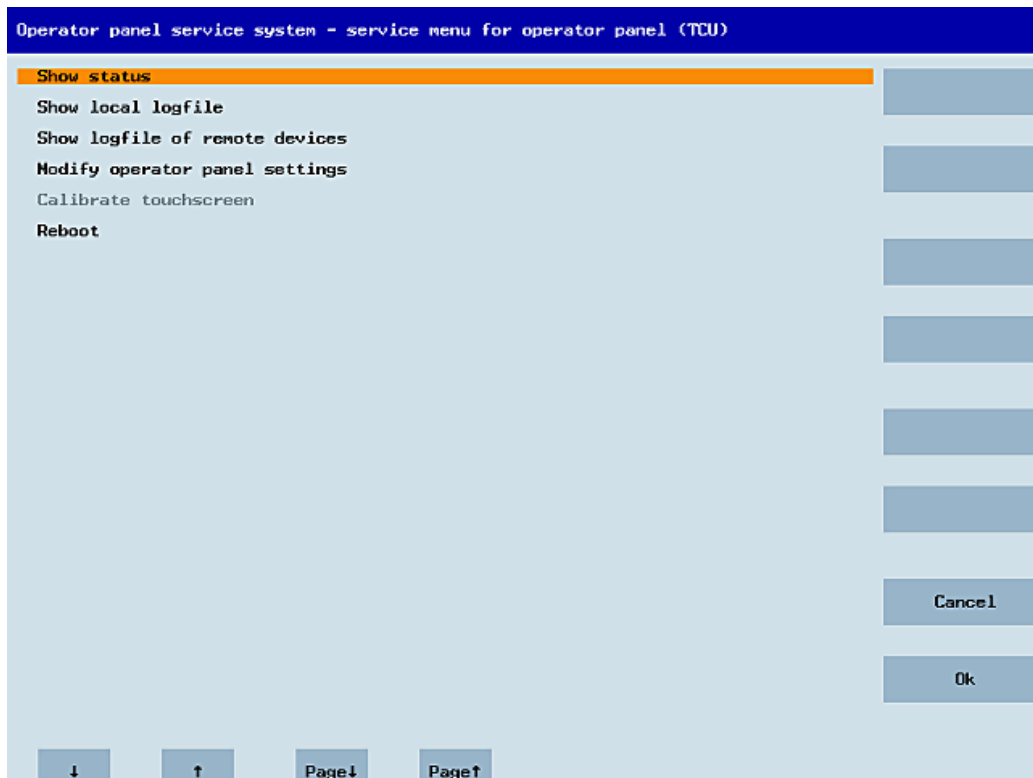

Figure 5-6 TCU menu: Service menu

The following menu items are available here:

- "Show status" displays status information including the software version, HW information, TCU network data, and the contents of the config.ini.

The screenshot shows a terminal window titled "Operator panel service system - Operator panel status". The content is as follows:

```

Operator panel service system - Operator panel status

Software
-----
Version      : L02.60.13.00

Hardware
-----
Hardware-ID  : 7.1.0.0 (TCU)
Feature flags: 00000000 (no direct keys, 0 hand wheels)
Panel size   : 800x600, depth 16
Input devices: 1 keyboard, 1 mouse, 0 touchscreens

Network Status
-----
Interface    : 100 MBit, full duplex
IP Address   : 192.168.214.10
Netmask      : 255.255.255.0
MAC Address  : 08:00:06:73:5a:7a
Boot Server  : 192.168.214.1
Gateway      : 192.168.214.1

config.ini
-----
[Station]
ncpIndex=192
tcuIndex=1
dckEnable=0

[Host_1]
Address = 192.168.214.1

[Host_2]
Address = 192.168.214.2
  
```

The interface includes a "Back" button on the right side and navigation buttons (down arrow, up arrow, Page down, Page up) at the bottom.

Figure 5-7 TCU menu: OP status

- "Show local logfile" displays a filtered version of the system logfile in the `/var/log/messages` directory containing local TCU messages only. Syslog messages received via the network are not displayed.

```

Operator panel service system - Local logfile
00:06:06 syslogd started: BusyBox v1.00 (2008.10.14-21:56+0000)
00:06:06 kernel: process `syslogd' is using obsolete setsockopt SO_BSDCOMPAT
00:06:06 udhcpc[821]: udhcp client (v0.9.7) started
00:06:08 udhcpc[821]: Lease of 192.168.214.18 obtained, lease time 864000
00:06:08 dhcpc: eth0 bound to 192.168.214.18 (server: 192.168.214.1)
00:06:09 sntp[973]: using NTP server ? (192.168.214.1)
00:06:09 sntp[973]: NTP server is unsynchronized
00:06:12 sysinit: basic system initialization finished
00:06:13 kernel: i2c adapter i2c-0: timeout in state quick
00:06:13 tcodatad[1876]: i2c_write 1b: Input/output error
00:06:13 tcodatad[1876]: have eeprom: failure, assuming no EEPROM
00:06:13 tcodatad[1876]: no EEPROM and no CF card, nothing to do
00:06:13 sysinit: starting subsystem /system/vncviewer: VNC Viewer version 02.60.→
10.00
00:06:14 startvnc[1186]: waiting for default server (192.168.214.1:0) being avail→
able
00:06:14 startvnc[1186]: HMS connection to 192.168.214.2:0 established
00:06:14 startvnc[1186]: HMS connection to 192.168.214.1:0 established
00:06:31 sntp[973]: NTP server is unsynchronized
00:06:47 lshd[1847]: lshd: publickey authentication for user root succeeded.
00:06:53 sntp[973]: NTP server is unsynchronized
00:07:15 sntp[973]: NTP server is unsynchronized
00:07:19 startvnc[1186]: default server connection aborted manually
00:07:37 sntp[973]: NTP server is unsynchronized
00:07:59 sntp[973]: NTP server is unsynchronized
00:08:21 sntp[973]: NTP server is unsynchronized
00:08:25 lshd[1847]: lshd: publickey authentication for user root succeeded.
00:08:43 sntp[973]: NTP server is unsynchronized
00:09:05 sntp[973]: NTP server is unsynchronized
00:09:13 lshd[1847]: lshd: publickey authentication for user root succeeded.
00:09:27 sntp[973]: NTP server is unsynchronized
00:09:49 sntp[973]: no acceptable packets received
00:12:20 lshd[1847]: lshd: publickey authentication for user root succeeded.
00:13:20 lshd[1847]: lshd: publickey authentication for user root succeeded.
00:14:02 lshd[1847]: lshd: publickey authentication for user root succeeded.
00:14:39 last message repeated 1 times

```

Figure 5-8 TCU menu: Local logfile

- "Show logfile of remote devices" displays the logfile of the other devices in the network: The syslog messages of devices in the system network which send syslog messages by broadcast, such as NCU 7x0, ...
- "Modify operator panel settings" calls a further submenu. Please refer to the next section.
- "Calibrate touch screen" is only active if there is a touch screen. This menu item recalibrates the touch screen.
- "Reboot" restarts the TCU.

Note

Where the contents of a line exceed the space available, the remaining text runs onto the next line so that you do not have to waste time scrolling across. When this occurs, the line has a right-facing arrow at its right edge.

"Modify settings for operator panel (TCU)" dialog

The following dialog appears when "Modify settings" is selected from the main menu:

Operator panel service system - Modify settings for operator panel (TCU)

Operator panel index - TCU [0-255]	1
Machine control panel address - MCP [0-255]	192
Electronic key system index - EKS [0-255]	0
Enable direct keys	No

Buttons: ↓ ↑ Char↓ Char↑ Ok

Figure 5-9 TCU menu: Settings

The central area is for setting the TCU parameters:

- "HT 8 individual mode" (yes/no)

This is only visible with HT 8, and is used to switch between Auto Mode and Individual Mode.

There is no need to make any settings if an HT 8 is in Auto Mode, as the name is determined automatically: ("DIP<n>") the MCP address and TCU index are determined by the DIP setting ("DIP<n>").

It is possible, however, that another device is registered for the name selected. Such situations may only prove to be temporary, as is the case when DIP settings or two HT 8 have been confused. For this reason, this status is not reported as an error immediately, but identified as a possible problem instead ("potential name/DIP setting collision"). The text will only read ("Name/DIP settings collision") if the situation remains unchanged after some time has elapsed.

The process itself is unaffected, as the changes only relate to how the warning or error is displayed. The explanatory text informs the user that they have probably assigned the same DIP number twice and suggests they change one of them before rebooting the HT 8.

- "Operator panel index - TCU" (0-255)"

This specifies the TCU index. It matches the [Station] tcuIndex setting from the config.ini file.

- "Machine control panel address - MCP" (0-255)
This specifies the address of the associated MCP. It matches the [Station] mcplIndex setting from config.ini.
 - "Electronic key system index - EKS" (0-255)"
This specifies the index of the associated EKS. It matches the [Station] eksIndex setting from config.ini.
 - "Enable direct keys" (yes/no)
This specifies whether direct keys (if present) should communicate with the PLC (yes) or be treated as ordinary keys (no).
- "OK" saves any modified values to the config.ini file or to the Flashstore (HT 8 individual mode).

Parameters for the "config.ini" file

Two steps need to be performed:

1. Select "New" or "Replacement for existing panel".
2. Select what is to be replaced.

When an unknown TCU (i.e. not yet registered with the boot server) is started, a selection menu containing both the "New" and "Replacement for existing panel" items will appear. The accessibility of all the registered TCUs is tested in the background.

The status of this test process appears in the message line: "(0/3 panels inactive)".

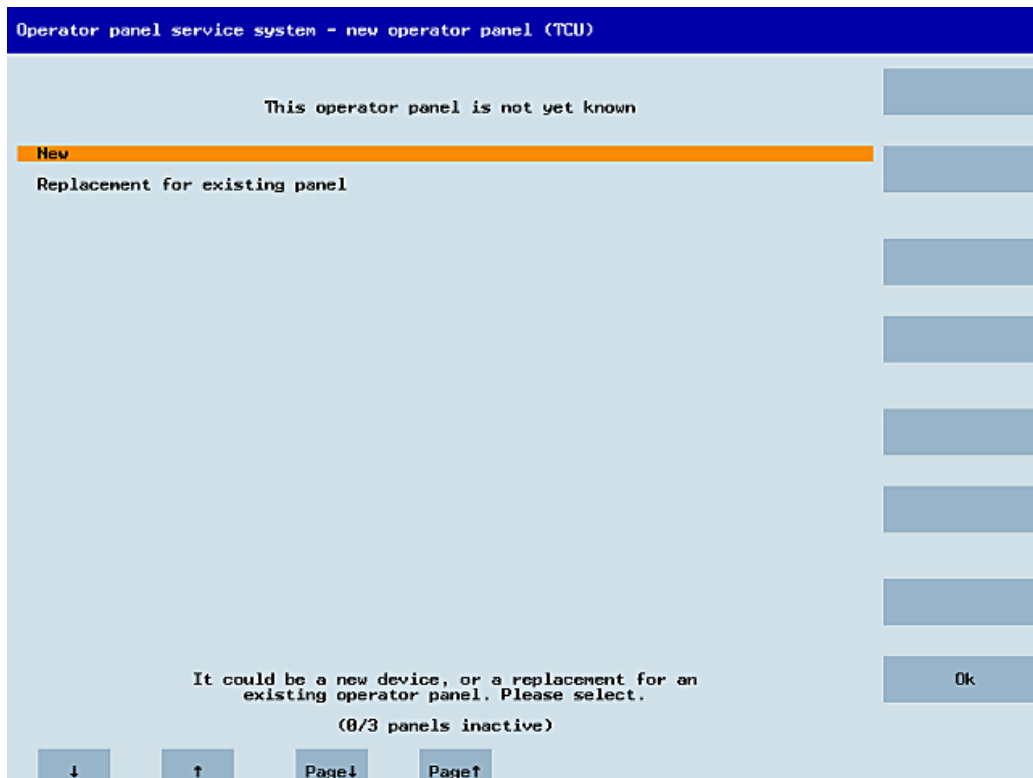

Figure 5-10 TCU menu: New TCU

If all the TCUs are active, the new one cannot be a replacement. The system will then automatically switch to the name assignment phase after a set period of time has elapsed.

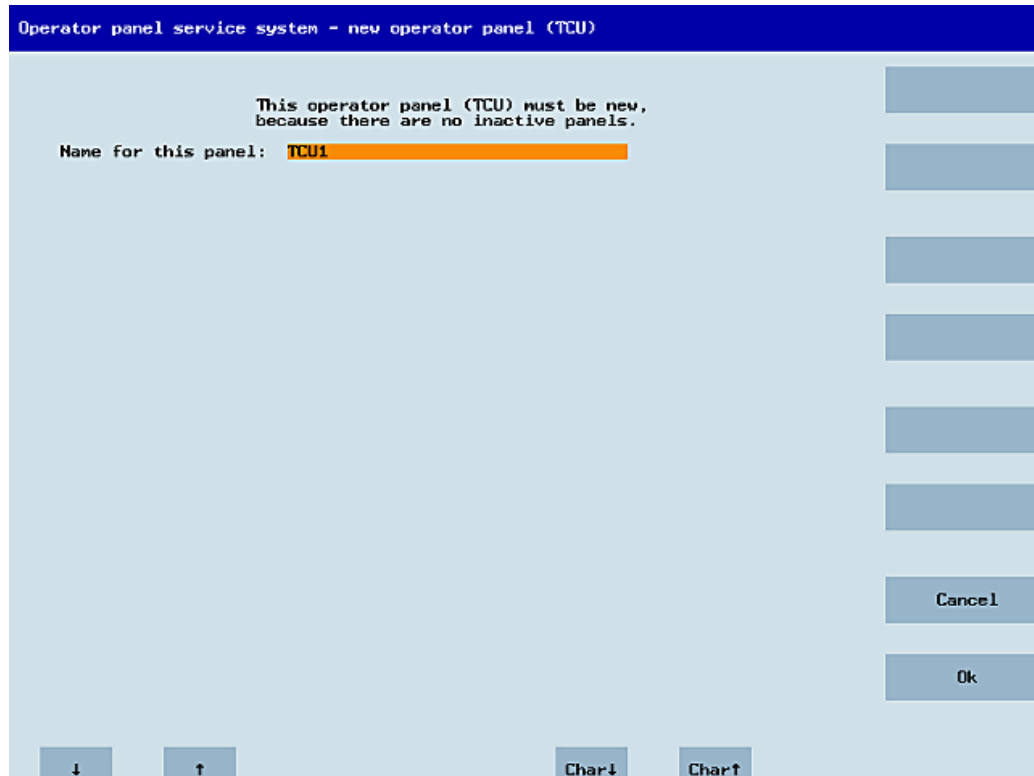

Figure 5-11 TCU menu: Name of TCU

Replacing a device

If "Replacement" is selected, all the registered TCUs will appear in a selection menu. Those which are active in the network will be grayed out. (As these are functioning, there should be no question of replacing them.) The cursor automatically defaults to the first row for selection.

As the accessibility test is still running in the background, the active status of the rows may change if panels are switched on or off.

If a name is ultimately chosen, it will be applied to the new TCU along with the associated saved settings.

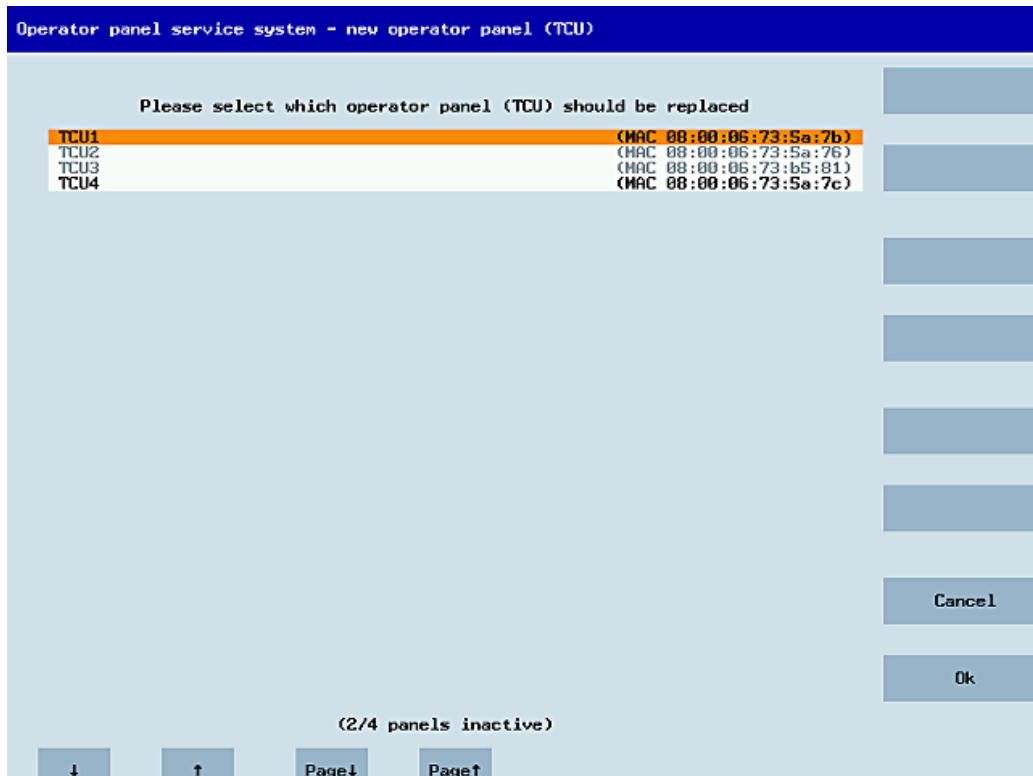

Figure 5-12 TCU menu: Spare TCU

Assigning a name

If, as described above, the system automatically follows the "New" path, an additional message will appear: "This operator panel (TCU) must be new, because there are no inactive panels." This message will not appear if "New" is selected manually.

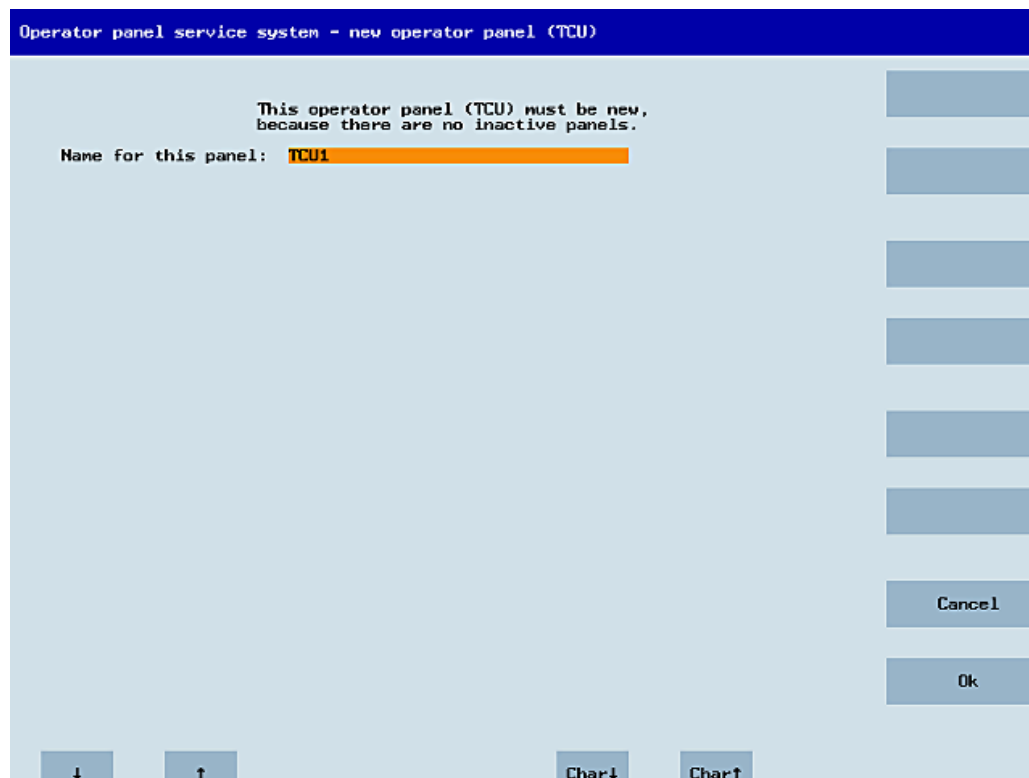

Figure 5-13 TCU menu: Name of TCU

An available TCU name is suggested in the input field, although the user is able to change this. The default name is "TCU<N>", where <N> is the lowest number yet to be used. If, however, the name is already allocated after the OK softkey has been pressed (which may happen if a number of TCUs log on at the same time) and the suggestion has not changed, a new and unused name will be specified.

If the name selected was still available, this will now be allocated, and the TCU settings can still be adapted if required. To enable any changes to be made, a new dialog will appear in which all the parameters have been pre-assigned their default values. You can make any changes you like or just select "OK" to accept the existing values.

5.2.3 How to register a TCU on the system network

Preconditions

The boot server (NCU or PCU 50) defined in the system network as a DHCP master, must be switched on and be available in the network.

Sequence for a TCU

Procedure:

1. Connect TCU.

This opens the dialog "New operator panel (TCU)".

2. Select "New" to connect a new TCU and "OK" to confirm.
3. In the next dialog, accept the name suggested by the system or enter a name and confirm this with "OK".

The following parameters are pre-selected for the TCU:

Operator panel index - TCU [0-255]	1
Machine control panel address - MCP [0-255]	192
Electronic key system index - EKS [0-255]	0
Enable direct keys	No

4. Restart the TCU to apply the new settings.
5. If you want to change the parameters, select "Main menu" → "Service this panel" → "Modify operator panel settings".

Sequence for the HT 8

Procedure:

1. Connect HT 8 to a connection module and calibrate the touch screen.

Additional softkeys are available for convenient touch panel operation:

- "OK" has the same effect as the <INPUT> key
- Select "DEF" to save the "Default" settings.
- "Edit" has the same effect as the <F10> or <MENU SELECT> key.

2. Select HT 8 Individual Mode:

According to the default setting for an HT 8, "HT 8 Individual Mode" is deselected with "No". This means "Auto" mode is activated for automatic detection in the system network. The HT 8 is automatically detected based on its name "DIP_". If "HT 8 Individual Mode" is activated with "Yes", the HT 8 is identified by its MAC address on the system network.

3. For an HT 8, confirm the "DIP..." name proposed by the system or adapt the name. You can select any other characters.

Press the <INPUT> key to apply the following values as default settings for the HT 8:

HT8 Individual Mode	No
Operator panel index - TCU [0-255]	10
Machine control panel address - MCP [0-255]	10
Electronic key system index - EKS [0-255]	0
Enable direct keys	No

The following message will then appear: "New TCU 'DIP10' registered."

Note

The TCU index is used to evaluate the direct keys. Direct keys can only be activated by appropriate devices. For an HT 8 the TCU index cannot be set, but is assigned by the system.

Activate direct keys

The signals from pressing the direct keys are sent directly to the PLC. In the PLC, the keys appear as 16 digital inputs.

Additional information on programming the PLC is provided in:

References: Function manual basic functions, basic PLC program (P3 sl)

Definition: Operator panel

The term operator panel designates a unit that consists of an OP/TP, a TCU or PCU and a machine control panel (MCP), that are connected to each other via Ethernet.

All TCUs and PCU 50 can be used along with OP/TP with "integrated TCU", e.g.: OP 08T, OP 015T, TP 015AT.

Specifying settings without machine control panel

If a PCU or a TCU has no Machine Control Panel (MCP), you must set one of the two following options:

- MCP address = 0 or no entry

After the change of user authorization, there is no switchover of the machine control panel; the previously active MCP remains active.

- MCP address = 255

If the user authorization is transferred to this PCU or TCU, the previous machine control panel is deactivated and there is no active machine control panel from this point on.

Connecting a replacement TCU

Procedure:

1. Connect the new TCU.

The following dialog lists the TCUs on the system network along with their "active" or "inactive" status.

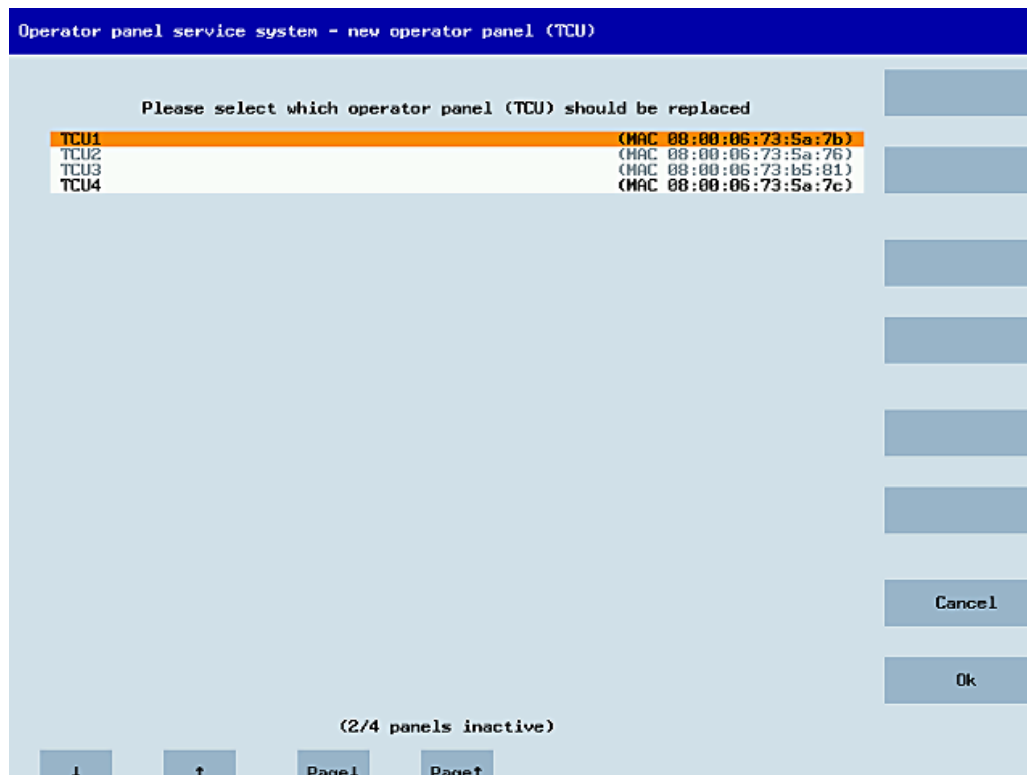

Figure 5-14 TCU menu: New operator panel (TCU)

2. Select the name previously assigned to the faulty TCU from the "New operator panel (TCU)" dialog. As a result, the new TCU is recognized on the network and acquires all of the configuration settings from the TCU that has been replaced.

See also

How to calibrate a touch panel (Page 68)

5.2.4 How to calibrate a touch panel

NOTICE
Service life of the touch screen
Do not touch the operating elements of the display with pointed or hard objects. This may considerably reduce their service lives.
With each HT 8-device, a Touchpen (order no. 6FC5348-0AA08-4AA0) is delivered. This should be used for calibration purposes and during operation.

Calibrate touch screen

The calibration is automatically started after switching on HT 8.

1. Follow the instructions on the screen:
2. Press the three calibration items one after the other.

This completes the calibration.

3. Press the corresponding horizontal softkey on the touch screen to close the command shell and to re-establish the connection to the desired PCU.

Recalibrate touch screen

Procedure:

1. The key combination below can be used to initiate further TCU calibration during operation, if required: <F9> + <F10>.

This corresponds to the key combination on an OP: Menu back key + <MENU SELECT>.

2. Select the menu item "Calibrate touch screen" to start calibration.

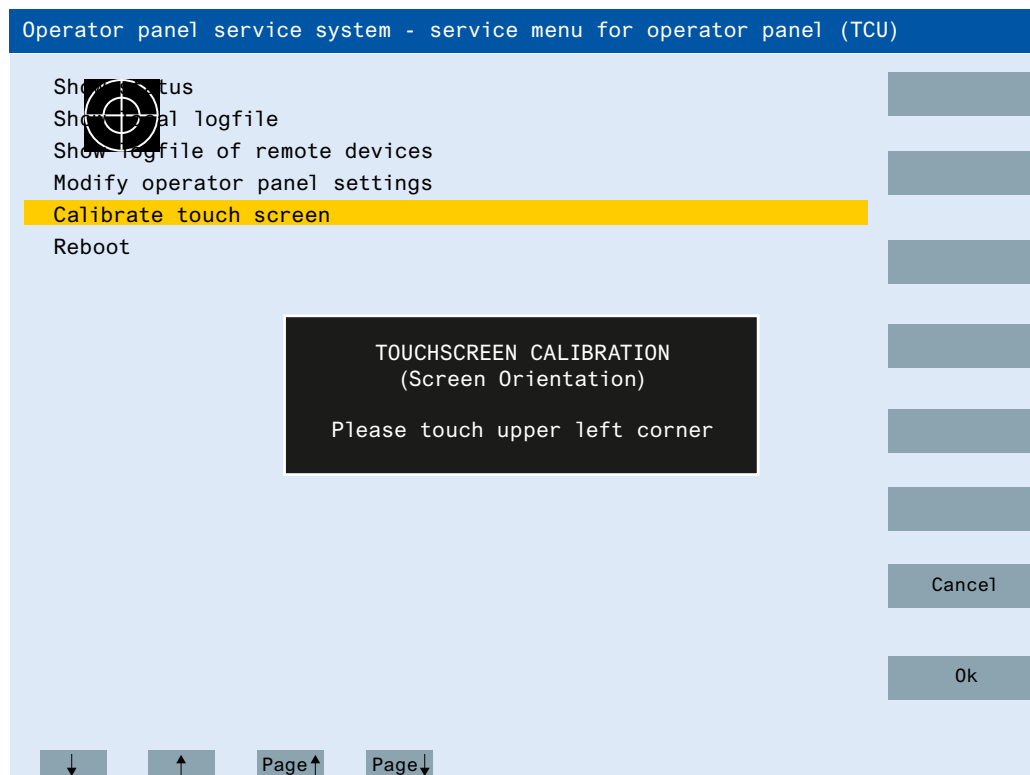

Figure 5-15 HT8 calibrating points

Note

The "Touchware" program, which is available with Windows XP, is deactivated on the TCU.

The calibration process on the HT 8 can alternatively be started with the following key combination: <Recall> + <MENU SELECT> and then the <U> key.

5.2.5 Connecting-up the SIMATIC Thin Client Touch Panel

Registration in the system network

The SIMATIC Thin Client Touch Panel behaves just like a TCU when connecting-up. When registering in "Operator Panel Service System" enter a name in the system network. After this, the device is available in the "Service Network Center" with the hardware ID "SIMATIC TC":

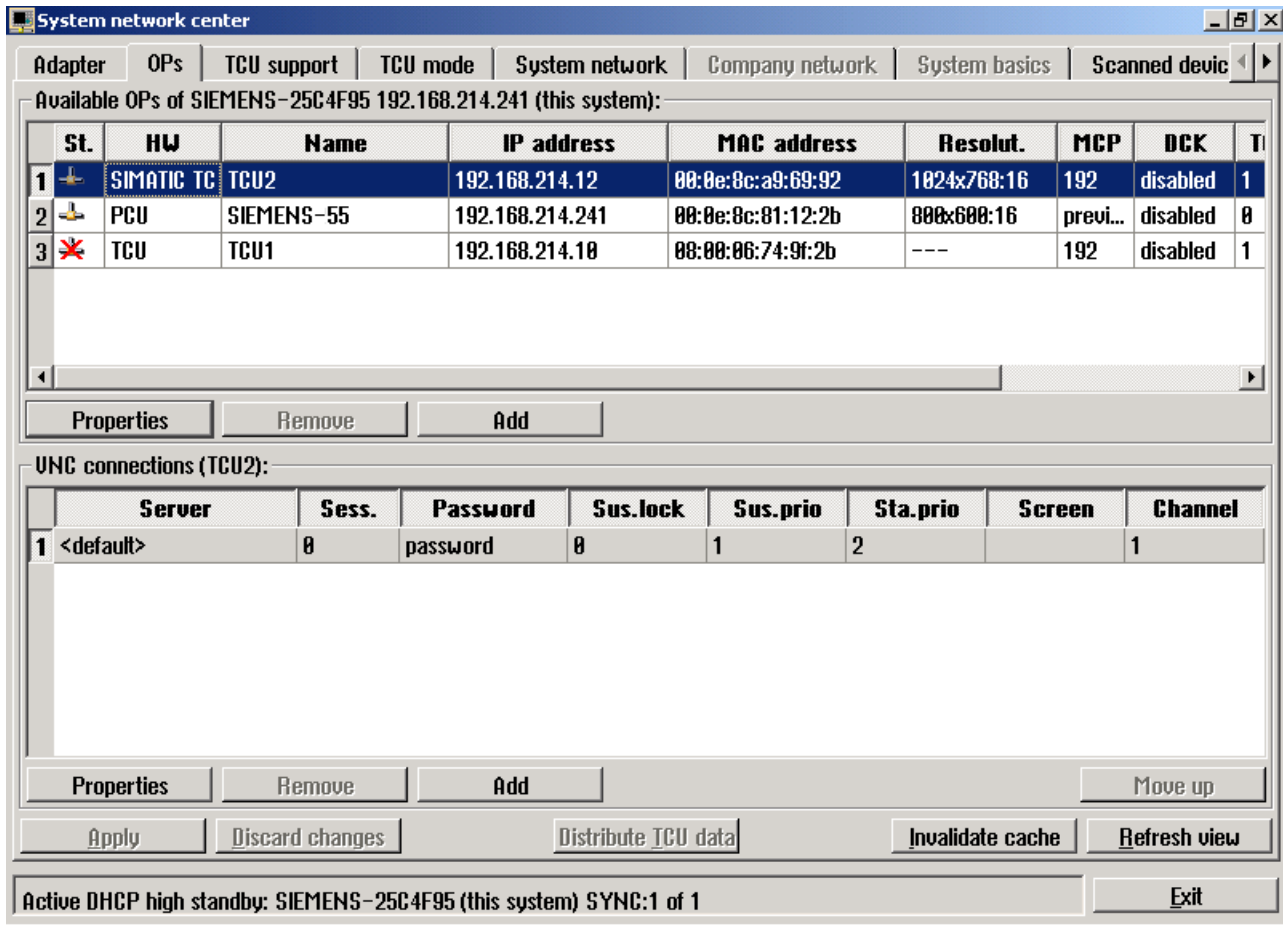

Figure 5-16 SIMATIC Thin Client

See also

How to register a TCU on the system network (Page 64)

Using the TCU's main menu (Page 50)

Note

The SIMATIC Thin Client Touch Panel has a USB connection at the rear, which behaves just like the USB connection X204 of a TCU.

An external keyboard is recommended for commissioning and to operate the "Operator Panel Service System".

Operating the Touch Panel

To operate the Touch Panel, use the integrated keyboard:



Figure 5-17 Virtual Keyboard

The integrated keyboard is activated using the button to the far right on the start bar.

Reference

SIMATIC HMI, Operating instructions: Thin Client, Thin Client PRO

5.2.6 This is how you configure the SIMATIC Thin Client Touch Panel

Operating the start bar

The following functions are available in the start bar of the SIMATIC Thin Client:

To select the SINUMERIK mode, press the button:



- The following buttons are important for operation as SINUMERIK operator panel:



To configure the SIMATIC Thin Client, press the button "Settings". You therefore open the "Operator panel service system":

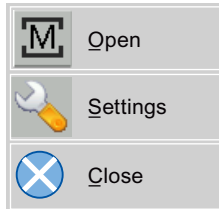

To exit the SINUMERIK mode, press the button "Close".

- To make the configuration settings, press the button:



Select "Configure Thin Client":

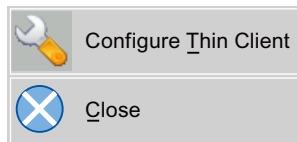

To exit the SIMATIC configuration menu, press the button "Close".

- Press the button to activate the integrated keyboard:



Preconditions

To make the following settings, you must be logged on as administrator.

Press the "Settings" button:



1. Log on as a administrator using the specified password.

Result: As administrator you can see the complete menu of the SIMATIC Thin Client.

Note

All changes only become effective after pressing the "Enter" button on the "Virtual Keyboard" on the relevant side.

SINUMERIK mode when restarting

In order to return to the SINUMERIK mode automatically after a restart, proceed as follows:

1. In the "Applications" menu, select the "Autostart client application" tab.
2. Select the "SINUMERIK" option.

Calibrate Touch Panel

To calibrate the Touch Panel, proceed as follows:

1. In the "Device setup" menu, select the "Touch calibration" tab.
2. Follow the instructions and touch the Touch Screen at the appropriate points to calibrate.

5.2.7 Settings in the "config.ini" file

Boot server

The active boot server (DHCP server) is detected and displayed in the System Network Center (SNC). The boot server accesses this configuration file accordingly. Changes to the config.ini file do not become effective until the relevant TCU or PCU is next booted.

Note

If too much time (> 15 min.) elapses between commands when the user is making entries (e.g. TCU name) as part of the initial TCU log-on process, the time-out error will be suppressed. No error message will appear and the FTP connection will be reopened.

Configuration of the config.ini file

The config.ini file has the following configuration:

Parameter	Range of values	Default setting	Meaning
[Station]			
tcuIndex = Number	0 ... 255	DIP 1	for TCU
mcpIndex = Number	1 ... 254	DIP 192	for MCP via Industrial Ethernet
eksIndex = Number	0 ... 255	DIP 0	for EKS
dckEnable = 0	0 or 1	0	for DCK
MaxHostIndex = Number		Number of subsequent PCUs or NCUs to which you can switch over.	
[DEFAULT]			
SessionNumber = Number			
Password = String			
SuspendLock = Number	0 or 1	0	0: No displacement disable 1: Displacement disable set
SuspendPriority = Number	1 ... 10	1	1: Lowest priority 10: Highest priority
StartupPrio = Number			Boot sequence: The lower the number the higher the priority
ScreenOnFocus = String Number		Not relevant	

Parameter	Range of values	Default setting	Meaning
ChannelOnFocus = Number		Not relevant	
[host_1]			
Address = [hostname IP-Adresse]			From data file structure
SessionNumber = NUMBER			
Password = STRING			
SuspendLock = NUMBER	0 or 1	0	0: No displacement disable 1: Displacement disable set
SuspendPriority = NUMBER	1 ... 10	1	1: Lowest priority 10: Highest priority
StartupActive = 0	0 or 1		Display screen after boot
StartupPrio = NUMBER	0 ... not too high		Boot sequence: The lower the number the higher the priority
ScreenOnFocus = STRING NUMBER		Not relevant	
ChannelOnFocus = NUMBER		Not relevant	
[host_2]			
...			
[host_MaxHostIndex]			
[T2M2N]			
SK1 = ch_grp x	2 x 8 characters	Empty	Softkey inscription (2 lines)
SK2 = ch_grp x	2 x 8 characters	Empty	Softkey inscription (2 lines)
SK3 = ch_grp y	2 x 8 characters	Empty	Softkey inscription (2 lines)
...			
SK32 = ch_grp z	2 x 8 characters	Empty	Softkey inscription (2 lines)
...			

Note

Connecting an MCP via PROFIBUS

If an MCP is connected via PROFIBUS, then the MCP Index = 0 should be set.

Compatibility of software versions

If a "config" file is available for the TCU, the data file structures of older versions are transferred to the config.ini file and the data file structure is then deleted.

Comment

In the config.ini file comment lines are indicated by the # character preceding a line.

5.2.8 Settings in the "TCU.ini" file

Directories

The tcu.ini files is created in the following directories:

- NCU: /siemens/system/etc/tcu.ini
 /user/system/etc/tcu.ini
 /oem/system/etc/tcu.ini
 /oem_i/system/etc/tcu.ini
- PCU: F:\addon_base\system\etc\tcu.ini
 F:\user_base\system\etc\tcu.ini
 F:\oem_base\system\etc\tcu.ini

Note

Only the following entries are evaluated by SINUMERIK Operate:

- VNCServer/VetoMode
 - VNCServer/AlarmBoxTimeOut
 - VNCServer/FocusTimeout
 - VNCServer/AdaptResolution
 - VNCServer/MaxActiveTCUs
 - VNCViewer/ExternalViewerSecurityPolicy
-

Structure and content

In the tcu.ini file comment lines are indicated by the # character preceding a line.

[VNCServer]

```
# VETO MODE

# VetoMode enabled:

# VNC server notifies the HMI regie before another
# panel gets the focus.

# VetoMode disabled:

# Focus timeout mode enabled (implicitly; see FOCUS TIMEOUT)
# (0=DISABLE, 1=ENABLE)

VetoMode=1

# FOCUS TIMEOUT

# Guaranteed time period (in sec) a panel can hold the
# focus at least before another panel can get the focus.
# The time period starts from the moment the panel has
# gained the focus.

FocusTimeout=10

# ALARMBOX TIMEOUT

# The time period (in sec) a messagebox is shown (i.e. is
# operable) in the case of VetoMode=1; no meaning else

AlarmBoxTimeOut=5

# RESOLUTION

0 = SYSTEM

1 = AUTO_OP_1 (default)

2 = AUTO_OP_2

3 = AUTO_MON_1

4 = AUTO_MON_2

5 = 640X480

6 = 800X600

7 = 1024X768

8 = 1280X1024
```

```
# RESOLUTION ADAPTION
# AdaptResolution enabled:
# At system runtime, the system resolution is automatically
# adapted to the resolution of that panel which
# currently owns the focus.
# AdaptResolution disabled:
# The system resolution is set at system startup phase.
# At system runtime, system resolution remains unchanged
# whichever resolution the currently focused panel owns.
# (0=DISABLE, 1=ENABLE)
AdaptResolution=1

# COLOR DEPTH
# The value the system color depth is set at system
# startup phase
# ColorDepth SYSTEM:
# System color depth remains unchanged whichever value
# the color depth is currently set to.
# ColorDepth 16_BIT
# System color depth is set to 16 bit.
# ColorDepth 32_BIT
# System color depth is set to 32 bit.
# (0=SYSTEM, 1=16_BIT, 2=32_BIT)
ColorDepth=1

# INIT TIMEOUT
# Guaranteed time period (in sec) the HMI manager waits
# for VNC server initialization.
InitTimeout=300

# PCU STARTUP TIMEOUT
# Attention: The parameter is only provided for a PCU
# configuration with local attached OP !
#
```



```
# The startup phase is completed if this timeout period
# has passed and no registration of a TCU has been car-
# ried out at this time.
PCUStartupTimeout = 90

# TCU STARTUP STEP TIME
# The startup phase starts at the first TCU registration.
# The startup phase is completed if the TCUStartupStepTime
# period has passed and no registration of another TCU has
# been carried out at this time.
TCUStartupStepTime = 30
```

[VNCViewer]

```
# EXTERNAL VIEWER MAX CONNECTIONS
# Maximum number of external Viewer Connections (1 or 2)
# ExternalViewerMaxConnections=2
ExternalViewerMaxConnections=1

# EXTERNAL VIEWER SECURITY POLICY
# The user rights, assigned to an external VNCViewer
# ExternalViewerSecurityPolicy=0 : no external viewers allowed
# ExternalViewerSecurityPolicy=1 : Guest Mode (View-Only)
# ExternalViewerSecurityPolicy=2 : Administrator Mode
# ExternalViewerSecurityPolicy=1

# EXTERNAL VIEWER MAX REFUSED REQUEST
# Number of refused external viewer requests, after which
# a timeout period is carried out for the viewer.
ExternalViewerMaxRefusedRequest=3

# EXTERNAL VIEWER CONNECTION TIMEOUT
# Timeout Period in seconds, after MaxRefusedRequest
# is reached. No viewer request is possible during the
# Timeout Period.
ExternalViewerConnectionTimeout=240
```

```
# EXTERNAL VIEWER REQUEST TIMEOUT
# The time period (in sec) the request-messagebox is shown (i.e. is
# operable)
ExternalViewerRequestTimeout=20

# EXTERNAL VIEWER REQUEST TIMEOUTMODE
# The behaviour if request-timeout elapsed
# ExternalViewerReqTimeoutMode=0 : dismiss request
# ExternalViewerReqTimeoutMode=1 : accept request
ExternalViewerReqTimeoutMode=1

# REMOTE ACCESS IP-ADDRESS
# IP-V4-format
X127RemoteAccessIP=192.168.215.29

# MODEM IP-ADDRESS
# IP-V4-format
X127ModemIP=192.168.215.30

# SERVICE HOST
# NCU with teleservice adapter on its X127 interface
# Use "Self" for your own X127 interface
# IP-V4-format or DNS-Name or Self
X127ServiceHost=Self

[PingService]
# PING SERVICE MODE
# (0=DISABLE, 1=ENABLE)
PingServiceMode=0

# PING SERVER IP-ADDRESS
# IP-V4-format
PingServerIP=
```

```
# PING SENDING DATA
PingTransmissionData=

# PING SERVER PORT-NUMBER
PingServerPort=

# PING TRANSMISSION PERIOD
# Period in minutes, in which transmission data will be sent
PingTransmissionPeriod=2

# PING TRANSMISSION INTERVAL
# Time-interval in seconds between two pings
PingTransmissionInterval=5
```

[externalTcu]

```
# EXTERNAL TCU IP-ADDRESSES
# List of accepted TCUs in IP-V4-format (index 1 to maximal 16)
ExternalTcuIP_1=
```

[TCU_HWSService]

```
# TCU CONNECT TIMEOUT
# Guaranteed time period (in sec) the HMI manager waits
# for TCUs recognized as connected TCUs by the TCU_HWS
# service.
TCUConnectTimeout=30

# TCU CONNECT TIMEOUT FOR HEADLESS STARTUP
# Guaranteed time period (in sec) the HMI manager waits
# for TCUs recognized as connected TCUs by the TCU_HWS
# service, if a PCU panel doesn't exist and no TCUs are
# connected till now. This time period is effective ad-
# ditionally to the time period TCUConnectTimeout.
HeadlessTCUConnectTimeout=60
```

See also

SNC: Configuring "TCU mode" (Page 101)

Prerequisite

Note

The "Operation without SINUMERIK OP" option is required when using more than 1 external VNC Viewer.

Operator control without SINUMERIK OP

If the "Operation without SINUMERIK OP" option is set, then a list of viewers that can be assigned in `tcu.ini` is handled by the system just like internal viewers (=TCU); this means that these viewers have full user authorization and participate in the user rights management. Towards the outside, they behave just the same as the viewer on the SINUMERIK operator panels.

Restrictions

Restrictions for such external operator control units are:

- Neither MCP and direct keys nor an EKS system can be assigned. This also means that these devices cannot be activated to be an operator control unit in the system.
- Direct control keys cannot be triggered, i.e. the softkeys to the direct keys can be triggered in the operating software. However, the keys do not appear in the direct key image to the PLC.
- There is no configuration file `config.ini`, as for a TCU, i.e. the settings to be made to a TCU are not possible for such an operator control unit (power-up behavior, displacement, `t:m:n`); however, the displacement mechanism to the external operator control units is effective.
- An external operator control unit is never signaled as active operator station in the PLC.

Configuring the external operator control units in the `tcu.ini` file in section:

```
[externalTcu]
# EXTERNAL TCU IP-ADDRESSES
# List of accepted TCUs in IP-V4-format (index 1 to maximal 16)
ExternalTcuIP_1=
```

The desired screen resolution can also be set in the file `tcu.ini`:

```
[VNCServer]
Resolution = ...
```

5.2.9 Displacement mechanism for TCUs

Supplementary conditions

The following supplementary conditions apply when operating the TCU:

2 active TCU connected in parallel to NCU 710.2, 710.3 PN

4 active TCU connected in parallel to NCU 720.2, NCU 730.2, NCU 720.3 PN,
NCU 730.3 PN

4 active TCU connected in parallel to PCU

To operate a machine with more operating stations than the maximum number the displacement mechanism ensures that **only the permitted number of TCUs are active** in shadowing grouping. The remaining TCUs are switched to a passive mode, which means they no longer represent a load relative to the resources. Thus the number of TCUs that can be connected to one HMI application is practically no longer limited, the limitation is the number of concurrently active TCUs.

Configuration

There are two new entries in the config.ini file for a TCU for the displacement mechanism:

- **SUSPENDLOCK:** controls whether the TCU can be displaced via the displacement mechanism.

SUSPENDLOCK = 0 means that a displacement disable is not set (preset), i.e. the TCU may be displaced by any other TCU.

SUSPENDLOCK=1 means that this TCU can never be displaced.
- **SUSPENDPRIORITY:** This entry specifies a priority for the displacement mechanism to the TCU. In a displacement process the TCUs among the active TCUs with the lowest priority that do not have a displacement disable will be displaced. The priority is specified as a numeric value in the range 1 - 10.

The preset is 1 (lowest priority).

Note

If you set a displacement disable for a TCU then specification of a displacement priority is unnecessary because it never is used due to the displacement disable.

Displacement rules

The TCU can assume the following states:

- **The TCU is active and has user authorization:** This can be identified as the TCU shows the screen of the operating software and the screen is bright.
- **The TCU is active,** however, in the monitoring mode (i.e. it presently has no user authorization): This can be identified as the TCU shows the screen of the operating software, however, it is darkened in comparison to the TCU with user authorization.
- **The TCU is passive:** The TCU shows the selection menu of the possible connections instead of a screen of the operating software, and the softkey for selection of the last active connection of the TCU is shown in color.

When a TCU boots, the TCU always attempts to establish the first connection specified in its config file. The TCUs from a shadowing group establish their specified connection one after the other as long as the maximum number of permissible active operator units is not exceeded.

If a TCU encounters the situation that this number is already reached in its power up, then it attempts to obtain a connection via the displacement mechanism. If it can displace a formerly active operator unit then it takes on the active status itself, otherwise it transitions to passive status immediately after booting.

5.2.10 Disable switchover between TCU via PLC

Overview

The TCU switchover disable offers the option of dynamically disabling switchover from one TCU to the next when the system is running via the PLC. For the duration of the disable, a user authorization request to change user authorizations between TCUs will be ignored by the system and rejected.

The rejected user authorization request causes a message to be output in the dialog line of the HMI, in the form of a feedback message for the requester. The message disappears after five seconds.

HMI ↔ PLC data interface

The “switchover disable” function is always active and does not have to be switched on explicitly. The function is controlled by a data bit in the PLC. The HMI transfers the active OP to the PLC, thus forming the basis of the control function in the PLC.

The control bits and control information for this function are stored in the m:n data interface of the PLC. In terms of m:n, this function can be operated separately for the currently overridden HMIs in both m:n online interfaces (DB19.DBW120 ff for HMI1 and DB19.DBW130 ff for HMI2). If a system is not running an m:n, only the first m:n online interface is used for this function.

Switchover disable is controlled by a TCU_SHIFT_LOCK bit, managed by the user, on each HMI in the PLC. The bit address for the first HMI is DB19.DBB126.6 and DB19.DBB136.6 for the second HMI.

The PLC m:n online interface is expanded so that byte DB19.DBB118 is still added to the first interface and byte DB19.DBB119 to the second. These bytes acquire the index of the active TCU (of the active OP) for the appropriate HMI. The byte is called TCU_INDEX. The appropriate HMI uses the TCU index configured for the active TCU to describe the TCU_INDEX byte.

The TCU_SHIFT_LOCK bit is monitored by the appropriate HMI. A value = 1 triggers the switchover disable; switchover is enabled if the value returns to 0. The TCU_SHIFT_LOCK bit can be set, for example, to the PLC by the user pressing a key or it can be managed by the PLC user program according to its own logic. The TCU_SHIFT_LOCK bit is managed in the PLC exclusively by the user; the HMI only accesses this bit in read-only mode.

The HMI assigns the configured index of the TCU or PCU whose OP currently possesses user authorization in the shadow grouping. If no OP is active, a value of 0 is entered in TCU_INDEX.

If no TCU index is configured for the active TCU (active OP), the value 255 = undefined is presented as the TCU index. This means that the values 0 and 255 may not be configured as the TCU index.

Configuration

The TCU index and machine control panel address (MCP address) are configured on the PCU. The TCU index is set in the "OP Properties" dialog of the "System Network Center" program.

Operating principle

If the TCU_SHIFT_LOCK bit is set for switchover disable, a user authorization request is not carried out independently of the mode set on the HMI for allocation of user authorizations (veto mode), i.e., a change of user authorization is rejected.

This message appears on all OPs for approximately 5 seconds:

```
"No switchover: Switchover disable set in current PLC."
```

While this message is displayed, operations on the OP with the user authorization can still be carried out unaffected.

Note

The switchover disable only relates to changing the user authorization on the OPs in a shadowing grouping on a PCU.

Active switching from one OP to another PCU is not prevented.

Special features

The following special cases should be noted:

- Even if switchover disable is set, the TCU_INDEX field value may change in the PLC. This is the case if:
 - The OP in possession of the user authorization is actively switched to another PCU. Depending on whether another TCU takes on the user authorization or whether no TCU is currently active, either the index of the TCU or the PCU itself (if its directly connected OP becomes active) is entered, in exactly the same way as when there is a user authorization switchover.

This can also be the value 255, if no TCU index is available for the OP. 0 is entered if an OP is no longer available in the shadow grouping.
 - An m:n switchover is in progress. The HMI program of the incoming PCU deactivates the HMI program which is active on it. An OP from the shadow grouping of the new (incoming) PCU must receive the user authorization. The TCU index of this OP is entered in the TCU_INDEX field.
 - A PCU is disconnected from a NCK/PLC in the context of m:n. No HMI program and, therefore, no OP with user authorization is then available on the exited NCK/PLC. This is signaled independently of a switchover disable by entering the value 0 into the TCU_INDEX field.
- If a TCU is actively switched over to another PCU, it can be deactivated there, i.e. it does not obtain the user authorization, if a switchover disable is set for the destination PCU.
- With an m:n PCU switchover – the PCU is switched to another NCK and, therefore, to another PLC – the PCU takes on the switchover disable settings of that PLC.
- The m:n interlock options on the PLC side have priority over the TCU switchover disable, so that a set TCU switchover disable cannot prevent an m:n switchover. If necessary, the m:n interference options should be synchronized here with those for the TCU in the PLC. It may, for example, be practical to set or remove the m:n displacement disable simultaneously with the TCU switchover disable.

Obtaining user authorization

On a TCU that has no user authorization, the first key that is pressed serves exclusively to request the user authorization, i.e. this key is not evaluated by the operating software.

The settings for the right to veto are stored in file `tcu.ini` and are only effective if the operating software is installed on the PCU. At the OP of the TCU, the operating software can be operated in exactly the same way as an OP directly connected to the PCU.

Note

These operator input sequence steps must only be carried out by qualified personnel!

5.2.11 Example: How to select the behavior of the TCUs during boot up

Example: Distributing boot support across two PCUs

To distribute boot support over two PCUs, "Boot support runtime and configuration only (TFTP/FTP)" must be selected on PCU_1 and "Boot support IP address only (DHCP)" must be selected on PCU_2.

The "No boot support" configuration must be selected on PCU_3:

Table 5- 1 "TCU support" settings

TCU_1	TCU_2	TCU_3	TCU_4
192.168.214.10	192.168.214.11	192.168.214.12	192.168.214.13
VNC connections: 192.168.214.241 192.168.214.242 192.168.214.243	VNC connections: 192.168.214.241 192.168.214.243	VNC connections: 192.168.214.241 192.168.214.243	VNC connections: 192.168.214.241 192.168.214.242
Switch to system network			
PCU_1	PCU_2	PCU_3	
192.168.214.241	192.168.214.242	192.168.214.243	
Services: <input checked="" type="checkbox"/> DHCP <input checked="" type="checkbox"/> TFTP <input checked="" type="checkbox"/> FTP <input checked="" type="checkbox"/> VNC	Services: <input checked="" type="checkbox"/> DHCP <input checked="" type="checkbox"/> TFTP <input checked="" type="checkbox"/> FTP <input checked="" type="checkbox"/> VNC	Services: <input checked="" type="checkbox"/> DHCP <input checked="" type="checkbox"/> TFTP <input checked="" type="checkbox"/> FTP <input checked="" type="checkbox"/> VNC	
Company network			

In this case, PCU_2 serves as the DHCP server which provides the IP addresses for the connected TCUs. PCU_3 is not involved in booting the TCUs, it is however displayed by the TCUs using VNC.

5.3 Configure the system network

5.3.1 System boot with system network

System behavior at boot

As of NCU system software V2.4 SP1 and PCU-Basesoftware V8.1, system boot behavior is based on the following principle:

- For configuration of an NCU 7x0 with a PU 50, the default for a network configuration is as follows: The NCU keeps the default IP address 192.168.214.1 on X120, the PCU 50 keeps the default IP address 192.168.214.241 on Eth2.
- For a configuration of more than 1 NCU 7x0 without PCU, with one or several PCU 50, then a differentiation must be made between two cases:
 - At boot automatically all address conflicts and DHCP conflicts are resolved and the system is ready for operation. In this configuration there is **no** guarantee that all NCUs and PCUs will always receive the same IP address at each system boot.
 - If in the user's view there is a requirement that all NCUs, and possibly also the PCUs, get a defined constant IP address at each boot, for example because the IP address is entered in the respective PLC program, then the user must configure a fixed IP address for each NCU 7x0/PCU 50 in question, in the basesys.ini file.
- The user **can** specify a DHCP master in the basesys.ini file.
- Assigning names:
 - The user should assign meaningful names for all NCUs in the basesys.ini file; if not the names will be generated automatically.
 - A PCU 50 always has a computer name that can be changed as needed.
- The IP addresses of TCUs and MCPs are freely assigned within the specified address band at each boot. The MCPs are identified in the PLC via their DIP switch setting.

Using DNS name service

Availability of the DNS (Domain Name System) name service offers the following advantages for system network administration:

- The name service enables easier configuration with names instead of IP addresses for management of operating units: All components in the system network can be addressed via a symbolic computer name. This name can to some extent be freely assigned, to some extent it is derived automatically from a DIP switch setting (MCP, MPP, EKS, HT 8, HT 2).
- A computer node in the system network (NCU, PCU, TCU, MCP, HT 8, etc.) can be addressed solely through assignment of the IP address, either via a freely selectable name or via an internally generated name in the system network, and thus becomes independent from its network address in the system network. Thus a change in the network address does not necessarily necessitate a series of additional setting changes.
- In addition, the name service is used by the system for address resolution for MCP/MPP, direct keys, and EKS when changing the user authorization.

5.3.2 System Network Center (SNC)

5.3.2.1 Function overview of the System Network Center

System Network Center (SNC) functions

The individual tabs are used to configure the system network:

Tab	PCU	NCU	Function
Adapter	✓	✓	The active network adapter (Page 92) is displayed.
OPs	✓	✓	A list of the known OPs (Page 93) and their codes are displayed: Status, name, IP address, resolution, and depth of color, MAC address, the assigned MCP address and TCU index. The VNC connections available and the associated IP address of the boot server, displacement disable, and displacement priority are listed for each TCU.
TCU support	✓	--	This tab is only active and available on a PCU. The services needed to operate a TCU (Page 99) can be started, stopped, and activated or deactivated.
TCU mode	✓	✓	TCU configuration (Page 101): "Veto mode", resolution adjustment, and the waiting times when booting.
System network	✓	✓	This tab is used for setting the X120 interface (Page 103).

Tab	PCU	NCU	Function
Company network	--	✓	This tab is only active and available on an NCU. This tab is used for setting the X130 interface (Page 105).
System basics	--	✓	This tab is only active and available on an NCU. This tab is used for setting additional parameters (Page 106).
Scanned devices	✓	✓	The devices in the system network (Page 106) are displayed on this tab.

Start SNC

The "System Network Center" program is available on both the NCU and the PCU:

- Use this link on the PCU's desktop to start the "System Network Center" program.

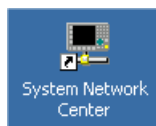

- Use the "sc start snc" command on the NCU to call the "System Network Center" program. To operate it, you will need a mouse.

Using the SNC

The following softkeys are available when using the SNC:

Button	Meaning
"Apply"	Press "Apply" to accept the changed settings. This button restarts a TCU or HT 8. Where changes have been made on a PCU (to the MCP index, for example), the PCU will be need to be restarted manually.
"Discard changes"	Select "Discard changes" to discard the changes.
"Distribute TCU data"	"Distribute TCU data" distributes TCU data to other machines in the system network. The "Distribute TCU data" button is only active on the active DHCP server.
"Invalidate cache"	
"Refresh view"	The data belonging to a TCU is reloaded in the display by pressing "Refresh view".
"Exit"	Press "Exit" to exit the dialog.

Note

Response after selecting "Apply":

- When "Apply" is used to confirm changes made to the settings for an OP, the OP will perform a restart to activate the changes.
 - During the boot sequence after the restart, the OP connects to the default server - which is SINUMERIK operate. The SNC does not start automatically during the boot sequence.
 - If you wish to change additional settings and/or parameters with the SNC, restart the SNC in the manner described above.
-

Integration in HMI PRO sl

Precondition: The option "Operation SW HMI PRO sl RT" is available.

For commissioning and network diagnostics in HMI PRO sl, integrate the "System Network Center" program in the operating software.

Procedure:

1. Open a DOS command shell with "Start menu" → "Run" and enter "cmd".
2. Enter, for example, the following command into the DOS command shell:

```
SNC -page scanned_devices -subpage all
```

Result: The "System Network Center" is opened with the tab page "Scanned devices" and the sub-tab "All" and can be edited. A mouse is recommended for operation.

Note

All tab pages can be specified. Spaces when labeling the tab page can be replaced in the command line using "_" underline.

Storage path for the "basesys.ini" file

Settings for the system network are also made in the "basesys.ini" file. In the current version note the following storage paths:

- On the PCU, the file is stored under E:\Siemens\system\etc and the user versions are stored under F:\user_base\system\etc.
In this basesys.ini file only the section [InternalInterface] is available.
- For a Linux basic system the original file can be found on the CompactFlash Card under the path /system/usr/etc. OEM versions are stored under /oem/system/etc, as well as user versions under /user/system/etc.

Note

Saving network settings: The network settings can be optionally saved in a commissioning archive and then read in again.

References

Commissioning Manual Base Software and Operating Software:

- "NCU operating system" (IM7) to the basesys.ini file
- "SINUMERIK Operate" (IM9) for saving the network settings

5.3.2.2 SNC: "Adapter" tab

"Adapter" tab

Default setting:

- PCU delivery condition: "Ethernet 2 (System Network)"
- **Only** "Ethernet 1 (Company Network)" is available on the NCU.

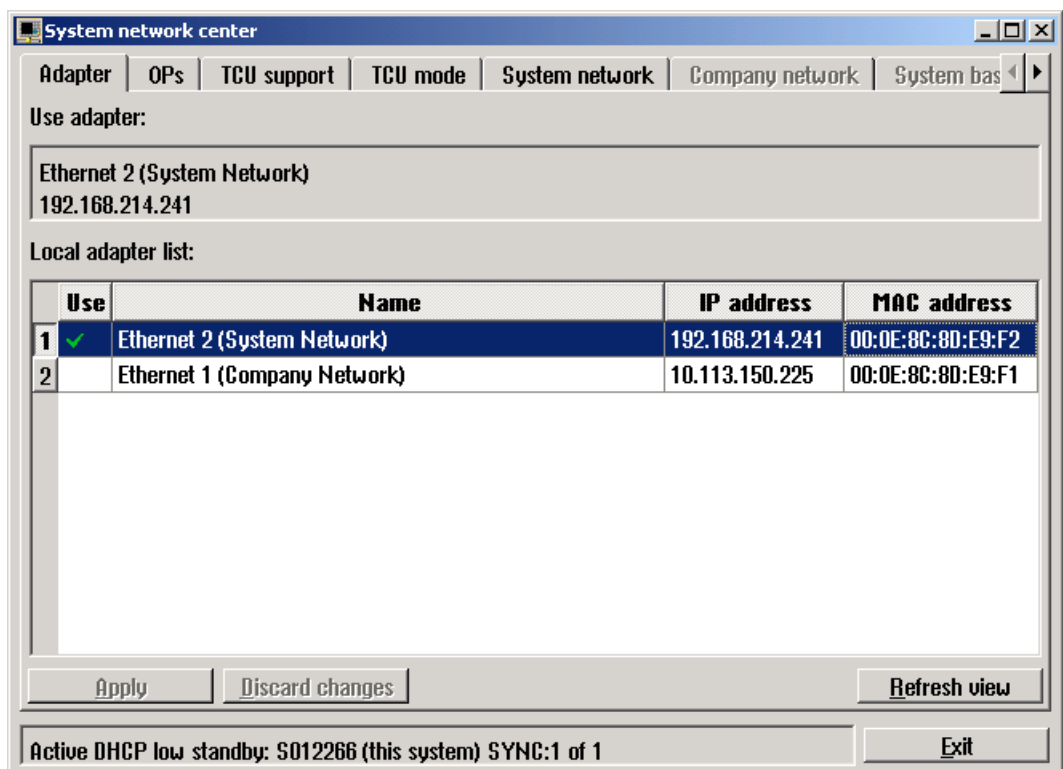

Figure 5-18 "Adapter" tab (default)

The following slave states are displayed:

- ✓ The connection is selected and active.
- ✗ The connection is selected and not active because the TCU is not switched on for example.
- ✗ The connection is not selected and cannot be accessed because e.g. no network cables are plugged in.

5.3.2.3 SNC: "OPs" tab

Distribution

The "OPs" tab is divided into two areas:

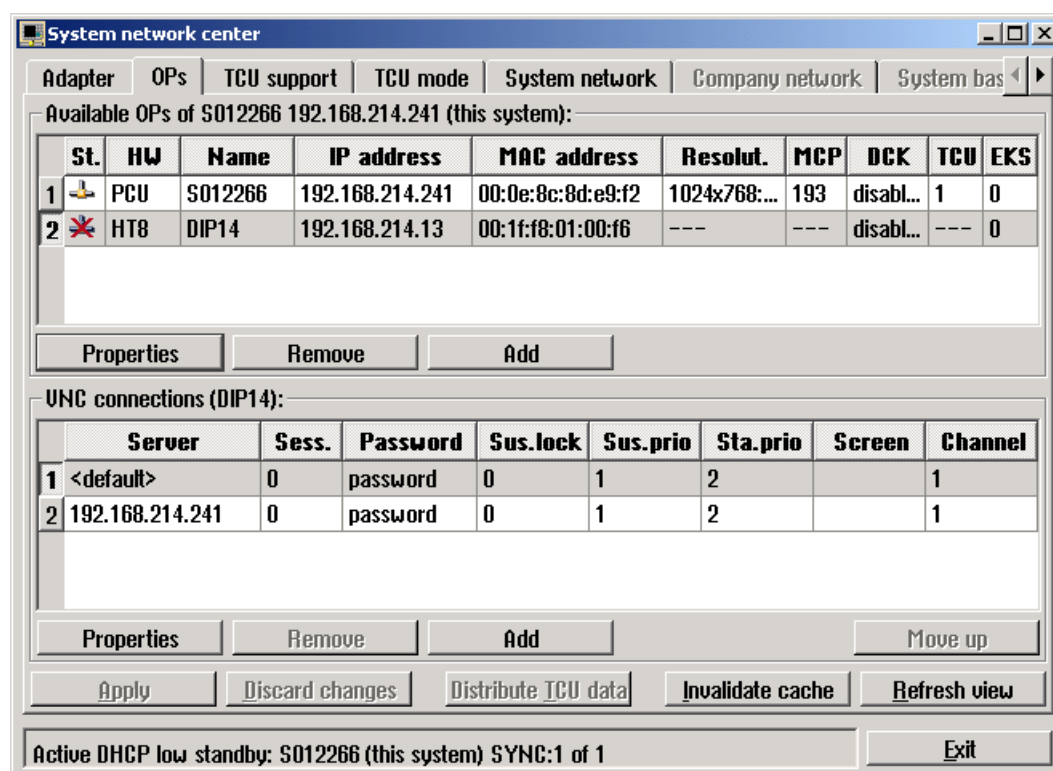

- ① In the top portion select an OP that you want to configure in the list of "Available OPs".
- ② In the lower portion select a VNC connection that you want to configure in the list of "VNC connections".
- ③ It is necessary to reboot all active TCUs for the changed data to become effective. To do this use the "Apply" button. Use the "Discard changes" button to discard the changes.

Figure 5-19 "OPs" tab

What will be displayed?

The "Available OPs" list contains all OPs that either have configuration data on the CPU or that are registered with the TCU hardware service. This produces the following states ("State" column) for an OP:

State	Meaning
✓ PCU	The local OP is switched on (or registered with the TCU hardware service) and configuration data is present on the CPU. Within this state all columns of the list are filled out.
✓	The TCU is switched on (or registered with the TCU hardware service) and configuration data is present on the PCU. Within this state all columns of the list are filled out.
✓✗	The TCU is switched on (or registered with the TCU hardware service) however no configuration data is present on the PCU. Within this state the MAC address, the MCP address, the index, and all VNC connection data are not available. Moreover this TCU cannot be edited because the appropriate configuration data are not available.
✗	The TCU is not switched on (or not registered with the TCU hardware service) however configuration data is present on the PCU. Within this state the IP address and the resolution are not available because these values cannot be determined for the TCU.
?	Question mark: the status of the device is unknown.

5.3.2.4 How to configure an OP

Configuring an OP

The "OPs" tab is divided into two areas.

All the devices in the system network are displayed under "Available OPs".

Use the following procedure:

1. To configure a TCU that has not yet been connected, use "Add".
2. A TCU that is presumably no longer operated on this system can be deleted. To do this click on the "Remove" button. Deleting the configuration data is only possible if the TCU is not connected.
3. If you click on the "Properties" button the dialog box opens for configuring the settings of the selected components:

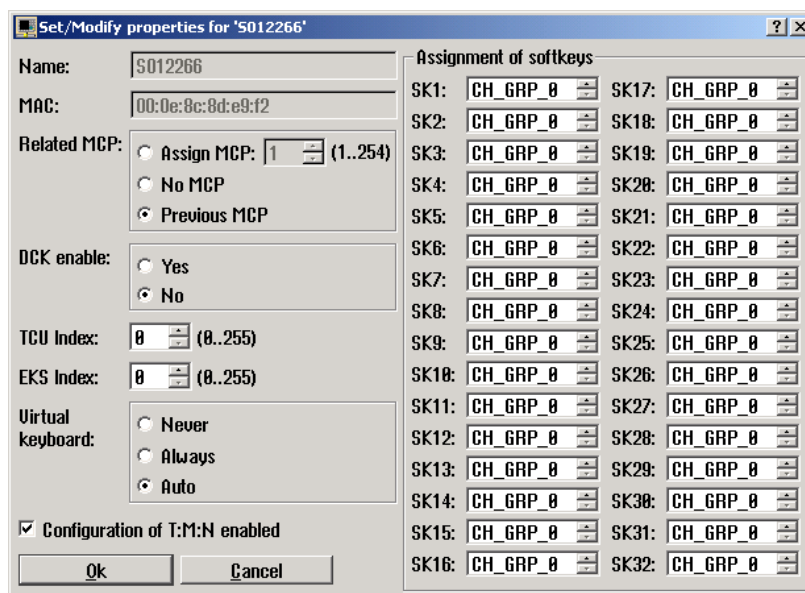

Figure 5-20 "OP Properties" dialog

Parameter	Range of values	Meaning
Name	<TCU Name>	The name of the TCU can be changed.
MAC		Displays the MAC address.
Related MCP	1 ... 254	DIP switch setting will be transferred. Default setting: Previous MCP
DCK enable	<No> <Yes>	Direct keys not activated (default setting). Direct key activated (only useful for appropriate devices).
TCU index	0 ... 255	The TCU index is used to evaluate the direct keys (only practical for appropriate devices).
EKS idex	0 ... 255	DIP switch setting will be transferred.
Virtual keyboard	<Never> <Always> <Auto>	The virtual keyboard is never displayed. The virtual keyboard is always displayed. The virtual keyboard is displayed when required (default setting).
Configuration of T:M:N enabled		
Softkey text	<2 x 8 characters>	Softkey inscription (2 lines)

References

Commissioning Manual Base Software and Operating Software (IM9)

5.3.2.5 How to configure VNC connections

Configuring a VNC connection

The "OPs" tab is divided into two areas:

All the connections that the selected TCU can make with VNC servers are shown under "VNC connections". The servers are specified using their IP address.

Note

The defaults for VNC connections cannot be deleted.

If a TCU or an HT 8 is operated via a PCU using direct keys or MCP, the IP address of the PCU and the IP address of the NCU must be entered under "VNC connections".

Use the following procedure:

1. To add a new connection use "Add".
2. If the selected TCU can no longer establish a connection to the selected VNC server, then delete the connection by clicking on the "Remove" button.
3. If you click on the "Properties" button the dialog box opens for configuring the VNC connection:

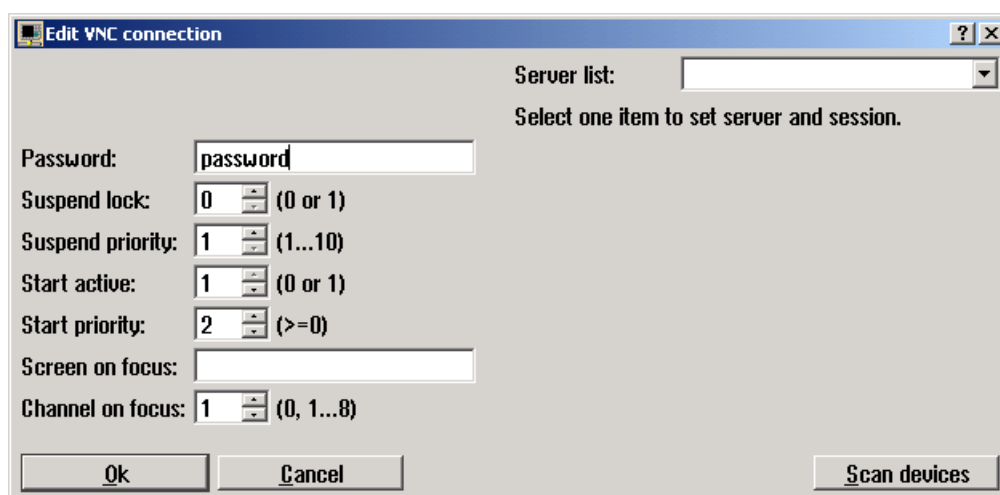

Figure 5-21 Dialog box "Edit VNC connection"

Parameters	Range of values	Meaning
Server list		IP address or name of a VNC server (NCU or PCU) consisting of a character string in accordance with the rules for hostname.
Password	password	Password, default setting: "password"
Suspend lock	0 or 1	0: No displacement disable 1: Displacement disable set
Suspend priority	1 ... 10	1: Lowest priority 10: Highest priority
Start active	0 or 1	After power up a screen is displayed.
Start priority	0 ... not too high	Boot sequence: The lower the number the higher the priority
Screen on focus		
Channel on focus	0, 1 ... 8	Default setting: 1

Note

If the operator panels have been set up in such a way that several operator panels are connected to the same SINUMERIK Operate after booting, it is not possible to predict which operator panel will be active after booting.

This may occur under the following conditions:

- No assignment has taken place in the config.ini.
 - The config.ini file specifies that several operator panels are connected to the same HMI.
-

"Scan devices" button

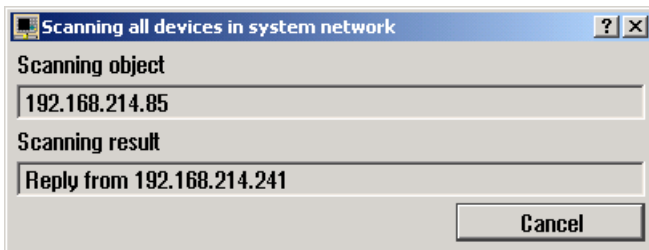

Figure 5-22 Scan devices

See also:

SNC: "Scanned devices" tab (Page 106)

5.3.2.6 SNC: Configuring TCU support services

"TCU support" tab

On the "TCU support" tab select which services will be started on the TCU at power up: The preset is the configuration "Complete TCU support".

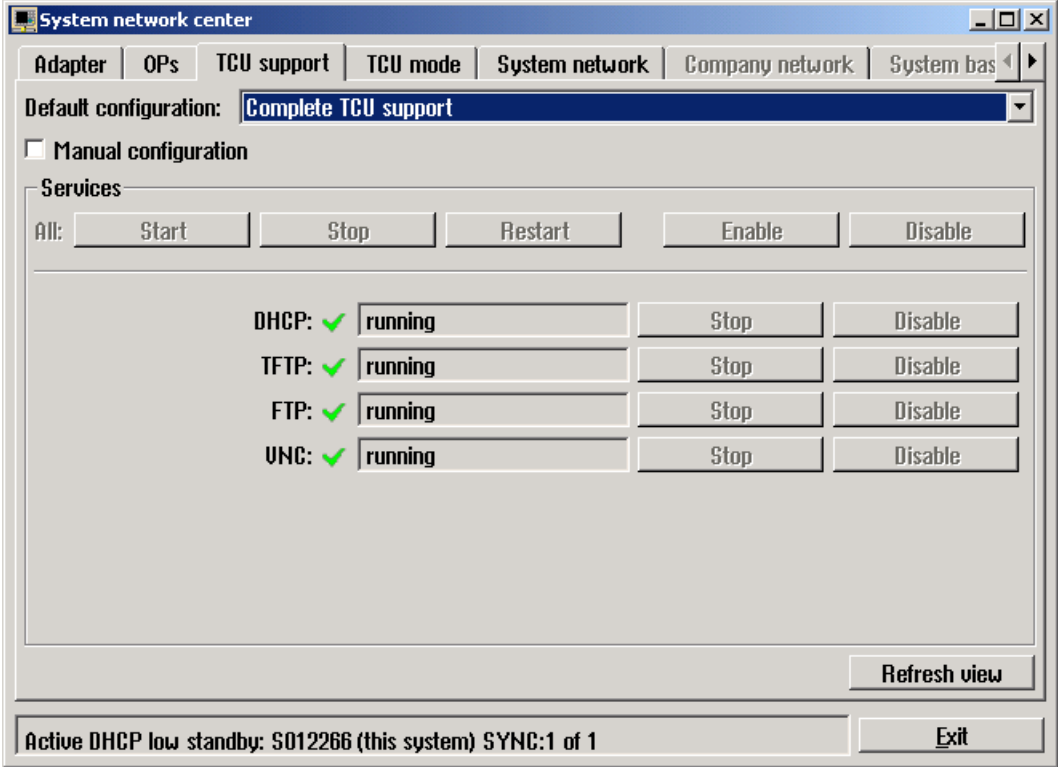

Figure 5-23 "TCU support" tab

Selecting a configuration

The following configurations are available under "Default configuration":

- **Complete TCU support:**

Complete TCU support is activated in these configurations and all the services listed below are carried out.

- **No boot support:**

The services for booting connected TCUs are deactivated in these configurations. The TCU hardware service and the VNC service are executed. The TCUs can only be booted from another PCU or NCU.

- **Boot support runtime and configuration only (TFTP/FTP):**

DHCP services are deactivated in this configuration. The remaining services are carried out. The IP addresses of the connected TCUs must come from another PCU or NCU. Booting is however executed from this PCU. To do this, the PCU or NCU supplying the IP addresses must use this PCU as "boot server".

- **Boot support IP addresses only (DHCP):**

TFTP and FTP services are deactivated in this configuration. The remaining services are executed.

The PCU provides the TCUs with IP addresses but the TCU must be booted by another PCU or NCU. A corresponding boot server must be specified for this purpose on the "DHCP settings" tab.

- **Manual configuration:**

With the manual configuration, each service can be started or stopped and activated or deactivated individually. The current status of the corresponding service is displayed in the status bar.

5.3.2.7 SNC: Configuring "TCU mode"

"TCU mode" tab

Set the following parameters on the "TCU mode" tab:

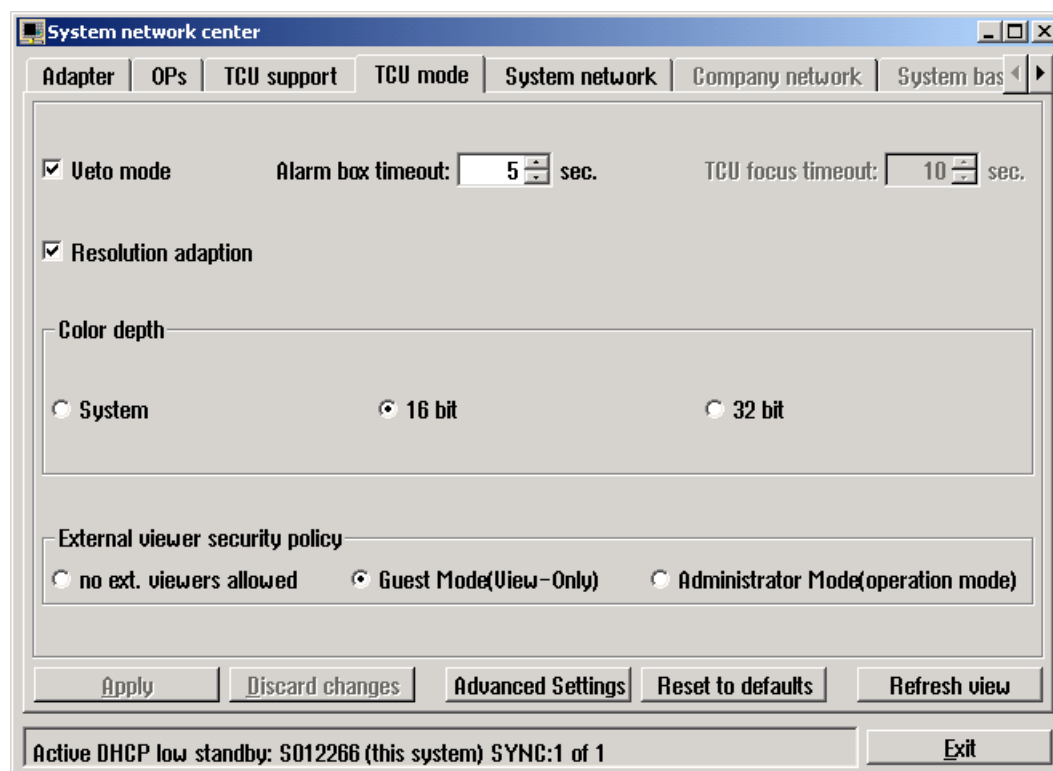

Figure 5-24 "TCU mode" tab

Description	Relevant parameter in the tcu.ini file
<ul style="list-style-type: none"> • Activate "Veto mode" on the TCU that loses the user authorization, a message will be output in this regard. The VNC service reports to HMI sequence control before another operating device receives user authorization. • Enter a time in seconds (Alarm box timeout) during which change of user authorization to a different TCU can be rejected. • If "Veto mode" is selected (this is the default setting), a user authorization request will appear. The user authorization request can be refused from the active OP. The "Veto mode" is only effective when the HMI program is active. "Veto mode" does not apply in "Service mode". 	VetoMode FocusTimeOut AlarmBoxTimeOut

Description	Relevant parameter in the tcu.ini file
<ul style="list-style-type: none"> If "Resolution Adaption" is activated (default) then during runtime the screen resolution is always adapted to the currently displayed operator panel. If "Resolution adaption" is deactivated, the zoom function will use the greatest resolution. In a worst-case scenario, the screen resolution may change from 15" to 8" and become difficult for the user to view. 	AdaptResolution
<ul style="list-style-type: none"> The default setting for color depth is 16 bits. The color depth should only be changed where this is definitely demanded by an application. 	Color depth
<p>For an external VNC viewer on a PG/PC or PCU 50:</p> <ul style="list-style-type: none"> no ext. viewer allowed: Maximum of 2 are permissible. Guest mode (view only): The user can only view. Administrator mode (operation mode): The user can also operate the system. 	ExternalViewerSecurityPolicy

Note

Resolution of the TP/OP

If the PCU has a directly connected OP, its resolution must be greater than or equal to the resolution of all the OPs on the TCUs.

This applies with and without "Resolution adaptation":

If a PCU does not have a directly connected OP, the greatest resolution of the active (switched on) TCUs/panels is determined and set during booting.

Advanced Settings (PCU only)

Use the "Advanced Settings" button to display additional setting possibilities. The changes made are saved in the tcu.ini file under F:\user_base\system\etc\tcu.ini.

See also

Settings in the "TCU.ini" file (Page 76)

5.3.2.8 SNC: Configuring the X120 interface (System network)

"System network" tab

Set the following parameters for X120 on this tab:

The screenshot shows the "System network center" window with the "System network" tab selected. The configuration is as follows:

- DHCP IP address allocation (X120):**
 - Range start: 129 . 88 . 7 . 10
 - Range end: 129 . 88 . 7 . 239
 - Subnet type: 16 bits network part
 - Subnet mask: 255 . 255 . 0 . 0
- Own IP addresses (X120):**
 - Static IP: 129 . 88 . 4 . 2
 - Subnet mask: 255 . 255 . 0 . 0
 - Alias IP: 0 . 0 . 0 . 0
 - Subnet mask: 255 . 255 . 255 . 0
- DHCP server synchronisation (X120):**
 - Sync mode: Off low priority high priority master priority
 - Timeout for waiting for master: 120 sec. client sync client no sync
- Miscellaneous:**
 - DNS Domain: localtest
 - PN station name: (empty)
 - NAT routing: X120 and X127 to X130 enabled
 - Host name: NCU3 (valid on X120, X130 and X127)

Buttons at the bottom: Apply, Discard changes, Clear DHCP, Distribute DHCP, Refresh view, Exit.

Active DHCP master: PCU2 SYNC:3 of 3

Figure 5-25 "System network" tab on NCU

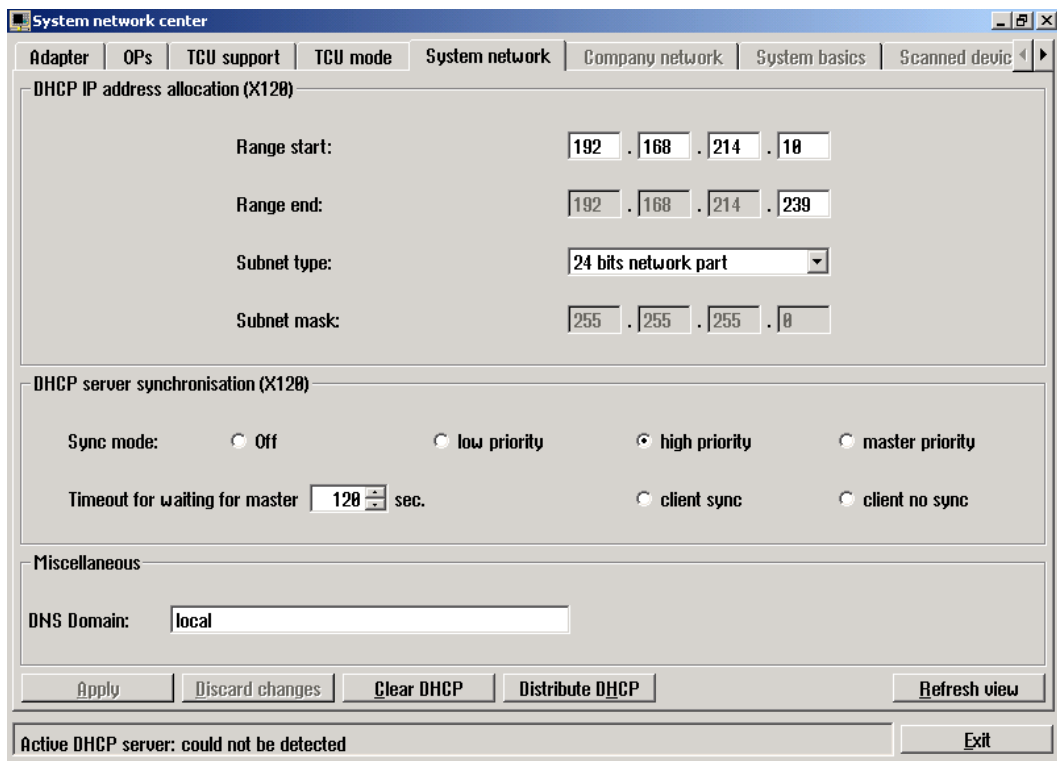

Figure 5-26 "System network" tab on PCU

Description	Relevant parameter in the basesys.ini file
<p>DHCP IP address allocation</p> <ul style="list-style-type: none"> This is used to specify the address range from which the clients of the DHCP server are supplied with IP addresses. The default range is sufficient for most cases. The default setting for "Subnet type" is "24 bits network part". 	<p>InternalDynRangeStart InternalDynRangeEnd InternalIP InternalNetMask</p>
<p>DHCP server synchronisation</p> <ul style="list-style-type: none"> As default synchronization of the DHCP server is activated. The "master priority" option only needs to be activated if a preferred server is to take over the role of the active server. Under "Timeout for waiting for master" set the time period that is allowed for the intended DHCP master to become the active DHCP server, regardless of whether it is switched off shortly afterwards or takes longer to boot than other controllers. 	<p>SyncModeDHCPD_SysNet DHCPDNoMasterWait</p>
<p>Miscellaneous</p> <ul style="list-style-type: none"> The default for the DNS service is ".local" and can be edited. 	<p>InternalDNSDomain</p>

"Clear DHCP" button

The "Clear DHCP" button is only active on the active DHCP server: It is used to execute the "sc clear dhcp [-X120]" command: This clears the status of the DHCP server at the specified interface (default setting: system network). It is reset to its starting status.

"Distribute DHCP" button

The button "Distribute DHCP" is only active at the active DHCP server: It is used to execute the "sc distribute dhcp" command:

5.3.2.9 SNC: Configuring the X130 interface (Company network)**"Company network" tab**

Set the following parameters for X130 on this tab:

The screenshot shows the "System network center" window with the "Company network" tab selected. The "DHCP client (X130)" is checked as "enabled". Below this, there are fields for "Static IP", "Subnet mas", and "Gateway", all set to 0.0.0.0. There are also fields for "Host name", "DNS server" (1, 2, 3), "Time server" (1, 2, 3), and "DNS Domain". At the bottom, there are "Apply", "Discard changes", and "Refresh view" buttons. A status bar at the bottom shows "Active DHCP high standby: ncu1 (this system) SYNC:1 of 1" and an "Exit" button.

Figure 5-27 "Company network" tab

[See basesys.ini: parameter InternalDNSDomain]

5.3.2.10 SNC: Configuring parameters on the "System basics" tab

"System basics" tab

Set the following parameters on this tab:

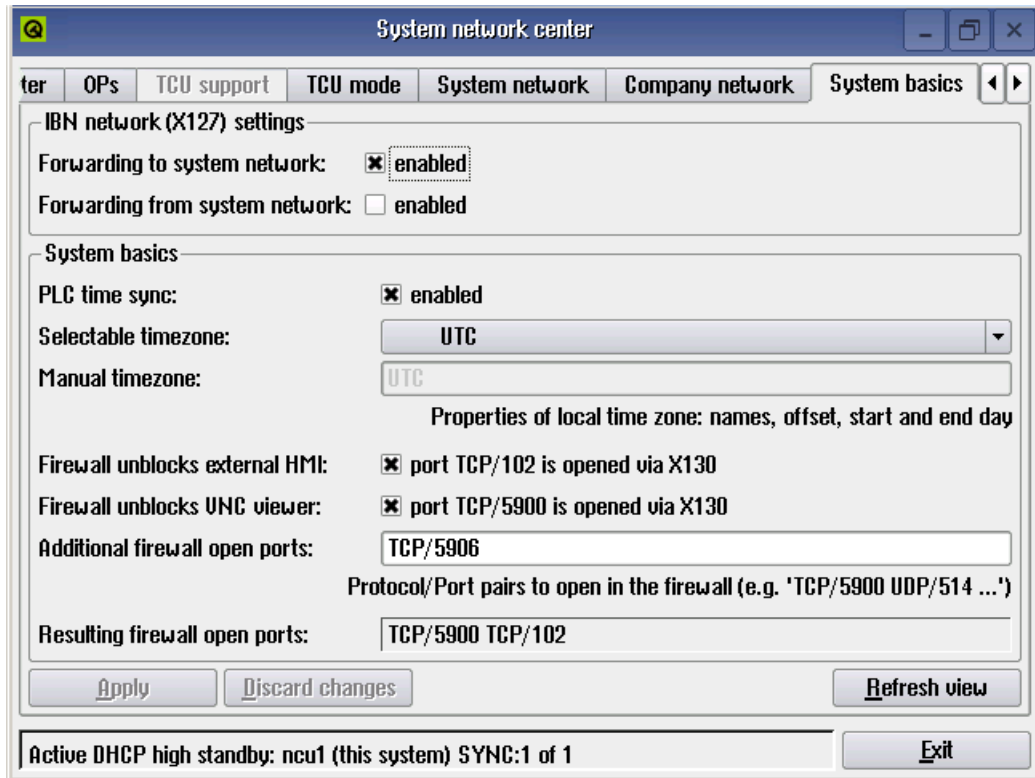

Figure 5-28 "System basics" tab

[See basesys.ini: parameter EnableSysNetToIBNForwarding]

5.3.2.11 SNC: "Scanned devices" tab

"Scanned devices" tab

The devices in the system network are displayed on this tab.

The following parameters are set for each device: name, IP address, and MAC address. If a fault occurs during the production cycle, it is possible to check whether all the configured devices are also accessible online and whether they have the defined attributes. Any deviations from the target state will become immediately apparent.

Saving the system configuration as the target configuration

In order to check (once a scan of the accessible stations has been performed) whether all the devices belonging to the system can also be accessed, a target configuration based on the accessible stations is defined and saved. This target configuration determines which devices belong to the system and (given this) must always be present.

When the target configuration is saved, a check is performed to see whether one already exists. If this is the case, a prompt asks whether it should be overwritten. It is always saved in a separate subdirectory of the active DHCP server's TCU directory. This has the advantage of allowing the target configuration to be transferred to the standby servers as well.

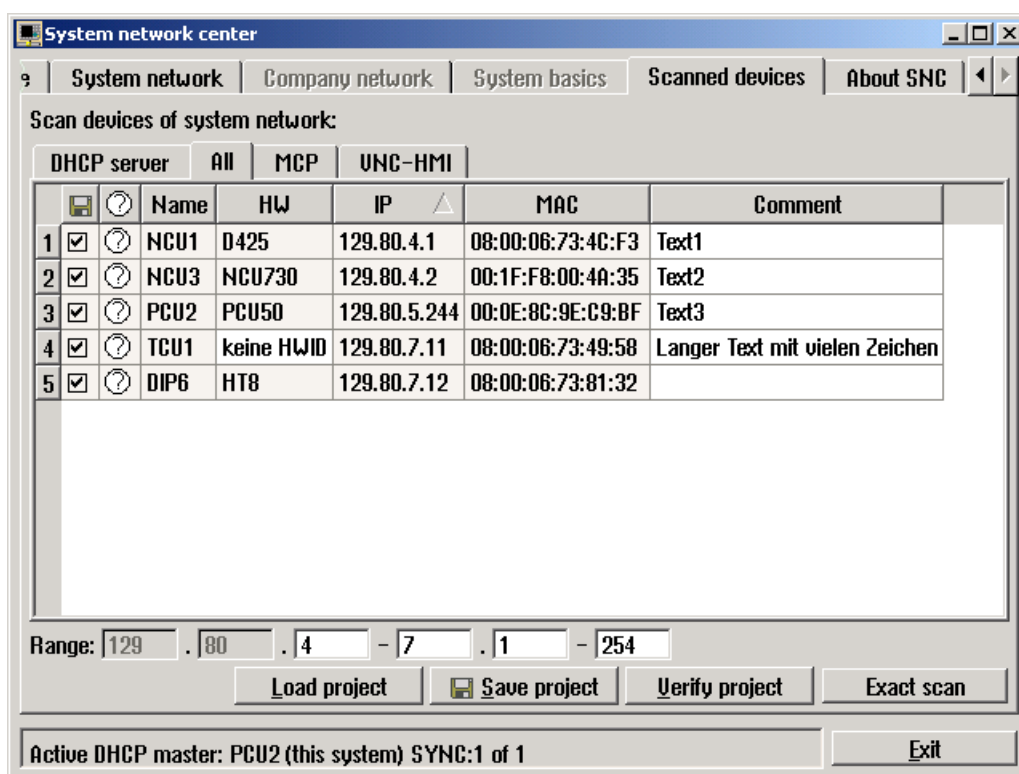

Figure 5-29 "Scanned devices" tab

Provided there is no preexisting target configuration before the scan is performed, the devices will appear on the screen against a light gray background as it is not yet clear whether they will be accessible in the system network. Editable table cells have a white background.

Button	Effect
Save project	Saves the target configuration (with callback, if applicable)
Load project	Loads the target configuration
Start scanning → Verify project	Starts the scanning process. Aligns the target and actual states if there is a preexisting target configuration

Devices which do not log onto the DNS server cannot be detected during scanning. This includes SIMATIC devices, for example. The cells in the table containing the name and HW type can still be edited; data can be inserted by double-clicking these cells.

NOTICE**Target configuration**

A target configuration can only be saved after all the devices selected have been given their own **unique** form of identification. This means each should have a unique name **and** IP address/MAC address.

Data type and storage location

The target configuration is always stored in a separate subdirectory of the active DHCP server's TCU directory. This does not apply if systems do not have an active DHCP server or if this server cannot be accessed. In such cases, an attempt is made to access a target configuration from the TCU directory on the local computer.

The target configuration is stored under:

```
PCU:          F:\user_base\common\tcu\${soll}\${soll}.ini
NCU:          /user/common/tcu/${soll}/${soll}.ini
```

The target configuration is saved as an INI file and has the following structure:

A central section [SOLL] containing:

- A scanning range for all 4 address bytes, a start and an end
- "NUMBER_DEVICES", the number of devices

For each device, there is a section [DEVICE_x] containing the following entries:

- "NAME", the name of the device (only if this was determined by the system)
- "ALIAS", the alias for the device (only if the system was unable to determine a name and the operator entered a name instead)
- "IP", the IP address for the device
- "MAC", the MAC address for the device
- "HWID", the HWID for the device (only if this was determined by the system)
- "HW_TYPE", the HW type for the device (only if the system was unable to determine a HWID and the operator entered a HW type instead)

Example for the target configuration

The file's contents might look like this:

```
[SOLL]
RANGE_START_1=192
RANGE_START_2=168
RANGE_END_2=168
RANGE_START_3=214
RANGE_END_3=214
RANGE_START_4=1
RANGE_END_4=254
NUMBER_DEVICES=2

[DEVICE_1]
NAME="PCU1"
IP=192.168.214.241
MAC=08:00:06:12:34:56
HWID=2.0.0.0

[DEVICE_2]
ALIAS="PLC1"
IP=192.168.214.4
MAC=08:00:06:11:22:33
HW_TYPE=S7-300
```

Target/actual comparison

For set/actual comparison, a check is made as to whether the devices configured in the system network can be reached: If a target configuration has been saved already, this information is retained and will be automatically loaded during any subsequent sessions. The operator can only perform a target/actual comparison if a target configuration has been saved already. This involves rescanning the defined range and comparing it with the existing list. Different colors are used to highlight deviations:

- **Green:** Problem-free devices which are configured and can also be accessed online.
- **Red:** Missing devices which are configured but cannot be accessed online.
- **Yellow:** Additional devices, which are not configured but can be accessed online.

Modified system configurations can only be saved if the green and yellow entries are selected by activating the corresponding check boxes.

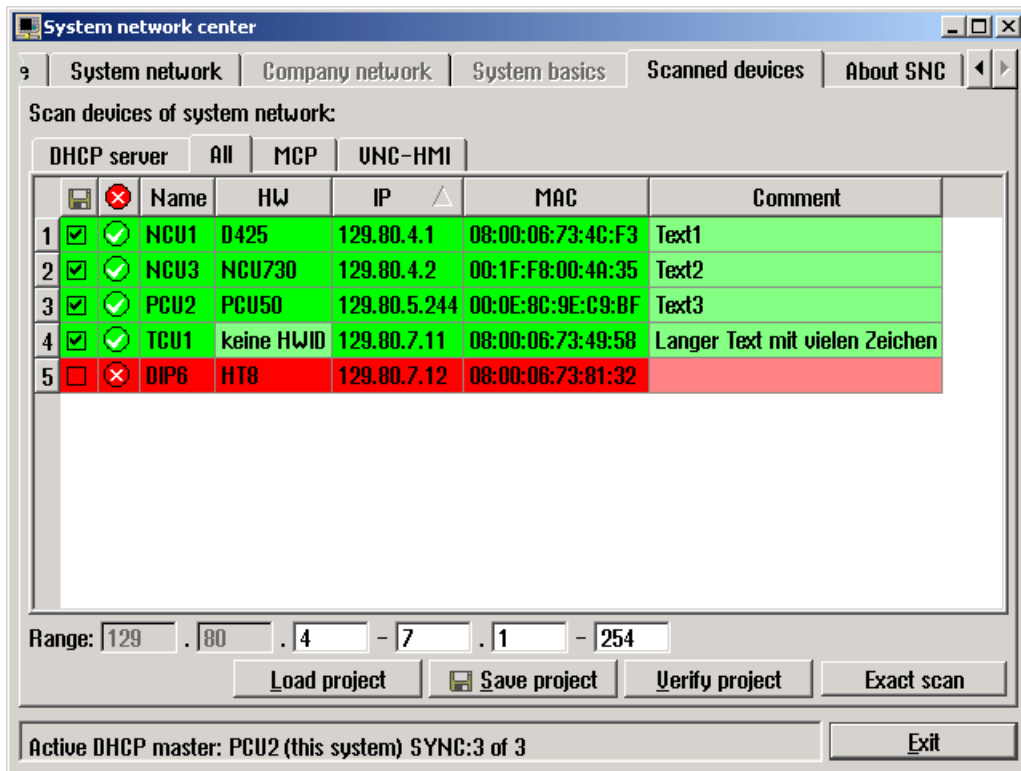

Figure 5-30 Result of the comparison

Note

In addition, a **descriptive text** for the device can be entered under the "All" tab in the "Comment" column so that the device can be more easily identified.

Result

A device (HT 8) was not found. Possible causes for this are:

- The device is not switched on.
- The device was not connected to the system network.
- By loading a new PLC project, the device has been allocated an IP address, which does not lie in the scanned address range.

5.4 Network configuration

5.4.1 Permissible network topologies

This chapter provides an overview of the permissible network topologies.

Ethernet connection

A SINUMERIK 840 D sl can only be operated as a network within which the individual components communicate with one another via Ethernet connections. This network must be set up.

The individual components are factory-set so that the most frequently occurring standard configurations can be operated without changing the settings related to the network.

Division into system network and company network

On the SINUMERIK solution line, the components are generally split into a company network on the one hand and a system network on the other.

The connection to the company network provides access to the network drives, for example. On the system network, process data communication and image transmission runs from the components with operator software to the display units – the TCUs.

This split is performed physically by means of the prescribed use of the Ethernet interfaces on the components:

- A TCU is connected exclusively to the system network.
- An NCU is always connected to the system network via X120.
- Ethernet interface Eth 2 of the PCU is preconfigured for connection to the system network; while Ethernet interface Eth 1 is used for connection to the company network.
- An NCU is connected to the company network via X130.

Meaning of the connections:

○	Eth 1 as a DHCP client
●	Eth 2 as a DHCP server
■	Eth 2 with a fixed IP address
Green connection	Uncrossed Ethernet cable
Gray connection	Crossed Ethernet cable (crossover)

5.4.2 Networks without connection to the company network

5.4.2.1 Configuration 1: NCU and TCU

Description

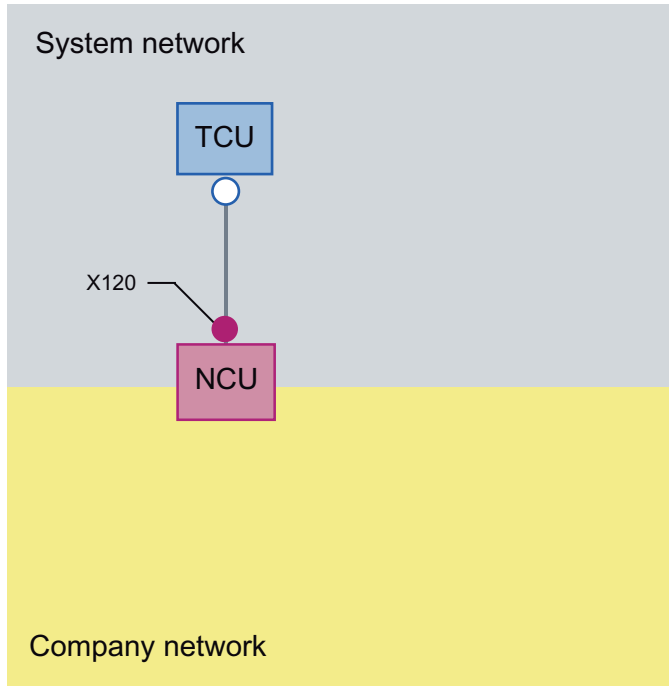

A direct Ethernet connection is used to connect a TCU to X120 of the NCU. NCU and TCU are suitably preconfigured with IP addresses.

The IP addresses are not significant for further operation.

The TCU is connected to the NCU via a **crossed** Ethernet cable.

The direct connection of the NCU via X120 to the TCU automatically forms a simple system network consisting of two computer nodes.

5.4.2.2 Configuration 2: NCU and PCU with direct OP

Description

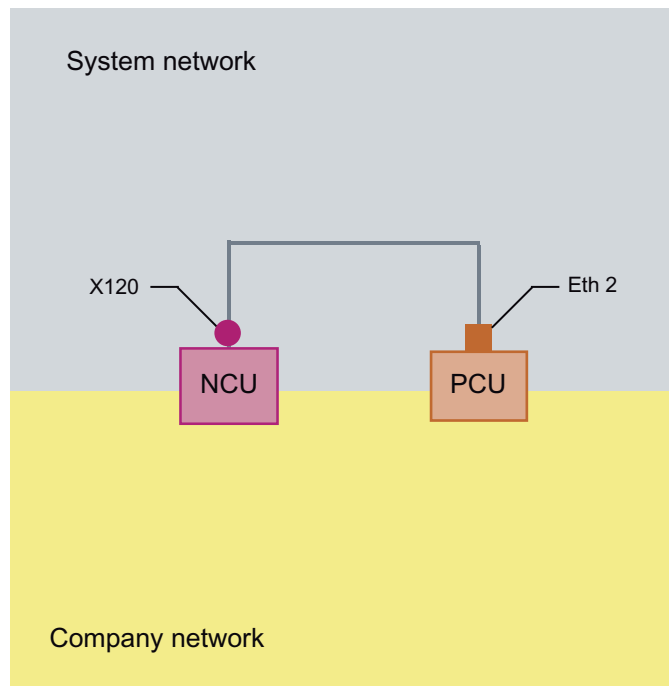

The NCU and PCU are connected via a **crossed** Ethernet cable.

The NCU is the DHCP server with the IP address 192.168.214.1.

For this Eth 2 configuration, the PCU is assigned a fixed IP address in the range 192.168.214.241 – 192.168.214.249 with a subnet mask 255.255.255.0.

5.4.3 Networks with NCU connection to the company network

5.4.3.1 Configuration 3: NCU and TCU

Description

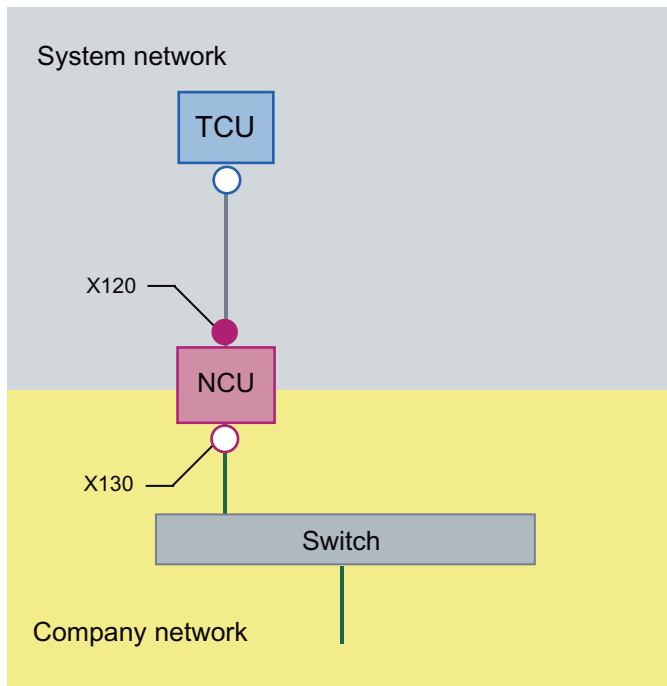

The TCU is connected to the NCU (directly) using a **crossed** Ethernet cable. On X120, the NCU is connected to a switch to the company network with a straight cable.

As in configuration 1, there is a direct Ethernet connection between a TCU and X120 of the NCU. NCU and TCU are suitably preconfigured with IP addresses. The IP addresses used here are not significant for further operation.

IP configuration: DHCP server on the company network

On X130, the NCU is set to the address reference via DHCP. If the company network has a DHCP server that provides the NCU with an IP address (IP configuration), the NCU is integrated into the company network.

Depending on the infrastructure available or the level of network administration of the company network, the following network parameters must be set for the NCU on X130:

- Computer name on the company network
- Address of a DNS server
- Address of a gateway (default router)

The IP address of the NCU to this connection is also assigned via network administration.

If the company network offers a low level of administration (in the worst case scenario the network has only one DHCP server that assigns the addresses from a predefined address range) the NCU receives an IP address that is initially unknown.

5.4.3.2 Configuration 4: NCU and PCU with direct OP

Description

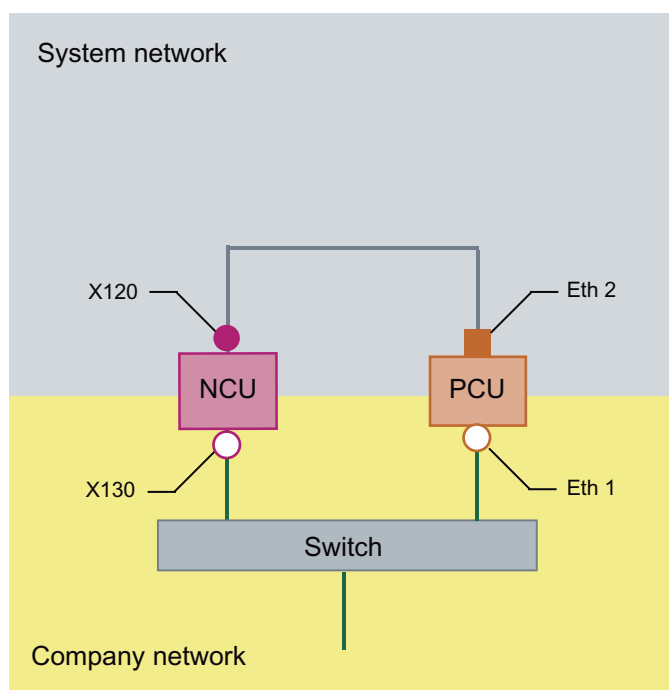

The NCU and PCU are connected via a **crossed** Ethernet cable.

On X120, the NCU occupies the fixed IP address 192.168.214.1 in its capacity as a DHCP server (not used in this configuration). For this Eth 2 configuration, the PCU is assigned a fixed IP address in the range 192.168.214.241 – 192.168.214.249 with a subnet mask 255.255.255.0.

The observations made for configuration 3 also apply here in relation to the connection to the company network. The connection to a switch on the company network is made via a **non-crossed** Ethernet cable.

5.4.3.3 Configuration 5: PCU with TCU on NCU

Description

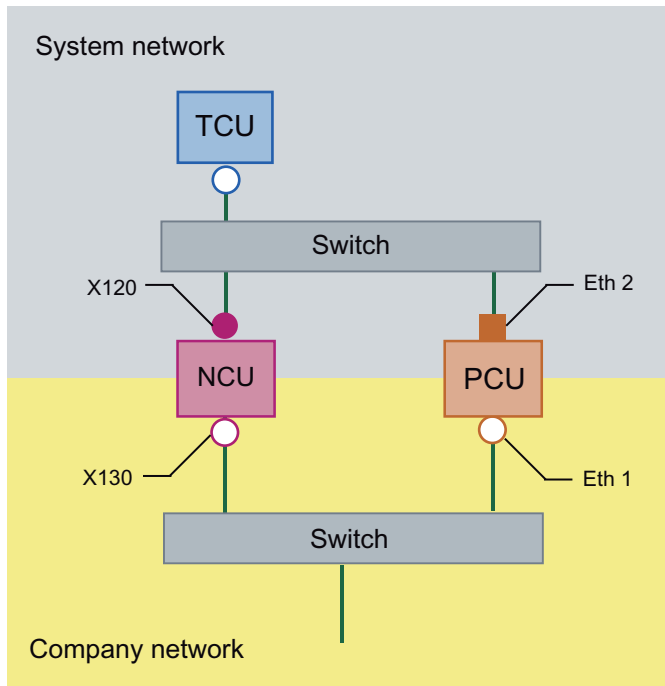

In this configuration, a switch is also required for the system network. All components are connected using straight Ethernet cables.

In terms of address allocation and the settings that need to be made, this configuration is identical to that of configuration 4. However, in this case, the DHCP server of the NCU actually supplies the TCU with an IP address and serves as a boot server for the TCU.

The observations made for configuration 3 also apply here in relation to the connection to the company network. The connection to a switch on the company network is made via a **straight** Ethernet cable.

To connect one TCU to both HMI systems you must create an additional connection to the NCU for the TCU, as described in the following chapter:

See also

How to configure VNC connections (Page 96)

5.4.3.4 Connecting the programming device (PG) to the NCU

Description

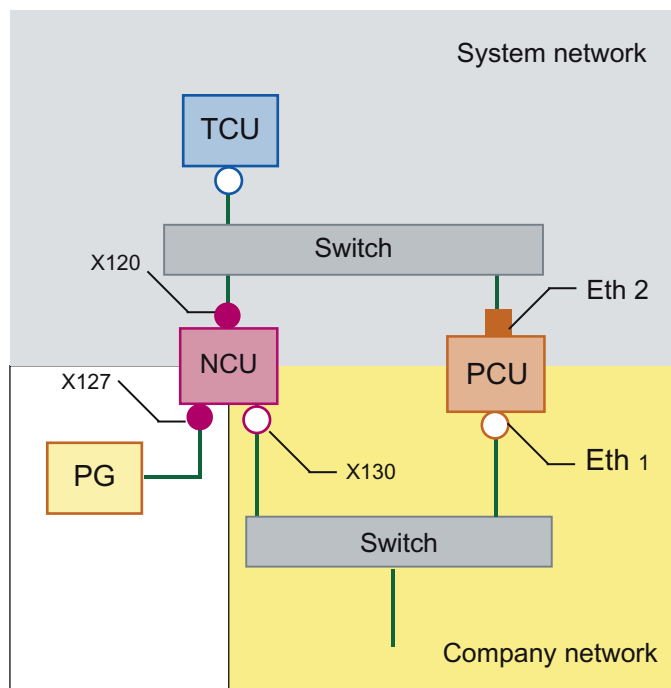

For service purposes a programming device is connected to the NCU at X127 as a standard DHCP client (automatically obtain an IP address). An NCU is a standard DHCP server on X127. On X127, the NCU occupies the fixed IP address 192.168.215.1 with the subnet mask 255.255.255.224.

At X127, IP addresses from 192.168.215.2 onwards are assigned via DHCP; e.g. to connect a programming device. This is the reason that a fixed IP address must not be set at the programming device.

5.4.4 Application example

Application

The configuration is suitable for the following application: Machine with concurrent operating option to two operator panels, a full-featured operating panel with PCU and an operator panel reduced to tool management.

Parallel operation of HMI-Advanced or SINUMERIK Operate on the PCU 50.3 and SINUMERIK Operate as component of the CNC software on the SINUMERIK 840D sl NCU:

Any OP connected to PCU 50.3 and any OP connected to the NCU can be simultaneously operated: in the example, OP 08T.

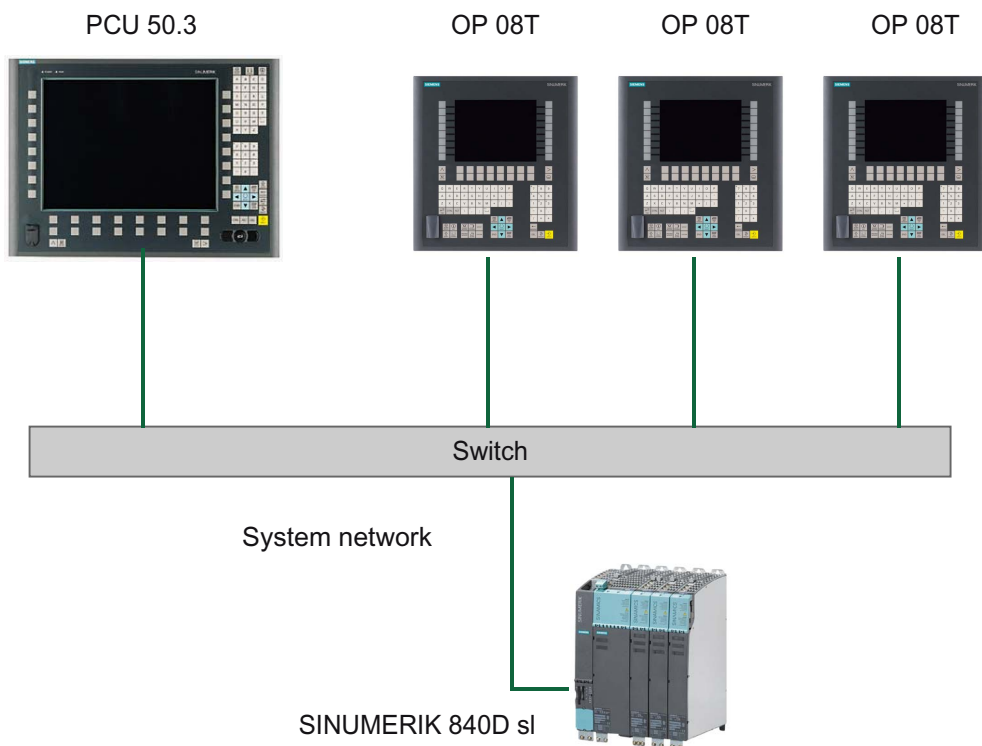

Figure 5-31 Configuration example

Proceed as follows

To configure the application example, proceed as follows:

1. PCU 50.3 with HMI Advanced

Deactivate the DHCP server on the PCU: For this select the option "Boot support runtime and configuration only (TFTP/FTP)" on the "TCU support" tab of the "System Network Center" program (SNC: Configuring TCU support services (Page 99))

2. SINUMERIK 840D sl from CNC software, version 2.4 and higher

The `systemconfiguration.ini` configuration file is included on the SINUMERIK 840D sl product DVD.

3. OP 08T operator panel

Once the installation of the OP 08T operator panel with SINUMERIK Operate has been completed, copy the `systemconfiguration.ini` file from the

`/Siemens/sinumerik/hmi/appl/systemconfig/tm/` directory to the `/oem/sinumerik/hmi/cfg/` directory. After this, a system restart is necessary.

Note**Subsequent changes**

Once the file has been copied, no further settings (e.g. changing language) can be implemented on the SINUMERIK Operate. If you want or need to implement changes later, the `systemconfiguration.ini` file can be renamed (e.g., as `systemconfiguration.save`). After this, a system restart is necessary. Following the restart, the full functional scope of SINUMERIK Operate is available once again.

5.5 Service and diagnostics

5.5.1 Booting of the TCU

Messages when booting

While the TCU is booting, progress is displayed after the BIOS has booted and before the operating system is loaded. In addition to messages, the current booting status is also indicated by a progress bar. While the IP address is being determined via DHCP and the TFTP is being downloaded (boot image), a progress bar indicates that booting of the TCU is not yet complete, or that a fault has occurred.

The structure of these messages is shown below:

```
Thin Client Boot loader                               V04.50.11.00  
  
IP address  
  
<1/F1> diagnosis window
```

You can see the current boot phase in the third line. Below that you are told whether you can call up information via <F1> if a fault occurs.

Diagnostics options during booting

In the following cases, the diagnostics window is displayed and booting of the TCU is interrupted:

- When the <1 / F1> function is selected during booting
- When a warning message is displayed
- When a fault occurs

Note

You can select the <1 / F1> to <F8> functions shown below using the horizontal softkeys on the OP. For example, to select <F7>, press the horizontal softkey 7.

Press the appropriate key <1> for <F1> at an HT8.

Calling up the diagnostics window with <1 / F1>

```

Thin Client Boot loader                                     V04.05.11.00

Boot progress:
BIOS                                                       V03.04.00.00
MAC address                                                08:06:00:F1:F7:F8
Hardware ID                                               7.7.0.0
Network link                                             1000MB, full duplex
IP address                                                192.168.214.1
Netmask                                                  255.255.255.0
Boot server                                               192.168.214.1
Image metadata                                           98 bytes
Image version                                             V04.50.11.00
Linux image (linux.bin)                                  3295436 bytes
Booting                                                  ready

<1/F1>details                                           <7/F7>continue <8/F8>reboot

```

Key / text	Meaning
F1 details	Display detailed information
F7 continue	Continue booting of the TCU
F8 reboot	Restart the TCU

Press <1 / F1> to continue

If you select function <F1> in the diagnostics window, the detailed diagnostic information is output.

Key / text	Meaning
F1 ... F6	Navigate within the window (alternatively, the relevant keys on the OP can be used).
F7 +	Display more information
F8 -	Display less information
F9 back	Return to diagnostics window

Index

A

Advanced settings, 102

B

Backup battery
 Connection conditions, 23
Boot server, 116

C

Calibrate touch panel
 HT 8, 68
 TCU, 69
Calibrate Touch Panel, 73
Color depth, 102
CompactFlash Card, 47
Company network, 46
Configuration file
 basesys.ini, 91
 config.ini, 74
 tcu.ini, 102
Connecting a PG, 117
Connection conditions
 Backup battery, 23
 EMC measures, 19
 Environmental conditions, 11
 Hard disk drives, 24
 Membrane connectors, 44
 Protective separation, 19
 User interface, 19

D

DCK (Direct Control Keys), 65
DHCP client, 48
DHCP server, 48
Direct control keys, 65
DNS (Domain Name System), 89

E

Electrostatically sensitive devices, 12

EMC measures, 21
 Connection conditions, 19
Environmental conditions
 Connection conditions, 11
Ethernet connection, 111
Ethernet interface, 111

F

Factory default settings, 48
Faults when booting, 120

H

Hard disk drives
 Connection conditions, 24
Heat dissipation
 Means of heat dissipation, 26
HT 8
 Calibrate, 68
 Rotary coding switch, 65

I

IP address
 Client, 103
 PG, 117

M

Membrane connectors
 Connection conditions, 44
Messages during TCU boot up, 120

N

Network topology, 111

O

Operator components
 Overview, 17
Overview
 Operator components, 17
 SINUMERIK 840D sl, 16

P

- Potential equalization, 20
- Protective separation
 - Connection conditions, 19

R

- Replacement TCU, 67
- Residual risks of drive systems, 13

S

- Safety instructions
 - Electrostatically sensitive devices, 12
- Screen resolution, 102
- Signal cables, 20
- SIMATIC Thin Client, 70
- SINUMERIK 840D sl
 - System overview, 16
- SINUMERIK DHCP client, 48
- SINUMERIK DHCP server, 49
- SINUMERIK mode, 73
- SNC
 - Adapter, 92
 - Company network, 105
 - OPs, 93
 - Scanned devices, 106
 - System basics, 106
 - System network, 103
 - TCU support, 99
 - Veto Mode TCU mode, 101
- SNC (System Network Center), 90
- Star structure, 45
- Start bar, 72
- Switchover disable, 84
- System
 - Boot behavior, 88
- System network, 45
 - Configuring, 89

T

- Target configuration, 107
- Target/actual comparison, 109
- TCU
 - Assign index, 85
 - Assign names, 64
 - Boot-up configuration, 100
 - Boot-up messages, 120
 - Main menu, 51

- Settings, 64
- Supplementary conditions, 47
 - Thin Client Unit, 47
- TCU diagnostics, 120

U

- User authorization, 101
- User interface
 - Connection conditions, 19

V

- Validity, manual, 45
- VNC connection, 96

SIEMENS

SINUMERIK

SINUMERIK 840D sl Operator panels

Manual



Operator panel front: OP 08T	1
Operator panel front: OP 010	2
Operator panel front: OP 010S	3
Operator panel front: OP 010C	4
Operator panel front: OP 012	5
Operator panel front: OP 015	6
Operator panel front: OP 015A	7
Operator panel front: OP 015AT	8
Operator panel front: TP 015A	9
Operator panel front: TP 015AT	10
Operator panel front: OP 019	11
Direct control key module	12
PCU 50.3	13
PCU 50.5	14
TCU x0.2	15

Valid for:
Control
SINUMERIK 840D sl / 840DE sl

Legal information

Warning notice system

This manual contains notices you have to observe in order to ensure your personal safety, as well as to prevent damage to property. The notices referring to your personal safety are highlighted in the manual by a safety alert symbol, notices referring only to property damage have no safety alert symbol. These notices shown below are graded according to the degree of danger.

 DANGER
indicates that death or severe personal injury will result if proper precautions are not taken.
 WARNING
indicates that death or severe personal injury may result if proper precautions are not taken.
 CAUTION
indicates that minor personal injury can result if proper precautions are not taken.
NOTICE
indicates that property damage can result if proper precautions are not taken.

If more than one degree of danger is present, the warning notice representing the highest degree of danger will be used. A notice warning of injury to persons with a safety alert symbol may also include a warning relating to property damage.

Qualified Personnel

The product/system described in this documentation may be operated only by **personnel qualified** for the specific task in accordance with the relevant documentation, in particular its warning notices and safety instructions. Qualified personnel are those who, based on their training and experience, are capable of identifying risks and avoiding potential hazards when working with these products/systems.

Proper use of Siemens products

Note the following:

 WARNING
Siemens products may only be used for the applications described in the catalog and in the relevant technical documentation. If products and components from other manufacturers are used, these must be recommended or approved by Siemens. Proper transport, storage, installation, assembly, commissioning, operation and maintenance are required to ensure that the products operate safely and without any problems. The permissible ambient conditions must be complied with. The information in the relevant documentation must be observed.

Trademarks

All names identified by ® are registered trademarks of Siemens AG. The remaining trademarks in this publication may be trademarks whose use by third parties for their own purposes could violate the rights of the owner.

Disclaimer of Liability

We have reviewed the contents of this publication to ensure consistency with the hardware and software described. Since variance cannot be precluded entirely, we cannot guarantee full consistency. However, the information in this publication is reviewed regularly and any necessary corrections are included in subsequent editions.

Table of contents

1	Operator panel front: OP 08T	11
1.1	Description	11
1.2	Control and display elements.....	12
1.2.1	View	12
1.2.2	Keyboard.....	13
1.2.3	Screen saver	15
1.3	Interfaces	15
1.4	Installation.....	17
1.5	Technical data.....	19
1.6	Spare parts.....	19
1.7	Accessories.....	20
1.7.1	Overview	20
1.7.2	Labeling the slide-in labels.....	20
1.7.3	Printing the slide-in labels	25
2	Operator panel front: OP 010.....	29
2.1	Description	29
2.2	Operating and display elements	30
2.2.1	View	30
2.2.2	Keyboard.....	31
2.2.3	Screen saver	33
2.3	Interfaces	33
2.4	Mounting	35
2.4.1	Preparation for mounting	35
2.4.2	Assembling an OP 010 and a PCU	36
2.4.3	Mounting on the mounting wall	37
2.4.4	Softkey labeling.....	37
2.5	Technical data.....	38
2.6	Spare parts.....	39
2.6.1	Overview	39
2.6.2	Replacement.....	41
3	Operator panel front: OP 010S	45
3.1	Description	45
3.2	Operating and display elements	46
3.2.1	View	46
3.2.2	Keyboard.....	47
3.2.3	Screen saver	47
3.3	Interfaces	48

3.4	Mounting.....	49
3.4.1	Preparation for mounting.....	49
3.4.2	Mounting on the mounting wall	50
3.4.3	Assembling an OP 010S and a PCU	50
3.5	Technical data.....	52
3.6	Spare parts.....	52
3.6.1	Overview	52
3.6.2	Replacement.....	53
4	Operator panel front: OP 010C.....	55
4.1	Description	55
4.2	Operating and display elements	56
4.2.1	View.....	56
4.2.2	Keyboard.....	57
4.2.3	Screen saver	59
4.3	Interfaces.....	59
4.4	Mounting.....	61
4.4.1	Preparation for mounting.....	61
4.4.2	Assembling an OP 010C and a PCU	63
4.4.3	Mounting on the mounting wall	63
4.5	Technical data.....	64
4.6	Spare parts.....	65
4.6.1	Overview	65
5	Operator panel front: OP 012.....	67
5.1	Description	67
5.2	Operating and display elements	68
5.2.1	View.....	68
5.2.2	Keyboard.....	69
5.2.3	Screen saver	71
5.3	Interfaces.....	71
5.4	Mounting.....	73
5.4.1	Preparation for mounting.....	73
5.4.2	Assembling an OP 012 and a PCU.....	74
5.4.3	Mounting on the mounting wall	77
5.4.4	Softkey labeling.....	78
5.5	Technical data.....	79
5.6	Spare parts.....	79
5.6.1	Overview	79
5.6.2	Replacement.....	82
6	Operator panel front: OP 015.....	85
6.1	Description	85
6.2	Operating and display elements	86
6.2.1	View.....	86
6.2.2	Keyboard.....	87

6.2.3	Screen saver	87
6.3	Interfaces	88
6.4	Mounting	89
6.4.1	Preparation for mounting	89
6.4.2	Assembling an OP 015 and a PCU	91
6.4.3	Mounting on the mounting wall	92
6.5	Technical data	93
6.6	Spare parts	94
6.6.1	Overview	94
6.6.2	Replacement	95
7	Operator panel front: OP 015A	99
7.1	Description	99
7.2	Operating and display elements	100
7.2.1	View	100
7.2.2	Keyboard	101
7.2.3	Screen saver	103
7.3	Interfaces	103
7.4	Mounting	105
7.4.1	Preparation for mounting	105
7.4.2	Assembling an OP 015A and a PCU	106
7.4.3	Mounting on the mounting wall	108
7.4.4	Softkey labeling	110
7.5	Technical specifications	111
7.6	Spare parts	111
7.6.1	Overview	111
7.6.2	Replacement	114
8	Operator panel front: OP 015AT	121
8.1	Description	121
8.2	Operator controls and indicators	122
8.2.1	View	122
8.2.2	Keyboard	123
8.2.3	Screen saver	124
8.3	Interfaces	125
8.4	Installation	126
8.4.1	Mounting	126
8.4.2	Softkey labeling	128
8.5	Technical data	129
8.6	Replacement parts	129
8.6.1	Overview	129
8.6.2	Replacement	132

9	Operator panel front: TP 015A.....	137
9.1	Description	137
9.2	Operating and display elements	139
9.2.1	View.....	139
9.2.2	Operation.....	140
9.2.3	Keyboard.....	140
9.2.4	Screen saver	142
9.3	Interfaces.....	142
9.4	Mounting.....	144
9.4.1	Preparation for mounting.....	144
9.4.2	Assembling TP 015A and PCU.....	145
9.4.3	Mounting on the mounting wall	145
9.4.4	Calibration of the touch screen	146
9.4.5	Softkey labeling.....	147
9.5	Technical specifications	148
9.6	Spare parts.....	148
9.6.1	Overview	148
9.6.2	Replacement.....	151
10	Operator panel front: TP 015AT.....	159
10.1	Description	159
10.2	Operator controls and indicators.....	160
10.2.1	View.....	160
10.2.2	Operation.....	161
10.2.3	Keyboard.....	161
10.2.4	Screen saver	163
10.3	Interfaces.....	163
10.4	Installation	165
10.4.1	Mounting.....	165
10.4.2	Calibration of the touch screen	166
10.4.3	Softkey labeling.....	167
10.5	Technical data.....	168
10.6	Replacement parts	168
10.6.1	Overview	168
10.6.2	Replacement.....	170
11	Operator panel front: OP 019.....	177
11.1	Description	177
11.2	Operator control and display elements	179
11.2.1	View.....	179
11.2.2	Keyboard.....	180
11.2.3	Softkeys.....	181
11.2.4	Screen saver	181
11.3	Interfaces.....	182
11.4	Mounting.....	184

11.4.1	Preparation for mounting	184
11.4.2	Assembling an OP 019 and a PCU	186
11.4.3	Assembling an OP 019 and a TCU	188
11.4.4	Mounting on the mounting wall	189
11.5	Technical data	190
12	Direct control key module	191
12.1	Description	191
12.2	Operating and display elements	192
12.3	Interfaces	193
12.4	Mounting	194
12.4.1	Overview	194
12.4.2	Combination with OP 012	195
12.4.3	Combination with OP 015A / TP 015A	200
12.5	Technical data	205
13	PCU 50.3	207
13.1	Description	207
13.2	Operating and display elements	210
13.3	Interfaces	211
13.3.1	External interfaces	211
13.3.2	Internal interfaces	213
13.3.2.1	Connector assignment of motherboard	213
13.3.2.2	Connector assignment of bus board	219
13.4	Installation	222
13.4.1	Preparation for mounting	222
13.4.2	Assembly of PCU and operator panel front (standard mounting)	226
13.4.3	Flat mounting	227
13.4.4	Upright mounting	229
13.4.5	Notes on installation	230
13.4.6	Mounting the Ethernet tension relief	232
13.4.7	Installing the anchor tie	233
13.5	Connecting	234
13.5.1	Ground terminal	234
13.5.2	I/O devices	235
13.5.3	DC power supply (24V)	236
13.5.4	Equipotential	236
13.6	Start up	237
13.6.1	Locking / unlocking hard disk	237
13.6.2	BIOS	239
13.6.2.1	BIOS powering up	239
13.6.2.2	Changing the BIOS settings	240
13.6.2.3	Status display	242
13.6.3	System start	243
13.6.4	Switching off / reset	243
13.6.5	Calibration of the touch screen	244
13.6.6	Operation with an S7-CPU (without NCU)	246

13.6.7	Configuring the 'fb9_proxy.ini' file	248
13.7	Technical data	252
13.7.1	PCU 50.3	252
13.7.2	DC power supply module of 24 V (integrated)	253
13.8	Spare parts	254
13.8.1	Overview	254
13.8.2	Replacement	255
13.8.2.1	Hard disk drive	256
13.8.2.2	Power supply	257
13.8.2.3	Power supply module fan	259
13.8.2.4	Device fan	260
13.8.2.5	Battery	261
13.9	Accessories	266
13.9.1	Overview	266
13.9.2	Installing and removing expansion modules	267
13.9.2.1	Memory expansion	267
13.9.2.2	PCI cards	269
13.9.2.3	CompactFlash card	272
14	PCU 50.5	275
14.1	Description	275
14.2	Operator control and display elements	278
14.2.1	On/off switch	278
14.2.2	Service module	279
14.3	Interfaces	281
14.3.1	External interfaces	281
14.3.2	Internal interfaces	284
14.3.2.1	Connector assignment of motherboard	284
14.3.2.2	Connector assignment of bus board	288
14.4	Mounting	293
14.4.1	Preparation for mounting	293
14.4.2	Assembly of PCU and operator panel front (standard mounting)	296
14.4.3	Flat mounting	297
14.4.4	Upright mounting	299
14.4.5	Notes on installation	302
14.4.6	Connecting Ethernet/USB strain relief	303
14.4.7	Relocating the service module	303
14.5	Connecting	305
14.5.1	Power supply	305
14.5.2	Equipotential	307
14.5.3	I/O devices	307
14.6	Commissioning	308
14.6.1	BIOS	308
14.6.1.1	BIOS powering up	308
14.6.1.2	Changing the BIOS settings	310
14.6.2	System start	312
14.6.3	Switching off / reset	312
14.6.4	Calibration of the touch screen	312

14.6.5	Operation with an S7-CPU (without NCU).....	315
14.6.6	Configuring the 'fb9_proxy.ini' file	317
14.7	Alarm, error and system messages	321
14.7.1	Boot error messages.....	321
14.7.2	BIOS beep codes.....	322
14.8	Technical data.....	326
14.8.1	PCU 50.5.....	326
14.8.2	Calculating the power	327
14.8.3	Power failure detection	327
14.9	Spare parts.....	328
14.9.1	Overview	328
14.9.2	Replace	328
14.9.2.1	SSD module.....	329
14.9.2.2	Power supply.....	331
14.9.2.3	Power supply fan	332
14.9.2.4	Device fan	334
14.9.2.5	Backup battery	335
14.10	Accessories.....	337
14.10.1	Overview	337
14.10.2	Installing and removing expansion modules.....	338
14.10.2.1	Memory expansion.....	338
14.10.2.2	PCI cards	339
14.10.2.3	CompactFlash card.....	342
15	TCU x0.2	345
15.1	Description	345
15.1.1	Overview	345
15.1.2	Configurations.....	347
15.2	Interfaces	348
15.3	Mounting the TCU on the operator panel front	349
15.4	Technical data.....	353
15.5	Accessories.....	354
	Index.....	355

Operator panel front: OP 08T

1.1 Description

The extremely compact SINUMERIK OP 08T operator panel front enables a distributed configuration of the operator panel front and controller.

The OP 08T operator panel front has a membrane keyboard with 79 keys (layout similar to SINUMERIK CNC editing keyboard KB 310C) as well as 2x8 horizontal and 2x8 vertical soft keys.

The distance to the operator panel fronts is determined by the maximum distance of two network nodes / access points.

The operator panel front OP 08T is connected to the PCU / NCU via the Ethernet as thin client in its own subnet (via DHCP server to PCU / NCU).

The mixed operation with an operator panel front is possible directly at the PCU.

The operator panel front is secured from the rear using special clamps supplied with the panel.

Validity

The description below applies to the OP 08T operator panel front
Order number: 6FC5203-0AF04-1BA0.

Features

- Ethernet 10/100 Mbit/s
- 2x USB 1.1 for connecting the mouse, keyboard and USB flash drive (1x front / 1x rear)
- 7.5" TFT flat screen with VGA resolution 640x480 pixels
- Membrane keyboard with alphabetic, numeric, cursor, and control keypad
- Softkeys / direct keys
 - 2 x 8 horizontal rows of keys with softkey function
 - 2 x 8 vertical rows of keys with softkey and direct key function
- Shift key for switchover to the second key level (not for switching over the letters, since they are uppercase only)
- Limited mounting depth
- Panel cutout (W x H): 285 x 304 mm
- IP65 degree of protection
- Attachment: tension jacks at the rear

1.2 Control and display elements

1.2.1 View

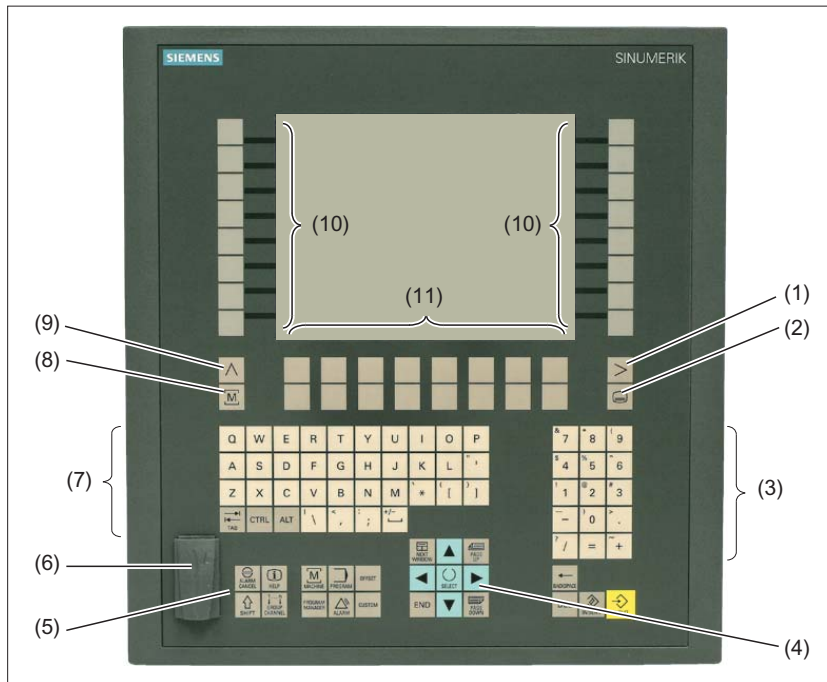

- (1) Menu forward key
- (2) Menu select key
- (3) Numeric key group
- (4) Cursor key group
- (5) Control key group
- (6) Interface USB 1.1
- (7) Alphabetic key group
- (8) Machine area key
- (9) Menu back key
- (10) Softkeys and direct keys (vertical slide-in labels)
- (11) Softkeys

Figure 1-1 View of OP 08T operator panel front

1.2.2 Keyboard

Keyboard

Several keys and keypads are installed on the operator panel front:

- The alphabetic block contains the letters A - Z (QWERTY), the space character and special characters.
- The numeric block contains the digits 0 - 9, and the characters "-", "/", "=", "+" and ".".
- The cursor key group is used to navigate on the screen.
- The control key group includes special functions.
- The softkeys call up functions that are available on the screen via a menu bar.
- The "Menu back" key switches back to the higher-level horizontal menu.
- The "Menu forward" key advances in the extended horizontal softkey bar.
- The "Menu select" key calls the main menu to select the operating area.
- The "Machine area" key selects the "Machine" operating area.

























Switching between upper and lower case

Upper case is always activated as standard.

To switch to lower case, keep the SHIFT key pressed.

Overview of the key symbols

The key symbols used on the operator panel front are shown below along with the corresponding function keys on the PC keyboard.

Key	Function corresponds to the PC key function	Key	Function corresponds to the PC key function
	Esc		End
	F11		Backspace
	F12		Tab
	Space		(only intended for internal keyboard changeover)
	Home		Ctrl key
	Page up		Alt key
	Page down		Delete
	Cursor up		Insert
	Cursor left		Enter
	Cursor right		F9
	Cursor down		F10
	5 (in numeric key group)	A, ..., Z	<Shift> A, ..., Z
	<Shift> F9		<Shift> F10

Display

Note

Pixel error according to DIN EN ISO 13406-2 Class II.

1.2.3 Screen saver

If a screen with high contrast is displayed unchanged for longer than an hour, the screen must be switched dark (screensaver) in order to protect the TFT display against so-called "freezing" of the last displayed screen.

The time can be adapted individually. Further information can be found at:
IM9 SINUMERIK Operate Commissioning Manual

1.3 Interfaces

Front side

USB 1.1 to connect an external keyboard, mouse and USB FlashDrive (see section: "Control and display elements" → "View")

Note

Note that the electromagnetic compatibility of commercially available peripheral devices operated via the USB interface is usually rated for office use only.

For industrial use, components with a higher degree of certification are recommended.

Rear side

- Ethernet
- USB 1.1
- Power supply

1.3 Interfaces

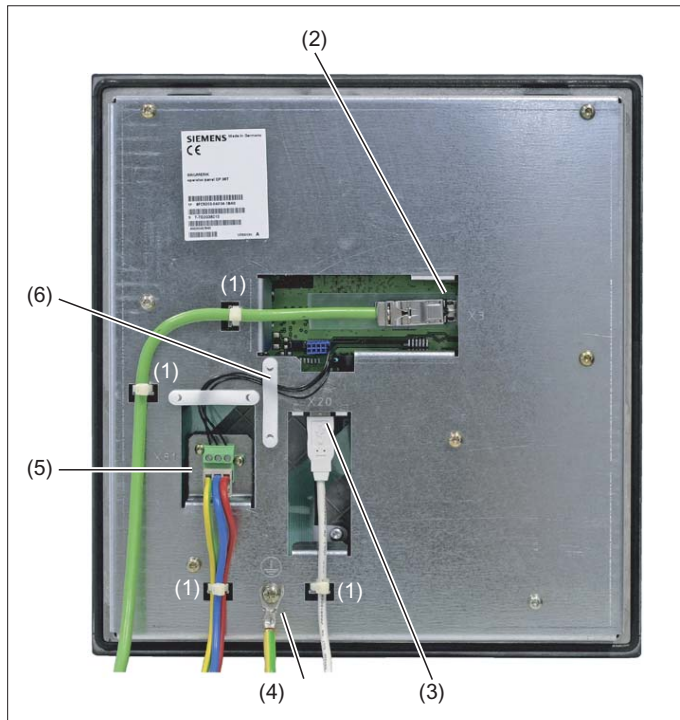

Figure 1-2 Rear view of OP 08T operator panel front

	Designation		Type
(1)	Strain relief for the connecting cable		
(2)	Ethernet interface	X3	8-pin RJ45 socket
(3)	Interface USB 1.1	X20	USB-A
(4)	Ground terminal		M5 screw (for screw connection with cable lug)
(5)	24 VDC power supply	X81	3-pin terminal block
(6)	Cable clamp		

1.4 Installation

The OP 08T operator panel front is fixed in a rectangular section with clamps. For this reason, bore holes or screw holes are not needed. The tightening torque of the clamp set screws must not exceed 0.5 Nm.

Table 1- 1 Dimensions of the mounting opening OP 08T

Width (mm)	Height (mm)	Depth (mm)
285	304	41 *)
*) Plus 10 mm cable connector and ventilation clearance		

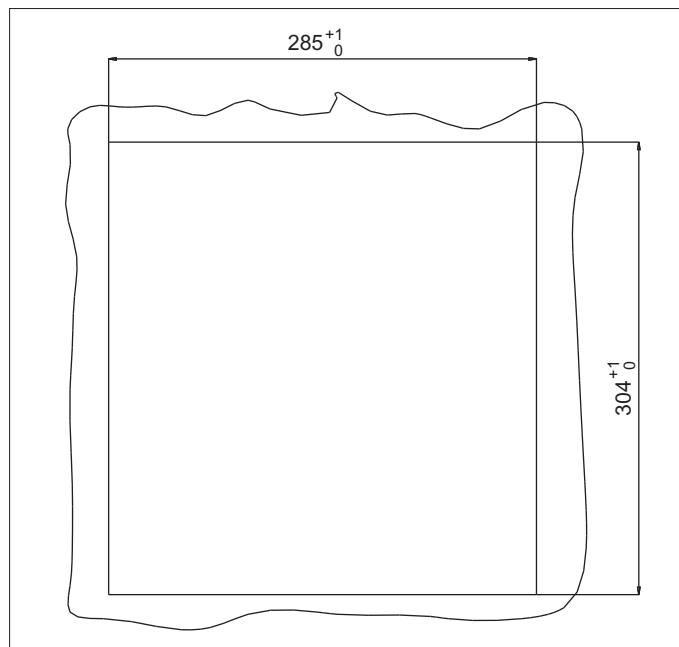

Figure 1-3 Panel cutout OP 08T

Dimension drawings

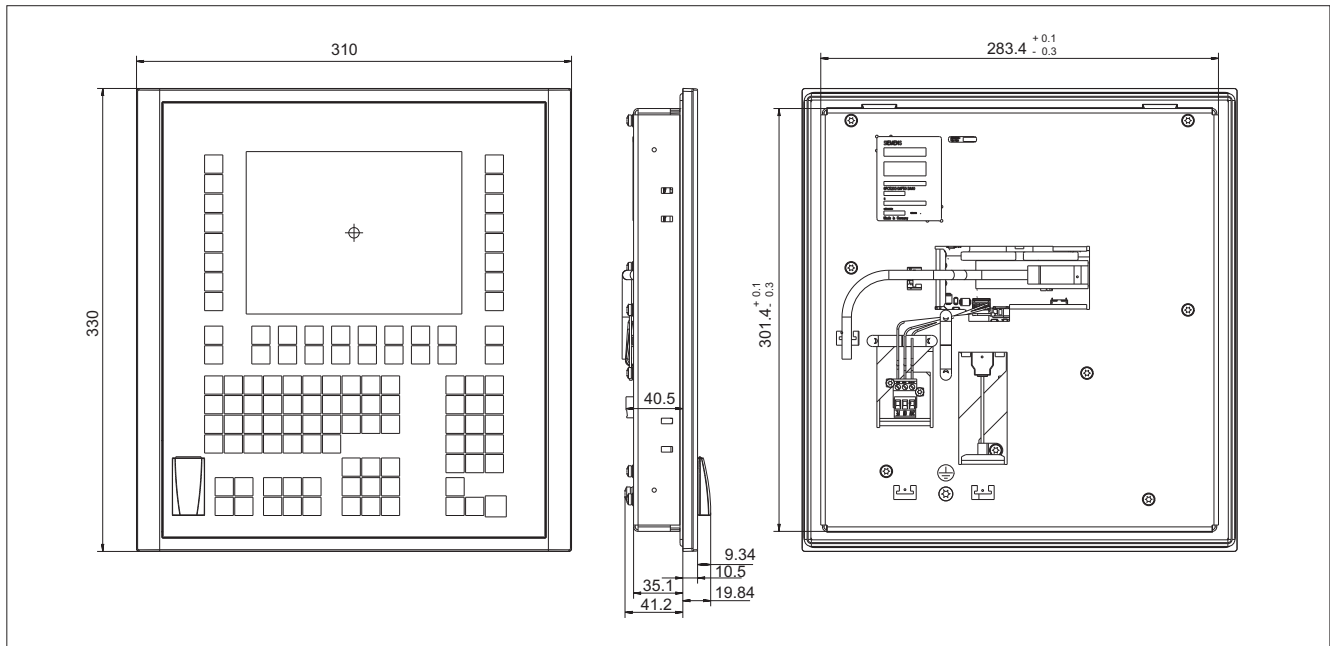

Figure 1-4 Dimension drawing OP 08T

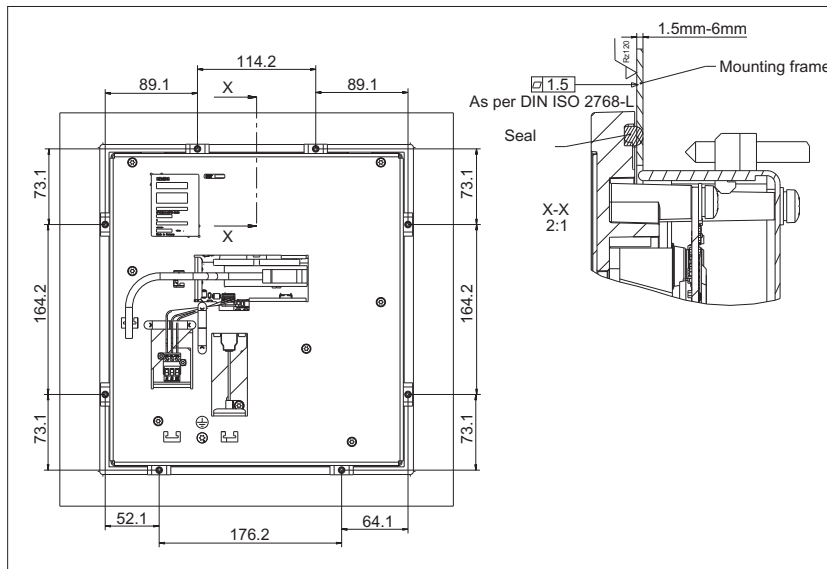

Figure 1-5 Dimensions of OP 08T clamps

1.5 Technical data

Safety			
Safety class	III; PELV according to EN 50178		
Degree of protection according to EN 60529	Front side IP65 Rear side IP00		
Approvals	CE / cULus		
Electrical data			
Power supply	24 VDC		
Power consumption	Max. approx. 15 W		
Mechanical data			
Dimensions	Width: 310 mm	Height: 330 mm	Depth: 41 mm
Weight	approx. 2.9 kg (without tension jack)		
Tightening torques, max.	Tension jacks: 0.4 - 0.5 Nm M5 grounding screw: 3 Nm		
Display			
Size / resolution	7.5" TFT / 640x480 pixel (VGA)		

Note

Information about the climatic and mechanical environmental conditions is contained in the associated section under:

"General notes and interconnection" → "Operational planning".

1.6 Spare parts

The following components are available as spare parts for the OP 08T operator panel front:

Spare parts	Order No.	Remarks
Tension jack (for supplementary components with 2.5 mm profile strength, length: 20 mm)	6FC5248-0AF14-0AA0	Set of 9
Sealing caps for USB connection	6FC5248-0AF05-0BA0	Set of 5

1.7 Accessories

1.7.1 Overview

The following accessories are available for the OP 08T operator panel front:

Component	Description	Amount	Order No.
Slide-in labels	Slide-in labels (3 films DIN A4)	1	6FC5248-0AF04-1BA0

1.7.2 Labeling the slide-in labels

The OP 08T operator panel front is delivered ex-factory with two vertical slide-in labels (unprinted / gray background color).



- (1) Part 1
- (2) Part 2

Figure 1-6 Position of the vertical OP 08T slide-in labels

Upon request, a spare part packet with three blank films can be ordered, in order to print the slide-in labels with the key symbols (see Section: "Spare parts" → "Overview").

Files for printing the blank film

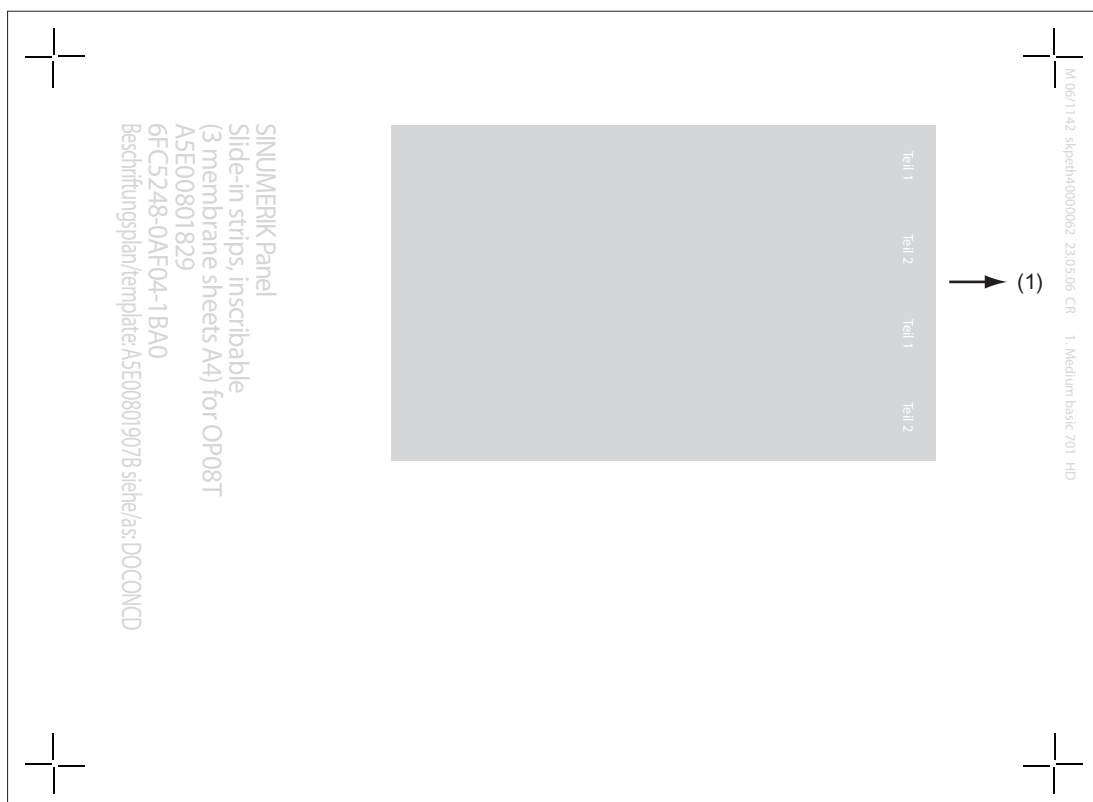

Figure 1-7 Blank film OP 08T [printing direction (1)]

The DOConCD / Catalog NC 61 (CD enclosed) contains two files for printing the blank films:

- Template_OP08T_13.doc
- Symbols_OP08T_13.doc

The file "Template_OP08T_13.doc" is a template for the exact positioning of the symbols on the printable film.

1.7 Accessories

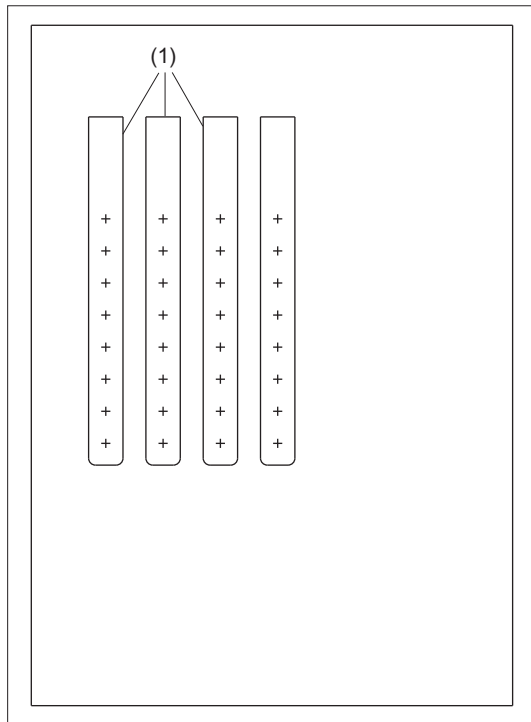

(1) Cutting edges

Figure 1-8 Template_OP08T_13.doc (blank template for film)

The "Symbols_OP08T_13.doc" file contains a wide range of key symbols:











Table 1-2 Key symbols OP 08T

	5000	MACHINE	5001		5002	MENU SELECT	5003	MANUAL	5068
EASYSTEP	5069	EASYSTEP	5070	CONTOUR	5071	CUT	5072	CYCLE	5073
CIRCLE	5074	CONICAL	5075	STRAIGHT	5076				
TAB	6000	CTRL	6001	ALT	6002	ALARM CANCEL	6003	HELP	6004
ALARM	6005	1...n GROUP CHANNEL	6006	NEXT WINDOW	6007	PAGE UP	6008	SELECT	6009
DEL	6010	SHIFT	6011	PROGRAM	6012	TOOL OFFSET	6013	PROG. MANAGER	6014
END	6015	PAGE DOWN	6016	BACK SPACE	6017	INSERT	6018	INPUT	6019

PROGRAM MANAGER	6069	OFFSET	6070	CUSTOM	6071		6072		6073
	6074		6075						
Q	6020	W	6021	E	6022	R	6023	T	6024
Y	6025	U	6026	I	6027	O	6028	P	6029
A	6030	S	6031	D	6032	F	6033	G	6034
H	6035	J	6036	K	6037	L	6038	Z	6040
X	6041	C	6042	V	6043	B	6044	N	6045
M	6046	" ,	6039	{ [6048	}]	6049	 \	6050
< ,	6051	: ;	6052	+/- └	6053	& 7	6054	* 8	6055
(9	6056	\$ 4	6057	% 5	6058	^ 6	6059	! 1	6060
@ 2	6061	# 3	6062	- —	6063) 0	6064	> .	6065
? /	6066	=	6067	、 *	7133	~ +	7134		
	7001		7002		7003		7004		7005
100%	7006		7007		7008		7009		7010
	7012		7013		7014		7015		7017
	7018		7020		7021		7024		7025
	7026		7027	4 4TH AXIS	7029	5 5TH AXIS	7030	6 6TH AXIS	7031
	7040		7041		7042		7043		7044
	7045		7046		7047		7048		7049

1.7 Accessories

	7051		7052		7053		7054	P1	7055
P2	7056		7057	P0	7058	P3	7059	P4	7060
	7061		7062	P5	7063	P6	7064		7065
	7066	P7	7067	P8	7068		7069		7070
P9	7071	P10	7072		7073		7074		7075
	7076		7077		7078		7086		7079
	7080		7081		7082		7083		7084
	7085		7087		7088		7089		7090
	7091		7092		7093		7094		7095
	7096		7099		7100		7101		7102
	7103		7104	100%	7105		7106		7107
	7108		7109		7110	-	7111	+	7112
	7113		7114		7115		7116	7 7TH AXIS	7120
8 TH AXIS	7121	9 9TH AXIS	7122		7123		7124	+C	7125
+X	7126	+Y	7127	+Z	7128	-X	7129	-Y	7130
-Z	7131	-C	7132		7135	ARTIS	7136		7137
	7138	M01	7139		7140		7141		7142
	7143	SKP	7144	SKP7	7145		7146		7147
	7148		7149		7150		7151		7152

	7153	AXIS 5...n	7154		7155		7156		7157
	7158		7159		7160		7161		7162
	7163		7164						

Preparing slide-in labels

Inserting symbols

1. Open the files "Template_OP08T_13.doc" and "Symbols_OP08T_13.doc" in MS Word.
2. Select a key symbol from the file "Symbols_OP08T_13.doc" by left-clicking.
3. Copy the desired key symbol to the clipboard via "Edit" → "Copy" or "Ctrl + C"
4. Return to the template file "Template_OP08T_13.doc"
5. Position the cursor before the insertion point in the desired table cell (in Fig.: "Template_OP08T_13.doc" the insertion point is displayed by "+").
6. Insert the key symbol via "Edit" → "Paste" or "Ctrl + V".
7. Repeat steps 2. to 6. until you have inserted all the key symbols.

Inserting characters/text

1. Open the "Template_OP08T_13.doc" files in the MS Word text processing program.
2. Set the "Arial" font to format characters.
(This font is comparable to the "Univers S57" font, used by Siemens for the key labeling.)
3. Position the cursor in the desired table cell and enter characters/text.

1.7.3 Printing the slide-in labels

Printing the slide-in labels

1. Place the blank film in the printing direction in the slot of your laser printer (see Figure: "Blank film OP 08T").
2. Select "film" as the printable medium if your printer allows this setting.

3. Start the printing process using MS Word.

Note

For labeling the slide-in labels, HP Color Laser Jet film C2936A is used.
Make a test print on paper before you print on the film.
Allow the film to cool after printing so that the ink can dry.

4. Cut the slide-in labels out of the film along the edges (see Figure: "Template_OP08T_13.doc").
5. Round off the corners of the slide-in labels approx. 3 mm to facilitate insertion.

Dimension drawing

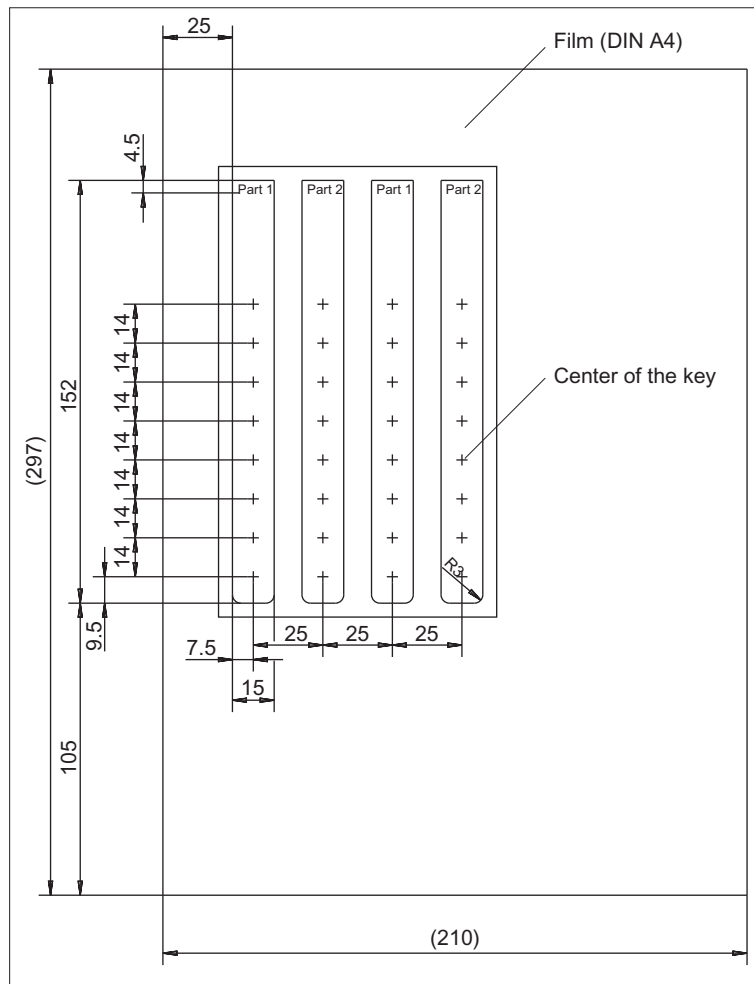

Figure 1-9 Dimensions for vertical slide-in labels

Creating your own symbols

- Drawing in a vector program (e.g. Freehand, CorelDraw)
 - Draw a 13 x 13 mm square, fill with the color white and give it an invisible border line.
 - Place the symbol in the center of this square.
 - Group the square and symbol together and add this group in the MS Word document Template_OP08T_13.doc.
- Drawing in an image editing program (e.g. Photoshop, Paintshop Pro)
 - Draw a square 13 x 13 mm (37 x 37 pixels), filled with the color white.
 - Draw the symbol in the center of this square.
 - Copy the symbol and the square together and add the group in the MS Word document Template_OP08T_13.doc.

Operator panel front: OP 010

2.1 Description

The SINUMERIK OP 010 operator panel front has a 10.4" TFT color display with a resolution of 640 x 480 pixels (VGA) and features a 62-key membrane keypad (with 8 + 4 horizontal softkeys and 8 vertical softkeys) that has been optimized for programming parts programs.

It is fixed from the rear using special clamps that are included in the delivery scope.

Validity

The description below applies to the OP 010 operator panel front.
Order number: 6FC5203-0AF00-0AA1

Features

- 19" mounting format, 7 HU (height units)
- Panel cutout (W x H): 450 x 290 mm
- Limited mounting depth
- 10.4" flat screen (color) with VGA resolution 640 x 480 pixels using TFT technology
- Membrane keyboard with alphabetic, numeric, cursor, control and hotkey key groups
- Softkeys: 8 + 4 horizontal and 8 vertical softkeys
- Shift key for switchover to the second key level (not for switching over the letters, since they are uppercase only)
- Status LEDs for power supply and overtemperature
- Front USB interface
- Degree of protection IP65
- Attachment: tension jacks at the rear
- Can be combined with PCU, TCU

2.2 Operating and display elements

2.2.1 View

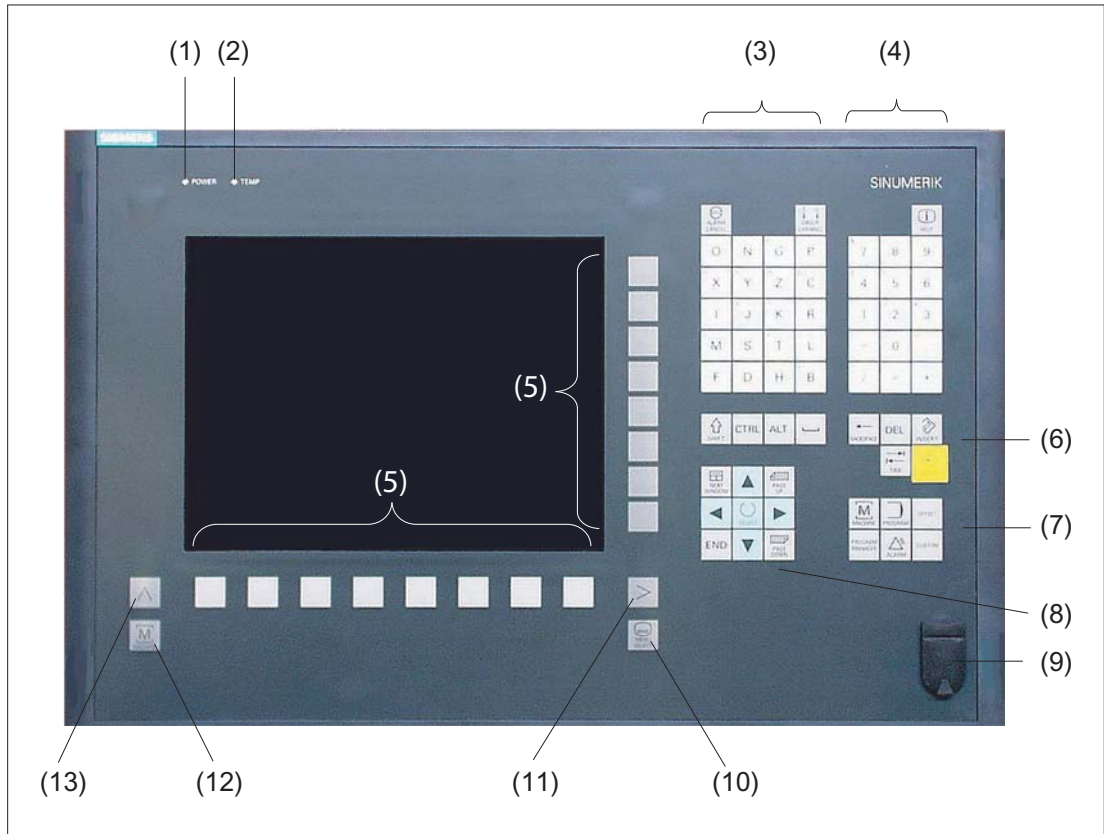

- (1) Status LED: POWER
- (2) Status LED: TEMP
Lit LEDs indicate increased wear.
- (3) Alphabetic key group
- (4) Numerical key group
- (5) Softkeys
- (6) Control key group
- (7) Hotkey group
- (8) Cursor key group
- (9) Front USB interface
- (10) Menu select key
- (11) Menu forward key
- (12) Machine area key
- (13) Menu back key

Figure 2-1 View of OP 010 operator panel front

2.2.2 Keyboard

Keyboard

Several keys and keypads are arranged on the OP 010 operator panel front:









- The alphabetic key group contains the letters A, ..., Z on two levels, arranged in accordance with programming requirements.
- The numeric block contains the digits 0 - 9, and the characters "-", "/", "=", "+" and ".".
- The control key group includes special functions.
- The hotkey group is used for the direct selection of operating areas.
- The cursor key group is used to navigate on the screen.
- The softkeys call up functions that are available on the screen via a menu bar.
- The "Menu back" key switches back to the higher-level horizontal menu.
- The "Menu forward" key advances in the extended horizontal softkey bar.
- The "Menu select" key calls the main menu to select the operating area.
- The "Machine area" key selects the "Machine" operating area.























Switching between upper and lower case

To toggle between upper and lower case letters, press the key combination Ctrl + Shift
Upper case is always activated as standard.

Overview of the key symbols

The key symbols used on the operator panel front are shown below along with the corresponding function keys on the PC keyboard.

Key	Function corresponds to the PC key function	Key	Function corresponds to the PC key function
	Esc		End
	F11		Backspace
	F12		Tab
	Space		(only intended for internal keyboard changeover)

Key	Function corresponds to the PC key function	Key	Function corresponds to the PC key function
	Home		Ctrl key
	Page up		Alt key
	Page down		Delete
	Cursor up		Insert
	Cursor left		Enter
	Cursor right		F9
	Cursor down		F10
	5 (in numeric key group)	A, ..., Z	<Shift> A, ..., Z
	<Shift> F9		<Shift> F10
			
			
			

Display

Note

Pixel error according to DIN EN ISO 13406-2 Class II.

2.2.3 Screen saver

If a screen with high contrast is displayed unchanged for longer than an hour, the screen must be switched dark (screensaver) in order to protect the TFT display against so-called "freezing" of the last displayed screen.

The time can be adapted individually. Further information can be found at:
IM9 SINUMERIK Operate Commissioning Manual

2.3 Interfaces

This operator panel front has the following interfaces:

Front side

USB 1.1 (type A) for connecting an external keyboard, mouse and USB FlashDrive (see View of OP 010 operator panel front).

Note

Note that the electromagnetic compatibility of commercially available peripheral devices operated via the USB interface is usually rated for office use only.

For industrial use, components with a higher degree of certification are recommended.

Rear side

- Two ribbon cables for connecting the PCU (see figure below):
 - I/O USB cable K1:
All signals that are used for the display interface and the connection of operator panel fronts (e.g. supply voltages)
 - Display cable K2
- Direct key interface X11 (under the cover plate)
- Interface X12 - reserved (under the cover plate)

2.3 Interfaces

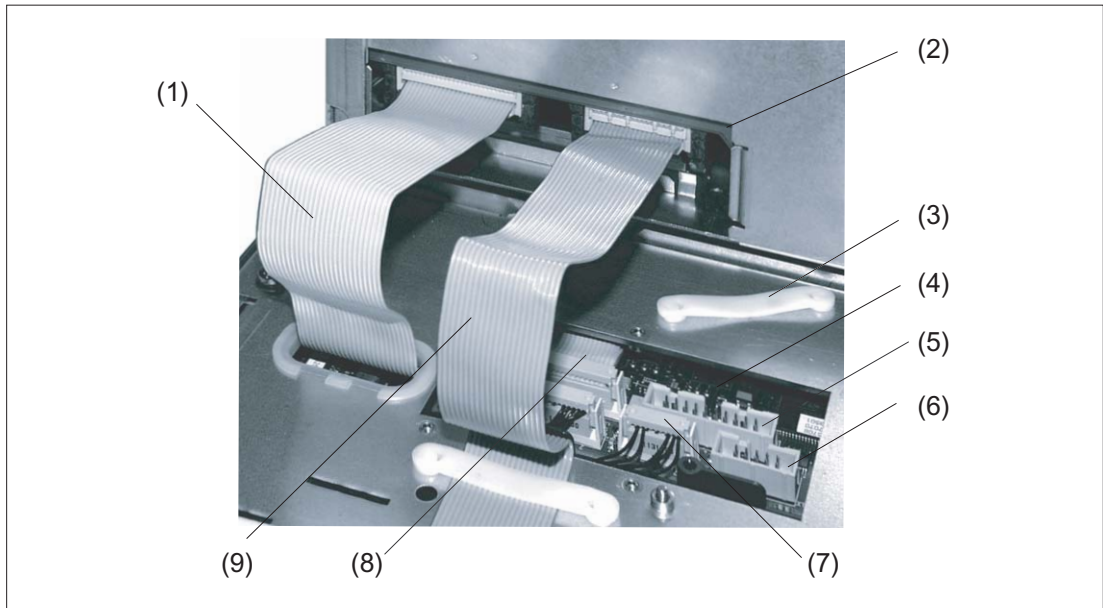

- (1) I/O USB cable K1
- (2) PCU main board
- (3) Retainer for direct key module connection
- (4) Keyboard controller
- (5) Direct key interface X11
- (6) Interface X12 (reserved)
- (7) Connection X14 for backlight
- (8) Connection X1 for I/O USB cable K1
- (9) Display cable K2

Figure 2-2 Connections on rear of housing: Connections to PCU

Pin assignment

For more detailed information, see "General information and networking", Chapter: "Connecting".

2.4 Mounting

2.4.1 Preparation for mounting

Table 2- 1 Dimensions of the mounting opening

Width (mm)	Height (mm)
450	290

Thanks to the tension jacks on the OP 010, drill-holes or screw holes are not needed.

This retaining method also enables the IP65 degree of protection (but only in conjunction with a circumferential seal and when the protective USB cap is fitted).

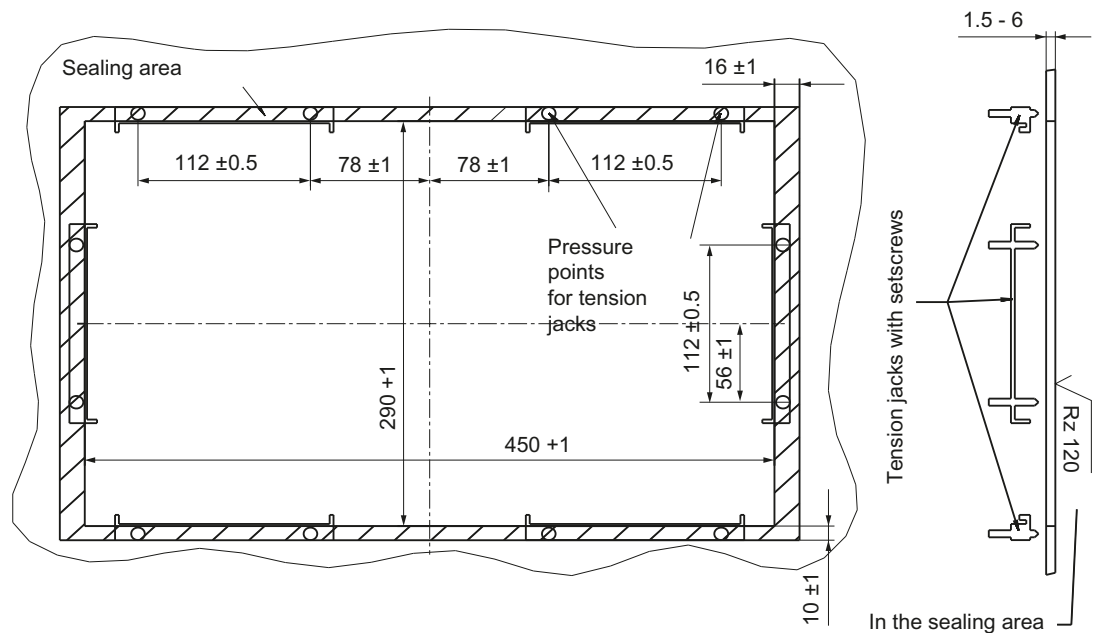

Figure 2-3 Dimension sheet for installing the OP 010 operator panel front

2.4 Mounting

Table 2- 2 Dimensions to be observed when installing

	Mounting depth T3 + clearance (mm)	Opening depth T5 (mm)	Protrusion P (mm)
PCU 50.3 / 50.5	101 + 10	377	39
TCU x0.2	50 + 10	350	-12

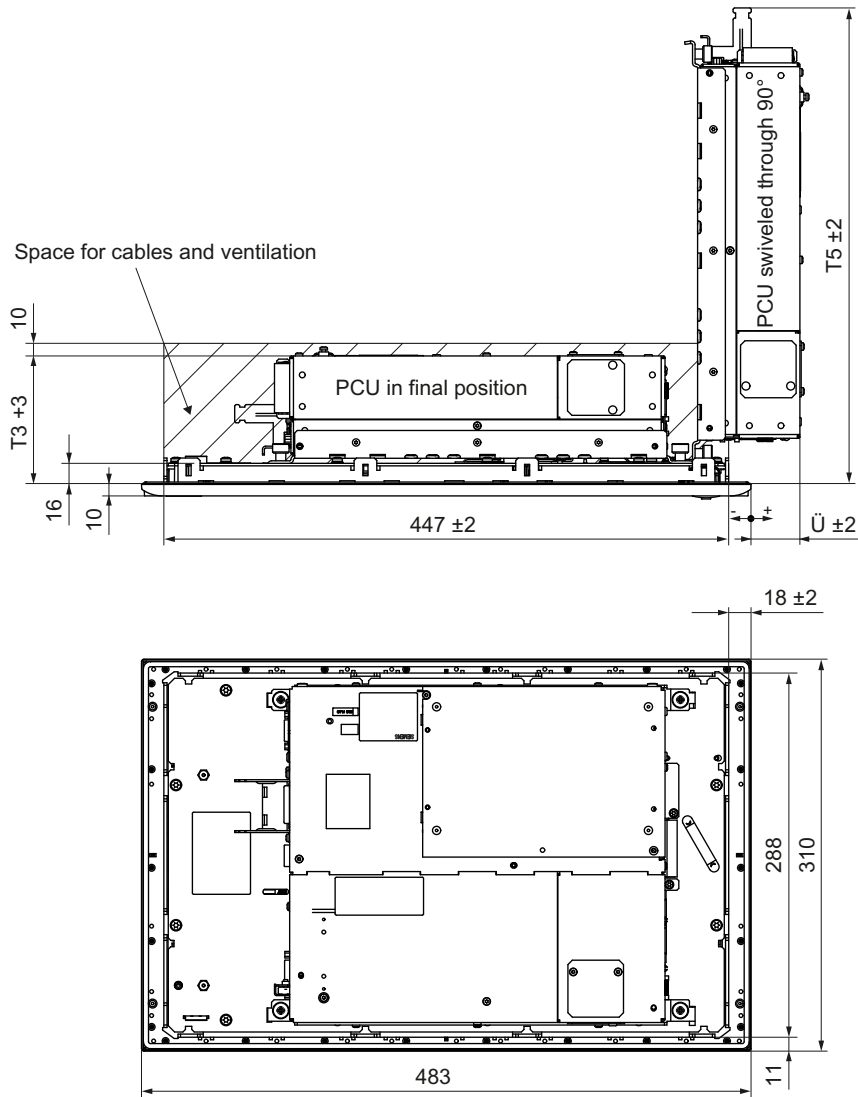

Figure 2-4 Dimension sheet for mounting the OP 010 with PCU

2.4.2 Assembling an OP 010 and a PCU

When combining an OP 010 and PCU, it is advisable to assemble them prior to installing them in the assembly panel.

Procedure

To do this, proceed as described in Section: "OP 012", Section: "Assembling the OP 012 and PCU".

2.4.3 Mounting on the mounting wall

The clearance at the rear of the PCU must be at least 10 mm to ensure sufficient ventilation (see Figure: "Attaching the PCU to the OP 012 operator panel front", Section: "OP 012", Section: "Assembling the OP 012 and PCU").

For more detailed information, please refer to the relevant PCU sections and in "General information and networking", Section: "Application planning", Section: "Climatic and mechanical environmental conditions" → "Cooling".

NOTICE
Impermissible mounting positions can cause malfunctions
Observe the permissible mounting position: Deviating by up to 5° from the vertical. This value can be further restricted by mounted components (PCU).

Procedure

1. Insert the assembled components (operator panel front and PCU) from the front into the panel cutout (see Figure 2-3 Dimension sheet for installing the OP 010 operator panel front (Page 35)).
2. Secure the operator panel front in the panel cutout from the rear using the tension jacks by tightening the setscrews (torque 0.4 - 0.5 Nm).

2.4.4 Softkey labeling

User-specific functions can be assigned to the horizontal and vertical softkey bars. Printed labeling strips can be used to label the softkeys.

Blank labels are already installed on delivery.

To make the labels, DIN-A4 film is available (Order No., see Section: "Spare parts").

Note

Use the "Arial" font to format text. This font is comparable to the "Univers S57" font, used by Siemens for the key labeling.

2.5 Technical data

Proceed as follows

1. Letter the mat side of the film using a laser printer.
2. Cut the printed labels along the preprinted lines.
3. Remove the PCU retaining screws and swing out the PCU away from the operator panel front.
4. Insert the strips into the slots provided on the rear side of the operator front panel.
5. Swing the PCU back to the operator panel and secure by tightening the screws.

If the operator panel front and PCU are dismantled, omit steps 3 and 5.

2.5 Technical data

Safety			
Safety class	III; PELV according to EN 50178		
Degree of protection according to EN 60529	Front side IP65 Rear side IP00		
Approvals	CE / cULus		
Electrical data			
Power supply (via K1 and K2)	Display	Backlight inverter	Logic / USB (with / without load)
Voltage Current (typ./max.)	5 V +/- 5% approx. 280/380 mA	12 V +/- 10% approx. 750/1000 mA	5.2 V +/- 2% approx. 350/1000 mA
Power consumption	Typical, approx. 10 W Maximum approx. 16 W		
Mechanical data			
Dimensions	Width: 483 mm	Height: 310 mm	Depth: 30 mm
Weight	approx. 5 kg		
Tightening torques, max.	Tension jack screws: 0.5 Nm	M3 screws: 0.8 Nm	M4 screws: 1.8 Nm
Display			
Size / resolution	10.4" / 640 x 480 pixels		
MTBF backlight	typ. 50,000 h at 25° C (dependent on the temperature)		

Note

Information about the climatic and mechanical environmental conditions is contained in the associated section under:

"General notes and interconnection" → "Operational planning".

2.6 Spare parts

2.6.1 Overview

The following diagram shows the OP 010 operator panel front dismantled into its individual parts.

The components provided with an order number are available as individual spare parts.

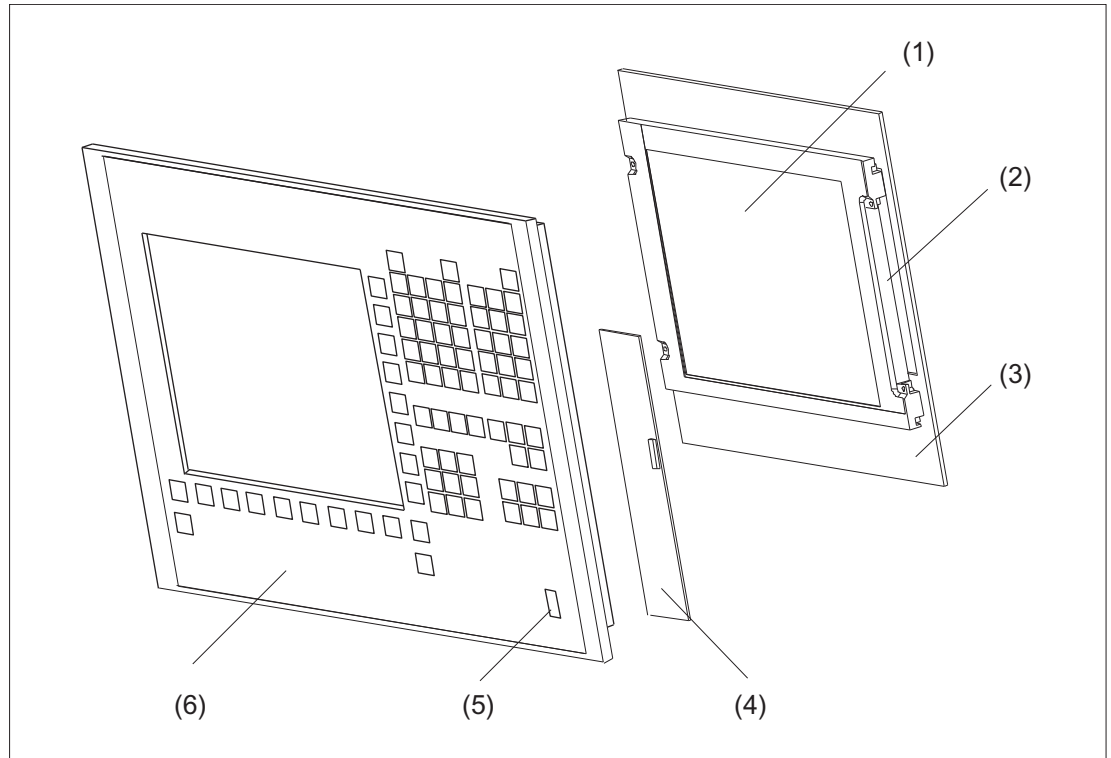

Figure 2-5 Individual parts for the OP 010 operator panel front

(1)	LCD unit		
(2)	Backlight with backlight inverter		
(3)	Display support		
(4)	Keyboard controller		
	Spare parts	Order number	Remarks
(5)	Cap for the USB port	6FC5248-0AF05-0AA0	Set of 10
(6)	Operator panel front without LCD unit	6FC5248-0AF00-0AA0	
	Tension jacks	6FC5248-0AF06-0AA0	Set of 6
	DIN A4 film	6FC5248-0AF07-0AA0	for slide-in labels for softkey labeling*) Set of 3

*) The dimensions for production of film slide-in labels for softkey labeling can be seen in the following diagram.

2.6 Spare parts

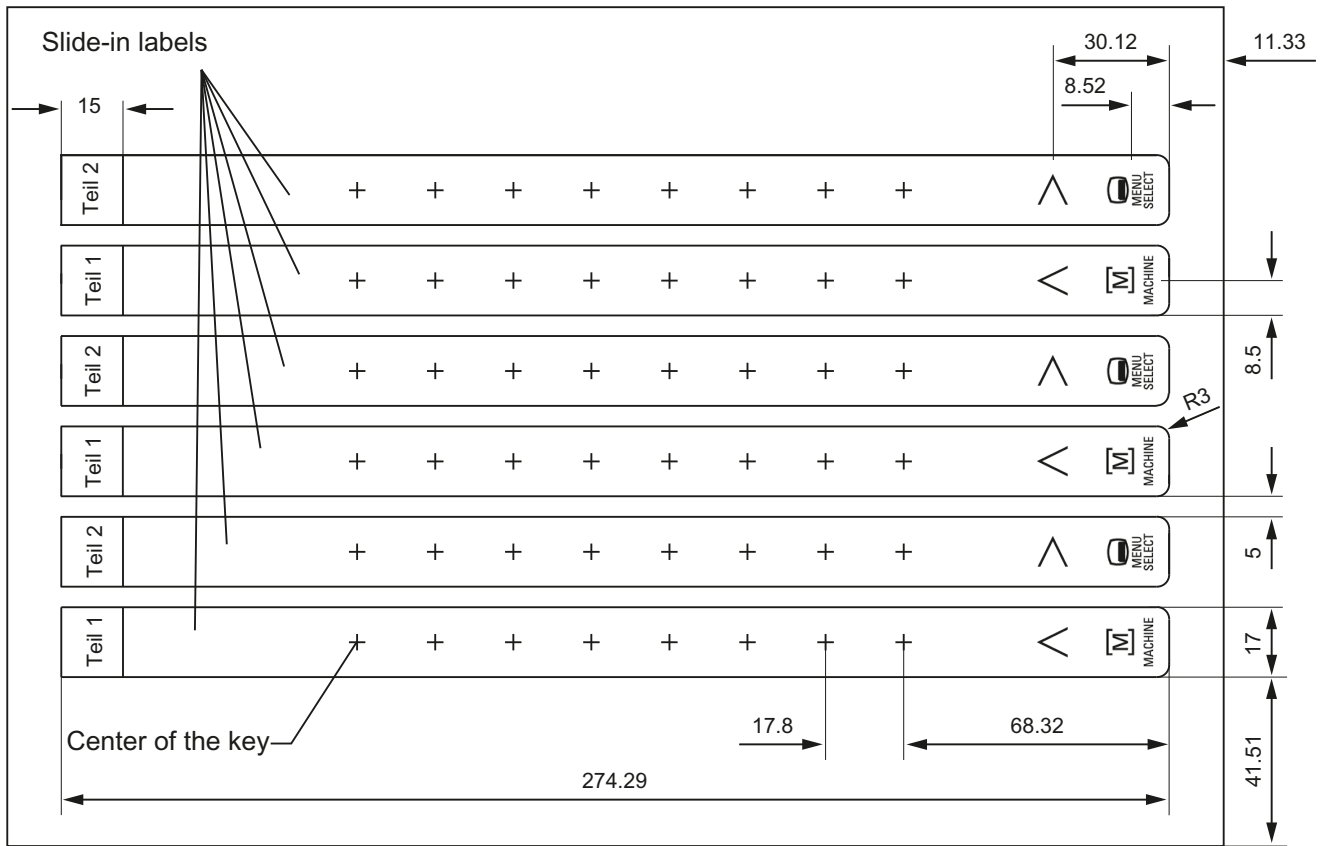

Figure 2-6 Dimensions for DIN A4 film

Note

The symbols for the four softkeys for navigation in the menus shown in the figure are not contained in the blank film. You can obtain the symbols from the "Symbols_OP08T_13.doc" document that accompanies the DOConCD. Alternatively, you can also use the "Template_OP010.pdf" file as print template also provided on the DOConCD - under **Separate supply > Slide-in labels > OP010**. To print the film, proceed as described in Section Printing the slide-in labels (Page 25).

2.6.2 Replacement

NOTICE
Risk of damage to sensitive components due to static electricity
Spare parts must always be replaced by properly trained personnel!

USB cap / tension jack

The replacement of the USB sealing cap and tension jacks will not be described since it is simple and self-explanatory.

Film labels

The procedure for replacement is as described in Section: "OP 012", Section: "Softkey labels".

Operator panel front

When replacing the operator panel front, the previous LCD unit and keyboard controller can be used again. They are therefore disassembled and reassembled after the appropriate component has been replaced.

Note

We recommend reusing the keypad controller to prevent any loss of the control parameters that have been programmed in.

Procedure

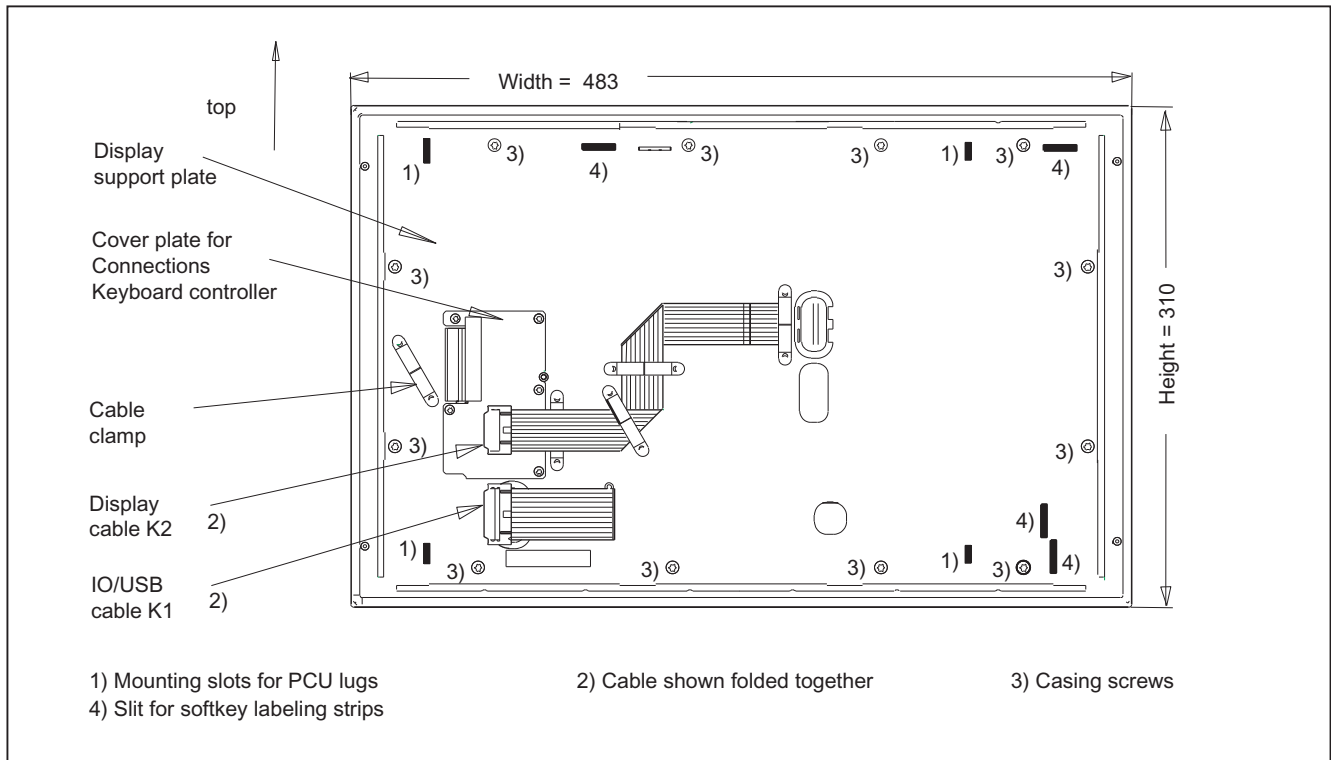

Figure 2-7 OP 010 rear side

1. Put the OP 010 face down on a flat, soft surface and loosen the 12 housing screws (see figure above).
2. Remove the softkey labeling strips and the cover plate.
3. Remove the following connectors from the keyboard controller (see following Figure): Backlight (socket X14) and I/O USB cable K1.
4. Lift off the display support with the display.
In addition to the keyboard controller, the rear sides of the mouse and USB interface become visible.
5. After bending back the two lugs, withdraw the USB interface.
6. Disconnect the three membrane connectors of the operator panel front keyboard from sockets X7, X8 and X10 (see note below for procedure).
7. Remove the retaining screws from the keyboard controller.

8. Lift USB interface and keyboard controller off the front plate. The interconnections may remain plugged.
9. Install the components into the new operator front panel in reverse order (procedure: see Note).

Note

Descriptions of how to disconnect and connect the membrane connector can be found in "General information and networking", Chapter: "Connecting", Section: "Handling membrane connectors".

When tightening the screws, observe the torques (refer to Section: "Technical data").

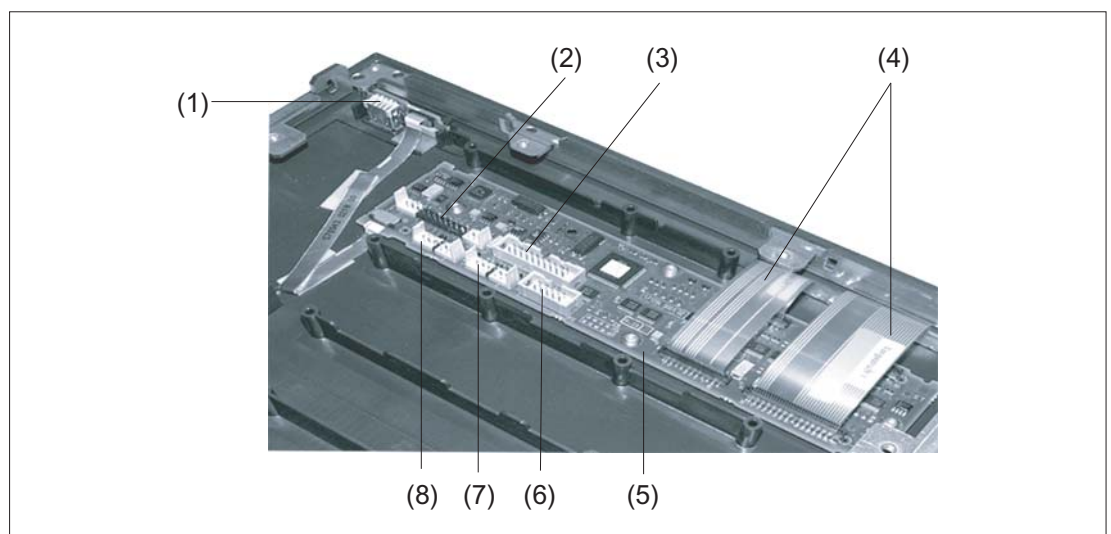

- (1) USB interface
- (2) Connection X1 for I/O USB cable K1
- (3) Direct key connection X11
- (4) Membrane connector for connecting the keyboard of the operator panel front
- (5) Keyboard controller
- (6) Connection X12 (reserved)
- (7) Connection X14 for backlight
- (8) Connection X4 for mouse

Figure 2-8 Changing the operator panel front

Operator panel front: OP 010S

3.1 Description

The slimline SINUMERIK OP 010S operator panel front and 10.4" TFT color display with a resolution of 640 x 480 pixels (VGA) features 8 +4 horizontal softkeys and 8 vertical softkeys.

It is fixed from the rear using special clamps that are included in the delivery scope.

Validity

The description below applies to the OP 010S operator panel front.
Order number 6FC5203-0AF04-0AA0

Features

The OP 010S operator panel front described in the following is characterized by:

- Mounting dimensions 310 x 330 mm
- Panel cutout (W x H): 285 x 304 mm
- Limited mounting depth
- 10.4" TFT flat screen (color) with VGA resolution 640 x 480 pixels
- Mechanical keys:
 - Eight horizontal softkeys
 - 8 vertical softkeys
 - Four control keys
- Status LEDs for power supply and overtemperature
- Front USB interface
- Degree of protection: IP54
- Attachment: Tension jacks at the rear
- Can be combined with PCU, TCU and a CNC full keyboard

3.2 Operating and display elements

3.2.1 View

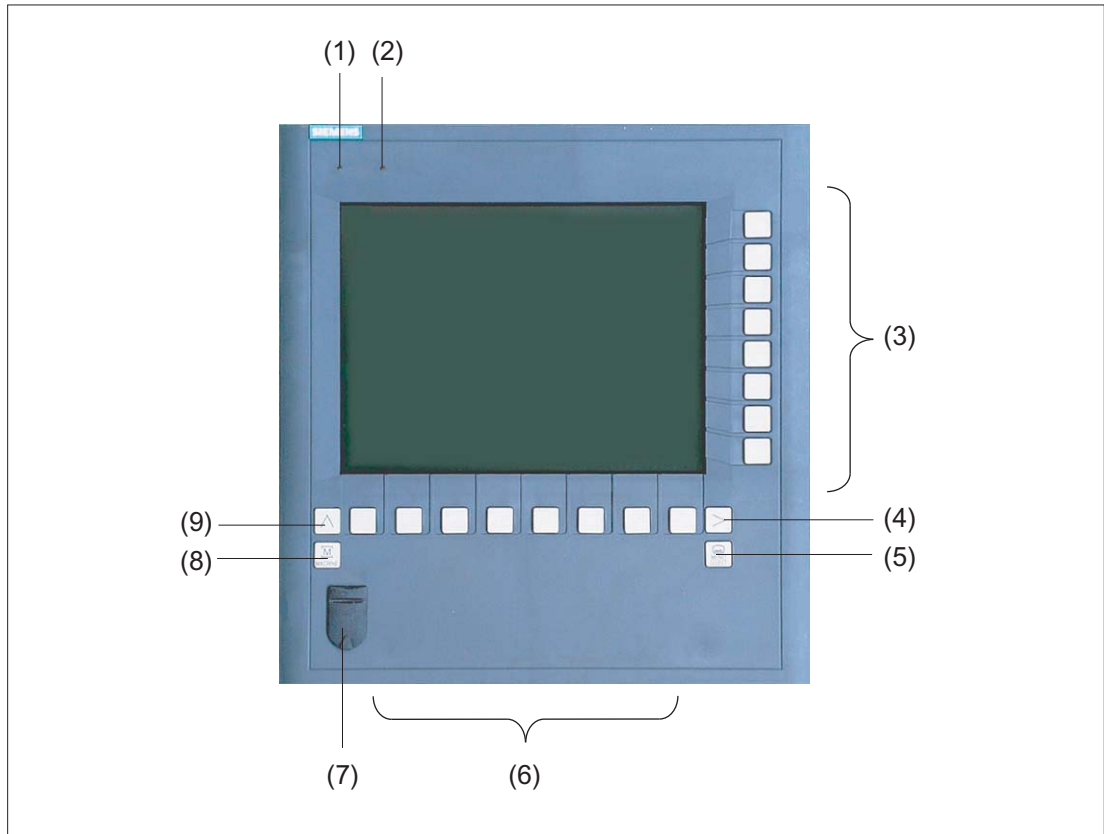

- (1) Status LED: POWER
- (2) Status LED: TEMP
Lit LEDs indicate increased wear.
- (3) Softkeys
- (4) Menu forward key
- (5) Menu select key
- (6) Softkeys
- (7) Front USB interface
- (8) Machine area key
- (9) Menu back key

Figure 3-1 View of OP 010S operator panel front





3.2.2 Keyboard

Keyboard

Several keys are arranged on the operator panel front:

- The eight vertical and horizontal softkeys call up functions that are available on screen via a menu bar.
- The "Menu back" key switches back to the higher-level horizontal menu.
- The "Menu forward" key advances in the extended horizontal softkey bar.
- The "Menu select" key calls the main menu to select the operating area.
- The "Machine area" key selects the "Machine" operating area.

The key symbols used on the operator panel front are shown below along with the corresponding function keys on the PC keyboard.

Key	Function corresponds to the PC key function	Key	Function corresponds to the PC key function
	<Shift> F9		F9
	<Shift> F10		F10

Display

Note

Pixel error according to DIN EN ISO 13406-2 Class II.

3.2.3 Screen saver

If a screen with high contrast is displayed unchanged for longer than an hour, the screen must be switched dark (screensaver) in order to protect the TFT display against so-called "freezing" of the last displayed screen.

The time can be adapted individually. Further information can be found at:
IM9 SINUMERIK Operate Commissioning Manual

3.3 Interfaces

This operator panel front has the following interfaces:

Front

USB 1.1 (type A) for connecting an external keyboard, mouse and USB FlashDrive (see Fig.: "View of operator panel front" in Section: "Control and display elements" → "View").

Note

Note that the electromagnetic compatibility of commercially available peripheral devices operated via the USB interface is usually rated for office use only.

For industrial use, components with a higher degree of certification are recommended.

Rear side

- Two ribbon cables for connecting the PCU (see figure below):
 - I/O–USB cable K1 (ribbon cable):
All signals that are used for the display interface and the connection of operator panel fronts (e.g. supply voltages)
 - Display cable K2

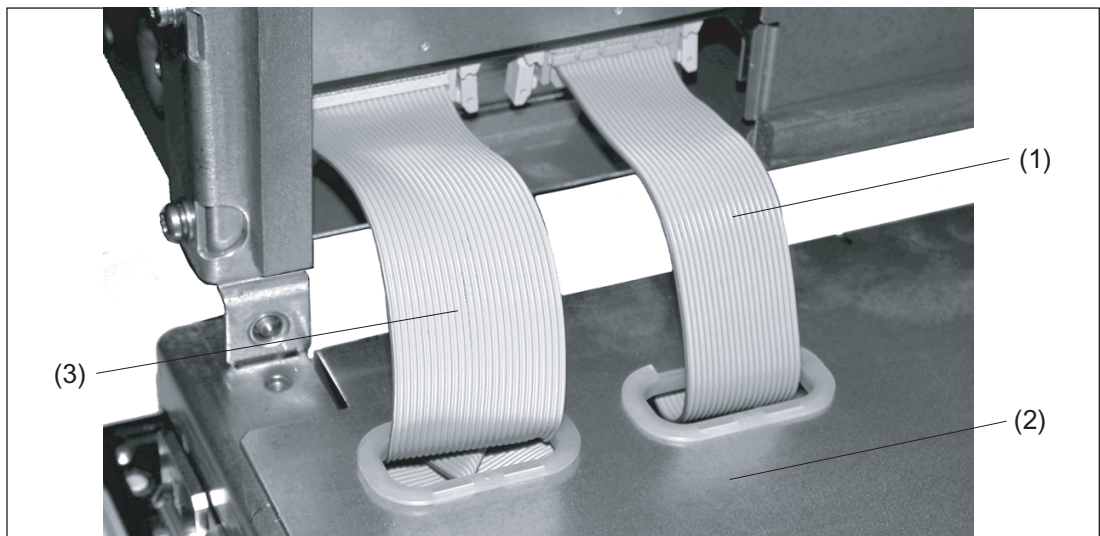

- (1) Display cable K2
- (2) Rear of operator panel
- (3) I/O USB cable K1

Figure 3-2 Connections on rear of housing Connections to the PCU

Pin assignment

For more detailed information, see "General information and networking", Chapter: "Connecting".

3.4 Mounting

3.4.1 Preparation for mounting

Table 3- 1 Dimensions of the mounting opening

Width (mm)	Height (mm)	Mounting depth T3 + clearance (mm)	
		285	304
		With TCU x0.2	69 + 10

Thanks to the tension jacks on the OP 010S, drill-holes or screw holes are not needed.

This retaining method also enables the IP65 degree of protection (but only in conjunction with a circumferential seal and when the protective USB cap is fitted).

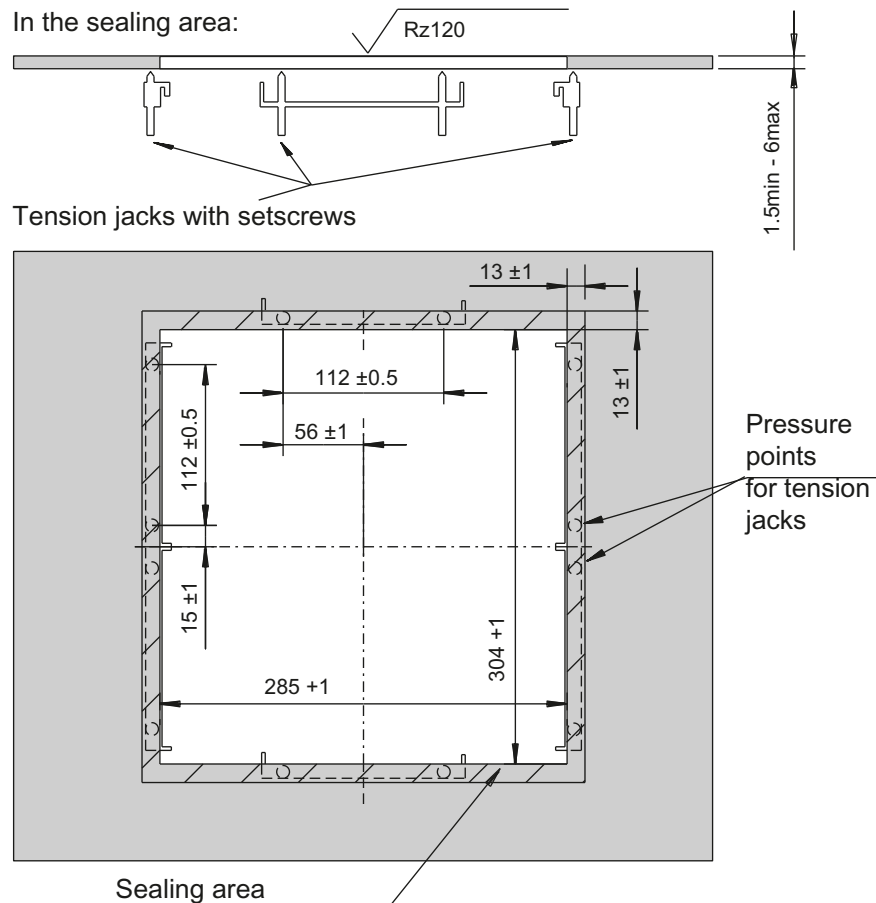

Figure 3-3 Dimension sheet for installing the OP 010S operator panel front

3.4 Mounting

3.4.2 Mounting on the mounting wall

When you are using a combination of OP 010S and PCU, it is advisable to install the OP 010S in the assembly panel first and then mount the PCU on the OP 010S.

NOTICE

Impermissible mounting positions can cause malfunctions

Observe the permissible mounting position: Deviating by up to 5° from the vertical.

This value can be further restricted by mounted components (e.g. PCU).

Procedure

1. Insert the OP 010S in the panel cutout from the front.
2. Use six tension jacks to secure it in the panel cutout from the rear (see Figure 3-3 Dimension sheet for installing the OP 010S operator panel front (Page 49)).
3. Tighten the setscrews (tightening torque 0.4 - 0.5 Nm).

3.4.3 Assembling an OP 010S and a PCU

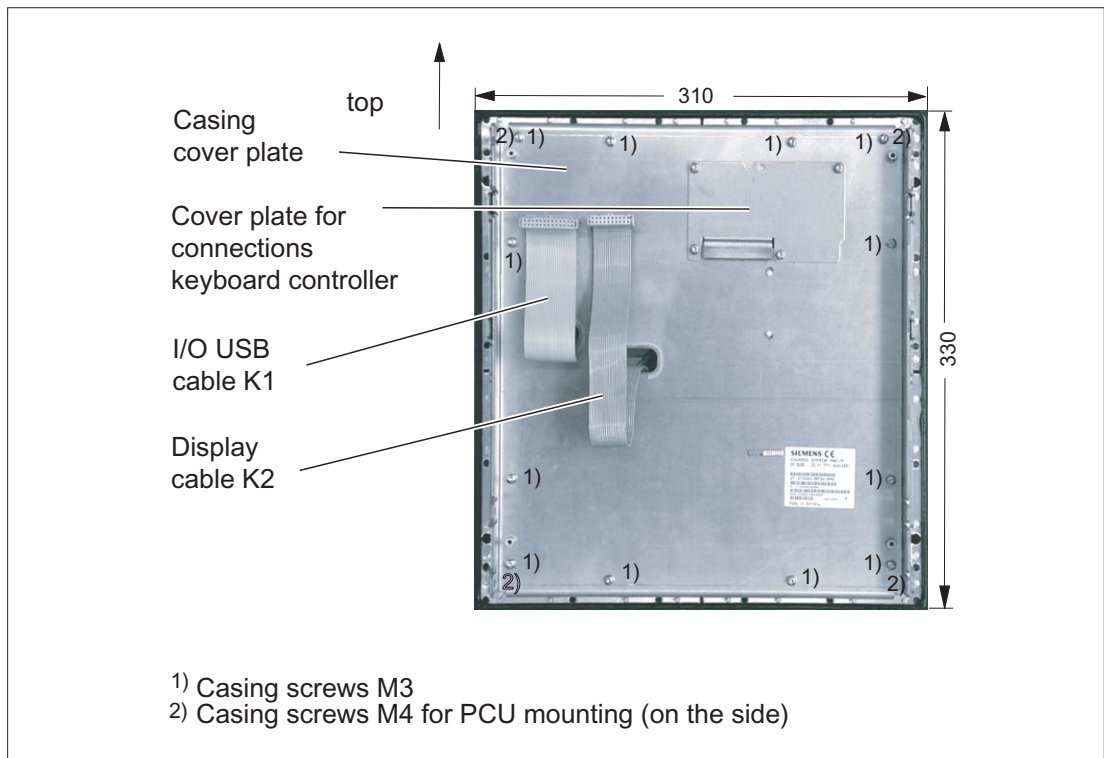

Figure 3-4 Rear side of operator panel front with arrangement of interfaces and mounting screws

Procedure

1. Position the PCU almost at right-angles to the OP (see figure in Section: "Interfaces").
2. Insert cable connectors K1 and K2 of the OP into the corresponding counterpieces behind the opening in the PCU housing.
Ensure that the connectors snap in and that the locks are closed.
3. Fold the PCU onto the OP.
4. Using the four M3 and four M4 screws supplied, attach the PCU to the side of the OP (tightening torques: M3 0.8 Nm; M4 1.8 Nm).

The clearance at the rear of the PCU must be at least 10 mm to ensure sufficient ventilation (see following Figure).

For more detailed information, please refer to the relevant PCU sections and in "General information and networking", Section: "Application planning", Section: "Climatic and mechanical environmental conditions" → "Cooling".

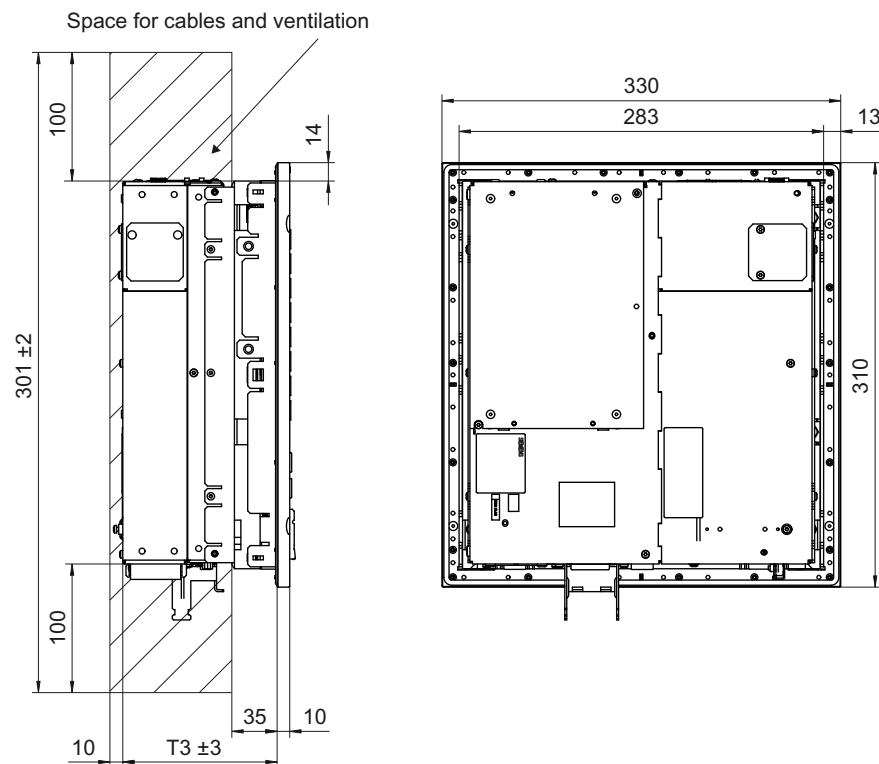

Figure 3-5 Mounting the PCU to the OP 010S operator panel front with clearances

Note

The OP 010S and TCU assembly is similar to that for a PCU.

3.5 Technical data

Safety			
Safety class	III; PELV according to EN 50178		
Degree of protection according to EN 60529	Front side IP54 Rear side IP00		
Approvals	CE / cULus		
Electrical data (without PCU)			
Power supply (via K1 and K2)	Display	Backlight inverter	Logic / USB (with / without load)
Voltage	5 V +/- 5%	12 V +/- 10%	5.2 V +/-2%
Current (typ./max.)	approx. 420/600 mA	approx. 900/1050 mA	approx. 350/1000 mA
Power consumption	Typical, approx. 10 W Maximum approx. 16 W		
Mechanical data			
Dimensions	Width: 310 mm	Height: 330 mm	Depth: 45 mm
Weight	approx. 5.5 kg		
Tightening torques, max.	Tension jack screws: 0.5 Nm	M3 screws: 0.8 Nm	M4 screws: 1.8 Nm
Display			
Size / resolution	10.4" TFT / 640 x 480 pixels		
MTBF backlight	typ. 50,000 h at 25° C (dependent on the temperature)		

Note

Information about the climatic and mechanical environmental conditions is contained in the associated section under:

"General notes and interconnection" → "Operational planning".

3.6 Spare parts

3.6.1 Overview

The diagram shows the OP 010S operator panel front dismantled into its individual parts.

The components provided with an order number are available as individual spare parts.

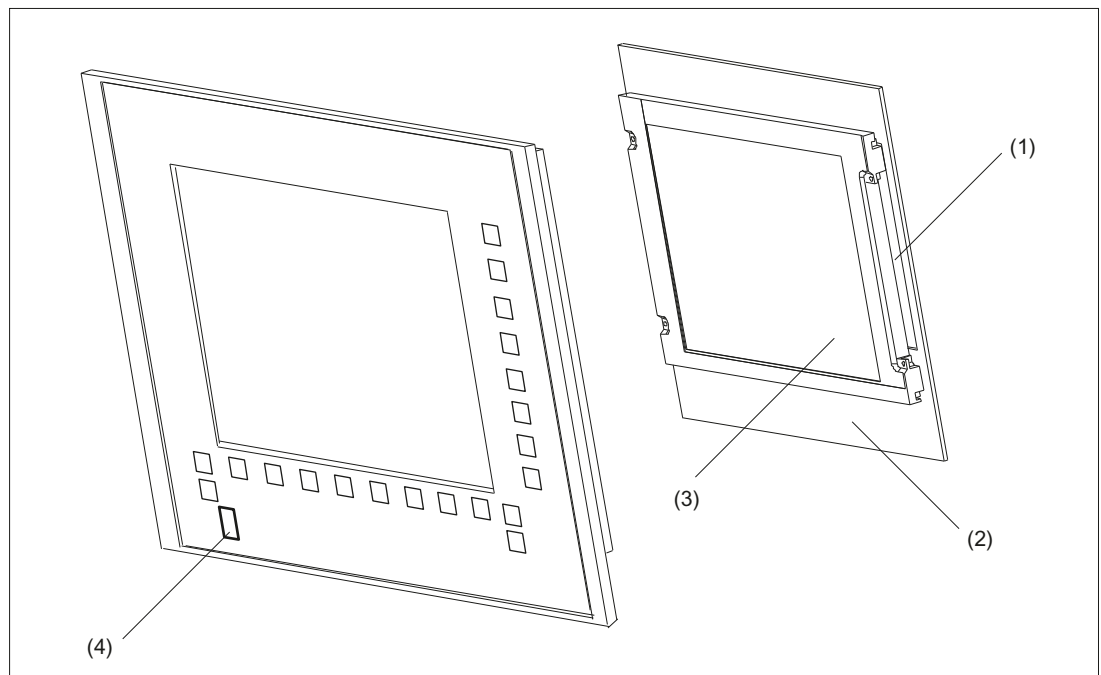

Figure 3-6 Individual parts for the OP 010S operator panel front

	Spare parts	Order number	Remarks
(1)	Backlight with backlight inverter		
(2)	Display holder with keyboard controller (rear side)		
(3)	LCD unit		
	Spare part	Order No.	Remark
(4)	Cap for the USB port	6FC5248-0AF05-0AA0	Set of 10
	Tension jacks	6FC5248-0AF06-0AA0	Set of 6

3.6.2 Replacement

NOTICE

Risk of damage to sensitive components due to static electricity

Spare parts must always be replaced by properly trained personnel!

USB cap / tension jack

The replacement of the USB sealing cap and tension jacks will not be described since it is simple and self-explanatory.

Operator panel front: OP 010C

4.1 Description

The SINUMERIK OP 010C operator panel front and 10.4" TFT color display with a resolution of 640 x 480 pixels (VGA) features a 65-key mechanical keypad with 8 + 4 horizontal softkeys and 8 vertical softkeys.

The 6 hotkeys are designed with replaceable key covers for machine-specific adaptation. The key covers can be freely inscribed using a laser.

The operator panel front is secured from the rear using special clamps supplied with the panel.

Validity

The description below applies to the OP 010C operator panel front.
Order number 6FC5203-0AF01-0AA0

Features

- 19" mounting format, 7 HU (height units)
- Panel cutout (W x H): 450 x 290 mm
- Limited mounting depth
- 10.4" TFT flat screen (color) with VGA resolution 640 x 480 pixels
- Mechanical short-stroke keys with alphabetic, numeric, cursor, control and hotkey key group
- Softkeys:
 - 1 horizontal row of 8 keys with softkey functions
 - 1 vertical row of 8 keys with softkey functions
- Shift key for switchover to the second key level (not for switching over the letters, since they are uppercase only)
- Status LEDs for power supply and overtemperature
- Front USB interface
- Degree of protection IP 54
- Attachment: Tension jacks at the rear
- Can be combined with PCU, TCU

4.2 Operating and display elements

4.2.1 View

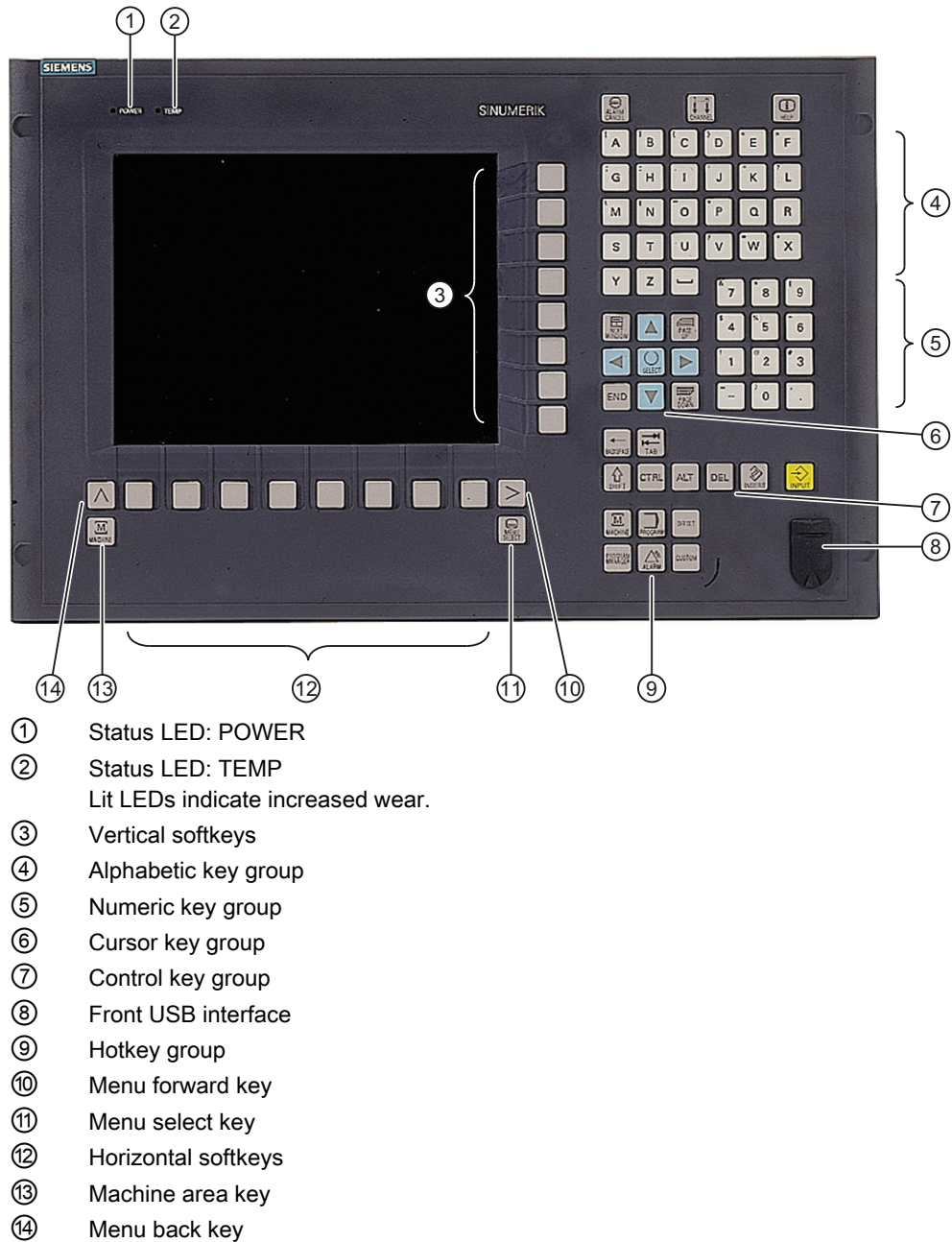

Figure 4-1 View of operator panel front OP 010C

4.2.2 Keyboard

Keyboard

Several keys and keypads are installed on the OP 010C operator panel front:

- The alphabetic block contains the letters A - Z and the space character.
- The numeric block contains the digits 0 - 9, and the characters "-" and ".".
- The cursor key group is used to navigate on the screen.
- The control key group includes special functions.
- The hotkey group is used for the direct selection of operating areas.
- The softkeys call up functions that are available on the screen via a menu bar.
- The "Menu back" key switches back to the higher-level horizontal menu.
- The "Menu forward" key advances in the extended horizontal softkey bar.
- The "Menu select" key calls the main menu to select the operating area.
- The "Machine area" key selects the "Machine" operating area.































Switching between upper and lower case

To toggle between upper and lower case letters, press the key combination Ctrl + Shift

Upper case is always activated as standard.

Overview of the key symbols

The key symbols used on the operator panel front are shown below along with the corresponding function keys on the PC keyboard.

Key	Function corresponds to the PC key function	Key	Function corresponds to the PC key function
	Esc		End
	F11		Backspace
	F12		Tab
	Space		(only intended for internal keyboard changeover)
	Home		Ctrl key
	Page up		Alt key
	Page down		Delete
	Cursor up		Insert
	Cursor left		Enter
	Cursor right		F9
	Cursor down		F10
	5 (in numeric key group)	A, ..., Z	<Shift> A, ..., Z
	<Shift> F9		<Shift> F10
			
			
			

Display

Note

Pixel error according to DIN EN ISO 13406-2 Class II.

4.2.3 Screen saver

If a screen with high contrast is displayed unchanged for longer than an hour, the screen must be switched dark (screensaver) in order to protect the TFT display against so-called "freezing" of the last displayed screen.

The time can be adapted individually. Further information can be found at:
IM9 SINUMERIK Operate Commissioning Manual

4.3 Interfaces

This operator panel front has the following interfaces:

Front side

USB 1.1 (type A) for connecting an external keyboard, mouse and USB FlashDrive (see Fig.: "View of operator panel front" in Section: "Control and display elements" → "View").

Note

Note that the electromagnetic compatibility of commercially available peripheral devices operated via the USB interface is usually rated for office use only.

For industrial use, components with a higher degree of certification are recommended.

Rear side

- Two flat ribbon cables for connecting the PCU:
 - I/O USB cable K1
all signals that are used for the display interface and the connection of operator panel fronts (e.g. supply voltages)
 - Display cable K2
- Direct key interface X11 (under cover plate)
- Interface X12 - reserved (under the cover plate)

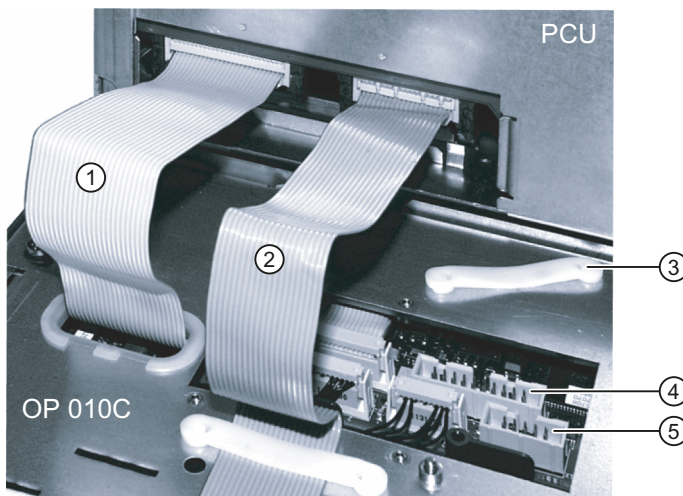

- ① I/O USB cable K1
- ② Display cable K2
- ③ Retainer for direct control key module connection
- ④ Direct key interface X11
- ⑤ Interface X12 (reserved)

Figure 4-2 Connections on rear of housing Connections to PCU

Pin assignment

For more detailed information, see "General information and networking", Chapter: "Connecting".

4.4 Mounting

4.4.1 Preparation for mounting

Table 4- 1 Dimensions of the mounting opening

Width (mm)	Height (mm)
450	290

Thanks to the tension jacks on the OP 010C, drill-holes or screw holes are not needed.

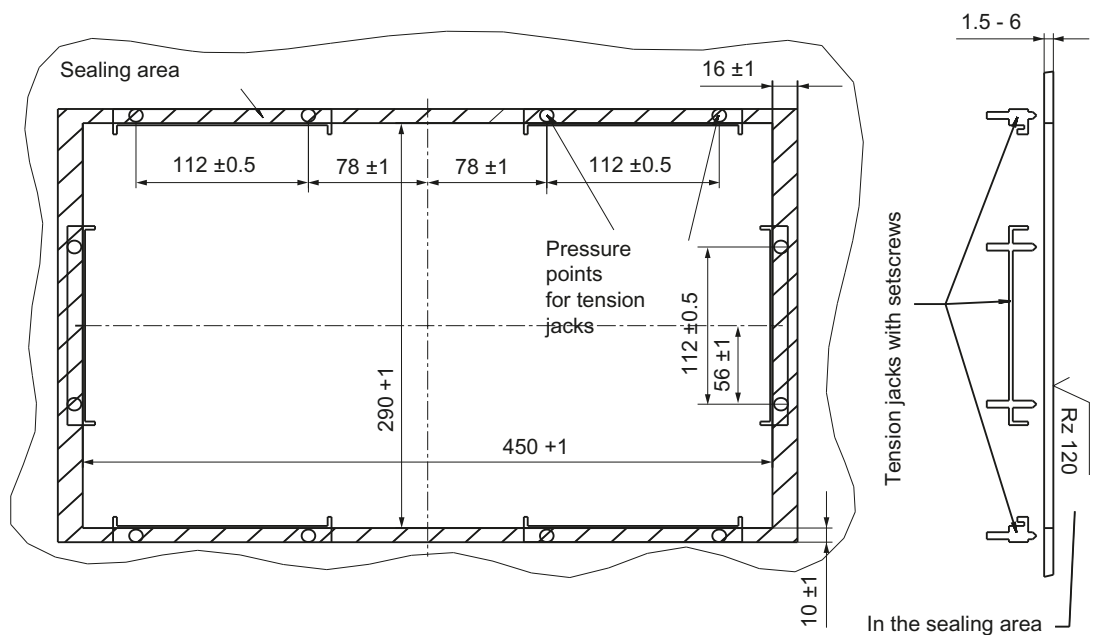

Figure 4-3 Dimension sheet for installing the OP 010C operator panel front

4.4 Mounting

Table 4- 2 Dimensions to be observed when installing

	Mounting depth T3 + clearance (mm)	Opening depth T5 (mm)	Protrusion P (mm)
PCU 50.3 / 50.5	101 + 10	377	39
TCU x0.2	50 + 10	350	-12

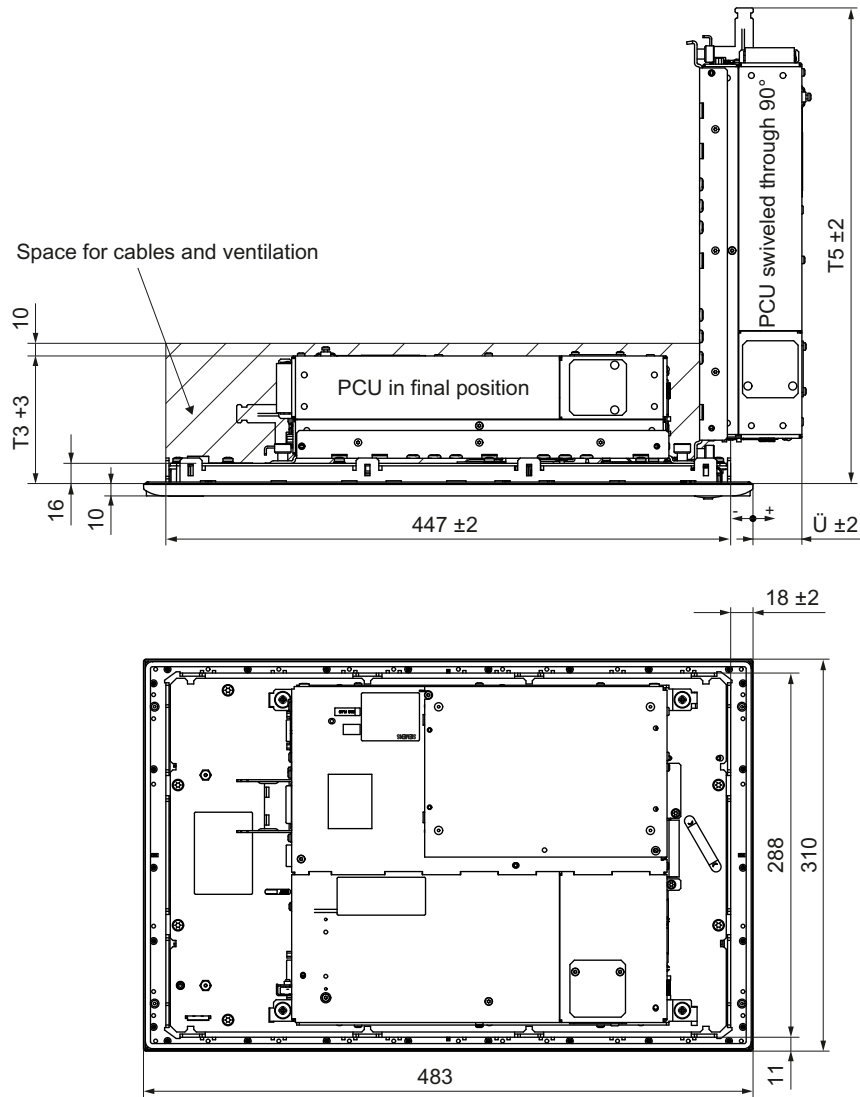

Figure 4-4 Dimension sheet for mounting the OP 010C with PCU

4.4.2 Assembling an OP 010C and a PCU

When combining an OP 010C and PCU, it is advisable to assemble them prior to installing them in the assembly panel.

Procedure

To do this, proceed as described in the section: "OP 012", section: "Assembling the OP 012 and PCU."

4.4.3 Mounting on the mounting wall

The clearance at the rear of the PCU must be at least 10 mm to ensure sufficient ventilation (see Figure: "Attaching the PCU to the OP 012 operator panel front", Section: "OP 012", Section: "Assembling the OP 012 and PCU").

For more detailed information, please refer to the relevant PCU sections and in "General information and networking", Section: "Application planning", Section: "Climatic and mechanical environmental conditions" → "Cooling".

NOTICE
Impermissible mounting positions can cause malfunctions
Observe the permissible mounting position: Deviating by up to 5° from the vertical.
This value can be further restricted by mounted components (e.g. PCU).

Procedure

1. Insert the assembled components (operator panel front and PCU) from the front into the panel cutout (see Figure 4-3 Dimension sheet for installing the OP 010C operator panel front (Page 61)).
2. Secure the operator panel front in the panel cutout from the rear using the tension jacks by tightening the setscrews (torque 0.4 - 0.5 Nm).

4.5 Technical data

Safety			
Safety class	III; PELV according to EN 50178		
Degree of protection according to EN 60529	Front side IP54 Rear side IP00		
Approvals	CE / cULus		
Electrical data			
Power supply (via K1 and K2)	Display	Backlight inverter	Logic / USB (with / without load)
Voltage Current (typ./max.)	5 V +/- 5% approx. 280/380 mA	12 V +/- 10% approx. 750/1000 mA	5.2 V +/- 2% approx. 350/1000 mA
Power consumption	Typical, approx. 10 W Maximum approx. 16 W		
Mechanical data			
Dimensions	Width: 483 mm	Height: 310 mm	Depth: 30 mm
Weight	Approx. 5 kg		
Tightening torques, max.	Tension jack screws: 0.5 Nm	M3 screws: 0.8 Nm	M4 screws: 1.8 Nm
Display			
Size / resolution	10.4" TFT / 640 x 480 pixels		
MTBF backlight	typ. 50,000 h at 25° C (dependent on the temperature)		

Note

Information about the climatic and mechanical environmental conditions is contained in the associated section under:

"General notes and interconnection" → "Operational planning".

4.6 Spare parts

4.6.1 Overview

The diagram shows the OP 010C front plate as an individual part.

The components available as spare parts are combined in one overview

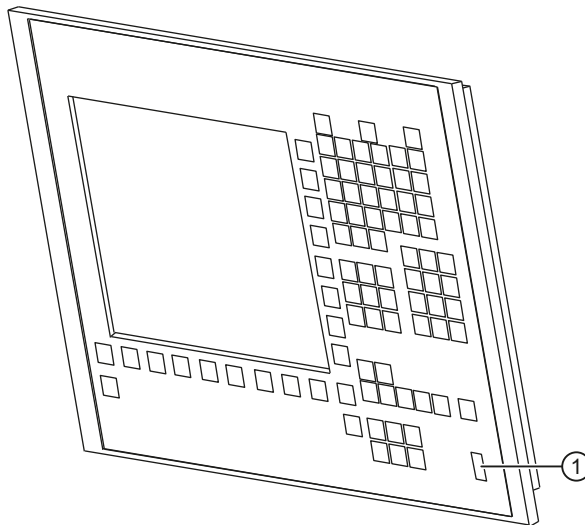

Figure 4-5 Front plate of OP 010C

	Spare parts	Order number	Remarks
(1)	Cap for the USB port	6FC5248-0AF05-0AA0	Set of 10
	Key cover (for labeling)	6FC5248-0AF12-0AA0	Set with 90 ergo-gray items 20 red items 20 yellow items 20 green items 20 medium gray items
	Tension jacks	6FC5248-0AF06-0AA0	Set of 6

Operator panel front: OP 012

5.1 Description

The SINUMERIK OP 012 operator panel front and 12.1" TFT color display with a resolution of 800 x 600 pixels (SVGA) features a 59-key membrane keypad as well as 2 x (8 + 2) horizontal and 2 x 8 vertical softkeys. The 2 x 8 vertical softkeys can be used as direct keys.

It is fixed from the rear using special clamps that are included in the delivery scope.

Validity

The description below applies to the OP 012 operator panel front.
Order number 6FC5203-0AF02-0AA1

Features

- 19" mounting format, 7 HU (height units)
- Panel cutout (W x H): 450 x 290 mm
- Limited mounting depth
- 12.1" TFT flat screen (color) with SVGA resolution 800 x 600 pixels
- Membrane keyboard with alphabetic, numeric, cursor, and control keypad
- Soft keys/direct keys:
 - 2 x 8 horizontal rows of keys with softkey function
 - 2 x 8 vertical rows of keys with softkey and direct key functions
 - Direct keys via direct key / handwheel module (optional), machine control panel, TCU or directly connectable to the I/Os
- Shift key for switchover to the second key level (not for switching over the letters, since they are uppercase only)
- Integrated mouse
- Status LEDs for power supply and overtemperature
- Front USB interface
- Degree of protection IP65
- Attachment: Tension jacks at the rear
- Can be combined with PCU, TCU

5.2 Operating and display elements

5.2.1 View

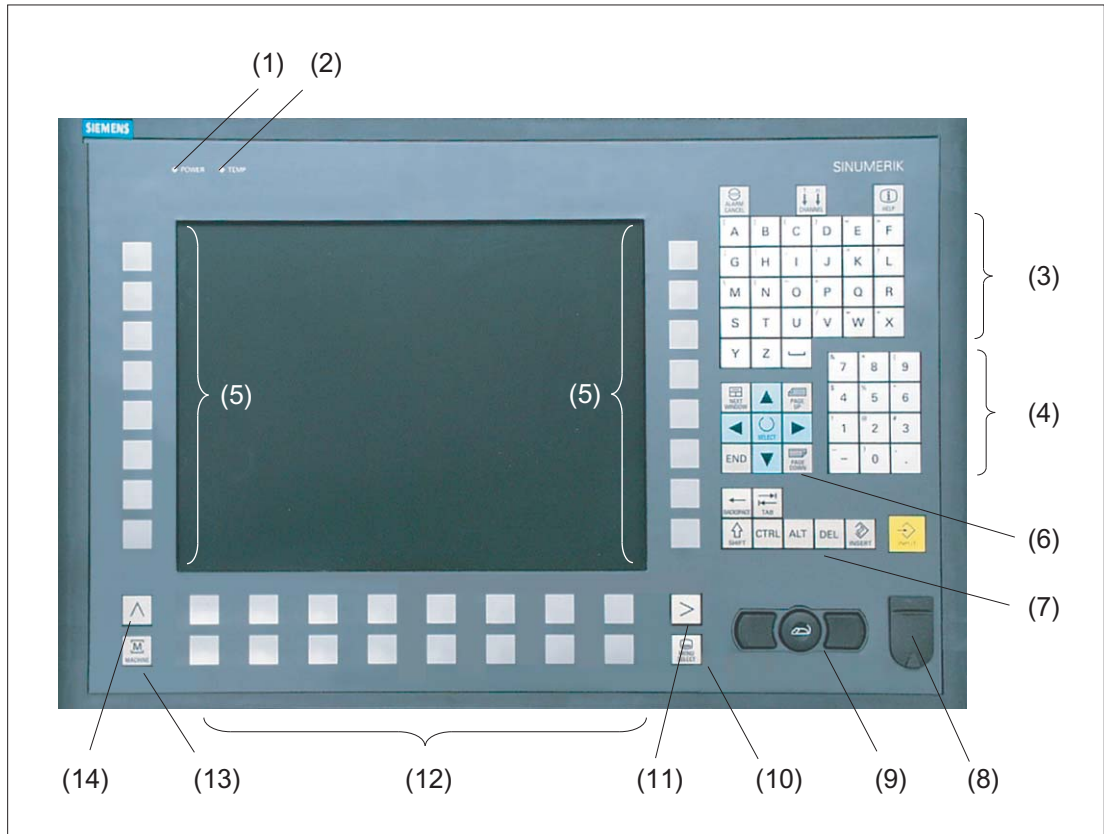

- (1) Status LED: POWER
- (2) Status LED: TEMP
Lit LEDs indicate increased wear.
- (3) Alphabetic key group
- (4) Numeric key group
- (5) Softkeys and direct keys
- (6) Cursor key group
- (7) Control key group
- (8) Front USB interface
- (9) Mouse
- (10) Menu select key
- (11) Menu forward key
- (12) Softkeys
- (13) Machine area key
- (14) Menu back key

Figure 5-1 Front view of operator panel front OP 012

5.2.2 Keyboard

Keyboard

Several keys and keypads are installed on the operator panel front:

- The alphabetic block contains the letters A - Z and the space character.
- The numeric block contains the digits 0 - 9, and the characters "-", "/", "=", "+" and ".".
- The cursor key group is used to navigate on the screen.
- The control key group includes special functions.
- The mouse comprises the center actuation field (corresponds to the function of a tracker ball) and two keys for the left and right mouse key.
- The softkeys call up functions that are available on the screen via a menu bar.
- The "Menu back" key switches back to the higher-level horizontal menu.
- The "Menu forward" key advances in the extended horizontal softkey bar.
- The "Menu select" key calls the main menu to select the operating area.
- The "Machine area" key selects the "Machine" operating area.

























Switching between upper and lower case

To toggle between upper and lower case letters, press the key combination Ctrl + Shift

Upper case is always activated as standard.

Overview of the key symbols

The key symbols used on the operator panel front are shown in the overview along with the corresponding function keys on the PC keyboard.

Key	Function corresponds to the PC key function	Key	Function corresponds to the PC key function
	Esc		End
	F11		Backspace
	F12		Tab
	Space		(only intended for internal keyboard changeover)
	Home		Ctrl key
	Page up		Alt key
	Page down		Delete
	Cursor up		Insert
	Cursor left		Enter
	Cursor right		F9
	Cursor down		F10
	5 (in numeric key group)	A, ..., Z	<Shift> A, ..., Z
	<Shift> F9		<Shift> F10

Display

Note

Pixel error according to DIN EN ISO 13406-2 Class II.

5.2.3 Screen saver

If a screen with high contrast is displayed unchanged for longer than an hour, the screen must be switched dark (screensaver) in order to protect the TFT display against so-called "freezing" of the last displayed screen.

The time can be adapted individually. Further information can be found at:
IM9 SINUMERIK Operate Commissioning Manual

5.3 Interfaces

The operator panel front has the following interfaces:

Front side

USB 1.1 (type A) for connecting an external keyboard, mouse and USB FlashDrive (see Figure: "View of operator panel front" in Section: "Control and display elements" → "View").

Note

Note that the electromagnetic compatibility of commercially available peripheral devices operated via the USB interface is usually rated for office use only.

For industrial use, components with a higher degree of certification are recommended.

Rear side

- Two ribbon cables for connecting the PCU (see figure below):
 - I/O USB cable K1 (ribbon cable):
All signals that are used for the display interface and the connection of operator panel fronts (e.g. supply voltages)
 - Display cable K2
- Direct key interface X11 (under the cover plate); signals from the 16 "vertical softkey" direct keys
- Interface X12 – reserved (under the cover plate)

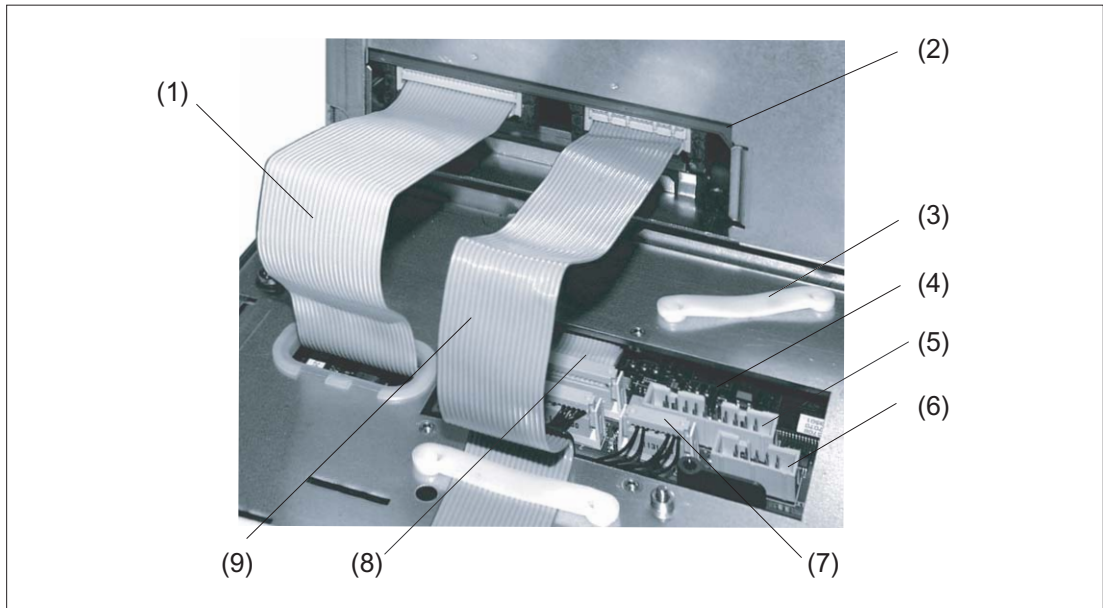

- (1) I/O USB cable K1
- (2) PCU main board
- (3) Cable clamp for connecting the direct key module
- (4) Keyboard controller
- (5) Direct key interface X11
- (6) Interface X12 (reserved)
- (7) Connection X14 for backlight
- (8) Connection X1 for I/O USB cable K1
- (9) Display cable K2

Figure 5-2 Connections on rear of housing: Connections to the PCU

Pin assignment

For more detailed information, see "General information and networking", Chapter: "Connecting".

5.4 Mounting

5.4.1 Preparation for mounting

Table 5- 1 Dimensions of the mounting opening

Width (mm)	Height (mm)
450	290

Thanks to the tension jacks on the OP 012, drill-holes or screw holes are not needed.

This retaining method also enables the IP65 degree of protection (but only in conjunction with a circumferential seal and when the protective USB cap is fitted).

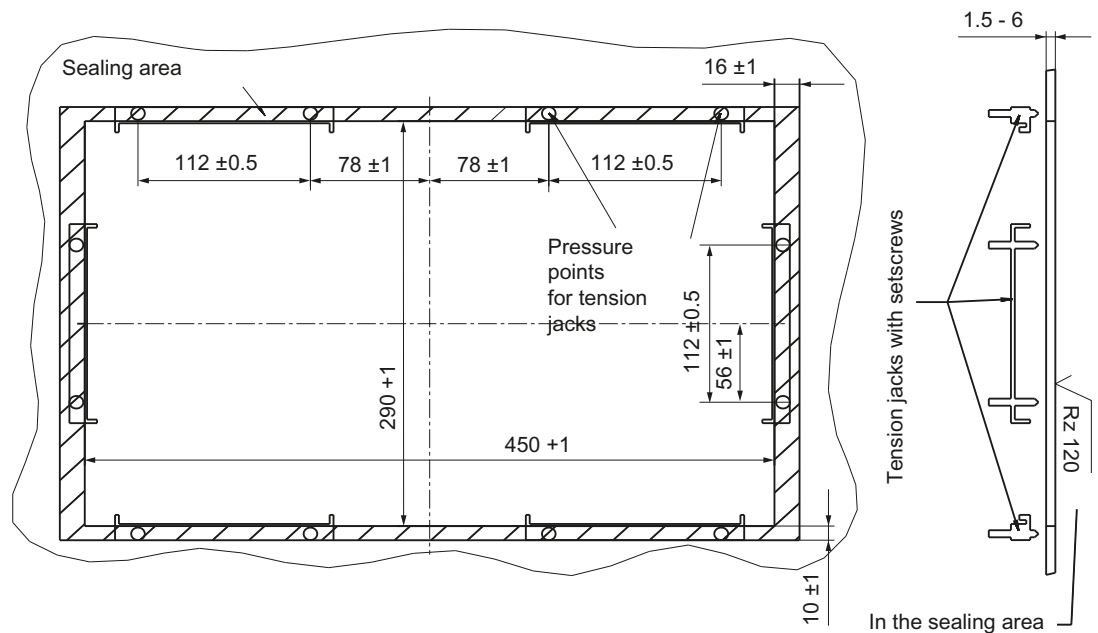

Figure 5-3 Dimension sheet for installing the OP 012 operator panel front

Table 5-2 Dimensions to be observed when installing

	Mounting depth T3 + clearance (mm)	Opening depth T5 (mm)	Protrusion P (mm)
PCU 50.3 / 50.5	101 + 10	377	39
TCU x0.2	50 + 10	350	-12

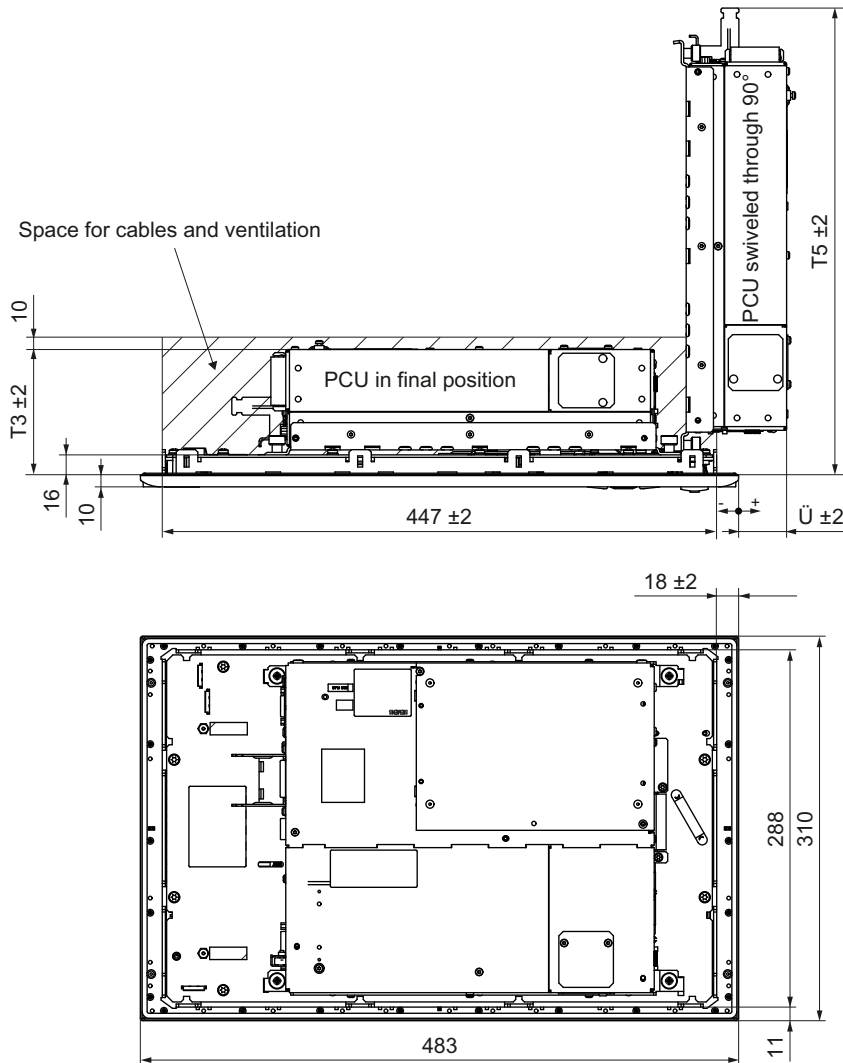

Figure 5-4 Dimension sheet for attaching the PCU to the OP 012 operator panel front

5.4.2 Assembling an OP 012 and a PCU

- When combining an OP 012 and PCU and possibly a direct key module, it is advisable to assemble them prior to installation in an assembly panel.
- When combining with a PCU 50.3, you must then undo the transport lock for the hard-drive, otherwise the system will not boot.

Requirement

The PCU must now be bolted to the mounting brackets prior to assembly (if this has not already been done) (see section: "PCU 50.3", Section: "Mounting")

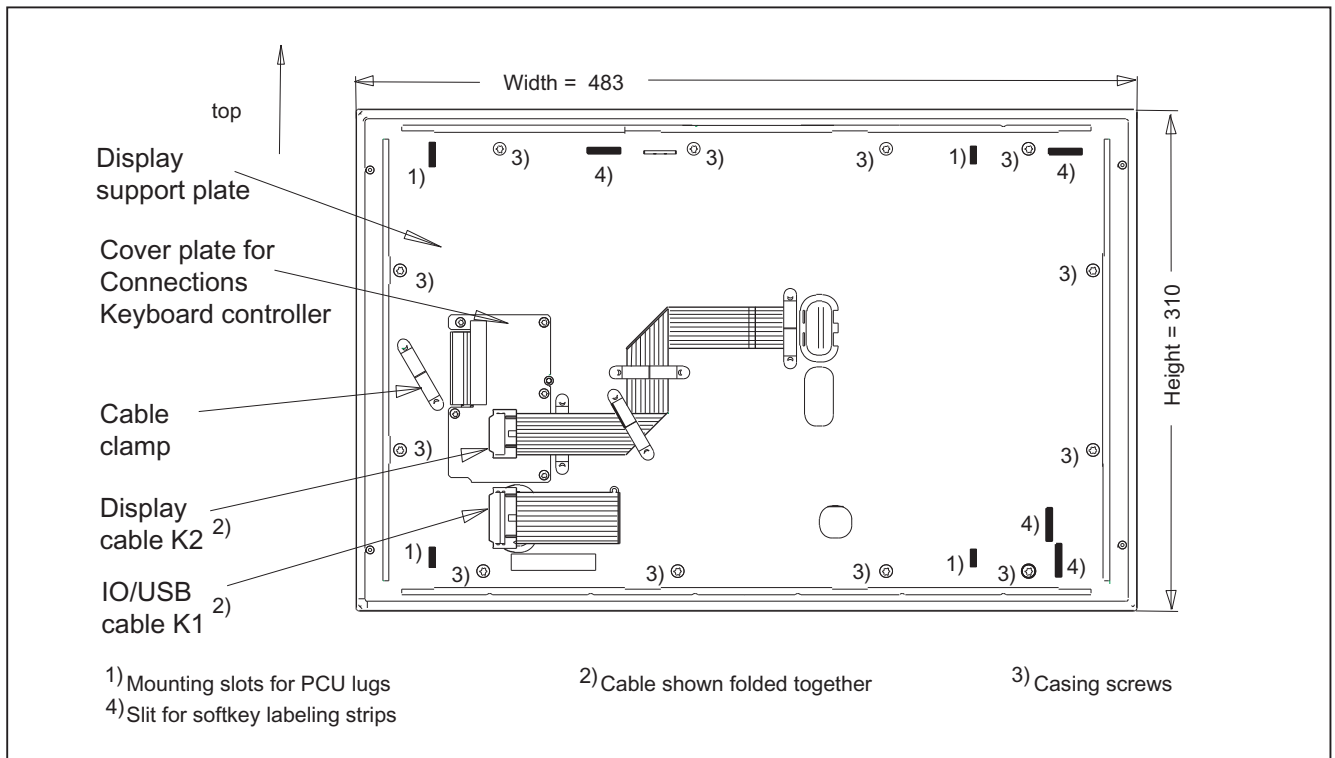

Figure 5-5 Rear side of the OP 012

Procedure

1. Place the OP 012 face down on a flat, soft (to avoid scratches) surface.
 - To install the direct control key module (see Section: "Direct control key module").
 - To install or replace the softkey labeling strips (see Section: "Softkey labels").
2. Remove the PCU's interface cover.
3. Place the PCU with the lugs of the bolted-on mounting brackets into the mounting slots on the OP 012 as shown by the white arrows in diagram (A).

To make it easier to insert the lugs, it can be helpful to reduce the 90° angle between the PCU and OP 012 by tilting the PCU as shown by the black arrow in the picture.

5.4 Mounting

4. Insert the cable connectors K1 and K2 of the OP 012 into the plug connectors behind the opening in the PCU casing (see gray arrows in diagram (A)). Make sure that the connectors lock in audibly and that the locks [see arrows in Fig: (B)] are closed.
5. Swivel the PCU into its final position and secure it with knurled screws, tightening torque of 1.8 Nm [see Fig.: (C)].

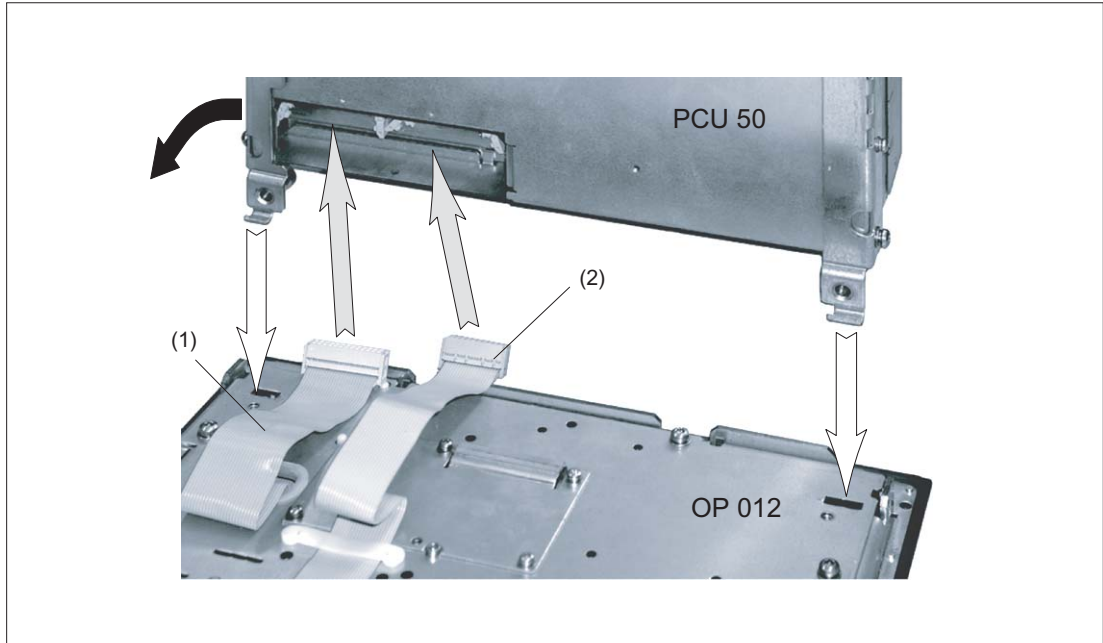

- (1) I/O / USB cable K1
- (2) Display cable K2

Figure 5-6 (A) Assembling PCU and OP 012

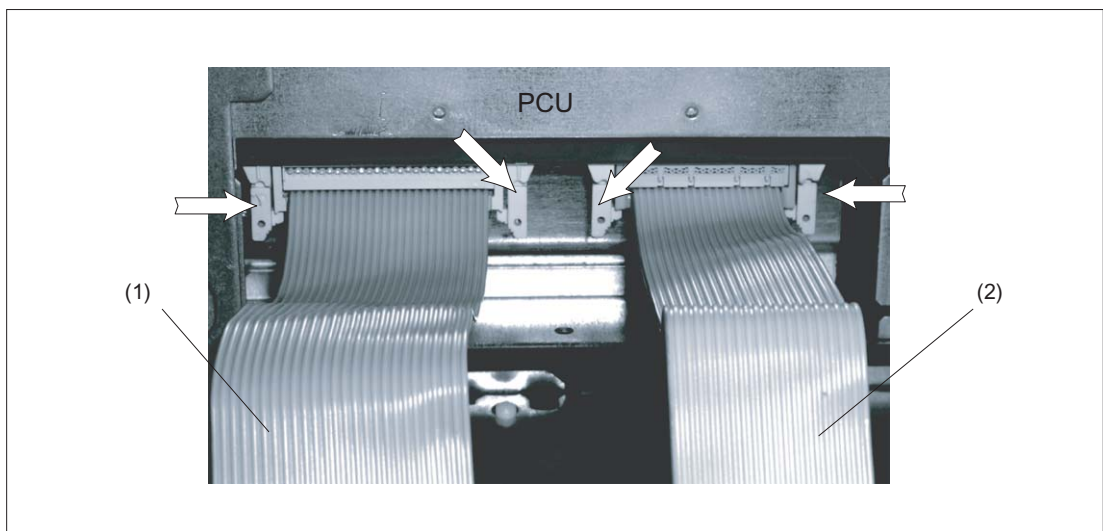

- (1) I/O / USB cable K1
- (2) Display cable K2

Figure 5-7 (B) Correct connection of IO/USB and display cables to the PCU

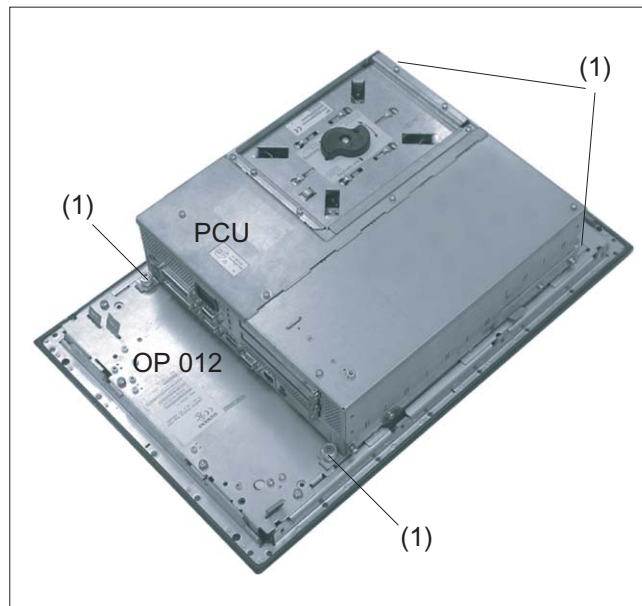

(1) Knurled screw

Figure 5-8 (C) OP 012 and PCU after assembly

Note

The OP 010 and TCU assembly is similar to that for a PCU.

5.4.3 Mounting on the mounting wall

The clearance at the rear of the PCU must be at least 10 mm to ensure sufficient ventilation (see Figure: "Attaching the PCU to the OP 012 operator panel front", Section: "OP 012", Section: "Assembling the OP 012 and PCU").

For more detailed information, please refer to the relevant PCU sections and in "General information and networking", Section: "Application planning", Section: "Climatic and mechanical environmental conditions" → "Cooling".

NOTICE
Impermissible mounting positions can cause malfunctions
Observe the permissible mounting position: Deviating by up to 5° from the vertical.
This value can be further restricted by mounted components (e.g. PCU).

Procedure

1. Insert the assembled components (operator panel front and PCU) from the front into the panel cutout (see Figure 5-3 Dimension sheet for installing the OP 012 operator panel front (Page 73)).
2. Secure the operator panel front in the panel cutout from the rear using the tension jacks by tightening the setscrews (torque 0.4 - 0.5 Nm).

5.4.4 Softkey labeling

User-specific functions can be assigned to the horizontal and vertical softkey bars. Printed labeling strips can be used to label the softkeys.

Blank labels are already installed on delivery.

To make the labels, DIN-A4 film is available (Order No., see Section: "Spare parts").

Note

Use the "Arial" font to format text. This font is comparable to the "Univers S57" font, used by Siemens for the key labeling.

Proceed as follows

1. Letter the mat side of the film using a laser printer.
2. Cut the printed labels along the preprinted lines.
3. Remove the PCU retaining screws and swing out the PCU away from the operator panel front.
4. Insert the strips into the slots provided on the rear side of the operator front panel.
5. Swing the PCU back to the operator panel and secure by tightening the screws.

If the operator panel front and PCU are dismantled, omit steps 3 and 5.

5.5 Technical data

Safety			
Safety class	III; PELV according to EN 50178		
Degree of protection according to EN 60529	Front side IP65 Rear side IP00		
Approvals	CE / cULus		
Electrical data			
Power supply (via K1 and K2)	Display	Backlight inverter	Logic / USB (with / without load)
Voltage	5 V +/- 5%	12 V +/- 10%	5.2 V +/- 2%
Current (typ./max.)	approx. 280/380 mA	approx. 750/1000 mA	approx. 350/1200 mA
Power consumption	Typical, approx. 16 W Maximum approx. 21 W		
Mechanical data			
Dimensions	Width: 483 mm	Height: 310 mm	Depth: 30 mm
Weight	Approx. 5 kg		
Tightening torques, max.	Tension jack screws: 0.5 Nm	M3 screws: 0.8 Nm	M4 screws: 1.8 Nm
Display			
Size / resolution	12.1" TFT / 800 x 600 pixels		
MTBF backlight	typ. 50,000 h at 25° C (dependent on the temperature)		

Note

Information about the climatic and mechanical environmental conditions is contained in the associated section under:

"General notes and interconnection" → "Operational planning".

5.6 Spare parts

5.6.1 Overview

The diagram shows the OP 012 operator panel front dismantled into its individual parts.

The components provided with an order number are available as individual spare parts.

5.6 Spare parts

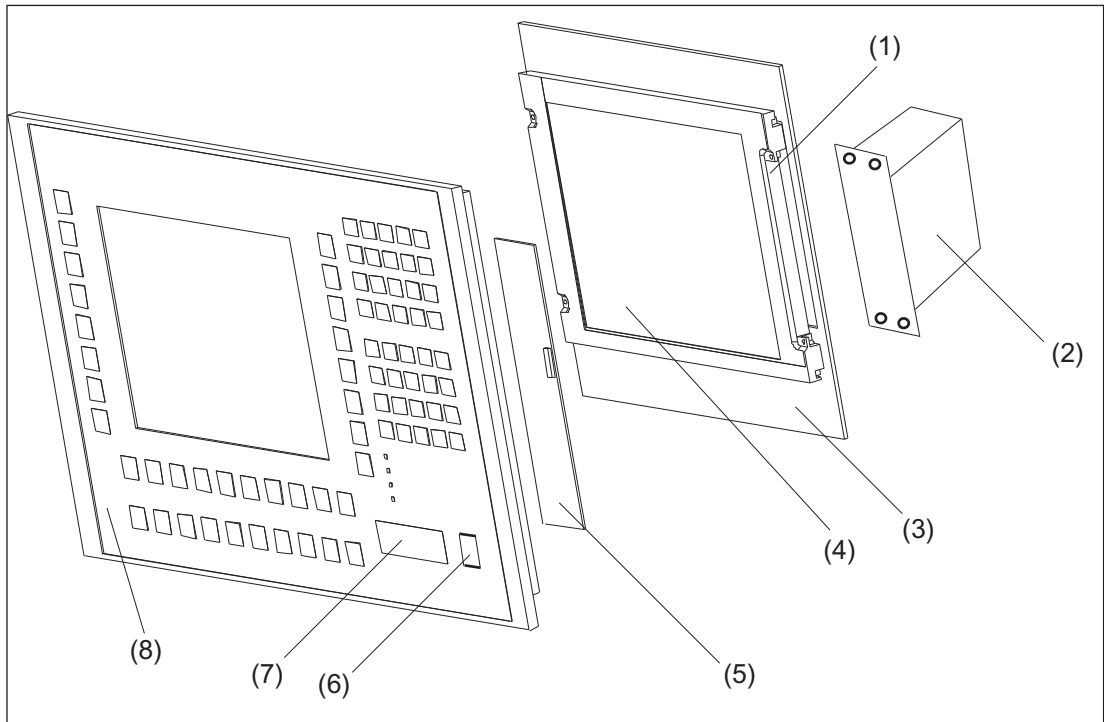

Figure 5-9 Individual parts for the OP 012 operator panel front

(1)	Backlight with backlight inverter		
	Spare parts	Order number	Remarks
(2)	Direct control key module	6FC5247-0AF11-0AA0	
(3)	Display support		
(4)	LCD unit		
(5)	Keyboard controller		
	Spare parts	Order number	Remarks
(6)	Cap for the USB port	6FC5248-0AF05-0AA0	Set of 10
(7)	USB mouse	6FC5247-0AF01-0AA0	
(8)	Operator panel front	6FC5248-0AF02-0AA0	Without LCD unit, without mouse, without keyboard controller, without direct control key module
	Slide-in labels *) (DIN A4 films)	6FC5248-0AF08-0AA0	Set of 3
	Tension jacks	6FC5248-0AF06-0AA0	Set of 6

*) The dimensions for production of film slide-in labels for softkey labeling can be seen in the following diagram.

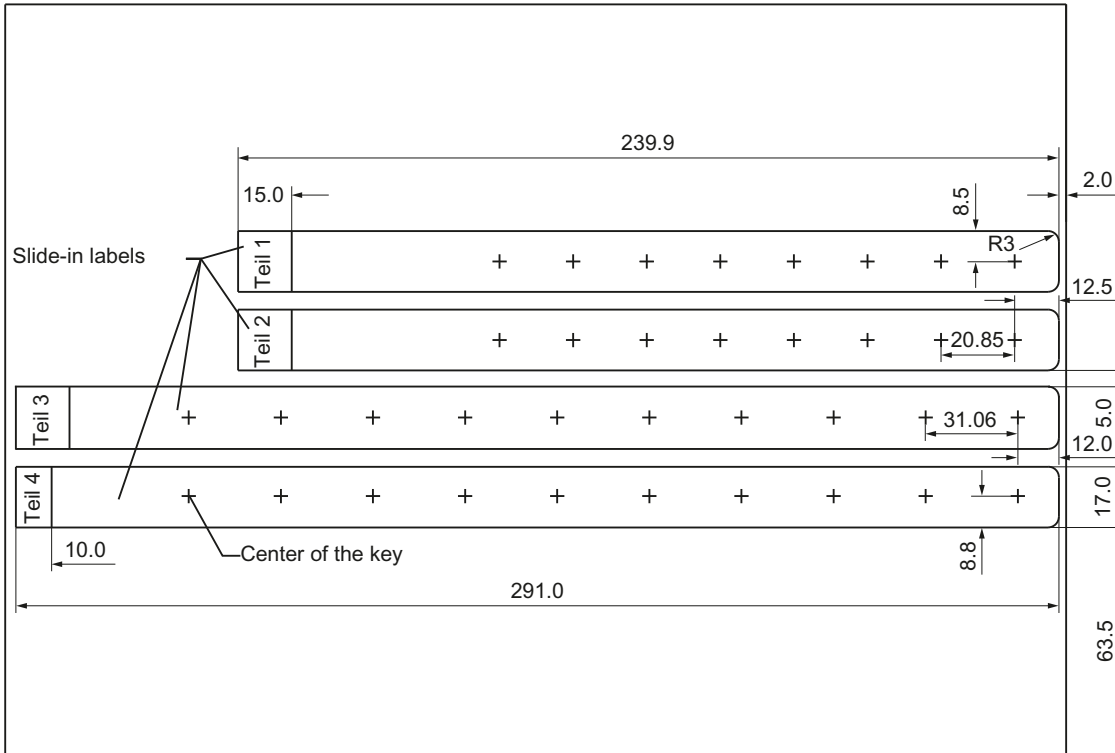

Figure 5-10 Dimensions for DIN A4 film

5.6.2 Replacement

NOTICE
Risk of damage to sensitive components due to static electricity
Spare parts must always be replaced by properly trained personnel!

USB cap / tension jack

The replacement of the USB sealing cap and tension jacks will not be described since it is simple and self-explanatory.

Film labels

The procedure for replacement is described in Section: "Softkey labels".

Operator panel front/mouse

When replacing the operator panel front, the previous mouse, LCD unit and keyboard controller can be used again. They are therefore disassembled and reassembled after the appropriate component has been replaced.

This description is therefore valid for both the operator panel front and the mouse.

Note

We recommend reusing the keypad controller to prevent any loss of the control parameters that have been programmed in.

Procedure

1. Put the OP 012 face down on a flat, soft surface and loosen the 12 housing screws (see Figure: "OP 012", Section: "Assembling the OP 012 and PCU").
2. Remove the softkey labeling strips and the cover plate.
3. Remove connector X14 for the backlight and the IO-USB cable K1 from the keyboard controller (see following Figure).
4. Lift off the display support and the display.
In addition to the keyboard controller, the rear sides of the mouse and USB interface become visible.
5. After bending back the two lugs, withdraw the USB interface.
6. Disconnect the three membrane connectors of the operator panel front keyboard from sockets X7, X8 and X10 (Procedure: see Note).
7. Remove the fastening screws from the mouse and keyboard controller.

8. Lift USB interface, mouse and keyboard controller off the front plate. The interconnections may remain plugged.
9. Install the components into the new operator front panel in reverse order (procedure: see Note).

Note

Descriptions of how to disconnect and connect the membrane connector can be found in "General information and networking", Chapter: "Connecting", Section: "Handling membrane connectors".

When tightening the screws, observe the torques (refer to Section: "Technical data").

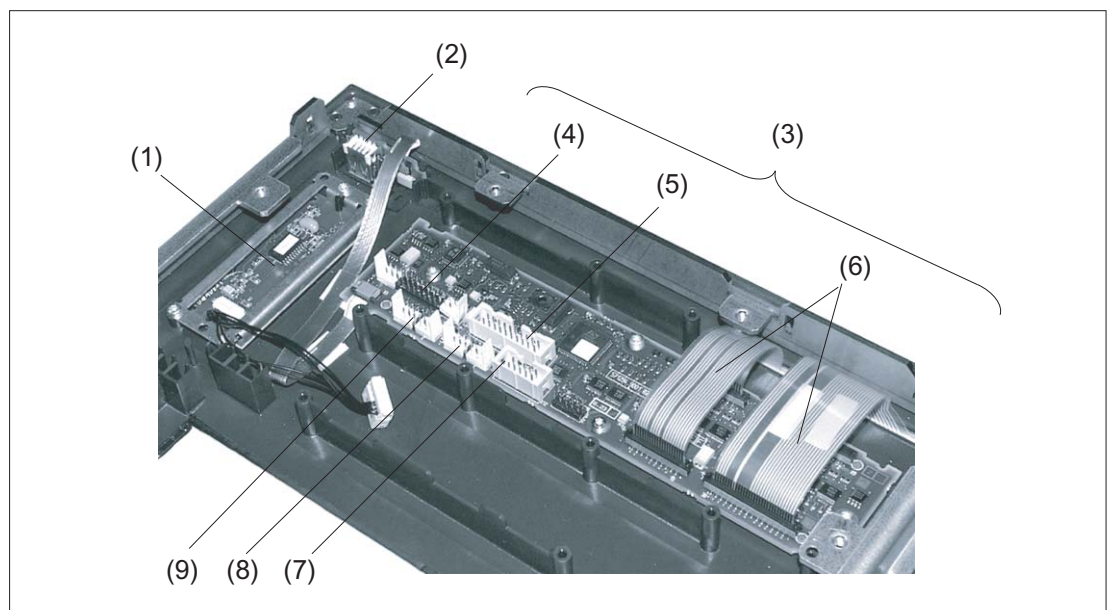

- (1) Mouse
- (2) USB interface
- (3) Keyboard controller
- (4) Connection X1 for IO-USB cable K1
- (5) Direct key connection X11
- (6) Membrane connector for connecting the keyboard of the operator panel front
- (7) Connection X12 (reserved)
- (8) Connection X14 for backlight
- (9) Connection X4 for mouse

Figure 5-11 Replacement of operator panel front OP 012

Operator panel front: OP 015

6.1 Description

The SINUMERIK OP 015 operator panel front and 15" TFT color display with a resolution of 1024 x 768 pixels (XGA) features 8 +4 horizontal and 8 vertical membrane softkeys.

The KB 483C full CNC keyboard can be used as an input keyboard.

It is fixed from the rear using special clamps that are included in the delivery scope.

Validity

The description below applies to the OP 015 operator panel front.
Order number 6FC5203-0AF03-0AA0

Features

- 19" mounting format, 7 HU (height units)
- Panel cutout (W x H): 450 x 290 mm
- Limited mounting depth
- 15" TFT flat screen (color) with resolution 1024 x 768 pixels
- Membrane keyboard:
 - 8 + 4 horizontal softkeys
 - 8 vertical softkeys
- Status LEDs for power supply and overtemperature
- Front USB interface
- Degree of protection: IP65
- Attachment: Tension jacks at the rear
- Can be combined with PCU, TCU

6.2 Operating and display elements

6.2.1 View

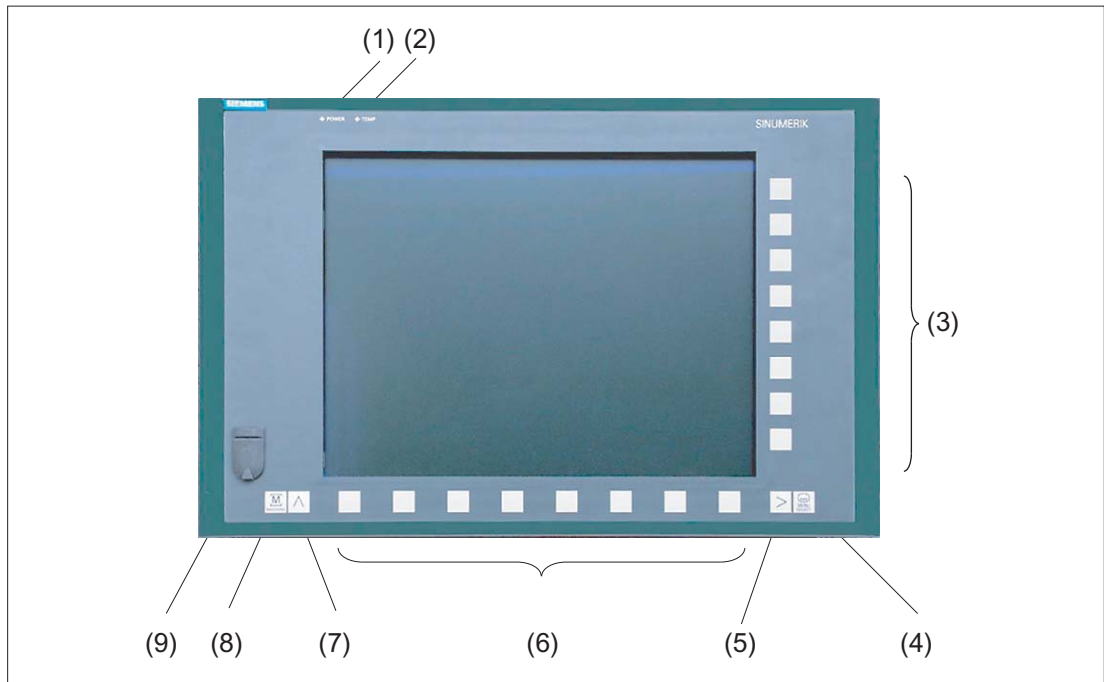

- (1) Status LED: POWER
- (2) Status LED: TEMP
Lit LEDs indicate increased wear.
- (3) Softkeys
- (4) Menu select key
- (5) Menu forward key
- (6) Softkeys
- (7) Menu back key
- (8) Machine area key
- (9) Front USB interface

Figure 6-1 View of operator panel front OP 015





6.2.2 Keyboard

Keyboard

Several keys are arranged on the operator panel front:

- The eight vertical and horizontal softkeys call up functions that are available on screen via a menu bar.
- The "Menu back" key switches back to the higher-level horizontal menu.
- The "Menu forward" key advances in the extended horizontal softkey bar.
- The "Menu select" key calls the main menu to select the operating area.
- The "Machine area" key selects the "Machine" operating area.

The key symbols used on the operator panel front are shown below along with the corresponding function keys on the PC keyboard.

Key	Function corresponds to the PC key function	Key	Function corresponds to the PC key function
	<Shift> F9		F9
	<Shift> F10		F10

Display

Note

Pixel error according to DIN EN ISO 13406-2 Class II.

6.2.3 Screen saver

If a screen with high contrast is displayed unchanged for longer than an hour, the screen must be switched dark (screensaver) in order to protect the TFT display against so-called "freezing" of the last displayed screen.

The time can be adapted individually. Further information can be found at:
IM9 SINUMERIK Operate Commissioning Manual

6.3 Interfaces

This operator panel front has the following interfaces:

Front

USB 1.1 (type A) for connecting an external keyboard, mouse and USB FlashDrive (see Fig.: "View of operator panel front" in Section: "Control and display elements" → "View").

Note

Note that the electromagnetic compatibility of commercially available peripheral devices operated via the USB interface is usually rated for office use only.

For industrial use, components with a higher degree of certification are recommended.

Rear side

- Two ribbon cables for connecting the PCU (see figure below):
 - I/O–USB cable K1 (ribbon cable):
All signals that are used for the display interface and the connection of operator panel fronts (e.g. supply voltages)
 - Display cable K2

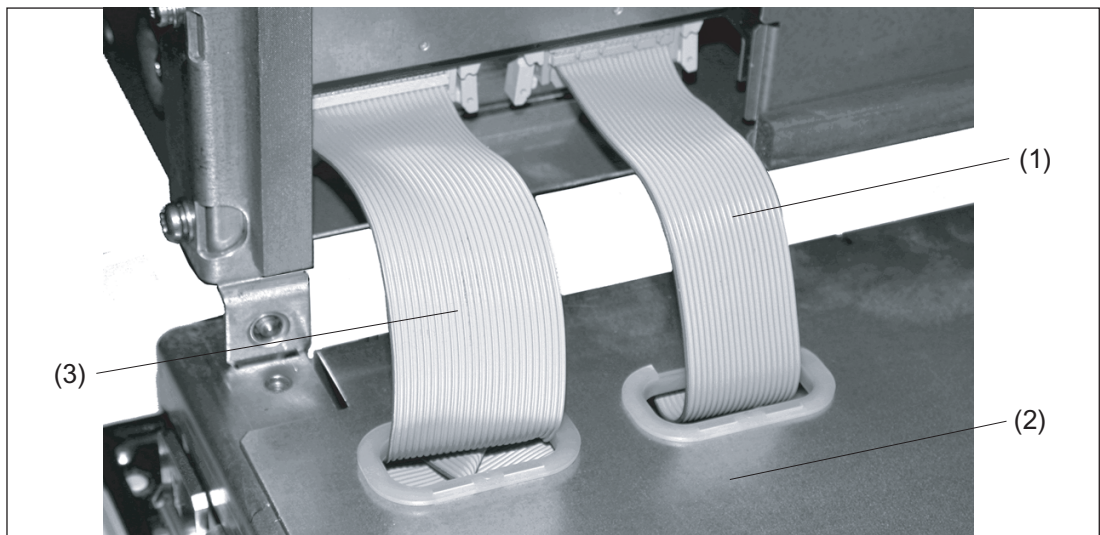

- (1) Display cable K2
- (2) Rear of operator panel
- (3) I/O USB cable K1

Figure 6-2 Connections on rear of housing Connections to the PCU

Pin assignment

For more detailed information, see "General information and networking", Chapter: "Connecting".

6.4 Mounting

6.4.1 Preparation for mounting

Table 6- 1 Dimensions of the mounting opening

Width (mm)	Height (mm)
450	290

Thanks to the tension jacks on the OP 015, drill-holes or screw holes are not needed.

This retaining method also enables the IP65 degree of protection (but only in conjunction with a circumferential seal and when the protective USB cap is fitted).

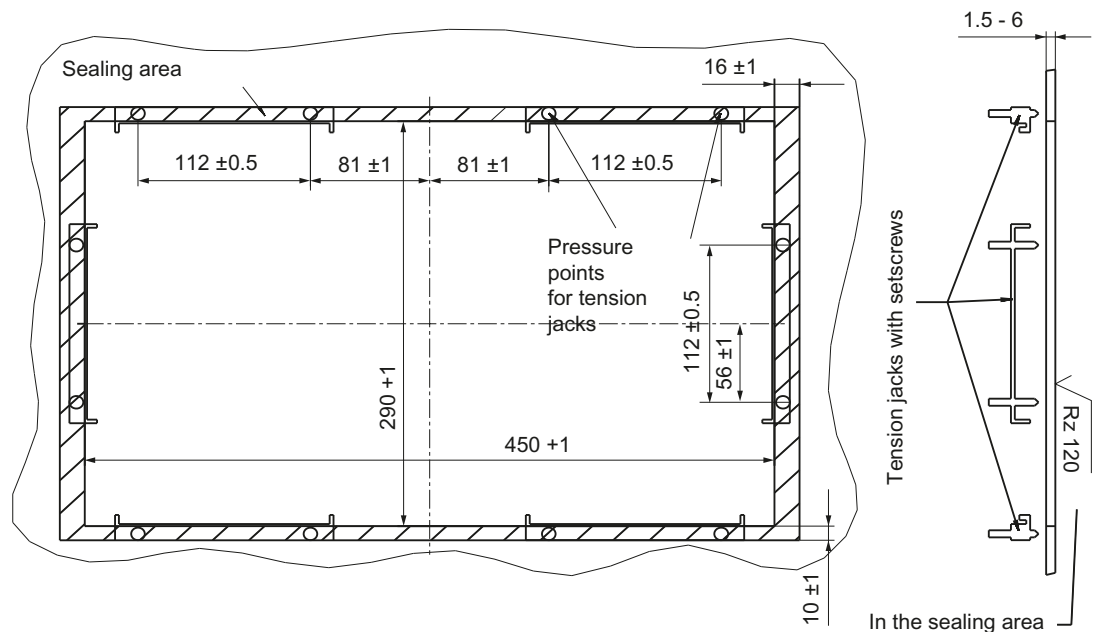

Figure 6-3 Dimension sheet for installing the OP 015 operator panel front

6.4 Mounting

Table 6-2 Dimensions to be observed when installing

	Mounting depth T3 + clearance (mm)	Opening depth T5 (mm)	Protrusion P (mm)
PCU 50.3 / 50.5	125 + 10	402	21
TCU x0.2	75 + 10	376	-30

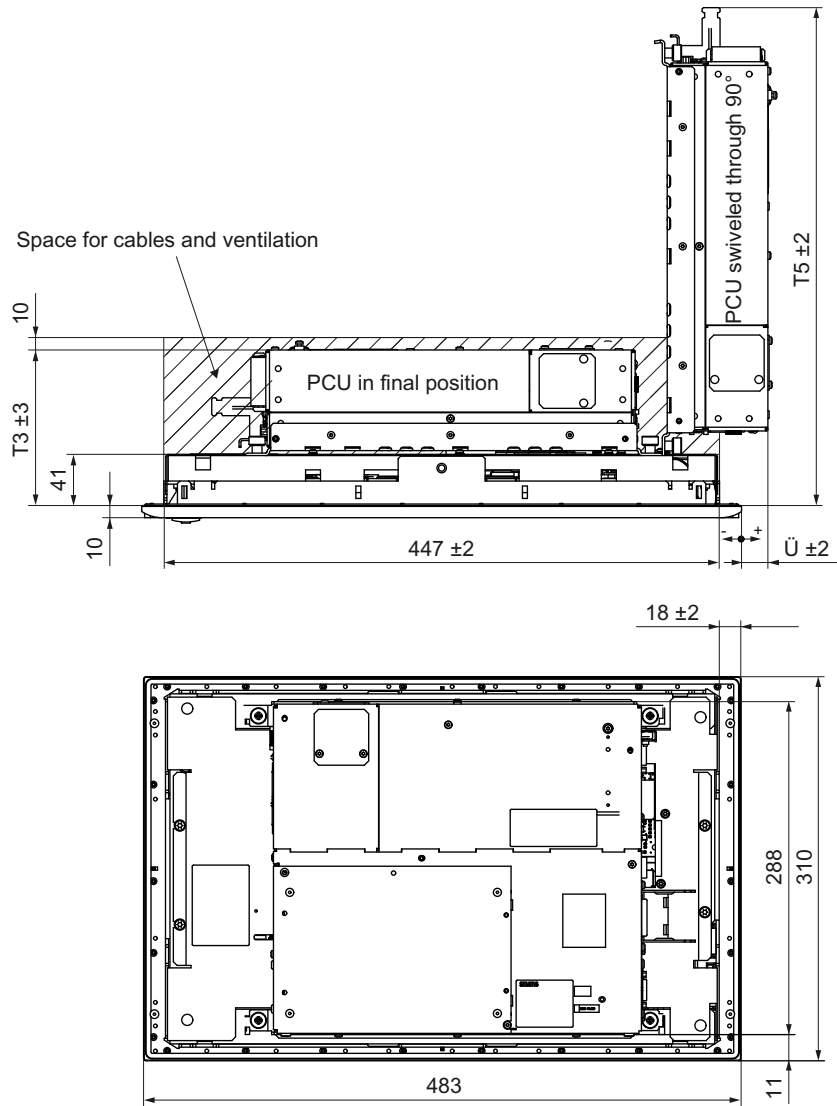

Figure 6-4 Dimension sheet for mounting the OP 015 with PCU

6.4.2 Assembling an OP 015 and a PCU

When combining an OP 015 and PCU, it is advisable to assemble them prior to installation in an assembly panel.

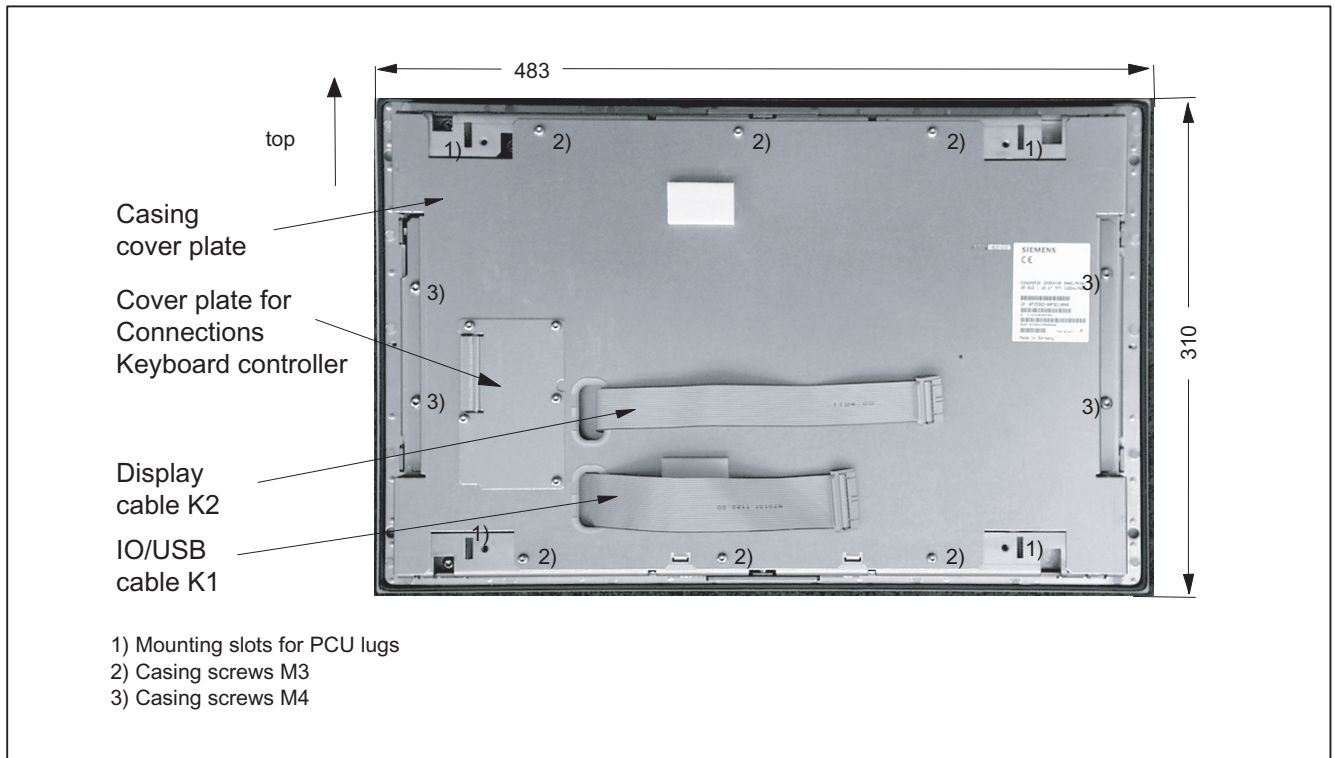

Figure 6-5 Rear side of operator panel front with position of interfaces and mounting slots

Procedure

To do this, proceed as described in Section: "OP 012", Section: "Assembling the OP 012 and PCU."

6.4.3 Mounting on the mounting wall

The clearance at the rear of the PCU must be at least 10 mm to ensure sufficient ventilation (see Figure 6-4 Dimension sheet for mounting the OP 015 with PCU (Page 90)).

For more detailed information, please refer to the relevant PCU sections and in "General information and networking", Section: "Application planning", Section: "Climatic and mechanical environmental conditions" → "Cooling".

NOTICE
Impermissible mounting positions can cause malfunctions
Observe the permissible mounting position: Deviating by up to 5° from the vertical.
This value can be further restricted by mounted components (e.g. PCU).

Procedure

1. Insert the assembled components (operator panel front and PCU) from the front into the panel cutout (see Figure 6-3 Dimension sheet for installing the OP 015 operator panel front (Page 89)).
2. Secure the operator panel front in the panel cutout from the rear using the six tension jacks by tightening the setscrews (torque 0.4 - 0.5 Nm).

6.5 Technical data

Safety			
Safety class	III; PELV according to EN 50178		
Degree of protection according to EN 60529	Front side IP65 Rear side IP00		
Approvals	CE / cULus		
Electrical data			
Power supply (via K1 and K2)	Display	Backlight inverter	Logic / USB (with / without load)
Voltage	5 V +/- 5%	12 V +/- 10%	5.2 V +/- 2%
Current (typ./max.)	approx. 420/600 mA	approx. 900/1050 mA	approx. 350/1000 mA
Power consumption	Typical, approx. 15 W Maximum approx. 24 W		
Mechanical data			
Dimensions	Width: 483 mm	Height: 310 mm	Depth: 52 mm
Weight	approx. 7 kg		
Tightening torques, max.	Tension jack screws: 0.5 Nm	M3 screws: 0.8 Nm	M4 screws: 1.8 Nm
Display			
Size / resolution	15" TFT / 1024 x 768 pixels		
MTBF backlight	typ. 40,000 h at 25° C (dependent on the temperature)		

Note

Information about the climatic and mechanical environmental conditions is contained in the associated section under:

"General notes and interconnection" → "Operational planning".

6.6 Spare parts

6.6.1 Overview

The diagram shows the OP 015 operator panel front dismantled into its individual parts. The components provided with an order number are available as individual spare parts.

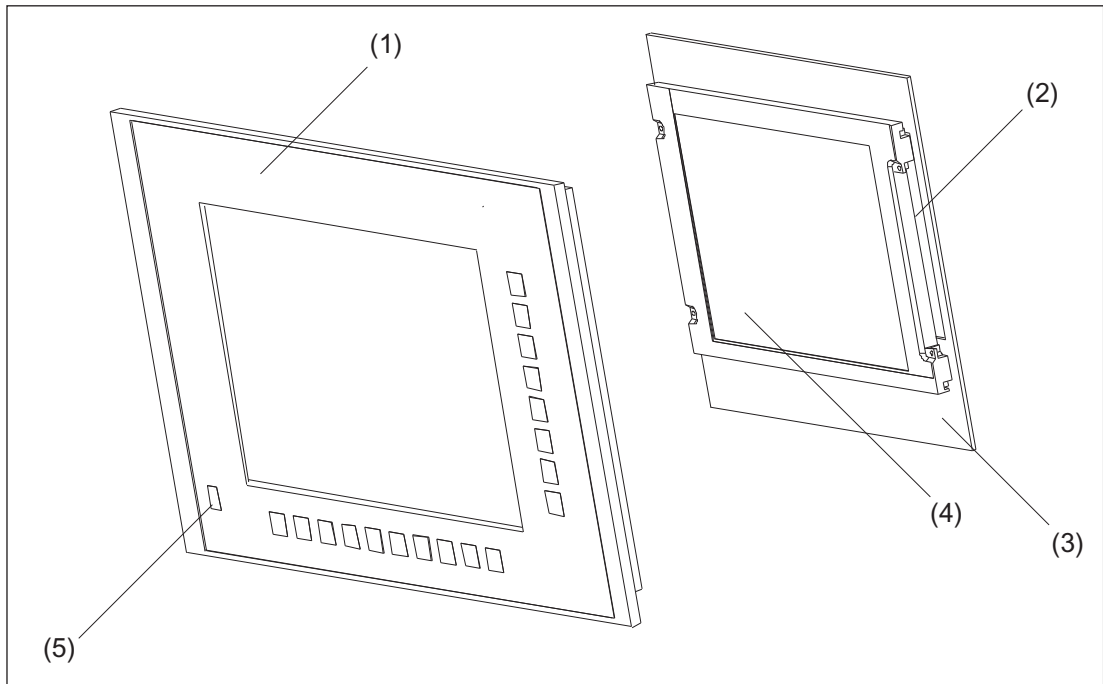

Figure 6-6 Individual parts for the OP 015 operator panel front

	Spare part	Order number	Remark
(1)	Operator panel front	6FC5248-0AF03-0AA0	Without LCD unit, USB port and keyboard controller
(2)	Background lighting with backlight inverter		
(3)	Display support with keyboard controller (rear side)		
(4)	LCD unit		
	Spare part	Order number	Remark
(5)	Cap for the USB port	6FC5248-0AF05-0AA0	Set of 10
	Tension jacks	6FC5248-0AF06-0AA0	Set of 6

6.6.2 Replacement

NOTICE
Risk of damage to sensitive components due to static electricity
Spare parts must always be replaced by properly trained personnel!

USB cap / tension jack

The replacement of the USB sealing cap and tension jacks will not be described since it is simple and self-explanatory.

Operator panel front

When changing the operator panel front, the existing USB interface and the display support (with display, backlight inverter and keyboard controller) can be reused. They are therefore disassembled and reassembled after the appropriate component has been replaced.

Note

We recommend reusing the keypad controller to prevent any loss of the control parameters that have been programmed in.

Procedure

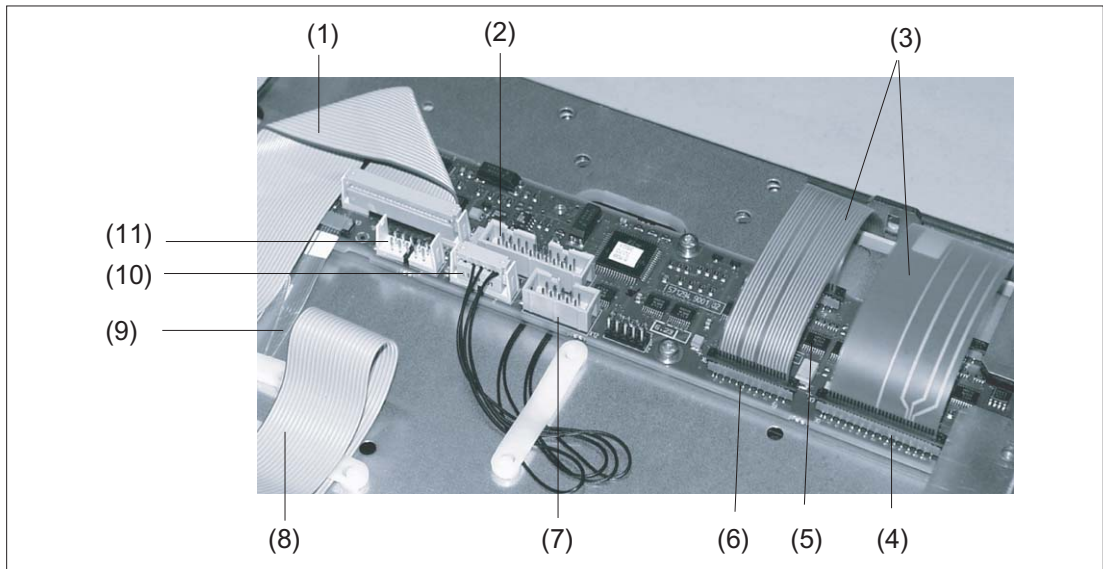

- (1) I/O USB cable K1
- (2) Connection X11 (reserved)
- (3) Membrane lines from the operator panel front keyboard
Connections for the operator panel front keyboard
- (4) X7
- (5) X8
- (6) X10
- (7) Connection X12 (reserved)
- (8) Display cable K2
- (9) USB membrane line
- (10) Connection X14 for display and backlight
- (11) Connection X4 (reserved)

Figure 6-7 Keyboard controller

1. Put the OP 015 and the replacement operator panel front face down on a flat, soft surface.
2. Loosen the housing screws (see Figure: "Rear side of operator panel front with position of interfaces and mounting slots", Section: "Assembling OP 015 and PCU 50") and remove the housing cover plate.

The display support with the keyboard controller (figure above) will be visible underneath and, in a cutout of the mounting plate, the rear side of the USB interface (figure below).
3. Disconnect the membrane connectors of the operator panel front keyboard from sockets X7, X8 and X10 (see note below for procedure).
4. Disconnect the membrane connection of the USB connection cable (figure below; see note below for procedure).
5. Remove the screws of the display support and lift it off.

6. Pull the USB interface off its seat and insert it into the replacement operator panel front.
7. Place the display support on the replacement operator panel front.
8. Assemble the operator panel front in reverse order.

Note

Descriptions of how to disconnect and connect the membrane connector can be found in "General information and networking", Chapter: "Connecting", Section: "Handling membrane connectors".

When tightening the screws, observe the torques (refer to Section: "Technical data").

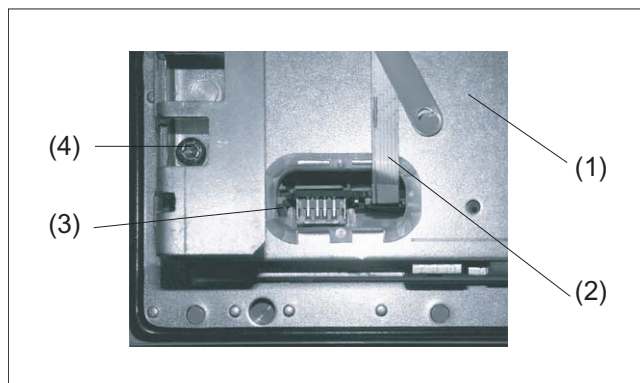

- (1) Display support
- (2) USB membrane line (figure above)
- (3) USB interface
- (4) Fastening screw M4

Figure 6-8 USB interface viewed from the operator panel rear side

Operator panel front: OP 015A

7.1 Description

The SINUMERIK OP 015A operator panel front and 15" TFT color display with a resolution of 1024 x 768 pixels (XGA) features a 62-key membrane keyboard with 2 x (8 + 2) horizontal and 2 x 8 vertical softkeys and an integral mouse. The 2 x 8 vertical softkeys can be used as direct keys.

The operator panel front is secured from the rear using special clamps supplied with the panel.

Validity

The description below applies to the OP 015A operator panel front.
Order number 6FC5203-0AF05-0AB0

Features

- 19" mounting format, 8 HU (height units)
- Panel cutout (W x H): 450 x 335 mm
- Limited mounting depth
- 15" TFT flat screen (color) with resolution 1024 x 768 pixels
- Membrane keyboard with alphabetic, numeric, cursor, and control keypad
- Soft keys / direct keys:
 - 2 x (8 + 2) horizontal rows of keys with softkey function
 - 2 x 8 vertical rows of keys with softkey and direct key functions
 - Direct keys via direct key / handwheel module (optional), machine control panel, TCU or directly connectable to the I/Os
- Shift key for switchover to the second key level (not for switching over the letters, since they are uppercase only)
- Integrated mouse
- Status LEDs for power supply and overtemperature
- USB front interface (USB 1.1)
- Degree of protection IP65 (front side)
- Attachment: Tension jacks at the rear
- Can be combined with PCU, TCU

7.2 Operating and display elements

7.2.1 View

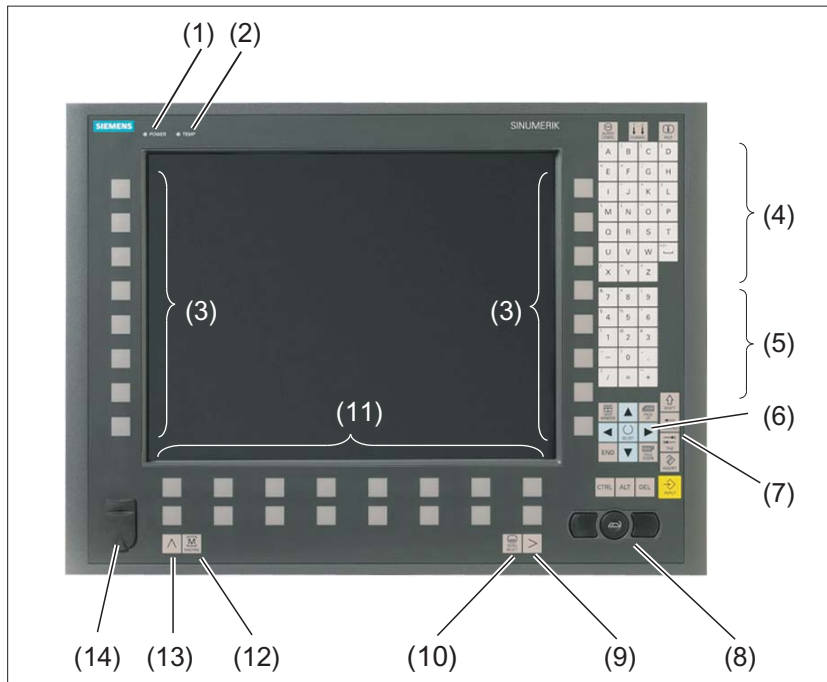

- (1) Status LED: POWER
- (2) Status LED: TEMP
Lit LEDs indicate increased wear.
- (3) Softkeys and direct keys
- (4) Alphabetic key group
- (5) Numeric key group
- (6) Cursor key group
- (7) Control key group
- (8) Mouse
- (9) Menu forward key
- (10) Menu select key
- (11) Softkeys
- (12) Machine area key
- (13) Menu back key
- (14) Front USB interface

Figure 7-1 Front view of the OP 015A operator panel front

7.2.2 Keyboard

Keyboard

Several keys and keypads are installed on the operator panel front:

- The alphabetic block contains the letters A - Z and the space character.
- The numeric block contains the digits 0 - 9, and the characters "-", "/", "=", "+" and ".".
- The cursor key group is used to navigate on the screen.
- The control key group includes special functions.
- The mouse comprises the center actuation field (corresponds to the function of a tracker ball) and two keys for the left and right mouse key.
- The softkeys call up functions that are available on the screen via a menu bar.
- The menu select key displays the area menu.
- The menu forward key enables an expansion of the horizontal softkey bar in the same menu.
- The machine area key switches directly into the "Machine" operating area.
- The menu back key returns to the higher-level menu, one window is closed.

























Switching between upper and lower case

To toggle between upper and lower case letters, press the key combination Ctrl + Shift

Upper case is always activated as standard.

Overview of the key symbols

The key symbols used on the operator panel front are shown below along with the corresponding function keys on the PC keyboard.

Key	Function corresponds to the PC key function	Key	Function corresponds to the PC key function
	Esc		End
	F11		Backspace
	F12		Tab
	Space		(only intended for internal keyboard changeover)
	Home		Ctrl key
	Page up		Alt key
	Page down		Delete
	Cursor up		Insert
	Cursor left		Enter
	Cursor right		F9
	Cursor down		F10
	5 (in numeric key group)	A, ..., Z	<Shift> A, ..., Z
	<Shift> F9		<Shift> F10

Display

Note

Pixel error according to DIN EN ISO 13406-2 Class II.

7.2.3 Screen saver

If a screen with high contrast is displayed unchanged for longer than an hour, the screen must be switched dark (screensaver) in order to protect the TFT display against so-called "freezing" of the last displayed screen.

The time can be adapted individually. Further information can be found at:
IM9 SINUMERIK Operate Commissioning Manual

7.3 Interfaces

The OP 015 operator panel front has the following interfaces:

Front side

USB 1.1 (type A) for connecting an external keyboard, mouse and USB FlashDrive (see figure in Section: "Control and display elements" → "View").

Note

Note that the electromagnetic compatibility of commercially available peripheral devices operated via the USB interface is usually rated for office use only.

For industrial use, components with a higher degree of certification are recommended.

Rear side

- Two cables for connecting the PCU (see figure below):
 - I/O USB cable K1 (ribbon cable):
All signals that are used for the display interface and the connection of operator panel fronts (e.g. supply voltages)
 - Display cable K2

Under the interface cover:

- Direct key interface X11: Signals from the 16 "vertical softkey" direct keys
- Interface X12 (reserved)

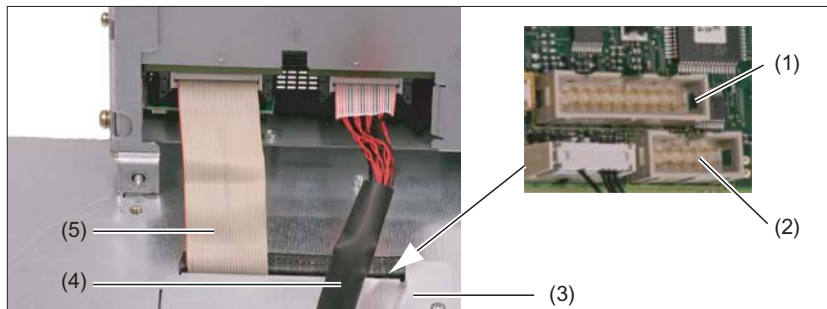

- (1) Direct key interface X11
- (2) Interface X12 (reserved)
- (3) Interface cover
- (4) Display cable K2
- (5) I/O USB cable K1

Figure 7-2 OP015A - Connections on rear side of housing: Connections to the PCU

Pin assignment

For more detailed information, see "General information and networking", Chapter: "Connecting".

7.4.2 Assembling an OP 015A and a PCU

- If you want to combine the OP 015A with a PCU and possibly a direct key module (see Section: "Direct key module"), assemble the components before installing them on the mounting wall.
- When combining with a PCU 50.3, you must then undo the transport lock for the hard-drive, otherwise the system will not boot.

Requirement

The PCU must now be bolted to the mounting brackets prior to assembly (if this has not already been done) (see section: "PCU 50.3", Section: "Mounting")

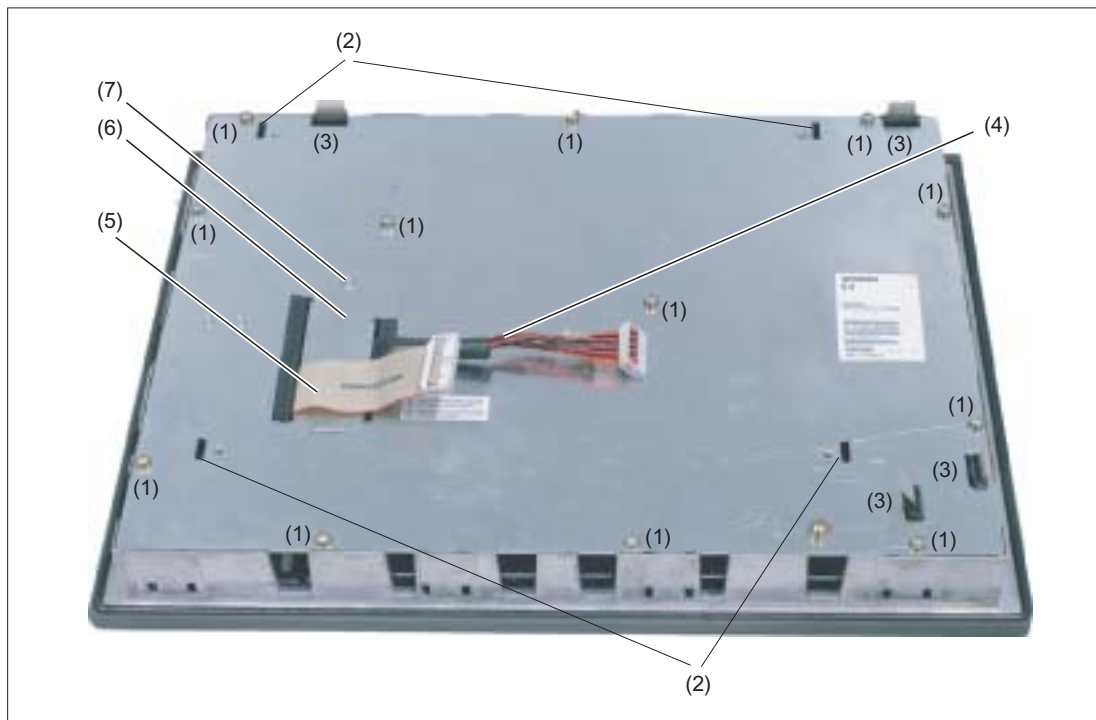

- (1) Casing screw (1x concealed under cable K1)
- (2) Mounting slots for PCU lugs
- (3) Slots for inserting softkey labeling strips
- (4) Display cable (K2)
- (5) I/O / USB cable (K1)
- (6) Cover plate for keyboard controller connections
- (7) Retaining screw for the cover plate

Figure 7-4 OP 015A rear side

Procedure

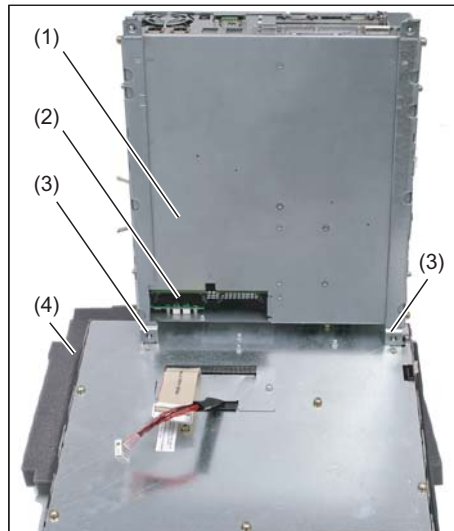

1. Place the front end of the OP 015A on a soft, horizontal support (4) to avoid damaging the surface of the operator panel front.
2. Remove the interface cover (2) of the PCU.
3. Position the PCU so that the mounting lugs (3) engage with the OP 015A.

- (1) PCU
- (2) Interface cover of the PCU (cover plate removed)
- (3) Mounting lugs
- (4) Mounting support

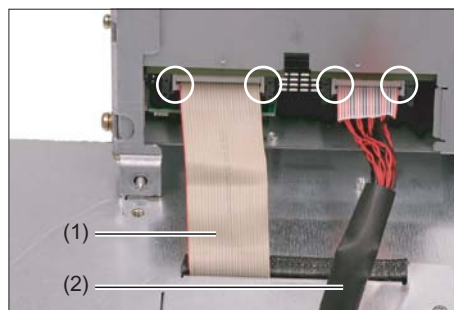

4. Connect the cable connectors K1 and K2 to the interfaces of the PCU.
5. Make sure that you hear the connectors lock in and that the locks are closed (see marked rings)

- (1) I/O USB cable K1
- (2) Display cable K2



6. Swing the PCU in the direction of the OP 015A, making sure that the cables are folded correctly.

7.4 Mounting

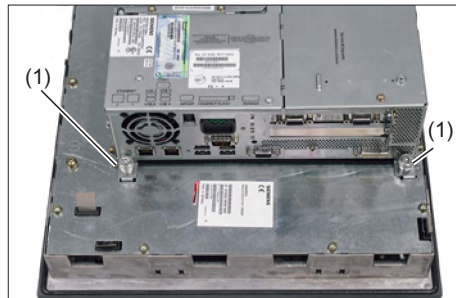

7. Secure the PCU with two knurled-head screws (1) at each end of the two mounting angles (torque 1.8 Nm). To tighten the screws, use a torque screwdriver (e.g. FACOM A.302A, tightening torque, max.: 1.8 Nm).

Note

The OP 010 and TCU assembly is similar to that for a PCU.

7.4.3 Mounting on the mounting wall

The clearance at the rear of the PCU must be at least 10 mm to ensure sufficient ventilation. For more detailed information, please refer to the relevant PCU sections and in "General information and networking", Section: "Application planning", Section: "Climatic and mechanical environmental conditions" → "Cooling".

NOTICE

Impermissible mounting positions can cause malfunctions

Observe the permissible mounting position: Deviating by up to 5° from the vertical.

This value can be further restricted by mounted components (e.g. PCU).

Procedure

1. Insert the assembled components (operator panel front and PCU) from the front into the panel cutout (see Figure 7-3 Dimension sheet for installing the OP 015A operator panel front (Page 105)).
2. Secure the operator panel front in the panel cutout from the rear using the twelve tension jacks by tightening the setscrews (torque 0.5 Nm).

Table 7- 2 Dimensions to be observed when installing

	Mounting depth T3 + clearance (mm)	Opening depth T5 (mm)	Protrusion P (mm)
PCU 50.3 / 50.5	127 + 10	402	32
TCU x0.2	76 + 10	376	-19

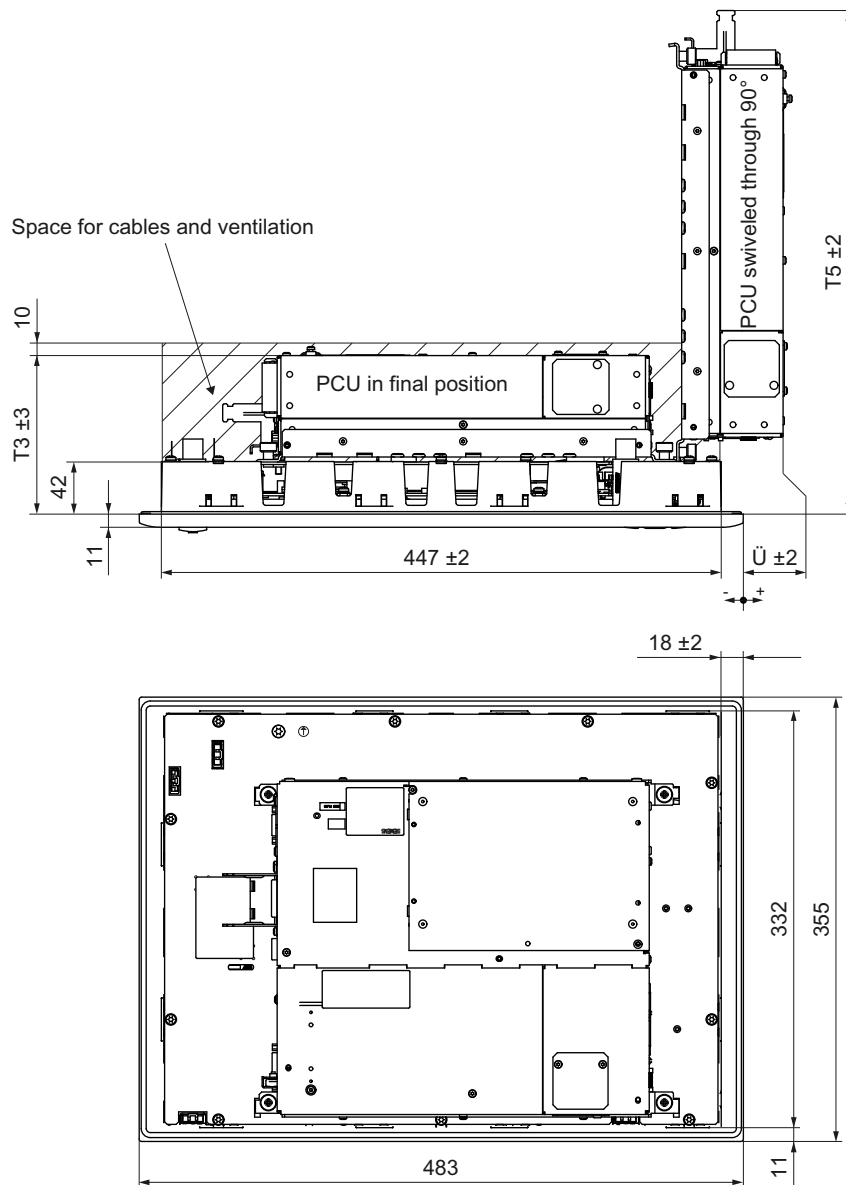

Figure 7-5 Attaching the PCU to the OP015A operator panel front

7.4.4 Softkey labeling

User-specific functions can be assigned to the two vertical softkey bars. Printed labeling strips can be used to label the softkeys.

Blank labels are already factory-installed.

DIN A4 films are available for preparing the vertical strips. You will find the order number in section: "Spare parts" → "Overview".

Note

Use the "Arial" font to format text. This font is comparable to the "Univers S57" font, used by Siemens for the key labeling.

Proceed as follows

1. Label the mat side of the film with a laser printer or another printer that allows "Film" to be set as a printable medium.
2. Cut the printed labels along the preprinted lines.
3. Insert the labeling strips into the slits provided from the rear of the operator panel front (refer to figure: "OP 015A Housing open" in section: "Spare parts" → "Replacement").

Note

In order to facilitate insertion of the "Part1" strip when the PCU is mounted, it is recommended that you

- unscrew the 4 retaining screws of the PCU and
- swing the PCU up.

Once you have inserted the strip, swing the PCU back to the operator panel and secure by tightening the screws.

7.5 Technical specifications

Safety			
Safety class	III; PELV according to EN 50178		
Degree of protection according to EN 60529	Front side: IP65 Rear side: IP00		
Approvals	CE / cULus		
Electrical data			
Power supply (via K1 and K2)	Display	Backlight inverter	Logic / USB
Voltage Current (typ./max.)	4.9 V - 5.25 V approx. 420/700 mA	12 V +/- 5% approx. 900/1100 mA	5.0 V - 5.2 V approx. 350/1050 mA
Power consumption	Typical, approx. 15 W Maximum approx. 25 W		
Mechanical data			
Dimensions	Width: 483 mm	Height: 355 mm	Depth: 53 mm
Weight	Approx. 8.4 kg		
Max. tightening torques:	Tension jack screws: 0.5 Nm	M3 screws: 0.8 Nm	M4 screws: 1.8 Nm
Display			
Size / resolution	15" TFT / 1024 x 768 pixels		
MTBF backlight	typ. 50,000 h at 25° C (dependent on the temperature)		

Note

Information about the climatic and mechanical environmental conditions is contained in the associated section under:

"General notes and interconnection" → "Operational planning".

7.6 Spare parts

7.6.1 Overview

The diagram shows the OP 015A operator panel front dismantled into its individual parts. The components provided with an order number are available as individual spare parts.

7.6 Spare parts

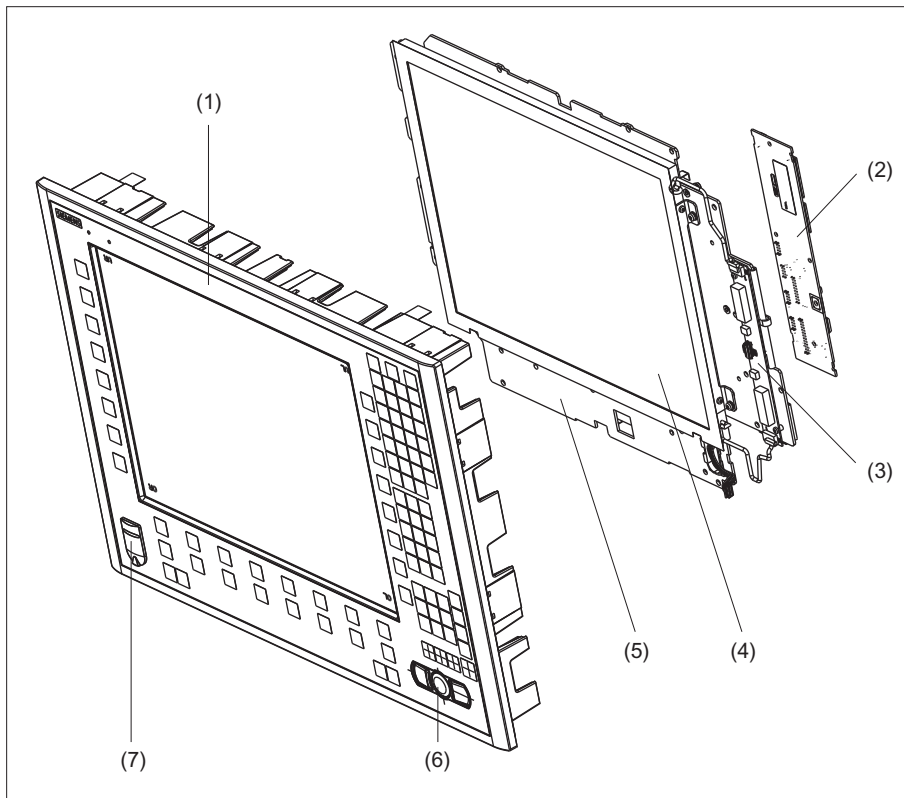

Figure 7-6 Individual parts for the OP 015A operator panel front

	Spare part	Order number	Remark
(1)	Operator panel front	A5E00405090	Without LCD unit, mouse, USB port and keyboard controller
(2)	Keyboard controller		
(3)	Background lighting with backlight inverter		
	Spare part	Order number	Remark
	Direct key module	6FC5247-0AF11-0AA0	
	Direct key module mounting kit	6FC5247-0AF30-0AA0	
(4)	LCD unit		
(5)	Display support		
	Spare part	Order number	Remark
(6)	USB mouse	6FC5247-0AF01-0AA0	
(7)	Cap for the USB port	6FC5248-0AF05-0AA0	Set of 10
	Tension jacks	6FC5248-0AF14-0AA0	Set of 9
	Mounting bracket	6FC5248-0AF20_2AA0	
	Slide-in labels *) (DIN A4 foils)	6FC5248-0AF24-0AA0	Set of 3

*) The dimensions for creating slide-in labels from foil for softkey labeling can be seen in the following diagram.

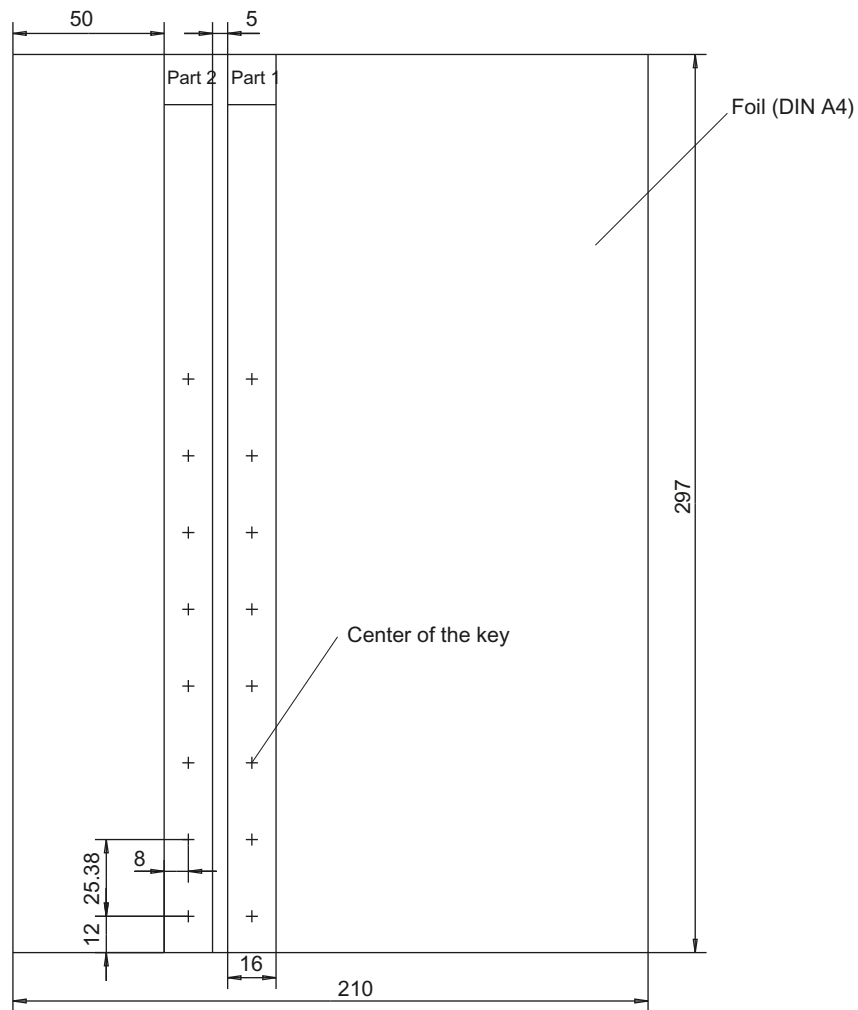

Figure 7-7 Dimensions for vertical side-in labels

7.6.2 Replacement

NOTICE

Risk of damage to sensitive components due to static electricity

Spare parts must always be replaced by properly trained personnel!

USB cap / tension jack

The replacement of the USB sealing cap and tension jacks will not be described since it is simple and self-explanatory.

Operator panel front

When the operator panel front is replaced, the display, keyboard controller, mouse, and USB interface can be used again. They are therefore disassembled and reassembled after the appropriate component has been replaced.

Note

We recommend reusing the keypad controller to prevent any loss of the control parameters that have been programmed in.

Dismounting individual parts from the operator panel front



1. Place the OP 015A on a soft, horizontal support.
Remove the retaining screw (1) from the cover plate (2) and lift off the cover plate.



2. Loosen the 13 housing screws (see also Figure: "Rear side of OP 015A operator panel front" in Section: "Mounting" → "Assembling OP 015A and PCU")
3. Lift off the cover.

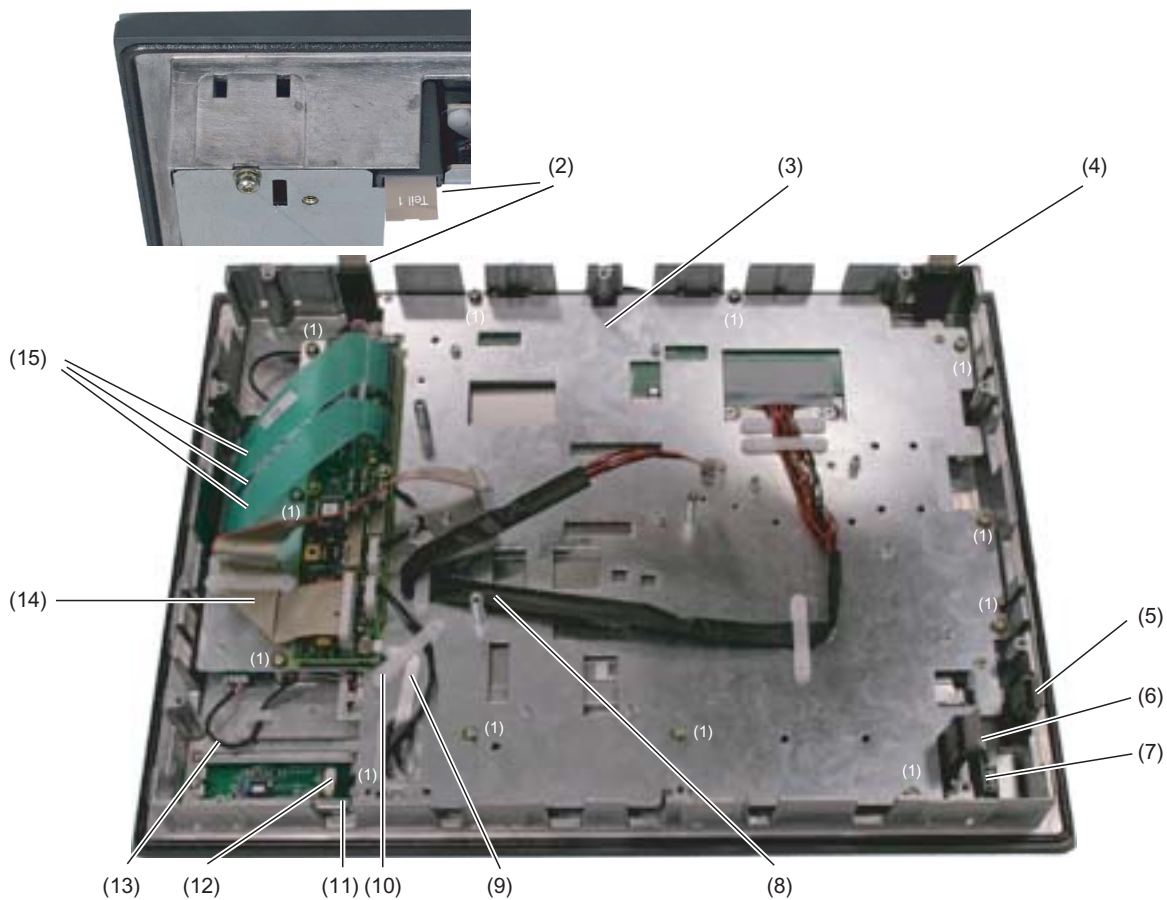

- (1) Screws (M4) for display support
- (2) Slide-in labels (Part1)
- (3) Display support
- (4) Slide-in labels (Part2)
- (5) Slide-in labels (Part3)
- (6) Slide-in labels (Part4)
- (7) USB interface
- (8) Display cable
- (9) Ribbon cable for keyboard controller / USB connection
- (10) Retainer for the mouse / keyboard controller cable
- (11) Interface for the mouse
- (12) Cable plug for mouse / keyboard controller
- (13) Backlight inverter cable
- (14) I/O USB cable
- (15) Keyboard cable

Figure 7-8 OP015A housing opened

Backlight inverter cable

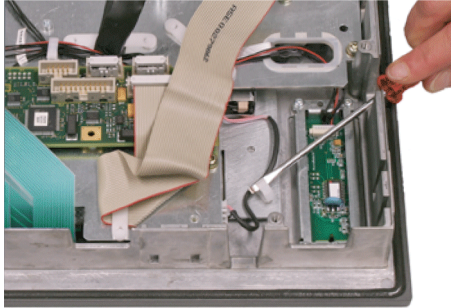

4. Remove the two cables to the backlight inverter (to the left and right of the display support) by raising the clips with a flat screwdriver and pulling out the cables.

Connection of keyboard controller / mouse

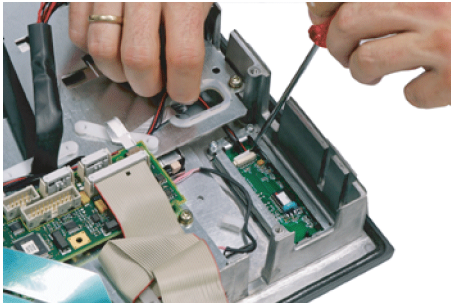

5. Undo the connection between the keyboard controller and the mouse by carefully pushing the connector back with a screwdriver.

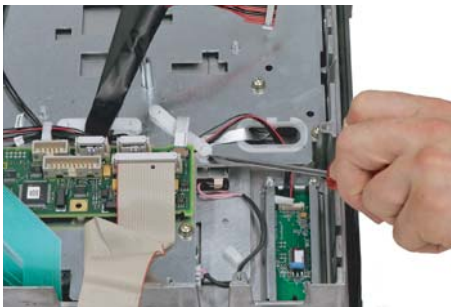

6. Remove the retainer for the cable running between the keyboard controller and mouse.

Connection of keyboard controller / USB interface

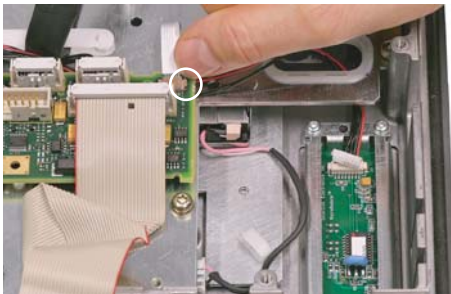

7. Disconnect the connection from the USB interface to the keyboard controller by pulling back the terminal clamps to the left and right of the plug.

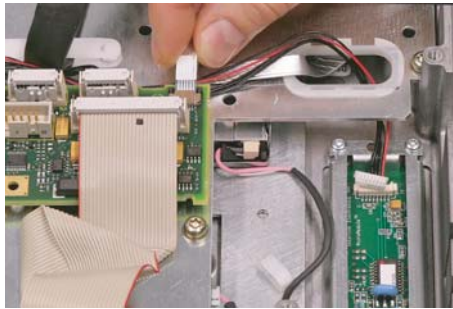

8. Remove the plug of the USB cable from the keyboard controller.

Keyboard cable

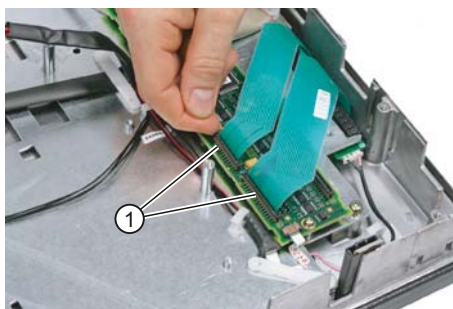

9. Disconnect the three keyboard cables by pushing up the terminal holders ① on the keyboard controller and pulling the keyboard cables out of the holder.

For detailed information about removal and insertion of membrane connectors, see also "General information and networking", Section: "Connecting", Section: "Handling membrane connectors".

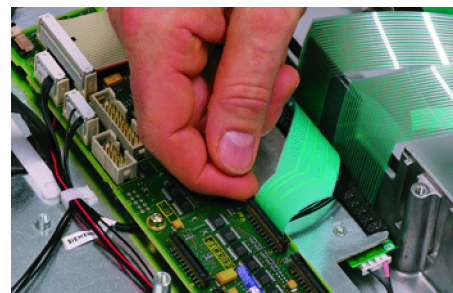

Display supports

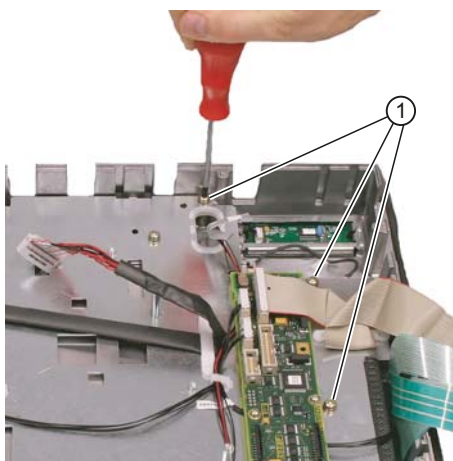

10. Remove the twelve screws ① from the display support.
For the arrangement of the screws on the display support, refer to Figure: "OP 015A Housing open".

7.6 Spare parts

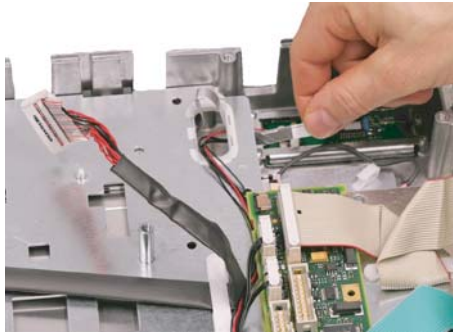

- 11. Insert the USB ribbon cable in the direction of the arrow through the opening and pull it out.
- 12. Lift off the display support.

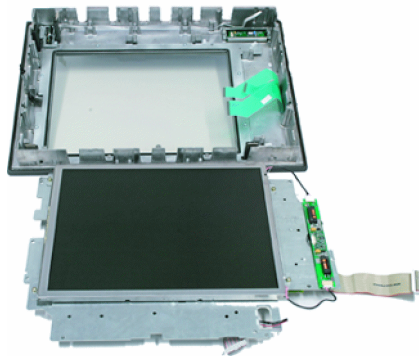

- 13. Lay the display support down on its back to avoid damaging the display.

USB board

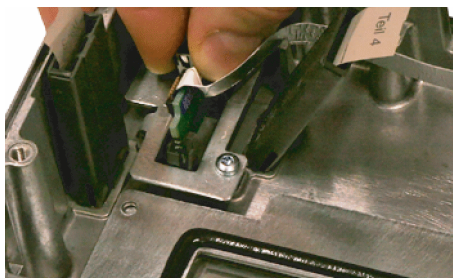

- 14. Remove the USB interface by sliding up both retaining clamps and pulling out the board.

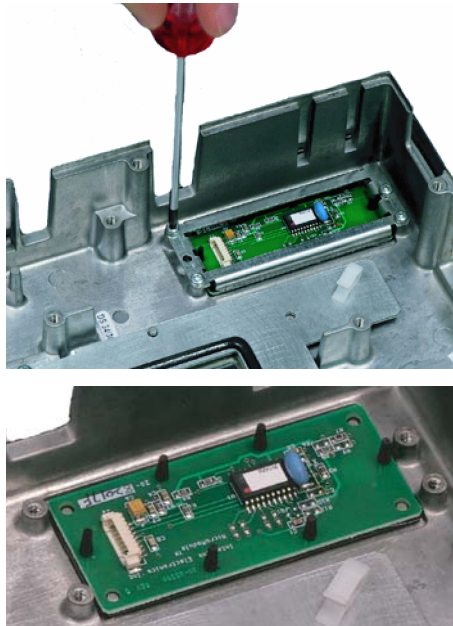
Mouse board

15. Loosen the four screws (M3) on the holder for the mouse board. Lift off the holder and the mouse board.

Installing the individual parts in the operator panel front

1. Remove the transportation safety precautions (adhesive strip for securing cables) and the screen protective sheeting from the inside.
2. Install the components in the new operator panel front in the order indicated:

NOTICE**Damage to the screws**

Pay attention to the torques when tightening the screws (see Technical specifications (Page 111)).

15. Mouse board and bracket**14. USB board**

Press the USB board into place until you hear it lock into the retaining clamps.

Check the secured position of the USB cable behind the guide pins ①.

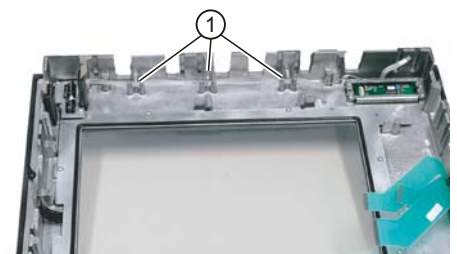

13. - 10. Display support

- 13. Bend the keyboard cables ① back slightly before inserting the display support to prevent pinching and damage, which could render them inoperable.

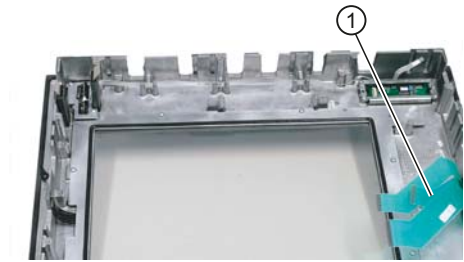

- 11. Insert the USB ribbon cable against the direction of the arrow through the opening and pull it out.

9. Keyboard cable

8. - 7. Connection of keyboard controller / USB interface

- 8. Ensure that the contact side ① of the USB plug faces upwards.

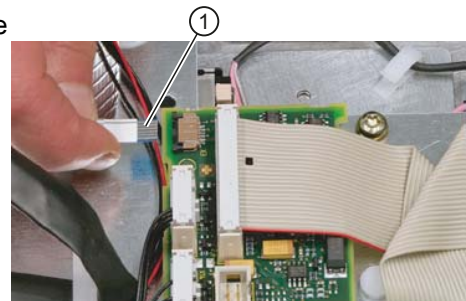

6. - 5. Connection of keyboard controller / mouse

4. Backlight inverter cable

3. - 1. Cover

Operator panel front: OP 015AT

8.1 Description

The SINUMERIK OP 015AT operator panel front with 15" TFT color display and 1024 x 768 pixels (XGA) enables the distributed installation of the operator panel front and the controller. It features a membrane keyboard with 62 keys and 2 x (8 + 2) horizontal and 2 x 8 vertical softkeys and an integrated mouse.

The OP 015AT operator panel front is linked to the PCU/NCU via Ethernet as thin client in a dedicated subnet (via DHCP server on the PCU/NCU). The distance to the operator panel fronts is determined by the maximum distance between two network nodes/access points (100 m). Mixed operation with several TCUs and one operator panel front directly on the PCU is possible.

The operator panel front is secured from the rear using special clamps supplied with the panel.

Validity

This description applies to:

Type	Description	Order number
OP 015AT	As a thin client, operator panel front with membrane keyboard	6FC5203-0AF05-1AB1

Features

- Ethernet 10/100/1000 Mbit/s
- 4 x USB (3 x rear, 1 x front)
- 15" TFT flat screen (color) with resolution 1024 x 768 pixels
- Membrane keyboard with alphabetic, numeric, cursor, and control keypad
- Soft keys / direct keys:
 - 2 x (8 + 2) horizontal rows of keys with softkey function
 - 2 x 8 vertical rows of keys with softkey and direct key function
- Shift key for switchover to the second key level (not for switching over the letters, since they are uppercase only)
- Integrated mouse
- Status LEDs for power supply and overtemperature
- Panel cutout (W x H): 450 x 335 mm
- Degree of protection IP65 (front side)
- Attachment: Tension jacks at the rear

8.2 Operator controls and indicators

8.2.1 View

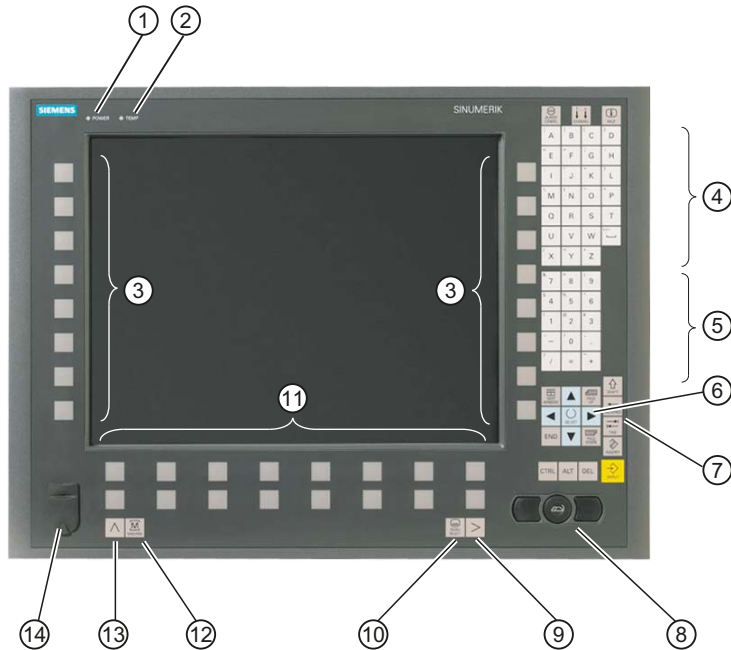

- ① Status LED POWER
- ② Status LED TEMP: Lit LEDs indicate increased wear.
- ③ Softkeys and direct keys
- ④ Alphabetic key group
- ⑤ Numeric key group
- ⑥ Cursor key group
- ⑦ Control key group
- ⑧ Mouse
- ⑨ Menu forward key
- ⑩ Menu select key
- ⑪ Softkeys
- ⑫ Machine area key
- ⑬ Menu back key
- ⑭ Front USB interface

Figure 8-1 Front view of the OP 015AT operator panel front

8.2.2 Keyboard

Keyboard

Several keys and keypads are installed on the operator panel front:

- The alphabetic block contains the letters A - Z and the space character.
- The numeric block contains the digits 0 - 9, and the characters "-", "/", "=", "+" and ".".
- The cursor key group is used to navigate on the screen.
- The control key group includes special functions.
- The mouse comprises the center actuation field (corresponds to the function of a tracker ball) and two keys for the left and right mouse key.
- The softkeys call up functions that are available on the screen via a menu bar.
- The menu select key displays the area menu.
- The menu forward key enables an expansion of the horizontal softkey bar in the same menu.
- The machine area key switches directly into the "Machine" operating area.
- The menu back key returns to the higher-level menu, one window is closed.









Switching between upper and lower case

















To toggle between upper and lower case letters, press the key combination Ctrl + Shift

Upper case is always activated as standard.

Overview of the key symbols

The key symbols used on the operator panel front are shown below along with the corresponding function keys on the PC keyboard.

Key	Function corresponds to the PC key function	Key	Function corresponds to the PC key function
	Esc		End
	F11		Backspace
	F12		Tab
	Space		(only intended for internal keyboard changeover)

Key	Function corresponds to the PC key function	Key	Function corresponds to the PC key function
	Home		Ctrl key
	Page up		Alt key
	Page down		Delete
	Cursor up		Insert
	Cursor left		Enter
	Cursor right		F9
	Cursor down		F10
	5 (in numeric key group)	A, ..., Z	<Shift> A, ..., Z
	<Shift> F9		<Shift> F10

Display

Note

Pixel error according to DIN EN ISO 13406-2 Class II.

8.2.3 Screen saver

If a screen with high contrast is displayed unchanged for longer than an hour, the screen must be switched dark (screensaver) in order to protect the TFT display against so-called "freezing" of the last displayed screen.

The time can be adapted individually. Further information can be found at: IM9 SINUMERIK Operate Commissioning Manual

8.3 Interfaces

Overview

The OP 015AT operator panel front has the following interfaces:

Function	Designation	Type
Ethernet interface	X202	8-pin RJ45 socket
Double USB interface	X203 / X204	USB 2.0 socket A
USB interface	X213	USB 2.0 socket A
24 VDC power supply	X206	3-pin terminal block
Front USB interface	-	USB 1.1 socket A

Rear side

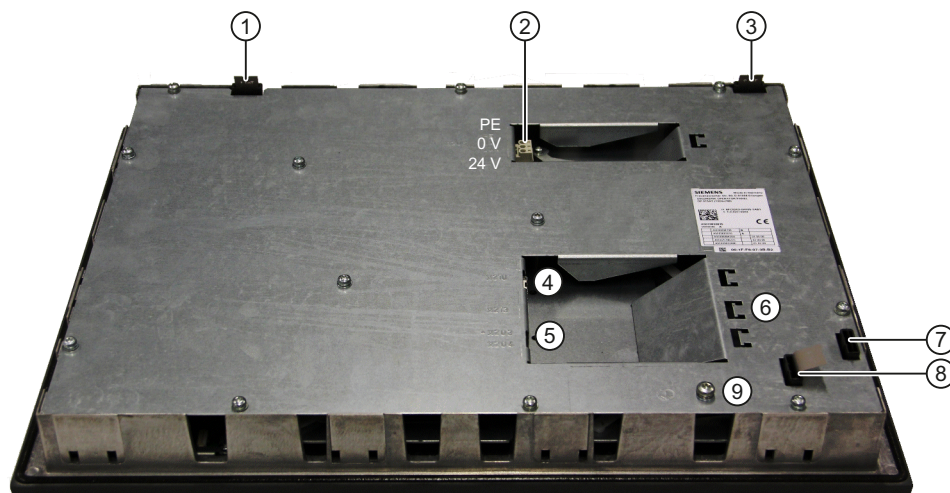

- | | | |
|---|---------------------|---|
| ① | Part 1 | Slide-in labels for vertical softkeys (see Section: Spare parts) |
| ② | X206 | Power supply (with connector that can be screwed in place) |
| ③ | Part 2 | Slide-in labels for vertical softkeys (see Section: Spare parts) |
| ④ | X202 | Ethernet interface |
| ⑤ | X203 / X 204 / X213 | USB interfaces |
| ⑥ | - | Strain relief for connecting cables |
| ⑦ | Part 3 | Slide-in labels for horizontal softkeys (for these, there is no foil as template) |
| ⑧ | Part 4 | |
| ⑨ | - | M5 grounding screw (for screw connection with cable lug) |



Figure 8-2 OP 015AT - Rear with interfaces

8.4 Installation

Front side

USB 1.1 to connect an external keyboard, mouse, or USB FlashDrive (see Figure 8-1 Front view of the OP 015AT operator panel front (Page 122)).

Note

Note that the electromagnetic compatibility of commercially available peripheral devices operated via the USB interface is usually rated for office use only.

For industrial use, components with a higher degree of certification are recommended.

Pin assignment

The pin assignment of the interfaces, see "General information and networking" → "Connecting".

8.4 Installation

8.4.1 Mounting

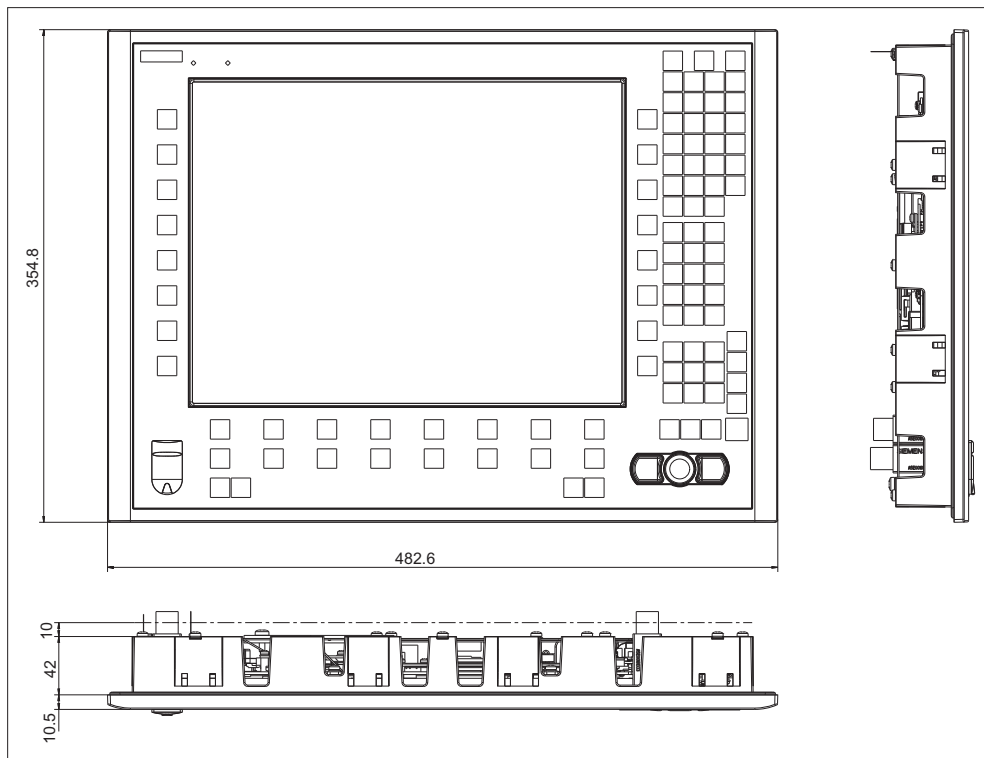

Figure 8-3 OP 015AT with TCU (integrated)

Table 8- 1 Dimensions of the mounting opening

Width (mm)	Height (mm)	Mounting depth + clearance (mm)
450	335	42 + 10

Thanks to the tension jacks on the OP 015AT, drill-holes or screw holes are not needed.

This retaining method also enables the IP65 degree of protection (but only in conjunction with a circumferential seal and when the protective USB cap is fitted).

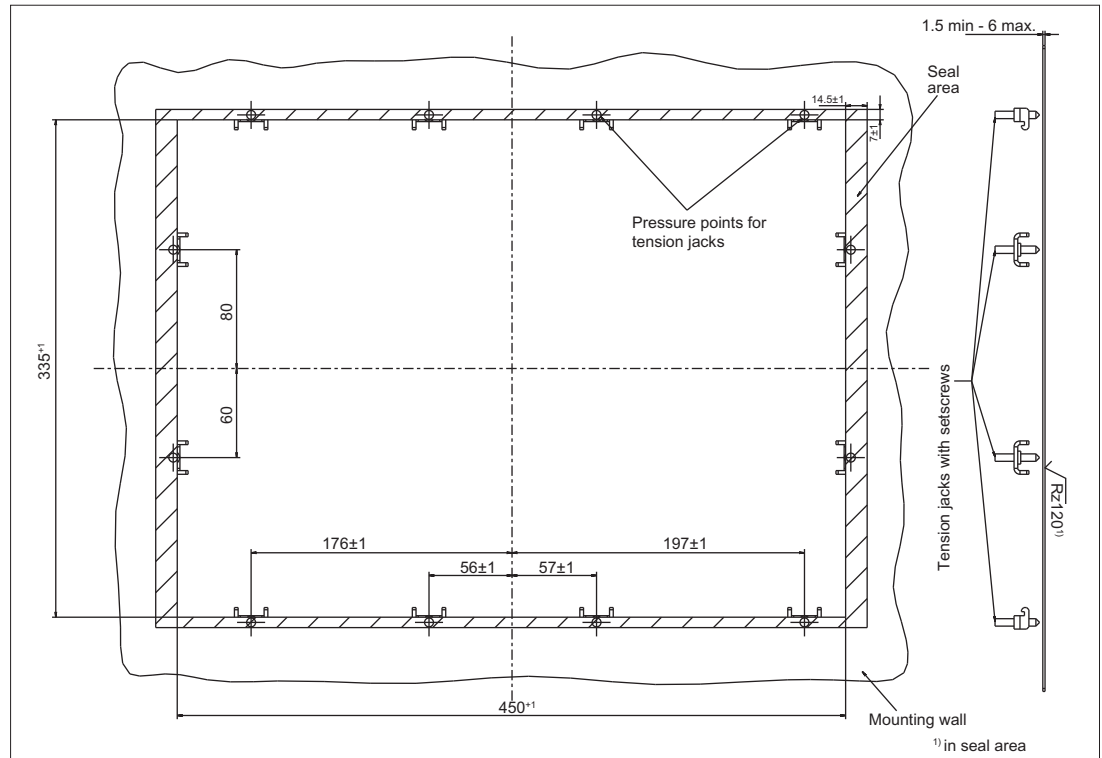

Figure 8-4 Dimension sheet for installing the OP 015AT operator panel front

8.4.2 Softkey labeling

User-specific functions can be assigned to the horizontal and vertical softkey bars. Printed labeling strips can be used to label the softkeys.

Blank labels are already installed on delivery.

To make the vertical labels, DIN A4 foils are available (see Chapter, "Spare parts" →Overview (Page 129)).

Note

Use the "Arial" font to format text. This font is comparable to the "Univers S57" font, used by Siemens for the key labeling.

Procedure

1. Letter the matt side of the foil using a laser printer.
2. Cut the printed labels along the preprinted lines.
3. Insert the strips into the slots provided on the rear side of the operator front panel (see Figure 8-2 OP 015AT - Rear with interfaces (Page 125)).

8.5 Technical data

Safety			
Safety class	III; PELV according to EN 50178		
Degree of protection according to EN 60529	Front side: IP65 Rear side: IP00		
Approvals	CE / cULus		
Electrical data			
Power supply	24 VDC		
Current consumption	Typical, approx. 0.9 A Max. approx. 2.4 A		
Power consumption	Typical, approx. 22 W Max. approx. 47.5 W		
Mechanical data			
Dimensions	Width: 483 mm	Height: 355 mm	Depth: 53 mm
Weight	Approx. 7.6 kg		
Tightening torques, max.	Tension jack screws: 0.5 Nm	M3 screws: 0.8 Nm	M4 screws: 1.8 Nm
	M5 grounding screw: 3 Nm		
Display			
Size / resolution	15" TFT / 1024 x 768 pixels		
MTBF backlight	typ. 50,000 h at 25° C (dependent on the temperature)		

Note

Information about the climatic and mechanical environmental conditions is contained in the associated section under:

"General notes and interconnection" → "Operational planning".

8.6 Replacement parts

8.6.1 Overview

The diagram shows the OP 015AT operator panel front disassembled into its individual parts.

The components provided with an order number are available as individual spare parts.

8.6 Replacement parts

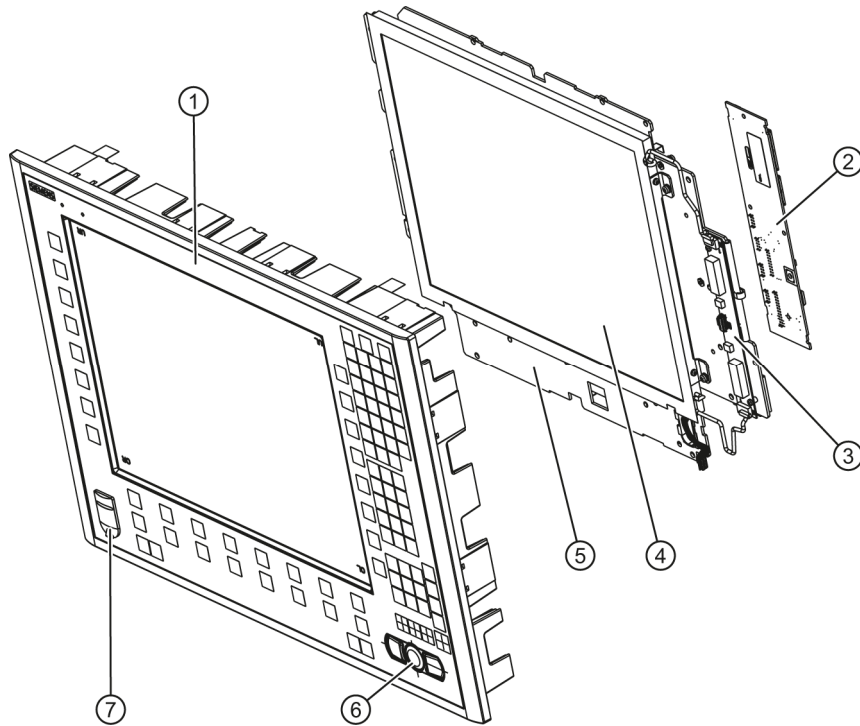

Figure 8-5 Individual parts for the OP 015AT operator panel front

	Spare part	Order number	Remark
①	Operator panel front	A5E00405090	Without LCD unit, mouse, USB port and keyboard controller
②	Keyboard controller		
③	Background lighting with backlight inverter		
④	LCD unit		
⑤	Display support		
	Spare part	Order number	Remark
⑥	Mouse	6FC5247-0AF01-0AA0	
⑦	Cap for the USB interface	6FC5248-0AF05-0AA0	Set of 10
	Tension jacks	6FC5248-0AF14-0AA0	Set of 9
	Slide-in labels *) (DIN A4 foils)	6FC5248-0AF24-0AA0	Set of 3

*) The dimensions for creating slide-in labels from foil for softkey labeling can be seen in the following diagram.

8.6.2 Replacement

NOTICE
Damage to sensitive components due to static electricity
Spare parts must always be replaced by properly trained personnel!

USB cap / tension jack

The replacement of the USB sealing cap and tension jacks will not be described since it is simple and self-explanatory.

Operator panel front

When the operator panel front is replaced, the display, keyboard controller, mouse, and USB interface can be used again. They are therefore disassembled and re-assembled after the appropriate component has been replaced.

Note

We recommend reusing the keypad controller to prevent any loss of the control parameters that have been programmed in.

Expansion of the individual parts of the operator panel front

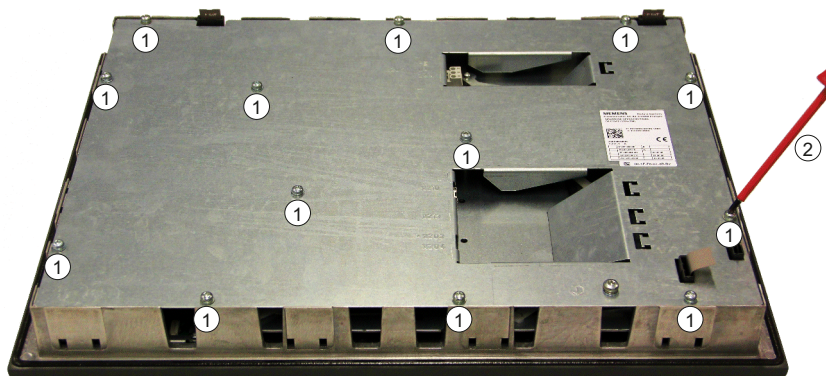

1. Place the OP 015AT on a soft horizontal surface. Loosen the 13 housing screws (M4) ① using a Torx screwdriver T25 ②.

2. Remove the cover.

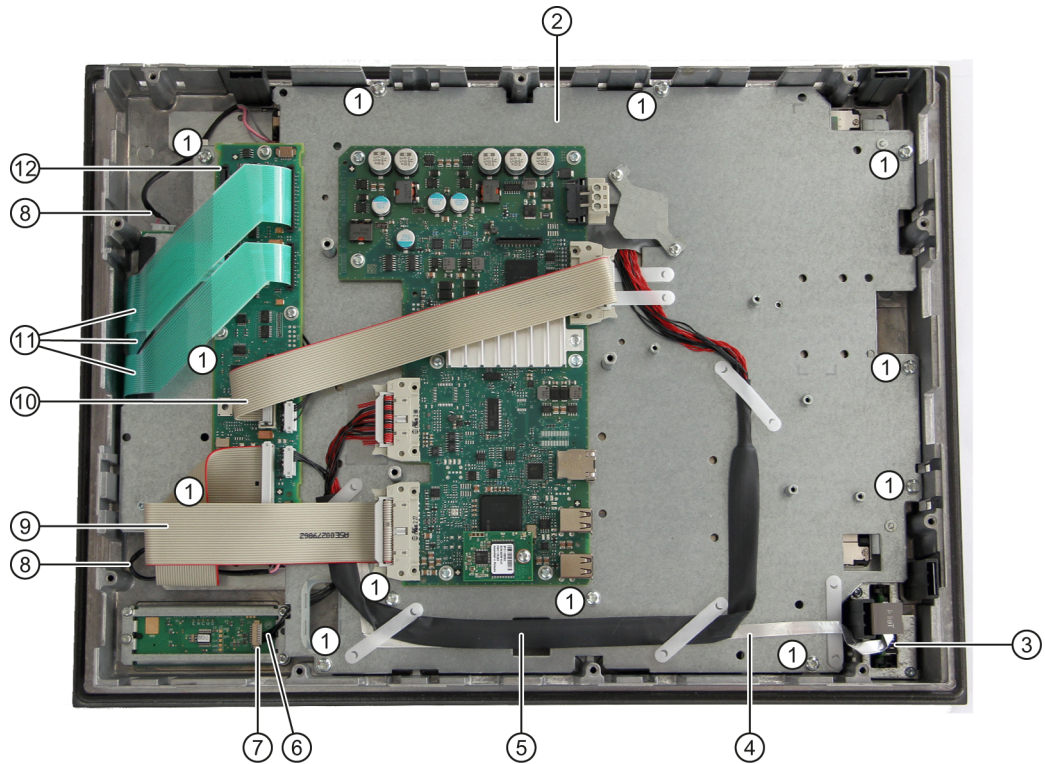

- ① Screws (M4) for display support
- ② Display support
- ③ USB interface
- ④ Ribbon cable for keyboard controller / USB interface
- ⑤ Display cable
- ⑥ Cable, mouse / keyboard controller
- ⑦ Connector, mouse interface
- ⑧ Backlight inverter cable
- ⑨ I/O USB cable
- ⑩ Direct key cable
- ⑪ Keyboard cables
- ⑫ Keyboard controller

Figure 8-7 OP 015AT housing opened

Cables, backlight inverter

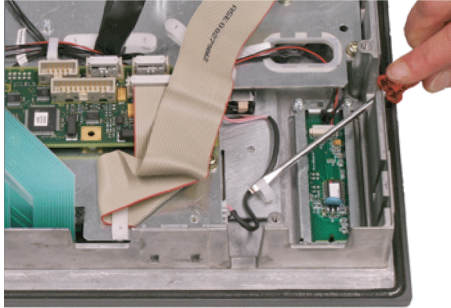

3. Remove the two cables to the backlight inverter by lifting the clips with a flat screwdriver and withdrawing the cables.

Connection of keyboard controller / mouse

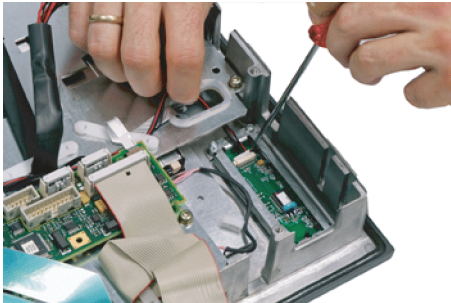

4. Undo the connection between the keyboard controller and the mouse by carefully pushing the connector back with a screwdriver.

USB board

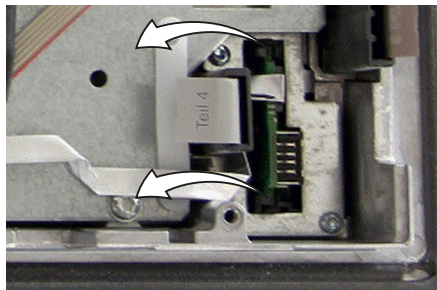

5. Release the connection to the keyboard controller by releasing both retaining clamps next to the USB board and withdrawing them.

Do not remove the cable from the board!

Keyboard cables

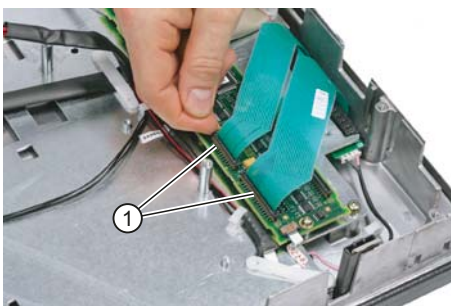

6. Disconnect the 3 keyboard cables by pushing up the terminal holders ① on the keyboard controller and pulling the keyboard cables out of the holder.

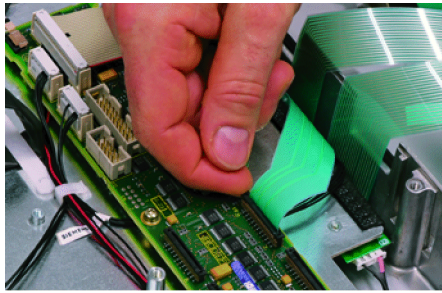

For detailed information about removal and insertion of membrane connectors, see "General information and networking", Chapter: "Connecting", Section: "Handling membrane connectors".

Display support

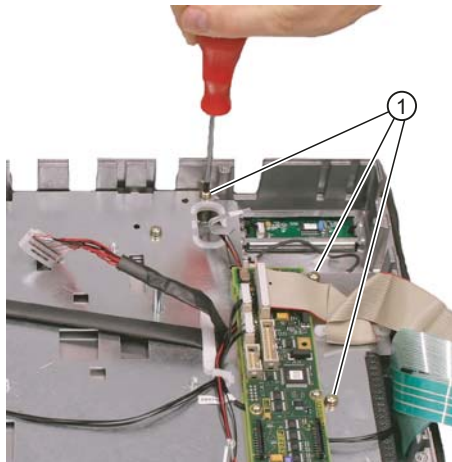

7. Remove the 12 screws ① from the display support.

For the arrangement of the screws on the display support, refer to Figure: "OP 015AT housing opened".

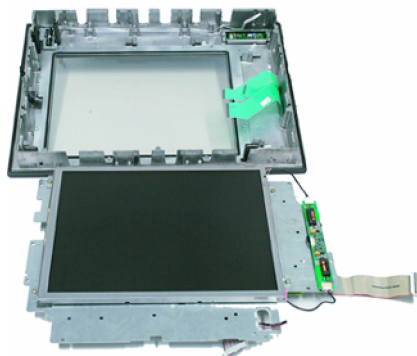

8. Lift off the display support.

9. Lay the display support down on its back to avoid damaging the display.

Mouse board

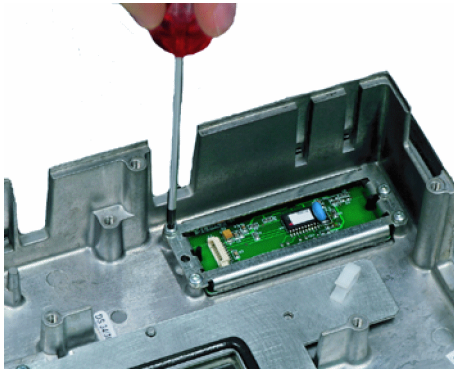

10. Loosen the 4 screws (M3) at the support for the mouse board using a Torx screwdriver T10. Lift off both the holder and the mouse board.

Installing the individual parts of the operator panel front

1. Remove the transportation safety precautions (adhesive strip for securing cables) and the screen protective foil from the inside.
2. Install the components in the new operator panel front in the order indicated:

NOTICE

Damage to the screws

Pay attention to the torques when tightening the screws (see Technical data (Page 129)).

2.1 Mouse board and bracket

2.2 Display support

Slightly bend the keyboard cables to the rear before installing the display carrier. Otherwise, they could jam or be damaged and therefore no longer function.

2.3 USB board

Press the USB board into place until you hear it lock into the retaining clamps.

2.4 Keyboard cables

2.5 Connection of keyboard controller / mouse

2.6 Cables, backlight inverter

2.7 Cover

Operator panel front: TP 015A

9.1 Description

The SINUMERIK TP 015A touch operator panel front and 15" TFT color display with a resolution of 1024 x 768 pixels (XGA) and touch screen features a 62-key membrane keyboard as well as 2 x (8 + 2) horizontal and 2 x 8 vertical softkeys and an integral mouse. The 2 x 8 vertical softkeys can be used as direct keys.

The operator panel front is secured from the rear using special clamps supplied with the panel.

Validity

The description below applies to the TP 015A operator panel front:

Type	Order number	Description
TP 015A	6FC5203-0AF08-0AB0	Discontinued product
TP 015A	6FC5203-0AF08-0AB2	Redesign with new touch controller

The new touch controller (6FC5203-0AF08-0AB2) requires a new set of drivers that are included as of certain SINUMERIK software releases:

When used with:	As of software version:
PCU 50.3	PCU base software 8.0 SP 2 HF 8
NCU/TCU	NCU sl 1.5 HF 4
	NCU sl 2.4 SP 1 HF 7
	NCU sl 2.5 HF 2

9.1 Description

Features

- 15" TFT flat screen (color) with resolution 1024 x 768 pixels
- Touch screen (analog resistive, 5-wire)
- Membrane keyboard with alphabetic, numeric, cursor, and control keypad
- Soft keys / direct keys:
 - 2 x (8 + 2) horizontal rows of keys with softkey function
 - 2 x 8 vertical rows of keys with softkey and direct key function
 - Direct keys via direct key / handwheel module (optional), machine control panel, TCU or directly connectable to the I/Os
- Shift key for switchover to the second key level (not for switching over the letters, since they are uppercase only)
- Integrated mouse
- Status LEDs for power supply and overtemperature
- USB front interface (USB 1.1)
- Degree of protection IP65 (front side)
- Attachment: Tension jacks at the rear
- Can be combined with PCU, TCU

9.2 Operating and display elements

9.2.1 View

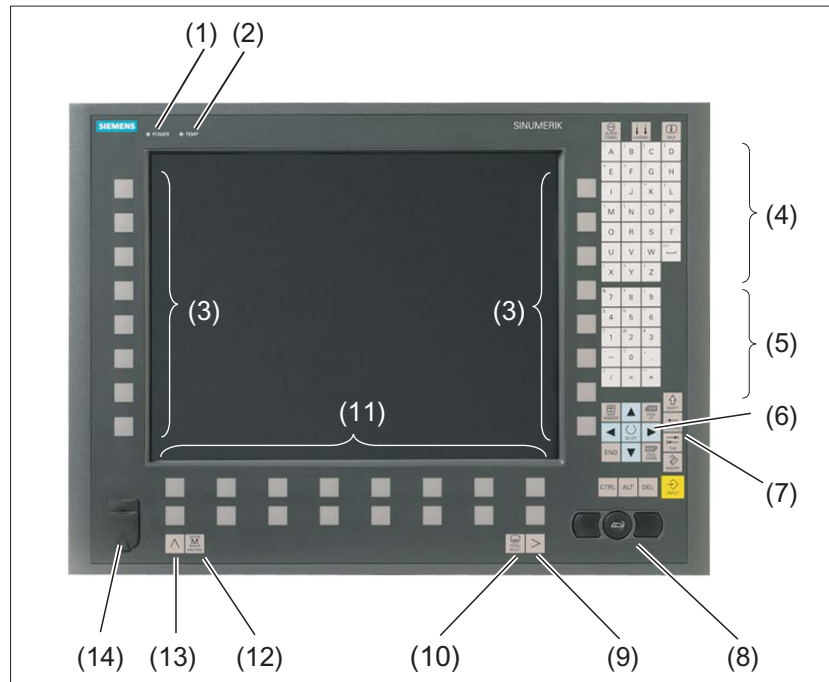

- (1) Status LED: POWER
- (2) Status LED: TEMP
Lit LEDs indicate increased wear.
- (3) Softkeys and direct keys
- (4) Alphabetic key group
- (5) Numeric key group
- (6) Cursor key group
- (7) Control key group
- (8) Mouse
- (9) Menu forward key
- (10) Menu select key
- (11) Softkeys
- (12) Machine area key
- (13) Menu back key
- (14) Front USB interface

Figure 9-1 Front view, TP 015A operator panel front

9.2.2 Operation

The operator panel front is operated by

- Using the touch screen to select the application-specific functions, e.g. by touching one of the displayed buttons.
- Softkeys
- Keys
- Mouse

NOTICE
Damage to the operator elements
Do not touch the operating elements with pointed or hard objects. This may considerably reduce their service lives.

9.2.3 Keyboard

Keyboard

Several keys and keypads are installed on the operator panel front:

- The alphabetic block contains the letters A - Z and the space character.
- The numeric block contains the digits 0 - 9, and the characters "-", "/", "=", "+" and ".".
- The cursor key group is used to navigate on the screen.
- The control key group includes special functions.
- The mouse comprises the center actuation field (corresponds to the function of a tracker ball) and two keys for the left and right mouse key.
- The softkeys call up functions that are available on the screen via a menu bar.
- The "Menu back" key switches back to the higher-level horizontal menu.
- The "Menu forward" key advances in the extended horizontal softkey bar.
- The "Menu select" key calls the main menu to select the operating area.
- The "Machine area" key selects the "Machine" operating area.

























Switching between upper and lower case

To toggle between upper and lower case letters, press the key combination Ctrl + Shift

Upper case is always activated as standard.

Overview of the key symbols

The key symbols used on the operator panel front are shown in the overview along with the corresponding function keys on the PC keyboard.

Key	Function corresponds to the PC key function	Key	Function corresponds to the PC key function
	Esc		End
	F11		Backspace
	F12		Tab
	Space		(only intended for internal keyboard changeover)
	Home		Ctrl key
	Page up		Alt key
	Page down		Delete
	Cursor up		Insert
	Cursor left		Enter
	Cursor right		F9
	Cursor down		F10
	5 (in numeric key group)	A, ..., Z	<Shift> A, ..., Z
	<Shift> F9		<Shift> F10

Display

Note

Pixel error according to DIN EN ISO 13406-2 Class II.

9.3 Interfaces

9.2.4 Screen saver

If a screen with high contrast is displayed unchanged for longer than an hour, the screen must be switched dark (screensaver) in order to protect the TFT display against so-called "freezing" of the last displayed screen.

The time can be adapted individually. Further information can be found at:
IM9 SINUMERIK Operate Commissioning Manual

9.3 Interfaces

The TP 015A operator panel front has the following interfaces:

Front

USB 1.1 (type A) for connecting an external keyboard, mouse and USB FlashDrive (see figure in Section: "Control and display elements" → "View").

Note

Note that the electromagnetic compatibility of commercially available peripheral devices operated via the USB interface is usually rated for office use only.

For industrial use, components with a higher degree of certification are recommended.

Rear side

- Two cables for connecting the PCU (see figure below):
 - I/O USB cable K1 (ribbon cable):
All signals that are used for the display interface and the connection of operator panel fronts (e.g. supply voltages)
 - Display cable K2

Under the interface cover:

- Direct key interface X11: Signals from the 16 "vertical softkey" direct keys
- Interface X12 (reserved)

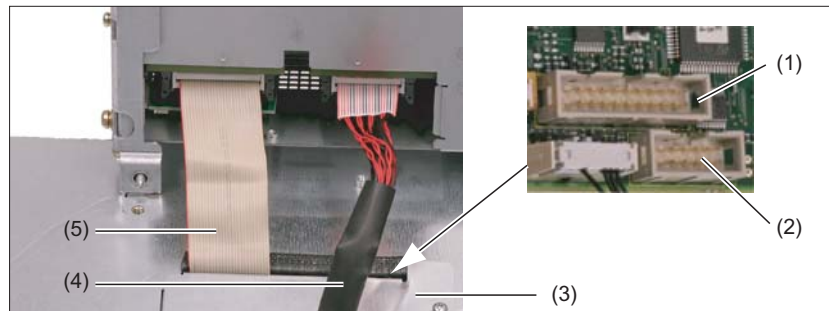

- (1) Direct key interface X11
- (2) Interface X12 (reserved)
- (3) Interface cover
- (4) Display cable K2
- (5) I/O USB cable K1

Figure 9-2 TP 015A - connections at the rear of the enclosure: Connections to the PCU

Pin assignment

For more detailed information, see "General information and networking", Chapter: "Connection".

9.4 Mounting

9.4.1 Preparation for mounting

Table 9- 1 Dimensions of the mounting opening

Width (mm)	Height (mm)
450	335

Thanks to the tension jacks on the TP 015A, drill-holes or screw holes are not needed.

This retaining method also enables the IP65 degree of protection (but only in conjunction with a circumferential seal and when the protective USB cap is fitted).

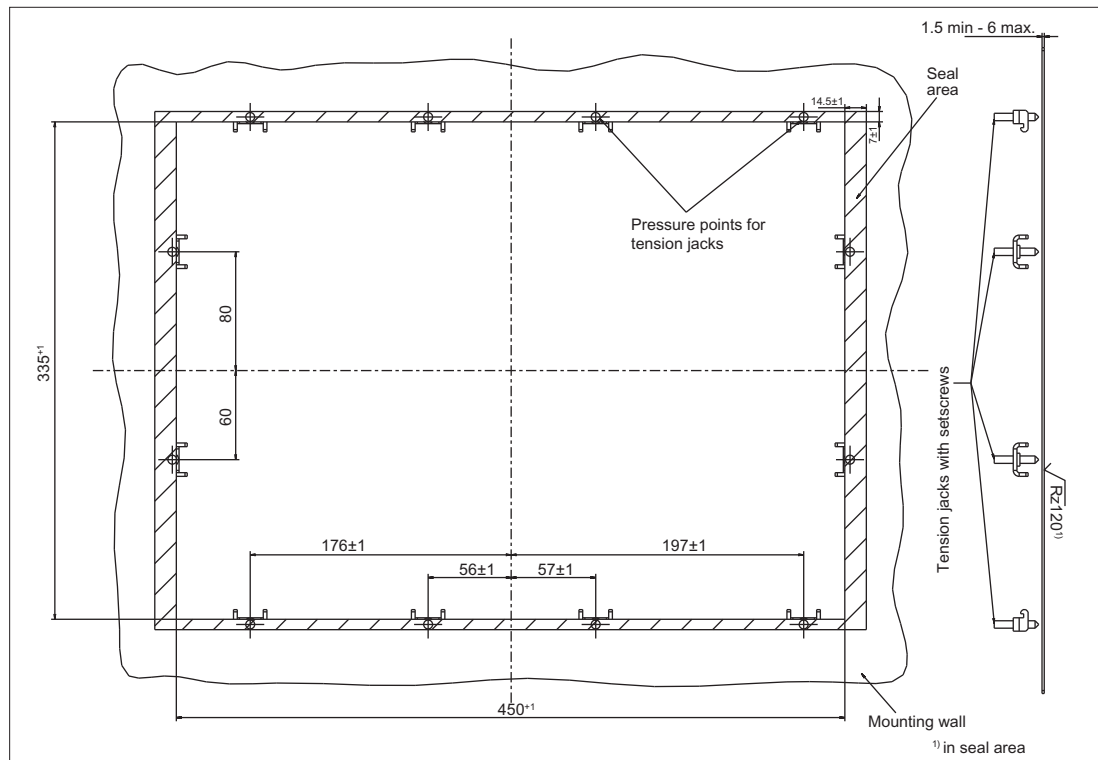

Figure 9-3 Dimension sheet for mounting the TP 015A operator panel front

9.4.2 Assembling TP 015A and PCU

The assembly functions in the same way as described in Section Assembling an OP 015A and a PCU (Page 106).

9.4.3 Mounting on the mounting wall

The clearance at the rear of the PCU must be at least 10 mm to ensure sufficient ventilation.

For more detailed information, please refer to the relevant PCU sections and in "General information and networking", Section: "Application planning", Section: "Climatic and mechanical environmental conditions" → "Cooling".

NOTICE

Impermissible mounting positions can cause malfunctions

Observe the permissible mounting position: Deviating by up to 5° from the vertical.

This value can be further restricted by mounted components (e.g. PCU).

Procedure

1. Insert the assembled components (operator panel front and PCU) from the front into the panel cutout (see Figure 9-3 Dimension sheet for mounting the TP 015A operator panel front (Page 144)).
2. Secure the operator panel front in the panel cutout from the rear using the twelve tension jacks by tightening the setscrews (torque 0.5 Nm).

Table 9- 2 Dimensions to be observed when installing

	Mounting depth T3 + clearance (mm)	Opening depth T5 (mm)	Protrusion P (mm)
PCU 50.3 / 50.5	127 + 10	402	32
TCU x0.2	76 + 10	376	-19

9.4 Mounting

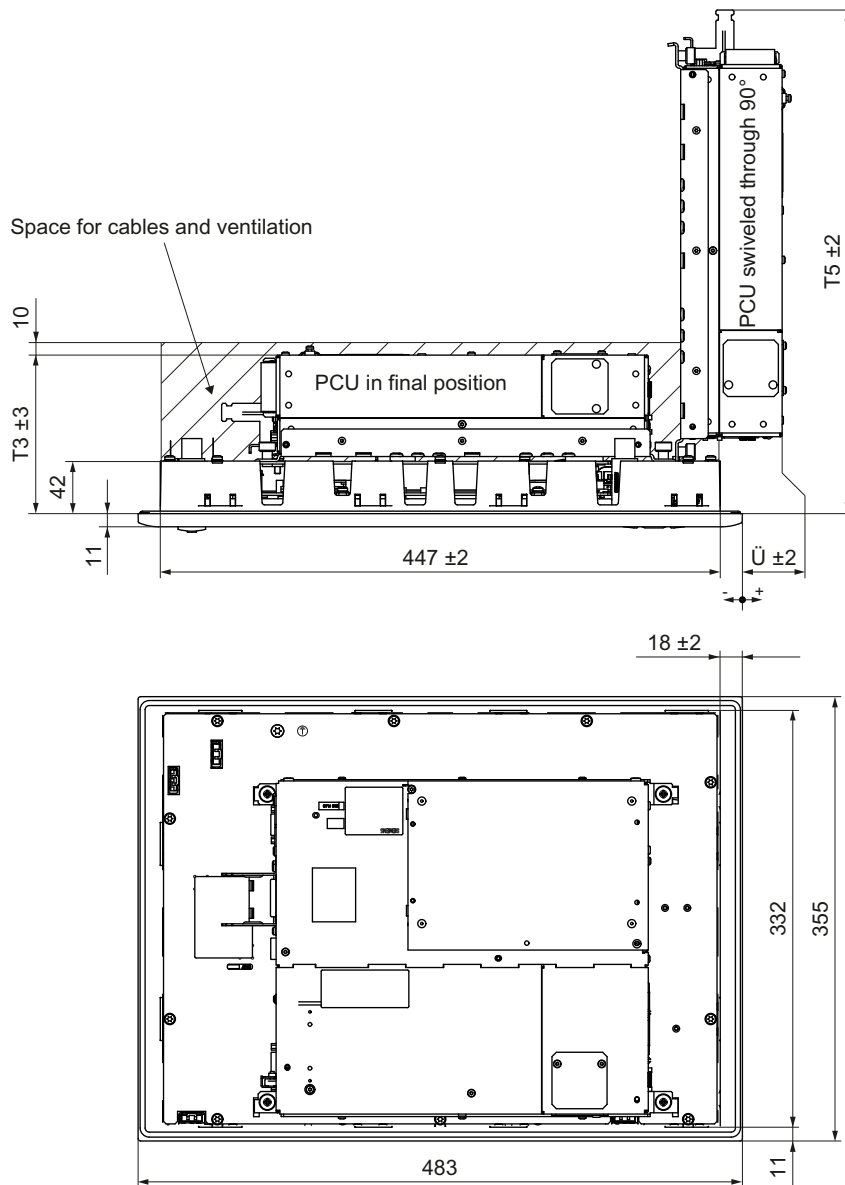

Figure 9-4 Mounting the PCU to the TP 015A operator panel front (as seen from above)

9.4.4 Calibration of the touch screen

Whenever a new operator panel front is connected, a screen calibration must be performed.

Procedure

A description of the calibration can be found

- in Chapter: "PCU 50.3", Section: "Start-up" → "Calibration of the touch screen"
- in "General information and networking", Chapter: "Networking"

9.4.5 Softkey labeling

User-specific functions can be assigned to the two vertical softkey bars. Printed labeling strips can be used to label the softkeys.

Blank labels are already factory-installed.

DIN A4 films are available for preparing the vertical strips. You will find the order number in section: "Spare parts" → "Overview".

Note

Use the "Arial" font to format text. This font is comparable to the "Univers S57" font, used by Siemens for the key labeling.

Proceed as follows

1. Label the mat side of the film with a laser printer or another printer that allows "Film" to be set as a printable medium.
2. Cut the printed labels along the preprinted lines.
3. Insert the labeling strips into the slits provided from the rear of the operator panel front (refer to figure: "TP 015A housing open" in section: "Spare parts" → "Replacement").

Note

In order to facilitate insertion of the "Part1" strip when the PCU is mounted, it is recommended that you

- unscrew the 4 retaining screws of the PCU and
- swing the PCU up.

Once you have inserted the strip, swing the PCU back to the operator panel and secure by tightening the screws.

9.5 Technical specifications

Safety			
Safety class	III; PELV according to EN 50178		
Degree of protection according to EN 60529	Front side: IP65 Rear side: IP00		
Approvals	CE / cULus		
Electrical data			
Power supply (via K1 and K2)	Display	Backlight inverter	Logic / USB
Voltage Current (typ./max.)	4.9 V - 5.25 V approx. 420/700 mA	12 V +/- 5% approx. 900/1100 mA	5.0 V - 5.2 V approx. 350/1050 mA
Power consumption	Typical, approx. 15 W Maximum approx. 25 W		
Mechanical data			
Dimensions	Width: 483 mm	Height: 355 mm	Depth: 53 mm
Weight	Approx. 8.4 kg		
Max. tightening torques:	Tension jack screws: 0.5 Nm	M3 screws: 0.8 Nm	M4 screws: 1.8 Nm
Display			
Size / resolution	15" TFT / 1024 x 768 pixels		
MTBF backlight	typ. 50,000 h at 25° C (dependent on the temperature)		

Note

Information about the climatic and mechanical environmental conditions is contained in the associated section under:

"General notes and interconnection" → "Operational planning".

9.6 Spare parts

9.6.1 Overview

The diagram shows the TP 015A operator panel front dismantled into its individual parts.

The components provided with an order number are available as individual spare parts.

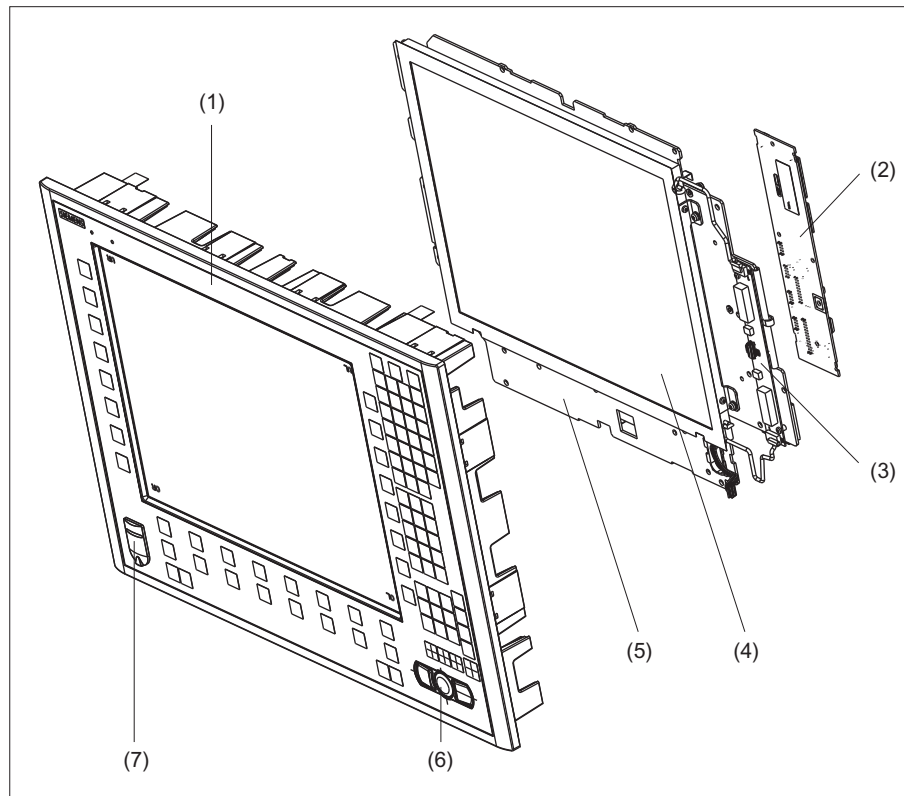

Figure 9-5 Individual parts for the TP 015A operator panel front

	Spare part	Order number	Remark
(1)	Operator panel front	A5E00405089 (for MLFB 6FC5203-0AF08-0AB0) A5E01136461 (for MLFB 6FC5203-0AF08-0AB2)	Without LCD unit, mouse, USB port and keyboard controller
(2)	Keyboard controller		
(3)	Background lighting with backlight inverter		
	Spare part	Order number	Remark
	Direct key module	6FC5247-0AF11-0AA0	
	Direct key module mounting kit	6FC5247-0AF30-0AA0	
(4)	LCD unit		
(5)	Display support		
	Spare part	Order number	Remark
(6)	USB mouse	6FC5247-0AF01-0AA0	
(7)	Cap for the USB port	6FC5248-0AF05-0AA0	Set of 10
	Tension jacks	6FC5248-0AF14-0AA0	Set of 9
	Mounting bracket	6FC5248-0AF20-2AA0	
	Slide-in labels *) (DIN A4 foils)	6FC5248-0AF24-0AA0	Set of 3

*) The dimensions for production of slide-in film labels for softkey labeling can be seen in the following diagrams.

9.6 Spare parts

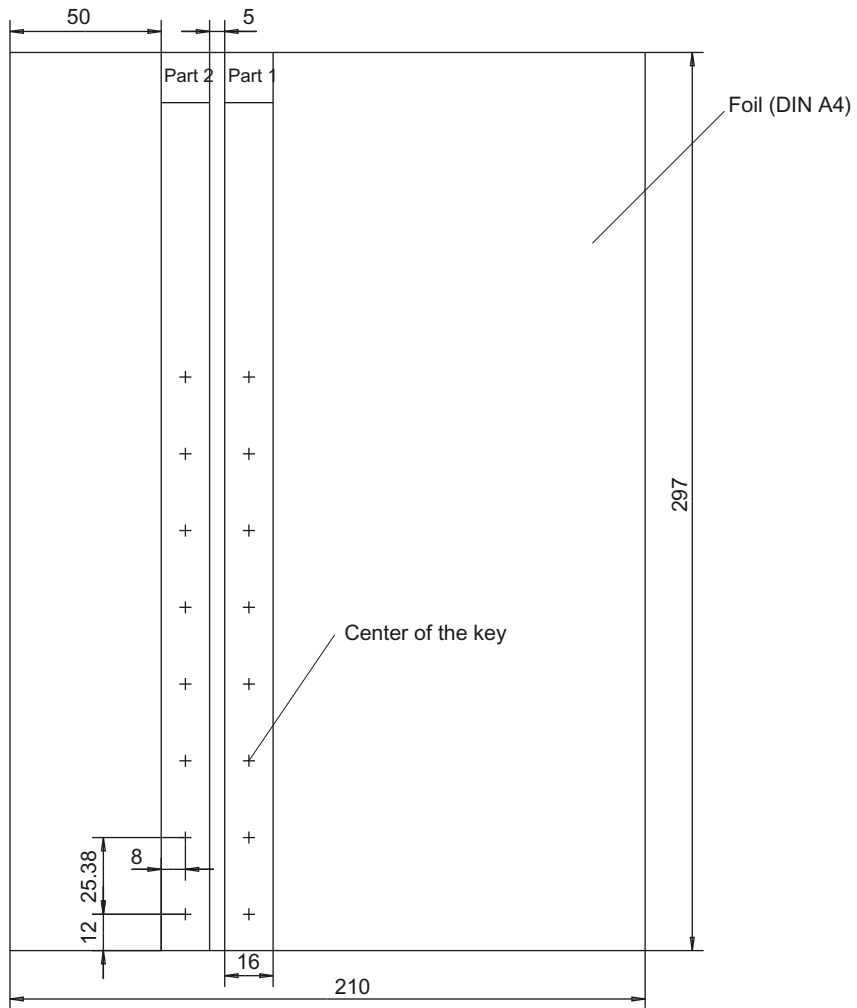

Figure 9-6 Dimensions for vertical slide-in labels

9.6.2 Replacement

NOTICE

Risk of damage to sensitive components due to static electricity

Spare parts must always be replaced by properly trained personnel!

USB cap / tension jack

The replacement of the USB sealing cap and tension jacks will not be described since it is simple and self-explanatory.

Operator panel front

When the operator panel front is replaced, the display, keyboard controller, touch controller, mouse and USB interface can be used again. They are therefore disassembled and reassembled after the appropriate component has been replaced.

Note

We recommend reusing the keypad controller to prevent any loss of the control parameters that have been programmed in.

Dismounting individual parts from the operator panel front



1. Place the TP 015A on a soft, horizontal support.
Remove the retaining screw (1) from the cover plate (2) and lift off the cover plate.



2. Release the 13 casing screws.
The exact positions of the housing screws are provided in "Rear of TP 015A operator panel front" in Section: "Installation"→ "Assembling TP 015A and PCU".
3. Lift off the cover.

9.6 Spare parts

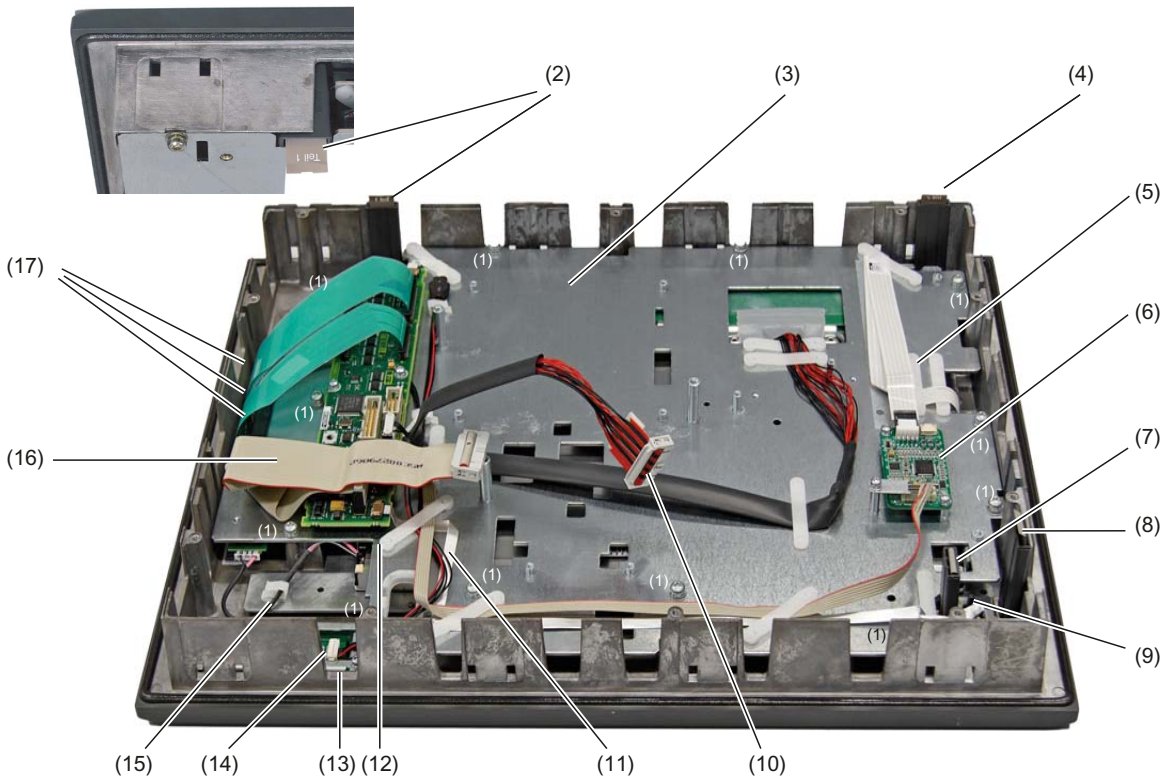

- (1) Screws (M4) for display support
- (2) Slide-in labels (Part1)
- (3) Display support
- (4) Slide-in labels (Part2)
- (5) Retainer for the cable of the touch controller
- (6) Touch controller
- (7) Slide-in labels (Part4)
- (8) Slide-in labels (Part3)
- (9) USB interface
- (10) Display cable
- (11) Ribbon cable for keyboard controller / USB connection
- (12) Retainer for the mouse / keyboard controller cable
- (13) Interface for the mouse
- (14) Cable plug for mouse / keyboard controller
- (15) Backlight inverter cable
- (16) I/O USB cable
- (17) Keyboard cable

Figure 9-7 TP 015A housing opened

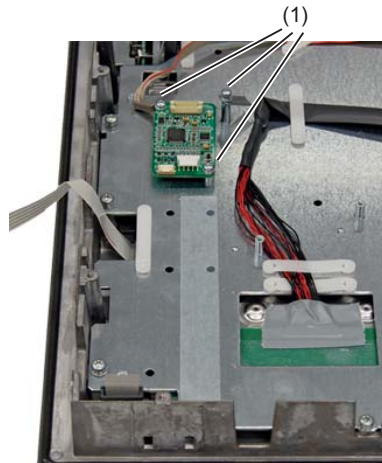
Touch controller

4. Remove the three M3 screws (1) that are holding the touch controller to the display support.
Do this with a TX10 screwdriver.

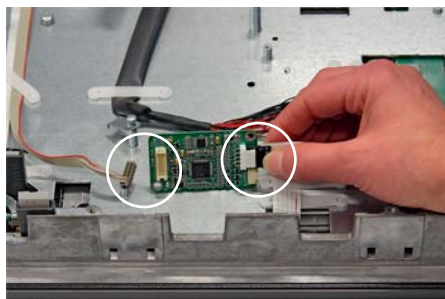

5. Release the two connectors (left/right) on the touch controller.
Left:
Hold the connector by the detent lugs at the top and bottom and pull it carefully up and out.
Right:
Press the cable terminal down gently and pull it backwards to remove it.

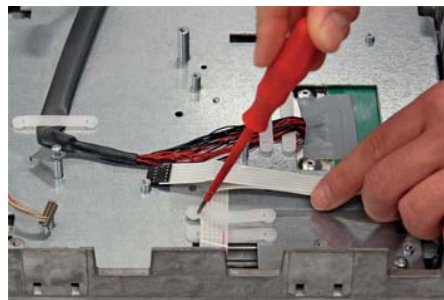

6. Remove the retainer of the touch screen / touch controller cable with a flat screwdriver.

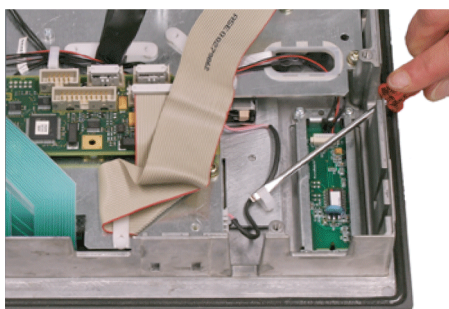
Backlight inverter cable

7. Remove the two cables to the backlight inverter (to the left and right of the display support) by raising the clamps with a flat screwdriver and pulling out the cables.

Connection of keyboard controller / mouse

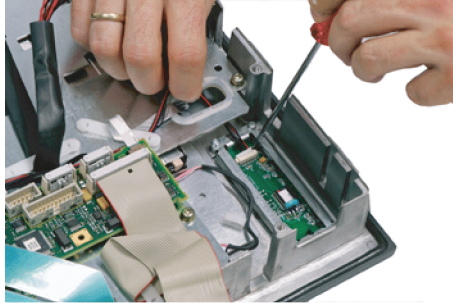

8. Undo the connection between the keyboard controller and the mouse by carefully pushing the connector back with a screwdriver.



9. Remove the retainer for the cable running between the keyboard controller and mouse.

Connection of keyboard controller / USB interface

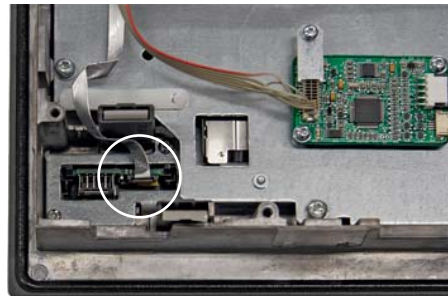

10. Release the connection between the USB interface and keyboard controller. Use a screwdriver to push up the black terminal clamp on the USB interface and then pull the cable out of the holder.

Keyboard cable

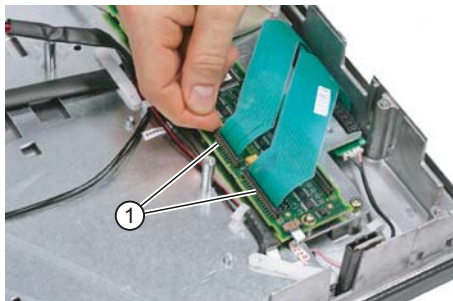

11. Disconnect the three keyboard cables by pushing up the terminal holders (1) on the keyboard controller and pulling the keyboard cables out of the holder.

For detailed information about removal and insertion of membrane connectors, see also "General information and networking", Section: "Connecting", Section: "Handling membrane connectors".

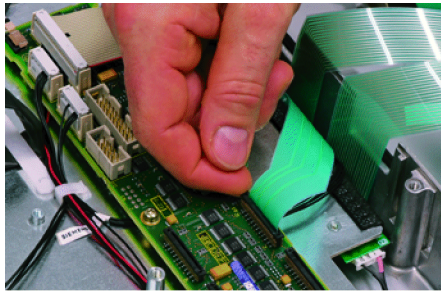

Display support

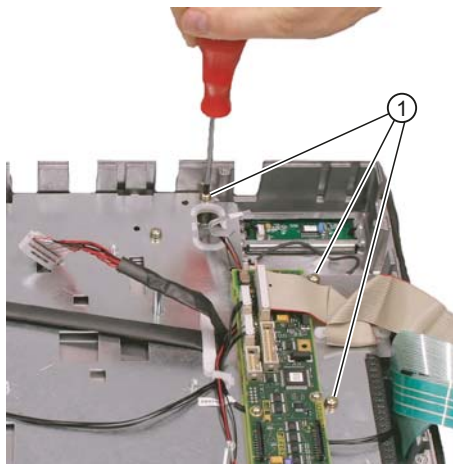

12. Remove the twelve screws (1) from the display support.
For the arrangement of the screws on the display support, refer to Figure: "TP 015A housing opened".



13. Lift off the display support.

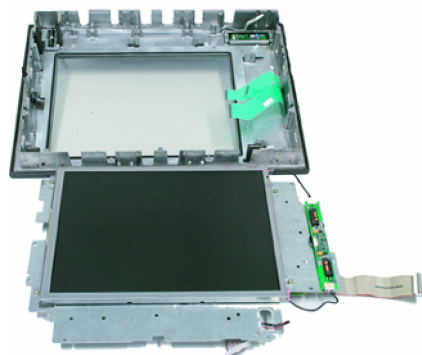

14. Lay the display support down on its back to avoid damaging the display.

USB board

15. Remove the USB board (see Figure: "TP 015AT housing open") by releasing the two screws.

Mouse board

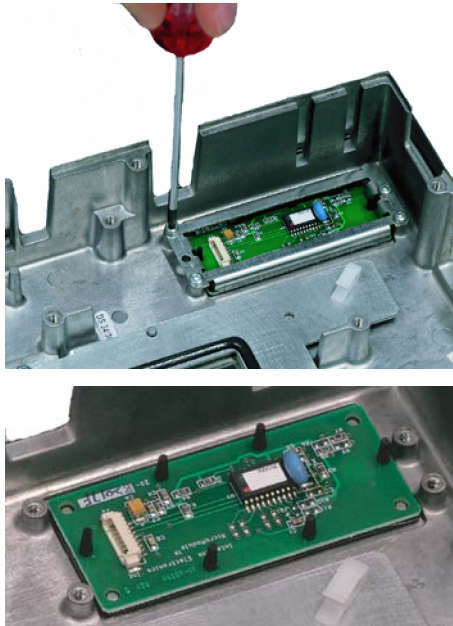

16. Loosen the four screws (M3) on the holder for the mouse board. Lift off the holder and the mouse board.

Installing the individual parts in the operator panel front

1. Remove the transportation safety precautions (adhesive strips for securing cables) and the screen protective film from the inside.
2. Install the components in the new operator panel front in the order indicated:

NOTICE
Damage to the screws Pay attention to the torques when tightening the screws (see Technical specifications (Page 148)).

- 16. Mouse board and holder
- 15. USB board
- 14. - 12. Display support
 - 14. Bend the keyboard cables (1) back slightly before inserting the display support to prevent pinching and damage, which could render them inoperable.

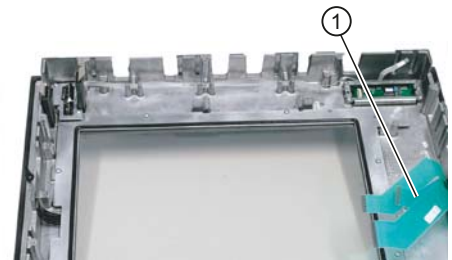

- 11. Keyboard cable
- 10. Connection of keyboard controller / USB interface

Ensure that the contact side of the USB plug faces outwards.

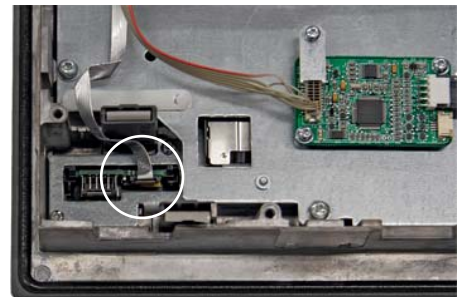

- 9. - 8. Connection of keyboard controller / mouse
- 7. Backlight inverter cable
- 6. - 4. Touch controller
- 3. - 1. Cover

Operator panel front: TP 015AT

10.1 Description

The SINUMERIK TP 015AT operator panel front with 15" TFT color display, 1024 x 768 pixels (XGA), and touch screen enables the distributed installation of the operator panel front and the controller. It features a membrane keyboard with 62 keys and 2 x (8 + 2) horizontal and 2 x 8 vertical softkeys and an integrated mouse.

The TP 015AT operator panel front is linked to the PCU/NCU via Ethernet as thin client in a dedicated subnet (via DHCP server on the PCU/NCU). The distance to the operator panel fronts is determined by the maximum distance between two network nodes/access points (100 m). Mixed operation with several TCUs and one operator panel front directly on the PCU is possible.

The operator panel front is secured from the rear using special clamps supplied with the panel.

Validity

This description applies to:

Type	Description	Order number
TP 015AT	Operator panel front as thin client, with touch screen and membrane keyboard	6FC5203-0AF08-1AB3

Features

- Ethernet 10/100/1000 Mbit/s
- 4 x USB (3 x rear, 1 x front)
- 15" TFT flat screen (color) with resolution 1024 x 768 pixels
- Membrane keyboard with alphabetic, numeric, cursor, and control keypad
- Soft keys / direct keys:
 - 2 x (8 + 2) horizontal rows of keys with softkey function
 - 2 x 8 vertical rows of keys with softkey and direct key function
- Shift key for switchover to the second key level (not for switching over the letters, since they are uppercase only)
- Integrated mouse
- Status LEDs for power supply and overtemperature
- Panel cutout (W x H): 450 x 335 mm
- Degree of protection IP65 (front side)
- Attachment: Tension jacks at the rear

10.2 Operator controls and indicators

10.2.1 View

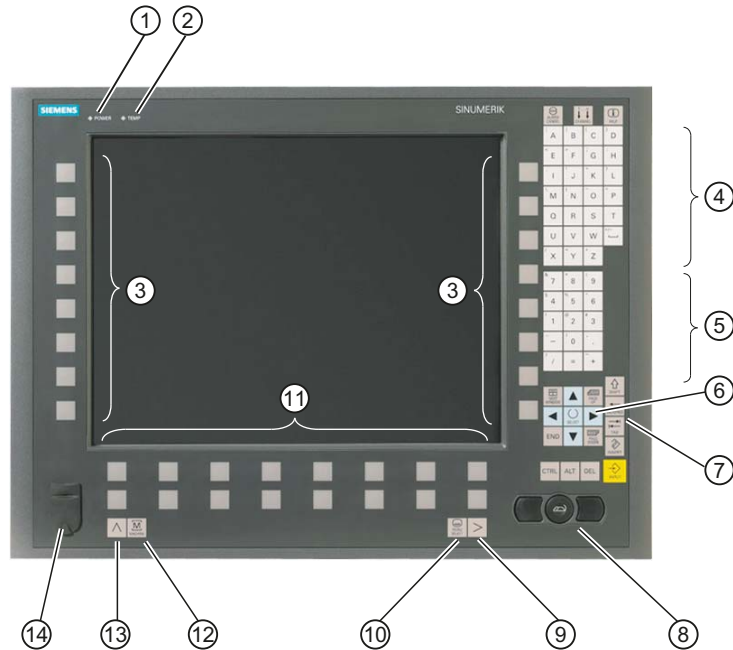

- ① Status LED: POWER
- ② Status LED: TEMP
(illuminated LEDs indicate increased wear)
- ③ Softkeys and direct keys
- ④ Alphabetic key group
- ⑤ Numeric key group
- ⑥ Cursor key group
- ⑦ Control key group
- ⑧ Mouse
- ⑨ Menu forward key
- ⑩ Menu select key
- ⑪ Softkeys
- ⑫ Machine area key
- ⑬ Menu back key
- ⑭ Front USB interface

Figure 10-1 Front view of the TP 015AT operator panel front

10.2.2 Operation

The operator panel front is operated by

- using the touch screen to select the application-specific functions, e.g. by touching one of the displayed buttons.
- Softkeys
- Keys
- Mouse

NOTICE
Damage to the operator controls
Do not touch the operating elements with pointed or hard objects. This may considerably reduce their service lives.

10.2.3 Keyboard

Keyboard

Several keys and keypads are installed on the operator panel front:

- The alphabetic block contains the letters A - Z and the space character.
- The numeric block contains the digits 0 - 9, and the characters "-", "/", "=", "+" and ".".
- The cursor key group is used to navigate on the screen.
- The control key group includes special functions.
- The mouse comprises the center actuation field (corresponds to the function of a tracker ball) and two keys for the left and right mouse key.
- The softkeys call up functions that are available on the screen via a menu bar.
- The menu select key displays the area menu.
- The menu forward key enables an expansion of the horizontal softkey bar in the same menu.
- The machine area key switches directly into the "Machine" operating area.
- The menu back key returns to the higher-level menu, one window is closed.

























Switching between upper and lower case

To toggle between upper and lower case letters, press the key combination Ctrl + Shift

Upper case is always activated as standard.

Overview of the key symbols

The key symbols used on the operator panel front are shown below along with the corresponding function keys on the PC keyboard.

Key	Function corresponds to the PC key function	Key	Function corresponds to the PC key function
	Esc		End
	F11		Backspace
	F12		Tab
	Space		(only intended for internal keyboard changeover)
	Home		Ctrl key
	Page up		Alt key
	Page down		Delete
	Cursor up		Insert
	Cursor left		Enter
	Cursor right		F9
	Cursor down		F10
	5 (in numeric key group)	A, ..., Z	<Shift> A, ..., Z
	<Shift> F9		<Shift> F10

Display

Note

Pixel error according to DIN EN ISO 13406-2 Class II.

10.2.4 Screen saver

If a screen with high contrast is displayed unchanged for longer than an hour, the screen must be switched dark (screensaver) in order to protect the TFT display against so-called "freezing" of the last displayed screen.

The time can be adapted individually. Further information can be found at:
IM9 SINUMERIK Operate Commissioning Manual

10.3 Interfaces

The TP 015AT operator panel front has the following interfaces:

Function	Designation	Type
Ethernet interface	X202	8-pin RJ45 socket
Double USB interface	X203 / X204	USB 2.0 socket A
USB interface	X213	USB 2.0 socket A
24 VDC power supply	X206	3-pin terminal block
Front USB interface	-	USB 1.1 socket A

Rear side

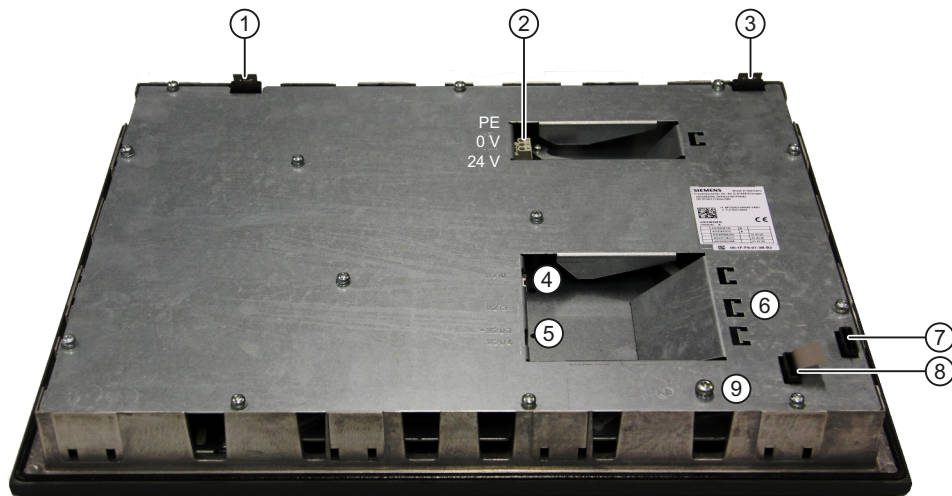

- ① Part 1 Slide-in labels for vertical softkeys (see Section: Spare parts)
- ② X206 Power supply (with connector that can be screwed in place)
- ③ Part 2 Slide-in labels for vertical softkeys (see Section: Spare parts)
- ④ X202 Ethernet interface
- ⑤ X203 / X 204 / X213 USB interfaces
- ⑥ - Strain relief for connecting cables
- ⑦ Part 3 Slide-in labels for horizontal softkeys (for these, there is no foil as template)
- ⑧ Part 4
- ⑨ - M5 grounding screw (for screw connection with cable lug)



Figure 10-2 TP 015AT - Rear with interfaces

Front side

USB 1.1 to connect an external keyboard, mouse, or USB FlashDrive (see Figure 10-1 Front view of the TP 015AT operator panel front (Page 160)).

Note

Note that the electromagnetic compatibility of commercially available peripheral devices operated via the USB interface is usually rated for office use only.

For industrial use, components with a higher degree of certification are recommended.

Pin assignment

The pin assignment of the interfaces, see "General information and networking" → "Connecting".

10.4 Installation

10.4.1 Mounting

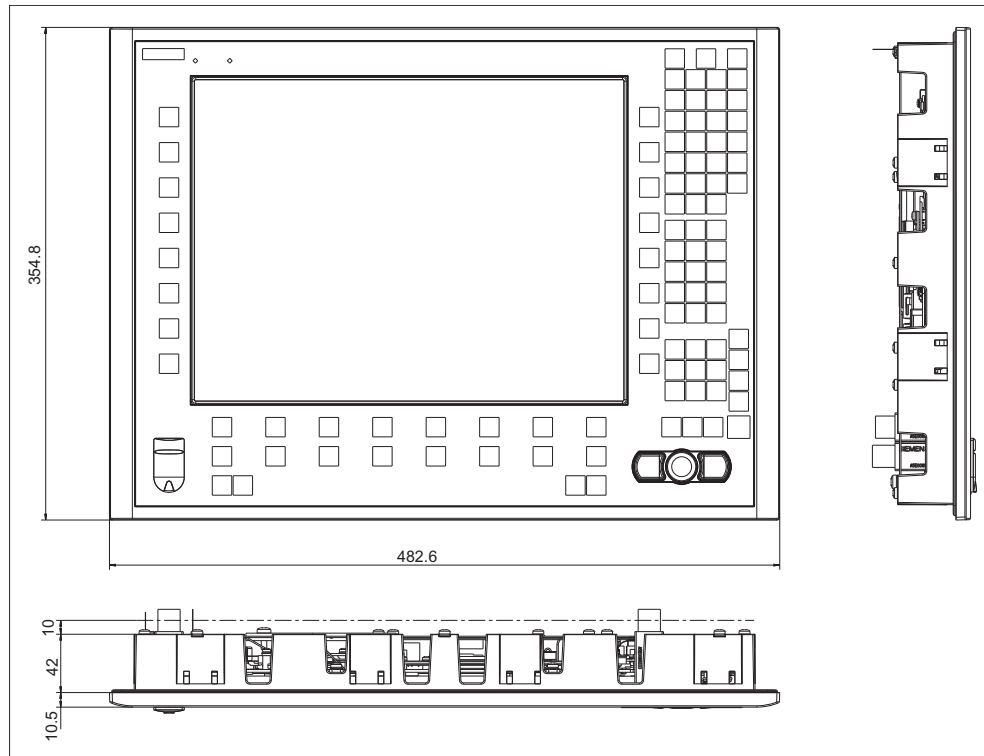

Figure 10-3 TP 015AT with TCU (integrated)

Table 10- 1 Dimensions of the mounting opening

Width (mm)	Height (mm)	Mounting depth + clearance (mm)
450	335	42 + 10

Thanks to the tension jacks on the TP 015AT, drill-holes or screw holes are not needed.

This retaining method also enables the IP65 degree of protection (but only in conjunction with a circumferential seal and when the protective USB cap is fitted).

10.4.3 Softkey labeling

User-specific functions can be assigned to the horizontal and vertical softkey bars. Printed labeling strips can be used to label the softkeys.

Blank labels are already installed on delivery.

To make the vertical labels, DIN A4 foils are available (see Chapter, "Spare parts" →Overview (Page 168)).

Note

Use the "Arial" font to format text. This font is comparable to the "Univers S57" font, used by Siemens for the key labeling.

Procedure

1. Letter the matt side of the foil using a laser printer.
2. Cut the printed labels along the preprinted lines.
3. Insert the strips into the slots provided on the rear side of the operator front panel (see Figure 10-2 TP 015AT - Rear with interfaces (Page 164)).

10.5 Technical data

Safety			
Safety class	III; PELV according to EN 50178		
Degree of protection according to EN 60529	Front side: IP65 Rear side: IP00		
Approvals	CE / cULus		
Electrical data			
Power supply	24 VDC		
Current consumption	Typical, approx. 1.0 A Max. approx. 2.5 A		
Power consumption	Typical, approx. 24 W Max. approx. 50 W		
Mechanical data			
Dimensions	Width: 483 mm	Height: 355 mm	Depth: 53 mm
Weight	Approx. 7.6 kg		
Tightening torques, max.	Tension jack screws: 0.5 Nm	M3 screws: 0.8 Nm	M4 screws: 1.8 Nm
	M5 grounding screw: 3 Nm		
Display			
Size / resolution	15" TFT / 1024 x 768 pixels		
MTBF backlight	typ. 50,000 h at 25° C (dependent on the temperature)		

Note

Information about the climatic and mechanical environmental conditions is contained in the associated section under:

"General notes and interconnection" → "Operational planning".

10.6 Replacement parts

10.6.1 Overview

The diagram shows the TP 015AT operator panel front disassembled into its individual parts.

The components provided with an order number are available as individual spare parts.

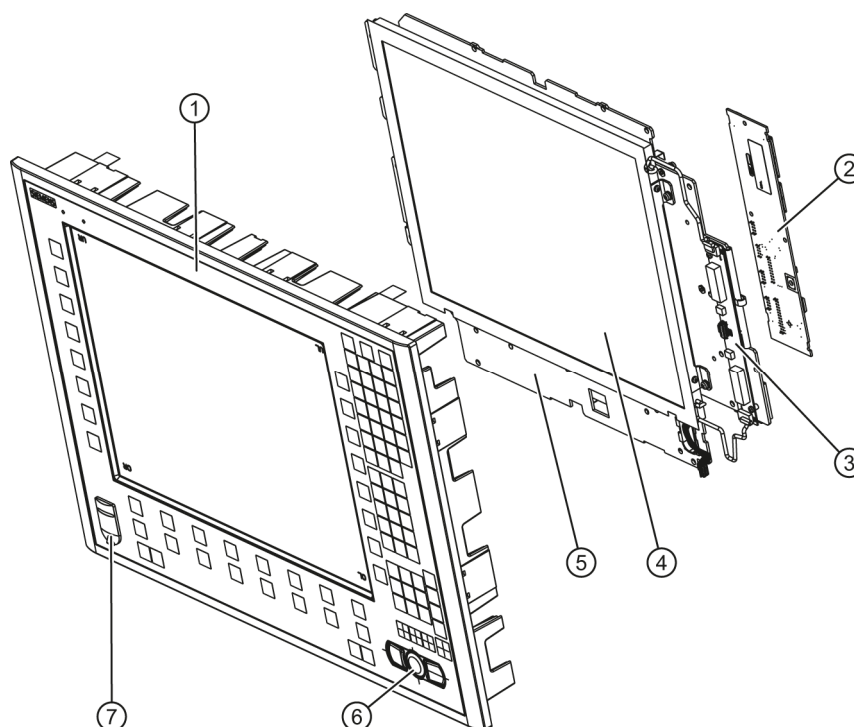

Figure 10-5 Individual parts for the TP 015AT operator panel front

	Spare part	Order number	Remark
①	Operator panel front	A5E00405089 (for MLFB 6FC5203-0AF08-1AB0) A5E01136461 (for MLFB 6FC5203-0AF08-1AB2)	Without LCD unit, mouse, USB port and keyboard controller
②	Keyboard controller		
③	Background lighting with backlight inverter		
④	LCD unit		
⑤	Display support		
	Spare part	Order number	Remark
⑥	Mouse	6FC5247-0AF01-0AA0	
⑦	Cap for the USB interface	6FC5248-0AF05-0AA0	Set of 10
	Tension jacks	6FC5248-0AF14-0AA0	Set of 9
	Slide-in labels *) (DIN A4 foils)	6FC5248-0AF24-0AA0	Set of 3

*) The dimensions for creating slide-in labels from foil for softkey labeling can be seen in the following diagram.

10.6 Replacement parts

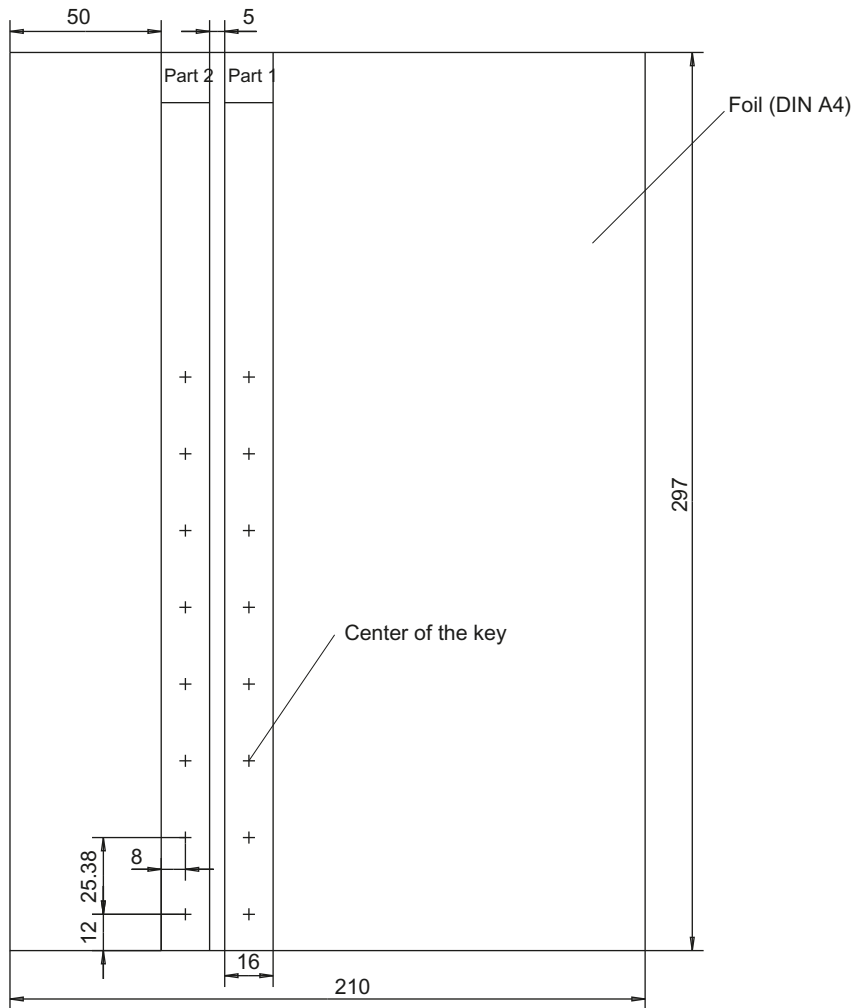

Figure 10-6 Dimensions for vertical slide-in labels

10.6.2 Replacement

NOTICE
Damage to sensitive components due to static electricity
Spare parts must always be replaced by properly trained personnel!

USB cap / tension jack

The replacement of the USB sealing cap and tension jacks will not be described since it is simple and self-explanatory.

Operator panel front

When the operator panel front is replaced, the display, keyboard controller, touch controller, mouse and USB interface can be used again. They are therefore disassembled and re-assembled after the appropriate component has been replaced.

Note

We recommend reusing the keypad controller to prevent any loss of the control parameters that have been programmed in.

Dismounting individual parts from the operator panel front

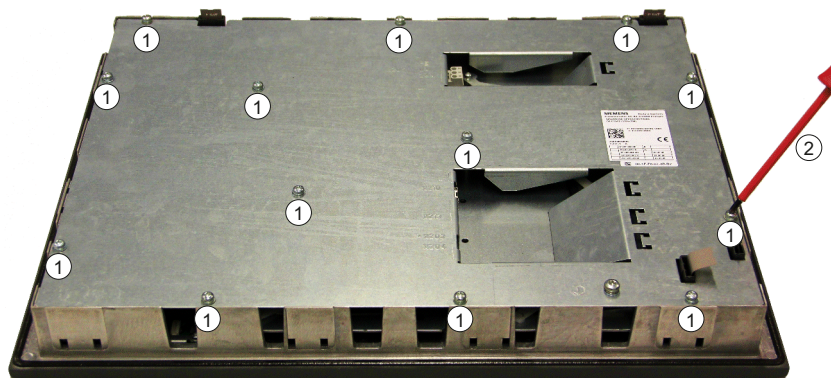

1. Place the TP 015AT on a soft horizontal surface. Loosen the 13 housing screws (M4) ① using a Torx screwdriver T25 ②.
2. Remove the cover.

10.6 Replacement parts

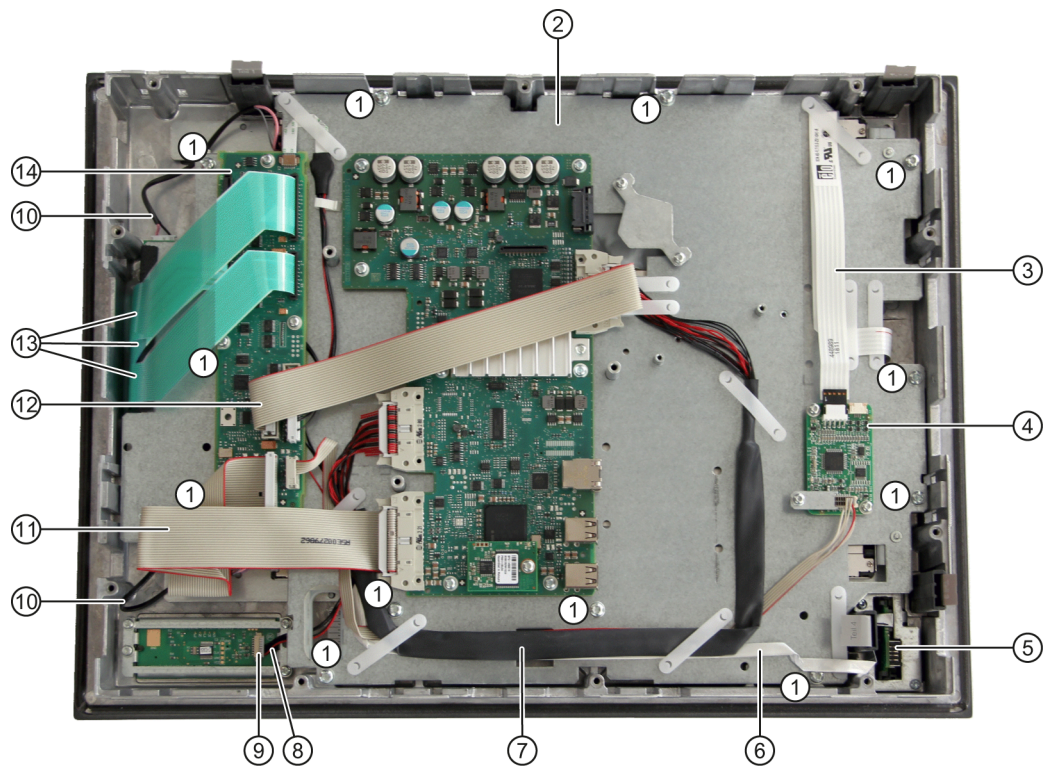

- ① Screws (M4) for display support
- ② Display support
- ③ Cable of the touch controller
- ④ Touch controller
- ⑤ USB interface
- ⑥ Ribbon cable for keyboard controller / USB interface
- ⑦ Display cable
- ⑧ Cable, mouse / keyboard controller
- ⑨ Connector, mouse interface
- ⑩ Backlight inverter cable
- ⑪ I/O USB cable
- ⑫ Direct key cable
- ⑬ Keyboard cables
- ⑭ Keyboard controller

Figure 10-7 TP015AT housing opened

Cables, backlight inverter

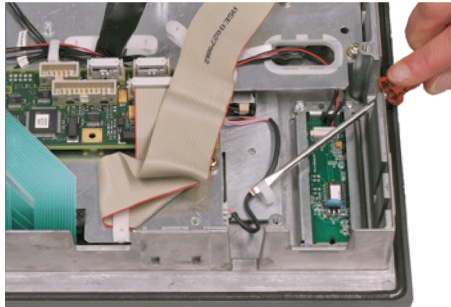

3. Remove the two cables to the backlight inverter (to the left and right of the display support) by raising the clips with a flat screwdriver and pulling out the cables.

Connection of keyboard controller / mouse

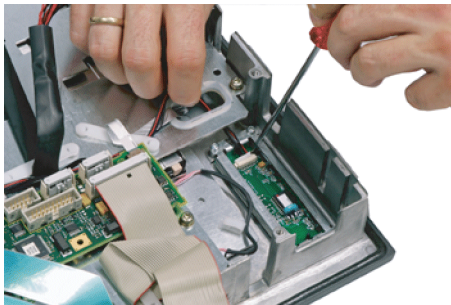

4. Undo the connection between the keyboard controller and the mouse by carefully pushing the connector back with a screwdriver.

USB board

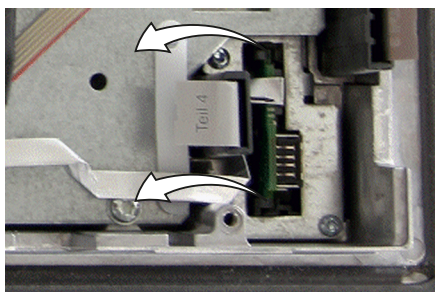

5. Release the connection to the keyboard controller by releasing both retaining clamps next to the USB board and withdrawing them.

Do not remove the cable from the board!

Keyboard cables

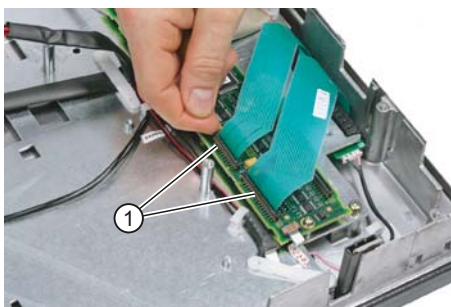

6. Disconnect the 3 keyboard cables by pushing up the terminal holders ① on the keyboard controller and pulling the keyboard cables out of the holder.

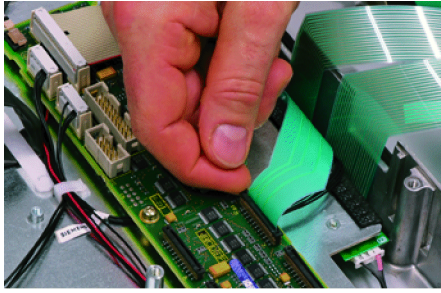

For detailed information about removal and insertion of membrane connectors, see also "General information and networking", Chapter: "Connecting", Section: "Handling membrane connectors".

Display support

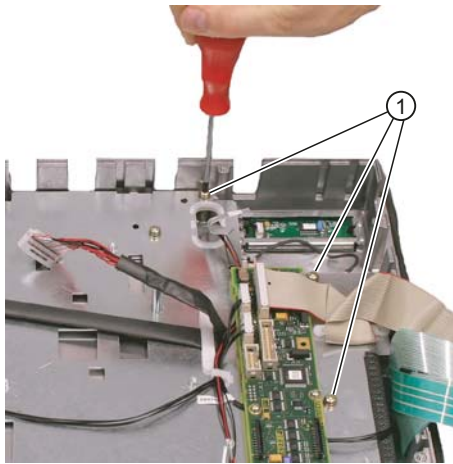

7. Remove the 12 screws ① from the display support and lift it off.

For details of how the screws are arranged on the display support, refer to Figure: "TP 015AT housing opened".

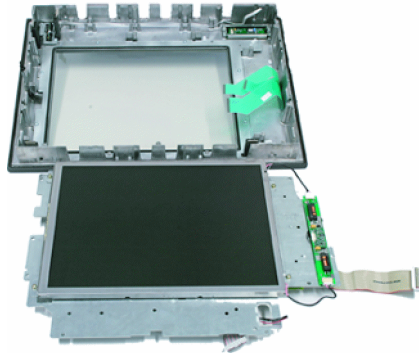

8. Lift off the display support.

9. Lay the display support down on its back to avoid damaging the display.

Mouse board

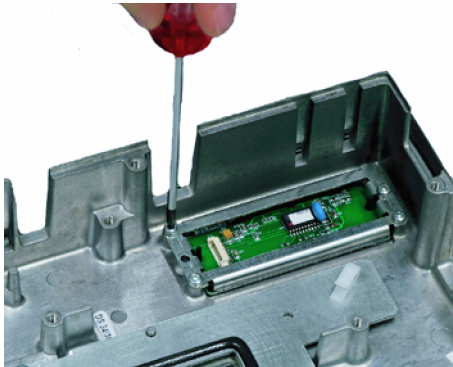

10. Loosen the 4 screws (M3) on the holder for the mouse board. Lift off both the holder and the mouse board.

Installing the individual parts in the operator panel front

1. Remove the transportation safety precautions (adhesive strip for securing cables) and the screen protective foil from the inside.
2. Install the components in the new operator panel front in the order indicated:

NOTICE
Damage to the screws
Pay attention to the torques when tightening the screws (see Technical data (Page 168)).

2.1 Mouse board and holder

2.2 Display support

Slightly bend the keyboard cables to the rear before installing the display carrier. Otherwise, they could jam or be damaged and therefore no longer function.

2.3 USB board

Press the USB board into place until you hear it lock into the retaining clamps.

2.4 Keyboard cables

2.5 Connection of keyboard controller / mouse

2.6 Cables, backlight inverter

2.7 Cover

Operator panel front: OP 019

11.1 Description

The SINUMERIK operator panel front OP 019 is equipped with a 19" TFT color display with a resolution of 1280 x 1024 pixels and with 16 + 4 horizontal and 16 vertical softkeys. The 2 x 8 vertical softkeys can be used as direct keys.

The KB 483C full CNC keyboard can be used as an input keyboard.

It is fixed from the rear using special clamps that are included in the delivery scope.

Note

It is not possible to use slide-in labels for the softkeys.

Validity

The description applies to the operator panel front:

Type	Key type	Order number
OP 019	Capacitive keys behind a glass front	6FC5303-0AF13-0AA0

Features

- Anti-glare glass front over the entire panel
- 19" mounting format, 9 HU (height units)
- Panel cutout (W x H): 450 x 380 mm
- Limited mounting depth
- 19" TFT flat screen (color) with a resolution of 1280 x 1024 pixels (SXGA)
- Capacitive keys, including optical feedback using LEDs when actuated:
 - 16 + 4 horizontal softkeys
 - 16 vertical softkeys
- Status LED for the power supply
- Degree of protection: IP65 / IP66

11.1 Description

- Attachment: Tension jacks at the rear
The tension jacks can be re-ordered as spare part: 6FC5248-0AF14-0AA0 (9 units)
- Can be combined with PCU 50.5 and TCU 30.2

Note

Connecting USB devices

OP 019 has no USB interfaces. If required, the USB interfaces of the PCU 50.5 / TCU 30.2 can be routed to the front via a USB-extension (see Chapter: "Keyboards and additional components").

11.2 Operator control and display elements

11.2.1 View

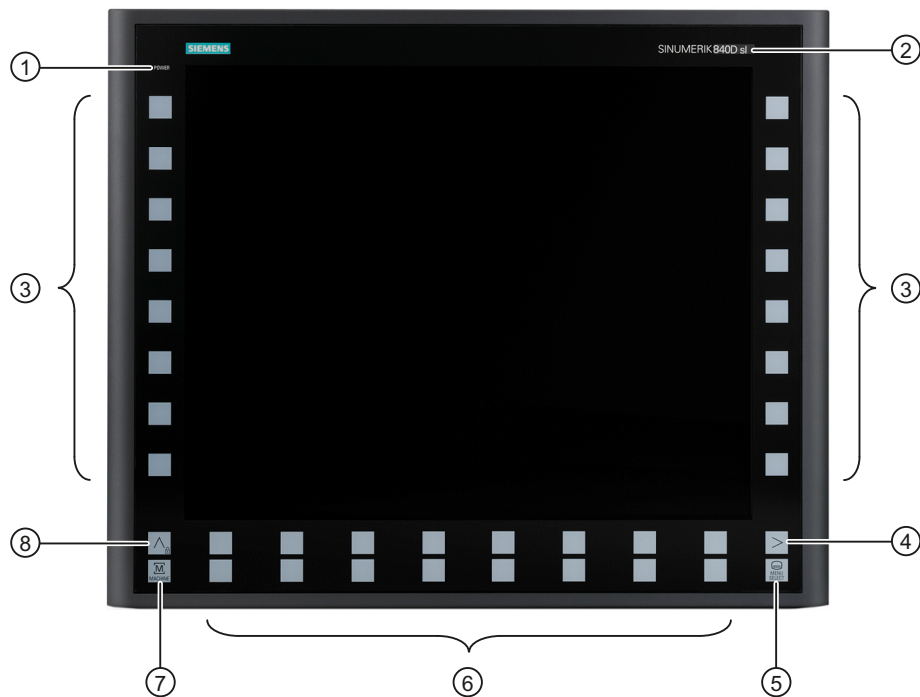

- ① Status LED: POWER
- ② Window for slide-in labels "System" (e.g. 840D sl)
- ③ Vertical softkeys
- ④ Menu forward key
- ⑤ Menu select key
- ⑥ Horizontal softkeys
- ⑦ Machine area key
- ⑧ Menu back key and key disable

Figure 11-1 Front view of the OP 019 operator panel front





11.2.2 Keyboard

Keyboard

The following keys are arranged on the operator panel front:

- The 16 vertical and horizontal softkeys call up functions that are available on screen via a menu bar.
- The menu back key switches to the higher-level horizontal menu back and is used to lock the keys.
- The menu forward key advances in the extended horizontal softkey bar.
- The Menu Select key calls the main menu to select the operating area.
- The machine area key selects the "Machine" operating area.

The key symbols used on the operator panel front are juxtapositioned with the corresponding function keys on the PC keyboard.

Key	Description	PC function key
	Menu back key / keyboard lock	F9
	Menu forward key	<Shift> F9
	Menu select key	F10
	Machine area key	<Shift> F10

Display

Note

Pixel error acc. to DIN EN ISO 13406-2 Class II.

11.2.3 Softkeys

Operation

The capacitive keys respond quickly and directly. In order to prevent accidental operation, the following measures must be applied:

- When the key is pressed a second time, the function is revoked
- Keyboard lock, e.g. when cleaning the keys/keyboard:
 - Press the menu back key for longer than 5 seconds to activate it
 - The associated LED flashes while the key lock is active
 - Deactivate the keyboard lock by pressing again (> 5 s)
- Traversing motion that is initiated using direct keys must be additionally interlocked: For example, using an acknowledgment button that is appropriately linked in the PLC

Note

Please observe the valid C standards for the particular machine type (e.g. for lathes: EN ISO 23125-2010, pages 36+49). This states that a button that initiates motion with the protective door open must be implemented using an additional acknowledgment device; this is because for single-channel keyboards – such as the OP 019 – generally no PL (performance level) level "d" can be achieved.

Special situations:

- 2 keys can be simultaneously pressed.
- The keys can also be actuated when operators are wearing gloves. However, especially thick, protective gloves can restrict operation or even prohibit it.

LED displays

All keys with LEDs flash green:

- As long as the operating system has not started while booting.
- If communication to the PCU/TCU has failed and this state lasts for more than 5 s.

Remedy: Re-install the standard keyboard driver.

11.2.4 Screen saver

If a screen with high contrast is displayed unchanged for longer than an hour, the screen must be switched dark (screensaver) in order to protect the TFT display against so-called "freezing" of the last displayed screen.

The time can be adapted individually. Further information can be found at:
IM9 SINUMERIK Operate Commissioning Manual

11.3 Interfaces

Key statement

All interfaces of the OP 019 operator panel front are located at the rear:

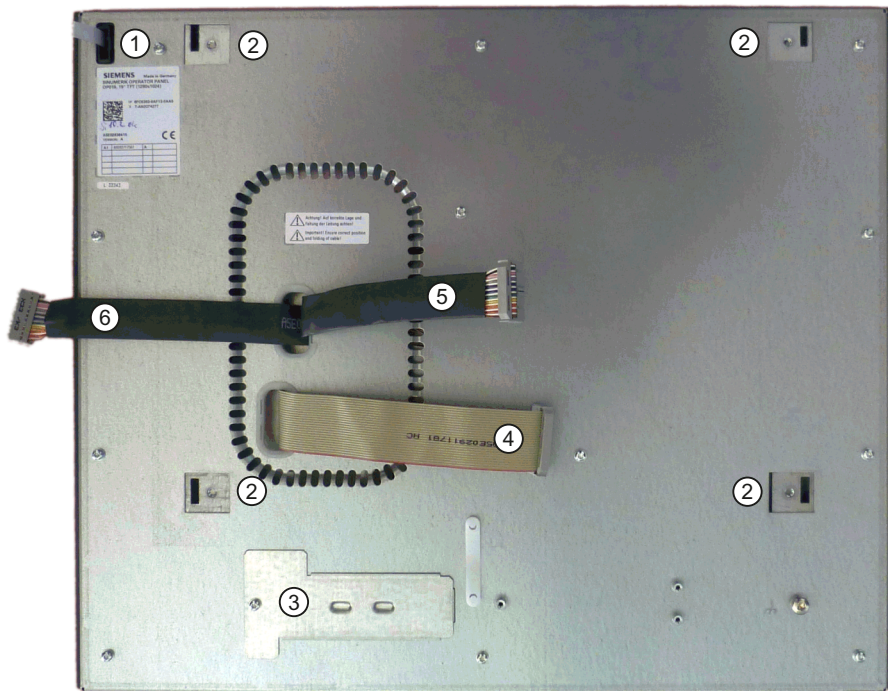

- ① Insertion slot for the "System" labeling strips

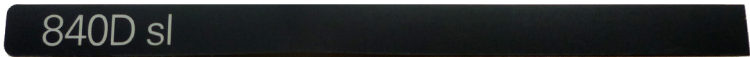

- ② Mounting slots for PCU/TCU lugs
- ③ Cover plate for the direct key interface X11
- ④ I/O USB cable K1
- ⑤ LVDS display cable K2
- ⑥ LVDS display cable K3

Figure 11-2 Rear of the OP 019

Interface description

- Three flat ribbon cables for connecting the PCU/TCU:
 - I/O USB cable K1:
all signals, which in addition to the display interface, are required to connect operator panel fronts (e.g. supply voltages)
 - LVDS display cable K2
 - LVDS display cable K3
- Direct key interface X11 ① for the two vertical softkey bars (16 keys).
Here, one of the following operator components can be connected:
 - MCP 483 / MCP 483 PN / MPP 483 / MPP 483 IE (X70)
 - TCU 30.2 (X205)

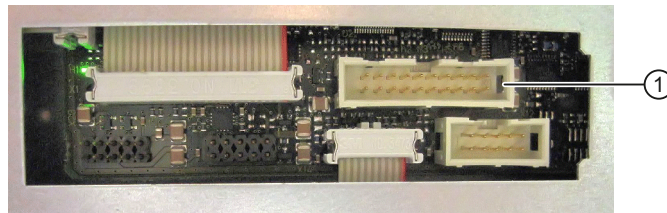

Pin assignment

The pin assignment of the interfaces, see "General information and networking" → "Connecting".

11.4 Mounting

11.4.1 Preparation for mounting

Overview

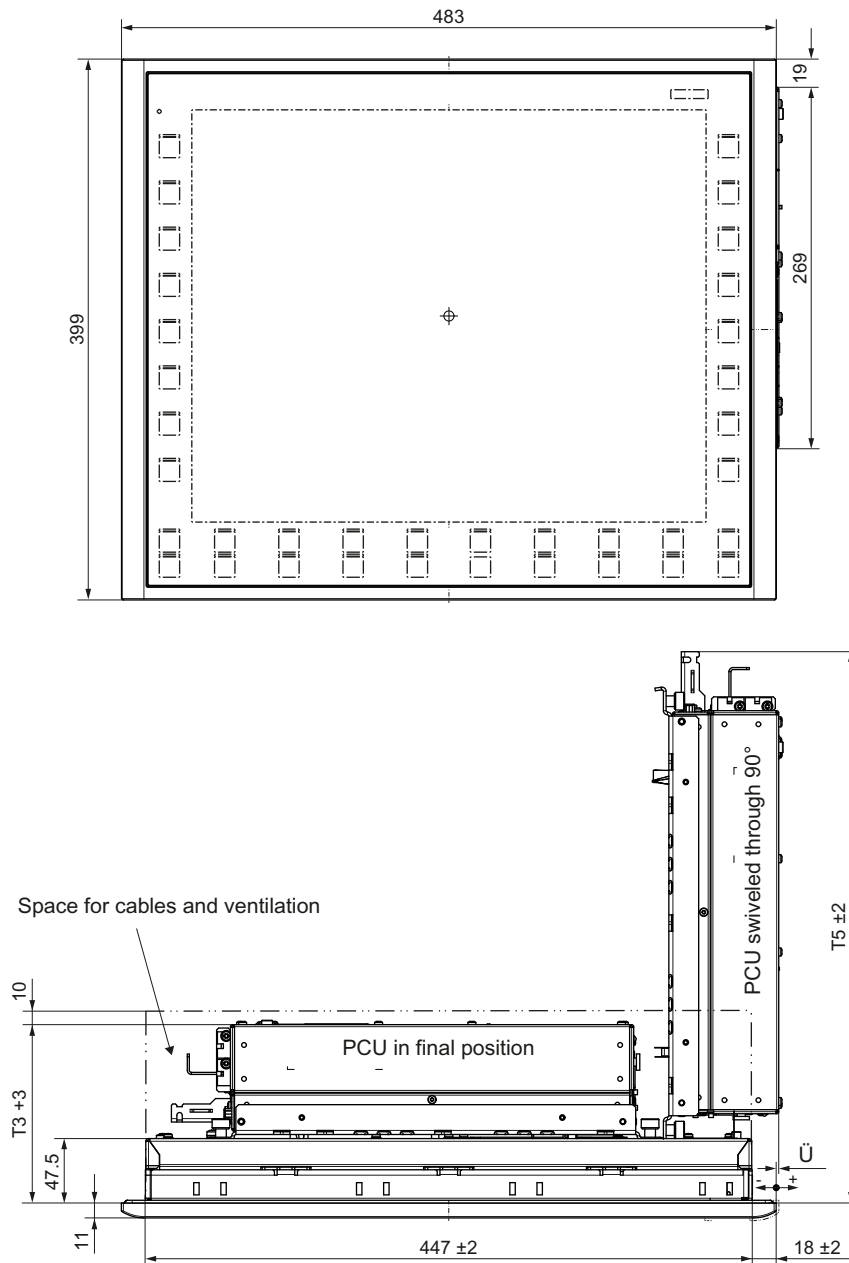

Figure 11-3 Mounting the PCU onto the operator panel front OP 019

Table 11- 1 Dimensions to be observed when installing

	Mounting depth T3 + clearance (mm)	Opening depth T5 (mm)	Protrusion P (mm)
PCU 50.5	132 + 10	408	2
TCU 30.2	81 + 10	382	-49

Panel cutout

Table 11- 2 Dimensions of the mounting opening

Width (mm)	Height (mm)
450	380

The OP 019 is mounted using the tension jacks provided (2.5 mm profile; 20 mm long). When using the tension jacks, holes or threaded holes are not required.

This mounting method also enables the IP65/IP66 degree of protection if the mounting panel corresponds to the requirements specified in the dimension drawing. The seal (PU foam seal) to the mounting panel is already provided on the OP 019.

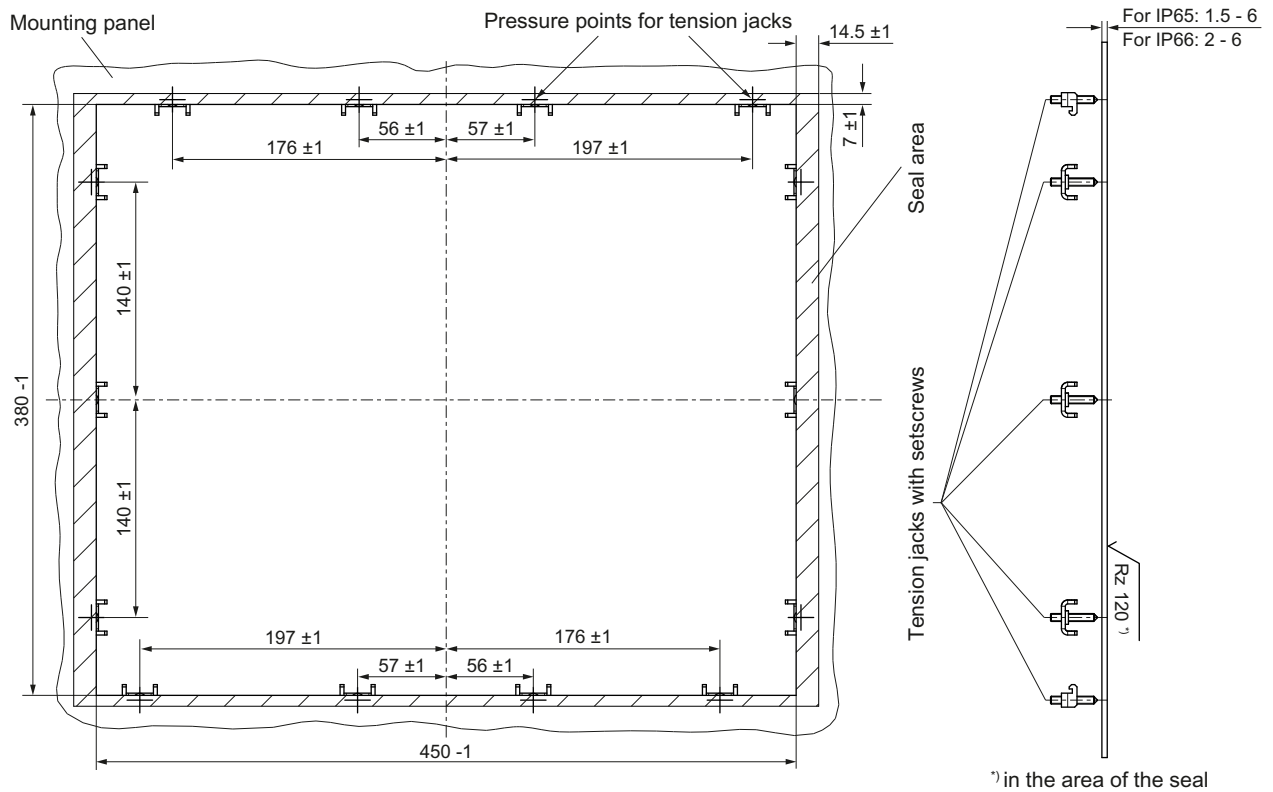

Figure 11-4 Dimension drawing for installing the OP 019 operator panel front

Precondition for the assembly with a PCU/TCU

Before you mount a PCU/TCU onto an OP 019, you must attach the mounting brackets on the PCU/TCU.

The mounting brackets for a TCU 30.2 are attached the same way as for a PCU.
Exception: When attaching, only 4x M4x8 fillister head screws are required.

11.4.2 Assembling an OP 019 and a PCU

If you wish to combine the OP 019 with a PCU, assemble the components before installing them into the mounting panel. This procedure is described in detail below. Alternatively, you can first install the OP 019 in the panel cutout and then mount the PCU on the installed OP.

Procedure

<p>1. Place the front of the OP 019 ① on a soft, horizontal surface ② to avoid damaging the surface of the operator panel front.</p>	
<p>2. Remove the interface cover ④ of the PCU ⑤.</p>	
<p>3. Position the PCU so that the mounting lugs ③ engage in the OP 019.</p>	
<p>4. Connect cables K1 ① and K2 ② to the interfaces of the PCU. K3 ③ is first routed through the opening behind K2.</p>	
<p>5. Ensure that the connectors of cables K1 and K2 snap audibly into place and that the interlocks are closed.</p>	

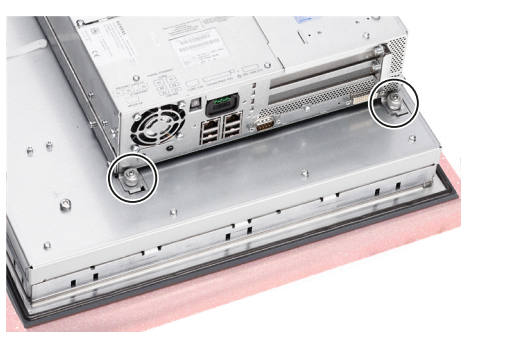
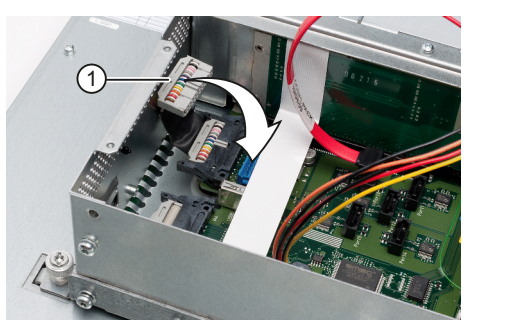
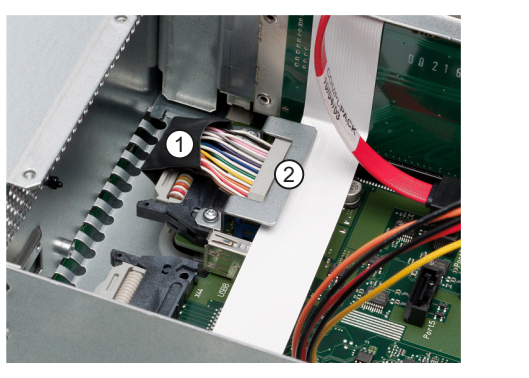
6.	Swivel the PCU in the direction of the OP 019 and make sure that the cables fold correctly into place.	
7.	Secure the PCU using two knurled screws at each end of the two mounting angles (torque: 1.8 Nm).	
8.	In order to insert cable K3 ①, you must remove the housing cover of the PCU hard disk, see SSD module (Page 329) Chapter PCU 50.5.	
9.	Connect cable K3 ① to the interface of the PCU, directly above K2, and secure the connector using the fixing bracket ② and two M2.5 screws (0.4 Nm).	
10.	Close the housing cover of the PCU (see 8.).	

11.4.3 Assembling an OP 019 and a TCU

If you wish to combine the OP 019 with a TCU, assemble the components before installing them into the mounting panel. This procedure is described in detail below. Alternatively, you can first install the OP 019 in the panel cutout and then mount the TCU on the installed OP.

Procedure

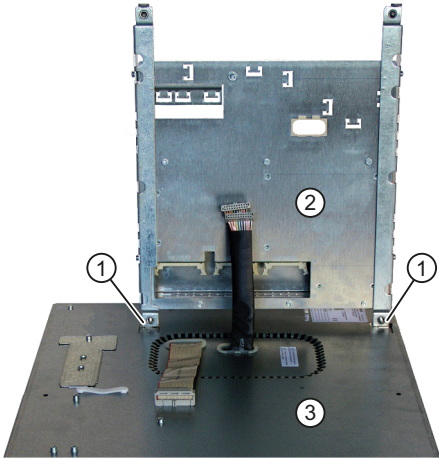
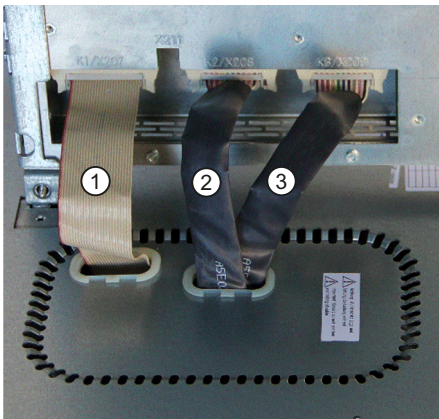
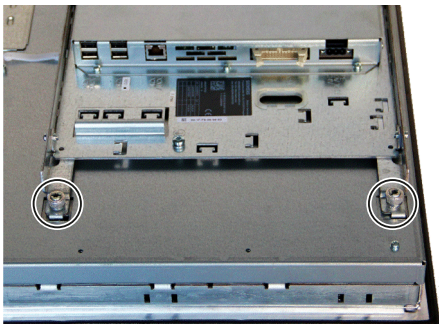
1.	Place the front of the OP 019 ③ on a soft, horizontal surface to avoid damaging the surface of the operator panel front.	
2.	Position the TCU ② so that the mounting lugs ① engage in the OP 019 ③.	
3.	Connect cables K1 ①, K2 ② and K3 ③ to the appropriate interfaces of the TCU.	
4.	Ensure that the connectors of cables K1 to K3 snap audibly into place and that the interlocks are closed.	
5.	Swivel the TCU in the direction of the OP 019 and make sure that the cables fold correctly into place.	
6.	Secure the TCU using two knurled screws at each end of the two mounting angles (torque: 1.8 Nm).	

11.4.4 Mounting on the mounting wall

The clearance at the rear of the PCU/TCU must be at least 10 mm to ensure sufficient ventilation (see Section: Preparation for mounting (Page 184)).

You should also observe the data provided in Section "General information and networking" → "Application planning" → "Climatic and mechanical environmental conditions" → "Cooling".

NOTICE

Impermissible mounting positions can cause malfunctions
--

Observe the permissible mounting position: Deviating by up to 5° from the vertical.

This value can be further restricted by mounted components (e.g. PCU).
--

Procedure

NOTICE

Damage to the glass front

Do not use suction grippers to lift the glass fronts in order to avoid damaging it.

1. Install the assembled components (e.g. operator panel front and PCU) from the front into the panel cutout (see Figure 11-4 Dimension drawing for installing the OP 019 operator panel front (Page 185)).

NOTICE

Damage to the sealing

It is not permissible that the seal is damaged when installing the device so that the maximum achievable degree of protection can be fulfilled. Therefore, locate the assembled components, centered in the middle of the panel cutout.

2. Secure the operator panel front in the panel cutout from the rear using the six tension jacks by tightening the setscrews (torque 0.4 - 0.5 Nm).

11.5 Technical data

Safety			
Safety class	III; PELV according to EN 50178		
Degree of protection according to EN 60529	Front, IP65 / IP66 Rear, IP20		
Approvals	CE / cULus		
Electrical and mechanical data			
Power consumption	Typical, approx. 35 W Maximum approx. 45 W		
Dimensions	Width: 483 mm	Height: 399 mm	Depth: 58.5 mm
Weight	approx. 11 kg		
Tightening torques screws, max.	Tension jacks: 0.5 Nm	M3 screws: 0.8 Nm	M4 screws: 1.8 Nm
Display			
Size / resolution	19" TFT / 1280 x 1024 pixels		
MTBF backlight	typ. 50,000 h at 25° C (dependent on the temperature)		

Note

Information about the climatic and mechanical environmental conditions is contained in the associated section under:

"General notes and interconnection" → "Operational planning".

Direct control key module

12.1 Description

The task of the direct key module (DKM) is to directly transfer the operating signals for the two rows of keys on the sides of an operator panel front to the controller (PLC) without diversion through intermediate firmware. The signal-to-key assignments are shown in the table and figure in Section: "Interfaces" → "Operator panel front."

The DKM can be combined with operator panel fronts OP 012, OP 015A and TP 015A.

The DKM converts the key signals to the PROFIBUS DP protocol by means of the ASIC LSPM2 (EN 50170-2, 12 MBaud).

Power is supplied via the operator panel front. The PROFIBUS is completely isolated from the DKM / operator panel front by means of an opto-coupler and DC/DC converter.

The DKM is operated as a slave on PROFIBUS. The address can be set between 1 and 99 using rotary switches. Two bytes of data are transferred.

In the controller, the keys are handled as if they were 16 ordinary digital inputs.

Validity

This description applies to the following components

Designation	Order number
Direct key module (with kit for OP 012)	6FC5247-0AF11-0AA0
Direct key module mounting kit for OP 015A, TP 015A	6FC5247-0AF30-0AA0

12.2 Operating and display elements

On the front of the direct key module there are

- Top coding switches: Unit places
- Coding switch below: Tens digits
- LED on the left-hand side: Bus error, Not connected
- LED on the right-hand side: Diagnostics



- ① Coding switches
- ② LEDs

Figure 12-1 Direct key module complete with coding switches and LEDs

12.3 Interfaces

The direct key module has a

- PROFIBUS connection ① and a
- Connection for the direct keys of the operator panel front ②.

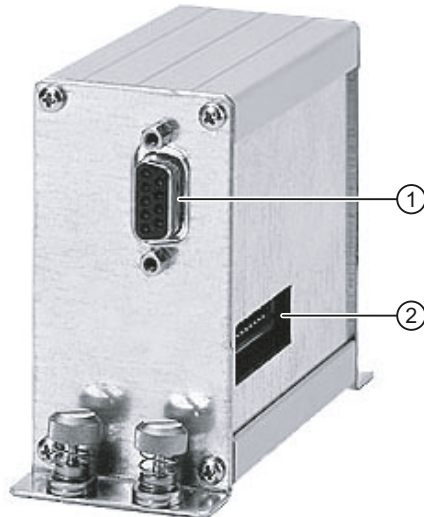

Figure 12-2 Direct key module with connections

Operator panel connection

The ribbon cable of the operator panel front is inserted through the cut-out in the housing ②. Here, the switching states of the vertical direct keys can be picked up without intermediate firmware. These signals can be evaluated by the PLC.

PROFIBUS connection

9-pin connector for connection to an NCU.

Note

The used PROFIBUS cable should have a connector with a straight cable outlet.

Pin assignment

For the pin assignment of the interfaces and other information about the direct keys connection, refer to Chapter:

"General notes and interconnection" → "Connecting".

12.4 Mounting

12.4.1 Overview

The DKM is installed to one side of the PCU on the operator panel front and connected to the keyboard controller via a short ribbon cable.

Mounting the DKM requires an installation kit appropriate to the operator panel front used (kit for the OP 012 already included with the DKM).

An installation kit is needed for OP 015A and TP 015A (see figure) and this has to be ordered. You will find the order number in section: "Description".

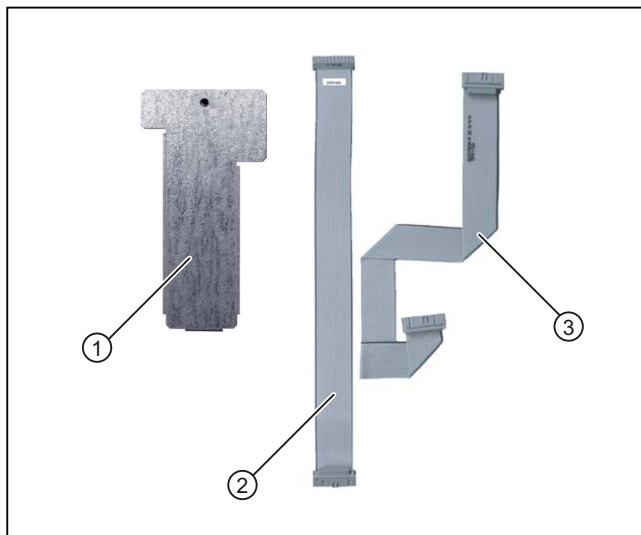

- (1) Cover plate for keyboard controller for OP 015A
- (2) DKM cable for OP 015A
- (3) DKM cable for TP 015A

Figure 12-3 DKM installation kit for OP 015A and TP 015A

12.4.2 Combination with OP 012

The OP 012 outputs the signals from the direct control keys at connector X11(3).

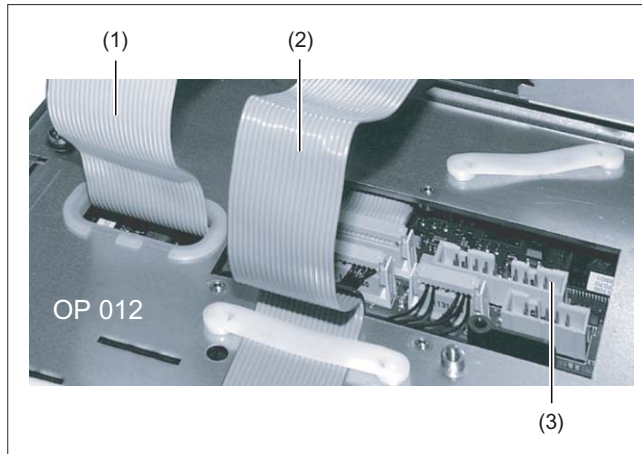

- (1) I/O USB cable K1
- (2) Display cable K2
- (3) Direct control key interface X11

Figure 12-4 Rear side of OP 012

Preparation

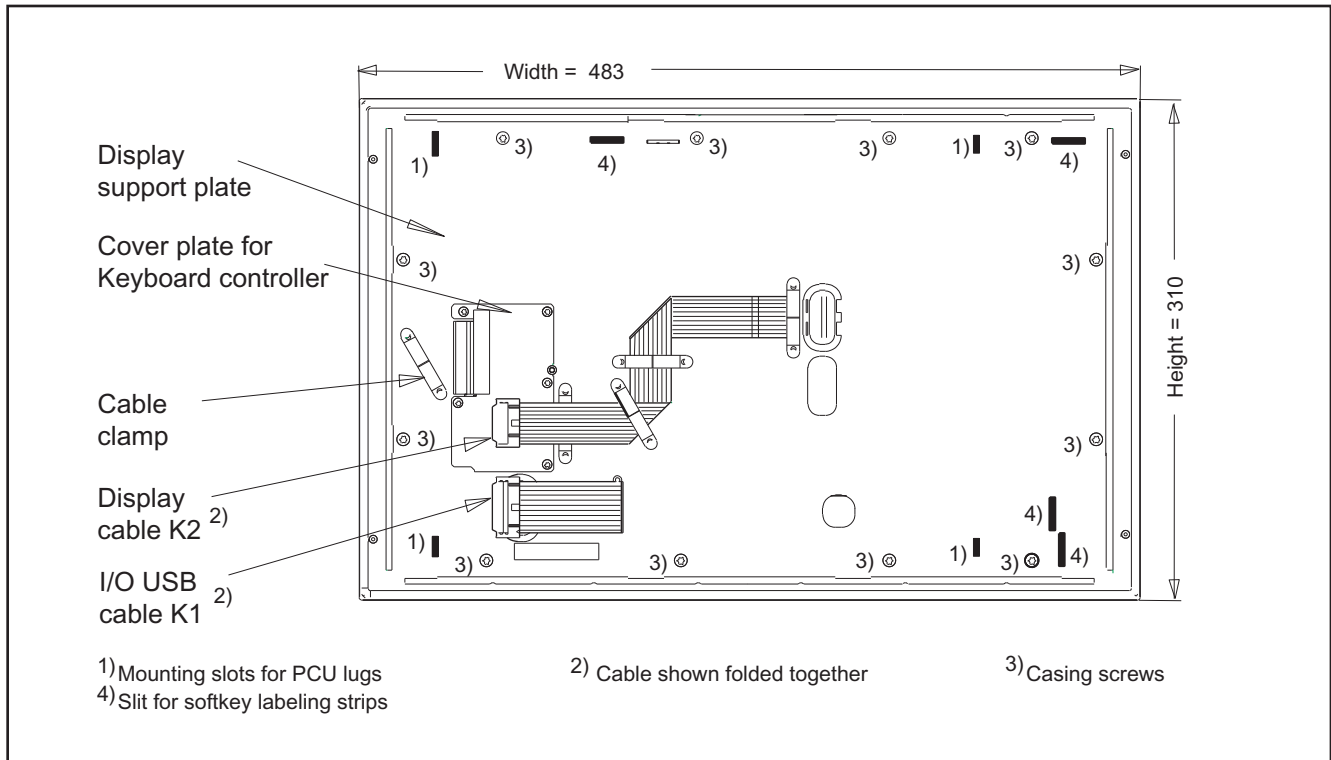
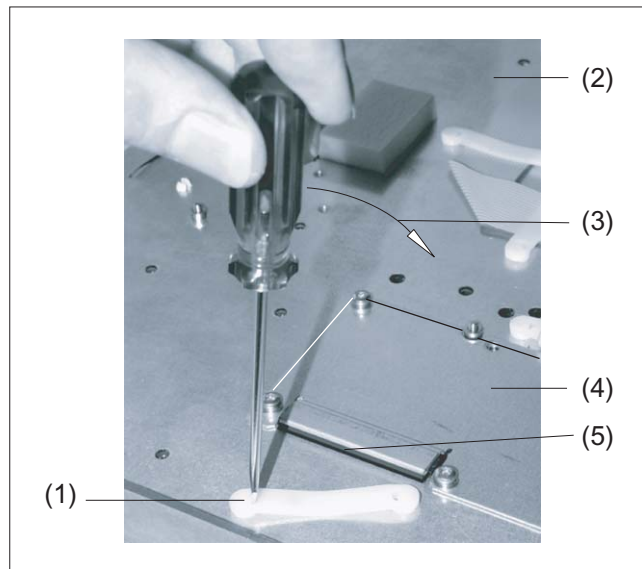

Figure 12-5 Rear side of OP 012

1. Deinstall the PCU (if it is already installed) by removing the knurled-head screws at the four corners and lifting off the PCU.
2. Remove the ribbon cable clamp (1) alongside the keyboard controller cover plate by inserting a pointed tool in each of the two slits and loosening the fixing cams by levering in the direction shown (3).
3. Unscrew the cover plate for the keyboard controller (4). It is no longer needed for assembly.
4. Remove the rubber rim (5) from the edge of the housing cutout (used to secure a pushbutton panel cable).



- (1) Cable clamp
- (2) OP 012
- (3) Tipping motion of tool
- (4) Previous cover plate
- (5) Rubber rim

Figure 12-6 Removing the cable clamp from the OP 012

Assembly

You will find the reference diagrams for the individual mounting stages at the end of the description of the procedure.

1. Insert the non-rubber-coated end of the ribbon cable supplied with the DKM through the slit in the cover also supplied with the DKM and into socket X11 on the keyboard controller.
2. Screw down the new cover tightly using the screws supplied **(A)**.
3. Install the PCU as described in section "OP 012," section: "Mounting."
4. Set Profibus addresses 01 to 99 using the top (units) and bottom (tens) coding switches of the DKM (see Fig. in section: "Operating and display elements").
5. Connect the ribbon cable to the DKM **(B)**.
6. Screw the DKM firmly to the cover using the knurled screws on the side.
7. Insert the Profibus plug (with straight outgoing cable) into the socket of the DKM **(C)**.

If the DKM is not connected to Profibus connector (or in the event of another fault), the "bus error" LED lights up.

Note

The direct control key module must be removed first on deinstallation of the PCU.

(A)



- (1) New cover plate
- (2) Securing nipple for DKM (1 of 3)
- (3) Cable to direct control key module
- (4) OP 012

Figure 12-7 Installation of the direct control key module on the OP 012

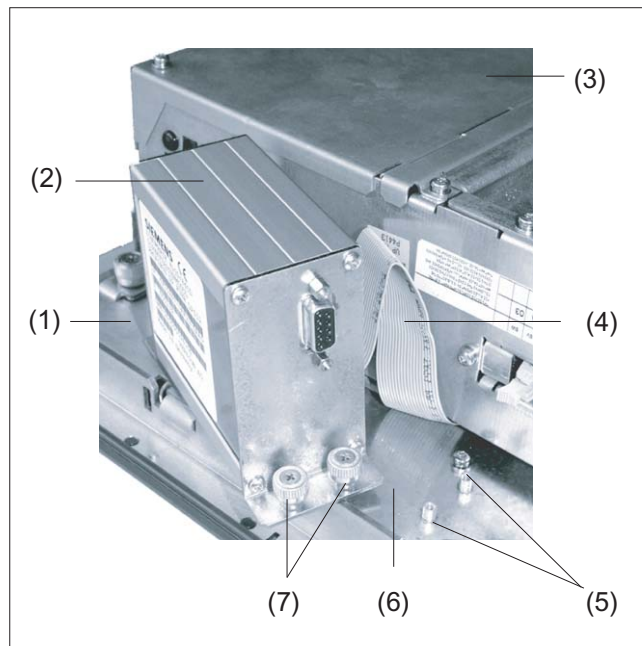
(B)

- (1) OP 012
- (2) Direct control key module
- (3) PCU 50
- (4) Cable from OP 012 to DKM
- (5) Securing nipple for DTM
- (6) Cover plate
- (7) Retaining screws

Figure 12-8 Installation of the direct control key module on the OP 012

(C)

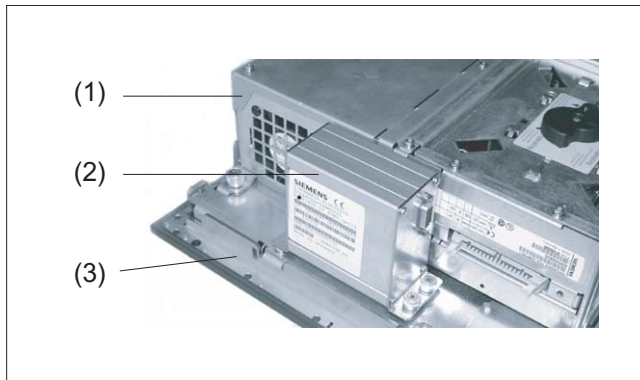

- (1) PCU 50
- (2) DKM
- (3) OP 012

Figure 12-9 Pre-installed direct control key module

12.4.3 Combination with OP 015A / TP 015A

Note

The installation of the direct key module on the TP 015A is described in the following. The procedure for assembly with the OP 015A is identical.

Preparation

1. Deinstall the PCU (if it is already installed) by removing the knurled-head screws at the four corners and lifting off the PCU.
2. Unscrew the cover plate for the keyboard controller (see figure).
The plate is required for re-installation.

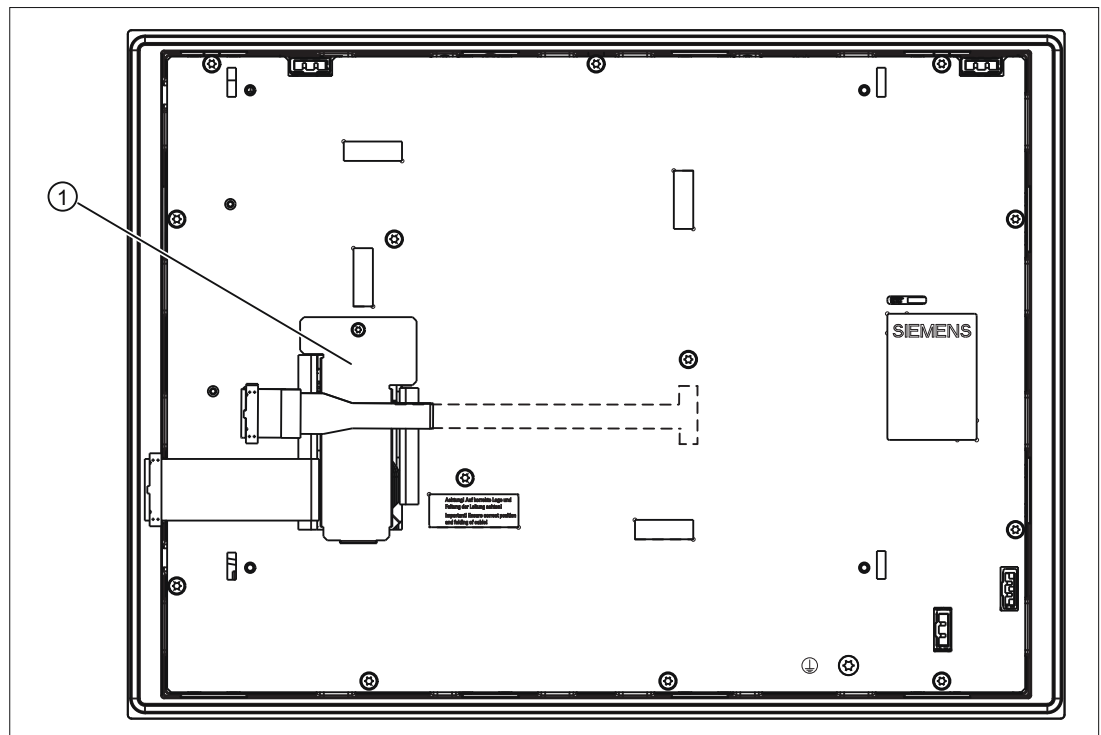

- (1) Cover plate for keyboard controller

Figure 12-10 TP 015A rear side

Assembly

You will find the reference diagrams for the individual mounting stages at the end of the description of the procedure.

1. Insert the DKM ribbon cable into socket X11 of the keyboard controller **(A)**
The cable has already been folded **(B)**.
2. Tighten the screws in the cover plate. Fold the DKM cable around as shown in **(C)**.
3. Fit the PCU as described in Chapter: "OP 012", Section: "Mounting".
4. Set PROFIBUS addresses 01 to 99 using the top (units) and bottom (tens) coding switches of the DKM (see figure in Section: "Operating and display elements").
5. Connect the ribbon cable to the DKM **(D)**.
6. Screw the DKM onto the securing nipple with the knurled screws.

(A)

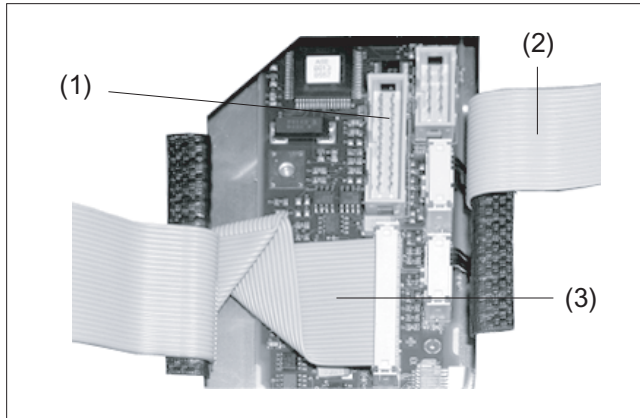

- (1) DKM interface X11:
- (2) I/O USB cable K1
- (3) Display cable K2

Figure 12-11 TP 015A: Keyboard controller connections

(B)

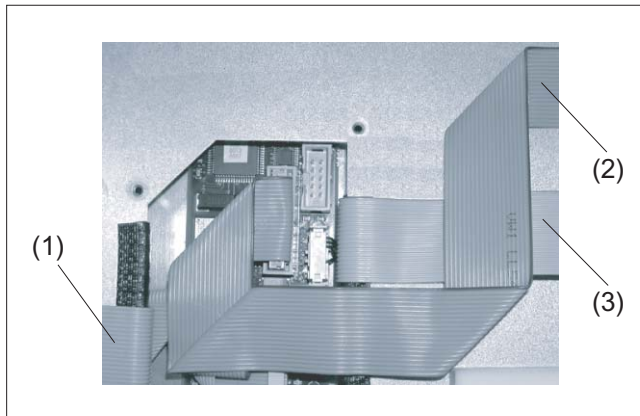

- (1) Display cable K2
- (2) DKM cable
- (3) I/O USB cable K1

Figure 12-12 TP 015A: DKM cable routing

(C)

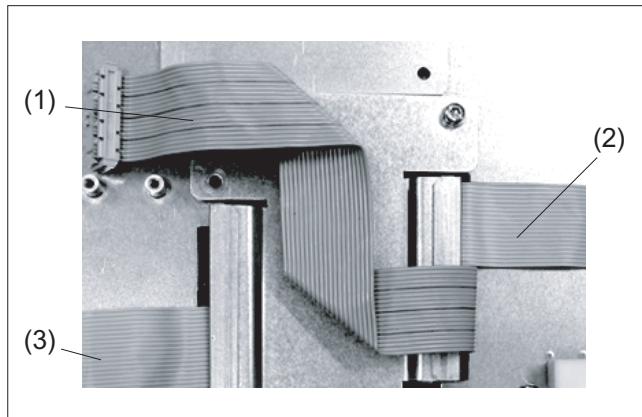

- (1) DKM cable
- (2) I/O USB cable K1
- (3) Display cable K2

Figure 12-13 TP 015A: Installing the cover plate

(D)

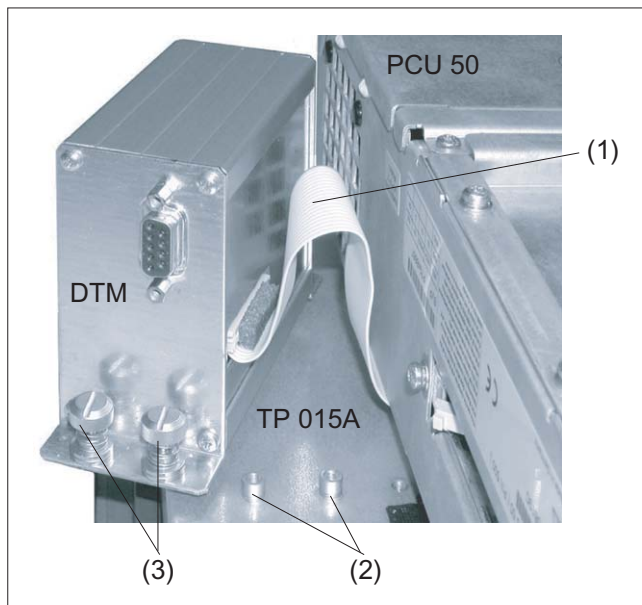

- (1) Cable from TP 015A to DKM
- (2) Securing nipple for direct key module
- (3) Retaining screws

Figure 12-14 Installation of the direct key module on the TP 015A

Note

Concealed fan for the PCU 50.3

After installation of the direct key module, the PCU fan is partially concealed. However, this does not have a negative effect, not even during operation.



Figure 12-15 Direct key module after installation

12.5 Technical data

Safety			
Degree of protection to DIN EN 60529	IP20		
Electrical data			
Input voltage	5 VDC		
Power consumption	Max. 0.75 W		
Mechanical data			
Dimensions	Width: 106 mm	Height: 42 mm	Depth: 80 mm
Weight	approx. 0.6 kg		

Note

Information about the climatic and mechanical environmental conditions is contained in the associated section under:

"General notes and interconnection" → "Operational planning".

PCU 50.3

13.1 Description

The powerful SINUMERIK PCU 50.3 not only has an integrated 150 W main power section but also all of the interfaces for communication via Ethernet and PROFIBUS DP already on board.

Four USB interfaces (USB 2.0) offer points where a keyboard, mouse and other peripheral devices can be connected.

A covered slot is available for CompactFlash cards (CF cards).

Two PCI slot connections are available for specific expansions.

A slot connection can be occupied depending on the device version.

Two 7-segment displays and/or LEDs are integrated for diagnostic purposes. These indicate the current operational state or, during powering up, the BIOS error codes.

The SINUMERIK PCU 50.3 is supplied with an operating system based on Windows XP - WinXP ProEmbSys.

Validity

The description applies to the following devices:

	Processor	RAM (DDR2)	Order number
PCU 50.3B-C	Celeron M 1.5 GHz	512 MB	6FC5210-0DF31-2AB0
PCU 50.3B-C incl. MCI2 board *)	Celeron M 1.5 GHz	512 MB	6FC5220-0AA31-2AB0
PCU 50.3B-P	Pentium M 2.0 GHz	1024 MB	6FC5210-0DF33-2AB0
PCU 50.3B-P incl. MCI2 board *)	Pentium M 2.0 GHz	1024 MB	6FC5220-0AA33-2AB0

*) These components can be used with the SINUMERIK 840Di sl.

Note

Redesign

The new "3B variants" with order number " ... -2AB0" replace the old PCUs with the order number " ... -2AA0". The new PCUs can be used as of PCU basic software 8.6 SP1 HF3.

For further information, please refer to the Service & Support article:
<http://support.automation.siemens.com/WW/view/en/46641428>

Features

- Robust design (continuous operation, high noise immunity)
- Compact construction for space-saving installation
- Service-friendly layout (e.g. battery can be accessed externally)
- Can be expanded via two PCI cards (min. 140 mm to max. 288 mm in length)
- The installation location and length vary due to the different types of mounting and mounting brackets
- Integrated 2-digit diagnostics display and status LEDs (e.g. for operating without a monitor)
- Powerful processors
 - Celeron M 1.5 GHz, 400 MHz FSB
 - Pentium M 2.0 GHz, 533 MHz FSB
- Working memory of 512 MB or 1024 MB (DDR2-RAM), max. 2048 MB
- Hard disk drive with cable dampers and 2.5" S-ATA hard disk, 40 GB
- Operating system based on Windows XP
- Screen resolutions with 32 bit colors , 85 Hz)
 - 640 x 480
 - 800 x 600
 - 1024 x 768
 - 1280 x 1024
 - 1600 x 1200 (max.)
- Power supply: 24 VDC, 190 W with On/Off switch
- Connections:
 - PROFIBUS (max. 12 MBaud)
 - DVI-I interface for external monitor
 - 2 x Ethernet 10/100 Mbit/s
 - 4 x USB 2.0
 - Serial interface COM1 (RS 232C)
- Expansion slots:
 - 2 x PCI (1 x 265 mm, 1 x 175 mm)
 - 1 x CompactFlash card (covered)

View



Figure 13-1 Perspective view of PCU 50.3 (without plug-in card)

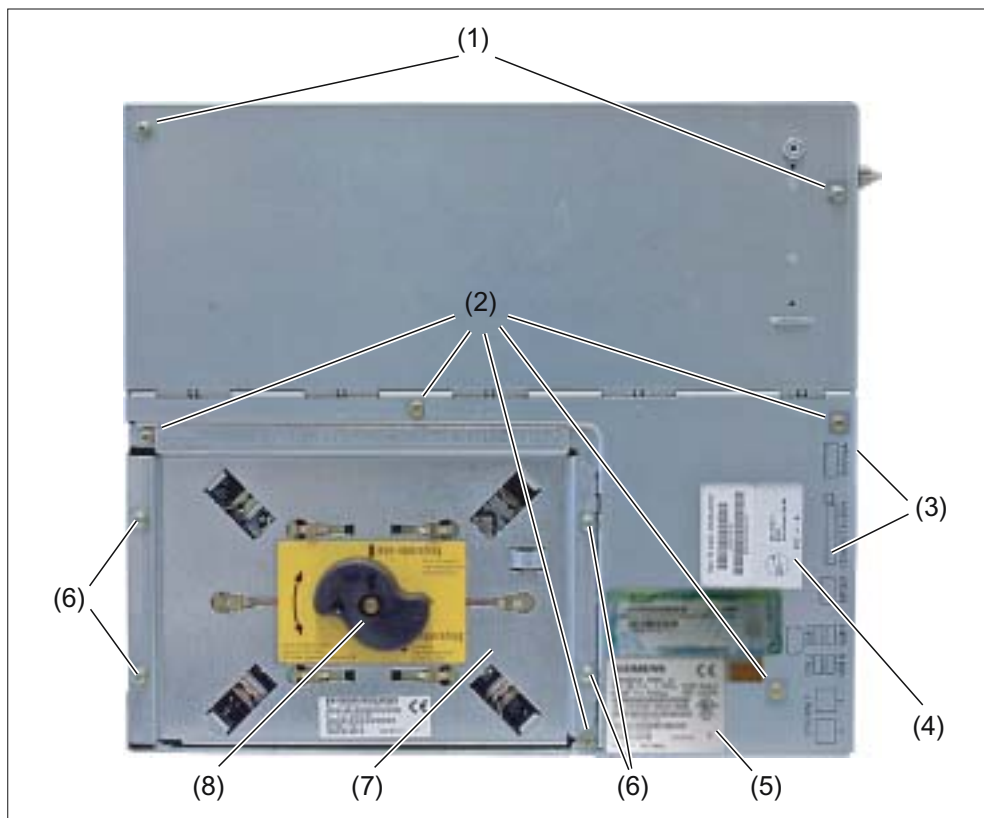

- (1) Housing cover screws
- (2) Power supply cover screws
- (3) Interfaces on right side of casing
- (4) Rating plate for power supply
- (5) Component label (with designation, order no., series no., version of the device)
- (6) Hard disk module screws
- (7) Hard disk drive
- (8) Handle for shipping lock

Figure 13-2 Top view of PCU 50.3

13.2 Operating and display elements

On/Off switch



Figure 13-3 PCU 50.3 On/Off switch

The integrated 24 V power supply for the PCU is switched on and off via the On/Off switch ①. It also serves as a substitute for the reset button, which is no longer provided, see Switching off / reset (Page 243).

13.3 Interfaces

13.3.1 External interfaces

Right-hand casing side

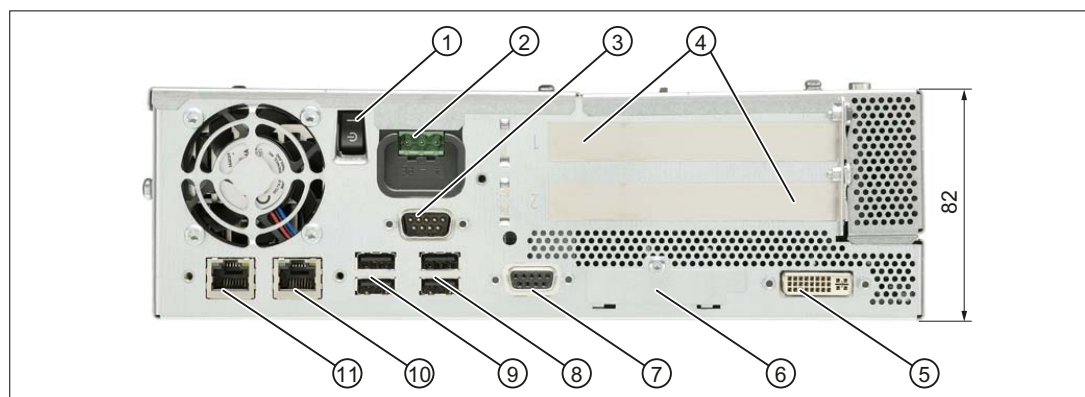
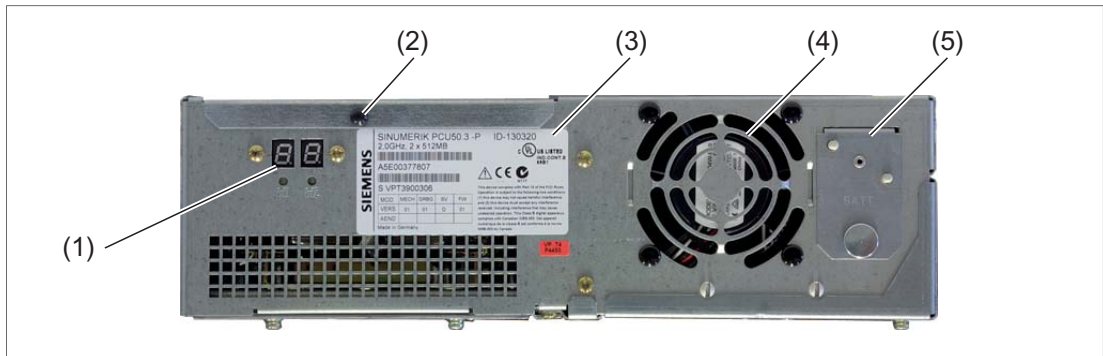

Figure 13-4 PCU 50.3 side view from right with interfaces (without plug-in card)

	Interface/connection		Function
①		Line breaker	On/Off switch (for standby) for the power supply unit
②	X1	Power supply connection	24 VDC, max. 190 W
③	COM1	V.24	Serial interface for devices such as a modem (V.24, Sub-D 9-pin plug, pins) ¹⁾
④		PCI slot (Slot 1 / Slot 2)	2 slots for expansion modules
⑤	X302	DVI-I interface	Bus for external monitor (VGA monitors via optional adapter)
⑥	X4	CompactFlash card	Slot for CF card under cover plug, not hot plug-capable
⑦	X600	PROFIBUS DP/MPI	12 MBit/s connection for connecting an S7 automation unit, potential-separated
⑧	X41	USB 4 / USB 5	4 external USB connections (USB 2.0 type A) - max. 2 can be operated at the same time as high-current ²⁾
⑨	X40	USB 0 / USB 2	
⑩	X501	Ethernet 1	2 x 10/100 MBit/s, connections for local networks (LAN), RJ45
⑪	X500	Ethernet 2	

- 1) The pin assignment of the COM interface can be found in "General information and networking", Chapter: "Connecting".
- 2) The max. current carrying capacity of the 4 USB connections is a total of 1.2 A. The max. current carrying capacity of a USB connection is 500 mA.

Left-hand casing side



- (1) Status displays
- (2) Cover plate with retaining screw
- (3) Type plate of the PC unit
- (4) Device fan
- (5) Cover plate for battery

Figure 13-5 Side view of PCU 50.3 from left

The cover plate (2) for the interfaces for connecting the operator panel fronts (see figure in Section: "Rear side of housing") is not installed at the factory and is delivered separately packaged.

Install it if the PCU 50.3 is built into a control cabinet.

Casing rear side

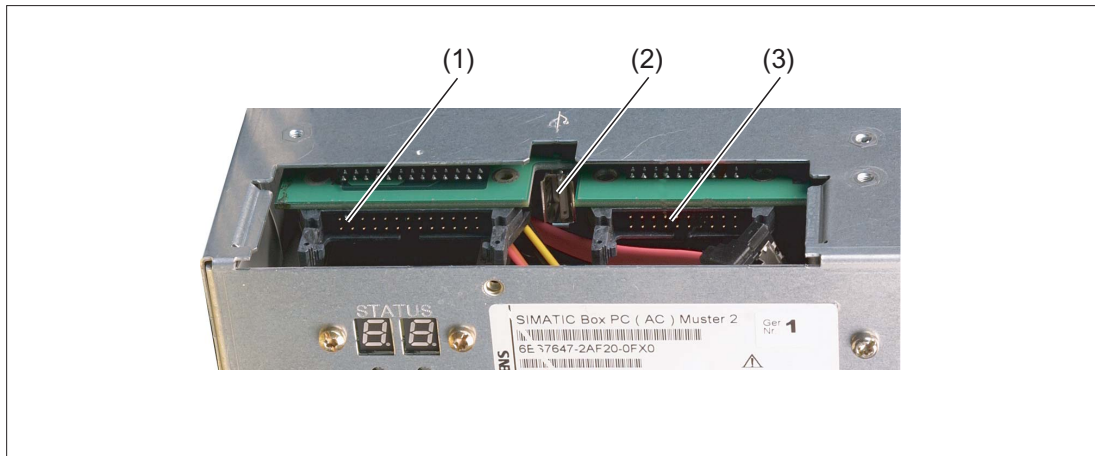

Figure 13-6 PCU 50.3 interfaces for connecting operator panel fronts

Interface/connection		
(1)	X44	I/O interface for connecting the I/O cable of the operator panel front
(2)	X42	Optimum connection for the operator panel front with USB 2.0 front interface
(3)	X400	LVDS interface for connecting a TFT display cable

Pin assignment for external interfaces

The pin assignments of the individual external interfaces can be found in "General information and networking", Chapter: "Connecting".

13.3.2 Internal interfaces

13.3.2.1 Connector assignment of motherboard

Overview

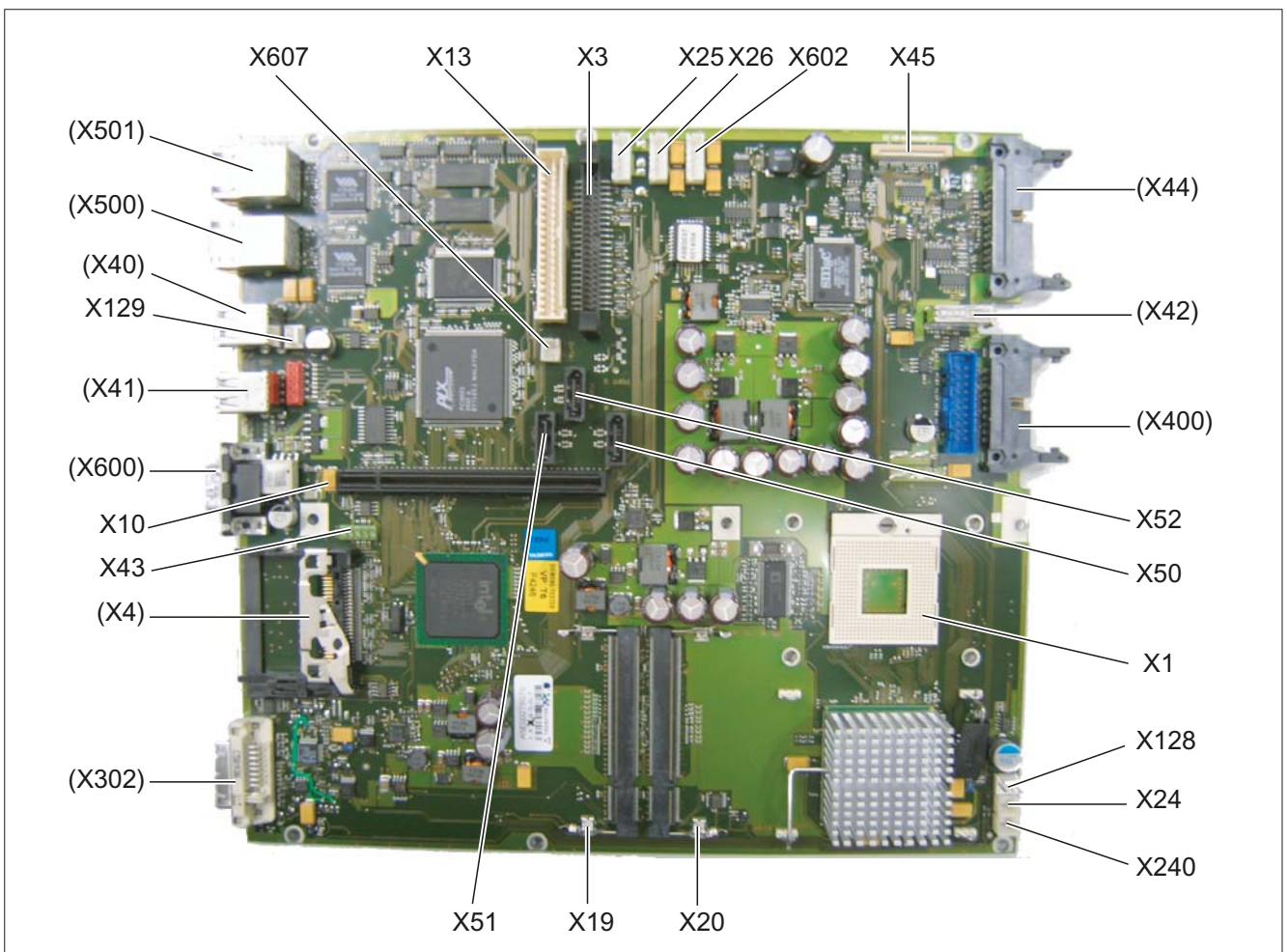

Figure 13-7 PCU 50.3 - Motherboard interfaces

Connector	Interface	Description
X1	Processor	Socket for FCPGA mobile processor
X3	Optical drive Parallel ATA	44-pin, 2 mm male connector
X10	Bus expansion	Socket for bus expansion, uses PCI bus signals
X13	Power supply	20-pin connection plug for power supply
X19 / X20	Memory	2 DIMM sockets, 64-bit
X24	Backup battery	Power supply for backup battery, 2-pin male connector
X25		SATA 0
X26		SATA 1
X602		SATA 2
X43	USB interface	USB channel 6 and 7
X45	Diagnostics	Connection for diagnostics module
X50	Serial ATA	SATA 0
X51		SATA 1
X52		SATA 2
X128	Connection for equipment fan	Power supply for equipment fan, 3-pin male connector
X129	Connection for PS fan	Power supply for CPU fan, 3-pin male connector
X240	Tap for backup battery	Voltage tap (= 3V) of the backup battery, 2-pin, male connector
X607		Lock status detection for MC hard disk module SATA
(X...)		External interfaces

Signal type:

- I Input
- O Output
- V Power supply
- Ground (reference potential) or N.C. (not connected)

Connection for DVD-ROM drive X3

Table 13- 1 X3 connector assignment

Connector	Pin	Name	Type	Remark
	1	RESET	i	Reset
	2	GND	-	Ground reference potential
	3	D7	I/O	Data signal D7
	4	D8		Data signal D8
	5	D6		Data signal D6
	6	D9		Data signal D9

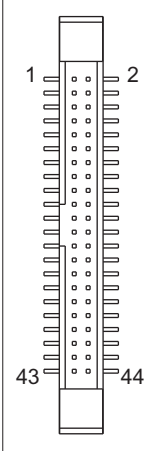
Connector	Pin	Name	Type	Remark
	7	D5	I/O	Data signal D5
	8	D10		Data signal D10
	9	D4		Data signal D4
	10	D11		Data signal D11
	11	D3	I/O	Data signal D3
	12	D12		Data signal D12
	13	D2		Data signal D2
	14	D13	Data signal D13	
	15	D1	I/O	Data signal D1
	16	D14		Data signal D14
	17	D0		Data signal D0
	18	D15		Data signal D15
	19	GND	-	Ground (reference potential)
	20	N.C.	-	Not connected
	21	DREQ	I	DMA request
	22	GND	-	Ground (reference potential)
	23	IOW_N	O	I/O write (writing signal)
	24	GND	-	Ground (reference potential)
	25	IOR_N	O	I/O read (reading signal)
	26	GND	-	Ground (reference potential)
	27	IORDY	I	I/O ready (ready signal)
	28	CSEL	O	Cable select
	29	DACK_N	O	DMA acknowledgement
	30	GND	-	Ground (reference potential)
	31	IRQ_R	I	IDE interrupt
	32	N.C.	-	Not connected
	33	AD_1	O	Address 1
	34	PDIAG_N	I/O	PDIAG
	35	AD_0	O	Address 0
	36	AD_2	O	Address 2
	37	CS1_N	-	Chip Select 1
	38	CS3_N	-	Chip Select 3
	39	HDACT_N	I	HD active
	40	GND	-	Ground (reference potential)
	41	P5V	V	+5V voltage supply (LOGIC)
	42	P5V	V	+5V voltage supply (MOTOR)
	43	GND	-	Ground (reference potential)
	44	-	-	Reserved

DC interface of the power supply X13

Table 13- 2 X13 connector assignment

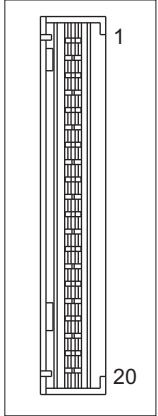
Connector	Pin	Name	Type	Remark
	1	P5V	V	+ 5 V
	2	P5V		+ 5 V
	3	P5V		+ 5 V
	4	P5V		+ 5 V
	5	P5V Sense	O	Sense 5 V
	6	PS_NAU_N		Power loss early warning signal
	7	PS_PWROK		Power Good Signal
	8	GND	-	Ground
	9	GND		Ground
	10	GND		Ground
	11	N12V	V	- 12 V
	12	GND	-	Ground
	13	GND		Ground
	14	GND		Ground
	15	P12V	V	+ 12 V
	16	P12V		+ 12 V
	17	P3V Sense	O	Sense 3.3 V
	18	P3V	V	+ 3.3 V
	19	P3V		+ 3.3 V
	20	P3V		+ 3.3 V

Connector for backup battery X24

The battery for backing up the CMOS-RAM is connected to this connection. A 3V lithium battery with a capacity of 750 mAh is used for this purpose.

Table 13- 3 Assignment of the X24 connector

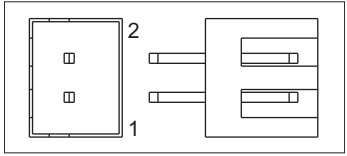
Connector	Pin	Name	Type	Remark
	1	+	VI	Plus pole
	2	-	VI	Minus pole

USB interface connector X43

Table 13- 4 X43 connector assignment

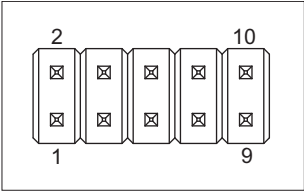
Connector	Pin	Name	Type	Remark	
	1	VCC 5V	O	+ 5 V fused	
	2	VCC 5V	O	+ 5 V fused	
	3	USB3	I/O	USB3_M	
	4	USB5		USB5_M	
	5	USB3		USB3_B	
	6	USB5		USB5_B	
	7	GND	-	-	Ground (reference potential)
	8	GND	-	-	Ground (reference potential)
	9	GND	-	-	Ground (reference potential)
	10	GND	-	-	Ground (reference potential)

Connection for equipment fan X128

Table 13- 5 X128 connector assignment

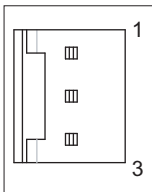
Connector	Pin	Name	Type	Remark
	1	GND	-	Ground (reference potential)
	2	+ 12 V	V	Switched voltage supply
	3	CPU FAN_CLK	I	Clock signal

Connection for power supply fan X129

Table 13- 6 X129 connector assignment

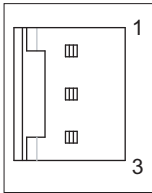
Connector	Pin	Name	Type	Remark
	1	GND	-	Ground (reference potential)
	2	+ 12 V	O	Switched voltage supply
	3	PG1 FAN_CLK	I	Clock signal

Tap for backup battery X240

This connection is intended for expansion modules with their own CMOS-RAM. The voltage of the backup battery can be tapped here to back up the CMOS-RAM data of the expansion module.

Table 13- 7 Assignment of the X240 connector

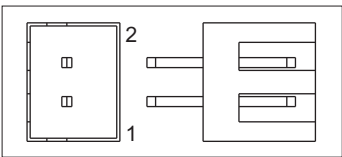
Connector	Pin	Name	Type	Remark
	1	+	VO	Plus pole of battery over 100 Ohm
	2	-	VO	Minus pole

Note

No battery should be connected to this connection.

Lock status detection connection X607

This connection serves to detect a locked MC hard disk.

Table 13- 8 Pin assignment of connector X607

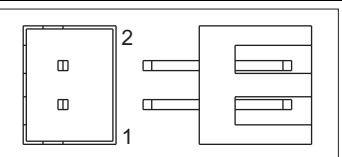
Connector	Pin	Name	Type	Remark
	1	SATA_GP0	I	Detection input
	2	GND	-	Ground

13.3.2.2 Connector assignment of bus board

The bus board is designed as a link between the motherboard and the expansion modules. It is mounted using two screws.

The bus board has two PCI slots (1x short, 1x long).

Expansion modules can be installed acc. to the PCI specification (rev. 2.1) for 5 V and 3.3 V. All PCI slots are capable of being masters.

The expansion modules are supplied with power via the bus board's connection to the motherboard.

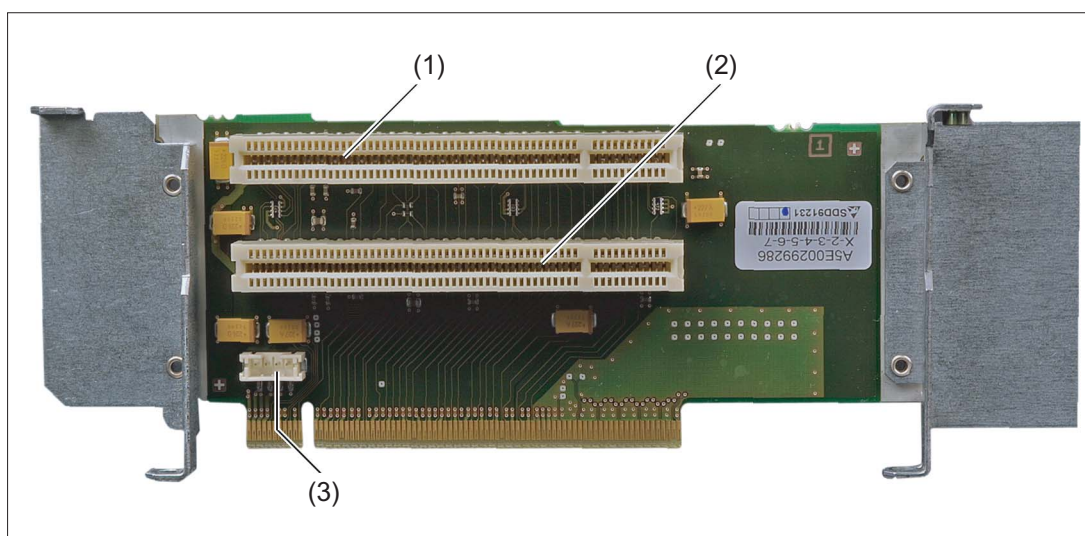

- (1) Slot 1
- (2) Slot 2
- (3) 12 V power supply connection for WinAC module

Figure 13-8 PCU 50.3 bus board

PCI slot pin assignment

	5V System Environment	
	Side B	Side A
1	- 12 V	TRST#
2	TCK	+ 12 V
3	Ground	TMS
4	TDO	TDI
5	+ 5 V	+ 5 V
6	+ 5 V	INTA#
7	INTB#	INTC#
8	INTD#	+ 5 V
9	PRSNT1#	Reserved
10	Reserved	+ 5 V (I/O)
11	PRSNT2#	Reserved

	5V System Environment	
	Side B	Side A
12	Ground	Ground
13	Ground	Ground
14	Reserved	Reserved
15	Ground	RST#
16	CLK	+ 5 V (I/O)
17	Ground	GNT#
18	REQ#	Ground
19	+ 5 V (I/O)	Reserved
20	AD[31]	AD[30]
21	AD[29]	+ 3.3 V
22	Ground	AD[28]
23	AD[27]	AD[26]
24	AD[25]	Ground
25	+ 3.3 V	AD[24]
26	C/BE[3]#	IDSEL
27	AD[23]	+ 3.3 V
28	Ground	AD[22]
29	AD[21]	AD[20]
30	AD[19]	Ground
31	+ 3.3 V	AD[18]
32	AD[17]	AD[16]
33	C/BE[2]#	+ 3.3 V
34	Ground	FRAME#
35	IRDY#	Ground
36	+ 3.3 V	TRDY#
37	DEVSEL#	Ground
38	Ground	STOP#
39	LOCK#	+ 3.3 V
40	PERR#	SDONE
41	+ 3.3 V	SBO#
42	SERR#	Ground
43	+ 3.3 V	PAR
44	C/BE[1]#	AD[15]
45	AD[14]	+ 3.3 V
46	Ground	AD[13]
47	AD[12]	AD[11]
48	AD[10]	Ground
49	Ground	AD[09]
50	CONNECTOR KEY	
51	CONNECTOR KEY	
52	AD[08]	C/BE[0]#

5V System Environment		
	Side B	Side A
53	AD[07]	+ 3.3 V
54	+ 3.3 V	AD[06]
55	AD[05]	AD[04]
56	AD[03]	Ground
57	Ground	AD[02]
58	AD[01]	AD[00]
59	+ 5 V (I/O)	+ 5 V (I/O)
60	ACK64#	REQ64#
61	+ 5 V	+ 5 V
62	+ 5 V	+ 5 V

Pin assignment 12V power supply connection for WinAC module

Pin	Name	Signal type	Remark
1	+ 12 V	V	12 V voltage
2	GND	-	Ground (reference potential)
3	GND	-	Ground (reference potential)
4	+ 5 V	V	5 V voltage

Interrupt assignment (PCI-IRQ)

PCU 50.3	PCI devices interrupt assignment (PCI IRQ)
INT - A	Graphics, USB A (channel 0+1), USB B (channel 2+ 3)
INT - B	Slot 1
INT - C	Slot 2
INT - D	Serial ATA
INT - E	Ethernet 1
INT - F	MPI/DP
INT - G	Ethernet 2, USB C (channel 4+5), USB D (channel 6 + 7)
INT - H	USB 2.0

Exclusive PCI hardware interrupt

Applications which have stringent requirements in terms of interrupt performance need a fast interrupt response time from the hardware.

The PCI hardware interrupt may only be assigned by one resource if a fast hardware response time is to be available.

To enable this, the Ethernet 1, PROFIBUS/MPI interfaces and the two slots each have an exclusive interrupt.

	IRQ assignments for Windows XP operating system (APIC mode)	IRQ assignments for DOS-based operating systems (PIC mode)
Ethernet 1	20	10
PROFIBUS/MPI	21	7
Slot 1	17	5
Slot 2	18	3

13.4 Installation

13.4.1 Preparation for mounting

Mounting of the PCU 50.3 depends on how it is going to be used. A distinction is made between the following types of mounting:

1. **Standard mounting: Operator panel on the machine**
- for assembly of PCU and operator panel front
2. **Flat mounting: In the control cabinet**
- for PCU flat on the control cabinet rear wall
3. **Book mounting: In the control cabinet**
- for PCU at an angle of 90° to the control cabinet rear wall

You require a suitable set of mounting brackets for each mounting method. You will find the corresponding order number in Section: "Accessories".

Note

First, screw the appropriate mounting brackets onto the PCU before you mount the PCU on an operator panel front.

The figures shows the PCU and mounting bracket for standard mounting correctly aligned before screwing together (tightening torque M3: 0.8 Nm, tightening torque M4: 1.8 Nm).

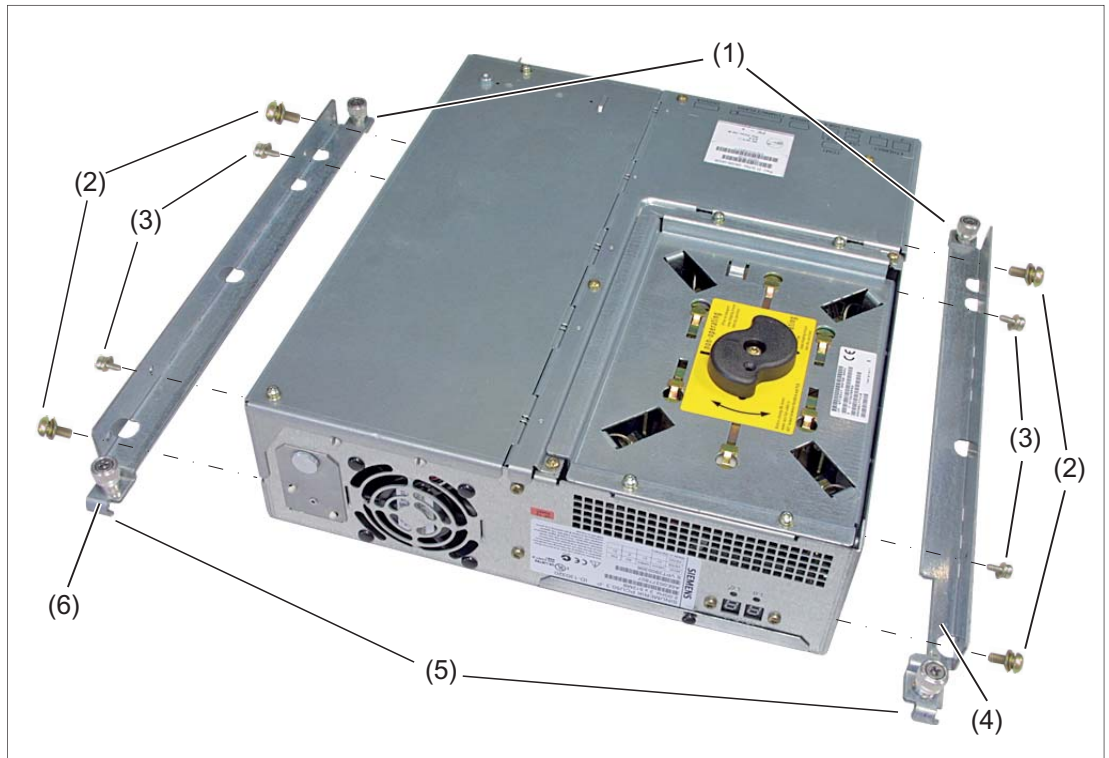

- (1) Lugs without hinged catch
- (2) M4x8 countersunk screw with high tension ring and washer
- (3) M3x8 countersunk screw with high tension ring and washer
- (4) B bracket
- (5) Lugs with hinged catch
- (6) A bracket

Figure 13-9 PCU 50.3 with mounting brackets (standard mounting)

⚠ WARNING

Securing the PCU on the wall or to the ceiling

Ensure that the wall or ceiling can support four times the total weight of the PCU (including mounting brackets and additional expansion modules).
The total weight of the PCU is max. 7 kg.

NOTICE

Damage to the mainboard

For installing the mounting brackets for the upright installation, use only M4x10 screws. For all remaining mounting brackets, use M3x8 and M4x8, (provided).

The mainboard will be damaged if you

- screw in the M3x8 and M4x8 screws without mounting brackets,
- or if you use other 8 mm screws (without a flat washer or tension ring) or
- longer screws,
- use the M4x10 screws for mounting the brackets on the PCU 50 (previous model).

Dimension drawings for mounting

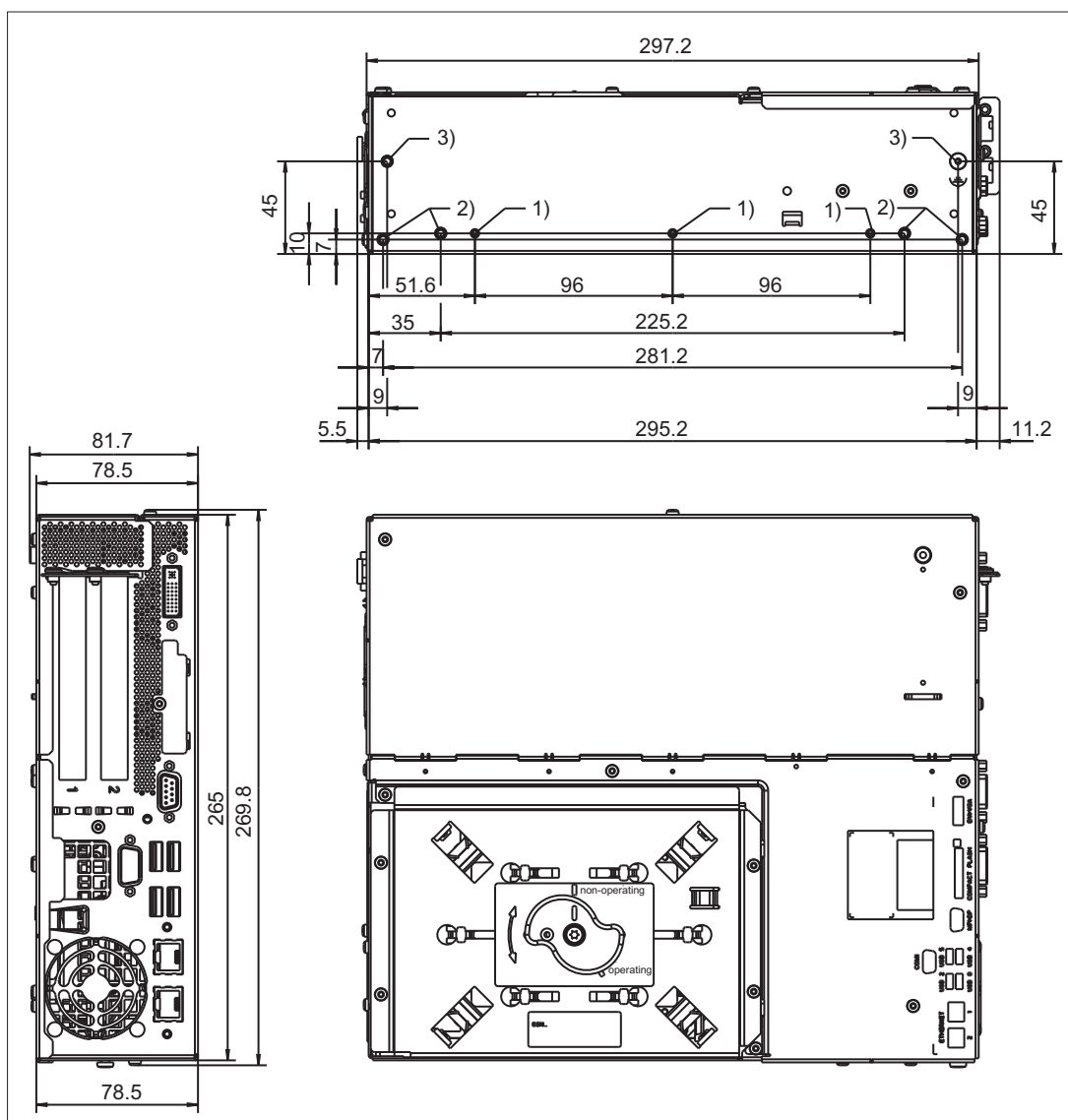

All dimensions in mm

- 1) M3x8 countersunk screw with high tension ring and washer
- 2) M4x8 countersunk screw with high tension ring and washer
- 3) M4 (only present on this side)

Figure 13-10 PCU 50.3 dimension drawing for mounting without ETH strain relief

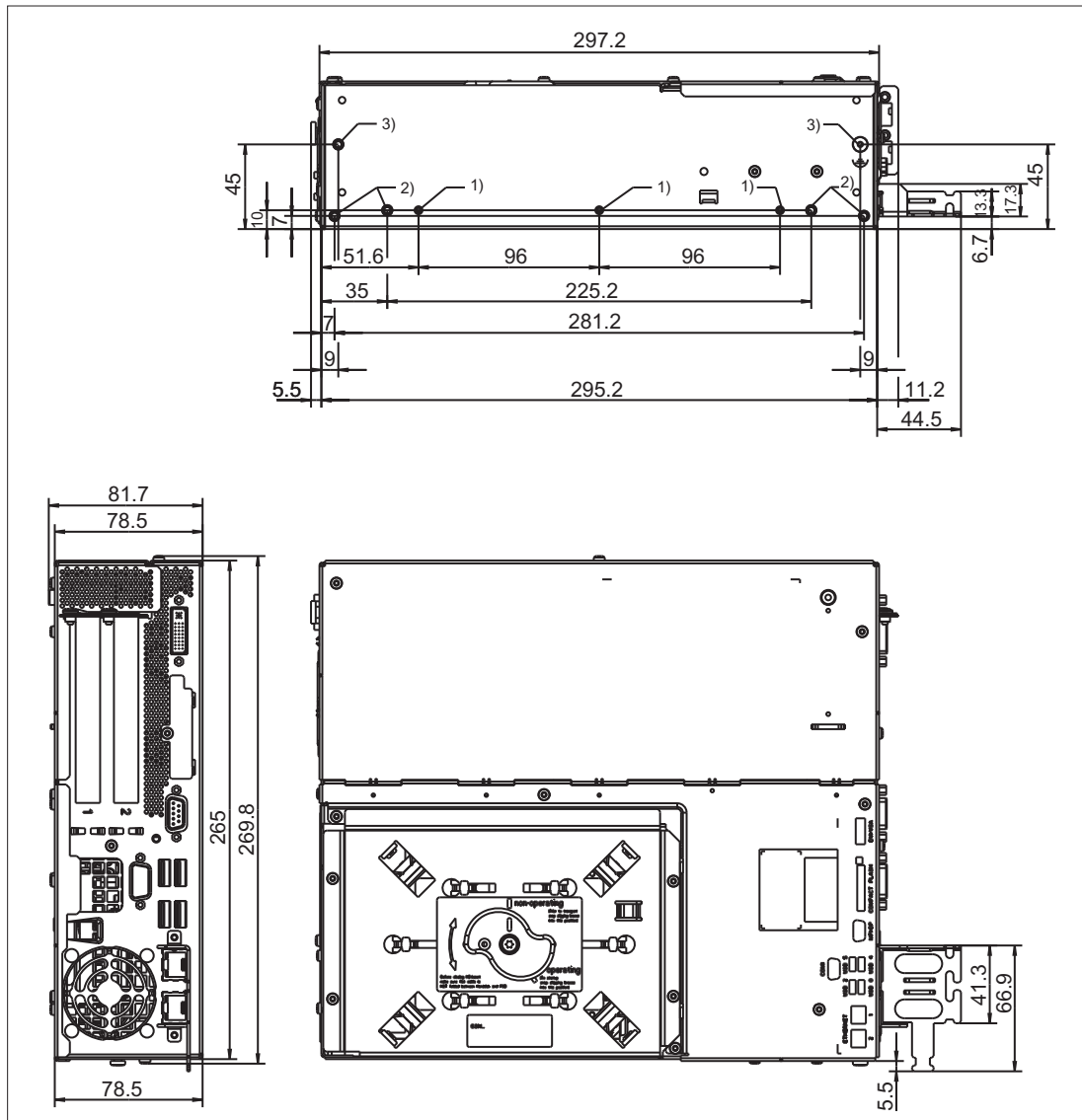

All dimensions in mm

- 1) M3x8 countersunk screw with high tension ring and washer
- 2) M4x8 countersunk screw with high tension ring and washer
- 3) M4 (only present on this side)

Figure 13-11 PCU 50.3 dimension drawing for mounting with ETH strain relief

13.4.2 Assembly of PCU and operator panel front (standard mounting)

Install the PCU and operator panel front as described in section: "OP 012," section: "Mounting" → "Assembling OP 012 and PCU."

13.4.3 Flat mounting

Use the 'flat' mounting bracket (see Section: "Accessories" → "Overview") to mount the PCU 50.3 flat on the side of the control cabinet.



Figure 13-12 PCU 50.3 with mounting brackets for flat mounting

Procedure

1. Mount the two brackets on the right and left of the PCU 50.3.
2. Mount the PCU 50.3 on the side of the control cabinet in accordance with the installation instructions (see Section: "Installation instructions").



Figure 13-13 PCU 50.3 - one bracket mounted

Dimension drawing

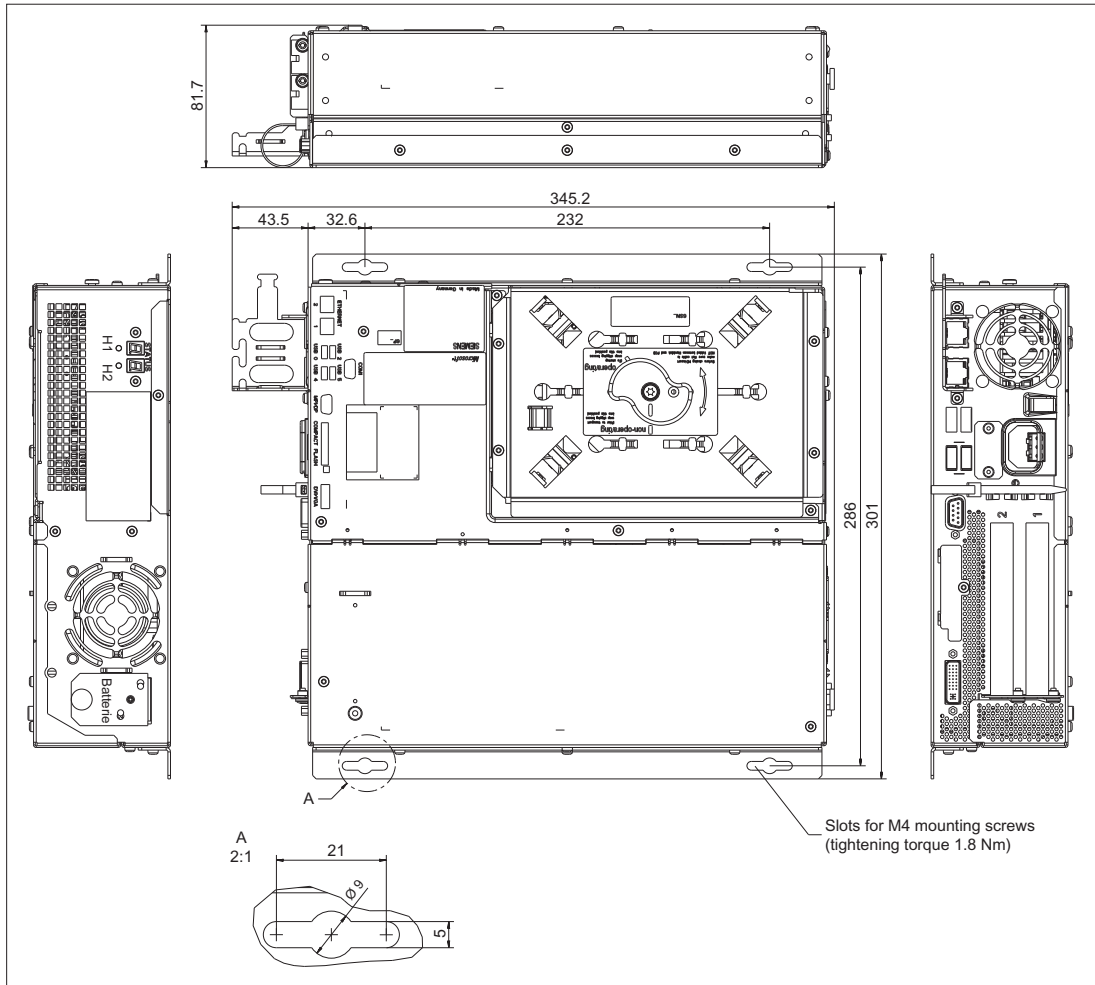

Figure 13-14 Dimension drawing, PCU 50.3 mounted flat

13.4.4 Upright mounting

Use the 'upright' mounting bracket (see Section: "Accessories" → "Overview"), to mount the PCU 50.3 in the control cabinet.

Only one mounting position (fan upwards) is possible.

Procedure

1. Mount the rear panel bracket on the right side of the PCU 50.3 (see figure).
2. Mount the PCU 50.3 at a 90° angle in the control cabinet.



- (1) 'Upright' mounting bracket
- (2) PCU 50.3

Figure 13-15 PCU 50.3 with mounting bracket for upright mounting

Dimension drawing

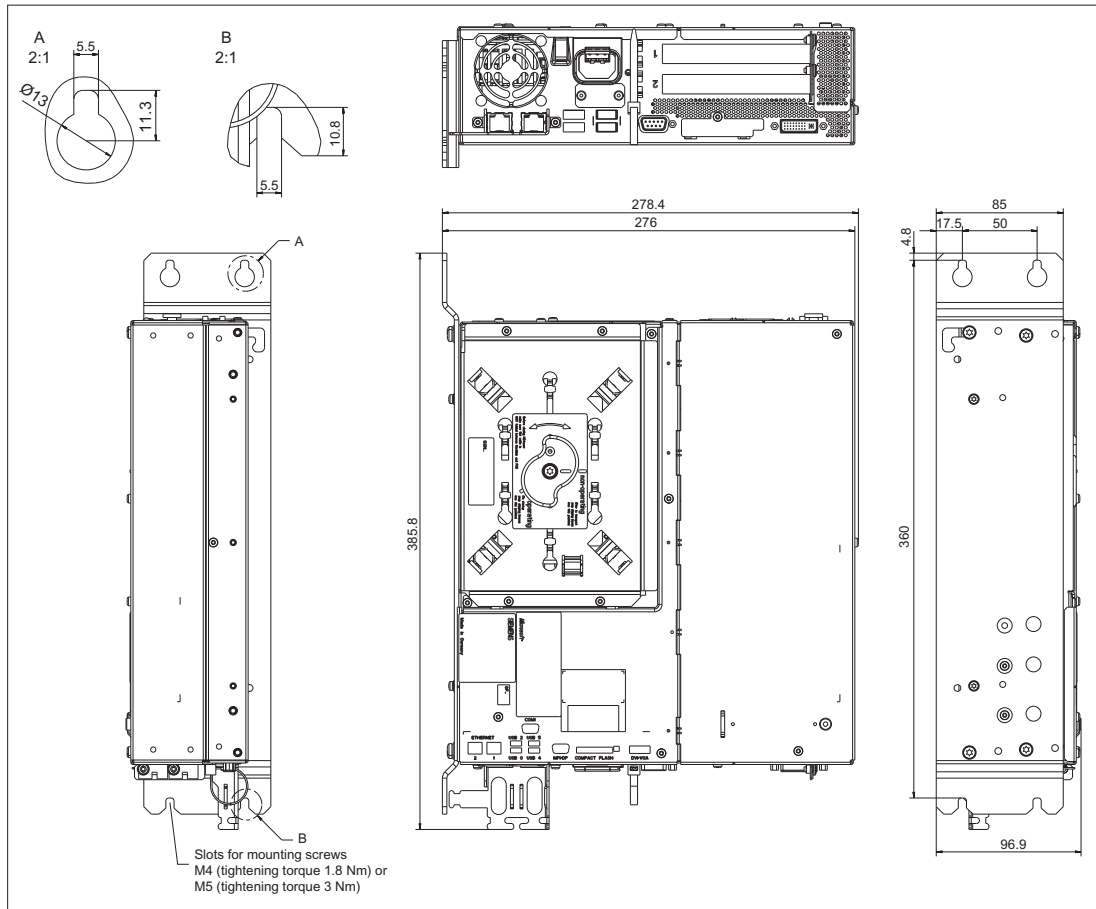

Figure 13-16 Dimension drawing, PCU 50.3 book mounting

13.4.5 Notes on installation

Observe the following during installation:

- Avoid extreme environmental conditions as far as possible.
Protect the PCU from severe vibrations, jolts, dust, humidity and heat.
- An external fire protection housing is required.
- Do not expose the PCU directly to the sun's rays.
- Install the device in such a way that no danger (e.g. by falling down) may result.

- Ventilation clearances:
 - Both fan sides: 50 mm each.
 - On top, on the bottom, on the rear side: 10 mm (see Fig.)
- Make sure that the vent slots are not covered.

Permissible mounting positions of PCU 50.3 acc. to UL508

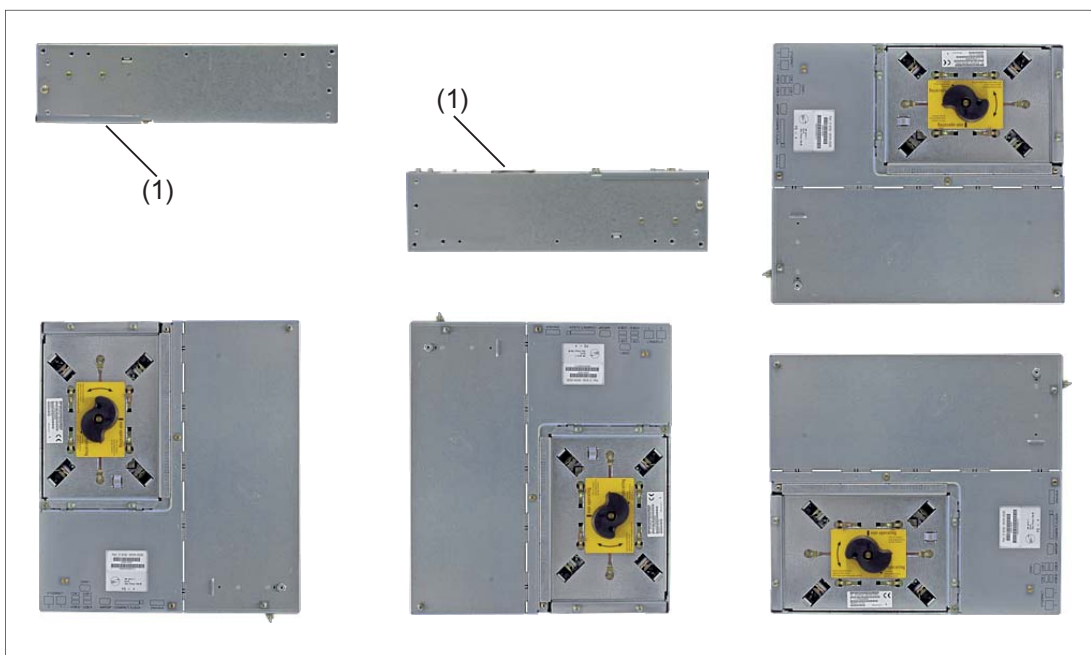

(1) Position of hard disk

Inclined position

On the basis of the standard mounting positions shown above (checked with a variance of $\pm 5^\circ$), an inclined position of up to $\pm 20^\circ$ is permitted if sufficient ventilation is still ensured.

13.4.6 Mounting the Ethernet tension relief

The **ETHERNET** strain relief serves to secure the main power connector on the PCU 50.3. The ETH strain relief is not mounted and is delivered in a separate package.

Procedure



1. Remove the cable ties (1), the ETH strain relief (2) and the two screws (M3) from the separate package.



2. Secure the ETH strain relief on the PCU by tightening the two screws with a Torx screwdriver T10.



3. Plug in the Ethernet cable.



4. Secure the Ethernet cable at the ETH strain relief with a cable tie.



13.4.7 Installing the anchor tie

The anchor tie (2) ensures strain relief for the cable to the USB interfaces. It has a releasable lock and can therefore be reused.

The anchor tie is supplied in a separate package from the factory.

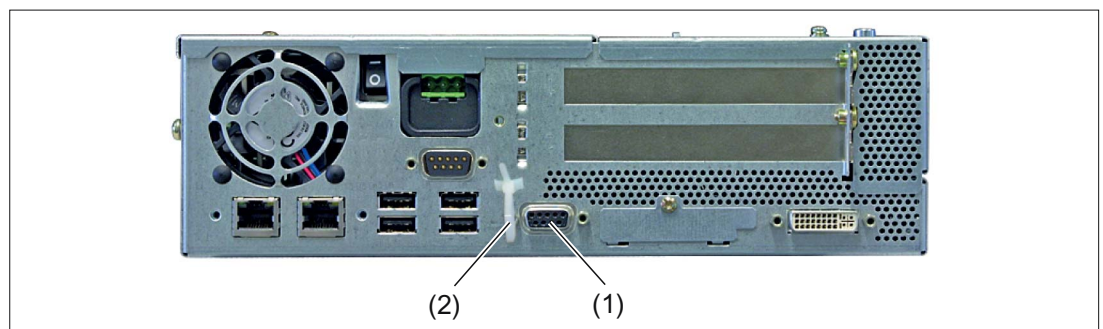

Figure 13-17 PCU 50.3 - anchor tie

Mounting

1. Press the anchor tie firmly in the drill-hole above the PROFIBUS DP / MPI interface **(1)**.
2. Undo the release and insert the USB cable.
3. After inserting the cable, tighten the anchor tie again, so that the cable is reliably relieved of strain.
4. Rotate the anchor tie in such a manner that the interfaces and connector remain freely accessible.

13.5 Connecting

13.5.1 Ground terminal

The ground terminal (1) of the PCU 50.3 is on the underside of the casing.

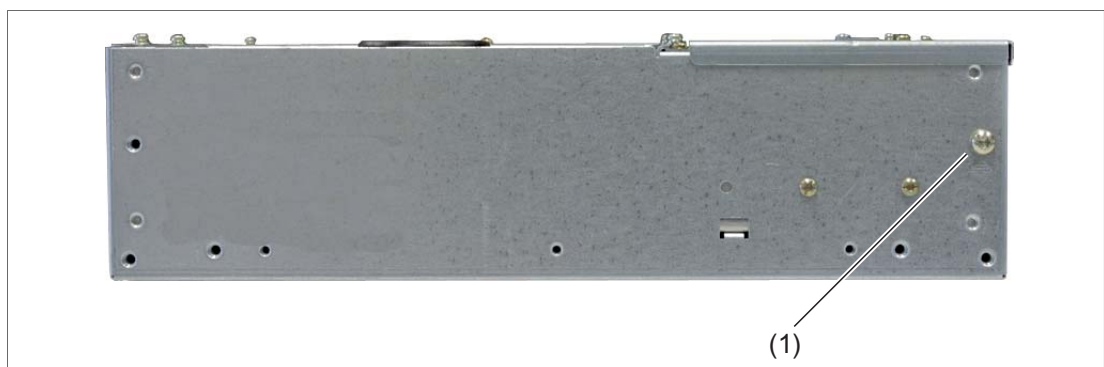

Figure 13-18 Underside of PCU 50.3

13.5.2 I/O devices

Note

When connecting up I/O devices, check that they are suitable for industrial applications acc. to EN 61000-6-2:2001.

Operator panel front

If you are using the PCU together with an operator front panel, before switching on the PCU first connect up the operator front panel.

Note

Simultaneous operation of the operator panel and monitor is no longer activated as standard under Windows XP. If required, activate in the Windows operator interface.

DVI / VGA monitor

Only switch on the PCU once you have connected the external monitor. Otherwise, this interface is automatically deactivated.

CF card

Only switch on the PCU once you have plugged in the CompactFlash card.

The CompactFlash interface is not capable of acting as a hot-plug. Never plug-in or pull a card while the PCU is operating.

Units based on USB

You can connect or disconnect units based on USB (USB 1.1 or 2.0) during PCU operations if they are supported by the operating system (e.g. Windows XP).

Note

If you are using commercially available USB devices, the interference immunity of the entire system can be reduced. The end user takes responsibility for the use of such devices.

Information on which connection cable is required and how to adapt and set the interface can be found in the User's Manual for your I/O device.

13.5.3 DC power supply (24V)

The PCU 50.3 is supplied with 24 VDC.

<p>! WARNING</p> <p>Impermissible cable cross-sections can damage the PCU</p> <p>The cable cross-section must be adapted to the short-circuit current of the 24 VDC power source so that no damage is caused by the cables if a short-circuit occurs. Only cables with a cross-section of at least 1.3 mm² (AWG16) and maximum 3.3 mm² (AWG12) may be connected.</p>
--

Note

The 24 VDC power source must be adapted to the input data of the PCU (see Section: "Technical data").

Connecting the PCU to the 24 VDC power supply

1. Ensure that the PCU's On/Off switch is in the '0' (Off) position to prevent unintentional startup of the device when connecting it to the power supply.
2. Switch off the 24 VDC power supply.
3. Connect the DC connector.

13.5.4 Equipotential

A low-impedance ground connection ensures that interference signals generated by external power supply cables, signal cables or cables to the I/O modules are safely discharged to ground.

The equipotential bonding terminal ① on the device (large surface, large-area contact) must be connected with the central grounding point of the cabinet or plant in which the PCU is to be installed.

The minimum cross section must not fall below 5 mm².



Figure 13-19 PCU 50.3 equipotential connection

13.6 Start up

13.6.1 Locking / unlocking hard disk

Protect the PCU hard disk drive during any form of transport by locking it.

Note

After a longer period of use, the wire rope damper inside can expand to such an extent that a locking of the hard disk is possible only when the PCU is positioned vertically.

Interlock

To lock the hard disk drive, turn the black rotary knob to the **"non-operating"** position. The sensitive dampers are then reliably protected from damage during transport.

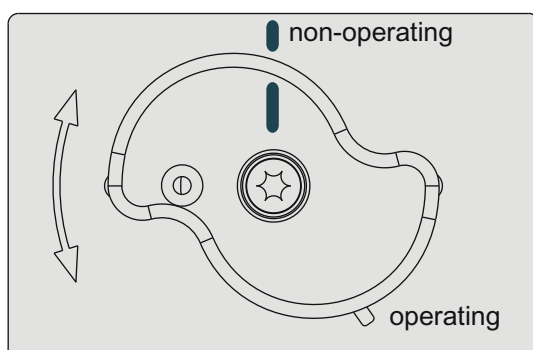

Figure 13-20 PCU 50.3 hard disk drive locked

Unlocking

To unlock the hard disk drive, turn the black rotary knob to the **"operating"** position. The sensitive dampers are then reactivated for subsequent operations.

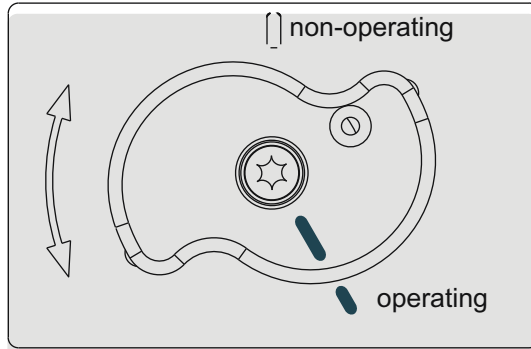

Figure 13-21 PCU 50.3 hard disk drive unlocked

Error message during locking

When the PCU BIOS is powered up, the system checks whether the hard disk drive has been unlocked.

If it has not been unlocked, the following error message is output on the screen:

```
"Error  
System halted - hard disk drive (HDD) locked!  
Please switch power off, remove HDD-interlock and reboot the system"
```

The status display is "A8" while the error message is output.

Action to take during error message:

1. Switch off the PCU.
2. Unlock the hard disk drive.
3. Switch the PCU on again.

13.6.2 BIOS

13.6.2.1 BIOS powering up

Once you have switched the PCU on, the preinstalled system powers up automatically.

During powering up, the parameters saved in the BIOS setup take effect.

If necessary, you can reactivate the factory-preset parameters (default values) at anytime during the setup using the <F2> key.

1. Press the <F9> (default load) key to do this.
2. Store the settings by pressing the <F10> button (save settings).

Once powering up is complete, the start screen is displayed (see IM8: start-up of PCU base software).

Checking the boot sequence

If you want to check or change the boot sequence:

1. Switch on the PCU.
2. Press the <Esc> key (or <Alarm Cancel> on the operator panel), if you are prompted to do so.
The boot list with all of the booted devices is displayed.
3. Select the desired boot device and press the enter key.

Booting using the USB FlashDrive

If you connect an external USB device or start from a boot-capable USB FlashDrive for servicing purposes, you have to manually call up the USB device from setup. Two options are available:

USB device is entered in boot list

1. Switch on the PCU.
2. Press the <F2> key.
3. Press the <Esc> key (or <Alarm Cancel> on the operator panel).
4. Select the corresponding USB device from the boot list.

USB device is not entered in boot list

1. Switch on the PCU.
2. Press the <F2> key.
3. Select the <Go to Setup> menu item to reach the Setup menu.
4. Go to the menu bar for <Boot>.
5. Use the '↓' button to reach the "Excluded from boot order" entry and select the USB device you want to enter in the boot list.
6. Press the 'x' key. The device is entered in the boot list
7. If you want to change the sequence of devices within the boot list, select the corresponding device and press the '+' key to move further up the list or the '-' key to move further down the list.
8. Then reboot the PCU.

PCU doesn't boot up

If the PCU no longer boots up as a result of incorrect settings in the BIOS:

1. Take the battery out (see section: "Spare parts" → "Replacement" → "Battery").
2. Bridge the pins of the PCU's battery connector for approx. 10 seconds with a conductive object.
3. Then wait approx. 1 minute.
4. Put the battery back in.
All the BIOS settings (including time and date) are thereby reset.
5. You can set the time and date using the <F2> key.
6. Use the <F9> button to load the default values and the <F10> button to save these.

13.6.2.2 Changing the BIOS settings

If additional components (e.g. an external USB diskette drive) are attached or removed, you may need to change the BIOS settings (see Section: "BIOS start up" → "Bootting using the USB flash drive").

NOTICE
Incorrect BIOS settings can prevent the system startup
Only change the BIOS settings if you are fully aware of the consequences of doing so!
Incorrect settings may result in the entire system (including the operating system) no longer starting (see Section: "BIOS start up" → "PCU not booting up").

Changing the BIOS settings using the standard keyboard

Creating your own user profile

Use the "User" profile in the setup menu if you need your own settings in the BIOS and want to permanently save these settings (also used after changing the battery).

1. Switch on the PCU and wait a few seconds.
2. Once you have been prompted to switch to the BIOS setup, press the <F2> button. The BIOS Setup menu will appear.
3. Select "User" under "Exit" → "Profile".
4. Make your specific settings in the other menu items.
5. Save the new settings permanently using the <F10> button by confirming the dialog with "Yes."
6. Your specific settings will be available once the machine has been restarted.

Calling up your own user profile

As soon as you select "User" at the "Exit" → "Profile" setup setting and save with "Yes" via the <F10> key, you receive the values saved originally after a reboot, provided that you do not change any data (with the exception of the date and time).

Changing data (with the exception of the date and time) is the same as creating a new user profile (see "Creating your own user profile").

Changing the BIOS settings via an operator panel front

1. Switch on the PCU and wait a few seconds.
 2. Once you have been prompted to switch to the BIOS setup, press the <F2> button. The BIOS Setup menu will appear.
 3. Use the cursor keys for navigating in the menu to the desired selection field (e.g. "Disk A:").
 4. Change the setting using the <+> key (press <SHIFT> and <X> at the same time) or the <-> key on in the numeric keypad.
 5. You can also use the cursor keys <-> (right) and <←> (left) to reach other setup menu items.
 6. Press the <Esc> button (<Alarm Cancel> button) to reach the "Exit" menu. (This menu can also be reached by pressing and holding down the <-> (right) cursor key.)
 7. Press the <Input> key to quit the setup menu.
 8. Press the <Input> key to confirm your decision to exit BIOS Setup with "Yes".
- Then power up the system (see Section: "BIOS startup").

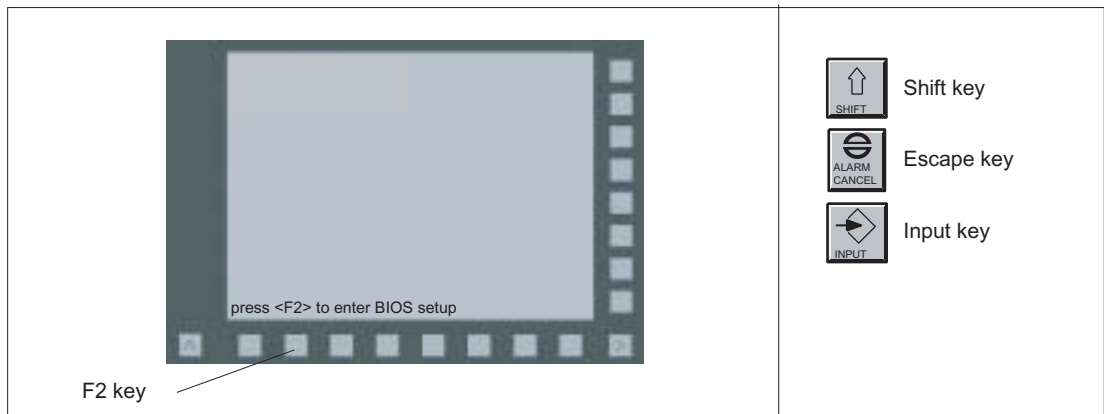
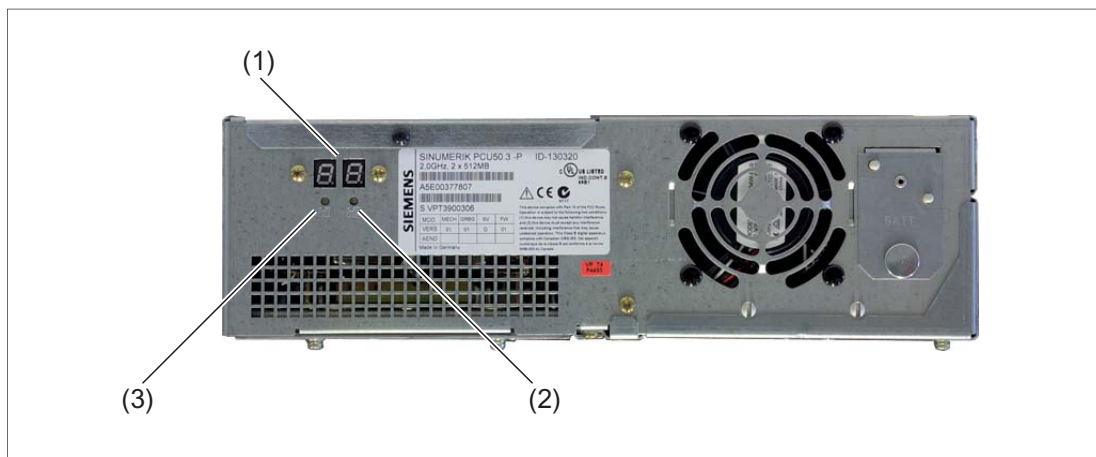

Figure 13-22 Using the BIOS Setup via an operator panel front

13.6.2.3 Status display

The status display consists of two 7-segment displays with two 2-color LEDs.



- (1) 2 x 7-segment display
- (2) LED H2
- (3) LED H1

Figure 13-23 PCU 50.3 status display

Function of the 7-segment display

During the BIOS powering up process, the POST codes of the corresponding test stage are displayed.

Once power up has been completed correctly, code 00 is displayed.

If an error occurs, the POST code of the last test stage started is displayed.

Application codes can also be displayed if required.

Function of LEDs H1 and H2

During the BIOS powering up process, both LEDs light up in two colors (red and green) to test their function.

Both LEDs are switched off once powering up is completed correctly.

Applications can trigger the two LEDs if required.

13.6.3 System start

More information on the system start can be found in the manual "IM8 start-up of PCU base software."

13.6.4 Switching off / reset

Closing Windows XP

To close the Windows XP operating system, select "Start" → "Shut down".

This ensures that the system and operating system can be restarted without any problems.

Switching off the PCU

Once you have closed and shut down Windows XP, the power supply module of the PCU is still on.

If you also want to switch off the power supply, tip the PCU's On/Off switch to the "0" position.

Reset

The PCU does not have a special reset button to restart the system.

If you want to enforce a system restart, use the On/Off switch to switch your PCU off and on again.

 CAUTION
Residual currents can cause injuries
When undertaking service work (opening the PCU), also disconnect the main power connector from the 24V power supply. This is the only way of totally de-energizing the unit!

13.6.5 Calibration of the touch screen

If you want to connect a new Touch Panel (TP 012 or TP 015A) to the PCU, you have to recalibrate the Touch Screen of the operator panel front. Touch software, required for the calibration, is included in the basic Windows XP software.

Procedure

A functioning touch panel system with PCU 50.3 is required.

1. Boot up the system in service mode.
2. Start the SINUMERIK desktop (password-protected).
3. Invoke the calibration menu from "Start" → "Programs" → "Touchware" → "Touchware" (see figure).

Note

On the TP 015A the default calibration is centrosymmetric to the center point. This means that you must press the top right of the screen to activate the "Start" button (bottom left).



Figure 13-24 Menu for touch screen calibration (Touchware version 5.64 SR3)

Note

Depending on the software version and setting, the screen can include 2, 4 or 5 calibration points.

You can toggle between 2 and 5 points (Touchware version 5.63 SR3) or between 2 and 4 points (Touchware version 5.64 SR3) from the menu "Tools" → "Options" → "Advanced" → "Style".

4. Press the "Calibrate" button. The following display will appear on the screen:



Figure 13-25 Calibration screen

5. Using the tip of one finger, touch the calibration point indicated by the hand symbol as accurately as possible for as long as the "Hold" prompt is displayed. The "Hold" prompt disappears after a few seconds and the hand moves to the next calibration point.

- Repeat the instructions in step 5 until all available points have been calibrated. Once the calibration point parameters have been saved, the following menu appears:

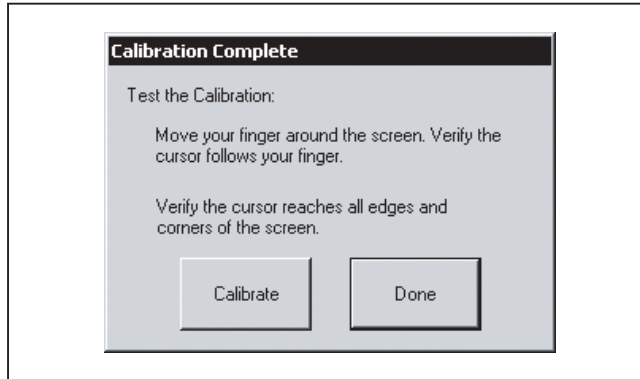

Figure 13-26 Test menu

- To test the calibration values, move your finger around the screen and observe the cursor. If necessary, recalibrate using "Calibrate."
- Exit the calibration menu via "Done" → "Close".

Note

If you take too long to calibrate the device, the whole process is canceled by a "timeout" and you have to start again from the beginning.

13.6.6 Operation with an S7-CPU (without NCU)

Application range

MCP communication is understood to be the transfer of I/O images to the following components:

- two machine control panels
- one HHU
- two direct key units of an OP

The machine control panel signals are communicated on SINUMERIK systems using the FB1 (MCP communication). On more complex systems, the FB9 is used to carry out the M:N switchover. The parameters are filed in DB7 and can be changed by the FB9. Since these blocks are not available in the SIMATIC environment, the FB9 Proxy assumes these tasks.

Prerequisites

It is a requirement that a DB19 is available on the installed S7-CPU in accordance with SINUMERIK specifications: PCU 50.3 with HMI application

The FB9 Proxy only functions if the MCP Client (mcpdrv) is also running.

Creating DB19 in the PLC user program

The user must create the DB19 for the PLC user program. If the DB19 is copied from an existing PLC project to a NCU, it may be that it is not saved during the series machine startup.

The DB19 copied from the existing SINUMERIK project was generated by the basic program and a corresponding generic bit set. This bit is evaluated during a series machine startup and the block would NOT be saved, as it has been generated by the system.

A new data block (DB19) is created via STEP 7 with the following structure:

```
STRUCT: Array [-32768..-32371] type: BYTE
```

Address	Name	Type	Start value
0.0		STRUCT	
+0.0	DB_VAR	ARRAY (-32768 ... -32371)	
+1.0		BYTE	
=398.0		END_STRUCT	

A flag is not set for blocks created by the user, i.e. not created by the system, and the block is always saved during the series machine startup.

Operation with a PCU 50.3 and SINUMERIK Operate

The two utilities, FB9 Proxy and MCP Client, are not started automatically by the system on the PCU 50.3. To start the two utilities, changes are made in the following files:

systemconfiguration.ini file with the following contents:

In the [processes] section, the MCP Client and the FB9 Proxy need to be entered after the CP entry.

```
...
[processes]
PROC000= image:=cp_840di, process:=CP_840di, background:=true
PROC001= image:=slsmhmihost, process:=SlHmiHost1, deferred:=true
PROC002= image:=mcpdrv, process:=mcpdrv, background:=true
PROC003= image:=fb9proxy, process:=fb9proxy, background:=true
```

13.6.7 Configuring the 'fb9_proxy.ini' file

Configuring the fb9_proxy.ini file

Example of configuration file when supplied:

```
[PLC]
;# Set GET_IP_BY_HMI to '0', if you want a static connection to PLC
;# with specified IP address
;# otherwise FB9-Proxy tries to determine IP address and CP interface
;# from mmc.ini of HMI
;GET_IP_BY_HMI = 1
;# if GET_IP_BY_HMI is set to '1' the following key 'IP ADDRESS'
;# has no effect
;# otherwise this key determines the static IP address of the PLC
;IP-ADDRESS = 192.168.214.241
;# if GET_IP_BY_HMI is set to '1' the following key ' CP-INTERFACE '
;# has no effect
;# otherwise this key determines the interface to the shared memory
;# of the CP software.
;# The key is useful to avoid collisions between FB9-Proxy and
;# the HMI. The CP software supports two shared memory interfaces.
;# Normally one interface is used by the HMI.
;# SINUMERIK Operate uses the interface with index 1.
;# So the FB9-Proxy uses by default the interface with index 2.
;# HMI Advanced uses the interface with index 2, so you have
;# to instruct the FB9-Proxy to use the interface with index 1.
;CP-INTERFACE = 2
;# 2 bytes for PLC alarms
;ALARM = AB80
;# address of 2 bytes for life sign of fb9proxy
;LIFESIGN = AB82
;# cycle for transmission of life sign
;# (valid values between 200 and 2000 milliseconds)
;LIFECYCLE = 200
```

```
[MCP1]
;BUS-ADDRESS = 6
;PROFILE = 0
;IN = EB0
;OUT = AB0
```

```
[MCP2]
;BUS-ADDRESS = 6
;PROFILE = 0
;IN = EB64
;OUT = AB64
```

```
[HHU]
;BUS-ADDRESS = ?
;PROFILE = 0
;IN = EB32
;OUT = AB32
```

```
[DCK1]
;BUS-ADDRESS = 6
;PROFILE = 1
;IN = EB16
;OUT = AB16
```

```
[DCK2]
;BUS-ADDRESS = 6
;PROFILE = 1
;IN = EB48
;OUT = AB48
```

Connection to the PLC

In the [PLC] section, the "IP-ADDRESS" key specifies the IP address of the S7-CPU. A connection is made to this PLC. This key is only evaluated if no IP address for the PLC is found in the mmc.ini file.

The IP address of the S7-CPU can be set via GET_IP_BY_HMI : The operator can define whether the IP address of the PLC is obtained from the mmc.ini or whether a static IP address is defined.

GET_IP_BY_HMI = 1 → IP address is obtained from the mmc.ini.

GET_IP_BY_HMI = 0 → Static IP address is defined via fb9_proxy.ini.

The "LIFESIGN" key can be used to obtain a sign of life from the FB9 Proxy on the PLC.

The "ALARM" key indicates the location in the PLC to which the two alarm bytes should be written. If this key does not exist, the alarm bytes are not transferred.

Triggering alarms

In contrast to the original FB9, it is not possible for the FB9 Proxy to trigger PLC alarms. The user program on the SIMATIC CPU can decide whether or not alarms are triggered. When the cause of the alarm has been remedied and this is detected by the FB9 Proxy, the relevant bit is reset. If the alarms are acknowledged, the user program on the SIMATIC CPU can reset the bits itself.

The alarms are entered in a byte array that can be transferred to the PLC. For this purpose, the variable "ALARM" must be specified in the [PLC] section in the INI file. In the case of transitional edges 0→1, the PLC user program can trigger the relevant alarms and, in the case of transitional edges 1→0, it can cancel the alarms again. The alarm bits are written to AB30 and AB31 by default.

List of alarms that can be triggered by FB9 Proxy via MCP communication:

Alarm number	Alarm text	Bit
400260	Failure of machine control panel 1	AB30.0
400261	Failure of machine control panel 2	AB30.1
400262	Failure of manual operating device	AB30.2
400274	Direct key 1 failed	AB30.3
400275	Direct key 2 failed	AB30.4
410900	M:N - call waiting discontinued	AB31.0
410901	M:N - HMI 1 not responding to displacement	AB31.1
410902	M:N - HMI 1 is not going offline	AB31.2
410903	M:N - HMI 2 not responding to displacement	AB31.3
410904	M:N - HMI 2 is not going offline	AB31.4
410905	M:N - HMI connection to assigned interface not available	AB31.5
410906	M:N - No sign of life on an HMI	AB31.6

References: Diagnostics Manual, PLC Alarms

Connection to additional components

The contents of the [MCP1], [MCP2], [HHU], [DCK1] and [DCK2] sections are configured in exactly the same way and are used to configure the connections to the MCP/DCK devices:

If the "BUS-ADDRESS" key exists, a static connection is set up for the relevant device, i.e. no dynamic request is required in the DB19 from an HMI application. If, however, a dynamic request is made by an HMI application, the static connection is stopped and the dynamic connection is made.

The "PROFILE" key indicates whether the standard parameter set or the direct key parameter set should be used from the MCP_CLIENT.INI file.

Default:

PROFILE=0 for machine control panels and HHU
PROFILE=1 for direct keys

The "IN" key is used for addressing the inputs (key information) and indicates the address to which information should be written.

The "OUT" key is used for addressing the outputs (LED information) and indicates the address from which information is read.

The length of the inputs and outputs is determined directly by the device and, therefore, does not need to be indicated. However, it is important to ensure that the addressing range is adequately dimensioned, so that information does not overlap. For example, if the address EB0 is configured for the MCP1 inputs and an HT 8 and an MCP483 are available for the M:N switchover, the direct key inputs can only be configured from EB16. The MCP483 inputs are 14 bytes long.

Note

m:n configuration

If there is an HMI application in the system that supplies the m:n interface in the DB19, the FB9 proxy dynamically establishes the connections with the names "MCP1" and "DCK1". In this case, these two connections cannot be configured statically.

Therefore, use to the connections with the names "MCP2", "HHU" and "DCK2" instead. The names have been selected with reference to the FB9 and are not linked to any semantics. The connection with the name "HHU" can also be used for an MCP.

For addresses for the memory areas in the PLC, expressions such as EBx, ABx, MBx and DBy.DBBx can be used. These are always byte addresses.

Examples:

IN = EB0 → Inputs are written to the PLC from EB0.
 OUT = DB100.DBB20 → Outputs are read from DB100 from byte 20.

13.7 Technical data

13.7.1 PCU 50.3

Safety			
Safety class	III (PELV) according to EN 61800-5-1		
Degree of protection according to EN 60529	IP 20		
Certificates	CE / cULus		
Electrical data			
Input voltage	24 VDC (20.4 V ... 28.8 V)		
Max. current output	USB external, each 0.5 A (in total: 1.2 A)		
	3.3 V	2 A	
	5 V	2 A	
	12 V	0.3 A	
	-12 V	0.05 A	
Power consumption	PCU basic unit		PCI slots
	typ. 65 W (at 55° C)		max. 15 W ¹⁾
Main power outage buffering time	min. 20 ms		
Mechanical data			
Dimensions	Width: 297 mm	Height: 267 mm	Depth: 82 mm
Weight	Max. 7 kg		
Slot 1:	Card length max. 288 mm (measured without slot plate) ²⁾		
Slot 2:	Card length max. 175 mm (measured without slot plate) ²⁾		

1) All of the slots must not exceed this total power.

2) With total power of slots amounting to 15 W

Note

Information about the climatic and mechanical environmental conditions is contained in the associated section under:

"General notes and interconnection" → "Operational planning".

13.7.2 DC power supply module of 24 V (integrated)

Technical data

Safety	
Protective class	III (PELV) acc. to EN 61800-5-1
Degree of protection in accordance with EN 60529	IP 20 (when mounted)
Approvals	CE / cULus
Electrical data	
Input voltage	DC 24 V (20.4 V ... 28.8 V)
Input current	Continuous current to 9 A (to 14 A for 30 ms at startup)
Power consumption	max. 190 W
Temperature-limited output power	max. 105 W (operation at 55 °C)
Main power outage buffering time	Min. 20 ms

Output voltages

Voltage	Max. current
+12 V	6.5 A, peak 8 A
- 12 V	0.3 A
+ 5 V	16.5 A ¹⁾ , peak 18.5 A
+ 3.3 V	8.5 A ¹⁾
1) The max. permitted accumulated power of the + 5 V and 3.3 V is 90 W.	

Power good signal on DC 24V power supply

(diagram)

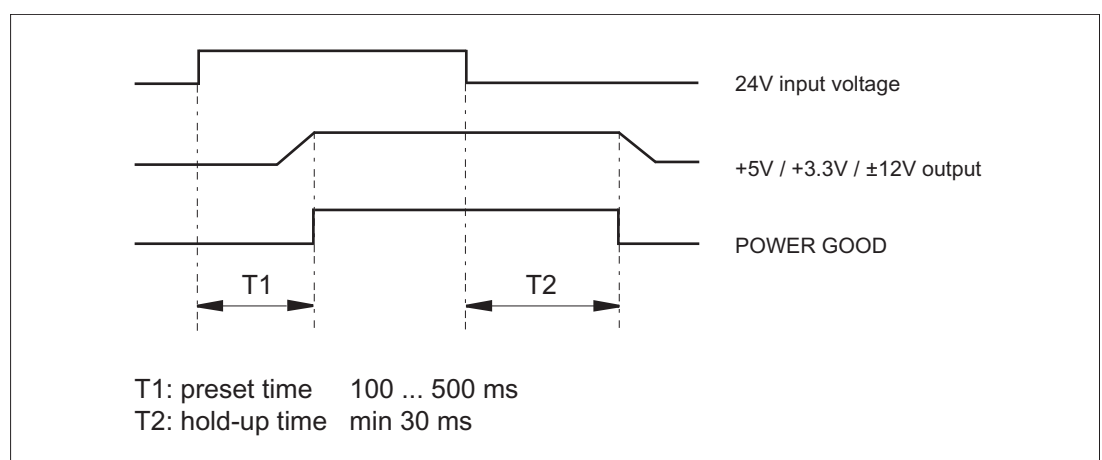

Figure 13-27 Power good signal on DC 24V power supply

NAU signal on DC 24V power supply

(diagram - main power failure alarm)

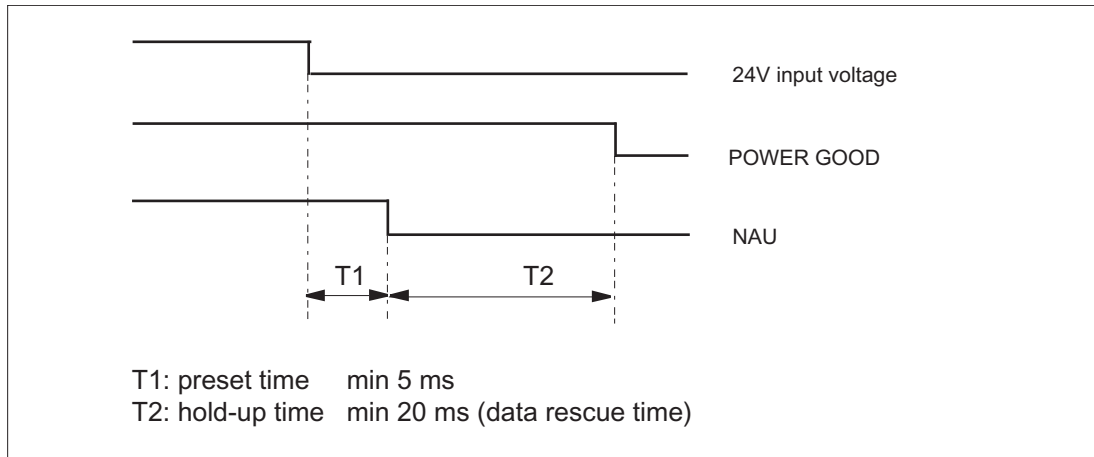

Figure 13-28 NAU signal on DC 24V power supply

13.8 Spare parts

13.8.1 Overview

The following spare parts are available for the PCU 50.3:

Component	Order number
Hard disk with mounting plate and damper	6FC5247-0AF08-4AA0
Device fan (60 mm)	A5E00319306
Power supply module fan (50 mm)	A5E00319305
CMOS battery 3V lithium CR 1/2AA	A5E00331143
150W DC power supply (24V)	A5E30947477

13.8.2 Replacement

To maintain high system availability, we recommend the preventative replacement of those PC components that are subject to wear. The table below indicates the intervals for this replacement.

Component	Replacement interval
Hard disk	4 years
Fan	5-7 years
CMOS backup battery	4/5 years

Hard disk

Despite the long service life and ruggedness that a hard disk now has, it remains a part subject to wear.

Factors that can shorten the service life, are high continuous temperatures and shock/vibration. Under typical industrial conditions, a replacement interval after four years of field service has proven itself.

Fan

Fans are wearing parts. The fan speed is monitored and in the event of a failure an alarm is issued.

Pollution is the main cause of fan failure. A visual inspection should be made as a first criterion for replacement. If the fan has a high degree of accumulated dirt, it should be replaced. If no pollution is present, then the usage time should be used as the criterion. The service life of the fans also depends on the operating conditions (temperature, humidity, number of operating hours per day), so that no fixed limits for all applications can be specified. In the field, under average industrial conditions, a replacement interval of 5-7 years has proven itself.

Backup battery

Batteries are wearing parts. They should be replaced every 5 years to ensure that the device functions permanently.

If an integrated PCI plug-in card is also supplied (central battery concept), preventive replacement intervals are shortened to 4 years.

13.8.2.1 Hard disk drive

The installed hard disk drive is connected to the main board by three cables.

- S-ATA data cable
- Power supply cable
- Cable for detection of lock status

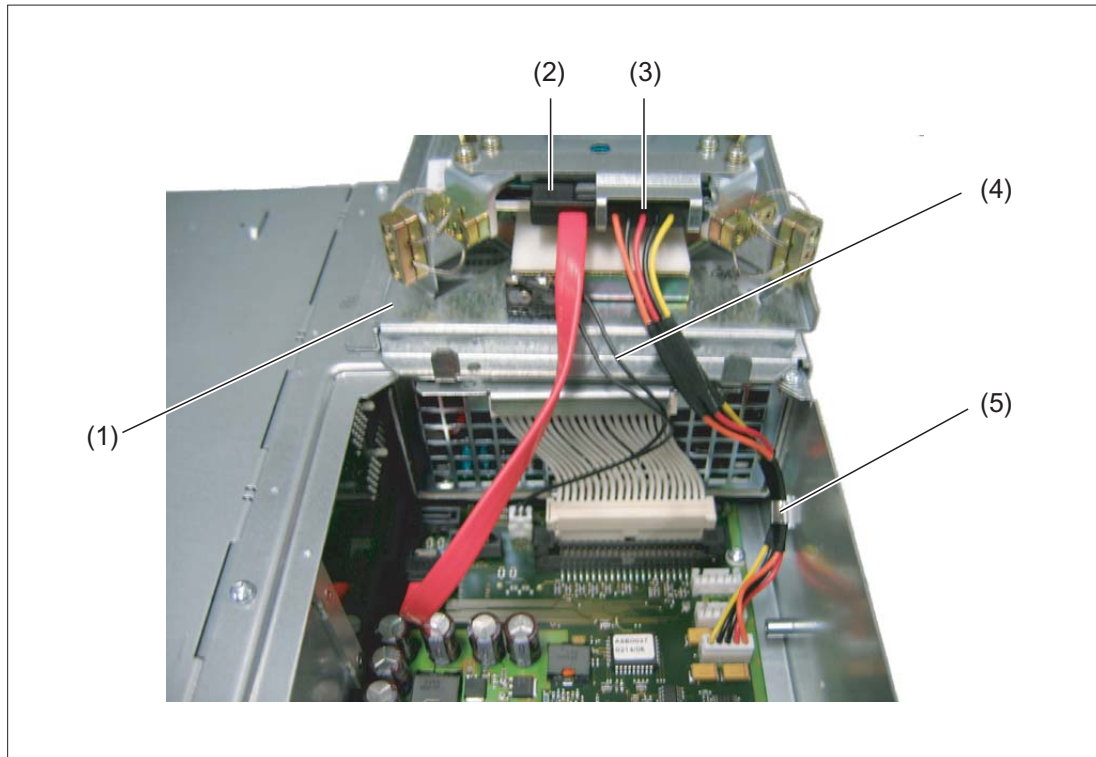

- (1) Hard disk module
- (2) Ribbon cable (S-ATA) for hard disk connection to port 0
- (3) Power supply cable of the hard disk module to X602
- (4) Locking cable for switch to X607
- (5) Fastening clip for power supply cable

Figure 13-29 PCU 50.3 with hard disk drive folded up

Procedure

1. Disconnect the PC from the power supply.
2. Apply the transport lock for the hard disk by setting the black rotary knob to the **"non-operating"** position (see Locking / unlocking hard disk (Page 237)).
3. Loosen the four fastening screws of the hard disk module.
4. Fold up the hard disk module (see Figure above).

5. Disconnect the ribbon cable (2) from the main board and note its position.
6. Also disconnect the other two cables (3) and (4) and note their slots on the main board.
7. When installing the new hard disk module, proceed in reverse order.
The new module must be of the same type or a compatible successor.
8. Release the transport lock by setting the black rotary knob to the **"operating"** position (see Locking / unlocking hard disk (Page 237)).

13.8.2.2 Power supply

Removing the power supply

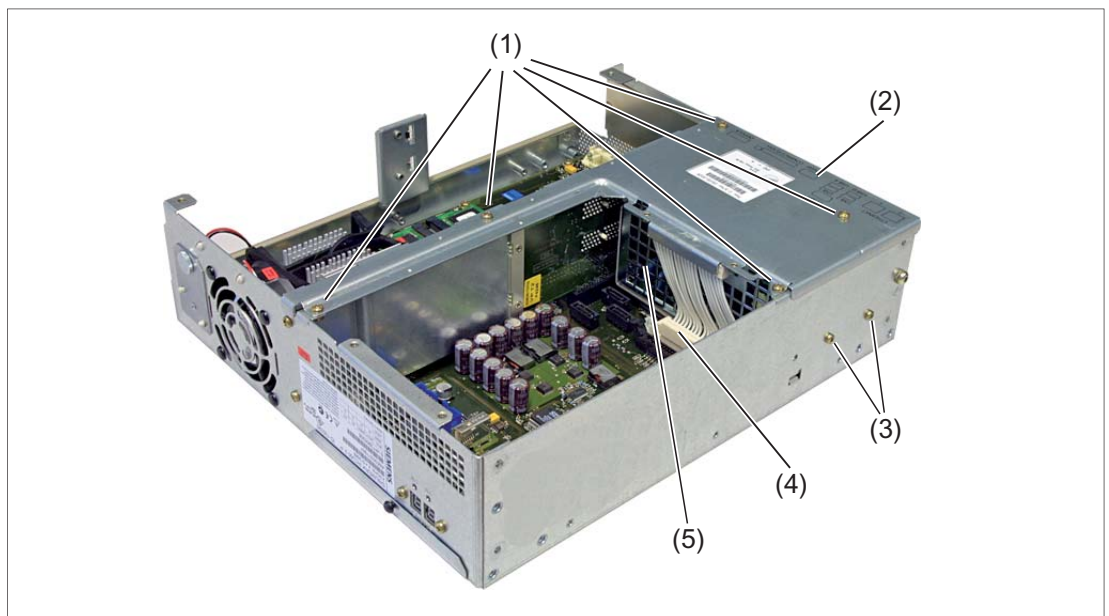

- (1) Retaining screws for the power supply cover
- (2) Power supply cover
- (3) Power supply retaining screws
- (4) Connector for power supply
- (5) Power supply

Figure 13-30 Removal and installation of the PCU 50.3 power supply

 **WARNING**

Unqualified tampering in the power supply causes severe injuries

The power supply may only be replaced by authorized personnel.

1. Disconnect the PC from the power supply.
2. Lock the transport lock for the hard disk (see Section: "Start-up" → "Lock/unlock hard disk") and remove the hard disk.
3. Undo the retaining screws (1) from the power supply cover (2) and take off the power supply cover.
4. Unscrew the power supply retaining screws (3) (Torx T10).
5. Disconnect the connection plug to the power supply (4) from the power supply.
6. Pull the power supply up and out of the housing.

Installing the power supply

Install the new power supply in the reverse order.

Note

Observe the correct position of the power supply latches for upright bus PCBs.

13.8.2.3 Power supply module fan

Before you can replace the power supply fan, you must first remove the power supply, see Power supply (Page 257).

Removing the power supply module fan

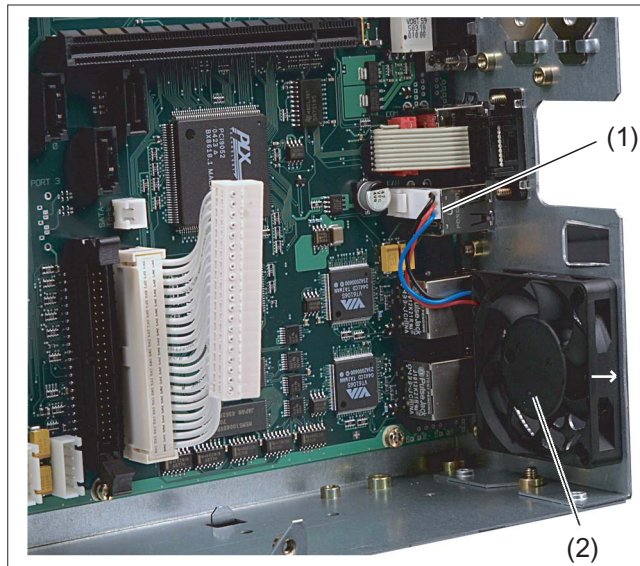

- (1) Connector for power supply
- (2) Power supply module fan (correct installation position - fan blows outward)

Figure 13-31 PCU 50.3 power supply module fan

1. Remove the power supply.
2. Remove the connector to the fan's power supply (1).
3. Loosen the four black plastic rivets or screws on the rear of the casing and take out the fan.

Installing the power supply module fan

Install the new fan in the reverse sequence. Ensure the correct mounting position.

Note

Only a fan of the same type may be installed.

13.8.2.4 Device fan

Removing the device fan

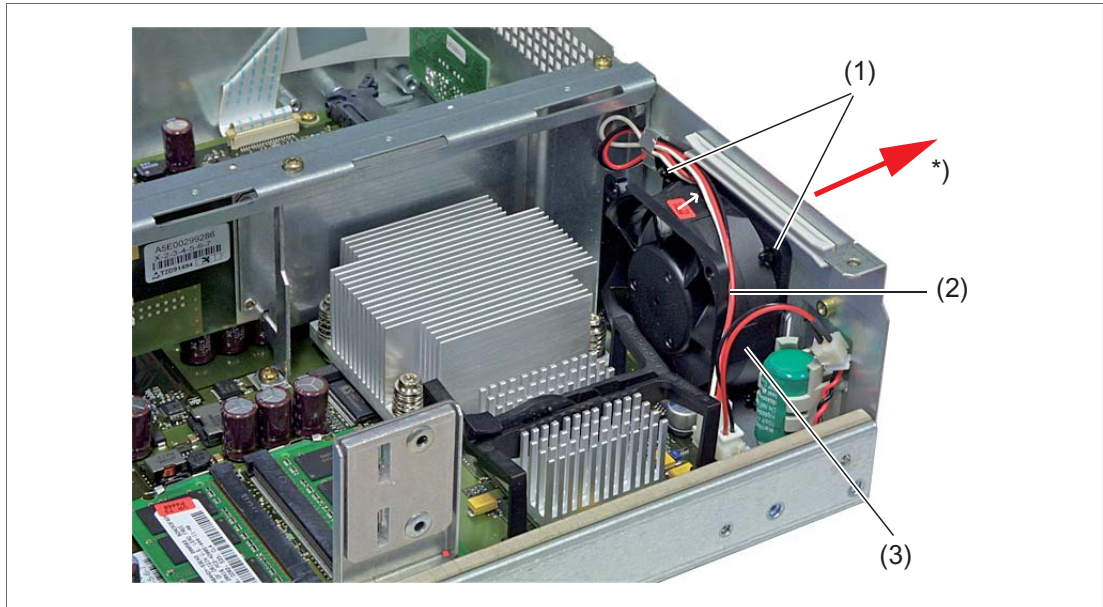

- (1) Expansion rivets for mounting the device fan
- (2) Power supply cable for device fan
- (3) Device fan (blows outward)

*) Direction of air flow

Figure 13-32 Replacement of the PCU 50.3 device fan

1. Disconnect the PC from the power supply.
2. Remove the casing cover by loosening the two screws (refer to "Plan view of PCU 50.3" diagram in Section Description (Page 207))
3. Pull the device fan's power supply cable out of the socket.
4. Loosen the four black plastic rivets on the rear of the casing.
5. Take the fan out of the casing.

Installing the device fan

Install the new fan in the reverse sequence. Ensure that correct mounting position is used (refer to the arrow in the figure above).

Note

Only a fan of the same type may be installed.

13.8.2.5 Battery



Note

Dispose of used batteries using the local connection point specifically set-up locally so that they are correctly recycled or are disposed of as hazardous waste.

The backup battery supplies voltage not only to any plug-in cards used during operations but also to the hardware clock once the device has been switched off. In addition to the clock time, the BIOS settings of the device are also stored.

This data is lost if the backup battery fails for longer than 1 minute or remains separate from the plug-in contact while the PCU is not switched on.

NOTICE
Excessive voltages can damage plug-in cards
Only use 3.0 V lithium batteries for the PCU 50.3 because any plug-in cards present must not be subjected to any permanent voltage in excess of 3.0 V.

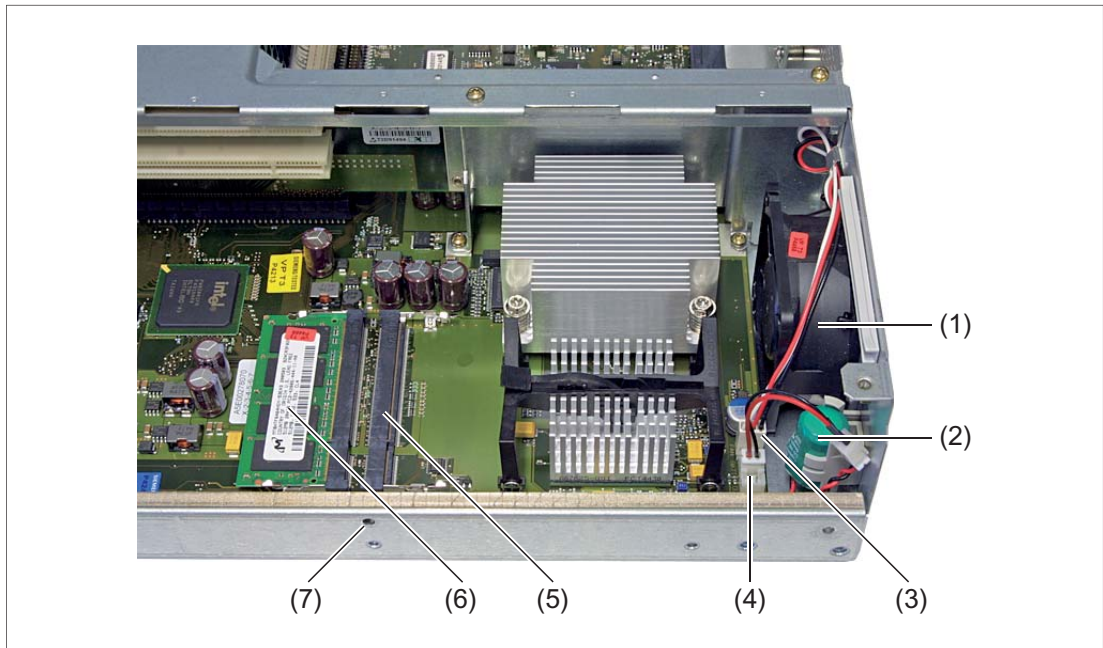

- (1) Device fan
- (2) Backup battery
- (3) Plug for connecting the device fan
- (4) Plug for connecting the backup battery
- (5) Socket for RAM bank 1 (not assigned)
- (6) RAM bank 0
- (7) Locating hole for module retainer

Figure 13-33 Main board of PCU 50.3 with assignment of RAMs and the backup battery

Note before replacing the battery

NOTICE**Risk of damage to the PCU**

The lithium battery may only be replaced with an identical battery or with a type recommended by the manufacturer (Order No.: A5E00331143).

All lithium batteries should be returned to the battery manufacturer / recycler for disposal or treated as special grade waste.

Note the current BIOS Setup settings. This must be done in particular if you have undertaken different settings which are not saved in the user profile.

If you have saved all settings in the user profile or if you are working with the standard settings, the settings will not be lost when the battery is replaced.

 **WARNING****Risk of explosion and release of harmful substances!**

Therefore, do not throw Lithium batteries into an open fire, do not solder or open the cell body, do not short-circuit or reverse polarity, do not heat up above 100° C, dispose as regulated and protected against direct exposure to sunlight, humidity and condensation.

Changing the backup battery

You will find the reference diagrams after this description.

Note

If you reconnect the new battery within one minute, all the settings (including date and time) and backed up data will be retained.

1. Open the battery box **(A)**.
2. Take out the battery holder **(B)**.
3. Remove the connection cable **(C)**.
4. Remove the old battery from the holder.
5. Secure the new battery in the holder.
6. Reconnect the connection cable.
7. Close the battery compartment.

Reference diagrams



Figure 13-34 (A) Opening the battery compartment

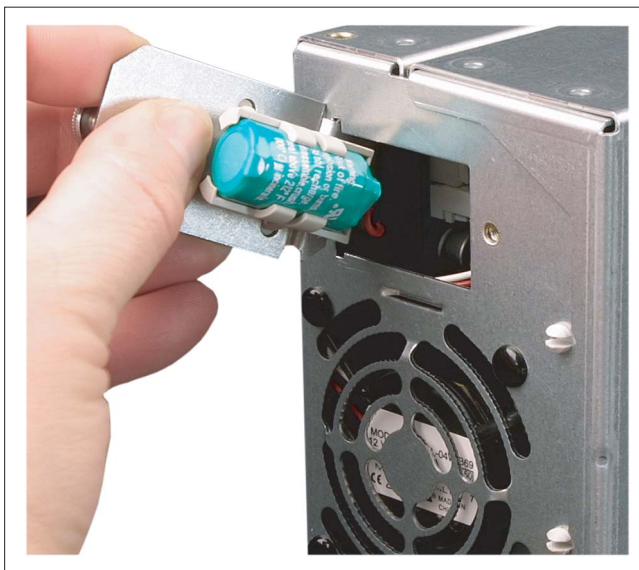

Figure 13-35 (B) Removing the battery holder

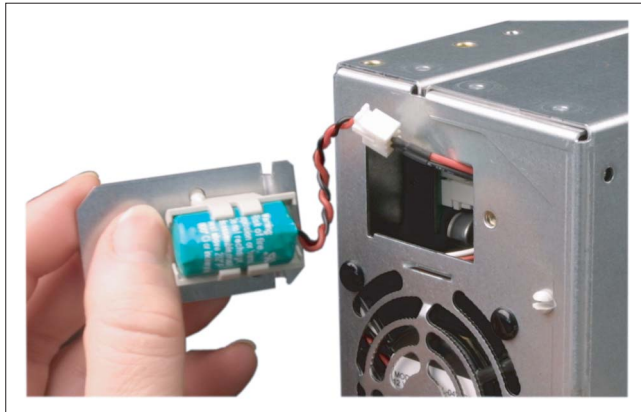

Figure 13-36 (C) Unplugging the cables

13.9 Accessories

13.9.1 Overview

The following accessories are available for the PCU 50.3:

Component		Order number
Mounting bracket (1 set = 2 items)	Mounting bracket for PCU, video link receiver or TCU behind the operator panel front	6FC5248-0AF20-2AA0
	Flat mounting bracket for PCU with or without video link transmitter in the control cabinet	6FC5248-0AF20-0AA0
	Book mounting bracket for PCU with or without video link transmitter in the control cabinet	6FC5248-0AF20-1AA1
Memory expansion	512 MB, DDR2 533, SODIMM	6ES7648-2AG30-0GA0
	1024 MB, DDR2 533, SODIMM	6ES7648-2AG40-0GA0
CompactFlash card	1 GB (empty)	6FC5313-5AG00-0AA1
	2 GB (empty)	6FC5313-5AG00-0AA2
	8 GB (empty)	6FC5313-6AG00-0AA0
USB FlashDrive	8 GB	6ES7648-0DC50-0AA0
SINUMERIK service pack Recovery Media WIN XP ProEmbSys	for PCU with Windows XP ProEmbSys on CD	
	CD1:	Windows XP ProEmbSys incl. SP2
	CD2:	Ghost of basic software; emergency boot
	CD3 to CD5:	Multilingual user interface pack (Chinese simplified, Chinese traditional, Danish, German, Finnish, French, Italian, Japanese, Korean, Dutch, Polish, Portuguese/Brazilian, Russian, Swedish, Czech, Turkish, Hungarian)
	Documentation (German/English)	
PCI Multi I/O module	2 x COM, LPT for PCU 50.3	6ES7648-2CA01-0AA0

13.9.2 Installing and removing expansion modules

13.9.2.1 Memory expansion

Expansion options

On the motherboard there are two slots for memory modules (RAM banks).

If you fill these slots with one or two modules, you can increase the memory capacity of the PCU to up to 2 GB.

184-pin DDR2 memory modules, unbuffered, no ECC can be used.

The following combinations are possible:

Combination	Slot X1	Slot X2	Removal max.
1	512/1024 MB		1 GB
2	512/1024 MB	512/1024 MB	2 GB

Note

It does not matter which modules are inserted into which slots.

Installation of a memory module

NOTICE

Damage to the module as result of missing EMC measures

The electrostatic components on the PCBs are highly sensitive to electrostatic discharge. It is therefore vital to take precautionary measures when handling these components. Refer to the directives for handling components that are sensitive to electrostatic charge.

1. Disconnect the device from the mains.
2. Remove the screws from the housing cover (see diagram "Plan view of PCU 50.3" in Section: "Description") and take off the housing cover.
3. Insert the module into the socket (see "Main board of PCU 50.3 with assignment of RAMs and the backup battery" diagram in Section: "Spare parts" → "Replacement" → "Battery"). When doing so, pay attention to the recess (anti-rotation element) on the plug side of the RAM module.

4. Press the module downwards, applying slight pressure until the locking snaps into place.

NOTICE
Loosely inserted modules can be damaged
Insert the module well into the socket so that it cannot fall out or become damaged.

5. Re-install the housing cover.

The installed memory module is detected automatically by the PCU.

When the device is switched on, the division into "Base Memory" and "Extended Memory" is shown.

Removal of the memory module

1. Disconnect the device from the mains and unplug all cables.
2. Loosen the casing housing screws (see Figure: "Plan view of PCU 50.3" in Section: "Description") and take off the housing cover.
3. Loosen the locks on the left and right sides of the memory module (see Figure).
4. Pull the memory module out of the slot.

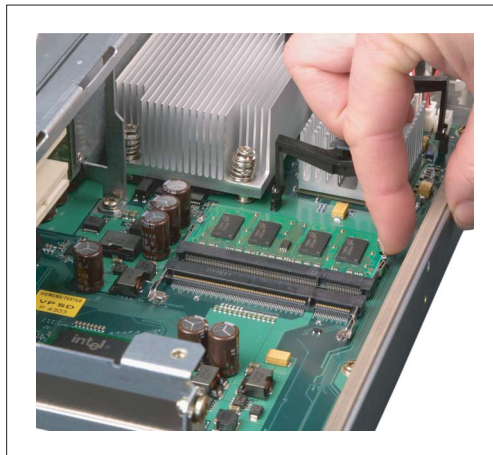
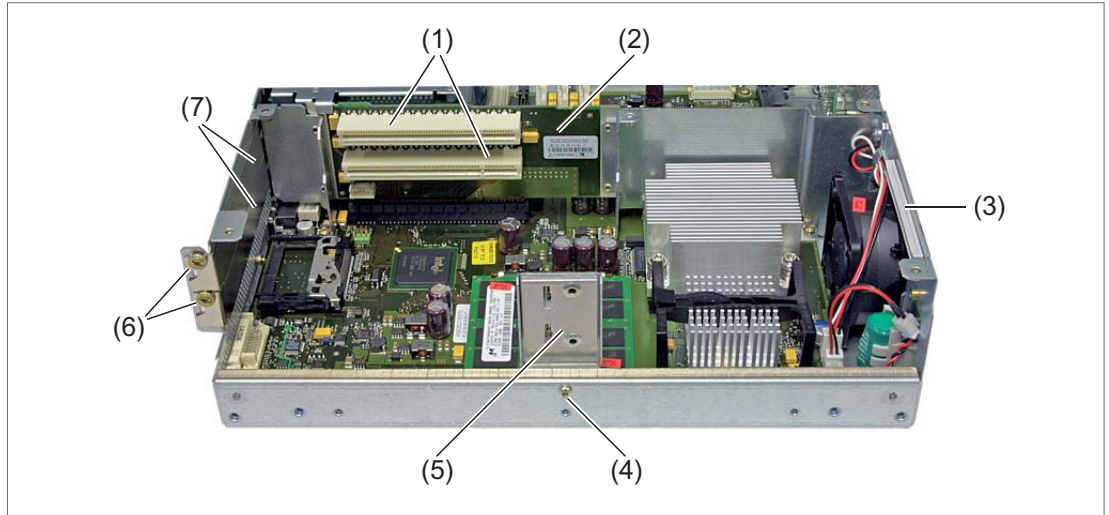

Figure 13-37 Unplug locks

13.9.2.2 PCI cards

The PCU 50.3 is designed for use with modules conforming to PCI specifications V 2.2. It has two PCI slots (1) for expansion modules.



- (1) PCI slots for expansion modules
- (2) Bus board
- (3) Rear guide rail
- (4) Retaining screw for the module retainer
- (5) Module retainer
- (6) Retaining screws for slot cover plates and/or external module connections
- (7) Cover plates for slots

Figure 13-38 Expansion slots

PCI modules with 5 V and 3.3 V supply voltage can be used.

The dimensions of the boards must not exceed the specified dimensions. Otherwise, contact problems, malfunctions and installation difficulty cannot be ruled out.

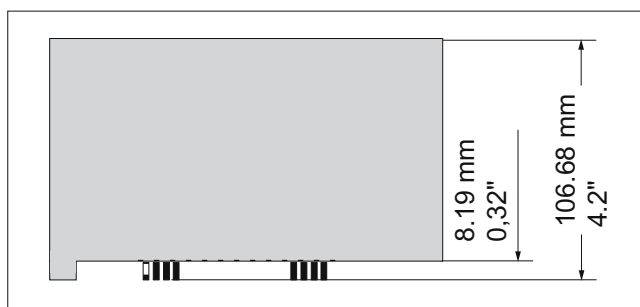

Figure 13-39 Typical PCI module (with a length between 170 - 175 mm)

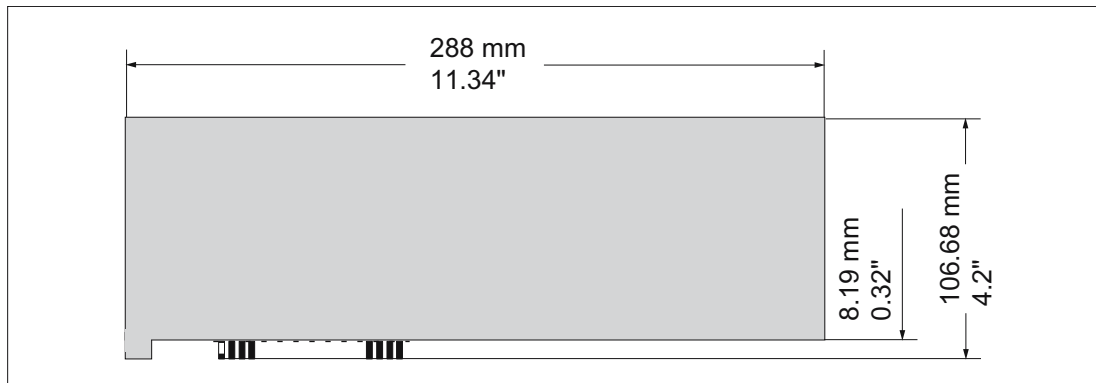
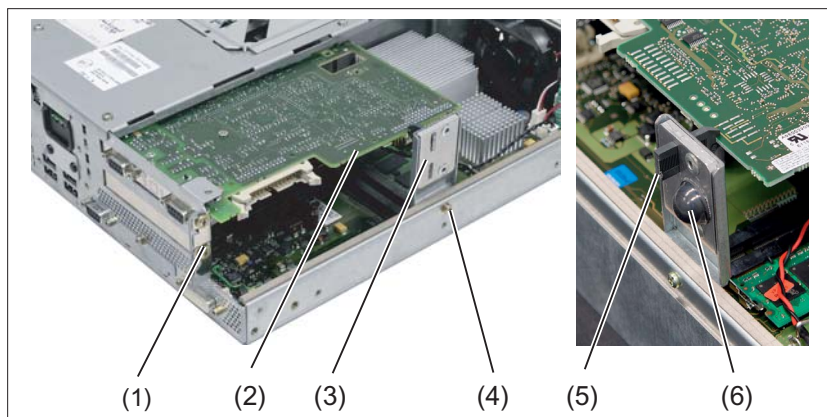

Figure 13-40 Maximum size of PCI module (only possible on slot 1)

Installing PCI cards

Note

When installing PCI cards, ensure that you do not touch or smudge the golden plug connections of the card. This protects the card from malfunctioning.



- (1) Retaining screw for the module retainer
- (2) PCI card (in slot 1 with short shape)
- (3) Module retainer
- (4) Retaining screw for the slot-steel sheet cover
- (5) Slider
- (6) Stabilizer

Figure 13-41 Installation of an expansion module

1. Separate the PCU 50.3 from the main power by disconnecting the main power connector.
2. Loosen the casing housing screws (see Figure: "Plan view of PCU 50.3" in Section: "Description") and take off the housing cover.
3. Remove the fastening screw (1) of the module retainer (3) and remove the bracket.

4. Undo the retaining screws of the slot cover plate (see Figure "Slots for expansion modules" (6)) for the corresponding upper or lower slot and remove the slot plate.
5. Carefully insert the PCI card (2); firm seat should be ensured. When using long PCI cards, be aware of the rear guide rail.
6. Install the module retainer (3).
7. Lock the PCI card (2) by inserting a slider (5) through the guide slot until it securely holds the edge of the module in its groove.

NOTICE**Damage to the module caused by squeezing the slider**

No pressure should be applied to the module. Therefore, do not apply excessive force to the slider when you push it onto the module.

8. Use a diagonal cutter to cut off the excess part of the slider (5).
9. Mount the housing cover.

For half-height PCI cards, the following points do not apply: 7. and 8.

Note

If you use cards with a battery connection, connect the connecting cable to the battery before you install the housing cover (point 9) (see Section: "Installing battery cable")

PCI Multi I/O module

If you use the PCI Multi I/O module (order no.: 6ES7648-2CA00-0AA0), install the driver from the accompanying driver CD according to the instructions.

To ensure the card works properly, it is necessary to make a change in the BIOS setup.

Make settings in the menu:

Advanced → I/O Device Configuration → Internal COM 1: Disabled

Installing the battery cable

- only for MC-specific PCI cards

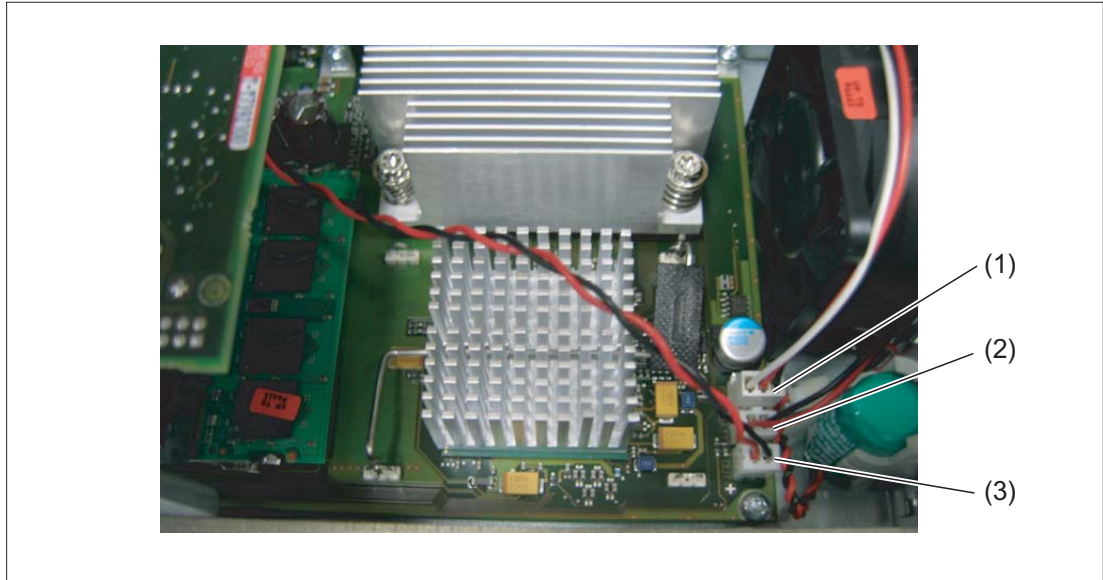

- (1) Plug for connecting the device fan
- (2) Plug for connecting the backup battery
- (3) Connector plug for connecting the PCI module to the battery

Figure 13-42 Installing the battery cable for PCI modules

Connect the PCI module via the cable (3) to the battery connection (see figure)

13.9.2.3 CompactFlash card

The PCU 50.3 has a slot for CompactFlash cards (types I/II).

We recommend using CF cards from Siemens for industrial applications because they offer special data security, service life and data transfer speeds.

Note

The slot for the CF card is not suitable for hot-plugging. You should therefore fit the CompactFlash card before you switch on the PCU and only remove the card once you have switched the PCU off.

Installing the CF card

1. Separate the PCU from the power supply by disconnecting the main power connector.
2. Release the fixing screw ③ for the cover plate ② of the receptacle.
3. Fold up the cover plate ② and slide it towards the DVI-I interface ①. Lift the cover plate slightly until it unlatches on the left side. Then slide it back until it unlatches on the right side.
4. Carefully slide the CF card straight into the card slot until it snaps in.
5. Close the card slot by inserting the cover plate ② (lock it on the left and right) and screw in the the fixing screw ③.

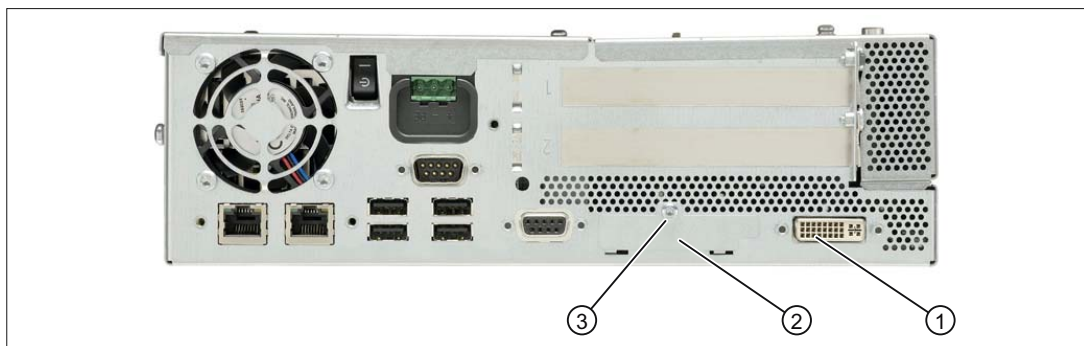

- ① DVI-I interface
- ② Cover plate for PC card slot
- ③ Retaining screw for cover plate

Figure 13-43 Installing CF card

Note

The slot for the CompactFlash card is coded against incorrect insertion of the card. If the CF card is inserted incorrectly, approx. 1 cm remains above the casing and the card does not function.

Removing the CF card

1. Open card slot as described under "Installing the CF card" (point 1-3).
2. Press the eject button on the right-hand side of the module slot (e.g. with narrow end of the cover plate - see figure).
3. Remove the CF card.
4. Close the card slot.

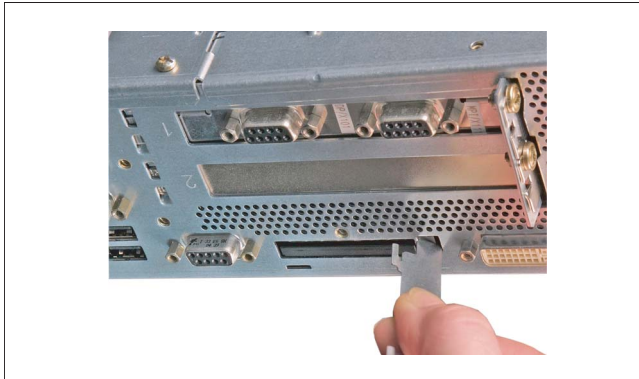

Figure 13-44 Press the eject button

PCU 50.5

14.1 Description

The powerful SINUMERIK PCU 50.5 not only has an integrated 150 W power supply, but also all of the interfaces for communication via Ethernet and PROFIBUS (depending on the particular device) are already on board.

Four USB interfaces (USB 2.0) offer points where a keyboard, mouse and other peripheral devices can be connected.

A covered slot is available for a CompactFlash Card (CF card).

Validity

The description applies to the following devices:

	WinXP ProEmbSys (32-bit) operating system		Win7 EmbSys (64-bit) operating system	
	PCU 50.5-C	PCU 50.5-P	PCU 50.5-C	PCU 50.5-P
Order number	6FC5210-0DF52-2AA0	6FC5210-0DF53-2AA0	6FC5210-0DF52-3AA0	6FC5210-0DF53-3AA0
Processor	Celeron 1.8 GHz	Core i5 2.4 GHz	Celeron 1.8 GHz	Core i5 2.4 GHz
Work memory	1024 MB	2048 MB	4096 MB	8192 MB
Mass storage	40 GB	40 GB	80 GB	80 GB
PROFIBUS DP	Yes	No	No	No
Slots	2 x PCI	PCI + PCIe x16	PCI + PCIe x16	PCI + PCIe x16

Features

- Robust design (continuous operation, high noise immunity)
- The installation location and length vary due to the different types of mounting and mounting brackets
- Can be expanded using two plug-in boards (min. 140 mm up to max. 185 mm long)
- For diagnostics (e.g. for operation without a monitor), two 7-segment displays, status LEDs and one service switch with power button are integrated.
- Graphic: QM57 Express chipset
- Work memory (with ECC):
 - For WinXP: Max. 4 GB
 - For Win7: Max. 8 GB
- Mass storage: Electronic SSD drive

- Screen resolutions, CRT monitor:
 - Up to 1280 x 1024 at 100 Hz / 32-bit color depth
 - Up to 1600 x 1200 at 60 Hz / 32-bit color depth
 - Max. resolution: 2038 x 1536 at 75 Hz / 16-bit color depth
- Screen resolution, LCD monitor via DVI: 1600 x 1200 at 60 Hz / 32-bit color depth
- Power supply: 24 VDC, max. 210 W with on/off switch
- Connections:
 - PROFIBUS (max. 12 Mbit/s, isolated, compatible with CP 5611, optional)
 - DVI-I interface for external monitor
 - 2 x Ethernet 10/100/1000 Mbit/s
 - 4 x USB 2.0 high current
 - Serial interface COM1 (RS 232C)

View

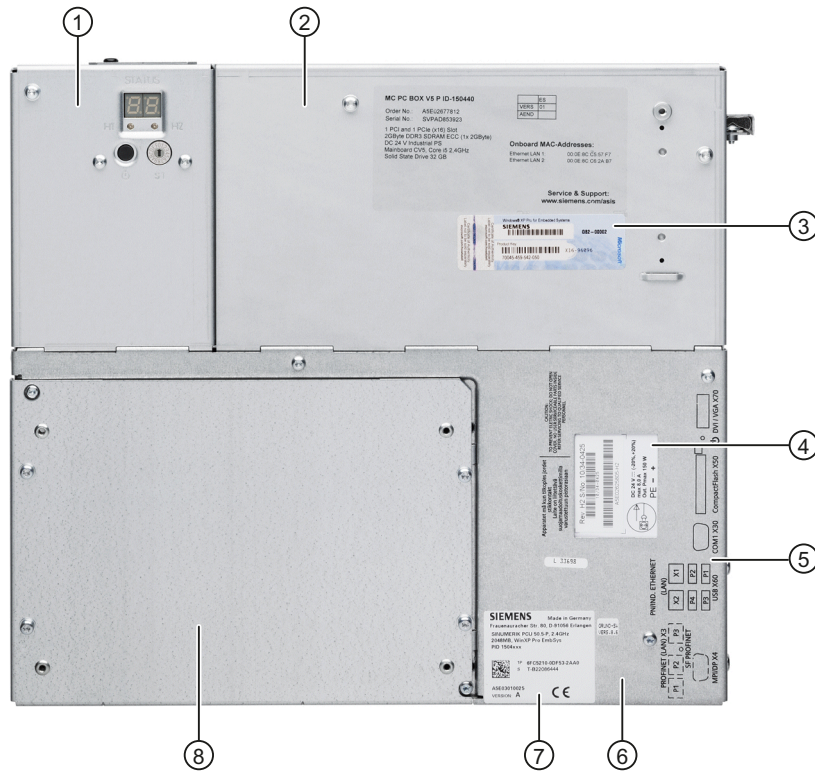

- ① Housing cover, service module
- ② Housing cover, motherboard
- ③ Windows license label
- ④ Rating plate for power supply
- ⑤ Print for the interfaces on the right-hand side of the housing
- ⑥ Housing cover, power supply
- ⑦ Type plate PCU
- ⑧ Housing cover, SSD

Figure 14-1 Top view of PCU 50.5

14.2 Operator control and display elements

14.2.1 On/off switch

On/Off switch

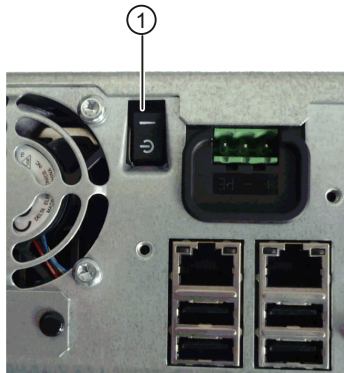

Figure 14-2 PCU 50.5 On/off switch

The integrated 24 V power supply for the PCU is switched on and off using the on/off switch ①. It also serves as a substitute for the reset button, which is no longer provided, see Switching off / reset (Page 312).

14.2.2 Service module

The service module is located, depending on the device mounting, at two positions:

- Side panel, next to the equipment fan for upright mounting in the control cabinet
- Cover above the equipment fan for standard installation in the operator panel

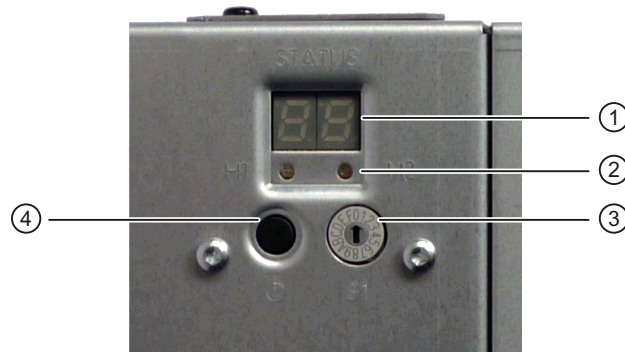

- ① 2 x 7-segment display
- ② 2 x LED: H1 and H2
- ③ Service switch
- ④ Power button

Figure 14-3 Service module

7-segment display

- When the device is switched on, a HW self-test of the service module is first carried out; Code 88 is output in the process.
- While the BIOS boots, the PCU base software runs through a self test, whereby the codes of the corresponding test step are displayed. Code 00 is displayed if booting is completed without any error. The code of the most recently started test step is displayed when an error occurs. See BIOS beep codes (Page 322).
- Display of the service switch positions.
- Codes of applications can also be displayed if required.

LEDs H1 and H2

- While the BIOS boots, the two LEDs light up in two colors (red and green) in order to test their operation. The two LEDs switch off when booting is completed without errors.
- Applications can control the two LEDs if required.

Service switch

The service switch is a rotary switch with 16 possible positions.

The following table provides an overview of the switch positions. When delivered, the switch is in position "0": Normal operation

Note

A change of the switch position only becomes effective after the next restart.

Selector position	Mode	Function
0		Normal operation (default setting)
6	-	Reserved for end users
B	Service	Performing a BIOS recovery after a failed update.
9	Service	Restore the default values automatically at the next boot (e.g. with BIOS update or SSD replacement).
E	Service	After a restart, booting is preferably from another storage medium (e.g. USB flash drive) as from the installed SSD.

The switch positions can be read-out using the PCU base software if it was selected in the BIOS setup that BIOS should evaluate the switch position. The default setting is "evaluate (Operation mode switch -> Enabled)".

Power button

The power button is located below the diagnostics display; it can be used to shut down as well as start up the Windows operating system. This means that the power button is an alternative to the on/off switch.

Additional references

For details on diagnostics and service, please refer the to the following manual
 Basic Software and Operating Software Commissioning Manual (IM8)

14.3 Interfaces

14.3.1 External interfaces

Right-hand casing side

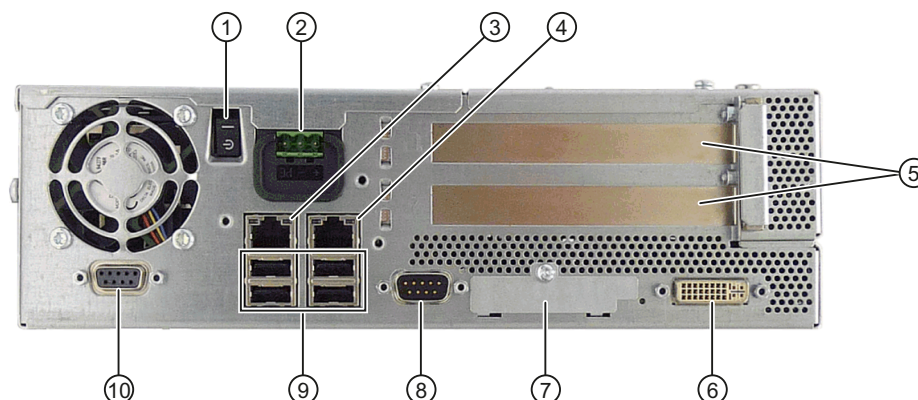
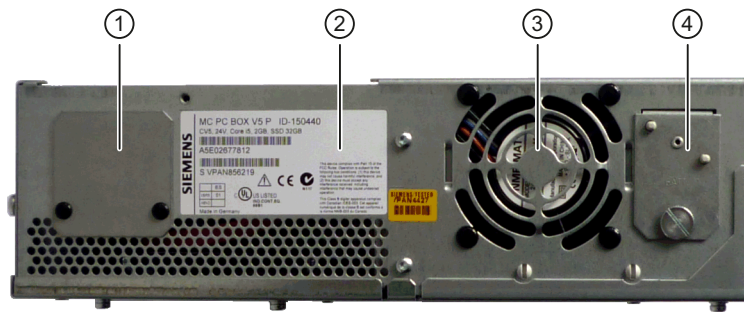

Figure 14-4 PCU 50.5 side view from the right with interfaces (without plug-in card)

	Interface/connection		Function
①	S0	Line side switch	On/Off switch (for standby) for the power supply unit
②	X0	Power supply	24 VDC (SELV)
③	X2	Ethernet 2	10/100/1000 Mbit/s, connection for the system network (e.g. operator panels)
④	X1	Ethernet 1	10/100/1000 Mbit/s, connection for the company network (LAN)
⑤		PCI slot (Slot 1 / Slot 2)	2 slots for expansion modules
⑥	X70	DVI-I interface	Bus for external monitor (VGA monitors via optional adapter)
⑦	X50	CompactFlash card	Slot for CF card under cover plug, not hot plug-capable
⑧	X30	COM1 (V.24)	Serial interface for e.g. a modem
⑨	X60	USB port 1 / 2 USB port 3 / 4	4 external USB connections (USB 2.0 type A) - max. 2 can be operated at the same time as high-current *)
⑩	X4	PROFIBUS DP/MPI	12 MBit/s connection for connecting an S7 automation unit, isolated (only for PCU 50.5-C with WinXP)

*) The max. current carrying capacity of the 4 USB connections is a total of 1.2 A.
The max. current carrying capacity of a USB connection is 500 mA.

Left-hand casing side



- ① Cover plate with retaining screws
- ② Type plate of the PC unit
- ③ Device fan
- ④ Cover plate for battery

Figure 14-5 Side view of the PCU 50.5 from left

Casing rear side

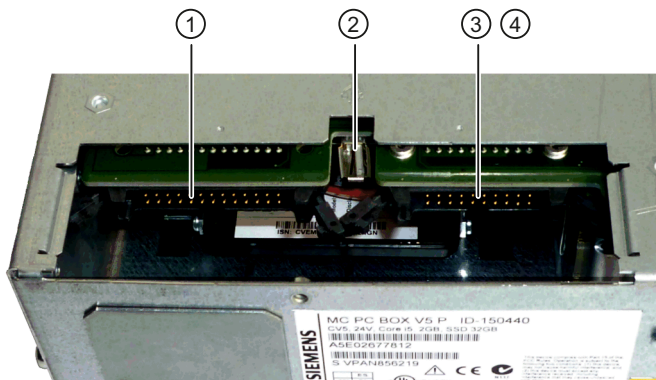

Figure 14-6 PCU 50.5 interfaces for connecting operator panel fronts

Interface/connection		
①	X44	I/O interface for connecting the I/O cable of the operator panel front
②	X42	Optimum connection for the operator panel front with USB 2.0 front interface
③	X400	1st LVDS interface for connecting a TFT display cable
④	X401	2nd LVDS interface for Dual LVDS display (e.g. OP 19) - located behind X400 (can be accessed when the SSD module is removed)

Pin assignment for external interfaces

In principle you will find the pin assignments of the individual external interfaces in "General information and networking", Section "Connecting", except for:

- PCI slots: See Connector assignment of bus board (Page 288).
- CompactFlash Card: See the description in Section "Keyboards and additional components".

14.3.2 Internal interfaces

14.3.2.1 Connector assignment of motherboard

Overview

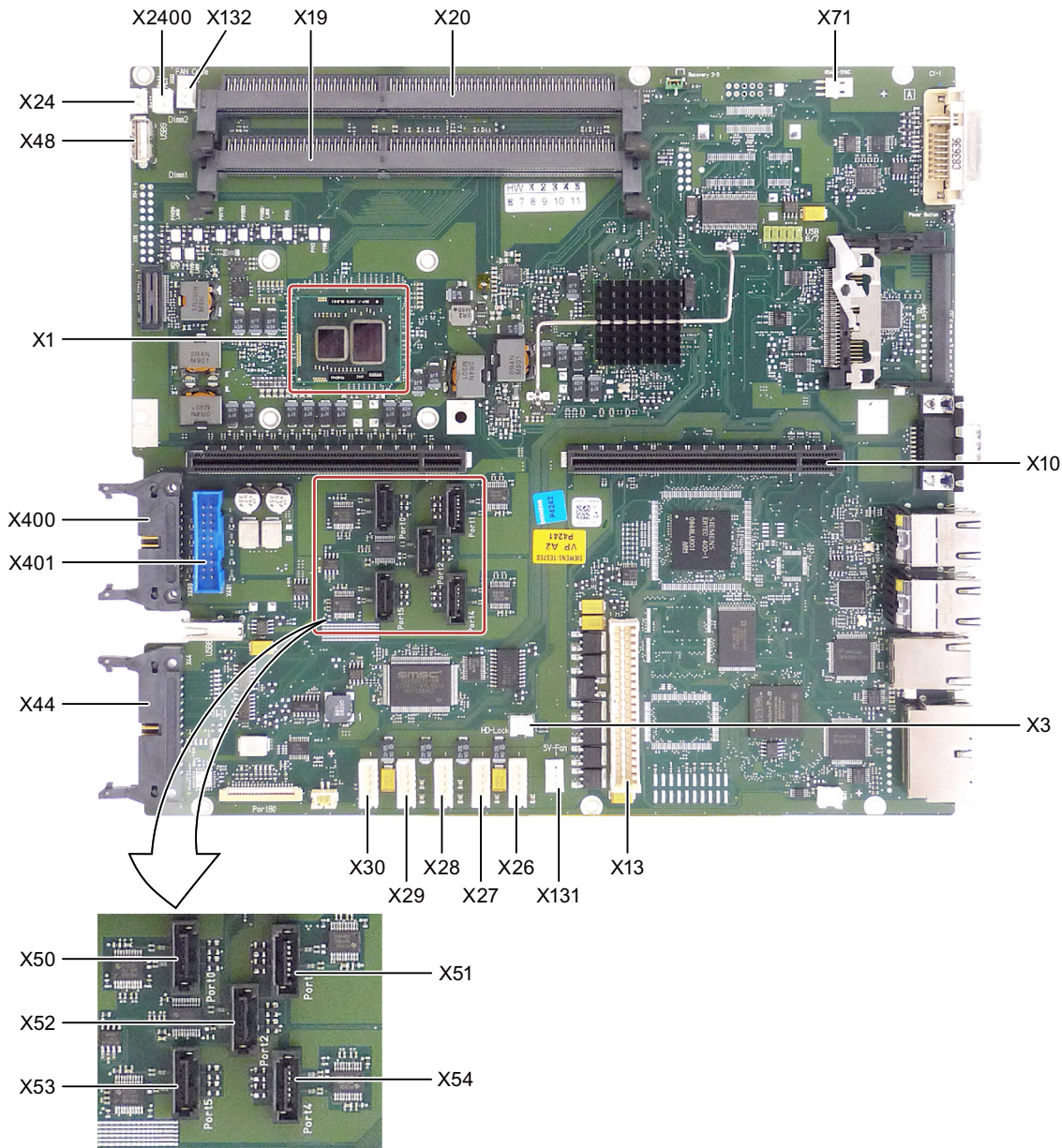

Figure 14-7 PCU 50.5 - motherboard interfaces

Connector	Interface	Description
X1		Processor
X10	Bus expansion	Socket for bus expansion, uses PCI bus signals
X13	Power supply	20-pin connection plug for power supply
X19 / X20	Memory	2 x SDRAM DDR3 with ECC
X24	Backup battery	Power supply for backup battery, 2-pin male connector
X26	Power supply	SATA 4 (optional)
X27		SATA 3 (optional)
X28		SATA 2
X29		SATA 1
X30		SATA 0
X50	Serial ATA	SATA 0
X51		SATA 1
X52		SATA 2
X53		SATA 3 (optional)
X54		SATA 4 (optional)
X3	HD-lock	Interlock identification for the optional MC hard disk module SATA
X131	Connection for PS fan	Power supply for CPU fan, 3-pin male connector
X132	Connection for device fan	Power supply for device fan, 3-pin male connector
X2400	Tap for backup battery	Voltage tap (= 3V) of the backup battery, 2-pin, male connector
X44	I/O interface	Connection of the I/O cable of the operator panel front
X400	1st LVDS interface	Connection of the display cable
X401	2nd LVDS interface	Additional display interface K3 for OP019
X71	RS485-SYNC (opt.)	Synchronizing several PCI boards to a common system clock cycle

Signal type:

- I Input
- O Output
- V Power supply
- Ground (reference potential) or N.C. (not connected)

DC interface of the power supply X13

Table 14- 1 X13 connector assignment

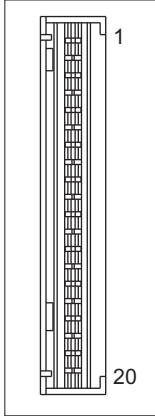
Connector	Pin	Name	Type	Remark
	1	P5V	V	+5 V
	2	P5V		+5 V
	3	P5V		+5 V
	4	P5V		+5 V
	5	P5V Sense	O	Sense 5 V
	6	PS_NAU_N		Power loss early warning signal
	7	PS_PWROK		Power Good Signal
	8	GND	-	Ground
	9	GND		Ground
	10	GND		Ground
	11	N12V	V	-12 V
	12	GND	-	Ground
	13	GND		Ground
	14	GND		Ground
	15	P12V	V	+12 V
	16	P12V		+12 V
	17	P3V Sense	O	Sense 3.3 V
	18	P3V	V	+3.3 V
	19	P3V		+3.3 V
	20	P3V		+3.3 V

Connector for backup battery X24

The battery for backing up the CMOS-RAM is connected to this connection. A 3V lithium battery with a capacity of 750 mAh is used for this purpose.

Table 14- 2 Assignment of the X24 connector

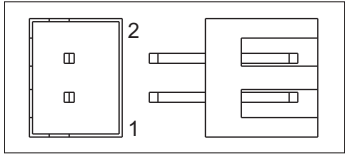
Connector	Pin	Name	Type	Remark
	1	+	VI	Plus pole
	2	-	VI	Minus pole

SYNC interface for PCI expansion modules X71

Using this interface, several PCI boards can synchronize to a common system clock (Global Control Telegram clock cycle duration of PROFIBUS DP operated in the isochronous mode). Their SYNC interfaces must be connected with one another using a looped through cable. The system clock transfer to the interface is realized differentially (RS485 signals).

Table 14- 3 Pin assignment of connector X71

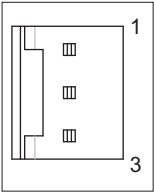
Connector	Pin	Name	Type	Remark
	1	NC	-	Ground via 100K
	2	XSYNC	I/O	Negated clock signal
	3	SYNC	I/O	Clock signal

Connection for power supply fan X131

Table 14- 4 Pin assignment of connector X131

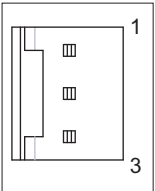
Connector	Pin	Name	Type	Remark
	1	GND	-	Ground (reference potential)
	2	+12 V	V	Switched voltage supply
	3	PG1 FAN_CLK	I	Clock signal

Connection for device fan X132

Table 14- 5 Pin assignment of connector X132

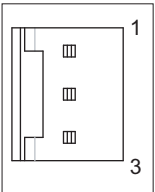
Connector	Pin	Name	Type	Remark
	1	GND	-	Ground (reference potential)
	2	+12 V	V	Switched voltage supply
	3	CPU FAN_CLK	I	Clock signal

Tap for backup battery X2400

This connection is intended for expansion modules with their own CMOS-RAM. The voltage of the backup battery can be tapped here to back up the CMOS-RAM data of the expansion module.

Table 14- 6 Assignment of connector X2400

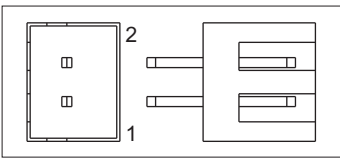
Connector	Pin	Name	Type	Remark
	1	+	VO	Plus pole of battery over 100 Ohm
	2	-	VO	Minus pole

Note

No battery should be connected to this connection.

14.3.2.2 Connector assignment of bus board

The bus board is designed as a link between the motherboard and the expansion modules. It is mounted using two screws. The expansion modules are supplied with power via the bus PCB to motherboard connection.

- The bus PCB has two PCI slots (max. 185 mm long).
- Expansion modules for 5 V and 3.3 V according to the following PCI specification can be installed.
 - PCI: Rev. 2.2
 - PCIe x16: Rev. 1.0
- All PCI slots support the master mode.

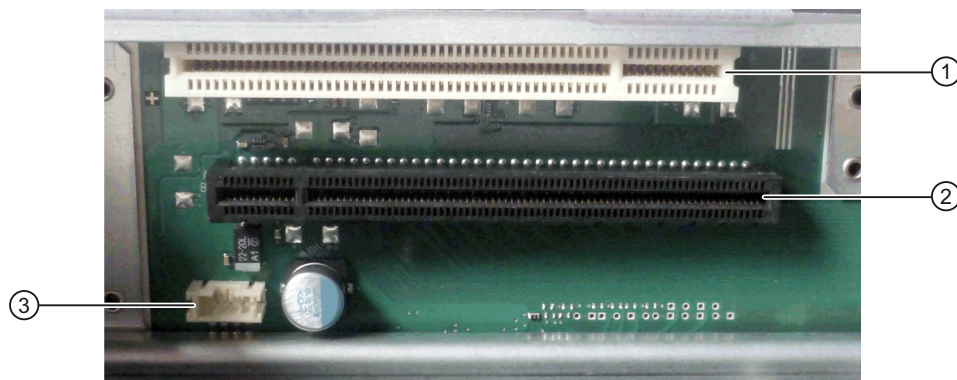

- ① Slot 1 PCI
- ② Slot 2 PCI Express x16
- ③ 12 V power supply connection for WinAC module

Figure 14-8 Bus PCB PCU 50.5-P

PCI slot pin assignment

	5V System Environment	
	Side B	Side A
1	- 12 V	TRST#
2	TCK	+ 12 V
3	Ground	TMS
4	TDO	TDI
5	+5V	+5V
6	+5V	INTA#
7	INTB#	INTC#
8	INTD#	+5V
9	PRSNT1#	Reserved
10	Reserved	+5V (I/O)
11	PRSNT2#	Reserved
12	Ground	Ground
13	Ground	Ground
14	Reserved	Reserved
15	Ground	RST#
16	CLK	+5V (I/O)
17	Ground	GNT#
18	REQ#	Ground
19	+5V (I/O)	Reserved
20	AD[31]	AD[30]
21	AD[29]	+ 3.3 V
22	Ground	AD[28]
23	AD[27]	AD[26]
24	AD[25]	Ground
25	+ 3.3 V	AD[24]
26	C/BE[3]#	IDSEL
27	AD[23]	+ 3.3 V
28	Ground	AD[22]
29	AD[21]	AD[20]
30	AD[19]	Ground
31	+ 3.3 V	AD[18]
32	AD[17]	AD[16]
33	C/BE[2]#	+ 3.3 V
34	Ground	FRAME#
35	IRDY#	Ground
36	+ 3.3 V	TRDY#
37	DEVSEL#	Ground
38	Ground	STOP#
39	LOCK#	+ 3.3 V

	5V System Environment	
	Side B	Side A
40	PERR#	SDONE
41	+ 3.3 V	SBO#
42	SERR#	Ground
43	+ 3.3 V	PAR
44	C/BE[1]#	AD[15]
45	AD[14]	+ 3.3 V
46	Ground	AD[13]
47	AD[12]	AD[11]
48	AD[10]	Ground
49	Ground	AD[09]
50	CONNECTOR KEY	
51	CONNECTOR KEY	
52	AD[08]	C/BE[0]#
53	AD[07]	+ 3.3 V
54	+ 3.3 V	AD[06]
55	AD[05]	AD[04]
56	AD[03]	Ground
57	Ground	AD[02]
58	AD[01]	AD[00]
59	+5V (I/O)	+5V (I/O)
60	ACK64#	REQ64#
61	+5V	+5V
62	+5V	+5V

Connector assignment, PCI Express slot x16

	5V System Environment	
	Side B	Side A
1	P12V	PRSNT1_N
2	P12V	GND
3	P12V	P12V
4	GND	GND
5	SMBCLK	PTCK
6	SMBDAT	PTDI
7	GND	PTDO
8	P3V3	PTMS
9	PTRST_N	P3V3
10	Aux_3V3	P3V3
11	PCIE_Wake_N	PCI RST_N
12	Reserved	GND

	5V System Environment	
	Side B	Side A
13	GND	GND
14	PCIE_TX_P(1)	GND
15	PCIE_TX_N(1)	GND
16	M	PCIE_RX_P(1)
17	PRSNT2_N	PCIE_RX_N(1)
18	GND	GND
19	PCIE_TX_P(2)	Reserved
20	PCIE_TX_N(2)	GND
21	GND	PCIE_RX_P(2)
22	GND	PCIE_RX_N(2)
23	PCIE_TX_P(3)	GND
24	PCIE_TX_N(3)	GND
25	GND	PCIE_RX_P(3)
26	GND	PCIE_RX_N(3)
27	PCIE_TX_P(4)	GND
28	PCIE_TX_N(4)	GND
29	GND	PCIE_RX_P(4)
30	GND	PCIE_RX_N(4)
31	PRSNT2_N	GND
32	GND	Reserved

Pin assignment 12V power supply connection for WinAC module

Pin	Name	Signal type	Remark
1	+ 12 V	V	12 V voltage
2	GND	-	Ground (reference potential)
3	GND	-	Ground (reference potential)
4	+5V	V	5 V voltage

Interrupt assignment (PCI-IRQ)

	IRQ Number																							Comments			
ACPI IRQ	0	1	2	3	4	5	6	7	8	9	10	11	12	13	14	15	16	17	18	19	20	21	22	23			
IRQ	0	1	2	3	4	5	6	7	8	9	10	11	12	13	14	15	16	17	18	19	20	21	22	23			
Function	Host PCI IRQ Line																A	B	C	D	E	F	G	H	1)		
Slot 1 (PCI)																	(1)	(2)	(3)	(4)	(5)	(6)	(7)	(8)			
PCI INT Pin A	-	-	-	Z	-	-	-	-	-	-	-	-	-	-	-	-	-	-	-	-	-	Y	-	-	-		
PCI INT Pin B	-	-	-	-	-	-	Z	-	-	-	-	-	-	-	-	-	-	-	-	-	-	-	Y	-	-	-	
PCI INT Pin C	-	-	-	-	-	-	Z	-	-	-	-	-	-	-	-	-	-	-	-	-	-	-	-	Y	-	-	
PCI INT Pin D	-	-	-	-	-	-	-	Z	-	-	-	-	-	-	-	-	-	-	-	-	-	-	-	-	Y	-	
Slot 2 (PCI)																											
PCI INT Pin A	-	-	-	-	-	-	Z	-	-	-	-	-	-	-	-	-	-	-	-	-	-	-	Y	-	-	-	
PCI INT Pin B	-	-	-	-	-	-	Z	-	-	-	-	-	-	-	-	-	-	-	-	-	-	-	-	Y	-	-	
PCI INT Pin C	-	-	-	-	-	-	-	Z	-	-	-	-	-	-	-	-	-	-	-	-	-	-	-	-	Y	-	
PCI INT Pin D	-	-	-	Z	-	-	-	-	-	-	-	-	-	-	-	-	-	-	-	-	Y	-	-	-	-	-	
Slot 2 (PCl express)																											
PCI INT Pin A	-	-	-	Z	-	-	-	-	-	-	-	-	-	-	-	-	Y	-	-	-	-	-	-	-	-	-	
PCI INT Pin B	-	-	-	-	-	-	-	-	-	-	-	-	-	-	-	-	-	Y	-	-	-	-	-	-	-	-	
PCI INT Pin C	-	-	-	-	-	-	-	-	-	-	Z	-	-	-	-	-	-	-	Y	-	-	-	-	-	-	-	
PCI INT Pin D	-	-	-	-	-	-	-	-	-	-	-	-	-	-	-	-	-	-	-	Y	-	-	-	-	-	-	

1) In the ACPI mode, host PCI-IRQ A to H is permanently assigned to IRQ 16 to 23. In the PIC mode, host PCI-IRQ A to H is automatically assigned to IRQ 0 to 15 from the BIOS. A certain assignment cannot be forced.

Y Interrupt in the APIC mode (e.g. Windows XP)

Z BIOS default interrupt in the PIC mode (e.g. DOS)

Figure 14-9 Interrupt assignment of the slot connectors on the bus PCB

Exclusive PCI hardware interrupt

Applications, which have high requirements regarding the interrupt performance, need a fast interrupt response time of the hardware. The PCI hardware interrupt should only be occupied by a resource in order that a fast hardware response time is possible.

Exclusive interrupt in the APIC mode

	IRQ assignments for Windows systems, (APIC mode)
Ethernet 1	16 ^{1) 2)}
Ethernet 2	17 ¹⁾
Profibus/MPI	19 ¹⁾
PCI slot 1	20 ¹⁾
PCI slot 2	21 ¹⁾
PCI Express slot	16 ^{1) 3)}

1) Precondition: The modules in the PCI slots each require only one interrupt

2) Precondition: VGA and PCl express do not require an interrupt

3) Precondition: VGA does not require an interrupt – and Ethernet1 is disabled

Exclusive interrupts in the PIC mode

The system BIOS is set when delivered so that for the system start, the interrupts are automatically assigned to the slots.

Depending on the system expansion, it is therefore possible that the same interrupt is assigned to several slots. In this case this is called interrupt sharing. No exclusive interrupts are available in the PIC mode. You must disable system resources in order to obtain exclusive interrupts. It cannot be predicted which PIC interrupts will be assigned by BIOS at the next start.

14.4 Mounting

14.4.1 Preparation for mounting

Mounting of the PCU 50.5 depends on how it is going to be used. A distinction is made between the following types of mounting:

1. **Standard mounting: Operator panel on the machine**
 - for assembly of PCU and operator panel front
2. **Flat mounting: In the control cabinet**
 - for PCU flat on the control cabinet rear wall
3. **Book mounting: In the control cabinet**
 - for PCU at an angle of 90° to the control cabinet rear wall

You require a suitable set of mounting brackets for each mounting method. You will find the corresponding order number in Section: "Accessories".

Note

First, screw the appropriate mounting brackets onto the PCU before you mount the PCU on an operator panel front.

NOTICE
Damage to the mainboard <p>For installing the mounting brackets for the upright installation, use only M4x10 screws. For all remaining mounting brackets, use M3x8 and M4x8, (provided).</p> <p>The mainboard will be damaged if you</p> <ul style="list-style-type: none">- screw in the M3x8 and M4x8 screws without mounting brackets,- or if you use other 8 mm screws (without a flat washer or tension ring) or- longer screws,- use the M4x10 screws for mounting the brackets on the PCU 50 (previous model).

 WARNING
Securing the PCU on the wall or to the ceiling
Ensure that the wall or ceiling can support four times the total weight of the PCU (including mounting brackets and additional expansion modules). The total weight of the PCU is max. 7 kg.

Dimension drawings for mounting

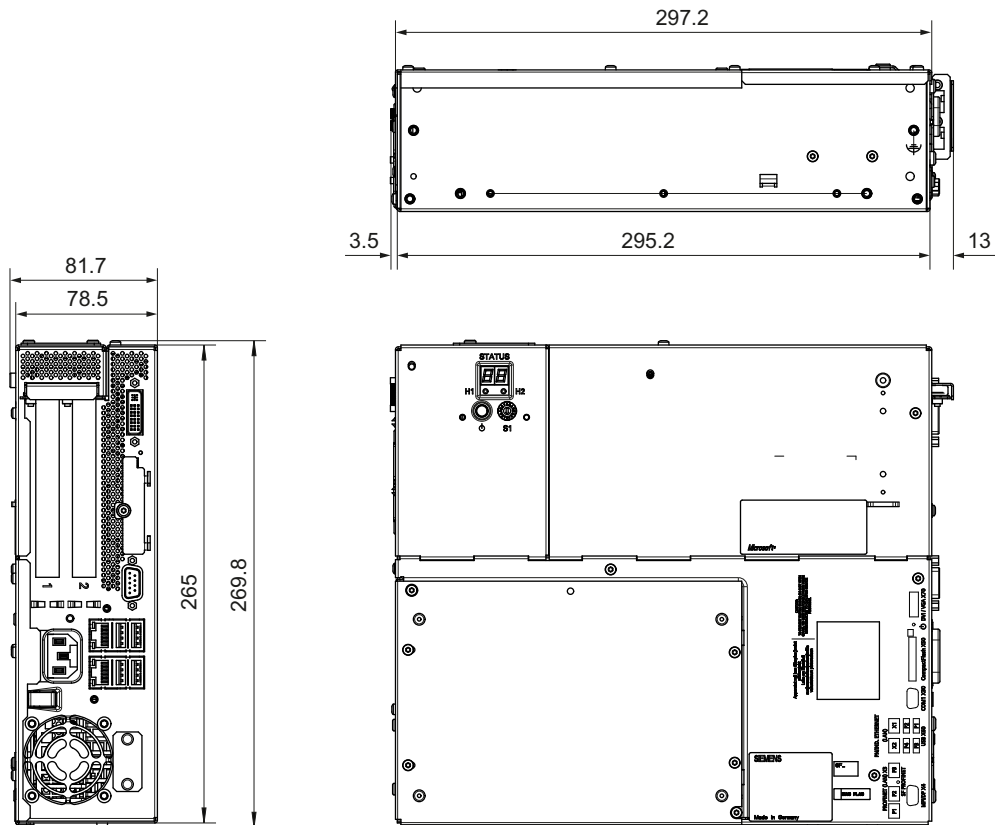

Figure 14-10 PCU 50.5 dimension drawing for mounting without ETH strain relief

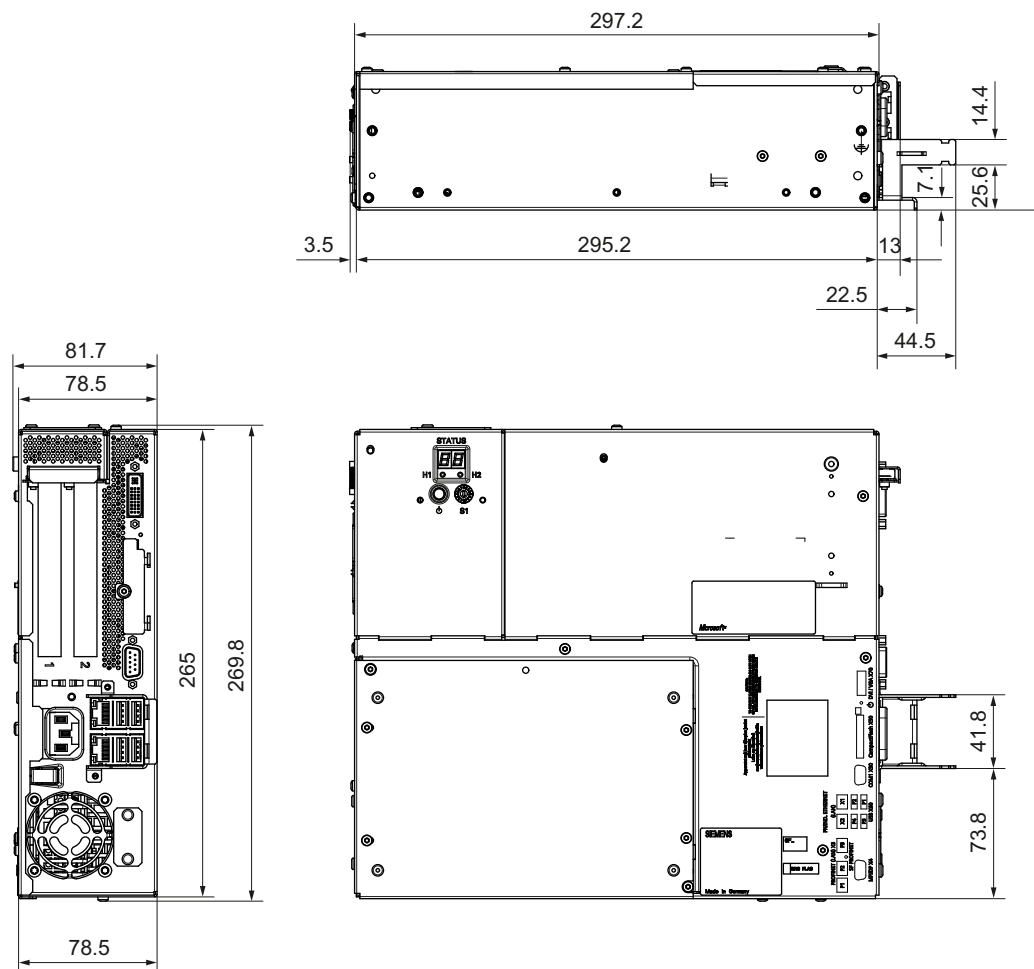
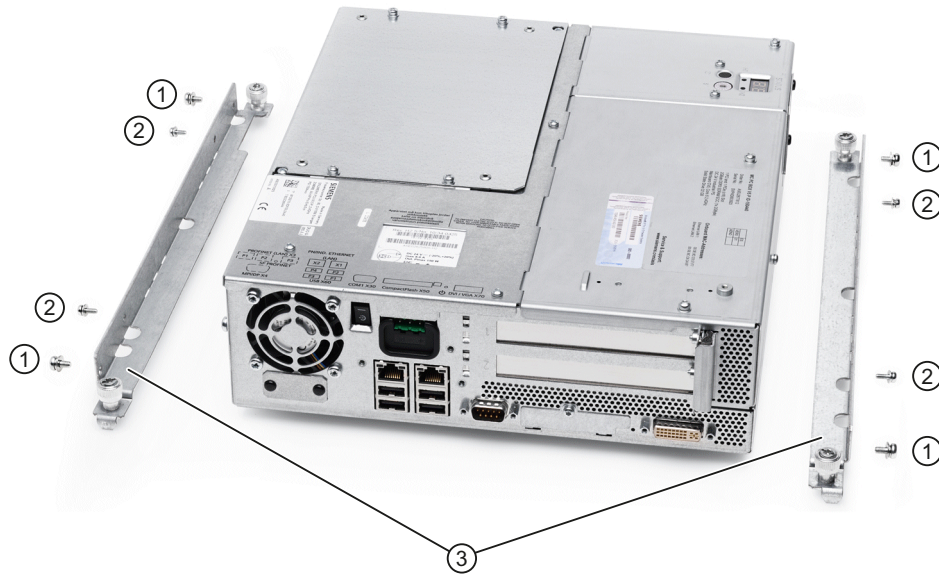

Figure 14-11 PCU 50.5 dimension drawing for mounting with ETH strain relief

14.4.2 Assembly of PCU and operator panel front (standard mounting)

The figures shows the PCU and mounting bracket for standard mounting correctly aligned before screwing together (tightening torque M3: 0.8 Nm, tightening torque M4: 1.8 Nm).



- ① M4x8 countersunk screw with high tension ring and washer
- ② M3x8 countersunk screw with high tension ring and washer
- ③ Mounting bracket

Figure 14-12 PCU 50.5 with mounting brackets (standard mounting)

Mounting the PCU 50.5 with an operator panel front depends on the size of the operator panel front:

- When mounting a PCU 50.5 and operator panel fronts with screen diagonals ≤ 15 inch, refer to Chapter: "OP 012," section: "Mounting" → "Assembling OP 012 and PCU."
- Mounting a PCU 50.5 with an operator panel front OP 019 is described in Chapter: "OP 019," Section: "Mounting" → "Assembling OP 019 and PCU 50.5".

14.4.3 Flat mounting

Use the 'flat' mounting bracket (see section: "Accessories" → "Overview") to mount the PCU flat onto the side panel of the control cabinet.

Procedure

1. Mount the two brackets on the right and left of the PCU one after the other.
2. Mount the PCU on the side panel of the control cabinet in accordance with the mounting instructions (see Section: "Mounting instructions").



Figure 14-13 PCU 50.5 with bracket for flat mounting

Dimension drawing

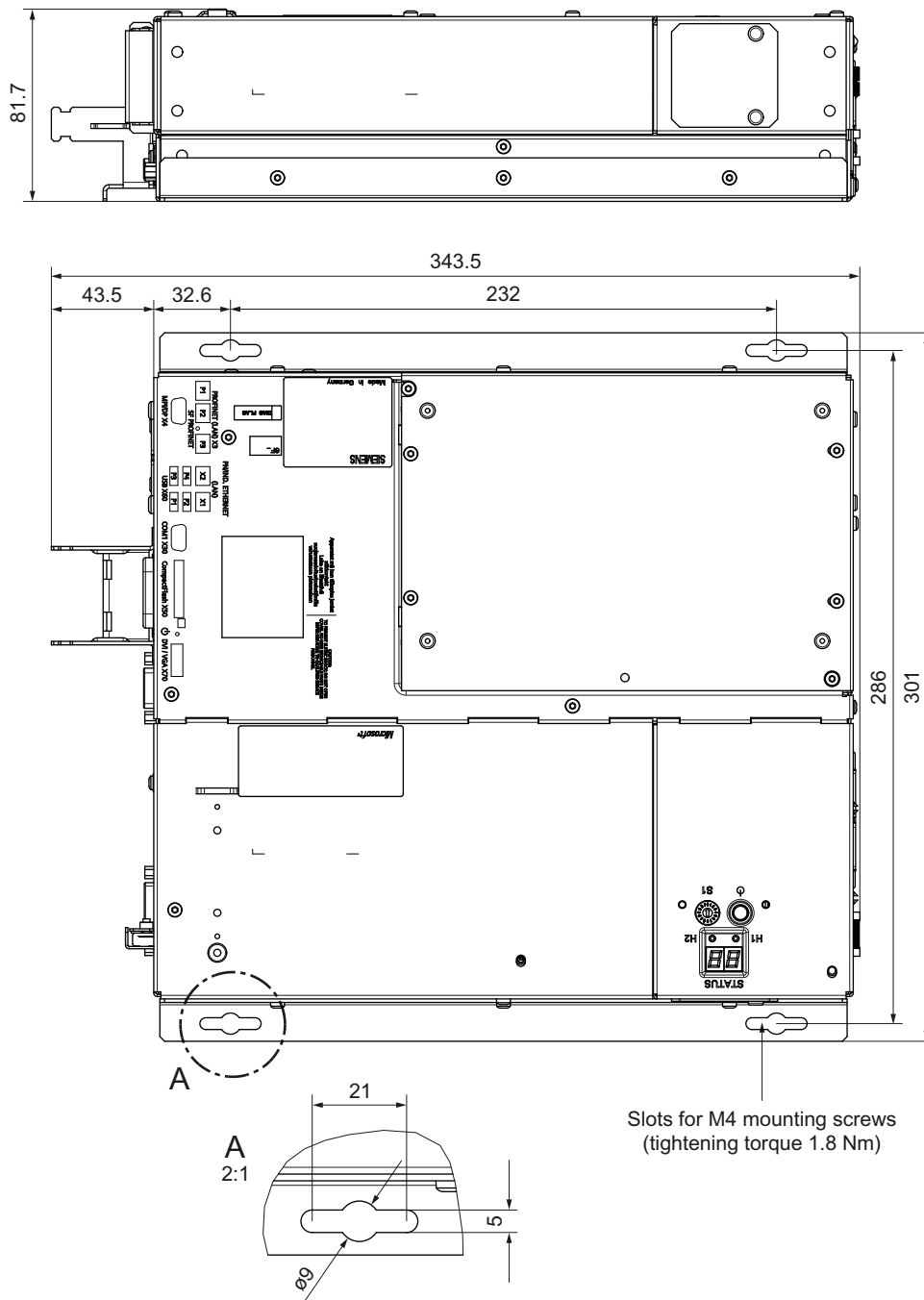

Figure 14-14 Dimension drawing, PCU 50.5 mounted flat

14.4.4 Upright mounting

Use the 'upright' mounting bracket (see Section: "Accessories" → "Overview"), to mount the PCU in the control cabinet.

Two mounting positions are possible:

- Power switch at the top
- Power switch at the bottom

Procedure

1. Mount the rear panel bracket on the right side of the PCU (see the diagram).
2. Mount the PCU at a 90° angle in the control cabinet.



① 'Upright' mounting bracket

Figure 14-15 PCU 50.5 with mounting bracket for upright mounting (power switch at the top)

Dimension drawing

A/B: Slots for mounting screws
 M4 (tightening torque 1.8 Nm) or
 M5 (tightening torque 3 Nm)

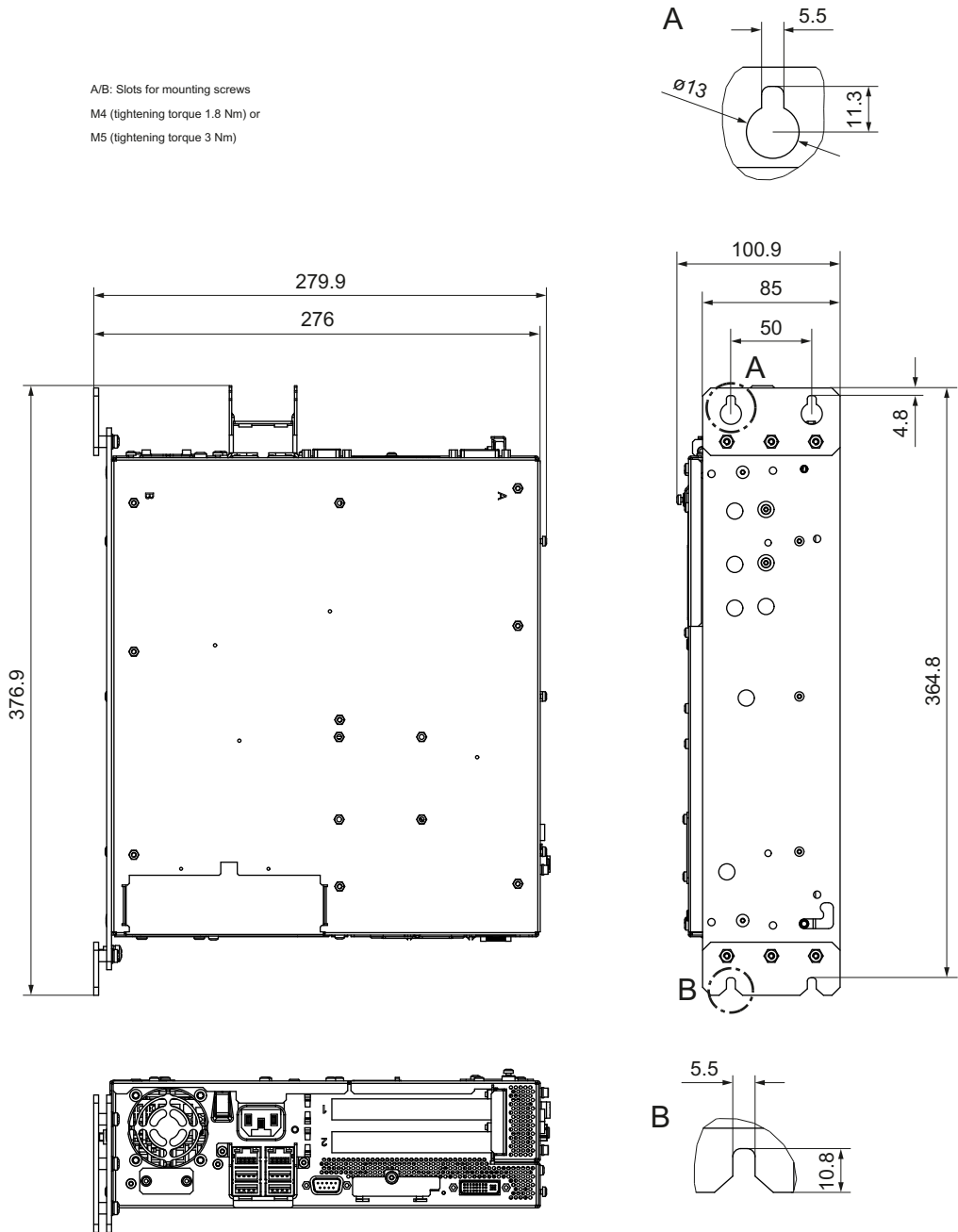

Figure 14-16 Dimension drawing for the upright mounting of the PCU 50.5 (power switch at the top)

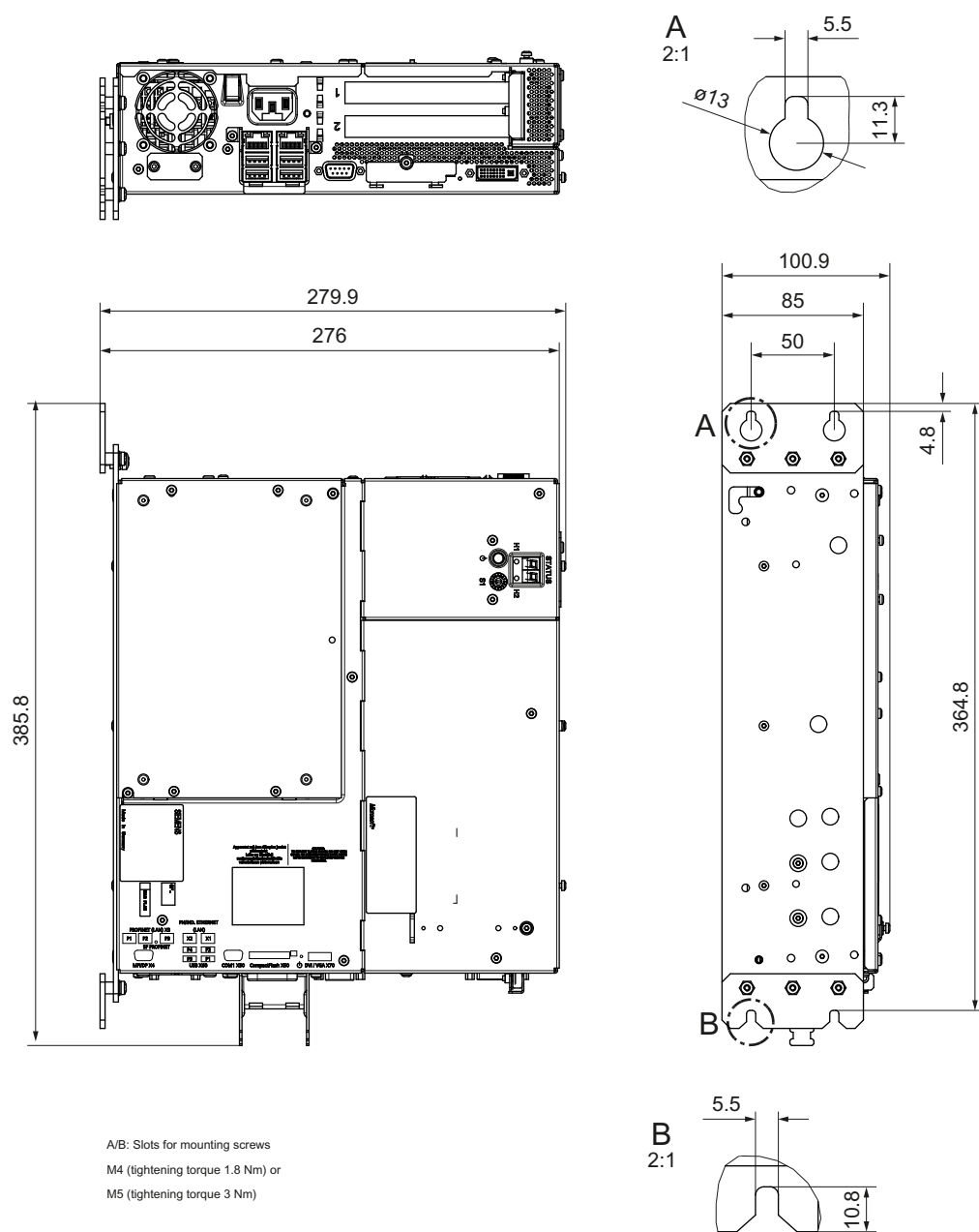

Figure 14-17 Dimension drawing for the upright mounting of the PCU 50.5 (power switch at the bottom)

14.4.5 Notes on installation

Observe the following during installation:

- Avoid extreme environmental conditions as far as possible.
Protect the PCU from severe vibrations, jolts, dust, humidity and heat.
- An external fire protection housing is required.
- Do not expose the PCU directly to the sun's rays.
- Install the device in such a way that no danger (e.g. by falling down) may result.
- Ventilation clearances:
 - Both fan sides: 50 mm each.
 - On top, on the bottom, on the rear side: 10 mm (see Fig.)
- Make sure that the vent slots are not covered.

Permissible mounting positions of the PCU 50.5 acc. to UL508

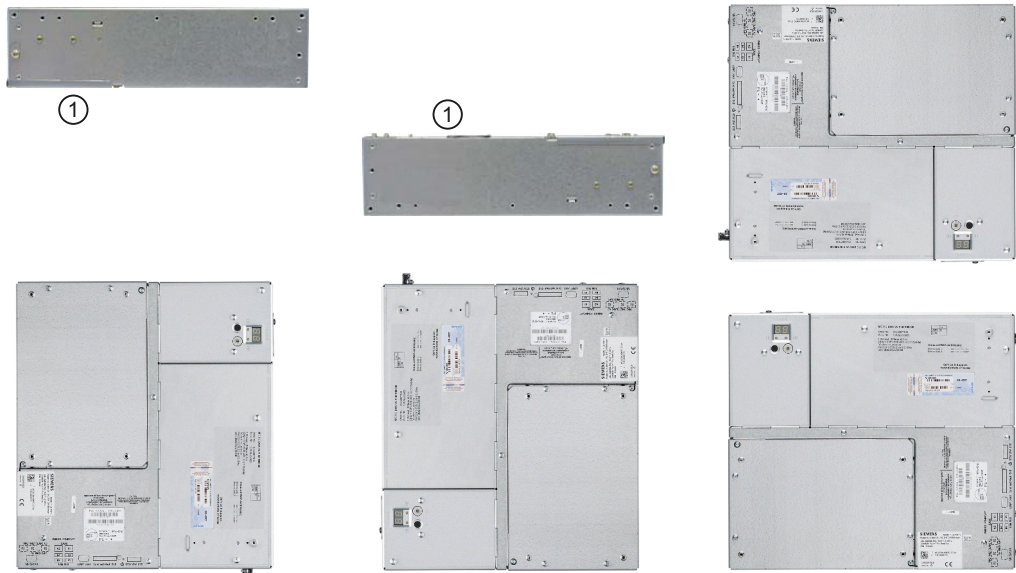

① Position of hard disk

Inclined position

On the basis of the standard mounting positions shown above (checked with a variance of $\pm 5^\circ$), an inclined position of up to $\pm 20^\circ$ is permitted if sufficient ventilation is still ensured.

14.4.6 Connecting Ethernet/USB strain relief

The Ethernet/USB strain relief supplied in the product package is used to prevent accidental removal of the Ethernet cable and Industrial Ethernet FastConnect connector from the device. You need two cable ties to use the strain relief. In addition to the Ethernet cables, you can also use this strain relief to protect the four USB cables from inadvertent removal.

Preconditions

- Take the strain relief ①, the cable tie ② and the two screws (M3) from the accessories pack provided.
- To secure the strain relief, you will need a TORX T10 screwdriver.

Procedure

1.	Fasten the Ethernet/USB strain relief ① to the device enclosure using two oval-head screws (M3 thread).	
2.	Connect the network/USB cable and attach it to the strain relief using cable ties ②.	



14.4.7 Relocating the service module

When delivered, the service module is integrated in the cover, see the top view of the PCU 50.5 in Chapter Description (Page 275). For upright mounting in the control cabinet, due to the serviceability, the service module should be relocated onto the side panel next to the equipment fan.

Preparations

1. Disconnect the device from the line supply.
2. Remove the enclosure cover of the motherboard.

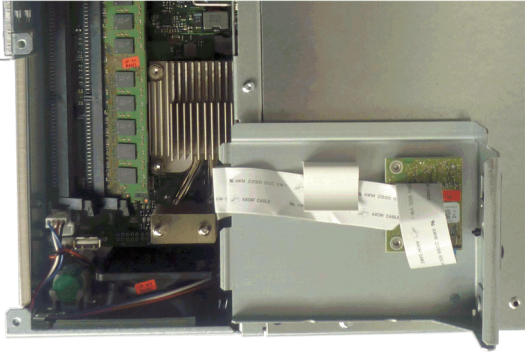
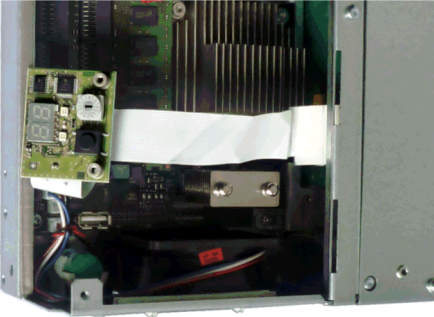
Procedure

<p>1. Loosen the screws for the enclosure cover of the service module and swing out the housing cover to the rear with the still attached service module.</p>	
<p>2. Release the fixing screws of the service module and place it down in the direction of the new mounting location.</p>	
<p>3. Remove the cover for the service module and mount it at the new location.</p>	
<p>4. Now mount the service module at the new location. Before closing the cover of the housing, ensure that the ribbon cable is correctly folded.</p>	

14.5 Connecting

14.5.1 Power supply

The PCU 50.5 is supplied with 24 VDC.

Preconditions

 WARNING
Impermissible cable cross-sections can damage the PCU
The cable cross-section must be adapted to the short-circuit current of the 24 VDC power source so that no damage is caused by the cables if a short-circuit occurs. Only cables with a cross-section of at least 1.3 mm ² (AWG16) and maximum 3.3 mm ² (AWG12) may be connected.

Note

The 24 VDC power source must be adapted to the input data of the PCU (see Section: "Technical data").

Ensure that the PCU's On/Off switch is in the '0' (Off) position to prevent unintentional startup of the device when connecting it to the power supply.

Procedure

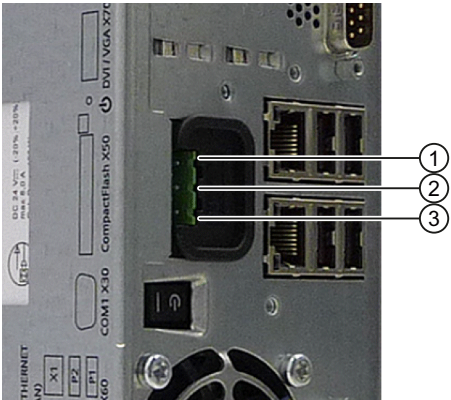
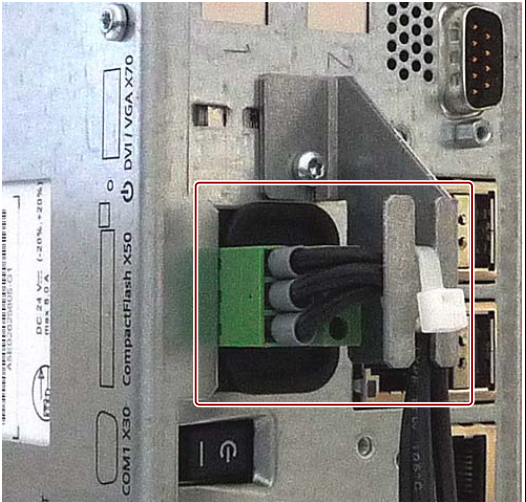
<ol style="list-style-type: none"> 1. Switch off the 24 VDC power source. 2. Connect the DC connector <ol style="list-style-type: none"> ① DC 24 V ② Ground ③ Protective conductor 	
<ol style="list-style-type: none"> 3. Fasten the cable with the supplied line connector interlock, if necessary. 	

Note

Reverse polarity protection

The DC power supply (24 V; -15% / +20%) has a mechanism to protect against reverse polarity. The unit is not damaged if the cables and ground are connected, interchanged. The unit does not switch on. After the power supply has been connected correctly, the unit will again be ready to operate.

14.5.2 Equipotential

A low-impedance ground connection ensures that interference signals generated by external power supply cables, signal cables or cables to the I/O modules are safely discharged to ground.

The equipotential bonding terminal ① on the device (large surface, large-area contact) must be connected with the central grounding point of the cabinet or plant in which the PCU is to be installed.

The minimum cross section must not fall below 5 mm².

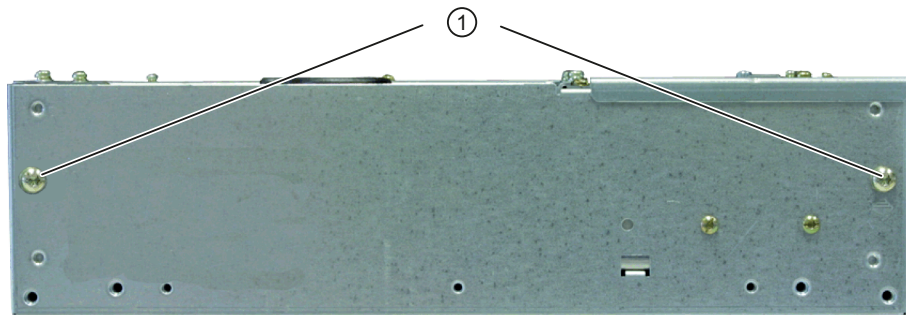

Figure 14-18 PCU 50.5 equipotential bonding connection

14.5.3 I/O devices

Note

When connecting up I/O devices, check that they are suitable for industrial applications according to EN 61000-6-2:2001.

Operator panel front

If you are using the PCU together with an operator front panel, before switching on the PCU first connect up the operator front panel.

Note

Simultaneous operation of the operator panel and monitor is no longer activated as standard under Windows XP. If required, activate in the Windows operator interface.

DVI / VGA monitor

Only switch on the PCU once you have connected the external monitor. Otherwise, this interface is automatically deactivated.

CF card

Only switch on the PCU once you have plugged in the CompactFlash card.

The CompactFlash interface is not capable of acting as a hot-plug. Never plug-in or pull a card while the PCU is operating.

Units based on USB

You can connect or disconnect units based on USB (USB 1.1 or 2.0) during PCU operations if they are supported by the operating system (e.g. Windows XP).

Note

If you are using commercially available USB devices, the interference immunity of the entire system can be reduced. The end user takes responsibility for the use of such devices.

Information on which connection cable is required and how to adapt and set the interface can be found in the User's Manual for your I/O device.

14.6 Commissioning

14.6.1 BIOS

14.6.1.1 BIOS powering up

Once you have switched the PCU on, the preinstalled system powers up automatically. During powering up, the parameters saved in the BIOS setup take effect.

If necessary, you can reactivate the factory-preset parameters (default values) at anytime during the setup using the <F2> key.

1. Press the <F9> (default load) key to do this.
2. Store the settings by pressing the <F10> button (save settings).

Once powering up is complete, the start screen is displayed (see IM8: Commissioning the PCU base software).

Checking the boot sequence

If you want to check or change the boot sequence:

1. Switch on the PCU.
2. By pressing <F12>, the boot menu and the boot options are displayed. Booting can also be optionally started from other devices (e.g. USB-FlashDrive).

Note

When setting up the boot operation, observe the service switch position, see Section Service module (Page 279).

3. Select the desired boot device and press the enter key.

Booting using the USB FlashDrive

If you connect an external USB device or start from a boot-capable USB FlashDrive for servicing purposes, you have to manually call up the USB device from setup. You have three options:

USB device automatically boots

1. Set the service switch to position "E".
2. After a restart, booting is realized automatically from the USB device.
3. For normal operation, set back to "0".

USB device is entered in the boot list (normal operation)

1. Switch on the PCU.
2. When requested, press the <F12> key.
3. Select the desired device from the boot list and confirm.

USB device is not entered in boot list

1. Switch on the PCU.
2. Press the <F2> key.
3. Go to the menu bar for <Boot>.
4. Use the '↓' button to reach the "Legacy Boot Type Order" entry and select the USB device you want to enter in the boot list.
5. If you want to change the sequence of devices within the boot list, select the corresponding device and press the '+' key to move further up the list or the '-' key to move further down the list.
6. Save the settings by pressing the <F10> key and confirm the changes with "Yes".
7. Then restart the PCU.

PCU doesn't boot up

If the PCU no longer boots up as a result of incorrect settings in the BIOS:

1. Take the battery out (see section: "Spare parts" → "Replacement" → "Battery").
2. Bridge the pins of the PCU's battery connector for approx. 10 seconds with a conductive object.
3. Then wait approx. 1 minute.
4. Put the battery back in.
All the BIOS settings (including time and date) are thereby reset.
5. You can set the time and date using the <F2> key.
6. Use the <F9> button to load the default values and the <F10> button to save these.

14.6.1.2 Changing the BIOS settings

If additional components (e.g. an external USB diskette drive) are attached or removed, you may need to change the BIOS settings (see Section: "BIOS start up" → "Bootting using the USB FlashDrive").

NOTICE
Incorrect BIOS settings can prevent the system startup
Only change the BIOS settings if you are fully aware of the consequences of doing so!
Incorrect settings may result in the entire system (including the operating system) no longer starting (see Section: "BIOS start up" → "PCU not booting up").

Changing the BIOS settings using the standard keyboard

Creating your own user profile

Use the "User" profile in the setup menu if you need your own settings in the BIOS and want to permanently save these settings (also used after changing the battery).

1. Switch on the PCU and wait a few seconds.
2. Once you have been prompted to switch to the BIOS setup, press the <F2> button. The BIOS Setup menu will appear.
3. Select "User" under "Exit" → "Profile".
4. Make your specific settings in the other menu items.
5. Save the new settings permanently using the <F10> button by confirming the dialog with "Yes".
6. Your specific settings will be available once the machine has been restarted.

Calling up your own user profile

As soon as you select the "User" selection from the "Exit" → "Profile" setup setting and save with the <F10> button and "Yes" the values saved originally appear after a reboot, provided that you do not change any data (with the exception of the date and time).

Changing data (with the exception of the date and time) is the same as creating a new user profile (see "Creating your own user profile").

Changing the BIOS settings via an operator panel front

1. Switch on the PCU and wait a few seconds.
2. Once you have been prompted to switch to the BIOS setup, press the <F2> button. The BIOS Setup menu will appear.
3. Use the cursor keys for navigating in the menu to the desired selection field (e.g. "Disk A:").
4. Change the setting using the <+> key (press <SHIFT> and <X> at the same time) or the <-> key on in the numeric keypad.
5. You can also use the cursor keys <-> (right) and <←> (left) to reach other setup menu items.
6. Press the <Esc> button (<Alarm Cancel> button) to go to the "Exit" menu.
(This menu can also be reached by pressing and holding down the <-> (right) cursor key.)
7. Press the <Input> key to quit the setup menu.
8. Press the <Input> key to confirm your decision to exit BIOS Setup with "Yes".

The system then starts (see Section: "BIOS startup").

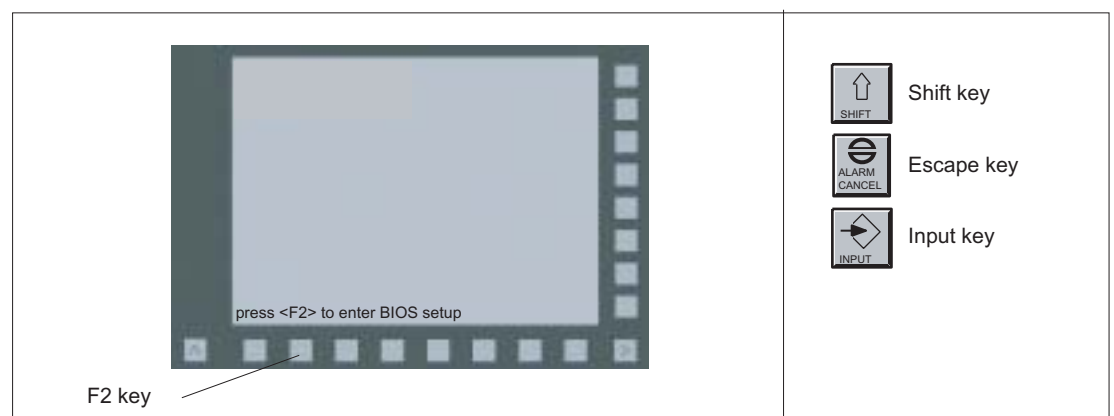

Figure 14-19 Using the BIOS Setup via an operator panel front

14.6.2 System start

More information on the system start can be found in the manual "IM8 start-up of PCU base software."

14.6.3 Switching off / reset

Exiting Windows

To close the operating system, select "Start" → "Shut down".
This ensures that the system and operating system can be restarted without any problems.

Switching off the PCU

Once you have closed and shut down Windows, the power supply module of the PCU is still switched on.

If you also want to switch off the power supply, tip the PCU's On/Off switch to the "0" position.

Reset

The PCU does not have a special reset button to restart the system.

If you want to enforce a system restart, use the On/Off switch to switch your PCU off and on again.

 CAUTION
Residual currents can cause injuries
When undertaking service work (opening the PCU), also withdraw the line connector to the 24 V power supply. This is the only way of totally de-energizing the unit!

14.6.4 Calibration of the touch screen

If you connect a touch panel (e.g. TP 015A) to the PCU, you must recalibrate the touch screen of this operator panel front. The touch software, required for the calibration, is included in the PCU base software.

Procedure

A functioning "touch panel with PCU 50.5" is required.

Note

If you take too long to calibrate the device, the whole process is canceled by a "timeout" and you have to start again from the beginning.

1. Boot up the system in service mode.
2. Start the SINUMERIK desktop (password-protected).
3. Invoke the calibration menu from "Start" → "Programs" → "Touchware" → "Touchware" (see figure).

Note

On the TP 015A the default calibration is centrosymmetric to the center point. This means that you must press the top right of the screen to activate the "Start" button (bottom left).



Figure 14-20 Menu for touch screen calibration (Touchware version 5.64 SR3)

Note

Depending on the software version and setting, the screen can include 2, 4 or 5 calibration points.

You can toggle between 2 and 5 points (Touchware version 5.63 SR3) or between 2 and 4 points (Touchware version 5.64 SR3) from the menu "Tools" → "Options" → "Advanced" → "Style".

4. Press the "Calibrate" button. The following display will appear on the screen:



Figure 14-21 Calibration screen

5. Using the tip of one finger, touch the calibration point indicated by the hand symbol as accurately as possible for as long as the "Hold" prompt is displayed. The "Hold" prompt disappears after a few seconds and the hand moves to the next calibration point.

6. Repeat the instructions in step 5 until all available points have been calibrated. Once the calibration point parameters have been saved, the following menu appears:

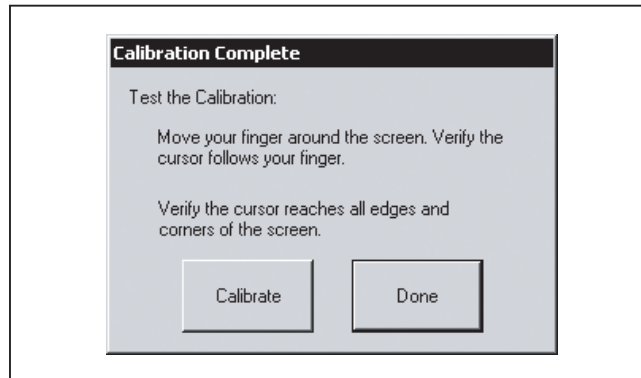

Figure 14-22 Test menu

7. To test the calibration values, move your finger around the screen and observe the cursor.
If necessary, recalibrate using "Calibrate."
8. Exit the calibration menu via "Done" → "Close".

14.6.5 Operation with an S7-CPU (without NCU)

Application range

MCP communication is understood to be the transfer of I/O images to the following components:

- two machine control panels
- one HHU
- two direct key units of an OP

The machine control panel signals are communicated on SINUMERIK systems using the FB1 (MCP communication). On more complex systems, the FB9 is used to carry out the M:N switchover. The parameters are filed in DB7 and can be changed by the FB9. Since these blocks are not available in the SIMATIC environment, the FB9 Proxy assumes these tasks.

Preconditions

It is a requirement that a DB19 is available on the installed S7-CPU in accordance with SINUMERIK specifications: PCU 50.5 with HMI application

The FB9 proxy only functions if the MCP client (mcpdrv) is also running.

Creating DB19 in the PLC user program

The user must create the DB19 for the PLC user program. If the DB19 is copied from an existing PLC project to a NCU, it may be that it is not saved during the series machine startup.

The DB19 copied from the existing SINUMERIK project was generated by the basic program and a corresponding generic bit set. This bit is evaluated during a series machine startup and the block would NOT be saved, as it has been generated by the system.

A new data block (DB19) is created via STEP 7 with the following structure:

```
STRUCT: Array [-32768..-32371] type: BYTE
```

Address	Name	Type	Start value
0.0		STRUCT	
+0.0	DB_VAR	ARRAY (-32768 ... -32371)	
+1.0		BYTE	
=398.0		END_STRUCT	

A flag is not set for blocks created by the user, i.e. not created by the system, and the block is always saved during the series machine startup.

Operation with a PCU 50.5 and SINUMERIK Operate

The two utility programs, FB9 proxy and MCP Client, are not started automatically by the system on the PCU 50.5. To start the two utilities, changes are made in the following files:

systemconfiguration.ini file with the following contents:

In the [processes] section, the MCP Client and the FB9 Proxy need to be entered after the CP entry.

```
...
[processes]
PROC000= image:=cp_840di, process:=CP_840di, background:=true
PROC001= image:=slsmhmihost, process:=SlHmiHost1, deferred:=true
PROC002= image:=mcpdrv, process:=mcpdrv, background:=true
PROC003= image:=fb9proxy, process:=fb9proxy, background:=true
```

14.6.6 Configuring the 'fb9_proxy.ini' file

Configuring the fb9_proxy.ini file

Example of configuration file when supplied:

```
[PLC]
;# Set GET_IP_BY_HMI to '0', if you want a static connection to PLC
;# with specified IP address
;# otherwise FB9-Proxy tries to determine IP address and CP interface
;# from mmc.ini of HMI
;GET_IP_BY_HMI = 1
;# if GET_IP_BY_HMI is set to '1' the following key 'IP ADDRESS'
;# has no effect
;# otherwise this key determines the static IP address of the PLC
;IP-ADDRESS = 192.168.214.241
;# if GET_IP_BY_HMI is set to '1' the following key ' CP-INTERFACE '
;# has no effect
;# otherwise this key determines the interface to the shared memory
;# of the CP software.
;# The key is useful to avoid collisions between FB9-Proxy and
;# the HMI. The CP software supports two shared memory interfaces.
;# Normally one interface is used by the HMI.
;# HMI Embedded and HMI s1 use the interface with index 1.
;# So the FB9-Proxy uses by default the interface with index 2.
;# HMI Advanced uses the interface with index 2, so you have
;# to instruct the FB9-Proxy to use the interface with index 1.
;CP-INTERFACE = 2
;# 2 bytes for PLC alarms
;ALARM = AB80
;# address of 2 bytes for life sign of fb9proxy
;LIFESIGN = AB82
;# cycle for transmission of life sign
;# (valid values between 200 and 2000 milliseconds)
;LIFECYCLE = 200
```

```
[MCP1]
;BUS-ADDRESS = 6
;PROFILE = 0
;IN = EB0
;OUT = AB0
```

```
[MCP2]
;BUS-ADDRESS = 6
;PROFILE = 0
;IN = EB64
;OUT = AB64
```

```
[HHU]
;BUS-ADDRESS = ?
;PROFILE = 0
;IN = EB32
;OUT = AB32
```

```
[DCK1]
;BUS-ADDRESS = 6
;PROFILE = 1
;IN = EB16
;OUT = AB16
```

```
[DCK2]
;BUS-ADDRESS = 6
;PROFILE = 1
;IN = EB48
;OUT = AB48
```

Connection to the PLC

In the [PLC] section, the "IP-ADDRESS" key specifies the IP address of the S7-CPU. A connection is made to this PLC. This key is only evaluated if no IP address for the PLC is found in the mmc.ini file.

The IP address of the S7-CPU can be set via GET_IP_BY_HMI : The operator can define whether the IP address of the PLC is obtained from the mmc.ini or whether a static IP address is defined.

GET_IP_BY_HMI = 1 → IP address is obtained from the mmc.ini.

GET_IP_BY_HMI = 0 → Static IP address is defined via fb9_proxy.ini.

The "LIFESIGN" key can be used to obtain a sign of life from the FB9 Proxy on the PLC.

The "ALARM" key indicates the location in the PLC to which the two alarm bytes should be written. If this key does not exist, the alarm bytes are not transferred.

Triggering alarms

In contrast to the original FB9, it is not possible for the FB9 Proxy to trigger PLC alarms. The user program on the SIMATIC CPU can decide whether or not alarms are triggered. When the cause of the alarm has been remedied and this is detected by the FB9 Proxy, the relevant bit is reset. If the alarms are acknowledged, the user program on the SIMATIC CPU can reset the bits itself.

The alarms are entered in a byte array that can be transferred to the PLC. For this purpose, the variable "ALARM" must be specified in the [PLC] section in the INI file. In the case of transitional edges 0→1, the PLC user program can trigger the relevant alarms and, in the case of transitional edges 1→0, it can cancel the alarms again. The alarm bits are written to AB30 and AB31 by default.

List of alarms that can be triggered by FB9 Proxy via MCP communication:

Alarm number	Alarm text	Bit
400260	Failure of machine control panel 1	AB30.0
400261	Failure of machine control panel 2	AB30.1
400262	Failure of manual operating device	AB30.2
400274	Direct key 1 failed	AB30.3
400275	Direct key 2 failed	AB30.4
410900	M:N - call waiting discontinued	AB31.0
410901	M:N - HMI 1 not responding to displacement	AB31.1
410902	M:N - HMI 1 is not going offline	AB31.2
410903	M:N - HMI 2 not responding to displacement	AB31.3
410904	M:N - HMI 2 is not going offline	AB31.4
410905	M:N - HMI connection to assigned interface not available	AB31.5
410906	M:N - No sign of life on an HMI	AB31.6

References: Diagnostics Manual, PLC Alarms

Connection to additional components

The contents of the [MCP1], [MCP2], [HHU], [DCK1] and [DCK2] sections are configured in exactly the same way and are used to configure the connections to the MCP/DCK devices:

If the "BUS-ADDRESS" key exists, a static connection is set up for the relevant device, i.e. no dynamic request is required in the DB19 from an HMI application. If, however, a dynamic request is made by an HMI application, the static connection is stopped and the dynamic connection is made.

The "PROFILE" key indicates whether the standard parameter set or the direct key parameter set should be used from the MCP_CLIENT.INI file.

Default:

PROFILE=0 for machine control panels and HHU
PROFILE=1 for direct keys

The "IN" key is used for addressing the inputs (key information) and indicates the address to which information should be written.

The "OUT" key is used for addressing the outputs (LED information) and indicates the address from which information is read.

The length of the inputs and outputs is determined directly by the device and, therefore, does not need to be indicated. However, it is important to ensure that the addressing range is adequately dimensioned, so that information does not overlap. For example, if the address EB0 is configured for the MCP1 inputs and an HT 8 and an MCP483 are available for the M:N switchover, the direct key inputs can only be configured from EB16. The MCP483 inputs are 14 bytes long.

Note**m:n configuration**

If there is an HMI application in the system that supplies the m:n interface in the DB19, the FB9 proxy dynamically establishes the connections with the names "MCP1" and "DCK1". In this case, these two connections cannot be configured statically.

Therefore, use to the connections with the names "MCP2", "HHU" and "DCK2" instead. The names have been selected with reference to the FB9 and are not linked to any semantics. The connection with the name "HHU" can also be used for an MCP.

For addresses for the memory areas in the PLC, expressions such as EBx, ABx, MBx and DBy.DBBx can be used. These are always byte addresses.

Examples:

IN = EB0 → Inputs are written to the PLC from EB0.
 OUT = DB100.DBB20 → Outputs are read from DB100 from byte 20.

14.7 Alarm, error and system messages

14.7.1 Boot error messages

BIOS first performs a **Power On Self Test (POST)** within the boot routine to verify proper operation of certain functional units of the PC. The boot sequence is interrupted immediately if fatal errors occur.

If the test does not return an error, the BIOS initializes and tests additional functional units. In this startup phase, the graphics controller is initialized and any error messages are output to the screen.

The error messages output by the system BIOS are listed below. For information on error messages output by the operating system or programs, refer to the corresponding manuals.

On-screen error messages

On-screen error message	Meaning / suggestions
Error - CMOS battery failed	The battery on the CPU module is defective or dead. Contact your technical support team.
Error - SMART failure detected on HDD	Hard disk error: An error bound suggested by the manufacturer has been exceeded. The operation of the hard disk is not secure. The hard disk must be replaced. Contact your technical support.
Error - Keyboard error	Check whether the keyboard is properly connected. Keyboard faults Contact your technical support. Notice: This error is not displayed per default, and must first be activated in the setup.
No bootable device -- Please restart system	Possible causes: <ul style="list-style-type: none"> • No operating system present • Wrong drive addressed (disk in drive A/B) • Incorrect active boot partition • Incorrect drive entries in the setup • Hard disk is not connected / defective
Error - Realtime clock has lost power	Clock chip error. Contact your technical support team.

14.7.2 BIOS beep codes

The essential POST codes are subsequently listed in the sequence in which they occur. Contact Technical Support for information on all other POST codes.

Display	Description	Remedy
4DH	MonoTonicCounter Initial	Service case
4EH	CPU Middle Initial	Service case
4FH	Multi-processor Middle Initial	Service case
50H	SMBUS Driver Initial	Service case
51H	SMART Timer Initial	Service case
52H	RTC Initial	Service case
53H	SATA Controller early initial	Service case
54H	Setup SMM Control service	Service case
55H	Setup Legacy Interrupt service	Service case
01H	CPU power on and switch to Protected mode	Service case
02H	Patching CPU microcode	Service case
03H	Setup Cache as RAM	Service case
04H	PCIE MMIO Base Address initial	Service case
05H	CPU Generic Machine Status Register initial	Service case
06H	Setup CPU speed	Service case
07H	Cache as RAM test	Service case
08H	Tune CPU frequency ratio to maximum level	Service case
09H	Setup BIOS ROM cache	Service case
0AH	Enter Boot Firmware Volume	Service case
70H	Super I/O initial	Service case
71H	CPU Early Initial	Service case
72H	Multi-processor Early initial	Service case
73H	HyperTransport initial	Service case
74H	PCIE MMIO BAR Initial	Service case
75H	North Bridge Early Initial	Service case
76H	South Bridge Early Initial	Service case
77H	PCIE Training	Service case
79H	SMBUS Early Initial	Service case
41H	South bridge Serial Peripheral Interface initial	Service case
42H	Setup Reset service	Service case
43H	South bridge Serial GPIO initial	Service case
44H	Setup SMM ACCESS service	Service case
45H	North bridge Middle initial	Service case

Display	Description	Remedy
46H	Super I/O DXE initial	Service case
47H	Setup Legacy Region service	Service case
48H	South Bridge Middle Initial	Service case
49H	Identify Flash device	Service case
4AH	Fault Tolerant Write verification	Service case
4BH	Variable Service Initial	Service case
4CH	Fail to initial Variable Service	Service case
26H	Dispatch option ROMs	Service case
27H	Get boot device information	Service case
	HD-Lock active	Release lock: Set HD-lock to "Operating".
28H	End of boot selection	Service case
29H	Enter Setup Menu	Service case
2AH	Enter Boot manager	Service case
2BH	Try to boot system to OS	Service case
2CH	Shadow Misc Option ROM	Service case
2DH	Save S3 resume required data in RAM	Service case
2EH	Last Chipset initial before boot to OS	Service case
2FH	Start to boot Legacy OS	Service case
30H	Start to boot UEFI OS	Service case
31H	Prepare to Boot to Legacy OS	Service case
32H	Send END of POST Message to ME via HECI	Service case
33H	Last Chipset initial before boot to Legacy OS.	Service case
34H	Ready to Boot Legacy OS.	Service case
35H	Fast recovery start flash	Service case
F9H	No Boot Device	Service case
FBH	UEFI Boot Start image	Service case
FDH	Legacy 16 boot entry	Service case
FEH	Try to Boot with INT 19	Service case
E5H	System wakeup from S5	Service case
10H	Enter Boot Device Selection entry	Service case
11H	Install Hotkey service	Service case
12H	Alert Standard Format Initial	Service case
13H	PCI enumeration	Service case
14H	PCI resource assign complete	As a test, disable HW components in setup or remove expansion modules that have been installed.
15H	PCI enumeration complete	Service case
16H	Keyboard Controller, Keyboard and Mouse initial	Run a test by replacing the keyboard/mouse

14.7 Alarm, error and system messages

Display	Description	Remedy
17H	Video device initial	Service case
18H	Error report device initial	Service case
19H	USB host controller initial	Service case
1AH	USB BUS driver initial	Service case
1BH	USB device driver initial	Service case
1CH	Console device initial fail	Service case
1DH	Display logo or system information	Service case
1EH	IDE controller initial	Service case
1FH	SATA controller initial	Service case
20H	Super IO controller initial	Service case
21H	ISA BUS driver initial	Service case
22H	Floppy device initial	Service case
23H	Serial device initial	Service case
24H	IDE device initial	Service case
25H	AHCI device initial	Service case
56H	Relocate SMM BASE	Service case
57H	SMI test	Service case
58H	VTD Initial	Service case
59H	Legacy BIOS initial	Service case
5AH	Legacy interrupt function initial	Service case
5BH	ACPI Table Initial	Service case
5CH	Setup SB SMM Dispatcher service	Service case
5DH	Setup SB IOTRAP Service	Service case
5EH	Build AMT (Active Management Technology) Table	Service case
5FH	Processor Power Management Initial	Service case
60H	Host Embedded Controller Interface Initial	Service case
61H	Variable store garbage collection and reclaim operation	Service case
7AH	Clock Generator Initial	Service case
7BH	Internal Graphic device early initial,	Service case
7CH	Host Embedded Controller Interface Initial	Service case
7DH	Watchdog timer initial	Service case
7EH	Memory Initial for Normal boot	Replace the memory modules
7FH	Memory Initial for Crisis Recovery	Replace the memory modules
80H	Simple Memory test	Replace the memory modules
81H	Trusted Execution Technology function early initial	Service case
82H	Start to use Memory	Service case

Display	Description	Remedy
83H	Set cache for physical memory	Service case
84H	Recovery device initial	Service case
85H	Found Recovery image	Service case
86H	Recovery image not found	Check whether the BIOS recovery image exists on the recovery medium (e.g. USB FlashDrive).
87H	Load Recovery Image complete	Service case
88H	Start Flash BIOS with Recovery image	Service case
89H	Loading BIOS image to RAM	Service case
8AH	Loading Driver Execution Environment (DXE) core	Service case
8BH	Enter DXE core	Service case

Special codes

The BIOS does not generate any beep codes.

14.8 Technical data

14.8.1 PCU 50.5

Safety			
Safety class	I (SELV) according to EN 61140		
Degree of protection according to EN 60529	IP 20		
Approvals	CE / cULus		
Electrical data			
Input voltage	24 VDC (20.4 V ... 28.8 V)		
Input current	max. 8 A (starting current: max. 14 A at max. 30 ms)		
Max. current output	USB external, each 0.5 A (in total: 1.2 A)		
	3.3 V	2 A	
	5 V	2 A	
	12 V	0.3 A	
	-12 V	0.05 A	
Power consumption	PCU basic unit	PCI slots	
	typ. 48 W (at 55° C)	max. 15 W ¹⁾	
Mechanical data			
Dimensions	Width: 297 mm	Height: 267 mm	Depth: 82 mm
Weight	approx. 4.5 kg		
Slot 1/2:	Card length, max. 185 mm (measured without the slot plate)		

¹⁾ All of the slots must not exceed this total power.

Note

Information about the climatic and mechanical environmental conditions is contained in the associated section under:

"General notes and interconnection" → "Operational planning".

14.8.2 Calculating the power

Component	Power
Base device with SSD	typ. 48 W / max. 76 W
USB expansion	max. 6 W
PCI/PCIe expansion	max. 15 W* (55°C)
Panel interface	max. 53 W ^{*)}
Total	max. 150 W

^{*)} with the onboard graphic disabled, max. 30 W (50°C)

Active power drawn at 24 V DC: max. 190 W / 210 W

14.8.3 Power failure detection

A pending power failure is internally displayed using the power failure signal. This signal is evaluated in the software, and transferred to the corresponding application.

This means that e.g. data save operations can be initiated, before the device hardware stops as the result of a central reset (Power Good End).

Power failure alarm schematic:

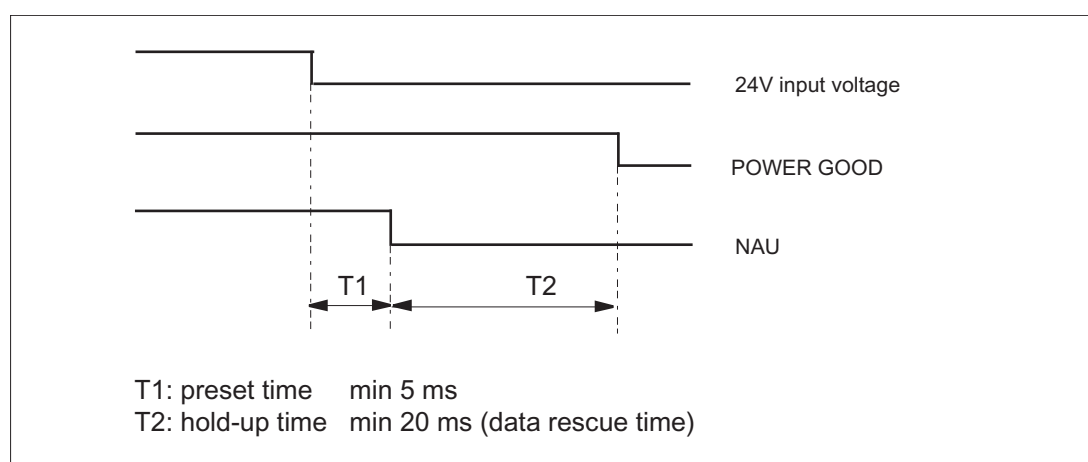

Figure 14-23 Power failure signal of the 24V DC power supply

14.9 Spare parts

14.9.1 Overview

The following spare parts are available for the PCU 50.5:

Component	Order number
Device fan	A5E02268846
Power supply fan	A5E02268847
Power supply 24 VDC / 150 W	A5E30947477
24 VDC power supply connector, 3-pin (5 units)	A5E03404000
CMOS battery 3 V Lithium CR 1/2 AA, PC	A5E00331143
Service module	A5E02518244

14.9.2 Replace

To maintain high system availability, we recommend the preventative replacement of those PC components that are subject to wear. The table below indicates the intervals for this replacement.

Component	Replacement interval
Hard disk drive SSD	> 5 years
Fan	5-7 years
CMOS backup battery	4/5 years

SSD

When compared to conventional hard disks, solid-state disks are significantly more rugged against mechanical vibration and shock and are less sensitive to temperature.

However, due to the fact that the write cycles are limited, SSDs are wearing parts, i.e. write access operations progressively wear the internal flash blocks. However, a long availability can be achieved through preventive internal measures such as wear leveling, keeping reserve blocks or error correction mechanisms.

In the industrial environment, a service life can be assumed that is higher than for conventional mechanical hard disks and according to what we know today, is > 5 years.

The write load that occurs is a significant factor that influences the life expectancy.

Fan

Fans are wearing parts. The fan speed is monitored and in the event of a failure an alarm is issued.

Pollution is the main cause of fan failure. A visual inspection should be made as a first criterion for replacement. If the fan has a high degree of accumulated dirt, it should be replaced. If no pollution is present, then the usage time should be used as the criterion. The service life of the fans also depends on the operating conditions (temperature, humidity, number of operating hours per day), so that no fixed limits for all applications can be specified. In the field, under average industrial conditions, a replacement interval of 5-7 years has proven itself.

Backup battery

Batteries are wearing parts. They should be replaced every 5 years to ensure that the device functions permanently.

If an integrated PCI plug-in card is also supplied (central battery concept), preventive replacement intervals are shortened to 4 years.

14.9.2.1 SSD module

Preparation

Disconnect the device from the line supply.

Note

The new module must be of the same type or a compatible successor.

Replacing an SSD module

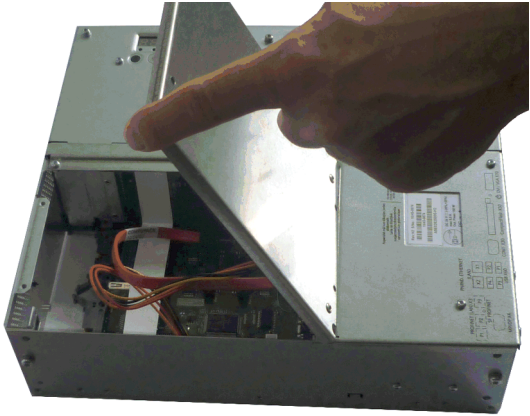
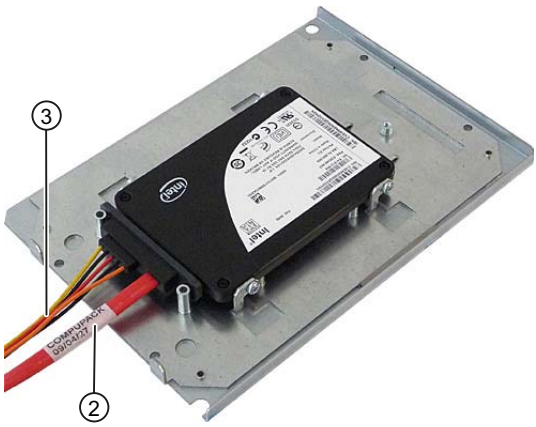
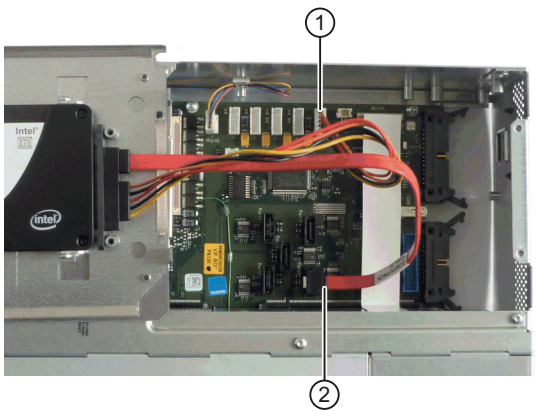
<p>1. Remove the enclosure cover of the SSD and place this on the device.</p>	
<p>2. Disconnect the power supply cable ③ and the data cable ② from the main board and replace the SSD module.</p>	
<p>3. Connect the new SSD module with the motherboard. Pay attention to the correct slots for the power supply ① and data cable ②.</p>	
<p>4. Mount the SSD enclosure cover.</p>	

14.9.2.2 Power supply

 WARNING
Unqualified tampering in the power supply causes severe injuries
Only authorized trained personnel are allowed to replace the power supply unit.

Preparations

1. Isolate the device from the line supply and disconnect all connecting cables.
2. Remove the hard disk drive.

Removing the power supply

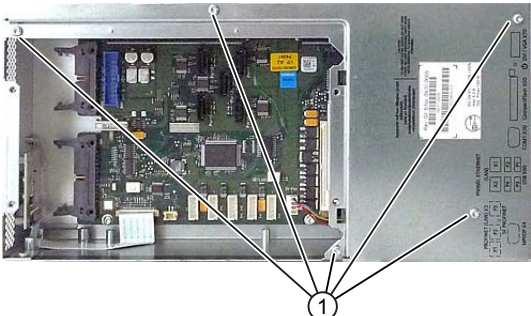
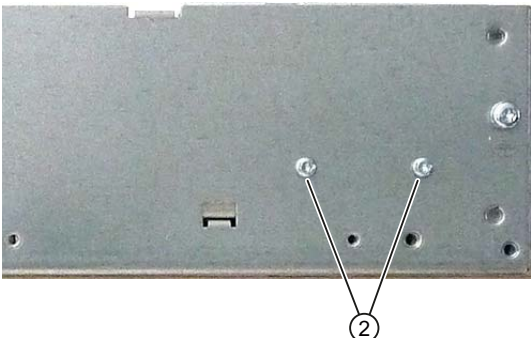
<p>1. Loosen the screws ① and remove the power supply cover.</p>	
<p>2. Remove the fixing screws ② of the power supply.</p>	

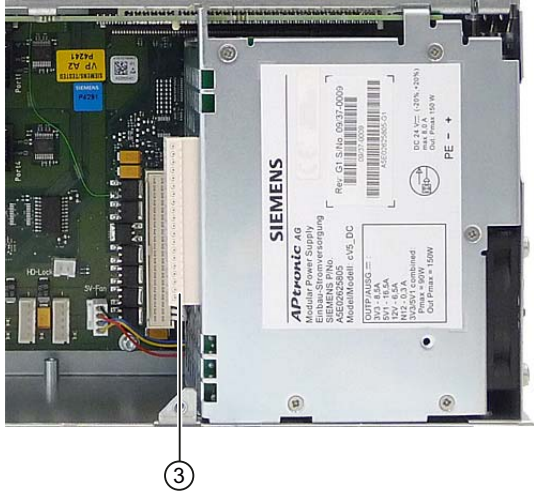
<p>3. Withdraw the power supply plug ③ from the power supply.</p>	
<p>4. Withdraw the power supply towards the top.</p>	

Installing the power supply

Install the new power supply in the reverse order.

Note

Observe the correct position of the power supply latches for upright bus PCBs.

14.9.2.3 Power supply fan

Preparations

1. Disconnect the device from the mains.
2. Remove the power supply.

Removing the power supply fan

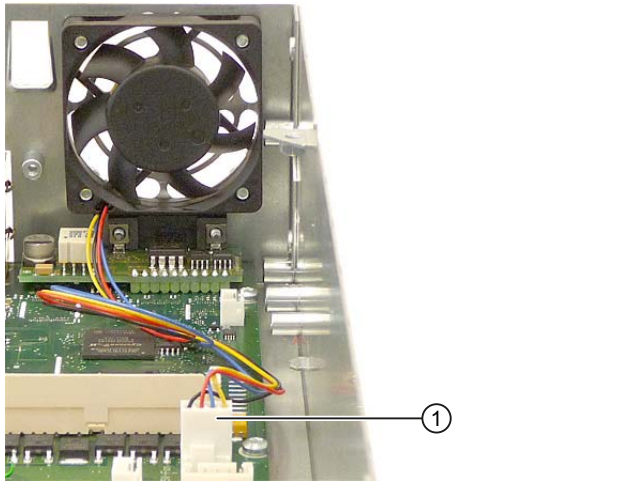
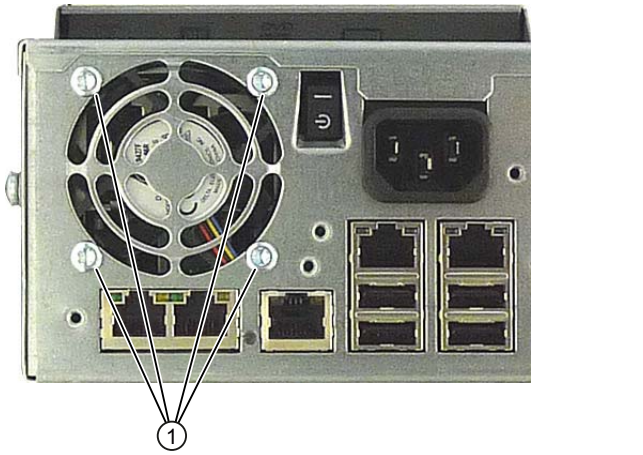
1. Withdraw the fan connector ①.	 A close-up photograph of the power supply unit's fan connector. A hand is shown pulling the fan's multi-colored cable out of the white plastic connector. A circled number '1' with a line points to the connector.
2. Loosen the four screws ① on the enclosure.	 A photograph of the power supply unit's fan enclosure. Four screws are being loosened from the metal fan housing. A circled number '1' with lines points to each of the four screws.
3. Remove the fan from the enclosure.	

Installing the power supply fan

Install the new fan in the reverse sequence. Ensure the correct installation position - fan blows air towards the outside.

Note

Only a fan of the same type may be installed.

14.9.2.4 Device fan

Preconditions

1. Disconnect the device from the line supply.
2. Remove the covers from the service module and motherboard.

Removing the device fan

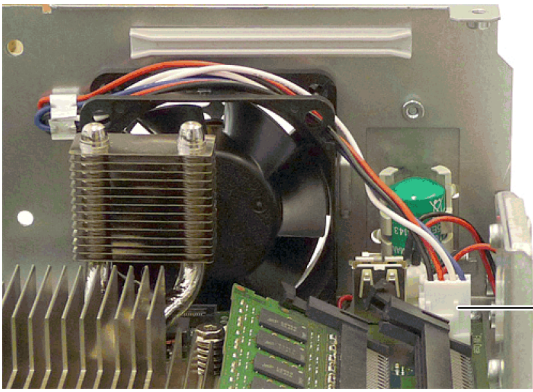
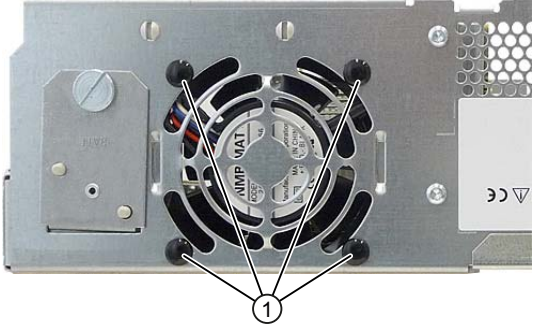
<p>1. Withdraw the fan plug from the motherboard.</p>	
<p>2. Loosen the four two plastic rivets on the enclosure.</p>	
<p>3. Remove the fan from the enclosure.</p>	

Installing the device fan

Install the new fan in the reverse sequence. Ensure the correct installation position - fan blows air towards the outside.

Note

Only a fan of the same type may be installed.

14.9.2.5 Backup battery

The backup battery supplies voltage not only to any plug-in cards used during operations but also to the hardware clock once the device has been switched off. In addition to the time, the BIOS settings of the device are also saved.

To be noted before you replace the battery

NOTICE**Excessive voltages can damage plug-in cards**

The lithium battery may only be replaced with an identical battery or with a type recommended by the manufacturer. For the PCU 50.5, only use 3.0 V lithium batteries, as any plug-in cards being used cannot tolerate any voltage exceeding 3.0 V.

**WARNING****Risk of explosion and release of harmful substances!**

For this reason, do not burn lithium batteries, do not solder on the cell body, do not open, do not short circuit, do not reverse polarity, do not heat above 100° C, dispose of correctly, and protect against direct sunlight, dampness and dew.

Disposal

NOTICE**Environmental contamination**

Dispose of used batteries using the local connection point specifically set-up locally so that they are correctly recycled or are disposed of as hazardous waste.

Preparation

Note

For the BIOS setting "Profile: Standard" the configuration data of the device is deleted when the battery replacement takes more than 30 seconds.

For the BIOS setting "Profile: User" the configuration data of the device is retained; only the date and time has to be reconfigured.

The content of the SRAM is lost if the battery replacement takes more than 30 seconds.

1. Note down the current settings of the BIOS Setup.
A list in which you can note down this information is found in the BIOS manual.
2. Isolate the device from mains and disconnect all connection cables.

Note

You can also replace the battery while the device is running, but do not touch anything in the device. We recommend switching off the device beforehand.

Replacing the battery

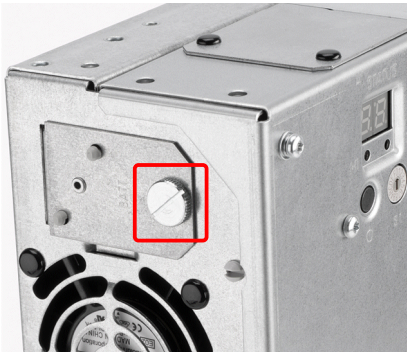
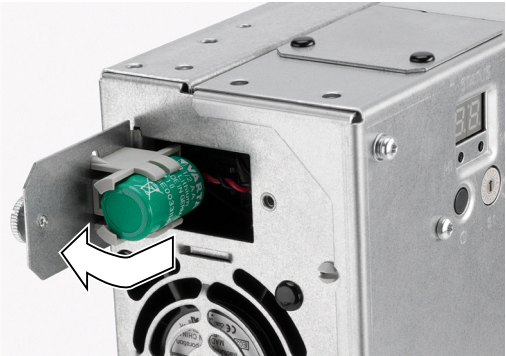
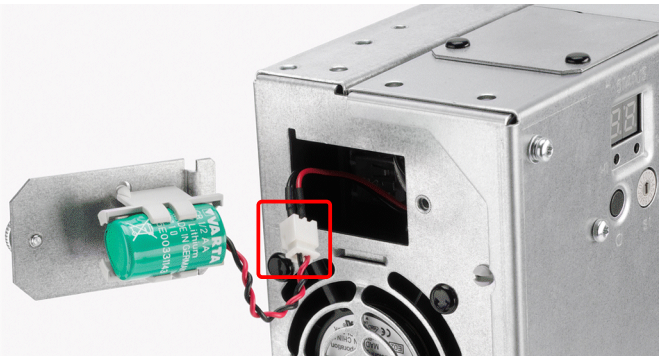
<p>1. Open the battery compartment.</p>	
<p>2. Remove the battery holder.</p>	
<p>3. Release the connecting cable.</p>	
<p>4. Remove the old battery.</p>	
<p>5. Fasten the new battery and reinsert the battery holder.</p>	
<p>6. Close the battery compartment.</p>	

Reconfiguring the BIOS setup

If the battery replacement took longer than 30 seconds, the configuration data of the device has been deleted and you need to reconfigure these in the BIOS Setup.

14.10 Accessories

14.10.1 Overview

The following accessories are available for the PCU 50.5:

Component		Order number
Mounting bracket (1 set = 2 items)	Mounting bracket for PCU, video link receiver or TCU behind the operator panel front	6FC5248-0AF20-2AA0
	Flat mounting bracket for PCU with or without video link transmitter in the control cabinet	6FC5248-0AF20-0AA0
	Book mounting bracket for PCU with or without video link transmitter in the control cabinet	6FC5248-0AF20-1AA1
Memory expansion	1 GB DDR3 1066 MHz DIMM with ECC	6ES7648-2AJ40-1KA0
	2 GB DDR3 1066 MHz DIMM with ECC	6ES7648-2AJ50-1KA0
	4 GB DDR3 1066 MHz DIMM with ECC	6ES7648-2AJ60-1KA0
CompactFlash card	1 GB (empty)	6FC5313-5AG00-0AA1
	2 GB (empty)	6FC5313-5AG00-0AA2
	8 GB (empty)	6FC5313-6AG00-0AA0
USB FlashDrive	8 GB	6ES7648-0DC50-0AA0
SINUMERIK service pack Recovery Media WIN XP ProEmbSys	for PCU with Windows XP ProEmbSys on DVD	
	Part 1:	Windows XP ProEmbSys incl. SP3
	Part 2:	Ghost of basic software; emergency boot
	Part 3 up to part 5:	Multilingual user interface pack (Chinese simplified, Chinese traditional, Danish, German, Finnish, French, Italian, Japanese, Korean, Dutch, Polish, Portuguese/Brazilian, Russian, Swedish, Czech, Turkish, Hungarian)
		Documentation (German/English)
PCI Multi I/O module	2 x COM, LPT	6ES7648-2CA01-0AA0

14.10.2 Installing and removing expansion modules

14.10.2.1 Memory expansion

Expansion options

On the motherboard there are two slots for memory modules (RAM banks).

Depending on what is inserted in the slots, you can expand the memory capacity of the PCU from 1 GB up to 8 GB.

184-pin DDR3 memory modules can be used, unbuffered, with ECC; memory size 1, 2 or 4 GB.

Note

We urgently recommend to use memory modules approved by Siemens. No liability can be accepted for restricted functionality when using memory modules from third-party suppliers.

Preparations

NOTICE
Damage to the module as result of missing EMC measures
The electrostatic components on the PCBs are highly sensitive to electrostatic discharge. It is therefore vital to take precautionary measures when handling these components. Refer to the directives for handling components that are sensitive to electrostatic charge.

1. Disconnect the device from the mains and withdraw all cables from the device.
2. Remove the covers from the service module and motherboard.

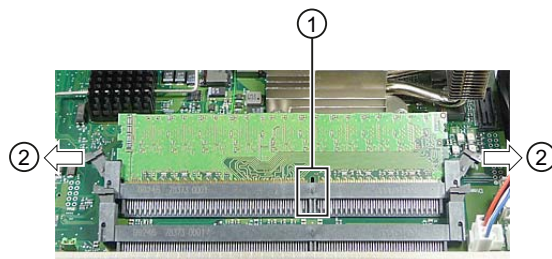

① Twist proof element

② Latches

Figure 14-24 Inserted memory module

Installation of a memory module

1. Insert the module into the socket. When doing so, pay attention to the recess and/or twist proof element ① on the connector side of the RAM module.
2. Press the module downwards, applying slight pressure, until the catches snap into place ②.

The PCU automatically detects the memory module that is installed. When switching on the device, the split between "Base-Memory" and "Extended-Memory" is displayed.

Removal of the memory module

1. Release the latches ② at the left-hand and right-hand sides of the memory module.
2. Withdraw the memory module from the slot.

14.10.2.2 PCI cards

The PCU 50.5 is designed for use with a maximum of two modules conforming to PCI specifications V 2.2. 5 V 32-bit PCI modules, universal (5 V & 3.3 V) 32-bit PCI modules and PCI Express x16 modules can be used.

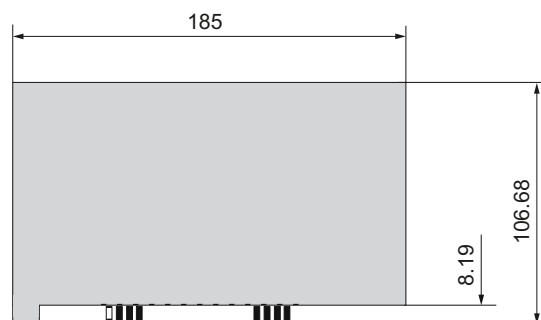

Figure 14-25 Dimension drawing of a short PCI module

Note

The dimensions of the boards must not exceed the specified dimensions. Otherwise, contact problems, malfunctions and installation difficulty cannot be ruled out.

Installing PCI cards

Note

When installing PCI cards, ensure that you do not touch or smudge the golden plug connections of the card. This protects the card from malfunctioning.

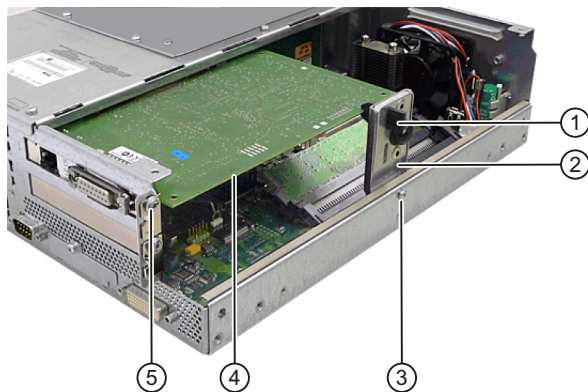

- ① Slider
- ② Module retainer
- ③ Retaining screw for the module retainer
- ④ Expansion module
- ⑤ Fixing screw for the slot sheet plate

Figure 14-26 Expansion module inserted

Procedure

1. Disconnect the PCU from the line supply by withdrawing the line connector.
2. Remove the covers from the service module and motherboard.
3. Release the fixing screw ③ of the module retainer ② and remove the retaining bracket.
4. Release the retaining screws of the slot cover plate ⑤ for the corresponding upper or lower slot and remove the slot plate.
5. Carefully but firmly insert the PCI card ④ into the appropriate slot.
6. Mount the module retainer ②.
7. Lock the PCI card ④ by inserting a slider ① through the guide slot until it securely holds the edge of the module in its groove.

NOTICE

Damage to the module caused by squeezing the slider

No pressure should be applied to the module. Therefore, do not apply excessive force to the slider when you push it onto the module.

8. Using a diagonal cutter, cut off the protruding part of the slider ①.

9. Mount the enclosure covers.

For half-height PCI cards, the following points do not apply: 7. and 8.

Note

If you use cards with a battery connection, connect the connecting cable to the battery before you mount the enclosure covers (see Section: "Installing battery connecting cable").

PCI multi I/O module

If you use the PCI multi I/O module, install the driver from the driver CD provided according to the instructions. The BIOS setup must be modified in order that the card functions error-free. In the menu, set:

Advanced → I/O Device Configuration → Internal COM 1: Disabled

Installing the battery connecting cable

- Only for MC-specific PCI cards.
- Connect the PCI module via the connecting cable to the battery connection ②.

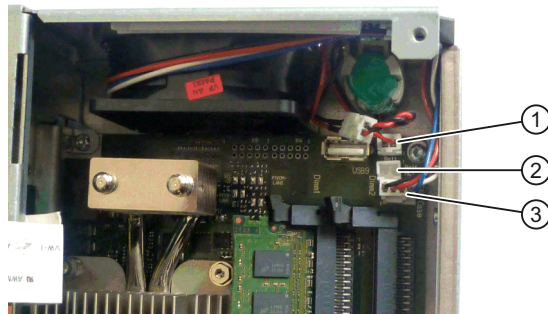

- ① Plug for connecting the backup battery
- ② Connector plug for connecting the PCI module to the battery
- ③ Plug for connecting the device fan

Figure 14-27 Installing the battery connecting cable for PCI modules

14.10.2.3 CompactFlash card

The PCU 50.5 provides a protected slot for CompactFlash cards (types I/II). The slot is located behind the cover plate ②.

We recommend using CompactFlash cards from Siemens for industrial applications because they offer special data security, service life and data transfer speeds.

Note

The slot for the CompactFlash card is not suitable for hot-plugging. You should therefore insert the CompactFlash card before you switch on the PCU and only remove the card after you have switched off the PCU.

Installing the CompactFlash card behind the cover plate

1. Separate the PCU from the power supply by disconnecting the main power connector.
2. Release the fixing screw ③ for the cover plate ② of the slot.
3. Fold up the cover plate ② and slide it towards the DVI-I interface ①. Lift the cover plate slightly until it releases on the left-hand side. Then slide it back until it releases on the right-hand side.
4. Carefully slide the CompactFlash card straight into the card slot until it snaps in. Hold the CompactFlash card so that its label side faces toward the front panel of the PC.
5. Close the card slot by inserting the cover plate ② (lock it on the left and right) and screw in the fixing screw ③.

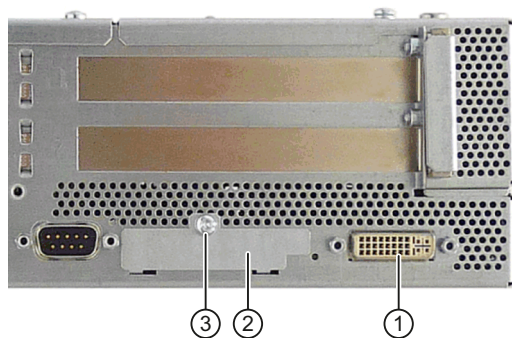

- ① DVI-I interface
- ② Cover plate of the CompactFlash card slot
- ③ Retaining screw for cover plate

Figure 14-28 Installing the CompactFlash card behind the cover plate

Note

The slot for the CompactFlash card is coded against incorrect insertion of the card. If it is incorrectly inserted, then approx. 1 cm protrudes out of the enclosure and it does not function.

NOTICE**Damage to the CompactFlash card caused by forced insertion**

If the CompactFlash card is difficult to insert, then turn the card over. Never insert the CompactFlash card with force.

Removing the CompactFlash card behind the cover plate

1. Open the card slot as described under "Installing the CompactFlash card ..." (points 1-3).
2. Press the eject button on the right-hand side of the module slot (e.g. using the narrow end of the cover plate).

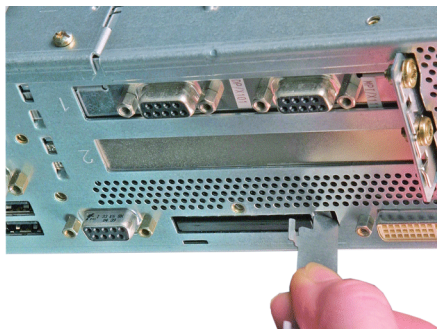

3. Remove the CompactFlash card.
4. Close the card slot.

TCU x0.2

15.1 Description

15.1.1 Overview

A Thin Client Unit (TCU) allows the spatial separation between an OP/TP operator panel front and the PCU/NCU. For this reason, the user interface is copied to one/several operator panel fronts, each with a TCU.

Validity

The description applies to the following TCU:

Designation	Order number
Thin Client Unit 20.2	6FC5312-0DA00-0AA2
Thin Client Unit 30.2	6FC5312-0DA00-1AA0

Features

- Design of flat operator panels through the shallow installation depth and low power loss.
- Graphic: Resolution for 16-bit color depth:
 - TCU 20.2: 640 x 480 to 1024 x 768 pixels
 - TCU 30.2: 640 x 480 to 1280 x 1024 pixels
- Low-vibration installation of the PCU in the control cabinet
- Effective operation of larger machines.
- Signal transmission between PCU/NCU and operator panel via Industrial Ethernet

The distance of the components is determined by the maximum distance between two network nodes/access points (100 m).
- The same operator control screen is displayed simultaneously on all operator panel fronts; it can also be operated from all operator panel fronts.
- The operation on an operator panel front connected via TCU has the same access rights as the operation on an operator panel front connected directly to the PCU.
- The mixed operation of operator panel fronts connected via TCU and an operator panel front connected directly to the PCU is possible.
- TCU x0.2 is compatible with previous models, which means that mixed operation is possible.

Preconditions

- NCU 7x0
- Operator panel fronts:
 - TCU 20.2 / TCU 30.2:
OP 010 / OP 010C / OP 010S / OP 012 / OP 015 / OP 015A / TP 015A
 - TCU 30.2: OP 019

Design

The TCUs are coupled via Ethernet as Thin Clients in a dedicated subnetwork (via DHCP server on the PCU/NCU) to the PCU/NCU.

Interfaces:

- To connect the mouse, keyboard and USB flash drive
 - TCU 20.2: 3 x USB 2.0
 - TCU 30.2: 5 x USB 2.0
- Ethernet 10/100/1000 Mbit/s

The speed in Ethernet system networks automatically sets itself to the maximum possible value. 1000 Mbit/s can only be achieved with NCU 7x0.3 PN and PCU 50.5 (if a PCU is required).

Note

The Ethernet interfaces have what is called autocrossing functionality, i.e. when required, send and receive lines switch over. If, however, the partner does not permit "Autocrossing", a crossover cable is required.

15.1.2 Configurations

Configurations

The following configurations of the distributed structure are possible with a TCU x0.2:

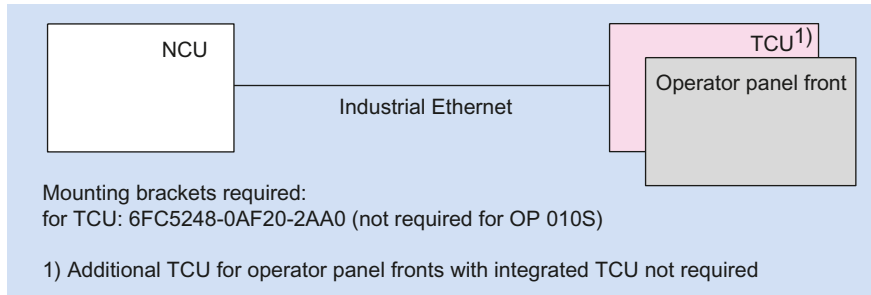

Figure 15-1 Minimum configuration with an operator panel front

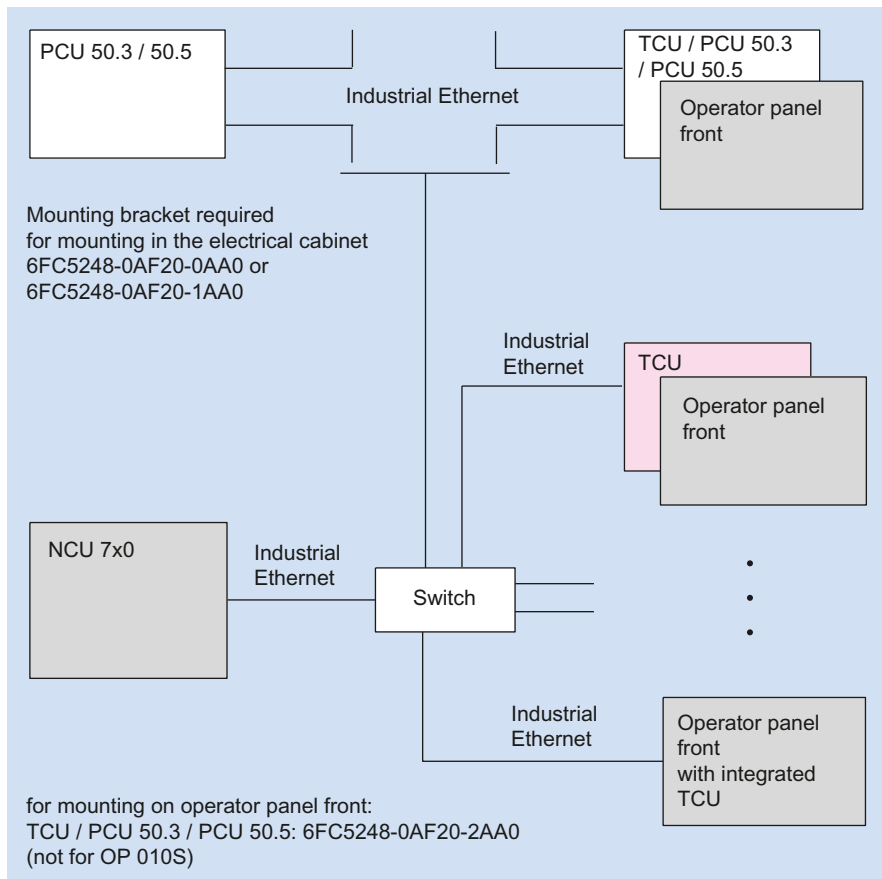

Figure 15-2 Maximum configuration, several TCUs connected to an NCU 7x0

Information about TCU commissioning can be found in "General information and networking", Chapter: "Networking".

15.2 Interfaces

Overview

Function	Designation	Description
Double USB interface 1 ¹⁾	X203 / X204	2 x USB 2.0 type A
Double USB interface 2 ¹⁾	X212 ²⁾ / X213	2 x USB 2.0 type A
Interface for direct keys	X205	2 x 10-pin plug connector
24 VDC power supply	X206	3-pin terminal block
I/O USB interface K1 ^{3) 4)}	X207	2 x 13-pin plug connector
LVDS display interface K2 ^{3) 4)}	X208	2 x 10-pin plug connector
LVDS display interface K3 ⁴⁾	X209 ²⁾	2 x 10-pin plug connector
Ethernet interface	X202	8-pin RJ45 socket
USB interface	X211 ²⁾	USB 2.0 type A

1) One of the interfaces can be loaded with 500 mA, the other with 100 mA.

2) Only TCU 30.2

3) To connect to an operator panel front 10" up to 15"

4) To connect to an operator panel front OP 019

View

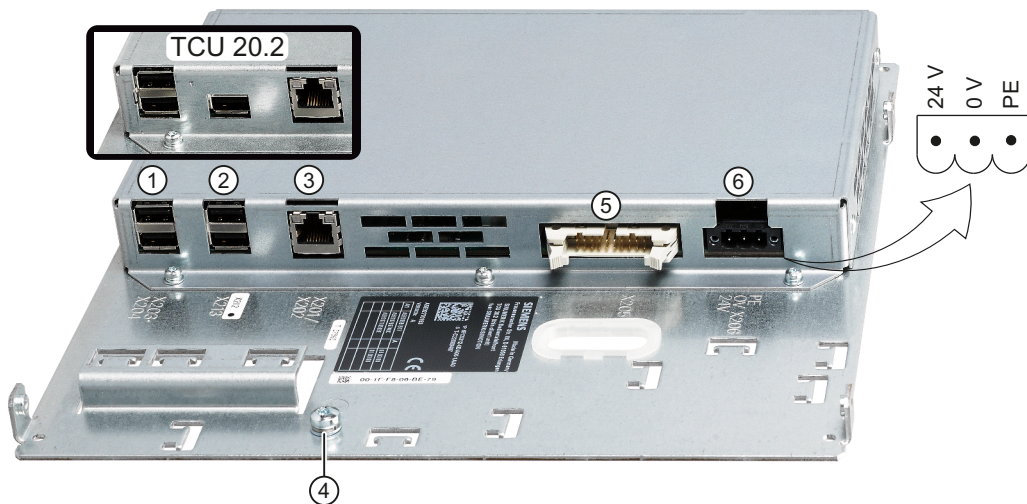

- ① X203/X204 USB interfaces
- ② X212/X213 USB interfaces (for TCU 20.2, there is no X212)
- ③ X202 Ethernet interface
- ④ - Grounding screw
- ⑤ X205 Interface for direct keys
- ⑥ X206 24 VDC power supply

Figure 15-3 Front view of the TCU 30.2 with interfaces

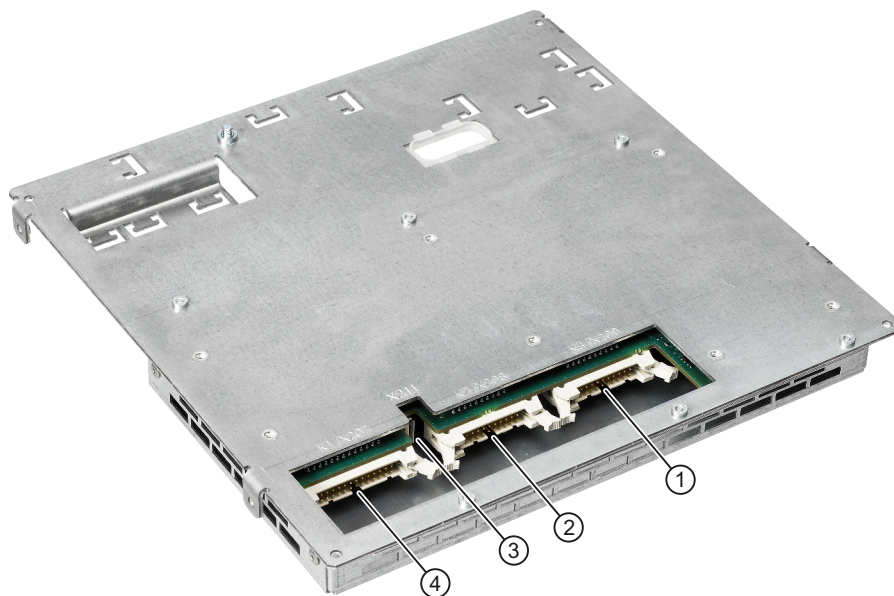

- | | | |
|---|------|--|
| ① | X209 | LVDS display interface K3 (not for TCU 20.2) |
| ② | X208 | LVDS display interface K2 |
| ③ | X211 | USB interface (not for TCU 20.2) |
| ④ | X207 | I/O USB interface K1 |

Figure 15-4 Rear view of the TCU 30.2 with interfaces

Pin assignment

The pin assignment of the interfaces, see "General information and networking" → "Connecting".

15.3 Mounting the TCU on the operator panel front

Before assembling the two components, the interface cables of the operator panel front (IO/USB cable K1, K2 display cable and, if necessary, K3) must be inserted into the corresponding socket of the TCU (visible behind the housing cut-out).

OP 010S

The operator panel front OP 010S and the TCU are screwed together without additional mounting brackets.

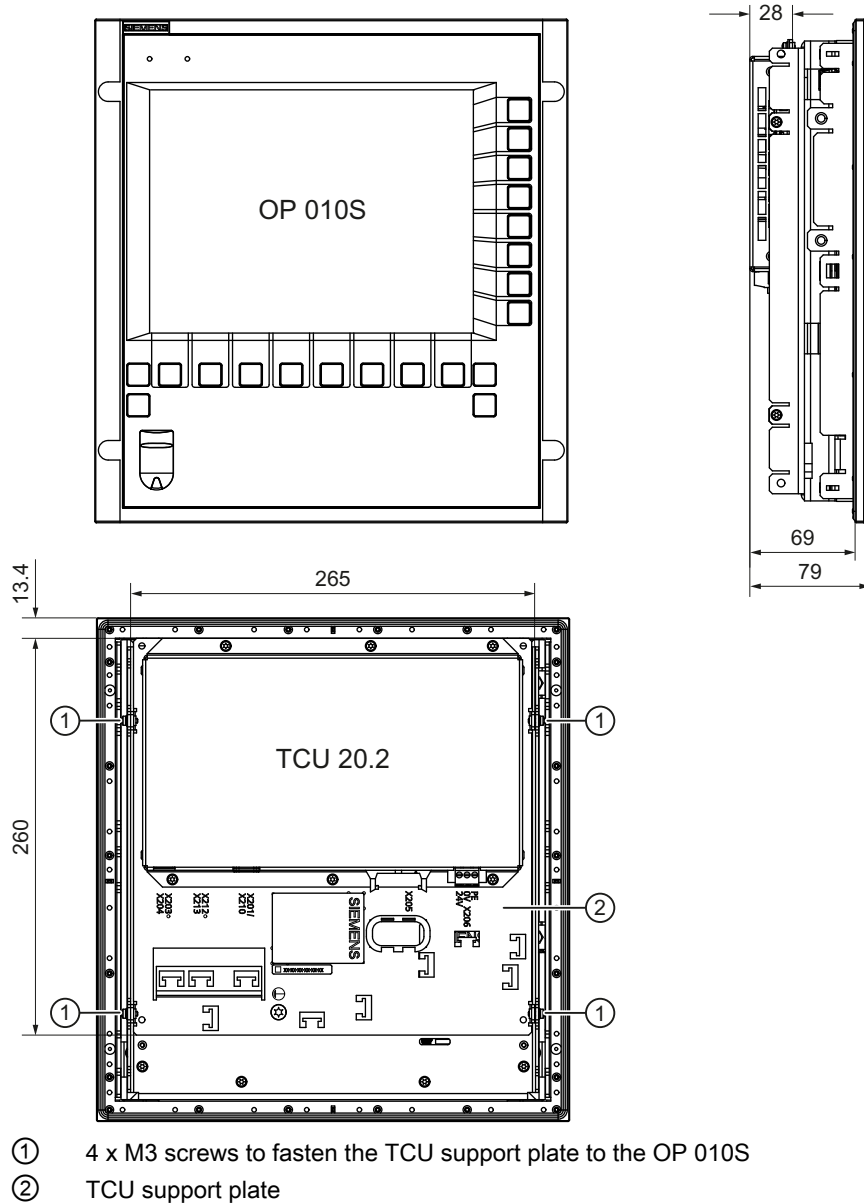
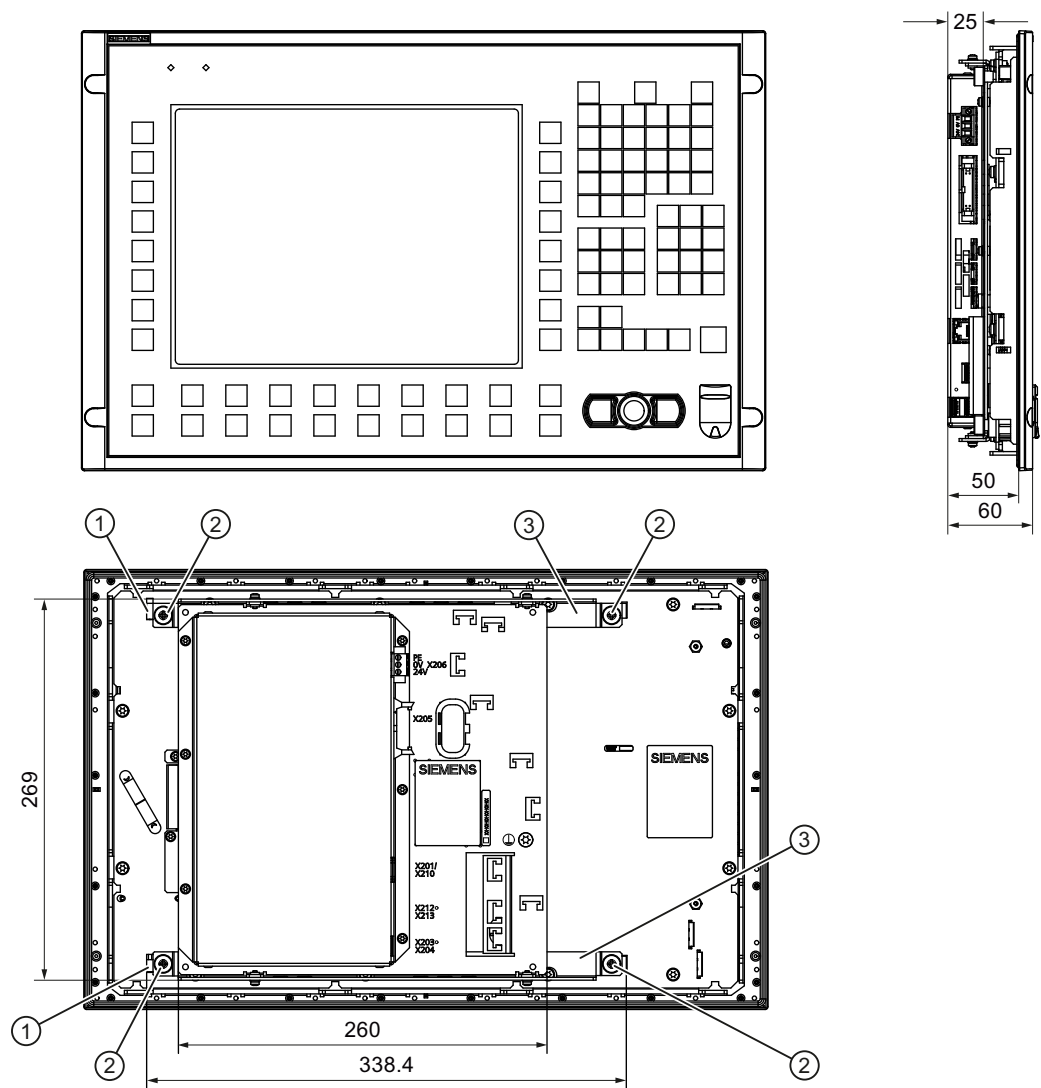

Figure 15-5 Mounted TCU with OP 010S, front, side and rear view

OP 010, OP 010C, OP 012, OP 015, OP 015A, TP 015A

Two mounting brackets (must be ordered separately) are required for mounting these operator panel fronts (see Section: "Accessories").

1. Screw the mounting bracket ③ onto the TCU.
2. Use the two hinge catches ① to suspend the TCU mounting bracket unit (like a PCU) in the operator panel front.
3. Insert cables K1 and K2.
4. Close the cabled TCU mounting bracket unit and attach it using the four knurled screws ②.



- ① 2 x hinge catches
- ② 4 x knurled screws for attaching the mounting brackets to the operator panel front
- ③ 2 x mounting brackets

Figure 15-6 Mounted TCU (example with OP 012) in front, side and rear view

OP 019

Two mounting brackets (must be ordered separately) are required for mounting this operator panel front (see Section: "Accessories").

1. Screw the mounting bracket ③ onto the TCU.
2. Use the two hinge catches ① to suspend the TCU mounting bracket unit (like a PCU) in the operator panel front.
3. Insert cables K1, K2 and K3.
4. Close the cabled TCU mounting bracket unit and attach it using the four knurled screws ②.

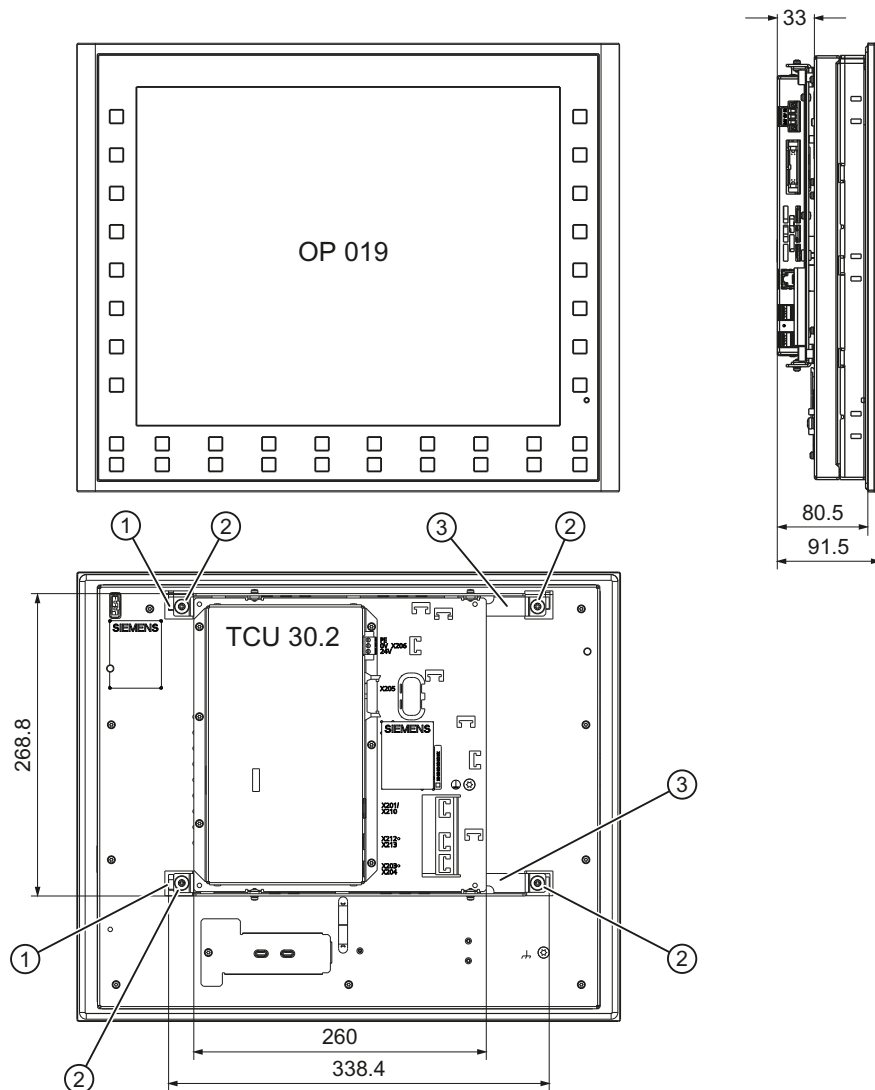

- ① 2 x hinge catches
- ② 4 x knurled screws for attaching the mounting brackets to the operator panel front
- ③ 2 x mounting brackets

Figure 15-7 Mounted TCU 30.2 with OP 019, front, side and rear views

Tensile strain relief

Since some of the interfaces do not have a cable strain relief for the cables to be connected, it is recommended to secure the cables to the u-shaped lugs on the supporting plate using cable ties.

15.4 Technical data

Safety			
Safety class	III; PELV according to EN 50178		
Degree of protection according to DIN 40050	IP20 (mounted)		
Approvals	CE / cULus		
Electrical data			
Power supply ¹⁾	24 VDC (20.4 V ... 28.8 V)		
Power consumption, max.	TCU 20.2: 9 W ²⁾ / 40 W ³⁾	TCU 30.2: 10 W ²⁾ / 60 W ⁴⁾	
Mechanical data (without packing)			
Dimensions	Width: 260 mm	Height: 265 mm	Depth: 34 mm
Weight	1.96 kg		

¹⁾ The power supply must be provided as protective extra low-voltage with safe isolation (according to EN 60204-1, PELV).

²⁾ Only TCU

³⁾ TCU with OP 015 and 2 x 0.5 A at USB

⁴⁾ TCU with OP 019 and 2 x 0.5 A / 4 x 0.1 A at USB

Note

Information about the climatic and mechanical environmental conditions is contained in the associated section under:

"General notes and interconnection" → "Operational planning".

15.5 Accessories

Table 15- 1 Accessories for TCU

Components		Description	Number	Order number
Mounting bracket		Mounting bracket for PCU, video link receiver or TCU behind operator panel front	1 set (2 items)	6FC5248-0AF20-2AA0
Direct key cable		Ribbon cable for connection of the direct key interfaces for OP and TCU.	1	6FC5347-0AF10-0AA0
Industrial Ethernet cable	IE FC Standard Cable GP 2 x 2 (Type A)	4-core, shielded TP installation cable for connection to IE FC Outlet RJ45/ IE FC RJ45 Plug; PROFINET-compatible; with UL approval; sold by the meter (max. 1000 m; min. 20 m);	1	6XV1840-2AH10
	IE FC Trailing Cable GP 2 x 2 (Type C)	4-core, shielded TP installation cable for connection to IE FC Outlet RJ45/ IE FC RJ45 Plug 180/90 for use in trailing cables; PROFINET-compatible; without UL approval; sold by the meter (max. 1000 m; min. 20 m);	1	6XV1840-3AH10
Plug-in connector	IE FC RJ45 Plug 180	RJ plug connector for Industrial Ethernet with robust metal housing and integrated cutting/clamping contacts; with 180° outgoing cable	1	6GK1901-1BB10-2AA0

Index

7

- 7-segment displays
 - PCU 50.3, 242

B

- Backlight inverter
 - OP 015, 95
 - OP 015A, 112
 - OP 015AT, 130
 - TP 015A, 149
 - TP 015AT, 169
- Backup battery
 - PCU 50.3, 261
- Battery replacement, 335
- BIOS setup
 - PCU 50.3, 242
 - PCU 50.5, 311
- Boot list
 - PCU 50.3, 239
- Boot sequence
 - Error messages, 321
- Booting
 - Error messages, 321

C

- Coding switches
 - Direct control key module, 197
 - Direct key module, 201
- Compact Flash card
 - PCU 50.3, 272
- CompactFlash card
 - PCU 50.5, 342
- Configurations
 - TCU 30.2, 347

D

- DB19, 316
- DHCP server
 - Thin Client Unit, 346
- Direct control key module
 - Coding switches, 197

- DKM cable, 194
 - Profibus connector, 197
- Direct key module
 - Coding switches, 201
 - Dimensions, 205
 - DKM cable, 202
 - LEDs, 192
 - Power consumption, 205
 - PROFIBUS cable, 193
 - PROFIBUS DP, 191
- Display support
 - OP 010, 42
 - OP 012, 82
 - OP 015, 95
 - OP 015A, 112
 - OP 015AT, 130
 - TP 015AT, 169
- DKM cable
 - Direct control key module, 194
 - Direct key module, 202

E

- Error messages
 - Booting, 321
- Ethernet cable
 - Thin Client Unit, 354
- Ethernet strain relief, 303
- Ethernet, industrial
 - PCU 50.3, 208
 - Thin Client Unit, 345

F

- FB9 Proxy, 315
- fb9_proxy.ini, 317
- Film labels
 - OP 010, 41
 - OP 012, 82
- Flat mounting
 - PCU 50.3, 222
- Front USB interface
 - OP 010, 30
 - OP 010C, 56
 - OP 010S, 46
 - OP 012, 68
 - OP 015, 86

OP 015A, 99
TP 015A, 138

H

Hard disk drive
PCU 50.3, 237
PCU 50.5, 275

I

Individual parts
OP 010, 39
OP 010C, 65
OP 010S, 52
OP 012, 79
OP 015, 94
OP 015A, 111
OP 015AT, 129
TP 015A, 148
TP 015AT, 168

K

Key symbols
OP 010, 31
OP 010C, 58
OP 010S, 87
OP 012, 141
OP 015, 87
OP 019, 180
OP 08T,
TP 015A, 141
Keyboard controller
OP 010, 41
OP 012, 82
OP 015, 95
OP 015A, 112
OP 015AT, 130
TP 015A, 151
TP 015AT, 171

L

LCD unit
OP 010, 41
OP 012, 82
OP 015, 94
OP 015A, 112
OP 015AT, 130

TP 015A, 149
TP 015AT, 169

LEDs

Direct key module, 192
PCU 50.3, 243
PCU 50.5, 279
Lithium battery, 335

M

Membrane connector
OP 012, 82
Memory expansion
PCU 50.3, 267
PCU 50.5, 338
Mounting bracket
OP 012, 75
OP 015A, 112
PCU 50.3, 222
Thin Client Unit, 354
TP 015A, 149

O

On/off switch
PCU 50.5, 278
On/Off switch
PCU 50.3, 210
OP 010
Dimension sheet, 35
Dimensions, 38
Front USB interface, 30
Individual parts, 39
Installation, 35
Key symbols, 31
Keypads, 31
Mounting opening, 61
Power consumption, 38
Slide-in labels, 39
TFT flat screen, 29
Tightening torques, 38
VGA resolution, 29
OP 010C
Dimension sheet, 61
Dimensions, 64
Front USB interface, 56
Individual parts, 65
Key symbols, 58
Keypads, 57
Power consumption, 64
TFT flat screen, 55

- Tightening torques, 64
 - VGA resolution, 55
 - OP 010S
 - Dimension sheet, 49
 - Dimensions, 52
 - Front USB interface, 46
 - Individual parts, 52
 - Key symbols, 87
 - Power consumption, 52
 - TFT flat screen, 45
 - Tightening torques, 52
 - VGA resolution, 45
 - OP 012
 - Dimension sheet, 73
 - Dimensions, 79
 - Front USB interface, 68
 - Individual parts, 79
 - Key symbols, 141
 - Keypads, 140
 - Mounting bracket, 75
 - Mounting opening, 73
 - Power consumption, 79
 - SVGA resolution, 67
 - TFT flat screen, 67
 - Tightening torques, 79
 - OP 015
 - Dimension sheet, 89
 - Dimensions, 93
 - Front USB interface, 86
 - Individual parts, 94
 - Key symbols, 87
 - Mounting opening, 185
 - Power consumption, 93
 - TFT flat screen, 85
 - Tightening torques, 93
 - OP 015A
 - Dimension sheet, 105
 - Dimensions, 111
 - Front USB interface, 99
 - Individual parts, 111
 - Mounting bracket, 112
 - Mounting opening, 105
 - Power consumption, 111
 - TFT flat screen, 99
 - Tightening torques, 111
 - OP 015AT
 - Dimension sheet, 127
 - Dimensions, 129
 - Individual parts, 129
 - Power consumption, 129
 - TFT flat screen, 121
 - Tightening torques, 129
 - OP 019
 - Dimensions, 190
 - Key symbols, 180
 - LED displays, 181
 - Mounting opening, 185
 - Order number, 177
 - Power consumption, 190
 - TFT flat screen, 177
 - Tightening torques, 190
 - View, 179
 - OP 08T
 - Dimensions, 19
 - Power consumption, 19
 - Tightening torques, 19
 - Operating system
 - PCU 50.3, 208
- P**
- PCI card
 - PCU 50.3, 271
 - PCU 50.5, 340
 - PCI hardware interrupt, 292
 - PCI multi I/O module, 341
 - PCU 50.3
 - 7-segment displays, 242
 - Backup battery, 261
 - BIOS setup, 242
 - Boot list, 239
 - Compact Flash card, 272
 - Device fan, 260
 - Dimensions, 252
 - Ethernet, industrial, 208
 - Flat mounting, 222
 - Hard disk drive, 256
 - LEDs, 243
 - Memory expansion, 267
 - Mounting bracket, 266
 - Mounting positions,
 - On/Off switch, 210
 - Operating system, 208
 - PCI card, 271
 - Power consumption, 252
 - Power supply, 258
 - Power supply module fan, 259
 - Processor, 208
 - Screen resolution, 208
 - Standard mounting, 222
 - Touch software, 244
 - USB FlashDrive, 239
 - Working memory, 208

PCU 50.5
 BIOS setup, 311
 CompactFlash card, 342
 Dimension drawings for mounting, 294
 Dimensions, 326
 Hard disk drive, 275
 Insert the battery connecting cable, 341
 LEDs, 279
 Memory expansion, 338
 Mounting bracket, 337
 Mounting positions, 302
 On/off switch, 278
 PCI card, 340
 Power consumption, 326
 Screen resolution, 276
 Touch software, 312
 USB FlashDrive, 309
 Work memory, 275
PLC alarms, 319
Power supply
 PCU 50.5, 331
Processor
 PCU 50.3, 208
PROFIBUS cable
 Direct key module, 193
Profibus connector
 Direct control key module, 197
PROFIBUS DP
 Direct key module, 191

R

Replacement intervals, 328
Replacing
 Battery, 335

S

Screen calibration
 TP 015A,
 TP 015AT,
Screen resolution
 PCU 50.3, 208
 PCU 50.5, 276
Slide-in labels
 OP 010, 39
 OP 012, 80
 OP 015A, 112
 OP 015AT, 130
 TP 015A, 149
 TP 015AT, 169

Standard mounting
 PCU 50.3, 222
SVGA resolution
 OP 012, 67

T

TCU 30.2
 Configurations, 347
TFT flat screen
 OP 010, 29
 OP 010C, 55
 OP 010S, 45
 OP 012, 67
 OP 015, 85
 OP 015A, 99
 OP 015AT, 121
 TP 015AT, 159
Thin Client Unit
 DHCP Server, 346
 Dimensions, 353
 Ethernet cable, 354
 Ethernet, industrial, 345
 Mounting bracket, 354
Touch controller
 TP 015A, 151
 TP 015AT, 171
Touch Screen
 TP 015A, 138
Touch software
 PCU 50.3, 244
 PCU 50.5, 312
TP 015A
 Dimension sheet, 144
 Dimensions, 148
 Front USB interface, 138
 Individual parts, 148
 Key symbols, 141
 Keypads, 140
 Mounting opening, 144
 Power consumption, 148
 Tightening torques, 148
 Touch Screen, 138
 XGA resolution, 138
TP 015AT
 Dimension sheet, 166
 Dimensions, 168
 Individual parts, 168
 Power consumption, 168
 TFT flat screen, 159
 Tightening torques, 168

U

USB FlashDrive
 PCU 50.3, 239
 PCU 50.5, 309

V

VGA resolution
 OP 010, 29
 OP 010C, 55
 OP 010S, 45

W

Work memory
 PCU 50.5, 275
Working memory
 PCU 50.3, 208

X

XGA resolution
 TP 015A, 138

SIEMENS

SINUMERIK

SINUMERIK 840D sl Handheld units

Manual

<u>Handheld Terminal HT 2</u>	1
<u>Handheld Terminal HT 8</u>	2
<u>Mini-handheld unit</u>	3
<u>Electronic handheld handwheel</u>	4
<u>Handheld unit / distributor box</u>	5
<u>Handwheel connection module</u>	6

Valid for:
Control
SINUMERIK 840D sl / 840DE sl



03/2013

6FC5397-1AP40-3BA0

Legal information

Warning notice system

This manual contains notices you have to observe in order to ensure your personal safety, as well as to prevent damage to property. The notices referring to your personal safety are highlighted in the manual by a safety alert symbol, notices referring only to property damage have no safety alert symbol. These notices shown below are graded according to the degree of danger.

 DANGER
indicates that death or severe personal injury will result if proper precautions are not taken.
 WARNING
indicates that death or severe personal injury may result if proper precautions are not taken.
 CAUTION
indicates that minor personal injury can result if proper precautions are not taken.
NOTICE
indicates that property damage can result if proper precautions are not taken.

If more than one degree of danger is present, the warning notice representing the highest degree of danger will be used. A notice warning of injury to persons with a safety alert symbol may also include a warning relating to property damage.

Qualified Personnel

The product/system described in this documentation may be operated only by **personnel qualified** for the specific task in accordance with the relevant documentation, in particular its warning notices and safety instructions. Qualified personnel are those who, based on their training and experience, are capable of identifying risks and avoiding potential hazards when working with these products/systems.

Proper use of Siemens products

Note the following:

 WARNING
Siemens products may only be used for the applications described in the catalog and in the relevant technical documentation. If products and components from other manufacturers are used, these must be recommended or approved by Siemens. Proper transport, storage, installation, assembly, commissioning, operation and maintenance are required to ensure that the products operate safely and without any problems. The permissible ambient conditions must be complied with. The information in the relevant documentation must be observed.

Trademarks

All names identified by ® are registered trademarks of Siemens AG. The remaining trademarks in this publication may be trademarks whose use by third parties for their own purposes could violate the rights of the owner.

Disclaimer of Liability

We have reviewed the contents of this publication to ensure consistency with the hardware and software described. Since variance cannot be precluded entirely, we cannot guarantee full consistency. However, the information in this publication is reviewed regularly and any necessary corrections are included in subsequent editions.

Table of contents

1	Handheld Terminal HT 2.....	7
1.1	Description	7
1.2	Operator control and display elements	9
1.2.1	Overview	9
1.2.2	Description	10
1.3	I/Os.....	14
1.3.1	Overview	14
1.3.2	Terminal Box PN	15
1.3.2.1	Features	15
1.3.2.2	PN Plus terminal box	17
1.3.2.3	Interface assignment on the PN Plus terminal box.....	18
1.3.2.4	PN Basic terminal box.....	25
1.3.3	Connection module Basic PN	26
1.3.3.1	Features	26
1.3.3.2	Dimension drawing	27
1.3.3.3	interfaces.....	28
1.3.3.4	Installing the terminating connector	31
1.3.4	Connection examples of enabling button and emergency stop button.....	33
1.3.5	Connecting cable	37
1.3.6	MPP 483 HTC.....	41
1.3.7	Power Supply.....	41
1.4	Unplugging/plugging during operation	42
1.5	Commissioning.....	42
1.5.1	BIOS.....	42
1.5.1.1	BIOS powering up.....	42
1.5.1.2	Settings in the BIOS menu.....	43
1.5.1.3	Error handling.....	45
1.5.2	Interface signals	46
1.5.3	Application example for HT8 and HT 2 involving mixed operation	53
1.5.4	Application example for two HT 2 units connected to SINUMERIK.....	55
1.6	Dimension drawing	57
1.7	Maintenance and Service	58
1.8	Technical data.....	59
1.8.1	Handheld Terminal HT 2.....	59
1.8.2	Connection module Basic PN	62
1.8.3	PN terminal box	63
1.9	Spare parts.....	64
1.10	Accessories.....	64
1.10.1	Overview	64
1.10.2	Mount	65
1.10.3	Retaining magnet.....	66

1.10.4	Slide-in label.....	69
1.10.4.1	Labeling the slide-in labels.....	69
1.10.4.2	Replacing the slide-in labels	74
2	Handheld Terminal HT 8.....	75
2.1	Description	75
2.2	Operator controls and indicators	77
2.2.1	View.....	77
2.2.2	Description	80
2.2.3	Screen brightness control	83
2.3	interfaces.....	84
2.3.1	Overview	84
2.3.2	Description	84
2.4	Ports	87
2.4.1	Overview	87
2.4.2	Terminal Box PN	88
2.4.2.1	Features	88
2.4.2.2	PN Plus terminal box.....	90
2.4.2.3	PN Basic terminal box.....	91
2.4.2.4	Interface assignments.....	92
2.4.3	Connecting module Basic PN	92
2.4.3.1	Features	92
2.4.3.2	Dimension drawing.....	94
2.4.3.3	interfaces.....	95
2.4.3.4	Installing the terminating connector	98
2.4.4	MPP 483HTC.....	99
2.4.5	Connecting cables.....	99
2.4.6	Power Supply	103
2.5	Commissioning.....	104
2.5.1	SINUMERIK Operate	104
2.5.1.1	Activating/deactivating the virtual keyboard.....	104
2.5.1.2	Configuring the traversing keys	104
2.5.1.3	Configuring user-specific key labeling	109
2.5.1.4	Configuring the function display at user-specific keys (U keys).....	112
2.5.2	HMI Advanced.....	114
2.5.2.1	Configuring the traversing keys of the HT 8.....	114
2.5.2.2	Configuring user-specific key labeling	116
2.6	Unplugging/plugging during operation	118
2.7	Maintenance and Service.....	119
2.8	Technical data	121
2.8.1	Handheld Terminal HT 8.....	121
2.8.2	Connection module Basic PN	124
2.8.3	PN terminal box.....	125
2.9	Spare parts.....	126
2.10	Accessories	126
2.10.1	Overview	126
2.10.2	Wall holder	127

3	Mini-handheld unit	129
3.1	Description	129
3.2	Operator controls	130
3.3	Dimension drawing	133
3.4	Connection	134
3.5	Configuration	138
3.6	Maintenance and Service	139
3.7	Technical specifications	141
3.8	Spare parts / accessories	142
4	Electronic handheld handwheel	147
4.1	Description	147
4.2	Dimension drawing	149
4.3	Connection	151
4.4	Technical specifications	152
4.5	Accessories	153
5	Handheld unit / distributor box	155
5.1	Description	155
5.2	Operating and display elements	156
5.2.1	View	156
5.2.2	Description	157
5.3	Connecting	160
5.3.1	Connecting a device	160
5.3.2	Connecting several devices	161
5.3.3	Unplugging/plugging during operation with emergency stop override	162
5.3.4	MPI/OPI networking rules	166
5.4	Start up	168
5.4.1	Settings in handheld unit	168
5.4.2	Configuring	170
5.4.3	Interface signals	171
5.5	Distributor box for handheld unit	178
5.5.1	Overview	178
5.5.2	Interfaces	179
5.5.3	Mounting	182
5.5.4	Connections	182
5.6	Technical data	183
5.7	Spare parts	184
5.8	Accessories	185

6	Handwheel connection module.....	187
6.1	Description	187
6.2	Interfaces.....	188
6.2.1	Overview	188
6.2.2	Input / output images.....	189
6.3	Settings via DIP switch S3	190
6.4	Mounting.....	191
6.5	Technical data.....	193
6.6	Accessories	193
	Index.....	195

Handheld Terminal HT 2

1.1 Description

The SINUMERIK HT 2 (Handheld Terminal 2) has been designed for manual operation of machine tools and distinguishes itself as a result of its ruggedness and ease of handling. The low weight and the ergonomic design make this unit easy to use, even over longer periods of time.

The HT 2 should be preferably used if it is necessary to be mobile while monitoring or controlling the machine tool (e.g. during setting-up procedures). In this case, the HT 2 can be connected at any system location via a PN Basic terminal box or a PN Plus terminal box. If used in conjunction with the PN Plus terminal box, the HT 2 can simply be withdrawn and inserted during actual operation without initiating an emergency stop.

For mounting in the control cabinet, the HT 2 is connected with a connection module PN Basic.

The HT 2 is suitable for both for right-handed and left-handed personnel as it has two enabling buttons. The magnetic handwheel allows intuitive axis feed motion. All of the HT 2 keys can be freely configured and labeled.

The HT 2 can be mounted using a retaining magnet or an appropriate bracket. Both the retaining magnet as well as the holder are available as accessory (refer to Section: "Accessories").

Validity

The following description applies to the following components:

Name	Features	Order No.
HT 2	Enabling button, emergency stop button, override rotary switch	6FC5303-0AA00-2AA0

The safety related accessories are market in the "Accessories" section with a *).

Function blocks

In the unit:

- PCB with CPU, memory
- Ethernet controller

Device front:

- LC display (black / white)
 - Resolution: 168 x 72 pixels
 - LCD controller on board
 - 4 lines each with 16 characters can be displayed
- 20-key membrane keyboard
 - 16 machine control keys
 - 4 keys (upper row of keys) can be assigned as softkey or system key
- Emergency stop button, 2-channel
- Rotary override switch (19 positions)
- Magnetic handwheel

Device rear side:

- Recess for the bracket or retaining magnet
- Cable duct for the HT 2 connecting cable to
 - terminal box PN (Basic / Plus)
 - PN Basic connection module

Right-hand side of the device

- Key-operated switch (3 positions, 2 keys)
- Enabling button (2-channel, 3-stage)

Left-hand side of the device:

- Enabling button (2-channel, 3-stage)

1.2 Operator control and display elements

1.2.1 Overview



- (1) Emergency stop button (stop button)
- (2) Rotary override switch
- (3) Display
- (4) Keyboard
- (5) Handwheel
- (6) Enabling button (left)
- (7) Enabling button (right)
- (8) Opening for the cable entry
- (9) Cable duct cover
- (10) Type plate
- (11) Standard position mounting bracket (optional: Retaining magnet)
- (12) Standard position retaining magnet (optional: Mounting bracket)
- (13) Key-operated switch

Figure 1-1 Operator control and display elements of the HT 2

1.2.2 Description

Display

The Handheld Terminal HT 2 is equipped with an LCD display (black / white). The display has a resolution of 168 x 72 pixels. This means that for a normal font of 16 pixels high, 4 lines each with 16 characters can be displayed.

Keyboard

On the HT 2 there are a total of 20 keys each assigned 1 LED. Of which











- All 4 keys in the upper row of keys can be used as softkeys as well as system keys.
- The remaining 16 keys are reserved for the machine control.

When supplied from the factory, the HT 2 has 5 horizontal slide-in labels.

One of these slide-in labels is not printed. The remaining four slide-in labels have standard symbols for the machine control printed on them.

The standard symbols used and their position on the slide-in labels are listed together with the corresponding symbol number in the table.

Table 1- 1 Standard symbols on the slide-in labels

-	(specific)	-	(specific)	-	(specific)	-	(specific)
 JOG	7001	 AUTO	7015		7048	X	7011
 FEED STOP	7025	 FEED START	7026	+	7112	Y	7022
 SPINDLE STOP	7013	 SPINDLE START	7124	 RAPID	7027	Z	7028
 CYCLE STOP	7020	 CYCLE START	7021	—	7111	4 4TH AXIS	7029

Symbols that you specify can be printed on all of the slide-in labels. Blank films are available for this purpose.

Information on the order number for the blank films and for printing as well as exchanging the slide-in labels is provided in the following Section: "Accessories" → "Slide-in labels".

Rotary override switch

The rotary override switch of the HT 2 has 19 positions.

The evaluation scale (0 to max.) is specified by the machine's manufacture in the form of machine data.

Handwheel

The HT 2 handwheel has magnetic bearings.

A turning knob is integrated in the handwheel knob. This allows fast rotary motion to be executed using a finger (run-on < 1 revolution).

Individual increments can be reliably moved at the machine – as the transition from one position to another can be clearly sensed.

The handwheel operates with 100 pulses/revolution and has a cogging torque of approx. 1.5 Ncm (+/- 0.3). The max. speed is 1000 rpm

Emergency stop button

The red emergency stop mushroom pushbutton has a yellow ring.

Directly under the mushroom pushbutton, there is also a black ring which identifies the position status of the emergency stop button.

	State	
Ring (black)	Visible	not visible
Emergency stop button	Not pressed	Pressed

If an emergency stop is triggered, the button locks into place.

If the button is locked into place, it can be unlocked by rotating it to the right.

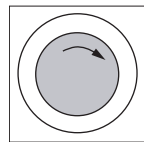

Emergency stop button

Press the red button in emergencies when

- people are at risk,
- there is the danger of machines or the workpiece being damaged.

As a rule, when operating the emergency stop button, all drives are brought to a standstill with max. braking torque.

Machine manufacturer

For other reactions to the emergency stop:

Refer to the machine tool manufacturer's instructions!



The signals are sent via the connecting cable to the terminal box or the connection module and are available for further wiring.

Enabling button

The HT 2 has two enabling buttons that are logically grouped.

This allows the enabling function to be triggered by either the left or the right hand during normal operation.

The enabling buttons comprise a 3-stage operator element and separate evaluation electronics. They have a 2-circuit configuration.

The actuator comprises two symmetrically arranged rockers whose position is determined using electrical sensors and which is transferred to the evaluation electronics.

The enabling buttons can assume one of three different switch positions.

Switch position	Function	Enabling button	Switching contact
1	Zero position	Not actuated	Off (open)
2	Agreement	Actuated	On (closed)
3	Panic	Pressed	Off (open)

The switching sequences, shown in the diagrams are possible for the enabling buttons.

Normal actuation

Zero position → X → Agreement → Y → Zero position

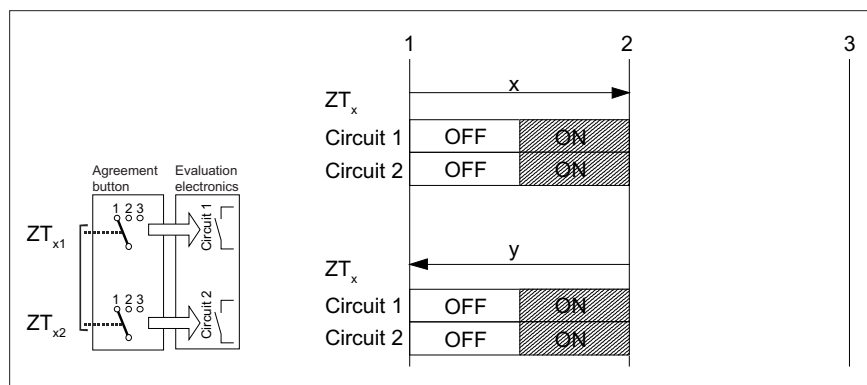

Figure 1-2 Switching distance diagram for normal actuation

Panic actuation

Completely pressing the actuator to the panic position is evaluated by the fact that when released, the agreement position is skipped.

Zero position → X → Agreement → U → Panic → Y → Zero position

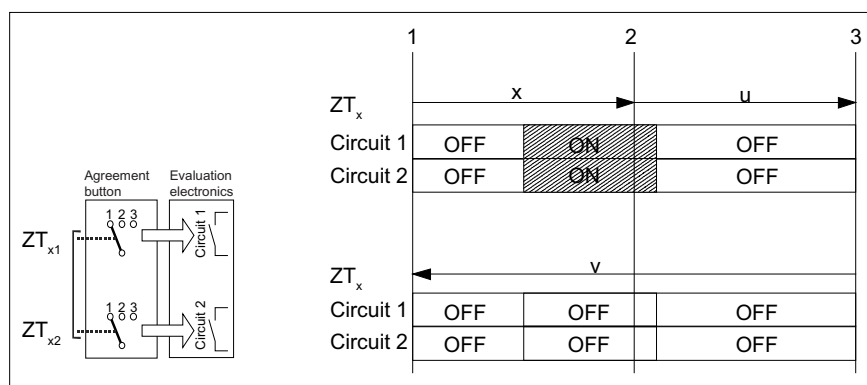

Figure 1-3 Switching distance diagram for panic actuation

The signals are sent via the connecting cable to the terminal box or the connection module and are available for further wiring.

 **WARNING**

Danger of death resulting from the misuse of the enabling button

It is not permitted to fix the enabling button in the "Enable" position by mechanical means.

Key-operated switch

The key-operated switch has three positions: I - 0 - II.

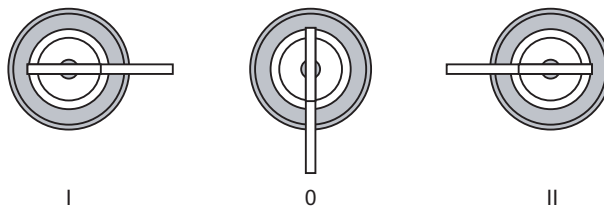

Figure 1-4 Key-operated switch positions

The key can be removed in the switch position 0.

Remove the key after use. This avoids possible damage to the key if the HMI device falls down.

Note

The key for the key-operated switch is provided with the HMI device. Its coding is not specific to the device. This means the key can be used on any Handheld Terminal HT 2.

1.3 I/Os

1.3.1 Overview

The Handheld Terminal HT 2 communicates with a control unit via

- PN Basic terminal box/PN Plus terminal box, or
- PN Basic connection module (for control cabinet installation) or
- MPP 483 HTC

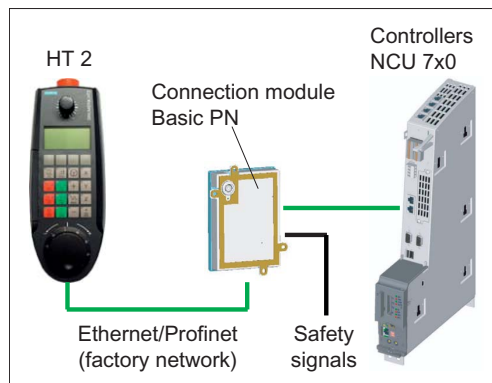

Figure 1-5 Example: Communication between HT 2 and NCU 7x0 via the PN Basic connection module

Note

The handwheel signals are only effective at a SINUMERIK control.

The system keys (machine control panel functionality / override) are transferred to a SINUMERIK PLC as well as also to a SIMATIC in a DB interface.

The safety signals for emergency stop and enabling are retrieved from the terminal box, the connection module or MPP 483 HTC via the connecting cable and connected to the safety relays in the control cabinet.

If no HT 2 is connected, observe the following:

WARNING

Danger of death resulting from improper access

- After disconnection, the HT 2 must be locked away.
- Emergency stop buttons that are inactive must not be identified as such or must be inaccessible. This is to prevent the emergency stop button from being used inadvertently.

1.3.2 Terminal Box PN

1.3.2.1 Features

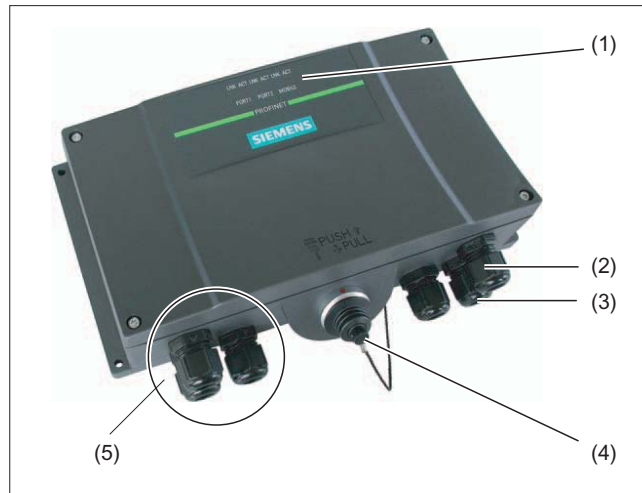

Figure 1-6 Terminal Box PN

- (1) LED displays
- (2) Screwed joint for power supply cable and shield
- (3) Screwed joint for cable with supplementary stop and agreement button signals and for PLC-accompanying signals
- (4) Connecting socket for the connector plug of the connecting cable (covered with dummy cap)
- (5) Screwed joint for process data line (Ethernet)

Note

Protection class IP65 at the terminal box is ensured with plugged-in HT 2 or plugged-in dummy cap.

The terminal box PN is available in two variants.

- PN Basic terminal box
- PN Plus terminal box

Note

The exterior of the terminal box PN variants differ only in the printing on the side.

PN Plus terminal box

The PN Plus terminal box features hot-plug capability. This means that it is possible to connect and disconnect during operation without any disruption. The Emergency Stop circuit is automatically maintained during the switching of connectors. The **PN Plus terminal box** is available under order no. **6AV6671-5AE11-0AX0**.

PN Basic terminal box

The PN Basic terminal box can be used if no hot-plug capability is required. The Emergency Stop circuit can be overridden here by external mechanisms. The **PN Basic terminal box** is available under order no. **6AV6671-5AE01-0AX0**.

Clearance

The following clearances are required around the Terminal Box PN:

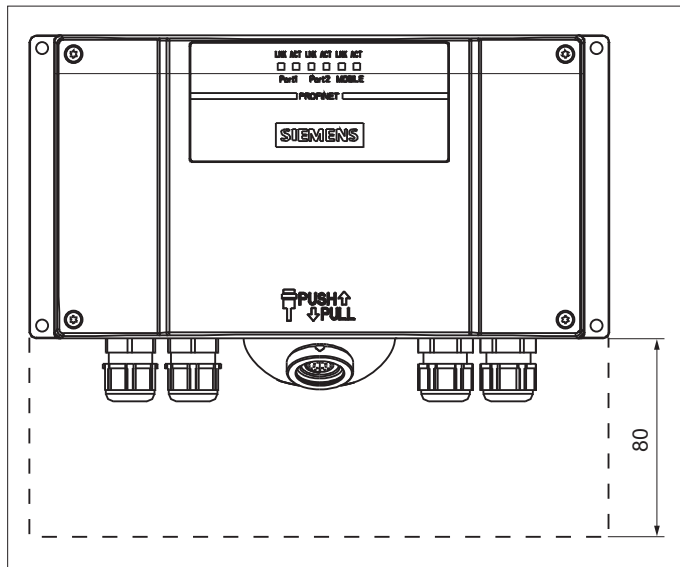

1.3.2.2 PN Plus terminal box

The PN Plus terminal box differs from a PN Basic terminal box in that it has four relays mounted on the board.

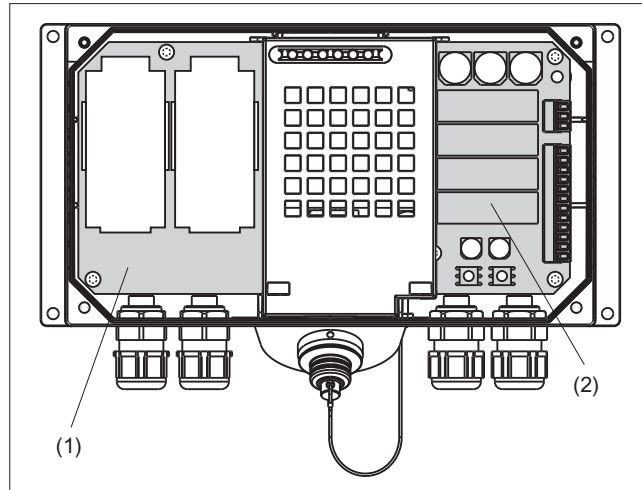

- (1) Board
- (2) Relays

Figure 1-7 PN Plus terminal box

Switching states of the emergency stop circuit

HT 2	Emergency stop button	Switching status, emergency stop circuit
Connected	Not pressed	Emergency stop circuit in the terminal box remains closed.
Connected	Pressed	The emergency stop circuit in the terminal box is open. The system to be monitored is stopped.
Not connected	-	Emergency stop circuit in the terminal box remains closed.

WARNING

Danger of death resulting from the inadvertent disconnection of the HT 2

If you disconnect the HT 2 from the PN Plus terminal box, the emergency stop circuit is closed, thereby clearing the stop state of the system to be monitored. This occurs irrespective of whether the emergency stop button has been pressed on the HT 2.

1.3.2.3 Interface assignment on the PN Plus terminal box

Location of the interfaces

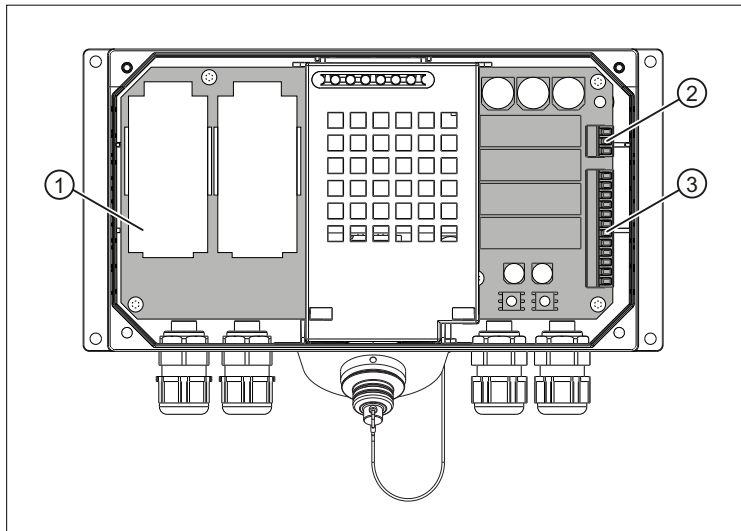

- ① Fast connector
- ② Terminal strip 1
- ③ Terminal strip 2

Fast Connector, 4-pin

The terminal box contains two fast connectors for connecting the PROFINET data cables. The figure below illustrates the assignment of the fast connector:

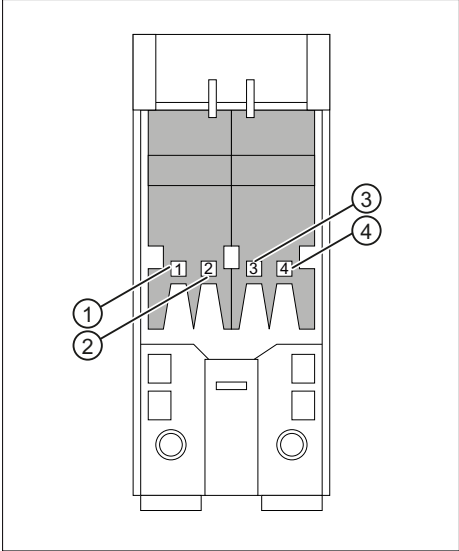

Pin	Signal name
1	TD+
2	RD+
3	TD-
4	RD-

Terminal strip 1, for power supply, 3-pin

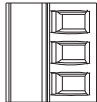
	Pin	Signal name
	1	PE
	2	M24
	3	P24

Terminal strip 2, 12-pin

The safety and additional functions are connected to this terminal strip. The terminal strip is mechanically coded to prevent it from being confused with terminal strip 1.

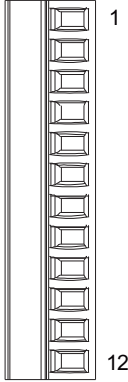
	Pin	Signal name	Circuit
	1	STOP13	Emergency stop button
	2	STOP14	
	3	STOP23	
	4	STOP24	
	5	CTL31 ¹⁾	PLC accompanying signals
	6	CTL32 ¹⁾	
	7	PRESENT31 ²⁾	
	8	PRESENT32	
	9	ENABLE2+	Enabling button
	10	ENABLE1-	
	11	ENABLE1+	
	12	ENABLE2-	

1) Active if emergency stop pressed

2) Active if HT 2 plugged in

Note

The "Emergency stop button pressed" signal has no error detection facility and must, therefore, not be used for safety-critical applications.

Typical circuit diagrams for Plus terminal box

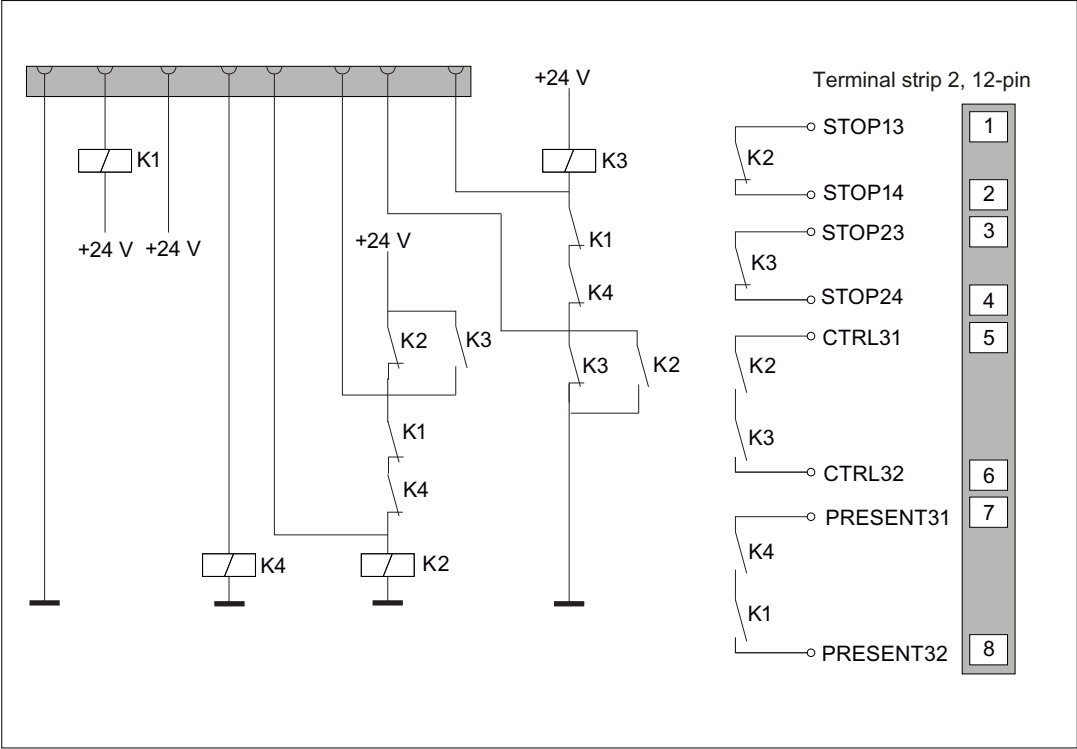

Figure 1-8 Circuit example: HT 2 not connected and power supply switched on:

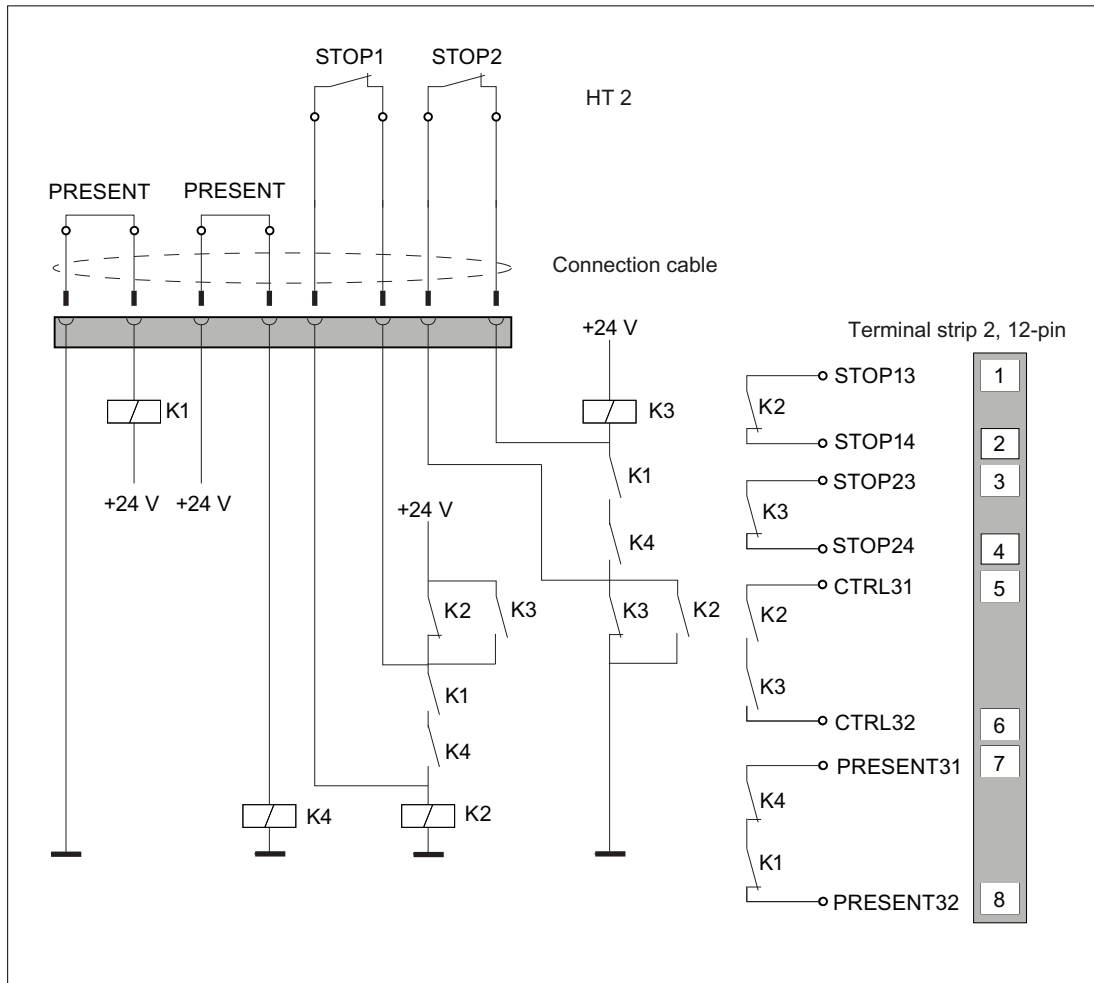

Figure 1-9 Circuit example: HT 2 connected, power supply switched on and emergency stop inactive

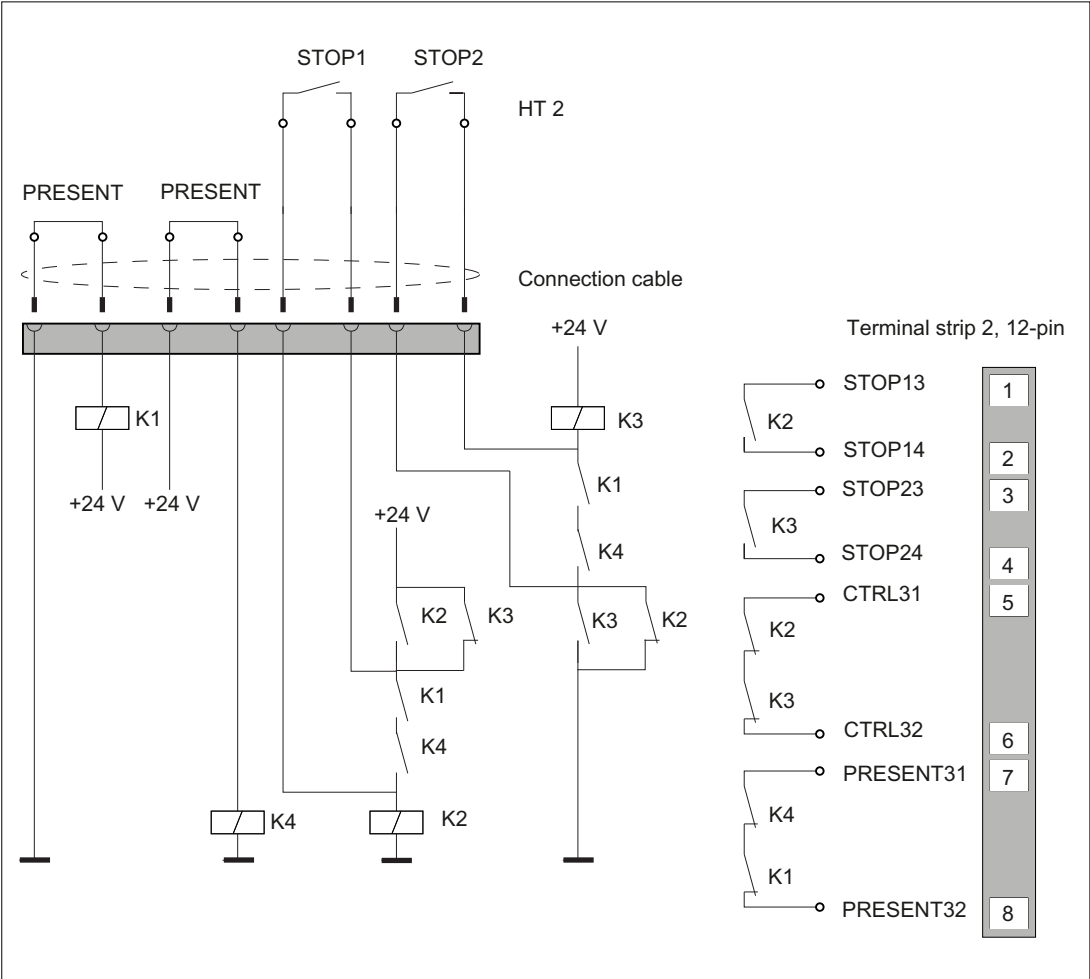

Figure 1-10 Circuit example: HT 2 connected, power supply switched on and emergency stop active

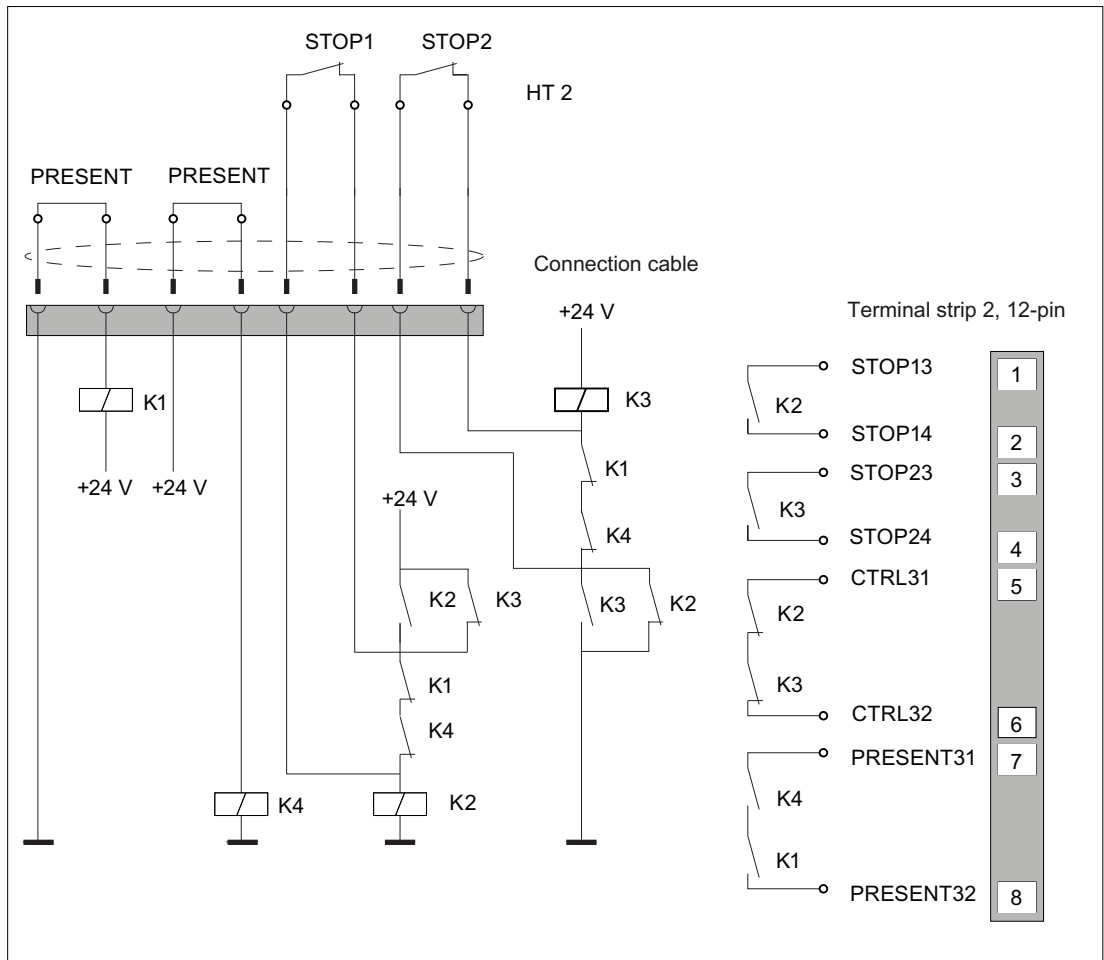

Figure 1-11 Circuit example: Power supply switched off

1.3.2.4 PN Basic terminal box

In contrast to the PN Plus terminal box, the "Stop loop through" function is not implemented on the PN Basic terminal box. Relays are so not required.

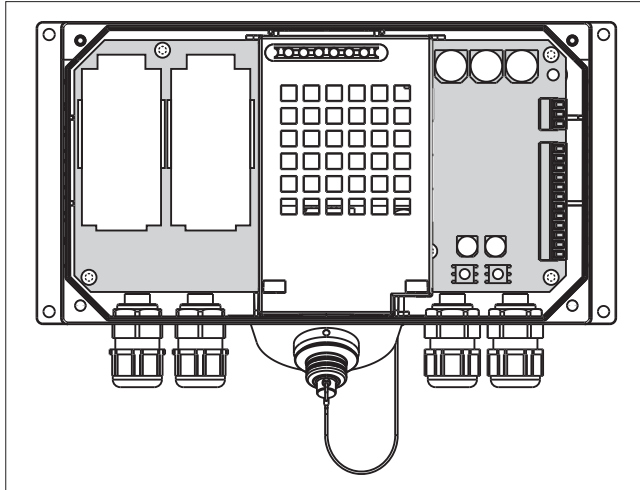

Figure 1-12 PN Basic terminal box

Note

The emergency stop circuit is controlled via the emergency stop button when the HT 2 is connected. If the connecting cable of the HT 2 is disconnected from the PN Basic terminal box, the emergency stop circuit is interrupted. This leads to a safe machine stop or an emergency stop of the system to be monitored.

Switching states of the emergency stop circuit

HT 2	Emergency Stop button	Switching status, emergency stop circuit
Connected	Not pressed	Emergency stop circuit in the terminal box remains closed.
Connected	Pressed	The emergency stop circuit in the terminal box is open. The system to be monitored is stopped.
Not connected	-	The emergency stop circuit in the terminal box is open. The system to be monitored is stopped.

WARNING

Danger of death resulting from the premature emergency stop unlocking

If you have shut down the system to be monitored, you can only release the emergency stop button or put the system to be monitored back into operation if the condition that triggered the emergency stop function has been corrected and a safe restart is carried out.

1.3.3 Connection module Basic PN

1.3.3.1 Features

The connection module Basic PN was specially developed for installation in the control cabinet. The terminating connector protrudes through the panel of the control cabinet so that the HT 2 can be connected from the outside.

The **Connection module Basic PN** is available under order no. **6FC5303-0AA01-1AA0**.

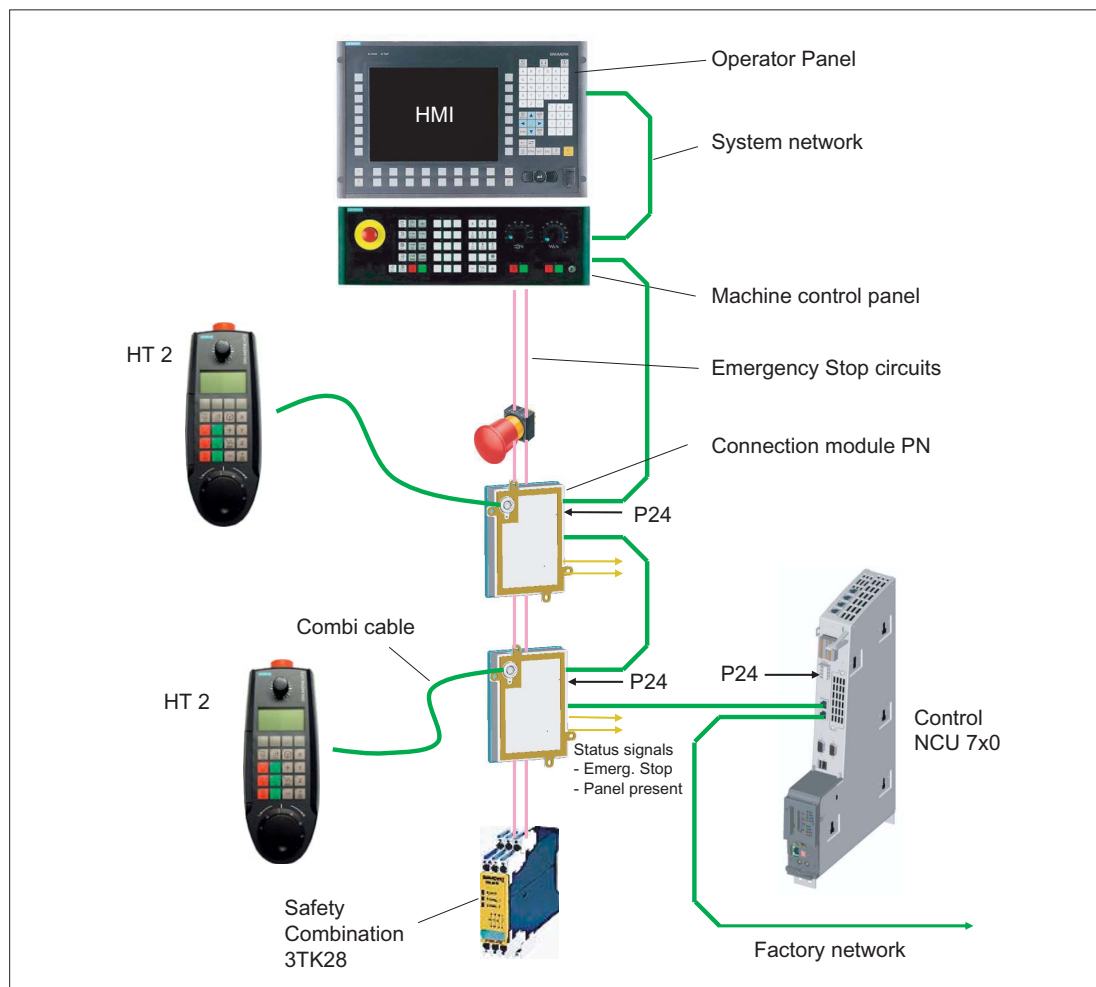

Figure 1-13 Block diagram - control cabinet installation

The connection module Basic PN is not hot plug-capable.

The HT 2 can either be connected directly to the NCU or to the PCU 50.3 as a Thin Client.

1.3.3.2 Dimension drawing

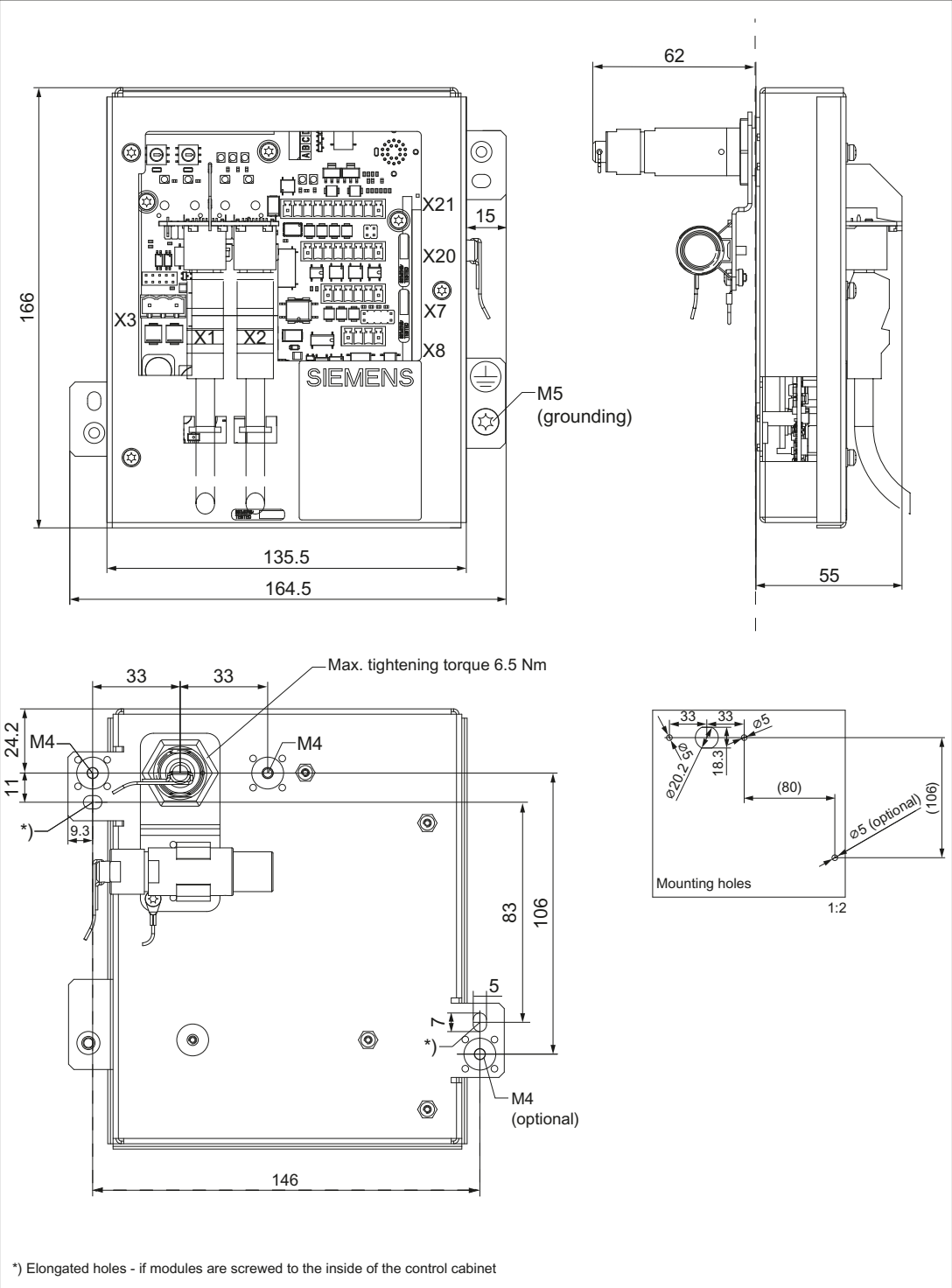
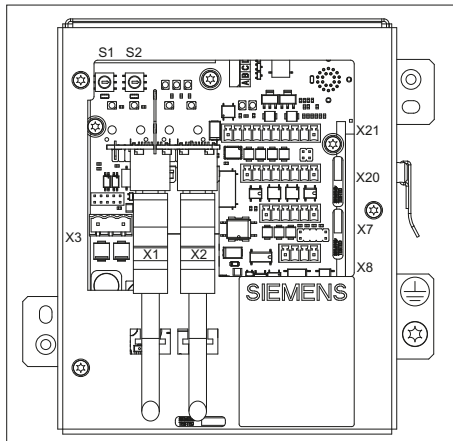

Figure 1-14 Connection module Basic PN - dimension drawing for control cabinet installation

1.3.3.3 interfaces

The HT 2 is connected to the connection module PN Basic via a round connector. The interfaces of the connection module are located on the rear side (see figure).



S1 / S2 DIP Fix switches (rotary coding switch)

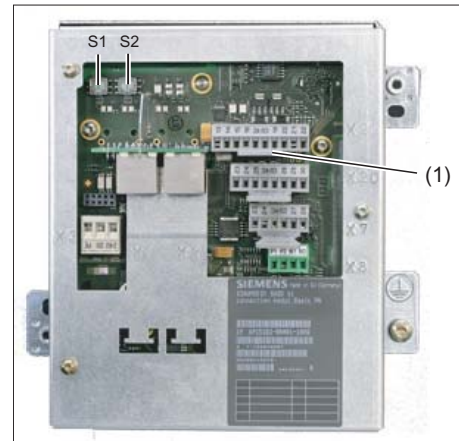

(1) Interfaces with attached connectors

Setting the box ID

You can use rotary coding switches S1 and S2 to set a unique ID on any connection module for station identification purposes.

Use a screwdriver to set the IDs.

The setting is entered in hexadecimal format. Equivalent decimal values of between 0 and 255 are supported.

By way of an example, the figure below illustrates address 27H, which corresponds to decimal address 39.

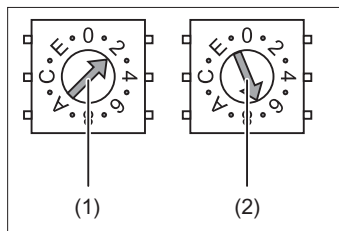

- (1) Rotary coding switch for higher-order bits (S1)
- (2) Rotary coding switch for lower-order bits (S2)

Figure 1-15 Example for the address "27H"

Connector pin assignments

Signal type:

- I** Input (Input)
- O** Output (Output)
- B** Bi-directional signals
- P** Potential

X3: Power supply

The pin assignment of the power supply interface X3 can be found in "General information and networking", Chapter: "Connecting", Section: "Pin assignment of the interfaces".

X7: Panel Present

Connector designation: **X7**

Connector type: 6-pole Phoenix terminal

Table 1- 2 Assignment of the interface Panel Present X7

Pin	Signal name	Signal type	Significance
1	PRES	O	"High": Panel (HT 2) plugged in
2	XCTL	O	"Low": EMER STOP button pressed ¹⁾
3	XFAULT	O	"Low": Error in emergency stop electronics ¹⁾
4	N.C.	-	Not connected
5	N.C.	-	Not connected
6	M	P	Ground

¹⁾ Function not implemented in PN Basic variant, output is not switched to "High"

X8: Emergency stop wiring terminal

Connector designation: **X8**

Connector type: 4-pole Phoenix terminal

Table 1- 3 Assignment of the emergency stop wiring terminal X8

Pin	Protective circuit
1	On-board jumper between 1 and 2
2	
3	On-board jumper between 3 and 4
4	

Note

Use this terminal for simple routing of the emergency stop cables, optional.

The connector is only used to assist looping through. The connected pins 1 and 2 as well as 3 and 4 have no additional function on the connection module.

X20: Enabling buttons

Connector designation: **X20**

Connector type: 8-pole Phoenix terminal

Table 1- 4 Assignment of the interface enabling buttons X20

Pin	Signal name	Signal type	Meaning
1	ZUST1P	I	Electronic enabling button 1 P
2	ZUST1M	O	Electronic enabling button 1 M
3	ZUST2P	I	Electronic enabling button 2 P
4	ZUST2M	O	Electronic enabling button 2 M
5	N.C.	-	Not connected
6	N.C.	-	Not connected
7	N.C.	-	Not connected
8	N.C.	-	Not connected

X21: Emergency stop and key-operated switchConnector designation: **X21**

Connector type: 10-pole Phoenix terminal

Table 1- 5 Assignment of the interface emergency stop and key-operated switch X21

Pin	Signal name	Signal type	Meaning
1	STOP23	B	Emergency stop circuit
2	STOP24		Emergency stop circuit
3	STOP13		Emergency stop circuit
4	STOP14		Emergency stop circuit
5	M	P	Ground
6	N.C.	-	-
7	IN_E9	P	P24 switched by key-operated switches
8	P24_FILT		Filtered 24V module power supply
9	IN_E9_EXT	O	"High": Key-operated switch actuated
10	IN_E12_EXT		"High": Terminating connector plugged in

Note

Pins 7 and 8 must be jumpered in order to supply a handheld terminal with power.

1.3.3.4 Installing the terminating connector

Proceed as follows

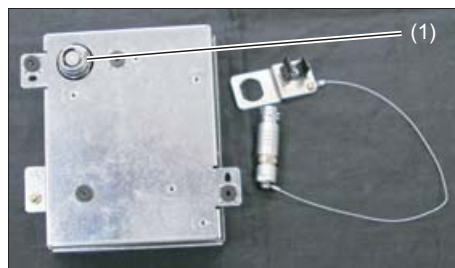

(1) Retaining nuts



1. Unscrew the retaining nuts.



2. Attach the bracket for the terminating connector.



3. Tighten the retaining nut and insert the terminating connector into the bracket.

Note

If you never remove the HT 2 from the connection module, it is not necessary to attach the terminating connector.

1.3.4 Connection examples of enabling button and emergency stop button

This section contains connection examples for enabling and emergency stop buttons corresponding to Category 3 PL d in accordance with EN ISO 13849-1:2008.

Note

To ensure Category 3 PL d in accordance with EN ISO 13849-1:2008, be sure to follow the operating instructions for the monitoring device being used.

The monitoring devices shown in the following examples satisfy Category 4 PL e in accordance with EN ISO 13849-1:2008.

The monitoring device and downstream components should be taken into consideration when calculating the overall "Enabling" safety function.

Connection – enabling button with evaluation unit

The diagram shows the connection of an evaluation unit with the enabling buttons of the HT 2.

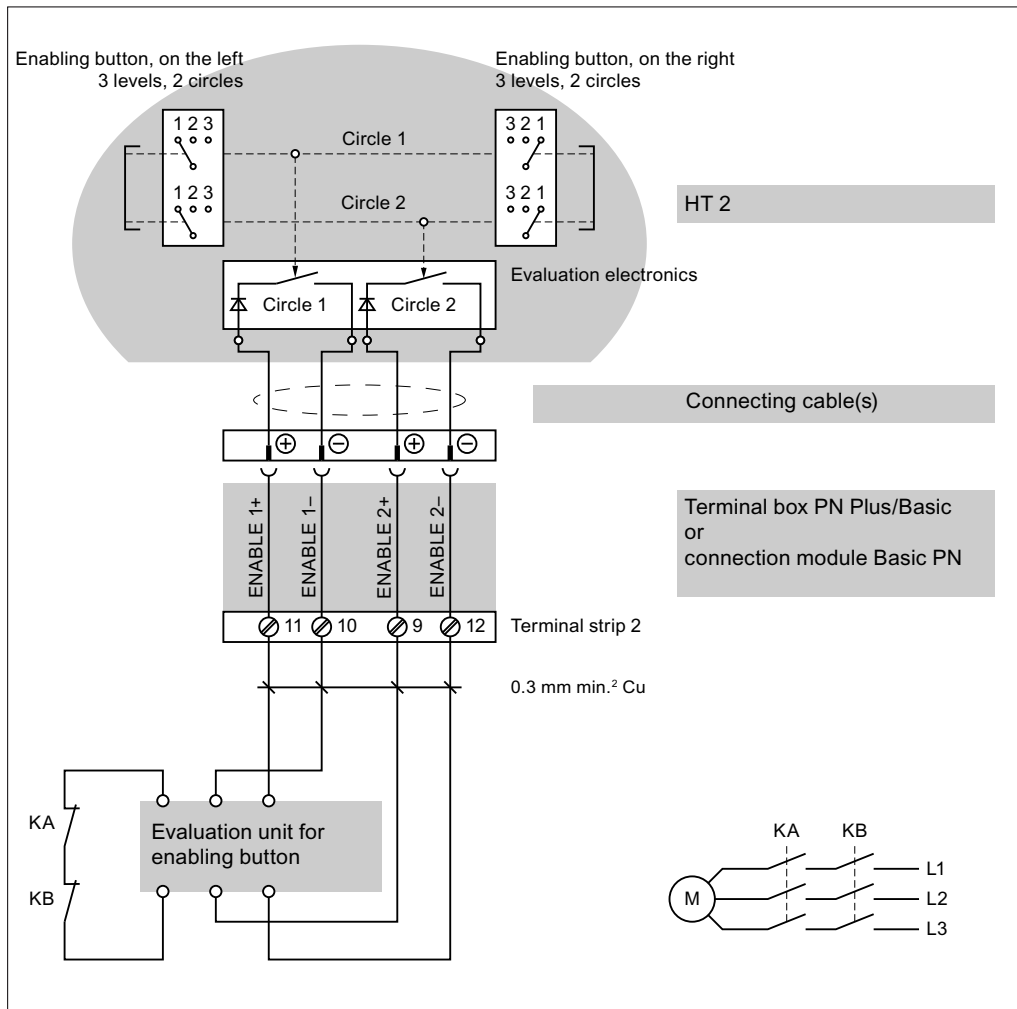

Figure 1-16 Enabling button with evaluation unit

All contacts of the safety relay (contactor) KA and KB are fitted with positively-driven contacts in accordance with EN 50205:2002.

Connection – enabling button with safety relay

The diagram shows the connection of safety switching device SIRIUS 3TK2841 with the enabling buttons of the HT 2.

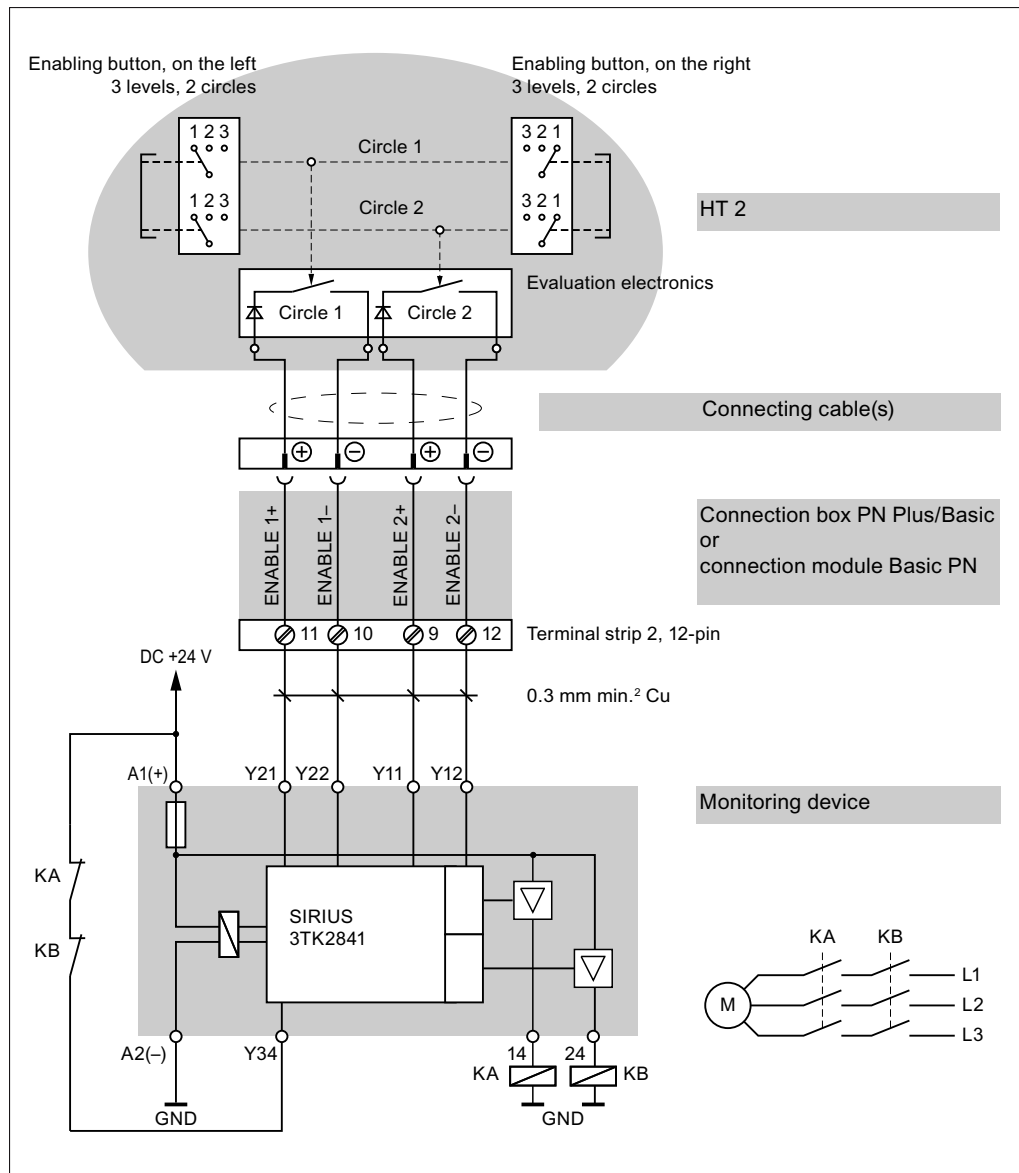

Figure 1-17 Enabling button with safety relay

All contacts of the safety relay (contactor) KA and KB are fitted with positively-driven contacts in accordance with EN 50205:2002.

Connection - emergency stop button with safety relay

The following figure shows the connection of the SIRIUS 3TK2822 or SIRIUS 3TK2841 safety relay to the emergency stop button of the HT 2.

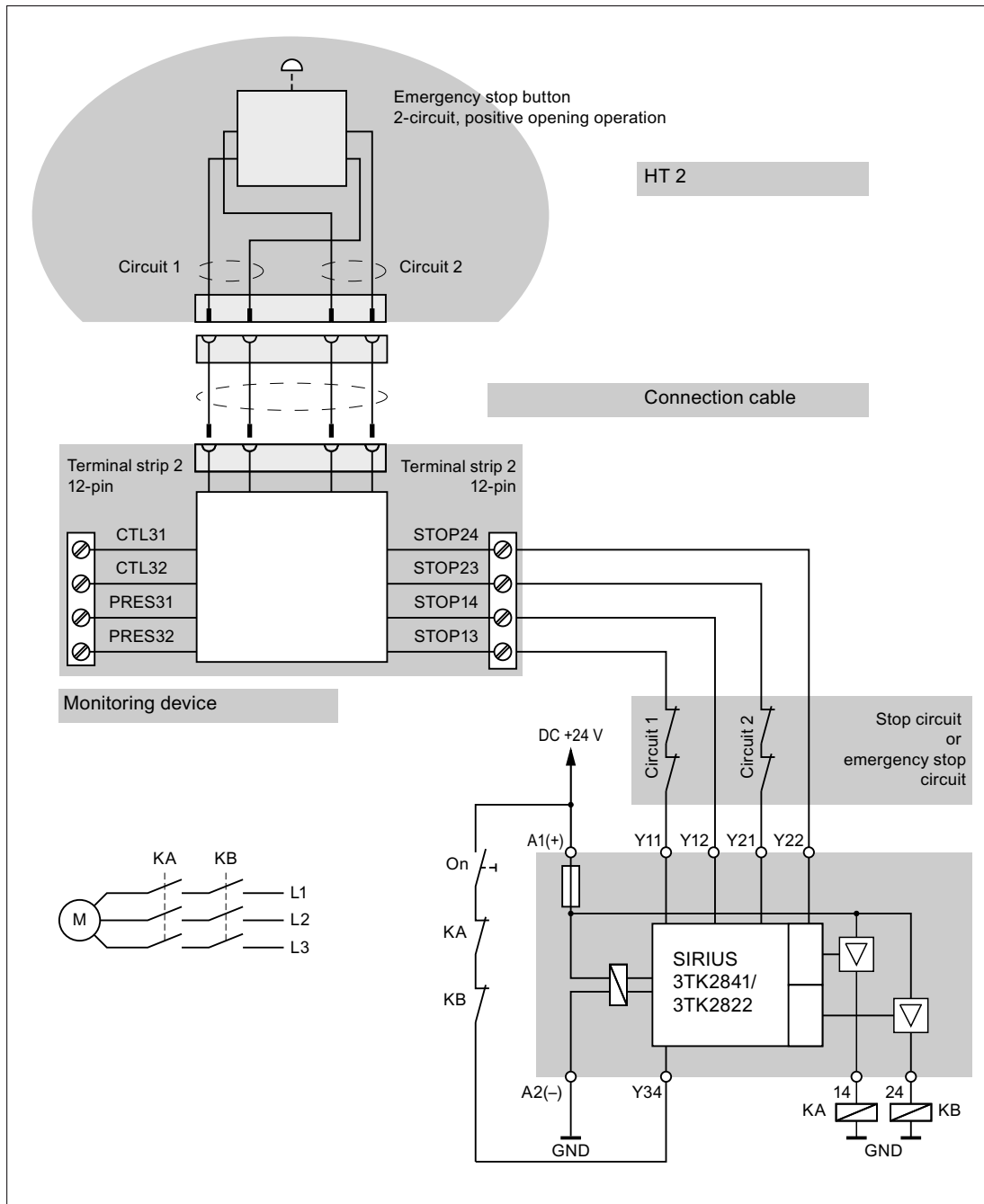

Figure 1-18 Emergency stop button with safety relay

All contacts of the safety relay (contactor) KA and KB are fitted with positively-driven contacts in accordance with EN 50205:2002.

Monitoring outputs may not be used for safety-related functions.

1.3.5 Connecting cable

The connecting cable is an industrial cable and, thus, resistant to many solvents and lubricants. The flexural strength is geared to the actual usage conditions.

The connecting cable is available in different lengths. You will find information in Section: "Accessories".

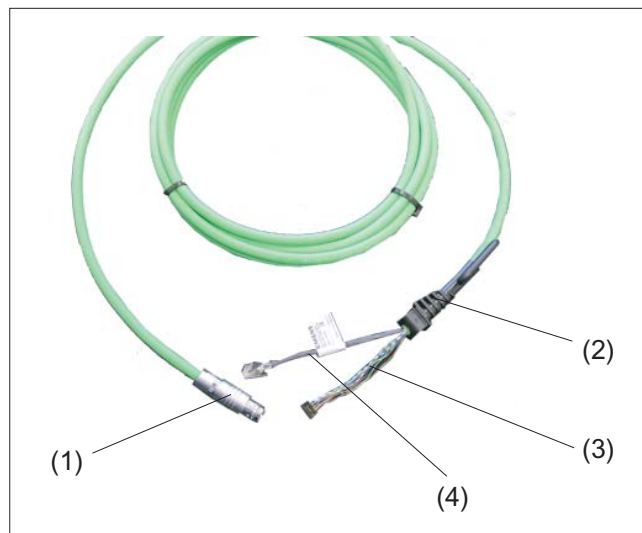

- (1) Metallic push-pull circular connector (ODU connector)
- (2) Strain relief and kink protection for connecting cable
- (3) Plug connector for enabling button, emergency stop, 24 V and safety signals
- (4) RJ45 connector (Ethernet connection)

Figure 1-19 Connecting cable of the HT 2

The connecting cable is connected to the HT 2 via the RJ 45 connector (3) and the plug connector (4). The ODU connector (1) serves to connect the connecting cable to the terminal box PN or the connection module PN (control cabinet installation). The tightening torque for the nut of the ODU socket is 6.5 Nm.

The HT 2 has one cable entry on its rear side for connecting the cable. It is located under the cover (see Section: "Control and display elements" → "Overview").

Laying the connecting cable

NOTICE

Damage to components

Only open the connection slot when the power supply voltage is switched off. Otherwise, components could be destroyed or non-defined signal states can occur.

When the connection slot is open, the Handheld Terminal HT 2 is sensitive with respect to electrostatic discharge.

Do not remove the ESD protection when opening the device.

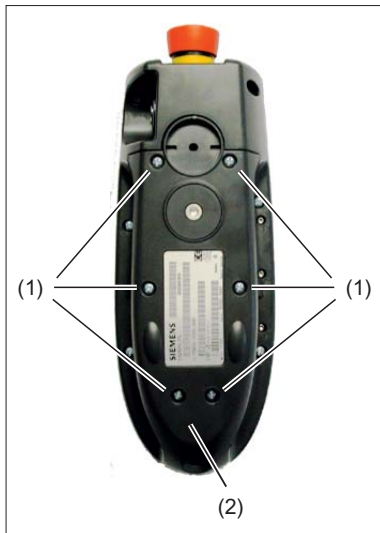

1. Place the device on a soft, horizontal surface so that the operator control components are not mechanically damaged.

Open the cable duct cover (2) by unscrewing the six PT screws (4 x 20 mm) approximately 1 cm (1).

To do this, use a crosstip size 2 screw driver.

Cable duct cover open

(1) Cable entry

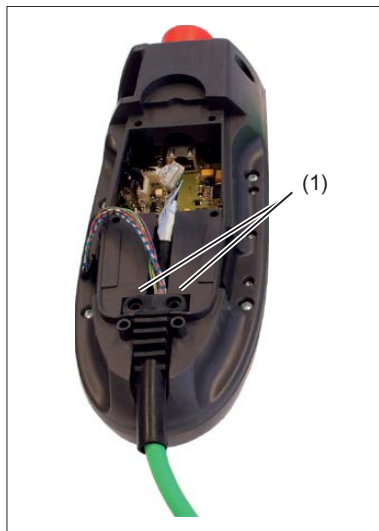
**2.** Insert the connecting cable into the cable entry.

Gently press the cable downwards until it is completely retained by the retaining elements (1).

Ensure that the cable doesn't sag away from the mounting surface, but is located flush to the mounting surface. Otherwise, the device could be pulled down to the floor and damaged.

In order to avoid damaging the cable sheath, do not route it over sharp edges.

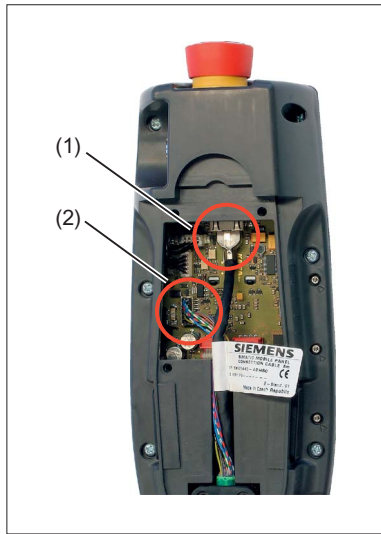

3. Connect the RJ-45 connector (1) to the Ethernet socket.
Press the plug connector (2) firmly into the power supply socket.

 WARNING
Improper installation of the cable can result in failure of the safety functions.
When plugging in the connector plug, ensure that all cables are lying straight in the cable guide. Check to ensure that all wires are aligned and straight and check the firm seating of the plug connector before replacing the cable duct cover. Make sure that the cable sleeve is installed correctly.

Note

Check to see that the cable label is not jammed in the seal.

4. Put the cable duct cover on and secure it by tightening the six screws.

NOTICE**Damage to the thread in the fastening holes**

The housing of the HT 2 is made of plastic. Therefore, the mounting hole threads cannot handle the same amount of stress as a comparable metallic housing. Therefore, do not exceed 0.4 to 0.5 Nm of torque when tightening the screws (also for protecting the connecting cable).

If you use a power screwdriver, ensure the max. speed of 600 rpm is adhered to (torque: 1 Nm).

The screws of the cable duct cover may only be loosened or tightened a maximum of 20 times. Otherwise, there is the danger that the threads might become damaged and the seal of the housing will be compromised which could lead to failure of the device.

1.3.6 MPP 483 HTC

The MPP 483 HTC variant of the machine control panel MPP 483 has an integrated connection module thereby providing a connection option for the HT 2.

1.3.7 Power Supply

The HT 2 is supplied with power via the connecting cable of the terminal box PN or of the connection module PN.

The input voltage range is designed for +24 VDC.

See also: "General information and networking", Chapter: "Safety instructions", Section: "Requirements for the 24 V power supply"

1.4 Unplugging/plugging during operation

The ability to detect a connected HT 2 in the PLC

1. **HW solution:**

The X7 interface of the connection module PN Basic signals "HT 2 Present" at pin 1 for the "active" connection module (see Section: "Connections" → "Connection module PN Basic" → "Interfaces").

If the connection module is "inactive", this signal is not set.

This makes the "active" connection module detectable in the PLC by wiring the above-mentioned pins of all connection modules to digital I/Os on PLC I/O modules.

2. **Permanently configured MCPs / HT 2 on one control:**

If there are only permanently configured MCPs / HT 2 on a control, removal of the MCP or HT 2 triggers the PLC alarm "400260 Machine Control Panel failed".

Based on this, an "active" or "inactive" MCP / HT 2 in the PLC can be detected.

The failure of an MCP / HT 2 is, however, only detected in the PLC if max. 2 MCP / HT 2 are permanently configured and no MCP changeover by means of FB9 (e.g. triggered by HMI when operator focus is switched).

1.5 Commissioning

1.5.1 BIOS

1.5.1.1 BIOS powering up

After you have switched-in the power supply voltage of the HT 2, the BIOS initializes the hardware and boots the system.

All LEDs are briefly activated after the hardware has been initialized.

The HT 2 is ready for operation.

Note

If errors occur while booting, an appropriate message is displayed (see Section: "Error messages").

1.5.1.2 Settings in the BIOS menu

You can activate the BIOS menu by keeping the upper left key pressed while booting. The BIOS main menu is opened.

Main menu

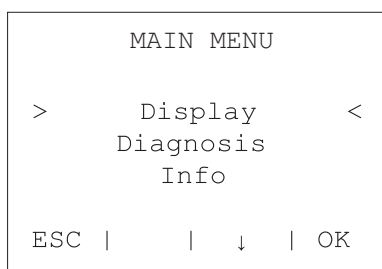

Figure 1-20 BIOS - main menu of the HT 2

The available sub-menus are displayed at the center of the screen. The functions that can be executed with the four keys of the upper row of keys (softkeys) are listed in the bar at the lower edge.

Functions		Key
< ESC >	Exiting the main menu	Left (outside)
< ↑ >	Scrolling upwards	Left (center)
< ↓ >	Scrolling downwards	Right (center)
< OK >	Activating the selected menu item	Right (outside)

Submenu: Display

Submenu	Menu item	Significance
Display	Brightness	Setting the display brightness
	Contrast	Setting the display contrast

Submenu: Diagnostics

Submenu	Menu item	Significance	Notes
Diagnostics	LEDs	The LEDs are switched-in one after the other in the form of a running light.	With this test, ensure that all of the LEDs light up and no LED remains permanently lit up.
	Keyboard	Visualizing the pressed keys. Multiple keys can be simultaneously pressed. In addition, the LEDs of all pressed keys are lit.	The upper left key exits this test.
	Enabling switch	Displays the state of the two enabling button circuits. - "Off" - "Enabled" - "Panic"	This test only checks the functionality of the enabling buttons. This test does not include any of the other safety-relevant components (e.g. correct connection of the enabling function at the machine)! If the state of a circuit is not correctly displayed, then the device must be immediately disabled.
	Override switch	Displays the position of the override rotary switch (value 0 to 18).	
	Key switch	Displays the key-operated switch position. - "Off" - "On (1)" - "On (2)"	
	Handwheel	Displays the actual counter state of the handwheel.	Each time that this menu item is called, the counter state is reset to zero.

Submenu: Info

Submenu	Menu item	Sub point	Significance
Info	Hardware	Memory	Displays the size of the main memory in MB
		Flash	Displays the size of the flash module in MB
		Supply	Displays the power supply voltage in volt
		Temperature	Displays the internal housing temperature in °C
	Software	BIOS	Displays the version number of the BIOS
		Boot loader	Displays the version number of the boot loader
		Coprocessor	Displays the version number of the coprocessor firmware
	Counters	Hours counter	Operating hours counter (units: hours)
		Power on	Power-on counter

1.5.1.3 Error handling

Faults

#	Problem	Cause	Solution
1	No display - all LEDs off	The power supply is interrupted.	Check the power supply connection. If the fault remains, then the device is defective.
2	No display - LEDs briefly flash once	The display contrast is incorrectly set.	<ol style="list-style-type: none"> 1. When powering-up, keep the lefthand (first) softkey pressed. 2. Press once, one after the other - the righthand (fourth) softkey - the third softkey - the righthand (fourth) softkey 3. Using the second and third softkeys, change the contrast until it is easy to read the display.
3	No display - all LEDs flash permanently	The display is defective.	
4	Displays the message: "Testcommandhandler"	The "Testcommandhandler" was activated.	Re-boot the HT 2.

Error messages

#	Display	Description	Cause	Solution
1	SDRAM data line test failed!	An error has occurred while testing the SDRAM data lines.	The hardware is defective.	
2	SDRAM data line test failed!	An error has occurred while testing the SDRAM address lines.	The hardware is defective.	
3	SDRAM access test failed!	An error has occurred when accessing the SDRAM.	The hardware is defective.	
4	SDRAM fill test failed!	An error has occurred when writing a test pattern to the SDRAM.	The hardware is defective.	
5	Unexpected SDRAM size!	The size of the SDRAM determined, does not correspond to the expected size.	The hardware is defective.	
6	Wrong coprocessor version, update required!	The firmware of the ATmega88 is too old.	The BIOS was updated - however not the ATmega88 firmware.	Update the ATmega88 firmware.
7	Coprocessor communication error!	An error has occurred for the cyclic SPI communication with the ATmega88.		

#	Display	Description	Cause	Solution
8	BIOS code corrupted!	The BIOS checksum is invalid.	The BIOS has been corrupted due to an unsuccessful update or a defective flash module.	
9	Hardware info block invalid!	The hardware information block is invalid.	The block was corrupted when updating or the flash module is defective.	
10	Serial number not set!	The serial number is missing.	It is possible that the serial number was deleted while updating.	
11	MAC ID not set!	There is no MAC ID.	The MAC ID may have been deleted while updating.	
12	No bootloader present!	There is no bootloader.		
13	Bootloader code corrupted!	The bootloader checksum is invalid.	The bootloader has been damaged due to an unsuccessful update or a defective flash module.	
14	Pressed keys detected!	One or several keys are pressed.	The hardware is defective if no keys have been pressed.	
15	Display error!	Reading back the display status was unsuccessful.	The hardware is defective.	

1.5.2 Interface signals

PLC module

The FC13 "HHUDisp" supports the handling of the LC display. For a detailed description, please refer to:

Literature: Function Manual, Basic Functions, Basic PLC Program (P3).

Note

The customer is responsible for programming the transfer of key signals to the interface in a PLC user program.

User interface

Layout of keys and LEDs

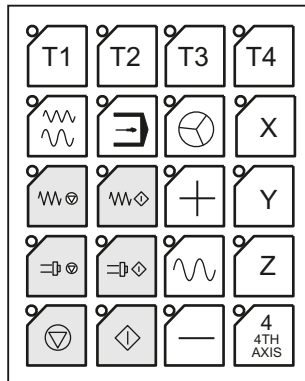

Figure 1-21 Operator keys, standard assignment

The first row of keys (free keys T1 ... T4) is not assigned as standard.

Input image HT 2

You can tap the signals for the keys, feed rate override switch, key-operated switch and acknowledgement of the digital display at the input area. The address range is set by parameter assignment with STEP7 tools.

Byte no.	Input signals to PLC								
Byte	Bit 7	Bit 6	Bit 5	Bit 4	Bit 3	Bit 2	Bit 1	Bit 0	
EB m + 0	Reserved	Reserved	Reserved	Reserved	Reserved	Reserved	Reserved	Reserved	
EB m + 1	Reserved	Reserved	Reserved	Reserved	Reserved	Reserved	Reserved	Reserved	
EB m + 2	Feed start	Free T2 key	AUTO-MATIC	NC stop	Spindle stop	Feed stop	Free T1 key	JOG	
EB m + 3	Free T3 key	Handwheel	4. Axis	Z	Y	X	NC Start	Spindle start	
EB m + 4	Direction key -	Rapid traverse override	Direction key +	Free T4 key					
EB m + 5	Acknowledgement digital display	Keyswitch	Rapid traverse / feed rate override switch						
			E	D	C	B	A		

Rotary switch positions HT 2

Position	%	EDCBA
0	0	00001
1	1	00011
2	2	00010
3	4	00110
4	6	00111
5	8	00101
6	10	00100
7	20	01100
8	30	01101
9	40	01111
10	50	01110
11	60	01010
12	70	01011
13	75	01001
14	80	01000
15	85	11000
16	90	11001
17	95	11011
18	100	11010

Output image HT 2

The signals for controlling the LEDs, HHU mode, display signals and digital display are present at the output area.

Byte no.	Output signals to the HHU							
	Bit 7	Bit 6	Bit 5	Bit 4	Bit 3	Bit 2	Bit 1	Bit 0
AB m + 0	always 1				Free T4 key	Free T3 key	Free T2 key	Free T1 key
AB m + 1	New data for selected line						Selection lines 3, 4	Selection lines 1, 2
AB m + 2	Feed start	Rapid traverse override	AUTO-MATIC	NC stop	Spindle stop	Feed stop	Direction key +	JOG
AB m + 3	Direction key -	Handwheel	4. Axis	Z	Y	X	NC Start	Spindle start

Note

Output byte **AB m + 0**, bit 7 must **always** have the value '1'!
This sets the display's output mode.

Output image of the digital display

Control of the digital display in the HT 2

Byte no.	Output signals to the HHU							
Byte	Bit 7	Bit 6	Bit 5	Bit 4	Bit 3	Bit 2	Bit 1	Bit 0
AB m + 4	Default setting of 1st character (right) of selected line							
AB m + 5	Default setting of 2nd character of selected line							
AB m + 6	Default setting of 3rd character of selected line							
AB m + 7	Default setting of 4th character of selected line							
AB m + 8	Default setting of 5th character of selected line							
AB m + 9	Default setting of 6th character of selected line							
AB m + 10	Default setting of 7th character of selected line							
AB m + 11	Default setting of 8th character of selected line							
AB m + 12	Default setting of 9th character of selected line							
AB m + 13	Default setting of 10th character of selected line							
AB m + 14	Default setting of 11th character of selected line							
AB m + 15	Default setting of 12th character of selected line							
AB m + 16	Default setting of 13th character of selected line							
AB m + 17	Default setting of 14th character of selected line							
AB m + 18	Default setting of 15th character of selected line							
AB m + 19	Default setting of 16th character (left) of selected line							

Display

The digital display is used as a 4-line alphanumeric display with 16 digits per line.

The display data is coded according to the character set given in the ASCII code table for the digital display via the ABm + 4...19 bytes. The decimal point is a separate character. The display always starts line by line right-justified with the byte ABm + 4 and is built up towards the left up to ABm + 19.

Selecting the line

ABm + 1, bit 0 and bit 1

This bit is used to select the line to be written.

Table 1- 6 Line selection

Bit 0	Bit 1	Selected line
0	0	1st line
1	0	2nd line
0	1	3rd line
1	1	4th line

New data for selected line

ABm + 1, bit 7

This bit is used to request writing in of new data into a line. The bit is set by the user program and can be reset on detection of the acknowledgement bit EBm + 5, bit 7.

Bit 7 = 0: Reset request.

Bit 7 = 1: Set request

Acknowledgement of the digital display

EBm + 5, bit 7

This bit is set by the system after the new data has been accepted.

Bit 7 = 0: No new data

Bit 7 = 1: New data has been accepted

Example of a signal chart

Example of a signal chart when writing data for two lines 1 and 2

1. Select the line with ABm + 1, bit 0 and bit 1.
2. Write new data with ABm + 4...19.
3. Set request: New data for selected line ABm + 1, bit 7
4. Acknowledgement digital display EBm + 5, bit 7, via system.
5. Reset request

Note

The request must be reset before a new line is written!

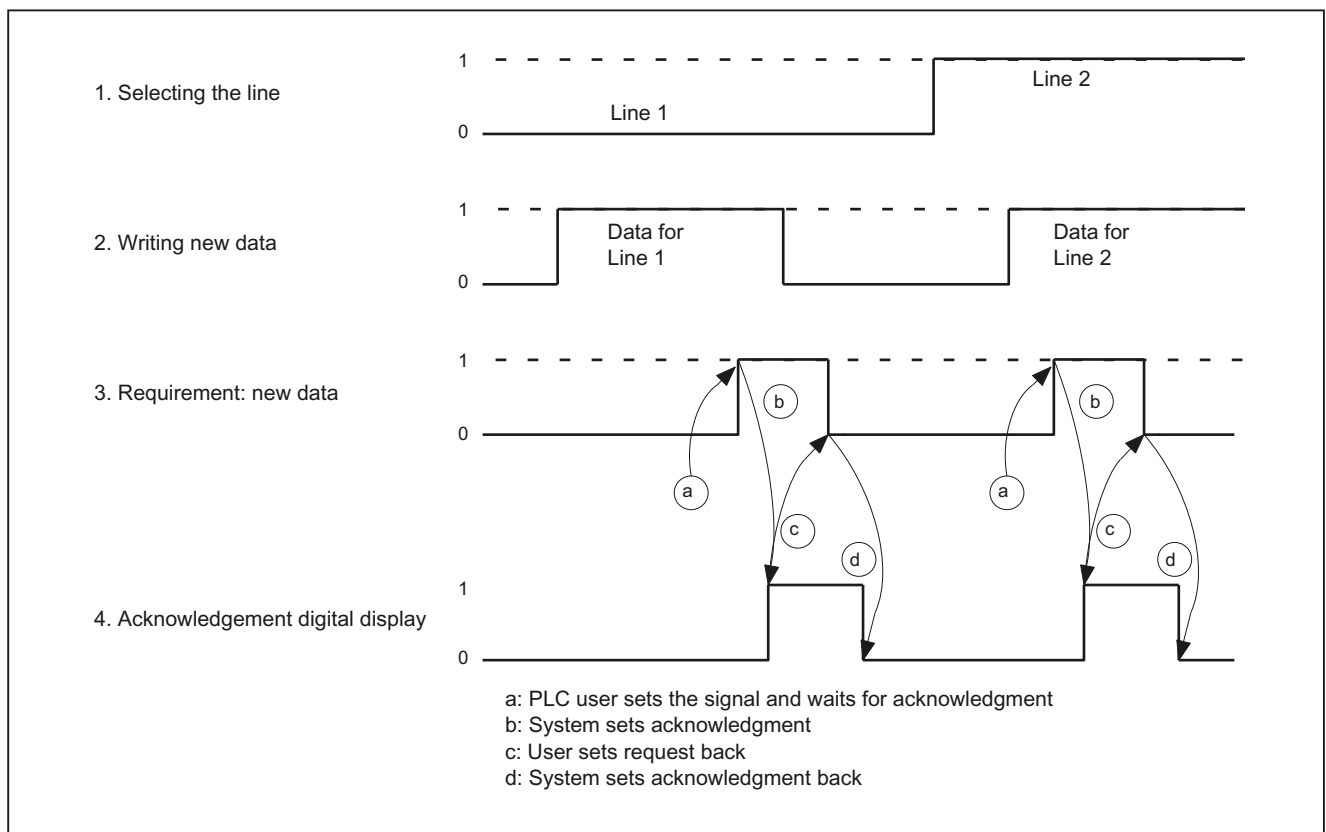

Figure 1-22 HT2 signal characteristic example for writing data into the HT 2 display

Proceed in the same way for the selection of line 3 and line 4.

ASCII code for digital display

Representation of characters by specifying the corresponding number system (hexadecimal/decimal) in the bytes ABm + 4...19. The characters from Hex 20 to Hex 7F are default values.

Table 1-7 Standard character set

ASCII Hex/dec	Char- acter	ASCII Hex/dec	Char- acter	ASCII Hex/dec	Char- acter	ASCII Hex/dec	Char- acter	ASCII Hex/dec	Char- acter	ASCII Hex/dec	Char- acter
20 / 32	¹⁾	30 / 48	0	40 / 64	@	50 / 80	P	60 / 96	`	70 / 112	p
21 / 33	!	31 / 49	1	41 / 65	O	51 / 81	Q	61 / 97	a	71 / 113	q
22 / 34	"	32 / 50	2	42 / 66	B	52 / 82	R	62 / 98	b	72 / 114	r
23 / 35	#	33 / 51	3	43 / 67	C	53 / 83	S	63 / 99	c	73 / 115	s
24 / 36	\$	34 / 52	4	44 / 68	D	54 / 84	T	64 / 100	d	74 / 116	t
25 / 37	%	35 / 53	5	45 / 69	E	55 / 85	U	65 / 101	e	75 / 117	u
26 / 38	&	36 / 54	6	46 / 70	F	56 / 86	V	66 / 102	f	76 / 118	v
27 / 39	'	37 / 55	7	47 / 71	G	57 / 87	W	67 / 103	g	77 / 119	w
28 / 40	(38 / 56	8	48 / 72	H	58 / 88	X	68 / 104	h	78 / 120	x
29 / 41)	39 / 57	9	49 / 73	I	59 / 89	Y	69 / 105	i	79 / 121	y
2A / 42	*	3A / 58	:	4A / 74	J	5A / 90	Z	6A / 106	j	7A / 122	z
2B / 43	+	3B / 59	;	4B / 75	K	5B / 91	[6B / 107	k	7B / 123	{
2C / 44	,	3C / 60	<	4C / 76	L	5C / 92	\	6C / 108	l	7C / 124	
2D / 45	-	3D / 61	=	4D / 77	M	5D / 93]	6D / 109	m	7D / 125	}
2E / 46	.	3E / 62	>	4E / 78	N	5E / 94	^	6E / 110	n	7E / 126	~
2F / 47	/	3F / 63	?	4F / 79	O	5F / 95	_	6F / 111	o	7F / 127	²⁾

¹⁾ Space

²⁾ Not defined

Table 1- 8 Extended character set

ASCII Hex/dec	Char- acter	ASCII Hex/dec	Char- acter	ASCII Hex/dec	Char- acter	ASCII Hex/dec	Char- acter	ASCII Hex/dec	Char- acter	ASCII Hex/dec	Char- acter
A0 / 160	¹⁾	B0 / 176	°	C0 / 192	À	D0 / 208	Ð	E0 / 224	à	F0 / 240	ð
A1 / 161	ı	B1 / 177	±	C1 / 193	Á	D1 / 209	Ñ	E1 / 225	á	F1 / 241	ñ
A2 / 162	¢	B2 / 178	²	C2 / 194	Â	D2 / 210	Ò	E2 / 226	â	F2 / 242	ò
A3 / 163	£	B3 / 179	³	C3 / 195	Ã	D3 / 211	Ó	E3 / 227	ã	F3 / 243	ó
A4 / 164	¤	B4 / 180	´	C4 / 196	Ä	D4 / 212	Ô	E4 / 228	ä	F4 / 244	ô
A5 / 165	¥	B5 / 181	µ	C5 / 197	Å	D5 / 213	Õ	E5 / 229	å	F5 / 245	õ
A6 / 166	¦	B6 / 182	¶	C6 / 198	Æ	D6 / 214	Ö	E6 / 230	æ	F6 / 246	ö
A7 / 167	§	B7 / 183	·	C7 / 199	Ç	D7 / 215	×	E7 / 231	ç	F7 / 247	÷
A8 / 168	¨	B8 / 184	¸	C8 / 200	È	D8 / 216	Ø	E8 / 232	è	F8 / 248	ø
A9 / 169	©	B9 / 185	¹	C9 / 201	É	D9 / 217	Ù	E9 / 233	é	F9 / 249	ù
AA / 170	ª	BA / 186	º	CA / 202	Ê	DA / 218	Ú	EA / 234	ê	FA / 250	ú
AB / 171	«	BB / 187	»	CB / 203	Ë	DB / 219	Û	EB / 235	ë	FB / 251	û
AC / 172	¬	BC / 188	¼	CC / 204	Ì	DC / 220	Ü	EC / 236	ì	FC / 252	ü
AD / 173	²⁾	BD / 189	½	CD / 205	Í	DD / 221	Ý	ED / 237	í	FD / 253	ý
AE / 174	®	BE / 190	¾	CE / 206	Î	DE / 222	Þ	EE / 238	î	FE / 254	þ
AF / 175	¯	BF / 191	¿	CF / 207	Ï	DF / 223	ß	EF / 239	ï	FF / 255	ÿ

1) Protected space

2) Conditional separator

1.5.3 Application example for HT8 and HT 2 involving mixed operation

Prerequisite

The following example relates to an 840D sl plus TCU with MCP xxx PN and an optional HT 8 or HT 2 connected to a PN box. All the components are connected to X120 of the NCU. The application example is equally valid for an MPP xxx IE H (with connection for HT 2/HT 8) instead of a connection module /terminal box.

The TCU and HT 8 function as "thin client units" and as soon as they assume the operating focus, they use their MCP address (db19.dbb123) and index (db19.dbb118) to register with the PLC.

This setting is specified for both devices during the initial connection and is stored on the NCU's CompactFlash card (config.ini).

By contrast, the HT 2 does not function as a "thin client unit". Consequently, it does not inform the PLC whether it is connected; it is addressed in the PLC via the DIP switch position of the connection point (PN box/module or MPP xxx IEH).

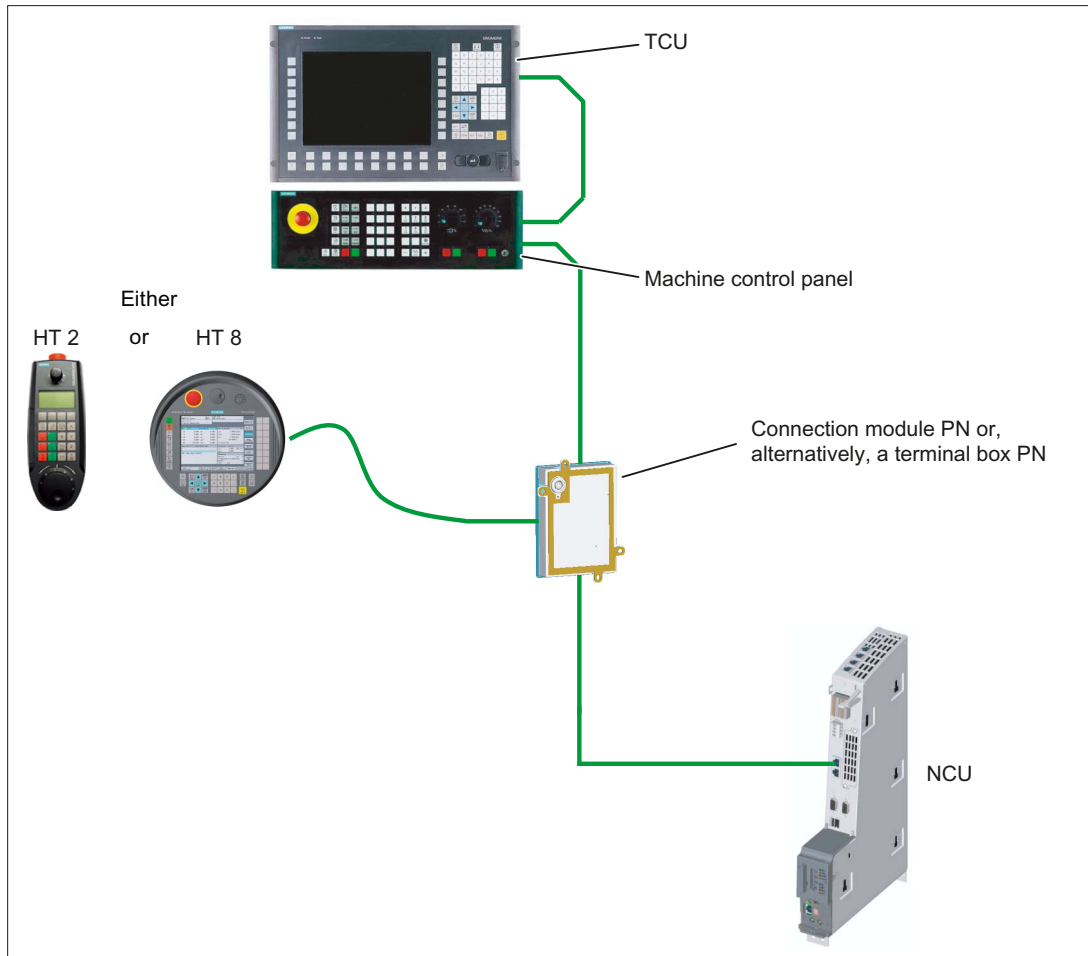

Configuration involving HT 8

The following is assumed:

TCU: MCP address = 192, index = 7

HT 8: MCP address = 10, index = 10

PN box DIP switch position = 10

Depending on whether we are dealing with the TCU or HT 8, either the MCP xxx PN or the integrated HT8_MCP should now be activated.

To do this, perform the following on the PLC:

Depending on whether it is the TCU or the HT 8 that has the operating focus (db19.dbb123), the relevant MCP bus address must be modified in DB7 ("gp_par"):

- Deactivate MCP via `"gp_par".MCP1Stop = 1`
- Define MCP address via `"gp_par".MCP1BusAdr = db19.dbb123`
- Activate MCP via `"gp_par".MCP1Stop = 0`

Configuration involving HT 2

To activate the HT 2, proceed as follows:

- Check whether the TCU has the operating focus (HT 8 disconnected/db19.dbb123==192).
- Activate the HT 2, e.g. via button using "gp_par".BHGStop = 0.

Relevant entries in OB100:

```
CALL FB 1, DB 7
MCPNum := 1
MCP1In := P#E 0.0
MCP1Out := P#A 0.0
MCP1StatSend := P#A 8.0
MCP1StatRec := P#A 12.0
MCP1BusAdr := 10 //<<-- MCP_addr. for HT 8
corresp. TCU settings / or
for MCP 483 xxx PN
MCPBusType := B#16#55 //55=Ethernet
BHG := 5 //5=Ethernet = HT 2
BHGIn := P#M 300.0
BHGOut := P#M 320.0
BHGRcGDNo := 10 // = DIP switch position on
PN box (or MPP xxx IE) to
which HT 2 is connected
```

1.5.4 Application example for two HT 2 units connected to SINUMERIK

Prerequisite

The following example relates to the operation of two HT 2 units on one network. The aim is to switch over from one HT 2 to the other. The following is assumed:

- There are two PN boxes on the network (with DIP switch positions 10 and 11).
- There is an HT 2 unit connected to each of these, but only one of them is activated.

The application example is equally valid for an MPP xxx IE H (with connection for HT 2) instead of a connection module / terminal box.

Activating an HT 2

The HT 2 that is being activated is addressed by specifying the DIP switch position in "gp_par".BHGRecGDNo.

Switchover during operation:

- Deactivate HHU via "gp_par".BHGStop = 1
- Modify the PN box assignment via "gp_par".BHGRecGDNo = 10 or 11
- Activate HHU via "gp_par".BHGStop = 0

If there is only one HT 2, it is sufficient to specify these parameters by means of FB1 parameter assignment in OB100 (DIP switch position 10):

```
CALL FB 1, DB 7
MCPNum := 1
MCP1In := P#E 0.0
MCP1Out := P#A 0.0
MCP1StatSend := P#A 8.0
MCP1StatRec := P#A 12.0
MCP1BusAdr := 10 //<<-- MCP_addr. for HT 8
corresp. TCU settings / or
for MCP 483 xxx PN
MCPBusType := B#16#55 //55=Ethernet
BHG := 5 //5=Ethernet = HT 2
BHGIN := P#M 300.0
BHGOOut := P#M 320.0
BHGRcGDNo := 10 // = DIP switch position on
PN box (or MPP xxx IE) to
which HT 2 is connected
```

1.6 Dimension drawing

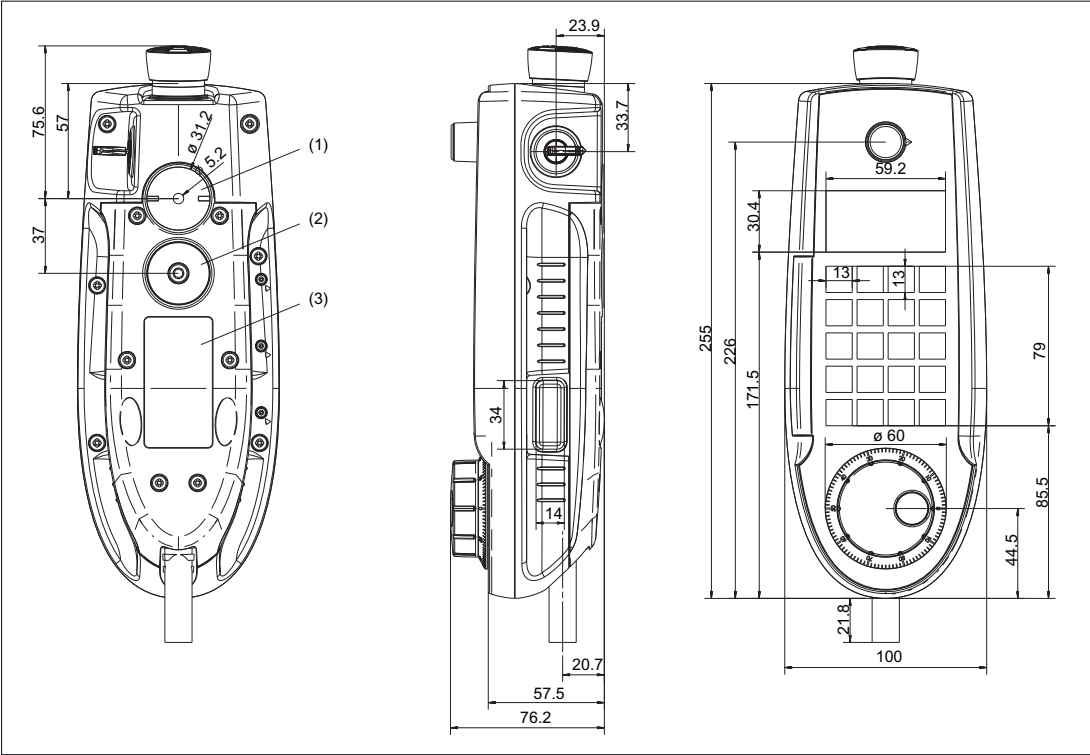

- (1) Standard position mounting bracket (optional: Retaining magnet)
- (2) Standard position retaining magnet (optional: mounting bracket)
- (3) Position for the type plate

Figure 1-23 HT 2 - dimension drawing

1.7 Maintenance and Service

Cleaning the device

Use a soft cloth moistened either with water or a mild cleaning agent to clean the housing, display and operator control elements of the HT 2.

Checking the device

In order to prevent foreign bodies or liquids entering the HT 2, regularly check the device

- that all the housing screws are in place and tight
- for damage to the housing
- for damage to the cable cover or cable entry

Protect the device from environmental effects

Protect the HT 2 against

- direct solar radiation and heat sources
- mechanical vibration and shock
- dust
- moisture, and
- strong magnetic fields

Checking the emergency stop button and the enabling button

Check the emergency stop button regularly to ensure that it functions correctly.

Check the enabling button regularly to ensure that it functions correctly in the enable and panic position.

 WARNING
--

Danger of death caused by damaged HT 2

Immediately check the functioning of the emergency stop button and the enabling button if the device was subject to significant shock (e.g. because it was dropped).
--

1.8 Technical data

1.8.1 Handheld Terminal HT 2

Handheld Terminal HT 2

Safety			
Safety class	III according to EN 61131-2 / EN 50178		
Degree of protection according to EN 60529	IP65		
Approvals	CE / cULus		
Electrical data			
Input voltage	24 VDC		
Current carrying capacity	Enabling button:	10 - 500 mA / 2-channel, 3-stage	
	Emergency stop button:	10 - 1000 mA / 2-channel	
Power consumption, max.	Approx. 2.5 W		
Mechanical data			
Dimensions	Height (without operator control elements): 76.2 mm	Width: 100 mm	Depth: 255 mm
Weight	0.69 kg		
Fall height, max.	1.20 m		
Display			
Resolution	168 x 72 pixels		

Note

Information about the climatic and mechanical environmental conditions is contained in the associated section under:

"General notes and interconnection" → "Operational planning".

Emergency Stop button

Nominal voltage	24 VDC
Current magnitude, max.	1 A
Current magnitude, min.	10 mA
Switching capacity	DC 13 according to EN 60947-5-1
Conditional rated short-circuit current	1000 A, 6A gL/gG according to EN 60947-5-1
B _{10d} (if no PN terminal box used)	100 000
When the PN Plus terminal box is used:	
PFH _d	1.01 * 10 ⁻⁷
Service life	20 years
Forced dormant error detection interval (mechanical actuation to the test the emergency stop)	1 year
Category	3
Performance Level	PL d

Note

The quantitative assessment of the emergency stop safety function must be based on the B_{10d} value corresponding to the used standards (e.g. ISO 13849-1) under consideration of the respective application (frequency of the actuation, service life, diagnostics by the evaluation unit, etc.). The B_{10d} value only applies when the technical properties of the emergency stop button are taken into account.

When using the PN Plus terminal box, the specified failure probability (PFH_d) must be taken into account. This value only applies when the technical properties of the PN Plus terminal box and the quantitative conditions specified here (e.g. service life) are observed.

Enabling button

Output type	Solid-state output
Nominal voltage that can be switched	24 VDC (voltage tolerance 19.2 VDC up to 30 VDC according to EN 61131-2)
Rated current that can be switched	500 mA (max.)
Switch-off current (max.)	
Circuit1	1.5 mA
Circuit2	0.8 mA
Inductive load (max.)	
Circuit1 / circuit2	145 mJ / 1.16 H @ 24 VDC, 500 mA (comparable, DC 13 according to EN 60947-5-1)
Reverse polarity protection	
Circuit1 / circuit2	Yes
Short-circuit and overload protection	
Circuit1	Yes (integrated in the output FET)
Circuit2	Yes (using a protective circuit)
Operating cycles	
Switch position 2	10 ⁵
Switch position 3	10 ⁴
Actuation forces	
From switch position 1 to 2, typically	6 N
From switch position 2 to 3, typically	12 N
PFH _d	1.35 * 10 ⁻⁷
Service life	20 years
Forced dormant error detection interval (mechanical actuation to the test the enable and panic position)	1 year
Category	3
Performance Level	PL d

Note

The PFH_d value only applies when the technical properties of the enabling button and the quantitative conditions specified here (e.g. service life) are observed.

The permissible number of switching cycles must also be observed in the application.

Handwheel

The handwheel of HT 2 is operated in the system as 3rd handwheel

General machine data:

MD 11350 \$MN_HANDWHEEL_SEGMENT[0] = 7

MD 11351 \$MN_HANDWHEEL_MODULE[0] = 1

MD 11352 \$MN_HANDWHEEL_INPUT[0] = 5

1.8.2 Connection module Basic PN

Safety			
Safety class	III according to IEC 60536		
Degree of protection according to EN 60529	IP54		
Approvals	CE / cULus		
Electrical data			
Input voltage	24 VDC (via X3 connector)		
Current carrying capacity	Enabling button contacts (X20 connector)	max. each 0.5 A / 2-channel	
	Emergency stop button contacts (X21 connector)	max. each 0.5 A / 2-channel	
Max. power consumption	Connection module without external loading	0.3 A	
	Panel (HT 2)	0.12 A	
	5 status signals (X7 and X21)	2.5 A (0.5 A each)	
	Total:	2.92 A	
Max. total power consumption	Approx. 70 W		
Mechanical data			
Dimensions	Height (without holder for terminating connector): 66 mm	Width: 165 mm	Length: 166 mm
Weight	0.75 kg		
Fall height, max.	1.20 m		

Note

Information about the climatic and mechanical environmental conditions is contained in the associated section under:

"General notes and interconnection" → "Operational planning".

1.8.3 PN terminal box

PN terminal box

Weight without packaging	Approx. 700 g
Degree of protection according to EN 60529	IP65 (with connected HT 2 or with inserted blanking cover)

Supply voltage

Rated voltage	+24 VDC
Range, permissible	20.4 to 28.8 V (-15%, +20%)
Transients, maximum permissible	35 V (500 ms)
Time between two transients, minimum	50 s
Current consumption of PN terminal box without HT 2 <ul style="list-style-type: none"> • Typical • Continuous current, maximum • Inrush current I^2t 	<ul style="list-style-type: none"> • Approx. 100 mA • Approx. 150 mA • Approx. 0.5 A²s
Current consumption of PN terminal box with HT 2 <ul style="list-style-type: none"> • Typical 	<ul style="list-style-type: none"> • Approx. 100 mA
Fuse, internal	Electronic
Current load PLC-accompanying signals	Max. 100 mA

Note

Recovery time

Wait for approximately one second after you have removed the connecting cable from the connection box before you plug the connecting cable back into the connection box.

After power failures lasting less than one second the connecting cable has to be disconnected.

1.9 Spare parts

The following spare parts are available for the HT 2:

Designation	Remark	Quantity	Order number
Service pack Connection box	Dummy plugs for cable compartment	1	6XV6574-1AA04-4AA0
	PG screw glands for connection box	2	
	1 set of screws for connection box cover	1	
	Terminal strips for connection box	2	

1.10 Accessories

1.10.1 Overview

The following accessories are available for the HT 2:

Designation	Remark	Number	Order No.
PN Basic terminal box	Without automatic emergency stop override for mounting in the system	1	6AV6671-5AE01-0AX0 *)
PN Plus terminal box	With automatic emergency stop override for mounting in the system	1	6AV6671-5AE11-0AX0 *)
PN Basic connection module	Without automatic emergency stop override for mounting in the control cabinet	1	6FC5303-0AA01-1AA0 *)
Connecting cable	Length: 2 m	1	6XV1440-4BH20 *)
	Length: 5 m	1	6XV1440-4BH50 *)
	Length: 8 m	1	6XV1440-4BH80 *)
	Length: 10 m	1	6XV1440-4BN10 *)
	Length: 15 m	1	6XV1440-4BN15 *)
	Length: 20 m	1	6XV1440-4BN20 *)
	Length: 25 m	1	6XV1440-4BN25 *)
Spiral connecting cable	Length: 1.5 m, can be expanded to 3.5 m	1	6FC5348-0AA08-3AA0 *)
Set of keys	Set of 5	1 set	6AV6574-1AG04-4AA0
Retaining magnet for HT 2		2	6FC5348-0AA08-0AA0
Holder for HT 2	For safekeeping, also suitable for stationary operation	2	6FC5348-0AA08-1AA0
Slide-in labels	Can be labeled (3 films, DIN A4)	1 set	6FC5348-0AA08-2AA0

*) Safety related accessories

1.10.2 Mount

Note

There is no counterpiece to the holder on the HT 2 in the scope of delivery and must be provided by the customer depending on the circumstances.

The HT 2 can be retained using the mounting rack.

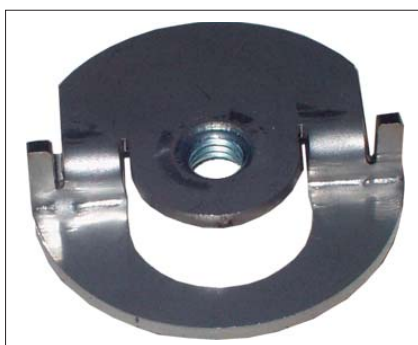

Figure 1-24 HT 2 mounting bracket

The mounting bracket is mounted the same way as the retaining magnets. A description about this can be found in Section: "Retaining magnet".

Note

Please ensure that the HT can be ergonomically mounted. Therefore, choose a suitable mounting height.

Dimension drawing

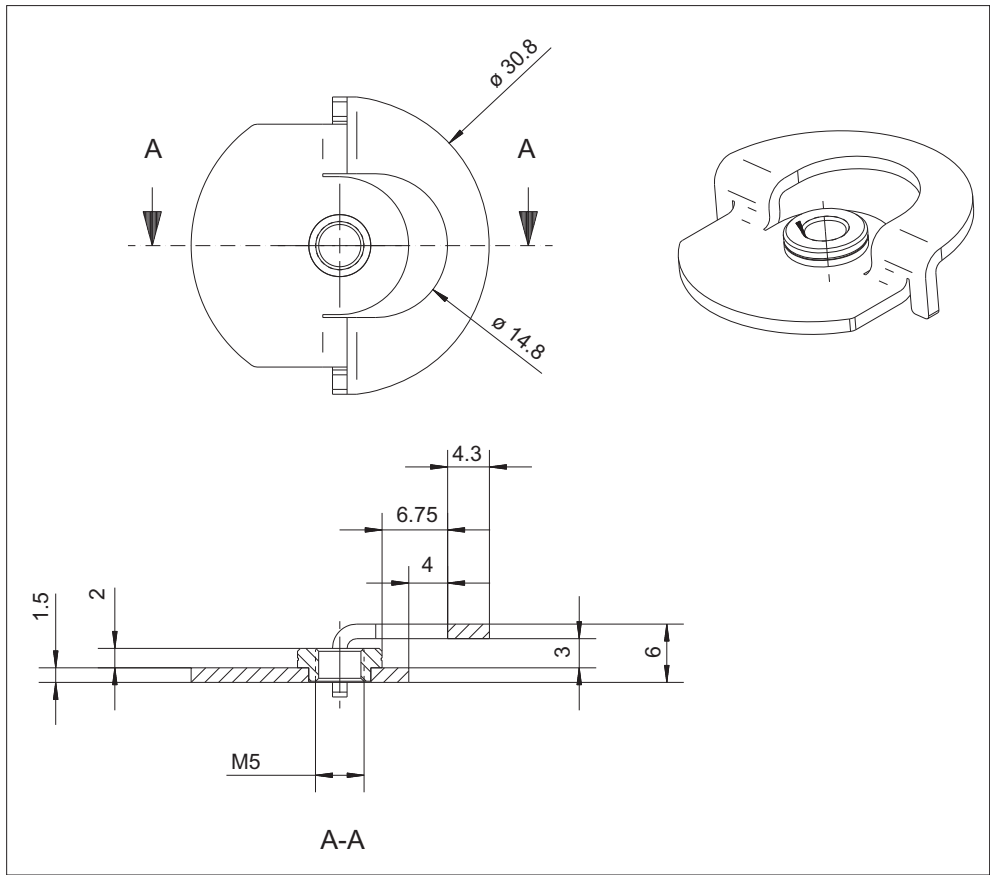

Figure 1-25 Dimension drawing of the HT 2 mounting bracket

1.10.3 Retaining magnet

The HT 2 can be mounted onto all sheet metal parts using the retaining magnets.

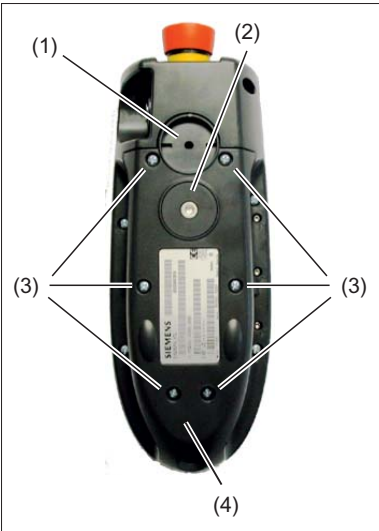

Figure 1-26 HT 2 retaining magnet

Mounting the retaining magnets

Note

A second magnet can be mounted at position (2) to increase the holding forces.

	1. Open the cable duct cover by unscrewing the six PT screws approximately 1 cm. To do this, use a crosstip size 2 screw driver.
(1)	Standard position retaining magnet (optional: Mounting bracket)
(2)	Standard position mounting bracket (optional: Retaining magnet) A second retaining magnet can be used when required.
(3)	PT screws (4 x 20 mm)
(4)	Cable duct cover

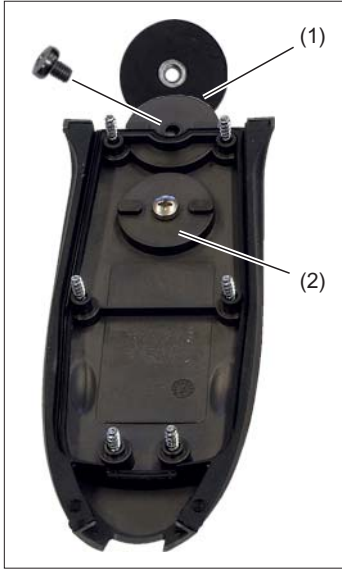
	2.	Locate the retaining magnets under the cable duct cover and retain them from the rear using the screw. To do this, use a slotted size 4 screwdriver.
	3.	Re-attach the cable duct cover of the HT 2. Ensure that the tightening torque does not exceed max. 0.4 - 0.5 Nm.
(1)	Retaining magnet with retaining screw	
(2)	Retaining magnet mounted	

Working with retaining magnets

<p>⚠ CAUTION</p> <p>Danger of injury from flying sparks</p> <p>Do not install the magnets in hazardous locations as they can cause arcing and sparking.</p>
<p>⚠ WARNING</p> <p>Danger of death due to strong magnetic fields</p> <p>Even at a considerable distance apart, magnets can be attracted to one another, repel one another or splitter when they collide. This involves strong forces. This is the reason that you should avoid that magnets collide and work with the appropriate protection in order to prevent skin crushing and other injuries.</p> <p>Strong magnetic fields can destroy electronic or mechanical elements and devices. This also applies to heart pacemakers. Therefore observe the necessary safety clearances. Information on this is provided in the documentation of the corresponding devices.</p> <p>Carefully observe the appropriate packing regulations when shipping by air.</p>

1.10.4 Slide-in label

1.10.4.1 Labeling the slide-in labels

In the factory, the Handheld Terminal HT 2 is supplied with five horizontal slide-in labels. With the exception of the slide-in label for the first row of keys, standard symbols for the machine control are printed on the slide-in labels.

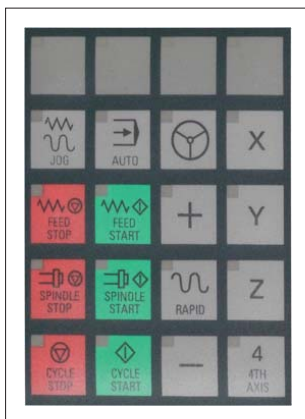

Figure 1-27 HT2 slide-in labels

When requested, an accessory package with three blank slide-in labels can be ordered, so that these strips can be printed with the key symbols according to your specifications (see Section: "Accessories" → "Overview").

Files for printing the blank film

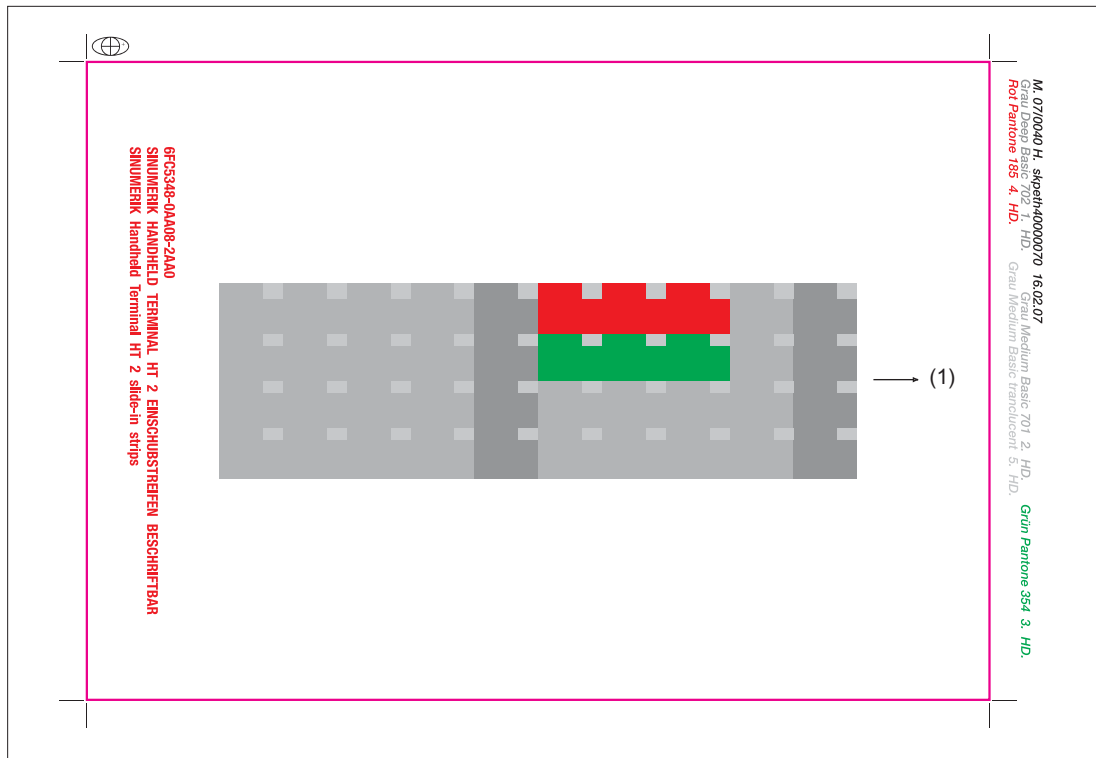

Figure 1-28 Blank film HT 2 [printing direction (1)]

The DOConCD / Catalog NC 61 (CD enclosed) contains two files for printing the blank films:

- **Template_HT2_13.doc**
- **Symbols_OP08T_13.doc**

The file "**Template_HT2_13.doc**" is a template for the exact positioning of the symbols on the printable film.

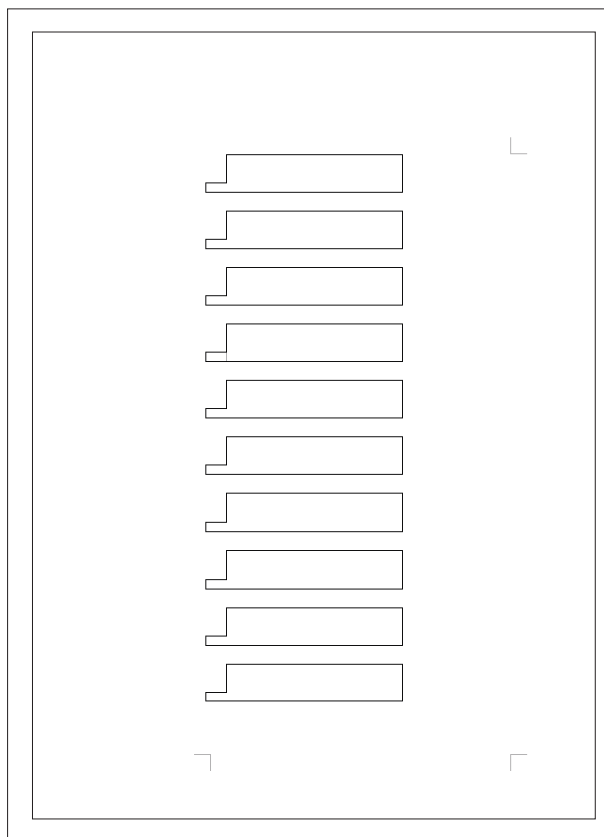

Figure 1-29 Template_HT2_13.doc (blank template for the film)

The "**Symbols_OP08T_13.doc**" file contains a broad range of key symbols. An overview of these can be found via "Operator panels" > "OP 08T operator panel front" > "Accessories" > "Labeling the slide-in labels".

Preparing slide-in labels

1. Open the files "Template_HT2_13.doc" and "Symbols_OP08T_13.doc" in MS Word.
2. Select a key symbol from the file "Symbols_OP08T_13.doc" by left-clicking.
3. Copy the desired symbol to the clipboard via "Edit" → "Copy" or "Ctrl + C"
4. Return to the template file "Template_HT2_13.doc"
5. Position the cursor before the insertion point in the desired table cell.
6. Insert the key symbol via "Edit" → "Paste" or "Ctrl + V".
7. To format the graphics, double click on the inserted symbol with the lefthand mouse key.
 - Select the "size" tab and set the symbol height to 1.1 cm.
 - Click on <OK> to accept the change.
8. Repeat steps 2. to 7. until you have inserted all the key symbols.

Printing the slide-in labels

1. Place the blank film in the printing direction in the slot of your laser printer (see Fig.: "Blank film HT 2").
2. Select "film" as the printable medium if your printer allows this setting.
3. Start the printing process using MS Word.

Note

For labeling the slide-in labels, HP Color Laser Jet film C2936A is used.
Make a test print on paper before you print on the film.
Allow the film to cool after printing so that the ink can dry.

4. Cut the slide-in labels out of the film along the edges (see Fig.: "Template_HT2_13.doc").
5. Round off the corners of the slide-in labels approx. 3 mm to facilitate insertion.

Dimension drawings

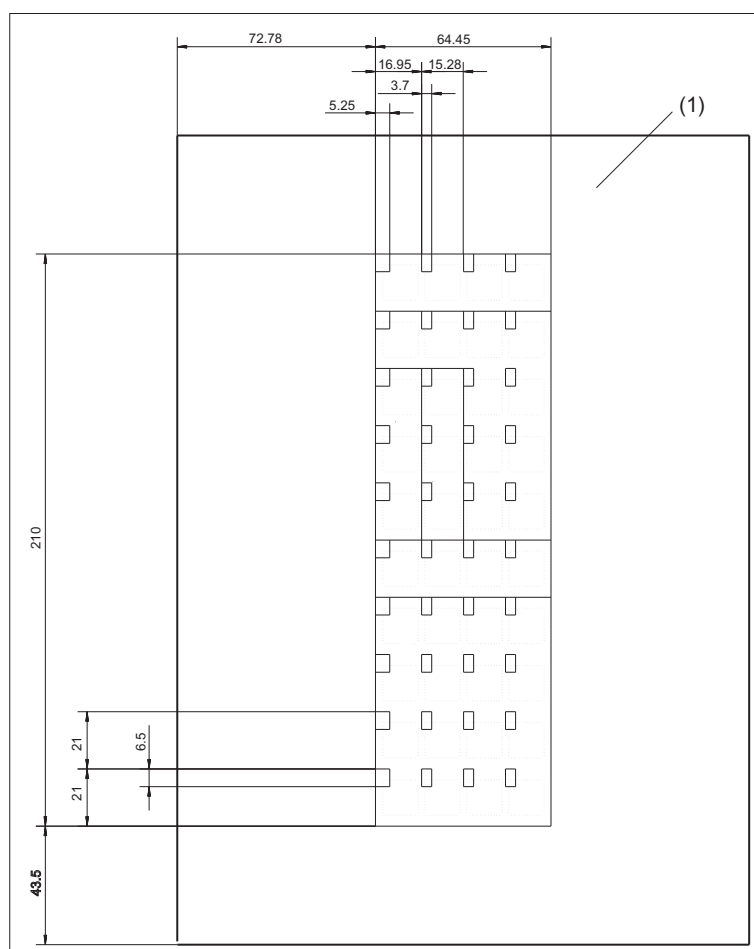

Figure 1-30 Dimensions for slide-in labels

Creating your own symbols

- Drawing in a vector program (e.g. Designer, Freehand, CorelDraw):
 - Draw a 13 x 13 mm square, fill with the color white and give it an invisible border line.
 - Place the symbol in the center of this square.
 - Group the square and symbol together and add this group in the MS Word document Template_HT2_13.doc.
- Drawing in an image editing program (e.g. Photoshop, Picture Publisher, Paint)
 - Draw a square 13x13 mm (37x37 pixel), filled with the color white.
 - Draw the symbol in the center of this square.
 - Copy the symbol and the square together and add the group in the MS Word document Template_HT2_13.doc.

1.10.4.2 Replacing the slide-in labels

The slots to insert the slide-in labels are located under a cover on the lefthand side of the HT 2 that is integrated into the device design.

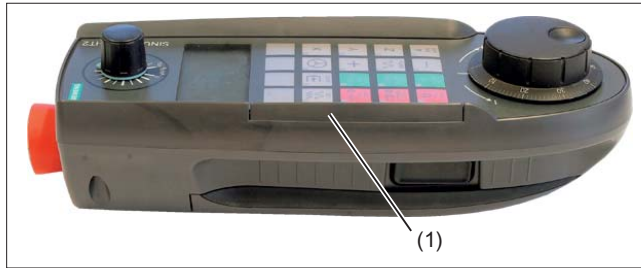

Figure 1-31 Cover of the slide-in labels (1)

The retaining screws of the cover are accessible from the rear of the HT 2.



1. Release the three cross-recessed screws (PT2, 5x14). To do this, use a crosstip size 1 screw driver (PH1). Each of the screws has a marking.



2. Remove the cover.

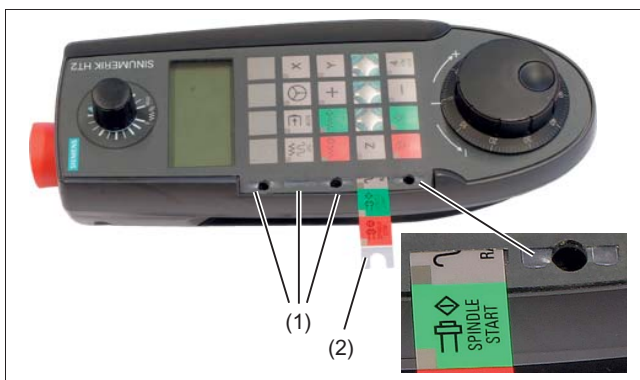

3. Withdraw the required slide-in label.
4. Insert the new slide-in labels.
5. Re-attach the cover and screw it into place.

- (1) Slide-in labels inserted
- (2) Slide-in labels withdrawn

Handheld Terminal HT 8

2.1 Description

The SINUMERIK HT 8 is an handheld operating and programming device that combines the functions of an operator panel front and a machine control panel. It enables direct plant and machine operation from any location. The HT 8 therefore operates according to the Thin Client principle (mobile Thin client, see also "Operator panels", Chapter: "Thin Client Unit").

The HT 8 has a 7.5" TFT color display and is operated via a touch screen and membrane keys. It is equipped with an emergency stop button and two 3-stage enabling buttons for left and right-handed people.

Its safety concept allows working in the danger zone of the machine, which is needed for teaching.

The HT 8 is hot-plug capable. This allows trouble-free connecting and disconnecting of the connector during operation, without triggering an emergency stop.

The HT 8 can be safely kept and operated in a stationary manner in the wall holder. The wall holder is available as an accessory (see Chapter: "Accessories").

The HT 8 is available in two variants:

- with enabling button, emergency stop button and override rotary switch
- with enabling button, emergency stop button, rotary override switch and handwheel

Validity

The following description applies to the following components:

Designation	Features	Order number
HT 8	Enabling button, emergency stop button, override rotary switch	6FC5403-0AA20-0AA0 as of version: 09
HT 8	Enabling button, emergency stop button, override rotary switch, handwheel	6FC5403-0AA20-1AA0 as of version: 09

The safety-related accessories are marked in the "Accessories" section with a *).

Function blocks

In the unit:

- PCB with CPU, memory
- Ethernet controller

Device front:

- LC display as a Touch Screen
 - 640 x 480 (VGA) Color TFT
 - Inverter on board
- 52-key membrane keyboard
 - 24 machine control keys
 - 28 control keys (number block keys, cursor pad, function keys)
- Emergency stop button, 2-channel
- Rotary override switch (19 positions)
- Handwheel (optional)

Device rear side:

- 2 enabling buttons (2-channel, 3-stage)
- Serial interfaces:
 - HT 8 connection cable to terminal box / connection module
 - USB interface (with dummy plugs)
- Power supply (+24 V)

2.2 Operator controls and indicators

2.2.1 View

Front

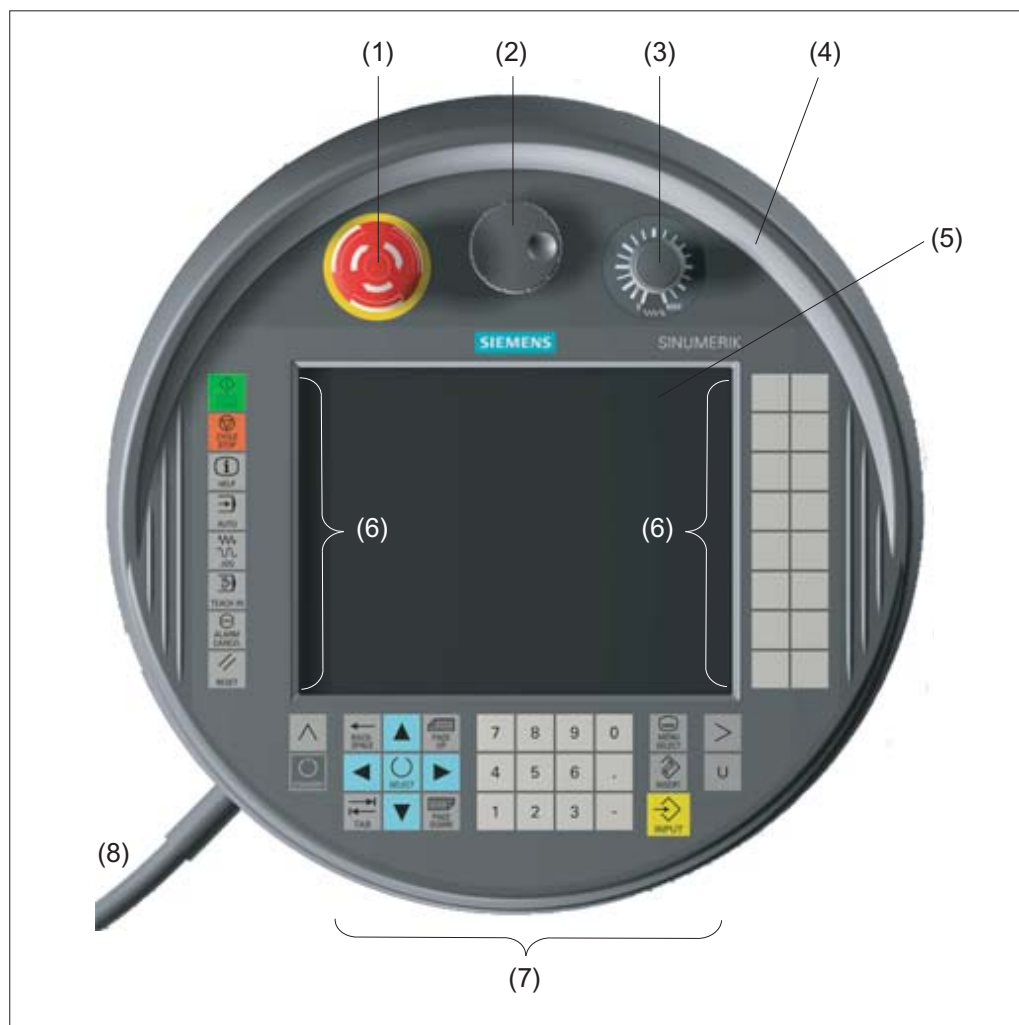

- (1) Emergency stop button
- (2) Handwheel
- (3) Rotary override switch
- (4) Protective collar
- (5) Display / Touch screen
- (6) Function keys machine control panel
- (7) HMI control keys
- (8) Connecting cable

Figure 2-1 Operator interface of the HT8

Rear side

Rear side of unit HT 8

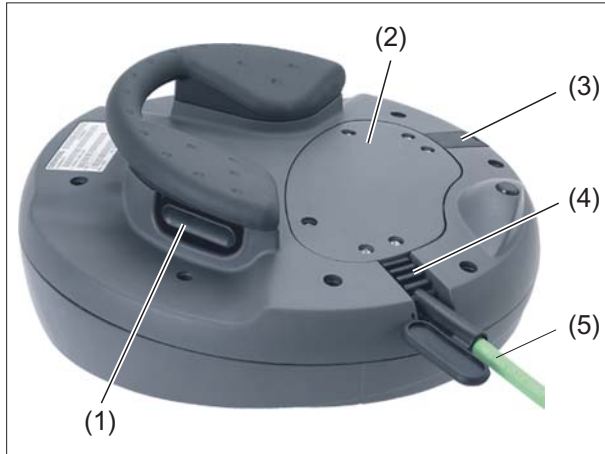

- (1) Enabling buttons
(one left and one right, under the grip)
- (2) Cable duct cover
- (3) Second cable entry
(connector with integrated USB 1.1 connection)
- (4) Sleeve for connecting cable
- (5) Connecting cable

USB 1.1 connection

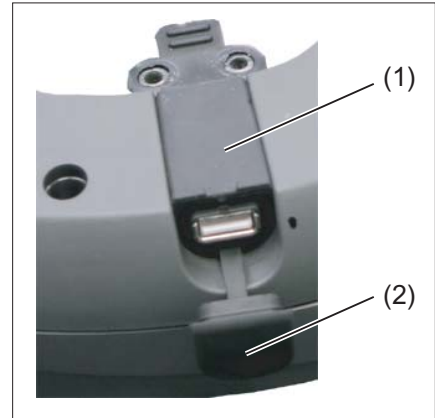

- (1) Connector with integrated USB 1.1 connection
- (2) USB protective cap

Bottom

The HT 8 consists of a double-walled housing (upper and lower shells).

On the lower shell, the HT 8 has three small drill-holes (2). These drill-holes are attached for the purpose of diverting the liquid that can penetrate into the space between the double-walled housing if the malleable protective shroud on the upper shell is pushed through.

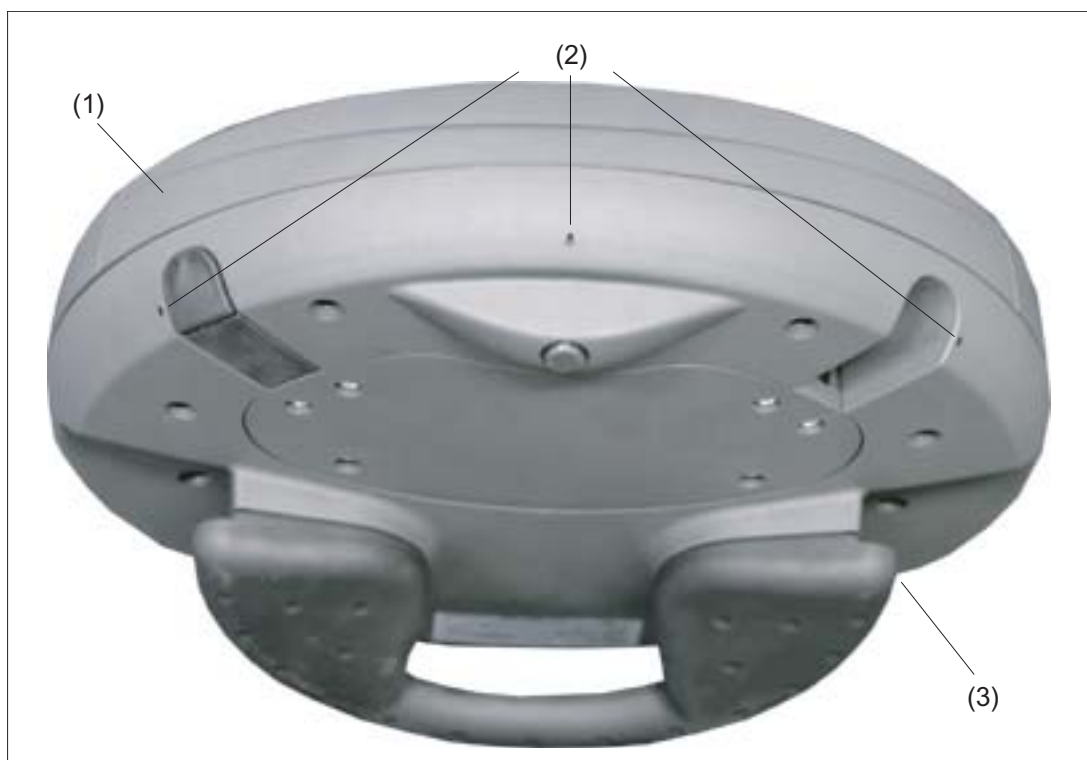

- (1) Upper shell
- (2) Holes
- (3) Lower shell

Figure 2-2 Lower shell HT 8

2.2.2 Description

Display / Touch screen

The display is a backlit CCFL unit.

Its service life can be prolonged if the brightness is reduced by dimming.

All the application-specific functions are displayed on the touch-sensitive display. One touch of a finger on the corresponding key, triggers the respective function.

NOTICE
Damage to the display by pointed or hard objects
Do not touch the operating elements of the display with pointed or hard objects, as this can damage it, sometimes beyond repair.

In order to achieve precise assignment by pixels, the touch-sensor must be calibrated and adjusted to the touch screen.

Information for calibrating the touch screen of the HT 8 can be found in: "General information and networking", Chapter: "Networking"

Note

Calibration of the touch sensor may also become necessary during operation, because the resistance values of the touch membrane change when there is a temperature change.

Membrane keyboard

On the front side of the HT8, 52 keys are arranged in several key blocks (see Section: "Control and display elements" → "View").

Function keys machine control panel

- Left: START, STOP, RESET, AUTO, JOG, TEACH, ALARM CANCEL
- Bottom: U (User button)
- Right: 2 x 6 traversing keys, 4 user keys (can be freely assigned)

HMI control keys

- The number block contains the numbers 1-9, the decimal point and the minus sign
- The cursor pad is used to navigate on the screen.
- 7 keys for
 - Input
 - Menu change
 - Switch-over of the softkey bars
 - Help function

Emergency stop button

The red mushroom-shaped head of the EMERGENCY STOP button is provided with a yellow ring.

Directly under the mushroom-shaped head, there is also a black ring which identifies the position status of the EMERGENCY STOP button.

	State	
Ring (black)	visible	not visible
Emergency stop button	Not pressed	Pressed

If an emergency stop is triggered, the button locks into place.

If the button is locked into place, it can be unlocked by rotating it to the right.

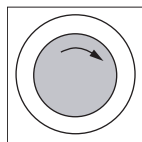

Emergency stop button

Press the red button in emergencies when

- people are at risk,
- there is the danger of machines or the workpiece being damaged.

As a rule, when operating the EMERGENCY STOP button, all drives are brought to a standstill with max. braking torque.

Machine manufacturer

For other reactions to the emergency stop:

Refer to the machine tool manufacturer's instructions



The signals are sent via the connecting cable to the terminal box or the connection module and are available for further wiring.

Rotary override switch

The rotary override switch of the HT 8 has 19 positions.

The evaluation scale (0 to max.) is specified by the machine's manufacture in the form of machine data.

Enabling button

The HT 8 has two enabling buttons that are logically grouped. This allows the enabling function to be triggered by either the left or the right hand during normal operation.

The enabling buttons are configured as 2-channel, 3-position switches for the following button positions:

- Released (no activation)
- Enabling (center position) - enabling for channel 1 and 2 is on the same switch.
- Panic (completely pushed through)

The signals are sent via the the connecting cable to the terminal box or the connection module and are available for further wiring in the control cabinet.

Connection examples of the enabling and emergency stop button can be found in Chapter: "HT 2", Section: "Connections" → "Connection examples of enabling button and emergency stop button"

Handwheel

The HT 8 is available with a handwheel
The handwheel operates with 50 pulses/revolution.

HT 8 operated with the handwheel

An HT 8 with a handwheel behaves in the same way as an MCP 483C PN (in Ethernet mode) with a handwheel. The handwheel pulses are transferred via Ethernet to the NCK using the HT 8 MCP process image.

NOTICE
Lack of care for traversing can cause damage to the tool/workpiece
The increments per revolution for a handwheel on a mobile HT 8 amount to 50 increments/revolution; for a stationary unit, it is 100 increments/revolution. A different length of the traverse path results from this difference.

Interface USB 1.1

A USB 1.1 interface is provided for connecting an external keyboard, mouse or USB FlashDrive.

It is integrated in the connector that closes off one of the two cable inlets on the rear side of the HT 8 (see Section: "Control and display elements" → "View").

NOTICE
Damage to the plug by missing protective cap
Replace the USB connector if its protective cap is torn, because in this case, the connector is no longer protected from dirt.

NOTICE

Damage to the inserted USB FlashDrive should the HT 8 fall

A plugged-in USB FlashDrive can be damaged or broken off if the device falls.

2.2.3 Screen brightness control

If a screen with high contrast is displayed unchanged for longer than 1 hour, the screen brightness control must be activated (screen switched dark) in order to protect the TFT display against a phenomenon known as "burn-in" of the last displayed screen.

For more information see:

- IM9 Commissioning Manual SINUMERIK Operate
- IM4 HMI-Advanced Commissioning Manual

NOTICE

You may do irreversible damage to your TFT display if the screen brightness control is not activated.

2.3 interfaces

2.3.1 Overview

The following figure shows the connection of the individual function units to the interfaces of the HT 8.

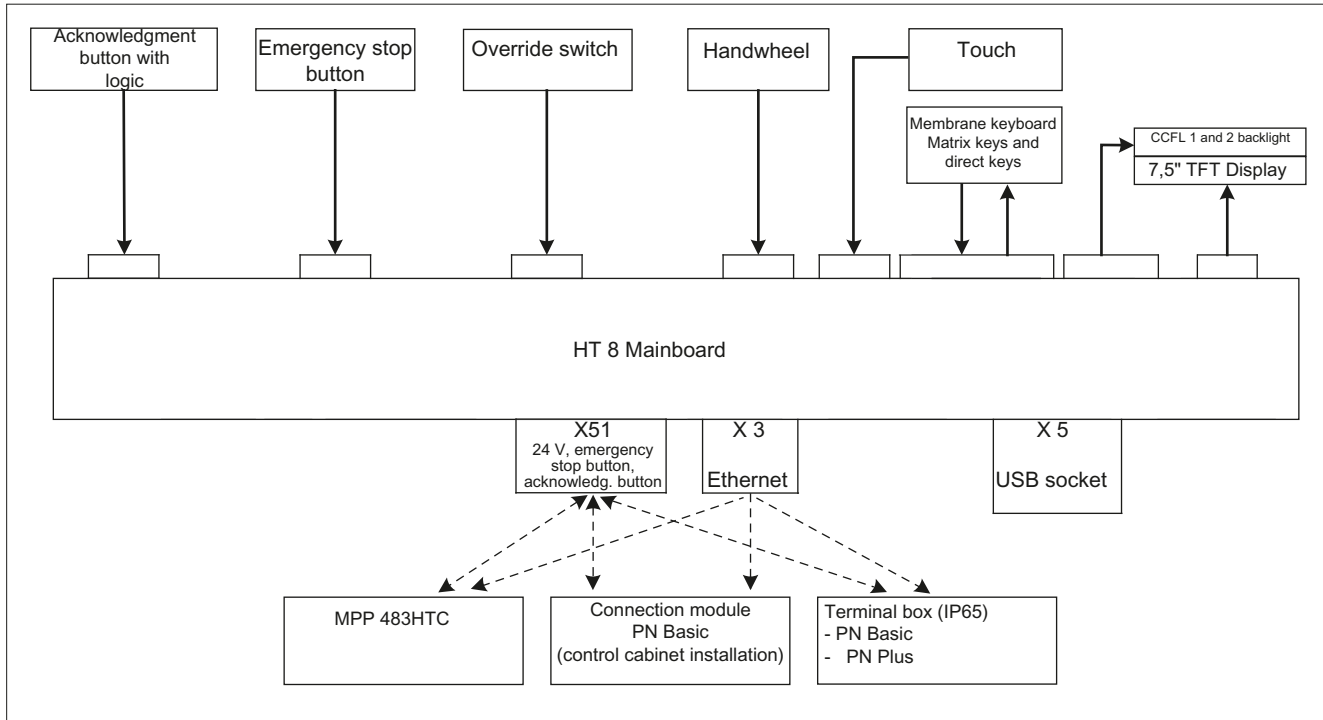

Figure 2-3 Block diagram of HT 8 interfaces

2.3.2 Description

- Signal type
- B** Bi-directional signal
 - O** Signal output
 - V** Power supply
 - I** Signal input
 - VI** Voltage input
 - VO** Voltage output
 - K** Contact

X3: EthernetConnector designation: **X3**

Connector type: 8-pole RJ45-socket with interlock (above)

Table 2- 1 X3 connector assignment

Pin	Signal	Signal type	Meaning
1	TD+	O	Transmit data +
2	TD-		Transmit data -
3	RD+	I	Receive data +
4	-	-	Unassigned
5	-	-	Unassigned
6	RD-	I	Receive data -
7	-	-	Unassigned
8	-	-	Unassigned

X5: USB 1.1 connectionConnector designation: **X5**

Connector type: 6-pole plug connector

Table 2- 2 Assignment of connector X5

Pin	Signal	Signal type	Meaning
1	Shield	V	Shield connection
2	+5 V	VO	Power supply for external devices
3	USB-DN	B	USB data channel 1
4	USB-DP		USB data+, channel 1
5	0 V	VO	Ground
6	Shield	V	Shield connection

X51: Supply 2

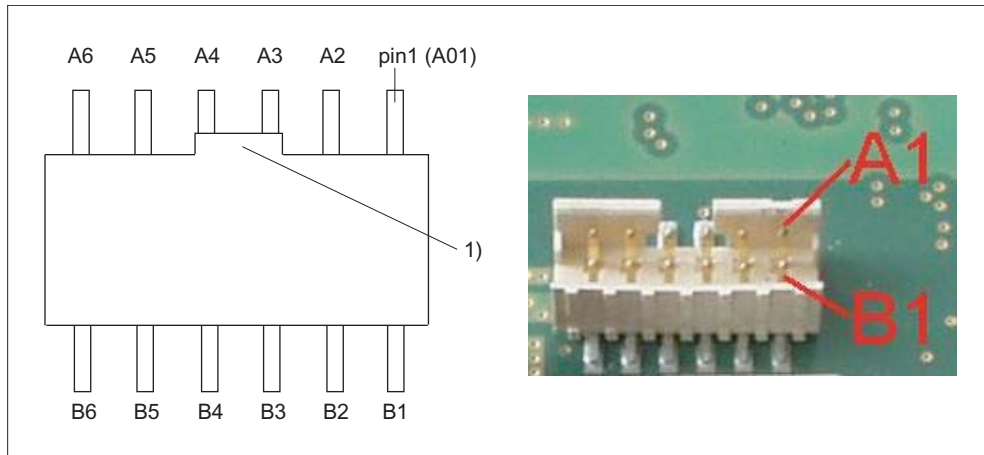

Figure 2-4 X51: Supply 2

(1) Recess

Connector designation: **X 51**

Connector type: 12-pole connector plug with coding and locking

Pin	Signal	Signal type	Meaning	Pin	Signal	Signal type	Meaning
A1	N.C.	-	Unassigned	B1	N.C.	-	Unassigned
A2	Enable 2+	O	Enabling button Channel 2, digital	B2	ENABLE 2-	O	Enabling button Channel 2, digital
A3	Enable 1+		Enabling button Channel 1, digital	B3	ENABLE 1-		Enabling button Channel 1, digital
A4	STOP -13	K	EMERGENCY STOP circuit 2	B4	STOP -14	K	EMERGENCY STOP circuit 2
A5	STOP -23		EMERGENCY STOP circuit 1	B5	STOP -24		EMERGENCY STOP circuit 1
A6	P24	VI	+24V power supply	B6	M24	VI	External ground

2.4 Ports

2.4.1 Overview

The HT 8 is connected via Ethernet (see Section: "Interfaces" → "Overview").

For a connection via Ethernet the individual bus nodes communicate via

- PN Basic terminal box/PN Plus terminal box
- PN Basic connection module (for control cabinet installation) or
- MPP 483HTC

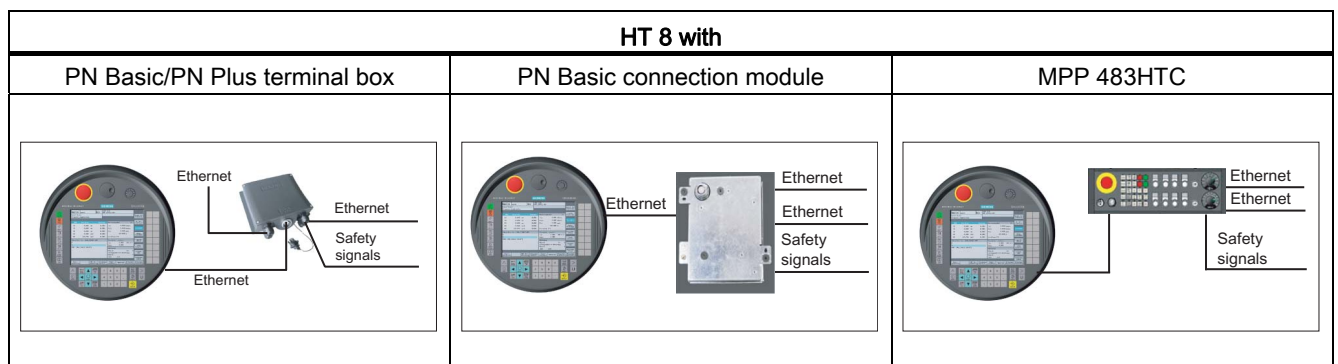

Connection via the PN Plus terminal box allows quick connection and disconnection during machine operation without an emergency stop being triggered.

If no HT 8 is connected, observe the following:

<p>⚠ WARNING</p> <p>Danger of death resulting from improper access</p> <ul style="list-style-type: none"> • After disconnection, the HT 8 must be locked away. • Emergency stop buttons that are inactive must not be identified as such or must be inaccessible. This is to prevent the emergency stop button from being used inadvertently.

Note

An example of TCU with MCP xxx PN as well as optionally an HT 8 or HT 2 on a PN box / PN module can be found in Chapter: "HT 2", Section: "Commissioning" → "Application example of HT8 and HT 2 in mixed operation".

2.4.2 Terminal Box PN

2.4.2.1 Features

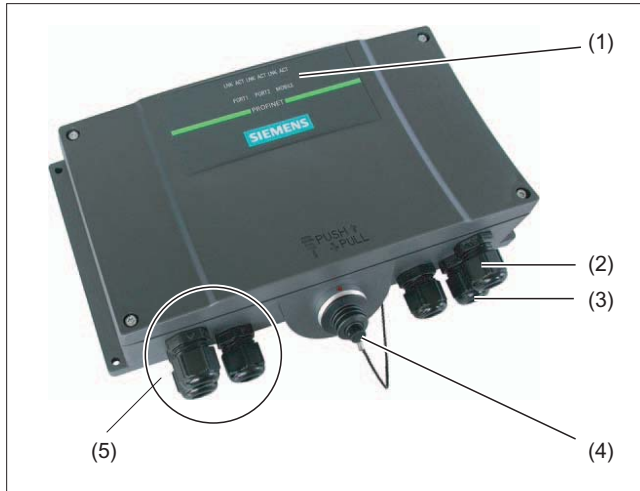

Figure 2-5 PN terminal box

- (1) LED displays
- (2) Screwed joint for power supply cable and shield
- (3) Screwed joint for cable with supplementary stop and acknowledgement button signals and for PLC accompanying signals
- (4) Connecting socket for the connector plug of the connecting cable (covered with dummy cap)
- (5) Screwed joint for process data line (Ethernet)

Note

Degree of protection IP65 at the terminal box is ensured with plugged-in HT 8 or plugged-in dummy cap.

The PN terminal box is available in two versions.

- PN Basic terminal box
- PN Plus terminal box

Note

The exterior of the PN terminal box versions only differs in terms of what is printed on the side.

The terminal boxes feature two rotary coding switches (S1 and S2) so that a unique ID can be set for the purpose of station identification. For further details, see section: "Connections" → "PN Basic connection module" → "Interfaces".

PN Plus terminal box

The PN Plus terminal box features hot-plug capability. This means that it is possible to connect and disconnect during operation without any disruption. The emergency stop circuit is automatically maintained during the switching of connectors.

The **PN Plus terminal box** is available under order no. **6AV6671-5AE11-0AX0**.

PN Basic terminal box

The PN Basic terminal box can be used if no hot-plug capability is required. The emergency stop circuit can be overridden here by external mechanisms.

The **PN Basic terminal box** is available under order no. **6AV6671-5AE01-0AX0**.

Clearance

The following clearances are required around the PN terminal box:

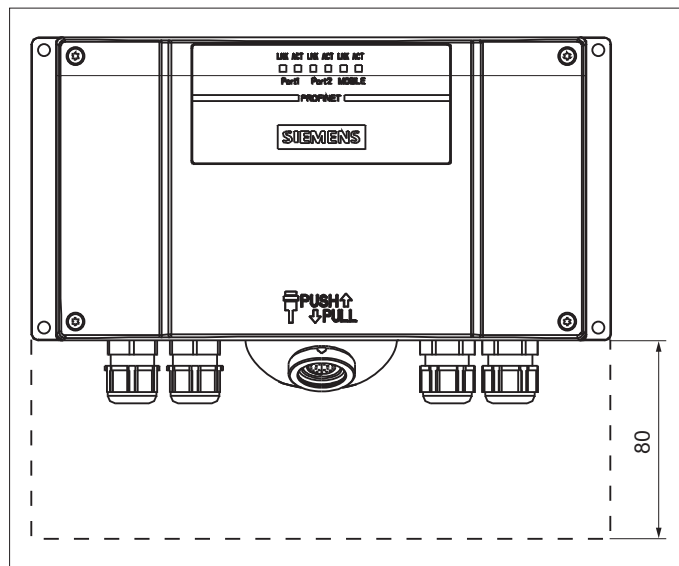

2.4.2.2 PN Plus terminal box

The PN Plus terminal box differs from a PN Basic terminal box in that it has four relays mounted on the board.

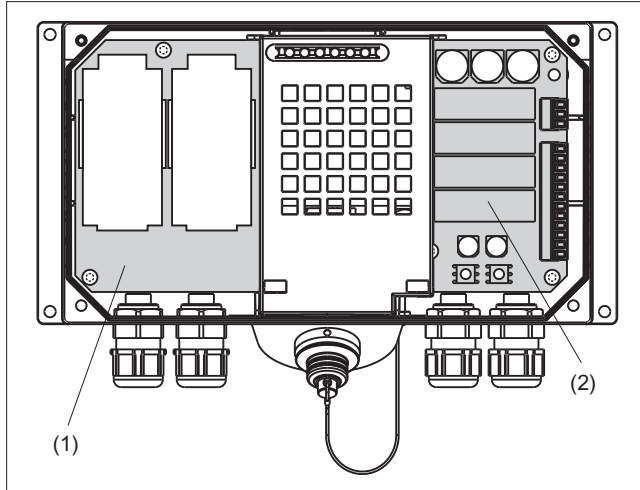

- (1) Board
- (2) Relays

Figure 2-6 PN Plus terminal box

Switching states of the emergency stop circuit

HT 8	Emergency Stop button	Switching status, emergency stop circuit
Connected	Not pressed	Emergency stop circuit in the terminal box remains closed.
Connected	Pressed	The emergency stop circuit in the terminal box is open. The system to be monitored is stopped.
Not connected	-	Emergency stop circuit in the terminal box remains closed.

<p>! WARNING</p> <p>Danger of death resulting from the inadvertent disconnection of the HT 8</p> <p>If you disconnect the HT 8 from the PN Plus terminal box, the emergency stop circuit is closed, thereby clearing the stop state of the system to be monitored. This occurs irrespective of whether the emergency stop button has been pressed on the HT 8.</p>
--

2.4.2.3 PN Basic terminal box

In contrast to the PN Plus terminal box, the "Stop loop through" function is not implemented on the PN Basic terminal box. Relays are so not required.

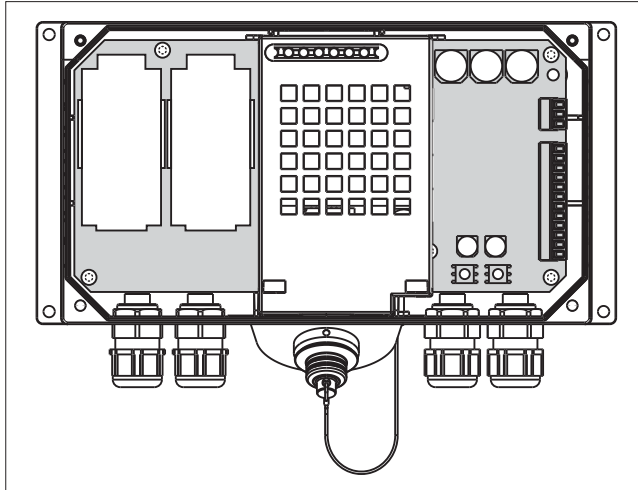

Figure 2-7 PN Basic terminal box

Note

The emergency stop circuit is controlled via the emergency stop button when the HT 8 is connected. If the connecting cable of the HT 8 is disconnected from the PN Basic terminal box, the emergency stop circuit is interrupted. This leads to a safe machine stop or an emergency stop of the system to be monitored.

Switching states of the emergency stop circuit

HT 8	Emergency Stop button	Switching status, emergency stop circuit
Connected	Not pressed	Emergency stop circuit in the terminal box remains closed.
Connected	Pressed	The emergency stop circuit in the terminal box is open. The system to be monitored is stopped.
Not connected	-	The emergency stop circuit in the terminal box is open. The system to be monitored is stopped.

WARNING

Danger of death resulting from the premature emergency stop unlocking

If you have shut down the system to be monitored, you can only release the emergency stop button or put the system to be monitored back into operation if the condition that triggered the emergency stop function has been corrected and a safe restart is carried out.

2.4.2.4 Interface assignments

Information concerning interface assignment on the PN Plus terminal box can be found in Chapter: "HT 2", Section: "Connections" → "PN terminal box" → "Interface assignment of the PN Plus terminal box".

Further information on the interface assignment of the PN terminal box can be found at

- SIMATIC HMI/HMI device Mobile Panel 177 (WinCC flexible)
- www.automation.siemens.com/simatic/portal/index_76.htm

2.4.3 Connecting module Basic PN

2.4.3.1 Features

The connection module PN Basic was specially developed for installation in the control cabinet. The terminating connector protrudes through the panel of the control cabinet so that the HT 8 can be connected from the outside.

The **Connection module Basic PN** is available under order no. **6FC5303-0AA01-1AA0**.

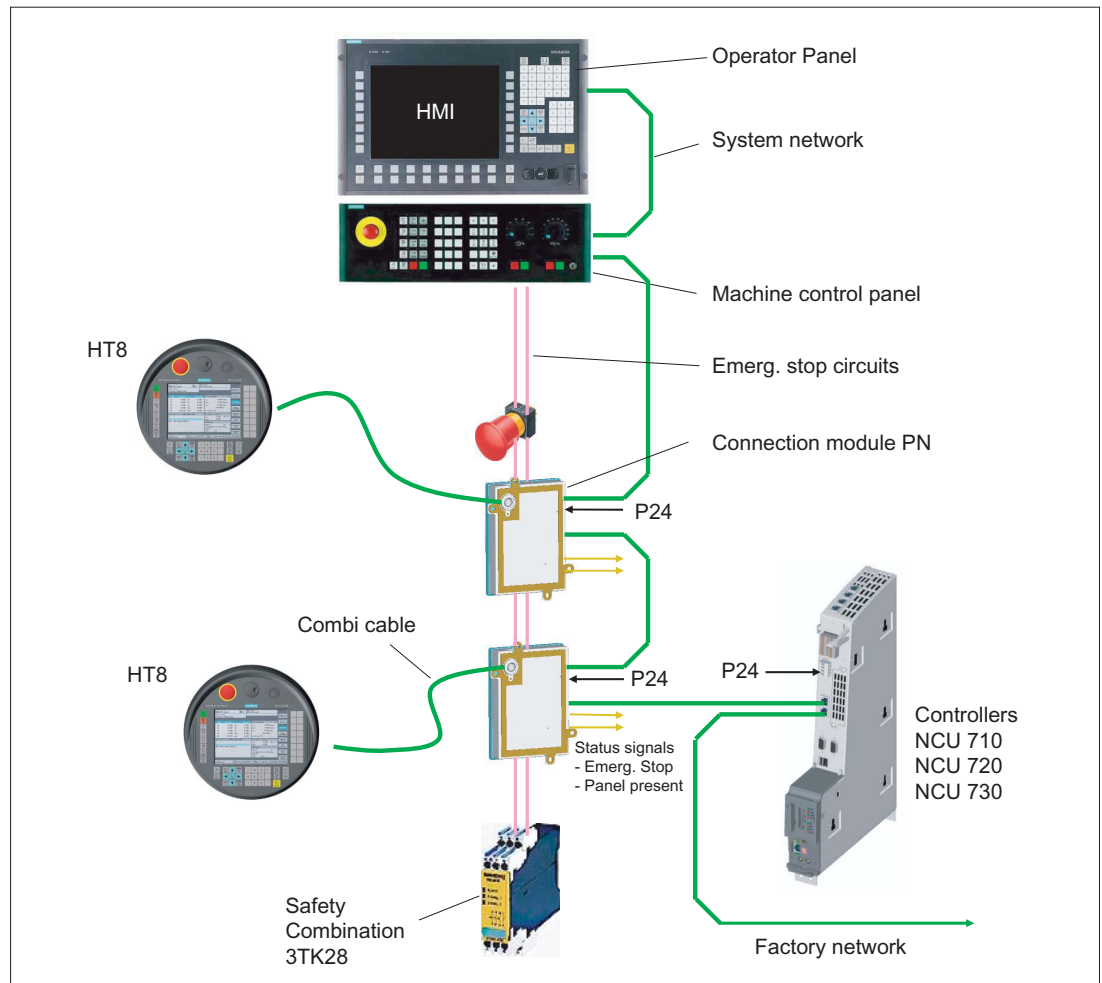

Figure 2-8 Block diagram - control cabinet installation

The connection module PN Basic is not hot plug-capable.

The HT 8 can either be connected directly to the NCU or to the PCU 50.3 as a Thin Client.

2.4.3.2 Dimension drawing

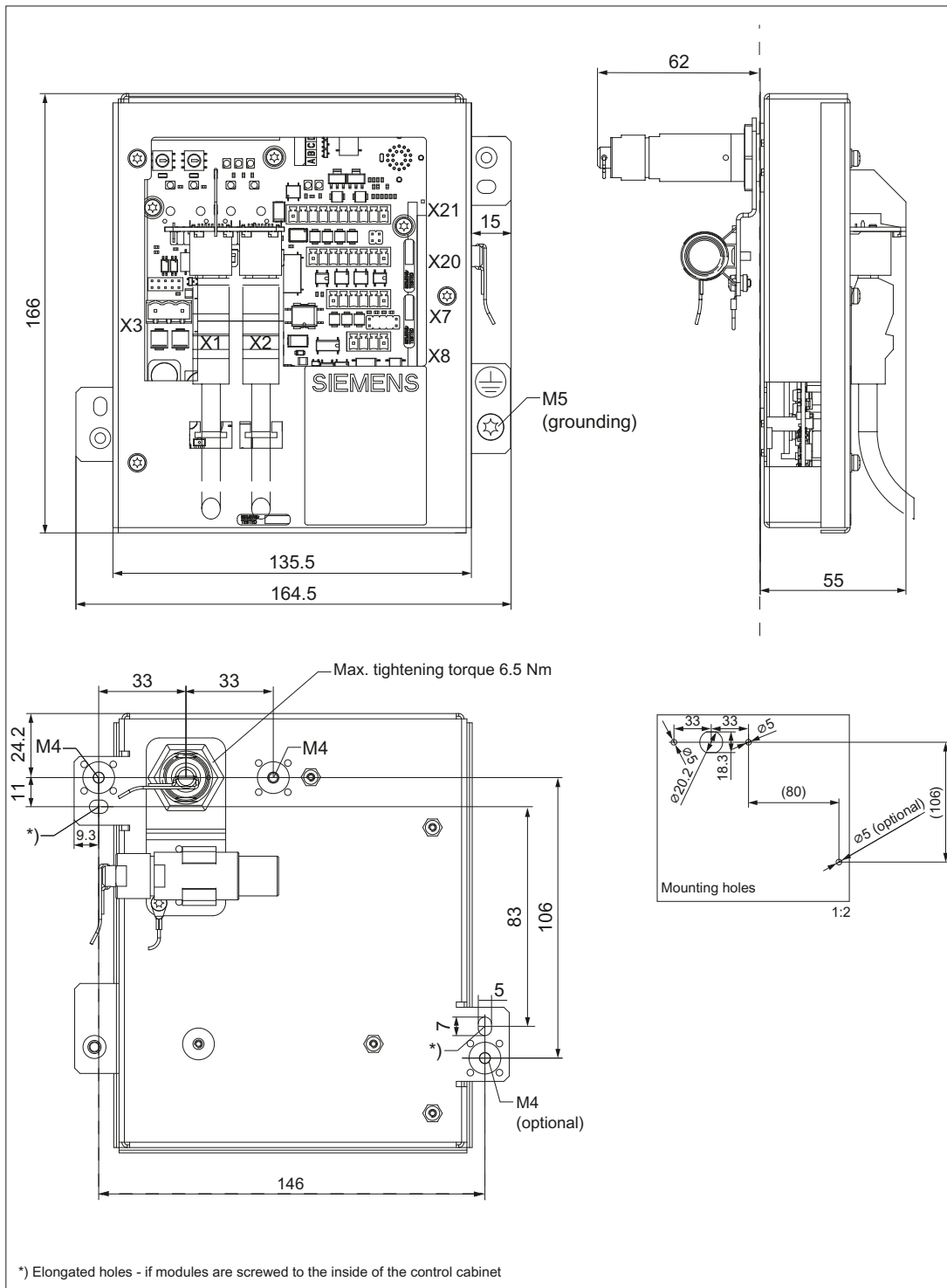
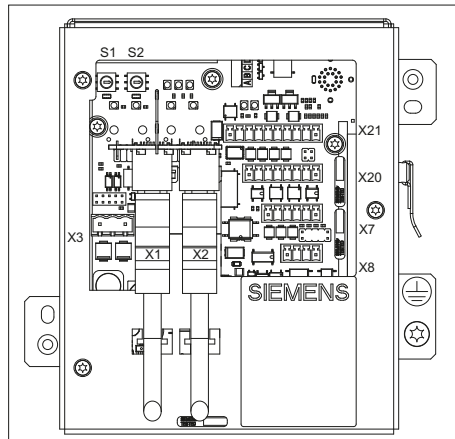

Figure 2-9 HT8 connection module Basic PN - dimension drawing for control cabinet installation

2.4.3.3 interfaces

The HT 8 is connected to the connection module PN Basic via a round connector. The interfaces of the connection module are located on the rear side (see figure).



S1 / S2 DIP Fix switches
(rotary coding switch)

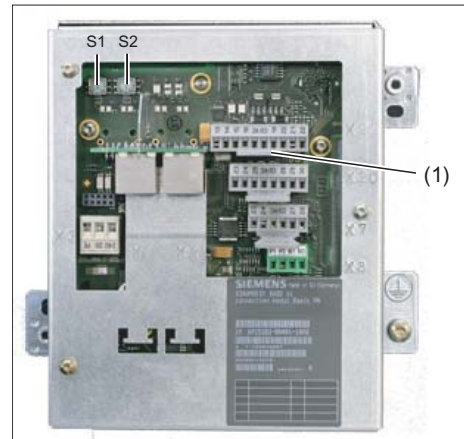

(1) Interfaces with attached connectors

Setting information can be found in:
"General information and networking", Chapter: "Networking"

Setting the box ID

You can use rotary coding switches S1 and S2 to set a unique ID on any connection module for station identification purposes.

Use a screwdriver to set the IDs.

The setting is entered in hexadecimal format. Equivalent decimal values of between 0 and 255 are supported.

By way of an example, the figure below illustrates address 27H, which corresponds to decimal address 39.

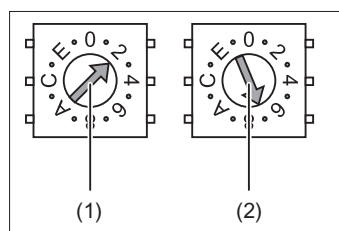

(1) Rotary coding switch for higher-order bits (S1)

(2) Rotary coding switch for lower-order bits (S2)

Figure 2-10 Example for the address "27H"

PN pin assignments of the connectors

Signal type:

- I Input
- O Output
- B Bi-directional signals
- P Potential

X3: Power supply

The pin assignment of the power supply interface X3 can be found in "General information and networking", Chapter: "Connecting", Section: "Pin assignment of the interfaces".

X7: Panel Present

Connector designation: **X7**
 Connector type: 6-pole Phoenix terminal

Table 2- 3 Assignment of the interface Panel Present X7

Pin	Signal name	Signal type	Meaning
1	PRES	O	"High": Panel (HT 8) plugged in
2	XCTL	O	"Low": EMER STOP button pressed ¹⁾
3	XFAULT	O	"Low": Error in EMER STOP electronics ¹⁾
4	N.C.	-	Not connected
5	N.C.	-	Not connected
6	M	P	Ground

¹⁾ Function not implemented in PN Basic variant, output is not switched to "High"

X8: Emergency stop wiring terminal

Connector designation: **X8**
 Connector type: 4-pole Phoenix terminal

Table 2- 4 Assignment of the EMER STOP wiring terminal X8

Pin	Protective circuit
1	On-board jumper between 1 and 2
2	
3	On-board jumper between 3 and 4
4	

Note

Use this terminal for simple routing of the emergency stop cables, optional.

The connector is only used to assist looping through. The connected pins 1 and 2 as well as 3 and 4 have no additional function on the connection module.

X20: Enabling buttonsConnector designation: **X20**

Connector type: 8-pole Phoenix terminal

Table 2- 5 Assignment of the interface enabling buttons X20

Pin	Signal name	Signal type	Meaning
1	ZUST1P	I	Electronic enabling button 1 P
2	ZUST1M	O	Electronic enabling button 1 M
3	ZUST2P	I	Electronic enabling button 2 P
4	ZUST2M	O	Electronic enabling button 2 M
5	N.C.	-	Not connected
6	N.C.	-	Not connected
7	N.C.	-	Not connected
8	N.C.	-	Not connected

X21: Emergency stop and key-operated switchConnector designation: **X21**

Connector type: 10-pole Phoenix terminal

Table 2- 6 Assignment of the interface EMER STOP and X21 key-operated switch

Pin	Signal name	Signal type	Meaning
1	STOP23	B	Emergency stop circuit
2	STOP24		Emergency stop circuit
3	STOP13		Emergency stop circuit
4	STOP14		Emergency stop circuit
5	M	P	Ground
6	N.C.	-	-
7	IN_E9	P	P24 switched by key-operated switches
8	P24_FILT		Filtered 24V module power supply
9	IN_E9_EXT	O	"High": Key-operated switch actuated
10	IN_E12_EXT		"High": Terminating connector plugged in

Note

Pins 7 and 8 must be jumpered in order to supply a handheld terminal with power.

2.4.3.4 Installing the terminating connector

Procedure

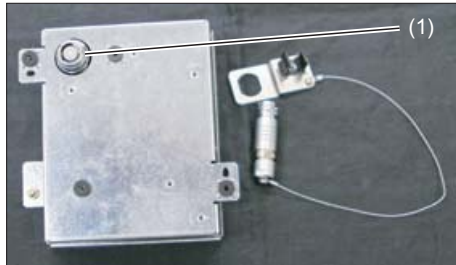

(1) Retaining nuts



1. Unscrew the retaining nuts.

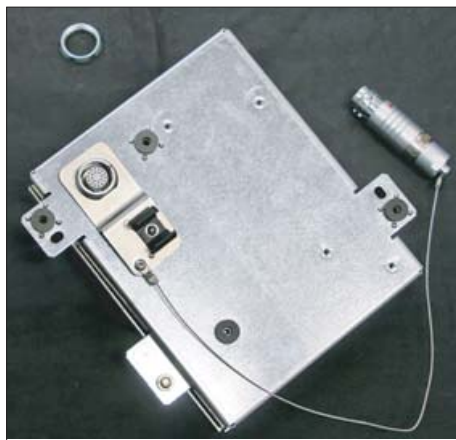

2. Attach the bracket for the terminating connector.



3. Tighten the retaining nut and insert the terminating connector into the bracket.

Note

If you never remove the HT8 from the connection module, it is not necessary to attach the terminating connector.

2.4.4 MPP 483HTC

The MPP 483HTC variant of the machine control panel MPP 483 has an integrated connection module thereby providing a connection option for the HT 8.

2.4.5 Connecting cables

The connecting cable is an industrial cable and, thus, resistant to many solvents and lubricants. The flexural strength is geared to the actual usage conditions.

The connecting cable is available in different lengths. You will find detailed information in Section: "Accessories".

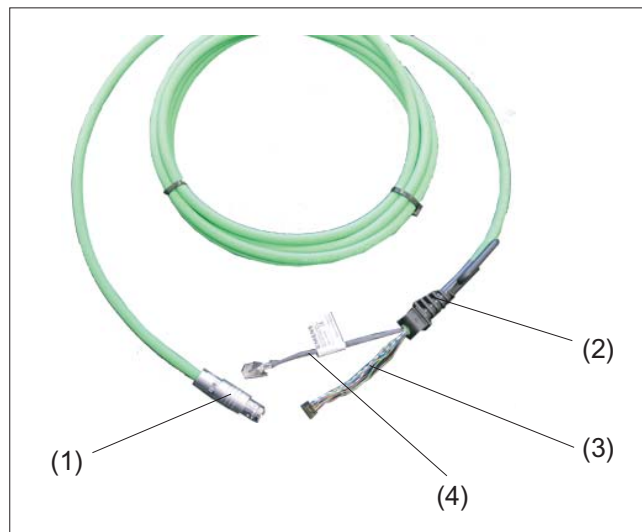

- (1) Metallic push-pull circular connector (ODU connector)
- (2) Strain relief and kink protection for connecting cable
- (3) RJ45 connector (Ethernet connection)
- (4) Plug connector for enabling button, emergency stop, 24V and safety signals

Figure 2-11 Connecting cable of the HT 8

The connecting cable is connected to the HT8 via the RJ45 connector (3) and the plug connector (4). The ODU connector (1) serves to connect the connecting cable to the terminal box PN or the connection module PN (control cabinet installation). The tightening torque for the nut of the ODU socket is 6.5 Nm.

The HT 8 has two cable inlets on its rear side for connecting the cable. This makes it possible to attach the connecting cable on either the right or left side. One of the cable inlets is closed at the factory by a connector in which an IP65-capable USB 1.1-connection is integrated.

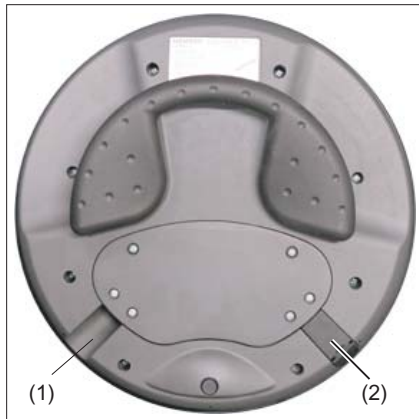

- (1) Cable inlet without connector plug
- (2) Cable inlet with connector plug

Figure 2-12 Rear side of the HT 8 with cable inlets

Laying the connecting cable



1. Open the cable duct cover by unscrewing the six PT screws (4 x 20 mm) approximately 1 cm. To do this, use a crosstip size 2 screw driver.

Cable duct cover open



2. Insert the connecting cable into the cable inlet that suits your intended application (left or right).

Press the cable downward slightly until it rests completely on the fastening burls (2).

Put a plug in the cable inlet that you do not intend to use.



3. Press the plug connector firmly into the power supply socket (1).

! WARNING

Improper installation of the cable can result in failure of the safety functions.

When plugging in the connector plug, ensure that all cables are lying straight in the cable guide. Check to ensure that all wires are aligned and straight and check the firm seating of the plug connector before replacing the cable duct cover. Make sure that the cable sleeve is installed correctly.



4. Connect the RJ-45 connector to the Ethernet socket.

Correctly laid connecting cable

HT 8 left rear side



HT 8 right rear side



5. Put the cable duct cover on and secure it by tightening the six screws.

NOTICE**Damage to the housing**

The housing of the HT 8 is made of plastic. Therefore, the mounting hole threads cannot handle the same amount of stress as a comparable metallic housing. Therefore, do not exceed 0.4 to 0.5 Nm of torque when tightening the screws (also for protecting the connecting cable).

If you use a power screwdriver, ensure the max. speed of 600 rpm is adhered to (torque: 1 Nm).

The screws of the cable duct cover may only be loosened or tightened a maximum of 20 times. Otherwise, there is the danger that the threads might become damaged and the seal of the housing will be compromised which could lead to failure of the device.

2.4.6 Power Supply

The HT 8 is supplied with power via the connecting cable of the terminal box PN or of the connection module PN.

The input voltage range is designed for +24 VDC.

See also: "General information and networking", Chapter: "Safety instructions", Section: "Requirements for the 24 V power supply"

2.5 Commissioning

2.5.1 SINUMERIK Operate

2.5.1.1 Activating/deactivating the virtual keyboard

The virtual keyboard is configured in the file "slguiconfig.ini".

Procedure

1. Copy the "slguiconfig.ini" file from the folder
/siemens/sinumerik/hmi/template/cfg.
2. Paste the copy of the file into the following directory:
/oem/sinumerik/hmi/cfg or /user/sinumerik/hmi/cfg.
3. Open the file in the editor.
4. To activate or deactivate the keyboard, make the following settings:
 - Activating the virtual keyboard:
In the section [TouchPanel], EnableTouch = true
In the section [Keyboard], EnableVirtualKeyBoard = true
 - Deactivating the virtual keyboard:
In the section [TouchPanel], EnableTouch = true
In the section [Keyboard], EnableVirtualKeyBoard = false
5. Double click in the input field to display the keyboard.

2.5.1.2 Configuring the traversing keys

The traversing keys of the HT 8 are not labeled as their type of action is not predefined. The labeling of the traversing keys should adapt dynamically to the type of action of the keys. To recognize the type of action of the traversing keys, they are shown within the display in the vertical softkey area.

The menu of the traversing keys consists of two vertical rows each with eight keys so that up to 16 texts can be configured. The top and bottom traversing key row remain empty and can be assigned other functions.

The following data can be displayed:

- Machine axis name
- Alias name for machine axis
- Any language-dependent text
- Symbol

The following user-specific files are required. You can use the sample files as template:

File	Meaning
"sljkconfig.ini" configuration file	File in which the traversing keys are configured.
Text file "oem_sljk_xxx.ts"	File for labeling traversing keys in a foreign language, xxx = language code

"sljkconfig.ini" configuration file

Entries	Meaning
[State_1]	Labeling type - changed via the PLC.
ParamText_x_y	Text of the traversing key that is made up of parameters. Two-line labeling is possible, whereby max. five characters are possible per line. x: Specifies the position of the key within the row (2 to 7). y: Specifies the key row (1 or 2).
	%m1 The machine axis name of the first axis is referenced and displayed as text. The current active axis number is read out from data block DB10. The name from the machine data is determined via this index.
	%n Defines the position in the text for the line break.
	%a1 The alias axis name of the first axis is referenced and displayed as text. The current active axis number is read out from data block DB10. The name from the "oem_sljk_eng.ts" text file is determined via this index.
TextId_x_y	Text of the traversing key that is read from the text file (target language text).
Picture_x_y	File name of the icon to be displayed. The files with the icons must be located in the following directories: /oem/sinumerik/hmi/ico and depending on the resolution of the subdirectories: /ico640 /ico800 /ico1024 /ico1280

Procedure

1. Copy the "sljkconfig.ini" configuration file from the folder
/siemens/sinumerik/hmi/template/cfg
2. Place the copy into the folder /oem/sinumerik/hmi/cfg
or /user/sinumerik/hmi/cfg
3. Open the copy in the Editor and define the traversing key labeling.

Example of a "sljkconfig.ini" configuration file

12 axes are defined in the example, with text for softkey 1 and softkey 2, as well as an image on softkey 3 and softkey 4.

```
[Settings]
FileType = INI

; A few examples for further configuration options
; Alias names of machine-axes (%a1, %a2, etc.), from oem_sljk_deu.ts (example)

[State_1]
TextId_1_1 = OEM_JK_TEXT_1
TextId_1_2 = OEM_JK_TEXT_2
ParamText_2_1 = %a1%n-
ParamText_2_2 = %a1%n+
ParamText_3_1 = %a2%n-
ParamText_3_2 = %a2%n+
ParamText_4_1 = %a3%n-
ParamText_4_2 = %a3%n+
ParamText_5_1 = %a4%n-
ParamText_5_2 = %a4%n+
ParamText_6_1 = %a5%n-
ParamText_6_2 = %a5%n+
ParamText_7_1 = %a6%n-
ParamText_7_2 = %a6%n+
Picture_8_1 = AlarmCancel.png
Picture_8_2 = AlarmNCReset.png
```

"oem_sljk_eng.ts" text file

Entries	Meaning
name	Freely selectable name of the text context. In the text file template, the name of the text context is "SIJkLabels" and stands for the traversing key labeling (solution line jog key labels). This identifier is already stored in the configuration file.
source	Traversing key identifier of the respective axis. This text ID is referenced in the "sljkconfig.ini" configuration file with the "TextId_2_1". The text IDs for the alias names (JK_AXISNAME_2 to JK_AXISNAME_7) must not be changed.
translation	Input of the foreign language text for the axis specified in <source>.

Language code in file names "xxx"

Language	Language code
German	deu
English	eng
French	fra
Spanish	esp
Italian	ita
Chinese	chs

Procedure

1. You can copy the sample file " oem_sljk_deu.ts" from the following directory:
/siemens/sinumerik/hmi/template/lng.
2. Store or create the file in the /oem/sinumerik/hmi/lng or /user/sinumerik/hmi/lng directory.
3. Give the file a name, e.g. for German texts: "sljk_deu.ts".
If you wish to set-up the labeling for additional languages, a separate file must be created for each language. Save the file with the appropriate language code in the file name. To do this, use the language codes specified above.
4. Open the file and in the <message> and </message> area, define the labeling.
5. Restart the HMI.
In order that the labeling is displayed during the program runtime, the file must be converted into a binary format. This conversion is only executed when the HMI powers up.

Example of a text file "sljk_deu.ts"

12 axes are defined in the example, with text for softkey 1 (SF1) and softkey 2 (SF2):

```
<?xml version="1.0" encoding="utf-8"?>
<!DOCTYPE TS>
<TS>
  <context>
    <name>SlJkLabels</name>
    <!-- Alias names for machine axis (%a1, %a2, etc.) -->
    <!-- Do not change the text ID (JK_AXISNAME_1, etc.) -->
    <message>
      <source>JK_AXISNAME_1</source>
      <translation>X</translation>
    </message>
    <message>
      <source>JK_AXISNAME_2</source>
      <translation>Y</translation>
    </message>
    <message>
      <source>JK_AXISNAME_3</source>
      <translation>Z</translation>
    </message>
    <message>
      <source>JK_AXISNAME_4</source>
      <translation>A</translation>
    </message>
    <message>
      <source>JK_AXISNAME_5</source>
      <translation>B</translation>
    </message>
    <message>
      <source>JK_AXISNAME_6</source>
      <translation>C</translation>
    </message>
    <message>
      <source>JK_AXISNAME_7</source>
      <translation>U</translation>
    </message>
    <message>
      <source>JK_AXISNAME_8</source>
      <translation>V</translation>
    </message>
    <message>
      <source>JK_AXISNAME_9</source>
```

```
        <translation>W</translation>
</message>
<message>
    <source>JK_AXISNAME_10</source>
    <translation>UV1</translation>
</message>
<message>
    <source>JK_AXISNAME_11</source>
    <translation>UV2</translation>
</message>
<message>
    <source>JK_AXISNAME_12</source>
    <translation>UV3</translation>
</message>
<!-- User defined language dependent text (example) -->
<message>
    <source>OEM_JK_TEXT_1</source>
    <translation>SF1</translation>
</message>
<message>
    <source>OEM_JK_TEXT_2</source>
    <translation>SF2</translation>
</message>
</TS>
```

2.5.1.3 Configuring user-specific key labeling

Labeling the keys for the HT 8

The texts of the CPF menu (CPF: Control Panel Function) for the HT 8 can be labeled with your own texts in the particular language of the country.

The texts are created in the "slck_XXX.ts" file.

"XXX" = language code for the corresponding language-specific labeling.

You can create and edit this file using the HMI or also externally on a PC.

Note

If you wish to create or edit the file on a PC, use an editor that supports UTF-8 coding.

Language code in file names "xxx"

Language	Language code
German	deu
English	eng
French	fra
Spanish	esp
Italian	ita
Chinese	chs

Creating key labeling

Tag	Meaning
source	Designation for the user softkey. "SK_USERKEY1" to "SK_USERKEY16" are possible, whereby the names may not be changed.
comment	User-specific description of the key assignment.
translation	Text that should be shown on the key. <ul style="list-style-type: none"> • A maximum of 10 characters are possible per line. • 2-line labeling is possible, whereby the line break is set using "%n".
remark	Remark for key assignment.
chars	Number of characters. A maximum of 10 characters per line are possible.
lines	Number of lines. 2 lines are possible.

Procedure

1. You can copy the sample file " oem_slck_deu.ts" from the following directory:
/siemens/sinumerik/hmi/template/lng.
2. Store or create the file in the /oem/sinumerik/hmi/lng or /user/sinumerik/hmi/lng directory.
3. Give the file a name, e.g. for German texts: "slck_deu.ts".
If you wish to create the key labeling for additional languages, then a separate file must be created for each language. Save the file with the appropriate language code in the file name. To do this, use the language codes specified above.
4. Open the file and in the <message> and </message> area, define the key labeling.
5. Restart the HMI.
In order that the key labeling is displayed during the program runtime, the file must be converted into a binary format. This conversion is only executed when the HMI powers up.

Example of a key label

```
<!DOCTYPE TS><TS>
<context>
  <name>SlCkDialog</name>
  <message>
    <source>SK_USERKEY1</source>
    <comment></comment>
    <translation>U1</translation>
    <remark>User key 1</remark>
    <chars>10</chars>
    <lines>2</lines>
    <languageIndependent>true</languageIndependent>
  </message>
  <message>
    <source>SK_USERKEY2</source>
    <comment></comment>
    <translation>U2</translation>
    <remark>User key 2</remark>
    <chars>10</chars>
    <lines>2</lines>
    <languageIndependent>true</languageIndependent>
  </message>
  <message>
    .....
  </message>
</context>
</TS>
```

2.5.1.4 Configuring the function display at user-specific keys (U keys)

Function

Active functions can be displayed at the configurable user keys via the PLC. For instance, small LEDs can be emulated on the softkeys.

You configure the function in the "slckcpf.ini" file.

Interface signals

The PLC bits are in the output image of the PLC-HT 8 interface and are analog to those in the input image.

Signals to the MCP1 (or MCP2) Interface PLC → HT 8								
Byte	Bit 7	Bit 6	Bit 5	Bit 4	Bit 3	Bit 2	Bit 1	Bit 0
AB n + 1		U4	U3		U2	U1		
AB n + 4	U9	U10	U11	U12	U13	U14	U15	U16
AB n + 5		U8	U7	U6	U5			

Adapt the display in the "slckcpf.ini" file

Section	Description
UserKeyLEDIcon	Name of the icon file. Standard entry: led_green.png
	OFF Deactivates the icon display.
	PRESSED Displays the active functions by pressing down the softkey.
UserKeyLEDIconAlignment	Specifies the position of the icon. Standard position: AlignLeft AlignTop Horizontal and vertical alignments can be combined. The two names are separated by the " " character. The following alignments are possible:
	AlignLeft Left
	AlignRight Right
	AlignHCenter Horizontal, center
	AlignTop Top
	AlignBottom Bottom
	AlignVCenter Vertical, center
UserKeyLEDMap	Specifies the start address of the output image. Entries can be made in the following form: "DBx.DBBy", "ABx", "MBx". Default setting: The start address is determined using DB7 MCP1Out (or MCP2Out).

Section	Description	
U1LED ... U16LED	The status bit address can be defined - different from the output image - using these entries. Note: The offsets from the HT 8 output image, for one or several softkeys, are not taken into consideration.	
VarIncLED		
SBLLED		
WCSLED		
showVarIncLED	true	When the increment mode is active, the icon is also displayed on the "[VAR]" softkey.
	false	The icon is not displayed.
showSBLLED	true	When the SingleBlock mode is active, then the icon is also displayed on the "Single Block" softkey.
	false	The icon is not displayed.
showWCSLED	true	When the SingleBlock mode is active, then the icon is also displayed on the "Single Block" softkey.
	false	The icon is not displayed.

1. You can copy the sample file "sickcpf.ini" from the following directory:
/siemens/sinumerik/hmi/template/cfg
2. Store the file in the /oem/sinumerik/hmi/cfg or /user/sinumerik/hmi/cfg directory.
3. If you use your own icon, then locate it together with the corresponding resolution for HT 8 directory: /oem/sinumerik/hmi/ico/ico640 or /user/sinumerik/hmi/ico/ico640.
4. Open the file and make the appropriate settings.

Sample file "sickcpf.ini"

```

Template for the configuration of the
; HT8 control panel function menu
;
; To activate the settings remove the
; commentary ';' at the beginning of the line
;; Display settings of the user key softkey leds
[UserKeyLED]
; Filename of the LED icon
;UserKeyLEDIcon = led_green.png
; Alignment of the LED icon
;UserKeyLEDIconAlignment= AlignLeft | AlignTop
; Use following led map start address instead of calculating DB7.MCP1Out
;UserKeyLEDMap = AB0
; Use the following settings to use this status bits instead of the led map for a
specific sk

```

```
;U1LED=/channel/parameter/R[U1,1]
;....
;U16LED=/channel/parameter/R[U1,16]
;VarIncLED = DB11.DBX8.5
;SBLEED = DB21.DBX0.4
;WCSLED = DB19.DBX0.7

; Show a LED for the var inc sk
;showVarIncLED = true
; Show a LED for the var single block sk
;showSBLEED = true
; Show a LED for the var wcs/mcs sk
;showWCSLED = true
```

2.5.2 HMI Advanced

2.5.2.1 Configuring the traversing keys of the HT 8

Prerequisite

In order to display or skip the labeling of the traversing keys, the HT 8 must have user authorization.

Parameterizing the MCP signals of the HT 8 in the PLC

HT 8-relevant blocks in the PLC program are FB 1 for HT 8/PLC communication and FC 26 for NCK/PLC communication.

Display/skip the labeling of traversing keys on HT 8

In order to inscribe the traversing keys, the names of the first six axes are established from the machine data 10000: AXCONF_MACHAX_NAME_TAB (indexed using DB 10, bytes 8 to 13).

The LED image of HT 8 serves as the interface for displaying the labeling by the PLC. The PLC sets a bit in the LED image of the HT 8 to display or skip the traversing keys:

Signal AB n+6 bit 7 = **1** for displaying

Signal AB n+6 bit 7 = **0** for skipping

Note

To ensure that the labeling of the traversing keys is displayed correctly, the names of the axes must not exceed 10 characters.

Example with labeling of traversing axes displayed:

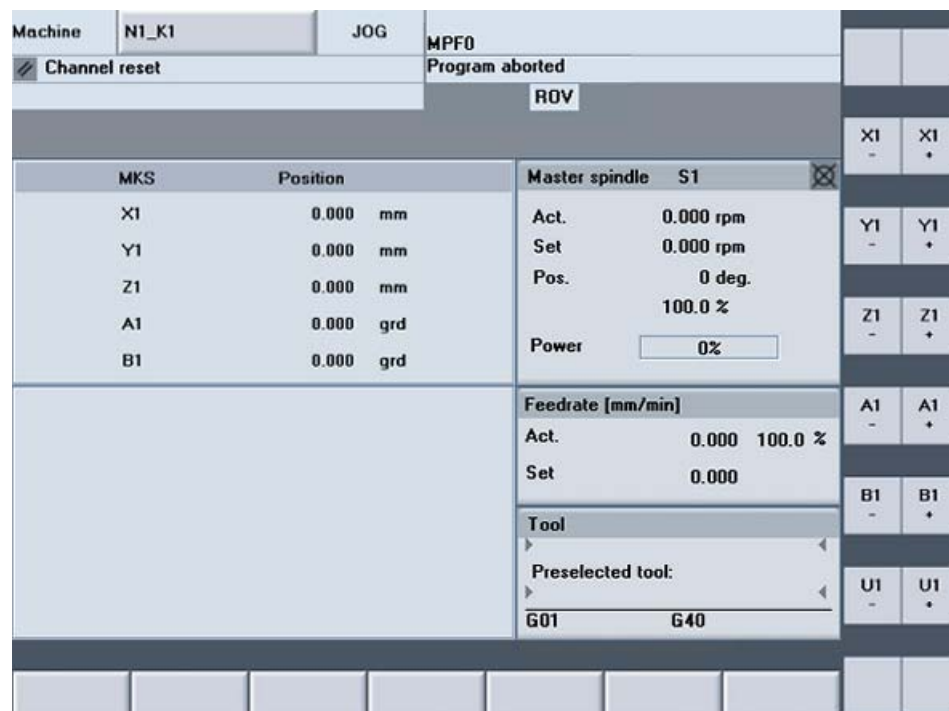

Figure 2-13 Traversing axes displayed

Acknowledging display/skipping by HMI on PLC

The HMI communicates to the PLC whether the traversing keys are displayed or hidden. This is done using bit 7 in byte 72 of DB 10:

Displayed: DB10.DBX72.7 = 1

Skipped: DB10.DBX72.7 = 0

User keys

The user keys (the 2 keys at the top and bottom) can be assigned in any way. User keys, which can be used to trigger a wide range of machine functions, are evaluated directly by the PLC program.

See also:

You will find additional information on the HT 8 in:

- Function Manual Basic Functions, basic PLC program (P3 sl)
- You will find a description of the machine data in:
Detailed Machine Data Description
- Operating Manual HMI-Advanced

2.5.2.2 Configuring user-specific key labeling

Labeling the keys for the HT 8

The texts of the CPF menu (CPF: Control Panel Function) for the HT 8 and the traversing keys can be labeled by the user with his own texts in his specific language.

A language-dependent file ht8_xx.ini is provided in directory \mmc2\language for this purpose. Only edit a copy of this original file and place this copy in one of the following directories:

- user\language
- oem\language
- addon\language

There are two sections in file ht8_xx.ini; one for the CPF menu ([CPFSOftkeyText]) and one for a maximum of 31 traversing keys ([AxiskeyText]). With no entry (e.g. U2="") or for the value <empty> (e.g. U2=<empty>) no labeling text is displayed on a softkey or on a traversing key (-/+).

- The entries for the CPF keys are pre-assigned as standard with U1 ... U16.
- The texts for the traversing keys are not activated as default setting for the following reason:

If no traversing key text is read, the name is determined from the machine data – with the axis number as index – and correspondingly output:

```
("ACC/NC_TEA/$MN_AXCONF_MACHAX_NAME_TAB[" & chAxisNbr(k%) & "]",
chAxisName(k%))
```

Note

It is not possible to combine the labeling texts – e.g. a part of the name from the INI file and another part from the machine data.

Configuration file

Example of a key labeling (ht8_xx.ini):

[CPFSOftkeyText]

```
U1 = "User%nKey 1" ; 2*10 → Text is two lines due to %n
U2 = "UserKey 2" ; 2*10 characters
U3 = "UserKey 3" ; 2*10 characters
U4 = "UserKey 4" ; 2*10 characters
U5 = "UserKey 5" ; 2*10 characters
U6 = "UserKey 6" ; 2*10 characters
U7 = "UserKey 7" ; 2*10 characters
U8 = "UserKey 8" ; 2*10 characters
U9 = "ETC-UKey 9" ; 2*10 characters
U10 = "ETC-UKey 10" ; 2*10 characters
U11 = "ETC-UKey 11" ; 2*10 characters
U12 = "ETC-UKey 12" ; 2*10 characters

U13 = "ETC-UKey 13" ; 2*10 characters
U14 = "ETC-UKey 14" ; 2*10 characters
U15 = "ETC-UKey 15" ; 2*10 characters
U16 = "ETC-UKey 16" ; 2*10 characters
```

[AxiskeyText]

```
; here, a line break is obtained with
; 2 blanks.
SF1 = "sf_1" ; 2*10 characters
SF2 = <EMPTY> ; 2*10 characters
SF3 = "sf_3" ; 2*10 characters
SF4 = "sf_4" ; 2*10 characters
AX1 = "Wx" ; 2*5 characters
AX2 = "Xx" ; 2*5 characters
AX3 = <empty> ; 2*5 No text is displayed on the
; traversing key (-/+).
AX4 = <EMPTY> ; 2*5 characters
AX5 = "Yx" ; 2*5 characters
AX6 = "Zx" ; 2*5 characters
```

Traversing keys

As standard, keys for axes 1 to 6 are displayed. If the 2nd vertical softkey is pressed in the CPF menu (change over traversing keys), then the next time that the traversing keys are displayed, keys 7 to 12 are displayed; after pressing the 2nd vertical softkey in the CPF menu, then axis keys 1 to 6 are displayed again, etc.

Note

Switch off CPF menu

The CPF_Disabled entry is evaluated in the [CONTROL] section of the MMC.INI configuration file: If the value = 1, the CPF menu will not be displayed.

2.6 Unplugging/plugging during operation

The ability to detect a connected HT 8 in the PLC

1. **HW solution:**

The X7 interface of the connection module PN Basic signals "HT 8 Present" at pin 1 for the "active" connection module (see Section: "Connections" → "Connection module PN Basic" → "Interfaces").

If the connection module is "inactive", this signal is not set.

This makes the "active" connection module detectable in the PLC by wiring the above-mentioned pins of all connection modules to digital I/Os on PLC I/O modules.

2. **Permanently configured MCPs / HT 8 on one control:**

If there are only permanently configured MCPs / HT 8 on a control, removal of the MCP or HT 8 triggers the PLC alarm "400260 Machine Control Panel failed".

Based on this, an "active" or "inactive" MCP / HT 8 in the PLC can be detected.

The failure of an MCP / HT 8 is, however, only detected in the PLC if max. 2 MCP / HT 8 are permanently configured and no MCP changeover by means of FB9 (e.g. triggered by HMI when operator focus is switched).

Note

Removing an HT 8 where the integrated machine control panel is active

Depending at which interface in the PLC (FB1: MCP1 or MCP2) the HT 8 is configured, before removing the HT 8, the transfer of the machine control panel signals must be stopped.

This is possible as direct axis via data block DB7 (instance of the FB1).

To do this, set the corresponding interface signal to "true":

- 1st interface: DB7.DBX62.1 (MCP1Stop)
- 2nd interface: DB7.DBX62.2 (MCP2Stop)

If the machine control panel signals are not stopped, then the message "400260 machine control panel x failed" is displayed at the HMI:

Transfer of the machine control panel signals can be restarted after inserting the HT 8. To do this, set the PLC interface signal DB.DBX62.1 (MCP1Stop) to "false".

2.7 Maintenance and Service

Cleaning the device

Use a soft cloth moistened either with water or a mild cleaning agent to clean the housing, display and operator control elements of the HT 8.

Checking the device

In order to prevent foreign bodies or liquids entering the HT 8, regularly check the device

- that all the housing screws are in place and tight
- for damage to the housing
- for damage to the cable cover or cable entry

Protect the device from environmental effects

Protect the HT 8 against

- direct solar radiation and heat sources
- mechanical vibration and shock
- dust
- moisture, and
- strong magnetic fields.

Checking the emergency stop button and the enabling button

Check the emergency stop button regularly to ensure that it functions correctly.

Check the enabling button regularly to ensure that it functions correctly in the enable and panic position.



WARNING

Danger of death caused by damaged HT 8

Immediately check the functioning of the emergency stop button and the enabling button if the device was subject to significant shock (e.g. because it was dropped).

2.8 Technical data

2.8.1 Handheld Terminal HT 8

Key statement

Safety		
Safety class	III according to EN 61131-2 / EN 50178	
Degree of protection according to EN 60529	IP65	
Approvals	CE / cULus	
Electrical data		
Input voltage	24 VDC	
Current carrying capacity	Enabling button:	10 - 400 mA / 2-channel, 3-stage
	Emergency stop button:	10 - 1000 mA / 2-channel
Max. current carrying capacity	USB 1.1 interface:	100 mA
	Power consumption, max.	Approx. 13 W
Mechanical data		
Dimensions	Diameter: Approx. 290 mm	Height (without operator control elements): Approx. 65 mm
Weight	1,730 g	
Fall height, max.	1.20 m	
Display		
Size	7.5" TFT	
Resolution	640 x 480 pixels	
Service life	At ambient temperatures of > 40° C and long periods of non-use, it is advisable to activate the screen saver function.	

Note

Information about the climatic and mechanical environmental conditions is contained in the associated section under:

"General notes and interconnection" → "Operational planning".

Emergency Stop button

Nominal voltage	24 VDC
Current magnitude, max.	1 A
Current magnitude, min.	10 mA
Switching capacity	DC 13 according to EN 60947-5-1
Conditional rated short-circuit current	1000 A, 6A gL/gG according to EN 60947-5-1
B _{10d} (if no PN terminal box used)	100 000
When the PN Plus terminal box is used:	
PFH _d	1.01 * 10 ⁻⁷
Service life	20 years
Forced dormant error detection interval (mechanical actuation to the test the emergency stop)	1 year
Category	3
Performance Level	PL d

Note

The quantitative assessment of the emergency stop safety function must be based on the B_{10d} value corresponding to the used standards (e.g. ISO 13849-1) under consideration of the respective application (frequency of the actuation, service life, diagnostics by the evaluation unit, etc.). The B_{10d} value only applies when the technical properties of the emergency stop button are taken into account.

When using the PN Plus terminal box, the specified failure probability (PFH_d) must be taken into account. This value only applies when the technical properties of the PN Plus terminal box and the quantitative conditions specified here (e.g. service life) are observed.

Enabling button

	2-circuit , 3-stage
Supply voltage:	24 VDC
Amperage, max.:	400 mA
Amperage, min.:	10 mA
Operating cycles	
Switch position 2	10 ⁵
Switch position 3	5 * 10 ⁴
Actuation forces	
From switch position 1 to 2, typically	5 N
From switch position 2 to 3, typically	20 N
PFH _d	1.35 * 10 ⁻⁷
Service life	20 years
Forced dormant error detection interval (mechanical actuation to the test the enable and panic position)	1 year
Category	3
Performance Level	PL d

Note

The PFH_d value only applies when the technical properties of the enabling button and the quantitative conditions specified here (e.g. service life) are observed.
The permissible number of switching cycles must also be observed in the application.

2.8.2 Connection module Basic PN

Safety			
Safety class	III according to IEC 60536		
Degree of protection according to EN 60529	IP54		
Approvals	CE / cULus		
Electrical data			
Input voltage	24 VDC (via X3 connector)		
Current carrying capacity	Enabling button contacts (X20 connector)	max. each 0.5 A / 2-channel	
	Emergency stop button contacts (X21 connector)	max. each 0.5 A / 2-channel	
Max. power consumption	Connection module without external loading	0.3 A	
	Panel (HT 8)	1.6 A	
	5 status signals (X7 and X21)	2.5 A (0.5 A each)	
	Total:	4.4 A	
Max. total power consumption	105.6 W		
Mechanical data			
Dimensions	Height (without holder for terminating connector): 66 mm	Width: 165 mm	Length: 166 mm
Weight	0.75 kg		
Fall height, max.	1.20 m		

Note

Information about the climatic and mechanical environmental conditions is contained in the associated section under:

"General notes and interconnection" → "Operational planning".

2.8.3 PN terminal box

PN terminal box

Weight without packaging	Approx. 700 g
Degree of protection according to EN 60529	IP65 (with connected HT 8 or with inserted blanking cover)

Supply voltage

Rated voltage	+24 VDC
Range, permissible	20.4 to 28.8 V (-15%, +20%)
Transients, maximum permissible	35 V (500 ms)
Time between two transients, minimum	50 s
Current consumption of PN terminal box without HT 8 <ul style="list-style-type: none"> • Typical • Continuous current, maximum • Inrush current I^2t 	<ul style="list-style-type: none"> • Approx. 100 mA • Approx. 150 mA • Approx. 0.5 A²s
Current consumption of PN terminal box with HT 8 <ul style="list-style-type: none"> • Typical 	<ul style="list-style-type: none"> • Approx. 550 mA
Fuse, internal	Electronic
Current load PLC-accompanying signals	Max. 100 mA

Note

Recovery time

Wait for approximately one second after you have removed the connecting cable from the connection box before you plug the connecting cable back into the connection box.

After power failures lasting less than one second the connecting cable has to be disconnected.

2.9 Spare parts

The following spare parts are available for the HT 8:

Designation	Remark	Quantity	Order number
Service pack Connection box	Dummy plugs for cable compartment	1	6XV6574-1AA04-4AA0
	PG screw glands for connection box	2	
	1 set of screws for connection box cover	1	
	Terminal strips for connection box	2	

2.10 Accessories

2.10.1 Overview

The following accessories are available for the HT 8:

Designation	Remark	Number	Order number
PN Plus terminal box	With automatic emergency stop override for mounting in the system	1	6AV6671-5AE11-0AX0 *)
PN Basic terminal box	Without automatic emergency stop override for mounting in the system	1	6AV6671-5AE01-0AX0 *)
PN Basic connection module	Without automatic emergency stop override for mounting in the control cabinet		6FC5303-0AA01-1AA0 *)
Wall holder	For safekeeping, also suitable for stationary operation	1	6AV6574-1AF04-4AA0
Connecting cable	Length: 2 m	1	6XV1440-4BH20 *)
	Length: 5 m	1	6XV1440-4BH50 *)
	Length: 8 m	1	6XV1440-4BH80 *)
	Length: 10 m	1	6XV1440-4BN10 *)
	Length: 15 m	1	6XV1440-4BN15 *)
	Length: 20 m	1	6XV1440-4BN20 *)
	Length: 25 m	1	6XV1440-4BN25 *)

*) Safety related accessories

2.10.2 Wall holder

The HT 8 can be safely kept and operated in a stationary manner in the wall holder.

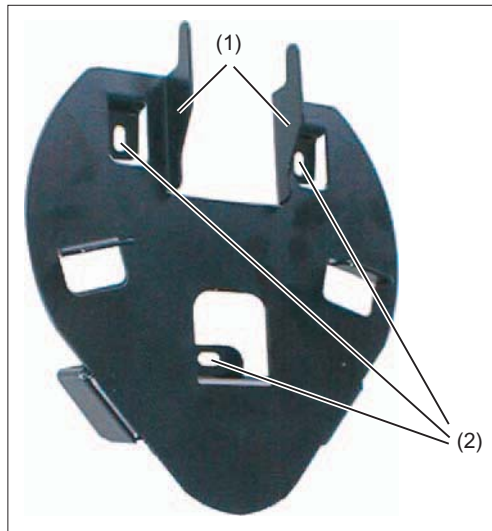

- (1) Hook for the grip on the handheld unit
- (2) Drill holes for screw fixing

Ensure that you position the wall holder in such a manner that

- the display of the hung-in HT 8 is not exposed directly to the sun's rays.
- the HT can be hung in based on ergonomic considerations. Therefore, choose a suitable mounting height.

Dimension drawing

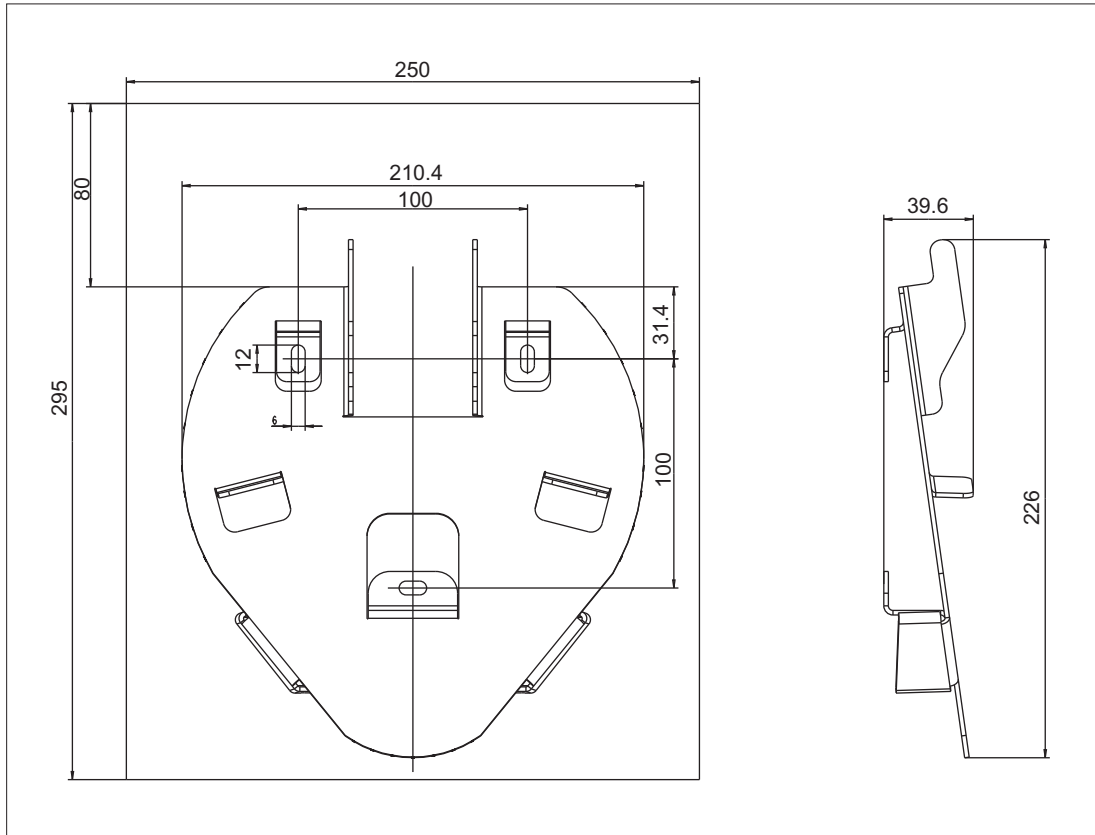

Figure 2-14 HT8 wall holder - dimension drawing

Mini-handheld unit

3.1 Description

The mini handheld unit (Mini HHU) is an easy-to-handle and ergonomic unit for setting up and operating simple machines in the JobShop area or similar applications.

Since coarse, medium and fine infeed can easily be graduated, the operator control concept offers fast, increment-precise positioning. The signals are sent parallel to the CNC controller.

Characteristics

- The mini HHU features a robust metal connector and is suitable for right-handed as well as left-handed operators.
- Key labeling can be customized using slide-in labels.
- The mini handheld unit can be fixed on metal surfaces by means of the integrated magnetic clamp. A retaining case is available as an option (see Section: "Accessories and spare parts").

Validity

This description applies to:

Designation	Features	Order number
Mini HHU	With spiral connection cable, emergency stop button (2-channel), enabling button (3-stage), metal connector, handwheel with magnetic latching	6FX2007-1AD03
	With straight cable, emergency stop button (2-channel), enabling button (3-stage), metal connector, handwheel with magnetic latching	6FX2007-1AD13

The safety-related accessories / spare parts are marked in the "Accessories and spare parts" section with a *).

3.2 Operator controls

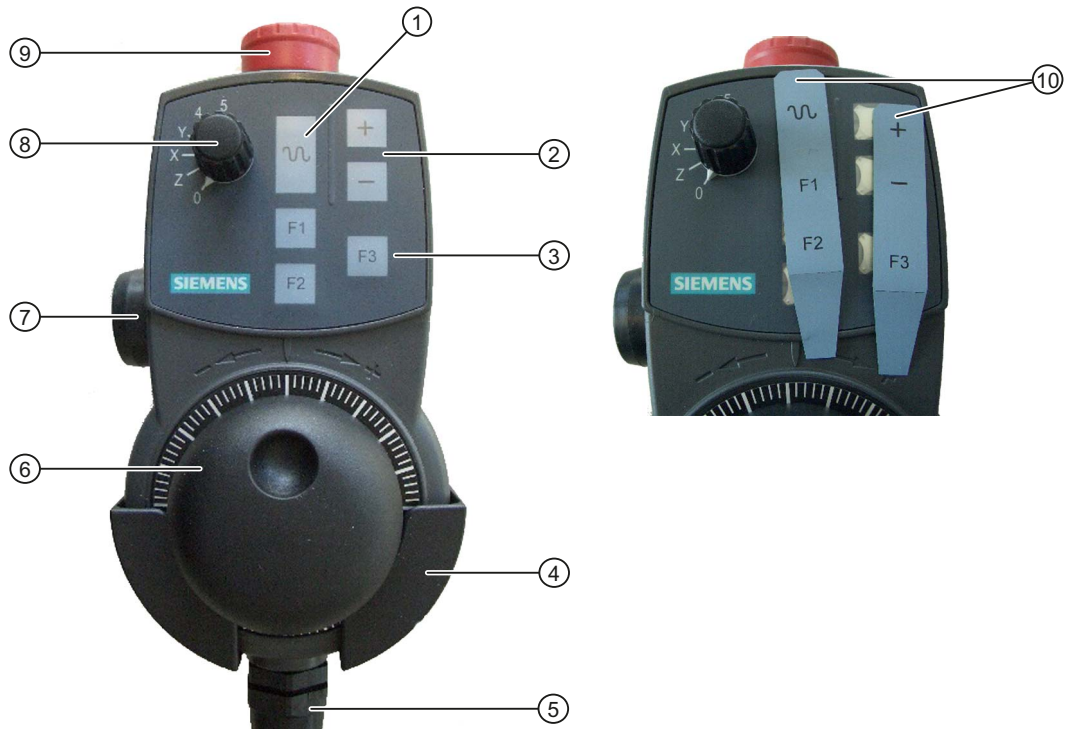

- ① Rapid traverse key for high-speed travel with traversing keys or handwheel
- ② Traversing key direction + / direction -
- ③ F1, F2, F3 function keys for customer-specific applications (freely assignable)
- ④ Retaining shell (optional) *)
- ⑤ Connecting cable
- ⑥ Handwheel
- ⑦ Enabling button, two channels, three positions
- ⑧ Selector switch for five axes and neutral position
- ⑨ Emergency stop button
- ⑩ Slide-in labels; see Chapter Spare parts / accessories (Page 142)

Figure 3-1 View of mini handheld unit

Emergency stop button

Press the red Emergency Stop button in emergencies when

- people are at risk,
- there is the danger of machines or the workpiece being damaged.

Turn the emergency stop button clockwise to unlatch it.

 WARNING
Danger of death due to premature restart
If you have shut down the system to be monitored, you can only release the emergency stop button or put the system to be monitored back into operation if the condition that triggered the emergency stop function has been corrected and a safe restart is carried out.

Note

Emergency stop

As a rule, when operating the emergency stop button, all drives are brought to a standstill with max. braking torque. For other responses to emergency stop, refer to the information supplied by the machine tool manufacturer.

Enabling button

The enabling button is designed as a 3-way switch. This must be held in its central position for traversing movements to be triggered.

Axis selection switch

You can select up to five axes with the axis selector switch. It is coded using Gray code.

Table 3- 1 Coding of axis selection switch

Connector X1			Switch position	Function
Pin 8	Pin 9	Pin 10		
0	0	0	-	Mini HHU not connected
1	1	0	0	No axis selected
0	1	0	Z	Z axis selected
0	1	1	X	X axis selected
1	1	1	Y	Y axis selected
1	0	1	4	Axis 4 selected
0	0	1	5	Axis 5 selected

Function keys

The function keys can be used to trigger machine-specific functions.

Traversing keys

The + and - traversing keys can be used to trigger traversing movements on the axis selected via the axis selector switch.

Handwheel

The handwheel can be used to initiate movements at the axis that has been selected with the axis selector switch. The handwheel supplies two track signals with 100 increments/revolution.

Rapid traverse key

The rapid traverse key increases the traversing speed of the axis that has been selected with the axis selector switch. The rapid traverse key affects traversing commands issued via the +/- keys as well as handwheel signals.

3.3 Dimension drawing

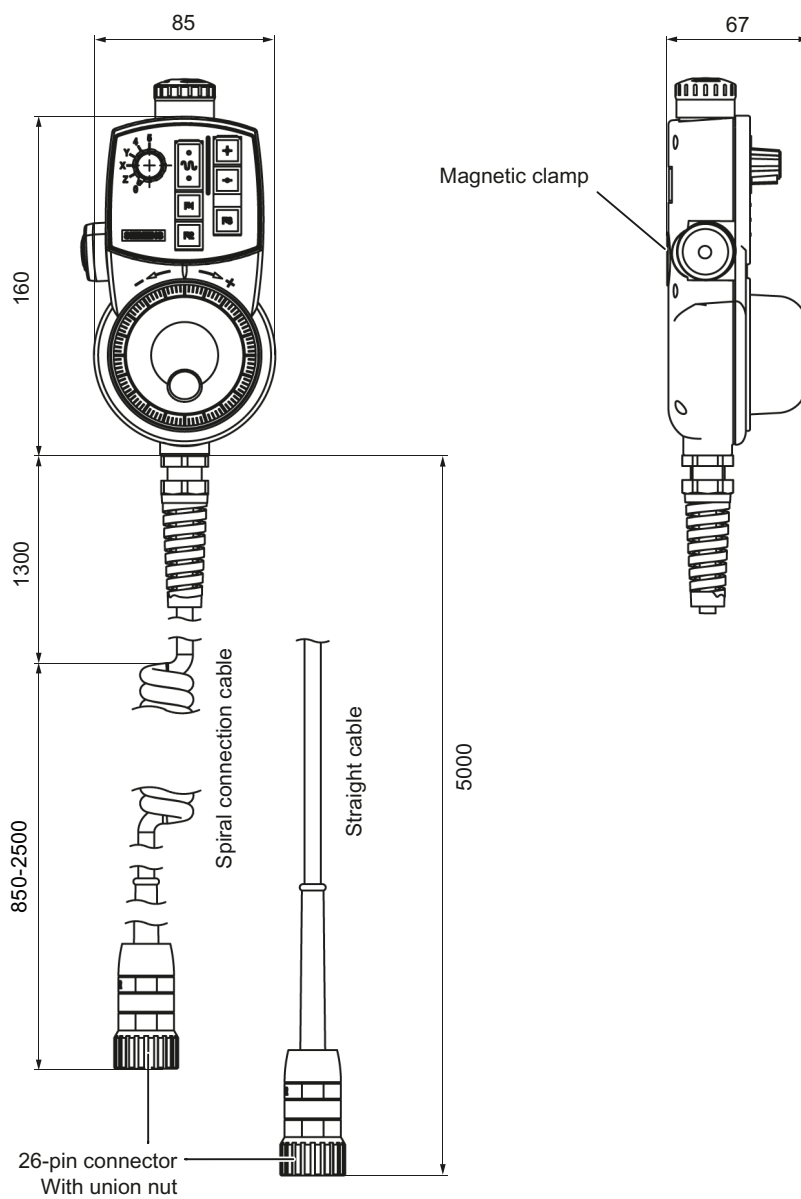

Figure 3-2 Dimensions of the mini handheld unit

3.4 Connection

Basic procedure

A connection kit is required to connect the mini HHU.

- You require a preassembled connection kit to connect to the MCP xxx PN. Should you wish to change the cable outlet direction, an angle socket is available for the connection kit. This allows the flange socket of the connection kit to be mounted 90° rotated.
- You require a preassembled connection kit to connect to the MCP xxx.

This connection kit contains a metal flange socket for installation at the machine and a terminating connector for overriding the emergency stop circuit when the HHU is not connected.

You will find the order numbers for the connection kit and angle socket in Section Spare parts / accessories (Page 142).

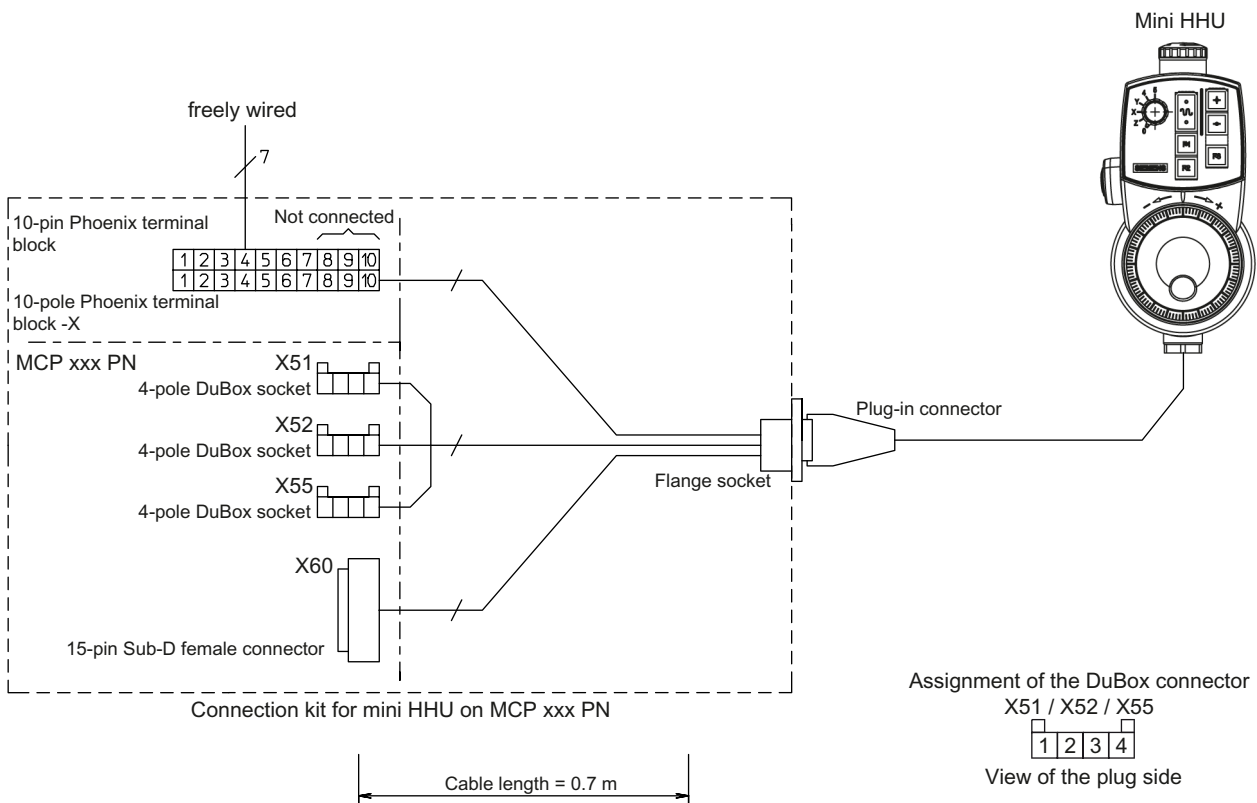

Figure 3-3 Connection diagram

1. Position the drilling pattern.
2. Route all the connecting cables through the large drill hole.
3. Mount the flange socket (with seal).

4. Plug the connecting cable into the mating connector according to the connector labeling.
5. Wire up the connectors (on the machine) of the emergency stop and enabling button on terminal block -X (see Fig.: "Circuit diagram").

Drilling pattern for the flange socket mounting

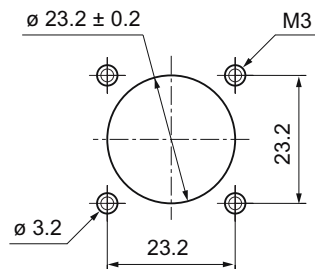

Figure 3-4 Drilling pattern for mounting

Flange socket

The mini HHU is connected to the PLC or to the connector for handwheels via a flange socket. The flange socket is part of the connection kit. There is no need for an additional connection distributor.

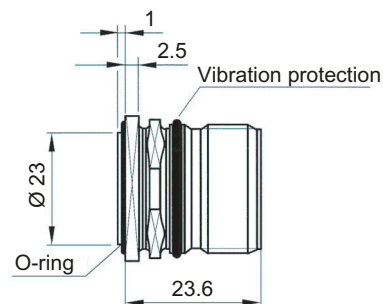

Figure 3-5 Flange socket

1. Plug the connector of the mini HHU (or the terminating connector) into the detent lugs/guideways of the flange socket.
2. Tighten the screw cap to secure the connector.

Note

Failure to insert the connectors correctly can result in damage to the contacts.

If no mini HHU is connected, observe the following:

 **WARNING**

Danger of death resulting from improper access

- After disconnection, the mini HHU must be locked away.
- Emergency stop buttons that are inactive must not be identified as such or must be inaccessible. This is to prevent the emergency stop button from being used inadvertently.

Wiring diagram for preassembled connection kit

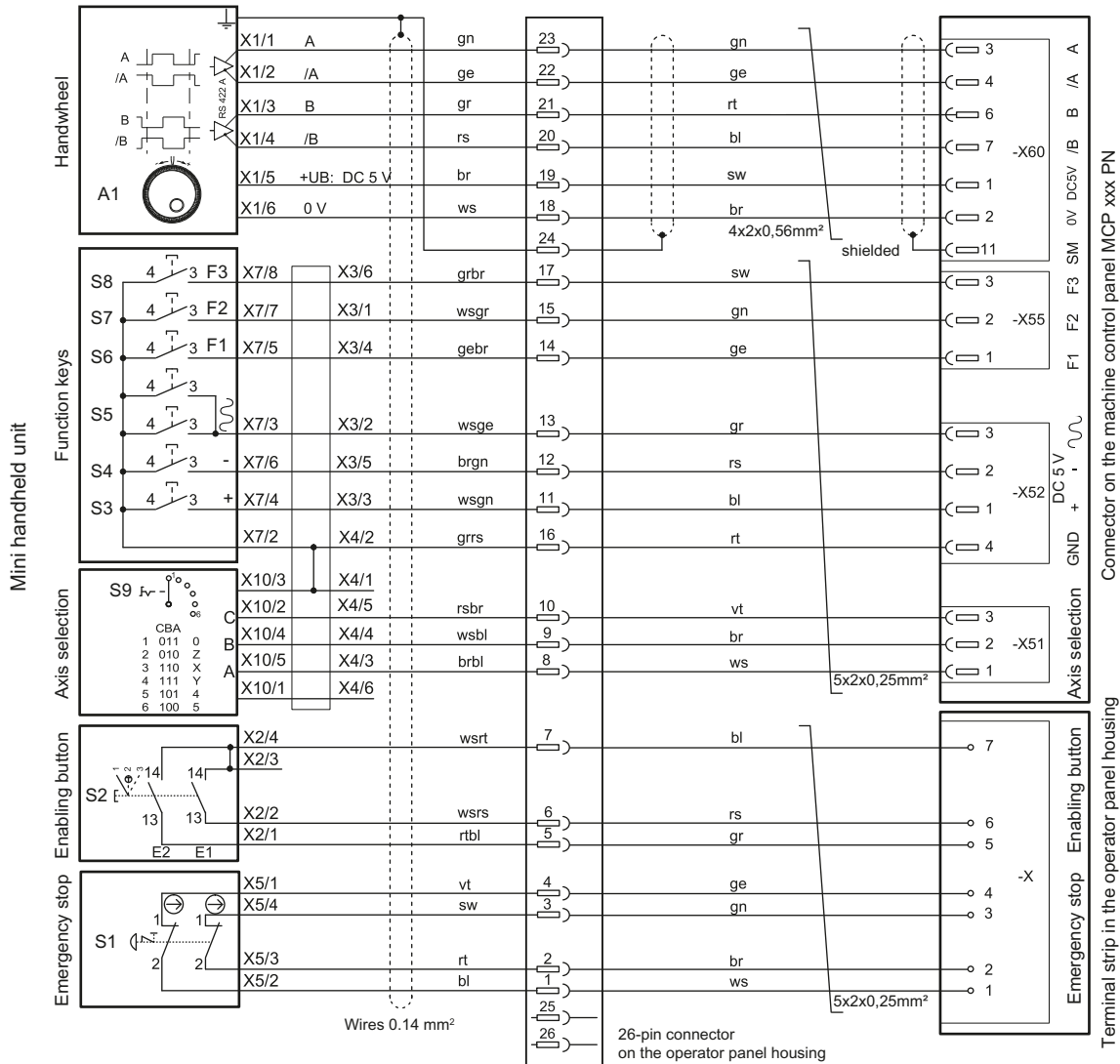

- | | | | |
|----|--------|------|--------------|
| bl | Blue | brbl | Brown-blue |
| br | Brown | gebr | Yellow-brown |
| ge | Yellow | grbr | Gray-brown |
| gn | Green | grrs | Gray-pink |
| gr | Gray | rsbr | Pink-brown |
| rs | Pink | rtbl | Red-blue |
| rt | Red | wsbl | White-blue |
| sw | Black | wsge | White-yellow |
| vt | Violet | wsgr | White-gray |
| ws | White | wsrs | Pink-white |
| | | wsrt | White-red |

3.5 Configuration

Configuring the mini HHU involves setting FB1 parameters in OB100 of the basic PLC program: See Function Manual Basic Functions, Basic PLC Program (P3 sl)

Mini HHU connection

The mini HHU is connected to connectors X51, X52, and X55 of an MCP xxx PN. There is no X55 connector for MCPs with PROFIBUS - X70 can be used as alternative in this case.

The customer keys (inputs) of the MCPs then cannot be used for other applications.

Information concerning the coding of the axis selector switch on the mini HHU and details of the connection to the customer keys are provided in the tables below.

Table 3- 2 Coding of axis selection switch X51:

2 ¹ X51.1 KT-IN1	2 ² X51.2 KT-IN2	2 ³ X51.3 KT-IN3	Switch position	Function
0	0	0	-	Mini HHU not connected
1	1	0	0	No axis selected
0	1	0	Z	Z axis selected
0	1	1	X	X axis selected
1	1	1	Y	Y axis selected
1	0	1	4	Axis 4 selected
0	0	1	5	Axis 5 selected

Table 3- 3 X52 traversing keys / rapid traverse key coding:



	Pin	Button	Function
KT-IN4	X52.1		Travel key + direction
KT-IN5	X52.2		Travel key - direction
KT-IN6	X52.3		Rapid traverse key

Table 3- 4 X55 function keys coding:

	Pin	Button	Function
KT-IN7	X55.1	F1	Function keys
KT-IN8	X55.2	F2	
KT-IN9	X55.3	F3	

Note

For the assignment of the customer keys to the input images, refer to the appropriate section of the particular machine control panel.

3.6 Maintenance and Service

Cleaning the device

Use a soft cloth moistened either with water or a mild cleaning agent to clean the housing and operator control elements of the mini HHU.

Checking the device

In order to prevent foreign bodies or liquids entering the mini HHU, regularly check the device

- that all the housing screws are in place and tight
- for damage to the housing
- for damage to the cable cover or cable entry

Protect the device from environmental effects

Protect the mini HHU against

- direct solar radiation and heat sources
- mechanical vibration and shock
- dust
- moisture, and
- strong magnetic fields.

Checking the emergency stop button and the enabling button

Check the emergency stop button regularly to ensure that it functions correctly.

Check the enabling button regularly to ensure that it functions correctly in the enable and panic position.



WARNING

Danger of death resulting from damaged mini-handheld device

Immediately check the functioning of the emergency stop button and the enabling button if the device was subject to significant shock (e.g. because it was dropped).

3.7 Technical specifications

Table 3- 5 Mini handheld unit

Control elements			
Enabling button	1 x: floating	2-channel, 3-stage	NO contact
Emergency stop button	1 x: floating	2-channel	NC contact, rotate to unlatch
Selection switch	5 axes: X, Y, Z. 4th 5th, and neutral position		
Jog key +	Positive traverse direction		
Jog key -	Negative traverse direction		
Jog key 	Rapid traverse for jog keys and handwheel		
Function keys	3 x: F1, F2, F3		
Handwheel	100 S/R		
Electrical data			
Operating voltage for switching signals	24 VDC		
Operating voltage for handwheel	5 V		
5 V current consumption	Approx. 90 mA		
Handwheel signals	RS 422		
Emergency stop button	24 V	2 A	NC contact
Enabling buttons	24 V	2 A	NO contact
General data			
Enclosure	Plastic (Pocan)		
Mounting	1 retaining magnet		
Connecting cable	Spiral connection cable or straight cable		
CE conformity	Yes		
Degree of protection	IP65 acc. to DIN EN 60529 (IEC 60529)		
Mechanical data			
Dimensions approx.	Height: 180 mm	Width: 90 mm	Depth: 67 mm
Weight	Approx. 0.5 kg without connecting cable		
Environmental conditions			
Temperature ranges		Use/operation	Storage/transport
		0 ... 55 °C	-20 ... 60 °C
Temperature change	Within 1 minute max. 0.2 K		
Permissible change in relative humidity EN 60721-3-3, Class 3K5			
Within 1 minute	Max. 0.1%		
Reliability data			
Emergency stop button	B _{10d} = 100 000		
Enabling button	B _{10d} = 100 000		

Note

The quantitative assessment of the emergency stop and enabling safety functions must be based on the B_{10d} value corresponding to the used standards (e.g. ISO 13849-1) under consideration of the respective application (frequency of the actuation, service life, diagnostics by the evaluation unit, etc.). The B_{10d} values only apply when the technical properties of the emergency stop and enabling buttons are taken into account.

3.8 Spare parts / accessories

The following accessories and spare parts can be supplied:

Item name	Order number	Can be used with 6FX2007-	
		-1AD03	-1AD13
6-pos. step switch with accessories	104899	X	X
Emergency stop button	104900 *)	X	X
ZXE-104833 (3-stage enabling button)	104901 *)	X	X
Protective cap and nut for ZXE	104902 *)	X	X
3.5 m spiral connecting cable	104903 *)	X	
5 m straight connecting cable	104904 *)		X
5 m (straight) extension cable	103832 *)	X	X
10 m (straight) extension cable	103833 *)	X	X
15 m (straight) extension cable	103834 *)	X	X
Connecting adapter (0.5 m adapter cable; metal coupling on mini HHU side to T+B plastic coupling on panel side)	103835 *)	X	X
Connector disassembly tool	105037	X	X

*) Safety-related

Ordering address

Euchner GmbH + Co
 Vertrieb Technik
 Kohlhammerstr. 16
 70771 Leinfelden-Echterdingen
 Germany

Phone +49 (0) 711 7597-0

Fax +49 (0) 711 7597-303

Table 3- 6 Further accessories

Component	Order No.	Remark
Connection kit	6FX2006-1BG03 *)	Non-assembled, metal version, with terminating connector
Connection kit	6FX2006-1BG11 *)	Pre-assembled for MCP xxx PN, metal version, with terminating connector
Retaining shell	6FX2006-1BG70	Providing a place to store the mini HHU in the case of non-metallic surfaces
Angle socket for connection kit	6FX2006-1BG56 *)	Non-assembled, metal version
Adapter plate for connection kit	6FX2006-1BG45	Non-assembled, plastic to metal version

*) Safety-related

Retaining shell

Optionally, the mini handheld unit can be stored in a screw-on retaining shell. The retaining shell is mounted using three M4 screws (included in scope of delivery).

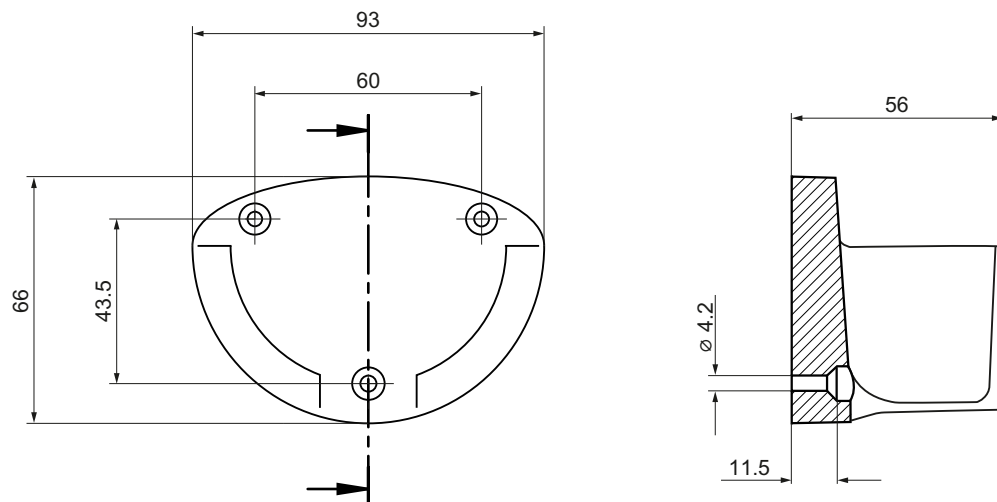

Figure 3-6 Dimension drawing for mounting the retaining shell

Angle box

An angle box is available as an option, which permits the cable outlet direction to be rotated through 90°.

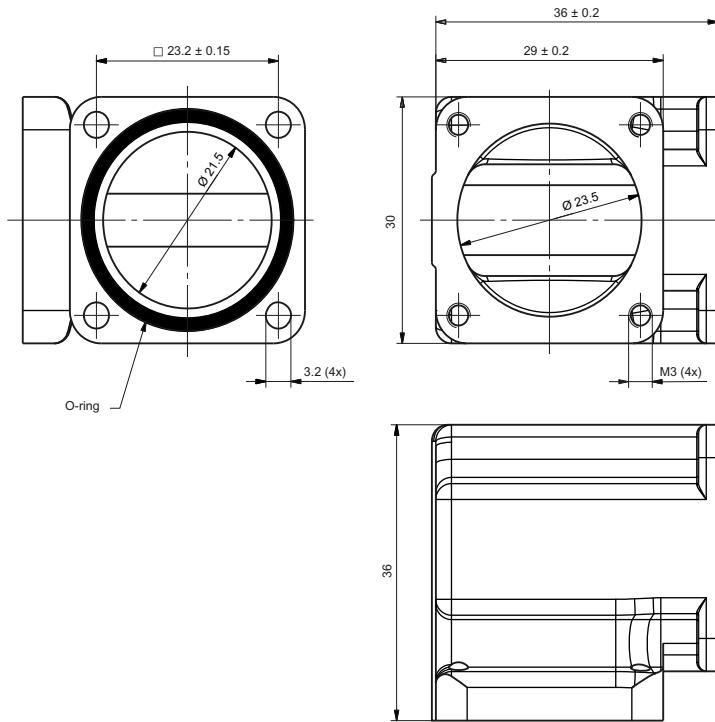

Figure 3-7 Dimension drawing of angle box

Adapter plate

The adapter plate is only required if the metal flange socket is being mounted at an installation location intended for plastic flange sockets.

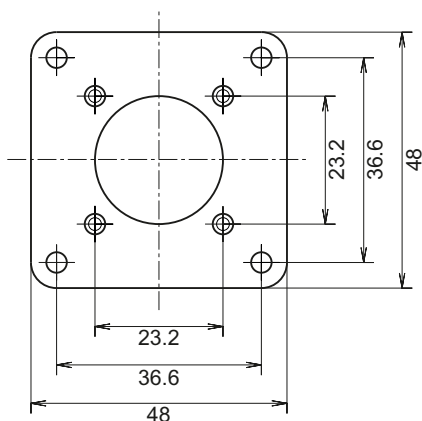

Figure 3-8 Dimension drawing of the adapter plate

Slide-in labels

The slide-in labels can be replaced. To do this, you must unscrew the six TORX screws on the rear of the housing. The housing can now be taken apart. The slide-in labels can now be pulled out of the guide on the front panel and replaced, if required.

Make sure that no connection cables are pinched during the re-assembly.

Electronic handheld handwheel

4.1 Description

The handheld handwheel is intended for use in conjunction with machines. A magnetic bracket and spiral connection cable can be found on its enclosure. The magnetic bracket (retaining magnet) enables the handwheel to be attached to metallic surfaces. So that it can also be safely stored on non-magnetic surfaces, there is also a retaining shell available (see Section: "Accessories").

The electronic handheld handwheel is an incremental encoder that generates signals according to how the manually operated wheel is rotated.

The handwheel's magnetic latching facility makes for an extremely precise incremental process. The axis selected via the control can be positioned so that the axes are parallel.

The handheld handwheel offers a PPR count of 100 S/R.

Validity

The description applies to the following electronic handheld handwheel:

Designation	Interface	Order number
Electronic handheld handwheel	DC 5 V, RS 422	6FC9320-5DE02

4.1 Description

Display



- ① Handwheel
- ② Spiral connection cable
- ③ 9-pin connector

Figure 4-1 View of electronic handheld handwheel

4.2 Dimension drawing

Front view and side view

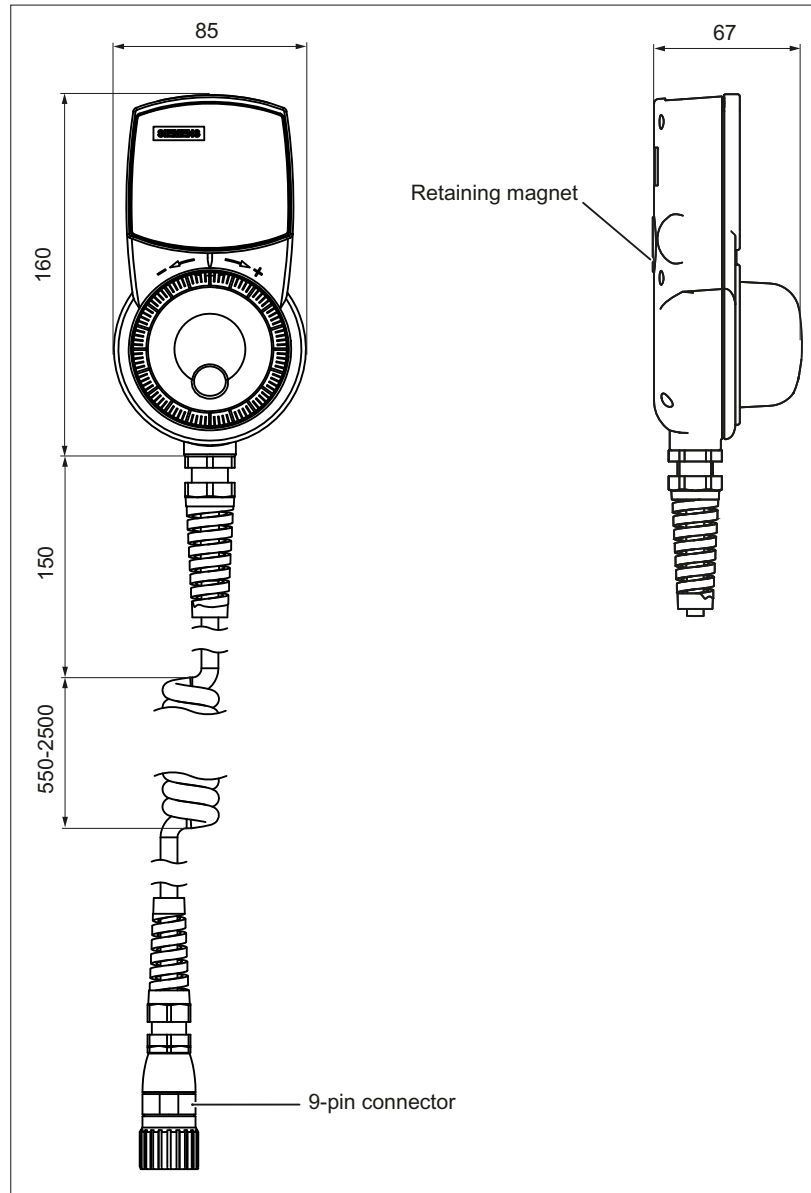
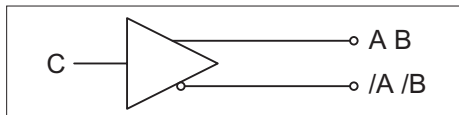

Figure 4-2 Dimensions of the electronic handheld handwheel

Outputs

RS 422 A



Load current ≤ 20 mA

Pulse diagram

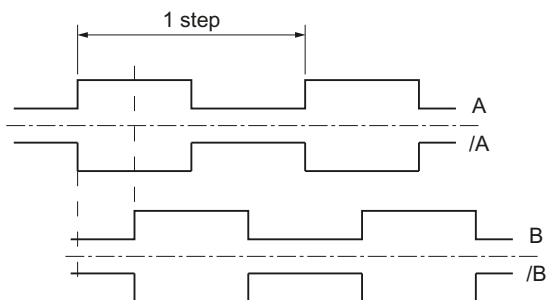

4.3 Connection

The handheld handwheel is connected via a flange socket using the spiral connection cable. You will find the order numbers for the recommended flange socket in section: "Accessories".

Electrical connection diagram

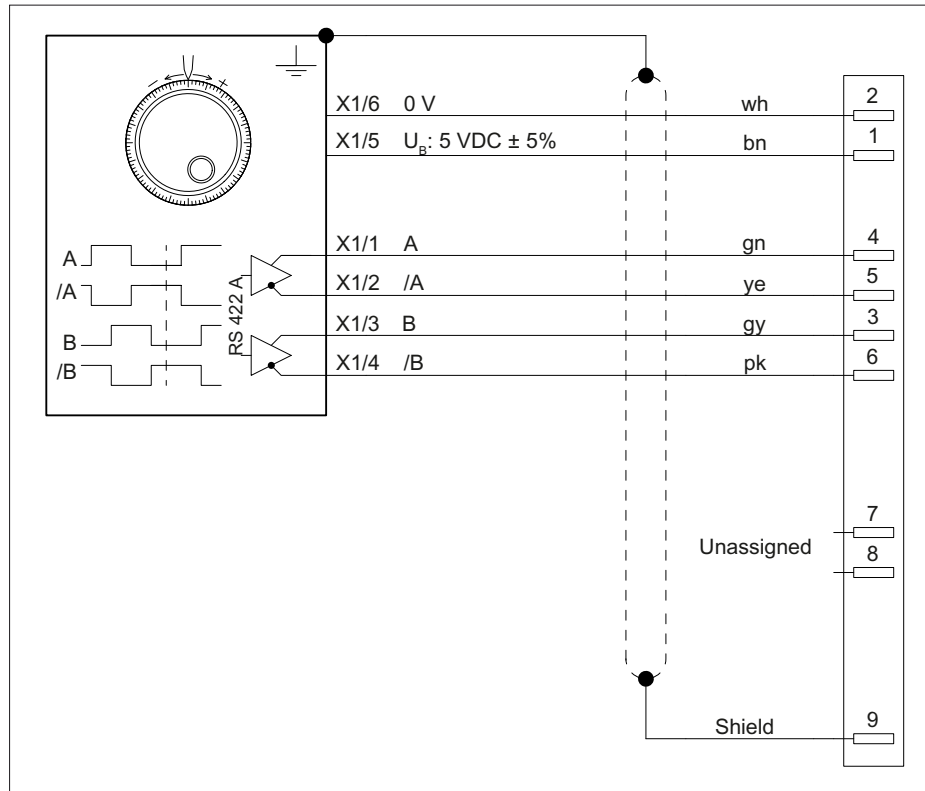

Note

If a connected handwheel triggers pulses while in the idle position or when there is only minimal contact, connect it the opposite way round to what is stated on the label.

Swap:

- The wires of terminal A with those of terminal /A
- The wires of terminal B with those of terminal /B

4.4 Technical specifications

Table 4- 1 Electronic handheld handwheel

Safety			
Safety class	I		
Degree of protection according to EN 60529	IP65		
Electrical data			
Operating voltage	5 VDC \pm 5%		
Current consumption	Max. 80 mA		
Limit frequency	10 kHz		
Number of pulses	100 increments/revolution		
Displacement of phase A to B	Typ. 90° electrical		
Interface	RS 422		
Mechanical data			
Dimensions approx.	Height: 160 mm	Width: 85 mm	Depth: 67 mm
Weight	0.3 kg (without spiral connection cable)		
Housing material	Thermoplastic		
Distance to NCU	20 m		
Actuating force	4 Ncm		
Speed	Max. 1,000 rpm		

Note

Information about the climatic and mechanical environmental conditions is contained in the associated section under:

"General notes and interconnection" → "Operational planning".

4.5 Accessories

The following components are available as accessories for the electronic handheld handwheel:

Component	Description	Order No.
Flange socket	9-pin flange socket	6FC9341-1AQ
Retaining shell	Providing a place to store the handwheel in the case of non-metallic surfaces	6FX2006-1BG70

Dimension drawing of retaining shell

Optionally, the electronic handheld handwheel can be stored in a screw-on retaining shell. The retaining shell is mounted using three M4 screws (included in scope of delivery).

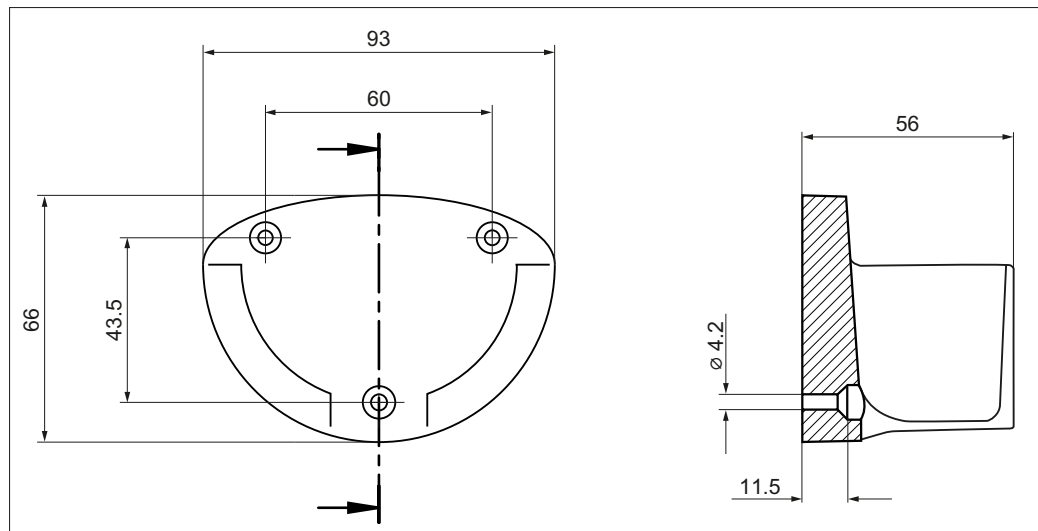

Figure 4-3 Dimension drawing for mounting the retaining shell

Handheld unit / distributor box

5.1 Description

The handheld unit type B-MPI features 2-channel emergency stop and enabling circuits. The enabling button is a 3-step enabling button.

The HHU is available with 3-wire or 4-wire enabling. In the version with 4-wire connection of the enabling buttons, monitoring for cross-circuit is possible in the enable circuit. Due to modified connector design, these HHUs can only be operated on the distributor designed for the corresponding mode. In the version with 4-wire connection of the enable keys, the connector insert of the connector is arranged coded at an angle of 45° to avoid destruction of the unit by accidental wrong connection.

The handheld unit type B-MPI is connected via a distributor to the MPI line. The distributor is designed for installation in a control cabinet or in a separate enclosure.

A retaining shell is available as an accessory for the HHU. The HHU can therefore also be securely fastened to non-magnetic surfaces (see Section: "Accessories").

Note

The handheld unit is designed for operation with SINUMERIK.

It cannot be used with SIMATIC.

Validity

The following description applies to the following components:

Designation	Features	Order number
Type B-MPI handheld unit 3-wire enabling	Spiral connection cable, 1.5 to 3.5 m	6FX2007-1AC04
	Straight cable, 10 m	6FX2007-1AC14
Type B-MPI handheld unit 4-wire enabling	Spiral connection cable, 1.5 to 3.5 m	6FX2007-1AE04
	Straight cable, 10 m	6FX2007-1AE14
Distributor	3-wire enabling incl. shorting plug	6FX2006-1BC01
Distributor	4-wire enabling incl. shorting plug	6FX2006-1BH01

5.2 Operating and display elements

5.2.1 View

Handheld unit

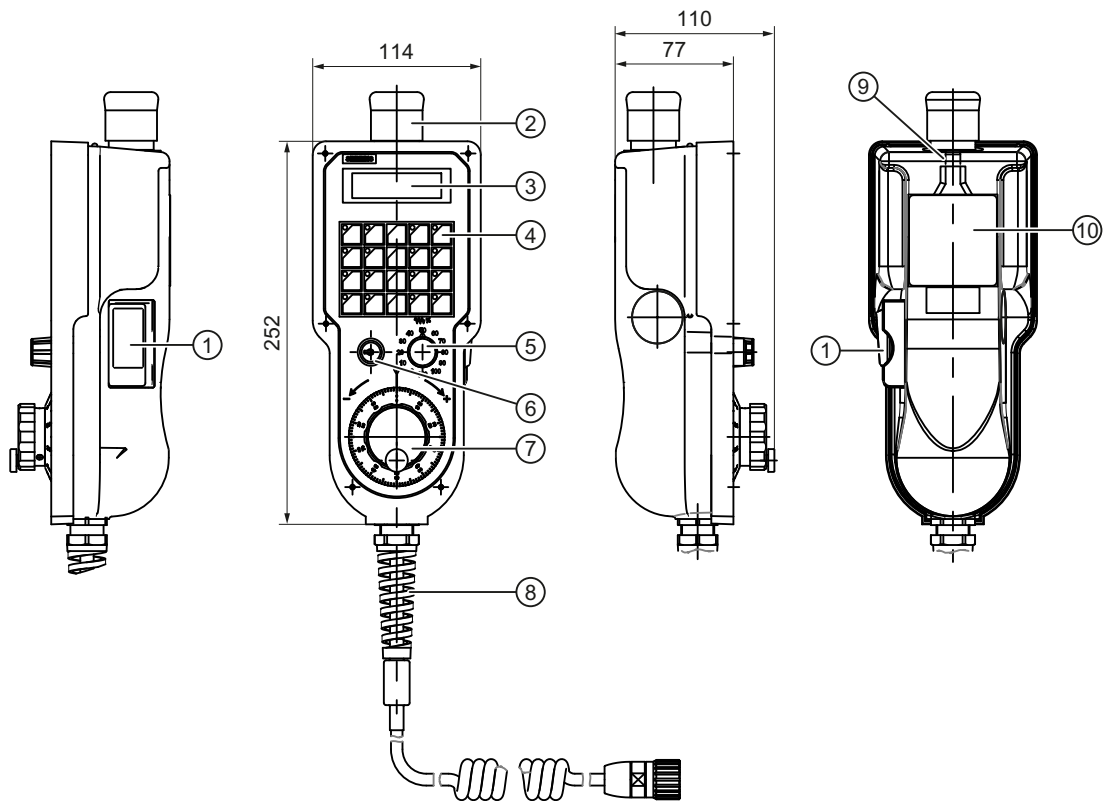

- ① Enabling button designed as a 3-position switch, two channels
- ② Emergency stop button, two channels
- ③ Two-line digital display 2 x 16 characters
- ④ 20 keys (16 of which with LEDs), freely assignable by user
- ⑤ Override switch with 12 positions
- ⑥ Key-switch with On/Off position
- ⑦ Electronic handwheel
- ⑧ Straight connecting cable 10 m or max. 3.5 m as a coiled cable
- ⑨ Suspension lug
- ⑩ Magnetic clamp

Key symbols

The key symbols are on a slide-in label that can be changed as necessary.

The labeling strip is located between the PCB and the front of the housing and can be accessed from the right.

Replacing labeling strips

To change the labeling strip, proceed as follows:

- Remove the labeling strip carefully to approx. halfway using flat pliers.
- Slide half of the new labeling strip under the old one.
- Remove the old labeling strip and slide the new one in to its final position.

Magnetic clamp

The magnetic clamp is not intended to permanently secure the HHU to the perpendicular sheet metal parts.

5.2.2 Description

Emergency stop button, NC contact, 24V/2A contact load

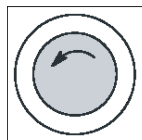

Emergency stop button

Press the red button in emergencies when

- people are at risk,
- there is the danger of machines or the workpiece being damaged.

As a rule, when operating the emergency stop button, all drives are brought to a standstill with max. braking torque.

Turn the EMERGENCY STOP button counterclockwise to unlatch it.



Machine manufacturer

For other reactions to the emergency stop:

Refer to the machine tool manufacturer's instructions

Enabling button

The enabling button is designed as a 3-position switch and is located at the left of the handheld unit. The buttons are NO contacts. They are two-channel keys. The connection is 3- or 4-wire, depending on type. A 4-wire connection allows cross short-circuit monitoring in the enable circuit.

24V/2A contact load.

Handwheel

The electronic handwheel supplies two tracks with rectangular signals. The signals can be tapped from the distributor and taken to the NCU connector X121 via the cable distributor.

Key-operated switch

Key-operated switch with two positions is transmitted to the PLC.

Override switch

Switch with 12 positions is transmitted to the PLC.

Keys

20 keys are transmitted to the PLC and are freely assignable by the user. The labeling symbols can be changed (unscrew HHU).

LED

16 LEDs in the keys, freely controllable via the PLC.

Digital display

2-tier digital display, each with 16 characters controlled via the PLC

Internal circuit of HHU and distributor with 3-wire connection for enabling button

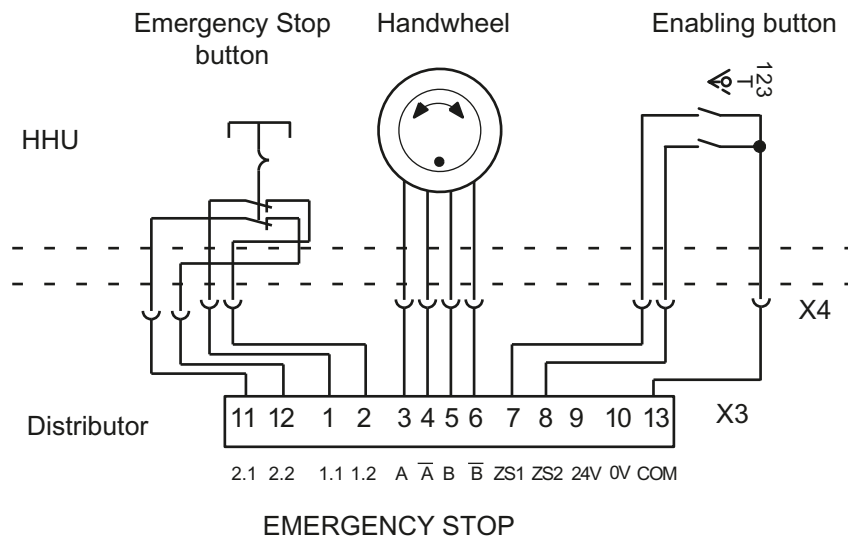

Figure 5-1 Internal circuit of emergency stop button, handwheel, enabling buttons 3-wire

Internal circuit of HHU and distributor with 4-wire connection for enabling button

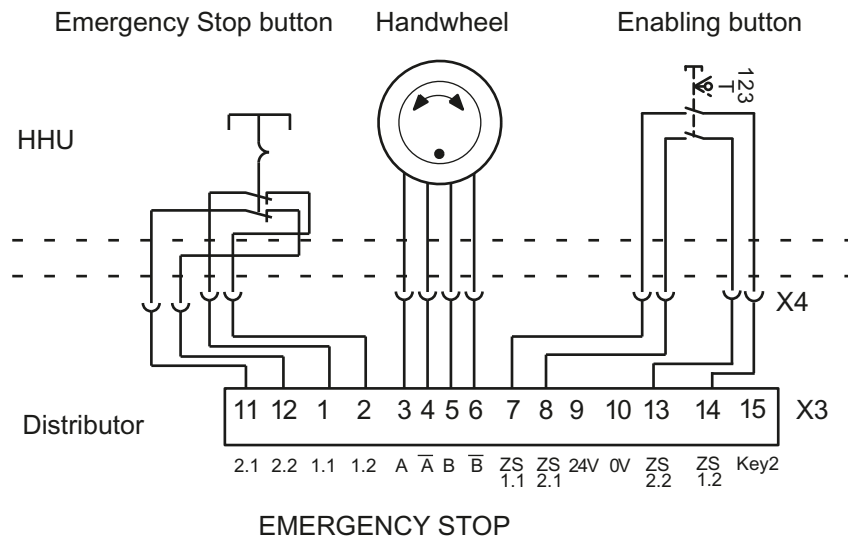

Figure 5-2 Internal circuit of emergency stop button, handwheel; enabling buttons 4-wire

5.3 Connecting

5.3.1 Connecting a device

Connecting cable

The HHU is connected to the distributor via the connecting cable (either a coiled cable with a max. length of 3.5 m or a 10 m connecting cable).

Note

If the connection between the HHU and the distributor is interrupted (HHU cable pulled out), an emergency stop is triggered. There is no automatic EMERGENCY STOP overriding function.

Interface to the distributor

The EMERGENCY STOP button and the enable keys, as well as the handwheel signals and the power supply are connected to terminal block X3.

Connection to the distributor

The HHU is connected to the distributor, connector X4. The emergency stop button, the enabling buttons and the handwheel signals are not transferred to the PLC but decoupled in the distributor terminal block X3. Power supply to the HHU is via the distributor. All other signals are transferred to the PLC via the MPI/OPI bus.

Note

Bus terminating resistors are permanently installed in the HHU, therefore only use MPI cables without bus terminators.

A maximum of two handheld units may be connected per bus segment.

Further HHUs can be connected using repeaters.

Connection to the control

In order that the PLC can access the input/output image of the HHU, the HHU must be connected via the distributor to the MPI bus of SINUMERIK solution line. The handwheel of the HHU cannot be connected directly to the control. The handwheel pulses are now transferred to the control via PROFIBUS. There are two options:

- Connection to NCU:

In addition to the MPI distributor, a PROFIBUS handwheel connection module 6FC5303-0AA02-0AA0 (see Chapter: "Handwheel connection module") is set. Two handwheels can be connected to this module.

- Connection to MCP/MPP:

The handwheel is connected to an already existing machine control panel. Note the permissible cable lengths.

When FB1 is parameterized as usual, the input/output image will not be transferred automatically via the basic PLC program. Transmission is performed through global data. The hardware configuration of the PLC must be adjusted accordingly.

A toolbox is required for configuring the hardware of the machine control panel or the handwheel connection module PROFIBUS nodes.

5.3.2 Connecting several devices

If more than one HHU is to be connected to a bus segment, or if the HHU cannot be connected at the end of the bus, a PROFIBUS repeater is recommended for the connection of the HHUs.

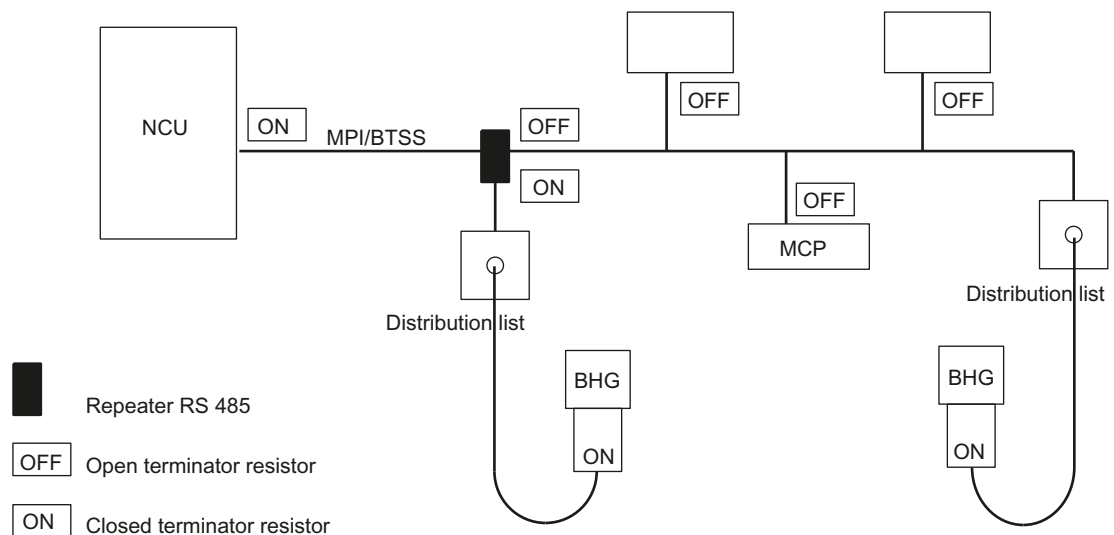

Figure 5-3 Connecting the HHU via repeater

Note

The numerical control must be located at the end of the connection!

Note

Only one HHU is supported by the basic PLC program. All further HHUs must be configured and operated via STEP 7 global communication.

Repeater RS-485

The repeater can be ordered under the number 6ES7972-0AA01-0XA0. For further information please refer to the Catalog: /IK PI/ Industrial Communication Networks SIMATIC-NET

Note

The cable length from the repeater to the distributor must not exceed 2 m

5.3.3 Unplugging/plugging during operation with emergency stop override

Trouble-free plugging and unplugging of the HHU during machine operation requires:

- Activation and deactivation of the power supply to the distributor,
- Release or override of the HHU emergency stop,
- Connection of the HHU to the OPI/MPI via repeater.

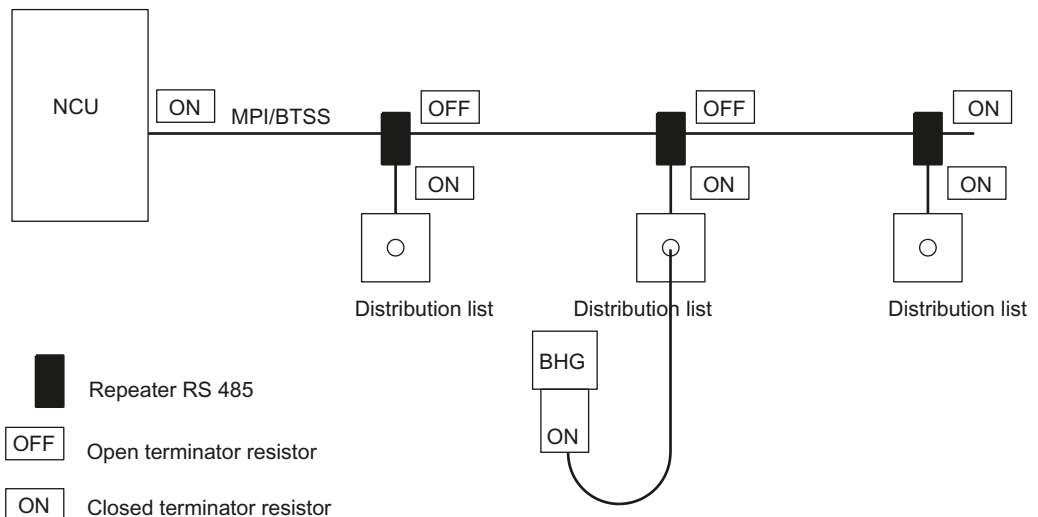

Figure 5-4 Connecting the HHU via a repeater

A repeater must be connected upstream of the HHU distributor for each branch. The individual bus segments (MPI/OPI line and/or the repeater and HHU) must be terminated with terminating resistors at the ends of the bus.

Repeater RS 485

The repeater can be ordered under the number 6AG1972-0AA01-7XA0.

For more information, see Catalog: /IK PI/ Industrial Communication Networks SIMATIC-NET

Note

The HHU already has an installed bus terminating resistor.

The cable length from the repeater to the distributor must not exceed 2 m.

Emergency stop override

A key-operated switch with two positions and two contacts must be installed at each HHU connection point.

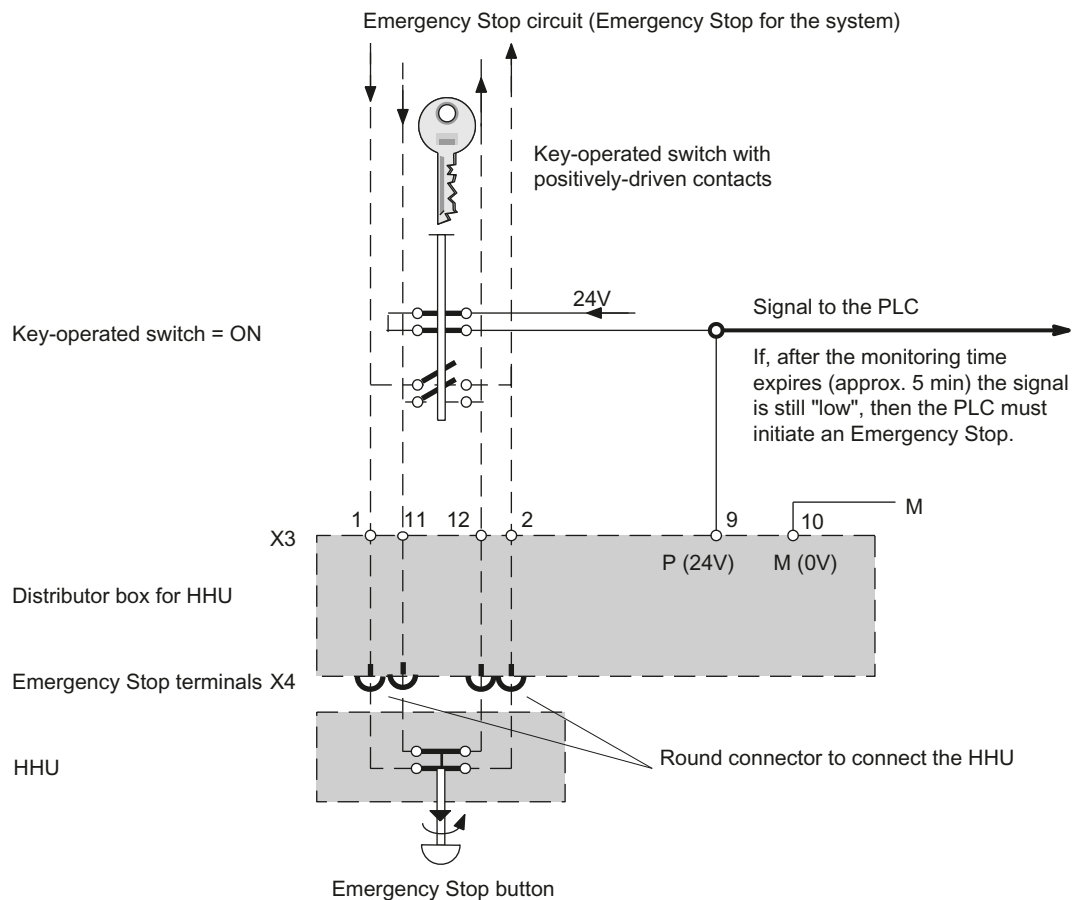

Figure 5-5 Suggested circuit for active emergency stop override

The figure shows the "key-operated switch = ON" state with connected HHU. The key-operated switch comprises two contact blocks and an actuating element.

Note

Please note that Siemens is not responsible for implementing the suggested circuit.

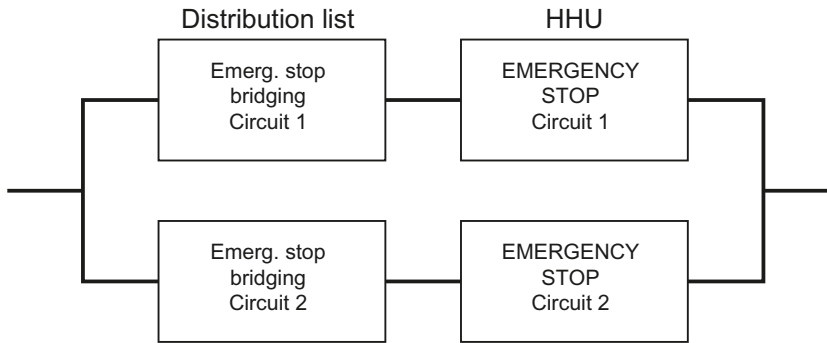



Figure 5-6 2-channel architecture of the emergency stop override contacts

In the event of an accidental failure, the contacts of the emergency stop override safety function form a 2-channel architecture together with the emergency stop button on the HHU. In addition to the B_{10d} value of the emergency stop button, the B_{10d} value of the key-operated switch must also be taken into consideration for the assessment in both emergency stop circuits.

The diagnostics for the contacts of the key-operated switch is performed on the HHU together with the diagnostics of the emergency stop button.

 WARNING
Danger of death caused by inadequately protected emergency stop override
The user must ensure that the emergency stop override is implemented in accordance with the safety goals required by the risk analysis of the machine. Actuation of the emergency stop override results in failure of the emergency stop safety function on the handheld unit. The user must implement suitable organization and/or technical procedures for this in order to achieve the safety goals.
As a technical measure, the signaling contacts of the key-operated switch can be used to trigger an "emergency stop" by the PLC after a monitoring time has expired (maximum five minutes). However, this measure alone does not satisfy the requirements of Category 3, PL d in accordance with EN ISO 13849-1:2008.

Connecting the HHU

Initial state:

- Key-operated switch is set to "OFF" position, HHU connection at distributor is passive.
- Emergency stop terminals to the HHU are overridden.
- Signal "HHU Stop" = 1 (or "HHU"=0), terminate communication.

Procedure:

1. Plug in HHU connector and screw down
Emergency stop of HHU must be unlocked.
2. Turn the key-operated switch to "ON", active.
HHU becomes active.
3. Signal "HHU Stop" = 0, communication commences with the HHU.

Disconnecting the HHU

Initial state:

Key-operated switch is set to "ON" position, HHU connection at distributor is active (incl. emergency stop).

Procedure:

1. Turn key-operated switch to "OFF," passive.
2. Signal "HHU Stop" = 0 switchover to 1 (terminate communication).
 - HHU has no voltage and goes into passive mode.
 - Emergency stop of the HHU is overridden.
3. Loosen the HHU connector and unplug it.

 WARNING
Danger of death caused by non-functioning emergency stop button
Emergency stop buttons that are inactive
<ul style="list-style-type: none">• Should not be recognizable as emergency stop buttons, or• Should not be accessible.
This is to prevent the emergency stop button from being used inadvertently.

5.3.4 MPI/OPI networking rules

Application

The following devices can be interconnected across the MPI bus:

- NCU
- Type B-MPI handheld unit

The MPI interconnecting cables are available in different lengths.

Network installation

Please take the following basic rules into account when undertaking network installations:

1. The MPI connection can be routed from one user to the next by plugging the MPI connector of the outgoing cable onto the MPI connector of the incoming cable.
2. The bus line must be terminated at both ends. To do this, enable the terminating resistor in the MPI connector of the first and last node and disable the remaining terminating resistors (see figure below).

Note

- Only two inserted terminating resistors are permitted.
 - In the case of B-MPI, bus terminating resistors are permanently installed in the device.
-

3. At least one terminator must be supplied with 5 V. This means that the MPI connector with an inserted terminating resistor must be connected to a device that is switched on.

Note

The NC must be located at the end of the connection.

4. Drop cables (feeder cable from bus segment to node) should be as short as possible.

Note

Unused spur lines should be removed.

5. Each MPI node must first be connected and then enabled. When disconnecting an MPI node, first deactivate the connection, then remove the connector.
6. A maximum of two B-MPI components can be connected per bus segment provided that they have different user addresses. Setting the addresses:
 - via the DIP switch or
 - via the display (see Chapter: "Commissioning")

7. At the distributor boxes of a B-MPI, no bus terminators may be inserted (see item 2.).
8. If more than one B-MPI is connected to a bus segment, this can be done with an intermediate repeater.
9. The following cable lengths for MPI or OPI for standard use without repeater must not be exceeded:

MPI (187.5 kbaud):

Max. cable length 1000 m in total

OPI (1.5 MBaud):

Max. cable length 200 m in total

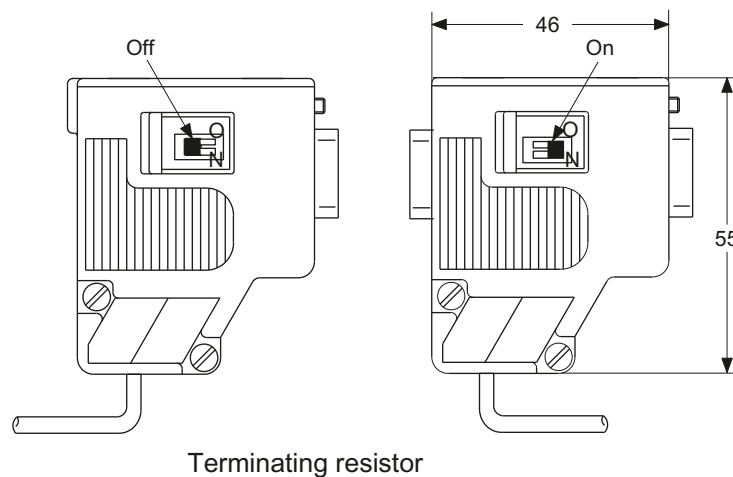

Figure 5-7 MPI connector

Literature: Catalog IK PI - Industrial Communication

5.4 Start up

5.4.1 Settings in handheld unit

Displaying the HHU's software version

The software version of the HHU is displayed after booting as long as the HHU is not communicating with the PLC.

Example: HHU display

Waiting for PLC

V04.01.01 F / 1.5 M Display changes between F and 1.5 M

- SW version of HHU is V04.01.01
- Bus address of HHU is F_{hex} (15_{dec})
- Baud rate of HHU is 1.5 MBaud

DIP switch

To set the bus parameters and the IDLE time (no-load time), two quadruple DIP switches are provided on the basic module of the HHU.

The HHU must be opened for access to the DIP switches.

NOTICE
Damage to the device due to improper opening <ul style="list-style-type: none">• Open the device only if the BHG connector has been previously removed!• Note the ESD protection measures.

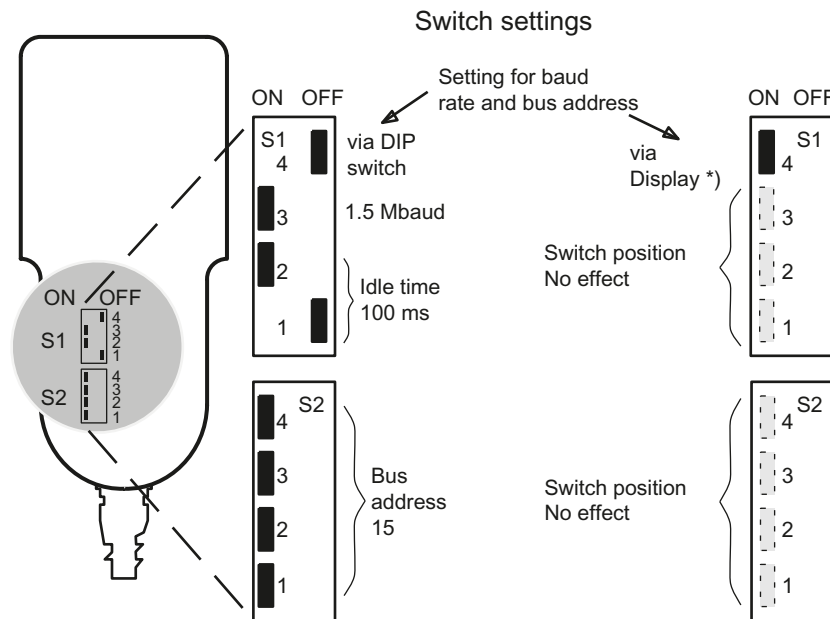

*) As of SW V04.01.01

Figure 5-8 DIP switches in the HHU

Meaning of DIP switches

Table 5- 1 Settings on switches S1 and S2 in HHU

Meaning		S1 1	S1 2	S1 3	S1 4	S2 1	S2 2	S2 3	S2 4
Baud rate and bus address setting	via display (only SW 4.1.1)				on				
	via DIP switches (all SW versions)				off				
IDLE time *)	100 ms	off	on						
Baud rate	1.5 Mbaud			on					
	187.5 kbaud			off					
Bus address *)	15					on	on	on	on
	14					on	on	on	off
	13					on	on	off	on
	12					on	on	off	off
	11					on	off	on	on
	10					on	off	on	off
	9					on	off	off	on
	8					on	off	off	off
	7					off	on	on	on
6					off	on	on	off	

5.4 Start up

Meaning		S1 1	S1 2	S1 3	S1 4	S2 1	S2 2	S2 3	S2 4
	5					off	on	off	on
	4					off	on	off	off
	3					off	off	on	on
	2					off	off	on	off
	1					off	off	off	on
	0					off	off	off	off
Delivery condition (default)	SW V01.01.02	off	on	on	off	on	on	on	on
	SW V04.01.01	off	on	on	on	on	on	on	on

*) If S1.4 = **on** and SW version ≥ V04.01.01: Switch has no function

Note

With switch position S1.4 = **on** and software version ≥ V04.01.01, bus addresses from 0 to 31 can be set, i.e. up to 32 nodes can be supported on the OPI/MPI.

Bus addresses that are already assigned are preceded by the * character on the display.

5.4.2 Configuring

It is necessary to set the GD parameters for the sub-module to communicate via the MPI interface.



The setting can be activated during the powering up phase (while waiting for the first GD telegram) of the PLC ("Waiting for PLC" status) via the HHU interface using the key combination JOG (above left, outside) and T2 (above right, outside). The individual parameters are then interrogated via the HHU display and entered via the HHU keyboard. The default values can be changed within the permissible value range by means of keys + and -.



The Automatic key selects the next parameter. Selection of the next parameter causes the preceding parameter to be stored in the flash EPROM. The parameters need therefore only be set during start-up and when interfaces are changed. If interface parameter assignment is not activated after power on, the stored values are accepted or the default values (see table) are loaded.

Significance of GD parameters

There are separate GD parameters for sending and receiving.

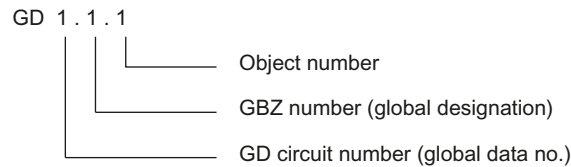

Figure 5-9 Significance of GD parameters

Note

The GD parameters of the HHU and PLC block FB1/0B100 must be set identically.

Designation	Display	Default value	Range of values
Receive GD circle no.	Rec-GD-No:	2	1-16
Receive global identifier number	Rec-GBZ-No	1	Fixed
Object number for receive global identifier number	Rec-Obj-No:	1	Fixed
Transmit GD circle no.	Send-GD-No:	2	Fixed
Transmit GI no.	Send-GBZ-No:	2	Fixed
Object number for transmit global identifier number	Send-Obj-No:	1	Fixed
Baud rate	Baud rate:	1.5 M	187.5 / 1.5 M
Bus address	Bus address:	15	0-31

5.4.3 Interface signals

PLC module

The FC13 "HHUDisp" supports the handling of the digital display. For a detailed description, please refer to:

Literature: Function Manual, Basic Functions, P3, "Basic PLC Program".

Note

The customer is responsible for programming the transfer of key signals to the interface in a PLC user program.

User interface

Layout of keys and LEDs:

The left-hand side of the figure shows the standard labeling with the free keys; the right-hand side contains the numbering.

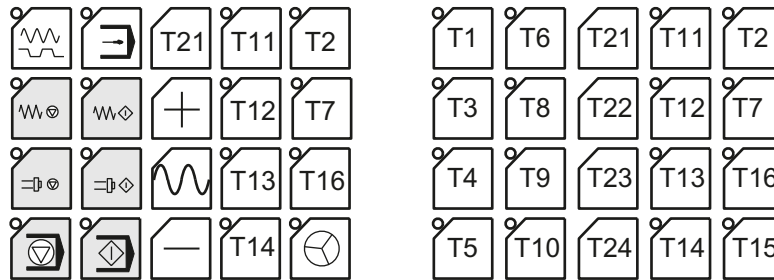

Figure 5-10 HHU control keys

Input image of handheld unit

You can tap the signals for the keys, feed rate override switch, key-operated switch and acknowledgement of the digital display at the input area. The address range is set by parameter assignment with STEP7 tools.

Byte no.	Input signals to PLC								
	Bit 7	Bit 6	Bit 5	Bit 4	Bit 3	Bit 2	Bit 1	Bit 0	
EB m	Reserved	Reserved	Reserved	Reserved	Reserved	Reserved	Reserved	Reserved	
EB m + 1	Reserved	Reserved	Reserved	Reserved	Reserved	Reserved	Reserved	Reserved	
EB m + 2	Feed start T8	Free key T7	AUTO-MATIC T6	NC stop T5	Spindle stop T4	Feed stop T3	Free key T2	JOG T1	
EB m + 3	Free key T16	Hand wheel T15	Free key T14	Free key T13	Free key T12	Free key T11	NC start T10	Spindle start T9	
EB m + 4	Direction key - T24	Rapid transverse override T23	Direction key + T22	Free key T21					
EB m + 5	Acknowledge digital display	Keyswitch	Rapid traverse / feed rate override switch						
			E	D	C	B	O		

HHU rotary switch positions

Position	%	EDCBA
1	0	00001
2	10	00100
3	20	01100
4	30	01101
5	40	01111
6	50	01110
7	60	01010
8	70	01011
9	80	01000
10	90	11001
11	100	11010
12	110	11111

HHU key-operated switch

— → 0 (horizontal position)

| → 1 (vertical position)

Output image of the handheld unit

The signals for controlling the LEDs, HHU mode, display signals and digital display are present at the output area.

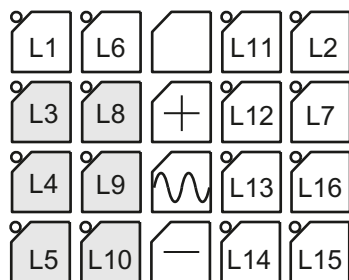

Figure 5-11 Control keys with integrated LEDs in HHU

5.4 Start up

Byte no.	Output signals to PLC							
Byte	Bit 7	Bit 6	Bit 5	Bit 4	Bit 3	Bit 2	Bit 1	Bit 0
AB m	1							
AB m + 1	New data for selected line							Selection line
AB m + 2	L8	L7	L6	L5	L4	L3	L2	L1
AB m + 3	L16	L15	L14	L13	L12	L11	L10	L9

Lx = 1 → LED lights up

Output image of the digital display

Control of the digital display in the HHU

Byte no.	Output signals to HHU							
Byte	Bit 7	Bit 6	Bit 5	Bit 4	Bit 3	Bit 2	Bit 1	Bit 0
AB m + 4	Default setting of 1st character (right) of selected line							
AB m + 5	Default setting of 2nd character of selected line							
AB m + 6	Default setting of 3rd character of selected line							
AB m + 7	Default setting of 4th character of selected line							
AB m + 8	Default setting of 5th character of selected line							
AB m + 9	Default setting of 6th character of selected line							
AB m + 10	Default setting of 7th character of selected line							
AB m + 11	Default setting of 8th character of selected line							
AB m + 12	Default setting of 9th character of selected line							
AB m + 13	Default setting of 10th character of selected line							
AB m + 14	Default setting of 11th character of selected line							

Byte no.	Output signals to HHU						
AB m + 15	Default setting of 12th character of selected line						
AB m + 16	Default setting of 13th character of selected line						
AB m + 17	Default setting of 14th character of selected line						
AB m + 18	Default setting of 15th character of selected line						
AB m + 19	Default setting of 16th character (left) of selected line						

Note

Output byte ABm bit 7 must always have the value 1!
This sets the display's output mode.

Display

The digital display is used as a 2-line alphanumeric display with 16 digits per line.

The display data is coded according to the character set given in the ASCII code table for the digital display via the ABm + 4...19 bytes. The decimal point is a separate character. The display always starts line by line right-justified with the byte ABm + 4 and is built up towards the left up to ABm + 19.

Selecting the line

ABm + 1, bit 0

This bit is used to select the line to be written.

Bit 0 = 0: The 1st line is selected

Bit 0 = 1: The 2nd line is selected.

New data for selected line

ABm + 1, bit 7

This bit is used to request writing in of new data into a line. The bit is set by the user program and can be reset on detection of the acknowledgement bit EBm + 5, bit 7.

Bit 7 = 0: Reset request.

Bit 7 = 1: Set request

Acknowledgement of the digital display

EBm + 5, bit 7

This bit is set by the system after the new data has been accepted.

Bit 7 = 0: No new data

Bit 7 = 1: New data has been accepted

Example of a signal chart

Example of a signal chart when writing data for two lines

1. Select the line with ABm + 1, bit 0.
2. Write new data with ABm + 4...19.
3. Set request: New data for selected line ABm + 1, bit
4. Acknowledgement of the digital display EBm + 5, bit 7, via the system.
5. Reset request

Note

The request must be reset before a new line is written!

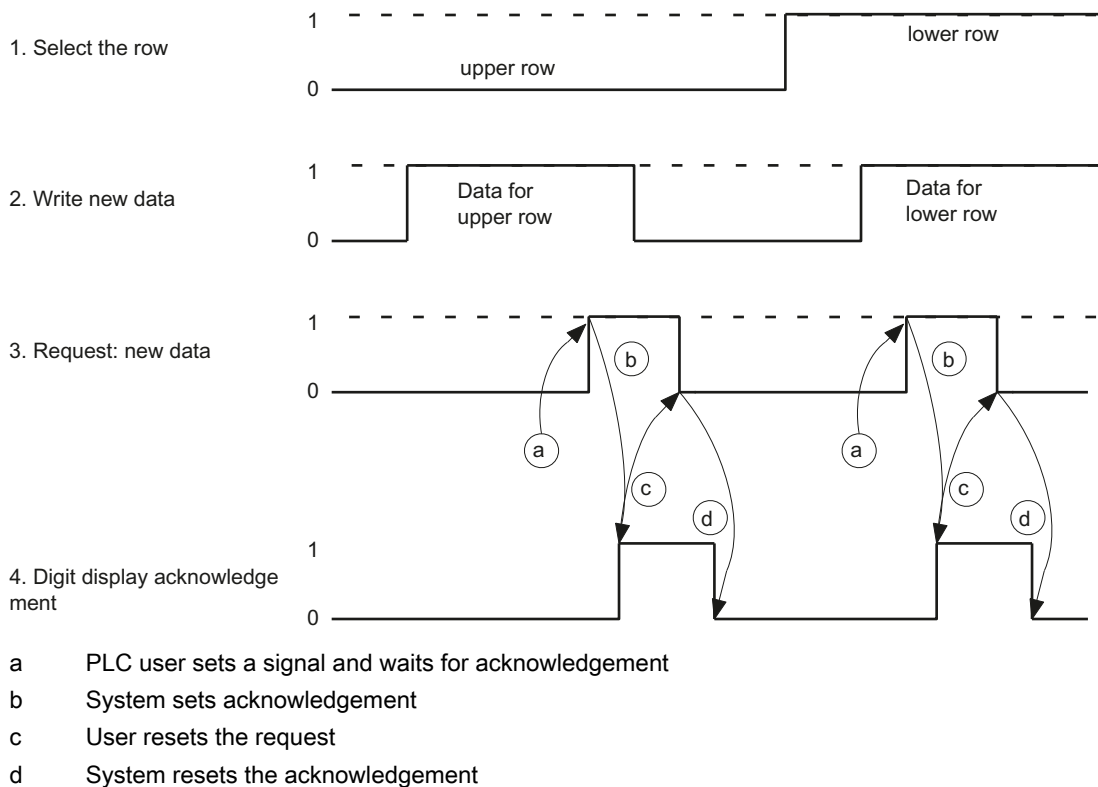

Figure 5-12 Signal chart example for writing data into the HHU display

ASCII code for digital display

Representation of characters by specifying the corresponding number system (hexadecimal/decimal) in the bytes ABm + 4...19. The characters from Hex 20 to Hex 7F are default values.

Table 5- 2 Standard character set

ASCII Hex/dec	Char- acter	ASCII Hex/dec	Char- acter	ASCII Hex/dec	Char- acter	ASCII Hex/dec	Char- acter	ASCII Hex/dec	Char- acter	ASCII Hex/dec	Char- acter
20 / 32	¹⁾	30 / 48	0	40 / 64	@	50 / 80	P	60 / 96	`	70 / 112	p
21 / 33	!	31 / 49	1	41 / 65	O	51 / 81	Q	61 / 97	a	71 / 113	q
22 / 34	"	32 / 50	2	42 / 66	B	52 / 82	R	62 / 98	b	72 / 114	r
23 / 35	#	33 / 51	3	43 / 67	C	53 / 83	S	63 / 99	c	73 / 115	s
24 / 36	\$	34 / 52	4	44 / 68	D	54 / 84	T	64 / 100	d	74 / 116	t
25 / 37	%	35 / 53	5	45 / 69	E	55 / 85	U	65 / 101	e	75 / 117	u
26 / 38	&	36 / 54	6	46 / 70	F	56 / 86	V	66 / 102	f	76 / 118	v
27 / 39	'	37 / 55	7	47 / 71	G	57 / 87	W	67 / 103	g	77 / 119	w
28 / 40	(38 / 56	8	48 / 72	H	58 / 88	X	68 / 104	h	78 / 120	x
29 / 41)	39 / 57	9	49 / 73	I	59 / 89	Y	69 / 105	i	79 / 121	y
2A / 42	*	3A / 58	:	4A / 74	J	5A / 90	Z	6A / 106	j	7A / 122	z
2B / 43	+	3B / 59	;	4B / 75	K	5B / 91	[6B / 107	k	7B / 123	{
2C / 44	,	3C / 60	<	4C / 76	L	5C / 92	\	6C / 108	l	7C / 124	
2D / 45	-	3D / 61	=	4D / 77	M	5D / 93]	6D / 109	m	7D / 125	}
2E / 46	.	3E / 62	>	4E / 78	N	5E / 94	^	6E / 110	n	7E / 126	~
2F / 47	/	3F / 63	?	4F / 79	O	5F / 95	_	6F / 111	o	7F / 127	²⁾

¹⁾ Space

²⁾ Not defined

Table 5- 3 Extended character set

ASCII Hex/dec	Char- acter	ASCII Hex/dec	Char- acter	ASCII Hex/dec	Char- acter	ASCII Hex/dec	Char- acter	ASCII Hex/dec	Char- acter	ASCII Hex/dec	Char- acter
A0 / 160	¹⁾	B0 / 176	°	C0 / 192	À	D0 / 208	Ð	E0 / 224	à	F0 / 240	ð
A1 / 161	ı	B1 / 177	±	C1 / 193	Á	D1 / 209	Ñ	E1 / 225	á	F1 / 241	ñ
A2 / 162	ç	B2 / 178	²	C2 / 194	Â	D2 / 210	Ò	E2 / 226	â	F2 / 242	ò
A3 / 163	£	B3 / 179	³	C3 / 195	Ã	D3 / 211	Ó	E3 / 227	ã	F3 / 243	ó
A4 / 164	¤	B4 / 180	´	C4 / 196	Ä	D4 / 212	Ô	E4 / 228	ä	F4 / 244	ô
A5 / 165	¥	B5 / 181	µ	C5 / 197	Å	D5 / 213	Õ	E5 / 229	å	F5 / 245	õ
A6 / 166	¦	B6 / 182	¶	C6 / 198	Æ	D6 / 214	Ö	E6 / 230	æ	F6 / 246	ö
A7 / 167	§	B7 / 183	·	C7 / 199	Ç	D7 / 215	×	E7 / 231	ç	F7 / 247	÷
A8 / 168	¨	B8 / 184	¸	C8 / 200	È	D8 / 216	Ø	E8 / 232	è	F8 / 248	ø
A9 / 169	©	B9 / 185	¹	C9 / 201	É	D9 / 217	Ù	E9 / 233	é	F9 / 249	ù
AA / 170	ª	BA / 186	º	CA / 202	Ê	DA / 218	Ú	EA / 234	ê	FA / 250	ú
AB / 171	«	BB / 187	»	CB / 203	Ë	DB / 219	Û	EB / 235	ë	FB / 251	û
AC / 172	¬	BC / 188	¼	CC / 204	Ì	DC / 220	Ü	EC / 236	ì	FC / 252	ü
AD / 173	²⁾	BD / 189	½	CD / 205	Í	DD / 221	Ý	ED / 237	í	FD / 253	ý
AE / 174	®	BE / 190	¾	CE / 206	Î	DE / 222	Þ	EE / 238	î	FE / 254	þ
AF / 175	¯	BF / 191	¿	CF / 207	Ï	DF / 223	ß	EF / 239	ï	FF / 255	ÿ

1) Protected space

2) Conditional separator

5.5 Distributor box for handheld unit

5.5.1 Overview

Distributor and HHU

The handheld unit is connected to the distributor.

The distributor is intended for mounting in the switch cabinet or in a separate enclosure. The distributor has an interface to the MPI bus and a terminal block for connecting emergency stops, enabling buttons, handwheels and the 24 V power supply.

The equipotential bonding connector is also arranged at the distributor. Equipotential bonding has to be made using a low-resistance connection between the distributor and the ground potential. The equipotential bonding conductor should be a stranded cable having a cross-section of at least 10 mm² and a length of < 30 cm, see "General information and networking" > "Application planning" > "Secondary electrical conditions" > "Grounding concept".

Versions of the distributor

The distributor must be designed for 3-wire or 4-wire connection of the enabling buttons, depending on the HHU used.

5.5.2 Interfaces

Position of the interfaces

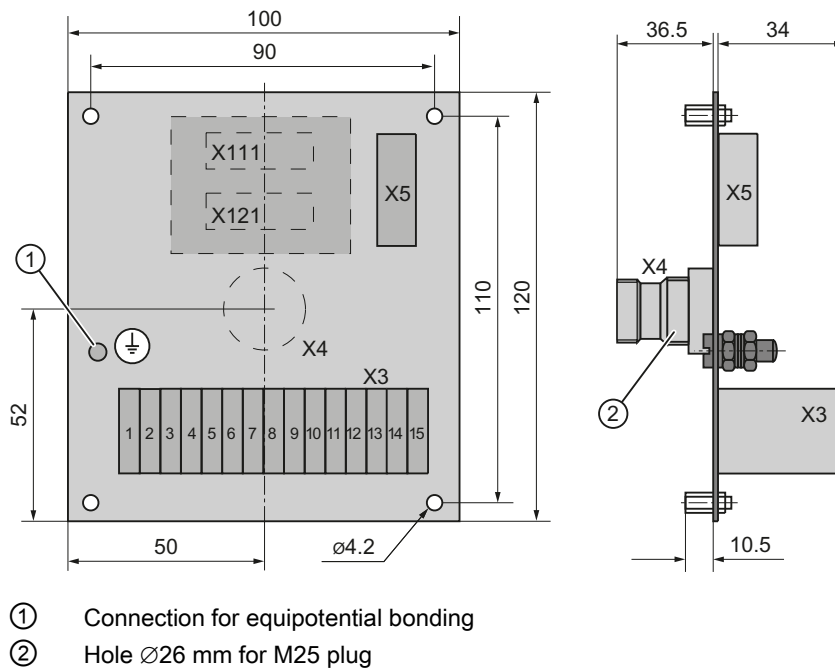

Figure 5-13 Distributor for MPI bus in the front and side view with 4-wire enabling

X111, X121

For connection to the MPC line; it is used only with SINUMERIK 840C.

X3

Terminal block for HHU control elements

Terminal block designation: **X3**Terminal block: Terminals for 1.5 mm²

Table 5- 4 Assignment of terminal block X3 with enabling key, 3-wire

Pin	Signal name	Signal type
1	Emergency stop button 1.1 (24 V, 2 A)	I, input
2	Emergency stop button 1.2 (24 V, 2 A)	O, output
3 / 4	Handwheel track A / handwheel track A	I/O, bi-directional
5 / 6	Handwheel track B / handwheel track B	
7 / 8	Enabling button ZS1 (24 V, 2 A) / Enabling button ZS2 (24 V, 2 A)	O, output
9	24 V (power supply for HHU)	I, input
10	0V (M _{ext} for HHU)	
11	Emergency stop button 2.1 (24 V, 1 A)	
12	Emergency stop button 2.2 (24 V, 1 A)	O, output
13	Enabling button (24V, 2A)	I, input

Table 5- 5 Signal assignment of terminal block X3 with enabling button, 4-wire

Pin	Signal name	Signal type
1	Emergency stop button 1.1 (24 V, 2 A)	I, input
2	Emergency stop button 1.2 (24 V, 2 A)	O, output
3 / 4	Handwheel track A / handwheel track A	I/O, bi-directional
5 / 6	Handwheel track B / handwheel track B	
7 / 8	Enabling button ZS1 (24 V, 2 A) / Enabling button ZS2 (24 V, 2 A)	O, output
9	24 V (power supply for HHU)	I, input
10	0V (M _{ext} for HHU)	
11	Emergency stop button 2.1 (24 V, 1 A)	
12	Emergency stop button 2.2 (24 V, 1 A)	O, output
13 / 14	Enabling button ZS 2.2 / Enabling button ZS 1.2	I, input
15	Key 2	Not connected

X4

HHU interface

Connector designation: **X4**

Connector type: Round connector for screw connection

Special feature: Interface must comply with IP54

X5

MPI interface

Connector designation: **X5**
 Connector type: 9-pin Sub-D socket connector
 Max. cable length: 200 m
 Special feature: Electrical isolation

Table 5- 6 Assignment of connector X5

Pin	Signal name	Signal type
1 / 2	Not connected	
3	RS_KP, differential RS485 data	B
4	Request to send RTSAS_KP automation system	O
5	M ground	VO
6	P5 5 V	VO
7	Not connected	
8	XRS_KP, differential RS485 data	B
9	RTSPG_KP Request to Send PG	I

Signal type

B Bi-directional
 O Output
 I Input
 VO Voltage Output

EMC measures

The interference currents are grounded via the shield plates. To prevent these discharged currents from becoming a source of interference themselves, make sure that the path of the interference currents to ground is of low-resistance.

- Securely tighten all retaining screws of cable connectors, modules and cables referred to a potential.
- Make sure that all contacting areas of cables referred to a potential are protected against corrosion.
- Use short potential reference cables of < 30 cm and a cross section of 10 mm².
- In order to avoid capacitive charges on unused cable cores, the unused cores of the emergency stop and enabling buttons (terminals NAUS1.1, NAUS1.2, NAUS2.1, NAUS2.2, ZS1, ZS2, ZUSTICO) must be connected to the equipotential bonding terminal.

5.5.3 Mounting

The HHU is connected to the distributor via the X4 screw connection. When producing a hole (e.g. in a casing) for the X4 screw connection, degree of protection IP54 must be ensured.

5.5.4 Connections

Connecting the 24 VDC power supply

The 24 VDC power supply is connected to terminal block X3, terminals 9 and 10.

MPI bus connection

The distributor is connected to the appropriate interface on the MPI bus of the control unit via the MPI bus terminal X5 with an MPI cable.

Emergency stop key connection

The emergency stop button is connected to the terminal block X3:

- The first channel to terminals 1 and 2
- The second channel to terminals 11 and 12

Handwheel connection

The electronic handwheel can be connected to terminal block X3, terminals 3 to 6. If the handwheel is to be connected to the NCU, a connection must be made to the cable distributor.

Enabling button connection

The enabling button is connected to terminal block X3.

Equipotential connection

Equipotential bonding has to be made using a low-resistance connection between the distributor and the ground potential. The equipotential bonding cable should be a stranded cable having a cross-section of at least 10 mm² and a length of < 30 cm.

5.6 Technical data

Table 5- 7 Handheld unit

Safety				
Degree of protection according to EN 60529	IP65			
Approvals	CE / UL			
Electrical data				
Power supply	24 VDC			
Power consumption approx.	250 mA	Handwheel: 500 mA	Emergency stop button: 2 A	Enabling button: 2 A
General data				
Handwheel	2 tracks	TTL level		
Emergency stop button	NC contact	B _{10d} = 100 000		
Enabling button	2 parallel NO contacts	B _{10d} = 100 000		
Key-operated switch	2 positions	ON/OFF		
Override switch	12 positions			
Long connection cable	3.5 m or 10 m			
Maximum distance to NCU	200 m			
Mechanical data				
Dimensions	Height: 252 mm	Width: 114 mm	Depth: 110 mm	
Weight	1.2 kg without connecting cable			

Note

Information about the climatic and mechanical environmental conditions is contained in the associated section under:

"General notes and interconnection" → "Operational planning".

Note

The quantitative assessment of the emergency stop and enabling safety functions must be based on the B_{10d} values corresponding to the used standards (e.g. ISO 13849-1) under consideration of the respective application (frequency of the actuation, service life, diagnostics by the evaluation unit, etc.). The B_{10d} values only apply when the technical properties of the emergency stop and enabling buttons are taken into account.

5.7 Spare parts

The following spare parts are available:

Designation	Length	Plug connector	Coding	Remarks	Euchner ID number
Spiral cable	3.5 m	17-pin	0 °	for 6FX2007-1AC04	075384
			45 °	for 6FX2007-1AE04	078999
Straight cable	10 m	17-pin	0 °	for 6FX2007-1AC14	075385
			45 °	for 6FX2007-1AE14	079000
Terminator with chain		17-pin	0 °	for 6FX2006-1BC01	072764
Terminator with chain		17-pin	45 °	for 6FX2006-1BH01	078952
Key-operated switch				Complete	072604
Spare key for				Key-operated switch	075387
Emergency stop button, pull-to-unlatch, 2-channel				For current HHUs	073985
Handwheel (encoder HKD100V100A05)				with ribbon connection cable	057036
Setting wheel C1702 (operating wheel)				for handwheel	071380
Cover for				keyboard	075772
Slide-in labels				Block: 1x printed, 1x not printed	075909
Override stepper switch, 12-way				gray-coded	077097
Rotary button for override stepper switch				with arrow dial	073973
Cover diaphragm for enabling button, 2 stages				2 x	055419
Enabling button, 3-positions					095256

For a detailed description, see "Service & Support", article no. 18651926:
<http://support.automation.siemens.com/WW/view/en/18651926>

Order address

Euchner GmbH + Co
 Vertrieb Technik
 Kohlhammerstr. 16
 D-70771 Leinfelden-Echterdingen, Germany

Phone: +49 711 7597-0
 Telefax: +49 711 7597 303

5.8 Accessories

The following components are available as accessories for this HHU:

Component	Order number	Remarks
Retaining shell	6FX2006-1HA00	Polystyrene, black, weight: 0.3 kg

The retaining shell is secured to the mounting face by four M5 countersunk screws (not included in delivery kit).

Dimension drawing

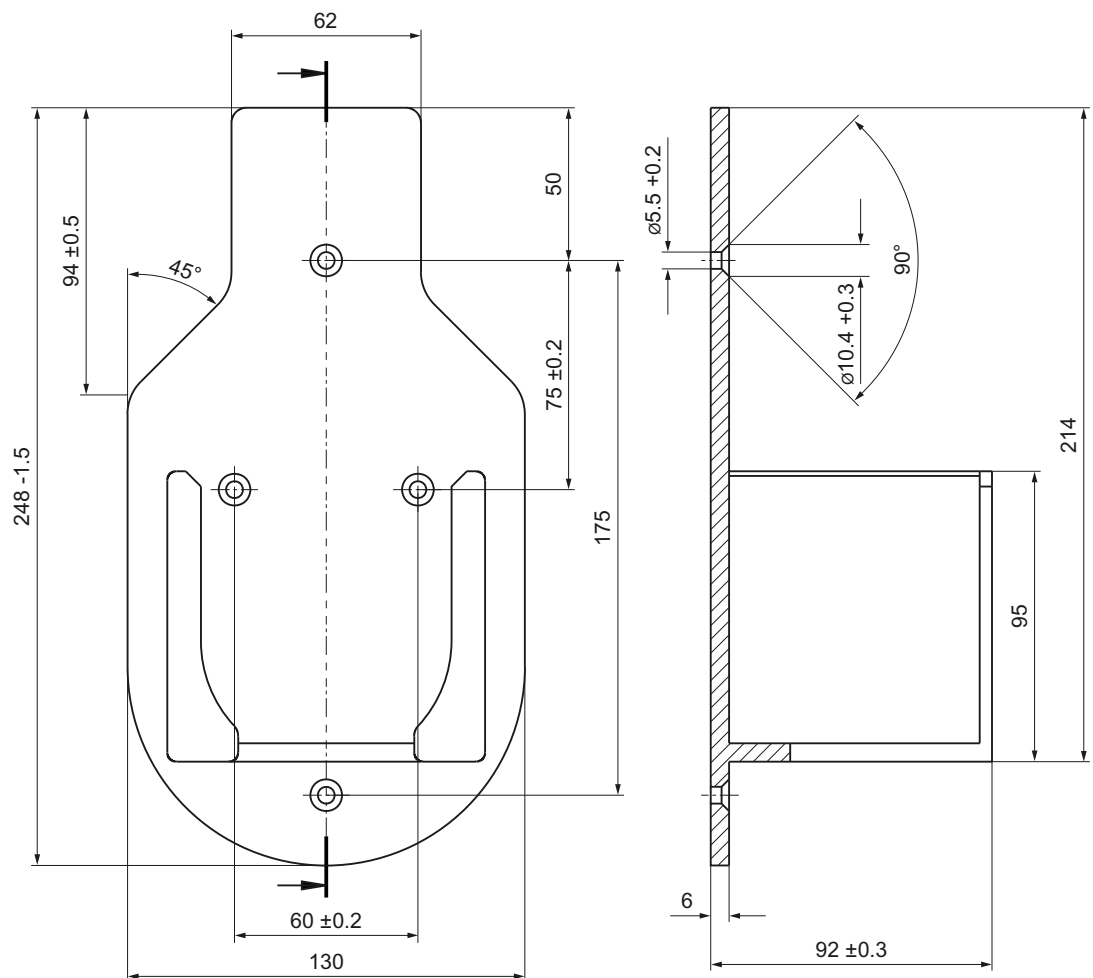

Figure 5-14 Retaining shell for HHU

Handwheel connection module

6.1 Description

The SINUMERIK handwheel connection module for PROFIBUS can be used to connect two handwheels or the handwheel of the handheld unit B-MPI and the mini handheld unit.

On the handwheel connection module for PROFIBUS, digital inputs, outputs, connections for rotary override switches and handwheels are provided as well as a PROFIBUS DP interface for communication.

The handwheel connection module for PROFIBUS is mounted into the control cabinet.

Validity

The following description applies to the handwheel connection module for PROFIBUS.
Order number: 6FC5303-0AA02-0AA0

Features

PROFIBUS DP interface for:

- 6 inputs
- 6 inputs and 6 outputs (additional cable set required)
- 16 direct keys of OP 012/OP 015A/TP 015A
- 2 handwheels

6.2 Interfaces

6.2.1 Overview

Position of the interfaces

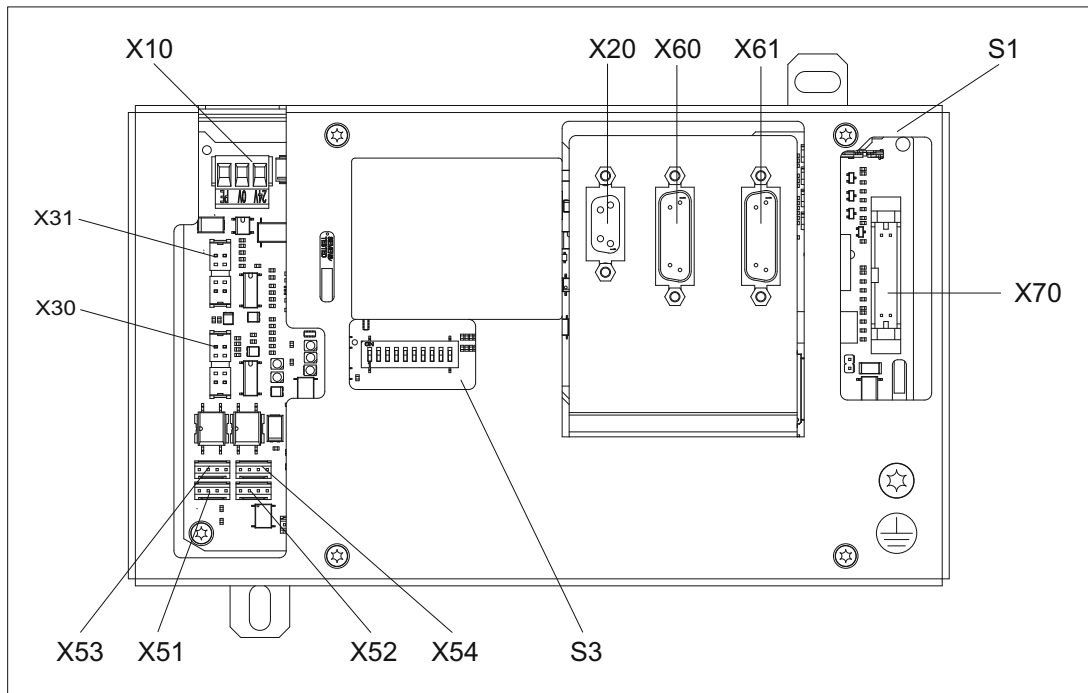

Figure 6-1 Handwheel connection module - location of the interfaces

X10	Power supply interface
X20	PROFIBUS DP interface
X30	Feed override
X31	Spindle override
X51 / X52	Customer-specific operator controls (pushbuttons incl. 24 V lamps)
X53 / X54	24 V control for customer pushbutton lamps
X60 / X61	Connections for two handwheels (TTL/differential)
X70	Direct keys interface for connecting the operator panel front direct keys
Jumper S1	Setting the handwheel signal type – S1 open: TTL – S1 closed: Differential interface
S3 DIP switch	Setting of the PROFIBUS address (see Settings via DIP switch S3 (Page 190))

Pin assignment

For more detailed information, see "General information and networking", Chapter: "Connecting".

6.2.2 Input / output images

Handwheel

Table 6- 1 Input image

Byte	Bit7	Bit6	Bit5	Bit4	Bit3	Bit2	Bit1	Bit0
EB n + 0	Handwheel 1 counter status (16 bit signed)							
EB n + 1								
EB n + 2	Handwheel 2 counter status (16 bit signed)							
EB n + 3								

Note

No output process image exists.

Handwheel + additional I/Os

Table 6- 2 Input image

Byte	Bit7	Bit6	Bit5	Bit4	Bit3	Bit2	Bit1	Bit0
EB n + 0	Handwheel 1 counter status (16 bit signed)							
EB n + 1								
EB n + 2	Handwheel 2 counter status (16 bit signed)							
EB n + 3								
EB n + 4	DT_07	DT_06	DT_05	DT_04	DT_03	DT_02	DT_01	DT_00
EB n + 5	DT_15	DT_14	DT_13	DT_12	DT_11	DT_10	DT_09	DT_08
EB n + 6	-	-	KT_6	KT_5	KT_4	KT_3	KT_2	KT_1
EB n + 7	-	-	-	Rotary switch 1 (5 bit) connector X30				
EB n + 8	-	-	-	Rotary switch 2 (5 bit) connector X31				

Note

DT_xx corresponds to direct key xx of connector X70.

KT_x corresponds to customer key x.

(connection of free customer keys or a direct key module.)

Table 6- 3 Output image

Byte	Bit7	Bit6	Bit5	Bit4	Bit3	Bit2	Bit1	Bit0
AB n + 0	Reserved, must be assigned value 0.							
AB n + 1	-	-	KL_6	KL_5	KL_4	KL_3	KL_2	KL_1

Note

KL_x corresponds to customer lamp x.

6.3 Settings via DIP switch S3

Delivery condition

Table 6- 4 Delivery condition setting

1	2	3	4	5	6	7	8	9	10	Meaning / value
on	off	on	off	on	on	off	off	off	off	Series

Note

The delivery condition setting MUST be changed in accordance with the "Assignment of the DIP switch S3" table (below).

Connection type: PROFIBUS DP

For PROFIBUS DP, the PROFIBUS address is set using switches 1 to 10:

Table 6- 5 Assignment of DIP switch S3

1	2	3	4	5	6	7	8	9	10	Meaning/value
										PROFIBUS
off	off	off	off	off	off	off	–	on	on	0
on	off	off	off	off	off	off	–	on	on	1
off	on	off	off	off	off	off	–	on	on	2
on	on	off	off	off	off	off	–	on	on	3
:	:	:	:	:	:	:	–	–	–	:(etc.)
on	off	on	on	on	on	on	–	on	on	125
off	on	on	on	on	on	on	–	on	on	126

6.4 Mounting

The handwheel connection module is intended for mounting onto the control cabinet wall. Use both lugs (1) to secure it in place.

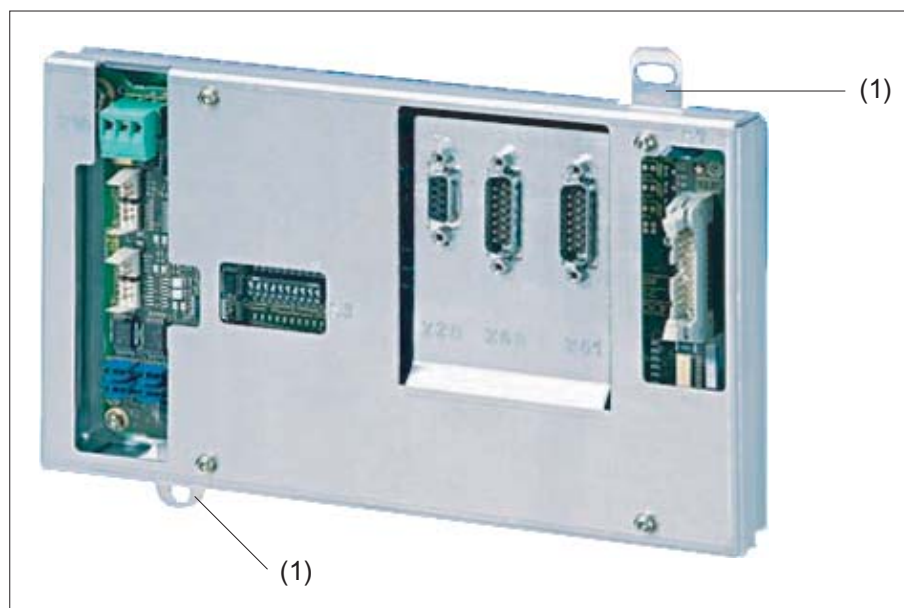

Figure 6-2 Front view of handwheel connection module

Dimension drawing

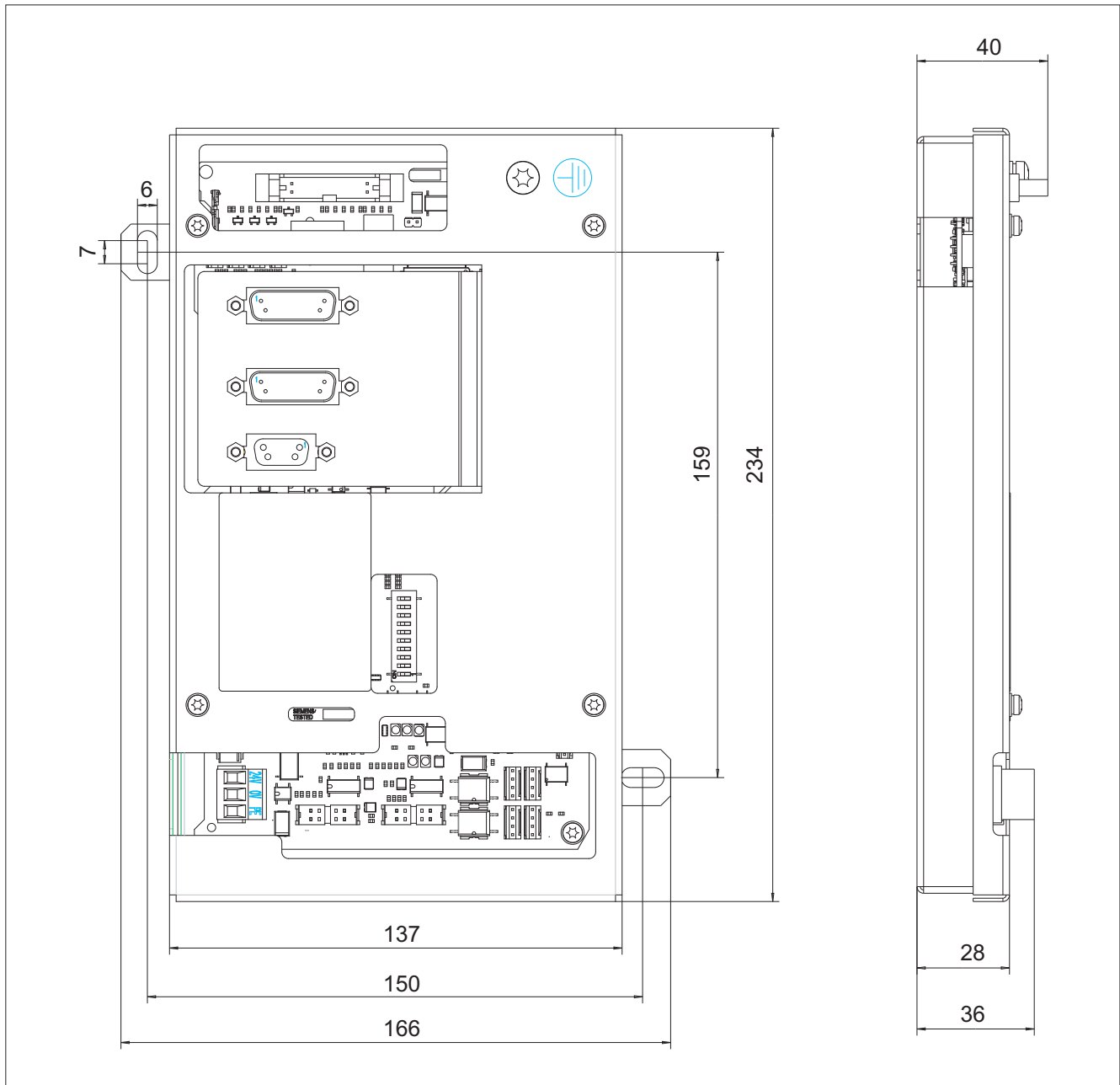

Figure 6-3 Dimension drawing for handwheel connection module

6.5 Technical data

Safety				
Safety class	III according to EN60204-1			
Degree of protection according to EN 60529	IP00			
Approvals	CE / cULus			
Electrical data				
Input voltage	24 VDC			
Power consumption, max.	Board: 6.2 W	Handwheels: 2 x 0.9 W	Lamps: 14.4 W (6 x 2.4 W) *)	Total: 22.4 W
Mechanical data				
Dimensions (W°x H°x°D)	234 x 137 x 40 mm			
Weight	Approx. 820 g			
*) The outputs for the illuminated pushbuttons (X53/X54) can have a max. permissible current of 0.3 A. However, the total current consumption of the components must not exceed 1.0 A (24 W).				

Note

Information about the climatic and mechanical environmental conditions is contained in the associated section under:

"General notes and interconnection" → "Operational planning".

6.6 Accessories

The following accessories are available for the handwheel connection module:

Component	Description	Quantity	Order number
Cable for handwheel	Length: < 5 m	1	6FX8002-2CP00-1Ax0
Rotary feed override switch	Feed rate/rapid traverse, override solid-state rotary switch 1x23G, T=32, cap, button, pointer, rapid-traverse and feed dials	1	6FC5247-0AF13-1AA0
Override for rotary spindle switch	Spindle/rapid traverse override, solid-state rotary switch 1x16G, T=24, cap, button, pointer, rapid-traverse and spindle dials	1	6FC5247-0AF12-1AA0
Cable set	for additional control devices of the machine control panels Length: 500 mm	60	6FC5247-0AA35-0AA0

Index

A

- Activate keyboard, 104
- ASCII code
 - Handheld unit B-MPI, 175
 - HT 2, 50

B

- B-MPI
 - Connection conditions, 166

C

- Connection conditions
 - B-MPI, 166
 - MPI bus, 166
 - Network installation, 166
- Connection kit
 - Mini handheld unit, 143
- Control cabinet installation
 - HT 2, 26

D

- Deactivate keyboard, 104
- DIP switch
 - Handheld unit B-MPI, 168
- Display
 - HT 8, 80

E

- EMC measures
 - Handheld unit B-MPI, 181
- Emergency stop button
 - Handheld unit B-MPI, 157
 - HT 2, 60
 - Mini handheld unit, 141
- Emergency Stop button
 - Handheld unit B-MPI, 182
 - HT 8, 122
- Enabling button
 - Handheld unit B-MPI, 182
 - HT 8, 82

- Equipotential bonding cable
 - Handheld unit B-MPI, 182
- Equipotential bonding conductor
 - Handheld unit B-MPI, 178

G

- GD parameters
 - Handheld unit B-MPI, 170

H

- Handheld unit B-MPI
 - ASCII code, 175
 - Dimensions, 183
 - DIP switch, 168
 - EMC measures, 181
 - Emergency stop button, 157
 - Emergency Stop button, 182
 - Enabling button, 182
 - Equipotential bonding cable, 182
 - Equipotential bonding conductor, 178
 - GD parameters, 170
 - Handwheel, 184
 - Key-operated switch, 184
 - Keys, 172
 - Labeling strips, 157
 - LEDs, 172
 - MPC bus, 179
 - MPI bus, 182
 - MPI cable, 182
 - Override switch, 158
 - Parameterization, 172
 - PLC, 171
 - Repeater, 162
 - Slide-in labels, 184
- Handwheel
 - Handheld, 147
 - Handheld unit B-MPI, 184
- Handwheel connection module
 - Dimensions, 193
 - PROFIBUS DP, 187
- HT 2
 - ASCII code, 50
 - Control cabinet installation, 26
 - Dimensions, 59
 - Display, 10

- Emergency stop button, 60
- Enabling button, 11
- Handwheel, 11
- Keyboard, 10
- Key-operated switch, 13
- Keys, 47
- Parameterization, 47
- PLC, 46
- Power consumption, 59
- Rotary override switch, 10
- HT 8
 - Activating, deactivating the virtual keyboard,
 - Configuring the traversing keys,
 - CPF menu, 118
 - Dimensions, 121
 - Display, 80
 - Displaying/hiding the traversing keys, 115
 - Emergency Stop button, 122
 - Enabling button, 82
 - Key labeling, 117
 - LED display on user keys,
 - Membrane keyboard, 80
 - oem_sljk_deu.ts,
 - Panel mounting, 92
 - Power consumption, 121
 - slguiconfig.ini,
 - sljkconfig.ini,
 - Thin Client, 75
 - Traversing keys, 116
 - USB interface, 82
 - User keys, 116
- K**
- Key-operated switch
 - Handheld unit B-MPI, 184
- Keys
 - Handheld unit B-MPI, 172
 - HT 2, 47
- L**
- Labeling strips
 - Handheld unit B-MPI, 157
- LEDs
 - Handheld unit B-MPI, 172
- M**
- Membrane keyboard
 - HT 8, 80
- Mini handheld unit
 - Connection kit, 143
 - Dimensions, 141
 - Emergency stop button, 141
- MPC bus
 - Handheld unit B-MPI, 179
- MPI bus
 - Connection conditions, 166
 - Handheld unit B-MPI, 182
- MPI cable
 - Handheld unit B-MPI, 182
- N**
- Network installation
 - Connection conditions, 166
- O**
- oem_slck_deu.ts, 110
- oem_sljk_deu.ts, 107
- Override switch
 - Handheld unit B-MPI, 158
- P**
- Panel mounting
 - HT 8, 92
- Parameterization
 - Handheld unit B-MPI, 172
 - HT 2, 47
- PLC
 - Handheld unit B-MPI, 171
 - HT 2, 46
- PROFIBUS DP
 - Handwheel connection module, 187
- R**
- Repeater
 - Handheld unit B-MPI, 162
- S**
- slckcpf.ini, 113
- Slide-in labels
 - Handheld unit B-MPI, 184

T

Thin Client
HT 8, 75

Touch screen
HT 8,

U

USB interface
HT 8, 82

SIEMENS

SINUMERIK

SINUMERIK 840D sl Machine control panels

Manual

Machine control panel: MCP 310C PN	1
Machine control panel: MCP 310 PN	2
Machine control panel: MCP 310	3
Machine control panel: MCP 483C PN	4
Machine control panel: MCP 483 PN	5
Machine control panel: MCP 483	6
Machine pushbutton panel: MPP 310 IE H	7
Machine pushbutton panel: MPP 483 IE	8
Machine pushbutton panel: MPP 483	9
MCP Interface PN	10
Electronic handwheels	11
Rotary override switch	12

Valid for: SINUMERIK 840D sl / 840DE sl control

Legal information

Warning notice system

This manual contains notices you have to observe in order to ensure your personal safety, as well as to prevent damage to property. The notices referring to your personal safety are highlighted in the manual by a safety alert symbol, notices referring only to property damage have no safety alert symbol. These notices shown below are graded according to the degree of danger.

 DANGER
indicates that death or severe personal injury will result if proper precautions are not taken.

 WARNING
indicates that death or severe personal injury may result if proper precautions are not taken.

 CAUTION
indicates that minor personal injury can result if proper precautions are not taken.

NOTICE
indicates that property damage can result if proper precautions are not taken.

If more than one degree of danger is present, the warning notice representing the highest degree of danger will be used. A notice warning of injury to persons with a safety alert symbol may also include a warning relating to property damage.

Qualified Personnel

The product/system described in this documentation may be operated only by **personnel qualified** for the specific task in accordance with the relevant documentation, in particular its warning notices and safety instructions. Qualified personnel are those who, based on their training and experience, are capable of identifying risks and avoiding potential hazards when working with these products/systems.

Proper use of Siemens products

Note the following:

 WARNING
Siemens products may only be used for the applications described in the catalog and in the relevant technical documentation. If products and components from other manufacturers are used, these must be recommended or approved by Siemens. Proper transport, storage, installation, assembly, commissioning, operation and maintenance are required to ensure that the products operate safely and without any problems. The permissible ambient conditions must be complied with. The information in the relevant documentation must be observed.

Trademarks

All names identified by ® are registered trademarks of Siemens AG. The remaining trademarks in this publication may be trademarks whose use by third parties for their own purposes could violate the rights of the owner.

Disclaimer of Liability

We have reviewed the contents of this publication to ensure consistency with the hardware and software described. Since variance cannot be precluded entirely, we cannot guarantee full consistency. However, the information in this publication is reviewed regularly and any necessary corrections are included in subsequent editions.

Table of contents

1	Machine control panel: MCP 310C PN.....	9
1.1	Description.....	9
1.2	Operator control and display elements.....	11
1.2.1	Front.....	11
1.2.2	Rear side.....	13
1.3	Interfaces.....	14
1.3.1	Overview.....	14
1.3.2	Description.....	15
1.3.3	Input / output images.....	19
1.4	Mounting.....	22
1.5	Connecting.....	23
1.6	Maintenance and Service.....	24
1.7	Technical data.....	25
1.8	Accessories and spare parts.....	26
2	Machine control panel: MCP 310 PN.....	29
2.1	Description.....	29
2.2	Operator controls and indicators.....	31
2.2.1	Front side.....	31
2.2.2	Rear side.....	33
2.3	interfaces.....	34
2.3.1	Overview.....	34
2.3.2	Description.....	35
2.3.3	Input / output images.....	35
2.4	Mounting.....	39
2.5	Connecting.....	40
2.6	Maintenance and Service.....	41
2.7	Technical data.....	42
2.8	Accessories and spare parts.....	43
2.8.1	Overview.....	43
2.8.2	Labeling the slide-in labels.....	44
2.8.3	Inserting the slide-in label "Part1".....	51
3	Machine control panel: MCP 310.....	55
3.1	Description.....	55
3.2	Operating and display elements.....	57
3.2.1	Front side.....	57
3.2.2	Rear side.....	58

3.3	Interfaces.....	59
3.4	Mounting.....	60
3.5	Settings via DIP switch S3.....	61
3.6	Connection via PROFIBUS DP.....	62
3.6.1	Overview.....	62
3.6.2	Prerequisites.....	63
3.6.3	Functions of the machine control panel.....	63
3.6.4	Configuring the DP slave MCP.....	64
3.6.5	Linking the DP slave MCP.....	66
3.6.6	Input / output images.....	68
3.7	Maintenance and Service.....	70
3.8	Technical data.....	71
3.9	Accessories and spare parts.....	72
3.9.1	Overview.....	72
3.9.2	Labeling the slide-in labels.....	73
3.9.3	Inserting the slide-in label "Part1".....	79
4	Machine control panel: MCP 483C PN.....	83
4.1	Description.....	83
4.2	Operating and display elements.....	85
4.2.1	Front side.....	85
4.2.2	Rear side.....	88
4.3	Interfaces.....	89
4.3.1	Overview.....	89
4.3.2	Description.....	89
4.3.3	Input / output images.....	90
4.4	Mounting.....	93
4.5	Connecting.....	94
4.6	Maintenance and Service.....	95
4.7	Technical data.....	96
4.8	Accessories and spare parts.....	97
5	Machine control panel: MCP 483 PN.....	99
5.1	Description.....	99
5.2	Operator controls and indicators.....	101
5.2.1	Front side.....	101
5.2.2	Rear side.....	103
5.3	interfaces.....	104
5.3.1	Overview.....	104
5.3.2	Description.....	105
5.3.3	Input / output images.....	106
5.4	Mounting.....	109
5.5	Connecting.....	110

5.6	Maintenance and Service.....	111
5.7	Technical data.....	112
5.8	Accessories and spare parts.....	113
5.8.1	Overview.....	113
5.8.2	Membrane keyboard: Labeling the slide-in labels.....	114
6	Machine control panel: MCP 483	121
6.1	Description.....	121
6.2	Operating and display elements.....	122
6.2.1	Front side.....	122
6.2.2	Rear side.....	124
6.3	Interfaces.....	125
6.4	Mounting.....	126
6.5	Settings via DIP switch S3.....	127
6.6	Connection via PROFIBUS DP.....	128
6.6.1	Overview.....	128
6.6.2	Prerequisites.....	128
6.6.3	Functions of the machine control panel.....	129
6.6.4	Configuring the DP slave MCP.....	129
6.6.5	Linking the DP slave MCP.....	132
6.6.6	Input / output images.....	134
6.7	Maintenance and Service.....	136
6.8	Technical data.....	137
6.9	Accessories and spare parts.....	138
6.9.1	Overview.....	138
6.9.2	Membrane keyboard: Labeling the slide-in labels.....	139
7	Machine pushbutton panel: MPP 310 IE H.....	145
7.1	Description.....	145
7.1.1	Overview.....	145
7.1.2	System features.....	146
7.1.3	Mechanical design.....	148
7.2	Operator controls and indicators.....	149
7.2.1	Overview.....	149
7.2.2	Description.....	151
7.2.2.1	Device front.....	151
7.2.2.2	Device rear side.....	152
7.3	Interfaces.....	154
7.3.1	Overview.....	154
7.3.2	Description.....	156
7.3.2.1	Control panel.....	156
7.3.2.2	COM board	157
7.3.2.3	User keys	158
7.3.2.4	Handheld unit connection HT 8	160
7.3.3	Connection elements for COM board, customer keys and handheld unit connection.....	163
7.3.4	Input / output images.....	164

7.4	Mounting.....	167
7.5	Connecting.....	169
7.5.1	MPP 310 IE H.....	169
7.5.2	Customer keys.....	171
7.5.3	Handheld unit connection HT 8 with emergency stop override.....	172
7.6	Circuits and wiring.....	175
7.7	Initialization.....	177
7.8	Maintenance and Service.....	179
7.9	Technical data.....	179
7.9.1	MPP 310 IE H.....	179
7.9.2	Input/output interface of individual wiring.....	180
7.10	Accessories and spare parts.....	182
7.10.1	Overview.....	182
7.10.2	Labeling the slide-in labels.....	183
7.10.3	Handwheel connection.....	188
7.10.4	Display elements and operator controls.....	188
7.11	Service information.....	190
8	Machine pushbutton panel: MPP 483 IE.....	193
8.1	Description.....	193
8.1.1	Overview.....	193
8.1.2	System features.....	194
8.1.3	Mechanical design.....	195
8.2	Operator controls and indicators.....	197
8.2.1	Standard versions.....	197
8.2.2	Special versions.....	199
8.2.3	Examples of assignment of free slots.....	203
8.2.4	Description.....	204
8.2.4.1	Device front.....	204
8.2.4.2	Device rear side.....	206
8.3	interfaces.....	208
8.3.1	Overview.....	208
8.3.2	Description.....	210
8.3.2.1	Control panel.....	210
8.3.2.2	COM board.....	212
8.3.2.3	User keys.....	212
8.3.2.4	Handheld unit connection HT 8.....	215
8.3.3	Connection elements for COM board, customer keys and handheld unit connection.....	219
8.3.4	Input / output images.....	219
8.4	Mounting.....	223
8.5	Connecting.....	225
8.5.1	MPP 483 IE.....	225
8.5.2	Customer keys.....	227
8.5.3	Handheld unit connection HT 8 with emergency stop override.....	228
8.6	Circuits and wiring.....	231

8.7	Initialization.....	233
8.8	Maintenance and Service.....	235
8.9	Technical data.....	235
8.9.1	MPP 483 IE.....	235
8.9.2	Input/output interface of individual wiring.....	236
8.10	Accessories and spare parts	239
8.10.1	Overview.....	239
8.10.2	Labeling the slide-in labels.....	240
8.10.3	Handwheel connection.....	244
8.10.4	Expansion panel.....	244
8.10.5	Display elements and operator controls.....	248
8.11	Service information.....	249
9	Machine pushbutton panel: MPP 483.....	253
9.1	Description.....	253
9.1.1	Overview.....	253
9.1.2	System features.....	254
9.1.3	Mechanical design.....	256
9.2	Operating and display elements.....	258
9.2.1	Standard versions.....	258
9.2.2	Special versions.....	261
9.2.3	Examples of assignment of free slots.....	266
9.2.4	Description.....	268
9.2.4.1	Device front.....	268
9.2.4.2	Device rear side.....	270
9.3	Interfaces.....	273
9.3.1	Overview.....	273
9.3.2	Description.....	274
9.3.2.1	Control panel.....	274
9.3.2.2	COM board	276
9.3.2.3	User keys	277
9.3.2.4	Handheld unit connection HT 6	280
9.3.2.5	Handheld unit connection HT 2/8.....	282
9.3.3	Connection elements for COM board, customer keys and handheld unit connection.....	285
9.3.4	Input / output images.....	286
9.4	Mounting.....	292
9.5	Connecting.....	295
9.5.1	MPP 483.....	295
9.5.2	COM board	299
9.5.3	Customer keys.....	299
9.5.4	Handheld unit connection HT 8 with emergency stop override.....	300
9.6	Circuits and wiring.....	303
9.7	Initialization.....	305
9.8	PROFIBUS communication.....	308
9.8.1	Prerequisites.....	308
9.8.2	Configuring the DP slave MPP 483.....	308

9.8.3	PLC user program.....	311
9.9	Maintenance and Service.....	311
9.10	Technical data.....	312
9.10.1	MPP 483.....	312
9.10.2	Input/output interface of individual wiring.....	313
9.11	Accessories and spare parts.....	316
9.11.1	Overview.....	316
9.11.2	Labeling the slide-in labels.....	316
9.11.3	Handwheel connection.....	321
9.11.4	Display elements and operator controls.....	322
9.12	Service information.....	323
10	MCP Interface PN.....	327
10.1	Description.....	327
10.2	Interfaces.....	329
10.2.1	Overview.....	329
10.2.2	Terminals.....	330
10.2.3	Switch.....	339
10.2.4	Input / output images.....	343
10.3	Mounting.....	345
10.4	Technical data.....	346
11	Electronic handwheels.....	349
11.1	Description.....	349
11.2	Dimension drawings.....	351
11.2.1	Encoder with 120 mm x 120 mm front panel, setting wheel (...-5DB01)	351
11.2.2	Encoder with front panel, 76.2 mm x 76.2 mm, setting wheel (...-5DC01)	352
11.2.3	Encoder without front panel, without setting wheel, mounting (...-5DF01)	353
11.2.4	Encoder with front panel, 76.2 mm x 76.2 mm, setting wheel (...-5DH01)	355
11.2.5	Encoder without front panel, setting wheel, small (...-5DM00)	356
11.3	Connections.....	357
11.4	Technical data.....	358
11.5	Accessories.....	359
12	Rotary override switch.....	361
12.1	Description.....	361
12.2	Mounting.....	362
12.2.1	Dimension drawings.....	362
12.2.2	Replacing the rotary switch.....	364
12.3	Technical data.....	366
	Index.....	369

Machine control panel: MCP 310C PN

1.1 Description

Machine control panel MCP 310C PN (PN = PROFINET) enables user-friendly operation of the machine functions. It is suitable for the machine-related operation of milling, turning, grinding and special machines)

Note

The IE functionality (IE = Industrial Ethernet) is still included and preset. Please note the switch position of S2.

All keys are designed with replaceable covers for machine-specific adaptations. The key covers can be freely inscribed using a laser. Clear key covers can be used as an alternative.

The machine control panel is secured from the rear with special clamps supplied with the panel.

Validity

The description applies to the machine control panel:

Type	Key type	Order number
MCP 310C PN (IE and PN)	Mechanical short-stroke keys	6FC5303-0AF23-0AA1
MCP 310C IE (IE only)	Mechanical short-stroke keys	6FC5303-0AF23-0AA0 ¹⁾

¹⁾ No longer available

The safety-related accessories / spare parts are marked in the "Accessories and spare parts" section with a *).

Features

Control elements:

- Mechanical short-stroke keys
- Operating mode and function keys:
 - 49 keys with assigned LEDs
 - Direction keys for milling machines with rapid traverse override (Key covers are supplied for direction keys for turning machines.)
For information, refer to Section: "Control and display elements" → "Front side").
- Feed control with override feed / rapid traverse (rotary switch with 23 positions)
- Key-operated switch (four positions and three different keys)

1.1 Description

Interfaces:

- Ethernet (transfer rate: 10/100 Mbit/s; for IE and PN)
- Nine customer-specific inputs (e.g. for illuminated pushbuttons)
- Six customer-specific outputs
- Connection for two handwheels (Sub-D)

Expansion slots:

Six slots for control devices (d = 16 mm)

(Additional cable set required for control devices, see Section: "Accessories and spare parts".)

Functions:

Table 1-1 Functions depending on the operating mode

Function	PN operating mode	IE operating mode	Requirement
Keys, LEDs, rotary switches	available soon	✓	
Handwheel	-	✓ as of NCU software 2.5	
		✓ as of NCU software 2.6 Handwheel with optimized response. This enables a "delete distance-to-go function" to be triggered in the PLC user program via a "handwheel stationary" signal.	Toolbox 2.6
Activate/Deactivate (T:N:M)	-	✓	

1.2 Operator control and display elements

1.2.1 Front

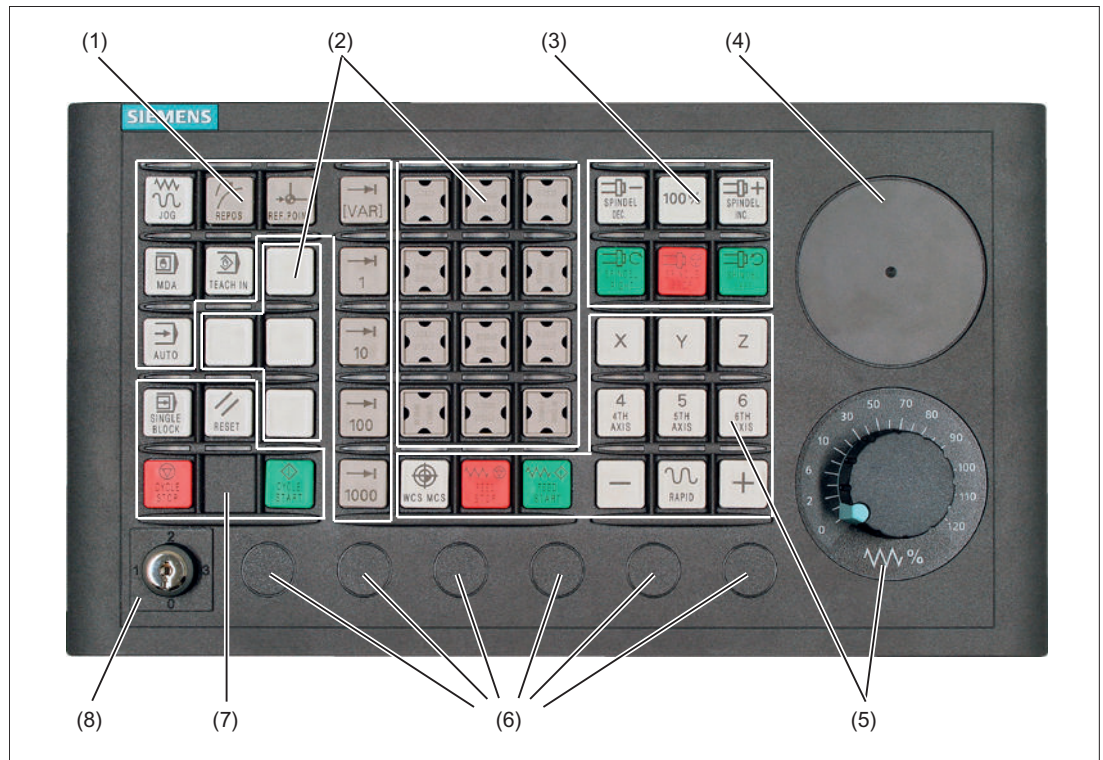

- (1) Operating modes and machine functions
 - (2) 16 customer keys
 - (3) Spindle control
 - (4) Slot for EMERGENCY STOP button or spindle override switch
 - (5) Feed control with override switch
 - (6) Slots for control devices 16 mm *)
 - (7) Program control
 - (8) Key-operated switch
- *) See slots for control devices

Figure 1-1 Arrangement of the MCP 310C PN control elements

EMERGENCY STOP button

If an EMERGENCY STOP button is added: See Chapter "Machine control panel MCP 483 PN", Section "Control and display elements" → "Front".

Slots for control devices

NOTICE

Damage to the front

Do not break the openings for the installation of operating devices (6), but rather drill them to the required size.

Key covers

All keys of the MCP 310C PN come with changeable key covers.

Refer to the following table for the additional replacement key covers provided for turning machines in the accessories pack.

Key cover	Symbol number	Key cover	Symbol number
 RAPID	7027	-X	7129
+C	7125	-Y	7130
+X	7126	-Z	7131
+Y	7127	-C	7132
+Z	7128		

You will find the order numbers for the key covers in Section: "Accessories and spare parts".

1.2.2 Rear side

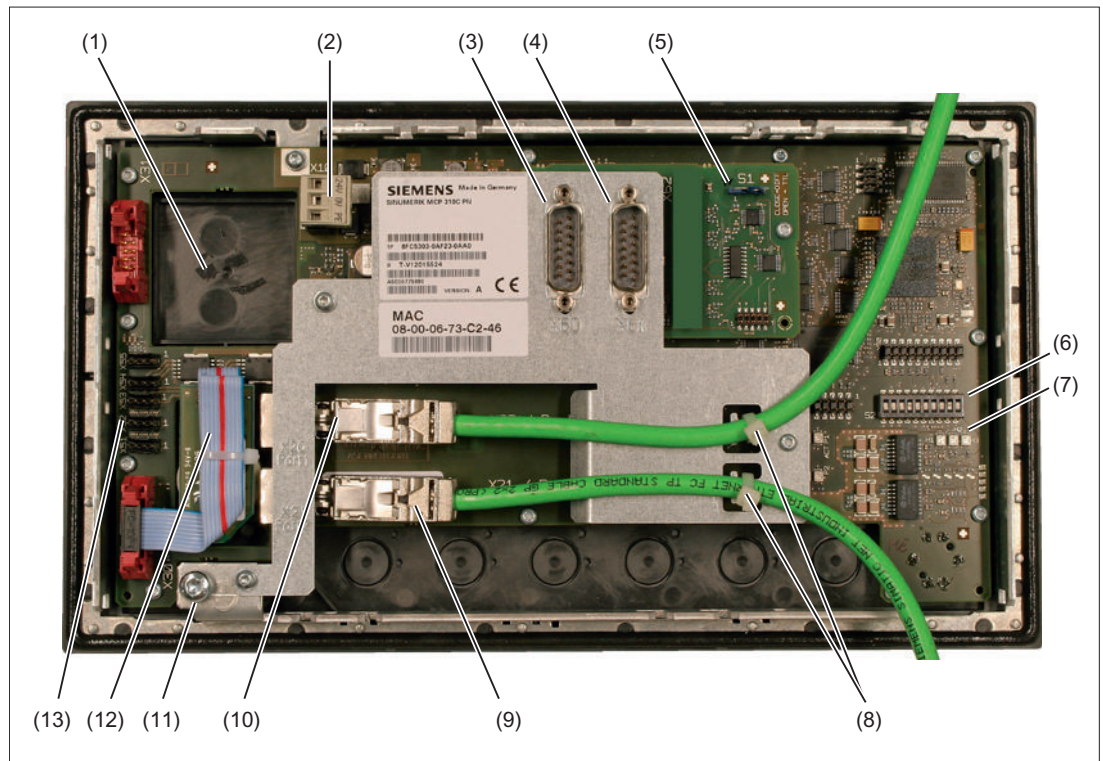

- (1) Slot for Emergency Stop button or spindle override
- (2) Power supply interface X10
- (3) Handwheel connection X60
- (4) Handwheel connection X61
- (5) switch S1 *)
- (6) Switch S2 *)
- (7) LEDs *)
- (8) Ethernet cable strain relief
- (9) Ethernet connection, port 2 X21
- (10) Ethernet connection, port 1 X20
- (11) Equipotential bonding
- (12) Feed override
- (13) Customer-specific inputs and outputs *)

*) Detailed description under: "Interfaces" → "Overview"

Figure 1-2 Rear of the MCP 310C PN with Ethernet connecting cables

1.3 Interfaces

1.3.1 Overview

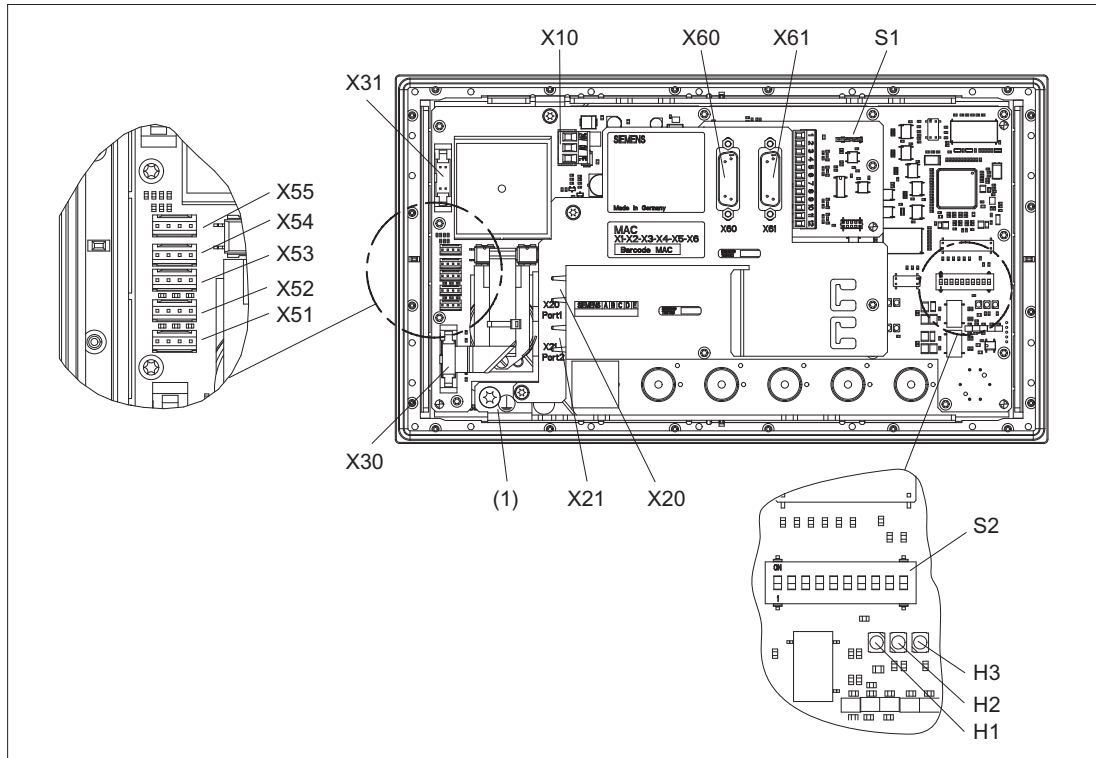

Figure 1-3 Rear of the MCP 310C PN with interfaces

X10	Power supply interface
X20	Ethernet port 1
X21	Ethernet port 2
X30	Interface for rotary switch feed override
X31	Interface for rotary switch spindle override / Emergency Stop (optional)
X51 / X52 / X55	Interfaces for customer-specific inputs
X53 / X54	Interfaces for customer-specific outputs
X60 / X61	Connections for 2 handwheels (TTL / differential - can be set with switch S1)
S1	Switch for setting the handwheel signal type
S2	Switch for setting the MCP address
(1)	Equipotential bonding

LEDs

H1	POWER OK (green)
H2	BUSSYNC
H3	BUSFAULT

Equipotential bonding

The equipotential bonding conductor is attached by means of an M5 screw.

1.3.2 Description

Pin assignment

For more detailed information, see "General information and networking", Chapter: "Connecting".

Switch S1

The handwheel signal type is set with switch S1.

- S1 open: TTL
- S1 closed: differential interface

Switch S1 is closed when supplied ex works.

Switch S2

MCP set up as PN

Table 1-2 Basic setting of the switch S2

1-8	9	10	Meaning
See Table "Settings of switch S2"	on	on	PN
	off	off	IE (default)

The two switches S2-9 and S2-10 must be set to "on" in order for PN functionality to be supported.

1.3 Interfaces

The switches S2-1 to S2-8 define the default device name.

Up to 128 default device names are supported. If these default device names are used, there is no need for initialization of the MCP.

Note

The default device names cannot be reconfigured using the STEP7 "Device initialization" facility for example.

If you are connecting the MCP to a SINUMERIK control as a PROFINET component, make sure that this functionality is supported by the control concerned.

DCP mode:

No default device name is available in this mode. The device name must be set by means of an initialization procedure and remains saved on the MCP. It is deleted again if the factory setting is restored, e.g. using STEP7.

Table 1-3 Settings of switch S2

1	2	3	4	5	6	7	8	9	10	Meaning
								on	on	
on	on	on	on	on	on	on	on			DCP mode
on	on	on	on	on	on	on	off			Default device name: mcp-pn127
off	on	on	on	on	on	on	off			Default device name: mcp-pn126
on	off	on	on	on	on	on	off			Default device name: mcp-pn125
off	off	on	on	on	on	on	off			Default device name: mcp-pn124
on	on	off	on	on	on	on	off			Default device name: mcp-pn123
off	on	off	on	on	on	on	off			Default device name: mcp-pn122
on	off	off	on	on	on	on	off			Default device name: mcp-pn121
off	off	off	on	on	on	on	off			Default device name: mcp-pn120
on	on	on	off	on	on	on	off			Default device name: mcp-pn119
off	on	on	off	on	on	on	off			Default device name: mcp-pn118
on	off	on	off	on	on	on	off			Default device name: mcp-pn117
off	off	on	off	on	on	on	off			Default device name: mcp-pn116
on	on	off	off	on	on	on	off			Default device name: mcp-pn115
off	on	off	off	on	on	on	off			Default device name: mcp-pn114
on	off	off	off	on	on	on	off			Default device name: mcp-pn113
off	off	off	off	on	on	on	off			Default device name: mcp-pn112
x	x	x	x	x	x	x	x			"
on	on	on	on	off	off	off	off			Default device name: mcp-pn15
off	on	on	on	off	off	off	off			Default device name: mcp-pn14
on	off	on	on	off	off	off	off			Default device name: mcp-pn13
off	off	on	on	off	off	off	off			Default device name: mcp-pn12
on	on	off	on	off	off	off	off			Default device name: mcp-pn11

1	2	3	4	5	6	7	8	9	10	Meaning
off	on	off	on	off	off	off	off			Default device name: mcp-pn10
on	off	off	on	off	off	off	off			Default device name: mcp-pn9
off	off	off	on	off	off	off	off			Default device name: mcp-pn8
on	on	on	off	off	off	off	off			Default device name: mcp-pn7
off	on	on	off	off	off	off	off			Default device name: mcp-pn6
on	off	on	off	off	off	off	off			Default device name: mcp-pn5
off	off	on	off	off	off	off	off			Default device name: mcp-pn4
on	on	off	off	off	off	off	off			Default device name: mcp-pn3
off	on	off	off	off	off	off	off			Default device name: mcp-pn2
on	off	off	off	off	off	off	off			Default device name: mcp-pn1
off	off	off	off	off	off	off	off			Default device name: mcp-pn

MCP set up as IE

A logical address can be assigned to the MCP for communication via Ethernet using the 10-bit switch S2.

Table 1-4 Switch S2 is set as delivered

1	2	3	4	5	6	7	8	9	10	Meaning
off	off	off	off	off	off	on	on	off	off	MCP address 192

The two switches S2-9 and S2-10 must remain set to "off" (IE functionality).

The switches S2-1 to S2-8 define the MCP address in the range of 0 to 255.

The addresses from 192 to 223 count as the default range.

The MCP address is used as a reference for addressing an MCP during PLC parameter assignment.

Table 1-5 Settings of switch S2

1	2	3	4	5	6	7	8	9	10	Meaning
								off	off	
on	on	on	on	on	on	on	on			MCP address 255
x	x	x	x	x	x	x	x			"
on	on	on	on	on	off	on	on			MCP address 223
off	on	on	on	on	off	on	on			MCP address 222
on	off	on	on	on	off	on	on			MCP address 221
off	off	on	on	on	off	on	on			MCP address 220
on	on	off	on	on	off	on	on			MCP address 219
off	on	off	on	on	off	on	on			MCP address 218
on	off	off	on	on	off	on	on			MCP address 217
off	off	off	on	on	off	on	on			MCP address 216
on	on	on	off	on	off	on	on			MCP address 215

1.3 Interfaces

1	2	3	4	5	6	7	8	9	10	Meaning
off	on	on	off	on	off	on	on			MCP address 214
on	off	on	off	on	off	on	on			MCP address 213
off	off	on	off	on	off	on	on			MCP address 212
on	on	off	off	on	off	on	on			MCP address 211
off	on	off	off	on	off	on	on			MCP address 210
on	off	off	off	on	off	on	on			MCP address 209
off	off	off	off	on	off	on	on			MCP address 208
on	on	on	on	off	off	on	on			MCP address 207
off	on	on	on	off	off	on	on			MCP address 206
on	off	on	on	off	off	on	on			MCP address 205
off	off	on	on	off	off	on	on			MCP address 204
on	on	off	on	off	off	on	on			MCP address 203
off	on	off	on	off	off	on	on			MCP address 202
on	off	off	on	off	off	on	on			MCP address 201
off	off	off	on	off	off	on	on			MCP address 200
on	on	on	off	off	off	on	on			MCP address 199
off	on	on	off	off	off	on	on			MCP address 198
on	off	on	off	off	off	on	on			MCP address 197
off	off	on	off	off	off	on	on			MCP address 196
on	on	off	off	off	off	on	on			MCP address 195
off	on	off	off	off	off	on	on			MCP address 194
on	off	off	off	off	off	on	on			MCP address 193
off	off	off	off	off	off	on	on			MCP address 192
x	x	x	x	x	x	x	x			"
on	off	off	off	off	off	off	off			MCP address 001
off	off	off	off	off	off	off	off			MCP address 000

You can find the settings for the basic PLC program in:
 Function Manual, Basic Functions (P3 sl)

1.3.3 Input / output images

Standard + two handwheels

The specifications for assigning input and output bytes listed in the tables can be changed in the PLC via parameter assignment.

Note

The following applies in respect of the process input and output images in the tables: n is defined by means of FB1 parameters in OB100 of the PLC.

Table 1-6 Process input image for MCP 310C PN

Byte	Bit7	Bit6	Bit5	Bit4	Bit3	Bit2	Bit1	Bit0
EB n + 0	* NC Stop	Spindle	Spindle 100%	Spindle +	Single block	JOG	MDA	AUTO
EB n + 1	NC start	Spindle right	* Spindle stop	Spindle left	Key-operated switch position 3	REF	REPOS	Teach IN
EB n + 2	Feed start	* Feed stop	INC VAR	Key-operated switch position 0	INC 1000	INC 100	INC 10	INC 1
EB n + 3	RESET	Key-operated switch		Feed override				
		Position 2	Position 1	E (2 ⁴)	D (2 ³)	C (2 ²)	B (2 ¹)	A (2 ⁰)
EB n + 4	Arrow keys			KT-IN5	KT-IN4	KT-IN3	KT-IN2	KT-IN1
	+	-	Rapid traverse	X52.2	X52.1	X51.3	X51.2	X51.1
EB n + 5	T16	KT-IN6 X52.3	Axis selection					
			6	5	4	Z	Y	X
EB n + 6	Unassigned customer keys				Unassigned customer keys			
	T9	T10	T11	T12	Work Machine	T13	T14	T15
EB n + 7	Unassigned customer keys							
	T1	T2	T3	T4	T5	T6	T7	T8
EB n + 8	-	-	-	-	-	-	-	-
EB n + 9	-	-	-	-	-	-	-	-
EB n + 10	KT-IN8 X55.2	KT-IN7 X55.1	KT-IN6 X52.3	KT-IN5 X52.2	KT-IN4 X52.1	KT-IN3 X51.3	KT-IN2 X51.2	KT-IN1 X51.1
EB n + 11	-	-	-	-	-	-	-	KT-IN9 X55.3
EB n + 12	-	-	-	-	-	-	-	-
EB n + 13	-	-	-	X31 pin 6 ¹⁾	X31 pin 7 ¹⁾	X31 pin 8 ¹⁾	X31 pin 9 ¹⁾	X31 pin 10 ¹⁾

1.3 Interfaces

Byte	Bit7	Bit6	Bit5	Bit4	Bit3	Bit2	Bit1	Bit0
Signals marked with * are inverse signals.								
1)	If the 4-stage rotary spindle override switch on X31 is replaced by a 5-stage rotary switch, the input information here can be measured in five stages.							

Table 1-7 Output image MCP 310C PN

Byte	Bit7	Bit6	Bit5	Bit4	Bit3	Bit2	Bit1	Bit0
AB n + 0	* NC stop	Spindle	Spindle 100%	Spindle +	Single block	JOG	MDA	AUTO
AB n + 1	NC start	Spindle right	* Spindle stop	Spindle left	RESET	REF	REPOS	Teach IN
AB n + 2	Feed start	* Feed stop	INC VAR	-	INC 1000	INC 100	INC 10	INC 1
AB n + 3	-	-	-	-	-	-	-	-
AB n + 4	+	-	Rapid traverse	KT-OUT5 X54.2	KT-OUT4 X54.1	KT-OUT3 X53.3	KT-OUT2 X53.2	KT-OUT1 X53.1
AB n + 5	T16	KT-OUT6 X54.3	6	5	4	Z	Y	X
AB n + 6	Unassigned customer keys							
	T9	T10	T11	T12	Work Machine	T13	T14	T15
AB n + 7	Unassigned customer keys							
	T1	T2	T3	T4	T5	T6	T7	T8

Signals marked with * are inverse signals

Default key assignment

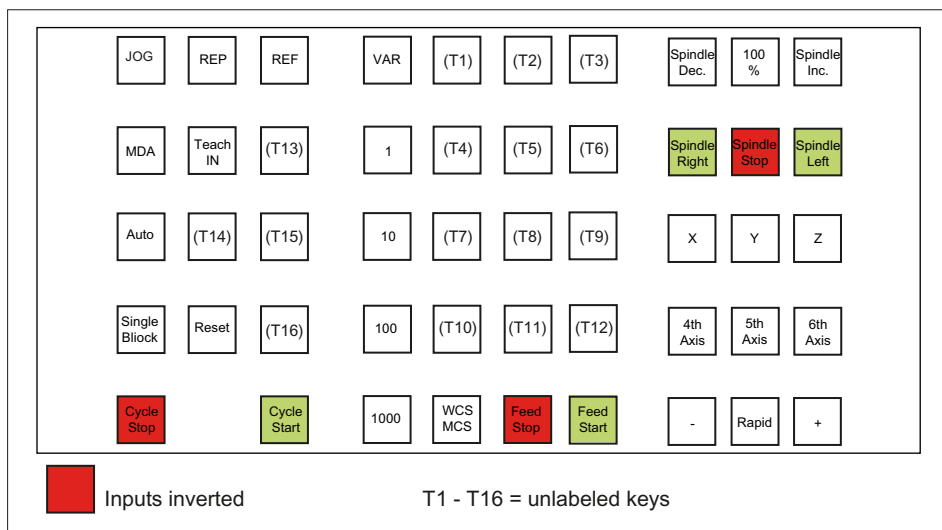

Figure 1-4 Default key assignment of MCP 310C PN

Assignment of the inputs (I) and outputs (O) to the keys and LEDs



Figure 1-5 Inputs and outputs of the MCP 310C PN keyboard

1.4 Mounting

Dimension drawing

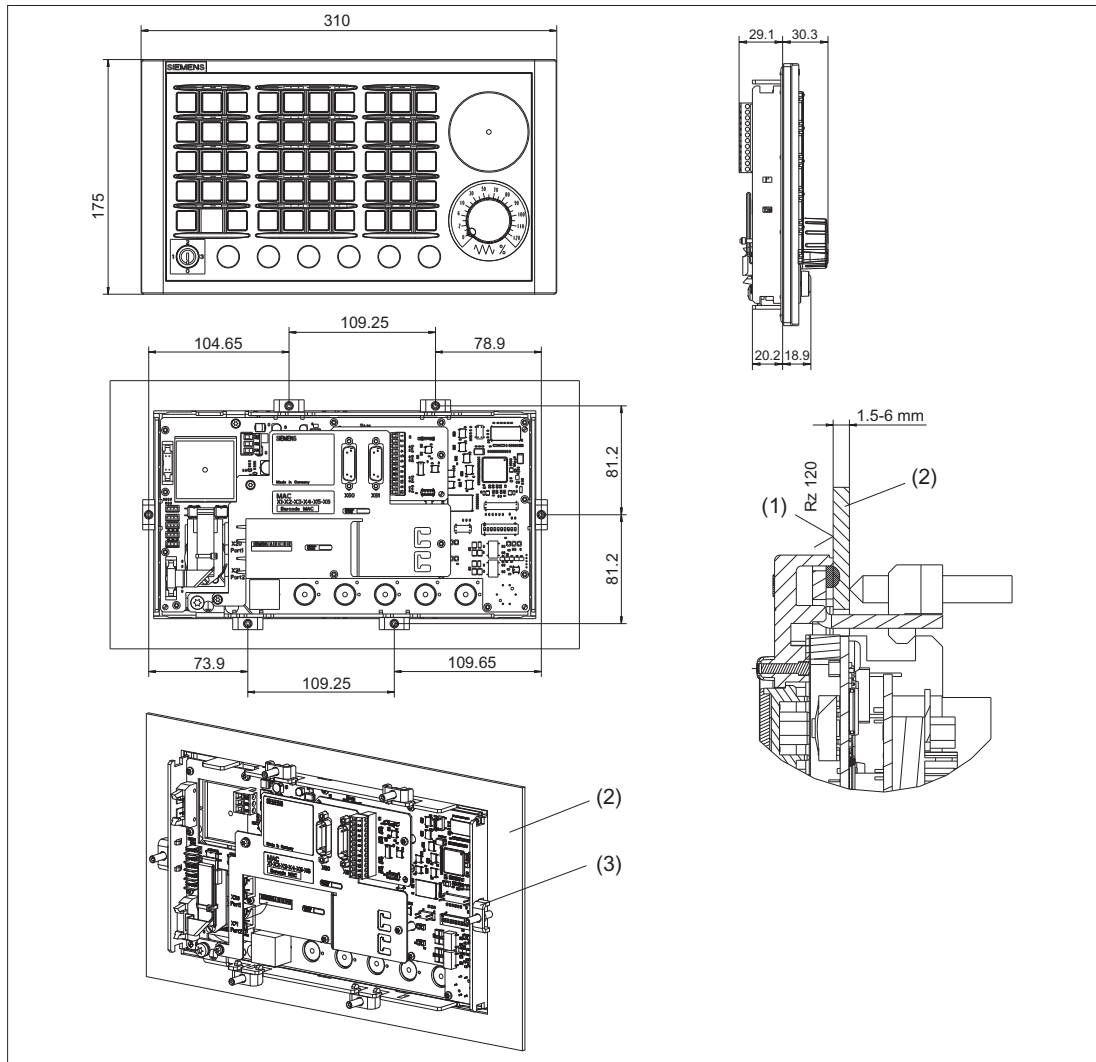

- (1) In the sealing area
- (2) Mounting frame
- (3) Tension jack (6 parts) - tightening torque 0,5 Nm

Figure 1-6 MCP 310C PN dimension drawing

Tension jacks

The machine control panel is attached using 6 tension jacks (tightening torque, 0.5 Nm).

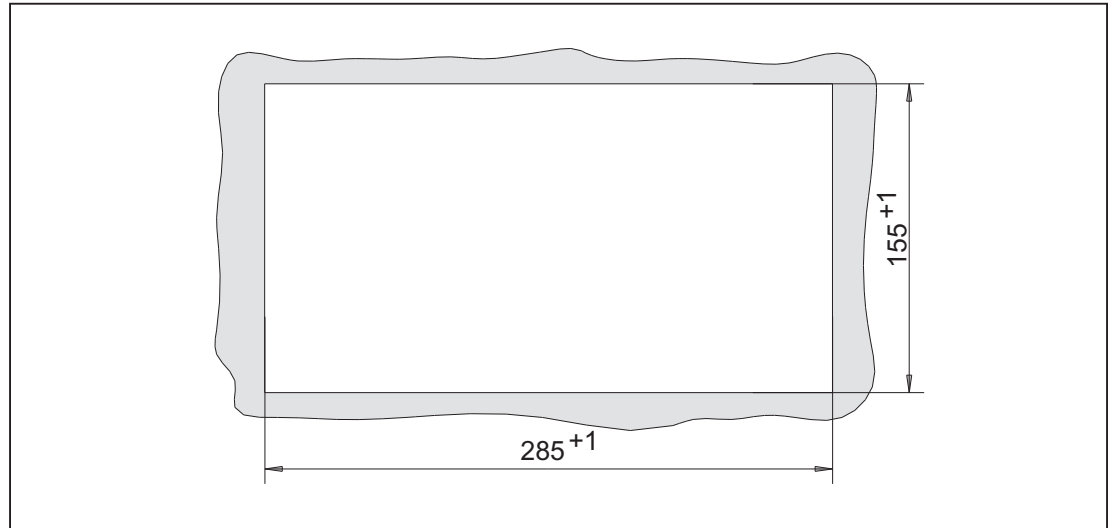

Figure 1-7 Panel cut-out for machine control panel MCP 310C PN

Mounting position

Max. 60° to the vertical.

For mounting positions greater than 60°, a fan must also be installed to keep the ambient temperature of the machine control panel constantly below 55 °C.

1.5 Connecting

Two equivalent connections (Fast Ethernet) are available for Ethernet/PROFINET transfer.

The Ethernet cables are not included in the scope of delivery. They must be ordered separately.

The following components are recommended:

- Ethernet FastConnect cables
- Ethernet FastConnect connectors

More information on this can be found in the SIEMENS IK PI catalog.

Securing Ethernet cables

Two cable ties are included in the scope of delivery. These are used to secure the Ethernet cables on the cover plate at the rear of the machine control panel (see figure in Section: "Control and display elements" → "Rear side").

NOTICE
Damaged cables caused by chafing edges
Make sure that all cables are routed so that they do not come into contact with chafing edges.

1.6 Maintenance and Service

Cleaning the device

Use a soft cloth moistened either with water or a mild cleaning agent to clean the housing and operator control elements of the machine control panel.

Checking the device

In order to prevent foreign bodies or liquids entering the machine control panel, regularly check the device

- that all the housing screws are in place and tight
- for damage to the housing
- for damage to the cable cover or cable entry

Protect the device from environmental effects

Protect the machine control panel against

- direct solar radiation and heat sources
- mechanical vibration and shock
- dust
- moisture, and
- strong magnetic fields

Check of the emergency stop button (if the emergency stop button has been retrofitted)

Check the emergency stop button regularly to ensure that it functions correctly.

1.7 Technical data

MCP 310C PN machine control panel

Safety				
Safety class	III; PELV according to EN 50178			
Degree of protection according to EN 60529	Front side: IP54		Rear side: IP00	
Approvals	CE / cULus			
Electrical data				
Input voltage	24 VDC			
Power consumption, max.	Board: 5 W	Lamps: 14.4 W (6 x 2.4 W) *)	Handwheels: 2 x 0.9 W	Total: 21.2 W
Mechanical data				
Dimensions	Width: 310 mm	Height: 175 mm	Depth: 85.2 mm Mounting depth: 29.1 mm	
Weight	Approx. 1.2 kg			

*) The outputs for the illuminated pushbuttons (X53/X54) can have a max. permissible current of 0.3 A. However, the total current consumption of the components must not exceed 1.0 A (24 W).

Note

Information about the climatic and mechanical environmental conditions is contained in the associated section under:

"General notes and interconnection" → "Operational planning".

Emergency stop button

Rated voltage	24 VDC
Current magnitude, max.	3 A
Current magnitude, min.	1 mA
Switching capacity	DC 13 according to EN 60947-5-1
Conditional rated short-circuit current	10 A gL/gG according to EN 60947-5-1
B _{10d}	500 000

Note

The quantitative assessment of the emergency stop safety function must be based on the B_{10d} values corresponding to the used standards (e.g. ISO 13849-1) under consideration of the respective application (frequency of the actuation, service life, diagnostics by the evaluation unit, etc.). The B_{10d} values only apply when the technical properties of the emergency stop button are taken into account.

1.8 Accessories and spare parts

Table 1-8 Accessories and spare parts for machine control panel 310C PN

Name	Description	Number	Order number
Emergency stop button	22 mm actuating element, 40mm mushroom pushbutton, snap action with tamper protection, latching, red, with holder, unlit	1	3SB3000-1HA20 *)
Switching element	with 2 contact pairs (1 NO + 1 NC), 2-pin, screw terminal (3rd contact pair can be connected additionally)	1	3SB3400-0A *)
Key	10 key sets, each with three keys for the key-operated switch settings 1, 2, 3	1 set	6FC5148-0AA03-0AA0
Tension jacks	Tension jack set (9 items) for supplementary components with 2.5 mm profile, length 20 mm	1 set	6FC5248-0AF14-0AA0
Override for rotary spindle switch	Override spindle / rapid traverse, electronic rotary switch 1x16G, T=24, cap, button, pointer, spindle dials and rapid traverse	1	6FC5247-0AF12-1AA0
Rotary feed override switch	Feed / rapid traverse override, electronic rotary switch 1x23G, T=32, cap, button, pointer, feed and rapid-traverse dials	1	6FC5247-0AF13-1AA0
Key cover	Square, can be labeled by laser, 1 set of 90, ergo-gray and 20 each of red / green / yellow / medium gray	1	6FC5248-0AF12-0AA0
Key cover	Square, for inscription plates, 1 set of 90, clear	1	6FC5248-0AF21-0AA0
Key cover	Square, can be written with laser, one set with 500 items, ergo-gray (light basic)	1	6FC5348-0AF00-0AA0
Key cover	Square, can be written with laser, one set with 500 items, mid-gray (light basic)	1	6FC5348-0AF01-0AA0
Cable set	For additional MCP control devices, length 500 mm	60	6FC5247-0AA35-0AA0
Handwheel connection	Handwheel cable, max. length: 5 m	1	6FX8002-2CP00-1Axy **)

**) xy is the length code: x (m) = A (0) ...F (5); y (dm) = 0 ... 8

*) Safety-related

Table 1-9 Accessories pack (for delivery ex works)

1	Keyset	9	Key covers for turning (labeled)
		30	Ergo grey key covers (for labeling)
		30	Clear key covers (for labeling)
1	Yellow backing plate for emergency stop		

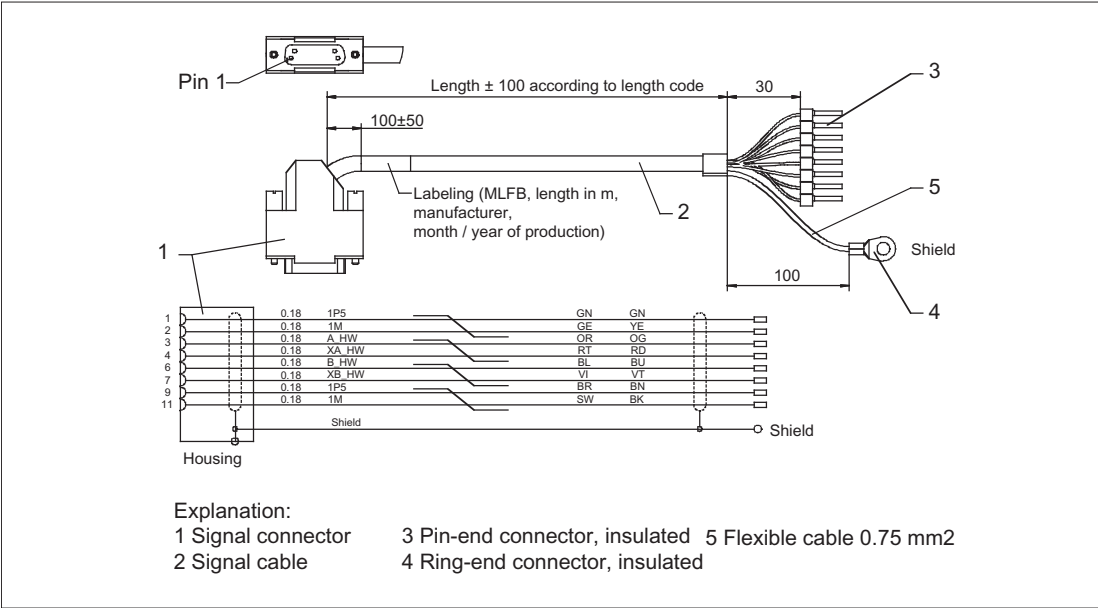

Figure 1-8 Connection cable for handwheel

Machine control panel: MCP 310 PN

2.1 Description

Machine control panel MCP 310 PN (PN = PROFINET) enables user-friendly operation of the machine functions, which are clearly laid out for the user. It is suitable for machine-level operation of milling, turning, grinding and special machines.

Note

The IE functionality (IE = Industrial Ethernet) is still included and preset. Please note the switch position of S2.

49 keys have user-inscribed slide-in labels for machine-specific adaptations. A DIN A4 film for labeling the slide-in labels is included in the delivery kit.

A connecting cable is included in the scope of delivery for connecting the direct keys of the SINUMERIK operator panel fronts OP 012 / OP 015A and TP 015A.

The machine control panel is secured from the rear using special clamps supplied with the panel.

Validity

This description applies to the machine control panel:

Type	Key type	Order number
MCP 310 PN (IE and PN)	Membrane keys	6FC5303-0AF23-1AA1
MCP 310 IE (IE only)	Membrane keys	6FC5303-0AF23-1AA0 ¹⁾

¹⁾ No longer available

The safety-related accessories / spare parts are marked in the "Accessories and spare parts" section with a *).

Features

Control elements:

- Membrane keys
- Operating mode and function keys:
 - 49 keys with assigned LEDs, 16 freely assignable customer keys in the standard assignment
 - Direction keys for milling machines with rapid traverse override
- Feed control with override feed / rapid traverse (rotary switch with 23 positions)
- Key-operated switch (four positions and three different keys)

2.1 Description

Interfaces:

- Ethernet (transfer rate: 10/100 Mbit/s; for IE and PN)
- Nine customer-specific inputs (e.g. for illuminated pushbuttons)
- Six customer-specific outputs
- For 16 direct keys of OP 012 / OP 015A / TP 015A (connection cable: 850 mm, included in scope of delivery)
- Connection for two handwheels (Sub-D)
(Velocity input and contour handwheel are only possible if connecting through the handwheel connection module 6FC5303-0AA02-0AA0.)

Expansion slots:

- Six slots for control devices (d = 16 mm)
(Additional cable set required for control devices, see Section: "Accessories and spare parts".)
- One slot for emergency stop key or rotary override switch (up to d = 22 cm)

Functions:

Table 2-1 Functions depending on the operating mode

Function	PN operating mode	IE operating mode	Requirement
Keys, LEDs, rotary switches	available soon	✓	
Handwheel	-	✓ as of NCU software 2.5	Toolbox 2.6
		✓ as of NCU software 2.6 Handwheel with optimized response. This enables a "delete distance-to-go function" to be triggered in the PLC user program via a "handwheel stationary" signal.	
Activate/Deactivate (T:N:M)	-	✓	

2.2 Operator controls and indicators

2.2.1 Front side

Overview

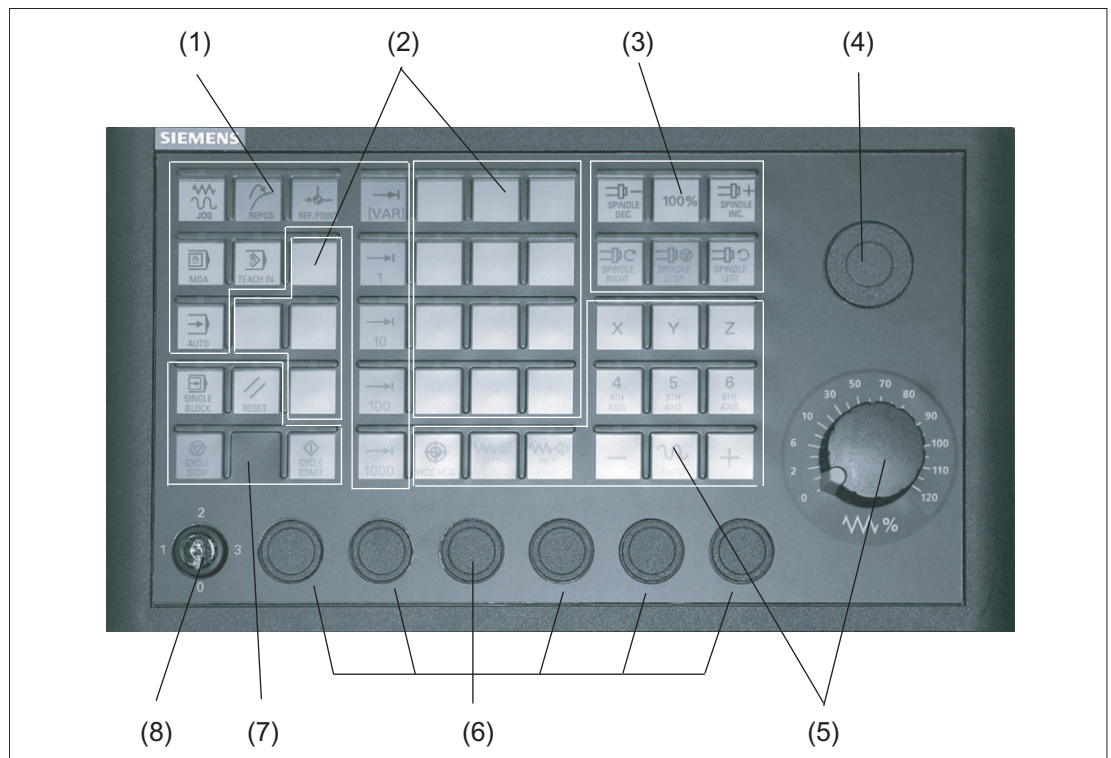

- (1) Operating modes and machine functions
 - (2) 16 customer keys
 - (3) Spindle control
 - (4) Slot for emergency stop button or spindle override switch
 - (5) Feed control with override switch
 - (6) Slots for control devices 16 mm *)
 - (7) Program control
 - (8) Key-operated switch
- *) see slots for control devices

Figure 2-1 Position of control elements on machine control panel MCP 310 PN

Emergency stop button

If an emergency stop button is added: see Chapter: "Machine control panel: MCP 483 PN", Section: "Display and operating elements" → "Front".

Slots for control devices

NOTICE
Damage to the front
Do not break the openings for the installation of operating devices (6), but rather drill them to the required size.

With the selection of the control devices, please take care of the surface characteristics of the MCP:
For technical reasons, the film ② is approximately 0.1 to 0.5 mm lower than the contact surface of the control device ①. Due to this difference, assess the height of the plastic ring.

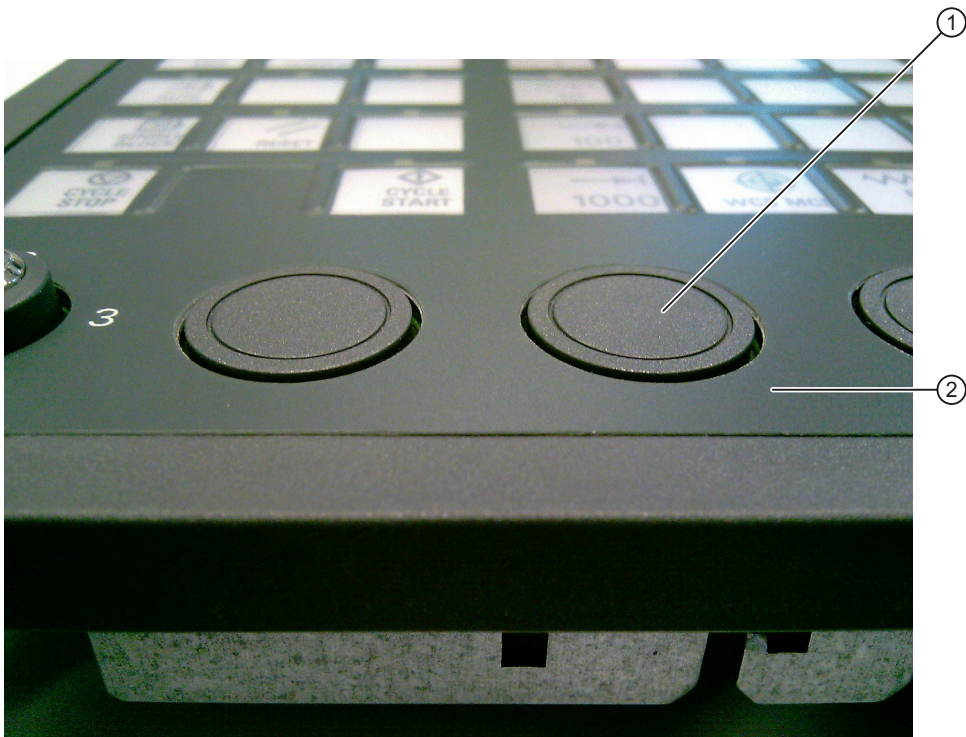
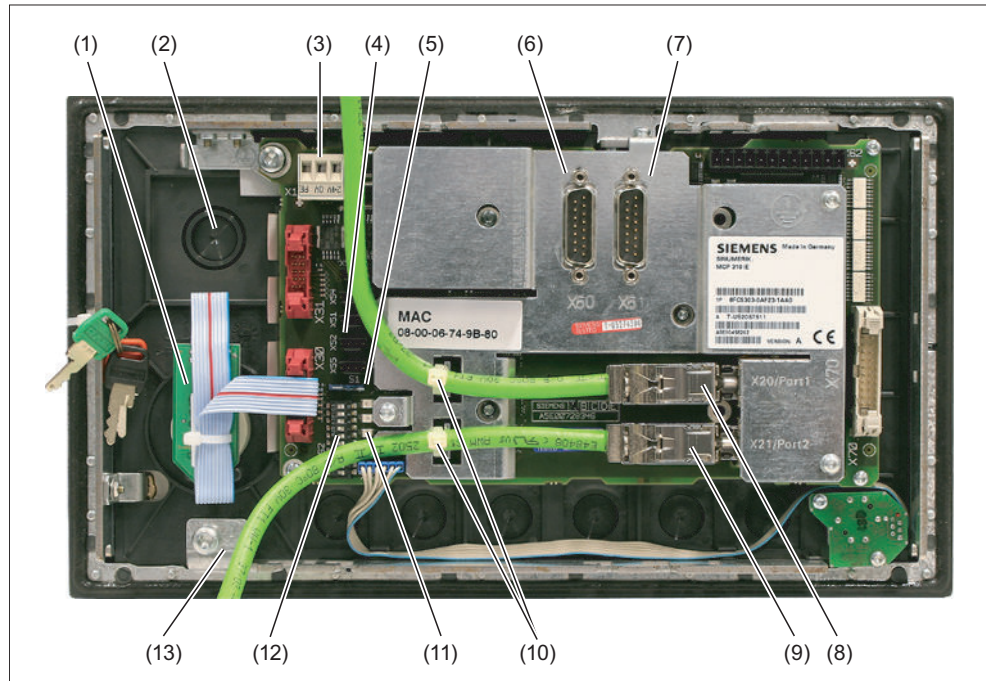

Figure 2-2 Installation of the control devices 16 mm

2.2.2 Rear side

Rear side



- | | | |
|------|--|-----|
| (1) | Feed override | X30 |
| (2) | Slot for emergency stop button or spindle override | |
| (3) | Power supply interface | X10 |
| (4) | Customer-specific inputs and outputs *) | |
| (5) | switch S1 *) | |
| (6) | Handwheel connection | X60 |
| (7) | Handwheel connection | X61 |
| (8) | Ethernet connection, port 1 | X20 |
| (9) | Ethernet connection, port 2 | X21 |
| (10) | Ethernet cable strain relief | |
| (11) | LEDs *) | |
| (12) | Switch S2 *) | |
| (13) | Equipotential bonding | |

*) Detailed description under "Interfaces" → "Description"

Figure 2-3 Rear of the MCP 310 PN with Ethernet connecting cables

2.3 interfaces

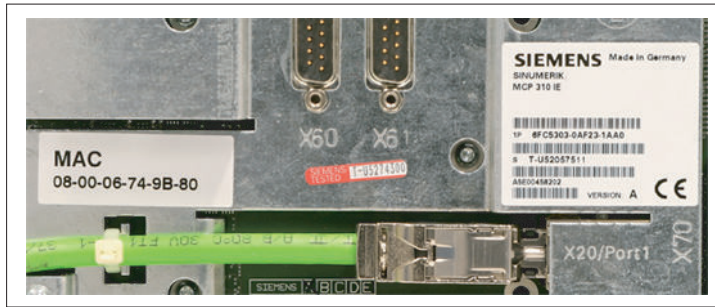

Figure 2-4 MCP 310 PN - MAC address/rating plate

2.3 interfaces

2.3.1 Overview

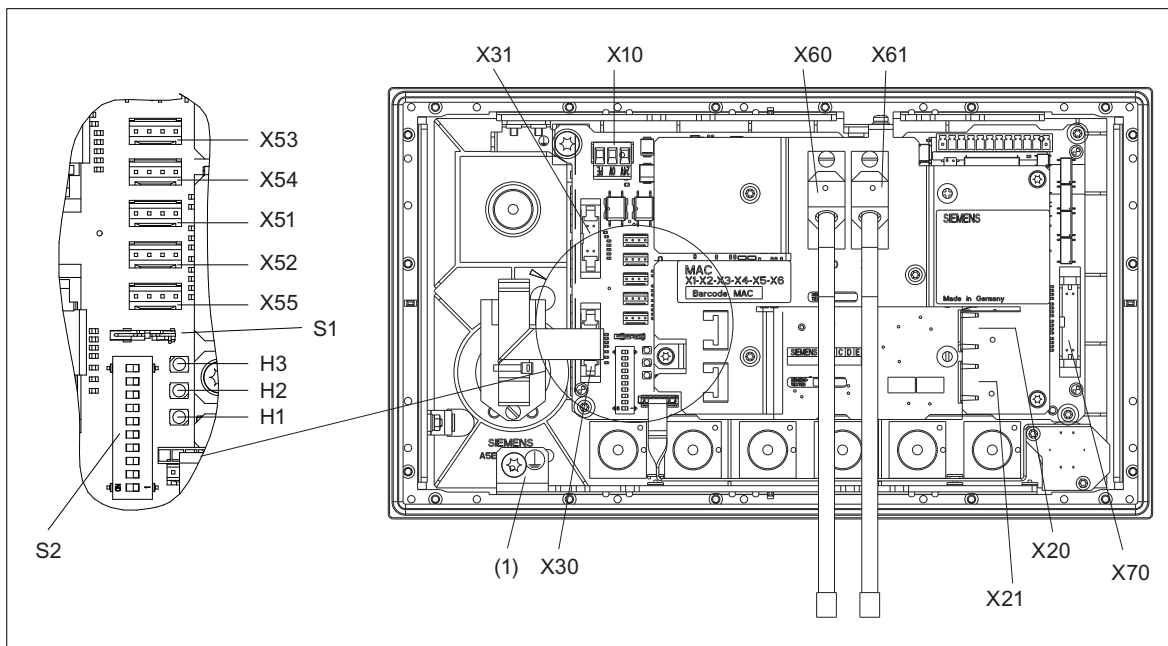

Figure 2-5 Rear of the MCP 310 PN with interfaces

- (1) Equipotential bonding
- X10 Power supply interface
- X20 Ethernet port 1
- X21 Ethernet port 2
- X30 Interface for rotary switch feed override

X31	Interface for rotary switch spindle override / emergency stop (optional)
X51 / X52 / X55	Interfaces for customer-specific inputs
X53 / X54	Interfaces for customer-specific outputs
X60 / X61	Connections for 2 handwheels (TTL / differential - can be set with switch S1)
X70	Interface for connecting 16 direct keys
S1	Switch for setting the handwheel signal type
S2	Switch for setting the MCP address

LEDs

H1	POWER OK (green)
H2	BUSSYNC
H3	BUSFAULT

Equipotential bonding

The equipotential bonding conductor is attached by means of an M5 screw.

2.3.2 Description

Pin assignment

For more detailed information, see "General information and networking", Chapter: "Connecting".

Switch S1/S2

Settings, see Chapter "Machine control panel: MCP 310C PN", Section "Interfaces".

2.3.3 Input / output images

Standard + two handwheels

The specifications for assigning input and output bytes listed in the tables can be changed in the PLC via parameter assignment.

Note

The following applies in respect of the process input and output images in the tables: n is defined by means of FB1 parameters in OB100 of the PLC.

2.3 interfaces

Table 2-2 Process input image for MCP 310 PN

Byte	Bit7	Bit6	Bit5	Bit4	Bit3	Bit2	Bit1	Bit0
EB n + 0	* NC stop	Spindle	Spindle 100%	Spindle +	Single block	JOG	MDA	AUTO
EB n + 1	NC start	Spindle right	* Spindle stop	Spindle left	Key-operated switch position 3	REF	REPOS	Teach IN
EB n + 2	Feed start	* Feed stop	INC VAR	Key-operated switch position 0	INC 1000	INC 100	INC 10	INC 1
EB n + 3	RESET	Key-operated switch		Feed override				
		Position 2	Position 1	E (2 ⁴)	D (2 ³)	C (2 ²)	B (2 ¹)	A (2 ⁰)
EB n + 4	Arrow keys			KT-IN5	KT-IN4	KT-IN3	KT-IN2	KT-IN1
	+	-	Rapid traverse	X52.2	X52.1	X51.3	X51.2	X51.1
EB n + 5	T16	KT-IN6 X52.3	Axis selection					
			6	5	4	Z	Y	X
EB n + 6	Unassigned customer keys				Unassigned customer keys			
	T9	T10	T11	T12	Work Machine	T13	T14	T15
EB n + 7	Unassigned customer keys							
	T1	T2	T3	T4	T5	T6	T7	T8
EB n + 8	DT 07	DT 06	DT 05	DT 04	DT 03	DT 02	DT 01	DT 00
EB n + 9	DT 15	DT 14	DT 13	DT 12	DT 11	DT 10	DT 09	DT 08
EB n + 10	KT-IN8 X55.2	KT-IN7 X55.1	KT-IN6 X52.3	KT-IN5 X52.2	KT-IN4 X52.1	KT-IN3 X51.3	KT-IN2 X51.2	KT-IN1 X51.1
EB n + 11	-	-	-	-	-	-	-	KT-IN9 X55.3
EB n + 12	-	-	-	-	-	-	-	-
EB n + 13	-	-	-	X31 pin 6 ¹⁾	X31 pin 7 ¹⁾	X31 pin 8 ¹⁾	X31 pin 9 ¹⁾	X31 pin 10 ¹⁾

Signals marked with * are inverse signals.

1) If the 4-stage rotary spindle override switch on X31 is replaced by a 5-stage rotary switch, the input information here can be measured in five stages.

Table 2-3 Input image for handwheel data

Byte	Bit7	Bit6	Bit5	Bit4	Bit3	Bit2	Bit1	Bit0
EB n + 14	Handwheel 1 counter status (16-bit signed, low-order byte equals byte n+14)							
EB n + 15								
EB n + 16	Handwheel 2 counter status (16-bit signed, low-order byte equals byte n+16)							
EB n + 17								

Within the SINUMERIK controller, the handwheel data is processed directly by the NCK and are not available to the PLC.

Table 2-4 Process output image for MCP 310 PN

Byte	Bit7	Bit6	Bit5	Bit4	Bit3	Bit2	Bit1	Bit0
AB n + 0	* NC stop	Spindle	Spindle 100%	Spindle +	Single block	JOG	MDA	AUTO
AB n + 1	NC start	Spindle right	* Spindle stop	Spindle left	RESET	REF.	REPOS	Teach IN
AB n + 2	Feed start	* Feed stop	INC VAR	-	INC 1000	INC 100	INC 10	INC 1
AB n + 3	-	-	-	-	-	-	-	-
AB n + 4	+	-	Rapid traverse	KT-OUT5 X54.2	KT-OUT4 X54.1	KT-OUT3 X53.3	KT-OUT2 X53.2	KT-OUT1 X53.1
AB n + 5	T16	KT-OUT6 X54.3	6	5	4	Z	Y	X
AB n + 6	Unassigned customer keys							
	T9	T10	T11	T12	Work Machine	T13	T14	T15
AB n + 7	Unassigned customer keys							
	T1	T2	T3	T4	T5	T6	T7	T8

Signals marked with * are inverse signals

Default key assignment

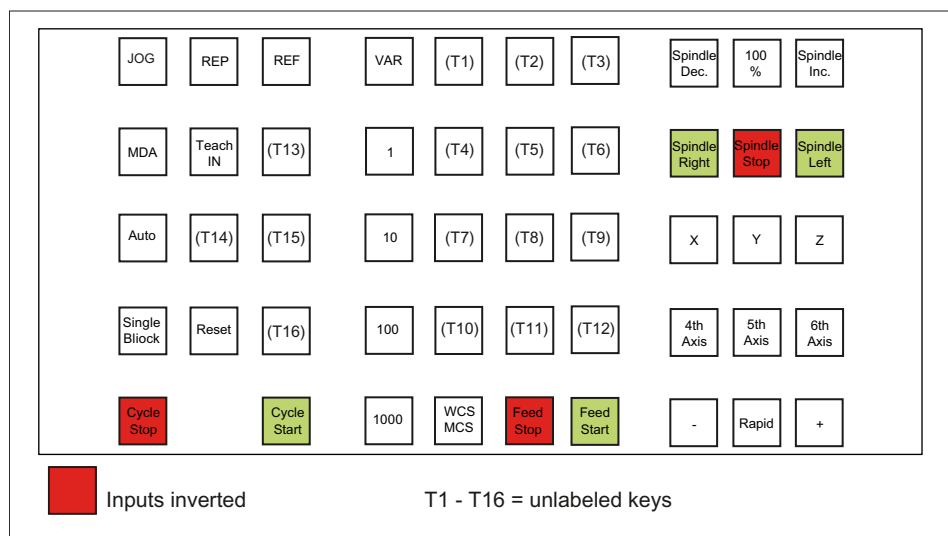

Figure 2-6 Default key assignment of MCP 310 PN

Assignment of the inputs (I) and outputs (O) to the keys and LEDs



Figure 2-7 Inputs and outputs of the MCP 310 PN keyboard

2.4 Mounting

Dimension drawing

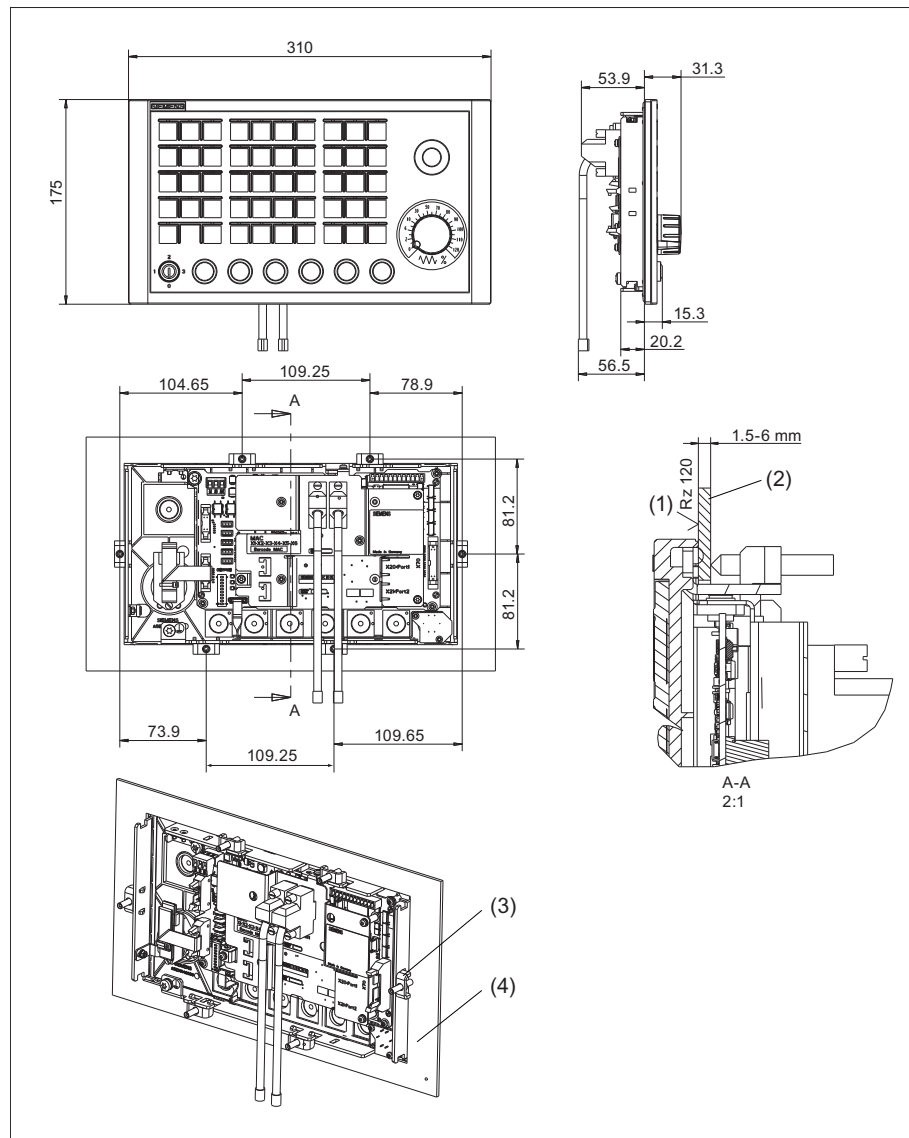

- (1) In the sealing area
- (2) Mounting frame
- (3) Tension jack (6 parts) - tightening torque 0.8 Nm
- (4) Mounting frame

Figure 2-8 Dimension drawing for machine control panel MCP 310 PN

2.5 Connecting

Tension jacks

The machine control panel is attached by means of 6 tension jacks (0.8 Nm; see dimension drawing).

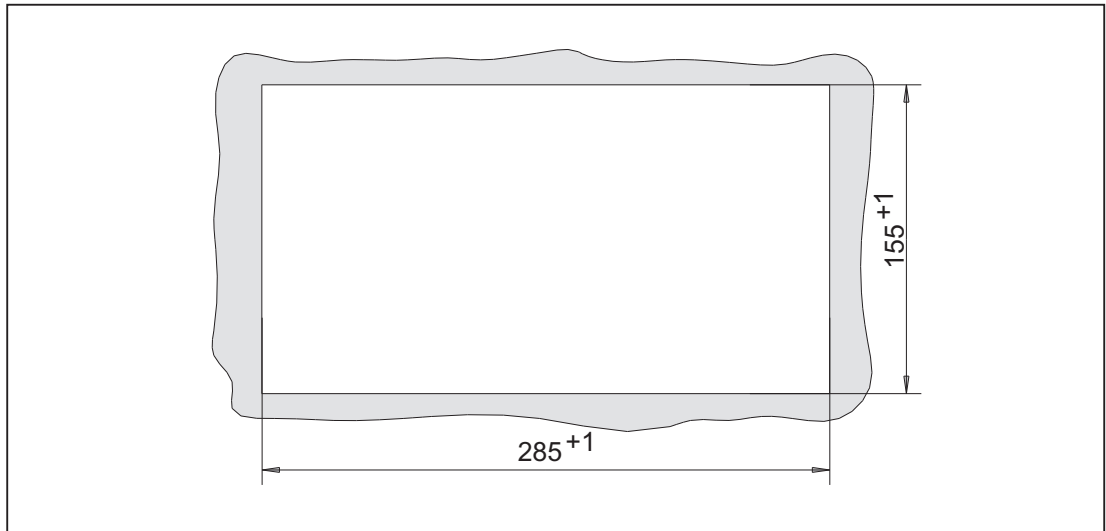

Figure 2-9 Panel cutout for machine control panel MCP 310 PN

Installation position

Max. 60° to the vertical. For mounting positions greater than 60°, a fan must also be installed to keep the ambient temperature of the machine control panel constantly below 55 °C.

2.5 Connecting

Two equivalent connections (Fast Ethernet) are available for Ethernet/PROFINET transfer.

The Ethernet cables are not included in the scope of delivery. They must be ordered separately.

The following components are recommended:

- Ethernet FastConnect cables
- Ethernet FastConnect connectors

More information on this can be found in the SIEMENS IK PI catalog.

Securing Ethernet cables

Two cable ties are included in the scope of delivery. These are used to secure the Ethernet cables on the cover plate at the rear of the machine control panel (see figure in Section: "Control and display elements" → "Rear side").

NOTICE
Damaged cables caused by chafing edges
Make sure that all cables are routed so that they do not come into contact with chafing edges.

2.6 Maintenance and Service

Cleaning the device

Use a soft cloth moistened either with water or a mild cleaning agent to clean the housing and operator control elements of the machine control panel.

Checking the device

In order to prevent foreign bodies or liquids entering the machine control panel, regularly check the device

- that all the housing screws are in place and tight
- for damage to the housing
- for damage to the cable cover or cable entry

Protect the device from environmental effects

Protect the machine control panel against

- direct solar radiation and heat sources
- mechanical vibration and shock
- dust
- moisture, and
- strong magnetic fields

Check of the emergency stop button (if the emergency stop button has been retrofitted)

Check the emergency stop button regularly to ensure that it functions correctly.

2.7 Technical data

Machine control panel MCP 310 PN

Safety				
Safety class	III; PELV according to EN 50178			
Degree of protection according to EN 60529	Front side: IP65	Key-operated switch: IP54	Rear side: IP00	
Approvals	CE / cULus			
Electrical data				
Input voltage	24 VDC			
Power consumption, max.	Board: 5 W	Lamps: 14.4 W (6 x 2.4 W) *)	Handwheels: 2 x 0.9 W	Total: 21.2 W
Mechanical data				
Dimensions	Width: 310 mm	Height: 175 mm	Depth: 85.2 mm Mounting depth: 53.9 mm	
Weight	Approx. 1.2 kg			

- *) The outputs for the illuminated pushbuttons (X53/X54) can have a max. permissible current of 0.3 A. However, the total current consumption of the components must not exceed 1.0 A (24 W).

Emergency Stop button

Rated voltage	24 VDC
Current magnitude, max.	3 A
Current magnitude, min.	1 mA
Switching capacity	DC 13 according to EN 60947-5-1
Conditional rated short-circuit current	10 A gL/gG according to EN 60947-5-1
B _{10d}	500 000

Note

The quantitative assessment of the emergency stop safety function must be based on the B_{10d} values corresponding to the used standards (e.g. ISO 13849-1) under consideration of the respective application (frequency of the actuation, service life, diagnostics by the evaluation unit, etc.). The B_{10d} values only apply when the technical properties of the emergency stop button are taken into account.

2.8 Accessories and spare parts

2.8.1 Overview

Table 2-5 Accessories and spare parts for machine control panel 310 PN

Name	Description	Quantity	Order number
Key-operated switch	Key-operated switch with key	1	6FC5247-0AF02-0AA0
Sets of keys	10 key sets, each with three keys for the key-operated switch settings 1, 2, 3	1 set	6FC5148-0AA03-0AA0
Set of tension jacks	Tension jack set (9 items) for supplementary components with 2.5 mm profile, length 20 mm	1 set	6FC5248-0AF14-0AA0
Override for rotary spindle switch	Override spindle / rapid traverse, electronic rotary switch 1x16G, T=24, cap, button, pointer, spindle dials and rapid traverse	1	6FC5247-0AF12-1AA0
Rotary feed override switch	Feed / rapid traverse override, electronic rotary switch 1x23G, T=32, cap, button, pointer, feed and rapid-traverse dials	1	6FC5247-0AF13-1AA0
Emergency stop button	22 mm actuating element, emergency stop mushroom-head pushbutton, red, mushroom head and support	1	3SB3000-1HA20 *)
	Contact block with 2 contacts, 1 NO + 1 NC, 2-pole ,screw terminal	1	3SB3400-0A *)
Slide-in labels	Slide-in label, (3 films, A4)	1 set	6FC5248-0AF23-1AA0
Cable set for additional control devices	Cable set (60 units) for additional control devices for the machine control panels Length: 500 mm	1 set	6FC5247-0AA35-0AA0
Cable for handwheel connection **)	Cable for handwheel connection max. cable length: 5 m	1	6FX8002-2CP00-1Axy
**) See figure; xy is the length code: x (m) = A (0) ...F (5); y (dm) = 0 ... 8			

*) Safety-related

2.8 Accessories and spare parts

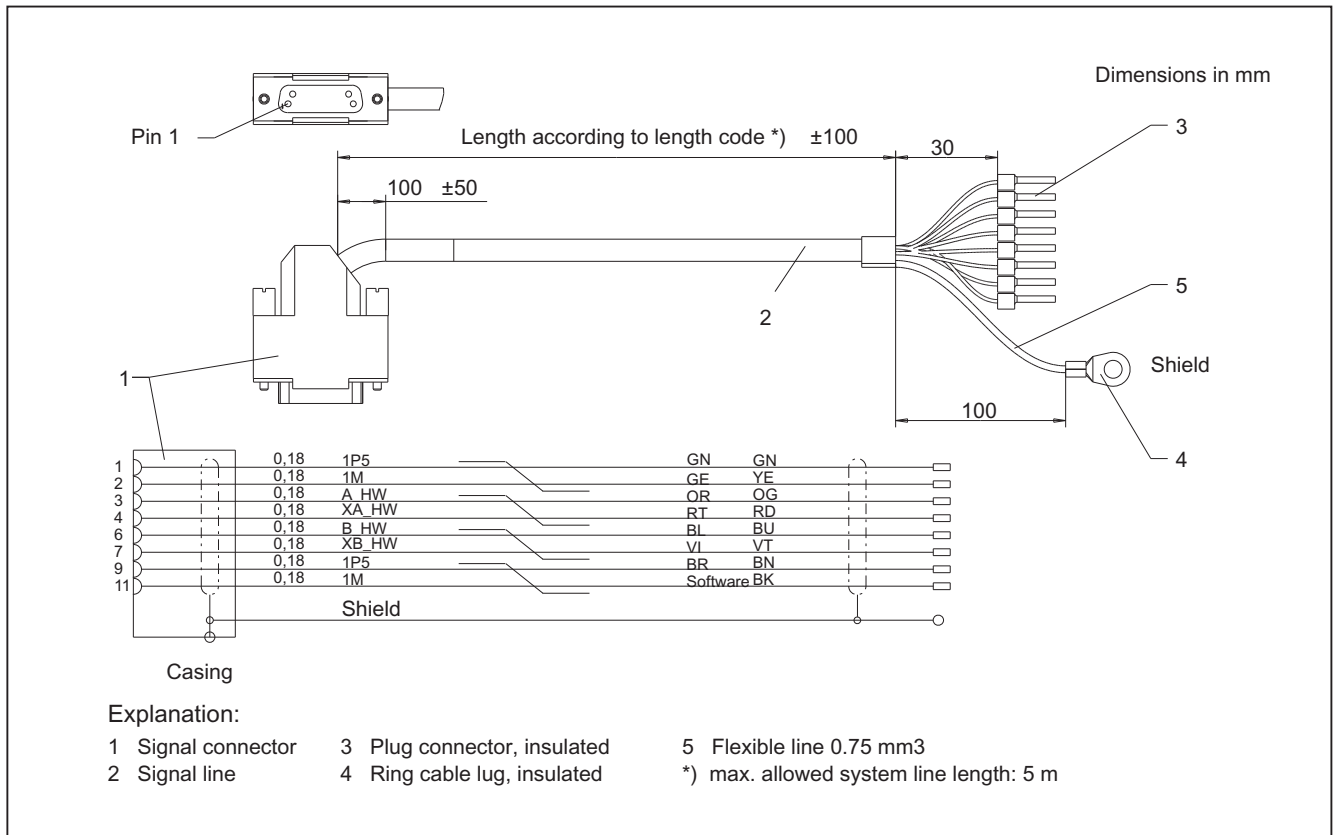

Figure 2-10 Connection cable for handwheel

2.8.2 Labeling the slide-in labels

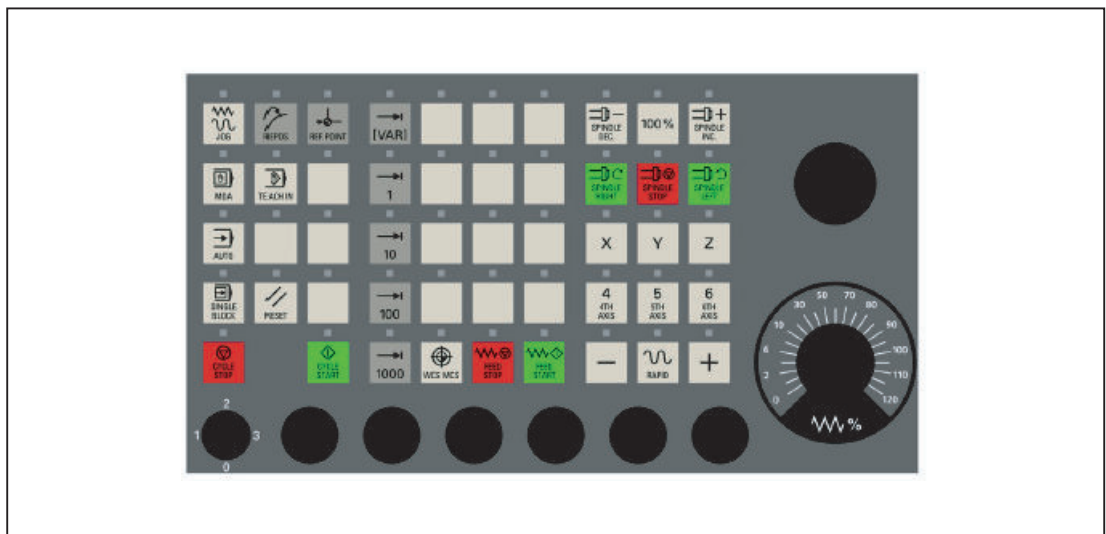
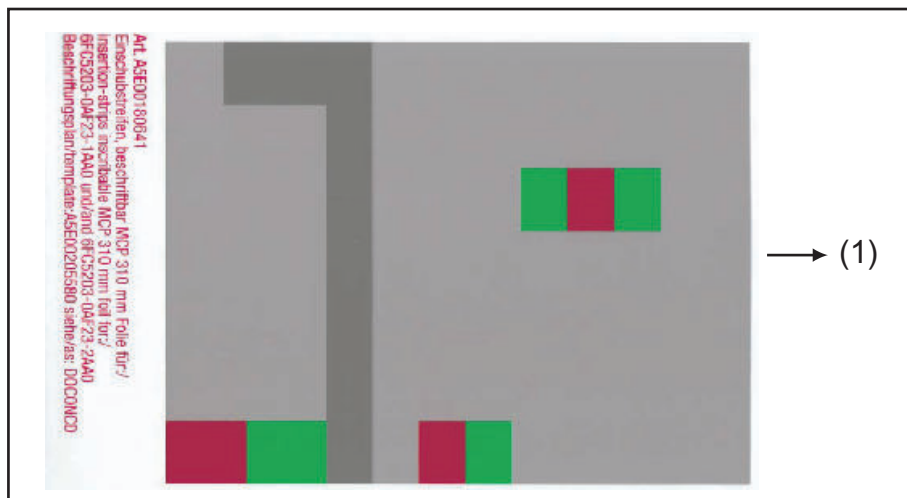

Figure 2-11 Machine control panel MCP 310 PN

The figure shows the Machine Control Panel (MCP) in its standard version.

You can create your own slide-in labels in order to change the key labels. A printable blank film (A4) is supplied with the panel for this purpose.

A spare parts kit containing 3 blank films is also available:
MLFB: 6FC5248-0AF23-1AA0 (Item No. A5E00179115)



(1) Print direction

Figure 2-12 Blank film for MCP 310 PN

Files for printing the blank film

The DOConCD / Catalog NC 61 (CD enclosed) contains three files for printing the blank films:

- **Template_M_MCP310.doc** [defaults for milling - standard shipped file; **(A)**]
- **Template_MCP310.doc** (blank template for film: Item No. A5E00205580; **(B)**)
- **Symbols.doc** Key symbols as Word file, inscription on labels as jpg file **(C)**

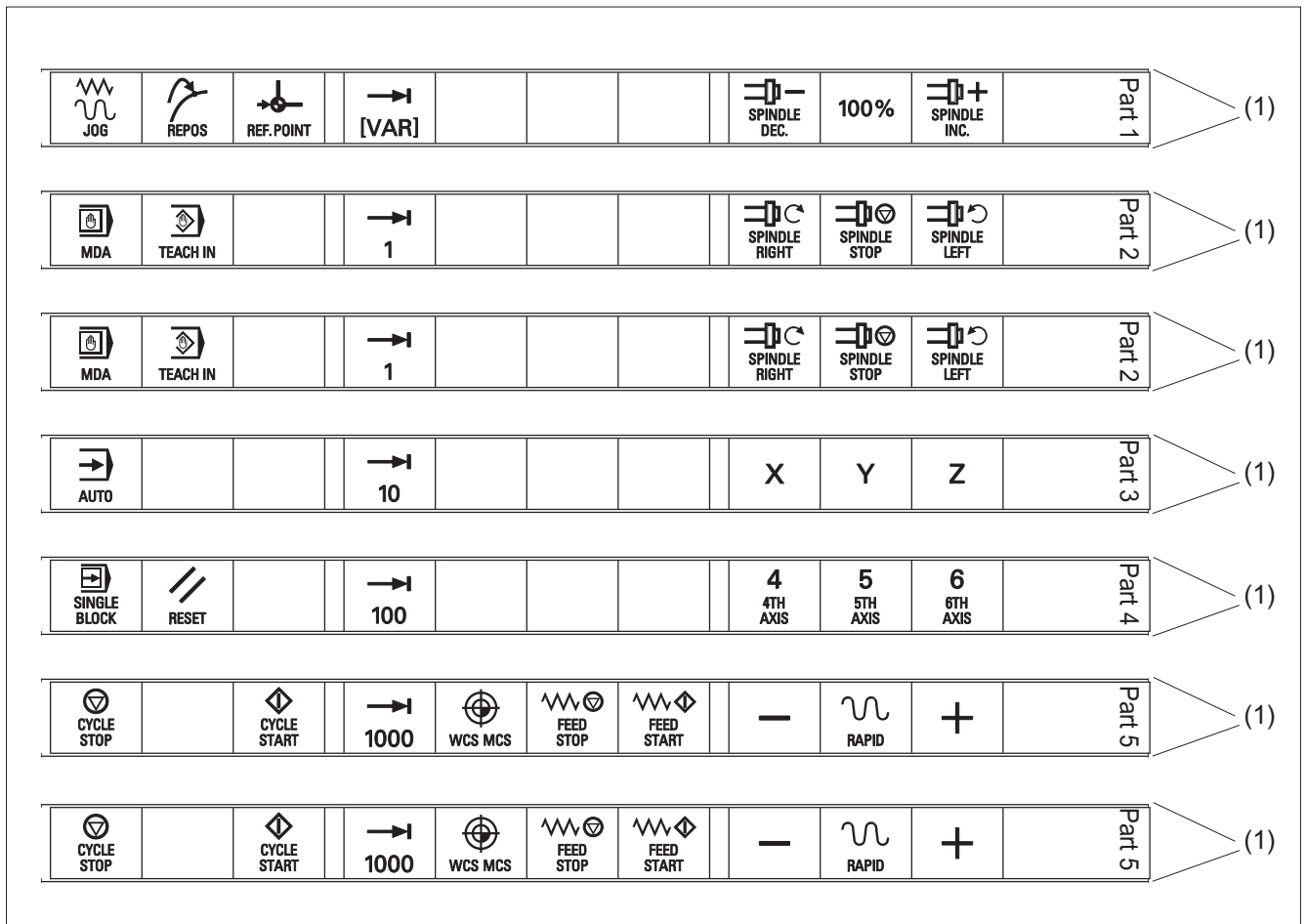

(1) Outer edges

Figure 2-13 Template_M_MCP310.doc for the "Milling" version **(A)**

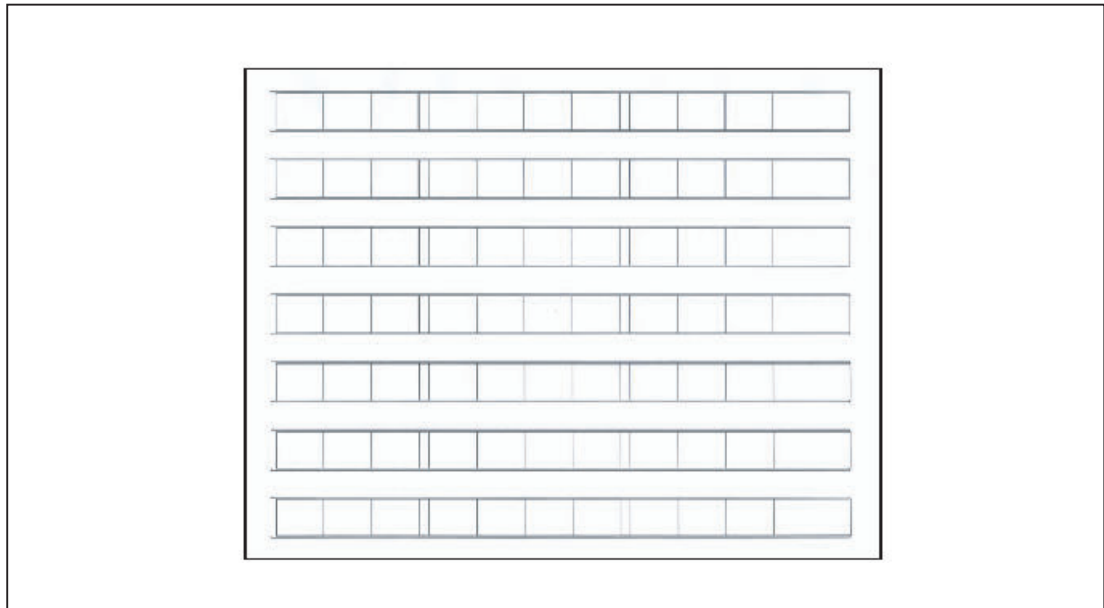





























Figure 2-14 Template_MCP310.doc (acc. to labeling plan /template: Item No. A5E00205580 (B))

Table 2-6 Symbols.doc file (C)

	7001		7013		7025		7124
	7002		7014		7026	+C	7125
	7003		7015		7027	+X	7126
	7004		7016	Z	7028	-Y	7127
	7005		7017	4 4TH AXIS	7029	+Z	7128
100%	7006		7018	5 5TH AXIS	7030	-X	7129
	7007		7019	6 6TH AXIS	7031	+Y	7130
	7008		7020	-	7032	-Z	7131
	7009		7021	+	7033	-C	7132
	7010	Y	7022	7 7TH AXIS	7120		

X	7011		7023		7121		
	7012		7024		7123		

Creating slide-in labels with the aid of the file: "Template_M_MCP310.doc" (A)

Open the file **Template_M_MCP310.doc** in the word-processing program MS Word.

To obtain an optimum printing result, remove all separating lines in each slide-in label (2) above, below and between the symbols.

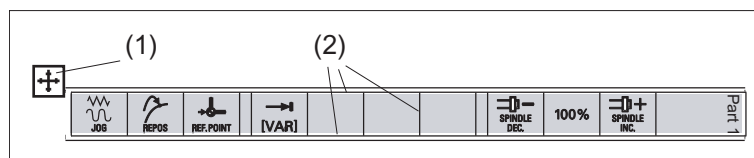

Do **not** highlight the slide-in label using the table symbol (1), but rather:

1. Place the cursor directly before the first symbol on the first slide-in label.
2. Highlight the entire row of the slide-in label by
 - pressing and holding the left mouse key and dragging it to the end of the row or
 - pressing the F8 key and the cursor key "→" until the entire row is selected.
3. Click on the highlighting with the right mouse key.
4. In the menu that appears, select the entry: "Table properties".
5. On the "Table" tab, select the entry: "Borders and shading...".
6. Select the tab "Borders" and click on "Setting:" in the symbol with the designation: "None".
7. Confirm the selection with "OK" → "OK" and remove the highlighting.
This removes all separating lines (with the exception of the outer edges) from this row.

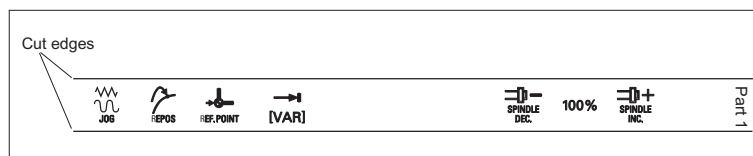

8. Remove the separating lines of the other slide-in labels in the same way.
9. Place the blank film in the printing direction in the slot of your laser printer (see figure: "Blank film for MCP 310 PN").
10. Select "film" as the printable medium if your printer allows this setting.

11. Start the printing process using MS Word.

Note

For labeling the slide-in labels, HP Color Laser Jet film C2936A is used.
Make a test print on paper before you print on the film.
Allow the film to cool after printing so that the ink can dry.

12. Cut the slide-in labels out of the film along the edges.
13. Round off the corners of the slide-in labels approx. 1.5 mm to facilitate insertion.

Preparing the slide-in labels with the aid of "Template_MCP310.doc" (B)

Inserting symbols with the "Symbols.doc" file (C)

1. Open both the "Template_MCP310.doc" file and the "Symbols.doc" file in MS Word.
2. Copy the desired key symbol from the file "Symbols.doc".
3. Position the cursor in the desired field of the template (B) and add the symbol.
4. If all the desired symbols have been added, remove the separating lines and start the printing process in accordance with the instructions in Section: Preparing the slide-in labels with the aid of "Template_M_MCP310.doc".

Inserting characters/text

1. Open the "Template_MCP310.doc" file in MS Word.
2. Set the "Arial" font to format characters.
(This font is comparable to the "Univers S57" font, used by Siemens for the key labeling.)
3. Position the cursor in the desired table cell and enter characters/text.

Creating your own symbols

- Printing in a vector program (e.g. Designer, Freehand, CorelDraw):
 - Draw a 15 x 15 mm square, fill with the color white and give it an invisible border line.
 - Place the symbol in the center of this square.
 - Copy the entire image (square and symbol) and paste it into the Word document (Template_MCP310.doc).
- Drawing in an image editing program (e.g. Photoshop, Picture Publisher, Paint):
 - Create a square area (e.g. 100 x 100 pixels) filled with the color white.
 - Draw the symbol in the center of this square.
 - Copy the entire image (square and symbol) and paste it into the Word document (Template_MCP310.doc).

Dimension drawings

The figure shows a dimension drawing for the MCP 310 PN blank template:

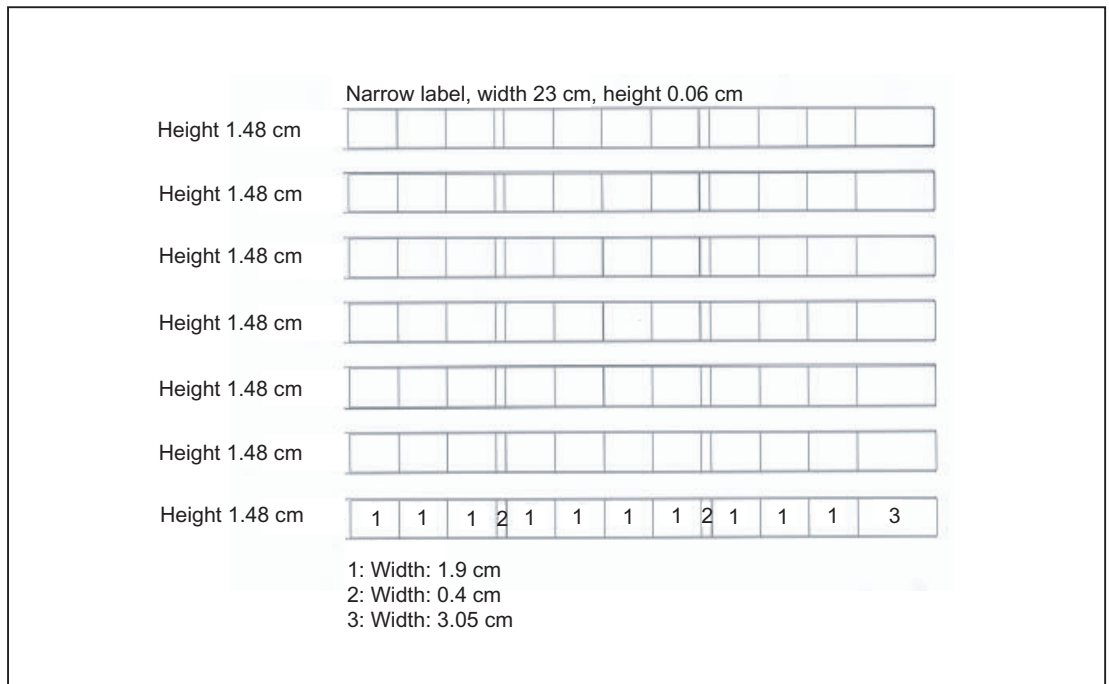
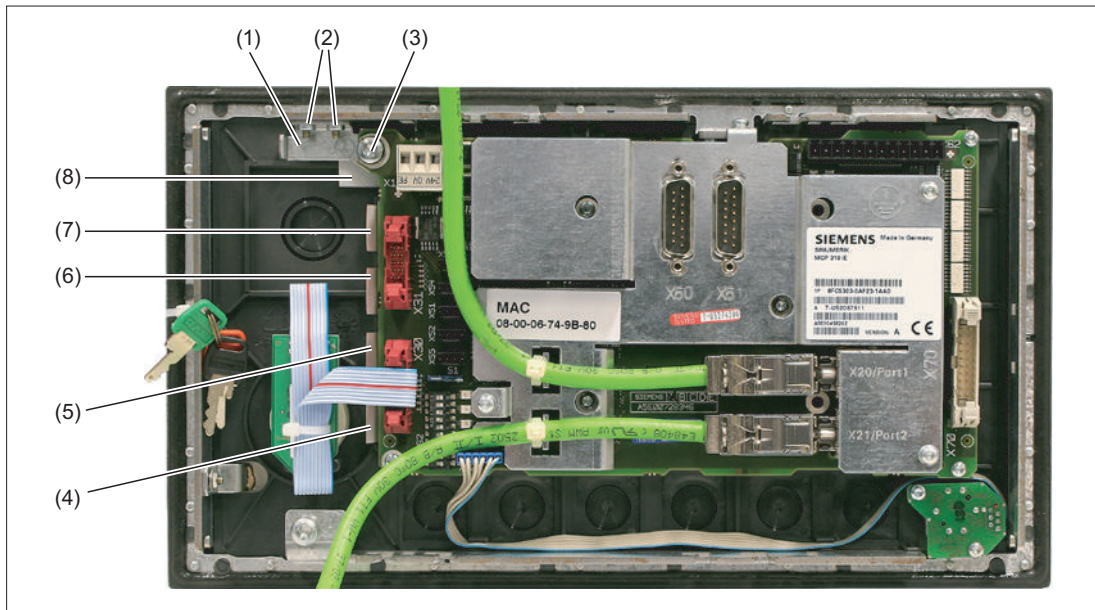

Figure 2-15 Dimension drawing for MCP 310 PN slide-in labels

2.8.3 Inserting the slide-in label "Part1"

The slide-in label "Part1" (8) is located under the grounding bracket (1).

Therefore, first remove the grounding bracket before you pull out or insert the slide-in label "Part 1".



- (1) Grounding bracket
- (2) Fastening screws (M3) for the grounding bracket (housing)
- (3) Fastening screw (M5) for the grounding bracket (COM board)
- (4) Slide-in labels "Part5"
- (5) Slide-in labels "Part4"
- (6) Slide-in labels "Part3"
- (7) Slide-in labels "Part2"
- (8) Slide-in labels "Part1"

Figure 2-16 MCP 310 PN - Rear with slide-in labels

Removing the grounding bracket

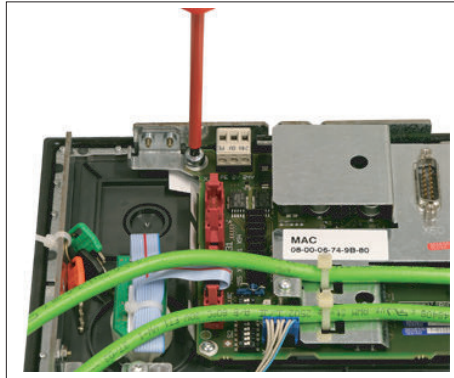

1. Remove the fastening screw (M5) using a TX 25 screwdriver.

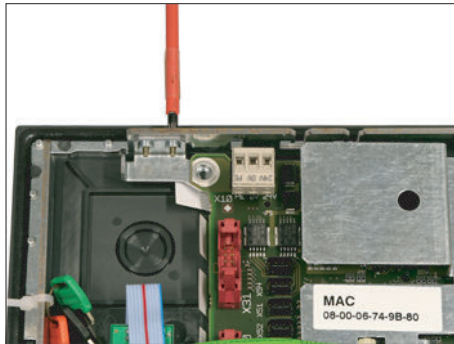

2. Remove the two fastening screws (M3) using a TX 10 screwdriver.

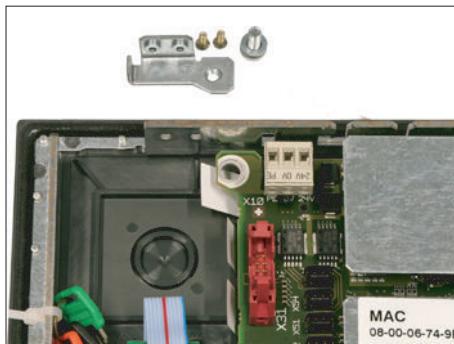

3. Take off the grounding bracket.

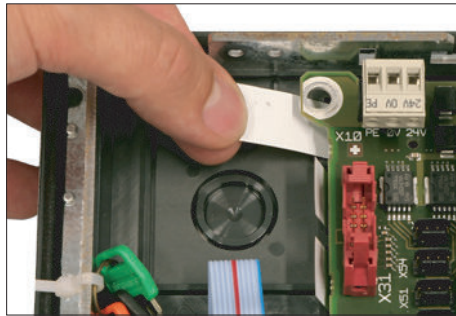

4. Pull out the slide-in label.

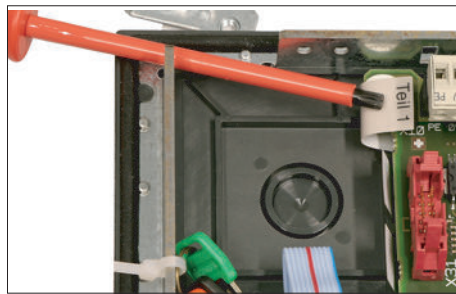

Installing the grounding bracket

Secure the grounding bracket after you have inserted the slide-in label by tightening the three fastening screws.

Note

Observe the proper torque values when tightening the screws:

- M3: 0.8 to 1.3 Nm
 - M5: 3.0 to 6.0 Nm
-

Machine control panel: MCP 310

3.1 Description

The machine control panel MCP 310 permits user-friendly and clear operation of the machine functions. It is suitable for machine-level operation of milling, turning, grinding and special machines.

49 keys have user-inscribed slide-in labels for machine-specific adaptations. A DIN A4 film for labeling the slide-in strips is included in the delivery kit.

A connecting cable is included in the scope of delivery for connecting the direct keys of the SINUMERIK operator panel fronts OP 012 / OP 015A and TP 015A.

The machine control panel is secured from the rear using special clamps supplied with the panel.

Validity

The description applies to the MCP 310 operator panel front.

Order number: 6FC5203-0AF23-1AA0

The safety-related accessories / spare parts are marked in the "Accessories and spare parts" section with a *).

Features

Operator controls

- Membrane keys
- Operating mode and function keys:
 - 49 keys with LEDs, 16 freely assignable customer keys in the standard assignment
 - Direction keys for milling machines with rapid traverse override
- Feed control with override feed / rapid traverse (rotary switch with 23 positions)
- Key-operated switch (four positions and three different keys)

Interfaces:

- PROFIBUS DP
- For 6 control devices (6 inputs / 6 outputs)
(additional cable set required for control devices; see Section: "Accessories and spare parts".)
- For 16 direct control keys for OP 012 / OP 015A and TP 015A when connected via PROFIBUS DP (connection cable: 850 mm, included in scope of delivery)
- For 2 handwheels when connected via PROFIBUS DP (max. cable length: 5 m)

3.1 Description

Expansion slots:

- 6 slots for control devices (d = 16 mm)
- One slot for emergency stop button or rotary override switch (to d = 22 cm)

3.2 Operating and display elements

3.2.1 Front side

Overview

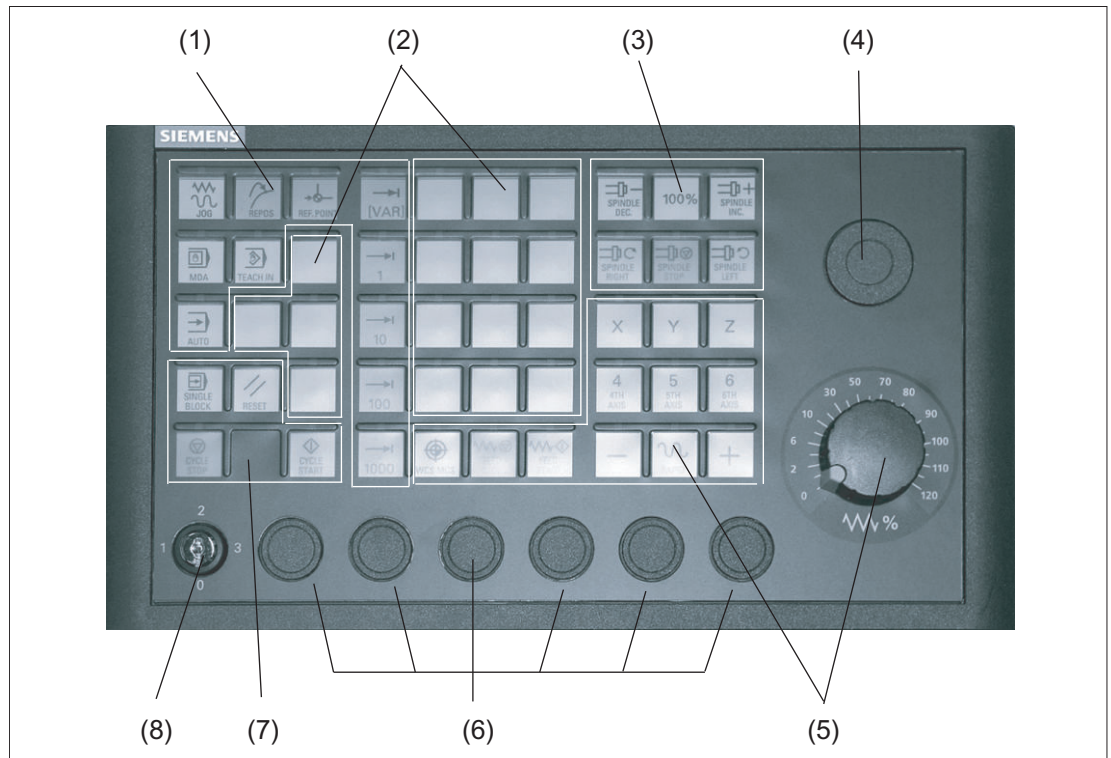

- (1) Operating modes and machine functions
 - (2) 16 customer keys
 - (3) Spindle control
 - (4) Slot for emergency stop button or spindle override switch
 - (5) Feed control with override switch
 - (6) Slots for control devices 16 mm *)
 - (7) Program control
 - (8) Key-operated switch
- *) see slots for control devices

Figure 3-1 Position of control elements on machine control panel MCP 310

Emergency stop button

If an EMERGENCY STOP button is added: See Section Front side (Page 122).

Slots for control devices

NOTICE
Damage to the front
The openings for mounting control devices must not be knocked out, but drilled to the required width.

Information for the installation, or to select control devices, please refer to the following Section: Front side (Page 31).

3.2.2 Rear side

COM board

The control and display elements on the rear of the MCP 310 are located on the COM board (shown with a gray background in the illustration).

The detailed cutout under or above the interface name shows the position of pin 1 on the connectors.

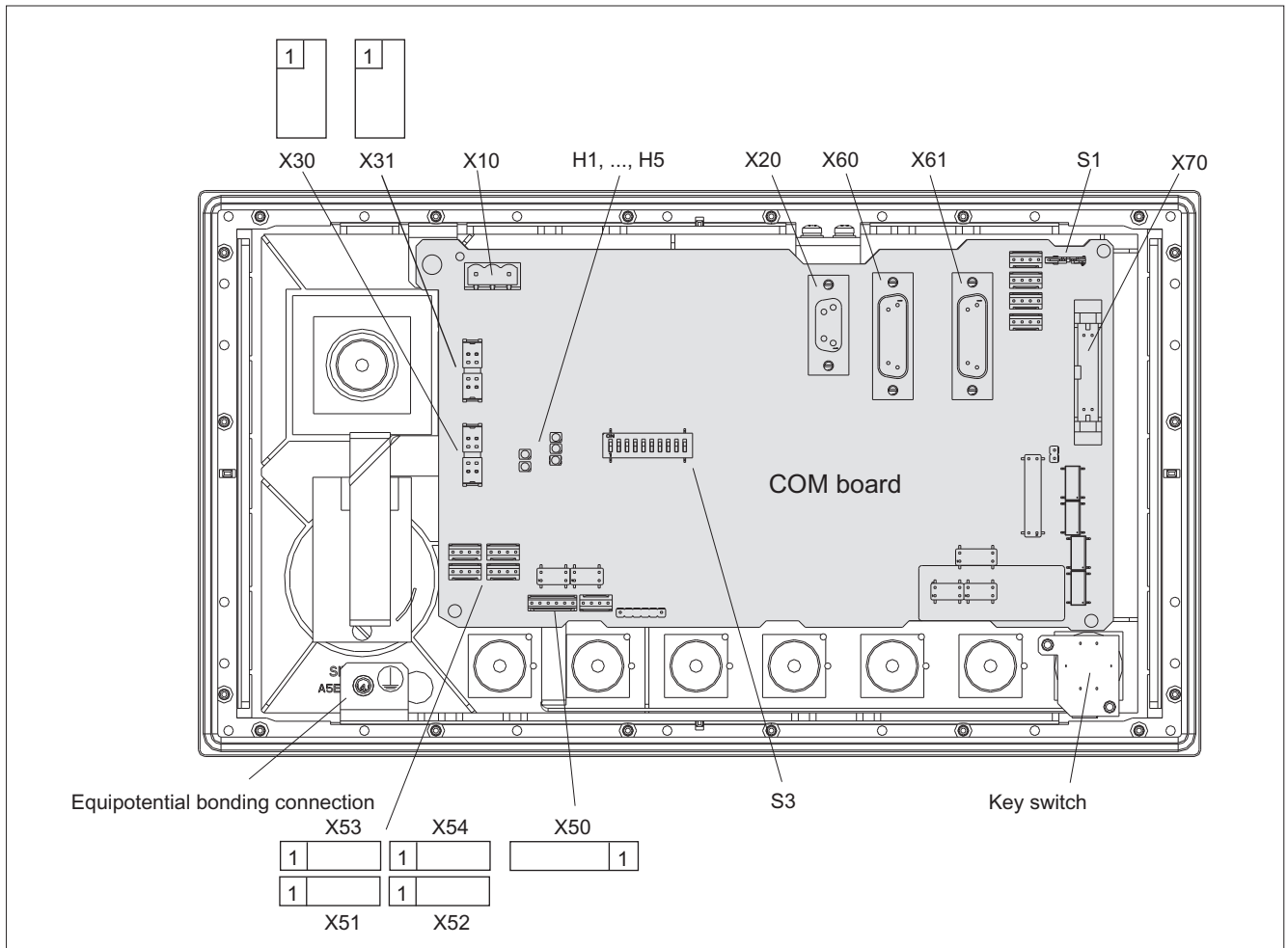

Figure 3-2 Rear of the MCP 310 showing the control and display elements and the interfaces

Description of rear control and display elements

see section: "Machine control panel MCP 483", section: "Control and display elements" --> "Rear side"

3.3 Interfaces

Location of the interfaces

MCP 310 communication is handled by the COM board where the interfaces are located (see section: "Control and display elements" --> "Rear side").

3.4 Mounting

Pin assignment

For more detailed information, see "General information and networking", Chapter: "Connecting".

3.4 Mounting

Dimension drawing

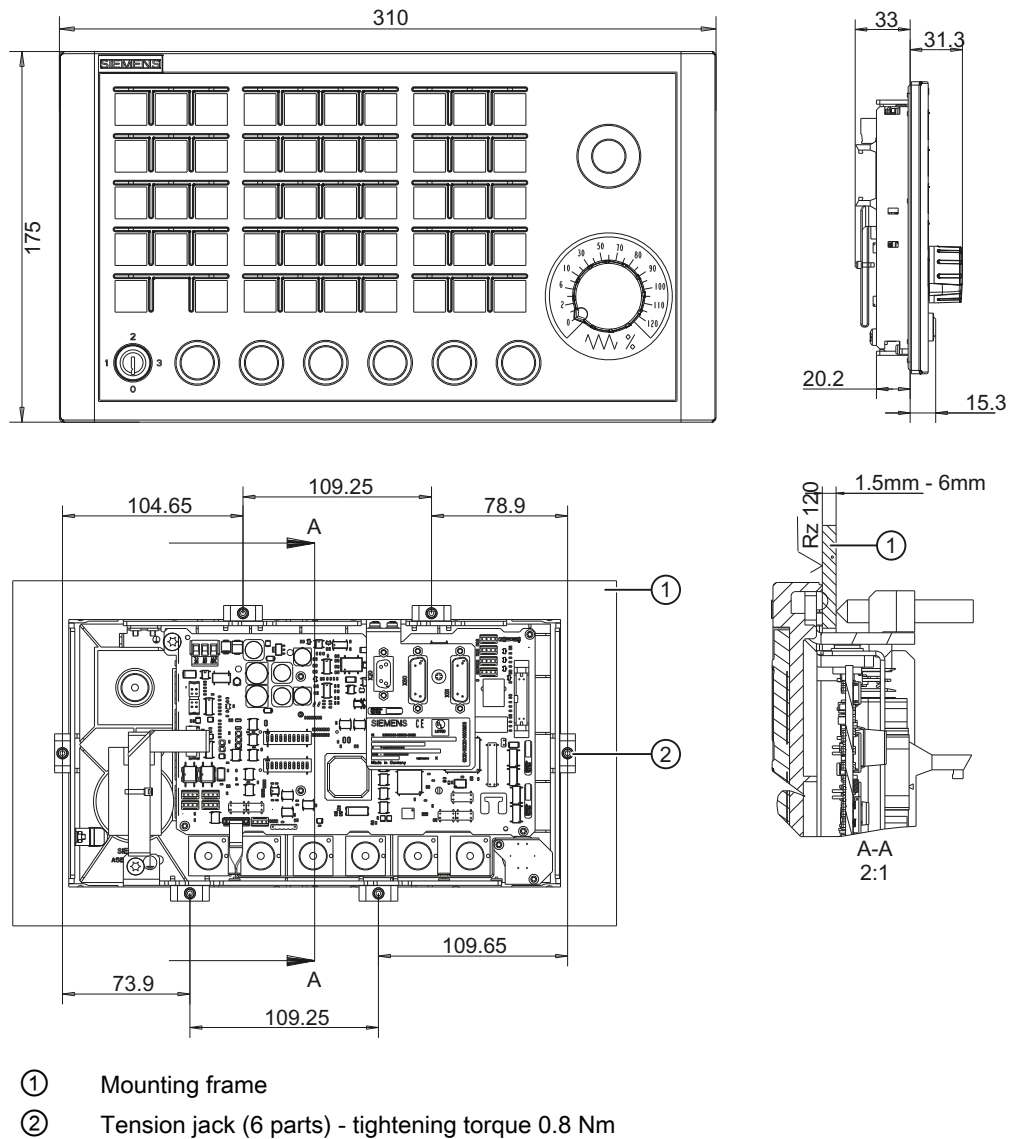

Figure 3-3 Dimension drawing for machine control panel MCP 310

Tension jacks

The machine control panel is attached by means of 6 tension jacks (0.8 Nm; see dimension drawing).

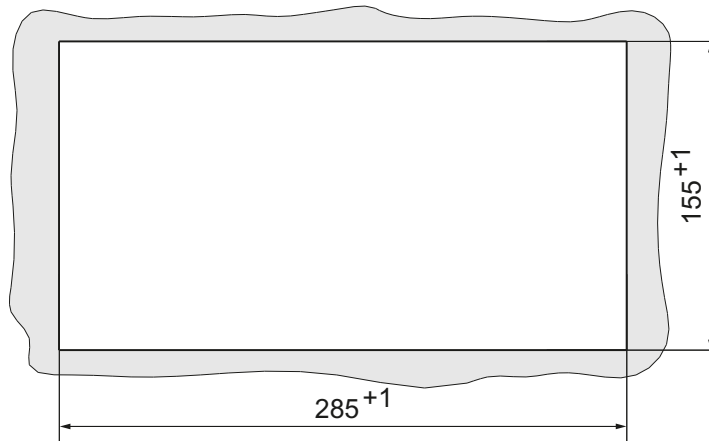

Figure 3-4 Panel cutout for machine control panel MCP 310

Mounting position

Max. 60° to the vertical. For mounting positions greater than 60°, a fan must also be installed to keep the ambient temperature of the machine control panel constantly below 55° C.

3.5 Settings via DIP switch S3

Delivery condition

Table 3-1 Delivery condition setting

1	2	3	4	5	6	7	8	9	10	Meaning/value
on	off	on	off	on	on	off	off	off	off	Series

Note

The delivery condition setting MUST be changed in accordance with the "Assignment of the DIP switch S3" table (below).

Connection type: PROFIBUS DP

For PROFIBUS DP, the PROFIBUS address is set using switches 1 to 10:

Table 3-2 Assignment of DIP switch S3

1	2	3	4	5	6	7	8	9	10	Meaning/value
										PROFIBUS
off	off	off	off	off	off	off	–	on	on	0
on	off	off	off	off	off	off	–	on	on	1
off	on	off	off	off	off	off	–	on	on	2
on	on	off	off	off	off	off	–	on	on	3
:	:	:	:	:	:	:	–	–	–	:(etc.)
on	off	on	on	on	on	on	–	on	on	125
off	on	on	on	on	on	on	–	on	on	126

3.6 Connection via PROFIBUS DP

3.6.1 Overview

This section describes:

- Requirements for adding a DP slave MCP to the hardware configuration for a SIMATIC S7 project.
- Configuring a DP slave MCP with STEP7 "HW config."
- Details of how to link the DP slave MCP to the basic PLC program and user program (optional).

Note

The instructions given in this chapter are essentially limited to the special requirements for configuring the DP slave MCP. For more details about working with SIMATIC STEP 7 please refer to the relevant SIMATIC documentation or online help.

Note

Both units can be linked up using the supplied 20-pin ribbon cable in order to transfer the direct key signals of the operator panel front to the COM board of the machine control panel. The direct key module therefore no longer needs to be connected.

3.6.2 Prerequisites

The following components are needed as prerequisites for adding a DP slave MCP to the hardware configuration:

- SIMATIC STEP 7 as of Version 5.4, Service Pack 4
- Toolbox 840D sl as of Version 2.6

Hardware configuration

The DP slave MCP is shown in SIMATIC STEP 7 in the hardware catalog of "HW Config" under the following path:

Profile: **Standard**

PROFIBUS DP > Other field devices > NC/RC > Motion Control > SINUMERIK MCP

If the module is not displayed, the GSD file must be installed. To do this, in "HW config" use menu command **Tools > Install new GSD file**.

Note

The GSD file of the DP slave MCP is located on the Toolbox CD in the directory:
...\\8x0d\\GSD\\MCP_310_483

3.6.3 Functions of the machine control panel

The machine control panel offers the following functions:

- Standard
The input/output data of the function keys and user-specific keys and outputs are transferred:
 - Input data: 8 bytes
 - Output data: 8 bytes
- Handwheel
The absolute values of the two handwheels that can be connected to the machine control panel are transferred.
- Additional I/Os
The data of the following non-default inputs/outputs is transferred:
 - Direct keys
 - Customer keys
 - Rotary switch

3.6.4 Configuring the DP slave MCP

This section describes how to configure a DP slave MCP with reference to the hardware configuration for a SIMATIC S7 project shown in the figure by way of example.

The hardware configuration has the following modules:

- SIMATIC Station 300 with SINUMERIK 840D sl
- SINUMERIK MCP with module: Standard + handwheel + additional I/O

Procedure

Configuring the DP slave MCP as an S7 project involves the following steps:

1. Add the DP slave MCP to the configuration ①.
2. Set the PROFIBUS address.
3. Add the appropriate module to the DP slave MCP depending on the required functions ②.
4. Set the I/O addresses of the individual slots.

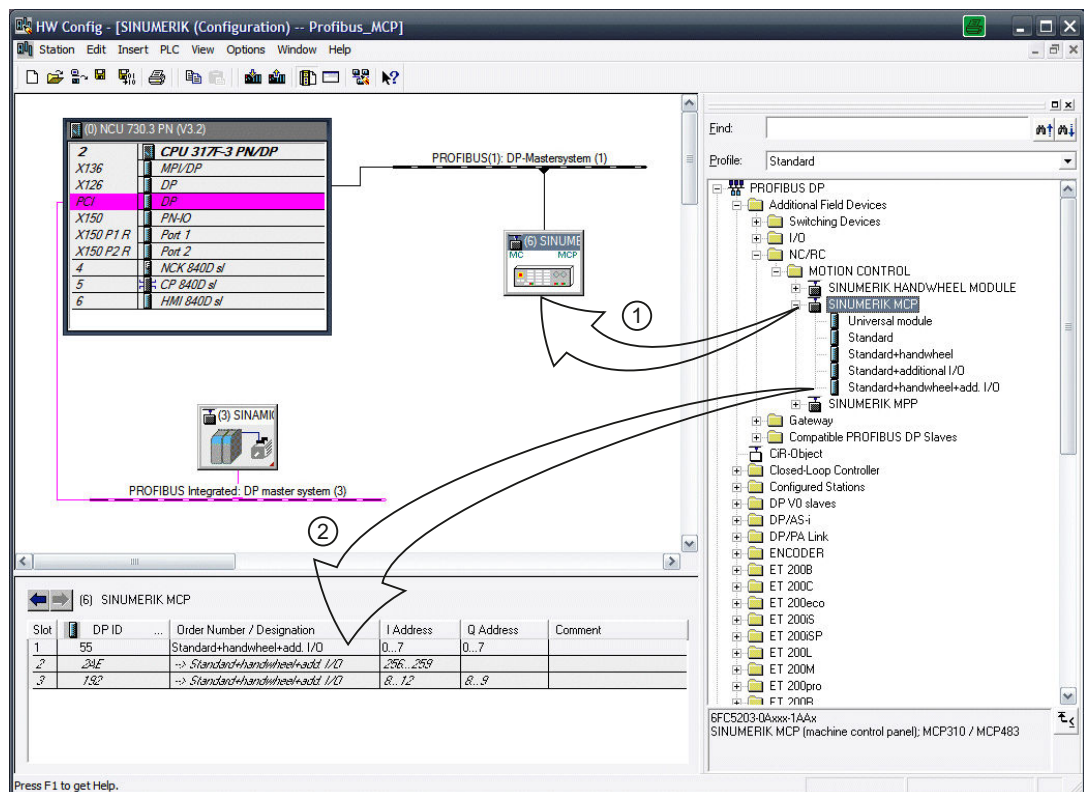

Figure 3-5 Configuration with DP slave MCP

Requirements: S7 project

The following status is required for the S7 project to which the DP slave MCP is to be added:

- The S7 project has been created.
- A SIMATIC 300 station with SINUMERIK controller has been defined.

Adding a DP slave MCP

To add a DP slave MCP to the configuration, open the hardware catalog using the menu command View > Catalog.

The DP slave MCP can be found at profile: **Standard PROFIBUS DP > Other field devices > NC/RC > Motion Control > SINUMERIK MCP**

Click with the left mouse button on the DP slave MCP (SINUMERIK MCP) in the hardware catalog and drag it onto the DP master system in the station window by holding down the left mouse button.

The DP master system is displayed in the station window with the following symbol:



When you release the left mouse button, the DP slave MCP is added to the configuration.

Note

As you drag the DP slave the cursor appears as a circle with a slash through it. When the cursor is positioned exactly over the DP master system, it changes to a plus sign, and the DP slave can be added to the configuration.

PROFIBUS parameters

As soon as you have inserted the MCP DP slave into the configuration, the "Properties - PROFIBUS interface SINUMERIK MCP" dialog box is displayed:

Dialog: Properties - PROFIBUS interface SINUMERIK MCP			
	Tab card: Parameters		
	Address: <PROFIBUS address>		
	Button: "Properties..."		
	Dialog: PROFIBUS properties		
	Tab card: Network settings		
	Data transfer rate: 12 Mbaud		
	Profile: DP		
	OK		
OK			

The following PROFIBUS parameters must either be set or verified:

- PROFIBUS address
- Data transfer rate
- Profile

Note

No automatic comparison of the PROFIBUS address!

The PROFIBUS address of the DP slave MCP set in the S7 project must match the PROFIBUS address set on the module (DIP switch S3) (see Section: "Settings via DIP switch S3")

The following data must agree:

1. SIMATIC S7 configuration DP slave MCP: **PROFIBUS address**
 2. Machine control panel DIP switch S3: **PROFIBUS address**
 3. FB1 call in OB100: **"MCP1BusAdr := "**
-

Adding a module

The active functions and hence the number of user data elements to be transferred are chosen by selecting the appropriate pre-configured module. The following modules are available in HW Config under "SINUMERIK MCP":

- *Universal module* (not applicable)
- Standard
- Standard + handwheel
- Standard + additional I/O
- Standard + handwheel + additional I/O

I/O addresses

If you add a module to slot 1 of the DP slave MCP, the I/O addresses are automatically assigned by STEP 7.

Double clicking with the left mouse button on a slot opens the "Properties - DP Slave" dialog box. This dialog box can be used to set the start addresses of the I/O data of the slot.

3.6.5 Linking the DP slave MCP

This chapter describes how to link the DP slave MCP

- in the basic PLC program for transferring the standard input/output data in the VDI interface
- to the PLC user program (optional) to implement a user-specific response to a module failure

Note

Processing of additional I/O data is the sole responsibility of the user (machine manufacturer) and is not supported by the PLC basic program.

PLC basic program

To transfer the standard I/O data of the MCP DP slave via the PLC basic program, the corresponding I/O range must be entered in the communication parameters of the FB1 function block.

Function block FB1

The communications parameters of the MCP are called MCPx... (x = 1 or 2) in function block FB1. A maximum of 2 machine control panels are supported by the basic PLC program.

To synchronize several MCPs, the PLC program must be adapted accordingly. This is the user's (machine manufacturer's) responsibility.

To operate an MCP 310 machine control panel as DP slave, only the parameters listed in the following table are relevant for the FB1 call in the OB100:

Parameters	Type	Description	Value
MCPNum:	INT	Number of active MCPs	:=1
MCP1In:	POINTER	Start address of the input signals	:= P#E 0.0
MCP1Out:	POINTER	Start address of the output signals	:= P#A 0.0
MCP1StatSend	POINTER	Status data word for sending	:= P#A 8.0
MCP1StatRec	POINTER	Status data word for receiving	:= P#A 12.0
MCP1BusAdr	INT	≙ S3 switch position on the MCP	:=6
MCP1Timeout	S5time	Cyclic sign-of-life monitoring of the MCP	:= S5T#700MS
MCP1Cycl	S5time	Time reference for the cyclic updating of the signals to the MCP	:= S5T#200MS
MCPBusType	BYTE	33 ≙ PROFIBUS (55 ≙ Ethernet)	:= B#16#33

VDI interface parameter assignment

The following function blocks are available for assigning the VDI interface parameters:

- FC 24: Transfer the signals for narrow MCP, M (milling) version
- FC 25: Transfer the MCP signals, T (turning) version

Note

The FC 19, FC 24 and FC 25 function blocks are part of the basic PLC program. It is the user's (machine manufacturer's) responsibility to call the block correctly and/or assign the interface the appropriate parameters.

References

A detailed description of the function blocks for transferring the machine control panel signals is available in:

Function Manual, Basic Functions: P3, Basic PLC Program

PLC user program

If an MCP is connected via PROFIBUS DP, the basic PLC program does not check for module failure.

In this case the MCP is monitored by a standard mechanism to monitor the active DP slave:

3.6 Connection via PROFIBUS DP

- PLC operating system
- PROFIBUS controller

If a failure of a DP slave MCP is detected, the PLC defaults to STOP.

Customized response

The following organization blocks can be added to the PLC user program to customize the response to a DP slave MCP failure:

- OB 82: Diagnostics interrupt
- OB 86: Rack failure

Please refer to the corresponding SIMATIC literature for details of linking organization blocks and evaluating diagnostic data.

Note

In the event of a failure of a connected machine control panel, the PLC basic program performs the following:

- Alarm "40026x machine control panel (x+1) failure"; with x = 0, 1 is initiated.
- The corresponding interface signal "MCP 1/2 ready" in the DB10.DBB104 is reset.

3.6.6 Input / output images

The specifications for assigning input and output bytes listed in the tables can be changed in the PLC via parameter assignment.

Note

The following applies in respect of the process input and output images in the tables: n is defined by means of FB1 parameters in OB100 of the PLC.

Table 3-3 MCP 310 input image

Byte	Bit7	Bit6	Bit5	Bit4	Bit3	Bit2	Bit1	Bit0
EB n + 0	* NC stop	Spindle	Spindle 100%	Spindle +	Single block	JOG	MDA	AUTO
EB n + 1	NC start	Spindle right	* Spindle stop	Spindle left	Key-operated switch position 3	REF	REPOS	Teach IN
EB n + 2	Feed start	* Feed stop	INC VAR	Key-operated switch position 0	INC 1000	INC 100	INC 10	INC 1
EB n + 3	RESET	Key-operated switch		Feed override				
		Position 2	Position 1	E (2 ⁴)	D (2 ³)	C (2 ²)	B (2 ¹)	A (2 ⁰)

Byte	Bit7	Bit6	Bit5	Bit4	Bit3	Bit2	Bit1	Bit0
EB n + 4	Arrow keys			-	-	-	-	-
	+	-	Rapid traverse					
EB n + 5	T16	-	Axis selection					
			6	5	4	Z	Y	X
EB n + 6	Unassigned customer keys					Unassigned customer keys		
	T9	T10	T11	T12	Work Machine	T13	T14	T15
EB n + 7	Unassigned customer keys							
	T1	T2	T3	T4	T5	T6	T7	T8
EB n + 8	DT 07	DT 06	DT 05	DT 04	DT 03	DT 02	DT 01	DT 00
EB n + 9	DT 15	DT 14	DT 13	DT 12	DT 11	DT 10	DT 09	DT 08
EB n + 10	-	-	KT-IN6 X52.3	KT-IN5 X52.2	KT-IN4 X52.1	KT-IN3 X51.3	KT-IN2 X51.2	KT-IN1 X51.1
EB n + 11	-	-	-	-	-	-	-	-
EB n + 12	-	-	-	-	-	-	-	-
EB n + 13	-	-	-	X31 pin 6 ¹⁾	X31 pin 7 ¹⁾	X31 pin 8 ¹⁾	X31 pin 9 ¹⁾	X31 pin 10 ¹⁾
Signals marked with * are inverse signals.								
1)	If the 4-stage rotary spindle override switch on X31 is replaced by a 5-stage rotary switch, the input information here can be measured in five stages.							

Table 3-4 MCP 310 output image

Byte	Bit7	Bit6	Bit5	Bit4	Bit3	Bit2	Bit1	Bit0
AB n + 0	* NC stop	Spindle	Spindle 100%	Spindle +	Single block	JOG	MDA	AUTO
AB n + 1	NC start	Spindle right	* Spindle stop	Spindle left	RESET	REF.	REPOS	Teach IN
AB n + 2	Feed start	* Feed stop	INC VAR	-	INC 1000	INC 100	INC 10	INC 1
AB n + 3	-	-	-	-	-	-	-	-
AB n + 4	+	-	Rapid traverse	KT-OUT5 X54.2	KT-OUT4 X54.1	KT-OUT3 X53.3	KT-OUT2 X53.2	KT-OUT1 X53.1
AB n + 5	T16	KT-OUT6 X54.3	6	5	4	Z	Y	X
AB n + 6	Unassigned customer keys							
	T9	T10	T11	T12	Work Machine	T13	T14	T15
AB n + 7	Unassigned customer keys							
	T1	T2	T3	T4	T5	T6	T7	T8
Signals marked with * are inverse signals								

Default key assignment

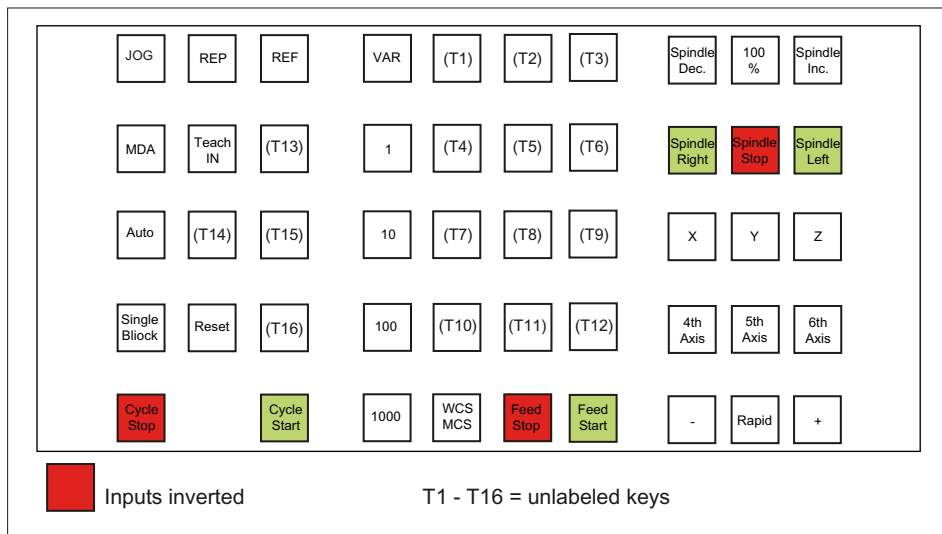

Figure 3-6 MCP 310 default key assignment

Assignment of the inputs (I) and outputs (O) to the keys and LEDs



Figure 3-7 Inputs and outputs of the MCP 310 keyboard

3.7 Maintenance and Service

Cleaning the device

Use a soft cloth moistened either with water or a mild cleaning agent to clean the housing and operator control elements of the machine control panel.

Checking the device

In order to prevent foreign bodies or liquids entering the machine control panel, regularly check the device

- that all the housing screws are in place and tight
- for damage to the housing
- for damage to the cable cover or cable entry

Protect the device from environmental effects

Protect the machine control panel against

- direct solar radiation and heat sources
- mechanical vibration and shock
- dust
- moisture, and
- strong magnetic fields

Check of the emergency stop button (if the emergency stop button has been retrofitted)

Check the emergency stop button regularly to ensure that it functions correctly.

3.8 Technical data

Machine control panel MCP 310

Safety				
Safety class	III; PELV according to EN 50178			
Degree of protection according to EN 60529	Front side: IP65	Key-operated switch: IP54	Rear side: IP00	
Approvals	CE			
Electrical data				
Input voltage	24 VDC			
Power consumption, max.	Board: 7 W	Lamps: 14.4 W (6 x 2.4 W) *)	Handwheels: 2 x 0.9 W	Total: 23.2 W
Mechanical data				
Dimensions	Width: 310 mm Height: 175 mm		Depth: 65 mm Mounting depth: 33 mm	
Distance from NCU/PCU	PROFIBUS DP: 100 m			
Weight	Approx. 1.2 kg			
*) The outputs for the illuminated pushbuttons (X53/X54) can have a max. permissible current of 0.3 A. However, the total current consumption of the components must not exceed 1.0 A (24 W).				

Note

Information about the climatic and mechanical environmental conditions is contained in the associated section under:

"General notes and interconnection" → "Operational planning".

Emergency Stop button

Rated voltage	24 VDC
Current magnitude, max.	3 A
Current magnitude, min.	1 mA
Switching capacity	DC 13 according to EN 60947-5-1
Conditional rated short-circuit current	10 A gL/gG according to EN 60947-5-1
B _{10d}	500 000

Note

The quantitative assessment of the emergency stop safety function must be based on the B_{10d} values corresponding to the used standards (e.g. ISO 13849-1) under consideration of the respective application (frequency of the actuation, service life, diagnostics by the evaluation unit, etc.). The B_{10d} values only apply when the technical properties of the emergency stop button are taken into account.

3.9 Accessories and spare parts

3.9.1 Overview

Table 3-5 Accessories and spare parts for machine control panel 310

Name	Description	Quantity	Order number
Key-operated switch	Key-operated switch with key	1	6FC5247-0AF02-0AA0
Sets of keys	10 key sets, each with three keys for the key-operated switch settings 1, 2, 3	1 set	6FC5148-0AA03-0AA0
Set of tension jacks	Tension jack set (9 items) for supplementary components with 2.5 mm profile, length 20 mm	1 set	6FC5248-0AF14-0AA0

Name	Description	Quantity	Order number
Override for rotary spindle switch	Override spindle / rapid traverse, electronic rotary switch 1x16G, T=24, cap, button, pointer, spindle dials and rapid traverse	1	6FC5247-0AF12-1AA0
Rotary feed override switch	Feed / rapid traverse override, electronic rotary switch 1x23G, T=32, cap, button, pointer, feed and rapid-traverse dials	1	6FC5247-0AF13-1AA0
Emergency stop button	22 mm actuating element, emergency stop button, red, mushroom head and support	1	3SB3000-1HA20 *)
	Contact block with 2 contacts, 1 NO + 1 NC, 2-pole ,screw terminal	1	3SB3400-0A *)
Slide-in labels	Slide-in label, (3 films, DIN A4)	1 set	6FC5248-0AF23-1AA0
Cable set for additional control devices	Cable set for additional control devices Length: 500 mm	1 set	6FC5247-0AA35-0AA0

*) Safety-related

3.9.2 Labeling the slide-in labels

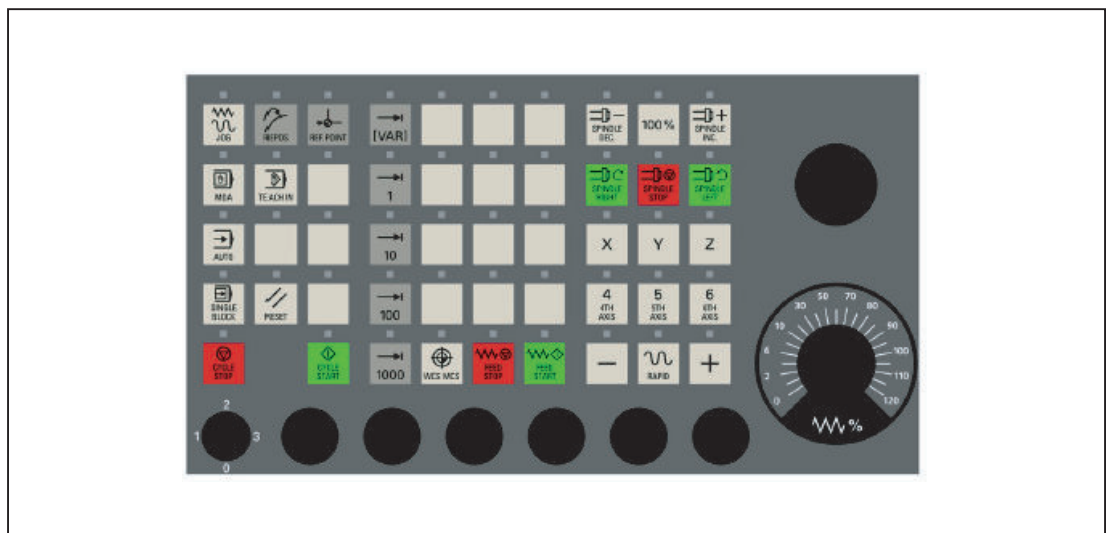
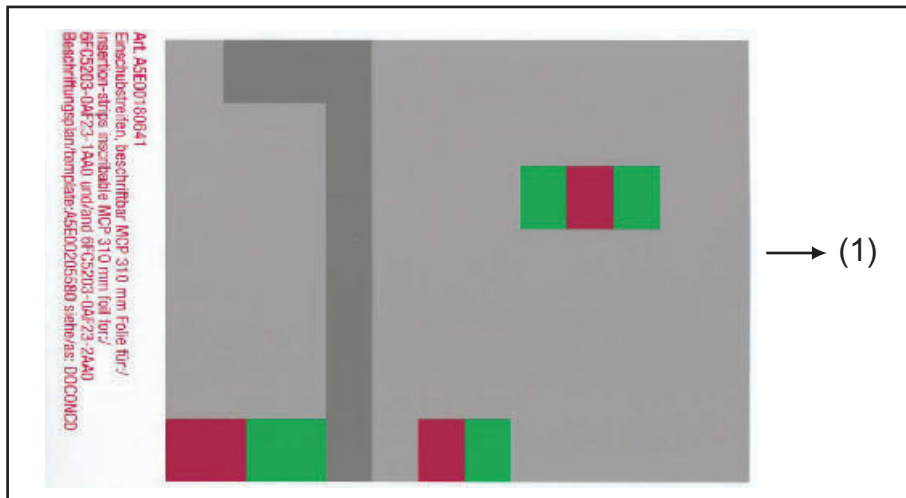

Figure 3-8 Machine control panel MCP 310

The figure shows the Machine Control Panel (MCP) in its standard version.

You can create your own slide-in labels to label the keys differently. A printable blank film (A4) is supplied with the panel for this purpose.

A spare parts kit containing three blank films is also available:
MLFB: 6FC5248-0AF23-1AA0 (Item No. A5E00179115)



(1) Print direction

Figure 3-9 Blank film for MCP 310

Files for printing the blank film

The DOConCD / Catalog NC 61 (CD enclosed) contains three files for printing the blank films:

- **Template_M_MCP310.doc** [defaults for milling - standard shipped file; **(A)**]
- **Template_MCP310.doc** (blank template for film: Item No. A5E00205580; **(B)**]
- **Symbols.doc** Key symbols as Word file, inscription on labels as jpg file **(C)**

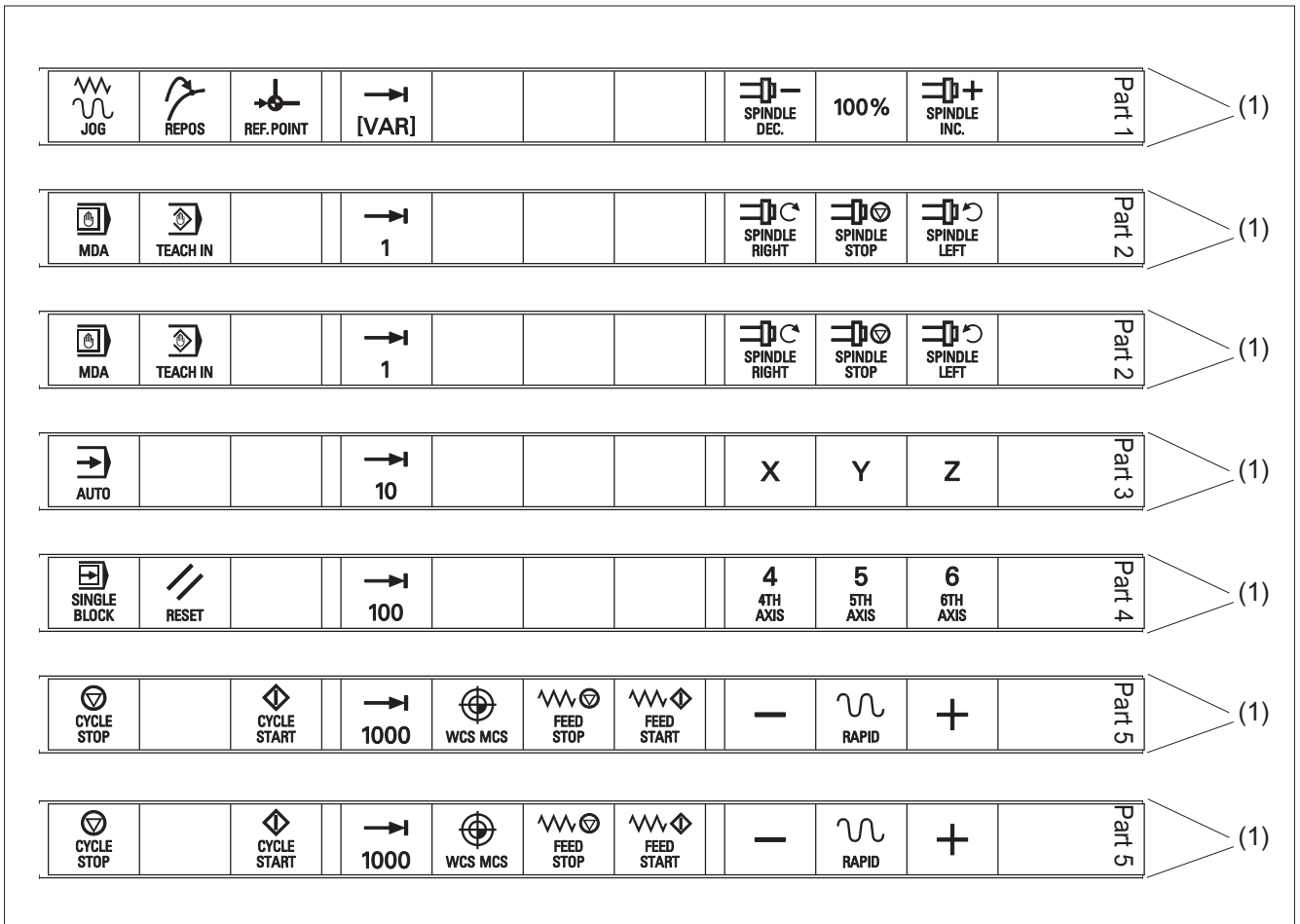

(1) Outer edges

Figure 3-10 Template_M_MCP310.doc for the "Milling" version (A)

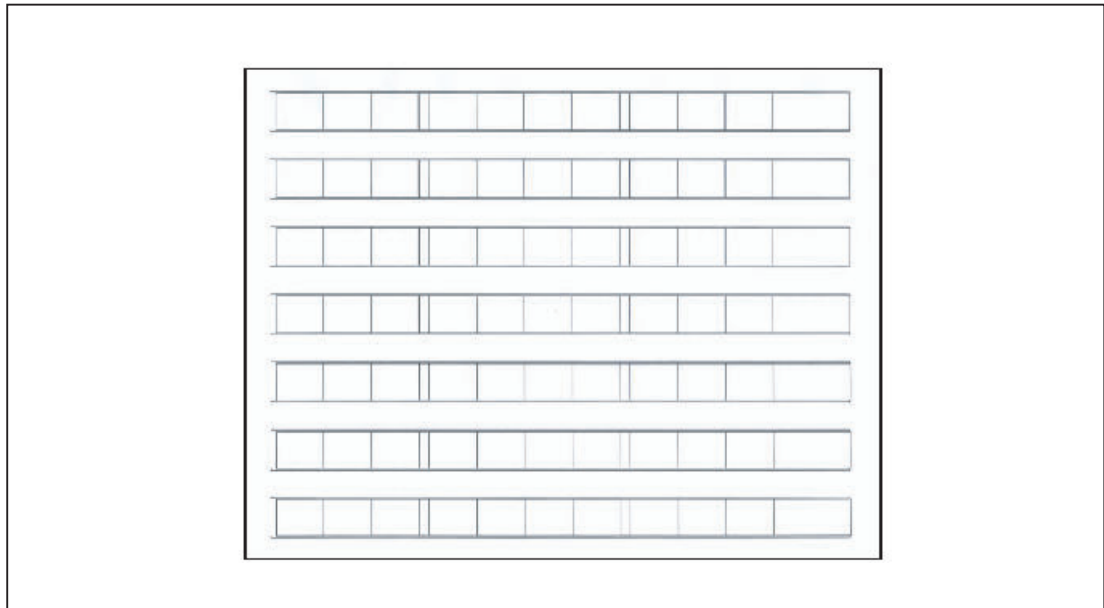





























Figure 3-11 Template_MCP310.doc (acc. to labeling plan /template: Item No. A5E00205580 (B))

Table 3-6 Symbols.doc file (C)

	7001		7013		7025		7124
	7002		7014		7026	+C	7125
	7003		7015		7027	+X	7126
	7004		7016	Z	7028	-Y	7127
	7005		7017	4 4TH AXIS	7029	+Z	7128
100%	7006		7018	5 5TH AXIS	7030	-X	7129
	7007		7019	6 6TH AXIS	7031	+Y	7130
	7008		7020	-	7032	-Z	7131
	7009		7021	+	7033	-C	7132
	7010	Y	7022	7 7TH AXIS	7120		

X	7011		7023		7121		
	7012		7024		7123		

Creating slide-in labels with the aid of the file: "Template_M_MCP310.doc" (A)

Open the file **Template_M_MCP310.doc** in the word-processing program MS Word.

To obtain an optimum printing result, remove all separating lines in each slide-in label (2) above, below and between the symbols.

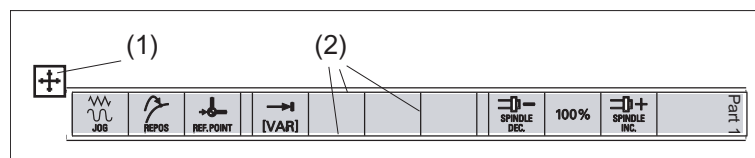

Do **not** highlight the slide-in labels using the table symbol (1), but rather:

1. Place the cursor directly before the first symbol on the first slide-in label.
2. Highlight the entire row of the slide-in label by
 - pressing and holding the left mouse key and dragging it to the end of the row or
 - pressing the F8 key and the cursor key "→" until the entire row is selected.
3. Click on the highlighting with the right mouse key.
4. In the menu that appears, select the entry: "Table properties".
5. On the "Table" tab, select the entry: "Borders and shading...".
6. Select the tab "Borders" and click on "Setting:" in the symbol with the designation: "None".
7. Confirm the selection with "OK" → "OK" and remove the highlighting.
This removes all separating lines (with the exception of the outer edges) from this row.

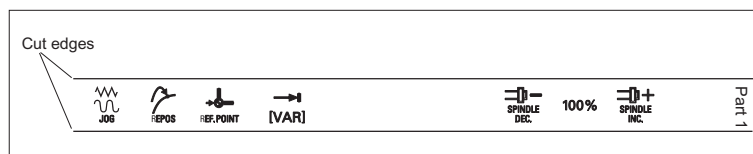

8. Remove the separating lines of the other slide-in labels in the same way.
9. Place the blank film in the printing direction in the slot of your laser printer (see figure: "Blank film for MCP 310").
10. Select "film" as the printable medium if your printer allows this setting.

11. Start the printing process using MS Word.

Note

For labeling the slide-in labels, HP Color Laser Jet film C2936A is used.
Make a test print on paper before you print on the film.
Allow the film to cool after printing so that the ink can dry.

12. Cut the slide-in labels out of the film along the edges.
13. Round off the corners of the slide-in labels approx. 1.5 mm to facilitate insertion.

Preparing the slide-in labels with the aid of "Template_MCP310.doc" (B)

Inserting symbols with the "Symbols.doc" file (C)

1. Open both the "Template_MCP310.doc" file and the "Symbols.doc" file in MS Word.
2. Copy the desired key symbol from the "Symbols.doc" file (C).
3. Position the cursor in the desired field of the template (B) and add the symbol.
4. If all the desired symbols have been added, remove the separating lines and start the printing process in accordance with the instructions in Section: Preparing the slide-in labels with the aid of "Template_M_MCP310.doc".

Inserting characters/text

1. Open the "Template_MCP310.doc" file in MS Word.
2. Set the "Arial" font to format characters.
(This font is comparable to the "Univers S57" font, used by Siemens for the key labeling.)
3. Position the cursor in the desired table cell and enter characters/text.

Creating your own symbols

- Printing in a vector program (e.g. Designer, Freehand, CorelDraw):
 - Draw a 15 x 15 mm square, fill with the color white and give it an invisible border line.
 - Place the symbol in the center of this square.
 - Copy the entire image (square and symbol) and paste it into the Word document (Template_MCP310.doc).
- Drawing in an image editing program (e.g. Photoshop, Picture Publisher, Paint):
 - Create a square area (e.g. 100 x 100 pixels) filled with the color white.
 - Draw the symbol in the center of this square.
 - Copy the entire image (square and symbol) and paste it into the Word document (Template_MCP310.doc).

Dimension drawings

The figure shows a dimension drawing for the blank template of the MCP 310:

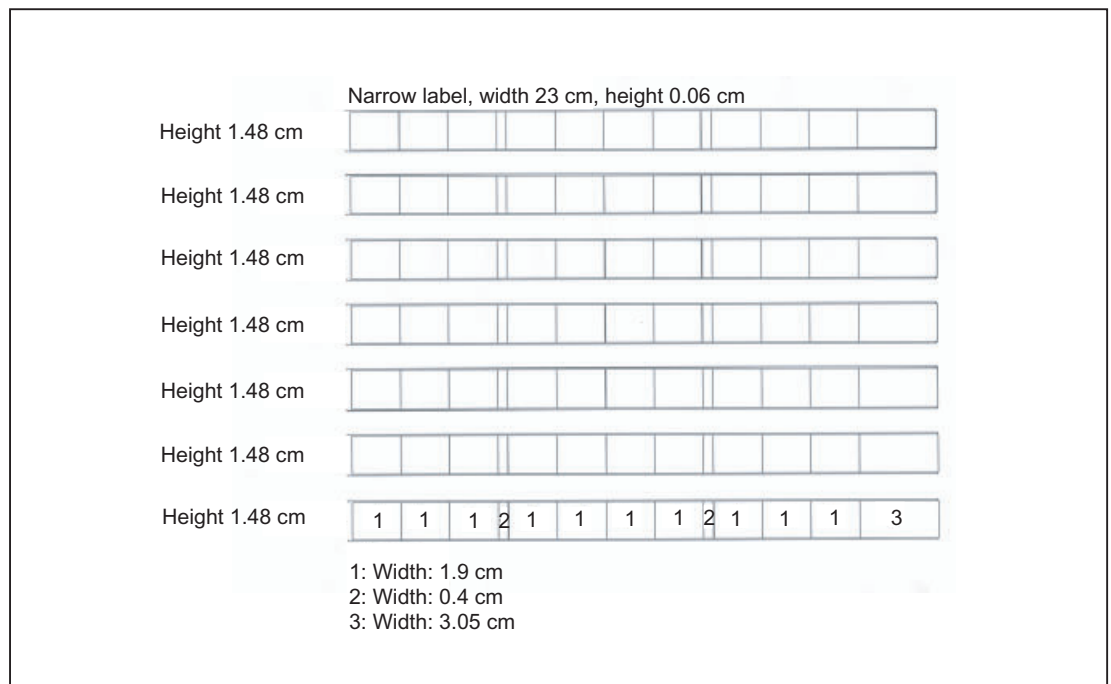
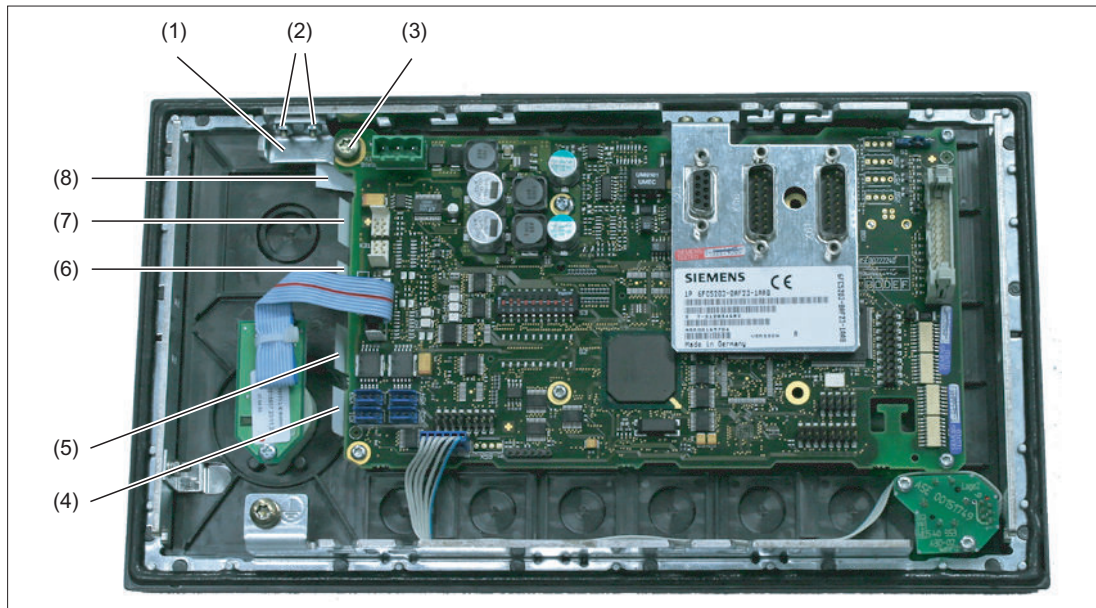

Figure 3-12 Dimension drawing for slide-in labels for MCP 310

3.9.3 Inserting the slide-in label "Part1"

The slide-in label "Part1" (8) is located under the grounding bracket (1).

Therefore, first remove the grounding bracket before you pull out or insert the slide-in label "Part 1".



- (1) Grounding bracket
- (2) Fastening screws (M3) for the grounding bracket (housing)
- (3) Fastening screw (M5) for the grounding bracket (COM board)
- (4) Slide-in labels "Part5"
- (5) Slide-in labels "Part4"
- (6) Slide-in labels "Part3"
- (7) Slide-in labels "Part2"
- (8) Slide-in labels "Part1"

Figure 3-13 MCP 310 - Rear side with slide-in labels

Removing the grounding bracket

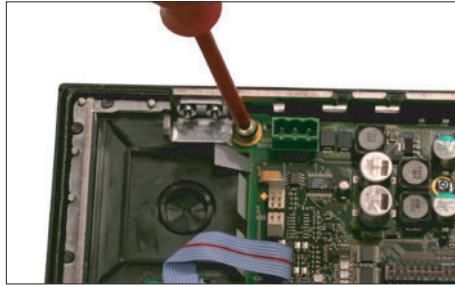

1. Remove the fastening screw (M5) using a TX 25 screwdriver.

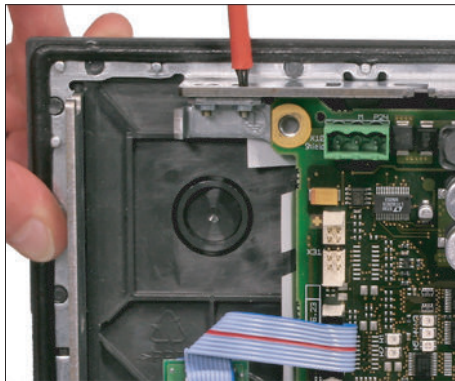

2. Remove the two fastening screws (M3) using a TX 10 screwdriver.

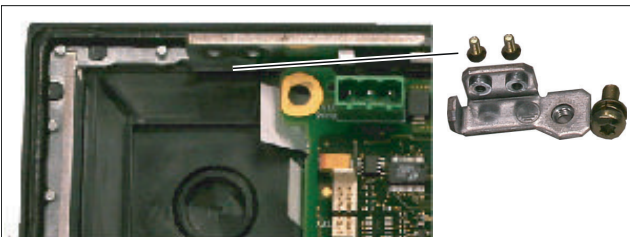

3. Take off the grounding bracket.



4. Pull out the slide-in label.

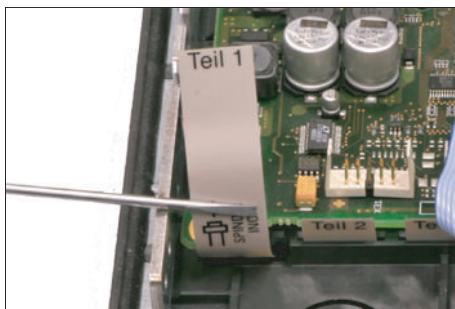

Installing the grounding bracket

Secure the grounding bracket after you have inserted the slide-in label by tightening the three fastening screws.

Note

Observe the proper torque values when tightening the screws:

- M3: 0.8 to 1.3 Nm
 - M5: 3.0 to 6.0 Nm
-

Machine control panel: MCP 483C PN

4.1 Description

Machine control panel MCP 483C PN (PN = PROFINET) enables user-friendly operation of the machine functions. It is suitable for machine-level operation of milling, turning, grinding and special machines.

Note

The IE functionality (IE = Industrial Ethernet) is still included and preset. Please note the switch position of S2.

All keys are designed with replaceable covers for machine-specific adaptations. The key covers can be freely inscribed using a laser. Clear key covers can be used as an alternative.

The machine control panel is secured from the rear with special clamps supplied with the panel.

Validity

The description applies to the following machine control panels:

Type	Key type	Order number
MCP 483C PN (IE and PN)	Mechanical short-stroke keys	6FC5303-0AF22-0AA1
MCP 483C IE (IE only)	Mechanical short-stroke keys	6FC5303-0AF22-0AA0 ¹⁾

¹⁾ No longer available

The safety-related accessories / spare parts are marked in the "Accessories and spare parts" section with a *).

Features

Control elements:

- Mechanical short-stroke keys
- Operating mode and function keys:
 - 50 keys with assigned LEDs, 17 freely assignable customer keys in the standard assignment
 - Arrow keys for milling machines with rapid traverse override (The key covers for the arrow keys for turning machines are supplied, see Section Front side (Page 85))
- Spindle control with override spindle (rotary switch with 16 positions)
- Feed control with override feed / rapid traverse (rotary switch with 23 positions)

4.1 Description

- Key-operated switch (four positions and three different keys)
- Emergency stop button, two contact blocks (1 NO + 1 NC)

Interfaces:

- Ethernet (transfer rate: 10/100 Mbit/s; for IE and PN)
- Nine customer-specific inputs (e.g. for illuminated pushbuttons)
- Six customer-specific outputs
- Connection for two handwheels (Sub-D)
(Velocity input and contour handwheel are only possible if connecting through the handwheel connection module 6FC5303-0AA02-0AA0.)

Expansion slots:

Two slots for control devices (d = 16 mm)
(additional cable set required for control devices, see Section: "Accessories and spare parts".)

Functions:

Table 4-1 Functions depending on the operating mode

Function	PN operating mode	IE operating mode	Requirement
Keys, LEDs, rotary switches	available soon	✓	
Handwheel	-	✓ as of NCU software 2.5	Toolbox 2.6
		✓ as of NCU software 2.6 Handwheel with optimized response. This enables a "delete distance-to-go function" to be triggered in the PLC user program via a "handwheel stationary" signal.	
Activate/Deactivate (T:N:M)	-	✓	

4.2 Operating and display elements

4.2.1 Front side

Overview

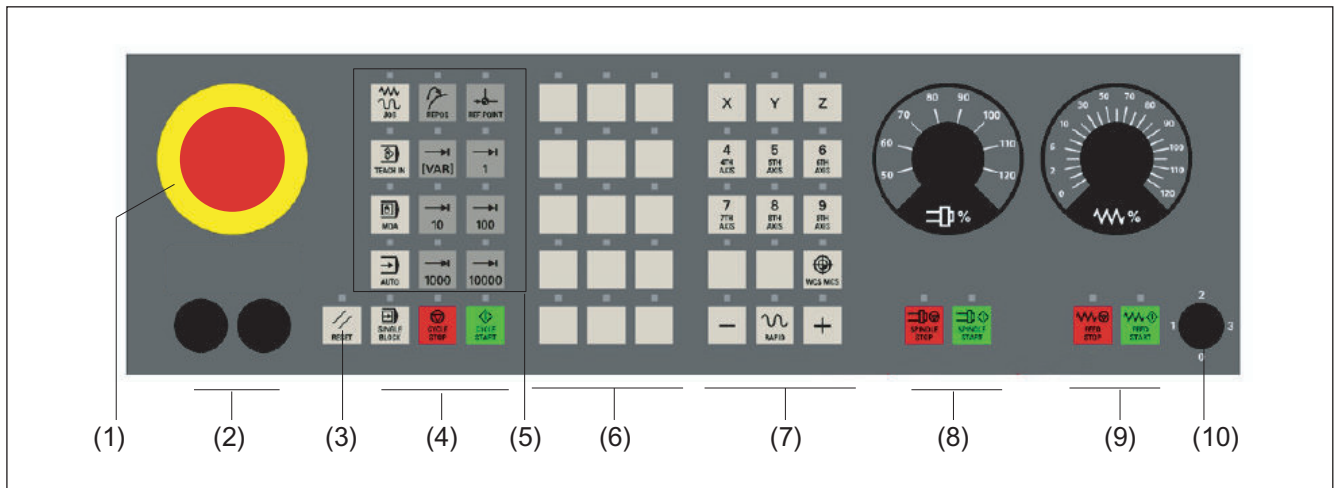

- (1) Emergency stop button
- (2) Slots for control devices (d = 16 mm)
- (3) Reset button
- (4) Program control
- (5) Operating modes, machine functions
- (6) User keys T1 to T15
- (7) Direction keys with rapid traverse override (R1 to R15)
- (8) Spindle control with override switch
- (9) Feed control with override switch
- (10) Key-operated switch (four positions)

Figure 4-1 Position of control elements on MCP 483C PN

Emergency stop button

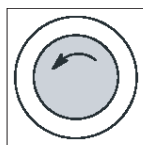

Emergency stop button

Press the red emergency stop button in emergencies if

- people are at risk,
- there is the danger of machines or the workpiece being damaged.

4.2 Operating and display elements

As a rule, when operating the emergency stop button, all drives are brought to a standstill with max. braking torque.

Turn the EMERGENCY STOP button counterclockwise to unlatch it.

Machine manufacturer

For other reactions to the emergency stop:

Refer to the machine tool manufacturer's instructions



 WARNING
Danger of death resulting from the premature emergency stop unlocking
If you have shut down the system to be monitored, you can only release the emergency stop button or put the system to be monitored back into operation if the condition that triggered the emergency stop function has been corrected and a safe restart is carried out.

Emergency stop circuit

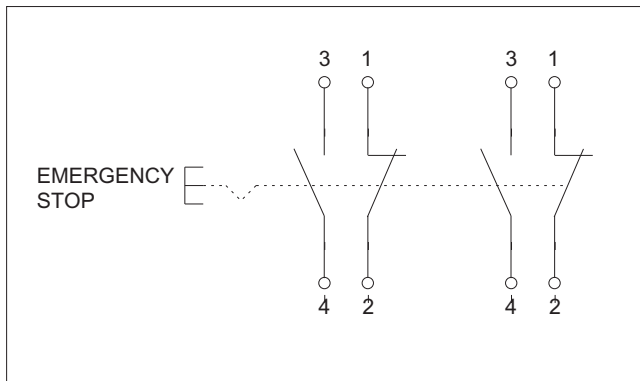

Figure 4-2 Emergency stop circuit









Slots for control devices

NOTICE
Damage to the front
The openings for mounting control devices (2) in Fig. "Position of control elements of MCP 483C PN" must not be knocked out, but drilled to the required width.

Key covers

All keys of the MCP 483C PN come with changeable key covers.

Refer to the following table for the additional replacement key covers provided for turning machines in the accessories pack.

Key cover	Symbol number	Key cover	Symbol number
	7027		7129
	7125		7130
	7126		7131
	7127		7132
	7128		

You will find the order numbers for the key covers in Section: "Accessories and spare parts".

4.2 Operating and display elements

4.2.2 Rear side

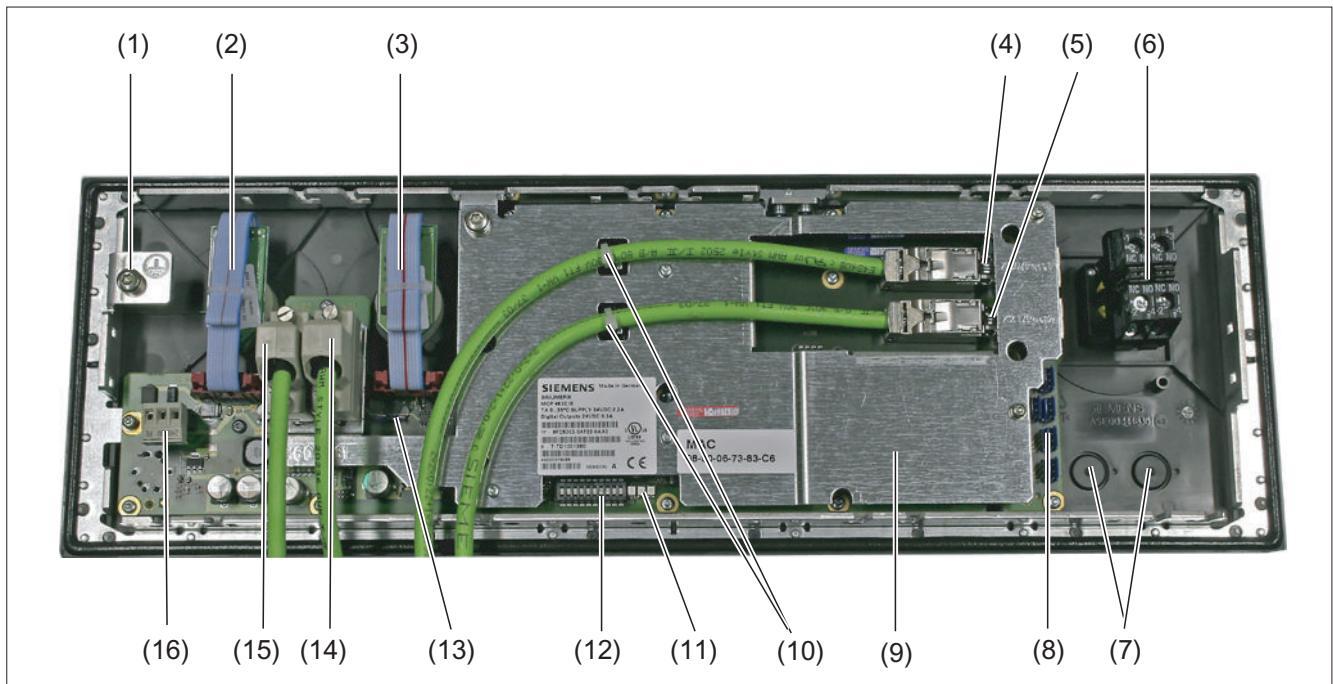

- (1) Ground terminal
- (2) Feed override X30
- (3) Spindle override X31
- (4) Ethernet connection (mechan. secured - Port1) X20
- (5) Ethernet connection (mechan. secured - Port2) X21
- (6) EMERGENCY STOP
- (7) Installation locations for additional control devices (d = 16 mm)
- (8) Customer-specific inputs and outputs
- (9) Cover plate
- (10) Ethernet cable strain relief
- (11) LEDs (see detailed figure)
- (12) Switch S2
- (13) Switch S1
- (14) Handwheel connection X61
- (15) Handwheel connection X60
- (16) Power supply interface X10

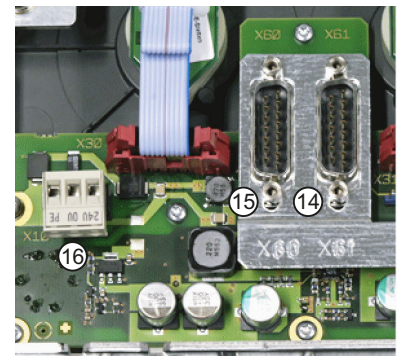

Details excerpt

Figure 4-3 Rear of MCP 483C PN with connecting cable (handwheel/Ethernet)

LEDs

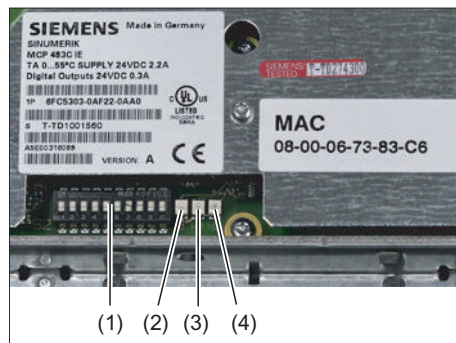

(1)	Switch S2	
(2)		H1 - POWER OK (green)
(3)	LEDs	H2 - BUSSYNC
(4)		H3 - BUSFAULT

Figure 4-4 MCP 483C PN - LEDs

4.3 Interfaces

4.3.1 Overview

Overview

X10	Power supply interface
X20	Ethernet port 1
X21	Ethernet port 2
X30	Interface for rotary switch feed override
X31	Interface for rotary switch spindle override
X51 / X52 / X55	Interfaces for customer-specific inputs
X53 / X54	Interfaces for customer-specific outputs
X60 / X61	Connections for 2 handwheels (TTL / differential - can be set with switch S1)

4.3.2 Description

Pin assignment

For more detailed information, see "General information and networking", Chapter: "Connecting".

4.3 Interfaces

Switch S1/S2

Settings, see Chapter "Machine control panel: MCP 310C PN", Section "Interfaces".

4.3.3 Input / output images

Standard + two handwheels

The specifications for assigning input and output bytes listed in the tables can be changed in the PLC via parameter assignment.

Note

The following applies in respect of the process input and output images in the tables: n is defined by means of FB1 parameters in OB100 of the PLC.

Table 4-2 Process input image for MCP 483C PN

Byte	Bit7	Bit6	Bit5	Bit4	Bit3	Bit2	Bit1	Bit0
EB n + 0	Spindle override				Mode			
	D (2 ³)	C (2 ²)	B (2 ¹)	A (2 ⁰)	JOG	TEACH IN	MDA	AUTO
EB n + 1	Machine function							
	REPOS	REF.	var. INC	10000 INC	1000 INC	100 INC	10 INC	1 INC
EB n + 2	Key-operated switch		Spindle start	* Spindle stop	Feed start	* Feed stop	NC start	* NC stop
	Position 0	Position 2						
EB n + 3	RESET	Key-operated switch position 1	Single block	Feed override				
				E (2 ⁴)	D (2 ³)	C (2 ²)	B (2 ¹)	A (2 ⁰)
EB n + 4	Arrow keys			Key-operated switch position 3	Axis selection			
	+ R15	- R13	Rapid traverse R14		X R1	4. axis R4	7. axis R7	R10
EB n + 5	Axis selection							
	Y R2	Z R3	5. axis R5	Motion command in MCS/WCS	R11	9. axis R9	8. axis R8	6. axis R6
EB n + 6	Unassigned customer keys							
	T9	T10	T11	T12	T13	T14	T15	-
EB n + 7	Unassigned customer keys							
	T1	T2	T3	T4	T5	T6	T7	T8
EB n + 8	-	-	-	-	-	-	-	-
EB n + 9	-	-	-	-	-	-	-	-
EB n + 10	KT-IN8 X55.2	KT-IN7 X55.1	KT-IN6 X52.3	KT-IN5 X52.2	KT-IN4 X52.1	KT-IN3 X51.3	KT-IN2 X51.2	KT-IN1 X51.1

Byte	Bit7	Bit6	Bit5	Bit4	Bit3	Bit2	Bit1	Bit0
EB n + 11	-	-	-	-	-	-	-	KT-IN9 X55.3
EB n + 12	-	-	-	-	-	-	-	-
EB n + 13	-	-	-	X31 pin 6 ¹⁾	X31 pin 7 ¹⁾	X31 pin 8 ¹⁾	X31 pin 9 ¹⁾	X31 pin 10 ¹⁾
Signals marked with * are inverse signals.								
1)	If the 4-stage rotary spindle override switch on X31 is replaced by a 5-stage rotary switch, the input information here can be measured in five stages.							

Table 4-3 Input image for handwheel data

Byte	Bit7	Bit6	Bit5	Bit4	Bit3	Bit2	Bit1	Bit0
EB n + 14	Handwheel 1 counter status (16-bit signed, low-order byte equals byte n+14)							
EB n + 15								
EB n + 16	Handwheel 2 counter status (16-bit signed, low-order byte equals byte n+16)							
EB n + 17								

Within the SINUMERIK controller, the handwheel data is processed directly by the NCK and are not available to the PLC.

Table 4-4 Process output image for MCP 483C PN

Byte	Bit7	Bit6	Bit5	Bit4	Bit3	Bit2	Bit1	Bit0
AB n + 0	Machine function				Mode			
	1000 INC	100 INC	10 INC	1 INC	JOG	TEACH IN	MDA	AUTO
AB n + 1	Feed start	* Feed stop	NC start	* NC stop	Machine function			
					REPOS	REF.	var. INC	10000 INC
AB n + 2	Arrow key - R13	Axis selection				Single block	Spindle Start	*Spindle Stop
		X R1	4. axis R4	7. axis R7	R10			
AB n + 3	Axis selection							Arrow key + R15
	Z R3	5. axis R5	Motion command in MCS/WCS	R11	9. axis R9	8. axis R8	6. axis R6	
AB n + 4	Unassigned customer keys							
	T9	T10	T11	T12	T13	T14	T15	Y R2
AB n + 5	Unassigned customer keys							
	T1	T2	T3	T4	T5	T6	T7	T8
AB n + 6	-	-	-	-	-	-	RESET	R14
AB n + 7	-	-	KT-OUT6 X54.3	KT-OUT5 X54.2	KT-OUT4 X54.1	KT-OUT3 X53.3	KT-OUT2 X53.2	KT-OUT1 X53.1
Signals marked with * are inverse signals								

4.3 Interfaces

Default key assignment

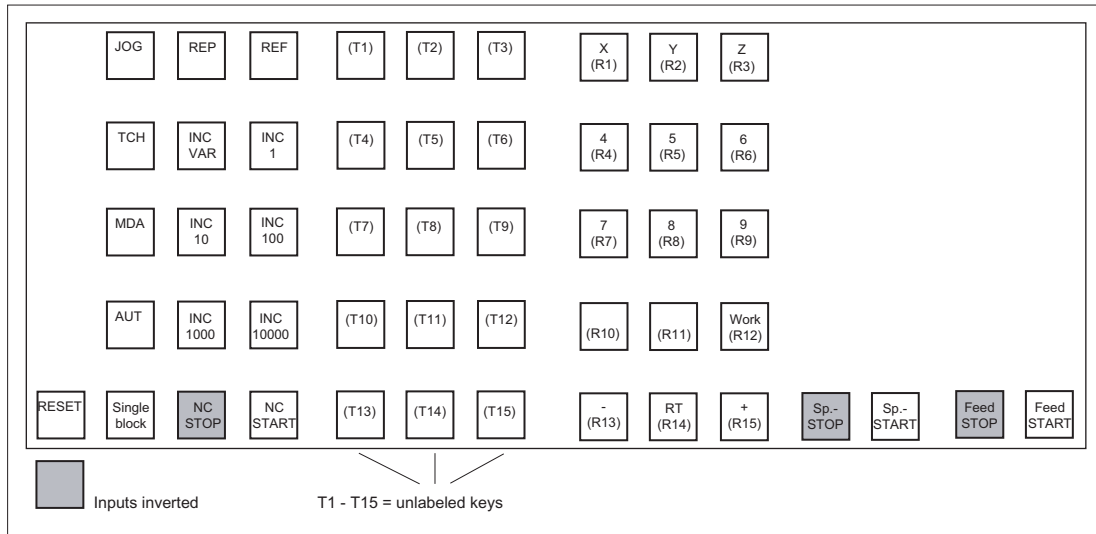

Figure 4-5 Default key assignment of MCP 483C PN

Assignment of the inputs (I) and outputs (O) to the keys and LEDs

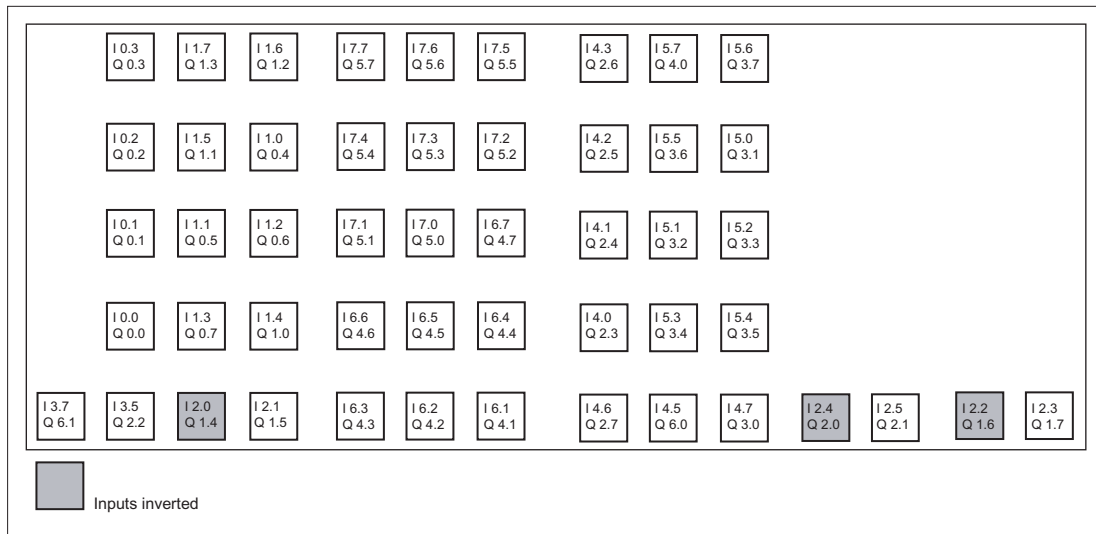

Figure 4-6 Inputs and outputs of the MCP 483C PN keyboard

4.4 Mounting

The MCP 483C PN machine control panel can be combined with all SINUMERIK operator panel fronts, preferably with a width of 483 mm.

The recommended combination sequence is shown in the figure.

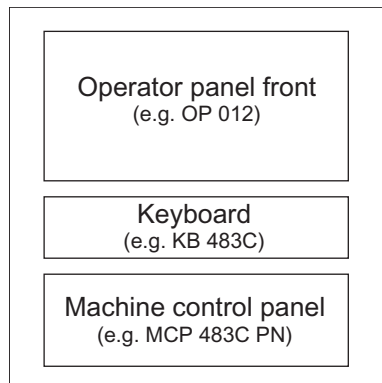

Figure 4-7 Combination sequence of the components

MCP 483C PN dimension drawing

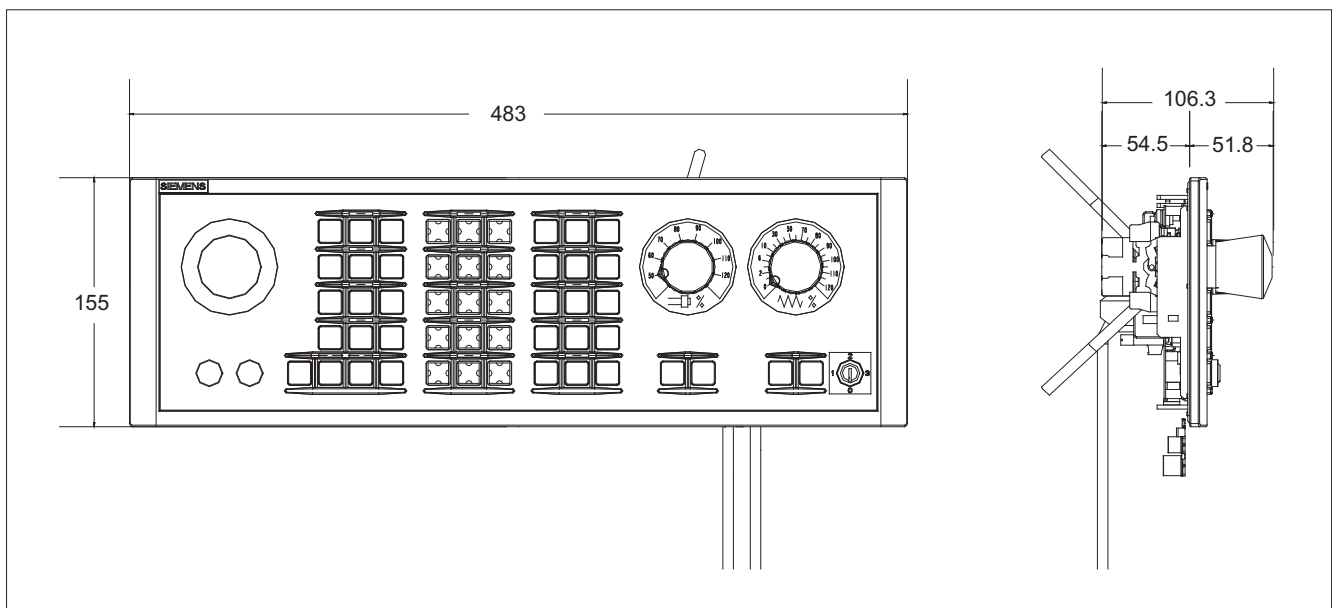

Figure 4-8 Front and side view of MCP 483C PN with connecting cable (handwheel and Ethernet)

Tension jacks

The machine control panel is mounted from the front in a rectangular cutout. It is secured with nine clamping fixtures (tightening torque 0.5 Nm, see dimension drawing), which are included in delivery.

4.5 Connecting

Clamping fixtures can also be obtained as spare parts (see Section: "Accessories and spare parts" → "Overview").

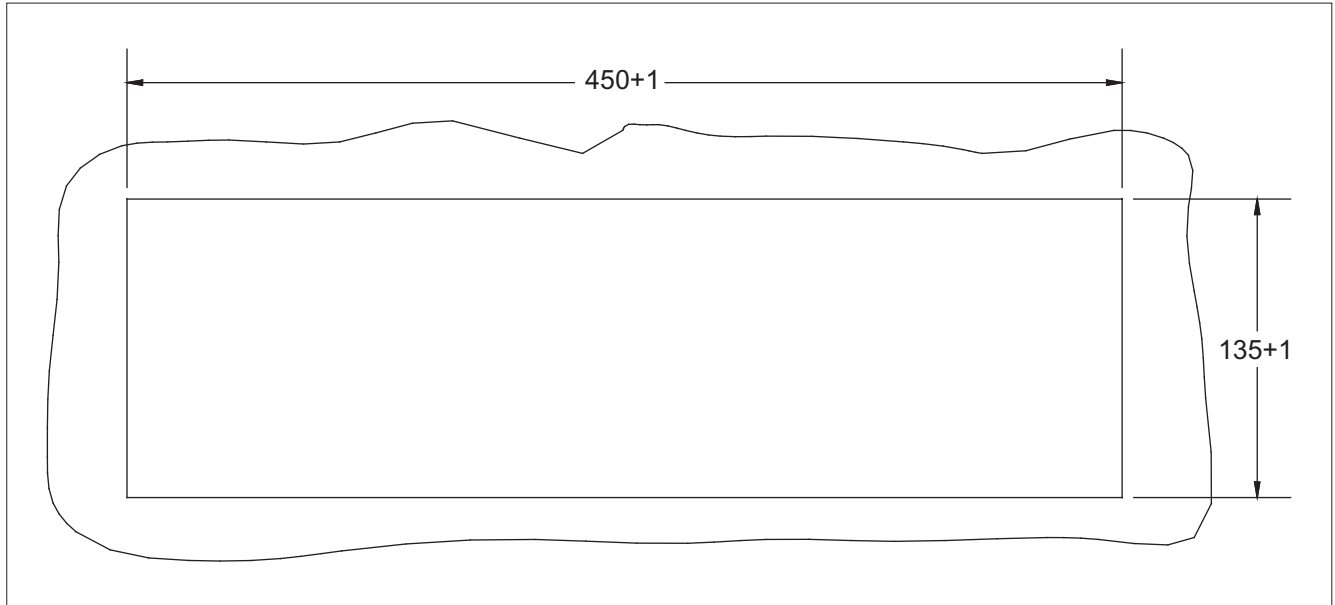

Figure 4-9 Panel cutout of MCP 483C PN

Mounting position

Max. 60° to the vertical.

For mounting positions greater than 60°, a fan must also be installed to keep the environmental temperature of the machine control panel constantly below 55 °C.

4.5 Connecting

Two equivalent connections (Fast Ethernet) are available for Ethernet/PROFINET transfer.

The Ethernet cables are not included in the scope of delivery. They must be ordered separately.

The following components are recommended:

- Ethernet FastConnect cables
- Ethernet FastConnect connectors

More information on this can be found in the SIEMENS IK PI catalog.

Securing Ethernet cables

Two cable ties are included in the scope of delivery. These are used to secure the Ethernet cables on the cover plate at the rear of the machine control panel (see figure in Section: "Control and display elements" → "Rear side").

NOTICE
Damaged cables caused by chafing edges
Make sure that all cables are routed so that they do not come into contact with chafing edges.

4.6 Maintenance and Service

Cleaning the device

Use a soft cloth moistened either with water or a mild cleaning agent to clean the housing and operator control elements of the machine control panel.

Checking the device

In order to prevent foreign bodies or liquids entering the machine control panel, regularly check the device

- that all the housing screws are in place and tight
- for damage to the housing
- for damage to the cable cover or cable entry

Protect the device from environmental effects

Protect the machine control panel against

- direct solar radiation and heat sources
- mechanical vibration and shock
- dust
- moisture, and
- strong magnetic fields

Checking the emergency stop button

Check the emergency stop button regularly to ensure that it functions correctly.

4.7 Technical data

MCP 483C PN machine control panel

Safety				
Safety class	III; PELV according to EN 50178			
Degree of protection according to EN 60529	Front side: IP54	Mounting frame: IP65	Rear side: IP00	
Approvals	CE / cULus			
Electrical data				
Input voltage	24 VDC			
Power consumption, max.	Board: 5 W	Handwheels: 2 x 0.9 W	Lamps: 14.4 W (6 x 2.4 W) *)	Total: 21.2 W
Mechanical data				
Dimensions	Width: 483 mm Height: 155 mm		Depth: 106 mm Mounting depth: 54.5 mm	
Weight	Approx. 2 kg			
*) The outputs for the illuminated pushbuttons (X53/X54) can have a max. permissible current of 0.3 A. However, the total current consumption of the components must not exceed 1.0 A (24 W).				

Note

Information about the climatic and mechanical environmental conditions is contained in the associated section under:

"General notes and interconnection" → "Operational planning".

Emergency Stop button

Rated voltage	24 VDC
Current magnitude, max.	3 A
Current magnitude, min.	1 mA
Switching capacity	DC 13 according to EN 60947-5-1
Conditional rated short-circuit current	10 A gL/gG according to EN 60947-5-1
B_{10d}	500 000

Note

The quantitative assessment of the emergency stop safety function must be based on the B_{10d} values corresponding to the used standards (e.g. ISO 13849-1) under consideration of the respective application (frequency of the actuation, service life, diagnostics by the evaluation unit, etc.). The B_{10d} values only apply when the technical properties of the emergency stop button are taken into account.

4.8 Accessories and spare parts

Table 4-5 Accessories and spare parts for machine control panel 483C PN

Name	Description	Quantity	Order number
Emergency stop button	22 mm actuating element, 40mm mushroom pushbutton, snap action with tamper protection, latching, red, with holder, unlit	1	3SB3000-1HA20 *)
Switching element	with 2 contact pairs (1 NO + 1 NC), 2-pin, screw terminal (3rd contact pair can be connected additionally)	1	3SB3400-0A *)
Key	10 key sets, each with three keys for the key-operated switch settings 1, 2, 3	1	6FC5148-0AA03-0AA0
Rapid traverse dial	for 16-stage rotary switch MCP 483C	20	6FC5248-0AF30-0AA0
Override spindle / rapid traverse	Electronic rotary switch 1x16G, T=24, cap, button, pointer, spindle dials and rapid traverse	1	6FC5247-0AF12-1AA0
Feed / rapid traverse override	Electronic rotary switch 1x23G, T=32, cap, button, pointer, feed and rapid-traverse dials	1	6FC5247-0AF13-1AA0
Tension jacks	Set of tensioners for operator components with 2.5 mm profile, 20 mm length	9	6FC5248-0AF14-0AA0
Key covers	Square, can be labeled by laser, One set of 90, ergo-gray and 20 each of red / green / yellow / medium gray	170	6FC5248-0AF12-0AA0
Key covers	Square, for inscription plates, One set of 90, clear	90	6FC5248-0AF21-0AA0
Key cover	Square, can be written with laser, one set with 500 items, ergo-gray (light basic)	1	6FC5348-0AF00-0AA0
Key cover	Square, can be written with laser, one set with 500 items, mid-gray (light basic)	1	6FC5348-0AF01-0AA0
Cables	Cable set for additional MCP control devices, length 500 mm	60	6FC5247-0AA35-0AA0
Handwheel connection	Handwheel cable, max. length: 5 m	1	6FX8002-2CP00-1Axy **)

**) xy is the length code: x (m) = A (0) ...F (5); y (dm) = 0 ... 8

*) Safety-related

Accessories pack (for delivery ex works)		
Keypad	9	Key covers for turning (labeled)
	30	Ergo grey key covers (for labeling)
	30	Clear key covers (for labeling)

4.8 Accessories and spare parts

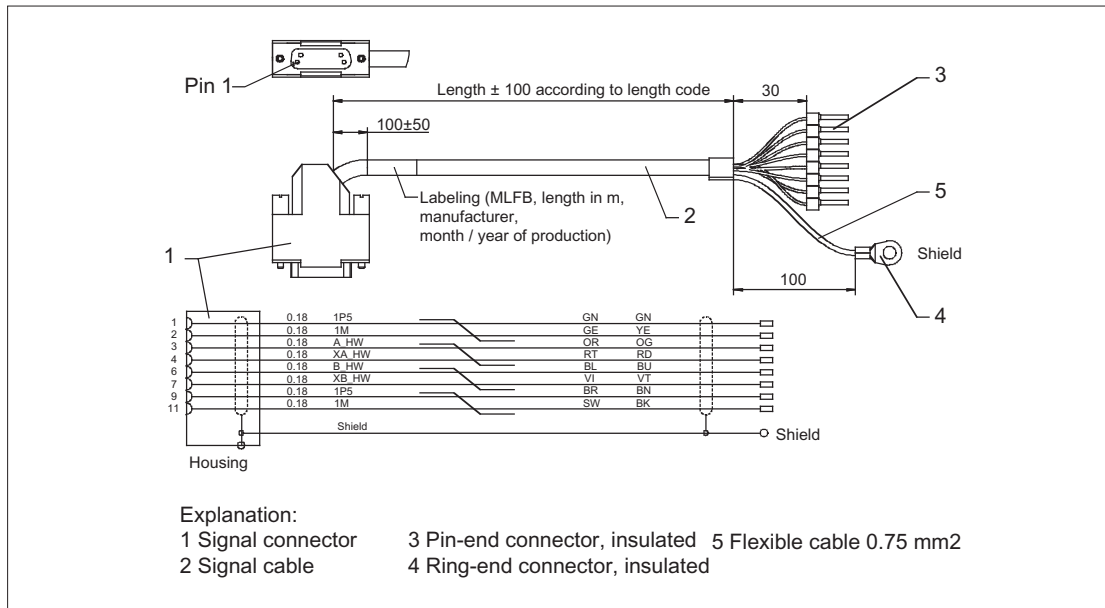

Figure 4-10 Connection cable for handwheel

Machine control panel: MCP 483 PN

5.1 Description

Machine control panel MCP 483 PN (PN = PROFINET) enables user-friendly operation of the machine functions, which are clearly laid out for the user. It is suitable for machine-level operation of milling and turning machines, and particularly grinding machines.

Note

The IE functionality (IE = Industrial Ethernet) is still included and preset. Please note the switch position of S2.

46 keys and both control device slots are equipped with user-inscribed slide-in labels for adapting to specific machines. A DIN A4 film for labeling the slide-in strips is included in the delivery kit.

A connecting cable is included in the scope of delivery for connecting the direct keys of the SINUMERIK operator panel fronts OP 012 / OP 015A and TP 015A.

The machine control panel is secured from the rear using special clamps supplied with the panel.

Validity

The description applies to the following machine control panels:

Type	Key type	Order number
MCP 483 PN (IE and PN)	Membrane keys	6FC5303-0AF22-1AA1
MCP 483 IE (IE only)	Membrane keys	6FC5303-0AF22-1AA0 ¹⁾

¹⁾ No longer available

The safety-related accessories / spare parts are marked in the "Accessories and spare parts" section with a *).

Features

Control elements:

- Membrane keys
- Operating mode and function keys:
 - 50 keys with assigned LEDs, 17 freely assignable customer keys in the standard assignment
 - Direction keys for milling machines with rapid traverse override
- Spindle control with override spindle (rotary switch with 16 positions)

5.1 Description

- Feed control with override feed / rapid traverse (rotary switch with 23 positions)
- Key-operated switch (four positions and three different keys)
- Emergency stop button, two contact blocks (1 NO + 1 NC)

Interfaces:

- Ethernet (transfer rate: 10/100 Mbit/s; for IE and PN)
- Nine customer-specific inputs (e.g. for illuminated pushbuttons)
- Six customer-specific outputs
- For 16 direct keys of OP 012 / OP 015A / TP 015A (connection cable: 850 mm, included in scope of delivery)
- Connection for two handwheels (Sub-D)
(Velocity input and contour handwheel are only possible if connecting through the handwheel connection module 6FC5303-0AA02-0AA0.)

Expansion slots:

2 slots for control devices (d = 16 mm).
(additional cable set required for control devices, see section: "Accessories and spare parts".)

Functions:

Table 5-1 Functions depend on operating mode

Function	PN operating mode	IE operating mode	Prerequisite
Keys, LEDs, rotary switches	available soon	✓	
Handwheel	-	✓ as of NCU software 2.5	
		✓ as of NCU software 2.6 Handwheel with optimized response. This means that a "delete distance-to-go function" can be triggered in the PLC user program via a "handwheel stationary" signal.	Toolbox 2.6
Activate/Deactivate (T:N:M)	-	✓	

5.2 Operator controls and indicators

5.2.1 Front side

Overview

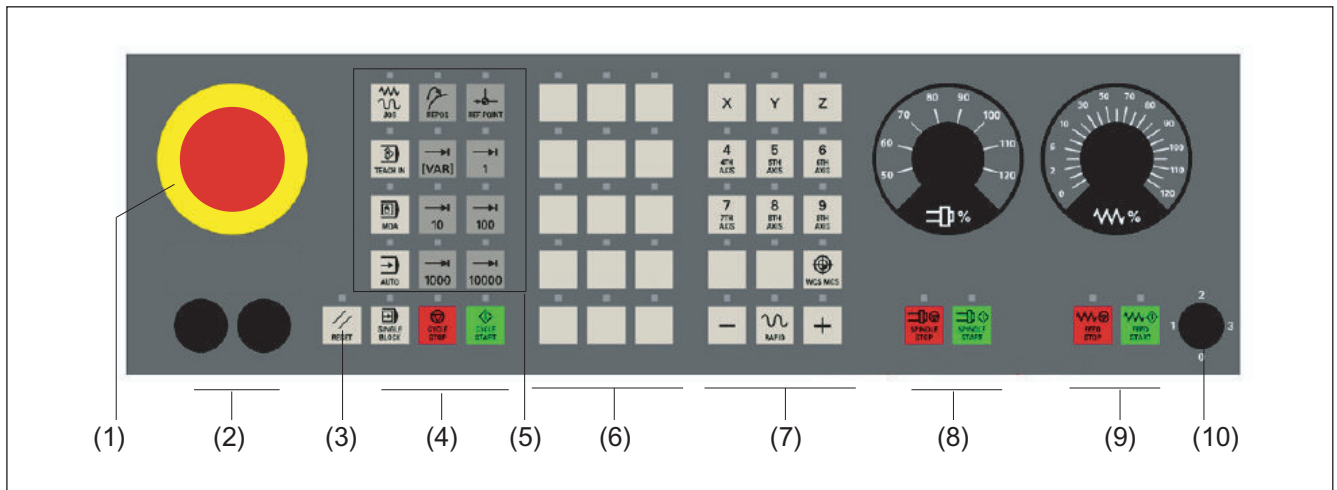

- (1) Emergency stop button
- (2) Slots for control devices (d = 16 mm)
- (3) Reset button
- (4) Program control
- (5) Operating modes, machine functions
- (6) User keys T1 to T15
- (7) Direction keys with rapid traverse override (R1 to R15)
- (8) Spindle control with override switch
- (9) Feed control with override switch
- (10) Key-operated switch (four positions)

Figure 5-1 Position of control elements on MCP 483 PN

Emergency stop button

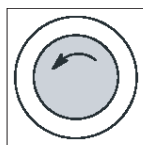

Emergency stop button

Press the red emergency stop button in emergencies if

- people are at risk,
- there is the danger of machines or the workpiece being damaged.

As a rule, when operating the Emergency Stop button, all drives are brought to a standstill with max. braking torque.

Turn the Emergency Stop button counterclockwise to unlatch it.

Machine manufacturer

For other reactions to the emergency stop:

Refer to the machine tool manufacturer's instructions



 WARNING
Danger of death resulting from the premature emergency stop unlocking
If you have shut down the system to be monitored, you can only release the emergency stop button or put the system to be monitored back into operation if the condition that triggered the emergency stop function has been corrected and a safe restart is carried out.

Emergency stop circuit

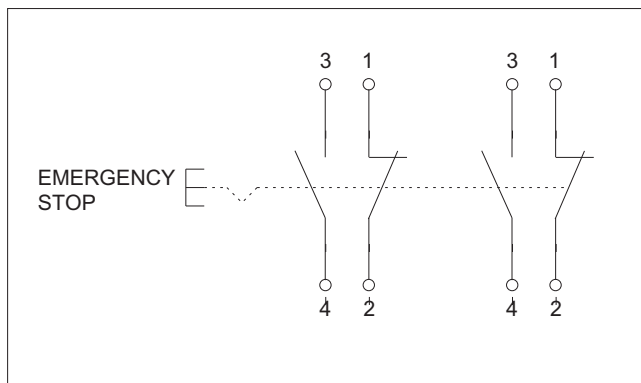

Figure 5-2 Emergency stop circuit

Slots for control devices

NOTICE
Damage to the front
Do not knock out the openings for mounting control devices (2) in "Position of control elements on MCP 483 PN", but drill them to the required width.

Information for the installation, or to select control devices, please refer to the following Section: Front side (Page 31).

5.2.2 Rear side

Rear side

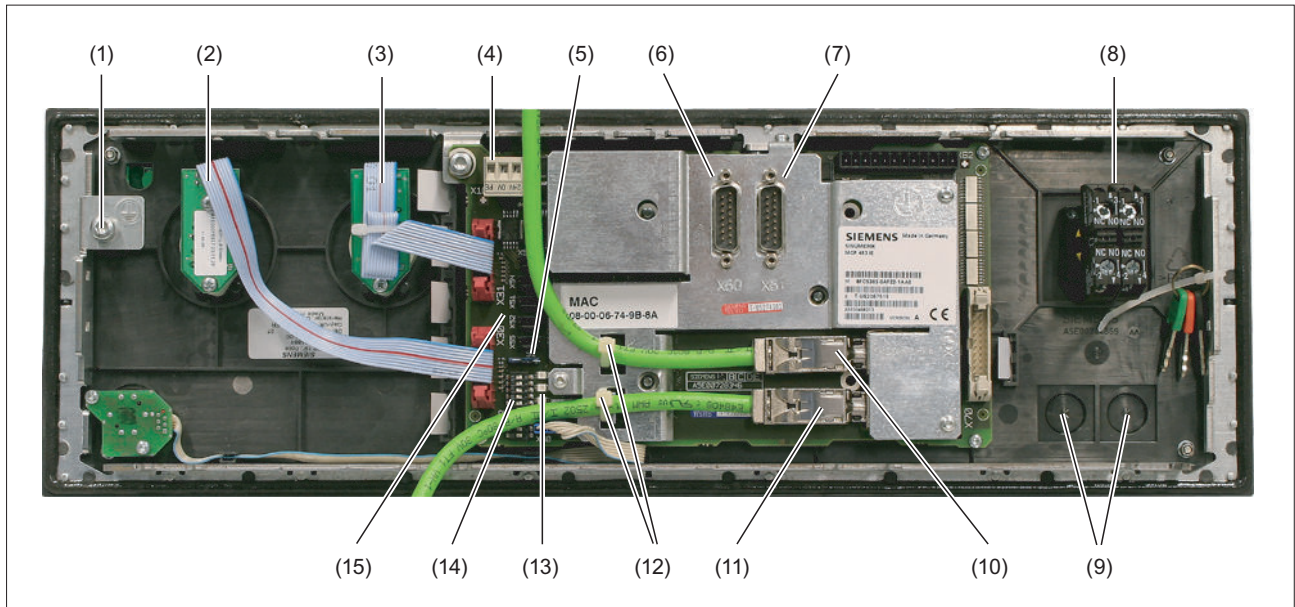

- | | | |
|------|---|-----|
| (1) | Ground terminal | |
| (2) | Feed override | X30 |
| (3) | Spindle override | X31 |
| (4) | Power supply interface | X10 |
| (5) | switch S1 *) | |
| (6) | Handwheel connection | X60 |
| (7) | Handwheel connection | X61 |
| (8) | Emergency stop | |
| (9) | Installation locations for additional control devices (d = 16 mm) | |
| (10) | Ethernet connection, port 1 | X20 |
| (11) | Ethernet connection, port 2 | X21 |
| (12) | Ethernet cable strain relief | |
| (13) | LEDs *) | |
| (14) | Switch S2 *) | |
| (15) | Customer-specific inputs and outputs *) | |

*) Detailed figure under "Interfaces" → "Description"

Figure 5-3 Rear of the MCP 483 PN with Ethernet connecting cables

5.3 interfaces

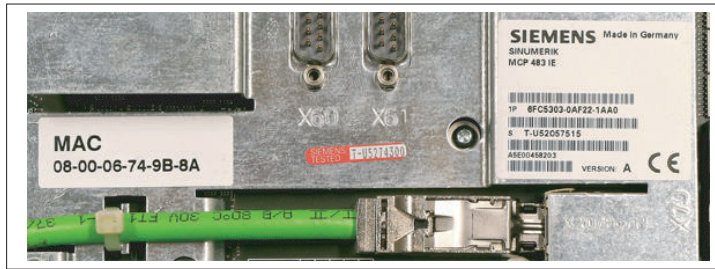

Figure 5-4 MCP 483 PN - MAC address/rating plate

5.3 interfaces

5.3.1 Overview

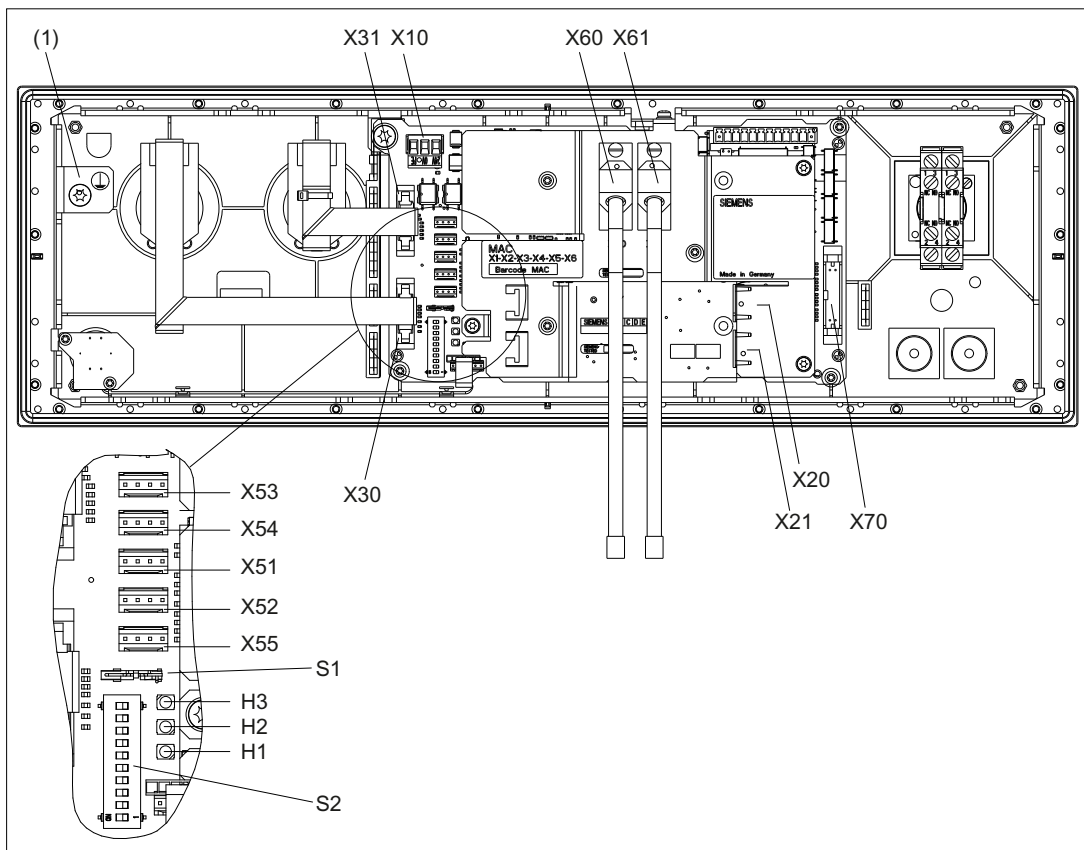

Figure 5-5 Rear of the MCP 483 PN with interfaces

(1)	Equipotential bonding
X10	Power supply interface
X20	Ethernet port 1
X21	Ethernet port 2
X30	Interface for rotary switch feed override
X31	Interface for rotary switch spindle override
X51 / X52 / X55	Interfaces for customer-specific inputs
X53 / X54	Interfaces for customer-specific outputs
X60 / X61	Connections for 2 handwheels (TTL / differential - can be set with switch S1)
X70	Interface for connecting 16 direct keys
S1	Switch for setting the handwheel signal type
S2	Switch for setting the MCP address

LEDs

H1	POWER OK (green)
H2	BUSSYNC
H3	BUSFAULT

Equipotential bonding

The equipotential bonding conductor is attached by means of an M5 screw.

5.3.2 Description

Pin assignment

For more detailed information, see "General information and networking", Chapter: "Connecting".

Switch S1/S2

Settings, see Chapter "Machine control panel: MCP 310C PN", Section "Interfaces".

5.3.3 Input / output images

Standard + two handwheels

The specifications for assigning input and output bytes listed in the tables can be changed in the PLC via parameter assignment.

Note

The following applies in respect of the process input and output images in the tables: n is defined by means of FB1 parameters in OB100 of the PLC.

Table 5-2 Process input image for MCP 483 PN

Byte	Bit7	Bit6	Bit5	Bit4	Bit3	Bit2	Bit1	Bit0
EB n + 0	Spindle override				Mode			
	D (2 ³)	C (2 ²)	B (2 ¹)	A (2 ⁰)	JOG	TEACH IN	MDA	AUTO
EB n + 1	Machine function							
	REPOS	REF.	var. INC	10000 INC	1000 INC	100 INC	10 INC	1 INC
EB n + 2	Key-operated switch		Spindle start	* Spindle stop	Feed start	* Feed stop	NC start	* NC stop
	Position 0	Position 2						
EB n + 3	RESET	Key-operated switch position 1	Single block	Feed override				
				E (2 ⁴)	D (2 ³)	C (2 ²)	B (2 ¹)	A (2 ⁰)
EB n + 4	Arrow keys			Key-operated switch position 3	Axis selection			
	+ R15	- R13	Rapid traverse R14		X R1	4. axis R4	7. axis R7	R10
EB n + 5	Axis selection							
	Y R2	Z R3	5. axis R5	Motion command in MCS/WCS	R11	9. axis R9	8. axis R8	6. axis R6
EB n + 6	Unassigned customer keys							
	T9	T10	T11	T12	T13	T14	T15	-
EB n + 7	Unassigned customer keys							
	T1	T2	T3	T4	T5	T6	T7	T8
EB n + 8	DT 07	DT 06	DT 05	DT 04	DT 03	DT 02	DT 01	DT 00
EB n + 9	DT 15	DT 14	DT 13	DT 12	DT 11	DT 10	DT 09	DT 08
EB n + 10	KT-IN8 X55.2	KT-IN7 X55.1	KT-IN6 X52.3	KT-IN5 X52.2	KT-IN4 X52.1	KT-IN3 X51.3	KT-IN2 X51.2	KT-IN1 X51.1
EB n + 11	-	-	-	-	-	-	-	KT-IN9 X55.3
EB n + 12	-	-	-	-	-	-	-	-

Byte	Bit7	Bit6	Bit5	Bit4	Bit3	Bit2	Bit1	Bit0
EB n + 13	-	-	-	X31 pin 6 ¹⁾	X31 pin 7 ¹⁾	X31 pin 8 ¹⁾	X31 pin 9 ¹⁾	X31 pin 10 ¹⁾
Signals marked with * are inverse signals.								
1)	If the 4-stage rotary spindle override switch on X31 is replaced by a 5-stage rotary switch, the input information here can be measured in five stages.							

Table 5-3 Input image for handwheel data

Byte	Bit7	Bit6	Bit5	Bit4	Bit3	Bit2	Bit1	Bit0
EB n + 14	Handwheel 1 counter status (16-bit signed, low-order byte equals byte n+14)							
EB n + 15								
EB n + 16	Handwheel 2 counter status (16-bit signed, low-order byte equals byte n+16)							
EB n + 17								

Within the SINUMERIK controller, the handwheel data is processed directly by the NCK and are not available to the PLC.

Table 5-4 Process output image for MCP 483 PN

Byte	Bit7	Bit6	Bit5	Bit4	Bit3	Bit2	Bit1	Bit0
AB n + 0	Machine function				Mode			
	1000 INC	100 INC	10 INC	1 INC	JOG	TEACH IN	MDA	AUTO
AB n + 1	Feed start	* Feed stop	NC start	* NC stop	Machine function			
					REPOS	REF.	var. INC	10000 INC
AB n + 2	Arrow key - R13	Axis selection			Single block	Spindle Start	*Spindle Stop	
		X R1	4. axis R4	7. axis R7				R10
AB n + 3	Axis selection							Arrow key + R15
	Z R3	5. axis R5	Motion command in MCS/WCS	R11	9. axis R9	8. axis R8	6. axis R6	
AB n + 4	Unassigned customer keys							
	T9	T10	T11	T12	T13	T14	T15	Y R2
AB n + 5	Unassigned customer keys							
	T1	T2	T3	T4	T5	T6	T7	T8
AB n + 6	-	-	-	-	-	-	RESET	R14
AB n + 7	-	-	KT-OUT6 X54.3	KT-OUT5 X54.2	KT-OUT4 X54.1	KT-OUT3 X53.3	KT-OUT2 X53.2	KT-OUT1 X53.1
Signals marked with * are inverse signals								

Default key assignment

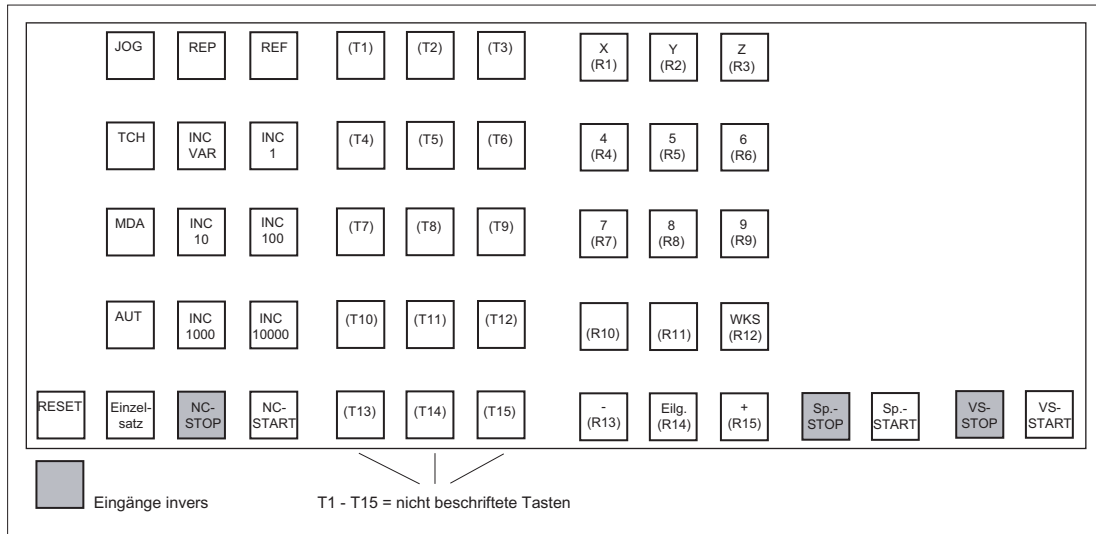

Figure 5-6 Default key assignment of MCP 483 PN

Assignment of the inputs (I) and outputs (O) to the keys and LEDs

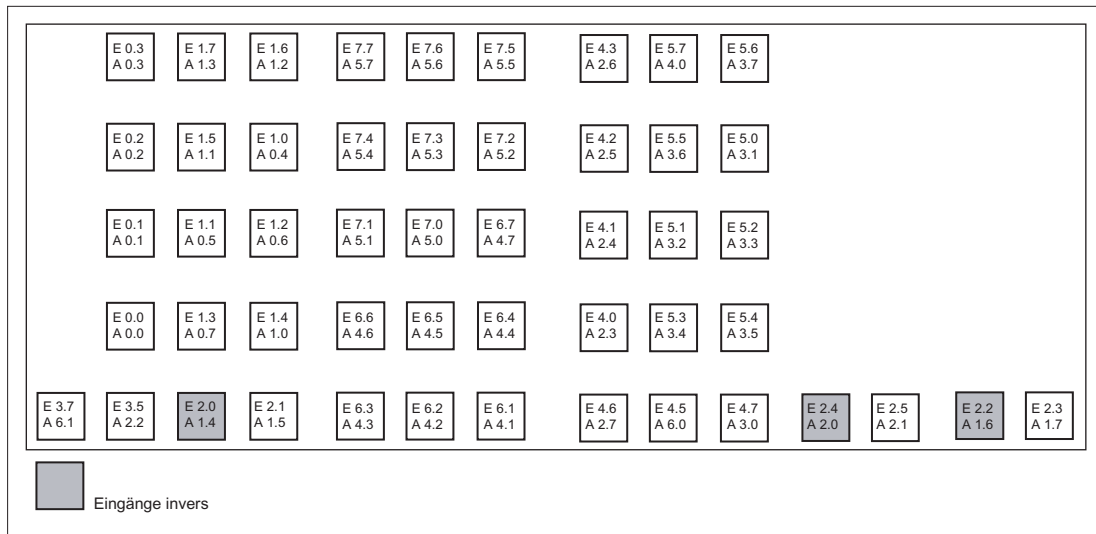
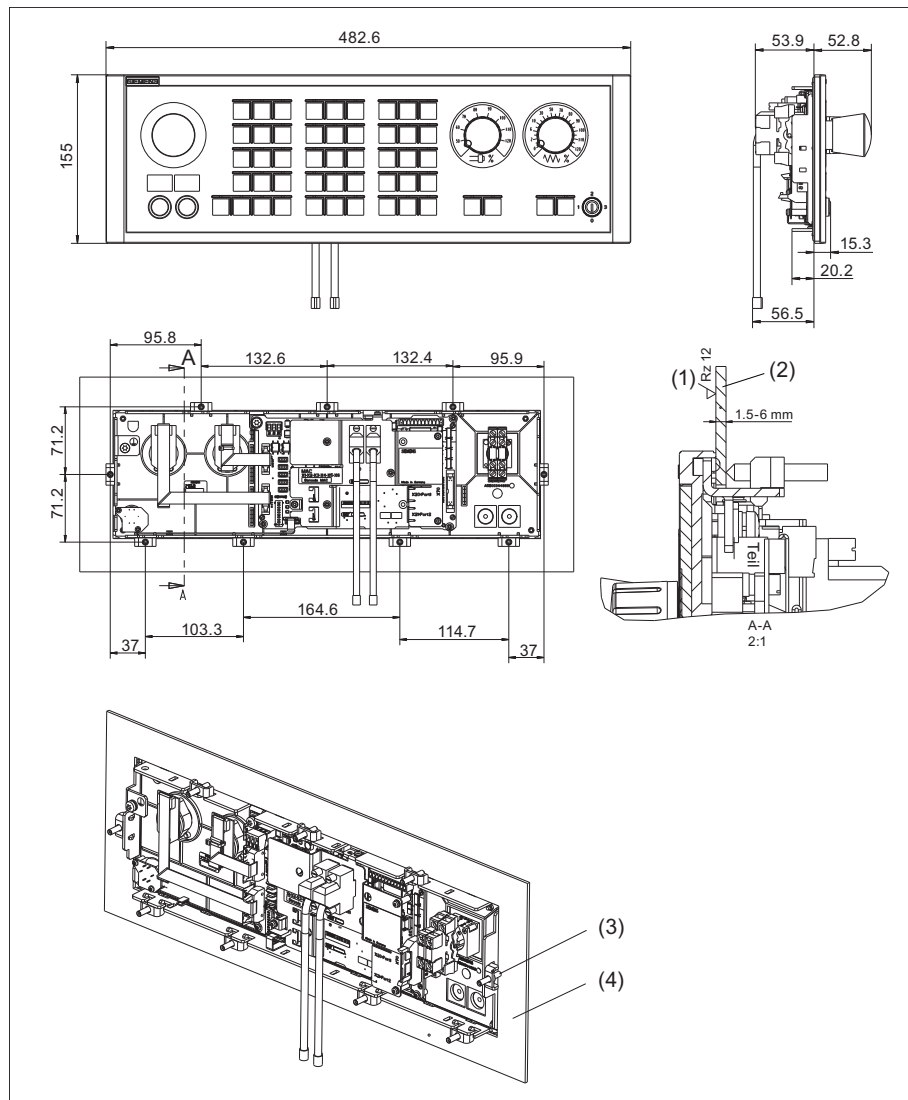

Figure 5-7 Inputs and outputs of the MCP 483 PN keyboard

5.4 Mounting

Dimension drawing of machine control panel MCP 483 PN



- (1) In the sealing area
- (2) Mounting frame
- (3) Tension jack (9 parts) tightening torque 0.8 Nm
- (4) Mounting frame

5.5 Connecting

Tension jacks

The machine control panel is attached by means of 9 tension jacks (tightening torque 0.8 Nm; see dimension drawing).

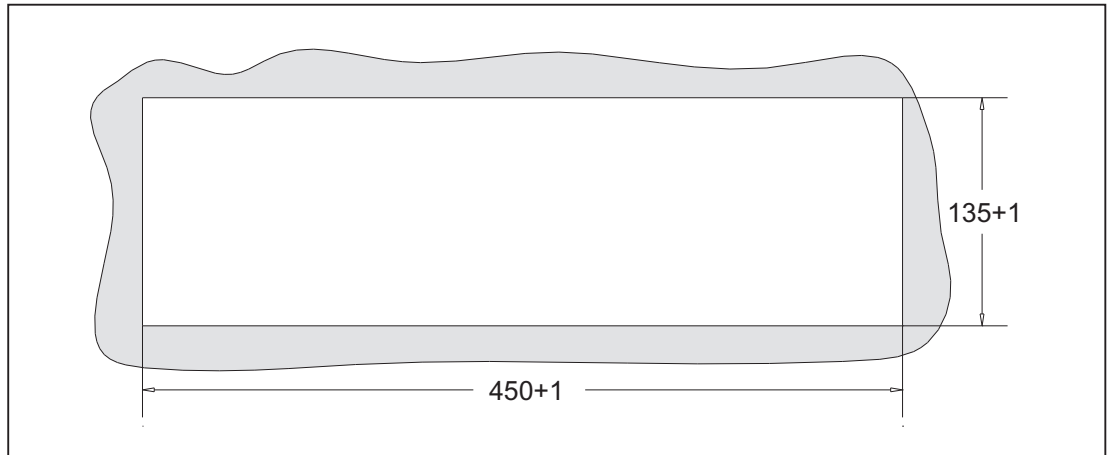

Figure 5-8 Panel cutout of MCP 483 PN

Mounting position

Max. 60° to the vertical. For mounting positions greater than 60° , a fan must also be installed to keep the ambient temperature of the machine control panel constantly below 55°C .

5.5 Connecting

Two equivalent connections (Fast Ethernet) are available for Ethernet/PROFINET transfer.

The Ethernet cables are not included in the scope of delivery. They must be ordered separately.

The following components are recommended:

- Ethernet FastConnect cables
- Ethernet FastConnect connectors

More information on this can be found in the SIEMENS IK PI catalog.

Securing Ethernet cables

Two cable ties are included in the scope of delivery. These are used to secure the Ethernet cables on the cover plate at the rear of the machine control panel (see figure in Section: "Control and display elements" → "Rear side").

NOTICE
Damaged cables caused by chafing edges
Make sure that all cables are routed so that they do not come into contact with chafing edges.

5.6 Maintenance and Service

Cleaning the device

Use a soft cloth moistened either with water or a mild cleaning agent to clean the housing and operator control elements of the machine control panel.

Checking the device

In order to prevent foreign bodies or liquids entering the machine control panel, regularly check the device

- that all the housing screws are in place and tight
- for damage to the housing
- for damage to the cable cover or cable entry

Protect the device from environmental effects

Protect the machine control panel against

- direct solar radiation and heat sources
- mechanical vibration and shock
- dust
- moisture, and
- strong magnetic fields

Checking the emergency stop button

Check the emergency stop button regularly to ensure that it functions correctly.

5.7 Technical data

Machine control panel MCP 483 PN

Safety				
Safety class	III; PELV according to EN 50178			
Degree of protection according to DIN IEC 529	Front side: IP54	Mounting frame: IP65		Rear side: IP00
Approvals	CE / cULus			
Electrical data				
Input voltage	24 VDC			
Power consumption, max.	Board: 5 W	Handwheels: 2 x 0.9 W	Lamps: 14.4 W (6 x 2.4 W) *)	Total: 21.2 W
Mechanical data				
Dimensions	Width: 483 mm	Height: 155 mm	Depth: 106.7 mm Mounting depth: 53.9 mm	
Weight	Approx. 1.6 kg			
*) The outputs for the illuminated pushbuttons (X53/X54) can have a max. permissible current of 0.3 A. However, the total current consumption of the components must not exceed 1.0 A (24 W).				

Note

Information about the climatic and mechanical environmental conditions is contained in the associated section under:

"General notes and interconnection" → "Operational planning".

Emergency Stop button

Rated voltage	24 VDC
Current magnitude, max.	3 A
Current magnitude, min.	1 mA
Switching capacity	DC 13 according to EN 60947-5-1
Conditional rated short-circuit current	10 A gL/gG according to EN 60947-5-1
B _{10d}	500 000

Note

The quantitative assessment of the emergency stop safety function must be based on the B_{10d} values corresponding to the used standards (e.g. ISO 13849-1) under consideration of the respective application (frequency of the actuation, service life, diagnostics by the evaluation unit, etc.). The B_{10d} values only apply when the technical properties of the emergency stop button are taken into account.

5.8 Accessories and spare parts

5.8.1 Overview

Table 5-5 Accessories and spare parts for machine control panel 483 PN

Name	Description	Quantity	Order number
Emergency stop button	22 mm actuating element, 40 mm mushroom pushbutton, snap action with tamper protection, latching, red, with holder, unlit	1	3SB3000-1HA20 *)
	Contact block with 2 contacts, 1 NO + 1 NC, 2-pole ,screw terminal	1	3SB3400-0A *)
Key-operated switch	Key-operated switch with key	1	6FC5247-0AF02-0AA0
Sets of keys	10 key sets, each with three keys for the key-operated switch settings 1, 2, 3	1 set	6FC5148-0AA03-0AA0
Set of tension jacks	Tension jack set (9 items) for supplementary components with 2.5 mm profile, length: 20 mm	1 set	6FC5248-0AF14-0AA0
Override for rotary spindle switch	Override spindle / rapid traverse, electronic rotary switch 1x16G, T=24, cap, button, pointer, spindle dials and rapid traverse	1	6FC5247-0AF12-1AA0
Rotary feed override switch	Feed / rapid traverse override, electronic rotary switch 1x23G, T=32, cap, button, pointer, feed and rapid-traverse dials	1	6FC5247-0AF13-1AA0
Slide-in labels	Slide-in label, (3 films, A4)	1 set	6FC5248-0AF22-1AA1
Cable set for additional control devices	Cable set (60 units) for additional control devices for the machine control panels Length: 500 mm	1 set	6FC5247-0AA35-0AA0
Handwheel connection **)	Cable for handwheel connection max. cable length: 5 m	1	6FX8002-2CP00-1Axy
**) See figure; xy is the length code: x (m) = A (0) ...F (5); y (dm) = 0 ... 8			

*) Safety-related

5.8 Accessories and spare parts

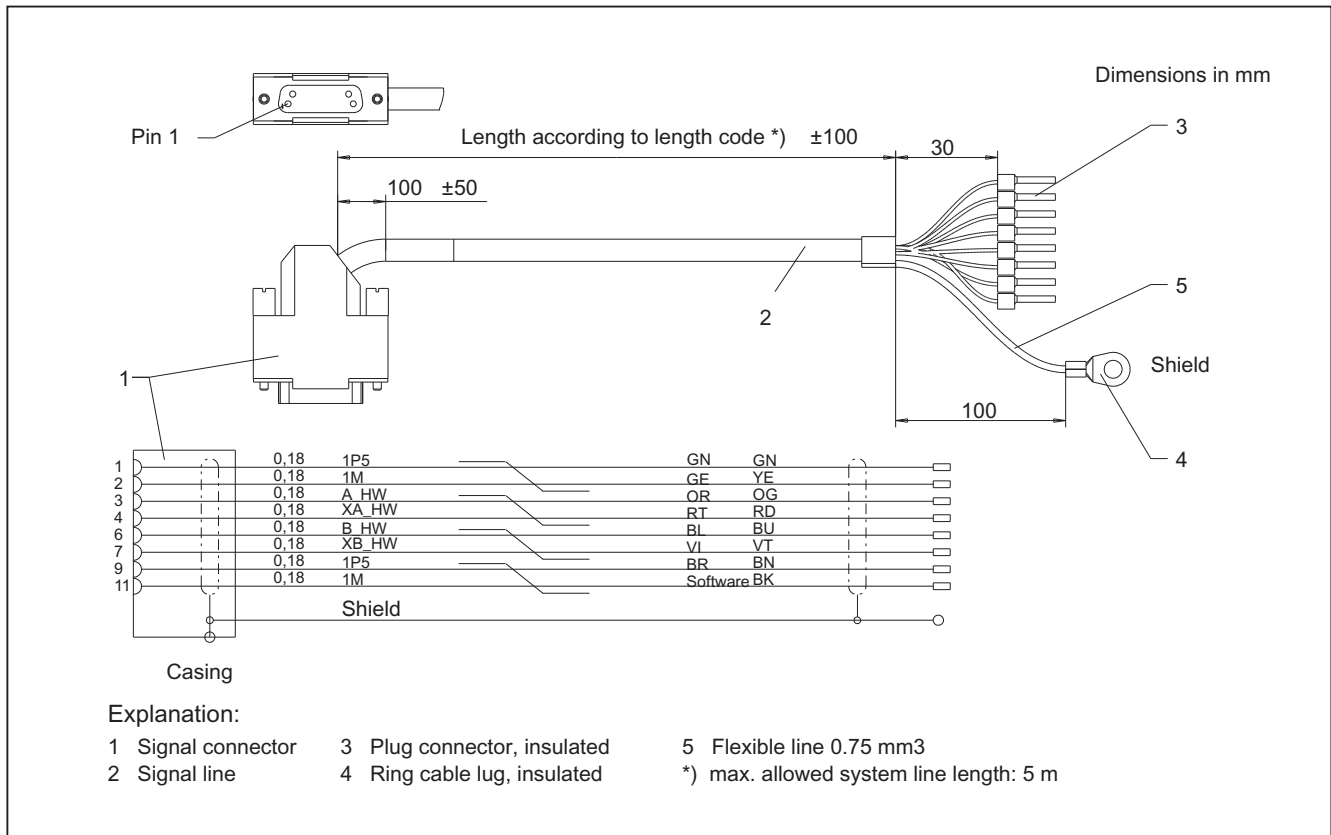

Figure 5-9 Connection cable for handwheel

5.8.2 Membrane keyboard: Labeling the slide-in labels

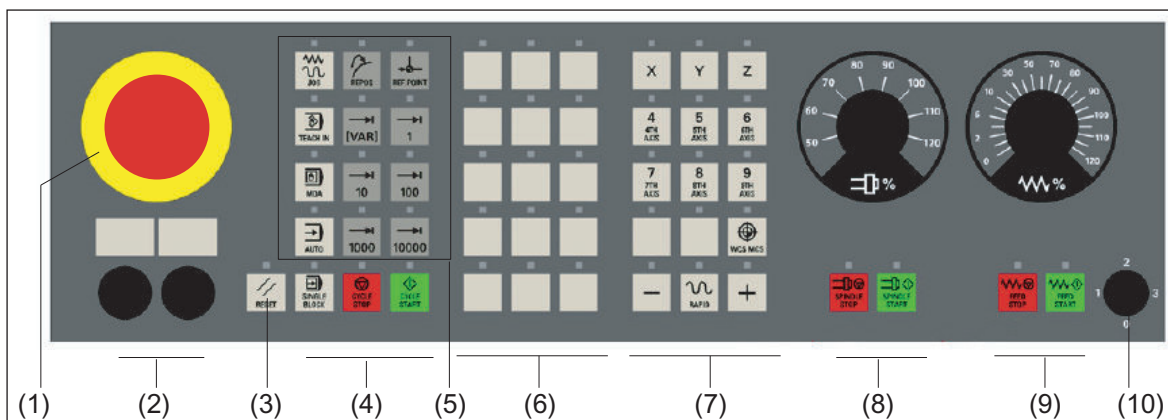

Figure 5-10 Machine control panel MCP 483 PN

The machine control panel (MCP) shown above is the standard shipped variant.

You can create your own slide-in labels to label the keys differently. A printable blank film (A4) is supplied with the panel for this purpose.

A spare parts kit containing 3 blank films is also available:
MLFB: 6FC5248-0AF22-1AA1 (Item No. A5E00179123)



Figure 5-11 Blank film for MCP 483 PN

Preparing slide-in labels

Instructions are given below on how to print the required key symbols on the supplied film or how to create your own individual film:

The software on the DOConCD / Catalog NC 61 (CD enclosed) includes four files for the blank films:

- **Template_M_MCP483.doc** [default assignment for milling - standard; **(A)**]
- **Template_T_MCP483.doc** [defaults for turning; **(B)**]
- **Template_MCP483.doc** (blank template for film: Item No. A5E00205579; **(C)**)
- **Symbols.doc** Key symbols as Word file, inscription on labels as jpg file **(D)**

Files **Template_M_MCP483.doc**, **Template_T_MCP483.doc** and **Template_MCP483.doc** include a table function showing the corresponding keyboard positions.

An example of each of the MCP files (milling and turning) is given below:

5.8 Accessories and spare parts

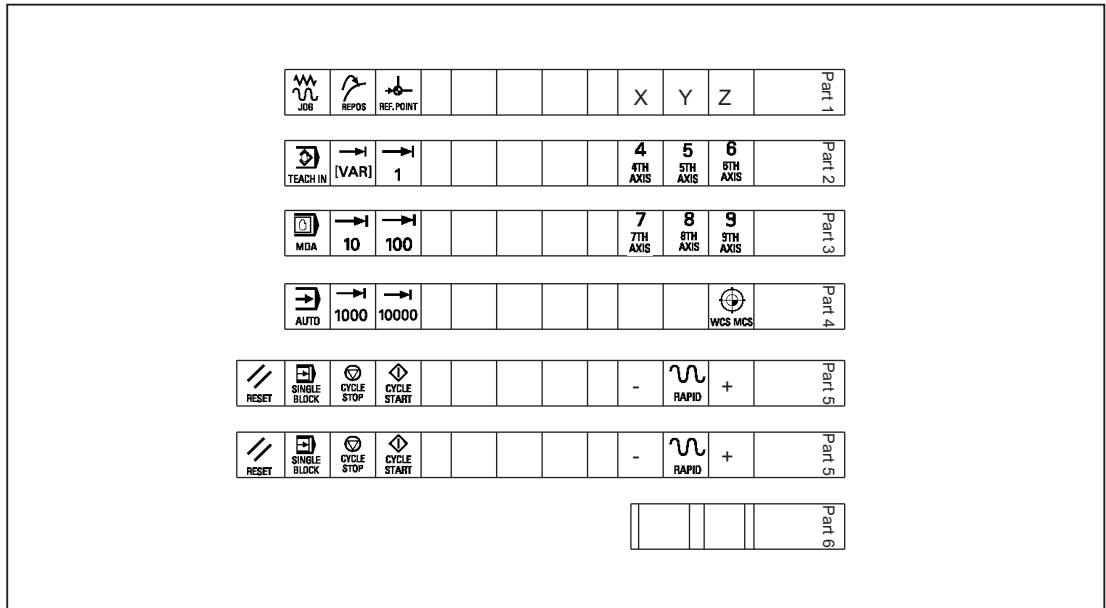

Figure 5-12 Template_M_MCP483.doc for the "Milling" version (A)

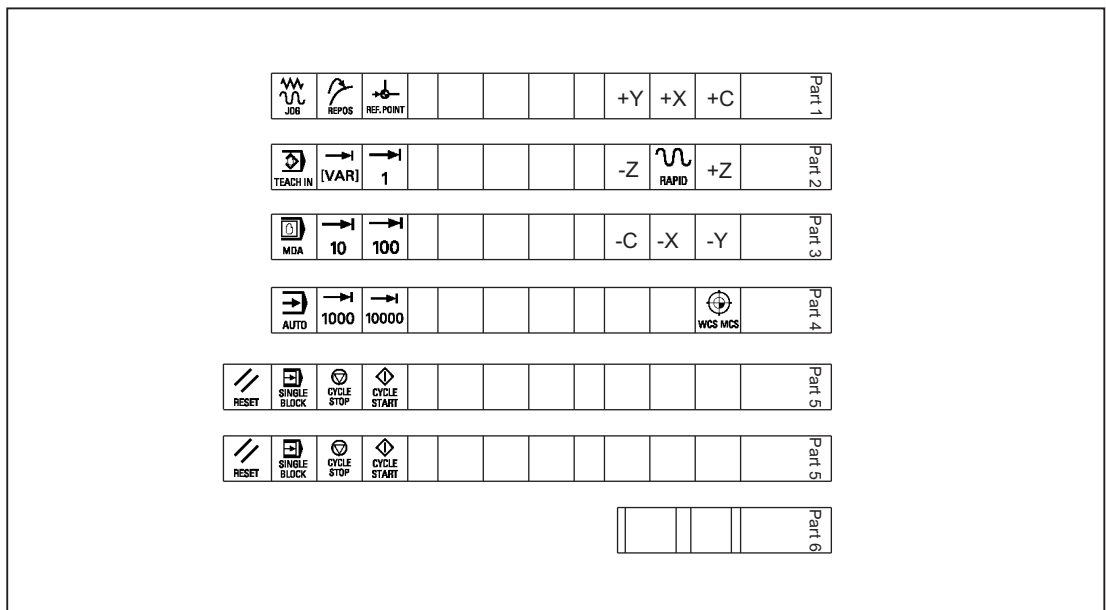

Figure 5-13 Template_T_MCP483.doc for the "Turning" version (B)

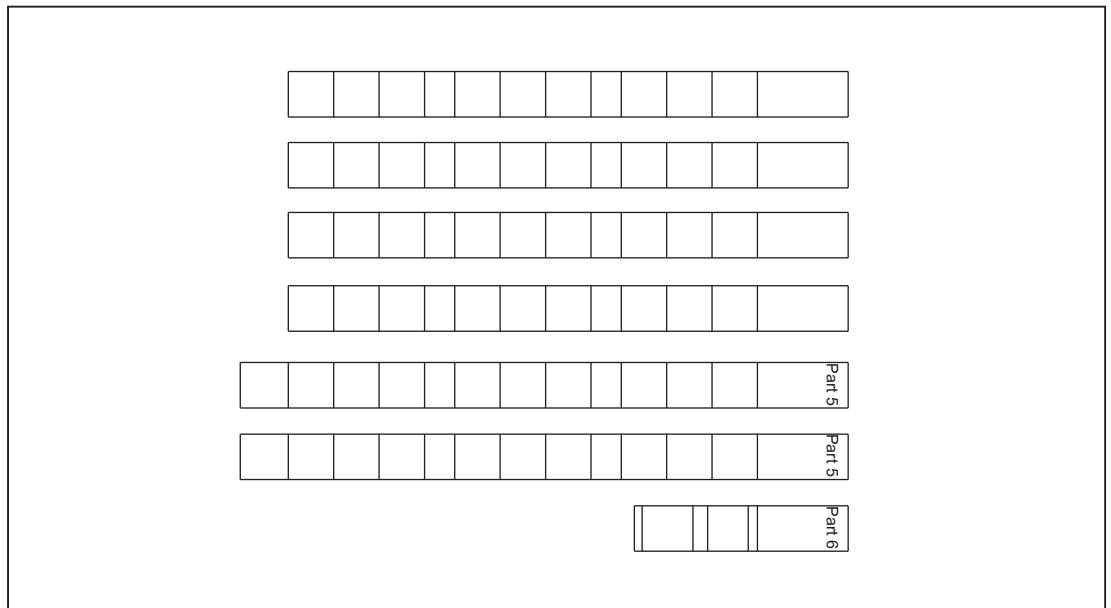

Figure 5-14 Template_MCP483.doc (blank template for film: Item No. A5E00205579 (C))

Within the table cells the key symbol required in each case can be copied and pasted into the corresponding table field.













The vertical bars shown in the diagram do not appear on the printed-out labels.

The strip "Part5" is included twice so that it is available optionally as either a 1-color or 3-color strip.

























Note

Use the "Arial" font to format text. This font is comparable to the "Univers S57" font, used by Siemens for the key labeling.

Table 5-6 Symbols.doc file (D)

	7001		7013		7025		7124
	7002		7014		7026	+C	7125
	7003		7015		7027	+X	7126
[VAR]	7004	10	7016	Z	7028	-Y	7127
	7005		7017	4 4TH AXIS	7029	+Z	7128

5.8 Accessories and spare parts

	7006		7018		7030		7129
	7007		7019		7031		7130
	7008		7020		7032		7131
	7009		7021		7033		7132
	7010		7022		7120		
	7011		7023		7121		
	7012		7024		7123		

Creating your own symbols

- Printing in a vector program (e.g. Designer, Freehand, CorelDraw):
 - Draw a 15 x 15 mm square, fill with the color white and give it an invisible border line.
 - Place the symbol in the center of this square.
 - Copy the entire image (square and symbol) and paste it into a Word document (Symbols.doc).
- Drawing in an image editing program (e.g. Photoshop, Picture Publisher, Paint):
 - Create a square area (e.g. 100 x 100 pixels) filled with the color white.
 - Draw the symbol in the center of this square.
 - Copy the entire image (square and symbol) and paste it into the Word document (Symbols.doc).

Dimension drawings

The following is a dimension drawing for the MCP 483 PN blank template:

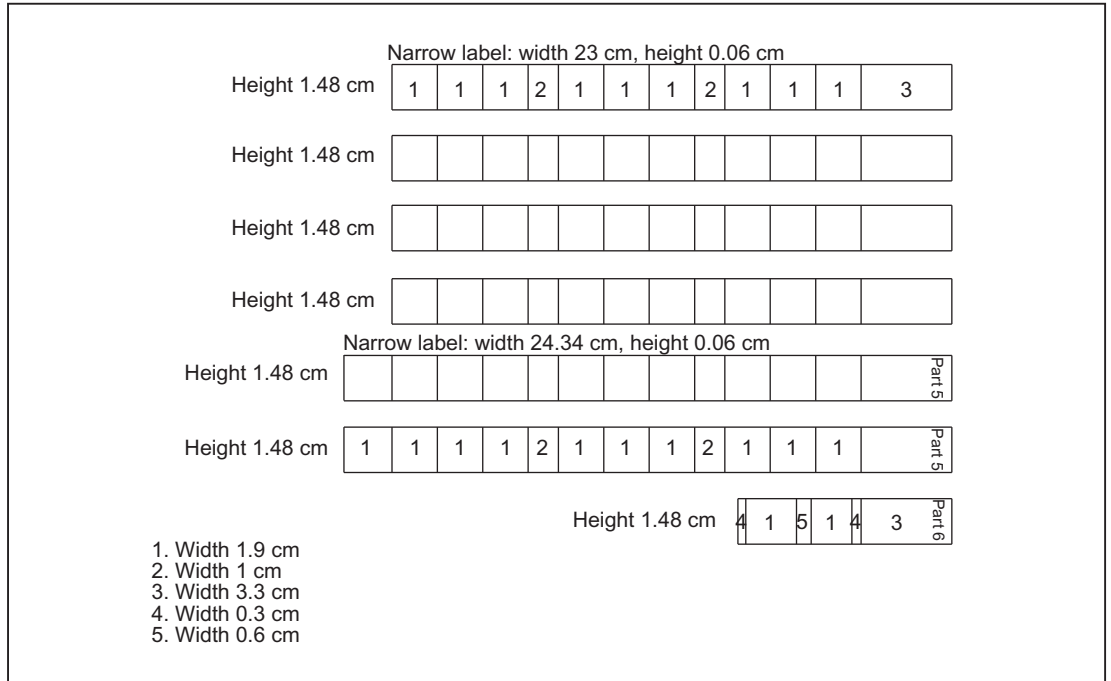

Figure 5-15 Dimension drawing for MCP 483 PN slide-in labels

Note

The slide-in strips are printed on the front with a laser printer. HP Color Laser Jet film C2936A is used.

To make the labels easier to slide in, they should be rounded by about 1.5 mm.

The outer lines of the strip are the cutting edge.

It is advisable to run a test print on normal paper before printing the labels on film.

Machine control panel: MCP 483

6.1 Description

The machine control panel MCP 483 permits user-friendly and clear operation of the machine functions. It is suitable for machine-level operation of milling and turning machines, and particularly grinding machines.

46 keys and both control device slots are equipped with user-inscribed slide-in labels for adapting to specific machines. A DIN A4 film for labeling the slide-in strips is included in the delivery kit.

A connecting cable is included in the scope of delivery for connecting the direct keys of the SINUMERIK operator panel fronts OP 012 / OP 015A and TP 015A.

The machine control panel is secured from the rear using special clamps supplied with the panel.

Validity

The description applies to the MCP 483 machine control panel.

Order number 6FC5203-0AF22-1AA2.

The safety-related accessories / spare parts are marked in the "Accessories and spare parts" section with a *).

Features

Control elements:

- Membrane keys
- Operating mode and function keys:
 - 50 keys with LEDs, 17 freely assignable customer keys in the standard assignment
 - Direction keys for milling machines with rapid traverse override
- Spindle control with override spindle (rotary switch with 16 positions)
- Feed control with override feed / rapid traverse (rotary switch with 23 positions)
- Key-operated switch (four positions and three different keys)
- Emergency stop button, two contact blocks (1 NO + 1 NC)

Interfaces:

- PROFIBUS DP
- 6 customer-specific input/outputs
(Additional cable set required for the control devices, see Section: "Accessories and spare parts".)

6.2 Operating and display elements

- For 16 direct keys of OP 012 / OP 015A / TP 015A (connection cable: 850 mm, included in scope of delivery)
- For two handwheels (max. cable length: 5 m)

Expansion slots:

Two slots for control devices (d = 16 mm)

6.2 Operating and display elements

6.2.1 Front side

Overview

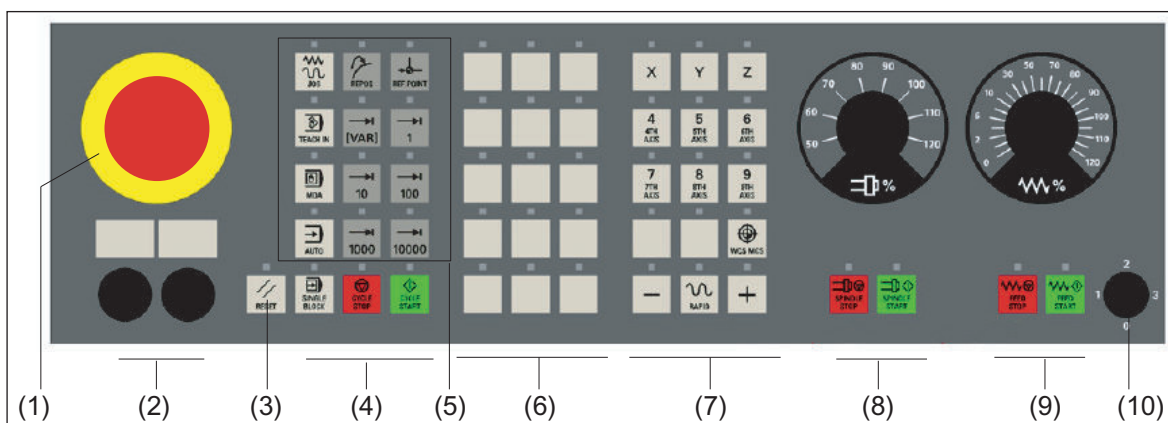

- (1) Emergency stop button
- (2) Slots for control devices (d = 16 mm)
- (3) Reset button
- (4) Program control
- (5) Operating modes, machine functions
- (6) User keys T1 to T15
- (7) Direction keys with rapid traverse override (R1 to R15)
- (8) Spindle control with override switch
- (9) Feed control with override switch
- (10) Key-operated switch (four positions)

Figure 6-1 Position of control elements on MCP 483 (milling version)

Emergency stop button

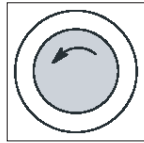

Emergency stop button

Press the red emergency stop button in emergencies if

- people are at risk,
- there is the danger of machines or the workpiece being damaged.

As a rule, when operating the Emergency Stop button, all drives are brought to a standstill with max. braking torque.

Turn the Emergency Stop button counterclockwise to unlatch it.

Machine manufacturer

For other reactions to the emergency stop:

Refer to the machine tool manufacturer's instructions



 **WARNING**

Danger of death resulting from the premature emergency stop unlocking

If you have shut down the system to be monitored, you can only release the emergency stop button or put the system to be monitored back into operation if the condition that triggered the emergency stop function has been corrected and a safe restart is carried out.

Circuit for emergency stop button

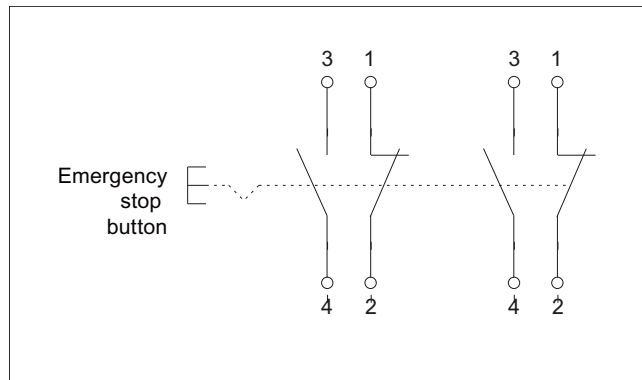

Figure 6-2 Emergency stop button screw-type terminal diagram

Slots for control devices

NOTICE

Damage to the front

The openings for mounting control devices (2) in Fig.: "Position of control elements of machine control panel MCP 483" must not be knocked out, but drilled to the required width.

Information for the installation, or to select control devices, please refer to the following Section: Front side (Page 31).

6.2.2 Rear side

COM board

The control and display elements on the rear of the MCP 483 are located on the COM board (shown with a gray background in the illustration):

The detailed cutout under or above the interface name shows the position of pin 1 on the connectors.

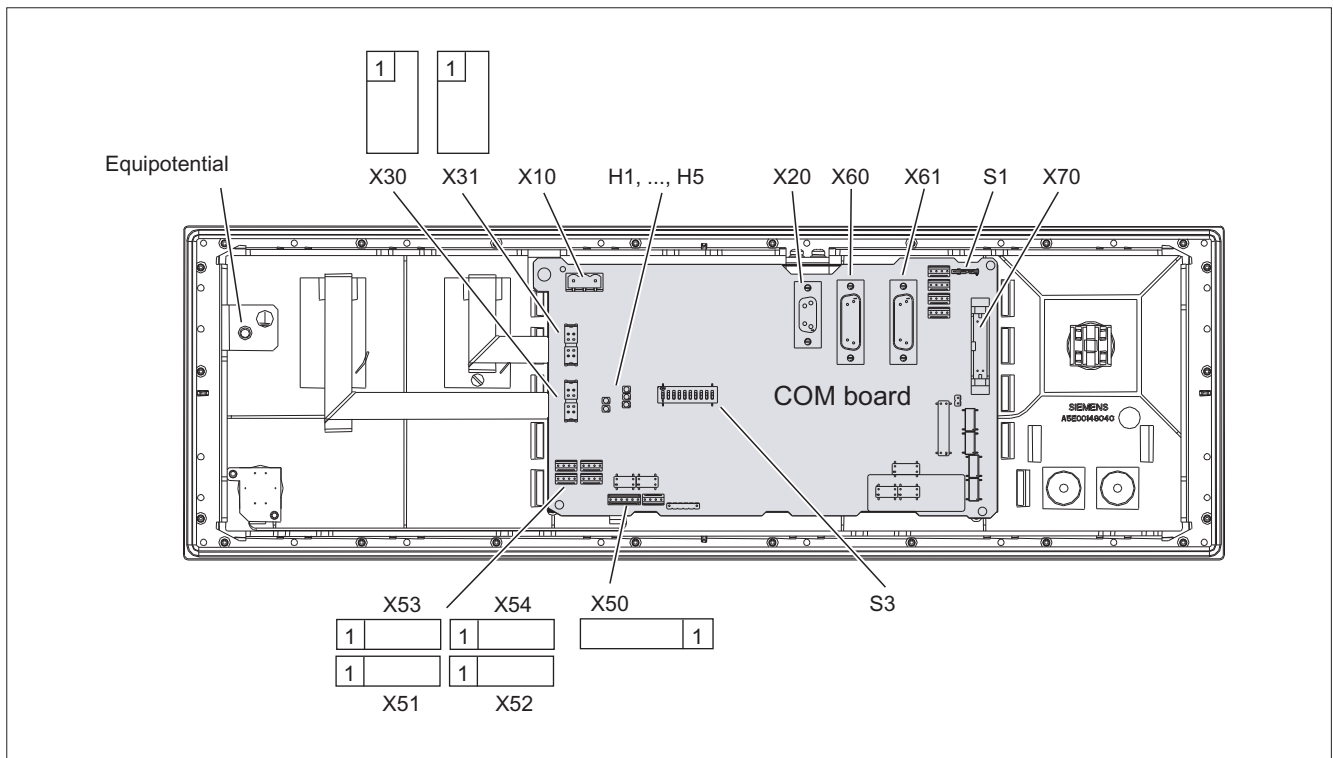

Figure 6-3 Rear of the MCP 483 showing the control and display elements and the interfaces

Jumper S1

Setting the handwheel signal type

- S1 open: TTL
- S1 closed: differential interface

S3 DIP switch

Sets e.g. baud rate, addresses and protocol (see section: "Settings via DIP switch S3")

Diagnostic LEDs H1 ... H5

No.	Monitoring of	Effect: LED ...	Diagnostics
H1	Hardware	Lights up red	Initialization error
H2	(reserved)	–	–
H3	Voltage	Lights up green	Logic voltages on board OK
H4	(reserved)	-	-
H5	PROFIBUS	flashes green	Ready for communication
		Lights up green	Communication in progress
		Lights up red	Channel interference or not yet ready (default after Power On)

6.3 Interfaces

MCP 483 communication is handled by the COM board where the interfaces are located (see Section: "Control and display elements" --> "Rear side").

Overview

- **X10:** Power supply interface
3-pin Phoenix terminal block
- **X20:** Operator panel interface (PROFIBUS DP)
9-pin Sub-D socket connector
- **X30:** Interface for connecting rotary feed override switch (23 graduations)
2 x 5-pin plug connector with lock
- **X31:** Interface for connecting rotary spindle override switch (16 graduations)
2 x 5-pin plug connector with lock
- **X50:** Interface to 4-way key-operated switch
1 x 6-pin plug connector

6.4 Mounting

- **X51-X54:** Optional interfaces for customer-specific input/outputs (pushbuttons, incl. 24 V lamps) each 1 x 4-pin plug connector
- **X60/X61:** Connection for two handwheels (TTL/DTTL) 15-pin sub-D socket each
- **X70:** Connection of direct control keys (16 digital inputs; opto-decoupled) 2 x 10-pin plug connector
- **Equipotential bonding**
The equipotential bonding conductor is attached by means of an M5 screw.

Pin assignment

For more detailed information, see "General information and networking", Chapter: "Connecting".

6.4 Mounting

Dimension drawing for machine control panel MCP 483

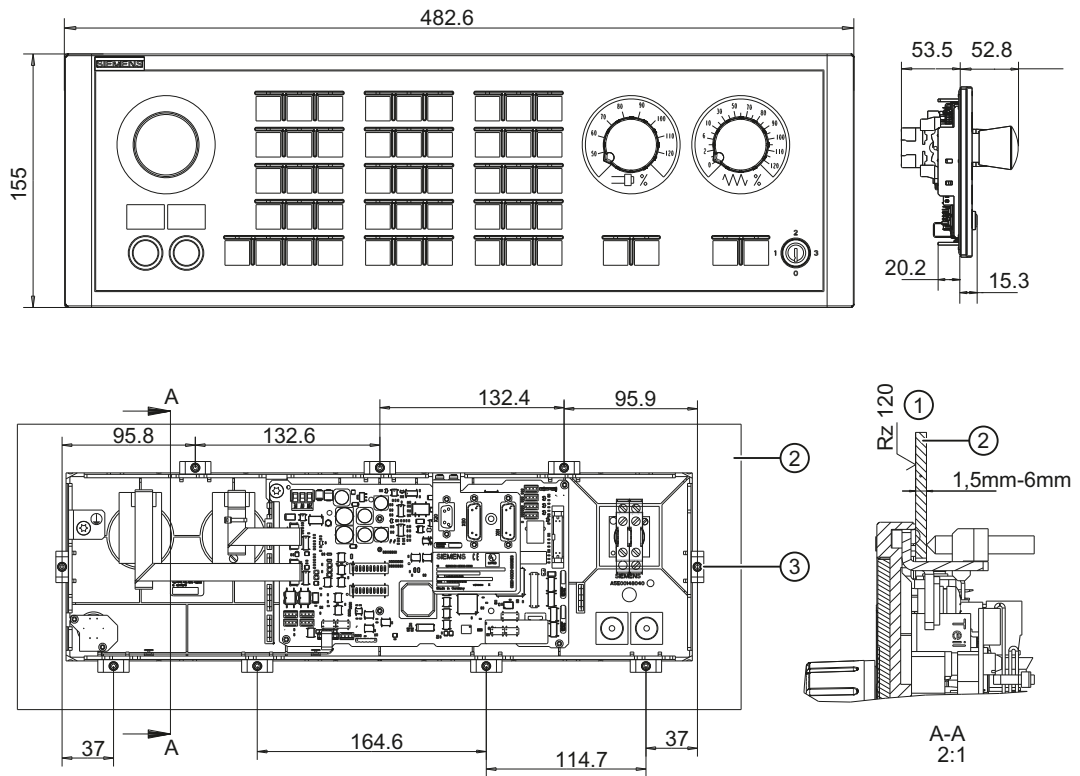

- ① In the sealing area
- ② Mounting frame
- ③ Tension jack (9 parts) tightening torque 0.8 Nm

Tension jacks

The machine control panel is attached by means of 9 tension jacks (tightening torque 0.8 Nm; see dimension drawing).

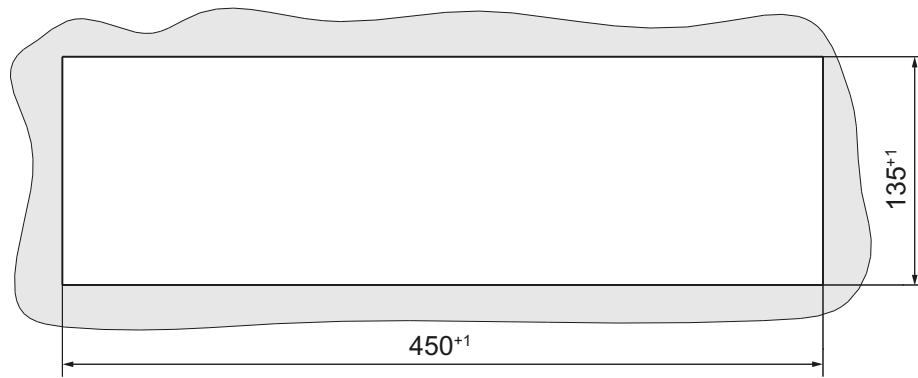

Figure 6-4 Panel cutout for machine control panel MCP 483

Mounting position

Max. 60° to the vertical. For mounting positions greater than 60°, a fan must also be installed to keep the ambient temperature of the machine control panel constantly below 55° C.

6.5 Settings via DIP switch S3

Delivery condition

Table 6-1 Delivery condition setting

1	2	3	4	5	6	7	8	9	10	Meaning/value
on	off	on	off	on	on	off	off	off	off	Series

Note

The delivery condition setting MUST be changed in accordance with the "Assignment of the DIP switch S3" table (below).

Connection type: PROFIBUS DP

For PROFIBUS DP, the PROFIBUS address is set using switches 1 to 10:

Table 6-2 Assignment of DIP switch S3

1	2	3	4	5	6	7	8	9	10	Meaning/value
										PROFIBUS

6.6 Connection via PROFIBUS DP

off	off	off	off	off	off	off	–	on	on	0
on	off	off	off	off	off	off	–	on	on	1
off	on	off	off	off	off	off	–	on	on	2
on	on	off	off	off	off	off	–	on	on	3
:	:	:	:	:	:	:	–	–	–	: (etc.)
on	off	on	on	on	on	on	–	on	on	125
off	on	on	on	on	on	on	–	on	on	126

6.6 Connection via PROFIBUS DP

6.6.1 Overview

This section describes:

- Requirements for adding a DP slave MCP to the hardware configuration for a SIMATIC S7 project.
- Configuring a DP slave MCP with STEP7 "HW config."
- Details of how to link the DP slave MCP to the basic PLC program and user program (optional).

Note

The instructions given in this chapter are essentially limited to the special requirements for configuring the DP slave MCP. For more details about working with SIMATIC STEP 7 please refer to the relevant SIMATIC documentation or online help.

Note

Both units can be linked up using the supplied 20-pin ribbon cable in order to transfer the direct key signals of the operator panel front to the COM board of the machine control panel. The direct key module therefore no longer needs to be connected.

6.6.2 Prerequisites

The following components are needed as prerequisites for adding a DP slave MCP to the hardware configuration:

- SIMATIC STEP 7 as of Version 5.4, Service Pack 4
- Toolbox 840D sl as of Version 2.6

Hardware configuration

The DP slave MCP is shown in SIMATIC STEP 7 in the hardware catalog of "HW Config" under the following path:

Profile: **Standard**

PROFIBUS DP > Other field devices > NC/RC > Motion Control > SINUMERIK MCP

If the module is not displayed, the GSD file must be installed. To do this, in "HW config" use menu command **Tools > Install new GSD file**.

Note

The GSD file of the DP slave MCP is located on the Toolbox CD in the directory:
...\\8x0d\\GSD\\MCP_310_483

6.6.3 Functions of the machine control panel

The machine control panel offers the following functions:

- **Standard**
The input/output data of the function keys and user-specific keys and outputs are transferred:
 - Input data: 8 bytes
 - Output data: 8 bytes
- **Handwheel**
The absolute values of the two handwheels that can be connected to the machine control panel are transferred.
- **Additional I/Os**
The data of the following non-default inputs/outputs is transferred:
 - Direct keys
 - Customer keys
 - Rotary switch

6.6.4 Configuring the DP slave MCP

This section describes how to configure a DP slave MCP with reference to the hardware configuration for a SIMATIC S7 project shown in the figure by way of example.

The hardware configuration has the following modules:

- SIMATIC Station 300 with SINUMERIK 840D sl
- SINUMERIK MCP with module: Standard + handwheel + additional I/O

Procedure

Configuring the DP slave MCP as an S7 project involves the following steps:

1. Add the DP slave MCP to the configuration ①.
2. Set the PROFIBUS address.

3. Add the appropriate module to the DP slave MCP depending on the required functions ②.
4. Set the I/O addresses of the individual slots.

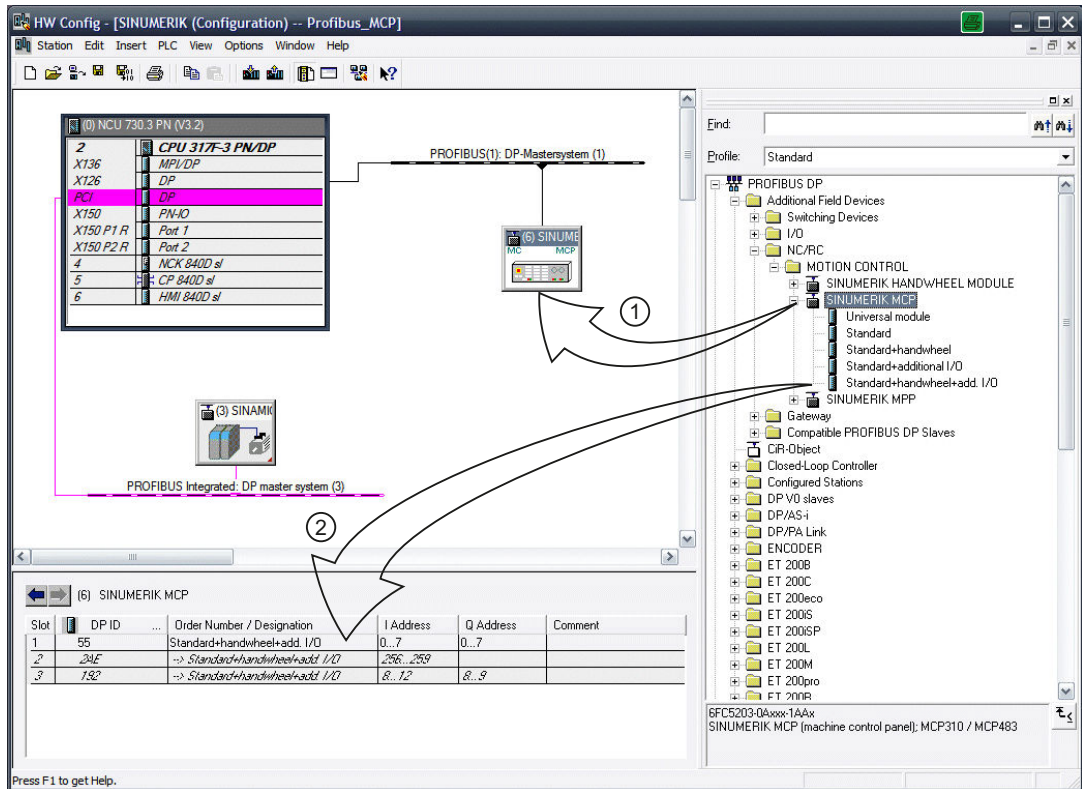

Figure 6-5 Configuration with DP slave MCP

Requirements: S7 project

The following status is required for the S7 project to which the DP slave MCP is to be added:

- The S7 project has been created.
- A SIMATIC 300 station with SINUMERIK controller has been defined.

Adding a DP slave MCP

To add a DP slave MCP to the configuration, open the hardware catalog using the menu command View > Catalog.

The DP slave MCP can be found at profile: **Standard PROFIBUS DP > Other field devices > NC/RC > Motion Control > SINUMERIK MCP**

Click with the left mouse button on the DP slave MCP (SINUMERIK MCP) in the hardware catalog and drag it onto the DP master system in the station window by holding down the left mouse button.

The DP master system is displayed in the station window with the following symbol:

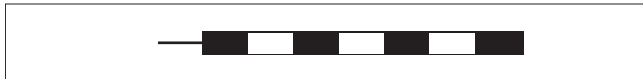

When you release the left mouse button, the DP slave MCP is added to the configuration.

Note

As you drag the DP slave the cursor appears as a circle with a slash through it. When the cursor is positioned exactly over the DP master system, it changes to a plus sign, and the DP slave can be added to the configuration.

PROFIBUS parameters

As soon as you have inserted the MCP DP slave into the configuration, the "Properties - PROFIBUS interface SINUMERIK MCP" dialog box is displayed:

Dialog: Properties - PROFIBUS interface SINUMERIK MCP			
Tab card: Parameters			
		Address: <PROFIBUS address> Button: "Properties..."	
		Dialog: PROFIBUS properties	
		Tab card: Network settings	
		Data transfer rate: 12 Mbaud Profile: DP	
		OK	
OK			

The following PROFIBUS parameters must either be set or verified:

- PROFIBUS address
- Data transfer rate
- Profile

Note

No automatic comparison of the PROFIBUS address!

The PROFIBUS address of the DP slave MCP set in the S7 project must match the PROFIBUS address set on the module (DIP switch S3) (see Section: "Settings via DIP switch S3")

The following data must agree:

1. SIMATIC S7 configuration DP slave MCP: **PROFIBUS address**
2. Machine control panel DIP switch S3: **PROFIBUS address**
3. FB1 call in OB100: **"MCP1BusAdr := "**

Adding a module

The active functions and hence the number of user data elements to be transferred are chosen by selecting the appropriate pre-configured module. The following modules are available in HW Config under "SINUMERIK MCP":

- *Universal module* (not applicable)
- Standard
- Standard + handwheel
- Standard + additional I/O
- Standard + handwheel + additional I/O

I/O addresses

If you add a module to slot 1 of the DP slave MCP, the I/O addresses are automatically assigned by STEP 7.

Double clicking with the left mouse button on a slot opens the "Properties - DP Slave" dialog box. This dialog box can be used to set the start addresses of the I/O data of the slot.

6.6.5 Linking the DP slave MCP

This chapter describes how to link the DP slave MCP

- In the basic PLC program for transferring the standard input/output data in the VDI interface
- To the PLC user program (optional) to implement a user-specific response to a module failure

Note

Processing of additional I/O data is the sole responsibility of the user (machine manufacturer) and is not supported by the PLC basic program.

PLC basic program

To transfer the standard I/O data of the MCP DP slave via the PLC basic program, the corresponding I/O range must be entered in the communication parameters of the FB1 function block.

Function block FB1

The communications parameters of the MCP are called MCPx... (x = 1 or 2) in function block FB1. A maximum of 2 machine control panels are supported by the basic PLC program.

To synchronize several MCPs, the PLC program must be adapted accordingly. This is the user's (machine manufacturer's) responsibility.

To operate an MCP 483 machine control panel as DP slave, only the parameters listed in the following table are relevant for the FB1 call in the OB100:

parameters	Type	Description	Value
MCPNum:	INT	Number of active MCPs	:=1
MCP1In:	POINTER	Start address of the input signals	:= P#E 0.0
MCP1Out:	POINTER	Start address of the output signals	:= P#A 0.0
MCP1StatSend	POINTER	Status data word for sending	:= P#A 8.0
MCP1StatRec	POINTER	Status data word for receiving	:= P#A 12.0
MCP1BusAdr	INT	≙ S3 switch position on the MCP	:=6
MCP1Timeout	S5time	Cyclic sign-of-life monitoring of the MCP	:= S5T#700MS
MCP1Cycl	S5time	Time reference for the cyclic updating of the signals to the MCP	:= S5T#200MS
MCPBusType	BYTE	33 ≙ PROFIBUS (55 ≙ Ethernet)	:= B#16#33

VDI interface parameter assignment

The following function modules are available for assigning the VDI interface parameters:

- FC 19: Transfer the signals for wide MCP, M (milling) version
- FC 25: Transfer the MCP signals, T (turning) version

Note

The FC 19, FC 19 and FC 25 function blocks are part of the basic PLC program. It is the user's (machine manufacturer's) responsibility to call the block correctly and/or assign the interface the appropriate parameters.

References

A detailed description of the function blocks for transferring the machine control panel signals is available in:

Function Manual, Basic Functions: P3, Basic PLC Program

PLC user program

If an MCP is connected via PROFIBUS DP, the basic PLC program does not check for module failure.

In this case the MCP is monitored by a standard mechanism to monitor the active DP slave:

- PLC operating system
- PROFIBUS controller

If a failure of a DP slave MCP is detected, the PLC defaults to STOP.

Customized response

The following organization blocks can be added to the PLC user program to customize the response to a DP slave MCP failure:

- OB 82: Diagnostics interrupt
- OB 86: Rack failure

6.6 Connection via PROFIBUS DP

Please refer to the corresponding SIMATIC literature for details of linking organization blocks and evaluating diagnostic data.

Note

In the event of the failure of a connected machine control panel, the PLC basic program performs the following:

- Alarm "40026x machine control panel (x+1) failure"; with x = 0, 1 is initiated.
- The corresponding interface signal "MCP 1/2 ready" in the DB10.DBB104 is reset.

6.6.6 Input / output images

The specifications for assigning input and output bytes listed in the tables can be changed in the PLC via parameter assignment.

Note

The following applies in respect of the process input and output images in the tables: n is defined by means of FB1 parameters in OB100 of the PLC.

Table 6-3 MCP 483 input image

Byte	Bit7	Bit6	Bit5	Bit4	Bit3	Bit2	Bit1	Bit0
EB n + 0	Spindle override				Mode			
	D (2 ³)	C (2 ²)	B (2 ¹)	A (2 ⁰)	JOG	TEACH IN	MDA	AUTO
EB n + 1	Machine function							
	REPOS	REF.	var. INC	10000 INC	1000 INC	100 INC	10 INC	1 INC
EB n + 2	Key-operated switch		Spindle start	* Spindle stop	Feed start	* Feed stop	NC start	* NC stop
	Position 0	Position 2						
EB n + 3	RESET	Key-operated switch position 1	Single block	Feed override				
				E (2 ⁴)	D (2 ³)	C (2 ²)	B (2 ¹)	A (2 ⁰)
EB n + 4	Arrow keys			Key-operated switch position 3	Axis selection			
	+ R15	- R13	Rapid traverse R14		X R1	4. axis R4	7. axis R7	R10
EB n + 5	Axis selection							
	Y R2	Z R3	5. axis R5	Motion command in MCS/WCS	R11	9. axis R9	8. axis R8	6. axis R6
EB n + 6	Unassigned customer keys							
	T9	T10	T11	T12	T13	T14	T15	-
EB n + 7	Unassigned customer keys							
	T1	T2	T3	T4	T5	T6	T7	T8

Byte	Bit7	Bit6	Bit5	Bit4	Bit3	Bit2	Bit1	Bit0
EB n + 8	DT07	DT06	DT05	DT04	DT03	DT02	DT01	DT00
EB n + 9	DT15	DT14	DT13	DT12	DT11	DT10	DT09	DT08
EB n + 10	-	-	KT-IN6 X52.3	KT-IN5 X52.2	KT-IN4 X52.1	KT-IN3 X51.3	KT-IN2 X51.2	KT-IN1 X51.1
EB n + 11	-	-	-	-	-	-	-	-
EB n + 12	-	-	-	-	-	-	-	-
EB n + 13	-	-	-	X31 pin 6 ¹⁾	X31 pin 7 ¹⁾	X31 pin 8 ¹⁾	X31 pin 9 ¹⁾	X31 pin 10 ¹⁾

Signals marked with * are inverse signals.

1) If the 4-stage rotary spindle override switch on X31 is replaced by a 5-stage rotary switch, the input information here can be measured in five stages.

Table 6-4 MCP 483 output image

Byte	Bit7	Bit6	Bit5	Bit4	Bit3	Bit2	Bit1	Bit0
AB n + 0	Machine function				Mode			
	1000 INC	100 INC	10 INC	1 INC	JOG	TEACH IN	MDA	AUTO
AB n + 1	Feed start	* Feed stop	NC start	* NC stop	Machine function			
					REPOS	REF.	var. INC	10000 INC
AB n + 2	Arrow key - R13	Axis selection				Single block	Spindle start	*Spindle Stop
		X R1	4. axis R4	7. axis R7	R10			
AB n + 3	Axis selection							Arrow key + R15
	Z R3	5. axis R5	Motion command in MCS/WCS	R11	9. axis R9	8. axis R8	6. axis R6	
AB n + 4	Unassigned customer keys							
	T9	T10	T11	T12	T13	T14	T15	Y R2
AB n + 5	Unassigned customer keys							
	T1	T2	T3	T4	T5	T6	T7	T8
AB n + 6	-	-	-	-	-	-	RESET	R14
AB n + 7	-	-	KT-OUT6 X54.3	KT-OUT5 X54.2	KT-OUT4 X54.1	KT-OUT3 X53.3	KT-OUT2 X53.2	KT-OUT1 X53.1

Signals marked with * are inverse signals

Default key assignment

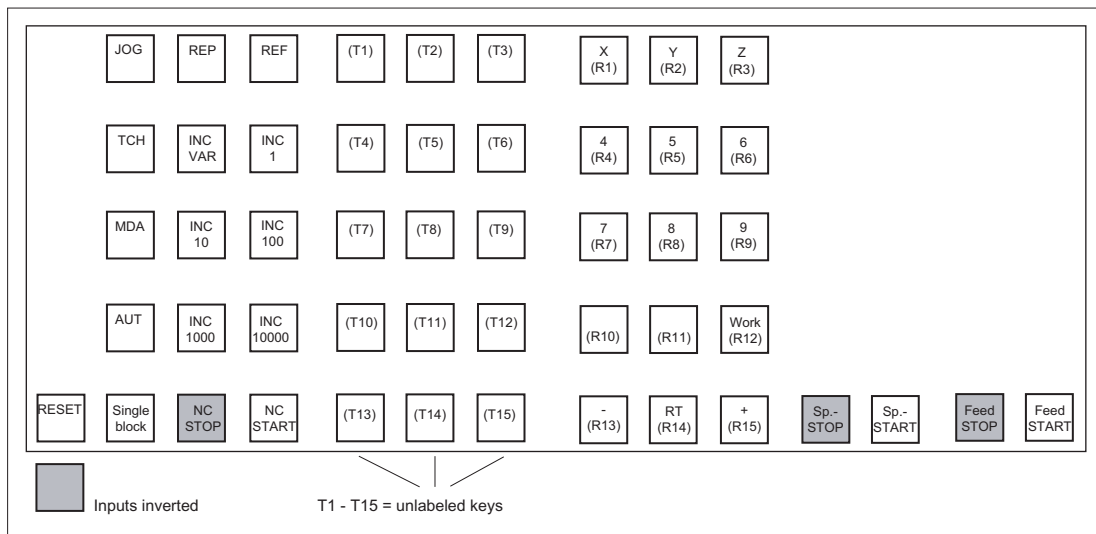

Figure 6-6 MCP 483 default key assignment

Assignment of the inputs (I) and outputs (O) to the keys and LEDs

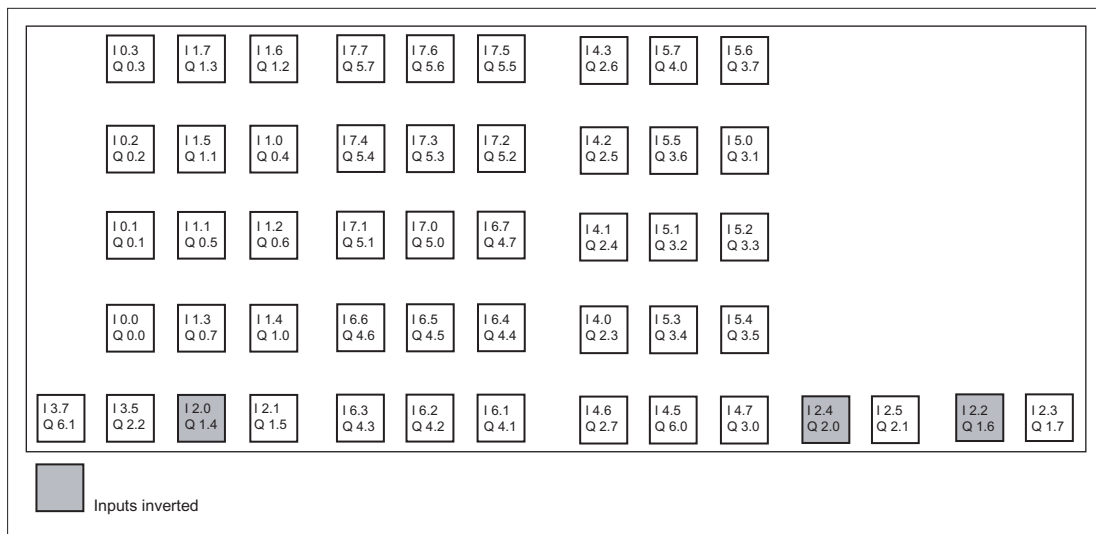

Figure 6-7 Inputs and outputs of the MCP 483 keyboard

6.7 Maintenance and Service

Cleaning the device

Use a soft cloth moistened either with water or a mild cleaning agent to clean the housing and operator control elements of the machine control panel.

Checking the device

In order to prevent foreign bodies or liquids entering the machine control panel, regularly check the device

- that all the housing screws are in place and tight
- for damage to the housing
- for damage to the cable cover or cable entry

Protect the device from environmental effects

Protect the machine control panel against

- direct solar radiation and heat sources
- mechanical vibration and shock
- dust
- moisture, and
- strong magnetic fields

Checking the emergency stop button

Check the emergency stop button regularly to ensure that it functions correctly.

6.8 Technical data

Machine control panel MCP 483

Safety				
Safety class	III; PELV according to EN 50178			
Degree of protection according to EN 60529	Front side: IP65	Key-operated switch: IP54	Rear side: IP00	
Approvals	CE			
Electrical data				
Input voltage	24 VDC			
Power consumption, max.	Board: 7 W	Lamps: 14.4 W (6 x 2.4 W) *)	Handwheels: 2 x 0.9 W	Total: 23.2 W
Mechanical data				
Dimensions	Width: 483 mm Height: 155 mm		Depth: 70 mm Mounting depth: 38 mm	
Distance from NCU/PCU	PROFIBUS DP: 100 m			
Weight:	Approx. 1.6 kg			
*) The outputs for the illuminated pushbuttons (X53/X54) can have a max. permissible current of 0.3 A. However, the total current consumption of the components must not exceed 1.0 A (24 W).				

Note

Information about the climatic and mechanical environmental conditions is contained in the associated section under:

"General notes and interconnection" → "Operational planning".

Emergency Stop button

Rated voltage	24 VDC
Current magnitude, max.	3 A
Current magnitude, min.	1 mA
Switching capacity	DC 13 according to EN 60947-5-1
Conditional rated short-circuit current	10 A gL/gG according to EN 60947-5-1
B _{10d}	500 000

Note

The quantitative assessment of the emergency stop safety function must be based on the B_{10d} values corresponding to the used standards (e.g. ISO 13849-1) under consideration of the respective application (frequency of the actuation, service life, diagnostics by the evaluation unit, etc.). The B_{10d} values only apply when the technical properties of the emergency stop button are taken into account.

6.9 Accessories and spare parts

6.9.1 Overview

Table 6-5 Accessories and spare parts for machine control panel 483

Name	Description	Quantity	Order number
Emergency stop button	22 mm actuating element, 40 mm mushroom pushbutton, snap action with tamper protection, latching, red, with holder, unlit	1	3SB3000-1HA20 *)
	Contact block with 2 contacts, 1 NO + 1 NC, 2-pole ,screw terminal	1	3SB3400-0A *)
Key-operated switch	Key-operated switch with key	1	6FC5247-0AF02-0AA0
Key	10 key sets, each with three keys for the key-operated switch settings 1, 2, 3	1 set	6FC5148-0AA03-0AA0

Name	Description	Quantity	Order number
Tension jacks	Tension jack set (9 items) for supplementary components with 2.5 mm profile, length: 20 mm	1 set	6FC5248-0AF14-0AA0
Override spindle / rapid traverse	Electronic rotary switch 1x16G, T=24, cap, button, pointer, spindle dials and rapid traverse	1	6FC5247-0AF12-1AA0
Override feed / rapid traverse	Electronic rotary switch 1x23G, T=32, cap, button, pointer, feed and rapid-traverse dials	1	6FC5247-0AF13-1AA0
Slide-in labels	Can be written, (3 films, A4)	1 set	6FC5248-0AF22-1AA1
Cables	Cable set (60 units) for additional control devices for the machine control panels Length: 500 mm	1 set	6FC5247-0AA35-0AA0

*) Safety-related

6.9.2 Membrane keyboard: Labeling the slide-in labels

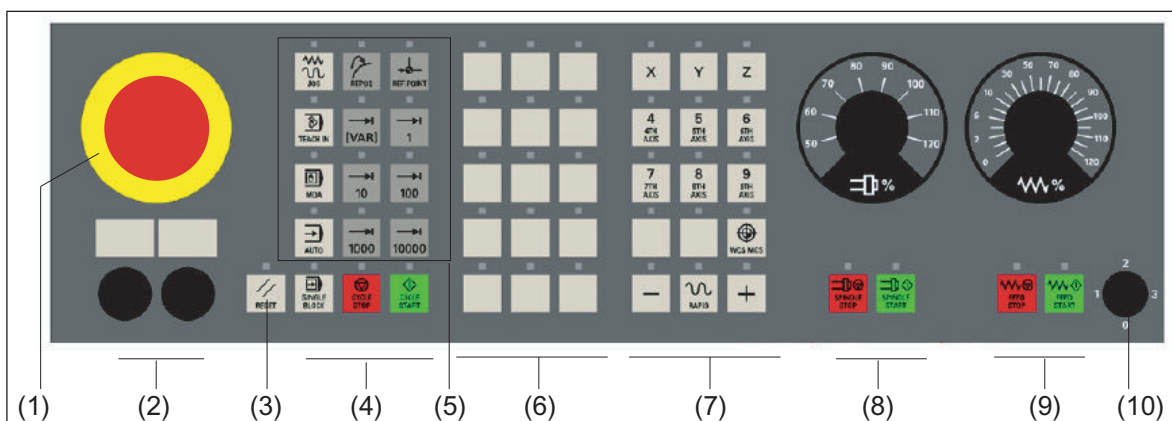

Figure 6-8 Machine control panel MCP 483

The machine control panel (MCP) shown above is the standard shipped variant.

You can create your own slide-in labels to label the keys differently. A printable blank film (A4) is supplied with the panel for this purpose.

A spare parts kit containing three blank films is also available:
MLFB: 6FC5248-0AF22-1AA1 (Item No. A5E00179123)



Figure 6-9 Blank film for MCP 483

Preparing slide-in labels

Instructions are given below on how to print the required key symbols on the supplied film or how to create your own individual film:

The software on the DOConCD / Catalog NC 61 (CD enclosed) includes four files for the blank films:

- **Template_M_MCP483.doc** [default assignment for milling - standard; **(A)**]
- **Template_T_MCP483.doc** [defaults for turning; **(B)**]
- **Template_MCP483.doc** [blank template for film: Item No. A5E00205579; **(C)**]
- **Symbols.doc** Key symbols as Word file, inscription on labels as jpg file **(D)**

Files **Template_M_MCP483.doc**, **Template_T_MCP483.doc** and **Template_MCP483.doc** include a table function showing the corresponding keyboard positions.

An example of each of the MCP files (milling and turning) is given below:

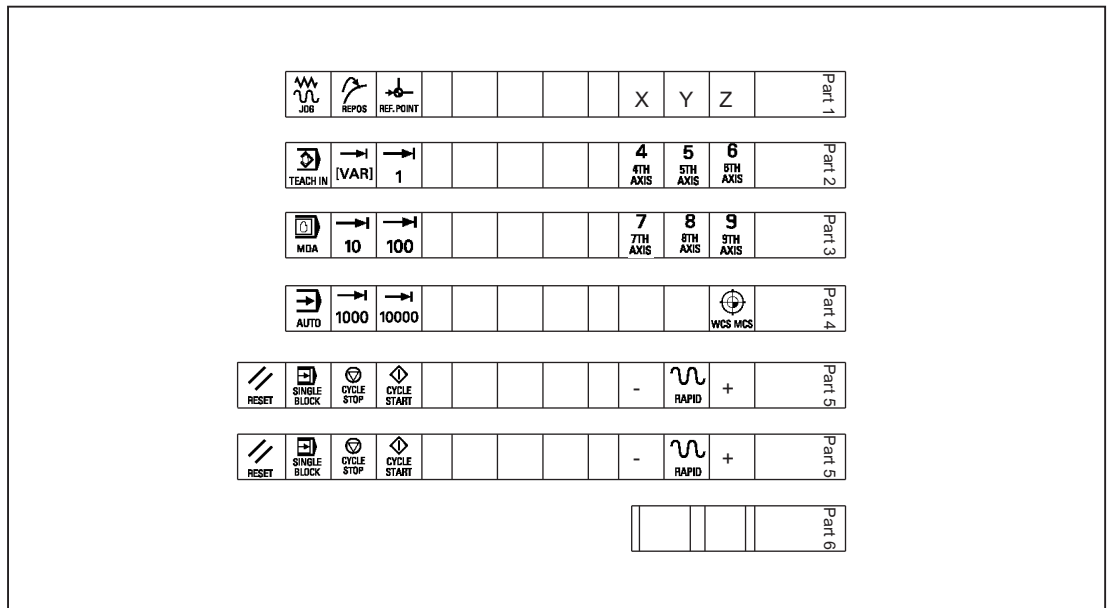

Figure 6-10 Template_M_MCP483.doc for the "Milling" version (A)

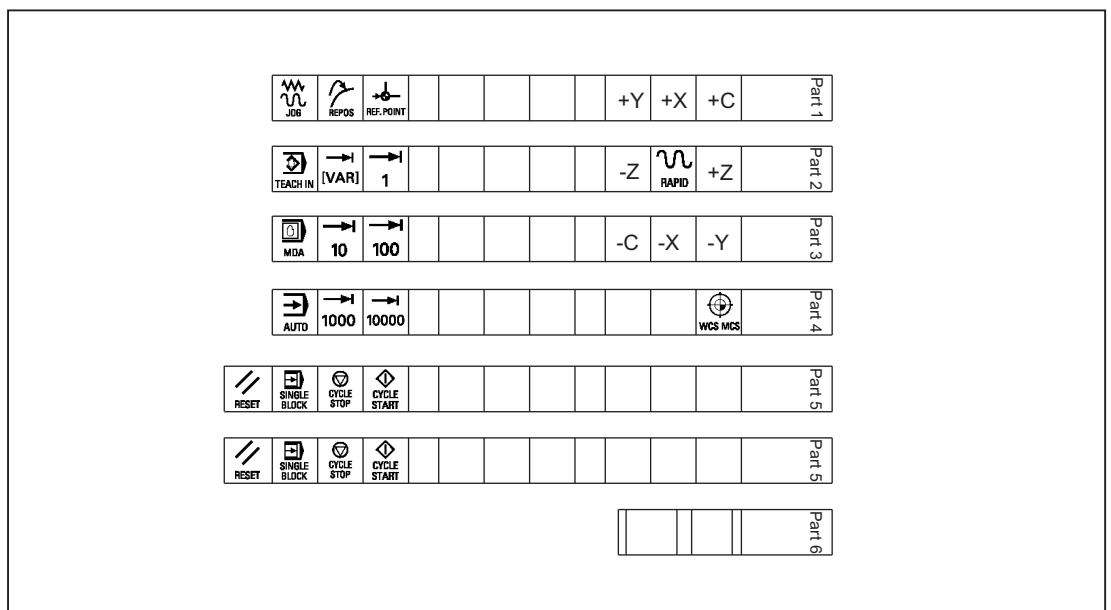

Figure 6-11 Template_T_MCP483.doc for the "Turning" version (B)

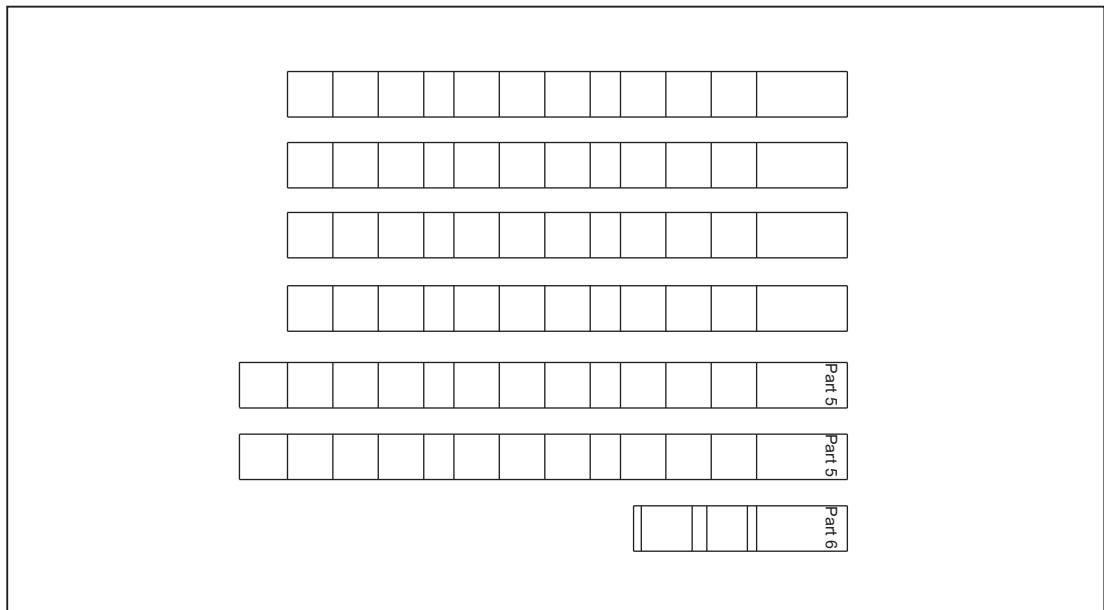

Figure 6-12 Template_MCP483.doc (blank template for film: Item No. A5E00205579 (C))

Within the table cells the key symbol required in each case can be copied and pasted into the corresponding table field.

The vertical bars shown in the diagram do not appear on the printed-out labels.

























The strip "Part5" is included twice so that it is available optionally as either a 1-color or 3-color strip.

Note

Use the "Arial" font to format text. This font is comparable to the "Univers S57" font used by Siemens for the key labeling.

Table 6-6 Symbols.doc file (D)

	7001		7013		7025		7124
	7002		7014		7026		7125
	7003		7015		7027		7126
	7004		7016		7028		7127
	7005		7017		7029		7128

	7006		7018		7030		7129
	7007		7019		7031		7130
	7008		7020		7032		7131
	7009		7021		7033		7132
	7010		7022		7120		
	7011		7023		7121		
	7012		7024		7123		

Creating your own symbols

- Printing in a vector program (e.g. Designer, Freehand, CorelDraw):
 - Draw a 15 x 15 mm square, fill with the color white and give it an invisible border line.
 - Place the symbol in the center of this square.
 - Copy the entire image (square and symbol) and paste it into a Word document (Symbols.doc).
- Drawing in an image editing program (e.g. Photoshop, Picture Publisher, Paint):
 - Create a square area (e.g. 100 x 100 pixels) filled with the color white.
 - Draw the symbol in the center of this square.
 - Copy the entire image (square and symbol) and paste it into a Word document (Symbols.doc).

Dimension drawings

The following is a dimension drawing for the blank template for MCP 483:

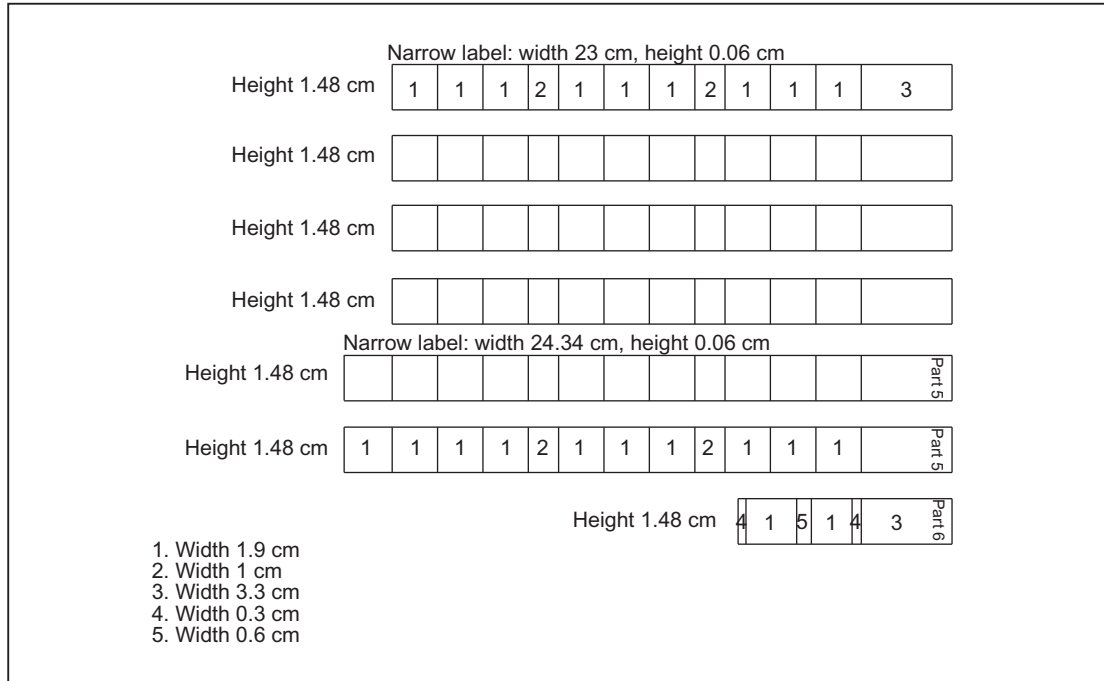

Figure 6-13 Dimension drawing for slide-in labels for MCP 483

Note

The slide-in strips are printed on the front with a laser printer. HP Color Laser Jet film C2936A is used.

To make the labels easier to slide in, they should be rounded by about 1.5 mm.

The outer lines of the strip are the cutting edge.

It is advisable to run a test print on normal paper before printing the labels on film.

Machine pushbutton panel: MPP 310 IE H

7.1 Description

7.1.1 Overview

The machine control panel MPP 310 IE (IE = Industrial Ethernet) permits user-friendly operation of the machine functions on complex machining stations. It is suitable for machine-level operation of milling, turning, grinding and special machines.

In addition to the standard elements of machine control, several freely assignable slots are integrated on the operator panel for connecting other control devices.

The function of the MPP 310 IE H can be extended considerably by fitting additional keys and through the EKS identification system provided by Euchner.

The machine control panel is easy to mount on the rear side using special tension jacks.

All keys have user-inscribed slide-in strips for machine-specific adaptations. Two DIN-A4 sheets (printed and white) for inscribing are supplied by the factory.

The machine control panel MPP 310 IE H is available with

- Ethernet bus interface
- EKS identification system
- Handheld unit connection HT 2/HT 8
- Extension keys
- Spindle override
- Feed override

Validity

The following description applies to the machine control panel:

Designation	Features	Order number
MPP 310 IE H	With handheld unit connection HT 2/HT 8	6FC5303-1AF20-8AA1

The safety-related accessories / spare parts are marked in the "Accessories and spare parts" section with a *).

Connectable control

SINUMERIK 840D sl

7.1.2 System features

- Industrial Ethernet (transfer rate: 10/100 MBit/s)
- Function keyboard with 5 x 5 key matrix, can be freely projected and labeled
- 8 long-stroke keys with LEDs,
- Interfaces for 2 handwheels (D-Sub)
(velocity input and contour handwheel are only possible when connecting through the handwheel connection module 6FC5303-0AA02-0AA0.)
- Emergency stop button (4-wire), latching, tamper-proof
- Emergency stop override button or emergency stop override through 2-position key-operated switch left and right probing (right position: customer-specific)
- Direct key connection for OP 012
- 2 override switches
- Handheld unit connection for HT 2/HT 8
- EKS identification system
- 4 extension keys with LEDs

System configuration

The figures show how the MPP 310 IE H is integrated into the control system.

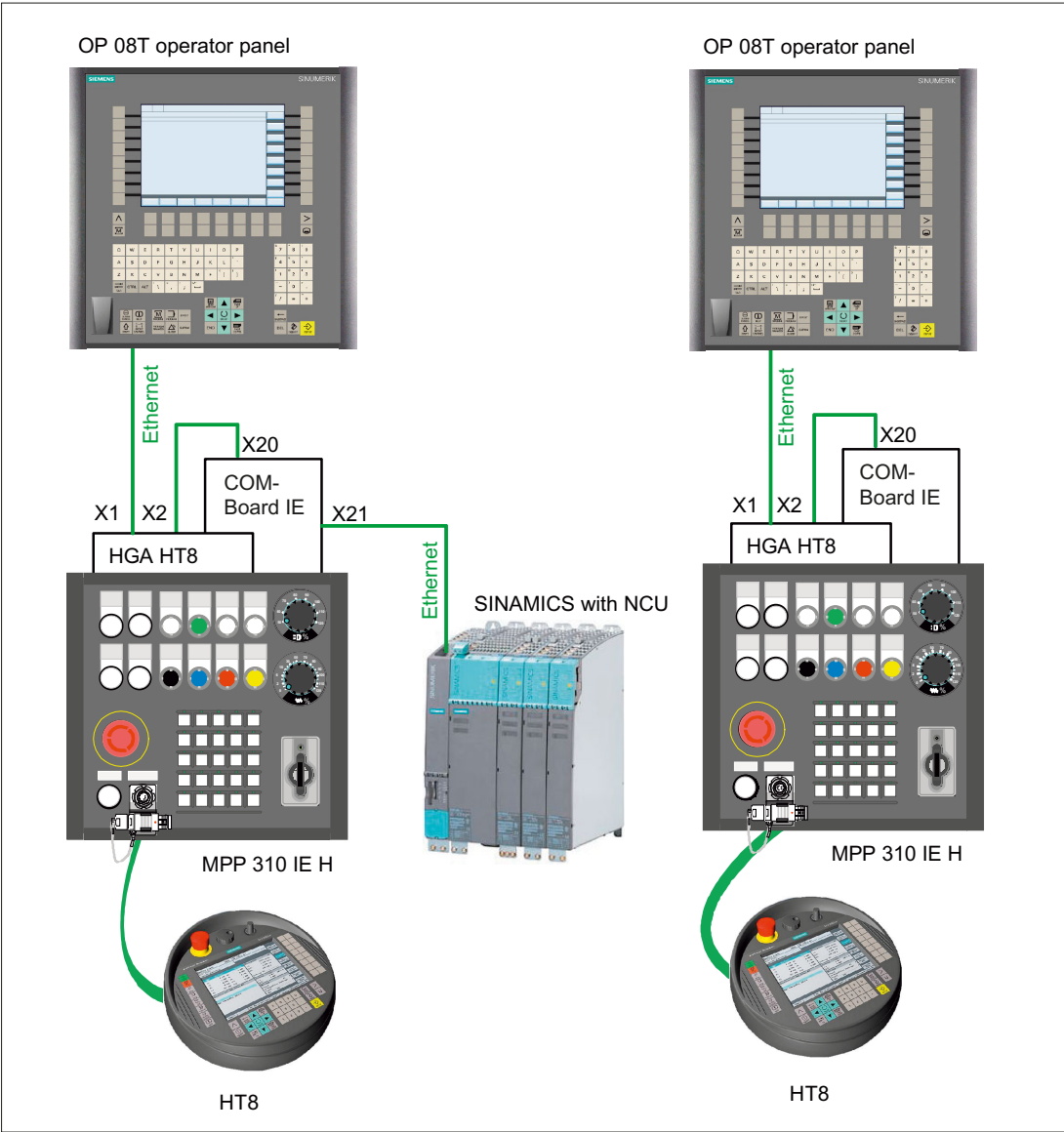

Figure 7-1 System configuration of the MPP 310 IE H

Note

The connection cables are not part of the scope of supply.

7.1 Description

7.1.3 Mechanical design

The machine control panel MCP 310 IE H consists of

- Control panel
- Handheld unit connection board (PCB HT 8)
- Customer keys board (PCB KT 310)
- COM board (PCB COM IE)

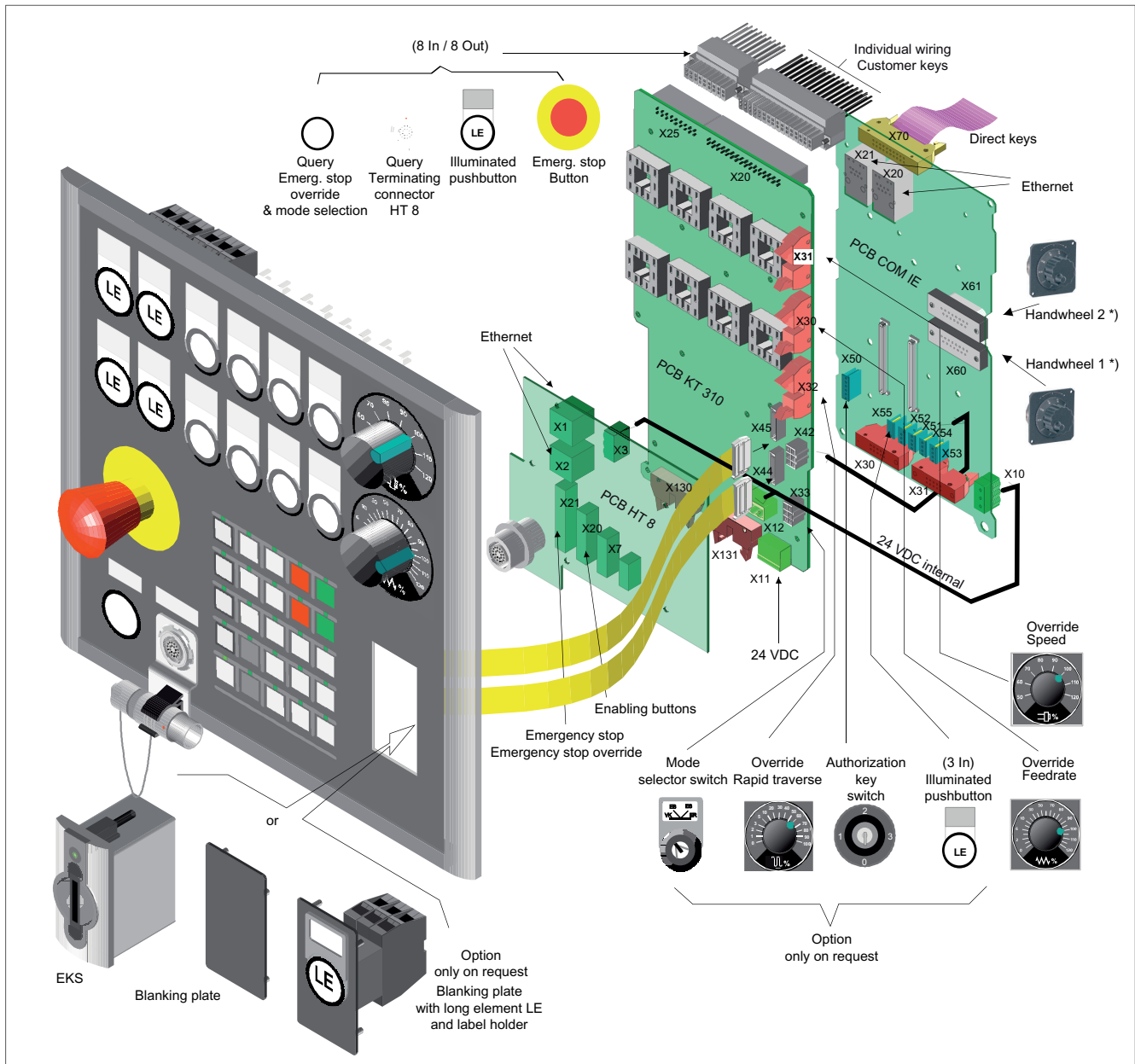

Figure 7-2 Mechanical structure of the MPP 310 IE H

*) Contour and velocity specification via handwheel are not supported.

7.2 Operator controls and indicators

7.2.1 Overview

Panel structure

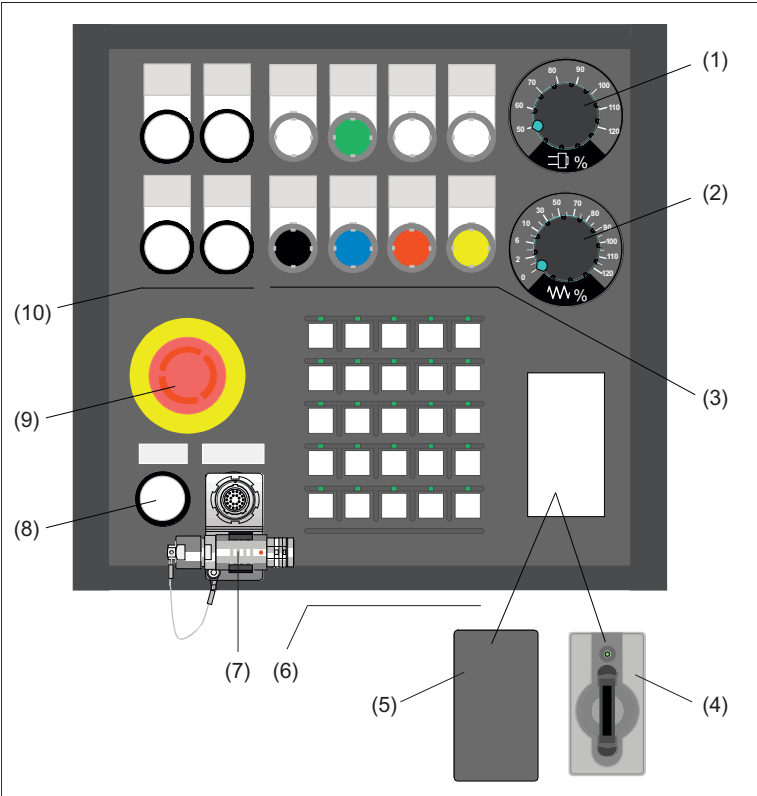

- (1) Spindle override
- (2) Feedrate override
- (3) 8 customer keys with LEDs (Schlegel keys), slide-in labels
- (4) EKS Ethernet
- (5) Blanking plate
- (6) 25 function keys with LEDs (membrane keys), slide-in labels
- (7) Handheld unit connection HT 2 / HT 8
- (8) Emergency stop override button
- (9) Emergency stop button
- (10) 4 extension keys with LEDs (3SB3 keys), slide-in labels

Figure 7-3 Panel of the MPP 310 IE H

Assignment of slots

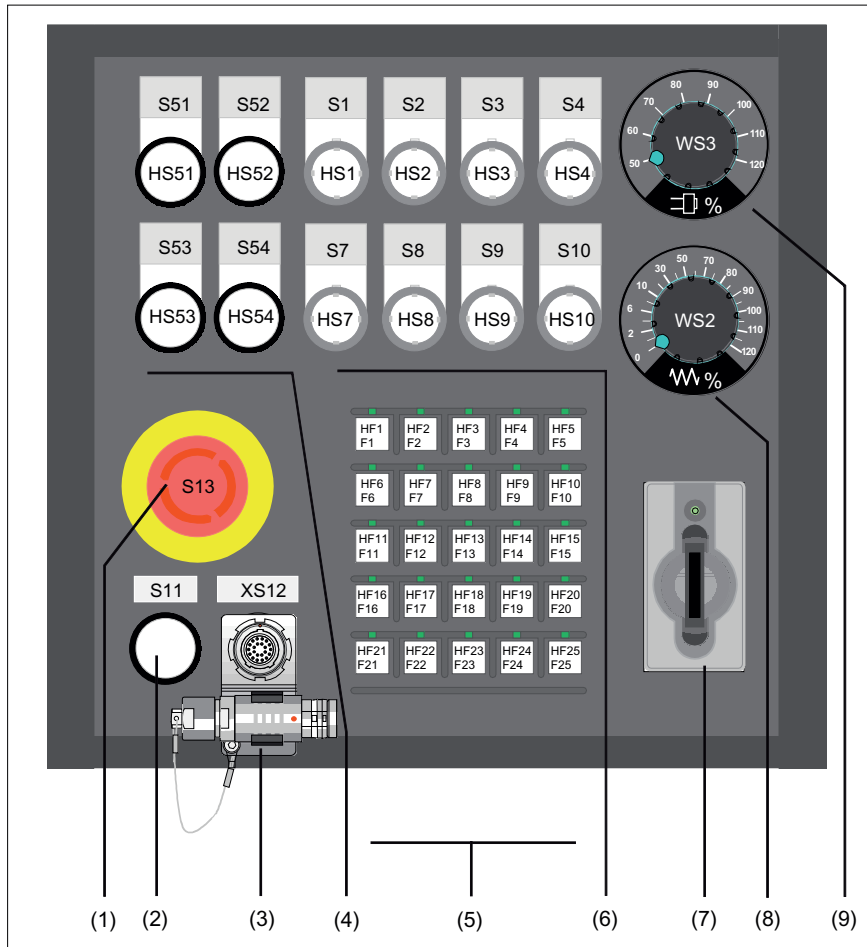

- (1) Emergency stop button
- (2) Emergency stop override
- (3) Handheld unit connection HT 2 / HT 8
- (4) 4 extension elements, 22.5 mm
- (5) Function keys
- (6) Customer keys (long-stroke keys)
- (7) EKS identification system
- (8) Feedrate override
- (9) Spindle override

Figure 7-4 Slots on the MPP 310 IE H

7.2.2 Description

7.2.2.1 Device front

Emergency stop chain

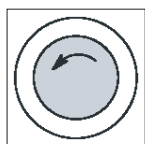

Emergency stop button

Press the red button in emergencies when

- people are at risk,
- there is the danger of the machine or workpiece being damaged.

An emergency stop generally shuts down all drives with the greatest possible braking torque in a controlled manner.

Turn the EMERGENCY STOP button counterclockwise to unlatch it.

When the emergency stop button is activated, the emergency stop chain of the MPP 310 H will ensure personal safety and protect the machine in hazardous situations.

The emergency stop chain is also active if the handheld units are removed. To prevent the emergency stop chain from being interrupted while you plug in or pull out the handheld unit, press the emergency stop override S11. This overrides the emergency stop button on the handheld unit.

WARNING

Danger of death caused by malfunction of the emergency stop override

To effectively deal with a malfunction of the emergency stop override S11 (e.g. jamming), the user PLC program must generate emergency stop when a monitoring time (approximately 5 min) expires (see Figure in Section: "Connecting" → "Handheld unit connection HT 8 with emergency stop override").

The emergency stop chain of the MPP 310 IE H should be integrated in the system emergency stop by the user.

Note

Machine manufacturer

For details of other or additional reactions to an Emergency-Stop: Please read the information supplied by the machine tool manufacturer!

WARNING

Danger of death resulting from the premature emergency stop unlocking

If you have shut down the system to be monitored, you can only release the emergency stop button or put the system to be monitored back into operation if the condition that triggered the emergency stop function has been corrected and a safe restart is carried out.

Actuation elements

Actuation elements S1 to S4 and S7 to S10 are activated by the control. They also have electrically isolated contacts (common roots) for user-specific wiring.

The following positions can be connected to control devices corresponding to the table in Section: "Accessories and spare parts" → "Display and operating elements":

- S1 to S4
- S7 to S10
- S51 to S54

Lamps

Lamps HS1 to HS4 and HS7 to HS10 are connected to the control via Ethernet. Alternatively, HS1 to HS4 and HS7 to HS10 can also be activated by externally non-isolated via X20 of the Customer keys PCB KT 310.

7.2.2.2 Device rear side

COM board IE

S1 (jumper)	Setting the handwheel signal type S1 open: TTL interface S1 closed: differential interface
S2	Setting of the MPP address (see Section: "Interfaces" → "Description" → "COM board")
Diagnostic LEDs	LED1 (H1) POWER OK (green) LED2 (H2) Bussync LED3 (H3) Busfault

Customer keys KT 310

Diagnostic LEDs	LED1 (H1) Voltage monitoring of customer keys LED2 (H2) Voltage monitoring of customer keys LED3 (H3) Voltage monitoring of customer keys
------------------------	---

HGA board HT 8

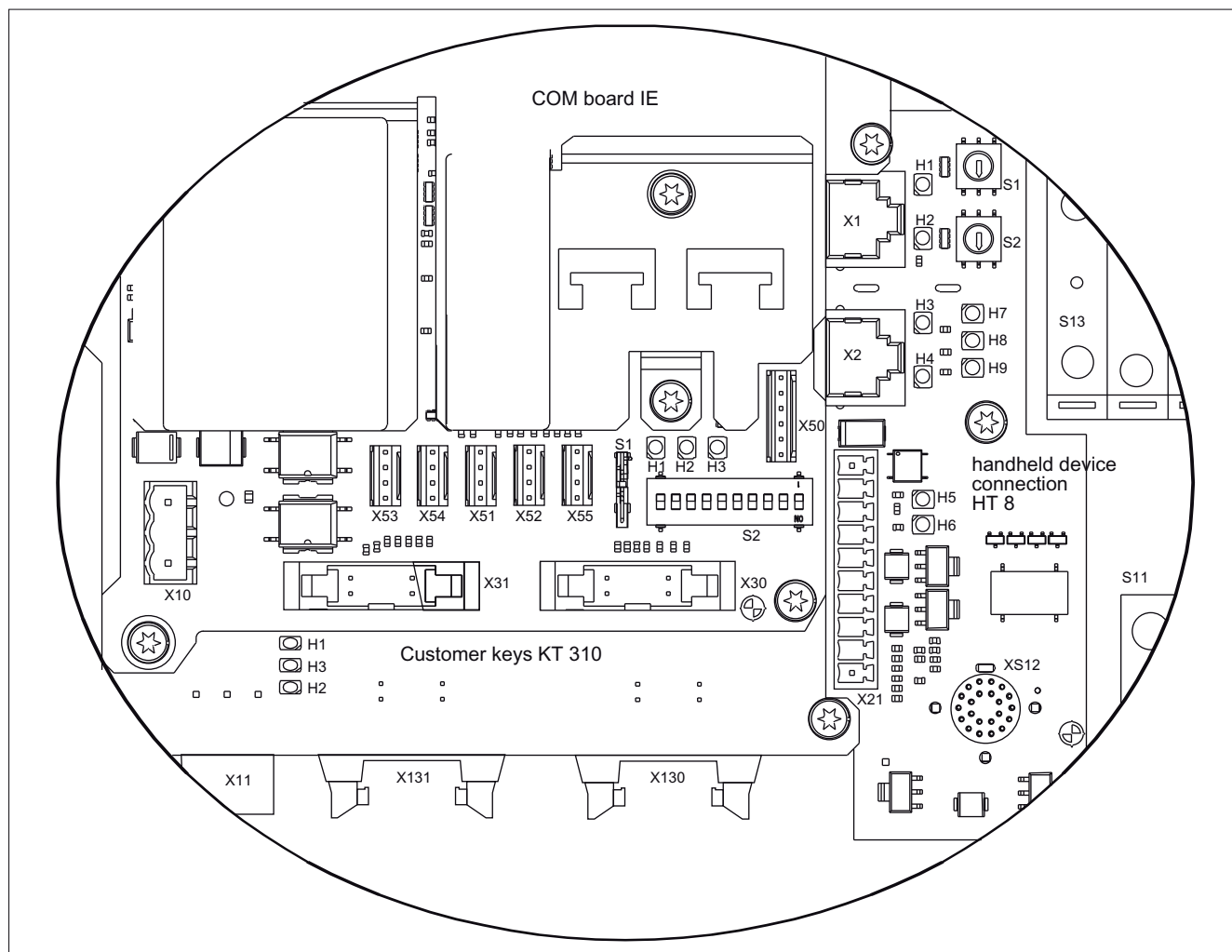

Figure 7-5 Rear of MPP 310 IE H with LEDs

Table 7-1 Diagnostic LEDs

LED		Color	for	Meaning
LED1 (H1)	LNK	Green	X1 RJ45	Connection established
LED2 (H2)	ACT	yellow	X1 RJ45	Transmission active
LED3 (H3)	LNK	Green	X2 RJ45	Connection established
LED4 (H4)	ACT	Yellow	X2 RJ45	Transmission active
LED5 (H5)	LNK	Green	HT 8 transmission	
LED6 (H6)	ACT	Yellow	HT 8 transmission	
LED7 (H7)	Power OK	Green		
LED8 (H8)	FAULT STAT1	Red		Fault
LED9 (H9)	FAULT STAT2	Red		Fault

7.3 Interfaces

Table 7-2 Coding switches	
S1	Module address bit 4 ... 7
S2	Module address bit 0 ... 3

7.3 Interfaces

7.3.1 Overview

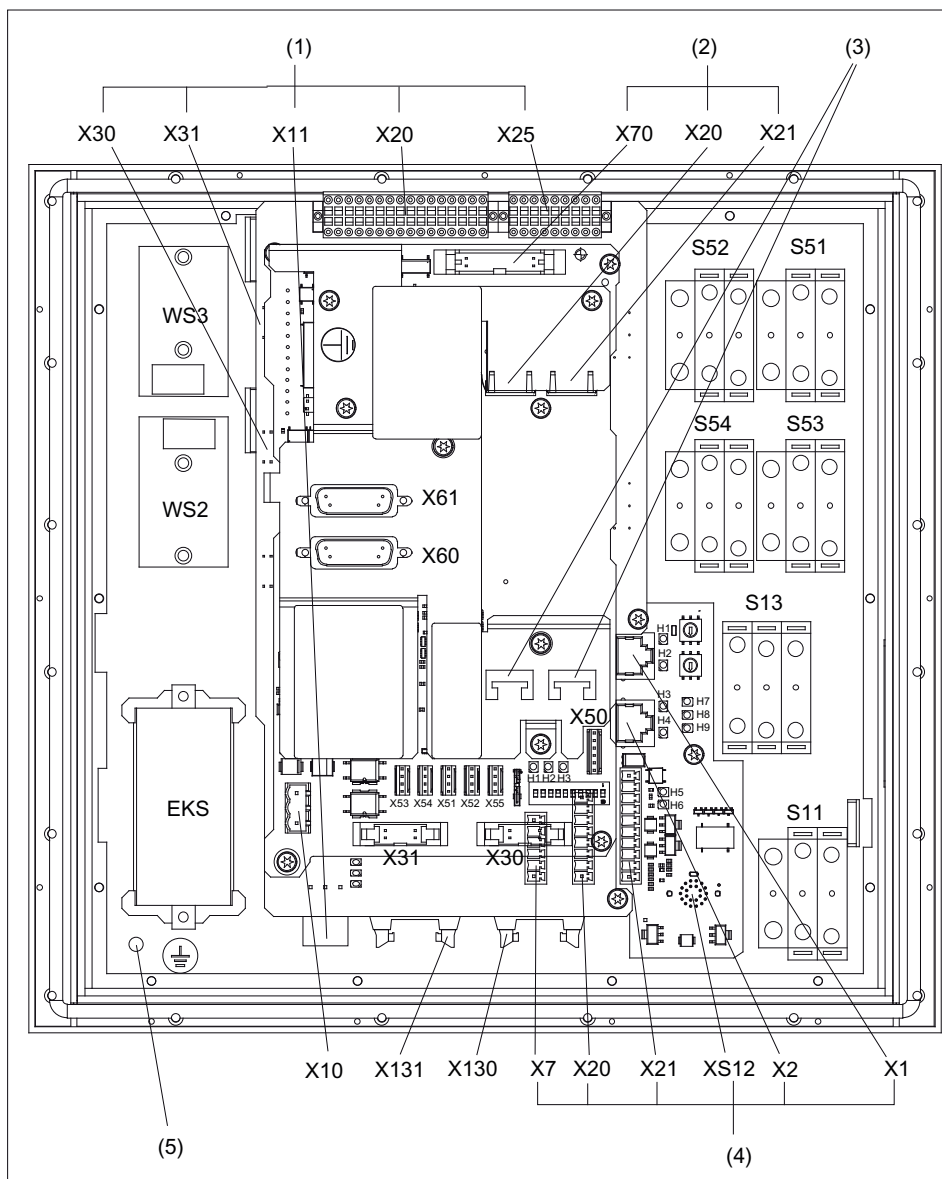

Figure 7-6 Rear of the MPP 310 IE H with interfaces

	Control panel	
(5)		Protective conductor connection
	S13	Emergency stop button
	S11	Emergency stop override
	S51 to S54	Extension keys
	WS2	Feedrate override
	WS3	Spindle override
	EKS	Identification system
(2)	COM board	
	X10	Power supply
	X20	Ethernet / Port 1
	X21	Ethernet / Port 2
	X60	Handwheel 1
	X61	Handwheel 2
	X70	Direct keys
(3)		Strain relief for Ethernet cable
(1)	Customer keys	
	X11	Power supply
	X20	Individual wiring
	X25	Extension
	X30	Feedrate override
	X31	Spindle override
(4)	Connection for handheld units	
	X1 / X2	Ethernet
	X7	Panel present
	X20	Enable
	X21	Emergency stop override
	XS12	Connection for handheld units

Signal type

O	Outputs
I	Inputs
B	Bidirectional signals
V	Power supply

7.3.2 Description

7.3.2.1 Control panel



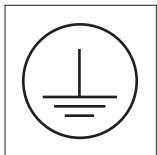



Protective Ground Connection

Pin	Signal	Connection	Connection cross-section
	PE	M5 x 2.5 cable lug	2.5 mm ²

Emergency stop button S13

Key designation: S13
 Key type: Mushroom, push-pull key 3SB3000-1HA20 with holder 3SB3901-0AB and 1 x NO 3SB3400-0B (internal use)



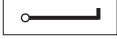



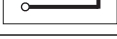
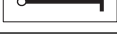

Table 7-3 Emergency stop contact block

Pin	Signal	Type	Signal name	Function
14	BZ_S13.14	I/O	Reference potential S1, S13	
13	S_S13.13		NO contact S1, S13	
31	OE_S13.31		NC contact OE1, S13	
32	BZ_S13.32		Reference potential OE1, S13	
21	OE_S13.21		NC contact OE2, S13	
22	BZ_S13.22		Reference potential OE2, S13	

Emergency stop override S11

Key designation: S11
 Key type: left probing, right probing, safety lock with actuation element according to the catalog: Low-Voltage Controls and Distribution (LV 1) carrier 3SB3901-0AC with pressure plates
 1 x NO contact 3SB3400-0B
 2 x 3SB3400-0A switching element 1xNC contact/1xNO contact elements positively driven

Table 7-4 Emergency stop override contact block

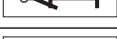
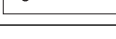
Pin	Signal	Type	Signal name	Function
14	BZ_S11.14	I/O	Reference potential S1, S11	
13	S_S11.13		NO contact S1, S11	
21	OE_S11.21		NC contact OE1, S11	
22	BZ_S11.22		Reference potential OE1, S11	
44	BZ_S11.44		Reference potential S2, S11	
43	S_S11.43		NO contact S2, S11	
31	OE_S11.31		NC contact OE2, S11	
32	BZ_S11.32		Reference potential OE2, S11	
54	BZ_S11.54		Reference potential S3, S11	
53	S_S11.53		NO contact S3, S11	
61	OE_S11.61		NC contact OE3, S11	
62	BZ_S11.62		Reference potential OE3, S11	

7.3.2.2 COM board

Pin assignment

For more detailed information, see "General information and networking", Chapter: "Connecting".

Switch S1

Settings, see Chapter "Machine control panel: MCP 310C PN", Section "Interfaces".

Switch S2

Settings, see Chapter "Machine control panel: MCP 310C PN", Section "Interfaces", mode "MCP set up as IE".

7.3 Interfaces

7.3.2.3 User keys

Power supply interface X11

Connector designation: X11

Connector type: 3-pin Phoenix terminal block

Cable length (max.): 10 m

Table 7-5 Interface power supply

Pin	Signal name	Type	Meaning
1	2P24	V	24 V potential
2	M24		Ground 24 V
3	Shield		Shield connection

Individual wiring











Connector X20



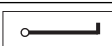





Connector designation: X20

Connector type: 32-pin S2L-SMT 3.5/180 Weidmüller

Cable length (max.): 30 m

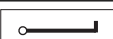
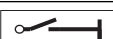
Table 7-6 Connector X20

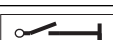
Pin	Signal	Type	Signal name	Function
B4	OE_S2	I/O	NC contact S2	
B3	OE_S1		NC contact S1	
B16	OE_S4	I/O	NC contact S4	
B15	OE_S3		NC contact S3	
B2	BZOE_S1-4	I/O	Reference potential NC contact S1 ... S4	
B1	BZS_S1-S6		Reference potential NO contact S1 ... S6	
B14	S_S4	I/O	NO contact S4	
B13	S_S3		NO contact S3	
B12	S_S2		NO contact S2	
B11	S_S1.1		NO contact S1.1	
B10	BZS_S1.2		Reference potential NO contact S1.2	

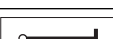
Pin	Signal	Type	Signal name	Function
B9	S_S1.2		NO contact S1.2	
B8	HS 4	I	Signaling lamp S4	All inputs "High" active
B7	HS 3		Signaling lamp S3	
B6	HS 2		Signaling lamp S2	
B5	HS 1		Signaling lamp S1	
A1	HS7	I	Signaling lamp S7	All inputs "High" active
A2	HS8		Signaling lamp S8	
A3	HS9		Signaling lamp S9	
A4	HS10		Signaling lamp S10	
A5	OE_S7	I/O	NC contact S7	
A6	OE_S8		NC contact S8	
A7	OE_S9		NC contact S9	
A8	OE_S10		NC contact S10	
A14	BZOE_S7-10		Reference potential NC contacts S7 ... S10	
A9	S_S7	I/O	NO contact S7	
A10	S_S8		NO contact S8	
A11	S_S9		NO contact S9	
A12	S_S10		NO contact S10	
A13	BZ S_S7-10		Reference potential NO contacts S7 ... S10	
A15	2P24	V	+24V potential	
A16	2P24		+24V potential	

Connector X25

Connector designation: X25

Connector type: 18-pin S2L-SMT 3.5/180 Weidmüller

Cable length (max.): 1.5 m

Table 7-7 Connector X25

Pin	Signal	Type	Signal name	Pin	Signal	Type	Signal name
B1	P24_OUT	V	Reference potential +24V	A1	M24_EXT	V	Reference potential +24V
B2	S13		Emergency stop button	A2	H55		LED_H55

7.3 Interfaces

Pin	Signal	Type	Signal name	Pin	Signal	Type	Signal name
B3	S59 *)	I	KT-IN3 emergency stop override	A3	H56	O	LED_H56
B4	S60		Mode selection	A4	H57		LED_H57
B5	S62 *)		S32 / HGA enabling unit plugged in / terminating connector	A5	H58		LED_H58
B6	S51		Ext. key S51	A6	H51		LED_H51
B7	S52		Ext. key S52	A7	H52		LED_H52
B8	S53		Ext. key S53	A8	H53		LED_H53
B9	S54		Ext. key S54	A9	H54		LED_H54
*) can only be used as a neutral input without HGA							

7.3.2.4 Handheld unit connection HT 8

You will find a detailed drawing showing the location of the interfaces in Section: "Control and display elements" → "Description" → "Device rear".

Ethernet X1 / X2

Connector designation: X1, X2

Connector type: RJ-45 socket

Table 7-8 Ethernet X1 / X2

Pin	Signal name	Type	Meaning
1	TD+	O	Transmit data +
2	TD-		Transmit data -
3	RD+	I	Receive data +
4	N.C.	-	Not connected
5	N.C.	-	Not connected
6	RD-	I	Receive data -
7	N.C.	-	Not connected
8	N.C.	-	Not connected

Note

Connection only on LAN, not on telecommunication networks!

Panel Present X7

Connector designation: **X7**
 Connector type: MCV 1.5/6-G3.81

Table 7-9 Assignment of the interface Panel Present X7

Pin	Signal name	Signal type	Meaning
1	PRES	O	"High": Panel (HT 8) plugged in
2	N.C.	-	Not connected
3	N.C.	-	Not connected
4	N.C.	-	Not connected
5	N.C.	-	Not connected
6	M	P	Ground

Enabling X20

Connector designation: X20
 Connector type: MCV 1.5/8-G3.81
 Cable length (max.): 30 m

Table 7-10 Enabling X20

Pin	Signal name	Type	Meaning
1	ZUST1P	I	Electronic enabling button 1P
2	ZUST1M	O	Electronic enabling button 1M
3	ZUST2P	I	Electronic enabling button 2P
4	ZUST2M	O	Electronic enabling button 2M
5	N.C.		Not connected
6	N.C.		Not connected
7	N.C.		Not connected
8	N.C.		Not connected

Emergency Stop override X21

Connector designation: X21
 Connector type: MCV 1.5/10-G3.81
 Cable length (max.): 30 m

Table 7-11 Emergency Stop override X21

Pin	Signal name	Type	Meaning
1	STOP23	I/O	Emergency Stop NC contact 1.1
2	STOP24		Emergency Stop NC contact 1.1
3	STOP13		Emergency Stop NC contact 2.1
4	STOP14		Emergency Stop NC contact 2.2
5	M	V	
6	N.C.	-	Not connected
7	IN_E9	I	Emergency Stop override negated
8	P24_FILT	V	24 V
9	IN_E9_EXT	O	Key-operated switch actuated
10	IN_E12_EXT		Terminating connector plugged in

Note

Emergency stop X21: Supply voltage: 24 VDC; switched current: Max. 500 mA.

Handheld unit connection XS12

Connector designation:XS12

Connector type: GX3BXC-T22QF10-0004

Table 7-12 Handheld unit connection XS12

Pin	Signal	Type	Meaning	Function
1	HH_PR_P	I	+ Present line	
2	HH_PR_M		- Present line	
3	HP24	V	24 V HH for present	Power supply
4	ZUST2M	O	Enabling button 2M	Enabling function
5	ZUST1P	I	Enabling button 1P	
6	ZUST1M	O	Enabling button 1M	
7	ZUST2P	I	Enabling button 2P	
8	HH_L2.2	I/O	HH emergency stop L2.2	Emergency stop
9	HH_L2.1		HH emergency stop L2.1	
10	HH_L1.2		HH emergency stop L1.2	
11	HH_L1.1		HH emergency stop L1.1	
12	M	V	Ground	Power supply
13	ABS_ST_PRES	I	Terminating connector	Terminating connector plugged in
14	HH_P24	V	24 V HH supply	Power supply
15	IDENT_B	I/O	Diff Signal Module Addr.	
16	TX-	O	Ethernet Transmit -	Ethernet transmitted data
17	TX+		Ethernet Transmit +	

Pin	Signal	Type	Meaning	Function
18	RX+	I	Ethernet receive +	Ethernet receive data
19	RX-		Ethernet receive -	
20	SHIELD	-	Cable shield	
21	M	V	Ground	Power supply
22	IDENT_A	I/O	Diff Signal Module Addr.	

Switch S1/S2

Module address of connection module for HT 8

Table 7-13 Coding switches for module address

8	7	6	5	4	3	2	1	Meaning
S1				S2				switch
0 to F				0 to F				Module address

7.3.3 Connection elements for COM board, customer keys and handheld unit connection

This table shows plug connection elements for the following modules:

- COM board (COM)
- Customer keys (KT)
- Connection for handheld units (HGA)

Table 7-14 Connection components

Module	Connector	Units	Terminal element	Connectable cross-section (max.)	Manufacturer
COM	X10	1	MSTB2,5/3-STZ-5,08,1776168	2.5 mm ²	PHOENIX CONTACT
	X20/X21	2	6GK1901-1BB10-2AB0		SIEMENS
	X60 / X61	2	6FC9348-7HX	0.75 mm ²	
	X70	1	A5E00026403		
KT	X11	1	MSTB2,5/3-ST-5,08,1757022	2.5 mm ²	PHOENIX CONTACT
	X20	1	BZL 3.5 / 32 F SN SW, 1748300000	1.5 mm ²	Weidmüller
	X25	1	BZL 3.5 / 32 F SN SW, 1748230000	1.5 mm ²	Weidmüller
HGA HT 8	X1 / X2	2	6GK1901-1BB10-2AB0		SIEMENS
	X7	1	MC1.5/6-STZ-3.81 GY BD1-6, 1713198	1.5 mm ²	PHOENIX CONTACT
	X 20	1	MC1.5/8-STZ-3.81 GY BD-1-8, 1713208	1.5 mm ²	
	X 21	1	MC1.5/10-STZ-3.81 GY BD1-10, 1901658	1.5 mm ²	

7.3.4 Input / output images

Input image MPP 310 IE H

Byte	Bit7	Bit6	Bit5	Bit4	Bit3	Bit2	Bit1	Bit0
n+0	BA switch				Function key	HG connection XS12:13	Emergency stop override	
	S11 right-hand side momentary -contact		S11 left-hand side momentary -contact		F21	S62	S60	S59
WS1/4 ¹⁾	WS1/3 ¹⁾	WS1/2 ¹⁾	WS1/1 ¹⁾					
n+1	F16*)	F11*)	F6*)	F1*)	Customer keys			
		Key ¹⁾		Extension key	S4	S3	S2	S1
n+2		WS4, pos. 0 ¹⁾		S51	Rapid traverse override ¹⁾			
	Key ¹⁾				WS5/8 ¹⁾	WS5/4 ¹⁾	WS5/2 ¹⁾	WS5/1 ¹⁾
n+3	WS4, pos.3 ¹⁾	WS4, pos.2 ¹⁾	WS4, pos.1 ¹⁾		WS5/8 ¹⁾	WS5/4 ¹⁾	WS5/2 ¹⁾	WS5/1 ¹⁾
	KT-IN9	Extension key	Emergency stop	Customer keys				Extension key
n+4	S79 ¹⁾	S53	S13	S10	S9	S8	S7	S52
	Direct keys							
n+5	DT8	DT7	DT6	DT5	DT4	DT3	DT2	DT1
	Direct keys							
n+6	DT16	DT15	DT14	DT13	DT12	DT11	DT10	DT9
	KT-IN8	KT-IN7	Spindle override					
n+7	S78 ¹⁾	S77 ¹⁾			WS3/8	WS3/4	WS3/2	WS3/1
			Extension key	Feedrate override				
n+8			S54	WS2/16	WS2/8	WS2/4	WS2/2	WS2/1
	Function keys							
n+9	F8	F7	F6	F5	F4	F3	F2	F1
	Function keys							
n+10	F16	F15	F14	F13	F12	F11	F10	F9
	Function keys							
n+11	F25	F24	F23	F22	F20	F19	F18	F17
	Reserve							
n+12					Feedrate override			
	WS2/16	WS2/8	WS2/4	WS2/2"	WS2/1			
n+13					Spindle override			
	WS3/16	WS3/8	WS3/4	WS3/2	WS3/1			
n+14	Handwheel 1 counter status (optional) (16-bit signed, low-order equals byte n+14)							
n+15								

n+16	Handwheel 2 counter status (optional) (16-bit signed, low-order equals byte n+16)
n+17	
*) The function keys are not active if WS1 is assigned.	
1) Option only upon request	

Keyboard layout - input image MPP 310 IE H

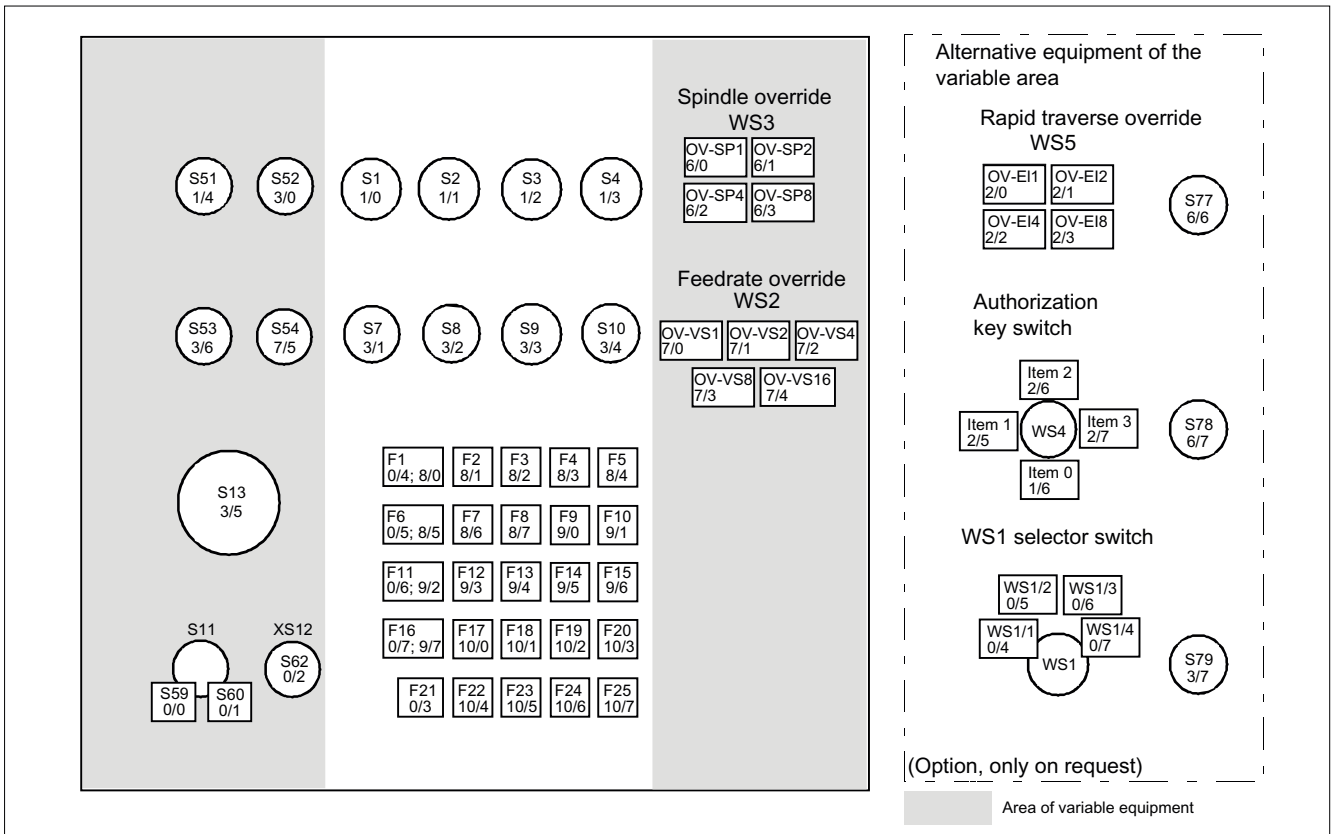

Figure 7-7 Keyboard layout input image

Output image MPP 310 IE H

Byte	Bit7	Bit6	Bit5	Bit4	Bit3	Bit2	Bit1	Bit0
n+0	Customer keys							
	HS8	HS7			HS4	HS3	HS2	HS1
n+1	Customer keys							
							HS10	HS9
n+2	Extension keys							
	H58	H57	H56	H55	H54	H53	H52	H51
n+3								

7.3 Interfaces

n+4	Function keys							
	HF8	HF7	HF6	HF5	HF4	HF3	HF2	HF1
n+5	Function keys							
	HF16	HF15	HF14	HF13	HF12	HF11	HF10	HF9
n+6	Function keys							
	HF24	HF23	HF22	HF21	HF20	HF19	HF18	HF17
n+7								Function key
								HF25

Keyboard layout - output image MPP 310 IE H

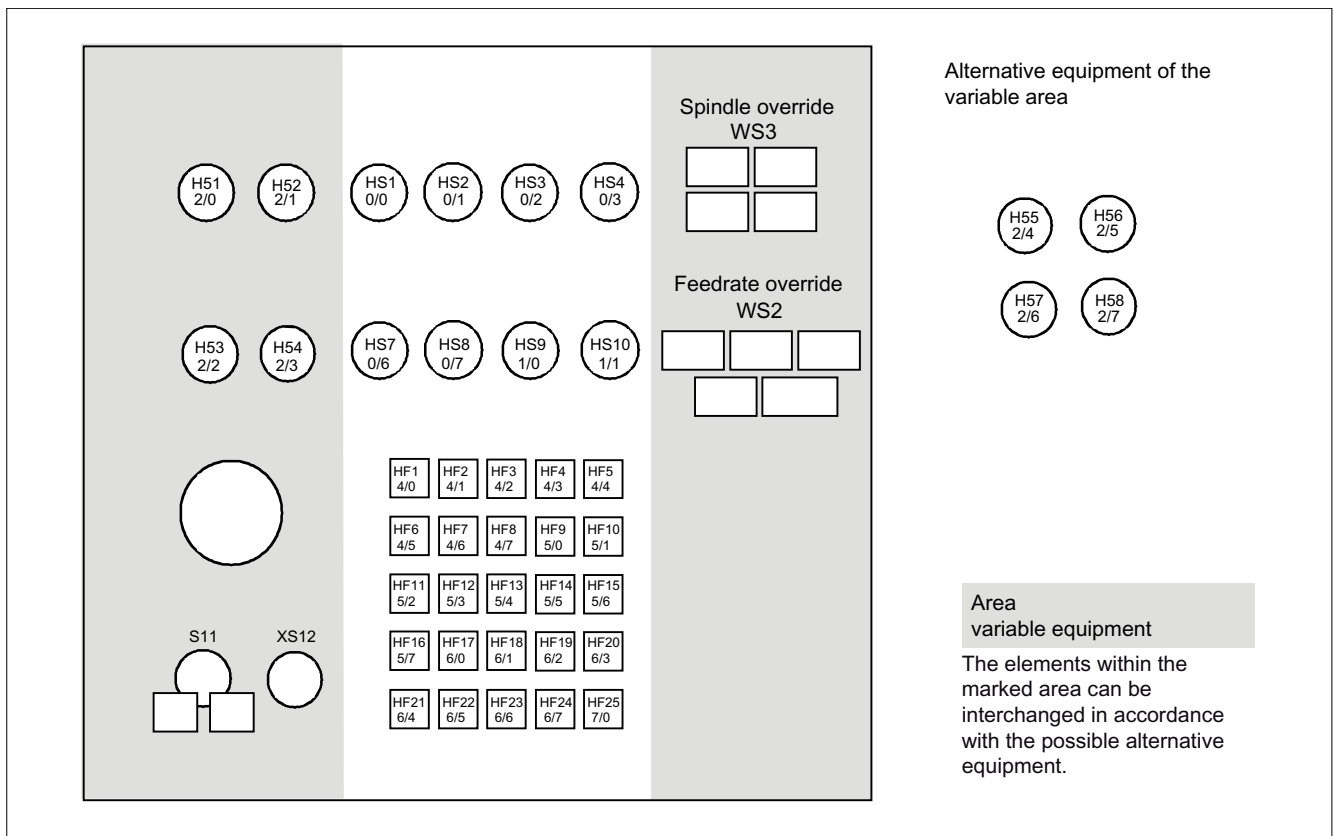

Figure 7-8 Tastaturlayout_Ausgangsabbild

7.4 Mounting

Dimensions of MPP 310 IE H

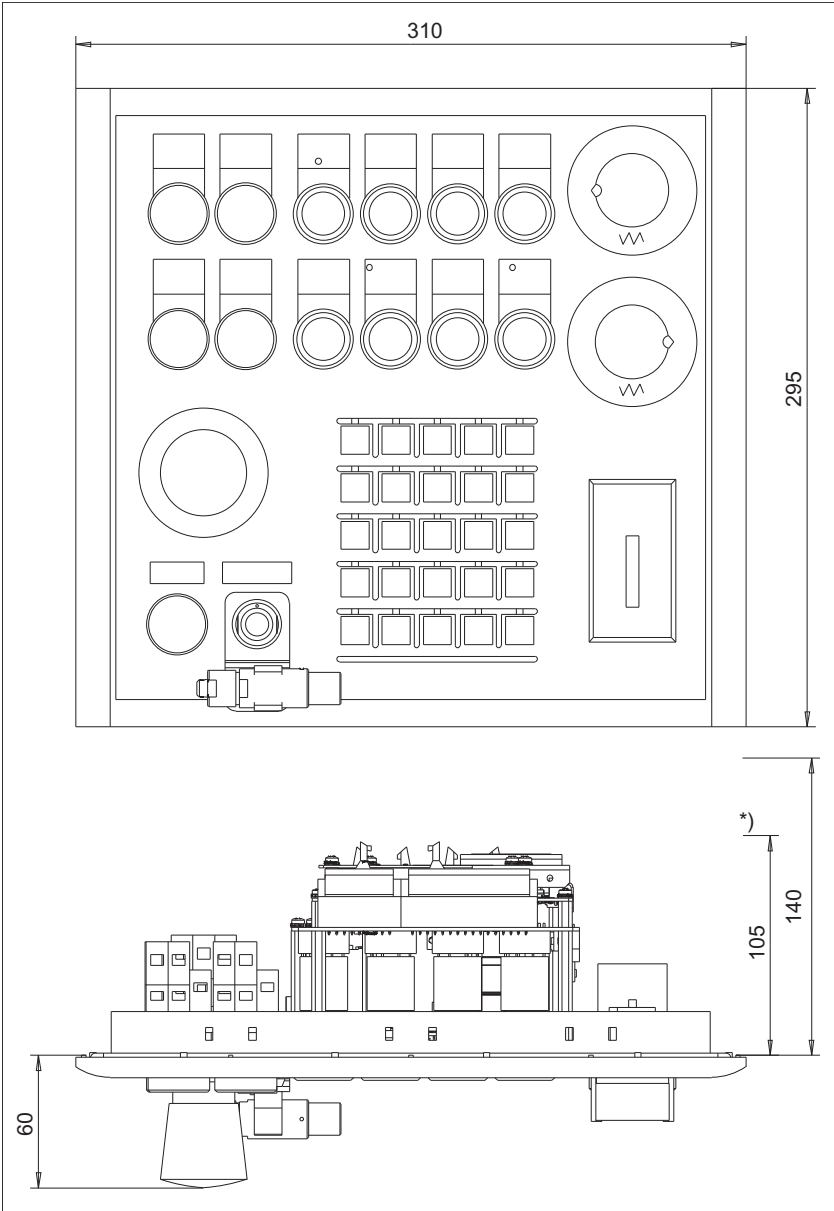

Figure 7-9 Dimension drawing of MPP 310 IE H

*) Depth 105 mm applies to MPPs without a handheld unit connector.

Panel cutout for MPP 310 IE H

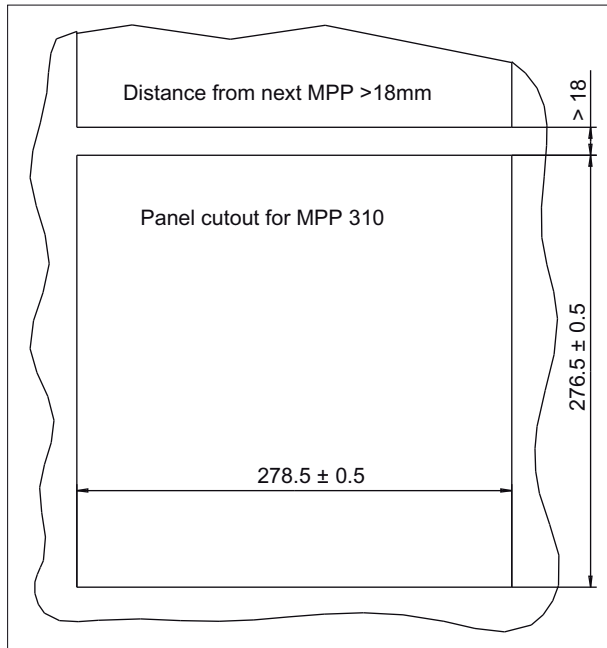

Figure 7-10 Panel cutout for MPP 310 IE H

The MPP 310 IE H is attached to the rear of the operator panel using 13 tension jacks (contained in the delivery kit). The tightening torque is 0.4 Nm.

Mounting position

The mounting position is max. 60° to the vertical.

For mounting positions greater than 60° , a fan must also be installed to keep the ambient temperature of the machine control panel constantly below 55° C.

Mounting position of LEDs

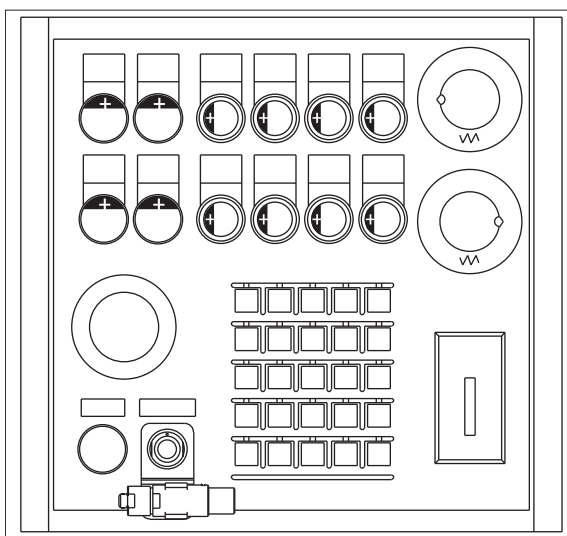

Figure 7-11 Mounting position of LEDs on the MPP 310 IE H

Table 7-15 Identification of anode connection



Insert polarity+ of LEDs in key on side marked

7.5 Connecting

7.5.1 MPP 310 IE H

Connecting the 24 V supply

The 24 V supply is connected via a 3-pin terminal block (see figure) at connector X11 on the rear of the machine control panel.

NOTICE

Damage to the device caused by unfused power supplies

The 24 VDC power supply must always be grounded and designed as Protective Extra-Low Voltage (PELV) - protection by function low voltage with safe isolation!

Emergency stop circuit connection

The connections of the emergency stop circuit are shown in Fig. "Ethernet connection".

Ethernet connection

- Connection of HGA - X1 to operator panel front (OP)
- Connection of HGA - X2 via COM X20 and COM X21 to control (NC)

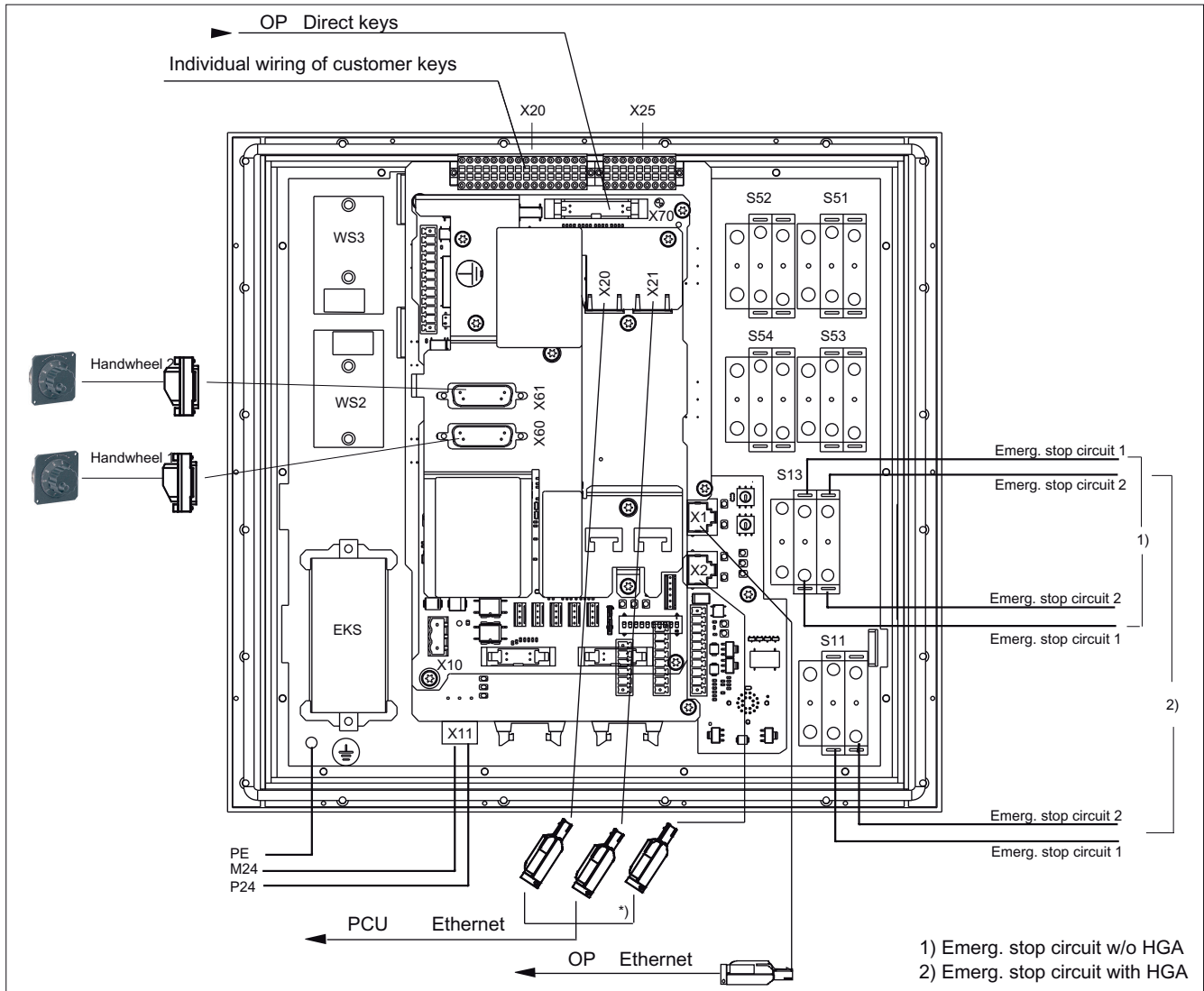

Figure 7-12 Ethernet connection

Individual wiring connection

The individual contacts are connected in accordance with the customer-specific links required (see Section: "Customer keys").

Note

Supply voltages for inputs and outputs must always be grounded!

7.5.2 Customer keys

The customer keys (KT 310) module links the operator panel and COM board.

The inputs for handheld unit connection and extension keys are opto-decoupled. The outputs belonging to these are issued by high-side drivers.

The floating individual contacts of function keys S1 ... S4 and S7 ... S10 are shown in the figure.

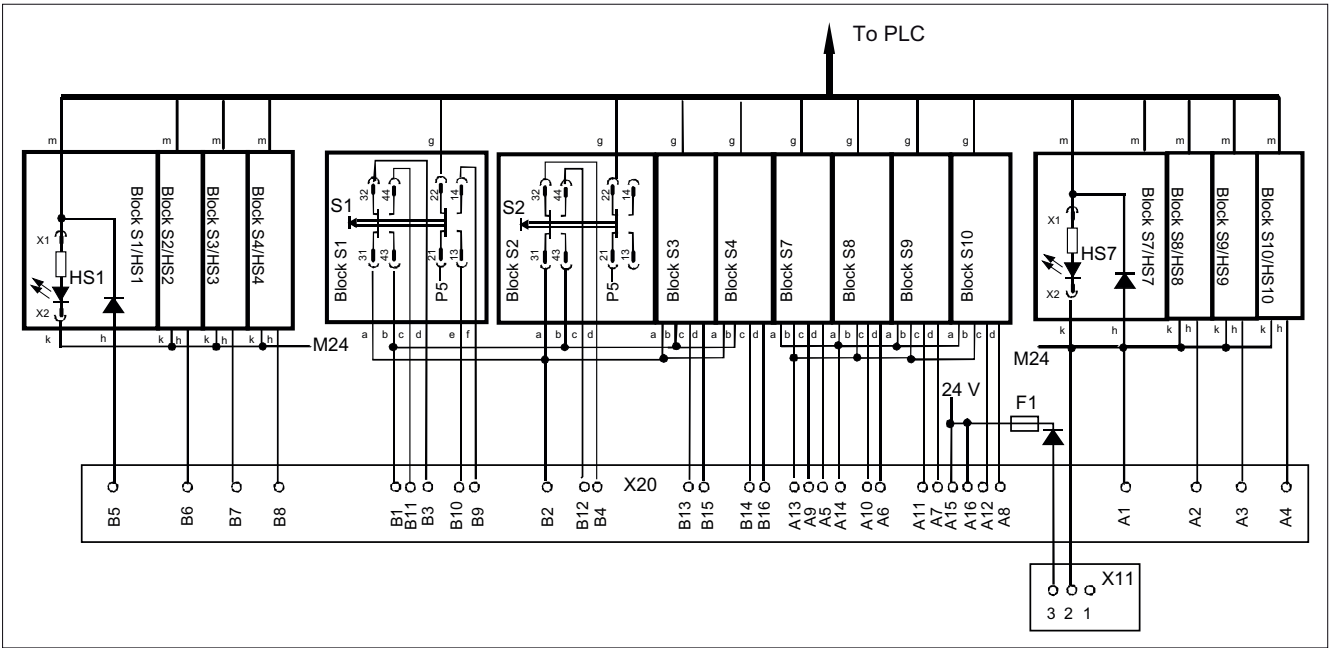

Figure 7-13 Individual wiring of the customer keys(a, b, ..., m designate IN and OUT of the individual blocks)

NOTICE

Damage to pushbutton contacts

When using an external 24 V encoder supply, always protect the key contacts against overload in the individual wiring with an external fuse for L+ with the following properties:
- fuse in accordance with UL248: 1.6 A.

If you use the encoder supply X20:A15/A16 or VS1/VS2 of the ET200S block 4/8 F DI 24 VDC PROFIsafe, the external fuse can be omitted.

7.5.3 Handheld unit connection HT 8 with emergency stop override

The connection for handheld units (HGA) of the HT 8 has four function complexes:

- Two-channel version of enabling function
- Three-port Ethernet switch
- Connection of HT 8
- Module address



WARNING

Danger of death if the enabling button is not DIN-conform

It is the user's responsibility to ensure that the enabling button or the enable control is implemented according to DIN EN 60204-1, Section 9.2.6.3, and the enabling button, when released or pushed down, stops dangerous movements reliably.

Emergency stop override S11

- Implemented as pushbutton or key-operated switch
- Pushbutton pressed or key-operated switch, left probing
 - "Emergency stop override" of the handheld unit connection → query via input E59
 - Interruption of the power supply for the handheld unit connection when actuated
- Key-operated switch, right probing: Unassigned function → query via input S60

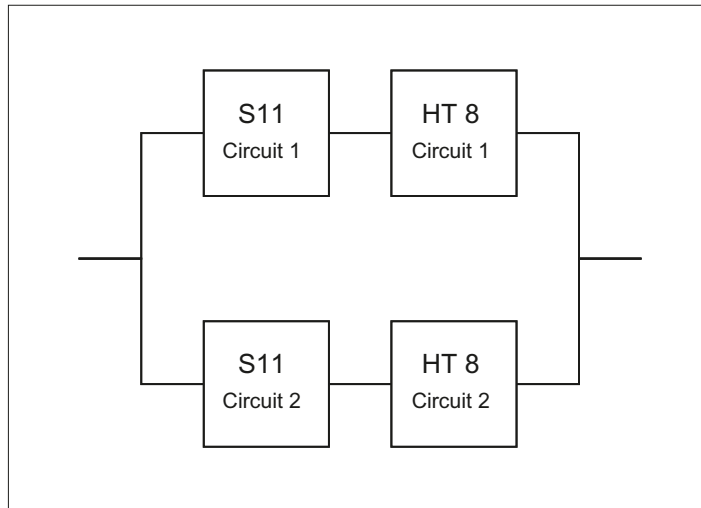

Figure 7-14 2-channel architecture of the emergency stop override contacts

With regard to their accidental failure, the contacts of the emergency stop override safety function form a 2-channel architecture together with the emergency stop button on the HT 8. In addition to the B_{10d} value of the emergency stop button, the B_{10d} value of S11 must also be taken into consideration for the assessment in both emergency stop circuits.

The diagnostics for the contacts of S11 is performed on the HT 8 together with the diagnostics of the emergency stop button.



WARNING

Danger of death caused by failure of the "emergency stop" safety function

The user must ensure that the emergency stop override is implemented in accordance with the safety goals required by the risk analysis of the machine.

Actuation of the emergency stop override results in failure of the emergency stop safety function on the HT 8. The user must implement suitable organization and/or technical procedures for this in order to achieve the safety goals.

As a technical measure, the signaling contacts on the S11: 31/32 and 61/62 can be used to trigger an "emergency stop" by the PLC after a monitoring time has expired (maximum five minutes) (see Remark 1 in the following figure).

However, this measure alone does not satisfy the requirements of Category 3, PL d in accordance with EN ISO 13849-1:2008.

All other functions can be found in the figure.

7.5 Connecting

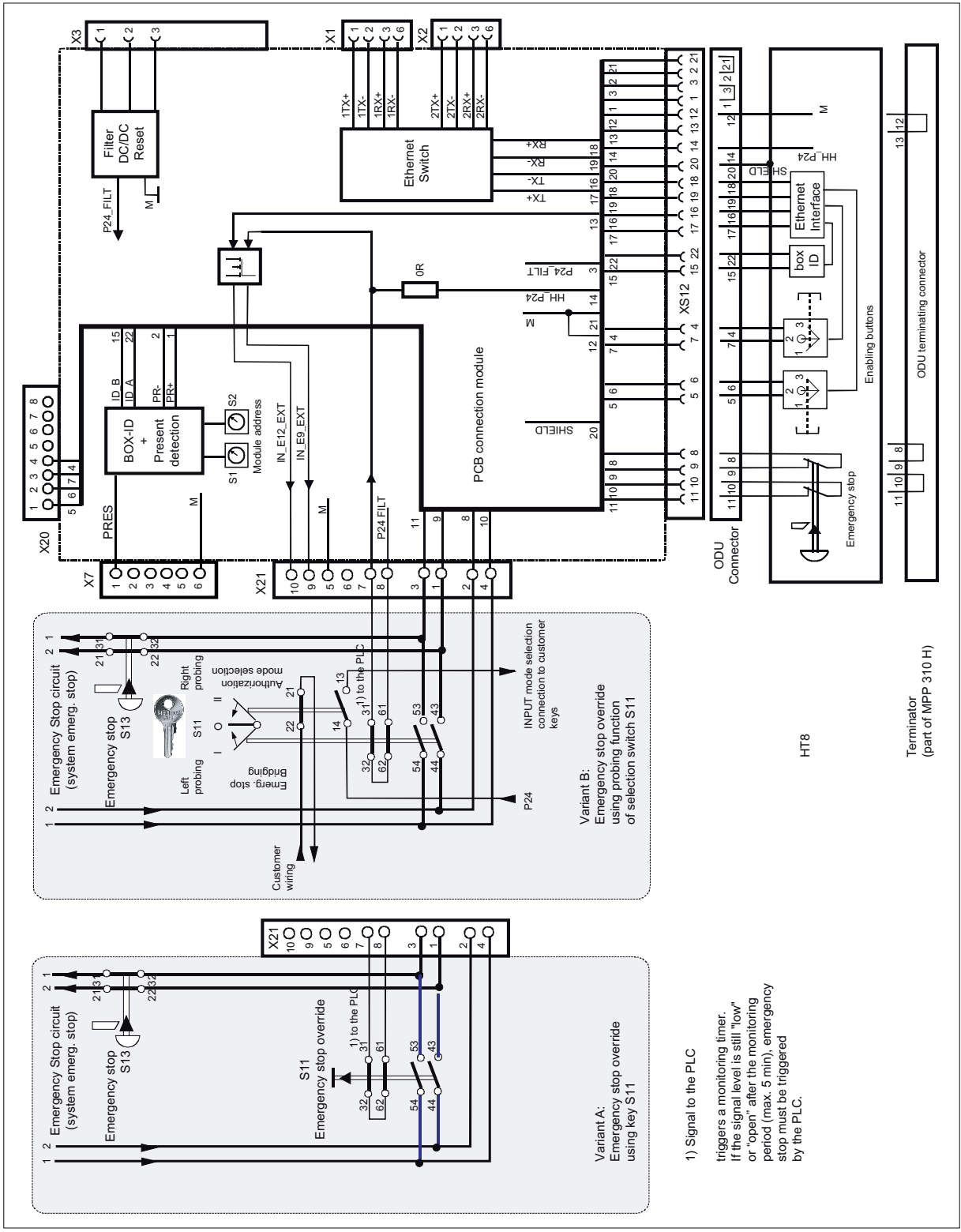

Figure 7-15 Handheld unit connection HT 8

7.6 Circuits and wiring

External control of signaling lamps

The following circuit diagram relates to the lights in HS1 to HS4 and HS7 to HS10 (see Section: "Connecting" → "Customer keys" → Fig.: "Individual wiring of customer keys").

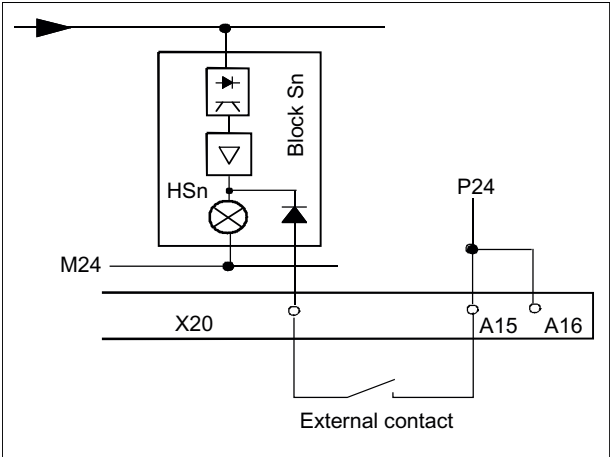

Figure 7-16 External control of signaling lamps

Extension keys connection

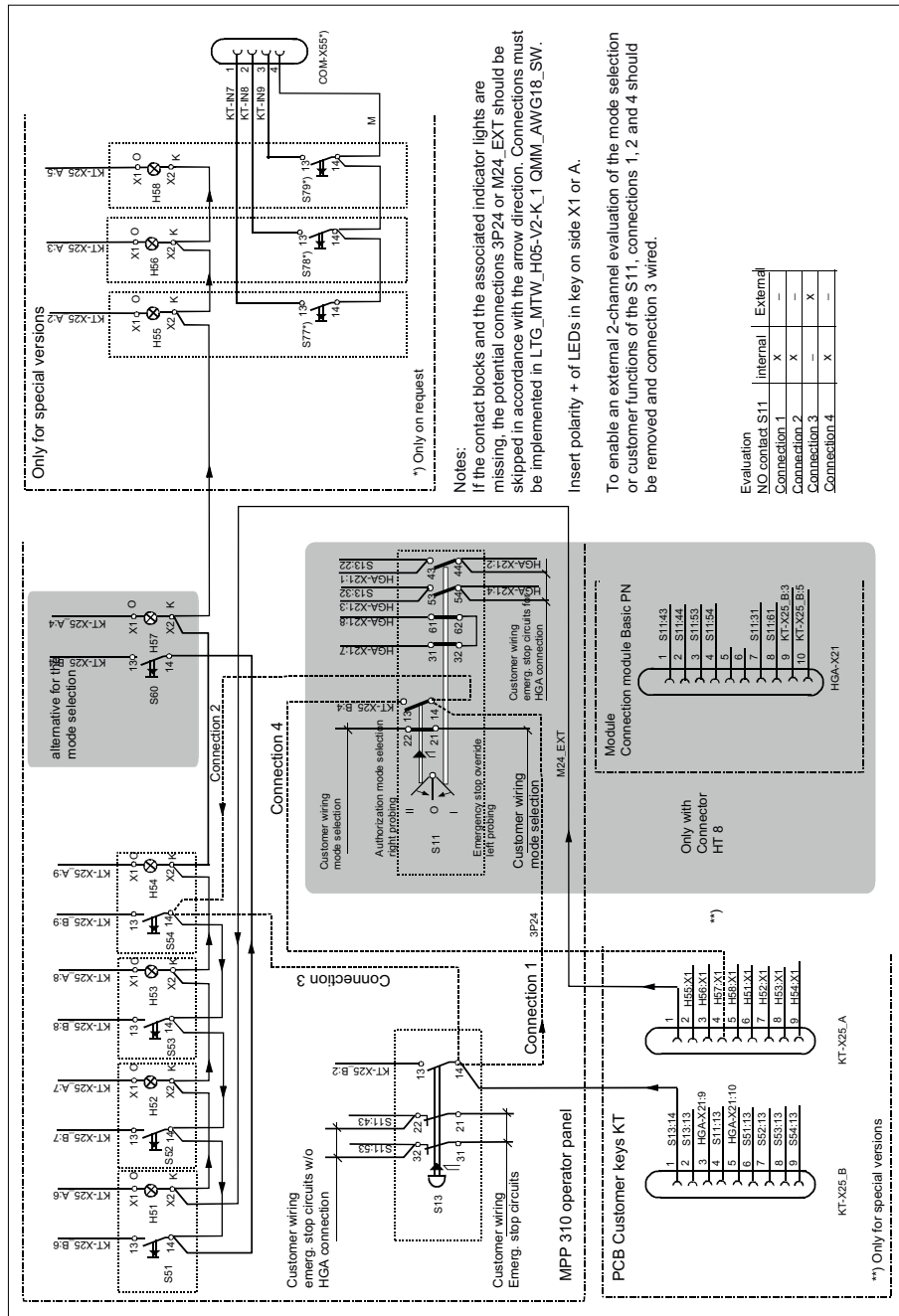

Figure 7-17 Extension keys connection

Customer function S11

The NC-NO combination 3SB34 03-0A is right probing and a customer function of the S11. The NO contact is wired on delivery and can be queried through the MPP 310 IE H. The probing function facilitates mode selection.

If an external evaluation of both contacts is required, the internal wiring on the NO contact 1.3/1.4 of the S 11 must be removed (see Fig.: "Extension keys connection" in this section).

- Remove connection 1 and connection 4
- If connection 2 exists, wire the connection of S11:1.3 to S13:1.4

Direct key connection

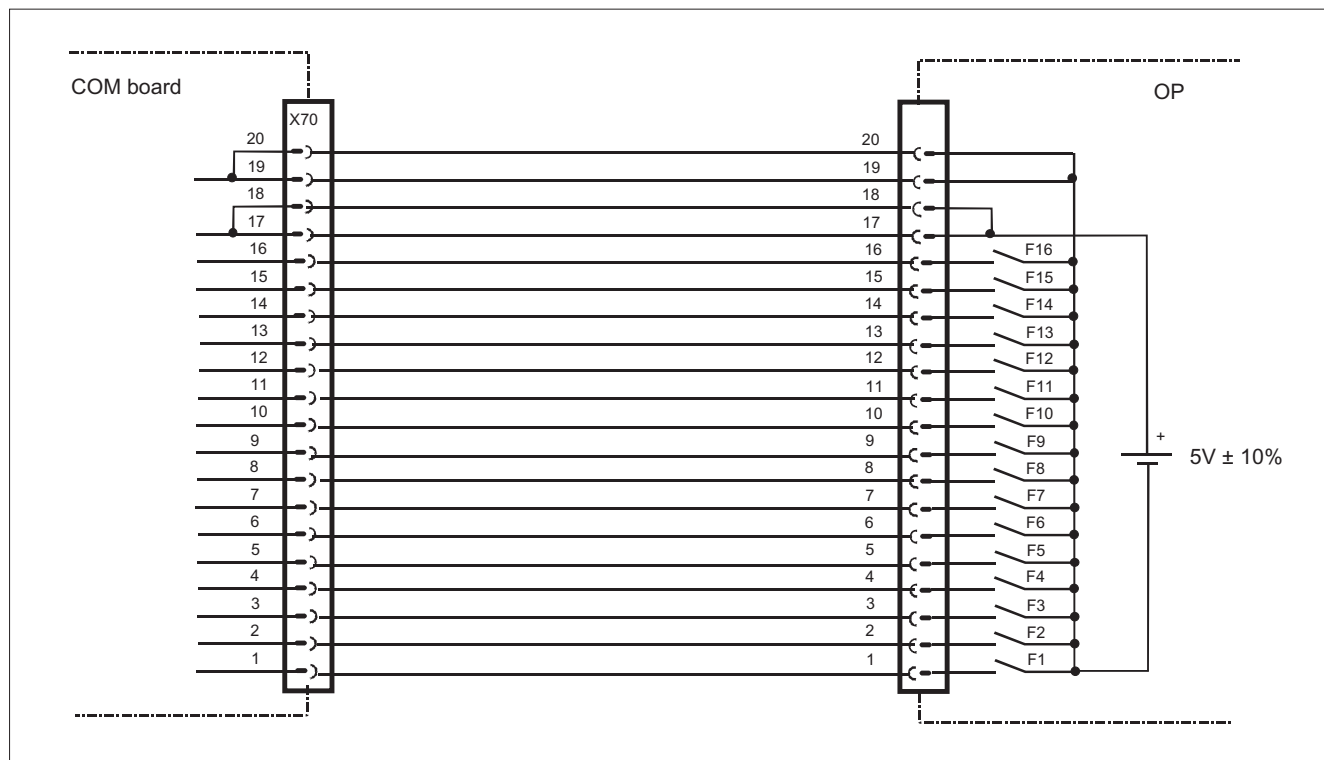

Figure 7-18 Direct key connection

7.7 Initialization

LEDs on the control panel

- HF1 to HF25
- HS1 to HS4
- HS7 to HS10

Switching on the MPP 310 IE H (POWER ON) also switches on all the LEDs on the control panel which then remain permanently lit.

7.7 Initialization

Once internal power-up is completed, the LEDs blink at approx. 1 Hz until communication is established with the control or another client ("Waiting for Client").

LEDs on the COM board

The LEDs on the COM board of the MPP 310 IE H (rear) are not controlled by the software. They are only used to signal the hardware states (for example, power supply OK).

Software version

If there is still no communication with the control, the MPP 310 IE H software version can be output on the panel via the LEDs.

The output is activated by pressing the "F21" and "F25" buttons at the same time. Flashing of the LEDs is thereby suppressed and the software version output on the function key block using three digits.

The individual digits are expressed in hexadecimal format by the number of LEDs activated in the first three LED lines on the MPP.

The lowest value bit position is always on the right.

The software version of the MPP V 02.01.00.00 is shown in the example given.

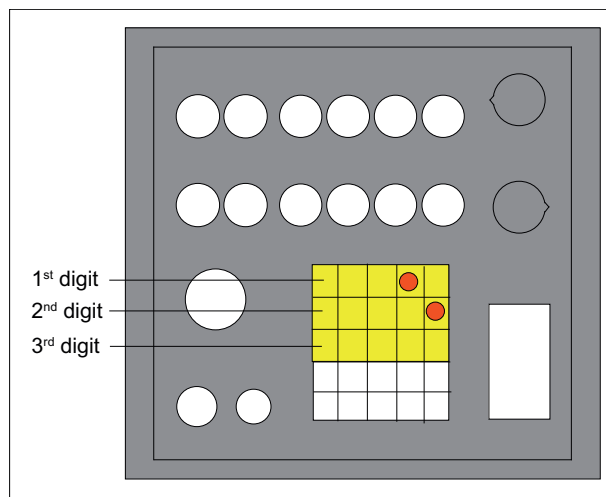

Figure 7-19 Sample displays of software version

Note

The software version can only be output while there is no communication with the control system.

Once communication has taken place, the software version is only displayed again after the power to the MPP 310 IE H has been switched OFF and ON!

7.8 Maintenance and Service

Cleaning the device

Use a soft cloth moistened either with water or a mild cleaning agent to clean the housing and operator control elements of the machine control panel.

Checking the device

In order to prevent foreign bodies or liquids entering the machine control panel, regularly check the device

- that all the housing screws are in place and tight
- for damage to the housing
- for damage to the cable cover or cable entry

Protect the device from environmental effects

Protect the machine control panel against

- direct solar radiation and heat sources
- mechanical vibration and shock
- dust
- moisture, and
- strong magnetic fields

Checking the emergency stop button

Check the emergency stop button regularly to ensure that it functions correctly.

7.9 Technical data

7.9.1 MPP 310 IE H

Safety		
Safety class according to EN 50178	III; PELV	
Degree of protection according to DIN EN 60529	Front side: IP54	Rear side: IP00
Approvals	CE / UL	
Electrical data		

7.9 Technical data

Input voltage	24 VDC				
Power consumption, max.	Boards: 5 W	Lamps: LED 6 W	Handheld unit: 13 W	Handwheels : 2 x 0.5 W	Total: Approx. 25 W
Fuse to be added	10 A	Minimum conductor cross-section 1.5 mm ² for max. working temperature on the conductor of 70° C			
Mechanical data					
Dimensions	Height: 295 mm	Width: 310 mm	Depth (front): 60 mm	Mounting depth: 140 mm ^{*)}	
Weight:	Approx. 3 kg				
Max. tightening torques	Tension jack screws: 0.4 Nm	M3 screws: 0.8 Nm	M4 screws: 1.8 Nm	M5 screws: 3 Nm	

^{*)} Without use of the handwheel connections X60 and X61 on the COM board IE: 105 mm

Note

Information about the climatic and mechanical environmental conditions is contained in the associated section under:

"General notes and interconnection" → "Operational planning".

7.9.2 Input/output interface of individual wiring

Button contact maker

Table 7-16 Contacts with floating outputs S1 to S4 and S7 to S10

		AC	DC
Rated insulation voltage	U _e	+ 50 V	+ 50 V
Rated operating current	I _e	2 A	
Rated operating current at 24 V	I _e		2 A
Min. rated operating current at 5 V	I _{min}		1 mA
Volume resistance			< 20 mΩ
Switching capacity		10 I _e	1.1 I _e

Emergency stop button S13

Rated voltage	24 VDC
Current magnitude, max.	3 A
Current magnitude, min.	1 mA
Switching capacity	DC 13 acc. to EN 60947-5-1

Conditional rated short-circuit current	10 A gL/gG acc. to EN 60947-5-1
B _{10d}	500 000

Note

The quantitative assessment of the emergency stop safety function must be based on the B_{10d} values corresponding to the used standards (e.g. ISO 13849-1) under consideration of the respective application (frequency of the actuation, service life, diagnostics by the evaluation unit, etc.). The B_{10d} values only apply when the technical properties of the emergency stop button are taken into account.

Emergency stop override S11

Table 7-17 Contacts with floating outputs

	Usage category (EN 60947-5-1)		AC	DC
Rated operating voltage		U _e	+ 24 V	+ 24 V
Switching capacity	AC-12	I _e	10 A	
	AC-15	I _e	6 A	
	DC-12	I _e		10 A
	DC-13	I _e		3 A
Min. rated operating current at 5 V		I _{min}		1 mA
For further parameters, see pushbutton and indicator light SIGNUM 3SB3				
B _{10d}	500 000			

Note

The quantitative assessment of the emergency stop safety function must be based on the B_{10d} values corresponding to the used standards (e.g. ISO 13849-1) under consideration of the respective application (frequency of the actuation, service life, diagnostics by the evaluation unit, etc.). The B_{10d} values only apply when the technical properties of the contact block are taken into account.

Inputs

The inputs are opto-decoupled.

Table 7-18 Emergency stop S13; extension keys S51 ... S54, S59, S60, S62

Status		Voltage switched	Remark
Number	15		Input characteristics curve following IEC61131, type 1
H signal	Rated value	+ 24 VDC	

7.10 Accessories and spare parts

Status		Voltage switched	Remark
L signal	Signal level	+15 V to +30 V	
	Rated value	0 V or open	
	Signal level	-3 V to +5 V	
In a group of	1		
Cable length	max. 50 m AWG 16		
Encoder power supply		18.5 V to 30 V	

LED outputs

Table 7-19 LED-H51 ... LED H58

Status		Voltage switched	Current switched
Number	14		
Load voltage 2P24		20.4 V ... 28.8 V	
Rated value		+24 VDC	0.5 A
H signal	Signal level min.	Ue - 0.16V	max. 0.7A / output
L signal	Max. signal level	2V (idling)	0.3 mA
Short-circuit protection	yes		
Typ. activation threshold			1.1 A
Eff. short circuit current			0.5 A
Electrical isolation	no		
In a group of	1		
Output total current			max. 3 A
Cable length	max. 50 m AWG 16		

Handheld unit connection XS12

The currents depend on the connected handheld unit.

The internal connecting cables of the handheld unit connection HT 8 are designed for a rated voltage of 24 VDC and 0.5 A.

7.10 Accessories and spare parts

7.10.1 Overview

Numerous spare parts and accessories are available for the MPP 310 IE H. Contact your Siemens service center to order accessories and spare parts.

7.10.2 Labeling the slide-in labels

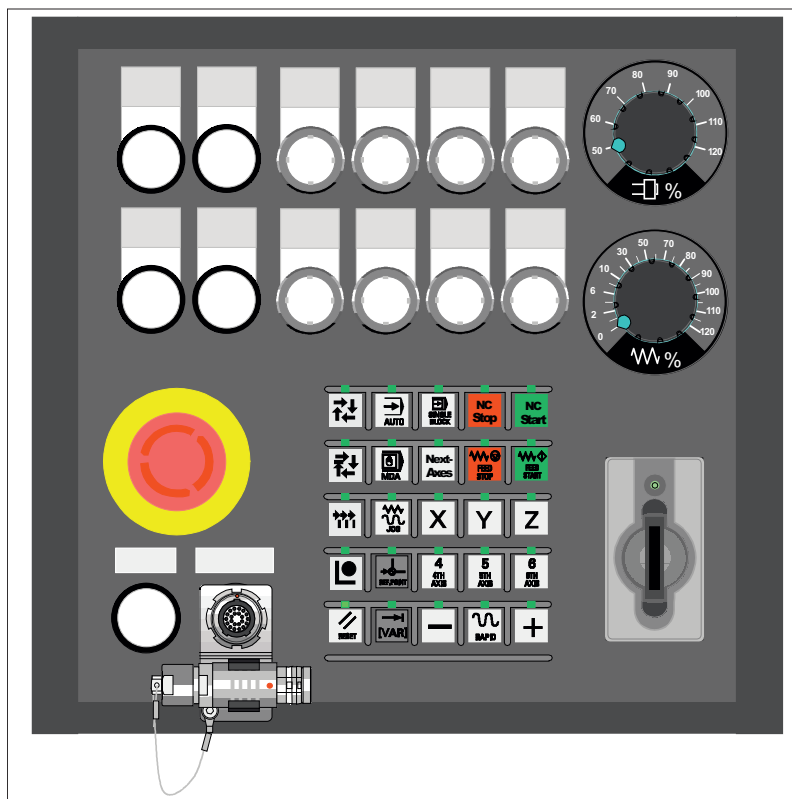

Figure 7-20 MPP 310 IE H Machine Pushbutton Panel

The figure shows the MPP 310 IE H in its standard version.

You can create your own slide-in labels in order to change the key labels. A printable blank film (DIN A4) is supplied with the panel for this purpose.

A spare parts kit containing three blank films is also available (Item no.: A5E00414151).



Figure 7-21 Blank film for MCP 310 IE H membrane keyboard

1) Print direction

Files for printing the blank film

The DOConCD / Catalog NC 61 (CD enclosed) contains two files for printing the blank films:

- Template_MPP310.doc [(A)]
- SymboleMPP483.doc [(B)]

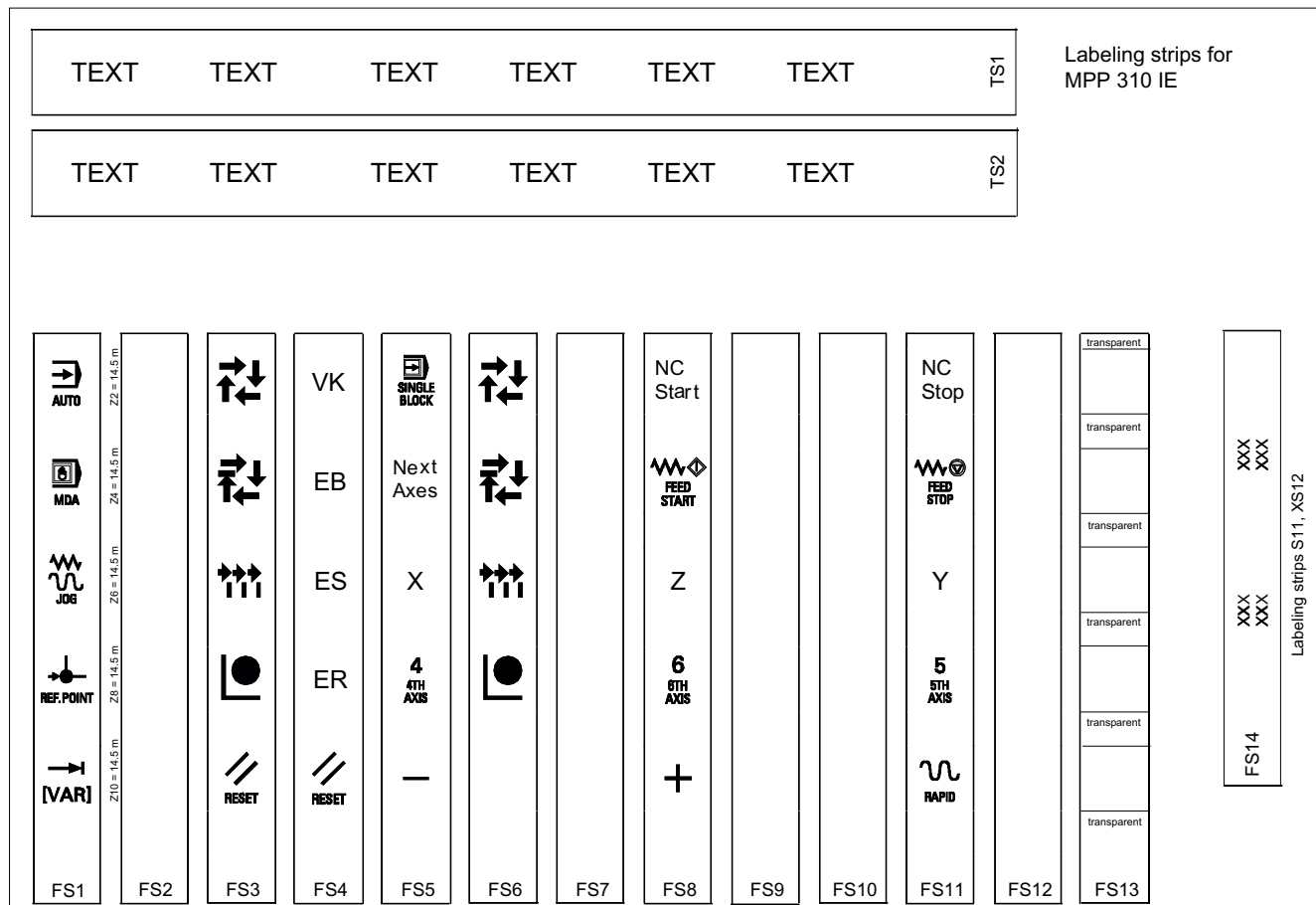





Figure 7-22 Template_MPP310.doc (A)

Table 7-20 Symbole_MPP483.doc (B)

					100%				
X					10				
	Y						Z		
	-	+						+X	-X

+Y	-Y	+Z	-Z	+C	-C				
VK	EB	ES	ER	IO	SM	SS	SU	Next Axes	
									
NC Start	NC Stop								

Preparing standard slide-in labels with the aid of the file: "Template_MPP310.doc" (A)

1. Open the file "Template_MPP310.doc" in MS Word.
The key symbols are arranged in a table on the position that corresponds to their location on the keyboard. The borders visible in the table are not printed.
2. Place the blank film in the printing direction in the slot of your laser printer (see figure: "Blank film for MPP 310 IEH membrane keyboard").
3. Select "film" as the printable medium if your printer allows this setting.
4. Start the printing process using MS Word.

Note

Make a test print on paper before you print on the film.
Allow the film to cool after printing so that the ink can dry.

5. Cut the slide-in labels out of the film along the edges (outer lines).
6. Round off the corners of the slide-in labels approx. 1.5 mm to facilitate insertion.
7. Slide in the printed slide-in label.

Preparing specific slide-in labels with the aid of the file: "Symbole_MPP483.doc" (B)

1. Open both the "Symbole_MPP483.doc" file and the "Template_MPP310.doc" file.
2. Copy the desired key symbol from the file "Symbole_MPP483.doc".
3. Position the cursor in the desired field of the template (A), add the symbol and adjust its size accordingly by dragging it by the gripping points.

4. To move a symbol to a different position,
 - select the symbol,
 - cut it out and
 - add it into the desired table cell.
5. If all the symbols are positioned as desired, follow the instructions in Section: "Preparing standard slide-in labels with the aid of the file: "Template_MPP310.doc" as of point 2.

Note

Input of characters/text instead of symbols

Use the "Arial" font to format text. This font is comparable to the "Univers S57" font, used by Siemens for the key labeling.

Creating your own symbols

- Drawing in a vector program (e.g. Designer, Freehand, CorelDraw):
 - Draw a square 15 x 15 mm without frames, filled with the color white.
 - Place the graphic in the center of this square.
 - Group the graphic and square together and add this group to the file "Template_MPP310.doc".
- Drawing in an image editing program (e.g. Photoshop, Picture Publisher, Paint)
 - Create a square area (e.g. 100 x 100 pixels) filled with the color white.
 - Draw the graphic or add an image in the center of this square.
 - Copy the graphic and square and add them both to the file "Template_MPP310.doc".

7.10.3 Handwheel connection

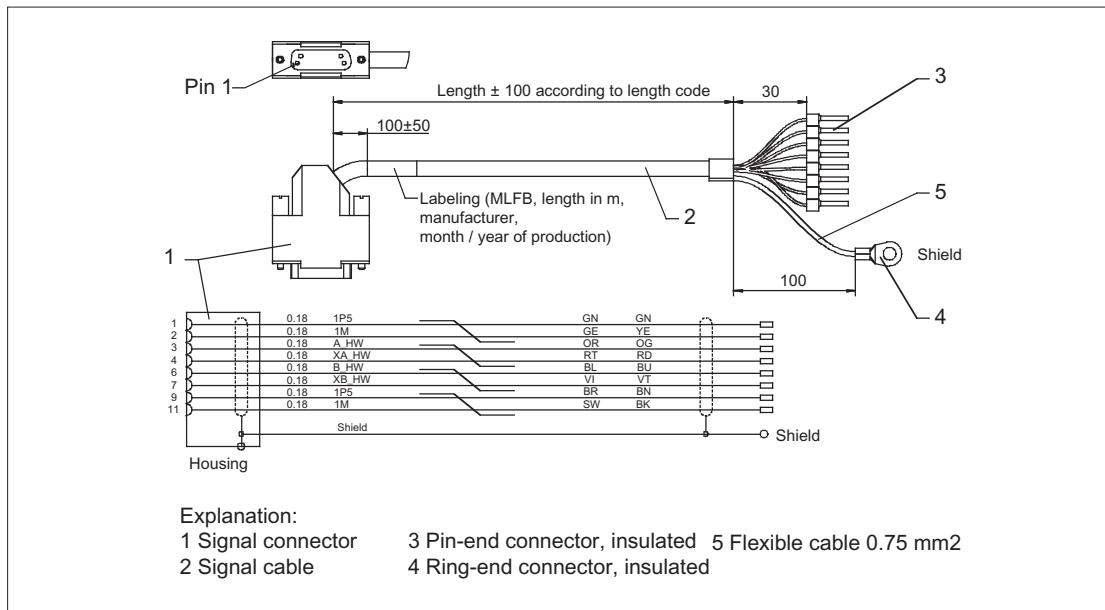

Figure 7-23 Connection cable for COM board handwheel

Order No.: 6FX8002-2CP00-1Axy

xy is the length code: x (m) = A (0) ... F (5); y (dm) = 0 ... 8

7.10.4 Display elements and operator controls

You can retrofit the following control elements:

Function	Upper section actuator / accessories	Lower section contact block/signaling light	Mounting location	Application
Signaling light	Illuminated nipple 28 mm ∅ RXJN-GB (yellow) RXJN-GN (green) RXJN-RT (red) RXJN-BL (blue) RXJN-KL (crystal clear) RXJN-WS (white)	AL5 lamp socket with spot LED	S1 ... S4 S7 ... S10	Light
Button	Pushbutton 28 mm ∅ RXJN-GB (yellow) RXJN-GN (green) RXJN-RT (red) RXJN-BL (blue) RXJN-KL (crystal clear) RXJN-GWS (black)	Button contact maker AT2	S1 ... S4 S7 ... S10	For S1, 1 NC internal, 2 NO + 1 NC external For S2 ... S4, S7 ... S10, 1 NC internal, 1 NO + 1 NC external

Function	Upper section actuator / accessories	Lower section contact block/signaling light	Mounting location	Application
Illuminated key with socket for T5.5K	Pushbutton 28 mm Ø RXJN-GB (yellow) RXJN-GN (green) RXJN-RT (red) RXJN-BL (blue) RXJN-KL (crystal clear)	Illuminated button contact maker ATL2 with spot LED	S1 ... S4 S7 ... S10	For S1, 1 NC internal, 2 NO + 1 NC external For S2 ... S4, S7 ... S10, 1 NC internal, 1 NO + 1 NC external
Spot LED		L5.5K28UW (white)	S1 ... S4 S7 ... S10	
Key-operated switch *) switching angle of 90°, 2 positions	Safety lock cylinder 28 mm Ø RXJSSA 15 E key can be removed when in both positions	Button contact maker AT2	S1 ... S4 S7 ... S10	For S1, 1 NC internal, 2 NO + 1 NC external For S2 ... S4, S7 ... S10, 1 NC internal, 1 NO + 1 NC external
Keys / position selector	RX-JEWEL 22.3 mm Schlegel catalog	Button contact maker AT2	S1 ... S4 S7 ... S10	
Raised keys 6FC5247-0AA41-0AA0	2 RTAO pushbuttons with plunger elongation	2 AT2 special version	S1 ... S4 S7 ... S10	

*) Safety-related

Note

When assigning the colors for keys and signaling lights to the corresponding functionality, observe the standard EN 60204 Part1 or VDE 0113 Part1, Chapter "Pushbuttons/Colors."

Name	Description	Number	Order number	Mounting location
Dummy plug	BVR22	1		S1 ... S4 S7 ... S10
Selector switch ¹⁾	Toggle FS1 Conversion to toggle switch	1		WS1
Override spindle/rapid traverse	Electronic rotary switch 1x16G, T=24, cap, button, pointer, spindle dials and rapid traverse	1	6FC5247-0AF12-1AA0	WS3
Override feed / rapid traverse	Electronic rotary switch 1x23G, T=32, cap, button, pointer, feed dials and rapid traverse	1	6FC5247-0AF13-1AA0	WS2
Override feed / rapid traverse ¹⁾	Electronic rotary switch 1x29G, T=32, cap, button, pointer, feed dials and rapid traverse	1	6FC5247-0AF14-1AA0	WS5
Emergency stop	22 mm actuating element, 40 mm mushroom pushbutton, snap action with tamper protection, latching, red, with holder, unlit	1	3SB3000-1HA20 *)	S13
	Contact block, 2 NC, Extension NC, emergency stop	1	3SB3400-0E *)	S13

7.11 Service information

Name	Description	Number	Order number	Mounting location
	Protective collar for front panel mounting, protection against accidental actuation	1	3SB3921-0AK	S13
Control and signaling devices	all elements marked with LE		3SB3 following selection from Low-Voltage Controls and Distribution Catalog (LV 1)	S51 ... S54
EKS Euchner identification system	Serial interface		EKS-A-ISX-G01-ST09/03	S14
	PROFIBUS DP interface		EKS-A-IDX-G01-ST09/03	
¹⁾ only for option				

*) Safety-related

7.11 Service information

Changing the lamps on illuminated keys

1. Use a screwdriver to pull the key cap forward and off.
2. Use lamp remover LZ6 to lever out the key carrier.
3. Change the lamp using service tool LZ6 or a suitable insulating tube
4. Reinstall the key carrier and key cap in reverse order.

Lamp remover LZ6 is not a SIEMENS product. It can be obtained from the Schlegel company.

Georg Schlegel GmbH & Co. KG

Am Kapellenweg
88525 Dürmentingen
Germany

Phone.: 0 73 71 / 502-0
Fax: 0 73 71 / 502 49
E-mail: info@schlegel.biz

Changing the lamps on pilot lamps

1. Use a screwdriver to pull the calotte and name bearing element forward and off.
2. Change the lamp using the lamp remover of service tool LZ6 or a suitable insulating tube
3. Reinstall the calotte and name bearing element.

Note

When using LEDs, make sure that they are connected with the correct polarity (see Fig.: "Mounting position of LEDs" in Section: "Mounting")

Mounting additional control elements

1. If necessary, unscrew the blank plug.
2. Place the contact maker on the socket and insert the lamp if required.
3. Insert pushbutton through front panel and screw on cap nut (by several turns).
4. Press pushbutton on contact maker. Note the position of the twist protection device!
5. Screw down cap nut (tightening torque 0.8 Nm).

Insert slide-in labels

1. Create the slide-in label (see Section: "Accessories and spare parts" → "Labeling the slide-in labels").
2. Pull protective films off slide-in slot.
3. Guide in the slide-in labels (labeling facing operator side).
4. Align text in window.

Note

Slide in the labels when the MPP is not yet installed.

Changing a contact maker

1. Loosen cap nut off pushbutton until just in front of contact maker.
2. Pull the pushbutton and the contact maker approximately 3 mm out of the fixture (the locating pin of the pushbutton must be freed).
3. Remove the LED.
4. Change the contact element, remove defective contact maker from fixture and press new contact maker onto fixture.
5. Insert pushbutton into aperture and partially screw on cap nut.
6. Press pushbutton on contact maker until it snaps in. Note the position of the snap nose!
7. Screw down cap nut (tightening torque 0.8 Nm).

Machine pushbutton panel: MPP 483 IE

8.1 Description

8.1.1 Overview

The machine control panel MPP483 IE (IE = Industrial Ethernet) permits user-friendly operation of the machine functions on complex machining stations. It is suitable for machine-level operation of milling, turning, grinding and special machines.

In addition to the standard elements of machine control, several freely assignable slots are integrated on the operator panel for connecting other control devices.

The function of the MPP 483 IE can be extended considerably by fitting additional keys and through the EKS identification system provided by Euchner.

The machine control panel is easy to mount on the rear side using special tension jacks.

All keys have user-inscribed slide-in strips for machine-specific adaptations. Two DIN-A4 sheets (printed and white) for inscribing are supplied by the factory.

The machine control panel MPP 483 IE is available as standard, in extended standard versions and in special versions.

Validity

The following description applies to the following machine control panels:

Table 8-1 Standard version

Designation	Features	Order number
MPP 483 IE	Without handheld unit connection	6FC5303-1AF10-0AA0

Table 8-2 Extended standard version

Designation	Features	Order number
MPP 483 IE H	With handheld unit connection HT 2/HT 8	6FC5303-1AF10-8AA0

Table 8-3 Special versions

Designation	Features	Interface	Order number
MPP 483 IE S			
MPP 483 IE Sxx	Height: 155 mm - with customer-specific equipment		6FC5303-1AF12-0__0 ¹⁾
MPP 483 IE H Sxx	Height: 155 mm - with customer-specific equipment - with handheld unit connection HT 2/HT 8		6FC5303-1AF12-8__0 ¹⁾

8.1 Description

Designation	Features	Interface	Order number
MPP 483 IE L			
MPP 483 IE /L Lxx	Height: 244 mm - with customer-specific equipment		6FC5303-1AF13-0__0 ¹⁾
MPP 483 IE H/L Lxx	Height: 244 mm - with customer-specific equipment - with handheld unit connection HT 2/HT 8		6FC5303-1AF13-8__0 ¹⁾

¹⁾ You can put together the components for occupancy of the free module locations according to your practical needs. The DOConCD / Catalog NC 61 (accompanying CD) contains a configuring tool and instructions for this purpose.

The safety-related accessories / spare parts are marked in the "Accessories and spare parts" section with a *).

8.1.2 System features

Standard for all versions:

- Industrial Ethernet (transfer rate: 10/100 MBit/s)
- Function keyboard with 5 x 5 key matrix, can be freely projected and labeled
- 8 long-stroke keys with LEDs,
- Interfaces for 2 handwheels (D-Sub)
(velocity input and contour handwheel are only possible when connecting through the handwheel connection module 6FC5303-0AA02-0AA0.)
- Emergency stop button (4-wire), latching, tamper-proof
- Key-operated switch with 2 settings - leftward probing setting and rightward probing setting (right setting is customer-specific)
- Direction control key connection for OP 012
- 2 free 22.5 mm slots or space for EKS
- Space for override

Supplementary elements for the extended standard and special versions:

- Integration of max. 3 override switches
- Handheld unit connection HGA for HT 2/HT 8 (instead of the handheld unit connection, the MPP 483 IE L can be equipped with 1 extension key.)
- EKS identification system
- Protective shroud for emergency stop button, REES emergency stop
- Emergency stop overridden by 2-position key-operated switch (probing position)
- 2 extension keys with LEDs can be variably fitted with contact blocks (on MPP 483 IE)
- 10 extension keys with LEDs can be variably fitted with contact blocks (on MPP 483 IE L)

- Mushroom-shaped button (SR)
- Authorization lock switch (ALS)
- BA selector switch, 4-positions as key or knob-operated switch

The positions of the individual elements on the machine control panels is shown in section: "Control and display elements" --> "Special versions".

System configuration

The figures show how the MPP 483 IE H is integrated into the control system.

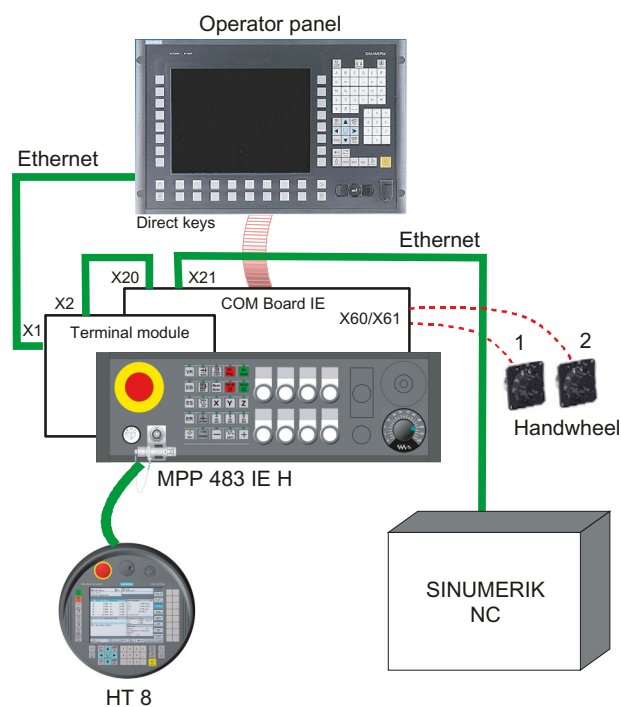

Figure 8-1 System configuration of the MPP 483 IE H

Note

The connection cables are not part of the scope of supply.

8.1.3 Mechanical design

The machine control panel MCP 483 IE consists of

- control panel
- Flat module with handheld unit connection (FBG HT 8)

8.1 Description

- Flat module with customer keys (FBG KT)
- Flat module with COM board (FBG COM IE)

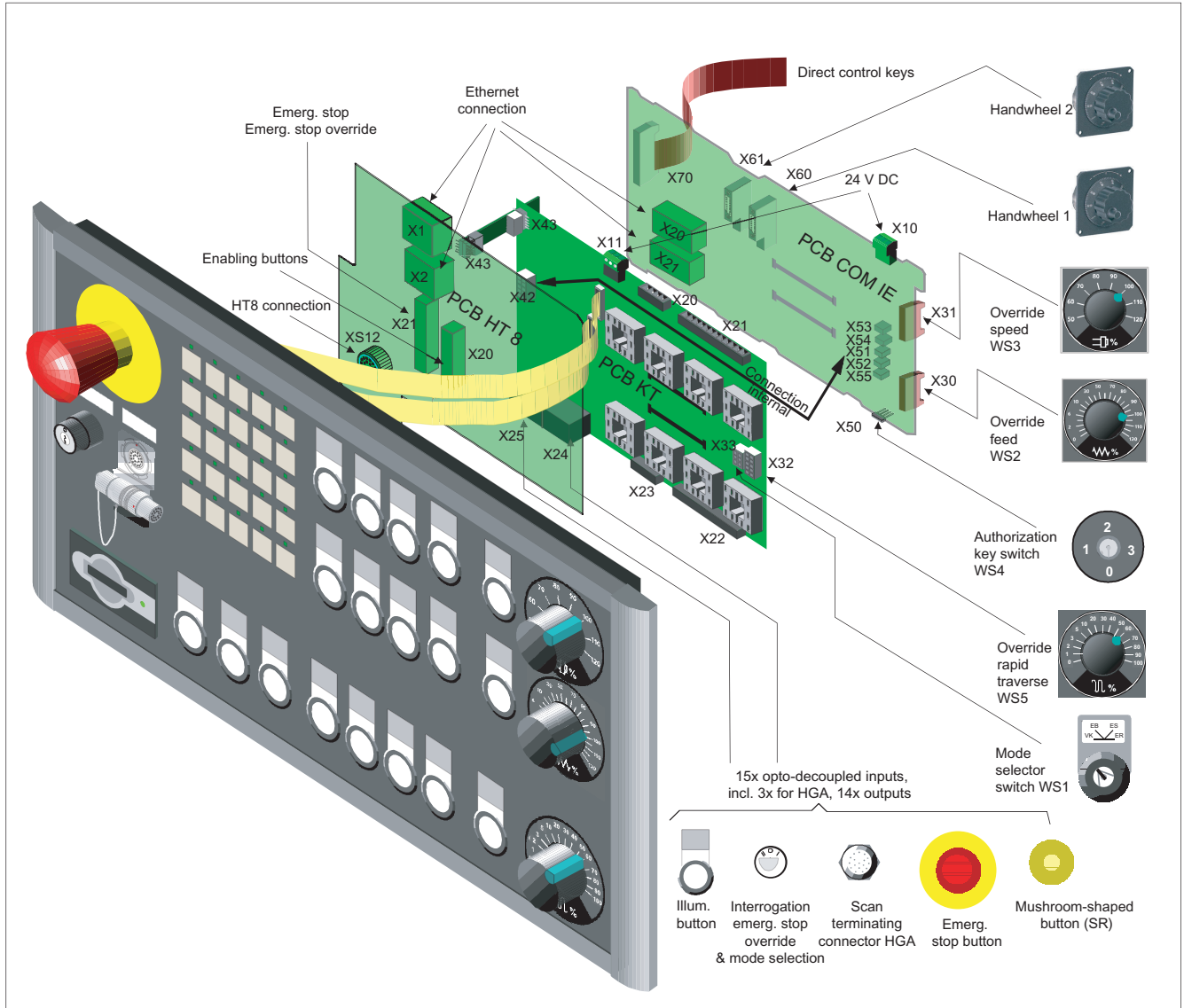
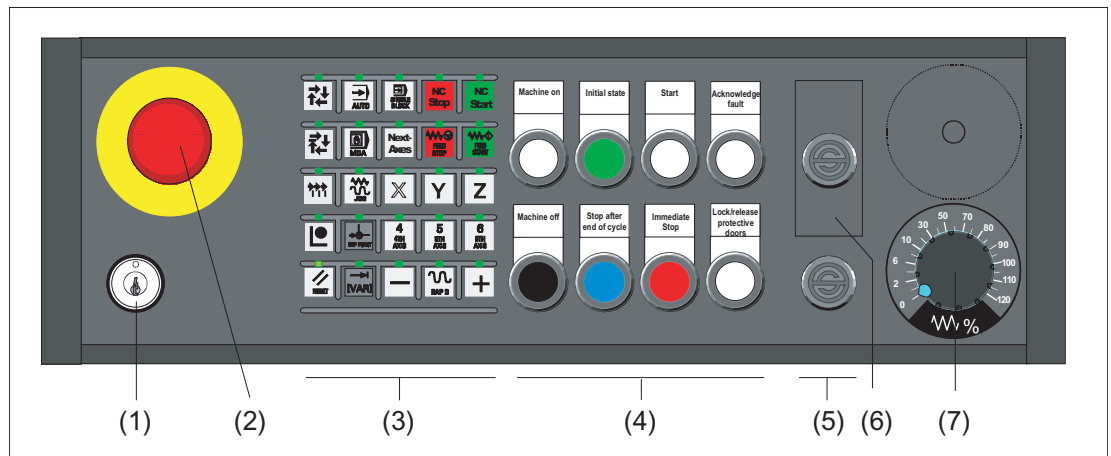

Figure 8-2 Mechanical design by way of example of the MPP 483 IE L

8.2 Operator controls and indicators

8.2.1 Standard versions

The machine control panel is available in the following standard versions:



- (1) Key-operated switch
- (2) Emergency stop button
- (3) Function keys with LEDs
- (4) Customer keys (long-stroke keys)
- (5) Dummy element
- (6) Cutout for EKS identification system
- (7) Feed override

Figure 8-3 MPP 483 IE standard version

8.2 Operator controls and indicators

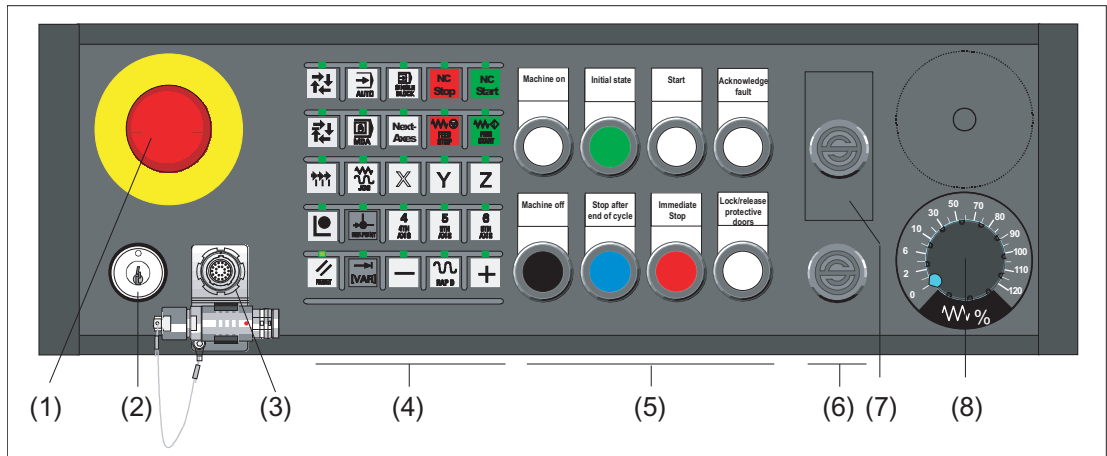

- (1) Emergency stop button
- (2) Key-operated switch
- (3) Handheld unit connection HT 2 / HT 8
- (4) Function keys with LEDs
- (5) Customer keys (long-stroke keys)
- (6) Dummy element
- (7) Cutout for EKS identification system
- (8) Feed override

Figure 8-4 MPP 483 IE H extended standard version

Note

The free slots can be assigned operator elements which are listed in Section: "Operation and display elements" → "Special versions" for the MPP 483 IE S or MPP 483 IE L variants.

A description of the individual components can be found in Section: "Accessories and spare parts" → "Display and operating elements".

8.2.2 Special versions

The machine control panel is available in the following special versions:

8.2 Operator controls and indicators

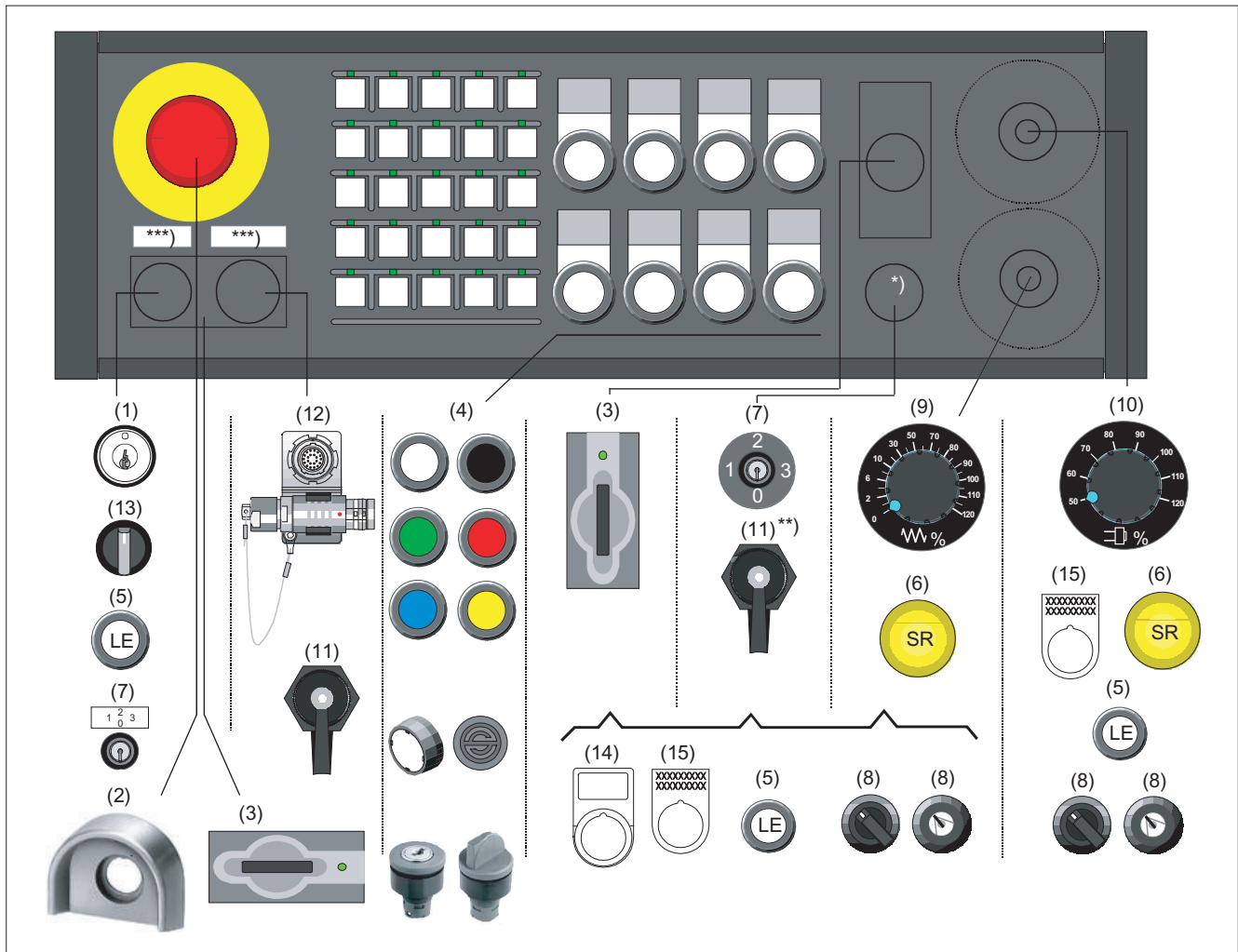

*) Designation bearing element can only be equipped without EKS (3)

***) Labeling only for variants without EKS

*) Designation bearing element can only be equipped without EKS (3)

***) Labeling only for variants without EKS

- | | |
|---|---|
| (1) Key-operated switch | (9) Feed override |
| (2) Protective shroud for emergency stop button | (10) Override spindle / rapid traverse |
| (3) EKS identification system | (11) RJ 45 bushing |
| (4) Keys with LEDs, actuators ¹⁾ | (12) Handheld unit connection HT 2 / HT 8 ²⁾ |
| (5) Long Element, button with LED ¹⁾ | (13) Toggle switch |
| (6) Mushroom-shaped button - rapid withdrawal | (14) Label holder |
| (7) Authorization lock switch | (15) Adhesive label ³⁾ |
| (8) Mode selector switch | |

¹⁾ Can be assigned according to Section: "Accessories and spare parts" → "Display and operating elements"

²⁾ Only in variant MPP 483 IE H Sxx

³⁾ xxxx... - place holder for the number of possible font characters

Figure 8-5 Special version MPP 483 IE S

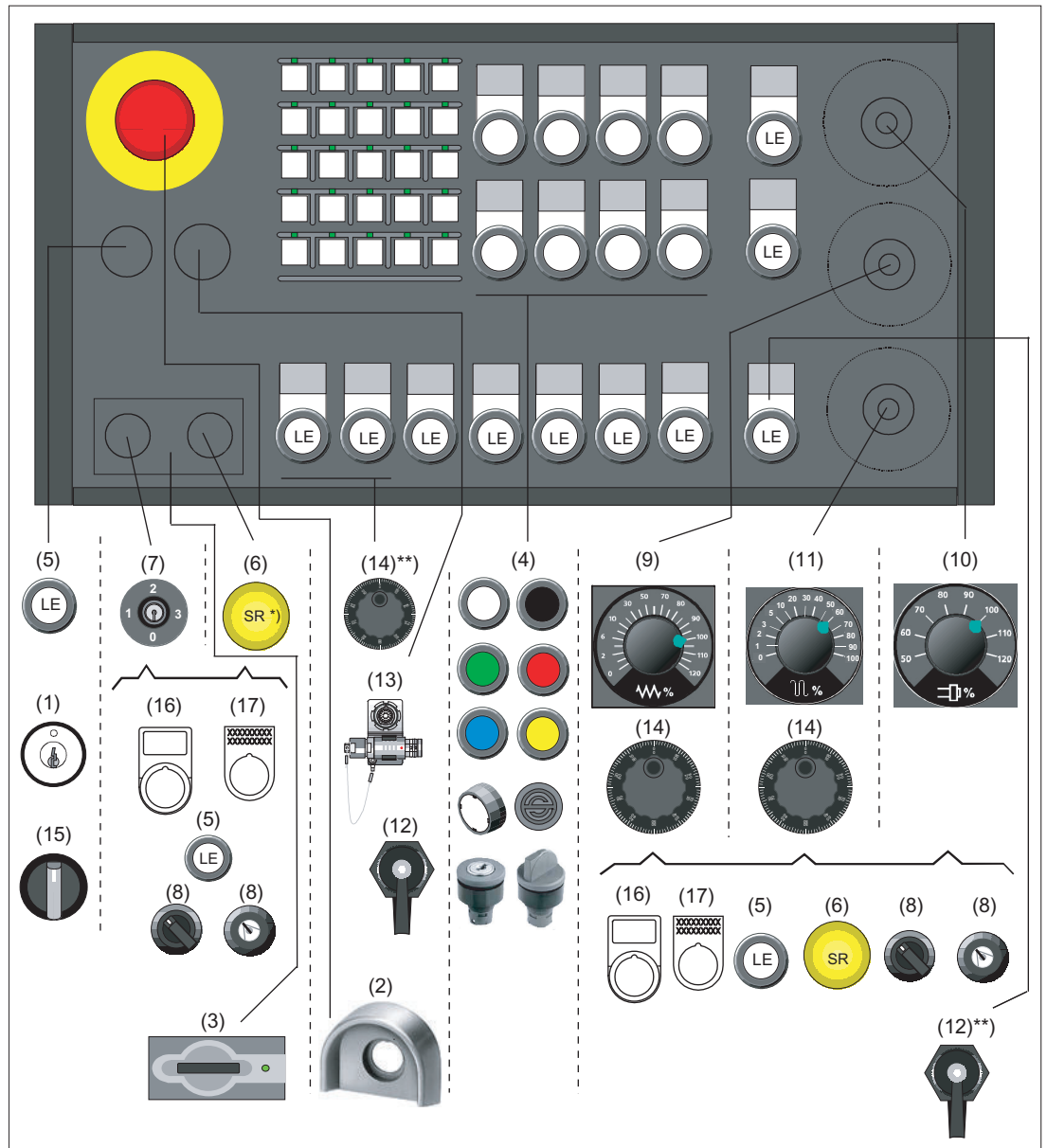

8.2 Operator controls and indicators

- *) Mushroom-shaped button can only be used if the adjacent spot is not occupied
- ***) Component in this slot needs a new cover
- (1) Key-operated switch
- (2) Protective shroud for emergency stop button
- (3) EKS identification system
- (4) Keys with LEDs, actuators ¹⁾
- (5) Long Element, button with LED ¹⁾
- (6) Mushroom-shaped button - rapid withdrawal
- (7) Authorization lock switch
- (8) Mode selector switch
- (9) Feed override
- (10) Override spindle / rapid traverse
- (11) Rapid traverse override
- (12) RJ45 bushing
- (13) Handheld unit connection HT 2 / HT 8 ²⁾
- (14) Handwheel
- (15) Toggle switch
- (16) Label holder
- (17) Adhesive label ³⁾

¹⁾ Can be assigned according to Section: "Accessories and spare parts" → "Display and operating elements"

²⁾ Only in variant MPP 483 IE H/L Lxx

³⁾ xxxx... - place holder for the number of possible font characters

Figure 8-6 Special version MPP 483 IE L

Note

You can use a configurator to put together the components for occupancy of the free module locations according to your practical needs.

The DOConCD / Catalog NC 61 (accompanying CD) contains the following files for this purpose:

- KonfigMPP483.zip (configuration tool)
- AnleitungKonfigurator_MPP483.pdf

You can also obtain the configurator via the Service & Support portal of Siemens:

<http://support.automation.siemens.com/WW/view/en/24533571>

8.2.3 Examples of assignment of free slots

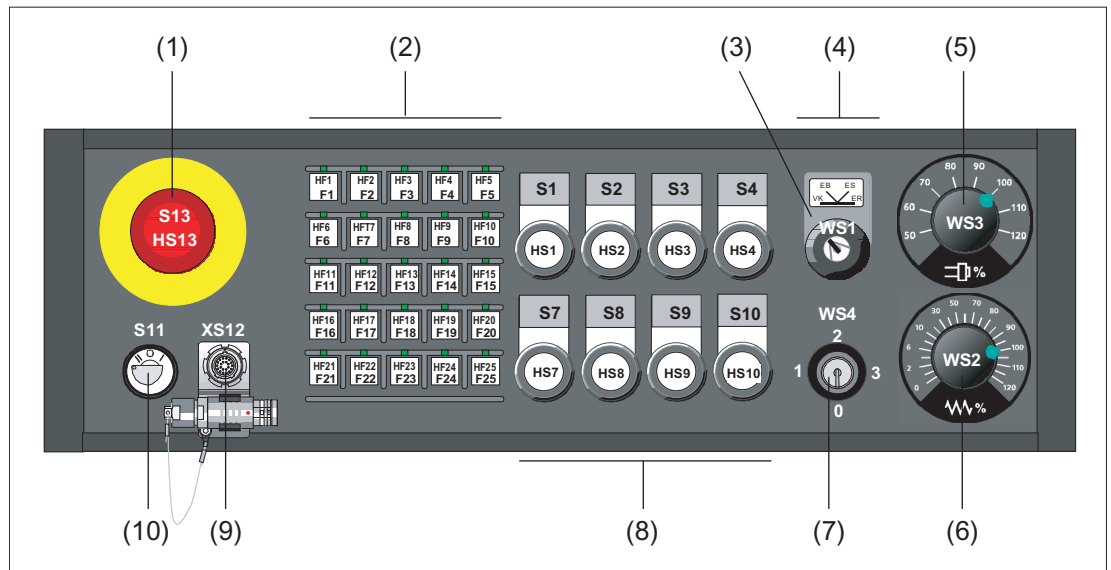

- (1) Emergency stop button
- (2) Function keys
- (3) Mode selector switch
- (4) EKS identification system or 2 extension elements 22.5 mm
- (5) Override spindle / rapid traverse
- (6) Feed override
- (7) Authorization lock switch
- (8) Customer keys (long-stroke keys)
- (9) Handheld unit connection or EKS identification system
- (10) Key-operated switch

Figure 8-7 MPP 483 IE S example

8.2 Operator controls and indicators

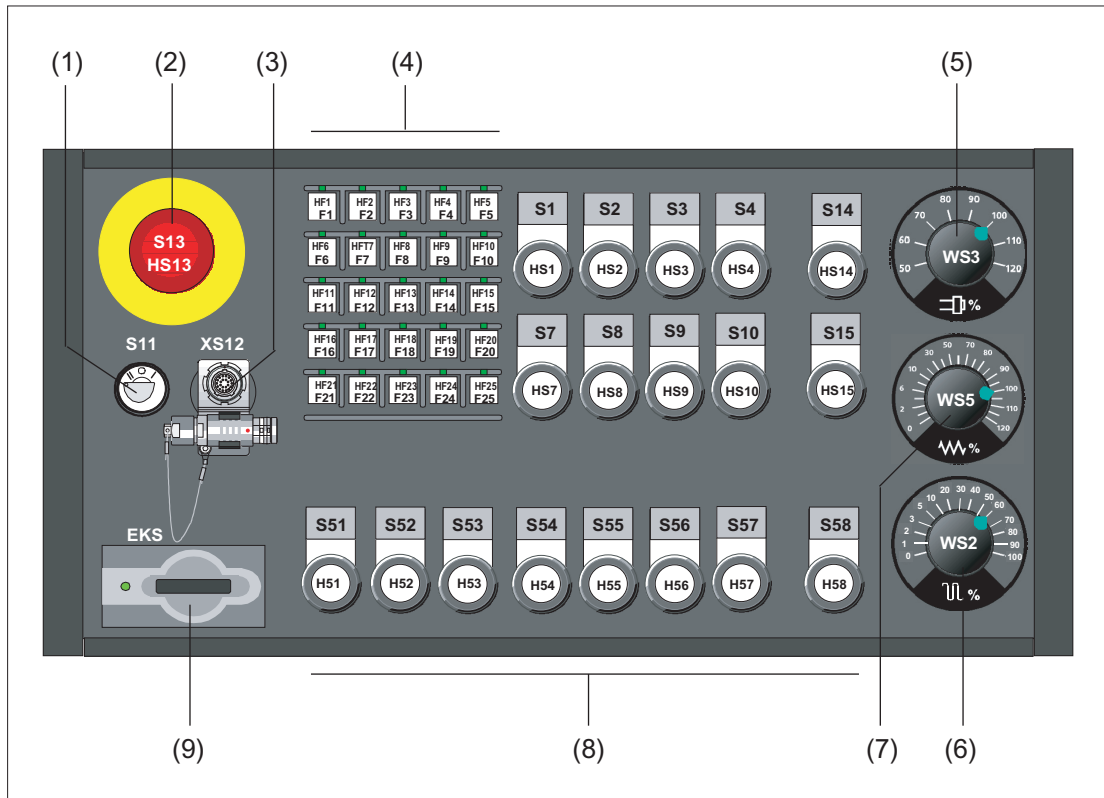

- (1) Key-operated switch
- (2) Emergency stop button
- (3) Connection for handheld units
- (4) Function keys
- (5) Override spindle / rapid traverse
- (6) Rapid traverse override
- (7) Feed override
- (8) Extension keys
- (9) EKS identification system or 2 extension elements 22.5 mm

Figure 8-8 Example MPP 483 IE L with EKS

8.2.4 Description

8.2.4.1 Device front

Connectable control elements

Inputs for

- 25 function keys
- 18 long-stroke keys (max.)

- 3 rotary selector switches
- Key-operated switch with four positions

Outputs for

- 47 LEDs (14 led to plug connector)

Emergency stop chain

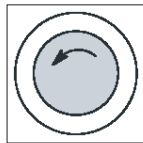

Emergency stop button

Press the red button in emergencies when

- people are at risk,
- there is the danger of the machine or workpiece being damaged.

An emergency stop generally shuts down all drives with the greatest possible braking torque in a controlled manner.

Turn the EMERGENCY STOP button counterclockwise to unlatch it.

When the emergency stop button is activated, the emergency stop chain of the MPP 483 will ensure personal safety and protect the machine in hazardous situations.

The emergency stop chain is also active if the handheld units are removed.

To prevent the emergency stop chain from being interrupted while you plug in or pull out the handheld unit, press the emergency stop override S11. This overrides the emergency stop button on the handheld unit.



WARNING

Danger of death caused by malfunction of the emergency stop override

To effectively deal with a malfunction of the emergency stop override S11 (e.g. jamming), the user PLC program must generate emergency stop when a monitoring time (approximately 5 min) expires (see Figure in Section: "Connecting" → "Handheld unit connection HT 8 with emergency stop override").

The emergency stop chain of the MPP 483 IE should be integrated in the system emergency stop by the user.

Note

Machine manufacturer

For other reactions to the EMERGENCY STOP:
refer to the machine tool manufacturer's instructions!



WARNING

Danger of death resulting from the premature emergency stop unlocking

If you have shut down the system to be monitored, you can only release the emergency stop button or put the system to be monitored back into operation if the condition that triggered the emergency stop function has been corrected and a safe restart is carried out.

8.2 Operator controls and indicators

Actuation elements

The actuating elements S1 to S4, S7 to S10, S14 and S15 are addressed via the control. They also have electrically isolated contacts (common roots) for user-specific wiring.

The following positions can be connected to control devices corresponding to the table in Section: "Accessories and spare parts" → "Display and operating elements":

- S1 to S4
- S7 to S10
- S14
- S15
- S51 to S58

Lamps

The lamps HS1 to HS4, HS7 to HS10, HS14 and HS15 are connected to the control via Ethernet. Alternatively, HS1 to HS4 and HS7 to HS10 can also be activated externally non-isolated.

WS1 selector switch

- 2-way, 4 stages, 60° switching angle
- Centrally mounted with front ring
- Designed as key-operated switch CG4-1A251-600 *FS1 V750D/2J. It can be changed by the customer to the toggle switch variant FS1
- Key can be removed in all positions

8.2.4.2 Device rear side

COM board

S1 (jumper)	Setting the handwheel signal type	
	S1 open:	TTL interface
	S1 closed:	Differential interface
S2	Setting of the MPP address (see Section: "Interfaces" → "Description" → "COM board")	
Diagnostic LEDs	LED1 (H1)	POWER OK (green)
	LED2 (H2)	Bussync
	LED3 (H3)	Busfault

Customer key board

Diagnostic LEDs	LED1 (H1)	Voltage monitoring of customer keys
	LED2 (H2)	Voltage monitoring of customer keys
	LED3 (H3)	Voltage monitoring of customer keys

HGA board HT 8

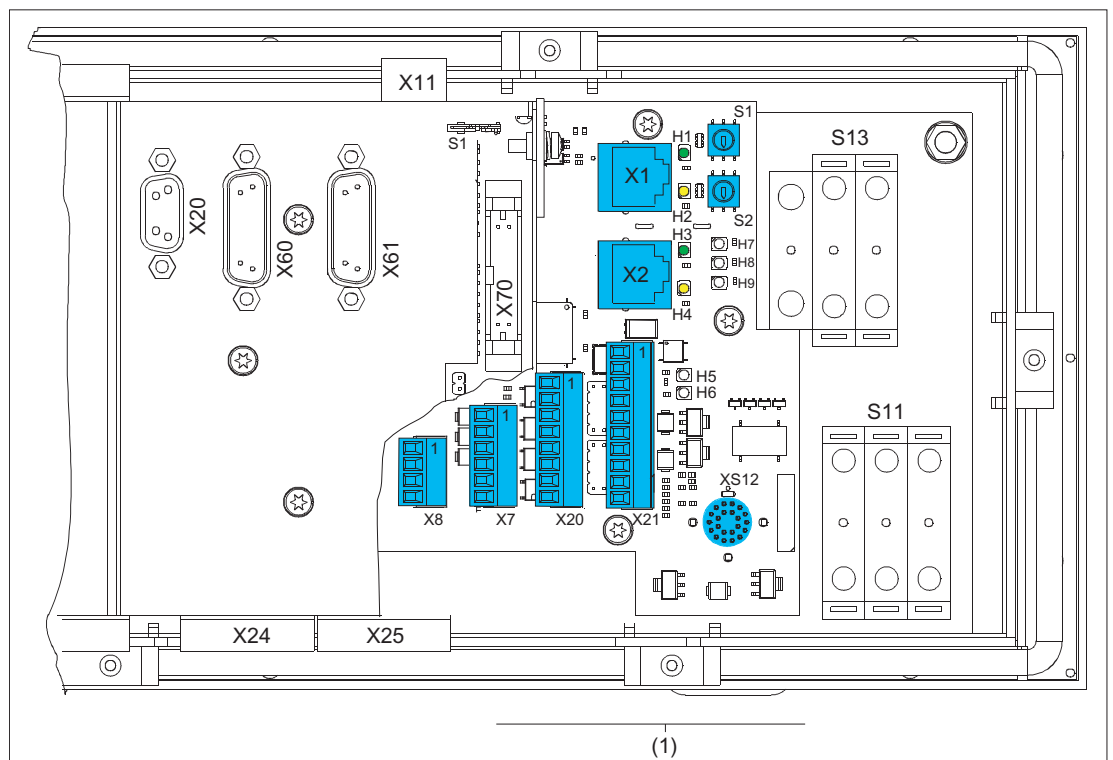

Figure 8-9 Rear MPP 483 IE with LEDs on HGA board HT 8 (1)

Table 8-4 Diagnostic LEDs

		Color	for	Meaning
LED1 (H1)	LNK	Green	X1 RJ-45	Connection established
LED2 (H2)	ACT	Yellow	X1 RJ-45	Transmission active
LED3 (H3)	LNK	Green	X2 RJ-45	Connection established
LED4 (H4)	ACT	Yellow	X2 RJ-45	Transmission active
LED5 (H5)	LNK	Green	HT 8 transmission	
LED6 (H6)	ACT	Yellow	HT 8 transmission	
LED7 (H7)	Power OK	Green		
LED8 (H8)	FAULT STAT1	Red		Fault
LED9 (H9)	FAULT STAT2	Red		Fault

8.3 interfaces

- S1 (coding switches) Module address bit 4 ... 7
- S2 (coding switches) Module address bit 0 ... 3

8.3 interfaces

8.3.1 Overview

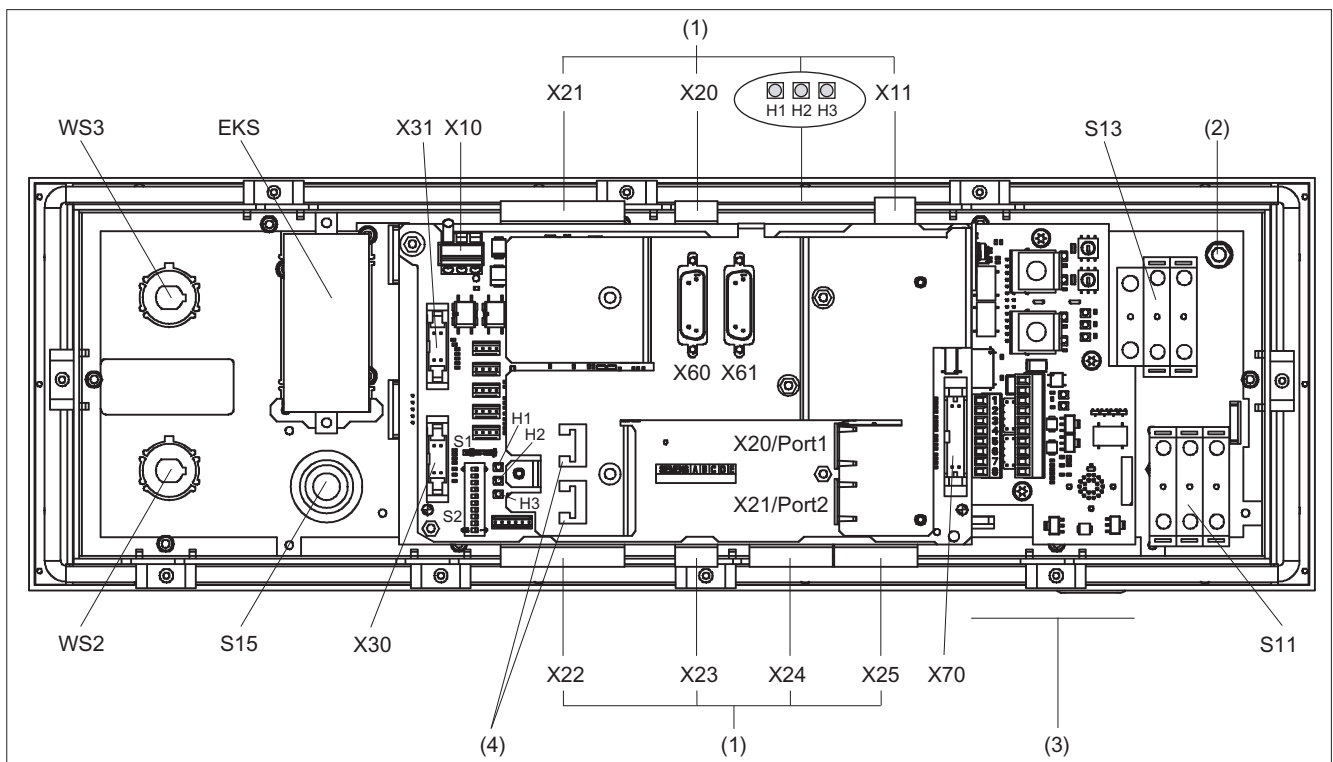

Figure 8-10 Rear of the MPP 483 IE with interfaces

Control panel	
(2)	Protective Ground Connection
S13	Emergency stop button
S11	Emergency stop override
COM board	
X10	Power supply
X20	Ethernet / Port 1
X21	Ethernet / Port 2
X30	Feed override
X31	Spindle override

	X60	Handwheel 1	
	X61	Handwheel 2	
	X70	Direct control keys	
(4)		Strain relief for Ethernet cable	
(1)	Customer keys		
	X11	Power supply	
	X20	Connector X20	Individual wiring
	X21	Connector X21	
	X22	Connector X22	
	X23	Connector X23	
	X24	Connector X24	Expansion
	X25	Connector X25	
(3)	Connection for handheld units		
	X1 / X2	Ethernet	
	X20	Enable	
	X21	Emergency stop override	
	XS12	Connection for handheld units	

Signal type

O	Outputs
I	Inputs
B	Bi-directional signals
V	Supply voltage
VI	Voltage input
VO	Voltage output

8.3.2 Description

8.3.2.1 Control panel



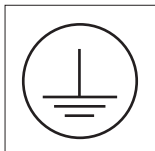

Protective Ground Connection

Pin	Signal	Connection	Connection cross-section
	PE	M5 x 2.5 cable lug	2.5 mm ²

Emergency stop button S13

Key designation: S13
 Key type: Mushroom, push-pull key 3SB3000-1HA20 with holder 3SB3901-0AB and 1 x NO 3SB3400-0B (internal use)









Table 8-5 Switching element for NC

Pin	Signal	Type	Signal name	Function
11	OE_S13.11	I/O	NC contact OE1, S13	
12	BZ_S13.12		Reference potential OE1, S13	
21	OE_S13.21		NC contact OE2, S13	
22	BZ_S13.22		Reference potential OE2, S13	

Emergency stop override S11

Key designation: S11
 Key type: left probing, right probing, safety lock with actuation element according to the catalog: Low-Voltage Controls and Distribution (LV 1) carrier 3SB3901-0AC with pressure plates
 1 x NO contact 3SB3400-0B
 2 x 3SB3400-0A switching element 1xNC contact/1xNO contact elements positively driven

Table 8-6 Emergency stop override

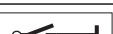
Pin	Signal	Type	Signal name	Function
14	BZ_S11.14	I/O	Reference potential S1, S11	
13	S_S11.13		NO contact S1, S11	
21	OE_S11.21		NC contact OE2, S11	
22	BZ_S11.22		Reference potential OE2, S11	
24	BZ_S11.24		Reference potential S2, S11	
23	S_S11.23		NO contact S2, S11	
31	OE_S11.31		NC contact OE3, S11	
32	BZ_S11.32		Reference potential OE3, S11	
34	BZ_S11.34		Reference potential S3, S11	
33	S_S11.33		NO contact S3, S11	

WS1 selector switch

Switch designation: WS1

Switch type: CG4-1 A251-600 *FS1 V750 D/2J

Table 8-7 WS1 selector switch

Pin	Signal	Type	Signal name	Switch position
11	ER	I/O	Mode	4
15	ES		Mode	3
10	BZ_WS		Reference signal	
13	EB		Mode	2
9	Linked mode		Mode	1

Rapid withdrawal (SR)



Key designation: SR

Key type: 3SB3000-1GA31

Switching element: NO contact 3SB3400-0B, input PLC

8.3 interfaces

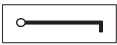
Table 8-8 Rapid withdrawal (SR)

Pin	Signal	Type	Signal name	Function
14	BZ_SR.14	I/O	Reference potential S1, SR	
13	S_SR.13		NO contact S1, SR	

8.3.2.2 COM board

Pin assignment

For more detailed information, see "General information and networking", Chapter: "Connecting".

Switch S1

Settings, see Chapter "Machine control panel: MCP 310C PN", Section "Interfaces".

Switch S2

Settings, see Chapter "Machine control panel: MCP 310C PN", Section "Interfaces", mode "MCP set up as IE".

8.3.2.3 User keys

Power supply interface X11

Connector designation: X11

Connector type: Combicon MSTBA2.5/3-G-5.08

Cable length (max.): 10 m

Table 8-9 Interface power supply

Pin	Signal name	Type	Meaning
1	2P24	V	24 V potential
2	M24		Ground 24 V
3	N.C.		Not connected

Individual wiring











Connector X20 / X21

Connector designation: X20/X21

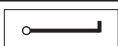
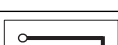
Connector type: Mini-Combicon MC 1.5/4-G-3.81

Cable length (max.): 30 m

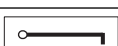
Table 8-10 Connector X20 / X21

Connector	Pin	Signal	Type	Signal name	Function
X20	1	OE_S2	I/O	NC contact S2	
	2	OE_S1		NC contact S1	
X21	1	OE_S4	I/O	NC contact S4	
	2	OE_S3		NC contact S3	
X20	3	BZOE_S1-4	I/O	Reference potential NC contact S1 ... S4	
	4	BZS_S1-S6		Reference potential NO contact S1 ... S6	
X21	3	S_S4	I/O	NO contact S4	
	4	S_S3		NO contact S3	
	5	S_S2		NO contact S2	
	6	S_S1.1		NO contact S1.1	
	7	BZS_S1.2		Reference potential NO contact S1.2	
	8	S_S1.2		NO contact S1.2	
	9	HS 4	I	Signaling lamp S4	All inputs "High" active
	10	HS 3		Signaling lamp S3	
11	HS 2	Signaling lamp S2			
12	HS 1	Signaling lamp S1			

Connector X22









Connector designation: X22

Connector type: Mini-Combicon MC 1.5/12-G-3.81

Cable length (max.): 30 m

8.3 interfaces

Table 8-11 Connector X22

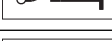
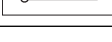
Pin	Signal	Type	Signal name	Function
1	OE_S7	I/O	NC contact S7	
2	OE_S8		NC contact S8	
3	OE_S9		NC contact S9	
4	OE_S10		NC contact S10	
10	BZOE_S7-S10		Reference potential NC contacts S7-10	
5	S_S7	I/O	NO contact S7	
6	S_S8		NO contact S8	
7	S_S9		NO contact S9	
8	S_S10		NO contact S10	
9	BZS_S7-S10		Reference potential NO contacts S7-10	
11	3P24	V	+24 V potential	
12	3P24		+24 V potential	

Connector X23

Connector designation: X23

Connector type: 4-pin Mini-Combicon MC 1.5/4-G-3.81

Cable length (max.): 30 m

Table 8-12 Connector X23

Pin	Signal	Type	Signal name	Function
1	HS 7	I	Signaling lamp S7	All inputs "High" active
2	HS 8		Signaling lamp S8	
3	HS 9		Signaling lamp S9	
4	HS 10		Signaling lamp S10	

Connector X24

Only the special versions MPP 483 IE S and MPP 483 IE L are equipped with these connectors.

Connector designation: X24

Connector type: MCD 1.5/8-G1-3.81 HT BK

Cable length (max.): 1.5 m

Table 8-13 Connector X24

Pin	Signal	Type	Signal name	Pin	Signal	Type	Signal name
B1	S51	I	Ext. key S51	A1	H51	O	LED_S51
B2	S52		Ext. key S52	A2	H52		LED_S52
B3	S53		Ext. key S53	A3	H53		LED_S53
B4	S54		Ext. key S54	A4	H54		LED_S54
B5	S55		Ext. key S55	A5	H55		LED_S55
B6	S56		Ext. key S56	A6	H56		LED_S56
B7	S57		Ext. key S57	A7	H57		LED_S57
B8	S58		Ext. key S58	A8	H58		LED_S58
Viewed from the PCB:							
B	at top of plug connector						
O	at bottom of plug connector						

Connector X25

Connector designation: X25

Connector type: MCD 1.5/8-G1-3.81 HT BK

Cable length (max.): 1.5 m

Table 8-14 Connector X25

Pin	Signal	Type	Signal name	Pin	Signal	Type	Signal name
B1	P24_OUT	V	Reference potential +24 V	A1	M24_EXT	V	Reference potential +24 V
B2	S13	I	Emergency stop button	A2	HS13	O	Emergency stop LED
B3	S14		KT-S14	A3	HS14		LED-S14
B4	S15		KT-S15	A4	HS15		LED-S15
B5	S59 *)		KT-IN3/emergency stop override	A5	H59		LED-S59
B6	S60		Mode selection	A6	H60		LED-S60
B7	S61		Rapid withdrawal	A7	H61		LED-S61
B8	S62 *)		S32 / HGA enabling unit plugged in / terminating connector	A8	M24_EXT		V
*) can only be used as a neutral input without HGA							

8.3.2.4 Handheld unit connection HT 8

You will find a detailed drawing showing the location of the interfaces in Section: "Control and display elements" → "Description" → "Device rear".

Ethernet X1 / X2

Connector designation: X1, X2
 Connector type: RJ-45 socket

Table 8-15 Ethernet X1 / X2

Pin	Signal name	Type	Meaning
1	TD+	O	Transmit data +
2	TD-		Transmit data -
3	RD+	I	Receive data +
4	N.C.	-	Not connected
5	N.C.	-	Not connected
6	RD-	I	Receive data -
7	N.C.	-	Not connected
8	N.C.	-	Not connected

Note

Connection only on LAN, not on telecommunication networks!

Panel Present X7

Connector designation: **X7**
 Connector type: 6-pin Phoenix terminal

Table 8-16 Assignment of the interface Panel Present X7

Pin	Signal name	Signal type	Meaning
1	PRES	O	"High": Panel (HT 8) plugged in
2	N.C.	-	Not connected
3	N.C.	-	Not connected
4	N.C.	-	Not connected
5	N.C.	-	Not connected
6	M	P	Ground

Emergency Stop wiring terminal X8

Connector designation: **X8**
 Connector type: 4-pin Phoenix terminal

Table 8-17 Assignment of the emergency stop wiring terminal X8

Pin	Protective circuit
1	On-board jumper between 1 and 2
2	
3	On-board jumper between 3 and 4
4	

Note

Use this terminal for simple routing of the emergency stop cables, optional.

The connector is only used to assist looping through. The connected pins 1 and 2 as well as 3 and 4 have no additional function on the connection module.

Enabling X20

Table 8-18 Enabling X20

Pin	Signal name	Type	Meaning
1	ZUST1P	I	Electronic enabling button 1P
2	ZUST1M	O	Electronic enabling button 1M
3	ZUST2P	I	Electronic enabling button 2P
4	ZUST2M	O	Electronic enabling button 2M
5	N.C.		Not connected
6	N.C.		Not connected
7	N.C.		Not connected
8	N.C.		Not connected

Emergency Stop override X21

Connector designation: X21

Connector type: MCV 1.5/10-G3.81

Cable length (max.): 30 m

Table 8-19 Emergency Stop override X21

Pin	Signal name	Type	Meaning
1	STOP23	I/O	Emergency Stop NC contact 1.1
2	STOP24		Emergency Stop NC contact 1.1
3	STOP13		Emergency Stop NC contact 2.1
4	STOP14		Emergency Stop NC contact 2.2
5	M	V	
6	N.C.	-	Not connected
7	IN_S59	I	Emergency Stop override negated

8.3 interfaces

Pin	Signal name	Type	Meaning
8	P24_FILT	V	24 V
9	IN_S59_EXT	O	Key-operated switch actuated
10	IN_S62_EXT		Terminating connector plugged in

Note

Emergency stop X21: Supply voltage: 24 VDC; switched current: Max. 500 mA.

Handheld unit connection XS12

Connector designation:XS12

Connector type: 9GX3BXC-T22QF10-0004

Table 8-20 Handheld unit connection XS12

Pin	Signal	Type	Meaning	Function
1	HH_PR_P	I	+ Present line	
2	HH_PR_M		- Present line	
3	HP24	V	24 V HH for present	Power supply
4	ZUST2M	O	Enabling button 2M	Enabling function
5	ZUST1P	I	Enabling button 1P	
6	ZUST1M	O	Enabling button 1M	
7	ZUST2P	I	Enabling button 2P	
8	HH_L2.2	I/O	HH emergency stop L2.2	Emergency stop
9	HH_L2.1		HH emergency stop L2.1	
10	HH_L1.2		HH emergency stop L1.2	
11	HH_L1.1		HH emergency stop L1.1	
12	M	V	Ground	Power supply
13	ABS_ST_PRES	I	Terminating connector	Terminating connector plugged in
14	HH_P24	V	24 V HH supply	Power supply
15	IDENT_B	I/O	Diff Signal Module Addr.	
16	TX-	O	Ethernet Transmit -	Ethernet transmitted data
17	TX+		Ethernet Transmit +	
18	RX+	I	Ethernet receive +	Ethernet receive data
19	RX-		Ethernet receive -	
20	SHIELD	-	Cable shield	
21	M	V	Ground	Power supply
22	IDENT_A	I/O	Diff Signal Module Addr.	

8.3.3 Connection elements for COM board, customer keys and handheld unit connection

This table shows plug connection elements for the following modules:

- COM board (COM)
- Customer keys (KT)
- Connection for handheld units (HGA)

Table 8-21 Connection components

Module	Connector	Units	Terminal element	Connectable cross-section (max.)	Manufacturer
COM	X10	1	MSTB2,5/3-STZ-5,08,1776168	2.5 mm ²	PHOENIX CONTACT
	X20/X21	2	6GK1901-1BB10-2AB0		SIEMENS
	X60 / X61	2	6FC9348-7HX	0.75 mm ²	
	X70	1	A5E00026403		
KT	X11	1	MSTB2,5/3-ST-5,08,1757022	2.5 mm ²	PHOENIX CONTACT
	X20 / X23	2	MC1.5/4-ST-3.81, 1803594	1.5 mm ²	
	X21/X22	2	MC1.5/12-ST-3.81, 1803675	1.5 mm ²	
	X24:A/B X25: A/B	4	MC1.5/8-ST-3.81, 1803633	1.5 mm ²	
HGA HT 8	X1 / X2	2	6GK1901-1BB10-2AB0		SIEMENS
	X7	1	MC1.5/6-STZ-3.81 GY BD1-6, 1713198	1.5 mm ²	PHOENIX CONTACT
	X8	1	MC1.5/4-STZ-3.81 GY BD1-4, 1713185	1.5 mm ²	
	X 20	1	MC1.5/8-STZ-3.81 GY BD-1-8, 1713208	1.5 mm ²	
X 21	1	MC1.5/10-STZ-3.81 GY BD1-10, 1901658	1.5 mm ²		

8.3.4 Input / output images

Process input image MPP 483 IE

Byte	Bit7	Bit6	Bit5	Bit4	Bit3	Bit2	Bit1	Bit0
n+0	BA switch				Function key	HG connection XS12:13	Emergency stop override	
	WS1/4 F16*)	WS1/3 F11*)	WS1/2 F6*)	WS1/1 F1*)	F21		S62	S60
n+1	Customer key	Key	Customer key	Extension key	Customer keys			
	S15	WS4, pos. 0	S14	S51	S4	S3	S2	S1

8.3 interfaces

n+2	Key			SR key	Rapid traverse override			
	WS4, pos.3	WS4, pos.2	WS4, pos.1	S61	WS5/8	WS5/4	WS5/2	WS5/1
n+3		Extension key	Emergency stop	Customer keys				Extension key
		S53	S13	S10	S9	S8	S7	S52
n+4	Direct control keys							
	DT8	DT7	DT6	DT5	DT4	DT3	DT2	DT1
n+5	Direct control keys							
	DT16	DT15	DT14	DT13	DT12	DT11	DT10	DT9
n+6			Extension keys		Spindle override			
			S58	S57	WS3/8	WS3/4	WS3/2	WS3/1
n+7	Extension keys			Feed override				
	S56	S55	S54	WS2/16	WS2/8	WS2/4	WS2/2	WS2/1
n+8	Function keys							
	F8	F7	F6	F5	F4	F3	F2	F1
n+9	Function keys							
	F16	F15	F14	F13	F12	F11	F10	F9
n+10	Function keys							
	F25	F24	F23	F22	F20	F19	F18	F17
n+11	Reserve							
n+12	Feed override							
				WS2/16	WS2/8	WS2/4	WS2/2"	WS2/1
n+13	Spindle override							
				WS3/16	WS3/8	WS3/4	WS3/2	WS3/1
*) The function keys are not active if WS1 is assigned.								

Optional 4-byte handwheel

Table 8-22 Input image for handwheel data

Byte	Bit7	Bit6	Bit5	Bit4	Bit3	Bit2	Bit1	Bit0
n+14	Handwheel 1 counter status (16-bit signed, low-order equals byte n+14)							
n+15								
n+16	Handwheel 2 counter status (16-bit signed, low-order equals byte n+16)							
n+17								

Keyboard layout - input image MPP 483 IE

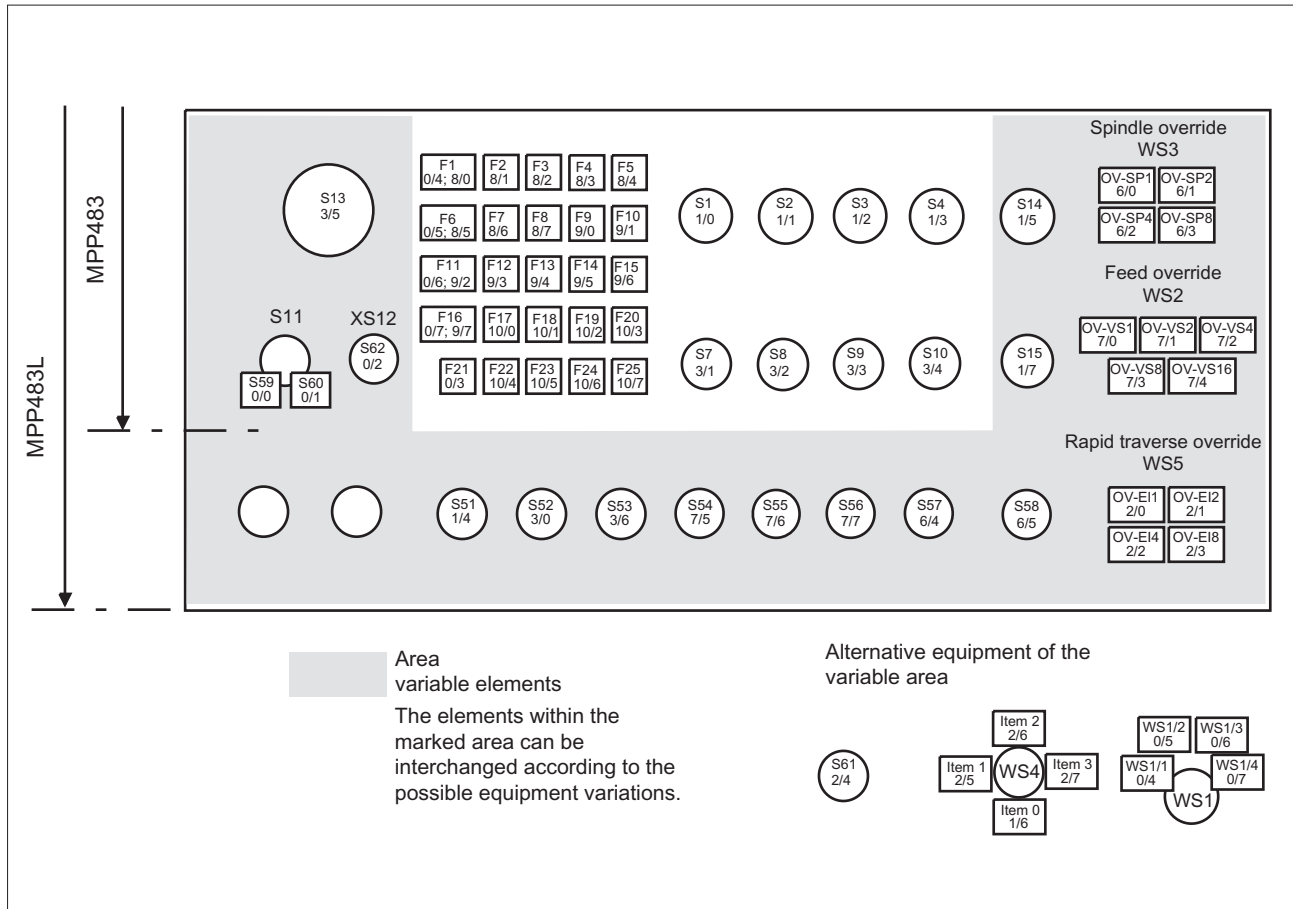

Figure 8-11 Front view

Output image MPP 483 IE

Byte	Bit7	Bit6	Bit5	Bit4	Bit3	Bit2	Bit1	Bit0
n+0	Customer keys							
	Hs8	HS7	HS15	HS14	HS4	HS3	HS2	HS1
n+1	Customer keys							
							HS10	HS9
n+2	Extension keys							
	H58	H57	H56	H55	H54	H53	H52	H51
n+3					SR key	Feedback for emergency stop	Extension keys S59/S60 when S11 is not used	
					H61		HS13	H60
n+4	Function keys							

8.3 interfaces

	HF8	HF7	HF6	HF5	HF4	HF3	HF2	HF1
n+5	Function keys							
	HF16	HF15	HF14	HF13	HF12	HF11	HF10	HF9
n+6	Function keys							
	HF24	HF23	HF22	HF21	HF20	HF19	HF18	HF17
n+7								Function key
								HF25

Keyboard layout - output image MPP 483 IE

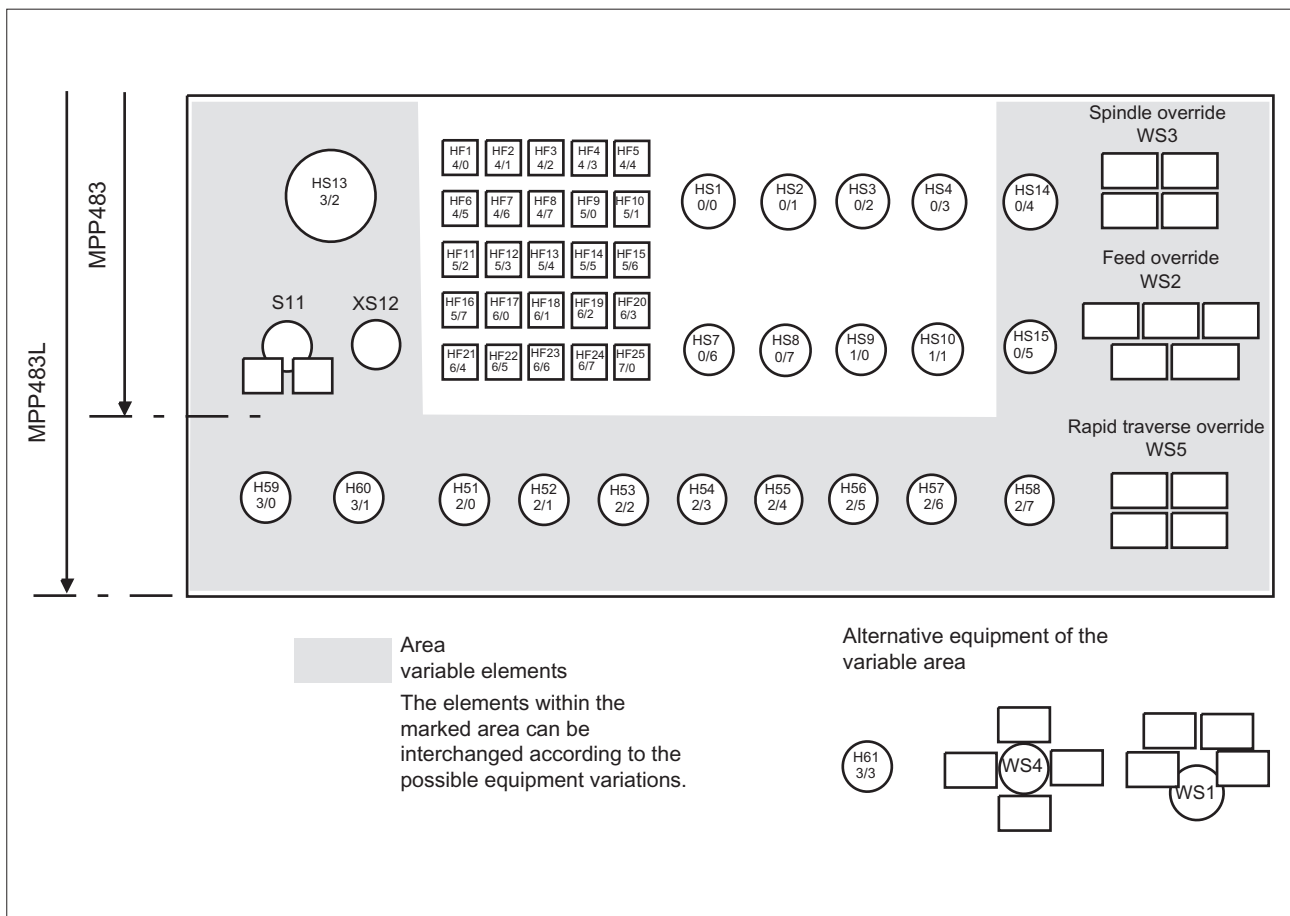

Figure 8-12 Front side

8.4 Mounting

Dimensions of the MPP 483 IE and MPP 483 IE L

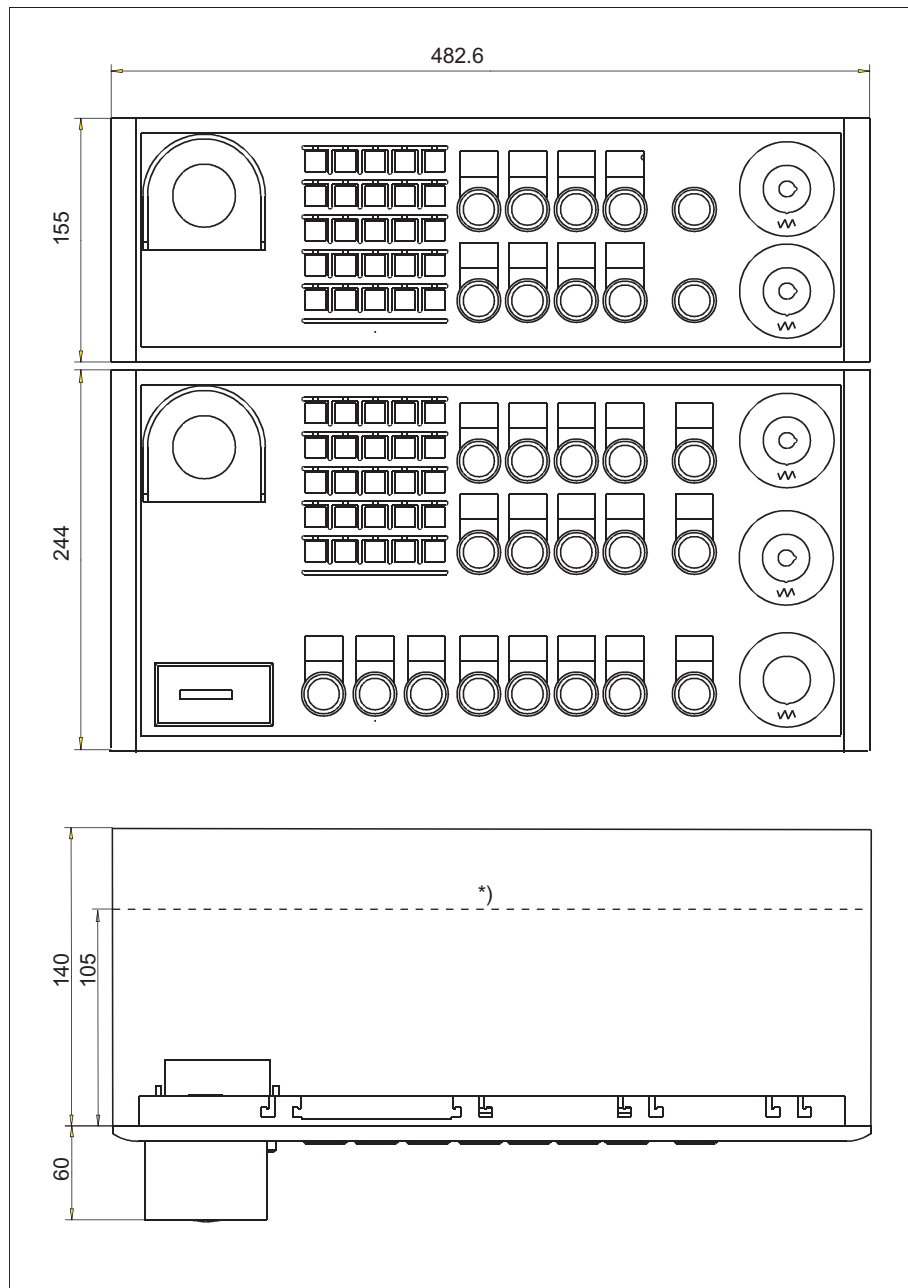

Figure 8-13 Dimension drawing of the MPP 483 IE and MPP 483 IE L

*) Depth 105 mm applies to MPPs without a handheld unit connector.

Panel cutouts MPP 483 IE and MPP 483 IE L

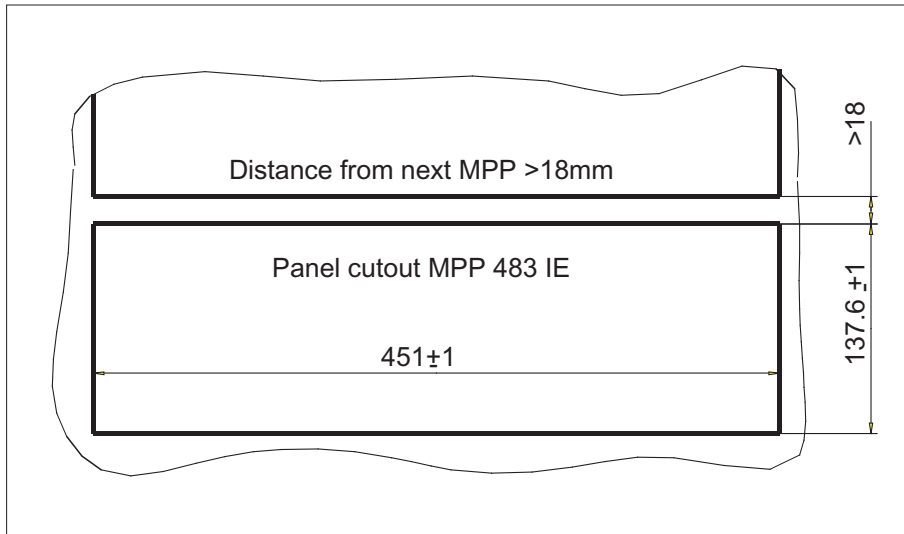

Figure 8-14 Panel cutout MPP 483 IE

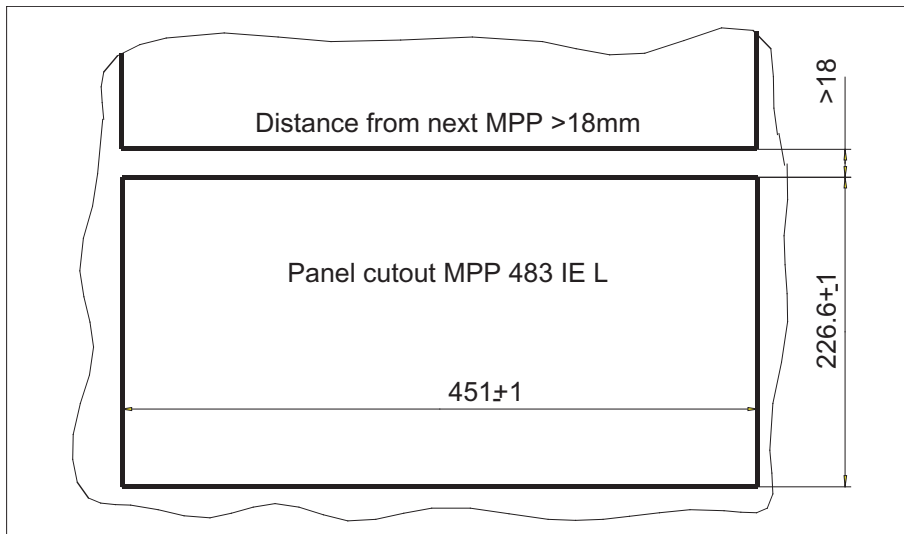

Figure 8-15 Panel cutout MPP 483 IE L

The MPP 483 IE is attached to the rear of the operator panel using 9 tension jacks (contained in the delivery kit). The tightening torque is 0.4 Nm.

Mounting position

The mounting position is max. 60° to the vertical.

For mounting positions greater than 60°, a fan must also be installed to keep the ambient temperature of the machine control panel constantly below 55° C.

Mounting position of LEDs

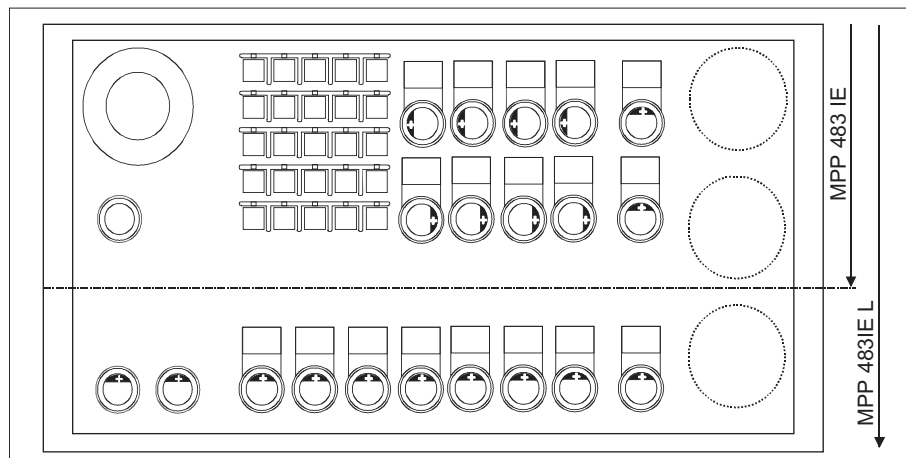

Figure 8-16 Mounting position of LEDs MPP 483 IE / MPP 483 IE L

Table 8-23 Identification of anode connection



Insert polarity+ of LEDs in key on side marked

8.5 Connecting

8.5.1 MPP 483 IE

Connecting the 24 V supply

The 24 V supply is connected via a 3-pin terminal block at connector COM X10 and KT X11 to the rear of the machine control panel (see Figure: "Rear side of MPP 483 IE with interfaces" in Section: "Interfaces" → "Overview").

The protective ground is secured to the M5 bolt.

NOTICE

Damage to the device caused by unfused power supplies

The 24 VDC power supply must always be grounded and designed as Protective Extra-Low Voltage (PELV) - protection by function low voltage with safe isolation!

8.5 Connecting

Emergency stop circuit connection

The connections of the emergency stop circuits are shown in Fig. "Ethernet connection".

Ethernet connection

- Connection of HGA - X1 to operator panel front (OP)
- Connection of HGA - X2 via COM X20 and COM X21 to control (NC)

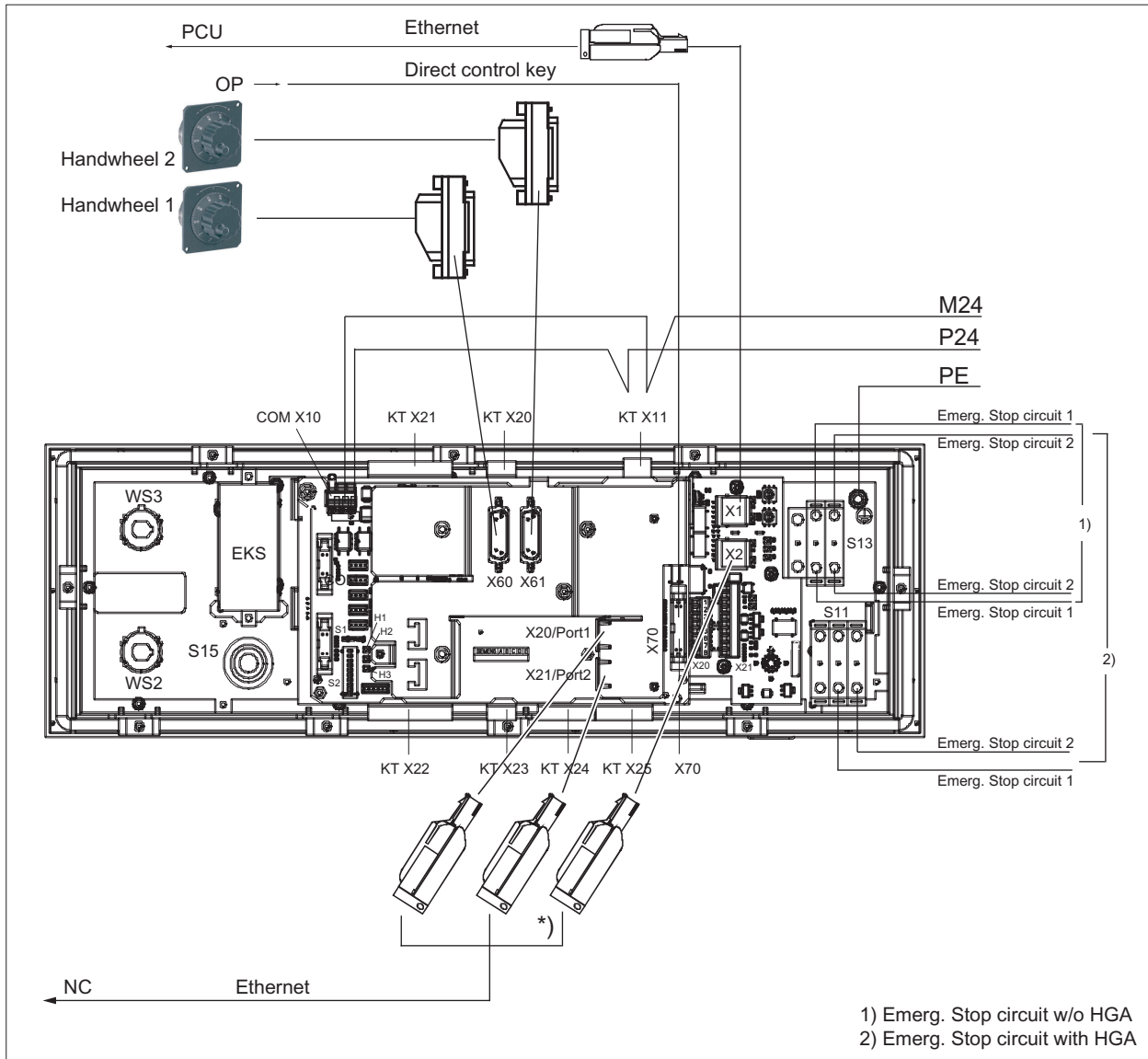

Figure 8-17 Ethernet connection

*) Not included with version without HGA. The operator panel front (OP) is connected to X20/Port1.

Individual wiring connection

The individual contacts are connected in accordance with the customer-specific links required (see Section: "Customer keys").

Note

Supply voltages for inputs and outputs must always be grounded!

8.5.2 Customer keys

The customer keys (KT) module links the operator panel, handheld unit connection and COM board.

The inputs for handheld unit connection and extension keys are opto-decoupled. The outputs belonging to these are issued by high-side drivers.

The floating individual contacts of function keys S1 ... S4 and S7 ... S10 are shown in the figure.

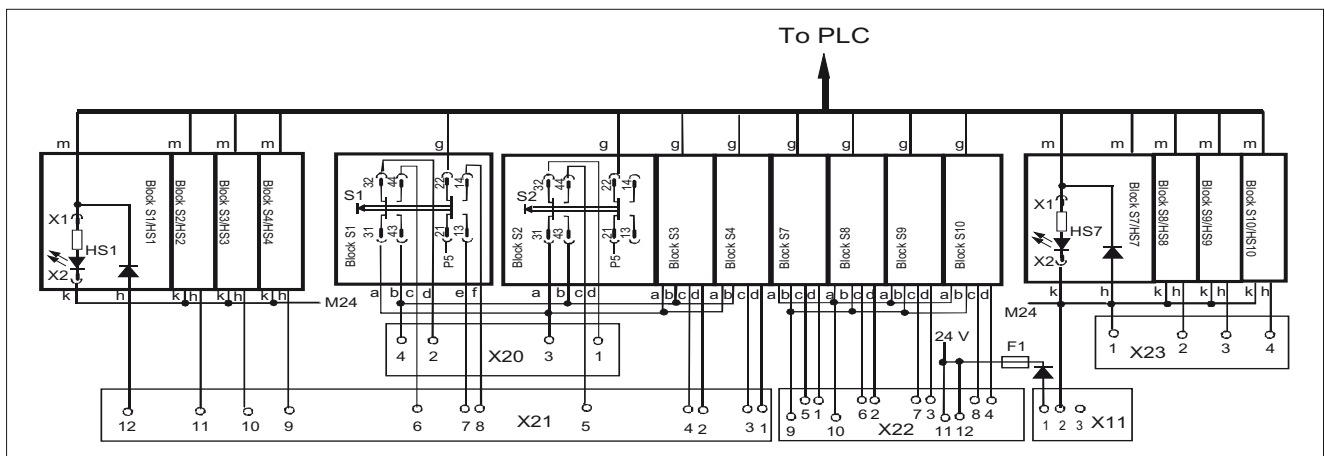

Figure 8-18 Individual wiring of the customer keys (a, b, ..., m designate IN and OUT of the individual blocks)

NOTICE

Damage to pushbutton contacts

When using an external 24 V encoder supply, always protect the key contacts against overload in the individual wiring with an external fuse for L+ with the following properties:

- circuit breaker of characteristic A, 1.6 A.

If you use the encoder supply X20:A15/A16 or VS1/VS2 of the ET200S block 4/8 F DI 24 VDC PROFIsafe, the external fuse can be omitted.

8.5.3 Handheld unit connection HT 8 with emergency stop override

The connection for handheld units (HGA) of the HT 8 has four function complexes:

- Two-channel version of enabling function
- Three-port Ethernet switch
- Connection of HT 8
- Module address

 WARNING
Danger of death if the enabling button is not DIN-conform
It is the user's responsibility to ensure that the enabling button or the enable control is implemented according to DIN EN 60204-1, Section 9.2.6.3, and the enabling button, when released or pushed down, stops dangerous movements reliably.

Emergency stop override S11

- Implemented as pushbutton or key-operated switch
- Pushbutton pressed or key-operated switch, left probing
 - "Emergency stop override" of the handheld unit connection → query via input E59
 - Interruption of the power supply for the handheld unit connection when actuated
- Key-operated switch, right probing: Unassigned function → query via input S60

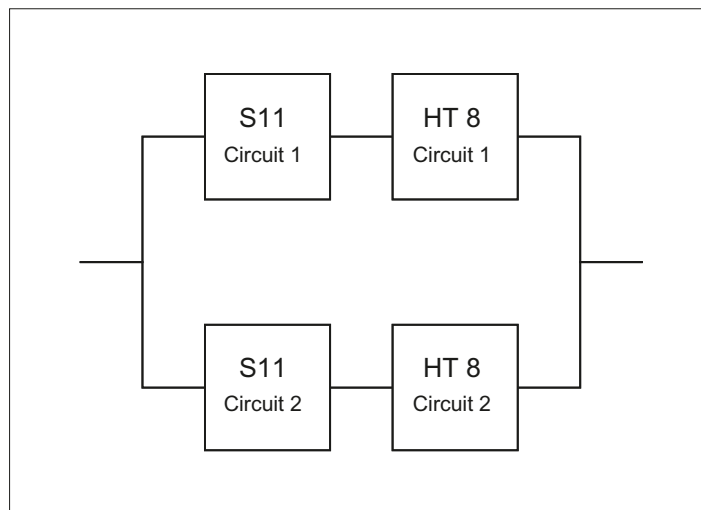

Figure 8-19 2-channel architecture of the emergency stop override contacts

With regard to their accidental failure, the contacts of the emergency stop override safety function form a 2-channel architecture together with the emergency stop button on the HT 8. In addition to the B_{10d} value of the emergency stop button, the B_{10d} value of S11 must also be taken into consideration for the assessment in both emergency stop circuits.

The diagnostics for the contacts of S11 is performed on the HT 8 together with the diagnostics of the emergency stop button.

**WARNING****Danger of death caused by failure of the "emergency stop" safety function**

The user must ensure that the emergency stop override is implemented in accordance with the safety goals required by the risk analysis of the machine.

Actuation of the emergency stop override results in failure of the emergency stop safety function on the HT 8. The user must implement suitable organization and/or technical procedures for this in order to achieve the safety goals.

As a technical measure, the signaling contacts on the S11: 31/32 and 61/62 can be used to trigger an "emergency stop" by the PLC after a monitoring time has expired (maximum five minutes) (see Remark 1 in the following figure).

However, this measure alone does not satisfy the requirements of Category 3, PL d in accordance with EN ISO 13849-1:2008.

All other functions can be found in the figure.

8.5 Connecting

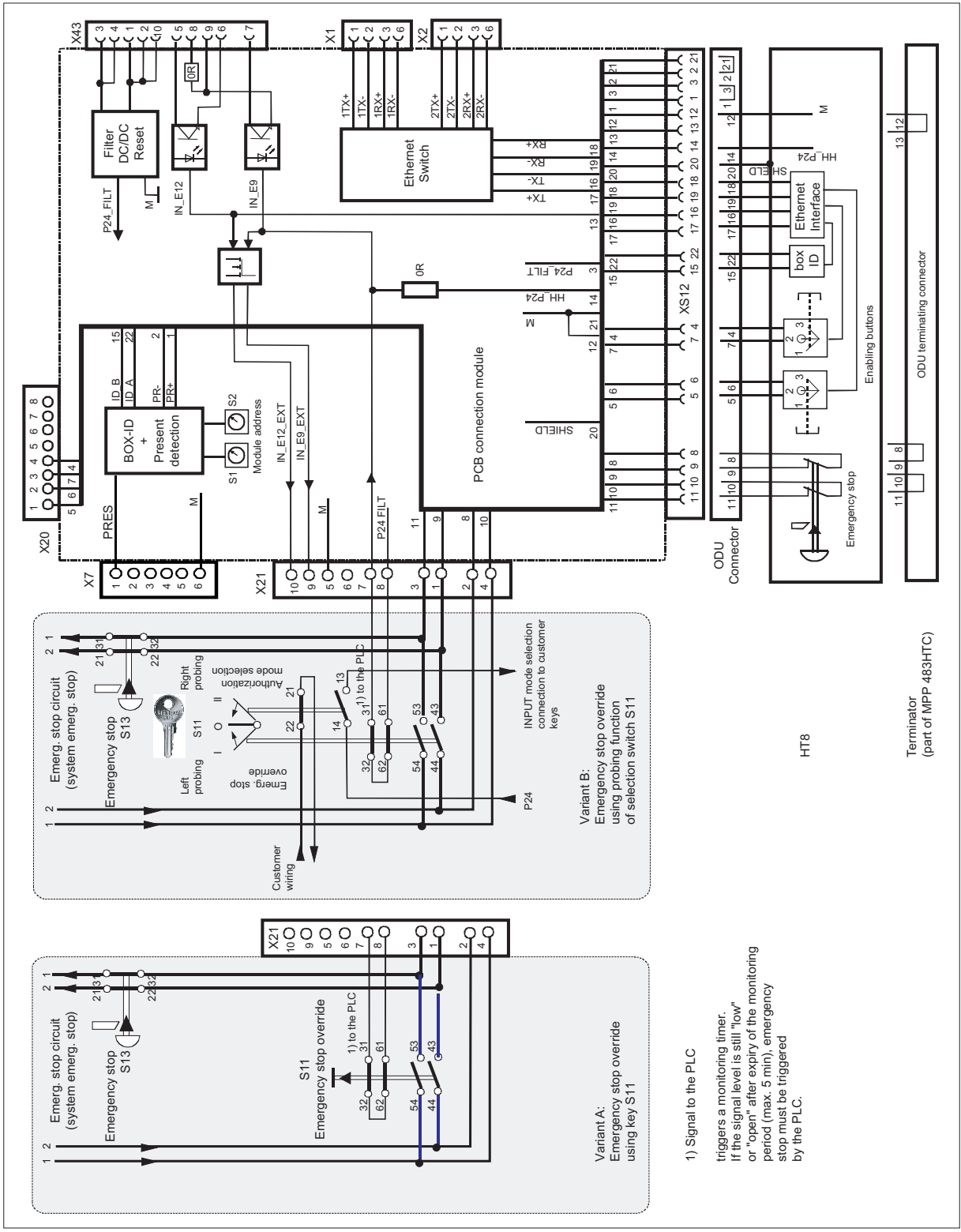
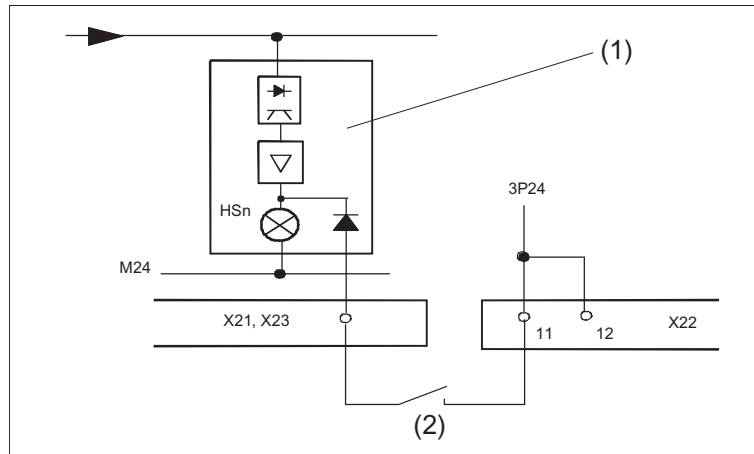

Figure 8-20 Handheld unit connection HT 8

8.6 Circuits and wiring

External control of signaling lamps

The following circuit diagram relates to the lights in HS1 to HS4 and HS7 to HS10.



- (1) Block Sn
- (2) External contact

Figure 8-21 External control of signaling lamps

Circuit for emergency stop button

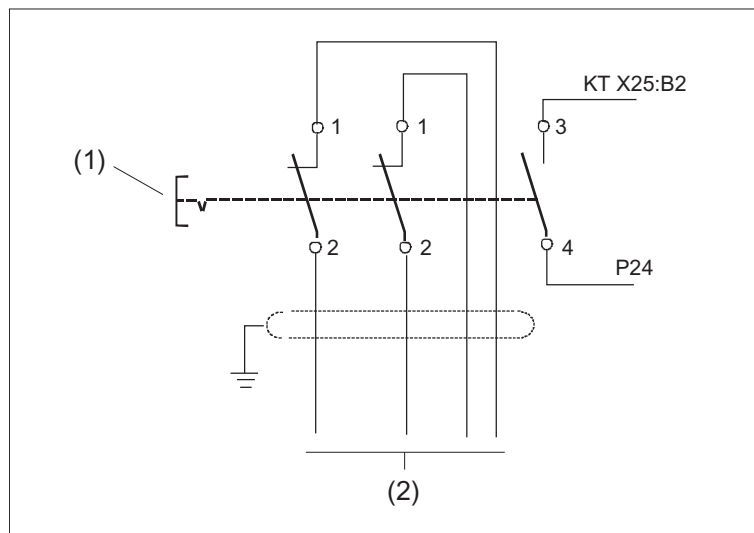

- (1) Emergency stop button S13
- (2) Emergency stop of the machine control

Figure 8-22 Circuit for emergency stop button

Extension keys connection

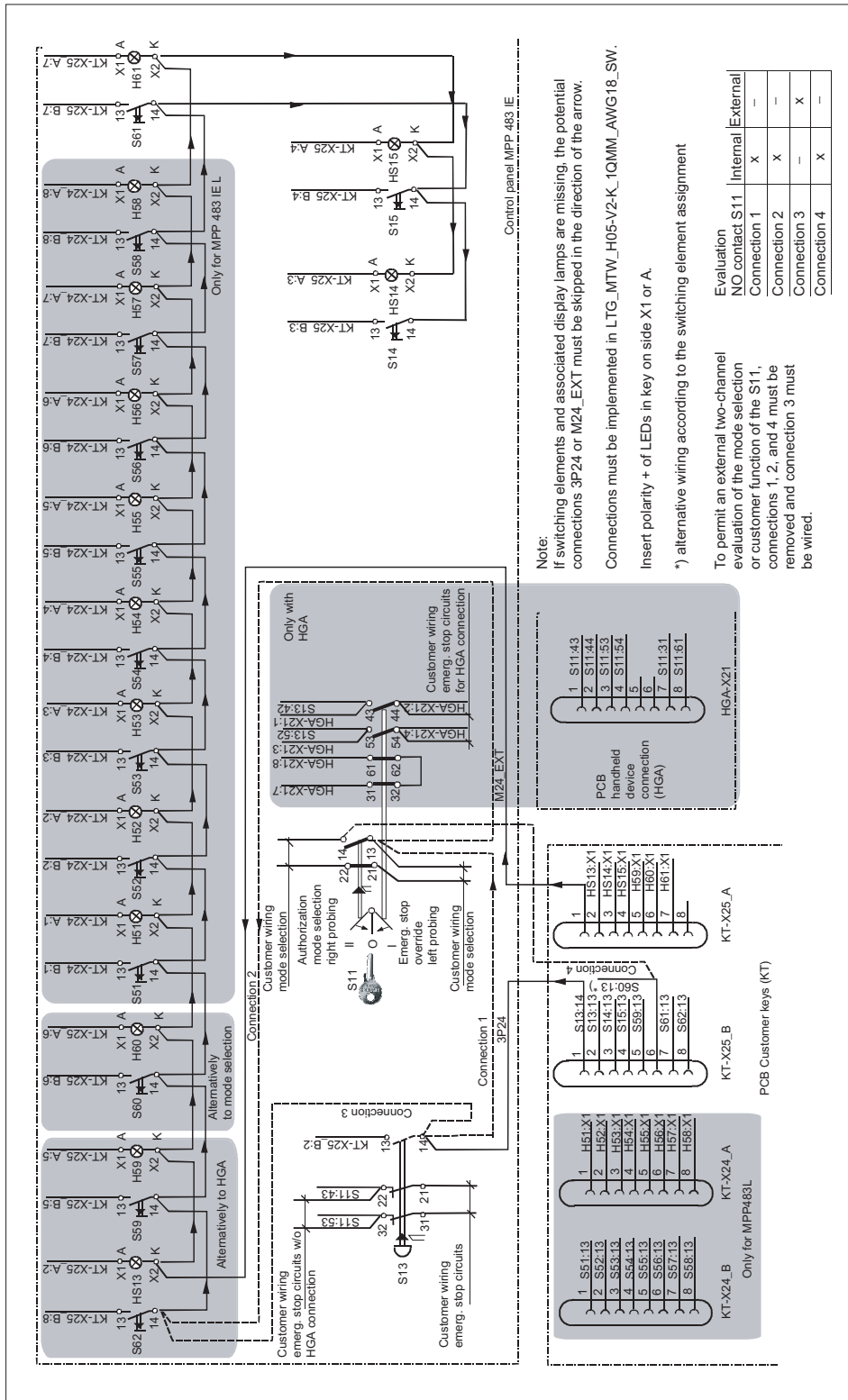

Figure 8-23 Extension keys connection

Customer function S11

The NC-NO combination 3SB34 03-0A is right probing and a customer function of the S11. The NO contact is wired on delivery and can be queried through the MPP 483 IE. The probing function facilitates mode selection.

If an external evaluation of both contacts is required, the internal wiring on the NO contact 1.3/1.4 of the S 11 must be removed (see Fig.: "Extension keys connection" in this section).

- Remove connection 1 and connection 4
- If connection 2 exists, wire the connection of S11:1.3 to S13:1.4

Direct key connection

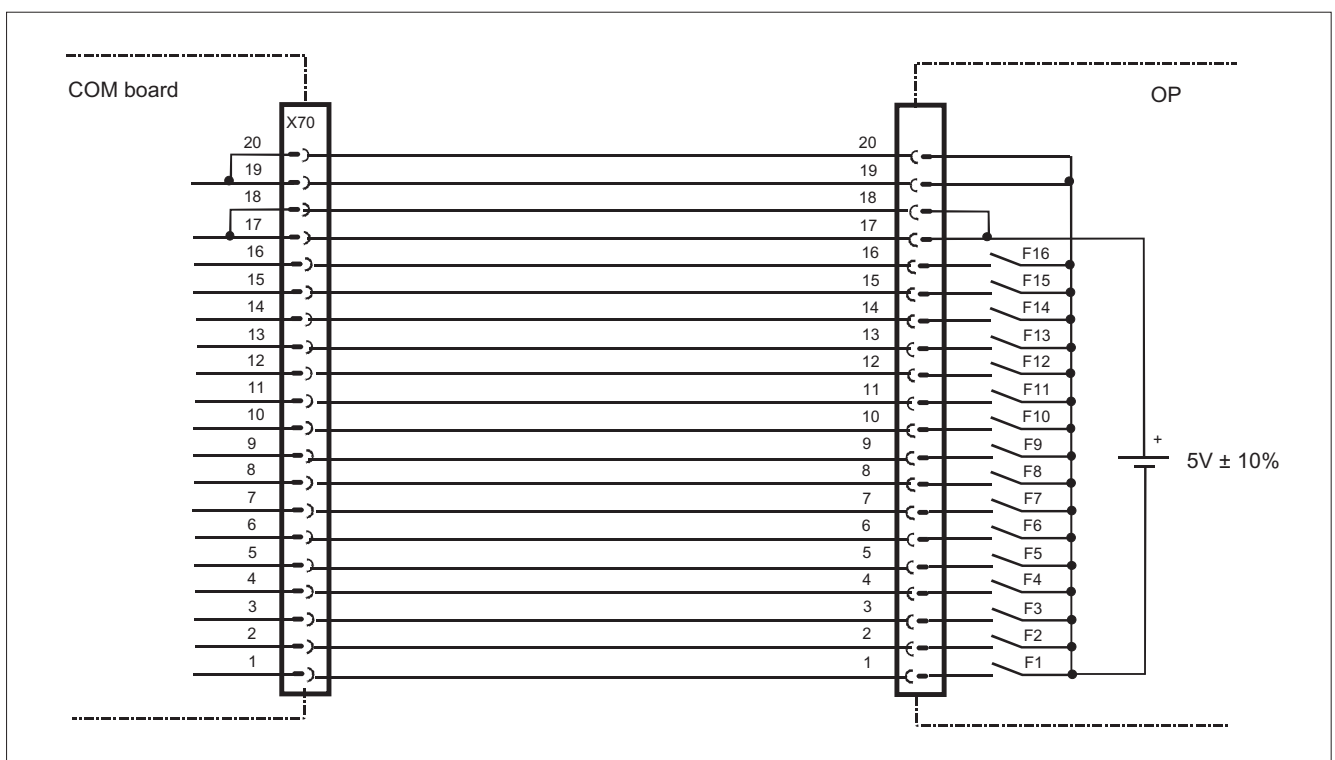

Figure 8-24 Direct key connection

8.7 Initialization

LEDs on the control panel

- HF1 to HF25
- HS1 to HS4
- HS7 to HS10

8.8 Maintenance and Service

Cleaning the device

Use a soft cloth moistened either with water or a mild cleaning agent to clean the housing and operator control elements of the machine control panel.

Checking the device

In order to prevent foreign bodies or liquids entering the machine control panel, regularly check the device

- that all the housing screws are in place and tight
- for damage to the housing
- for damage to the cable cover or cable entry

Protect the device from environmental effects

Protect the machine control panel against

- direct solar radiation and heat sources
- mechanical vibration and shock
- dust
- moisture, and
- strong magnetic fields

Checking the emergency stop button

Check the emergency stop button regularly to ensure that it functions correctly.

8.9 Technical data

8.9.1 MPP 483 IE

Safety		
Safety class according to EN 50178	III; PELV	
Degree of protection according to DIN EN 60529	Front side: IP54	Rear side: IP10A
Approvals	CE / UL	
Electrical data		

8.9 Technical data

Input voltage	24 VDC				
Power consumption, max.	Boards: 5 W	Lamps: LED 6 W	Handheld unit: 13 W	Handwheels : 2 x 0.5 W	Total: 25 W
Fuse to be added	10 A	Minimum conductor cross-section 1 mm ² for max. working temperature on the conductor of 70°C			
Mechanical data					
	Dimensions (mm)				Weight:
	Height:	Width:	Depth (front):	Mounting depth:	
MPP 483 IE	155	483	60	140 / 105 ^{*)}	Approx. 3 kg
MPP 483 IE L	244	483	60	140 / 105 ^{*)}	Approx. 4.5 kg
Max. tightening torques	Tension jack screws: 0.4 Nm	M3 screws: 0.8 Nm	M4 screws: 1.8 Nm	M5 screws: 3 Nm	

^{*)} without connector for handwheel connection

Note

Information about the climatic and mechanical environmental conditions is contained in the associated section under:

"General notes and interconnection" → "Operational planning".

8.9.2 Input/output interface of individual wiring

Button contact maker

Table 8-24 Contacts with floating outputs S1 to S4; S7 to S10 (NC contact or NO contact)

		AC	DC
Rated insulation voltage	U _e	50 V	50 V
Rated operating current	I _e	2 A	
Rated operating current at 24 V	I _e		2 A
Min. rated operating current at 5 V	I _{min}		1 mA
Volume resistance			< 20 mΩ
Switching capacity		10 I _e	1.1 I _e

Selector switch

Table 8-25 Contacts with floating outputs WS1 / 9–11, 13, 15

		AC	DC
Max. operating voltage	U _e	50 V	50 V
Switching capacity with resistive load		10 A	
Switching capacity with inductive load		> 2 A	
Switching capacity at 24 V with resistive load			10 A
Switching capacity at 24 V with inductive load			6 A
Rated values for arc-free switching at 24 V		0.3 A	0.22 A

Emergency stop button S13

Rated voltage	24 VDC
Current magnitude, max.	3 A
Current magnitude, min.	1 mA
Switching capacity	DC 13 according to EN 60947-5-1
Conditional rated short-circuit current	10 A gL/gG according to EN 60947-5-1
B _{10d}	500 000

Note

The quantitative assessment of the emergency stop safety function must be based on the B_{10d} values corresponding to the used standards (e.g. ISO 13849-1) under consideration of the respective application (frequency of the actuation, service life, diagnostics by the evaluation unit, etc.). The B_{10d} values only apply when the technical properties of the emergency stop button are taken into account.

SR mushroom-head button S61

Table 8-26 Contacts with floating outputs

	Usage category (EN 60947-5-1)		AC	DC
Rated operational voltage		U _e	24 V	24 V
Switching capacity	AC-12	I _e	10 A	
	AC-15	I _e	6 A	
	DC-12	I _e		10 A
	DC-13	I _e		3 A
Min. rated operating current at 5 V		I _{min}		1 mA
For further parameters, see pushbutton and indicator light SIGNUM 3SB3				
B _{10d}	500 000			

8.9 Technical data

Note

The quantitative assessment of the emergency stop safety function must be based on the B_{10d} values corresponding to the used standards (e.g. ISO 13849-1) under consideration of the respective application (frequency of the actuation, service life, diagnostics by the evaluation unit, etc.). The B_{10d} values only apply when the technical properties of the contact block are taken into account.

Emergency stop override S11

Table 8-27 Contacts with floating outputs

	Usage category (EN 60947-5-1)		AC	DC
Rated operational voltage		U_e	24 V	24 V
Switching capacity	AC-12	I_e	10 A	
	AC-15	I_e	6 A	
	DC-12	I_e		10 A
	DC-13	I_e		3 A
Min. rated operating current at 5 V		I_{min}		1 mA
For further parameters, see pushbutton and indicator light SIGNUM 3SB3				
B_{10d}	500 000			

Note

The quantitative assessment of the emergency stop safety function must be based on the B_{10d} values corresponding to the used standards (e.g. ISO 13849-1) under consideration of the respective application (frequency of the actuation, service life, diagnostics by the evaluation unit, etc.). The B_{10d} values only apply when the technical properties of the contact block are taken into account.

Inputs

The inputs are opto-decoupled.

Table 8-28 Extension keys S14, S15, S51 ... S62, emergency stop S13

Status		Switching voltage	Remark
Number	15		Input characteristics curve following IEC61131, type 1
H signal	Rated value	+ 24 VDC	
	Signal level	+15 V to +30 V	
L signal	Rated value	0 V or open	

Status		Switching voltage	Remark
	Signal level	-3 V to +5 V	
In a group of	1		
Cable length	Max. 50 m AWG 16		
Encoder power supply		18.5 V to 30 V	

LED outputs

Table 8-29 S14, S15, S51 ... S61, emergency stop HS13

Status		Switching voltage	Switching current
Number	14		
Load voltage 2P24		20.4 V ... 28.8 V	
Rated value		+24 VDC	0.5 A
H signal	Signal level min.	Ue - 0.16 V	Max. 0.7 A / output
L signal	Max. signal level	2 V (idling)	0.3 mA
Short-circuit protection	Yes		
Typ. activation threshold			1.1 A
RMS short-circuit current			0.5 A
Electrical isolation	No		
In a group of	1		
Output total current			Max. 3 A
Cable length	Max. 50 m AWG 16		

Handheld unit connection XS12

The currents depend on the connected handheld unit.

The internal connecting cables of the handheld unit connection HT 8 are designed for a rated voltage of 24 VDC and 0.5 A.

8.10 Accessories and spare parts

8.10.1 Overview

Numerous spare parts and accessories are available for the MPP 483 IE. Contact your Siemens service center to order accessories and spare parts.

Files for printing the blank film

The DOConCD / Catalog NC 61 (CD enclosed) contains two files for printing the blank films:

- **Template_MPP483.doc** [assignment for standard variants of MPP 483 IE - (A)]
- **SymbolsMPP483.doc** [key symbols as Word file - (B)]

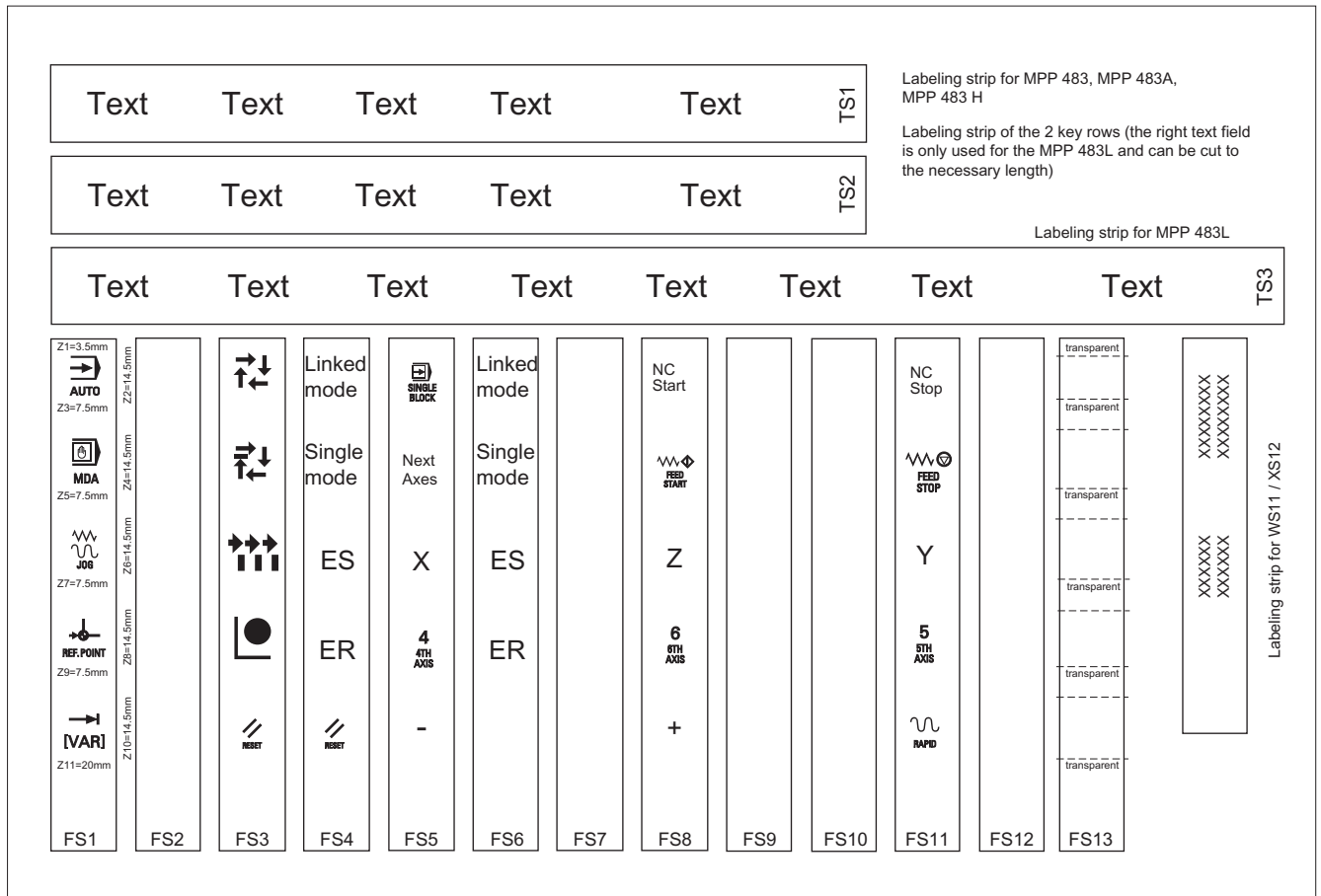





Figure 8-28 Template_MPP483.doc (A)

Table 8-30 Symbole_MPP483.doc (B)

					100%				
X									
	Y						Z		
	-	+							

+Y	-Y	+Z	-Z	+C	-C				
VK	EB	ES	ER	IO	SM	SS	SU	Next Axes	
									
NC Start	NC Stop								

Preparing standard slide-in labels with the aid of the file: "Template_MPP483.doc" (A)

1. Open the file "Template_MPP483.doc" in MS Word.
The key symbols are arranged in a table on the position that corresponds to their location on the keyboard. The borders visible in the table are not printed.
2. Place the blank film in the printing direction in the slot of your laser printer (see figure: "Blank film for MPP 483 IE membrane keyboard").
3. Select "film" as the printable medium if your printer allows this setting.
4. Start the printing process using MS Word.

Note

Make a test print on paper before you print on the film.
Allow the film to cool after printing so that the ink can dry.

5. Cut the slide-in labels out of the film along the edges (outer lines).
6. Round off the corners of the slide-in labels approx. 1.5 mm to facilitate insertion.
7. Slide in the printed slide-in label.
8. Shorten the labeling strips for the long-stroke keys for MPP 483 IE, because only the first four text fields of the strips TS1 and TS2 are needed on this device.

Preparing specific slide-in labels with the aid of the file: "Symbole_MPP483.doc" (B)

1. Open both the "Symbole_MPP483.doc" file and the "Template_MPP483.doc" file.
2. Copy the desired key symbol from the file "Symbole_MPP483.doc".
3. Position the cursor in the desired field of the template (A), add the symbol and adjust its size accordingly by dragging it by the gripping points.

4. To move a symbol to a different position,
 - select the symbol,
 - cut it out and
 - add it into the desired table cell.
5. If all the symbols are positioned as desired, follow the instructions in Section: "Preparing standard slide-in labels with the aid of the file: "Template_MPP483.doc" as of point 2.

Note

Input of characters/text instead of symbols

Use the "Arial" font to format text. This font is comparable to the "Univers S57" font, used by Siemens for the key labeling.

Creating your own symbols

- Drawing in a vector program (e.g. Designer, Freehand, CorelDraw):
 - Draw a square 15 x 15 mm without frames, filled with the color white.
 - Place the graphic in the center of this square.
 - Group the graphic and square together and add this group to the file "Template_MPP483.doc".
- Drawing in an image editing program (e.g. Photoshop, Picture Publisher, Paint)
 - Create a square area (e.g. 100 x 100 pixels) filled with the color white.
 - Draw the graphic or add an image in the center of this square.
 - Copy the graphic and square and add them both to the file "Template_MPP483.doc".

Front view with section

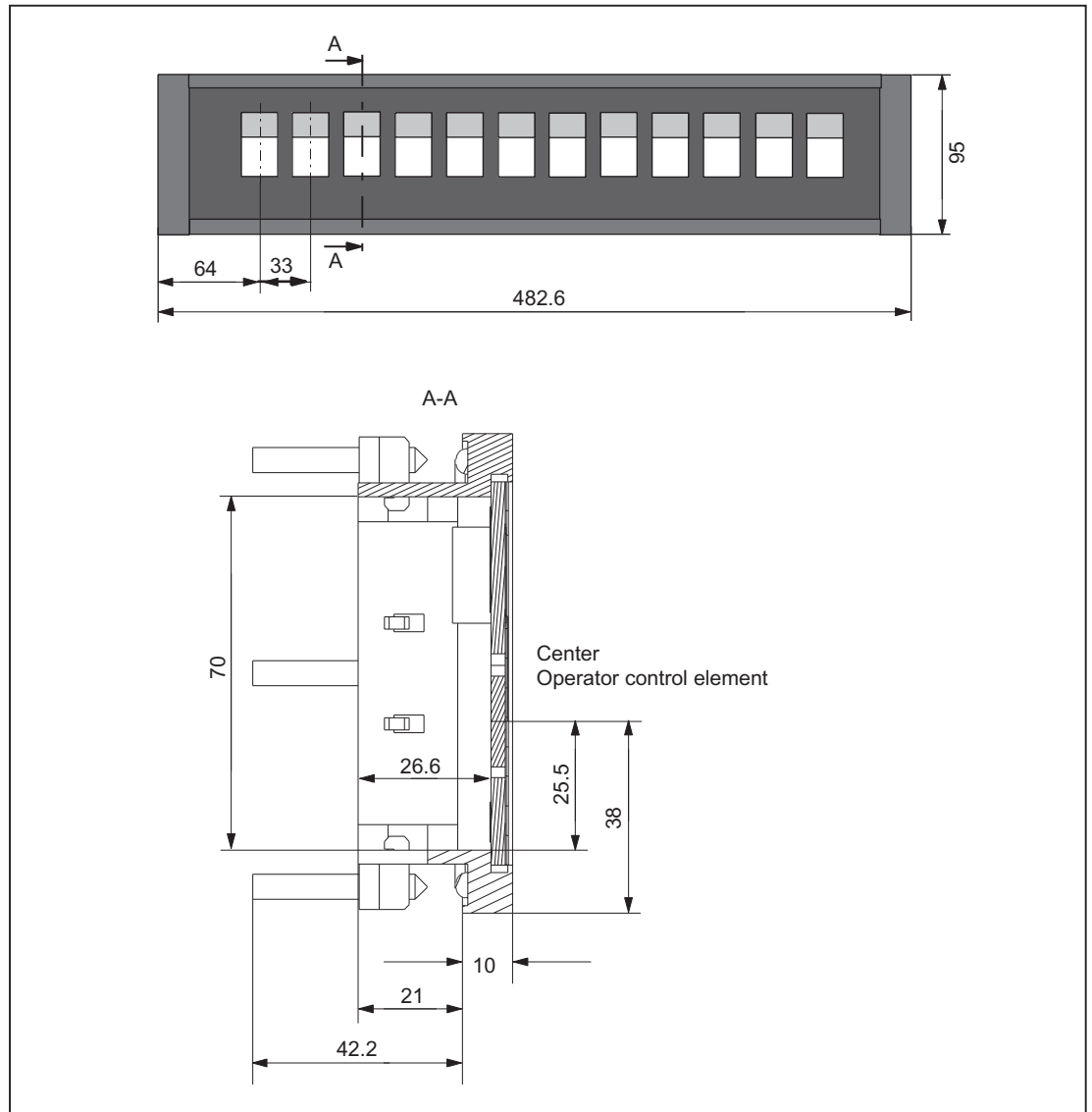

Figure 8-30 View of the expansion panel

- Product name: SINUMERIK expansion panel 19"
- Order No.: 6FC5247-0AA43-1AA0
- Can be equipped with max. 12 control devices, diameter 22 mm, grid 33 mm
- Labeling with exchangeable text labels

Mounting

Installation is with tension jacks.

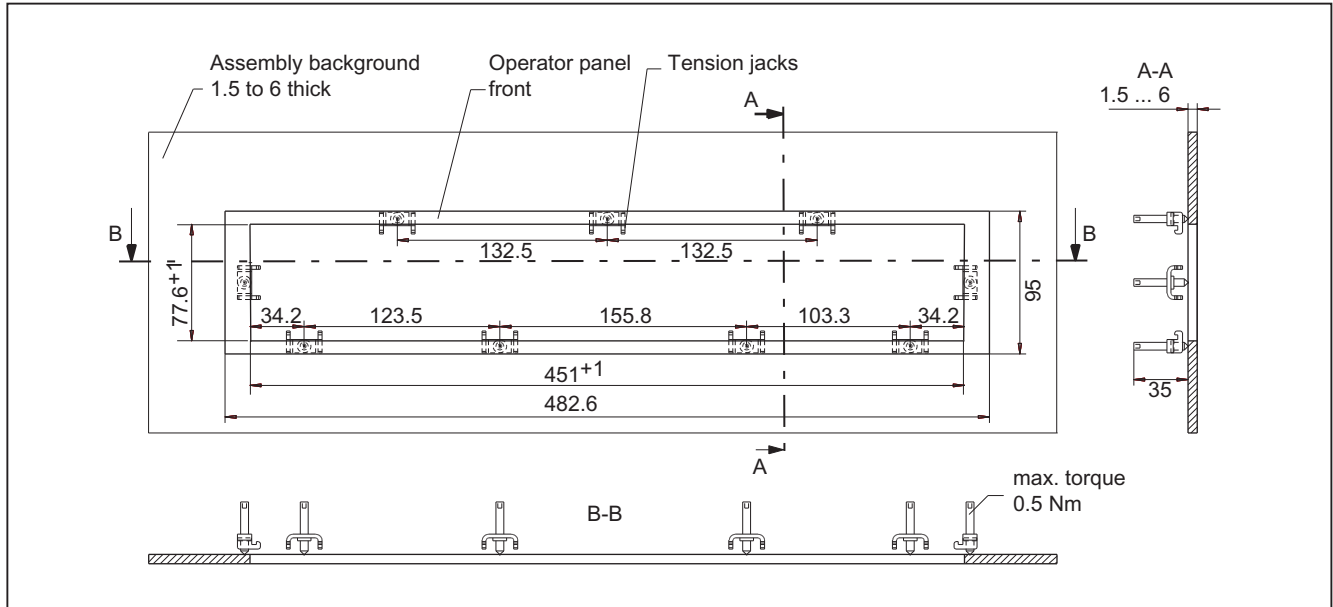

Figure 8-31 Expansion panel cutout

Dimensions for labeling the slide-in labels

The following drawing is intended purely as an example; multiple slide-in labels can also be arranged.

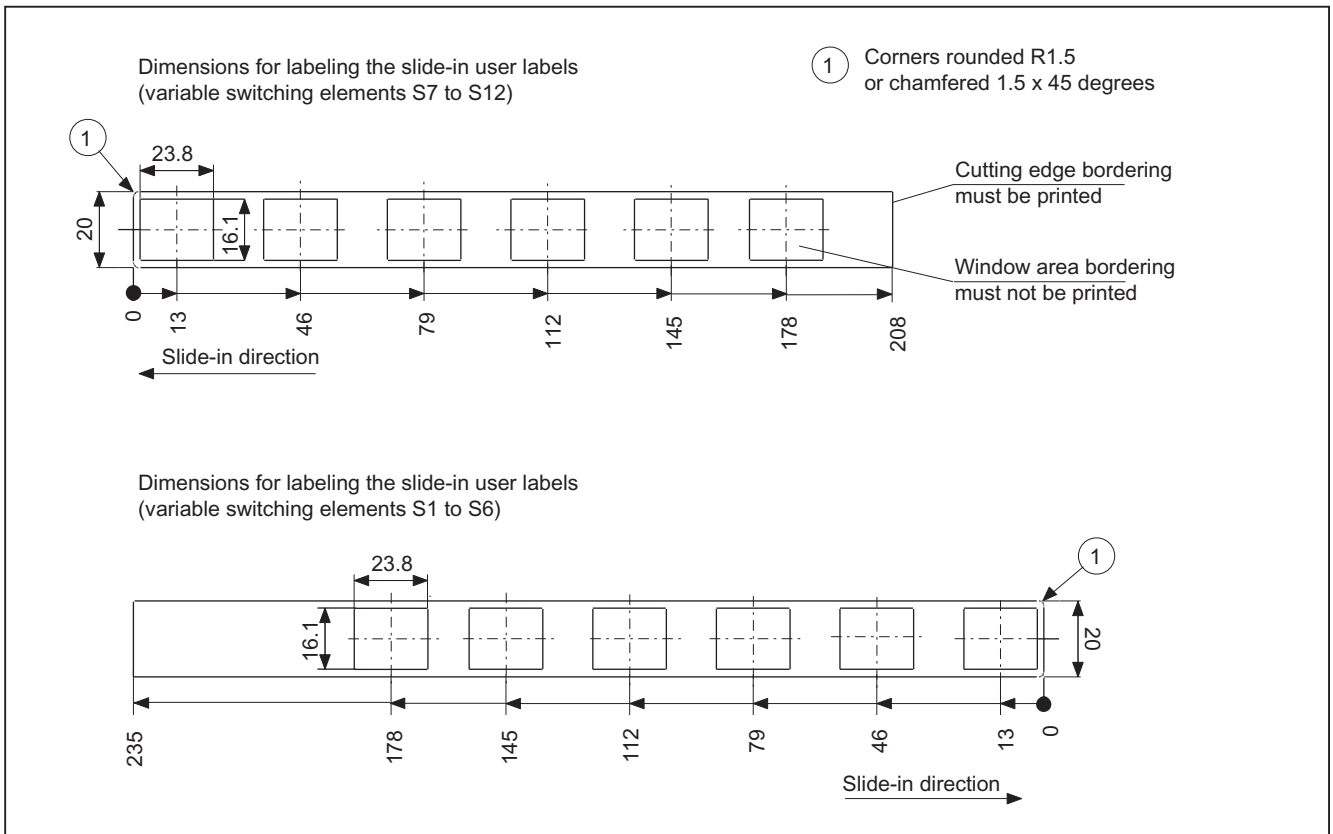

Figure 8-32 Dimensions for texts and labeling strips

8.10.5 Display elements and operator controls

You can retrofit the following control elements:

Function	Upper section actuator / accessories	Lower section contact block/signaling light	Mounting location	Application
Signaling light	Illuminated nipple 28 mm Ø RXJN-GB (yellow) RXJN-GN (green) RXJN-RT (red) RXJN-BL (blue) RXJN-KL (crystal clear) RXJN-WS (white)	AL5 lamp socket with spot LED	S1 ... S4 S7 ... S10	Light
Button	Pushbutton 28 mm Ø RXJN-GB (yellow) RXJN-GN (green) RXJN-RT (red) RXJN-BL (blue) RXJN-KL (crystal clear) RXJN-GWS (black)	Button contact maker AT2	S1 ... S4 S7 ... S10	For S1, 1 NC internal, 2 NO + 1 NC external For S2 ... S4, S7 ... S10, 1 NC internal, 1 NO + 1 NC external
Illuminated key with socket for T5.5K	Pushbutton 28 mm Ø RXJN-GB (yellow) RXJN-GN (green) RXJN-RT (red) RXJN-BL (blue) RXJN-KL (crystal clear)	Illuminated button contact maker ATL2 with spot LED	S1 ... S4 S7 ... S10	For S1, 1 NC internal, 2 NO + 1 NC external For S2 ... S4, S7 ... S10, 1 NC internal, 1 NO + 1 NC external
Spot LED		L5.5K28UW (white)	S1 ... S4 S7 ... S10	
Key-operated switch *) switching angle of 90°, 2 positions	Safety lock cylinder 28 mm Ø RXJSSA 15 E key can be removed when in both positions	Button contact maker AT2	S1 ... S4 S7 ... S10	For S1, 1 NC internal, 2 NO + 1 NC external For S2 ... S4, S7 ... S10, 1 NC internal, 1 NO + 1 NC external
Keys / position selector	RX-JEWEL 22.3 mm Schlegel catalog	Button contact maker AT2	S1 ... S4 S7 ... S10	
Raised keys 6FC5247-0AA41-0 AA0	2 RTAO pushbuttons with plunger elongation	2 AT2 special version	S1 ... S4 S7 ... S10	

*) Safety-related

Note

When assigning the colors for keys and signaling lights to the corresponding functionality, observe the standard EN 60204 Part1 or VDE 0113 Part1, Chapter "Pushbuttons/Colors."

Name	Description	Number	Order number	Mounting location
Dummy plug	BVR22	1		S1 ... S4 S7 ... S10
Selector switch	Toggle FS1 Conversion to toggle switch	1		WS1
Override spindle / rapid traverse	Electronic rotary switch 1x16G, T=24, cap, button, pointer, spindle dials and rapid traverse	1	6FC5247-0AF12-1AA0	WS3
Override feed / rapid traverse	Electronic rotary switch 1x23G, T=32, cap, button, pointer, feed dials and rapid traverse	1	6FC5247-0AF13-1AA0	WS2
Override feed / rapid traverse ¹⁾	Electronic rotary switch 1x29G, T=32, cap, button, pointer, feed dials and rapid traverse	1	6FC5247-0AF14-1AA0	WS5
Emergency stop	22 mm actuating element, 40 mm mushroom pushbutton, snap action with tamper protection, latching, red, with holder, unlit	1	3SB3000-1HA20 *)	S13
	Contact block, 2 NC, Extension NC, emergency stop	1	3SB3400-0E *)	S13
	Protective collar for front panel mounting, protection against accidental actuation	1	3SB3921-0AK	S13
Control and signaling devices	All elements marked with LE		3SB3 following selection from Low-Voltage Controls and Distribution Catalog (LV 1)	S51 ... S62 S14, S15
EKS Euchner identification system	Serial interface		EKS-A-ISX-G01-ST09/03	S14
	PROFIBUS DP interface		EKS-A-IDX-G01-ST09/03	
¹⁾ only for option				

*) Safety-related

8.11 Service information

Changing the lamps on illuminated keys

1. Use a screwdriver to pull the key cap forward and off.
2. Use lamp remover LZ6 to lever out the key carrier.
3. Change the lamp using service tool LZ6 or a suitable insulating tube
4. Reinstall the key carrier and key cap in reverse order.

Lamp remover LZ6 is not a SIEMENS product. It can be obtained from the Schlegel company.

8.11 Service information

Georg Schlegel GmbH & Co. KG

Am Kapellenweg
88525 Dürmentingen
Germany

Phone.: 0 73 71 / 502-0
Fax: 0 73 71 / 502 49
E-mail: info@schlegel.biz

Changing the lamps on pilot lamps

1. Use a screwdriver to pull the calotte and name bearing element forward and off.
2. Change the lamp using the lamp remover of service tool LZ6 or a suitable insulating tube
3. Reinstall the calotte and name bearing element.

Note

When using LEDs, make sure that they are connected with the correct polarity (see Fig.: "Mounting position of LEDs" in Section: "Mounting")

Mounting additional control elements

1. If necessary, unscrew the blank plug.
2. Place the contact maker on the socket and insert the lamp if required.
3. Insert pushbutton through front panel and screw on cap nut (by several turns).
4. Press pushbutton on contact maker. Note the position of the twist protection device!
5. Screw down cap nut (tightening torque 0.8 Nm).

Insert slide-in labels

1. Create the slide-in label (see Section: "Accessories and spare parts" → "Labeling the slide-in labels").
2. Pull protective films off slide-in slot.
3. Guide in the slide-in labels (labeling facing operator side).
4. Align text in window.

Note

Slide in the labels when the MPP is not yet installed.

Changing a contact maker

1. Loosen cap nut off pushbutton until just in front of contact maker.
2. Pull the pushbutton and the contact maker approximately 3 mm out of the fixture (the locating pin of the pushbutton must be freed).
3. Remove the LED.

4. Change the contact element, remove defective contact maker from fixture and press new contact maker onto fixture.
5. Insert pushbutton into aperture and partially screw on cap nut.
6. Press pushbutton on contact maker until it snaps in. Note the position of the snap nose!
7. Screw down cap nut (tightening torque 0.8 Nm).

Machine pushbutton panel: MPP 483

9.1 Description

9.1.1 Overview

The machine control panel MPP 483 permits user-friendly operation of the machine functions on complex machining stations. It is suitable for machine-level operation of milling, turning, grinding and special machines.

In addition to the standard elements of machine control, several freely assignable slots are integrated on the operator panel for connecting other control devices.

The function of the MPP 483 can be extended considerably by fitting additional keys and through the EKS identification system provided by Euchner.

The machine control panel is easy to mount on the rear side using special tension jacks.

All keys have user-inscribed slide-in strips for machine-specific adaptations. Two DIN-A4 sheets (printed and white) for inscribing are supplied by the factory.

The machine control panel MPP 483 is available as standard, in extended standard versions and in special versions.

Validity

The following description applies to the following machine control panels:

Table 9-1 Standard version

Designation	Features	Order number
MPP 483	Without handheld unit connection	6FC5303-1AF00-0AA1

Table 9-2 Extended standard versions

Designation	Features	Order number
MPP 483 H	With handheld unit connection B-MPI	6FC5303-1AF00-1AA1
MPP 483 HTC	With handheld unit connection HT 2/HT 8	6FC5303-1AF00-8AA1
MPP 483 A	for mounting applications (without override)	6FC5303-1AF01-0AA1

Table 9-3 Special versions

Designation	Features	Order number
MPP 483 S		
MPP 483 Sxx	Height: 155 mm - with customer-specific equipment	6FC5303-1AF02-0__0 ¹⁾

9.1 Description

Designation	Features	Order number
MPP 483 H Sxx	Height: 155 mm - with customer-specific equipment - with handheld unit connection B-MPI	6FC5303-1AF02-1__0 ¹⁾
MPP 483 HTC Sxx	Height: 155 mm - with customer-specific equipment - with handheld unit connection HT 2/HT 8	6FC5303-1AF02-8__0 ¹⁾
MPP 483 L		
MPP 483 /L Lxx	Height: 244 mm - with customer-specific equipment	6FC5303-1AF03-0__0 ¹⁾
MPP 483 H/L Lxx	Height: 244 mm - with customer-specific equipment - with handheld unit connection B-MPI	6FC5303-1AF03-1__0 ¹⁾
MPP 483 HTC/L Lxx	Height: 244 mm - with customer-specific equipment - with handheld unit connection HT 2/HT 8	6FC5303-1AF03-8__0 ¹⁾

¹⁾ You can put together the components for occupancy of the free module locations according to your practical needs. The DOConCD / Catalog NC 61 (accompanying CD) contains a configuring tool and instructions for this purpose.

The safety-related accessories / spare parts are marked in the "Accessories and spare parts" section with a *).

Connectable controls

- SINUMERIK 840D sl
- SIMATIC S7-300

Note

When using mobile RT units (e.g. mobile phones, 2-way radios) with a transmission power of > 1 W close to the equipment (< 1.5 m), malfunctions may occur!

9.1.2 System features

Standard for all versions:

- PROFIBUS or MPI/OPI
- Function keyboard with 5 x 5 key matrix, can be freely projected and labeled
- Eight long-stroke keys with LEDs
- Interfaces for two handwheels for connection via PROFIBUS DP (function depends on NCU software)
- Emergency stop button (4-wire), latching, tamper-proof
- Key-operated switch with 2 settings - leftward probing setting and rightward probing setting (right setting is customer-specific)

- Direction control key connection for OP 012
- Two free 22.5 mm slots or space for EKS
- Space for override

Supplementary elements for the extended standard and special versions:

- Integration of max. 3 override switches
- Handheld unit connection HGA for HHU or HT 2 / HT 8 (instead of the handheld unit connection, the MPP 483 L can be equipped with one extension key)
- EKS identification system
- Protective shroud for emergency stop button, REES emergency stop
- Emergency stop overridden by 2-position key-operated switch (probing position)
- Two extension keys with LEDs can be variably fitted with contact blocks (on MPP 483)
- Ten extension keys with LEDs can be variably fitted with contact blocks (on MPP 483 L)
- Mushroom-shaped button (SR)
- Authorization lock switch (ALS)
- Mode selector switch, 4-positions as key-operated or toggle switch

The positions of the individual elements on the machine control panels is shown in Section: "Control and display elements" → "Special versions".

9.1 Description

System configuration

The figure shows the ways in which the MPP 483 HTC can be integrated in the control system.

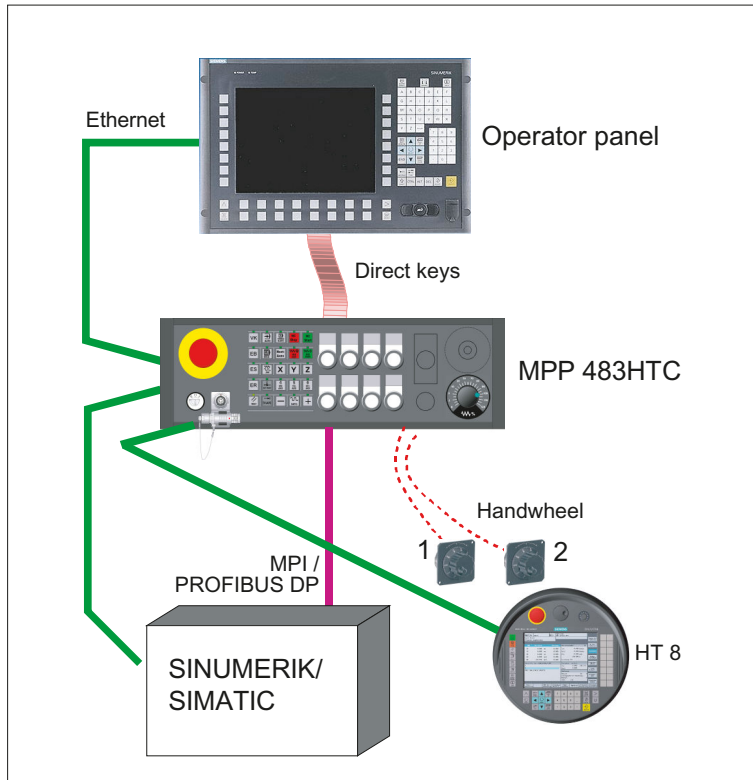

Figure 9-1 System configuration of the MPP 483 HTC

Note

The connection cables are not part of the scope of supply.

9.1.3 Mechanical design

The machine control panel MCP 483 consists of

- Control panel
- flat module with handheld unit connection (option)
- Flat module customer keys
- Flat module COM board

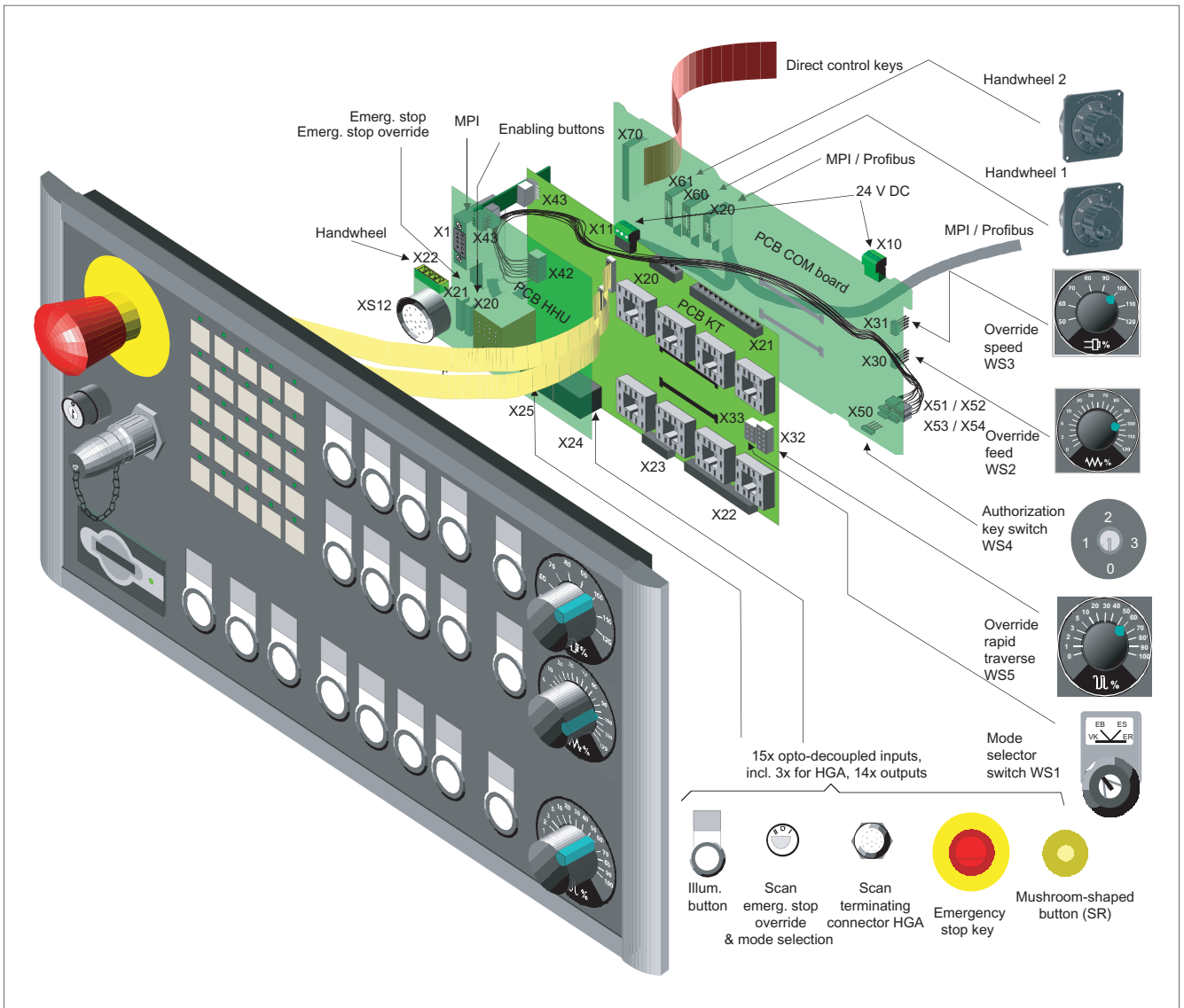

Figure 9-2 Mechanical design taking example of the MPP 483 L

9.2 Operating and display elements

9.2.1 Standard versions

Standard version

The machine control panel is available in the following standard version:

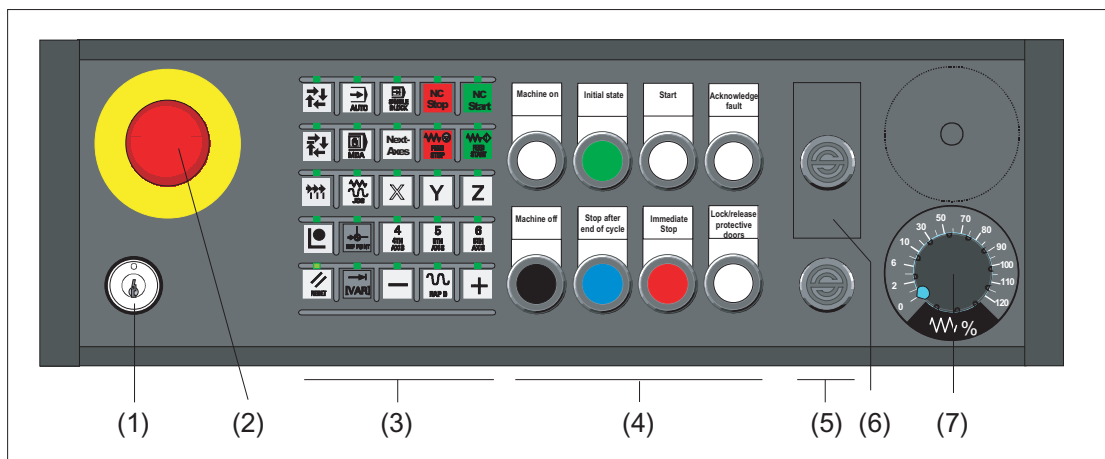

- (1) Key-operated switch
- (2) Emergency stop button
- (3) Function keys with LEDs
- (4) Customer keys (long-stroke keys)
- (5) Dummy element
- (6) Cutout for EKS identification system
- (7) Feed override

Figure 9-3 MPP 483 standard version

Extended standard versions

The machine control panel is available in the following extended standard versions:

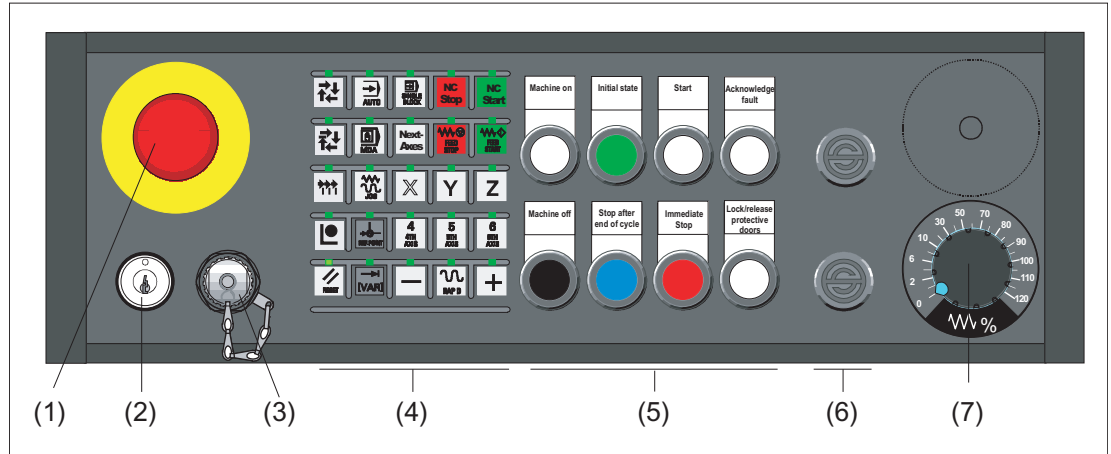

- (1) Emergency stop button
- (2) Key-operated switch
- (3) Handheld unit connection B-MPI
- (4) Function keys with LEDs
- (5) Customer keys (long-stroke keys)
- (6) Dummy element
- (7) Feed override

Figure 9-4 MPP 483 H extended standard version

9.2 Operating and display elements

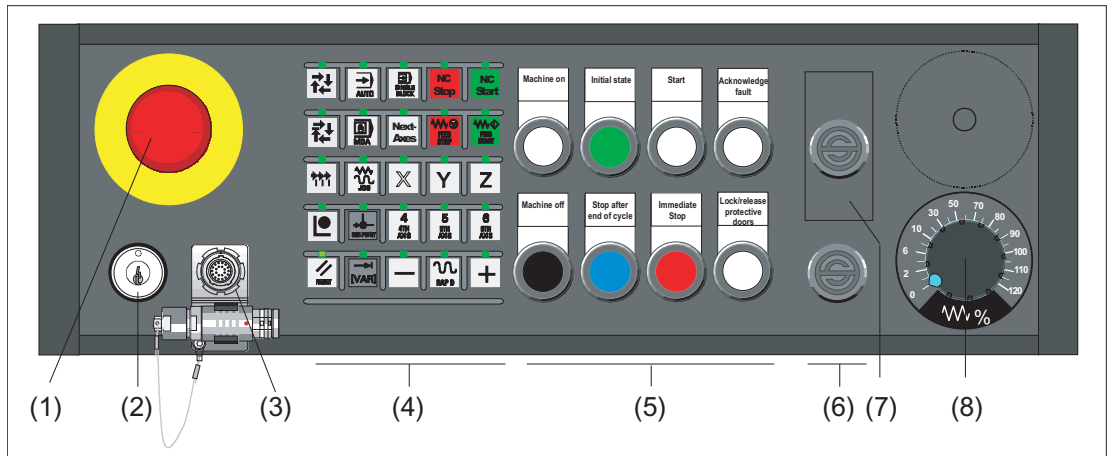

- (1) Emergency stop button
- (2) Key-operated switch
- (3) Handheld unit connection HT 2 / HT 8
- (4) Function keys with LEDs
- (5) Customer keys (long-stroke keys)
- (6) Dummy element
- (7) Cutout for EKS identification system
- (8) Feed override

Figure 9-5 MPP 483 HTC extended standard version

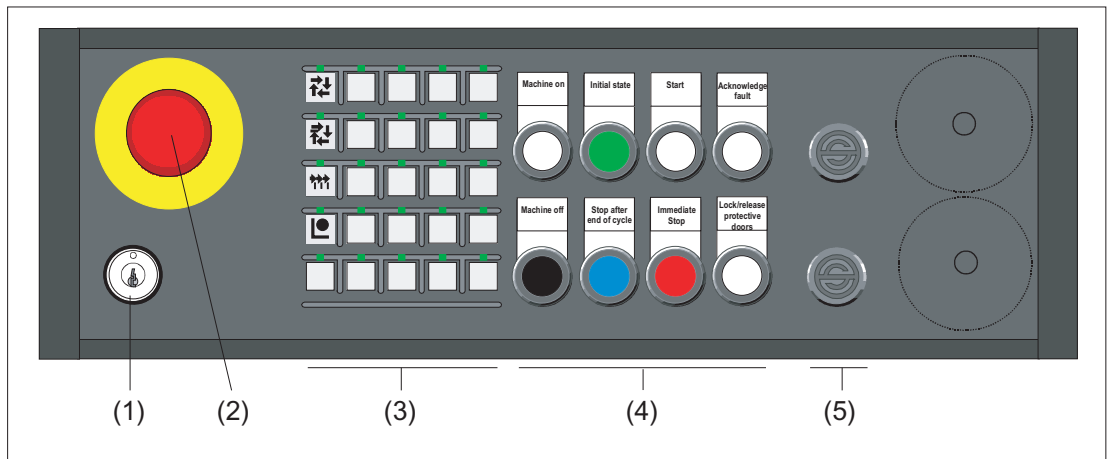

- (1) Key-operated switch
- (2) Emergency stop button
- (3) Function keys with LEDs
- (4) Customer keys (long-stroke keys)
- (5) Dummy element

Figure 9-6 MPP 483 A extended standard version

Note

When using the 8 byte MPI function, only the function keys in the first column can be used (see Section: "Interfaces" → "Input / output image" → "Input image of MPI standard"). If you use the WS1 selector switch, you use this to assign these keys.

The free slots can be assigned operator elements which are listed in Section: "Operation and display elements" → "Special versions" for the MPP 483 S or MPP 483 L variants.

A description of the individual components can be found in Section: "Accessories and spare parts" → "Display and operating elements".

9.2.2 Special versions

The machine control panel is available in the following special versions:

MPP 483 S

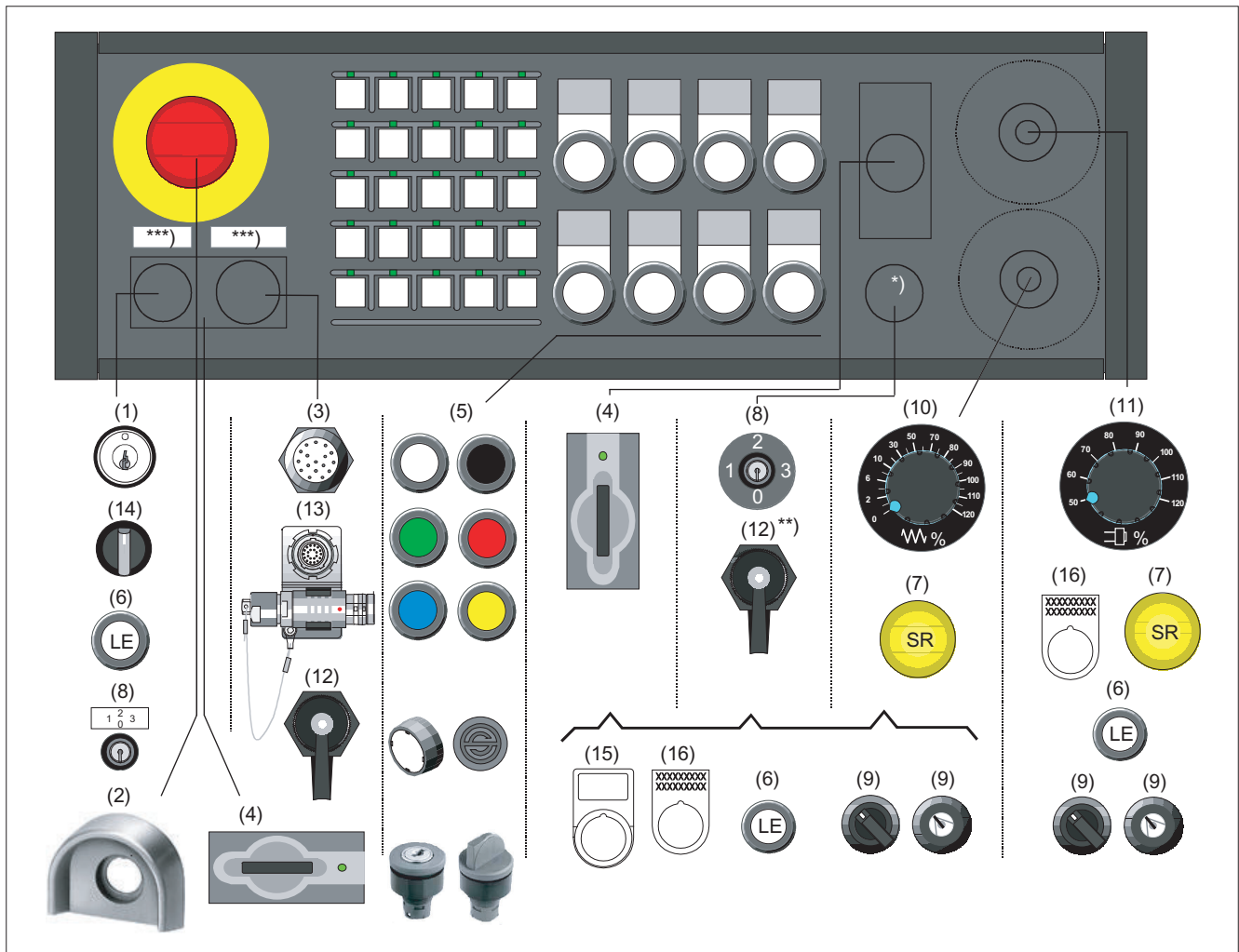

- *) Designation bearing element can only be equipped without EKS (4)
- ***) Component in this slot needs a new cover
- ***) Labeling only for variants without EKS
- | | |
|--|---|
| (1) Key-operated switch | (9) Mode selector switch |
| (2) Protective shroud for emergency stop button | (10) Feedrate override |
| (3) Handheld unit connection B-MPI ¹⁾ | (11) Spindle/rapid traverse override |
| (4) EKS identification system | (12) RJ 45 bushing |
| (5) Keys with LEDs, actuators ²⁾ | (13) Handheld unit connection HT 2 / HT 8 ³⁾ |
| (6) Long Element, button with LED ²⁾ | (14) Toggle switch |
| (7) Mushroom-shaped button - rapid withdrawal | (15) Label holder |
| (8) Authorization lock switch | (16) Adhesive label ⁴⁾ |
- ¹⁾ Only in variant MPP 483 H Sxx
- ²⁾ Can be assigned according to Section: "Accessories and spare parts" → "Display and operating elements"
- ³⁾ Only in variant MPP 483 HTC Sxx
- ⁴⁾ xxxx... - place holder for the number of possible font characters

Figure 9-7 Special version MPP 483 S

- *) Mushroom-shaped button can only be used if the adjacent spot is not occupied
- ***) Component in this slot needs a new cover
- | | |
|---|---|
| (1) Key-operated switch | (10) Feedrate override |
| (2) Protective shroud for emergency stop button | (11) Spindle/rapid traverse override |
| (3) Handheld unit connection
B-MPI ¹⁾ | (12) Rapid traverse override |
| (4) EKS identification system | (13) RJ45 bushing |
| (5) Keys with LEDs, actuators ²⁾ | (14) Handheld unit connection HT 2 / HT 8 ³⁾ |
| (6) Long Element, button with LED ²⁾ | (15) Handwheel |
| (7) Mushroom-shaped button - rapid withdrawal | (16) Toggle switch |
| (8) Authorization lock switch | (17) Label holder |
| (9) Mode selector switch | (18) Adhesive label ⁴⁾ |

¹⁾ Only in variant MPP 483 H/L Lxx

²⁾ Can be assigned according to Section: "Accessories and spare parts" → "Display and operating elements"

³⁾ Only in variant MPP 483 HTC/L Lxx

⁴⁾ xxxx... - place holder for the number of possible font characters

Figure 9-8 Special version MPP 483 L

Note

You can use a configurator to put together the components for occupancy of the free module locations according to your practical needs.

The DOConCD / Catalog NC 60, NC 61 (accompanying CD) contains the following files for this purpose:

- KonfigMPP483.zip (configuration tool)
- AnleitungKonfigurator_MPP483.pdf

You can also obtain the configurator via the Service & Support portal of Siemens:

<http://support.automation.siemens.com/WW/view/en/24533571>

9.2.3 Examples of assignment of free slots

MPP 483 H / MPP 483 A / MPP 483 S

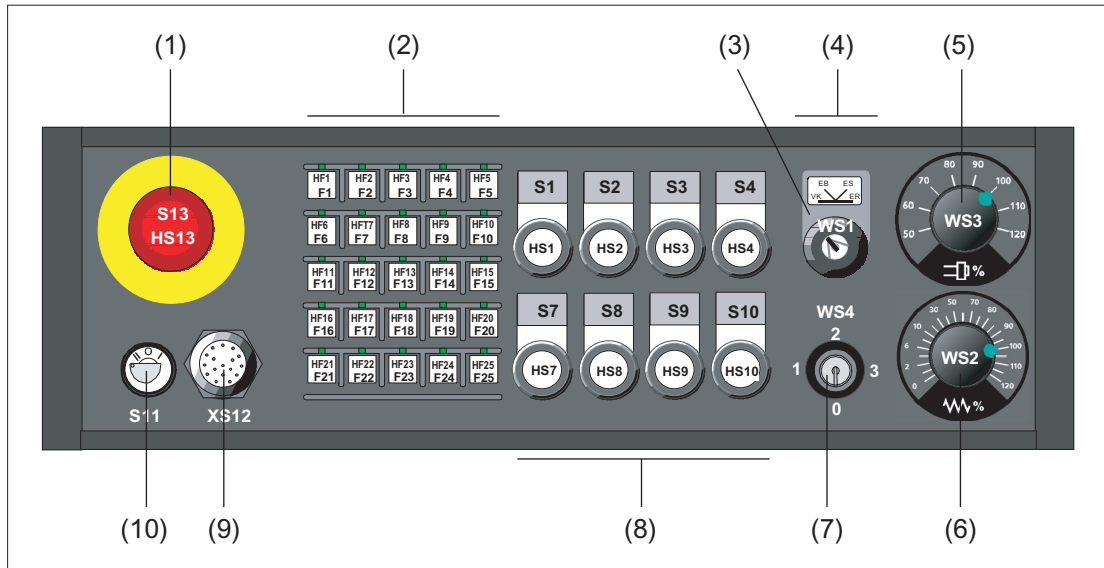

- (1) Emergency stop button
- (2) Function keys
- (3) Mode selector switch
- (4) EKS identification system or 2 extension elements 22.5 mm
- (5) Override spindle / rapid traverse
- (6) Feed override
- (7) Authorization Lock Switch
- (8) Customer keys (long-stroke keys)
- (9) Handheld unit connection or EKS identification system
- (10) Key-operated switch

Figure 9-9 Example of MPP 483 H/A/S

MPP 483 H / MPP 483 L with EKS

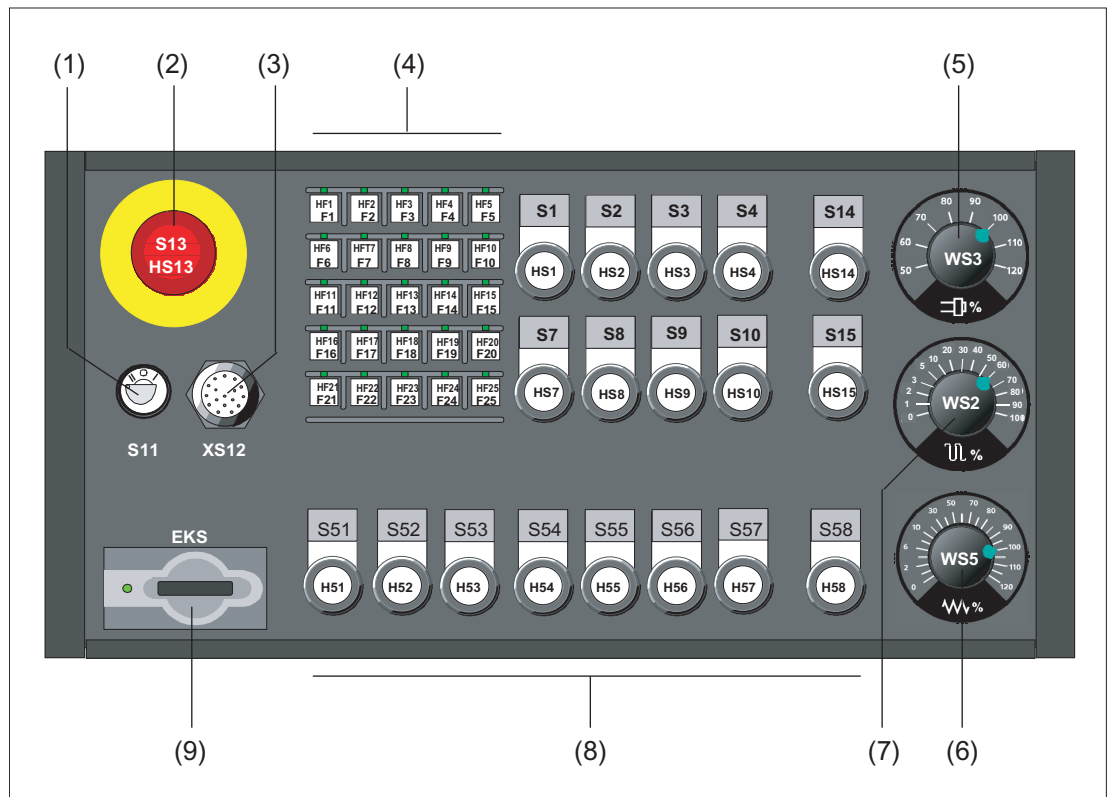

- (1) Key-operated switch
- (2) Emergency stop button
- (3) Connection for handheld units
- (4) Function keys
- (5) Override spindle / rapid traverse
- (6) Rapid traverse override
- (7) Feed override
- (8) Extension keys
- (9) EKS identification system or 2 extension elements 22.5 mm

Figure 9-10 Example MPP 483 H/L with EKS

9.2.4 Description

9.2.4.1 Device front

Connectable control elements

Inputs for

- 25 function keys
- 18 long-stroke keys (max.)
- 3 rotary selector switches
- Key-operated switch with four positions

Outputs for

- 47 LEDs (14 led to plug connector)

Emergency stop chain

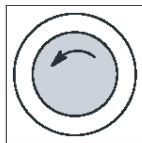

Emergency stop button

Press the red button in emergencies when

- people are at risk,
- there is the danger of the machine or workpiece being damaged.

An emergency stop generally shuts down all drives with the greatest possible braking torque in a controlled manner.

Turn the EMERGENCY STOP button counterclockwise to unlatch it.

When the emergency stop button is activated, the emergency stop chain of the MPP 483 will ensure personal safety and protect the machine in hazardous situations.

The emergency stop chain is also active if the handheld units are removed.

To prevent the emergency stop chain from being interrupted while you plug in or pull out the handheld unit, press the emergency stop override S11. This overrides the emergency stop button on the handheld unit.



WARNING

Danger of death caused by malfunction of the emergency stop override

To effectively deal with a malfunction of the emergency stop override S11 (e.g. jamming), the user PLC program must generate emergency stop when a monitoring time (approximately 5 min) expires (see Figure in Section: "Connecting" → "Handheld unit connection HT 8 with emergency stop override").

The emergency stop chain of the MPP 483 should be integrated in the system emergency stop by the user.

Note**Machine manufacturer**

For other reactions to the EMERGENCY STOP:
refer to the machine tool manufacturer's instructions!

 **WARNING****Danger of death resulting from the premature emergency stop unlocking**

If you have shut down the system to be monitored, you can only release the emergency stop button or put the system to be monitored back into operation if the condition that triggered the emergency stop function has been corrected and a safe restart is carried out.

Actuation elements

Actuation elements S1 to S4, S7 to S10, S14 and S15 are activated by the control.
They also have electrically isolated contacts (common roots) for user-specific wiring.

The following positions can be connected to control devices corresponding to the table in Section: "Accessories and spare parts" → "Display and operating elements":

- S1 to S4
- S7 to S10
- S14
- S15
- S51 to S58

Lamps

The lamps HS1 to HS4, HS7 to HS10, HS14 and HS15 are connected to the control system via MPI/OPI. Alternatively, they can also be activated externally non-isolated.

WS1 selector switch

- 2-way, 4 stages, 60° switching angle
- Centrally mounted with front ring
- Designed as key-operated switch CG4-1A251-600 *FS1 V750D/2J. It can be changed by the customer to the toggle switch variant FS1
- Key can be removed in all positions

Note

When the WS1 mode selector switch is used, function keys F1, F6, F11 and F16 cannot be evaluated with the MPI standard input image (8 bytes).

9.2.4.2 Device rear side

COM board

S1 (jumper) Setting the handwheel signal type
 S1 open: TTL interface
 S1 closed: Differential interface

S3 (coding switches) Baud rate, address and protocol setting

Table 9-4 Settings for switch S3

1	2	3	4	5	6	7	8	9	10	Meaning
									off	MPP with MPI communication
								off		Compatible mode 8/8 bytes I/O
								on		Extended assignment 12/8 bytes I/O
						on	on			Reserved
						on	off			Parameter set 3 ³⁾
						off	on			Parameter set 2 ²⁾
						off	off			Parameter set 1 ¹⁾
		on	on	on	on					Bus address: 15
		on	on	on	off					Bus address: 14
		on	on	off	on					Bus address: 13
		on	on	off	off					Bus address: 12
		on	off	on	on					Bus address: 11
		on	off	on	off					Bus address: 10
		on	off	off	on					Bus address: 9
		on	off	off	off					Bus address: 8
		off	on	on	on					Bus address: 7
		off	on	on	off					Bus address: 6
		off	on	off	on					Bus address: 5
		off	on	off	off					Bus address: 4
		off	off	on	on					Bus address: 3
		off	off	on	off					Bus address: 2
		off	off	off	on					Bus address: 1
		off	off	off	off					Bus address: 0
	on									Transmission cycle time: 200 ms
	off									Transmission cycle time: 100 ms
on										OPI baud rate: 1.5 Mbaud
off										MPI baud rate: 187.5 kbaud

1) GD parameters 1, 1, 1 - 1, 2, 1 (fixed)
 2) GD parameters 2, 1, 1 - 2, 2, 1 (fixed)
 3) Assignment depends on the set bus address

Diagnostic LEDs	LED1 (H1)	Hardware test underway. If errors are found, the LED lights up red.
	LED2 (H2)	Not connected
	LED3 (H3)	Logic voltages on the module OK
	LED4 (H4)	During data transfer via the operator panel interface, the LED flashes yellow.
	LED5 (H5)	LED for PROFIBUS:
	Status	Meaning
	Flashes green	Ready to communicate
	Lights up green	Communication taking place
	Lights up red	Channel interference or not yet ready (default after Power On)

Customer key board

Diagnostic LEDs	LED1 (H1)	Voltage monitoring of customer keys
	LED2 (H2)	Voltage monitoring of customer keys
	LED3 (H3)	Voltage monitoring of customer keys

HGA board handheld unit B-MPI

The arrangement of the LEDs on the HGA board handheld unit B-MPI is shown in the Figure: "Rear side of MPP 483H with interfaces" in Section: "Interfaces" → "Overview".

Diagnostic LEDs	LED1 (H1)	Bus request Repeater Segment 2
	LED2 (H2)	Bus request Repeater Segment 1
	LED3 (H3)	Voltage of repeater segment 1 (>4.7V)
	LED4 (H4)	Voltage of repeater segment 2 (>4.7V)

HGA board HT 2 / 8

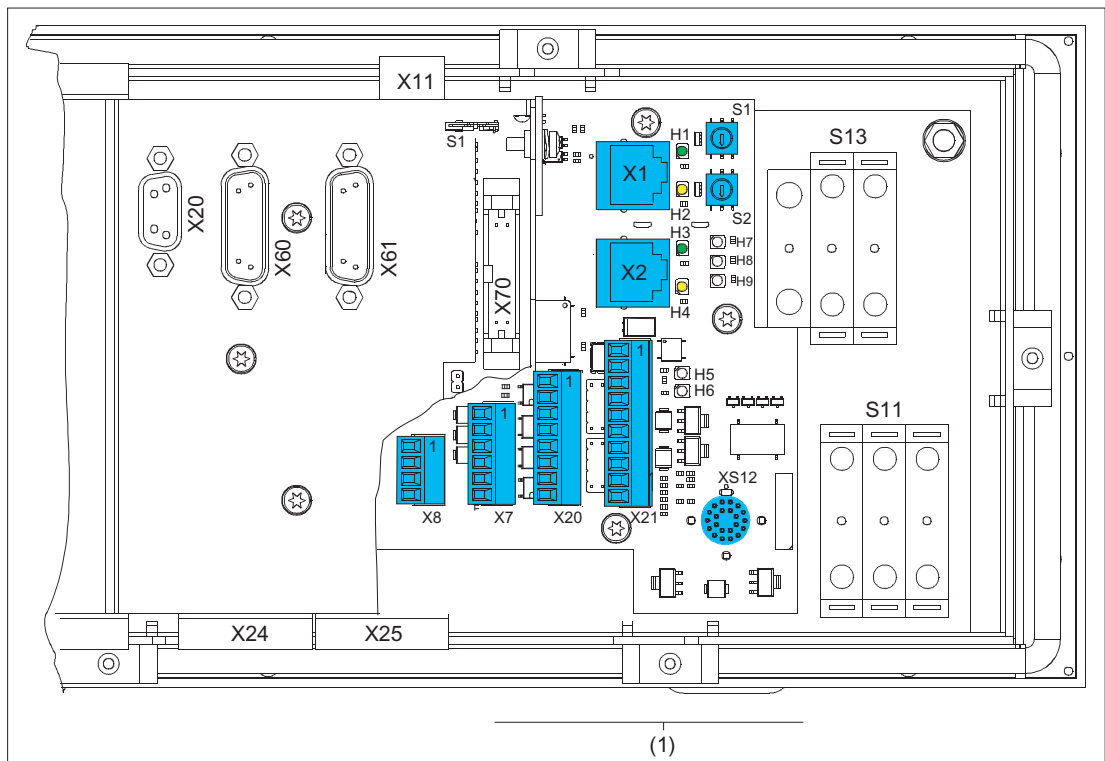

Figure 9-11 Rear MPP 483HTC with LEDs on HGA board HT 2 / 8 (1)

Table 9-5 Diagnostic LEDs

		Color	for	Meaning
LED1 (H1)	LNK	Green	X1 RJ-45	Connection established
LED2 (H2)	ACT	Yellow	X1 RJ-45	Transmission active
LED3 (H3)	LNK	Green	X2 RJ-45	Connection established
LED4 (H4)	ACT	Yellow	X2 RJ-45	Transmission active
LED5 (H5)	LNK	Green	HT transfer	
LED6 (H6)	ACT	Yellow	HT transfer	
LED7 (H7)	Power OK	Green		
LED8 (H8)	FAULT STAT1	Red		Fault
LED9 (H9)	FAULT STAT2	Red		Fault

S1 (coding switches) Module address bit 4 ... 7

S2 (coding switches) Module address bit 0 ... 3

9.3 Interfaces

9.3.1 Overview

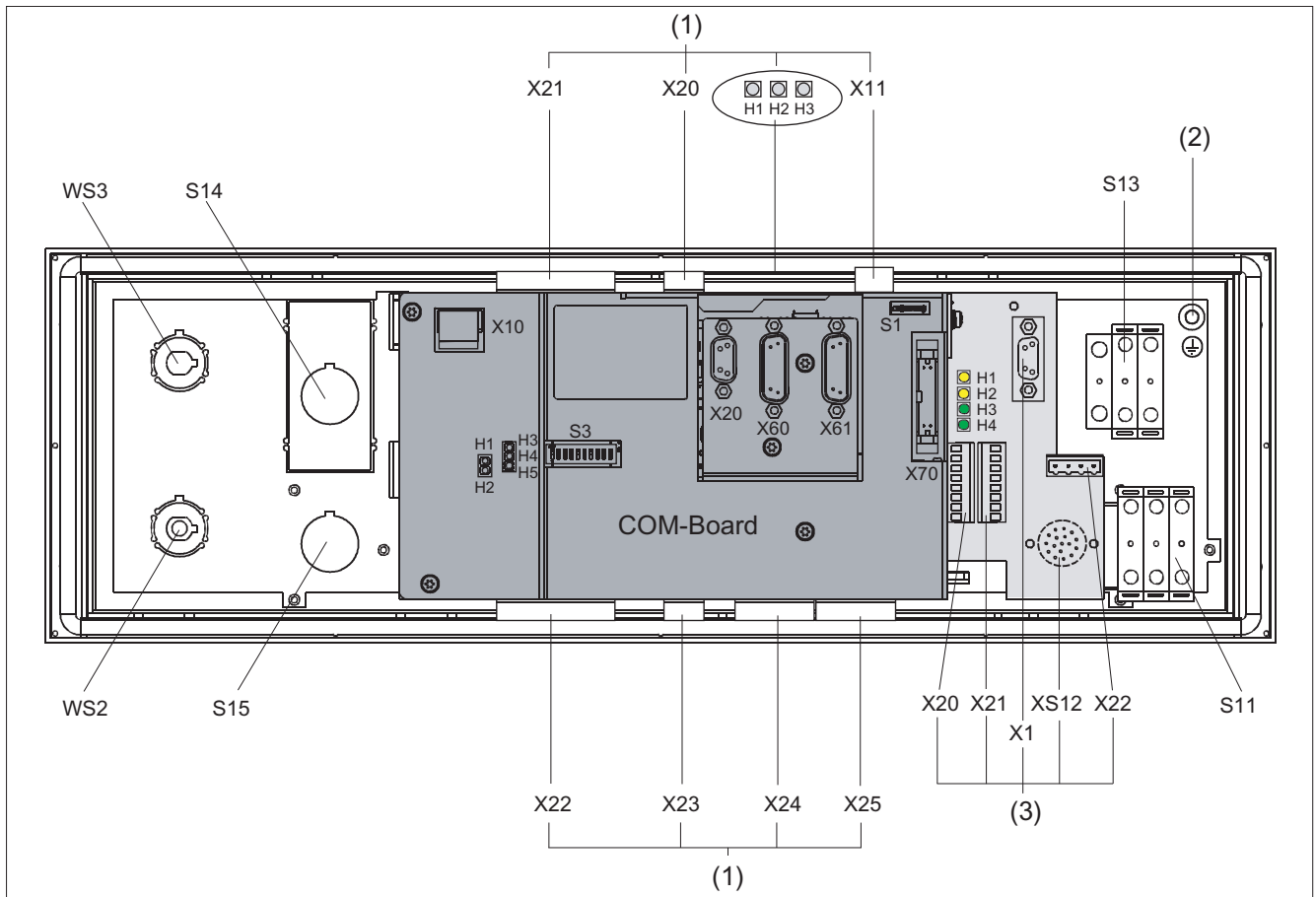

Figure 9-12 Rear side of MPP 483H with interfaces

	Control panel	
(2)		Protective Ground Connection
	S13	Emergency stop button
	S11	Emergency stop override
	COM board	
	X10	Power supply
	X20	PROFIBUS DP/MPI
	X60	Handwheel 1
	X61	Handwheel 2
	X70	Interface for direct keys

9.3 Interfaces

(1)	Customer keys		
	X11	Power supply	
	X20	Connector X20	Individual wiring
	X21	Connector X21	
	X22	Connector X22	
	X23	Connector X23	
	X24	Connector X24	
	X25	Connector X25	Expansion
(3)	Connection for handheld units		
	X1	MPI/OPI	
	X20	Enable	
	X21	Emergency stop override	
	X22	Handwheel	
	XS12	Connection for handheld units	

Signal type

- O Outputs
- I Inputs
- B Bi-directional signals
- V Power supply
- VI Voltage input
- VO Voltage output

9.3.2 Description

9.3.2.1 Control panel



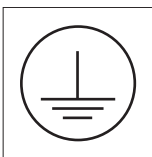

Protective Ground Connection

Pin	Signal	Connection	Connection cross-section
	PE	M5 x 2.5 cable lug	2.5 mm ²

Emergency stop button S13

Key designation: S13
 Key type: Mushroom, push-pull key 3SB3000-1HA20 with holder 3SB3901-0AB and 1 x NO 3SB3400-0B (internal use)

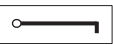

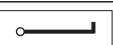



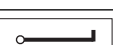
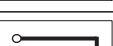

Table 9-6 Switching element for NC

Pin	Signal	Type	Signal name	Function
11	OE_S13.11	I/O	NC contact OE1, S13	
12	BZ_S13.12		Reference potential BZ, S13	
21	OE_S13.21		NC contact OE2, S13	
22	BZ_S13.22		Reference potential BZ2, S13	

Emergency stop override S11

Key designation: S11
 Key type: left probing, right probing, safety lock with actuation element according to the catalog: Low-Voltage Controls and Distribution (LV 1) carrier 3SB3901-0AC with pressure plates
 1 x NO contact 3SB3400-0B
 2 x 3SB3400-0A switching element 1xNC contact/1xNO contact elements positively driven

Table 9-7 Emergency stop override

Pin	Signal	Type	Signal name	Function
14	BZ_S11.14	I/O	Reference potential S1, S11	
13	S_S11.13		NO contact S1, S11	
21	OE_S11.21		NC contact OE2, S11	
22	BZ_S11.22		Reference potential BZ2, S11	
24	BZ_S11.24		Reference potential S2, S11	
23	S_S11.23		NO contact S2, S11	
31	OE_S11.31		NC contact OE3, S11	
32	BZ_S11.32		Reference potential BZ3, S11	
34	BZ_S11.34		Reference potential S3, S11	
33	S_S11.33		NO contact S3, S11	

WS1 selector switch

Switch designation: WS1
 Switch type: CG4-1 A251-600 *FS1 V750 D/2J



Table 9-8 WS1 selector switch

Pin	Signal	Type	Signal name	Switch position
11	ER	I/O	Mode	4
15	ES		Mode	3
10	BZ_WS		Reference signal	
13	EB		Mode	2
9	Linked mode		Mode	1

Rapid withdrawal (SR)

Key designation: SR
 Key type: 3SB3000-1GA31
 Switching element: NO contact 3SB3400-0B, input PLC

Table 9-9 Rapid withdrawal (SR)

Pin	Signal	Type	Signal name	Function
14	BZ_SR.14	I/O	Reference potential S1, SR	
13	S_SR.13		NO contact S1, SR	

9.3.2.2 COM board

Pin assignment

For more detailed information, see "General information and networking", Chapter: "Connecting".

Switch S1

Settings, see Chapter "Machine control panel: MCP 310C PN", Section "Interfaces".

9.3.2.3 User keys

Power supply interface X11

Connector designation: X11

Connector type: Combicon MSTBA2.5/3-G-5.08

Cable length (max.): 10 m

Table 9-10 Interface power supply

Pin	Signal name	Type	Meaning
1	2P24	V	24 V potential
2	M24		Ground 24 V
3	N.C.		Not connected

Individual wiring







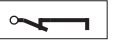

Connector X20 / X21

Connector designation: X20/X21

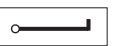

Connector type: Mini-Combicon MC 1.5/4-G-3.81

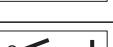
Cable length (max.): 30 m

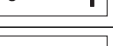
Table 9-11 Connector X20 / X21

Connect or	Pin	Signal	Type	Signal name	Function
X20	1	OE_S2	I/O	NC contact S2	
	2	OE_S1		NC contact S1	
X21	1	OE_S4	I/O	NC contact S4	
	2	OE_S3		NC contact S3	
X20	3	BZOE_S1-4	I/O	Reference potential NC contact S1 ... S4	
	4	BZS_S1-S6		Reference potential NO contact S1 ... S6	
X21	3	S_S4	I/O	NO contact S4	
	4	S_S3		NO contact S3	
	5	S_S2		NO contact S2	
	6	S_S1.1		NO contact S1.1	

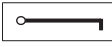
9.3 Interfaces

Connector	Pin	Signal	Type	Signal name	Function
	7	BZS_S1.2	I	Reference potential NO contact S1.2	
	8	S_S1.2		NO contact S1.2	
	9	HS 4		Signaling lamp S4	All inputs "High" active
	10	HS 3		Signaling lamp S3	
	11	HS 2		Signaling lamp S2	
	12	HS 1		Signaling lamp S1	







Connector X22

Connector designation: X22

Connector type: Mini-Combicon MC 1.5/12-G-3.81

Cable length (max.): 30 m

Table 9-12 Connector X22

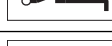
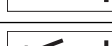
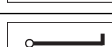
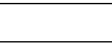
Pin	Signal	Type	Signal name	Function
1	OE_S7	I/O	NC contact S7	
2	OE_S8		NC contact S8	
3	OE_S9		NC contact S9	
4	OE_S10		NC contact S10	
10	BZOE_S7-S10		Reference potential NC contacts S7-10	
5	S_S7	I/O	NO contact S7	
6	S_S8		NO contact S8	
7	S_S9		NO contact S9	
8	S_S10		NO contact S10	
9	BZS_S7-S10		Reference potential NO contacts S7-10	
11	3P24	V	+24 V potential	
12	3P24		+24 V potential	

Connector X23

Connector designation: X23

Connector type: 4-pin Mini-Combicon MC 1.5/4-G-3.81

Cable length (max.): 30 m

Table 9-13 Connector X23

Pin	Signal	Type	Signal name	Function
1	HS 7	I	Signaling lamp S7	All inputs "High" active
2	HS 8		Signaling lamp S8	
3	HS 9		Signaling lamp S9	
4	HS 10		Signaling lamp S10	

Connector X24

Only the special versions MPP 483 S and MPP 483 L are equipped with these connectors.

Connector designation: X24

Connector type: MCD 1.5/8-G1-3.81 HT BK

Cable length (max.): 1.5 m

Table 9-14 Connector X24

Pin	Signal	Type	Signal name	Pin	Signal	Type	Signal name
B1	S51	I	Ext. key S51	A1	H51	O	LED_ S51
B2	S52		Ext. key S52	A2	H52		LED_ S52
B3	S53		Ext. key S53	A3	H53		LED_ S53
B4	S54		Ext. key S54	A4	H54		LED_ S54
B5	S55		Ext. key S55	A5	H55		LED_ S55
B6	S56		Ext. key S56	A6	H56		LED_ S56
B7	S57		Ext. key S57	A7	H57		LED_ S57
B8	S58		Ext. key S58	A8	H58		LED_ S58
Viewed from the PCB:							
B	at top of plug connector						
A	at bottom of plug connector						

Connector X25

Connector designation: X25

Connector type: MCD 1.5/8-G1-3.81 HT BK

Cable length (max.): 1.5 m

Table 9-15 Connector X25

Pin	Signal	Type	Signal name	Pin	Signal	Type	Signal name
B1	P24_OUT	V	Reference potential +24 V	A1	M24_EXT	V	Reference potential +24 V
B2	S13	I	Emergency stop button	A2	HS13	O	Emergency stop LED
B3	S14		KT-S14	A3	HS14		LED-S14
B4	S15		KT-S15	A4	HS15		LED-S15

9.3 Interfaces

Pin	Signal	Type	Signal name	Pin	Signal	Type	Signal name
B5	S59 *)		KT-IN3/emergency stop override	A5	H59		LED-S59
B6	S60		Mode selection	A6	H60		LED-S60
B7	S61		Rapid withdrawal	A7	H61		LED-S61
B8	S62 *)		S32 / HGA enabling unit plugged in / terminating connector	A8	M24_EXT	V	Reference potential +24 V

*) can only be used as a neutral input without HGA

9.3.2.4 Handheld unit connection HT 6

MPI / OPI X1 interface

The interface supports transfer rates of up to 1.5 MBit/s.

Connector designation: X1

Connector type: 9-pin sub-D socket

Cable length (max.): 100 m

Table 9-16 MPI / OPI X1 interface

Pin	Signal name	Type	Meaning
1	N.C.	-	Not connected
2	N.C.	-	Not connected
3	RS_DP	I/O	RS-465 differential signal
4	N.C.	-	Not connected
5	M5EXT	V	5 V external ground
6	P5EXT	V	5 V external potential
7	N.C.	-	Not connected
8	XRS_DP	I/O	RS-465 differential signal
9	N.C.	-	Not connected

Enabling X20

Connector designation: X20

Connector type: MCV 1.5/8-G3.81

Cable length (max.): 30 m

Table 9-17 Enabling X20

Pin	Signal name	Type	Meaning
1	ZS1.1		Enabling button 1
2	ZS1.2		Call-up enabling button 1

Pin	Signal name	Type	Meaning
3	ZS2.1		Enabling button 2
4	ZS2.2		Call-up enabling button 2

Emergency Stop override X21

Connector designation: X21

Connector type: MCV 1.5/8-G3.81

Cable length (max.): 30 m

Table 9-18 Emergency Stop override X21

Pin	Signal name	Type	Meaning
1	NOT_ HALT 1.1		EMERGENCY STOP NC contact 1.1
2	NOT_ HALT 1.2		EMERGENCY STOP NC contact 1.2
3	NOT_ HALT 2.1		EMERGENCY STOP NC contact 2.1
4	NOT_ HALT 2.2		EMERGENCY STOP NC contact 2.2
5/6	N.C.	-	Not connected
7	XNAUE	I	Emergency Stop override negated
8	3P24_HGA	V	24 V

Note

Emergency stop X21: Supply voltage: 24 VDC; switched current: Max. 500 mA.

Handwheel X22

Connector designation: X22

Connector type: MCV 1.5/4-G5.08

Cable length (max.): 30 m

Table 9-19 Handwheel X22

Pin	Signal name	Type	Meaning
1	HR_A	O	Handwheel A
2	HR_XA		Handwheel A negated
3	HR_B		Handwheel B
4	HR_XB		Handwheel B negated

9.3 Interfaces

Handheld unit connection XS12

Connector designation:XS12

Connector type: RC-17S1YM2H3SW

Table 9-20 Handheld unit connection XS12

Pin	Signal name	Type	Meaning	Function
1	NOT_ HALT 2.1		EMERGENCY STOP NC contact 2.1	EMERGENCY STOP
2	MPI_A	I/O	RS-485 data	MPI
3	3M24	V	Ground 24 V	Power supply
4	3P24		+24 V	
5	ZS1.1		Enabling button 1	Enabling function
6	ZS1.2		Call-up enabling button 2	
7	HR_B	O	Handwheel B	Handwheel
8	HR_A		Handwheel A	
9	NOT_ HALT 1.2		EMERGENCY STOP NC contact 1.2	EMERGENCY STOP
10	NOT_ HALT 1.1		EMERGENCY STOP NC contact 1.1	
11	ASS	I	Terminating connector	Terminating connector plugged in
12	NOT_ HALT 2.2		EMERGENCY STOP NC contact 2.2	EMERGENCY STOP
13	MPI_B	I/O	RS-485 data	MPI
14	ZS2.1		Enabling button 2	Enabling function
15	HR_XA	O	Handwheel A negated	Handwheel
16	ZS1.2		Call-up enabling button 1	Enabling function
17	HR_XB	O	Handwheel B negated	Handwheel

9.3.2.5 Handheld unit connection HT 2/8

Ethernet X1 / X2

Connector designation:X1, X2

Connector type: RJ-45 socket

Table 9-21 Ethernet X1 / X2

Pin	Signal name	Type	Meaning
1	TD+	O	Transmit data +
2	TD-		Transmit data -
3	RD+	I	Receive data +

Pin	Signal name	Type	Meaning
4	N.C.	-	Not connected
5	N.C.	-	Not connected
6	RD-	I	Receive data -
7	N.C.	-	Not connected
8	N.C.	-	Not connected

Panel Present X7

Connector designation: **X7**
Connector type: 6-pin Phoenix terminal

Table 9-22 Assignment of the interface Panel Present X7

Pin	Signal name	Signal type	Meaning
1	PRES	O	"High": Panel (HT 2/8) plugged in
2	N.C.	-	Not connected
3	N.C.	-	Not connected
4	N.C.	-	Not connected
5	N.C.	-	Not connected
6	M	P	Ground

Emergency Stop wiring terminal X8

Connector designation: **X8**
Connector type: 4-pin Phoenix terminal

Table 9-23 Assignment of the emergency stop wiring terminal X8

Pin	Protective circuit
1	On-board jumper between 1 and 2
2	
3	On-board jumper between 3 and 4
4	

Note

Use this terminal for simple routing of the emergency stop cables, optional.

The connector is only used to assist looping through. The connected pins 1 and 2 as well as 3 and 4 have no additional function on the connection module.

9.3 Interfaces

Enabling X20

Connector designation: X20
 Connector type: MCV 1.5/8-G3.81
 Cable length (max.): 30 m

Table 9-24 Enabling X20

Pin	Signal name	Type	Meaning
1	ZUST1P	I	Electronic enabling button 1P
2	ZUST1M	O	Electronic enabling button 1M
3	ZUST2P	I	Electronic enabling button 2P
4	ZUST2M	O	Electronic enabling button 2M
5	N.C.		Not connected
6	N.C.		Not connected
7	N.C.		Not connected
8	N.C.		Not connected

Emergency Stop override X21

Connector designation: X21
 Connector type: MCV 1.5/10-G3.81
 Cable length (max.): 30 m

Table 9-25 Emergency Stop override X21

Pin	Signal name	Type	Meaning
1	STOP23	I/O	Emergency Stop NC contact 1.1
2	STOP24		Emergency Stop NC contact 1.2
3	STOP13		Emergency Stop NC contact 2.1
4	STOP14		Emergency Stop NC contact 2.2
5	M	V	
6	N.C.	-	Not connected
7	IN_S59	I	Emergency Stop override negated
8	P24_FILT	V	24 V
9	IN_S59_EXT	O	Key-operated switch actuated
10	IN_S62_EXT		Terminating connector plugged in

Note

Emergency stop X21: Supply voltage: 24 VDC; switched current: Max. 500 mA.

Handheld unit connection XS12

Connector designation:XS12

Connector type: 9GX3BXC-T22QF10-0004

Table 9-26 Handheld unit connection XS12

Pin	Signal	Type	Meaning	Function
1	HH_PR_P	I	+ Present line	
2	HH_PR_M		- Present line	
3	HP24	V	24 V HH for present	Power supply
4	ZUST2M	O	Enabling button 2M	Enabling function
5	ZUST1P	I	Enabling button 1P	
6	ZUST1M	O	Enabling button 1M	
7	ZUST2P	I	Enabling button 2P	
8	HH_L2.2	I/O	HH emergency stop L2.2	Emergency stop
9	HH_L2.1		HH emergency stop L2.1	
10	HH_L1.2		HH emergency stop L1.2	
11	HH_L1.1		HH emergency stop L1.1	
12	M	V	Ground	Power supply
13	ABS_ST_PRES	I	Terminating connector	Terminating connector plugged in
14	HH_P24	V	24 V HH supply	Power supply
15	IDENT_B	I/O	Diff Signal Module Addr.	
16	TX-	O	Ethernet Transmit -	Ethernet transmitted data
17	TX+		Ethernet Transmit +	
18	RX+	I	Ethernet receive +	Ethernet receive data
19	RX-		Ethernet receive -	
20	SHIELD	-	Cable shield	
21	M	V	Ground	Power supply
22	IDENT_A	I/O	Diff Signal Module Addr.	

9.3.3 Connection elements for COM board, customer keys and handheld unit connection

This table shows plug connection elements for the following modules:

- COM board (COM)
- Customer keys (KT)
- Connection for handheld units (HGA)

9.3 Interfaces

Table 9-27 Connection elements

Module	Connector	Units	Terminal element	Connectable cross-section (max.)	Manufacturer
COM	X10	1	MSTB2,5/3-STZ-5,08,1776168	2.5 mm ²	PHOENIX CONTACT
	X20	1	6ES7972-0BA50-0XA0 6ES7972-0BB50-0XA0 *)		SIEMENS
	X60 / X61	2	6FC9348-7HX	0.75 mm ²	
	X70	1	A5E00026403		
KT	X11	1	MSTB2,5/3-ST-5,08,1757022	2.5 mm ²	PHOENIX CONTACT
	X20 / X23	2	MC1.5/4-ST-3.81, 1803594	1.5 mm ²	
	X21/X22	2	MC1.5/12-ST-3.81, 1803675	1.5 mm ²	
	X24:A/B X25: A/B	4	MC1.5/8-ST-3.81, 1803633	1.5 mm ²	
HGA handheld unit B-MPI	X1	1	6ES7972-0BA50-0XA0		SIEMENS
	X20/X21	2	MC1.5/8-ST-3.81, 1803633	1.5 mm ²	PHOENIX CONTACT
	X22	1	MC1.5/4-ST-5.08, 1836095	1.5 mm ²	
HGA HT 2/8	X1 / X2	2	6GK1901-1BB10-2AB0		SIEMENS
	X7	1	MC1.5/6-STZ-3.81 GY BD1-6.1713198	1.5 mm ²	PHOENIX CONTACT
	X8	1	MC1.5/4-STZ-3.81 GY BD1-4.1713185	1.5 mm ²	
	X 20	1	MC1.5/8-STZ-3.81 GY BD-1-8, 1713208	1.5 mm ²	
	X 21	1	MC1.5/10-STZ-3.81 GY BD1-10, 1901658	1.5 mm ²	

*) With PG connection

9.3.4 Input / output images

MPI standard input image

Byte	Bit7	Bit6	Bit5	Bit4	Bit3	Bit2	Bit1	Bit0
n+0	BA switch				Function key	HG connection HT 2 / HT 8 XS12:13	Emergency stop override	
							S11 right-hand side momentary -contact	S11 left-hand side momentary -contact
	WS1/4 F16*)	WS1/3 F11*)	WS1/2 F6*)	WS1/1 F1*)	F21	S62	S60	S59
n+1	Customer key	Key	Customer key	Extension key	Customer keys			
	S15	WS4, pos. 0	S14	S51	S4	S3	S2	S1
n+2	Key			SR key	Rapid traverse override			
	WS4, pos.3	WS4, pos.2	WS4, pos.1	S61	WS5/8	WS5/4	WS5/2	WS5/1

n+3		Extension key	Emergency stop	Customer keys				Extension key
		S53	S13	S10	S9	S8	S7	S52
n+4	Direct keys							
	DT8	DT7	DT6	DT5	DT4	DT3	DT2	DT1
n+5	Direct keys							
	DT16	DT15	DT14	DT13	DT12	DT11	DT10	DT9
n+6	Extension keys			Spindle override				
			S58	S57	WS3/8	WS3/4	WS3/2	WS3/1
n+7	Extension keys			Feed override				
	S56	S55	S54	WS2/16	WS2/8	WS2/4	WS2/2	WS2/1
*) The function keys are not active if WS1 is assigned.								

MPI extended input image

Byte	Bit7	Bit6	Bit5	Bit4	Bit3	Bit2	Bit1	Bit0
n+0	BA switch				Function key	HG connection HT 2 / HT 8 XS12:13	Emergency stop override	
							S11 right-hand side momentary -contact	S11 left-hand side momentary -contact
	WS1/4	WS1/3	WS1/2	WS1/1	F21	S62	S60	S59
	F16*)	F11*)	F6*)	F1*)				
n+1	Customer key	Key	Customer key	Extension key	Customer keys			
	S15	WS4, pos. 0	S14	S51	S4	S3	S2	S1
n+2	Key			SR key	Rapid traverse override			
	WS4, pos.3	WS4, pos.2	WS4, pos.1	S61	WS5/8	WS5/4	WS5/2	WS5/1
n+3		Extension key	Emergency stop	Customer keys				Extension key
		S53	S13	S10	S9	S8	S7	S52
n+4	Direct keys							
	DT8	DT7	DT6	DT5	DT4	DT3	DT2	DT1
n+5	Direct keys							
	DT16	DT15	DT14	DT13	DT12	DT11	DT10	DT9
n+6	Extension keys			Spindle override				
			S58	S57	WS3/8	WS3/4	WS3/2	WS3/1
n+7	Extension keys			Feed override				
	S56	S55	S54	WS2/16	WS2/8	WS2/4	WS2/2	WS2/1
n+8	Function keys							
	F8	F7	F6	F5	F4	F3	F2	F1
n+9	Function keys							
	F16	F15	F14	F13	F12	F11	F10	F9

9.3 Interfaces

n+10	Function keys							
	F25	F24	F23	F22	F20	F19	F18	F17
n+11	Reserve							

*) The function keys are not active if WS1 is assigned.

PROFIBUS-DP input image

Byte	Bit7	Bit6	Bit5	Bit4	Bit3	Bit2	Bit1	Bit0
n+0	BA switch				Function key	HG connection HT 2 / HT 8 XS12:13	Emergency stop override	
	WS1/4	WS1/3	WS1/2	WS1/1			S11 right-hand side momentary -contact	S11 left-hand side momentary -contact
	F16*)	F11*)	F6*)	F1*)	F21	S62	S60	S59
n+1	Customer key	Key	Customer key	Extension key	Customer keys			
	S15	WS4, pos. 0	S14	S51	S4	S3	S2	S1
n+2	Key			SR key	Rapid traverse override			
	WS4, pos.3	WS4, pos.2	WS4, pos.1	S61	WS5/8	WS5/4	WS5/2	WS5/1
n+3		Extension key	Emergency stop	Customer keys				Extension key
		S53	S13	S10	S9	S8	S7	S52
n+4	Direct keys							
	DT8	DT7	DT6	DT5	DT4	DT3	DT2	DT1
n+5	Direct keys							
	DT16	DT15	DT14	DT13	DT12	DT11	DT10	DT9
n+6	Extension keys			Spindle override				
			S58	S57	WS3/8	WS3/4	WS3/2	WS3/1
n+7	Extension keys			Feed override				
	S56	S55	S54	WS2/16	WS2/8	WS2/4	WS2/2	WS2/1
n+8	Function keys							
	F8	F7	F6	F5	F4	F3	F2	F1
n+9	Function keys							
	F16	F15	F14	F13	F12	F11	F10	F9
n+10	Function keys							
	F25	F24	F23	F22	F20	F19	F18	F17
n+11	Reserve							
n+12	Feed override							
			WS2/16	WS2/8	WS2/4	WS2/2"	WS2/1	
n+13	Spindle override							
			WS3/16	WS3/8	WS3/4	WS3/2	WS3/1	

*) The function keys are not active if WS1 is assigned.

Optional 4-byte handwheel

n+0	Handwheel 1
n+1	Handwheel 1
n+2	Handwheel 2
n+3	Handwheel 2

Keyboard layout - input image MPP 483

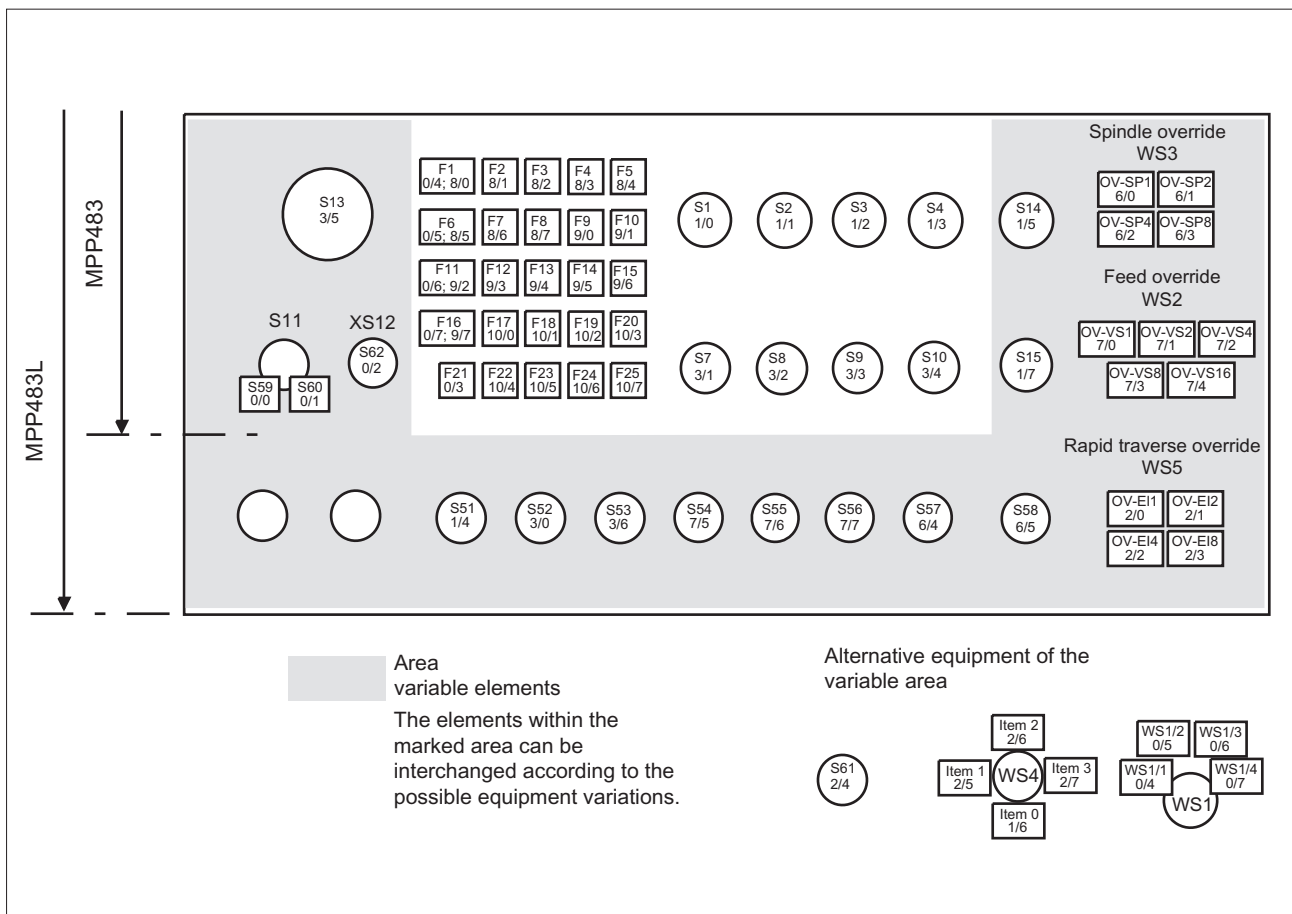

Figure 9-13 Front view

Output image MPI / PROFIBUS-DP

Byte	Bit7	Bit6	Bit5	Bit4	Bit3	Bit2	Bit1	Bit0
n+0	Customer keys							
	Hs8	HS7	HS15	HS14	HS4	HS3	HS2	HS1
n+1							Customer keys	

9.3 Interfaces

							HS10	HS9
n+2	Extension keys							
	H58	H57	H56	H55	H54	H53	H52	H51
n+3					SR key	Feedback for emergency stop	Extension keys E9/E10 when S11 is not used	
					H61	HS13	H60	H59
n+4	Function keys							
	HF8	HF7	HF6	HF5	HF4	HF3	HF2	HF1
n+5	Function keys							
	HF16	HF15	HF14	HF13	HF12	HF11	HF10	HF9
n+6	Function keys							
	HF24	HF23	HF22	HF21	HF20	HF19	HF18	HF17
n+7								Function key
								HF25

Keyboard layout - output image MPP 483

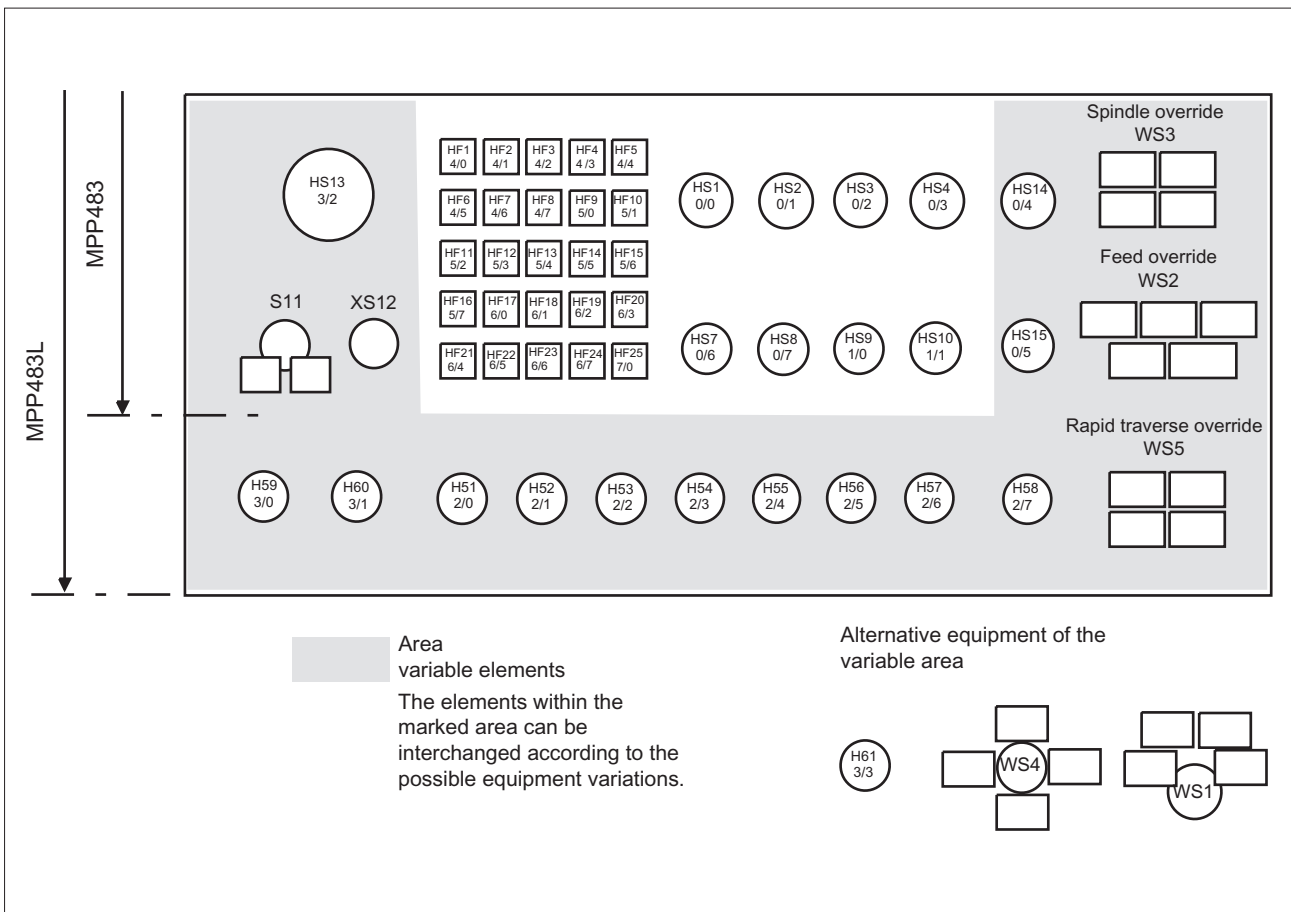

Figure 9-14 Front

9.4 Mounting

Dimensions for MPP 483 and MPP 483 L

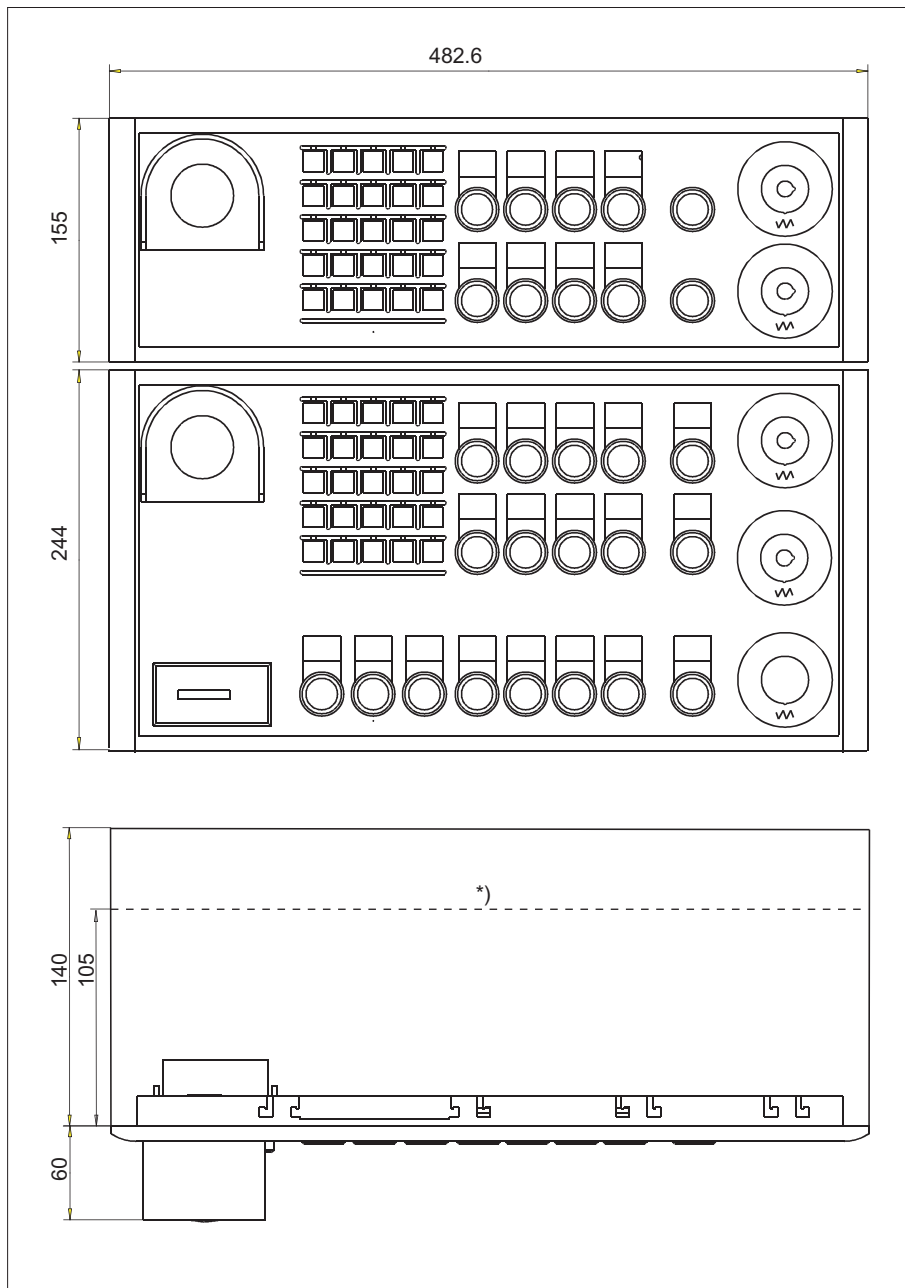

Figure 9-15 Dimension drawing for MPP 483 and MPP 483 L

*) The depth of 105 mm is only attainable with a Profibus adapter.

Panel cutout for MPP 483 and MPP 483 L

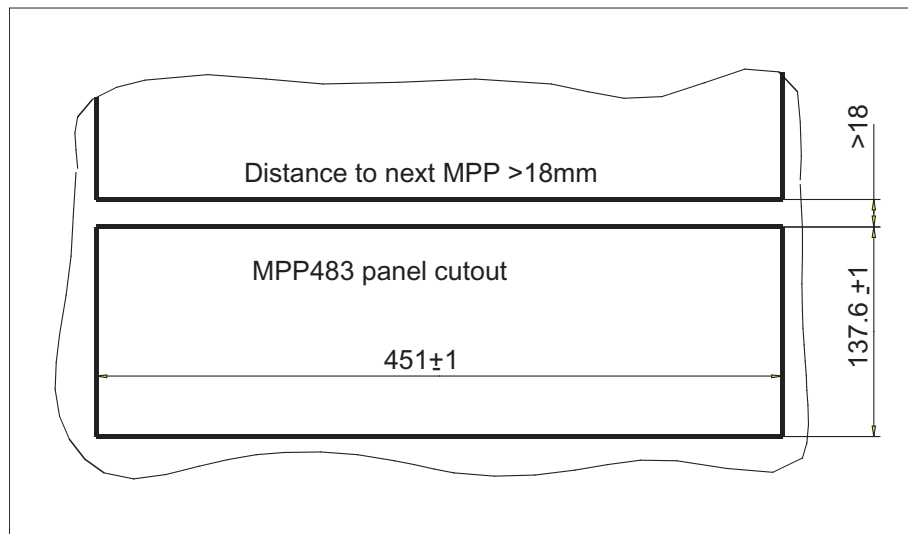

Figure 9-16 Panel cutout for MPP 483

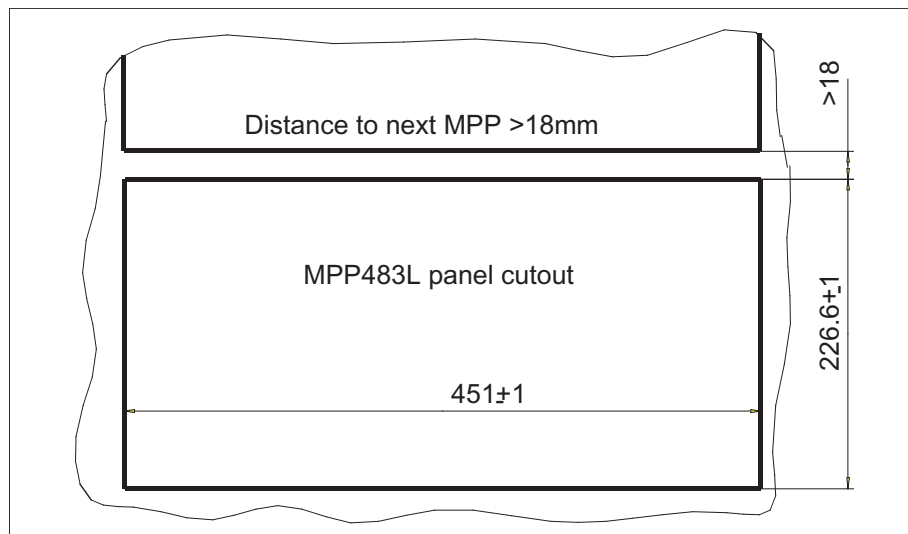

Figure 9-17 Panel cutout for MPP 483 L

The MPP 483 is attached to the rear side of the operator panel using 9 tension jacks (contained in the delivery kit). The tightening torque is 0.4 mm.

Mounting position

The mounting position is max. 60° to the vertical.

For mounting positions greater than 60° , a fan must also be installed to keep the ambient temperature of the machine control panel constantly below 55° C.

Mounting position of LEDs

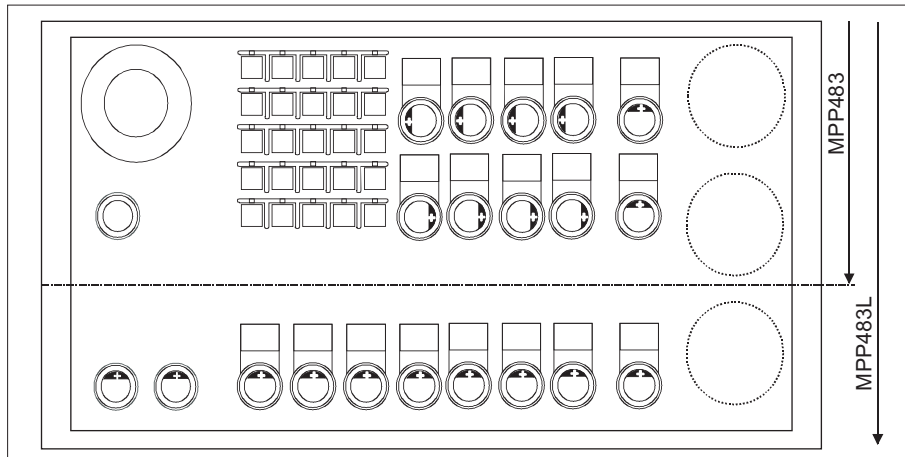

Figure 9-18 Mounting position for MPP 483 / MPP 483 L LEDs

Table 9-28 Identification of anode connection



Insert polarity+ of LEDs in key on side marked

Installing Profibus adapter

If no handwheels are connected, the installation depth can be reduced from 140 mm to 105 mm. For this, insert the PCB Profibus adapter (1) according to the figure.

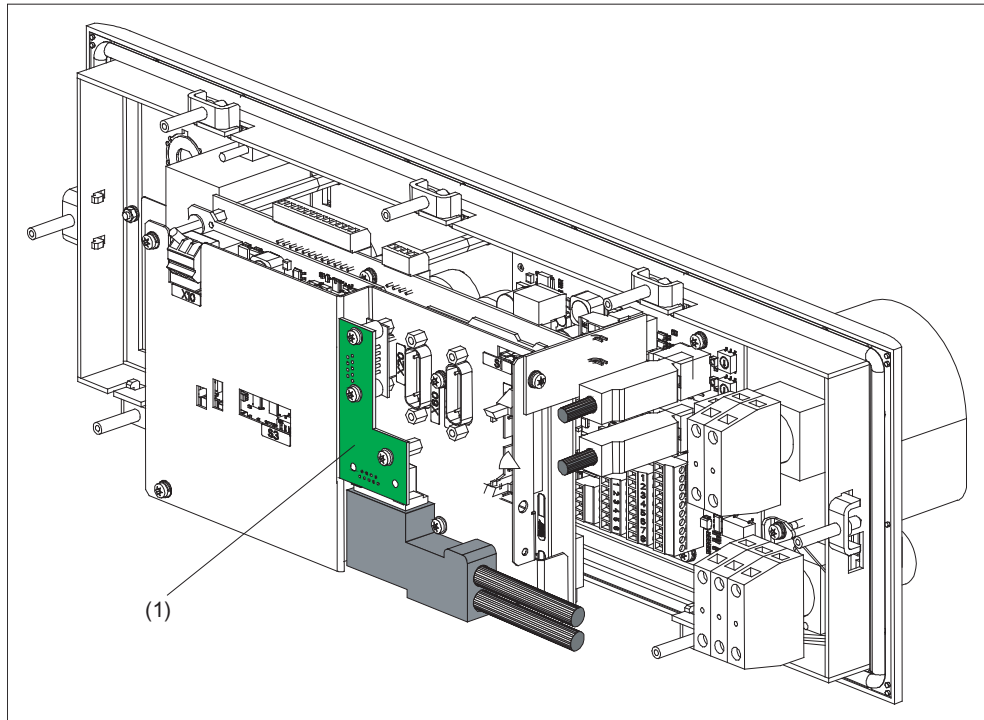

Figure 9-19 Installing Profibus adapter

9.5 Connecting

9.5.1 MPP 483

Connecting the 24 V supply

The 24 V supply is connected via a 3-pin terminal block at connector X10 and X11 to the rear of the machine control panel (see Figure: "Rear side of MPP 483 with interfaces" in Section: "Interfaces" → "Overview").

The protective ground is secured to the M5 bolt (see Figure: "MPI connection").

NOTICE

Damage to the device caused by unfused power supplies

The 24 VDC supply must always be grounded and designed as "Protective Extra-Low Voltage" (PELV) - protection by function low voltage with safe isolation!

9.5 Connecting

Emergency stop circuit connection

The emergency stop circuit connections are shown in figures "MPI connection" and "PROFIBUS DP connection."

MPI connection

Connection of X1 (HGA) to X20 (COM board) and to the control

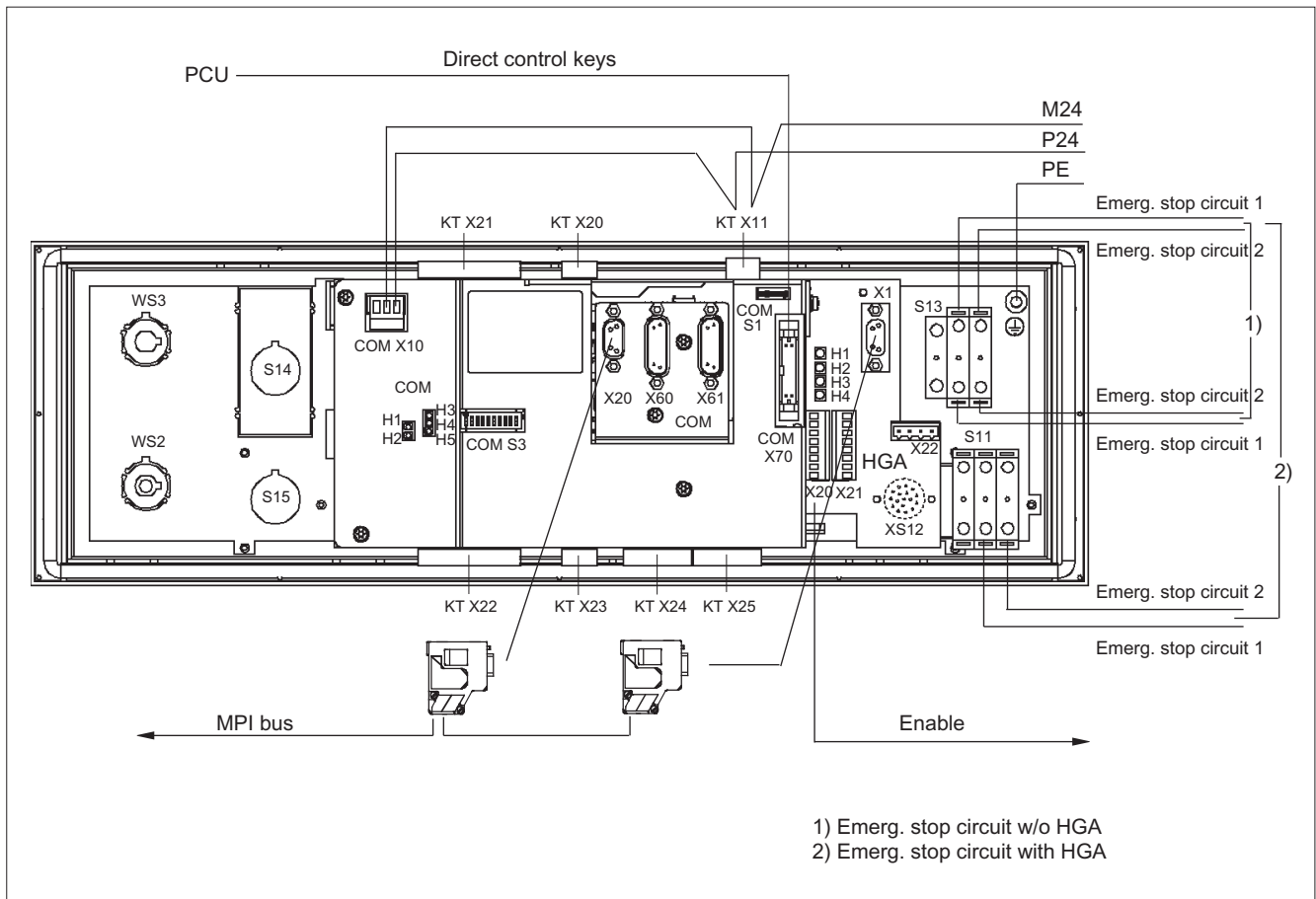

Figure 9-20 MPI connection

PROFIBUS DP connection

- DP connection via X20 (COM board) to the control
- MPI connection via X1 (HGA) to the PCU of the panel
- Handwheel 1 from X60 (COM board) to connection X22 (HGA) for the handheld unit

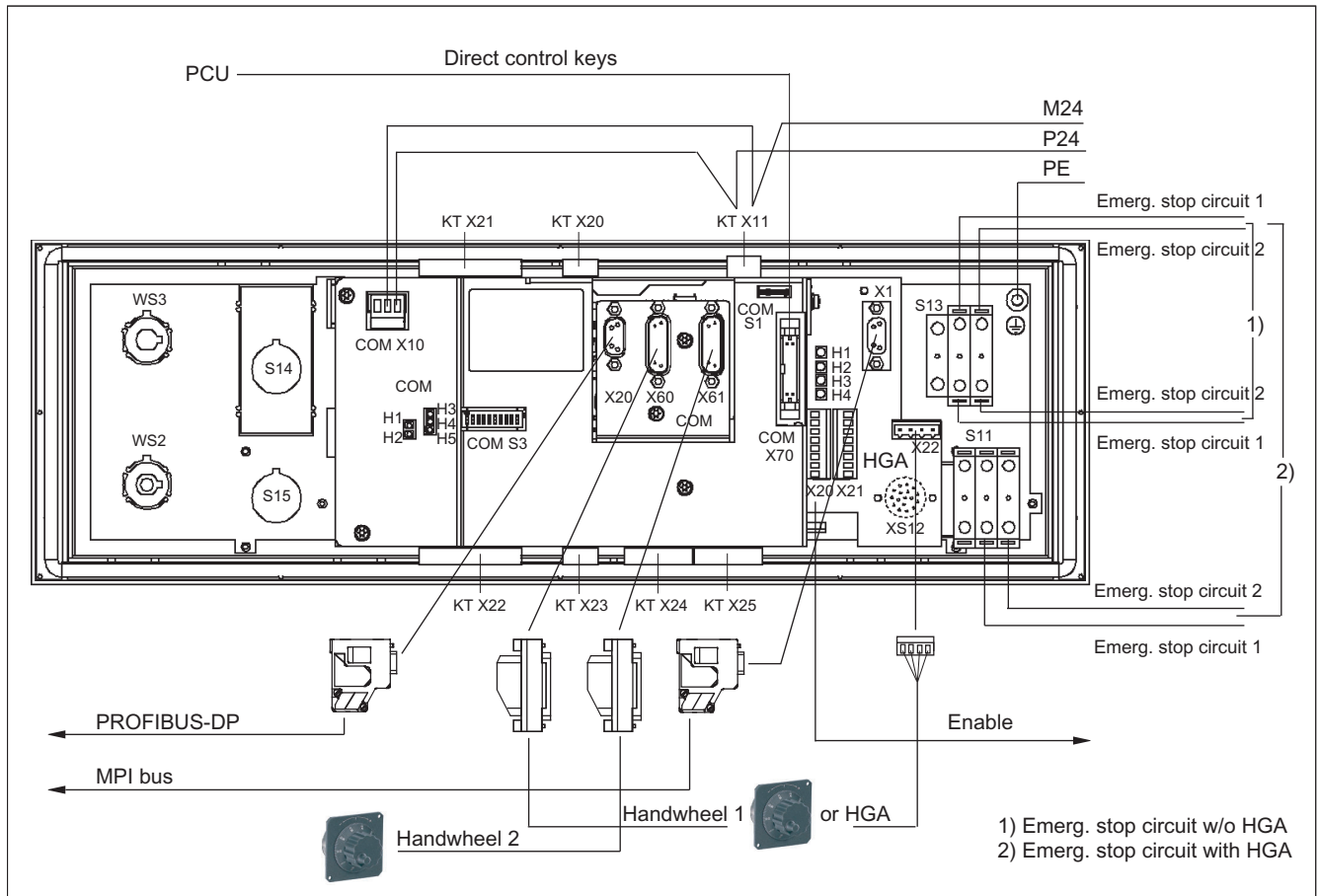

Figure 9-21 PROFIBUS DP connection

9.5 Connecting

Connection for HT 8

- DP connection via X20 (COM board) to the control
- Ethernet connection X1 / X2

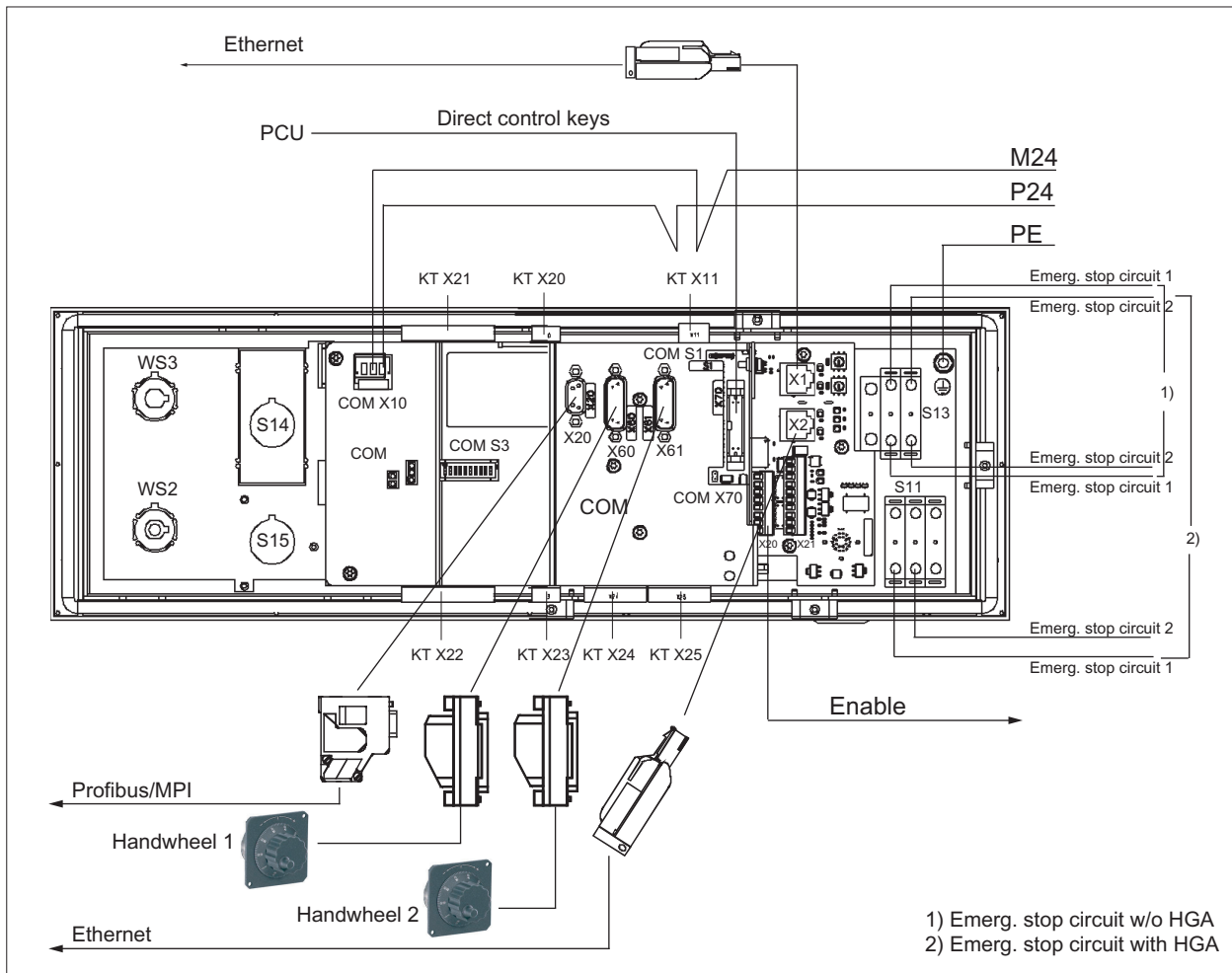

Figure 9-22 Ethernet connection

Individual wiring connection

Selector switches and individual contacts are connected in accordance with the customer-specific links required (see figure in Section: "Customer keys (KT) module").

Note

Supply voltages for inputs and outputs must always be grounded!

9.5.2 COM board

The COM board provides communication via the bus and forms the interface to the superordinate system.

The parameters are set on coding switch S3.

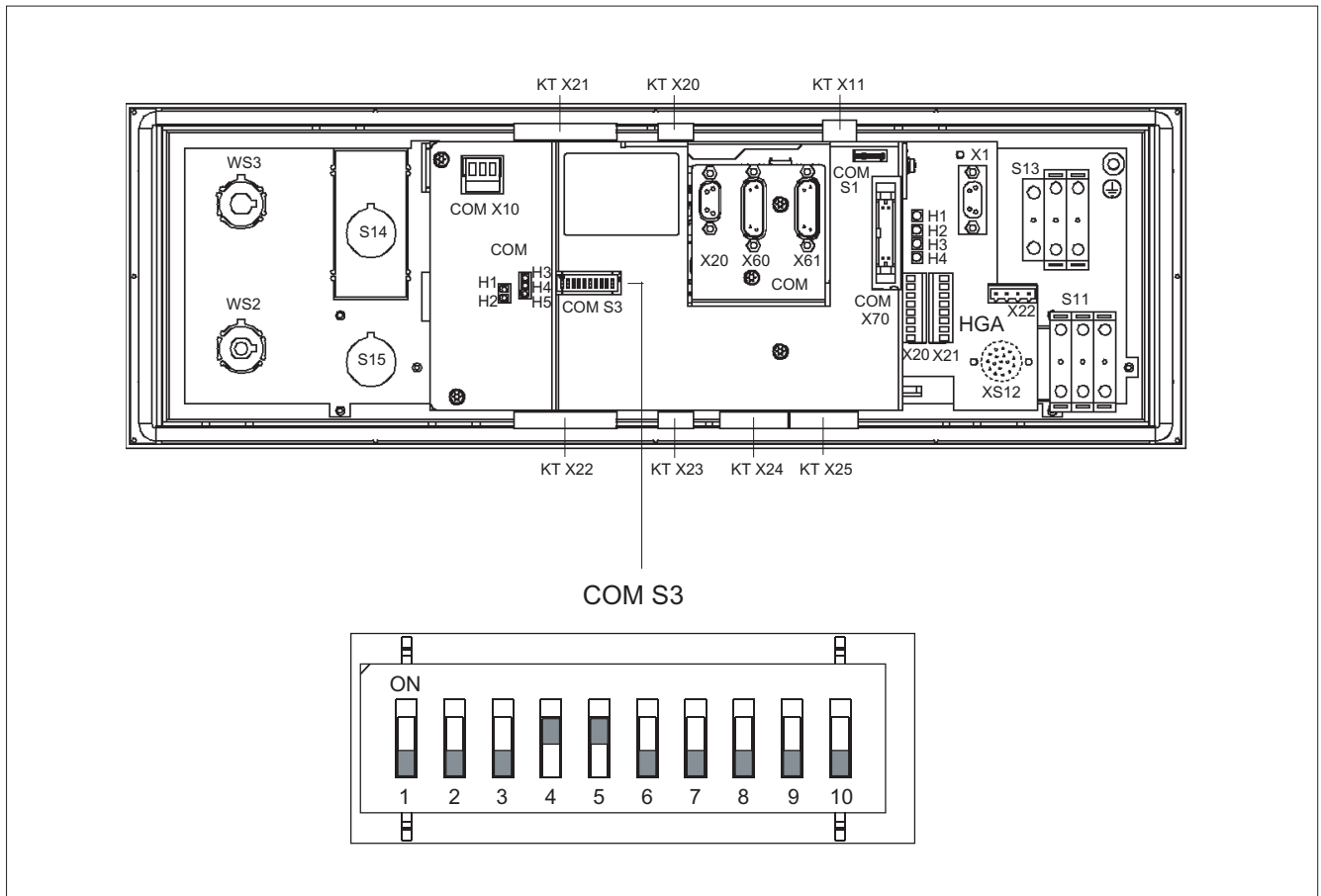

Figure 9-23 Coding switch S3

9.5.3 Customer keys

The customer keys (KT) module links the operator panel, handheld unit connection and COM board.

The inputs for handheld unit connection and extension keys are opto-decoupled. The outputs belonging to these are issued by high-side drivers.

The floating individual contacts of function keys S1 ... S4 and S7 ... S10 are shown in the figure.

9.5 Connecting

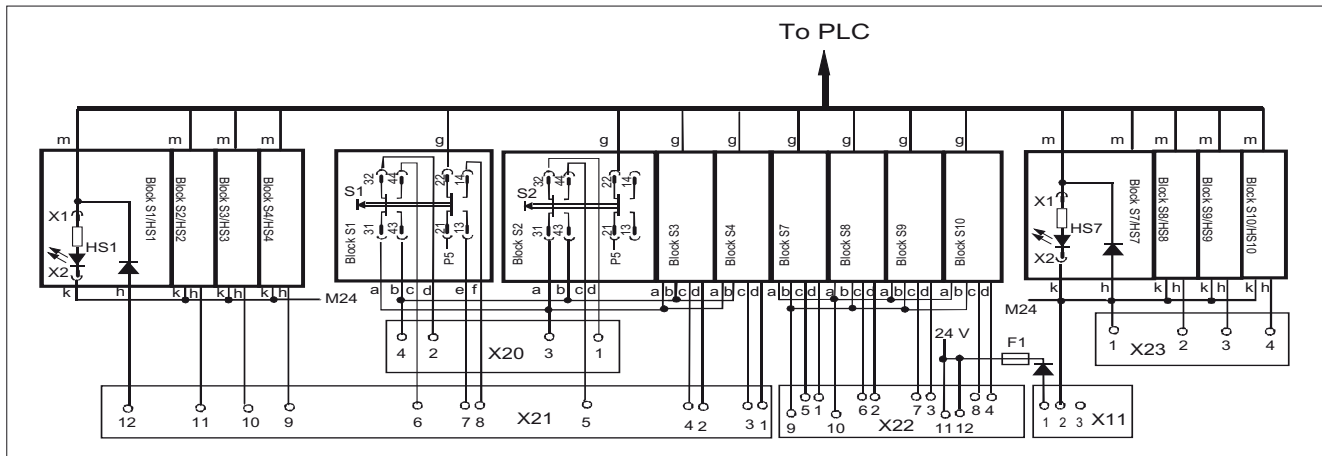

Figure 9-24 Individual wiring of the customer keys (a, b, ..., m designate IN and OUT of the individual blocks)

NOTICE

Damage to pushbutton contacts

When using an external 24 V encoder supply, always protect the key contacts against overload in the individual wiring with an external fuse for L+ with the following properties:

- circuit breaker of characteristic A, 1.6 A.

If you use the encoder supply X20:A15/A16 or VS1/VS2 of the ET200S block 4/8 F DI 24 VDC PROFIsafe, the external fuse can be omitted.

9.5.4 Handheld unit connection HT 8 with emergency stop override

The connection for handheld units (HGA) of the HT 8 has four function complexes:

- Two-channel version of enabling function
- Three-port Ethernet switch
- Connection of HT 8
- Module address

! WARNING

Danger of death if the enabling button is not DIN-conform

It is the user's responsibility to ensure that the enabling button or the enable control is implemented according to DIN EN 60204-1, Section 9.2.6.3, and the enabling button, when released or pushed down, stops dangerous movements reliably.

Emergency stop override S11

- Implemented as pushbutton or key-operated switch
- Pushbutton pressed or key-operated switch, left probing
 - "Emergency stop override" of the handheld unit connection → query via input E59
 - Interruption of the power supply for the handheld unit connection when actuated
- Key-operated switch, right probing: Unassigned function → query via input S60

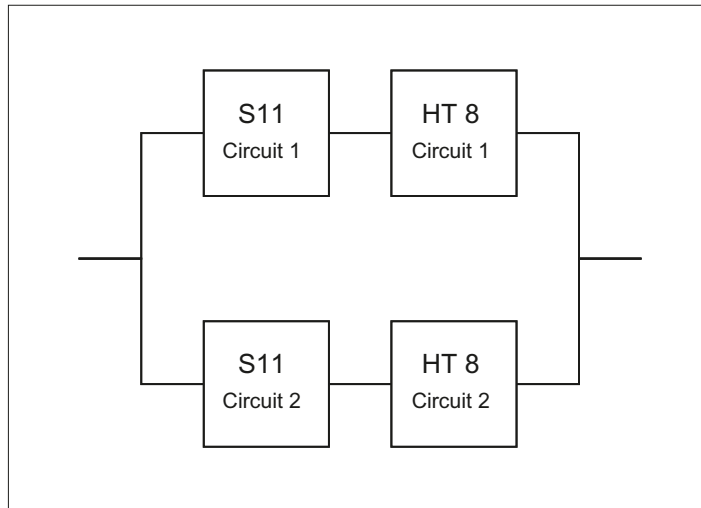

Figure 9-25 2-channel architecture of the emergency stop override contacts

With regard to their accidental failure, the contacts of the emergency stop override safety function form a 2-channel architecture together with the emergency stop button on the HT 8. In addition to the B_{10d} value of the emergency stop button, the B_{10d} value of S11 must also be taken into consideration for the assessment in both emergency stop circuits.

The diagnostics for the contacts of S11 is performed on the HT 8 together with the diagnostics of the emergency stop button.



WARNING

Danger of death caused by failure of the "emergency stop" safety function

The user must ensure that the emergency stop override is implemented in accordance with the safety goals required by the risk analysis of the machine.

Actuation of the emergency stop override results in failure of the emergency stop safety function on the HT 8. The user must implement suitable organization and/or technical procedures for this in order to achieve the safety goals.

As a technical measure, the signaling contacts on the S11: 31/32 and 61/62 can be used to trigger an "emergency stop" by the PLC after a monitoring time has expired (maximum five minutes) (see Remark 1 in the following figure).

However, this measure alone does not satisfy the requirements of Category 3, PL d in accordance with EN ISO 13849-1:2008.

All other functions can be found in the figure.

9.5 Connecting

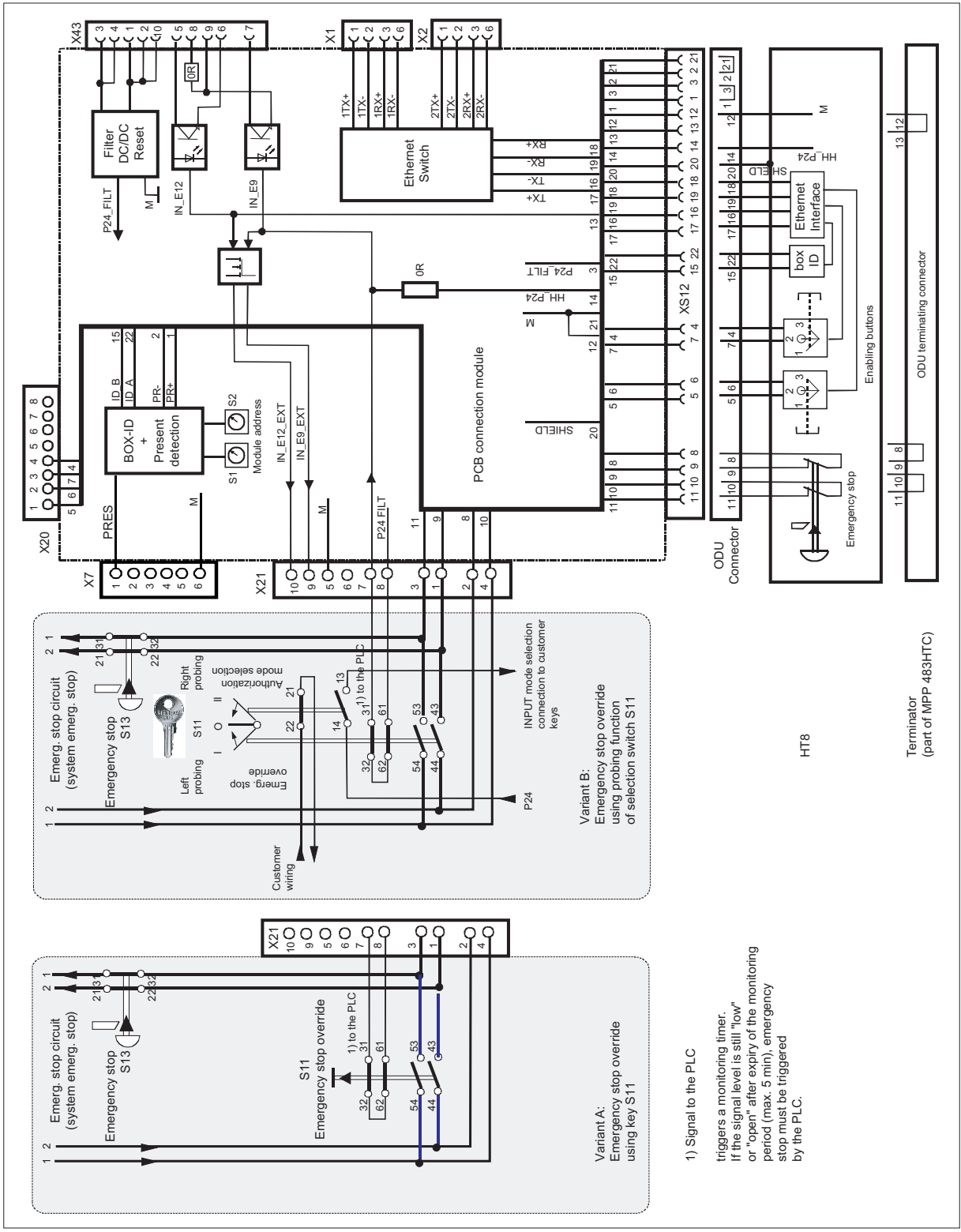
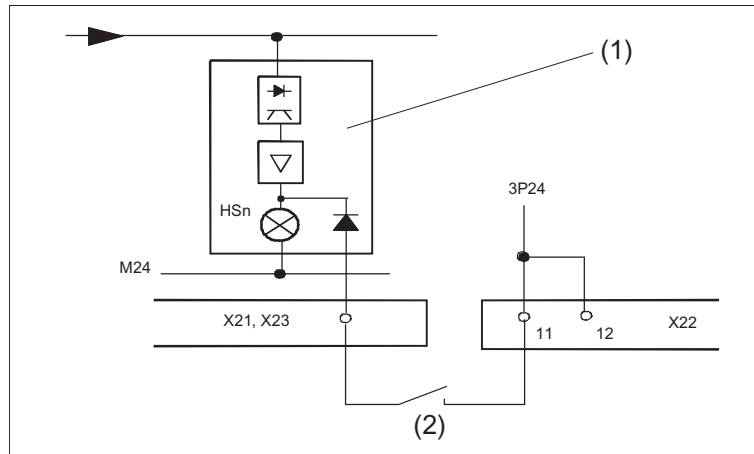

Figure 9-26 Handheld unit connection HT 8

9.6 Circuits and wiring

External control of signaling lamps

The following circuit diagram relates to the lights in HS1 to HS4 and HS7 to HS10.



- (1) Block Sn
- (2) External contact

Figure 9-27 External control of signaling lamps

Circuit for emergency stop button

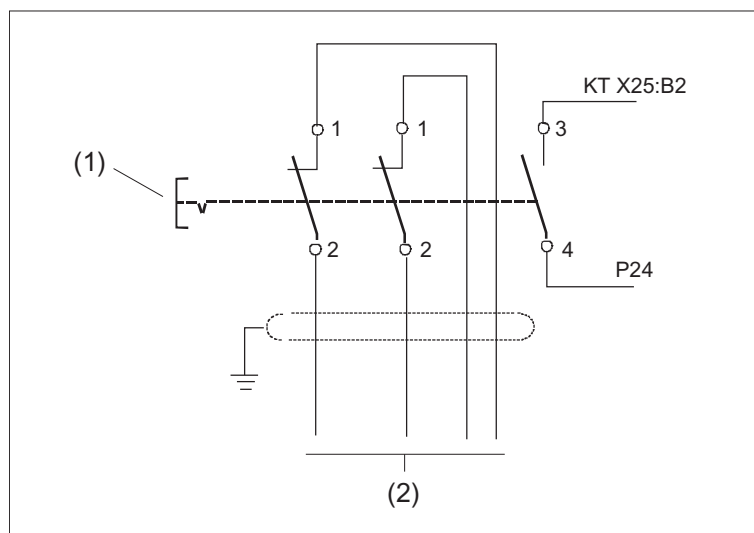

- (1) Emergency stop button S13
- (2) Emergency stop of the machine control

Figure 9-28 Circuit for emergency stop button

Extension keys connection

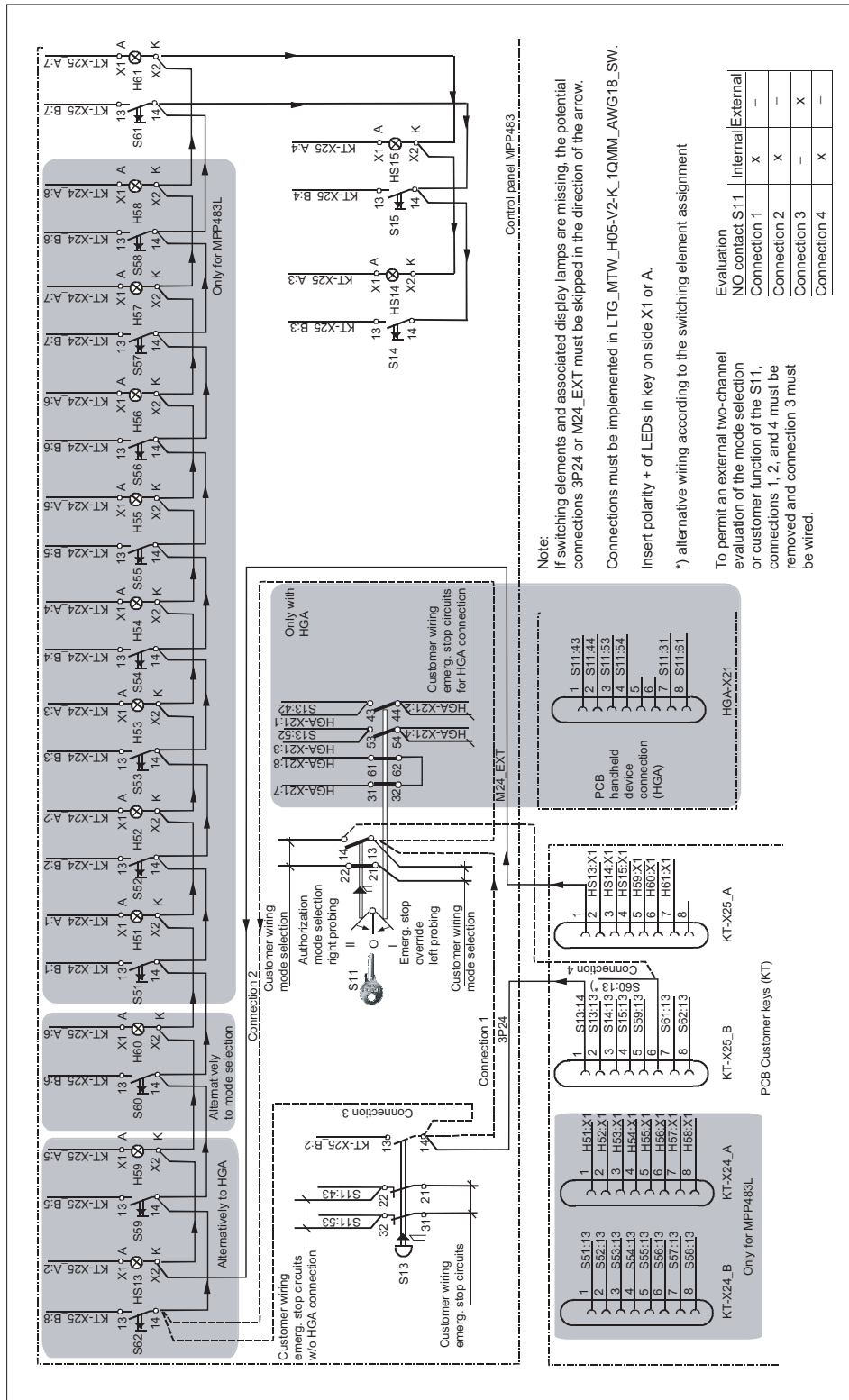

Figure 9-29 Extension keys connection

Direct key connection

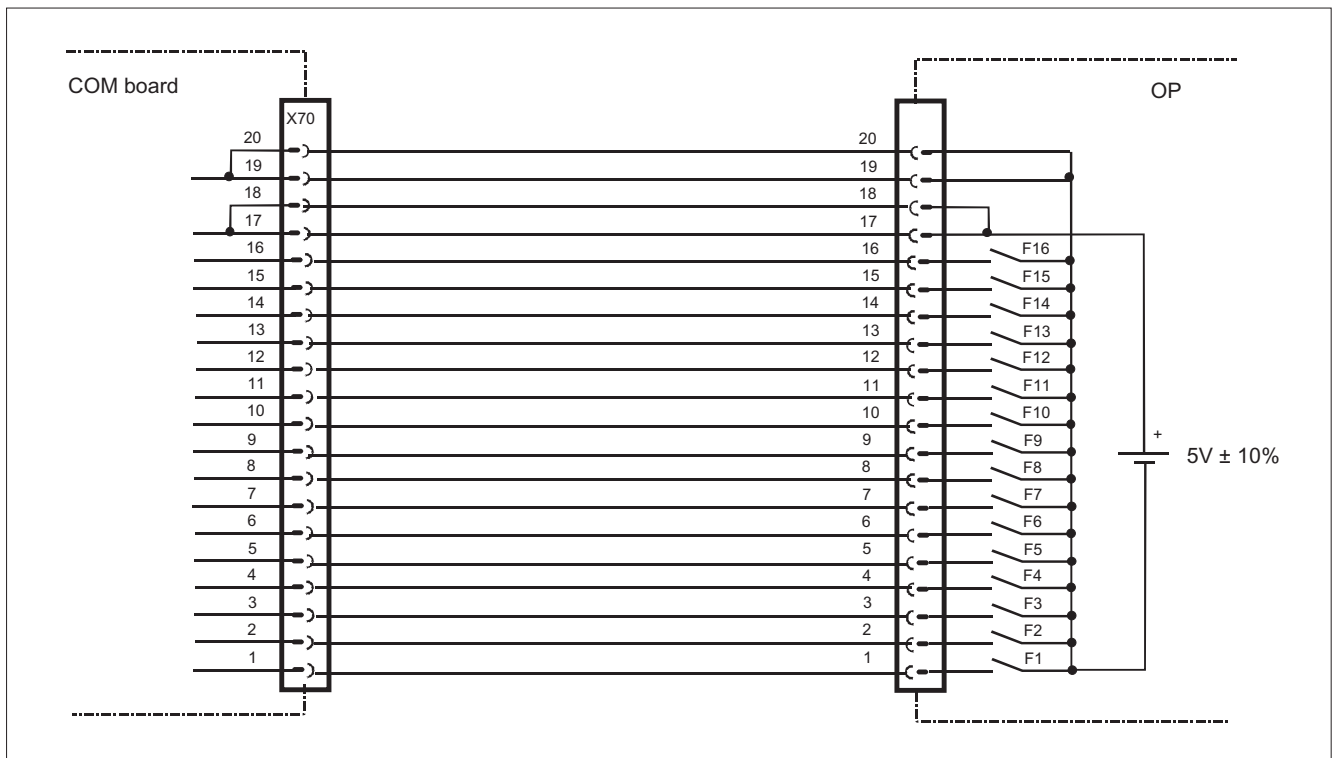

Figure 9-30 Direct key connection

Customer function S11

The NC-NO combination 3SB34 03-0A is right probing and a customer function of the S11. The NO contact is wired on delivery and can be queried through the MPP 483. The probing function facilitates mode selection.

If an external evaluation of both contacts is required, the internal wiring on the NO contact 1.3/1.4 of the S 11 must be removed (see Fig.: "Extension keys connection" in this section).

- Remove connection 1 and connection 4
- If connection 2 exists, wire the connection of S11:1.3 to S13:1.4

9.7 Initialization

The configurations which are available for the MPP 483 are displayed broken down by PROFIBUS DP and MPI (GD) communication protocols.

For PROFIBUS DP, the PROFIBUS slave ID which has been specified by PI is also named.

9.7 Initialization

	Slave ID	Configuration	IN/OUT
MPI (GD)		Standard	8/8 bytes
		Extended standard	12/8 bytes
PROFIBUS DP	8122	Standard	14/8 bytes
		Standard + handwheel	14/8 bytes + 2/0 words

Software version

If there is still no communication with the control / PROFIBUS master, the MPP 483 software version can be output on the panel using the LEDs.

The output is activated by pressing the "F21" and "F25" buttons at the same time. Flashing of the LEDs is thereby suppressed and the software version is output on the function key block with three digits.

The individual digits are expressed in hexadecimal format by the number of LEDs activated in the first three LED lines on the MPP.

The lowest value bit position is always on the right.

The software version of the MPP V 02.01.00.00 is shown in the example given.

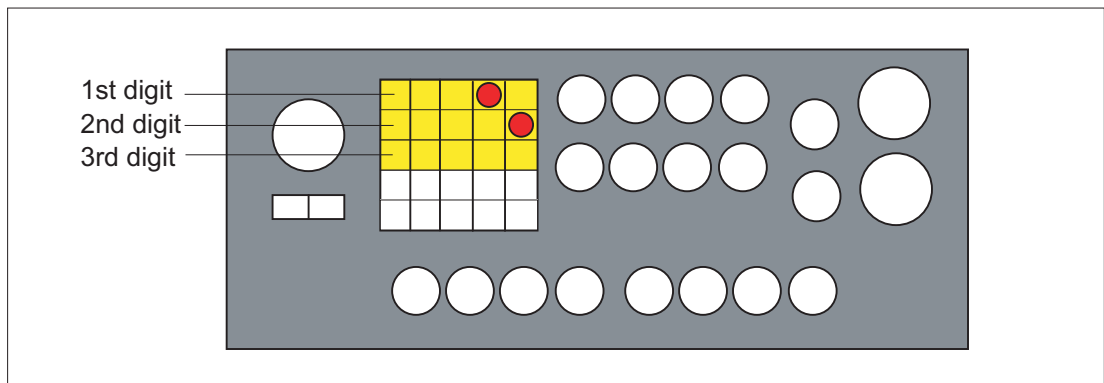

Figure 9-31 Sample displays of software version

Note

The software version can only be output while there is no communication with the control system.

Once communication has taken place, the software version is only displayed again after the power to the MPP 483 has been switched OFF and ON!

Settings for coding switch S3

Table 9-29 Settings for coding switch S3 for PROFIBUS DP

1	2	3	4	5	6	7	8	9	10	Meaning
									on	MPP 483 as PROFIBUS slave
							off	off		Reserved
off	off	off	off	off	off	off				Bus address: 0
on	off	off	off	off	off	off				Bus address: 1
off	on	off	off	off	off	off				Bus address: 2
on	on	off	off	off	off	off				Bus address: 3
...				etc.
off	off	on	on	on	on	on				Bus address: 124
on	off	on	on	on	on	on				Bus address: 125
off	on	on	on	on	on	on				Bus address: 126

Bits 8 and 9 are reserved during PROFIBUS mode and should be assigned "off".

Table 9-30 Module address connection module HT 8

8	7	6	5	4	3	2	1	Meaning
S1				S2				Switch
0 to F				0 to F				Module address

LEDs

- HF1 to HF25
- HS1 to HS4
- HS7 to HS10

After power to the MPP 483 is switched ON, all LEDs / lights are first activated.

Once the MPP 483 has been powered up internally, the LEDs flash at different frequencies.

- For setting the MPP 483 with GD communication (compatible mode) with approx. 1.3 Hz
- For setting the MPP 483 as PROFIBUS slave with approx. 0.5 Hz

On the MPP 483, all LEDs above the buttons flash if there is no communication with the control system / PROFIBUS master.

Table 9-31 LEDs on the COM board

	H1	H2	H3	H4	H5
After power on	Red	Off	Green	Yellow	Red
PROFIBUS communication without master	Red	Off	Green	Off	Green *)
PROFIBUS communication with master	Off	Off	Green	Off	Green
Fatal error	Red *)	Off	Green *)	Yellow *)	Green *)
*) LED flashing					

9.8 PROFIBUS communication

9.8.1 Prerequisites

The assignment and quantity structure of PROFIBUS mode are shown in section: "Interfaces" → "Input/output images".

PROFIBUS mode also offers the following functions:

- Connection of two handwheels
- 5-position spindle override

Prerequisites

The following components are needed as prerequisites for adding a DP slave MPP to the hardware configuration:

- SIMATIC STEP 7 as of Version 5.4, Service Pack 4
- Toolbox 840D sl as of Version 2.6

Hardware configuration

The DP slave MPP is shown in SIMATIC STEP 7 in the hardware catalog of "HW Config" under the following path:

Profile: **Standard**

PROFIBUS DP > Other field devices > NC/RC > Motion Control > SINUMERIK MPP

If the module is not displayed, the GSD file must be installed. To do this, in "HW config" use menu command

Tools > Install new GSD file.

Note

The GSD file of the DP slave MCP is located on the Toolbox CD in the directory:
...\\8x0d\\GSD\\MPP

9.8.2 Configuring the DP slave MPP 483

This section describes how to configure a DP slave MPP with reference to the hardware configuration for a SIMATIC S7 project shown in the figure by way of example.

The hardware configuration has the following modules:

- SIMATIC Station 300 with SINUMERIK 840D sl
- SINUMERIK MPP with module: Standard+Handwheel

Procedure

Configuring the DP slave MPP as an S7 project involves the following steps:

1. Add the DP slave MPP to the configuration ①.
2. Set the PROFIBUS address.
3. Add the appropriate module to the DP slave MPP depending on the required functions ②.
4. Set the I/O addresses for the individual slots.

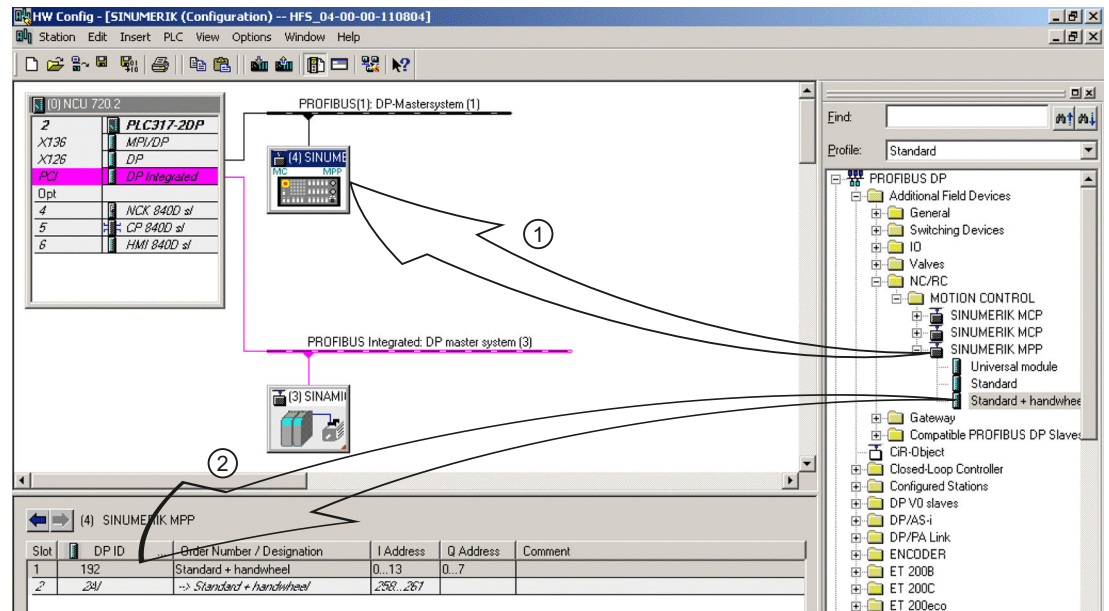

Figure 9-32 Configuring the DP slave MPP 483

Requirements: S7 project

The following status is required for the S7 project to which the DP slave MPP is to be added:

- The S7 project has been created.
- A SIMATIC 300 station with SINUMERIK controller has been defined.

Adding a DP slave MPP

To add a DP slave MPP to the configuration, open the hardware catalog using the menu command **View > Catalog**.

The DP slave MCP can be found at profile: **Standard**
PROFIBUS DP > Other field devices > NC/RC > Motion Control > SINUMERIK MPP

Click with the left mouse button on the DP slave MPP (SINUMERIK MPP) in the hardware catalog and drag it onto the DP master system in the station window by holding down the left mouse button.

The DP master system is displayed in the station window with the following symbol:



When you release the left mouse button, the DP slave MPP is added to the configuration.

Note

As you drag the DP slave the cursor appears as a circle with a slash through it. When the cursor is positioned exactly over the DP master system, it changes to a plus sign, and the DP slave can be added to the configuration.

PROFIBUS parameters

As soon as you have inserted MPP DP slave into the configuration, the "Properties - PROFIBUS Interface SINUMERIK MPP" dialog box is displayed.

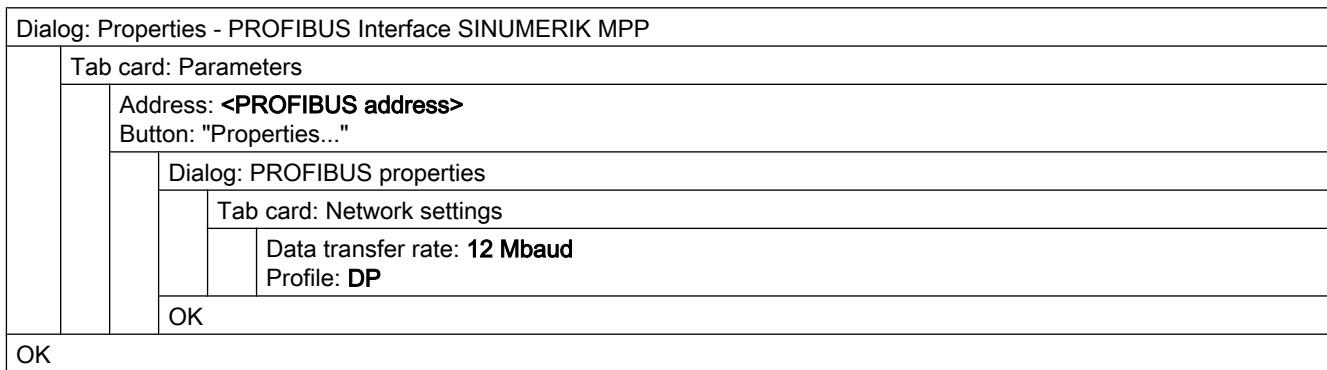

The following PROFIBUS parameters must either be set or verified:

- PROFIBUS address
- Data transfer rate
- Profile

Note

No automatic comparison of the PROFIBUS address!

The PROFIBUS address of the DP slave MPP set in the S7 project must match the PROFIBUS address set on the module (coding switch S3) (see Section: "Initialization")

Adding a module

The active functions and hence the number of user data elements to be transferred are chosen by selecting the appropriate pre-configured module. The following modules are available in HW Config under "SINUMERIK MPP":

- *Universal module* (not applicable)
- Standard
- Standard + handwheel

Setting the I/O addresses

If you add a module to slot 1 of the DP slave MPP, the input/output addresses are automatically assigned by STEP 7.

Double clicking with the left mouse button on a slot opens the "Properties - DP Slave" dialog box. The starting addresses for the I/O data for the slot can be set here.

9.8.3 PLC user program

If the MPP is connected via PROFIBUS DP, the basic PLC program does not check for module failure.

In this case the MPP is monitored by a standard mechanism to monitor the active DP slave:

- PLC operating system
- PROFIBUS controller

If a failure of a DP slave MPP is detected, the PLC defaults to STOP.

Customized response

The following organization blocks can be added to the PLC user program to customize the response to a DP slave MPP failure:

- OB 82: Diagnostics interrupt
- OB 86: Rack failure

Please refer to the corresponding SIMATIC literature for details of linking organization blocks and evaluating diagnostic data.

9.9 Maintenance and Service

Cleaning the device

Use a soft cloth moistened either with water or a mild cleaning agent to clean the housing and operator control elements of the machine control panel.

Checking the device

In order to prevent foreign bodies or liquids entering the machine control panel, regularly check the device

- that all the housing screws are in place and tight
- for damage to the housing
- for damage to the cable cover or cable entry

9.10 Technical data

Protect the device from environmental effects

Protect the machine control panel against

- direct solar radiation and heat sources
- mechanical vibration and shock
- dust
- moisture, and
- strong magnetic fields

Checking the emergency stop button

Check the emergency stop button regularly to ensure that it functions correctly.

9.10 Technical data

9.10.1 MPP 483

Safety					
Safety class according to EN 50178	III; PELV				
Degree of protection according to EN 60529	Front side: IP54 Rear side: IP10A				
Approvals	CE / UL				
Electrical data					
Input voltage	24 VDC				
Power consumption, max.	Boards: 12 W	Lamps: LED 8.8 W	Handheld unit: 12 W	Handwheels: 2 x 0.9 W	Total: 35 W
Fuse to be added	10 A	Minimum conductor cross-section 1.5 mm ² for max. working temperature on the conductor of 70° C			
Mechanical data					
	Dimensions (mm)				Weight:
	Height:	Width:	Depth (front):	Mounting depth:	
MPP 483	155	483	60	140 / 105 ^{*)}	Approx. 3 kg
MPP 483 L	244	483	60	140 / 105 ^{*)}	Approx. 4.5 kg
Max. tightening torques	Tension jack screws: 0.4 Nm M3 screws: 0.8 Nm		M4 screws: 1.8 Nm M5 screws: 3 Nm		

^{*)} When a PROFIBUS adapter is used

Note

Information about the climatic and mechanical environmental conditions is contained in the associated section under:

"General notes and interconnection" → "Operational planning".

9.10.2 Input/output interface of individual wiring

Button contact maker

Table 9-32 Contacts with floating outputs S1 to S4; S7 to S10 (NC contact or NO contact)

		AC	DC
Rated insulation voltage	U _e	50 V	50 V
Rated operating current	I _e	2 A	
Rated operating current at 24 V	I _e		2 A
Min. rated operating current at 5 V	I _{min}		1 mA
Volume resistance			< 20 mΩ
Switching capacity		10 I _e	1.1 I _e

Selector switch

Table 9-33 Contacts with floating outputs WS1 / 9–11, 13, 15

		AC	DC
Max. operating voltage	U _e	50 V	50 V
Switching capacity with resistive load		10 A	
Switching capacity with inductive load		> 2 A	
Switching capacity at 24 V with resistive load			10 A
Switching capacity at 24 V with inductive load			6 A
Rated values for arc-free switching at 24 V		0.3 A	0.22 A

Emergency stop button S13

Rated voltage	24 VDC
Current magnitude, max.	3 A
Current magnitude, min.	1 mA
Switching capacity	DC 13 according to EN 60947-5-1
Conditional rated short-circuit current	10 A gL/gG according to EN 60947-5-1
B _{10d}	500 000

Note

The quantitative assessment of the emergency stop safety function must be based on the B_{10d} values corresponding to the used standards (e.g. ISO 13849-1) under consideration of the respective application (frequency of the actuation, service life, diagnostics by the evaluation unit, etc.). The B_{10d} values only apply when the technical properties of the emergency stop button are taken into account.

SR mushroom-head button S61

Table 9-34 Contacts with floating outputs

	Usage category (EN 60947-5-1)		AC	DC
Rated operational voltage		U_e	24 V	24 V
Switching capacity	AC-12	I_e	10 A	
	AC-15	I_e	6 A	
	DC-12	I_e		10 A
	DC-13	I_e		3 A
Min. rated operating current at 5 V		I_{min}		1 mA
For further parameters, see pushbutton and indicator light SIGNUM 3SB3				
B_{10d}	500 000			

Note

The quantitative assessment of the emergency stop safety function must be based on the B_{10d} values corresponding to the used standards (e.g. ISO 13849-1) under consideration of the respective application (frequency of the actuation, service life, diagnostics by the evaluation unit, etc.). The B_{10d} values only apply when the technical properties of the contact block are taken into account.

Emergency stop override S11

Table 9-35 Contacts with floating outputs

	Usage category (EN 60947-5-1)		AC	DC
Rated operational voltage		U_e	24 V	24 V
Switching capacity	AC-12	I_e	10 A	
	AC-15	I_e	6 A	
	DC-12	I_e		10 A
	DC-13	I_e		3 A
Min. rated operating current at 5 V		I_{min}		1 mA

	Usage category (EN 60947-5-1)	AC	DC
For further parameters, see pushbutton and indicator light SIGNUM 3SB3			
B _{10d}	500 000		

Note

The quantitative assessment of the emergency stop safety function must be based on the B_{10d} values corresponding to the used standards (e.g. ISO 13849-1) under consideration of the respective application (frequency of the actuation, service life, diagnostics by the evaluation unit, etc.). The B_{10d} values only apply when the technical properties of the contact block are taken into account.

Inputs

The inputs are opto-decoupled.

Table 9-36 S51 ... S62, S14, S15, emergency stop S13

Status		Switching voltage	Remark
Number	15		Input characteristics curve following IEC61131, type 1
H signal	Rated value	+ 24 VDC	
	Signal level	+15 V to +30 V	
L signal	Rated value	0 V or open	
	Signal level	-3 V to +5 V	
In a group of	1		
Cable length	Max. 50 m AWG 16		
Encoder power supply		18.5 V to 30 V	

LED outputs

Table 9-37 S51 ... S61, S14, S15, emergency stop HS13

Status		Switching voltage	Switching current
Number	14		
Load voltage 2P24		20.4 V ... 28.8 V	
Rated value		+24 VDC	0.5 A
H signal	Signal level min.	U _e - 0.16 V	Max. 0.7 A / output
L signal	Max. signal level	2 V (idling)	0.3 mA
Short-circuit protection	Yes		
Typ. activation threshold			1.1 A
RMS short-circuit current			0.5 A

9.11 Accessories and spare parts

Status		Switching voltage	Switching current
Electrical isolation	No		
In a group of	1		
Output total current			Max. 3 A
Cable length	Max. 50 m AWG 16		

Handheld unit connection XS12

The currents depend on the connected handheld unit.

The internal connecting cables of the handheld unit connection B-MPI are designed for a rated voltage of 24 VDC and 2 A.

The internal connecting cables of the handheld unit connection HT 8 are designed for a rated voltage of 24 VDC and 0.5 A.

9.11 Accessories and spare parts

9.11.1 Overview

Numerous spare parts and accessories are available for the MPP 483. Contact your Siemens service center to order accessories and spare parts.

9.11.2 Labeling the slide-in labels

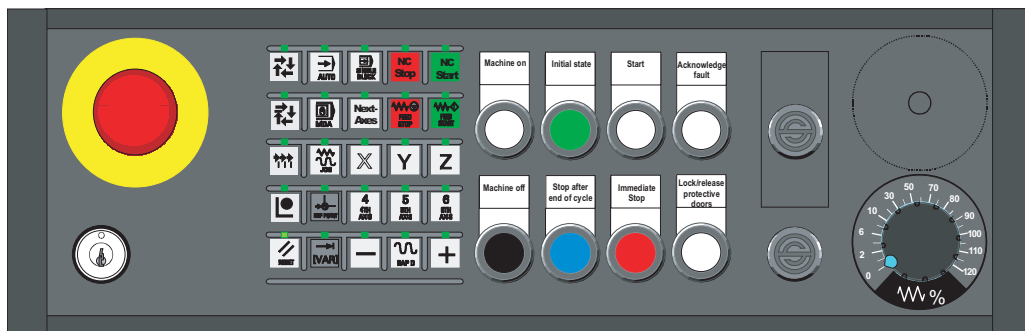

Figure 9-33 MPP 483 Machine Push Button Panel

The figure shows the MPP 483 in the standard version.

The same slide-in labels can be used for the MPP 483H and the MPP 483A.

You can create your own slide-in labels in order to change the key labels. A printable blank film (DIN A4) is supplied with the panel for this purpose.

A spare parts kit containing three blank films is also available (Item no.: A5E00414151).



Figure 9-34 Blank film for MCP 483 film keyboard

1) Print direction

Files for printing the blank film

The DOConCD / Catalog NC 61 (CD enclosed) contains two files for printing the blank films:

- **Template_MPP483.doc** [assignment for standard variants of MPP 483 - (A)]
- **SymbolsMPP483.doc** [key symbols as Word file - (B)]

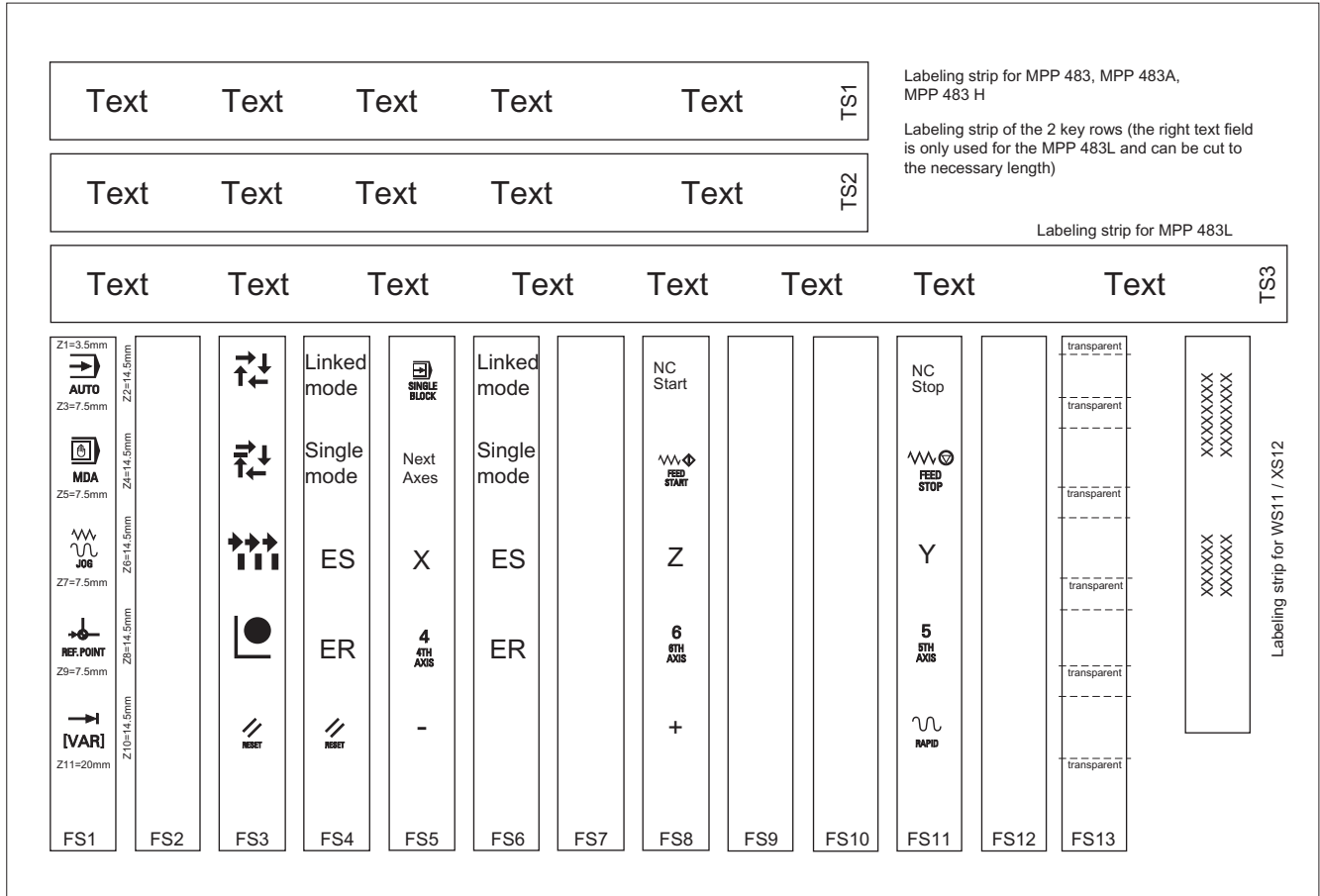





Figure 9-35 Template_MPP483.doc (A)

Table 9-38 Symbole_MPP483.doc (B)

					100%				
X					10				
	Y						Z		
	-	+							

+Y	-Y	+Z	-Z	+C	-C				
VK	EB	ES	ER	IO	SM	SS	SU	Next Axes	
									
NC Start	NC Stop								

Preparing standard slide-in labels with the aid of the file: "Template_MPP483.doc" (A)

1. Open the file "Template_MPP483.doc" in MS Word.
The key symbols are arranged in a table on the position that corresponds to their location on the keyboard. The borders visible in the table are not printed.
2. Place the blank film in the printing direction in the slot of your laser printer (see figure: "Blank film for MPP 483 membrane keyboard").
3. Select "film" as the printable medium if your printer allows this setting.
4. Start the printing process using MS Word.

Note

Make a test print on paper before you print on the film.
Allow the film to cool after printing so that the ink can dry.

5. Cut the slide-in labels out of the film along the edges (outer lines).
6. Round off the corners of the slide-in labels approx. 1.5 mm to facilitate insertion.
7. Slide in the printed slide-in label.
8. Shorten the labeling strip for the long-stroke keys for MPP 483 and MPP 483A, because only the first four text fields of the strips TS1 and TS2 are needed.

Preparing specific slide-in labels with the aid of the file: "Symbole_MPP483.doc" (B)

1. Open both the "Symbole_MPP483.doc" file and the "Template_MPP483.doc" file.
2. Copy the desired key symbol from the file "Symbole_MPP483.doc".
3. Position the cursor in the desired field of the template (A), add the symbol and adjust its size accordingly by dragging it by the gripping points.

4. To move a symbol to a different position,
 - select the symbol,
 - cut it out and
 - add it into the desired table cell.
5. If all the symbols are positioned as desired, follow the instructions in Section: "Preparing standard slide-in labels with the aid of the file: "Template_MPP483.doc" as of point 2.

Note

Input of characters/text instead of symbols

Use the "Arial" font to format text. This font is comparable to the "Univers S57" font, used by Siemens for the key labeling.

Creating your own symbols

- Drawing in a vector program (e.g. Designer, Freehand, CorelDraw):
 - Draw a square 15 x 15 mm without frames, filled with the color white.
 - Place the graphic in the center of this square.
 - Group the graphic and square together and add this group to the file "Template_MPP483.doc".
- Drawing in an image editing program (e.g. Photoshop, Picture Publisher, Paint)
 - Create a square area (e.g. 100 x 100 pixels) filled with the color white.
 - Draw the graphic or add an image in the center of this square.
 - Copy the graphic and square and add them both to the file "Template_MPP483.doc".

9.11.3 Handwheel connection

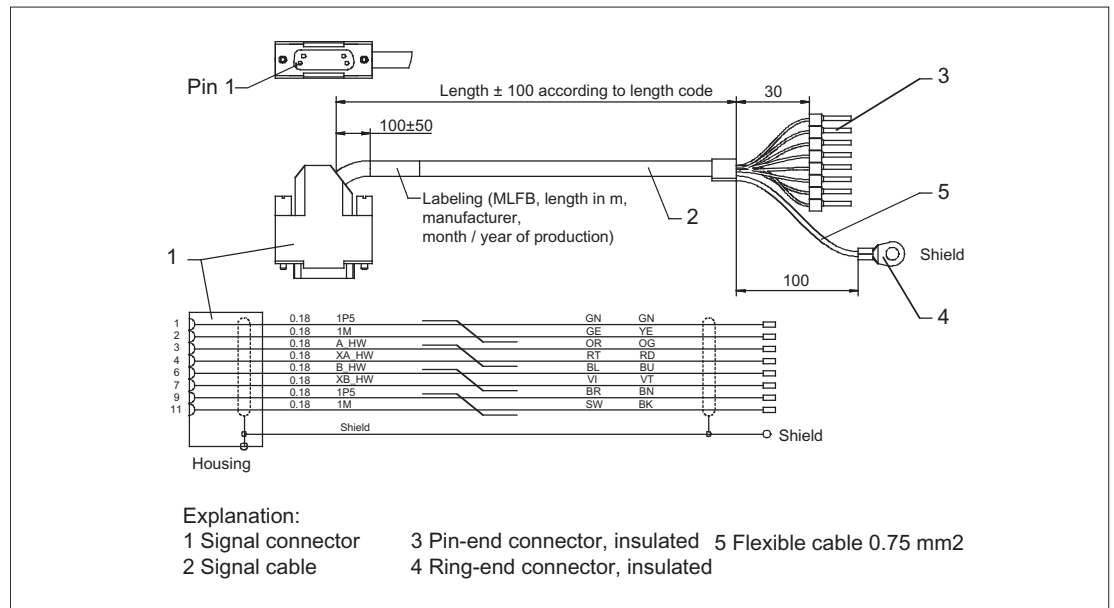

Figure 9-36 Connection cable for COM board handwheel

Order no.: 6FX8002-2CP00-1Axy

xy is the length code: x (m) = A (0) ...F (5); y (dm) = 0 ... 8

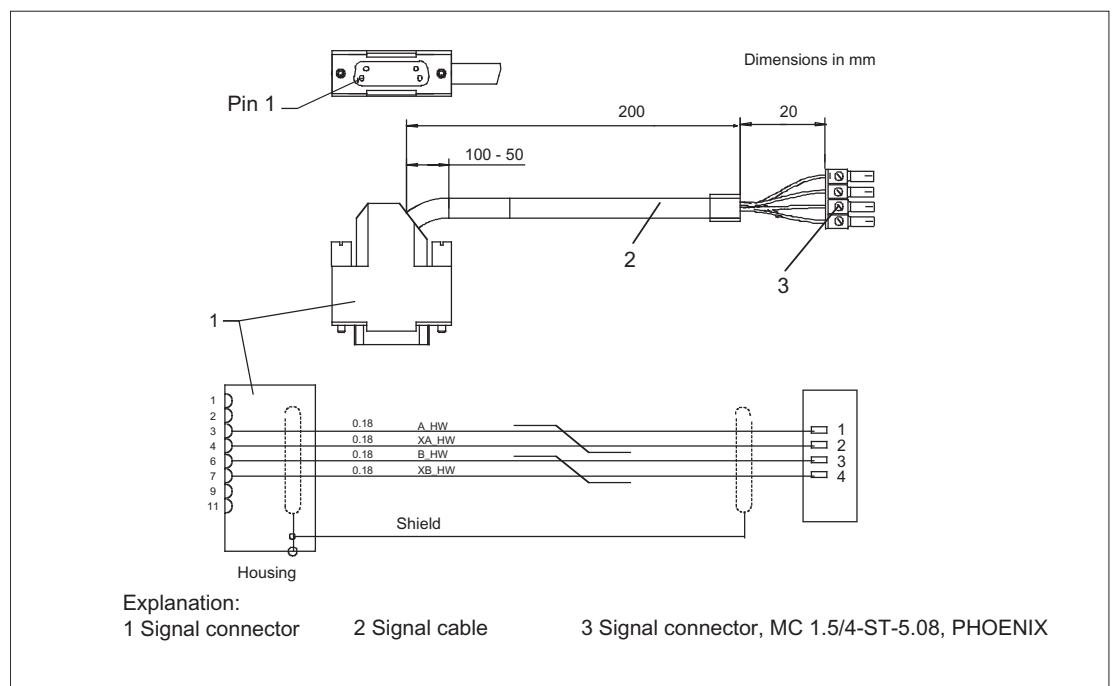

Figure 9-37 Connection cable for HHU handwheel

9.11.4 Display elements and operator controls

You can retrofit the following control elements:

Function	Upper section actuator / accessories	Lower section contact block/signaling light	Mounting location	Application
Signaling light	Illuminated nipple 28 mm Ø RXJN-GB (yellow) RXJN-GN (green) RXJN-RT (red) RXJN-BL (blue) RXJN-KL (crystal clear) RXJN-WS (white)	AL5 lamp socket with spot LED	S1 ... S4 S7 ... S10	Light
Button	Pushbutton 28 mm Ø RXJN-GB (yellow) RXJN-GN (green) RXJN-RT (red) RXJN-BL (blue) RXJN-KL (crystal clear) RXJN-GWS (black)	Button contact maker AT2	S1 ... S4 S7 ... S10	For S1, 1 NC internal, 2 NO + 1 NC external For S2 ... S4, S7 ... S10, 1 NC internal, 1 NO + 1 NC external
Illuminated key with socket for T5.5K	Pushbutton 28 mm Ø RXJN-GB (yellow) RXJN-GN (green) RXJN-RT (red) RXJN-BL (blue) RXJN-KL (crystal clear)	Illuminated button contact maker ATL2 with spot LED	S1 ... S4 S7 ... S10	For S1, 1 NC internal, 2 NO + 1 NC external For S2 ... S4, S7 ... S10, 1 NC internal, 1 NO + 1 NC external
Spot LED		L5.5K28UW (white)	S1 ... S4 S7 ... S10	
Key-operated switch *) switching angle of 90°, 2 positions	Safety lock cylinder 28 mm Ø RXJSSA 15 E key can be removed when in both positions	Button contact maker AT2	S1 ... S4 S7 ... S10	For S1, 1 NC internal, 2 NO + 1 NC external For S2 ... S4, S7 ... S10, 1 NC internal, 1 NO + 1 NC external
Keys / position selector	RX-JEWEL 22.3 mm Schlegel catalog	Button contact maker AT2	S1 ... S4 S7 ... S10	
Raised keys 6FC5247-0AA41-0 AA0	2 RTAO pushbuttons with plunger elongation	2 AT2 special version	S1 ... S4 S7 ... S10	

*) Safety-related

Note

When assigning the colors for keys and signaling lights to the corresponding functionality, observe the standard EN 60204 Part1 or VDE 0113 Part1, Chapter "Pushbuttons/Colors."

Name	Description	Number	Order number	Mounting location
Dummy plug	BVR22	1		S1 ... S4 S7 ... S10
Selector switch	Toggle FS1 Conversion to toggle switch	1		WS1
Override spindle / rapid traverse	Electronic rotary switch 1x16G, T=24, cap, button, pointer, spindle dials and rapid traverse	1	6FC5247-0AF12-1AA0	WS3
Override feed / rapid traverse	Electronic rotary switch 1x23G, T=32, cap, button, pointer, feed dials and rapid traverse	1	6FC5247-0AF13-1AA0	WS2
Override feed / rapid traverse ¹⁾	Electronic rotary switch 1x29G, T=32, cap, button, pointer, feed dials and rapid traverse	1	6FC5247-0AF14-1AA0	WS5
EMERGENCY STOP	22 mm actuating element, 40 mm mushroom pushbutton, snap action with tamper protection, latching, red, with holder, unlit	1	3SB3000-1HA20 *)	S13
	Contact block, 2 NC, Extension NC, emergency stop	1	3SB3400-0E *)	S13
	Protective collar for front panel mounting, protection against accidental actuation	1	3SB3921-0AK	S13
Control and signaling devices	All elements marked with LE		3SB3 following selection from Low-Voltage Controls and Distribution Catalog (LV 1)	S51 ... S62 S14, S15
EKS Euchner identification system	Serial interface		EKS-A-ISX-G01-ST09/03	S14
	PROFIBUS DP interface		EKS-A-IDX-G01-ST09/03	
¹⁾ only for option				

*) Safety-related

9.12 Service information

Changing the lamps on illuminated keys

1. Use a screwdriver to pull the key cap forward and off.
2. Use lamp remover LZ6 to lever out the key carrier.
3. Change the lamp using service tool LZ6 or a suitable insulating tube
4. Reinstall the key carrier and key cap in reverse order.

Lamp remover LZ6 is not a SIEMENS product. It can be obtained from the Schlegel company.

Georg Schlegel GmbH & Co. KG

Am Kapellenweg
88525 Dürmentingen
Germany

Phone.: 0 73 71 / 502-0
Fax: 0 73 71 / 502 49
E-mail: info@schlegel.biz

Changing the lamps on pilot lamps

1. Use a screwdriver to pull the calotte and name bearing element forward and off.
2. Change the lamp using the lamp remover of service tool LZ6 or a suitable insulating tube
3. Reinstall the calotte and name bearing element.

Note

When using LEDs, make sure that they are connected with the correct polarity (see Fig.: "Mounting position of LEDs" in Section: "Mounting")

Mounting additional control elements

1. If necessary, unscrew the blank plug.
2. Place the contact maker on the socket and insert the lamp if required.
3. Insert pushbutton through front panel and screw on cap nut (by several turns).
4. Press pushbutton on contact maker. Note the position of the twist protection device!
5. Screw down cap nut (tightening torque 0.8 Nm).

Insert slide-in labels

1. Create the slide-in label (see Section: "Accessories and spare parts" → "Labeling the slide-in labels").
2. Pull protective films off slide-in slot.
3. Guide in the slide-in labels (labeling facing operator side).
4. Align text in window.

Note

Slide in the labels when the MPP is not yet installed.

Changing a contact maker

1. Loosen cap nut off pushbutton until just in front of contact maker.
2. Pull the pushbutton and the contact maker approximately 3 mm out of the fixture (the locating pin of the pushbutton must be freed).
3. Remove the LED.

4. Change the contact element, remove defective contact maker from fixture and press new contact maker onto fixture.
5. Insert pushbutton into aperture and partially screw on cap nut.
6. Press pushbutton on contact maker until it snaps in. Note the position of the snap nose!
7. Screw down cap nut (tightening torque 0.8 Nm).

MCP Interface PN

10.1 Description

The MCP Interface PN module enables customer-specific machine control panels to be connected to a machine tool. Communication is handled via PROFINET RT or Industrial Ethernet.

You can connect the following operator controls to the interface:

- 80 single keys
- 64 LEDs
- 2 handwheels
- 2 rotary override switches

The following inputs/outputs are also available:

- 9 digital inputs (5 V)
- 6 digital inputs (24 V)
- 15 digital inputs (24 V / each 0.15 A)

Validity

The following description applies to the MCP Interface PN.
Order number: 6FC5303-0AF03-0AA0

System configuration

The following representation shows a system configuration with PROFINET. If you configure your system with Ethernet, please use the X120 connection on the NCU.

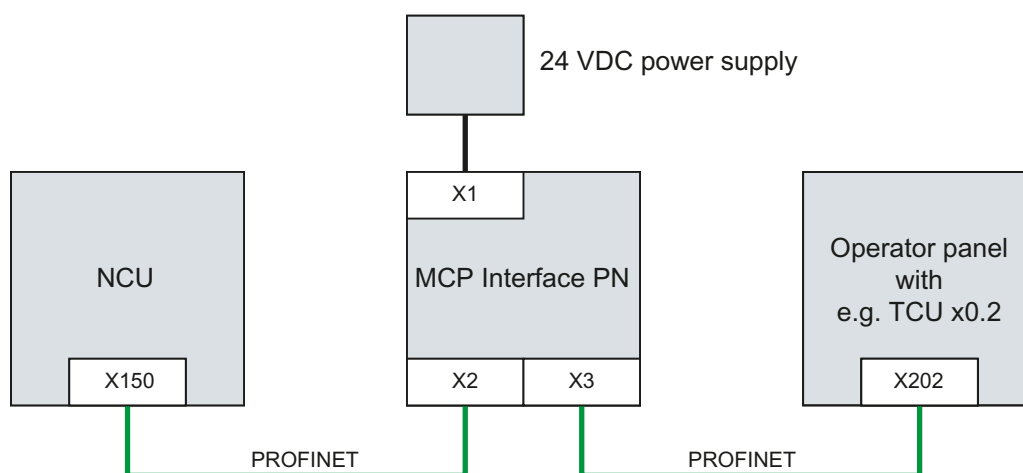

10.1 Description

Graphic

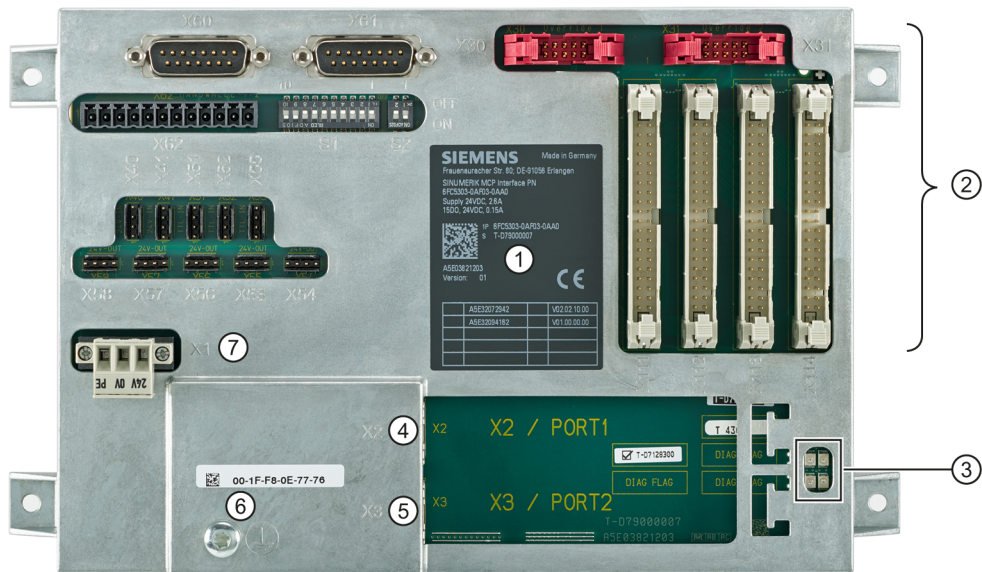

- ① Type plate
- ② Terminal strips / connectors for operator controls
- ③ Diagnostic LEDs
- ④ PROFINET interface X2 (Industrial Ethernet 10/100 Mbit/s)
- ⑤ PROFINET interface X3 (Industrial Ethernet 10/100 Mbit/s)
- ⑥ Grounding screw M5 for potential equalization connection
- ⑦ 24 VDC power supply X1

Figure 10-1 View of MCP Interface PN

LED displays

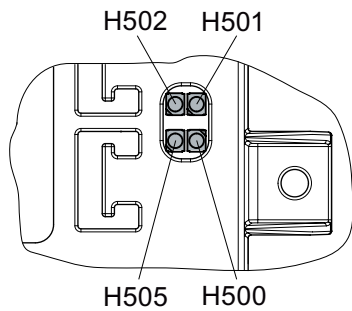

Name	Function	State	Meaning
H500	POWER OK (green)	Lights up	All internal voltages are in the setpoint range.
		Does not light up	At least one of the generated voltages has exceeded its setpoint; a reset will be initiated.

Name	Function	State	Meaning
H501	BUS_SYNC	Does not light up	No PROFINET communication.
		Lights up	PROFINET is synchronized (STOP state).
		Flashes (0.5 Hz)	PROFINET is synchronized (RUN state).
H502	BUS_FAULT	Lights up	PROFINET group fault.
H505	Temperature alarm (red)	Lights up	The upper limit temperature (T_Critical) of temperature sensor LM77 has been exceeded.

10.2 Interfaces

10.2.1 Overview

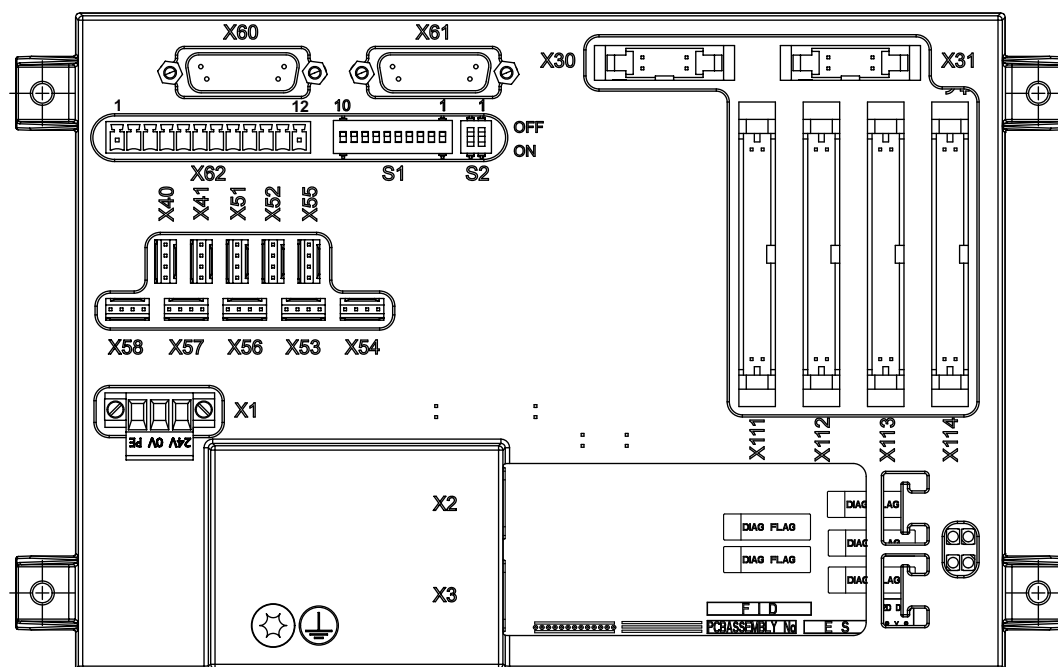

Figure 10-2 MCP Interface PN interfaces

Function	Designation
24 VDC power supply	X1
PROFINET interface	X2
PROFINET interface	X3
Feed rotary override switch	X30
Spindle override rotary switch	X31
Digital inputs (24 V)	X40, X41

Function	Designation
Digital inputs (TTL)	X51, X52, X55
Digital outputs (24 V)	X53, X54, X56, X57, X58
Handwheels	X60, X61, X62
Keys and LED interface	X111, X112, X113, X114
DIP switch for setting the MCP address	S1
DIP switch for setting the handwheel signal type	S2

10.2.2 Terminals

Pin assignment

In principle you will find the pin assignments of the individual interfaces in "General information and networking", Section "Connecting", except for: The interfaces for digital inputs/outputs and the handwheel terminal strip X62.

Digital inputs X40, X41

A total of six 24 V signals can be evaluated via the X40 and X41 connectors.

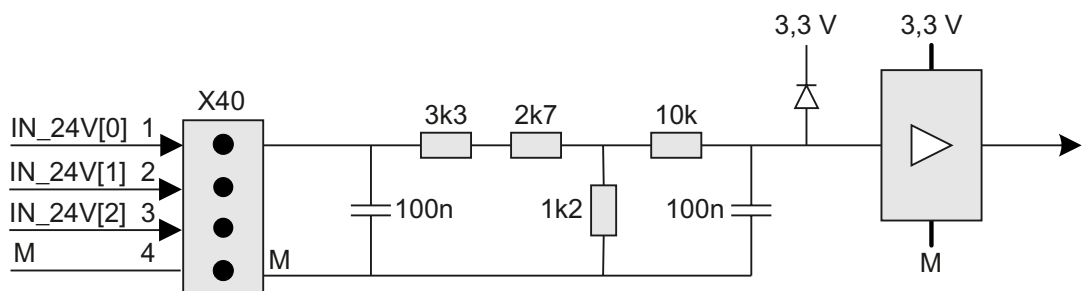

Figure 10-3 Schematic circuit diagram for X40

Connector designation: **X40, X41**
 Connector type: 4-pin plug connector
 Special features: No galvanic isolation, short-circuit proof
 Max. cable length: 0.6 m

Table 10-1 Assignment of connector X40

Pin	Name	Type	Meaning
1	IN_24V[0]	I	24 V input 0
2	IN_24V[1]		24 V input 1
3	IN_24V[2]		24 V input 2
4	M	V	Ground

Table 10-2 Assignment of connector X41

Pin	Name	Type	Meaning
1	IN_24V[3]	I	24 V input 3
2	IN_24V[4]		24 V input 4
3	IN_24V[5]		24 V input 5
4	M	V	Ground

Table 10-3 Technical data for X40 and X41

Parameters	Value
Voltage:	-3 V to 30 V
Typical current consumption:	6 mA at 24 VDC
Signal level (including ripple):	High signal level: 15 V to 30 V
	Low_Level: -3 V to 5 V

Digital inputs X51, X52, X55

Only switches (passive inputs) may be connected via the X51, X52 and X55 connectors. Typically, illuminated pushbuttons are connected here. The lamps in the pushbuttons are activated via X53, X54, X56, X57 and X58.

Note

Connection miniature handheld unit

Alternatively, at the inputs X51, X52 and X55, one miniature handheld unit may be operated. For details, please refer to the corresponding section.

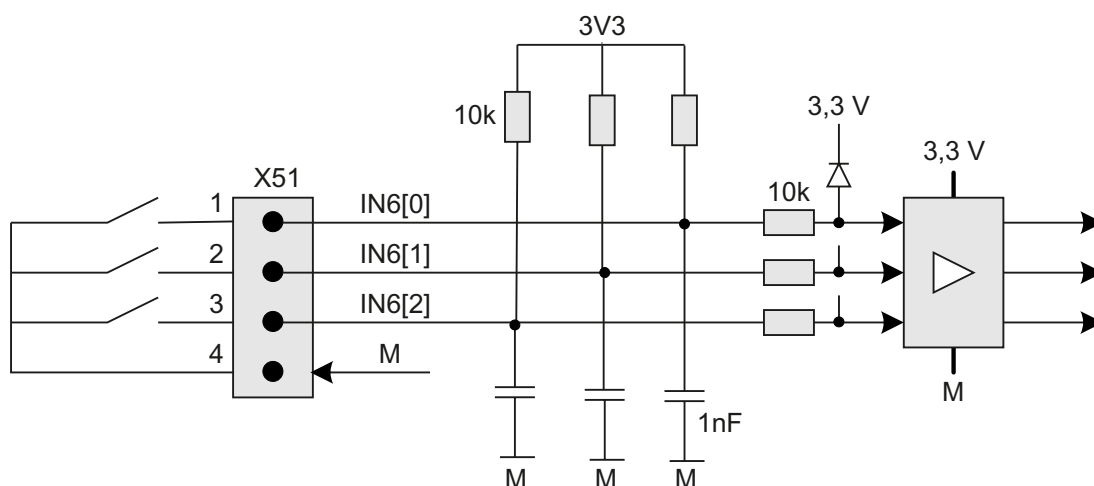

Figure 10-4 Schematic circuit diagram for X51

Connector designation: **X51, X52, X55**
 Connector type: 4-pin plug connector

Special feature: No galvanic isolation
 Max. cable length: 0.6 m

Table 10-4 Assignment of connector X51

Pin	Name	Type	Meaning
1	IN6[0]	I	Customer key 0
2	IN6[1]		Customer key 1
3	IN6[2]		Customer key 2
4	M	V	Ground

Table 10-5 Assignment of connector X52

Pin	Name	Type	Meaning
1	IN6[3]	I	Customer key 3
2	IN6[4]		Customer key 4
3	IN6[5]		Customer key 5
4	M	V	Ground

Table 10-6 Assignment of connector X55

Pin	Name	Type	Meaning
1	IN6[6]	I	Customer key 6
2	IN6[7]		Customer key 7
3	IN6[8]		Customer key 8
4	M	V	Ground

Table 10-7 Technical data for X51, X52 and X55

Parameters	Value
Voltage:	Nominal: 0 V to 5 V
	Permissible: -3 V to 30 V
Typical current consumption:	0.2 mA at 5 VDC
	-0.3 mA at 0 VDC
Signal level (including ripple):	High signal level: 2.3 V to 5 V
	Low signal level: 0 V to 1 V

Digital outputs X53, X54, X56, X57, X58

The fifteen outputs are provided to control lamps in the illuminated pushbuttons. Recommended are lamps with 1.2 W (50 mA). Only "small" relays, valves, etc. can be connected.

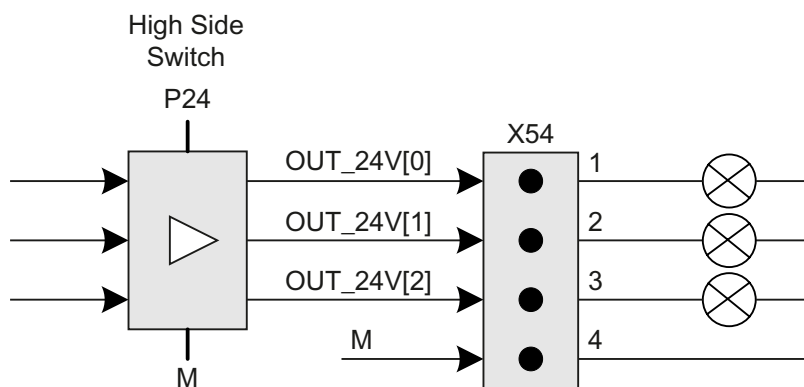

Figure 10-5 Schematic circuit diagram for X54

Note

Observe the utilization of the power supply

The fifteen 24 V outputs are divided into two groups with eight or seven outputs.

- Group 1 covers the output signals OUT_24V[0 ... 7]
- Group 2 covers the output signals OUT_24V[8 ... 14]

Each group may load the 24 V power supply with max. 1.2 A.

Connector designation:	X53, X54, X56, X57, X58
Connector type:	4-pin plug connector
Special features:	No galvanic isolation, short-circuit proof
Max. cable length:	0.6 m

Table 10-8 Assignment of connector X54

Pin	Name	Type	Meaning
1	OUT_24V[0]	O	24 V output 0 (group 1)
2	OUT_24V[1]		24 V output 1 (group 1)
3	OUT_24V[2]		24 V output 2 (group 1)
4	M	V	Ground

Table 10-9 Assignment of connector X53

Pin	Name	Type	Meaning
1	OUT_24V[3]	O	24 V output 3 (group 1)
2	OUT_24V[4]		24 V output 4 (group 1)

Pin	Name	Type	Meaning
3	OUT_24V[5]		24 V output 5 (group 1)
4	M	V	Ground

Table 10-10 Assignment of connector X56

Pin	Name	Type	Meaning
1	OUT_24V[6]	O	24 V output 6 (group 1)
2	OUT_24V[7]		24 V output 7 (group 1)
3	OUT_24V[8]		24 V output 8 (group 2)
4	M	V	Ground

Table 10-11 Assignment of connector X57

Pin	Name	Type	Meaning
1	OUT_24V[9]	O	24 V output 9 (group 2)
2	OUT_24V[10]		24 V output 10 (group 2)
3	OUT_24V[11]		24 V output 11 (group 2)
4	M	V	Ground

Table 10-12 Assignment of connector X58

Pin	Name	Type	Meaning
1	OUT_24V[12]	O	24 V output 12 (group 2)
2	OUT_24V[13]		24 V output 13 (group 2)
3	OUT_24V[14]		24 V output 14 (group 2)
4	M	V	Ground

Table 10-13 Technical data for X53, X54, X56, X57 and X58

Parameters	Value
Voltage:	Nominal: 24 V
	Permissible: 18 V to 30 V
Max. load current:	Per output: 0.7 A
	Per connector: 1 A
	Per output at 100% simultaneity of all fifteen outputs: 0.15 A
UL certified rating	Each output: 24 V / 0.15 A general, resistive 24 V / 3.6 W tungsten 24 V / 0.15 A pilot duty

X62 handwheels

Up to two handwheels can be connected via the X62. This means, purely on the basis of calculations, together with X60 and X61, four handwheels can be inserted. However, only a total of two handwheels can be operated concurrently because the signals from X60 and X61 are routed parallel to X62.

Switching between TTL and differential signals: See switch S2.

Note

The handwheels are supplied by the MCP Interface PN module with 5 V / 100 mA. An external power supply is not permitted.

Connector designation: **X62**
 Connector type: 12-pin plug connector
 Special features: No galvanic isolation
 Max. cable length: 5 m

Table 10-14 Assignment of connector X62

Pin	Name	Type	Meaning
1	P5HW	V	5 V power supply
2	M	V	Ground
3	HW1_A	I	Handwheel 1 pulses track A
4	HW1_XA	I	Handwheel 1 pulses track A (negated)
5	HW1_B	I	Handwheel 1 pulses track B
6	HW1_XB	I	Handwheel 1 pulses track B (negated)
7	P5HW	V	5 V power supply
8	M	V	Ground
9	HW2_A	I	Handwheel 2 pulses track A
10	HW2_XA	I	Handwheel 2 pulses track A (negated)
11	HW2_B	I	Handwheel 2 pulses track B
12	HW2_XB	I	Handwheel 2 pulses track B (negated)

Digital inputs and outputs X111, X112, X113, X114

You can connect up to 80 keys and 64 LEDs. The connectors are connected to the machine control panel with ribbon cables.

- Inputs:
 - All keys signal "high" in the idle state (= open). When actuated, the state changes to "low". Short-stroke keyboards and membrane keyboards can be connected. 5 V signals can also be applied to the inputs. They are TTL-compatible, but not 24 V-tolerant.
- Outputs:
 - Instead of a LED, an external logic with TTL-compatible inputs can also be connected. Because the P5 (=5 V) routed externally are not short-circuit proof, they may be loaded in total (X111 to X114) with maximum 500 mA.
 - Because of the series resistor, the outputs are short-circuit proof but not protected against external overvoltage.

NOTICE

The provision of an external voltage can destroy the module.

No voltage may be supplied at the P5 connections.

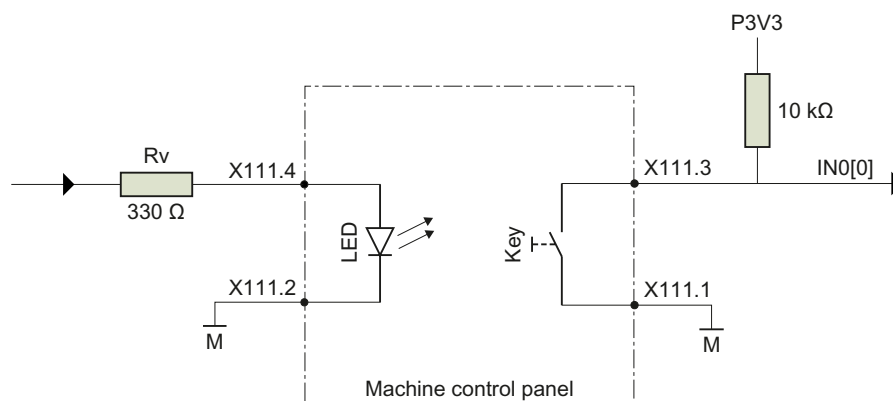

Figure 10-6 X111 schematic circuit diagram

Note

LED brightness

The setting of the LED brightness can be implemented by an additional external resistor connected in series. Alternatively, the LEDs can also be operated with polarity reversal at P5, in which case the LEDs illuminate for low signal level.

Connector designation:	X111, X112, X113, X114
Connector type:	40-pin plug connector
Special features:	No galvanic isolation, with interlock
Max. cable length:	2 m

Note**Allocation of the inputs/outputs**

- The inputs INi[j] are allocated into five groups (i=0..4) each of 16 inputs (j=0..15).
- The outputs OUTi[j] are allocated into four groups (i=0..3) each of 16 inputs (j=0..15).

Example: IN0[0] = input 0 of group 0

Table 10-15 Assignment of connector X111

Pin	Name	Type	Pin	Name	Type
1	Ground	V	2	Ground	V
3	IN0[0]	I	4	OUT0[0]	O
5	IN0[1]		6	OUT0[1]	
7	IN0[2]		8	OUT0[2]	
9	IN0[3]		10	OUT0[3]	
11	IN0[4]		12	OUT0[4]	
13	IN0[5]		14	OUT0[5]	
15	IN0[6]		16	OUT0[6]	
17	IN0[7]		18	OUT0[7]	
19	IN0[8]		20	OUT0[8]	
21	IN0[9]		22	OUT0[9]	
23	IN0[10]		24	OUT0[10]	
25	IN0[11]		26	OUT0[11]	
27	IN0[12]		28	OUT0[12]	
29	IN0[13]		30	OUT0[13]	
31	IN0[14]		32	OUT0[14]	
33	IN0[15]	34	OUT0[15]		
35	IN4[0]	36	IN4[1]	I	
37	IN4[2]	38	IN4[3]	I	
39	P5 = 5 V	V	40	P5 = 5 V	V

Table 10-16 Assignment of connector X112

Pin	Name	Type	Pin	Name	Type
1	Ground	V	2	Ground	V
3	IN1[0]	I	4	OUT1[0]	O
5	IN1[1]		6	OUT1[1]	
7	IN1[2]		8	OUT1[2]	
9	IN1[3]		10	OUT1[3]	
11	IN1[4]		12	OUT1[4]	
13	IN1[5]		14	OUT1[5]	
15	IN1[6]		16	OUT1[6]	
17	IN1[7]		18	OUT1[7]	

Pin	Name	Type	Pin	Name	Type		
19	IN1[8]		20	OUT1[8]			
21	IN1[9]		22	OUT1[9]			
23	IN1[10]		24	OUT1[10]			
25	IN1[11]		26	OUT1[11]			
27	IN1[12]		28	OUT1[12]			
29	IN1[13]		30	OUT1[13]			
31	IN1[14]		32	OUT1[14]			
33	IN1[15]		34	OUT1[15]			
35	IN4[4]		36	IN4[5]		I	
37	IN4[6]		38	IN4[7]		I	
39	P5 = 5 V		V	40		P5 = 5 V	V

Table 10-17 Assignment of connector X113

Pin	Name	Type	Pin	Name	Type
1	Ground	V	2	Ground	V
3	IN2[0]	I	4	OUT2[0]	O
5	IN2[1]		6	OUT2[1]	
7	IN2[2]		8	OUT2[2]	
9	IN2[3]		10	OUT2[3]	
11	IN2[4]		12	OUT2[4]	
13	IN2[5]		14	OUT2[5]	
15	IN2[6]		16	OUT2[6]	
17	IN2[7]		18	OUT2[7]	
19	IN2[8]		20	OUT2[8]	
21	IN2[9]		22	OUT2[9]	
23	IN2[10]		24	OUT2[10]	
25	IN2[11]		26	OUT2[11]	
27	IN2[12]		28	OUT2[12]	
29	IN2[13]		30	OUT2[13]	
31	IN2[14]	32	OUT2[14]		
33	IN2[15]	34	OUT2[15]		
35	IN4[8]	36	IN4[9]	I	
37	IN4[10]	38	IN4[11]	I	
39	P5 = 5 V	V	40	P5 = 5 V	V

Table 10-18 Assignment of connector X114

Pin	Name	Type	Pin	Name	Type
1	Ground	V	2	Ground	V
3	IN3[0]	I	4	OUT3[0]	O
5	IN3[1]		6	OUT3[1]	
7	IN3[2]		8	OUT3[2]	
9	IN3[3]		10	OUT3[3]	

Pin	Name	Type	Pin	Name	Type	
11	IN3[4]		12	OUT3[4]		
13	IN3[5]		14	OUT3[5]		
15	IN3[6]		16	OUT3[6]		
17	IN3[7]		18	OUT3[7]		
19	IN3[8]		20	OUT3[8]		
21	IN3[9]		22	OUT3[9]		
23	IN3[10]		24	OUT3[10]		
25	IN3[11]		26	OUT3[11]		
27	IN3[12]		28	OUT3[12]		
29	IN3[13]		30	OUT3[13]		
31	IN3[14]		32	OUT3[14]		
33	IN3[15]		34	OUT3[15]		
35	IN4[12]		36	IN4[13]		I
37	IN4[14]		38	IN4[15]		I
39	P5 = 5 V		V	40		P5 = 5 V

Table 10-19 Technical data of the inputs of X111 to X114

Parameters	Value
Voltage:	0 V to 5 V
Typical current consumption:	0.2 mA at 5 VDC
	-0.3 mA at 0 VDC
Signal level (including ripple):	High signal level: 2.3 V to 5 V
	Low signal level: 0 V to 1 V

Table 10-20 Technical data of the outputs of X111 to X114

Parameters	Value
Voltage:	0 V to 5 V (depending on the load)
Typical load current (without external series resistor):	8 mA at LED flow voltage = 2.3 V
	15 mA at short-circuit

10.2.3 Switch

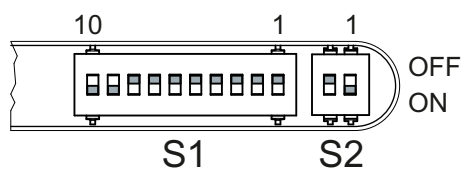

Figure 10-7 DIP switches S1, S2 in the delivered condition

The switches have the following meaning in the delivered condition:

- S1 is in PROFINET mode with default device name "mcp-pn".
- S2 is in the "differential interface connection" handwheel signal type position.

Switch S1 in PROFINET mode

Table 10-21 General switch S1 setting

1-8	9	10	Meaning
off	on	on	PROFINET device name: mcp-pn

The two switches S1-9 and S1-10 must remain set to "on" in order for PN functionality to be supported.

The switches S1-1 to S1-8 define the default device name. Up to 128 default device names are permitted: If these default device names are used, there is no need for initialization of the MCP.

Note

The default device names cannot be reconfigured using the STEP7 "device initialization" facility for example.

If you are connecting the MCP Interface PN to a SINUMERIK control as a PROFINET component, make sure that this functionality is supported by the control concerned.

DCP mode:

No default device name is available in this mode. The device name must be set by means of an initialization procedure and remains saved on the interface. It is deleted again if the factory setting is restored, e.g. using STEP7.

Table 10-22 Switch S1 settings in PROFINET mode

1	2	3	4	5	6	7	8	9	10	Meaning
								on	on	
on	on	on	on	on	on	on	on			DCP mode
on	on	on	on	on	on	on	off			Default device name: mcp-pn127
off	on	on	on	on	on	on	off			Default device name: mcp-pn126
on	off	on	on	on	on	on	off			Default device name: mcp-pn125
off	off	on	on	on	on	on	off			Default device name: mcp-pn124
on	on	off	on	on	on	on	off			Default device name: mcp-pn123
off	on	off	on	on	on	on	off			Default device name: mcp-pn122
on	off	off	on	on	on	on	off			Default device name: mcp-pn121
off	off	off	on	on	on	on	off			Default device name: mcp-pn120
on	on	on	off	on	on	on	off			Default device name: mcp-pn119
off	on	on	off	on	on	on	off			Default device name: mcp-pn118
on	off	on	off	on	on	on	off			Default device name: mcp-pn117
off	off	on	off	on	on	on	off			Default device name: mcp-pn116

1	2	3	4	5	6	7	8	9	10	Meaning
on	on	off	off	on	on	on	off			Default device name: mcp-pn115
off	on	off	off	on	on	on	off			Default device name: mcp-pn114
on	off	off	off	on	on	on	off			Default device name: mcp-pn113
off	off	off	off	on	on	on	off			Default device name: mcp-pn112
x	x	x	x	x	x	x	x			"
on	on	on	on	off	off	off	off			Default device name: mcp-pn15
off	on	on	on	off	off	off	off			Default device name: mcp-pn14
on	off	on	on	off	off	off	off			Default device name: mcp-pn13
off	off	on	on	off	off	off	off			Default device name: mcp-pn12
on	on	off	on	off	off	off	off			Default device name: mcp-pn11
off	on	off	on	off	off	off	off			Default device name: mcp-pn10
on	off	off	on	off	off	off	off			Default device name: mcp-pn9
off	off	off	on	off	off	off	off			Default device name: mcp-pn8
on	on	on	off	off	off	off	off			Default device name: mcp-pn7
off	on	on	off	off	off	off	off			Default device name: mcp-pn6
on	off	on	off	off	off	off	off			Default device name: mcp-pn5
off	off	on	off	off	off	off	off			Default device name: mcp-pn4
on	on	off	off	off	off	off	off			Default device name: mcp-pn3
off	on	off	off	off	off	off	off			Default device name: mcp-pn2
on	off	off	off	off	off	off	off			Default device name: mcp-pn1
off	off	off	off	off	off	off	off			Default device name: mcp-pn

Switch S1 in Ethernet mode

A logical address can be assigned to the MCP for communication via Ethernet using the 10-bit switch S1.

Table 10-23 Example for setting switch S1

1	2	3	4	5	6	7	8	9	10	Meaning
off	off	off	off	off	off	on	on	off	off	MCP address 192

The two switches S1-9 and S1-10 must be set to "off" (IE functionality).

The switches S1-1 to S1-8 define the MCP address in the range of 0 to 255.

The addresses from 192 to 223 count as the default range.

The MCP address is used as a reference for addressing an MCP during PLC parameter assignment.

Table 10-24 Switch S1 settings in Ethernet mode

1	2	3	4	5	6	7	8	9	10	Meaning
								off	off	
on	on	on	on	on	on	on	on			MCP address 255

10.2 Interfaces

1	2	3	4	5	6	7	8	9	10	Meaning
x	x	x	x	x	x	x	x			"
on	on	on	on	on	off	on	on			MCP address 223
off	on	on	on	on	off	on	on			MCP address 222
on	off	on	on	on	off	on	on			MCP address 221
off	off	on	on	on	off	on	on			MCP address 220
on	on	off	on	on	off	on	on			MCP address 219
off	on	off	on	on	off	on	on			MCP address 218
on	off	off	on	on	off	on	on			MCP address 217
off	off	off	on	on	off	on	on			MCP address 216
on	on	on	off	on	off	on	on			MCP address 215
off	on	on	off	on	off	on	on			MCP address 214
on	off	on	off	on	off	on	on			MCP address 213
off	off	on	off	on	off	on	on			MCP address 212
on	on	off	off	on	off	on	on			MCP address 211
off	on	off	off	on	off	on	on			MCP address 210
on	off	off	off	on	off	on	on			MCP address 209
off	off	off	off	on	off	on	on			MCP address 208
on	on	on	on	off	off	on	on			MCP address 207
off	on	on	on	off	off	on	on			MCP address 206
on	off	on	on	off	off	on	on			MCP address 205
off	off	on	on	off	off	on	on			MCP address 204
on	on	off	on	off	off	on	on			MCP address 203
off	on	off	on	off	off	on	on			MCP address 202
on	off	off	on	off	off	on	on			MCP address 201
off	off	off	on	off	off	on	on			MCP address 200
on	on	on	off	off	off	on	on			MCP address 199
off	on	on	off	off	off	on	on			MCP address 198
on	off	on	off	off	off	on	on			MCP address 197
off	off	on	off	off	off	on	on			MCP address 196
on	on	off	off	off	off	on	on			MCP address 195
off	on	off	off	off	off	on	on			MCP address 194
on	off	off	off	off	off	on	on			MCP address 193
off	off	off	off	off	off	on	on			MCP address 192
x	x	x	x	x	x	x	x			"
on	off	off	off	off	off	off	off			MCP address 001
off	off	off	off	off	off	off	off			MCP address 000

You can find the settings for the basic PLC program in:
Function Manual, Basic Functions (P3 sl)

Switch S2

The handwheel signal type is set with switch S2-1.

Table 10-25 Switch S2 settings

1	Meaning
on	differential interface
off	TTL interface

Note

Switch S2-2 is reserved for test purposes.

10.2.4 Input / output images

Standard + two handwheels

The specifications for assigning input and output bytes listed in the tables can be changed in the PLC via parameter assignment. The inputs/outputs can be accessed word-oriented.

Note

The following applies for the process input and output images in the tables: n is defined by means of FB1 parameters in OB100 of the PLC.

Table 10-26 MCP Interface PN input image

Byte	Bit7	Bit6	Bit5	Bit4	Bit3	Bit2	Bit1	Bit0
EB n + 0	IN0[7] X111.17	IN0[6] X111.15	IN0[5] X111.13	IN0[4] X111.11	IN0[3] X111.9	IN0[2] X111.7	IN0[1] X111.5	IN0[0] X111.3
EB n + 1	IN0[15] X111.33	IN0[14] X111.31	IN0[13] X111.29	IN0[12] X111.27	IN0[11] X111.25	IN0[10] X111.23	IN0[9] X111.21	IN0[8] X111.19
EB n + 2	IN1[7] X112.17	IN1[6] X112.15	IN1[5] X112.13	IN1[4] X112.11	IN1[3] X112.9	IN1[2] X112.7	IN1[1] X112.5	IN1[0] X112.3
EB n + 3	IN1[15] X112.33	IN1[14] X112.31	IN1[13] X112.29	IN1[12] X112.27	IN1[11] X112.25	IN1[10] X112.23	IN1[9] X112.21	IN1[8] X112.19
EB n + 4	IN2[7] X113.17	IN2[6] X113.15	IN2[5] X113.13	IN2[4] X113.11	IN2[3] X113.9	IN2[2] X113.7	IN2[1] X113.5	IN2[0] X113.3
EB n + 5	IN2[15] X113.33	IN2[14] X113.31	IN2[13] X113.29	IN2[12] X113.27	IN2[11] X113.25	IN2[10] X113.23	IN2[9] X113.21	IN2[8] X113.19

Byte	Bit7	Bit6	Bit5	Bit4	Bit3	Bit2	Bit1	Bit0
EB n + 6	IN3[7] X114.17	IN3[6] X114.15	IN3[5] X114.13	IN3[4] X114.11	IN3[3] X114.9	IN3[2] X114.7	IN3[1] X114.5	IN3[0] X114.3
EB n + 7	IN3[15] X114.33	IN3[14] X114.31	IN3[13] X114.29	IN3[12] X114.27	IN3[11] X114.25	IN3[10] X114.23	IN3[9] X114.21	IN3[8] X114.19
EB n + 8	IN4[7] X112.38	IN4[6] X112.37	IN4[5] X112.36	IN4[4] X112.35	IN4[3] X111.38	IN4[2] X111.37	IN4[1] X111.36	IN4[0] X111.35
EB n + 9	IN4[15] X114.38	IN4[14] X114.37	IN4[13] X114.36	IN4[12] X114.35	IN4[11] X113.38	IN4[10] X113.37	IN4[9] X113.36	IN4[8] X113.35
EB n + 10	Temperature alarms ^{*)}			OV_VS16 X30.6	OV_VS8 X30.7	OV_VS4 X30.8	OV_VS2 X30.9	OV_VS1 X30.10
	T_Critical	T_High	T_Low					
EB n + 11	-	-	-	OV_SP16 X31.6	OV_SP8 X31.7	OV_SP4 X31.8	OV_SP2 X31.9	OV_SP1 X31.10
EB n + 12	IN6[7] X55.2	IN6[6] X55.1	IN6[5] X52.3	IN6[4] X52.2	IN6[3] X52.1	IN6[2] X51.3	IN6[1] X51.2	IN6[0] X51.1
EB n + 13	IN_24V[5] X41.3	IN_24V[4] X41.2	IN_24V[3] X41.1	IN_24V[2] X40.3	IN_24V[1] X40.2	IN_24V[0] X40.1	-	IN6[8] X55.3

^{*)} A logical 1 in the appropriate bit means that the associated temperature alarm is present.

The GSDML-V2.1-siemens-sinumerik-mcpRT-20111001.xml file is required to configure the PROFINET. The module must be configured as MCP/MPP universal component on slot 1.

This expands the input image by two further bytes:

- EB n + 14: Current temperature of the module measured in degrees Celsius. The measured value of temperature sensor LM77 is represented as an integer value in 8-bit one's complement. Theoretically representable value range: -127 °C to +127 °C. Real value range of temperature sensor LM77: -55 °C to +125 °C. For examples, see table:

Temperature in °C	Representation in byte EB n + 14	^{*)}	Meaning
+0 = T_Low	00000000 = 0x00	0	Prewarning level for lower ambient temperature
+1	00000001 = 0x01	1	
...	
+70 = T_High	01000110 = 0x46	70	Prewarning level for upper ambient temperature
...	
+75 = T_Critical	01001011 = 0x4B	75	Max. permissible ambient temperature
...	
+127	01111111 = 0x7F	127	
-127	10000000 = 0x80	128	
...	
-0	11111111 = 0xFF	255	

^{*)} Interpreted as an unsigned figure

- EB n + 15: Identifier for the 'MCP Interface PN' module: 0x8D

Table 10-27 Input image for handwheel data

Byte	Bit7	Bit6	Bit5	Bit4	Bit3	Bit2	Bit1	Bit0
EB m + 0	Handwheel 1 counter status (16-bit signed, low-order byte equals byte m + 0)							
EB m + 1								
EB m + 2	Handwheel 2 counter status (16-bit signed, low-order byte equals byte m + 2)							
EB m + 3								

Note

Within the SINUMERIK control, the handwheel data is processed directly by the NCK and is not available to the PLC.

Table 10-28 MCP Interface PN output image

Byte	Bit7	Bit6	Bit5	Bit4	Bit3	Bit2	Bit1	Bit0
AB n + 0	OUT0[7] X111.18	OUT0[6] X111.16	OUT0[5] X111.14	OUT0[4] X111.12	OUT0[3] X111.10	OUT0[2] X111.8	OUT0[1] X111.6	OUT0[0] X111.4
AB n + 1	OUT0[15] X111.34	OUT0[14] X111.32	OUT0[13] X111.30	OUT0[12] X111.28	OUT0[11] X111.26	OUT0[10] X111.24	OUT0[9] X111.22	OUT0[8] X111.20
AB n + 2	OUT1[7] X112.18	OUT1[6] X112.16	OUT1[5] X112.14	OUT1[4] X112.12	OUT1[3] X112.10	OUT1[2] X112.8	OUT1[1] X112.6	OUT1[0] X112.4
AB n + 3	OUT1[15] X112.34	OUT1[14] X112.32	OUT1[13] X112.30	OUT1[12] X112.28	OUT1[11] X112.26	OUT1[10] X112.24	OUT1[9] X112.22	OUT1[8] X112.20
AB n + 4	OUT2[7] X113.18	OUT2[6] X113.16	OUT2[5] X113.14	OUT2[4] X113.12	OUT2[3] X113.10	OUT2[2] X113.8	OUT2[1] X113.6	OUT2[0] X113.4
AB n + 5	OUT2[15] X113.34	OUT2[14] X113.32	OUT2[13] X113.30	OUT2[12] X113.28	OUT2[11] X113.26	OUT2[10] X113.24	OUT2[9] X113.22	OUT2[8] X113.20
AB n + 6	OUT3[7] X114.18	OUT3[6] X114.16	OUT3[5] X114.14	OUT3[4] X114.12	OUT3[3] X114.10	OUT3[2] X114.8	OUT3[1] X114.6	OUT3[0] X114.4
AB n + 7	OUT3[15] X114.34	OUT3[14] X114.32	OUT3[13] X114.30	OUT3[12] X114.28	OUT3[11] X114.26	OUT3[10] X114.24	OUT3[9] X114.22	OUT3[8] X114.20
AB n + 8	OUT_24V [7] X56.2	OUT_24V [6] X56.1	OUT_24V [5] X53.3	OUT_24V [4] X53.2	OUT_24V [3] X53.1	OUT_24V [2] X54.3	OUT_24V [1] X54.2	OUT_24V [0] X54.1
AB n + 9	-	OUT_24V [14] X58.3	OUT_24V [13] X58.2	OUT_24V [12] X58.1	OUT_24V [11] X57.3	OUT_24V [10] X57.2	OUT_24V [9] X57.1	OUT_24V [8] X56.3

10.3 Mounting

The module can be attached at a suitable position via the four mounting holes (e.g. behind the machine control panel or in the control cabinet). The selection of the appropriate mounting position depends on the interfaces used and the associated maximum cable lengths.

Four standard torx-slotted screws T20/M4 are used to attach the module.

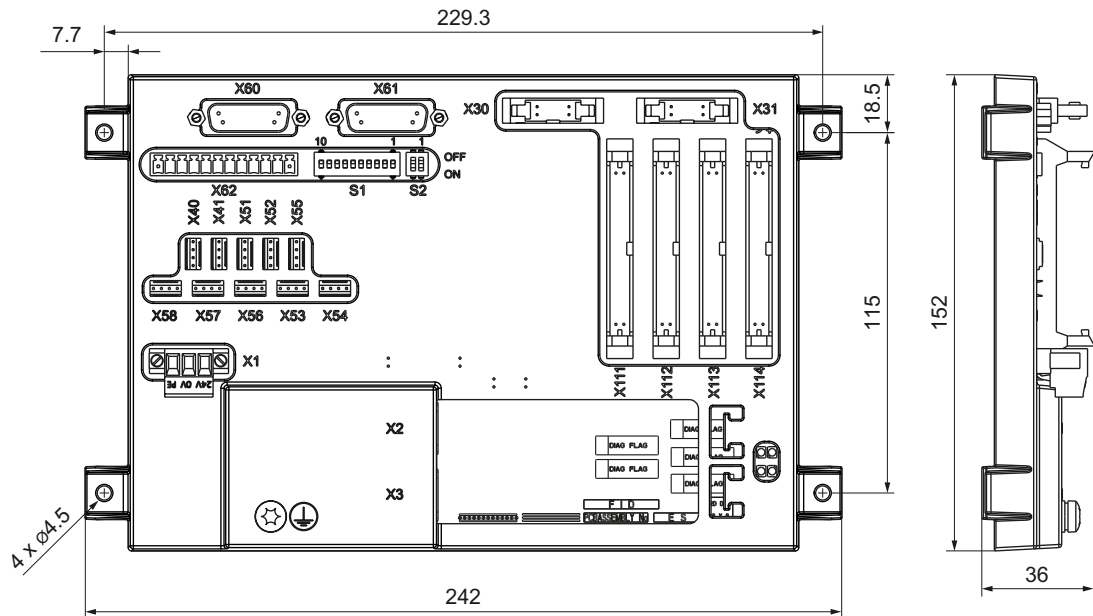

Figure 10-8 MCP Interface PN dimension drawing

10.4 Technical data

Safety					
Safety class	III according to EN60204-1				
Degree of protection according to EN 60529	IP00				
Approvals	CE / cULus				
Electrical data					
Input voltage	24 VDC				
Typical current consumption	min. 0.1 A ¹⁾ / max. 2.6 A ²⁾				
Power consumption, max.	Board: 2.4 W	Handwheels: 2 x 0.9 W	Lamps: 54 W (15 x 3.6 W)	LEDs: 4 W (80 x 0.05 W)	Total: 62.4 W
Mechanical data					
Dimensions (W x H x D)	242 x 152 x 36 mm				
Weight	557 g				

1) Without connection (no handwheels, no loading of the outputs ...)

2) Max. connection with two handwheels, two rotary override switches, loading of the 24 V outputs ...

Note

Information about the climatic and mechanical environmental conditions is contained in the associated section under:

"General notes and interconnection" → "Operational planning".

Electronic handwheels

11.1 Description

Electronic handwheels are incremental encoders whose signals correspond to rotation of the wheel actuated by hand.

They are equipped with a magnetic latching mechanism that supports traversing with incremental accuracy. The axis selected via the control can be positioned so that the axes are parallel.

All handwheels have 100 I/U lines.

The electronic handwheels are available in several variants.

They can be distinguished by the interface and size of the front panel.

The snapping torque and size of the setting wheel are adapted to the front plate.

If necessary, the front panel may have to be removed.

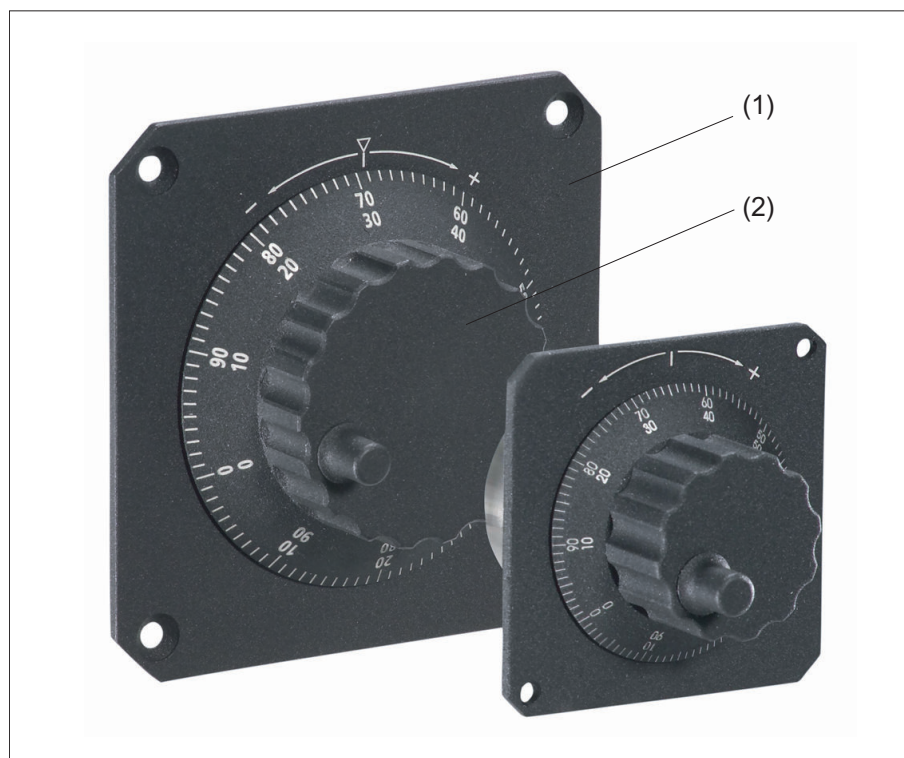

- (1) Front panel
- (2) Rotary knob

Figure 11-1 View

11.1 Description

The portable handwheel is intended for machine level usage. A magnet bracket and spiral cable can be found on its casing.

The electronic handwheel with 24V operating voltage and a HTL signal level is designed for connecting to I/O modules.

An adapter set is available for installing the handwheels with central mounting in front panels which are intended for the installation of handwheels with 3-hole mountings (see section: "Accessories").

Validity

The description applies to the following electronic handwheels:

Name	Dimensions of front panel (mm)	Interface	Order number
Encoder with setting wheel	120 x 120	DC 5V, RS 422	6FC9320-5DB01
Encoder with setting wheel	76.2 x 76.2	DC 5V, RS 422	6FC9320-5DC01
Encoder without setting wheel (for mounting)	without front panel	DC 5V, RS 422	6FC9320-5DF01
Encoder with setting wheel	76.2 x 76.2	DC 24V, HTL	6FC9320-5DH01
Encoder with setting wheel, small	without front panel	DC 5V, RS 422	6FC9320-5DM00

11.2 Dimension drawings

11.2.1 Encoder with 120 mm x 120 mm front panel, setting wheel (...-5DB01)

Front view and side view

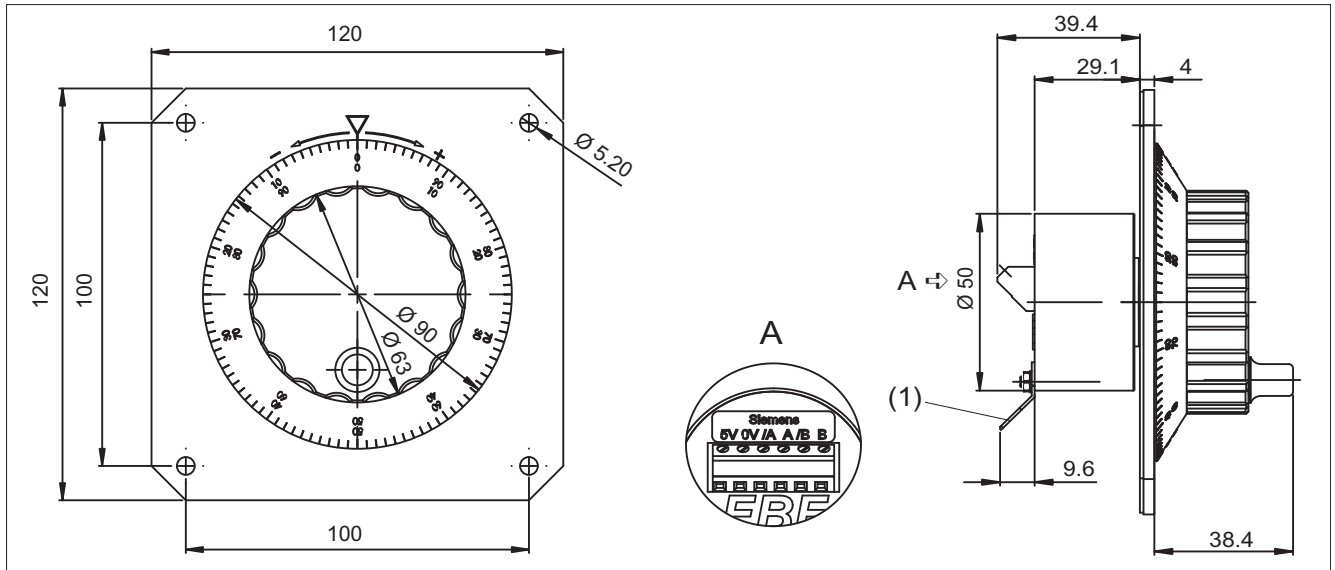

(1) Flat connector for push-on contacts 6.3 mm

Outputs

A = Antivalent
RS 422 A

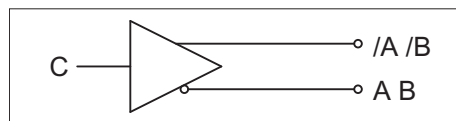

Load current ≤ 20 mA

Pulse diagram

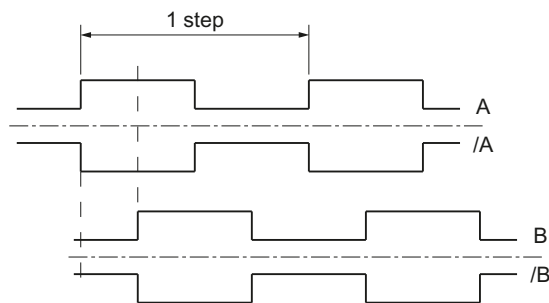

11.2.2 Encoder with front panel, 76.2 mm x 76.2 mm, setting wheel (...-5DC01)

Front view and side view

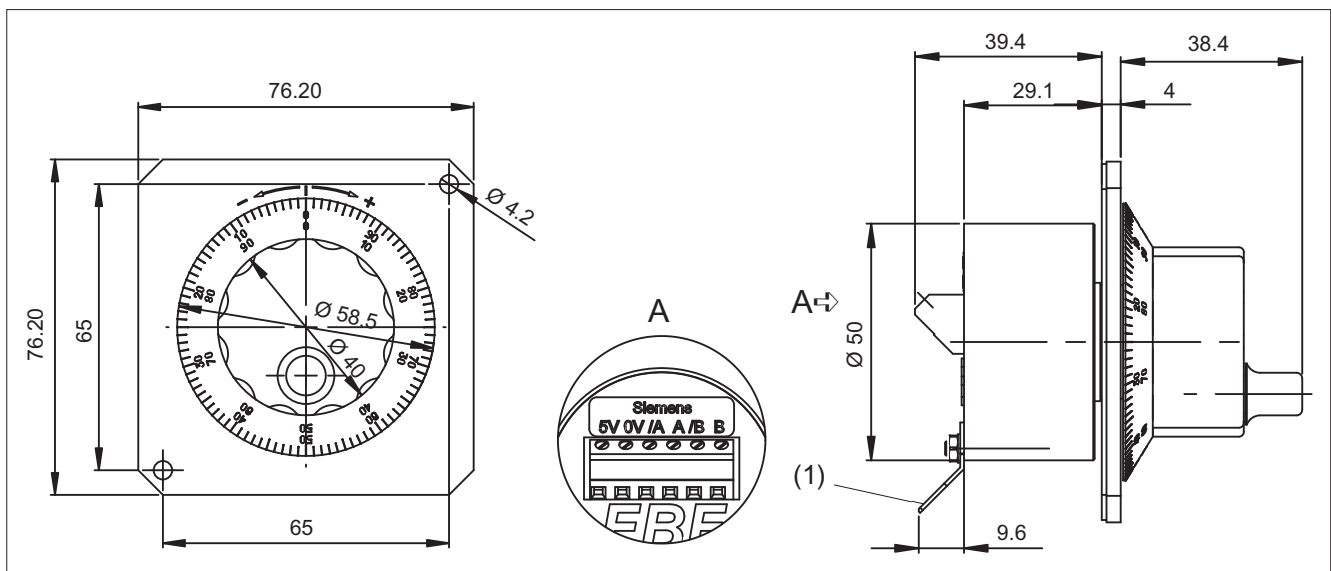

(1) Flat connector for push-on contacts 6.3 mm

Outputs

A = Antivalent
RS 422 A

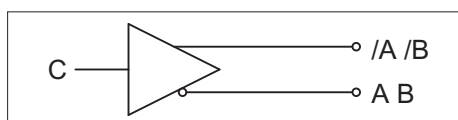

Load current ≤ 20 mA

Pulse diagram

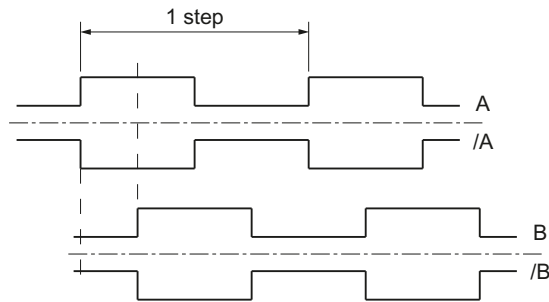

11.2.3 Encoder without front panel, without setting wheel, mounting (...-5DF01)

Front view and side view

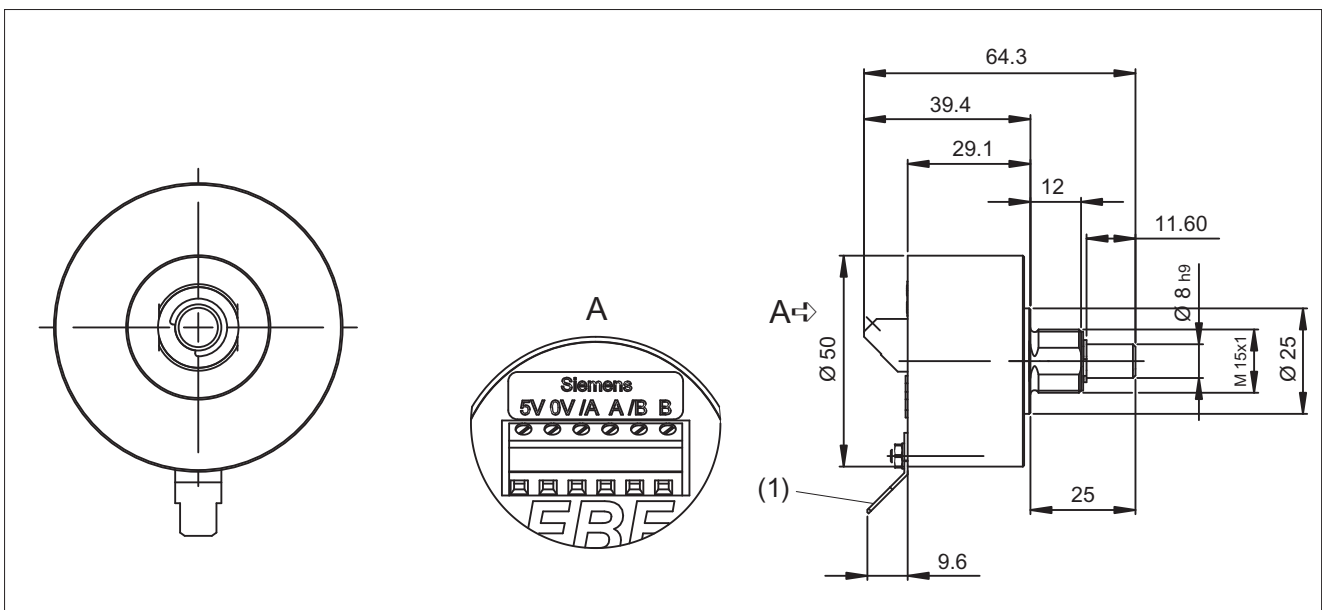

(1) Flat connector for push-on contacts 6.3 mm

Switch panel cutout for mounting version

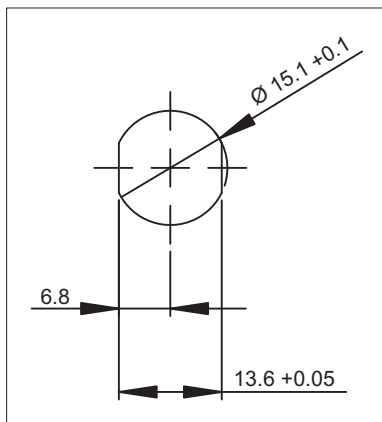

Outputs

A = Antivalent
RS 422 A

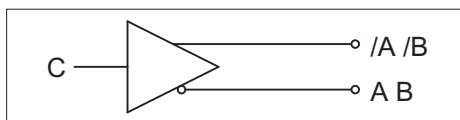

Load current ≤ 20 mA

Pulse diagram

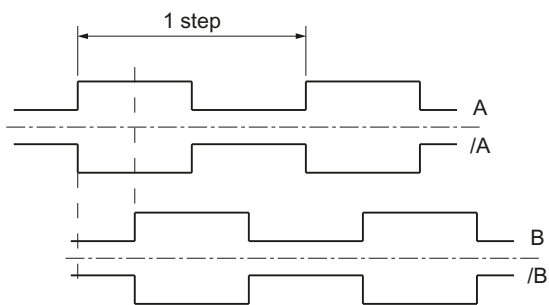

11.2.4 Encoder with front panel, 76.2 mm x 76.2 mm, setting wheel (...-5DH01)

Front view and side view

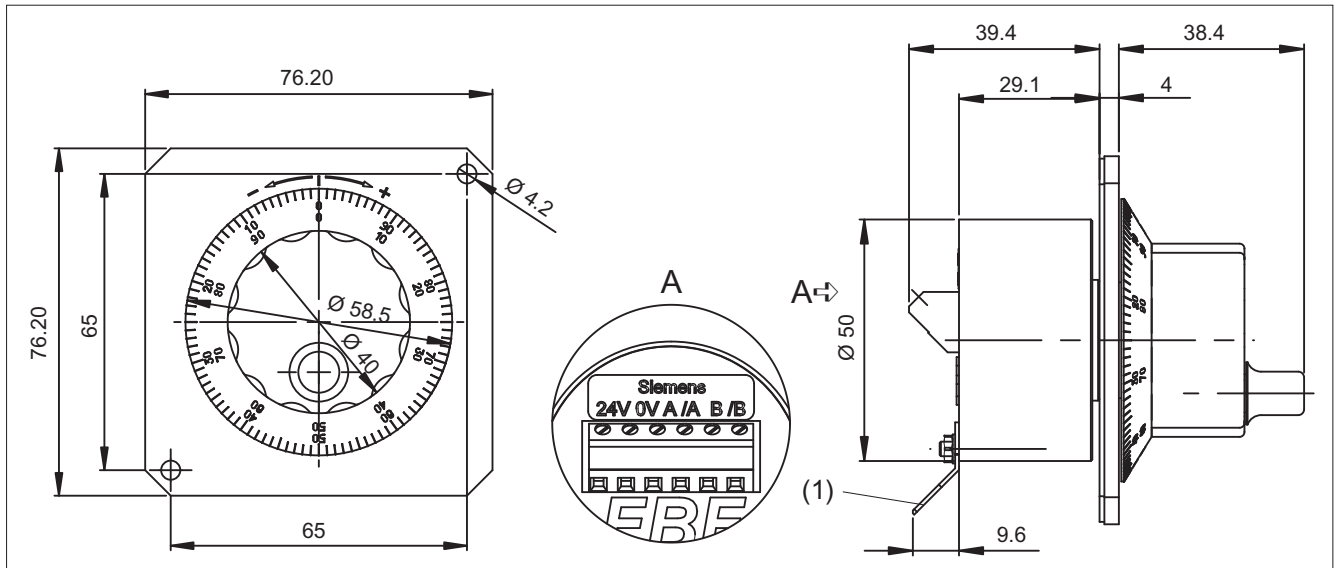

(1) Flat connector for push-on contacts 6.3 mm

Outputs

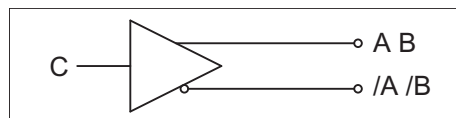

Load current ≤ 10 mA

Pulse diagram

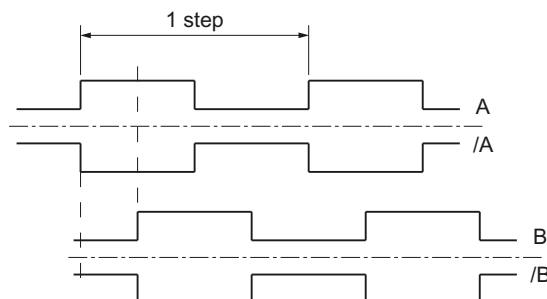

11.2.5 Encoder without front panel, setting wheel, small (...-5DM00)

Components

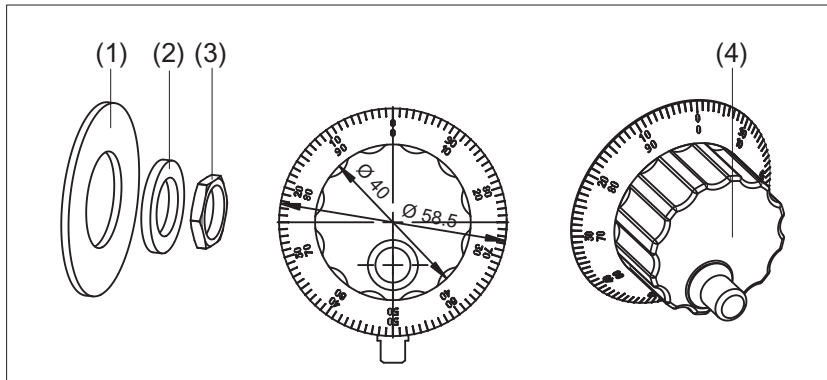

- (1) Sealing washer
- (2) Washer
- (3) Nut
- (4) Rotary button with crank

Side view

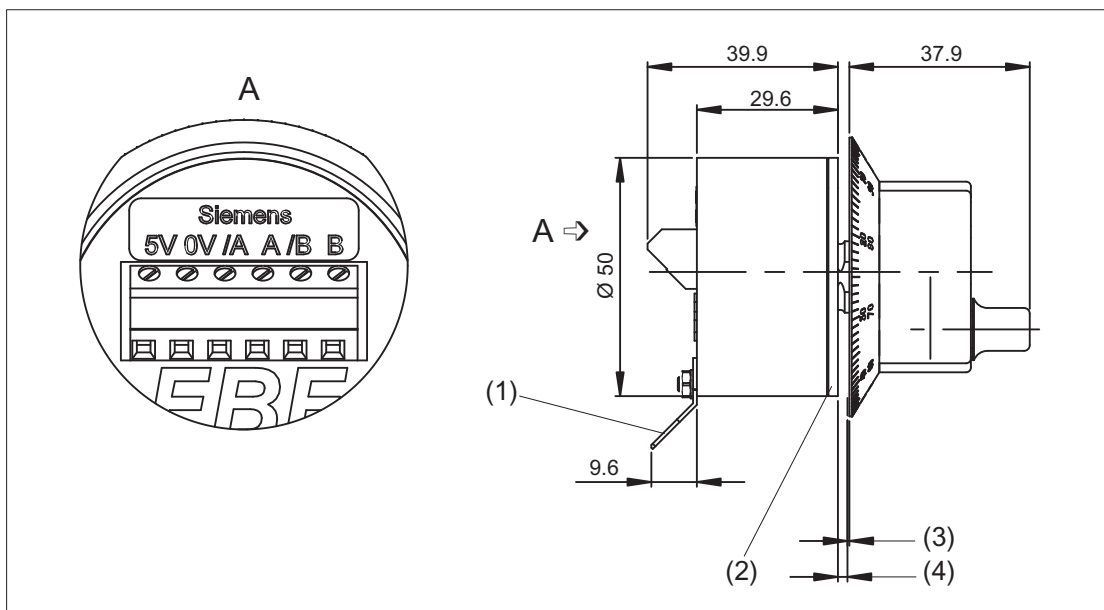

- (1) Flat connector for push-on contacts 6.3 mm
- (2) Sealing washer
- (3) Recommended distance of 0.40 mm switch panel / rotary button
- (4) Switch panel thickness 2 to max. 6 mm

Switch panel cutout for mounting version

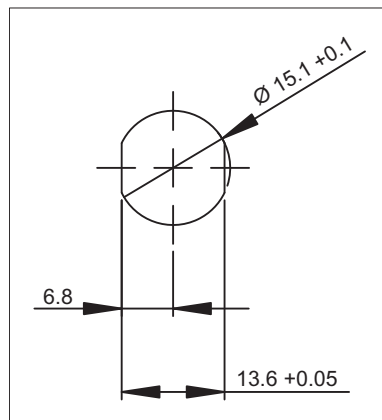

Outputs

A = Antivalent
RS 422 A

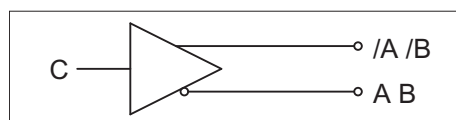

Load current ≤ 20 mA

Pulse diagram

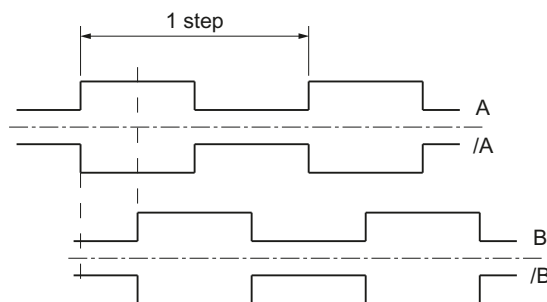

11.3 Connections

Connection for all variants of the electronic handwheel acc. to AWG14:

Connection:	6-pin screw-type terminal
Nominal area	2.5 mm ² single wire 1.5 mm ² ultra fine wire

Note

When a connected handwheel triggers pulses from its idle position or in the event of tiny contacts, connect it so that the label is facing the wrong way.

Replace

- the wire of terminal A with the wire of terminal /A
- the wire of terminal B with the wire of terminal /B

11.4 Technical data

Safety		
Safety class	I	
Degree of protection according to EN 60529	Front side: IP65	Connection side: IP50
Electrical data		
	Type: 5 V	Type: 24 V
Nominal voltage	5 VDC ± 5%	10 VDC - 30V
Rated current	Max. 60 mA	Max. 15 mA
Output frequency	Max. 2 kHz	
Speed	Max. 1000 rpm	
Number of pulses	2 x 100 I/U	
Displacement of phase A to B	Typ. 90° electrical	
Interface	RS 422 (TTL)	HTL
Mechanical data		
Weight	Approx. 0.4 kg with 76.2 x 76.2 mm front panel	
	Approx. 0.6 kg with 120 x 120 mm front panel	
Housing material	Steel / plastic	
Max. distance to MCP/HAM	25 m	
Actuating force	4 Ncm	
	8 Ncm (variant with 120 x 120 mm front panel)	

Note

Information about the climatic and mechanical environmental conditions is contained in the associated section under:

"General notes and interconnection" → "Operational planning".

11.5 Accessories

The following adapter set is available for installing the handwheels with central mounting in front panels which are intended for the installation of handwheels with 3-hole mountings:

Component	Description	Number	Order number
Adapter set	For installation with 3-hole mounting	1	6FC9320-5DN00

The figures show the adapter set with its individual parts and the dimension drawing for mounting.

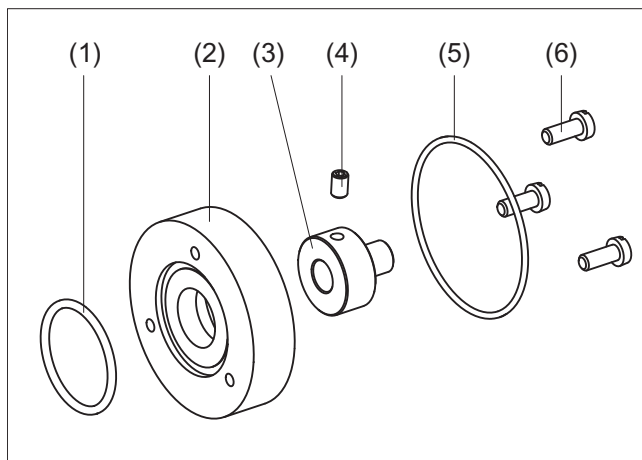

- (1) O-ring
- (2) Adapter ring
- (3) Axle adapter
- (4) Threaded stud
- (5) O-ring
- (6) Cylinder-head screw

Figure 11-2 Components of adapter set

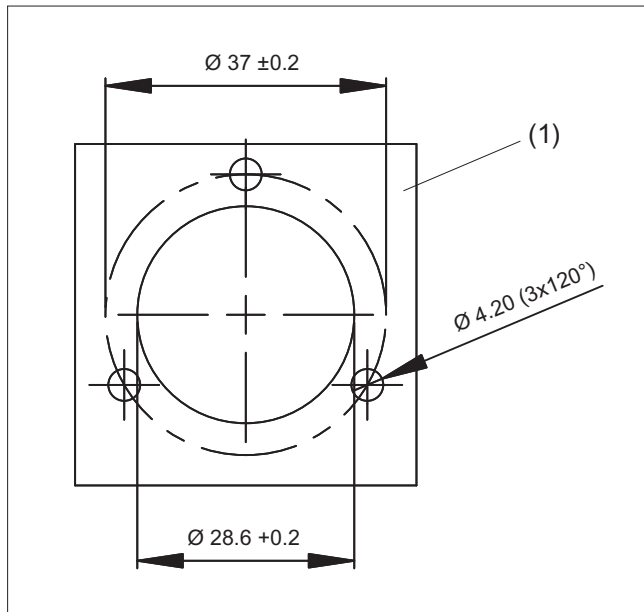

(1) Mounting frame

Figure 11-3 Dimension drawing of adapter set

Rotary override switch

12.1 Description

Although some of the rotary override switches described in this chapter already belong to the standard scope of an MCP/MPP, they can also be provided as an upgrade or installed in their own operator panels.

Note

The connection to an MCP/MPP is via X30/X31.

Validity

The description applies to the following rotary override switches

Type	Type	Order number
Override spindle / rapid traverse	Electronic, 1x16G, T=24	6FC5247-0AF12-1AA0
Override feed / rapid traverse	Electronic, 1x23G, T=32	6FC5247-0AF13-1AA0
Override feed / rapid traverse	Electronic, 1x29G, T=32	6FC5247-0AF14-1AA0
Override spindle / rapid traverse	Mechanical, 1x16G, T=24	6FC5247-0AF12-0AA0
Override feed / rapid traverse	Mechanical, 1x23G, T=32	6FC5247-0AF13-0AA0

Features

- Gray-code coding
- Central attachment
- Connection via ribbon cable with plug connector

Pin	Meaning	
	Electronic variants	Mechanical variants
1	Not connected	Not connected
2	Not connected	Not connected
3	Ground	Ground
4	Not connected	Vcc (4.75 ... 5.5 V)
5	Vcc (4.75 ... 5.5 V)	Not connected
6	Weighting factor 16	Weighting factor 16
7	Weighting factor 8	Weighting factor 8
8	Weighting factor 4	Weighting factor 4
9	Weighting factor 2	Weighting factor 2
10	Weighting factor 1	Weighting factor 1

12.2 Mounting

12.2.1 Dimension drawings

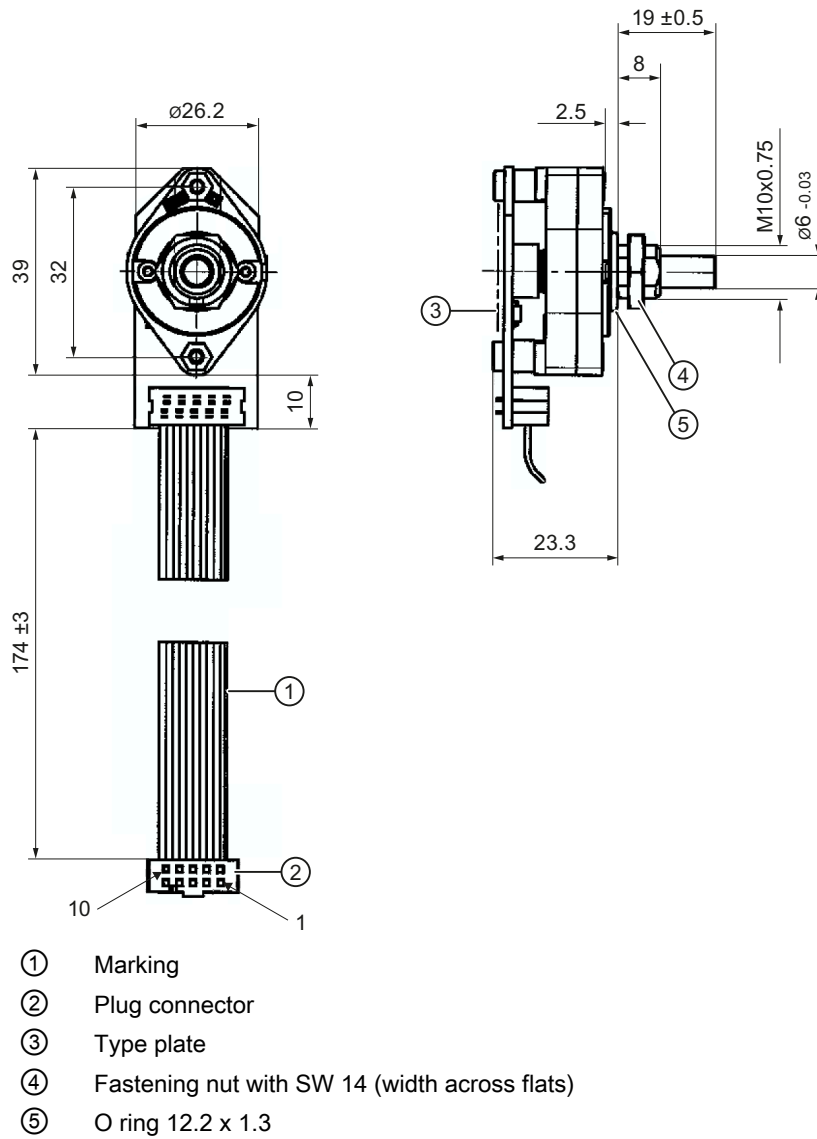

Figure 12-1 Dimension drawing for electronic rotary override switch

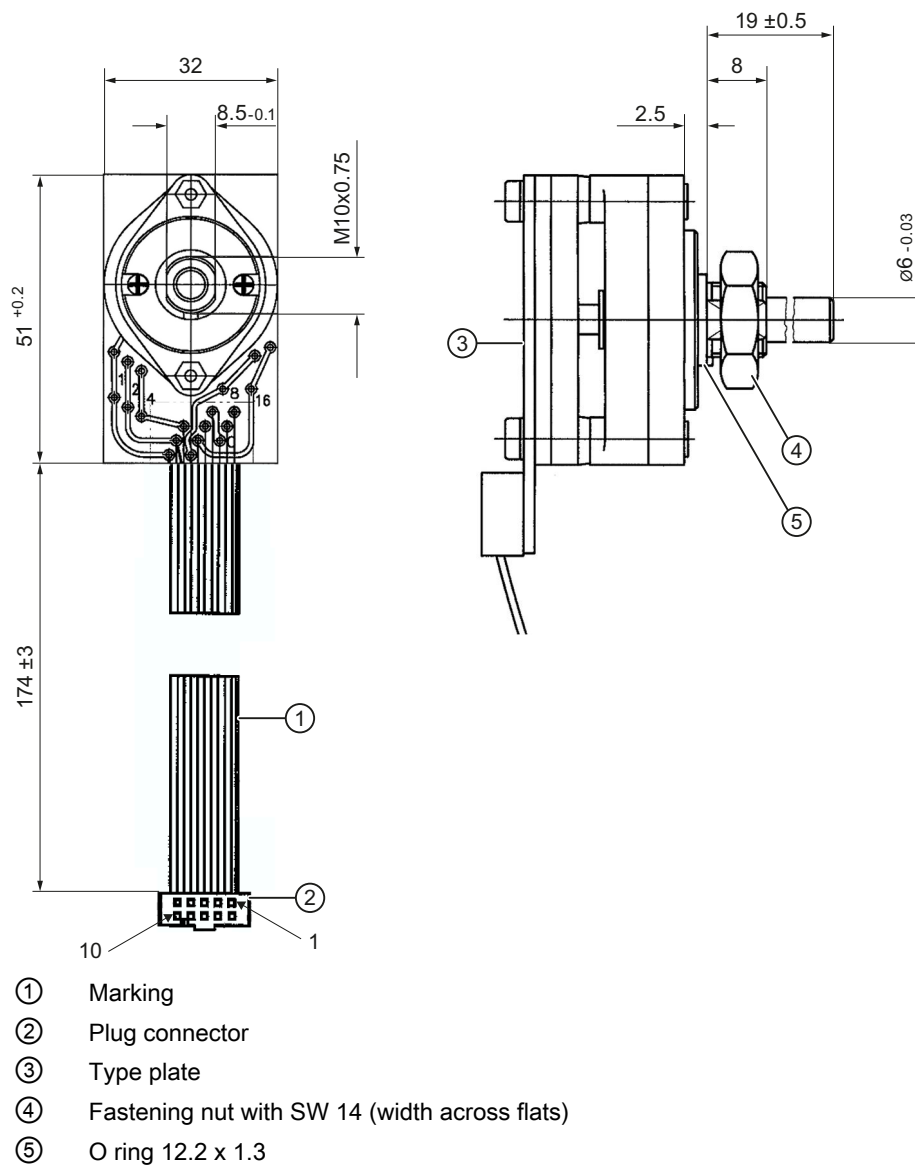

Figure 12-2 Dimension drawing for mechanical rotary override switch

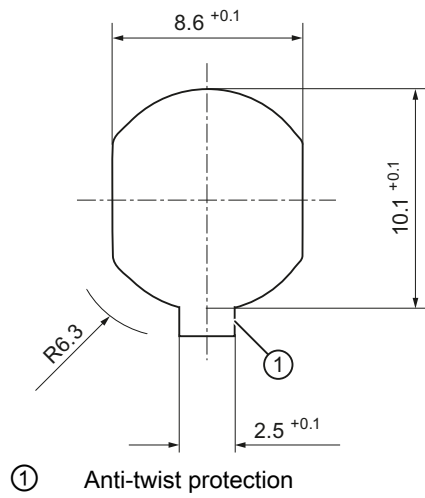
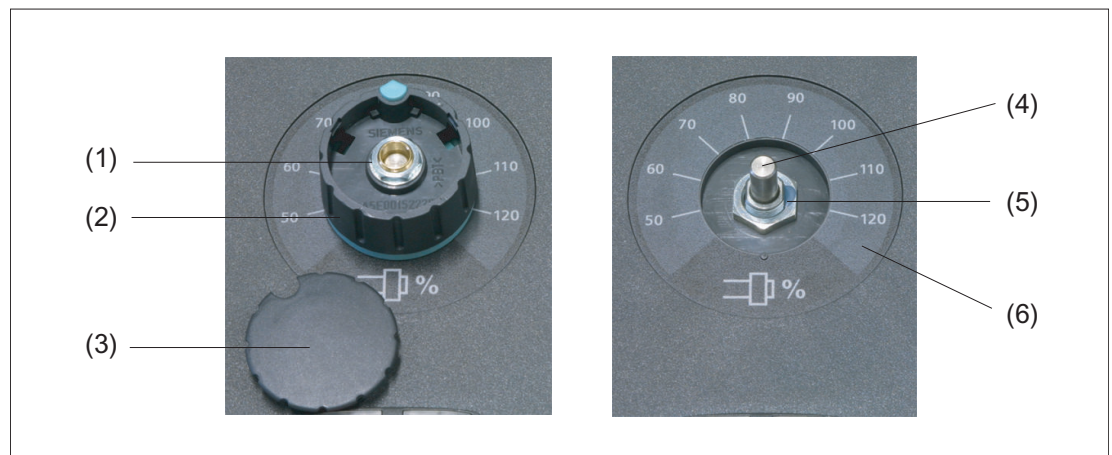

Figure 12-3 Operator panel cutout for fastening the rotary override switch

12.2.2 Replacing the rotary switch

Removal of a rotary switch

1. Lever the cap (3) off the rotary knob (2) (snap-on connection!).
2. Remove the nut of the collet (1) with a wrench (width 10).
3. Remove the entire rotary knob (2).
4. Remove the fastening nut (5) on the shaft of the rotary switch (4) with a wrench (width 14).
5. Remove the connector on the end of the rotary switch cable from the slot.
6. Remove the rotary switch.



- (1) Nut of the collet
- (2) Rotary knob
- (3) Cap
- (4) Rotary switch shaft
- (5) Fastening nut
- (6) Scale

Figure 12-4 Removal of a rotary switch

Installation of a rotary switch

NOTICE

Damage to the rotary switch during the fastening

It is essential to use the correct tightening torques shown below.

1. Push the O-ring (1) onto the shaft of the new rotary switch as a seal.
2. Insert the rotary switch into the front cutout so that pressure is applied to the O-ring.
3. Tighten the fastening nut (4) on the shaft of the rotary switch from the front with a wrench (width 14) (tightening torque: 3 Nm).
4. Connect the arrow ring (3) and the rotary knob (5).
5. Slide both parts onto the shaft of the rotary switch.
6. Align the arrow point on the ring with position "0" on the scale.
7. Tighten the collet nut of the rotary knob by hand and using a torque spanner with 2 Nm torque.
8. Place the cap (2) on the rotary knob and snap it into position.
9. Fold and fasten the connecting cable (7) as shown in the figure on the right.

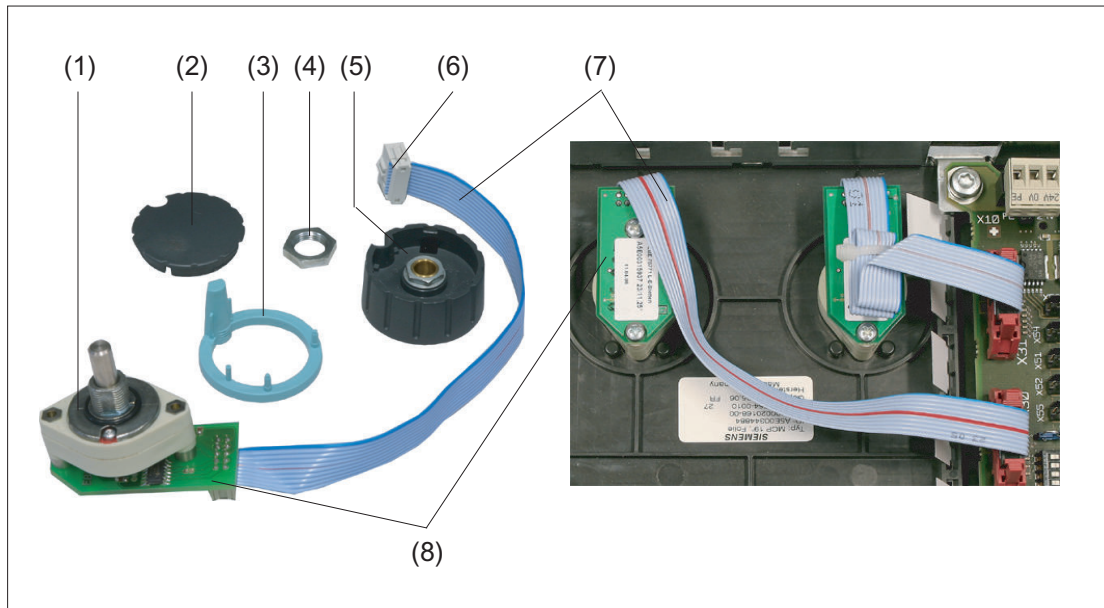

- (1) O-ring
- (2) Cap
- (3) Arrow ring
- (4) Fastening nut
- (5) Rotary knob
- (6) Connector (see detail diagram)
- (7) Connecting cable
- (8) Connection PCB

Detail diagram of the connector

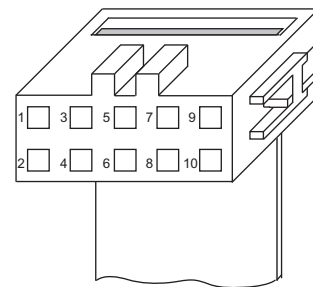

Figure 12-5 Installation of a rotary switch

12.3 Technical data

Electrical data	
Power supply (Vcc)	4.75 ... 5.5 VDC ± 100 mV
Power consumption typical/ maximum	25 mA / 75 mA (all outputs loaded)
Reverse polarity protection	Up to 12 V
Short-circuit protection	limited short-circuit protection (max. 50 ms)
Output level	"low" < 0.6 V; "high" > Vcc - 1 V
Output current	Max. 10 mA
Mechanical data	
Activation torque	approx. 9 Ncm
Stop strength	2.5 Nm
Starting torque	max. 500 Nm
Dust protection	Sensor range protected with a cap

Service life	50,000 cycles	
Ambient temperature	Operation: -25° C ... +85° C	Storage: -40° C ... +135° C
Vibration strength	1g; 2 - 200 Hz; 1 octave/min, 133 min according to IEC 68-2-6	
Shock/impact strength	10g, 11 ms according to IEC 28-2-27	

Index

C

- COM board
 - MCP 310, 58, 59
 - MCP 483, 124, 125
 - MPP 483, 299, 307

D

- DIP switch
 - MCP 483, 125
- Direct keys
 - MPP 310 IE H, 177
 - MPP 483, 305
 - MPP 483 IE, 233
- DP slave MPP
 - MPP 483, 308

E

- EKS identification system
 - MPP 310 IE H, 145
 - MPP 483, 253
 - MPP 483 IE, 193
- Emergency stop button
 - MCP 310 PN, 30, 43
 - MCP 310C PN, 25
 - MPP 483, 303
 - MPP 483 IE, 231
- Emergency Stop button
 - MCP 310, 56, 57, 72
 - MCP 310 PN, 31, 42
 - MCP 483, 121, 122, 138
 - MCP 483 PN, 100, 112
 - MCP 483C PN, 84, 96, 97
- Emergency stop circuit
 - MCP 483 PN, 102
 - MCP 483C PN, 86
- Ethernet
 - MCP 310C PN, 10
 - MCP 483C PN, 84
- Expansion panel, 244
- Extension keys
 - MPP 310 IE H, 176
 - MPP 483, 304
 - MPP 483 IE, 232

G

- GD communication
 - MPP 483, 307

H

- Handwheel
 - MCP 310C PN, 10
 - MCP 483, 122, 125
 - MCP 483C PN, 84

K

- Key covers
 - MCP 310C PN, 9, 26
 - MCP 483C PN, 83, 97
- Key-operated switch
 - MCP 310, 55, 57, 72
 - MCP 310 PN , 29, 31, 43
 - MCP 310C PN, 9
 - MCP 483, 121, 122, 138
 - MCP 483 PN , 100, 113
 - MCP 483C PN, 84

L

- LEDs
 - MCP 483, 125
 - MPP 483, 307

M

- MCP 310
 - COM board, 58, 59
 - Dimension drawing, 60
 - Dimensions, 71
 - Emergency Stop button, 56, 57, 72
 - Key-operated switch, 55, 57, 72
 - Mounting position, 61
 - Power consumption, 71
 - PROFIBUS DP, 62, 127
 - Rotary switch, 55
 - Slide-in labels, 55, 73
 - Slots, 56, 57

- MCP 310 PN
 - Dimensional drawing, 39
 - Dimensions, 42
 - Emergency Stop button, 30, 31, 42, 43
 - Installation position, 40
 - Key-operated switch, 29, 31, 43
 - Power consumption, 42
 - Rotary switch, 29
 - Slide-in labels, 29, 43, 45
 - Slots, 30, 31
- MCP 310C PN
 - Dimensions, 25
 - Emergency stop button, 25
 - Ethernet, 10
 - Handwheel, 10
 - Key covers, 9, 12, 26
 - Key-operated switch, 9
 - Power consumption, 25
- MCP 483
 - Dimension drawing , 126
 - COM board, 124, 125
 - Dimensions, 137
 - DIP switch, 125
 - Emergency Stop button, 121, 122, 138
 - Equipotential bonding conductor, 126
 - Handwheel, 122, 125
 - Key symbols, 140
 - Key-operated switch, 121, 122, 138
 - LEDs, 125
 - Mounting position, 127
 - Power consumption, 137
 - Slide-in labels, 121, 139
 - Slots, 122
- MCP 483 PN
 - Dimension drawing , 109
 - Emergency stop circuit, 102
 - Dimensions, 112
 - Emergency Stop button, 100, 112
 - Key symbols, 115
 - Key-operated switch, 100, 113
 - Mounting position, 110
 - Power consumption, 112
 - Slide-in labels, 99, 113, 114
- MCP 483C PN
 - Dimension drawing, 93
 - Dimensions, 96
 - Emergency Stop button, 84, 96, 97
 - Emergency stop circuit, 86
 - Ethernet, 84
 - Handwheel, 84
 - Key covers, 83, 97
 - Key-operated switch, 84
 - Mounting position, 94
 - Power consumption, 96
 - Rotary switch, 97
- MPP 310 IE H
 - Actuation elements, 152
 - Anode connection for LEDs, 169
 - COM board IE, 152
 - Dimensions, 180
 - Direct keys, 177
 - EKS identification system, 145
 - Extension keys, 176
 - Lamps, 152
 - Mounting position, 168
 - Power consumption, 180
 - Signaling lamps, 175
 - Slide-in labels, 145
 - Software Version, 178
 - System configuration, 147
- MPP 483
 - Actuation elements, 269
 - Anode connection for LEDs, 294
 - Coding switch S3 , 299
 - COM board, 270, 299
 - Dimensions, 312
 - Direct keys, 305
 - DP slave MPP, 308
 - EKS identification system, 253
 - Emergency stop button, 303
 - Extension keys, 304
 - GD communication, 307
 - GSD file, 308
 - Lamps, 269
 - LEDs, 307
 - Mounting position, 293
 - Power consumption, 312
 - PROFIBUS DP, 305
 - PROFIBUS parameters, 310
 - Signaling lamps, 303
 - Slide-in labels, 253
 - Software Version, 306
 - Special versions, 253
 - Standard version, 253
 - Standard version, extended, 253
 - Supplementary elements, 255
 - System configuration, 256
- MPP 483
 - COM board, 307
- MPP 483 IE
 - Actuation elements, 206
 - Anode connection for LEDs, 225
 - COM board, 206
 - Customer key board, 207

- Dimensions, 236
- Direct keys, 233
- EKS identification system, 193
- Emergency stop button, 231
- Extension keys, 232
- Lamps, 206
- Mounting position, 224
- Power consumption, 236
- Signaling lamps, 231
- Slide-in labels, 193
- Software Version, 234
- Special versions, 193
- Standard version, 193
- Standard version, extended, 193
- Supplementary elements, 194
- System configuration, 195

MPP 483 IE HTC

- HGA board, 207

P

PROFIBUS DP

- MCP 310, 62, 127
- MPP 483, 305

PROFIBUS parameters

- MPP 483, 310

R

Rotary switch

- MCP 310, 55
- MCP 310 PN , 29
- MCP 483C PN, 97

S

Slide-in labels

- MCP 310, 55, 73
- MCP 310 PN, 29
- MCP 310 PN , 43, 45
- MCP 483, 121, 139
- MCP 483 PN, 99
- MCP 483 PN , 113, 114
- MPP 310 IE H, 145
- MPP 483, 253
- MPP 483 IE, 193

Slots

- MCP 310, 56, 57
- MCP 310 PN , 30, 31
- MCP 483, 122

SIEMENS

SINUMERIK

SINUMERIK 840D sl Keyboards and additional components

Manual

Standard PC keyboard KBPC CG US	1
Keyboard tray	2
Full CNC keyboard: KB 310C	3
Full CNC keyboard: KB 483C	4
CompactFlash card	5
3.5" floppy disk drive with USB interface	6
Card reader with USB interface	7
USB extension	8

Valid for:
Control
SINUMERIK 840D sl / 840DE sl



03/2013

6FC5397-1AP40-3BA0

Legal information

Warning notice system

This manual contains notices you have to observe in order to ensure your personal safety, as well as to prevent damage to property. The notices referring to your personal safety are highlighted in the manual by a safety alert symbol, notices referring only to property damage have no safety alert symbol. These notices shown below are graded according to the degree of danger.

 DANGER
indicates that death or severe personal injury will result if proper precautions are not taken.
 WARNING
indicates that death or severe personal injury may result if proper precautions are not taken.
 CAUTION
indicates that minor personal injury can result if proper precautions are not taken.
NOTICE
indicates that property damage can result if proper precautions are not taken.

If more than one degree of danger is present, the warning notice representing the highest degree of danger will be used. A notice warning of injury to persons with a safety alert symbol may also include a warning relating to property damage.

Qualified Personnel

The product/system described in this documentation may be operated only by **personnel qualified** for the specific task in accordance with the relevant documentation, in particular its warning notices and safety instructions. Qualified personnel are those who, based on their training and experience, are capable of identifying risks and avoiding potential hazards when working with these products/systems.

Proper use of Siemens products

Note the following:

 WARNING
Siemens products may only be used for the applications described in the catalog and in the relevant technical documentation. If products and components from other manufacturers are used, these must be recommended or approved by Siemens. Proper transport, storage, installation, assembly, commissioning, operation and maintenance are required to ensure that the products operate safely and without any problems. The permissible ambient conditions must be complied with. The information in the relevant documentation must be observed.

Trademarks

All names identified by ® are registered trademarks of Siemens AG. The remaining trademarks in this publication may be trademarks whose use by third parties for their own purposes could violate the rights of the owner.

Disclaimer of Liability

We have reviewed the contents of this publication to ensure consistency with the hardware and software described. Since variance cannot be precluded entirely, we cannot guarantee full consistency. However, the information in this publication is reviewed regularly and any necessary corrections are included in subsequent editions.

Table of contents

1	Standard PC keyboard KBPC CG US.....	5
1.1	Description	5
1.2	Operator controls and indicators.....	6
1.3	Technical data.....	6
2	Keyboard tray	7
2.1	Description	7
2.2	Technical data.....	7
3	Full CNC keyboard: KB 310C	9
3.1	Description	9
3.2	Operating and display elements	10
3.3	Interfaces	11
3.4	Mounting	12
3.5	Technical data.....	14
3.6	Accessories.....	15
4	Full CNC keyboard: KB 483C	17
4.1	Description	17
4.2	Operating and display elements	18
4.3	Interfaces	20
4.4	Mounting	21
4.5	Technical data.....	23
4.6	Accessories.....	24
5	CompactFlash card.....	25
5.1	Description	25
5.2	Technical data.....	27
6	3.5" floppy disk drive with USB interface.....	29
6.1	Description	29
6.2	Interfaces	31
6.3	Mounting	32
6.4	Notes about operation.....	33
6.4.1	Hardware.....	33
6.4.2	Software	34
6.5	Technical data.....	34

7	Card reader with USB interface	35
7.1	Description	35
7.2	Operator controls and indicators	36
7.3	Interfaces.....	37
7.4	Installation	37
7.5	Memory cards	38
7.6	Technical data.....	39
7.7	Accessories	39
8	USB extension	41
	Index.....	43

Standard PC keyboard KBPC CG US

1.1 Description

Programs and texts can be edited easily with the KBPC CG US standard PC keyboard.

The standard PC keyboard KBPC CG US is not suitable for industrial use (EMC) and should not be used as a permanent installation. It must be used only for servicing and commissioning.

Validity

The description applies to the following components:

Designation	Remark	Order number
PC standard keyboard KBPC CG US	MF-II compatible, 104 key layout, connection: USB, length of connecting cable: 1.7 m	6FC5203-0AC01-3AA0

Features

- Flat compact design, ergonomic keys
- MF-II compatible, 104 keys layout
- System compatibility: USB 1.1, USB 2.0
- Interface: USB

1.2 Operator controls and indicators



Figure 1-1 View of PC standard keyboard: KBPC CG US

1.3 Technical data

Certificates and approvals	FCC, GS, CE, c-tick, cURus		
Input voltage	+ 5.25 VDC		
Power consumption	0.1 W		
Degree of protection DIN EN 60529 (IEC 60529)	IP20		
Permissible ambient temperature	Storage and transportation - 20 ... 60° C	Operation 0 ... 50° C	
Weight	Approx. 1.3 kg		
Dimensions (mm)	Width: 405	Height: 44	Depth: 180
Electromagnetic compatibility	CE certification in accordance with EU Directives EN 55022/B, EN 55024, EN 61000-3-2, EN 61000-3-3		

Keyboard tray

2.1 Description

The extremely stable 19" keyboard tray in anthracite facilitates your work when using a standard external keyboard with an operator panel.

Special screws permit easy attachment of the keyboard tray, and equally easy removal after the work is finished.

If required, a version with an additional removable tray for a mouse is also available.

Validity

The description applies to the following components:

Designation	Remark	Order number
Keyboard tray	for keyboard with two collar screws	6FC5247-0AA40-0AA0

View

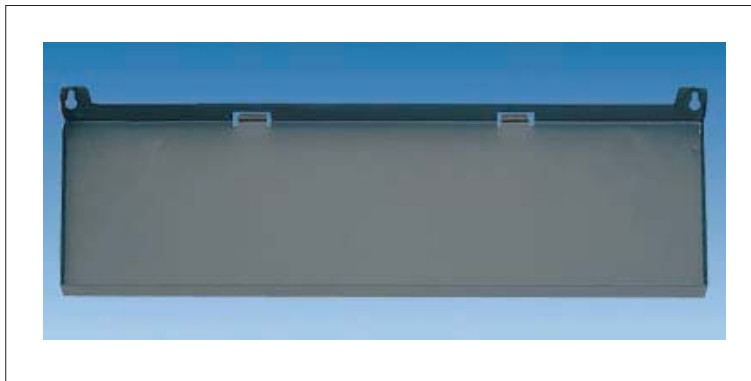

Figure 2-1 View of keyboard tray

2.2 Technical data

Weight	approx. 1.6 kg	
Dimensions (mm)	Width: 487	Depth: 196

Full CNC keyboard: KB 310C

3.1 Description

The SINUMERIK KB 310C full CNC keyboard permits user-friendly input of programs and text.

It is equipped with short-stroke keys.

The key layout is predefined and cannot be modified, i.e. the key caps cannot be transposed.

The keyboard is secured from the rear using special clamps supplied with the panel.

Validity

The following description applies to the component:

Name	Keyboard	Order number
CNC full keyboard KB 310C	mechanical	6FC5203-0AF21-0AA1

Features

- Keys
 - Standard/US QWERTY layout
 - 75 mechanical keys
- Key groups
 - Alphabetic key group with special characters
 - Numeric key group with special characters
 - Cursor key group
 - CNC function keys with hot keys for fast selection of the control area
- Connections
 - USB 1.1

3.2 Operating and display elements

Key assignments

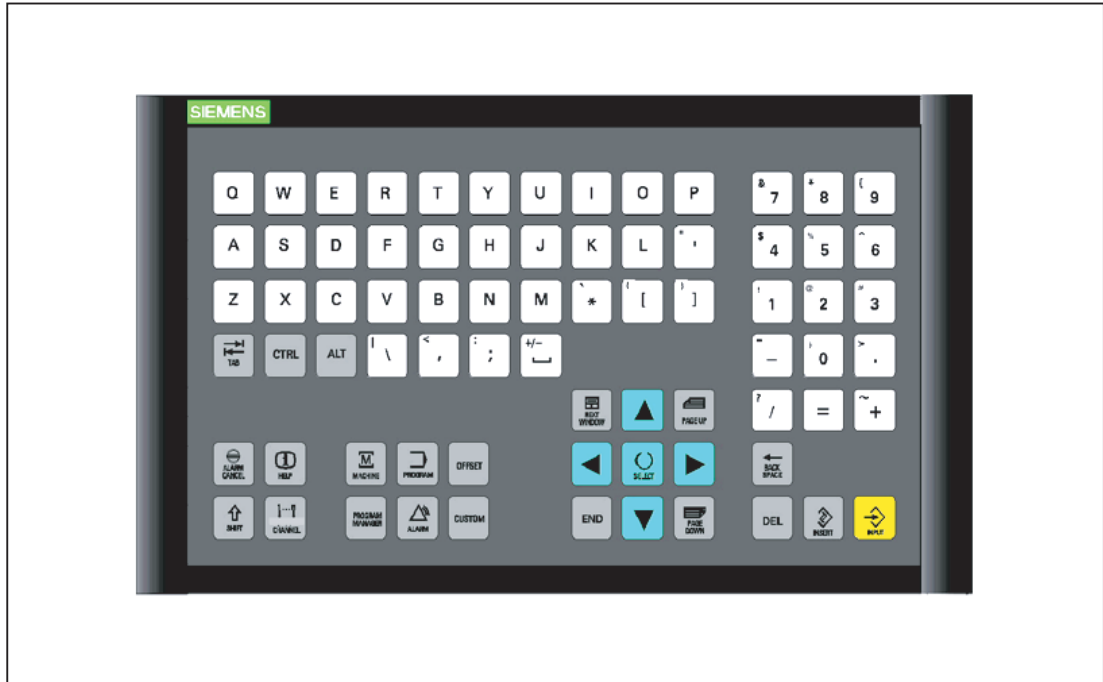

Figure 3-1 Layout of CNC full keyboard KB 310C

Keyboard codes

For keyboard codes can be found in section: "CNC full keyboard KB 483C", section: "Operating and display elements".

3.3 Interfaces

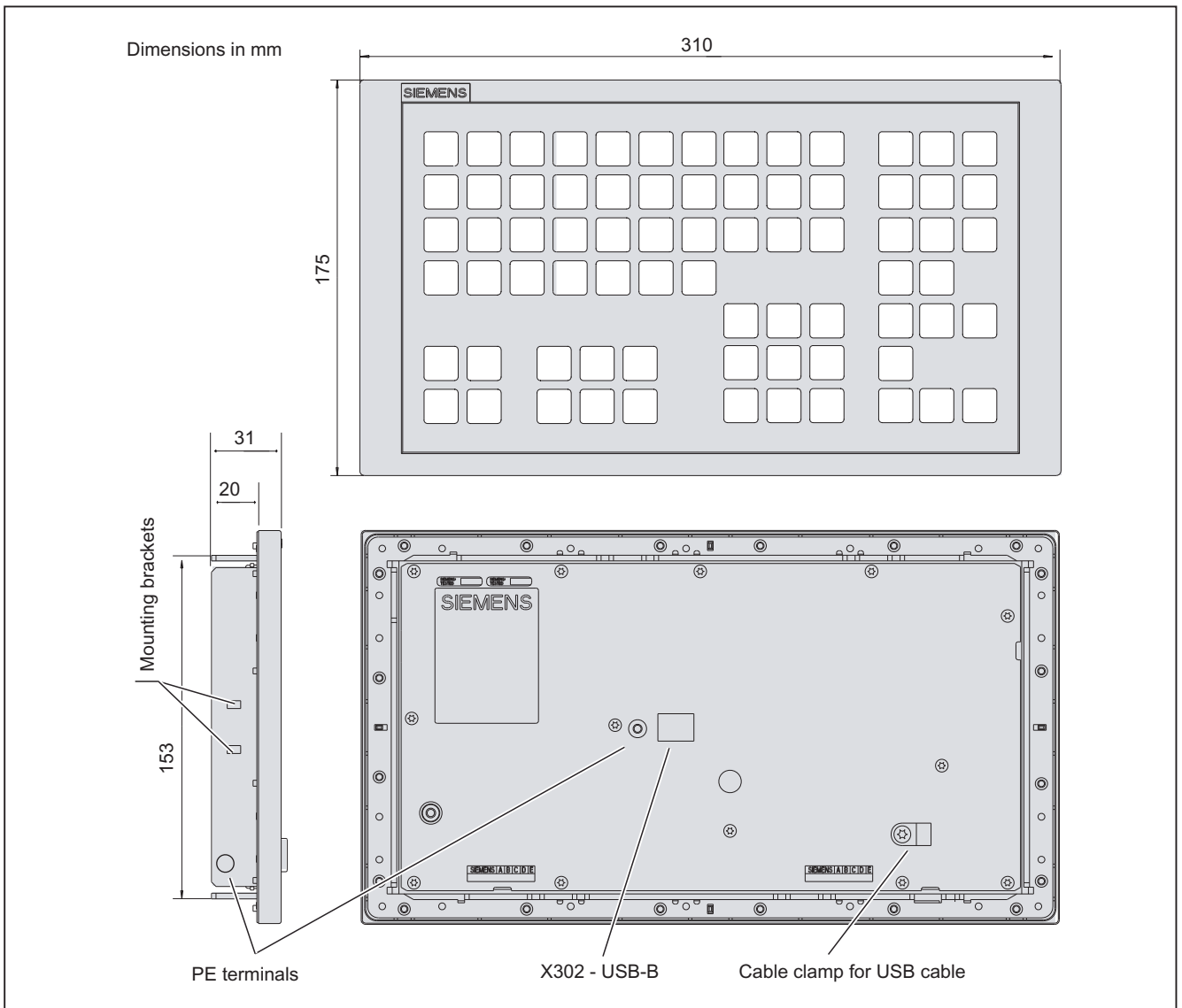

Figure 3-2 Front, side and rear views of CNC full keyboard KB 310C

USB upstream port X302

The interface (see figure) is designed as a "high powered interface" (5 V / 500 mA). As a result, the keyboard can be connected only to USB hubs which possess their own power supply and whose downstream ports are capable of supplying a 500 mA current. A standard USB 2.0 cable of max. 3 m in length (recommended: 1.5 m) is supported.

Connector designation: **X302**
Plug-connector type: USB-B connector (4-pin)

Pin assignment, see "General information and networking", Chapter: "Connecting"

3.4 Mounting

Note

When mounting, install and secure the USB connecting cable properly to ensure that it cannot chafe against the frame of the keyboard.

Panel cutout

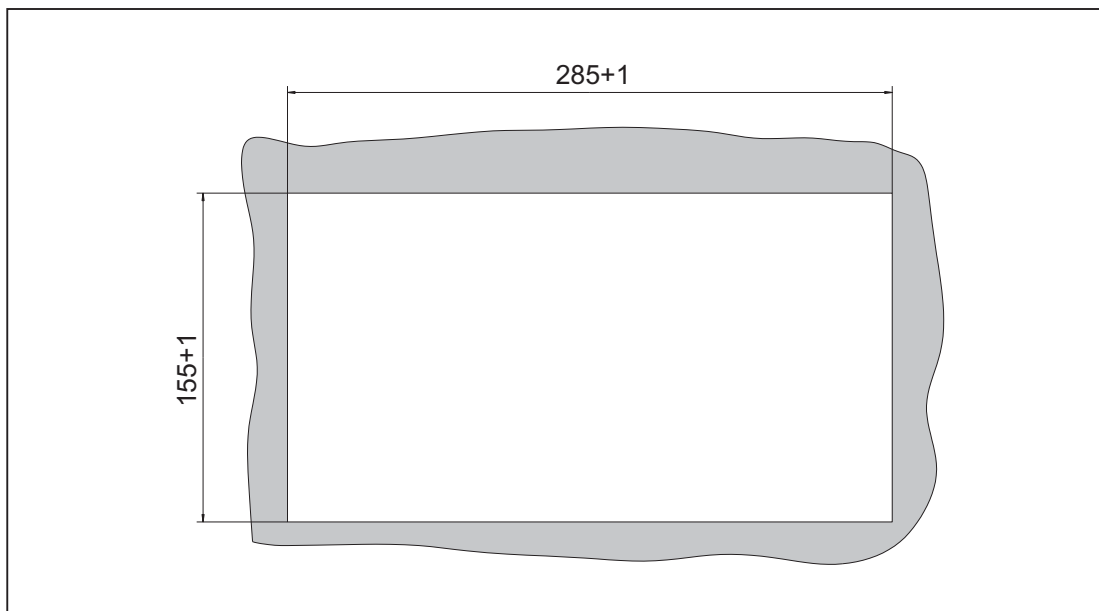

Figure 3-3 Panel cutout for CNC full keyboard KB 310C (plate thickness 1.5 - 6.0 mm)

Dimension drawing for mounting

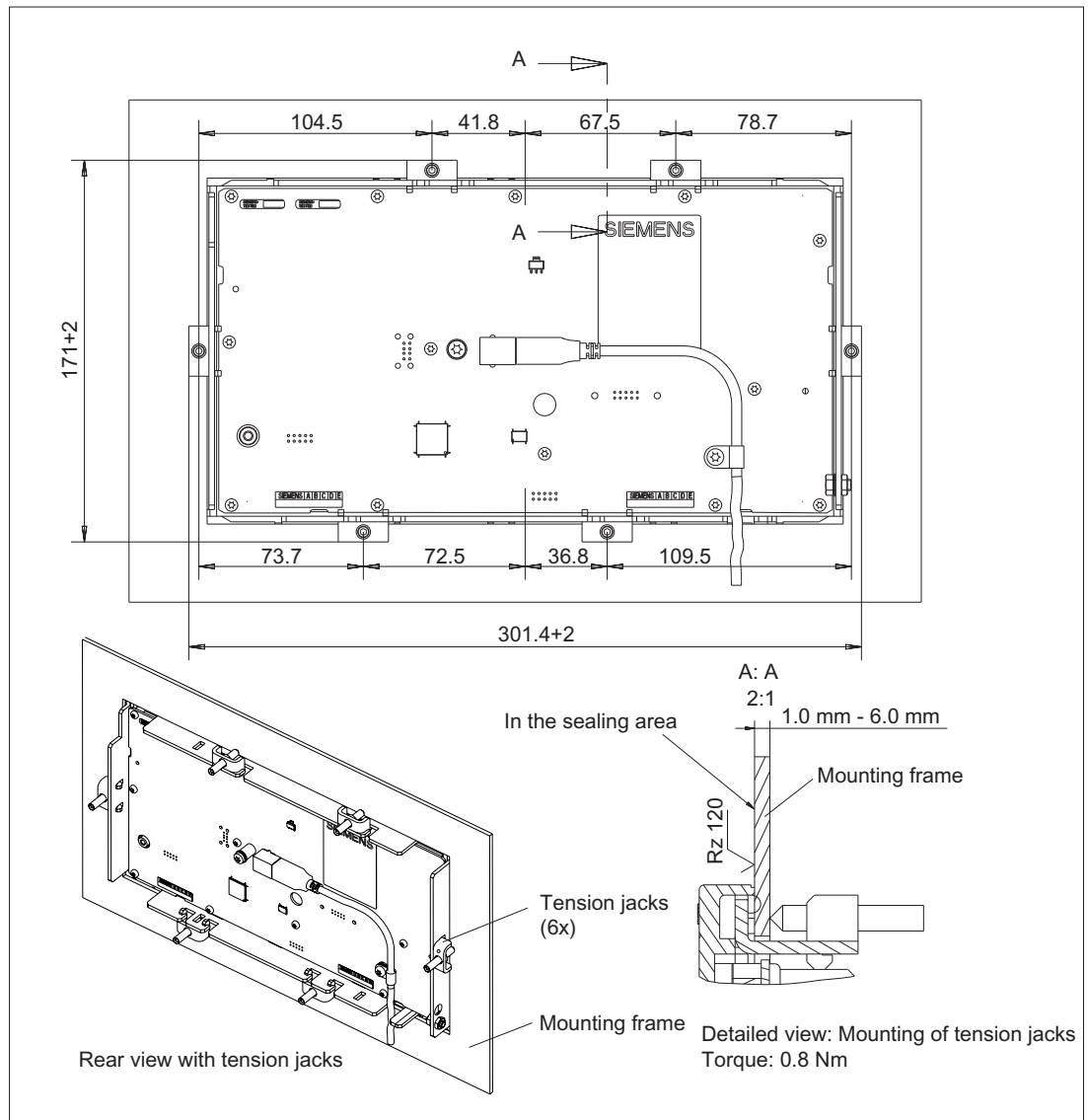

Figure 3-4 Dimension drawing for mounting the CNC full keyboard KB 310C

3.5 Technical data

Mounting position

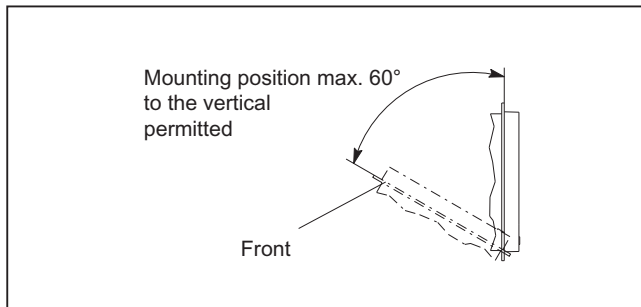

Figure 3-5 Mounting position

3.5 Technical data

Safety			
Safety class / approvals	III; PELV according to EN 50178 / CE		
Degree of protection according to EN 60529	Front side IP54	Rear side IP00	Seating to the cabinet: IP65
Immunity			
ESD	Air discharge ± 8 kV / contact discharge ± 4 kV		
HF radio	10 V/m, 80% AM, 1 kHz / 80 - 1000 MHz		
HF conducted (on USB cable)	10 V, 80% AM, 1 kHz / 0.15 - 80 MHz		
Electrical data			
Supply voltage / current (typ.)	4.75 ... 5.25 V / 102 mA		
Power consumption, max.	0.4 W		
Mechanical data			
Dimensions	Width: 310 mm Height: 175 mm	Depth: 31 mm Mounting depth: 20 mm	
Weight	Approx. 0.9 kg		
Maximum distance to PCU/TCU	3 m (recommended: 1.5 m)		
Housing base color	Anthracite 614		
Key color	Pastel turquoise RAL 6034, pantone yellow light basic 700, medium basic 701		

Note

Information about the climatic and mechanical environmental conditions is contained in the associated section under:

"General notes and interconnection" → "Operational planning".

3.6 Accessories

Set of tension jacks

Component	Description	Number	Order number
Set of tension jacks	for supplementary components with 2.5 mm profile, length: 20 mm	Set of 9	6FC5248-0AF14-0AA0

Full CNC keyboard: KB 483C

4.1 Description

The SINUMERIK KB 483C full CNC keyboard permits user-friendly input of programs and text.

It is fitted with short-stroke keys.

The key layout is predefined and cannot be modified, i.e. the key covers cannot be transposed.

The keyboard is secured from the rear using special clamps supplied with the panel.

Validity

The following description applies to the component:

Designation	Key type	Order number
CNC full keyboard KB 483C	mechanical	6FC5203-0AF20-0AA1

Features

The keyboard has 78 mechanical keys based on the standard/US QWERTY layout.

- Key groups
 - Alphabetic key group with special characters
 - Numeric key group with special characters
 - Cursor key group
 - CNC function keys with hot keys for fast selection of the control area
- Connections
 - USB 1.1

4.2 Operating and display elements

Key assignments



Figure 4-1 Layout of CNC full keyboard KB 483C

The following table shows the differences of the key assignment to the US/standard keyboard. Also note that the following keys on the KB 483C always correspond to the left-hand keys on the standard keyboard:

Shift, Ctrl, Alt

Note

The keyboard does not support Suspend mode or a Remote Wakeup function.

KB 483C key	KB 483C key function	Corresponding US standard key	KB 483C key function	Corresponding US standard key
	without SHIFT		with SHIFT	
	Space	Space	+/-	SHIFT + GRAVE ACCENT
=	=	=	Not connected	
+	+	+ (NB)	~	SHIFT + GRAVE ACCENT
*	*	SHIFT + 8	'	'
INPUT	Input confirmation	ENTER	Not connected	
MACHINE	Calls the "Machine" operating area.	SHIFT + F11	Not connected	
PROGRAM MANAGER	Calls the "Program Manager" operating area.	7 (NB)	Not connected	
PROGRAM	Calls the "Program" operating area.	1 (NB)	Not connected	
ALARM	Calls the "Diagnosis" operating area.	9 (NB)	Not connected	

KB 483C key	KB 483C key function	Corresponding US standard key	KB 483C key function	Corresponding US standard key
	without SHIFT		with SHIFT	
OFFSET	Calls the "Parameters" operating area.	3 (NB)	Not connected	
CUSTOM	Calls the "Custom" operating area.	SHFT + F12	Not connected	
ALARM CANCEL	Deletes alarms and messages.	ESC	SW-dependent	SHIFT + ESC
CHANNEL	Steps for multiple channels.	F11	Not connected	
HELP	Calls the context-sensitive online help.	F12	Not connected	
NEXT WINDOW	Toggles between the windows.	HOME	Selects the first entry in the selection lists.	SHIFT + HOME
SELECT	Steps in selection lists.	5 (NB)	SW-dependent	SHIFT + 5 (NB)

NB = numeric block

The key functions of the SINUMERIK keyboard depend on the used operating software and largely match the keys of the operator panels. A detailed description of the keys is contained in the operating manuals.

4.3 Interfaces

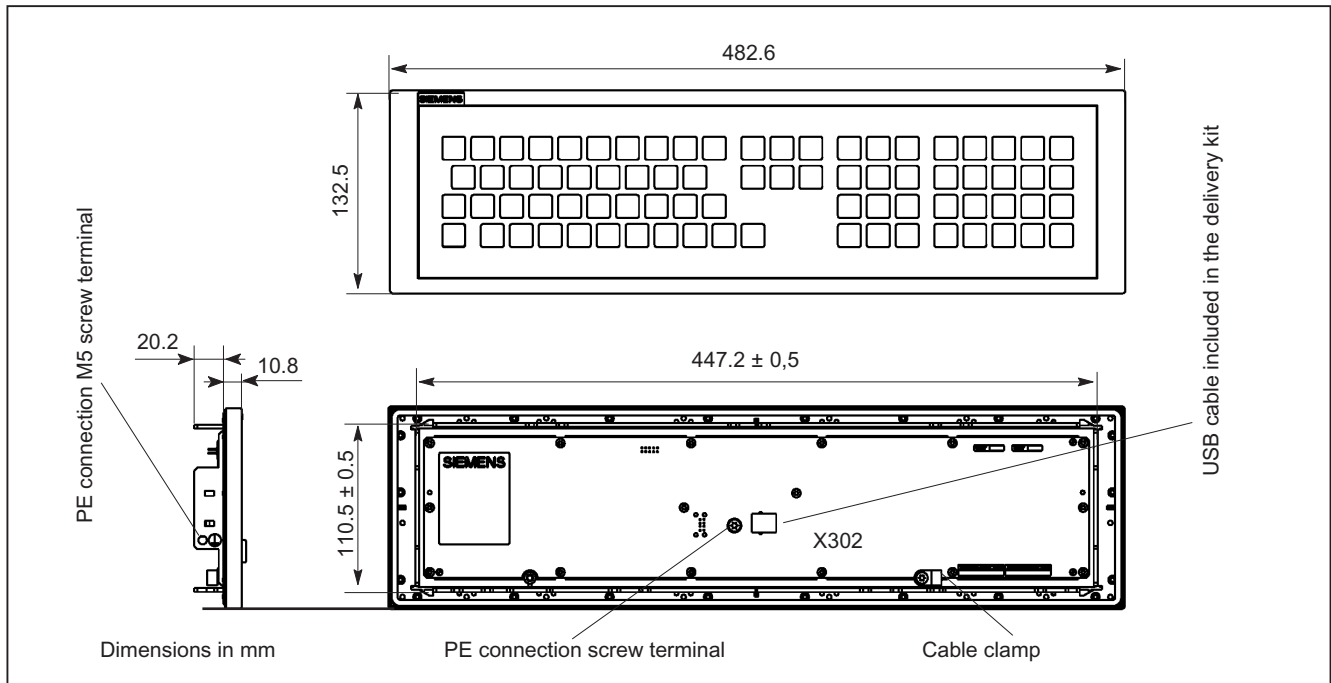

Figure 4-2 Front, side and rear views of CNC full keyboard KB 483C

USB upstream port X302

The interface (see figure) is designed as a "high powered interface" (5 V / 500 mA). As a result, the keyboard can be connected only to USB hubs which possess their own power supply and whose downstream ports are capable of supplying a 500 mA current. A standard USB 2.0 cable of max. 3 m in length (recommended: 1.5 m) is supported.

Connector designation: **X302**
Connector type: USB-B connector (4-pin)

Pin assignment, see "General information and networking", Chapter: "Connecting"

4.4 Mounting

Panel cutout

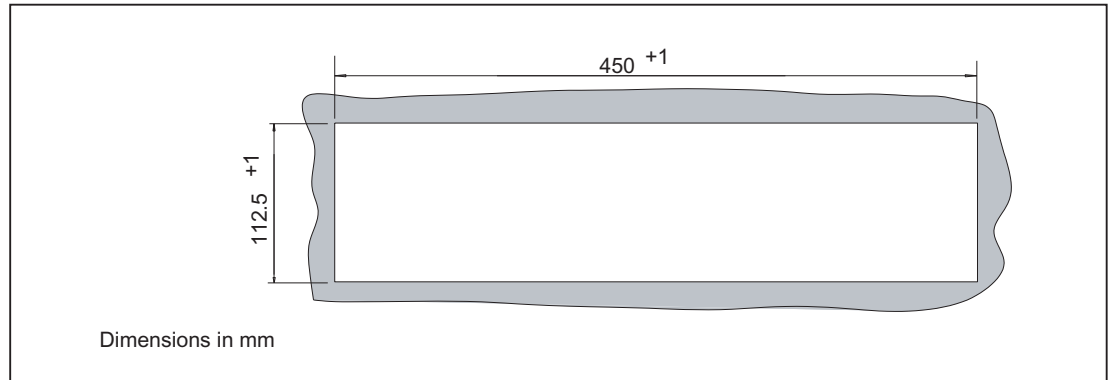

Figure 4-3 Panel cutout for CNC full keyboard KB 483C (plate thickness 1.5 - 6.0 mm)

Dimension drawing

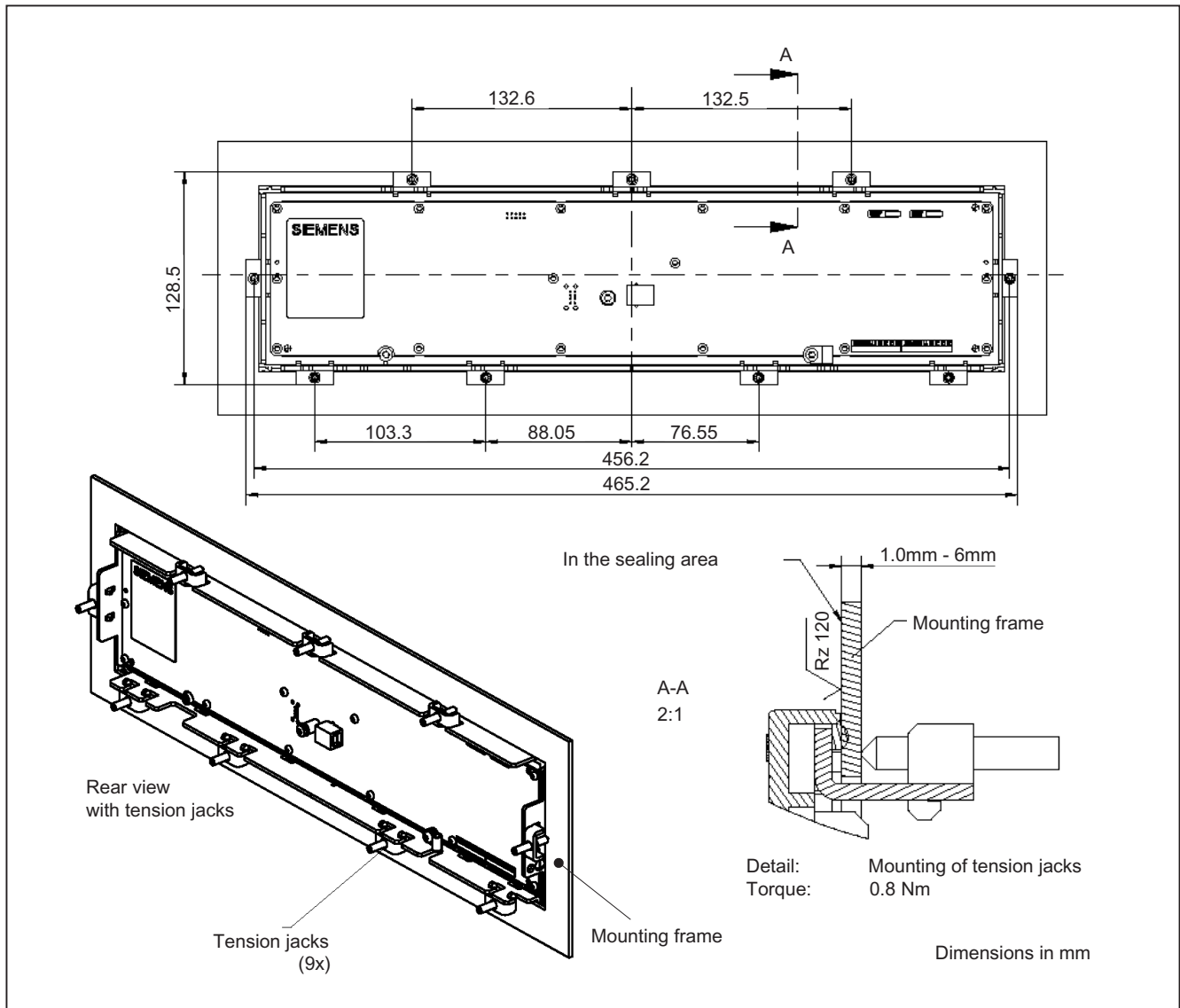

Figure 4-4 Dimension drawing for mounting the CNC full keyboard KB 483C

Mounting position

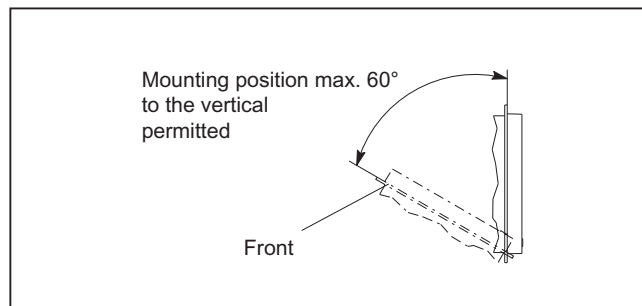

Figure 4-5 Mounting position

4.5 Technical data

Safety			
Safety class / approvals	III; PELV according to EN 50178 / CE		
Degree of protection according to EN 60529 (IEC 60529)	Front side IP54	Rear side IP00	Fusing to cabinet: IP65
Immunity			
ESD	Air discharge ± 8 kV / contact discharge ± 4 kV		
HF radio	10 V/m, 80% AM, 1 kHz / 80 -1000 MHz		
HF conducted (on USB cable)	10 V, 80% AM, 1 kHz / 0.15 - 80 MHz		
Electrical data			
Supply voltage / current (typ.)	4.75 ... 5.25 V / 102 mA		
Power consumption, max.	0.4 W		
Mechanical data			
Dimensions	Width: 483 mm Height: 133 mm	Depth: 31 mm Mounting depth: 20.2 mm	
Weight	approx. 1.3 kg		
Max. distance from PCU	3 m (recommended: 1.5 m)		
Housing base color	Anthracite 614		
Key color	Pastel turquoise RAL 6034, pantone yellow light basic 700, medium basic 701		

Note

Information about the climatic and mechanical environmental conditions is contained in the associated section under:

"General notes and interconnection" → "Operational planning".

4.6 Accessories

Set of tension jacks

Component	Description	Number	Order number
Set of tension jacks	for supplementary components with 2.5 mm profile, length: 20 mm	Set of 9	6FC5248-0AF14-0AA0

CompactFlash card

5.1 Description

The CompactFlash card is used to store user data.

Validity

The following description applies to the following components

Designation	Order number
SINUMERIK CompactFlash card, 1 GB, empty	6FC5313-5AG00-0AA1
SINUMERIK CompactFlash card, 2 GB, empty	6FC5313-5AG00-0AA2
SINUMERIK CompactFlash card, 8 GB, empty	6FC5313-6AG00-0AA0

Safety instructions

- Insert the CompactFlash card carefully with the correct orientation into the memory card slot (observe indicators such as arrow or similar). This way you avoid mechanical damage to the memory card or the device. Note the general ESD information.
- Only use the memory card type provided by Siemens with its formatting (e.g. FAT16) for your device, in order to guarantee the basic functions - especially when the operating system is started from the card.
- It is recommended that the card contents be backed up regularly. Use the appropriated procedure in the respective documentation.
- Do not remove the memory card while it is being accessed. If possible, use the eject function for removable data carriers in Windows. If this is not observed, it can result in data loss through to irreparable damage of the memory card.
- If a memory card does not function with your device, it may be an unsuitable card, a card not formatted for the device or a card with defective contents.
- Protect an unused card against pollution - especially the connector area - by keeping it in a suitable protective sleeve.

View



Figure 5-1 View of CompactFlash card

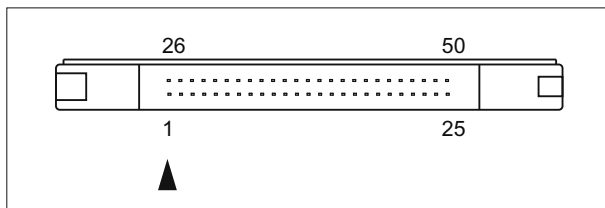

Figure 5-2 Schematic diagram of the CompactFlash card socket connector

NOTICE

Note reverse polarity protection

Do not use force to insert the CompactFlash card. There are various guide grooves to protect against reverse polarity. As can be seen in the above figure, the groove on the left is wider than the groove on the right. The arrow always indicates pin 1.

5.2 Technical data

Safety			
Degree of protection as per EN 60529	IP20		
Mechanical data			
Dimensions (mm)	Width: 43	Height: 3	Depth: 37
Weight	12 g		
Climatic environmental conditions			
Condensation, spraying water and icing	Not permitted		
	Operation	Storage and transportation	
Applicable standards	EN 60721-3-3	EN 60721-3-1 / -3-2	
Permissible ambient temperature	0 ... 55 °C	-25 ... 85 °C	
Limits for relative humidity	10 ... 80 %	5 ... 95 %	

3.5" floppy disk drive with USB interface

6.1 Description

The 3.5" disk drive (USB) is suitable for archiving user data and can be installed in front panels. It is connected via a USB1.1 interface.

Validity

This description applies to the component:

Type	Connection	Order number
3.5" diskette drive, USB	USB 1.1	6FC5235-0AA05-1AA2

Features

- The diskette drive is used to load and save data from/to 3.5" diskette with a "Normal density" capacity (720 KB) and "High density" capacity (1.2 / 1.44 MB)
- It can be mounted in front panels.
- The system can be booted from diskette drive.
- Connection: USB 1.1

The diskette drive is connected with the supplied 1 m USB cable.

6.1 Description

View

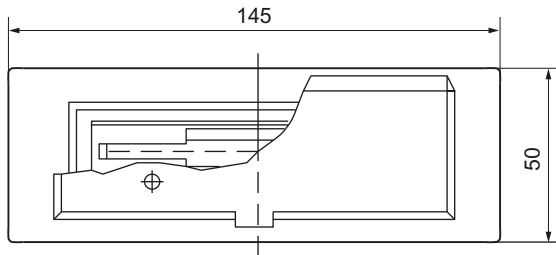

Figure 6-1 Front view

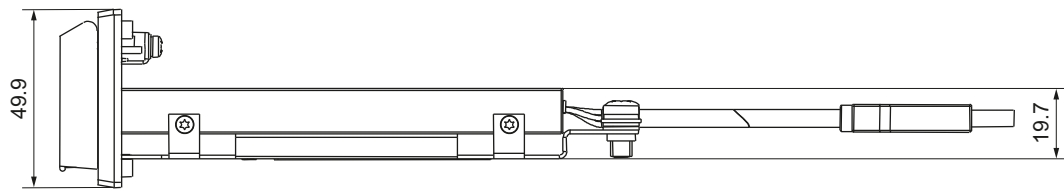

Figure 6-2 Side view from right

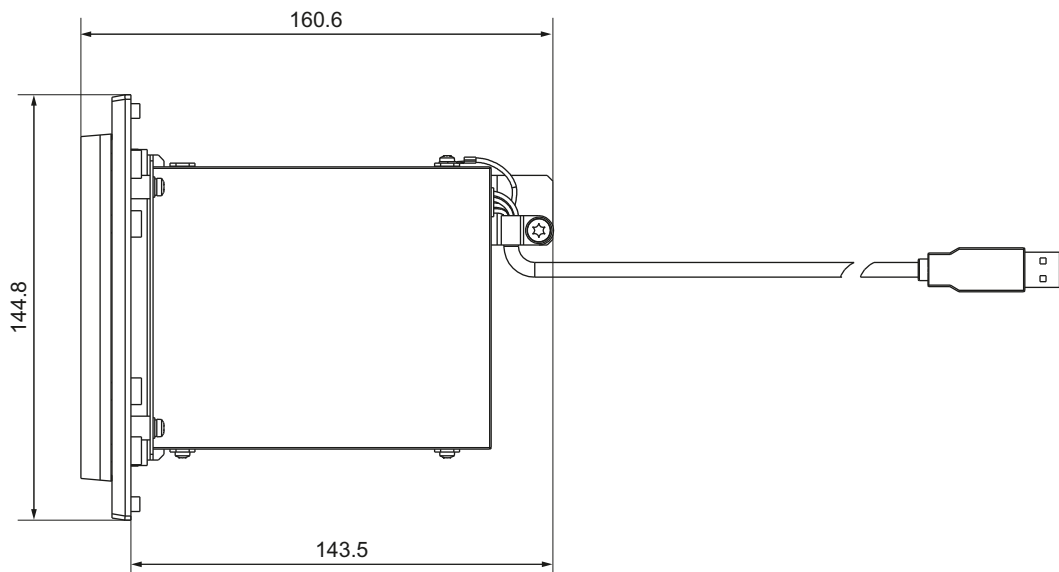

Figure 6-3 Top view

6.2 Interfaces

Connector assignment

Table 6- 1 Connector assignment - USB standard 1.1

Contact No.	Signal name	Description
1	Vcc	Power supply
2	- Data	Data-
3	+ Data	Data +
4	Ground	Ground

Cable

The 1 m USB cable at the rear of the device has a standard USB-A connector.



Figure 6-4 Strain relief for the cable

6.3 Mounting

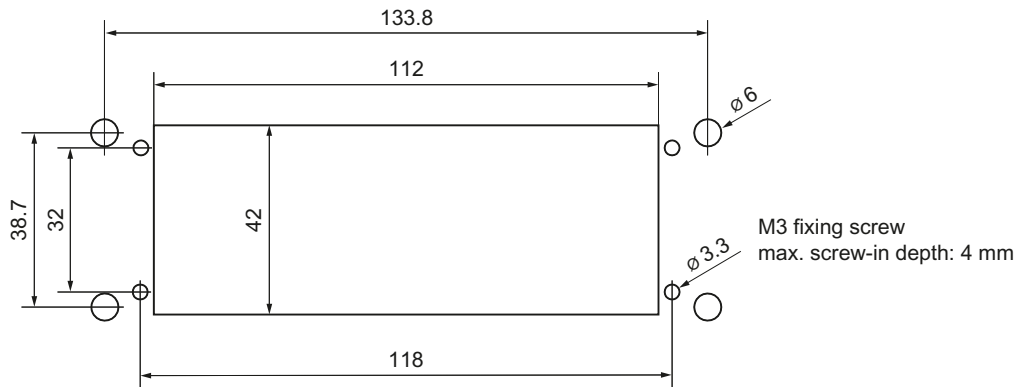

Figure 6-5 Panel cutout

NOTICE
Diskette cannot be read or written for incorrect installation position
The mounting position of the diskette drive is shown in the following two figures. The "top down" installation is not permitted because the functionality of the diskette drive cannot be guaranteed for this position.

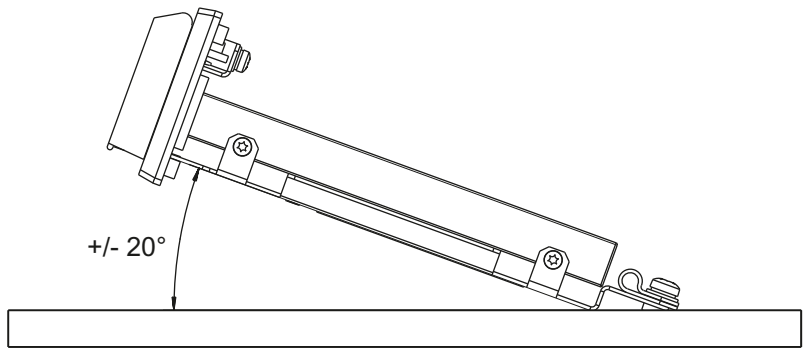

Figure 6-6 Side view of mounting position

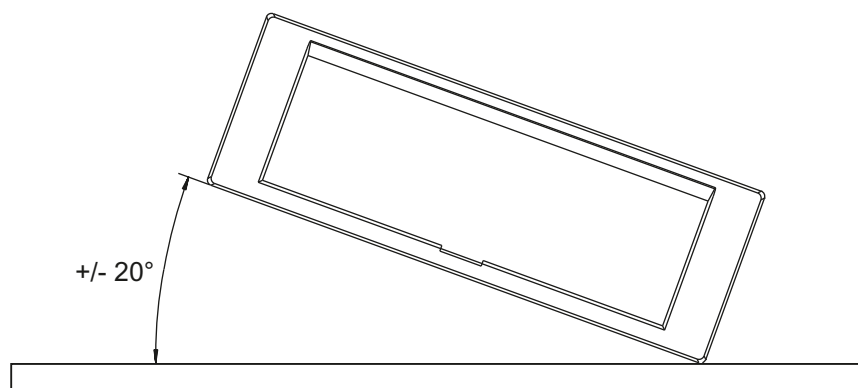

Figure 6-7 Front view of mounting position

NOTICE**Damage to the diskette drive for open front cover**

The front cover must be closed to prevent ingress of dirt or damage.

6.4 Notes about operation

6.4.1 Hardware

Cable extension

It is not permissible to extend the USB cable.

Required power

The drive is a high-power unit (needing up to 500 mA of power). This means it must not be operated at low-power USB outputs (up to 100 mA).

Leaving diskettes in drive

Do not leave diskettes in the drive for long periods of time because

1. they and the drive are not protected against dust in this situation,
2. the risk of data errors increases at temperatures higher than 45°C .

6.4.2 Software

The USB diskette drive is approved for the MS Windows 2000 and MS Windows XP operating systems. The appropriate drivers for the diskette drive are supplied with the operating system software.

SINUMERIK PCU 50.3

The USB diskette drive can be operated on the PCU 50.3 with PCU base software WinXP without an additional driver.

Before it is switched on, the drive must be connected to a USB line of the PCU 50.3 and is then assigned drive letter **a:**: provided it is the only diskette drive (does not apply to connection to a TCU).

It is possible to boot the PCU 50.3 from the USB diskette drive with the standard BIOS settings by selecting the diskette drive in the boot menu of the BIOS. For that, the USB diskette drive must be connected to a USB line of the PCU 50.3.

6.5 Technical data

Safety		
Safety class	III; PELV according to EN 50178	
Degree of protection according to EN 60529	Front side IP54	Rear side IP00
Approvals	CE	
Electrical data		
Input voltage	4.75 V - 5.25 V	
Input current	Max. 500 mA	
Mechanical data		
Dimensions	Width: 145 mm Height: 50 mm	Depth: 161 mm Mounting depth: 144 mm
Weight	Approx. 0.32 kg	
Orientation	any (except upside down)	
Distance from PCU	max. 5 m	

Note

Information about the climatic and mechanical environmental conditions is contained in the associated section under:

"General notes and interconnection" → "Operational planning".

Card reader with USB interface

7.1 Description

The SINUMERIK card reader is intended for archiving and exchanging user data.

The card reader is connected via the USB interface.

It can be installed in a front panel. This makes data exchange possible without opening the control cabinet.

The card reader can be booted.

All cards can be inserted and removed during operation.

Validity

This description applies to card reader

Order No.: 6FC5335-0AA00-0AA0.

Features

- Suitable for CF, SD, and MMC cards
- Installation in front panels
- Bootability
- Connection: USB 2.0

The card reader is delivered with attached 1 m USB cable.

Possible connections

The card reader is suitable for connection to:

- PCU 50.3 / 50.5
- TCU x0.2

7.2 Operator controls and indicators

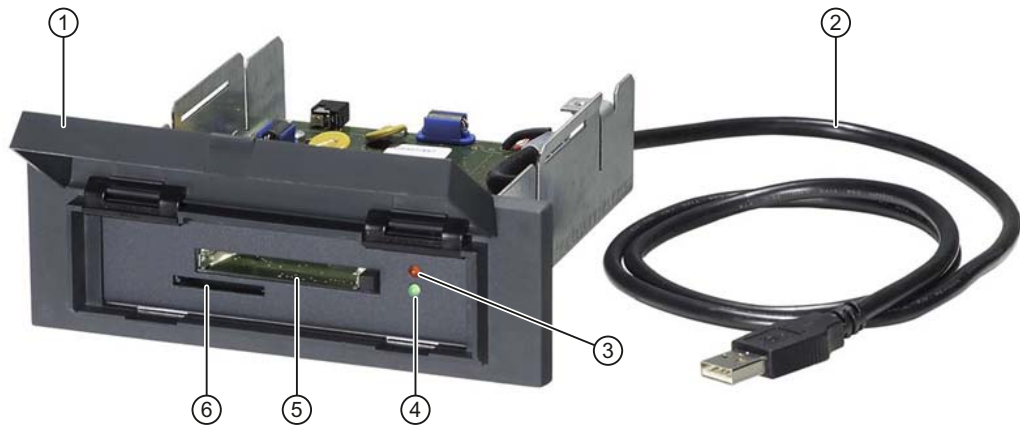

- ① Slot cover
- ② USB line
- ③ LED for displaying read and write processes (red)
- ④ LED for displaying operational readiness (green)
- ⑤ Slot for CF cards
- ⑥ Slot for SD / MMC cards

Figure 7-1 Front view of the USB card reader

Function of the LEDs

Two LEDs (see Fig.) with different functions are located next to the slot for CF cards.

LED	Display
Green	lit permanently if the card reader is ready for operation
Red	lit if reading or writing is in progress

Card slots

The two card slots of the reader are located under the cover.

Cards can be inserted in both slots at the same time as they operate simultaneously. In this way, it is possible to

- Copy files from one card to the other,
- Read or write to the media from various applications at the same time.

Note

Only use card types and sizes offered by Siemens.
You will find the order numbers in Catalog NC 61.

We cannot guarantee that every card available on the market can be used.

7.3 Interfaces

The card reader has a USB interface (USB 2.0).

The card reader can be connected via this interface to a USB interface of the PCU / TCU whose maximum current carrying capacity is 500 mA.

Transmission speed

If the card reader is connected to a USB 2.0 interface, the bus speed is automatically 480 Mbit/s (high speed).

The card reader switches to 12 Mbits/s (full speed) on a USB 1.1 interface.

7.4 Installation

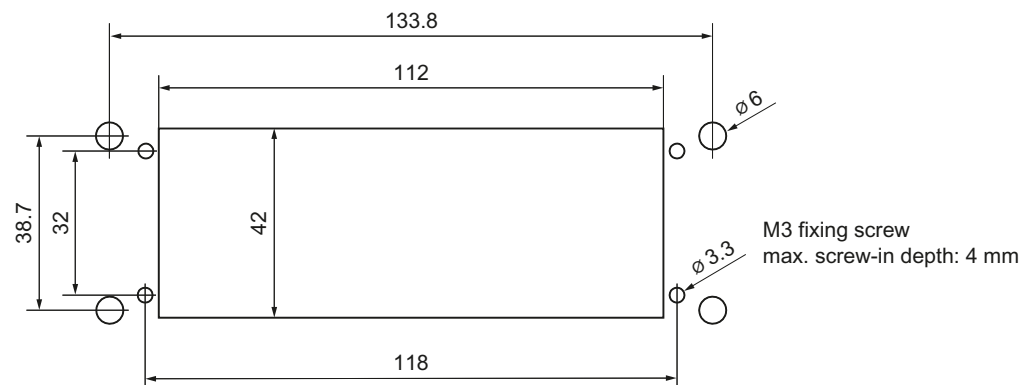

Figure 7-2 Panel cutout

NOTICE

Damage to the drive drive for open top cover

The slot cover of the card reader must be closed to prevent dirt entering or damage during installation.

7.5 Memory cards

The card reader is suitable for

- Compactflash cards (CF)
- SecureDigital cards (SD)
- Multimedia cards (MMC)
- MicroMemory cards (Simatic MMC)

Note

The read and write speed depends on the card used!

Booting

With the exception of the Simatic MMC, all other cards are bootable.

Card type	Bootable
CF cards	X
SD cards	X
MMC cards	X
Simatic MMC cards	-

Note

The card reader works like a USB drive.

Please note therefore that restrictions in the BIOS or operating system may not always allow booting from such a drive.

7.6 Technical data

Safety		
Safety class	III; PELV according to EN 50178	
Degree of protection according to EN 60529	Front side IP54	Rear side IP00
Approvals	CE	
Electrical data		
Input voltage	4.75 V - 5.25 V	
Input current	Max. 500 mA	
Mechanical data		
Dimensions	Width: 145 mm Height: 50 mm	Depth: 143 mm Mounting depth: 125 mm
Weight	Approx. 0.4 kg	
Card slots	2 (for every 10,000 mating cycles)	

Note

Information about the climatic and mechanical environmental conditions is contained in the associated section under:

"General notes and interconnection" → "Operational planning".

7.7 Accessories

The following accessories are available for the card reader:

Component	Description	Number	Order number
Cover	for diskette drive and card reader	1	6FC5247-0AA20-0AA0

USB extension

Description

Some operator panel fronts have no USB front interfaces. If required, you can, however, use the USB interfaces for PCU/TCU. The USB extension is used for external connection of the rear USB interface to the operator panel housing front.

Advantages:

- Undetachable protective cover.
- The bolted protective cap retains the degree of protection of the housing.
- Because the locknut automatically cuts itself into the paint or anodized layer, a conductive connection results.

Validity

This description applies to the following component:

	USB standard	Length	Order number
USB extension	1.1, 2.0	1 m	6FC5347-0AF01-1AA0

Display



Figure 8-1 USB extension

Mounting

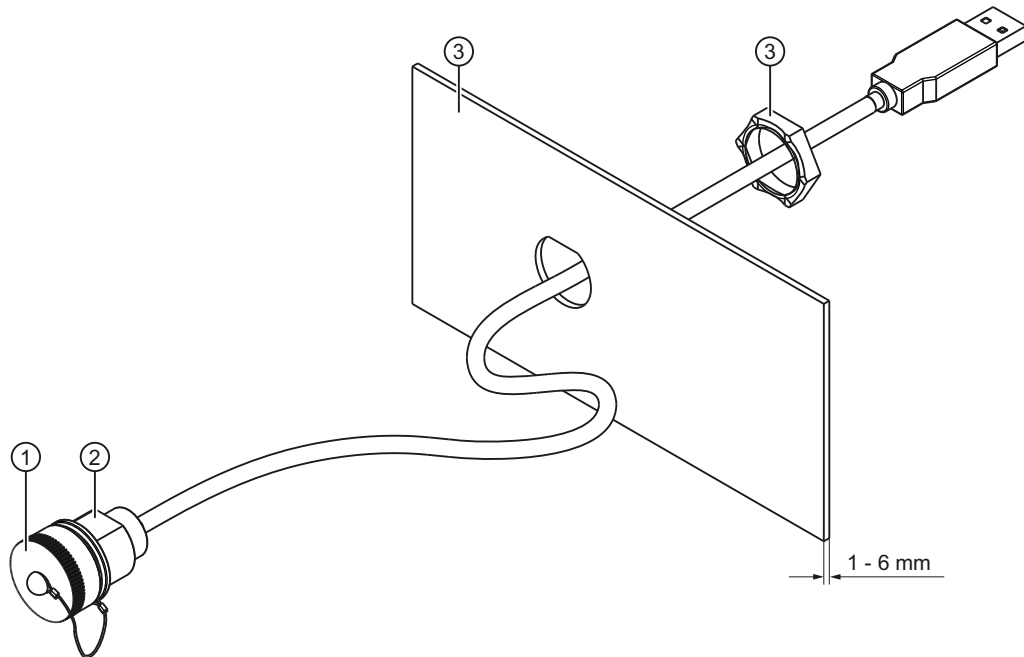

- ① Protective cap
- ② Anti-twist protection
- ③ Operator panel housing front
- ④ Locknut

Figure 8-2 Laying the USB extension

1. Mark the position on the operator panel housing front for the cable entry.
2. Punch the hole for the cable entry in order to ensure the anti-twist protection:

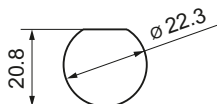

NOTICE
Damage to the USB extension
The USB cable must not be damaged. Consequently, remove any burrs in the hole.

3. Insert the USB extension through the hole.
4. Tighten the locknut with a tightening torque of 0.5 Nm to 0.75 Nm.

Index

C

- Card reader
 - Dimensions, 39
- CF card
 - Dimensions, 27
- CNC keyboard
 - KB 310C, 9
 - KB 483C, 17

D

- Disk drive, 29
- Diskette drive 3.5" (USB)
 - Mounting position, 32

K

- KB 310C
 - CNC keyboard, 9
 - Dimension drawing, 13
 - Dimensions, 14
 - Key codes, 10
 - Key groups, 9
 - Key layout, 10
 - Mounting position, 14
 - Power consumption, 14
 - USB technology, 12
- KB 483C
 - CNC keyboard, 17
 - Dimension drawing, 22
 - Dimensions, 23
 - Key groups, 17
 - Key layout, 18
 - Mounting position, 23
 - Power consumption, 23
 - USB technology, 20
- KBPC CG US standard PC keyboard
 - Dimensions, 6
 - Power consumption, 6
- Key codes
 - KB 310C, 10
- Key groups
 - KB 310C, 9
 - KB 483C, 17

- Key layout
 - KB 310C, 10
 - KB 483C, 18
- Keyboard tray
 - Dimensions, 7

U

- USB technology
 - KB 310C, 12
 - KB 483C, 20

Appendix

A.1 Abbreviations

AC	Alternating Current
ASIC	Application-Specific Integrated Circuit
BA	Mode selector switch
BIOS	Basic Input Output System
HHU	Handheld Unit
ALS	Authorization Lock Switch
OPI	Operator Panel Interface
CCFL	Cold Cathode Fluorescent Lamp: fluorescent lamp for background lighting
CDROM	Compact Disk ROM
CRT	Cathode Ray Tube
COM	Communications module
CPU	Central Processing Unit
DC	Direct Current
DCP	Discovery and basic Configuration Protocol: Standard for the assignment of IP addresses
DIP	Dual In-Line Package: dual in-line arrangement
DRAM	Dynamic RAM
DKM	Direct Key Module
I/O	Input/Output
ECC	Error Correction Code: method error correction in memory blocks
ESD	Electrostatic Sensitive Device
EKS	Electronic Key System: Identification system from EUCHNER
EMC	Electromagnetic Compatibility
EEA	European Economic Area
FB	Function Block
EN	European standard
FBG	Function Block Group
FSB	Front Side Bus
GD	Global Data communication
GND	Ground
GSD	Generic Station Description: The file describes a PROFIBUS slave in accordance with the PROFIBUS standard
HAM	Handwheel connection module
HF	Function keys LED
HGA	Connection for handheld units
HID	Human Interface Device: Device class of the USB standard that describes devices with which users interact directly, e.g. keyboard, mouse.
HMI	Human Machine Interface: SINUMERIK operator interface for operating, programming and simulation.

Appendix

A.1 Abbreviations

HT	Handheld Terminal
HW	Hardware
IC	Integrated Circuit: integrated electronic circuit
IDE	Integrated Drive Electronics
IE	Industrial Ethernet
I/O	Input/Output
IP	International Protection: ID letter for IPxx degree of protection
ISA	Industry Standard Architecture: Bus standard for IBM-compatible PCs
KT	Customer keys
LCD	Liquid Crystal Display
LE	Long Element
LED	Light-Emitting Diode
LPT	Line Print Terminal: Data transfer via a parallel interface
LVDS	Low Voltage Differential Signaling: standardized high-speed data transmission for the digital control of liquid crystal screens.
MCP	Machine Control Panel
MFII	Multifunction keyboard II
MLFB	Machine-readable product designation $\hat{=}$ order number
Modem	Modulator-demodulator
MPI	Multi-Point Interface: multi-point serial interface
MPP	Machine Pushbutton Panel
MCP	Machine Control Panel (MCP/MPP)
N.C.	Not Connected: Connection unassigned
NAU	Power failure
NC	Numerical Control
NCK	Numerical Control Kernel
NCU	Numerical Control Unit
OP	Operator Panel: operator panel front
PC	Personal Computer
PCU	PC Unit: computer unit
PE	Potential Earth
PELV	Protective Extra-Low Voltage
PG	Programming device
PLC	Programmable Logic Controller: component of the numerical control system
PNO	PROFIBUS user organization
PROFIBUS	Process Field Bus
RAM	Random Access Memory: Read/write memory
ROM	Read Only Memory
S/R	Steps per Revolution
SDRAM	Synchronous Dynamic Random Access Memory: synchronous DRAM
SR	Mushroom-shaped button for rapid withdrawal
SSD	Solid State Drive: Electronic hard disk drive
STN	Super Twisted Nematic: Flat screen technology
SVGA	Super VGA: Screen resolution 800 x 600 pixels, maximum 16.7 million colors

SXGA	Super Extended Graphics Array: Screen resolution 1280 x 1024 pixels
SW	Software
TCU	Thin Client Unit
TFT	Thin Film Transistor (flat screen technology)
UL	Underwriters Laboratories
USB	Universal Serial Bus
RS-232-C	Interface standard in accordance with CCITT RS-232-C
VGA	Video Graphics Array: Computer graphics standard with 640 x 480 pixel resolution, 16 colors
WS	Selector switch
XGA	Extended Graphics Array: Screen resolution 1024 x 768 pixels

A.2 Documentation overview

