

SIEMENS

SIMATIC HMI

HMI device MP 277

Operating Instructions

Preface

Overview

1

Safety instructions and approvals

2

Planning application

3

Installing and connecting the device

4

Operator controls and displays

5

Configuring the device

6

Commissioning a project

7

Operating a project

8

Maintenance and care

9

Technical specifications

10

Appendix

A



Abbreviations

B

Legal information

Warning notice system

This manual contains notices you have to observe in order to ensure your personal safety, as well as to prevent damage to property. The notices referring to your personal safety are highlighted in the manual by a safety alert symbol, notices referring only to property damage have no safety alert symbol. These notices shown below are graded according to the degree of danger.

 DANGER
indicates that death or severe personal injury will result if proper precautions are not taken.
 WARNING
indicates that death or severe personal injury may result if proper precautions are not taken.
 CAUTION
indicates that minor personal injury can result if proper precautions are not taken.
NOTICE
indicates that property damage can result if proper precautions are not taken.

If more than one degree of danger is present, the warning notice representing the highest degree of danger will be used. A notice warning of injury to persons with a safety alert symbol may also include a warning relating to property damage.

Qualified Personnel

The product/system described in this documentation may be operated only by **personnel qualified** for the specific task in accordance with the relevant documentation, in particular its warning notices and safety instructions. Qualified personnel are those who, based on their training and experience, are capable of identifying risks and avoiding potential hazards when working with these products/systems.

Proper use of Siemens products

Note the following:

 WARNING
Siemens products may only be used for the applications described in the catalog and in the relevant technical documentation. If products and components from other manufacturers are used, these must be recommended or approved by Siemens. Proper transport, storage, installation, assembly, commissioning, operation and maintenance are required to ensure that the products operate safely and without any problems. The permissible ambient conditions must be complied with. The information in the relevant documentation must be observed.

Trademarks

All names identified by ® are registered trademarks of Siemens AG. The remaining trademarks in this publication may be trademarks whose use by third parties for their own purposes could violate the rights of the owner.

Disclaimer of Liability

We have reviewed the contents of this publication to ensure consistency with the hardware and software described. Since variance cannot be precluded entirely, we cannot guarantee full consistency. However, the information in this publication is reviewed regularly and any necessary corrections are included in subsequent editions.

Preface

Purpose of the operating instructions

These operating instructions provide information for manuals derived from the requirements for mechanical engineering documentation according to DIN EN 62079. This information relates to the place of use, transport, storage, mounting, use and maintenance.

These operating instructions are intended for:

- Users
- Commissioning engineers
- Maintenance personnel

Pay particular attention to the section "Safety Instructions (Page 25)".

You can find more information such as operating instructions, examples and reference information in the online help of the configuration software.

Required knowledge

General knowledge of automation technology and process communication is needed to understand the operating instructions.

It is also assumed that those using the manual have experience in using personal computers and an understanding of Microsoft operating systems.

Scope of the operating instructions

The operating instructions apply to the HMI device MP 277 in conjunction with the following configuration software:

- WinCC (TIA Portal)
- WinCC flexible

Conventions

The following text notation will facilitate reading this manual:

Notation	Scope
"Add screen"	<ul style="list-style-type: none">• Terminology that appears in the user interface, for example dialog names, tabs, buttons, menu commands• Required input, for example, limits, tag values.• Path information
"File > Edit"	Operating sequences, for example, menu commands, shortcut menu commands
<F1>, <Alt+P>	Keyboard operation

Please observe notes labeled as follows:

Note

Notes contain important information concerning the product, its use or a specific section of the documentation to which you should pay particular attention.

Illustrations in this manual

This documentation includes illustrations associated with the product. These illustrations may differ from the factory state of the product.

Table of contents

	Preface	3
1	Overview.....	9
1.1	Product overview	9
1.2	Design of the HMI Device MP 277 8" Touch	10
1.3	Design of the HMI Device MP 277 8" Key	11
1.4	Design of the HMI Device MP 277 10" Touch	13
1.5	Design of the HMI Device MP 277 10" Key	14
1.6	Accessory kit.....	16
1.7	Accessories.....	16
1.8	The HMI device in the operating process	18
1.9	Functional scope with WinCC and WinCC flexible	19
1.10	Software options	21
1.11	Communications	22
2	Safety instructions and approvals.....	25
2.1	Safety Instructions	25
2.2	Standards, certificates and approvals.....	27
2.3	Notes about usage.....	30
2.4	Electromagnetic compatibility	31
2.5	Transport and storage conditions	33
3	Planning application.....	35
3.1	Notes about usage.....	35
3.2	Mounting positions	37
3.3	Preparing for Mounting	38
3.4	Specifications for Insulation Tests, Protection Class and Degree of Protection	40
3.5	Rated voltages	40
4	Installing and connecting the device.....	41
4.1	Checking the package contents.....	41
4.2	Mounting the HMI Device	41
4.3	Connecting the HMI device.....	44
4.3.1	Overview	44
4.3.2	Ports.....	45
4.3.3	Connecting the equipotential bonding circuit.....	46
4.3.4	Connecting the Power Supply	48
4.3.5	Connecting the PLC.....	50
4.3.6	Connecting a Configuring PC	53
4.3.7	Connecting a USB device.....	55
4.3.8	Connecting a Printer.....	57

4.4	Switching on and Testing the HMI device.....	58
4.5	Securing the cables	59
5	Operator controls and displays.....	61
5.1	Front operator controls.....	61
5.2	Using Memory Cards with the HMI Device	63
5.3	Labeling the Function Keys at the MP 277 Key.....	65
6	Configuring the device	69
6.1	Loader	69
6.2	Enabling and disabling SecureMode	74
6.3	Control Panel	74
6.3.1	Overview	74
6.3.2	Reference for functions.....	76
6.3.3	Operating the Control Panel	77
6.3.3.1	Overview	77
6.3.3.2	Entries using the touch screen.....	78
6.3.3.3	Input with the Keyboard	80
6.4	Changing settings for operation.....	84
6.4.1	Setting up the screen keyboard	84
6.4.2	Setting the Character Repetition of the Keyboard	85
6.4.3	Setting the Double-click	86
6.4.4	Calibrate touch screen	87
6.5	Changing Password Protection.....	89
6.6	Changing HMI device settings	90
6.6.1	Setting the Date and Time	90
6.6.2	Changing Regional Settings	92
6.6.3	Backing up Registry Information	92
6.6.4	Changing monitor settings	94
6.6.5	Setting the screen saver	94
6.6.6	Changing the Printer Properties.....	96
6.6.7	Set the volume	97
6.6.8	Restarting the HMI Device	99
6.6.9	Displaying Information about the HMI Device.....	100
6.6.10	Displaying System Properties	101
6.7	Setting the Delay Time.....	102
6.8	Setting the uninterruptible power supply.....	104
6.9	State of uninterruptible power supply	105
6.10	Change the communication settings.....	106
6.10.1	Changing S7 transfer settings.....	106
6.10.2	Configuring the data channel.....	109
6.10.3	Enabling PROFINET IO	111
6.11	Configuring network operation.....	113
6.11.1	Overview of network operation	113
6.11.2	Setting the device name of the HMI device	115
6.11.3	Changing the Network Configuration.....	116
6.11.4	Changing the Logon Data	118
6.11.5	Changing E-Mail Settings	119

6.11.6	Changing internet settings	121
6.11.6.1	Changing General Internet Settings	121
6.11.6.2	Setting the Proxy Server	122
6.11.6.3	Changing Privacy Settings.....	123
6.11.6.4	Importing and Deleting Certificates.....	125
6.12	Backing up data to external storage device.....	126
6.13	Restoring data from external storage device	128
6.14	Activate Memory Management	131
7	Commissioning a project.....	133
7.1	Overview	133
7.2	Operating modes	134
7.3	Using existing projects	135
7.3.1	WinCC flexible projects.....	135
7.3.2	WinCC projects	135
7.4	Data Transmission Options	136
7.5	Transfer project to the HMI device.....	137
7.5.1	Transfer project with WinCC	137
7.5.1.1	Setting the transfer mode	137
7.5.1.2	Starting the transfer	139
7.5.1.3	Testing a project	140
7.5.2	Transfer project with WinCC flexible.....	141
7.5.2.1	Overview	141
7.5.2.2	Starting manual transfer.....	142
7.5.2.3	Starting automatic transfer.....	143
7.5.2.4	Starting backtransfer.....	144
7.5.2.5	Testing a project	145
7.6	Backup and restore.....	147
7.6.1	Overview	147
7.6.2	Backup and restore using ProSave	148
7.7	Updating the operating system	149
7.7.1	Overview	149
7.7.2	Updating the Operating System using ProSave	151
7.8	Installing and removing options	152
7.8.1	Overview	152
7.8.2	Installing and removing options using ProSave.....	152
7.9	Transferring and transferring back license keys	154
7.9.1	Overview	154
7.9.2	Transfer of license keys with the Automation License Manager	154
8	Operating a project	157
8.1	Overview	157
8.2	Direct keys	160
8.3	Setting the project language	161
8.4	Entering values using the touch screen.....	162
8.4.1	Overview	162
8.4.2	Entering and Editing Numerical Values	163
8.4.3	Entering and editing alphanumeric values	166

8.4.4	Entering the date and time	168
8.4.5	Entering Symbolic Values	168
8.4.6	Displaying Infotext.....	169
8.5	Entering values using the keys	170
8.5.1	Control keys	170
8.5.2	Example: Enter characters using the alphanumeric keyboard	173
8.5.3	Function keys	173
8.5.4	General procedures	174
8.5.5	Entering and editing numerical values.....	174
8.5.6	Entering and editing alphanumerical values	176
8.5.7	Entering the date and time	177
8.5.8	Entering Symbolic Values	177
8.5.9	Displaying Infotext.....	178
8.6	Closing the project	179
9	Maintenance and care.....	181
9.1	Maintenance and care	181
9.2	Clean screen on MP 277 Touch	182
9.3	Spare Parts and Repairs.....	182
9.4	Recycling and disposal	182
10	Technical specifications	183
10.1	Dimension drawings.....	183
10.1.1	Dimension drawing of the MP 277 8" Touch.....	183
10.1.2	Dimension drawing of the MP 277 8" Key	184
10.1.3	Dimension drawing of the MP 277 10" Touch.....	185
10.1.4	Dimension drawing of the MP 277 10" Key	186
10.2	Specifications	186
10.2.1	Specifications of the MP 277 Touch	186
10.2.2	Specifications of the MP 277 Key	188
10.3	Bit assignment of the direct keys	189
10.4	Description of the ports	191
10.4.1	Power supply.....	191
10.4.2	X10/IF 1B (RS 422/RS 485).....	191
10.4.3	X20, X21 (USB).....	192
10.4.4	X1 (Ethernet/LAN).....	192
A	Appendix	193
A.1	Service and support	193
A.2	System events.....	193
A.3	ESD guideline	194
B	Abbreviations	197
	Glossary	199
	Index	205

Overview

1.1 Product overview

Possible applications of the MP 277

The Multi Panel MP 277 units are an extension of the 270 series.

The HMI devices are based on the innovative standard operating system, Microsoft Windows CE 5.0. The Multi Panel MP 277 units belong to the "Multifunctional Platform" product category. The HMI devices offer enhanced communication options to the office world. The Pocket Internet Explorer is already installed on the HMI devices.

The MP 277 offers a variety of application uses, high performance and a favorable cost/performance ratio.

The devices are equipped with:

- PROFIBUS port
- Ethernet port for connection to PROFINET
- 2 USB ports
- TFT screen with up to 64k color

Thanks to the wide range of devices, you get to use the device that is suited to you.

The HMI devices support the following software options:

- Sm@rtService
- Sm@rtAccess
- /Audit
- OPC server

1.2 Design of the HMI Device MP 277 8" Touch

Front view and side view

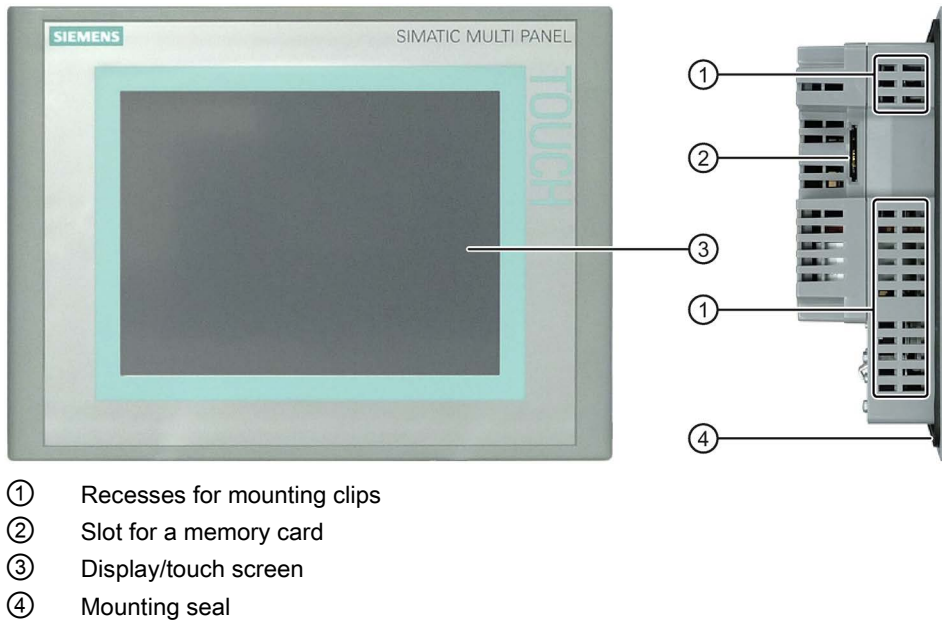

Bottom view

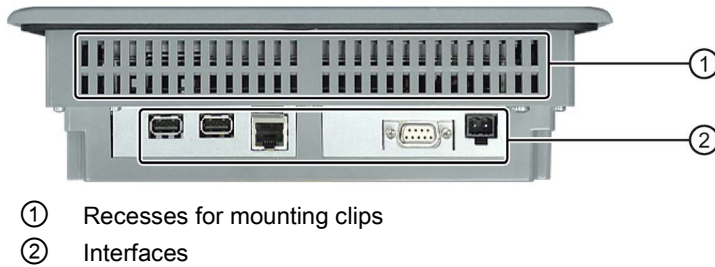

Rear view

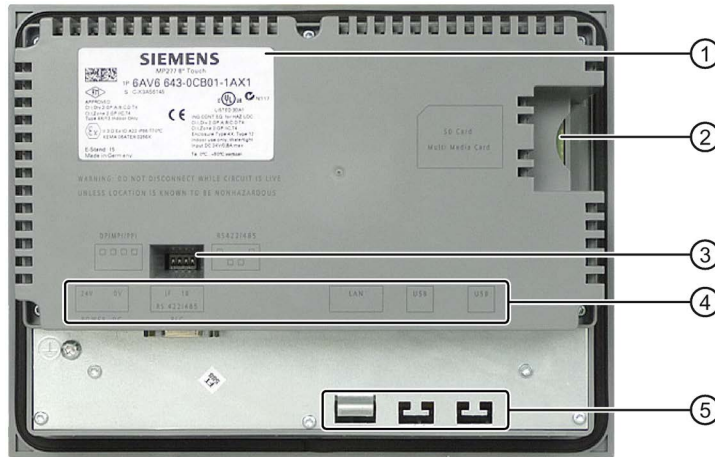

- ① Rating plate
- ② Slot for a memory card
- ③ DIP switch
- ④ Interface name
- ⑤ Fixing elements for strain relief

1.3 Design of the HMI Device MP 277 8" Key

Front view and side view

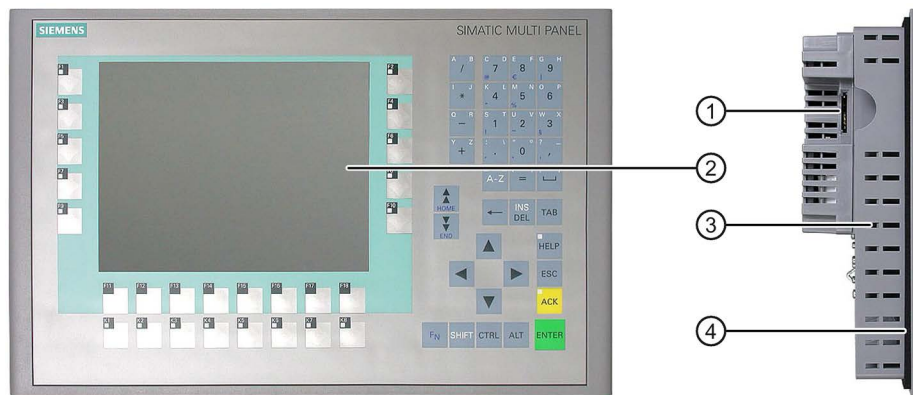

- ① Slot for a memory card
- ② Display
- ③ Recesses for mounting clips
- ④ Mounting seal

Bottom view



- ① Recesses for a mounting clip
- ② Interfaces

Rear view



- ① Rating plate
- ② Slot for a memory card
- ③ DIP switch
- ④ Interface name
- ⑤ Fixing elements for strain relief

1.4 Design of the HMI Device MP 277 10" Touch

Front view and side view

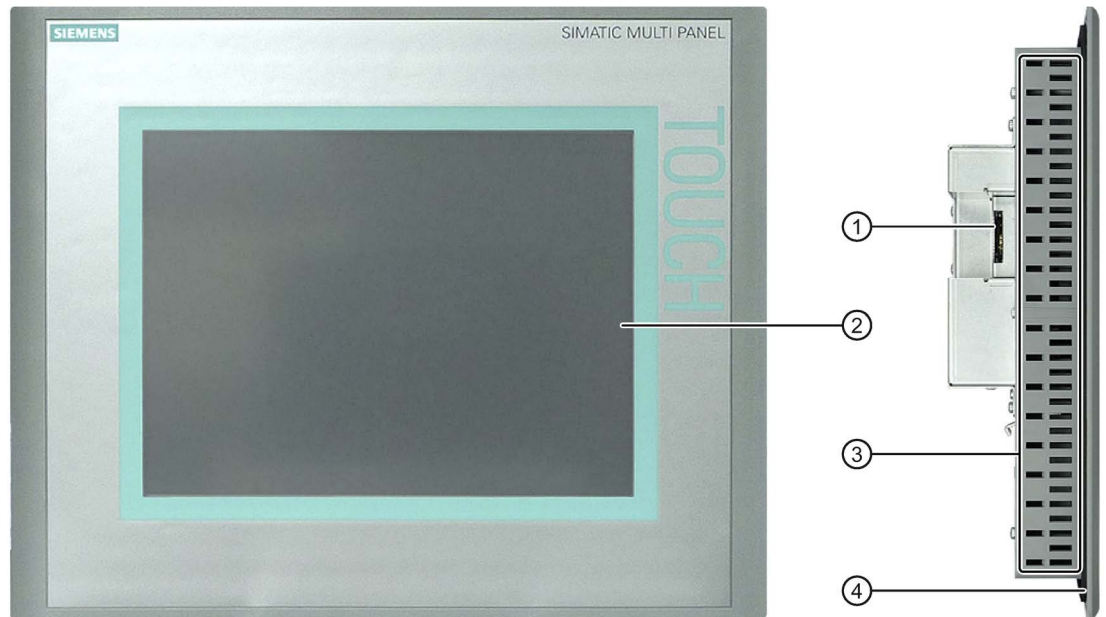

- ① Slot for a memory card
- ② Display/touch screen
- ③ Recesses for mounting clips
- ④ Mounting seal

Bottom view

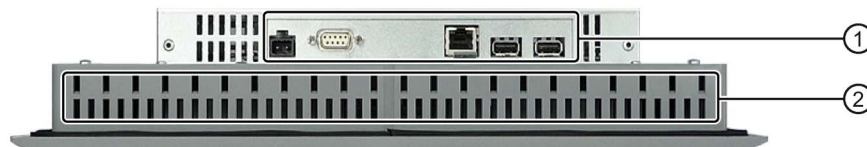

- ① Interfaces
- ② Recesses for mounting clips

1.5 Design of the HMI Device MP 277 10" Key

Rear view

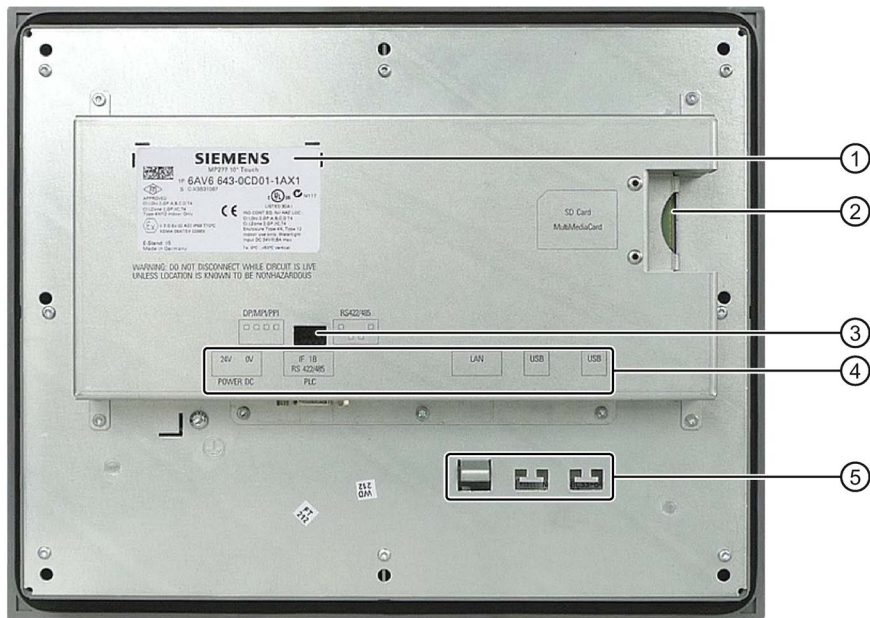

- ① Rating plate
- ② Slot for a memory card
- ③ DIP switch
- ④ Interface name
- ⑤ Fixing elements for strain relief

1.5 Design of the HMI Device MP 277 10" Key

Front view and side view

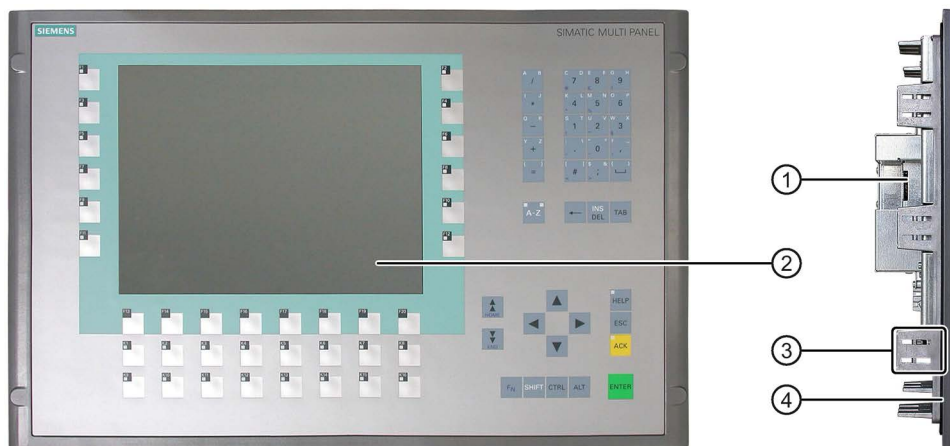

- ① Slot for a memory card
- ② Display
- ③ Recesses for a mounting clip
- ④ Mounting seal

Bottom view

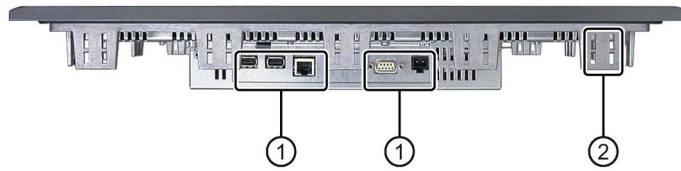

- ① Interfaces
- ② Recesses for a mounting clip

Rear view

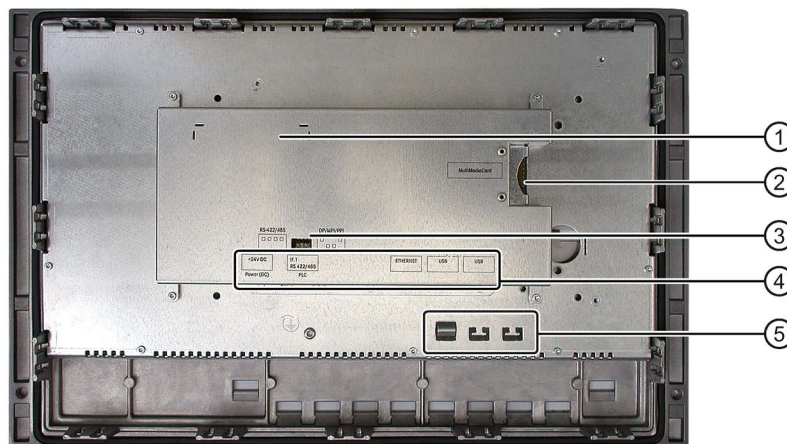

- ① Rating plate
- ② Slot for a memory card
- ③ DIP switch
- ④ Interface name
- ⑤ Fixing elements for strain relief

1.6 Accessory kit

The accessory kit contains the following:

- Mains terminal for the power supply
- Mounting clips for mounting the HMI device

Additional documents may be enclosed with the accessory kit.

Mounting clips

Spring mounting clips or aluminum mounting clips are provided for mounting the device. The mounting clips hook into oblong holes on the HMI device. The main dimensions of the HMI device are not exceeded by this.

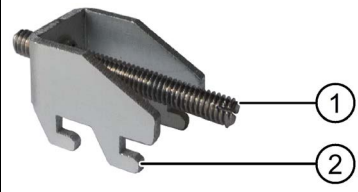
Spring mounting clip	Aluminum mounting clip
 <p>① Slot ② Hook</p>	 <p>① Threaded pin ② Hook</p>

A product information with notes on mounting of the HMI device with mounting clips is supplied with the HMI device.

The product information is available in the Internet at the following links:

- Product Information "Spring clamp"
(<http://support.automation.siemens.com/WW/view/en/34916893>)
- Product Information "Metal mounting clamps"
(<http://support.automation.siemens.com/WW/view/en/34915725>)

1.7 Accessories

Accessories are not included in the product package of the HMI device, but can ordered on the Internet at Industry Mall (<https://mall.industry.siemens.com>).

Converter RS 422-RS 232

The converter is required for the connection of controllers of other manufacturers. Connect the RS 422 to RS 232 converter to the RS 422 / RS 485 interface. The converter converts the input signals to RS-232 signals.

Order number: 6AV6 671-8XE00-0AX0

PC/PPI cable

You need the cable to update the operating system with reset to factory settings. You can also use the cable for data transfer. Connect the PC/PPI cable to the RS 422/RS 485 port. The cable converts the input signals to RS-232 signals.

Order number: 6ES7 901-3CB30-0XA0

Note

Set a lower bit rate if the connection is lost during the operating system update. If you use a high bit rates, you need to use PC/PPI cable version 3 or higher. The version code is printed on the cable ("E stand 3," for example, corresponds to version 3).

90° elbow adapter

If space is limited, you can use an elbow adapter at the RS 422/RS 485 interface.

Order number: 6AV6 671-8XD00-0AX0

Clamping frame

IP65 degree of protection or enclosure type 4X/type 12 can be achieved with a clamping frame even with little material thickness at the mounting cut-out. For additional information, see Section Preparing for Mounting (Page 38).

Clamping frames are available with the following order numbers:

Clamping frame for HMI device	Order number
MP 277 8" Touch	6AV6671-3CS00-0AX0
MP 277 8" Key	6AV6671-3CS01-0AX0
MP 277 10" Touch	6AV6671-8XS00-0AX0

Service pack

Content of the service package for all HMI devices:

- Mounting seals
- Mounting clips
- Power supply terminal, 2-pin

Order number: 6AV6671-3XA01-0AX1

1.8 The HMI device in the operating process

The HMI device is part of the operating process. The following two phases are key to the way the HMI device is integrated in the operating process:

- Project design
- Process management

Project design

Visualization of the operating process is known as project design. Project design comprises:

- writing project data
- saving project data
- testing project data
- simulating project data

Project design is undertaken independently of the HMI device and results in a project. Once this has been generated, the project can be transferred to the HMI device to control the operating process.

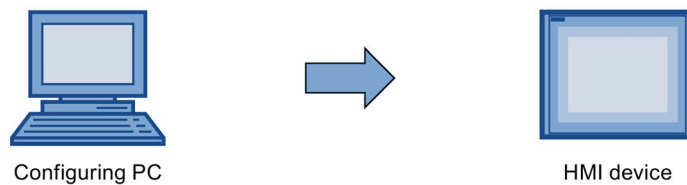

Process management

Process management is marked by two-way communication between HMI device and controller. This lays the foundations for operator control and monitoring.

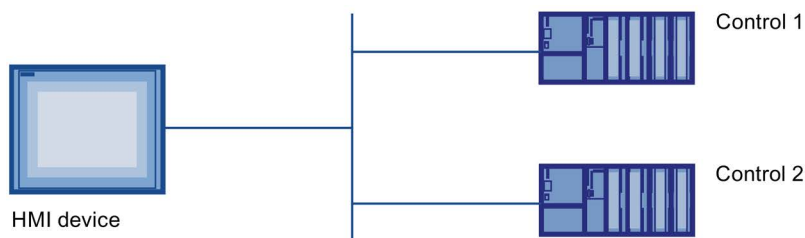

The operator can intervene in the operating process on the HMI device for control purposes. The controller in turn supplies the results of the operating process which are displayed on the HMI device.

1.9 Functional scope with WinCC and WinCC flexible

The following tables show the objects that can be integrated in a project for an MP 277.

Messages

Object	Specification	WinCC	WinCC flexible
Messages	Number of discrete alarms	4000	
	Number of analog alarms	200	
	Length of the alarm text	80 characters	
	Number of tags in an alarm	Max. 8	
	Display	Alarm line, Alarm window, Alarm view	
	Acknowledge error alarm individually	Yes	
	Acknowledge multiple error alarms simultaneously (group acknowledgement)	16 alarm groups	
	Edit alarm	Yes	
	Alarm indicator	Yes	
ALARM_S	Display S7 alarms	Yes	
Alarm buffer, retentive	Alarm buffer capacity	512 alarms	
	Simultaneously queued alarm events	Max. 250	
	View alarm	Yes	
	Delete alarm buffer	Yes	
	Print alarm by line	Yes	

Tags, values and lists

Object	Specification	WinCC	WinCC flexible
Tags	Number	2048	
Limit monitoring	Input/output	Yes	
Linear scaling	Input/output	Yes	
Text lists	Number	500 ¹	
Graphics lists	Number	400 ¹	

¹ The maximum total of text and graphics lists is 500.

Screens

Object	Specification	WinCC	WinCC flexible
Screens	Number	500	
	Fields per screen	200	
	Tags per screen	500	200
	Complex objects per screen (for example, bars)	10	
	Template	Yes	

Recipes

Object	Specification	WinCC	WinCC flexible
Recipes	Number	300	
	Data records per recipe	500	
	Entries per recipe	1000	
	Recipe memory	64 KB	
	Storage location	<ul style="list-style-type: none"> • Memory card ¹ • USB memory stick ¹ • Network drive 	

¹ The number of recipe data records may be restricted by the capacity of the storage medium.

Logs

Note

The HMI devices are suitable for the logging of relatively small volumes of data.

Manage the data in several adjacent archives in a segmented circular log. The use of a large circular log has a negative effect on performance.

Object	Specification	WinCC	WinCC flexible
Logs	Number of logs	20	
	Number of partial logs in a segmented circular log	400	
	Entries per log	10000	
	Filing format	CSV with ANSI character set	
	Storage location	<ul style="list-style-type: none"> • Memory card ¹ • USB memory stick ¹ • Network drive 	

¹ The number of entries in the log may be restricted by the capacity of the storage medium.

Safety

Object	Specification	WinCC	WinCC flexible
Safety	Number of user groups	50	
	Number of users	50	
	Number of authorizations	32	

Info texts

Object	Specification	WinCC	WinCC flexible
Info texts	Length (no. of characters)	320 (depending on font)	
	For alarms	Yes	
	For screens	Yes	
	For screen objects (for example, for I/O field, switch, button, invisible button)	Yes	

Additional functions

Object	Specification	WinCC	WinCC flexible
Screen settings	Touch screen calibration ¹	Yes	
	Brightness setting	Yes	
Language switching	Number of languages	16	
VBScript	User-specific extension of the functionality	Yes	
	Number of scripts	50	
Graphic objects	Vector and pixel graphics	Yes	
Trends	Number	300	
Scheduler	Number of tasks	48	
Text objects	Number	10000	
Direct keys	PROFIBUS DP direct keys	Yes	
	PROFINET IO direct keys	Yes	

¹ MP 277 Touch only

1.10 Software options

The following software options are available for the MP 277:

- **Sm@rtService**
The Sm@rtService option enables you to access a remote HMI device from the HMI device or PC via Ethernet.
- **Sm@rtAccess**
The Sm@rtAccess option enables you to set up communication between different HMI systems.
- **/Audit**
The /Audit option extends the HMI device to include functions for recording operations in an audit trail and electronic signature.
- **OPC server (OPC XML)**
The OPC-Server option enables you to create communications to OPC-capable applications from an HMI device or PC via Ethernet.

1.11 Communications

Number of connections

Connection	MP 277
Number using a bus connection	6
Number of connections based on "SIMATIC HMI HTTP Protocol"	8

Note

In the following cases, you may not enable PROFINET IO in the Control Panel of the HMI device:

- Use of PLCs from other manufacturers
- Use of SIMATIC 500/505 via NITP

PLCs

The following table shows the PLCs which can be used with the HMI devices and the protocols or profiles which can be used.

PLC	Protocol	MP 277
SIMATIC S7	<ul style="list-style-type: none"> • PPI • MPI¹ • PROFIBUS DP • TCP/IP (Ethernet) 	Yes
SIMATIC S5	<ul style="list-style-type: none"> • PROFIBUS DP 	Yes
SIMATIC 500/505	<ul style="list-style-type: none"> • NITP • PROFIBUS DP 	Yes
SIMATIC HMI HTTP Protocol	<ul style="list-style-type: none"> • HTTP/HTTPS (Ethernet) 	Yes
Allen-Bradley	PLC series SLC500, SLC501, SLC502, SLC503, SLC504, SLC505, MicroLogix and PLC5/11, PLC5/20, PLC5/30, PLC5/40, PLC5/60, PLC5/80 <ul style="list-style-type: none"> • DF1 ^{2,5} • DH+ via KF2 module ³ • DH485 via KF3 module ⁴ • DH485 ⁴ 	Yes
GE Fanuc Automation	PLC series 90–30, 90–70, VersaMax Micro <ul style="list-style-type: none"> • SNP 	Yes
LG Industrial Systems (Lucky Goldstar) / IMO	PLC series GLOFA GM (GM4, GM6 and GM7) / Series G4, G6 and G7 <ul style="list-style-type: none"> • Dedicated communication 	Yes

PLC	Protocol	MP 277
Mitsubishi Electric	PLC series MELSEC FX and MELSEC FX0 <ul style="list-style-type: none"> FX 	Yes
Mitsubishi Electric	PLC series MELSEC FX0, FX1n, FX2n, AnA, AnN, AnS, AnU, QnA and QnAS <ul style="list-style-type: none"> Protocol 4 	Yes
OMRON	PLC series SYSMAC C, SYSMAC CV, SYSMAC CS1, SYSMAC alpha and CP <ul style="list-style-type: none"> Hostlink/Multilink (SYSMAC Way) 	Yes
Modicon (Schneider Automation)	PLC series Modicon 984, TSX Quantum and TSX Compact <ul style="list-style-type: none"> Modbus RTU ⁵ PLC series Quantum, Momentum, Premium and Micro PLC series Compact and 984 via Ethernet bridge <ul style="list-style-type: none"> Modbus TCP/IP (Ethernet) 	Yes

¹ Not possible when connected to S7-212.

² Applies to controllers SLC503, SLC504, SLC505, PLC5, MicroLogix

³ Applies to controllers SLC504, PLC5 over DF1

⁴ Applies to controllers SLC500 to SLC 505 and MicroLogix

⁵ Only with converter RS 422-RS 232 6AV6 671-8XE00-0AX0 (option)

Safety instructions and approvals

2.1 Safety Instructions

Working on the control cabinet

 WARNING
<p>Open equipment</p> <p>The HMI device is open equipment. This means that the HMI device may only be mounted in housings or cabinets, whereby the device can be operated from the front panel.</p> <p>The cubicle or cabinet in which the HMI device is installed may only be accessed with a key or tool and only by trained, authorized personnel.</p> <p>Dangerous voltage</p> <p>Opening the cabinet will expose high voltage parts. Contact with these parts could be fatal. Disconnect the cabinet from the mains before opening it.</p>

Potentially explosive atmospheres

When operating the HMI device in hazardous areas the following warning applies.

 WARNING
<p>Explosion Hazard</p> <p>Do not disconnect while circuit is live unless area is known to be non-hazardous. Substitution of components may impair suitability for Class I, Division 2 or Zone 2.</p>

 ATTENTION
<p>RISQUE D'EXPLOSION</p> <p>NE PAS DÉBRANCHER TANT OUE LE CIRCUIT EST SOUS TENSION, À MOINS QU'IL NE S'AGISSE D'UN EMPLACEMENT NON DANGEREUX.</p>

 WARNING
<p>EXPLOSION HAZARD</p> <p>SUBSTITUTION OF COMPONENTS MAY IMPAIR SUITABILITY FOR CLASS I, DIVISION 2.</p>

 ATTENTION
RISQUE D'EXPLOSION
LA SUBSTITUTION DE COMPOSANTS PEUT RENDRE CE MATÉRIEL INACCEPTABLE POUR LES EMPLACEMENTS DE CLASSE I, DIVISION 2.

High frequency radiation

Note

Unintentional operating situations

High frequency radiation, for example, from cellular phones, can trigger unwanted operating states.

Installation as intended

 WARNING
Installation only in machinery that conforms to the machinery directive
It is not allowed to commission the HMI device unless it has been verified that the machine in which the HMI device is to be installed complies with Directive 2006/42/EC.

Industrial Security

Siemens offers products and solutions with Industrial Security functions that support the safe operation of equipment, solutions, machines, devices and/or networks. They are important components in a comprehensive Industrial Security concept. As a result the products and solutions from Siemens are constantly evolving. Siemens recommends obtaining regular information regarding product updates.

For safe operation of Siemens products and solutions appropriate protective measures (e.g., cell protection concept) must be taken and each component must be integrated in a comprehensive Industrial Security concept, which corresponds with the current state of technology. The products of other manufacturers need to be taken into consideration if they are also used. You can find addition information on Industrial Security under (<http://www.siemens.com/industrialsecurity>).

Sign up for our product-specific newsletter to receive the latest information on product updates. For more information, see under (http://www.siemens.de/automation/csi_en_WW).

Disclaimer for third-party software updates

This product includes third-party software. Siemens AG only provides a warranty for updates/patches of the third-party software, if these have been distributed as part of a Siemens software update service contract or officially released by Siemens AG. Otherwise, updates/patches are undertaken at your own risk. You can find more information about our Software Update Service offer on the Internet at Software Update Service (<http://www.automation.siemens.com/mcms/automation-software/en/software-update-service/Pages/Default.aspx>).

Notes on protecting administrator accounts

A user with administrator privileges has extensive access and manipulation options in the system.

Therefore, ensure there are adequate safeguards for protecting the administrator accounts to prevent unauthorized changes. To do this, use secure passwords and a standard user account for normal operation. Other measures, such as the use of security policies, should be applied as needed.

2.2 Standards, certificates and approvals

Approvals

Note

The following overview shows possible approvals. The HMI device itself is certified as shown on the label on its rear panel.

CE approval



The HMI device meets the general and safety-related requirements of the EMC Directive (2004/108/EC "Electromagnetic Compatibility") and conforms to the harmonized European standards (EN) for programmable logic controllers published in the official gazettes of the European Union:

- 94/9/EU "Devices and protection systems for use as prescribed in potentially explosive areas" (Guidelines for Explosion Protection)

EC Declaration of Conformity

The EC Declarations of Conformity are available to the relevant authorities at the following address:

Siemens AG
Industry Sector
I IA AS FA DH Amb
P.O. Box 1963
92209 Amberg
Germany

Ex approval

The following standards and approvals are in effect for the HMI devices:

- EN 61241-0:2006
- EN 61241-1:2004

	II 3 D	Ex tD A22 IP6x T 52 °C or T 70 °C x ... Temperature value, see EC design examination certificate
---	--------	---

The KEMA 06ATEX0266 X test number applies to the following HMI devices:

- 6AV6643-0CB01-1AX2 (8" Touch V2)
- 6AV6643-0CB01-1AX2 (10" Touch V2)
- 6AV6643-0DD01-1AX2 (10" Key V2)
- 6AV6643-0CB01-1AX1 (8" Touch)
- 6AV6643-0CD01-1AX1 (10" Touch)
- 6AV6643-0DD01-1AX1 (10" Key)
- 6AV6643-0CB01-1AX5 (8" Touch, small frame)
- 6AV6643-0CD01-1AX5 (10" Touch, small frame)

The following standards and approvals are in effect for the 10" INOX HMI device:

- EN 60079-0:2006
- EN 60079-15:2005
- EN 61241-0:2006
- EN 61241-1:2004

	II 3 G	Ex nA II T4
	II 3 D	Ex tD A22 IP65 T 70 °C

The KEMA 08ATEX0063 X test number applies to the following HMI device:

- 6AV6643-0ED01-2AX0 (10" INOX)

The HMI devices meet the requirements of the European Directive 94/9/EG of the European Parliament and the Council on the approximation of the laws of the member states concerning equipment and protective systems intended for use in potentially explosive atmospheres.

The table below includes the associated test numbers.

Manufacturer site	HMI device class	Test number
Siemens AG Industry Sector Werner-von-Siemens-Straße 50 D-92209 Amberg	Multi Panel	KEMA 06ATEX0266 X KEMA 08ATEX0063 X

UL approval



Underwriters Laboratories Inc., conforming to

- UL 508 (Industrial Control Equipment)
- CSA C22.2 No. 142 (Process Control Equipment)

or



Underwriters Laboratories Inc., conforming to

- UL 508 (Industrial Control Equipment)
- CSA C22.2 No. 142 (Process Control Equipment)
- ANSI/ISA 12.12.01 (Hazardous Location)
- CSA-213 (Hazardous Location)

Approved for use in

- Class I, Division 2, Group A, B, C, D or
- Class I, Zone 2, Group IIC or
- non-hazardous locations

FM approval



Factory Mutual Research (FM) conforming to

- Approval Standard Class Number 3611, 3600, 3810

Approved for use in

- Class I, Division 2, Group A, B, C, D T4
- Class I, Zone 2, Group IIC T4

Marking for Australia



The HMI device fulfills the requirements of standard AS/NZS CISPR 16 (Class A).

IEC 61131

The HMI device satisfies the requirements and criteria conforming to IEC 61131-2, Programmable Logic Controllers, Part 2: Operating resource requirements and tests.

Shipbuilding approvals

The following shipbuilding approvals are in effect for the HMI device:

- ABS
- BV
- DNV
- GL
- LRS
- ClassNK

2.3 Notes about usage

Industrial applications

The HMI device is designed for industrial applications. It conforms to the following standards:

- Requirements of the emission standard for industrial environments, EN 61000-6-4: 2007 + A1:2011
- Requirements for interference immunity EN 61000-6-2:2005

Use in residential areas

Note

The HMI device is not intended for use in residential areas. Operation of an HMI device in residential areas can have a negative influence on radio/TV reception.

If the HMI device is used in a residential area, you must take measures to achieve Limit Class B conforming to EN 55016 for RF interference.

Suitable measures for achieving the degree of noise suppression for Limit Class B include, for example:

- Installation of the HMI device in grounded control cabinets
- Use of filters in electrical supply lines

Individual acceptance is required.

2.4 Electromagnetic compatibility

Introduction

The HMI device fulfills, among other things, the requirements of the EMC law pertaining to the domestic European market.

EMC-compatible installation of the HMI device

The EMC-compliant installation of the HMI device and the application of interference-proof cable is the basis for interference-free operation. The "Directives for interference-free installation of PLCs" and the "PROFIBUS Networks" manual also apply for the installation of the HMI device.

Pulse-shaped disturbance

The following table shows the electromagnetic compatibility of modules with regard to pulse-shaped interference. The precondition for electromagnetic compatibility is that the HMI device meets the specifications and guidelines for electrical installation.

Pulse-shaped disturbance	Tested with	Degree of severity
Electrostatic discharge in accordance with IEC 61000-4-2	Air discharge: 8 kV Contact discharge: 6 kV	3
Burst pulses (high-speed transient interference) in accordance with IEC 61000-4-4	2 kV power supply cable 2 kV signal cable, > 30 m 1 kV signal cable, < 30 m	3
High-power surge pulses in accordance with IEC 61000-4-5, external protective circuit required (refer to the manual Automation System S7-300, Installation, "Lightning and overvoltage protection" section)		
Asymmetrical coupling	2 kV power cable DC voltage with protective elements 2 kV signal/data cable, > 30 m, with protective elements as required	3
Symmetrical coupling	1 kV power cable DC voltage with protective elements 1 kV signal cable, > 30 m, with protective elements as required	3
Pulse-shaped disturbance Magnetic fields with power frequencies according to IEC 61000-4-8	Magnetic field strength 50/60 Hz, 100 A/m	3

Sinusoidal interference

The following table shows the EMC behavior of the modules with respect to sinusoidal interference. This requires the HMI device to meet the specifications and directives for electrical installation.

Sinusoidal interference	Test values	Degree of severity
HF radiation (in electromagnetic fields) in accordance with IEC 61000-4-3	80% amplitude modulation at 1 kHz <ul style="list-style-type: none"> • Up to 10 V/m in the 1 to 2 GHz range • Up to 3 V/m in the 1.4 to 2 GHz range • Up to 3 V/m in the 2 to 2.7 GHz range 	3
RF interference current on cables and cable shielding conforming to IEC 61000-4-6	Test voltage 10 V, with 80% amplitude modulation of 1 kHz in the 10 kHz to 80 MHz range	3

Emission of radio interference

The following table shows the unwanted emissions from electromagnetic fields in accordance with EN 55011, Limit Value Class A, Group 1, measured at a distance of 10 m.

Frequency	Interference emission
30 to 230 MHz	< 40 dB (µV/m) quasi-peak
230 to 1 000 MHz	< 47 dB (µV/m) quasi-peak
1 to 3 GHz	<ul style="list-style-type: none"> • 66 dB (mV/m) peak • 46 dB (mV/m) average value
3 to 6 GHz	<ul style="list-style-type: none"> • 70 dB (mV/m) peak • 50 dB (mV/m) average value

Additional measures

If you want to connect an HMI device to the public power supply system, you must ensure Limit Value Class B in accordance with EN 55022.

Interference emission for mains AC power supply

The following table below shows the interference emission for mains AC power supply.

Frequency	Interference emission
0.15 to 0.5 MHz	<ul style="list-style-type: none"> • < 79 dB (µV) quasi-peak • < 66 dB (µV) average value
0.5 to 30 MHz	<ul style="list-style-type: none"> • < 73 dB (µV) quasi-peak • < 60 dB (µV) average value

2.5 Transport and storage conditions

Mechanical and climatic conditions for transportation and storage

This HMI device meets the requirements for IEC 61131-2 relating to transportation and storage conditions. The following specifications apply to the transportation and storage of an HMI device in its original packaging.

The climatic conditions conform to the following standards:

- IEC 60721-3-3, Class 3K7 for storage
- IEC 60721-3-2, Class 2K4 for transport

The mechanical conditions correspond to IEC 60721-3-2, Class 2M2.

Type of condition	Permitted range
Drop test (in transport package)	≤ 1 m
Temperature	From -20 to +60° C
Atmospheric pressure	From 1 140 hPa to 660 hPa, corresponds to an elevation of -1 000 to 3 500 m
Relative humidity	From 10 to 90%, without condensation
Sinusoidal vibration in accordance with IEC 60068-2-6	5 to 9 Hz: 3.5 mm 9 Hz to 500 Hz: 9.8 m/s ²
Shock in accordance with IEC 60068-2-29	250 m/s ² , 6 ms, 1 000 shocks

Note

Avoid condensation

If the HMI device is subjected to low temperatures or extreme fluctuations in temperature during transportation, moisture could occur on or inside the HMI device. Condensation can occur. This can cause malfunctions.

The HMI device must have acquired room temperature before it is put into operation. Do not expose the HMI device to direct radiation from a heater in order to warm it up. If there is condensation, wait approximately 4 hours until the HMI device has dried completely before switching it on.

Proper transport and storage, installation and assembly as well as careful operation and maintenance are required to ensure trouble-free and safe operation of the HMI device.

The warranty for the HMI device will be deemed void if these stipulations are not heeded.

Planning application

3.1 Notes about usage

Mechanical and climatic conditions of use

The HMI device is designed for use in a location protected from the effects of the weather. The conditions of use meet the requirements for DIN IEC 60721-3-3:

- Class 3M3 (mechanical requirements)
- Class 3K3 (climatic requirements)

Use with additional measures

The HMI device should not be used at the following locations unless additional measures are taken:

- In locations with a high degree of ionizing radiation
- In locations with severe operating conditions, for example, due to:
 - Corrosive vapors, gases, oils or chemicals
 - Electrical or magnetic fields of high intensity
- In plants that require special monitoring, for example:
 - Elevators
 - Systems in especially hazardous rooms

Mechanical environmental conditions

The mechanical environmental conditions for the HMI device are specified in the following table in terms of sinusoidal vibration.

Frequency range	Constant	Occasional
10 Hz ≤ f ≤ 58 Hz	Amplitude 0.0375 mm	Amplitude 0.075 mm
58 Hz ≤ f ≤ 150 Hz	Constant acceleration 0.5 g	Constant acceleration 1 g

Reducing vibrations

If the HMI device is subjected to greater shocks or vibrations, you must take appropriate measures to reduce acceleration or amplitudes.

We recommend mounting the HMI device on damping materials (on rubber-metal vibration dampers, for example).

Testing mechanical environmental conditions

The following table provides information on the type and scope of tests for mechanical environmental conditions.

Test for	Test standard	Comments
Vibrations	Vibration test in accordance with IEC 60068, part 2-6 (sinusoidal)	Type of vibration: Transitional rate of the frequency: 1 octave/minute. 10 Hz ≤ f ≤ 58 Hz, constant amplitude of 0.075 mm 58 Hz ≤ f ≤ 150 Hz, constant acceleration 1 g Vibration duration: 10 frequency cycles per axis at each of the three associated vertical axes
Shock	Shock test in accordance with IEC 60068, Part 2 -29	Type of shock: Half-sine Shock intensity: Peak value 15 g, duration 11 ms Direction of impact: 3 shocks in ± direction at each one of the three associated vertical axes

Climatic environmental conditions

The following table shows the climatic conditions for operation of the HMI device.

Environmental conditions	Permitted range	Comments
Temperature <ul style="list-style-type: none"> • Vertical mounting • Mounting at an angle 	From 0 to 50° C From 0 to 40° C	See the "Mounting positions and type of fixation" section
Relative humidity	10 to 90%, without condensation	
Atmospheric pressure	1 140 to 795 hPa	Corresponds to an elevation of -1 000 to 2 000 m
Pollutant concentration	SO ₂ : < 0.5 ppm; Relative humidity < 60%, no condensation	Test: 10 cm ³ /m ³ ; 10 days
	H ₂ S: < 0.1 ppm; Relative humidity < 60%, no condensation	Test: 1 cm ³ /m ³ ; 10 days

3.2 Mounting positions

Mounting position

The HMI device is suitable for installation in:

- Mounting cabinets
- Control cabinets
- Switchboards
- Consoles

In the following, all of these mounting options are referred to by the general term "cabinet".

The HMI device is self-ventilated and approved for vertical and inclined mounting in stationary cabinets.

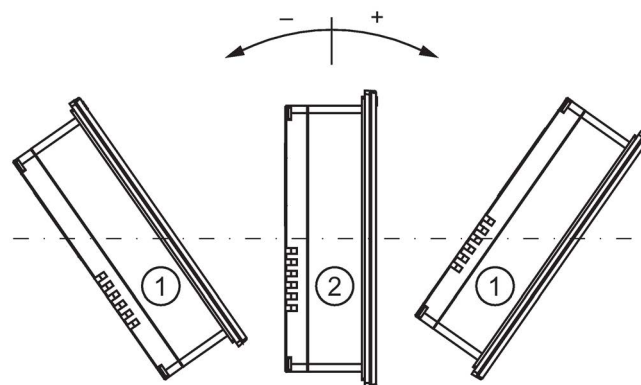

	Mounting position	Deviation from the vertical
①	Inclined	$\leq 35^\circ$
②	Vertical	0°

NOTICE

Damage due to overheating

Convection through the HMI device is reduced with installation at an angle. This fact also reduces the maximum permitted operating temperature for operation. With sufficient forced ventilation, you can operate the HMI device at an inclined mounting position up to the permitted ambient temperature for vertical installation. Otherwise the HMI device may be damaged and the approvals and warranty may become obsolete.

3.3 Preparing for Mounting

Select the mounting location of the HMI device

Points to observe when selecting the mounting location:

- Position the HMI device so that it is not subjected to direct sunlight.
- Position the HMI device such that it is ergonomically accessible for the user. Choose a suitable mounting height.
- Ensure that the air vents of the HMI device are not covered as a result of the mounting.
- Observe the permissible mounting positions for the HMI device.

Note

Stability of the mounting cut-out

The material in the area of the mounting cut-out must provide sufficient strength to guarantee enduring and safe mounting of the HMI device.

The force of the mounting clips or operation of the device may not lead to deformation of the material in order to achieve the degrees of protection described below.

The material thickness at the mounting cut-out must be at least 1.0 mm.

Degrees of protection

The protection ratings are only ensured if the mounting cutout conforms to the following:

- Permitted deviation from plane at the mounting cutout: ≤ 0.5 mm
This condition must be fulfilled for the mounted HMI device.
- Permissible surface roughness in the area of the seal: ≤ 120 μm (R_z 120)
- With IP65 degree of protection or for enclosure type 4X/type 12 (indoor use only), the material thickness at the mounting cut-out can be a maximum of 6 mm.

Spring mounting clips or aluminum mounting clips, each with or without clamping frames, are used depending on the material thickness at the mounting cut-out.

The relationships are shown in the table below:

Material thickness	Spring mounting clips	Aluminum mounting clips	Clamping frame required
1.0 mm to 1.5 mm	x	x	Yes
1.5 to 2 mm	x	-	No
	-	x	Yes
2 to 4 mm	x	-	No
4 to 6 mm	-	x	No

The clamping frame is available as an accessory, see section Accessories (Page 16).

Dimensions of the mounting cut-out

The following table shows the dimensions of the required mounting cut-out:

Mounting cut-out	MP 277 8" Touch	MP 277 8" Key	MP 277 10" Touch	MP 277 10" Key
Width	226 ⁺¹ mm	338 ⁺¹ mm	310 ⁺¹ mm	434 ⁺¹ mm
Height	166 ⁺¹ mm	206 ⁺¹ mm	248 ⁺¹ mm	291 ⁺¹ mm
Depth	61 mm	61 mm	61 mm	60 mm

Mounting compatibility

The mounting cut-outs of the Multi Panels are compatible with the mounting cut-outs of the following SIMATIC HMI devices:

Multi Panel mounting cut-out	Compatible to the mounting cut-outs of the HMI device	
MP 277 10" Touch	Thin Client 10" Touch KTP1000 Basic TP 270 10"	MP 270B 10" Touch MP 277 INOX 10" Touch MP 377 12" Touch
MP 277 10" Key	MP 270B 10" Key	OP 270 10"

Maintaining clearances

The HMI device must be installed with the following clearances:

- Always allow 50 mm above and below the mounting cutout respectively for ventilation
- Right and left of the mounting cutout respectively for attaching the mounting clips:
 - When using a clamping frame: 25 mm each
 - Without clamping frame, with spring mounting clips: 25 mm each
 - Without clamping frame, with aluminum mounting clips: 15 mm each
- At least 10 mm behind the rear panel of the HMI device

Note

Ensure that the maximum ambient temperature is not exceeded when mounting the device in a cabinet and especially in a closed enclosure.

3.4 Specifications for Insulation Tests, Protection Class and Degree of Protection

Test voltages

Insulation stability is demonstrated in the type test with the following test voltages in accordance with IEC 61131-2:

Circuits with a nominal voltage of U_n to other circuits or ground	Test voltage
< 50 V	500 V DC

Protection class

Protection Class I in accordance with IEC 60536, i.e. protective conductor connection to profile rail required.

Protection against foreign objects and water

Degree of protection in accordance with IEC 60529	Explanation
Front	When mounted: <ul style="list-style-type: none"> • IP65 • Enclosure Type 4X/Type 12 (indoor use only)
Rear panel	IP20 Touch protection test with standard test probes. There is no protection against ingress by water.

The degree of protection provided by the front side can only be guaranteed when the mounting seal lies completely against the mounting cut-out.

3.5 Rated voltages

The following table shows the rated voltage and the corresponding tolerance range.

Nominal voltage	Tolerance range
+24 VDC	20.4 V to 28.8 V (-15 %, +20 %)

Installing and connecting the device

4.1 Checking the package contents

Check the package contents for visible signs of transport damage and for completeness.

Note**Damaged parts**

A damaged part will cause the HMI device to malfunction.

Do not install parts damaged during shipment. In the case of damaged parts, contact your Siemens representative.

The following is supplied along with the HMI device:

- HMI device
- Accessory kit with mounting clips and mains terminal

Additional documents may be included in the product package of all HMI devices.

The documentation belongs to the HMI device and is required for subsequent commissioning. Retain all enclosed documentation for the entire service life of the HMI device. You must pass on the enclosed documentation to any subsequent owner or user of the HMI device. Make sure that every supplement to the documentation that you receive is stored together with the operating instructions.

4.2 Mounting the HMI Device

Requirement

All packaging components and protective foils should be removed from the HMI device.

To install the HMI device, you need the mounting clips from the accessories. The mounting seal must be fitted on the HMI device. If the mounting seal is damaged, order a replacement seal. The mounting seal is part of the associated service pack.

Mounting

Note

Always mount the HMI device according to the instructions in this manual.

4.2 Mounting the HMI Device

Proceed as follows:

1. Check that the mounting seal is fitted on the HMI device.
Do not install the mounting seal turned inside out. This may cause leaks in the mounting cut-out.
2. Insert the HMI device into the mounting cutout from the front.
3. Insert a mounting clip into a recess on the HMI device.
4. Fasten the mounting clip as described in the enclosed product information. The product information on spring mounting clips or aluminum mounting clips is available on the Internet at the following link:
 - Product Information "Spring clamp"
(<http://support.automation.siemens.com/WW/view/en/34916893>)
 - Product Information "Metal mounting clamps"
(<http://support.automation.siemens.com/WW/view/en/34915725>)
5. Repeat steps 3 and 4 for all mounting clips that are required for the installation of the HMI device.

Note

Check the fit of the mounting seal on the front. The mounting seal must not protrude from the HMI device.

Otherwise, repeat steps 1 to 5.

Positions of mounting clips on the MP 277 8" Touch

You will need 10 mounting clips in total. The following figure shows the positions of the mounting clips.

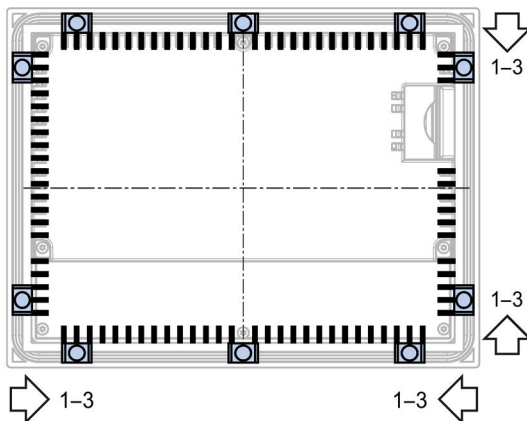

Positions of mounting clips on the MP 277 10" Touch

You will need 12 mounting clips in total. The following figure shows the positions of the mounting clips.

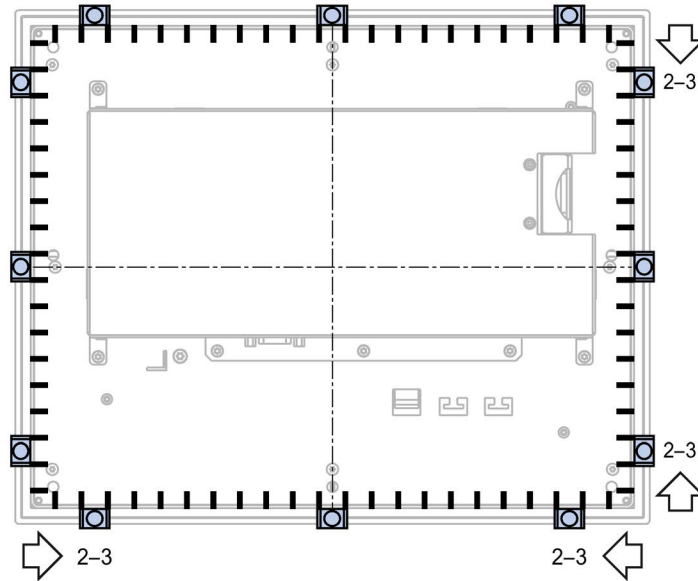

Positions of the mounting clips on the MP 277 8" Key

You will need 14 mounting clips in total. The following figure shows the positions of the mounting clips.

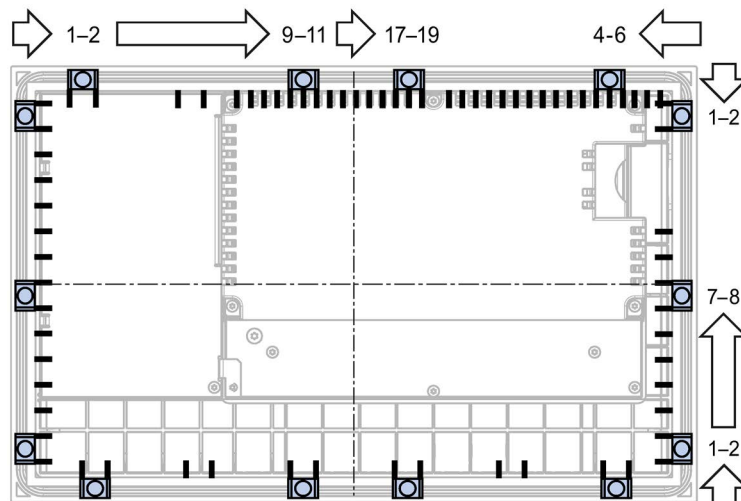

Positions of the mounting clips on the MP 277 10" Key

You will need 10 mounting clips in total. The following figure shows the positions of the mounting clips.

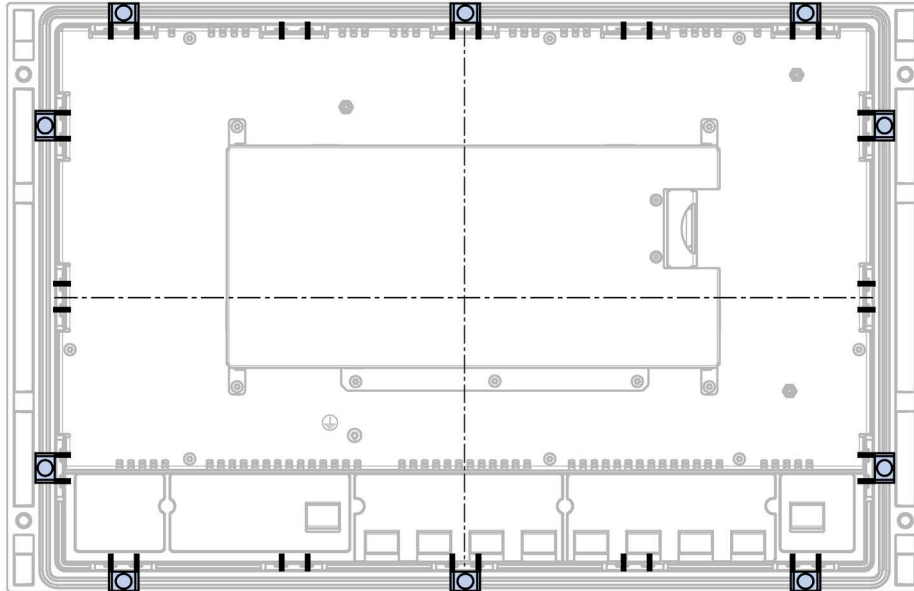

4.3 Connecting the HMI device

4.3.1 Overview

Requirement

- The HMI device must be mounted according to the specifications of these operating instructions.
- Always use shielded standard cables.

Additional information is available in the catalog and online order system at Industry Mall (<https://mall.industry.siemens.com>).

Connection sequence

Note

Damage to the HMI device

If you do not keep to the connection sequence you could damage the HMI device.

Ensure you connect the HMI device in the sequence described above.

1. Equipotential bonding

2. Power supply

Perform a power-up test to ensure the power supply is connected with the correct polarity.

3. Controller

4. Configuration PC as necessary

5. I/Os as necessary

Disconnect the HMI device by completing the above steps in reverse order.

Connecting the cables

When connecting the cables, ensure that the contact pins are not bent. Secure the cable connectors by screwing the connector onto the socket.

See also

Safety Instructions (Page 25)

4.3.2 Ports

The following figure shows the interfaces of the MP 277 HMI device.

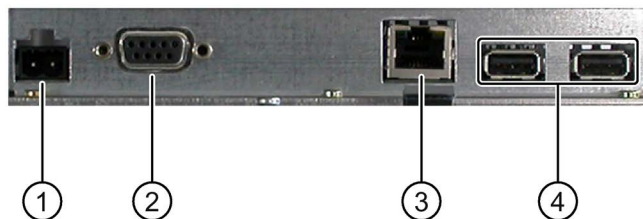

- ① Power supply connector
- ② RS 422/RS 485 interface X10 / IF1b
- ③ Ethernet interface
- ④ USB ports X20 and X21

See also

Power supply (Page 191)

X10/IF 1B (RS 422/RS 485) (Page 191)

X20, X21 (USB) (Page 192)

X1 (Ethernet/LAN) (Page 192)

4.3.3 Connecting the equipotential bonding circuit

Differences in electrical potential

Differences in potential may occur between spatially separated system parts. Such differences in electrical potential can lead to high equalizing currents over the data cables and therefore to the destruction of their interfaces. Equalizing currents can develop if the cable shielding is terminated at both ends and grounded to different parts of the system.

Differences in potential can develop when a system is connected to different mains.

General requirements of equipotential bonding

Differences in electrical potential must be reduced using equipotential bonding to ensure trouble-free operation of the relevant components of the electronic system. The following must therefore be observed when installing the equipotential bonding circuit:

- The effectiveness of equipotential bonding increases as the impedance of the equipotential bonding conductor decreases or as its cross-section increases.
- If two plant parts are interconnected by means of shielded data cables and their shielding is bonded at both ends to the grounding/protective conductor, the impedance of the additionally installed equipotential bonding cable must not exceed 10% of the shielding impedance.
- The cross-section of a selected equipotential bonding conductor must be capable of handling the maximum equalizing current. Experience has shown that equipotential bonding conductors with a minimum cross-section of 16 mm² should be fitted between the control cabinets or the ground point of the supporting arm or the stand for PRO HMI devices.
- Use equipotential bonding conductors made of copper or galvanized steel. Establish a large surface contact between the equipotential bonding conductors and the grounding/protective conductor and protect them from corrosion.
- Use a suitable cable clip to clamp the shield of the data cable flush to the equipotential bonding rail. Keep the length of cable between the HMI device and the equipotential bonding rail as short as possible.
- Route the equipotential bonding conductor and data cables in parallel and with minimum clearance between them.

Configuration graphic

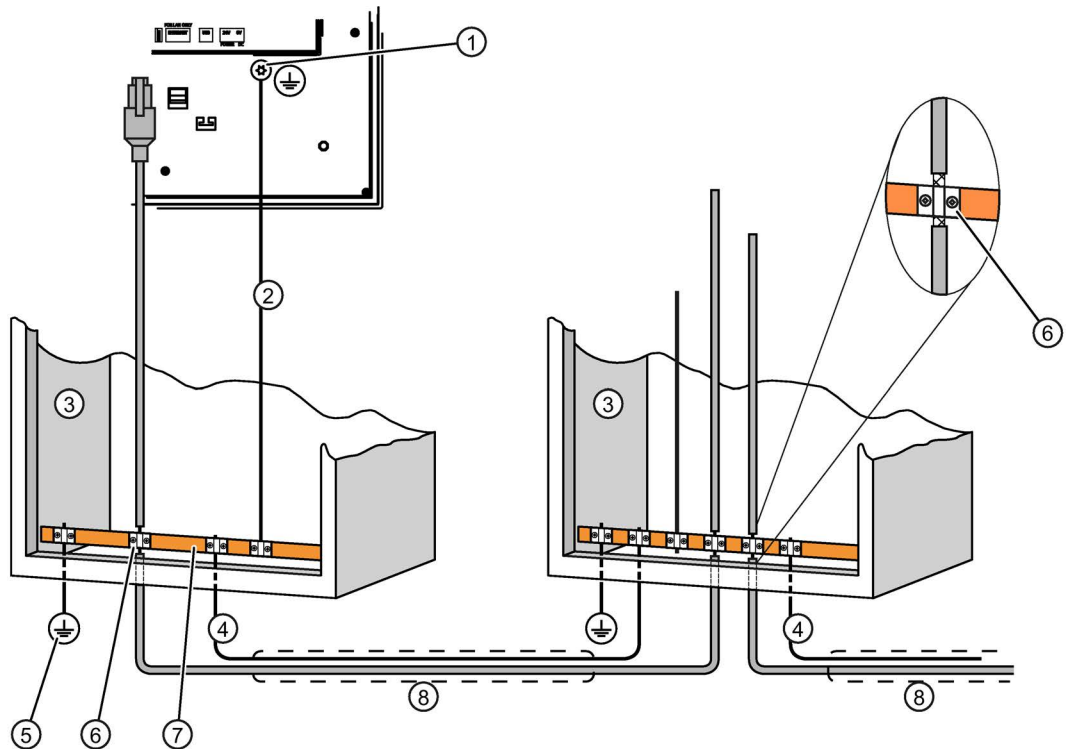

- ① Chassis terminal on the HMI device, example
- ② Equipotential bonding conductor cross-section: 4 mm²
- ③ Control cabinet
- ④ Equipotential bonding conductor cross-section: min. 16 mm²
- ⑤ Ground connection
- ⑥ Cable clip
- ⑦ Equipotential bonding rail
- ⑧ Parallel routing of the equipotential bonding conductor and data cable

NOTICE**Damage to the interface modules possible**

Cable shielding is not suitable for equipotential bonding.

Use only the prescribed equipotential bonding conductors. The equipotential bonding conductor ④ must have a minimum cross-section of 16 mm². The interface modules may otherwise be damaged or destroyed.

4.3.4 Connecting the Power Supply

Configuration graphic

The following figure shows the connection of the HMI device and the power supply.

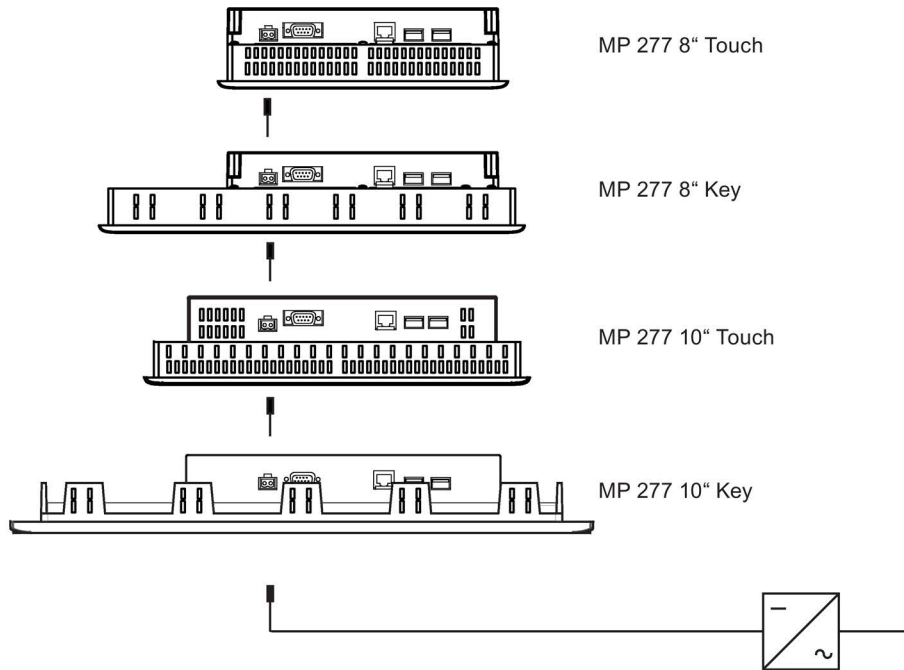

Note when connecting

The mains terminal for connecting the power supply is contained in the accessory kit. The mains terminal is designed for cables with a maximum cross-section of 1.5 mm².

Connecting the mains terminal

Note

Damage

Do not tighten the screws of the power supply terminal if it is plugged into the HMI device. The pressure from the screwdriver may otherwise damage the HMI device socket.

Only connect the wires when the mains terminal is withdrawn.

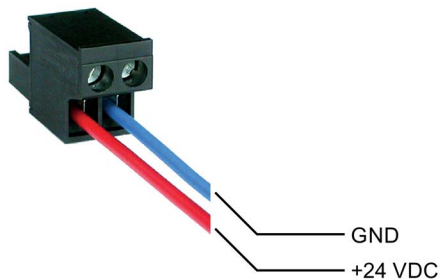

Connect the power supply terminal to the cables of the power supply as shown in the figure above. Ensure that the lines are connected properly to the correct terminals. Refer to the label for the contact pins on the rear of the HMI device.

Reverse polarity protection

The HMI device is equipped with reverse polarity protection.

Connecting the power supply

NOTICE

Safe electrical isolation

Use only 24 VDC power supply units with safe electrical isolation in accordance with IEC 60364-4-41 or HD 384.04.41 (VDE 0100, Part 410), for example, in accordance with the PELV standard.

The supply voltage must be within the specified voltage range. Malfunctions in the HMI device may otherwise result.

Applies to non-isolated system design:

Connect the connection for GND 24 V from the 24 V power supply output to equipotential bonding for uniform reference potential. You should always select a central point of termination.

See also

Ports (Page 45)

4.3.5 Connecting the PLC

Configuration graphic

The following figure shows the connection of the HMI device and the controller.

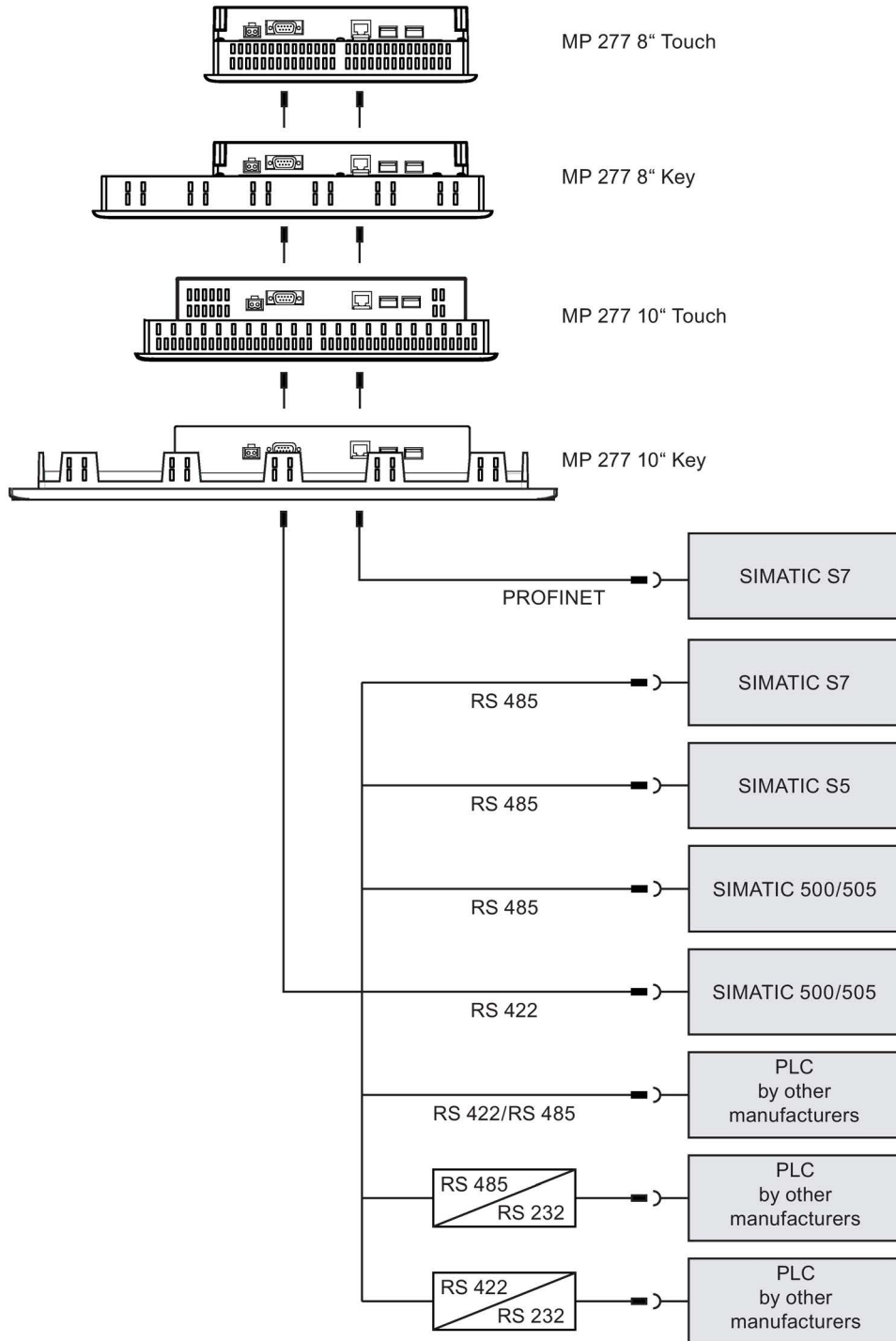

Note

Use only the approved cables to connect a SIMATIC S7 controller.

Standard cables are available for the connection. You can find additional information on this on the Internet at Industry Mall (<https://mall.industry.siemens.com>).

Connecting PROFINET

Note

Use a cross-cable for the PROFINET connection when using a point-to-point connection.

Note

PROFINET IO

If you use PROFINET IO direct keys, the HMI device must be connected with a switch. For detailed instructions regarding the installation of PROFINET networks, please refer to the PROFINET system description manual.

Only connect the HMI device to public Ethernet networks using a switch or comparable device.

Configuring an RS 422/RS 485 interface

A DIP switch for the configuration of the RS 422/RS 485 interface is located on the back of the HMI device.

In the factory state, the DIP switch is set for communication with the SIMATIC S7 PLC via RS 485.

Note

Note the diagrams of DIP switch settings on the rear panel of the HMI device.

4.3 Connecting the HMI device

The following table shows the DIP switch settings. The send and receive direction is toggled internally by the RTS signal.

Communication	Switch setting	Meaning
PROFIBUS DP/ MPI/PPI	<div style="display: flex; justify-content: space-around; width: 100px;"> 4321 </div> <div style="border: 1px solid black; width: 100px; height: 30px; margin: 5px 0;"> <input type="checkbox"/> <input type="checkbox"/> <input type="checkbox"/> <input type="checkbox"/> </div> <div style="text-align: right; margin-right: 10px;">ON</div>	No RTS on plug, for data transfer between PLC and HMI device (factory state)
	<div style="display: flex; justify-content: space-around; width: 100px;"> 4321 </div> <div style="border: 1px solid black; width: 100px; height: 30px; margin: 5px 0;"> <input type="checkbox"/> <input type="checkbox"/> <input type="checkbox"/> <input type="checkbox"/> </div> <div style="text-align: right; margin-right: 10px;">ON</div>	RTS on pin 4, same as PLC, for example for commissioning
	<div style="display: flex; justify-content: space-around; width: 100px;"> 4321 </div> <div style="border: 1px solid black; width: 100px; height: 30px; margin: 5px 0;"> <input type="checkbox"/> <input type="checkbox"/> <input type="checkbox"/> <input type="checkbox"/> </div> <div style="text-align: right; margin-right: 10px;">ON</div>	RTS on pin 9, same as programming device, for commissioning, for example
RS 422/RS 485	<div style="display: flex; justify-content: space-around; width: 100px;"> 4321 </div> <div style="border: 1px solid black; width: 100px; height: 30px; margin: 5px 0;"> <input type="checkbox"/> <input type="checkbox"/> <input type="checkbox"/> <input type="checkbox"/> </div> <div style="text-align: right; margin-right: 10px;">ON</div>	RS 422 interface is active.

See also

Ports (Page 45)

Accessories (Page 16)

4.3.6 Connecting a Configuring PC

Configuration graphic

The following figure shows the connection of the HMI device and the configuration PC.

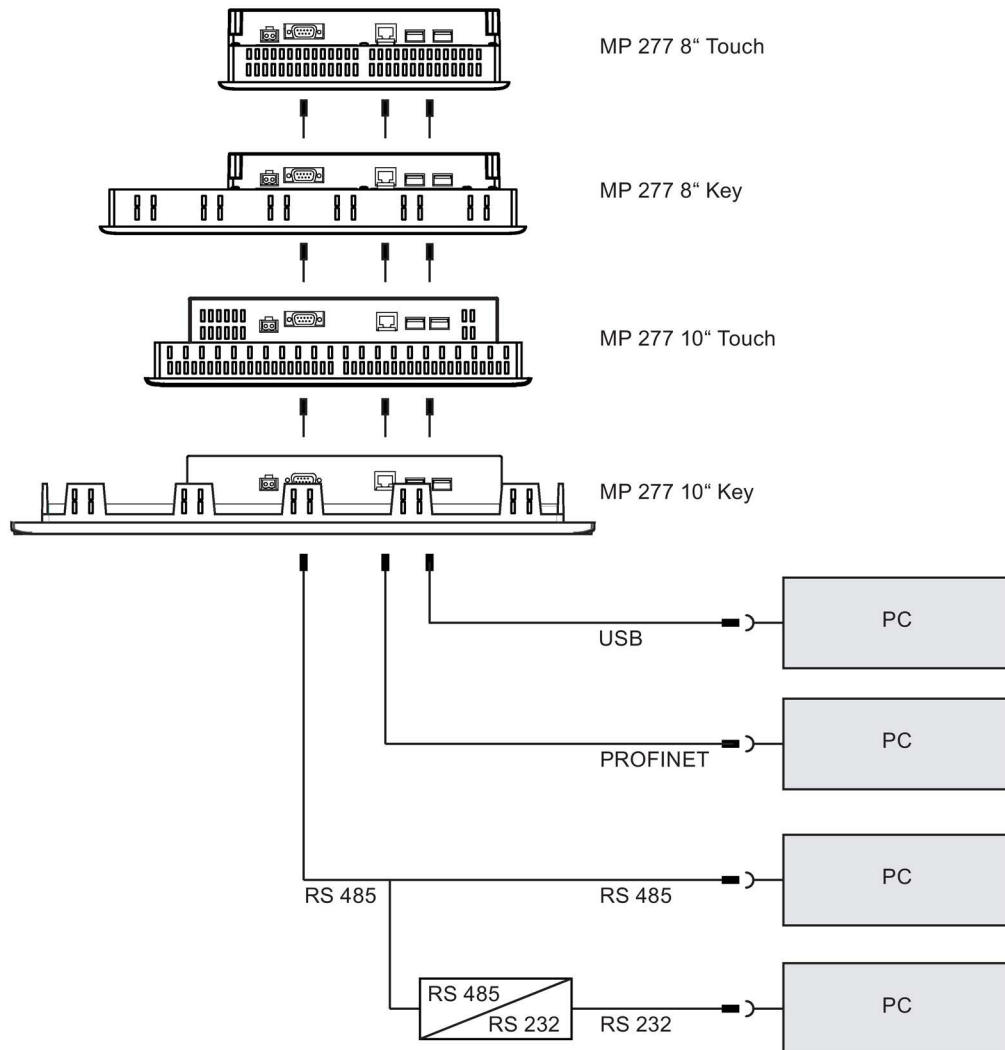

Use a cross-cable for the PROFINET connection when using a point-to-point connection.

The interfaces are described in the specifications.

For RS 485-RS 232 conversion, you can order the PC/PPI cable from Siemens AG.

Configuring the PC/PPI cable

Use the DIP switches to configure the transfer rate of the PC/PPI cable.

Note

Set a lower bit rate if the connection is lost during the operating system update. If you use a high bit rates, you need to use PC/PPI cable version 3 or higher. The version code is printed on the cable ("E stand 3," for example, corresponds to version 3).

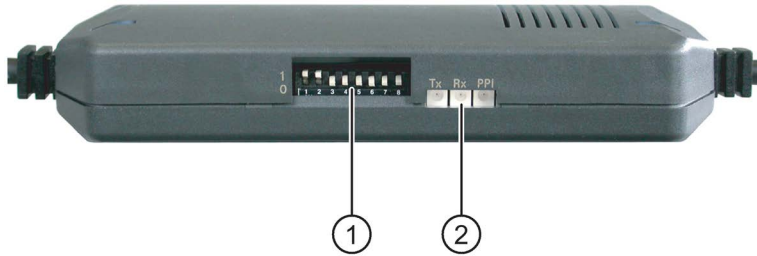

- ① DIP switch
- ② LEDs

Set the value of the transfer rate with DIP switches 1 to 3 to the same value that is specified in the configuration software. DIP switches 4 to 8 must be set to "0".

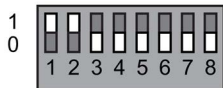

The following bit rates can be set:

Bit rate in kbps	DIP switch 1	DIP switch 2	DIP switch 3
115.2	1	1	0
57.6	1	1	1
38.4	0	0	0
19.2	0	0	1
9.6	0	1	0
4.8	0	1	1
2.4	1	0	0
1.2	1	0	1

In the figure, the bit rate is set to 115.2 kbps.

Note when connecting

Note

USB connection sequence

Observe the following sequence when connecting by USB:

1. HMI device
2. PC

USB host-to-host cable

Use only the driver for the USB host-to-host cable that is supplied with the configuration software. Never use the driver supplied with the USB host-to-host cable.

Update operating system

If there is no serviceable HMI device image on the HMI device, you can only update the operating system by restoring the factory settings. Use the RS 422/RS 485 interface with the PC/PPI cable on the HMI device.

Replacing the HMI device

If you connect more than one HMI device with the same IP address in succession to a single configuration PC, you need to ping the configuration PC once from the HMI device on each changeover of the HMI device.

See also

Ports (Page 45)

Accessories (Page 16)

4.3.7 Connecting a USB device

Note

Use only devices approved for connection to the HMI device.

Lists of devices approved for connection to HMI devices via the USB port are available on the Internet at the following addresses:

- <http://support.automation.siemens.com/WW/view/en/19188460>
(<http://support.automation.siemens.com/WW/view/en/19188460>)
 - <http://support.automation.siemens.com/WW/view/en/11376409>
(<http://support.automation.siemens.com/WW/view/en/11376409>)
-

4.3 Connecting the HMI device

Below are examples of devices you can connect to the USB port of the HMI device:

- Mouse
- Keyboard
- Printer
- Industrial USB Hub 4
- USB memory devices
- Barcode reader

Note

USB mouse and USB keyboard for commissioning only

Connect a USB mouse or USB keyboard only for commissioning and servicing purposes to the USB port.

Functional problem with USB port

If you connect an external device with a 230 V power supply to the USB port without using a non-insulated installation, you may experience functional problems.

Use a non-insulated system design.

Rated load of the interface

Malfunctions may occur on a USB device that presents an electrical overload on the port.

Adhere to the values for the maximum load on the USB port.

See also

Connecting the Power Supply (Page 48)

X20, X21 (USB) (Page 192)

4.3.8 Connecting a Printer.

Configuration graphic

The following figure shows the connection of the HMI device and the printer.

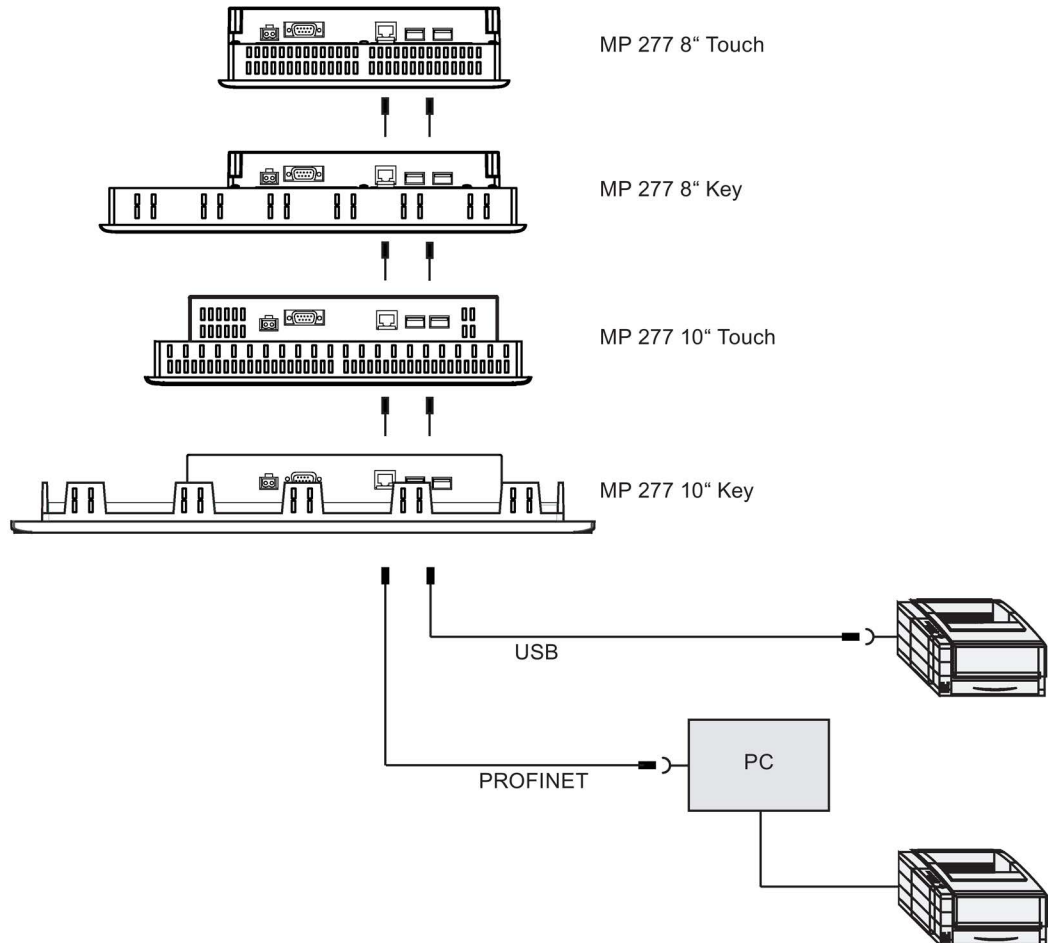

Note when connecting

Note

Use only cables with metal-braided shielding grounded at both ends to connect the HMI device and printer.

Use a cross-cable for the Ethernet connection when using a point-to-point connection.

Some printers may require the ASCII character set used in the project to also be defined on the printer.

You can find the list of current printers and required settings for HMI devices on the Internet (<http://support.automation.siemens.com/WW/view/en/11376409>).

Read the documentation supplied with the printer when connecting it.

See also

Ports (Page 45)

Connecting a USB device (Page 55)

4.4 Switching on and Testing the HMI device

Procedure

Proceed as follows:

1. Switching on the power supply.

The screen lights up after power is switched on. A progress bar is displayed during startup.

If the HMI device fails to start, you have probably crossed the wires on the mains terminal. Check the connected wires and change their connection. The Loader opens once the operating system has started.

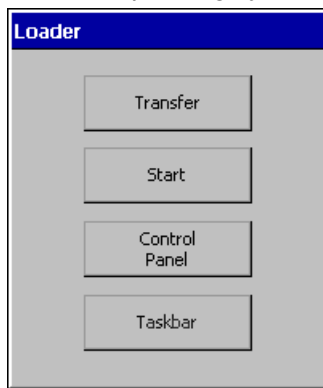

The HMI device automatically switches to "transfer" mode during initial startup under the following conditions:

- No project is loaded on the HMI device.
- At least one data channel has been configured.

During this process the following dialog appears:

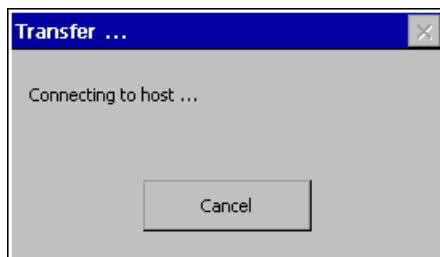

2. Press "Cancel" to stop the transfer.

Result

The Loader appears again.

Note

When restarting the system, a project may already be loaded on the HMI device. The system then skips "Transfer" mode and starts the project.

Use the relevant operating element to close the project.

Refer to your plant documentation to find any available additional information on this topic.

Function test

Perform a function test following commissioning. The HMI device is fully functional when one of the following states is indicated:

- The "Transfer" dialog is displayed.
- The loader is displayed.
- A project is started.

Shutting down the HMI device

Terminate the project at the HMI device before switching it off.

You have the following options for switching off the HMI device:

- Switch off the power supply.
- Remove the mains terminal from the HMI device.

4.5 Securing the cables

After the power-on test, to ensure strain relief, use cable ties to secure the connected cables to the marked fixing elements.

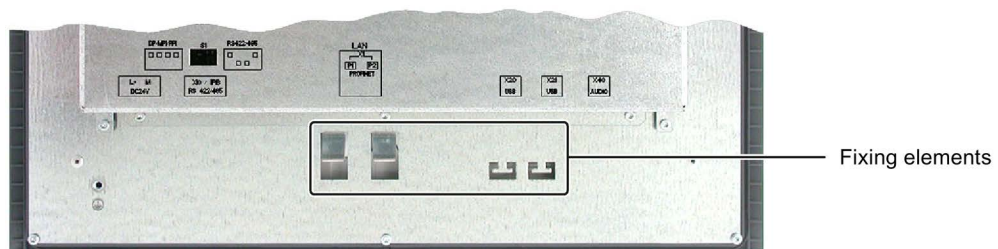

Operator controls and displays

5.1 Front operator controls

MP 277 Touch



- ① Display with touch screen

The assignment of the operator controls for the MP 277 8" Touch and the MP 277 10" Touch is basically the same.

You can operate the MP 277 Touch using the touch screen. All operating elements required for operation are displayed on the display once the HMI device has been started.

MP 277 Key

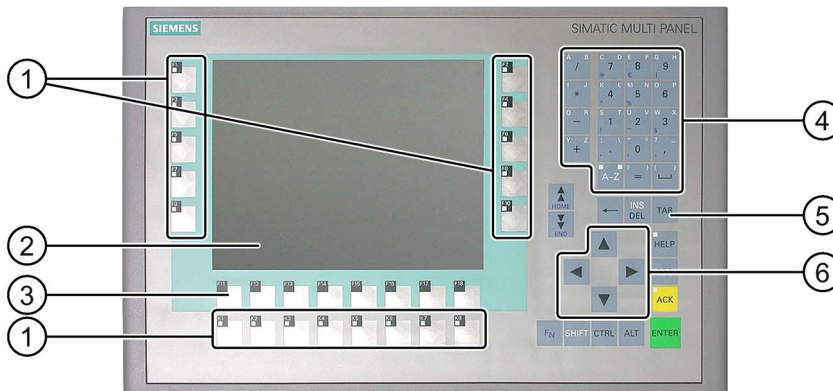

- ① Function keys with LED
- ② Display
- ③ Function keys without LED
- ④ System keys - alphanumeric keys
- ⑤ System keys - control keys
- ⑥ System keys - cursor keys

The assignment of the operator controls for the MP 277 8" Key and the MP 277 10" Key is basically the same.

The MP 277 Key is operated using the system keys and the function keys.

The function assigned to a specific function key is defined during configuration. The function keys have no function prior to the project being opened.

Note

Unintentional action possible

Do not carry out several operations simultaneously. You may otherwise trigger unintentional actions.

- With touch control: Always touch only one operating element on the screen.
- With key control: Do not press more than two keys simultaneously.

Note

Risk of damage to the touch screen

Do not touch the touch screen with pointed or hard objects. Avoid applying excessive pressure to the touch screen with hard objects. Both will substantially reduce the service life of the touch screen and can even lead to total failure.

Always operate the touch screen of the HMI device with your fingers or with a touch pen.

Damage to the keyboard

Use only your fingers to operate the keys of your HMI device.

Using hard instruments to press the keys considerably reduces the service life of the key mechanism.

See also

Design of the HMI Device MP 277 8" Touch (Page 10)

Design of the HMI Device MP 277 8" Key (Page 11)

Design of the HMI Device MP 277 10" Touch (Page 13)

Design of the HMI Device MP 277 10" Key (Page 14)

5.2 Using Memory Cards with the HMI Device

Introduction

The following can be saved to the memory card of the HMI device:

- HMI device image (backup)
- Logs
- Recipes
- Operating system
- Applications
- Additional specifications

The memory card can be inserted and removed during operation. Do not remove the memory card while data is being accessed by an application, for example during backup or recipe transfer.

Note

Multimedia card

The multimedia card of the SIMATIC S7 controller is not compatible with the HMI device.

Procedure – inserting a memory card

Proceed as follows:

Insert the memory card into the memory card slot.

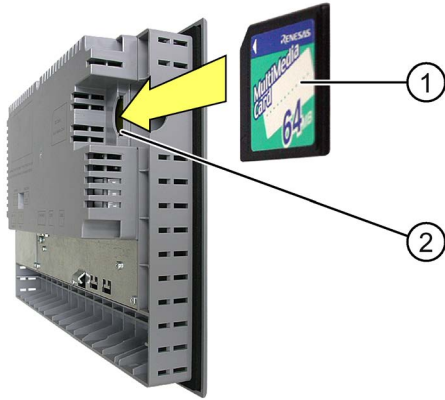

- ① Memory card
- ② Memory card slot

When inserting the memory card, please note that it can only be inserted as shown in the diagram. When the memory card is correctly inserted into the slot, it stands approx. 3 mm proud of the slot.

Using a memory card for the first time

Note

Data loss

The first time you use a memory card the HMI device will request that you format the card. Save a backup copy of memory card data to a PC beforehand.

Proceed as follows in order to prevent data loss:

1. Cancel the formatting procedure by pressing "ESC".
2. Save a backup copy of vital data to a PC.
3. Format the memory card on the HMI device.
4. Transfer the backup data from the PC to the memory card.

You can now transfer the backup data from the memory card to the HMI device.

Procedure – removing a memory card

Note

Data loss

The data on the memory card may be lost if you attempt to remove it while the HMI device is accessing its data.

Do not remove the memory card while data is being accessed. Observe the corresponding alarms on the screen.

Proceed as follows:

1. Unplug the memory card from the memory card slot.
2. Store the memory card in a safe place.

5.3 Labeling the Function Keys at the MP 277 Key

Introduction

You can label the function keys as required for your project. Use the labeling strips for this purpose.

Labeling strip templates are available in a Word document on the Internet at the following address:

Labeling strips for SIMATIC HMI devices
(<http://support.automation.siemens.com/WW/view/en/93994525>)

Note

Do not write on the keyboard to label the function keys.

Any printable and writable foil can be used as labeling strip. The permitted thickness of the labeling strip is 0.13 mm. Paper labeling strips are inappropriate.

You can use transparent foil, the keyboard membrane of the HMI device is printed on the reverse side. Use transparent foil so that the LEDs of the function keys can be seen.

Dimensions of the labeling strip for the MP 277 8" Key

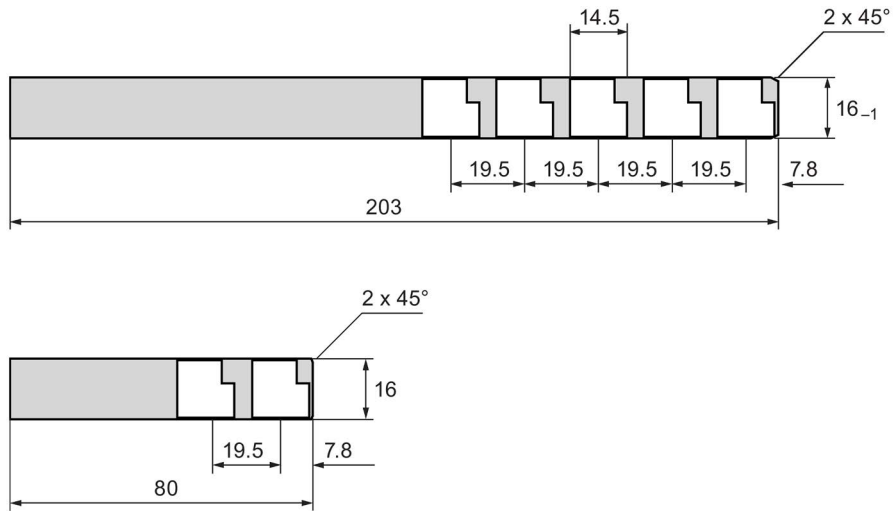

Dimensions of the labeling strip for the MP 277 10" Key

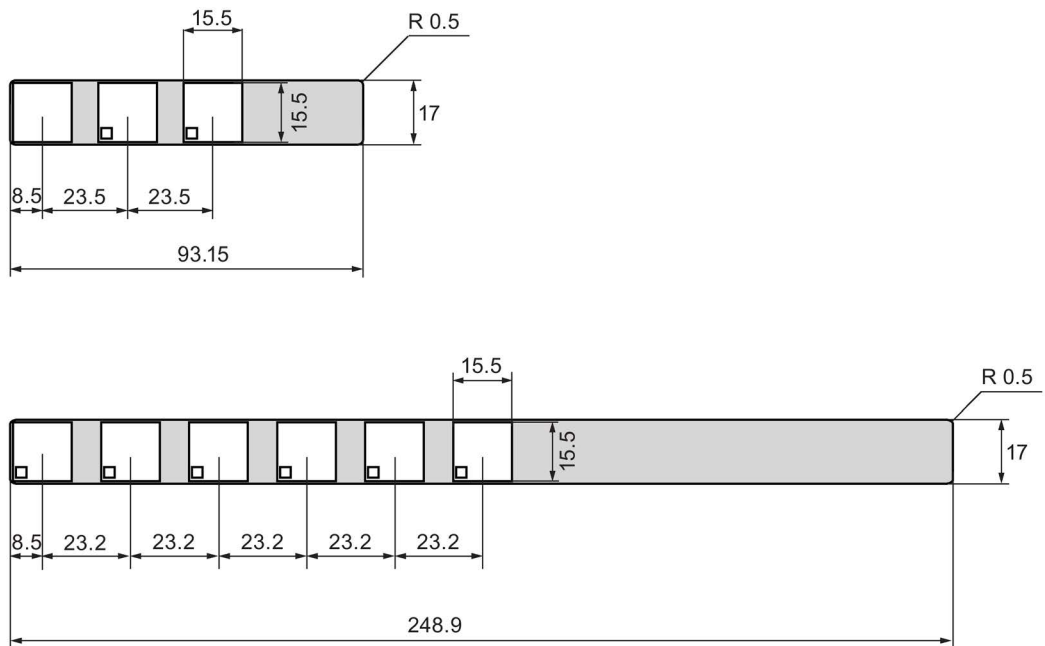

Procedure

Proceed as follows:

1. Edit the template and then it on the foil.

Another option is to print blank templates and later label them manually.

2. Apply a fixing spray to the labeling strips.

The fixing spray ensures that the text is water resistant and does not smear, and that the printer ink on the keyboard membrane does not run.

3. Cut out the labeling strip.

Ensure that the corners are cut according to the diagram shown above as this makes it easier to slide them into the slot.

4. Remove any existing labeling strips.

Note

Wait for the printed labeling strips to dry before you insert them.

5. Slide the labeling strips ② into the slot ①.

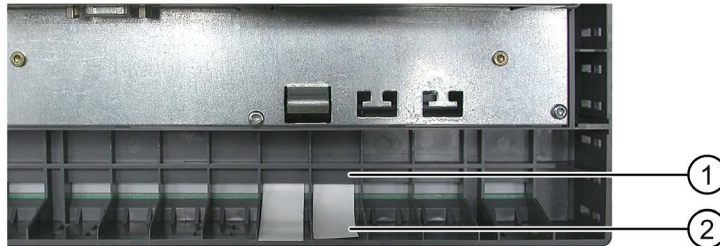

6. Slide the labeling strips into the slot up to the stop.

The labeling strip will protrude approximately 3 cm out of the slot. The template dimensions for the labeling strips are designed so that the labeling is correctly placed for the function keys. It is not necessary to secure the labeling strip.

When mounting the HMI device, ensure that the labeling strips do not become jammed between the mounting cut-out and the HMI device.

Configuring the device

6.1 Loader

The following figure shows the loader.

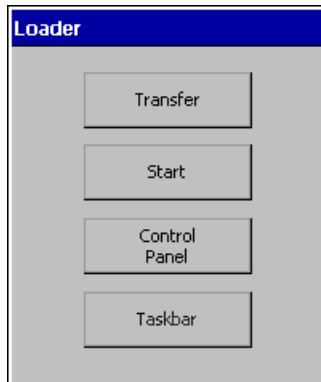

The loader buttons have the following functions:

- Press the "Transfer" button to set the HMI device to "Transfer" mode.
The transfer mode can only be activated when at least one data channel has been enabled for the transfer.
- Press the "Start" button to start the project on the HMI device.
If you do not perform an operation, the project on the HMI device will automatically start after a delay.

6.1 Loader

- Press the "Control Panel" button to open the Control Panel of the HMI device.
You can change various settings in the Control Panel, for example, the transfer settings.
- Press the "Taskbar" button to activate the taskbar with opened Windows CE Start menu:

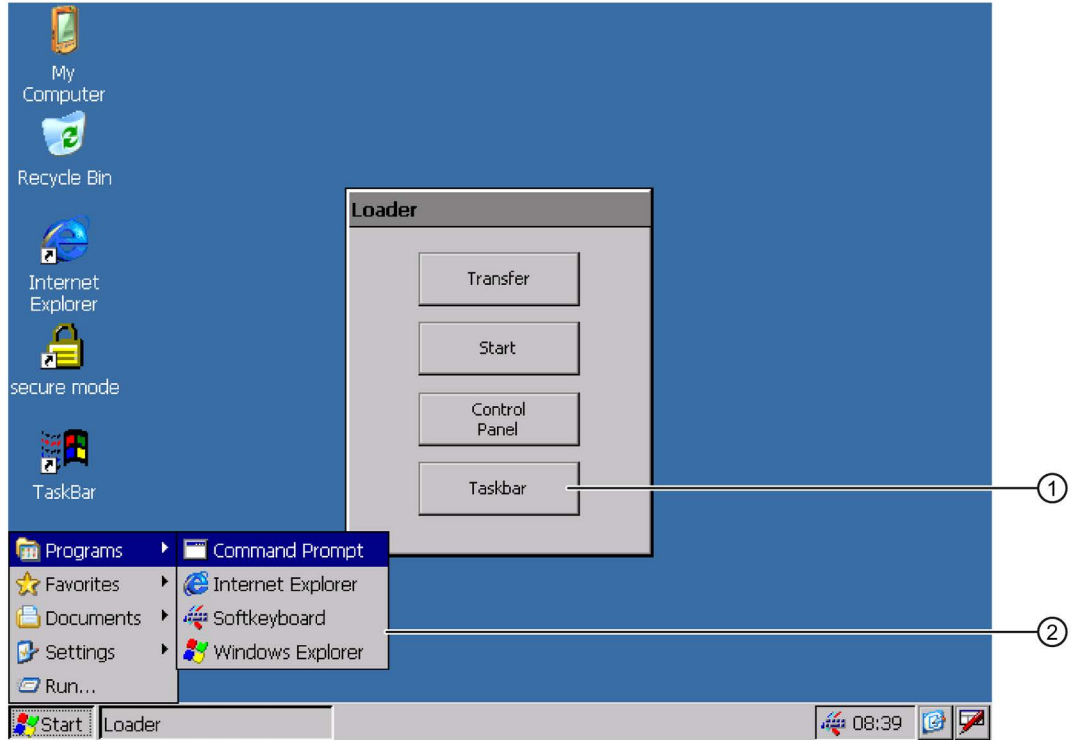

- ① "Taskbar" button in the loader
- ② Windows CE Start menu

Open loader

The following options are available to open the loader:





- The loader appears briefly after starting the HMI device.
- The loader appears when the project is closed.

If configured, use the relevant operating element to close the project.

Refer to your plant documentation to find any available additional information on this topic.

Key operation in the loader

The following table shows the key combinations for navigating in the loader.

Key combination			Function
			The next or previous entry is selected.
	–	–	The selected button is operated.

Protection against unauthorized use

You can protect the control panel against unauthorized access by using a password.

You can also protect the taskbar and the Desktop with the help of SecureMode. If the HMI device is protected, "secure mode" is displayed on the Windows CE desktop. You can find additional information on this in the section "Enabling and disabling SecureMode (Page 74)".

The "Transfer" and "Start" buttons can always be used without having to enter a password.

Password protection prevents maloperation. This increases the security of the system or equipment because settings for the current project can only be changed after entering the password.

NOTICE

Loss of data possible

If the password is no longer available, you can only cancel password protection by updating the operating system. All data on the HMI device will be deleted when you update the operating system.

Back up the HMI device's data.

Pocket Internet Explorer

The Pocket Internet Explorer is installed on the HMI device.

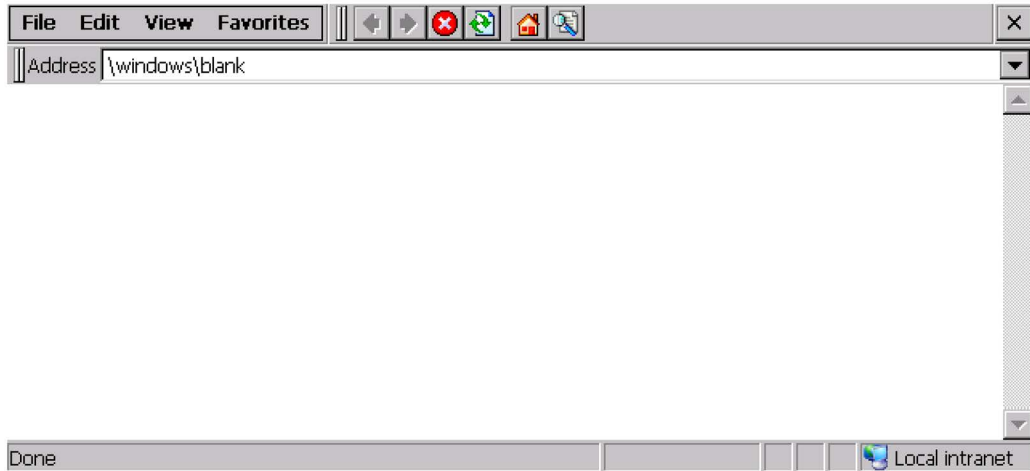

Note

The Pocket Internet Explorer and the PC version of the Internet Explorer differ in terms of functional range. Internet Explorer for Windows CE has separate proxy settings that are independent of the settings in the control panel of the HMI device.

You can find additional information on the Microsoft's website.















Key operation in the user interface

The following table shows the key combinations for navigating in the user interface.

Key combination		Function
CTRL	ESC	The task bar is activated with the open Windows CE start menu.
ALT	ESC	The next active program is displayed.
ALT	TAB	The Task Manager is opened.

Key operation in the Explorer

The following table shows the key combinations for navigating in the Explorer.

Key combination		Function
	–	<ul style="list-style-type: none"> • Toggles the active window. • Toggles between the Windows CE Desktop and the window.
		Selects the first entry.
		Selects the last entry.
		Selects everything, if the left LED of the key  lights up.
	–	Activates the menu bar.
	–	Changes to the higher level.
		Opens the shortcut menu.
		Displays the properties.

See also

Switching on and Testing the HMI device (Page 58)

Configuring the data channel (Page 109)

Changing Password Protection (Page 89)

6.2 Enabling and disabling SecureMode

SecureMode prevents unauthorized access to the desktop and the taskbar of the HMI device. In SecureMode, all functions on the desktop and the taskbar of the HMI device are locked.

Procedure

Enabling SecureMode

1. Assign a password in the Control Panel for the HMI device.
2. If no password has been assigned for the HMI device, double-click the following icon on the desktop.



SecureMode is enabled. The text "secure mode" appears on the desktop.

Disabling SecureMode

1. If a password is assigned for the HMI device, then delete it.
2. If no password has been assigned for the HMI device, operate the "Taskbar" button once in the Loader.

6.3 Control Panel

6.3.1 Overview

Control Panel of the HMI device

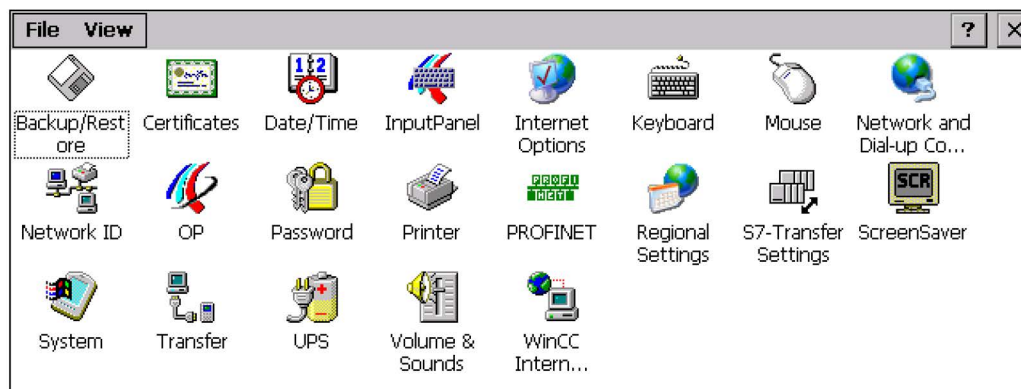

You can configure the following settings in the Control Panel of the HMI device:

- Date/time
- Screen saver
- Regional settings
- Transfer settings
- Network settings
- Delay time
- Password

Opening the Control Panel

The Control Panel can be opened as follows:

- In the startup phase
Press "Control Panel" to open the HMI device Control Panel in the Loader.
- In a running project
Operate the operating element provided for the respective task, if configured.

Alternatively you can open the Control Panel from the Windows CE start menu as follows.

- For an HMI device with key operation use the following key combination:















- For an HMI device with touch operation, press the key on the alphanumeric screen keyboard twice:











Select "Settings > Control Panel".

6.3.2 Reference for functions

The following table shows the settings in the Control Panel.

Symbol	Function
	Backing up data to external storage device (Page 126) Restoring data from external storage device (Page 128)
	Importing and Deleting Certificates (Page 125)
	Setting the Date and Time (Page 90)
	Setting up the screen keyboard (Page 84)
	Changing General Internet Settings (Page 121)
	Setting the Proxy Server (Page 122)
	Changing Privacy Settings (Page 123)
	Setting the Character Repetition of the Keyboard (Page 85)
	Setting the Double-click (Page 86)
	Changing the Network Configuration (Page 116)
	<ul style="list-style-type: none"> • IP address • Name server
	Changing the Logon Data (Page 118)
	Backing up Registry Information (Page 92)
	Changing monitor settings (Page 94)
	Displaying Information about the HMI Device (Page 100)
	Restarting the HMI Device (Page 99)
	Calibrate touch screen (Page 87) ¹
	Activate Memory Management (Page 131)
	Changing Password Protection (Page 89)
	Changing the Printer Properties (Page 96)
	Enabling PROFINET IO (Page 111)

Symbol	Function
	Changing Regional Settings (Page 92) <ul style="list-style-type: none"> • Number format • Currency • Time format • Date format
	Changing S7 transfer settings (Page 106)
	Setting the screen saver (Page 94) <ul style="list-style-type: none"> • Screen saver • Reducing screen backlighting
	Displaying System Properties (Page 101)
	Setting the device name of the HMI device (Page 115)
	Configuring the data channel (Page 109)
	Setting the Delay Time (Page 102)
	Setting the uninterruptible power supply (Page 104)
	State of uninterruptible power supply (Page 105)
	Set the volume (Page 97)
	Changing E-Mail Settings (Page 119) ²

¹ For MP 277 Touch only

² Additional tabs may appear in the "WinCC Internet Settings" dialog. This depends on the options that have been enabled for network operation in the project.

6.3.3 Operating the Control Panel

6.3.3.1 Overview

The hardware of the HMI device determines which of the following devices are available:

- Touch screen

The operating elements shown in the dialogs are touch-sensitive. Touch objects are basically operated in the same way as mechanical keys. You activate operating elements by touching them with your finger. To double-click them, touch an operating element twice in succession.

- HMI device keyboard

The operating elements shown in the dialogs are selected and operated using the keys of the HMI device.

- External USB keyboard

An external keyboard can be used to operate the Control Panel in exactly the same way as the HMI device keyboard. Use the keys of the external keyboard which correspond to the HMI device keys in the description.

- External USB mouse

The Control Panel can be operated with an external mouse in exactly the same way as with the HMI touch screen. Click the described operating elements with the mouse.

6.3.3.2 Entries using the touch screen

The Control Panel is operated with the touch screen of the HMI device.

Procedure

1. Close the project.

Use the provided operating element. The loader is displayed.

2. Open the Control Panel by pressing the "Control Panel" button.
3. To open the required dialog, double-click its symbol.
4. Change as required by touching the tab.
5. Now make the necessary changes.

Touch the respective input object to make entries.

- Use the screen keyboard of the HMI device to enter the new values in the text boxes.
- Touch a button to operate it.
- Touch the selection box to open a drop down list box. Touch the required entry from the drop down list box.
- Touch the check box to activate or deactivate a check box.
- Touch a radio button to select it.

6. Confirm the selection with the button or abort the entries with the button.



The dialog box closes.

7. Close the Control Panel with the button.
8. Start the project by pressing the "Start" button in the Loader.

Input with the screen keyboard

A screen keyboard is available for data input. The screen keyboard is displayed as soon as you touch a text box. You can also call up the screen keyboard directly from the Control Panel.

Display methods for the screen keyboard

You can change the display method for the screen keyboard and fix the position on the screen. Confirm the entry with the  button or abort the entry with the  key. Either action closes the screen keyboard.

- Numerical screen keyboard



- Alphanumerical screen keyboard









The alphanumerical screen keyboard has various levels.

- Normal level
- Shift level
- Reduced screen keyboard



Changing the display of the screen keyboard

Key	Function
	Switching between the numerical and alphanumerical keyboard
	Switching between the normal level and Shift level of the alphanumerical screen keyboard
	Activation and deactivation of the numerical and alphanumerical keys of the alphanumerical screen keyboard
	Switching from full display to reduced display
	Switching from reduced display to full display
	Closing of reduced display of the screen keyboard

Moving the screen keyboard

1. Touch the following icon:



2. Without lifting your finger, move the screen keyboard on the touch screen.
3. Release the icon when the required position is reached.

See also

Setting up the screen keyboard (Page 84)

Entering and Editing Numerical Values (Page 163)

Entering and editing alphanumeric values (Page 166)

Front operator controls (Page 61)

6.3.3.3 Input with the Keyboard

The Control Panel is operated with the system keys of the HMI device.

Procedure

1. Close the project.
Use the provided operating element.
2. Open the Control Panel.
The loader is displayed.
 - Select the "Control Panel" button in the loader using the cursor keys.





– Press .





The Control Panel is opened.



3. Select the symbol of the required dialog with the cursor keys.
4. Press  to open the dialog.
5. Change the tab as required.

Press  until the name of the tab is selected. Now switch to the other tabs using the cursor keys.

6. Press  to return to the input area and make the necessary changes.

Select the respective input object by pressing the  key to make entries.
 - Use the system keys of the HMI device to enter the new values in the text boxes.
 - To operate a button, select the button with the cursor keys and then press .
 - Open the selection lists with the key combination  + .Select the required entry from the selection list using the cursor keys.







Confirm the selected entry by pressing .
- Press  to activate or deactivate a check box.
- Select a option button of a group using the cursor keys.
7. Confirm your entries with  or discard your entries with .
- If you have selected an input object, you first have to complete entry.
The dialog box closes.
8. Close the Control Panel.

Press . This opens the Control Panel menu.
 - Select the "Close" entry using the cursor keys.
 - Press .The loader is displayed.
9. Start the project.
 - Select the "Start" button in the loader using the cursor keys.
 - Press .The project is started.















Control keys

The tables below show the control keys used to operate the Control Panel.





Select operating elements

Key/Keys	Function	Description
	–	Tabulator Selects the next/previous operating element in the tab sequence.
 		
   	Cursor keys	Selects the next operating element to the left, right, above or below the current screen object. Navigates in the operating element.

Using operating elements

Key/Keys	Function	Description
	–	Scroll back Scrolls back a page in a list.
 	–	Scroll to the beginning Scrolls to the beginning of a list.
	–	Scroll forward Scrolls one page forward in a list.
 	–	Scroll to the end Scrolls to the end of a list.
	–	Enter key <ul style="list-style-type: none"> Operates a button. Accepts and ends an entry.
	–	Cancel <ul style="list-style-type: none"> Deletes the characters of a value entry and restores the original value. Closes the active dialog.
	–	Delete characters Deletes the character to the right of the current cursor position.
	–	Delete characters Deletes the character to the left of the current cursor position.
 	–	Open selection list Opens a selection list.
 	–	Accept value Accepts the selected value in the selection list without closing the list.

Enter key combinations

Key	Function	Purpose
	Toggle key assignment	<p>Toggles the assignment for a key with multiple assignment.</p> <ul style="list-style-type: none"> No LED is lit: The number assignment is enabled. Pressing the button once toggles to letter assignment. An LED is lit: The left or right letter assignment is enabled. Each time the key is pressed, the system toggles between the left letter assignment, the right letter assignment and the number assignment.
	Toggle between upper-case and lower-case	Used in key combinations, for example for entering upper-case letters.
	Switch to additional key assignment	<p>Some of the keys contain a key assignment imprinted blue, for example the "%" character.</p> <p>Used in key combinations for the blue key assignment.</p>
	General control function	Used in key combinations
	General control function	Used in key combinations

See also

Entering and editing numerical values (Page 174)

Entering and editing alphanumerical values (Page 176)

Front operator controls (Page 61)

6.4 Changing settings for operation

6.4.1 Setting up the screen keyboard

You set up the layout and the position of the screen keyboard.

Requirement

You have opened the "Siemens HMI InputPanel - Options" with the "InputPanel" icon.

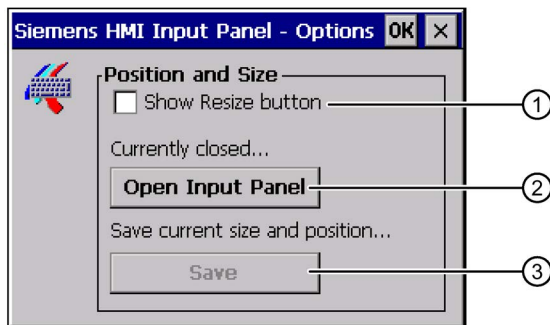

- ① Button for displaying the screen keyboard
- ② Button for saving the screen keyboard settings
- ③ Button for closing the screen keyboard

Procedure

1. Display the screen keyboard by pressing the "Open Input Panel" button.
2. By pressing the  button, you can switch between the numerical and alphanumerical screen keyboard.
3. Set the position of the screen keyboard by moving the screen keyboard on the screen.
4. Save your settings by pressing the "Save" button.
5. Close the screen keyboard by pressing the "Close Input Panel" button.
6. Close the dialog.

The screen keyboard settings have been modified.

See also

Entries using the touch screen (Page 78)

6.4.2 Setting the Character Repetition of the Keyboard

You can set the character repeat for the keyboard or screen keyboard in the Control Panel.

Requirement

You have opened the "Keyboard Properties" dialog box with the "Keyboard" icon.

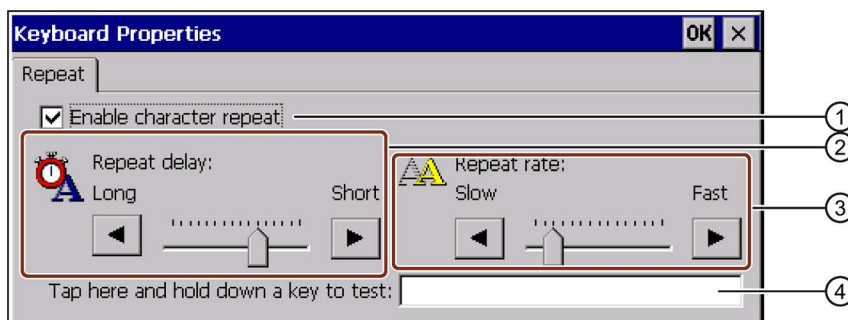

- ① Check box for activating the character repeat
- ② Slider control and buttons for the delay time before character repeat
- ③ Slider control and buttons for the rate of the character repeat
- ④ Test field

Procedure

1. Select the "Enable character repeat" check box to enable the character repeat.
2. Use the buttons to set the delay and rate of the character repeat. You can also use the slider control for this.
3. Verify your settings.

For HMI devices with touch operation.

- Touch the test field. The screen keyboard opens.
- Move the screen keyboard as needed.
- Touch any character and keep it pressed.
- Check the implementation of the character repetition and the rate of the character repetition in the test field.
- Correct your setting if necessary.

For HMI devices with key operation.

- Select the test field.
- Press an alphanumeric key and keep the key pressed down.
- Check the implementation of the character repetition and the rate of the character repetition in the test field.
- Correct your setting if necessary.

4. Confirm your entries.

The dialog box closes.

The character repeat for the keyboard is now set.

6.4.3 Setting the Double-click

You can start applications in the Control Panel and in Windows CE with a double-click. A double-click corresponds to two brief touches in sequence.

In the "Mouse Properties" dialog, make the following adjustments for touch screen operation and operation with external mouse:

- Interval between two touch contacts on the touch screen
- Interval between mouse clicks

Note

If you make this setting with an external mouse on a device with touch screen, you may encounter problems with the touch recognition.

Requirement

You have opened the "Mouse Properties" dialog using the "Mouse" icon.

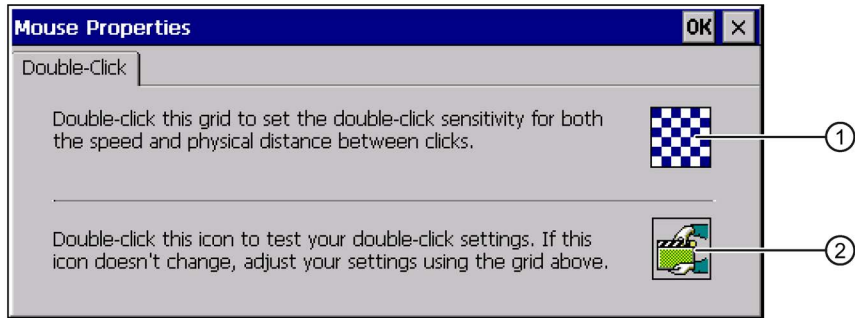

- ① Pattern
- ② Symbol

Procedure

1. Double-click on the grid.

After one double-click, the pattern is shown in inverse colors.



2. Double-click on the icon.

If the double-click is valid, the symbol is displayed as follows:



3. If the symbol remains unchanged, double-click on the pattern again.
4. Confirm your entries.

The dialog box closes.

The double-click adjustment is completed.

6.4.4 Calibrate touch screen

Depending on the mounting position and viewing angle, parallax may occur on the touch screen. To prevent any operating errors caused by parallax, calibrate the touch screen again in the startup phase or during runtime.

Requirement

You have opened the "Touch" tab in the "OP Properties" dialog box with the "OP" icon.



- ① Button for calibrating the touch screen

Procedure

1. Touch the "Recalibrate" button to open the following dialog:

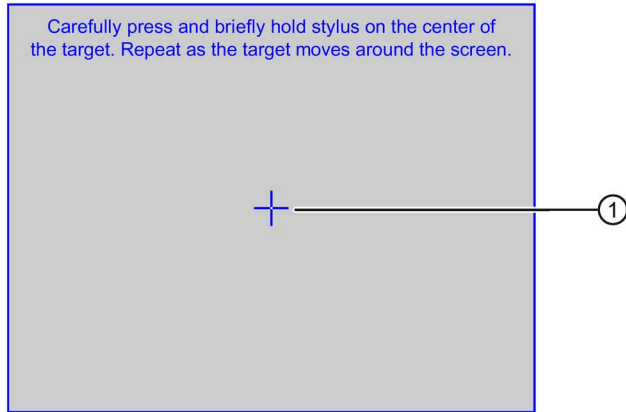

2. Briefly touch the middle of the calibration crosshairs ①.

The calibration crosshairs is then displayed at four more positions. Touch the middle of the calibration crosshairs for each position. If you do not touch the middle of the calibration crosshairs, the procedure is repeated.

Once you have touched the calibration crosshairs for all positions, the following dialog appears:

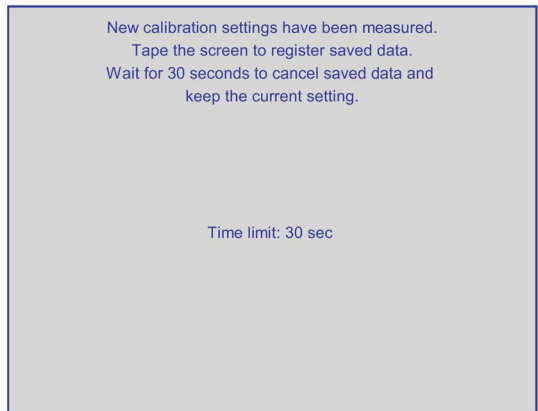

3. Touch the touch screen within 30 seconds.

The new calibration is saved. If you wait longer than 30 seconds, the new calibration is discarded and the original calibration remains in effect.

The "OP Properties" dialog , "Touch" tab is displayed again.

4. Close the dialog.

The touch screen of the HMI device is recalibrated.

6.5 Changing Password Protection

You can protect the Control Panel and Windows CE taskbar with a password. Pay particular attention to the section "Enabling and disabling SecureMode (Page 74)".

Requirement

You have opened the "Password Properties" dialog box with the "Password" icon.

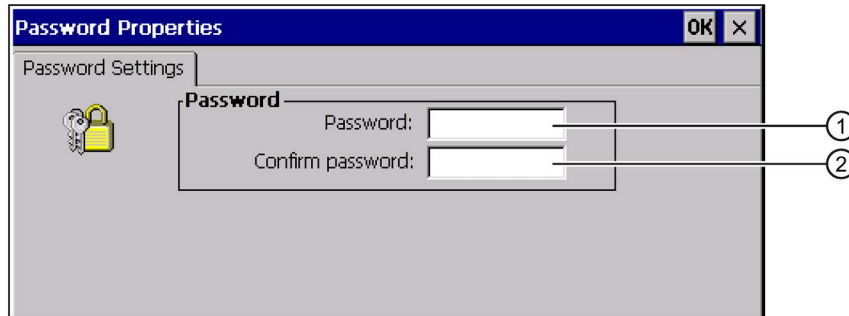

- ① Password text box
- ② Text box for entering the password a second time

Note

If the password is no longer available, you cannot do the following until you have updated the operating system.

- Making changes to the Control Panel
- Operating the Windows CE task bar

All data on the HMI device will be overwritten when you update the operating system!

Procedure

Activating password protection

1. Enter a password in the "Password" text box.

Note

The following characters cannot be used in passwords:

- Blank
 - Special characters * ? . % / \ ' "
-

2. Repeat the password entry in the "Confirm Password" text box.
3. Confirm your entries.

The dialog box closes.

You cannot open the Control Panel or Windows CE taskbar without entering a password.

Deactivating password protection

1. Delete the entries in the "Password" and "Confirm password" text boxes.
2. Confirm your entries.

The dialog box closes.

Password protection for the Control Panel and Windows CE taskbar is disabled.

6.6 Changing HMI device settings

6.6.1 Setting the Date and Time

You can set the date and time on the HMI device. The HMI must be restarted in the following cases:

- You have changed the time zone setting.
- You have changed the setting of the "Daylight savings time currently in effect" check box .

Requirement

You have opened the "Date/Time Properties" dialog using the "Date/Time Properties" icon.



- ① Time zone
- ② Time
- ③ Date
- ④ "Daylight savings" check box
- ⑤ Button for applying changes

Procedure

1. Select the appropriate time zone for the HMI device in the "Time Zone" selection box.
2. Touch the "Apply" button to confirm your entry.
The time of day shown in the "Current Time" field is adjusted correspondingly to the selected time zone.
3. Set the date in the selection box.
4. Set the current time of day in the "Current Time" text box.

Note

The system does not automatically switch between standard time and daylight saving time.

5. If you want to switch from standard time to daylight saving time, select the "Daylight saving time currently in effect" check box.
When you press the "Apply" button, the time is brought forward by one hour.
6. If you want to switch from daylight saving time to standard time, deactivate the "Daylight saving time currently in effect" check box.
When you press the "Apply" button, the time is brought back by one hour.
7. Confirm your entries.
The dialog box closes.
The settings for the date and time of day have now been changed.

Synchronizing the date and time with the PLC

The date and time of the HMI device can be synchronized with the PLC if this has been configured in the project and the PLC program. You can find more information on this topic in the online help of the configuration software.

Note

You have to synchronize the date and time when time-controlled responses are triggered in the PLC by the HMI device.

See also

Restarting the HMI Device (Page 99)

6.6.2 Changing Regional Settings

In different countries, for example, the date, time and decimal points are displayed differently. You can adjust the display format to meet the requirements of different regions.

The country-specific settings apply to the current project. If the project language is changed, the country-specific settings are also changed.

Requirement

You have opened the "Regional and Language Settings" dialog box with the "Regional Settings" icon.



① Region selection box

Procedure

1. Select the region from the selection box.
 2. Change to the "Number", "Currency", "Time" and "Date" tabs and set the selection boxes to the desired settings.
 3. Confirm your entries.
The dialog box closes.
- The HMI device's regional settings have been changed.

6.6.3 Backing up Registry Information

Backing up registry information and temporary data

You can install and uninstall your own programs on the HMI devices under Windows CE. You must save the registry settings after installation or uninstallation.

You can save the following data to the flash memory:

- Registry information
- Temporary files

Restoring file system from a memory card

If memory cards are used, the file system on the memory card may become damaged, perhaps due to a power failure. The HMI device detects the defective file system on start-up or when the memory card is inserted. The HMI device can restore the file system automatically or on request.

Requirement

You have opened the "Persistent Storage" tab in the "OP Properties" dialog box with the "OP" icon.

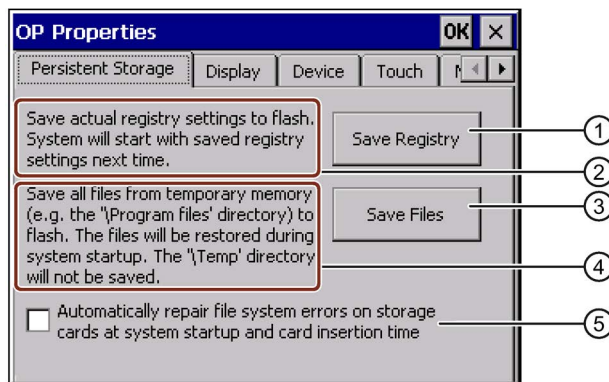

- ① Button for saving registry information
- ② Meaning of the text in the dialog:
Saves the current registry information to the flash memory. The HMI device loads the saved registry information the next time it boots.
- ③ Button for saving temporary files
- ④ Meaning of the text in the dialog:
Saves all the files in temporary storage to the flash memory (for example, from the "Program Files" directory). These files are written back when the HMI device is started. The "\Temp" directory is not saved.
- ⑤ Check box for automatically restoring the file system on the memory card when the HMI device starts up and when a memory card is inserted.

Procedure

1. Select the "Save Registry" button to save the current registry settings.
2. Select the "Save Files" button to save temporary files.
3. Specify how the file system on the memory card should be restored.
 - Activate the check box "Automatically Repair ..." to activate automatic restore.
 - Deactivate the check box "Automatically Repair ..." if you wish to have the files system restored only upon prompting.
4. Confirm your entries.
The dialog box closes.

The HMI device uses the saved registry information the next time it starts. The temporary files are copied back.

6.6.4 Changing monitor settings

Requirement

You have opened the "Display" tab in the "OP Properties" dialog using the "OP" icon.

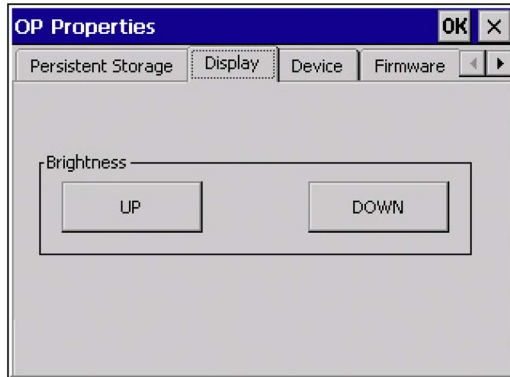

Procedure

1. If you want to increase the brightness, press the "UP" button.
2. If you want to decrease the brightness, press the "DOWN" button.
3. Confirm your entries.

The dialog box closes.

The screen settings have been changed.

6.6.5 Setting the screen saver

You can set the following time intervals on the HMI device:

- For the automatic activation of the screen saver
- For the automatic reduction in the screen's backlighting

When you do not undertake an operation within the configured interval, the configured function will be activated automatically.

The screen saver and the reduced screen backlighting functions are switched back off by means of the following actions:

- By pressing any key
- By touching the touch screen

The function associated to the key or button will not be executed by this.

Note

Deterioration of the backlight brightness

The brightness of the backlighting decreases incrementally during its operational life. In order to increase the operational lifetime of the backlighting, activate the backlighting reduction.

Burn-in effects

The prolonged display of screen contents can occasionally lead to a burn-in effect in the background.

This burn-in effect automatically disappears after a certain amount of time, for example, after the screensaver was activated. The longer the same content is displayed on the screen, the longer it will take for the burn-in effect to disappear.

Generally, you should always activate the screen saver.

When the screen saver is active, the backlighting is reduced at the same time.

Requirement

You have opened the "ScreenSaver" dialog box with the "ScreenSaver" icon.

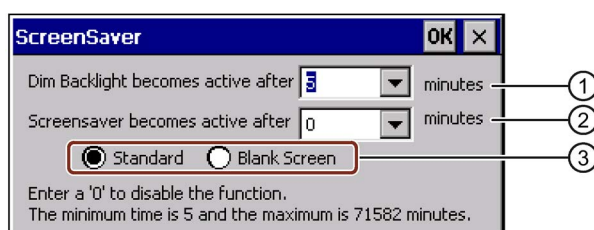

- ① Time interval in minutes until backlighting is reduced
- ② Period of time in minutes before the screen saver is activated
- ③ Screen saver setting

Procedure

1. Enter the interval in minutes after which the backlighting is to be reduced.
Entering "0" will deactivate the backlighting reduction.
2. Enter the number of minutes before the screen saver is to be activated.
The minimum time is 5 minutes and the maximum time is 71582 minutes.
Entering "0" disables the screen saver.

- 3. Select either the standard screen saver or an empty screen.
 - In order to select the standard screen saver, activate the "Standard" option.
 - In order to select an empty screen as screen saver, activate the "Blank Screen" option.
 - 4. Confirm your entries.

The dialog box closes.
- The screen saver and the reduced backlighting for the HMI device is set.

6.6.6 Changing the Printer Properties

HMI devices can print on local printers or network printers. You can print hardcopy and logs on network printers. Line printing of alarms is not possible on a network printer.

You can find the list of current printers and required settings for HMI devices on the Internet at Printers approved for SIMATIC Panels and Multi Panels (<http://support.automation.siemens.com/WW/view/en/11376409>).

Requirement

You have opened the "Printer Properties" dialog box with the "Printer" icon.

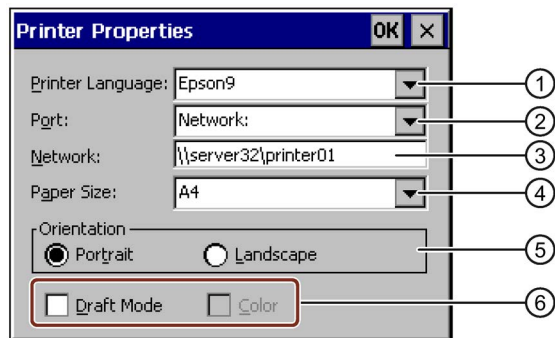

- ① Printer selection box
- ② Interface
- ③ Network address of the printer
- ④ Paper size selection box
- ⑤ Orientation setting
- ⑥ Print quality setting

Procedure

1. Select the printer in the "Printer Language" selection box.
2. Select the port for the printer in the "Port" selection box.
3. If you wish to print via the network, enter "Network:" in the text box the network address of the printer.
4. Select the paper format in the "Paper Size" selection box.
5. Select the required option button in the "Orientation" group:
 - "Portrait" for vertical format
 - "Landscape" for horizontal format
6. Select the print quality.
 - Select the "Draft Mode" check box if you want to print a draft.
 - Clear the "Draft Mode" check box if you want to print with higher quality.
7. Set the color mode.
 - Select the check box "Color" if you wish to print in color.
8. Confirm your entries.

The dialog box closes.

The settings for the printer have now been changed.

6.6.7 Set the volume

You can activate an acoustic feedback for keyboard and touch screen operations. With each touch or activation of a key, an acoustic signal is emitted.

Requirement



You have opened the "Volume & Sounds Properties" dialog box with the "Volume & Sounds" icon.

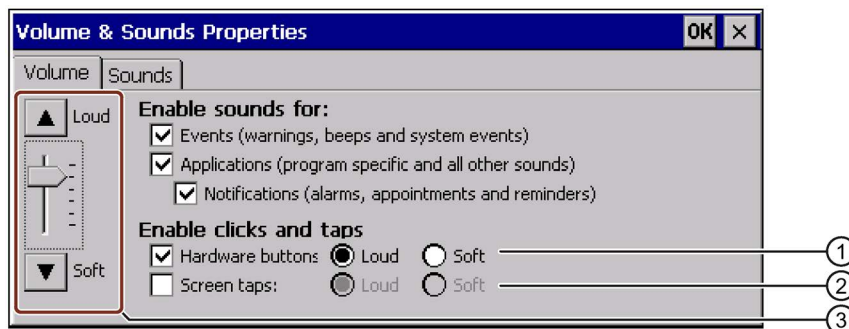

- ① Check boxes and radio buttons for acoustic feedback when using the keyboard
- ② Check boxes and radio buttons for acoustic feedback when using the touch screen
- ③ Buttons for adjusting the volume

Note

If you deactivate the settings under "Enable sounds for:" no more acoustic signals will be emitted during inadvertent operations.

Procedure

1. For HMI devices with keys:
 - Click the check box "Hardware buttons" to activate the acoustic signal.
 - Choose between a loud and soft acoustic signal using the "Loud" and "Soft" radio buttons.
2. For HMI devices with touch screen:
 - Activate the "Screen Taps" check box to activate the acoustic signal.
 - Choose between a loud and soft acoustic signal using the "Loud" and "Soft" radio buttons.
3. Choose the required volume using the "Loud" and "Soft" radio buttons.
4. Confirm your entries.

The dialog box closes.

Note

The entries in the "Sounds" tab are of no relevance for the HMI device.

The properties of the acoustic operation feedback are now set up.

See also

Overview (Page 157)

6.6.8 Restarting the HMI Device

You need to start the HMI device again in the following situations:

- You have activated or deactivated the PROFINET IO direct keys.
- You have changed the time zone setting.
- You have changed the automatic daylight savings and standard setting.

NOTICE

Data loss when the HMI device is restarted

All volatile data is lost when the HMI device is rebooted.

Check the following:

- The project on the HMI device is not open.
- No data is being written to the flash memory.

Requirement

You have opened the "OP Properties" dialog box by pressing the "OP" icon.

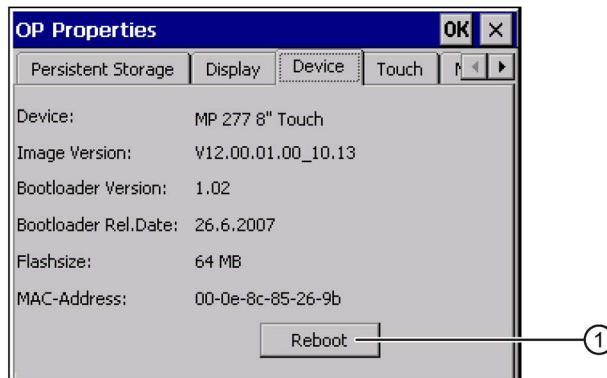

- ① Button for rebooting the HMI device

Procedure

1. Change to the "Device" tab in the "OP Properties" dialog.
2. Click "Reboot".

The following warning is displayed:

"If you run this function, all data which has not been backed up will be lost. Close all applications before you restart the device.

Reboot?"

The HMI device reboots immediately if you confirm this warning.

The HMI device reboots.

See also

Enabling PROFINET IO (Page 111)
Setting the Date and Time (Page 90)

6.6.9 Displaying Information about the HMI Device

You will need the device-specific information when you contact Technical Support.

Requirement



You have opened the "Device" tab in the "OP Properties" dialog box with the "OP" icon.

The figure below shows the dialog using MP 277 8" Touch as an example.

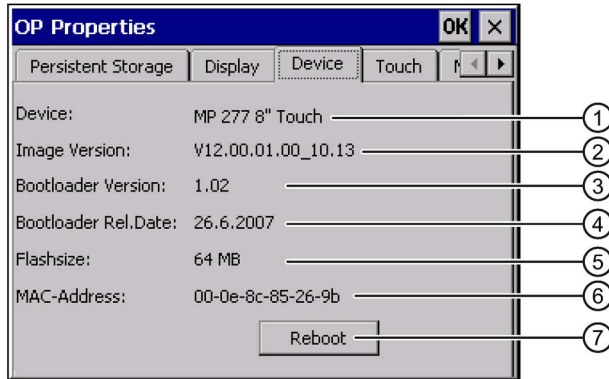

- ① HMI device name
- ② Version of the HMI device image
- ③ Version of the boot loader
- ④ Boot loader release date
- ⑤ Size of the internal flash memory in which the HMI device image and project are stored
- ⑥ MAC address of the HMI device
- ⑦ Button for restarting the HMI device

Procedure

1. The device-specific information is displayed in the "Device" tab.
2. Close the dialog when the information is no longer required.

Note

The size of the internal flash memory does not correspond to the available working memory for a project.

6.6.10 Displaying System Properties

The system-specific information provides you with information about the processor, operating system and memory of the HMI device.

Requirement

You have opened the "System Properties" dialog box, "General" tab with the "System" icon.

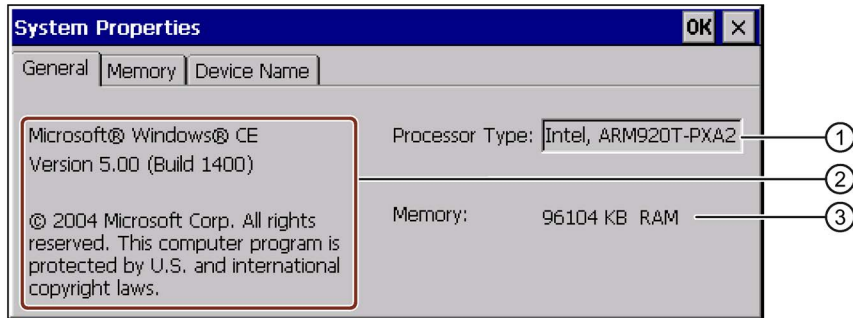

- ① Copyright to Microsoft Windows CE
- ② Processor information
- ③ Size of internal flash memory

Procedure

Note

Do not change the memory distribution in the "Memory" tab.

Only applies for the usage of ProSave options according to section "Installing and removing options using ProSave (Page 152)":

An alteration to the memory distribution may be necessary. Please refer to the accompanying documentation for further information.

1. Change to the "Memory" tab.

The memory information is displayed.

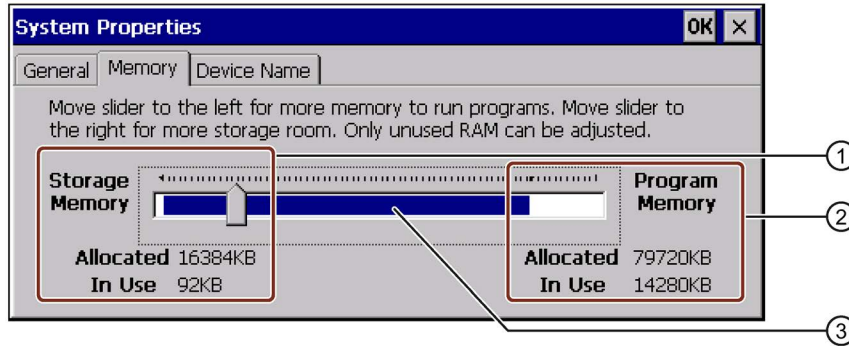

- ① Size of data storage space
- ② Size of program storage space
- ③ The blue area shows the size of the available memory.

2. If you want to change the size of the assigned storage space, move the slider.

The change is displayed under "Allocated". The slider sets the ratio between data and program storage space.

3. Close the dialog.

6.7 Setting the Delay Time

The project is opened following a delay time when the HMI device is switched on. The Loader is displayed during the delay time. Read the description of the "Start" button in the section "Loader (Page 69)" when doing this.

Note

Do not use the delay time to implement a temporary access protection.

Requirement

You have opened the "Directories" tab in the "Transfer Settings" dialog box with the "Transfer" icon.

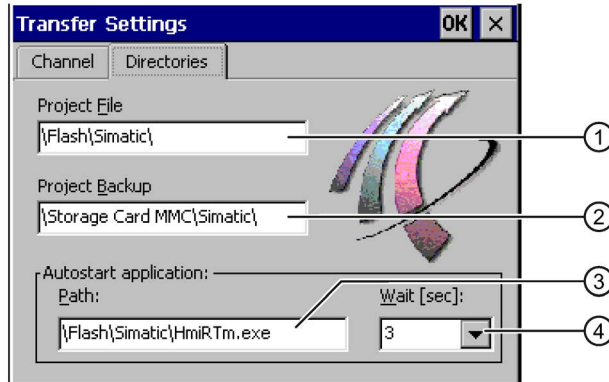

- ① Directory where the project file is saved
- ② Directory where the compressed source file of your project is saved
The external memory card or the network connection can be defined as the storage location.
During the next backup process, the project's source file is stored in the specified location.
- ③ Storage location and initialization file of the HMI device for process operation
- ④ Region selection box

NOTICE

Settings in "Project File" and "Path"

The project may not open at the next start of the HMI device if changes are made here.
Do not change the setting in the "Project File" and "Path" fields.

Procedure

1. Select the desired delay time in seconds in the "Wait [sec]" selection box.
With the value "0", the project starts immediately. It is then no longer possible to call the Loader after switching on the HMI device. If you still wish to access the Loader, an operating element must be configured to close the project.
2. Confirm your entries.
The dialog box closes.
The delay time for the HMI device is now set.

6.8 Setting the uninterruptible power supply

UPS monitoring is an option you load as an add-on with ProSave.

A UPS ensures that the HMI device is shut down in a controlled manner after a buffer time in the event of a power failure. This avoids the loss of data. The following uninterruptible power supplies are supported:

- SITOP DC UPS modules as of a rated power value of 6 A, e.g. 6EP1931-2DC42

Configure the USB port for UPS monitoring.

Requirement

- The UPS is connected to the 24 V input and a USB port.
- You have opened the "Configuration" tab in the "UPS Properties" dialog box with the "UPS" icon.

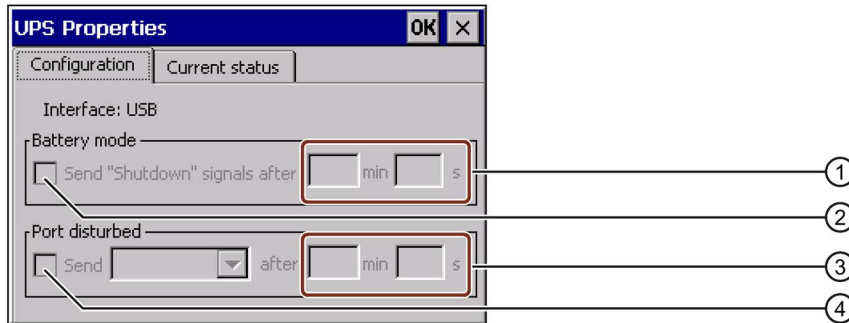

- ① Text box for the time after which the "Battery mode activated" message is displayed
- ② Check box for enabling battery mode
- ③ Text box for the time after which the "Faulty port" message is displayed
- ④ Check box for the "Faulty port" message

Procedure

1. If you want to enable battery mode, activate the "Battery mode" check box.
2. Enter the time for terminating applications in the "min" and "s" text boxes.
You will receive a message when UPS takes effect. Applications such as HMI Runtime and WinAC MP are then terminated depending on the time entered.
3. If the port to which the UPS is connected is faulty and you therefore want to receive a message, activate the "Port disturbed" check box.
4. Select the message you want from the list box.
5. Enter the time after which the "Faulty port" message is displayed in the "min" and "s" text boxes.

Port monitoring for the UPS is set.

6.9 State of uninterruptible power supply

If you have connected a UPS to a USB port, you can display the monitoring state of this port.

Requirement

You have opened the "Current status" tab in the "UPS Properties" dialog using the "UPS" icon.

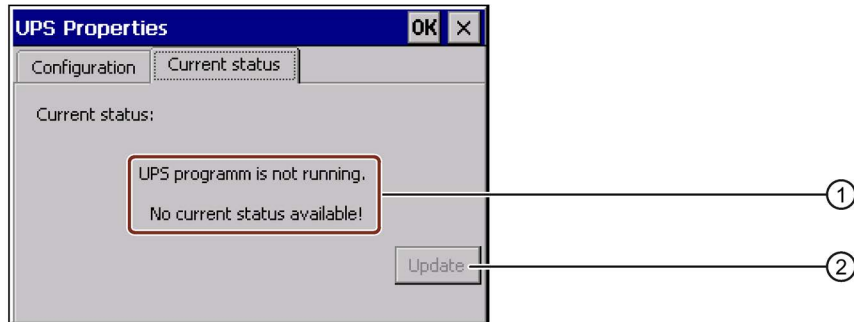

- ① The "UPS program is not running. No current status available." message appears when the UPS is not connected.
- ② Update

Procedure

1. Installing the UPS monitoring software.
2. Connect the UPS.
3. If you want to update the monitoring state, press the "Update" button.

The message is changed according to the current setting. The message will remain unchanged if no check boxes in the "Configuration" tab have been activated.

The current monitoring state for the UPS is displayed.

6.10 Change the communication settings

6.10.1 Changing S7 transfer settings

The communication settings between the HMI device and PLC are defined in the HMI device project. In the following cases, the communication settings might have to be changed:

- The first time the project is transferred
- If changes are made to the project but are only applied later

NOTICE
Transfer mode using MPI/PROFIBUS DP
The changed MP/PROFIBUS DP settings are overwritten in the following cases:
<ul style="list-style-type: none">• The project is started.• A project is transferred
The bus parameters are read from the project currently loaded on the HMI device. You can change the settings for MPI / PROFIBUS DP transfer. The following steps are required:
<ul style="list-style-type: none">• Close the project.• Change the settings on the HMI device.• Then return to "Transfer" mode.

Note

- A project can only be transferred from the configuration PC to the HMI device when at least one data channel is activated on the HMI device.
- If no DP connection is configured in the project, the data channel is deactivated when the project is started.
- If the HMI device is in "Transfer" mode while changes are made to the transfer settings, the settings only go into effect after the transfer function is restarted.

Requirement

You have opened the "S7-Transfer Settings" dialog box with the "S7-Transfer Settings" icon.

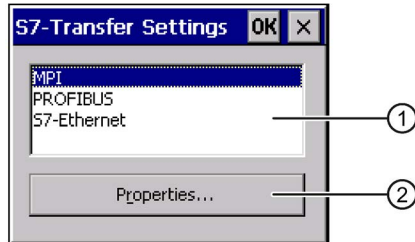

- ① Network selection
- ② Button for opening the properties dialog

Procedure

1. Select a network.
 - If you have selected "S7 Ethernet", click the "Properties" button to open the "SMC LAN91C111 Ethernet Settings" dialog and proceed as described in the Changing the Network Configuration (Page 116) section to edit the Ethernet settings.
 - If you have selected "MPI" or "PROFIBUS", proceed as described in the steps below.
2. Open the "MPI" or "PROFIBUS" dialog with the "Properties" button:

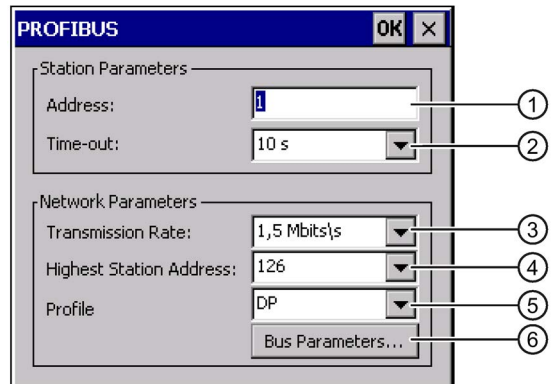
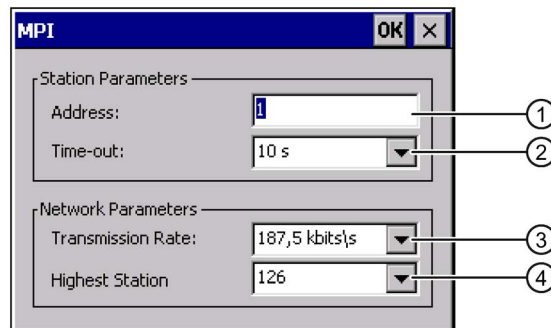

6.10 Change the communication settings

3. If more masters are connected to the bus, deactivate the check box "Panel is the only master on the bus".
4. Enter the bus address for the HMI device in the "Address" text box.

Note

The bus address in the "Address" text box must be unique throughout the MPI/PROFIBUS DP network.

5. Select the transmission rate in the "Transmission Rate" text box.
6. Select the highest station address on the bus in the "Highest Station Address" or "Highest Station" text box.
7. Select the desired profile from the "Profile" selection box.
8. The profile information is displayed when you select "Bus Parameters" button in the PROFIBUS dialog. The "Profile" dialog is read-only.

Note

The bus parameters must be the same for all stations in the MPI/PROFIBUS DP network.

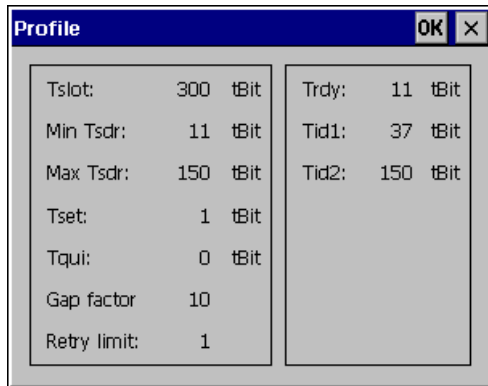

9. Close the "Profile" dialog.
10. Confirm your entries in the "MPI" or "PROFIBUS" dialog.

The dialog box closes.

The MPI/PROFIBUS DP settings of the HMI device have been changed.

6.10.2 Configuring the data channel

If you block all data channels, the HMI device is protected against unintentional overwriting of the project data and HMI device image.

Note

A project can only be transferred from the configuration PC to the HMI device when at least one of the data channels is enabled on the HMI device.

Requirement

You have opened the "Transfer Settings" dialog box with the "Transfer Settings" icon.



- ① Group for data channel 1 (Channel 1)
- ② Group for data channel 2 (Channel 2)
- ③ Button for the dialog "S7 Transfer Settings" or "Network and Dial-Up Connections."

The "Directories" tab is described in the section "Setting the Delay Time (Page 102)".

Note

Changes during "Transfer" mode

If the change transfer settings during "Transfer" mode, the changed transfer settings will not into effect until the next time you start the transfer.

This may occur if the Control Panel is opened to change the transfer properties in an active project.

Procedure

1. You can clear the required data channel by activating the associated "Enable Channel" check box in the "Channel 1" or "Channel 2" group.

In the "Channel 1" group, the RS-422/RS-485 port is configured for the serial data transfer.

- Select the "Enable Channel" check box to enable the data channel.
- Clear the "Enable Channel" check box to lock the data channel.

Note

Only select the "Remote Control" check box in the "Channel 1" group, if serial transfer is in progress. Clear the check box before changing to "Online" mode.

2. Enable automatic transfer by activating the respective "Remote Control" check box in the "Channel 1" or "Channel 2" group.

 WARNING
Unintentional transfer mode
If the HMI is accidentally switched to Transfer mode, unintentional actions can be triggered in the plant.
Ensure that the configuration PC does not inadvertently switch the HMI device to transfer mode while the project is in runtime.

3. Select the required protocol for "Channel 2" in the selection box.

Note

Serial transfer mode via channel 2

The bus parameters, for example address of the HMI device, are read out of the project that is currently running on the HMI device.

You can change the settings for the transfer via channel 2.

The following steps are required:

- Close the project.
- Change the settings on the HMI device.
- Then return to "Transfer" mode.

The next time the project is started on the HMI device, the settings will be overwritten by the values from the project.

4. Enter further parameters if required.

- Applies to "MPI/Profibus/S7-Ethernet:"

Press the "Advanced" button to change to the "S7-Transfer Settings" dialog. There you can change the settings for MPI/PROFIBUS or S7 Ethernet.

Confirm your entries.

The "S7-Transfer Settings" dialog box closes.

- Applies to "ETHERNET":

Press the "Advanced" button to change to the "Network&Dial-Up Connections."

Open the "LAN9001" entry. You can change the TCP/IP settings there.

Confirm your entries.

Close "Network&Dial-Up Connections".

- Applies to "USB:"

No further settings are required for "USB".

5. Confirm your entries.

The dialog box closes.

The data channel is configured.

See also

Changing S7 transfer settings (Page 106)

Changing the Network Configuration (Page 116)

Operating modes (Page 134)

6.10.3 Enabling PROFINET IO

If the HMI device is connected to the PLC via PROFINET, function keys or buttons, for example, can be configured as PROFINET IO direct keys. If PROFINET IO direct keys are used in the project, they must be enabled.

Note

If you enable PROFINET IO direct keys, you cannot use the RS 422/RS 485 port for serial communication. PROFINET IO direct keys and PROFIBUS DP direct keys are mutually exclusive.

Requirement

You have opened the "PROFINET" dialog box with the "PROFINET" icon.

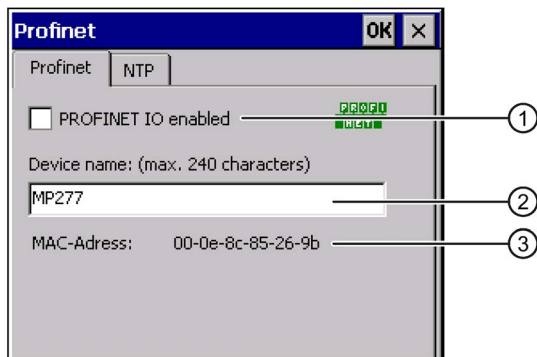

- ① Enabling or disabling the PROFINET IO direct keys
- ② Text box for the device name
- ③ MAC address of the HMI device

Note

If the device name does not match the device name entered in the HW Config of STEP 7, the direct keys do not work. Use the device name from the HW Config of STEP 7. This device name does not correspond to the device name used under Windows CE.

Within the ETHERNET data network, the device name must be unique and satisfy the DNS conventions. These include:

- Restriction to 127 characters in total (letters, digits, hyphen or point).
- A name component within the device name, e.g. a string between two points, may not exceed 63 characters.
- Special characters such as umlauts, brackets, underscores, slashes, spaces etc. are not permitted. The hyphen is the one exception.
- The device name must not start or end with a the "-" character.
- The device name must not take the form n.n.n.n (n = 0 to 999).
- The device name must not start with the character sequence "port-xyz-" (x, y, z = 0 to 9).

Procedure

1. If you want to enable the PROFINET IO direct keys, select the "PROFINET IO enabled" check box.
 2. Enter the device name of the HMI device.
 3. Confirm your entries.
The dialog box closes.
 4. Reboot the HMI device after saving the settings.
- The PROFINET IO direct keys are enabled.

See also

Restarting the HMI Device (Page 99)
Overview (Page 157)

6.11 Configuring network operation

6.11.1 Overview of network operation

You can connect the HMI device to a PROFINET network via the Ethernet port.

The connection to a network offers, for example, the following options:

- Printing via a network printer

The HMI device's operating system does not support line by line alarm logging via a network printer. All other printing functions, for example hardcopy or logs are available without restriction via the network.

- Saving, exporting and importing of recipe data records on or from a server
- Setting up of message and data archives
- Transferring a project
- Backing up data

Note

The HMI device can only be used in PROFINET networks.

The HMI device only has client functionality in the PC network. This means that users can access files of a node with TCP/IP server functionality from the HMI device via the network. However, you cannot, for example, access data on the HMI device from a PC via the network.

Note

Information on communication using SIMATIC S7 over PROFINET is provided in the online help of the configuration software.

Addressing the computer

Within a PROFINET network, computers are usually addressed using computer names. These computer names are translated from a DNS or WINS server to TCP/IP addresses. This is why a DNS or WINS server is needed for addressing via computer names when the HMI device is in a PROFINET network. Such servers are usually present in PROFINET networks.

Note

The use of TCP/IP addresses to address PCs is not supported by the operating system.

For additional questions on addressing in your network, contact your network administrator.

Requirement

Before beginning the configuration, request the following network parameters from your network administrator.

- Does the network use DHCP for dynamic assignment of network addresses?
If not, get a new TCP/IP network address for the HMI device.
- Which TCP/IP address does the default gateway have?
- If a DNS network is used, what are the addresses of the name server?
- If a WINS network is used, what are the addresses of the name server?

General procedure for configuring the network

The HMI device must be configured prior to network operation. The configuration is basically divided into the following steps:

1. Enter the computer name of the HMI device.
2. Configure the network address.
3. Set the logon information.
4. Back up the settings.

6.11.2 Setting the device name of the HMI device

The HMI device uses the device name to identify itself in the network.

Requirement

You have opened the "System Properties" dialog box with the "System" icon.



- ① Device name of the HMI device
- ② Description for the HMI device (optional)

Note

Change the device name for the HMI device in the "Device name" text box to activate the network functions.

Procedure

1. Enter the device name for the HMI device in the "Device name" text box.
2. Enter a description for the HMI device in the "Device description" text box.
3. Confirm your entries.

The dialog box and the screen keyboard are closed.

The device name for the HMI device is now set.

See also

Overview of network operation (Page 113)

6.11.3 Changing the Network Configuration

You can change the network settings for the LAN connection under "Network & Dial-Up Connections".

Requirement

You have opened the following display using the "Network&Dial-Up Connections" icon.

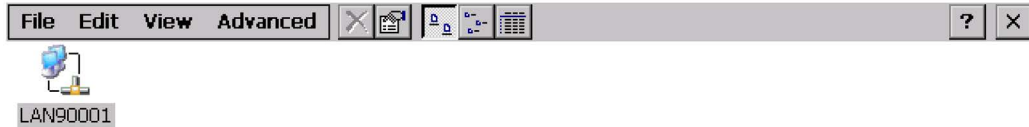

Procedure

1. Open the "LAN90001" entry.

The following dialog is displayed.

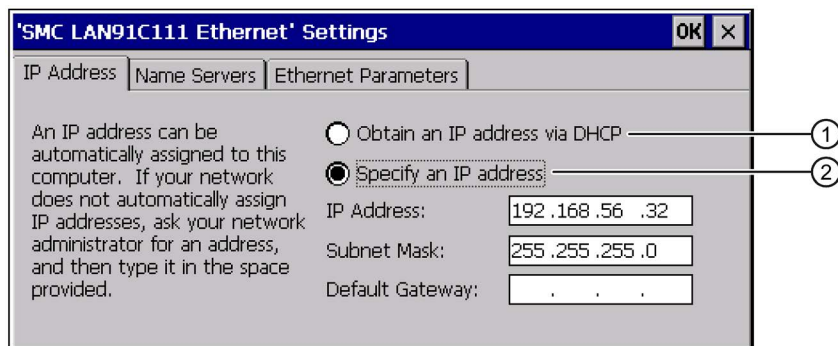

- ① IP address over DHCP
- ② Manual IP address

2. Select either automatic address assignment over DHCP or manual address input.
3. If you assign the address manually, enter the required address in the text boxes for "IP Address", "Subnet Mask" and, if used, "Default Gateway".
4. If a name server is used in the network, change to the "Name Servers" tab.

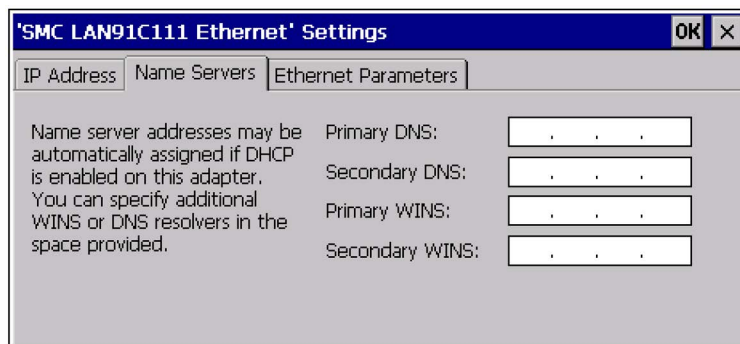

Note the FAQ during setting "Integrating an HMI device into a local network (<http://support.automation.siemens.com/WW/view/en/13336639>)".

5. Enter the respective addresses in the text boxes.
6. Change to the "Ethernet Parameters" tab.

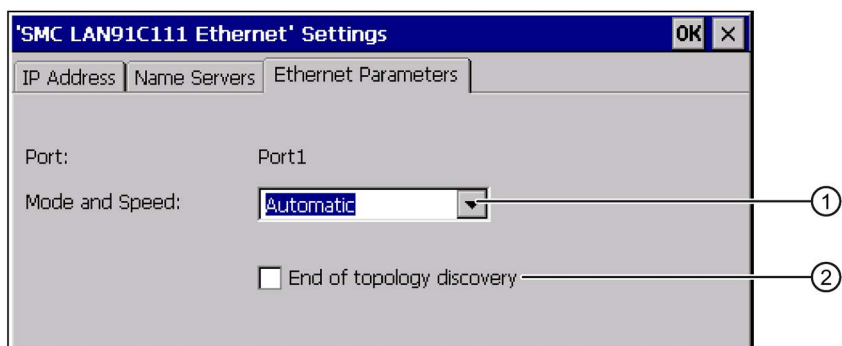

- ① Selection list with entries for transfer type and transfer speed
- ② Refers to network topology

You can find information on the MP 277 in the online help of the TIA Portal.

7. In the "Mode and Speed" selection list, select the transfer type and the transfer speed.
Take the transfer type and transfer speed of the connected devices in the network into consideration when you make your selection.
8. Confirm your entries.
The dialog box closes.
9. Close the "Network&Dial-Up Connections" view.
The Control Panel is displayed again.
The LAN connection parameters for the HMI device have been changed.

See also

Overview of network operation (Page 113)

6.11.4 Changing the Logon Data

Windows CE uses this information to gain access to the network resources. Enter the user name, password and domain you have received from your administrator.

Requirement

You have opened the "Network ID" dialog box with the "Network ID" icon.

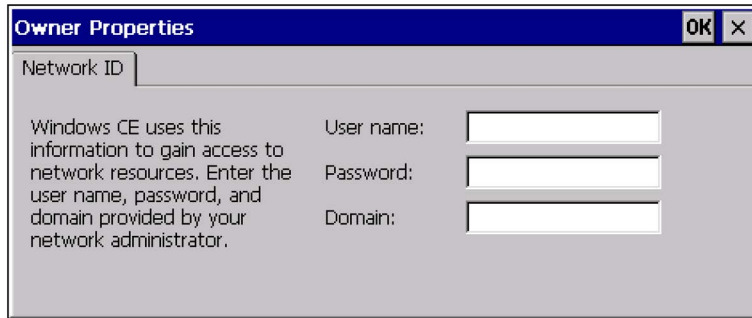

Procedure

1. Enter the user name in the "User name" text box.
2. Enter your password in the "Password" text box.
3. Enter the domain name in the "Domain" text box.
4. Confirm your entries.

The dialog box closes.

The logon information has now been set.

See also

Overview of network operation (Page 113)

6.11.5 Changing E-Mail Settings

Requirement

You have opened the "WinCC Internet Settings" dialog box with the "WinCC Internet Settings" icon.

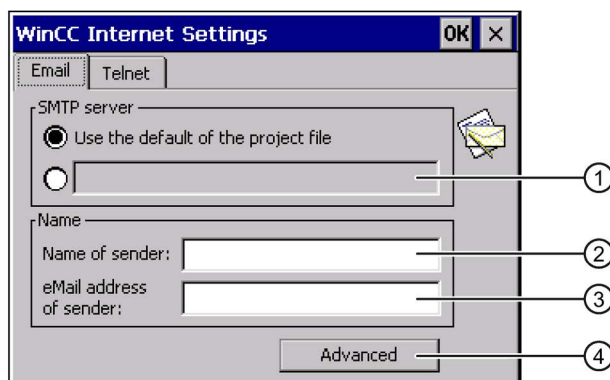

- ① Setting the SMTP server
- ② Name for the sender
- ③ E-mail account
- ④ Button for the "Advanced" dialog

Note

Additional tabs may appear in the "WinCC Internet Settings" tab. This depends on the options that have been enabled for network operation in the project.

Procedure

1. Specify the SMTP server.
 - Select the "Use the default of the project file" option button if you want to use the SMTP server configured in the project.
 - Deactivate the "Use the default of the project file" option button if you do not want to use the SMTP server configured in the project.
 - Specify the required SMTP server.
2. Enter the name for the sender in the "Name of sender" text box.
3. Enter the e-mail account for your e-mail in the "E-mail address of sender" text box.

Some e-mail providers only allow you to send mail if you specify the e-mail account. The "E-mail address of sender" text box can remain empty if your e-mail provider allows you to send mail without checking the account.

- 4. If you want to save the e-mail settings, press the "Advanced" button.

The following dialog appears:

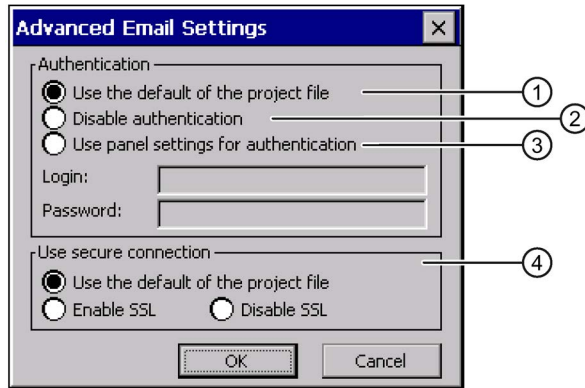

- ① Default values of the project file
- ② Disable authentication
- ③ Use panel settings for authentication
- ④ Enter secure connection

The following message is displayed when you make changes:

Restart the SIMATIC HMI Runtime for the settings to become effective.

- 5. Confirm your entries.

The dialog box closes.

The e-mail settings have been changed.

See also

Overview of network operation (Page 113)

6.11.6 Changing internet settings

6.11.6.1 Changing General Internet Settings

Requirement

You have opened the "General" tab in the "Internet Options" dialog box with the "Internet Options" icon. The dialog is an example.

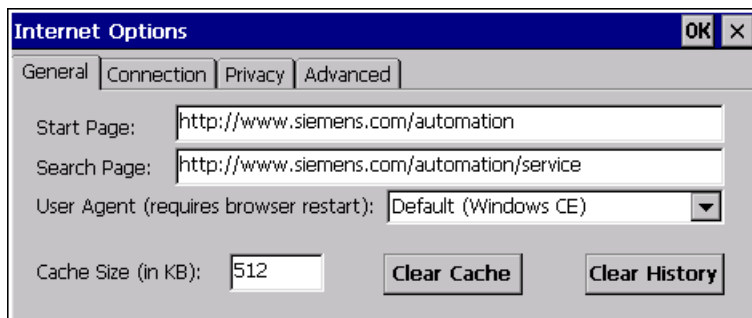

Note

Do not change the settings in the "User Agent" field.

Procedure

1. Enter the required start page for the browser in the "Start Page" text box.
2. Enter the address of the standard search engine in the "Search Page" text box.
3. Enter the required cache memory size in the "Cache" text box.
4. The cache can be deleted by means of the "Clear Cache" button.
5. The history can be deleted by means of the "Clear History" button.
6. Confirm your entries.

The dialog box closes.

The general parameters for the Internet browser have been set.

See also

Overview of network operation (Page 113)

6.11.6.2 Setting the Proxy Server

Requirement

You have opened the "Connection" tab in the "Internet Options" dialog box with the "Internet Options" icon.



- ① Settings for the LAN connection
- ② Settings for the Internet connection
- ③ Button to open the "Advanced Proxy Settings" dialog box

Procedure

1. Activate the "Use LAN (no autodial)" check box.
2. If you use a proxy server, activate the "Access the Internet using a proxy server" check box in the network group.

Specify the address of the proxy server and the port.

Note

The proxy settings in the Control Panel apply to all applications that are running on the HMI device. The Pocket Internet Explorer requires independent proxy settings that you must specify in the properties of the Pocket Internet Explorer.

You can find additional information on the Microsoft website.

3. If you want to bypass the proxy server for local addresses, activate the "Bypass proxy server for local addresses" check box.

4. If you do not want to use specific proxy servers, press the "Advanced" button.

The following dialog appears:



- ① Proxy server addresses that are to be excluded from the Internet connection

5. Specify the address components of the proxy server you want to exclude.
Separate multiple entries with a semicolon.

6. Confirm your entries.

The dialog box closes.

See also

Overview of network operation (Page 113)

6.11.6.3 Changing Privacy Settings

Cookies and encryption

Cookies are pieces of information sent by a web server to a browser. In the event of subsequent access to the web server, the cookies are sent back. This enables information to be stored between the accesses.

In order to ensure a high level of privacy, data are sent via the Internet in encrypted form. Common encryption protocols include SSL and TLS. You can activate or deactivate the usage of encryption protocols.

The required settings can be obtained from your network administrator.

Requirement

You have opened the "Privacy" tab in the "Internet Options" dialog box with the "Internet Options" icon.



Procedure

1. Select the required cookie behavior by means of the option buttons.
 - "Accept"
Cookies are stored without request.
 - "Block"
Cookies will not be stored.
 - "Prompt"
Cookies will be stored on request.
2. If you want allow cookies which are restricted to a single session, activate the "Always allow session cookies" checkbox.
3. Change to the "Advanced" tab.

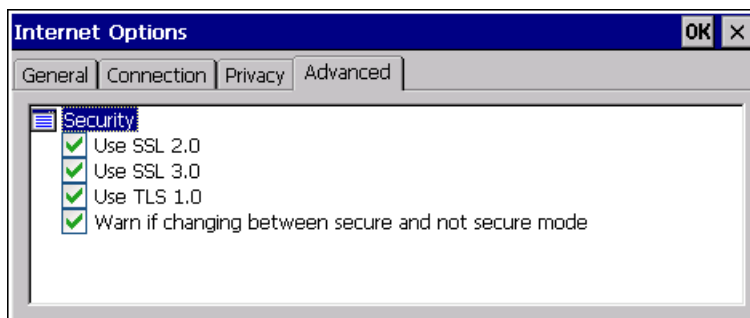

Double-click the displayed folder structure to close and open it.

4. Select the required encryption protocols and if a warning is to be displayed when you change from secure to insecure mode.
5. Confirm your entries.

The dialog box closes.
The logon information has now been set.

See also

Overview of network operation (Page 113)

6.11.6.4 Importing and Deleting Certificates

You can import, view and delete certificates that have been imported for the HMI device. The certificates differ in the following ways:

- Certificates that you trust
- Own certificates
- Other certificates

You can import additional certificates and delete certificates that are not required.

The required settings can be obtained from your network administrator.

Requirement

You have opened the "Certificates" dialog box with the "Certificates" icon.



- ① Selection box of the certificate types
- ② Assigned certificates

Procedure

1. Select the type of certificate from the selection box:
 - "Trusted Authorities"
 - "My Certificates"
 - "Other Certificates"
2. If you want to import a certificate, press the "Import" button.
The "Import Certificate or Key" dialog box is displayed.
3. Select the storage location.
4. Confirm your entries.
The certificate is added.
5. If you want to remove a certificate, select the specific certificate.
6. Click "Remove".
The certificate is removed.

- 7. Press the "View" button to list the properties of the selected certificate.
- 8. Close the dialog.

The changes to the certificates have been undertaken.

See also

Overview of network operation (Page 113)

6.12 Backing up data to external storage device

A backup involves copying the operating system, applications and data from the internal in flash memory of the HMI device to an external storage device.

The following external storage devices are possible:

- External memory
- USB memory stick

Requirement

- The HMI device features an external storage device with sufficient free space.
- You have opened the "Backup/Restore" dialog box with the "Backup/Restore" icon.



First time use of the memory card

Note

The first time you use a memory card the HMI device will request that you format the card. Save a backup copy of memory card data to a PC before formatting.

1. Cancel the formatting procedure by pressing "ESC".
2. Remove the memory card from the HMI device.
3. Save a backup copy of vital data to a PC.
4. Insert the memory card into the HMI device.
5. Format the memory card on the HMI device.

Procedure

1. Press the "BACKUP" button to open the "Select Storage Card" dialog.

The "--- no storage card available ---" message appears if there is no external memory in the HMI device or if this memory is defective. Insert an external memory or a different one.

2. Select the external memory for backup from the "Please select a Storage Card" list box.
3. Click on the "Start Backup" button.

The HMI device checks the external memory.

If the "This storage card..." message appears, an external memory with a greater memory capacity is needed. Acknowledge this message. Backup is aborted. Insert an external memory with a greater memory capacity and restart the backup process.

If the "You may have an old backup on the storage card. Do you want to delete it?" message appears, there is already a backup on the external memory. If you do not want to overwrite the backup, press the "No" button. Otherwise click on the "Yes" button.

Several messages are displayed in sequence in the "Backup" dialog box:

- Saving registry data
- Copy files
- Saving CE-Image

A progress bar shows the status of the backup process. When the backup process is completed, the following message is displayed:

"The operation completed successfully."

4. Acknowledge this message.

The dialog box closes.

The HMI device data is now saved on the external memory.

6.13 Restoring data from external storage device

A restore operation deletes the old data from flash memory of the HMI device on confirmation. The data stored on the external memory is then copied to the internal flash Flash memory.

Requirement

- The external storage device with data backup is inserted in the HMI device.
- You have opened the "Backup/Restore" dialog with the "Backup/Restore" icon.



NOTICE

Loss of data possible

All data on the HMI device will be deleted during a restore operation. License keys are deleted after a security prompt.

Back up existing data before you restore them, if required.

Note

This applies to the first time use of a storage device – read the section "Using Memory Cards with the HMI Device (Page 63)".

Procedure

1. Press the "RESTORE" button to open the "Storage Card" dialog.



- ① List of detected storage devices
- ② Button to refresh the list of detected storage devices
- ③ Button to start the Restore process

2. Select the external storage device with the backup in the "Storage Card with Backup detected" selection box.

Note

If several external storage devices with data backups are plugged in, the data cannot be restored. Remove the external storage device with the data backups not needed.

The "--- no storage card available ---" message appears if there is no storage device in the HMI device or if it is defective.

3. If the "--- no storage card available ---" message appears, press the "Cancel" button.

Restoring is then aborted.

- Insert the storage device or another one.
- Click "Refresh".

The content of the selection box will be changed.

- Select the external storage device with the backup in the "Storage Card with Backup detected" selection box.

4. Click on the "Start Restore" button.

Restoring is started.

6.13 Restoring data from external storage device

5. The data to be restored is checked.

The following messages are displayed in sequence in the "Restore" dialog:

- Starting Restore
- Checking data

When the data has been checked, the following message is displayed:

"You are starting RESTORE now. All files (except files on storage cards) and the registry will be erased. Are you sure?"

The message means that the restore process can be started. All files except those located on the external memory will be deleted. Tab entries are also deleted. Are you sure?

6. If you do not want to allow the data to be deleted from the HMI device, abort the restore process by pressing the "No" button.
7. Start to restore the data by selecting "Yes".

The following messages are displayed in sequence during the restore:

- Deleting files on flash
- Restore CE-Image

A progress bar shows the status of the restore process.

When restore is completed, the following message is displayed:

"Restore of CE Image finished. The device will be rebooted now. Don't remove the storage card."

8. Acknowledge this message.

The HMI device reboots.

The "Restore" dialog box is displayed after booting. Finally, the following message is displayed:

"Restore successfully finished. Press ok, remove your storage card and reboot your device."

9. Remove the storage device with the data backup.
10. Restart the HMI device.

The data from the external storage device is now on the HMI device.

Note

You may have to recalibrate the touch screen after the restore operation.

6.14 Activate Memory Management

If reorganization of the memory is required during the runtime of project, the HMI device can shut down the project autonomously. The project is shut down and the HMI device will display a message. You have to start the project again.

Note

If you do not activate memory management, undefined states can occur during the runtime of the project.

Requirement

You have opened the "Memory Monitoring" tab in the "OP Properties" dialog box with the "OP" icon.

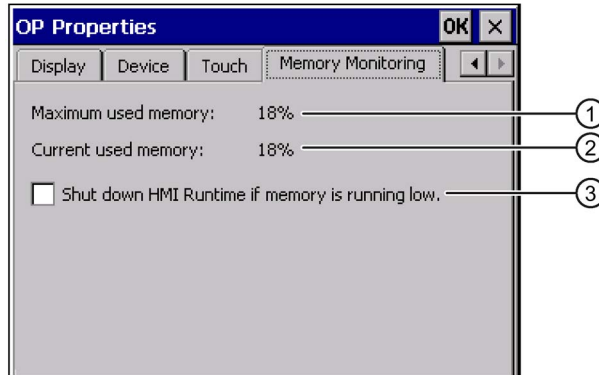

- ① Maximum memory used since the HMI device was last switched on
- ② Currently used memory
- ③ Check box for selecting memory management

Procedure

1. In order to start memory management, activate the control box.
2. Confirm your entries.

A message is displayed briefly. The dialog box closes.

Memory management is activated.

Commissioning a project

7.1 Overview

Configuration phase

A project – the process image of the working process – is produced during configuration to visualize automated working processes. The process displays for the project contain displays for values and messages which provide information about process statuses. The process control phase follows the configuration phase.

Process control phase

The project must be transferred to the HMI device if it is to be used in process control. Another precondition for process control is that the HMI device is connected online to a controller. Current working processes - operating and observing - can then be subject to process control.

Transferring the project to the HMI device

You can transfer a project to an HMI device as follows:

- Transfer from the configuring PC
- Restore from a PC using ProSave

In this case, an archived project is transferred from a PC to the HMI device. The configuration software need not be installed on this PC.

Commissioning and recommissioning

Initial and re-start-ups differ in the following respects:

- When the HMI device is commissioned there is no project at first.
The HMI device is also in this state after the operating system has been updated.
- When recommissioning, any project already on the HMI device is replaced.

7.2 Operating modes

Operating modes

The HMI device may be in the following operating modes:

- Offline
- Online
- Transfer

"Offline mode" and "Online mode" can be set on both the configuring PC and the HMI device. To set these modes on the HMI device, use a corresponding operating element of the project.

Changing the operating mode

The configuration engineer must have configured an appropriate operating element to allow a change of the operating mode on the HMI device during ongoing operation.

Further information on this may be available in your plant documentation

"Offline" operating mode

In this mode, there is no communication between the HMI device and PLC. Although the HMI device can be operated, it cannot exchange data with the PLC.

"Online" operating mode

In this mode, the HMI device and PLC communicate. You can operate the plant on the HMI device according to your system configuration.

"Transfer" mode

In this mode, you can transfer a project from the configuring PC to the HMI device or backup and restore HMI device data, for example.

The following options are available for setting "Transfer" mode on the HMI device:

- When the HMI device starts up

Start "Transfer" mode manually in the HMI device Loader.

- During ongoing operation

Start the "Transfer" mode manually within the project using an operating element. The HMI device toggles to "Transfer" mode when automatic mode is set and a transfer is initiated on the configuring PC.

7.3 Using existing projects

7.3.1 WinCC flexible projects

The following table shows how you can reuse existing projects, while observing the screen size:

HMI device in the existing project	New HMI device
TP 270 10"	MP 277 10" Touch or MP 277 8" Touch
OP 270 10"	MP 277 10" Key
MP 270 6" Touch	TP 277 6" ¹⁾
MP 270 10" Touch	MP 277 10" Touch or MP 277 8" Touch
MP 270 10" Key	MP 277 10" Key

¹ If you have set options on the MP 270 6" Touch, you must use the MP 277 8" Touch as the successor.

The following cases are possible:

1. Project exists in ProTool:

Migrate the project to WinCC flexible and subsequently carry out an HMI device switch.

2. Project in WinCC flexible exists:

Carry out an HMI device switch in WinCC flexible.

Further information on the subject can be found in the WinCC flexible Online Help or in the "WinCC flexible Migration" manual.

7.3.2 WinCC projects

To use an existing WinCC flexible project in WinCC, migrate the project to WinCC.

You can find more information on this topic in the WinCC online help.

7.4 Data Transmission Options

The following table shows the options for data transfer between the MP 277 and the configuration PC.

Type	Data channel	MP 277
Backing up	Serial ¹	Yes
	MPI/PROFIBUS-DP	Yes
	USB	Yes
	Ethernet	Yes
Restoring	Serial ¹	Yes
	MPI/PROFIBUS-DP	Yes
	USB	Yes
	Ethernet	Yes
Update operating system	Serial, with reset to factory settings ¹	Yes
	Serial ¹	Yes
	MPI/PROFIBUS-DP	Yes
	USB	Yes
	Ethernet	Yes
Transferring a project	Serial ¹	Yes
	MPI/PROFIBUS-DP	Yes
	USB	Yes
	Ethernet	Yes
Installing or removing an option	Serial ¹	Yes
	MPI/PROFIBUS-DP	Yes
	USB	Yes
	Ethernet	Yes
License key transferring or transferring back	Serial ¹	Yes
	MPI/PROFIBUS-DP	Yes
	USB	Yes
	Ethernet	Yes

¹ Applies when PC/PPI cable is used

7.5 Transfer project to the HMI device

7.5.1 Transfer project with WinCC

7.5.1.1 Setting the transfer mode

Introduction

You can start the "Transfer" mode manually or automatically on the HMI device.

If the automatic transfer is enabled, the HMI device automatically switches to "Transfer" mode when the following event occurs during runtime: You start project transfer on the connected configuration PC.

Note

With automatic transfer, the HMI device only switches to "Transfer" mode when the project is running on the HMI device.

Automatic transfer is particularly suited for the test phase of a new project because the transfer is completed without interfering with the HMI device.

Note

If automatic transfer is activated on the HMI device and a transfer is initiated on the configuration PC, the project currently running is automatically stopped. The HMI device then automatically switches to "Transfer" mode.

After the commissioning phase, deactivate the automatic transfer so that the HMI device cannot be inadvertently switched to transfer mode. The transfer mode can trigger unintentional reactions in the system.

You can issue a password in the Control Panel to restrict access to the transfer settings and thus avoid unauthorized modifications.

Requirement

- The Control Panel is open.
- The Runtime software is terminated.

Procedure

Proceed as follows:

1. Open the "Transfer Settings" dialog with the Transfer Settings icon.
2. Open the "Channel" tab.

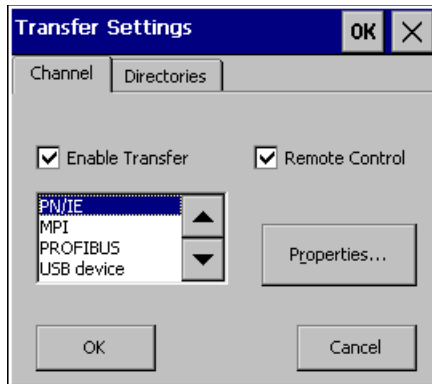

3. Select "Enable Transfer".
4. Select the data channel and set its parameters using "Properties...".
Exception: The "USB device" data channel has no parameters.
5. To start "Transfer" mode automatically:
 - Select "Remote Control".
 - Close the dialog with "OK".
6. To start "Transfer" mode manually:
 - Disable "Remote Control".
 - Close the dialog with "OK".
 - Close the Control Panel.
 - Enable transfer mode in the loader with "Transfer".

Result

"Transfer" mode is set. The project is transferred from the configuration PC via the data channel selected on the HMI device. If required, configure the corresponding data channel on the configuration PC.

Transferred data is written directly to the internal memory of the HMI device.

Alternative procedure

You can also set "Transfer" mode on the HMI device using an operating element in the project. To do this, configure the "SetDeviceMode" system function on an operating element event, for example, on a button.

You can find more information on this topic in the WinCC online help.

See also

Configuring the data channel (Page 109)

7.5.1.2 Starting the transfer

Introduction

To make a project executable on an HMI device, transfer the project from the configuration PC to the HMI device. With a transfer, you particularly specify whether to overwrite existing data on the HMI device such as "User management" or "Recipe data".

Requirement

- The project is opened in WinCC on the configuration PC.
- Project tree is displayed.
- configuration PC is connected to the HMI device.
- Transfer mode is set on the HMI device.

Procedure

Proceed as follows:

1. Select the "Download to device > Software" command in the shortcut menu of the HMI device.
2. When the "Extended download to device" dialog opens, configure the "Transfer settings". Make sure that the "Transfer settings" match the "Transfer settings on the HMI device":
 - Select the protocol used, for example, Ethernet or USB.
If you are using Ethernet or PROFINET, you can also configure the network address in the "Devices & Networks" editor in WinCC. You can find more information on this topic in the WinCC online help.
 - Configure the corresponding interface parameters on the configuration PC.
 - Make the specific interface or protocol settings on the HMI device as required.
 - Click "Download".

You can open the "Extended download to device" dialog at any time using the menu command "Online > Extended download to device...".

The "Load preview" dialog opens. The project is compiled at the same time. The result appears in the "Load preview" dialog.

3. Check the displayed default settings and change them, if necessary.
4. Click "Download".

Result

The project is transferred to the selected HMI device. If errors or warnings occur during the transfer, alarms are displayed in the Inspector window under "Info> Download".

When the transfer is completed successfully, the project is executable on the HMI device.

7.5.1.3 Testing a project

Introduction

There are two options to test a project:

- Test the project on the configuration PC

You can test a project on a configuration PC, using a simulator. You can find more detailed information on this in the WinCC online help.

- Offline testing of the project on the HMI device

Offline testing means that communication between the HMI device and the controller is down while the test is being carried out.

- Online testing of the project on the HMI device

Online testing means that the HMI device and the controller communicate with each other during testing.

Perform the tests, starting with the "Offline test", followed by the "Online test".

Note

You should always test the project on the HMI device on which the project will be used.

Check the following:

1. Check the correct layout of the screens
2. Check the screen navigation
3. Check the input objects
4. Enter the tag values

The test increases the certainty that the project will run error-free on the HMI device.

Requirement for offline testing

- The project has been transferred to the HMI device.
- The HMI device is in "Offline" mode.

Procedure

In "Offline" mode, you can test individual project functions on the HMI device without them being affected by the controller. Controller tags, therefore, are not updated.

Test the operating elements and visualization of the project as far as possible without connection to the controller.

Requirement for online testing

- The project has been transferred to the HMI device.
- The HMI device is in "Online" mode.

Procedure

In "Online" mode, you can test individual project functions on the HMI device without them being affected by the controller. Controller tags are updated in this case.

You have the option to test all communication-related functions, such as alarms, etc.

Test the operating elements and views of the project.

7.5.2 Transfer project with WinCC flexible

7.5.2.1 Overview

Transfer

Transfer the executable project from the configuring PC to the HMI device.

You can start the "Transfer" mode manually or automatically on the HMI device.

Transferred data is written directly to the internal flash memory on the HMI device. For the transfer, you use a data channel which you have to configure before starting a transfer.

Backtransfer

You have the option to transfer the compressed project file together with the runtime project to the HMI device. If necessary, the compressed project file can be transferred back to the configuring PC and edited.

The HMI device must be equipped with an external memory card to which the compressed project file can be saved.

Note

Compressed project file

WinCC flexible does not check whether the compressed project file stored on the HMI device corresponds to the existing runtime project.

7.5.2.2 Starting manual transfer

Introduction

You can manually switch the HMI device to "Transfer" mode as follows:

- With a configured operating element during ongoing operation.
- In the Loader of the HMI device.

Requirements

- The project "*.hmi" is opened in WinCC flexible.
- The HMI device is connected to a configuring PC
- The data channel is configured on the HMI device
- The HMI device is in "Transfer" mode

Procedure

Proceed as follows:

1. On the configuring PC, select the "Transfer settings" command in the menu "Project > Transfer" in WinCC flexible.

The "Select devices for transfer" dialog opens.

2. Select the HMI device in the left area of the dialog.
3. Select the type of connection between the HMI device and the configuring PC.
Set the connection parameters.
4. Set the transfer parameters in the right area of the dialog.
5. If you wish to transfer the compressed project file together with the runtime project to the HMI device:
Select the "Enable backtransfer" check box.
6. Start transfer in WinCC flexible with "Transfer".

The configuring PC checks the connection to the HMI device. The project is transferred to the HMI device. If the connection is not available or is defective, an error message is displayed on the configuring PC.

Result

When the transfer is completed successfully, the project can be found on the HMI device. The transferred project is then started automatically.

See also

Operating modes (Page 134)

Configuring the data channel (Page 109)

Data Transmission Options (Page 136)

7.5.2.3 Starting automatic transfer

Introduction

The HMI device can be automatically switched to "Transfer" mode during runtime as soon as transfer is started on the configuring PC connected.

Automatic transfer is particularly suited for the test phase of a new project since transfer is completed without interfering with the HMI device.

Automatic transfer is available for the following data channels:

- Serial
- MPI/PROFIBUS DP
- USB
- Ethernet

Note

If the automatic transfer has been activated on the HMI device and a transfer is initiated on the configuring PC, the project currently running is automatically stopped. The HMI device then automatically switches to "Transfer" mode.

After the commissioning phase, deactivate the automatic transfer so that the HMI device cannot be inadvertently switched to transfer mode. The transfer mode can trigger unintentional actions in the device.

You can set a password for the Loader of the HMI device to restrict access to the transfer settings and thus avoid unauthorized modifications.

Requirements

- The project *.hmi is opened in WinCC flexible.
- The HMI device is connected to a configuring PC
- The data channel is configured on the HMI device
- The automatic transfer is activated in the data channel for the transfer.
- The project is started on the HMI device.

Procedure

Proceed as follows:

1. On the configuring PC, select the "Transfer settings" command in the menu "Project > Transfer" in WinCC flexible.

The "Select devices for transfer" dialog opens.

2. Select the HMI device in the left area of the dialog.
3. Select the type of connection between the HMI device and the configuring PC.

Set the connection parameters.

4. Set the transfer parameters in the right area of the dialog.

5. If you wish to transfer the compressed project file together with the runtime project to the HMI device:

Select the "Enable backtransfer" check box.

6. Start transfer in WinCC flexible with "Transfer".

The configuring PC checks the connection to the HMI device. The HMI device shuts down the current project and automatically switches to "Transfer" mode. The project is transferred to the HMI device. If the connection is not available or is defective, an error message is displayed on the configuring PC.

Result

When the transfer is completed successfully, the project can be found on the HMI device. The transferred project is then started automatically.

See also

Operating modes (Page 134)

Configuring the data channel (Page 109)

Data Transmission Options (Page 136)

7.5.2.4 Starting backtransfer

Requirements

- No project is open on the configuring PC in WinCC flexible
- The HMI device is connected to this configuring PC
- The data channel is configured on the HMI device
- The HMI device is in "Transfer" mode
- The memory card containing the compressed project file is inserted into the HMI device

Procedure

Proceed as follows:

1. On the configuring PC, select the "Communication settings" command in the menu "Project > Transfer" in WinCC flexible.

The "Communication Settings" dialog opens.

2. Select the type of HMI device.
3. Select the type of connection between the HMI device and the configuring PC.

Set the connection parameters.

4. Close the dialog with "OK".
5. Select the "Transfer" > "Backtransfer" command in the "Project" menu.

The "Backtransfer" dialog opens.

6. Click "OK" to start the backtransfer process.

The configuring PC checks the connection to the HMI device. The compressed project file is transferred back from the HMI device to the configuring PC. If the connection is not available or is defective, an error message is displayed on the configuring PC.

Result

After successful backtransfer, the project is opened on the configuring PC in WinCC flexible.

7.5.2.5 Testing a project

Introduction

There are two options to test a project:

- Test the project on the configuring PC

You can test a project at a configuring PC, using a simulator. For detailed information, refer to the "WinCC flexible" user manual and to the WinCC flexible Online Help.

- Offline testing of the project on the HMI device

Offline testing means that communication between the HMI device and PLC is down while the test is being carried out.

- Online testing of the project on the HMI device

Online testing means that the HMI device and PLC communicate with each other during testing.

Perform the tests, starting with the "Offline test", followed by the "Online test".

Note

You should always test the project on the HMI device on which the project will be used.

Check the following:

1. Check the correct layout of the screens
2. Check the screen navigation
3. Check the input objects
4. Enter the tag values

The test increases the certainty that the project will run error-free on the HMI device.

Requirements for offline testing

- The project has been transferred to the HMI device
- The HMI device is in "Offline" mode

Procedure

In "Offline" mode, you can test individual project functions on the HMI device without them being affected by the PLC. PLC tags, therefore, are not updated.

Test the operating elements and visualization of the project as far as possible without connecting to the PLC.

Requirements for online testing

- The project has been transferred to the HMI device
- The HMI device is in "Online" mode

Procedure

In "Online" mode, you can test individual project functions on the HMI device without them being affected by the PLC. PLC tags are updated in this case.

You have the option to test all communication-dependent functions, for example alarms, etc.

Test the operating elements and views of the project.

7.6 Backup and restore

7.6.1 Overview

Note**Power failure**

If a complete restore operation is interrupted due to power failure on the HMI device, the operating system of the HMI device may be deleted. The operating system then has to be updated.

Compatibility conflict

If a message is output on the HMI device warning of a compatibility conflict during the restore operation, the operating system must be updated.

Backing up and restoring by means of external storage device

The "Backup / Restore" function is approved for MMC and SD memory cards as well as USB mass storage devices.

Backing up and restoring by means of PC

Note**License keys**

License keys are not taken into account for backups and restores. License keys are saved in the working memory of the HMI device and cannot be deleted.

You can back up and restore the following data found in the internal flash memory of the HMI device with a PC:

- Project and HMI device image
- Password list
- Recipe data

Use one of the following tools for backup and restore:

- WinCC
- WinCC flexible
- ProSave

The backup and restore with ProSave is described below. Information on backup and restore with WinCC or WinCC flexible is described in the associated online help.

7.6.2 Backup and restore using ProSave

Requirements

- The HMI device is connected to a PC on which ProSave is installed
- The data channel is configured on the HMI device

Procedure for backup

Proceed as follows:

1. From the Windows Start menu, start ProSave on the PC.
2. Select the HMI device type in the "General" tab.
3. Select the type of connection between the HMI device and the PC.
Set the connection parameters.
4. Select the data to be backed up in the "Backup" tab.
5. Select a destination folder and a file name for the "*.psb" backup file.
6. Set "Transfer" mode on the HMI device.

If automatic transfer mode is enabled on the HMI device, the HMI device automatically sets "Transfer" mode when a backup is initiated.

7. Start the backup operation in ProSave with "Start Backup".

Follow the instructions in ProSave.

A status view opens to indicate the progress of the operation.

Result

The system outputs a message when the backup is completed.

The relevant data is now backed up on the PC.

Procedure for restore

Proceed as follows:

1. From the Windows Start menu, start ProSave on the PC.
2. Select the HMI device type in the "General" tab.
3. Select the type of connection between the HMI device and the PC.
Set the connection parameters.
4. Select the "*.psb" backup file to be restored from the "Restore" tab.

You can see the HMI device for which the backup file was created and the type of backup data the file contains.

5. Set "Transfer" mode on the HMI device.

If automatic transfer mode is enabled on the HMI device, the device automatically sets "Transfer" mode when a restore operation is initiated.

6. Start the restore operation in ProSave on the PC with "Start Restore".

Follow the instructions in ProSave.

A status view opens to indicate the progress of the operation.

Result

When the restore is successfully completed, the data backed up on the PC is now on the HMI device.

See also

Overview (Page 147)

Data Transmission Options (Page 136)

Operating modes (Page 134)

Configuring the data channel (Page 109)

7.7 Updating the operating system

7.7.1 Overview

A compatibility conflict may occur when transferring a project to the HMI device. This is caused by different versions of the configuration software used and the HMI device image available on the HMI device. If there are different versions, the transfer is aborted. A message indicating a compatibility conflict is displayed on the configuration PC.

There are two ways to match the versions:

- Update the HMI device image if the project was created with a more recent version of the configuration software.
- Transfer a matching version of the HMI device image if you do not want to adapt the project for the HMI device to the current version of the configuration software for the project.

Note

- Two versions are available for each device type – recognizable by their article number. The images of the device versions are not compatible.
 - All data on the HMI device, such as the project and licenses, will be deleted when you update the operating system.
 - When WinAC MP is used, all data channel parameters are reset.
 - After the update, you may have to recalibrate the touch screen.
-

Resetting to factory settings

In ProSave, WinCC or WinCC flexible, you can update the operating system with or without resetting to factory settings.

- Updating the operating system without reset to factory settings

First, switch into "Transfer" mode on the HMI device or use the automatic transfer function if the project is active. Then start the operating system update in ProSave, WinCC or WinCC flexible.

- Updating the operating system with reset to factory setting
-

Note

Loss of license keys

The license keys on the HMI device is deleted when resetting to factory settings. The license keys on the HMI device are retained when updating the operating system without resetting to factory settings.

Note

Data channels

When resetting to factory settings, all data channel parameters are reset. The transfer can only be started following reconfiguration of the data channels.

Note

You have to perform an operating system update with reset to factory setting if the HMI device does not yet have an operating system or if the HMI device's operating system is corrupt.

First, start the operating system update in ProSave, WinCC or WinCC flexible, and switch the power on the HMI device off and on again when prompted.

The update of the operating system with ProSave is described below. Information on update of the operating system with WinCC or WinCC flexible is described in the associated online help.

7.7.2 Updating the Operating System using ProSave

Requirement

- The HMI device is connected to a PC on which ProSave is installed.
- When updating the operating system without reset to factory settings only:
The data channel is configured on the HMI device.

Procedure

Proceed as follows:

1. When updating the operating system with reset to factory settings only:
Switch off power to the HMI device.
2. Go to the Windows Start menu and start ProSave on the PC.
3. Select the HMI device type in the "General" tab.
4. Select the type of connection between the HMI device and the PC, then set the connection parameters.
5. Select the "OS Update" tab.
6. Select whether to update the operating system with or without restoring the factory settings by setting the "Reset to factory settings" check box accordingly.
7. Select the HMI device image file "*.img" under "Image path".

The HMI device image files are available under "WinCC flexible Images" in the WinCC flexible installation folder or on the WinCC flexible installation CD.

The output area provides information on the version of the successfully opened HMI device image file.
8. When updating without reset to the factory settings only:
Set "Transfer" mode on the HMI device.

If automatic transfer mode is enabled on the HMI device, the device automatically sets "Transfer" mode when an update is initiated.
9. Select "Update OS" on the PC to run the operating system update.
10. When updating with reset to the factory settings only:
Switch on the power supply to the HMI device.
11. Follow the instructions in ProSave.

A progress bar indicates the progress of the operating system update.

Result

A message is displayed when the operating system update is successfully completed.
The HMI device no longer contains any project data.

See also

Overview (Page 152)
Configuring the data channel (Page 109)
Operating modes (Page 134)
Data Transmission Options (Page 136)

7.8 Installing and removing options

7.8.1 Overview

You can install options on the HMI device, for example, additional programs developed especially for the HMI device.

You can also remove the option from the HMI device again.

Note

License key

A license key may be needed to run an option. The license key unlocks the option for use.

The installation of options with ProSave is described below. Information on installation of options with WinCC or WinCC flexible is described in the associated online help.

7.8.2 Installing and removing options using ProSave

Requirement

- The HMI device is connected to a PC on which ProSave is installed.
- The data channel is configured on the HMI device.

Procedure for installing an option

Proceed as follows:

1. Go to the Windows Start menu and start ProSave on the PC.
2. Select the HMI device type in the "General" tab.
3. Select the type of connection between the HMI device and the PC.
4. Set the connection parameters.
5. Select the "Options" tab.
6. Select the desired option under "Available options".
7. Set "Transfer" mode on the HMI device.

If automatic transfer mode is enabled on the HMI device, the device automatically sets "Transfer" mode when the installation of an option is initiated.

8. Start the installation of the option in ProSave with the ">>" button.
9. Follow the instructions in ProSave.

A status display appears indicating the progress of the installation.

Result

The option has now been installed on the HMI device.

Procedure for removing an option

Proceed as follows:

1. Go to the Windows Start menu and start ProSave on the PC.
2. Select the HMI device type in the "General" tab.
3. Select the type of connection between the HMI device and the PC.
4. Set the connection parameters.
5. Select the "Options" tab.
6. Press the "Device status" button to update the display.
7. Select the desired option under "Installed options".
8. Set "Transfer" mode on the HMI device.

If automatic transfer mode is enabled on the HMI device, the device automatically sets "Transfer" mode when the removal of an option is initiated.

9. Start the removal of the option in ProSave with the "<<" button.

Follow the instructions in ProSave.

A status display appears indicating the progress of the removal.

Result

The option has now been removed on the HMI device.

See also

Overview (Page 152)

Configuring the data channel (Page 109)

Operating modes (Page 134)

Data Transmission Options (Page 136)

7.9 Transferring and transferring back license keys

7.9.1 Overview

With the purchase of an add-on package, you obtain a specific user license with an associated license key. Once you have installed an add-on, transfer a license key to the HMI device. The license key unlocks an add-on for use.

You can also transfer back the license key from the HMI device to a license diskette.

Note

License keys can only be transferred and transferred back with the Automation License Manager or the configuration software.

The transfer and back transfer of license keys with the "Automation License Manager" is described below. Information on transfer and back transfer of license keys with WinCC or WinCC flexible is described in the associated online help.

7.9.2 Transfer of license keys with the Automation License Manager

Requirement

- The HMI device is connected to the configuration PC or to the PC with the "Automation License Manager".
- If you use the configuration PC: The HMI device is selected in the project tree.

Procedure

To transfer the license keys, follow these steps:

1. Open the "Automation License Manager". On a PC without a WinCC installation, open the "Automation License Manager" from the Windows Start menu.

The "Automation License Manager" starts.

2. Select the "Connect HMI device" command in the "Edit > Connect Target System" menu.

The "Connect target system" dialog opens.

3. Select the "device type" of your HMI device.
4. Select the "connection".

- Configure the corresponding "connection parameters", depending on the selected connection.

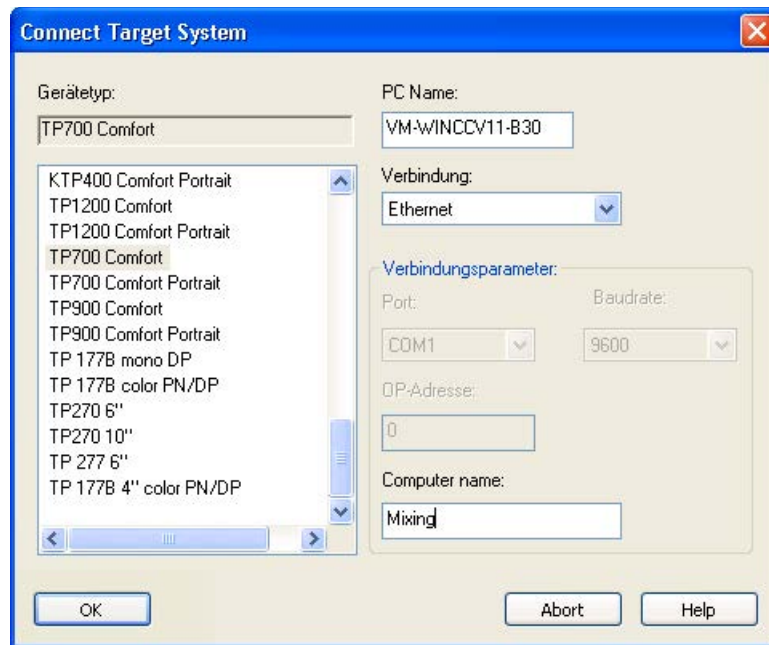

- Click "OK".

The connection to the HMI device is established. The connected HMI device is displayed in the left area of the "Automation License Manager".

- Transfer the license keys to the HMI device:
 - In the left area, select the drive on which the license keys are located. The license keys are shown in the right area.
 - Select the license keys.
 - Drag-and-drop the license keys to the HMI device.

You can also remove license keys from the HMI device by means of drag-and-drop.

Alternative procedure

On a PC with a WinCC installation, you can also launch the "Automation License Manager" from WinCC: Select the "Authorize/License" command in the "Online > HMI device maintenance" menu.

Result

The license keys are transferred to the HMI device.

To back up the license keys on the HMI device, drag them from the HMI device to an available drive.

Operating a project

8.1 Overview

Configuration and process control phase

HMI devices can be used to operate and monitor tasks in process and production automation. The plant screens on the HMI devices are used to provide a clear overview of the active processes.

The HMI device project, which includes the plant screens, is created during the configuration phase. The configuration engineer defines which tasks the HMI device has in the process and defines the following in detail:

- Which process data is displayed on the individual HMI device
- Which plant components are controlled by this HMI device

The configuration engineer stores this information in the project's screens. The project is transferred to the HMI device during commissioning.

After transfer to the HMI device, current processes can be operated and monitored in the project's screens. The screens enable you to observe, for example, operational states, current process data and faults in a plant. Operating elements which are used to operate the process, for example buttons, I/O fields and alarm windows, are displayed in the screens.

Operator control options

The hardware of the HMI device determines which of the following operator control options are available:

- Touch screen

The operating elements shown in the dialogs are touch-sensitive. Touch objects are basically operated in the same way as mechanical keys. You activate operating elements by touching them with your finger. To double-click them, touch an operating element twice in succession.

- HMI device keyboard

The operating elements shown in the screens are selected and operated using the keys of the HMI device.

- External keyboard, connected via USB
- External mouse, connected via USB

 **CAUTION**

Risk of damage to the touch screen

Do not use pointed or sharp objects to operate the touch screen. Otherwise, you can damage the plastic membrane of the touch screen.

The following paragraphs provide instructions for operating a project with the touch screen and the keyboard.

Operating a project with an external keyboard

An external keyboard can be used to operate a project in exactly the same way as with the HMI keyboard or screen keyboard.

Note

The function keys of the external keyboard are disabled.

Use the other keys of the external keyboard, which correspond to the HMI device keys in the description.

Operating a project with an external mouse

The project can be operated with an external mouse in exactly the same way as with the HMI touch screen. Click the described operating elements with the mouse.

Unintentional actions

 **CAUTION**

Unintentional actions possible

Do not carry out several operations simultaneously. You may otherwise trigger unintentional actions.

- With touch control:
Always touch only one operating element on the screen.
- With key control:
Do not press more than two keys simultaneously.

Observing the plant documentation

Some operations with the project may require in-depth knowledge about the specific plant on the part of the operator. Proceed with caution, for example, when you use jog mode. Refer to your plant documentation to find any available additional information on this topic.

Operation feedback from operating elements

The HMI device provides operation feedback as soon as it detects that an operating element has been selected. This operation feedback is independent of any communication with the PLC. Therefore, this operation feedback does not indicate whether the relevant action is actually executed or not.

Optical feedback from operating elements

The operating element receives the focus and is selected. The configuration engineer can also configure the selection of an operating element so that it deviates from the standard. Refer to your plant documentation to find any available additional information on this topic.

The type of optical feedback depends on the operating element:

- Buttons

The HMI device outputs different views of the "Pressed" and "Unpressed" states, provided the configuration engineer has configured a 3D effect:

– "Pressed" state:

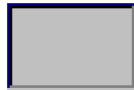

– "Unpressed" state:



The configuration engineer determines the appearance of a selected field, for example, line width and color for the focus.

- Invisible buttons

By default, invisible buttons are not displayed as pressed when they are touched. No optical feedback is provided in this case.

The configuration engineer may, however, configure invisible buttons so that their outline appears as lines when touched. This outline remains visible until you select another operating element.

- I/O fields

When you select an I/O field, the content of the I/O field is displayed against a colored background. With touch operation, a screen keyboard is displayed for the entering of values.

Acoustic feedback from operating elements

An acoustic signal is generated as soon as the HMI device detects that the touch screen has been touched or a key has been pressed. You can activate or deactivate this acoustic operation feedback.

Note

The acoustic feedback is only possible if you interact with the project directly on the touch screen or press one of the keys of the HMI device. If you use an external mouse or keyboard for interaction, no acoustic signal is issued.

Acoustic signal for inadvertent operations

If you try to enter an invalid character, the HMI device issues an acoustic signal in accordance with the setting.

See also

Set the volume (Page 97)

8.2 Direct keys

Introduction

Direct keys on the HMI device are used to set bits in the I/O area of a SIMATIC S7.

Direct keys enable operations with short reaction times that are, for example, a jog mode requirement.

Note

Direct keys are still active when the HMI device is in "offline" mode.

Note

If you operate a function key with direct key functionality in a running project, the direct key function is always executed, independent of the current screen contents.

Note

You can only use direct keys when there is a connection via PROFIBUS DP or PROFINET IO.

Direct keys result in additional basic load on the HMI device.

Direct keys

The following objects can be configured as a direct key:

- Buttons
- Function keys

You can also define image numbers in the case of HMI devices with touch operation. In this way, the project engineer can configure the direct keys on an image-specific basis.

Further information on configuring direct keys can be found in the "WinCC flexible Communication" system manual.

See also

Bit assignment of the direct keys (Page 189)

Enabling PROFINET IO (Page 111)

8.3 Setting the project language

Introduction

The HMI device supports multilingual projects. You must have configured a corresponding operating element which lets you change the language setting on the HMI device during runtime.

The project always starts with the language set in the previous session.

Requirements

- The required language for the project must be available on the HMI device
- The language switching function must be logically linked to a configured operating element such as a button

Selecting a language

You can change project languages at any time. Language-specific objects are immediately output to the screen in the new language when you switch languages.

The following options are available for switching the language:

- A configured operating element switches from one language to the next in a list
- A configured operating element directly sets the desired language

Please refer to your system documentation to check whether additional information on this subject is available there.

See also

Changing Regional Settings (Page 92)

8.4 Entering values using the touch screen

8.4.1 Overview

Screen keyboard

A screen keyboard appears on the HMI device touch screen when you touch an operating element that requires input. The screen keyboard is displayed in the following cases:

- An I/O field is selected for input
- A password must be entered for accessing a password-protected function

The screen keyboard is automatically hidden again when input is complete.

Based on the configuration of the operating element, the system displays different screen keyboards for entering numerical or alphanumerical values.

Note

The screen keyboard display is independent of the configured project language.

General procedure

The operating elements of a screen are operated by touching the touch screen.

Proceed as follows:

1. Touch the desired operating element within the screen.
2. Depending on the operating element, perform further actions. Detailed descriptions can be found under the respective operating element.

Examples:

- I/O field: Enter numerical, alphanumerical or symbolic values in the I/O field
- Symbolic I/O field: Select an entry from the drop down list box
- Slider control: Move the slider control

Procedure for text boxes

Values are entered in the project text boxes. Based on your configuration, the values are saved to tags and transferred, for example, to the PLC.

Proceed as follows:

1. Touch the desired text box within the screen.

The screen keyboard opens.

Depending on your configuration, you can enter values in the text box in the following manner:

- Numerical values, for example decimal numbers, hexadecimal numbers, binary values
- Alphanumerical values, for example digits and letters
- Date/time

2. Enter the value.

3. Confirm your entry with  or discard your entry with .

8.4.2 Entering and Editing Numerical Values

Numerical screen keyboard

When you touch an operating element for numerical input on the HMI device touch screen, the numerical screen keyboard appears. This is the case, for example, for a text box. The screen keyboard is automatically hidden again when input is complete.



Note

Opened screen keyboard

When the screen keyboard is open, PLC job 51, "Select screen" has no function.

Formats for numerical values

You can enter values in numerical text boxes based on the following formats:

- Decimal
- Binary
- Hexadecimal

Note

Entry of hexadecimal values

When you enter values in hexadecimal format, the alphanumerical screen keyboard opens.

Limit test of numerical values

Tags can be assigned limits. If you enter a value that lies outside of this limit, it will not be accepted, for example, 80 with a limit of 78. In this case the HMI device will deliver a system alarm, if an alarm window is configured. The original value is displayed again.

Decimal places for numerical values

The configuration engineer can define the number of decimal places for a numerical text box. The number of decimal places is checked when you enter a value in this type of I/O field.

- Decimal places in excess of the limit are ignored.
- Empty decimal places are filled with "0".

Procedure

Numerical values can be entered character-by-character via the buttons on the numerical screen keyboard.

Proceed as follows:



1. Touch the desired operating element within the screen.

The numerical screen keyboard opens. The existing value is displayed in the screen keyboard and is selected.

2. Enter the value.

The keys with for example the letters G to Z are available to enter a hexadecimal value; however, the characters are not entered. Depending on the settings, the HMI device outputs an audible signal.

You have the following options to enter a value:



- The selected value is deleted when you enter the first character. Completely reenter the value.
- Use the  and  keys to move the cursor within the current value. You can now edit the characters of the current value or add characters.

Use the  key to delete the character to the left of the cursor. If the value is selected, use this key to delete the selected part of the value.

The  key deletes the character positioned to the right of the cursor. If the value is selected, use this key to delete the selected part of the value.

- Use the  key to display the info text of the I/O field.

This key is only enabled if info text has been configured for the input object or the current screen.

3. Use the  key to confirm your entry or cancel it with . Either action closes the screen keyboard.

Result

You have changed the numerical value or entered a new one.

8.4.3 Entering and editing alphanumerical values

Alphanumerical screen keyboard

When you touch an operating element for alphanumerical input on the HMI device touch screen, the alphanumerical screen keyboard appears. This is the case, for example, for a text box. The screen keyboard is automatically hidden again when input is complete.



Note

Opened screen keyboard

When the screen keyboard is open, PLC job 51, "Select screen" has no function.

Language switching

Language switching in the project has no influence on the alphanumerical screen keyboard. The entry of Cyrillic or Asian characters is therefore not possible.

Keyboard levels

The alphanumerical screen keyboard has various levels:

- Normal level
- Shift level

If you change the levels with key , the key assignments change.

Procedure

Alphanumerical values can be entered character-by-character via the buttons on the alphanumerical screen keyboard.



Proceed as follows:

1. Touch the desired operating element within the screen.

The alphanumerical screen keyboard opens. The existing value is displayed in the screen keyboard and is selected.



2. Enter the value.

You have the following options to enter a value:



- The selected value is deleted when you enter the first character. Completely reenter the value.
- Use the  and  keys to move the cursor within the current value. You can now edit the characters of the current value or add characters.

Use the  key to delete the character to the left of the cursor. If the value is selected, use this key to delete the selected part of the value.

The  key deletes the character positioned to the right of the cursor. If the value is selected, use this key to delete the selected part of the value.

- Using key  it is possible to switch between the keyboard levels of the screen keyboard. On switchover, the key assignments of the screen keyboard change.
- Use the  key to display the info text of the I/O field.

This key is only enabled if info text has been configured for the input object or the current screen.

3. Use the  key to confirm your entry or cancel it with . Either action closes the screen keyboard.

Result

You have changed the alphanumeric value or entered a new one.

8.4.4 Entering the date and time

Entering the date and time

Enter the date and time in the same way you enter alphanumerical values.

Note

When entering the date and time, please note that the format is determined by the configured project language.

See also

Entering and Editing Numerical Values (Page 163)

Entering and editing alphanumerical values (Page 166)

8.4.5 Entering Symbolic Values

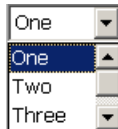

Selection list

Operating element for entering symbolic values offer you a list from which you can select the input values. When you touch a symbolic I/O field on the HMI device touch screen, the following selection list opens.



Procedure

Proceed as follows:

1. Touch the required operating element.
The selection list of the operating element opens. Select  and  to scroll in the selection list.
2. Touch the required entry in the selection list.
The selected entry is accepted as an entry.

Result

You have changed the symbolic value or entered a new one.

8.4.6 Displaying Infotext

Purpose

The configuration engineer uses info text to provide additional information and operating instructions. The configuration engineer can configure info text on screens and operator controls.

The infotext of an I/O field can contain, for example, information on the value to be entered.

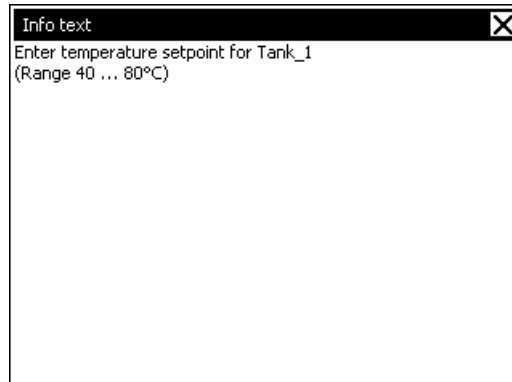

Opening info text for operator controls

1. Touch the required operator control.

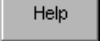
The screen keyboard opens. You can see from the appearance of the  key whether info text has been configured for the operator control or the current screen.

2. Touch the  key on the screen keyboard.

The info text for the operator control is displayed. If there is no info text for the selected screen object, the info text for the current screen is displayed, if it has been configured.

You can scroll through the contents of long info text with  and .

Note

Switching between displayed info text

The configuration engineer can configure infotext for an I/O field and the associated screen. You can switch between two info texts by touching the info text window.

3. Close the displayed info text by pressing .

Alternative procedure

Depending on your configuration, info text can also be called via a configured operator control.

Refer to your plant documentation to find any available additional information on this topic.

8.5 Entering values using the keys

8.5.1 Control keys

Introduction







The following tables show the control keys with which you operate the project.

Multi-key operation



















Unwanted actions may be triggered, if the operator unintentionally actuates a key combination.

 CAUTION
Unintentional actions In "Online" mode, simultaneous operation of more than two keys may cause unintentional actions in the plant. Never press more than two keys simultaneously.





Select operating elements

Key/Keys	Function	Description
 –	Tabulator	Selects the next/previous operating element in the tab sequence.
 		
   	Cursor keys	Navigates in the operating element.

Using operating elements

Key/Keys	Function	Description	
   	Position the cursor	Positions the cursor within an operating element, e.g. in the I/O field.	
	–	Scroll back	Scrolls back a page in a list.
		Scroll to the beginning	Scrolls to the beginning of a list.
	–	Scroll forward	Scrolls one page forward in a list.
		Scroll to the end	Scrolls to the end of a list.
	–	Enter key	<ul style="list-style-type: none"> Operates buttons. Accepts and ends an entry. Opens a selection list. Toggles within a text box between character mode and normal mode. <p>In character mode, a single character is selected. In this mode, you can advance in the character set using the cursor keys.</p>
	–	Cancel	<ul style="list-style-type: none"> Deletes the characters of a value entry and restores the original value. Closes the active dialog.
	–	Delete characters	Deletes the character to the right of the current cursor position.
	–	Delete characters	Deletes the character to the left of the current cursor position.
		Open selection list	Opens a selection list.
		Accept value	Accepts the selected value in the selection list without closing the list.

Enter key combinations

Key	Function	Purpose
	Toggle key assignment	Switches over key assignment of keys with multiple assignment. <ul style="list-style-type: none"> No LED is lit: The number assignment is enabled. Pressing the button once toggles to letter assignment. An LED is lit: The left or right letter assignment is enabled. Each time the key is pressed, the system toggles between the left letter assignment, the right letter assignment and the number assignment.
	Toggle between upper-case and lower-case	Used in key combinations, for example for entering upper-case letters.
	Switch to additional key assignment	Some of the keys contain a key assignment imprinted blue, for example the "%" character. Used in key combinations for the blue key assignment.
	General control function	Used in key combinations
	General control function	Used in key combinations

Acknowledge alarms





Key	Function	Description
	Acknowledge	Acknowledges the currently displayed fault alarm or all the alarms of an alarm group as group acknowledgment. The LED lights up as long as unacknowledged fault alarms are active.

Displaying info text



Key	Function	Description
	Displaying info text	Opens a window with the configured info text at the selected object, e.g. alarm or I/O field. If an info text exists for the selected object, the LED lights up.

8.5.2 Example: Enter characters using the alphanumeric keyboard

Using the same keys of the alphanumeric keyboard you can enter up to six different characters. The entry result depends on the combination of the keys pressed.

The values "5", "M", "m", "N", "n" and "%" are entered using the same key  of the keyboard. You can use the keys ,  and  to switch between the different assignments..

The following table shows the entry options using the key .

Key 	Key 	Key 	Result
No LED is lit	Not relevant	Not pressed	5
Left LED is illuminated.	Not pressed	Not pressed	m
Left LED is illuminated.	Pressed	Not pressed	M
Right LED is illuminated.	Not pressed	Not pressed	n
Right LED is illuminated.	Pressed	Not pressed	N
Not relevant	Not relevant	Pressed	%

8.5.3 Function keys

Function keys

Function key assignment is defined during configuration. The configuration engineer can assign function keys globally and locally.

Function keys with global function assignment

A globally assigned function key always triggers the same action on the HMI device or in the PLC irrespective of the screen displayed. Such an action could be, for example, the activation of a screen or the closure of an alarm window.

Function keys with local function assignment

A function key with local function assignment is screen-specific and is therefore only effective within the active screen.

The function assigned locally to a function key can vary from screen to screen.

The function key of a screen can be assigned one function only, either a global or local one. The local assignment function takes priority over the global setting.

The configuration engineer can assign function keys in such a way that you can manipulate operating elements with function keys, for example, the alarm view, trend view, recipe view or status/force.

8.5.4 General procedures

Introduction

The control keys and function keys of the HMI device are available for key control

General procedure

The operating elements of a screen are operated using the control keys of the HMI device.

Proceed as follows:

1. Continue to press the key  or the cursor keys until the required operating element is selected on the screen.
2. Depending on the operating element, perform further actions. Detailed descriptions can be found under the respective operating element.

Examples:

- I/O field: Enter numerical, alphanumeric or symbolic values in the I/O field
- Slider control: Move the slider control

3. Confirm the operation with the key  or abort the operation with the key .

8.5.5 Entering and editing numerical values

Formats for numerical values

You can enter values in numerical text boxes based on the following formats:

- Decimal
- Hexadecimal
- Binary

Limit value test of numerical values

Tags can be assigned limit values. If you enter a value that lies outside of this limit, it will not be accepted, for example, 80 with a limit value of 78. In this case the HMI device will deliver a system alarm, if an alarm window is configured. The original value is displayed again.

Procedure

Numerical and alphanumerical values can be entered in character mode using the system keys.

Proceed as follows:



1. Select the desired text box within the screen with .

The existing value is selected in the text box.

2. Enter the value using the numerical keypad.

You have the following options to enter a value:

- The existing value is deleted when you enter the first character. Completely reenter the value.
- Press  and a cursor key simultaneously. The selection of the field content is canceled. Move the cursor in the existing value. You can now edit the characters of the current value or add characters.

The  key deletes the character positioned to the right of the cursor. Use the  key to delete the character to the left of the cursor.

To enter the hexadecimal characters "A" to "F", switch the numerical keypad to letter assignment using the key .

- If the LED of the  key is lit, infotext is available for the selected object or the current screen.

Use the key  to display the infotext for the operating element or current screen.

3. Select  to confirm your entry.

Result

You have changed the numerical value or entered a new one.

8.5.6 Entering and editing alphanumerical values

Procedure

Alphanumerical values can be entered in character mode using the system keys.

Proceed as follows:



1. Select the desired text box within the screen with .

The existing value is selected in the text box.

2. Enter the value using the system keys.

You have the following options to enter a value:

- The existing value is deleted when you enter the first character. Completely reenter the value.
- Press  and a cursor key simultaneously. The selection of the field content is canceled. Move the cursor in the existing value. You can now edit the characters of the current value or add characters.

The  key deletes the character positioned to the right of the cursor. Use the  key to delete the character to the left of the cursor.

To enter letters, switch the numerical keypad to letter assignment using the key .

- If the LED of the  key is lit, infotext is available for the selected object or the current screen.

Use the key  to display the infotext for the operating element or current screen.

3. Select  to confirm your entry.

Result

You have changed the alphanumeric value or entered a new one.

8.5.7 Entering the date and time

Entering the date and time

Enter the date and time in the same way you enter alphanumerical values.

Note

When entering the date and time, please note that the format is determined by the configured project language.

See also

Entering and editing numerical values (Page 174)

Entering and editing alphanumerical values (Page 176)

8.5.8 Entering Symbolic Values

Selection list



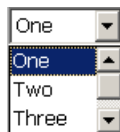



When you select a symbolic IO field, a selection list opens.



Procedure

Symbolic values are selected from the entries of a selection list.

Proceed as follows:

1. Select the desired symbolic text box within the screen with .
2. Open the selection list using the  key. The selection list opens.
3. Select the required entry using the cursor keys ,  or .
4. Confirm your entry with the  key.

Result

You have changed the symbolic value or entered a new one.

8.5.9 Displaying Infotext

Purpose

The configuration engineer uses info text to provide additional information and operating instructions. The configuration engineer can configure info text on screens and operator controls.

The infotext of an I/O field can contain, for example, information on the value to be entered.

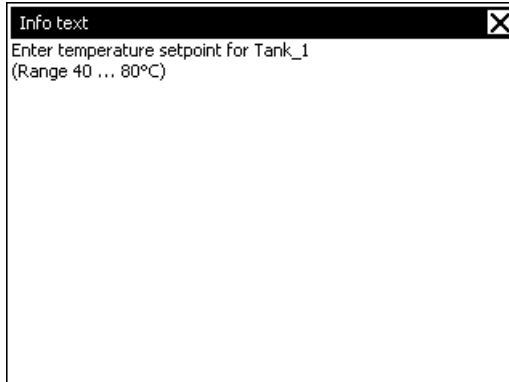



If the LED of the  key lights up, an infotext has been configured for the selected display object or for the current screen.

Procedure

1. Press .

The info text for the selected screen object is displayed. If there is no info text for the selected screen object, the info text for the current screen is displayed, if it has been configured.

You can scroll through the contents of long info texts using the cursor keys  and .

Note

Switching between displayed info text

The configuration engineer can configure infotext for an I/O field and the associated screen. You can switch between two infotexts by pressing the  key.

2. Close the infotext by pressing the  key.

Alternative procedure

Depending on your configuration, info text can also be called via a function key or via an existing operator control.

Refer to your plant documentation to find any available additional information on this topic.

8.6 Closing the project

Procedure

Proceed as follows:

1. Use the corresponding operating element object to close the project.
Wait for the Loader to open after you closed the project.
2. Switch off power to the HMI device.

Maintenance and care

9.1 Maintenance and care

Scope of maintenance

The HMI device is designed for maintenance-free operation. The touch screen and keyboard cover should still be cleaned regularly.

Preparation

 CAUTION
--

Inadvertent operation

Always switch off the HMI device before cleaning it. This will ensure that you do not trigger functions unintentionally when you touch the keys.
--

Requirement

Use a cleaning cloth dampened with a cleaning agent to clean the equipment. Only use water with a little liquid soap or a screen cleaning foam.

NOTICE

Damage caused by unauthorized cleaning products
--

Do not clean the HMI device with compressed air or steam jet blowers. Never use aggressive solvents or scouring powder.

Procedure

Proceed as follows:

1. Switch off the HMI device.
2. Spray the cleaning solution onto a cleaning cloth.
Do not spray directly onto the HMI device.
3. Clean the HMI device.
When cleaning the display wipe from the screen edge inwards.

9.2 Clean screen on MP 277 Touch

Clean screen

The touch screen of the HMI device can be cleaned when it is switched on and a project is running. An operating element must be available in the project with which the clean screen can be called. Once the clean screen is activated, touch screen operation is locked for a configured period of time. The time the touch screen is locked can be set between 5 and 30 seconds. The time remaining for the lockout is indicated by a progress bar.

 **WARNING**

Locking operating elements

Always open the clean screen or switch off the HMI device before you clean the touch screen while the system is running.

It is important to note when the clean screen function is unlocked. Ignoring this instruction may lead to inadvertent operation of a function.

9.3 Spare Parts and Repairs

Repairs

In case of repair, the HMI device must be shipped to the Return Center in Fürth. Repairs may only be carried out at the Return Center in Fürth.

Depending on the work necessary to repair the device, the Center may decide to give you a credit note. In this case, it is your responsibility to order a new device.

The address is:

Returns Center
Siemensstr. 2
90766 Fürth
Germany

Spare parts

You can find spare parts and accessories for the HMI devices in the section Accessories (Page 16).

9.4 Recycling and disposal

The HMI devices described in these operating instructions can be recycled due to their low levels of pollutants. Contact a certified disposal service company for environmentally sound recycling and disposal of your old devices.

Technical specifications

10.1 Dimension drawings

10.1.1 Dimension drawing of the MP 277 8" Touch

The HMI device MP 277 8" Touch is available in two enclosure models. The enclosure models have different article numbers. The article number is on the back of the HMI device.

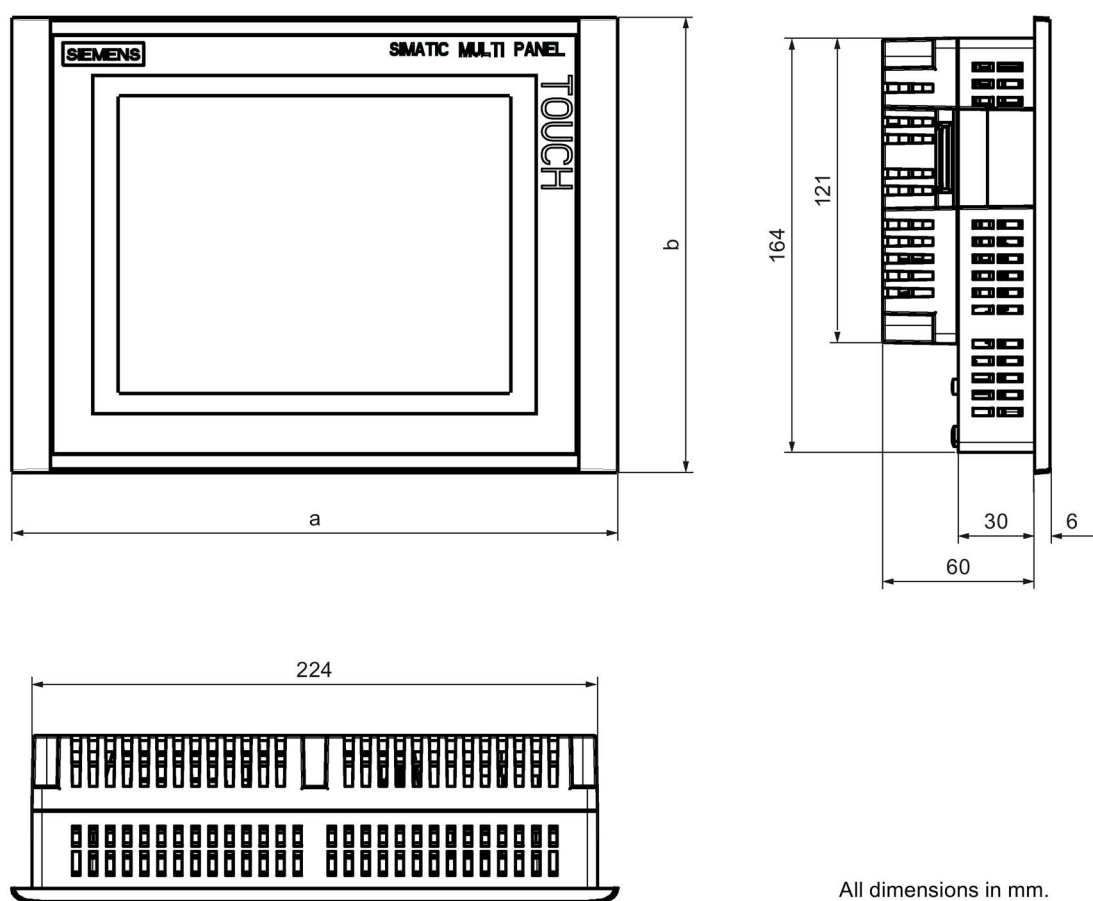

All dimensions in mm.

Article number	a	b
6AV6643-0CB01-1AX2	250 mm	190 mm
6AV6643-0CB01-1AX1	250 mm	190 mm
6AV6643-0CB01-1AX5	240 mm	180 mm

10.1.2 Dimension drawing of the MP 277 8" Key

The HMI device MP 277 8" Key is available in two enclosure models. The enclosure models have different article numbers. The article number is on the back of the HMI device.

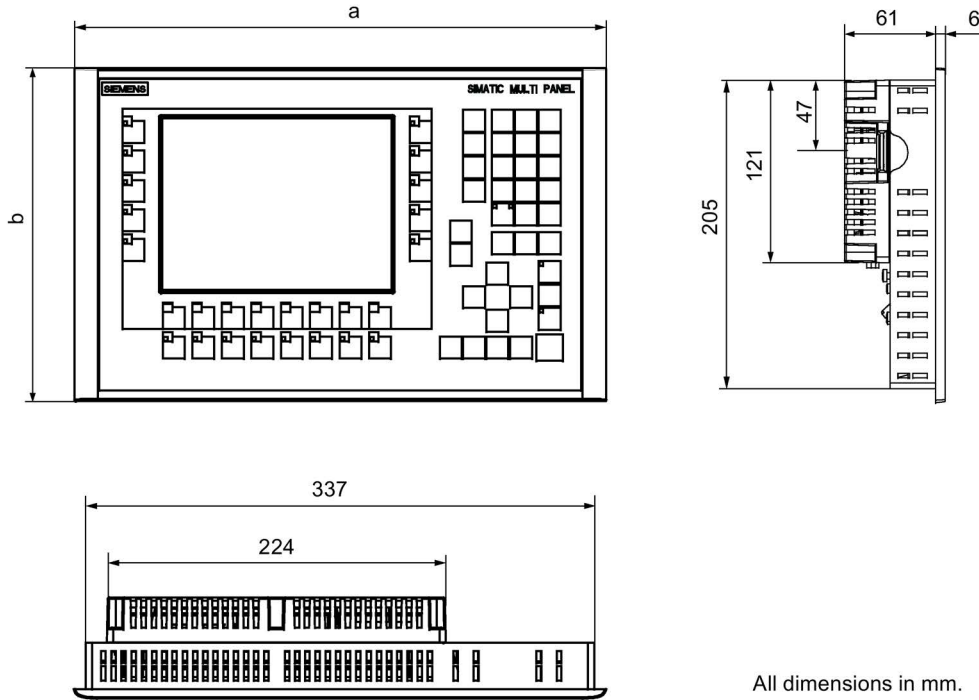

All dimensions in mm.

Article number	a	b
6AV6643-0CB01-1AX2	362 mm	231 mm
6AV6643-0CB01-1AX1	362 mm	231 mm
6AV6643-0CB01-1AX5	352 mm	221 mm

10.1.3 Dimension drawing of the MP 277 10" Touch

The HMI device MP 277 10" Touch is available in two enclosure models. The enclosure models have different article numbers. The article number is on the back of the HMI device.

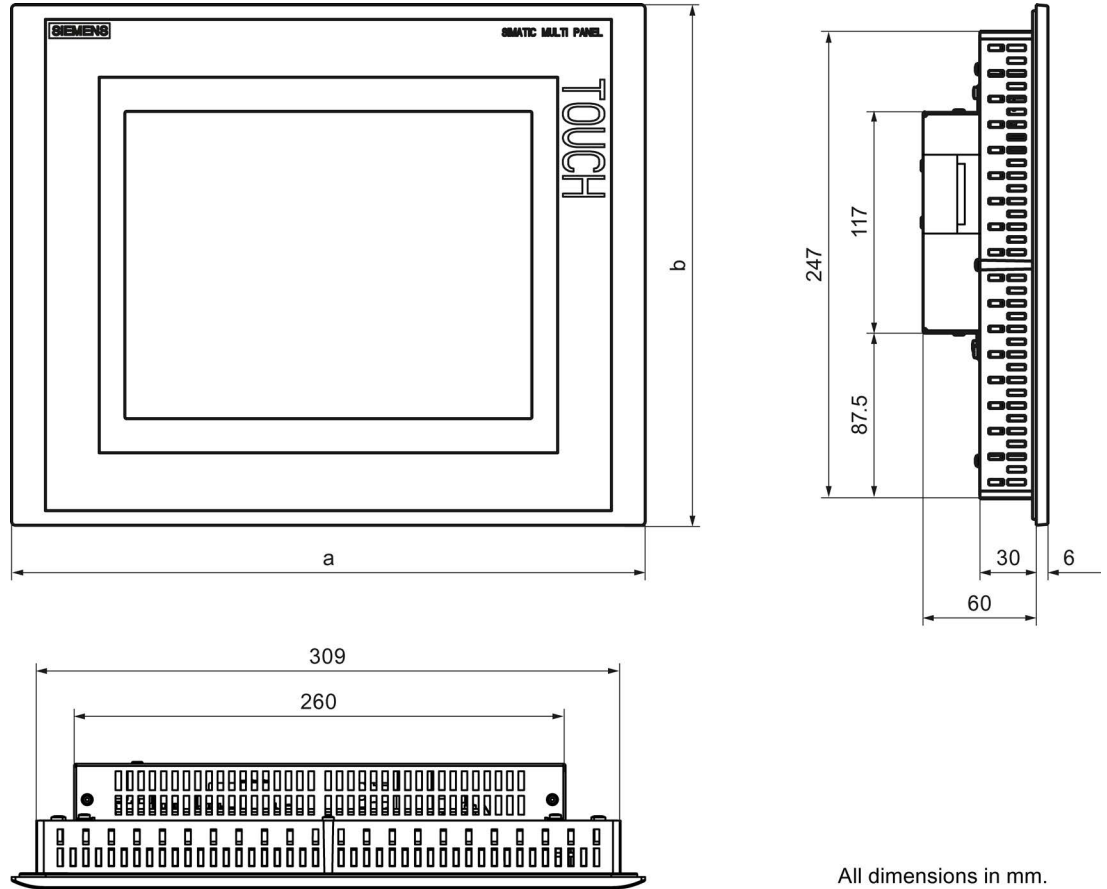

All dimensions in mm.

Article number	a	b
6AV6643-0CD01-1AX2	335 mm	275 mm
6AV6643-0CD01-1AX1	335 mm	275 mm
6AV6643-0CD01-1AX5	325 mm	263 mm

10.1.4 Dimension drawing of the MP 277 10" Key

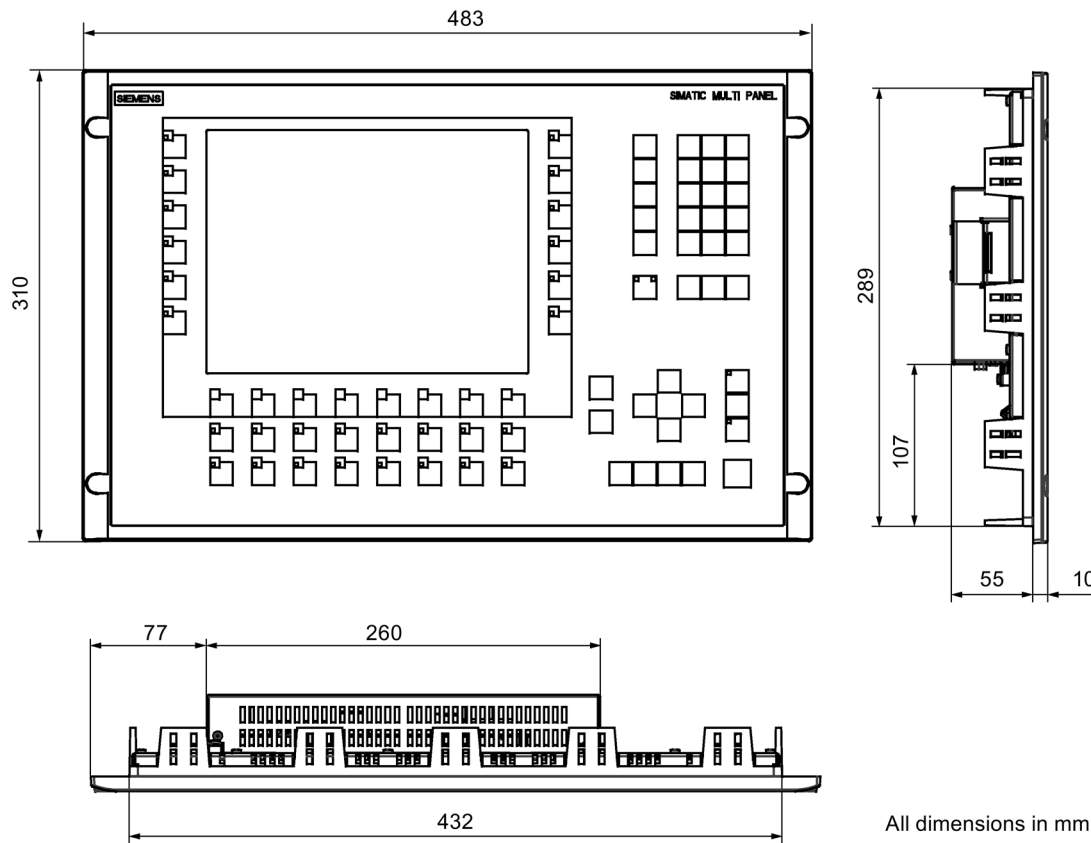

10.2 Specifications

10.2.1 Specifications of the MP 277 Touch

HMI device

	MP 277 8" Touch	MP 277 10" Touch
Weight without packaging	Approx. 1610 g	Approx. 2650 g

Display

	MP 277 8" Touch	MP 277 10" Touch
Display area, active	153.7 mm x 115.8 mm (7.5")	211.2 mm x 158.4 mm (10.4")
Type	LCD TFT	
Resolution	640 x 480 pixels	
Colors, displayable	64k	
Brightness control	Yes	

Input device

	MP 277 8" Touch	MP 277 10" Touch
Type	Resistive analog touch screen	

Memory

	MP 277 8" Touch	MP 277 10" Touch
Application memory	6 MB	

Ports

	MP 277 8" Touch	MP 277 10" Touch
1 x RS 422/RS 485	Max. 12 Mbps	
2 x USB	USB host; conforms to USB standard 1.1 (supporting low-speed and full-speed USB devices) Maximum load 500 mA	
1 x Ethernet	RJ45 10/100 Mbps	

Supply voltage

	MP 277 8" Touch	MP 277 10" Touch
Rated voltage	+24 V DC	
Range, permissible	20.4 V to 28.8 V (-15%, +20%)	
Transients, maximum permissible	35 V (500 ms)	
Time between two transients, minimum	50 s	

10.2 Specifications

	MP 277 8" Touch	MP 277 10" Touch
Current consumption		
<ul style="list-style-type: none"> • Typical • Constant current, maximum • Power on current surge I²t 	<ul style="list-style-type: none"> • Approx. 600 mA • Approx. 1000 mA • Approx. 1 A²s 	<ul style="list-style-type: none"> • Approx. 700 mA • Approx. 1100 mA • Approx. 1 A²s
Fuse, internal	Electronic	

Miscellaneous

	MP 277 8" Touch	MP 277 10" Touch
Realtime clock, buffered ¹⁾	Yes	
Magnetic field intensity	50/60 Hz; 100 A/m RMS	

¹ Bridging time of the buffering, approx. 6 weeks.

10.2.2 Specifications of the MP 277 Key

HMI device

	MP 277 8" Key	MP 277 10" Key
Weight without packaging	Approx. 2250 g	Approx. 4950 g

Display

	MP 277 8" Key	MP 277 10" Key
Display area, active	153.7 mm x 115.8 mm (7.5")	211.2 mm x 158.4 mm (10.4")
Type	LCD TFT	
Resolution	640 x 480 pixels	
Colors, displayable	64k	
Brightness control	Yes	

Input device

	MP 277 8" Key	MP 277 10" Key
Type	Membrane keyboard	
Function keys	26 function keys, of which 18 with LED	34 function keys, of which 26 with LED

Memory

	MP 277 8" Key	MP 277 10" Key
Application memory	6 MB	

Ports

	MP 277 8" Key	MP 277 10" Key
1 x RS 422/RS 485	Max. 12 Mbps	
2 x USB	USB host; conforms to USB standard 1.1 (supporting low-speed and full-speed USB devices) Maximum load 500 mA	
1 x Ethernet	RJ45 10/100 Mbps	

Supply voltage

	MP 277 8" Key	MP 277 10" Key
Rated voltage	+24 V DC	
Range, permissible	20.4 V to 28.8 V (-15 %, +20%)	
Transients, maximum permissible	35 V (500 ms)	
Time between two transients, minimum	50 s	
Current consumption	<ul style="list-style-type: none"> • Typical • Constant current, maximum • Power on current surge I²t 	<ul style="list-style-type: none"> • Approx. 700 mA • Approx. 1100 mA • Approx. 1 A²s
	<ul style="list-style-type: none"> • Approx. 800 mA • Approx. 1200 mA • Approx. 1 A²s 	
Fuse, internal	Electronic	

10.3 Bit assignment of the direct keys

The following figures show the assignment of the keys and LEDs to the bytes in the PLC process image.

Further information may be available in your plant documentation.

Note

Do not use the LED bits "ACK", "A-Z I", "A-Z r" and "HELP" when a project is running on the HMI device.

10.3 Bit assignment of the direct keys

Bit assignment of the direct keys for the MP 277 8" Key

Button bits								Byte	LED bits							
7	6	5	4	3	2	1	0		7	6	5	4	3	2	1	0
F8	F7	F6	F5	F4	F3	F2	F1	n	F8	F7	F6	F5	F4	F3	F2	F1
F16	F15	F14	F13	F12	F11	F10	F9	n + 1							F10	F9
K4	K3	K2	K1			F18	F17	n + 2	K4	K3	K2	K1				
				K8	K7	K6	K5	n + 3					K8	K7	K6	K5
ACK	ALT	CTRL	SHIFT					n + 4	ACK	A-Z l	A-Z r	HELP				

Bit assignment of the direct keys for the MP 277 10" Key

Button bits								Byte	LED bits							
7	6	5	4	3	2	1	0		7	6	5	4	3	2	1	0
F8	F7	F6	F5	F4	F3	F2	F1	n	F8	F7	F6	F5	F4	F3	F2	F1
F16	F15	F14	F13	F12	F11	F10	F9	n + 1					F12	F11	F10	F9
K4	K3	K2	K1	F20	F19	F18	F17	n + 2	K4	K3	K2	K1				
K12	K11	K10	K9	K8	K7	K6	K5	n + 3	K12	K11	K10	K9	K8	K7	K6	K5
ACK	ALT	CTRL	SHIFT	K16	K15	K14	K13	n + 4	ACK	A-Z l	A-Z r	HELP	K16	K15	K14	K13

Bit assignment of the direct keys for the MP 277 8" Touch

Touch assignment								Byte
7	6	5	4	3	2	1	0	
7	6	5	4	3	2	1	0	n
15	14	13	12	11	10	9	8	n + 1
23	22	21	20	19	18	17	16	n + 2
31	30	29	28	27	26	25	24	n + 3
39	38	37	36	35	34	33	32	n + 4

Bit assignment of the direct keys for the MP 277 10" Touch

Touch assignment								Byte
7	6	5	4	3	2	1	0	
7	6	5	4	3	2	1	0	n
15	14	13	12	11	10	9	8	n + 1
23	22	21	20	19	18	17	16	n + 2
31	30	29	28	27	26	25	24	n + 3
39	38	37	36	35	34	33	32	n + 4

See also

Direct keys (Page 160)

10.4 Description of the ports

10.4.1 Power supply

Plug connector, 2-pin



Pin	Assignment
1	+24 VDC (L+)
2	GND 24 V (M)

10.4.2 X10/IF 1B (RS 422/RS 485)

Sub-D socket, 9-pin, with screw lock

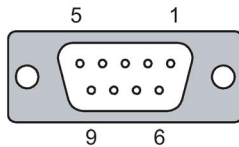

Pin	Assignment for the RS 422	Assignment for the RS 485
1	n. c.	n. c.
2	GND 24 V	GND 24 V
3	TxD+	Data channel B (+)
4	RD+	RTS ¹⁾
5	GND 5 V, floating	GND 5 V, floating
6	+5 VDC, floating	+5 VDC, floating
7	+24 VDC, out (max. 100 mA)	+24 VDC, out (max. 100 mA)
8	TxD-	Data channel A (-)
9	RxD-	RTS ¹⁾

¹⁾ On pin 4 or pin 9, can be set with DIP switch on the rear of the device

10.4.3 X20, X21 (USB)

USB socket

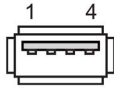

Pin	Assignment
1	+5 VDC, out (max. 500 mA)
2	USB-DN
3	USB-DP
4	GND

10.4.4 X1 (Ethernet/LAN)

RJ45 plug connector

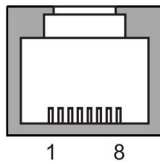

Pin	Assignment
1	Tx+
2	Tx-
3	Rx+
4	n. c.
5	n. c.
6	Rx-
7	n. c.
8	n. c.

Appendix

A.1 Service and support

You can find additional information and support for the products described on the Internet at the following addresses:

- Technical support (http://www.siemens.de/automation/csi_en_VW)
- Support request form (<http://www.siemens.com/automation/support-request>)
- After Sales Information System SIMATIC IPC/PG (<http://www.siemens.com/asis>)
- SIMATIC Documentation Collection (<http://www.siemens.com/simatic-tech-doku-portal>)
- Your local representative
(<http://www.automation.siemens.com/mcms/aspa-db/en/Pages/default.aspx>)
- Training center (<http://sitrain.automation.siemens.com/sitrainworld/?AppLang=en>)
- Industry Mall (<https://mall.industry.siemens.com>)

When contacting your local representative or Technical Support, please have the following information at hand:

- MLFB of the device
- BIOS version for industrial PC or image version for HMI device
- Other installed hardware
- Other installed software

Tools & downloads

Please check regularly if updates and hotfixes are available for download to your device. The download area is available on the Internet at the following link:

After Sales Information System SIMATIC IPC/PG (<http://www.siemens.com/asis>)

A.2 System events

System events on the HMI device provide information about internal states of the HMI device and the controller.

Note

System events are only indicated if an alarm window was configured. System events are output in the language currently set on your HMI device.

System event parameters

System events may contain encrypted parameters which are relevant to troubleshooting because they provide a reference to the source code of the runtime software. These parameters are output after the text "Error code:".

Description of the system events

A listing of all system alarms for your HMI device is provided in the online help of your configuration software.

A.3 ESD guideline

Meaning



An electronic module is equipped with highly integrated electronic components. Due to their design, electronic components are highly sensitive to overvoltage and thus to the discharge of static electricity. Such electronic components are labeled as electrostatic sensitive devices (ESD).

The following abbreviations are commonly used for electrostatic sensitive devices:

- ESD
- ESD

Electrostatic charge

The damage to an ESD caused by overvoltage is usually not recognized immediately. The damage only becomes apparent after a long period of operation.

NOTICE
Electrostatic charge
ESDs may be destroyed by voltages far below the level perceived by human beings. If you are not discharged electrostatically, the voltage that you transfer when touching a component or the contact points of a module can already cause damage.
Discharge any electrostatic charge of your body before you touch the ESD.

Anyone who is not connected conductively to their surroundings is subject to electrostatic charge.

The following diagram shows the maximum voltage values to which a person can be charged electrostatically. The values depend on the material and humidity. The shown values are in conformity with the specifications of EN 61000-4-2.

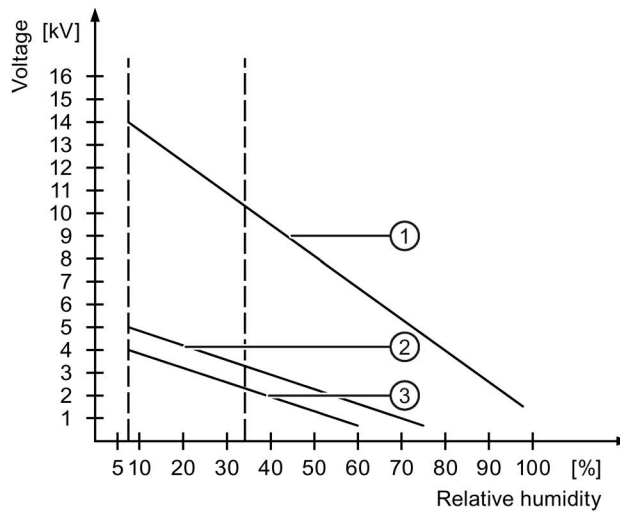

- ① Synthetic materials
- ② Wool
- ③ Antistatic materials such as wood or concrete

Protective measures against discharge of static electricity

NOTICE
<p>Grounding measures</p> <p>There is no equipotential bonding without grounding. An electrostatic charge is not discharged and may damage the ESD.</p> <p>When working with electrostatic sensitive devices, make sure that the person and the workplace are properly grounded.</p>

Note the following:

- Only touch the ESD if it is absolutely necessary.
- When you touch ESD modules, avoid touching the pins or the PCB tracks.
This precaution reduces the risk of damaging an ESD.
- Discharge electrostatic electricity from your body if you are performing measurements on an ESD.
To do so, touch a grounded metal object before you carry out the measurement.
- Always use grounded measuring instruments.

Abbreviations

ANSI	American National Standards Institution
CSV	Comma Separated Values
DC	Direct Current
DHCP	Dynamic Host Configuration Protocol
DIL	Dual-in-Line (electronic chip housing design)
DNS	Domain Name System
DP	Distributed I/O
IO	Input and Output
ESD	Components and modules endangered by electrostatic discharge
EMC	Electromagnetic Compatibility
EN	European standard
ESD	Components and modules endangered by electrostatic discharge
GND	Ground
HF	High Frequency
HMI	Human Machine Interface
IEC	International Electronic Commission
IF	Interface
IP	Internet Protocol
LED	Light Emitting Diode
MAC	Media Access Control
MPI	Multipoint Interface (SIMATIC S7)
n. c.	Not connected
OP	Operator Panel
PC	Personal Computer
PG	Programming device
PPI	Point-to-Point Interface (SIMATIC S7)
PELV	Protective Extra Low Voltage
RJ45	Registered Jack Type 45
RTS	Request to send
RxD	Receive Data
PLC	Programmable Logic Controller
Sub-D	Subminiature D (plug)
TAB	Tabulator
TCP/IP	Transmission Control Protocol/Internet Protocol
TFT	Thin Film Transistor
TxD	Transmit Data

UL	Underwriter's Laboratory
USB	Universal Serial Bus
WINS	Windows Internet Naming Service

Glossary

"Transfer" mode

The "Transfer" operating mode is an operating mode of the HMI device in which an executable project is transferred from the configuration PC to an HMI device.

Acknowledge

Acknowledgment of an alarm confirms that it has been noted.

Alarm logging

Output of user-specific alarms to a printer, in parallel to their output to the HMI device screen.

Alarm, acknowledgment

Acknowledgment of an alarm confirms that it has been noted.

Automation system

An automation system is a PLC of the SIMATIC S7 series, for example SIMATIC S7-300

Boot loader

The boot loader is used to start the operating system and is started automatically after power on of the HMI device. The loader is displayed after the operating system has loaded.

Configuration PC

A configuration PC is a programming device or PC on which plant projects are created using an engineering software.

Configuration software

Configuration software is used to create projects used for the purpose of process visualization. WinCC flexible is such a configuration software, for example.

Controller

PLC is a general term for devices and systems with which the HMI device communicates, e.g. SIMATIC S7.

Degree of protection

The degree of protection specifies a standard of electronic equipment for a variety of environmental conditions – and the protection of humans against potential danger when using this equipment.

The degree of protection classified by IP differs from the protection class. But both involve protection against touching dangerous electric voltage. The degree of protection also classifies the protection of equipment against dirt and moisture.

EMC

Electromagnetic compatibility (EMC) refers to a usually desirable state, in which technical equipment does not disturb one another with unwanted electrical or electromagnetic effects. Electromagnetic compatibility deals with technical and regulatory questions of undesired, mutual influence in electrical engineering.

Event

Functions are triggered by defined incoming events. Events can be configured. Events which can be assigned to a button include "Press" and "Release", for example.

Field

Area reserved in configured screens for the input and output of values.

Flash memory

Flash memory is a non-volatile memory with EEPROM chips that is implemented either as mobile storage medium, or as permanently installed memory module on the motherboard.

Function keys

Function keys on the HMI device can be assigned user-specific functions. The functions assigned to these keys are defined during configuration. The assignment of the function keys may be specific to an active screen or independent of it.

Half Brightness Life Time

Time period after which brightness is reduced to 50% of the original value. The specified value depends on the operating temperature.

Hardcopy

Output of the screen content to a printer.

HMI device

An HMI device is a device used for the operation and monitoring of machines and plants. The machine or plant states are visualized on the HMI device by means of graphic objects or signal lamps. The operator controls of the HMI device allow the operator to interact with the processes of the machine or plant.

HMI device image

The HMI device image is a file that can be transferred from the configuration PC to the HMI device. The HMI device image contains the operating system for the HMI device and the elements of the runtime software required to run a project.

I/O field

An I/O field enables the input or output of values on the HMI device which are transferred to the PLC.

Info text

An info text is a configured information on objects within a project. Info text for an alarm, for example, may contain information on the cause of the fault and troubleshooting routines.

Object

An object is a project element such as a screen or an alarm. Objects are used to view or enter texts and values on the HMI device.

Operating element

An operating element is a component of a project used to enter values and trigger functions. A button, for example, is an operating element.

Plant

General term referring to machines, processing centers, systems, plants and processes which are operated and monitored on an HMI device.

PLC job

A PLC job triggers a function for the PLC on the HMI device.

Project

A project is the result of a configuration using a configuration software. The project normally contains several screens with embedded system-specific objects, basic settings and alarms. A project configured in WinCC flexible is saved to a project file with the extension *.hmi.

You need to distinguish between a project on the configuration PC and an executable project on an HMI device. A project on the configuration PC can be available in more languages than can be managed on the HMI device. The project on the configuration PC can also be set up for different HMI devices. You can only transfer an executable project to an HMI device if it has been especially compiled for it.

Project file

A project file is a file from which the executable project file for use on the HMI device is generated. The project file is usually not transferred and is retained on the configuration PC.

The file name extension of a project file is *.hmi.

Project file, compressed

Compressed format of the project file. The compressed project file can be transferred in addition to the executable project file to the corresponding HMI device. For this purpose, backtransfer must be enabled in the project on the configuration PC. The compressed project file is usually saved to an external memory card.

A compressed project file has the extension *.pdz.

Project file, executable

An executable project file is the file generated from the project file for a specific HMI device. The executable project file is transferred to the associated HMI device where it is used to operate and monitor plants.

An executable project file has the extension "*.fwx".

Protection class

The protection class is used in electrical engineering to classify and identify electrical equipment in relation to existing safety measures designed to prevent electric shock.

There are four protection classes for electrical equipment.

Recipe

A recipe is a combination of tags that form a fixed data structure. The configured data structure can be assigned data in the configuration software or on the HMI device and is then referred to as a record. The use of recipes ensures that all data assigned to a data record is transferred synchronously to the PLC.

Runtime software

The runtime software is a process visualization software used to test a project on a configuration PC.

Screen

A screen is a form of visualization for all logically related process data in a plant. The representation of the process data can be visually supported by graphic objects.

Screen object

A screen object refers to objects such as rectangles, I/O fields, or alarm views which are configured for visualization or operation of the plant.

STEP 7

STEP 7 is the programming software for SIMATIC S7, SIMATIC C7 and SIMATIC WinAC PLCs.

Symbolic I/O field

A symbolic I/O field is a field for the input and output of a value. Contains a list of default entries from which one can be selected.

System alarm

A system alarm is assigned to the "System" alarm class. A system alarm refers to internal states on the HMI device and the PLC.

Tab order

The tab order defined in the course of project engineering determines the sequence for activating objects by pressing the <TAB> key.

Tag

A tag is a defined memory location to which values can be written and from which values can be read. This can be done from the PLC or the HMI device. We distinguish between external tags (process tags) and internal tags, depending on whether or not the tag is interconnected with the PLC.

Transfer

Transfer of a runtime project from the configuration PC to the HMI device.

WinAC MP

WinAC is a software PLC for multifunctional platforms.

Index

/

/Audit, 21

A

ACK key, 172
Acknowledge
 Alarm, 172
Acknowledge key, 172
Acoustic feedback, 160
Acoustic signal, 165
 Inadvertent operation, 160
Acoustics
 Feedback, 97
Activate
 Password protection, 89
Address assignment
 TCP/IP network, 116
Addressing, 114
Alarm
 Acknowledge, 172
 Functional scope, 19
Alarm buffer
 Functional scope, 19
ALARM_S, 19
Alphanumerical
 Key assignment, 83, 172
 Screen keyboard, 166
Alphanumerical value
 Changing, 167, 176
 Entering, 167, 176
ALT key, 83, 172
Applications
 MP 277, 9
Approval for Australia, 29
Approvals, 27
Automatic
 Transfer, 143
A-Z key, 83, 172

B

Backing up, 136, 147, 148
 Registry information, 76, 92
 Temporary files, 92

 to external storage device, 126
 To memory card, 76
 With ProSave, 148
Backlighting
 Reducing, 95
 Setting, 77
Backspace key, 82, 171
Backtransfer, 141, 145
Backup, 76, 128
Booting, 99
Bottom view, 10, 12, 13, 15
Brightness
 Changing, 94
Browser
 Home page, 76
 Setting, 76
Bus connection, 22
Bus parameters
 Profile, 108

C

Cable
 Connecting, 45
Calibrating
 Touch screen, 87
Cancel key, 82, 171
Care, 181
CE approval, 27
Certificate
 Delete, 125
 Deleting, 76
 Displaying, 76
 Importing, 76, 125
Certificates, 76
Changing
 Brightness, 94
Character repeat, 76
 Screen keyboard, 85
Charge
 Electrostatic, 194
Clamping frame, 17
Clean screen, 182
Clearance
 MP 277, 39
Climatic
 Shipping conditions, 33
 Storage conditions, 33

- Closing
 - Project, 179
 - Compatibility conflict, 147
 - Computer name
 - Setting, 77
 - Condensation, 33
 - Conductor cross-section, 48
 - Equipotential bonding, 46
 - Configuration graphic
 - Configuration PC, 53
 - Controller, 50
 - Equipotential bonding, 47
 - Power supply, 48
 - Printer, 57
 - Configuration PC
 - Configuration graphic, 53
 - Connecting, 53
 - Configuration phase, 133
 - Configure
 - Network, 114
 - Configuring
 - Data channel, 77, 109
 - Operating system, 70
 - PC/PPI cable, 54
 - RS 422/RS 485 interface, 51
 - Screen keyboard, 76, 84
 - Configuring PC, 133
 - Connecting
 - Configuration PC, 53
 - Controller, 50
 - Equipotential bonding, 46
 - Mains terminal, 49
 - Power supply, 48, 49
 - Printer, 57
 - PROFINET, 51, 53
 - USB device, 56
 - Connection, 22
 - Connection sequence, 45
 - Connections to PLCs
 - Number, 22
 - Control cabinet
 - Working on, 25
 - Control keys
 - Keyboard unit, 81
 - Control Panel
 - MPI, 107
 - Open, 75
 - Operating, 78, 80
 - Password protection, 71
 - PROFIBUS, 107
 - Screen keyboard, 78
 - Control Panel:Operate, 77
 - Controller
 - Configuration graphic, 50
 - Configuring the interface, 51
 - Connecting, 50
 - Conventions, 4
 - Converter RS 422-RS 232, 16
 - Cookies, 123
 - CTRL key, 83, 172
 - Currency, 77
 - Cursor key, 82, 170
- D**
- Data channel
 - Configuring, 77, 109
 - Enabling, 109
 - Locking, 109
 - Data transfer, 136
 - Date, 76
 - Entering, 168, 177
 - Setting, 90
 - Synchronizing, 91
 - Date format, 77, 92
 - Date/time properties, 76, 90
 - Deactivating
 - Password protection, 90
 - Decimal, 164
 - Default gateway, 116
 - Degree of protection, 38
 - Protection against ingress of solid foreign bodies, 40
 - Protection against water, 40
 - Delay time
 - Setting, 77, 103
 - Delete
 - Certificate, 125
 - Delete key, 82, 82, 171, 171
 - Device name
 - For network operation, 115
 - DHCP, 116
 - DIP switch
 - Setting, 51
 - Direct key, 161
 - Functional scope, 21
 - Direct keys
 - Assignment, 189
 - Disabling
 - SecureMode, 74
 - Display
 - MP 277 Key, 188
 - MP 277 Touch, 187
 - Display format, 174

- Displaying
 - Certificate, 76
 - HMI device information, 76
 - Info text, 169, 178
 - Information on the MP 277, 100
 - Memory information, 101
 - System information, 101
 - UPS status, 77

- Disposal, 182
- Disturbance
 - Pulse-shaped, 31
 - Sinusoidal, 32

- DNS, 116

- DNS
 - Server, 114

- Documentation
 - Enclosed, 41

- Double-click, 76
 - Setting, 86

E

- EC Declaration of Conformity, 27

- Elbow adapter, 17

- Electrical
 - Safe separation, 49

- Electrical potential difference, 46

- Electrostatic charge, 194

- E-mail
 - Set, function overview, 77
 - Setting, 119

- EMC directive, 27

- Emission, 30, 32

- Enabling
 - SecureMode, 74

- Encryption, 123

- END key, 82, 171

- Enter key, 82, 171

- ENTER key, 82, 171

- Entering
 - Alphanumerical value, 167, 176
 - Date, 168, 177
 - Key combination, 83, 172
 - Numerical value, 165, 175
 - Symbolic value, 168
 - Text box, 163
 - Time, 168, 177

- Entry on the HMI device
 - By means of function key, 173
 - Using operating elements, 157

- Environmental conditions
 - Climatic, 36

- Mechanical, 35

- Test, 36

- Equipotential bonding
 - Cable, 47
 - Configuration graphic, 47
 - Connecting, 46
 - Requirements, 46
- Equipotential bonding rail, 47
- ESC key, 82, 171
- Ethernet settings
 - IP address, 116

F

- Feedback
 - Acoustic, 97, 160
 - Optical, 159

- Fixation, 16

- FM approval, 29

- Fn key, 83, 172

- Front view, 10, 11, 13, 14

- Function
 - Additional, 21

- Function key
 - Labeling, 65

- Function keys
 - Global assignment, 173
 - Local assignment, 173

- Function test, 59

- Functional scope
 - Alarm buffer, 19
 - ALARM_S, 19
 - Graphics list, 19
 - Info text, 21
 - Limit monitoring, 19
 - Log, 20
 - Messages,
 - Recipe, 20
 - Safety, 20
 - Scaling, 19
 - Screen, 19
 - Tag, 19
 - Text list, 19

G

- Graphics list
 - Functional scope, 19
- Group acknowledgement, 172
- Guidelines for Explosion Protection, 28

H

- High frequency radiation, 26
- HMI device
 - Cold restart, 99
 - EMC-compatible installation, 31
 - Information, 76
 - Interfaces, 45
 - Restarting, 76
 - Shutting down, 59
 - Specifications, 186, 188
 - Switching on, 58
 - Testing, 58
 - Transfer license key, 154
- HMI Input Panel
 - Options, 84
- HOME key, 82, 171
- Home page
 - Internet, 121
- Host cable
 - Safety instruction, 55

I

- Identification, 118
- Importing
 - Certificate, 76, 125
- Inadvertent operation
 - Acoustic signal, 160
- Info text
 - Displaying, 169, 178
 - Functional scope, 21
 - Key, 172
 - LED, 172
- Information
 - For the HMI device, 100
- Initial startup, 133
- Input device
 - MP 277 Key, 188
 - MP 277 Touch, 187
- Input Panel, 76
- Installation as intended, 26
- Installing
 - Option, 136, 152, 152
- Instructions
 - General, 30
- Insulation test
 - Test voltage, 40
- Interfaces
 - MP 277, 45
 - Rated load, 56

Internet

- Home page, 121
 - Options, 76
 - Search engine, 121
 - Security settings, 76
 - Settings, 119
 - Settings, overview of functions, 77
- Internet options**
- Privacy, 124
- IP address**
- Ethernet, 116

K**Key**

- ACK, 172
 - ALT, 83, 172
 - A-Z, 83, 172
 - Backspace, 171
 - Cancel, 82
 - CTRL, 83, 172
 - Cursor, 82, 170
 - Delete, 82, 82, 171
 - END, 82, 171
 - ENTER, 82, 171
 - ESC, 82, 171
 - Fn, 83, 172
 - HOME, 82, 171
 - Info text, 172
 - Scroll back, 82, 171
 - Scroll forward, 82, 171
 - SHIFT, 83, 172
 - TAB, 82, 170
 - Tabulator, 82
- Key combination**
- Entering, 83, 172
- Key control, 170, 174**
- Keyboard**
- Safety instruction, 62
 - Keyboard properties, 76

L**Labeling**

- Approvals, 29
 - EC Declaration of Conformity, 27
 - Function key, 65
 - Guidelines for Explosion Protection, 28
- Labeling strips**
- Attaching, 67
 - Dimensions, 66

LAN connection, 76
 Language switching
 Functional scope, 21
 LED
 Info text, 172
 License
 Managing, 154
 License key
 Transfer to an HMI device, 154
 Transferring, 136
 Transferring back, 136
 Limit monitoring
 Functional scope, 19
 Limit test, 164
 Limit value test, 174
 Loader, 70
 Operating, 71
 Locking
 Operating element, 182
 Log
 Functional scope, 20
 Logon data, 118

M

Main dimensions
 MP 277 10" Touch, 185
 MP 277 8" Key, 184
 MP 277 8" Touch, 183
 Mains terminal
 Connecting, 49
 Maintenance, 181
 Managing
 License, 154
 Manual
 Transfer, 142
 Mechanical
 Shipping conditions, 33
 Storage conditions, 33
 Memory
 MP 277 Key, 189
 MP 277 Touch, 187
 Memory card
 First time use, 127
 Inserting, 64
 Restoring file system, 93
 Unplug, 65
 Memory information
 Displaying, 101
 Memory management, 76, 131
 Mounting
 EMC-compatible, 31
 Mounting clip, 42, 43, 44
 Mounting clip, 16
 Mounting, 42, 43, 44
 Mounting cut-out
 Dimensions, 39
 Preparing, 39
 Mounting location, 38
 Mounting position, 37
 Mouse properties, 76
 MP 277
 Applications, 9
 Clearance, 39
 Displaying information, 100
 Interfaces, 45
 Mounting, 41
 Operator control, 61
 Switching on, 58
 Testing, 58
 MP 277 10" Key
 Bottom view, 15
 Front view, 14
 Overall dimensions, 186
 Rear view, 15
 Side view, 14
 MP 277 10" Touch
 Bottom view, 13
 Front view, 13
 Main dimensions, 185
 Rear view, 14
 Side view, 13
 MP 277 8" Key
 Bottom view, 12
 Front view, 11
 Main dimensions, 184
 Rear view, 12
 Side view, 11
 MP 277 8" Touch
 Bottom view, 10
 Front view, 10
 Main dimensions, 183
 Rear view, 11
 Side view, 10
 MP 277 Key
 Specifications, 188
 MPI
 Setting, 77, 107
 Multi-key operation, 158, 170
 Multimedia card, 63

N

- Name server, 116
- Network
 - Configure, 114
 - Logon data, 76
 - Set up, 114
 - Setting, 116
- Network & dial-up connections, 76
- Network ID, 76
- Network operation
 - Device name, 115
 - Options, 77, 119
- Nominal voltage, 40
- Non-isolated plant configuration, 49
- NOTE
 - License key, 152
- Number format, 77, 92
- Numerical
 - Key assignment, 83, 172
 - Screen keyboard, 163
- Numerical value
 - Changing, 165, 175
 - Decimal places, 164, 164
 - Display format, 174
 - Entering, 165, 175
 - Limit test, 164
 - Limit value test, 174

O

- Offline
 - Operating mode, 134
 - Test, 140, 146
- Online
 - Operating mode, 134
 - Test, 141, 146
- OP properties, 76
 - Device, 100
 - Memory monitoring, 131
 - Persistent storage, 93
 - Touch, 87
- OPC server, 21
- Open
 - Control Panel, 75
 - Selection list, 82, 171
- Operate:Control Panel, 77
- Operating
 - Control Panel, 78
 - Feedback, 159
 - Key, 170, 174
 - Loader, 71

- Operating element, 82, 171
 - Project, 157
 - With external keyboard, 158
 - With external mouse, 158
- Operating element
 - Locking, 182
 - Operating, 82, 171
 - Selecting, 82
- Operating instructions
 - Scope, 3
- Operating mode, 134
 - Changing, 134
 - Offline, 134
 - Online, 134
 - Transfer, 58, 134
- Operating system
 - Configuring, 70
 - Safety instruction, 55
 - Update using ProSave, 151
 - Updating, 149
- Operation feedback, 159
- Operator control
 - Memory card slot, 64
 - MP 277, 61
- Optical feedback, 159
- Option
 - Installing, 136, 152
 - Installing with ProSave, 152
 - Removing, 136, 152
 - Removing with ProSave, 153
- Options, 21
 - Network operation, 77, 119
- Overall dimensions
 - MP 277 10" Key, 186

P

- Password
 - Specifying, 89
- Password properties, 76, 89, 89
- Password protection, 71, 76
 - Activate, 89
 - Deactivating, 90
 - Windows CE taskbar, 71
- PC/PPI
 - Cable, 17
 - Configuring the cable, 54
 - Setting the adapter, 54
- PELV, 49
- Peripheral
 - Rated load, 56

- Plant configuration
 - Non-insolated, 49
- PLC
 - Number of connectable, 22
 - Protocol, 22
- Ports
 - MP 277 Key, 189
 - MP 277 Touch, 187
- Power failure, 147
- Power supply
 - Configuration graphic, 48
 - Connecting, 48, 49
- Printer
 - Configuration graphic, 57
 - Connecting, 57
 - Setting properties, 76
- Printer connection
 - Setting, 96
- Printer properties, 76, 96
- Printing
 - Via network printer, 113
- Process control phase, 133
- PROFIBUS
 - Setting, 77
- PROFIBUS DP
 - Setting, 107
- PROFINET, 114
 - Addressing, 114
 - Connecting, 51, 53
- PROFINET IO
 - Disabling direct keys, 112
 - Enabling direct keys, 112
 - Releasing, 76
- Project
 - Closing, 179
 - in ProTool, 135
 - In WinCC flexible, 135
 - Offline testing, 140, 146
 - Operating, 157
 - Reuse, 135, 135, 135
 - Testing online, 141, 146
 - Transferring, 133, 136
- Protection class, 40
- Protective measure
 - Static electricity, 195
- Protocol
 - PLC, 22
- Proxy
 - Server, 76, 119, 122
 - Setting, 76
- R**
 - Radiation
 - High frequency, 26
 - Radio interference, 30
 - Emission, 32
 - Rated load
 - Interface, 56
 - Rear view, 11, 12, 14, 15
 - Recipe
 - Functional scope, 20
 - Recommissioning, 133
 - Recycling, 182
 - Regional and language settings, 77, 92
 - Regional settings, 92
 - Registry information
 - Backing up, 76, 92
 - Regulations for the prevention of accidents, 25
 - Removing
 - Option, 136, 152, 153
 - Repairs, 182
 - Reset to factory setting, 136
 - Resetting to factory settings, 151
 - Restore, 76, 126
 - Restoring, 136, 147, 148
 - from external storage device, 128
 - From memory card, 76, 93
 - With ProSave, 148
 - Returns Center, 182
 - Reverse polarity protection, 49
 - RS 422/RS 485 interface
 - Configuring, 51
- S**
 - S7 transfer settings, 77
 - Safe electrical isolation, 49
 - Safety
 - Functional scope, 20
 - Standards, 27
 - Safety instruction
 - Backlighting, 95
 - Compatibility conflict, 147
 - Compressed project file, 141
 - Damage to the HMI device, 45
 - Data channel, 150
 - Direct key, 160
 - Equipotential bonding cable, 47
 - Functional problem, 56
 - High frequency radiation, 26
 - Interface, 56
 - Keyboard, 62

- License key, 147, 150
- Memory card, first use, 64
- Memory distribution, 101
- Multi-key operation, 158
- Power failure, 147
- Preventing inadvertent operation, 181
- Replacing the HMI device, 55
- Storage, 33
- Switching info text, 169, 178
- Touch screen, 62
- Transfer mode, 106, 109
- Transfer mode channel 2, 110
- Transport, 33
- Unintentional action, 62, 170
- Unintentional transfer mode, 110
- Update operating system, 55
- USB host-to-host cable, 55
- Working on the control cabinet, 25
- Safety regulations, 25
- Scaling
 - Functional scope, 19
- Scheduler
 - Functional scope, 21
- Screen
 - Functional scope, 19
- Screen keyboard, 76, 162
 - Alphanumerical, 166
 - Change layout, 79
 - Character repeat, 85
 - Configuring, 84
 - For Control Panel, 78
 - Keyboard level, 166
 - Language switching, 166
 - Numeric, 163
 - Representation types, 79
- Screen saver, 95
 - Overview of functions, 77, 77
 - Setting, 95
- Screen settings
 - Changing, 76
- Scroll back key, 82, 171
- Scroll forward key, 82, 171
- Search engine
 - Internet, 121
- SecureMode
 - Disabling, 74
 - Enabling, 74
- Security settings, 76
- Selecting
 - Operating element, 82
- Selection list, 168, 177
 - Open, 82, 171
- Service pack, 17
- Set up
 - Network, 114
- Setting
 - Backlighting, 77
 - Browser, 76
 - Computer name, 77
 - Date, 90
 - Date format, 92
 - Date/Time, 76
 - Delay time, 77, 103
 - DIP switch, 51
 - Double-click, 86
 - E-mail, 77
 - E-mail connection, 119
 - Language, 161
 - MPI, 77, 107
 - Network, 116
 - Number format, 92
 - PC/PPI adapter, 54
 - Printer connection, 96
 - Printer properties, 76
 - PROFIBUS, 77, 107
 - PROFINET IO, 76
 - Proxy, 76
 - Regional data, 92
 - Screen saver, 95
 - Time, 90
 - Time format, 92
 - Transfer mode, 138
 - UPS, 77, 104, 104
 - Volume, 77
- Setting language, 161
- Setting the time zone, 90
- Settings
 - Internet, 77
 - Language, 77
 - Regional, 77
 - S7-Transfer, 77
- Shift key, 83
- SHIFT key, 83, 172
- Shipping conditions, 33
- Shutting down
 - HMI device, 59
- Side view, 10, 11, 13, 14
- Siemens HMI input panel options, 76
- Sm@rtAccess, 21
- Sm@rtService, 21
- SMTP server, 119
- Software options, 21
- Specifications
 - Display, 187, 188

- Input device, 187, 188
- Memory, 187, 189
- MP 277 Key, 188
- MP 277 Touch, 186, 188
- Ports, 187, 189
- Supply voltage, 187, 189
- Standard operating system, 9
- Start
 - HMI device, 99
 - Transfer, 139
- Static electricity
 - Protective measures, 195
- Storage conditions, 33
- Storage device
 - Backing up to external, 126
 - Restoring from external, 128
- Strain relief, 59
- Subnet mask, 116
- Supply voltage
 - MP 277 Key, 189
 - MP 277 Touch, 187
- Switching on
 - MP 277, 58
- Symbolic value
 - Changing, 168
 - Entering, 168
- Synchronizing
 - Date and time, 91
- System, 101
- System event
 - in the online help, 194
 - Parameters, 194
- System information, 77
 - Displaying, 101
- System properties, 77
 - Device name, 115
 - General, 101
 - Memory, 101

T

- TAB key, 82, 170
- Tabulator key, 82, 170
- Tag
 - Functional scope, 19
- TCP/IP address, 116
- Temporary files
 - Backing up, 92
- Test
 - For environmental conditions, 36
- Testing
 - MP 277, 58

- Text box, 163
 - Character mode, 171
 - Normal mode, 171
- Text list
 - Functional scope, 19
- Time, 76
 - Entering, 168, 177
 - Setting, 90
 - Synchronizing, 91
- Time format, 77, 92
- Touch screen
 - Calibrating, 76, 87
 - Safety instruction, 62
- Transfer, 133, 134, 137, 141
 - Automatic, 143
 - Cancel, 58
 - Manual, 142
 - Start, 139
 - Starting automatically, 137
 - Starting manually, 137
- Transfer mode
 - Setting, 138
 - Unintentional, 110
 - Via MPI, 106
 - Via PROFIBUS DP, 106
- Transfer settings, 109
 - Channel, 109
 - Directories, 103
 - Overview of functions, 77
- Transferring
 - License key, 136
 - License key on HMI device, 154
 - Project, 133, 136
- Transferring back
 - License key, 136
- Transport damage, 41
- Trends
 - Functional scope, 21

U

- UL approval, 29
- Unintentional action, 62, 158
- Unintentional transfer mode, 110
- Update operating system, 136
- Updating
 - Operating system, 149
 - Using ProSave, 151
- UPS
 - Displaying status, 77
 - Setting, 77, 104, 104

- UPS properties
 - Configuration, 104, 104
 - Current status, 105, 105, 105, 105
- USB device
 - Connecting, 56
- Use
 - Conditions, 35
 - In residential areas, 30
 - Industrial, 30
 - With additional measures, 35
- User name, 118, 118

V

- VBScript
 - Functional scope, 21
- Volume, 97, 97
 - Setting, 77
- Volume & Sounds Properties, 77

W

- Weight
 - MP 277 Key, 188
- Weight of the MP 277 Touch, 186
- WinCC flexible
 - Internet Settings, 77
- WinCC flexible internet settings
 - E-mail, 119
- Windows CE taskbar, 70
 - Password protection, 71
- WINS, 116
 - Server, 114
- Working on the control cabinet, 25