

SIEMENS

SIMATIC HMI

HMI device OP 73, OP 77A, OP 77B (WinCC flexible)

Operating Instructions

Preface

Overview

1

Safety instructions and general notes

2

Planning use

3

Mounting and connection

4

Operator control components and LEDs

5

Configuring the operating system

6

Preparing and backing up a project

7

Operating a project

8

Operating alarms

9

Operating recipes on OP 77A and OP 77B

10

Maintenance and Service

11

Specifications

12

Appendix

A

Abbreviations

B

Order no. 6AV6691-1DA01-0AB1

Safety Guidelines

This manual contains notices you have to observe in order to ensure your personal safety, as well as to prevent damage to property. The notices referring to your personal safety are highlighted in the manual by a safety alert symbol, notices referring only to property damage have no safety alert symbol. These notices shown below are graded according to the degree of danger.

⚠ DANGER
indicates that death or severe personal injury will result if proper precautions are not taken.
⚠ WARNING
indicates that death or severe personal injury may result if proper precautions are not taken.
⚠ CAUTION
with a safety alert symbol, indicates that minor personal injury can result if proper precautions are not taken.
CAUTION
without a safety alert symbol, indicates that property damage can result if proper precautions are not taken.
NOTICE
indicates that an unintended result or situation can occur if the corresponding information is not taken into account.

If more than one degree of danger is present, the warning notice representing the highest degree of danger will be used. A notice warning of injury to persons with a safety alert symbol may also include a warning relating to property damage.

Qualified Personnel

The device/system may only be set up and used in conjunction with this documentation. Commissioning and operation of a device/system may only be performed by **qualified personnel**. Within the context of the safety notes in this documentation qualified persons are defined as persons who are authorized to commission, ground and label devices, systems and circuits in accordance with established safety practices and standards.

Prescribed Usage

Note the following:

⚠ WARNING
This device may only be used for the applications described in the catalog or the technical description and only in connection with devices or components from other manufacturers which have been approved or recommended by Siemens. Correct, reliable operation of the product requires proper transport, storage, positioning and assembly as well as careful operation and maintenance.

Trademarks

All names identified by ® are registered trademarks of the Siemens AG. The remaining trademarks in this publication may be trademarks whose use by third parties for their own purposes could violate the rights of the owner.

Disclaimer of Liability

We have reviewed the contents of this publication to ensure consistency with the hardware and software described. Since variance cannot be precluded entirely, we cannot guarantee full consistency. However, the information in this publication is reviewed regularly and any necessary corrections are included in subsequent editions.

(A)

가

Preface

Purpose of the operating instructions

This operating instruction manual provides information based on the requirements defined by DIN 8418 for mechanical engineering documentation. This information relates to the device, its place of use, transport, storage, installation, use and maintenance.

These operating instructions are intended for:

- Users
- Commissioning engineers
- Service technicians
- Maintenance technicians

Please read the section "Safety instructions and general notes" carefully.

The help integrated in WinCC flexible, the WinCC flexible Information System, contains detailed information. The Information System contains instructions, examples and reference information in electronic form.

Basic knowledge required

General knowledge of automation technology and process communication is needed to understand the operating instructions.

It is also assumed that those using the manual have experience in using personal computers and knowledge of Microsoft operating systems.

Operating instructions' range of validity

These operating instructions apply to the HMI devices OP 73, OP 77A and OP 77B in combination with the WinCC flexible software package.

Position in the information landscape

These operating instructions form part of the SIMATIC HMI documentation. The following information provides you with an overview of the SIMATIC HMI information landscape.

User manuals

- WinCC flexible Micro:
Describes basic principles of configuration using the WinCC flexible Micro Engineering System.

- WinCC flexible Compact/Standard/Advanced:
Describes basic principles of configuration using the WinCC flexible Compact Engineering System/WinCC flexible Standard/WinCC flexible Advanced
- WinCC flexible Runtime:
Describes how to commission and operate your runtime project on a PC.
- WinCC flexible Migration:
 - Describes how to convert an existing ProTool project to WinCC flexible.
 - Describes how to convert an existing WinCC project to WinCC flexible.
 - Describes how to convert an existing ProTool project including a change of the HMI device, e.g. from OP7 to OP 77B or OP7 to OP 77B.
 - Describes how to convert an existing ProTool project including a change from a graphics device to a Windows CE device.
- Communication:
 - Communication Part 1 describes the connection of the HMI device to SIMATIC PLCs.
 - Communication Part 2 describes the connection of the HMI device to third-party PLCs.

Operating instructions

- Operating instructions for SIMATIC HMI devices.
 - OP 73micro, TP 177micro
 - OP 73, OP 77A, OP 77B
 - TP 177A
 - TP 170micro, TP 170A, TP 170B, OP 170B
 - Mobile Panel 170
 - TP 270, OP 270
 - MP 270B
 - MP 370
- Operating instructions (compact) for the HMI devices SIMATIC OP 77B and Mobile Panel 170

Getting Started

- WinCC flexible for first time users:
Based on an example project, this is a step-by-step introduction to the basics of configuring screens, alarms, recipes and screen navigation.
- WinCC flexible for advanced users:
Based on an example project, this is a step-by-step introduction to the basics of configuring logs, project reports, scripts, user management and multilingual projects and integration in STEP 7.
- WinCC flexible options:
Based on an example project, this is a step-by-step introduction to the basics of configuring the WinCC flexible Sm@rtServices, Sm@rtAccess and OPC Server options.

Online availability

Technical documentation on SIMATIC products and SIMATIC systems is available in PDF format in various languages at the following addresses:

- SIMATIC Guide Technische Dokumentation in Deutsch:
["http://www.ad.siemens.de/simatic/portal/html_00/techdoku.htm"](http://www.ad.siemens.de/simatic/portal/html_00/techdoku.htm)
- SIMATIC Guide for Technical Documentation in English:
["http://www.ad.siemens.de/simatic/portal/html_76/techdoku.htm"](http://www.ad.siemens.de/simatic/portal/html_76/techdoku.htm)

Conventions

Configuration and runtime software differ with regard to their names as follows:

- "WinCC flexible 2004," for example, refers to the configuration software.
 The term "WinCC flexible" is used in a general context. The full name, for example "WinCC flexible 2004", is always used when it is necessary to differentiate between different versions of the configuration software.
- "WinCC flexible Runtime" refers to the runtime software that can run on HMI devices.

Text is highlighted as follows to simplify reading the operating instructions:

Notation	Scope
"Add screen"	<ul style="list-style-type: none"> • Terminology that appears in the user interface, e.g., dialog names, tabs, buttons, menu entries • Inputs required, e.g., limit values, tag values • Path information
"File > Edit"	Operational sequences, e.g., menu commands, context menu commands
<F1>, <Alt+P>	Keyboard operation

Please observe notes labeled as follows:

Note

Notes contain important information concerning the product, its use or a specific section of the documentation to which you should pay particular attention.

Registered trademarks

Names labeled with a ® symbol are registered trademarks of the Siemens AG. Other names used in this documentation may be trademarks, the use of which by third parties for their own purposes could violate the rights of the owner.

- HMI®
- SIMATIC®
- SIMATIC HMI®
- SIMATIC ProTool®
- SIMATIC WinCC®
- SIMATIC WinCC flexible®
- SIMATIC OP 73®
- SIMATIC OP 77A®
- SIMATIC OP 77B®

Representatives and offices

If you have any further questions relating to the products described in this manual, please contact your local representative at the SIEMENS branch nearest you.

Find your contact partner at:

["http://www.siemens.com/automation/partner"](http://www.siemens.com/automation/partner)

Training center

Siemens AG offers a variety of training courses in order to familiarize you with automation systems. Please contact your regional training center or the central training center in D-90327 Nuremberg, Germany.

Phone: +49 (911) 895-3200

Internet: ["http://www.sitrain.com"](http://www.sitrain.com)

Service & support on the Internet

Service & Support offers online services for additional, comprehensive information on SIMATIC products at

["http://www.siemens.com/automation/support"](http://www.siemens.com/automation/support):

- The newsletter offers you the latest information about your products.
- A large document base is available using our Service & Support search engine.
- A forum for global exchange of information by users and experts
- Current product information, FAQs and downloads
- Your local Automation & Drives representative
- Information about field service, repairs, spare parts and much more under the heading "Services"

Table of contents

	Preface	3
1	Overview.....	13
1.1	Product overview	13
1.2	Design of the OP 73micro HMI device.....	14
1.3	Design of the OP 77A HMI device	15
1.4	Design of the OP 77B HMI device	16
1.5	Accessories.....	17
1.6	Other	17
1.7	Range of HMI software functions.....	18
1.8	Communication of OP 73 and OP 77A with Controllers	20
1.9	OP 77B communication with PLCs	21
2	Safety instructions and general notes	23
2.1	Safety Information	23
2.2	Standards, Certificates and Approvals	24
2.3	Notes about usage	26
2.4	Electromagnetic compatibility	29
2.5	Transport and storage conditions	31
3	Planning use.....	33
3.1	Mounting information	33
3.2	Mounting positions and fixation.....	35
3.3	Preparing for mounting	36
3.4	Information on insulation tests, protection class and degree of protection.....	39
3.5	Nominal voltages	40
4	Mounting and connection.....	41
4.1	Checking the package contents.....	41
4.2	Mounting and connecting the OP 73	41
4.2.1	Mounting the HMI device	41
4.2.2	Connecting the HMI device.....	42
4.2.2.1	Interfaces	43
4.2.2.2	Connecting the equipotential bonding circuit.....	44
4.2.2.3	Connecting the PLC.....	46
4.2.2.4	Connecting the configuration computer	46
4.2.2.5	Connecting the power supply.....	47
4.2.3	Switching on power and testing the HMI	49

4.3	Mounting and connecting the OP 77A and OP 77B	51
4.3.1	Mounting the HMI device	51
4.3.2	Connecting the HMI device	52
4.3.2.1	Interfaces	53
4.3.2.2	Connecting the equipotential bonding circuit	54
4.3.2.3	Installing the equipotential circuit	55
4.3.2.4	Connecting the PLC	56
4.3.2.5	Connecting the configuration computer	58
4.3.2.6	Wiring I/O to OP 77B.....	59
4.3.2.7	Connecting the power supply.....	60
4.3.3	Switching on power and testing the HMI.....	62
5	Operator control components and LEDs.....	65
5.1	Control elements on the OP 73 front panel.....	65
5.2	Operator control components and LEDs on the front panel of OP 77A and OP 77B.....	66
5.3	Additional elements on the OP 77A and OP 77B	67
5.3.1	Use of a memory card on OP 77B	68
5.3.2	Labeling the function keys of OP 77A and OP 77B	70
5.3.3	Setting the DIL switch	71
6	Configuring the operating system	73
6.1	Configuring the operating system of the OP 73	73
6.1.1	Overview	73
6.1.2	"Info/Settings" menu.....	74
6.1.2.1	Overview	74
6.1.2.2	Setting screen contrast	76
6.1.2.3	Displaying information about the HMI	76
6.1.2.4	Viewing information about the version of the HMI image	77
6.1.3	"Settings" menu.....	77
6.1.3.1	Overview	77
6.1.3.2	Setting the delay	78
6.1.3.3	Setting the screen saver	78
6.1.3.4	Assigning, changing and deleting passwords.....	79
6.1.3.5	Configuring the data channel	80
6.2	Configuring the OP 77A and OP 77B operating system.....	84
6.2.1	Overview	84
6.2.2	"Info/Settings" menu.....	85
6.2.2.1	Overview	85
6.2.2.2	Setting screen contrast	86
6.2.2.3	Displaying information about the HMI	87
6.2.2.4	Viewing information about the version of the HMI image	87
6.2.3	"Settings" menu.....	88
6.2.3.1	Overview	88
6.2.3.2	Setting the delay	89
6.2.3.3	Setting the Screen Saver	89
6.2.3.4	Changing regional settings for OP 77B.....	90
6.2.3.5	Assigning, editing and deleting passwords.....	90
6.2.3.6	Backup and restore functions for OP 77B.....	92
6.2.3.7	Configuring the data channel	92
6.2.4	"Printer Settings" menu of OP 77B	99
6.2.4.1	Overview	99
6.2.4.2	Set printer language.....	100
6.2.4.3	Setting the paper format.....	100
6.2.4.4	Setting the print orientation	101

6.2.4.5	Setting the print mode.....	101
7	Preparing and backing up a project	103
7.1	Overview	103
7.1.1	Setting the operating mode.....	105
7.1.2	Reusing existing projects	106
7.1.3	Data Transfer Options.....	106
7.2	Transfer.....	107
7.2.1	Overview	107
7.2.2	Starting the transfer manually	107
7.2.3	Starting the transfer automatically	108
7.2.4	Testing a project	110
7.2.5	Uploading a project from OP 77B	111
7.3	Backup and restore.....	113
7.3.1	Overview	113
7.3.2	Backup and Restore via WinCC flexible	114
7.3.3	Backup and Restore via ProSave	116
7.3.4	Backup and restore operations with MMC on OP 77B	118
7.4	Updating the operating system	121
7.4.1	Overview	121
7.4.2	Updating the Operating System Using WinCC flexible.....	122
7.4.3	Updating the Operating System Using ProSave.....	123
8	Operating a project	125
8.1	Operating a project on OP 73	125
8.1.1	Overview	125
8.1.2	Setting the project language	127
8.1.3	Entries and help within a project.....	127
8.1.3.1	Overview	127
8.1.3.2	Entering and editing numerical and alphanumerical values	129
8.1.3.3	Entering and editing symbolic values	133
8.1.3.4	Entering and modifying date and time	133
8.1.3.5	Displaying infotext.....	134
8.1.4	Project security	135
8.1.4.1	Overview	135
8.1.4.2	User logon.....	137
8.1.4.3	User logoff.....	138
8.1.4.4	Creating users.....	138
8.1.4.5	Changing user data.....	140
8.1.4.6	Deleting a user	141
8.1.5	Closing the project	142
8.2	Operating a project on OP 77A and OP 77B.....	143
8.2.1	Overview	143
8.2.2	Setting the project language	145
8.2.3	Entries and help within a project.....	146
8.2.3.1	Overview	146
8.2.3.2	Entering and editing numerical and alphanumerical values	147
8.2.3.3	Entering and editing symbolic values	151
8.2.3.4	Entering and modifying date and time	152
8.2.3.5	Viewing infotext.....	152
8.2.4	Project security	153
8.2.4.1	Overview	153
8.2.4.2	User logon.....	156
8.2.4.3	User logoff.....	157

8.2.4.4	Creating users	158
8.2.4.5	Changing user data	159
8.2.4.6	Deleting a user	161
8.2.5	Closing the project	162
9	Operating alarms	163
9.1	Overview	163
9.2	Alarms on the OP 73	165
9.2.1	Displaying alarms	165
9.2.2	Acknowledge alarm	167
9.2.3	Edit alarm	167
9.3	Alarms on the OP 77A and OP 77B	168
9.3.1	"Error" alarm class	168
9.3.2	Viewing alarms	169
9.3.3	Acknowledge alarm	171
9.3.4	Edit alarm	171
10	Operating recipes on OP 77A and OP 77B	173
10.1	Overview	173
10.2	Structure of a recipe	174
10.3	Recipes in the Project	176
10.4	Recipe view	178
10.5	Operating the Simple Recipe View	179
10.6	Creating a Recipe Data Record	182
10.7	Editing a Recipe Data Record	183
10.8	Deleting a Recipe Data Record	184
10.9	Reading a Recipe Data Record from the PLC	185
10.10	Transferring a Recipe Data Record to the PLC	186
10.11	Exporting and Importing Recipe Data Records on the OP 77B	187
11	Maintenance and Service	189
11.1	Maintenance and service	189
11.2	Servicing and spare parts	190
12	Specifications	191
12.1	Dimension drawings	191
12.1.1	Dimension Drawings of the OP 73	191
12.1.2	Dimension Drawings of OP 77A and OP 77B	192
12.2	Specifications	193
12.2.1	Specifications of the OP 73	193
12.2.2	Specifications of the OP 77A	194
12.2.3	Specifications of the OP 77B	195
12.3	Description of interfaces	197
12.3.1	Power supply	197
12.3.2	RS 485 (IF 1B) on OP 73	197
12.3.3	RS 485 (IF 1B) on OP 77A	198
12.3.4	RS 422/RS 485 (IF 1B) on OP 77B	198
12.3.5	RS 232 (IF 1A) on OP 77B	199

12.3.6	USB on OP 77B	200
A	Appendix.....	201
A.1	ESD Directives	201
A.2	System alarms	203
B	Abbreviations.....	227
	Glossary	229
	Index.....	235

Overview

1.1 Product overview

Big changes in small plants - the new graphic HMI devices of the 70 series

The new OP 73 and OP 77 operator panels represent low-cost devices in the class of graphic HMI devices for first-time user. These devices offer many options ranging from a fully graphical 3" or 4.5" display unit, to their configuration in WinCC flexible in up to 32 engineering and online languages, including Asian and Cyrillic characters. The new operator panels are therefore highly suitable for small-scale HMI tasks.

OP 73 and OP 77 replace the text-based OP3 and OP7. Existing OP3/OP7 projects in WinCC flexible can be migrated to OP73/OP77 projects. The previous engineering work is thus retained.

1.2 Design of the OP 73micro HMI device

Views of the HMI device

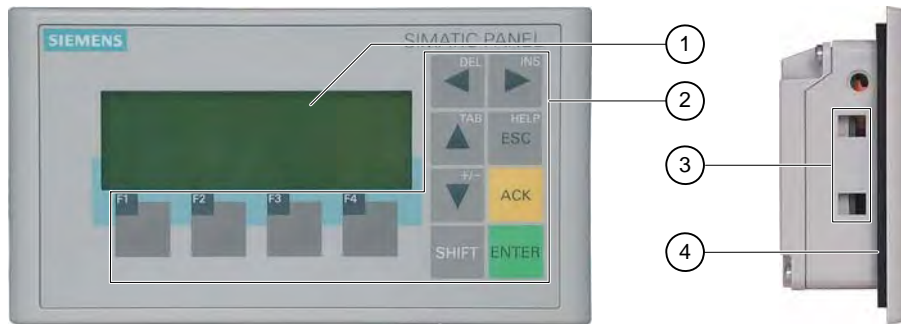

Figure 1-1 Front and side view

- ① Display
- ② Membrane keyboard
- ③ Clamping recess
- ④ Mounting seal



Figure 1-2 Bottom view

1.3 Design of the OP 77A HMI device

Views of the HMI device

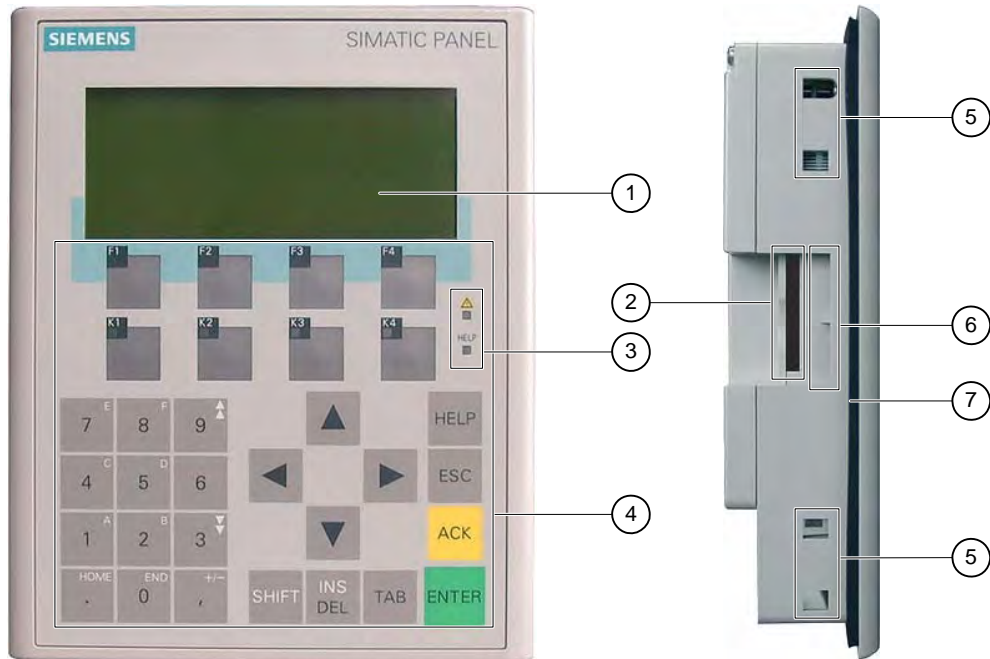

Figure 1-3 Front and side view

- ① Display
- ② Construction-related opening – not a slot for a memory card
- ③ LED display
- ④ Membrane keyboard
- ⑤ Clamping recess
- ⑥ Guides for the labeling strips
- ⑦ Mounting seal



Figure 1-4 Bottom view

1.4 Design of the OP 77B HMI device

Views of the HMI device

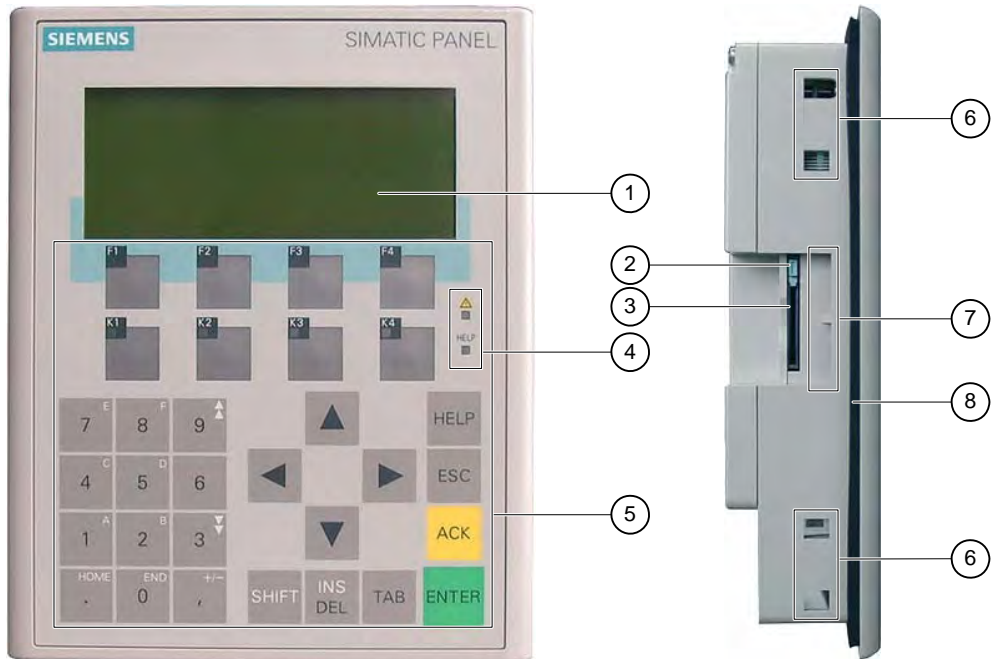

Figure 1-5 Front and side view

- ① Display
- ② Memory card holder
- ③ MMC slot
- ④ LED display
- ⑤ Membrane keyboard
- ⑥ Clamping recess
- ⑦ Guides for the labeling strips
- ⑧ Mounting seal



Figure 1-6 Bottom view

1.5 Accessories

Accessory kit

The accessory kit contains the following:

- A terminal block for the power supply
- Two mounting clamps for installing an OP 73
- Four mounting clamps for installing an OP 77A or OP 77B

Additional documents may be enclosed with the accessory kit.

Memory card

For the OP 77B:

An MMC (Multi Media Card), tested and approved by Siemens AG, can be used as an external storage medium. The memory card is an option and can be ordered separately.

NOTICE
The MMC of the SIMATIC S7 controller cannot be used.

1.6 Other

PC-PPI adapter for OP 73 and OP 77A

For the conversion from RS 232 to RS 485, order the PC-PPI adapter, order no. 6ES7 901- 3CB30-0XA0, from Siemens AG. You also need the PC-PPI adapter to update the operating system, for example. The PC-PPI adapter is also used for file transfers.

RS 232-TTY converter for OP 77B

To convert RS 232 to TTY, you can order the TTY-RS 232 converter, order no. 6ES5 734-1BD20, from Siemens AG.

Labeling strips for OP 77A and OP 77B

Labeling strips are not supplied as options. The labeling strips can be produced with the help of a template. The templates for the labeling strips are in the "SLIDE_OP77B.DOC" file on the "WinCC flexible" installation CD in the "\Support\Documents" folder. Pay attention to the information provided in the file.

1.7 Range of HMI software functions

General

The tables below show the objects which can be integrated in a project for an OP 73, OP 77A and OP 77B.

Note

The specified values are maximum values of the individual objects. Simultaneous use of multiple objects with their maximum value can lead to problems in the active project.

Alarms

Object	Specification	OP 73	OP 77A	OP 77B
Alarm	Number of discrete alarms	500	1000	1000
	Length of the alarm text	80 characters		
	Number of tags in an alarm	max. 8		
	Display	Alarm view, alarm window		
	Acknowledge single error alarms	Yes		
	Acknowledge several error alarms simultaneously (group acknowledgement)	Yes		
	Edit alarm	Yes		
	Alarm indicator	Yes	No	No
Volatile alarm buffer	Alarm buffer capacity	256		
	Simultaneously queued alarm events	max. 16	max. 64	max. 64
	View alarm	Yes		
	Delete alarm buffer	Yes		
ALARM_S	View SIMATIC S7 alarms	No	No	Yes

Tags, values and lists

Object	Specification	OP 73	OP 77A	OP 77B
Tags	Number	1000		
Limit-value monitoring	Input	Yes		
Linear Scaling	Input/Output	Yes		
Text lists	Number	150	300	300

Screens

Object	Specification	OP 73	OP 77A	OP 77B
Screen	Number	500		
	Fields per screen	20	30	30
	Tags per screen	20	30	30
	Complex elements per screen (bar graph, for example)	5		
	Template	Yes		

Recipes

The specified values are maximum values and should not be used additively. For example, you can create 5 recipes each with 20 records and 20 entries for OP 77A.

Object	Specification	OP 73	OP 77A	OP 77B
Recipe	Number	–	10	100
	Data records per recipe	–	20	200
	Entries per recipe	–	50	200
	Recipe screens	–	No	Yes

Infotext

Object	Specification	OP 73	OP 77A	OP 77B
Infotext	Length (no. of characters)	320		
	For alarms	Yes		
	For screens	Yes		
	For screen objects (e.g. IO fields)	Yes		
	For recipes	No	No	Yes
	Help indicator	Yes	No	No

Additional functions

Object	Specification	OP 73	OP 77A	OP 77B
Monitor settings	Contrast	Yes		
Screen saver	–	Yes		
Language switching	Number of languages	5		
Graphic objects	Graphics	Yes		
Text objects	–	1000	1000	2500
Security	Number of users	25	50	50
Print	Protocols	No		Yes
	Hardcopy of the screen content	No		Yes
	Alarm logging	No		Yes

1.8 Communication of OP 73 and OP 77A with Controllers

Number of connections

Table 1-1 Number of controllers connected to OP 73 and OP 77A

Interconnection	OP 73	OP 77A
Number with MPI/PROFIBUS DP	2 (on the same bus)	4 (on the same bus)

Siemens controllers

The following table shows the Siemens controllers and protocols or profiles that can be used for OP 73 and OP 77A:

Controller	Protocol/Profile	OP 73	OP 77A
SIMATIC S7-200	<ul style="list-style-type: none"> MPI¹ 	yes	yes
SIMATIC S7-300/400	<ul style="list-style-type: none"> MPI PROFIBUS DP up to 1.5 Mbps PROFIBUS DP up to 12 Mbps 	yes yes no	yes yes no

1 Set the "DP" profile in WinCC flexible if you need a transmission rate of 9.6 kbps.

1.9 OP 77B communication with PLCs

Number of connections

Table 1-2 Number of PLCs connected to OP 77B

Interconnection	OP 77B
Number with MPI/PROFIBUS DP	4 (similar PLCs)

Siemens PLCs

The following table shows which Siemens PLCs can be used for OP 77 B.

Controller	Protocol
SIMATIC S5	<ul style="list-style-type: none"> • AS 511, via adapter and converter • PROFIBUS DP up to 12 Mbps
SIMATIC S7-200	<ul style="list-style-type: none"> • MPI¹
SIMATIC S7-300/400	<ul style="list-style-type: none"> • MPI • PROFIBUS DP up to 12 Mbps
SIMATIC 500/505	<ul style="list-style-type: none"> • NITP • PROFIBUS DP up to 12 Mbps

1 Set the "DP" profile in WinCC flexible if you need a transmission rate of 9.6 kbps.

PLCs from other manufacturers

The following table shows which third-party PLCs can be used for OP 77 B.

Controller	Protocol
Allen-Bradley PLC series SLC500, SLC501, SLC502, SLC503, SLC504, SLC505, MicroLogix	<ul style="list-style-type: none"> • DF1 ^{1) 3)} • DH+ via DF1 gateway (KF2 module)^{2) 3)} • DH485 via DF1 gateway (via KF3 module)³⁾ • DH485 ³⁾
Allen-Bradley PLC series PLC5/11, PLC5/20, PLC5/30, PLC5/40, PLC5/40L, PLC5/60, PLC 5/60L, PLC5/80	<ul style="list-style-type: none"> • DF1³⁾ • DH+ via DF1³⁾
GE Fanuc Automation PLC series 90-30, 90-70, 90-Micro	SNP ³⁾
LG Industrial Systems (Lucky Goldstar)/IMO PLC series GLOFA-GM/G4, G6, G7M	Dedicated communication ³⁾
Mitsubishi Electric PLC series MELSEC FX, MELSEC FX0	FX ³⁾
Mitsubishi Melsec PLC series FX, A, Ans, Q, QnAS	Protocol 4 ³⁾
OMRON PLC series SYSMAC C, SYSMAC CV, SYSMAC CS1, SYSMAC alpha, CP	Hostlink/Multilink (SYSMAC Way) ³⁾
Schneider Automation (Modicon) PLC series Modicon 984, TSX Quantum, TSX Compact	Modbus RTU ³⁾
Telemecanique PLC series: <ul style="list-style-type: none"> • TSX 7 with P47 411 • TSX 7 with P47/67/87/107 420 • TSX 7 with P47/67/87/107 425 • Module TSX SCM 21.6 with the aforementioned TSX 7 CPUs • TSX 17 with module SCG 1161 • TSX 37 (Micro) • TSX 57 (Premium) 	Uni-Telway ³⁾

- 1) Applies to controllers SLC503, SLC504, SLC505, MicroLogix
- 2) Applies to controllers SLC504 over DF1.
- 3) Activate the "Enable (Remote off)" function under "Channel 1 serial" in the "Transfer Settings".

Safety instructions and general notes

2.1 Safety Information

Working on the cabinet

 WARNING
Open equipment The HMI device is an open equipment. This means that the HMI device may only be installed in cubicles or cabinets, whereby the device can be operated from the front panel. Access to the cubicle or cabinet in which the HMI device is installed should only be possible by means of a key or tool and for personnel who have received instruction or are authorized.
Danger, high voltage Opening the cabinet will expose high voltage parts. Contact with these parts could be fatal. Switch off the power supply to the cabinet before opening it.

Hazardous areas

When operating the HMI device in hazardous areas the following warning applies.

 WARNING
Explosion Hazard Do not disconnect while circuit is live unless area is known to be non-hazardous. Substitution of components may impair suitability for Class I, Division 2 or Zone 2.

High frequency radiation

NOTICE
Unintentional operating situations High frequency radiation, from mobile phones for example, can cause unintentional operating situations.

See also

Connecting the HMI device (Page 52)

2.2 Standards, Certificates and Approvals

Valid approvals

 CAUTION
Valid approvals The overview below provides information on available approvals The HMI device itself is certified as shown on the label on its rear panel.

CE approval



The automation system meets the general and safety-related requirements of the following EC directives and conforms to the harmonized European standards (EN) for programmable logic controllers published in the official gazettes of the European Union:

- 89/336/EEC "Electromagnetic Compatibility" (EMC guideline)
- 94/9/EG "Equipment and protective systems intended for use in potentially explosive atmospheres" (ATEX).

EC declaration of conformity

The EC declarations of conformity are kept available for the responsible authorities at the following address:

Siemens Aktiengesellschaft
Automation & Drives
A&D AS RD ST PLC
PO Box 1963
D-92209 Amberg

UL certification



Underwriters Laboratories Inc. conforming to

- UL 508 (Industrial Control Equipment)
- CSA C22.2 No. 142, (Process Control Equipment)

or



Underwriters Laboratories Inc. conforming to

- UL 508 (Industrial Control Equipment)
- CSA C22.2 No. 142, (Process Control Equipment)
- UL 1604 (Hazardous Location)
- CSA-213 (Hazardous Location)

Approved for use in

- Class I, Division 2, Group A, B, C, D or
- Class I, Zone 2, Group IIC or
- non-hazardous locations

FM Approval



Factory Mutual Research (FM) conforming to

- Approval Standard Class Number 3611, 3600, 3810

Approved for use in

- Class I, Division 2, Group A, B, C, D T4
- Class I, Zone 2, Group IIC T4

Ex approval



In compliance with EN 50021 (Electrical apparatus for potentially explosive atmospheres;
Type of protection "n")

- II 3 G/D EEx nA II T4
- IP65
- 04 ATEX 1297X

Tick-mark for Australia



The HMI device fulfills the requirements of standard AS/NZS 2064 (Class A).

IEC 61131

The HMI device fulfills the requirements and criteria conforming to IEC 61131-2, Programmable Logic PLCs, Part 2: Operating resource requirements and tests.

2.3 Notes about usage

Use in industry

The HMI device is designed for industrial use. The following standards are met:

- Requirements of the emission of interference EN 61000-6-4: 2001
- Requirements for noise immunity EN 61000-6-2: 2001

Residential use

If the HMI device is used in a residential area, you must take measures to achieve Limit Class B conforming to EN 55011 for RF interference.

Suitable measures to achieve Limit Class B for suppression of radio interference include:

- Installation of the HMI device in a grounded control cabinet
- Use of filters in electrical supply lines

Use in potentially explosive atmosphere, Zone 2



 DANGER
Risk of explosion
Operate the HMI device only in a Zone 2 potentially explosive atmosphere if it has been identified as approved for such environments.



Figure 2-1 Explosion protection label

- II 3 G/D EEx nA II
- IP65
- 04 ATEX 1297X

 WARNING
Personal injury and property damage can occur.
Personal injury and property damage can occur in potentially explosive atmospheres if an electric plug is disconnected from the HMI device while the system is in operation.
In potentially explosive atmospheres, always turn off power to the HMI device before disconnecting any connectors.

Potentially explosive atmosphere, Zone 2

Potentially explosive atmospheres are organized by zones. The zones are classified according to the probability of the presence of an explosive atmosphere.

Zone	Risk of explosion	Example
2	Infrequent and brief development of an explosive gas atmosphere	Areas around flanged pipe joints with flat gaskets in closed rooms
Safe zone	no	<ul style="list-style-type: none"> • Outside Zone 2 • Standard applications of distributed IO

 WARNING
<p>Observe the degree of protection</p> <p>The HMI device must be installed in a metal enclosure or in a cabinet. The minimum degree of protection of these is IP54 (conforming to EN 60529). Make allowances for the ambient conditions under which you install the HMI device. The enclosure must have a manufacturer's declaration for Zone 2 (conforming to EN 50021).</p>

Special conditions for operation in potentially explosive atmospheres of Zone 2

- In situations where the temperature on the cable or at the cable inlet of this enclosure exceeds 70° C or the temperature on the wire branching point exceeds 80° C under operating conditions, the properties of the cables used must ensure that these can withstand the actually measured temperatures.
- The cable inlets must be compliant with the required degree of protection (conforming to 50021.)
- All peripheral devices connected to the HMI device must be certified conforming to explosion protection types EEx nA or EEx nC.
- Measures must be taken to prevent transient voltages from causing the voltage to exceed its nominal value by more than 40%.
- Ambient temperature range: 0° C ... 50° C vertical
- The temperature of the HMI device's cabinet surface should not exceed 60° C.
- The HMI device should be switched off immediately and replaced if damaged.

Such damage might be:

 - Tears or detachment of individual membranes
 - A tear in proximity to the viewing window

- A label with the following warning must be attached to the inside of the switch cabinet/cubing at a place that is clearly visible upon opening:

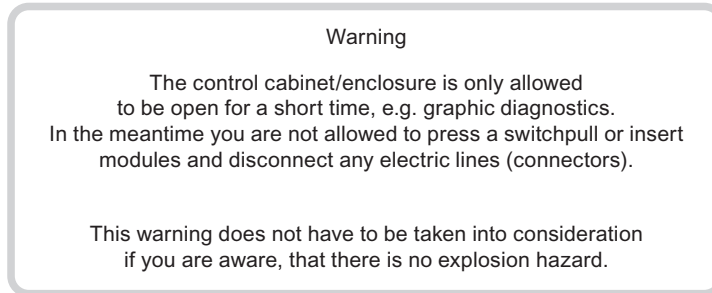

List of approved HMI devices

The list of approved HMI devices is available on the Internet under:

["http://www4.ad.siemens.de/view/cs"](http://www4.ad.siemens.de/view/cs)

under article ID 13702947.

Further information

The "HMI device in potentially explosive atmospheres of Zone 2 and Zone 22" flyer is part of the package and must be complied with.

Maintenance

Defective HMI devices must be returned to the manufacturer for repair. Repair may only be carried out by the manufacturer at his site.

Location of the manufacturer:

Siemens AG
Automation & Drives
Werner-von-Siemens-Straße 50
92224 Amberg
Germany

Approval

Note

HMI devices with approval to II 3 G EEx nA II T4 may only be used on SIMATIC systems of device category 3.

2.4 Electromagnetic compatibility

Introduction

The HMI device fulfills requirements of the EMC Directive of the domestic European market and other requirements.

EMC-compliant installation of HMI devices

An EMC-compliant installation of the HMI device and the use of interference-proof cables form the basis of trouble-free operation. The "Directives for interference-free installation of PLCs" and the "PROFIBUS Networks" manual also apply for the installation of the HMI device.

Pulse-shaped interference

The following table shows the EMC properties of the modules with respect to pulse-shaped interference. A requirement for this is that the HMI device meets the specifications and directives regarding electrical installation.

Table 2-1 Pulse-shaped interference

Pulse-shaped interference	Tested with	Corresponds to test intensity
Electrostatic discharge conforming to IEC 61000-4-2	Air discharge: 8 kV Contact discharge: 4 kV	3
Burst pulses (high-speed transient interference) conforming to IEC 61000-4-4	2 kV power supply cable 2 kV signal cable, > 30 m 1 kV signal cable, < 30 m	3
High-power surge pulses conforming to IEC 61000-4-5, external protective circuit required (refer to S7 300 PLC, Installation, chapter "Lightning and overvoltage protection").		
<ul style="list-style-type: none"> Asymmetric coupling 	2 kV power cable DC voltage with protective elements 2 kV signal/data cable, > 30 m, with protective elements as required	3
<ul style="list-style-type: none"> Asymmetric coupling 	1 kV power cable DC voltage with protective elements 1 kV signal cable, > 30 m, with protective elements as required	3

Sinusoidal interference

The table below shows the EMC properties of the modules with respect to sinusoidal interference. A requirement for this is that the HMI device meets the specifications and directives regarding electrical installation.

Table 2-2 Sinusoidal interference

Sinusoidal interference	Test values	Corresponds to test intensity
RF interference (electromagnetic fields) <ul style="list-style-type: none"> • conforming to IEC 61000-4-3 • conforming to IEC 61000-4-3 	10 V/m with 80 % amplitude modulation of 1 kHz in the range from 80 MHz to 1 GHz and 1.4 GHz to 2 GHz 10 V/m with 50% pulse modulation at 900 MHz 10 V/m with 50% pulse modulation at 1.89 GHz	3
RF interference current on cables and cable shielding conforming to IEC 61000-4-6	Test voltage 10 V with 80% amplitude modulation of 1 kHz in the range from 9 kHz to 80 MHz	3

Emission of radio interference

Emission of electromagnetic interference conforming to 55011, Limit value class A, Group 1, measured at a distance of 10 m:

From 30 to 230 MHz	< 40 dB (V/m) quasi-peak
From 230 to 1000 MHz	< 47 dB (V/m) quasi-peak

Additional measures

Before you connect an HMI device to the public network, ensure that it is compliant with Limit Class B conforming to 55022.

2.5 Transport and storage conditions

Mechanical and climatic transport and storage conditions

The transport and storage conditions of this HMI device exceed requirements conforming to IEC 61131-2. The following specifications apply to the transport and storage of an HMI device in its original packing.

The climatic conditions comply to the following standards:

- IEC 60721-3-3, Class 3K7 for storage
- IEC 60721-3-2, Class 2K4 for transport

The mechanical requirements are compliant with EC 60721-3-2, Class 2M2.

Table 2-3 Transport and storage conditions

Type of condition	Permissible range
Drop test (in transport package)	≤ 1 m
Temperature	from -20° C to +60° C
Atmospheric pressure	from 1080 hPa to 660 hPa, corresponds to an elevation of - 1000 m to 3500 m
Relative humidity	from 10% to 90% without condensation
Sinusoidal vibration conforming to IEC 60068-2-6	5 Hz to 9 Hz: 3.5 mm 9 Hz to 150 Hz: 9.8 m/s ²
Shock conforming to IEC 60068-2-29	250 m/s ² , 6 ms, 1000 shocks

NOTICE

Ensure that no condensation (dewing) develops on or inside the HMI device after transporting it at low temperatures or after it has been exposed to extreme temperature fluctuations.

The HMI device must have acquired room temperature before it is put into operation. Do not expose the HMI device to direct radiation from a heater in order to warm it up. If dewing has developed, wait approximately four hours before you switch on the HMI device.

Prerequisite for the trouble-free and safe operation of the HMI device is proper transport and storage, installation and assembly and careful operation and maintenance.

Warranty for the HMI device is deemed void if these specifications are ignored.

Planning use

3.1 Mounting information

Mechanical and climatic conditions of use

The HMI device is intended for installation in weatherproof permanent locations. The conditions of use are compliant with requirements to DIN IEC 60721-3-3:

- Class 3M3 (mechanical requirements)
- Class 3K3 (climatic requirements)

Use with additional measures

Examples of applications where the use of the HMI device requires additional measures:

- In locations with a high degree of ionizing radiation
- In locations with extreme operating conditions resulting from situations as follows:
 - Corrosive vapors, gases, oils or chemicals
 - Electrical or magnetic fields of high intensity
- In plants requiring special monitoring features, for example:
 - Elevator systems
 - Systems in especially hazardous rooms

Mechanical ambient conditions

The mechanical ambient conditions for the HMI device are specified in the following table in terms of sinusoidal vibration.

Table 3-1 Mechanical ambient conditions

Frequency range in Hz	Continuous	Occasional
$10 \leq f \leq 58$	Amplitude 0.0375 mm	Amplitude 0.075 mm
$58 \leq f \leq 150$	0.5 g constant acceleration	Constant acceleration 1 g

Reduction of vibration

If the HMI device is subjected to greater shocks or vibrations, you must take appropriate measures to reduce acceleration or amplitudes.

We recommend fitting the HMI device to vibration-absorbent material (on metal shock absorbers, for example).

3.1 Mounting information

Check of mechanical ambient conditions

The following table provides information on the type and scope of the check of mechanical ambient conditions.

Table 3-2 Check of mechanical ambient conditions

The check includes	Test standard	Remarks
Vibrations	Vibration test conforming to IEC 60068, part 2-6 (sinusoidal)	Type of vibration: Transitional rate of the frequency: 1 octave/minute. 10 ≤ f ≤ 58, Constant amplitude 0.075 mm 58 ≤ f ≤ 150, Constant acceleration 1 g Vibration duration: 10 frequency cycles per axis in each of the three axes vertical to each other
Shock	Shock test conforming to IEC 60068, part 2-29	Type of shock: Half-sine Shock intensity: Peak value 15 g, duration 11 ms Direction of impact: 3 shocks in ± direction of axis in each of the three axes vertical to each other

Climatic ambient conditions

The HMI device may be used under the following climatic ambient conditions:

Table 3-3 Climatic ambient conditions

Ambient conditions	Permissible range	Remarks
Temperature <ul style="list-style-type: none"> • Vertical mounting • Inclined mounting 	from 0° C to 50° C from 0 °C to 40 °C	See the "Mounting positions and type of fixation" section
Relative humidity	10% to 90%	Without condensation, corresponds to a relative humidity, stress class 2 conforming to IEC 61131, part 2
Atmospheric pressure	1080 hPa to 795 hPa	Corresponds to an elevation of -1000 to 2000 m
Pollutant concentration	SO ₂ : < 0.5 ppm; relative humidity < 60%, no condensation H ₂ S: < 0.1 ppm; relative humidity < 60 %, no condensation	Test: 10 ppm; 4 days Test: 1 ppm; 4 days

3.2 Mounting positions and fixation

Mounting position

The HMI device is designed for mounting in racks, switch cabinets, switchboards and consoles. In the following, all of these mounting options are referred to by the general term "cabinet".

The HMI device is self-ventilated and approved for vertical and inclined mounting in stationary cabinets.

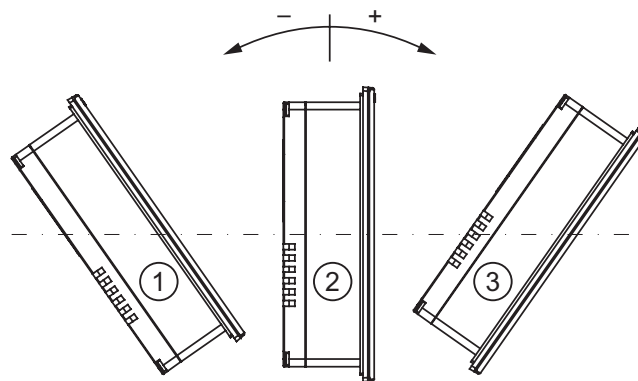

Figure 3-1 Permitted mounting positions

Permitted mounting conditions without auxiliary ventilation

	Mounting position	Deviation from the vertical
①	Inclined	$\leq -80^\circ$
②	Vertical	0°
③	Inclined	$\leq 80^\circ$

CAUTION

Impermissible ambient temperatures

Do not operate the HMI device without auxiliary ventilation if the maximum permissible ambient temperature is exceeded. The HMI device may otherwise get damaged and its approvals and warranty will be void!

Type of fixation

Spring clamps are provided for mounting the device. Hook the clamps into the recesses of the HMI device. The overall HMI device dimensions are not exceeded by this.

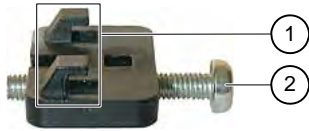

Figure 3-2 View of a mounting clamp

- ① Hook
- ② Recessed head screw

3.3 Preparing for mounting

Select the HMI device mounting location

What to observe when selecting the mounting location:

- Position the HMI device so that the display is not exposed to direct sunlight or other sources of light.
- Position the HMI device to provide an ergonomic position for the operator and select a suitable mounting height.
- Ensure that the air vents are not covered as a result of the mounting.
- Observe the permissible mounting positions for the HMI device.

Preparing the mounting cut-out

The degrees of protection are only guaranteed when the following is observed:

- Applies to OP 73:
Material thickness at the mounting cut-out: 2 mm to 4 mm
- Applies to OP 77A and OP 77B
Material thickness at the mounting cut-out: 2 mm to 6 mm
- The deviation from the plane for the panel cut-out is ≤ 0.5 mm
This condition must be fulfilled for the mounted HMI device.
- Permissible surface roughness in the area of the seal: ≤ 120 μm (friction coefficient 120)

The figure below shows the required cut-out:

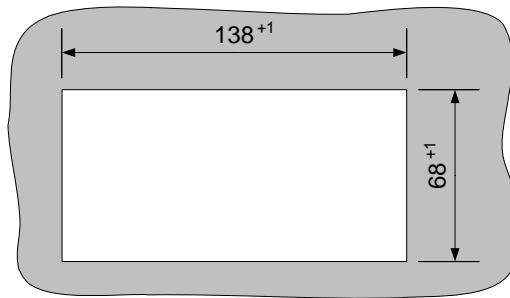

Figure 3-3 Cut-out for panel-mounting the OP 73micro

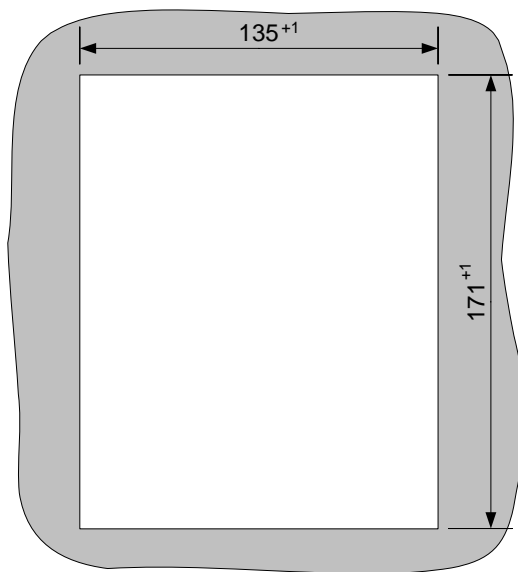

Figure 3-4 Cut-out for panel-mounting an OP 77A and OP 77B

Maintaining clearances

The following clearance is required around the HMI device in order to its ensure self-ventilation:

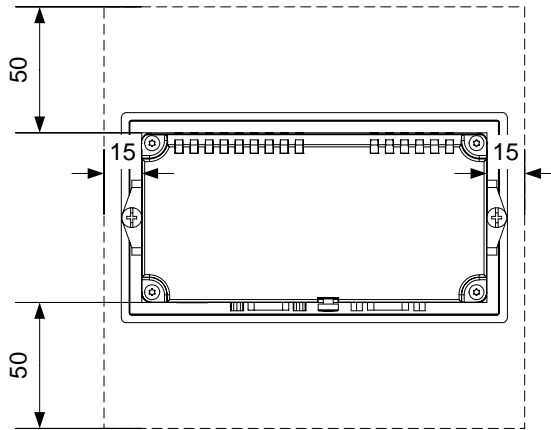

Figure 3-5 Clearance around OP 73

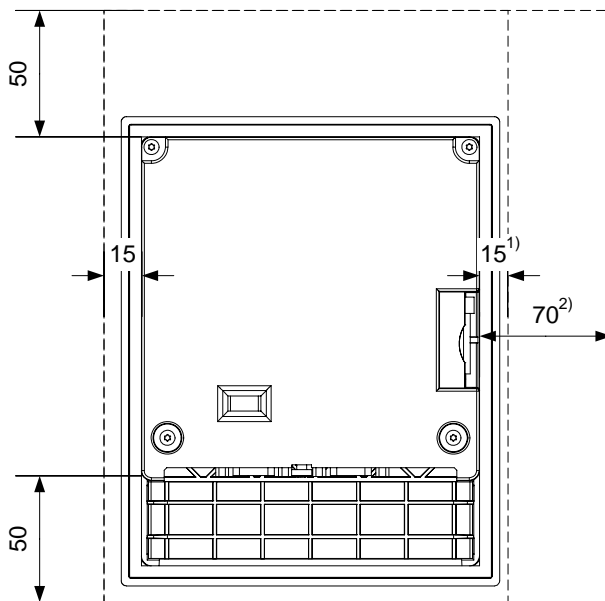

Figure 3-6 Clearance around OP 77A and OP 77B

- 1) Applies to OP 77A
- 2) Applies to OP 77B

At least 10 mm clearance is required at the rear.

NOTICE

Ensure that the maximum ambient temperature is not exceeded when mounting the device in a cabinet and especially in a closed enclosure.

3.4 Information on insulation tests, protection class and degree of protection

Test voltages

Insulation strength is demonstrated in the type test with the following test voltages conforming to IEC 61131-2:

Table 3-4 Test voltages

Circuits with a nominal voltage of U_n to other circuits or ground	Test voltage
< 50 V	500 V DC

Class of protection

Protection Class I conforming to IEC 60536, i.e. grounding conductor to profile rail required!

Protection from foreign objects and water

Degree of protection conforming to IEC 60529	Explanation
Front panel	When mounted: <ul style="list-style-type: none"> • IP65 • NEMA 4X/NEMA 12 (indoor use only)
Rear panel	IP20 Protection against touch with standard test fingers. There is no protection against ingress by water.

The degree of protection provided by the front side can only be guaranteed when the mounting seal lies completely against the mounting cut-out.

NOTICE
<p>Degree of protection IP65</p> <p>This degree of protection is only ensured if the following conditions are satisfied:</p> <ul style="list-style-type: none"> • The material strength at the mounting cut-out is at least 2 mm. • The deviation from the plane of the mounting cut-out in an installed HMI device is ≤ 0.5 mm. <p>Degree of protection NEMA 4X/NEMA 12 (indoor use only)</p> <p>This degree of protection is only ensured if the following conditions are satisfied:</p> <ul style="list-style-type: none"> • The material strength at the mounting cut-out is at least 3 mm. • The deviation from the plane of the mounting cut-out in an installed HMI device is ≤ 0.5 mm.

3.5 Nominal voltages

The following table shows the permitted nominal voltage and the corresponding tolerance range.

Table 3-5 Permitted nominal voltages

Nominal voltage	Tolerance range
+24 V DC	20.4 V to 28.8 V (-15%, +20%)

Mounting and connection

4.1 Checking the package contents

Check the package contents for visible signs of transport damage and for completeness.

NOTICE
Do not install parts damaged during shipment. In the case of damaged parts, contact your Siemens representative.

Keep the supplied documentation in a safe place. The documentation belongs to the HMI device and is required for subsequent commissioning.

4.2 Mounting and connecting the OP 73

4.2.1 Mounting the HMI device

Requirements

You need two mounting clamps from the accessories kit for the installation. The mounting seal must be available on the HMI device. If the mounting seal is damaged, order a replacement seal. The mounting seal is part of the associated service pack.

Mounting

NOTICE
Always mount the HMI device according to the instructions in this manual.

Proceed as follows:

1. Check that the mounting seal is fitted on the HMI device.
Do not install the mounting seal turned inside out. This may cause leaks in the mounting cut-out.
2. Insert the HMI device into the mounting cut-out from the front.
3. Insert the mounting clamps into the recesses on the side of the HMI device.

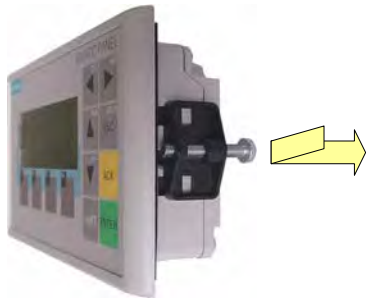

Figure 4-1 Inserting the clamp

Adjust and then fasten the clamps.

1. Tighten the clamp by screwing down the recessed head screw; permitted torque: 0.15 N/m.

NOTICE
Check the fit of the mounting seal on the front. The mounting seal must not protrude from the HMI device Otherwise, repeat steps 1 to 4.

4.2.2 Connecting the HMI device

Requirement

The HMI device must be mounted according to the specifications of these operating instructions.

Connection sequence

Connect the HMI device in the following sequence:

1. Equipotential bonding
2. Power supply
Perform a power-up test to ensure that the correct polarity of the supply voltage.
3. PLC/configuration computer as necessary
4. Peripheral equipment as necessary

NOTICE

Connection sequence

Always follow the correct sequence for connecting the HMI device. Failure to do so may result in damage to the HMI device.

Connecting the cables

When connecting the cables, ensure that you do not bend any of the contact pins.

Secure the connectors with screws.

Always use shielded data cable. Always use standard cables. Additional information can be found in the SIMATIC HMI Catalog ST 80.

The pin assignment of the interfaces is described in the specifications.

See also

Safety Information (Page 23)

4.2.2.1 Interfaces

The figure below shows the interfaces of the HMI device.

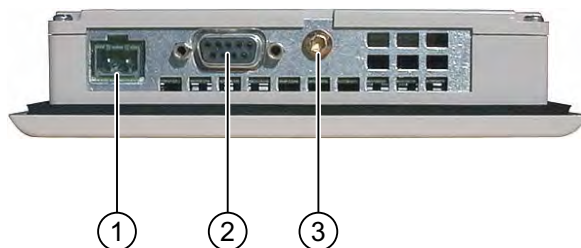

Figure 4-2 Interfaces of the HMI device

- ① Power supply connector
- ② RS 485 interface (IF 1B)
- ③ Chassis ground terminal

See also

Power supply (Page 197)

RS 485 (IF 1B) on OP 73 (Page 197)

4.2.2.2 Connecting the equipotential bonding circuit

Potential differences

Differences in potential between spatially separated system parts can lead to high equalizing currents over the data cables and therefore to the destruction of their interfaces. This situation may arise if the cable shielding is terminated at both ends and grounded at different system parts.

Potential differences may develop when a system is connected to different mains.

General requirements of equipotential bonding

Potential differences must be reduced by means of equipotential bonding in order to ensure trouble-free operation of the relevant components of the electronic system. The following must therefore be observed when installing the equipotential bonding circuit:

- The effectiveness of equipotential bonding increases as the impedance of the equipotential bonding conductor decreases or as its cross-section increases.
- If two system parts are connected to each other via shielded data lines with shielding connected to the grounding/protective conductor on both sides, the impedance of the additionally installed equipotential bonding cables may not exceed 10% of the shielding impedance.
- The cross-section of a selected equipotential bonding conductor must be capable of handling the maximum equalizing current. The best results for equipotential bonding between two cabinets were achieved with a minimum conductor cross-section of 16 mm².
- Use equipotential bonding conductors made of copper or galvanized steel. Establish a large-surface contact between the equipotential bonding conductors and the grounding/protective conductor and protect these from corrosion.
- Terminate the shielding of the data cable on the HMI device flush and near the equipotential busbar using suitable cable clamps.
- Route the equipotential bonding conductor and data cables in parallel with minimum clearance between these. See the wiring diagram.

NOTICE
Equipotential bonding conductor Cable shielding is not suitable for equipotential bonding. Always use the prescribed equipotential bonding conductors. The minimum cross-section of a conductor used for equipotential bonding is 16 mm ² . When you install MPI and PROFIBUS DP networks, always use cables with a sufficient crosssection since otherwise the interface modules may be damaged or destroyed.

Wiring diagram

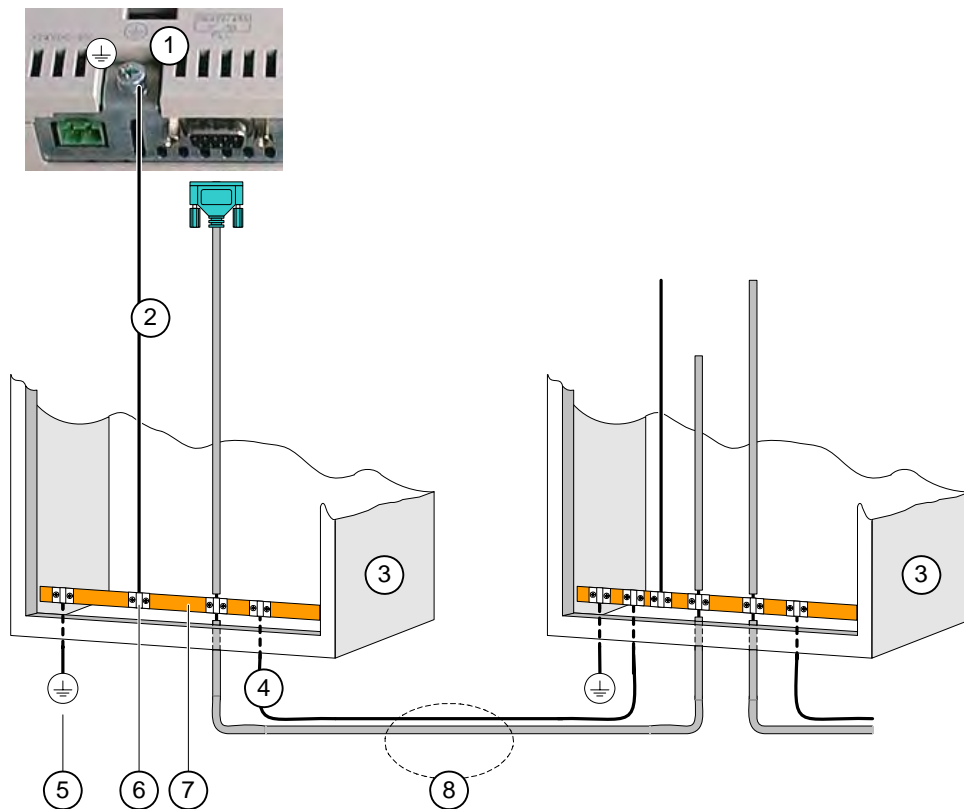

Figure 4-3 Installing the equipotential circuit

- ① Chassis ground terminal on the HMI device (example)
- ② Equipotential bonding conductor cross-section: 4 mm²
- ③ Cabinet
- ④ Equipotential bonding conductor cross-section: min. 16 mm²
- ⑤ Ground terminal
- ⑥ Cable clamp
- ⑦ Voltage bus
- ⑧ Parallel routing of the equipotential bonding conductor and data cable

See also

Electromagnetic compatibility (Page 29)

4.2.2.3 Connecting the PLC

Wiring diagram

The figure below illustrates the connection between the HMI device and PLC.



Figure 4-4 Connecting the PLC

NOTICE
Always use the approved cables for connecting a SIMATIC S7 PLC.

Standard cables are available for the connection. For further information, refer to the SIMATIC HMI Catalog ST 80.

See also

Interfaces (Page 43)

4.2.2.4 Connecting the configuration computer

Wiring diagram

The figure below illustrates the connection between the HMI device and configuration computer.

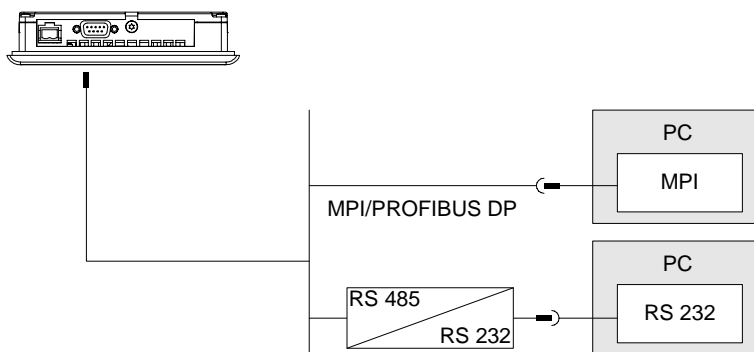

Figure 4-5 Connecting the configuration computer

See also

- Interfaces (Page 43)
- Starting the transfer manually (Page 107)
- Starting the transfer automatically (Page 108)
- Backup and Restore via WinCC flexible (Page 114)
- Backup and Restore via ProSave (Page 116)
- Updating the Operating System Using WinCC flexible (Page 122)
- Updating the Operating System Using ProSave (Page 123)

4.2.2.5 Connecting the power supply

Wiring diagram for the power supply module

The figure below illustrates the connection between the power supply and the HMI device.

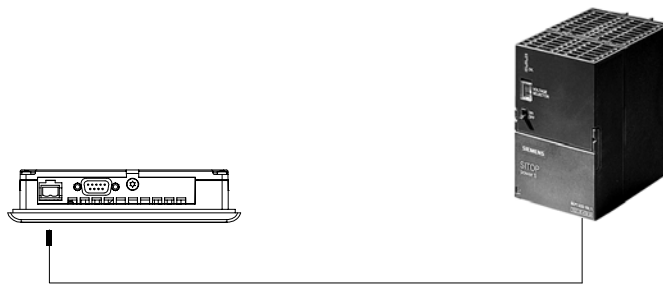

Figure 4-6 Connecting the power supply

Note when connecting

The power terminal block is included in the assembly kit and is designed for conductors with a maximum cross-section of 1.5 mm².

Connecting the terminal block

NOTICE
Damage Pressure on the screwdriver may damage the HMI device socket if the terminal block is plugged in when you tighten the screws. Always remove the terminal block to connect the wires.

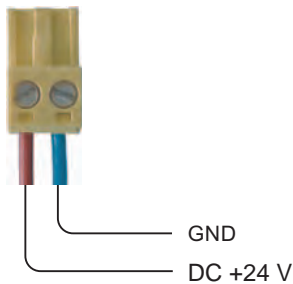

Figure 4-7 Connecting the terminal block

Connect the power supply cables to the terminal block as shown in the figure above. Ensure that the cables are not crossed. Refer to the label showing the pin-out on the rear of the HMI device.

Polarity reversal protection

The HMI device is equipped with a polarity reversal protection circuit.

Connecting the power supply

CAUTION
Ensure safe electrical insulation of the power supply. Always use power supply modules that conform to IEC 364-4-41 or HD 384.04.41 (VDE 0100, Part 410). Always use power supply modules that comply to SELV (Safety Extra-Low Voltage) and PELV (Protective Extra Low Voltage) standards. The power supply voltage must always be within the specified range to prevent malfunctions on the HMI device. Equipotential bonding Therefore, wire the 24 V output of the power supply to the equipotential circuit.

See also

Interfaces (Page 43)

4.2.3 Switching on power and testing the HMI

Procedure

Proceed as follows:

1. Plug the terminal block into the HMI device.
2. Switch on the power supply.

After power is on, the display lights up and the bootloader appears briefly.

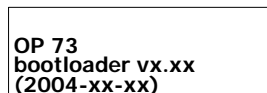

Figure 4-8 Bootloader display (example)

If the HMI device does not start, it is possible the wires on the terminal block have been crossed. Check the connected wires and change the connections if necessary. The Loader opens once the operating system has started.

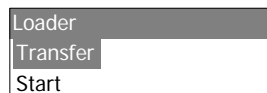

Figure 4-9 Loader view

The HMI device automatically sets transfer mode during initial startup if it does not contain any project data yet. The following dialog appears:

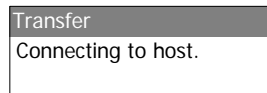



Figure 4-10 "Transfer" dialog

3. Press  to cancel the transfer.

Result

The Loader appears again.





Note

When restarting the system, a project may already be loaded on the HMI device. The system then skips transfer mode and starts the project.

Close the project by pressing the corresponding control object.

Further information on this may be available in your plant documentation.

Navigating in the Loader

Button	Action
 or 	Press one of these cursor keys to select the next entry in arrow direction.
	<ul style="list-style-type: none">• The input is confirmed.• The submenu or dialog shown below opens.
	<ul style="list-style-type: none">• Move back Returns to the next higher menu layer.• Cancel transfer mode

Function test

Perform a function test following commissioning. The HMI device is fully functional when one of the following states is indicated:

- The "Transfer" dialog is displayed.
- The Loader is displayed.
- A project is started.

Switching off the HMI device

You can switch off the HMI device in the following ways:

- Switch off the power supply.
- Disconnect the terminal block from the HMI device.

4.3 Mounting and connecting the OP 77A and OP 77B

4.3.1 Mounting the HMI device

Requirements

Four mounting clamps from the kit are needed to mount the HMI device. The mounting seal must be available on the HMI device. If the mounting seal is damaged, order a replacement seal. The mounting seal is part of the associated service pack.

Mounting

NOTICE
Always mount the HMI device according to the instructions in this manual.

Proceed as follows:

1. Check that the mounting seal is fitted on the HMI device.
Do not install the mounting seal turned inside out. This may cause leaks in the mounting cut-out.
2. Insert the HMI device into the mounting cut-out from the front.
3. Insert the mounting clamps into the recesses on each side of the HMI device.

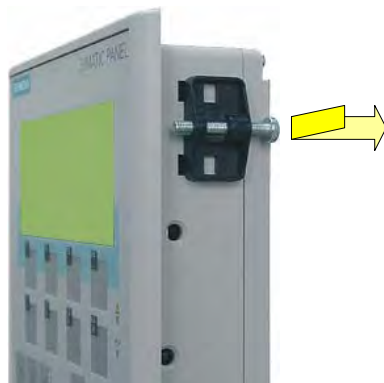

Figure 4-11 Inserting the clamp

Insert all four clamps in the HMI device and fasten them.

1. Tighten the clamps by screwing down the recessed head screw; permitted torque: 0.15 N/m.

NOTICE
Check the fit of the mounting seal on the front. The mounting seal must not protrude from the HMI device
Otherwise, repeat steps 1 to 4.

4.3.2 Connecting the HMI device

Requirement

The HMI device must be mounted according to the specifications of these operating instructions.

Connection sequence

Connect the HMI device in the following sequence:

1. Equipotential bonding
2. Power supply
Perform a power-up test to ensure that the correct polarity of the supply voltage.
3. PLC/configuration computer as necessary
4. Peripheral equipment as necessary

NOTICE
Connection sequence Always follow the correct sequence for connecting the HMI device. Failure to do so may result in damage to the HMI device.

Connecting the cables

When connecting the cables, ensure that you do not bend any of the contact pins.

Secure the connectors with screws.

Always use shielded data cable. Always use standard cables. Additional information can be found in the SIMATIC HMI Catalog ST 80.

The pin assignment of the interfaces is described in the specifications.

4.3.2.1 Interfaces

The figures below show the interfaces of the HMI device.

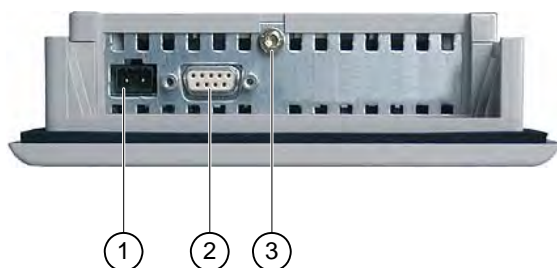

Figure 4-12 Interfaces of OP 77A

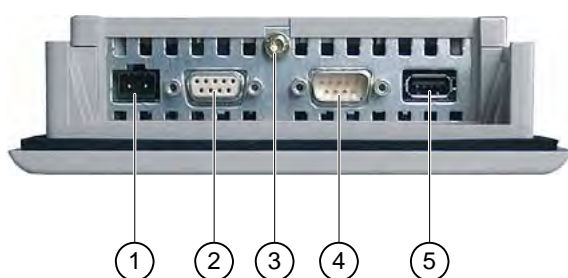

Figure 4-13 Interfaces of OP 77B

- 1 Power supply connector
- 2 RS 485 interface (IF 1B) of OP 77A
RS 422/RS 485 interface (IF 1B) of OP 77B
- 3 Chassis ground terminal
- 4 RS 232 interface (IF 1A)
- 5 USB port

See also

- Power supply (Page 197)
- RS 485 (IF 1B) on OP 73 (Page 197)
- RS 422/RS 485 (IF 1B) on OP 77B (Page 198)
- USB on OP 77B (Page 200)
- RS 232 (IF 1A) on OP 77B (Page 199)
- RS 485 (IF 1B) on OP 77A (Page 198)

4.3.2.2 Connecting the equipotential bonding circuit

Potential differences

Differences in potential between spatially separated system parts can lead to high equalizing currents over the data cables and therefore to the destruction of their interfaces. This situation may arise if the cable shielding is terminated at both ends and grounded at different system parts.

Potential differences may develop when a system is connected to different mains.

General requirements of equipotential bonding

Potential differences must be reduced by means of equipotential bonding in order to ensure trouble-free operation of the relevant components of the electronic system. The following must therefore be observed when installing the equipotential bonding circuit:

- The effectiveness of equipotential bonding increases as the impedance of the equipotential bonding conductor decreases or as its cross-section increases.
- If two system parts are connected to each other via shielded data lines with shielding connected to the grounding/protective conductor on both sides, the impedance of the additionally installed equipotential bonding cables may not exceed 10% of the shielding impedance.
- The cross-section of a selected equipotential bonding conductor must be capable of handling the maximum equalizing current. The best results for equipotential bonding between two cabinets were achieved with a minimum conductor cross-section of 16 mm².
- Use equipotential bonding conductors made of copper or galvanized steel. Establish a large-surface contact between the equipotential bonding conductors and the grounding/protective conductor and protect these from corrosion.
- Terminate the shielding of the data cable on the HMI device flush and near the equipotential busbar using suitable cable clamps.
- Route the equipotential bonding conductor and data cables in parallel with minimum clearance between these. See the wiring diagram.

NOTICE
Equipotential bonding conductor Cable shielding is not suitable for equipotential bonding. Always use the prescribed equipotential bonding conductors. The minimum cross-section of a conductor used for equipotential bonding is 16 mm ² . When you install MPI and PROFIBUS DP networks, always use cables with a sufficient crosssection since otherwise the interface modules may be damaged or destroyed.

4.3.2.3 Installing the equipotential circuit

Wiring diagram

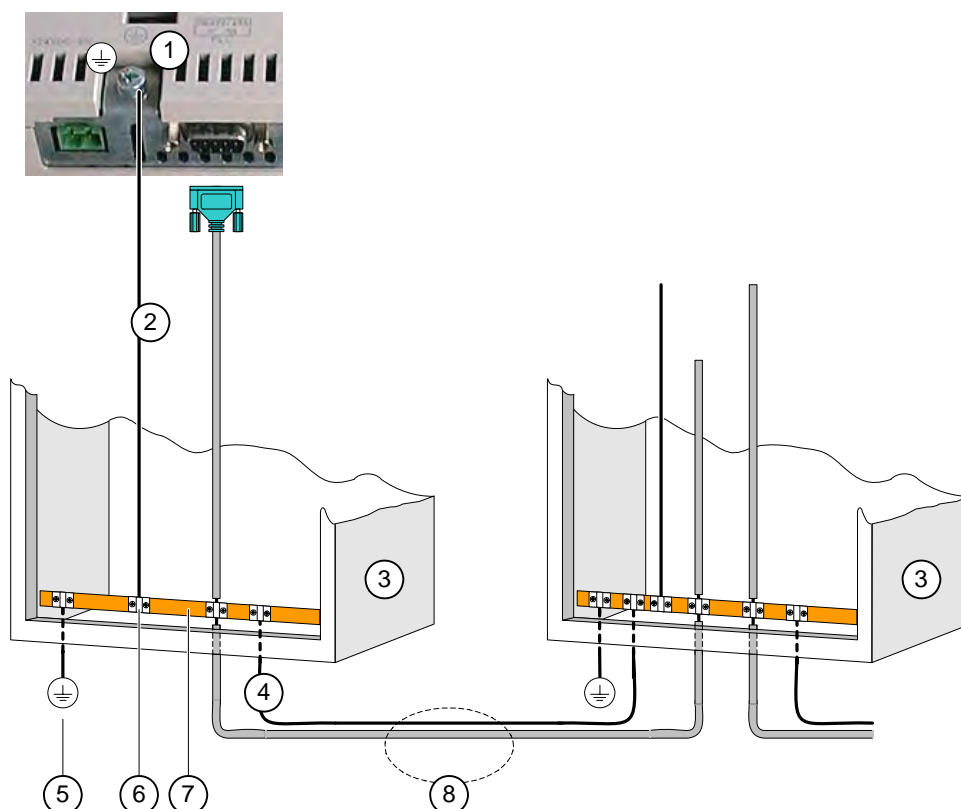

Figure 4-14 Installing the equipotential circuit

- ① Chassis ground terminal on the HMI device (example)
- ② Equipotential bonding conductor cross-section: 4 mm²
- ③ Cabinet
- ④ Equipotential bonding conductor cross-section: min. 16 mm²
- ⑤ Ground terminal
- ⑥ Cable clamp
- ⑦ Voltage bus
- ⑧ Parallel routing of the equipotential bonding conductor and data cable

See also

Electromagnetic compatibility (Page 29)

4.3.2.4 Connecting the PLC

Wiring diagram

The figure below illustrates the connection between the HMI device and PLC.



Figure 4-15 Connecting a PLC to OP 77A

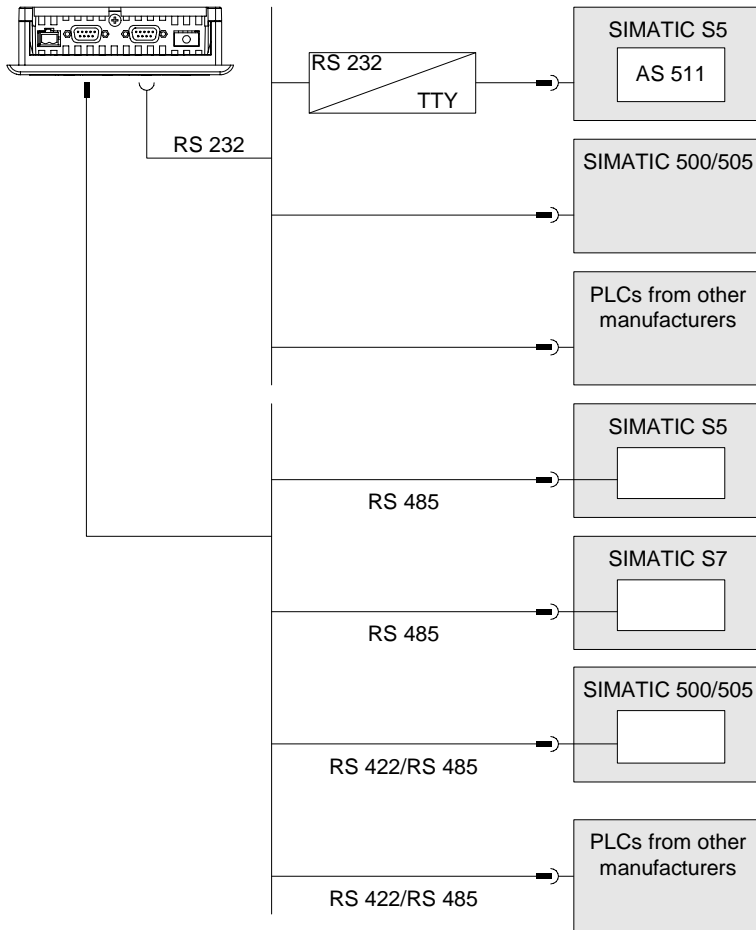

Figure 4-16 Connecting a PLC to OP 77B

NOTICE

Always use the approved cables to connect a SIMATIC S7 PLC.

Applies to OP 77B:

For serial operation, connect the PLC either to the RS 232 or to the RS 422/RS 485 port.

Standard cables are available for the connection. For further information, refer to the SIMATIC HMI Catalog ST 80.

Configuring the interface

A DIL switch for the configuration of the RS 485 interface is located on the back side of the HMI device.





In the factory state, the DIL switch is set for communication with the SIMATIC S7 controller.

Note

Note the diagrams of the DIL switch settings on the back of the HMI device.

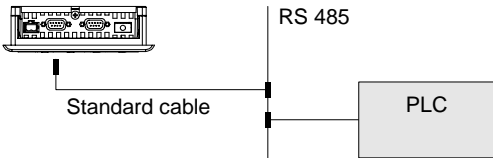
The following table shows the settings of the DIL switch. The transmitting and receiving direction is switched internally with the RTS signal.

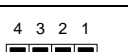
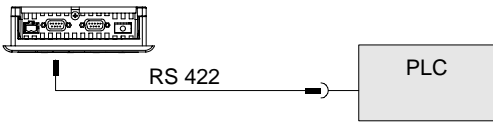
Table 4-1 DIL switch settings in OP 77A or OP 77B

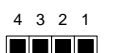
Communication	Switch setting	Meaning
 <p>Standard cable</p> <p>RS 485</p> <p>PLC</p>	<p>4 3 2 1</p> 	RTS on Pin 9, like programming device
	<p>4 3 2 1</p> 	RTS on Pin 4, like controller
	<p>4 3 2 1</p> 	No RTS on connector
 <p>RS 422</p> <p>PLC</p>	<p>4 3 2 1</p> 	Applies to OP 77B: the RS 422 port is enabled
<p>Button</p> 	<p>4 3 2 1</p> 	Factory state

See also

Setting the DIL switch (Page 71)

4.3.2.5 Connecting the configuration computer

Wiring diagram

The figures below illustrates the connection between the HMI device and PLC.

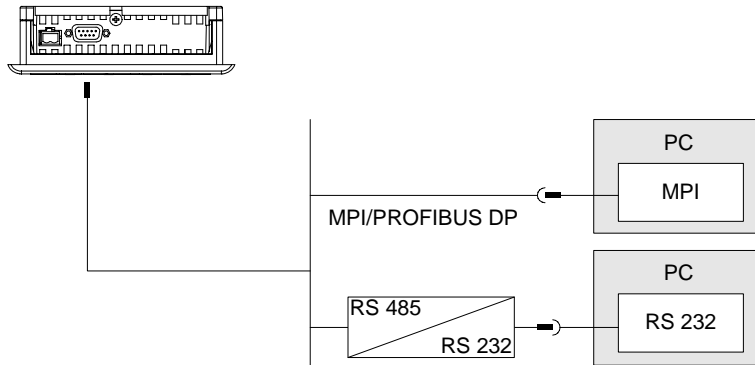

Figure 4-17 Connecting a configuration computer to an OP 77A

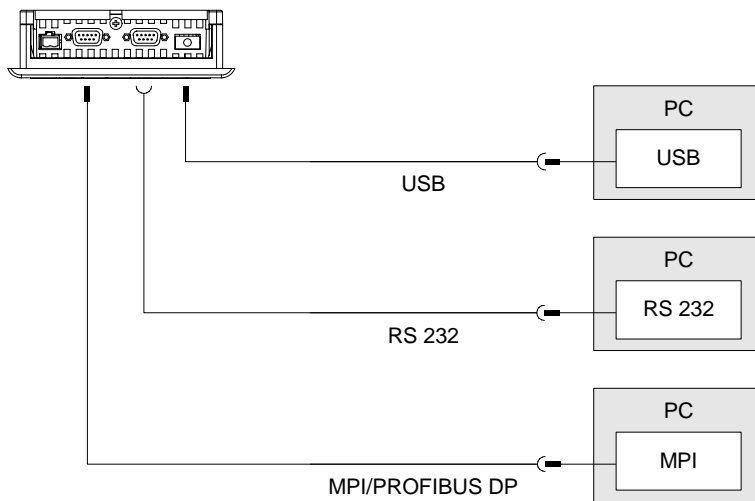

Figure 4-18 Connecting a PG to OP 77B

Applies to the USB port:

The HMI device and PC or configuration computer are masters. You need a USB host adapter for the USB port.

NOTICE

Use the driver for the USB host adapter which is included in the WinCC flexible package. Do NOT use the driver included in the adapter kit.

See also

- Interfaces (Page 53)
- Starting the transfer manually (Page 107)
- Starting the transfer automatically (Page 108)
- Backup and Restore via WinCC flexible (Page 114)
- Backup and Restore via ProSave (Page 116)
- Updating the Operating System Using WinCC flexible (Page 122)
- Updating the Operating System Using ProSave (Page 123)

4.3.2.6 Wiring I/O to OP 77B

Wiring diagram

The diagram below shows the connection between the HMI device and peripherals. A printer can be connected as a peripheral.

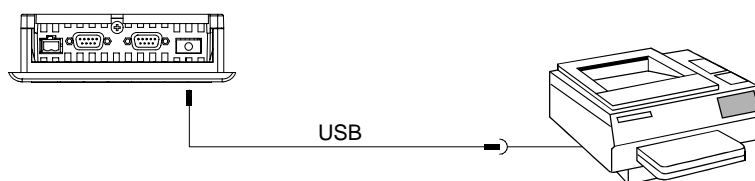

Figure 4-19 Connecting a printer to the OP 77B

Note when connecting

NOTICE
Use the driver for the USB host adapter which is included in the WinCC flexible package. Do NOT use the driver which is supplied with the adapter kit.
Always use cables with metal shielding braid which is grounded on both ends to connect the printer to the HMI device.
On some printers you may also have to set the ASCII character set used in the project.

A list of printers released by Siemens AG is available in the Siemens Catalog ST 80, chapter 80. A current list of released printers is available on the Internet under Service & Support.

NOTICE
Rated load of the interface
The load capacity of the USB port is limited to 100 mA. Avoid any higher loads. Equipment connected to the port may otherwise malfunction.

Note

Documentation for peripherals

Observe the printer documentation when you connect the printer.

See also

Interfaces (Page 53)

4.3.2.7 Connecting the power supply

Wiring diagram for the power supply module

The figure below illustrates the connection between the power supply and the HMI device.

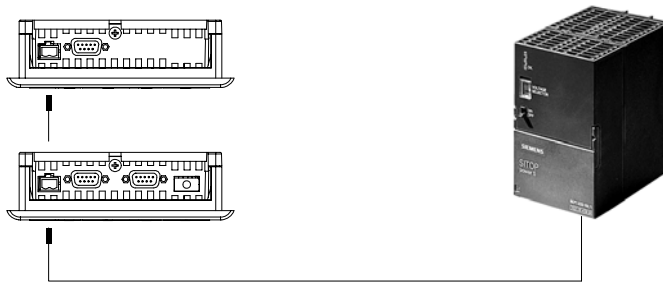

Figure 4-20 Connecting the power supply

Note when connecting

The power terminal block is included in the assembly kit and is designed for conductors with a maximum cross-section of 1.5 mm².

Connecting the terminal block

NOTICE

Damage

Pressure on the screwdriver may damage the HMI device socket if the terminal block is plugged in when you tighten the screws.

Always remove the terminal block to connect the wires.

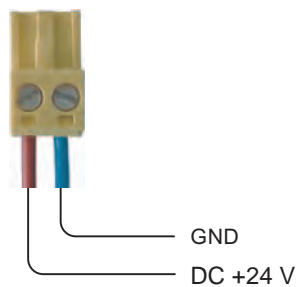

Figure 4-21 Connecting the terminal block

Connect the power supply cables to the terminal block as shown in the figure above. Ensure that the cables are not crossed. Refer to the label showing the pin-out on the rear of the HMI device.

Polarity reversal protection

The HMI device is equipped with a polarity reversal protection circuit.

Connecting the power supply

CAUTION

Ensure safe electrical insulation of the power supply. Always use power supply modules that conform to IEC 364-4-41 or HD 384.04.41 (VDE 0100, Part 410).

Always use power supply modules that comply to SELV (Safety Extra-Low Voltage) and PELV (Protective Extra Low Voltage) standards.

The power supply voltage must always be within the specified range to prevent malfunctions on the HMI device.

Equipotential bonding

Therefore, wire the 24 V output of the power supply to the equipotential circuit.

See also

Interfaces (Page 53)

4.3.3 Switching on power and testing the HMI

Switching on power and testing the HMI device

Proceed as follows:

1. Plug the terminal block into the HMI device.
2. Switch on the power supply.

After power is on, the display lights up and the bootloader appears briefly.

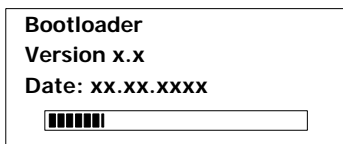

Figure 4-22 Bootloader display, example OP 77B

If the HMI device does not start, it is possible the wires on the terminal block have been crossed. Check the connected wires and change the connections if necessary. The Loader menu opens after the operating system has started.

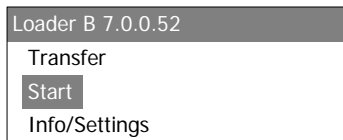

Figure 4-23 Loader view

The HMI device automatically sets transfer mode during initial startup if it does not contain any project data yet. This opens the following dialog:

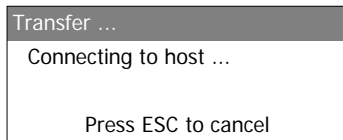



Figure 4-24 "Transfer" dialog

3. Press  to cancel the transfer.

Result

The Loader appears again.







Note

When restarting the system, a project may already be loaded on the HMI device. The system then skips transfer mode and starts the project.

Close the project by pressing the corresponding control object.

Further information on this may be available in your plant documentation.

Navigating in the Loader

Button	Action
 or 	Pressing one of these keys selects the menu command one level up. Pressing the key longer moves the selection continuously.
 or 	Pressing one of these keys selects the menu command one level down. Pressing the key longer moves the selection continuously.
	<ul style="list-style-type: none"> • The input is confirmed. • The submenu or dialog shown below opens.
	<ul style="list-style-type: none"> • Move back Returns to the next higher menu layer. • Cancel transfer mode

Function test

Perform a function test following commissioning. The HMI device is fully functional when one of the following states is indicated:

- The "Transfer" dialog is displayed.
- The Loader is displayed.
- A project is started.

Switching off the HMI device

Options for switching off the HMI device:

- Switch off the power supply.
- Disconnect the terminal block from the HMI device.

Operator control components and LEDs

5.1 Control elements on the OP 73 front panel

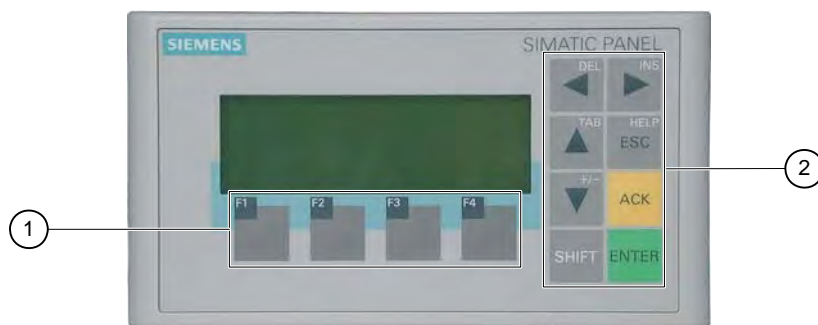

Figure 5-1 Operator control components and LEDs

- ① Soft keys
- ② System keys – control keys

Standard input device at the HMI device is the keyboard. This is basically composed of two key groups:

- Soft keys
F1 to F4

The soft keys can only be assigned within a project and do not have any function in the Loader menu.

- System keys

These include the control keys, for example.

NOTICE

Unintentional actions

Unwanted actions may be triggered if the operator unintentionally actuates several keys at once.

Never press more than two keys simultaneously.

Keyboard damage

Operation of the keys with hard, pointed or sharp objects or hard impact may lead to a considerable reduction of the service life and even to complete failure.

Always use your fingers to operate the keys of your HMI device.

See also

Design of the OP 73micro HMI device (Page 14)

5.2 Operator control components and LEDs on the front panel of OP 77A and OP 77B

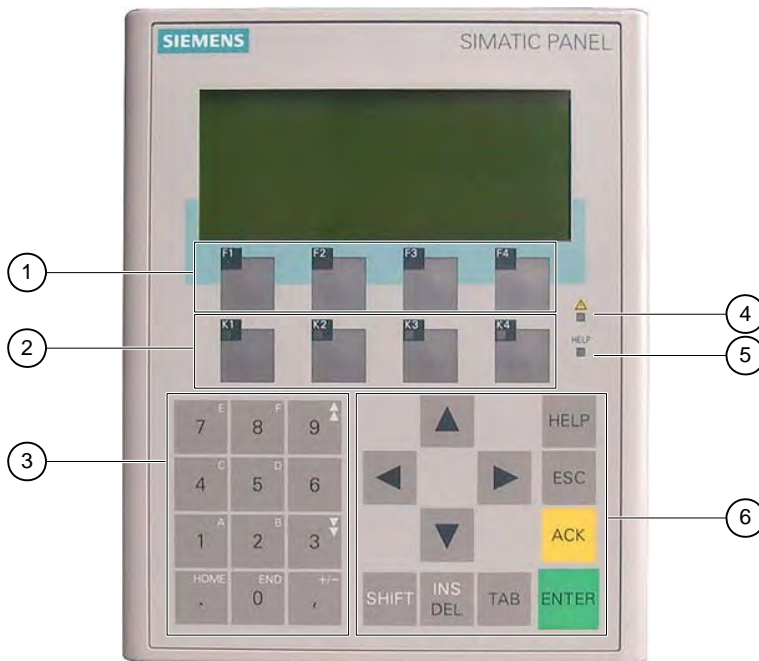

Figure 5-2 Operator control components and LEDs

- ① Function keys without LED
- ② Function keys with LED
- ③ System keys – numerical keypad
- ④ "Alarm indicator" LED
- ⑤ "Infotext" LED
- ⑥ System keys – control keys

Standard input device at the HMI device is the keyboard. This is basically composed of two key groups:

- Soft keys

F1 to F4, and K1 to K4

The soft keys can only be assigned within a project and do not have any function in the Loader menu.

- System keys

The numerical keypad and control keys belong to this group.

NOTICE
Unintentional actions Unwanted actions may be triggered if the operator unintentionally actuates several keys at once. Never press more than two keys simultaneously.
Keyboard damage Operation of the keys with hard, pointed or sharp objects or hard impact may lead to a considerable reduction of the service life and even to complete failure. Always use your fingers to operate the keys of your HMI device.

See also

Design of the OP 77A HMI device (Page 15)

5.3 Additional elements on the OP 77A and OP 77B

Operator control components on the side and rear panel of the HMI device:

- Memory Card slot of OP 77B
- Labeling strip guides on OP 77A and OP 77B
- DIL switch for toggling the RS 422/RS 485 ports on OP 77B

5.3.1 Use of a memory card on OP 77B

Procedure - Inserting a memory card

Proceed as follows:

1. Insert the MMC into the memory card slot.

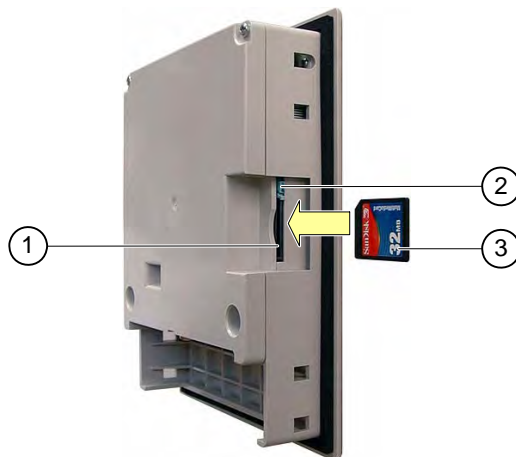

Figure 5-3 Inserting a memory card

- ① Memory card slot
- ② Memory card interlock
- ③ MMC

When inserting the memory card, please note that it can only be inserted as shown in the diagram. The MMC is inserted correctly in the memory card slot when the card interlock engages.

NOTICE

Data loss

When requested by the HMI device to format an MCC for first time use, you should save a backup copy of MCC data to a PC.

To prevent loss of data:

1. Cancel the format operation with .
2. Save a backup copy of vital data to a PC.
3. Format the MMC on the HMI device.
4. Restore the backup data to the MMC.

You can now transfer the backup data from the MMC to the HMI device.

Do not insert or remove the MMC while its data is being accessed by an application, for example, by an active backup function or recipe transfer. The MMC can be inserted and removed during runtime in any other situation.

Procedure - Removing a memory card

NOTICE

Data loss

All data on the MMC is lost if you attempt to remove it while the HMI device is accessing its data.

Do not remove the MMC while data is being accessed. Observe the corresponding alarms on the screen.

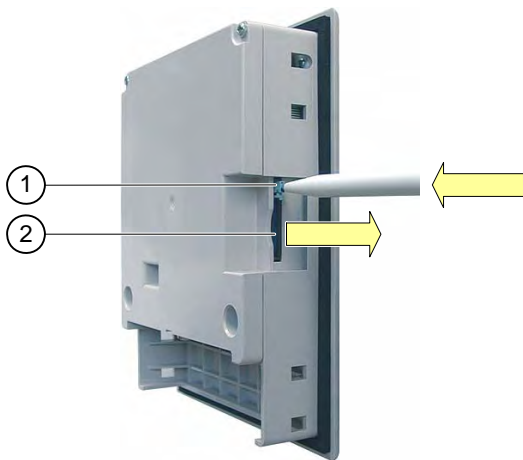

Figure 5-4 Removing the memory card

- ① Eject button
- ② MMC

Proceed as follows:

1. Press the ejection mechanism.
This slides the MMC out of the slot.
2. Store the memory card in a protective case.

NOTICE

Do not force the ejector. This could damage its mechanism.

5.3.2 Labeling the function keys of OP 77A and OP 77B

Labeling the function keys

Label the function keys as required for your project. Use labeling strips to do so.

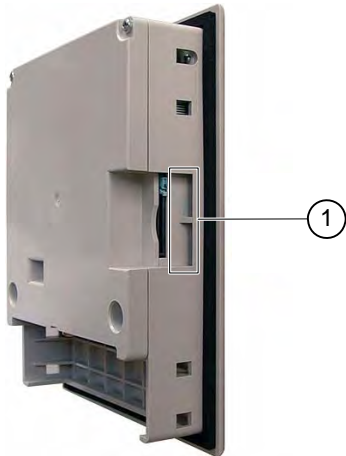

Figure 5-5 Labeling the function keys

① Guides for the labeling strips

The labeling strips can be inserted before or after you installed the HMI device.

Printing labeling strips

The labeling strip templates are available on the "WinCC flexible" installation CD, under "\Support\Documents\SLIDE_OP77B.DOC".

Observe the information in this file.

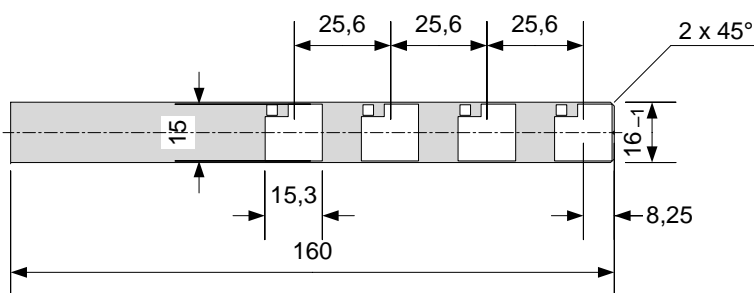

Figure 5-6 Dimensions of the labeling strip

Printable foil or paper can be used as labeling strips. Use transparent foil to retain visibility of the function key LED. Permitted thickness of the labeling strip: 0.15 mm.

Procedure

Proceed as follows:

1. Edit and then print the template.

You can also print blank templates and label them manually.

NOTICE

Do not write on the keyboard to label the function keys.
--

2. Cut out labeling strips

Ensure that the corners are cut according to the diagram shown above. This makes it easier to slide them into the guide.

3. Remove any old labeling strips.
4. Slide the labeling strips into the guide.

Note

Wait for the printed labeling strips to dry before you insert them.

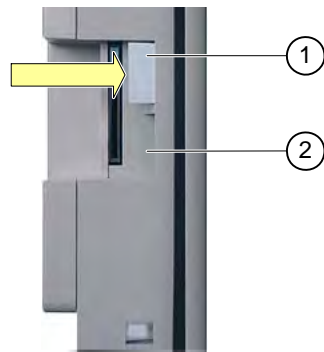

Figure 5-7 Inserting the labeling strips

- ① Labeling strips
- ② Guide

5. Slide the labeling strips into the guide up to the end stop.

The labeling strip will protrude approximately 1 cm out of the guide. Select the template dimensions so that the labeling is correctly placed behind the function key fields. An interlock is not required for the labeling strips.

5.3.3 Setting the DIL switch

The DIL switches are already configured for connecting the HMI device to a SIMATIC S7.

See also

Connecting the PLC (Page 56)

Configuring the operating system

6.1 Configuring the operating system of the OP 73

6.1.1 Overview

Loader

The figure below shows the Loader. It appears briefly when the HMI device starts up.

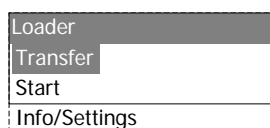





Figure 6-1 Loader

The Loader menu commands have the following functions:





- "Transfer"
Select this menu command to set the HMI device transfer mode.
- "Start"
Select this menu command to start the project which is stored on the HMI device.
- "Info/Settings"
Select this menu command to open the HMI device configuration menu.

The Loader also appears when you close the project.

Navigating in the Loader

Button	Action
 or 	By pressing one of these buttons, you select the next menu command in the direction of the cursor key.
	The corresponding menu opens.
	Returns to the next higher menu layer.

Editing dialog entries

Button	Action
 or 	Selects the previous or next list entry.
	The selected list entry is accepted.
	You can undo your input as long you have not yet confirmed the selected list entry with  .

See also

Switching on power and testing the HMI (Page 49)

6.1.2 "Info/Settings" menu

6.1.2.1 Overview

Requirements

"Info/Settings" was called in the Loader.

"Info/Settings" menu

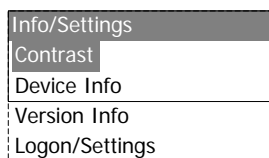

Figure 6-2 "Info/Settings" menu

- "Contrast" Menu command for setting the display contrast
- "Device Info" Menu command with information on the HMI device
- "Version Info" Menu command with information on the version of the HMI device image
- "Logon/Settings" Menu command of the "Logon/Settings" menu

Password protection

You can protect the "Logon/Settings" menu from unauthorized access by assigning a password.

This prevents inadvertent wrong operation and increases security for the plant or machine security because access to the settings is denied. If the user does not enter a password, this user can only access the "Contrast", "Device Info" and "Version Info" menu commands.

When a password is assigned, the following dialog appears when the user attempts to open the "Logon/Settings" menu:

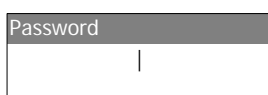

Figure 6-3 Password dialog

You need to enter the password again to access the "Logon/Settings" menu after you closed the previous session.

NOTICE
Password no longer available
If the Loader password is no longer available, you can only call the "Logon/Settings" menu again after you update the operating system.
All data on the HMI device will be overwritten when you update the operating system.

Note

The currently active entry is always indicated in a dialog.

See also

Assigning, changing and deleting passwords (Page 79)

6.1.2.2 Setting screen contrast

Requirements

"Info/Settings ► Contrast" was selected from the Loader menu.

Principle

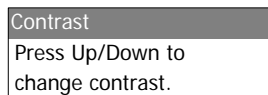

Figure 6-4 "Contrast" dialog

This dialog is used to adjust the contrast and therefore indirectly controls screen brightness.

NOTICE
Screen contrast
The screen contrast can be increased and reduced within a wide range. Note that this may lead to the screen content becoming unrecognizable under unfavorable lighting conditions.



reduces the contrast and



increases the contrast.

6.1.2.3 Displaying information about the HMI

Requirements

"Info/Settings ► Device Info" was selected from the Loader menu.

Principle

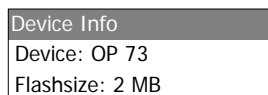

Figure 6-5 "Device Info" dialog

This dialog is used to indicate the name of the HMI device ("Device") and the size of internal Flash memory ("Flashsize"). The Flash memory is used to store the HMI device image and project data. The size of the internal Flash memory does not correspond to the available working memory for a project.

6.1.2.4 Viewing information about the version of the HMI image

Requirements

"Info/Settings ► Version Info" was selected from the Loader menu.

Principle

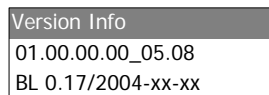

Figure 6-6 "Version Info" dialog – Example

The "Version Info" dialog shows information on the Bootloader and the HMI device image file and therefore the version of the operating system.

This information is required when you contact A&D Technical Support.

6.1.3 "Settings" menu

6.1.3.1 Overview

Requirement

"Info/Settings ► Logon/Settings" was selected from the Loader menu. You have entered the password for the "Settings" menu.

"Settings" menu

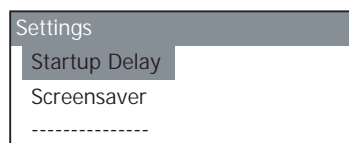

Figure 6-7 "Settings" menu

"Startup Delay"	Menu command for setting the startup delay on the HMI device
"Screen Saver"	Menu command for the screen saver
"Password"	Menu command for the password
"Transfer Settings"	Menu command for transfer settings

Select the "Settings" menu to edit the system settings for your HMI device.

Access to this menu can be protected by a password.

Procedure

Proceed as follows:

1. Close the project.
2. Open the "Logon/Settings" menu.
3. Edit the settings.
4. Close the "Logon/Settings" menu.

6.1.3.2 Setting the delay

Requirements

"Info/Settings ▶ Logon/Settings ▶ Startup Delay" was selected from the Loader menu.

Principle



Figure 6-8 "Startup Delay" dialog

The delay defines the period which the HMI device automatically delays the startup of a stored project.

When the value "0" is set, the project starts immediately. It is then no longer possible to call the Loader after switching on the HMI device. To handle this situation, you must have configured an operator control object you can use to close the project.

Valid range of values: 0 s to 60 s.

6.1.3.3 Setting the screen saver

Requirement

"Info/Settings ▶ Logon/Settings ▶ Screen saver" was selected from the Loader menu.

Principle

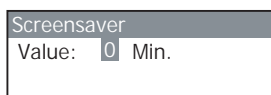

Figure 6-9 "Screen saver" dialog

Use this dialog to set the activation delay for the screen saver.

Valid range of values: 5 min to 360 min. The screen saver is disabled when you set 0.

6.1.3.4 Assigning, changing and deleting passwords

Introduction

To restrict access to the "Settings" menu to specific members of staff, define a password in the "Password" dialog.

Requirements

- "Info/Settings ► Logon/Settings ► Password" was selected from the Loader menu.
- The "Password" dialog opens.



Figure 6-10 "Password" dialog

Procedure – Assigning and editing passwords

Proceed as follows:

1. Enter the password.

Select the first character with  or . Press  to enter additional characters.

Note

Password entry

The last character of the password entered is shown in plain text. The remaining characters are represented by a * character.

2. Press .

You have now completed entry of the password. The "Confirm Password" dialog appears.

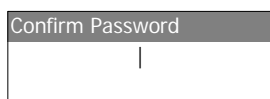

Figure 6-11 "Confirm Password" dialog

You need to enter the password twice to confirm it.

1. Enter the password again.

2. Press .



You have now completed the password confirmation. The password is accepted if both password entries are identical. Otherwise, an error message appears. The "Settings" menu opens. Repeat the password input.

Result

- The "Settings" menu opens.
- The "Settings" menu is password protected.

Procedure – Deleting a password

Proceed as follows:

1. Press  – do not enter any other characters.
The "Confirmation" dialog opens.
2. Press  – do not enter any other characters.
The system confirms the deletion.

Result

- The "Settings" menu opens.
- You have revoked the password protection of the "Settings" menu.

See also

Overview (Page 74)

6.1.3.5 Configuring the data channel

Introduction

By disabling a data channel, you can protect the HMI device from unintentional overwriting of project data and of the HMI device image.

Requirements

"Info/Settings ▶ Logon/Settings ▶ Transfer Settings" was selected from the Loader menu.

Overview

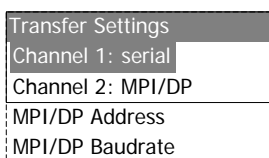

Figure 6-12 "Transfer Settings" menu

Note

You can set each dialog entry separately. Default entry for "Channel 2: MPI/DP" is "disabled".

Serial channel

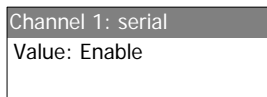



Figure 6-13 "Channel1: Serial" dialog

This dialog is used to configure the RS495 port for serial data transfer. Select  or  to make the following settings:

- "Disable"
Serial data transfer is disabled.
- "Enable"
Serial data transfer is enabled.

MPI/PROFIBUS DP channel

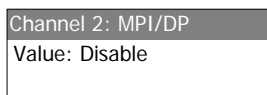



Figure 6-14 "Channel 2: MPI/DP" dialog

Use this dialog to set the transfer parameters for the MPI/PROFIBUS DP interface. Select  or  to make the following settings:

- "Disable"
MPI/PROFIBUS DP data transfer is disabled.
- "Enbl (rem. off)"
MPI/PROFIBUS DP data transfer is enabled. Automatic transfer is disabled.
- "Enbl (rem. on)"
MPI/PROFIBUS DP data transfer is enabled. Automatic transfer is enabled.

MPI/PROFIBUS DP address



Figure 6-15 "MPI/DP Address" dialog

Use this dialog to set the MPI/PROFIBUS DP address of the HMI device. Permitted range of values: 0 to 126.

Note

MPI/PROFIBUS DP address

The assigned MPI/PROFIBUS DP address must be unique in the network.

MPI/PROFIBUS DP baud rate

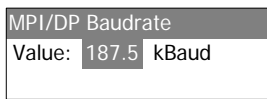

Figure 6-16 "MPI/DP Baudrate" dialog

Use this dialog to set the MPI/PROFIBUS DP baud rate for the HMI device. Select  or



to make the following settings:

- "1500 Kbps"
- "187.5 Kbps"
- "19.2 Kbps"
- "9600 bps"

If the HMI device is a node on the MPI/PROFIBUS DP network, the value setting is derived from MPI/PROFIBUS DP network configuration. Select the corresponding value.

Note

MPI/DP baud rate

The MPI/PROFIBUS DP baud rate must be consistent throughout the network.

Procedure – Setting the serial channel

Proceed as follows:

1. Select "Channel 1: Serial".

Procedure – Setting the MPI/PROFIBUS DP channel

Proceed as follows:

1. Select "Channel 2: MPI/DP".

2. Set automatic transfer.

Enable or disable the automatic transfer of a project. Automatic transfer is enabled when "Remote on" is set.

3. Set the MPI/PROFIBUS DP address.
4. Set the MPI/PROFIBUS DP baud rate.
5. Open the loader.

Result

The data channel is configured.

General notes

 WARNING
<p>Unintentional Transfer mode</p> <p>Ensure that the configuration computer does not inadvertently switch the HMI device to Transfer mode during ongoing operation. This could cause unintentional actions to be triggered in the plant.</p>

<p>NOTICE</p>
<p>Transfer mode using MPI/PROFIBUS DP</p> <p>For MPI/PROFIBUS DP transfer, the bus parameters, for example the MPI/PROFIBUS DP address of the HMI device, are read from the current project on the HMI device.</p> <p>The settings for MPI/PROFIBUS DP transfer can be modified. For this, you must first close the project and then change the settings on the HMI device. Then go back to "Transfer" mode.</p> <p>The HMI device uses the new MPI/DP settings until you transfer a new project to it. During the next transfer of a project to the HMI device, the MPI/DP settings will be overwritten with the values from the transferred project.</p> <p>You can thus edit the MPI/DP settings irrespective of the project settings.</p> <p>Transfer settings</p> <p>A project can only be transferred from the configuration computer to the HMI device when at least one of the data channels is enabled on the HMI device.</p>

6.2 Configuring the OP 77A and OP 77B operating system

6.2.1 Overview

Loader

The figure below shows the Loader. It appears briefly when the HMI device starts up.

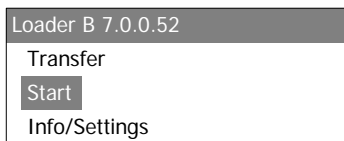





Figure 6-17 Loader on the OP 77B (example)

The Loader menu commands have the following functions:







- "Transfer"
Select this menu command to set the HMI device transfer mode.
- "Start"
Select this menu command to start the project which is stored on the HMI device.
- "Info/Settings"
Select this menu command to open the HMI device configuration menu.

The Loader also appears when you close the project.

Navigating in the Loader

Button	Action
 or 	By pressing one of these buttons, you select the next menu command in the direction of the cursor key.
	The corresponding menu opens.
	Returns to the next higher menu layer.

Editing dialog entries

Button	Action
 or 	Selects the previous or next list entry.
 up to 	You can use the numerical keypad for direct input of values.
	The selected list entry is accepted.
	You can undo your input as long you have not yet confirmed the selected list entry with  .

See also

Switching on power and testing the HMI (Page 62)

6.2.2 "Info/Settings" menu

6.2.2.1 Overview

Requirements

"Info/Settings" was called in the Loader.

"Info/Settings" menu

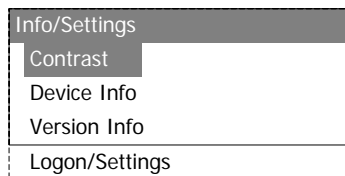

Figure 6-18 "Info/Settings" menu

"Contrast"	Menu command for setting the display contrast
"Device Info"	Menu command with information on the HMI device
"Version Info"	Menu command with information on the version of the HMI device image
"Logon/Settings"	Menu command of the "Logon/Settings" menu

Password protection

You can protect the "Logon/Settings" menu from unauthorized access by assigning a password.

This prevents inadvertent wrong operation and increases security for the plant or machine security because access to the settings is denied. If the user does not enter a password, this user can only access the "Contrast", "Device Info" and "Version Info" menu commands.

When a password is assigned, the following dialog appears when the user attempts to open the "Logon/Settings" menu:

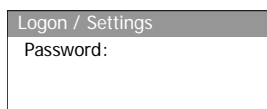

Figure 6-19 Password dialog, example OP 77B

You need to enter the password again to access the "Logon/Settings" menu after you closed the previous session.

NOTICE
Password no longer available If the Loader password is no longer available, you can only call the "Logon/Settings" menu again after you update the operating system. All data on the HMI device will be overwritten when you update the operating system.

Note
The currently active entry is always indicated in a dialog.

See also

Assigning, editing and deleting passwords (Page 90)

6.2.2.2 Setting screen contrast

Requirements

"Info/Settings ▶ Contrast" was selected from the Loader menu.

Principle

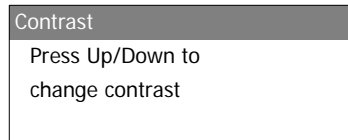

Figure 6-20 "Contrast" dialog

This dialog is used to adjust the contrast and therefore indirectly controls screen brightness.

NOTICE
Screen contrast The screen contrast can be increased and reduced within a wide range. Note that this may lead to the screen content becoming unrecognizable under unfavorable lighting conditions.

 reduces the contrast and  increases the contrast.

6.2.2.3 Displaying information about the HMI

Requirements

"Info/Settings ► Device Info" was selected from the Loader menu.

Principle

Device Info	
Device:	OP 77A
Flashsize:	2 MB

Figure 6-21 "Device Info" dialog for OP 77A

Device Info	
Device:	OP 77B
Flashsize:	4 MB

Figure 6-22 "Device Info" dialog for OP 77B

This dialog is used to indicate the name of the HMI device ("Device") and the size of internal Flash memory ("Flashsize"). The Flash memory is used to store the HMI device image and project data. The size of the internal Flash memory does not correspond to the available working memory for a project.

6.2.2.4 Viewing information about the version of the HMI image

Requirements

"Info/Settings ► Version Info" was selected from the Loader menu.

Principle

Version Info	
01.00.00.00_05.08	
BL 0.25/2004-xx-xx	

Figure 6-23 "Version Info" dialog for OP 77A, example

Version Info	
Bootloader:	1.02/xx.x.2004
Image:	B 7.0.0.xx

Figure 6-24 "Version Info" dialog on the OP 77B, example

The "Version Info" dialog shows information on the Bootloader and the HMI device image file and therefore the version of the operating system.

This information is required when you contact A&D Technical Support.

6.2.3 "Settings" menu

6.2.3.1 Overview

Requirement

"Info/Settings ► Logon/Settings" was selected from the Loader menu. You have entered the password for the "Settings" menu.

"Settings" menu

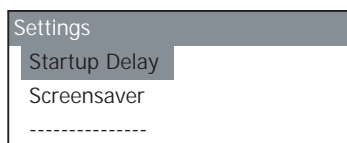

Figure 6-25 "Settings" menu for OP 77A

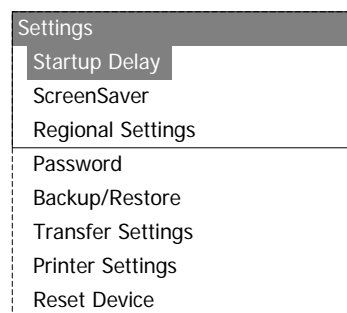

Figure 6-26 "Settings" menu on the OP 77B

"Startup Delay"	Menu command for setting the startup delay on the HMI device
"Screen Saver"	Menu command for the screen saver
"Regional Settings"	Menu command for regional settings
"Password"	Menu command for the password
"Backup/Restore"	Menu command for backup/restore
"Transfer Settings"	Menu command for transfer settings
"Printer Settings"	Menu command for printer settings
"Reset Device"	Reset menu commands, only appears if a password has been assigned.

Select the "Settings" menu to edit the system settings for your HMI device.

Access to this menu can be protected by a password.

Procedure

Proceed as follows:

1. Close the project.
2. Open the "Info/Settings" menu.
3. Edit the settings.
4. Close the "Info/Settings" menu.

6.2.3.2 Setting the delay

Requirements

"Info/Settings ▶ Logon/Settings ▶ Startup Delay" was selected from the Loader menu.

Principle

Startup Delay		
Value:	3	sec

Figure 6-27 "Startup Delay" dialog

The delay defines the period which the HMI device automatically delays the startup of a stored project.

When the value "0" is set, the project starts immediately. It is then no longer possible to call the Loader after switching on the HMI device. To handle this situation, you must have configured an operator control object you can use to close the project.

Valid range of values: 0 s to 60 s.

6.2.3.3 Setting the Screen Saver

Requirement

"Info/Settings ▶ Logon/Settings ▶ Screen saver" was selected from the Loader menu.

Principle

ScreenSaver		
Activation:	0	min

Figure 6-28 "Screen Saver" dialog, example OP 77B

Use this dialog to set the activation delay for the screen saver.

You can enter the following values:

- OP 77A: 5 min to 360 min.
- OP 77B: 1 min to 60 min.

The screen saver remains disabled if you enter 0 as the value.

6.2.3.4 Changing regional settings for OP 77B

Requirements

"Info/Settings ► Logon/Settings ► Regional Settings" was selected from the Loader menu.

Principle



Figure 6-29 "Region" dialog

Use this dialog to set the date and time format, for example. The decimal places in numerical values are delimited either by a point or comma, based on the configured regional language.

Note

If the HMI device operating system does not support a specific project language, it automatically uses the default set in the "Regional Settings" dialog.

6.2.3.5 Assigning, editing and deleting passwords

Introduction

To restrict access to the "Settings" menu to specific members of staff, define a password in the "Password" dialog.

Requirements

- "Info/Settings ► Logon/Settings ► Password" was selected from the Loader menu.
- The "Password" dialog opens.

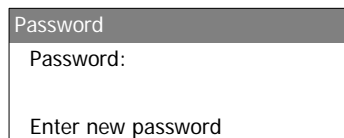

Figure 6-30 "Password" dialog, example OP 77B

Procedure – Assigning and editing passwords

Proceed as follows:

1. Enter the password.

Select the first character with  or . Press  to enter further characters.

Note

Password entry

The last character of the password entered is shown in plain text. The remaining characters are represented by a * character.

2. Press .

You have now completed entry of the password. The "Confirm Password" dialog appears.

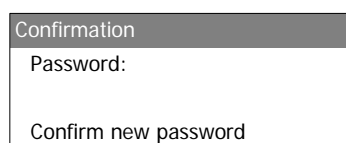

The image shows a dialog box titled "Confirmation". It contains two input fields: "Password:" and "Confirm new password".

Figure 6-31 "Confirmation" dialog, example OP 77B

For the password to become valid, it must be entered again to confirm it.

1. Enter the password again.

2. Press .

You have now completed entry of the password. The password is accepted if both password entries are identical. Otherwise, an error message appears. The "Settings" menu opens. Repeat the password input.

Result

- The "Settings" menu opens.
- The "Settings" menu is password protected.

Procedure – Deleting a password

Proceed as follows:

1. Press  – do not enter any other characters.

The "Confirmation" dialog opens.

2. Press  – do not enter any other characters.

The system confirms the deletion.

Result

- The "Settings" menu opens.
- You have revoked the password protection of the "Settings" menu.

See also

Overview (Page 85)

6.2.3.6 Backup and restore functions for OP 77B

Requirements

- "Info/Settings ▶ Logon/Settings ▶ Backup/Restore" was selected from the Loader menu.
- An MMC is inserted in the HMI device.

Principle

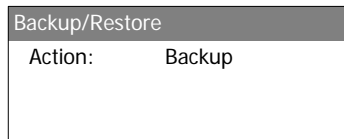



Figure 6-32 "Backup/Restore" dialog

When using an MMC, select the "Backup" and "Restore" functions from this dialog. The selected "Backup" or "Restore" function is executed immediately when you press .

See also

Overview (Page 103)

Backup and restore operations with MMC on OP 77B (Page 118)

6.2.3.7 Configuring the data channel

Introduction

By disabling a data channel, you can protect the HMI device from unintentional overwriting of project data and of the HMI device image.

Requirements

"Info/Settings ▶ Logon/Settings ▶ Transfer Settings" was selected from the Loader menu.

Overview

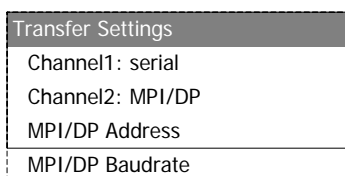

Figure 6-33 "Transfer Settings" menu on OP 77A

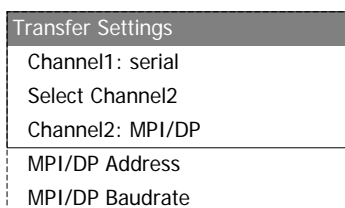

Figure 6-34 "Transfer Settings" menu for MPI/DP on OP 77B

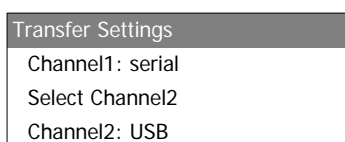

Figure 6-35 "Transfer Settings" menu for USB on OP 77B

Note

You can set each dialog entry separately.

Serial channel

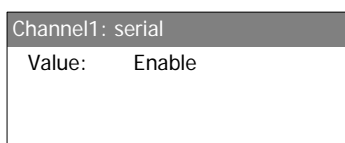

Figure 6-36 "Channel1: Serial" dialog on OP 77A

Use this dialog to configure the RS495 port for serial data transfer on the OP 77A. Select



to make the following settings:

- "Disable"
Serial data transfer is disabled.
- "Enable"
Serial data transfer is enabled.

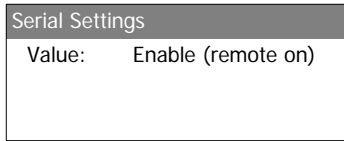

Figure 6-37 "Channel1: Serial" dialog on OP 77B

Use this dialog to configure the RS232 port for serial data transfer on the OP 77B. Select

and to make the following settings:

- "Disable"
Serial data transfer is disabled.
- "Enable (remote off)"
Serial data transfer is enabled. Automatic transfer is disabled.
- "Enable (remote on)"
Serial data transfer is enabled. Automatic transfer is enabled.

USB channel or MPI/PROFIBUS DP channel on OP 77B

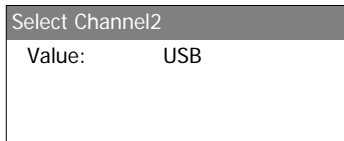

Figure 6-38 "Select Channel2" dialog

Use this dialog to toggle between the MPI/PROFIBUS DP and USB ports. Select and

to make the following settings:

- "USB"
The USB port is enabled for data channel 2.
- "MPI/DP"
The RS 422/RS 485 interface is enabled for data channel 2.

MPI/PROFIBUS DP channel

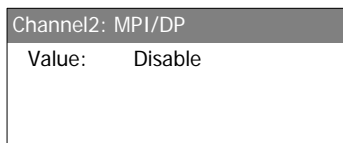

Figure 6-39 "Channel2 MPI/DP" dialog on OP 77A

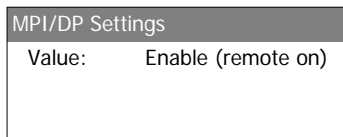

Figure 6-40 "Channel2 MPI/DP" dialog on OP 77B

Use this dialog to set the transfer parameters for the MPI/PROFIBUS DP interface. Select

and to make the following settings:

- "Disable"
Disables MPI/PROFIBUS DP data transfer.
- "Enable (remote off)"
Enables MPI/PROFIBUS DP data transfer. Automatic transfer is disabled.
- "Enable (remote on)"
Enables MPI/PROFIBUS DP data transfer. Automatic transfer is enabled.

MPI/PROFIBUS DP address

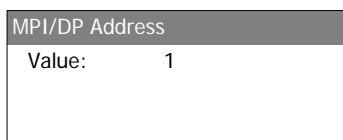

Figure 6-41 "MPI/DP Address" dialog

Use this dialog to set the MPI/PROFIBUS DP address of the HMI device. Permitted range of values: 0 to 126.

Entries can be made using the numerical keyboard or the cursor keys.

Note

MPI/PROFIBUS DP address

The assigned MPI/PROFIBUS DP address must be unique in the network.

MPI/PROFIBUS DP baud rate

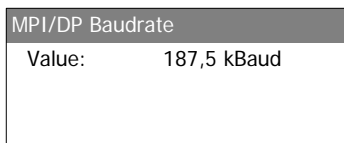





Figure 6-42 "MPI/DP Baudrate" dialog

Use this dialog to set the MPI/PROFIBUS DP baud rate for the HMI device.

Select  and  to make the following settings on the OP 77A:

- "1500 Kbps"
- "187.5 Kbps"
- "19.2 Kbps"
- "9600 bps"

Select  and  to make the following settings on the OP 77B:

- "12 Mbps"
- "6 Mbps"
- "3 Mbps"
- "1.5 Mbps"
- "187.5 Kbps"
- "19.2 Kbps"

If the HMI device is a node on the MPI/PROFIBUS DP network, the value setting is derived from MPI/PROFIBUS DP network configuration. Select the corresponding value.

Note

MPI/DP baud rate

The MPI/PROFIBUS DP baud rate must be consistent throughout the network.

Procedure – Setting the serial channel

Proceed as follows:

1. Select "Channel 1: Serial".
2. Setting automatic transfer (applies to OP 77B)

Enable or disable the automatic transfer of a project. Automatic transfer is enabled when "Remote on" is set.

Procedure – Setting the MPI/PROFIBUS DP channel on the OP 77A

Proceed as follows:

1. Select "Channel 2: MPI/DP".
2. Set automatic transfer.
Enable or disable the automatic transfer of a project. Automatic transfer is enabled when "Remote on" is set.
3. Set the MPI/PROFIBUS DP address.
4. Set the MPI/PROFIBUS DP baud rate.

Procedure – Setting the MPI/PROFIBUS DP channel on the OP 77B

Proceed as follows:

1. Select "Select Channel 2".
2. Select "MPI/PROFIBUS DP".
3. Set automatic transfer.
Enable or disable the automatic transfer of a project. Automatic transfer is enabled when "Remote on" is set.
4. Set the MPI/PROFIBUS DP address.
5. Set the MPI/PROFIBUS DP baud rate.

 WARNING
Unintentional Transfer mode
Ensure that the configuration computer does not inadvertently switch the HMI device to Transfer mode during ongoing operation. This could cause unintentional actions to be triggered in the plant.

6. Open the loader.

Result

The data channel is configured.

General notes

<p>NOTICE</p> <p>Transfer mode using MPI/PROFIBUS DP</p> <p>For MPI/PROFIBUS DP transfer, the bus parameters, for example the MPI/PROFIBUS DP address of the HMI device, are read from the current project on the HMI device.</p> <p>The settings for MPI/PROFIBUS DP transfer can be modified. For this, you must first close the project and then change the settings on the HMI device. Then go back to Transfer mode.</p> <p>OP 77A</p> <p>The HMI device uses the new MPI/DP settings until you transfer a new project to it. During the next transfer of a project to the HMI device, the MPI/DP settings will be overwritten with the values from the transferred project.</p> <p>You can thus edit the MPI/DP settings irrespective of the project settings.</p> <p>OP 77B</p> <p>The HMI device uses the new MPI/DP settings until you start a new project or transfer a project to it. During the next start or transfer of a project to the HMI device, the MPI/DP settings will be overwritten with the values from the project.</p> <p>Transfer settings</p> <p>A project can only be transferred from the configuration computer to the HMI device when at least one of the data channels is enabled on the HMI device.</p> <p>Do not edit the transfer settings while a project is active or the HMI device is in transfer mode.</p>
--

Setting the USB channel on OP 77B

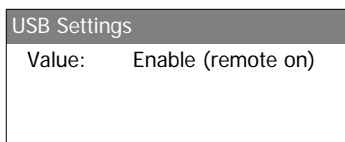



Figure 6-43 "Channel 2 USB" dialog on OP 77B

Use this dialog to set the transfer parameters for the USB port. Select  and  to make the following settings:

- "Disable"
USB data transfer is disabled.
- "Enable (remote off)"
USB data transfer is enabled. Automatic transfer is disabled.
- "Enable (remote on)"
USB data transfer is enabled. Automatic transfer is enabled.

Procedure – Setting the USB channel on OP 77B

Proceed as follows:

1. Select "Select Channel2".
2. Select "USB".
3. Set automatic transfer.

Enable or disable the automatic transfer of a project. Automatic transfer is enabled when "Remote on" is set.

<p> WARNING</p> <p>Unintentional Transfer mode</p> <p>Ensure that the configuration computer does not inadvertently switch the HMI device to Transfer mode during ongoing operation. This could cause unintentional actions to be triggered in the plant.</p>
--

4. Open the loader.

Result

The data channel is configured.

6.2.4 "Printer Settings" menu of OP 77B

6.2.4.1 Overview

Requirements

"Info/Settings ▶ Logon/Settings ▶ Printer Settings" was selected from the Loader menu.

"Printer Settings" menu

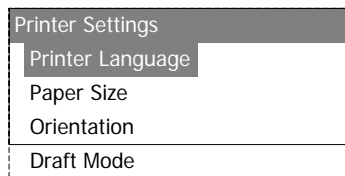

Figure 6-44 "Printer Settings" menu

- | | |
|--------------------|--|
| "Printer Language" | Menu command for setting the printer language |
| "Paper Size" | Menu command for setting the paper format |
| "Orientation" | Menu command for setting the print orientation |
| "Draft Mode" | Menu command for setting the draft mode |

6.2.4.2 Set printer language

Requirements

"Info/Settings ▶ Logon/Settings ▶ Printer Settings" was selected from the Loader menu.

Principle

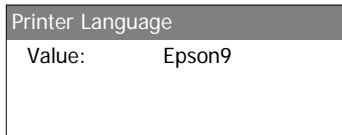

Figure 6-45 "Printer Language" dialog

Use this dialog to set the printer language. The following printer languages can be set:

- "Epson9"
- "Epson24"
- "Stylus Color"
- "PLC Laser"
- "PLC Inkjet"

Refer to the printer manual to find out which of these printer languages is used.

6.2.4.3 Setting the paper format

Requirements

"Info/Settings ▶ Logon/Settings ▶ Printer Settings ▶ Paper size" was selected from the Loader menu.

Principle

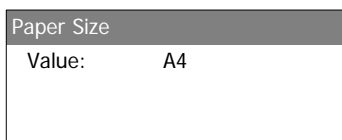

Figure 6-46 "Paper Size" dialog

Use this dialog to set the page format for printing. The following page formats are available:

- "A4"
- "Letter"
- "Legal"
- "B5"

6.2.4.4 Setting the print orientation

Requirements

"Info/Settings ▶ Logon/Settings ▶ Printer Settings ▶ Orientation" was selected from the Loader menu.

Principle

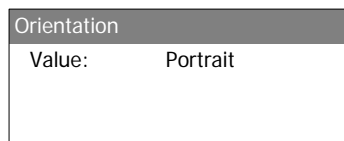

Figure 6-47 "Orientation" dialog

Use this dialog to set the printer orientation. The following printer orientations are available:

- "Portrait"
The print is output in portrait format.
- "Landscape"
The print is output in landscape format.

6.2.4.5 Setting the print mode

Requirements

The "Info/Settings ▶ Logon/Settings ▶ Printer Settings ▶ Draft Mode" menu command was selected.

Principle

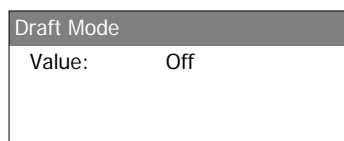

Figure 6-48 "Draft Mode" dialog

Use this dialog to set the print quality. The following settings are possible:

- "Off"
Draft mode is disabled. The print is output in best quality.
- "On"
Draft mode is enabled. The print is output in draft quality. The print speed, however, is higher in this mode.

Preparing and backing up a project

7.1 Overview

HMI devices can be used to operate and monitor tasks in process and production automation. The plant screens on the HMI devices are used to provide a clearer overview of active processes. The HMI device project, which includes the plant screens, is created during the configuration phase.

Once the project is transferred to the HMI device and the HMI device is connected to a PLC in the automation system, processes can be operated and monitored in the process management phase.

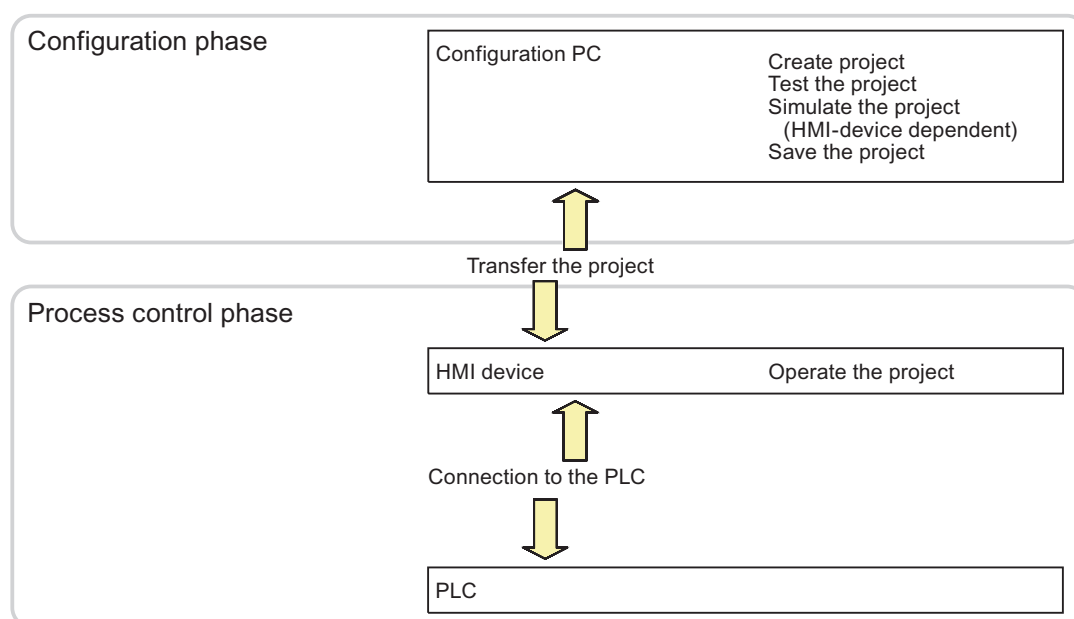

Figure 7-1 Configuration and process management phases

Transferring the project to the HMI device

The following can be performed to transfer a project to an HMI device:

- Transfer the project from the configuration computer
- Restore the project on the HMI device

A project is restored from the backup copy on MMC to the internal flash memory of the HMI device.

- Restore the project from a PC using ProSave

In this case, an archived project is transferred from a PC to the HMI device. The engineering software need not be installed on this PC.

These procedures can be available for commissioning and recommissioning a project.

Commissioning and recommissioning

- When the HMI device is commissioned there is no project at first.
The HMI device is also in this state after the operating system has been updated.
- When recommissioning, any project on the HMI device is replaced.

Transfer, backup and restore functions

OP 77B supports backup and restore functions with MMC.

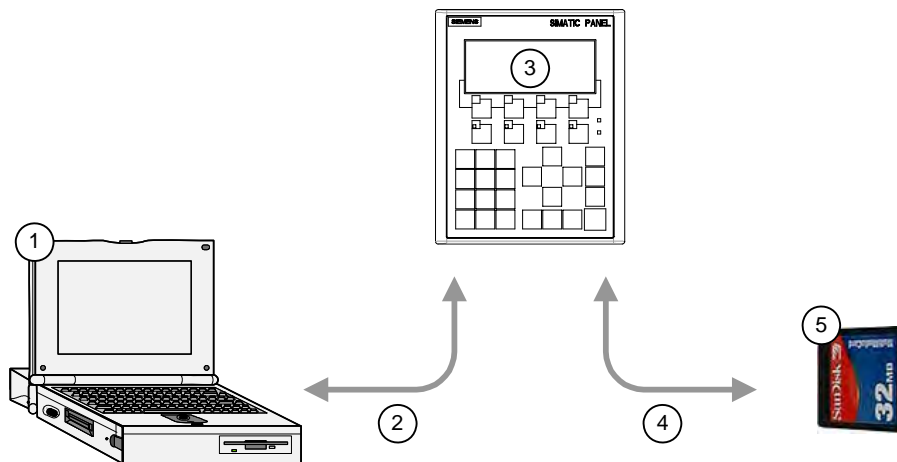

Figure 7-2 Schematic diagram of the transfer, backup and restore functions

- ① Configuration computer with project file *.hmi
- ② Transfer, backup and restore operations
- ③ HMI device with executable *.fwx project
- ④ Backup and Restore functions
- ⑤ MMC with compressed project file *.pdz

7.1.1 Setting the operating mode

Operating modes

Operating modes of the HMI device:

- Offline
- Online
- Transfer

"Offline mode" and "Online mode" can be set on the configuration computer and on the HMI device. To set these modes on the HMI device, use a corresponding operator control object of the project.

Changing the operating mode

The configuration engineer must have configured an appropriate operator control object to allow a change of the operating mode on the HMI device during ongoing operation.

Further information on this may be available in your plant documentation.

"Offline" mode

In this mode, there is no communication between the HMI device and PLC. Although the HMI device can be operated, it cannot exchange data with the PLC.

"Online" mode

In this mode, the HMI device and PLC communicate. You can operate the plant on the HMI device according to your system configuration.

"Transfer" mode

In this mode, you can transfer a project from the configuration computer to the HMI device or backup and restore HMI device data, for example.

The following options are available for setting "Transfer" mode on the HMI device:

- When the HMI device starts up
 - Start "Transfer" mode manually in the HMI device Loader.
- During ongoing operation
 - Start transfer mode manually within the project using an operator control object. The HMI device toggles to "Transfer" mode when automatic mode is set and a transfer is initiated on the configuration computer.

7.1.2 Reusing existing projects

You can reuse projects created for an OP3 HMI device on an OP 73. You can also reuse existing projects created for an OP7 HMI device on an OP 77A or OP 77B.

The following cases are possible:

- OP3 to OP 73
Migrate the project to WinCC flexible.
- OP7 to OP 77B
Migrate the project to WinCC flexible.
- OP7 to OP 77A
Migrate the project to WinCC flexible, then replace OP7 with an OP 77A HMI device in WinCC flexible.

For further information, refer to the WinCC flexible Online Help or to the "WinCC flexible Migration" user manual..

7.1.3 Data Transfer Options

Overview

The table below shows the options for transferring data between the configuration computer and OP 73, OP 77A and OP 77B.

Type	Type	OP 73	OP 77A	OP 77B
Backup	Serial (with reset to factory setting)	No	No	No
	Serial	Yes	Yes	Yes
	MPI/PROFIBUS DP	Yes	Yes	Yes
	USB	No	No	Yes
Restore	Serial (with reset to factory setting)	Yes ¹ /No ²	Yes ¹ /No ²	No
	Serial	No ¹ /Yes ²	Yes	Yes
	MPI/PROFIBUS DP	No ¹ /Yes ²	Yes	Yes
	USB	No	No	Yes
Operating system update	Serial (with reset to factory setting)	Yes	Yes	Yes
	Serial	Yes	Yes	Yes
	MPI/PROFIBUS DP	Yes	Yes	Yes
	USB	No	No	Yes
Transfer of a project	Serial (with reset to factory setting)	No	No	No
	Serial	Yes	Yes	Yes
	MPI/PROFIBUS DP	Yes	Yes	Yes
	USB	No	No	Yes

- 1 Applies to complete restore
- 2 Applies to restoring the password list

Serial data transmission with OP 73 and OP 77A

You can use one of the following adapters for serial transmission between OP 73 or OP 77A and a configuration PC:

- RS 232/PPI cable MM Multimaster
- USB/PPI cable MM Multimaster (as of manufacturer version 05 of the cable)

Serial data transmission with the OP 77B

Use an RS 232 / null-modem cable for serial transmission between OP 77B and a configuration PC.

7.2 Transfer

7.2.1 Overview

Transfer

During transfer, the project is downloaded from the configuration computer to the HMI device.

The "Transfer" mode can be started manually or automatically on the HMI device.

Transferred data is written directly to the flash memory on the HMI device. The transfer function uses a data channel you need to configure before you initiate any transfers.

7.2.2 Starting the transfer manually

Introduction

You can set "Transfer" mode manually on the HMI device using a configured operator control object and during ongoing operation.

Requirements

- The *.hmi project is opened in WinCC flexible.
- The HMI device is connected to a configuration computer.
- The data channel is configured on the HMI device.
- The HMI device Loader is opened.

Procedure

Proceed as follows to initiate the transfer:

1. Switch to "Transfer" mode on the HMI device.
2. Proceed as follows on the configuration computer:
 - Select the "Project ▶Transfer ▶Transfer Settings" menu command in WinCC flexible.
 - Select the HMI device and define the parameters for the connection.
 - Start the download with "Transfer".

The configuration computer verifies its connection to the HMI device. If the connection is not available or is faulty, the configuration computer outputs an alarm. If no communication error is detected, the project is transferred to the HMI device.

Result

When the transfer is completed successfully, the data can be found on the HMI device. The transferred project is then started automatically.

See also

Overview (Page 107)

Configuring the data channel (Page 80)

Configuring the data channel (Page 92)

Data Transfer Options (Page 106)

Setting the operating mode (Page 105)

7.2.3 Starting the transfer automatically

Introduction

The HMI device can be automatically switched to "Transfer" mode during runtime as soon as transfer is started on the configuration computer connected.

Automatic startup is particularly suited for the test phase of a new project since transfer is completed without interfering with the HMI device.

OP 73 and OP 77A support automatic transfers only via MPI/PROFIBUS DP.

NOTICE

If the automatic transfer has been activated on the HMI device and a transfer is initiated on the configuration computer, the project currently running is automatically stopped. The HMI device then automatically switches to "Transfer" mode.

After the commissioning phase, deactivate the automatic transfer so that the HMI device cannot be inadvertently switched to Transfer mode. The transfer mode can trigger unintentional actions in the device.

You can set a password in the Loader of the HMI device to restrict access to the transfer settings and thus avoid unauthorized modifications.

Applies to OP 77B:

The current project can not be closed if there is an active dialog. Close the dialog or cancel the transfer operation on the configuration computer.

Requirements

- The HMI device is connected to a configuration computer.
- The data channel is configured on the HMI device.
- The automatic transfer is activated in the data channel for the transfer.
- The project is started.

Procedure

Proceed as follows on the configuration computer:

1. Select the "Project ▶Transfer ▶Transfer Settings" menu command in WinCC flexible.
2. Select the HMI device and define the parameters for the connection.
3. Start the download with "Transfer".

The connection to the HMI device is checked. If the connection is not available or defective, the configuration computer issues the corresponding error message. In the case of an error-free connection, the HMI device ends the running project and switches to "Transfer" mode. The selected data is transferred to the HMI device.

Result

When the transfer is completed successfully, the data can be found on the HMI device. The transferred project is then started automatically.

See also

Configuring the data channel (Page 80)

Configuring the data channel (Page 92)

Data Transfer Options (Page 106)

Overview (Page 107)

7.2.4 Testing a project

Introduction

There are two options on the HMI device testing a project:

- Offline testing of the project

Offline testing means that communication between the HMI device and PLC is down while the test is being carried out.

- Online testing of the project

Online testing means that the HMI device and PLC communicate with each other during testing.

Perform both tests, starting with the "Offline test", followed by the "Online test".

Note

Applies to OP 77B:

The project can also be debugged on a configuration computer by means of the Simulator. For detailed information, refer to the "WinCC flexible" user manual and to the WinCC flexible Online Help.

Testing a project

You should always test the project on the HMI device on which the project will be used.

Check the following:

1. Check the correct layout of the screens.
2. Check the screen structure.
3. Check the input objects.
4. Enter the tag values.

The test increases the certainty that the project will run error-free on the HMI device.

Requirements for the offline test

- The project has been transferred to the HMI device.
- The HMI device is in "Offline" mode.

Procedure

In "Offline" mode, you can test the various project functions on the HMI device without them being affected by the PLC. PLC tags, therefore, are not updated.

Test the operator control objects and visualization of the project as far as possible without connecting to the PLC.

Requirements of the online test

- The project has been transferred to the HMI device.
- The HMI device is in "Online" mode.

Procedure

In "Offline" mode, you can test the various project functions on the HMI device without them being affected by the PLC. PLC tags are updated in this case.

Test the operator control objects and views of the project.

You should especially test the project objects which require communication with the PLC:

- Alarms
- Screen selection by the PLC or on PLC request.

Applies to OP 77B:

- Recipes
- Print function

See also

Setting the operating mode (Page 105)

7.2.5 Uploading a project from OP 77B

Introduction

When the "Enable Upload" check box is set on the configuration computer for transferring a project, the corresponding compressed source file is included in the transfer operation. This allows the upload from the HMI device to the configuration computer.

After you uploaded a compressed source file, you can be analyzed and modify the active project. This is of particular importance when:

- The original configuration computer is not available.
- The project source file is no longer available.

Requirements

Requirements for uploading the project from the HMI:

- The HMI device is connected to a configuration computer.
- The compressed source file of the project must be available on an MMC which is inserted in the HMI device.
- A project is open in WinCC flexible.

NOTICE

Project ID

The uploaded compressed source file can only be opened in the engineering software if the following condition is satisfied:

The project ID of the currently used engineering software is higher than or equal to the project ID of the engineering software used to create the project.

Verifying the source file

There is no check in WinCC flexible or on the HMI device to determine if the project file on the HMI device and the compressed source file on the MMC belong to the same project. Only the project file is transferred when the "Enable Upload" check box is disabled. Any source file on the MMC must therefore belong to a previously transferred project.

Procedure

Proceed as follows on the configuration computer:

1. In WinCC flexible, select the menu command "Project ► Transfer ► Communication Settings".

The "Communication Settings" dialog opens.

2. Select the HMI device type.
3. Select the type of connection between the HMI device and the configuration computer.
4. Set the connection parameters.
5. Select "OK".

Proceed as follows on the HMI device:

1. Select transfer mode from the Loader.

Proceed as follows on the configuration computer:

1. In WinCC, select the menu command "Project ► Transfer ► Upload".

This initiates the upload.

Result

When all data are uploaded to the configuration computer, the WinCC flexible engineering software unpacks the compressed file. The uploaded project can now be opened for editing on the configuration computer. The file is available in *.hmi format

See also

Configuring the data channel (Page 92)

Setting the operating mode (Page 105)

7.3 Backup and restore

7.3.1 Overview

Introduction

Data located on the HMI device can be backed up using a PC external to the HMI device and can be restored from it.

The following data in the internal Flash memory can be backed up and restored:

- Project
- HMI device image
- Password list
- Recipe data list (applies only to OP 77B)

Based on the type of HMI device used, you can backup and restore the data using:

- MMC (applies only to OP 77B)
- WinCC flexible
- ProSave

General notes

NOTICE

Power failure

If an operation for restoring data is interrupted due to power failure on the HMI device, the operating system of the HMI device may be deleted! The operating system then has to be updated.

Compatibility conflict

If a message is output on the HMI device warning of a compatibility conflict during the restore operation, the operating system must be updated.

Resetting to factory settings

In ProSave or WinCC flexible, you can perform a restore with or without resetting to factory settings, depending on the HMI device used.

- Restore without reset to factory setting
First, set "Transfer" mode on the HMI device or use the automatic transfer function if the project is active. Then start the restore in ProSave or WinCC flexible.
- Restore with reset to factory setting
First, start the restore in ProSave or WinCC flexible and then switch the power on the HMI device off and on again.

Note

Restoring with reset to factory setting is also possible when the HMI device operating system is corrupt and you can therefore no longer run the Loader of the HMI device.

Use the "Reset to factor state" check box in ProSave to determine the restoring procedure.

7.3.2 Backup and Restore via WinCC flexible

Introduction

Backup and restore operations transfer the relevant data between flash memory on the HMI device and a configuration computer.

Requirement

- The HMI device is connected to a configuration computer.
- No project is open in WinCC flexible.
- Relevant only for backup or for restore operations without reset to factory setting:
The data channel is configured on the HMI device.

Procedure - backup

Proceed as follows:

1. Select the menu command "Project ▶ Transfer ▶ Communication Settings" in WinCC flexible on the configuration computer.
The "Communication Settings" dialog opens.
2. Select the HMI device type.
3. Select the type of connection between the HMI device and the configuration computer, then set the communication parameters.
4. Close the dialog with "OK".
5. In WinCC flexible, select the menu command "Project ▶ Transfer ▶ Backup".
The "Backup Settings" dialog opens.
6. Select the data to be backed up.
7. Select a destination folder and a file name for the *.psb backup file.
8. Set "Transfer" mode on the HMI device.
If automatic transfer mode is enabled on the HMI device, the device automatically sets "Transfer" mode when a backup is initiated.
9. Start the backup operation in WinCC flexible with "OK" on the configuration computer.
Follow the instructions in WinCC flexible.
A status view opens to indicate the progress of the operation.

Result

The system outputs a message when the backup is completed.

The relevant data is now backed up on the configuration computer.

Procedure - restore

Proceed as follows:

1. Select the menu command "Project ► Transfer ► Communication Settings" in WinCC flexible on the configuration computer.
The "Communication Settings" dialog opens.
2. Select the HMI device type.
3. Select the type of connection between the HMI device and the configuration computer, then set the communication parameters.
4. Close the dialog with "OK".
5. In WinCC flexible, select the menu command "Project ► Transfer ► Restore".
The "Restore Settings" dialog opens.
6. Select the *.psb backup file to be restored from the "Open" dialog.
The view shows from which HMI device the backup file originates and the type of data it contains.
7. Set "Transfer" mode on the HMI device.
If automatic transfer mode is enabled on the HMI device, the device automatically sets "Transfer" mode when a restore operation is initiated.
8. Start the restore operation in WinCC flexible with "OK" on the configuration computer.
Follow the instructions in WinCC flexible.
A status view opens to indicate the progress of the operation.

Result

The transfer is completed when the backup data is restored from the configuration computer to the HMI device.

See also

- Overview (Page 113)
- Data Transfer Options (Page 106)
- Setting the operating mode (Page 105)
- Configuring the data channel (Page 92)
- Configuring the data channel (Page 80)

7.3.3 Backup and Restore via ProSave

Introduction

Backup and restore operations transfer the relevant data between flash memory on the HMI device and a PC.

Requirement

- The HMI device is connected to a PC on which ProSave is installed.
- Relevant only for backup or for restore operations without reset to factory setting:
The data channel is configured on the HMI device.

Procedure - backup

Proceed as follows:

1. From the Windows Start menu, run ProSave on the PC.
2. Select the HMI device type from the "General" tab.
3. Select the type of connection between the HMI device and the configuration computer, then set the communication parameters.
4. Use the "Backup" tab to select the relevant data.
5. Select a destination folder and a file name for the *.psb backup file.
6. Set "Transfer" mode on the HMI device.
If automatic transfer mode is enabled on the HMI device, the device automatically sets "Transfer" mode when a backup is initiated.
7. Start the backup operation in ProSave with "Start Backup".

Follow the instructions in ProSave.

A status view opens to indicate the progress of the operation.

Result

The system outputs a message when the backup is completed.

The relevant data is now backed up on the PC.

Procedure - restore

Proceed as follows:

1. When restoring with reset to factory setting only:
Switch off power to the HMI device.
2. From the Windows Start menu, run ProSave on the PC.
3. Select the HMI device type from the "General" tab.
4. Select the type of connection between the HMI device and the configuration computer, then set the communication parameters.
5. Select whether to restore with/without resetting to factory settings by accordingly setting the "Reset to factory setting" check box in the "Restore" tab.
6. Select the *.psb backup file to be restored from the "Restore" tab.
The view shows from which HMI device the backup file originates and the type of data it contains.
7. When restoring without reset to factory setting only:
Set "Transfer" mode on the HMI device.
If automatic transfer mode is enabled on the HMI device, the device automatically sets "Transfer" mode when a restore operation is initiated.
8. Start the restore operation in ProSave with "Start Restore".
Follow the instructions in ProSave.
A status view opens to indicate the progress of the operation.

Result

The transfer is completed when the backup data is restored from the PC to the HMI device.

See also

- Overview (Page 113)
- Data Transfer Options (Page 106)
- Setting the operating mode (Page 105)
- Configuring the data channel (Page 80)
- Configuring the data channel (Page 92)

7.3.4 Backup and restore operations with MMC on OP 77B

Introduction

The system generates a backup copy of the operating system, applications and data in flash memory of the HMI device and writes it to an MMC. Any backup date on the MMC will be deleted on confirmation.

A restore operation deletes all old data from flash memory of the HMI device on confirmation. Next, the backup data are copied from the MMC to the internal flash memory.

Requirements

You require an MMC with a minimum capacity of 32 MB.

The system outputs an alarm if no MMC is found in the MMC slot. Insert the required MMC and confirm with . If you do not insert an MMC, acknowledge the alarm to return to the "Settings" menu.

The system outputs the following message when you insert a SIMATIC S7 MMC memory card:

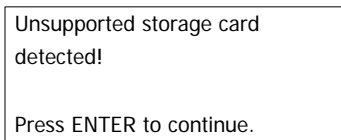

Figure 7-3 Dialog box with alarm

Replace the MMC as described in Accessories.

Procedure - Backup

Proceed as follows:



1. Insert the MMC into the memory card slot
2. Select "Info/Settings ▶ Logon/Settings ▶ Backup/Restore" from the Loader menu.

The "Backup/Restore" dialog opens.

3. Select "Backup".
4. Press 

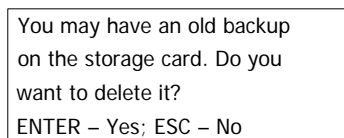
If previous backup data are found on the MMC, the system outputs the following message:



Confirm with  to overwrite any existing backup data on the MMC. Select  to cancel the backup operation.

After the backup copy has been created, the following alarm appears:

Backup successfully completed.
Press OK and remove your
storage card.
Press ENTER to continue.

Remove the MMC.

5. Press .

This concludes the backup operation.

Result

The transfer is completed when all HMI data are backed up to the MMC.

Label the MMC with the date and version of the backed up project, for example, and then store it in a safe place.

Procedure - Restore

Proceed as follows:

1. Insert the MMC into the memory card slot
2. Select "Info/Settings ▶ Logon/Settings ▶ Backup/Restore" from the Loader menu.
The "Backup/Restore" dialog opens.
3. Select "Restore".

Press .

The system outputs the following message:

Checking data ...

The MMC content is now checked. The system outputs the following message if a valid backup copy is found on the MMC:

You are starting RESTORE now.
All installed licenses, all files (except
files on storage card) and the regis-
try will be erased. Are you sure?
ENTER – Yes; ESC – No

An alarm is output if no valid data are found on the MMC. Select  to return to the "Logon/Settings" menu.

4. Press  to initiate the restore operation.

The system outputs the following message:

"Deleting files on flash"

The system transfers the HMI device image and outputs the following message:

Restore CE-Image

- Select  to cancel the restore operation.

The system outputs the following message when the transfer of the HMI device image from MMC to the HMI device is completed:

Restore of CE image finished.
Device will be rebooted now.
Don't remove the storage card.
Press ENTER to continue.

Leave the MMC in the HMI device.

5. Press 

The HMI device performs a restart.

After the HMI device restarts, the system transfers the remaining backup data from the MMC to the HMI device and then outputs the following message:

Restore successfully finished. Press
OK, remove your storage card and
reboot your device.
Press Enter to continue.

6. Remove the MMC from the HMI device.

7. Press 

The HMI device performs a restart.

Result

The transfer is completed when all backup data were copied from the MMC and are available on the HMI device.

See also

Setting the operating mode (Page 105)

Backup and restore functions for OP 77B (Page 92)

7.4 Updating the operating system

7.4.1 Overview

Overview

A compatibility conflict may occur when transferring a project to the HMI device. This is caused by different versions of the engineering software and the HMI device image. The configuration computer cancels the transfer and triggers an alarm to indicate a compatibility conflict. You must update the operating system of the HMI device.

NOTICE

Data loss

An operating system update deletes all data such as projects and passwords from the HMI device.

Resetting to factory settings

In ProSave or WinCC flexible, you can update the operating system with or without resetting to factory settings, depending on the HMI device used.

- Updating the operating system without reset to factory setting

First, set "Transfer" mode on the HMI device or use the automatic transfer function if the project is active. Then start the operating system update in ProSave or WinCC flexible.

- Updating the operating system with reset to factory setting

First, start the operating system update in ProSave or WinCC flexible. Then switch the power on the HMI device off and on again.

Note

You can perform an operating system update with reset to factory setting even if the HMI device does not yet have an operating system or if the operating system of the HMI device is corrupt.

In ProSave or WinCC flexible, set the "Reset to factory state" check box status according to your selected operating system update mode.

7.4.2 Updating the Operating System Using WinCC flexible

Requirement

- The HMI device is connected to a configuration computer.
- No project is open in WinCC flexible.
- When updating the operating system without reset to factory setting only:
The data channel is configured on the HMI device.

Procedure

Proceed as follows:

1. When updating the operating system with reset to factory setting only:
Switch off power to the HMI device.
2. Select the menu command "Project ► Transfer ► Communication Settings" in WinCC flexible on the configuration computer.
This opens the "Communication Settings" dialog.
3. Select the HMI device type.
4. Select the type of connection between the HMI device and the configuration computer, then set the communication parameters.
5. Close the dialog with "OK".
6. In WinCC flexible, select the menu command "Project ► Transfer ► Update operating system".
7. Select whether to update the operating system with/without resetting to factory settings by setting the "Reset to factory state" check box accordingly.
8. In "Image path," select the folder which contains the HMI device image file, *.img.
The HMI device image files are available under "WinCC flexible Images" in the WinCC flexible installation folder and on the corresponding WinCC flexible installation CD.
9. Select "Open".
In the output area, you are provided information on the version of the HMI device image file after it is opened.
10. When restoring without reset to factory setting only:
Set "Transfer" mode on the HMI device.
If automatic transfer mode is enabled on the HMI device, the device automatically sets "Transfer" mode when a restore operation is initiated.
11. In WinCC flexible, select "Update OS" to run the operating system update.
Follow the instructions in WinCC flexible.
A status view opens to indicate progress.

Result

The system outputs and alarm when the operating system update is completed.

This operation has deleted the project data from the HMI device.

Note

HMI device OP 73

After the transfer via MPI, the transfer settings are automatically reset to serial transfer.

7.4.3 Updating the Operating System Using ProSave

Requirement

- The HMI device is connected to a PC on which ProSave is installed.
- When updating the operating system without reset to factory setting only:
The data channel is configured on the HMI device.

Procedure

Proceed as follows:

1. When updating the operating system with reset to factory setting only:
Switch off power to the HMI device.
2. From the Windows Start menu, run ProSave on the PC.
3. Select the HMI device type from the "General" tab.
4. Select the type of connection between the HMI device and the configuration computer, then set the communication parameters.
5. Select the "OS Update" tab.
6. Select whether to update the operating system with/without resetting to factory settings by setting the "Reset to factory settings" check box accordingly.
7. In "Image path," select the folder which contains the HMI device image file, *.img.
The HMI device image file is available on the corresponding WinCC flexible installation CD.
8. Select "Open".
In the output area, you are provided information on the version of the HMI device image file after it is opened.
9. When restoring without reset to factory setting only:
Set "Transfer" mode on the HMI device.
If automatic transfer mode is enabled on the HMI device, the device automatically sets "Transfer" mode when a restore operation is initiated.
10. On the PC, select "Update OS" to run the operating system update.
Follow the instructions in ProSave.
A status view opens to indicate progress.

Result

The system outputs and alarm when the operating system update is completed.

This operation has deleted the project data from the HMI device.

Note

HMI device OP 73

After the transfer via MPI, the transfer settings are automatically reset to serial transfer.

Operating a project

8.1 Operating a project on OP 73

8.1.1 Overview

Soft keys with global function assignment

A soft key with global function assignment always triggers the same action on the HMI device or in the PLC, regardless of the current screen. An example of such an action is the activation of a screen.

The soft key of a screen can be assigned either a global or a local function. The local function takes priority over the global setting.

Soft keys with local function assignment

A soft key with local function assignment is screen-specific and is therefore only effective within the active screen.

The function assigned to a soft key can vary from screen to screen.

Operation with key combinations

















Unwanted actions may be triggered if the operator unintentionally actuates a key combination.

 CAUTION
Unintentional actions
In "Online" mode, simultaneous operation of more than two keys may cause unintentional actions in the plant.
Never press more than two keys simultaneously.

System keys



The system keys (control keys) are used for operator input on the HMI device.

Table 8-1 Overview of control keys

Function	Action
Moving the cursor  , 	Activates the next field in horizontal direction
 , 	Activates the next field in vertical direction
Activate field  + 	Activates the next field in the tab order defined in your project
	Enables an overlay function of a further system key
Viewing infotext  + 	Opens a window containing infotext on the selected object You can press  to toggle between infotext for a screen and an object, for example, for an IO field.
Cancel action. 	<ul style="list-style-type: none"> Undo You can undo your input as long you have not yet confirmed it with . Close the alarm window - if configured. Cancel the output of infotext to return to the previous view.
Acknowledge alarm 	Acknowledges the current indicated or selected alarm or all alarms of an acknowledgment group, depending on your configuration.
	<ul style="list-style-type: none"> Call editing mode – initiates input with  and  Exit editor mode and confirm input

Navigating in lists

Table 8-2 Keys for navigation in lists

Button	Action on pressing
 or 	Selects the previous or next list entry

8.1.2 Setting the project language

Introduction

The HMI device supports multilingual projects. You need to configure a corresponding operator control object which lets you change the language setting on the HMI device during runtime.

The project always starts with the language set in the previous session.

Requirements

- The relevant project language must be available on the HMI device.
- The language changeover function must be logically linked to a configured operator control object such as a button.

Selecting a language

You can change project languages at any time. Language-specific objects are immediately output to the screen in the relevant language when you switch languages.

The following options are available for switching the language:

1. A configured operator control object switches from one project language to the next in a list.
2. A configured operator control directly sets the desired project language.

Further information on this may be available in your plant documentation.

8.1.3 Entries and help within a project

8.1.3.1 Overview

Procedure

Values are entered in the project input fields. The values are transferred from the input fields to the PLC.

Proceed as follows:

1. Select the required input field on the screen.

Based on your configuration, you can enter the following type of values in the input field:



- Numerical
- Alphanumerical
- Symbolic
- Date/time

2. Set the value.

3. Confirm your entries with  or cancel your entries with .

Numerical values

Enter the characters of numerical values using the system keyboard. Press  to edit any character of the value with the help of the cursor keys.

You can delete a value from the field by pressing  + .

Formats for the visualization of numerical values

You can enter values in numerical input fields based on the following formats:

- Decimal
- Hexadecimal
- Binary

The entry can be aligned left or right, depending on the configuration.

Limit value test of numerical values



Tags can be assigned limit values. If an alarm window has been configured, a system alarm is automatically output to indicate any violation of set limits of the input value, for example, 80 exceeds the set limit value of 78. The value entered is rejected. The original value is displayed again.

Decimal places for numerical values

If a numerical input field is configured for a specific number of decimal points, decimal places in excess of the limit are ignored. Empty decimal places are filled with "0" after the number is confirmed.

Alphanumerical values

Enter the alphanumerical values, numbers and letters character by character using the system keyboard. Press  to edit any character of the value with the help of the cursor keys.

You can delete a value from the field by pressing  + .

The extended character set is available for fields with "String" format.

Symbolic values

Symbolic values are by selecting configured entries and not using the keyboard. These entries are stored in symbolic IO fields.

Date and time

Date and time are entered in alphanumerical format.



8.1.3.2 Entering and editing numerical and alphanumerical values

Requirement

An IO field has been enabled with  +  or using the cursor keys.









Navigating in fields

Table 8-3 Overview of control keys for navigating in fields

Key	Action
 or 	The previous or following character is marked.

Control keys for character input

Table 8-4 Overview of the control keys for character input

Key	Action
 + 	Changes the sign of a numerical value. Press  +  to toggle between the two characters.
	This toggles between upper and lower case letters.
 or 	All characters available in the extended character set are called in succession.
	Validates the input
	Deletes the entry Restores the original value





Options of entering numerical and alphanumerical characters:

- Enters value and thereby fully replace the existing value
- Edit a character in an existing value

Procedure – entering values

To enter a new value instead of editing a character, you can delete the entire contents of the input field.







Proceed as follows:

1.  press to mark the entire field contents
2. Enter the value with  or .
3. Press .

This confirms your entries. To cancel the entry, press .



Procedure – editing specific characters of a value

Proceed as follows:

1. Press .
2. Select the relevant character with  or .
3. Replace the character with  or .
4. Press .

This confirms your entries. To cancel the entry, press .

Call sequence of the characters

When you initially enter a value in an alphanumeric input field, the letter "A" is called by pressing  or . The same applies when you add characters.

The following applies for further entries:



- Press  to enter letters.
Upper and lower case letters are indicated first, followed by the special characters and numbers.

To toggle between an upper and a lower case letter, press .

- Press  to enter numbers.
The list opens with various special characters and continues with the numbers.

Press  or  to view the next value if you already entered a value.

Procedure – deleting a character



1. Press .
2. Position the cursor on the character to be deleted.
3. Press  + .

The selected character will be deleted. The remaining characters to the right of the cursor shift by one position to the left.

If the characters are right aligned:

The selected character will be deleted. The remaining characters to the left of the cursor shift one position to the right.

Procedure – inserting characters

1. Press .
2. Move the cursor to the required position.
3. Press  +  to insert a space character.









The characters already entered move one position to the right from the cursor position.





If the characters are right aligned:

The characters already entered move one position to the left from the cursor position.

Example for numerical input











Activate the the input box. The following table shows the keys you need to press to enter "-12.34":

Key	Instruction	Display
	Press 1 x to begin input	+00.00 
	Press 5 x to move the marking five positions to the left	+ 00.00
	Keep pressing until "-" appears	- 00.00
	Press 1 x to move the marking one position to the right	- 0 00.00
	Keep pressing until "1" appears	- 1 00.00
	Press 1 x to move the marking one position to the right	- 1 0 00.00
	Keep pressing until "2" appears	- 1 2 00.00

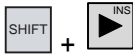
Key	Instruction	Display
	Press 2 x to move the marking one position to the right	-12. 0 0
	Keep pressing until "3" appears	-12. 3 0
	Press 1 x to move the marking one position to the right	-12.3 0
	Keep pressing until "4" appears	-12.3 4
	Press 1 x to end input	-12.34

Example for alphanumerical input

Activate the the input box. The following table shows the keys you need to press to enter "OP 73":





Key	Instruction	Display
	Press 1 x to begin input	A
	Keep pressing until "O" appears	O
	Press 1 x to move the marking one position to the right	O A
	Keep pressing until "P" appears	OP
	Press both keys 1 x simultaneously to create a space character	OP
	Press 1 x to move the marking one position to the right	OP A
	Keep pressing until "7" appears	OP 7
	Press 1 x to move the marking one position to the right	OP 7 A
	Keep pressing until "3" appears	OP 7 3
	Press 1 x to end input	OP 7 3

8.1.3.3 Entering and editing symbolic values

Requirements

A symbolic IO field has been with  +  or using the cursor keys.

Control keys for character input



Button	Action
 , 	Scrolls in a single-line list field until the required entry is found
	Validates the selected entry Disables editing mode
	Restores the original entry Disables editing mode

Procedure

Proceed as follows:



1. Enable the selection list with .

This enables the selection list which contains the configured symbolic entries.

2. Select an entry with  or .
3. Save or cancel the entry.

8.1.3.4 Entering and modifying date and time

Requirements

A date/time input field has been enabled with  +  or using the cursor keys.

Entering the date and time

Use numerical and alphanumerical values to set the date and time.

Note

When entering the date and time, please note that the format is determined by the configured project language.

See also

Entering and editing numerical and alphanumerical values (Page 129)
Setting the project language (Page 127)

8.1.3.5 Displaying infotext

Introduction

The configuration engineer uses infotext to provide additional information and operating instructions with respect to screens and operable screen objects.

An infotext may contain information on the value to be set in an IO field, for example.

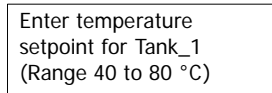

Figure 8-1 Infotext for an IO field, example

A help indicator can also be configured.







Figure 8-2 Help indicator

If there is an infotext available for the active screen, the help indicator is always displayed. If infotext is available for a screen object, the help indicator is displayed as soon as the cursor is placed over the screen object. If there is no infotext for the selected operator control object or the active screen, the help indicator is hidden.

Procedure

To view an infotext on the HMI device, press  + . There are two viewing options:

- If the cursor is positioned in a field for which infotext has been configured, press  +  to view the infotext.
- If  +  is pressed and no infotext is available for the field, the infotext configured for the active screen is shown instead.

If an infotext is not available for this active screen, the system opens the following dialog:

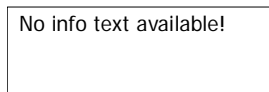

In this dialog, scroll through the list with  or . Press  to close the dialog.

If you have configured screen and IO field infotexts, you can toggle these in your view by pressing .

8.1.4 Project security

8.1.4.1 Overview

Overview

Operation of a project can be protected by the configuration engineer by implementing a security system.

The security system of the HMI device is based on authorizations, user groups and users.

If operator control objects protected by a password are operated, the HMI device requests the entry of a password. A logon screen is displayed in which you enter your user name and password. After logging in, you can operate the operator control objects for which you have the necessary authorizations.

The Logon dialog can be set up by the configuration engineer via an individual operator control object.

In the same way, the configuration engineer can set up an operator control object to log off. After logging off, objects assigned password protection can no longer be operated; to do so, log on again.

Additional information on this may be available in your plant documentation.

User groups and authorizations

Project-specific user groups are created by the configuration engineer. The "Administrators" group is included in all projects by default. User groups are assigned authorizations. The authorization required for an operation is specifically defined for each individual object and function in the project.

Users

Each user is assigned to exactly one user group.

Users can be created as follows:

- By the configuration engineer during configuration
- By the administrator on the HMI device
- By a user with user administration authorization on the HMI device

Logoff times

A logoff time is configured in the system for each user. If the time between any two user actions, e.g. entering a value or changing screens, exceeds this logoff time, the user is automatically logged off. The user must then log on again to continue to operate objects assigned password protection.

Passwords

Users can only log on to the HMI device if they are in the list of users and enters their user name and password. The passwords can be assigned by the configuration engineer, by the administrator (or by a user who has administration authorization) or by the user himself.

The authorizations of a user after logging on depends on the user group to the user is assigned.

Additional information on this may be available in your plant documentation.

The user data is encrypted and saved on the HMI device to protect it from loss due to power failure.

Note

Depending on the transfer settings, changes to the user data is overwritten when the project is transferred again.

User view

Use the User view to display the users on the HMI device.

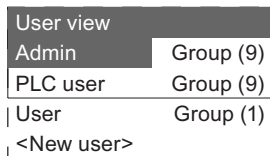

User view	
Admin	Group (9)
PLC user	Group (9)
User	Group (1)
<New user>	

All users on the HMI device system are displayed in the User view to the administrator or to a user with administrator authorizations. When user administration authorization is lacking, only the personal user entry is displayed.

The group to which each user is assigned is displayed next to the user names.

As administrator or user with user administration authorization, you can also add new users. To do so, select "<new user>".

Backup and restore

The users, passwords, group assignments and logoff times can be backed up and restored on the HMI device. This prevents you having to enter all of the data again on another HMI device.

NOTICE
During a restore, the currently valid user data is overwritten. The restored user data and passwords are valid immediately.

Limit values for user, password and user view

	Number of characters
Length of user name, maximum	40
Length of password, minimum	3
Length of password, maximum	24
Entry in user view, maximum	50

8.1.4.2 User logon

Requirements

Use the logon dialog to log onto the security system of the HMI device. Enter user name and password in the logon dialog.

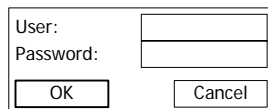



Figure 8-3 Logon dialog



You have the following options for displaying the logon dialog:

- Touch the operator control object with password protection.
- Touch an operator control object that was configured for displaying the logon dialog.
- Press  when the user view is active.
- At the beginning of the project, the logon dialog will be automatically displayed in certain circumstances.

Further information on this may be available in your plant documentation.

Procedure

Proceed as follows:

1. Enter the user name and password.
2. Enable the "OK" button with  +  or using the cursor keys.
3. Press .

Result

After successful logon to the security system, you can execute password-protected functions on the HMI device for which you have authorizations.

An error message is displayed if you enter the wrong password. In this case, no user is logged onto the project.

8.1.4.3 User logoff

Requirements

You have logged onto the security system of the HMI device.

Procedure

You have the following options for logging off:

- If the logoff time has been exceeded without user activity, the user is automatically logged off.
- Touch the operator control object that was configured for logoff.

Further information on this may be available in your plant documentation.

Result

The user is no longer logged into the project. In order to operate an operator control object with password protection, you must first log on again.

8.1.4.4 Creating users

Requirements

New users are created in the user view.

To display the user view, switch to the screen that contains the user view.

To add a new user, you must have user administration authorization.

Procedure

Proceed as follows:

1. In the user view, select "New User" with  or .

2. Press .

The following dialog appears:

User:	<input type="text"/>
<input type="button" value="OK"/>	<input type="button" value="Cancel"/>

3. Enter the user name.
4. Select "OK".

5. Press .

The following dialog appears:

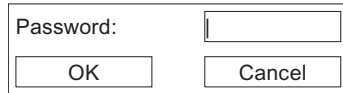

A dialog box with the label "Password:" on the left and an empty text input field on the right. Below the input field are two buttons: "OK" on the left and "Cancel" on the right.

6. Enter the password.

7. Select "OK".

8. Press .

The following dialog appears:

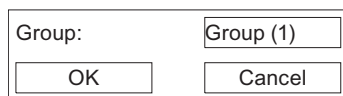

A dialog box with the label "Group:" on the left and a text input field containing "Group (1)" on the right. Below the input field are two buttons: "OK" on the left and "Cancel" on the right.

9. From the list of available groups, select the one granted the corresponding user access rights and assign the user to this group.

10. Select "OK".

11. Press .

The following dialog appears:

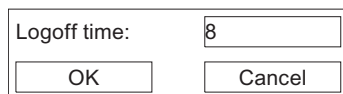

A dialog box with the label "Logoff time:" on the left and a text input field containing "8" on the right. Below the input field are two buttons: "OK" on the left and "Cancel" on the right.

12. Enter the logon timeout value in minutes.

13. Select "OK".

14. Press .

Result

The new user is created.

8.1.4.5 Changing user data

Requirements

Change user data in the user view.

To display the user view, switch to the screen that contains the user view.

The following options are available for the range of changes that can be made:

- The administrator or a user with user administration authorization can change the data for all users on the HMI device system in the user view.
 - User name
 - Group assignment
 - Password
 - Logoff time
- Users without user administration authorization can only change their own user data.
 - Password
 - Logoff time

Note

You can only change the logoff time and password for the "Admin" user.

You can only change the logoff time for the "PLC_User". This user entry is used for logging on via the PLC.

Procedure

This procedure describes changing user data by the administrator or a user with user administration authorization.

Proceed as follows:

1. From the user view, select the profile using the cursor keys.

2. Press .

The following dialog appears:



A dialog box with a title bar. It contains a label 'User:' followed by a text input field containing 'User 1'. Below the input field are two buttons: 'OK' and 'Cancel'.

3. Enter the new user name as required.
4. Select "OK".
5. Press .

6. Enter the new password as required.

Password:	*****
<input type="button" value="OK"/>	<input type="button" value="Cancel"/>

7. Select "OK".

8. Press .

9. Select the new user group as required.

Group:	Group (1)
<input type="button" value="OK"/>	<input type="button" value="Cancel"/>

10. Select "OK".

11. Press .

12. Edit the logon timeout value as required.

Logoff time:	8
<input type="button" value="OK"/>	<input type="button" value="Cancel"/>

13. Select "OK".

14. Press .

Result

The user data for the user is changed.

8.1.4.6 Deleting a user

Requirements

You delete users in the user view: Select the screen which contains the user view.

To delete a user, you must have user administration authorization.

There are two methods of deleting a user:



- Directly in the user view
- Using the user dialog

Note

The "Admin" and "PLC_User" users exist by default and cannot be deleted.

Procedure – Deleting users directly in the user view

Proceed as follows:

1. From the user view, select the user you want to delete using the cursor keys.
2. Press  + .

Result

The user is deleted.

Procedure – Deleting users using the user dialog



Proceed as follows:

1. From the user view, select the user you want to delete using the cursor keys.
2. Press .

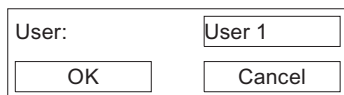
This opens the user dialog.



The user dialog box contains a label 'User:' followed by an input field containing 'User 1'. Below the input field are two buttons: 'OK' and 'Cancel'.

3. Select the "User" input field.
4. Press  + .
- Delete all characters from the input field.
5. Select "OK".
6. Press .

Result

The user is deleted.

8.1.5 Closing the project

Procedure

Proceed as follows:

1. Use the corresponding operator control object to close the project.
Wait for the Loader to open after you closed the project.
2. Switch off power to the HMI device.

8.2 Operating a project on OP 77A and OP 77B

8.2.1 Overview

Soft keys with global function assignment

A soft key with global function assignment always triggers the same action on the HMI device or in the PLC, regardless of the current screen. These actions include:

- Enabling a screen
- Output of the content of the active screen to a printer (applies to OP 77B)

The soft key of a screen can be assigned either a global or a local function. The local function takes priority over the global setting.

Soft keys with local function assignment

A soft key with local function assignment is screen-specific and is therefore only effective within the active screen.

The function assigned to a soft key can vary from screen to screen.

The dual-row keys are particularly suited for controlling binary states and machine functions, as shown in the figure below.

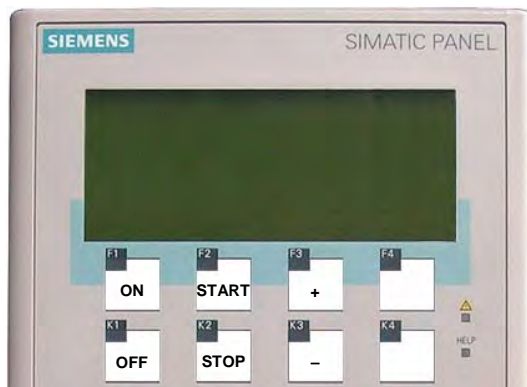

Figure 8-4 Example of dual-row, labeled keys

Operation with key combinations

Unwanted actions may be triggered if the operator unintentionally actuates a key combination.

CAUTION

Unintentional actions

In "Online" mode, simultaneous operation of more than two keys may cause unintentional actions in the plant.



















Never press more than two keys simultaneously.

System keys

System keys are used to input commands on the HMI device and can be organized as follows:







- Numerical keypad
- Control keys

Table 8-5 Overview of control keys

Function	Action on pressing
Moving the cursor  , 	Activates the next field in horizontal direction
 , 	Activates the next field in vertical direction
Select field 	Activates the next field in the tab order defined in your project
	Enables the overlay function of a further key
 + 	Reverses the tab order
Deletes characters 	In input fields, this deletes the character at the current cursor position. The next characters shift one position to the left.
Viewing infotext 	Opens a window containing infotext on the selected object Requirement: An infotext exists for the selected object only if the LED  is lit. Pressing  can be used to toggle between infotext for a screen and an object, for example, for an IO field.
Cancel action. 	<ul style="list-style-type: none"> • Undo You can undo your input as long you have not yet confirmed it with . • Close the alarm window - if configured. • Cancel the output of infotext to return to the previous view.
Acknowledge alarm 	Acknowledges the current indicated or selected alarm or all alarms of an acknowledgment group, depending on your configuration.
	<ul style="list-style-type: none"> • Confirms your entries and closes the dialog. • Initiates input by means of  and 

Navigating in lists

Table 8-6 Keys for navigation in lists

Button	Action on pressing
 or 	Selects the previous or next list entry
 	Scrolls one page up or down to open further list entries
 	Selects the first or last entry in a list

8.2.2 Setting the project language

Introduction

The HMI device supports multilingual projects. You need to configure a corresponding operator control object which lets you change the language setting on the HMI device during runtime. The project always starts with the language set in the previous session.

Requirements

- The relevant project language must be available on the HMI device.
- The language changeover function must be logically linked to a configured operator control object such as a button.

Selecting a language

You can change project languages at any time. Language-specific objects are immediately output to the screen in the relevant language when you switch languages.

The following options are available for switching the language:

1. A configured operator control object switches from one project language to the next in a list.
2. A configured operator control directly sets the desired project language.

Further information on this may be available in your plant documentation.

Changing the project language on OP 77B

After the HMI device restart, the new project language is only set if the project was closed by an operator control object before you switched off power.

8.2.3 Entries and help within a project

8.2.3.1 Overview

Procedure

Values are entered in the project input fields. The values are transferred from the input fields to the PLC.

Proceed as follows:

1. Select the required input field on the screen.

Based on your configuration, you can enter the following type of values in the input field:

- Numerical
- Alphanumerical
- Symbolic
- Date/time

2. Set the value.

3. Confirm your entries with  or cancel your entries with .

Numerical values

Enter the characters of numerical values using the system keyboard. Press  to edit any character of the value with the help of the cursor keys.

All values in this input field are deleted by pressing .

Formats for the visualization of numerical values

You can enter values in numerical input fields based on the following formats:

- Decimal
- Hexadecimal
- Binary

Limit value test of numerical values

Tags can be assigned limit values. The system automatically outputs a system alarm if a number entered exceeds a set limit (for example, "80" when a limit of "78" is set), provided an alarm window has been configured. The value entered is rejected. The original value is displayed again.

Decimal places for numerical values

If a numeric input field is configured for a specific number of decimal places, decimal places in excess of the limit are ignored. Empty decimal places are filled with "0" after the value is confirmed.

Alphanumerical values

Enter the alphanumerical values, numbers and letters character by character using the system keyboard. Press  to edit any character of the value with the help of the cursor keys.

All values in this input field are deleted by pressing .

Symbolic values

Symbolic values are by selecting configured entries and not using the keyboard. These entries are stored in symbolic IO fields.

Date and time

Date and time are entered in alphanumerical format.



8.2.3.2 Entering and editing numerical and alphanumerical values

Requirements

An IO field was selected with  or the cursor keys.

















Navigating in fields

Table 8-7 Overview of control keys for navigating in fields

Button	Action on pressing
 or 	Selects the previous or next character

Control keys for character input

Table 8-8 Overview of the control keys for character input



Button	Action on pressing
 up to 	Enters the numbers 0 to 9
 , 	Enters a comma separator or a decimal point
 + 	Changes the sign of a numerical value Press  and  to toggle between the characters.
 +  to  + 	The characters A to F can be entered.
 or 	The characters of the extended character set are called in succession.
	Validates the input
	Deletes the input Restores the original value

Options of entering numerical and alphanumerical characters:

- Overwrite the existing value
- Edit a character in an existing value





Procedure – Entering a value using the numerical keypad

Proceed as follows:

1. Enter the values using the numerical keypad.
The existing value is deleted when you enter the first character.
2. Press .
3. This confirms your entries. To cancel the entry, press .

Procedure – Entering a value using the cursor keys





Proceed as follows:

1. Press .
2. Delete the field content with .
3. Enter the value with  or .
4. Press .

This confirms your entries. To cancel the entry, press .

Procedure – Editing values digit by digit using the numerical keypad







Proceed as follows:

1. Press .
2. Select the relevant character with  or .
3. Edit the characters using the numerical keypad.
4. Press .

This confirms your entries. To cancel the entry, press .

Procedure – Editing values digit by digit using the cursor keys

Proceed as follows:

1. Press .
2. Select the relevant character with  or .
3. Replace the character with  or .
4. Press .

This confirms your entries. To cancel the entry, press .

Call sequence of the characters

When you initially enter a value in an alphanumerical input field, the letter "A" is called by pressing or . The same applies when you add characters.

The following applies for further entries:

- Press to enter letters.
Upper and lower case letters are output first, followed by the special characters and numbers.
- Press to enter numbers.
Some special characters are shown, followed by the numbers.

If a value has already been entered, select the next value with or .

Example for alphanumerical input

To enter "OP 77B", activate the combo box. When using the cursor keys, press and hold the corresponding cursor key or until the required character appears. Press the following keys:

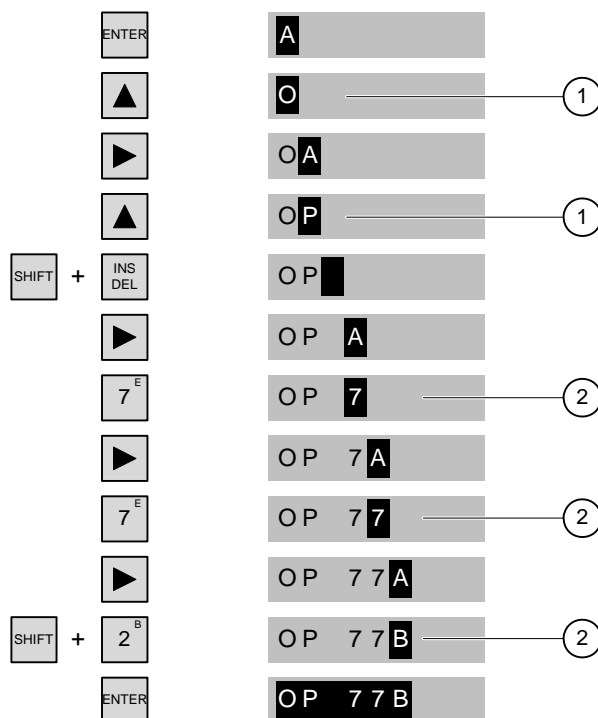



Figure 8-5 Example of input using the cursor keys and the numeric keypad

- ① Input using the cursor keys
- ② Input using the numeric keypad

Procedure – Deleting a character



1. Press .
2. Position the cursor on the character to be deleted.
3. Press .

The selected character will be deleted. The remaining characters to the right of the cursor shift by one position to the left.

If the characters are right aligned:

The selected character will be deleted. The remaining characters to the left of the cursor shift one position to the right.

Procedure – Inserting characters

1. Press .
2. Move the cursor to the insert position.
3. Press  and  to insert a space character.

The characters already entered move one position to the right from the cursor position.

If the characters are right aligned:





The characters already entered move one position to the left from the cursor position.

8.2.3.3 Entering and editing symbolic values

Requirements

An IO field was selected with  or using the cursor keys.

Control keys for character input



Button	Action on pressing
 , 	Scrolls in a single-line list field until the required entry is found
	Validates the selected entry Disables editing mode
	Restores the original entry Disables editing mode

Procedure

Proceed as follows:

1. Enable the selection list with .

This enables the selection list which contains the configured symbolic entries.

2. Select an entry with  or .
3. Save or cancel the entry.

8.2.3.4 Entering and modifying date and time

Requirements

A date and time field was selected with  or the cursor keys.

Entering the date and time

Use numerical and alphanumerical values to set the date and time.

Note

When entering the date and time, please note that the format is determined by the configured project language.

See also

Entering and editing numerical and alphanumerical values (Page 147)

Setting the project language (Page 145)

8.2.3.5 Viewing infotext

Introduction

The configuration engineer uses infotext to provide additional information and operating instructions with respect to screens and operable screen objects.

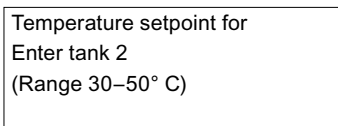

An infotext may contain information on the value to be set in an IO field, for example.





Temperature setpoint for
Enter tank 2
(Range 30–50° C)

Figure 8-6 Infotext for an IO field, example

Procedure

The availability of an infotext is indicated by the lit  LED. Press  to view the infotext on the HMI device. Two cases are possible:

- If the cursor is positioned in a field for which infotext has been configured, press  to view the infotext.
- When you press  and no infotext is available for the box, the system outputs the infotext for the active screen.

If an infotext is not available for this active screen, the system opens the following dialog:

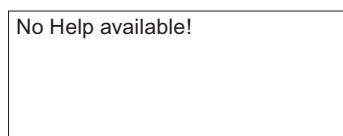

In this dialog, scroll through the list with  or . Press  to close the dialog.

Provided you have configured screen and IO field infotexts, you can toggle these in your view by pressing .

8.2.4 Project security

8.2.4.1 Overview

Overview

Operation of a project can be protected by the configuration engineer by implementing a security system.

The security system of the HMI device is based on authorizations, user groups and users.

If operator control objects protected by a password are operated, the HMI device requests the entry of a password. A logon screen is displayed in which you enter your user name and password. After logging in, you can operate the operator control objects for which you have the necessary authorizations.

The Logon dialog can be set up by the configuration engineer via an individual operator control object.

In the same way, the configuration engineer can set up an operator control object to log off. After logging off, objects assigned password protection can no longer be operated; to do so, log on again.

Additional information on this may be available in your plant documentation.

User groups and authorizations

Project-specific user groups are created by the configuration engineer. The "Administrators" group is included in all projects by default. User groups are assigned authorizations. The authorization required for an operation is specifically defined for each individual object and function in the project.

Users

Each user is assigned to exactly one user group.

Users can be created as follows:

- By the configuration engineer during configuration
- By the administrator on the HMI device
- By a user with user administration authorization on the HMI device

Logoff times

A logoff time is configured in the system for each user. If the time between any two user actions, e.g, entering a value or changing screens, exceeds this logoff time, the user is automatically logged off. The user must then log on again to continue to operate objects assigned password protection.

Passwords

Users can only log on to the HMI device if they are in the list of users and enters their user name and password. The passwords can be assigned by the configuration engineer, by the administrator (or by a user who has administration authorization) or by the user himself.

The authorizations of a user after logging on depends on the user group to the user is assigned.

Additional information on this may be available in your plant documentation.

The user data is encrypted and saved on the HMI device to protect it from loss due to power failure.

Note

Depending on the transfer settings, changes to the user data is overwritten when the project is transferred again.

User view

Use the User view to display the users on the HMI device.

User view	
Admin	Group (9)
PLC user	Group (9)
User	Group (1)
<New user>	

All users on the HMI device system are displayed in the User view to the administrator or to a user with administrator authorizations. When user administration authorization is lacking, only the personal user entry is displayed.

The group to which each user is assigned is displayed next to the user names.

As administrator or user with user administration authorization, you can also add new users. To do so, select "<new user>".

Backup and restore

The users, passwords, group assignments and logoff times can be backed up and restored on the HMI device. This prevents you having to enter all of the data again on another HMI device.

NOTICE
During a restore, the currently valid user data is overwritten. The restored user data and passwords are valid immediately.

Limit values for user, password and user view

	Number of characters
Length of user name, maximum	40
Length of password, minimum	3
Length of password, maximum	24
Entry in user view, maximum	50

8.2.4.2 User logon

Requirements

Use the logon dialog to log onto the security system of the HMI device. Enter user name and password in the logon dialog.

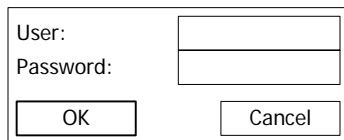



Figure 8-7 Logon dialog



You have the following options for displaying the logon dialog:

- Touch a protected operator control object.
- Touch an operator control object which is assigned a function for opening the Logon dialog.
- Press  when the user view is active.
- At the beginning of the project, the logon dialog will be automatically displayed in certain circumstances.

For further information, refer to your system documentation.

Procedure

Proceed as follows:

1. Enter the user name and password.
2. Enable the "OK" button with  or using the cursor keys.
3. Press .

Result

After successful logon to the security system, you can execute password-protected functions on the HMI device for which you have authorizations.

An error message is displayed if you enter the wrong password. In this case, no user is logged onto the project.

8.2.4.3 User logoff

Requirements

You have logged onto the security system of the HMI device.

Procedure

You have the following options for logging off:

- If the logoff time has been exceeded without user activity, the user is automatically logged off.
- Touch the operator control object that was configured for logoff.
Further information on this may be available in your plant documentation.

Result

The user is no longer logged into the project. In order to operate an operator control object with password protection, you must first log on again.

8.2.4.4 Creating users

Requirements



New users are created in the user view.

To display the user view, switch to the screen that contains the user view.

To add a new user, you must have user administration authorization.

Procedure

Proceed as follows:



1. In the user view, select "New User" with  or .

2. Press .

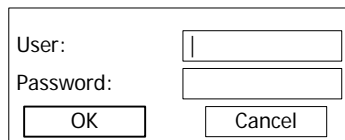
The following dialog appears:





A dialog box with two input fields. The first is labeled "User:" and the second is labeled "Password:". Below the fields are two buttons: "OK" and "Cancel".

3. Press .
4. Enter the user name.
5. Select  to move to the next input field.
6. Enter the password.
7. Select "OK".
8. Press .

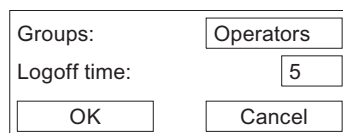
The following dialog appears:



A dialog box with two input fields. The first is labeled "Groups:" and contains the text "Operators". The second is labeled "Logoff time:" and contains the number "5". Below the fields are two buttons: "OK" and "Cancel".

9. From the list of available groups, select the one granted the corresponding user access rights and assign the user to this group.
10. Select  to move to the next input field.
11. Enter the logon timeout value in minutes.
12. Select "OK".
13. Press .

Result

The new user is created.

8.2.4.5 Changing user data

Requirements

Change user data in the user view.

To display the user view, switch to the screen that contains the user view.

The following options are available for the range of changes that can be made:

- The administrator or a user with user administration authorization can change the data for all users on the HMI device system in the user view.
 - User name
 - Group assignment
 - Password
 - Logoff time
- Users without user administration authorization can only change their own user data.
 - Password
 - Logoff time

Note



You can only change the logoff time and password for the "Admin" user.

You can only change the logoff time for the "PLC_User". This user entry is used for logging on via the PLC.

Procedure

This procedure describes changing user data by the administrator or a user with user administration authorization.



Proceed as follows:

1. Select an entry from the user view with  or .
2. Press .

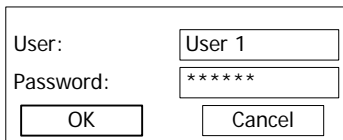
The following dialog appears:





A dialog box with two input fields and two buttons. The first field is labeled 'User:' and contains the text 'User 1'. The second field is labeled 'Password:' and contains six asterisks '*****'. Below the fields are two buttons: 'OK' on the left and 'Cancel' on the right.

3. Edit the user name as required.
4. Select  to move to the next input field.
5. Edit the password as required.
6. Select "OK".
7. Press .

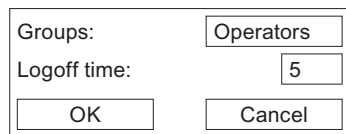
The following dialog appears:



A dialog box with two input fields and two buttons. The first field is labeled 'Groups:' and contains the text 'Operators'. The second field is labeled 'Logoff time:' and contains the number '5'. Below the fields are two buttons: 'OK' on the left and 'Cancel' on the right.

8. Edit the user group as required.
9. Select  to move to the next input field.
10. Edit the logon timeout as required.
11. Select "OK".
12. Press .

Result

The user data for the user is changed.

8.2.4.6 Deleting a user

Requirements

You delete users in the user view: Select the screen which contains the user view.

To delete a user, you must have user administration authorization.

There are two methods of deleting a user:



- Directly in the user view
- By means of the user dialog

Note

The "Admin" and "PLC_User" users exist by default and cannot be deleted.

Procedure – Deleting users directly in the user view

Proceed as follows:



1. In the user view, select  or  to select the user you want to delete.
2. Press .

Result

The user is deleted.

Procedure – Deleting users by means of the user dialog



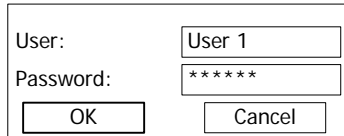

Proceed as follows:

1. In the user view, select  or  to select the user you want to delete.
2. Press .

This opens the user dialog.



The user dialog box contains two input fields: "User:" with the text "User 1" and "Password:" with six asterisks "*****". Below the input fields are two buttons: "OK" and "Cancel".

3. Select the "User" input field with .
4. Press .
5. Press .
6. Select "OK" with .
7. Press .

Delete all characters from the input field.

Result

The user is deleted.

8.2.5 Closing the project

Procedure

Proceed as follows:

1. Use the corresponding operator control object to close the project.
Wait for the Loader to open after you closed the project.
2. Switch off power to the HMI device.

Operating alarms

9.1 Overview

Alarms

Alarms indicate events and states on the HMI device which have occurred in the system, in the process or on the HMI device itself. A status is reported when it is received.

An alarm could trigger one of the following alarm events:

- Activate
- Deactivate
- Acknowledge

The configuration engineer defines which alarms must be acknowledged by the user.

An alarm may contain the following information:

- Date
- Time
- Alarm text
- Location of fault
- Status
- Alarm class
- Alarm number
- Acknowledgement group

Alarm classes

Alarms are assigned to various alarm classes:

- Error
Alarms in this class must always be acknowledged. Alarms normally indicate critical errors within the plant such as "Motor temperature too high".
- Warning
Warning alarms usually indicate states of a plant such as "Motor switched on".
- System
System alarms indicate states or events which occur on the HMI device.
- User-specific alarm classes
The properties of this alarm class are defined in the configuration.
- STEP 7 alarm classes (applies to OP 77B)
The alarm classes configured in STEP 7 are also available to the HMI device.

Further information on this may be available in your plant documentation.

Alarm buffer

Alarm events are saved to an internal, volatile buffer. The size of this alarm buffer depends on the HMI device type.

Alarm log (only for OP 77B)

When alarm logging is enabled, alarm events are output directly to the printer.

You can set the logging function separately for each alarm. The system outputs "activated" and "deactivated" alarm events to the printer.

The output of alarms of the "System" class to a printer must be initiated by means of the corresponding alarm buffer. This outputs the content of the alarm buffer to the printer. To be able to initiate this print function, you need to configure a corresponding control object in the project.

9.2 Alarms on the OP 73

9.2.1 Displaying alarms

Alarm view and alarm window

Alarms are indicated in the alarm view or in the alarm window on the HMI device.

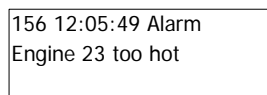

Figure 9-1 Alarm view

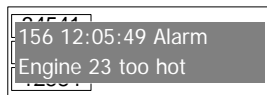

Figure 9-2 Alarm window







The layout and operation of the alarm window correspond to that of the alarm view.

The alarm window is independent of the process screen. Depending on the configuration, the alarm window appears automatically as soon as a new, unacknowledged alarm has been received. The alarm window can be configured so that it only closes after all the alarms have been acknowledged.

Additional information on this may be available in your plant documentation.

Operator control components

Functions of the HMI device keys in the alarm view:

Button	Function
 + 	Show an alarm infotext
	Edit alarm
	Acknowledge alarm
	Show the full text of the selected alarm in a separate window, the alarm text window. You can scroll the alarm text window using the cursor keys.
 , 	Select the next or previous alarm from the alarm view

Alarm class layout

The various alarm classes are identified in order to distinguish between them in the alarm view.

Symbol	Alarm class
!	Error
(empty)	Warning
(depending on the configuration)	User-defined alarm classes
\$	System

The configuration engineer can edit the alarm class symbols. Additional information on this may be available in your plant documentation.

Displaying infotext

An alarm can be assigned an infotext.

Proceed as follows to view the infotext:

1. Select the relevant alarm in the alarm view using the cursor keys.

2. Press  and .

The infotext assigned to this alarm is shown.

3. Press  to close the infotext.

Viewing long alarm text



The alarm text window can be used to view infotexts which can not be output in full length in the alarm view.

1. Select the alarm using the cursor keys.

2. Press .

This opens the alarm text window shown below.

```
502 15:05:49 Alarm
switch off unit 4,
disconnect main linkage,
close by-pass stop valve 2,
start cooling unit 23 and
open pipes 12 and 53,
acknowledge button ACK
```

3. Press  or  to view the full alarm text.

4. Press .

This closes the alarm text window.

Alarm indicator

The alarm indicator is a graphic symbol that shows alarms to be acknowledged.

The following figure shows the alarm indicator:



The alarm indicator flashes as long as alarms are queued for acknowledgment. The alarm indicator is displayed and does not flash as long as acknowledged alarms are still queued. When no alarm is in the queue, the alarm indicator is hidden.

9.2.2 Acknowledge alarm

Requirements

- The alarm to be acknowledged is shown in the alarm window or in the alarm view.
- Either the alarm window or the alarm view is enabled.
- The alarm must be acknowledged.

Procedure

Proceed as follows to acknowledge an alarm:

1. From the alarm window or alarm view, select the relevant alarm using the cursor keys.
2. Press .

Result

The alarm or all alarms of the corresponding acknowledgement group are acknowledged. You may find additional information about acknowledgment groups in your plant documentation.

9.2.3 Edit alarm

Introduction

The configuration engineer can assign additional functions to each alarm. These functions are executed when the alarm is processed.

Requirements

- The alarm to be edited is indicated in the alarm window or in the alarm view.
- Either the alarm window or the alarm view is enabled.

Procedure

Proceed as follows to edit an alarm:

1. From the alarm view, select the alarm you want to edit using the cursor keys.
2. Press .

Result

The system executes the additional functions of the alarm. You may find additional information on this in your plant documentation.

Note

When you edit an unacknowledged alarm, it is acknowledged automatically.

9.3 Alarms on the OP 77A and OP 77B

9.3.1 "Error" alarm class

"Error" class alarms are indicated by the "alarm indicator" LED:



Figure 9-3 "Alarm indicator" LED

The "alarm indicator" LED can signal the following states:

- LED off
No "error" class alarm.
- LED flashes
At least on unacknowledged "error" class alarm.
- LED is lit
At least one acknowledged "error" class alarm, but no unacknowledged alarms.

9.3.2 Viewing alarms

Alarm view and alarm window

Alarms are indicated on the HMI device in the Alarm View or Alarm Window.

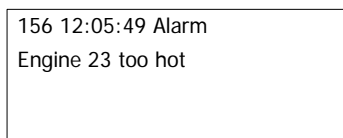

Figure 9-4 Alarm view

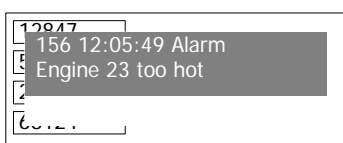

Figure 9-5 Alarm window







The layout and operation of the alarm window correspond to that of the alarm view.

The alarm window is independent of the process screen. Depending on the configuration, the alarm window appears automatically as soon as a new, unacknowledged alarm has been received. The alarm window can be configured so that it only closes after all the alarms have been acknowledged.

For further information, refer to your plant documentation.

Operator control components

Functions of the HMI device keys in the alarm view:

Button	Function
	Displays an alarm infotext
	Edits an alarm
	Acknowledges an alarm
	Displays the full text of the selected alarm in a separate window, the alarm text window You can scroll in the alarm text window.
 , 	Selects the next or previous alarm from the alarm view

Alarm class layout

The following identifiers are used to distinguish between the various alarm classes in the alarm view:

Symbol	Alarm class
!	Error
(empty)	Warning
(depending on the configuration)	User-defined alarm classes
\$	System

The configuration engineer can edit the alarm class symbols. Further information on this may be available in your plant documentation.

Viewing infotext

An alarm can be assigned an infotext.

To view the infotext:

1. Select the relevant alarm in the alarm view using the cursor keys.

2. Press .

The infotext assigned to this alarm is shown.

3. Press  to close the infotext.

Viewing long alarm text



The alarm text window can be used to view infotexts which can not be output in full length in the alarm view.

1. Select the alarm using the cursor keys.

2. Press .

This opens the alarm text window shown below.

502 15:05:49 Alarm
switch off unit 4,
disconnect main linkage,
close by-pass stop valve 2,
start cooling unit 23 and
open pipes 12 and 53,
acknowledge button ACK

3. Press  or  to view the full alarm text.

4. Press .

This closes the alarm text window.

9.3.3 Acknowledge alarm

Requirements

- The alarm to be acknowledged is shown in the alarm window or in the alarm view.
- Either the alarm window or the alarm view is enabled.
- The alarm must be acknowledged.

Procedure

Proceed as follows to acknowledge an alarm:

1. From the alarm window or alarm view, select the relevant alarm using the cursor keys.
2. Press .

Result

The alarm or all alarms of the corresponding acknowledgement group are acknowledged. You may find additional information about acknowledgment groups in your plant documentation.

9.3.4 Edit alarm

Introduction

The configuration engineer can assign additional functions to each alarm. These functions are executed when the alarm is processed.

Requirements

- The alarm to be edited is indicated in the alarm window or in the alarm view.
- Either the alarm window or the alarm view is enabled.

Procedure

Proceed as follows to edit an alarm:

1. From the alarm view, select the alarm you want to edit using the cursor keys.
2. Press .

Result

The system executes the additional functions of the alarm. You may find additional information on this in your plant documentation.

Note

When you edit an unacknowledged alarm, it is acknowledged automatically.

Operating recipes on OP 77A and OP 77B

10.1 Overview

Introduction

Recipes are used when different variants of a product are manufactured with the same process. In this case, the product variants differ in terms of their type and quantity of the components, but not in terms of the manufacturing process sequence. The configuration engineer can store the combination of each individual product variant in a recipe.

Field of application

Recipes can be used everywhere the same product components are used in variable combinations to create different product variants.

Examples:

- Beverage industry
- Food processing industry
- Pharmaceutical industry
- Paint industry
- Building materials industry
- Steel industry

10.2 Structure of a recipe

Recipes

The recipe collection for the production of a product family can be compared to a file cabinet. A recipe which is used to manufacture a product corresponds to a drawer in a file cabinet.

Example:

In a plant for producing fruit juice, recipes are required for different flavors. There is a recipe, for example, for the flavors orange, grape, apple and cherry.

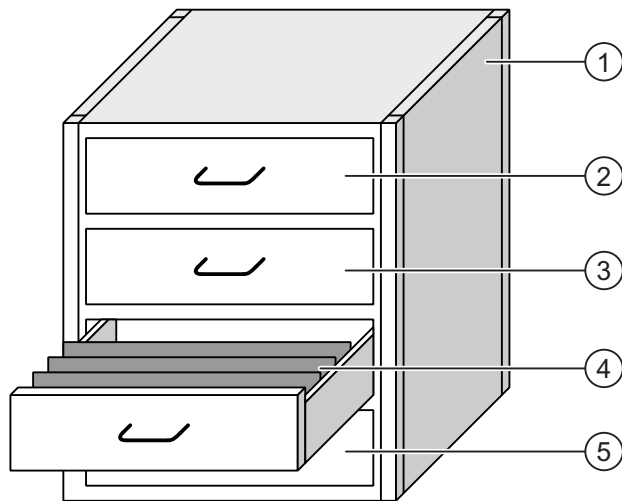

①	File cabinet	Recipe collection	Recipes for a fruit juice plant
②	Drawer	Recipe	Orange flavored drinks
③	Drawer	Recipe	Grape flavored drinks
④	Drawer	Recipe	Apple flavored drinks
⑤	Drawer	Recipe	Cherry flavored drinks

Recipe data records

The drawers of the file cabinet are filled with suspension folders. The suspension folders in the drawers represent records required for manufacturing various product variants.

Example:

Product variants of the flavor apple might be a soft drink, a juice or nectar, for example.

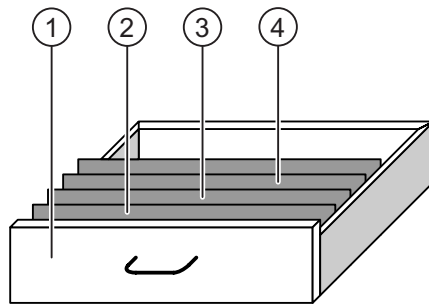

①	Drawer	Recipe	Product variants of apple flavored drinks
②	Suspension folder	Recipe data record	Apple drink
③	Suspension folder	Recipe data record	Apple nectar
④	Suspension folder	Recipe data record	Apple juice

Elements

In the figure showing the file cabinet, each suspension folder contains the same number of sheets. Each sheet in the suspension folder corresponds to an element of the recipe data record. All the records of a recipe contain the same elements. The records differ, however, in the value of the individual elements.

Example:

All drinks contain the same components: water, concentrate, sugar and flavoring. The records for soft drink, fruit juice or nectar differ, however, in the quantity of sugar used in production.

10.3 Recipes in the Project

Overview

If recipes are used in a project, the following components interact:

- HMI device recipe memory

Recipes are saved in the form of data records in the HMI device recipe memory.

The recipe data can also be saved in recipe tags.

- Recipe view / recipe screen

On the HMI device, recipes are displayed and edited in the recipe view or in a recipe screen.

- The recipe data records from the internal memory of the HMI device are displayed and edited in the recipe view.
- The values of the recipe tags are displayed and edited in the recipe screen.

Note

The same recipe tags can be configured in a variety of recipes. If you modify the value of a recipe tag in a recipe, the value of this recipe tag changes in all other recipes.

- Recipe tags on OP 77A

The recipe tags contain recipe data. Recipe tags configured in IO fields are always automatically synchronized with the recipe view. You can exchange the values of the recipe tags with the PLC.

- Recipe tags on OP 77B

The recipe tags contain recipe data. When you edit recipes in a recipe screen, the recipe values are stored in recipe tags.

The recipe tags are not automatically synchronous with the recipe view. You can synchronize the recipe tags with the recipe data records so that the same values are saved in both. Depending on the configuration, the values of the recipe tags are exchanged with the PLC.

- Memory card of OP 77B

The memory card is an external storage medium for recipe data records. The recipe data records are exported from the HMI device recipe memory and are saved on the memory card in a CSV file. The records can be imported again from the memory card to the recipe memory.

Data Flow

The following figure shows the data flow in a project with recipes:

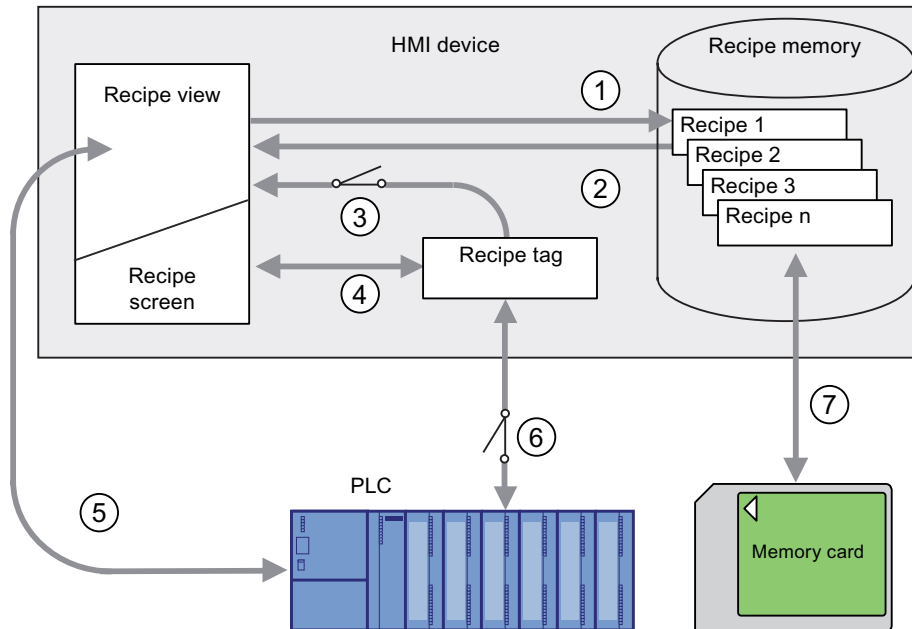

- ① Editing, saving or deleting a recipe data record
- ② Display recipe data record
- ③ Synchronize or do not synchronize recipe tags
The recipe tags are always synchronized on the OP 77A.
- ④ Display and edit recipe tags in the recipe screen
- ⑤ Write records from the recipe view to the PLC or read records from the PLC and display them in the recipe view.
- ⑥ OP 77B: Recipe tags are to the PLC online or offline
- ⑦ OP 77B: Export or import recipe data record to memory card

10.4 Recipe view

Recipe view

You display recipes and edit them in the recipe view. A recipe view is a screen object used to manage recipe data records. The recipe view shows recipe data records in tabular form. The configuration engineer defines which operator controls are displayed in the recipe view. Only a simple recipe view can be configured on the OP 77A and OP 77B.

Layout of the Simple Recipe View

The simple recipe view consists of three areas:

- Recipe list
- Record list
- Element list

In the simple recipe view, each area is shown separately on the HMI device. Depending on the configuration, the simple recipe view starts with the recipe list.

The figure below shows an example of the simple recipe view with a data record list.

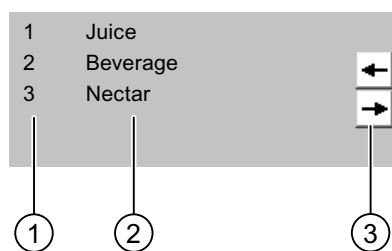

- ① Number of the recipe data record
- ② Recipe data records
- ③ Buttons for changing the displayed list and calling the menu

10.5 Operating the Simple Recipe View

Introduction

The simple recipe view consists of three areas:

- Recipe list
- Record list
- Element list

You can use the shortcut menu to operate each of these display areas.

Operation









The simple recipe view can be operated as follows:

- Create recipe data records
- Save recipe data records or save them under a new name
- Rename recipe data records
- Delete recipe data records
- Transfer recipe data records from the PLC and to the PLC

Operator controls of the simple recipe view

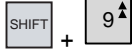
Toggle between the display areas and the shortcut menus to operate the simple recipe views.

The table below shows the operation of the display area:

Key	Function
	The next lower display area opens, i.e. the data record list or the element list.
	The next higher display area opens, i.e. the recipe list or the data record list.
	The shortcut menu of the display area opens.
	The previous/next entry is selected in the display area.
	A display page is scrolled up in the display area.
	A display page is scrolled down in the display area.
	The first entry is selected and highlighted.
	The last entry is selected and highlighted.





The table below shows the operation of the shortcut menu.

Key	Function
	The menu is closed. The display area opens.
Number of the menu command	The menu command is executed.







Shortcut menus of the simple recipe view

A shortcut menu can be called for each display area by pressing the  key. The commands available in the shortcut menu depend on the currently selected display area. A number is assigned to each command. The command is executed when you enter the number of the command. You can also use the system keys for some commands.



- Recipe list

Menu command	System Key	Function
New	 + 	A new recipe data record is created for the selected recipe. If an initial value has been configured, this is shown in this input field.
Viewing infotext		The infotext configured for the simple recipe view is displayed.
Open		The record list of the selected recipe opens.



- Record list

Menu command	System Key	Function
New	 + 	A new data record is created. If an initial value has been configured, this is shown in this input field.
Delete		The selected recipe data record is deleted.
Save as		The selected recipe data record is saved under another name. A dialog box opens in which the name is entered.
Rename		The selected recipe data record is renamed. A dialog box opens in which the name is entered.
Open		The element list of the selected recipe data record opens.
Back		The recipe list opens.
With the OP 77A HMI device, the following menu commands can also be configured for the record list:		
To PLC		The displayed values of the selected recipe data record are transferred from the HMI device to the PLC.
From PLC		The recipe values from the PLC are displayed on the HMI device in the recipe view.
Viewing infotext		The infotext configured for the simple recipe view is displayed.

- Element list

Menu command	System Key	Function
Save		The selected recipe data record is saved.
To PLC		The displayed values of the selected recipe data record are transferred from the HMI device to the PLC.
From PLC		The recipe values from the PLC are displayed on the HMI device in the recipe view.
Save as		The selected recipe data record is saved under a new name. A dialog box opens in which the name is entered.
With the OP 77A HMI device, the following menu commands can also be configured for the element list:		
Viewing infotext		The infotext configured for the simple recipe view is displayed.
Rename		The selected record is renamed. A dialog box opens in which the name is entered.
Back		The data record list opens.

Keyboard operation of the simple recipe view

1. Press  until the simple recipe view is selected.
2. Select the desired recipe with the cursor keys.
3. Press .
The shortcut menu opens.
4. Use the cursor keys to select the desired menu command and confirm it with the  key.
Alternatively, press the number of the desired menu command.
The menu command is executed.

10.6 Creating a Recipe Data Record

Introduction

Create a new recipe data record in the recipe list or in the record list. Then enter the values for the new record in the element list and save the record.

Requirement

A screen with a simple recipe view is displayed.

Procedure

Proceed as follows:

1. If the recipe list contains several recipes: Select the recipe for which you want to create a new recipe data record.
2. Open the recipe list menu.
3. Select the menu command "New".

A new record is created.

The element list of the new record opens.

4. Enter values for the elements of the data record.
The tags of the record can be assigned default values depending on the configuration.
5. Open the menu of the element list and select the command "Save".
6. Enter a name for the new record.
7. Confirm your entries.

If you change the new data record number to an existing data record number, the existing data record is overwritten.

Result

The new recipe data record is saved to the selected recipe.

See also

Operating the Simple Recipe View (Page 179)

10.7 Editing a Recipe Data Record

Introduction

Edit the values of the recipe data records in a simple recipe view.

Synchronization with the PLC

If you want to display the current recipe values from the PLC in the simple recipe view, you first have to read the current values from the PLC with the menu command "From PLC" in the element list.

The values changed in the recipe view only take effect in the PLC when you transfer the edited data record to the PLC with the menu command "To PLC".

Requirement

A screen with a simple recipe view is displayed.

Procedure

Proceed as follows:

1. If the recipe list contains several recipes: Select the recipe which contains the desired recipe data record.
2. Open the data record list.
3. Select the recipe data record you want to change.
4. Open the element list.
5. Change the values of the records as required.
6. Save your changes with the menu command "Save".

The recipe data record is saved.

Result

The edited recipe data record has now been saved in the selected recipe.

See also

Operating the Simple Recipe View (Page 179)

10.8 Deleting a Recipe Data Record

Introduction

You can delete all the data records which are not required.

Requirement

A screen with a simple recipe view is displayed.

Procedure

Proceed as follows:

1. If the recipe list contains several recipes: Select the recipe which contains the desired recipe data record.
2. Open the data record list.
3. Select the data record you want to delete.
4. Open the menu.
5. Select the menu command "Delete".

Result

The data record is deleted.

See also

Operating the Simple Recipe View (Page 179)

10.9 Reading a Recipe Data Record from the PLC

Introduction

The values of recipe elements are exchanged with the PLC via tags.

In the current project, the values which are also stored in the recipes in the HMI device can be changed directly in the plant. This is the case, for example, if a valve was opened further directly at the plant than is stored in the recipe. The values of the tags on the HMI device possibly no longer match the values in the PLC.

To synchronize the recipe values, read the values from the PLC and display them in the recipe view.

OP 77A

With the OP 77A HMI device, the "From PLC" menu command can also be configured for the data record list: In this case, you can also select the "From PLC" menu command in the data record list.

Requirement

A screen with a simple recipe view is displayed.

Procedure

Proceed as follows:

1. If the recipe list contains several recipes: Select the recipe which contains the desired recipe data record.
2. Select the element list of the recipe data record to which you want to apply the values from the PLC.
3. Open the menu.
4. Select the menu command "From PLC".
The values are read from the PLC.
5. If you want to save the displayed values in the HMI device, select the menu command "Save".

Result

The values were read from the PLC, displayed on the HMI device and saved to the selected recipe data record.

See also

Operating the Simple Recipe View (Page 179)

10.10 Transferring a Recipe Data Record to the PLC

Introduction

In order for an edited recipe data record to take effect in the process, you must transfer the values to the PLC.

The displayed values in the recipe view are always transferred to the PLC.

OP 77A

With the OP 77A HMI device, the "To PLC" menu command can also be configured for the data record list: In this case, you can also select the "To PLC" menu command in the data record list.

Requirement

A screen with a simple recipe view is displayed.

Procedure

Proceed as follows:

1. If the recipe list contains several recipes: Select the recipe which contains the desired recipe data record.
2. Select the element list of the recipe data record whose values you want to transfer to the PLC.
3. Open the menu.
4. Select the menu command "To PLC".

Result

The values of the recipe data record were transferred to the PLC and take effect in the process.

See also

Operating the Simple Recipe View (Page 179)

10.11 Exporting and Importing Recipe Data Records on the OP 77B

Introduction

Based on your configuration, you can either export recipe data records to a CSV file for editing in MS Excel, for example, or import these from a CSV file. The extent to which you can influence these processes is determined by the project configuration. For example, you can configure various input fields on the user interface:

- Input of the path to the CSV file
- Selection of the recipe data records for export
- Overwriting an existing CSV file

Export recipe data record

Requirement

Export functions are configured.

Procedure

1. Customize the export settings on the user interface of the HMI device.
2. Press the button or the corresponding key on the HMI device configured with the "Export recipe records" function.

Result

The recipe data records are exported to a CSV file.

Note

New data records created in runtime can be exported to an external file.

Importing recipe records

Requirement

Import functions are configured.

Procedure

1. Customize the import settings on the user interface of the HMI device.
2. Use the button or the key on the HMI device which is assigned the "Import recipe records" function.

Result

The recipe data records are imported. If the structure of the CSV file is different from the recipe structure, deviations are treated as follows:

- Any additional values in the CSV file will be rejected.
- If the CSV file contains values of the wrong data type, the configured default value is set in the recipe record.

Example:

The CSV file contains values that show the tank contents and were input as floating point numbers. However, the corresponding recipe tag expects an integer value. In this case, the system discards the imported value and uses the configured default.

- The system also applies the configured default value to the recipe data record if the CSV file contains an insufficient number of values.

Maintenance and Service

11.1 Maintenance and service

Scope of maintenance

The HMI device is designed for maintenance-free operation. However, you should clean the keyboard membrane and the display unit at regular intervals.

Preparation

 CAUTION

Faulty operation

Always switch off the HMI device before cleaning it. This will ensure that you do not trigger unintended functions when you touch the keys.

Use a cloth dampened with a cleaning agent to clean the equipment. Only use water with a little liquid soap or a screen cleaning foam.

Procedure

Never spray the cleaning agent directly onto the HMI device. Apply it to a cloth. Never use aggressive solvents or scouring powder.

CAUTION

Do not clean the HMI device with compressed air or steam jet blowers.

11.2 Servicing and spare parts

Repairs

A defective device must be returned to the manufacturer's site for repair. The HMI device may only be repaired at the manufacturer's site.

Service pack

A service pack can be ordered for servicing purposes. It contains the following spare parts:

- Mounting seal
- Labeling strips
- Mounting clamps
- Terminal block

The service pack can be ordered from your Siemens representative.

Specifications

12.1 Dimension drawings

12.1.1 Dimension Drawings of the OP 73

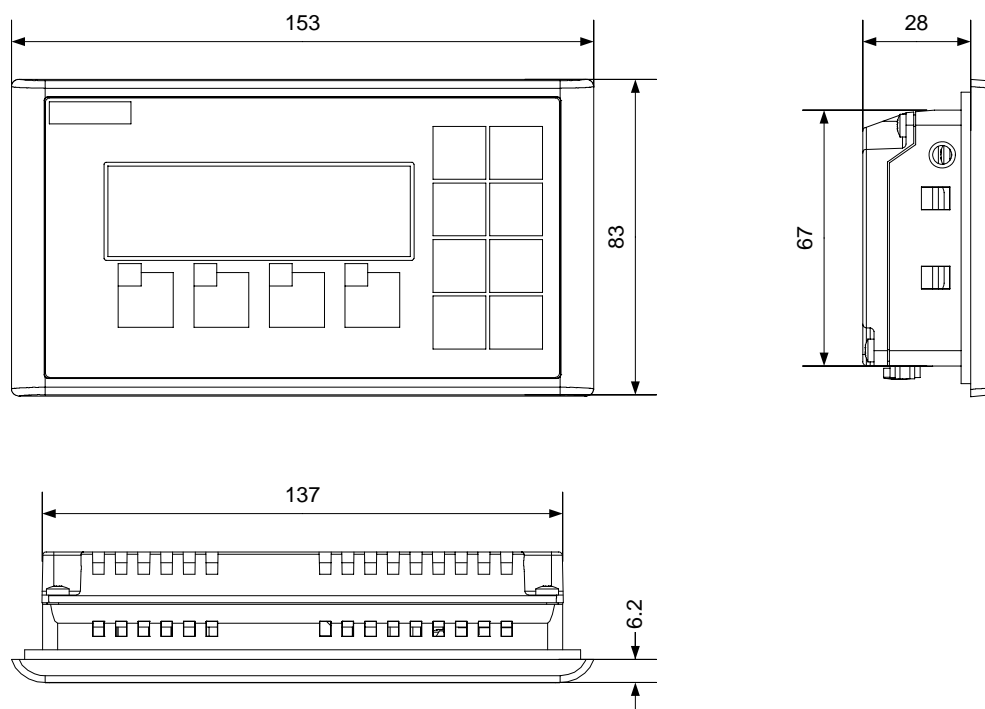

Figure 12-1 Overall dimensions of the HMI device

12.1.2 Dimension Drawings of OP 77A and OP 77B

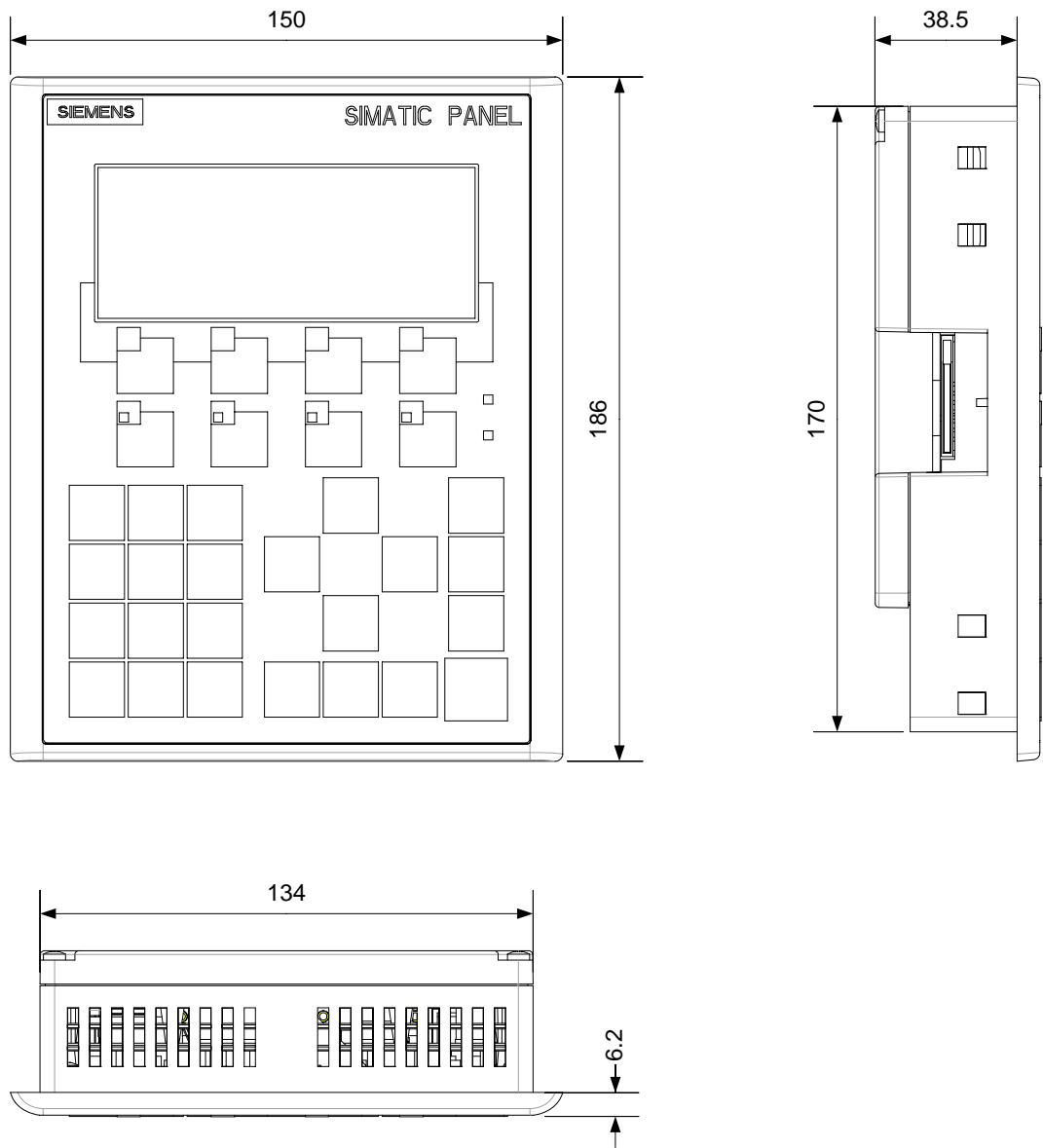

Figure 12-2 Dimension drawings of OP 77A and OP 77B

12.2 Specifications

12.2.1 Specifications of the OP 73

Enclosure

Weight without packing	Approx. 250 g
------------------------	---------------

Display

Type	LCD STN
Display area, active	79.98 mm x 23.98 mm or 3"
Resolution	160 x 48 pixels
Colors, displayable	2
Contrast control	Yes
Back-lighting	LED green
Half Brightness Life, typical	100,000 h

Input unit

Type	Membrane keyboard
System keys with dedicated functions	8
Soft keys	4
Of those freely configurable	4

Memory

Working memory	256 KB
----------------	--------

Power supply

Nominal voltage	+24 V DC
Range, permissible	20.4 V to 28.8 V (–15 %, +20 %)
Transients, maximum permissible	35 V (500 msec)
Time between two transients, minimum	50 s
Current consumption at nominal power	
<ul style="list-style-type: none"> • Typical • Constant current, maximum • Power on current surge I²t 	<ul style="list-style-type: none"> • Approx. 80 mA • Approx. 210 mA • Approx. 0.5 A²s
Fuse, internal	Electronic

See also

- Standards, Certificates and Approvals (Page 24)
- Electromagnetic compatibility (Page 29)
- Transport and storage conditions (Page 31)
- Mounting information (Page 33)
- Mounting positions and fixation (Page 35)
- Information on insulation tests, protection class and degree of protection (Page 39)

12.2.2 Specifications of the OP 77A

Enclosure

Weight without packing	Approx. 500 g
------------------------	---------------

Display

Type	LCD STN
Display area, active	102.38 mm x 40.94 mm or 4.3"
Resolution	160 x 64 pixels
Colors, displayable	Monochrome, yellow-green
Contrast control	Yes
Brightness, typical	20 cd/m ²
Back-lighting	LED green
Half Brightness Life, typical	100,000 h

Input unit

Type	Membrane keyboard
System keys with dedicated functions	23
Soft keys	8
Of those freely configurable	8
Labeling strips	2 for the keys: F1 to F4 and K1 to K4
Keys with LEDs	4, keys K1 to K4

Memory

Working memory	256 KB
----------------	--------

Power supply

Nominal voltage	+24 V DC
Range, permissible	20.4 V to 28.8 V (–15%, +20%)
Transients, maximum permissible	35 V (500 msec)
Time between two transients, minimum	50 s
Current consumption at nominal power <ul style="list-style-type: none"> • Typical • Constant current, maximum • Power on current surge I²t 	<ul style="list-style-type: none"> • Approx. 200 mA • Approx. 300 mA • Approx. 0.5 A²s
Fuse, internal	Electronic

See also

- Standards, Certificates and Approvals (Page 24)
- Electromagnetic compatibility (Page 29)
- Transport and storage conditions (Page 31)
- Mounting information (Page 33)
- Mounting positions and fixation (Page 35)
- Information on insulation tests, protection class and degree of protection (Page 39)

12.2.3 Specifications of the OP 77B

Enclosure

Weight without packing	Approx. 500 g
------------------------	---------------

Display

Type	LCD STN
Display area, active	102.38 mm x 40.94 mm or 4.3"
Resolution	160 x 64 pixels
Colors, displayable	Monochrome, yellow-green
Contrast control	Yes
Brightness, typical	20 cd/m ²
Back-lighting Half Brightness Life, typical	LED green 100,000 h

Input unit

Type	Membrane keyboard
System keys with dedicated functions	23
Soft keys Of those freely configurable	8 8
Labeling strips	2 for the keys: F1 to F4 and K1 to K4
Keys with LEDs	4, keys K1 to K4

Memory

Working memory	1 MB
Memory card	MMC, optional

Power supply

Nominal voltage	+24 V DC
Range, permissible	20.4 V to 28.8 V (-15%, +20%)
Transients, maximum permissible	35 V (500 msec)
Time between two transients, minimum	50 s
Current consumption at nominal power <ul style="list-style-type: none"> • Typical • Constant current, maximum • Power on current surge I^2t 	<ul style="list-style-type: none"> • Approx. 200 mA • Approx. 300 mA • Approx. 0.5 A²s
Fuse, internal	Electronic

See also

- Standards, Certificates and Approvals (Page 24)
- Electromagnetic compatibility (Page 29)
- Transport and storage conditions (Page 31)
- Mounting information (Page 33)
- Mounting positions and fixation (Page 35)
- Information on insulation tests, protection class and degree of protection (Page 39)

12.3 Description of interfaces

12.3.1 Power supply

Plug connector, 2-pin



Figure 12-3 Power supply pin assignment

PIN	Assignment
1	+24 V DC
2	GND 24 V

12.3.2 RS 485 (IF 1B) on OP 73

Sub-d socket, 9-pin, with screw lock

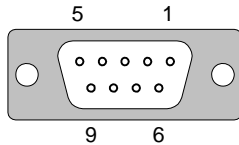

Figure 12-4 RS 485 interface pin assignment

PIN	Assignment
1	n. c.
2	GND 24 V
3	Data channel B (+)
4	RTS
5	GND 5 V, floating potential
6	+5 V DC, floating potential
7	+24 V DC, out (max. 100 mA) or +24 V DC in ¹
8	Data channel A (-)
9	n. c.

¹ Applies when power is supplied from the CPU

CAUTION

Power supply

When the HMI device is supplied with power from the CPU, do not connect an external power supply to it.

12.3.3 RS 485 (IF 1B) on OP 77A

Sub-d socket, 9-pin, with screw lock

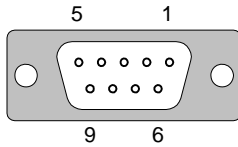

Figure 12-5 RS 485 interface pin assignment

PIN	Assignment
1	n. c.
2	GND 24 V
3	Data channel B (+)
4	RTS ¹
5	GND 5 V, floating potential
6	+5 V DC, floating potential
7	+24 V DC, out (max. 100 mA)
8	Data channel A (-)
9	RTS ¹

1 On pin 4 or 9, set with DIL switch

12.3.4 RS 422/RS 485 (IF 1B) on OP 77B

Sub-d socket, 9-pin, with screw lock

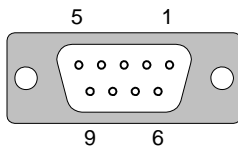

Figure 12-6 Pin assignment of the RS 485 and RS 422 interfaces

PIN	Pin assignment RS 422	Pin assignment RS 485
1		n. c.
2		GND 24 V
3	TxD+	Data channel B (+)
4	RxD+	RTS ¹
5		GND 5 V, floating potential
6		+5 V DC, floating potential
7		+24 V DC, out (max. 100 mA)
8	TxD-	Data channel A (-)
9	RxD-	RTS ¹

1 On pin 4 or 9, set with DIL switch

12.3.5 RS 232 (IF 1A) on OP 77B

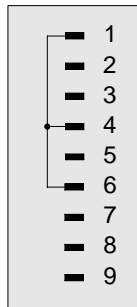

Figure 12-7 Pin switching

Sub-D plug, 9-pin, secured by screws

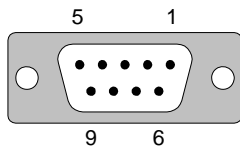

Figure 12-8 RS 232 interface pin assignment

PIN	Assignment
1	DCD
2	RxD
3	TxD
4	DTR
5	GND
6	DSR
7	RTS
8	CTS
9	n. c.

12.3.6 USB on OP 77B

USB standard connector

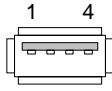

Figure 12-9 USB standard connector pin assignment

PIN	Assignment
1	+5 V DC, out (max. 100 mA)
2	USB-DN
3	USB-DP
4	GND 5 V

Appendix

A.1 ESD Directives

What does ESD mean?

All electronic modules are equipped with highly integrated modules or components. Based on their design, these electronic components are highly sensitive to overvoltage and thus to discharge of static electricity. These electronic components are therefore specially identified as ESD.

Abbreviation

The following abbreviations are commonly used for electrostatic sensitive devices:

- ESD – **E**lectrostatic **S**ensitive **D**evelopments
- ESD – **E**lectrostatic **S**ensitive **D**evice as common international designation

Labeling

ESD modules are labeled with the following symbol:



Figure A-1 ESD label

Electrostatic charge

CAUTION

Electrostatic charge

ESDs may be destroyed by voltages well below the perception threshold of persons. Voltages of this kind develop when a component or an assembly is touched by a person who is not grounded against static electricity. Usually, it is unlikely that damage to an ESD as a result of overvoltage is detected immediately but may become apparent only after a longer period of operation.

Prevent electrostatic charge of your body before you touch the ESD!

Anyone who is not connected to the electrical potential of their surroundings is subjected to electrostatic charge.

The figure indicates the maximum electrostatic charge anyone is subjected to when contacting the materials shown. These values correspond with specifications to IEC 801-2.

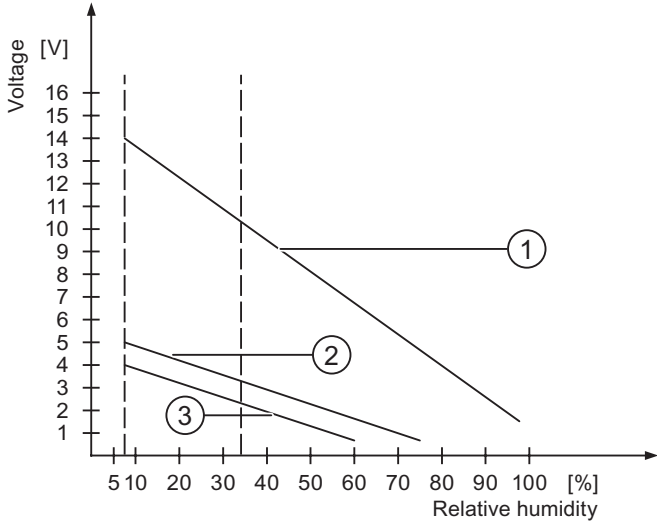

Figure A-2 Electrostatic voltages with which a person can be charged.

- ① Synthetic materials
- ② Wool
- ③ Antistatic materials such as wood or concrete

Protective measures against discharge of static electricity

CAUTION
Grounding measures When working with electrostatic sensitive devices, make sure that the person, the workplace and the packaging are properly grounded. This helps to avoid electrostatic charge.

As a rule, only touch the ESD if this is unavoidable. Example: for maintenance. When you touch modules, make sure that you do not touch the pins on the modules or the PCB tracks. This prevents any discharge of static electricity to sensitive component and thus avoids damage.

Discharge electrostatic electricity from your body if you are performing measurements on an ESD. To do so, touch a grounded metallic object.

Always use grounded measuring instruments.

A.2 System alarms

Introduction

System alarms on the HMI device provide information about internal states of the HMI device and PLC.

The overview below shows the causes of system alarms and how to eliminate the cause of error.

Depending on functionality, only parts of the system alarms described in this section apply to the various HMI devices.

Note

System alarms are only indicated if an alarm window was configured. System alarms are output in the language currently set on your HMI device.

System alarm parameters

System alarms may contain encrypted parameters which are relevant to troubleshooting because they provide a reference to the source code of the Runtime software. These parameters are output after the text "Error code:"

Meaning of the system alarms

Number	Effect/cause	Remedy
10000	The print job could not be started or was canceled due to an unknown error. Faulty printer setup. Or: Access to the network printer is not allowed. Power supply failure during data transfer.	Check the printer settings, cable connections and the power supply. Set up the printer once again. Obtain a network printer authorization. If the error persists, contact the Hotline!
10001	No printer is installed or a default printer has not been set up.	Install a printer and/or select it as the default printer.
10002	Overflow of the graphics buffer for printing. Up to two images are buffered.	Allow sufficient intervals between successive print jobs.
10003	Images can now be buffered again.	-
10004	Overflow of the buffer for printing lines in text mode (e.g.alarms). Up to 1000 lines are buffered.	Allow sufficient intervals between successive print jobs.
10005	Text lines can now be buffered again.	-
10006	The Windows printing system reports an error. Refer to the output text and the error ID to determine the possible causes. Nothing is printed or the print is faulty.	Repeat the action if necessary.
20010	An error has occurred in the specified script line. Execution of the script was therefore aborted. Note the system alarm that may have occurred prior to this.	Select the specified script line in the configuration. Ensure that the tags used are of the allowed types. Check system functions for the correct number and types of parameters.
20011	An error has occurred in a script that was called by the specified script. Execution of the script was therefore aborted in the called script. Take the system alarm that may have occurred prior to this into account.	In the configuration, select the script that has been called directly or indirectly by the specified script. Ensure that the tags used are of the allowed types. Check the system functions for the correct number and type of parameters.
20012	The configuration data is inconsistent. The script could therefore not be generated.	Recompile the configuration.
20013	The scripting component of WinCC flexible Runtime is not correctly installed. Therefore, no scripts can be executed.	Reinstall WinCC flexible Runtime.
20014	The system function returns a value that is not written in any return tag.	Select the specified script in the configuration. Check if the script name has been assigned a value.
20015	Too many successive scripts have been triggered in short intervals. When more than 20 scripts are queued for processing, any subsequent scripts are rejected. In this case, the script indicated in the alarm is not executed.	Find what is triggering the scripts. Extend the times, e.g. the polling time of the tags which trigger the scripts.
30010	The tag could not accept the function result, e.g. when it has exceeded the value range.	Check the tag type of the system function parameter.
30011	A system function could not be executed because the function was assigned an invalid value or type in the parameter.	Check the parameter value and tag type of the invalid parameter. If a tag is used as a parameter, check its value.
40010	The system function could not be executed since the parameters could not be converted to a common tag type.	Check the parameter types in the configuration.

Number	Effect/cause	Remedy
40011	The system function could not be executed since the parameters could not be converted to a common tag type.	Check the parameter types in the configuration.
50000	The HMI device is receiving data faster than it is capable of processing. Therefore, no further data is accepted until all current data have been processed. Data exchange then resumes.	-
50001	Data exchange has been resumed.	-
60000	This alarm is generated by the "DisplaySystemAlarms" function. The text to be displayed is transferred to the function as a parameter.	-
60010	The file could not be copied in the direction defined because one of the two files is currently open or the source/target path is not available. It is possible that the Windows user has no access rights to one of the two files.	Restart the system function or check the paths of the source/target files. Using Windows NT/2000/XP: The user executing WinCC flexible Runtime must be granted access rights for the files.
60011	An attempt was made to copy a file to itself. It is possible that the Windows user has no access rights to one of the two files.	Check the path of the source/target file. Using Windows NT/2000/XP with NTFS: The user executing WinCC flexible Runtime must be granted access rights for the files.
70010	The application could not be started because it could not be found in the path specified or there is insufficient memory space.	Check if the application exists in the specified path or close other applications.
70011	The system time could not be modified. The error alarm only appears in connection with area pointer "Date/time PC". Possible causes: <ul style="list-style-type: none"> An invalid time was transferred in the job mailbox. The Windows user has no right to modify the system time. If the first parameter in the system alarm is displayed with the value 13, the second parameter indicates the byte containing the incorrect value.	Check the time which is to be set. Using Windows NT/2000/XP: The user executing WinCC flexible Runtime must be granted the right to change the system time of the operating system.
70012	An error occurred when executing the function "StopRuntime" with the option "Runtime and operating system". Windows and WinCC flexible Runtime are not closed. One possible cause is that other programs cannot be closed.	Close all programs currently running. Then close Windows.
70013	The system time could not be modified because an invalid value was entered. Incorrect separators may have been used.	Check the time which is to be set.
70014	The system time could not be modified. Possible causes: <ul style="list-style-type: none"> An invalid time was transferred. The Windows user has no right to modify the system time. Windows rejects the setting request. 	Check the time which is to be set. Using Windows NT/2000/XP: The user executing WinCC flexible Runtime must be granted the right to change the system time of the operating system.

Number	Effect/cause	Remedy
70015	The system time could not be read because Windows rejects the reading function.	-
70016	An attempt was made to select a screen by means of a system function or job. This is not possible because the screen number specified does not exist. Or: A screen could not be generated due to insufficient system memory.	Check the screen number in the function or job with the screen numbers configured. Assign the number to a screen if necessary.
70017	Date/Time is not read from the area pointer because the address set in the controller is either not available or has not been set up.	Change the address or set up the address in the controller.
70018	Acknowledgment that the password list has been successfully imported.	-
70019	Acknowledgment that the password list has been successfully exported.	-
70020	Acknowledgment for activation of alarm reporting.	-
70021	Acknowledgment for deactivation of alarm reporting.	-
70022	Acknowledgment to starting the Import Password List action.	-
70023	Acknowledgment to starting the Export Password List action.	-
70024	The value range of the tag has been exceeded in the system function. The calculation of the system function is not performed.	Check the desired calculation and correct it if necessary.
70025	The value range of the tag has been exceeded in the system function. The calculation of the system function is not performed.	Check the desired calculation and correct it if necessary.
70026	No other screens are stored in the internal screen memory. No other screens can be selected.	-
70027	The backup of the RAM file system has been started.	-
70028	The files from the RAM have been copied in the Flash memory. The files from the RAM have been copied in the Flash memory. Following a restart, these saved files are copied back to the RAM file system.	-
70029	Backup of the RAM file system has failed. No backup copy of the RAM file system has been made.	Check the settings in the "Control Panel > OP" dialog and save the RAM file system using the "Save Files" button in the "Persistent Storage" tab.
70030	The parameters configured for the system function are faulty. The connection to the new controller was not established.	Compare the parameters configured for the system function with the parameters configured for the controllers and correct them as necessary.
70031	The controller configured in the system function is not an S7 controller. The connection to the new controller was not established.	Compare the S7 controller name parameter configured for the system function with the parameters configured for the controller and correct them as necessary.

Number	Effect/cause	Remedy
70032	The object configured with this number in the tab order is not available in the selected screen. The screen changes but the focus is set to the first object.	Check the number of the tab order and correct it if necessary.
70033	An e-mail cannot be sent because a TCP/IP connection to the SMTP server no longer exists. This system alarm is generated only at the first attempt. All subsequent unsuccessful attempts to send an e-mail will no longer generate a system alarm. The event is regenerated when an e-mail has been successfully sent in the meantime. The central e-mail component in WinCC flexible Runtime attempts, in regular intervals (1 minute), to establish the connection to the SMTP server and to send the remaining e-mails.	Check the network connection to the SMTP server and re-establish it if necessary.
70034	Following a disruption, the TCP/IP connection to the SMTP server could be re-established. The queued e-mails are then sent.	-
70035	The e-mail queue of the central component in WinCC flexible Runtime responsible for sending e-mails is full. The e-mail could therefore not be entered into the queue and therefore not sent. The cause may be a broken connection to the SMTP server or an overload resulting from too much e-mail traffic. This system alarm is generated only at the first attempt. The next system alarm is only generated when at least one e-mail has been successfully sent to the queue in the meantime.	Check if <ul style="list-style-type: none"> the network connection still exists or the connection is overloaded (for example, due to reoccurring system alarms resulting from disruptions).
70036	No SMTP server for sending e-mails is configured. An attempt to connect to an SMTP server has failed and it is not possible to send e-mails. WinCC flexible Runtime generates the system alarm after the first attempt to send an e-mail.	Configure an SMTP server: In WinCC flexible Engineering System using "Device settings > Device settings" In the Windows CE operating system using "Control Panel > Internet Settings > E-mail > SMTP Server"
70037	An e-mail cannot be sent for unknown reasons. The contents of the e-mail are lost.	Check the e-mail parameters (recipient etc.).
70038	The SMTP server has rejected sending or forwarding an e-mail because the domain of the recipient is unknown to the server or because the SMTP server requires authentication. The contents of the e-mail are lost.	Check the domain of the recipient address or deactivate the authentication on the SMTP server if possible. SMTP authentication is currently not used in WinCC flexible Runtime.
70039	The syntax of the e-mail address is incorrect or contains illegal characters. The contents of the e-mail are discarded.	Check the e-mail address of the recipient.
70040	The syntax of the e-mail address is incorrect or contains illegal characters.	-
80001	The log specified is filled to the size defined (in percent) and must be stored elsewhere.	Store the file or table by executing a 'move' or 'copy' function.
80002	A line is missing in the specified log.	-

Number	Effect/cause	Remedy
80003	The copying process for logging was not successful. In this case, it is advisable to check any subsequent system alarms, too.	-
80006	Since logging is not possible, this causes a permanent loss of the functionality.	In the case of databases, check if the corresponding data source exists and start up the system again.
80009	A copying action has been completed successfully.	-
80010	Since the storage location was incorrectly entered in WinCC flexible, this causes a permanent loss of the functionality.	Configure the storage location for the respective log again and restart the system when the full functionality is required.
80012	Log entries are stored in a buffer. If the values are read to the buffer faster than they can be physically written (using a hard disk, for example), overloading may occur and recording is then stopped.	Archive fewer values. Or: Increase the logging cycle.
80013	The overload status no longer applies. Archiving resumes the recording of all values.	-
80014	The same action was triggered twice in quick succession. Since the process is already in operation, the action is only carried out once.	-
80015	This system alarm is used to report DOS or database errors to the user.	-
80016	The logs are separated by the system function "CloseAllLogs" and the incoming entries exceed the defined buffer size. All entries in the buffer are deleted.	Reconnect the logs.
80017	The number of incoming events cause a buffer overflow. This can be caused, for example, by several copying actions being activated at the same time. All copy jobs are deleted.	Stop the copy action.
80018	All connections between WinCC flexible and the logs have been reestablished, for example, after executing the system function "OpenAllLogs". Entries are written into the logs again.	-
80019	The connection between WinCC flexible and all logs were closed, for example, after executing the system function "CloseAllLogs". Entries are written to the buffer and are then written to the logs when a connection is re-established. There is no connection to the storage location and the storage medium may be replaced, for example.	-
80020	The maximum number of simultaneously copy operations has been exceeded. Copying is not executed.	Wait until the current copying actions have been completed, then restart the last copy action.
80021	An attempt was made to delete a log which is still busy with a copy action. Deletion has not been executed.	Wait until the current copying actions have been completed, then restart the last action

Number	Effect/cause	Remedy
80022	An attempt was made to start a sequence log, which is not a sequence log, from a log using the system function "StartSequenceLog". No sequence log file is created.	In the project, check <ul style="list-style-type: none"> • if the "StartSequenceLog" system function was properly configured • if the tag parameters are properly provided with data on the HMI device
80023	An attempt was made to copy a log to itself. The log is not copied.	In the project, check <ul style="list-style-type: none"> • if the "CopyLog" system function was properly configured • if the tag parameters are properly provided with data on the HMI device
80024	The "CopyLog" system function does not allow copying when the target log already contains data ("Mode" parameter). The log is not copied.	Edit the "CopyLog" system function in the project if necessary. Before you initiate the system function, delete the destination log file.
80025	You have canceled the copy operation. Data written up to this point are retained. The destination log file (if configured) is not deleted. The cancellation is reported by an error entry \$RT_ERR\$ at the end of the destination log.	-
80026	This alarm is output after all logs are initialized. Values are written to the logs from then on. Prior to this, no entries are written to the logs, irrespective whether WinCC flexible Runtime is active or not.	-
80027	The internal Flash memory has been specified as the storage location for a log. This is not permissible. No values are written to this log and the log file is not created.	Configure "Storage Card" or a network path as the storage location.
80028	The alarm returns a status report indicating that the logs are currently being initialized. No values are logged until the alarm 80026 is output.	-
80029	The number of logs specified in the alarm could not be initialized. The logs are initialized. The faulty log files are not available for logging jobs.	Evaluate the additional system alarms, related to this alarm which is also generated. Check the configuration, the ODBC (Open Database Connectivity) and the specified drive.
80030	The structure of the existing log file does not match the expected structure. Logging is stopped for this log.	Delete the existing log data manually, in advance.
80031	The log in CSV format is corrupted. The log cannot be used.	Delete the faulty file.
80032	Logs can be assigned events. These are triggered as soon as the log is full. If WinCC flexible Runtime is started and the log is already full, the event is not triggered. The log specified no longer logs data because it is full.	Close WinCC flexible Runtime, delete the log, then restart WinCC flexible Runtime. Or: Configure a button which contains the same actions as the event and press it.
80033	"System Defined" is set in the data log file as the data source name. This causes an error. No data is written to the database logs, whereas the logging to the CSV logs works.	Install MSDE again.

Number	Effect/cause	Remedy
80034	An error has occurred in the initialization of the logs. An attempt has been made to create the tables as a backup. This action was successful. A backup has been made of the tables of the corrupted log file and the cleared log was restarted.	No action is necessary. However, it is recommended to save the backup files or delete them in order to make the space available again.
80035	An error has occurred in the initialization of the logs. An attempt has been made to create backups of the tables and this has failed. No logging or backup has been performed.	It is recommended to save the backups or to delete them in order to release memory.
110000	The operating mode was changed. "Offline" mode is now set.	-
110001	The operating mode was changed. "Online" mode is now set.	-
110002	The operating mode was not changed.	Check the connection to the controllers. Check if the address area for the area pointer 88 "Coordination" in the controller is available.
110003	The operating mode of the specified controller was changed by the system function "SetConnectionMode". The operating mode is now "offline".	-
110004	The operating mode of the specified controller has been changed by the system function "SetConnectionMode". The operating mode is now "online".	-
110005	An attempt was made to use the system function SetConnectionMode to switch the specified controller to "online" mode, although the entire system is in "offline" mode. This changeover is not allowed. The controller remains in "offline" mode.	Switch the complete system to "online" mode, then execute the system function again.
110006	The content of the "project version" area pointer does not match the user version configured in WinCC flexible. WinCC flexible Runtime is therefore closed.	Check: <ul style="list-style-type: none"> the project version entered on the controller the project version entered in WinCC flexible
120000	The trend is not shown because you configured an incorrect axis to the trend or an incorrect trend.	Change the configuration.
120001	The trend is not shown because you configured an incorrect axis to the trend or an incorrect trend.	Change the configuration.
120002	The trend is not displayed because the tag assigned attempts to access an invalid controller address.	Check if the data area for the tag exists in the controller, the configured address is correct and the value range for the tag is correct.
130000	The action was not executed.	Close all other programs. Delete files no longer required from the hard disk.
130001	The action was not executed.	Delete files no longer required from the hard disk.
130002	The action was not executed.	Close all other programs. Delete files no longer required from the hard disk.
130003	No data medium found. The operation is canceled.	Check, for example, if <ul style="list-style-type: none"> the correct data medium is being accessed the data medium is inserted
130004	The data medium is write-protected. The operation is canceled.	Check if access has been made to the correct data carrier. Remove the write protection.

Number	Effect/cause	Remedy
130005	The file is read only. The operation is canceled.	Check if access has been made to the correct file. Edit the file attributes if necessary.
130006	Access to file failed. The operation is canceled.	Check, for example, if <ul style="list-style-type: none"> • the correct file is being accessed • the file exists • another action is preventing simultaneous access to the file
130007	The network connection is interrupted. Data records cannot be saved or read over the network connection.	Check the network connection and eliminate the cause of error.
130008	The storage card is not available. Data records cannot be saved to / read from the storage card.	Insert the storage card.
130009	The specified folder does not exist on the storage card. Any files saved to this directory are not backed up when you switch off the HMI device.	Insert the storage card.
130010	The maximum nesting depth can be exhausted when, for example, a value change in a script results in the call of another script and the second script in turn has a value change that results in the call of yet a further script etc. The configured functionality is not supported.	Check the configuration.
140000	An online connection to the controller is established.	-
140001	The online connection to the controller was shut down.	-
140003	No tag updating or writing is executed.	Check the connection and if the controller is switched on. Check the parameter definitions in the Control Panel using "Set PG/PC interface". Restart the system.
140004	No tag update or write operations are executed because the access point or the module configuration is faulty.	Verify the connection and check if the controller is switched on. Check the access point or the module configuration (MPI, PPI, PROFIBUS) in the Control Panel with "Set PG/PC interface". Restart the system.
140005	No tag updating or writing is executed because the HMI device address is incorrect (possibly too high).	Use a different HMI device address. Verify the connection and check if the controller is switched on. Check the parameter definitions in the Control Panel using "Set PG/PC interface". Restart the system.
140006	No tag updating or writing is executed because the baud rate is incorrect.	Select a different baud rate in WinCC flexible (according to module, profile, communication peer, etc.).

Number	Effect/cause	Remedy
140007	Tag are not updated or written because the bus profile is incorrect (see %1). The following parameter could not be written to the registry: 1: Tslot 2: Tqui 3: Tset 4: MinTsdr 5: MaxTsdr 6: Trdy 7: Tid1 8: Tid2 9: Gap Factor 10: Retry Limit	Check the user-defined bus profile. Check the connection and if the controller is switched on. Check the parameter definitions in the Control Panel using "Set PG/PC interface". Restart the system.
140008	No tag updating or writing is executed because baud rate is incorrect. The following parameters could not be written to the registry: 0: General error 1: Wrong version 2: Profile cannot be written to the registry. 3: The subnet type cannot be written to the registry. 4: The Target Rotation Time cannot be written to the registry. 5: Faulty Highest Address (HSA).	Check the connection and if the controller is switched on. Check the parameter definitions in the Control Panel using "Set PG/PC interface". Restart the system.
140009	Tags are not updated or written because the module for S7 communication was not found.	Reinstall the module in the Control Panel using "Set PG/PC interface".
140010	No S7 communication partner found because the controller is shut down. DP/T: The option "PG/PC is the only master" is not set in the Control Panel under "Set PG/PC interface."	Switch the controller on. DP/T: If only one master is connected to the network, disable "PG/PC is the only master" in "Set PG/PC interface". If several masters are connected to the network, enable these. Do not change any settings, for this will cause bus errors.
140011	No tag updating or writing is executed because communication is down.	Check the connection and that the communication partner is switched on.
140012	There is an initialization problem (e.g. when WinCC flexible Runtime was closed in Task Manager). Or: Another application (e.g. STEP7) with different bus parameters is active and the driver cannot be started with the new bus parameters (transmission rate, for example).	Restart the HMI device. Or: Run WinCC flexible Runtime, then start your other applications.
140013	The MPI cable is disconnected and, thus, there is no power supply.	Check the connections.
140014	The configured bus address is in already in use by another application.	Edit the HMI device address in the controller configuration.
140015	Wrong transmission rate Or: Faulty bus parameters (e.g.HSA) Or: OP address > HSA or: Wrong interrupt vector (interrupt does not arrive at the driver)	Correct the relevant parameters.

Number	Effect/cause	Remedy
140016	The hardware does not support the configured interrupt.	Change the interrupt number.
140017	The set interrupt is in use by another driver.	Change the interrupt number.
140018	The consistency check was disabled by SIMOTION Scout. Only a corresponding note appears.	Enable the consistency check with SIMOTION Scout and once again download the project to the PLC.
140019	SIMOTION Scout is downloading a new project to the controller. Connection to the controller is canceled.	Wait until the end of the reconfiguration.
140020	The version in the controller and that of the project (FWX file) do not match. Connection to the controller is canceled	The following remedies are available: Download the current version to the PLC using SIMOTION Scout. Regenerate the project using WinCC flexible ES, close WinCC flexible Runtime and restart with a new configuration.
150000	No more data is read or written. Possible causes: <ul style="list-style-type: none"> • The cable is defective. • The PLC does not respond, is defective, etc. • The wrong port is used for the connection. • System overload. 	Ensure that the cable is plugged in, the controller is operational, the correct interface is being used. Restart the system if the system alarm persists.
150001	Connection is up because the cause of the interruption has been eliminated.	-
160000	No more data is read or written. Possible causes: <ul style="list-style-type: none"> • The cable is defective. • The PLC does not respond, is defective, etc. • The wrong port is used for the connection. • System overload. 	Ensure that the cable is plugged in, the controller is operational, the correct interface is being used. Restart the system if the system alarm persists.
160001	Connection is up because the cause of the interruption has been eliminated.	-
160010	No connection to the server because the server identification (CLS-ID) cannot be determined. Values cannot be read or written.	Check access rights.
160011	No connection to the server because the server identification (CLS-ID) cannot be determined. Values cannot be read or written.	Check, for example, if <ul style="list-style-type: none"> • the server name is correct • the computer name is correct • the server is registered
160012	No connection to the server because the server identification (CLS-ID) cannot be determined. Values cannot be read or written.	Check, for example, if <ul style="list-style-type: none"> • the server name is correct • the computer name is correct • the server is registered Note for advanced users: Interpret the value from HRESULT.
160013	The specified server was started as InProc server. This has not been released and may possibly lead to incorrect behavior because the server is running in the same process area as the WinCC flexible Runtime software.	Configure the server as OutProc Server or Local Server.

Number	Effect/cause	Remedy
160014	Only one OPC server project can be started on a PC/MP. An alarm is output when an attempt is made to start a second project. The second project has no OPC server functionality and cannot be located as an OPC server by external sources.	Do not start a second project with OPC server functionality on the computer.
170000	S7 diagnostics events are not indicated because it is not possible to log on to the S7 diagnostics functions at this device. The service is not supported.	-
170001	The S7 diagnostics buffer cannot be viewed because communication with the controller is shut down.	Set the controller to online mode.
170002	The S7 diagnostics buffer cannot be viewed because reading of the diagnostics buffer (SSL) was canceled with error.	-
170003	An S7 diagnostics event cannot be visualized. The system returns internal error %2.	-
170004	An S7 diagnostics event cannot be visualized. The system returns an internal error of error class %2, error number %3.	-
170007	It is not possible to read the S7 diagnostics buffer (SSL) because this operation was canceled with an internal error of class %2 and error code %3.	-
180000	A component/OCX received configuration data with a version ID which is not supported.	Install a newer component.
180001	System overload because too many actions running in parallel. Not all the actions can be executed, some are rejected.	Several remedies are available: <ul style="list-style-type: none"> • Increase the configured cycle times or basic clock. • Generate the alarms at a slower rate (polling). • Initiate scripts and functions at greater intervals. If the alarm appears more frequently: Restart the HMI device.
180002	The on-screen keyboard could not be activated. Possible causes: "TouchInputPC.exe" was not registered due to a faulty Setup.	Reinstall WinCC flexible Runtime.
190000	It is possible that the tag is not updated.	-
190001	The tag is updated after the cause of the last error state has been eliminated (return to normal operation).	-
190002	The tag is not updated because communication with the controller is down.	Select the system function "SetOnline" to go online.
190004	The tag is not updated because the configured tag address does not exist.	Check the configuration.
190005	The tag is not updated because the configured controller type does not exist for this tag.	Check the configuration.
190006	The tag is not updated because it is not possible to map the controller type in the data type of the tag.	Check the configuration.

Number	Effect/cause	Remedy
190007	The tag value is not modified because the connection to the controller is interrupted or the tag is offline.	Set online mode or reconnect to the controller.
190008	The threshold values configured for the tag have been violated, for example, by <ul style="list-style-type: none"> • a value entered • a system function • a script 	Observe the configured or current threshold values of the tag.
190009	An attempt has been made to assign the tag a value which is outside the permitted range of values for this data type. For example, a value of 260 was entered for a byte tag or a value of -3 for an unsigned word tag.	Observe the range of values for the data type of the tags.
190010	Too many values are written to the tag (for example, in a loop triggered by a script). Values are lost because only up to 100 actions are saved to the buffer.	Increase the time interval between multiple write actions.
190011	Possible cause 1: The value entered could not be written to the configured controller tag because the high or low limit was exceeded. The system discards the entry and restores the original value. Possible cause 2: The connection to the controller was interrupted.	Make sure that the value entered lies within the range of values of the control tags. Check the connection to the PLC.
190012	It is not possible to convert a value from a source format to a target format, for example: An attempt is being made to assign a value to a counter that is outside the valid, PLC-specific value range. A tag of the type Integer should be assigned a value of the type String.	Check the range of values or the data type of the tags.
190100	The area pointer is not updated because the address configured for this pointer does not exist. Type 1 Warning alarms 2 Error alarms 3 Controller acknowledgment 4 HMI device acknowledgment 5 LED mapping 6 Trend request 7 Trend transfer 1 8 Trend transfer 2 No.: consecutive number shown in WinCC flexible ES.	Check the configuration.
190101	The area pointer is not updated because it is not possible to map the PLC type to the area pointer type. Parameter type and no.: see alarm 190100	-

Number	Effect/cause	Remedy
190102	The area pointer is updated after the cause of the last error state has been eliminated (return to normal operation). Parameter type and no.: See alarm 190100.	-
200000	Coordination is not executed because the address configured in the controller does not exist/is not set.	Change the address or set up the address in the controller.
200001	Coordination is canceled because the write access to the address configured in the PLC is not possible.	Change the address or set the address in the controller at an area which allows write access.
200002	Coordination is not carried out at the moment because the address format of the area pointer does not match the internal storage format.	Internal fault
200003	Coordination can be executed again because the last error state is eliminated (return to normal operation).	-
200004	The coordination may not be executed.	-
200005	No more data is read or written. Possible causes: <ul style="list-style-type: none"> • The cable is defective. • The PLC does not respond, is defective, etc. • System overload. 	Ensure that the cable is plugged in and the controller is operational. Restart the system if the system alarm persists.
200100	Coordination is not executed because the address configured in the controller does not exist/is not set.	Change the address or set up the address in the controller.
200101	Coordination is canceled because the write access to the address configured in the PLC is not possible.	Change the address or set the address in the controller at an area which allows write access.
200102	Coordination is not carried out at the moment because the address format of the area pointer does not match the internal storage format.	Internal fault
200103	Coordination can be executed again because the last error state is eliminated (return to normal operation).	-
200104	The coordination may not be executed.	-
200105	No more data is read or written. Possible causes: <ul style="list-style-type: none"> • The cable is defective. • The PLC does not respond, is defective, etc. • System overload. 	Ensure that the cable is plugged in and the controller is operational. Restart the system if the system alarm persists.
210000	Jobs are not processed because the address configured in the controller does not exist/has not been set up.	Change the address or set up the address in the controller.
210001	Jobs are not processed because read/write access to the address configured in the controller is not possible.	Change the address or set up the address in the controller in an area which allows read/write access.
210002	Jobs are not executed because the address format of the area pointer does not match the internal storage format.	Internal fault
210003	The job buffer is processed again because the last error status has been eliminated (return to normal operation).	-

Number	Effect/cause	Remedy
210004	It is possible that the job buffer will not be processed.	-
210005	A control request with an illegal number was initiated.	Check the controller program.
210006	An error occurred while attempting to execute the control request. As a result, the control request is not executed. Observe the next/previous system alarms.	Check the parameters of the control request. Recompile the configuration.
220001	The tag is not downloaded because the associated communication driver / HMI device does not support the download of Boolean/discrete data types.	Change the configuration.
220002	The tag is not downloaded because the associated communication driver / HMI device does not support write access to the data type BYTE.	Change the configuration.
220003	The communication driver cannot be loaded. The driver may not be installed.	Install the driver by reinstalling WinCC flexible Runtime.
220004	Communication is down and no update data is transferred because the cable is not connected or defective etc.	Check the connection.
220005	Communication is up.	-
220006	The connection between the specified PLC and the specified port is active.	-
220007	The connection to the specified controller is interrupted at the specified port.	Check if <ul style="list-style-type: none"> • the cable is plugged in • the controller is OK • the correct port is used • the configuration is OK (interface parameters, protocol settings, PLC address). Restart the system if the system alarm persists.
220008	The communication driver cannot access or open the specified port. The port may be in use by another application or the port used is not available on the destination device. There is no communication with the controller.	Close all the applications which access this port and restart the computer. Use another port of the system.
230000	The value entered could not be accepted. The entered value is discarded and the previous value is restored. Either the value range has been exceeded or impermissible characters were entered.	Enter a permissible value.
230002	The currently logged on user is not granted write access rights. The system therefore discards the input and restored the previous value.	Log on as a user with appropriate rights.
230003	Changeover to the specified screen failed because the screen is not available/configured. The current screen remains selected.	Configure the screen and check the screen selection function.
230005	The value range of the tag has been exceeded in the IO field. The original value of the tag is retained.	Observe the range of values for the tag when entering a value.

Number	Effect/cause	Remedy
230100	During navigation in the web browser, the system returned a message which may be of interest to the user. The web browser continues to run but may not (fully) show the new page.	Navigate to another page.
230200	The connection to the HTTP channel was interrupted due to an error. This error is explained in detail by another system alarm. Data is no longer exchanged.	Check the network connection. Check the server configuration.
230201	The connection to HTTP channel was established. Data is exchanged.	-
230202	WININET.DLL has detected an error. This error usually occurs when an attempt to connect to the server fails or the server refuses to connect because the client lacks the proper authorization. An unknown server certificate may also be the cause if the connection is encrypted by means of SSL. The alarm text provides details. This text is always in the language of the Windows installation because it is returned by the Windows OS. Process values are no longer exchanged.	Depending on the cause: When an attempt to connect fails or a timeout error occurs: <ul style="list-style-type: none"> • Check the network connection and the network. • Check the server address. • Check if the web server is actually running on the destination computer. Faulty authorization: <ul style="list-style-type: none"> • The configured user name and/or password do not match those on the server. Establish consistency. When the server certificate is rejected: Certificate signed by an unknown CA (): <ul style="list-style-type: none"> • Either ignore this item in your project, or • Install a certificate that has been signed with a root certificate known to the client computer. The date of the certificate is invalid: <ul style="list-style-type: none"> • Either ignore this item in your project, or • Install a certificate with a valid date on the server. Invalid CN (Common Name or Computer Name): <ul style="list-style-type: none"> • Either ignore this item in your project, or • Install a certificate with a name that corresponds to that of the server address.
230203	Although a connection can be made to the server, the HTTP server refuses to connect because <ul style="list-style-type: none"> • WinCC flexible Runtime is not running on the server, or • the HTTP channel is not supported (503 Service unavailable). Other errors can only occur if the web server does not support the HTTP channel. The language of the alarm text depends on the web server. Data is not exchanged.	Error 503 Service unavailable: Check if WinCC flexible Runtime is running on the server the HTTP channel is supported.
230301	An internal error has occurred. An English text explains the error in more detail. This may be caused by insufficient memory. OCX does not work.	-
230302	The name of the remote server cannot be resolved. The attempt to connect failed.	Check the configured server address. Check if the DNS service is available on the network.

Number	Effect/cause	Remedy
230303	The remote server is not running on the addressed computer. Wrong server address. The attempt to connect failed	Check the configured server address. Check if the remote server is running on the target computer.
230304	The remote server on the addressed computer is incompatible to VNCOCX. The attempt to connect failed.	Use a compatible remote server.
230305	The authentication has failed because the password is incorrect. The attempt to connect failed.	Configure the correct password.
230306	Error in the connection to the remote server. This may occur as a result of network problems. The attempt to connect failed.	Check if <ul style="list-style-type: none"> • the bus cable is plugged in • there are network problems
230307	The connection to the remote server was shut down because <ul style="list-style-type: none"> • the remote server was shut down, or • the user instructed the server to close all connections. The connection is closed.	-
230308	This alarm provides information on the connection status. An attempt is made to connect.	-
240000	WinCC flexible Runtime is operating in demo mode. You have no authorization or your authorization is corrupted.	Install the authorization.
240001	WinCC flexible Runtime is operating in demo mode. Too many tags are configured for the installed version.	Load an adequate authorization / powerpack.
240002	WinCC flexible Runtime is operating with a time-limited emergency authorization.	Restore the full authorization.
240003	Authorization failed. Without authorization, WinCC will run in demo mode.	Restart WinCC flexible Runtime or reinstall it.
240004	Error while reading the emergency authorization. WinCC flexible Runtime is operating in demo mode.	Restart WinCC flexible Runtime, install the authorization or repair the authorization (see Commissioning Instructions Software Protection).
250000	The tag in the specified line in "Status force" is not updated because the address configured for this tag is not available.	Check the set address and then verify that the address is set up in the controller.
250001	The tag in the specified line in "Status force" is not updated because the controller type configured for this tag does not exist.	Check the set address.
250002	The tag in the specified line in "Status force" is not updated because it is not possible to map the controller type in the tag type.	Check the set address.
250003	An attempt to connect to the PLC failed. The tags are not updated.	Check the connection to the PLC. Check that the controller is switched on and is online.
260000	An unknown user or an unknown password has been entered in the system. The current user is logged off from the system.	Log on to the system as a user with a valid password.

Number	Effect/cause	Remedy
260001	The logged on user does not have sufficient authorization to execute the protected functions on the system.	Log on to the system as a user with sufficient authorization.
260002	This alarm is triggered by the system function "TrackUserChange".	-
260003	The user has logged off from the system.	-
260004	The user name entered into the user view already exists in the user administration.	Select another user name because user names have to be unique in the user administration.
260005	The entry is discarded.	Use a shorter user name.
260006	The entry is discarded.	Use a shorter or longer password.
260007	The logon timeout value entered is outside the valid range of 0 to 60 minutes. The new value is discarded and the original value is retained.	Enter a logon timeout value between 0 and 60 minutes.
260008	An attempt was made to read a PTProRun.pwl file created with ProTool V 6.0 in WinCC flexible. Reading the file was canceled due to incompatibility of the format.	-
270000	A tag is not indicated in the alarm because it attempts to access an invalid address in the controller.	Check if the data area for the tag exists in the controller, the configured address is correct and the value range for the tag is correct.
270001	There is a device-specific limit as to how many alarms may be queued for output (see the operating instructions). This limit has been exceeded. The view no longer contains all the alarms. However, all alarms are written to the alarm buffer.	-
270002	The view shows alarms of a log for which there is no data in the current project. Wildcards are output for the alarms.	Delete older log data if necessary.
270003	The service cannot be set up because too many devices want to use this service. A maximum of four devices may execute this action.	Reduce the number of HMI devices which want to use the service.
280000	Connection is up because the cause of the interruption has been eliminated.	-
280001	No more data is read or written. Possible causes: <ul style="list-style-type: none"> • The cable is defective. • The PLC does not respond, is defective, etc. • The wrong port is used for the connection. • System overload. 	Check if <ul style="list-style-type: none"> • the cable is plugged in • the controller is OK • the correct port is used Restart the system if the system alarm persists.
280002	The connection used requires a function block in the controller. The function block has responded. Communication is now enabled.	-

Number	Effect/cause	Remedy
280003	The connection used requires a function block in the controller. The function block has not responded.	Check if <ul style="list-style-type: none"> the cable is plugged in the controller is OK the correct port is used Restart the system if the system alarm persists. Remedy depends on the error code: 1: The function block must set the COM bit in the response container. 2: The function block must not set the ERROR bit in the response container. 3: The function block must respond within the specified time (timeout). 4: Go online to the PLC.
280004	The connection to the controller is interrupted. There is no data exchange at present.	Check the connection parameters in WinCC flexible. Ensure that the cable is plugged in, the controller is operational, the correct interface is being used. Restart the system if the system alarm persists.
290000	The recipe tag could not be read or written. It is assigned the start value. The alarm can be entered in the alarm buffer for up to four more failed tags if necessary. After that, alarm 290003 is output.	Check in the configuration that the address has been set up in the controller.
290001	An attempt has been made to assign a value to a recipe tag which is outside the value range permitted for this type. The alarm can be entered in the alarm buffer for up to four more failed tags if necessary. After that, alarm 290004 is output.	Observe the value range for the tag type.
290002	It is not possible to convert a value from a source format to a target format. The alarm can be entered in the alarm buffer for up to four more failed recipe tags if necessary. After that, alarm 290005 is output.	Check the value range or type of the tag.
290003	This alarm is output when alarm number 290000 is triggered more than five times. In this case, no further separate alarms are generated.	Check in the configuration that the tag addresses have been set up in the controller.
290004	This alarm is output when alarm number 290001 is triggered more than five times. In this case, no further separate alarms are generated.	Observe the value range for the tag type.
290005	This alarm is output when alarm number 290002 is triggered more than five times. In this case, no further separate alarms are generated.	Check the value range or type of the tag.
290006	The threshold values configured for the tag have been violated by values entered.	Observe the configured or current threshold values of the tag.

Number	Effect/cause	Remedy
290007	There is a difference between the source and target structure of the recipe currently being processed. The target structure contains an additional data recipe tag which is not available in the source structure. The data recipe tag specified is assigned its start value.	Insert the specified data recipe tag in the source structure.
290008	There is a difference between the source and target structure of the recipe currently being processed. The source structure contains an additional data recipe tag which is not available in the target structure and therefore cannot be assigned. The value is rejected.	Remove the specified data recipe tag in the specified recipe from the project.
290010	The storage location configured for the recipe is not permitted. Possible causes: Illegal characters, write protection, data carrier out of space or does not exist.	Check the configured storage location.
290011	The data record with the specified number does not exist.	Check the source for the number (constant or tag value).
290012	The recipe with the specified number does not exist.	Check the source for the number (constant or tag value).
290013	An attempt was made to save a data record under a data record number which already exists. The action is not executed.	The following remedies are available: <ul style="list-style-type: none"> • Check the source for the number (constant or tag value). • First, delete the data record. • Change the "Overwrite" function parameter.
290014	The file specified to be imported could not be found.	Check: <ul style="list-style-type: none"> • The file name • Ensure that the file is in the specified directory.
290020	Message reporting that the download of data records from the HMI device to the PLC has started.	-
290021	Message reporting that the download of data records from the HMI device to the PLC was completed.	-
290022	Message reporting that the download of data records from the HMI device to the PLC was canceled due to an error.	Check in the configuration whether: <ul style="list-style-type: none"> • The tag addresses are configured in the controller • The recipe number exists • The data record number exist • The "Overwrite" function parameter is set
290023	Message reporting that the download of data records from the PLC to the HMI device has started.	-
290024	Message reporting that the download of data records from the PLC to the HMI device was completed.	-

Number	Effect/cause	Remedy
290025	Message reporting that the download of data records from the PLC to the HMI device was canceled due to an error.	Check in the configuration whether: <ul style="list-style-type: none"> • The tag addresses are configured in the controller • The recipe number exists • The data record number exist • The "Overwrite" function parameter is set
290026	An attempt has been made to read/write a data record although the data record is not free at present. This error may occur in the case of recipes for which downloading with synchronization has been configured.	Set the data record status to zero.
290027	Unable to connect to the controller at present. As a result, the data record can neither be read nor written. Possible causes: No physical connection to the controller (no cable plugged in, cable is defect) or the controller is switched off.	Check the connection to the PLC.
290030	This alarm is output after you selected screen which contains a recipe view in which a data record is already selected.	Reload the data record from the storage location or retain the current values.
290031	While saving, it was detected that a data record with the specified number already exists.	Overwrite the data record or cancel the action.
290032	While exporting data records it was detected that a file with the specified name already exists.	Overwrite the file or cancel the process.
290033	Confirmation request before deleting data records.	-
290040	A data record error with error code %1 that cannot be described in more detail occurred. The action is canceled. It is possible that the data record was not installed correctly on the controller.	Check the storage location, the data record, the "Data record" area pointer and if necessary, the connection to the controller. Restart the action after a short time. If the error persists, contact Customer Support. Forward the relevant error code to Customer Support.
290041	A data record or file cannot be saved because the storage location is full.	Delete files no longer required.
290042	An attempt was made to execute several recipe actions simultaneously. The last action was not executed.	Trigger the action again after waiting a short period.
290043	Confirmation request before storing data records.	-
290044	The data store for the recipe has been destroyed and is deleted.	-
290050	Message reporting that the export of data records has started.	-
290051	Message reporting that the export of data records was completed.	-
290052	Message reporting that the export of data records was canceled due to an error.	Ensure that the structure of the data records at the storage location and the current recipe structure on the HMI device are identical.
290053	Message reporting that the import of data records has started.	-

Appendix

A.2 System alarms

Number	Effect/cause	Remedy
290054	Message reporting that the import of data records was completed.	-
290055	Message reporting that the import of data records was canceled due to an error.	Ensure that the structure of the data records at the storage location and the current recipe structure on the HMI device are identical.
290056	Error when reading/writing the value in the specified line/column. The action was canceled.	Check the specified line/column.
290057	The tags of the recipe specified were toggled from "offline" to "online" mode. Each change of a tag in this recipe is now immediately downloaded to the controller.	-
290058	The tags of the specified recipe were toggled from "offline" to "online" mode. Modifications to tags in this recipe are no longer immediately transferred to the controller but must be transferred there explicitly by downloading a data record.	-
290059	Message reporting that the specified data record was saved.	-
290060	Message reporting that the specified data record memory was cleared.	-
290061	Message reporting that clearing of data record memory was canceled due to an error.	-
290062	The data record number is above the maximum of 65536. This data record cannot be created.	Select another number.
290063	This occurs with the system function "ExportDataRecords" when the parameter "Overwrite" is set to No. An attempt has been made to save a recipe under a file name which already exists. The export is canceled.	Check the "ExportDataRecords" system function.
290068	Request to confirm if all data records in the recipe should be deleted.	-
290069	Request to confirm if all data records of all recipes should really be deleted.	-
290070	The data record specified is not in the import file.	Check the source of the data record number or data record name (constant or tag value).
290071	During the editing of data record values, a value was entered which exceeded the low limit of the recipe tag. The entry is discarded.	Enter a value within the limits of the recipe tag.
290072	When editing data record values, a value was entered which exceeds the high limit of the recipe tag. The entry is discarded.	Enter a value within the limits of the recipe tag.

Number	Effect/cause	Remedy
290073	An action (e.g. saving a data record) failed due to an unknown error. The error corresponds to the status alarm IDS_OUT_CMD_EXE_ERR in the large recipe view.	-
290074	While saving, it was detected that a data record with the specified number already exists but under another name.	Overwrite the data record, change the data record number or cancel the action.
290075	A data record with this name already exists. The data record is not saved.	Please select a different data record name.
300000	Faulty configuration of process monitoring (e.g. using PDiag or S7-Graph): More alarms are queued than specified in the specifications of the CPU. No further ALARM_S alarms can be managed by the PLC and reported to the HMI devices.	Change the controller configuration.
300001	ALARM_S is not registered on this controller.	Select a controller that supports the ALARM_S service.
310000	An attempt is being made to print too many reports in parallel. Only one log file can be output to the printer at a given time; the print job is therefore rejected.	Wait until the previous active log was printed. Repeat the print job if necessary.
310001	An error occurred on triggering the printer. The report is either not printed or printed with errors.	Evaluate the additional system alarms related to this alarm. Repeat the print job if necessary.
320000	The movements have already been indicated by another device. The movements can no longer be controlled.	Deselect the movements on the other display units and select the motion control screen on the required display unit.
320001	The network is too complex. The faulty addresses cannot be indicated.	View the network in STL.
320002	No diagnostics alarm selected. The unit belonging to the alarm could not be selected.	Select a diagnostics alarm from the ZP_ALARM alarm screen.
320003	No alarms exists for the selected unit. The detail view cannot visualize any networks.	Select the defective unit from the overview screen.
320004	The required signal states could not be read by the PLC. The faulty addresses cannot be found.	Check the consistency between the configuration on the display unit and the PLC program.
320005	The project contains ProAgent elements which are not installed. ProAgent diagnostic functions cannot be performed.	In order to run the project, install the optional ProAgent package.
320006	You have attempted to execute a function which is not supported in the current constellation.	Check the type of the selected unit.
320007	No error-triggering addresses were found on the networks. ProAgent cannot indicate any faulty addresses.	Switch the detail screen to STL layout mode and check the status of the addresses and exclusion addresses.
320008	The diagnostic data stored in the configuration are not synchronized with those in the PLC. ProAgent can only indicate the diagnostic units.	Download the project to the HMI device again.

Number	Effect/cause	Remedy
320009	The diagnostic data stored in the configuration are not synchronized with those in the PLC. The diagnostic screens can be operated as usual. ProAgent may be unable to show all diagnostic texts.	Download the project to the HMI device again.
320010	The diagnostic data stored in the configuration are not synchronized with those in STEP7. The ProAgent diagnostics data is not up-to-date.	Download the project to the HMI device again.
320011	A unit with the corresponding DB number and FB number does not exist. The function cannot be executed.	Check the parameters of the "SelectUnit" function and the units selected in the project.
320012	The "Step sequence mode" dialog is no longer supported.	Use the ZP_STEP step sequence screen from the corresponding standard project for your project. Instead of calling the Overview_Step_Sequence_Mode function, call the "FixedScreenSelection" function using ZP_STEP as the screen name.
320014	The selected controller cannot be evaluated for ProAgent. The alarm view assigned to the "EvaluateAlarmDisplayFault" system function could not be found.	Check the parameters of the "EvaluateAlarmDisplayFault" system function.
330022	Too many dialogs open on the HMI device.	Close all dialogs you do not require on the HMI device.

Abbreviations

CPU	Central Processing Unit
CSV	Comma Separated Values
CTS	Clear To Send
DC	Direct Current
DCD	Data Carrier Detect
DIL	Dual-in-Line (electronic chip housing design)
DP	Distributed I/O
DSN	Data Source Name
DSR	Data Set Ready
DTR	Data Terminal Ready
EMC	Electromagnetic Compatibility
EN	European standard
ES	Engineering System
ESD	Electrostatic Discharge, the components and modules endangered by such
ESD	Electrostatic Sensitive Device
GND	Ground
HF	High Frequency
HMI	Human Machine Interface
IEC	International Electronic Commission
IF	Interface
LED	Light Emitting Diode
MMC	Multi-Media Card
MOS	Metal Oxide Semiconductor
MPI	Multipoint Interface (SIMATIC S7)
MS	Microsoft
MTBF	Mean Time Between Failures
n. c.	Not connected
OP	Operator Panel
PC	Personal Computer
PG	Programming device
PLC	Programmable Logic Controller
PPI	Point to Point Interface (SIMATIC S7)
RAM	Random Access Memory
RTS	Request To Send

RxD	Receive Data
SELV	Safety Extra Low Voltage
SP	Service pack
STN	Super Twisted Nematic
Sub-D	Subminiature D (plug)
TAB	Tabulator
TCP/IP	Transmission Control Protocol/Internet Protocol
TFT	Thin Film Transistor
TxD	Transmit Data
UL	Underwriter's Laboratory

Glossary

Acknowledge

Acknowledging an alarm confirms that you have noted it.

AG

Controller of the SIMATIC S5 series such as the AG S5-115U, for example

Alarm logging

Output of user-specific alarms to a printer, in parallel to their output to the HMI device screen.

Alarm, acknowledging

Acknowledgement of an alarm confirms that it has been noted.

Alarm, activated

Moment at which an alarm is triggered by the controller or HMI device.

Alarm, deactivated

Moment at which the initiation of an alarm is reset by the controller.

Alarm, user-specific

A user-specific alarm can be assigned to one of the following alarm classes:

- Error
- Warning
- User-specific alarm classes

A user-specific alarm designates a certain operating status of the plant connected to the HMI device via the controller.

AS

Controller of the SIMATIC S7 series such as a SIMATIC S7-300

AS 511

Protocol of the programming device interface of a SIMATIC S5 controller

Boot loader

Used to start the operating system. Automatically started when the HMI device is switched on. A start screen appears during startup. After the operating system has been loaded, the Loader opens.

Configuration computer

General term for programming devices (PGs) and PCs on which plant projects are created using an engineering software.

Control request

Triggers a function via the controller.

Controller

General term for devices and systems with which the HMI device communicates, e.g. SIMATIC S7.

Display duration

Defines whether and how long a system alarm is displayed on the HMI device.

EMC

Electromagnetic compatibility is the ability of electrical equipment to function properly in its electromagnetic environment without influencing this environment.

Engineering software

Software for the creation of projects for process visualization – see also project, process visualization and runtime software

Event

Functions are triggered by defined incoming events. Events can be configured. Events which can be assigned to a button include "Press" and "Release", for example.

Fault time

Refers to the time interval between an activated and deactivated alarm.

Field

Area reserved in configured screens for the input and output of values.

Flash memory

Non-volatile memory with EEPROM chips, used as mobile storage medium or as memory module installed permanently on the motherboard.

Half brightness lifetime

Time period until the brightness degrades to 50% of its original value. The specified value is dependent on the operating temperature.

Hardcopy

Output of the screen content to a printer.

HMI device image

File which can be transferred from the programming device to the HMI device. The HMI device image contains the operating system and elements of the runtime software required to run a project.

Infotext

Configured information on objects within a project. An alarm infotext, for example, may contain information on the cause of the fault and troubleshooting routines.

IO field

Enables the input or output of values on the HMI device which are transferred to the controller.

Notation

System consisting of characters, symbols and rules. In particular used to define the write format of a programming language in data processing.

Object

Component of a project. Example: screen or alarm. Objects are used to view or enter texts and values on the HMI device.

Operator control object

Component of a project which is used to enter values and trigger functions. A button, for example, is an operator control object.

Process visualization

Visualization of processes from the areas of production, logistics and services in text-based and graphics format. Configured plant screens allow operator intervention in active plant processes by means of the input and output data.

Project

Result of a configuration using an engineering software. The project normally contains several screens with embedded system-specific objects, basic settings and alarms. The project file of a project configured in WinCC flexible is saved under the file name extension *.hmi.

You distinguish between the project on the configuration computer and that on an HMI device. A project may be available in more languages on the configuration computer than can be managed on the HMI device. The project on the configuration computer can also be set up for different HMI devices. Only the project set up for a particular HMI device can be transferred to that HMI device.

Project file

File which is generated based on a source file for a specific HMI device when the configuration is completed. The project file is transferred to the corresponding HMI device and is used to operate and monitor plants. Refer to Source file.

Recipe

Combination of tags forming a fixed data structure. The data structure configured can be assigned data on the HMI device and is then referred to as a data record. The use of recipes ensures that when a data record is downloaded, all the assigned data is transferred synchronously to the controller.

Runtime software

Process visualization software which can be used to debug a project on a configuration computer. Also refer to "Project" and "Engineering software".

Screen

Form of the visualization of all logically related process data for a plant. The visualization of the process data can be supported by graphic objects.

Screen object

Configured object for operating and monitoring the system, e.g. a rectangle, an IO field or a recipe view.

Softkey

Key on the HMI device which supports user-specific functions. A function is assigned to the key in the configuration. The assignment of the keys may be specific to an active screen or not.

Source file

File from which various project files can be created, depending on the configuration. The source file is not transferred and remains on the configuration computer.

The file name extension of a source file is *.hmi. Refer to Source file, compressed and Project file.

Source file, compressed

Compressed form of the source file. Can be transferred in addition to the project file to the corresponding HMI device. "Enable Upload" must be set in the project on the configuration computer. The file extension of a compressed source file is *.pdz. The standard memory location for a compressed source file is the external MMC. Refer to Source file.

To restore a source file, it is necessary to use the same WinCC flexible version which was used to configure the project.

STEP 7

Programming software SIMATIC S7, SIMATIC C7 and SIMATIC WinAC controllers.

STEP 7 Micro/WIN

Programming software for controllers of the SIMATIC S7-200 series.

Symbolic IO field

Box for the input/output of a parameter. Contains a list of default entries from which one can be selected.

System alarms

Assigned to the "System" alarm class. A system alarm refers to internal states on the HMI device and the controller.

Tab order

In the configuration, this sets the sequence in which objects are focused on pressing the <TAB> key.

Tag

Defined memory location to which values can be written to and read from. This can be done from the controller or the HMI device. Based on whether the tag is interconnected with the controller or not, we distinguish between "external" tags (process tags) and "internal" tags.

Transfer

The transfer of an executable project to the HMI device.

"Transfer" mode

HMI device operating mode, set to transfer an executable project from the configuration computer to the HMI device.

Index

A

Accessories

Accessory kit, 17

Memory card, 17

Accessory kit, 17

Acknowledging

Alarm, 167, 171

Alarm, 18

Acknowledging, 167, 171

Editing, 168, 171

Infotext for, 166, 170

Viewing, 165, 169

Alarm buffer, 164

Alarm class, 164, 168

Layout, 166, 170

Alarm indicator, 167, 168

Alarm log, 164

Alarm text

Long, 166, 170

Alarm text window, 166, 170

Alarm view, 165, 169

Alarm window, 165, 169

Alphanumerical characters

Editing, 130, 149

Entering, 130, 148

Alphanumerical value, 128, 147

Alphanumerical values

Entering, 130

Approvals, 24, 28

Authorization, 135, 154

Automatic transfer, 108

B

Backing up, 113, 114, 116

Using ProSave, 116

Using WinCC flexible, 114

Backup, 92, 106, 118

From MMC, 119

Schematic, 104

to memory card, 92

to MMC, 118

Bootloader, 49, 62

Bottom view OP 73, 14

Bottom view OP 77A, 15

Bottom view OP 77B, 16

C

Call sequence

Characters, 130, 150

Calling

HMI device information, 76, 87

Regional settings, 90

Version information, 77, 87

Channel 1:

Serial, 81, 93

Channel 2:

MPI/DP, 81, 95

USB, 98

Character input

Using control keys, 129, 133, 148, 151

Characters

Call sequence, 130, 150

Delete, 131

Deleting, 151

Inserting, 131, 151

Cleaning agents, 189

Clearance, 36

Climatic

Storage conditions, 31

Transport conditions, 31

Conductor cross-section, 47, 60

Configuring

Interfaces, 57

Operating system, 73, 84

Connecting

Configuration computer, 46, 58

Connection sequence, 42, 52

Controller, 46, 56

Equipotential bonding, 44, 54

HMI device, 42, 52

Peripherals, 59

Connecting peripherals

Wiring diagram, 59

Connecting the configuration computer

Wiring diagram, 46, 58

Connecting the terminal block, 48, 61
Connection sequence, 42, 52
Connections
 Number, 20, 21
Contrast, 76, 86
 Setting, 76, 86
Control keys, 144
 For symbolic input, 129, 133, 148, 151
Controller
 Configuring the interface, 57
 Connecting, 46, 56
 Protocols of SIMATIC controllers, 20
Creating
 Recipe data record, 182

D

Data channel
 Configuring, 80, 92
Data flow, 177
Data record
 Exporting, 187
 Importing, 187
Date and time, 128, 147
 Entering, 133, 152
Decimal places, 128, 147
Delay time
 Setting, 78, 89
Delete
 Recipe data record, 184
Deleting
 Password, 80, 91
 Users, 141, 161
Device Info, 76, 87
Dialog entries
 Editing, 74, 84
DIL switch
 Setting, 57
Display, 193, 194, 195
Display format, 128, 146
Draft Mode, 101

E

EC declaration of conformity, 24
Editing
 Recipe data record, 183
Electrostatic charge, 202
Element list, 178, 181
Enclosure, 193, 194, 195
Enclosure, 196
Entering

Alphanumerical characters, 130, 148
Alphanumerical value, 128, 147
Alphanumerical values, 130
Date and time, 128, 133, 147
Numerical characters, 130, 148
Numerical value, 128, 146
Numerical values, 130
Symbolic value, 128, 147
Equipotential bonding
 Connecting, 44, 54
 Installing, 45, 55
 Requirements, 44, 54
 Wiring diagram, 45, 55
Equipotential bonding cable, 44, 54
Explosion protection
 Labels, 26
Exporting
 Recipe, 187
 Recipe record, 187

F

Factory settings
 Resetting to, 113, 121
Field
 Activate, 126
 Navigating in the, 129, 147
Front view OP 73, 14
Front view OP 77A, 15
Front view OP 77B, 16
Function test, 50, 63

H

Help in a project, 152
Help indicator, 134
High frequency radiation, 23
HMI device
 Bottom view, 15, 16
 Connecting, 42, 52
 EMC-compliant installation, 29
 Front view, 15, 16
 Initial startup, 104
 Interfaces, 53
 Mounting position, 35
 Recommissioning, 104
 Side view, 15, 16
 Switching off, 50, 63
 Switching on, 49, 62
 Testing, 49, 62
 Type of fixation, 36

HMI device information
 Calling, 76, 87

I

IF 1A, 199
 IF 1B, 197, 198
 Importing
 Recipe, 187
 Recipe record, 187
 Info/Settings, 74, 85
 Infotext, 19
 Viewing, 134, 166, 170
 Input
 Alphanumerical, 131, 150
 Example, 131, 150
 Numerical, 131, 150
 Input on the HMI device
 System keys, 144
 Using soft keys, 125, 143
 Using system keys, 126, 144
 Input unit, 193, 194, 196
 Instructions
 General, 26
 Security, 23, 26
 Working on the cabinet, 23
 Interfaces, 43, 53
 Configuring, 57
 Rated load, 59
 Interference
 Pulse-shaped, 29
 Sinusoidal, 30

K

Keyboard operation
 Simple recipe view, 181

L

Labeling
 Approvals, 24
 EC declaration of conformity, 24
 Soft keys, 70, 143
 Labeling strips, 17, 67, 70
 Labels
 Explosion protection, 26
 Language
 Setting, 127
 LEDs, 65, 66
 Limit value test, 128, 146

Limit values for user, password and user view, 137, 155

List, 18

Lists

 Navigating in, 126, 145

Loader, 49, 62

 Navigating in the, 73, 84

 OP 73, 73

 OP 77A, 84

 OP 77B, 84

Location of the manufacturer, 28

Logging off

 Users, 138, 157

Logging on

 Users, 137, 156

Logoff time, 135, 154

M

Maintenance, 189, 190

Manual transfer, 107

Mechanical

 Storage conditions, 31

 Transport conditions, 31

Memory, 193, 194, 196

Memory card, 17

 Backup to, 92

 Restoring from, 92

 Using, 68

Menu

 Info/Settings, 74, 85

 Printer Settings, 99

 Settings, 77

 Transfer settings, 93

MMC, 68

Mounting

 EMC-compliant, 29

Mounting clamp, 36

 using, 41, 51

Mounting cut-out

 Clearance, 38

 Dimensions, 36

 Preparing, 36

Mounting position, 35

MPI/DP address, 81, 95

MPI/DP baud rate, 82, 96

MPI/DP settings, 95

MPI/PROFIBUS DP address

 Setting, 81, 95

MPI/PROFIBUS DP baud rate

 Setting, 82, 96

MPI/PROFIBUS DP channel

 Setting, 81, 94

N

- Navigating
 - In lists, 126, 145
 - In the field, 129, 147
 - in the Loader, 50, 63, 73, 84
 - Nominal voltage, 40
 - Numerical characters
 - Editing, 130, 149
 - Entering, 130, 148
 - Numerical keypad, 144
 - Numerical value
 - Decimal places, 128, 147
 - Display format, 128, 146
 - Limit value test, 128, 146
 - Numerical values
 - Entering, 130
- O**
- Object
 - Additional, 19
 - Alarms, 18
 - Infotext, 19
 - Recipe, 19
 - Screens, 19
 - Tags, values, lists, 18
 - Offices, 6
 - Offline, 105
 - Offline test, 110
 - Online, 105
 - Online test, 111
 - Operating mode
 - Changing, 105
 - Offline, 105
 - Online, 105
 - Overview, 105
 - Transfer, 105
 - Operating system
 - Configuring, 73, 84
 - Updating, 106, 121
 - Operation with key combinations, 125
 - Operator control components, 65, 66, 67
 - Labeling strips, 67
 - Operator controls
 - Simple recipe view, 179
 - Orientation, 101
 - Overall dimensions
 - OP 73, 191
 - OP 77A, 192
 - OP 77B, 192

P

- Paper size
 - Setting, 100
- Paper Size, 100
- Password, 79, 91, 136, 154
 - Assigning, 79, 91
 - Backup and restore, 136, 155
 - Deleting, 80, 91
 - Editing, 79, 91
 - Limit values, 137, 155
- Password entry, 79, 91
- Password list, 136, 154
- Password protection, 75, 85
- PC-PPI adapter, 17
- Peripherals
 - Rated load, 59
- Pin assignment
 - Power supply, 197
 - RS 485, 197
 - RS-232, 199
 - RS-422, 198
 - USB, 200
- PLC
 - Reading recipe data record, 185
 - Transferring recipe data record, 186
- Polarity reversal protection, 48, 61
- Potential differences, 44, 54
- Potentially explosive atmosphere, 26
- Power failure, 113
- Power supply, 193, 195, 196
 - Conductor cross-section, 47, 60
 - Connecting, 48, 61
 - Connecting the terminal block, 48, 61
 - Polarity reversal protection, 48, 61
 - Wiring diagram, 47, 60
- Print orientation
 - Setting, 101
- Print quality
 - Setting, 101
- Printer language
 - Setting, 100
- Printer Language, 100
- Printer Settings, 99
- Project
 - Closing, 142, 162
 - Help, 152
 - Testing offline, 110
 - Testing online, 111
 - Transfer, 106
 - Transferring, 104
 - Upload, 111
- Project ID, 112

- Project language
 - Setting, 145
- Protocol
 - SIMATIC controllers, 20
- R**
- Radiation
 - High frequency, 23
- Rated load
 - Interface, 59
- Reading out
 - Recipe data record, 185
- Recipe, 19, 174
 - Control, 175
 - Data flow, 177
 - Data record, 175
 - Exporting, 187
 - Field of application, 173
 - Importing, 187
 - Recipe view, 178
- Recipe data record
 - Creating, 182
 - Delete, 184
 - Editing, 183
 - Reading from PLC, 185
 - Transferring to PLC, 186
- Recipe list, 178, 180
- Recipe record
 - Exporting, 187
 - Importing, 187
- Recipe view, 178
 - Menu commands, 180
 - Operator controls, 179
 - Simple, 178
- Record list, 178, 180
- Region, 90
- Regional settings
 - Calling, 90
- Registered trademarks, 6
- Representatives, 6
- Reset to factory setting, 106
- Reset to factory settings, 113
- Resetting to factory settings, 121
- Restore, 92, 106
 - to MMC, 118
- Restoring, 113, 115, 117, 118
 - from MMC, 119
 - In the case of compatibility conflict, 113
 - Schematic, 104
 - To memory card, 92
 - Using ProSave, 117
 - Using WinCC flexible, 115
 - With reset to factory setting, 113
 - Without reset to factory setting, 113
- RS 232 (IF 1A), 199
- RS 232-TTY converter, 17
- RS 422 (IF 1B), 198
- RS 485 (IF 1B), 197, 198
- S**
- Safety instructions
 - High frequency radiation, 23
 - Potentially explosive atmosphere, 26
 - Working on the cabinet, 23
- Scope of maintenance, 189
- Screen, 19
- Screen saver, 78, 89
 - Setting, 78, 89
- Security, 135, 153
- Security system, 135, 153
- Select Channel 2, 94
- Selecting
 - In the field, 126
- Serial channel
 - Setting, 81, 93
- Service
 - On the Internet, 6
- Service pack, 190
- Setting
 - Contrast, 76, 86
 - Delay time, 78, 89
 - Paper size, 100
 - Print orientation, 101
 - Print quality, 101
 - Printer language, 100
 - Project language, 145
 - Screen saver, 78, 89
- Settings, 77
- Side view OP 73, 14
- Side view OP 77A, 15
- Side view OP 77B, 16
- SIMATIC controllers
 - Protocol, 20
- Simple recipe view
 - Keyboard operation, 181
 - Menu commands, 180
 - Operator controls, 179
- Simple Recipe View, 178
- Soft keys, 65, 66
 - Global function assignment, 125, 143
 - Labeling, 70, 143
 - Local function assignment, 125, 143

Source file
 Verifying, 112
Specifications
 Display, 193, 194, 195
 Enclosure, 193, 194, 195
 Input unit, 193, 194, 196
 Memory, 193, 194, 196
 OP 77A overall dimensions, 192
 OP 77B overall dimensions, 192
 Overall dimensions OP 73, 191
 Power supply, 193, 195, 196, 197
 RS 485, 197
 RS-232, 199
 RS-422, 198
Startup delay, 78, 89
Storage conditions, 31
Support
 On the Internet, 6
Switching off
 HMI device, 50, 63
Switching on
 HMI device, 49, 62
Symbolic value, 128, 147
 Entering, 152
Symbolic values
 Entering, 133
System alarms
 Meaning, 204
 Parameters, 203
System keys, 65, 66, 126, 144

T

Tag, 18
Testing
 HMI device, 49, 62
 Project, 110
Time, 128, 147
Training center, 6
Transfer, 104, 105, 106
 Automatic, 108
 Backup, 104
 Manual, 107
 Restoring, 104
Transfer mode
 Unintentional, 83, 97, 99
Transfer settings, 80, 83, 93, 98
 Menu, 80
Transferring
 Project, 104
 Recipe data record, 186
Transport conditions, 31

Type of fixation, 36

U

Upkeep, 189
Upload, 111, 112
USB channel
 Setting, 94
USB settings, 98
Use
 Conditions, 33
 In industry, 26
 In residential areas, 26
 In the potentially explosive atmosphere, 26
 With additional measures, 33
User data
 Backup and restore, 136, 155
User group, 135, 154
User view, 136, 155
 Limit values, 155
 Limits, 137
Users, 135, 154
 Change password, 140, 159
 Changing group assignments, 140, 159
 Changing the logoff time, 140, 159
 Changing the user name, 140, 159
 Changing user data, 140, 159
 Creating, 138, 158, 160
 Deleting, 141, 161
 Limit values, 155
 Limits, 137
 Logging off, 138, 157
 Logging on, 137, 156

V

Value, 18
Version Info, 77, 87
Version information
 Calling, 77, 87

W

Wiring diagram
 Connecting peripherals, 59
 Connecting the configuration computer, 46, 58
 Connecting the equipotential bonding circuit, 45, 55
 Connecting the PLC, 46, 56
 Connecting the power supply, 47, 60
Working on the cabinet, 23