

SIEMENS

SIMATIC HMI

WinCC V7.5

WinCC: Working with WinCC

System Manual

Print of the Online Help

09/2018

A5E45518672-AA

<u>Working with Projects</u>	1
<u>Working with Tags</u>	2
<u>Creating Process Pictures</u>	3
<u>Process Picture Dynamics</u>	4
<u>Setting up a Message System</u>	5
<u>Archiving Process Values</u>	6
<u>User archive</u>	7
<u>Working with Cross Reference</u>	8
<u>Documentation of Configuration and Runtime Data</u>	9
<u>Creating Page Layouts</u>	10
<u>Creating Line Layouts</u>	11
<u>COM Provider in the Layout Editor</u>	12
<u>Setting Up Multilingual Projects</u>	13
<u>Structure of the User Administration</u>	14
<u>Integration of WinCC in SIMATIC Manager</u>	15
<u>SmartTools</u>	16

Legal information

Warning notice system

This manual contains notices you have to observe in order to ensure your personal safety, as well as to prevent damage to property. The notices referring to your personal safety are highlighted in the manual by a safety alert symbol, notices referring only to property damage have no safety alert symbol. These notices shown below are graded according to the degree of danger.

⚠ DANGER
indicates that death or severe personal injury will result if proper precautions are not taken.

⚠ WARNING
indicates that death or severe personal injury may result if proper precautions are not taken.

⚠ CAUTION
indicates that minor personal injury can result if proper precautions are not taken.

NOTICE
indicates that property damage can result if proper precautions are not taken.

If more than one degree of danger is present, the warning notice representing the highest degree of danger will be used. A notice warning of injury to persons with a safety alert symbol may also include a warning relating to property damage.

Qualified Personnel

The product/system described in this documentation may be operated only by **personnel qualified** for the specific task in accordance with the relevant documentation, in particular its warning notices and safety instructions. Qualified personnel are those who, based on their training and experience, are capable of identifying risks and avoiding potential hazards when working with these products/systems.

Proper use of Siemens products

Note the following:

⚠ WARNING
Siemens products may only be used for the applications described in the catalog and in the relevant technical documentation. If products and components from other manufacturers are used, these must be recommended or approved by Siemens. Proper transport, storage, installation, assembly, commissioning, operation and maintenance are required to ensure that the products operate safely and without any problems. The permissible ambient conditions must be complied with. The information in the relevant documentation must be observed.

Trademarks

All names identified by ® are registered trademarks of Siemens AG. The remaining trademarks in this publication may be trademarks whose use by third parties for their own purposes could violate the rights of the owner.

Disclaimer of Liability

We have reviewed the contents of this publication to ensure consistency with the hardware and software described. Since variance cannot be precluded entirely, we cannot guarantee full consistency. However, the information in this publication is reviewed regularly and any necessary corrections are included in subsequent editions.

Table of contents

1	Working with Projects.....	35
1.1	Working with Projects.....	35
1.2	Opening WinCC Explorer.....	36
1.3	Closing WinCC Explorer.....	40
1.4	The WinCC Explorer.....	42
1.4.1	The WinCC Explorer.....	42
1.4.2	Windows of the WinCC Explorer.....	42
1.4.3	Menu Bar of the WinCC Explorer.....	45
1.4.4	Toolbar of the WinCC Explorer.....	48
1.4.5	Status Bar and Title Bar of WinCC Explorer.....	49
1.4.6	Search Function.....	50
1.4.7	Converting project data.....	52
1.5	The WinCC Configuration Studio.....	54
1.5.1	Introduction.....	54
1.5.2	Interface.....	55
1.5.3	Operating the navigation area.....	58
1.5.3.1	Operating the navigation area.....	58
1.5.3.2	Copying, pasting and deleting data in the navigation area.....	61
1.5.4	Operating the data area.....	62
1.5.4.1	Data area.....	62
1.5.4.2	Shortcut menu of the table columns.....	64
1.5.4.3	Operating the data area.....	65
1.5.4.4	Selecting cells, areas, rows and columns.....	67
1.5.4.5	Data entry in the data area.....	68
1.5.4.6	Sorting in the data area.....	75
1.5.4.7	Search / replace in the data area.....	76
1.5.4.8	Filtering in the data area.....	86
1.5.4.9	Using macros.....	95
1.5.5	Using the "Properties" window.....	96
1.5.6	Exporting data records.....	97
1.5.7	Importing data records.....	99
1.5.8	Drag&Drop in the WinCC Configuration Studio.....	100
1.5.8.1	Drag&Drop within the Configuration Studio.....	100
1.5.8.2	Drag-and-drop from the Configuration Studio to the Graphics Designer.....	102
1.5.8.3	Drag-and-drop from the Configuration Studio to other applications.....	109
1.6	Project Types.....	110
1.6.1	Single-User Project.....	110
1.6.2	Multi-User Project.....	110
1.6.3	Client Project.....	111
1.6.4	Changing Project Type.....	113
1.6.4.1	How to Change a Single-User Project into a Multi-User Project.....	113
1.6.4.2	How to Change a Multi-User Project to a Single-User Project.....	114
1.7	Creating and Editing Projects.....	115

1.7.1	Preparation to Create a Project.....	115
1.7.2	WinCC Project with "Basic Process Control".....	118
1.7.3	How to Create a Project.....	120
1.7.4	How to Specify the Computer Properties.....	123
1.7.5	How to use multiuser engineering.....	125
1.7.6	How to support multiple picture windows.....	128
1.7.7	Setting Time in WinCC.....	130
1.7.7.1	Setting Time in WinCC.....	130
1.7.7.2	How to Set the Time Base in the Project.....	133
1.7.7.3	How to Set the Time Base for Controls.....	134
1.7.7.4	How to Set the Time Base for Runtime Documentation.....	135
1.7.8	Online configuration.....	137
1.7.9	Loading Online Changes.....	142
1.7.9.1	Loading Online Changes.....	142
1.7.9.2	Requirements for Loading Online Changes.....	144
1.7.9.3	Use and Limitations of Load Online Changes.....	146
1.7.9.4	Run Diagnosis of Online Change Loading.....	148
1.7.9.5	How to Activate Load Online Changes.....	151
1.7.9.6	How to Download Load Online Changes.....	153
1.7.9.7	How to Reset Load Online Changes.....	157
1.8	Determining the Global Design.....	158
1.8.1	Global Design of the Objects.....	158
1.8.2	The Elements of the Global Design.....	160
1.8.3	How to work with global object designs.....	161
1.8.4	How to edit your own global design.....	163
1.8.5	How to determine the global design of the objects.....	165
1.9	Making Settings for Runtime.....	168
1.9.1	Settings for Runtime.....	168
1.9.2	How to Set Up a Startup List.....	172
1.9.3	How to Assign Hotkeys in the Project.....	174
1.9.4	Effect of External Applications at Runtime.....	175
1.9.5	System diagnostics with performance tags.....	176
1.9.6	Setting up Runtime.....	180
1.9.6.1	How to set up Runtime.....	180
1.9.6.2	How to change the computer name.....	181
1.9.6.3	How to configure the applications available in Runtime.....	182
1.9.6.4	How to Change the default settings for Language, Time and Key Combinations.....	184
1.9.6.5	How to specify favorite process pictures.....	185
1.9.6.6	How to set up the system dialogs.....	186
1.9.6.7	How to change the language in Runtime.....	187
1.9.6.8	How to navigate in process pictures in Runtime.....	188
1.9.6.9	How to define hotkeys for operation and screen navigation.....	191
1.9.6.10	How to define a picture as the start picture in Runtime.....	194
1.9.6.11	How to configure the cursor control in Runtime.....	196
1.9.6.12	How to Activate Zoom Functions in Runtime.....	198
1.9.6.13	How to make computer-specific settings for runtime.....	200
1.10	Activating Project.....	204
1.10.1	Activating Project.....	204
1.10.2	How to Start Runtime.....	204
1.10.3	How to Set Up Autostart.....	207
1.10.4	How to Exit Runtime.....	209

1.11	Copying and Duplicating Projects.....	212
1.11.1	Copying and Duplicating Projects.....	212
1.11.2	How to Copy a Project.....	212
1.11.3	How to Duplicate a Project for Redundant Servers.....	215
1.11.4	How to duplicate a redundant project at runtime.....	217
1.12	Appendix.....	219
1.12.1	Editors and Functions in WinCC Explorer.....	219
1.12.2	WinCC status and control in the system tray.....	222
1.12.3	WinCC diagnostics window and license information.....	224
1.12.4	Illegal Characters.....	226
1.12.5	File Structure of a Project.....	230
2	Working with Tags.....	233
2.1	Tag management.....	233
2.2	The Tag Management editor.....	234
2.3	Working in the "Tag Management" editor.....	237
2.4	Basics of Tag Management.....	238
2.4.1	Tags.....	238
2.4.1.1	Tags.....	238
2.4.1.2	Internal Tags.....	239
2.4.1.3	Process Tags.....	241
2.4.1.4	Properties of a tag.....	243
2.4.1.5	Structure Types and Structure Tags.....	246
2.4.1.6	Data types of structure tags.....	249
2.4.1.7	Properties of a structure tag.....	249
2.4.1.8	Use: Structure tags in picture windows.....	251
2.4.1.9	Tag Groups.....	253
2.4.1.10	Communication Driver.....	254
2.4.2	Tag types.....	254
2.4.2.1	Tag Types.....	254
2.4.2.2	Binary Tags.....	255
2.4.2.3	Signed 8-bit value.....	256
2.4.2.4	Unsigned 8-bit value.....	257
2.4.2.5	Signed 16-bit value.....	258
2.4.2.6	Unsigned 16-bit value.....	259
2.4.2.7	Signed 32-bit value.....	260
2.4.2.8	Unsigned 32-bit value.....	261
2.4.2.9	Floating-point number 32-bit IEEE 754.....	262
2.4.2.10	Floating-Point Number 64-Bit IEEE 754.....	263
2.4.2.11	Text Tag 8-Bit Character Set and Text Tag 16-Bit Character Set.....	265
2.4.2.12	Raw Data Tag.....	265
2.4.2.13	Text Reference.....	266
2.4.2.14	Date/time.....	267
2.4.3	Selecting tags in WinCC.....	268
2.4.4	Displaying status information in Runtime.....	271
2.5	Configuration in Tag Management.....	273
2.5.1	Creating communication drivers and connections.....	273
2.5.1.1	How to add a new communication driver.....	273
2.5.1.2	How to create a new connection.....	274

2.5.1.3	How to set system parameters for a connection.....	275
2.5.1.4	How to set the connection parameters.....	276
2.5.2	Creating Tags.....	277
2.5.2.1	Creating Tags.....	277
2.5.2.2	Creating Internal Tags.....	278
2.5.2.3	How to Create a Process Tag.....	279
2.5.2.4	How to edit the properties of a tag.....	280
2.5.2.5	Creating structure types and structure tags.....	281
2.5.2.6	Tag groups.....	288
2.5.3	Editing Tags.....	289
2.5.3.1	Editing Tags.....	289
2.5.3.2	Copying, Moving and Deleting Tags.....	290
2.5.3.3	How to Rename Tags.....	291
2.5.3.4	Editing Tags in Runtime.....	292
2.5.3.5	In this way, you display the value, status and quality code for tags.....	293
2.5.4	Importing and exporting tags.....	294
2.5.4.1	How to export tags.....	294
2.5.4.2	How to import tags.....	296
3	Creating Process Pictures.....	297
3.1	Creating Process Pictures.....	297
3.2	How to start the Graphics Designer.....	298
3.3	The Graphics Designer in the WinCC Explorer.....	299
3.3.1	The Graphics Designer in the WinCC Explorer.....	299
3.3.2	The shortcut menu in the Navigation window.....	300
3.3.3	How to configure the object selection.....	304
3.3.4	How to configure the control selection.....	306
3.3.5	The pop-up menu in the Data Window.....	309
3.3.6	Displaying the properties of a picture file.....	313
3.3.7	Displaying the configured dynamics of a process picture.....	315
3.4	Elements and Basic Settings of the Graphics Designer.....	319
3.4.1	Elements and Basic Settings of the Graphics Designer.....	319
3.4.2	The Coordinate System of a Process Picture.....	319
3.4.3	The Coordinate System of an Object.....	321
3.4.4	The Rectangle Surrounding the Object.....	323
3.4.5	The Start Screen of the Graphics Designer.....	325
3.4.5.1	The Start Screen of the Graphics Designer.....	325
3.4.5.2	Alignment palette.....	328
3.4.5.3	Layer palette.....	330
3.4.5.4	Color palette.....	331
3.4.5.5	Object palette.....	334
3.4.5.6	Font palette.....	334
3.4.5.7	Standard palette.....	336
3.4.5.8	Status bar.....	337
3.4.5.9	Zoom palette.....	338
3.4.5.10	Output window.....	339
3.4.5.11	Symbol library.....	339
3.4.5.12	SVG library.....	340
3.4.5.13	Controls.....	341
3.4.5.14	Dynamic Wizard.....	342
3.4.5.15	Process pictures.....	342

3.4.5.16	Standard.....	344
3.4.5.17	Styles.....	345
3.4.5.18	Tags.....	346
3.4.6	The Central Color Palette.....	346
3.4.6.1	The central color palette.....	346
3.4.6.2	How to define the central color palette.....	350
3.4.6.3	How to export and import color palettes.....	353
3.4.7	The Basic Settings of the Graphics Designer.....	355
3.4.7.1	The Basic Settings of the Graphics Designer.....	355
3.4.7.2	How to Set the Grid.....	356
3.4.7.3	How to set the options in Graphics Designer.....	358
3.4.7.4	Making layers invisible.....	362
3.4.7.5	Showing and hiding layers and objects.....	364
3.4.7.6	Managing the default settings of objects.....	366
3.4.7.7	Changing the default trigger.....	368
3.4.8	Customizing the Working Environment.....	370
3.5	Working with Pictures.....	372
3.5.1	Working with Pictures.....	372
3.5.2	Saving in file system.....	374
3.5.3	How to create a new picture.....	376
3.5.4	How to save the pictures.....	378
3.5.5	How to open a picture.....	378
3.5.6	How to Copy the Picture.....	379
3.5.7	How to Rename a Picture.....	380
3.5.8	How to Delete a Picture.....	382
3.5.9	How to export graphics.....	384
3.5.10	How to set the picture properties.....	385
3.5.11	How to configure a picture background.....	386
3.5.12	How to protect pictures with a password.....	387
3.5.13	Working with Layers.....	388
3.5.13.1	Working with Layers.....	388
3.5.13.2	How to assign a layer.....	390
3.5.13.3	How to use the layers palette.....	391
3.5.14	Working with Multiple Pictures.....	392
3.5.14.1	Working with Multiple Pictures.....	392
3.5.14.2	How to transfer picture properties to another picture.....	392
3.5.14.3	How to transfer objects to another picture.....	393
3.5.14.4	How to copy objects to another picture.....	394
3.6	Working with Faceplate Types.....	396
3.6.1	Overview: Faceplate types.....	396
3.6.2	Configuring a faceplate type.....	399
3.6.2.1	Overview: Configuring faceplate types.....	399
3.6.2.2	Properties and events.....	402
3.6.2.3	How to create a Faceplate type.....	405
3.6.2.4	How to protect faceplate types with a password.....	406
3.6.2.5	Interface tags.....	407
3.6.2.6	Faceplate tags.....	410
3.6.2.7	Structure types and structure type elements.....	413
3.6.2.8	Property of a faceplate type.....	416
3.6.2.9	Event of a Faceplate type.....	420
3.6.2.10	How to create faceplate tags.....	421

3.6.2.11	How to define instance-specific interface tags.....	422
3.6.2.12	How to define instance-specific object properties.....	424
3.6.2.13	How to define instance-specific structures.....	425
3.6.2.14	How to create text lists and graphics lists in faceplate types.....	428
3.6.2.15	How to link faceplate tags with a properties node.....	431
3.6.2.16	How to define instance-specific events.....	432
3.6.2.17	Making a Faceplate type dynamic.....	433
3.6.3	Configuring a faceplate instance.....	435
3.6.3.1	How to configure a faceplate instance.....	435
3.6.3.2	Updating faceplate instance.....	438
3.6.3.3	How to update a faceplate instance in the Graphics Designer.....	441
3.6.4	Example: How to dynamize a faceplate instance.....	442
3.6.5	Example of faceplate tags: How to dynamize a faceplate instance.....	446
3.7	Working with text list and graphic lists.....	449
3.7.1	How to create text lists.....	449
3.7.2	How to create graphic lists.....	452
3.8	Working with Objects.....	456
3.8.1	Working with Objects.....	456
3.8.2	How to change the default setting of object types.....	457
3.8.3	Basic Static Operations.....	459
3.8.3.1	Basic Static Operations.....	459
3.8.3.2	How to insert an object into a picture.....	460
3.8.3.3	How to add a text from a WinCC editor as an object.....	461
3.8.3.4	How to Rename Objects.....	462
3.8.3.5	How to select an object.....	464
3.8.3.6	Multiple Selection of Objects.....	465
3.8.3.7	How to Select Multiple Objects.....	467
3.8.3.8	How to position objects.....	469
3.8.3.9	How to Align Multiple Objects.....	471
3.8.3.10	How to scale an object.....	472
3.8.3.11	How to mirror the objects.....	474
3.8.3.12	How to rotate the objects.....	475
3.8.3.13	How to delete objects.....	476
3.8.3.14	How to cut objects.....	477
3.8.3.15	How to copy objects.....	478
3.8.3.16	How to insert the contents of the clipboard.....	479
3.8.3.17	How to duplicate objects.....	480
3.8.3.18	How to change the position of an object.....	481
3.8.3.19	You can change the text contents of objects.....	483
3.8.4	Basic Dynamic Operations.....	485
3.8.4.1	Basic Dynamic Operations.....	485
3.8.4.2	How to make attributes dynamic.....	485
3.8.4.3	How to configure events.....	487
3.8.4.4	How to configure a dynamic dialog.....	489
3.8.4.5	How to animate an object.....	491
3.8.4.6	How to configure a C action.....	494
3.8.4.7	How to configure a VBS action.....	495
3.8.4.8	How to Configure a Tag Connection.....	497
3.8.4.9	How to change the tag connection of objects using linking.....	499
3.8.4.10	How to Configure a Direct Connection.....	502
3.8.4.11	Example: How to animate a circle as signal light.....	504

3.8.4.12	Example: How to animate the operability of a button.....	508
3.8.5	The Properties of an Object.....	511
3.8.5.1	The Properties of an Object.....	511
3.8.5.2	The "Object Properties" Window.....	512
3.8.5.3	Property Groups and Attributes.....	530
3.8.5.4	Special Runtime Settings.....	557
3.8.6	Working with Standard Objects.....	565
3.8.6.1	Working with Standard Objects.....	565
3.8.6.2	How to Draw a Line.....	567
3.8.6.3	How to Draw a Polygon.....	570
3.8.6.4	How to Draw a Polyline.....	573
3.8.6.5	How to Draw an Ellipse.....	576
3.8.6.6	How to Draw a Circle.....	578
3.8.6.7	How to Draw an Ellipse Segment.....	580
3.8.6.8	How to Draw a Pie Segment.....	582
3.8.6.9	How to draw an Ellipse Arc.....	584
3.8.6.10	How to Draw a Circular Arc.....	587
3.8.6.11	How to Draw a Rectangle.....	589
3.8.6.12	How to Draw a Rounded Rectangle.....	590
3.8.6.13	How to Insert Static Text.....	593
3.8.6.14	How to use the connector.....	595
3.8.7	Working with Smart Objects.....	598
3.8.7.1	Working with Smart Objects.....	598
3.8.7.2	How to Insert an Application Window.....	602
3.8.7.3	How to insert a picture window.....	605
3.8.7.4	How to insert a control.....	608
3.8.7.5	How to Insert an OLE Object.....	610
3.8.7.6	I/O Field.....	612
3.8.7.7	Bar.....	623
3.8.7.8	How to insert a graphic object.....	631
3.8.7.9	Status display.....	633
3.8.7.10	Text list.....	639
3.8.7.11	How to insert multiline text.....	649
3.8.7.12	How to insert a combobox.....	651
3.8.7.13	How to insert a list box.....	653
3.8.7.14	How to insert a Faceplate instance.....	655
3.8.7.15	How to insert a .NET control.....	656
3.8.7.16	How to insert a WPF control.....	658
3.8.7.17	How to Insert a 3D Bar.....	659
3.8.7.18	How to Insert a Group Display.....	662
3.8.7.19	How to Configure the Extended Status Display.....	667
3.8.7.20	How to Configure the Extended Analog Display.....	672
3.8.7.21	Format Function of the Analog Display.....	676
3.8.7.22	How to add an SVG object.....	677
3.8.7.23	How to configure a DataSet object.....	678
3.8.8	Working with Windows Objects.....	679
3.8.8.1	Working with Windows Objects.....	679
3.8.8.2	Button.....	681
3.8.8.3	How to insert a check box.....	686
3.8.8.4	How to insert an radio box.....	688
3.8.8.5	How to insert a round button.....	691
3.8.8.6	Slider.....	693

3.8.9	Working with Tube Objects.....	698
3.8.9.1	Working with tube objects.....	698
3.8.9.2	How to insert a polygone tube.....	699
3.8.9.3	How to insert a T-piece.....	700
3.8.9.4	How to insert a double T-piece.....	701
3.8.9.5	How to insert a tube bend.....	702
3.8.10	Quick Object Configuration.....	703
3.8.10.1	Quick Object Configuration.....	703
3.8.10.2	Selecting a tag.....	705
3.8.10.3	Selecting pictures.....	706
3.8.11	Working with Combined Objects.....	709
3.8.11.1	Working with Combined Objects.....	709
3.8.11.2	Working with Groups.....	710
3.8.11.3	Working with Customized Objects.....	713
3.8.12	Working with libraries.....	737
3.8.12.1	Working with the library.....	737
3.8.12.2	Working with the SVG Library.....	740
3.8.12.3	Toolbar of the libraries.....	741
3.8.12.4	How to work with SVG project libraries	743
3.8.12.5	How to insert objects into a library.....	744
3.8.12.6	How to import library objects into a picture.....	746
3.8.12.7	How to insert an SVG graphic as a "Picture" object property.....	747
3.9	Working with Controls.....	749
3.9.1	Working with Controls.....	749
3.9.2	Short Description of the WinCC Controls and Additional Controls.....	749
3.9.3	This is how you insert an ActiveX control as a smart object:.....	751
3.9.4	This is how you insert a .NET or WPF control as a smart object.....	752
3.9.5	How to insert a control from the selection window.....	754
3.9.6	How to Resize a Control.....	756
3.9.7	How to Position a Control.....	757
3.9.8	How to configure the control selection.....	758
3.9.9	This is how you change the registration of an ActiveX control.....	761
3.9.10	How to Change the Properties of a Control.....	763
3.9.11	ActiveX controls.....	764
3.9.11.1	Siemens HMI Symbol Library.....	764
3.9.11.2	WinCC AlarmControl.....	772
3.9.11.3	WinCC BarChartControl.....	772
3.9.11.4	WinCC Digital/Analog Clock Control.....	773
3.9.11.5	WinCC FunctionTrendControl.....	778
3.9.11.6	WinCC Gauge Control.....	779
3.9.11.7	WinCC Media Control.....	789
3.9.11.8	WinCC OnlineTableControl.....	792
3.9.11.9	WinCC OnlineTrendControl.....	792
3.9.11.10	WinCC RulerControl.....	793
3.9.11.11	WinCC Slider Control.....	793
3.9.11.12	WinCC SysDiagControl.....	801
3.9.11.13	WinCC UserAdminControl.....	801
3.9.11.14	WinCC UserArchiveControl.....	802
3.9.11.15	WinCC WebBrowser Control.....	802
3.9.11.16	How to adapt table elements and buttons of the controls.....	803
3.9.12	.NET controls.....	805
3.9.13	WPF controls.....	806

3.10	Process Pictures in Runtime.....	807
3.10.1	Process Pictures in Runtime.....	807
3.10.2	How to activate / deactivate Runtime.....	807
3.10.3	Touch operation.....	809
3.10.3.1	Touch operation in Runtime.....	809
3.10.3.2	Supported gestures in Runtime.....	810
3.10.3.3	Supported gestures in WinCC Controls.....	812
3.10.3.4	Two-handed operation of process pictures	814
3.10.3.5	How to configure two-handed operation.....	815
3.10.4	Menus and Toolbars.....	816
3.10.4.1	User-defined menus and toolbars.....	816
3.10.4.2	Procedures and dynamization of menus and toolbars.....	818
3.10.4.3	Configurable properties of menus and toolbars.....	820
3.10.4.4	How to Create a Menu.....	822
3.10.4.5	How to Create a Toolbar.....	825
3.10.4.6	How to configure menus and toolbars for runtime display.....	827
3.10.4.7	How to configure menus and toolbars in a picture window.....	828
3.10.4.8	How to define the font for the various languages.....	829
3.10.5	Virtual keyboard.....	831
3.10.5.1	Virtual keyboard - General Information.....	831
3.10.5.2	How to configure the activation of the virtual keyboard.....	832
3.10.5.3	How to operate the virtual keyboard.....	834
3.10.6	Setting up Mouseless Operation of a Picture.....	836
3.10.6.1	How to set up a picture for mouseless operation.....	836
3.10.6.2	Defining the Alpha cursor's tab sequence.....	837
3.10.6.3	Specifying the tab sequence of the tab order cursor.....	839
3.11	Object properties.....	842
3.11.1	"Axis" Property Group.....	842
3.11.1.1	Axis Section (AxisSection).....	842
3.11.1.2	Alignment.....	842
3.11.1.3	Bar Scaling (ScalingType).....	842
3.11.1.4	Label Each (Long StrokesText Each).....	843
3.11.1.5	Exponent Display (Exponent).....	843
3.11.1.6	Large Tick Marks (LongStrokesBold).....	843
3.11.1.7	Large Tick Marks Length (LongStrokesSize).....	844
3.11.1.8	Decimal Places (RightComma).....	844
3.11.1.9	Zero Point (ZeroPoint).....	844
3.11.1.10	Only Large Tick Marks (LongStrokesOnly).....	844
3.11.1.11	Scale (Scaling).....	845
3.11.1.12	Scale Marks (ScaleTicks).....	845
3.11.1.13	Digits to the Left of the Decimal Point (LeftComma).....	845
3.11.2	"Output / Input" Property Group.....	845
3.11.2.1	Number of Visible Lines (NumberLines).....	845
3.11.2.2	Output Format (OutputFormat).....	846
3.11.2.3	Output Value (OutputValue).....	846
3.11.2.4	Bit Number (BitNumber).....	846
3.11.2.5	Data Format (DataFormat).....	846
3.11.2.6	Input value.....	847
3.11.2.7	Field Type (BoxType).....	847
3.11.2.8	List Type (ListType).....	847
3.11.2.9	Clear on Invalid Input (ClearOnError).....	847

3.11.2.10	Clear on New Input (ClearOnNew).....	848
3.11.2.11	Selected Boxes (Process).....	848
3.11.2.12	Selected Box (Process).....	848
3.11.2.13	Sorting of the text list (TextListSort).....	849
3.11.2.14	Text list (Textlist).....	849
3.11.2.15	Apply on Exit (AssumeOnExit).....	849
3.11.2.16	Apply on Complete Input (AssumeOnFull).....	850
3.11.2.17	Hidden Input (HiddenInput).....	850
3.11.2.18	Assignments (Assignments).....	850
3.11.3	"Picture" Property Group.....	851
3.11.3.1	Picture (PictureName).....	851
3.11.3.2	Picture Referenced (PicReferenced).....	851
3.11.3.3	Picture Transparent Color (PicTransColor).....	851
3.11.3.4	Picture Transparent Color On (PicUseTransColor).....	852
3.11.3.5	Keep aspect ratio.....	852
3.11.4	"Pictures" Property Group.....	852
3.11.4.1	Picture Off Referenced (PicUpReferenced).....	852
3.11.4.2	Picture Off Transparent Color (PicUpTransparent).....	852
3.11.4.3	Picture Off Transparent Color On (PicUpUseTransColor).....	853
3.11.4.4	Picture Deact. Referenced (PicDeactReferenced).....	853
3.11.4.5	Picture Deact. Transparent Color (PicDeactTransparent).....	853
3.11.4.6	Picture Deact. Transparent Color On (PicDeactUseTransColor).....	853
3.11.4.7	Picture On Referenced (PicDownReferenced).....	854
3.11.4.8	Picture On Transparent Color (PicDownTransparent).....	854
3.11.4.9	Picture On Transparent Color On (PicDownUseTransColor).....	854
3.11.4.10	Picture Status Off (PictureUp).....	855
3.11.4.11	Picture Status Deactivated (PictureDeactivated).....	855
3.11.4.12	Picture Status On (PictureDown).....	855
3.11.4.13	X picture alignment (PictAlignment).....	855
3.11.5	"Flashing" Property Group.....	856
3.11.5.1	Flashing (EnableFlashing).....	856
3.11.5.2	Flashing Background Active (FlashBackColor).....	856
3.11.5.3	Flashing Line Active (FlashBorderColor).....	856
3.11.5.4	Flashing Border Active (FlashBorderColor).....	856
3.11.5.5	Flashing Text Active (FlashForeColor).....	857
3.11.5.6	Flash Frequency (FlashRate).....	857
3.11.5.7	Background Flash Frequency (FlashRateBackColor).....	857
3.11.5.8	Line Flash Frequency (FlashRateBorderColor).....	858
3.11.5.9	Border Flash Frequency (FlashRateBorderColor).....	858
3.11.5.10	Text Flash Frequency (FlashRateForeColor).....	858
3.11.5.11	Flashing Background Color Off (BackFlashColorOff).....	859
3.11.5.12	Flashing Background Color On (BackFlashColorOn).....	859
3.11.5.13	Flashing Line Color Off (BorderFlashColorOff).....	859
3.11.5.14	Flashing Line Color On (BorderFlashColorOn).....	860
3.11.5.15	Flashing Border Color Off (BorderFlashColorOff).....	860
3.11.5.16	Flashing Border Color On (BorderFlashColorOn).....	860
3.11.5.17	Flashing Text Color Off (ForeFlashColorOff).....	861
3.11.5.18	Flashing Text Color On (ForeFlashColorOn).....	861
3.11.6	The property group "Control Properties".....	861
3.11.6.1	A.....	861
3.11.6.2	B.....	866
3.11.6.3	C.....	888

3.11.6.4	D.....	901
3.11.6.5	E.....	904
3.11.6.6	F.....	909
3.11.6.7	G.....	911
3.11.6.8	H.....	912
3.11.6.9	I.....	918
3.11.6.10	L.....	918
3.11.6.11	M.....	920
3.11.6.12	N.....	931
3.11.6.13	O.....	932
3.11.6.14	P.....	940
3.11.6.15	R.....	942
3.11.6.16	S.....	945
3.11.6.17	T.....	961
3.11.6.18	U.....	1013
3.11.6.19	V.....	1017
3.11.6.20	X/Y.....	1030
3.11.7	The "Display" property group.....	1037
3.11.7.1	Display Options (DisplayOptions).....	1037
3.11.7.2	Global Shadow.....	1037
3.11.7.3	Global Color Scheme.....	1038
3.11.7.4	Object Transparency.....	1038
3.11.7.5	[V6.2] Windows Style.....	1038
3.11.7.6	WinCC style.....	1038
3.11.8	"Colors" Property Group.....	1039
3.11.8.1	Colors - 3D to H.....	1039
3.11.8.2	Colors - I to R.....	1043
3.11.8.3	Colors - S to Z.....	1046
3.11.9	"Filling" Property Group.....	1048
3.11.9.1	Dynamic Filling (Filling).....	1048
3.11.9.2	Fill Level (FillingIndex).....	1048
3.11.9.3	Filling direction (FillingDirection).....	1049
3.11.10	"Geometry" Property Group.....	1049
3.11.10.1	Geometry - A to B.....	1049
3.11.10.2	Geometry - C to Z.....	1056
3.11.11	"Limits" Property Group.....	1063
3.11.11.1	Limits - A.....	1063
3.11.11.2	Limits - Bar color.....	1069
3.11.11.3	Limits - Bar fill color.....	1077
3.11.11.4	Limits - Bar fill style.....	1079
3.11.11.5	Limits - C to T.....	1081
3.11.11.6	Limits - U to Z.....	1089
3.11.12	The "Background picture" property group.....	1102
3.11.12.1	BackPictureName.....	1102
3.11.12.2	Show as (Back Picture Alignment).....	1102
3.11.13	"Message Types" Property Group.....	1102
3.11.13.1	Display Text (MCText).....	1102
3.11.13.2	Went Out Unacknowledged - Background Flashing (GNQBackFlash).....	1103
3.11.13.3	Went Out Unacknowledged - Background Flashing (MCGUBackFlash).....	1103
3.11.13.4	Went Out Unacknowledged - Background Color Off (GNQBackColorOff).....	1103
3.11.13.5	Went Out Unacknowledged - Background Color Off (MCGUBackColorOff).....	1103
3.11.13.6	Went Out Unacknowledged - Background Color On (GNQBackColorOn).....	1104

3.11.13.7	Went Out Unacknowledged - Background Color On (MCGUBackColorOn).....	1104
3.11.13.8	Went Out Unacknowledged - Text Flashing (GNQTextFlash).....	1104
3.11.13.9	Went Out Unacknowledged - Text Flashing (MCGUTextFlash).....	1104
3.11.13.10	Went Out Unacknowledged - Text Color Off (GNQTextColorOff).....	1104
3.11.13.11	Went Out Unacknowledged - Text Color Off (MCGUTextColorOff).....	1105
3.11.13.12	Went Out Unacknowledged - Text Color On (GNQTextColorOn).....	1105
3.11.13.13	Went Out Unacknowledged - Text Color On (MCGUTextColorOn).....	1105
3.11.13.14	Came In - Background Flashing (CBackFlash).....	1105
3.11.13.15	Came In - Background Flashing (MCKOBackFlash).....	1106
3.11.13.16	Came In - Background Color Off (CBackColorOff).....	1106
3.11.13.17	Came In - Background Color Off (MCKOBackColorOff).....	1106
3.11.13.18	Came In - Background Color On (CBackColorOn).....	1106
3.11.13.19	Came In - Background Color On (MCKOBackColorOn).....	1106
3.11.13.20	Came In - Text Flashing (CTextFlash).....	1107
3.11.13.21	Came In - Text Flashing (MCKOTextFlash).....	1107
3.11.13.22	Came In - Text Color Off (CTextColorOff).....	1107
3.11.13.23	Came In - Text Color Off (MCKOTextColorOff).....	1107
3.11.13.24	Came In - Text Color On (CTextColorOn).....	1107
3.11.13.25	Came In - Text Color On (MCKOTextColorOn).....	1108
3.11.13.26	Came In Acknowledged - Background Flashing (CQBackFlash).....	1108
3.11.13.27	Came In Acknowledged - Background Flashing (MCKQBackFlash).....	1108
3.11.13.28	Came In Acknowledged - Background Color Off (CQBackColorOff).....	1108
3.11.13.29	Came In Acknowledged - Background Color Off (MCKQBackColorOff).....	1109
3.11.13.30	Came In Acknowledged - Background Color On (CQBackColorOn).....	1109
3.11.13.31	Came In Acknowledged - Background Color On (MCKQBackColorOn).....	1109
3.11.13.32	Came In Acknowledged - Text Flashing (CQTextFlash).....	1109
3.11.13.33	Came In Acknowledged - Text Flashing (MCKQTextFlash).....	1109
3.11.13.34	Came In Acknowledged - Text Color Off (CQTextColorOff).....	1110
3.11.13.35	Came In Acknowledged - Text Color Off (MCKQTextColorOff).....	1110
3.11.13.36	Came In Acknowledged - Text Color On (CQTextColorOn).....	1110
3.11.13.37	Came In Acknowledged - Text Color On (MCKQTextColorOn).....	1110
3.11.13.38	Using global alarm classes (UseGlobalAlarmClasses).....	1111
3.11.13.39	Message Type (MessageClass).....	1111
3.11.14	The "Object" Property Group.....	1111
3.11.14.1	Layer (Layer).....	1111
3.11.14.2	Faceplate Type FPT.....	1112
3.11.14.3	Window Contents (Application).....	1112
3.11.14.4	Object Name (ObjectName).....	1112
3.11.14.5	Template (Template).....	1113
3.11.15	"Font" Property Group.....	1113
3.11.15.1	Bold (FontBold).....	1113
3.11.15.2	Format (Format).....	1113
3.11.15.3	Index (Index).....	1114
3.11.15.4	Italic (FontItalic).....	1114
3.11.15.5	Text Orientation (Orientation).....	1115
3.11.15.6	Text (Text).....	1115
3.11.15.7	Underline (FontUnderline).....	1115
3.11.15.8	X alignment (AlignmentLeft).....	1115
3.11.15.9	Y alignment (AlignmentTop).....	1116
3.11.15.10	Font (FontName).....	1116
3.11.15.11	Font Size (FontSize).....	1116
3.11.16	"Miscellaneous" Property Group.....	1116

3.11.16.1	Others - A to B.....	1116
3.11.16.2	Others - C to O.....	1123
3.11.16.3	Others - P to S.....	1130
3.11.16.4	Others - T to Z.....	1136
3.11.17	"Lock" Property Group.....	1141
3.11.17.1	Lock Display (LockStatus).....	1141
3.11.17.2	Lock Display Text (LockText).....	1141
3.11.17.3	Lock Background Color (LockBackColor).....	1141
3.11.17.4	Lock Text Color (LockTextColor).....	1141
3.11.18	"Styles" Property Group.....	1142
3.11.18.1	3D Border Width (BackBorderWidth).....	1142
3.11.18.2	Bar Pattern (FillStyle2).....	1142
3.11.18.3	Border Weight (BackBorderWidth).....	1142
3.11.18.4	Display as DropDownList.....	1142
3.11.18.5	Latch Down (Toggle).....	1142
3.11.18.6	Box Alignment (BoxAlignment).....	1143
3.11.18.7	Fill Pattern (FillStyle).....	1143
3.11.18.8	Fill Pattern (FillStyle).....	1143
3.11.18.9	Pressed (Pressed).....	1143
3.11.18.10	Background (Background).....	1144
3.11.18.11	Light Effect (LightEffect).....	1144
3.11.18.12	Line Style (BorderStyle).....	1144
3.11.18.13	Line End Style (BorderEndStyle).....	1145
3.11.18.14	Line Weight (BorderWidth).....	1145
3.11.18.15	Line connection type (LineJoinStyle).....	1145
3.11.18.16	Pattern alignment (Fill Style Alignment).....	1146
3.11.18.17	Draw Border Inside (DrawInsideFrame).....	1146
3.11.18.18	Border Style (BorderStyle).....	1146
3.11.18.19	Border Width (BorderWidth).....	1147
3.11.18.20	Dividing Line Style (ItemBorderStyle).....	1147
3.11.18.21	Dividing Line Weight (ItemBorderWidth).....	1147
3.11.18.22	Windows Style (WindowsStyle).....	1147
3.11.19	"Connected Objects" Property Group.....	1148
3.11.19.1	Connection point index of source object (TopConnectedConnectionPointIndex).....	1148
3.11.19.2	Connection point index of target object (BottomConnectedConnectionPointIndex).....	1148
3.11.19.3	Object name of source object (TopConnectedObjectName).....	1148
3.11.19.4	Object name of target object (BottomConnectedObjectName).....	1148
3.11.19.5	Change Orientation (Orientation).....	1149
3.11.19.6	Connection Type (ConnectorType).....	1149
3.11.20	"Assignment" Property Group.....	1149
3.11.20.1	Using global settings (UseGlobalSettings).....	1149
3.11.20.2	Message Types for Button 1 (Button1MessageClasses).....	1149
3.11.20.3	Message Types for Button 2 (Button2MessageClasses).....	1150
3.11.20.4	Message Types for Button 3 (Button3MessageClasses).....	1150
3.11.20.5	Message Types for Button 4 (Button4MessageClasses).....	1150
3.11.20.6	Message Types for Button 5 (Button5MessageClasses).....	1151
3.11.20.7	Message Types for Button 6 (Button6MessageClasses).....	1151
3.11.20.8	Message Types for Button 7 (Button7MessageClasses).....	1151
3.11.20.9	Message Types for Button 8 (Button8MessageClasses).....	1151
3.11.21	"Status" Property Group.....	1152
3.11.21.1	Current Status (Index).....	1152
3.11.21.2	Bit Selection 0 (BitSelect0).....	1152

3.11.21.3	Bit Selection 1 (BitSelect1).....	1152
3.11.21.4	Bit Selection 2 (BitSelect2).....	1153
3.11.21.5	Bit Selection 3 (BitSelect3).....	1153
3.11.21.6	Flash Picture.....	1153
3.11.21.7	Flash Picture (FlashPicture).....	1154
3.11.21.8	Flash Picture Referenced (FlashPicReferenced).....	1154
3.11.21.9	Flash Picture Transparent Color (FlashPicTransColor).....	1154
3.11.21.10	Flash Picture Transparent Color On (FlashPicUseTransColor).....	1154
3.11.21.11	Flashing Flash Picture Active (FlashFlashPicture).....	1155
3.11.21.12	Flash Picture Flash Frequency(FlashRateFlashPic).....	1155
3.11.21.13	Graphic list (Graphiclist).....	1155
3.11.21.14	Basic Picture (BasePicture).....	1156
3.11.21.15	Basic Picture (BasePicture).....	1156
3.11.21.16	Basic Picture Referenced (BasePicReferenced).....	1156
3.11.21.17	Basic Picture Transparent Color (BasePicTransColor).....	1156
3.11.21.18	Basic Picture Transparent Color On (BasePicUseTransColor).....	1157
3.11.21.19	Highest Index (MaxIndex).....	1157
3.11.21.20	Index (Index).....	1157
3.11.21.21	Priority Bit 16 (PrioBit16).....	1157
3.11.21.22	Priority Bit 17 (PrioBit17).....	1157
3.11.21.23	Priority Bit 18 (PrioBit18).....	1158
3.11.21.24	Priority Bit 19 (PrioBit19).....	1158
3.11.21.25	Priority Bit 20 (PrioBit20).....	1158
3.11.21.26	Priority Bit 21 (PrioBit21).....	1158
3.11.21.27	Priority Bit 22 (PrioBit22).....	1159
3.11.21.28	Priority Bit 23 (PrioBit23).....	1159
3.11.21.29	Priority Bit 24 (PrioBit24).....	1159
3.11.21.30	Priority Bit 25 (PrioBit25).....	1159
3.11.21.31	Priority Bit 26 (PrioBit26).....	1159
3.11.21.32	Priority Bit 27 (PrioBit27).....	1160
3.11.21.33	Priority Bit 28 (PrioBit28).....	1160
3.11.21.34	Priority Bit 29 (PrioBit29).....	1160
3.11.21.35	Priority Bit 30 (PrioBit30).....	1160
3.11.21.36	Priority Bit 31 (PrioBit31).....	1161
3.11.21.37	Status Word Bit 0 (BitPosition0).....	1161
3.11.21.38	Status Word Bit 1 (BitPosition1).....	1161
3.11.21.39	Status Word Bit 2 (BitPosition2).....	1161
3.11.21.40	Status Word Bit 3 (BitPosition3).....	1162
4	Process Picture Dynamics.....	1163
4.1	Types of Dynamization.....	1163
4.2	Configuration recommendations.....	1165
4.2.1	Configuration recommendations for dynamization.....	1165
4.2.2	Configuration recommendations: Cycle times.....	1166
4.2.3	Configuration recommendations: Dynamizing object properties.....	1167
4.2.4	Configuration recommendations: Tags and tag triggers.....	1169
4.2.5	Configuration recommendations: Faceplate types.....	1171
4.3	Using tag prefixes and server prefixes.....	1173
4.4	Trigger Types.....	1175
4.4.1	Trigger Types.....	1175
4.4.2	Cyclic Triggers.....	1175

4.4.3	Tag Triggers.....	1176
4.4.4	Event-Driven Triggers.....	1178
4.5	Dynamic Wizard.....	1179
4.5.1	Dynamizing Using Dynamic Wizard.....	1179
4.5.2	Picture Functions.....	1180
4.5.3	Picture Components.....	1183
4.5.4	Import Functions.....	1184
4.5.5	Standard Dynamics.....	1185
4.5.6	Color Dynamics with Table.....	1189
4.5.7	System Functions.....	1192
4.5.8	SFC.....	1193
4.6	Dynamizing by Means of Tag Connection.....	1195
4.6.1	Dynamizing by Means of Tag Connection.....	1195
4.6.2	How to Configure a Tag Connection.....	1195
4.6.3	Example: Dynamic Filling of Rectangle.....	1196
4.7	Dynamizing by Means of Direct Connection.....	1198
4.7.1	Dynamizing by Means of Direct Connection.....	1198
4.7.2	Application Examples of Direct Connection.....	1198
4.7.3	How to Configure a Direct Connection.....	1200
4.7.4	Example: Picture Change in Picture Window.....	1201
4.8	Dynamizing Using the Dynamic Dialog.....	1204
4.8.1	Dynamizing Using the Dynamic Dialog.....	1204
4.8.2	How to Configure Dynamization Using the Dynamic Dialog.....	1205
4.8.3	Creating Expressions.....	1207
4.8.4	Defining a Valid Range.....	1211
4.8.5	Monitoring Tag Status.....	1215
4.8.6	Monitoring Quality Code.....	1216
4.8.7	Editing Triggers.....	1218
4.8.8	Example: Color Change Depending on Position.....	1220
4.9	Dynamizing Using VBS Action.....	1223
4.9.1	Dynamizing Using VBS Action.....	1223
4.9.2	Working with VBS Actions.....	1224
4.9.3	Action Editor in Graphics Designer.....	1225
4.9.4	Working in Action Editor.....	1228
4.9.5	How to Configure a VBS Action.....	1230
4.9.6	Editing Triggers.....	1232
4.10	Dynamizing Using C Action.....	1234
4.10.1	Dynamizing Using C Action.....	1234
4.10.2	Working with C Actions.....	1235
4.10.3	How to Configure a C Action.....	1236
4.10.4	How to Apply Functions in the Action Code.....	1238
4.10.5	Editing Triggers.....	1240
4.10.6	Importing and Exporting Actions.....	1241
5	Setting up a Message System.....	1243
5.1	WinCC Alarm Logging.....	1243
5.2	Message System in WinCC.....	1244
5.3	Principles of the Message System.....	1251

5.3.1	Principles of the Message System.....	1251
5.3.2	"Alarm Logging" editor.....	1252
5.3.3	Working in the Alarm Logging areas.....	1255
5.3.4	Tips and tricks.....	1257
5.4	Configuring the Message System.....	1260
5.4.1	Configuring the Message System.....	1260
5.4.2	Working with Message Blocks.....	1260
5.4.2.1	Working with Message Blocks.....	1260
5.4.2.2	Description of System Blocks.....	1261
5.4.2.3	How to select message blocks for use.....	1264
5.4.2.4	How to change properties of a message nlock.....	1264
5.4.3	Working with Message Classes.....	1266
5.4.3.1	Working with Message Classes.....	1266
5.4.3.2	How to Add Message Classes.....	1266
5.4.3.3	How to insert the copy of a message class.....	1267
5.4.3.4	How to change the properties of a message class.....	1268
5.4.3.5	How to Delete Message Classes.....	1269
5.4.3.6	System Message Classes.....	1269
5.4.4	Working with message types.....	1270
5.4.4.1	Working with message types.....	1270
5.4.4.2	How to Add Message Types for the Message Class.....	1271
5.4.4.3	How to insert copies of a message type.....	1272
5.4.4.4	How to change the properties of a message type.....	1272
5.4.4.5	How to Configure the Acknowledgment of a Message Type.....	1273
5.4.4.6	How to Configure the Status Texts of a Message Type.....	1275
5.4.4.7	How To Configure Colors for the Display.....	1277
5.4.4.8	How to delete message types.....	1278
5.4.5	Working with messages.....	1278
5.4.5.1	Working with messages.....	1278
5.4.5.2	The properties of a message.....	1280
5.4.5.3	How to Create a Message.....	1284
5.4.5.4	How to Edit Multiple Messages.....	1286
5.4.5.5	How to Delete a Message	1287
5.4.5.6	Tags of a Single Message.....	1287
5.4.5.7	How to specify the text of a message.....	1291
5.4.5.8	How to Insert Process Values in User Text Blocks.....	1293
5.4.5.9	How to Link a Picture to a Message.....	1295
5.4.5.10	How to Configure the Hiding of Messages.....	1296
5.4.5.11	Importing and Exporting Messages.....	1300
5.4.6	Working with Message Groups.....	1302
5.4.6.1	Message groups.....	1302
5.4.6.2	Working with Message Groups.....	1302
5.4.6.3	How to Create a User-Defined Message Group.....	1303
5.4.6.4	How to Change the Properties of a Message Group.....	1304
5.4.6.5	Tags of a message group.....	1305
5.4.6.6	How to Add a Message to a User-Defined Message Group.....	1311
5.4.6.7	How to add another user-defined message group to a user-defined message group.....	1311
5.4.6.8	How to Remove a Message from a User-Defined Message Group.....	1312
5.4.6.9	How to Delete a User-Defined Message Group.....	1313
5.4.7	Working with system messages.....	1313
5.4.7.1	How To Use System Messages.....	1313
5.4.7.2	Description of WinCC System Messages.....	1317

5.4.8	Working with the Limit Monitoring.....	1328
5.4.8.1	Working with the Limit Monitoring.....	1328
5.4.8.2	Messages of the Limit Monitoring.....	1329
5.4.8.3	How to Create Limit Monitoring.....	1329
5.4.8.4	How to Use Message Blocks for Limit Monitoring.....	1330
5.4.8.5	How to Configure Limit Monitoring.....	1331
5.4.8.6	How to Display the Messages of the Limit Monitoring.....	1333
5.4.8.7	How to Delete the Limit Monitoring.....	1333
5.4.8.8	Examples of Configuring a Limit Value.....	1334
5.4.9	Working with AS messages.....	1335
5.4.9.1	AS messages.....	1335
5.4.9.2	How to download AS alarms from the controller.....	1339
5.4.9.3	How to download AS messages/text lists offline.....	1343
5.4.9.4	How to configure the automatic update of S7-1500 alarms.....	1346
5.4.9.5	How to export AS messages.....	1347
5.4.10	Working with operator messages.....	1348
5.4.10.1	Operator messages.....	1348
5.5	Message Archiving.....	1351
5.5.1	Message Archiving in WinCC.....	1351
5.5.2	Configuration of Message Archiving.....	1352
5.5.2.1	Configuration of Message Archiving.....	1352
5.5.2.2	How to Configure Messages for Archiving.....	1354
5.5.2.3	How to Configure a Message Archive.....	1354
5.5.2.4	How to Configure the Archive Backup.....	1359
5.5.2.5	How to link an archive.....	1361
5.5.2.6	How to disconnect an archive.....	1362
5.5.3	Output of Message Archive Data.....	1363
5.5.3.1	Output of Message Archive Data in Runtime.....	1363
5.5.3.2	How to Display Archived Messages in Runtime.....	1364
5.5.3.3	How to Configure Reloading of Messages Following a Power Failure.....	1366
5.5.3.4	How to Configure a Message Archive Report.....	1367
5.5.3.5	Direct Access to the Archive Database.....	1369
5.5.4	Message Server.....	1370
5.6	Display of Messages during Runtime.....	1372
5.6.1	WinCC AlarmControl.....	1372
5.6.2	Configuring the AlarmControl.....	1373
5.6.2.1	How to configure the AlarmControl.....	1373
5.6.2.2	How to configure the message blocks.....	1374
5.6.2.3	How to specify message window contents.....	1376
5.6.2.4	How to determine the selection in the message window.....	1379
5.6.2.5	How to determine the sorting in the message window.....	1382
5.6.2.6	How to configure the display for the table.....	1384
5.6.2.7	How to configure the toolbar and the status bar.....	1388
5.6.2.8	How to Configure a Hit List of Messages.....	1392
5.6.2.9	How to configure operator messages.....	1394
5.6.2.10	How to export runtime data.....	1397
5.6.2.11	How to define the effect of the online configuration.....	1399
5.6.2.12	SQL statements for filtering messages in AlarmControl.....	1401
5.6.2.13	How to make the toolbar for the AlarmControl dynamic.....	1404
5.6.2.14	How to adapt table elements and buttons of the controls.....	1405
5.6.3	Operation during runtime.....	1406

5.6.3.1	Operating the AlarmControl in runtime.....	1406
5.6.3.2	How to select messages in Runtime.....	1412
5.6.3.3	How to Lock and Unlock Messages.....	1414
5.6.3.4	How to Perform an Emergency Acknowledgement.....	1417
5.6.3.5	How to Sort the Display of Messages.....	1418
5.6.3.6	How to Hide and Unhide Messages.....	1421
5.6.4	AlarmControl example project.....	1423
5.6.4.1	Examples of configuring an AlarmControl.....	1423
5.6.4.2	How to Configure the Message System.....	1424
5.6.4.3	How to Configure Single Messages.....	1427
5.6.4.4	How to configure the AlarmControl in the Graphics Designer.....	1428
5.6.4.5	How to Configure Buttons for Changing Message Tags.....	1434
5.6.4.6	Example of making the toolbar of the AlarmControl dynamic.....	1435
5.6.4.7	How to operate the example on AlarmControl.....	1435
5.7	Before WinCC V7: Display of Messages during Runtime.....	1437
5.7.1	WinCC Alarm Control.....	1437
5.7.2	Configuration of the Alarm Control.....	1438
5.7.2.1	Configuration of the WinCC Alarm Control.....	1438
5.7.2.2	How to Configure the Message System.....	1439
5.7.2.3	How to Configure Single Messages.....	1441
5.7.2.4	How to Configure the Alarm Control in the Graphics Designer.....	1443
5.7.2.5	How to Configure Buttons for Changing Message Tags.....	1450
5.7.2.6	How to Configure a Hit List of Messages.....	1451
5.7.2.7	How to Activate the Example for Alarm Control.....	1457
5.7.3	Operation during runtime.....	1458
5.7.3.1	Operation of Alarm Control during Runtime.....	1458
5.7.3.2	How to Select Messages.....	1461
5.7.3.3	How to Lock and Unlock Messages.....	1463
5.7.3.4	How to Hide and Show Messages.....	1467
5.7.3.5	How to Perform an Emergency Acknowledgement.....	1469
5.7.3.6	How to Sort the Display of Messages.....	1470
5.7.3.7	Standard Functions for Operation of WinCC Alarm Control.....	1473
5.7.3.8	Example of the Use of Standard Functions.....	1475
5.7.4	SQL Statements for Filtering of Messages in Alarm Control.....	1479
6	Archiving Process Values.....	1481
6.1	Archiving Process Values.....	1481
6.2	Process Value Archiving in WinCC.....	1482
6.3	Basics of Process Values Archiving.....	1484
6.3.1	Basics of Process Values Archiving.....	1484
6.3.2	Process Value Archiving for Multi-User Projects.....	1485
6.3.3	Process Values and Tags.....	1487
6.3.3.1	Process Values and Tags.....	1487
6.3.3.2	External and Internal Tags.....	1487
6.3.3.3	Process-controlled tags.....	1488
6.3.3.4	Structure of a Telegram with Raw Data Tags.....	1489
6.3.3.5	Diagnostic Tags of Tag Logging Runtime.....	1492
6.3.4	Properties in Tag Logging.....	1493
6.3.4.1	Properties of a cycle time.....	1493
6.3.4.2	Properties of a time series.....	1494
6.3.4.3	Properties of a process value archive.....	1496

6.3.4.4	Properties of a compressed archive.....	1497
6.3.4.5	Properties of archive tags (binary, analog, text).....	1499
6.3.4.6	Properties of process-controlled tags.....	1502
6.3.4.7	Properties of compressed tags.....	1503
6.3.5	Archiving Methods.....	1505
6.3.5.1	Archiving Methods.....	1505
6.3.5.2	Cycles and Events.....	1506
6.3.5.3	Continuous cyclic process value archiving.....	1508
6.3.5.4	Cyclic-Selective Process Value Archiving.....	1510
6.3.5.5	Acyclic Process Value Archiving.....	1511
6.3.5.6	Process value archiving "When necessary".....	1512
6.3.5.7	Process-Controlled Process Value Archiving.....	1514
6.3.5.8	Swinging Door algorithm for process value archiving.....	1514
6.3.5.9	Compressed Archive.....	1518
6.3.6	Storing Process Values.....	1521
6.3.7	Swapping Out Process Values.....	1523
6.3.8	Significance of Archive Value Flags.....	1525
6.4	Configuration of Process Value Archiving.....	1527
6.4.1	Configuration of Process Value Archiving.....	1527
6.4.2	Tag Logging editor.....	1527
6.4.3	Working in the Tag Logging areas.....	1530
6.4.4	Cycle times and time series.....	1531
6.4.4.1	Times for acquisition and archiving.....	1531
6.4.4.2	How to Configure a New Cycle Time.....	1532
6.4.4.3	How to configure a new time series.....	1533
6.4.5	Configuring Archives.....	1535
6.4.5.1	Configuring Archives.....	1535
6.4.5.2	How to Configure a Process Value Archive.....	1535
6.4.5.3	How to configure the data buffer.....	1536
6.4.5.4	How to Configure Compressed Archives.....	1537
6.4.6	Creating Archive Tags.....	1538
6.4.6.1	Creating Archive Tags.....	1538
6.4.6.2	How to create an archive tag.....	1539
6.4.6.3	How to configure the properties of an archive tag.....	1540
6.4.6.4	How to Create a Process-Controlled Tag.....	1540
6.4.6.5	How to configure the properties of a process-controlled tag.....	1542
6.4.6.6	How to Create a Compressed Tag.....	1542
6.4.6.7	How to configure the properties of a compressed tag.....	1544
6.4.7	Configuring archives.....	1545
6.4.7.1	Calculating memory requirements.....	1545
6.4.7.2	How to Configure Archive.....	1546
6.4.7.3	How to Assign Archive Tags to Archive Types.....	1548
6.4.8	Archive backup.....	1550
6.4.8.1	How to Configure an Archive Backup.....	1550
6.4.8.2	How to Link an Archive Backup.....	1553
6.4.8.3	How to Disconnect an Archive Backup.....	1555
6.5	Output of Process Values.....	1557
6.5.1	Output of Process Values.....	1557
6.5.2	Process Value Output in Process Pictures.....	1558
6.5.2.1	Process value output in process pictures.....	1558
6.5.2.2	Process Value Output in Table Format.....	1560

6.5.2.3	Process Value Output in the Form of Trends in Process Pictures.....	1604
6.5.2.4	Displaying process values in bar form in process pictures.....	1662
6.5.2.5	Process Value Output as a Function of Another Tag.....	1688
6.5.3	Process value output in reports.....	1728
6.5.3.1	Process value output in reports.....	1728
6.5.4	Process value output before WinCC V7.....	1730
6.5.4.1	Process value output in process pictures before WinCC V7.....	1730
6.5.4.2	Before WinCC V7: Process Value Output in Table Format.....	1732
6.5.4.3	Before WinCC V7: Process Value Output in the Form of Trends in Process Pictures.....	1753
6.5.4.4	Before WinCC V7: Process Value Output as a Function of Another Tag.....	1789
6.6	Direct Access to the Archive Database.....	1840
6.7	Function Call Templates.....	1842
6.7.1	Function Call Templates.....	1842
6.7.2	Function During Start of Archiving.....	1842
6.7.3	Function for Conversion of Tag Values.....	1843
6.7.4	Function to Start Archiving.....	1844
6.7.5	Function to Stop Archiving.....	1844
6.7.6	Appendix.....	1844
6.7.6.1	Action for Swap-Out.....	1844
6.7.6.2	Action upon Sending.....	1845
6.7.6.3	Action upon Reception.....	1846
7	User archive.....	1847
7.1	Basics.....	1847
7.1.1	Introduction to archives/user archives.....	1847
7.1.2	Properties of a user archive.....	1848
7.1.3	Properties of a user archive field.....	1850
7.1.4	Properties of a view.....	1851
7.1.5	Properties of a user archive column.....	1852
7.1.6	User archives and redundancy.....	1853
7.1.7	Overview of unusable names.....	1854
7.2	Configurations in the user archive.....	1856
7.2.1	The "User Archive" editor.....	1856
7.2.2	Configuration of a User Archive.....	1858
7.2.2.1	How to create a user archive.....	1858
7.2.2.2	How to edit properties of a user archive.....	1859
7.2.2.3	How to configure the communication to tags.....	1860
7.2.2.4	How to configure the control tags.....	1861
7.2.2.5	Example for the use of control tags.....	1862
7.2.2.6	How to specify the authorizations for the archive.....	1865
7.2.2.7	How to create user archive fields.....	1866
7.2.2.8	How to edit properties of a user archive field.....	1867
7.2.2.9	How to edit the position of a user archive field.....	1868
7.2.2.10	How to configure multilingual text.....	1868
7.2.2.11	How to make changes in the user archive.....	1869
7.2.3	Configuring a view.....	1869
7.2.3.1	How to create a view.....	1869
7.2.3.2	How to edit properties of a view.....	1870
7.2.3.3	How to create the user archive columns of a view.....	1870
7.2.3.4	How to edit properties of a user archive column.....	1871
7.2.3.5	How to edit the position of a user archive column.....	1871

7.2.3.6	How to display the data of a view.....	1872
7.2.3.7	Example for relation.....	1873
7.2.4	Export and import.....	1873
7.2.4.1	How to export the configuration data of the user archive.....	1873
7.2.4.2	How to import the configuration data of the user archive.....	1874
7.2.5	Runtime data.....	1875
7.2.5.1	How to edit the Runtime data in the user archive.....	1875
7.2.5.2	How to export runtime data of the user archive.....	1876
7.2.5.3	How to import runtime data of the user archive.....	1877
7.3	Data communication with automation systems.....	1879
7.3.1	SIMATIC interfaces.....	1879
7.3.2	Data communication with S7 via raw data tags.....	1879
7.3.2.1	How to configure data communication via raw data tags.....	1879
7.3.2.2	Data format differences between WinCC and S5/S7.....	1882
7.3.2.3	Sending jobs and data from S7 to WinCC.....	1883
7.3.2.4	Receiving data and processing acknowledgment in S7.....	1884
7.3.2.5	Structure of the message frame header.....	1884
7.3.2.6	Job Header.....	1885
7.3.2.7	Data of the job.....	1885
7.3.2.8	The acknowledgement header.....	1886
7.3.2.9	Description of the job types.....	1887
7.3.2.10	Description of the error codes.....	1887
7.4	User archive functions.....	1889
7.4.1	General information.....	1889
7.4.2	How to use the functions of the user archive.....	1889
7.4.3	Example of a user archive script.....	1892
7.4.4	Functions for Configuring User Archives.....	1901
7.4.4.1	Functions for Configuring User Archives.....	1901
7.4.4.2	uaAddArchive.....	1901
7.4.4.3	uaAddField.....	1902
7.4.4.4	uaGetArchive.....	1902
7.4.4.5	uaGetField.....	1903
7.4.4.6	uaGetNumArchives.....	1904
7.4.4.7	uaGetNumFields.....	1904
7.4.4.8	UaQueryConfiguration.....	1905
7.4.4.9	uaReleaseConfiguration.....	1905
7.4.4.10	uaRemoveAllArchives.....	1906
7.4.4.11	uaRemoveAllFields.....	1907
7.4.4.12	uaRemoveArchive.....	1907
7.4.4.13	uaRemoveField.....	1908
7.4.4.14	uaSetArchive.....	1908
7.4.4.15	uaSetField.....	1909
7.4.4.16	Structure of the field configuration "uaCONFIGFIELD".....	1910
7.4.4.17	Structure of the user archive configuration "uaCONFIGARCHIVE".....	1910
7.4.5	General runtime functions.....	1912
7.4.5.1	General runtime functions.....	1912
7.4.5.2	uaConnect.....	1912
7.4.5.3	uaDisconnect.....	1913
7.4.5.4	uaGetLocalEvents.....	1913
7.4.5.5	ualsActive.....	1914
7.4.5.6	uaOpenArchives.....	1914

7.4.5.7	uaOpenViews.....	1914
7.4.5.8	uaQueryArchive.....	1915
7.4.5.9	uaQueryArchiveByName.....	1916
7.4.5.10	uaReleaseArchive.....	1916
7.4.5.11	uaSetLocalEvents.....	1917
7.4.5.12	uaUsers.....	1917
7.4.6	Archive-specific runtime functions.....	1918
7.4.6.1	Archive-specific runtime functions.....	1918
7.4.6.2	uaArchiveClose.....	1919
7.4.6.3	uaArchiveDelete.....	1920
7.4.6.4	uaArchiveExport.....	1920
7.4.6.5	uaArchiveGetCount.....	1921
7.4.6.6	uaArchiveGetFieldLength.....	1922
7.4.6.7	uaArchiveGetFieldName.....	1922
7.4.6.8	uaArchiveGetFields.....	1923
7.4.6.9	uaArchiveGetFieldType.....	1923
7.4.6.10	uaArchiveGetFieldValueDate.....	1924
7.4.6.11	uaArchiveGetFieldValueDouble.....	1925
7.4.6.12	uaArchiveGetFieldValueFloat.....	1925
7.4.6.13	uaArchiveGetFieldValueLong.....	1926
7.4.6.14	uaArchiveGetFieldValueString.....	1927
7.4.6.15	uaArchiveGetFilter.....	1927
7.4.6.16	uaArchiveGetID.....	1928
7.4.6.17	uaArchiveGetName.....	1928
7.4.6.18	uaArchiveGetSort.....	1929
7.4.6.19	uaArchiveImport.....	1929
7.4.6.20	uaArchiveInsert.....	1930
7.4.6.21	uaArchiveMoveFirst.....	1931
7.4.6.22	uaArchiveMoveLast.....	1931
7.4.6.23	uaArchiveMoveNext.....	1932
7.4.6.24	uaArchiveMovePrevious.....	1932
7.4.6.25	uaArchiveOpen.....	1933
7.4.6.26	uaArchiveReadTagValues.....	1933
7.4.6.27	uaArchiveReadTagValuesByName.....	1934
7.4.6.28	uaArchiveRequery.....	1935
7.4.6.29	uaArchiveSetFieldValueDate.....	1935
7.4.6.30	uaArchiveSetFieldValueDouble.....	1936
7.4.6.31	uaArchiveSetFieldValueFloat.....	1937
7.4.6.32	uaArchiveSetFieldValueLong.....	1937
7.4.6.33	uaArchiveSetFieldValueString.....	1938
7.4.6.34	uaArchiveSetFilter.....	1939
7.4.6.35	uaArchiveSetSort.....	1939
7.4.6.36	uaArchiveUpdate.....	1940
7.4.6.37	uaArchiveWriteTagValues.....	1941
7.4.6.38	uaArchiveWriteTagValuesByName.....	1941
7.4.7	Troubleshooting functions.....	1942
7.4.7.1	uaGetLastError.....	1942
7.4.7.2	uaGetLastHResult.....	1944
7.5	WinCC UserArchiveControl.....	1945
7.5.1	WinCC UserArchiveControl.....	1945
7.5.2	Configuring the UserArchiveControl.....	1946
7.5.2.1	How to configure the UserArchiveControl.....	1946

7.5.2.2	How to define the contents of the UserArchiveControl.....	1947
7.5.2.3	How to configure the display for the table.....	1950
7.5.2.4	How to configure the toolbar and the status bar	1954
7.5.2.5	How to export runtime data.....	1958
7.5.2.6	How to define the effect of the online configuration.....	1959
7.5.2.7	How to make the toolbar for the UserArchiveControl dynamic.....	1961
7.5.3	Operation in runtime.....	1962
7.5.3.1	Operating the UserArchiveControl in runtime.....	1962
7.5.3.2	To process the data in the UserArchiveControl:.....	1965
7.5.3.3	How to select the data of the user archive.....	1966
7.5.3.4	How to sort the display of user archive data.....	1968
7.6	Before WinCC V7: WinCC User Archives Table Element.....	1970
7.6.1	Functionality.....	1970
7.6.2	Configuration of User Archives Table Element.....	1971
7.6.2.1	Configuring a User Archives Table Element.....	1971
7.6.2.2	Place the User Archive Table Element in a process screen.....	1972
7.6.2.3	Define properties of the User Archives Table Element.....	1974
7.6.2.4	Delete the User Archives Table Element.....	1975
7.6.3	Properties of WinCC User Archives Table Element.....	1975
7.6.3.1	Properties of WinCC User Archives Table Element.....	1975
7.6.3.2	"General" tab.....	1977
7.6.3.3	"Columns" tab.....	1979
7.6.3.4	"Toolbar" Tab.....	1980
7.6.3.5	"Status Bar" Tab.....	1982
7.6.3.6	"Filter/ Sorting" tab.....	1983
7.6.3.7	"Fonts" Tab.....	1985
7.6.3.8	"Colors" tab.....	1986
7.6.4	Configuring a Form View.....	1986
7.6.4.1	Configuring a Form View.....	1986
7.6.4.2	Insert "Text" form field.....	1988
7.6.4.3	Insert "Edit" form field.....	1989
7.6.4.4	Insert "Button" form field.....	1990
7.6.4.5	Edit form fields subsequently.....	1991
7.6.4.6	Delete form fields.....	1991
7.6.5	User Archives Table Elements in Runtime.....	1991
7.6.5.1	Table of User Archives Table Element.....	1991
7.6.5.2	The User Archives Table Element Form.....	1992
7.6.5.3	Toolbar of WinCC User Archives Table Element.....	1993
7.6.5.4	Operating the Control using Dynamized Objects.....	1997
7.6.5.5	List of properties for the User Archives Table Element.....	2000
7.6.5.6	Overview of the dynamizable properties in the layout.....	2003
8	Working with Cross Reference.....	2005
8.1	The functionality of Cross Reference.....	2005
8.2	How to filter the lists of the Cross Reference.....	2009
8.3	How to jump to a place of use.....	2010
8.4	How to link tags in the pictures.....	2011
8.5	How to export the lists of Cross Reference.....	2014
8.6	Example: Filtering and jumping to places of use.....	2016

8.7	Example: Linking of tags.....	2020
8.8	Configuration instructions for tags and picture names.....	2023
9	Documentation of Configuration and Runtime Data.....	2025
9.1	Documentation of Configuration and Runtime Data.....	2025
9.2	How to Set Up Reports in the Page Layout.....	2027
9.3	How to Create Reports in Line Layout.....	2029
9.4	Print Jobs in WinCC.....	2031
9.4.1	Print Jobs in WinCC.....	2031
9.4.2	Print Job Properties.....	2032
9.4.3	Selecting the Print Range.....	2035
9.4.4	Defining a Printer.....	2037
9.5	Project Documentation.....	2041
9.5.1	Introduction to Project Documentation.....	2041
9.5.2	How to Output Project Documentation.....	2042
9.5.3	How to Open a Project Documentation Preview.....	2044
9.5.4	How to Create a New Print Job.....	2045
9.5.5	How to Change an Existing Print Job.....	2048
9.5.6	Project documentation in the WinCC Explorer/Tag Management.....	2049
9.5.7	Project Documentation in the Graphics Designer.....	2050
9.5.8	Project Documentation in Alarm Logging.....	2053
9.5.9	Project Documentation in Tag Logging.....	2054
9.5.10	Project Documentation in Global Script.....	2055
9.5.11	Project Documentation in the Text Library.....	2057
9.5.12	Project Documentation in the User Administrator.....	2058
9.5.13	Project documentation in the Cross Reference.....	2059
9.5.14	Project Documentation in the Time Synchronization Editor.....	2060
9.5.15	Project documentation in the horn.....	2060
9.5.16	Project documentation in the Picture Tree.....	2061
9.5.17	Project Documentation in Lifebeat Monitoring.....	2062
9.5.18	Project Documentation in the OS Project Editor.....	2063
9.5.19	Project Documentation in the Component List Editor.....	2064
9.6	Runtime Documentation.....	2066
9.6.1	Introduction to Runtime Documentation.....	2066
9.6.2	How to Create Layouts for Runtime Documentation.....	2070
9.6.3	How to create print jobs for the Runtime documentation.....	2072
9.6.4	How to Change Output Options in Runtime.....	2074
9.6.5	Dynamizable Parameters for Runtime Documentation.....	2077
9.6.6	Reporting Messages in Runtime.....	2084
9.6.6.1	Reporting Messages in Runtime.....	2084
9.6.6.2	How to Output Runtime Data from the Message Lists.....	2085
9.6.6.3	How to Output Online Data with Message Sequence Report.....	2086
9.6.6.4	How to Create a User-Defined Message Sequence Report.....	2089
9.6.7	Reporting Process Values in Runtime.....	2090
9.6.8	How to Output Data from User Archives.....	2092
9.6.9	Reporting Data from Other Data Sources.....	2093
9.6.9.1	Reporting Data from Other Data Sources.....	2093
9.6.9.2	How to Output Data from an ODBC Database in a Report.....	2094
9.6.9.3	How to Output Data from a CSV Table in a Log.....	2095

9.6.9.4	Example of the Output of CSV Files in a Report.....	2096
9.6.9.5	Requirements to be Met by a CSV File for Reporting.....	2099
9.6.9.6	How to Output a Hard Copy by Means of a Log Object.....	2102
9.6.9.7	How to Output a Hard Copy by Means of a Key Combination.....	2103
9.6.9.8	Output Parameters for Hard Copy.....	2105
9.6.9.9	How to Output Data from a COM Server in a Report.....	2110
9.7	Appendix.....	2112
9.7.1	System Layouts for Project Documentation.....	2112
9.7.2	System Layouts and Print Jobs for Runtime Documentation.....	2115
9.7.3	Filter criteria for alarm output.....	2117
10	Creating Page Layouts.....	2121
10.1	Creating Page Layouts.....	2121
10.2	How to Start the Page Layout Editor.....	2122
10.3	The Page Layout Editor.....	2123
10.3.1	The Page Layout Editor.....	2123
10.3.2	The Standard Toolbar.....	2125
10.3.3	The Object Palette.....	2127
10.3.3.1	The Object Palette.....	2127
10.3.3.2	Standard Objects.....	2128
10.3.3.3	Objects for the Runtime Documentation.....	2132
10.3.3.4	COM Server Objects.....	2134
10.3.3.5	Objects for the Project Documentation.....	2134
10.3.4	The Style Palette.....	2135
10.3.5	The Alignment Palette.....	2136
10.3.6	The Zoom Palette.....	2138
10.3.7	The Color Palette.....	2139
10.3.8	The Font Palette.....	2140
10.3.9	The Status Bar.....	2141
10.3.10	Customizing the Working Environment.....	2141
10.3.10.1	Customizing the Working Environment.....	2141
10.3.10.2	How to Create Custom Colors.....	2142
10.3.10.3	How to Show and Hide the Toolbar and Palettes.....	2143
10.3.10.4	How to Arrange the Toolbar and Palettes.....	2143
10.3.10.5	How to Change the Standard Toolbar.....	2144
10.3.10.6	The Basic Settings of the Page Layout Editor.....	2146
10.4	Working with Layouts.....	2152
10.4.1	Working with Layouts.....	2152
10.4.2	Layout File Operations.....	2153
10.4.3	How to Display the Layout Properties.....	2157
10.4.4	Changing Predefined Layouts.....	2158
10.4.5	Working with Multiple Layouts.....	2160
10.5	Working with Objects.....	2163
10.5.1	Working with Objects.....	2163
10.5.2	The coordinate system in the Report Designer.....	2164
10.5.3	The Rectangle Surrounding the Object.....	2166
10.5.4	How to Paste an Object into a Layout.....	2167
10.5.5	How to Edit Objects.....	2168
10.5.6	Multiple Selection of Objects.....	2170
10.5.6.1	Multiple Selection of Objects.....	2170

10.5.6.2	How to Select Multiple Objects.....	2172
10.5.6.3	How to Align Multiple Objects.....	2173
10.5.7	The Properties of an Object.....	2175
10.5.7.1	The Properties of an Object.....	2175
10.5.7.2	The Object Properties Window.....	2175
10.5.7.3	How to Change an Attribute.....	2181
10.5.7.4	How to Transfer Object Properties.....	2182
10.5.7.5	How to Rename Objects.....	2183
10.5.7.6	The Colors Property Group.....	2185
10.5.7.7	The Geometry Property Group.....	2186
10.5.7.8	The Font Property Group.....	2189
10.5.7.9	The Miscellaneous Property Group.....	2191
10.5.7.10	The Styles Property Group.....	2192
10.5.8	Working with Standard Objects.....	2194
10.5.8.1	Working with Standard Objects.....	2194
10.5.8.2	Working with Static Objects.....	2195
10.5.8.3	Working with Dynamic Standard Objects.....	2224
10.5.8.4	Working with System Objects.....	2237
10.5.8.5	Working with the Layout Object.....	2239
10.5.9	Working with Objects for the Runtime Documentation.....	2240
10.5.9.1	Working with Objects for the Runtime Documentation.....	2240
10.5.9.2	Modify output options for WinCC Online Table Control.....	2241
10.5.9.3	Modify output options for WinCC Online Trend Control.....	2246
10.5.9.4	Modify output options for WinCC Function Trend Control.....	2251
10.5.9.5	Modify output options for WinCC Alarm Control.....	2255
10.5.9.6	Change output options for WinCC UserArchiveControl.....	2259
10.5.9.7	Changing Output Options for Message Reports from Alarm Logging.....	2261
10.5.9.8	Changing Output Options for User Archive Tables.....	2267
10.5.9.9	How to Change the Output Options for CSV Provider Tables.....	2271
10.5.9.10	How to Change the Output Options for CSV Provider Trends.....	2273
10.5.10	Working with Objects for the Project Documentation.....	2275
10.5.10.1	Working with Objects for the Project Documentation.....	2275
10.5.10.2	How to Call up the Selection Dialogs.....	2276
10.5.10.3	How to Change Output Options for Single Message from Alarm Logging CS.....	2278
10.5.10.4	How to Change the Output Options for the Selection of User Archives.....	2279
10.5.10.5	How to Change the Output Options for the Selection of Views.....	2282
10.5.10.6	How to Change the Output options for the Selection of the Picture Statistics.....	2283
10.5.10.7	How to Change the Output Options for the Selection of Attributes.....	2285
10.5.10.8	How to Change the Output Options for the Selection of Object Statistics.....	2287
10.5.10.9	How to Change the Output Options for the Selection of Action types.....	2289
10.5.10.10	How to Change the Output Options for the Selection of Archives from Tag Logging.....	2290
10.5.10.11	How to Change the Output Options for the Selection of the Archive Tags from Tag Logging.....	2293
10.5.10.12	How to Change the Output Options for the Language Selection from the Text Library.....	2296
10.5.10.13	How to Change the Output Options for the Tag Table of WinCC Explorer.....	2297
10.5.10.14	How to Change the Output Options for the Selection of Connection List.....	2300
10.5.10.15	How to Change the Output Options for the Dynamic Texts.....	2301
10.5.10.16	How to Change the Output Options for the Dynamic Metafiles.....	2302
10.5.10.17	How to Change the Output Options for the Dynamic Tables without Data Selection.....	2304
10.6	Appendix.....	2306
10.6.1	Requests to a CSV File for Reporting.....	2306
10.6.2	Filter criteria for alarm output.....	2308

11	Creating Line Layouts.....	2313
11.1	Creating Line Layouts.....	2313
11.2	How to Start the Line Layout Editor.....	2314
11.3	The Line Layout Editor.....	2315
11.3.1	The Line Layout Editor.....	2315
11.3.2	The Standard Toolbar.....	2316
11.3.3	The Page Size and Margins Areas.....	2317
11.3.4	The Header and Footer Areas.....	2318
11.3.5	The Table Area.....	2319
11.3.6	The Time Range.....	2320
11.4	Working with the Line Layout Editor.....	2321
11.4.1	Working with the Line Layout Editor.....	2321
11.4.2	How to Set the Page Size.....	2321
11.4.3	How to Create Headers and Footers.....	2322
11.4.4	How to Create a Table in the Line Layout.....	2323
11.4.5	How to Change the Output Options for the Message Sequence Report.....	2325
12	COM Provider in the Layout Editor.....	2329
12.1	COM Provider in the Layout Editor.....	2329
12.2	Working with COM Server Objects.....	2330
12.3	How to Output Data from a COM Server in a Report.....	2331
12.4	Example of an integration of a COM server.....	2332
12.5	Details of the COM Interface for Reporting.....	2333
13	Setting Up Multilingual Projects.....	2337
13.1	Setting Up Multilingual Projects.....	2337
13.2	Language support in WinCC.....	2338
13.2.1	Language support in WinCC.....	2338
13.2.2	Language expressions in WinCC.....	2339
13.2.3	Configuring Multiple Languages.....	2342
13.2.4	How to Create a Multilingual Project.....	2345
13.2.5	How to Switch the Language of the Operating System.....	2346
13.2.6	How to Change Languages in WinCC.....	2347
13.2.7	Fonts in Multilingual Projects.....	2350
13.2.8	Prohibited Characters in WinCC.....	2351
13.2.9	Configuring with Non-Latin Fonts.....	2351
13.3	Text export and text import with the Text Distributor.....	2353
13.3.1	Text export and text import in the Text Distributor.....	2353
13.3.2	How to export language-dependent texts.....	2354
13.3.3	Structure of the Export Files.....	2356
13.3.3.1	Export File Overview.....	2356
13.3.3.2	Construction of files with text from the Text Library.....	2357
13.3.3.3	Construction of files with text records from the "Graphics Designer" editor.....	2358
13.3.3.4	Structure of the "_Languages" Files.....	2360
13.3.3.5	Status bar for the export and import.....	2361
13.3.4	How to edit and translate exported text files.....	2362
13.3.5	How to import language-dependent texts.....	2364

13.4	Text Management with the "Text Library" Editor.....	2367
13.4.1	Text management with the "Text Library" editor.....	2367
13.4.2	Operator's overview of the Text Library.....	2369
13.4.3	This is how you perform an external translation of the texts.....	2372
13.4.4	Multilingual messages	2373
13.5	Multilingual Pictures in the "Graphics Designer" Editor.....	2375
13.5.1	Multilingual pictures in the "Graphics Designer" editor.....	2375
13.5.2	Language-dependent properties of picture objects.....	2376
13.5.3	How to export and import text from pictures.....	2377
13.5.4	How to configure picture objects for more languages in the "Graphics Designer" editor...	2379
13.5.5	Configuring a Text List in Multiple Languages.....	2381
13.6	Reports for Multilingual Projects.....	2383
13.6.1	Reports for Multilingual Projects.....	2383
13.6.2	Layout and layout file.....	2383
13.6.3	How to change or create layouts.....	2385
13.6.4	How to change or create print jobs	2387
13.6.5	How to create the multilingual project documentation.....	2389
13.6.6	Multilingual logs in runtime.....	2390
13.7	Displaying Regional Date and Time.....	2391
13.8	Languages in Runtime.....	2393
13.8.1	Languages in Runtime.....	2393
13.8.2	How to Set the Runtime Computer Starting Configuration.....	2394
13.8.3	Configuring Language Changes.....	2394
13.9	Example of Configuration.....	2397
13.9.1	Example of Configuration.....	2397
13.9.2	Example: How to Configure a Multilingual Graphic Object.....	2397
13.9.3	Example: How to Configure Language Changes.....	2398
13.9.4	Example: How to Change Language in Runtime.....	2399
13.9.5	Example: How to translate the text records in different linguistic regions.....	2402
14	Structure of the User Administration.....	2405
14.1	Setting up user administration.....	2405
14.2	Overview of the configuration steps.....	2407
14.3	Administering authorizations.....	2409
14.3.1	Adding authorizations.....	2409
14.3.2	Deleting authorizations.....	2409
14.3.3	Plant-specific authorizations.....	2410
14.3.4	Overview of Authorizations.....	2412
14.3.4.1	Default Authorizations.....	2412
14.3.4.2	System authorizations.....	2414
14.3.4.3	Basis Process Control Authorizations.....	2415
14.3.4.4	PCS 7 system authorizations.....	2416
14.4	Administering users.....	2417
14.4.1	Creating a user group.....	2417
14.4.2	Setting up users.....	2417
14.4.3	Administrating users.....	2419
14.4.4	Administrating user groups.....	2421
14.4.5	Administering users for web access.....	2422

14.5	Configuring automatic logout.....	2424
14.6	Configuring logon with a tag.....	2425
14.7	Configuring operator authorization.....	2427
14.8	Configuring an electronic signature.....	2428
14.9	Logging on as user.....	2431
14.10	Logon with a chip card.....	2432
14.11	User administration in distributed systems.....	2433
14.11.1	User administration in a distributed system.....	2433
14.11.2	Exporting/importing User Administrator configuration data.....	2435
14.11.3	Example: Operator authorization on server and client configuration.....	2436
14.11.4	Example: Importing / exporting the configuration of the user administrator.....	2437
14.11.5	Example: Role concept.....	2438
14.12	Central user administration with SIMATIC Logon.....	2440
14.12.1	Overview of SIMATIC Logon.....	2440
14.12.2	Windows settings for SIMATIC Logon.....	2441
14.12.3	How to use SIMATIC Logon with WinCC.....	2442
14.12.4	How to configure an electronic signature with SIMATIC Logon.....	2445
14.12.5	Creating an electronic signature in a VBS action.....	2447
14.12.6	Creating an electronic signature in a C action.....	2449
14.12.7	Notes on WinCC/PCS7-OS integration.....	2451
15	Integration of WinCC in SIMATIC Manager.....	2453
15.1	Integration of WinCC in SIMATIC Manager.....	2453
15.2	Advantages and Prerequisites of Integration.....	2454
15.3	Managing WinCC Projects and Objects in the SIMATIC Manager.....	2457
15.3.1	Managing WinCC Projects and Objects in the SIMATIC Manager.....	2457
15.3.2	WinCC Application.....	2460
15.3.2.1	WinCC Application.....	2460
15.3.2.2	How to Create a WinCC Application.....	2461
15.3.2.3	How to Set the Path to the Target Computer.....	2463
15.3.2.4	How to Select the Standby Computer.....	2467
15.3.2.5	How to Load the Project on the Target Computer.....	2470
15.3.2.6	How to Create a Reference to a WinCC Application.....	2471
15.3.3	Operator Station OS.....	2473
15.3.3.1	Operator Station OS.....	2473
15.3.3.2	How to Create an Operator Station.....	2474
15.3.3.3	How to Set the Path to the Target Computer.....	2475
15.3.3.4	How to Load the Project on the Target Computer.....	2479
15.3.3.5	How to Configure a Reference to an OS.....	2480
15.3.4	How to Import a WinCC Project with the SIMATIC Manager.....	2481
15.3.5	Handling WinCC Projects Between STEP 7 Projects and Libraries.....	2483
15.3.6	Accepting Language Settings from SIMATIC Managers.....	2484
15.3.7	Working With WinCC Objects.....	2485
15.3.7.1	Working With WinCC Objects.....	2485
15.3.7.2	How to Create WinCC Objects.....	2486
15.3.7.3	How to Handle WinCC Objects.....	2486
15.3.7.4	How to Import WinCC Objects.....	2488

15.3.7.5	Setting Up and Monitoring of Server Assignment.....	2489
15.3.7.6	How to Create Model Solutions of WinCC Projects or WinCC Objects.....	2492
15.3.8	How to Open the WinCC Project.....	2494
15.3.9	Starting a Simulation in STEP 7.....	2495
15.4	Transferring Tags, Texts and Reports to WinCC.....	2497
15.4.1	Transferring Tags, Texts and Reports to WinCC.....	2497
15.4.2	Compiling OS.....	2498
15.4.2.1	Compiling OS.....	2498
15.4.2.2	How to Compile the Entire OS.....	2499
15.4.2.3	How to Compile Changes.....	2504
15.4.2.4	Compilation log.....	2508
15.4.3	How to Display Transferred Tags.....	2509
15.4.4	Displaying Transferred Messages and Texts.....	2510
15.4.5	How to Configure Messages in STEP7.....	2511
15.5	Compiling and Loading Objects.....	2515
15.6	How to use multiuser engineering in SIMATIC Manager.....	2518
15.7	Settings for Web access.....	2520
15.7.1	Configuring Web settings.....	2520
15.7.2	How to configure a custom "Monitoring only" cursor.....	2520
15.7.3	How to configure the publishing of process images.....	2521
15.8	Selection of STEP 7 Symbols.....	2525
15.8.1	Selection of STEP 7 Symbols.....	2525
15.8.2	Tag Selection Dialog.....	2526
15.8.2.1	Tag Selection Dialog.....	2526
15.8.2.2	How to Display STEP 7 Symbols.....	2527
15.8.2.3	How to Select STEP 7 Symbols.....	2529
15.8.2.4	How to Transfer STEP 7 Symbols.....	2531
15.8.3	Tag Bar.....	2534
15.8.3.1	Tag Bar.....	2534
15.8.3.2	How to Display STEP 7 Symbols.....	2535
15.8.3.3	How to Select STEP 7 Symbols.....	2537
15.9	Diagnostic Support.....	2539
15.9.1	Diagnostic Support.....	2539
15.9.2	Network Entry Jump.....	2539
15.9.2.1	Network Entry Jump.....	2539
15.9.2.2	How to Configure the Network Entry Jump.....	2540
15.9.3	Network Return.....	2543
15.9.4	Jump to Hardware Diagnosis.....	2546
15.9.4.1	Jump to Hardware Diagnosis.....	2546
15.9.4.2	How to Configure the Entry Jump into the Hardware Diagnostics.....	2546
16	SmartTools.....	2553
16.1	Overview.....	2553
16.2	Tag simulator.....	2554
16.2.1	WinCC Tag Simulator.....	2554
16.2.2	Using the Tag Simulator.....	2555
16.2.3	Start simulator.....	2556
16.2.4	Configuring functions for the simulation.....	2557
16.2.5	How to simulate tags.....	2560

16.3	Dynamic Wizard Editor.....	2563
16.3.1	Dynamic Wizard Editor: Overview.....	2563
16.3.2	Installation of the Dynamic Wizard Editor.....	2565
16.3.3	Structure.....	2566
16.3.3.1	Structure.....	2566
16.3.3.2	Toolbar.....	2566
16.3.3.3	Editor window.....	2568
16.3.3.4	Help Editor.....	2569
16.3.3.5	Output window.....	2570
16.3.4	Structure of a Dynamic Wizard function.....	2570
16.3.4.1	Structure of a Dynamic Wizard function.....	2570
16.3.4.2	Dynamic Wizard dialog.....	2571
16.3.4.3	Integrating header files and DLLs.....	2571
16.3.4.4	Language-dependent definitions.....	2572
16.3.4.5	Wizard flags.....	2573
16.3.4.6	Property list.....	2574
16.3.4.7	System interface.....	2575
16.3.4.8	Global variables.....	2576
16.3.4.9	Options list.....	2576
16.3.4.10	Trigger list.....	2579
16.3.4.11	Display of parameter assignment.....	2581
16.3.4.12	Wizard Functions for parameter input.....	2582
16.3.4.13	Wizard functions for generating dynamics.....	2607
16.3.4.14	Wizard WinCC functions.....	2619
16.3.4.15	Wizard progress functions.....	2622
16.3.4.16	Wizard Windows functions.....	2625
16.3.5	Examples.....	2631
16.3.5.1	Examples.....	2631
16.3.5.2	Demo Wizard.....	2631
16.3.5.3	Dynamic motor.....	2634
16.4	Documentation Viewer	2638
16.4.1	WinCC Documentation Viewer.....	2638
16.4.2	Installing WinCC Documentation Viewer.....	2638
16.4.3	Description.....	2639
16.4.4	Creating the .emf file(s).....	2640
16.5	WinCC CrossReferenceAssistant.....	2641
16.5.1	WinCC CrossReferenceAssistant.....	2641
16.5.2	Installation of the CrossReferenceAssistant.....	2641
16.5.3	General.....	2641
16.5.4	Known functions (script management).....	2642
16.5.5	Project selection.....	2646
16.5.6	File selection.....	2647
16.5.7	Conversion.....	2648
16.5.8	Expanded settings.....	2649
16.6	WinCC/Cloud Connector.....	2651
16.6.1	WinCC Cloud Connector.....	2651
16.6.2	Licensing.....	2652
16.6.3	Specify settings for the cloud connection.....	2652
16.6.4	Settings in the configuration studio.....	2656
16.6.5	Transfer of data to the cloud via MQTT.....	2657

16.6.6	System tags for the current connection status of the cloud connection.....	2659
16.6.7	Enabling/disabling Cloud Connector communication in runtime.....	2660
16.6.8	Diagnostics file for the Cloud Connector.....	2660
Index		2663

Working with Projects

1.1 Working with Projects

Content

Before you can monitor and control a process, you must first create a project in WinCC. You define all necessary elements and settings in this project.

This section shows you

- How to open and close WinCC and the WinCC Explorer
- The structure of the WinCC Explorer
- The types of project in WinCC
- How to create a project and work with it
- How to activate and deactivate a project
- How to copy a project

1.2 Opening WinCC Explorer

Introduction

When you start WinCC, the WinCC Explorer normally is opened.

After the installation, WinCC is entered in the Windows program group "Siemens Automation". You can start WinCC with the entry "WinCC Explorer".

The WinCC Explorer can also be opened from the desktop or using the Windows Explorer.

Note

If you only have a Runtime license installed on a computer, you can only work in the WinCC Explorer or in a WinCC editor for one hour. If the WinCC Explorer or a WinCC editor remains open for more than one hour, WinCC changes to the demonstration mode.

Principle

You can open the WinCC Explorer in the following ways:

- via the "Siemens Automation" Windows program group
 - via the "WinCCExplorer.exe" file in Windows Explorer
 - using a shortcut from the Windows Desktop
 - via the "<PROJECT>MCP" project file in the Windows Explorer
 - with Autostart
 - with a project that opens in Autostart
 - by dragging and dropping the "<PROJECT>.MCP" project file on the "WinCCExplorer.exe" file or on the shortcut on the desktop
- The WinCC Explorer opens with the corresponding project opened.

You can start WinCC only once on a computer.

If you attempt to open the WinCC Explorer when it is already open, this will be prevented without an error message. You can continue to work normally in the open WinCC Explorer.

Start Mode of the WinCC Explorer

Open project

When you start WinCC the first time, the WinCC Explorer is opened without a project. Whenever you start WinCC again, the last project you had open will be opened again.

With the key combination <SHIFT> + <ALT>, you can prevent WinCC from opening a project immediately. Press the <SHIFT> key and the <ALT> key while WinCC is opening. Keep the keys pressed until the window of the WinCC Explorer is displayed. The WinCC Explorer opens without opening a project.

Activated Project

If the project was activated when you exited WinCC Runtime, it will be opened in Runtime again when you restart WinCC.

If you close a project and open another project that was opened the last time in the activated state, WinCC once again opens the project in Runtime.

With the key combination <SHIFT> + <CTRL>, you can prevent WinCC activating Runtime immediately. Press the <SHIFT> key and the <CTRL> key while WinCC is opening. Keep the keys pressed until the project is open and displayed fully in the WinCC Explorer. WinCC opens the last project without starting Runtime.

Opening WinCC Explorer

"Siemens Automation" Windows program group

You can open the WinCC Explorer via the entry "WinCC Explorer".

WinCC Explorer is opened.

Windows Explorer

You can start WinCC with the WinCCExplorer.exe start file.

The WinCCExplorer.exe file can be found in the Windows Explorer in your installation path in WinCC\bin.

Windows Desktop

You can create a shortcut for the WinCCExplorer.exe file.

You then place this shortcut on the desktop of the computer.

Opening a Project in the Windows Explorer

You can start WinCC by opening a WinCC project in the Windows Explorer.

Open the <PROJECT>.MCP file in the installation path of the project.

You can only start a project from the Windows Explorer when WinCC has not yet started.

Autostart

You can also start WinCC using Autostart when the computer starts up.

To do this, use the "AutoStart Configuration" tool of WinCC. Each time you start the Windows system, WinCC will also be started automatically.

Opening the WinCC Explorer with a Project Open

You can close the WinCC Explorer without closing the open project.

With the "WinCC Explorer" entry, you can reopen the WinCC Explorer.

This also applies even if you open a project using Autostart only in Runtime.

Remote WinCC Startup

You can start WinCC of another computer in the network.

You find more detailed information in the WinCC Information System under Configurations > Multi-User Systems > Remote Configuration.

Open project

File > Open

In the WinCC Explorer, you open a project with the Open command in the File menu.

In the Open window, select the project folder and open the <PROJECT>.MCP project file.

File > Last File

In the File menu, you can open one of the last files opened with the Last File command.

Up to eight projects are displayed.

"Open" Button

You can open a project with the  button in the toolbar.

Opening a Project with Autostart

You can open a specific project using Autostart when your computer starts up.

To do this, use the "AutoStart Configuration" tool of WinCC.

Note

Opening a project deactivates Runtime

If you open a project while another project is active in Runtime, Runtime is deactivated and the previously active project is closed.

Note

WinCC project file cannot be opened

Lock mechanisms in WinCC prevent projects from being opened during a long-lasting process.

A lock mechanism takes effect each time a WinCC project is opened. The "ProjectOpened.lck" text file is created in the project folder.

A second lock mechanism takes effect in the following situation:

- An OS is downloaded in SIMATIC Manager
- A WinCC project is duplicated using Project Duplicator

The "wincc.lck" text file is created in the project folder.

The opening lock is retained if termination of this process was prevented, for example, because a program was aborted, or the PC was restarted. The project folder contains the "ProjectOpened.lck" and "wincc.lck" text files with a readable process ID.

If all processes are completed, you can delete the "ProjectOpened.lck" and "wincc.lck" files.

See also

- Editors and Functions in WinCC Explorer (Page 219)
- How to Start Runtime (Page 204)
- Closing WinCC Explorer (Page 40)

1.3 Closing WinCC Explorer

Introduction

When you close the WinCC Explorer, you normally close the project that was last open at the same time.

Closing WinCC Explorer with activated Runtime

If Runtime is activated, or if you have opened a WinCC editor, you can close the WinCC Explorer separately:

- The project remains open and active if it was already active.
- Open editors are not closed.

You can open the WinCC Explorer again via the entry "WinCC Explorer".

Closing WinCC Explorer with an open project

You can close the WinCC Explorer regardless of whether a project is open:

- The relevant WinCC processes continue to run in the background.
- When you open the WinCC Explorer again, WinCC does not need to reload the project data and the Explorer takes less time to open.

Principle

You can exit WinCC in the following ways:

- With the Exit command in the WinCC Explorer menu bar
- With the Close button
- When you shut down Windows
- With a C action in the activated project

Note

After starting, WinCC always opens the last project that was open before you exited.

If the project was activated when you exited WinCC, it will be opened in Runtime again.

Closing WinCC Explorer

File > Exit

Close the WinCC Explorer with the Exit command in the File menu. The Exit WinCC Explorer dialog box is opened.

In the list box, you can select one of the following options:

Selection	WinCC Action
Close project and exit WinCC Explorer	If active, the project is also deactivated and closed. The WinCC Explorer and all open WinCC editors are closed.
Exit WinCC Explorer	Only the WinCC Explorer closes. The project remains open and active if it was already active. WinCC editors remain open.

File > Shut Down

In the File menu of the menu bar, select the Shut Down command.

Depending on your computer configuration, you can exit WinCC with Shut Down and at the same time shut down the computer.

Close Button

You can close the WinCC Explorer with the  button in the top right corner of the window.

Exiting Windows

When you exit Windows or log off the current user, WinCC closes completely.

C Action in the Activated Project

You can, for example, configure a button in the project with which you can exit WinCC or Windows.

To do this, use the Exit WinCC or Exit WinCC or Windows dynamic wizards.

See also

How to Exit Runtime (Page 209)

Opening WinCC Explorer (Page 36)

1.4 The WinCC Explorer

1.4.1 The WinCC Explorer

Introduction

When you start WinCC, the WinCC Explorer is opened. With the WinCC Explorer, you can

- Create a project
- Open a project
- Manage project data and archives
- Open editors
- Activate or deactivate a project.

See also

Activating Project (Page 204)

Editors and Functions in WinCC Explorer (Page 219)

Closing WinCC Explorer (Page 40)

Opening WinCC Explorer (Page 36)

1.4.2 Windows of the WinCC Explorer

Introduction

In the WinCC Explorer, you work in the navigation window and in the data window.

In these windows, you can open the context-sensitive help for each element with the right mouse button. If a project is active in Runtime, a tooltip is available for elements of the tag management in the data window.

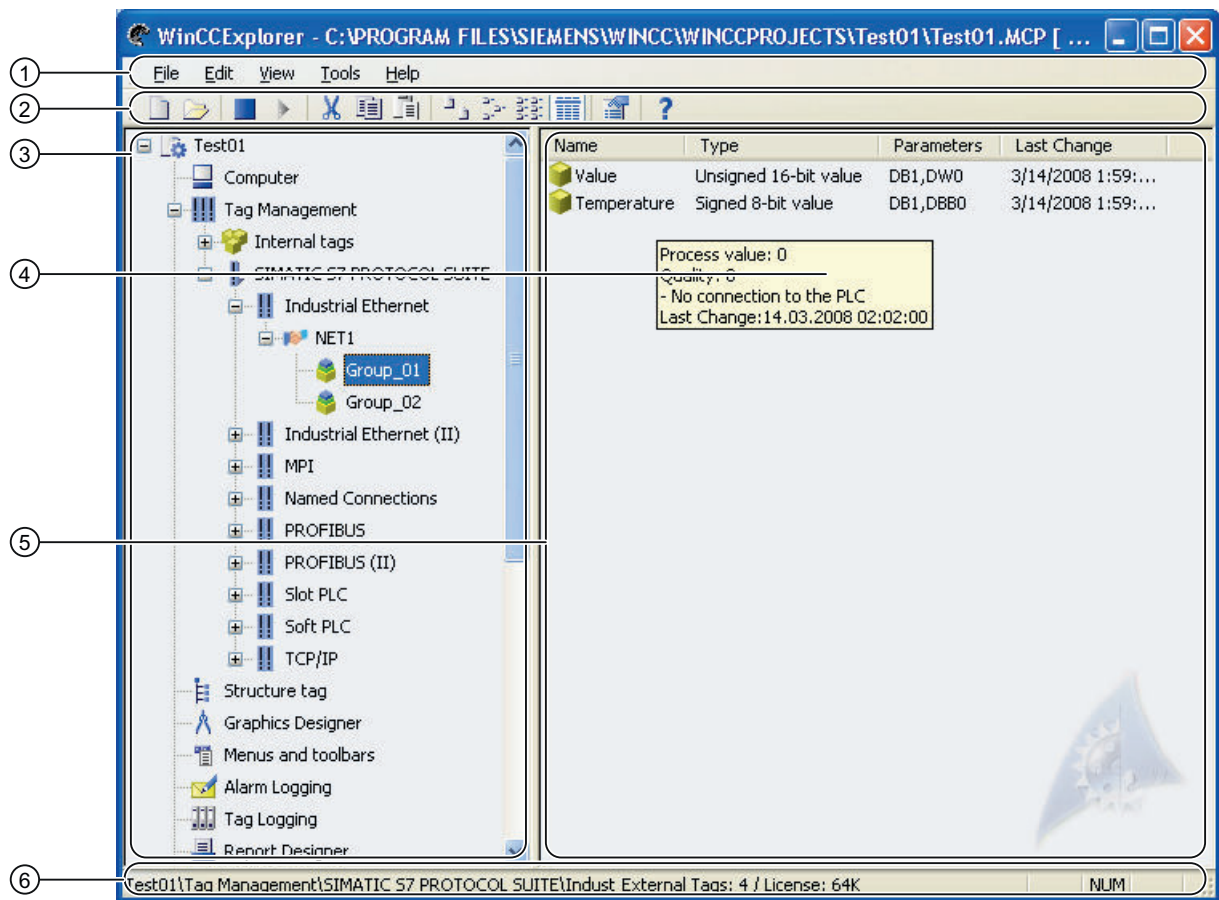

- ① Menu bar
- ② Toolbar
- ③ Navigation window
- ④ Tooltip
- ⑤ Data Window
- ⑥ Status bar

Navigation window

The navigation window contains the list of editors and functions in the WinCC Explorer. You can open an element in the navigation window by double-clicking it or using the shortcut menu.

You open the shortcut menu with the right mouse button. The Open command is displayed. Additional commands for selection are displayed depending on the element.

For the editors Graphics Designer and Report Designer > Layouts you can show the

Information column of the data window using the Display Column Information option. The entry in this column shows how the corresponding object was created.

Method of Creating the Object	Entry in the Information column
Object has been created using WinCC Explorer.	<No entry>
Object has been created using WinCC Explorer and then imported to SIMATIC Manager using the Import WinCC Objects function.	Created by SIMATIC Manager
Object has been created using SIMATIC Manager.	Created by SIMATIC Manager

If you click the plus character in front of the Tag Management or Structure Tag entries, you expand the folder tree. In these folders, you can navigate, create, or move objects.

The Graphics Designer and Global Script editors also have subdirectories. If you click one of these editors, WinCC displays these directories. The Report Designer contains the two folders Layouts and Print Job. Global Script contains the two folders Actions and Standard Functions.

For more detailed information on the editors, refer to the relevant sections of the WinCC Information System.

Data Window

If you click an Editor or a folder in the navigation window, the data window displays the elements belonging to the editor or folder. The information displayed varies from editor to editor.

Double-click an element in the data window to open it. Depending on the element, WinCC performs one of the following actions:

- Opens an object in the appropriate editor.
- Opens the Properties dialog of an object.
- Displays the next level of a folder path.

Right-click an element to call up the shortcut menu where you can select the Properties dialog of the element. With some editors, other commands are displayed that you can select.

You can rename the elements in the data window with the <F2> key or by clicking the selected name.

Tooltips

If Runtime is activated, WinCC displays information on tags and connections in the form of a tooltip. For more detailed information, refer to the WinCC Information System under Working with Tags.

Copying the project path to the clipboard

In the title bar of the WinCC Explorer, you can right-click and select the shortcut menu command "Copy project path to clipboard" to copy the project path to the clipboard for further use.

See also

Editors and Functions in WinCC Explorer (Page 219)
 Status Bar and Title Bar of WinCC Explorer (Page 49)
 Toolbar of the WinCC Explorer (Page 48)
 Menu Bar of the WinCC Explorer (Page 45)
 Search Function (Page 50)

1.4.3 Menu Bar of the WinCC Explorer

Introduction

The menu bar of the WinCC Explorer includes most of the commands that you can use in the Windows Explorer. Commands that you cannot use in the current situation are disabled (displayed in gray).

Some commands are available only when you open the Shortcut menu of an element in a window.

Some commands can be activated using the key combinations (shortcut keys) familiar from Windows.

The following tables provide brief information on the commands in the menu bar. The Online Help (section) column indicates the relevant sections in the WinCC Information System that contain more detailed information.

File Menu

The File menu includes the following commands:

Command	Keyboard shortcut	Function	Online help (section)
New	<CTRL+N>	Creates a new project.	Working with Projects > Creating and Editing Projects
Open	<CTRL+O>	Opens an existing project.	Working with Projects > Creating and Editing Projects
Close	---	Closes an open project.	Working with Projects > Creating and Editing Projects
Activate	---	Starts an open project in Runtime.	Working with Projects > Activate project
Print Project Documentation	---	Prints the project documentation.	Documentation of Configuration and Runtime Data > Project Documentation
View Project Documentation	---	Starts the print preview of the project documentation.	Documentation of Configuration and Runtime Data > Project Documentation
Project Documentation - Setup	---	Sets up the project documentation for printing.	Documentation of Configuration and Runtime Data > Project Documentation

Command	Keyboard shortcut	Function	Online help (section)
Recent File	---	Displays the most recently opened projects up to a maximum of eight. You can select one of the projects and open it.	Working with Projects > Creating and Editing Projects
Exit	<ALT+F4>	Opens a dialog in which you can close the WinCC Explorer.	Working with projects > Closing the WinCC Explorer

Edit Menu

The Edit menu includes the following commands:

Command	Keyboard shortcut	Function	Online help (section)
Undo	<CTRL+Z>	Undoes the last action. This command is not available for all actions.	---
Cut	<CTRL+X>	Cuts the selected object. With Paste, the object can be moved to another location.	---
Copy	<CTRL+C>	Copies the selected object to the clipboard.	---
Paste	<CTRL+V>	Pastes a copied or cut object.	---
Delete		Deletes a selected element.	---
Properties	---	Displays the Properties dialog of a selected element.	Refer to the description of the relevant editor.

View Menu

The View menu includes the following commands:

Command	Keyboard shortcut	Function	Online help (section)
Toolbar	---	Displays or hides the toolbar.	Working with Projects > The WinCC Explorer
Status bar	---	Displays or hides the status bar.	Working with Projects > The WinCC Explorer
Extra Large Icons	---	Displays the contents of the created pictures as miniatures in the Graphics Designer data window (tiles).	---
Large Symbols	---	Displays the elements in the data window as large symbols.	---
Symbols	---	Displays the elements in the data window as small symbols.	---
List	---	Displays the elements in the data window as a list of names.	---
Details	---	Displays the elements in the data window as a list of names with additional information, for example date modified and file type.	Refer to the description of the relevant editor.
Refresh	<F5>	Refreshes the view in the data window.	---

Tools Menu

The Tools menu includes the following commands:

Command	Function	Online help (section)
Language	Changes the user interface language of the WinCC Explorer and editors.	Structure of Multi-language Projects > Language Support in WinCC
Converting Project Data	Converts pictures and scripts from projects that were created with previous versions.	Working with Projects > The WinCC Explorer > Convert Project Data
Status of Driver Connections	Displays the status of logical connections in the project.	Communication Diagnostics> Channel Diagnostics
Status of Server Connections	Displays the communication in a multi-user system in the WinCC client or in the WinCC server for a server-server communication. <ul style="list-style-type: none"> Green = Connection status: Established, data exchange active. The communication between the computers and not the redundancy status is displayed here. Multiple green symbols do not mean multiple master servers. Gray = connection status: Established, no data exchange, only redundancy connection. Red = connection status: Disconnected. ? = Status unknown. 	Working with Projects > The WinCC Explorer
Status of Client Connections	Displays the current status of all servers and clients involved in a WinCC server. <ul style="list-style-type: none"> Green = Connection status: Established, data exchange active. The communication between the computers and not the redundancy status is displayed here. Multiple green symbols do not mean multiple master servers. Gray = connection status: Established, no data exchange, only redundancy connection. Red = connection status: Disconnected. ? = Status unknown. 	Working with Projects > The WinCC Explorer

Help Menu

The Help menu includes the following commands:

Command	Keyboard shortcut	Function	Online help (section)
Contents and Index	---	Opens the WinCC information system.	---
Direct Help	<F1>	Activates the direct help (What's this?).	---
About WinCC Explorer	---	Displays the installed version and the installed components of WinCC.	---

See also

- Editors and Functions in WinCC Explorer (Page 219)
- Activating Project (Page 204)
- Closing WinCC Explorer (Page 40)
- Opening WinCC Explorer (Page 36)
- Windows of the WinCC Explorer (Page 42)
- Status Bar and Title Bar of WinCC Explorer (Page 49)
- Toolbar of the WinCC Explorer (Page 48)
- Converting project data (Page 52)
- Creating and Editing Projects (Page 115)
- Project Documentation (Page 2041)
- The WinCC Explorer (Page 42)
- Language support in WinCC (Page 2338)

1.4.4 Toolbar of the WinCC Explorer

Introduction





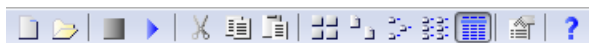

Using the buttons in the toolbar, you can activate commands. You can also hide the toolbar in the WinCC Explorer by selecting the View menu in the menu bar and clicking the Toolbar command.

Buttons in the Toolbar



The toolbar in the WinCC Explorer contains buttons with the following functions:

Icon	Tooltip	Description
	New	Creates a new project.
	Open	Opens a project.
	Deactivate	Exits Runtime.
	Activate	Starts the project in Runtime.
	Cut	Cuts a selected object. The object is deleted at its original location as soon as it is pasted elsewhere.
	Copy	Copies an object to the clipboard. The object can be duplicated at the same location or a comparable location in the path.
	Paste	Pastes a cut or copied object.

Icon	Tooltip	Description
	Tiles	Displays the contents of the created pictures as miniatures in the Graphics Designer data window.
	Large Symbols	Elements in the data window are displayed as large symbols.
	Small Symbols	Elements in the data window are displayed as small symbols.
	List	Elements in the data window are displayed as a list of names only.
	Details	Elements in the data window are displayed as a list with detailed information.
	Properties	Opens the Properties dialog of an element.
	Help	Activates the direct help for an element you then left click.

For more information on the commands, refer to chapter Menu Bar.

See also

Activating Project (Page 204)

Opening WinCC Explorer (Page 36)

Windows of the WinCC Explorer (Page 42)

Status Bar and Title Bar of WinCC Explorer (Page 49)

Menu Bar of the WinCC Explorer (Page 45)

1.4.5 Status Bar and Title Bar of WinCC Explorer

Introduction

The status bar and title bar contain general information on the project and settings in the editor.

Title bar

The current path of the open WinCC project is displayed.

Status bar

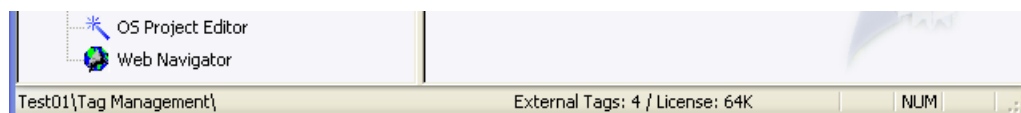

Field	Description
Status	Displays tips on editing and displays the current path of a file.
Number of configured tags / Number of power tags	Number of configured external tags / Number of tags covered by a license. The number of tags and licenses is displayed in WinCC Explorer only when you select tag management and the structure types.
Object(s)	Number of objects of the selected editor, for example, the number of pictures with the Graphics Designer. The number of tags and licenses is displayed in WinCC Explorer when you select tag management and the structure types.
CAPS	SHIFT function is active (upper case).
NUM	The numeric pad on the right of the keyboard is active.
SCRL	The Windows Scroll function is active.

See also

Windows of the WinCC Explorer (Page 42)

Toolbar of the WinCC Explorer (Page 48)

Menu Bar of the WinCC Explorer (Page 45)

1.4.6 Search Function

Starting the Search Function

You can start a search in the navigation window and in the data window of the WinCC Explorer. by selecting the Find... command in the shortcut menu of the project, the computer, or the tag management. The Find dialog opens.

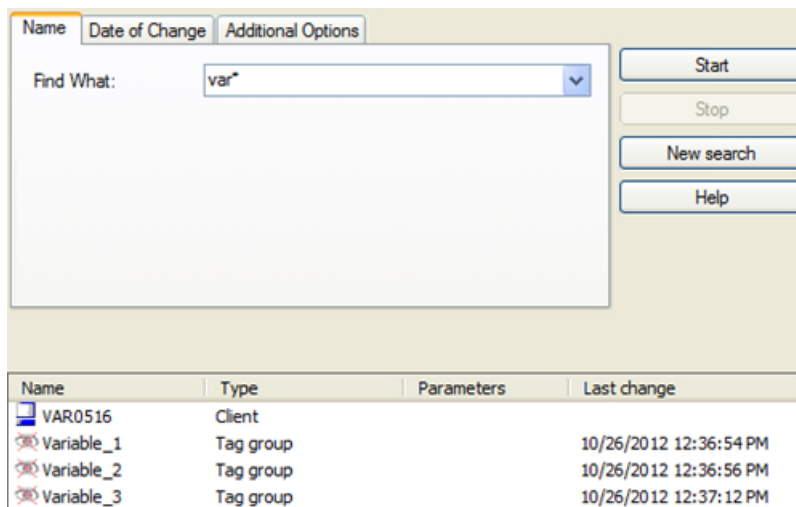

Searchable elements

You can search for the following elements in a project:

- Client computers
- Server computers
- Driver connections
- Channel units
- Connections
- Tag groups
- Tags

You can restrict the search to individual element types. Select the required element type on the Additional Options tab in the Type list box. In the Parameter Text field, you can specify an individual parameter as an additional search criterion.

Searching by Name

On the Name tab, you can enter the name of the required element in the Find What list box. If you have made several searches, you can display the list of terms you have searched for in the Find What list box.

The entries you make for searches are not case-sensitive.

Wildcard

The "*" character can be used as a wildcard. This replaces any number of characters at the beginning or end of the name.

If you enter "var*", all elements whose names start with "var", are displayed, e.g.

- "Variable_2" tag,
- "variablegroup_tank" tag group,
- a computer with the name "VAR0516".

In the same way, you could enter "*tank" to search for all elements whose name ends with "tank".

Searching by Date

In the Date of Change tab, you can search for elements created or modified during a specific period.

Starting and Stopping a Search

Once you have specified all options for the search, start the search with the Start button. Click the Stop button if you want to stop the search.

If you double-click an object that has been found, you change to the path in which this object is located in the WinCC Explorer.

To delete all search information you have entered, click the New Search button. You can then formulate a new search.

To close the "Search" window, click the  button in the top right corner.

See also

Editors and Functions in WinCC Explorer (Page 219)

Windows of the WinCC Explorer (Page 42)

Status Bar and Title Bar of WinCC Explorer (Page 49)

Toolbar of the WinCC Explorer (Page 48)

Menu Bar of the WinCC Explorer (Page 45)

1.4.7 Converting project data

You can import data and files from projects that were created with previous versions into the WinCC project and thereby access existing configuration data.

To do this, you need to adapt screens and script files, for example, to the current version of WinCC and convert them to the current format.

Behavior during converting

Converting pictures and libraries can take some time.

Limitations during converting

- It is not possible to convert an individual picture or library object.
- System screens that you have set as invisible in the computer properties or in the Graphics Designer.

NOTICE
Conversion is irrevocable
Conversion of data cannot be undone.
The conversion starts immediately, as soon as you confirmed the dialog with "OK".

Procedure

1. In the WinCC Explorer, select the menu command "Tools > Convert project data".
2. Select the project data to be converted:
 - Pictures and faceplates
 - Global libraries
 - Project libraries
 - Page layouts and line layouts
 - C and VB project functions and actions
 - C and VB standard functions
 - Data for Basic Process Control
3. Select the configuration language of the WinCC project from which the project data originated.
4. Confirm with "OK".
The selected data is converted to the current version of WinCC.

1.5 The WinCC Configuration Studio

1.5.1 Introduction

Introduction

WinCC Configuration Studio provides a simple and efficient means of configuring bulk data for WinCC projects.

The user interface is divided into two areas: a navigation area similar to Microsoft Outlook and a data area similar to Microsoft Excel. This setup lets you configure bulk data for a WinCC project, while taking operational benefits that you already know from spreadsheet programs.

This section will provide you with an overview of the functionality and operation of WinCC Configuration Studio.

WinCC editors

The following editors are integrated in the WinCC Configuration Studio:

- Tag management
- Alarm Logging
- Tag Logging
- Text Library
- User Administrator
- User Archive
- Horn
- Picture Tree
- Text and graphics lists

The Configuration Studio is also used as editor in some WinCC options, for example, in WinCC/Audit and WinCC/PerformanceMonitor.

1.5.2 Interface

Structure of the WinCC Configuration Studio

The user interface consists of a navigation area with navigation bar, the data area with tables and the "Properties" area.

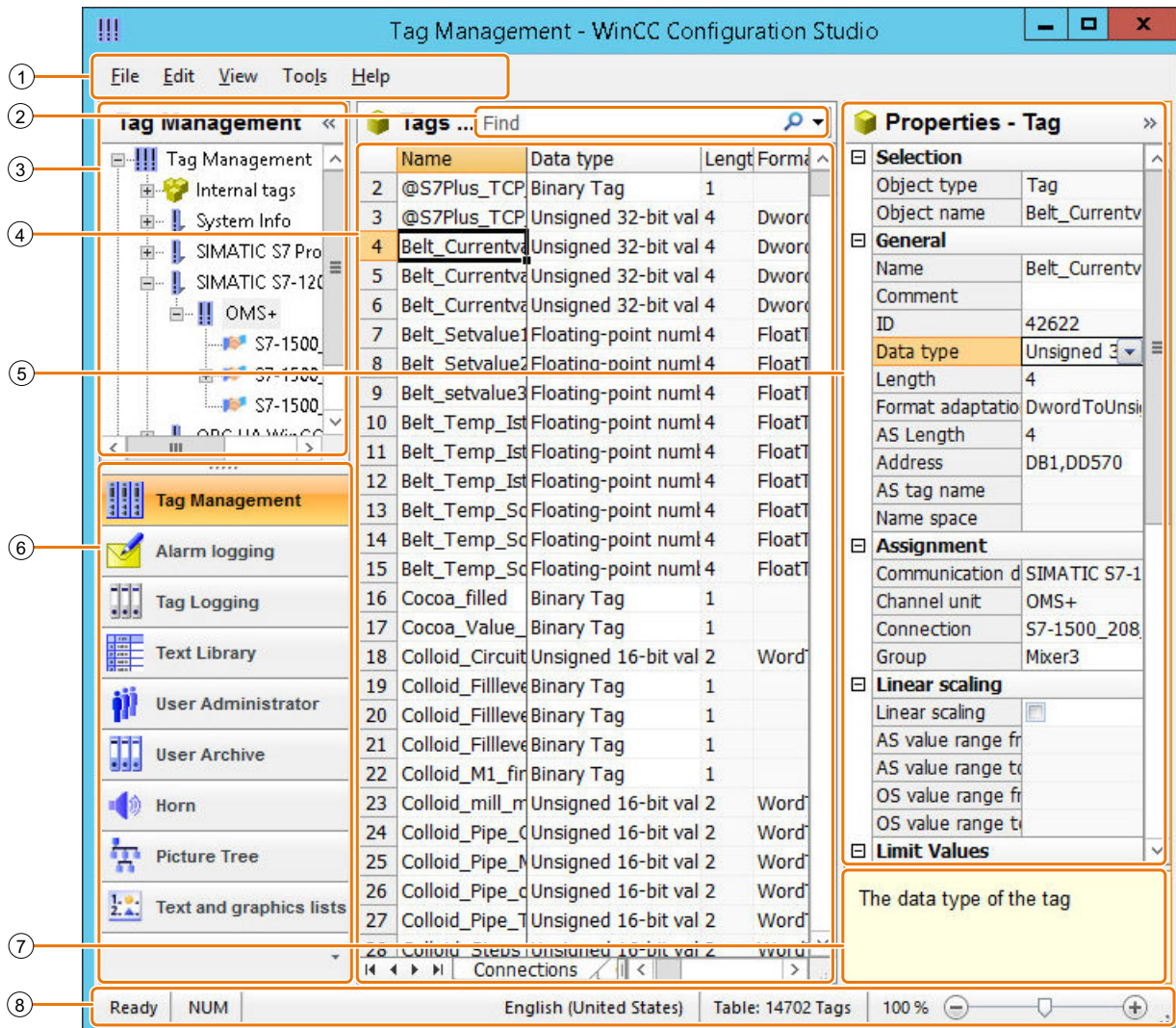

- ① Menu bar
- ② Fast search in data area
- ③ Navigation area
- ④ Data area (table)
- ⑤ "Properties" window
- ⑥ Navigation bar
- ⑦ "What's this?" for the selected property
- ⑧ Status bar

Menu bar

With the menu bar, you can activate the following functions:

File > Project Documentation - Setup	Open the "Print Job Properties" dialog
File > Project Documentation - Preview	Open a preview of the report to be output
File > Project Documentation - Print	Print a report immediately
File > Exit	Exit WinCC Configuration Studio
Edit > Copy / Paste	Copy and paste selected data For additional information, refer to "Copying and pasting in the data area (Page 74)".
Edit > Undo	Undo last action in the Configuration Studio
Edit > Redo	Redo last action in the Configuration Studio
Edit > Import	Importing data records For additional information, refer to "Importing data records (Page 99)".
Edit > Export	Exporting data records For additional information, refer to "Exporting data records (Page 97)".
View > Input language	Switch configuration language to one of the configured languages Additional information on the configuration of multilingual projects is available under "Language support in WinCC (Page 2338)".
View > Color scheme	Changing color scheme in the Configuration Studio
Tools > Macros	Opens the Macro editor When a macro was created with the VBA editor, you start the macro in the WinCC Configuration Studio using this dialog. For additional information, refer to "Fast search in data area (Page 76)".
Tools > Visual Basic Editor	Opens the VBA editor "Microsoft Visual Basic for Applications". You can find additional information under "Working with WinCC > VBA for automatic configuring > VBA in the WinCC Configuration Studio".
Help > Contents and Index	Call the online help
Help > Info on WinCC Configuration Studio	Information on version and system

Fast search in data area

To search for entries in the data area, enter the required text in the "Search" field. If one or more fields were selected in the data area, the search is limited to the selected fields.

For additional information, refer to "Fast search in data area (Page 76)".

Navigation area

The objects of the selected editor or the selected structure level are displayed in the navigation area as tree view. The structure of the tree view includes all elements that are displayed in the data area.

For additional information, refer to "Operating the navigation area (Page 58)".

Data area

The data area has the structure of a table view in a spreadsheet program. This table area displays the data records of the structure level that is selected in the navigation area.

Just as in the "Properties" window, you can configure the data records in the data area. In addition, you can use regular table functions, for example:

- Sort by columns
- Filter
- Autofilling
- Exporting and importing data records

For additional information, refer to "Operating the data area (Page 62)".

"Properties" window

In the "Properties" window you edit a data record of the selected editor or the selected structure level. The inputs are applied to the visible columns of the data area.

For additional information, refer to the documentation of the respective editor under "Using the "Properties" window (Page 96)".

Navigation bar

In the navigation bar, you switch between the WinCC editors.

What's this?

The window contains information on the selected field in the "Properties" window.

The direct help may also include links that you can use to request additional help from the WinCC Information System.

Long texts may not be shown in full in the window. Resize (enlarge) the window with the mouse to read the full text. To scroll the text, click the window and drag it with the mouse or press the arrow keys down or to the right.

Status bar

This information bar contains the following information:

- System status, e.g. "Ready"
- Key settings, e.g. lock key, NUM-Lock key

- Current input language
- Number of selected data records when table cells are selected
- Number of data records in the displayed data area, for example, tags, messages, archives
- Search results: Number of data records that are found with a quick search
- Filter results: Number of data records that are found with a filter setting
- Filtered search results: Number of data records that are found with a quick search in a filtered display
- Zoom function and zoom status for the table area
There are several options for zooming in and out of the table view:
 - Use the mouse to drag the slider for zooming in and out of the display.
 - To zoom in increments of 10%, click the "-" or "+" symbols next to the slider.
 - Hold the <Ctrl> key down while turning the mouse wheel.

See also

Fast search in data area (Page 76)

Exporting data records (Page 97)

Copying and pasting in the data area (Page 74)

Importing data records (Page 99)

Using the "Properties" window (Page 96)

Using macros (Page 95)

Operating the navigation area (Page 58)

Operating the data area (Page 62)

Language support in WinCC (Page 2338)

1.5.3 Operating the navigation area

1.5.3.1 Operating the navigation area

The navigation area

You access the navigation area of an editor or a structure level with the navigation bar.

The navigation area displays the tree view of the editor or the selected structure level. The associated data records of the element are displayed in the data area.

You can show or hide the navigation area by clicking the following buttons: 

Navigation bar

You start the available editors in the navigation bar using the respective button.

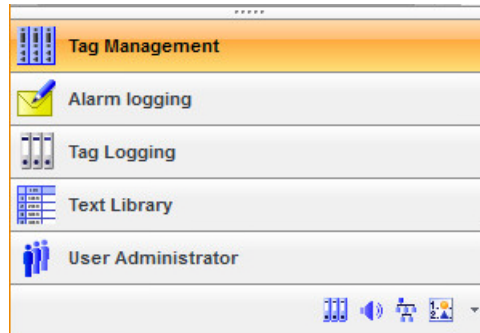

To start hidden editors, click on the corresponding symbol in the bottom part of the navigation bar.

Symbol	Editor
	Tag management
	Alarm Logging
	Tag Logging
	Text Library
	User Administrator
	User Archive
	Horn
	Picture Tree
	Text and graphics lists

Showing or hiding buttons in the navigation bar

You open the drop-down menu in the bottom part of the navigation bar to show or hide buttons in the navigation bar.

Procedure

1. Click on the symbol for the drop-down menu.



The drop-down menu opens.

2. To show buttons, select "Show additional buttons".
To hide buttons, select "Show fewer buttons".

Alternative procedure

Use the mouse to shift the separator line between the navigation bar and the tree view.

Opening an editor

Click the required editor in the navigation bar.

Alternatively, select "Open" from the shortcut menu.

Opening individual editors

You can open multiple editors in parallel in new windows.

1. Right-click on the required editor in the navigation bar.
2. Select "Open in new window" in the shortcut menu.

Releasing editors for other users

Multiple configuration engineers can work in the same WinCC project simultaneously. While a configuration engineer is working in an editor, this editor is locked for other users.

As soon as you open the WinCC Configuration Studio, all editors it includes are reserved for your job. To enable other users to work with WinCC editors that you do not need, you must release these editors individually.

1. Right-click on the editor in the navigation bar.
2. Select "Release" in the shortcut menu.
3. If necessary, close the editor.

The editor is released for other configuration engineers in the project.



For additional information on the joint working in a WinCC project, refer to "How to use multiuser engineering (Page 125)".

Tree view

Navigate in the structure of the editor to display data records or to create new structures.

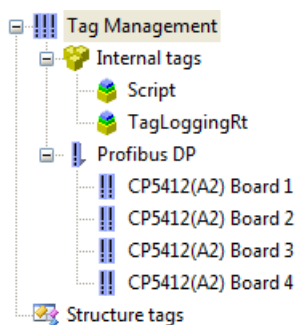
The structured display of the data records depends on the selected editor. The order of the elements in a structure cannot be changed in most editors.



Individual folders or structure levels of the tree view are expanded or collapsed by clicking the following buttons:  

You create lower-level elements mostly in the shortcut menu, for example, communication drivers or tag groups in Tag Management.

Depending on the editor, the shortcut menu of a structure contains additional functions.

Select all data records

To display all configured data records of the editor or the structure level in the data area, select the top element from the tree view, for example, "Tag Management".

This function records depends on the selected editor.

1.5.3.2 Copying, pasting and deleting data in the navigation area

Working in the navigation area

You can copy, paste, and delete elements in the tree view of the navigation area.

But you always copy or delete only one element. Multiple selection is not possible.

The behavior depends on the selected editor.

The procedure in the data area is described in section "Copying and pasting in the data area (Page 74)".

Copying and pasting an element in the tree view

When you copy a higher-level element, any elements it contains are not copied.

If necessary, copy the lower-level elements in a second step.

Procedure

1. To copy an element to the clipboard, select "Copy" in the shortcut menu of the element.
2. Select the higher-level element below which you want to paste the element.
3. Click "Paste" in the shortcut menu.

Alternative procedure

1. Select the element and then press the <Ctrl+C> key combination.
2. To paste the element, press the <Ctrl+V> key combination.

Deleting element from the tree view

Some elements cannot be deleted because they are always part of a WinCC project.

Procedure

To delete an element, click "Delete" in the shortcut menu of the element.

Alternative procedure

Select the element to delete in the tree view and press the key.

1.5.4 Operating the data area

1.5.4.1 Data area

The data area contains the data records of the WinCC project that are edited with the selected editor. A table cell is created for each data record.

The properties of a data record are shown in the table columns. The display and editing of a table cell depends on the data type of the property.

The structure and editing of the data area depends on the editor and the selected structure level.

Operator controls in the data area

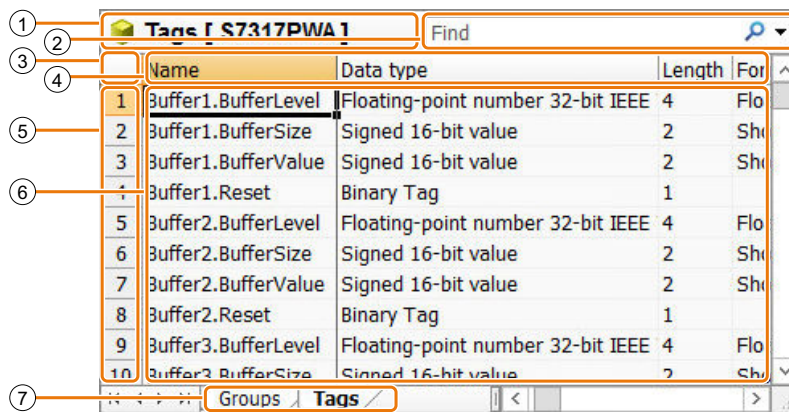

Number	Name	Description
①	Title of the data area	Indicates the structure element to which the displayed data records belong.
②	Search window	You filter the displayed data records with the "Search" field.
③	"Mark all" button	Click this button to select all displayed data records in the data area.
④	Column header	A table column, such as name or data type, is created for each configurable property of a data record. You right-click the column header to open the shortcut menu of the column. The shortcut menu offers, amongst other things, the following functions: <ul style="list-style-type: none"> • Hiding columns • Sorting data records • Filtering data records
⑤	Line number	Consecutive numbering of the lines. To export a line, click on the line number. This marks the entire line for editing.

Number	Name	Description
⑥	Data records in the table area	The data records and their properties are displayed. You create new data records as new row in the table area. You usually edit the properties of a data record in the "Properties" window. In the data area you edit the properties of multiple data records, for example, with autofill of cells or with Find and replace. To hide the data records, use the filter function and the quick search.
⑦	Tab	You use the tabs to display different types of data records in the data area.

Shortcut menus in the data area

You can open a shortcut menu for the following elements of the data area with the right mouse button:

- Search field
- Column headers
- Line numbers
- Data records

1.5.4.2 Shortcut menu of the table columns

Open the shortcut menu

Right-click the column header to open the shortcut menu for the column.

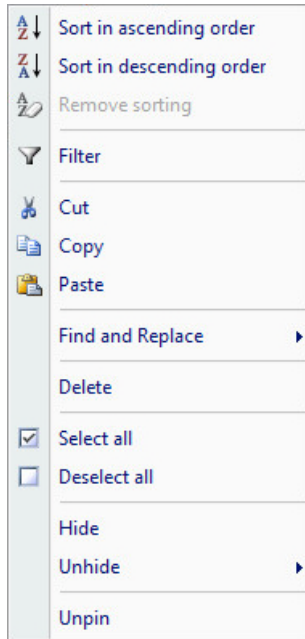

Functions in the shortcut menu

If the function is not available in the selected column, the entry is grayed out or hidden in the shortcut menu. When all columns are already shown, the entry "Unhide" may, for example, be grayed out.

Functions such as "Cut" are always active. If the function is not supported in a column, you will be notified by a message.

Function	Description
Sort in ascending order / Sort in descending order	Sorts the table after the selected column.
Remove sorting	Uses the original standard sorting of the table.
Filter	Only shows the data records with the properties selected in the filter. The other data records are hidden. To deactivate the filter, click on the entry "Filter" once again.
Filter only on first level	The option is only available when the table contains structured rows which can be collapsed and expanded. If this option is activated, the results from the subordinate rows are not considered in the filter.
Cut	Copies the content to the clipboard. All entries in the column are deleted without prompt.

Function	Description
Copy	Copies the content of a column to the clipboard. You can paste the copied content at a suitable point in the editor or export it to an external program, e.g. Excel.
Paste	Pastes the content of the clipboard to the column. You use this function, for example, to import properties of data records from another program.
Find and Replace	Enables finding and replacing of character strings in the column.
Delete	Deletes all entries in the column.
Select all / Deselect all	When the column contains check boxes, all cells are activated or deactivated.
Hide	The column is no longer displayed in the table area.
Unhide	Shows hidden columns once again. To show a column in the table area once again, activate the entry and click into any field. The hidden column is once again shown at the original position. You cannot change the order of the columns.
Pin / Unpin	The column and all columns shown to the left remain visible while scrolling horizontally. When pinning is canceled, all columns are moved to the left of the visible area once again.

1.5.4.3 Operating the data area

Cell types in the data area

The data area contains various cell types:

- Text input or text display
- Check box
- Drop-down list box

Cells can be edited, or are read only. There are two types of read only cells:

- Write-protected, e.g. automatically assigned ID
- Context-dependent write protection, e.g. address of internal tags

Working in the data area

The following options are available in the data area:

- Create new data records (Page 68)
- Edit data records:
 - Entering data in the text field (Page 69)
 - Data entry via drop-down list (Page 70)
 - Entering data via check box (Page 71)
 - Entering data via dialog (Page 73)
 - Automatic continuation ("drag-down") (Page 72)
 - Copy and paste (Page 74)
 - Undoing an action (Page 74)
- Importing data records (Page 99)
- Exporting data records (Page 97)
- Filtering data records (Page 86)
- Search and replace data records (Page 81)
- Change displayed columns (Page 64)

This scope of functions depends on the selected editor and the selected structure level.

Note

Changes visible immediately

All inputs and changes in the data area become effective immediately.

Editing has an immediate effect in runtime.

Delete in the data area

You can delete entire data records or only individual properties.

Select the entry "Delete" from the shortcut menu of the property. Alternatively, select the table cell and press the key.

To delete a data record, click the line number of the data record. The entire cell is selected. Choose the "Delete" entry from the shortcut menu of the line or press the key.

Note

Delete without prompt

Delete is effective immediately.

To undo a deletion, select the entry "Edit > Undo" in the menu.

1.5.4.4 Selecting cells, areas, rows and columns

Selecting cells and areas

To copy or edit data, select one or more cells in the data area. You can select cells, areas, lines, columns or all data in the data area.

Specific applications are described in the documentation of the corresponding editors.

Selecting cells in the data area

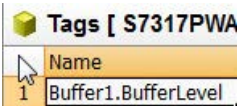
Selected area	Action
One individual cell	Mouse: <ul style="list-style-type: none"> Select the cell with a mouse click. Keyboard: <ul style="list-style-type: none"> To get to the desired cell, use the arrow keys.
Cell area	Mouse: <ol style="list-style-type: none"> Select the first cell of the area. Holding down the mouse button, drag the mouse pointer down to the last cell. Keyboard: <ol style="list-style-type: none"> Hold down the SHIFT key. To expand the selection, press the arrow keys or use the scroll bar.
Large cell area	Mouse: <ol style="list-style-type: none"> Select the first cell of the area. Hold down the SHIFT key. Select the last cell of the area. To get to the last cell quickly, use the scroll bar.
All cells in the data area	Mouse: <ul style="list-style-type: none"> Click the "Select All" button.  <p>Alternatively, select a cell in the data area and press <Ctrl+A>.</p>
Cells that are not next to each other	Mouse: <ol style="list-style-type: none"> Select the first cell. Hold down the <Ctrl> key while selecting additional cells. In most cases you can only select cells in the same column.

Selected area	Action
Columns	Mouse: <ul style="list-style-type: none">• Click on the column header. Selecting several columns: <ul style="list-style-type: none">• Hold down the <Ctrl> key while clicking additional column headers.• To select connected columns, drag while holding down the mouse button.
Lines	Mouse: <ul style="list-style-type: none">• Click on the line number. Selecting several lines: <ul style="list-style-type: none">• Hold down the <Ctrl> key while clicking additional line numbers.• To select connected lines, drag while holding down the mouse button.

1.5.4.5 Data entry in the data area

Create new data record

Creating elements

You can create new data records in the navigation area and in the table area.

The procedure depends on the selected editor and the selected structure level.

Note

Changes visible immediately

All inputs and changes in the data area become effective immediately.

Editing has an immediate effect in runtime.

Tag Management example

Using the tag group as an example, we are showing the options available for creating a new data record in the WinCC Configuration Studio.

Creating a group in the navigation area

Function	Procedure
Shortcut menu	<ol style="list-style-type: none"> 1. Select the entry "New group" in the shortcut menu of the connection. An empty field is displayed in the navigation tree under the connection. 2. Enter the name and confirm with <Enter>.
Copy and paste	<ol style="list-style-type: none"> 1. Copy a group in the navigation tree. 2. Select the connection in the navigation tree. 3. Add a copy of the group.
Importing data records	<ol style="list-style-type: none"> 1. Create a file in the suitable import format. Structure and procedure depend on the editor and the respective data records. 2. Select the "Edit > Import" menu command. The data records are created automatically.

Creating a group in the table area

Function	Procedure
Creating a line	<ol style="list-style-type: none"> 1. Click in the first input cell marked in yellow: ✖ 2. Enter the name in the table cell and confirm with <Enter>. <p>If lines have already been created in the data area, you can only create new lines at the end of the list. You can not insert new lines in between existing lines.</p>
Copy and paste a line	<ol style="list-style-type: none"> 1. To select the entire line, click on the line number. 2. Copy the line. 3. Click the line number of the next free line. 4. Add a copy of the line.
Continue cell automatically	<ol style="list-style-type: none"> 1. Click a tag group in the "Name" cell. 2. Drag the lower right corner of the frame down or up. 3. Copies of the tag group are created in the selected lines. Existing tag groups are overwritten in these lines. To restore overwritten tag groups, select the "Edit > Undo" menu command.
Importing data records	<ol style="list-style-type: none"> 1. Copy the data records from a different application to the clipboard, e.g. from an Excel table. 2. Click the line number of the next free line. Paste the copied data records.

Entering data in the text field**Working with text fields**

You use the text field to enter data in the data area.

Depending on the type of text field, the following entries are possible:

- Text including numbers and special characters
- Multi-line text
- Numbers only
- Numbers and possibly special characters, e.g.:
 - + and –
 - Decimal separator
 - "e" or "E" for exponential notation

Restrictions

Depending on the data record and field, restrictions may apply for the entry, e.g. ASCII character set.

These specifications are already checked during input. Any incorrect entries are rejected with a message.

Procedure

1. Double-click the table cell into which you want to enter text.
Alternatively, press the <F2> key.
2. Enter the text in the cell.
The text cursor is displayed during the input.



3. To complete the input, exit the table cell with <Enter> or click in a different cell.

Data entry via drop-down list

Working with drop-down lists

When a column only contains a defined list of properties, a selection list is usually offered.

In Tag Management, for example, select the property "Data type" in a drop-down list.

The drop-down list content may be context-specific. For example, only tag groups that are created under the selected connection are offered in the "Groups" column for tags.

Procedure

1. Select a table cell.
2. Click the icon  to open the drop-down list.
3. Select the entry from the drop-down list.

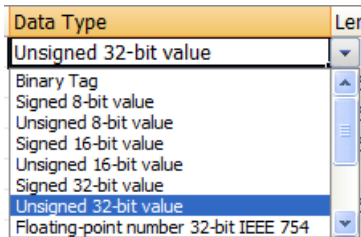

Entering data via check box

Working with check boxes

For properties that are only activated or deactivated, the table cell contains a check box, for example, the property "Flashing" for messages.

Click in the field to set the check mark or to remove the check mark.

<input checked="" type="checkbox"/>	Option selected
<input type="checkbox"/>	Option deselected

Select all / Deselect all

When you select an area in the table area which only contains check boxes, the commands "Select all" and "Deselect all" are available from the shortcut menu.

Procedure

Editing a checkbox

1. Select a table cell.
2. Click the check box with the mouse.
Alternatively, select or deselect the check box with the space bar.

Editing multiple check boxes

1. Select several check boxes that are next to each other.
2. Right-click in the selected area.
3. Select "Select all" or "Deselect all" in the shortcut menu.

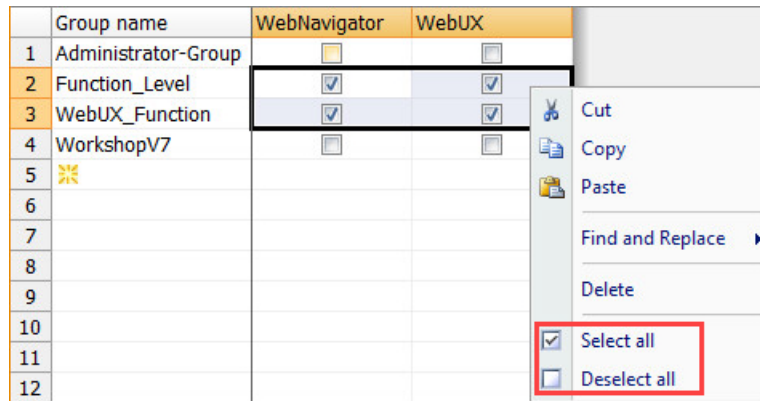

Alternatively, apply the setting of a check box by automatic continuation in neighboring cells. The procedure is described under "Automatic continuation ("drag-down") (Page 72)".

Automatic continuation ("drag-down")**Continue dragging cell content**

For fast filling of cells with data sets, select a cell and drag the small fill box.

Position the mouse pointer over the bottom right corner of a table cell. Transformation of the mouse pointer indicates that automatic continuation is available.

Behavior during automatic continuation

Automatic continuation is only possible within a cell.

The cells are automatically filled with the respective entry:

- Option boxes apply the selected option of the marked cell.
- A consecutive numbering is added to texts in table cells during automatic filling.
- Numeric values are incremented.

Note**Overwriting during dragging**

Existing contents are overwritten without prompt.

To restore overwritten contents, select the "Edit > Undo" menu command.

Procedure

1. Select the table cells for continuation.
2. Click the bottom right corner of the selection and hold down the left mouse button.



3. Drag the small fill box over the cells to be filled automatically and then release the mouse button.

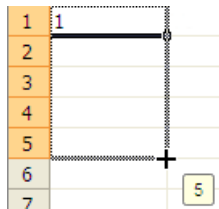

The table cells will be filled automatically with corresponding values.

Entering data via dialog

Cells with dialog call

You fill out some table cells with a dialog that is opened in addition. When you click in the corresponding cell, a symbol appears with which you can open the dialog: 

You can also partially configure these fields directly using the text input. An invalid input is rejected.

Design and content of a dialog depend on the selected editor from the selected structure level and the data type. For additional information, refer to the documentation of the respective editor.

Dialog types

There are basically two versions:

- Configuration dialog
Tag Management example:
The "Address" property depends on the communication driver to which the connection belongs. This means the tag address is configured in a separate dialog.
- Selection dialog
Alarm Logging example:
To connect a message to a tag, the tag selection dialog is opened in the "Message tag" column.

Procedure

1. Select a table cell.
The following symbol is displayed at the right margin of the cell: 
2. Click on the symbol.
A dialog box opens.

3. Configure the required settings.
4. To apply the input, close the dialog. In most cases, you use the "OK" button to do so.

Copying and pasting in the data area

Copy function

You may also copy and paste data records within WinCC Configuration Studio:

- Copy or cut contents from table cells and paste them to other table cells
- Copy entire table rows and paste into a new table row
- It is not possible to cut entire table rows from the data area.

The table cells for which this function is supported depends on the selected editor and the selected structure level.

Note

Overwriting and deleting without prompt

During pasting, the contents of a cell are overwritten without prompt.

During cutting, the contents of a cell are deleted without prompt.

Data exchange with third-party applications

The function enables the exchange with other programs, for example, text processing or spreadsheet programs.

You can, for example, copy a list of tag names from an Excel table to Tag Management.

Please note that not all fields permit copying from third-party applications.

Procedure

1. Select the cells or data records you want to copy.
2. Select "Copy" from the shortcut menu, or press <Ctrl+C>. To paste the data records from a third-party application to the clipboard, use the commands of the corresponding program.
3. Click the position in the data area where you want to paste the copied contents.
4. Select "Paste" from the shortcut menu, or press <Ctrl+V>. To paste the clipboard content to a third-party application, use the commands of the corresponding program.

Undoing an action

You can undo most inputs and delete processes in the data area.

Restrictions

- You cannot undo some of the edits you have made. See the documentation for the respective editor. If necessary, test the behavior before you delete or overwrite data.
- All editing steps are completed when you close the WinCC Configuration Studio. When you open it again, only the functions "Undo" and "Redo" are possible for the new editing steps.

Undo editing

- Select the "Edit > Undo" menu command.
- Alternatively, press the key combination <Ctrl+Z>.

Redo editing

You can restore edits you have undone or redo edits:

- Select the "Edit > Redo" menu command.
- Alternatively, press the key combination <Ctrl+Y>.

1.5.4.6 Sorting in the data area

You can resort the data in the table area by the content of a table column.

Sorting always applies to one structure level only. When switching between editors, sorting is retained until you close the WinCC Configuration Studio.

Types of sorting

You can only sort by table column. Staggered sorting is not possible. If necessary, you can also use the filter function.

Sorting depends on the data type of the sorted column.



Data type	Sorting
Text	Alphabetically ascending or descending
Numbers	Numerical values are treated separately in the sorting order. This ensures that the numeral 1 is followed by the numeral 2, and not the numeral 10, in a sorted column: <ul style="list-style-type: none"> • Ascending from lowest to highest number • Descending from highest to lowest number
Date/time	Ascending or descending by topicality

Remove sorting

To undo sorting, select the entry "Remove sorting" in the shortcut menu of the table column.

Sorting is reset in all editors when you close the WinCC Configuration Studio.

Procedure

1. Right-click the header of the column where sorting is to take place.
2. Select the sorting option from the shortcut menu.
 - Ascending sorting order 
 - Descending sorting order 

Alternatively, double-click the column header for sorting. To reverse the sort order, double-click again.

Result

The column representing the sorting order origin is marked by an arrow symbol next to the column header.



See also

Filtering using the filter list box (Page 86)

1.5.4.7 Search / replace in the data area

Fast search in data area

Search function

You filter the displayed lines in the data area for the character string you are looking for with the "Search" field.

The search for the search text is for a connected character string. The character string can be at any location.



Behavior during quick search

Restrictions:

- Search text input is not case sensitive.
- Logic combination of multiple search terms is not possible (Boolean Operators, e.g. "OR").
- Wildcards are not supported: * (asterisk) or ? (question mark)
No results will be displayed when you use * or ? as truncation symbols.

Displaying results:

- Matches are highlighted in color when you enter the search text.
- Data records that mismatch your entry are hidden.

Browsed fields

Quick search only searches in table columns that contain the major identification characteristic of the data record.

In most cases this is the name of the data record or the first table column.

Examples from some editors:

- Tag Management: Tag name, group name, connection name
- Alarm Logging: Message number, message tag, message group
- Tag Logging: Archive name, name of the process tag
- Text Library: All text columns
- User Administrator: Group name, user name, authorization
- User Archive: Archive name, field name, name of the view, column name
- Picture Tree: Picture name

To browse a different column, select the advanced quick search.

Procedure

1. Click in the search box in the title bar of the data area.
2. Enter a search term.
Only the lines that contain the character string you are looking for are displayed.

	Name	Data type	Group
1	@S7Plus_TCP_01@ConnectionState	Binary Tag	@S7Plus_TCP_01
2	@S7Plus_TCP_01@ForceConnection\$	Unsigned 32-bit va	@S7Plus_TCP_01
3	Components_data_Conbar_Current_V	Floating-point numr	
4	Components_data_Conbar_Soll_Weig	Floating-point numr	
5	Components_data_Conbar_Temp_cu	Floating-point numr	
6	Components_data_Conbar_Temp_Cu	Floating-point numr	
7	Components_data_Conbar_Temp_Cu	Floating-point numr	
8	Components_data_Conbar_Temp_ou	Floating-point numr	
9	Components_data_Conbar_Temp_Sc	Floating-point numr	
10	Components_data_Conbar_Temp_Sc	Floating-point numr	
11	Components_data_Conbar_Temp_Sc	Floating-point numr	
12	Components_data_M3_Comp_conden	Unsigned 16-bit va	
13	Components_data_M3_Comp_conden	Unsigned 16-bit va	
14	Components_data_M3_Comp_conden	Unsigned 16-bit va	
15	Components_data_M3_Comp_conden	Unsigned 16-bit va	
16	Components_data_M3_Comp_conden	Unsigned 16-bit va	
17	M3_Comp_condMilk_Motor	Unsigned 16-bit va Mixer3	

3. You can deactivate the search by deleting the entry and clicking the icon in the search field.
Alternatively, deactivate the search with the <Esc> key.
All lines are once again visible in the data area.

Advanced quick search in data area

Refine quick search

To refine the search in the data area, open the search options using the button next to the search field.

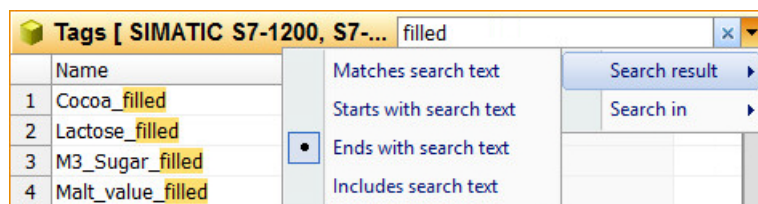

Browsing in table columns

Use "Search in" to select the columns in which you want to conduct the search. The first column is selected by default.

Alternatively, select the command "Find and replace > Find" or "Find Next" in the shortcut menu of a column.

Limiting search results

You can select the following search options:

Search result	Description
Matches search text	A table cell contains exactly the text you have entered.
Begins with search text	The content of a table cell starts with the entered text.
Ends with search text	The content of a table cell ends with the entered text.
Contains search text	The entered text is included in the text of the table cell. The cell can include additional text before and/or after the entered text. This search option is set by default.

Procedure

1. Open the search menu with the following symbol: 
2. Select the search option required:

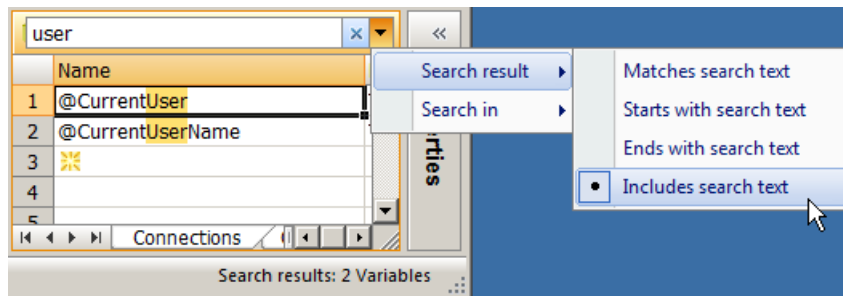

3. Enter a search term.
You can, for example, display all tags that contain the string "user".
Only the lines that contain the character string you are looking for are displayed.
4. You can deactivate the search by deleting the entry and clicking the  icon in the search field.
Alternatively, deactivate the search by clicking in the search field and pressing the <Esc> key.
The search text is deleted and all lines are once again visible in the data area.

See also

- Fast search in data area (Page 76)
- Search and replace in the data area (Page 81)
- Extending strings with prefixes and suffixes (Page 84)

Search with the "Find and Replace" dialog

Opening the "Find and Replace" dialog

To open the "Find and Replace" dialog, click in a table cell and press <Ctrl+F>.

Alternatively, select the "Find and Replace > Find" command in the shortcut menu of the data area.

While the dialog is open, you can continue working in the data area.

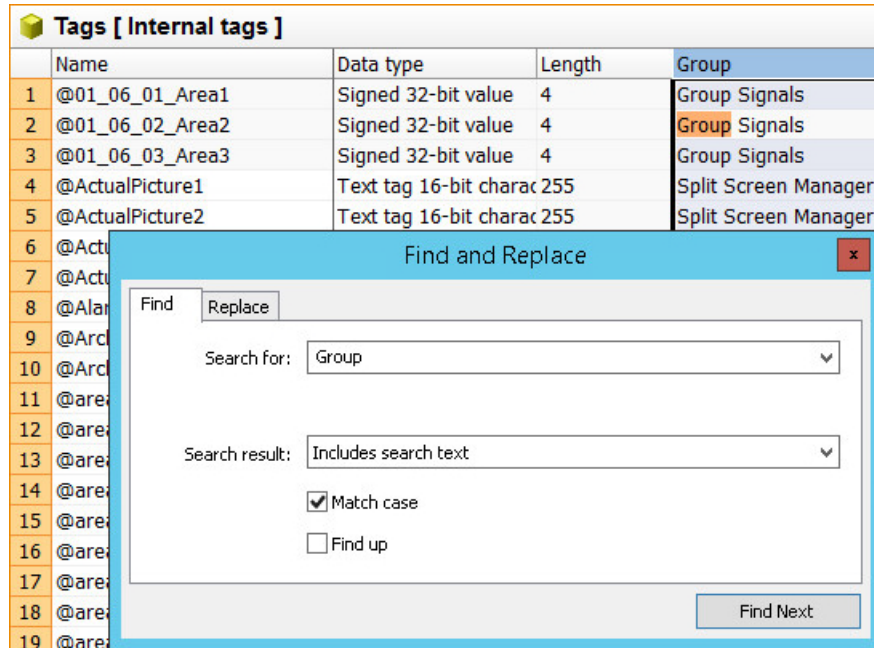

Behavior during advanced search

Search behavior:

- When you click on a column header or a line number, the search is limited to the selected column or line.
- While the dialog is open, you can change the search area and select a different column or all data records, for example.
- The text from the selected table cell is automatically applied in the search field when you open the dialog.
The text from selected table cell is applied to a search area.
- The data records are searched in descending order by default.
To search the data records in ascending order, select the "Find up" option.

Restrictions:

- The search is only case-sensitive when you select the "Match case" option button.
- Logic combination of multiple search terms is not possible (Boolean Operators, e.g. "OR").
- Wildcards are not supported: * (asterisk) or ? (question mark)
No results will be displayed when you use * or ? as truncation symbols.

Displaying results:

- Matches are highlighted in color when you enter the search text.
- Unlike with quick search, all table rows remain visible.
- Use "Find Next" to jump to the next table cell that was found.
The next field that contains the text you are looking for is selected.

Limiting search results

You can select the following search options in the "Search result" field:

Search result	Description
Matches search text	A table cell contains exactly the text you have entered.
Begins with search text	The content of a table cell starts with the entered text.
Ends with search text	The content of a table cell ends with the entered text.
Contains search text	The entered text is included in the text of the table cell. The cell can include additional text before and/or after the entered text. This search option is set by default.

Procedure

1. Select the range of cells you want to search.
If the entire data area is to be searched, click on any cell.
2. Open the "Find and Replace" dialog with the <Ctrl+F> key combination.
3. Select the desired option under "Search result".
4. If necessary, activate the option "Match case".
5. Enter the text you are looking for in the "Search for" field.
Alternatively, select a search text you have used before in the "Search for" drop-down list.
6. Start the search with <Enter>.
To skip, click "Find next".
The cell containing the next match found is marked. Matches are highlighted in color.
7. To change the search direction, select the "Find up" option.
8. Click the "x" symbol in the top right-hand corner to close the dialog.
Alternatively, close the dialog with the <Esc> key.

Search and replace in the data area

Opening the "Find and Replace" dialog

To open the "Find and Replace" dialog, click in a table cell and press <Ctrl+H>.

Alternatively, select the "Find and Replace > Replace" command in the shortcut menu of the data area.

While the dialog is open, you can continue working in the data area.

Note

Changes visible immediately

All inputs and changes in the data area become effective immediately.

Editing has an immediate effect in runtime.

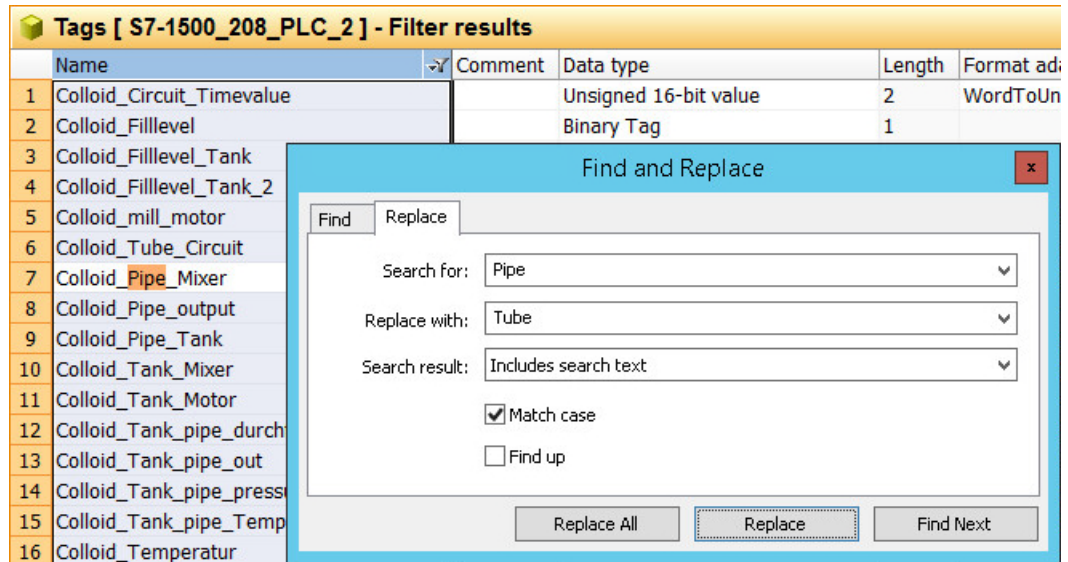

Search area

The current selection in the data area specifies the location for the search and replace operation:

- Select any cell to run the search in all data records.
- Click on the column header to search in a table column.
- Click on the row number to search in a table row.
- To search in a specific area, select all cells of this area.
For information on selection in the data area, refer to "Selecting cells, areas, rows and columns (Page 67)".
- The data records are searched in descending order by default.
To search the data records in ascending order, select the "Find up" option button.

Behavior during Find and Replace

Search behavior:

- When you click on a column header or a line number, the search is limited to the selected column or line.
- While the dialog is open, you can change the search area and select a different column or all data records, for example.
- The text from the selected table cell is automatically applied in the search field when you open the dialog.
The text from selected table cell is applied to a search area.

Restrictions:

- The search is only case-sensitive when you select the "Match case" option button.
- Logic combination of multiple search terms is not possible (Boolean Operators, e.g. "OR").
- Wildcards are not supported: * (asterisk) or ? (question mark)
No results will be displayed when you use * or ? as truncation symbols.

Displaying results:

- Matches are highlighted in color when you enter the search text.
- Unlike with quick search, all table rows remain visible.
- Use "Find Next" to jump to the next table cell that was found.
The next field that contains the text you are looking for is selected.
- Use "Replace" to jump to the next table cell that was found.
The text in the cell is replaced.
- A click on "Replace all" replaces all matches without prompt.
The number of replacements is displayed in a message.

Search settings

You can select the following search options in the "Search result" field:

Search option	Description
Matches search text	A table cell contains exactly the text you have entered.
Begins with search text	The content of a table cell starts with the entered text. Use this setting to insert a prefix when replacing.
Ends with search text	The content of a table cell ends with the entered text. Use this setting to insert a suffix when replacing.
Contains search text	The entered text is included in the text of the table cell. The cell can include additional text before and/or after the entered text. This search option is set by default.

Advanced settings

The "Search for" and "Replace with" boxes allow you to enter special text, such as control characters or Asian characters.

Click in the box and select the desired setting in the shortcut menu:

Entry	Description
Right to left reading order	The writing direction runs from right to left.
Show Unicode control characters	Show or hide the entered control characters.
Insert Unicode control characters	List of control characters that mainly support the entry of non-Latin fonts.
Start IME / close IME	Input of characters from non-Latin fonts using the Windows Input Method Editor (IME).
Convert back	Conversion of characters back into Latin font.

Procedure

1. Select the range of cells you want to search.
If the entire data area is to be searched, click on any cell.
2. Open the "Find and Replace" dialog with the <Ctrl+H> key combination.
3. Select the desired option under "Search result".
4. If necessary, activate the option "Match case".
5. Enter the text you are looking for in the "Search for" field.
Alternatively, select a search text you have used before in the "Search for" drop-down list.
6. Enter the string that is to replace the search result in the "Replace with" field.
If the string in the "Search for" field is to be deleted, leave the "Replace with" field blank.
7. Click "Find next" to search for the next match.
The cell containing the next match found is marked. Matches are highlighted in color.
8. Click "Replace" to replace only the marked match.
9. Click "Replace all" to replace all matches.
10. Click the "x" symbol in the top right-hand corner to close the dialog.
Alternatively, close the dialog with the <Esc> key.

See also

Fast search in data area (Page 76)

Advanced quick search in data area (Page 78)

Extending strings with prefixes and suffixes (Page 84)

Extending strings with prefixes and suffixes

Inserting suffixes and prefixes using "Find and Replace"

You can use this function, for example, to insert a server prefix in front of multiple tag names.

You can use this function in all fields that allow the entry of free text or numbers.

Select the following search options:

Search option	Effects
Begins with search text	Use this setting to insert a prefix.
Ends with search text	Use this setting to insert a suffix.

Procedure

- Select the cells in which you want to change the string.
To do this, select a contiguous range of cells that contain equivalent information.
For information on selection in the data area, refer to "Selecting cells, areas, rows and columns (Page 67)".
- Open the "Find and Replace" dialog with the <Ctrl+H> key combination.

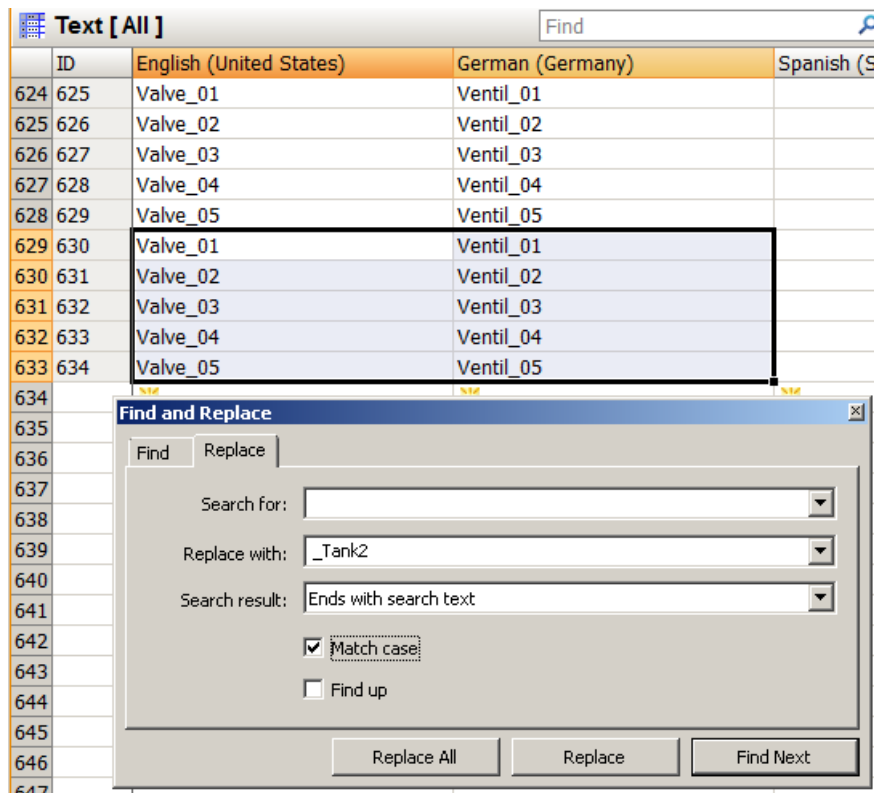

- Leave the "Search for" box empty.
- In the "Replace with" box, enter the string that is to be added as prefix or suffix.

5. Select the desired option under "Search results".
 - Insert prefix before the existing string: "Starts with search text"
 - Insert the suffix at the end of the existing string: "Ends with search text"
6. To extend the strings in all selected cells, click "Replace All".

ID	English (United States)	German (Germany)
625	Valve_01	Ventil_01
626	Valve_02	Ventil_02
627	Valve_03	Ventil_03
628	Valve_04	Ventil_04
629	Valve_05	Ventil_05
630	Valve_01_Tank2	Ventil_01_Tank2
631	Valve_02_Tank2	Ventil_02_Tank2
632	Valve_03_Tank2	Ventil_03_Tank2
633	Valve_04_Tank2	Ventil_04_Tank2
634	Valve_05_Tank2	Ventil_05_Tank2

When you click "Replace", only the string in the first selected cell is extended.

See also

Search and replace in the data area (Page 81)

Advanced quick search in data area (Page 78)

Selecting cells, areas, rows and columns (Page 67)

1.5.4.8 Filtering in the data area

Filtering using the filter list box

Filter function

You can set a filter for each column of the data area. You open the filter function using the context menu of the respective table column.

You use the filter list box to set the filter criterion. The filter list box lists all cell contents of the respective table column.

Depending on the data type of the table column, the shortcut menu offers additional filter criteria:

- Text filter (Page 88)
- Number filter (Page 91)
- Date filter (Page 93)

Behavior during filtering

Restrictions:

- No distinction is made between upper and lower case.
- Wildcards are not supported: * (asterisk) or ? (question mark)
No results will be displayed when you use * or ? as truncation symbols.

Displaying results:

- Table cells that do not match the filter criteria are hidden.
- The Filter symbol is displayed in the header of the filtered table column: 
- To change the filter settings, click the filter symbol in the column header.
The shortcut menu of the column is displayed with the current settings.
- To further restrict a filtered data area, select additional filters in the other table columns.
- The filter setting applies to one structure level only.
- The filter setting is retained when switching between editors until you close the WinCC Configuration Studio.

Filter only on first level

In some editors, the table can contain structured rows. Additional rows under a row can be expanded and collapsed using an arrow.

The "Filter only on first level" option is then displayed in the shortcut menu.

If you activate the option, the contents of the subordinate rows are not considered for filtering. Only the contents of the higher-level rows are filtered.

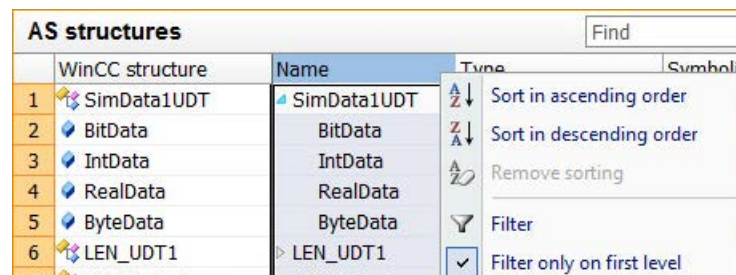

Deactivating a filter

To deactivate a filter, click the "Filter" command in the shortcut menu of the table column.

To deactivate all filters, select the entire data area and click the "Filter" command in the shortcut menu.

The filters in all included editors are reset when you close the WinCC Configuration Studio.

Procedure

1. Right-click the column header to open the shortcut menu.
2. Click "Filter".

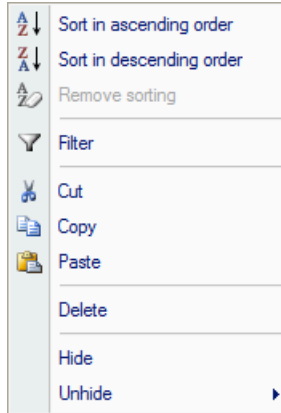

3. To select the criteria by which you want to filter the table column, activate the corresponding check boxes.

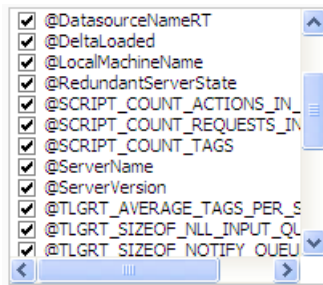

4. To activate the filter, click "OK".

See also

Sorting in the data area (Page 75)

Filtering by means of text filter

Advanced filtering with the text filter is possible in table columns with the data type "Text".

Text filter options

The filter options open a second window in which you can enter the text for which you want to filter.

If you are selecting a negation, e.g., "Does not correspond to" or "Does not contain", the lines with the text you have entered are hidden.

Filter option	Description
Corresponds to... Does not correspond to...	The table cell contains exactly the text you have entered.
Starts with... Ends with...	The content of a table cell starts or ends with the entered text.
Contains... Does not contain...	The entered text is included in the text of the table cell. The cell can include additional text before and/or after the entered text.
User-defined filter	<p>In the "User-defined filter" you can combine two different filter criteria with "And" or "Or".</p> <p>The following options are available in addition to the filter options of the shortcut menu:</p> <ul style="list-style-type: none"> • Text filter: <ul style="list-style-type: none"> – Does not start with – Does not end with • Numerical filters: <ul style="list-style-type: none"> – Larger than – Larger than or equal to – Smaller than – Smaller than or equal to

Procedure

1. Select a column header and click the "Filter" shortcut menu command.
2. Select the desired option under the "Text filter" entry, for example " Ends with".

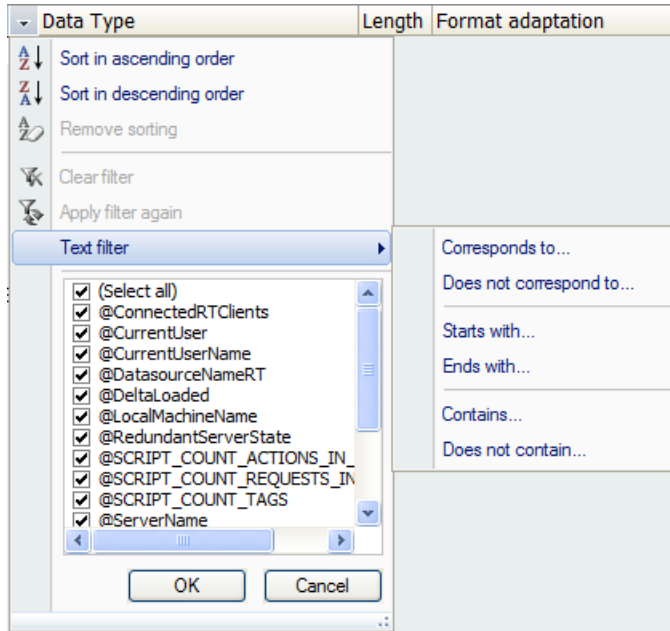

An input window opens.

3. Enter the required filter text.

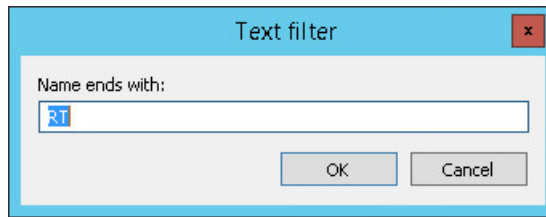

To combine multiple search criteria, use the text filter "User-defined filter":

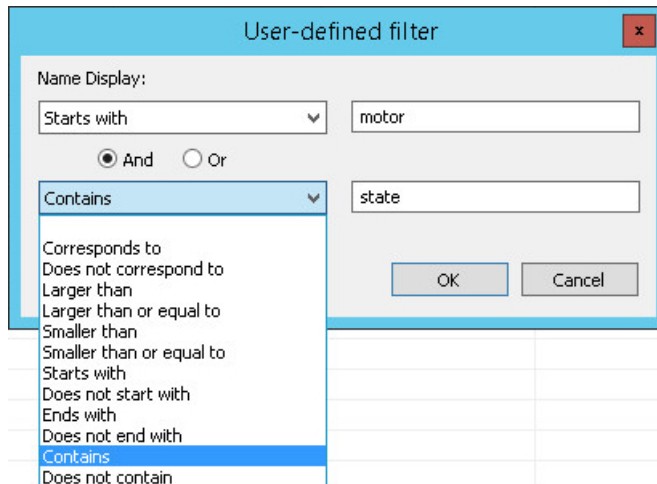

4. To activate the filter, click "OK".

Filtering by means of number filter

Advanced filtering with the number filter is possible in table columns with numerical data types.

Number filter options

The filter options open a second window in which you can enter the values for which you want to filter.

If you are selecting a negation, e.g., "Is not equal to", the lines with the value you have entered are hidden.

Filter option	Description
Is equal to Is not equal to	The table cell contains exactly the value you have entered.
Larger than Larger than or equal to	The value of a table cell is larger than the entered value or is equal to the value.

Filter option	Description
Smaller than Smaller than or equal to	The value of a table cell is smaller than the entered value or is equal to the value.
User-defined filter	<p>In the "User-defined filter" you can combine two different filter criteria with "And" or "Or".</p> <p>The following options are available in addition to the filter options of the shortcut menu:</p> <ul style="list-style-type: none"> • Starts with... • Does not start with • Ends with... • Does not end with • Contains... • Does not contain...

Procedure

1. Select a column header and click the "Filter" shortcut menu command.
2. Select the desired option under the "Number filter" entry, for example, "Smaller than or equal to".

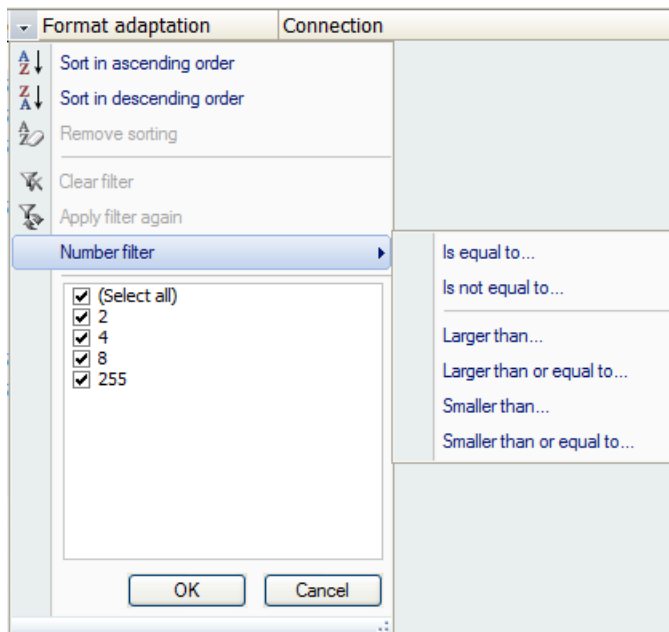

An input window opens.

3. Enter the required value.

To search for two different values or a value range, use the number filter "User-defined filter":

4. To activate the filter, click "OK".

Filtering by date

Advanced filtering with the date filter is possible in table columns with the data type "Date" or "Time".

Number filter options

The filter options open a second window in which you can enter the values for which you want to filter. Note the date format of the selected input language during input.

If you are selecting a negation, e.g., "Is not equal to", the lines with the value you have entered are hidden.

Filter option	Description
Is equal to	The table cell contains exactly the date you have entered.
Smaller than	Earlier: The date in the table cell is an earlier date than the one entered.
Larger than	Later: The date in the table cell is a later date than the one entered.
Today	The date in the table cell matches the selected time period based on the current date:
Yesterday	The current date or the day before is displayed.

Filter option	Description
This week Last week	The date in the table cell matches the selected time period based on the current date: The last seven days or the seven days before then are displayed.
User-defined filter	In the "User-defined filter" you can combine two different filter criteria with "And" or "Or". The following options are available in addition to the filter options of the shortcut menu: <ul style="list-style-type: none"> • Is not equal to • Larger than or equal to • Smaller than or equal to • Starts with... • Does not start with • Ends with... • Does not end with • Contains... • Does not contain...

Procedure

1. Select a column header and click the "Filter" shortcut menu command.
2. Select the desired option under the "Date filter" entry, for example, "Larger than".

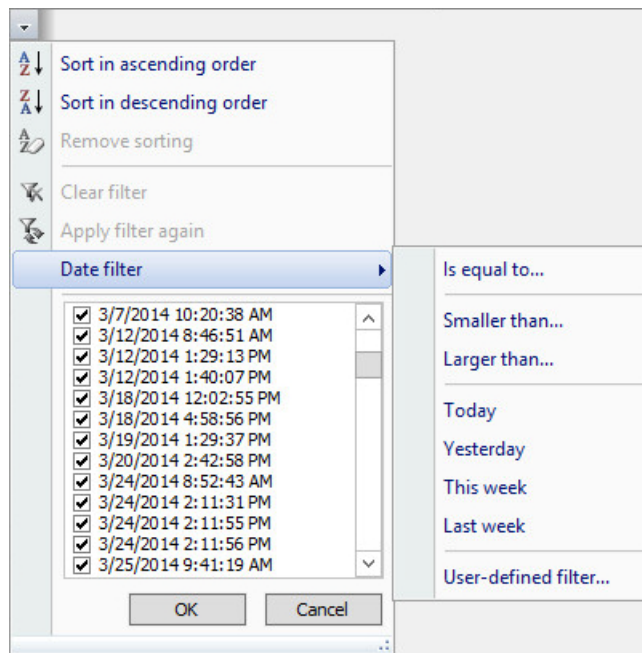

An input window opens.

3. Enter the required date in the correct format.
When the input language "English (USA)" is selected in the WinCC project, use the following date format:
 - MM/DD/YYYY hh:mm:ss AM/PM

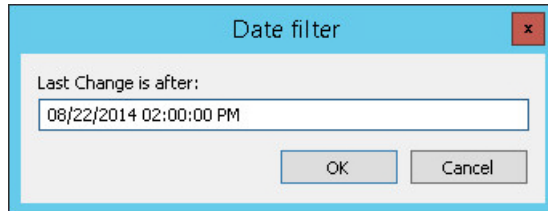

To filter a time range, for example, use the date filter "User-defined filter":

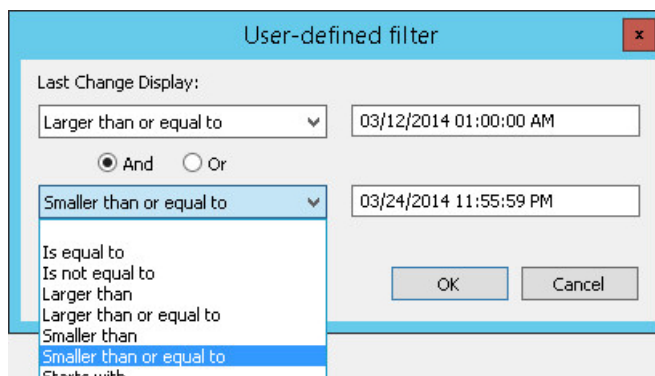

4. To activate the filter, click "OK".

1.5.4.9 Using macros

You can create your own VBA macros for the editors of the WinCC Configuration Studio in the WinCC project.

By using macros, you automate frequently occurring editing steps, for example, creating tags in Tag Management.

To create a VBA macro for the Configuration Studio, select "Tools > Visual Basic Editor" in the menu bar. You can find additional information under "Working with WinCC > VBA for automatic configuring":

- VBA in the WinCC Configuration Studio
- Example VBA907: VBA in the WinCC Configuration Studio

Display macros

The "Macros" dialog contains a list of VBA scripts that were created for the Configuration Studio.

To open the dialog, select "Tools > Macros" in the menu bar.

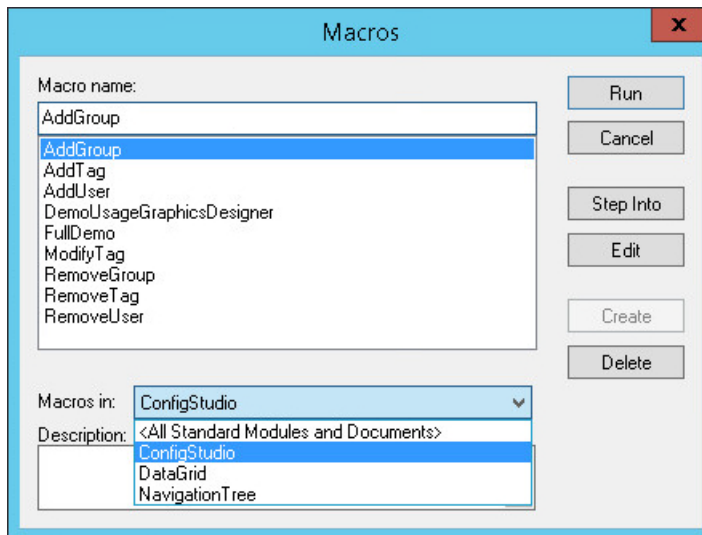

"Macros" dialog

Function	Description
Macros in	Select an entry in the drop-down list to show the corresponding macros. To show all macros, select "All Standard Modules and Documents".
Run	Starts the selected macro Alternatively, double-click the macro in the "Macro name" field.
Edit	Opens the script in the Visual Basic Editor.
Step Into	Opens the script in the Visual Basic Editor and runs the macro step-by-step.
Delete	Deletes the selected macro
Description	You can add a description of the macro.

1.5.5 Using the "Properties" window

The "Properties" window

When you select an element in the navigation area or in the data area, the detailed information is displayed in the "Properties" window:

- Properties of a structure element: Select the entry in the navigation area in the tree view.
- Properties of a data record: Click any cell of the associated table row in the data area.

You can edit the properties that are not write-protected or defined by the system. Unlike in the table area, you can only edit one element at a time.

This scope of functions depends on the selected editor and the selected structure level.

You can show or hide the "Properties" window by clicking the following buttons: << >>

Working in the "Properties" window

Editing of the properties is similar to working in the data area. Depending on the data type, you have the following options:

- Entering data in the text field
- Entering data via drop-down list
- Entering data via check box
- Entering data via dialog
- Copy and paste
- Undoing an action

The editing of properties partially depends on the context. You can, for example, only specify a "Substitute value at low limit" when you have configured a low limit.

For additional information, see "Data entry in the data area (Page 68)" and refer to the documentation of the respective editor.

Note



Changes visible immediately

All inputs and changes in the data area become effective immediately.

Editing has an immediate effect in runtime.

Property groups

For a better overview, the properties can be arranged in groups.

To hide or show property groups, click the following buttons:  

"What's This?" for the property

Click on the name of the property, the input field or the property group.

A description of the property or property group is shown in the 'What's This?' window.

1.5.6 Exporting data records

Data export

During the export, the data records are stored in a structure that can be imported again. During copying, only the selected data is copied to the clipboard.

You use the export of data records in the following cases:

- You want to use data records in another WinCC project.
- You want to edit data records in an external application, for example, for translation of texts in the Text Library.

Information on importing exported files is available under "Importing data records (Page 99)".

The function depends on the selected editor and the selected structure level. For additional information, refer to the documentation of the respective editor.

Scope of export

You can start the export in the navigation area or in the data area.

- **Navigation area:**
All data records or the data records of the selected structure level are exported.
The data records are stored in a structure that supports import in WinCC or another SIMATIC product.
- **Data area:**
The contents of the selected table cells are exported.
For information on selection in the data area, refer to "Selecting cells, areas, rows and columns (Page 67)".

Export format

The exported data is saved in a file. You can choose from the following file formats:

- Unicode text (*.txt)
- Excel workbook (*.xlsx)
Separate spreadsheets are created for different data types.

Procedure

1. Select the required data records in the data area.
To export all data records of a structure element, select the required element in the navigation area.
2. Select the "Edit > Export" menu command.
The "Export" dialog opens.
3. Select the storage location and enter a file name.
4. Select the required file format.
5. Click "Export" to close the dialog.

Result

A progress bar indicates writing of the data records.

A statistics of the exported data is displayed after the export.

1.5.7 Importing data records

Data import

You import data records from third-party applications or other WinCC projects in the WinCC Configuration Studio.

The file structure must be analogous to the WinCC database structure. This means you usually only import files that were created by an export from WinCC or another SIMATIC product. You can find information about the export from WinCC at "Exporting data records (Page 97)".

The function depends on the selected editor and the selected structure level. For additional information, refer to the documentation of the respective editor.

NOTICE

Changing the WinCC database

If necessary, existing data records are overwritten during the import.

You cannot undo the import of data records.

Import format

The following file formats are supported:

- Unicode text (*.txt)
- Excel workbook (*.xlsx)
- TIA Portal export file (*.xlsx)
Data records from TIA Portal projects, such as tag tables, messages and text lists, can also be imported offline.
- ConfigTool file (*.xlsx)

Diagnostics data

A statistics of the imported data is displayed after the import.

A log file is created and linked in the statistics window if an error occurred during the import. The log file is located in the same folder as the import file.

Requirements

- The data records you load may not be in use by any other application.
- Depending on the editor, structure levels that are contained in the data records must have already been created in the WinCC project.
Example: The corresponding communication drivers and connections for the tag import must be created in the Tag Management.

Procedure

1. Select the required editor in the navigation area.
2. Select "Import" from the shortcut menu of the editor.
The "Select file" dialog opens.
3. Select the file to import.

Result

A progress bar indicates loading of the data records.

A statistics of the imported data is displayed after the export.

If necessary, a log file is created in the storage path of the imported file.

1.5.8 Drag&Drop in the WinCC Configuration Studio

1.5.8.1 Drag&Drop within the Configuration Studio

Introduction

Drag-and-drop functionality simplifies your work configuring WinCC in the WinCC Configuration Studio:

- Moving selected data within an editor and between the editors
- Inserting tags created in Tag Management in the "Tag Logging" and "Alarm Logging" editors
- Configuring message groups in "Alarm Logging"

Drag-and-drop selected data into a column of the table area

Drag-and-drop within an editor in the Configuration Studio

1. Select one or more rows in a column in the table area.
2. Move the mouse to the edge of the selection rectangle.
The cursor changes from a "+" to a cross.
3. Hold down the left mouse button while dragging the selected data to the destination.
4. Release the mouse button in the cells at the destination.
The selected data is entered at the destination and removed at the source.

Drag-and-drop within an editor in the Configuration Studio

For an example of the procedure, tags from the Tag Management are inserted as message tags in Alarm Logging.

1. Select one or more rows in the "Name" column in the table area of the in Tag Management.
2. Move the mouse to the edge of the selection rectangle.
The cursor changes from a "+" to a cross.

3. Hold down the left mouse button while dragging the tag selection in the navigation area to the "Alarm Logging" entry.
4. Stay at least two seconds on the entry in the navigation area until the "Alarm Logging" editor opens.
5. Drag the tag selection in the "Message tag" column to the rows in which you want to use the tags.
If the columns or rows of the destination are not displayed in the editor, drag the mouse to the edge of the table display to scroll to the destination.
6. Release the mouse button at the destination.
The tag selection is entered at the destination.
The tags are now defined as message tags for the selected messages.
If the data used at the destination do not meet the requirements of the input values, an error message appears and the data are not accepted.

Drag-and-drop tags into the editors

Creating messages in Alarm Logging

1. Select one or more rows in the table area of Tag Management.
2. Move the mouse to the edge of the selection rectangle.
The cursor changes from a "+" to a cross.
3. Hold down the left mouse button while dragging the tag selection to the destination.
4. Stay at least two seconds on the "Alarm Logging" entry in the navigation area until the editor opens.
5. Drag the tag selection in the navigation area onto one of the entries of the messages.
If you want to drag the tags to a subentry of a tree, keep your mouse briefly on the tree until the subentries are displayed.
6. Release the mouse button at the destination.
The tag selection is entered at the destination.
New messages are created and added tags are used as message tags.
The message class and message type are used for the message, in which you have added the tag selection.
When you insert the tag selection into a higher-level message class or a message class with multiple message types, the first available message class or message type is used for the newly created message.

Creating archive tags in Tag Logging

1. Select one or more rows in the table area of Tag Management.
2. Move the mouse to the edge of the selection rectangle.
The cursor changes from a "+" to a cross.
3. Hold down the left mouse button while dragging the tag selection to the destination.
4. Stay at least two seconds on the "Tag Logging" entry in the navigation area until the editor opens.

5. Drag the tag selection in the navigation area to one of the created process value archives. If only the tree with all archives is displayed, keep your mouse briefly on the tree until the individual archives are displayed.
6. Release the mouse button at the destination.
The tag selection is entered at the destination.
New archive tags are created in the process value archive and connected to the added tags.

Creating compressed tags in Tag Logging

1. Select one or more rows in the table area of a process value archive.
2. Move the mouse to the edge of the selection rectangle.
The cursor changes from a "+" to a cross.
3. Hold down the left mouse button while dragging the tag selection to one of the created compressed archives in the navigation area.
4. Release the mouse button at the destination.
The tag selection is entered at the destination.
New compressed tags are created and are used as source tags with the dragged tags.

Configuring the message groups in "Alarm Logging"

1. Select a message group in the navigation area.
2. Hold down the left mouse button while dragging the selected message group to another message group.
The message group is moved to the destination message group.
3. Hold down the left mouse button and "Alt" key while dragging the selected message group to another message group.
The message group is moved to the same level as the destination message group.

See also

Drag-and-drop from the Configuration Studio to other applications (Page 109)

Drag-and-drop to WinCC controls (Page 102)

Drag-and-drop to smart objects (Page 107)

1.5.8.2 Drag-and-drop from the Configuration Studio to the Graphics Designer

Drag-and-drop to WinCC controls

Introduction

Drag-and-drop functionality simplifies your work configuring WinCC controls in the Graphics Designer.

You can create WinCC controls or add or change trends or columns in WinCC controls already configured.

You can use the following data from the WinCC Configuration Studio:

- Tags from Tag Management
- Tags of an archive or compressed archive from Tag Logging
- Archives and views from a user archive
- Fields from archives and columns of views of a user archive

Note

After configuring or creating a WinCC control using drag-and-drop, the configuration cannot be reversed using the "Undo" menu command in the Graphics Designer.

Requirement

- WinCC Configuration Studio is open.
- The Graphics Designer is opens with a picture.

Creating WinCC controls**With tags from Tag Management**

1. Select one or more rows in the table area of Tag Management.
2. Move the mouse to the edge of the selection rectangle.
The cursor changes from a "+" to a cross.
3. Hold down the right mouse button while dragging the tag selection to an empty area of a picture in the Graphics Designer.
4. Release the mouse button in the picture.
A shortcut menu is displayed in the Graphics Designer.
5. Select a control in the lower area of the shortcut menu.
The control created contains the trends or columns with a data connection depending on the selected tags in Tag Management.
You can only insert a WinCC FunctionTrendControl if you have selected two tags in Tag Management.

With tags of an archive or compressed archive from Tag Logging

1. Select one or more rows in the table area of Tag Logging.
2. Move the mouse to the edge of the selection rectangle.
The cursor changes from a "+" to a cross.

3. Hold down the right mouse button while dragging the tag selection to an empty area of a picture in the Graphics Designer.
4. Release the mouse button in the picture.
A shortcut menu is displayed in the Graphics Designer.
Select a control in the shortcut menu.
 - The control created contains the trends or columns with a data connection depending on the selected tags in Tag Logging.
 - When you select a text tag, a WinCC Online Table Control is created.
 - You can only insert a WinCC FunctionTrendControl if you have selected two tags in Tag Logging.

Or:

1. Select one or more rows in the table area of Tag Logging.
2. Move the mouse to the edge of the selection rectangle.
The cursor changes from a "+" to a cross.
3. Hold down the left mouse button while dragging the tag selection to an empty area of a picture in the Graphics Designer.
4. Release the mouse button in the picture.
A WinCC OnlineTrendControl is created.
 - The control created contains the trends or columns with a data connection depending on the selected tags in Tag Logging.
 - When you only select a text tag, a WinCC Online Table Control is created.
 - When you select a text tag and a numerical tag, a WinCC OnlineTrendControl is created. The text tag is ignored.
5. If you press the "Alt" key while dragging the tag selection, a WinCC OnlineTableControl is created.

With archives and views from a user archive

1. Select the following data in the table area of the user archive:
 - One archive from all archives
 - One view from all views
2. Move the mouse to the edge of the selection rectangle.
The cursor changes from a "+" to a cross.
3. Hold down the left mouse button while dragging the data selection to an empty area of a picture in the Graphics Designer.
4. Release the mouse button in the picture.
A WinCC UserArchiveControl is created.
The control created contains the archive or view. All columns are selected in the control.

With fields of archives and columns of views of a user archive

1. Select the following data in the table area of the user archive:
 - One or more fields of an archive
 - One or more columns of an archive
2. Move the mouse to the edge of the selection rectangle.
The cursor changes from a "+" to a cross.
3. Hold down the left mouse button while dragging the data selection to an empty area of a picture in the Graphics Designer.
4. Release the mouse button in the picture.
A WinCC UserArchiveControl is created.
The control created contains the archive or view. The columns are selected in the control, which you have selected as fields or columns in the user archive.
5. If you press the "Alt" key while dragging the data selection, a WinCC FunctionTrendControl is created.
You need to select two fields or columns in the user archive for this.

Or:

1. Hold down the right mouse button while dragging the data selection to an empty area of a picture in the Graphics Designer.
2. Release the mouse button in the picture.
A shortcut menu is displayed in the Graphics Designer.
3. Select a control in the shortcut menu.
A WinCC UserArchiveControl created contains the archive or view. The columns are selected in the control, which you have selected as fields or columns in the user archive.
You can only insert a WinCC FunctionTrendControl if you have selected two fields or columns in the user archive.

Expanding or changing WinCC controls already configured**Requirement**

- You have configured a WinCC control in the Graphics Designer.
- The configuration dialog of a control is not open.

Adding or replacing trends in the WinCC OnlineTrendControl

1. Select one or more rows in the table area of the following editors.
 - Tags in Tag Management
 - Tags of an archive or compressed archive in Tag Logging
2. Move the mouse to the edge of the selection rectangle.
The cursor changes from a "+" to a cross.
3. Hold down the left mouse button while dragging the tag selection to a WinCC OnlineTrendControl already configured in the Graphics Designer.
Dragging does not work in the configuration dialog.

4. Release the mouse button in the WinCC OnlineTrendControl.
A trend is added in the OnlineTrendControl for each tag selected. The data in the trends are connected to the respective tags.
5. If you press the "Shift" key while dragging the tag selection, the existing trends are replaced in the OnlineTrendControl.

Adding or replacing trends in the WinCC FunctionTrendControl

1. Select two rows in the table area in the following editors:
 - Tags in Tag Management
 - Tags of an archive or compressed archive in Tag Logging
 - Fields of an archive in the user archive
2. Move the mouse to the edge of the selection rectangle.
The cursor changes from a "+" to a cross.
3. Hold down the left mouse button while dragging the data selection to a WinCC FunctionTrendControl already configured in the Graphics Designer.
Dragging does not work in the configuration dialog.
4. Release the mouse button in the FunctionTrendControl.
A trend is added to the FunctionTrendControl.
The first row selected in the Configuration Studio is used for the X axis, the second row for the Y axis.
 - If you press the "Alt" key while dragging the data selection, the first row is used for the Y axis and the second row for the X axis.
 - If more than two lines are selected, the extra data is ignored.
 - If you press the "Shift" key while dragging the data selection, the existing trends are replaced in the FunctionTrendControl.

Adding or replacing columns in the WinCC OnlineTableControl

1. Select one or more rows in the table area of the following editors.
 - Tags in Tag Management
 - Tags of an archive or compressed archive in Tag Logging
2. Move the mouse to the edge of the selection rectangle.
The cursor changes from a "+" to a cross.
3. Hold down the left mouse button while dragging the tag selection to a WinCC OnlineTableControl already configured in the Graphics Designer.
Dragging does not work in the configuration dialog.
4. Release the mouse button in the OnlineTableControl.
A value column is added with a corresponding time column in the OnlineTableControl for each selected tag. The data of the value columns are connected to the respective tags.
5. If you press the "Shift" key while dragging the tag selection, one or more columns are replaced in the OnlineTableControl.

Adding archives and views from a user archive to the WinCC UserArchiveControl

1. Select the following data in the table area of the user archive:
 - One archive from all archives
 - One or more fields of an archive
 - One view from all views
 - One or more columns of an archive
2. Move the mouse to the edge of the selection rectangle.
The cursor changes from a "+" to a cross.
3. Hold down the left mouse button while dragging the data selection to a WinCC UserArchiveControl already configured in the Graphics Designer.
Dragging does not work in the configuration dialog.
4. Release the mouse button in the UserArchiveControl.
The following data are added to the UserArchiveControl:
 - Dragging an archive from all archives:
The archive is added and all columns are selected in the control.
 - Dragging one or more fields of an archive:
The archive is added and the columns are selected in the control, which you have selected as fields in the user archive.
 - Dragging a view from all views:
The view is added and all columns are selected in the control.
 - Dragging one or more columns of a view:
The view is added and the columns are selected in the control, which you have selected as columns in the user archive.
5. If there is already an archive or a view in the UserArchiveControl, you cannot add fields/columns of another archive or another view.

See also

Drag-and-drop to smart objects (Page 107)

Drag&Drop within the Configuration Studio (Page 100)

Drag-and-drop to smart objects

Introduction

Drag-and-drop functionality simplifies your work configuring smart objects with tag connection in the Graphics Designer.

Note

After configuring or creating an object using drag-and-drop, the configuration cannot be reversed using the "Undo" menu command in the Graphics Designer.

Requirement

- WinCC Configuration Studio is open.
- The Graphics Designer is opens with a picture.

Creating I/O fields with tag connection or replacing a tag in the I/O field

1. Select one or more rows in the table area of Tag Management.
2. Move the mouse to the edge of the selection rectangle.
The cursor changes from a "+" to a cross.
3. Hold down the left mouse button while dragging the tag selection to an empty area of a picture in the Graphics Designer.
4. Release the mouse button in the picture.
An I/O field is created for each selected tag or row in Tag Management. The I/O fields are connected to the respective tags.
If you drag a selected tag in an I/O field already configured, the existing tag is replaced by the added tag in the I/O field.

Creating smart objects with tag connection

1. Select one or more rows in the table area of Tag Management.
2. Move the mouse to the edge of the selection rectangle.
The cursor changes from a "+" to a cross.
3. Hold down the right mouse button while dragging the tag selection to an empty area of a picture in the Graphics Designer.
4. Release the mouse button in the picture.
A shortcut menu is displayed in the Graphics Designer.
5. Select a smart object in the shortcut menu.
A smart object is created for each selected tag or row in Tag Management.

The following property of a smart object is then dynamized with a tag:

Smart object	Property group	Property
I/O field	Output/Input	Output value
Status display	Status	Current status
Text list	Output/Input	Output value
Combo box	Miscellaneous	Selected box
List box	Miscellaneous	Selected box
Bar	Miscellaneous	Process driver connection

See also

How to add a text from a WinCC editor as an object (Page 461)

Drag-and-drop to WinCC controls (Page 102)

Drag&Drop within the Configuration Studio (Page 100)

1.5.8.3 Drag-and-drop from the Configuration Studio to other applications

Introduction

You can use drag-and-drop functionality in the WinCC Configuration Studio to drag data from the table area in the editors outside WinCC.

The data obtains "Unicode" text format and can be used in Microsoft Excel and WordPad, for example.

Procedure

1. Select one or more columns and rows in the table area of an editor.
2. Move the mouse to the edge of the selection rectangle.
The cursor changes from a "+" to a cross.
3. Hold down the left mouse button while dragging the data selection to an editor that is open.
4. Release the mouse button at the destination.
The data selection is used in the editor.

You can learn how to insert text, from Excel for example, into the Graphics Designer in order to create graphic objects on the page "How to add a text from a WinCC editor as an object (Page 461)".

See also

Drag&Drop within the Configuration Studio (Page 100)

How to add a text from a WinCC editor as an object (Page 461)

1.6 Project Types

1.6.1 Single-User Project

Introduction

If you only want to work with one computer in a WinCC project, create a single-user project.

The WinCC project runs on one computer that functions as the server for processing the data and as an operator input station. Other computers cannot access the project.

General procedure

The computer on which you create the single-user project is configured as a server.

The computer is connected to the programmable controller via the process communication.

Remote access

Remote access is disabled by default. To access a computer from a redundant server or via the Intranet, for example, enable the remote configuration in the SIMATIC Shell.

Redundancy

You can also create a single-user project as a redundant system. In this case, you configure a single-user project with a second redundant server.

Archive Server

You can also create an archive server for a single-user project. In this case, you configure a single-user project and a second server on which the data of the single-user project is archived.

See also

Multi-User Project (Page 110)

1.6.2 Multi-User Project

Introduction

If you only want to work with several computers in a WinCC project, create a multi-user project.

For a multi-user system, there are two basic options:

- Multi-user system with one or more servers:
Several servers with one or more clients. One client accesses several servers. The Runtime data is distributed on different servers. The configuration data is on the servers and on the clients.
- Multi-user system with only one server:
One server with one or more clients. All data is on the server.

General procedure

You create a multi-user project on the server. The server is connected to the programmable controller via the process communication.

In the multi-user project, you configure the clients that access the server. In a second step, you create the required client projects on the relevant computers.

If you want to work with several servers, duplicate the multi-user project on the second server. Adapt the duplicated project accordingly. You can also create a second multi-user project on the second server that is independent of the project on the first server.

A server can also access another server in the role of client. You can use this option, for example, when you use an archive server or a file server.

See also

Single-User Project (Page 110)

Client Project (Page 111)

1.6.3 Client Project

Introduction

If you create a multi-user project, you must then create the clients that access the server. You create a client program on the computer that will be used as a client.

For a WinCC client, there are two basic options:

- Multi-user system with one or more servers:
The client accesses several servers. The Runtime data is distributed on different servers. The configuration data on the multi-user projects is on the relevant servers. There may be local configuration data in the client projects on the clients: Pictures, scripts and tags.
- Multi-user system with only one server:
The client only attempts to access one specific server. All data is located on the server and is referenced on the clients.

An archive server or a file server can also access another server in the role of client.

Note

The WinCC client replaces the clients and multi-clients that were used in WinCC up to version V5.1. Depending on the configuration, a WinCC client takes over the role of a V5.1 client or a V5.1 multi-client.

General procedure

You create a multi-user project on the server. The server is connected to the programmable controller via the process communication. In the multi-user project, you create the clients that access the server.

If you configure a multi-user system with only one server, you do not create a separate client project on the WinCC client.

If you configure a multi-user system with several servers, you must create a separate client project on each client. This also applies when you only want to access one server but require additional configuration data on the client.

Multi-User System with One or More Servers

To access more than one server, you create a client project on the client. You specify the project properties on the WinCC client.

On the server, you create packages using the Serverdata component. The packages contain all important configuration data of the multi-user project. You load the packages on the WinCC client.

You only need to create and compile the packages once manually. If the configuration data on a server is modified, WinCC automatically generates the required packages. The packages can be downloaded to the clients automatically or manually.

Central Server Configuration for a Multi-User System with One Server

If you want to configure a client that accesses only one server, specify all settings in the multi-user system on the server. When you edit the startup list of the client, you should only start applications that are actually required on the client.

You do not create a separate project on the client. You start the server project using remote access. You find more detailed information in the WinCC Information System under Configurations > Multi-User Systems.

Web Client

You can configure a client that accesses the server over the intranet or over the Internet. If you require this type of access, you create a Web client with the WinCC Web Navigator option.

See also

Multi-User Project (Page 110)

1.6.4 Changing Project Type**1.6.4.1 How to Change a Single-User Project into a Multi-User Project****Introduction**

You can change a project you created as a single-user project to a multi-user project.

This can, for example, be useful when you want to create and test an entire project before running it in a multi-user system.

Procedure

1. Select the project name in the navigation window of the WinCC Explorer. Open the "Project Properties" dialog in the shortcut menu.
2. Go to the General tab and select the Multi-User Project project type in the Type list box. Click "OK" to confirm.
3. The "Change Project Type" dialog opens with the message: "The project type has been changed. Do you want to delete the startup list?"
If you want to include the startup list in the modified project, select "No".
If you want to create a new startup list, select "Yes". After changing the project type, create the startup list.
4. A dialog opens with the message: "The changes to the project type will take effect when the project is closed and reopened on all computers on which the project is currently open." Click "OK" to confirm.
5. Close the project in the WinCC Explorer and open it again. WinCC then accepts the changed project type.
6. Create the required clients under the Computer component. Create the WinCC clients you require and adapt the configuration.

See also

How to Change a Multi-User Project to a Single-User Project (Page 114)

How to Set Up a Startup List (Page 172)

Single-User Project (Page 110)

Multi-User Project (Page 110)

1.6.4.2 How to Change a Multi-User Project to a Single-User Project

Introduction

You can change a project you created as a multi-user project to a single-user project. The clients you created are not included because only one computer is created in a single-user project.

This can, for example, be useful when you want to use an existing configuration for a new project.

Procedure

1. Select the project name in the navigation window of the WinCC Explorer. Open the "Project Properties" dialog in the shortcut menu.
2. Go to the General tab and select the "Single-User Project" project type in the Type list box. Click "OK" to confirm.
3. The Project Properties dialog opens with the message: A change from a multi-user to a single-user or client project will delete all configured client computers from the computer list. Click OK to perform this change or Cancel to keep the multi-user project. Click "OK" to confirm.
4. The "Change Project Type" dialog opens with the message: "The project type has been changed. Do you want to delete the startup list?"
If you want to include the startup list in the modified project, select "No".
If you want to create a new startup list, select "Yes". After changing the project type, create the startup list.
5. A dialog opens with the message: "The changes to the project type will take effect when the project is closed and reopened on all computers on which the project is currently open." Click "OK" to confirm.
6. Close the project in the WinCC Explorer and open it again. WinCC then accepts the changed project type.
7. Adapt the computer properties and the configuration.

See also

[How to Change a Single-User Project into a Multi-User Project \(Page 113\)](#)

[How to Set Up a Startup List \(Page 172\)](#)

[Single-User Project \(Page 110\)](#)

[Multi-User Project \(Page 110\)](#)

1.7 Creating and Editing Projects

1.7.1 Preparation to Create a Project

Introduction

You don't yet need detailed planning to create a WinCC project. To create the WinCC project efficiently, you should nevertheless give some initial thought to the structure of the project. Depending on the size of the planned project and number of configuration engineers involved, it may be useful to make certain settings and decide on certain rules.

This chapter contains information on some of the elements in a project that you should specify before you start the configuration work:

- Project Type
- Project Path
- Naming conventions
- Tags and tag groups
- Picture hierarchy and folder structure
- Faceplate types
- Reusing project sections
- User administration
- Optimizing performance

Project Type

Before you start to plan your project, you should already know whether you require a single-user system or multi-user system.

If you are planning a project with WinCC clients or Web clients, make sure you know the factors affecting performance.

Project Path

A WinCC project does not need to be created on the same partition on which you installed WinCC. It is sometimes better to create a separate partition for a project.

When you create a partition, make sure you have adequate space for the anticipated amounts of data. If you archive a lot of data, the WinCC project can take up several gigabytes of space.

A separate partition also ensures that the WinCC project and all data contained in it are not lost if there is a system crash.

Note

No storage on compressed drives or folders

WinCC projects should not be saved to compressed drives or directories.

Naming Conventions

Using naming conventions can make it easier to handle large projects.

You can increase the clarity in your project particularly if you use conventions for naming tags, pictures, or functions in your project.

Note the restrictions applying to names outlined in chapter Illegal Characters.

Project name

Changing the name of a project once it has been created involves a number of steps. It is advisable to decide on a suitable name before creating the project.

Tags

You can give tags a prefix that identifies the tag type or the connection assigned to the tag. You could, for example, give all text tags the prefix "txt_" and internal tags the prefix "int_".

If you develop a company standard, the prefixes should be the same for all projects.

Pictures

You can specify prefixes for pictures, for example to identify plant pictures and system pictures.

If you create a large number of pictures, you can include continuous numbers in the picture names.

Functions

With functions, it is useful to introduce a prefix for your company standard.

This makes it clear at a glance which functions are required for the standard.

Tags and tag groups

To structure tags, you can create tag groups.

In WinCC, you cannot nest groups but can only create one level with tag groups.

If you require many tags with the same properties, work with structure types and structure tags.

Picture hierarchy and folder structure

If you want to reduce the configuration time, you should plan the picture hierarchy in your project before you start the project. It is advisable to work out an overview of the pictures you need to create.

Using a basic picture and the tag prefix, you can structure navigation within your project.

Folder structure

To store pictures and referenced files in a structured manner, you can create additional subfolders in the "GraCS" folder in the project path.

Define the folder structure and the folder names before configuring the process pictures.

If you change folder names or storage paths later, you need to adapt the paths in the configuration accordingly, e.g. in scripts and in direct connections.

For pictures, faceplate types and referenced files located in the subfolders of "GraCS", the folder path is part of the name in each case.

Faceplate types

You can configure, save and reuse individual objects or groups of objects as faceplate types in different pictures as faceplate instances.

Thus, you can avoid always recompiling and configuring frequently used picture elements.

Reusable Project Sections

You can take various project sections from existing WinCC projects.

These include, for example, tags, pictures, user-defined menus and toolbars, functions and actions.

Standard project

If you do not want to repeatedly take data from an existing WinCC project, you should create a standard project. In this project, you can configure basic project sections to suit your needs.

When you create a new WinCC project, you can simply copy the standard project and then work with the copy. This saves you time during configuration.

User administration

Depending on the number of planned WinCC users, it makes sense to define the required roles and authorizations in advance.

You can find additional information under "Structure of the User Administration > User administration in distributed systems".

Optimizing performance

To operate your WinCC system at optimum performance, take the information on quantity structure and optimum configuration, for example, into account.

You can find additional information under "Dynamize Process Pictures > Configuration recommendations".

See also

- File Structure of a Project (Page 230)
- Illegal Characters (Page 226)
- Settings for Runtime (Page 168)
- Configuration recommendations for dynamization (Page 1165)
- User administration in a distributed system (Page 2433)
- System diagnostics with performance tags (Page 176)

1.7.2 WinCC Project with "Basic Process Control"

Introduction

WinCC projects can be created and managed in PCS 7 within the framework of Totally Integrated Automation. The result is connections between the configuration of operator stations and automation systems with the WinCC configuration. You run the WinCC configuration in the SIMATIC Manager and in the WinCC Explorer.

The WinCC Explorer with the "Basic Process Control" option offers various editors, many of which you use intensively for configuring the operator station (OS). Much data in the WinCC project is already assigned by the configuration of the engineering station (ES). If necessary, you can configure the configuration using the editors of the WinCC Explorer.

Requirement

- The "Basic Process Control" option must be installed on all computers in a WinCC project with multiple computers.

Overview of Basic Process Control in a WinCC Project

The following editors of Basic Process Control determine the appearance and behavior of the operator station:

- OS Project Editor
- Time Synchronization
- Lifebeat monitoring
- Horn
- Picture Tree
- Component List Editor

OS Project Editor - Configuration of the runtime system and message system

When an OS project is created in the PCS 7 ES, the OS Project Editor is called automatically and initialized with default settings with reference to the runtime system and the message system. Only if you want a configuration other than the default configuration do you have to start the OS Project Editor in the WinCC Explorer and configure your desired project settings.

If you create a new WinCC project with Basic Process Control, you must start the OS Project Editor. The OS Project Editor must be run before the User Administrator is opened, otherwise the User Administrator will be initialized with the authorization levels of WinCC.

The OS Project Editor creates the picture construction in overview area, work area, and button area as well as basic data in the WinCC server or client projects. The areas in the picture hierarchy are displayed automatically in the overview area of Runtime. In Runtime, the Split Screen Manager manages the screen data, the screen compositions, and the picture changes according to the picture hierarchy. The picture change is configured with the standard functions of the Split Screen Manager.

All necessary data for the message configuration and the message display is created by the OS Project Editor. There is no need to configure a WinCC Alarm Control. You can change the default settings for display of the message system on the operator station in the OS Project Editor.

Hiding system pictures

WinCC Explorer displays the system pictures contained in the basic data with "@" prefix at the "Graphics Designer" editor. You can hide the system pictures in WinCC Explorer.

Select the "Graphics-Runtime" tab in the properties dialog of the computer and activate the "Use prefix" option in the "Hide system pictures" field. The text field on the right must contain the "@" prefix. If necessary, activate the option "Observe upper-case/lower-case".

In order to hide system pictures in the Graphics Designer in the "Process pictures" window, activate the option under "Extras > Settings > Options" .

Time Synchronization - Time synchronization via LAN and Industrial Ethernet Bus

To ensure time synchronization for all operator stations, you have to configure the time synchronization using the "Time Synchronization" editor for every operator station.

Lifebeat Monitoring - Lifebeat monitoring for all automation systems and operator stations

The lifebeat monitoring function monitors functionality of all automation systems and operator stations and creates a process control message, if necessary. You configure the lifebeat monitoring in WinCC using the "Lifebeat Monitoring" editor.

Horn - Acoustic and optical signal generator for certain messages

The "Horn" editor is used to control optical and acoustic signaling devices or the output from audio files when messages come in.

Picture Tree - Management of the system hierarchy with the respective pictures

The "Picture Tree" editor is used to manage a hierarchy of systems, subsystems and Graphics Designer pictures. Using Picture Tree, the hierarchy of the group displays can also be recalculated or updated.

Component List Editor - Configuration of entry point pictures and areas for the measuring points

You can see all components that you have inserted in the ES configuration in the Component List Editor. You can create new measuring points yourself using the Component List Editor. You allocate components to the pictures and areas in the Component List Editor. This allows the system operator to switch directly to this picture using the "Loop in Alarm" function in the message list and the "Picture from measuring point" button.

1.7.3 How to Create a Project

Introduction

If you want to create a new project, you must first make several basic settings in WinCC. Based on these settings, WinCC creates a project that you can edit immediately.

Principle

Follow the steps outlined below when creating a project:

- Define project type
- Specify the project name and project folder
- If required, enter the name of the configuration engineer, the project version, and a comment
- Defining computer properties
- Specify the settings for Runtime

You can specify the computer properties and the settings for Runtime immediately after creating the project or during configuration. For more detailed information, refer to sections Defining Computer Properties and Settings for Runtime.

Procedure

1. In the toolbar of the WinCC, click the  button. The "WinCC Explorer" dialog opens.

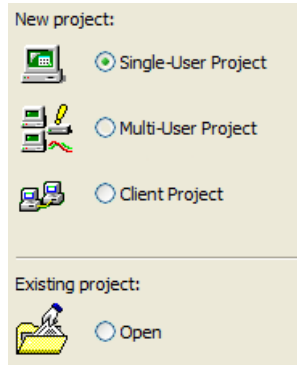

2. Select the required project type and confirm with "OK". The "Create new project" window opens.

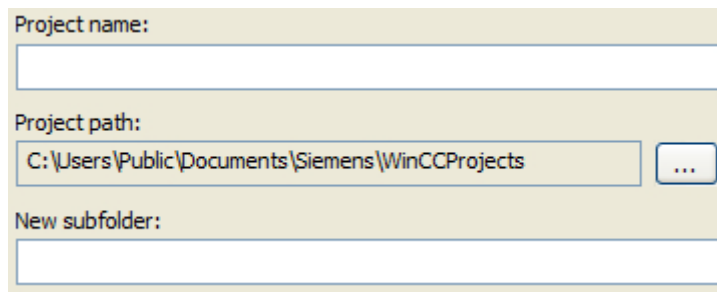

3. Enter the project name in the "Project Name" box. If you want the name of the project folder to be different from the project name, enter the required folder name in the "New Subfolder" box.
4. In the "Folder" list box under "Project Path", select the path in which you want to create the project folder.
5. Confirm with "Create". WinCC creates a project with the specified name and opens it in WinCC Explorer.

6. Click the project name in the navigation window of the WinCC Explorer and select the Properties command in the shortcut menu.
The "Project Properties" dialog opens.

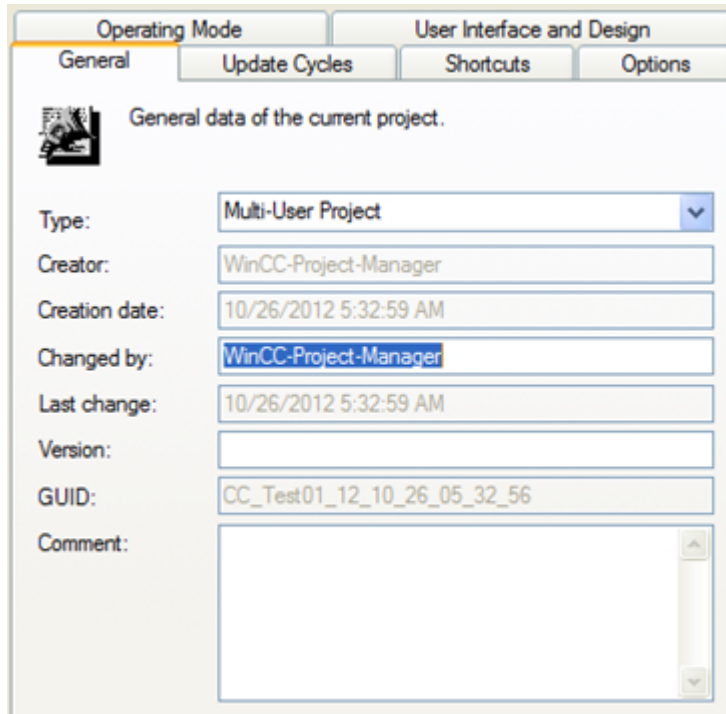

7. In the General tab, you go to the name of the configuration engineer, a project version, and a comment. Change the project type in the Type list box.
8. Click "OK" to close the dialog.

Alternative procedure

You can create a new project in the following ways:

- When you first start WinCC
- In the menu bar of the WinCC Explorer in the File menu with the New command
- With the shortcut key <CTRL+N>

Activating Runtime on ES

To activate Runtime for an integrated project on the ES, you can centrally release this option for the project. In WinCC Explorer, select the Project Properties option in the shortcut menu of the current project. Activate the "Allow activation on ES" check box in the "Options" tab. For more information, refer the Online Help related to WinCC integration in SIMATIC Manager.

NOTICE

Activating Runtime and synchronizing UserArchive Runtime data

The UserArchive-Server is also started whenever you launch the "User Archive" editor on the ES. The server synchronizes the Runtime data with the redundant partner. The standby server will therefore receive the Runtime data of the ES. This operation leads to inconsistency of the Runtime data.

Activate this check box only if you are actually going to use the ES as Runtime server.

Note

To test integrated WinCC projects, use the "Start OS Simulation" function. This approach will safely exclude negative impacts on system runtime. Activation of integrated WinCC projects on the ES is not appropriate in this context.

See also

Settings for Runtime (Page 168)

Opening WinCC Explorer (Page 36)

How to Specify the Computer Properties (Page 123)

Preparation to Create a Project (Page 115)

Managing WinCC Projects and Objects in the SIMATIC Manager (Page 2457)

Starting a Simulation in STEP 7 (Page 2495)

1.7.4 How to Specify the Computer Properties

Introduction

When you create a project, you must adapt the properties of the computer on which the project will be activated.

In a multi-user system, you must adapt the properties individually for each computer you create.

Procedure

1. Click the Computer component in the navigation window of the WinCC Explorer. WinCC displays the list of computers in the data window.
2. Select the computer and then click the Properties command in the shortcut menu. The Computer Properties dialog is opened.

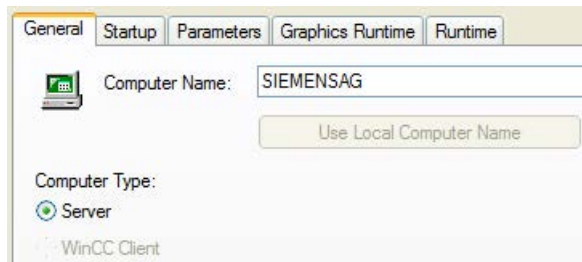

3. Check whether the correct computer is entered in the Computer Name input box. You will find the name of the computer in the Windows Control Panel under "System" on the "Computer Name" tab.
4. Click "Use Local Computer Name" to adapt the computer name to the local computer name.
5. When you insert a multi-location project, the Computer type area shows whether the computer is projected as a server or a client. If you have already inserted other computers in the project, then the same are displayed in the Client Name or Server Name area. The labeling of the box depends on whether you are displaying the computer properties of a server or of a client.
6. Click "OK" to close the dialog.

Note

If the field Computer Name does not contain the correct computer name, Graphics Designer opens a picture in the English configuration language, regardless of the language settings. You may reset the desired language in Graphics Designer.

Changing computer name

You can change the computer name in a project. Before WinCC accepts the modified computer name, you must close and reopen the project.

See also

How to Create a Project (Page 120)

Effect of External Applications at Runtime (Page 175)

Settings for Runtime (Page 168)

Opening WinCC Explorer (Page 36)

1.7.5 How to use multiuser engineering

Introduction

Under certain circumstances, multiple users can edit a project simultaneously from different computers and use different resources.

For versions up to WinCC V7.2, it was only possible for multiple configuration clients to edit the same project simultaneously with remote configuration if the client computers were entered for the server.

If you are using integrated operation with SIMATIC Manager, note the additional information under "Integration of WinCC in SIMATIC Manager > How to use multiuser engineering in SIMATIC Manager".

Note

WinCC/Calendar Options

The WinCC option "Calendar Options" does not support multiuser engineering.

SIMATIC Process Historian

Process Historian does not support multiuser engineering.

Advantages of multiuser engineering compared with the configuration client

- The configuration computer does not have to be entered on the server.
- You do not need to configure user authorizations in the User Administrator.
- The computer can be connected to all WinCC project types
 - Single-user project
 - Multi-user project
 - A client with its own project
- You can only activate Runtime if the project is on the local computer and has not already been opened by another computer.
Accordingly, the project can no longer be opened on another computer when Runtime is activated.

How to make multiuser engineering possible

Requirement:

- No clients are entered in the computer list of the server.
- The editors must be closed on all computers involved when multiuser engineering is activated.
- The following property is disabled in the "Project properties" dialog: "Project directory is shared for read-only access only."

Procedure:

1. In the shortcut menu of the project name in WinCC Explorer, select "Properties".
2. On the "Options" tab, select the check box "Multiuser engineering".

The computers connected to the project can now use various different project resources.

Sequence of multiuser engineering

When one computer has opened certain resources, the other computer can no longer open these resources. The other computer can always open the project properties dialog. Only the "Options" tab is shown in this dialog to access the resources dialog.

Other computers have read-only access to some database-based resources, but do not receive an update after changes. These changes are only displayed when the resource is opened once again.

For editors that are using file-based resources, such as pictures or reports, only the files already open are locked for editing on the other computers.

You use the resources dialog to determine which resources are already reserved and which computers access the project. Select the "Options" tab and click "Resources". The "Multiuser resources" dialog opens. Select the "Display reserved resources of all users" check box to get an overview of all used resources and computers.

Multiuser engineering cannot be deactivated if a project is opened by multiple users. To disable multiuser engineering, only one computer may access the project. If a computer blocks disabling of multiuser engineering due to a connection problem, you can release the computer.

Note

If a new print job is created on a computer, the print job is not immediately visible in WinCC Explorer.

The change is only visible once the editor has been closed and opened again.

Releasing resources that cannot be edited

You may have to release locked resources under certain circumstances to continue working with them, for example if the connection is interrupted.

There are two ways to release resources:

- The project is closed and re-opened remotely.
Opening the project automatically releases all resources of the non-connected computer that are still pending. The resources used by the other computers are not affected by release.
- You can release individual resources with the resources dialog.
Before releasing resources, you must make sure that none of them are currently in use by any other users. Release must therefore be coordinated with all users involved so that the users close the configuration dialogs / the editor on the relevant computers. This leaves only the non-editable resources in the dialog.

NOTICE

Release resources only in case of an emergency

Only release resources via the dialog in specific cases, for example when a computer can no longer be reached due to an interrupted connection.

Otherwise you may release resources that are currently being used.

Simultaneous access to the same resources is not permitted, as release means that the resources can no longer be managed.

Using the resources dialog to release non-editable resources

1. On the "Options" tab in the project properties, click the "Resources" button. The "Multiuser resources" dialog opens.
2. Select the "Show reserved resources of all users" check box.
The dialog shows a list of all resources used by users and computers involved in the project. Only the locked resources are displayed.

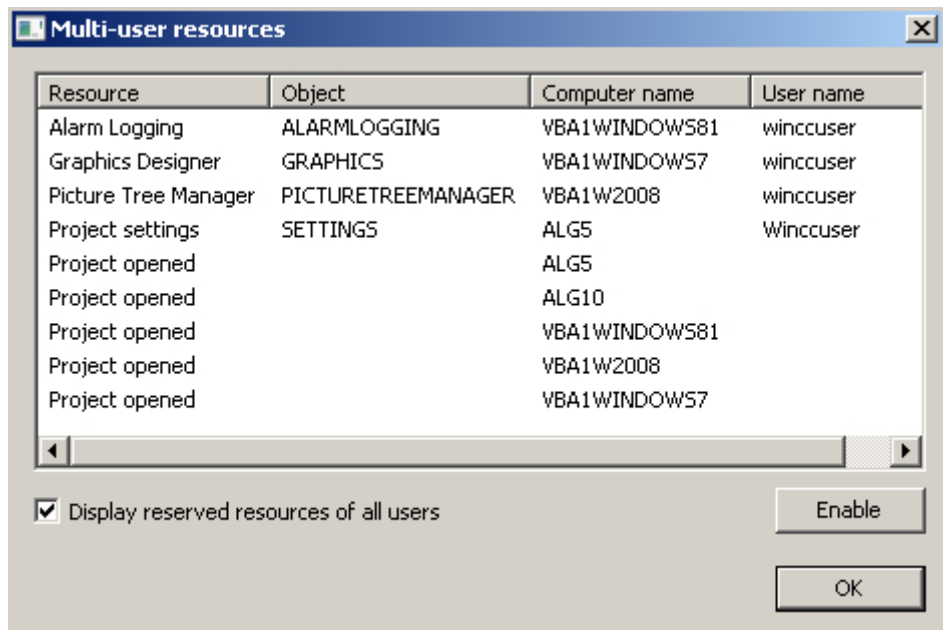

Note

To refresh the dialog display, deselect and then re-select the check box "Show reserved resources of all users".

3. Select the resources to be released. Click the "Release" button.
This forces the release of the selected resources.

Releasing a computer with a connection problem

NOTICE

Only release a computer that actually has connection problems

Only release a computer via the dialog if there are actually connection problems. Example: The network card of the computer is defective.

Otherwise, the result could be a loss of data in the WinCC project.

1. On the "Options" tab in the project properties, click the "Resources" button. The "Multiuser resources" dialog opens.
2. Select the "Show reserved resources of all users" check box to view a list of all computers and resources used.
3. Select the "Project open" row on the computer to be released. Click the "Release" button. This forces the release of the selected computer.

Releasing the resources of individual editors in the Configuration Studio

For large WinCC projects, the configuration engineer wants to have multiple editors open in one instance of the Configuration Studio so that the comprehensive data is loaded and the engineer has rapid access to it during configuration. This will, however, reserve the resources of these editors.

The configuration engineer can release a resource in the Configuration Studio for the following scenario. The other computer or user wants to access an editor whose data has been loaded to the configuration engineer's computer but is not currently being edited by the engineer.

In the Configuration Studio, the configuration engineer then selects the option "Release" in the shortcut menu in the navigation area to unload the data. The resource is now released and can be used by another computer. You can release each editor that is reserved but not currently in use using the shortcut menu.

1.7.6 How to support multiple picture windows

Introduction

WinCC supports independent picture windows. Independent picture windows can be used and positioned absolutely without being connected to the respective process picture. With the respective hardware and the support of the operating system, you can control more monitors to handle processes with greater scope and differentiation.

For example, you can visualize the process on monitors 1 to 3 and use monitor 4 to display another view of the process with an Excel list.

The main window, in which you have configured the individual picture window, is no longer required. You can hide it to increase the impact of more independent runtime windows.

Note

WinCC/WebUX: No support of independent windows

The WinCC option WebUX does not support independent picture windows.

The configured independent windows behave like other picture windows in Runtime.

Procedure

1. Configure more picture windows with the desired process pictures in the start picture.
2. Open the properties for each picture window with a double click.
The "Object Properties" dialog is opened.

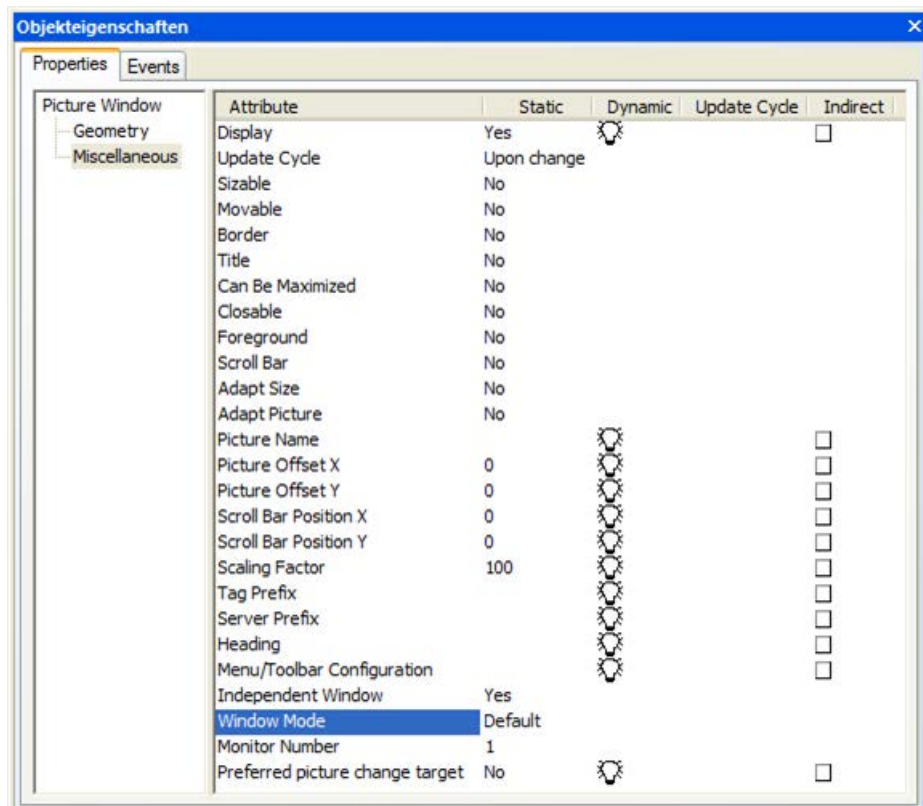

3. Set the attribute "Independent window" to "Yes".
4. Define the display for the configured picture window with window mode:
 - Standard: configured size in the configured position
 - Center: configured size in the central position
 - Maximize: display adapted to the size of the monitor
5. If you want to use more monitors:
Select the desired monitor for the picture window with the "Monitor number" attribute.

6. If you want to hide the main window:
Select "Properties" in the WinCC Explorer of the shortcut menu of the computer, select the respective computer and click on "Properties".
The "Computer Properties" dialog opens.
7. Activate check box "Hide main window" on the "Graphics Runtime" tab under "Independent picture window".

Result

In runtime, the selected process pictures appear in several picture windows that are to be controlled independent of one another.

See also

How to insert a picture window (Page 605)

1.7.7 Setting Time in WinCC

1.7.7.1 Setting Time in WinCC

Introduction

In WinCC Runtime, you can display data with the date/time information in the local valid time or in coordinated universal time. It is normally practical to display the local time of your workstation location. If you wish to display a time zone-independent time, use coordinated universal time.

When you create a new project, WinCC uses the local time zone as the default. Internally, WinCC works with the coordinated universal time as a time base and converts to the selected time zone for the displayed time.

You set the time base for the entire project on one computer. In a multi-user system, you can set the time base individually on each computer.

Additionally, you may configure if the date and time format can be configured at the individual components or if it should be forced centrally by the WinCC project at all components in ISO 8601 format.

Note

Changing the time zone can have effects on date changes.

Multi-User System with Three Servers

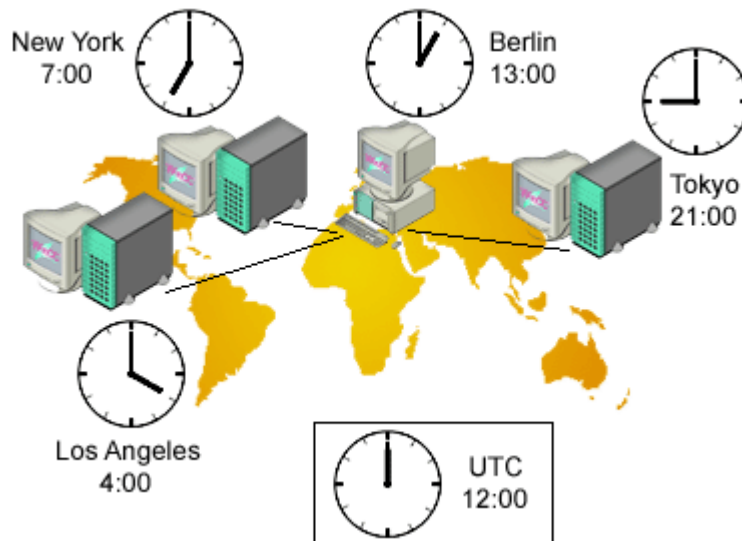

The local time zone is displayed in the stations in Los Angeles, New York, and Tokyo.

Data is collected from the stations in the center in Berlin. With the default setting, the operator sees all data in the local Berlin time. To be able to compare the data more easily in discussions with the stations, bus operators change over to UTC.

Note

The use of UTC is always advisable when you want to display or edit time-dependent data from different time zones on one computer. If, for example, you want to display messages from different time zones on one client, UTC should be selected in the Alarm Control of this client so that the messages are sorted in the correct chronological order and appear correctly in the single-line message window.

Possible Settings

For runtime displays, the following settings are available. The settings are configured in the properties of the computer on the "Parameters" tab.

Selection	Meaning
Local time zone (LOC)	<p>During Runtime, time information is displayed in the local time zone of the client or server.</p> <p>For this display, UTC is converted to the local time zone. ¹⁾</p> <p>The local time zone is the default when you create a new project. The individual objects use the default setting Apply Project Settings.</p>
Coordinated Universal Time (UTC)	<p>During Runtime, coordinated universal time is displayed. UTC stands for Universal Time Coordinated.</p> <p>UTC is not dependent on time zones and is used internationally. This time corresponds to the Greenwich Mean Time (Central European Time minus an hour). In UTC, there is no daylight saving time.</p>

Selection	Meaning
Time zone of server	In Runtime, the local time zone of the server is displayed. In single-user systems, this time corresponds to the time of the local time zone. During display of the local time zone in ISO 8601 format, no deviations to UTC time are shown. Note: We recommend using this setting only in projects migrated from WinCC V5.x.
Apply Project Settings ²⁾	This option is available only for layouts and controls. The object adopts the time zone selected in the project settings.
¹⁾ You set the local time zone in the Control Panel of your computer under "Date/Time". ²⁾ We recommend applying the "Apply Project Settings" setting to all objects and only changing it in certain cases. This setting facilitates the project-wide conversion of the time zone.	

PLC clock setting

You can set the time base for communication with the automation system:

- UTC (Coordinated Universal Time) Default setting
- Local winter time (all year): Available for compatibility reasons

The settings are configured in the properties of the computer on the "Parameters" tab.

Central Date and Time Formatting in ISO 8601 format

In the computer properties of the WinCC project, you may configure if the date and time format should be configured at the individual components or if it should be forced centrally by the WinCC project at all components in ISO 8601 format.

The following conditions apply to ISO 8601 format.

- The date is always displayed in YYYY-MM-DD format.
- The time is shown in 24-hour format.
- UTC times are identified with suffix Z, e.g. 17:01:03.099Z.
- The time of the local time zone is displayed as local time plus the offset to UTC, e.g. 17:01:03.099+01:30.
- The display of time is specified by the time format hh:mm:ss. Only the additional display of milliseconds is optional for the components. The time display is then in the format hh:mm:ss.msc, e.g. 17:01:03.099.

Note

If the central display of date and time in ISO 8601 format is forced, this takes effect on configurable time formats and time display throughout the project, e.g. in Controls, Reports or in Alarm Logging on system message blocks Time and Date.

See also

Opening WinCC Explorer (Page 36)
Preparation to Create a Project (Page 115)
How to Set the Time Base for Runtime Documentation (Page 135)
How to Set the Time Base for Controls (Page 134)
How to Set the Time Base in the Project (Page 133)
Displaying Regional Date and Time (Page 2391)

1.7.7.2 How to Set the Time Base in the Project

Introduction

The time basis applicable as default setting for the entire project is entered in the Computer Properties dialog. This setting applies to all objects displayed on this computer in Runtime. The exceptions to this are objects for which you have set a separate time base.

You may also use this dialog to set whether or not central date and time formatting according to ISO 8601 should be forced in all components.

Note

You can also change the time base setting in Runtime. To update the display in Runtime, you must reselect the corresponding picture or report.

If the central display of date and time in ISO 8601 format is forced, this takes effect on configurable time formats and time display throughout the project, e.g. in ActiveX Controls, Reports or in Alarm Logging on system message blocks Time and Date.

Procedure

1. Click the Computer component in the navigation window of the WinCC Explorer. WinCC displays the list of computers in the data window.
2. Select the computer and then click the Properties command in the shortcut menu. The Computer Properties dialog is opened.
3. Click the Parameters tab.
4. Select required time base in the Time Basis for Time Display in Runtime list box.
5. In the Central Date and Time Formatting area, choose if the format for date and time may be configured at individual components, such as Alarm Control, or if the format in accordance with ISO 8601 should be forced at all components.
6. Click "OK" to close the dialog.

See also

- How to Set the Time Base for Runtime Documentation (Page 135)
- Preparation to Create a Project (Page 115)
- How to Set the Time Base for Controls (Page 134)
- Setting Time in WinCC (Page 130)

1.7.7.3 How to Set the Time Base for Controls

Introduction

For some controls, you can assess the time base individually.

In the default setting, the control takes the time base from the project properties. The Apply Project Settings setting makes sure that you always see the same time zone in your controls as in the rest of the project. With this setting, you can change the time base for all controls in one action in the computer properties.

If you change the time base of a control, the modified setting is retained. You can no longer change the time base of the controls in one action in the computer properties. To adapt to control to the display in run-time again, you must modify the properties manually or change the Apply Project Settings setting.

Controls

You can adapt the time base individually for the following controls:

- WinCC Online Table Control
- WinCC Online Trend Control
- WinCC Function Trend Control
- WinCC Alarm Control
- WinCC User Archives Table Control

Time Base for Controls

The following settings are available for the time base:

- Apply Project Settings (default)
- Time zone of server
- Local time zone
- Coordinated Universal Time (UTC)

Note

You can also change the time base setting in Runtime.

Procedure

1. Open the Properties dialog of the control.
2. Select the General tab or the Time Axis tab for the Online Trend Control.
3. Select the required time base in the selection window under Time Base.
4. Click "OK" to close the dialog.

Time Format in Controls

If the central date and time format in ISO 8601 format is forced in the Computer Properties dialog, this also has an effect on the configurable time formats and time displays in the controls.

WinCC User Archives Table Control

For the User Archives Table Control, sets the time base for the LastAccess field in the General tab. The time of the last access is displayed in the Last Access column.

WinCC Digital/Analog Clock Control

The Digital/Analog Clock Control always displays the local computer time. The displayed time is not influenced by the time base of the project.

See also

- Preparation to Create a Project (Page 115)
- How to Set the Time Base for Runtime Documentation (Page 135)
- How to Set the Time Base in the Project (Page 133)
- Setting Time in WinCC (Page 130)

1.7.7.4 How to Set the Time Base for Runtime Documentation

Introduction

In the log system of WinCC, you have dynamic objects available which allow you to output Runtime data into a report. You can set the time base of the dynamic objects individually in the properties.

WinCC accepts the time base from the project properties as default setting. The Apply Project Settings setting makes sure that you always see the same time zone in your reports as in the rest of the project. With this setting, you can change the time base for all dynamic objects in one action in the computer properties.

If you change the time base of a dynamic object, the modified setting is retained. You can no longer change the time base of the object in one action in the computer properties. To adapt the reports to the display in Runtime again, you must modify the settings in the object properties manually or change the Apply Project Settings.

Reports

You can change the time base of the following objects:

- Archive reports (Alarm Logging Runtime)
- Message reports (Alarm Logging Runtime)
- User archive tables (User Archive Runtime)
- Tag tables (Tag Logging Runtime)
- Trends (Tag Logging Runtime)
- Message sequence report tables (in the Line Layout Editor)
- Message sequence report tables (in the Page Layout Editor)

Time Base for Line Layouts and Page Layouts

The Runtime documentation states when an event, such as a message, occurred. If you change the time base output, WinCC converts the time stamps of the messages into the new time base.

You can select the following settings as the time base:

- Apply Project Settings (default)
- Time zone of server
- Local time zone
- Coordinated Universal Time (UTC)

Note

You can also change the time base setting in Runtime.

Exception: You cannot change the time base of message sequence reports in Runtime.

Procedure for Page Layouts

1. Open the required page layout in the page layout editor.
2. Double-click the dynamic object you want to edit.
The "Object Properties" dialog is opened.
3. On the tab Connect, select the object in the navigation window.
4. In the table in the right window, select the Time Base entry and click the Edit button.
The Time Base Entry dialog is displayed.
5. Select the required time base and confirm with "OK".

Procedure for Line Layouts

1. Open the desired line layout in the line layout editor.
2. Click in the Table area on the Time Base... button.
The Time Base Entry dialog is displayed.
3. Select the required time base and confirm with "OK".

Selection for Layouts

In the filter criteria for alarm output, WinCC always uses the time base of the corresponding dynamic object.

Start Time and Selected Time Range for Print Jobs

The start time and the selected time range of the data to be printed is always shown in local computer time. The start time and the selected time range are not influenced by the time base of the project nor by the time base of a dynamic object.

Time Format in Reports

If the central date and time format in ISO 8601 format is forced in the Computer Properties dialog, this also has an effect on time displays in the reports.

See also

- Preparation to Create a Project (Page 115)
- How to Set the Time Base for Controls (Page 134)
- How to Set the Time Base in the Project (Page 133)
- Setting Time in WinCC (Page 130)

1.7.8 Online configuration

Introduction

You can edit a project in a single-user system or a multi-user system during Runtime. Remember, however, that some configuration tasks are not possible.

WinCC also provides the Load Online Changes function. With the Load Online Changes function, you can edit a project on one computer while it is running on another computer in

Runtime. When configuring with Load Online Changes, there are other restrictions than those that apply to online configuration.

Note

Effect on performance in runtime

In time-critical projects, remember that online configuration can affect the response of your project over time.

Restrictions

For more detailed information on the possibilities for online data editing, refer to the description of the relevant editor in the WinCC Information System.

You can edit the following elements while the project is activated in Runtime:

Element	Create	Delete	Edit	Remarks
Project name / Project properties	---	---	No	---
Computer	Yes	No	No	---
Computer properties	---	---	Yes	Edit: Modifications only become effective in runtime after the project has been deactivated and run-time restarted.
Time base (Computer properties)	---	---	Yes	Edit: Depending on the configuration, a modification in a picture is only updated in runtime after the picture has been reselected.
User cycle (Project properties)	---	---	No	---
Tags (Tag Management)	Yes	Yes	Yes	Delete/edit: Only possible with external tags only if the channel being used supports the function. This currently applies only to the S7 channel
Tag groups (Tag Management)	Yes	Yes	Yes	Delete: Only valid when the contained tags can be deleted.
Structure types	Yes	Yes	Yes	Delete: Only valid if the structure type does not contain structure tags. Edit: Only valid as long as no structure tag has been created under the structure type.
Structure tags (Structure types)	Yes	Yes	Yes	Delete: Only valid when the associated structure tag elements can be deleted.

Element	Create	Delete	Edit	Remarks
Connections (Tag Management)	Yes	Yes	Yes	Changes to a connection can lead to loss of data. Delete/edit: Currently only valid for the S7 channel.
Channels (Tag Management)	No	No	No	---
Channel units (Tag Management)	No	No	No	---
Text entries (Text Library)	Yes	Yes	Yes	---
Favorites and favorites order (WinCC Explorer)	---	---	Yes	Mark process pictures as favorites or remove and change their order in the "Favorites" system.
Pictures (PDL files, Graphics Designer)	Yes	Yes	Yes	A picture is updated at Runtime only after reselection.
Library, color palette (Graphics Designer)	Yes	Yes	Yes	---
Text lists, graphic lists (Text and graphic lists)	Yes	Yes	Yes	---
Menus and toolbars	Yes	Yes	Yes	Changes are only applied when the configuration file has been loaded again. In picture windows, a picture change is sufficient. Changed VBS procedures are only applied after a runtime restart.
Archives, archive tags (Tag Logging, User Archives)	Yes	Yes	Yes	Edit: Archiving cycle cannot be modified
Reports, layouts (Report Designer)	Yes	Yes	Yes	Create/delete/edit: Only valid for the runtime documentation.
Scripts (Global Script)	Yes	Yes	Yes	---
Access authorizations (User Administrator)	Yes	Yes	Yes	---
Other files	Yes	Yes	Yes	---
Packages (Server data)	Yes	Yes	Yes	---
Messages (Alarm Logging)	---	---	---	Refer to the Online Configuration with Messages table below.

Configuring messages online

Note**Message archiving: Delayed runtime display**

The online configuration in Alarm Logging has the effect that a new archive segment of the message archive is created. The creation of the segment can take several minutes.

The changes in Alarm Logging are not visible in Runtime until a segment has been changed, a new message arrives or a screen change is performed.

Element	Attribute	Create	Delete	Edit	Remarks
Single messages		Yes	Yes	Yes	Edit: Valid for most attributes. Exceptions are listed individually:
	<ul style="list-style-type: none"> • Number 	---	---	No	---
	<ul style="list-style-type: none"> • User-defined message group 	---	---	Yes	---
	<ul style="list-style-type: none"> • Class 	---	---	Yes	The message is updated immediately.
	<ul style="list-style-type: none"> • Type 	---	---	Yes	If the acknowledgment requirement is changed, the message is deleted. If the message class is changed but not the acknowledgment requirement, the message is updated immediately.
	<ul style="list-style-type: none"> • Triggered on falling edge • Message tag • Message bit • Norm DLL 	---	---	Yes	If you change the attribute, the message is deleted.
	<ul style="list-style-type: none"> • Controls the central signaling device • Will be archived • Priority 	---	---	Yes	Updated in Runtime only when the status of the message changes.
	<ul style="list-style-type: none"> • Info text 	---	---	Yes	The message is updated immediately.
	<ul style="list-style-type: none"> • User text block • Process value block 	---	---	Yes	Updated in Runtime only when the status of the message changes.
Message groups from message classes/message types		No	No	No	---
User-defined message groups		Yes	Yes	Yes	---

Element	Attribute	Create	Delete	Edit	Remarks
Limit monitoring		Yes	Yes	Yes	Edit: If the "Message" attribute is modified, the message is deleted.
System blocks		Yes	Yes	Yes	Create/delete/edit: Only updated in runtime after you reselect the corresponding picture. Create/delete: Reconfiguration in OCX required.
User text blocks		Yes	Yes	Yes	Create/delete/edit: Only updated in runtime after you reselect the corresponding picture. Create/delete: Reconfiguration in OCX required.
Process value blocks		Yes	Yes	Yes	Create/delete/edit: Only updated in runtime after you reselect the corresponding picture. Create/delete: Reconfiguration in OCX required.
Message classes		Yes	No	Yes	---
Message types		Yes	No	Yes	Edit: Valid for most attributes. Exceptions are listed individually:
	<ul style="list-style-type: none"> Class names Status text 	---	---	Yes	Updated in Runtime only when the status of the message changes or when you reselect the picture.
	<ul style="list-style-type: none"> Acknowledgment philosophy 	---	---	Yes	If the acknowledgment requirement is changed, the message is deleted.
Raw data tags		Yes	Yes	Yes	Change/delete: The message is deleted.
Tags		---	Yes	Yes	Change/delete: The message is deleted.

See also

Use and Limitations of Load Online Changes (Page 146)

Loading Online Changes (Page 142)

How to Configure a Message Archive (Page 1354)

1.7.9 Loading Online Changes

1.7.9.1 Loading Online Changes

Introduction

With the Load Online Changes function, you can edit a project on one computer while it is running on another computer in Runtime. Load online changes work under multi-user systems and distributed systems under the same conditions as the use in multi-user systems.

The computer on which you configure will be referred to as the configuring station in the following description. The computer on which Runtime is activated will be referred to as the Operator Station.

If you want to use the changes on the operator station, start a download of the changed data. The project is updated in Runtime.

You can test the modified project on the configuring station before you user modifications in Runtime. You can update the project at any time.

Working with load online changes is possible only when you maintain a consistent project.

Note

In time-critical projects, remember that downloading changes online can affect the response of your project over time.

Application Scenarios

During various phases, for example commissioning, operation, or maintenance, you will normally find it necessary to make changes to an existing project. These changes can then be adopted in the activated project; in other words, online.

You can download changes online in the following situations:

- **Continuous automation tasks:**
All modifications are made online from a central configuration station. As a result, you do not need to make a configuration changes directly on site. It is also possible to add, modify, and delete Runtime objects, for example tags, alarms, and archives without deactivating WinCC.
- **Testing modifications in a protected environment:**
The configuring station can be used to run intended modifications offline before they are loaded in the activated project. The configuration planner can, therefore, test the modifications in a protected environment before adopting them in active operation. This allows configuration errors to be detected before they can cause problems in the process or stop the plant.
- **Simultaneous loading of modifications which influence each other:**
Configuration changes often relate to settings which are linked to each other. Such modifications should be downloaded consistently and take effect at the same time. This case occurs, for example, when a calculated value of an archive representation is added. It may be necessary to create new tags and add them to a new archive. Finally, the archive will be displayed in a picture. In the situation, if the information is not adopted as a unit, this will lead to error messages.

Note

If Load Online Changes is to be used in redundant systems, STEP7 or PCS7 is required. More information is available in the chapter "Advantages and requirements of integration".

General procedure

A project runs on the operator station during Runtime. Load Online Changes is automatically activated. The menus for Load Online Changes cannot be operated in WinCC Explorer.

You edit a copy of the project on a second computer, the configuration station. Activate the load online changes function in the WinCC Explorer on the configuration station. From this point onwards, WinCC records all changes made in the project. Online configurations on the configuration station are not, however, recorded.

When you have completed your modifications in the project, start the online download of the changes. This exports the modified data to the operator station. The project is updated in Runtime.

In the case of multi-user systems, WinCC generates packages after each download. Depending on the settings selected, the packages can be automatically imported by the clients.

See also

Online configuration (Page 137)

How to Download Load Online Changes (Page 153)

How to Reset Load Online Changes (Page 157)

How to Activate Load Online Changes (Page 151)

Use and Limitations of Load Online Changes (Page 146)

Requirements for Loading Online Changes (Page 144)

Run Diagnosis of Online Change Loading (Page 148)

Advantages and Prerequisites of Integration (Page 2454)

1.7.9.2 Requirements for Loading Online Changes

Introduction

Make sure that you use the function for downloading changes online only with consistent projects:

- Before activating the Load Online Changes function, the projects on the configuring station and on the operator station must be synchronized to the same project state.
- The project on the engineering station must be tested and run correctly when Load Online Changes is started.
- You can only configure changes that can be recorded by the Load Online Changes function. If the download changes online function cannot record a configuration, a warning is displayed. If you configure the change despite this warning, the Load Online Changes function is reset. The changes can no longer be transferred.

If you edit an inconsistent project, you take the risk that the activated project will no longer run correctly following the download. You can then only correct errors in Runtime in the deactivated status.

Note

If you edit a WinCC project which was created using the SIMATIC Manager, there will be no menu item "Load Online Changes" in WinCC Explorer. This also applies to WinCC projects created in WinCC and subsequently imported into SIMATIC Manager by using the function "Importing WinCC objects". This type of project is also called a TIA project.

If you copy a TIA project with WinCC Explorer and subsequently edit the copy, menu item Load Online Changes in WinCC Explorer is displayed.

Synchronizing Project to the Same Status

Synchronize the project on the computers participating so they have the same data before activating Load Online Changes. You can do this by copying the current version of your project from the operator station to the configuring station using the Project Duplicator.

If the project is edited on the configuring station, observe the following:

- The project must not be modified on the operator station.
- The project must not be edited either on the configuring station or on the operator station from another computer.
- The configuration on the operator station must also not be modified by scripts.
- In the case of a client/server system, the Notify after Export check box must be deactivated in the Implicit Update menu on the configuring station in WinCC Explorer/Serverdata.

Configuring with Load Online Changes Activated

Edit the project on the configuring station only when the Load Online Changes function is activated. Only configure changes that can be recorded by the download changes online function.

Keeping the Project Consistent

Test your edited project on the configuring station before starting Load Online Changes.

This ensures that fully functional data is transferred to the operator station and that no errors occur in the activated project.

Configuring in multiple partial steps

You can configure the changes that are to be entered in the online change shop in multiple partial steps. For this, exit WinCC after every configuration session if you have switched on the online changes shop. During the next configuration session, the project will be started in the same status and can be processed further. After completing the partial configurations, download the modified project in one step to the operator station.

Quantity structure

Using the Load Online Changes function, you should not configure and transfer more than 500 tags, archive tags, and messages. The Load Online Changes function is not intended or suitable for transferring mass data.

New segments are created in the archive manager if you make changes to existing archive variables. This can decrease performance of the load online changes feature. No additional segments are created when adding or removing variables in the TagLogging Editor.

Configure major modifications in several steps. After configuration, transfer each partial package to the operator station.

Note

Load Online Changes can also be switched off on the configuring station. However, Load Online Changes should only be switched off when no configuration modifications need to be carried out online and prefer to execute a complete download onto the OS. Do not select Turn Off if Load Online Changes should be interrupted. The consistency of the project can then no longer be guaranteed.

See also

How to Activate Load Online Changes (Page 151)

How to Download Load Online Changes (Page 153)

How to Reset Load Online Changes (Page 157)

Use and Limitations of Load Online Changes (Page 146)

Run Diagnosis of Online Change Loading (Page 148)

1.7.9.3 Use and Limitations of Load Online Changes

Introduction

When Load Online Changes is active, not all configurations can be executed which are possible when Load Online Changes is deactivated.

Basic Limitations

Opened Files

In the case of Load Online Changes, no open files are transferred, e.g. screens which are open in Graphics Designer at that moment. After the download, an entry is made in the message window of the Progress dialog. Close all applications and editors except Load Online Changes and start the transfer again.

Project in runtime

The project must not be active in runtime on the configuring station.

WinCC server

Observe the following procedure during download of Load Online Changes to a server:

The respective WinCC project should be open on all clients with an imported server package.

You can also perform the download if the corresponding project is not open on all clients. You must then wait at least 10 minutes after confirmation of the last dialog of Load Online Changes before opening the project on the client.

Redundant Systems

You can only use Load Online Changes in redundant systems when certain requirements have been met. If Load Online Changes should be used in redundant systems, you require SIMATIC Manager, or STEP 7 or PCS 7.

You must always start the download of Load Online Changes via the master server. This will also perform a download of Load Online Changes on the standby server. Starting the download from the standby server is not possible.

Changes to user archive configuration data, such as deleted fields in the archive, cannot be transferred with an online download of changes to a redundant server pair.

Files and Elements

Load Online Changes supports editing of the following elements:

Element	Create	Delete	Edit	Remarks
Project name, Project properties	---	---	No	---
Computer	Yes	No	No	---
Computer properties	---	---	No	---
Time base (computer properties)	---	---	No	---

Element	Create	Delete	Edit	Remarks
User cycle (project properties)	---	---	No	---
Tags (tag management)	Yes	Yes	Yes	Create: SIMTIC S7-1200, S7-1500 Channel: Not possible if tags are created with the function "AS Symbols > Load from AS". Delete/Edit: Only possible with external tags when the channel used supports the function. Currently only valid for the S7 channel.
Tag groups (tag management)	Yes	Yes	Yes	Delete: Only valid when the contained tags can be deleted.
Structure types	Yes	Yes	Yes	Delete: Only possible if the structure type does not contain structure tags. Edit: Only possible as long as no structure tag has been set up under the structure type.
Structure tags (structure types)	Yes	Yes	Yes	Delete: Only possible if the associated structure tag elements can be deleted.
Connections (tag management)	Yes	Yes	Yes	Changes to a connection can lead to loss of data. Delete/Edit: Currently only valid for the S7 channel.
Channels (tag management)	No	No	No	---
Channel units (tag management)	No	No	No	---
Text entries (Text Library)	Yes	Yes	Yes	---
Pictures (PDL files, Graphics Designer)	Yes	Yes	Yes	A picture is updated at Runtime only after re-selection.
Library, color palette (Graphics Designer)	---	---	No	---
Text lists, graphic lists (Text and graphic lists)	Yes	Yes	Yes	---
Messages (Alarm Logging)	Yes	Yes	Yes	The processing of message blocks and message groups from message classes is not supported. The processing of user-defined message groups is supported. Deletion of message classes is not supported.
Archives, archive tags (Tag Logging, User Archives)	Yes	Yes	Yes	
Reports, layouts (Report Designer)	Yes	Yes	Yes	---

Element	Create	Delete	Edit	Remarks
Scripts (Global Script)	Yes	Yes	Yes	---
Access rights (User Administrator)	Yes	Yes	Yes	---
Other files	Yes	Yes	Yes	The files must be in the project directory or one of the following subdirectories: GraCS, Library, ScriptLib, PRT, Textbib.

Support for WinCC Web Navigator

Load Online Changes supports the transfer of published pictures and scripts of WinCC Option Web Navigator, if the Web Navigator Server is installed on configuration station and operator station.

See also

- Online configuration (Page 137)
- How to Download Load Online Changes (Page 153)
- How to Reset Load Online Changes (Page 157)
- How to Activate Load Online Changes (Page 151)
- Loading Online Changes (Page 142)
- Requirements for Loading Online Changes (Page 144)

1.7.9.4 Run Diagnosis of Online Change Loading

Introduction

After downloading changes online, you should check that all changes have been adopted correctly in the project on the operator station. You can export the error messages that occurred during download to a diagnosis file.

Log files for diagnostics of the online download of changes

The following log files are created in the WinCC diagnostics folder:

Engineering Station:

- DIDiagnosisSetMode.log
- DIDownloadES_<Name of the target computer>
- DIDiagnosisError.log

Operator Station:

- DIDIagnosisSetMode.log
- DIDownloadOS
- DIDIagnosisError.log

Notes on Diagnostics and Configuration

There are various reasons for a change not being adopted in the activated project.

Behavior	Procedure / Configuration
Changes to picture are not displayed (PDL file)	Reselect the picture in Runtime
Changes in a script are not displayed	Save the script again in the Global Script editor and reselect the picture in Runtime
Changes to a control are not displayed	Reconnect the control in the Graphics Designer
Correction required in the configuration	If there is an error in the configuration, correct the error on the configuring station with Load Online Changes activated. Transfer the corrected project data to the operator station again with the download changes online function.
Network failure during the download	If the network fails during the download, the download changes online function can only update some of the recorded data. The Runtime project is therefore inconsistent. Start the download again. The operator station must remain in Runtime. Load Online Changes is full executed once again. Ignore the fault messages displayed. No further configurations may be completed on the configuring station as long as Load Online Changes is not concluded.

Export error messages to a diagnosis file

You can export the error messages that have occurred while loading online changes to a diagnosis file.

1. When loading is complete, click "Export".

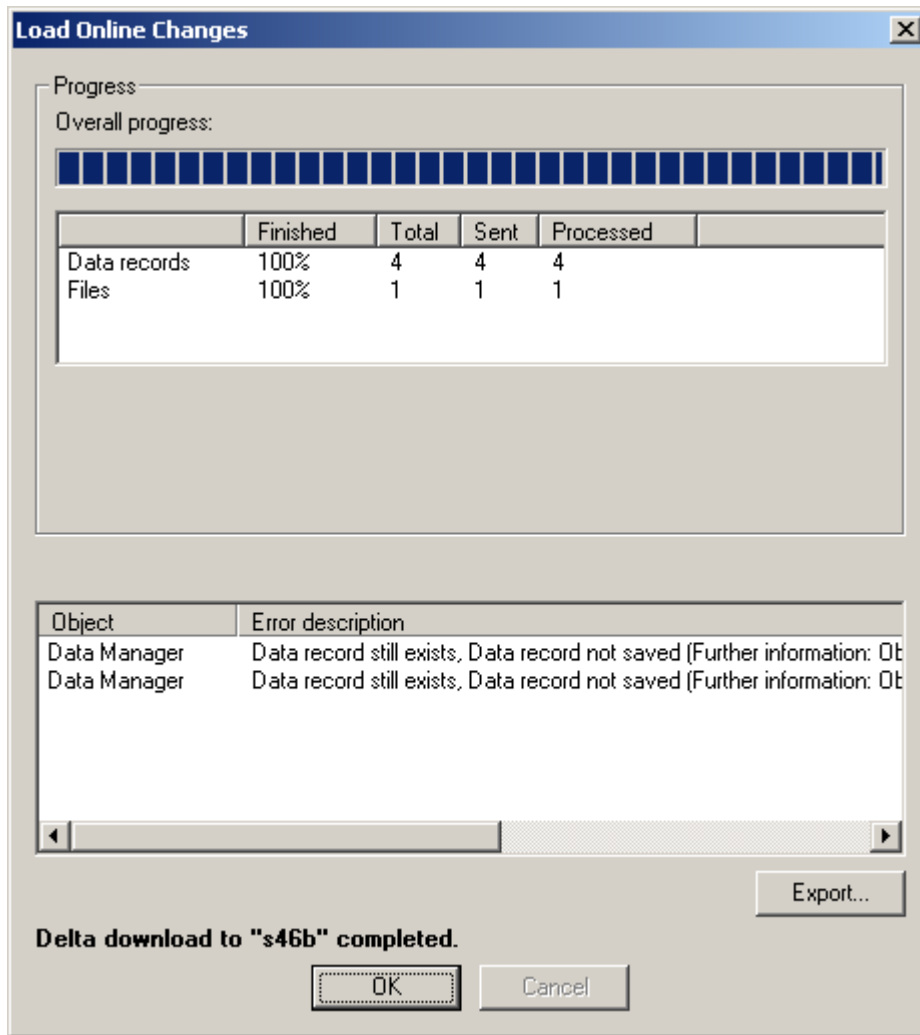

This will open the "Save As" dialog.

2. Select the desired directory and enter a meaningful file name.

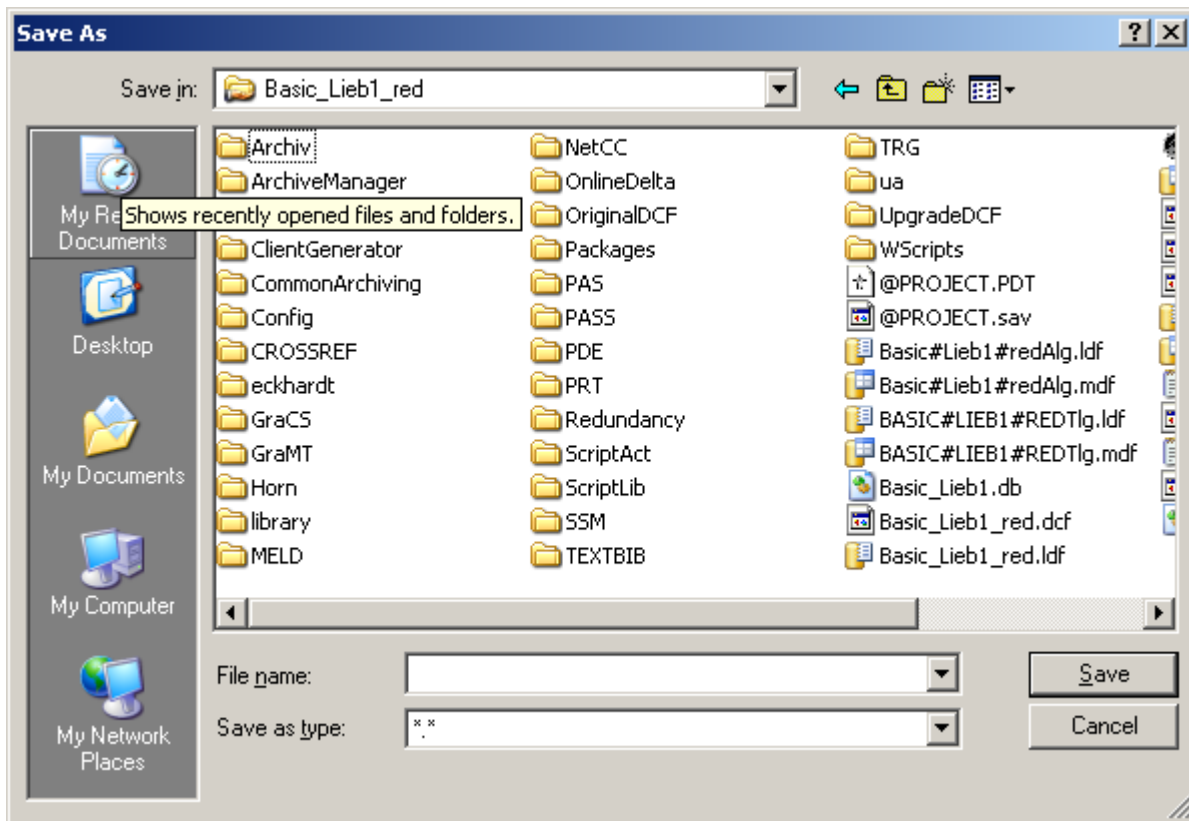

3. Click on the "Save" button. The file is written to the selected directory.

See also

- How to Download Load Online Changes (Page 153)
- How to Reset Load Online Changes (Page 157)
- How to Activate Load Online Changes (Page 151)
- Use and Limitations of Load Online Changes (Page 146)
- Requirements for Loading Online Changes (Page 144)

1.7.9.5 How to Activate Load Online Changes

Introduction

As soon as Load Online Changes has been activated on the configuring station, WinCC detects all configured changes. If you want to use the changes on the operator station, start a download of the changed data. The project is updated in Runtime.

Before activating the Load Online Changes, copy the project to the configuring station. Use the Project Duplicator for this. This prevents inconsistency. The project can be duplicated from the operator station while Runtime is active. When the copied project is opened on the

configuring station, Runtime is started automatically. If Runtime is terminated, Load Online Changes remains activated. Reset Load Online Changes first to ensure the changes are assumed when the project is restarted.

NOTICE

Ensure that the project is consistent.

Ensure that configuration only takes place on the configuring station on which Load Online Changes is active.

If you edit an inconsistent project, you take the risk that the activated project will no longer run correctly following the download. You can then only correct errors in Runtime in the deactivated status.

Procedure

1. Right-click Load Online Changes in the navigation window of the WinCC Explorer.
2. When the project has been copied, select the Reset option in the shortcut menu before starting with the changes.
3. Also select Turn On in the shortcut menu.
Load Online Changes is activated and immediately records all changes made in the project.

If a change is made that cannot be recorded by Load Online Changes, the following dialog is displayed:

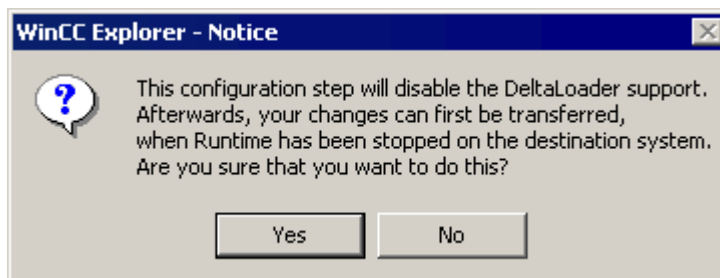

It is possible that the change is necessary and that the project would otherwise be inconsistent and cause errors in Runtime. In this case, confirm with Yes. Reset the download changes online function and continue to configure without it.

Note

If you edit a WinCC project which was created using the SIMATIC Manager, there will be no menu item "Load Online Changes" in WinCC Explorer. This also applies to WinCC projects created in WinCC and subsequently imported into SIMATIC Manager by using the function "Importing WinCC objects". This type of project is also called a TIA project.

If you copy a TIA project with WinCC Explorer and subsequently edit the copy, menu item Load Online Changes in WinCC Explorer is displayed.

See also

- How to Copy a Project (Page 212)
- How to Download Load Online Changes (Page 153)
- How to Reset Load Online Changes (Page 157)
- Use and Limitations of Load Online Changes (Page 146)
- Loading Online Changes (Page 142)
- Requirements for Loading Online Changes (Page 144)

1.7.9.6 How to Download Load Online Changes

Introduction

If you want to adopt the changes recorded by the download online changes function in an activated project, start a download. This exports the modified data from the configuring station to the operator station. The project is updated in Runtime.

The changes can be transferred to several operator stations. A condition for this is that the same project status prevails on all target systems.

Before downloading, make sure that the modified project is fault-free. Test the changes on the configuring station in Runtime.

If you are editing a multi-user project, WinCC generates the required packages on the operator station after each download. The automatic package update is used to by the clients to import the changes as packages and to load them. To do this, select the "Server data" item in WinCC Explorer on the OS client, and activate the Notify After Export check box in the Implicit Update menu.

If the package is changed by the server in a redundant multi-user system, so that the clients are automatically updated, reregister the preferred server on the clients, or reassign the preferred server by reloading of the clients.

Requirements

- The project was copied from the operator station with the Project Duplicator before activating the Load Online Changes function.
- The project can only be edited with the Load Online Changes function active at all times.
- The project on the configuring station is consistent and has been tested in Runtime.
- The unchanged project is activated in Runtime on the operator station.
- The operator station should perform as few operations as possible while the download of Load Online Changes takes place. In time-critical projects, remember that Load Online Changes can affect the response of your project over time.
- Use the configuring station to check that the files to be transferred are not open.
- All WinCC editors must be closed on the configuring station.

Procedure

1. Right-click Load Online Changes in the navigation window of the WinCC Explorer.
2. Select the Start Download command in the shortcut menu.
The Remote Computer dialog is opened.

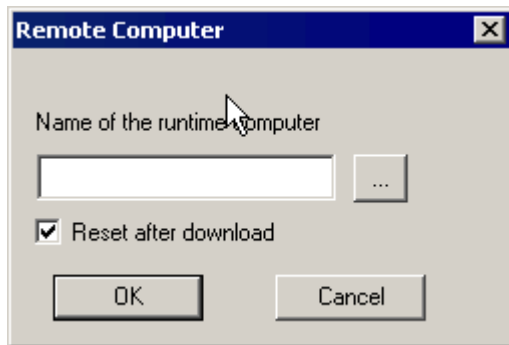

3. Click the **...** button to select the operator station on which you want to update the project.
4. To transfer the changes to several operator stations, deactivate the check box "Reset after download" before the download. After downloading to the first operator station, the same data are available for a further download.
5. Start the download with OK.
The Progress Dialog dialog is opened. The window contains a progress bar for the entire download and a second progress bar for the current action.
6. If the Reset After Download check box is selected, a reset occurs after Load Online Changes.
7. After the download, close the Progress Dialog dialog with OK.

Note

After Load Online Changes has been reset, the file with the recorded data is deleted. If transfer of the changes should be made to an operator station, the entire project must be copied from the configuring station. In this case, Runtime must be terminated on the operator station and WinCC closed.

If you edit a WinCC project which was created using the SIMATIC Manager, there will be no menu item "Load Online Changes" in WinCC Explorer. This also applies to WinCC projects created in WinCC and subsequently imported into SIMATIC Manager by using the function "Importing WinCC objects". This type of project is also called a TIA project.

If you copy a TIA project with WinCC Explorer and subsequently edit the copy, menu item Load Online Changes in WinCC Explorer is displayed.

Canceling the Download

The downloading process can be stopped. This should only be done in exceptional circumstances, e.g. when the procedure threatens to take too much time. Only part of the project changes are updated, according to the following sequence:

1. Connections
2. Tag groups, tags, structures
3. Texts
4. Messages
5. Archives, archive tags
6. User Administrator
7. Pictures
8. Scripts
9. Reports

If only a part of the download is completed, the project on the operator station is not fully functional:

- A tag, for example, has been deleted. The tag management has been updated but the pictures were not transferred in which the tags are displayed.
- A screen jump, for example has been configured but does not function. One screen was transferred but not the other.

Changes already transferred are not reset on the operator station.

Following a cancellation, the Load Online Changes download can be restarted. The download is then completed fully.

Pay attention to the following during the download:

- The operator station remains in Runtime.
- Ignore the fault messages displayed.
- No further configurations may be completed on the configuring station as long as Load Online Changes has not been concluded.

Monitoring the Download Process

You can configure a message or use an internal tag that indicate the start and finish of the download on the operator station.

Monitoring with control center options

If you have configured the WinCC system messages in the message system, downloading changes online triggers the following OS process control messages:

Load online changes	Message no.	Message text
Download started	1012242	Delta loading was started
Download ended	1012243	Delta loading ended

The messages can only be displayed when the process control options of WinCC are installed.

Monitoring via the internal tags "@DeltaLoaded", "@SFCDeltaLoaded" and "@SFCDeltaLoaded"

The system tags "@DeltaLoaded", "@SFCDeltaLoaded" and "@DeltaCompiled" indicate the download status as follows:

@DeltaLoaded

Value	is set
0	at the start of the download on the configuration station and on the operator station
1	at the start of the online change loading on the operator station, directly before sending the process control message "1012242"
2	when canceling the online change load on the operator station
2	at the finish of the online change loading on the operator station, directly before sending the process control message "1012243"

On the configuration station, "@DeltaLoaded" is always "0". On the operator station, the value depends on the delta loading process. The value is not changed during the activation or deactivation.

@SFCDeltaLoaded

Value	is set
0	at the start of the transfer of the SFC database on the operator station in the course of the online change loading
1	at the finish of the transfer of the SFC database on the operator station in the course of the online change loading

On the configuration station, "@SFCDeltaLoaded" is not set. On the operator station, "@SFCDeltaLoaded" is used to synchronize the SFC clients. The SFC clients must terminate access to the SFC database before the download. The value is not changed during the activation or deactivation.

@DeltaCompiled

Value	is set
0	Initial value
1	OS compiling of change is running
2	OS compiling of change has been completed

You can monitor the OS compiling of changes using "@DeltaCompiled" system tag.

See also

How to Activate Load Online Changes (Page 151)

How to Reset Load Online Changes (Page 157)

Requirements for Loading Online Changes (Page 144)

Loading Online Changes (Page 142)

Use and Limitations of Load Online Changes (Page 146)

Run Diagnosis of Online Change Loading (Page 148)

Integration of WinCC in SIMATIC Manager (Page 2453)

1.7.9.7 How to Reset Load Online Changes

Introduction

When you deactivate the Load Online Changes function, all changes recorded by the function are deleted. If you want to record your changes again with the Load Online Changes function, you must Runtime it again.

By resetting the download changes online function, you avoid an unwanted configuration being transferred to an operator station. You can undo changes you have made and re-edit your project with the Load Online Changes function activated.

Procedure

1. Right-click Load Online Changes in the navigation window of the WinCC Explorer.
2. Select the Reset command in the shortcut menu.
The following dialog is displayed:

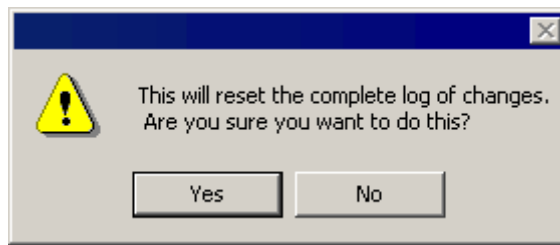

3. Click on OK to confirm.
The recorded changes are deleted in the download changes online function and can no longer be downloaded.

Note

If you edit a WinCC project which was created using the SIMATIC Manager, there will be no menu item "Load Online Changes" in WinCC Explorer. This also applies to WinCC projects created in WinCC and subsequently imported into SIMATIC Manager by using the function "Importing WinCC objects". This type of project is also called a TIA project.

If you copy a TIA project with WinCC Explorer and subsequently edit the copy, menu item Load Online Changes in WinCC Explorer is displayed.

See also

- How to Download Load Online Changes (Page 153)
- How to Activate Load Online Changes (Page 151)
- Use and Limitations of Load Online Changes (Page 146)
- Loading Online Changes (Page 142)
- Requirements for Loading Online Changes (Page 144)

1.8 Determining the Global Design

1.8.1 Global Design of the Objects

Introduction

In WinCC, you have numerous options for changing the way your projects appear in Runtime.

To do this, you choose from a series of predetermined and self-created designs. The design contains colors, patterns and other optical effects.

You determine the global design in the project properties.

Global Designs

WinCC provides the following designs for the projects:

- WinCC Dark (standard design)
Design in dark gray to black color tones with relief-like 3D design of the objects.
- WinCC 3D
Design in gray color tones with relief-like 3D design of the objects.
- WinCC Glass
Design in blue color tones with a glass-like shimmer effect.
- WinCC Simple
Simple design in light blue color tones.
- WinCC Ocean
Dark design in blue-green color tones with its own central color palette.
- WinCC Retro
The design imitates the appearance of "WinCC Classic". The functionality corresponds to the other WinCC-Designs in WinCC V7 or higher.
- WinCC Classic (migrated projects)
WinCC V6.2 standard design which, for compatibility reasons, is available for migrated projects.
The design supports only a portion of the functions that were introduced as of WinCC V7.0:
For example, you cannot use any SVG graphics.

In addition to the provided designs, you can create, edit, rename and delete your own designs.

You can also export your own designs and import them into another WinCC project.

Design Features

The design contains determinations on the following properties of the objects:

- For all objects:
 - Shadow
 - Hover
The hover effect changes the display temporarily, as long as the mouse pointer is over the object.
- Different for the different groups of object types:
 - Style
 - Color scheme
 - Transparency
- For the WinCC project:
 - Central color palette

The design features of the global design cannot be used in full for all object types.

Settings in the Object Properties

If nothing else is set in the object properties, the settings of the selected global design apply to all graphical objects in the project.

If an attribute is defined by a global design, it remains static and can no longer be dynamized. Even a dynamization that has already been performed remains without effect.

To enable dynamization of an object, disable the global color scheme or the global shadow in the object properties.

Windows objects

For the Windows objects "Button", "Round Button" and "Slider Object", you can accept the global design or activate the user-defined settings.

Alternatively, you can also accept the display style of the Windows operating system for the button and the slider object.

Settings in the Computer Properties

The global design requires the recommended hardware equipment.

You can improve the computer's reaction behavior by switching off certain elements of the global design in the WinCC computer properties.

See also

How to make computer-specific settings for runtime (Page 200)

How to change the default setting of object types (Page 457)

1.8.2 The Elements of the Global Design

Introduction

You determine the uniform optical design of the process pictures in the "Global Design Settings" dialog.

If you are designing your own design, you have different options in the individual object groups.

Design Features of a Global Design

A global design has the following design features for the individual object types:

Object group	Objects	Style	Color scheme
Simple	Geometric object (Standard objects)	Single	Fill color (fill pattern color) Background color Fill pattern Line background color Line color
	Tubes (Tube objects)	Single	Background color (line color)
	Background (Process picture)	Single	Fill color (fill pattern color) Background color Fill pattern
Smart	Text object (I/O field, combo box, list box, multiple row text)	Single	Text color (font color) Fill color (fill pattern color) Background color Fill pattern Line background color Line color
	Bargraph (3D-Bar)	Single	Text color (font color) Fill color (fill pattern color) Background color Fill pattern

Object group	Objects	Style	Color scheme
Windows	Button	Single Color gradient Rectangular Aero Glass	Text color (font color) Background color
	Round Button	Single 3D style Aero Glass Sphere	Text color (font color) Background color
	Slider object	Single Color gradient Rectangular Aero Glass	Background Color
	Check box/option group (check box, option group)	Single	Text color (font color) Fill color (fill pattern color) Background color Fill pattern Line background color Line color
Control	Display gauge / clock	Single Color gradient 3D style	Text color (font color) Background color
	Runtime controls	Single Standard Basic Process Control ocean	-
Toolbar	Menus/toolbars	Windows Color gradient	Text color (font color) Background color
OnScreen- Keyboard	Button (Screen keyboard)	Single	Text color (font color) Background color Line color
	Background (Screen keyboard)	Single	Background color
Color palette	WinCC Standard WinCC Ocean User-defined central color palettes	-	-

1.8.3 How to work with global object designs

Introduction

You can use global designs in WinCC.





In addition to the provided designs, the designs that you create on your own are also available.

Working with Designs

You can display the settings for the provided designs and edit your own designs.

To adapt the current user-created design, edit the following design elements: shadow, hover effect and color scheme.

You also have the following options:

Function		
Import design		Integrates another design in WinCC. Select the required design in the file selection dialog.
Export design		Saves a selected design in XML format to use a design in another project.
Add new design		Creates a new design with an automatically assigned name.
Delete current design		Deletes a self-created design.
Rename current design		Opens a dialog for renaming a self-created design.

Note

"WinCC Classic" design

"WinCC Classic" ensures compatibility with WinCC versions prior to WinCC V7.0. Only certain color settings are available with this design. No other configuration options are offered.

If you configure changes in another global design, such as a central color palette, and then change to the design "WinCC Classic", the changes are accepted and not reverted.

During export/import of the "WinCC Classic" design, only the color settings from this design will be loaded.

Procedure

1. Click the project name in the navigation window of the WinCC Explorer and select the Properties command in the shortcut menu.
The "Project Properties" dialog opens.
Alternatively, open the global design settings in the Graphics Designer using the menu entry "Tools > Global Design Settings".
2. On the "User Interface and Design" tab, click "Edit" next to "Active Design".
The "Global Design Settings" dialog opens.
All existing designs are displayed in the upper bar.
The preview shows how the objects will appear for the selected objects.

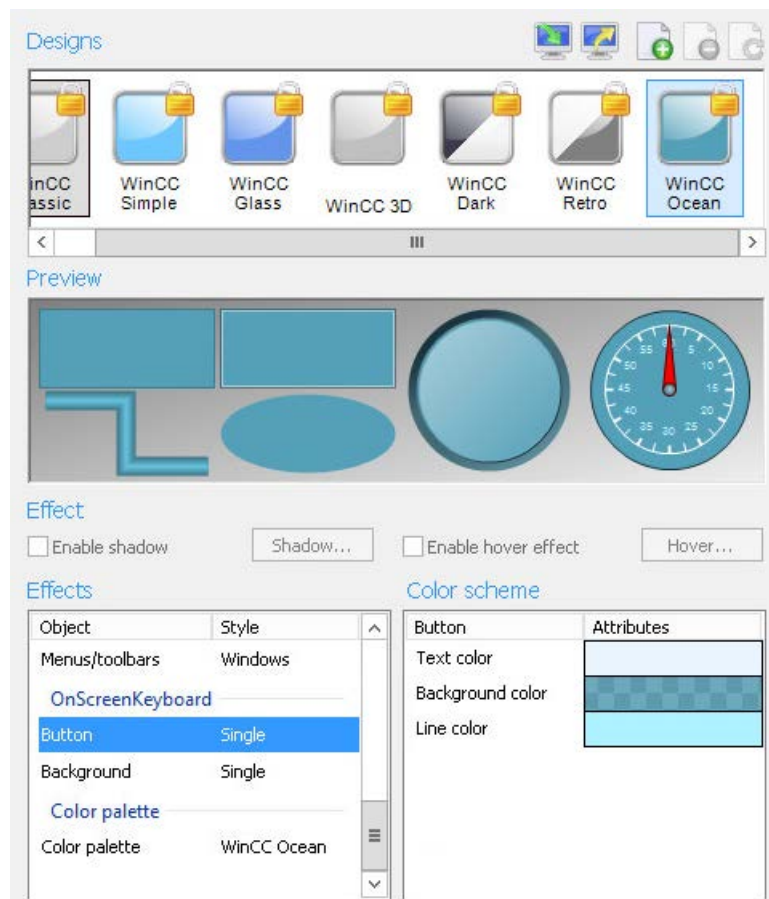

3. In order to select a design for the current project, click the corresponding symbol.
4. Confirm with "OK".

1.8.4 How to edit your own global design

Introduction

You can determine the design of the objects globally, i.e. project-wide.



You can select from provided designs or create and activate your own designs.

The provided designs cannot be changed. You can only edit the designs that you create yourself.

Procedure

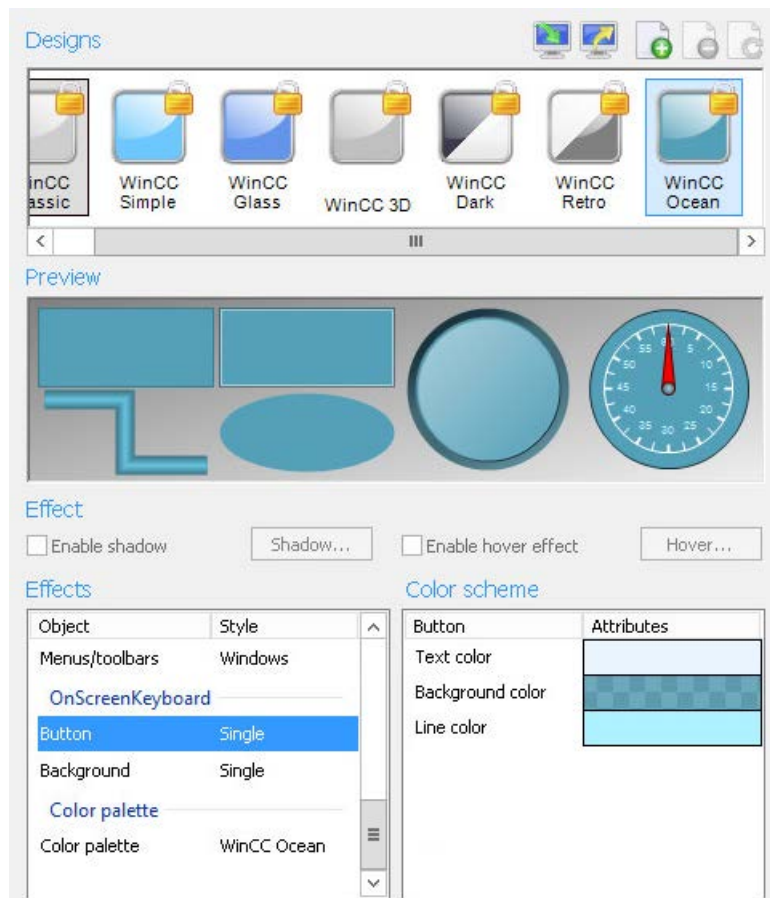
1. Click on the project name in the navigation window of WinCC Explorer.
Select the "Properties" entry in the shortcut menu.
The "Project Properties" dialog opens.
Alternatively, open the global design settings in the Graphics Designer using the menu entry "Tools > Global Design Settings".
2. On the "User Interface and Design" tab, click "Edit" next to "Active Design".
The "Global Design Settings" dialog opens.



3. Select a design whose properties you want to apply as the basic setting.
If you create a new design, the properties of the last clicked-on design are applied.
4. To add a new design, click on .
A new design is created to the right of the existing designs.
5. To rename the design, click on .
Assign an appropriate name for the design.

6. If necessary, activate the shadow view and click on the "Shadow" button.
The "Shadow Settings" dialog is opened.
7. Set the shadow offset and the shadow color and confirm with "OK".
When you check "Synchronize", the offset in x and in y always remains the same.
8. If necessary, activate the hover effect and click on the "Hover" button.
The "Hover Settings" dialog is opened.
The hover effect changes the object when the mouse pointer is moved over it.
9. Set the desired hover effect and confirm with "OK".
 - Increase brightness: The entire object becomes brighter.
 - Inner glow: The inside of the object glows in the selected color.
 - Outer glow: The edge of the object glows in the selected color.
10. Under "Display", select the central color palette that is linked with the design.
11. Under "Display", select the desired object group or the desired design element.
Select the desired style from the drop-down list, if necessary.
Select the desired colors and the transparency of the object properties in the color scheme.
12. Click on "Apply" to save temporarily.
13. To close the dialog and save the settings, click "OK".

Result

The created design is displayed in the preview.

The new design is applied as an active design in the WinCC project.

1.8.5 How to determine the global design of the objects

Introduction

You can determine the design of the objects globally, i.e. project-wide.

You can select from provided designs or create and activate your own designs.

Procedure

1. Click the project name in the navigation window of the WinCC Explorer and select the Properties command in the shortcut menu.
The "Project Properties" dialog opens.
Alternatively, open the global design settings in the Graphics Designer using the menu entry "Tools > Global Design Settings".
2. On the "User Interface and Design" tab, click "Edit" next to "Active Design".
The "Global Design Settings" dialog opens.

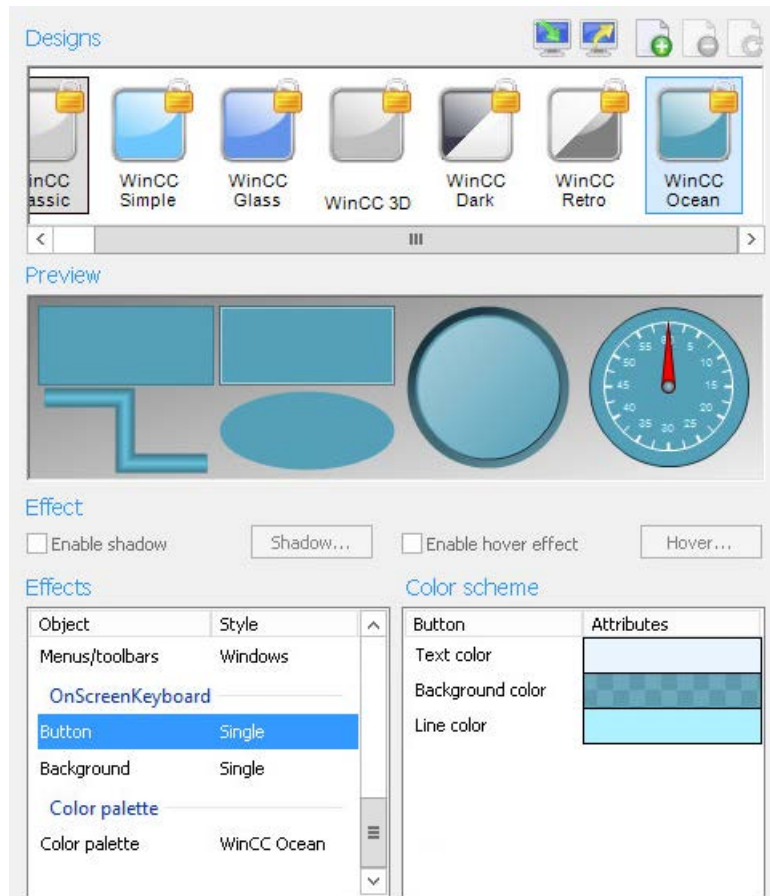

3. Under "Designs", click on the desired design and confirm with "OK".
The selected design is displayed in the preview.

Your Own Designs

You can edit your own designs in any manner.

In particular, you can individually determine the following settings:

- Global shadow
- Hover effect

- Style of an object group
- Color scheme of an object group:
 - Central color palette
 - Object colors
 - Display of the onscreen keyboard

1.9 Making Settings for Runtime

1.9.1 Settings for Runtime

Verifying Data Execution Prevention (DEP)

You need to verify and possibly adjust the performance options for data execution prevention (DEP) prior to the initial start of Runtime.

1. Double-click "System" to open the system properties dialog in the control panel.
2. Click "Settings" in the "Performance" field of the "Advanced" tab.
3. Select the "Data Execution Prevention" tab in the "Performance Options" dialog.
4. Activate the "Turn on DEP for essential Windows programs and services only" option if not already active.
5. Click "Apply" and then confirm your entries with "OK".

Runtime settings

WinCC adopts the default settings for Runtime in every project. There are, however, some settings you must make yourself.

When starting Runtime, WinCC uses the settings from the following dialogs:

- "Computer Properties" dialog
 - "Startup" tab
 - "Parameters" tab
 - "Graphics Runtime" tab
 - "Runtime" tab
- "Project properties" dialog
 - "HotKeys" tab
 - "Options" tab
 - "User Interface and Design" tab

You can change the settings for Runtime at any time.

If a project is running in Runtime, while you edit the settings, you must exit Runtime and restart. The changes are then applied.

Computer properties: Startup

Entry	Function
Start sequence of WinCC Runtime	Applications that are loaded in Runtime
Additional tasks/ applications	Programs or tasks to start with WinCC Runtime (e.g. MS Excel) Make sure that you only start tasks that you actually need on the computer.

Computer properties: Parameters

Entry	Function
Runtime language	The language in which the enabled project is displayed (language setting during runtime).
Runtime Default Language	If there are no texts in the configured Runtime language, Runtime shows the text of this language.
Start Information	<no function assigned>
Disable keys	Preventing access to operating system level via shortcut in Runtime.
Time base for the clock shown in Runtime	Base for setting the time in WinCC
PLC Time Setting	Valid time setting for the PLC
Central time and date formatting	Determines whether date and time are displayed in accordance with ISO8601 everywhere or whether the format can be set locally.

Computer properties: Graphics Runtime

Entry	Function
Project file	Shows the path and name of the current project file
Start Picture	PDL file opened as the starting picture in Runtime
Start configuration of Menu and Toolbars	Configuration file with customized menus and toolbars
Window Attributes	Appearance of the window in Runtime
Turn Off	Prevents operator input in windows and switches off memory-intensive picture operations
Hide system screens	Limiting access to process pictures in the data window of the WinCC Explorer This option has no effect on WinCC Runtime. You specify which process pictures are hidden in the WinCC Explorer through the prefix and the "Match case" option.
Independent picture windows	Makes it possible to hide the main window in order to let picture windows appear like independent windows.
Cursor control: Behavior / keys	Navigation with the cursor in the picture
Hotkeys	Key combinations for operator input and screen navigation
Buffer size (number of pictures)	Maximum number of entries allowed in the list of the called project pictures

Computer properties: Runtime

Entry	Function
VBS Debug Options Graphics/Global Script: Start Debugger (only suitable for test and commissioning purposes)	Starts the debugger in Runtime, when the first picture is selected with a VBS script.
VBS Debug Options Graphics/Global Script: Display error dialog (only suitable for test and commissioning purposes)	Opens a dialog in Runtime if a VBS error occurs and allows you to start the debugger. Script processing is interrupted.
Design settings	Makes it possible to disable design options to improve the response of the computer. The "WinCC Classic" design ensures compatibility with versions prior to WinCC V7.0 but does not support all functions of the current WinCC version.
Runtime options	Activates or deactivates additional possible operations on the respective computer: <ul style="list-style-type: none"> • Monitor keyboard • "Swipe" gesture • Runtime system dialogs You configure the call of the systems dialogs in the "Project properties > User Interface and Design" dialog. Deactivation of Direct2D can improve the response of the computer.
Picture Cache	Path for the temporary storage of pictures
Mouse Pointer	Actions of the mouse pointer in the picture

Project properties: HotKeys

Entry	Function
Assign	The entered key combinations call the assigned action in Runtime: <ul style="list-style-type: none"> • Logon • Logoff • Hardcopy • Runtime system dialogs

Project properties: Options

Entry	Function
Allow activation on ES	The option is only available for integrated WinCC projects.
Help in Runtime	Preventing access to operating system level by calling the online help in Runtime.
C scripts with "Dynamic" language setting	Select the language in which the C script is executed in Runtime: <ul style="list-style-type: none"> • "Respective set WinCC Runtime language" option: WinCC Runtime language • Selected operating system language: Code page setting of the operating system

Project properties: User Interface and Design

Entry	Function
Activation of Runtime system dialogs	The system dialogs are opened via an assigned hotkey or an activation gesture on the touch screen. The setting applies to the complete WinCC project. For individual computers in a multi-user project, deactivate or activate the call in the "Computer Properties > Runtime" dialog. The system dialogs provide the following functions: <ul style="list-style-type: none"> • Screen change to start screen • Picture change to the next or most recently called process picture • Display process pictures marked as favorites • Changing languages in Runtime
Activate hardware accelerated graphic representation	Direct2D is used to display the graphics.
Active design	Representation of the windows, dialogs and objects
Central color palette	Definition of own color palette for the configuration

See also

How to Start Runtime (Page 204)

How to Set the Time Base in the Project (Page 133)

Effect of External Applications at Runtime (Page 175)

How to Assign Hotkeys in the Project (Page 174)

How to Set Up a Startup List (Page 172)

How to Specify the Computer Properties (Page 123)

How to make computer-specific settings for runtime (Page 200)

How to set the options in Graphics Designer (Page 358)

1.9.2 How to Set Up a Startup List

Introduction

When you activate a project, additional program modules required for execution in Runtime are loaded. In the startup list, you specify which applications will be started when you activate a project.

Depending on the configuration, WinCC itself enters some applications in the startup list. Graphics Runtime is always started and is activated by default.

To achieve better performance, you should only start applications that you actually require in Runtime.

Procedure

1. Click the Computer component in the navigation window of the WinCC Explorer. WinCC displays the list of computers in the data window.
2. Select the computer and then click the Properties command in the shortcut menu. The Computer Properties dialog is opened.
3. Click the Startup tab.

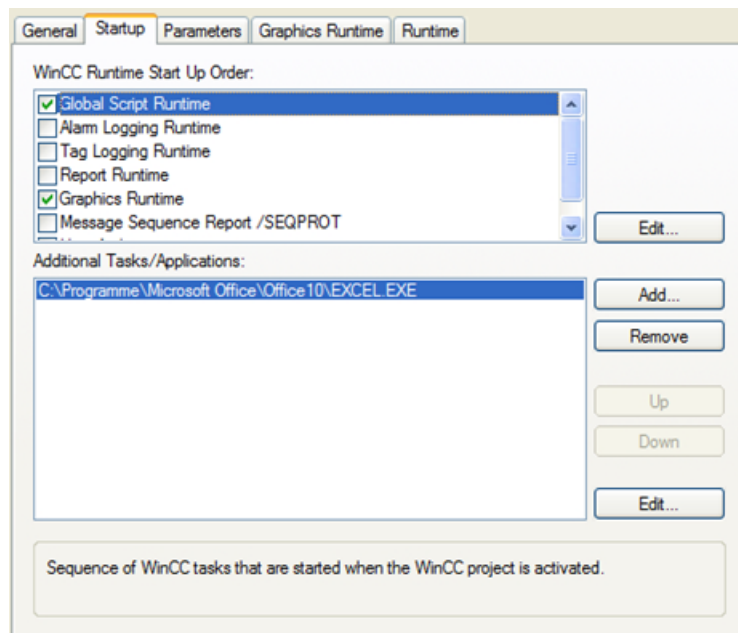

4. Activate the applications to be loaded when Runtime starts in the Start sequence of the WinCC Runtime list box. The activated modules are marked with a check mark in front of the entry in the list. With the Edit button, you can open a dialog in which you can enter start parameters for an application.

5. If you want to open additional programs or tasks when you start Runtime, click the Add button.

The Add Application dialog is opened.

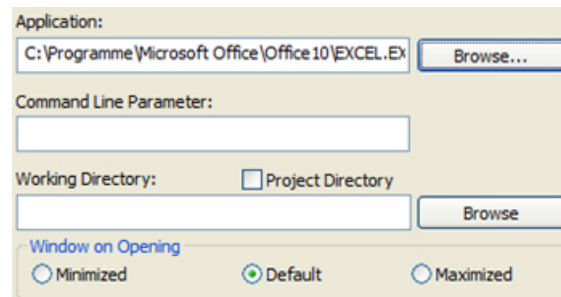

Application: C:\Programme\Microsoft Office\Office10\EXCEL.EX Browse...

Command Line Parameter:

Working Directory: Project Directory Browse

Window on Opening

Minimized Default Maximized

6. Enter the application and the full path in the Application input box. You can locate the file using the Browse button.
7. If required, select the start parameters, the working folder for the application, and the window properties. Click OK to confirm. The added application is entered in the Additional Tasks/Applications box. With the Remove button, you can delete an application from the startup list.
8. Select an application and click the Up and Down buttons. This is how you specify the order in which the applications are started. The list of additional applications is read out from top to bottom.
9. Click "OK" to close the dialog.

Multi-user system

In a multi-user system, make sure that you only start tasks on the client that the client really needs.

See also

- How to Specify the Computer Properties (Page 123)
- How to set up Runtime (Page 180)
- How to Start Runtime (Page 204)
- Settings for Runtime (Page 168)

1.9.3 How to Assign Hotkeys in the Project

Introduction

You can assign the following shortcut keys for your project:

- Logon opens a window to log on a user in Runtime
- Logoff opens a window to log off a user in Runtime
- Hardcopy opens a dialog for printing the screen in Runtime
- "Runtime system dialogs" opens the system dialogs in Runtime

Procedure

1. Click the project name in the navigation window of the WinCC Explorer and select the Properties command in the shortcut menu.
The "Project Properties" dialog opens.
2. Select the Hotkeys tab and choose the required action in the Actions list box.

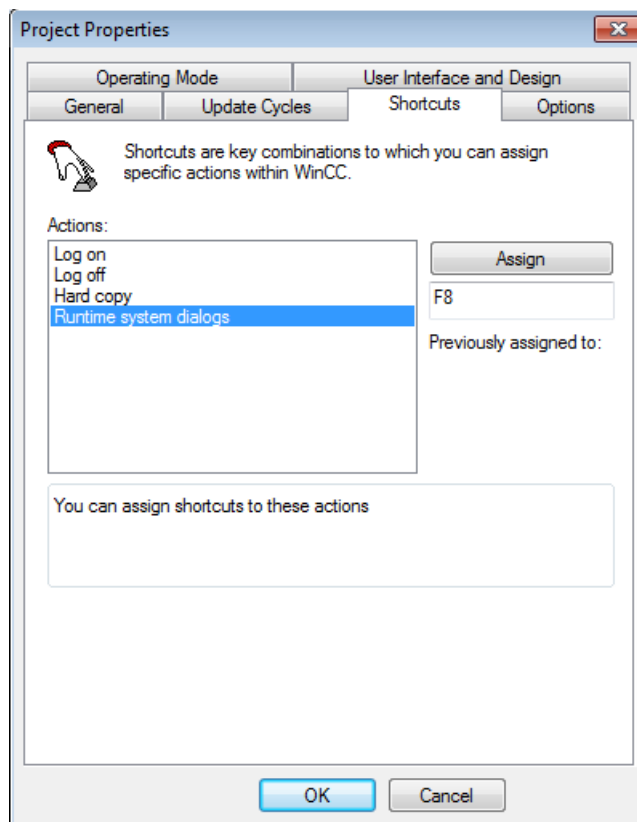

3. Click in the Previously Assigned to input box. Press the required key combination.
WinCC indicates the actuated buttons.
4. Click the Assign button.
WinCC activates the keystroke for calling the action.

5. Assign other shortcut keys to any other actions you require.
6. Click "OK" to close the dialog.

See also

How to Start Runtime (Page 204)

Preparation to Create a Project (Page 115)

Settings for Runtime (Page 168)

1.9.4 Effect of External Applications at Runtime

Introduction

There are numerous applications that can place a heavy load on a computer. These applications have nothing to do with WinCC but affect the system resources.

Cyclic Printing

Printing large amounts of data can utilize a lot of resources. You should defined cyclic print jobs so that they do not all start at the same time in Runtime.

Using Virus Scanners

When using a virus scanner, make sure that the computer has sufficient system resources. Updates started automatically over the network can cause load on the system. You can find the approved virus scanner versions in the WinCC Release Notes under "Notes on operation".

Screen savers

Using a screen saver takes up processor time. This can lead to overload on the system. Defective screen savers that do not free up parts of the work memory significantly reduce the useable work memory. The Windows "Logon screen saver" can be used.

Optimizing Processor Utilization

During continuous operation, the usable work memory becomes badly fragmented after a time. To allow Windows to reorganize the work memory, the average utilization of the processor should be below 75 %. You can check the processor utilization in the Windows System Monitor. If you cannot achieve processor utilization less than 75 %, you should upgrade your computer.

Defragmenting a Hard Disk

Using the Windows file system frequently can result in an unfavorable organization of the disk memory, e.g. if changed data are saved during commissioning.

To avoid loss of performance, the hard disk drive should be optimized regularly.

NOTICE

Deactivating automatic optimization

When operating WinCC in Runtime, make sure that no automatic optimization is activated. The time required for these activities can serious detrimental effects on WinCC performance.

Deactivating Power Management

To allow the WinCC Runtime system to operate correctly, power management must be deactivated in the BIOS setup and in the Control Panel of Windows.

If power management is activated, you may encounter problems when archiving process data and messages. The function can lead to a lack of resources when virtual memory is accessed.

Fast reactions to operator input are then no longer possible.

FindFast.exe

The Microsoft FindFast.exe application is used to accelerate searches for documents.

When configuring with WinCC, it is possible that FindFast.exe takes up a considerable percentage of processor capacity. You should therefore remove Microsoft Indexing from the Autostart folder of the operating system.

See also

Preparation to Create a Project (Page 115)

Settings for Runtime (Page 168)

System diagnostics with performance tags (Page 176)

1.9.5 System diagnostics with performance tags

WinCC provides the "@PRF_..." system tags to analyze the WinCC project.

This allows you to evaluate the time behavior of the server.

Creating performance tags

You will find the system tags for performance analysis in the internal tag group "Performance" in the WinCC Tag Management.

The system tags are assigned to different components:

Tag name	Component	Creating the tags
@PRF_DMRT_SRV_...	WinCC Tag Management (data manager)	The WinCC Tag Management creates the system tags when a WinCC project is created.
@PRF_TLGRT_...	WinCC Tag Logging	
@PRF_DMRT_CHNCON_<connection_name>_...	WinCC process communication	As soon as you create a new connection under a communication driver, additional performance tags are created for this connection. You can find additional information under "Communication Diagnostics > Channel Diagnostics > Check connection with performance tags".

Types of performance tags

The "Performance" tag group contains the following tag types:

Tags	Data type	Access	Description
Relative tags	Floating-point number 64-bit IEEE 754	Read	Values which apply relatively to the time of reading, e.g. currently pending values or values per second. The reset tag does not have an influence on these values. The tag name ends in: <ul style="list-style-type: none"> • ..._ACTIVE • ..._PENDING • ..._QUEUE • ..._SECOND Update cycle: 1 second
Counter tags	Floating-point number 64-bit IEEE 754	Read	Absolute values since Runtime activation You can reset the value to "0" by using the reset tag. The tag name ends in: <ul style="list-style-type: none"> • ..._TOTAL Update cycle: 1 second
Reset tags	Unsigned 32-bit value	Read Write	You can set the value of the reset tags via scripts, for example: <ul style="list-style-type: none"> • 0: Disabled • 1: The value of all associated counter tags is reset to "0".

Performance tags

System tag	Component	Description
@PRF_DMRT_RESET	Tag Management Tag Logging	The reset tag resets the values of the following performance tags: <ul style="list-style-type: none"> • @PRF_DMRT_SRV_..._TOTAL • @PRF_TLGRT_..._TOTAL • @PRF_DMRT_RESET
@PRF_DMRT_SRV_CYCLIC_READ_CALLBACKS_PENDING	Tag Management	Tag updates requested during cyclic reading of client applications that have not yet been sent. A constantly rising value indicates a system overload. Possible causes: <ul style="list-style-type: none"> • Cyclic read requests are processed too slowly by one or multiple client applications. • During cyclic reading, tags are written faster than the clients can read the values.
@PRF_DMRT_SRV_CYCLIC_READ_REQUESTS_ACTIVE	Tag Management	Pending cyclic read requests A constantly rising value indicates a system overload. Possible cause: <ul style="list-style-type: none"> • Too many active client applications or client applications too slow
@PRF_DMRT_SRV_CYCLIC_READ_REQUESTS_TOTAL	Tag Management	Cyclic read requests since activation of Runtime A relatively fast rising value can indicate the following behavior: <ul style="list-style-type: none"> • Frequent restarts • An inefficient client application
@PRF_DMRT_SRV_READ_REQUESTS_ACTIVE	Tag Management	Pending read requests Cyclic read requests are not included. A constantly rising value indicates a system overload. Possible causes: <ul style="list-style-type: none"> • A data source is overloaded and does not process the read requests quickly enough. • The Data Manager is overloaded.
@PRF_DMRT_SRV_READ_REQUESTS_PER_SECOND ¹⁾	Tag Management	Read requests/second Cyclic read requests are not included.
@PRF_DMRT_SRV_READ_REQUESTS_TOTAL	Tag Management	Read requests since activation of Runtime Cyclic read requests are not included.
@PRF_DMRT_SRV_TAG_READS_PER_SECOND ¹⁾	Tag Management	Tags read/second Tag updates because of cyclic read requests are not included.
@PRF_DMRT_SRV_TAG_READS_TOTAL	Tag Management	Tags read since activation of Runtime Tag updates because of cyclic read requests are not included.
@PRF_DMRT_SRV_TAG_WRITES_PER_SECOND ¹⁾	Tag Management	Tags written/second

System tag	Component	Description
@PRF_DMRT_SRV_TAG_WRITES_TOTAL	Tag Management	Tags written since activation of Runtime
@PRF_DMRT_SRV_WRITE_REQUESTS_ACTIVE	Tag Management	Pending write requests A constantly rising value indicates a system overload. Possible causes: <ul style="list-style-type: none"> • A data source is overloaded and does not process the write requests quickly enough. • The Data Manager is overloaded.
@PRF_DMRT_SRV_WRITE_REQUESTS_PER_SECOND ¹⁾	Tag Management	Write requests/second
@PRF_DMRT_SRV_WRITE_REQUESTS_TOTAL	Tag Management	Write requests since activation of Runtime
@PRF_TLGRT_AVERAGE_TAGS_PER_SECOND	Tag Logging	Main indicator for the average performance of the archiving system: Average number of archived tags/second
@PRF_TLGRT_MAX_SIZEOF_ARCHIVING_QUEUE	Tag Logging	Maximum archiving queue size
@PRF_TLGRT_MAX_SIZEOF_NOTIFY_QUEUE	Tag Logging	Maximum notification queue size Contains the notifications of all registered WinCC clients
@PRF_TLGRT_MAX_TAGS_LAST_SECOND	Tag Logging	Maximum number of tags that were archived in all archives one second ago In connection with the value of the @PRF_TLGRT_TAGS_PER_SECOND tag, this value is an indicator of an even archiving load.
@PRF_TLGRT_MIN_SIZEOF_ARCHIVING_QUEUE	Tag Logging	Minimum archiving queue size
@PRF_TLGRT_MIN_SIZEOF_NOTIFY_QUEUE	Tag Logging	Minimum notification queue size Contains the notifications of all registered WinCC clients
@PRF_TLGRT_MIN_TAGS_LAST_SECOND	Tag Logging	Minimum number of tags that were archived in all archives one second ago In connection with the value of the @PRF_TLGRT_TAGS_PER_SECOND tag, this value is an indicator of an even archiving load.
@PRF_TLGRT_SIZEOF_ARCHIVING_QUEUE	Tag Logging	Archiving queue size
@PRF_TLGRT_SIZEOF_NOTIFY_QUEUE	Tag Logging	Notification queue size Contains the notifications of all registered WinCC clients
@PRF_TLGRT_TAGS_LAST_SECOND	Tag Logging	Number of tags that were archived in all archives one second ago In connection with the value of the @PRF_TLGRT_TAGS_PER_SECOND tag, this value is an indicator of an even archiving load.
@PRF_TLGRT_TAGS_PER_SECOND ¹⁾	Tag Logging	Main indicator for the current performance of the archiving system: Tags that are archived in all archives per second

1) The information "PER_SECOND" relates to the last second before tag update.

See also

Preparation to Create a Project (Page 115)

Effect of External Applications at Runtime (Page 175)

Configuration recommendations for dynamization (Page 1165)

1.9.6 Setting up Runtime

1.9.6.1 How to set up Runtime

Introduction

To test a WinCC project in Runtime, first setup the project's applications and operator functions that available in Runtime. These project settings must be adjusted for every computer on which the project should run.

Using the "Computer properties" dialog, which is opened from WinCC Explorer, you can make the following project settings:

- "General" tab
Configure computer name and computer type
- "Startup" tab
Define modules and applications, which are to be started using the command "Activate Runtime".
- "Parameter" tab
Change default settings for Language and Time in Runtime and lock certain key combinations
- "Graphics Runtime" tab
Change default settings for the use of process pictures in Runtime
- "Runtime" tab
User-specific settings for all WinCC projects on this computer

Requirement

- A project must be opened.

Open the "Computer properties" dialog

1. Select the entry "Computer" in the navigation window of the WinCC Explorer.
All computers that are available for the current project, will be displayed in the data window.
2. In WinCC Explorer's data window, double-click the desired computer.
The "Computer Properties" dialog will open.

See also

- How to change the computer name (Page 181)
- How to configure the applications available in Runtime (Page 182)
- How to Specify the Computer Properties (Page 123)
- How to Set Up a Startup List (Page 172)
- How to Change the default settings for Language, Time and Key Combinations (Page 184)
- How to define hotkeys for operation and screen navigation (Page 191)
- How to define a picture as the start picture in Runtime (Page 194)
- How to configure the cursor control in Runtime (Page 196)
- How to Activate Zoom Functions in Runtime (Page 198)
- How to make computer-specific settings for runtime (Page 200)
- Activating Project (Page 204)
- The Graphics Designer in the WinCC Explorer (Page 299)
- Virtual keyboard - General Information (Page 831)
- How to set up a picture for mouseless operation (Page 836)
- Process Pictures in Runtime (Page 807)

1.9.6.2 How to change the computer name

Introduction

To test a WinCC project in Runtime, the local computer name must be entered as a computer name in the project.

The computer name is changed on the "General" tab in the "Computer properties" dialog.

Requirement

- A project must be opened.
- The "Computer properties" dialog must be open.

Procedure

1. Click the "General" tab.
2. Enter the name of the computer in the "Computer name" field.

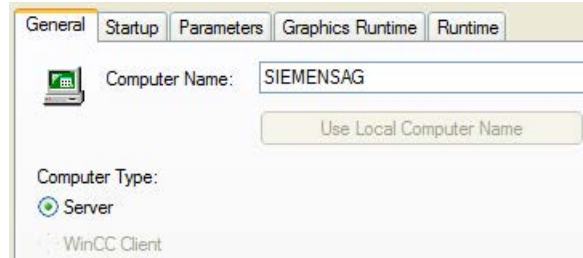

3. In the "Computer Type" area, define which function is performed by this computer.
4. Confirm your entry with "OK".
The changed computer name will not be applied until WinCC is restarted.

See also

How to set up Runtime (Page 180)

1.9.6.3 How to configure the applications available in Runtime

Introduction

The "Runtime" command is used to load additional program modules, which are required for the execution of Runtime. To ensure the maximum performance, activate only the applications that are actually needed in Runtime.

The applications, which will be available in Runtime, are configured on the "Startup" tab in the "Computer properties" dialog.

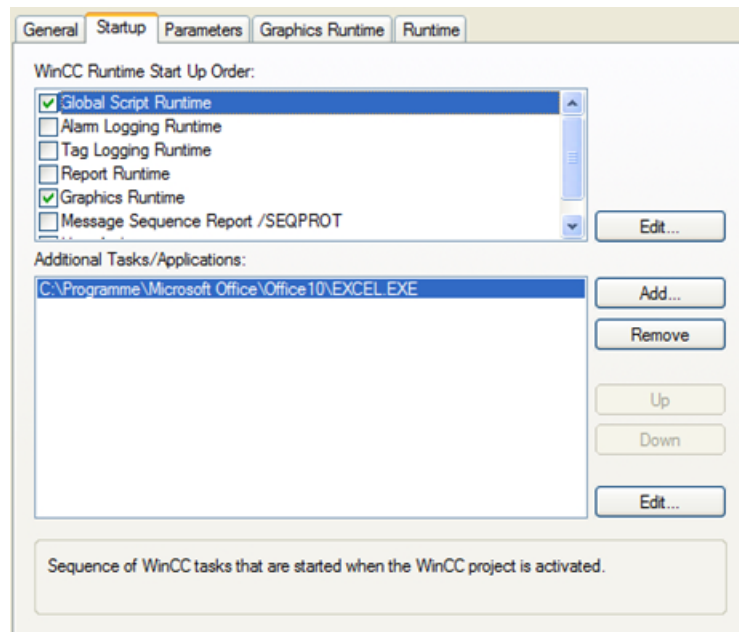

Start sequence of WinCC Runtime

Select the modules that should be loaded while activating Runtime. The activated modules will be identified by a tick in front of each associated entry in the list.

Click the "Edit" button to modify the start parameter for a selected Runtime module.

Additional Tasks / Applications

In addition to the modules given in the upper area, other applications can be also be linked to start with the "Runtime" command.

Click the "Add" button to add the required applications to the list. You can clear an entry from the list by selecting it and then clicking on "Remove".

Click the "Edit" button to modify the start parameter for a selected application.

To change the sequence in which the individual applications are started, use the "Up" and "Down" buttons to rearrange the selected entries in the list. The list of additional applications, which should be started, is read from top to bottom.

Note

Each module requires computing power. Therefore, make certain that you only activate the modules that will be needed in Runtime.

See also

How to set up Runtime (Page 180)

1.9.6.4 How to Change the default settings for Language, Time and Key Combinations

Introduction

The configured language and the display mode for the time can be preset before activating Runtime. It is also possible to lock specific key-combinations.

The default settings for language, time and key-combinations are configured on the "Parameters" tab in the "Computer properties" dialog.

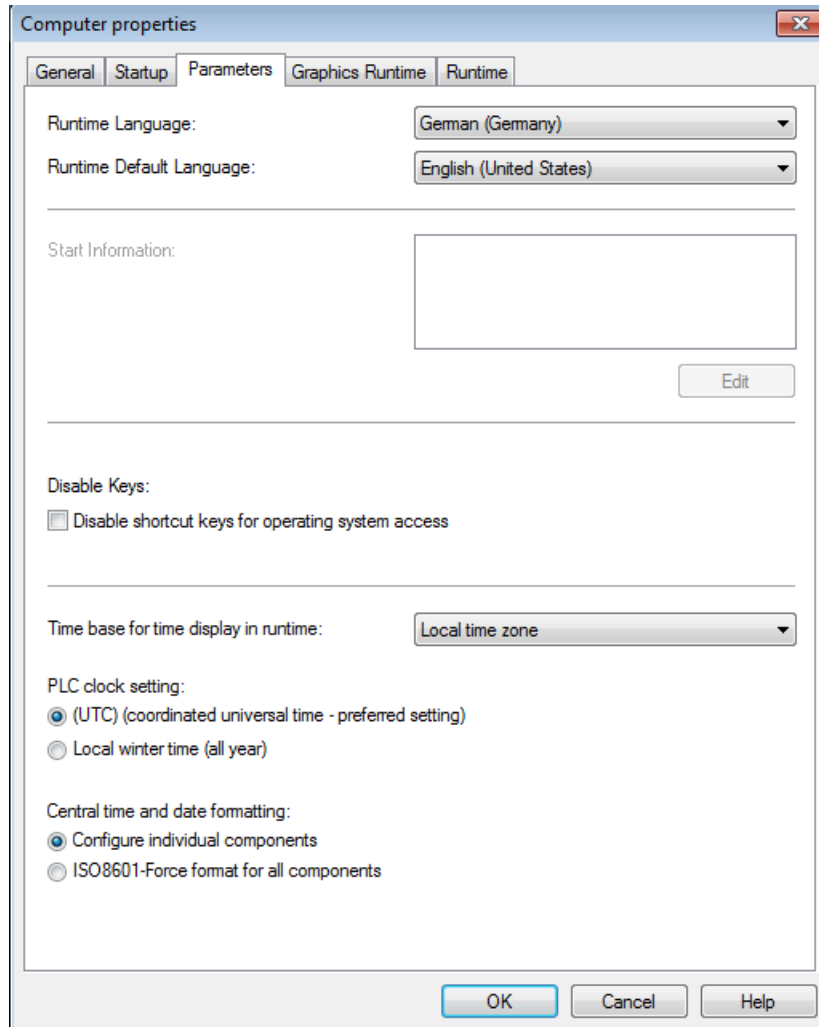

Runtime language

Select the language with which the project should be activated in Runtime on the selected computer.

Runtime Default Language

Select the alternate language in which the text of graphics objects is supposed to be displayed if the respective translations do not exist in the language specified under "Runtime language".

Disable Keys

To prevent operator errors in Runtime, Windows-typical key-combinations can be locked. Activate a check box to lock the respective key combination in Runtime.

PLC Time Setting

Select the time setting that is valid for the PLC. A detailed description can be found in the chapter entitled "Time Settings in WinCC".

Time base for the time shown in Runtime

Select the mode for displaying the time in Runtime and in the report system. The following options are available "Local time zone", "Coordinated world time (UTC)" and "Server's time zone".

Central date and time formatting

Specify if date and time formatting should be configured at the components or if it should be forced at all components using the ISO 8601 format. A detailed description can be found in the chapter entitled "Time Settings in WinCC".

See also

Setting Time in WinCC (Page 130)

How to set up Runtime (Page 180)

1.9.6.5 How to specify favorite process pictures

Introduction

In WinCC Explorer you can mark process pictures as favorites. You can select these marked process pictures in Runtime by means of system dialogs, "Favorites".

You can create up to 54 favorites.

Procedure

1. Left-click the "Graphics Designer" entry in the navigation window of WinCC Explorer. The data window displays all process pictures of the current project (PDL format).
2. Click on the desired process picture. Select the "Mark picture(s) as favorite" option from the shortcut menu.
The process picture is marked as favorite.
To mark several process pictures as favorites at the same time, hold down the <Ctrl> key while clicking the process pictures.
3. To change the order in the "Favorites" system dialog, open the shortcut menu of the Graphics Designer and select the "Edit Favorites order" command.
The "WinCC Favorites Configuration" dialog box opens.
4. To change the order, drag the pictures to the desired location.
Click "X" to remove a picture from the Favorites view.

Result

The selected process picture is identified with a star symbol.

You can select the process picture in the runtime system dialogs by clicking "Favorites".

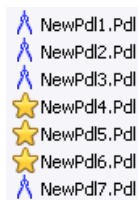

1.9.6.6 How to set up the system dialogs

Introduction

Activate access to the system dialogs in RT prior to the start of runtime. Make the two following settings for the project:

- Activate the system dialogs
- Specify the hotkey or activation action

You can activate the system dialogs in a project for all computers, or for a single computers only.

Note

The system dialogs are not available in PCS 7 environments.

Note

Runtime system dialogs:

The system dialogs are called in Runtime by means of hotkey or activation action.

Procedure

1. Right-click the project name in the navigation window of WinCC Explorer and then select "Properties" from the shortcut menu.
The "Project Properties" dialog opens.
2. Click the "User interface and design" tab and set the "Activate Runtime System Dialogs" check box.

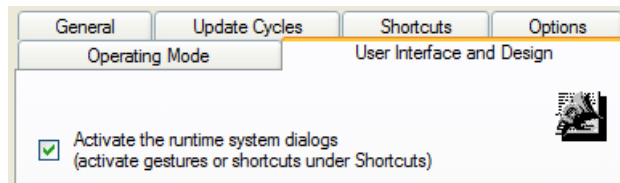

3. Specify a hotkey or activation action in the "HotKeys" tab. (Page 191)
4. Click "OK" to close the dialog.

Proceed as follows to activate the system dialogs on single computers:

1. Open the "Computer properties" dialog.
2. Select the "Runtime" tab.
3. Set the "Activate Runtime System Dialogs" check box.

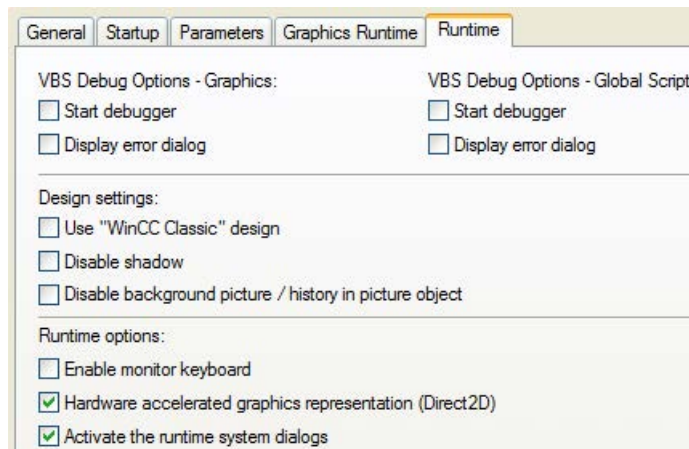

4. Click "OK" to close the dialog.

Result

You can call the system dialogs by means of hotkey or activation action after the start of Runtime.

1.9.6.7 How to change the language in Runtime

Introduction

After the start of runtime, you can change the language in the process pictures by calling the system dialogs. The languages are displayed with their national flag.

Requirements

- System dialogs are activated
- Hotkeys or activation actions are available.
- Runtime has started.

Procedure

1. Launch the system dialogs by pressing the defined hotkey, or by means of activation action on the touch screen.

Note

The "Languages" button is only displayed in the system dialogs if more than one language was configured in the text library.

2. Click "Languages" in the system dialogs.
The language menu opens.

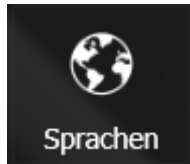

3. Click the flag icon to select the language.
The language-dependent parts of the process pictures are no displayed in runtime in the selected language.

See also

How to set up the system dialogs (Page 186)

1.9.6.8 How to navigate in process pictures in Runtime





Introduction

After the start of runtime, you can use the system dialogs to navigate in process pictures.

If you have specified a language-dependent display name for a process picture, this name is displayed in the system dialog.

System dialogs

The system dialogs provide the following options for process picture navigation:

Button	Description
 Startbild	"Start picture": Calls the process picture that is defined s start picture.
 Vorwärts	"Forward": Navigates to the next process picture.
 Zurück	"Back" Navigates to the previously called process picture.
 Favoriten	"Favorites" Displays a selection of the process pictures that were marked as favorites.

"Favorites" system dialog

You may toggle between the 3D and 2D views, depending on the graphics adapter that you are using.

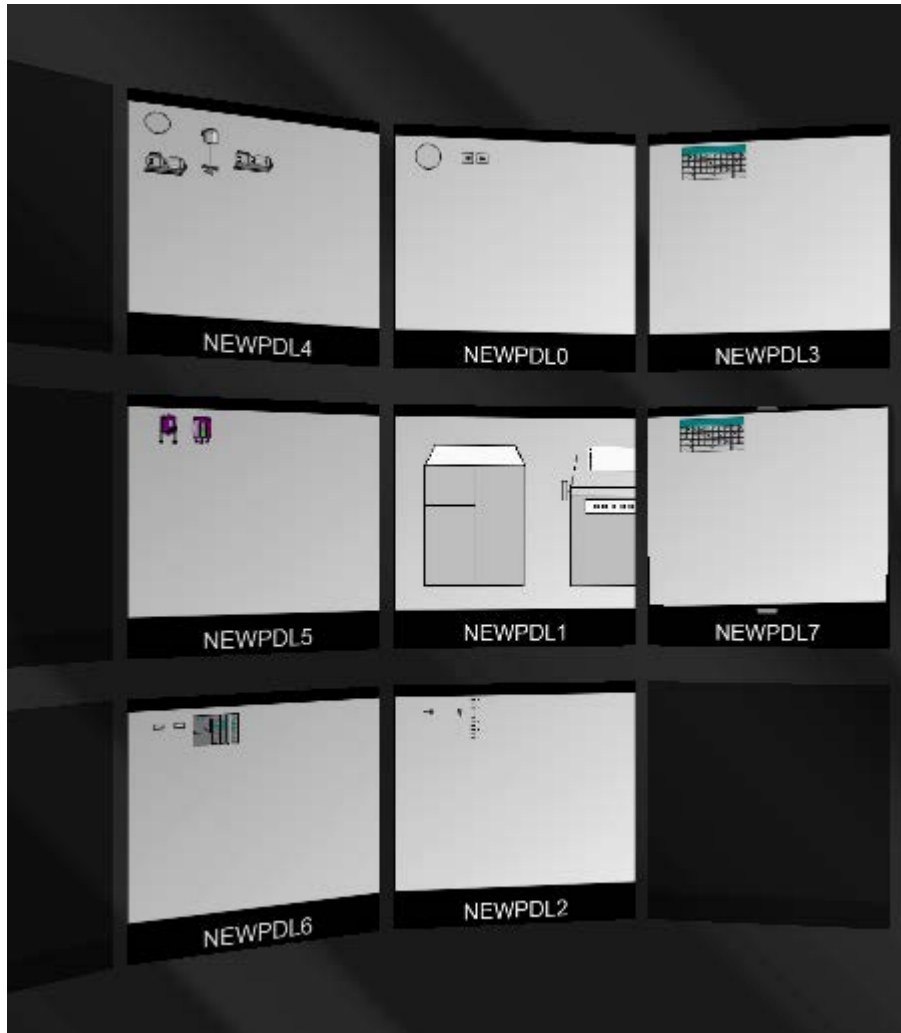

Requirements

- System dialogs are enabled.
- Hotkeys or activation gestures are specified.
- Runtime has started.

Note

Favorites view in the system dialogs

The "Favorites" button is hidden in the system dialogs if no process pictures are marked as favorites.

Procedure

1. To open the system dialogs, press the defined hotkey button or perform the activation gesture on the touch screen.
You can run a preview of the favorites in the favorites view using the mouse wheel or touchscreen input.
2. To change the order of the process pictures in the Favorites view, select edit mode using the  icon.
3. Drag the respective process picture to the desired location.
4. To remove a picture from the favorites, click "X".

Alternatively, you can edit the favorites display in the WinCC Explorer by selecting "Edit Favorites order" in the shortcut menu of the Graphics Designer.

See also

How to set up the system dialogs (Page 186)

How to change the language in Runtime (Page 187)

1.9.6.9 How to define hotkeys for operation and screen navigation

Introduction

You can operate the process pictures even if you cannot control them with a mouse. Key combinations must be defined for the required operating functions.

You specify the most important shortcut keys for operation without a mouse in Runtime in the "Computer properties" dialog on the "Graphics Runtime" tab.

Procedure

1. Click in the entry field of the desired function to activate it for the entry of a shortcut key (combination), for example “Window On Top”.
2. Press the required shortcut key and keep it pressed.
You can use <Ctrl>, <Alt> or <SHIFT> as shortcut keys.
3. Also press the key that is to call up the function.
The selected key combination is displayed in the input field, e.g. <Alt+F>.
4. Click the input field again to change your entry.

You can also use individual keys or one of the function keys <F1> to <F12> instead of a key combination.

Note

You may not configure the function key <F12> as system-wide shortcut key.

Hotkey

Changes made to the shortcut keys are first effective after the system has been restarted.

Window On Top

This shortcut key is used to navigate between multiple picture windows, which are configured in a main picture. The shortcut key activates the next picture window for an operation.

Tab or Alpha Cursor

This shortcut key toggles the "Cursor Mode" attribute. You can use it to operate a process picture with the alpha cursor and the tab order. A TAB sequence must be configured for both types of cursor.

Runtime Cursor On/Off

By default, the selected object in Runtime will not be highlighted. Use this shortcut key to activate a Runtime cursor that highlights the currently selected object with a frame.

Note

You cannot use the key as hotkey.

Screen navigation

The shortcut keys for screen navigation allow a simple switch between the process pictures called up last in Runtime.

Process pictures will be recorded in a temporary list whenever they are called. Use the "Forward" or "Backward" function to scroll through this list.

Picture buffer

You specify the maximum permitted number of entries in the temporary list by means of "Buffer size (number of pictures)". If this picture buffer size is exceeded, the oldest entry will be replaced when a new process picture is called.

With the default value for "Picture Buffer Size", the list will record the calls for a maximum of 30 pictures.

As a rule, it is not reasonable to substantially increase this value, since the switchover can only be done in single steps. You can achieve more efficient screen navigation using picture modules.

Shortcut keys for screen navigation

You can define shortcut keys for the following functions:

- "Forward": Calls up the next configured process picture.
- "Backward": Calls up the previously configured process picture.
- "Start picture": Calls the picture that has been defined as the start picture.
- "Stored Picture": Calls up the picture identified last with the function "Store picture".
- "Store picture": Memory function for the currently displayed picture.

Note

System dialogs in Runtime

You may also use the system dialogs in Runtime to navigate through pictures.

Event "Keyboard > press / release"

Screen navigation is blocked if a button with the action of a picture change is configured in one of the pictures which is triggered with the event "Press keyboard" or "Release keyboard".

The configured action is executed instead of navigating through the pictures using the set shortcut keys.

See also

How to set up the system dialogs (Page 186)

How to configure the cursor control in Runtime (Page 196)

How to set up Runtime (Page 180)

Virtual keyboard - General Information (Page 831)

How to set up a picture for mouseless operation (Page 836)

1.9.6.10 How to define a picture as the start picture in Runtime

Introduction

Runtime can only be started, when one of the project's process pictures has been defined as the start picture. This start picture will be displayed when Runtime is activated from WinCC Explorer.

The start picture is defined on the "Graphics Runtime" tab card in the "Computer properties" dialog.

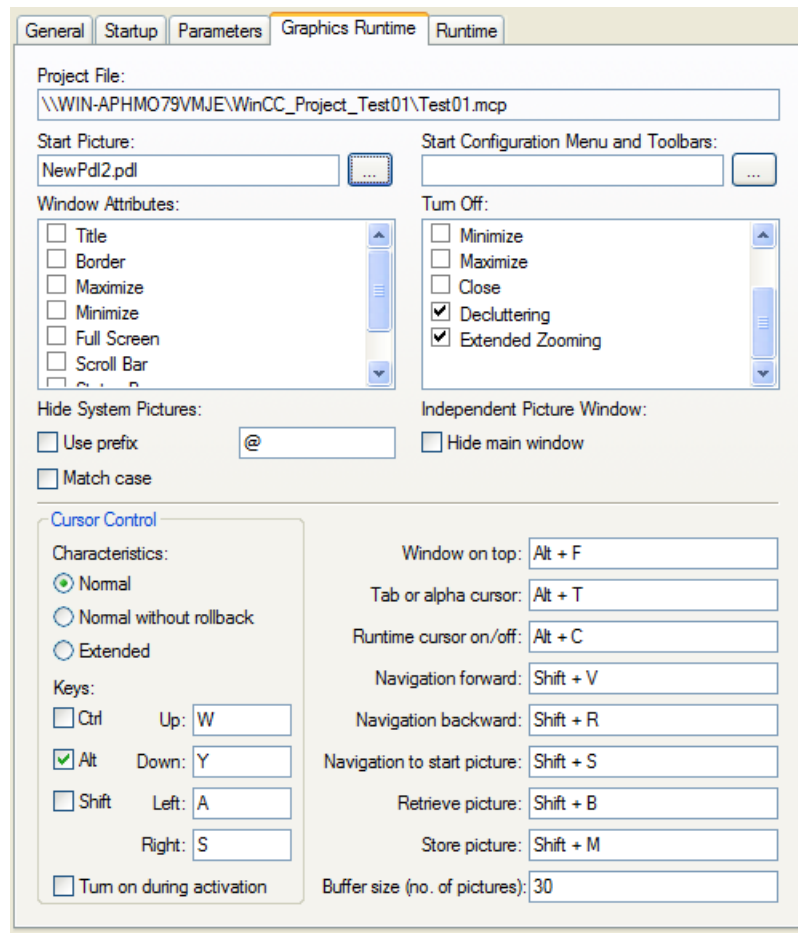

Requirement

- A project must be opened.
- The "Computer properties" dialog must be open.

Procedure

In the "Start picture" field, enter the name of the desired picture file in the PDL format or click the "Find..." button to select it.

Alternative Procedure

1. Click in the navigation window of the WinCC Explorer with the left-hand mouse button on the entry "Graphics Designer".
All pictures of the current project are displayed in the data window (format PDL).
2. Now right click the desired picture and select "Define screen as start screen".
The selected picture is entered into the "Start picture" field in the tab "Graphics Runtime".

See also

How to set up Runtime (Page 180)

The pop-up menu in the Data Window (Page 309)

1.9.6.11 How to configure the cursor control in Runtime

Introduction

In process pictures with objects arranged in a tabular form, it is possible to define a cursor control to permit mouseless navigation between the configured objects.

The shortcut keys for the cursor control and the behavior of the cursor are set on the "Graphics Runtime" tab in the "Computer properties" dialog.

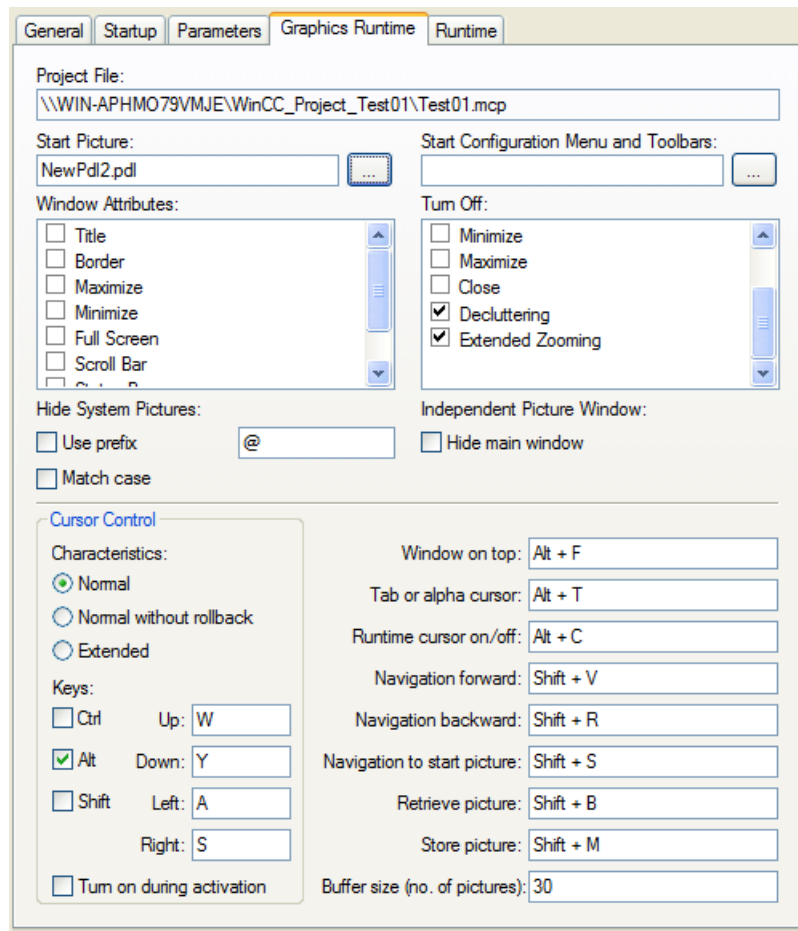

Reaction

Specify how the cursor should react in a table of listed objects, once it has reached the last object in a line or column: This requires all objects are assembled as a complete table. The table cannot have gaps. The height and width of the objects must be identical and the objects must be arranged vertically and horizontally to the exact pixel.

Normal

The cursor returns to the first object in the same line or column.

Normal without rollback

The cursor remains positioned on the last object in the line or column.

Extended

The cursor continues to the first object in the next line or column.

keys

Four shortcut keys can be defined here for cursor control in Runtime.

First select the desired combination key by placing a tick in the associated check box. Then press a key for the desired cursor direction in the corresponding entry field.

Select the option "Turn on during activation", if the shortcut keys for cursor control should always be available in Runtime.

See also

How to set up Runtime (Page 180)

Virtual keyboard - General Information (Page 831)

1.9.6.12 How to Activate Zoom Functions in Runtime

Introduction

Zooming in Runtime is supported by three techniques:

- **Decluttering**
Layers and the objects stored there can be shown and hidden. Limit values for masking and unmasking of objects are specified in menu "Tools>Settings" on the "Hide/Show" tab of Graphics Designer.
- **Extended zooming**
The view of a process picture in Runtime may be zoomed in or out using the mouse wheel. Hold the <CTRL> key down while turning the mouse wheel. If you turn the mouse wheel away from your hand, you increase the zoom factor.
- **Panning**
If a picture has a zoom factor that shows the picture with scrollbars, you can move a picture section within the document. A navigation crosshair appears upon clicking on the mouse wheel. Moving the mouse pointer scrolls in the desired direction. The distance between mouse pointer and navigation crosshair determines the scrolling speed. Another click will deactivate panning.

Conditions for Using Zoom Function:

- Mouse driver by Logitech or Microsoft Intellimouse
- Mouse wheel must be set to "Autoscroll".

Both functions Decluttering and Extended Zooming may be turned off in the "Graphics Runtime" tab of the "Computer Properties" dialog. Activate the checkboxes of both respective entries in the area "Turn off". In the default setting the checkboxes are deactivated, i.e. the functions Decluttering and Extended Zooming are turned on.

Configuring Extended Zooming Picture-Specific

The Extended Zoom function may be turned on or off for each picture. The setting is specified in the object properties of the selected picture in the "Miscellaneous" property group.

If you turn of the function Extended Zooming for a process picture, Extended Zooming must also be turned on for all process pictures in the "Graphics Runtime" tab of the "Computer Properties" dialog.

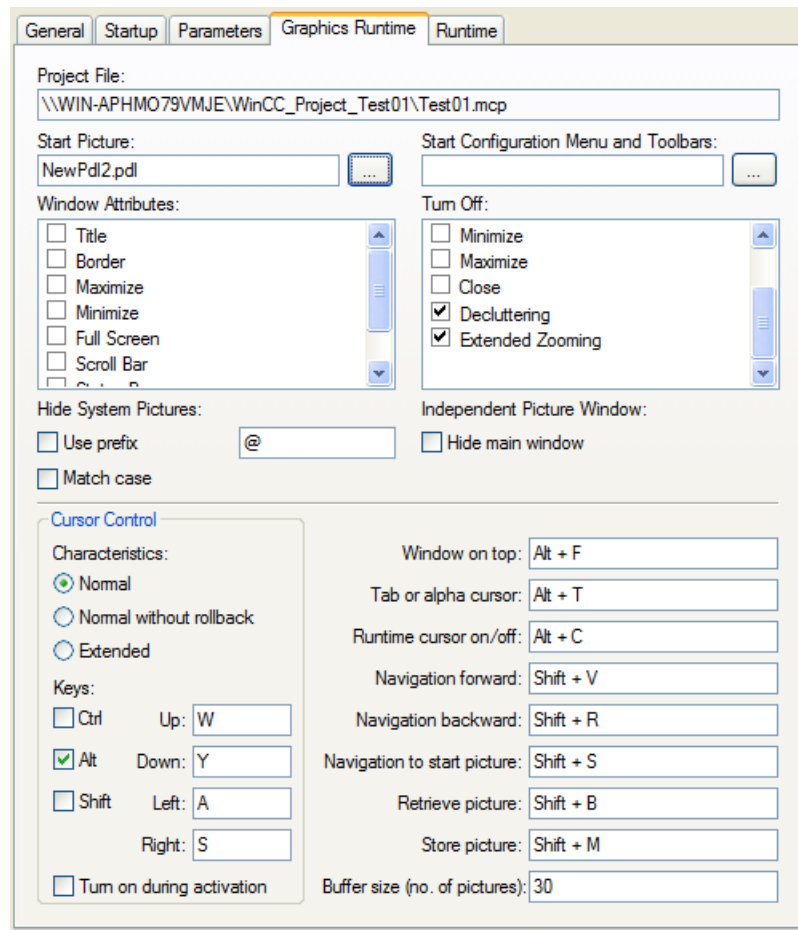

A detailed description of the zoom function may be found in Chapter "Showing and Hiding Layers and Objects".

Note

WinCC Controls cannot be decluttered, except for "WinCC Slider Control", "WinCC Clock Control" and "WinCC Gauge Control".

See also

How to set up Runtime (Page 180)

Showing and hiding layers and objects (Page 364)

Elements and Basic Settings of the Graphics Designer (Page 319)

Zoom palette (Page 338)

1.9.6.13 How to make computer-specific settings for runtime

Introduction

Some additional functions for WinCC Runtime can be activated in the Runtime tab in the Computer Properties dialog.

The following settings can be made:

- Set debug options for Visual Basic scripts in Graphics Designer
- Set debug options for Visual Basic scripts in Global Script
- Restrict global design effects
- Activate Runtime options
- Use picture cache
- Change mouse pointer

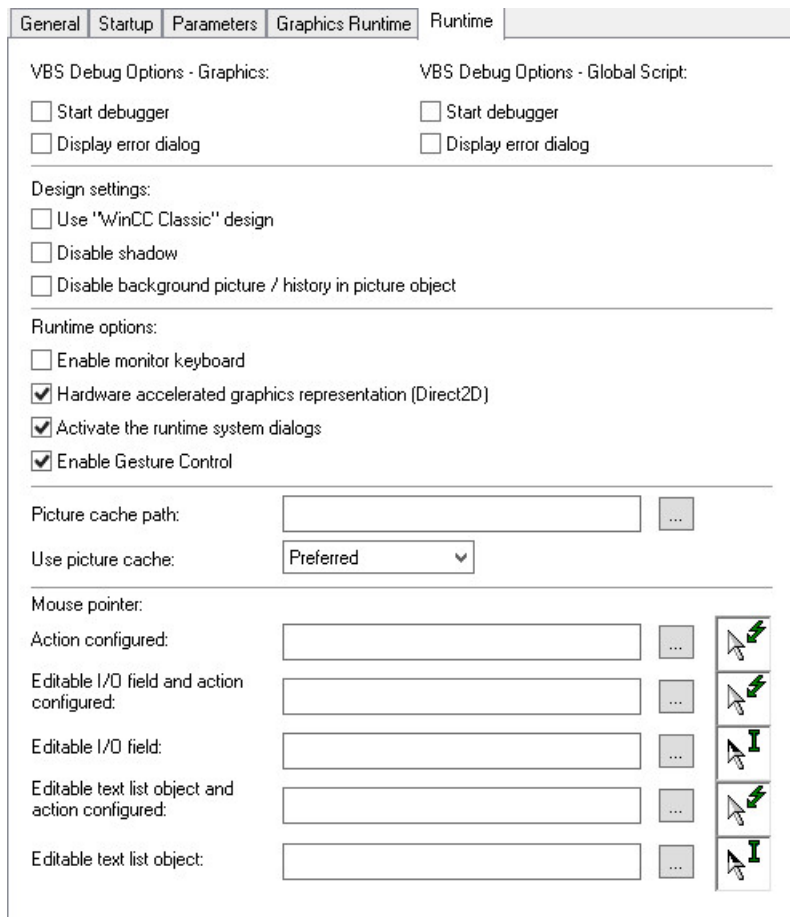

Start Debugger

If the function "Start Debugger" is activated, the debugger is started when you start the first VB script in runtime. A debugger for Visual Basic must be installed. The function speeds up the troubleshooting during the planning phase.

The option "Start Debugger" can be activated separately for VBS in pictures of the Graphics Designer and in Global Script.

Note

An exception message appears during the activation of the debugger in runtime

An exception message appears when the debugger is activated in runtime. The exception has no effect on the execution of the script.

Display Errors Dialog

If the function "Display error dialog" is activated, an error dialog with information on the error that occurred is displayed when an error occurs in VBS. You can start a debugger using a button in the error dialog. A debugger for Visual Basic must be installed.

The option "Display error dialog" can be activated separately for VBS in pictures of the Graphics Designer and in Global Script.

Design settings

The global design requires the recommended hardware equipment. You can improve the computer's reaction time by switching off certain elements of the global design:

- Using "WinCC Classic" design: WinCC Runtime appears in the WinCC Classic Design regardless of the settings in the project properties. Not all WinCC program elements can be used in WinCC Classic Design.
- Deactivating shadow: The shadow is generally switched off in the process pictures.
- Deactivating background/progressions: Switches off the background picture and the color progressions.

Runtime options

Enable on-screen keyboard

The on-screen keyboard is enabled when WinCC Runtime starts.

For further information, please see the section entitled "Monitor keyboard".

Activation of Runtime system dialogs

The system dialogs for the individual computers are enabled.

Enable "Swipe" gesture control

The swipe gestures "Left", "Right", and "Down" are enabled.

You can find more information under "Working with WinCC > Creating Process Pictures > Process Pictures in Runtime > Touch Operation".

Hardware accelerated graphics representation (Direct2D):

Direct2D is used to display the graphics. Soft shadows are displayed.

Direct2D can be disabled for individual computers for performance reasons even if Direct2D is enabled in the project settings.

Direct2D is always disabled in the following cases:

- In the case of integrated operation in the SIMATIC Manager
- When Basic Process Control is used (process control options)
- In process pictures containing ActiveX controls

Picture cache

To show Runtime pictures, WinCC usually accesses the connected WinCC server and calls up the current pictures there. Use "Picture cache" to store the WinCC pictures locally on the computers. The option only makes sense for WinCC clients that are connected with a WinCC server using a telecommunication connection. The client does not have to permanently load the pictures.

The required pictures must be saved on the client computer which should use the picture cache:

1. On the client computer, create the folder "PDLCache" in the folder <installation directory \bin>. This folder is stored as standard directory in the WinCC project.
2. If you select a different folder, enter this folder in the "Path" field. Enter the path to the directory in which the folder "PDLCache" is located.
3. In the folder "PDLCache", create a folder named after the server prefix of the server.
4. Copy the pictures to the server prefix folder.

Example:

- Path for picture storage: C:\WinCCProjekt\Pictures\PDLCache\<Server prefix>
- Entry in the "Path" field: C:\WinCCProjekt\Pictures\

You have the following selection with the "Use cache" selection field:

Selection	Function
Never	The picture cache is not used.
Preferred	Changed pictures are read by the server. Pictures that are not changed are read from the picture cache.
Always	Pictures are always read from the picture cache.

Note

If a picture is changed on the WinCC server, you have to update the picture manually in the picture cache.

Mouse pointer

Use the "mouse pointer" to configure other cursor representation for operation of WinCC Runtime.

With the  button, open the file selection dialog and navigate to the place where the cursor is saved. Select the desired cursor.

The cursor data must be available in the ".cur" or ".ani" file format.

See also

[Global Design of the Objects \(Page 158\)](#)

[Settings for Runtime \(Page 168\)](#)

[Touch operation in Runtime \(Page 809\)](#)

[How to set up Runtime \(Page 180\)](#)

[Virtual keyboard - General Information \(Page 831\)](#)

1.10 Activating Project

1.10.1 Activating Project

Introduction

If you want to operate and monitor a process, you have to activate the respective project. WinCC starts Runtime and activates communication with the programmable controller. All process data is stored in the Runtime databases.

In this chapter, you will learn

- the settings you can make in Runtime
- how to Runtime a project
- how to deactivate a project
- how to Runtime a project automatically when you boot your computer

Note

When you start WinCC or open a project, holding down the keys <CTRL>+<SHIFT> prevents WinCC from activating Runtime at the same time.

If you keep the key combination <Alt+Shift> pressed when you start WinCC, you prevent WinCC from opening a project at the same time. This also prevents Runtime being started at the same time.

See also

How to Exit Runtime (Page 209)

How to Set Up Autostart (Page 207)

How to Start Runtime (Page 204)

Settings for Runtime (Page 168)

1.10.2 How to Start Runtime

Introduction

When you start Runtime, you activate your project. All configured processes are started and run if the status of the system permits. You can also activate your project on a test system. You may receive error messages, however, it processes cannot run as intended on the test system.

Principle

You can start Runtime in several ways:

- From the toolbar of the WinCC Explorer
- From the menu bar of the WinCC Explorer
- When you start WinCC
- From Autostart when you start the Windows system

During configuration you can call individual pictures in Runtime:

- From the toolbar of the Graphics Designer
- From the menu bar of the Graphics Designer

Requirements

- The computer must have the required Runtime license installed.
- The DEP settings must have been verified.
- The correct computer name must be entered in the project.
- A picture must be specified as the start picture.

Note

On project activating, free memory space of at least 100 MB must be available.

Procedure

1. Open the required project in the WinCC Explorer.
2. Click the toolbar button .
The "Activate DATABASENAME" dialog opens. WinCC displays the applications that will be started. The WinCC Runtime window opens with the settings you selected in the Computer Properties dialog.

Note

During start of WinCC or during opening of a project, holding down the key combination <SHIFT>+<CTRL> prevents that WinCC activates the project immediately.

When starting WinCC, if you hold down the keys <SHIFT>+<ALT>, you prevent WinCC opening a project immediately. This also prevents Runtime being started at the same time.

Alternative Procedures

Menu Bar of the WinCC Explorer

Open the File menu in the menu bar and select the Activate command. As long as Runtime is activated, WinCC displays a check mark beside the Activate command.

When you start WinCC

You can exit WinCC while a project is activated. When you restart WinCC again, WinCC opens the project and starts Runtime immediately.

Autostart when You Start the Windows System

You can also start WinCC using Autostart when the computer starts up. You can also specify that WinCC starts immediately in Runtime.

Graphics Designer

You can call a picture opened in the Graphics Designer in Runtime. If Runtime is already open, the picture replaces the current screen.

You can use this function in the following situations:

- You want to test a picture in Runtime.
- You want to update a picture in an activated project without any delay.

Click the toolbar  button to start Runtime.

In the menu bar, you can start Runtime in the File menu with the Activate Runtime command.

Note

You cannot exit Runtime from Graphics Designer. Exit Runtime in WinCC Explorer.

Multi-User Systems

In a multi-user system you must start Runtime on all servers first. Once all projects are activated you start Runtime on the WinCC clients.

Redundant Systems

When you start a project in a redundant system, you must first start Runtime on the master server. You can then start Runtime on the standby server.

Activating the project remotely

In a multi-user system, you can activate a project on a computer from another computer. You must have the necessary access rights. You find more detailed information in the WinCC Information System under Configurations > Multi-User Systems.

See also

How to Set Up Autostart (Page 207)

How to Exit Runtime (Page 209)

Settings for Runtime (Page 168)

Opening WinCC Explorer (Page 36)

1.10.3 How to Set Up Autostart

Introduction

When you boot your computer, WinCC can be started with a selected project.

Specify the project to be opened using the "AutoStart Configuration" tool.

Variants of Autostart

When you set up Autostart, you have the following options:

Setting in Autostart	Action when the Windows system starts
Autostart active	<ul style="list-style-type: none"> WinCC starts up. The project is opened in the WinCC Explorer. If the project was activated when you last exited, Runtime starts.
Activate project at startup	<ul style="list-style-type: none"> WinCC starts up. WinCC Explorer is not opened. The project is started in Runtime. <p>If the autostart configuration of the client has set the check box Activate Project at Startup and the server is in CS and is available, the server and then the client will be activated.</p>
Allow "Cancel" on activation	If the project is started in Runtime, you can use the "Cancel" button to cancel activation of it.
A client without its own project: Login / Password	<ul style="list-style-type: none"> WinCC starts up. When opening the WinCC project, the settings in the area "Multi-user project" are applied. The WinCC user specified under "Login" is signed in.
Automatic login for all Windows users	<ul style="list-style-type: none"> WinCC starts up. When opening the WinCC project, the settings in the area "Multi-user project" are applied. After login in Windows, a WinCC user is automatically signed in to WinCC.
Add an alternative / redundant project	<p>If you wish to start a client with redundant servers using autostart, also enter the alternative/redundant project into the autostart configuration.</p> <p>If the server is not available, the alternative project is started after a certain amount of time.</p>

Note

WinCC client without its own project

In the case of autostart on a client without a separate project, the user needs the "Configure remote" WinCC system authorization.

The project is opened implicitly in the background on the client during autostart.

Integrated projects

After the overall loading from the Engineering Station (ES) to the Operator Station (OS), you must reconfigure autostart on the client for safety reasons.

You must enter user name and password again.

Autostart in WinCC ServiceMode

If you have configured Autostart for a project in WinCC ServiceMode, the project is also restarted when the "SIMATIC WinCC CCProjectMgr" service is restarted. Additional information on the Autostart behavior in Service Mode is available in the WinCC Information System under the topic "Configurations > WinCC Service Mode > Configure WinCC Service Mode > How to define a project as a service project".

Procedure

1. In the "SIMATIC> WinCC" group select the entry "Autostart".
Alternatively, look for autostart in the Windows Search box.
The "AutoStart Configuration" dialog opens. The settings of the local computer are displayed.
2. Enter the computer name, select the local computer or select a computer in the network path with .
To display the current configuration of the selected computer, click "Read configuration".
3. Select the required project by clicking the button beside the Project box.
The project file and its full path are entered in the box.
The project type is displayed under the path.
4. Configure the settings for the autostart behavior.
5. Activate the option "Autostart active".
If the option is deactivated, autostart is not executed for the configured computer.
6. Confirm your settings with "Apply" and close with "OK".
The next time you boot the computer, WinCC starts automatically and the selected project is opened.

Removing WinCC from Autostart

If you no longer want WinCC to start when you boot the computer, you can remove the project from Autostart.

To do this, open the "AutoStart Configuration" dialog.

Temporarily deactivating Autostart

Deactivate the option "Autostart active".

WinCC is removed from Autostart. The project path remains registered in the "Project" box and the settings are retained.

Removing Autostart settings

If you want to completely remove the WinCC project from Autostart, click the "Delete input fields" button.

Select "Apply" and confirm your query.

All Autostart data is deleted on the selected computer.

See also

Opening WinCC Explorer (Page 36)

How to Start Runtime (Page 204)

1.10.4 How to Exit Runtime

Introduction

When you exit Runtime, you deactivate your project. All active processes are stopped.

Principle

You can exit Runtime in several ways:

- From the toolbar of the WinCC Explorer
- From the menu bar of the WinCC Explorer
- When you close a project
- When you close the WinCC Explorer
- With a C Action in the activated project

Procedure

1. Change to the WinCC Explorer.
2. Click the  button in the toolbar.
The "Deactivate DATABASENAME" dialog opens. WinCC displays the applications that will be exited.
The WinCC Runtime window is closed.

Alternative procedure

Menu bar of the WinCC Explorer

Open the "File" menu in the menu bar and select the "Activate" entry.

WinCC removes the check mark beside the entry that indicates activated Runtime.

Closing the Project

You can close the project running in Runtime.

This deactivates the project.

Closing the WinCC Explorer

You can close WinCC while a project is activated.

This deactivates the project.

Note

After starting, WinCC always opens the last project that was open before you exited.

If the project was activated when WinCC is closed, then WinCC opens the project again in Runtime.

C Action in the Activated Project

For example, you configure a button in the project you use to exit WinCC or Windows.

To do this, use the Exit WinCC Runtime and Exit WinCC dynamic wizards.

External application (C++ project)

If you use an uninterruptible power supply (UPS), you can also close WinCC via an external program.

You need UPS software that can automatically start a program when a power failure is detected.

You can find additional information in Product Support under Entry Number "89257244":

- Internet: FAQ 89257244 "How do you safely close WinCC via an external application" (<https://support.industry.siemens.com/cs/ww/en/view/89257244>)

Multi-user systems

In a multi-user system, you can deactivate a project in any order on the servers and clients.

If you first exit Runtime on a server, the boxes with the missing process values in the client projects are deactivated (gray). As soon as you start the corresponding server again, WinCC adopts the current values in the client project.

Deactivating a Project from a Remote Computer

In a multi-user system, you can deactivate a project on a computer from another computer.

You must have the necessary access rights.

You can find detailed information in the WinCC Information System under "Configurations > Distributed systems > Remote configuration".

See also

How to Start Runtime (Page 204)

Closing WinCC Explorer (Page 40)

Internet: FAQ 89257244 "How do you safely close WinCC via an external application" (<https://support.industry.siemens.com/cs/ww/en/view/89257244>)

Dynamizing Using Dynamic Wizard (Page 1179)

1.11 Copying and Duplicating Projects

1.11.1 Copying and Duplicating Projects

Introduction

You copy or duplicate a project with all important data onto the local or another computer using the Project Duplicator.

A project can be copied using the "Save As ..." feature in the following cases:

- You want the same project to be edited on several computers.
- You want a project to run in a multi-user system on several computers.
- You want to edit a project and use the download changes online function.
- You want to archive a project as a backup.

After you have copied the project, you can save it to a storage medium.

You duplicate a project in the following case:

- You want a project to be duplicated on a redundant server.

See also

How to duplicate a redundant project at runtime (Page 217)

How to Duplicate a Project for Redundant Servers (Page 215)

How to Copy a Project (Page 212)

1.11.2 How to Copy a Project

Introduction

You can copy the configuration data of a closed project.

Note

The copying of variables or structure types from an open project to another project is not allowed. For example, you open an old project and copy a structure type and the structure variables. Then you open a new project and add the structure type and the structure variables.

Make regular backups of a project during configuration. This allows you to go back to a previous version of the project and continue from there.

If you modify a project later, you should also make a backup on completion of each change. If necessary, you can then revert to the original version without having to edit the project again.

Principle

Select the project you want to copy in the Project Duplicator.

Enter the folder into which the project will be copied. In the description below, this folder is called the target folder.

The target folder can be on the same computer or on another computer in the network for which you have access rights. The project folder is created in the target folder. When you copy it, you can change the name of the project. The project folder is created with the project name.

You can only copy the entire project and the entire folder structure. The "ArchiveManager" folder will not be copied.

After the project has been copied, you can open and edit it or activate it immediately. If you open the project on another computer, you need to change the computer name.

Note

If the Duplicate or Save As ... options of the Project Duplicator are used, the same WinCC version must be installed on the target computer.

WinCC projects created using SIMATIC Manager should not be copied using the Project Duplicator.

You can also create a separate WinCC project from the integrated WinCC project. You can find information on the page "Integration of WinCC in the SIMATIC Manager > Advantages and disadvantages of the integration".

Copying to a storage medium

You cannot copy a project directly to a data medium.

If you want to copy a project to an external data medium for archiving, copy the project to a local folder. Then copy this folder to the data medium.

If you compress the project files before copying, for example in a ZIP archive, you need less space on the data medium. This approach also prevents each file from becoming read-only after copying.

Copying a project with project-based access protection

SIMATIC STEP 7 must be installed in order to create a copy of a WinCC project with project-based access protection.

When you click the "Save As" button in the "WinCC Project Duplicator" dialog, you have to enter the password for the STEP 7 project.

If SIMATIC STEP 7 is not installed or you enter the wrong password, the Project Duplicator aborts with an error message.

Requirements

- The project to be copied must be closed.
Another project may remain open on the source computer and may run in Runtime.
- The target folder has been created.

- You have access rights for the target folder.
- No WinCC project must be open on the target computer since write-protected or system-accessed data cannot be overwritten by the Project Duplicator.
- The target computer has enough free space on the hard disk.

Procedure

1. In the "Siemens Automation" Windows program group, select the entry "Project Duplicator". The WinCC Project Duplicator is opened.

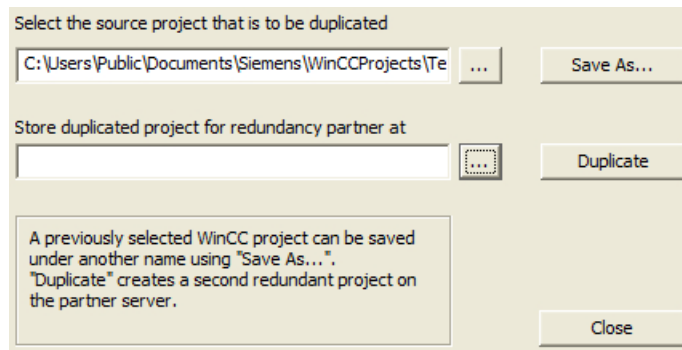

2. Enter the project you want to duplicate in the "Select the source project that is to be duplicated" field.
Enter the path and the <PROJECT>.MCP project file directly or search for them by clicking the button.
3. Click the Save As... button.
The "Saves a WinCC project" dialog is opened.
4. Select the folder to which you want to copy your project and enter the name of the project in the "File name" field.
If you wish to save a copy of the project with a different name, enter the new name. The project files are renamed accordingly when the project is copied.
5. Click on the "Save" button.
The "Copy ..." window opens.
When copying, the Project Duplicator displays the files and folders with a progress bar. Use the "Cancel" button to stop the copying.
6. Close the Project Duplicator with the Close button.
7. If you have copied the project to another computer, the original computer name is still entered in the project properties.
Correct the computer name in the project properties when the project is opened for the first time.
The modified computer name is adopted after you close and open the project again.

Alternative procedure

You can also copy a project in the SIMATIC Manager using the "Download to CPU" feature.

For more detailed information, refer to the WinCC Information System under "Working with WinCC > Integration of WinCC in the SIMATIC Manager".

Copying a multi-user project

If you copy a multi-user project to another computer, you must adapt the computer name after opening the project.

If you have already created packages in the copied project, the old computer name will be used when the packages are generated.

Before the packages are created, correct the computer name in the "Symbolic computer name" and "Physical computer name" fields.

1.11.3 How to Duplicate a Project for Redundant Servers

Introduction

The two redundant servers must be set up to be functionally identical with regard to their hardware and software.

After completing the WinCC configuration and after every change in the WinCC project, use the WinCC Project Duplicator to generate the redundant partner project.

The Project Duplicator performs the following:

- Copying of all associated project data, such as pictures, scripts and archives to the redundant partner.
- Configuring all the required settings on the target computer, if the computer is already configured for the use of WinCC Redundancy.

You must change computer-specific settings manually afterward.

Note

To transfer a project to a redundant server, you cannot use the Windows Explorer.

You can save minor changes using the function for downloading changes online in SIMATIC Manager and then transfer them to the servers in runtime.

Principle

Select the project you want to duplicate in the Project Duplicator.

Specify the target computer and folder in which the project is duplicated. The project folder is created in this target folder.

You cannot duplicate a project on the local computer. You always duplicate a project on another computer in the network to which you have access rights.

Depending on the status of the project, you can copy the configuration data and the runtime data into the selected folder:

Project Status	Configuration Data	Runtime Data
Project closed	+	+
Project open and deactivated	+	-
Project in Runtime	+	-

You can only duplicate the entire project and the entire folder structure. You cannot exclude any data or folders from the duplicate operation.

Requirements

- The WinCC Redundancy option is installed on both computers.
- The target folder for the duplication is created on the target computer and is made available for access.
- You have access rights for the target folder.
- The target computer has enough free space on the hard disk.
- The correct WinCC version must be installed on the target computer. The computer must be started.
- Runtime is deactivated on the target computer.
- The project is closed on the target computer.

Procedure

1. In the "Siemens Automation" Windows program group, select the entry "Project Duplicator". The WinCC Project Duplicator is opened.

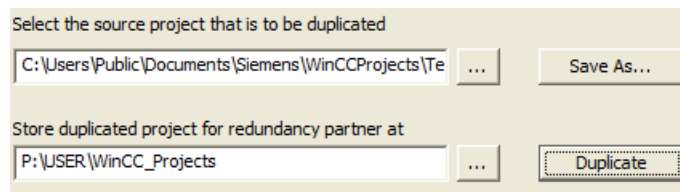

2. Enter the project you want to duplicate in the "Select the source project that is to be duplicated" box.
Enter the path and the <PROJECT>.MCP project file directly or search by clicking the button.
3. Enter the path where the duplicated project will be stored in the "Store duplicated project for redundancy partner at" box.
Enter the folder path and the <PROJECT>.MCP project file directly or search by clicking the button.

4. Click the Duplicate button.
The "Copy" window is opened. During duplication, the Project Duplicator displays the files and folders with a progress bar. Use the "Cancel" button to stop duplication.
After duplicating the "Notes on the Project Duplicator" window is opened.
WinCC indicates the settings that you still need to check.

Note

If you duplicate an open WinCC project on the source computer, no progress bar will be displayed.

5. Close the Project Duplicator with the Close button.
6. Check the settings in the duplicated project and change them if necessary.
7. Check the following:
 - The computer name.
 - The settings in the Redundancy Editor.
 - If necessary, the settings in the editors.

Duplicating a project with project-based access protection

SIMATIC STEP 7 must be installed in order to transfer a WinCC project with project-based access protection to a redundant server.

When you click the "Duplicate" button in the "WinCC Project Duplicator" dialog, you have to enter the password for the STEP 7 project.

If SIMATIC STEP 7 is not installed or you enter the wrong password, the Project Duplicator aborts with an error message.

1.11.4 How to duplicate a redundant project at runtime

Introduction

If you edit a redundant project, you can also update the project on the redundant server during operation.

You can save minor changes with the Save Online Changes function and then transfer them to the servers. You should also refer to the documentation on the topic of "Load Online Changes".

Duplication using the Project Duplicator

Some configuration cannot be saved by the download online changes function. In this case, you must generate a duplicate of the project to the redundant server using the Project Duplicator.

Note

No Redundancy

For changes during normal operation, you must deactivate one of the partner servers. During this time, no redundancy is available.

Requirements

- The target folder has been created.
- You have access rights for the target folder.
- The redundant server on which the copied project will be stored has enough free hard disk space.

Procedure

This chapter describes how to use this function in a redundant system with the two servers Server1 and Server2.

1. Exit Runtime on the redundant Server1 and close the project.
2. Make the configuration changes on Server2 in Runtime and save the changes.
3. Start the Project Duplicator on Server2.
4. Use the "Duplicate" button to duplicate the project on Server1 to the target folder of the project deactivated under "1." and overwrite the project.
5. Open the project on Server1.
6. Check the settings.
7. Start Runtime and wait for the redundancy synchronization.

1.12 Appendix

1.12.1 Editors and Functions in WinCC Explorer

Introduction

You can see the installed WinCC editors and functions in the navigation window of the WinCC Explorer.

The editor belonging to an option is only visible in the navigation window when the option is installed.

Some tools and some WinCC options are not displayed in the WinCC Explorer. You open the tools in the Windows program group "Siemens Automation".

You can open some of the editors of the WinCC options independently of WinCC. For more detailed information, refer to the help on the specific options.

Opening an Editor

You can open an editor in the WinCC Explorer in the following ways:

- Using the shortcut menu of the editor in the data window or in the navigation window
- By double-clicking the editor in the navigation window

List of Editors and Functions

The following two tables list all editors and functions that you can open using the WinCC Explorer.

The tables contain the following information:

- **Object:**
Name of the editor or function in the WinCC Explorer.
- **Use:**
Information on what the object is used for.
- **Online Help:**
Refers to the relevant chapters in the WinCC Information System that contain more detailed information on the object.
- **Import/Export Tools:**
Refers to tools which can be used to import or export data.
- **Switch language:**
Indicates whether or not foreign languages can be configured.
- **Online Configuration:**
Indicates whether or not the object can be used while the project is active in Runtime. You find information on restrictions regarding online configuration in chapter Online Configuration and in the description of the editors.

Object	Use	Online Help ¹⁾	Import/Export Tools	Language Switching	Online configuration
Computer	Computer name and properties, project properties (client and servers)	Working with projects	---	Yes	Yes ²⁾
Tag Management	Tag Management: <ul style="list-style-type: none"> • Creating and editing tags and Communication drivers • Creating and editing structure types and structure tags 	Working with tags Structure tags: Process picture dynamics	WinCC Configuration Studio	---	Yes ²⁾
Graphics Designer	Creating and editing process pictures	Creating Process Pictures	Export function of the editor	Yes	Yes
Menus and toolbars	Configure user-defined menus and toolbars for process pictures	Creating Process Pictures	---	Yes	Yes
Text and Graphics List	Smart object "text list": Linking tag values with texts Smart object "status display": Link states with graphics	Creating process pictures	---	Yes	Yes
Alarm Logging	Configuring messages and archiving events	Setting up an Alarm System	WinCC Configuration Studio	Yes	Yes ²⁾
Tag Logging	Logging and archiving tags	Working with process values	WinCC Configuration Studio	---	Yes
Report Designer	Configuring reports and report layouts	Documentation of Configuration and Runtime Data	---	Yes	Yes ²⁾
Global Script	Making a project dynamic with C functions and actions or the VB scripts	ANSI-C for creating functions and actions VBS for creating procedures and actions	Export function of the editor	Yes	Yes
Text library	Creating and editing language-dependent user texts	Setting up multilingual projects	WinCC Configuration Studio	Yes	Yes
Text Distributor	Exporting and importing language-dependent text	Setting up multilingual projects	Export and Import function of the Editor	Yes	Yes
User Administrator	Managing access permissions for users and user groups	Setting up user administration	WinCC Configuration Studio	Yes	Yes
Cross Reference	Localizing, displaying, and rewiring the location at which objects are used	Working with Cross Reference	---	---	Yes
Server data	Creating and editing packages for multi-user systems	Configurations > Distributed systems	---	---	Yes

Object	Use	Online Help ¹⁾	Import/Export Tools	Language Switching	Online configuration
Load online changes	Transferring edited data to the operator station	Working with projects	---	---	Yes ²⁾
Tag simulation	Testing a WinCC project: Simulating tags and process values	SmartTools > Tags simulator	Yes	Yes	Yes

¹⁾ The listed sections can be found in the WinCC Information System in the book "Working with WinCC" or under the specified path in the table of contents.

²⁾ With restrictions

Options

Object	Use	Online Help	Import/Export Tools	Language Switching	Online configuration
WebNavigator	Operating and monitoring using Internet/intranet	Options > WebNavigator	---	Yes	---
DataMonitor	Displaying archive values in Internet/intranet	Options > WebNavigator > DataMonitor	---	Yes	---
WebUX	Operator control and monitoring over the Internet/intranet in any Web browser with HTML5 capability	Options > WebUX	---	---	---
Redundancy	Operating two servers at the same time in a redundant system	Configurations > Redundant Systems	---	---	Yes
User archive	Configurable database system for data from technical processes, for example for recipes and setpoints	Options > User Archives	WinCC Configuration Studio	Yes	Yes
OS Project Editor	Initializing and configuring the Runtime user interface and alarm systems in PCS 7	Options for Process Control > OS Project Editor	---	---	---
Time synchronization	Synchronizing the time of day on all clients and servers	Options for Process Control > Time synchronization	---	---	Yes
Horn	Indicating message-relevant events on signal modules and PC sound cards	Options for Process Control > Audio alarm	WinCC Configuration Studio	---	Yes
Picture Tree	Managing picture hierarchies and name hierarchies	Options for Process Control > Picture Tree	WinCC Configuration Studio	Yes	Yes
Lifebeat monitoring	Permanent monitoring of the system	Options for Process Control > Lifebeat Monitoring	---	---	---
Component List Editor	Allocating entry point pictures and areas to the measuring points	Options for Process Control > Component List Editor	---	---	---

Object	Use	Online Help	Import/Export Tools	Language Switching	Online configuration
Calendar Options	Calendar Scheduler: Managing time-controlled activities for monitoring and controlling WinCC projects Event Notifier: Managing notifications about alarm states	Options > Calendar Options	---	Yes	Yes ¹⁾
Audit	Monitoring and saving project changes and operations	Options > Audit	---	Yes	Yes
ProAgent	Configuring process diagnostics to detect and eliminate problems	Options > ProAgent	---	---	Yes

¹⁾ With restrictions

See also

Windows of the WinCC Explorer (Page 42)

1.12.2 WinCC status and control in the system tray

Introduction



WinCC shows the "SIMATIC WinCC" symbol in the Taskbar Notification Area, the so-called tray area.



This symbol provides information on the project status.

The WinCC project can be activated and deactivated via the symbol's shortcut menu.

Project status

The following table shows which project status goes with which symbol:

SIMATIC WinCC symbol	Status
	<ul style="list-style-type: none"> WinCC is not active. No project is open.
	WinCC changes the status: <ul style="list-style-type: none"> WinCC opens a project. WinCC activates a project. WinCC deactivates a project. WinCC closes a project.
	Project is open.

SIMATIC WinCC symbol	Status
	The project is activated.
	Project is activated and the server has the "Fault" status.

Control Options via the Pop-up Menu

The shortcut menu of the "SIMATIC WinCC" symbol provides the following functions:

- Start Graphics Runtime.
- End Graphics Runtime.
- Activate project.
- Deactivate project.
- Open diagnostics window.

SIMATIC WinCC® Window

To open the "SIMATIC WinCC" window, click on the "SIMATIC WinCC" symbol.

Example: Window with Runtime activated

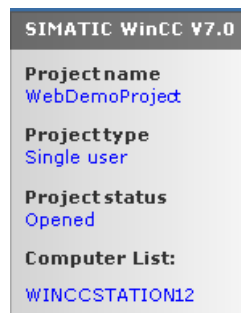

The window shows the following information:





- Project name
- Project type
- Project status
- Computer List
The local computer is represented in blue.

Computer List

The computer list contains all computers on the network.

If the project is activated, the connection status of all existing computers is shown.

The following table shows the icons of the connection status and their meaning:

Icon	Status
	<ul style="list-style-type: none"> No connection Connection disconnected
	<ul style="list-style-type: none"> Local computer Redundant partner server
	Connected <ul style="list-style-type: none"> With standby server With master server, but standby server is the preferred server
	Connected <ul style="list-style-type: none"> With master server With standby server as preferred server

This view only provides information on the status of the PCs in the network.

To query the connection status for the controller, use the "Status of driver connections" function in WinCC Explorer or the system tag "@<Connectionname>@ConnectionStateEx".

1.12.3 WinCC diagnostics window and license information

Introduction

The diagnostics window provides information on the diagnostics of the local computer and connected servers.

The "WinCC Diagnostics" dialog shows WinCC e.g. invalid licenses of the local computer and the connected servers.

Information on Invalid Runtime Licenses

WinCC shows invalid Runtime licenses of the local computer and all connected servers in a dialog that requires acknowledgement. The name of the concerned computer is listed in brackets.



You can only use the "Details" button locally on the computer with the invalid license.

Use the "Details" button to start the Automation License Manager. The Automation License Manager provides further information and installs the required licenses.

1.12.4 Illegal Characters

Introduction

Depending on the language and components, only certain characters are permitted in names. In WinCC, you can use all characters of the ASCII character set.

Regional special characters

You should generally avoid national special characters, e.g. umlauts.

Especially avoid special characters in the following cases:

- In object names when the object names are used in scripts
- In object names when the object name is specified as an URL in the Web browser.
- In the project name when you are using WebNavigator or WebUX.

Illegal characters in WinCC

The table lists the characters that must not be used in WinCC components, identifiers, and names.

Component	Illegal characters
WinCC project: Names of WinCC projects	. , ; : ! ? " ' + = / \ @ * [] { } < > space case-sensitive
Tags: Tag names	: ? " ' \ * % space not case-sensitive "@ is used only in system tags. The period is used as a separator in structure tags.
Tags: Names of process tags in Tag Logging	: ? " ' \ * % > space
Tags: Names of archive tags in Tag Logging	: ? " ' \ * % > space
Tags: Names of tag groups	' \ space not case-sensitive
Structure types: Names of structure types, structure type elements, structure tags	. : ? ' \ * % space A structure tag cannot have the name "EventState".
Graphics Designer: Names of subfolders	The path name of the project folders including picture name is limited to 180 characters. When you create subfolders in the project path in the "GraCS" folder, avoid periods in the folder name. VB scripts can only access subfolders that have no period in their name.
Graphics Designer: Names of pictures (PDL files)	: ? " ' / \ * < > Avoid periods in the names of process pictures that are located in subfolders of "GraCS" and referenced in scripts.
Graphics Designer: Names of objects in pictures	/ The name can be no longer than 180 characters. If you use special characters, the maximum number of characters is further restricted. Avoid using special characters if the object name is used in scripts. For more detailed information, refer to the documentation on VBS in the section Testing with the Debugger > Action and Procedure Names in the Debugger.

Component	Illegal characters
Graphics Designer: Text list object type	Restriction for assigned and referenced texts: ;
Graphics Designer: Names in the Dynamic Wizard	%
Graphics Designer: Faceplate	The following applies to the names of properties (Properties) and results (Events): !"§\$%&/=@ . , ; - _ # * ~ + ° ^ () [] { } < > Ä Ö Ü ä ö ü Spaces Lead characters
Alarm Logging: Names of message blocks, message classes, message types and message texts	' Enter line break
Tag Logging: Archive name	. , ; : ! ? " ' ^ ` ~ - + = / \ * # % & § ° () [] { } < > space
Tag logging / trend control: Labeling time axis and value axis	Single "&" character is not displayed. Double "&" character is displayed once.
Report Designer: Names in the page layout and line layout	: ? " / \ * < >
User Administrator: User names	' \ not case-sensitive Length: at least 4 characters, maximum of 24 characters
User Administrator: Group names	' \ not case-sensitive Length: at least 4 characters, maximum of 24 characters
User Administrator: Passwords	Case-sensitive Length: at least 6 characters, maximum of 24 characters
User Administrator: User authorizations	Length: maximum of 70 characters
User archives: Names for archives, fields, views and columns	. , ; : ! ? " ' ^ ` ~ - + = / \ @ * # \$ % & § ° () [] { } < > space The first character must be a letter. National special characters, for example umlauts or Asian characters are not permitted.
Server data: Names of packages	, / \ National special characters, for example umlauts (ä, ü etc.) are not permitted.

Illegal characters for basic settings

Component	Illegal characters
Computer name	.,;:!?""'^`~_ + = / \ @ * # \$ % & § ° () [] { } < > space Uppercase only The first character must be a letter.
DNS host names	.,;:!?""'^`~_ _ + = / \ @ * # \$ % & § ° () [] { } < > space
Folder path: Names of folders	: ? " ' " / * < >
WinCC Explorer	Restrictions depending on individual components
Communication: Names of connections under a channel unit	Restrictions in relation to the SQL database
Communication / OPC: Used names	. : ? " ' " \ * % space Regional special characters
Web client: Used names	.,;:!?""'^`~_ - + = / \ @ * # \$ % & § ° () [] { } < > space

Illegal characters for integrating in the SIMATIC Manager

Component	Illegal characters
SIMATIC Manager: Names of WinCC projects	.,;:!?""' + = / \ @ * % [] { } < > space
OS compilation: AS-OS connection names	. : ? " ' " \ * % space
PCS7: Hierarchy folder	. " / \ %

See also

Preparation to Create a Project (Page 115)

File Structure of a Project (Page 230)

1.12.5 File Structure of a Project

Introduction

In a WinCC project, you find additional information in certain folders and files. By default, WinCC projects are stored in the path Siemens\WinCC\WinCCProjects\

Imported Files

Imported files, for example graphics, scripts, texts, programs, OCS files are located within the folder structure.

Data storage

The table lists the most important data and folders.

Path	File	Type	Function
<Project folder>	---	Folder	Contains all files created for the project.
<Project folder>\GraCS	---	Folder	Contains all pictures and picture files of a project. Can contain additional subfolders.
<Project folder>\CommonArchiving	---	Folder	Contains all databases for archiving.
<Project folder>	<Project>.MCP	Project file	Starts WinCC and opens the project in the WinCC Explorer.
<Project folder>	<Project>.MDF	Database	Configuration database
<Project folder>	<Project>RT.MDF	Database	Runtime database, database management (master database)
<Project folder>	<Computer>_<Project>_ALG_JJJJMMTTHHMM.MDF	Database	Runtime Data Alarm Logging
<Project folder>	<Computer>_<Project>_TLG_F_JJJJMMTTHHMM.MDF	Database	Runtime data Tag Logging fast (acquisition cycle < 1 min)
<Project folder>	<Computer>_<Project>_TLG_S_JJJJMMTTHHMM.MDF	Database	Runtime data Tag Logging slow (acquisition cycle > 1 min)
Siemens\WinCC\bin	WinCC_SQL.MDF	Database	Empty Runtime database that can, when necessary, be copied to the project and re-named. Created when you create a new project.

Path	File	Type	Function
Siemens\WinCC	*.LOG	Log files	Reports: setup, system status, error messages.
<Project folder>	UAEditor.loc	Temporary file	Created when the editor's user archives are opened. Must be deleted if the editor is not closed correctly.

See also

Preparation to Create a Project (Page 115)

Working with Tags

2.1 Tag management

Introduction

Tag Management handles the tags and communication drivers used in the project.

Tag Management is an editor in the WinCC Configuration Studio.

You open the editor by double-clicking on the "Tag Management" entry  in WinCC Explorer.

Usage

Tags with values supplied by the process are referred to in WinCC as process tags, raw data tags, or external tags. In the case of process tags, Tag Management determines the communication driver by means of which WinCC communicates with the automation system and how the exchange of data takes place. The associated tags are created in the folder structure of this communication driver.

Tags not supplied with values by the process, known as internal tags, are created in the "Internal Tags" folder.

For a better overview, tags can be arranged in groups.

2.2 The Tag Management editor

In Tag Management, you manage the tags and communication drivers used in the WinCC project.

You start the editor with a double-click on the "Tag Management" entry in the WinCC Explorer.

Structure of the "Tag Management" editor

The Tag Management editor is divided into three areas:

- **Navigation area**
 - Tree view showing objects as folders
 - Navigation bar for switching between the editors
- **Table area**
 - Creation and editing of multiple objects
- **Properties area**
 - Properties of a selected object
 - "What's this?" for the selected property

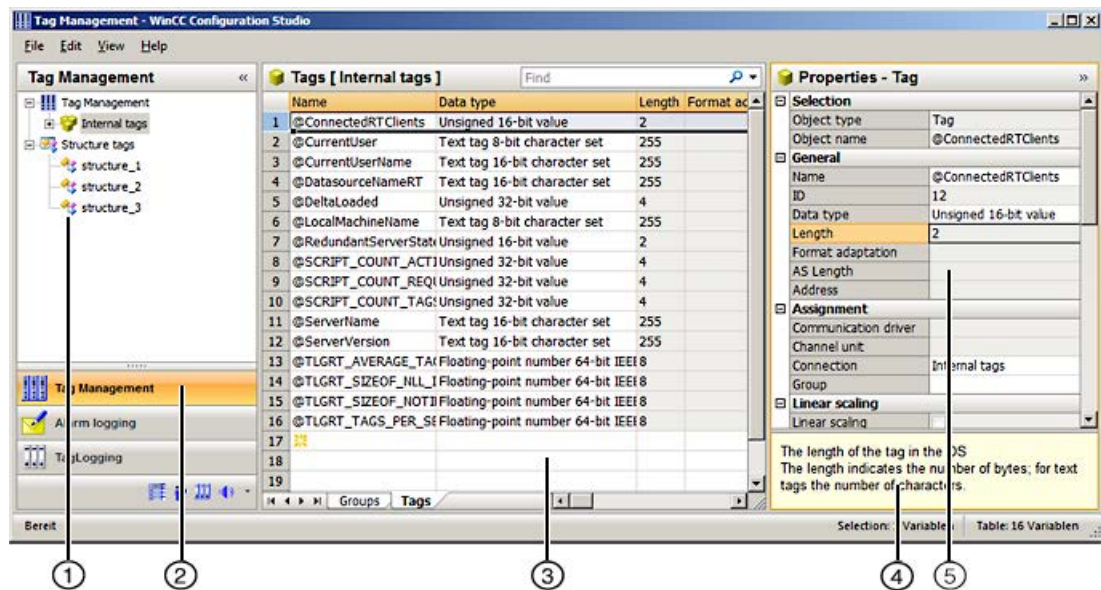

① Navigation area

The navigation area displays the Tag Management objects in a tree view.

The folders of the top level are:

- Tag Management
- Structure tags

The elements assigned to a selected folder are displayed in the table area, e.g. groups, structure types, communication drivers, connections.

A shortcut menu is available for each folder. The shortcut menu provides commands for the folder as well as general commands such as "Copy / Paste" and "Export".

WinCC creates a new folder in the navigation area for each communication driver that is set up. Under the communication driver folder, you configure a channel unit, its connections and the associated tag groups.









Tooltip

In Runtime, you can view the status information on connections as a tooltip.

To view it, move the mouse pointer in the data window to the connection you want.

Symbols

Tag Management uses the following icons:

Symbol	Meaning
	Tag Management
	Internal Tags
	Communication drivers
	Channel unit
	Connection
	Tag group
	Tag
	Structure type
	Symbols If you select a channel for which AS symbols are loaded, switch to the "Symbols" view using the button in the header.

② Selection of the editors

The navigation bar is displayed in the area below the tree view; it provides access to additional WinCC editors.

③ Table area

The table displays the elements that are assigned to the folder selected in the tree view. You can, for example, display all tags or the tags of a selected group only.

You create new tags, groups and structures in the table area. You can edit the properties of these data records in the table.

Note

Inconsistent entries have a colored background in the table window.

In the event of inconsistent configuration, a note is displayed which describes the incorrect configuration.

Tabs

Depending on the selected structure level, you can display various elements using tabs.

Navigation keys allow you to scroll through tabs. You select a tab by clicking on it, with the navigation keys, or from the shortcut menu of the navigation keys.

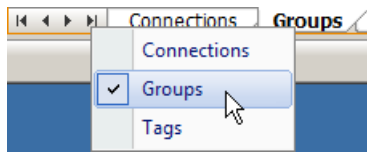

④ **What's this?**

Displays an explanation of the selected property.

⑤ **Properties**

The properties of a selected object are displayed.

You edit the properties of a data record. However, some properties are only displayed and can not be edited.

Status bar

The status bar at the bottom edge of the editor includes the following information, among other things:

- Number of data records in the displayed data area, for example, connections, groups, tags, structure types, structure tags.
- Number of selected data records when table cells are selected.

2.3 Working in the "Tag Management" editor

You work and navigate in the "Tag Management" editor as you would in the overall WinCC Configuration Studio. Configuration is user-friendly and supports the configuration engineer during editing. The handling is similar to that for a spreadsheet program.

Detailed information on operating the Configuration Studio is available in the WinCC Information System under "Working with WinCC > Working with projects > WinCC Configuration Studio (Page 54)".

Working in the table area

Creating a new object

You create new tags in the table area. You can also create additional objects, such as connections or tag groups, in the table area as an option.

To create a new object, you edit the first empty cell. The cell is identified by a yellow icon: ✖

Enter the name of the object.

Tags [Internal tags]		
	Name	Data type
16	@TLGRT_TAGS_PER_SECOND	Floating-point number 64-bit IEEE
17	✖	

Editing text fields

Tag Management contains the following text fields:

Data type	Valid entries
Text	All entries, except line breaks
Multi-line text	All entries
Unsigned integer	Numerical input only
Signed integer	Input of numbers and characters "+" and "-"
Floating-point number	Input of numbers, characters "+" and "-", decimal point, and the "e" or "E" character for exponential notation

Inconsistent entries

If an entered value is faulty or inconsistent, you will see a corresponding note, for example:

- Invalid entries are created when you edit several entries by dragging a cell.

The cell for the message number may have a red background in the table area and in the "Properties" area.

See also

The WinCC Configuration Studio (Page 54)

2.4 Basics of Tag Management

2.4.1 Tags

2.4.1.1 Tags

Introduction

Data are passed on in a WinCC project by means of tags. A tag has a data address and a symbolic name, which is used in the project. The data address is used in communication with the automation system.

WinCC works with two kinds of tags:

- Process tags
- Internal Tags

WinCC simplifies tag handling by means of two other object types:

- Tag groups
- Structure types

Naming conventions

Note

WinCC is case-sensitive in handling the names of tags.

You cannot create tags whose names differ only with respect to case in the editor.

Note

You may not create tags with a name starting with @. Tags with an @ prefix are created only by WinCC and PCS 7.

When naming tags, you must respect certain conventions:

- Tag names must be unique throughout the entire project.
- Tag names are not to exceed 128 characters. This limit applies to the entire expression "Structure tag name + dot + structure type element name" for structure tag elements.
- You must not use certain characters in tag names. The characters that cannot be included in a name can be found in the WinCC Information System under "Working with projects" > "Valid characters".

Updating Tags

In the case of process tags, the current tag values are transferred over the communication connection between WinCC and the connected automation systems in Runtime. In this instance, WinCC accesses the data area on the automation system that is defined in the tag properties. The current value of the process tag is made available by WinCC in Tag Management after it has been transferred for further processing and evaluation. Conversely, WinCC can also write data back to the automation system.

In WinCC you set the frequency of data transfer and of updating in the display. Remember while you are configuring that periodic updating of tags results in severe loading of the system and can have an adverse effect on performance.

Importing tags

You can import tags that have been exported from another WinCC project.

You can import tags from external applications. The data must be available in "Office Open XML Workbook" format with the ".xlsx" file extension.

See also

Properties of a tag (Page 243)

2.4.1.2 Internal Tags

Definition

Internal tags are not connected to the process.

You use Internal tags to manage data within a project or to transfer data to an archive.

A corresponding setting of the "Runtime persistency" property lets you set retention of the internal tags on closing Runtime. The value saved is used as start value for the restart of Runtime.

You can set the following properties for internal tags:

- Name
- Comment
- Data type
- Updates project-wide/on local computers (only relevant with multi-user projects without additional client projects)
- Limits
- Start value
- Runtime persistence
- Tag synchronization (Online synchronization the internal tags in the server project with the redundant partner)

Usable data types

You can use the following data types for internal tags:

- Binary tag
- Signed 8-bit value
- Unsigned 8-bit value
- Signed 16-bit value
- Unsigned 16-bit value
- Signed 32-bit value
- Unsigned 32-bit value
- Floating-point number 32-bit IEEE 754
- Floating-point number 64-bit IEEE 754
- Text tag, 8-bit character set
- Text tag, 16-bit character set
- Raw data tag
- Text reference
- Date/time

System tags

WinCC applications create tags required for internal administration of the project.

The names of these tags begin with an "@" character.

Note

Tags with @ prefix

You may not create tags with a name starting with @.

Tags with an @ prefix are created only by WinCC and PCS 7.

Working with system tags

You cannot delete or rename system tags.

You can evaluate, but not change, the value of the tag. The following system tags are exceptions:

- You can change the values of tags created by the "Redundancy" option by means of scripts, for example:
 - @RM_MASTER
 - @RM_MASTER_NAME
- You can reset the values of Performance tags via the following tags:
 - @PRF_DMRT_RESET
 - @PRF_DMRT_CHNCON_<...>_RESET

Description of system tags

The following sections contain additional information on specific system tags:

- Working with Projects > Making Settings for Runtime > System Diagnostics with Performance Tags (Page 176)
- Working with Projects > Loading Online Changes > How to Download Load Online Changes (Page 153)
- Archiving Process Values > Basics of Archiving Process Values > Process Values and Tags > Diagnostic Tags of Tag Logging Runtime (Page 1492)
- Process Communication > WinCC Process Communication > Configuring tags for the connection status in Runtime
- Communication Diagnostics > Channel Diagnostics > Check connection with performance tags
- Configurations > Redundant Systems > Scenarios for WinCC Redundancy > WinCC Redundancy System Tags
- ANSI-C for creating functions and actions > ANSI-C Function Descriptions > Internal Functions > WinCC > FillDiagnoseInTags
- Options for Process Control > Acoustic Alarm > Tags for controlling runtime
- Options for Process Control > Process Control Runtime > User Interface > Overview Area

See also

Tags (Page 238)

2.4.1.3 Process Tags

Definition

You use process tags for communication between WinCC and the automation system.

The properties of process tags depend on the communication driver being used. Therefore, create process tags in Tag Management also under a specific communication driver, its channel unit and its connections.

You can set the following properties for process tags:

- Name
- Comment
- Data type
- Address on the channel unit
- Format adaptation
- Limits
- Start value
- Substitute value
- Scaling

Note

Process tags are also referred to "external tags" on the system.

Usable data types

You can use the following data types for process tags:

- Binary tag
- Signed 8-bit value
- Unsigned 8-bit value
- Signed 16-bit value
- Unsigned 16-bit value
- Signed 32-bit value
- Unsigned 32-bit value
- Floating-point number 32-bit IEEE 754
- Floating-point number 64-bit IEEE 754
- Text tag, 8-bit
- Text tag, 16-bit character set
- Raw data tag
- Date/time
The values of process tags of the "Date/Time" data type are always logged in the Coordinated World Time, UTC. Adapt the runtime settings accordingly.

Licensing of Power Tags

For WinCC, you purchase licenses to be able to use a certain number of process tags and archive tags.

Power tags are licensed process tags. With a license covering 2048 power tags, for example, you can operate a WinCC project in Runtime in which up to 2048 process tags are used on a computer. The number of licensed and configured process tags will be seen in the status bar of WinCC Explorer.

Licenses are divided into the following types:

- "RC": for configuration and Runtime of a certain number of process tags
- "RT": only for Runtime of a certain number of process tags

Note

The process tags required for the System Info channel need no licenses. Thus, the tags are not entered in the license count.

See also

Tags (Page 238)

2.4.1.4 Properties of a tag

Introduction

You can edit the properties of a tag in the "Properties" area of the Tag Management editor.

In the table area, the following properties can additionally be shown:

- Value: Shows the current value of the tag
- Tag status
- Quality code

Properties of a tag

Selection

Displays the object type and the name of the selected object.

General

Name	Name of the tag, can be edited here
Comment	Comment editable, Max. 100 characters, language-neutral
ID	ID, cannot be edited
Data type	Selection from drop-down list with all the available data types, see Tag Types (Page 254)
Length	Length of the tag in WinCC, determined by the data type
Type conversion	Selection from drop-down list with the format adaptations that are available for the selected data type.

AS length	Length of the tag in the automation system, results from the selected format adaptation.
Address	Depends on connection. A dialog for entering the address data opens. For system tags, such as specification of the representation format, selection of a drive, selection of the CPU
AS tag name	Name of the tag in the external device
AS namespace	Name of the data block or namespace of tags in the external device. The property is read-only. The namespace is defined with the OPC client configuration.

Assignment

Communication driver	Display, depends on the selected connection
Channel unit	
Connection	Selection from drop-down list with the created communication drivers and the "Internal tags" connection
Group	Selection from drop-down list with the groups created under the selected connection

Linear scaling

Linear scaling is only available for process tags. You cannot scale internal tags.

Linear scaling	Select the "Linear scaling" option. With the help of linear scaling, you can map the values of process tags in WinCC onto any second range of values. You use linear scaling when you want to display a process value differently from how it was supplied by the automation system. The process value itself is not modified. This can be practical, for example, if you want to use the process value as a percentage or for calculations. Example: A temperature sensor measures the resistance in the system and transfers the values in ohms. Specific values correspond to specific temperatures. With the help of linear scaling, you can automatically convert the resistance values to the temperature scale. This ensures that the measured resistance is immediately displayed as temperature in the project.
AS value range from	Low and high value of the value range in the automation system.
AS value range to	
OS value range from	Low and high value of the value range in WinCC.
OS value range to	

Limits

Low limit	Enter limit values to prevent the value of a tag from being outside the defined limits. If, for example, a process value exceeds a limit, the value is grayed out and processing stops.
High limit	

Start value	<p>Value assumed at the start of Runtime.</p> <p>Specified text for text tags, for example.</p> <p>If a start value has been configured, the start value is returned at the first reading of a process tag, even if a process value already exists. This accelerates the opening of the picture when Runtime is started and when the picture is changed. To prevent this behavior, you need to configure a direct read call using the corresponding functions in VBS and C.</p> <p>If you want to specify both a start value and a substitute value, check the settings in the "Use substitute value" area.</p>
Substitute value	Value assumed when the corresponding option under "Use substitute value" is selected.

Use substitute value

Here, you determine when WinCC is to use the substitute value. In this case, the current process value from the automation system is not accepted.

Substitute value at low limit	WinCC uses the substitute value as soon as the process value violates the specified high or low limit.
Substitute value at high limit	<p>If you have set a high or low limit in an input/output field, you cannot enter any value outside these limits.</p> <p>WinCC ignores incorrect entries and therefore does not set a substitute value. The substitute value is only set by WinCC when an incorrect process value is read.</p>
Substitute value as start value	WinCC sets the substitute value when the project is activated and there is no current process value. If a start value has already been defined, it is not possible to select "Substitute value as start value".
Substitute value on connection errors	WinCC sets the substitute value when the connection to the automation system is disturbed and there is no valid process value.

Options

Computer-local	<p>Option selected: The tag is updated only locally on the computer.</p> <p>Option not selected: The tag is updated throughout the project.</p> <p>The option is relevant for clients without their own project. Otherwise, the following applies:</p> <ul style="list-style-type: none"> • WinCC server: project-wide update • WinCC client with its own project: computer-local update
Synchronization	Option selected: Value of an internal tag is synchronized to the value on the redundant partner.
Runtime persistence	<p>Option selected: Value is saved when closing Runtime and restored on restart.</p> <p>On clients without their own project, the option has no effect if the "Computer-local" setting is enabled.</p>
OPC write protection	The WinCC OPC server only has read access to the tag value.
OPC read protection	<p>The WinCC OPC server has neither write nor read access to the tag value.</p> <p>When this is activated, the "OPC write protection" option is also activated.</p> <p>When OPC read protection is disabled, the "OPC write protection" option remains activated.</p>

Good Manufacturing Practice	
WinCC Cloud	Requested tag values are sent to the WinCC Cloud.

Various

Author ID	ID of the component that created the tag. System tags of the WinCC project and tags created in the Tag Management have the ID "0".
Last change	Time stamp of the last change to the properties of the tags.

Structure tag element

Display only when a structure tag element is highlighted, cannot be edited.

Structure type	Information on the structure of the selected instance, see "Structure Types and Structure Tags (Page 246)"
Structure tag	
Structure type element	
Structure type element number	The number can be changed by arranging the structure type elements in the navigation area.

See also

- Tags (Page 238)
- Properties of a structure tag (Page 249)
- Structure Types and Structure Tags (Page 246)
- Tag types (Page 254)

2.4.1.5 Structure Types and Structure Tags

Definition

WinCC structure types simplify the creation of several tags having identical properties.

In WinCC Configuration Studio, you create a structure type in the navigation area of the Tag Management editor.

Name	Definition
Structure type	A structure type denotes a scheme that is used in WinCC to create a certain group of tags. A structure type contains at least one structure element. Structure types are created and displayed in the "Structure tags" folder in the navigation area.
Structure type element	A structure type element is a component of a structure type. In the structure type element, the tag properties are defined as a template for the instances of the structure tags. Structure type elements are created and displayed in the folder of a structure type in the navigation area.

Name	Definition
Structure tag	<p>A structure tag is a tag that is linked with a structure type.</p> <p>When a structure type is assigned, the instances of the structure tag take on the properties of the contained structure type elements.</p> <p>The name of a structure tag is also referred to as a tag prefix.</p> <p>Structure tags are created and displayed in the table area on the "Structure tags" tab.</p>
Structure tag element	<p>Structure tag elements are not configured. They are generated automatically when you create structure tags:</p> <p>A structure tag instance, a so-called structure tag element, is created for each structure type element of the selected structure type.</p> <p>The name of a structure tag element consists of the name of the structure tag and the name of the structure type element being used. The two parts of the name are separated by a dot.</p> <p>The created structure tag elements are displayed for the selected structure type in the table area.</p> <p>The structure tag elements are displayed as addressable tags in the tag selection dialog.</p>

Principle

You define a tag structure when you create a structure type.

1. You create a structure type in the "Tag Management" editor.
2. Under the structure type, you create one structure type element for each desired tag type.
3. You assign to a structure type element the properties that the tags created by that structure type element should possess.
4. When creating a structure tag, assign a created structure type as data type.
The structure types available are displayed in the "Data type" selection window.
5. WinCC creates the corresponding structure tag elements under the relevant structure type.
These created instances of the structure tags are defined by the structure type elements of the selected type.
The structure tag elements are displayed on the "Structure tags" tab under "Structure tags" in the Tag Management. In addition, the elements are displayed under "Internal tags" or under the selected connection.

Process tags and internal tags

You can define structure type elements for internal tags and process tags in the same structure type.

Structure type elements are created for internal tags by default. The associated structure tag elements are created and displayed in the Tag Management under "Internal tags".

If the option "External" is activated for a structure tag element, the associated structure tag elements are created as process tags.

You choose the communication driver and connection under which the instances are created in the properties of the structure tag.

Naming conventions

When naming, you must respect certain conventions:

- Tag names must be unique throughout the entire project.
- Tag names are not to exceed 128 characters.
This limit applies to the entire expression "Structure tag name + dot + structure type element name" for structure tags.
- There are certain characters which you cannot use in the names of structure types, structure type elements and structure tags.
The characters that cannot be included in a name can be found in the WinCC Information System under "Working with projects > Illegal Characters (Page 226)".

Note

Uppercase/lowercase letters

WinCC is case-sensitive in handling the names of tags.

However, you cannot create tags whose names differ only with respect to case in the editor.

The name cannot begin with @

You may not create tags with a name starting with @.

Tags with an @ prefix are created only by WinCC and PCS 7.

Modifying structure types

If you have used a structure type to create a structure tag element, you can no longer modify the properties of this structure type.

You must first delete the structure tag elements. In doing so, you also delete all associated structure tags.

After that, you can change the properties of the structure type and structure type elements and create a structure tag element again.

You can modify the properties of structure instances and structure tags later. If you rename a structure tag, then rename the associated structure tag elements at the same time.

See also

Tags (Page 238)

Properties of a structure tag (Page 249)

Illegal Characters (Page 226)

Use: Structure tags in picture windows (Page 251)

2.4.1.6 Data types of structure tags

Data types

The data type for the tag automatically precedes the name of a structure element in WinCC. This data type corresponds to a certain tag type, e.g. the BYTE data type, the tag type Unsigned 8-bit value.

If you want to address a structure tag with a script, then you have to use the C function for this data type.

The following designations are used:

Tag type	Data type	Associated C function
Binary tag	BIT	GetTagBit
Signed 8-bit value	CHAR	GetTagSByte
Unsigned 8-bit value	BYTE	GetTagByte
Signed 16-bit value	SHORT	GetTagSWord
Unsigned 16-bit value	WORD	GetTagWord
Signed 32-bit value	LONG	GetTagSDWord
Unsigned 32-bit value	DWORD	GetTagDWord
Floating-point number 32-bit IEEE 754	FLOAT	GetTagFloat
Floating-point number 64-bit IEEE 754	DOUBLE	GetTagDouble
Text tag, 8-bit character set	TEXT8	GetTagChar
Text tag, 16-bit character set	TEXT16	GetTagChar
Text reference (internal tags only)	TEXTREF	GetTagChar

Further information can be found in the section "Tag Types" and in the description of the internal functions for ANSI-C.

Note

BIT tags have a fixed length of one word in a structure. Therefore, bit positions 0 to 15 are the only positions possible. This length of two bytes has to be taken into account for the offset value of the following element.

See also

Properties of a structure tag (Page 249)

2.4.1.7 Properties of a structure tag

Introduction

The properties of a structure type, except for the name, cannot be edited.

The properties of structure type elements and structure tags correspond to those of tags. See section "AUTOHOTSPOT".

Properties of structure tag elements

The properties of a structure tag element are determined by the properties of the structure type elements and the structure tags.

Object	Properties ¹⁾
Structure type	Name
Structure type element	<p>General information:</p> <ul style="list-style-type: none"> • Name • External When the option is disabled, the structure tag elements are created as internal tags. When the option is enabled, the structure tag elements are created as process tags. You configure the connection of the desired communication channel in the structure tags. • Data type: Tag type • Type conversion • AS offset <hr/> <p>Linear scaling:</p> <ul style="list-style-type: none"> • Linear scaling • AS value range from/to • OS value range from/to <hr/> <p>Limits:</p> <ul style="list-style-type: none"> • Low limit • High limit • Start value • Substitute value <hr/> <p>Use substitute value:</p> <ul style="list-style-type: none"> • Substitute value at low limit • Substitute value at high limit • Substitute value as start value • Substitute value on connection errors <hr/> <p>Options:</p> <ul style="list-style-type: none"> • Computer-local • Synchronization • Runtime persistence

Object	Properties ¹⁾
Structure tag	<p>General information:</p> <ul style="list-style-type: none"> • Name • Data type: Structure type • Address <hr/> <p>Assignment:</p> <ul style="list-style-type: none"> • Connection All connections of all communication channels that can be selected are displayed. The communication driver and the channel unit depend on the selected connection. If the "External" option is disabled for all structure type elements of the selected structure type, the list only contains "internal tags". • Group: Tag group
Structure tag element	<p>General information:</p> <ul style="list-style-type: none"> • Comment <hr/> <p>Options:</p> <ul style="list-style-type: none"> • OPC write protection • OPC read protection • Good Manufacturing Practice • WinCC Cloud <hr/> <p>You can change the following properties of the connected structure type element:</p> <ul style="list-style-type: none"> • General information: <ul style="list-style-type: none"> – Address • Linear scaling • Limits • Use substitute value • Options <ul style="list-style-type: none"> – Computer-local – Synchronization – Runtime persistence

1) Some properties can only be configured when the "External" option is enabled or disabled.

See also

Data types of structure tags (Page 249)

Structure Types and Structure Tags (Page 246)

2.4.1.8 Use: Structure tags in picture windows

If a certain tag configuration occurs several times in your system, use structure types as a template for tag creation.

In this case, for example, several sensors can be involved that are always set up according to the same principle.

Note

Child picture windows: No additional tag prefix

If a picture window is configured in a referenced picture of a picture window, the tag prefix of the parent picture window is applied to the child picture window of the tag prefix.

Do not specify an additional tag prefix in the child picture window, because WinCC does not support bundled structure tags.

The interpretation "Tag_prefix1.Tag_prefix2.Tag_name" cannot be used for dynamization.

Example: Temperature controller

Determine which tags you require for a temperature controller.

Create a structure type in which each tag is represented by a structure type element.

When you create a new structure tag with this structure type, WinCC automatically generates all structure tag elements for the corresponding temperature controller.

You use the created structure tags when, for example, you configure pictures which you would like to integrate by means of picture windows.

Procedure

1. Create a TEMPERATURE structure type.
2. Create a structure type element for each tag, e.g. ELEMENT_1, ELEMENT_2, ELEMENT_3.
3. Create the structure tags, e.g. CONTROLLER_A, CONTROLLER_B, CONTROLLER_C.
4. Configure a TEMP_CONTROLLER.PDL picture for the temperature controller.
5. Connect the objects in the picture, e.g. an I/O field, with structure type elements and not with tags.
To do this, you have to enter the names of the structure type elements manually, since you cannot address elements directly via a dialog, e.g. "ELEMENT_1".
Alternatively, you can connect structure tags you have created and delete the first part of the name, which is determined by the structure tag. For example, you connect the structure CONTROLLER_A: In the displayed tag name, e.g. CONTROLLER_A.ELEMENT_1, delete the name of the structure tag CONTROLLER_A and the linking point in the input box.
6. Configure a picture window in a second process picture. Integrate the TEMP_CONTROLLER.PDL picture.

7. Accept one of the created structure instances with a dot behind the name as the "Tag prefix" object property of the picture window, e.g.:
 - CONTROLLER_A.
8. Configure a second picture window with the picture TEMP_CONTROLLER.PDL and the next structure tag as tag prefix, e.g.:
 - CONTROLLER_B.

Result

In Runtime, WinCC composes the names of the called tags as follows:

- Tag prefixes of the picture window
- Names of the structure type elements connected in the picture TEMP_CONTROLLER.PDL

The result is the name of the corresponding structure tag elements.

Then the first picture window displays the state of regulator A and the second picture window the state of regulator B.

See also

Structure Types and Structure Tags (Page 246)

2.4.1.9 Tag Groups

Definition

You can assemble your tags into tag groups in Tag Management.

Create a tag group as folder under "Internal Tags" or under the connection to a channel unit. Subgroups are not possible.

Usage

When creating a large number of tags in your project, group them according to subject.

You can create, for example, a tag group for every picture in your project. You create the tags you use in one of your pictures in the appropriate group.

In this way, WinCC makes it easier for you to assign and retrieve tags.

Naming conventions

Note

WinCC is case-sensitive in handling the names of tags.

You cannot create tags whose names differ only with respect to case in the editor.

The names of tag groups must be unique in the whole project. You must not use the same name simultaneously for tags and tag groups.

You must not use certain characters in the names of tag groups. You can find a list of characters that are not permitted in a name in the WinCC Information System under "Working with Projects" > "Prohibited characters".

2.4.1.10 Communication Driver

Establishing Communication

A communication driver is used for communication by WinCC with the connected automation system. The communication drivers supported by WinCC are listed in the WinCC Information System under "Communication".

The documentation on the different channels contains detailed information about creating channel units and connections.

Licensing of Communication Drivers

If you wish to use a communication driver, you must install the corresponding license on the computer.

Deleting Communication Driver

When you delete a communication driver, WinCC automatically deletes all tags created for this communication driver. Should you still require tags, move these tags to a different communication driver. Use the "Cut" and "Paste" commands for this purpose. After moving them, check the addresses of the moved tags.

Note

If a communication driver was created in WinCC with "Compile OS" using the SIMATIC Manager, you cannot delete the communication driver in WinCC Explorer.

2.4.2 Tag types

2.4.2.1 Tag Types

Introduction

When you create a tag, you assign one of the possible data types to the tag.

This data type depends on the type of data for which you would like to use the tag.

Note

If you modify the data type of an existing process tag, the previously defined tag address is deleted. This reason for this is that the PLC address changes when the data type is modified.

Format adaptation

The data type of a tag in WinCC can differ from the data type used in the automation system. You can then set that WinCC converts the data type of a tag for transfer to the automation system.

Tag types with format adaptation	Tag types without format adaptation
Signed 8-bit value	Text reference
Unsigned 8-bit value	Binary tag
Signed 16-bit value	Text tag, 8-bit character set
Unsigned 16-bit value	Text tag, 16-bit character set
Signed 32-bit value	Raw data type
Unsigned 32-bit value	Structure types
Floating-point number 32-bit IEEE 754	
Floating-point number 64-bit IEEE 754	

Detailed information on format adaptation is available in the WinCC Information System under "Communication" > "Process communication" > "WinCC Process communication" > "External tags".

2.4.2.2 Binary Tags

Definition

The data type "binary tag" corresponds to one bit. A binary tag can assume the values TRUE or "1" and FALSE or "0".

The binary tag is stored as a byte on the system.

Note

Some communication drivers cannot transfer single bits. The use of binary tags can result in degraded performance with these communication drivers. Note the help on the respective communication driver in the WinCC Information System under "Communication".

Bit

The data type "binary tag" is also referred to as "Bit".

Format adaptation

There is no format adaptation for the data type "binary tag".

2.4.2.3 Signed 8-bit value

Definition

The data type "Signed 8-bit value" has a length of one byte and a sign (plus or minus).

Char/Signed Byte

The data type "Signed 8-bit value" is also referred to as "Char" or "Signed Byte".

Format adaptation

If you create a new tag with the data type "Signed 8-bit value", "CharToSignedByte" is displayed by default in the "Format adaptation" box. The range of numbers is -128 to +127.

The following format adaptations are possible for the data type "Signed 8-bit value":

Format adaptation	Number range
CharToSignedByte	-128...+127 (no conversion)
CharToUnsignedByte	0...127
CharToUnsignedWord	0...127
CharToUnsignedDword	0...127
CharToSignedWord	-128...+127
CharToSignedDword	-128...+127
CharToMSBByte	-127...+127
CharToMSBWord	-128...+127
CharToMSBDword	-128...+127
CharToBCDByte	0...99
CharToBCDWord	0...127
CharToBCDDword	0...127
CharToSignedBCDByte	-9...+9
CharToSignedBCDWord	-128...+127
CharToSignedBCDDword	-128...+127
CharToExtSignedBCDByte	-79...+79
CharToExtSignedBCDWord	-128...+127
CharToExtSignedBCDDword	-128...+127
CharToAikenByte	0...99
CharToAikenWord	0...127
CharToAikenDword	0...127
CharToSignedAikenByte	-9...+9
CharToSignedAikenWord	-128...+127

Format adaptation	Number range
CharToSignedAikenDword	-128...+127
CharToExcessByte	0...99
CharToExcessWord	0...127
CharToExcessDword	0...127
CharToSignedExcessByte	-9...+9
CharToSignedExcessWord	-128...+127
CharToSignedExcessDword	-128...+127

2.4.2.4 Unsigned 8-bit value

Definition

The data type "Unsigned 8-bit value" has a length of one byte and no sign.

Byte/Unsigned Byte

The data type "Unsigned 8-bit value" is also referred to as "Byte" or "Unsigned Byte".

Format adaptation

If you create a new tag with the data type "Unsigned 8-bit value", "ByteToUnsignedByte" is displayed by default in the "Adapt format" box. The range of numbers is 0 to 255.

The following format adaptations are possible for the data type "Unsigned 8-bit value":

Format adaptation	Number range
ByteToUnsignedByte	0...255 (no conversion)
ByteToUnsignedWord	0...255
ByteToUnsignedDword	0...255
ByteToSignedByte	0...127
ByteToSignedWord	0...255
ByteToSignedDword	0...255
ByteToBCDByte	0...99
ByteToBCDWord	0...255
ByteToBCDDword	0...255
ByteToAikenByte	0...99
ByteToAikenWord	0...255
ByteToAikenDword	0...255
ByteToExcessByte	0...99
ByteToExcessWord	0...255
ByteToExcessDword	0...255

2.4.2.5 Signed 16-bit value

Definition

The data type "Signed 16-bit value" has a length of two byte and a sign (plus or minus).

Short/Signed Word

The data type "Signed 16-bit value" is also referred to as "Short" or "Signed Word".

Format adaptation

If you create a new tag with the data type "Signed 16-bit value", "ShortToSignedWord" is displayed by default in the "Adapt format" box. The range of numbers is -32768 to +32767.

The following format adaptations are possible for the data type "Signed 16-bit value":

Format adaptation	Number range
ShortToSignedWord	-32768...+32767 (no conversion)
ShortToUnsignedByte	0...255
ShortToUnsignedWord	0...32767
ShortToUnsignedDword	0...32767
ShortToSignedByte	-128...+127
ShortToSignedDword	-32768...+32767
ShortToMSBByte	-127...+127
ShortToMSBWord	-32767...+32767
ShortToMSBDword	-32768...+32767
ShortToBCDByte	0...99
ShortToBCDWord	0...9999
ShortToBCDDword	0...32767
ShortToSignedBCDByte	-9...+9
ShortToSignedBCDWord	-999...+999
ShortToSignedBCDDword	-32768...+32767
ShortToExtSignedBCDByte	-79...+79
ShortToExtSignedBCDWord	-7999...+7999
ShortToExtSignedBCDDword	-32768...+32767
ShortToAikenByte	0...99
ShortToAikenWord	0...9999
ShortToAikenDword	0...32767
ShortToSignedAikenByte	-9...+9
ShortToSignedAikenWord	-999...+999
ShortToSignedAikenDword	-32768...+32767
ShortToExcessByte	0...99
ShortToExcessWord	0...9999
ShortToExcessDword	0...32767

Format adaptation	Number range
ShortToSignedExcessByte	-9...+9
ShortToSignedExcessWord	-999...+999
ShortToSignedExcessDword	-32768...+32767

2.4.2.6 Unsigned 16-bit value

Definition

The data type "Unsigned 16-bit value" has a length of two byte and no sign.

Word/Unsigned Word

The data type "Unsigned 16-bit value" is also referred to as "Word" or "Unsigned Word".

Format adaptation

If you create a new tag with the data type "Signed 16-bit value", "WordToUnsignedWord" is displayed by default in the "Adapt format" box. The range of numbers is 0 to 65535.

The following format adaptations are possible for the data type "Unsigned 16-bit value":

Format adaptation	Number range
WordToUnsignedWord	0...65535 (no conversion)
WordToUnsignedByte	0...255
WordToUnsignedDword	0...65535
WordToSignedByte	0...127
WordToSignedWord	0...32767
WordToSignedDword	0...65535
WordToBCDByte	0...99
WordToBCDWord	0...9999
WordToBCDDword	0...65535
WordToAikenByte	0...99
WordToAikenWord	0...9999
WordToAikenDword	0...65535
WordToExcessByte	0...99
WordToExcessWord	0...9999
WordToExcessDword	0...65535
WordToSimaticCounter	0...999
WordToSimaticBCDCounter	0...999

2.4.2.7 Signed 32-bit value

Definition

The data type "Signed 32-bit value" has a length of four byte and a sign (plus or minus).

Long / Signed Dword

The data type "Signed 32-bit value" is also referred to as "Long" or "Signed Dword".

Format adaptation

If you create a new tag with the data type "Signed 32-bit value", "LongToSignedDword" is displayed by default in the "Format adaptation" box. The number range is -2147483648...+2147483647.

The following format adaptations are possible for the data type "Signed 32-bit value":

Format adaptation	Number range
LongToSignedDword	-2147483648...+2147483647 (no conversion)
LongToUnsignedByte	0...255
LongToUnsignedWord	0...65535
LongToUnsignedDword	0...2147483647
LongToSignedByte	-128 ...+127
LongToSignedWord	-32768 ... + 32767
LongToMSBByte	-127...+127
LongToMSBWord	-32767 ... + 32767
LongToMSBDword	-2147483647...+2147483647
LongToBCDByte	0...99
LongToBCDWord	0...9999
LongToBCDDword	0...99999999
LongToSignedBCDByte	-9 ... + 9
LongToSignedBCDWord	-999 ... + 999
LongToSignedBCDDword	-9999999 ... + 9999999
LongToExtSignedBCDByte	-79 .. + 79
LongToExtSignedBCDWord	-7999 ... + 7999
LongToExtSignedBCDDword	-79999999 ... + 79999999
LongToAikenByte	0...99
LongToAikenWord	0...9999
LongToAikenDword	0...99999999
LongToSignedAikenByte	-9 ... + 9
LongToSignedAikenWord	-999 ... + 999
LongToSignedAikenDword	-9999999 ... + 9999999
LongToExcessByte	0...99
LongToExcessWord	0...9999

Format adaptation	Number range
LongToExcessDword	0...99999999
LongToSignedExcessByte	-9 ... + 9
LongToSignedExcessWord	-999 ... + 999
LongToSignedExcessDword	-9999999 ... + 9999999
LongToSimaticTimer	10...9990000
LongToSimaticBCDTimer	10...9990000

2.4.2.8 Unsigned 32-bit value

Definition

The data type "Unsigned 32-bit value" has a length of four byte and no sign.

Dword / Unsigned Dword

The data type "Unsigned 32-bit value" is also referred to as "Dword" or "Unsigned Dword".

Format adaptation

If you create a new tag with the data type "Signed 32-bit value", "DwordToUnsignedDword" is displayed by default in the "Adapt format" box. The range of numbers is 0 to 4294967295.

The following format adaptations are possible for the data type "Unsigned 32-bit value":

Format adaptation	Number range
DwordToUnsignedDword	0...4294967295 (no conversion)
DwordToUnsignedByte	0...255
DwordToUnsignedWord	0...65535
DwordToSignedByte	0...127
DwordToSignedWord	0...32767
DwordToSignedDword	0...2147483647
DwordToBCDByte	0...99
DwordToBCDWord	0...9999
DwordToBCDDword	0...99999999
DwordToAikenByte	0...99
DwordToAikenWord	0...9999
DwordToAikenDword	0...99999999
DwordToExcessByte	0...99
DwordToExcessWord	0...9999
DwordToExcessDword	0...99999999
DwordToSimaticTimer	10...9990000

Format adaptation	Number range
DwordToSimaticBCDTimer	10...9990000
DwordToSimaticLTimeOfDay	0...86399999 (milliseconds since 00:00 hours)

2.4.2.9 Floating-point number 32-bit IEEE 754

Definition

The data type "Floating-point number 32-bit IEEE 754" has a length of four bytes and a sign (plus or minus).

Float

The data type "Floating-point number 32-bit IEEE 754" is also referred to as "Float".

Format adaptation

If you create a new tag with the data type "Floating-point number 32-bit IEEE 754", "FloatToFloat" is displayed by default in the "Adapt format" box. The number range is $+3.402823e+38$.

Note

Only the first seven digits are considered for each format adaptation "FloatTo...Dword". The float data type only allows seven digits. If you use an S7 connection, the number range for the format adaptation "FloatToFloat" is $+3.402823e+38$.

The following format adaptations are possible for the "Floating-point number 32-bit IEEE 754" data type:

Format adaptation	Number range
FloatToFloat	$+3.402823e+38$ (no conversion)
FloatToUnsignedByte	0...255
FloatToUnsignedWord	0...65535
FloatToUnsignedDword	0 to 4.294967e+09
FloatToSignedByte	-128...+127
FloatToSignedWord	-32768...+32767
FloatToSignedDword	-2.147483e+09 to +2.147483e+09
FloatToDouble	$+3.402823e+38$
FloatToMSByte	-127...+127
FloatToMSBWord	-32767...+32767
FloatToMSBDword	-2.147483e+09 to +2.147483e+09
FloatToBCDByte	0...99
FloatToBCDWord	0...9999
FloatToBCDDword	0 to 9.999999e+07

Format adaptation	Number range
FloatToSignedBCDByte	-9...+9
FloatToSignedBCDWord	-999...+999
FloatToSignedBCDDword	-9999999...+9999999
FloatToExtSignedBCDByte	-79...+79
FloatToExtSignedBCDWord	-7999...+7999
FloatToExtSignedBCDDword	-7.999999e+07 to +7.999999e+07
FloatToAikenByte	0...99
FloatToAikenWord	0...9999
FloatToAikenDword	0 to 9.999999e+07
FloatToSignedAikenByte	-9...+9
FloatToSignedAikenWord	-999...+999
FloatToSignedAikenDword	-9999999...+9999999
FloatToExcessByte	0...99
FloatToExcessWord	0...9999
FloatToExcessDword	0 to 9.999999e+07
FloatToSignedExcessByte	-9...+9
FloatToSignedExcessWord	-999...+999
FloatToSignedExcessDword	-9999999...+9999999
FloatToS5Timer	10...9990000
FloatToS5Float	+1.701411e+38
FloatToSimaticTimer	10...9990000
FloatToSimaticBCDTimer	10...9990000

2.4.2.10 Floating-Point Number 64-Bit IEEE 754

Definition

The "Floating-point number 64-bit IEEE 754" data type is eight bytes long and is signed (plus or minus).

Double

The "Floating-point number 64-bit IEEE 754" data type is also referred to as "Double".

Format adaptation

If you create a new tag with the "Floating-point number 64-bit IEEE 754" data type, the "Type Conversion" box will display the "DoubleToDouble" by default. The number range is $\pm 1.79769313486231 \times 10^{308}$.

Note

For every "DoubleToFloat" format adaptation, only the first seven places are considered. The float data type only allows seven digits.

The following format adaptations are possible for the "Floating-point number 64-bit IEEE 754" data type:

Format adaptation	Number range
DoubleToDouble	$\pm 1.79769313486231 \times 10^{308}$ (no conversion)
DoubleToUnsignedByte	0...255
DoubleToUnsignedWord	0...65535
DoubleToUnsignedDword	0...4294967295
DoubleToSignedByte	-128 ... +127
DoubleToSignedWord	-32768 ... + 32767
DoubleToSignedDword	-2147483648...+2147483647
DoubleToFloat	$\pm 3.402823 \times 10^{38}$
DoubleToMSBByte	-127...+127
DoubleToMSBWord	-32767 ... + 32767
DoubleToMSBDword	-2147483647...+2147483647
DoubleToBCDByte	0...99
DoubleToBCDWord	0...9999
DoubleToBCDDword	0...99999999
DoubleToSignedBCDByte	-9 ... + 9
DoubleToSignedBCDWord	-999 ... + 999
DoubleToSignedBCDDword	-9999999 ... + 9999999
DoubleToExtSignedBCDByte	-79 ... + 79
DoubleToExtSignedBCDWord	-7999 ... + 7999
DoubleToExtSignedBCDDword	-79999999 ... + 79999999
DoubleToAikenByte	0...99
DoubleToAikenWord	0...9999
DoubleToAikenDword	0...99999999
DoubleToSignedAikenByte	-9 ... + 9
DoubleToSignedAikenWord	-999 ... + 999
DoubleToSignedAikenDword	-9999999 ... + 9999999
DoubleToExcessByte	0...99
DoubleToExcessWord	0...9999
DoubleToExcessDword	0...99999999
DoubleToSignedExcessByte	-9 ... + 9

Format adaptation	Number range
DoubleToSignedExcessWord	-999 ... + 999
DoubleToSignedExcessDword	-9999999 ... + 9999999
DoubleToS5Timer	10...9990000
DoubleToS5Float	+/-1.701411e+38
DoubleToSimaticTimer	10...9990000
DoubleToSimaticBCDTimer	10...9990000

2.4.2.11 Text Tag 8-Bit Character Set and Text Tag 16-Bit Character Set

Definition

Text tags are distinguished by the character set that has to be displayed:

- With the data type "Text tag 8-bit character set" each character displayed in this tag has a length of one byte. With the 8-bit character set, the ASCII character set can be displayed for example.
- With the data type "Text tag 16-bit character set" each character displayed in this tag has a length of two byte. You require a tag of this type to display the Unicode character set, for example.

Process Tag with the Text Tag Data Type

For process tags with the data type "Text tag 8-bit character set" or "Text tag 16-bit character set" you must specify the length of the text tag. A text tag that is required to accommodate 10 characters later must be ten long for the "8-bit character set" and 20 long for the "16-bit character set".

Format adaptation

There is not format adaptation for the data types "Text tag 8-bit character set" and "Text tag 16-bit character set".

2.4.2.12 Raw Data Tag

Definition

You can create external and internal tags of the "Raw data type" type in the WinCC tag management. The format and the length of a raw data tag are not fixed. Its length can be in the range from 1 and 65535 bytes. It is either defined by the user or results from a specific application.

The contents of a raw data tag are not fixed. Only senders and receivers can interpret the contents of a raw data tag. They are not interpreted by WinCC.

Note

A raw data tag cannot be displayed within the "Graphics Designer".

Potential Applications within WinCC

Raw data tags can be used in the following modules within WinCC:

- "Alarm Logging": For data exchange with the message blocks on the automation system with message and acknowledgement processing of the message system.
- "Global Script": In scripts for data exchanged with the help of functions "Get/SetTagRaw".
- "Tag Logging": For process controlled archiving with process controlled tags in the process value archive.
- "User Archive": For transferring jobs, data, processing acknowledgements between WinCC and the automation systems.

Note

If the raw data tag is displayed in the I/O box, the conventions of the string must conform with a closing "\0" character.

"Properties address"

The "Properties address" is not the same for all communication drivers with external raw data tags because the parameters of the tag address and the supported raw data tag type depend on the communication driver used.

Format adaptation

There is no format adaptation in WinCC for the "raw data type".

2.4.2.13 Text Reference

Definition

With tags having the Text reference data type, you refer to an entry in the WinCC Text Library. You can only configure text references as internal tags.

You will use text references, for e.g., to display a text from the text library for an object; the text will change according to the language setting when you switch languages. You assign the corresponding text ID of the entry in the Text Library to the tag.

Creating a Text Reference

You create a tag with the Text reference data type as an internal tag.

In the "Tag Properties" dialog box, select the "Start value" check box on the Limits/Reporting tab. Enter the text ID from the Text Library as the start value.

Note

In a multi-user system, WinCC uses for text output the language of the computer on which the text reference was created.

Format adaptation

Format adaptation does not take place for the "Text reference" data type.

2.4.2.14 Date/time

Definition

The "Date/Time" data type has a length of 8 bytes as a floating-point number 64-bit IEEE 754.

The tag takes the date and time and is implemented as a floating-point number, the integer component of which is the number of days before or after midnight on December 30, 1899, and the decimal point of which is the time on this day divided by 24.

For example, midnight December 31, 1899 is represented as 1.0, 6 o'clock in the morning on January 1, 1900 is represented as 2.25; midnight December 29, 1899 is represented as -1.0, and 6 o'clock in the morning December 29, 1899 is represented as -1.25.

Process tag with "Date/Time" data type

The value of a process tag is always logged in the Coordinated World Time, UTC.

If needed, adjust the time display in the computer properties as well as the properties of the WinCC controls.

Format adaptation

If you create a new tag with the data type "Date/Time", "DateTimeToDateTime" is displayed by default in the "Format adaptation" box.

The following format adaptations are possible for the "Date/Time" data type:

Format adaptation	Number range
DateTimeToDateTime	$\pm 1.79769313486231e+308$, (no conversion) The minimum OLE automation date is midnight on January 1, 0100. The maximum date is the last second of December 31, 9999.
DateTimeToSimaticDateAndTime	TIA system interface: Date_And_Time, PLC: DT, BCD coded. Restriction year: 1990-2089.

Format adaptation	Number range
DateTimeToSematicDateAndLTime	Time interval. TIA system interface: LTime, PLC: LTIME. Signed 64-bit integer, includes time interval in nanoseconds (292 years 4 month 11 days 23 hours 47 min 16 sec 854 ms 775 µs 807 ns)
DateTimeToSematicDTL	An extended time/date structure that summarizes a time period or time and date as separate integers: <pre>typedef structure DTL uint year; // 1970 .. 2554 usint month; // 01 .. 12 usint day; // 01 .. 31 usint weekday; // 1 .. 7 // Sunday to Saturday usint hour; // 00 .. 23 usint minute; // 00 .. 59 usint second; // 00 .. 59 udint: nanoseconds; // 0 .. 999 999 999 end</pre>
DateTimeToSematicDate	Unsigned 16-bit integer, days since 01/01/1990 0 ... 65535
DateTimeToSematicTimeOfDay	Unsigned 32-bit integer, milliseconds since 00:00 h 0 ... 86399999 Milliseconds
DateTimeToSematicLTimeOfDay	Unsigned 64-bit integer, nanoseconds since 00:00 h 0 ... 863999999999999 Nanoseconds

2.4.3 Selecting tags in WinCC

Working with the tag selection dialog

The tag selection dialog opens as soon as you connect up a tag in an editor of WinCC.

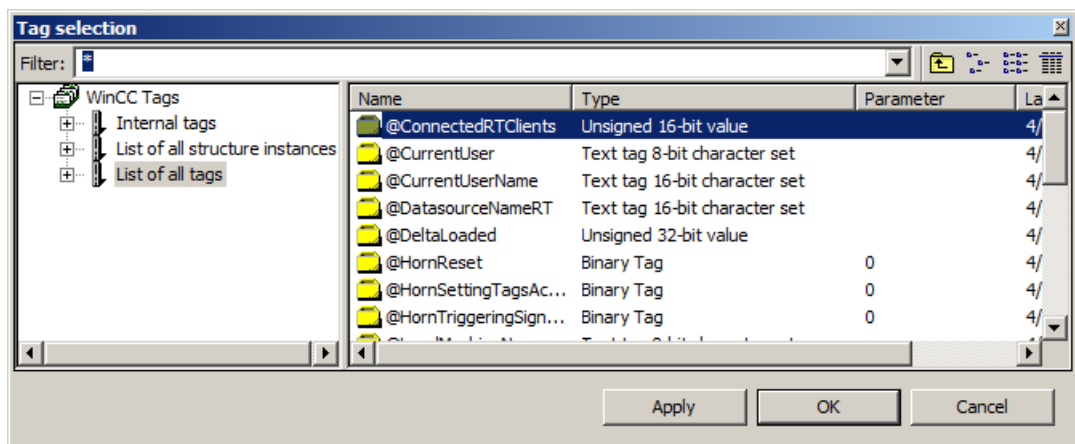

WinCC Configuration Studio

The tag selection dialog is displayed as soon as you click in a selection field of a tag.

If the required tag does not exist yet, you can switch to the "Tag Management" editor to create the tag. The tag selection dialog remains open. Once the tag is created, it is displayed in the tag selection dialog.

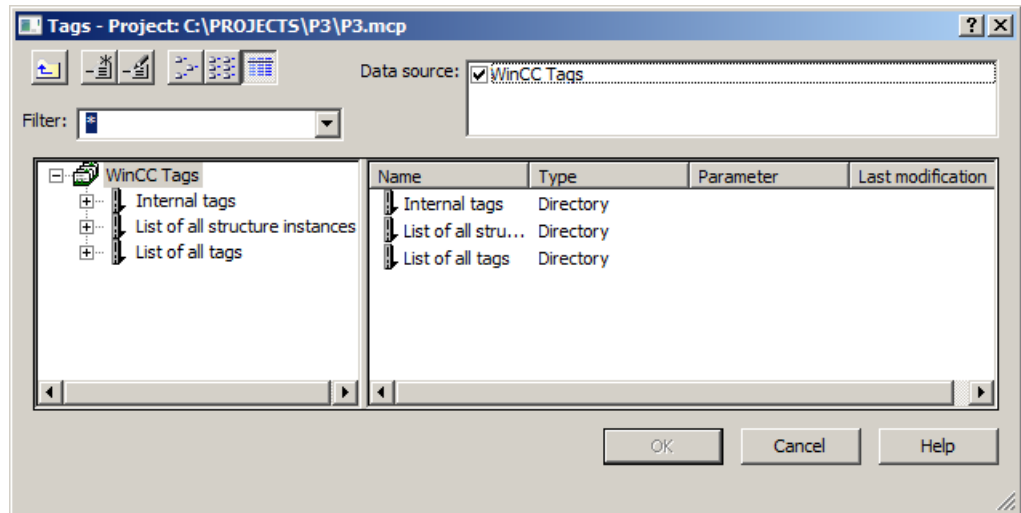

Graphics Designer

You can display the tag selection dialog continuously. Call up the entry "View" > "Toolbars..." in the menu bar. Select the check box next to the entry "Tags".

Global Script editor

Open the tag selection dialog with the entry "Edit" > "Tag dialog".

In the tag selection dialog, you can either display all tags of the project or navigate in the directory structure. You select a highlighted tag with the "OK" button.

Drag and drop

You can connect a tag to an object or object attribute using drag-and-drop. When using drag-and-drop, there are two locations where you can drop the tag:

- Over a picture:
If a tag is dragged directly into the picture via drag-and-drop, an input field to which the tag is directly interconnected is automatically generated.
- Over an attribute in the "Object properties" dialog, Properties tab:
Drop the tag over an attribute in the "Object properties" dialog, Properties tab. This attribute is then dynamized by the tag.
The attribute to be dynamized is specified in the case of objects which have a simplified configuration dialog. The table shows the objects and the dynamized attribute:

Object	Attribute
I/O Field	Output value
Bar	Process connection
Status display	Current status
Text list	Output value
Check box	Selected boxes
Option button	Selected boxes
Slider object	Process connection

When you open the tag selection dialog from other editors, for example Graphics Designer, you have the option of creating a new tag or editing an existing one directly from the dialog.

Filter

Note

The search operation in the tag selection dialog can take some time when there is a large number of tags. Searching lasts about one minute with 15,000 tags.

It is helpful to use the filter to make a preselection in the tag selection dialog.

Using the filter function, you can reduce the selected number of tags or symbols so as to search more efficiently.

Use the placeholders "*" and "?" in the search. You can only use alphanumeric characters when searching for names. WinCC saves the last 20 search criteria you entered.

Example

You can create the following internal tags in WinCC, for example: "var1"; "var2"; "var3"; "smv2" and "apm1". Enter "a*" as search criterion and exit the filter function with the <Tab> key. WinCC now displays all tags whose name starts with "a". Which means the tag "apm1" in the folder "List of all tags".

Data source

This function is available when you are working with WinCC integrated in STEP 7.

In this box you can select the data source from which you would like to attach a tag.

"WinCC Tags" data source

Note

In certain situations the tag selection dialog sets a filter to the data type of the tag.

WinCC displays all configured internal tags and process tags. You can create new tags with the function "Create new tag". You can edit existing WinCC tags with the function "Edit tag".

"ES Tags" data source

WinCC displays all PCS 7 process tags. PCS 7 process tags are all operable and visible CFC and SFC modules which were configured in the PCS 7 Engineering System.

The "Update ES tags"  button is available when you have selected the data source "ES tags".

You can update the attributes of the displayed tag by pressing the button. This is necessary only when an attribute is modified in the PCS 7 Engineering System while the tag selection dialog is open. Attributes are items such as name, type or comment relating to a process tag. You can also use the button to update the CFC/SFC connections. When you extend STEP 7 connections, you can update the corresponding engineering station with this function.

In the Configuration Studio, you can define prefixes and suffixes for the names of the process tags in the properties of the connection. The prefix or suffix is added automatically for each tags of the connection after you import the process tags via the tag selection dialog. Changing the prefix or suffix does not affect tags already imported.

More information on this is available in the section "Integration in the SIMATIC Manager" and in the "Process Control System PCS7 Operator Station" device manual.

"STEP 7 Symbols" data source

WinCC displays all the inputs, outputs, and bit memories in the STEP 7 symbol list and all the global data blocks. The symbol lists and the data blocks are created in SIMATIC Manager. In this case, data blocks themselves cannot be mapped. Only the parameters of the prevailing data block displayed in the data window can be mapped.

The "Transfer data"  button is available when you have selected the data source "STEP 7 Symbols".

With the function "Transfer data" WinCC accepts the selected symbols or parameters of data blocks in the WinCC database.

2.4.4 Displaying status information in Runtime

Introduction

Status information on tags and connections is displayed in the "Tag Management" editor.

Status information in Runtime

Tooltip in the navigation area

WinCC shows the status information of a connection as a tooltip when you point to a connection with the mouse pointer in the data window.

Displaying the current value of tags

Show the "Value" column in the table area using the shortcut menu.

Displaying quality code

Quality codes provide encoded information about the status and quality of a tag.

Show the "Quality Code" column in the table area using the shortcut menu.

You can find the overview of the quality codes in the WinCC Information System under "Communication" > "Diagnostics of communication" > "Quality of tags".

Displaying the connection status

With system tag "@<Connectionname>@ConnectionStateEx" you can determine the current status of the connection between WinCC and controller.

You can find additional information on the connection status in Runtime in the WinCC Information System under "Communication" > "Process communication" > "WinCC Process communication".

2.5 Configuration in Tag Management

2.5.1 Creating communication drivers and connections

2.5.1.1 How to add a new communication driver

In WinCC Configuration Studio, you add a communication driver in the navigation area of the Tag Management editor.

Introduction

A communication driver is used for communication between WinCC and the connected automation system.

You can find information about supported WinCC communication drivers in the WinCC Information System under "Communication".

Channel units are provided by the communication driver. You then set up the connections.

Procedure

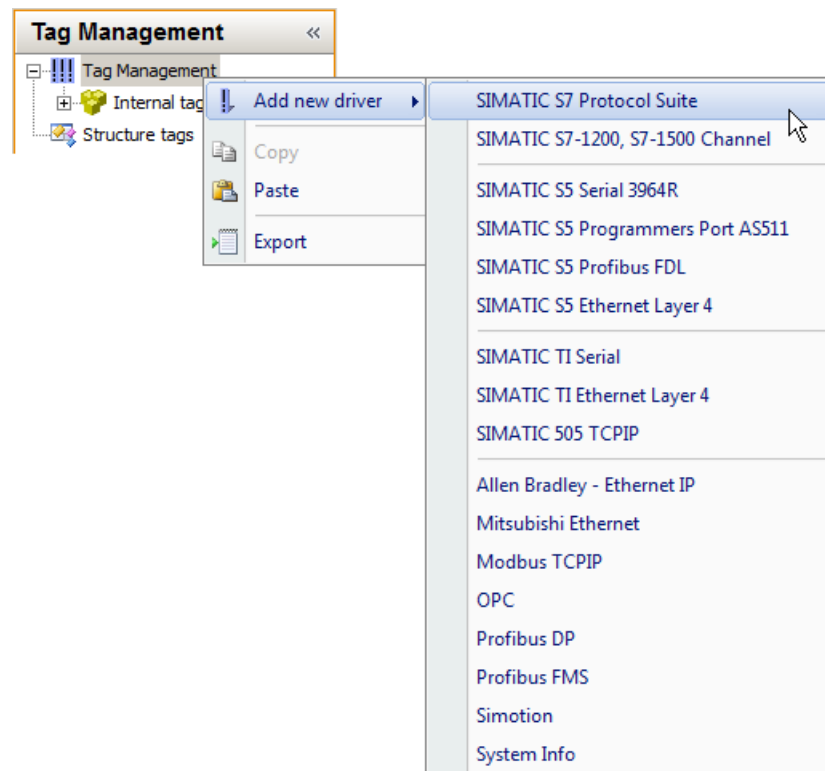

1. Select the "Tag Management" folder in the navigation area.
2. Select the "Add New Driver" from the shortcut menu.
3. Select the communication driver from the list that is displayed.
The selected driver appears as a new folder in the navigation area. Subfolders for the available channel units are displayed in the folder.

Note

Deleting a communication driver

To delete a communication driver, select the driver in the navigation area. From the shortcut menu, select the "Delete" command.

Channel units cannot be individually deleted or created.

2.5.1.2 How to create a new connection

In WinCC Configuration Studio, you set up a connection in the navigation area of the Tag Management editor.

Procedure

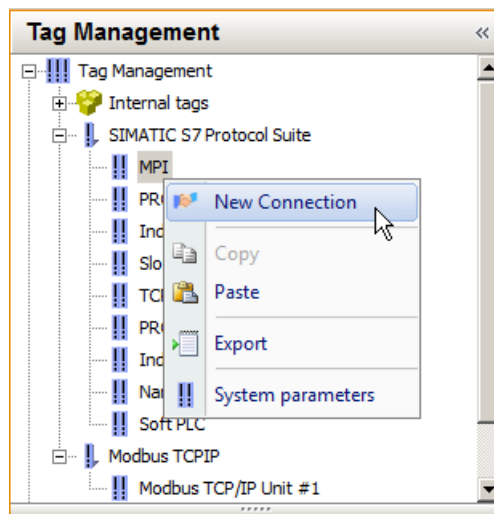

1. Select the folder of a channel unit in the navigation area. Channel units are provided by communication drivers.
2. Select the "New Connection" command from the shortcut menu.
The connection appears as a new folder in the navigation area.

3. Enter a descriptive name for the connection.
 - In the navigation area: Select the "Rename" command from the shortcut menu.
 - In the table area: Change the name in the "Name" column on the "Connections" tab.
 - Change the name under "General" in the "Properties" area.
4. You can now create process tags or tag groups for a connection.

Alternative procedure

1. Select the folder of a channel unit in the navigation area.
2. Select the "Connections" tab in the table area.
3. Click in the top free cell of the "Name" column. The cell is identified by a yellow icon.
4. Enter a name.
The connection is created.

Creating multiple connections

1. Select the lowest full cell in the "Name" column in the table area.
2. Drag down the selection of the cell with the bottom right handle while keeping the mouse button pressed.
A new connection is created in each row over which you drag the selection.

2.5.1.3 How to set system parameters for a connection

In WinCC Configuration Studio, you define the system parameters of a channel unit in the navigation area of the Tag Management editor.

System parameters

Note

The settings you can make are determined by the communication driver used for the respective connection.

You can find more detailed information about the possible settings for a connection in the documentation of the communication driver.

System parameters can be adjusted for some channel units.

Example for the system parameters of a channel unit:

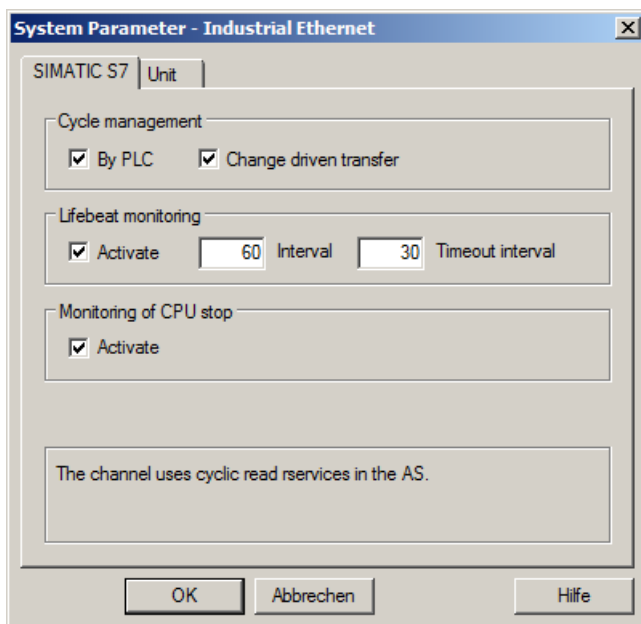

How to set the system parameters

1. Select the folder of a channel unit in the navigation area and then select "System parameters" in the shortcut menu. The "System Parameters" dialog opens.
2. Make your settings in the "System Parameters" dialog.

2.5.1.4 How to set the connection parameters

In WinCC Configuration Studio, you define the connection parameters of a connection in the navigation area of the Tag Management editor.

Connection parameters

Note

The settings you can make are determined by the communication driver used for the respective connection.

You can find more detailed information about the possible settings for a connection in the documentation of the communication driver.

Example for connection parameters of a channel unit:

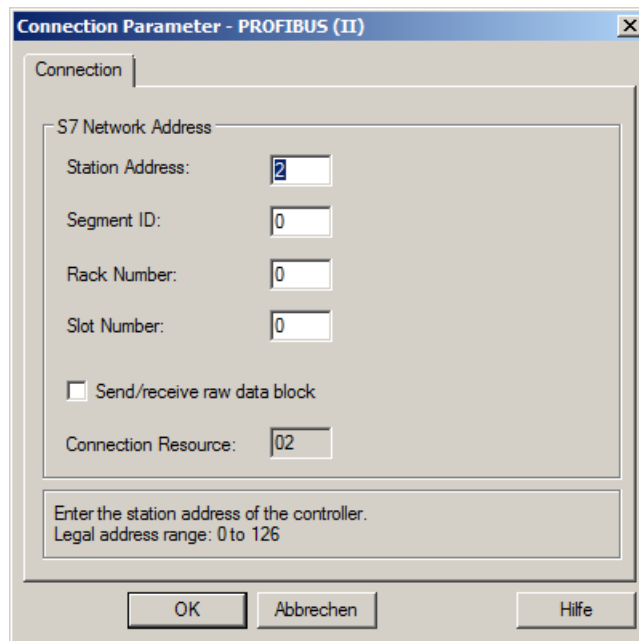

How to set the connection parameters

1. Select the folder of the connection in the navigation area and then select "Connection parameters" in the shortcut menu.
The "Connection parameters" dialog opens
2. Make your settings in the "Connection parameters" dialog.

2.5.2 Creating Tags

2.5.2.1 Creating Tags

Introduction

This section describes how you create tags and structures:

- Process tags
- Internal tags
- Structure types
- Tag groups

Detailed instructions on format adaptation is available in the WinCC Information System under "Communication" > "Process communication" > "WinCC Process communication" > "External tags".

Note

Tags that you create are available immediately.

Changes, for example to properties, are written directly and without explicit saving to the database and therefore take effect immediately in Runtime.

2.5.2.2 Creating Internal Tags

In WinCC Configuration Studio, you create tags in the table area of the Tag Management editor.

Introduction

You use internal tags to transfer data within your project.

You can create internal tags in groups or move them to groups once they have been created.

Internal tags on a client without its own project

Project-wide or computer-local update

The "Computer-local" option is only relevant if you configure a client without its own project.

The setting has no effect in most other cases:

- Internal tags that you create on a WinCC server are always updated project-wide.
- Internal tags you create on a WinCC client with its own project are always updated on a computer-local basis.

Runtime persistence

If the "Computer-local" setting is enabled, the "Runtime persistence" setting has no effect.

Modified tag values are reset again when Runtime is deactivated.

Procedure

1. Select the "Internal Tags" folder in the "Tag Management" editor.
If necessary, select one of the groups subordinate to the "Internal tags" folder.



2. Click the "Tags" tab below the table area.
3. Click in the top free cell of the "Name" column.
4. Enter the name for the tag.
In doing so, pay due consideration to the name conventions in the section "Tag Management and Tags" > "Tags".
5. Set the data type in the "Data type" field.
6. Specify limits, the start value and substitute value as necessary.
A start value is set if no process value is available when the project is activated.
7. Activate the "Runtime persistency" option to retain the value of the internal tag on closing Runtime.
The value saved is used as start value for the restart of Runtime. The start value configured is only used at the first start of Runtime and after the data type was changed.

2.5.2.3 How to Create a Process Tag

In WinCC Configuration Studio, you create tags in the table area of the Tag Management editor.

Introduction

You use process tags for communication between WinCC and the automation system.

You can create process tags in groups or move them to groups once they have been created.

Requirement

- You have installed a communication driver and created at least one connection below it.

Procedure

1. In the Tag Management editor, select the folder of the communication driver for which you would like to create a process tag.
2. Open the folder of the desired channel unit.

3. Select the corresponding connection.

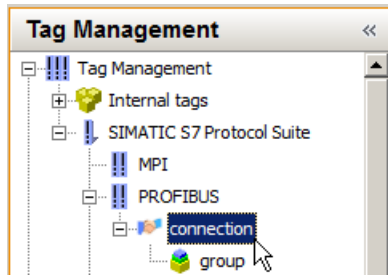

4. Click the "Tags" tab below the table area.
5. Click in the top free cell of the "Name" column.
6. Enter the name for the tag. In doing so, pay due consideration to the name conventions in the section "Tag Management and Tags" > "Tags".
7. Set the data type in the "Data type" field.
8. If necessary, modify the set format adaptation and set Linear Scaling if required.
9. Set the address of the tag.
For this purpose, click in the "Address" field and then on the  button.
The "Address Properties" dialog box opens. After entering the address, close the dialog box by clicking "OK".
The address properties depend on the channel unit you selected. You can find more information on addressing a process tag in the WinCC Information System under "Communication" in the respective communication driver.
10. Specify limits, the start value and substitute value as necessary.
A start value is set if no process value is available when the project is activated.
11. After downloading the tags of the AS, you can define prefixes and suffixes for the tag names for the instance of the connection. The prefix or suffix is added automatically for each tags of the connection after you import the process tags via the tag selection dialog. Changing the prefix or suffix does not affect tags already imported.

2.5.2.4 How to edit the properties of a tag

The properties of tags are displayed in the table area and in the "Properties" area in the Tag Management editor.

Displaying and editing properties

Fields highlighted in color cannot be edited. Whether you can edit properties may depend on the activation or deactivation of individual options or a selection for another property.

1. In the navigation area, select the "Tag Management" folder to display all tags in the table area.
2. In the navigation area, select the folder of a group, a connection or a channel unit to display the assigned tags.

3. In the tag area, select a row to display and edit the properties of the tags in the "Properties" area.
To display tags in the table area, you may need to select the "Tags" tab.
4. To edit multiple tags at the same time, you can use, for example, the "Select and pull selection down" function or the shortcut menu commands "Deselect all" and "Select all". In the table area, you can use the shortcut menu of a column header to show or hide specific columns (and therefore properties). You can display tags clearly using filtering and sorting options.

2.5.2.5 Creating structure types and structure tags

How to configure structure types

Introduction

You can use structure types to create multiple tags as structure tag elements simultaneously in one step. You can create internal tags and process tags in doing so.

With respect to configuration in the editors, structure tag elements do not differ from other tags.

Note

Define properties before configuration

Perform all settings before applying the structure type for creating tags. You can then modify the properties of the created structure tags later.

To modify the properties of a structure type, you must first delete all associated structure tags.

Procedure

1. Create a structure type; see "How to Create a Structure Tag (Page 282)".
2. Create structure type elements; see "How to create a structure type element (Page 283)".
3. Create structure tags; see "How to create a structure tag (Page 285)".
WinCC generates the structure tag elements. Integrate them into the project.
For every element created in the structure type, WinCC generates a structure tag element with the appropriate properties. The name of the structure tag is composed of the name of the structure instance and the name of the structure element, separated by a dot.

Creating Internal Tags

When creating an internal tag, the structure types available to you are those that do not contain structure elements for process tags.

Structure types, in which structure elements are defined for process tags, can only be used when you create tags under the connection of a channel unit.

You can create structure tags with a structure type, in which only structure elements for internal tags are defined, under the connection of a channel unit. The structure instance is displayed

under structure types; the associated structure tags under "Internal tags". No entry appears under the connection in the data window.

If you try to delete a connection, a message appears however that there are still elements which will also be deleted. If this message is confirmed, the structure instance and the structure tags will also be deleted.

Internal structure tags on a client without its own project

Computer-local update

If you create internal structure tags in a multi-user project, you can specify a project-wide or computer-local update with the "Computer-local" option.

Define the required update with the created structure tags.

The setting in the structure instance is not transferred when creating the associated structure tag.

This setting is only relevant on clients without their own project.

Runtime persistence

If the "Computer-local" setting is enabled, the "Runtime persistence" setting has no effect.

Modified tag values are reset again when Runtime is deactivated.

See also

[How to Create a Structure Tag \(Page 282\)](#)

[How to create a structure type element \(Page 283\)](#)

[How to create a structure tag \(Page 285\)](#)

How to Create a Structure Tag

Introduction

In WinCC Configuration Studio, you create structure types in the navigation area of the "Tag Management" editor.

Once the structure type is created, you create the individual structure type elements.

You assign the structure type to structure tags as data type. In this way, you generate the tags defined in the structure type.

Procedure

1. Select the "Structure tags" folder in the "Tag Management" editor.

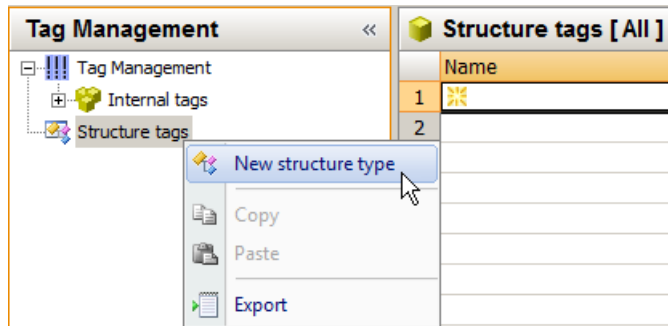

2. Select the "New Structure Type" from the shortcut menu. You have created a new structure type.
3. Change the name of the structure type. Adhere to the naming conventions.
 - In the navigation area: Select the "Rename" command from the shortcut menu.
 - In the table area: Change the name in the "Name" column on the "Structure type elements" tab.
 - Change the name under "General" in the "Properties" area.

Alternative procedure

1. Select the "Structure tags" folder in the navigation area.
2. Select the "Structure types" tab in the table area.
3. Click in the top free cell of the "Name" column. The cell is identified by a yellow icon.
4. Enter a name. You have successfully created the structure type.

Creating multiple structure types

1. Select the lowest full cell in the "Name" column in the table area.
2. Drag down the selection of the cell with the bottom right handle while keeping the mouse button pressed. A new structure type is created in each row over which you drag the selection.

How to create a structure type element

In WinCC Configuration Studio, you create structure type elements in the navigation area of the Tag Management editor.

Procedure

1. Select the folder of a structure type in the "Tag Management" editor.

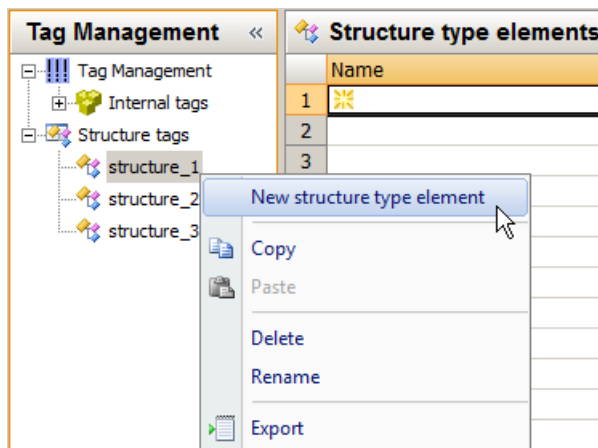

2. Select the "New Structure Type Element" from the shortcut menu. A new structure type element is created.
3. Change the name of the structure type element. Adhere to the naming conventions.
 - In the navigation area: Select the "Rename" command from the shortcut menu.
 - In the table area: Change the name in the "Name" column on the "Structure type elements" tab.
 - Change the name under "General" in the "Properties" area.

Alternative procedure

1. Select the folder of a structure type in the navigation area.
2. Select the "Structure type elements" tab in the table area.
3. Click in the top free cell of the "Name" column. The cell is identified by a yellow icon.
4. Enter a name. The structure type element is created.

Creating multiple structure type elements

1. Select the lowest full cell in the "Name" column in the table area.
2. Drag down the selection of the cell with the bottom right handle while keeping the mouse button pressed. A new structure type element is created in each row over which you drag the selection.

Arranging structure type elements

You can change the order of the structure type elements in the navigation area.

1. Select the structure type element that you want to move.
2. Select "Move up" or "Move down" in the shortcut menu.
The selected item is moved to a new location.

How to create a structure tag

Introduction

In WinCC Configuration Studio, you set up structure tags in the table area of the "Tag Management" editor.

After you have defined the structure for the structure tags by configuring structure types and the corresponding structure type elements, you can create structure tags in the table area.

The instances of the tags (structure tag elements) are generated automatically.

Procedure

1. Select the structure for which you want to create tags in the navigation area.
2. Select the "Structure tags" tab in the table area.

3. Enter the name for the tag in the top free field of the "Name" column. Adhere to the naming conventions.

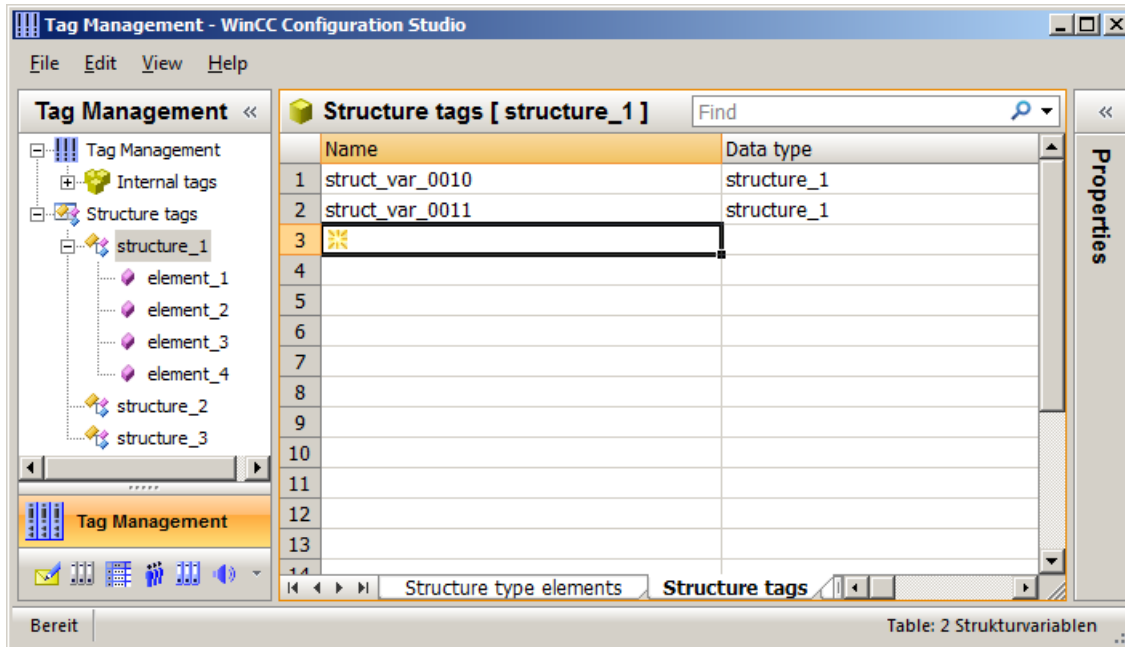

4. Edit the properties of the tag in the table area or in the "Properties" area.
 - Under "Connection", select whether the tag is an internal tag or a process tag.
 - For process tags, set Linear scaling as necessary.
 - Change the given format adaptation for process tags as necessary. You can select a channel unit from the "Use additional format adaptations from" selection box. WinCC then also features the format adaptations that are supported by that channel unit.
 - Check the "AS offset" value for process tags. This value defines the offset of the structure element relative to the start address in bytes. The offset value of a new or copied element is incremented automatically. You may customize the settings.

Creating multiple structure tags

1. Select the lowest full cell in the "Name" column in the table area.
2. Drag down the selection of the cell with the bottom right handle while keeping the mouse button pressed. A new structure tag is created in each row over which you drag the selection.

Result: Structure tag elements

The structure tag elements are generated based on the configured structure tags and the configured structure type elements.

You can find a list of them in the "Structure tag elements" tab in the table area.

How to edit the properties of structure tags

Introduction

In WinCC Configuration Studio, you edit the properties of structure tags in the table area or in the "Properties" area of the Tag Management editor.

When creating a structure type, you create the individual structure type elements. You assign a structure type as data type when you create a structure tag. In this way, you create the structure tag elements defined by the structure type.

The properties of a structure tag element are determined by the properties of the structure type element and the structure tag.

Displaying and editing properties

The properties of structure type elements, structure tags and structure tag elements are displayed in the table area and in the "Properties" area.

Fields highlighted in color cannot be edited.

Whether you can edit properties may depend on the activation or deactivation of individual options or a selection for another property.

Procedure

1. In the navigation area, select the "Structure tags" folder to display all tags in the table area.
2. In the navigation area, select the folder of a structure type to display the assigned elements.
3. Select the corresponding tab in the table area:
 - Structure type elements
 - Structure tags
 - Structure tag elements
4. In the table area, select a row to display and edit the properties in the "Properties" area.
5. To edit multiple elements at the same time, you can use, for example, the "Select and pull selection down" function or the shortcut menu commands "Deselect all" and "Select all".
In the table area, you can use the shortcut menu of a column header to show or hide specific columns (and therefore properties).
You can display tags clearly using filtering and sorting options.
6. Change the given format adaptation for process tags as necessary.
7. Check the "AS offset" and "AS offset bit" properties for process tags.
This value defines the offset of the structure element relative to the start address in bytes.
The offset value of a new or copied element is incremented automatically.
You may customize the settings.

2.5.2.6 Tag groups

How to Create a Tag Group

Introduction

You create tag groups in the "Tag Management" editor.

You create tag groups for internal tags directly in the folder "Internal tags". You create tag groups for process tags in the folder of a connection.

You can create tags in a tag group. You can assign existing tags to a group. A tag group cannot contain another tag group.

Procedure

1. In the navigation area, select the folder in which you want to create the tag group.
2. Select "New Group" in the shortcut menu.
3. Change the name of the group. Adhere to the naming conventions.
 - In the navigation area: Select the "Rename" command from the shortcut menu.
 - In the table area: Change the name in the "Name" column on the "Groups" tab.
 - Change the name under "General" in the "Properties" area.

Alternative procedure

1. Select a folder in the navigation area.
2. Select the "Groups" tab in the table area.
3. Click in the top free cell of the "Name" column. The cell is identified by a yellow icon.
4. Enter a name.
The group is created with this symbol .

Creating multiple groups

1. Select the lowest full cell in the "Name" column in the table area.
2. Drag down the selection of the cell with the bottom right handle while keeping the mouse button pressed.
A new group is created in each row over which you drag the selection.

How to assign tags to a group

Introduction

Groups are an efficient means of managing and calling tags. A tag can only be assigned to one group. This assignment can be changed at any time. Before you can assign tags to a group, you first need to create this group.

Assigning tags to a group

1. Select the column of a tag in the table area.
2. If you want to assign the tag to a different connection or to the "Internal tags", select the connection from the drop-down list in the "Connection" field in the properties area under "Assignment".
3. Under "Assignment" in the "Group" field of the properties area, select the group to which the tag should be assigned from the drop-down list.
The groups which were created under the corresponding connection or the "Internal tags" folder are available.
The tag is assigned to the group.

It is not possible to assign tags to a group by means of cut and paste.

2.5.3 Editing Tags

2.5.3.1 Editing Tags

Introduction

This section informs you of the possibilities of editing tags, tag groups and structure types:

- Copy
- Move
- Delete
- Rename
- Edit in Runtime
- Display value, quality code and tag status

Note

If a tag was created in WinCC with "Compile OS" using the SIMATIC Manager, you cannot edit the tag in WinCC Explorer.

Note

Changes, for example to properties, are written directly and without explicit saving to the database and therefore take effect immediately in Runtime.

2.5.3.2 Copying, Moving and Deleting Tags

Introduction

The shortcut menu in the navigation area and in the table area lets you edit tags, groups and selected areas:

- Copy
- Cut
- Paste
- Delete

You can thus edit tag groups or structure type elements, for example, in the navigation area. If the action cannot be performed, a message appears.

Alternatively, you use the keyboard shortcuts <Ctrl+C> (copy) and <Ctrl+V> (paste).

In the table area, you use the shortcut menu to edit rows, columns or selected areas.

In the table area, you can also create copies of an object by selecting an object in the "Name" column and dragging the selection at the bottom right corner while keeping the left mouse button pressed.

Copying Tags, Tag Groups and Structure Types

Note

If a tag was created in WinCC with "Compile OS" using the SIMATIC Manager, you cannot copy or delete the tag in WinCC Explorer.

If you wish to configure several tags with identical properties, for example, you can copy an existing tag and paste it at the desired position. WinCC automatically increments numeric values at the end of the name.

Examples

Selected tags	Copied tag
VarOne	VarOne_1 VarOne_2
VarOne_2 VarOne_3	VarOne_4 VarOne_5
VarOne_1 VarOne_3 VarOne_5	VarOne_7 VarOne_9 VarOne_11

Moving Tags and Tag Groups

Note

If you move a tag between the tag management "Internal tags" and a communication driver or between communication drivers, you have to adapt the properties of the tag afterwards.

If you want to move tags or tag groups, edit the "Connection" or "Group" property.

You can move tags:

- from one tag group to another tag group
- from the connection of a communication driver to the connection of another communication driver
- from tag management "Internal tag" to a communication driver
- from a connection of a communication driver to the tag management "Internal tags"

Structure types and structure tag elements cannot be moved.

Deleting tags

Note

When deleting tags, data inconsistencies may result in other parts of the project which could lead to errors or faults.

1. Select the row of a tag in the table area and select "Delete" from the shortcut menu. Alternatively, press . If you select individual fields instead of a row, the corresponding contents are deleted, not the tag.
2. To delete all tags of a group, select the group in the navigation area and the "Delete" command from the shortcut menu.

If you delete a connection, a structure type or a structure type element, all assigned tags are deleted.

2.5.3.3 How to Rename Tags

Introduction

Note

If a tag was created in WinCC with "Compile OS" using the SIMATIC Manager, you cannot edit the tag in WinCC Explorer.

You can rename the following elements in Tag Management:

- Tags, structure tags
- Tag groups
- Structure types, structure type elements
- Connections

Upper/lower case text

WinCC is case-sensitive in handling the names of tags.

You cannot create tags whose names differ only with respect to case in the editor.

Procedure

1. Select a tag, tag group, connection, or structure type in the navigation area.
2. Select the "Rename" command from the shortcut menu.
The item can now be renamed.

Alternative procedure

- Press the <F2> function key in the navigation area.
- Click the "Name" field in the table area or in the "Properties" area and enter the new name.

If the selected object cannot be renamed (for example, because an object already exists with the same name), you receive a message.

Special features with structure types

If you change the name of a structure tag or a structure type element, the name of the respective structure tag element automatically changes at the same time.

If you change the name of a structure type, this has no impact on the lower-level objects.

2.5.3.4 Editing Tags in Runtime

Introduction

If you have activated a project, you can edit tags in parallel. There are a few constraints.

Editing in Runtime

Note

If a tag was created in WinCC with "Compile OS" using the SIMATIC Manager, you cannot edit the tag in WinCC Explorer.

You can edit the following elements in Runtime:

	Tags	Tag groups	Structure types	Structure instances
Create	X	X	X	X
Address	X	---	---	X
Cut	X ²⁾	---	---	---
Copy	X ²⁾	X	X	X
Paste	X	X	X	X
Delete	X ^{1) 2)}	X ¹⁾	---	X
Modify properties	X	X	X ³⁾	X
Rename	X ^{1) 2)}	X	---	X

¹⁾ Possible with external tags only if the channel supports the function. This currently only applies to the channel "SIMATIC S7 Protocol Suite".

²⁾ Does not apply to structure tags.

³⁾ Not possible if structure tags are created.

2.5.3.5 In this way, you display the value, status and quality code for tags

Introduction

You can display the current value, the status and the quality code of tags in the table area of the Tag Management editor.

Procedure

1. In the navigation area, select the folder to which the corresponding tags are assigned.
2. Select the "Tag Management" or "Structure tags" folder to display all tags of this folder in the table area.
3. Select the "Tags" or "Structure tag elements" tab in the table area.
4. Click in a column header and select the column to be shown, for example "Value", from the shortcut menu.

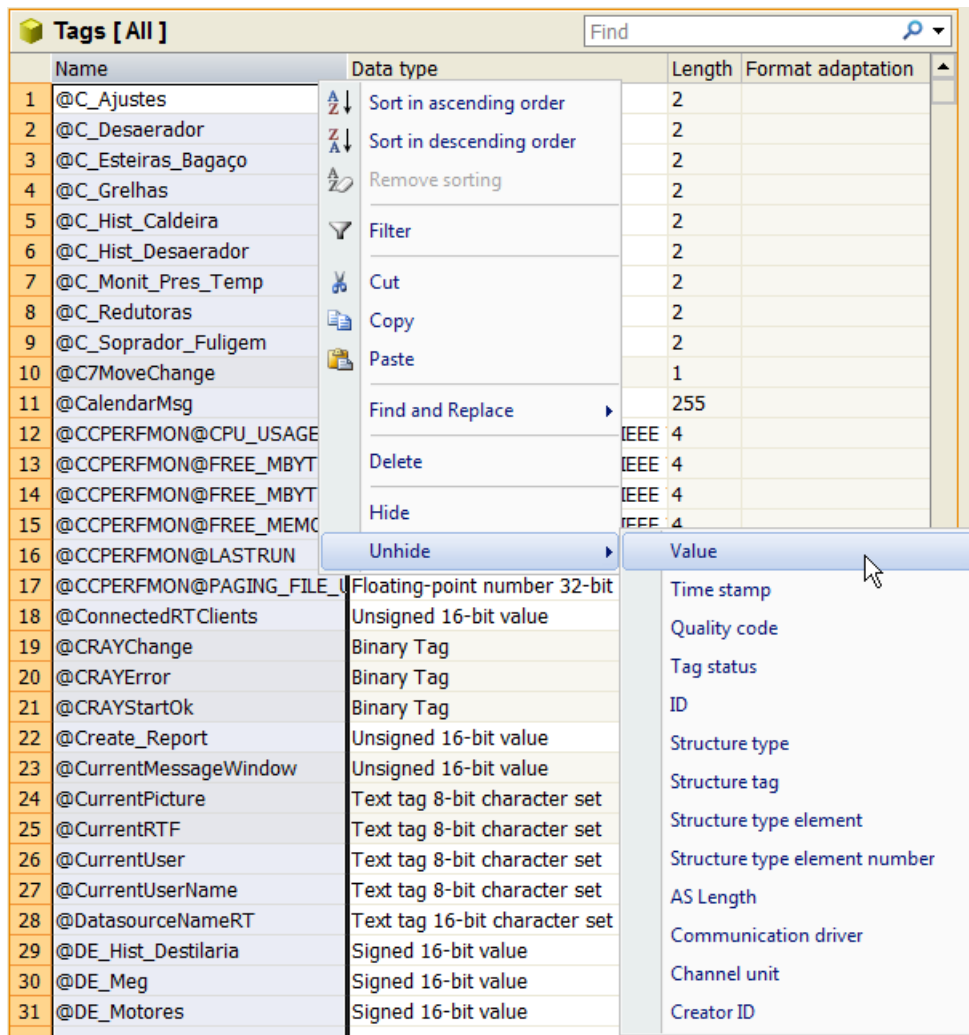

The corresponding column is shown in the table area. You can read the current values here.

Note

The tag values are updated regularly in Runtime. If tag values are shown permanently, this could strongly impede the performance of the system.

2.5.4 Importing and exporting tags

2.5.4.1 How to export tags

Introduction

You can export tags and the structures in which tags are embedded.

The exported tags are either saved as text files (*.txt) or as Excel workbooks (*.xlsx).

Preparation for export

- Select the folder you wish to export in the navigation area.
- Select the rows of individual tags or tag groups you want to export in the table area.
To do so, select the row numbers of the items.
Press the <Shift> key at the same time to select consecutive items.
Press the <Ctrl> key at the same time to select non-consecutive items.

Procedure

1. Select the objects you want to export.
2. Select "Export" in the shortcut menu.
3. Select the file format (Text or Excel workbook).
The marked objects are written to a file.
A message confirms that export has been completed successfully.

Note

Select the "Edit > Export" command from the main menu to export all tags of Tag Management.

Structure of the export file

The format of the export file is either Unicode text or an Excel workbook.

All dependencies are also exported.

Unicode text

The individual properties are separated by tabs; the lines are separated by line breaks (CR-LF) .

Depending on the selected export, the file lists tags, tag groups, structure types, connections, etc. with all the properties.

You can open and edit the file in spreadsheet programs (such as MS Excel).

Excel workbook

Tags, tag groups, structure types, etc. are represented on separate spreadsheets in Microsoft Excel format.

2.5.4.2 How to import tags

Introduction

You can import data records from third-party applications or other WinCC projects in the WinCC Configuration Studio. These data records must be available in "Office Open XML Workbook" format. Files of this format have the ".xlsx" extension and can be opened and edited in spreadsheet programs.

Note

You cannot undo the import of data records.

Requirements

- The data records you load may not be in use by any other application.
- The connections contained in the data records must be available by their name in WinCC Configuration Studio.

Procedure

1. Select the required editor in the navigation area.
2. Select "Import" from the shortcut menu of the editor.
The "Select file" dialog opens.
3. Select the file to import.

The data records will be loaded. A progress bar is displayed.

Creating Process Pictures

3.1 Creating Process Pictures

Contents

The Graphics Designer is an editor for creating process pictures and making them dynamic.

This chapter will show you

- how to use the "Graphics Designer" editor
- how to create and edit process pictures
- how to adapt the object properties to the requirements of your project
- how to configure and use objects of the Object Palette and library
- how to combine and configure objects of the Object Palette
- how to integrate and configure controls in process pictures
- how to test process pictures in Runtime

Chapter "Object properties" describes the properties of the objects of the Graphics Designer.

How to make process pictures dynamic is described in detail in the chapter "Making Process Pictures Dynamic".

3.2 How to start the Graphics Designer

Introduction

The Graphics Designer can only be started for the project currently opened in the WinCC Explorer.

Requirements

- A project must be opened.

Procedure

The Graphics Designer can be opened in the following ways:

- Navigation window of the WinCC Explorer
Select the command "Open" in the shortcut menu of the entry "Graphics Designer".
This will start Graphics Designer and a new picture opens.
- Navigation window of the WinCC Explorer
Double-click on the "Graphics Designer" entry in the navigation window.
This will start Graphics Designer and a new picture opens.
- Data window of the WinCC Explorer
Select the entry "Graphics Designer" in the navigation window. The pictures available in the project are shown in the data window.
Select the command "Open picture(s)" in the shortcut menu of a picture.
This will start Graphics Designer, and the selected picture opens.
- Data window of the WinCC Explorer
Select the entry "Graphics Designer" in the navigation window. The pictures available in the project are shown in the data window.
Double-click a picture.
This will start Graphics Designer, and the selected picture opens.

See also

The pop-up menu in the Data Window (Page 309)

The shortcut menu in the Navigation window (Page 300)

The Graphics Designer in the WinCC Explorer (Page 299)

3.3 The Graphics Designer in the WinCC Explorer

3.3.1 The Graphics Designer in the WinCC Explorer

Introduction

For working with the Graphics Designer, the WinCC Explorer offers the following functions and configuration options:











- Starting Graphics Designer
- Opening, creating, renaming and deleting a picture
- Specifying a picture as a start picture or marking it as a favorite
- Saving a picture as "web-enabled"
- Password protection of the pictures
- Display properties of pictures and their dynamics
- Configuring object libraries and ActiveX controls
- Configuring and starting Runtime



You can call commands via the toolbar and the shortcut menus in the navigation and data windows.

To convert libraries and pictures from older program versions, use the "Convert Project Data" function in WinCC Explorer.

Picture types in the Graphics Designer

Icons in the data window:

	Process picture
	Process picture - web-enabled
	Process picture - Start picture
	Faceplate type that can be inserted as an instance in a process picture ¹⁾
	Faceplate type - web-enabled ¹⁾
	Process picture with faceplate instances that are affected by type changes ¹⁾
	Process picture marked as a favorite. In runtime you can select the picture as a favorite by means of the system dialogs.
	Process picture - Favorite and start picture
	Process picture - Favorite and web-enabled
	Process picture is protected by a password.
	Process picture - Favorite, web-enabled and password-protected

	Process picture - Favorite, web-enabled, start picture and password-protected
	Folder under "GraCS" Double-click the icon to show the process pictures in the folder.

1) You can find additional information on faceplate types and faceplate instances in the section "Working with faceplate types".

See also

- How to configure the control selection (Page 306)
- How to protect pictures with a password (Page 387)
- Working with Pictures (Page 372)
- Converting project data (Page 52)
- Working with Faceplate Types (Page 396)
- How to configure the object selection (Page 304)
- Displaying the properties of a picture file (Page 313)
- Displaying the configured dynamics of a process picture (Page 315)
- How to start the Graphics Designer (Page 298)
- How to set up Runtime (Page 180)
- How to activate / deactivate Runtime (Page 807)
- The shortcut menu in the Navigation window (Page 300)
- The pop-up menu in the Data Window (Page 309)

3.3.2 The shortcut menu in the Navigation window

Introduction

A shortcut menu permits rapid access to frequently required functions. The navigation window is the left-hand window in the WinCC Explorer. The shortcut menu can be used to modify the components of the opened project. The shortcut menu of the Graphics Designer enables you to create new pictures or integrate controls.

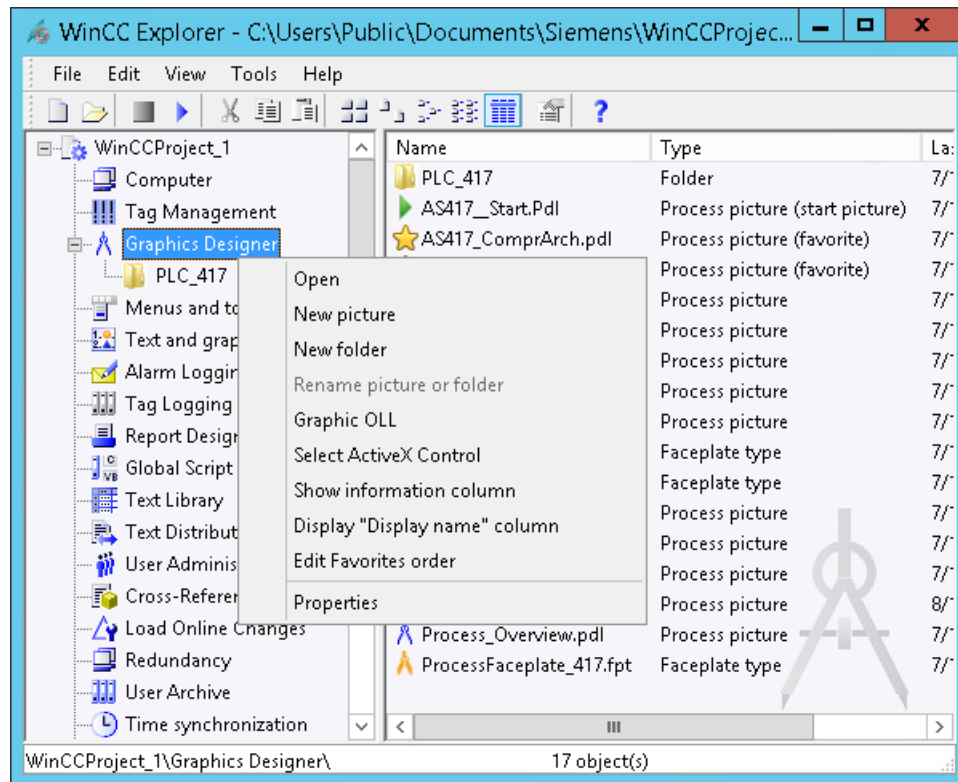

Requirements

- A project must be opened.

Procedure

1. Right-click the "Graphics Designer" entry or one of the subfolders.
The shortcut menu opens.
2. Select one of the entries from the shortcut menu.

Open

Selecting the "Open" command creates a new picture with the name "NewPdl1" in "PDL" format and opens it with the Graphics Designer.

New picture

Selecting the command "New picture" creates a new picture in "PDL" format. The new picture is displayed in the data window.

The new picture is automatically assigned a sequential name. You can change the name following this. You can find additional information under "The pop-up menu in the Data Window (Page 309)".

Insert picture

You can copy process pictures and faceplate types that have already been created from another WinCC project to your WinCC project:

1. Open the "GraCS" folder in the project path in Windows Explorer.
2. Drag-and-drop the required picture to the WinCC Explorer data window.

Alternatively, copy the picture in the Windows Explorer to the "GraCS" folder of the current project.

Create subfolders of the "GraCS" folder and organize also in the Windows Explorer.

New Folder

Selecting the command "New folder" creates a new subdirectory in the "GraCS" project directory. The new folder is displayed in the data window and in the navigation window.

You can create additional subfolders in a folder.

The new folder is automatically assigned a sequential name. You can change the name following this.

Folder names

- The path name of the project folders including picture name is limited to 180 characters.
- Different folders can contain files and subfolders with the same name.
- When you create subfolders in the project path in the "GraCS" folder, avoid periods in the folder name.
VB scripts can only access subfolders that have no period in their name.
- If you change a folder name, you may need to check the folder paths in scripts, in the picture navigation and in object properties.
For pictures, faceplate types and referenced files located in the subfolders of "GraCS", the folder path is part of the name in each case.

Graphic OLL

The "Object OLL" dialog is opened. This dialog indicates which object libraries are available for the Graphics Designer.

The object selection can be configured for the current project. Via the "Search..." button, you can use objects from other object libraries in your current project.

This dialog is described in detail in the section "How to configure the object selection".

Selecting ActiveX controls

The "Select OCX Controls" dialog is opened. This dialog shows all the ActiveX Controls that are registered in the operating system.

A red check mark indicates the controls that are shown in the object palette of the Graphics Designer in the "Controls" tab.

You can make other controls available for the Graphics Designer. You can integrate Windows controls or external controls and use these in your project.

This "Select OCX Controls" dialog is described in detail in the section "How to configure the control selection of the object palette".

Display Column Information

The Display Column Information entry in the data window of WinCC Explorer is used to show the Information column.

The entry in this column shows how the corresponding picture was created.

Type of object creation	Entry in the Information column
Picture has been created using WinCC Explorer.	<No entry>
Picture has been created using WinCC Explorer and then imported to SIMATIC Manager using the Import WinCC objects function.	Created by SIMATIC Manager
Picture has been created using SIMATIC Manager.	Created by SIMATIC Manager

Display "Display name" column

In the WinCC Explorer data window, the configured display names are shown in the "Display names" column.

You configure the display name in the Graphics Designer in the object properties of the picture under "Miscellaneous".

To configure the display name in multiple WinCC user interface languages, open the "Text input" dialog with a double-click on the attribute. The name is then displayed in the set WinCC user interface language in Windows Explorer.

Editing the Favorites sequence

Favorite pictures are marked with an asterisk in the data window. The order of these favorites can be changed with this entry.

The section "How to specify favorite process pictures (Page 185)" describes in detail how to specify pictures as favorites.

Properties

The "Properties" windows contains the version information of the Graphics Designer.

See also

How to configure the control selection (Page 306)

How to specify favorite process pictures (Page 185)

Working with Pictures (Page 372)

Saving in file system (Page 374)

How to configure the object selection (Page 304)

How to start the Graphics Designer (Page 298)

The pop-up menu in the Data Window (Page 309)

The Graphics Designer in the WinCC Explorer (Page 299)

3.3.3 How to configure the object selection

Introduction

The object selection available in the Graphics Designer can be configured for the current project. Other object libraries can be imported using the "Browse" button. It is possible, for example, to integrate other button or text objects and then use them in the project.

Requirements

A project must be opened.

Opening the "Object OLL" dialog

Right-click in the navigation window on the entry "Graphics Designer". Select the entry "Graphic OLL" from the shortcut menu.

This "Object OLL" dialog indicates which object libraries are available for the Graphics Designer. The availability of object libraries can be changed as required.

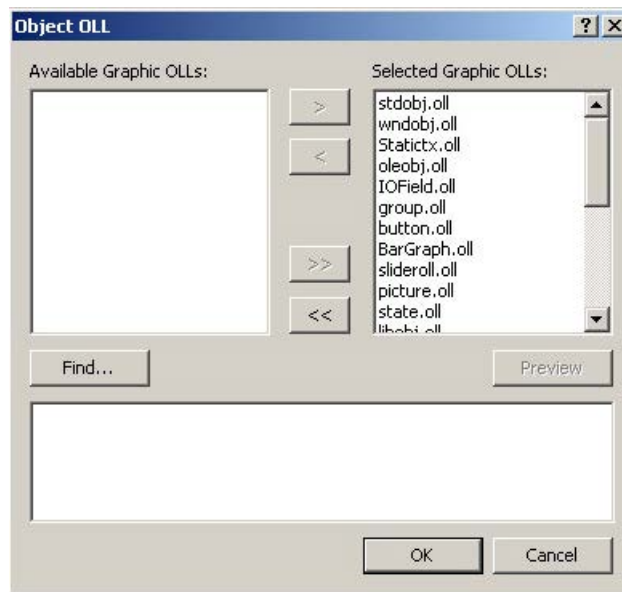

Available Graphic OLLs

All of the object libraries registered in WinCC in the left-hand area of the dialog.

Selected Graphic OLLs

The right-hand area of the dialog lists all the object libraries that have been selected for use in the Graphics Designer.

Arrow buttons

Use the arrow buttons to move object libraries in the relevant arrow direction.

Button "Find"

Click the "Find" button to add other object libraries to WinCC.

Button "Preview"

Select the desired OLL file in one of the two upper areas. Click the "Preview" button to display the content of the selected object library as a preview.

Configuring the Graphic OLL

In the Graphics Designer, only the object libraries listed in the area "Selected Graphic OLLs" are available. Use the arrow buttons to move a selected object library in the relevant arrow direction. You can also select a number of OLL files if you click the desired files while holding down the <SHIFT> or <CTRL> keys.

The arrow buttons have the following function:



Moves the selected OLL file from the left-hand area into the right-hand area



Moves the selected OLL file from the right-hand area into the left-hand area.



Moves all the OLL files displayed in the left-hand area into the right-hand area.



Moves all the OLL files displayed in the right-hand area into the left-hand area.

Adding Graphic OLLs

You can use the "Object OLL" dialog to link other object libraries in WinCC by copying them from another directory into the area "Available Graphic OLLs".

1. Click the "Search" button.
2. Enter the path of the requested source directory.
3. Confirm your selection by clicking "OK".
The selected OLL files will be displayed in the left area of the dialog "Object OLL".

Note

Object libraries are WinCC files of the format OLL and they are located in the subfolder "Bin" of the WinCC installation directory.

Additional object libraries can be purchased through your WinCC sales partner.

See also

How to start the Graphics Designer (Page 298)

The shortcut menu in the Navigation window (Page 300)

The Graphics Designer in the WinCC Explorer (Page 299)

3.3.4 How to configure the control selection

Introduction

The "Controls" tab in the "Standard" selection window of the Graphics Designer contains a selection of controls in the folders "ActiveX controls", ".NET controls" and "WPF controls". You can insert these controls directly into a picture.

You can configure the selection of controls available in the tab yourself:

- Change the selection of the ActiveX controls in the dialog "Select OCX Controls". You can add any of the ActiveX controls registered in the operating system to the list of controls and remove individual controls from the selection.
- Change the selection of the .NET controls in the dialog "Select .NET Object".
- Change the selection of the WPF controls in the dialog "Select WPF Object".

Note

The use of controls from third party providers can lead to errors as well as drops in performance or system blockage. The user of the software is responsible for problems caused by the deployment of external controls.

We recommend a thorough test before implementation.

Configuring ActiveX controls

1. Open the "Controls" tab and select the entry "Add/Remove" in the shortcut menu of the "ActiveX Controls" folder. The "Select OCX Controls" dialog is opened.

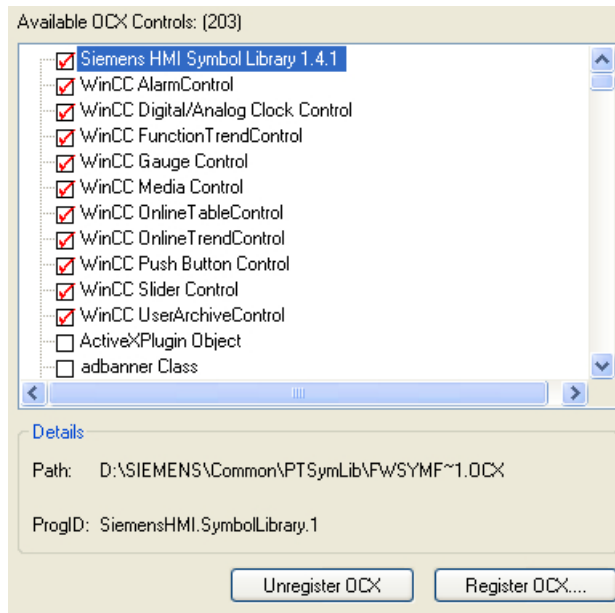

In the area "Available OCXs (Number)", the "Select OCX Controls" dialog shows all the ActiveX Controls that are registered in the operating system. The exact number is shown in the title of the area after the registration has been read in. A red check mark indicates those controls that are available in the "Controls" tab dialog of the Object Palette. The path and the program ID of the selected ActiveX Controls are displayed in the area "Details". You can open the "Select OCX Controls" dialog also from the WinCC Explorer. Click on the entry "Graphics Designer" in the navigation window and select the entry "Select ActiveX Control" in the shortcut menu.

2. To add an ActiveX control in the "Controls" tab, select the required control in the area "Available OCX Controls".
A red check mark indicates that the control is added to the "Controls" tab.
3. To remove an ActiveX control deactivate the control in question in the area "Available OCX Controls".
The red check mark disappears.
4. Confirm your changes by clicking "OK".

Configuring .NET objects and WPF objects

1. Open the "Controls" tab and select the entry "Add/Remove" in the shortcut menu of the ".NET Controls" folder or the "WPF Controls" folder.
The dialog "Select .NET Object" or "Select WPF Object" opens.

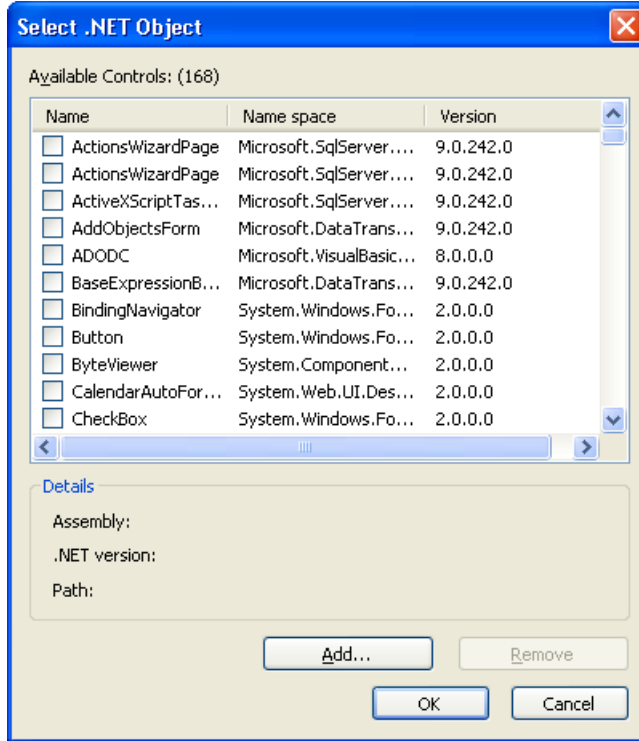

In the area "Available Controls (Number)", the dialog shows all the .NET objects or WPF objects on your computer. The precise number is displayed in the title of the area. A red check mark indicates those controls that are available in the "Controls" tab dialog of the Object Palette. The assembly, .NET version and path of the selected object are displayed in the area "Details".

2. To add a control in the "Controls" tab, select the required control in the area "Available Controls".
A red check mark indicates that the control is added to the "Controls" tab.
3. To remove a control deactivate the control in question in the area "Available Controls".
The red check mark disappears.
4. Confirm your changes by clicking "OK".

See also

The Graphics Designer in the WinCC Explorer (Page 299)

The shortcut menu in the Navigation window (Page 300)

3.3.5 The pop-up menu in the Data Window

Graphics Designer: Shortcut menu in the data window

The data window is the right-hand window in the WinCC Explorer.

A shortcut menu permits rapid access to frequently required functions. You can also call all of the functions listed in the shortcut menu using the menu bar.

Using the shortcut menu, the clicked picture can be opened, renamed or deleted, for example. In the data window, you can also define a picture as the start picture.

If you have not selected a picture, the shortcut menu of the Graphics Designer that is also open in the navigation window is displayed.

Procedure

1. Left-click the "Graphics Designer" entry in the navigation window of the WinCC Explorer. The data window displays all pictures (PDL) and faceplate types (FPT) of the current project. If the "GraCS" project directory contains one or more subfolders, the folders are displayed as well.
2. To display the pictures, faceplate types or subfolders of a folder, click on the folder in the navigation window.
Alternatively, double-click the folder in the data window.
3. Right-click one of the one or more of the displayed pictures.
The shortcut menu opens.



4. Select one of the entries from the shortcut menu.

Properties

The "Properties" window provides an overview of the most important properties of the process picture or the faceplate type:

- The "Preview" tab shows a preview with information on the file properties.
- The "Dynamizations" tab contains a statistical summary and detailed information on the configured dynamizations.

Opening (a) picture(s)

The selected picture or the selected faceplate type is opened in the Graphics Designer. If necessary, the Graphics Designer is started.

More than one can be selected.

Opening pictures in folders

When you call the function in the shortcut menu of a folder, all files in this folder are opened.

Renaming picture or folder

Renaming a picture, faceplate type or folder cannot be undone.

Different folders can contain files and folders with the same name.

Updating references and scripts

When you rename a file or folder, you must update the folder paths accordingly, for example in scripts and direct connections.

For pictures, faceplate types and referenced files located in the subfolders of "GraCS", the folder path is part of the name in each case.

You can check referenced pictures in the "Cross Reference" editor. Other referenced files as well as faceplate types and faceplate instances are not monitored by Cross Reference.

File format

When you rename pictures or faceplate types in WinCC Explorer, the file format "PDL" or "FPT" is always retained.

Names of process pictures and objects

When you rename a picture, the new picture name must not have the same name as an object in the picture.

The software does not check whether the new name already exists as object name.

Using a name that is already in use can lead to conflicts during access via VBA or during dynamization.

Note

SIMATIC Manager

You cannot rename process pictures that were created or imported in SIMATIC Manager.

Delete picture(s)

The selected picture or faceplate type is deleted. More than one can be selected.

As soon as you confirm deletion with "OK", the picture or the faceplate type is removed from the project. If necessary, change the dynamizations and scripts in which the deleted files are referenced.

The deletion cannot be undone.

Editing pictures and faceplate types in folders

When you call the function in the shortcut menu of a folder, all pictures and faceplate types in this folder are deleted.

Note

SIMATIC Manager

If you create pictures using the SIMATIC Manager, these cannot be deleted in WinCC Explorer.

This also applies to pictures created in WinCC and subsequently imported into SIMATIC Manager by using the function "Import WinCC objects".

You can recognize these pictures from the "Created by SIMATIC Manager" entry in the Information column of the data window.

Delete folders

The selected folder is deleted. More than one can be selected.

Files in the folder are also deleted without additional confirmation.

The deletion cannot be undone.

Checking the contents of the folder

As soon as you confirm deletion of the folder with "OK", the folder and all pictures and faceplate types it contains are removed from the project.

- Before you start deleting, check in Windows Explorer whether the folder contains other files that are not displayed in WinCC Explorer, such as videos or graphic files.
If necessary, move files that you want to continue using in the project to other GraCS subfolders.
- If necessary, change the dynamizations and scripts in which the deleted or moved files are referenced.
Referenced pictures are listed in the "Cross Reference" editor. Other referenced files as well as faceplate types and faceplate instances are not monitored by Cross Reference.

Define as start picture

The selected picture is defined as the start screen in runtime.

The selected picture is entered in the "Start screen" field in the "Graphics Runtime" tab of the "Computer properties" dialog.

Marking picture(s) as favorite

The selected picture is identified as a favorite with an asterisk. More than one can be selected.

You can use the system dialogs to select the process pictures marked as favorites in runtime.

Do not mark picture(s) as favorite

When you select multiple pictures or a favorite, the shortcut menu shows the entry "Do not mark picture(s) as favorite".

Editing pictures in folders

When you call the function in the shortcut menu of a folder, all process pictures in this folder are selected as favorites or disabled.

Activate "web-enabled"

The selected picture or the selected faceplate type is saved as web-enabled and can be executed in a web browser. More than one can be selected.

Editing pictures and faceplate types in folders

When you call the function in the shortcut menu of a folder, all files in this folder are saved as web-enabled.

Password protection

The selected pictures and faceplate types are protected by a password. More than one can be selected.

Select the "Apply to all" check box if the same password should apply to all process pictures and faceplate types.

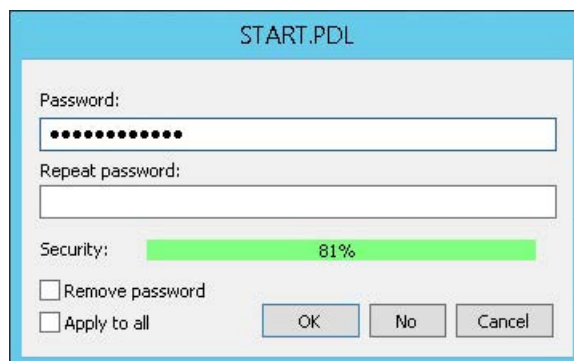

Editing pictures and faceplate types in folders

When you call the function in the shortcut menu of a folder, all files in this folder are edited:

- The password dialog is opened individually for each process picture and each faceplate type in the folder.
The name and path of the respective file is shown as dialog title.
- Select "Apply to all" to assign the same password to all files of the folder.
You can also use this option when removing the password protection for multiple pictures.

Confirm all type changes

The function is relevant for process pictures with faceplate instances. More than one can be selected.

Type-specific changes in faceplate types are transferred to the faceplate instances.

Editing pictures in folders

When you call the function in the shortcut menu of a folder, all process pictures in this folder are edited.

You can find additional information under "Working with faceplate types".

See also

Working with Pictures (Page 372)

How to create a new picture (Page 376)

How to Copy the Picture (Page 379)

How to Rename a Picture (Page 380)

How to Delete a Picture (Page 382)

Saving in file system (Page 374)

How to protect faceplate types with a password (Page 406)

3.3.6 Displaying the properties of a picture file

Introduction

If the entry "Graphics Designer" is selected in the navigation window of the WinCC Explorer, all the pictures of the current project are displayed in the data window. The entry "Properties" in the pop-up menu of a picture opens the "Properties" dialog. The "Properties" dialog has two tabs that provide an overview of the most important picture properties.

The "Preview" tab shows a preview of the selected process picture as well as the statistical characteristics of the picture file.

Requirements

- A project must be opened.
- In the navigation window of the WinCC Explorer, the entry "Graphics Designer" must be selected.
- For a complete display of the properties, the desired picture should not be opened in the Graphics Designer.

Displaying statistical characteristics

Right-click one of the pictures in the data window and select the entry "Properties" from the pop-up menu. Select the "Preview" tab.

The picture properties can also be opened using the menu bar of the WinCC Explorer.

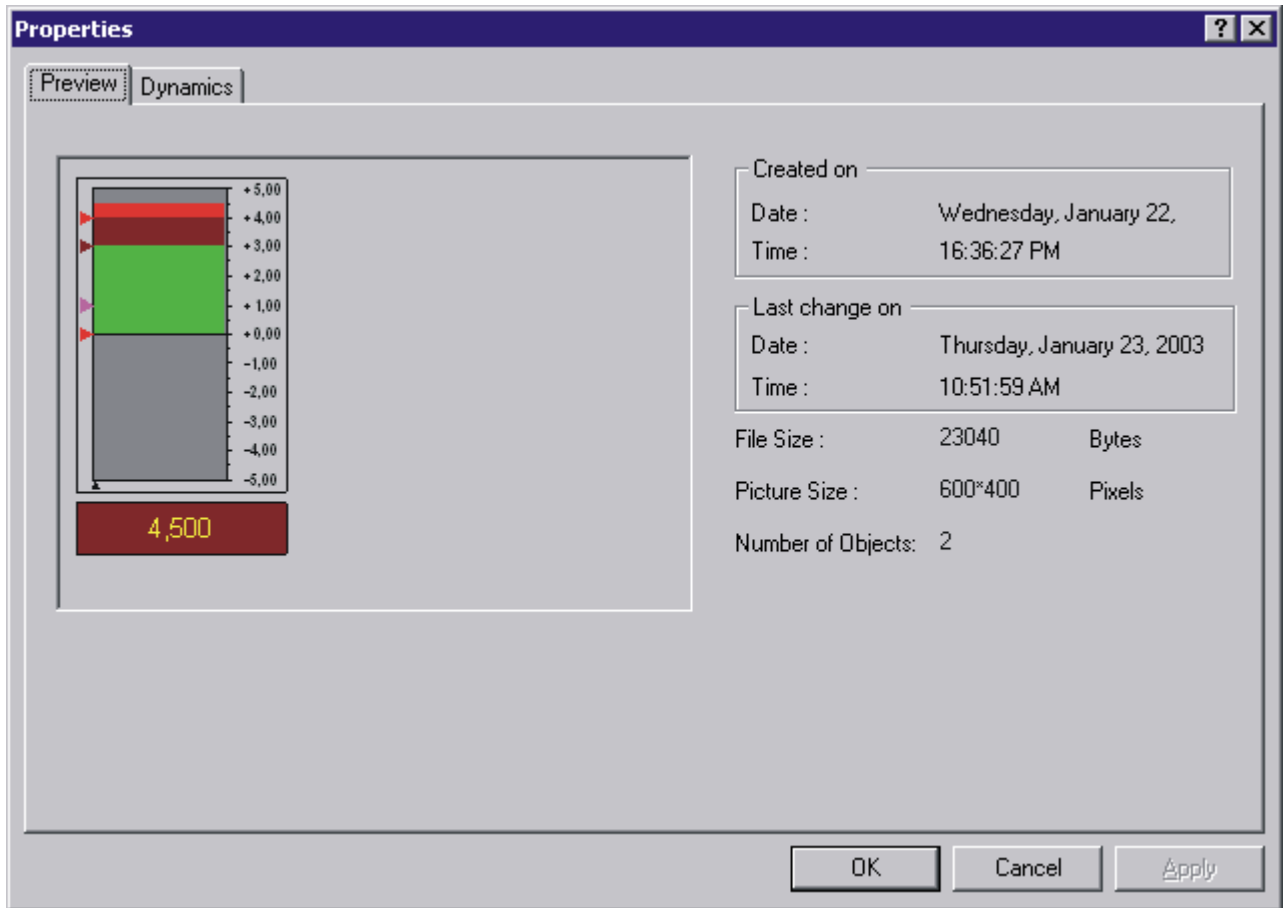

Creation date

The date and time the picture was created are shown in the "Created on" field.

Date of change

The date and time the picture was last edited are shown in the "Last change on" field.

File size

Shows the size of the PDL file in bytes.

Picture size

Shows the dimensions of the picture as "width by height" in pixels.

No. of objects

Shows the number of objects contained in the picture. The displayed value is calculated from the total number of all configured single, group and customized objects. Also included in the calculation are the single objects contained in groups.

See also

The Graphics Designer in the WinCC Explorer (Page 299)

The shortcut menu in the Navigation window (Page 300)

The pop-up menu in the Data Window (Page 309)

Displaying the configured dynamics of a process picture (Page 315)

3.3.7 Displaying the configured dynamics of a process picture**Introduction**

If the entry "Graphics Designer" is selected in the navigation window of the WinCC Explorer, all the pictures of the current project are displayed in the data window. The entry "Properties" in the pop-up menu of a picture opens the "Properties" dialog. The "Properties" dialog has two tabs that provide an overview of the most important picture properties.

With the functions of the "Dynamics" tab dialog, details of all dynamics defined for the selected picture can be displayed.

Requirements

- A project must be opened.
- In the navigation window of the WinCC Explorer, the entry "Graphics Designer" must be selected.
- For a complete display of the picture properties, the desired picture should not be opened in the Graphics Designer.

Displaying configured dynamics

Right-click one of the pictures in the data window and select the entry "Properties" from the pop-up menu. Select the "Dynamics" tab.

The picture properties can also be opened using the menu bar of the WinCC Explorer.

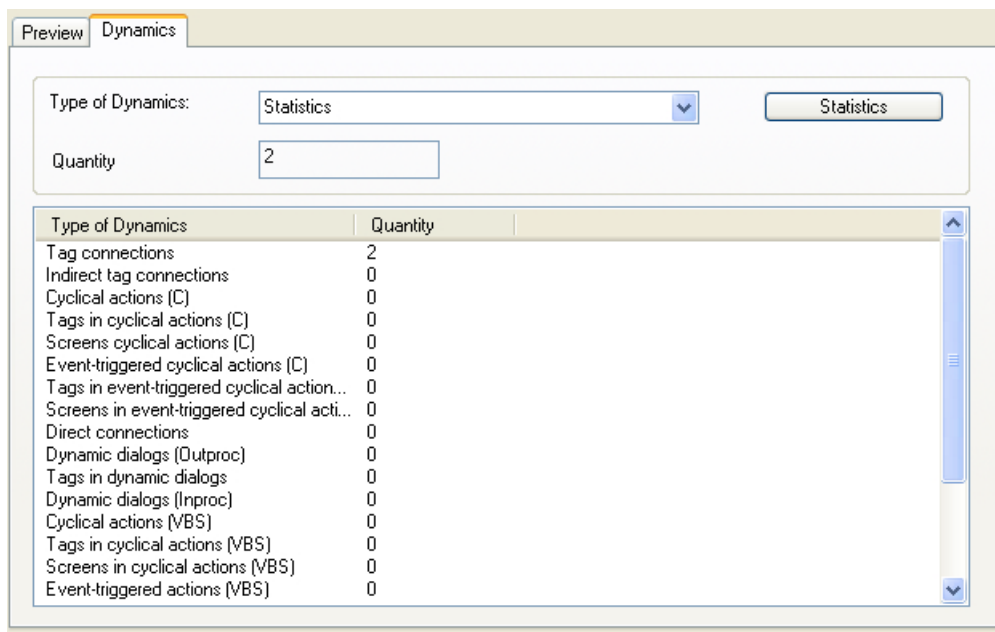

The first time the "Dynamics" tab is opened, the entry "Statistics" is the default setting as type of dynamics. The overview list displays all the types of dynamics and the frequency of their configuration in the selected picture. Double-clicking calls the detailed view for the different types of dynamics.

Type of dynamics

From the selection list "Type of Dynamics" select a dynamization for which you want to display statistics on the use.

"Statistics" button

This button displays all the types of dynamics with the number of uses in the data window. The contents of the data window and the selection list "Type of Dynamics" are reset.

Number

The "Number" field shows the total number of dynamics configured in the selected picture for the selected type of dynamics.

Overview list

All the objects of the selected picture for which the selected type of dynamics is configured are shown in the overview list line by line. The columns of the overview list contain the corresponding settings for these objects. The number and content of the columns depend on the selected type of dynamics.

The sort order of the table can be changed by clicking on the column header.

Types of dynamics and their meaning

Type of dynamics	Meaning
Tag connections	When a tag is connected to a property of an object, the value of the tag is transferred directly to the object property.
Indirect tag connections	When a tag is connected to a property of an object, the value of the tag is interpreted as the tag name.
Cyclic actions (C) Cyclic actions (VBS)	With a cyclic trigger the action is executed when the triggering event occurs.
Tags in cyclic actions (C) Tags in cyclic actions (VBS)	The action is executed when the value of one of the trigger tags has changed.
Pictures in cyclic actions (C) Pictures in cyclic actions (VBS)	Picture change at a cyclic action, for example: C: OpenPicture("NewImage.pdl"); Refer to the WinCC encoding rules. VBS: HMIRuntime.BaseScreenName="NewImage"
Event-triggered actions (C) Event-triggered actions (VBS)	The action that is connected to an event is executed when the event occurs.
Tags in event-triggered actions (C) Tags in event-triggered actions (VBS)	An event-triggered action contains tags in the script.
Pictures in event-triggered actions (C) Pictures in event-triggered actions (VBS)	Picture change in an event-triggered action.
Direct connections	If an event occurs in Runtime, the value of a source element is used for a target element.
Dynamic dialogs (Outproc)	The dynamization of the tags runs in a separate task if the criteria for "Dynamic dialogs (Inproc)" are not given.
Tags in dynamic dialogs	The tags that are used in dynamic dialogs when printing.
Dynamic dialogs (Inproc)	The functions of the script, which execute the functionality of the dynamic dialog configuration, run in the process context of the Graphics Runtime. Criteria for "Inproc": - Use of just one tag as the trigger tag - No additional function calls
Tags in the general cyclic part (VBS)	The tags are declared in the cyclic part in the declaration area of the VBS Editor.
Pictures in the general cyclic part (VBS)	The pictures are declared in the cyclic part in the declaration area of the VBS Editor.
Tags in the general event part (VBS)	The tags are declared in the event in the declaration area of the VBS Editor.
Pictures in the general event part (VBS)	The pictures are declared in the event in the declaration area of the VBS Editor.

See also

Displaying the properties of a picture file (Page 313)

The pop-up menu in the Data Window (Page 309)

The shortcut menu in the Navigation window (Page 300)

The Graphics Designer in the WinCC Explorer (Page 299)

Basic Dynamic Operations (Page 485)

3.4 Elements and Basic Settings of the Graphics Designer

3.4.1 Elements and Basic Settings of the Graphics Designer

Introduction

The Graphics Designer is a combination of a graphics program and a tool for representing processes. Based on the Windows standard, the Graphics Designer provides functions for the creation and dynamic modification of process pictures. The familiar Windows program interface makes it easy to begin using the complex program. Direct Help provides fast answers to questions. The user can set up a personalized working environment.

This chapter contains information on the structure of the Graphics Designer, on the elements and basic settings of the program.

See also

Customizing the Working Environment (Page 370)

The Basic Settings of the Graphics Designer (Page 355)

The Start Screen of the Graphics Designer (Page 325)

3.4.2 The Coordinate System of a Process Picture

Introduction

In the Graphics Designer, the basis for setting positions and specifying sizes is a two-dimensional coordinate system. The two axes of the coordinate system, x-axis and y-axis, are perpendicular to one another and intersect at the coordinate origin.

The coordinate origin lies with the coordinates ($X = 0 / Y = 0$) in the top left corner of the desktop. Starting from the coordinate origin, the horizontal x-axis runs in positive direction towards the right-hand border of the desktop. The vertical y-axis points in a positive direction towards the lower border of the desktop. The X and Y values of the current position of the mouse pointer are displayed in the status bar of the Graphics Designer. The values for X and Y rise when the mouse pointer is moved from the top left to the bottom right on the desktop. The coordinates are shown in pixels.

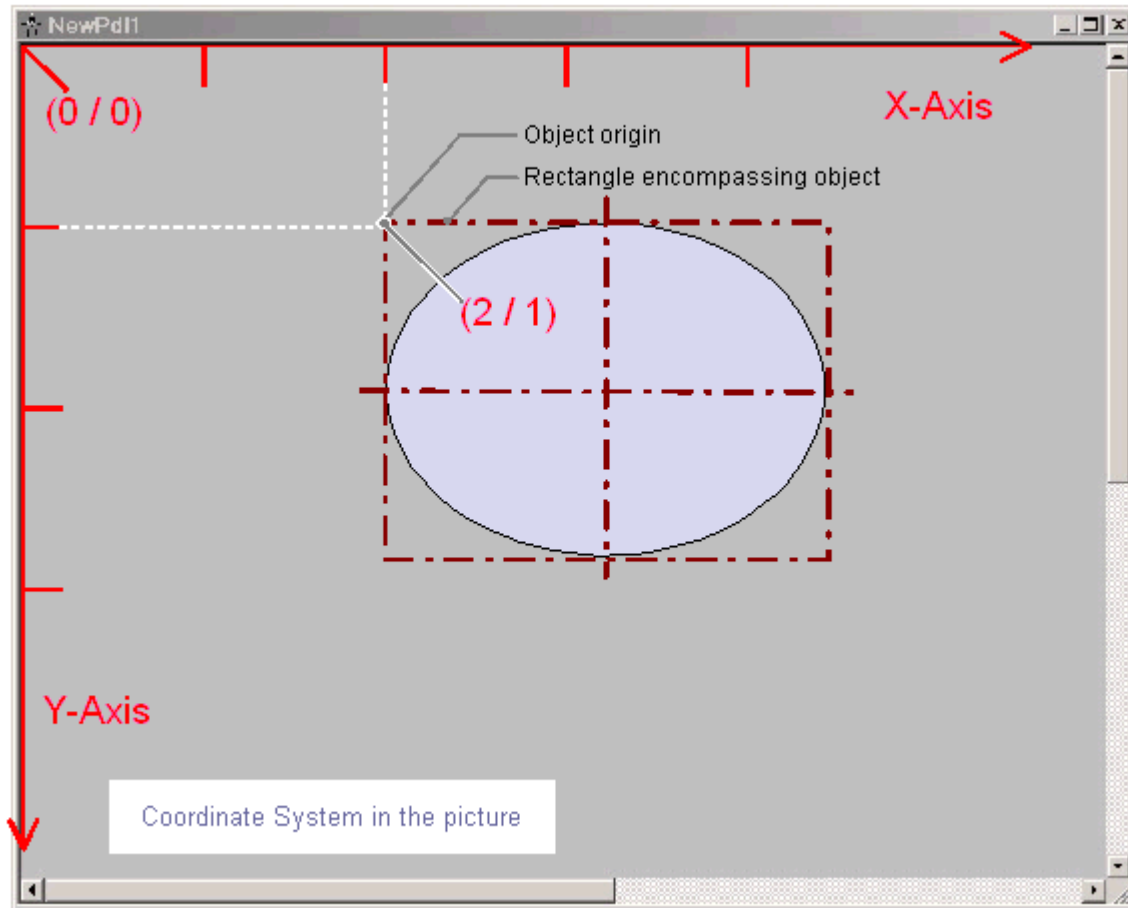

The position and size of objects of a picture are determined by the coordinates that an object has in the coordinate system. For example, the position of the object origin is set by the attributes "Position X" and "Position Y". The object origin therefore has the coordinates $X = \text{"Position X"} / Y = \text{"Position Y"}$. The values of these attributes describe the distance of the object origin from the coordinate axes.

Definition of origin

The origin is defined as the point of an area or an object that is used as the reference point for entering position and size. For the creation of process pictures in the Graphics Designer, the following reference points are of significance:

Coordinate origin

The "coordinate origin" is the top left corner of the desktop.
Coordinates: $X = 0 / Y = 0$

Picture origin

The "picture origin" is the top left corner of a process picture.
Coordinates: $X = 0 / Y = 0$

If the picture on the work area is not displayed as a window but maximized, the picture origin is the same as the coordinate origin.

Object origin

The "object origin" is the top left corner of the rectangle surrounding the object.

Coordinates: X = "Position X" / Y = "Position Y"

See also

Working with Objects (Page 456)

Status bar (Page 337)

The Rectangle Surrounding the Object (Page 323)

The Coordinate System of an Object (Page 321)

3.4.3 The Coordinate System of an Object

Introduction

The validity of the normal coordinate system is canceled for displays within an object. The following special forms are used for the internal coordinate system of an object:

- 2D coordinate system of an object
- 3D coordinate system of an object

2D coordinate system of an object

The two-dimensional coordinate system of an object differs from that of a process picture in the direction of the y-axis:

The positive direction of the Y-axis points upward.

The positive direction of the X-axis points to the right.

3D coordinate system of an object

For display in the object "3D bar", a three-dimensional coordinate system is used. In addition to the horizontal x-axis and the vertical y-axis, this three-dimensional coordinate system has a z-axis that points into the picture level. The coordinate system for the spatial representation of the 3D bar can be customized with the following attributes:

- "Display axis"
Determines the coordinate axis, where the value scale displayed by the 3D bar runs.
- "Bar direction"
Determines the direction for the "Display axis", which the positive axis section points to.

- "Alpha"
Determines the angle for the depth display of the Z-axis.
- "Beta"
Determines the angle for the depth display of the X-axis.

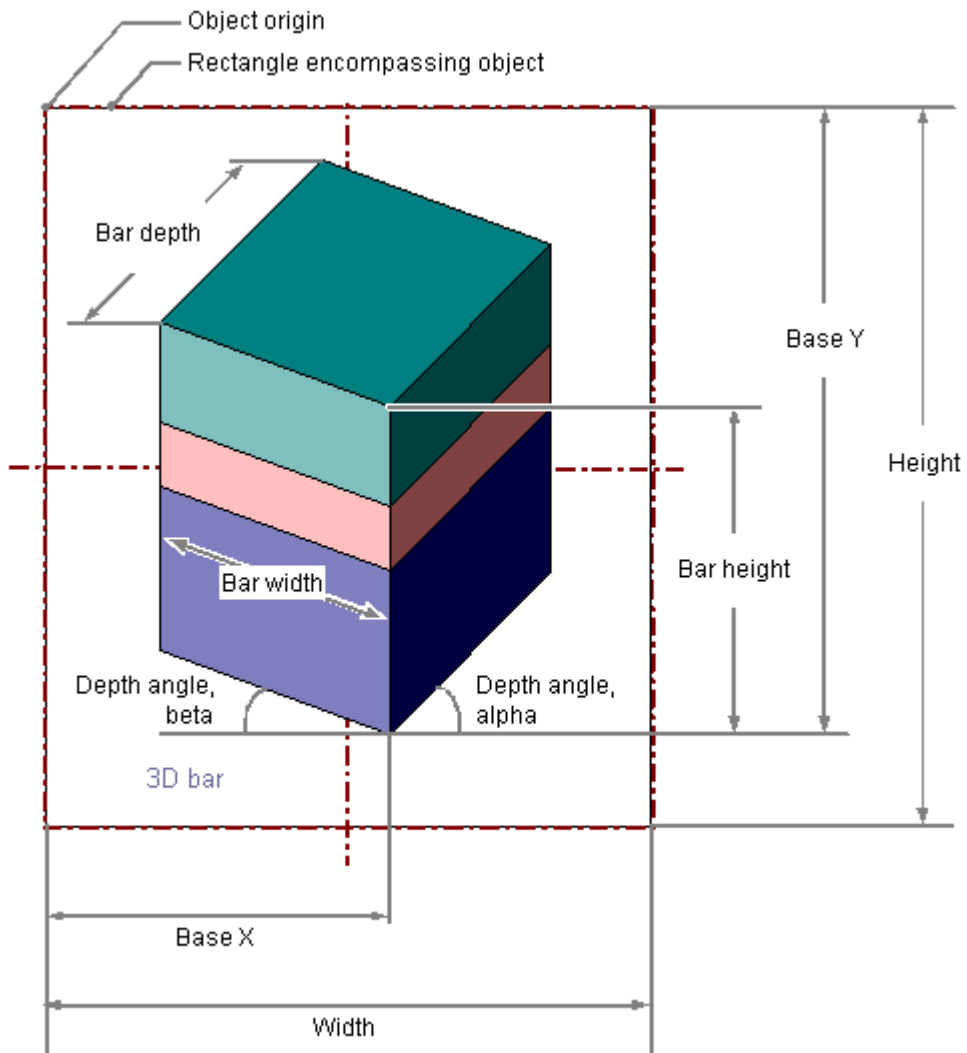

The following graphic illustrates the three adjustable display axes.

Display axis of the 3D bar

Example: "Bar Direction" = Positive, "Alpha" = 45 Degrees, "Beta" = 0 Degrees

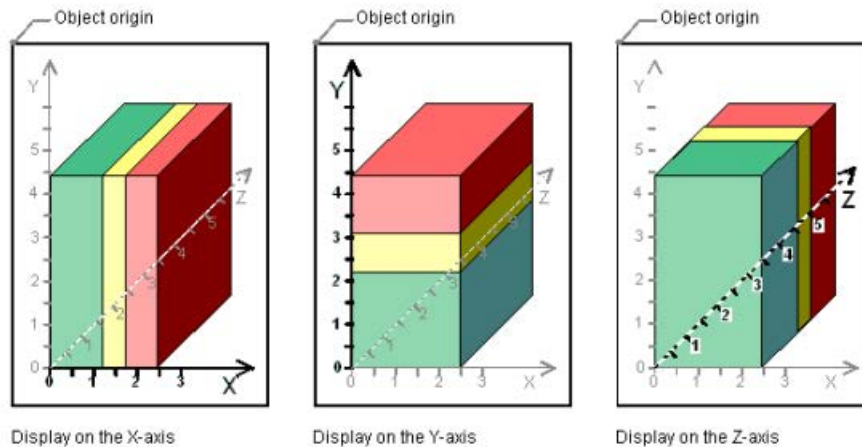

3.4.4 The Rectangle Surrounding the Object

Introduction

The rectangle surrounding an object is defined as a rectangular frame which lies on the outer border lines of an object. The rectangle surrounding the object itself is not visible in the Graphics Designer. As soon as you select an object, selection marks are shown however. These handles serve as grab points for changing the object size with the mouse. The handles mark the center axes and corner points of the rectangle surrounding the object.

Note

If the object has 100% transparency, the selections marks are invisible as well.

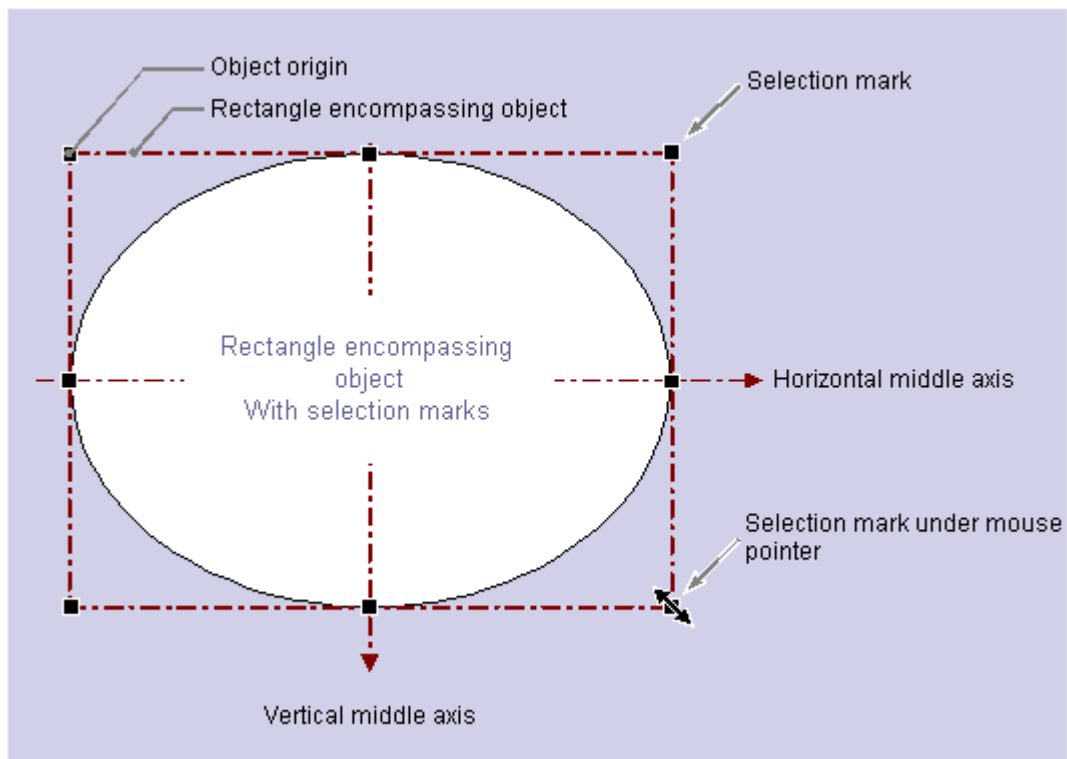

The significance of the rectangle surrounding the object for determining the position is illustrated with a circular or ellipse-shaped object as an example:
The position of an object is defined as the position of its origin in the coordinate system. The object origin has the coordinates ("Position X"m "Position Y") and is defined as the upper left corner of the rectangle surrounding the object. Specified in this way, the position of a circular or ellipse-shaped object is set clearly.

The handles of the rectangle surrounding the object

The handles of the rectangle surrounding the object appear as soon as you select an object. You can change the size of an object by shifting a selection mark to a new position with the mouse.

As soon as the mouse pointer is positioned to a selection mark, it switches into a double arrow. The alignment of the double arrow indicates the directions in which the handle can be moved:

- Horizontal double arrow
You change the width of the object using the selection marks on the horizontal center axis.
- Vertical double arrow
You change the height of the object using the selection marks on the vertical center axis.
- Diagonal double arrow
The selection marks on the corners of the object can be used to change the height and width of the object.

Note

You can change the overall size of circular objects. These have no selection marks for the center axes.

See also

Working with Objects (Page 456)
How to scale an object (Page 472)
How to Select Multiple Objects (Page 467)
Multiple Selection of Objects (Page 465)
How to select an object (Page 464)
The Coordinate System of an Object (Page 321)
The Coordinate System of a Process Picture (Page 319)

3.4.5 The Start Screen of the Graphics Designer

3.4.5.1 The Start Screen of the Graphics Designer

Introduction

When you open the Graphics Designer, the screen with the default settings and an empty picture in the "PDL" file format appears.

Use the "Process Pictures" selection window to open pictures and faceplates you wish to edit. Several open pictures and faceplates are arranged in color-coordinated tabs above the workspace.

Structure of the working environment in the Graphics Designer

The Graphics Designer consists of the following components:

- Workspace
- Menu bar

- Palettes
- Selection window
- Status bar

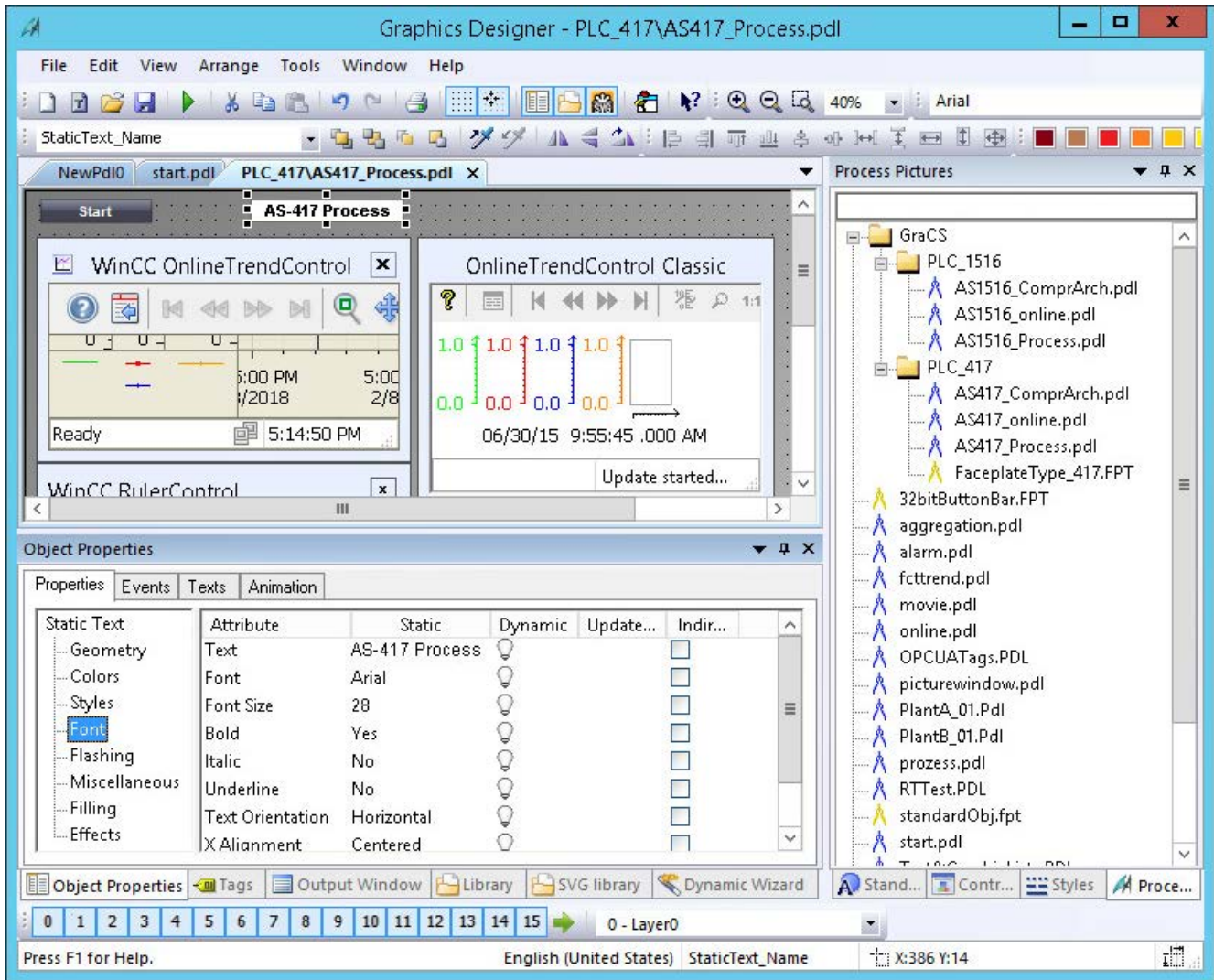

Displaying contents

If the content cannot be fully displayed in a window, scroll bars are shown, for example, for large pictures, object properties or object lists. Use the scroll bars or arrow keys of the keyboard to move the visible area.

The Graphics Designer also offers operation with the mouse wheel. Click the mouse wheel. The mouse pointer changes and you can move the visible picture area simply by moving the mouse.

The palettes and selection windows

- Palettes:
 - Default palette: For creating and saving documents, activating Runtime and further basic functions.
 - Zoom palette: For setting the zoom factor.
 - Font palette: For changing the font and font size.
 - Object palette: For selecting a picture or object, for example, to change the properties.
 - Alignment palette: For aligning multiple objects.
 - Color palette: For quickly changing the colors of an object.
 - Layer palette: For showing and hiding individual layers.
- Selection window and editing window:
 - Object properties: For checking and assigning statistical and dynamic object properties.
 - Tags: For fast assignment of tags to objects that can be made dynamic.
 - Output window: For displaying faulty picture configurations during saving.
 - Symbol library ("Library" palette): For selecting completed objects from libraries.
 - SVG library: For selecting SVG graphics from libraries.
 - Dynamic Wizard: For making objects dynamic with pre-prepared C actions.
 - Standard: For selecting basic objects that are used often, for example, I/O field or static text.
 - Controls: For integrating elements for controlling and monitoring system processes.
 - Styles: For changing the line type, line thickness, line ends and fill patterns.
 - Process pictures: For opening additional pictures and faceplates of the project.
 - Status bar: For displaying the coordinates, the object type and the language setting.

All are shown in the default setting.

You can show or hide the individual elements by using "View > Toolbars".

To reset all settings of the Graphics Designer to their original state, select "View > Toolbars > Reset".

Layout of palettes and selection windows

You can layout the palettes and selection windows in accordance with your requirements:

- You can position the palettes in the toolbar or freely floating
- You can position the selection windows using  :
 - Undock
 - Docking
 - Document in tab format
 - Automatically in background
 - Hiding

See also

The Properties of an Object (Page 511)

3.4.5.2 Alignment palette

Introduction

You can show or hide the alignment palette by using "View > Toolbars" and position it anywhere on the screen.



You edit multiple objects together with the functions of the alignment palette.

You can also call up these functions from the "Arrange > Align" menu.

Note

"Static Text" object





If rotation angle is not "0" for the "Static Text" object, the object cannot use the "Align" functions of the alignment palette.

Requirements

- You have selected at least two objects.

Overview

The Alignment Palette contains the following functions for processing the objects in a multiple selection:

Button	Function	Reference object
	<p>Align: The selected objects are aligned on the left, right, top or bottom.</p>	<p>If you have selected the objects using a selection border (lasso) with the mouse, the object located the furthest towards the outside is used as reference.</p> <p>If you have selected the objects with the <SHIFT> key and left-click, the first selected object is used as reference.</p> <p>If you have selected the objects with <Ctrl+A>, the reference object of the original selection applies; otherwise that on the outermost object.</p>
	<p>Center: The selected objects are centered horizontally or vertically.</p>	<p>The reference is the shared center axis of the selected objects, independent of the type of selection.</p>
	<p>Distribute: The selected objects are distributed evenly, horizontally or vertically. The outermost objects remain unchanged.</p>	<p>No reference object</p>
	<p>Adjust width or height: The width or height of the selected objects is adjusted to match each other.</p>	<p>If you have selected the objects using a selection border (lasso) with the mouse, the object with the largest width or height is used as reference.</p> <p>If you have selected the objects with the <SHIFT> key and left-click, the first selected object is used as reference.</p> <p>If you have selected the objects with <Ctrl+A>, the reference object of the original selection applies; otherwise the object with the greatest width or height.</p>
	<p>Adjust width and height: The width and height of the selected objects are adjusted to match each other.</p>	<p>The reference object is then the object configured first in the multiple selection.</p>

See also

[How to Align Multiple Objects \(Page 471\)](#)

[How to Select Multiple Objects \(Page 467\)](#)

[Multiple Selection of Objects \(Page 465\)](#)

[The Start Screen of the Graphics Designer \(Page 325\)](#)

3.4.5.3 Layer palette

Introduction

In order to simplify the processing of individual objects in complex process pictures, the Graphics Designer allows you to work with layers. For example, you can distribute the contents of a process picture across up to 32 layers. You can display or hide the layers individually. In the default setting all layers are visible; the active layer is layer 0.

You display or hide the layer palette with "View > Toolbars". To the left of the palette is a handle, which you can use to move the palette to any position on the screen.

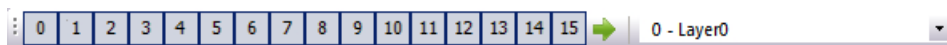

Making layers visible / invisible

Pressed buttons indicate the visible layers. Click a button to make the layer visible or invisible.

Active layer

The active layer is set in the selection list of the layer palette.

Renaming layers

The "Settings" menu on the "Visible Layers" tab is used to rename layers. Double-click the required layer; you can then enter a new name.

Assigning objects to layers

The assignment of an object to a layer can be changed in the "Object Properties" window.

Note

The following WinCC controls are displayed in separate windows and cannot be integrated in the picture layer system:

- WinCC OnlineTableControl
- WinCC OnlineTrendControl
- WinCC UserArchiveControl
- WinCC AlarmControl
- WinCC FunctionTrendControl
- WinCC RulerControl
- .Net Control
- Application window

You can assign a layer to these controls, but this setting will be ignored in Runtime.

See also

How to use the layers palette (Page 391)

Working with Layers (Page 388)

The Start Screen of the Graphics Designer (Page 325)

3.4.5.4 Color palette

Introduction

You can show or hide the color palette with "View > Toolbars" and position it anywhere on the screen.



The color palette allows a fast changing of the color properties of an object.



The 16 standard colors are adapted to the colors of the Microsoft standard programs.



View in the Graphics Designer

To display the changed colors of an object, disable the object property "Effects > Global Color Scheme".

Buttons of color palette

The actual behavior depends on the respective object.

Button	Name	Description	Objects
Color field	Name of the color	Assign color	All WinCC objects with color properties
	Other colors	Defining additional colors in the "Color picker" dialog	-
	Border color	Configuring border color or line color	WinCC objects with the following properties: <ul style="list-style-type: none"> • Line color • Border color
	Background color	Configuring background color	WinCC objects with the following properties: <ul style="list-style-type: none"> • Background color • Line background color

Button	Name	Description	Objects
	Font color	Configuring font color	WinCC objects with the following properties: <ul style="list-style-type: none"> • Font color • Bar color (bar) • Foreground color (WinCC digital/ analog clock control)
	Color picker	Apply color from another object	All objects with color properties

"Color picker" button

Use the "Color picker" button to select a color of an object in the process picture: 

To apply the color, click the button and then click on the color in the process picture. You can also select a color that is displayed on the screen outside the Graphics Designer, e.g. from the desktop. The behavior depends on the clicked-on object in each case.

The color is adopted for the "Border color" button. If you have previously used "Background color" or "Font color", this color is set.

Alternatively, you can also use the color selection in the "Object Properties" window: To apply a color from the process picture for a color attribute, click on the "Color picker" button in the "Static" column.

To apply all properties of an object, use the "Copy properties" button from the object palette.

"Color picker" dialog

You open the "Color picker" dialog with the "Other colors" button. In this dialog you can create other colors in addition to the 16 standard colors.

You can either define these colors directly or select and use a color from the central color palette.

"Colors" tab

To create a user-defined color, you have the following options:

- Color square
- Color circle
- Slider
- Input of RGB values

"Palette" tab

Select a palette color from one of the created project palettes.

If you change the palette color in the central color palette, this change will also be applied in the object properties.

Which project palettes are displayed is dependent on the global design of the WinCC project:

If you have selected the "WinCC Ocean" design, for example, the four project palettes of the linked central color palette "WinCC Ocean" are displayed. To change this setting or to edit another central color palette, open the project properties. Change the settings on the "User Interface and Design" tab.

Display of palette colors

If you click on "Other colors" during selection of the background color, for example, and specify a color from the project palette in the color picker dialog, a bar appears at the color in the font palette:



The color index from the color palette is then displayed for the background color in the object properties.

Using the colors of the color palette

To use one of the 16 standard colors, click on an object and then on the desired color button.

To set specific object properties, combine mouse click and button. The behavior depends on the selected object:

Object	Action	Changed object property
Text objects and closed objects, e. g. rectangle	Click	Background color
	<Ctrl>+Click	Fill pattern color
	<Shift>+Click	Border color
	<Shift+Ctrl>+Click	Border background color
Open objects, e.g. polyline	Click	Line background color
	<Shift>+Click	Line color
WinCC controls	Click	Background color
	<Shift>+Click	Border color (not for all controls)
Siemens HMI Symbol Library:	Click	Background color
	<Ctrl>+Click	Foreground color
No object is selected.	Click	Background color of the active process picture
	<Ctrl>+Click	Fill pattern color of the active process picture

See also

Font palette (Page 334)

How to Transfer Object Properties (Page 529)

The central color palette (Page 346)

"Colors" Property Group (Page 538)

The Start Screen of the Graphics Designer (Page 325)

3.4.5.5 Object palette

Introduction

In the object palette, you select a picture or objects of a picture in order to modify properties or edit objects, for example.



The buttons of the object palette

Icon	Function
	Places the selected object within the layer in the foreground. Objects in the foreground cover objects behind them.
	Places the selected object within the layer in the background. Objects in the background are covered by objects in the foreground.
	Moves the selected object one level below the current level.
	Moves the selected object one level above the current level.
	Copies line and color properties of an object to transfer them to another object.
	Assigns properties of an object to another object. This function is only active if you have copied the properties.
	Mirrors a selected object on its vertical center axis. If a number of objects have been selected, the center axis of the individual objects applies in each case.
	Mirrors a selected object on its horizontal center axis. If a number of objects have been selected, the center axis of the individual objects applies in each case.
	Rotates a selected object by 90° clockwise around its center point. If a number of objects have been selected, the center point of the individual objects applies in each case.

3.4.5.6 Font palette

Overview

You can show or hide the font palette by using "View > Toolbars" and positioning it anywhere on the screen.



You can edit the following text properties with the font palette:

- Character set
- Character set size
- Select special characters from the character map

The font color is selected using the color palette.

Other text properties, such as text in italics or bold print, can be set in the "Object Properties" window.

Default setting of the text properties

You can adapt the default settings of the text properties for each text object through the object properties, see section "The basic settings of the Graphics Designer".

Alternatively, change the default setting by using the font palette:

1. Select a text object in the object palette.
2. Change the properties in the font palette.
3. When you insert the object, the new text properties are applied.

This default setting applies to all process pictures in the WinCC project and is also retained after the project is closed.

In a different WinCC project the object still has the default properties.

Working with the character map

This button opens the "Character map" dialog: 

Alternatively, open the character map in the Graphics Designer via the menu command "Tools > Character map".

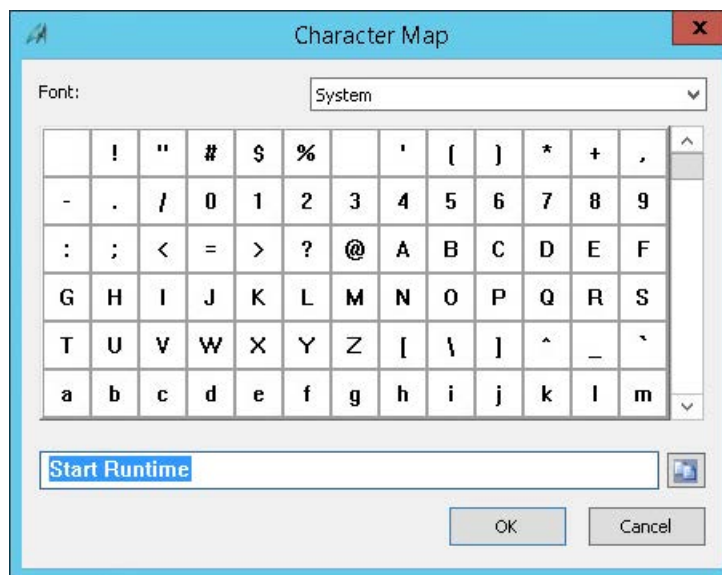

Procedure

1. Select one or more objects in the process picture and click the button .
2. Select the preferred font.
3. To insert a special character in the text field, double-click the character.

4. To copy the content of the text field to the clipboard, click the following button: 
5. To assign the font to the selected objects, confirm with OK.
Depending on the object concerned, the entered text is applied as object property, e.g. as static text.
When you open the character map from the object properties, insert the special characters directly into the selected text attribute.

Clipboard

If no object is selected, you can use the character map to select fonts and characters and copy them to the clipboard.

When you end the dialog with the "Close" button, the text is retained in the text box and displayed again the next time it is opened.

See also

- Color palette (Page 331)
- The Basic Settings of the Graphics Designer (Page 355)
- Managing the default settings of objects (Page 366)
- "Font" Property Group (Page 547)

3.4.5.7 Standard palette





Introduction













The buttons of the standard palette include common commands such as "Save" and special buttons of the Graphics Designer such as "Activate Runtime".

You can display or hide the standard palette with "View > Toolbars". At the left of the palette is a handle, which you can use to move the palette to any position on the screen.



The buttons of the standard palette

Icon	Function	Key combination
	Create a new process picture.	<Ctrl+N>
	Creates a new Faceplate type.	<Ctrl+T>
	Opens an existing process picture.	<Ctrl+O>
	Saves the active process picture.	<Ctrl+S>
	Starts Runtime, for example to test the active process picture. This function is only available if a process picture has been opened.	-

Icon	Function	Key combination
	Cuts out the selected object and copies the object into the clipboard. This function is only available if an object has been selected.	<Ctrl+X>
	Copies the selected object onto the clipboard. This function is only available if an object has been selected.	<Ctrl+C>
	Pastes the content of the clipboard into the active process picture. This function is not available if the clipboard is empty.	<Ctrl+V>
	Undoes the last actions (maximum of 30). This function is only available if an action has been performed beforehand.	<Ctrl+Z>
	Redoes the last undone action. This function is only available if an action has been undone beforehand.	<Ctrl+Y>
	Prints the content of the active process picture. This function is only available if a process picture has been opened.	<Ctrl+P>
	Hides and shows the grid in the active window.	-
	Switches the function "Snap to Grid" on and off.	-
	Shows or hides the "Object Properties" window.	-
	Shows or hides the "Library" window.	-
	Shows or hides the "SVG Library" window. Finished devices can be stored in the project libraries of the Graphics Designer so that they can be inserted later in another process picture. The "Global Library" area contains many standard forms, such as electric circuits or sensors.	-
	Opens the VBA Editor.	<Alt+F11>
	Activates the direct help (What's this?).	<SHIFT+F1>

See also

The Start Screen of the Graphics Designer (Page 325)

3.4.5.8 Status bar

Introduction

The status bar contains information about:

- The language currently set
- The designation of the active object
- The position of the active object in the picture
- Keyboard settings

You can display or hide the status bar with "View > Toolbars".

Overview



- <F1> is used to call up the direct help of the selected icon or window.
- The language currently selected in the Graphics Designer is displayed.
- The designation of the selected object is displayed. If a number of objects have been selected, "Multiple Selection" is displayed.



- Coordinates of the selected object
At "X:250 Y:40" the selected object lies 250 pixels to the right and 40 pixels below the origin of coordinates. The values are updated automatically during the movement of an object, thus making exact placement easier.
- Size of the selected object
At "X:50 Y:50" the selected object is 50 pixels wide and 50 pixels high. The values are updated automatically during the size change of an object, thus making exact scaling easier.



- CAPS: "Caps locked". <CAPS LOCK> was pressed. The text is entered in upper-case characters.
- NUM: <NUM> was pressed. The numerical keyboard is activated
- SCR: "Scroll locked" <SCROLL LOCK> was pressed.

See also

Working with Standard Objects (Page 565)

The Coordinate System of a Process Picture (Page 319)

The Coordinate System of an Object (Page 321)

The Start Screen of the Graphics Designer (Page 325)

3.4.5.9 Zoom palette

Overview

You can show or hide the zoom palette by using "View > Toolbars" and position it anywhere on the screen.



You select the required zoom factor with the zoom palette.

- Use the icons for zooming in or out or the displayed percentage value to the next higher or lower value.
- Use the "Zoom selection" icon to zoom into the selection of the process picture. Then drag the frame to the required size. The aspect ratio of the process picture window is maintained.
- Enter a percentage between 2% and 800%.
- Click the drop-down button to use the pre-defined zoom factors.
- Zooming with the mouse wheel: "<Ctrl>+mouse wheel".

Note

You can define the minimum and maximum zoom factor individually for all layers. For example, you can place detailed representations on a separate layer and only display the representations above a specific zoom factor. You can find additional information in the section "Showing and hiding layers and objects".

Use the scroll bars to move the visible area with a large zoom factor.

The Graphics Designer offers operation with the mouse wheel. Click the mouse wheel. The mouse pointer changes and you can move the visible picture area simply by moving the mouse.

See also

Showing and hiding layers and objects (Page 364)

The Start Screen of the Graphics Designer (Page 325)

3.4.5.10 Output window**Overview**

The output window displays information, errors and warnings regarding the configuration when saving a picture. Double-clicking a message selects the respective picture object, for example, or the property of the object that contains the respective script.

You can copy the entries in the output window to the clipboard.

3.4.5.11 Symbol library**Overview**

The Symbol library of the Graphics Designer is a versatile tool for saving and managing graphic objects that can be used for creating process pictures.

Global library

The "Global Library" offers a variety of pre-defined graphic objects that you can insert into a picture as library objects and configure as required. Graphic objects such as machines and plant components, measuring equipment, operator control elements and buildings are thematically organized in folders.

Project Library

The "Project Library" enables a project-specific library to be built. The objects can be sorted by subjects by creating folders and subfolders.

You can find detailed information under "Working with objects/Working with libraries"

See also

Working with the library (Page 737)

3.4.5.12 SVG library

Overview

The SVG library of the Graphics Designer is a versatile tool for saving and managing graphic objects that can be used for creating process pictures.

Global library

The global Library contains read-only SVG libraries with prefabricated SVG graphics that are available as "zip" files under "SVGLibrary" in the WinCC installation folder. WinCC installs a separate Standard SVG Library. PCS 7 and other products can provide their own SVG libraries.

You can select the global SVG libraries individually and use them in your WinCC project with the shortcut menu command "Use in project". These libraries are copied uncompressed into the project folder under "GraCS/SVGLibrary" and added to the "Project Library". The SVG graphics they contain can be used in the objects of the Graphics Designer that have the "Picture" property.

The global SVG libraries contain version information. This enables you to distinguish modified libraries in the installation folder from libraries already used in the project. When you open the Graphics Designer, you receive a message that newer versions of the global SVG libraries are available. You can decide whether you want to update these libraries for the project.

Project Library

The "Project Library" enables a project-specific library to be built. The objects in the library are stored in the project folder under "GraCS/SVGLibrary". The "Project Library" may also contain metadata ("PXL" files), which load the contents of the SVG objects.

When you create a new WinCC project, the project folder is empty. You manage the project library using the shortcut menu. The objects can be sorted by subjects by creating folders and subfolders.

To expand or change the libraries, you need to remove the write protection via the shortcut menu. You can recognize a read-only SVG project library by the red color of the folder.

You store user-defined objects here as a copy and make them available for multiple use. Because the Project Library is only available for the current project, you can only include dynamized objects in this library. The names of user-defined objects inserted into the library can be freely selected.

You can find detailed information under "Working with objects > Working with libraries > Working with the SVG Library" and "How to work with SVG project libraries".

See also

How to work with SVG project libraries (Page 743)

3.4.5.13 Controls

Introduction

The "Controls" selection window displays those control objects used often by default. You display or hide the selection window with "View > Toolbars". The selection window can be moved to any position on the screen.



Overview

The following control groups are differentiated:

- ActiveX controls are used for monitoring and visualization of measured values and system parameters.
- .NET controls are control elements from any supplier with the .NET Framework as of 2.0 from Microsoft.
- WPF Controls are control elements from any supplier with the .NET Frameworks as of 3.0 from Microsoft.

You can integrate additional controls by using the "Add/Remove" pop-up menu.

When some control objects are selected, you may be able to open additional dialog and configuration windows.

See also

How to configure the object selection (Page 304)

The Start Screen of the Graphics Designer (Page 325)

Working with Standard Objects (Page 565)

- Working with Smart Objects (Page 598)
- Working with Windows Objects (Page 679)
- Working with Controls (Page 749)

3.4.5.14 Dynamic Wizard

Overview

The Dynamic Wizard provides a large number of predefined C Actions to support configuration of frequently recurring processes. The C Actions are sorted in topics in the form of tabs. The content of the individual tabs can vary depending on the selected object type.

You display or hide the selection window with "View > Toolbars". The selection window can be moved to any position on the screen.

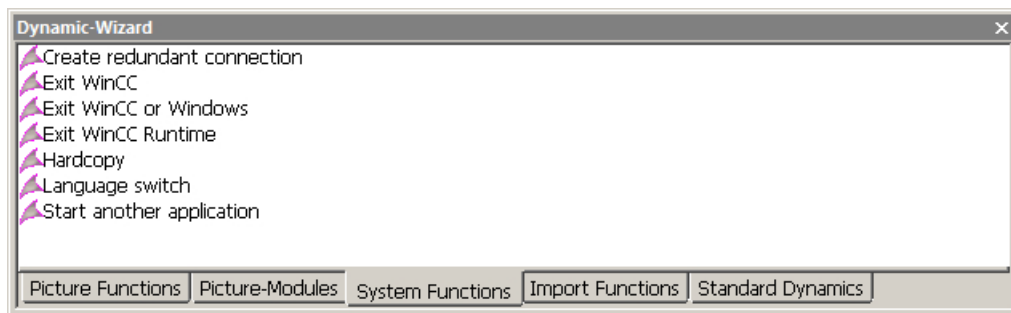

You can find a detailed description of the Dynamic Wizard in the section "Making Process Pictures Dynamic".

See also

- Dynamic Wizard (Page 1179)
- The Start Screen of the Graphics Designer (Page 325)

3.4.5.15 Process pictures

Introduction

The "Process pictures" selection window displays all pictures and faceplates from the "GraCS" folder of the project. The content of the selection window is updated as soon as you copy new files to the folder.

You display or hide the selection window with "View > Toolbars". The selection window can be moved to any position on the screen.

Overview

Double-click an entry in the selection window to open the selected picture.

You can select several entries.

Filtering process pictures

Use the file filter in case of many pictures.

Enter a letter string. The selection window only displays pictures with the filtered letter string.

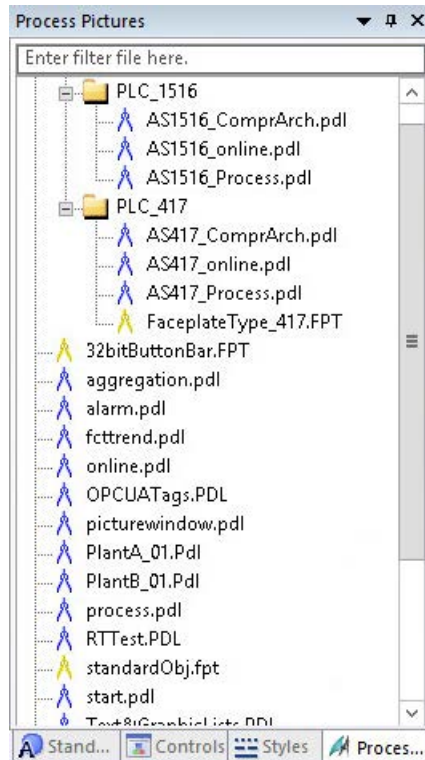

Drag&Drop to a process picture

When you drag a picture or faceplate type to an open process picture, the following actions are triggered:

- PDL file:
A button with the pre-configured picture change at mouse click is created.
- FPT file:
A faceplate instance is created in the picture.
- Drag a PDL file to a picture while pressing the <Alt> key:
A picture window with the picture file is created.
- Drag PDL file to a picture with a right-click:
Choose whether a button or a picture window is created.

3.4.5.16 Standard

Introduction

The "Standard" selection window makes available various object types that are often used for the process pictures.

You display or hide the selection window with "View > Toolbars". The selection window can be moved to any position on the screen.

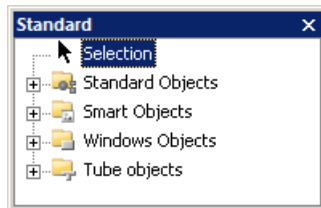

Overview

The following object groups are differentiated:

- Standard objects: e.g. line, polygon, circle, rectangle, static text
- Smart objects: e.g. application window, picture window, I/O field, bars, status display
- Windows objects: e.g. button, check box, option group, slider object
- Tube objects

You can read about how to configure the Object Palette yourself in the chapter "Configuring object selection".

Using the objects

Select the required object from the selection list. Drag this object with the mouse and drop into the desired area of the picture. The object can be moved freely within the picture using the mouse.

See also

The Start Screen of the Graphics Designer (Page 325)

How to configure the object selection (Page 304)

Working with Smart Objects (Page 598)

Working with Windows Objects (Page 679)

Working with Tube Objects (Page 698)

Working with Standard Objects (Page 565)

3.4.5.17 Styles

Introduction

In the "Styles" selection window you can change the line type, line thickness, line ends and fill patterns.

You display or hide the selection window with "View > Toolbars". The selection window can be moved to any position on the screen.

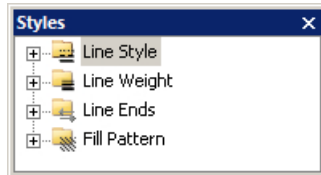

Overview

- Line type: Contains different line representations such as dashed or dotted.
- Line thickness: Determines the line thickness. The line weight is specified in pixels.
- Line ends: You have the ends of lines displayed, for example, as arrows or rounded.
- Fill pattern: Provides the option of displaying closed objects with a transparent or checkered background.

The "Global Color Scheme" entry is based on the selected object. If no fill pattern is configured for the object, the selected object uses the "Global Color Scheme" property. If no object is selected, the setting relates to the fill pattern on the basic picture.

Drag-and-drop a design element

If you use drag-and-drop to insert a style item into one or more objects of the picture or the picture itself, the object/picture applies the style item.

The "Global Color Scheme" object property is automatically set to "No". To reset the property for the object, you need to drag the "Global Color Scheme" entry under "Fill pattern" onto the object.

Displaying the current settings

If an object has been selected, the specified style properties of the object are highlighted in a bold font.

See also

The Start Screen of the Graphics Designer (Page 325)

3.4.5.18 Tags

Introduction

The "Tags" selection window enables fast linking of process tags to objects.

You display or hide the selection window with "View > Toolbars". The selection window can be moved to any position on the screen.

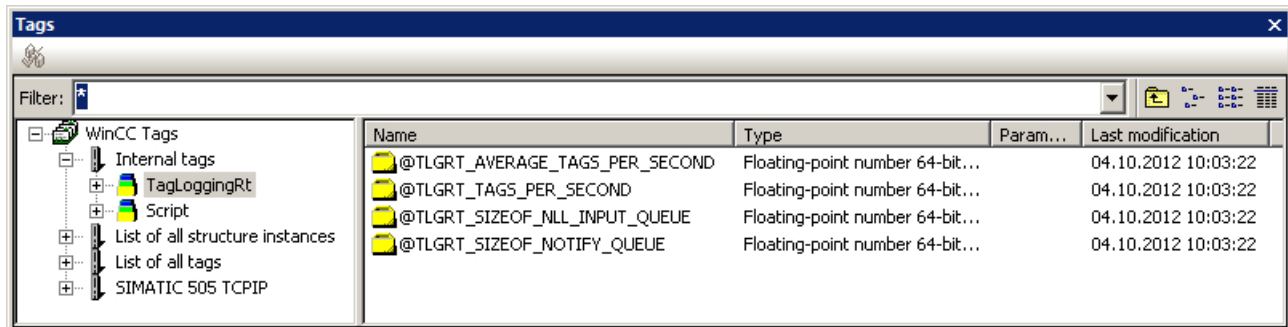

Overview

The "Tags" selection window contains a list of all of the tags available in the project as well as a list of the internal tags. You can use filters, change the view and update the connectors.

With the mouse button pressed, the tags in the right-hand window can be dragged to attributes of an object in the "Object Properties" window.

See also

The Start Screen of the Graphics Designer (Page 325)

Basic Dynamic Operations (Page 485)

Selecting a tag (Page 705)

How to change the tag connection of objects using linking (Page 499)

3.4.6 The Central Color Palette

3.4.6.1 The central color palette

Introduction

In WinCC, you can work with a central color palette.

This requires assigning certain index colors of your choice. You can then not only assign explicit colors to the object properties in the Graphics Designer but also color indices from the central color palette as well.

When you then change the central color palette, the color settings are simultaneously changed in all objects for which color indices of the palette are defined.

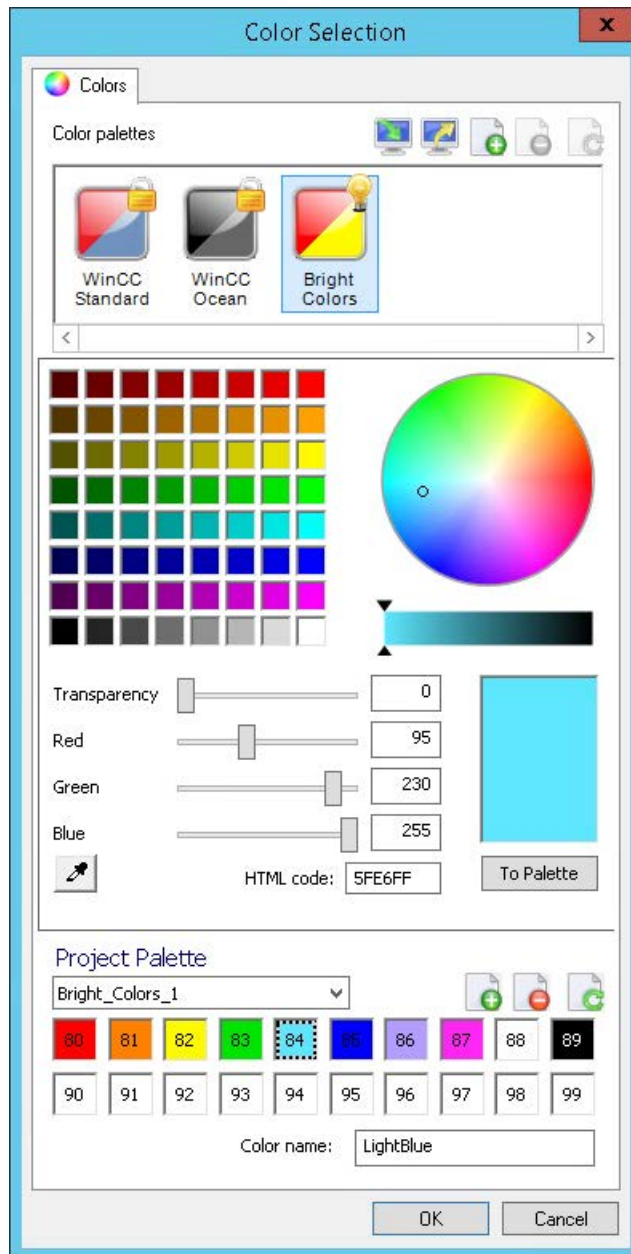

Requirements

- "WinCC Classic" is not set as the global design. Only certain color settings are available with this design. All other designs support the central color palette.

Use in the Graphics Designer:





- The desired central color palette is linked to the current global design.
Only the color palette of the active design is displayed in the "Color Selection" or "Central Color Palette" dialog in the Graphics Designer.
- The "Global color scheme" is set to "No" in the object properties under "Display".

Working with palettes

You manage the color palettes of the WinCC project in the "Color Selection" dialog that you open using the "Project Properties" dialog.

The "WinCC Standard" color palettes and "WinCC Ocean" are already created. These color palettes are used for the predefined global designs.

You can create additional color palettes or import color palettes from other projects.

Icon	Action	
	Create palette	Create your own color palette or a new project palette. Create a new color palette: The linked project palettes of the last displayed color palette are copied and linked to the new color palette. Changes to the new, copied project palettes have no effect on the other color palettes.
	Delete palette	You delete the currently displayed color palette or project palette.
	Rename palette	Select a descriptive name for the new color palette or project palette.
	Import color palette	You import a color palette from a different WinCC project.
	Export color palette	You export the color palette of the project as XML file.
	Edit palette	You can create multiple project palettes for each color palette. You can also edit the project palettes using the Graphics Designer. You add, change or delete colors in the project palettes. Each color palette may contain up to 10 project palettes with 20 colors each. The palette does not have to be completely defined. As soon as you change the central color palette in the project settings, it affects those object elements in the objects that have colors assigned from the central color palette.

Selecting a color palette

The central color palette is defined by the selected global design of the WinCC project.

To use another color palette, change the design in the project properties.

Procedure

1. In WinCC Explorer, select the "Properties" entry in the shortcut menu of the project.
The "Project Properties" dialog opens.
2. On the "User Interface and Design" tab, click the "Edit" button in the "Active Design" area.
The "Global Design Settings" dialog opens.

3. Click on the "Color palette" entry in the "Effects" area.
Select the desired color palette from the drop-down list.
Alternatively, select a different design that is linked to the desired color palette.
4. Confirm with OK.
The name of the color palette that is linked to the active design is displayed in the "Central color palette" area.

Using the central color palette for objects

In the Graphics Designer the linked project palettes are shown in the color selection on the "Palette" tab.

When selecting the color for an object element, you can select a color index from the central palette.

If you open a process image on the server from a client, the central color palette of the server is used.



See also

How to define the central color palette (Page 350)

How to export and import color palettes (Page 353)

"Colors" Property Group (Page 538)

Color palette (Page 331)

How to Change an Attribute (Page 525)

How to change the default setting of object types (Page 457)

3.4.6.2 How to define the central color palette

Introduction

The central color palette contains indices for assigning certain colors. If you change the central color palette, you also change all of the indexed colors from the central color palette used in the objects along with it.



The central color palette contains a maximum of 10 project palettes with 20 colors each.

The central color palette does not have to be completely defined.

Procedure

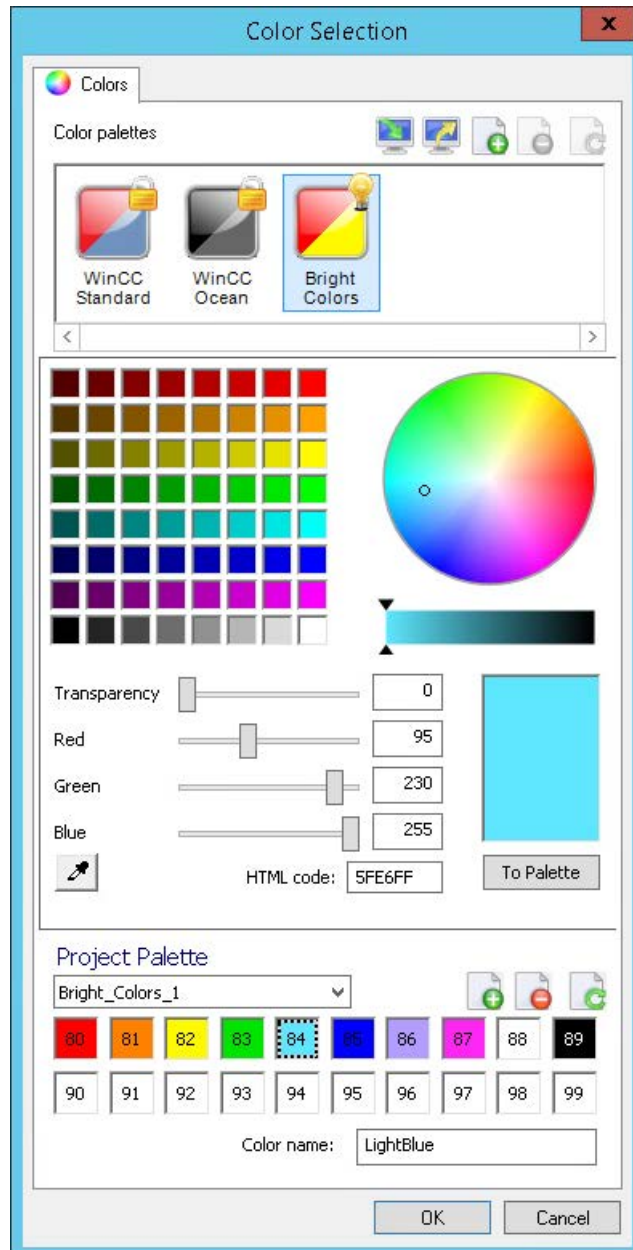
1. Click on the project name in the navigation window of WinCC Explorer. Select the "Properties" entry in the shortcut menu.
The "Project properties" dialog opens.
2. On the "User Interface and Design" tab, click on "Edit" in the "Central color palette" area.
The "Color selection" dialog box is opened.
The central color palettes created in the WinCC project are displayed in the "Color palettes" area. All WinCC projects already contain the color palettes that were supplied with the WinCC installation.



3. In order to create a new color palette, click on  in the "Color palettes" area.
A new color palette is created.
The linked project palettes of the last displayed color palette are copied in the "Project palette" area. The colors of the copied project palettes are applied.
4. To rename the color palette, click on .
Assign a descriptive name for the palette.
5. Select the desired palette in the "Project palette" area.
You can rename or delete the copied palettes and create new project palettes using the symbols in the "Project palette" area.
6. Define the desired color by moving the sliders for red, green and blue to the desired values.
Alternative procedures:
 - Click in the color square or in the color circle. Define the brightness on the scale.
 - Enter the RGB value directly or via the HTML code.
 - Copy a color with the "Color Selection" symbol: .
Click the symbol and then click on the color of an object on the screen.
The behavior depends on the clicked-on object in each case.
7. Determine the transparency of the color.
8. Click on the "To Palette" button and then in the relevant box.
The color is transferred to the box.
9. Click on the box to enter a color name. The selection is displayed as a dashed frame.
Enter the color name. The entered name is applied for the selected box.
10. Repeat steps 6 to 9 until the project palette is full.
11. Repeat steps 5 to 9 for additional project palettes, if necessary.
12. Confirm with "OK".

Graphics Designer: Defining the project palette

To create or change project palettes in the Graphics Designer, select the entry "Tools > Central Color Palette" in the menu.

However, only the central color palette that is linked to the active global design is displayed in the "Central color palette" dialog.

Result

The central color palette is defined.

If you change the colors of the project palettes, all of the colors selected from the central color palette are also automatically changed in the objects.

See also

The central color palette (Page 346)

3.4.6.3 How to export and import color palettes

Introduction

The central color palette contains indices that are assigned to certain colors. If you change the central color palette, you also change all indexed colors used in the objects from the central color palette.

The central color palette is subdivided into a maximum of 10 color areas each with 20 colors.

Note

The central color palette does not need to be fully defined.

You can make a central color palette that you have created available to another project by exporting or you can import the palette from another project into your project. To export or import a color palette, proceed as follows:

Procedure

1. Click the project name in the navigation window of the WinCC Explorer and select the Properties command in the pop-up menu. The "Project properties" dialog will open.
2. On the "User Interface and Design" tab, click "Edit" next to "Central Color Palette". The "Color Selection" dialog box opens.

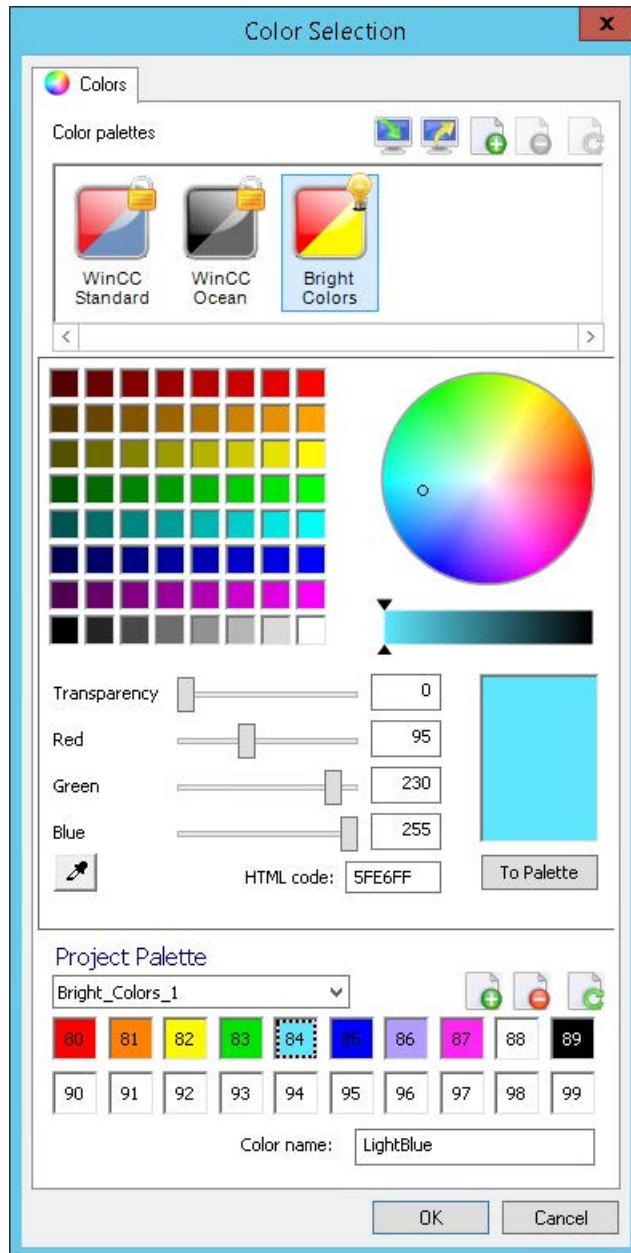

3. To export the current central color palette, click on  "Export palette".
4. Enter the path and name of the XML file in the dialog and confirm with "OK". The color palette is exported.

- To import a palette, click on  "Import palette", select the desired XML file in the file selection dialog and click "Open".
The dialog box for importing the palettes appears.

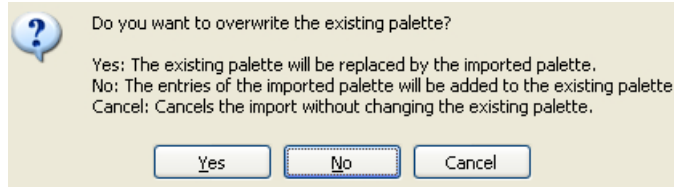

- Select one of the three options.

Note

If the attachment of the imported palette exceeds the total maximum number of colors, the excess colors will not be imported.

The palette is imported.

All indexed colors, i.e. those selected from the central color palette, are then automatically changed in the objects.

Attaching a Color Palette That is Too Large

The following example shows the attachment of a color palette that is too large.

Example:

Your palette has five color areas, i.e. 100 indexed colors. You want to import a color palette with seven color areas, i.e. 140 indexed colors.

Result:

The first five color areas of the palette to be imported are imported; the last two color areas of the palette are not imported.

See also

The central color palette (Page 346)

3.4.7 The Basic Settings of the Graphics Designer

3.4.7.1 The Basic Settings of the Graphics Designer

Introduction

The following basic settings of the Graphics Designer can be customized:

- Displaying and setting the grid
- Visibility and zoom factors of the individual layers

- Default objects configuration
- General settings and options

Opening the "Settings" window

In the "Options" menu, select the "Settings..." command. A window with the tabs for the various setting options opens.

As an alternative, you can also open the window using the entries "Grid" or "Layers" in the "View" menu.

See also

Elements and Basic Settings of the Graphics Designer (Page 319)

Customizing the Working Environment (Page 370)

Working with Layers (Page 388)

Changing the default trigger (Page 368)

Managing the default settings of objects (Page 366)

Showing and hiding layers and objects (Page 364)

Making layers invisible (Page 362)

How to set the options in Graphics Designer (Page 358)

How to Set the Grid (Page 356)

3.4.7.2 How to Set the Grid

Introduction

You can display a background grid in the Graphics Designer to enable precise work.

If required, you can enable the option "Snap to grid". Then, all objects that are created or moved are automatically aligned to the grid.

Showing the grid and aligning to the grid can be set via the Standard Toolbar. The grid width is set via the basic settings of the Graphics Designer.

The set grid properties are not saved with the process picture. When opening again or when a new picture is created, the default settings of the program are used once again.

Opening the "Settings" window

In the "Extras" menu bar, select the "Settings..." menu. Click the "Grid" tab.
As an alternative, you can also open the window using the entries "Grid" or "Layers" in the "View" menu.

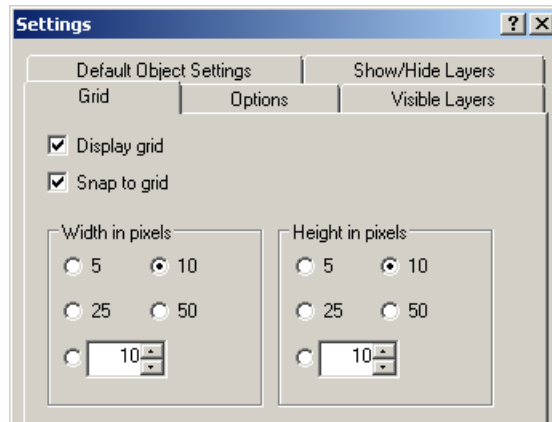

Snap to Grid

If the check box is enabled, objects are aligned to the grid points when they are created, inserted and moved. Objects that have already been created are only aligned to the grid when they are moved.

Display grid

When the check box is enabled, the grid points are shown.

Width in pixels

Horizontal spacing of the grid points. Maximum distance: 100 pixels

Height in pixels

Vertical spacing of the grid points. Maximum distance: 100 pixels

With a large grid width, objects are aligned to the left or upper grid points, as the case may be.

Alternative procedure

All grid properties can be changed in the "Object Properties" window of the active process picture. The color of the grid can also be changed there.

Note

The minimum grid spacing that can be displayed on the screen is 10 pixels. If you want to set a smaller value, you can align objects to this grid. On the screen, however, the grid spacing displayed is the first multiple of the grid value that is greater than or equal to ten.

Example: You set 6 pixels as grid spacing; a grid of 12 pixels is shown on the screen. Objects can be placed on one grid point or between two grid points.

3.4.7.3 How to set the options in Graphics Designer

Introduction

Different program settings of the Graphics Designer can be changed and saved.

Opening the "Settings" window

In the menu bar, select "Tools" and click on "Settings...". The window with the tabs for the various setting options opens. Click on the "Options" tab.

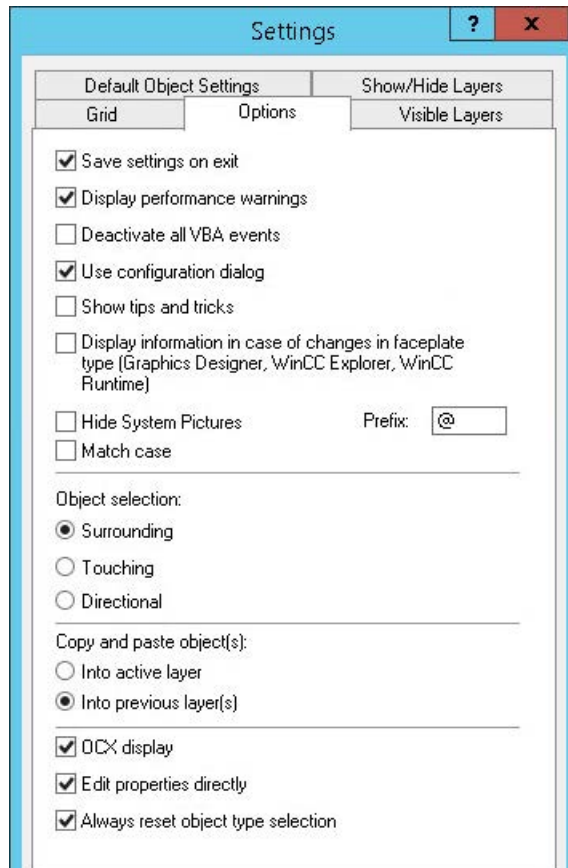

Save settings on exit

If this check box is enabled, the changes you have made in the "Settings" window are saved when you exit from the program. If the check box is disabled, the changed settings are lost. The default setting is that the check box is enabled.

Note

The "Save settings on exit" check box must be enabled for the settings in this dialog to be retained when you exit from the program.

Issue performance warnings

Cyclic triggers can lead to a high system load.

If the check box is enabled, a warning is issued in the event of a system overload as soon as the picture is to be saved. This warning contains the name of the object and the attribute that has been made dynamic and has led to the overload. If the check box is disabled, you do not

receive a warning, i.e. also no indication of the cause of the overload. The default setting is that the check box is enabled.

Disable all VBA events

If the check box is enabled, the configured VBA events to monitor the VBA actions is not triggered. The default setting is that the check box is disabled.

Use configuration dialog

If the check box is activated, the "Configuration Dialog" window opens automatically if the inserted object has a configuration dialog.

Objects with configuration dialog:

- Smart objects: I/O field, bar, graphic object, status display, text list, DataSet, SVG object.
- Windows objects: Button, Slider object
- Controls: All except WinCC Digital/Analog Clock Control, WinCC Gauge Control, WinCC Slider Control, WinCC Media Control, WinCC WebBrowser Control

If the check box is not enabled, the objects are inserted with the default settings.

Independent of whether the check box is enabled, the configuration dialog can be opened at any time via the context-sensitive menu. Right-click the object and select the entry "Configuration Dialog..." in the shortcut menu.

The configuration dialog is always opened when the following objects are inserted:

- Smart objects: Application window, Control, OLE object, Faceplate instance, .NET Control, WPF Control.

Hide system screens

If the check box is activated, those pictures are hidden in the "Process pictures" window whose name begins with the selected prefix.

- The prefix can be all characters or strings with which the name of a process picture can begin.
- To further limit the selection, select the option "Match case".
- To hide all WinCC system screens, select the prefix "@".

All the process pictures continue to be displayed in the selection dialog "File > Open" as well as in the WinCC Explorer data window.

In order to hide process pictures in the WinCC Explorer, activate the option in the dialog "Computer Properties > Graphics Runtime".

Display information in case of changes in faceplate type

If the check box is selected, the "Faceplate instances with type change" dialog box is shown with all faceplate instances that are to be checked. The dialog opens in Graphics Designer when you want to save a picture with faceplate instances that are affected by a change in type-specific properties and events.

Check all scripts linked with the faceplate instance, as a complete, automatic adjustment of the scripts in the instances cannot be guaranteed.

When you have checked the scripts and adjusted them as necessary, select the check box in front of the instance in the dialog. This hides the red crosses over invalid faceplate instances.

Display tips and tricks

If the check box is enabled, every time the Graphics Designer is started a tip on creating or optimizing process pictures is displayed.

The default setting is that the check box is enabled. Tips and tricks are displayed during the program start.

Object selection

Objects can be selected by clicking or by drawing a selection border. This selection border is also referred to as a 'lasso'.

You can specify whether the lasso must fully enclose the objects or whether contact with the lasso is sufficient to select an object.

- With the option "Surrounding", the complete objects must lie in the selection border (lasso).
- With the option "Touching", it is sufficient that an object touches the selection border (lasso).
- With the option "Directional" the direction of movement of the mouse determines the behavior:
 - Drag mouse from top to bottom: Surrounding
 - Drag mouse from bottom to top: Touching

The default setting is that the "Surrounding" option is selected.

Copy and paste objects

If the option "In active layer" is selected, copied objects are pasted into the active layer, independent of the layer from which they have been copied.

If the option "in present layer(s)" is selected, copied objects are inserted into the layer from which they were copied. If a number of objects are selected and copied from different layers, each individual object retains the layer to which it was allocated.

OCX display

If the check box is activated, ActiveX controls in the Graphics Designer are shown in your activated look. Setting the OCX representation only has an effect when process pictures are being created, not in Runtime. The default setting is that the representation of ActiveX Controls is enabled.

Directly edit properties

Attributes of objects can be changed via the object properties. Whether a value can be entered directly in the "Object Properties" window or whether a dialog box is to be opened is specified using the "Directly edit properties" check box.

If the check box is enabled, the value of an attribute can be changed by double-clicking on the attribute in the "Object Properties" window. If the check box is not enabled, double-clicking opens a window for value input. The default setting is that the check box is enabled; digits and text can be entered directly in the "Object Properties" window.

Always reset object type selection

If the check box is enabled, the mouse pointer turns back into the selection mouse pointer after an object has been inserted. However, if you want to insert a number of objects of the same type, you can disable the check box. Then, the active object type remains active after an object has been inserted, and the same object can be quickly inserted a number of times. You then do not have to reselect the object type for each object to be inserted. The default setting is that the check box is enabled.

See also

Settings for Runtime (Page 168)

3.4.7.4 Making layers invisible

Introduction

You can make the individual layers of a picture visible or invisible in Graphics Designer. This shows or hides the objects of the various layers.

The settings can be made independently of one another for CS (Configuration System) and RT (Runtime). The different visibility of the layers has the advantage that you can include more information in the picture than is visible in Runtime.

When a picture is opened, all layers in the Configuration System are always visible. The settings of the layers that were invisible during the editing are not stored when the Graphics Designer is terminated.

You can rename a layer after double-clicking it.

The settings in this tab are retained when you exit from the program if the "Save settings on exit" check box is enabled in the "Options" tab.

Opening the "Settings" window

In the "Extras" menu bar, select the "Settings..." menu. Click on the "Visible Layers" tab.

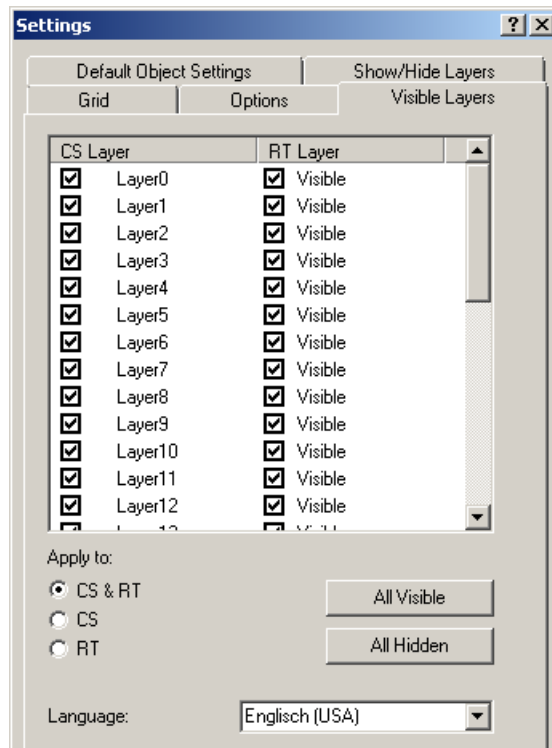

Layers window

You can make the individual layers of a picture visible or invisible. When the check box is enabled, the corresponding layer is visible. The active layer always remains visible.

All layers visible / invisible

Clicking on one of the buttons makes all layers visible or invisible. If you click "All invisible", only the active layer remains visible. Depending on the setting "Apply to", the buttons change the layers in the CS and/or in Runtime. The active layer always remains visible.

Language

You can change the names of the layers for each language. Set the language and rename the layers in the 'Layers' window.

3.4.7.5 Showing and hiding layers and objects

Introduction

Whether layers and objects are shown or hidden in the process picture can be made dependent on the current zoom factor. For example, it is possible to show details as of a certain zoom factor and not before.

Each layer can be assigned its own minimum and maximum zoom in Graphics Designer. It is also possible to show only objects whose display size lies within a defined range.

The settings in this tab are retained when you exit from the program if the "Save settings on exit" check box is enabled in the "Options" tab.

Opening the "Settings" window

In the "Extras" menu bar, select the "Settings..." menu. Click the "Show/hide layers" tab.

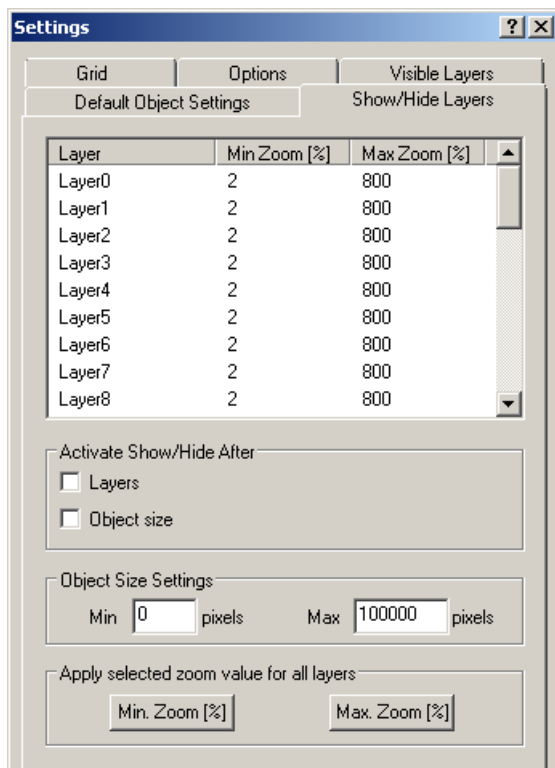

Setting zoom ranges for individual layers

Double-click the digits in the columns "Min Zoom" or "Max Zoom" to set the zoom range in which the contents of a layer is to be displayed. The zoom range is specified in %. The minimum value is 2%, the maximum value 800%.

Activate the "Layers" check box under "Activate show/hide".

Note

If you have set the zoom ranges for the layers and want to zoom in on the process picture when processing, disable the "Layers" check box. The set zoom ranges for the layers are disabled but are retained, and you see all the details of the picture.

Example

The coarse display lies on Layer 8; the detail display of an area lies on Layer 10. Layer 8 is displayed in the zoom range between 80% and 800%; Layer 10 is displayed in the zoom range between 100% and 800%, see figure below. With this setting, the details of Layer 10 are only shown when the user zooms in to the picture by over 100%.

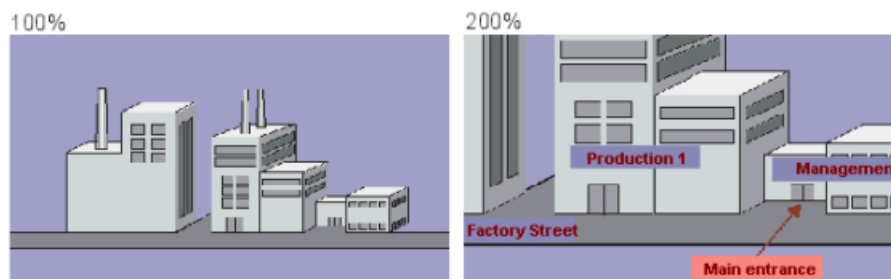

Setting the size range for the display of objects

If objects are only to be displayed in the range between a minimum and maximum display size, you can define the size range. The display size is independent of the object size: An object is shown within the zoom factors that show the object in the set size.

Enable the "Object Size" check box and enter the minimum and maximum size in pixels. When you confirm this input with "OK", only objects in this display size are displayed.

Note

If you have set the display size and want to zoom in on the process picture when processing, disable the "Object size" check box. The settings are disabled but are retained, and you see all the details of the picture.

Adopting selected zoom value for all layers

If you want to change the zoom range for all layers, set it in the upper window for a layer and click the "MinZoom" or "MaxZoom" button. The layer from which the zoom ranges are adopted must be selected. Enable the "Layers" check box to display the settings.

3.4.7.6 Managing the default settings of objects

Introduction

In the Graphics Designer, the various object types have default properties. If an object from the Object Palette is inserted in a picture, the object adapts to these default settings.

Working with default objects

You can adapt default settings for individual object types to meet your needs. Ideally you adapt the default settings before you begin creating a process picture. In this way, the extent of later adaptations, such as for frequently used objects, can be limited.

If you want to represent a complex process and need numerous process pictures with identical property settings for it, it is appropriate to create a "master picture". You define the object settings in this picture and use it as a template for all individual process pictures.

All information on the default setting for object types is contained in a file with the format "PDD". By default this is the "Default.pdd" file in the "GraCS" project folder. You can use the "Default Objects Configuration" tab to select the following options for default settings of object types:

- Saving the default settings immediately or automatically when terminating the Graphics Designer
- Loading default settings of a different project into the current project
- Changing the file name and folder path for saving the PDD file

Opening the "Settings" window

In the "Extras" menu bar, select the "Settings..." menu. Click on the "Default Objects Configuration" tab.

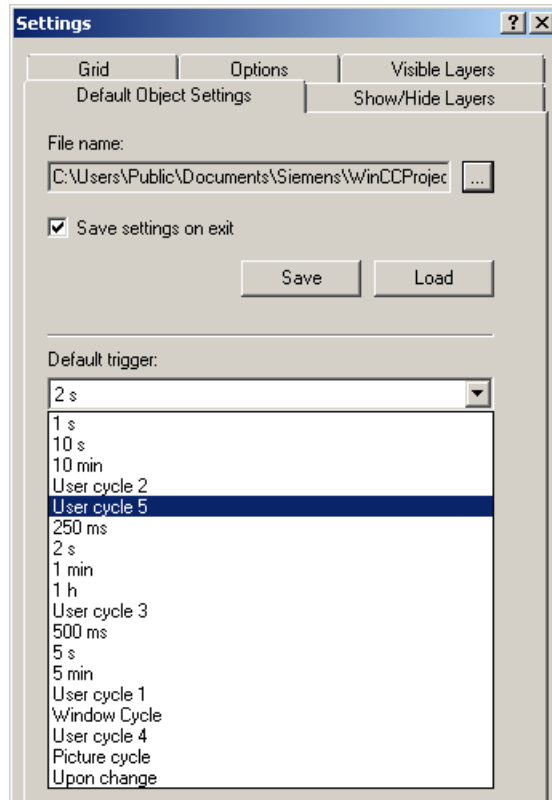

Saving default settings of objects

1. In the "File name" field click the button .
The "Default objects" dialog is opened.
2. Select the PDD file in which you want to save the changes and confirm your selection with "OK".
By default, the PDD file of a project is stored in the "GraCS" folder.
3. In the "Save" field, click the "Save Now" button.
The changed default settings are saved in the selected PDD file.
4. Enable the "Save Configuration on Exit" check box if you want the default object configuration to be saved when you exit from the Graphics Designer.

Loading default settings of objects

1. Click the  button in the "File" field.
The "Default objects" dialog is opened.
2. Select the PDD file you would like to load and confirm your selection with "OK".
By default, the PDD file of a project is stored in the "GraCS" folder.

3. Click on the button "Load now".
The default objects configuration is imported from the selected PDD file into the current project.
4. You can now save the loaded default settings in the current project folder:
In the "File" field click the button .
The "Default objects" dialog opens.
5. Select the PDD file of the current project and confirm your selection with "OK".
6. In the "Save" field, click the "Save Now" button.
The imported default settings of the objects are saved in the PDD file of the current project.

Note

The default settings for objects do not apply across all projects. The changed default settings only apply to the pictures of the currently opened WinCC project. The basic settings of the Graphics Designer are not changed.

See also

- Changing the default trigger (Page 368)
- How to Change an Attribute (Page 525)
- How to change the default setting of object types (Page 457)
- Controls (Page 341)
- The Properties of an Object (Page 511)
- The Basic Settings of the Graphics Designer (Page 355)

3.4.7.7 Changing the default trigger

Introduction

The trigger set in Graphics Designer specifies the update cycle of the process pictures in Runtime.

The value selected as "default trigger" is the default update cycle for all objects.

For individual objects, you can assign individual update cycles to the attributes that have been made dynamic.

Example:

- If you want to update numerous objects in a cycle of 2 seconds, select the default trigger to "2 s".
The trigger setting for tag connection of the individual attributes has been changed for all process pictures and objects.
- If you want to update the attributes of some objects in a different cycle, change the trigger setting in the object properties of the objects.

Differentiation from Tag Logging

The update cycle of the process pictures is independent of the "Acquisition cycle" or "Logging cycle" in the process value archiving.

Opening the "Settings" window

In the "Extras" menu bar, select the "Settings..." menu.

Click on the "Default Objects Configuration" tab.

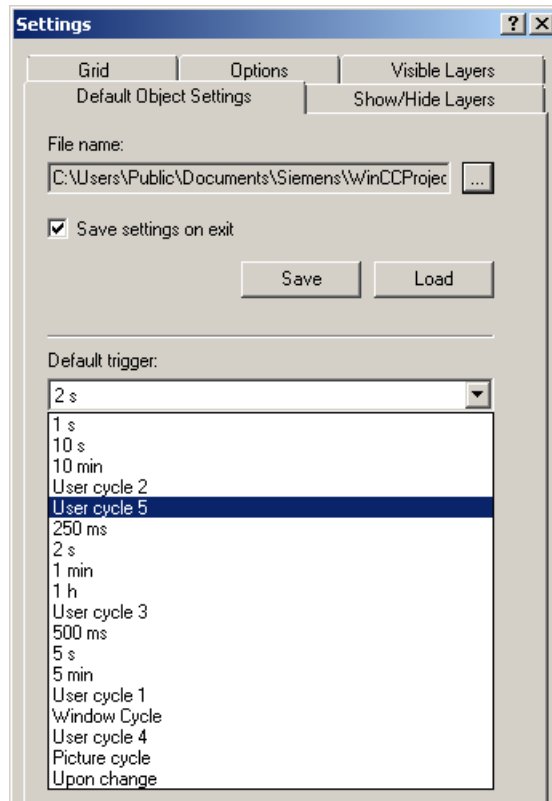

Selecting the default trigger

Open the dropdown list box and select a value.

You can find the list of default triggers in the project properties in the "Update cycles" tab.

The standard cycles cannot be changed. You can define the five user cycles "User cycle <x>" yourself.

Picture cycle

A cyclic trigger is used as the trigger.

The cycle time is defined by the object property "Update Cycle" of the picture object.

This cycle defines all the actions, tag connections and dynamic dialogs used in a process picture centrally.

Window Cycle

A cyclic trigger is used as the trigger.

The cycle time is defined by the object property "Update Cycle" of the "Picture Window" object.

This value applies to all actions, tag links and dynamic dialogs, which were configured with the trigger type "Window cycle".

Upon change

This trigger updates the object every time a change is made.

In the case of external tags, there might be a brief delay.

Internal tag changes lead to an immediate update.

Time values (250 ms - 1 h)

This trigger updates the object in the set cycle.

User cycle (1 - 5)

You can set these triggers as needed.

How to define the user cycles:

1. In the shortcut menu of the project name in WinCC Explorer, select "Properties".
2. Select the "Update Cycles" tab.
3. Select one of the user cycles "User cycle <x>".
4. Change the update to ms and change the cycle name, if necessary.

Note that the configured user cycles are based on a 250 ms time pattern. If you set 800 ms, for example, a 750 ms cycle is actually used.

You have to restart the Graphics Designer to make your individual user cycles available.

Note

Improving performance

The shorter the set update cycles, the higher the system load.

To prevent an overload, the update should not take place more often than necessary.

3.4.8 Customizing the Working Environment

Introduction

The Graphics Designer provides a great many possibilities to customize the working environment. For example, you can change the toolbars and palettes. You can define your own colors and change the basic settings of the program.

Positioning viewlets

You can drag viewlets in the Graphics Designer to a desired location and dock them there.

If you drop a viewlet directly above the central position symbol, it is inserted in the selected window as a new tab.

Showing/hiding toolbars and viewlets

To show or hide individual toolbars or viewlets, select the menu command "View > Toolbars". Enable or disable the required element.

Restoring the factory settings

To restore the factory settings of the Graphics Designer, select the menu command "View > Toolbars > Reset".

Saving settings

Please bear in mind that the default setting of the Graphics Designer is such that changes to the working environment are saved when you exit from the program. If you do not want to save the settings, open the "Extras" menu, then "Settings..."; select the "Options" tab and disable the "Save settings on exit" check box.

See also

Elements and Basic Settings of the Graphics Designer (Page 319)

The Basic Settings of the Graphics Designer (Page 355)

The Start Screen of the Graphics Designer (Page 325)

3.5 Working with Pictures

3.5.1 Working with Pictures

Introduction

In Graphics Designer, a picture is a file in the form of a sheet of drawing paper. You can adapt the size of the sheet of drawing paper.

A sheet of drawing paper has 32 layers, which you can use to improve the organization of the drawing.

Using process pictures

You can distribute the complete process to be displayed across several individual pictures that are interconnected.

In addition, you can call other applications and files from the process pictures.

The more complex the process to be configured, the more detailed the planning must be.

Project planning guideline

- Plan the structure of the process display:
How many pictures are required in which hierarchy?
Example: subprocesses can be shown in individual pictures, which are then merged into a main picture.
- Plan the navigation within a picture and between the individual pictures:
Operating sequence, buttons and hotkeys should be uniform in all pictures.
- Create a Master picture in which the picture properties, default settings and object settings are defined.
This Master picture should then be used as the template for each individual picture.
- Use the program functions for creating process pictures efficiently:
 - Copying and transferring properties between pictures
 - Picture levels
 - User objects as reusable object compositions
 - Faceplate types as process picture templates that can be changed centrally
 - Libraries
- Configure each picture in the size in which it is displayed on the target computer.
This avoids changes in the picture layout and unnecessary scroll bars.
- Use only fonts that are available on the target computer.

The shortcut menu in the Graphics Designer

When creating and opening pictures and faceplate types, the files are located in the tabs of the Graphics Designer.

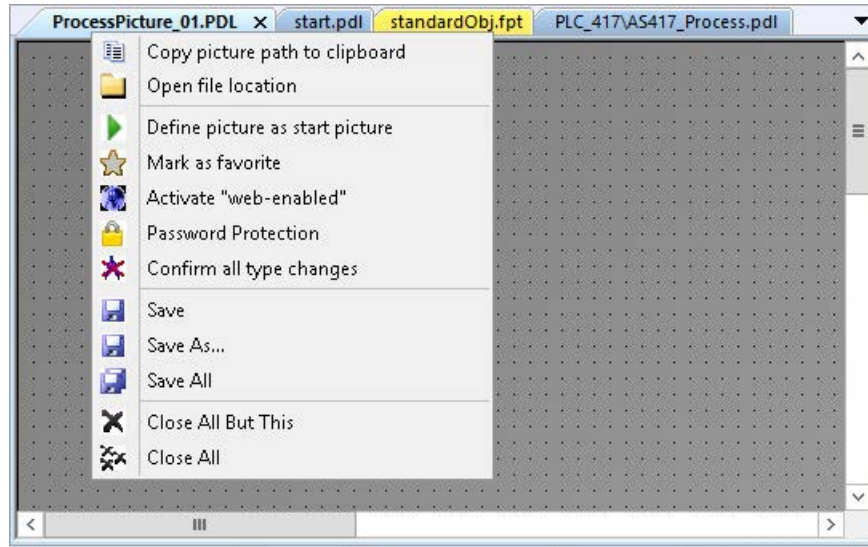

Right-clicking on a tab with a picture or faceplate type opens the shortcut menu.

You can perform the following actions using the shortcut menu in the Graphics Designer:

- Copy the file path to the clipboard
- Open the folder containing the file in Windows Explorer
- Define the process picture as start picture
- Mark the process picture as favorite
- Save the process picture or the faceplate type as "web-enabled"
- Creating, editing, or removing password protection for the file
- Confirm all type changes of the integrated faceplate types in the process picture
- Save the process picture or the faceplate type
- Save all open files:
Any changes to the integrated faceplate types in the open process pictures are automatically confirmed.
- Close the open files

See also

[Working with Objects \(Page 456\)](#)

[Working with Multiple Pictures \(Page 392\)](#)

[Working with Layers \(Page 388\)](#)

[How to set the picture properties \(Page 385\)](#)

[How to export graphics \(Page 384\)](#)

- How to Delete a Picture (Page 382)
- How to Rename a Picture (Page 380)
- How to Copy the Picture (Page 379)
- How to open a picture (Page 378)
- How to save the pictures (Page 378)
- How to create a new picture (Page 376)
- The shortcut menu in the Navigation window (Page 300)
- The Graphics Designer in the WinCC Explorer (Page 299)
- Converting project data (Page 52)
- Saving in file system (Page 374)
- Overview: Faceplate types (Page 396)

3.5.2 Saving in file system

Introduction

Process pictures and faceplate types are saved in the project directory in the "GraCS" folder or in a subfolder of "GraCS".

File formats

The process pictures are saved in the "PDL" format.

Faceplate types are saved in the "FPT" format.

Restoring files

If you save a process picture or a faceplate type, the system creates a backup in the "GraCS" project directory in the following file format:

- Process picture: *.sav
In order to restore the process picture from the backup, change the file format from "*.sav" to "*.pdl".
- Faceplate type: *.saf
In order to restore the faceplate type from the backup, change the file format from "*.saf" to "*.fpt".

Managing files and folders

You manage the process pictures, faceplate types and folders under GraCS in WinCC Explorer.

Some actions are also possible in Windows Explorer:

Action	WinCC Explorer	Microsoft Windows Explorer ¹⁾
Create file	Shortcut menu	-
Create folder	Shortcut menu	Yes
Rename file/folder ²⁾	Shortcut menu <F2>	Yes
Move file/folder ²⁾	Shortcut menu Drag-and-drop in WinCC Explorer Drag-and-drop from Windows Explorer	Yes
Copy file/folder	Drag-and-drop from Windows Explorer	Yes
Delete file/folder ²⁾	Shortcut menu	Yes
Open file for editing	Shortcut menu Double-click	-
Change file properties	Shortcut menu	-

1) Changes in Windows Explorer are displayed immediately in the WinCC Explorer and in the "Process pictures" window of the Graphics Designer.

2) When you move, rename or delete a file or folder, you must update the folder paths accordingly, for example in scripts and direct connections.

Displaying and opening a folder

The entire storage path of the project is displayed in the header of WinCC Explorer.

When you display the content of a "GraCS" subfolder in the data window, the folder path is shown in the status bar.

To open the storage folder of a picture or faceplate type, follow these steps:

1. Open the process picture or the faceplate type in the Graphics Designer.
2. Select "Open file location" from the context menu of the picture name.

Working with "GraCS" subfolders

For a better overview of the many process pictures, sort the files into subfolders.

The "GraCS" subfolders have the following properties:

- System pictures whose name starts with "@" must always be located directly in the "GraCS" folder.
- Subfolders can contain additional folders.
- Different folders can contain files and subfolders with the same name.

- The path name of a project folder including picture name is limited to 180 characters.
- Avoid periods in the names of subfolders.
VB scripts can only access subfolders that have no period in their name.
If a process picture in a subfolder is referenced in a VB script, the picture name also should not contain a period.
 - Permitted: GraCS\subfolder\processpicture.pdf
 - Not permitted: GraCS\sub.folder\process.picture.pdf

Note

Integrated projects: Do not use subfolders

Do not use any folders in the Graphics Designer in integrated projects.

In WinCC projects that are integrated in SIMATIC Manager, pictures are not found in subfolders of "GraCS".

Before you import WinCC process pictures in SIMATIC Manager, move the pictures in the subfolders to the "GraCS" folder. In integrated projects, you manage pictures in the plant hierarchy of the SIMATIC Manager.

See also

Working with Pictures (Page 372)

How to create a new picture (Page 376)

How to Copy the Picture (Page 379)

How to Delete a Picture (Page 382)

Overview: Faceplate types (Page 396)

The pop-up menu in the Data Window (Page 309)

The shortcut menu in the Navigation window (Page 300)

3.5.3 How to create a new picture

Introduction

Depending on the selected method of working, you either create a new picture using the default settings or take your Master picture and save this under a new file name.

The advantage of working with a master picture is that all of the changes that you make while creating it will then be kept consistently throughout the project.

Creating pictures in a subfolder

If you have created additional folders under the "GraCS" project folder, you can also create new pictures directly in these folders.

System pictures whose name starts with "@", however, must always be located directly in the "GraCS" folder.



Storage path and picture name

The path name of the project folders including picture name is limited to 180 characters.

If pictures are referenced in a VB script, neither the pictures nor the subfolders can have a period in their name.

- Permitted: GraCS\subfolder\processpicture.pdl
- Not permitted: GraCS\sub.folder\process.picture.pdl

Procedure

1. In Graphics Designer, select the menu command "File > New".
Alternatively, press <Ctrl+V> or click .
A new picture is created with the default settings.
2. To save the file, select the menu command "File > Save" and enter a meaningful name.
Alternatively, press <Ctrl+S> or click .

Alternative procedure

1. Click "Graphics Designer" in the navigation window of WinCC Explorer.
2. Right-click in the data window and select the "New picture" menu command in the shortcut menu.
3. If you want to create the picture in a subfolder, select the command "New folder".
Navigate to the subfolder and create the picture in it.
You can also move the pictures to other folders later with drag-and-drop.

Inserting pictures from other projects

You can copy process pictures and faceplate types that have already been created from another WinCC project to your WinCC project:

1. Select the "Graphics Designer" in the navigation window of the WinCC Explorer.
2. Open the "GraCS" folder in the project path in the Windows Explorer, for example:
C:\Users\Public\Documents\Siemens\WinCCProjects\serverproject\GraCS
3. Drag-and-drop the required picture from the Windows Explorer to the WinCC Explorer data window.

See also

How to Copy the Picture (Page 379)

Saving in file system (Page 374)

3.5.4 How to save the pictures

Introduction

Files are saved in Graphics Designer in the usual Windows manner.

Procedure

- An active picture can either be saved via the button , with the menu entry "File", "Save", or with the key combination <CTRL+S>.
- To save the active picture under a new file name, select "Save As" in the "File" menu.
- To save all of the open pictures, select "Save All" in the "File" menu.

See also

Working with Pictures (Page 372)

How to Copy the Picture (Page 379)

3.5.5 How to open a picture

Introduction

Picture files are opened in Graphics Designer in the usual Windows manner.

Note

Opening pictures in Graphics Designer only

Pictures may only be opened in WinCC Explorer or in the Graphics Designer.

The properties and contents of the pictures may only be edited in the Graphics Designer.

Pictures may not be opened in Windows Explorer or with similar programs.

Procedure

1. Click on the button  in the Graphics Designer or select the command "File > Open" in the menu bar.
2. Select a PDL format file.
The picture is opened in the Graphics Designer.

Alternative procedure

1. Click "Graphics Designer" in the navigation window of WinCC Explorer or one of the subfolders.
2. In the data window, double-click the picture or select the "Open picture(s)" command from the shortcut menu.
3. To open all pictures of a folder, select the folder in the data window. Select the "Open picture(s)" command in the folder shortcut menu. All process pictures and faceplate types contained in the folder are opened in the Graphics Designer.

See also

Working with Pictures (Page 372)

3.5.6 How to Copy the Picture

Introduction

If you want to reuse the settings that you have made in a picture in a new picture, save the old picture under a different name. You use the same procedure for faceplate types.

It is not possible to copy a picture and then insert it with a different file name in WinCC Explorer. To accomplish this, use Windows Explorer.

Note

SIMATIC Manager

You cannot rename or delete process pictures that were created or imported in SIMATIC Manager. You can recognize these pictures from the "Created by SIMATIC Manager" entry in the Information column of the data window.

If you copy these pictures using "Save As", you can also rename or delete this copy in WinCC Explorer.

Names of process pictures and objects

When you copy a picture, the new picture name must not have the same name as an object in the picture.

The software does not check whether the new name already exists as object name.

Using a name that is already in use can lead to conflicts during access via VBA or during dynamization.

Procedure

1. Open the picture in Graphics Designer.
2. Select "Save As" from the "File" menu.
3. Enter a new file name in the windows "Save as".
4. Edit the new picture.

Alternative procedure

1. Open the "GraCS" folder in the project directory in Windows Explorer.
2. Copy the file using the standard Windows functions.
Make sure that you keep the file format "PDL" or "FPT".

See also

How to create a new picture (Page 376)

Saving in file system (Page 374)

How to open a picture (Page 378)

How to Delete a Picture (Page 382)

How to Rename a Picture (Page 380)

Working with Pictures (Page 372)

3.5.7 How to Rename a Picture

Introduction

You can rename a picture in WinCC Explorer or in Windows Explorer. You use the same procedure for faceplate types.

Renaming a picture, faceplate type or folder cannot be undone.

Note

SIMATIC Manager

If you create pictures using the SIMATIC Manager, these cannot be renamed in WinCC Explorer.

This also applies to pictures created in WinCC and subsequently imported into SIMATIC Manager by using the function "Import WinCC objects".

You can recognize these pictures from the "Created by SIMATIC Manager" entry in the Information column of the data window.

Updating references and scripts

When you rename a file or folder, you must update the folder paths accordingly, for example in scripts and direct connections.

For pictures, faceplate types and referenced files located in the subfolders of "GraCS", the folder path is part of the name in each case.

You can check referenced pictures in the "Cross Reference" editor. Other referenced files as well as faceplate types and faceplate instances are not monitored by Cross Reference.

Names of process pictures and objects

When you rename a picture, the new picture name must not have the same name as an object in the picture.

The software does not check whether the new name already exists as object name.

Using a name that is already in use can lead to conflicts during access via VBA or during dynamization.

Requirement

- The selected picture is not opened in the Graphics Designer:
 - You can only rename a file when it is not opened in Graphics Designer.
 - You can only rename a folder when all the pictures and faceplate types it contains are closed.

Procedure

1. Click "Graphics Designer" in the navigation window of WinCC Explorer or one of the subfolders.
2. In the data window select the "Renaming picture or folder" command in the shortcut menu of the picture.
3. Enter a new name.
When you rename pictures or faceplate types in WinCC Explorer, the file format "PDL" or "FPT" is always retained.

Alternative procedure

1. Open the "GraCS" folder in the project directory in Windows Explorer.
2. Change the file name using the standard Windows functions.
Make sure that you keep the file format "PDL" or "FPT".

See also

How to Copy the Picture (Page 379)

How to open a picture (Page 378)

How to Delete a Picture (Page 382)

Working with Pictures (Page 372)

The shortcut menu in the Navigation window (Page 300)

3.5.8 How to Delete a Picture

Introduction

You can delete a picture in WinCC Explorer or in Windows Explorer. You use the same procedure for faceplate types.

The deletion cannot be undone.

Note

SIMATIC Manager

If you create pictures using the SIMATIC Manager, these cannot be deleted in WinCC Explorer.

This also applies to pictures created in WinCC and subsequently imported into SIMATIC Manager by using the function "Import WinCC objects".

You can recognize these pictures from the "Created by SIMATIC Manager" entry in the Information column of the data window.

Deleting pictures and folders

Deleting picture(s)

You can delete multiple pictures at once by using multiple selection in the data window of WinCC Explorer.

Deleting pictures and faceplate types in folders

To delete all pictures and faceplate types in a folder, select the "Open picture(s)" command in the folder shortcut menu.

Delete folders

To delete a folder, select the "Delete folder" command in the folder shortcut menu.

You can delete multiple folders at once by using multiple selection.

Note**Folder with content: Back up files**

If a folder contains further folders and files, this data is deleted without additional confirmation.

Recommended procedure:

1. Before you start deleting, check in Windows Explorer whether the folder contains other files that are used as background picture, such as videos or graphic files. These files are not displayed in WinCC Explorer.
 2. Move the files you still need to a different folder below "GraCS".
 3. Then update the referenced paths in the object properties and in scripts.
-

Requirement

- The selected picture is not opened in the Graphics Designer:
 - You can only delete a file when it is not opened in Graphics Designer.
 - You can only delete a folder when all the pictures and faceplate types it contains are closed.

Procedure

1. Click "Graphics Designer" in the navigation window of WinCC Explorer or one of the subfolders.
2. Select one or more pictures or folders in the data window.
3. Select the "Delete picture(s)" or "Delete folder" command from the shortcut menu.
4. As soon as you confirm deletion with "OK", the selected objects are removed from the WinCC project.
If necessary, change the dynamizations and scripts in which the deleted files are referenced.

Alternative procedure

1. Open the "GraCS" folder in the project directory in Windows Explorer.
2. Delete the files and folders using the standard Windows functions.

See also

Saving in file system (Page 374)

How to Copy the Picture (Page 379)

How to open a picture (Page 378)

How to Rename a Picture (Page 380)

Working with Pictures (Page 372)

The shortcut menu in the Navigation window (Page 300)

3.5.9 How to export graphics

Introduction

You can export graphics in the following formats from the Graphics Designer:

- "EMF" (Enhanced Metafile). Dynamic settings and some object-specific properties are lost with the export, because they are not supported by the graphic format.
- "PDL". The dynamizations are retained when a PDL file is exported. You can then insert the exported picture into a picture window or open it as a file.

Note

Check exported pictures for both completeness and interpretation errors by the importing program before editing them further in other programs.

Special features

- Some programs do not use the same graphic filters. It is possible that some programs will not be able to open a graphic that was exported from Graphics Designer. Furthermore, fonts and object information will also sometimes be incorrectly interpreted by other programs. If the screen must appear precisely as it is in Graphics Designer, but your program displays it incorrectly, you can solve this problem by making a screenshot.
- When exporting a picture created with the Graphics Designer, all object properties dynamics of the individual objects are lost.

Procedure

1. Select the objects that you want to export. If you do not select an object, the entire picture will be exported.
2. Open the "Tools" menu and select the entry "Settings". The "Save as metafile" window is opened.
By default, the "GraCS" folder of the WinCC project is displayed as the storage location. You can export the file to any other folder.
3. Enter the file name.
4. Select the file type to be exported, "EMF" or "PDL".
5. Confirm your entries with "Save".

See also

Working with Pictures (Page 372)

3.5.10 How to set the picture properties

Introduction

In Graphics Designer, a process picture is treated as an object and is called a Picture Object. You can adapt the properties and dynamics of the picture at any time.

If no object has been selected in the picture, the "Object Properties" window will display the properties of the Picture Object.

"Start Picture" and "Favorite" properties

The following properties are not configured in the Graphics Designer:

- Favorite: Use the picture shortcut menu in WinCC Explorer.
- Start Picture: Use the picture shortcut menu in WinCC Explorer. Alternatively, select the start picture in the computer properties in the "Graphics Runtime" tab.

Requirement

- The process picture is open in the Graphics Designer.
- No object is selected in the picture.

Procedure

1. Open the "Object Properties" window by clicking the button . As an alternative, the "Object Properties" window can also be opened via the pop-up menu or by selecting "Properties" in the "View > Properties" menu.
2. Check whether the picture properties are displayed. The entry with the file name of the selected picture object is displayed in the object palette. You may edit the attributes contained in the "Properties" or "Event" tabs similar to editing object attributes. For more information, refer to the section "How to edit an attribute".

See also

Working with Pictures (Page 372)

The Properties of an Object (Page 511)

The "Object Properties" Window (Page 512)

How to Change an Attribute (Page 525)

Displaying the configured dynamics of a process picture (Page 315)

Displaying the properties of a picture file (Page 313)

How to transfer picture properties to another picture (Page 392)

3.5.11 How to configure a picture background

Introduction

You can use a picture file as a background for a process picture. The background picture and the respective parameters belong to the properties of the picture.

Insert background picture

1. Make sure that no object is selected in the picture on which you click in the background picture. The entry with the selected "picture object" is then displayed in the object palette.
2. Open the window "Object properties" by clicking the button  in the toolbar.
As an alternative, the "Object Properties" window can also be opened via the shortcut menu or by selecting "Properties" in the "View > Properties" menu.
3. Click on the "Background picture" property.
4. Double click on "Picture".
5. Select the desired background picture in the "Picture" dialog.
Use "Find" to open the file selection dialog for loading other pictures into the selection. You can use the following file types as backgrounds:
EMF, WMF, DB, BMP, GIF, JPG, JPEG, ICO and SVG ¹⁾.
6. Select the layout for the background picture after double clicking on "Show as":
 - Normal: The background picture is centered in the original size.
 - Stretched (window): If the Runtime window is larger than the configured process picture, the background picture is scaled to the size of the Runtime window. Otherwise, the background picture is scaled to the size of the process picture.
 - Tiled: The process picture is arranged with the picture in the original size.
 - Stretched (Picture): The background picture is scaled to the configured size of the process picture.
7. Close the Properties dialog.

The current picture is provided with the selected background.

¹⁾ SVG: Not possible with the global design "WinCC Classic".

Delete background picture

1. Make sure that no object is selected in the picture. The entry with the selected "picture object" is then displayed in the object palette.
2. Open the window "Object properties" by clicking the button  in the toolbar.
As an alternative, the "Object Properties" window can also be opened via the shortcut menu or by selecting "Properties" in the "View" menu.
3. Click on the "Background picture" property.
4. Double-click on the "Picture".

5. Click on "Cancel selection" in the dialog and confirm with "OK".
The background picture is removed from the picture.
6. Close the Properties dialog.

3.5.12 How to protect pictures with a password

Introduction

A process picture can be assigned a password. This measure protects your VBA scripts against unauthorized access, for example.

You can assign a password to one or more pictures and faceplate types from the shortcut menu of the "Graphics Designer" entry in the data window of the WinCC Explorer.

Creating a password

1. Make certain that no object is selected in the picture.
2. Open the "Object properties" window using the shortcut menu or the "View" > "Properties" menu.
3. Check whether the picture properties are displayed. The entry with the file name of the selected picture object is displayed in the object palette.
4. You may edit the attributes contained in the "Properties" or "Event" tabs similar to editing object attributes. For more information, refer to the section "How to edit an attribute".
5. Click the "Miscellaneous" property.
6. Double-click "Password protection".
7. Enter a password that consists of at least six characters.
8. Repeat your password entry.
9. Click "OK".

The current picture is protected by a password. The password is queried the next time the picture is opened.

Removing a password

1. Make certain that no object is selected in the picture.
2. Open the "Object properties" window using the shortcut menu or the "View" > "Properties" menu.
3. Check whether the picture properties are displayed. The entry with the file name of the selected picture object is displayed in the object palette.
4. You may edit the attributes contained in the "Properties" or "Event" tabs similar to editing object attributes. For more information, refer to section "Editing attributes".
5. Click the "Miscellaneous" property.

6. Double-click "Password protection".
7. Set the "Remove password" check box.

The current picture is no longer protected by password.

3.5.13 Working with Layers

3.5.13.1 Working with Layers

Introduction

In the Graphics Designer, a picture consists of 32 layers in which objects can be inserted. The position of an object in a picture is set when it is assigned to a layer. Objects of layer 0 are located at the background of the picture, while objects of layer 31 are located in the foreground. Not all objects in the Graphics Designer observe the layer technique, for example ActiveX Controls.

Objects in the layer

Always insert the objects into the active layer. You can change the assignment to a layer by using the "Layer" attribute in the "Object Properties" window.

When creating a process picture, the objects of a level are by default arranged in the order in which they were configured. The object inserted first lies at the very back of the level, each additional object is inserted one position toward the front.

You have the following options to change the positioning of the objects within a layer:

- Via the buttons in the object palette
- Via the shortcut menu of the object with the "Sort Objects" command.
- Via keyboard shortcuts. You can find the shortcuts in the shortcut menu for the "Sort Objects" command.
- Via the menu "Arrange > Sort Objects"

Note

You can define the level to insert a copied object into with the Graphics Designer settings. More information on these settings can be found under topic "Create process pictures > Elements and basic settings of the Graphics Designer > The basic settings of the Graphics Designer > How to set options" in section "Copying and inserting objects".

Principle of the layer technique

When a picture is opened, all 32 layers of the picture will be displayed. You cannot change this setting. You can hide all layers except the active layer with the layer palette. This allows you to explicitly edit objects of the active layer. Layers are particularly useful when preparing pictures that contain many different types of object types.

For example, you could place all of the "Bar" objects on Layer 1 and all of the "I/O Field" objects on Layer 2. If you later decide to change the font color of all of the I/O fields, you can now display just Layer 2 and then select all of the objects on this layer. The time-consuming selection of individual I/O fields scattered throughout the picture is thus unnecessary.

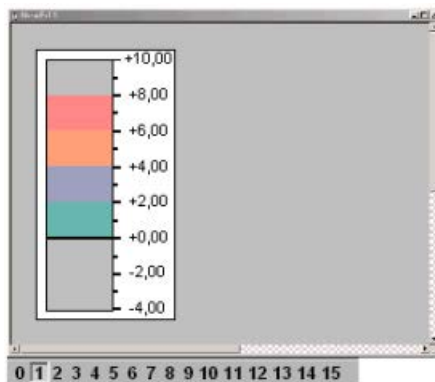

Bar on layer 1

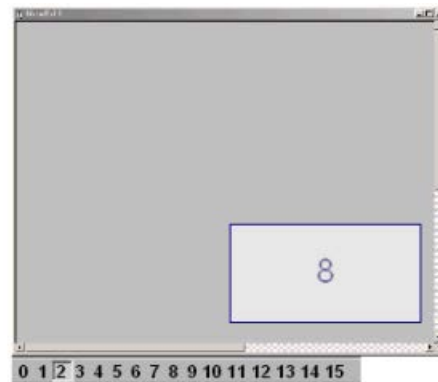

I/O field on Layer 2

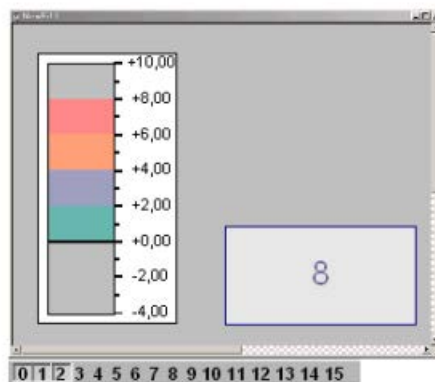

Layers 0, 1 and 2 appear

Note

The following WinCC controls are displayed in separate windows and cannot be integrated in the picture layer system:

- WinCC OnlineTableControl
- WinCC OnlineTrendControl
- WinCC UserArchiveControl
- WinCC AlarmControl
- WinCC FunctionTrendControl
- WinCC RulerControl
- .Net Control
- WinCC Web Control
- Application window

You can assign a layer to these controls, but this setting will be ignored in Runtime.

3.5.13.2 How to assign a layer

Introduction

The "Object Properties" window is used to set the layer in which an object is placed.

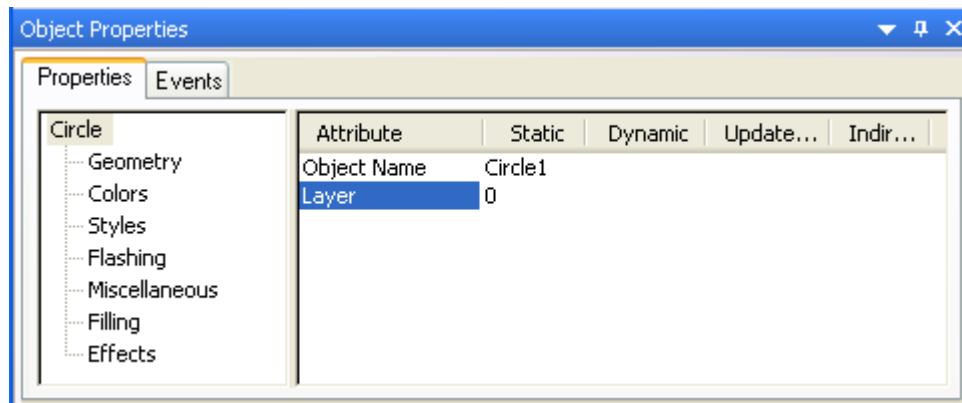

Assigning Layers

1. Select an object.
2. Open the "Object Properties" window.
3. Select the object type and double-click the "Layer" attribute.
4. Enter the name of the required layer.

Moving several objects on different layers to one layer

If you want to move objects located on Layers 2, 5 and 7 to Layer 9, for example, use multiple selection.

1. Display only Layers 2, 5 and 7.
2. Select the objects.
3. In the "Object Properties" window assign Layer 9 to the "Multiple selection" object type. All of the objects are then moved to Layer 9.

See also

How to assign a layer (Page 390)

Making layers invisible (Page 362)

Showing and hiding layers and objects (Page 364)

How to use the layers palette (Page 391)

Layer palette (Page 330)



Working with Layers (Page 388)

3.5.13.3 How to use the layers palette

Introduction

With the aid of the Layers palette, it is possible to display only those layers that are actually used for editing a picture. Up to 31 layers can be hidden if need be. The active layer remains visible.

Making layers visible / invisible

Click on one of the buttons on the Layers palette. When the button is pressed, the corresponding layer is visible. With  you display Layers 16-31; with  Layers 0-15.

Select the Active Layer

Open the drop-down list and select an active layer.

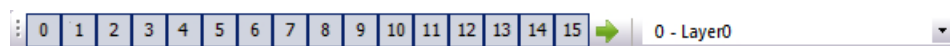

Renaming layers

Layers are renamed in the "Visible Layers" tab in the "Options > Settings..." menu. Double-click a layer there and enter a new name.

See also

Making layers invisible (Page 362)

How to assign a layer (Page 390)

Showing and hiding layers and objects (Page 364)

How to change the default setting of object types (Page 457)

Layer palette (Page 330)

Working with Layers (Page 388)

3.5.14 Working with Multiple Pictures

3.5.14.1 Working with Multiple Pictures

Introduction

Multiple process pictures are quite useful when working with complex processes. These process pictures are then linked to each other and one picture can be integrated in another. Graphics Designer supports a number of features which ease the process of working with multiple pictures.

- The properties of a picture can transferred to another picture.
- Objects can be transferred from one picture to another.
- Objects can be copied from one picture to another.

See also

Working with Pictures (Page 372)

How to copy objects to another picture (Page 394)

How to transfer objects to another picture (Page 393)



How to transfer picture properties to another picture (Page 392)

3.5.14.2 How to transfer picture properties to another picture

Introduction

With the exception of the display of the grid and the grid width, you can transfer the properties of a picture to other pictures with the aid of the "Pipette".

Procedure

1. Open the picture with the properties you want to copy. Objects may not be selected.
2. Click  in the object palette.
The picture properties are copied.
3. Open picture to which the properties should be assigned. Objects may not be selected.
4. Click  in the object palette.
The properties are assigned.

You can alternatively call up the functions for copying and assigning properties through the "Edit > Properties" menu.

See also

How to transfer objects to another picture (Page 393)

How to copy objects to another picture (Page 394)

Working with Multiple Pictures (Page 392)

Working with Pictures (Page 372)

3.5.14.3 How to transfer objects to another picture

Introduction

Use "Cut" and "Paste" to cut out a selected object and transfer it to the clipboard. From the clipboard you can paste the object into any picture. You can insert the object several times, even into different pictures.



Multiple selection

You can simultaneously cut out several selected objects and paste them into another picture.

Requirements

- Select an object of any type.

Procedure

1. Press <Ctrl+X> or click  in the standard palette to cut out the selected object.
2. Open the picture into which you want to insert the object from the clipboard.
3. Press <Ctrl+V> or click  in the standard palette.
The current contents of the clipboard are inserted into the active picture and selected.
4. Repeat this step to insert further copies of the contents.

Alternative handling with drag-and-drop

Select the object to be transferred and drag it with the left mouse button depressed to another picture.

Note

Objects from other applications can also be inserted via the clipboard.

The positions "X" and "Y" of the inserted object are each 20 pixels higher than in the original object.

The inserted object receives the object name of the original object but is supplemented by a continuous number.

See also

How to duplicate objects (Page 480)

How to cut objects (Page 477)

How to insert the contents of the clipboard (Page 479)

How to delete objects (Page 476)

How to copy objects to another picture (Page 394)

Working with Multiple Pictures (Page 392)

Working with Pictures (Page 372)

3.5.14.4 How to copy objects to another picture

Introduction

Use the "Copy" and "Paste" commands to copy a selected object to the clipboard and then paste it into any picture. When copying to the clipboard you can insert the object several times, even into different pictures.

Multiple selection

You can copy several selected objects simultaneously and paste them into another picture.

Requirement

- Select an object of any type.

Procedure

1. Press <Ctrl+C> or click  in the standard palette to copy the selected object to the clipboard.
2. Open the picture into which you want to insert the object from the clipboard.

3. Press <CTRL+V> or click  in the standard palette.
The current contents of the clipboard are pasted into the active picture and selected.
4. Repeat this step to insert further copies of the contents.

Note

Objects from other applications can also be inserted via the clipboard.

The positions "X" and "Y" of the inserted object are each 20 pixels higher than in the original object.

The inserted object receives the object name of the original object but is supplemented by a continuous number. No special characters are used in the object name.

See also

How to duplicate objects (Page 480)

How to cut objects (Page 477)

How to insert the contents of the clipboard (Page 479)

How to delete objects (Page 476)

How to transfer objects to another picture (Page 393)

Working with Pictures (Page 372)

Working with Multiple Pictures (Page 392)

3.6 Working with Faceplate Types

3.6.1 Overview: Faceplate types

Faceplate types

The faceplate types of WinCC supports you in the planning of standardized picture objects that are used multiple times in the WinCC project.

You can reduce engineering work for creating and changing objects.

A type instance model is the base:

- You create the objects in the types.
- You create instances as local places of use for types in process pictures.

WinCC saves the faceplate type as a FPT file.

Just like the process pictures, the FPT files are located in the "GraCS" project directory or in "GraCS" subfolders. Management is the same for faceplate types and process pictures, for example, during renaming, moving or deleting.

Centralized management of faceplate types

Performing changes to faceplate types at a central location reduces the engineering work:

- You create a faceplate type and configure the desired properties.
- Add the faceplate type in the process pictures as a faceplate instances. Once it is configured, you can reuse a faceplate type in any number of process pictures.
- You edit a faceplate instance similar to a customized object in the Graphics Designer.
- If necessary, change the faceplate type and apply the change in the instances in the process pictures.

Basic procedure

1. Create faceplate type in the Graphics Designer
2. Insert objects and configure
3. Create interface tags and faceplate tags
4. Configuring instance-specific properties, events and tags
5. Dynamize faceplate type
6. Insert the "Faceplate instance" object in the process picture and connect it to the faceplate type
7. Configure faceplate instance in process picture

Differentiation from customized objects

Faceplate types and instances are configured similar to customized objects.

You can find additional information on customized objects under "Working with Customized Objects (Page 713)".

The following table shows the main differences between faceplate types and customized objects.

	Customized objects	Faceplate types
Storage	Customized objects exist only as objects in a process picture.	Faceplate types are created as files that you can copy into other WinCC projects.
Objects	Supported by customized objects, but not by faceplate types: <ul style="list-style-type: none"> • Connector • WinCC Controls 	Supported by faceplate types, but not by customized objects: <ul style="list-style-type: none"> • Grouped objects
Changing the output object	You can change the customized objects individually in each process picture or copy a modified customized object.	The faceplate type supports centralized editing: Changes in the faceplate type are automatically applied to all faceplate instances. For complex changes, you can automatically update all faceplate instances or manually update individual instances.
Dynamization	In process picture: <ul style="list-style-type: none"> • Properties of the customized object • Selected properties of the objects contained within 	In process picture: <ul style="list-style-type: none"> • Properties of the "Faceplate instance" object • Instance-specific properties of the single objects Additional dynamization in the faceplate type: <ul style="list-style-type: none"> • Type-specific properties of single objects To dynamize the type, use structure tags, interface tags, faceplate tags and faceplate-internal scripts. • Simple and quick dynamization of faceplate instances via structure tags.

	Customized objects	Faceplate types
File size	<p>The objects are created at each place of use and saved.</p> <p>The size of the process pictures depends on the number and size of customized objects they contain.</p>	<p>The objects are created once in faceplate type and are then referenced.</p> <p>The size of the process pictures depends on the number of faceplate instances they contain.</p> <p>Faceplate types require less storage space with large object compositions.</p>
Applications / performance	<p>You can use customized objects and faceplate types in all the usual scenarios.</p> <p>The performance during the picture change depends on the following factors:</p> <ul style="list-style-type: none"> • Number of customized objects or faceplate instances in a process picture • Number of connected scripts or number of internal scripts in the faceplate • Faceplate type: Number of tags <p>Interface tags are much more powerful than faceplate tags.</p>	

See also

- How to create a Faceplate type (Page 405)
- Property of a faceplate type (Page 416)
- How to define instance-specific object properties (Page 424)
- Event of a Faceplate type (Page 420)
- How to define instance-specific events (Page 432)
- Faceplate tags (Page 410)
- How to create faceplate tags (Page 421)
- How to link faceplate tags with a properties node (Page 431)
- Making a Faceplate type dynamic (Page 433)
- How to configure a faceplate instance (Page 435)
- How to protect faceplate types with a password (Page 406)
- Overview: Configuring faceplate types (Page 399)
- Working with Customized Objects (Page 713)
- Updating faceplate instance (Page 438)
- Working with Combined Objects (Page 709)
- Working with Pictures (Page 372)
- Saving in file system (Page 374)

3.6.2 Configuring a faceplate type

3.6.2.1 Overview: Configuring faceplate types

Configuration

A faceplate type is the template for the faceplate instances.

You configure faceplate types similar to WinCC pictures in the Graphics Designer:

You add objects from the "Default" selection window and configure their properties. These objects are referred to as "single objects" in the following description.

All faceplate instances contain these single objects and apply the configured properties. The values of selected, instance-specific properties can be adapted to the individual faceplate instances in the process picture.

Tags in the faceplate type

You can use different types of tags in the faceplate type:

- Faceplate tags
- Interface tags
- Structure type elements

The tags are configured and stored in the faceplate type, but configured and used differently.

Tag	Configuration Dialog	Description	Use
Interface tags	Configure Faceplate Type: "Tags" tab	In the faceplate type, interface tags are linked to object properties and created as instance-specific tags. Interface tags are much faster than faceplate tags.	Use the interface tags to dynamize properties of the faceplate instance and to connect to with process tags, for example.
Structure type elements	Configure Faceplate Type: "Tags" tab Alternative procedure: Dragging the structure types to the faceplate instance in the process picture	Structure type elements of the WinCC Tag Management are linked with the object properties of faceplate type. In the faceplate instances, you link the instance-specific structure types or structure type elements to the corresponding structure instances. The runtime behavior corresponds to the interface tags.	Use structure type elements to quickly interface a large number of always identical tags in the faceplate type.
Faceplate tags	Edit Faceplate Tags	Faceplate tags are created for handling over values within a faceplate type. This internal value transfer is not possible via interface tags.	Use faceplate tags, for example, to exchange values between two single objects of the faceplate type. Example A faceplate instance contains a bar and a button. The bar is displayed or hidden using the button. This behavior is only configured in the faceplate type. The configuration of the faceplate instance in the process picture has no influence on this.

Objects in the faceplate type

You can insert all Windows objects and tube objects as well as most standard objects and smart objects in the faceplate type.

Unusable objects

The following object types cannot be used as single objects in the faceplate type:

- Customized object
- Standard objects:
 - Connector
- Smart objects:
 - Application window
 - Picture window
 - OLE object
 - Faceplate instance

- WinCC controls and other objects of the "Controls" selection window
- Symbols of the Siemens HMI Symbol Library

Copy and paste objects

When you copy objects from one faceplate type to another, configured properties and dynamizations are copied as well.

However, you have to recreate the faceplate tags and the instance-specific configuration of the object.

Copying between faceplate types and process pictures

If you copy an object between faceplate types and pictures, all dynamization of the object are discarded. This avoids the following configuration errors can:

- In faceplate type:
Copied single objects with invalid scripts that use WinCC tags
- In process picture:
Copied single objects with invalid scripts that use the faceplate tags

Restrictions in the configuration

Editing faceplate types

The following functions of the Graphics Designer are not available:

- Enabling runtime
- Creating or editing a customized object
- Rewiring > tag connections
- Dynamization > Dynamic dialog
- Dynamization > C action
- Dynamization of events > C action
- Dynamization of event > Direct connection
- "Dynamic Wizard" selection window
- "Tags" selection window or tag selection dialog

Do not change file name

You cannot change the name of a faceplate type or the folder containing the faceplate type later.

Faceplate instances use the file name and the ID to identify the faceplate type. The folder path below "GraCS" is a part of the name in each case.

If you nevertheless rename a faceplate type in Windows Explorer, you must insert the corresponding faceplate instances again.

The affected process pictures are not marked in the WinCC Explorer. In the Graphics Designer, the faceplate instance is marked with a red cross.

Copy faceplate types

"Save As" function

You can use "Save As" to create a copy of the faceplate type with a new ID.

Instances of a faceplate type are not connected to the copy of the faceplate type.

Copying a faceplate type in a WinCC project

You can copy the FPT file of the faceplate type from a WinCC project folder in another project in the Windows Explorer.

You can immediately edit the copied faceplate type in the Graphics Designer and insert an instance.

See also

Properties and events (Page 402)

How to create a Faceplate type (Page 405)

Faceplate tags (Page 410)

Making a Faceplate type dynamic (Page 433)

Interface tags (Page 407)

Structure types and structure type elements (Page 413)

3.6.2.2 Properties and events

Type-specific and instance-specific properties and events

The objects contained in the faceplate type are referred to as "single objects" in the following description.

The single objects in faceplate types have two types of properties and events:

- Type-specific
- Instance-specific

Properties and events of the single objects are generally type-specific. You define which properties, events and which internal scripts in the faceplate tags are instance-specific in the "Configure Faceplate Type" dialog. Instance-specific tags are treated like object properties.

In a process picture, you only configure the instance-specific properties and events of the faceplate instance. The properties are displayed in the "Faceplate instance" object in the following property groups:

- UserDefined2:
 - Instance-specific properties
 - Instance-specific events
 - Instance-specific faceplate tags
- UserDefined3:
 - Instance-specific interface tags
 - Instance-specific structure type elements

The linked object properties are only visible in the faceplate type. Therefore, assign descriptive names to the instance-specific tags.

Instance-specific properties are also called "published properties".

Type-specific properties and events

- All properties and events that are not defined as instance-specific.
- You only configure these properties and events centrally in the faceplate type. They cannot be configured in the faceplate instances.
- No internal dynamization is possible via interface tags or structure type elements.
- Changes in the faceplate type apply to all faceplate instances. The instances are not automatically updated, however. You apply the changes to one or more process pictures, for example, via a command in the WinCC Explorer.

Instance-specific Properties and Events

- Properties and events that you have defined as instance-specific.
- You configure these properties and events in the faceplate instances.
- When you insert an instance in a process picture, the default values are taken from the faceplate type. You can adapt the instance-specific properties and events individually to the process picture. You can configure other settings for each instance. For a high-performance dynamization in the process picture, link the instance-specific properties in the faceplate type with interface tags or structure type elements.

The following picture shows the use of the type- and instance-specific properties in the faceplate instances.

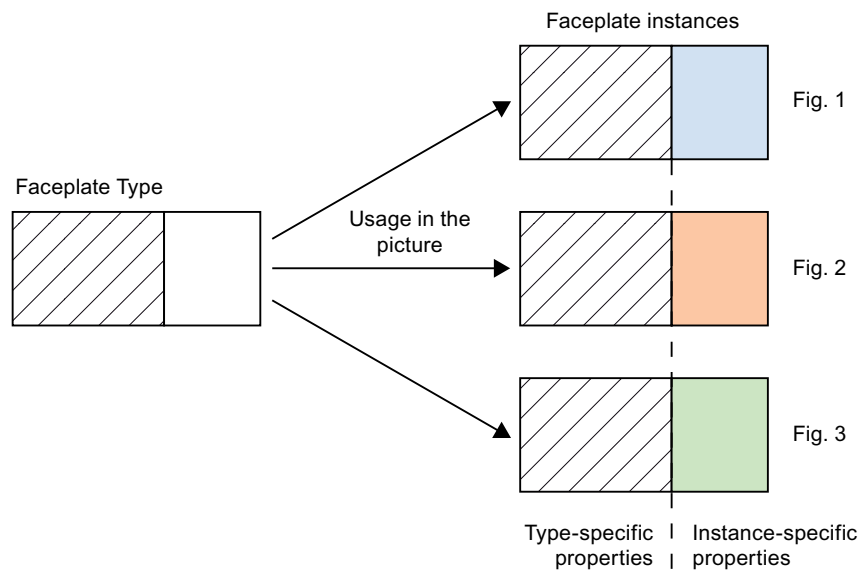

Property nodes and event nodes

For instance-specific properties and events, you create each property node and node event in the configuration dialog.

Assign a meaningful name to a node when you create it.

Only the name of the node is displayed in the faceplate instances. You do not see which object properties or events are linked to the node.

The names of property nodes and event nodes are language neutral. They cannot be translated into other languages.

Property nodes

The property node can have the following links:

- One or more object properties of a single object
- One or more object properties of multiple single objects
- An interface tag which is linked with one or more object properties of one or more single objects
- A structure type whose structure type elements are linked to one or more object properties of one or more single objects
- A structure type element that is linked to one or more object properties of one or more single objects
- One or more faceplate tags
- Both object properties and faceplate tags
- No link

You use these "empty" property nodes for dynamization of the faceplate type. You can find additional information under "Making a Faceplate type dynamic (Page 433)".

Event nodes

Each event node is linked to a single event of the single objects.

See also

Property of a faceplate type (Page 416)

Event of a Faceplate type (Page 420)

Overview: Configuring faceplate types (Page 399)

Making a Faceplate type dynamic (Page 433)

3.6.2.3 How to create a Faceplate type

You configure a faceplate type in the Graphics Designer.

To create the FPT file, insert objects from the "Default" selection window and configure their properties.

You can find additional information on inserting and configuring objects of the Graphics Designer in the section "Working with objects".

Requirement

- The Graphics Designer is open.

Procedure

1. Select the "New Faceplate type" command from the "File" menu.
A new picture with the *.FPT format opens.
2. Select the "Save" command on the "File" menu.
3. Assign a meaningful name to the faceplate type. Confirm with "Save".
The faceplate type is created in the "GraCS" project folder.
4. Insert the single objects from the object palette.
5. Configure the object properties of the single objects.
In the faceplate type you should dynamize only object properties which you do not define as instance-specific property.
6. Select "File" > "Save" to save your changes to the faceplate type.

Result

A faceplate type is created as a template.

The next step is to configure the tags of the faceplate type and the instance-specific properties and events.

Alternative procedure

You can copy faceplate types that have already been created from another WinCC project to your WinCC project:

1. Open the "GraCS" folder in the project path in Windows Explorer.
2. Drag-and-drop the required faceplate type to the WinCC Explorer data window.

You can also copy or move FPT files to the "GraCS" subfolder in Windows Explorer.

See also

Making a Faceplate type dynamic (Page 433)

Interface tags (Page 407)

Structure types and structure type elements (Page 413)

Working with Objects (Page 456)

3.6.2.4 How to protect faceplate types with a password

You protect a faceplate type against unauthorized access with a password:

- Configuration change
- Access to proprietary scripts

Requirement

- A faceplate type is open in the Graphics Designer.
- No object is selected in the faceplate type.

Procedure

1. Select the "Background picture" property in the faceplate type.
2. Double-click on the "Password protection" property in the "Miscellaneous" property group. The "Password Protection" dialog opens.
3. Enter a password that consists of at least six characters.
4. Repeat your password entry.
5. Click "OK".

Result

The current faceplate type is protected by a password.

One it is closed, the faceplate type can only be opened again when the correct password is entered.

Removing passwords

1. To delete the password, enable the "Remove password" option in the "Password Protection" dialog.
2. Confirm with "OK".

The faceplate type is no longer protected by password.

Alternative procedure

You can open the "Password Protection" dialog in the shortcut menu of the process picture:

- Graphics Designer > <Process screen name> tab > shortcut menu
 - WinCC Explorer > Data window > Shortcut menu of the process picture
- An advanced dialog box opens in which you can set the same password for all process pictures and faceplate types.

3.6.2.5 Interface tags

Introduction

Interface tags are used in a faceplate type for the connection with instance-specific object properties:

- Dynamization of a faceplate instance in the process picture
- Use of values of the faceplate type in the process picture

Create the interface tags in each faceplate type. They are only valid for the faceplate type in which the tags were created.

"Configure Faceplate Type" dialog

Opening the configuration dialog

To open the configuration dialog, select command "Configure Faceplate Type" in the "Edit" menu .

"Tags" tab

In the "Tags" tab, define the interface tags as instance-specific tags.

Link these nodes with object properties of the faceplate type.

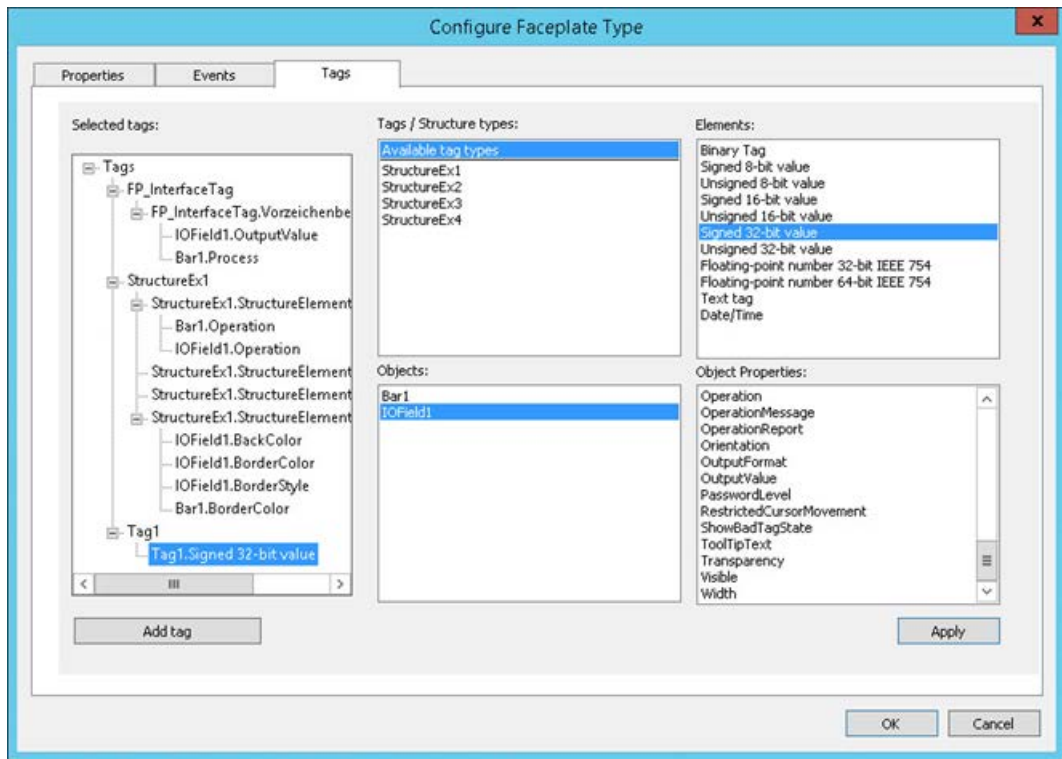

"Tags / Structure types" area

In this area, select whether you want to create the interface tags or structure types as nodes. To select the data type of an interface tag, click on "Available tag types".

"Elements" area

If you have clicked the "Available tag types" entry in the "Tags / Structure types" area, the possible data types are displayed.

To create an interface tag, drag-and-drop the desired type into the "Selected tags" area.

"Object" area

This area contains all objects included in the faceplate type.

Select an object for which you want to show the available properties in the "Object properties" area.

"Object Properties" area

This area contains all available properties for the selected object.

The list only contains dynamic properties.

The following object properties are generally type-specific and are not displayed:

- Layer (Layer)
- Position X (Left)
- Position Y (Top)

"Selected Tags" area

This area contains the instance-specific tag nodes of the faceplate type and their links.

Link the tag nodes to one or more object properties of the single objects.

Creating nodes

You have two options for creating a node under "Properties":

- Drag-and-drop the required tag type from the "Elements" area to the "Selected tags" area.
- Click on the "Add tag" button.
Drag-and-drop the required tag type from the "Elements" area to the tag.

Assign a descriptive name to the node. This name is independent of language and cannot be translated into other languages.

Only the name of the property node is displayed in the object properties of the faceplate instance. You do not see which object properties are linked with the property node.

Linking object properties

- An object property of a single object can only be linked to a single tag node.
- You cannot use object properties that are configured as instance-specific property nodes on the "Properties" tab.
- Object properties that are dynamized in the faceplate type should not be defined as instance-specific.
Do not link this property with an interface tag.

Interface tags in faceplate instances

The instance-specific interface tags are created as user-defined object property in a faceplate instance.

You cannot create new interface tags or change the tag properties.

Configuring user-defined object properties

Ensure that you configure the user-defined object properties effectively.

When values are entered in the "Static" column, it is not checked if the entered value matches the connected instance-specific object properties or tags.

Example:

An instance-specific faceplate tag of the type "Date/Time" is connected to the user-defined object property "Time stamp".

You can enter a corresponding value in "Object properties" window in the "Static" column, for example: "12/12/2016 12:00:00 AM".

If you enter the string "Start time" instead, for example, this value cannot be processed by the faceplate tags.

Behavior in Runtime

A node is in each case linked to an interface tag and also to one or more object properties.

When a value of the property node is changed in Runtime, the following applies:

- The linked object properties of the faceplate instance are changed.
- The values of the linked interface tags are changed.

See also

Structure types and structure type elements (Page 413)

How to create a Faceplate type (Page 405)

How to define instance-specific interface tags (Page 422)

3.6.2.6 Faceplate tags

Introduction

You use faceplate tags in a faceplate type for the following purposes:

- In faceplate type:
 - Dynamization of single objects
 - Faceplate-internal scripts
- Connection to instance-specific object properties:
 - Dynamization of a faceplate instance in the process picture
 - Use of values of the faceplate type in the process picture

To increase the performance, use interface tags or structure type elements.

You create the faceplate tags in each faceplate type. They are only valid for the faceplate type in which the tags were created.

Note

Faceplate tags and internal faceplate scripts affect the performance

The performance when opening or updating a process picture in runtime is affected by the following factors:

- Number of faceplate instances in the process picture
 - Number of faceplate tags in the faceplate types and faceplate instances
To increase the performance, use interface tags and structure types.
 - Using scripts in the faceplate types and faceplate instances
-

"Faceplate tags" configuration dialog

When a faceplate type is opened in the Graphics Designer, you can open the "Faceplate Tags" dialog.

You create faceplate tags and configure or change their properties in this configuration dialog.

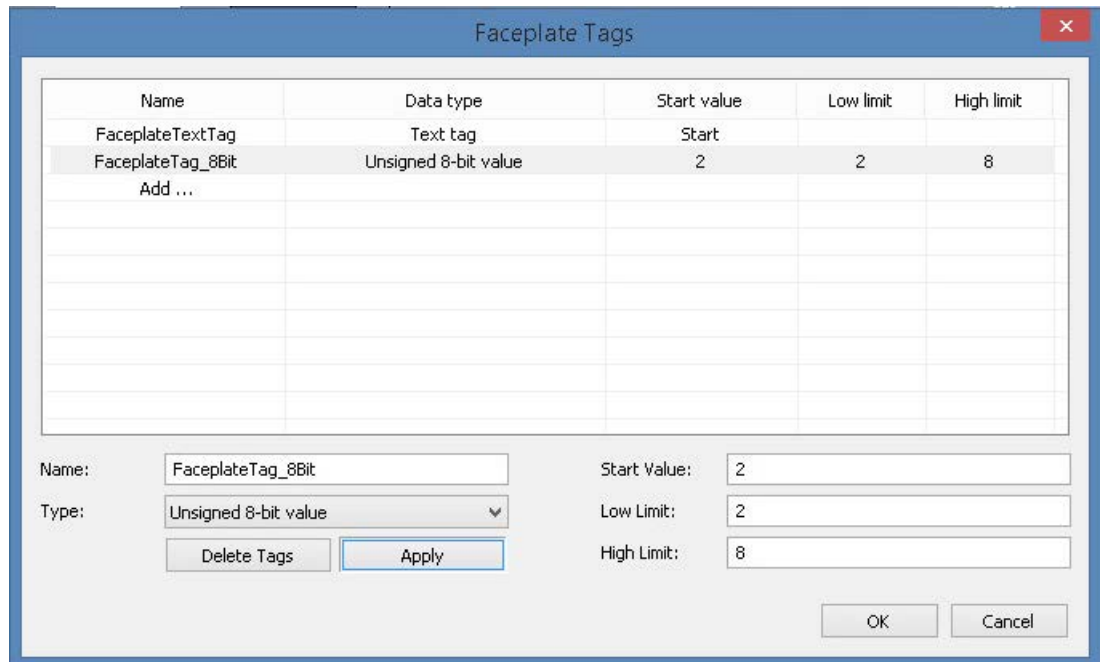

Opening the configuration dialog

You have two options for opening the "Faceplate tags" configuration dialog: Via the menu bar or in the "Object Properties" window.

Menu bar of the Graphics Designer

Select the "Edit Faceplate Tags" command from the "Edit" menu.

"Object Properties" window

1. Select a single object of the faceplate type.
2. Select an attribute that you want to dynamize in the "Object properties" window.
3. Select the "Tag" command from the shortcut menu of the "Dynamic" column.

Faceplate tags

You configure the following properties for faceplate tags:

- Tag name
- Tag type
You can use all tag types except "Raw data tag" and "Text reference".
- Tag values, depending on the tag type:
 - Start value
 - Low limit
 - High limit

Faceplate tags in faceplate instances

The instance-specific faceplate tags are created as custom object properties in a faceplate instance.

You cannot create new faceplate tags or change the tag properties.

Configuring user-defined object properties

Ensure that you configure the user-defined object properties effectively. When values are entered in the "Statics" column, it is not checked if the entered value matches the connected instance-specific object properties or tags.

Example:

An instance-specific faceplate tag of the type "Date / time" is connected to the user-defined object property "Time stamp".

You can enter a corresponding value in "Object properties" window in the "Statics" column, for example: "12/12/2016 12:00:00 AM". If you enter the string "Start time" instead, for example, this value cannot be processed by the faceplate tag.

Behavior in Runtime

A property node can be linked to several faceplate tags and also with one or more object properties.

When a value of the property node is changed in Runtime, the following applies:

- The linked object properties of the faceplate instance are changed.
- The values of the linked faceplate tags are changed.
This triggers dynamic display of the faceplate type in the active faceplate instance in some cases.

See also

How to create faceplate tags (Page 421)

How to link faceplate tags with a properties node (Page 431)

3.6.2.7 Structure types and structure type elements

Introduction

To link multiple faceplate instances efficiently always with the same tags, use the structure tags from the WinCC Tag Management.

In the faceplate type, define a structure type or a structure type element as instance-specific tag. The structure type elements are used to link the instance-specific object properties.

The structure types of the tag management can be used in several different faceplate types. Ensure that no conflicts occur in the WinCC project due to the configuration.

The runtime behavior is comparable with interface tags.

"Configure Faceplate Type" dialog

Opening the configuration dialog

To open the configuration dialog, select command "Configure Faceplate Type" in the "Edit" menu .

"Tags" tab

In the "Tags" tab, define the structure types and structure type elements as instance-specific tags.

Link these nodes with object properties of the faceplate type.

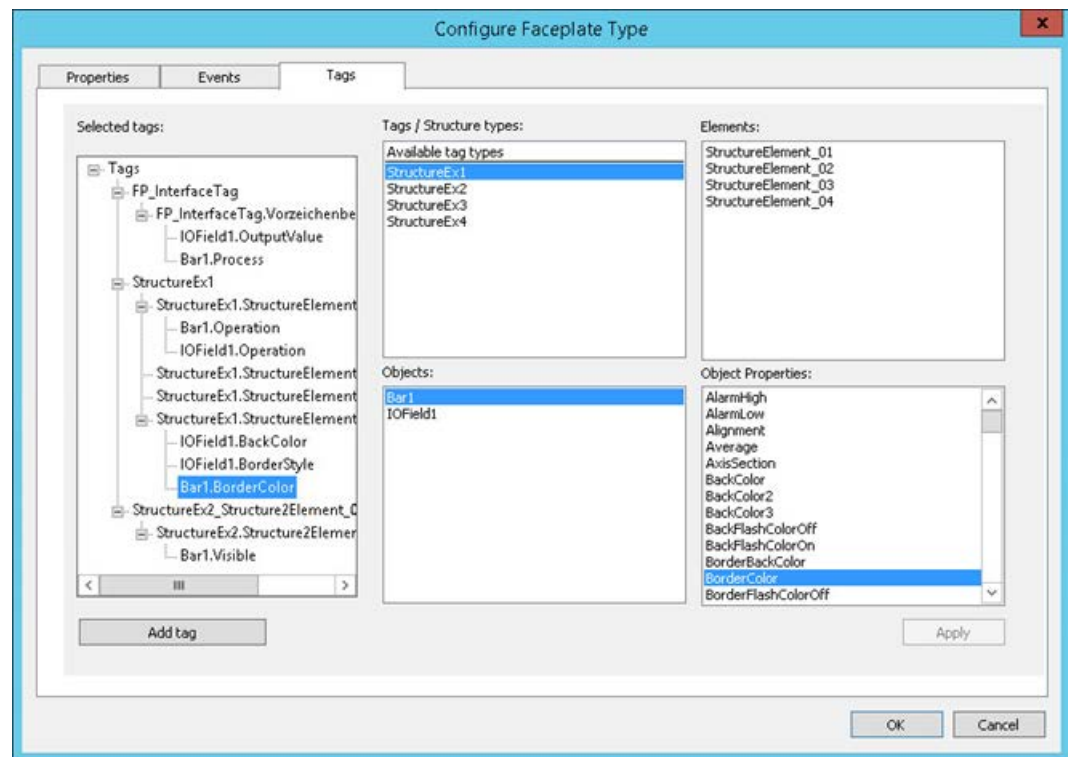

"Tags / Structure types" area

In this area, select whether you want to create the interface tags or structure types as nodes.

The configured structure types are listed:

- Structures that were created in the WinCC Tag Management
- Structures which were imported from the TIA Portal or an OPC UA server, for example

If no structure types are created in the WinCC Tag Management, the field under "Available tag types" remains empty.

To use the structure, drag-and-drop the structure type into the "Selected tags" area.

"Elements" area

If you have clicked the structure type in the "Tags / Structure types" area, the structure type elements are displayed.

You can also use drag-and-drop to place single structure type elements in the "Selected tags" area and create them as tag nodes.

"Object" area

This area contains all objects included in the faceplate type.

Select an object for which you want to show the available properties in the "Object properties" area.

"Object Properties" area

This area contains all available properties for the selected object.

The list only contains dynamic properties.

The following object properties are generally type-specific and are not displayed:

- Layer (Layer)
- Position X (Left)
- Position Y (Top)

"Selected Tags" area

This area contains the instance-specific tag nodes of the faceplate type and their links.

Link the tag nodes to one or more object properties of the single objects.

Creating nodes

To create a node for a structure type, drag-and-drop the structure type into the "Tags / Structure types" area of the "Selected tags" area.

Alternatively, drag a structure type element from the "Elements" area to the "Selected tags" area.

Assign a descriptive name to the node. This name is independent of language and cannot be translated into other languages.

Only the name of the property node is displayed in the object properties of the faceplate instance. You do not see which object properties are linked with the property node.

Linking object properties

- An object property of a single object can only be linked to a single instance-specific structure type element.
- You cannot use object properties that are configured as instance-specific property nodes on the "Properties" tab.
- Object properties that are dynamized in the faceplate type should not be defined as instance-specific.
Do not link this property with a structure type element.

Structures in faceplate instances

Instance-specific structures and individually created structure type elements behave differently in the faceplate instances:

- Instance-specific structures are displayed as one single user-defined object property. You can only connect the user-defined structure with one tag. Other dynamizations are not possible.
- If you have created a single structure type element as instance-specific node, the element is created as a user-defined object property.
All the usual dynamization types are possible for these properties.

Automatically link structure in process picture

You can link faceplate instances efficiently and with little effort with structure tags in the process image.

Drag-and-drop a structure instance into the process picture from the selection window "Tags" or from Tag Management.

All faceplate types in which you have created an instance-specific tag of the structure are displayed in a selection dialog.

When creating a faceplate instance, the instance-specific structure type elements are automatically linked to the corresponding structure tags.

See also

Interface tags (Page 407)

How to create a Faceplate type (Page 405)

How to define instance-specific interface tags (Page 422)

How to define instance-specific structures (Page 425)

3.6.2.8 Property of a faceplate type

Introduction

In the configuration dialog of a faceplate type, specify the properties, events and internal faceplate tags that can be configured in the faceplate instances.

If you insert the faceplate type as an instance in a process picture, the instance-specific properties and events are displayed.

All other properties and events are type-specific and can only be configured in the faceplate type.

Text lists and graphics lists

You can also use text lists and graphics lists in faceplate types. You can find additional information under "How to create text lists and graphics lists in faceplate types (Page 428)".

"Configure Faceplate Type" dialog

Opening the configuration dialog

To open the configuration dialog, select command "Configure Faceplate Type" in the "Edit" menu .

"Properties" tab

You define the properties that should be able to be configured in the instances in the "Properties" tab.

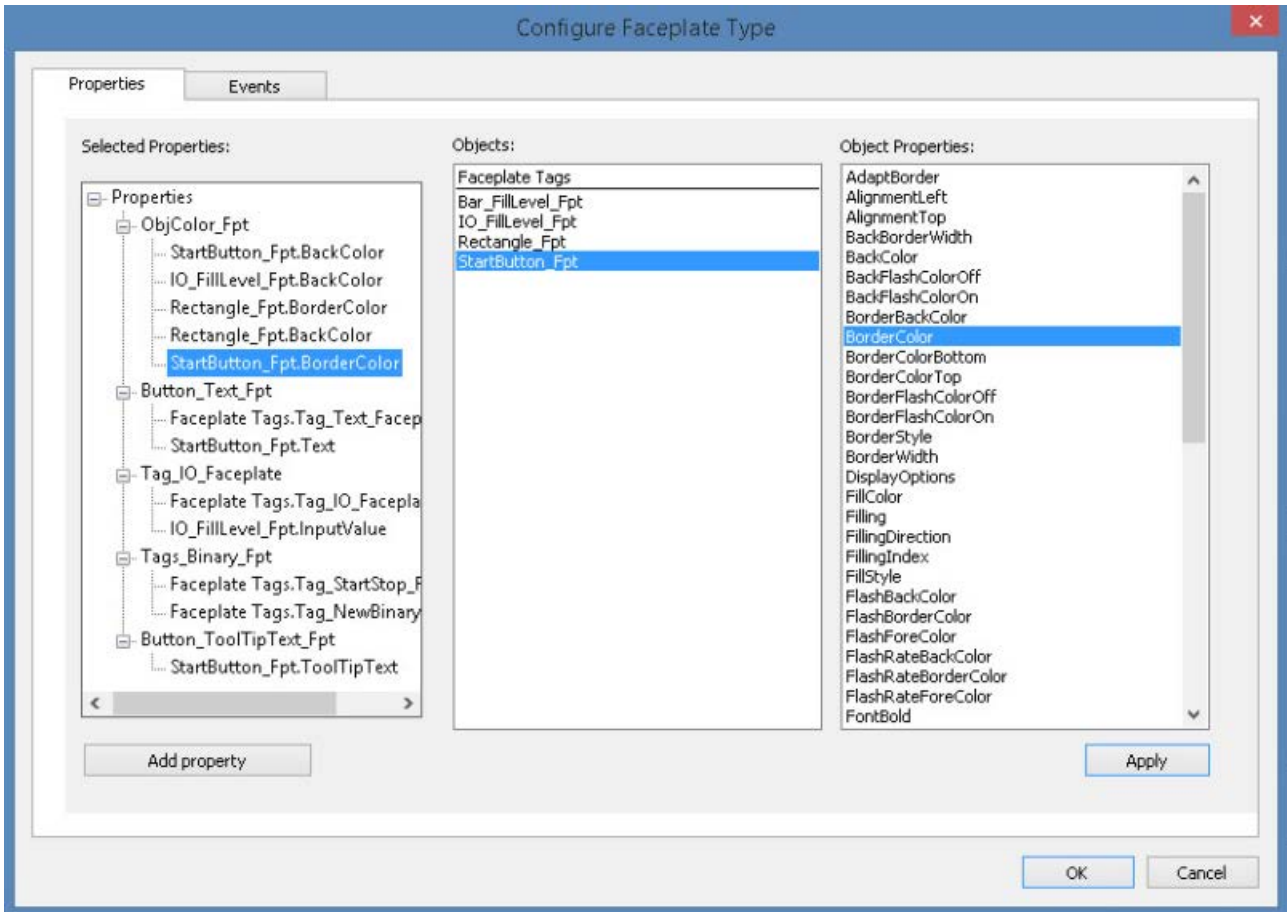

"Object" area

This area contains all objects included in the faceplate type as well as the "Faceplate tags" entry.

Select an object for which you want to show the available properties in the "Object Properties" area.

To link interface tags or structures with the object properties, change to the "Tags" tab.

"Properties of the object" area

This area contains all available properties for the selected object. The list only contains dynamic properties.

The following object properties are generally type-specific and are not displayed:

- Layer (Layer)
- Position X (Left)
- Position Y (Top)

If the "Faceplate Tags" entry is selected in the "Objects" area, the faceplate tags of the faceplate type are displayed.

The "Selected properties" area

This area contains the instance-specific property nodes of the faceplate type and their links. You link the property nodes to one or more object properties of the single objects.

Creating property nodes

You have two options for creating a property node under "Properties":

- Click on the "Add Property" button.
- Drag the desired object property from the "Object properties" area and drop it into "Selected properties".

Assign a meaningful name to the property node. This name is independent of language and cannot be translated into other languages.

Only the name of the property node is displayed in the object properties of the faceplate instance. You do not see which object properties are linked with the property node.

Linking object properties

- An object property of a single object can only be linked to a single property node.
- In the "Properties" tab, you can no longer use object properties that are linked with an interface tag or structure.
- Object properties that are dynamized in the faceplate type should not be defined as instance-specific.
Do not link this property with a property node.

Grouping object properties

- Move the same or similar properties of single objects under the same property node. How to group properties that are uniformly configured, for example, the border color or the "Flashing" property of multiple single objects.
- Make sure that you form meaningful groups.
Example: When you group the properties "Line weight" and "Background color", you can no longer meaningfully configure this property node in the faceplate instances.

Behavior in Runtime

A separate data storage is created and managed in Runtime for each faceplate instance:

- Tag Management of the internal faceplate tags
- Faceplate-internal scripts (MS Scripting Engine)

Accordingly, the dynamic display of type-specific properties are always only triggered in the given instance.

A process picture can include multiple instances of the same faceplate type, which are operated independent of one another.

Value change	Result
<p>Process picture The value of a property node is changed.</p>	<p>Faceplate instance All links of the property node are changed:</p> <ul style="list-style-type: none"> • Properties of single objects • Faceplate tags <p>The change only affects the faceplate instance whose property node has been changed.</p>
<p>Process picture The value of an interface tag or structure tag is changed.</p>	<p>Faceplate instance All links of the property node are changed:</p> <ul style="list-style-type: none"> • Properties of single objects • Interface tag or structure tag <p>The change only affects the faceplate instance whose property node has been changed.</p>
<p>Faceplate instance The value of a faceplate tags is changed.</p>	<p>Faceplate instances The change is applied in the active faceplate instance. No values are changed in the other associated faceplate instances.</p> <p>Process picture If the faceplate tag is linked to a property node, the corresponding object property is changed to the active faceplate instance. You can read this value from the object property and continue using it in the process picture via scripts or tag connection.</p>
<p>Faceplate instance The object property of a single object is changed.</p>	<p>Faceplate instances The change is applied in the active faceplate instance. No object properties are changed in the other associated faceplate instances.</p> <p>Process picture If the object property is linked to a property node, the corresponding object property is changed to the active faceplate instance. You can continue to use the property change in the process picture via scripts or tag connection.</p>

See also

How to define instance-specific object properties (Page 424)

Making a Faceplate type dynamic (Page 433)

Illegal Characters (Page 226)

Properties and events (Page 402)

How to create text lists and graphics lists in faceplate types (Page 428)

How to define instance-specific interface tags (Page 422)

3.6.2.9 Event of a Faceplate type

Introduction

In the configuration dialog of a faceplate type, specify the properties, faceplate tags and events that can be configured in the faceplate instances.

If you insert the faceplate type as an instance in a process picture, the instance-specific properties and events are displayed.

All other properties and events are type-specific and can only be configured in the faceplate type.

"Configure Faceplate Type" dialog

Opening the configuration dialog

To open the configuration dialog, select command "Configure Faceplate Type" in the "Edit" menu .

"Events" Tab

You define the events that should be able to be configured in the instances in the "Events" tab.

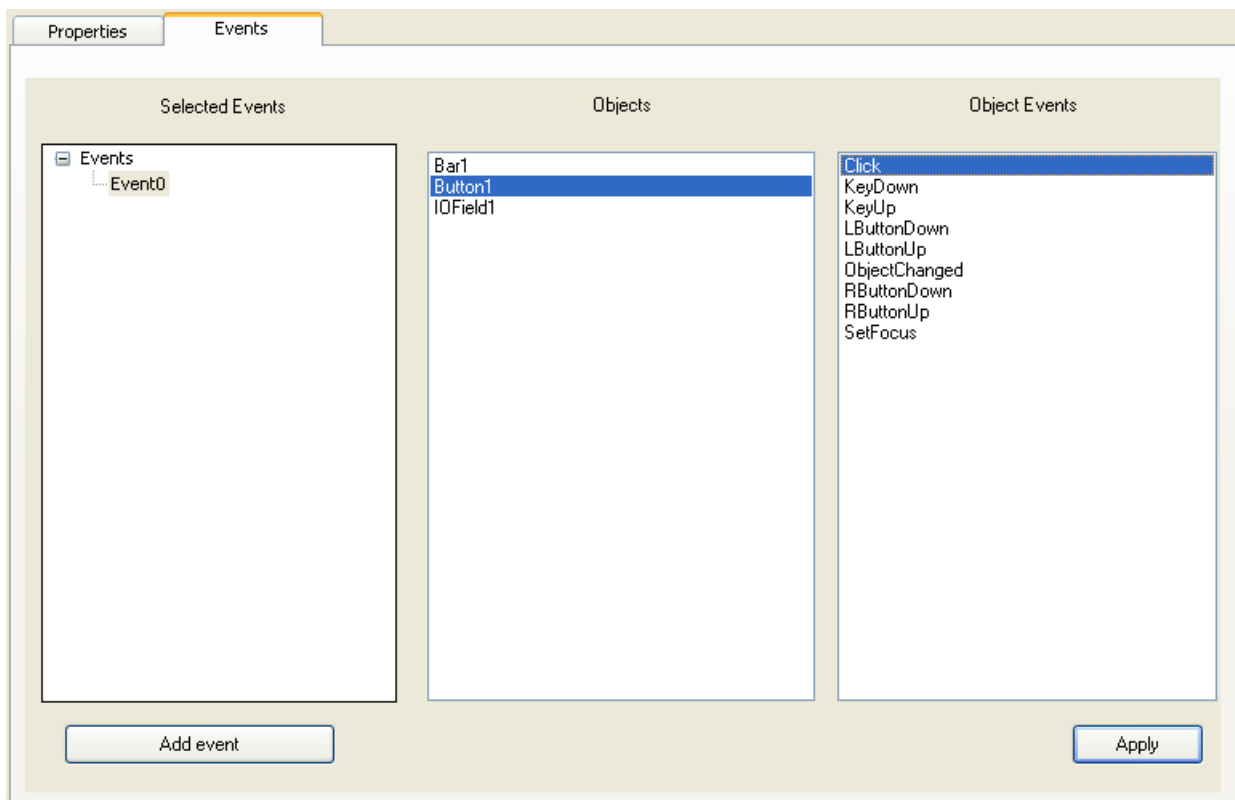

"Object" area

This area contains all objects included in the faceplate type.

Select an object for which you want to show the available events in the "Object Events" area.

"Object events" area

This area contains all available events for the selected object.

"Selected events" area

This area contains the instance-specific event node of the faceplate type. Assign each of these event nodes exactly one event of the single objects.

You have two options for creating an event node under "Events":

- Click on the "Add Event" button.
- Drag the desired event from the "Object events" area and drop it into "Selected events".

Assign a meaningful name to the event node. This name is independent of language and cannot be translated into other languages.

Only the name of the event node is displayed in the object properties of the faceplate instance. You do not see which event is linked with the event node.

Link events

You can only link one single event of the single objects to each instance-specific event.

Events that are dynamized in the faceplate type should not be defined as instance-specific. Do not link this event to an event node.

Behavior in Runtime

1. A process picture with a faceplate instance is displayed in Runtime.
2. The instance-specific event of the single object is triggered in the faceplate instance, for example, a "Mouse click".

See also

How to define instance-specific events (Page 432)

Properties and events (Page 402)

3.6.2.10 How to create faceplate tags

Introduction

A faceplate type can be given a dynamic response with faceplate tags. Tags from the WinCC tag management are not available.

You configure the faceplate tags each for a specific faceplate type in the Graphics Designer.

Requirements

- A faceplate type is opened in the Graphics Designer.

Procedure

1. Select the "Edit Faceplate tags" command from the "Edit" menu.
The "Faceplate tags" dialog opens.
2. Double-click the "Add" table window.
A new tag is created with default values.
3. Double-click on the created tag.
The input fields are activated in the lower portion of the window.
4. Configure the desired tag properties in the fields.
To apply the changes, click in the table window or "Apply".
5. To delete a tag, click on the respective row in the table window and then "Delete tag".
6. Close the dialog with "OK" and save the faceplate type

Result

You can create faceplate tags for the faceplate type.

You use the faceplate tags for dynamization of the faceplate type.

You can change the properties of the tags afterwards when selecting tags in "Object Properties" dialog.

See also

Faceplate tags (Page 410)

How to link faceplate tags with a properties node (Page 431)

3.6.2.11 How to define instance-specific interface tags

Introduction

To reach high performance for the dynamization in the process picture, use interface tags or structure type elements.

For this purpose, you create interface tags as tag nodes that are linked to the properties of the single objects.

These interface tags can only be dynamized in the faceplate instance.

Every instance-specific tag node can be connected with multiple properties of different single objects.

You configure these links in the "Configure Faceplate Type" dialog on the "Tags" tab.

Requirements

- A faceplate type is open in the Graphics Designer.
- The "Tags" tab is selected in the "Configure Faceplate Type" dialog.

Procedure

1. To select the data type of the interface tag, click "Available tag types".
The data types are displayed in the "Elements" area.
2. To create a tag node, drag-and-drop a data type into the "Selected properties" area.
Alternatively, click "Add tag" and drag the data type to the new tag node.
3. To assign a meaningful name to the tag node, select "Rename" in the shortcut menu.
Only the name of the tag nodes appear as an object property in the faceplate instances.
4. Select a single object of the faceplate type in the "Objects" area.
The available properties are displayed in the "Object properties" area.
5. Drag-and-drop the selected property onto the tag node in the "Selected properties" area.
The property of the single object is placed under the tag node.
If required, select another update cycle in the shortcut menu of the object property.
6. If required, drag additional object properties of the individual objects onto the tag node.
7. If you want to delete a tag node or the link to a property, select "Delete" in the shortcut menu.
8. Click "Apply".
Confirm the message that the change affects the faceplate instances where appropriate.
The configurations are applied.
9. Close the configuration dialog with "OK" and save the faceplate type

Result

In the object properties of the faceplate type, the link is identified by the following symbol: 

Double-clicking the symbol in the "Dynamization" column opens the "Configure Faceplate Type" dialog.

Faceplate instance

The tag node is displayed in the "User-defined3" property group of the "Faceplate instance" object in faceplate instances.

Changing object properties later

You can always assign a different object property to an instance-specific tag node. This change may affect the associated faceplate instances.

In this case, check the existing faceplate instances. If necessary, adapt the configuration in the process picture.

A red cross is displayed at the instance in the pictures containing the respective faceplate type instances.

See also

How to define instance-specific object properties (Page 424)

How to link faceplate tags with a properties node (Page 431)

Property of a faceplate type (Page 416)

Structure types and structure type elements (Page 413)

Interface tags (Page 407)

How to define instance-specific structures (Page 425)

3.6.2.12 How to define instance-specific object properties

Introduction

In the "Configure Faceplate Type" dialog you define which properties are configurable in the instances in the "Properties" tab.

For this, you create property nodes that are link ed to the properties of the single objects.

You can link each instance-specific property node to multiple object properties.

Interface tags / structures

To reach high performance for the dynamization in the process picture, use interface tags or structure type elements.

You configure the instance-specific links consistently on the "Tags" tab.

Requirements

- A faceplate type is open in the Graphics Designer.
- The "Properties" tab is selected in the "Configure Faceplate Type" dialog.

Procedure

1. To create a property node in the "Selected properties" area, click "Add Property".
2. To assign a meaningful name to the property node, select "Rename" in the shortcut menu. Only the name of the property nodes appear as an object property in the faceplate instances. If you only want to configure an "empty" property node with no links to the single objects, close the dialog with "OK".
3. Select a single object of the faceplate type in the "Objects" area. The available properties are displayed in the "Object properties" area.
4. Drag-and-drop the selected property onto the properties node in the "Selected properties" area. The property of the single object is placed under the property node. If you drag-and-drop the object property onto the "Properties" node, a property node with the name of the object property is created.

5. If needed, group similar properties of the single objects.
Link these properties to a common property node.
6. If you want to delete a property node or the link to a property, select "Delete" in the shortcut menu.
7. Click "Apply".
Confirm the message that the change affects the faceplate instances where appropriate.
The configurations are applied.
8. Close the configuration dialog with "OK" and save the faceplate type

Result

The property node is displayed in the "User-defined2" property group of the "Faceplate instance" object in faceplate instances.

Changing object properties later

You can always assign a different object property to an instance-specific property. This change may affect the associated faceplate instances.

In this case, check the existing faceplate instances. If necessary, adapt the configuration in the process picture.

A red cross is displayed at the instance in the pictures containing the respective faceplate type instances.

See also

[How to configure a faceplate instance \(Page 435\)](#)

[How to link faceplate tags with a properties node \(Page 431\)](#)

[Property of a faceplate type \(Page 416\)](#)

[How to define instance-specific interface tags \(Page 422\)](#)

[How to define instance-specific structures \(Page 425\)](#)

3.6.2.13 How to define instance-specific structures

Introduction

To reach high performance for the dynamization in the process picture, use interface tags or structure type elements.

To use structures, create the structure types, structure type elements and structure tags in the WinCC tag management.

Link the structure type elements with the object properties of the individual objects in the "Configure Faceplate Type" dialog on the "Tags" tab. Create an instance-specific property for this.

In the faceplate instance, you link the instance-specific property with the structure tag. These instance-specific properties can only be dynamized in the faceplate instance.

Linking the structure automatically

To link the faceplate instances with structure tags efficiently and with little effort, drag the structure instance into the process picture and select the associated faceplate type.

Requirements

- A faceplate type is open in the Graphics Designer.
- The "Tags" tab is selected in the "Configure Faceplate Type" dialog.
- Structure types and structure type elements have been created in the Tag Management.

Procedure

1. Click a structure type in the "Tags / Structure types" area.
The structure type elements are displayed in the "Elements" area.
2. Drag a structure type into the "Selected properties" area.
A group containing the name of the structure type is created.
In this group, the structure type elements are displayed as linked tag nodes.
3. To create an individual structure type element as a tag node, drag the element into the "Selected properties" area.
In this case, you are no longer able to create the complete structure as tag node anymore but only additional structure type elements.
4. To assign a meaningful name to the tag node, select "Rename" in the shortcut menu.
Only the name of the tag nodes appear as an object property in the faceplate instances.
5. Select a single object of the faceplate type in the "Objects" area.
The available properties are displayed in the "Object properties" area.
6. Drag-and-drop the selected property onto the tag node in the "Selected properties" area.
The property of the single object is placed under the tag node.
If required, select another update cycle in the shortcut menu of the object property.
7. If required, drag additional object properties of the individual objects onto the tag node.
8. If you want to delete a tag node or the link to a property, select "Delete" in the shortcut menu.
9. Click "Apply".
Confirm the message that the change affects the faceplate instances where appropriate.
The configurations are applied.
10. Close the configuration dialog with "OK" and save the faceplate type

Result

In the object properties of the faceplate type, the link is identified by the following symbol: 

Double-clicking the symbol in the "Dynamization" column opens the "Configure Faceplate Type" dialog.

Faceplate instance

The tag node is displayed in the "User-defined3" property group of the "Faceplate instance" object in faceplate instances:

- If you have created a structure type as a group, the structure type is displayed as a user-defined property.
- If you have created a single structure type element as a tag node, the element is displayed as a user-defined property.

You link these user-defined properties in the process picture with the structure tags of the structure.

Linking the structure automatically

You can have a faceplate type that is linked with a structure automatically configured when the instance is inserted:

Procedure

1. Configure the structure type in the faceplate type as an instance-specific tag.
2. Activate the "Tags" view in Graphics Designer.
Alternatively, position the Graphics Designer and the Tag Management as windows next to each other.
3. Drag-and-drop a structure instance into the process picture.
4. Select the faceplate type from the list of available faceplate types.
The list only contains faceplate types in which the relevant structure is used.

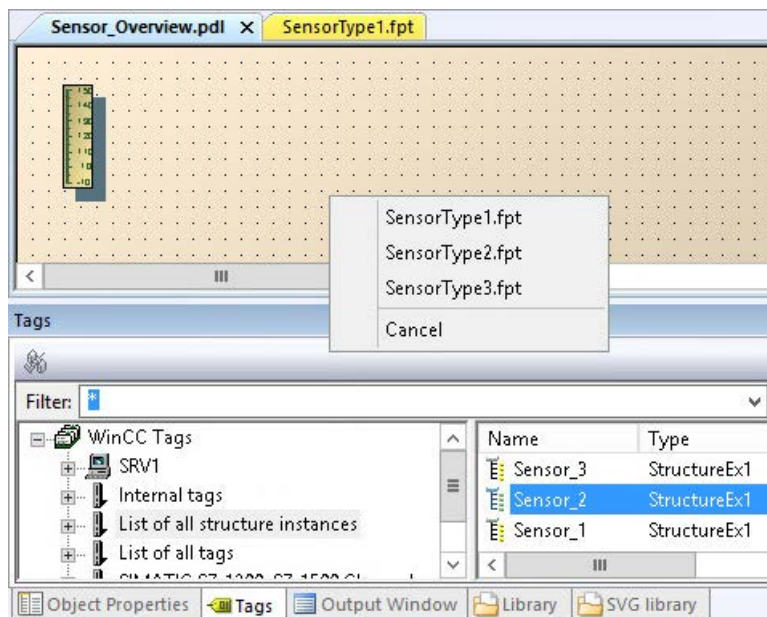

Result

The selected faceplate instance is created.

The structure type elements of the instance-specific structure are linked to the structure tags.

Changing object properties later

You can always assign a different object property to an instance-specific tag node. This change may affect the associated faceplate instances.

In this case, check the existing faceplate instances. If necessary, adapt the configuration in the process picture.

A red cross is displayed at the instance in the pictures containing the respective faceplate type instances.

See also

How to define instance-specific object properties (Page 424)

How to define instance-specific interface tags (Page 422)

Structure types and structure type elements (Page 413)

3.6.2.14 How to create text lists and graphics lists in faceplate types

Text lists and graphics lists in faceplate types

In faceplate types also, you can reference and dynamize text lists and graphics lists in the corresponding WinCC objects.

You create the faceplate lists in the Graphics Designer. Lists that are created in the "Text and graphics lists" editor are not available in faceplates.

Faceplate text lists and faceplate graphics lists are only available for the faceplate in which they were created. They are not displayed in the "Text and graphics lists" editor.

Text lists: Translation

The texts of a faceplate text list are only created in the WinCC configuration language.

To create the texts in multiple languages, change the configuration language in the Graphics Designer via the menu item "View > Language".

If you configure the "Text list" object property as an instance-specific property, you can edit the translations in the faceplate instances. Change the texts for the respective faceplate instance on the "Texts" tab of the object properties.

Procedure: Text lists in faceplate types

1. Open a faceplate type in the Graphics Designer.
2. Select the "Edit > Configure text list for faceplate" menu command.
The "Text List Configuration" dialog opens.

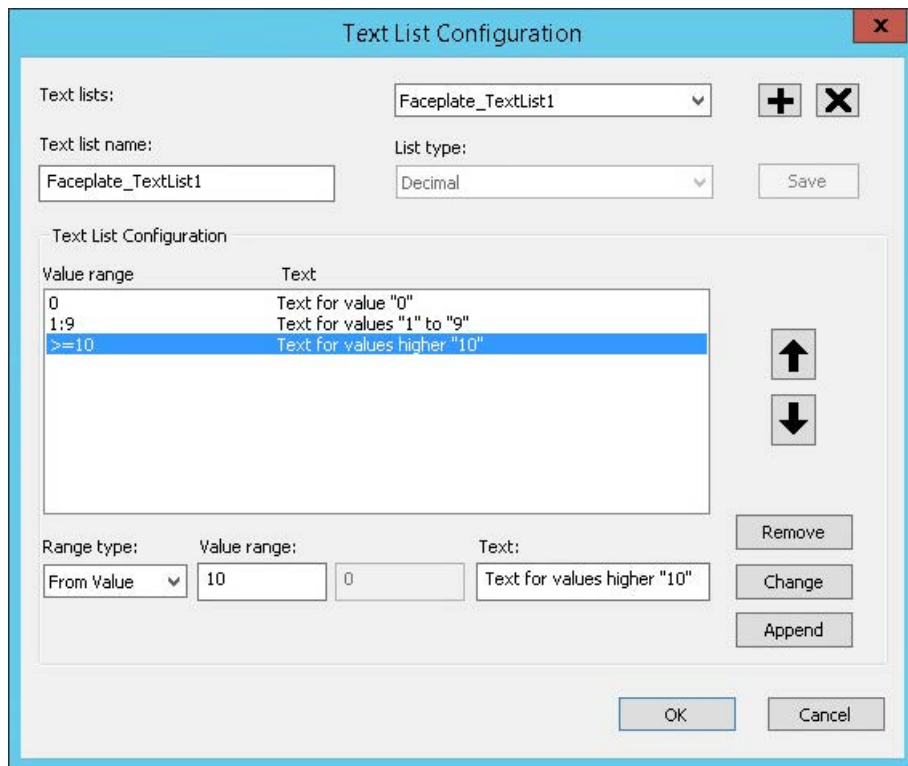

3. Click "+" to create a new list.
Enter a name in the "Text list name" box.
4. Select the list type.
The display in the value range is adapted to the list type.
5. Configure the value range.
Add additional rows using "Append", if necessary.
6. Save the list and close the dialog.
7. Use the faceplate text list with the "Text list" object property of a WinCC object.
8. To dynamize the list in the faceplate instances, configure the "Text list" object property as instance-specific property.

Procedure: Graphics lists in faceplate types

1. Open a faceplate type in the Graphics Designer.
2. Select the "Edit > Configure graphic list for faceplate" menu command. The "Status Display Configuration" opens.

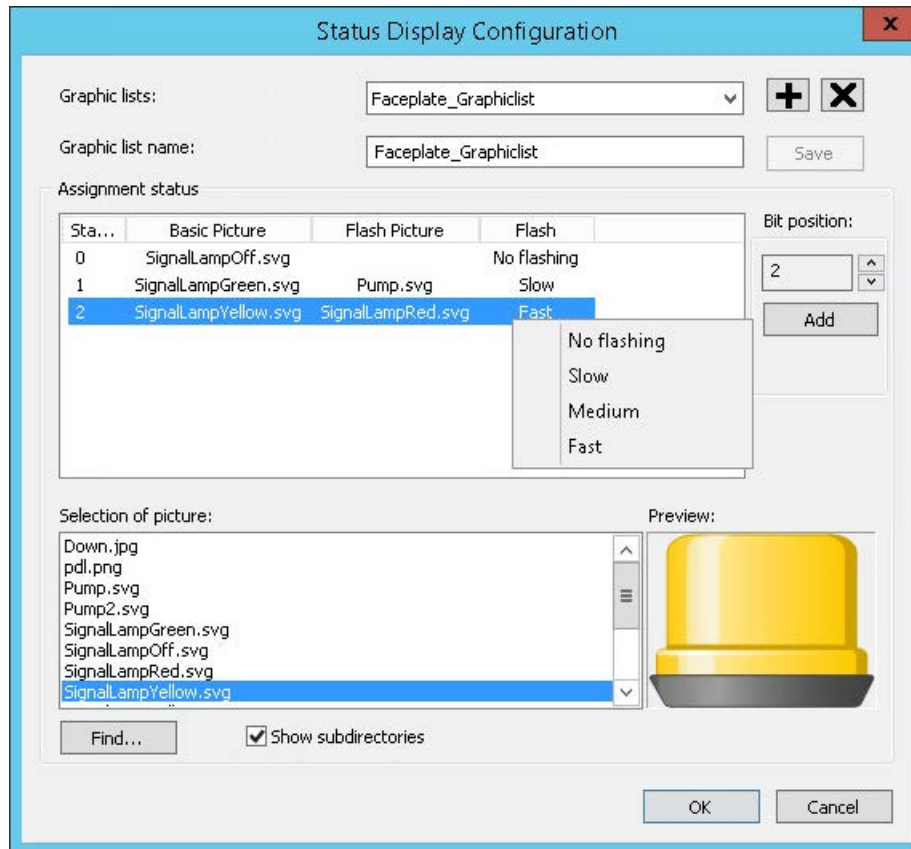

3. Click "+" to create a new list. Enter a name in the "Graphics list name" box.
4. In the "Picture Selection" area, the graphics are displayed in the "GraCS" project folder and in the subfolders. If necessary, load the desired graphics via the "Find" button.
5. Using drag-and-drop, drag a graphic into the "Basic Picture" or "Flash Picture" column in the "Assignment status" area.
6. Select the flash behavior in the shortcut menu of the "Flash" column.
7. To add additional states, select a bit position and click "Add".
8. Save the list and close the dialog.
9. Connect the faceplate graphics list with the "Graphics list" object property of a WinCC object.
10. To dynamize the list in the faceplate instances, configure the "Graphics list" object property as instance-specific property.

See also

- Property of a faceplate type (Page 416)
- How to create text lists (Page 449)
- How to create graphic lists (Page 452)

3.6.2.15 How to link faceplate tags with a properties node

Introduction

You determine which faceplate tags can be configured in the instances in the "Properties" tab. For this, you create property nodes that are linked to the faceplate tags of faceplate type. You can link each instance-specific property node to multiple faceplate tags.

Requirements

- A faceplate type is open in the Graphics Designer.
- At least one faceplate tag is created in a faceplate type.
- The "Properties" tab is selected in the "Configure Faceplate Type" dialog.

Procedure

1. If necessary, create a new property node.
2. To assign a meaningful name to the property node, select "Rename" in the shortcut menu. Only the name of the property nodes appear as an object property in the faceplate instances.
3. Select the "Faceplate tags" entry in the "Objects" area. The faceplate tags available are listed in the "Object properties" area.
4. Drag-and-drop the selected tag onto the property node in the "Selected properties" area. The faceplate tag is placed below the property node. If you drag-and-drop the faceplate tag onto the "Properties" node, the property node is created with the tag name.
5. If needed, group similar tags under a common property node.
6. If you want to remove a link to a property node, select "Delete" in the shortcut menu of the linked faceplate tag.
7. Click "Apply". Confirm the message that the change affects the faceplate instances where appropriate. The configurations are applied.
8. Close the configuration dialog with "OK" and save the faceplate type

Result

The property node is displayed in the "User-defined2" property group of the "Faceplate instance" object in faceplate instances.

Changing tag links later

You can later link an instance-specific object property to another faceplate tag. This change may affect the associated faceplate instances.

In this case, check the existing faceplate instances. If necessary, adapt the configuration in the process picture.

A red cross is displayed at the instance in the pictures containing the respective faceplate type instances.

See also

Faceplate tags (Page 410)

How to define instance-specific object properties (Page 424)

How to create faceplate tags (Page 421)

How to define instance-specific interface tags (Page 422)

3.6.2.16 How to define instance-specific events

Introduction

In the "Configure Faceplate Type" dialog you define which events are configurable in the instances in the "Events" tab.

For this, you create event nodes that are linked to the events of the single objects.

Every instance-specific event node can be connected with only one event of the individual object.

Requirements

- A faceplate type is open in the Graphics Designer.
- The "Events" tab is selected in the "Configure faceplate type" tab.

Procedure

1. Click on "Add Event" in order to create an event node in the "Selected events" area.
2. To assign a meaningful name to the event node, select "Rename" in the shortcut menu. Only the name of the event nodes appear as an object property in the faceplate instances.
3. Select a single object of the faceplate type in the "Objects" area. The events available are displayed in the "Object Events" area.
4. Drag-and-drop the desired event onto the event node in the "Selected events" area. The event of the single object is placed under the event node. If you drag-and-drop the event onto the "Events" node, the event node is created with the event name.
5. If you want to delete an event node or link it to an event, select "Delete" in the shortcut menu.

6. Click "Apply".
Confirm the message that the change affects the faceplate instances where appropriate.
The configurations are applied.
7. Close the configuration dialog with "OK" and save the faceplate type

Result

The event node is displayed on the "Event" tab in the "User-defined2" group of the "Faceplate instance" object.

Changing events later

You can assign another event to an instance-specific event at a later point in time. This change may affect the associated faceplate instances.

In this case, check the existing faceplate instances. If necessary, adapt the configuration in the process picture.

A red cross is displayed at the instance in the pictures containing the respective faceplate type instances.

See also

How to configure a faceplate instance (Page 435)

Event of a Faceplate type (Page 420)

3.6.2.17 Making a Faceplate type dynamic

Introduction

The following applies to dynamization in a faceplate type:

- The tags of the WinCC Tag Management are unavailable.
- The dynamizations that you configure in a faceplate type are only valid for this faceplate type and its instances.
- The following types of dynamics are not possible in a faceplate type:
 - Dynamic Wizard
 - Dynamic dialog
 - ANSI C actions

Available dynamizations

The following types of dynamics are possible in a faceplate type:

- Tag connection to tags:
 - Interface tags
 - Structure type elements
 - Faceplate tags
- Animation
- VB Scripts

Dynamizing through a tag connection

You can use only internal tags of the faceplate type and structure type elements in a faceplate type for tag connection.

The following configuration paths are available for the tag connection:

Interface tags	"Configure Faceplate Type" dialog	Use drag-and-drop to link an object property with an interface tag or a structure type element.
Structure type elements		
Faceplate tags	"Object Properties" window	Select the faceplate tag of the object property in the "Dynamic" column.

Dynamization with VB scripts

In the script of the faceplate type, you can call the system functions or program new functions, e.g. to convert values.

The VB scripts are available only in the faceplate type.

SmartTags object

Use the "SmartTags" object for the dynamic modification of a faceplate type.

You can access the faceplate tags and the properties of the faceplate type with the SmartTags object.

You can find additional information in the VBS reference under "SmartTags object".

ScreenItems object (listing)

You access "ScreenItems" on the single objects of a faceplate type.

You can find additional information in the VBS reference under "ScreenItems object (listing)".

HMIRuntime object not available

You cannot use VB scripts to access data outside of the faceplate type.

The "HMIRuntime" object as well as the functions of "HMIRuntime" are not available in the faceplate type.

However, debugging is possible for scripts in faceplate types.

See also

Example of faceplate tags: How to dynamize a faceplate instance (Page 446)
Properties and events (Page 402)
Example: How to dynamize a faceplate instance (Page 442)
Dynamizing by Means of Tag Connection (Page 1195)
Dynamizing Using VBS Action (Page 1223)

3.6.3 Configuring a faceplate instance

3.6.3.1 How to configure a faceplate instance

To use a faceplate type, insert the "Faceplate instance" object in a process picture.

Number of instances per process picture

You can create multiple instances of the same faceplate type in a process picture.
The number of faceplate instances in a picture is not limited.

Note

Faceplate tags and internal faceplate scripts affect the performance

The performance when opening or updating a process picture in runtime is affected by the following factors:

- Number of faceplate instances in the process picture
 - Number of faceplate tags in the faceplate types and faceplate instances
To increase the performance, use interface tags and structure types.
 - Using scripts in the faceplate types and faceplate instances
-

Configuration notes

You configure a faceplate instance similarly to a customized object. Configure the following properties:

- Properties of the "Faceplate instance" object
- Instance-specific properties of the faceplate instance

Restrictions in the configuration

The following operations are not supported:

- Object palette: Mirroring a faceplate instance
- Object palette: Rotate faceplate instance

Using faceplate types from other WinCC projects

The faceplate type must be in the open project.

To use a faceplate type of another WinCC project, copy the FPT file in the WinCC project.

Requirement

- A faceplate type is created in the WinCC project.
- A process picture is open in the Graphics Designer.

Procedure

1. Insert the "Faceplate instance" object from the object palette into the picture.
The dialog for selecting a file is displayed.
2. Select the desired faceplate type.
The faceplate instance is inserted in the picture.
If you select no faceplate types or an invalid faceplate type, the faceplate object is deleted from the picture.
3. Configure the object properties of the "Faceplate instance" object.
To display the instance exactly like the faceplate type, select the "1:1" scaling mode in the "Miscellaneous" property group.

4. Configure the instance-specific properties in the "Object Properties" window.

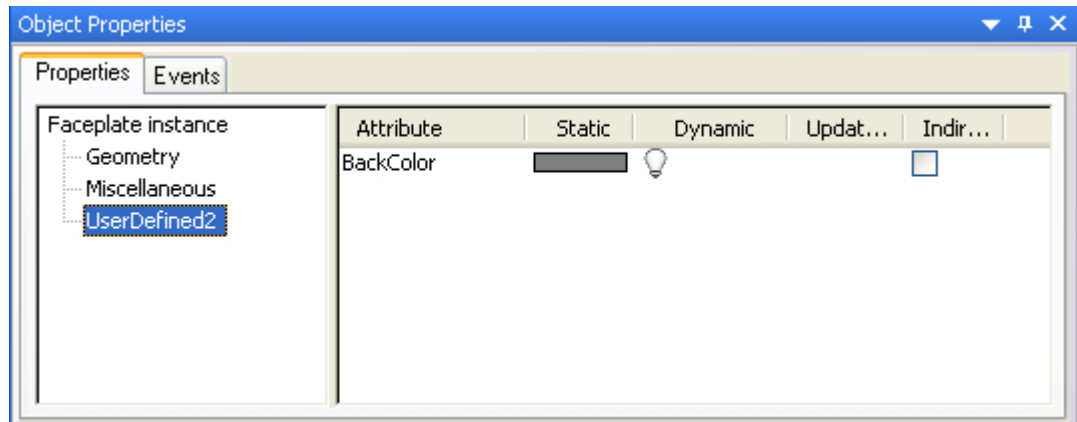

5. Configure the instance-specific events in the "Events" tab.

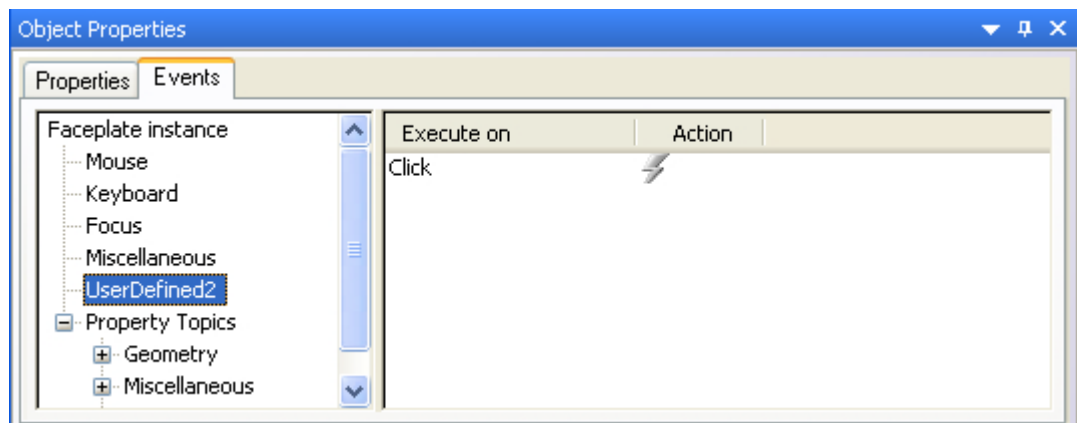

Alternative procedure

To insert a faceplate type in a process picture as an instance, you can also do the following:

1. Select the desired faceplate type from the "Process pictures" window in the Graphics Designer.
2. Drag-and-drop the faceplate type into the process picture.
A faceplate instance is created in the process picture.

Inserting a structure instance

If you have created a structure type as instance-specific tag in a faceplate type, you also link the structure tags during insertion:

Drag-and-drop a structure instance from the "Tags" selection window or from the Tag Management into the process picture. The available faceplate types are displayed as a list.

Select a faceplate type to insert an instance. The instance-specific structure type elements are automatically linked with the structure tags.

Result

You can insert a faceplate instance in the process picture.

See also

How to define instance-specific object properties (Page 424)

How to define instance-specific events (Page 432)

How to update a faceplate instance in the Graphics Designer (Page 441)

Updating faceplate instance (Page 438)

Example of faceplate tags: How to dynamize a faceplate instance (Page 446)

Example: How to dynamize a faceplate instance (Page 442)

3.6.3.2 Updating faceplate instance

Changing faceplate types

If you change instance-specific properties in the faceplate type, you must apply these changes in the faceplate instances.

This also applies when you move a faceplate type under "GraCS" to another folder.

Check the process pictures in each case. Faceplate types and faceplate instances are not monitored by the "Cross Reference" editor.



NOTICE
Checking and adapting scripts
Scripts that use type-specific properties are not automatically adapted in the instances.
These scripts may no longer be executed correctly in Runtime.
This may trigger operation errors without them being indicated to the user.
Therefore, check all scripts in the process picture linked to the faceplate instance.

Enable display of type changes

Select the display of the type changes in the Graphics Designer:

- "Tools > Settings" > "Options" tab > "Display information in case of changes in faceplate type" option

Faceplate instances with a changed faceplate type are marked with a red cross:

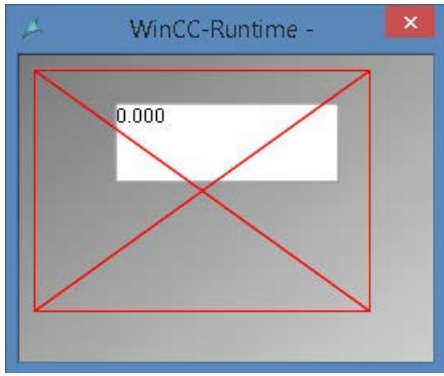
<ul style="list-style-type: none">• WinCC Explorer: Data window	 <p>Process picture symbol</p>  <p>"Tiles" view</p>
<ul style="list-style-type: none">• Process picture properties: Preview• Graphics Designer• WinCC Runtime	 <p>Red cross via the faceplate instance</p>

Updating faceplate instances

WinCC offers the following options for updating the faceplate instances:

- WinCC Explorer:
The "Confirm all type changes" function performs the update in the background.
- Graphics Designer:
Open and save the process picture with the faceplate instance.
The procedure is described in "How to update a faceplate instance in the Graphics Designer (Page 441)"

"Faceplate instances with type change" dialog

When "Display information in case of changes in faceplate type" option is enabled, the affected faceplate instances are listed when you save the process picture.

The dialog only shows the faceplate instances that contain modified type-specific properties, and events.

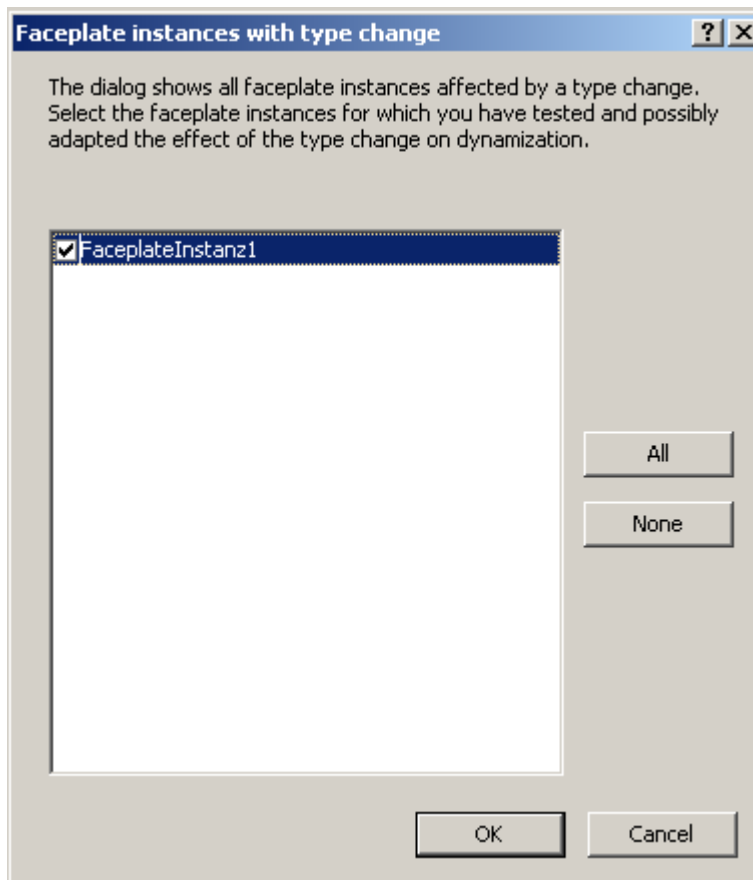

Procedure

1. If necessary, cancel the dialog to check whether the associated scripts of the listed instances have been updated.
2. If needed, adapt the scripts not yet updated.
3. The next time you save, select the check box of the verified faceplate instances.
4. Save the process picture and activated faceplate instances with "OK".

Faceplate instances that you have not selected continued to be marked as changed and are shown again the next time you save the process picture.

If you use the "Confirm all type changes" function, this display is skipped. If necessary, check the process pictures afterwards for updated scripts.

Avoid "Save All"

- The "File > Save All" command only updates process pictures in which additional changes have been made.
The each changed faceplate instances is displayed and updated for these process pictures.
- Process pictures in which nothing has been changed are not be saved.
The faceplate instances contained in them are not updated.

WinCC Explorer: Confirm all type changes

To update the pictures in WinCC Explorer, select the shortcut menu command "Confirm all type changes".

Requirement: The process pictures may not be opened in the Graphics Designer.

WinCC performs the following actions in the background:

- The pictures are opened.
- The application of the type change is confirmed for all contained instances.
- The pictures are saved.
- When saving the pictures, the VBA events "Before Document_Save" and "Document_Save" are not executed.

Use the command if you are sure that the changes do not affect the configured dynamics of the process picture.

If necessary, re-configure the process picture later.

See also

How to update a faceplate instance in the Graphics Designer (Page 441)

How to configure a faceplate instance (Page 435)

3.6.3.3 How to update a faceplate instance in the Graphics Designer

If scripts are configured in process pictures that access type-specific properties or events, we recommend updating the process pictures individually.

This way, the Graphics Designer displays a list of all faceplate instances in the process picture that are affected by a type change.

If you do not want to check each process picture separately, use the "Confirm all type changes" function. You can find additional information under "Updating faceplate instance (Page 438)".

Requirement

- An instance of the faceplate type is inserted in a process picture.
- In the Graphics Designer, the option "Information in faceplate type view changes" enabled.

Procedure

1. Open the faceplate type in the Graphics Designer.
2. Configure the changes in the faceplate type.
When making changes in the "Configure Faceplate Type" dialog, you are reminded that you must adapt the instances.
Confirm the message with "Yes".
3. Save the faceplate type.
For process pictures already opened, the faceplate instances are marked with a red cross.
You can leave these pictures open.

4. Open additional process pictures that are marked in the WinCC Explorer with the red cross if needed.
5. To save a process picture, use the "Save" icon, the shortcut keys <Ctrl+S> or the menu command "File > Save".
Save the process pictures one after the other. The "File > Save All" command only affects process pictures in which additional changes should be saved.
The "Faceplate Instances with Type Change" dialog opens for each save operation. The dialog lists all faceplate instances whose faceplate type has been changed.
6. To check and adapt the linked scripts, cancel the save.
Select "Save" again to update the scripts.
7. Enable the faceplate instances that are to be updated.
If you exclude faceplate instances from updating, these instances remain marked in red. The next time you save the process picture, the faceplate instance is listed again.
8. Save the process picture with "OK".
The changes to the faceplate type are accepted in the faceplate instances.

Result

The faceplate instance is updated and the status is reset.

In Runtime or the WinCC Explorer, the red cross is no longer displayed when opening the picture in the Graphics Designer.

See also

Updating faceplate instance (Page 438)

How to configure a faceplate instance (Page 435)

Example of faceplate tags: How to dynamize a faceplate instance (Page 446)

Example: How to dynamize a faceplate instance (Page 442)

3.6.4 Example: How to dynamize a faceplate instance

Introduction

In this example, you configure an I/O field and a bar in a faceplate instance.

You read the values using a VB script. You use these values in the faceplate instance to update the process picture.

Note**Faceplate tags and internal faceplate scripts affect the performance**

The performance when opening or updating a process picture in runtime is affected by the following factors:

- Number of faceplate instances in the process picture
 - Number of faceplate tags in the faceplate types and faceplate instances
To increase the performance, use interface tags.
 - Using scripts in the faceplate types and faceplate instances
-

Requirement

- You have created two internal tags with the data type "Signed 16-bit value" in the tag management.
 - Bar_Level
 - IO_BarChange
- The option "Display information in case of changes in faceplate type" is activated in the Graphics Designer settings.
- The "Global Script Runtime" component is enabled in the "Startup" tab in the computer properties.

Procedure: Configuring a faceplate type

1. Create a faceplate type "FP_InterfaceTagsType".
2. Insert an "IOField1" I/O field and a "Bar1" bar.
Close the configuration dialog in each case without change.
3. Create an "FP_InterfaceTag" tag in the "Configure Faceplate Type" dialog in the "Tags" tab.
To do this, drag-and-drop the available tag type "Signed 16-bit value" to the "Selected tags" area
Change the tag name via the shortcut menu.
4. Select the "IOField1" I/O field in the "Objects" area.
5. Link the "OutputValue" object property with the "FP_InterfaceTag" tag.

- Also link the "Process" object property of the bar "Bar1" with "FP_InterfaceTag". Select the update cycle "Upon change" in the shortcut menu.

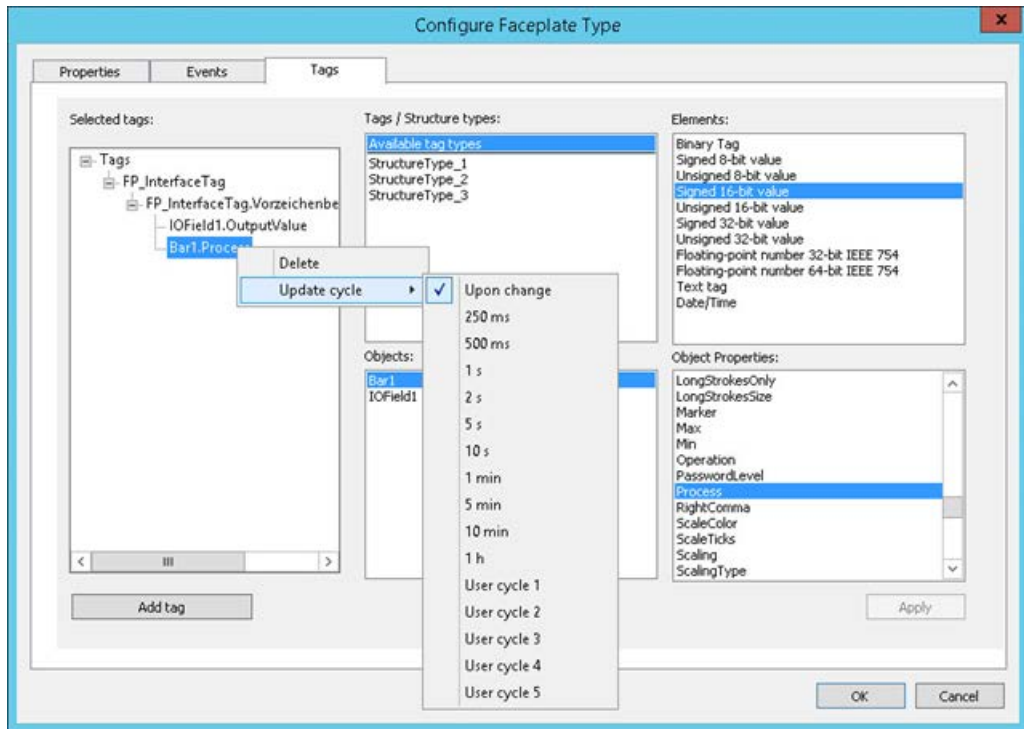

- Confirm with "OK" and save the faceplate type
You have configured an instance-specific property which addresses the following elements in the faceplate instance:
 - Interface tag "FP_InterfaceTag"
 - Output value of the I/O field
 - Output value of the bar

Procedure: Faceplate instance in the process picture

- Insert the "FP_InterfaceTagsType" faceplate type in a "Test_Faceplates.pdl" process picture as an instance.
To update the process picture after changes in the faceplate type, select "Confirm all type changes" in the shortcut menu of the picture name.
For more information, refer to "How to update a faceplate instance in the Graphics Designer (Page 441)".
- In the process picture, create an "IO_Picture" I/O field and select the "Bar_Level" WinCC tag.
- Select the property group "UserDefined3" in the "Faceplate instance" object.
- Connect the user-defined property "FP_InterfaceTag" with the WinCC tag "Bar_Level".
- Save the process picture and test the response in runtime.
Value changes in the two I/O fields are reflected in the another I/O field and in the bar.

Procedure: VB script

1. Insert an application window of the GSC Diagnostics type in the process picture.
2. Insert an "FPTag_Value" button in the process picture.
3. Select the "Click" event in the object properties in the "Mouse" group.
4. Select the "VBS Action" dynamization.
5. Enter the example VBS374.
6. Save the process picture and test the response in runtime.
Value changes in the two I/O fields are output by clicking on the button in the diagnostic window.

Example code

```
'VBS374  
Dim objTag  
Set objTag = HMIRuntime.Tags("Bar_Level")  
HMIRuntime.Trace "Value: " & objTag.Read & vbCrLf
```

Procedure: Direct connection

To display the value of the "IOField1" single object in a bar in the process picture or to process it in a script, follow these steps:

1. In the process picture, create a "Bar_Picture" bar and select the "IO_BarChange" WinCC tag.
2. In the "Event" window of the "Faceplate instance" object, select the user-defined properties "UserDefined3".
3. For the "Change" event of the instance-specific property "FP_InterfaceTag", select the "Direct connection" type of dynamics.
4. Connect the property "FP_InterfaceTag" to the WinCC tag "IO_BarChange".
The value of the "IOField1" I/O field is written to the "IO_BarChange" tag and displayed in the bar.

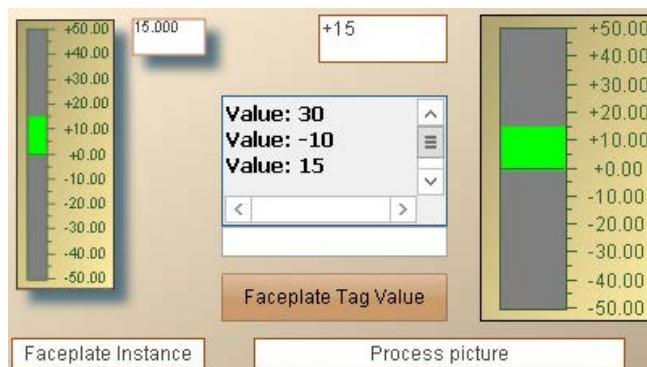

See also

Making a Faceplate type dynamic (Page 433)

Example of faceplate tags: How to dynamize a faceplate instance (Page 446)

How to configure a faceplate instance (Page 435)

3.6.5 Example of faceplate tags: How to dynamize a faceplate instance

Introduction

In this example, you configure an I/O field and a bar in a faceplate instance with faceplate tags. You read the values using a VB script. You use these values in the faceplate instance to update the process picture.

Note

Faceplate tags and internal faceplate scripts affect the performance

The performance when opening or updating a process picture in runtime is affected by the following factors:

- Number of faceplate instances in the process picture
 - Number of faceplate tags in the faceplate types and faceplate instances
To increase the performance, use interface tags.
 - Using scripts in the faceplate types and faceplate instances
-

Requirement

- You have created two internal tags with the data type "Signed 16-bit value" in the tag management.
 - Bar_Level
 - IO_BarChange
- The option "Display information in case of changes in faceplate type" is activated in the Graphics Designer settings.
- The "Global Script Runtime" component is enabled in the "Startup" tab in the computer properties.

Procedure: Configuring a faceplate type

1. Create a "FP_FaceplateTagsType" faceplate type.
2. Insert an "IOField1" I/O field.
The configuration dialog of the I/O fields.
3. Click on the "..." button next to the "Tag" field.
The "Faceplate Tag" dialog opens.

4. Create a "FPTag_IOField" faceplate tag with the data type "Signed 16-bit value". Close the dialogs with "OK".
5. Insert a "Bar1" bar and select the faceplate tag "FPTag_IOField". The value of the I/O field is displayed on the bar in Runtime.
6. Click on "Faceplate tags" in the "Configure Faceplate Type" dialog in the "Objects" area.
7. Link the "FPTag_IOField" faceplate tag with the "FPTag_IOField" property node. Drag the tag from the "Object properties" area to the "Properties" node in the "Selected properties" area.
8. Drag the object property "OutputValue" of the I/O field "IOField1" to the node "Properties". The output value of the IO field is configured as instance-specific property.
9. Save the faceplate type.

Procedure: Faceplate instance in the process picture

1. Insert the "FP_FaceplateTagsType" faceplate type in a "Test_Faceplates.pdl" process picture as an instance.
To update the process picture after changes in the faceplate type, select "Confirm all type changes" in the shortcut menu of the picture name.
For more information, refer to "How to update a faceplate instance in the Graphics Designer (Page 441)".
2. In the process picture, create an "IO_Picture2" I/O field and select the "Bar_Level" WinCC tag.
3. Select the property group "UserDefined2" in the "Faceplate instance" object.
4. Connect the user-defined properties "FPTag_IOField" and "OutputValue" to the "Bar_Level" WinCC tag.
5. Save the process picture and test the response in runtime.
Value changes in the two I/O fields are reflected in the another I/O field and in the bar.

Procedure: VB script

1. Insert an application window of the GSC Diagnostics type in the process picture.
2. Insert a "FPTag_Value" button into the process picture.
3. Select the "Click" event in the object properties in the "Mouse" group.
4. Select the "VBS Action" dynamization.
5. Enter the VBS374 example.
6. Save the process picture and test the response in runtime.
Value changes in the two I/O fields are output by clicking on the button in the diagnostic window.

Example code

```
'VBS374  
Dim objTag  
Set objTag = HMIRuntime.Tags("Bar_Level")  
HMIRuntime.Trace "Value: " & objTag.Read & vbCrLf
```

Procedure: Direct connection

To display the value of the "IOField1" single object in a bar in the process picture or to process it in a script, follow these steps:

1. In the process picture, create a "Bar_Picture2" bar and select the "IO_BarChange" WinCC tag.
2. In the "Event" window of the "Faceplate instance" object, select the user-defined properties "UserDefined2".
3. For the "Change" event of the instance-specific property "OutputValue", select the "Direct connection" type of dynamics.
4. Connect the "OutputValue" property to the WinCC tag "IO_BarChange".
The value of the "IOField1" I/O field is written to the "IO_BarChange" tag and displayed in the bar.

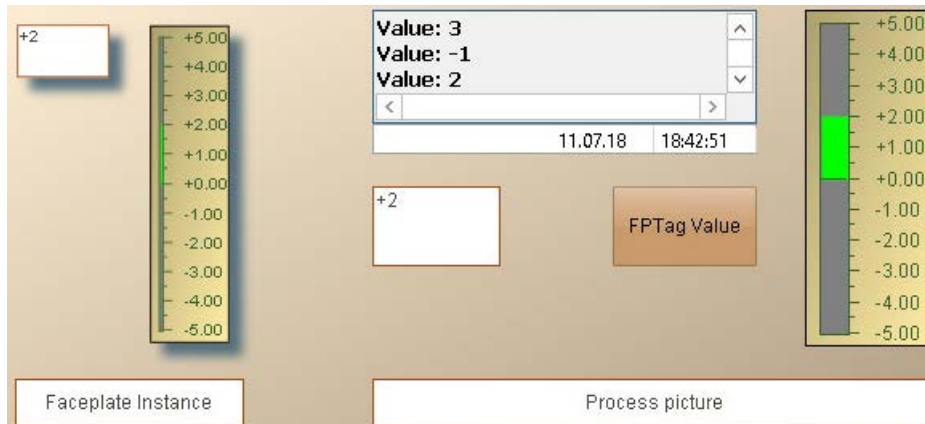

See also

- Making a Faceplate type dynamic (Page 433)
- How to configure a faceplate instance (Page 435)
- Example: How to dynamize a faceplate instance (Page 442)

3.7 Working with text list and graphic lists

3.7.1 How to create text lists

Introduction

You can create text lists that you reference in WinCC objects in the Graphics Designer in the "Text and graphic lists" editor. The referenced texts are then displayed in runtime as input list or output list.

You centrally configure the assignment of values to individual texts and thus avoid configuring at each individual object.

You can use the text list for the following WinCC objects:

- Smart objects
 - Text list
 - Combo box
 - List box
- Windows objects
 - Check box
 - Radio box
- Faceplate types

Faceplate text lists

You can also reference and dynamize a text list in faceplate types for the listed WinCC objects.

To dynamize the text list in the faceplate instances, define the "Text list" object property as instance-specific property.

For this purpose, open the "Text List Configuration" dialog in the Graphics Designer via the "Edit > Configure text list for faceplate" menu command.

Faceplate text lists are only available for the faceplate in which they were created. They are not displayed in the "Text and graphics lists" editor.

Translation

The configured texts are stored in the text library.

The texts from faceplate text lists are saved in the faceplate and translated with the Text Distributor. For the export in Text Distributor, select the option "Graphics Designer > Texts in pictures".

Defining the list type

When you select a text list in the navigation area, you define the format of the text list in the "Selection" field.

You then select the corresponding values for each text in the "Range from" and "Range to" fields.

Selection	Description	List Type
Value/range	Assignment of texts to specific values or value ranges The maximum value range corresponds to a signed 32-bit value.	Decimal
Bit number (0-31)	Assignment of texts for each bit number You can define up to 32 texts.	Binary
Bit (0,1)	Assignment of texts for the states: <ul style="list-style-type: none"> • 1 = Bit set • 0 = Bit not set 	Bit

Smart object "text list"

List type and assignment of the display texts

For the "Text list" smart object, the selection corresponds to the selection of the "List type" object property.

The text properties "Range from" and "Range to" correspond to the information provided in the "Assignments" object property.

If you use a configured text list, these object properties are grayed out. The settings of the configured text list are applied to the "List type" and "Assignment" object properties.

Sorting display texts in runtime

You can change the sorting of display texts for each object of the "Text list" smart object.

You define the sorting with the "Sorting of text list" object property:

- None: Original sorting of the text list in the "Text and graphic lists" editor
- Value: Numerically increasing according to configured value/range
- Text: Alphabetically according to the configured text
The setting is language-dependent.

If no configured text list is linked to the object, the object property is grayed out.

Procedure

1. Select the entry "Text" in the navigation area.
2. Enter the name of the text list in the data area.
Alternatively, select the entry "New text list" from the "Text" shortcut menu.

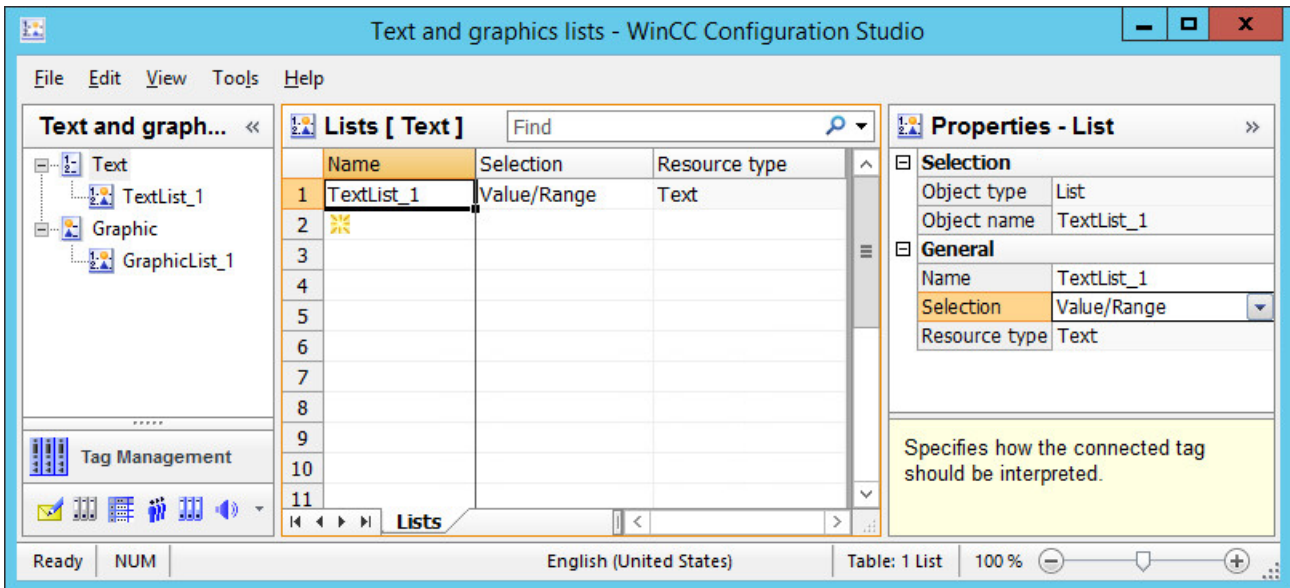

3. Select the list type in the data area in the "Selection" column.
4. Select the text list in the navigation area.
5. Enter the texts in the data area or in the properties area.
"Translation" area: Enter the translated texts for the Runtime languages. Alternatively, translate the texts using the text library.

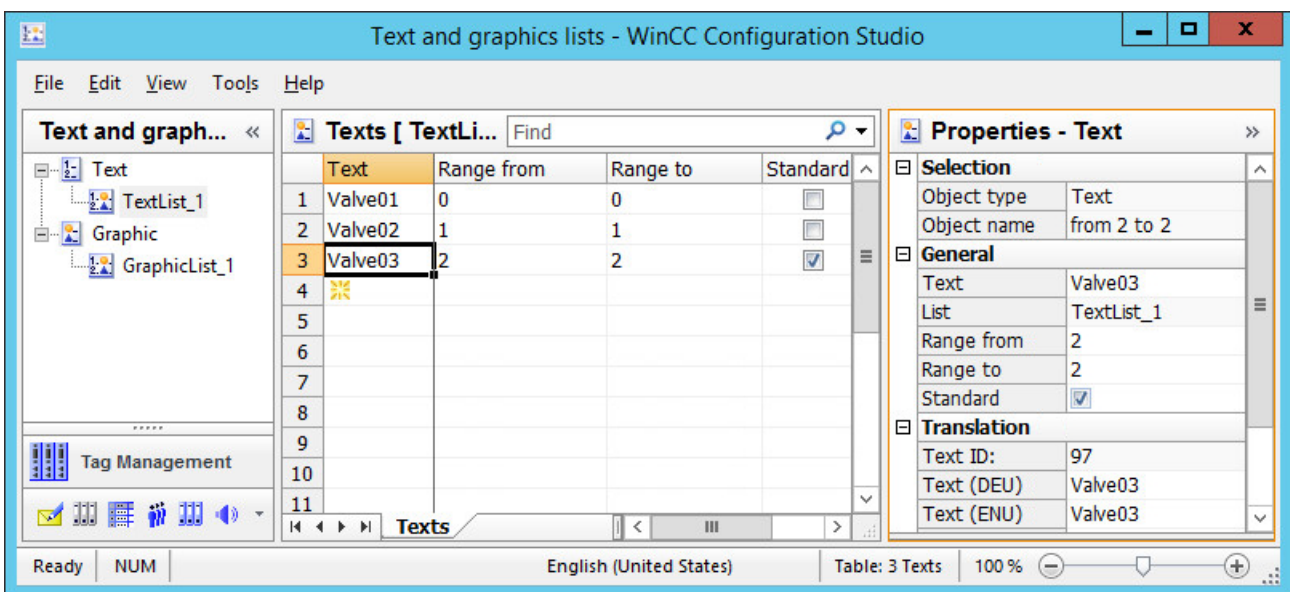

6. Enter the desired value or value range for each text.
The values must not overlap.

3.7 Working with text list and graphic lists

7. Select the "Standard" option for a text that is displayed for all values that have not been assigned a text.
8. In Graphics Designer, double-click the "Text list" object property of the WinCC object in the "Input/Output" property group.
9. Select the desired text list from the drop-down list.
The configured texts of the text list and the list type are applied to the object.

See also

How to create graphic lists (Page 452)

How to create text lists and graphics lists in faceplate types (Page 428)

The WinCC Configuration Studio (Page 54)

3.7.2 How to create graphic lists

Introduction

You use a graphic list to select the picture for configuration of the status display.

You link any number of different object states to graphic files and set the flashing frequency.

The names of the assigned graphics are stored in the text library.

Faceplate graphics lists

You can also reference and dynamize a graphics list in status displays that are contained in faceplate types.

To dynamize the graphics list in the faceplate instances, define the "Graphic list" object property as instance-specific property.

For this purpose, open the "Status Display Configuration" dialog in the Graphics Designer via the "Edit > Configure graphic list for faceplate" menu command.

Faceplate graphics lists are only available for the faceplate in which they were created. They are not displayed in the "Text and graphics lists" editor.

Integrating graphics in the WinCC project

You only use pictures from the "GraCS" project folder or from a "GraCS" subfolder for the graphic list.

You use Windows Explorer to integrate the pictures in the WinCC project:

- Copy the graphics to the "GraCS" folder.
The pasted graphics are immediately available in the editor.
- Create a "GraCS" subfolder in Windows Explorer.
Graphics that you copy to the subfolder are immediately available in the editor.
The folder path is displayed when the graphic is selected in the editor.

Alternatively, import the graphics to the project folder in the "Text and graphic lists" editor.

Importing graphics

You import individual graphics or the content of an entire folder from a different storage path.

The graphics are always copied to the "GraCS" folder. If necessary, move the graphics to the preferred folder structure in Windows Explorer.

1. Select the entry "Graphic" in the navigation area.
2. Select "Import graphics > Import files / Import folder" from the shortcut menu.
3. Navigate to the storage path and select the desired files or folders.
You can select multiple files or folders.
4. Click "Import".

Deleting or moving graphics

When you move or delete a graphic that is already in use, the corresponding cell is marked in red in the data area of the editor.

Select the graphic again from the changed storage path or select a different graphic.

Requirement

- The "Text and graphic lists" editor is open.
- The graphics for the graphic lists are available in the "GraCS" folder or in a subfolder of "GraCS".

Procedure

1. Select the entry "Graphic" in the navigation area.
2. Enter the name of the graphic list in the data area.
Alternatively, select the entry "Graphic" from the "New graphic list" shortcut menu.
The type of assignment is always "Value/Range" in the "Selection" column.

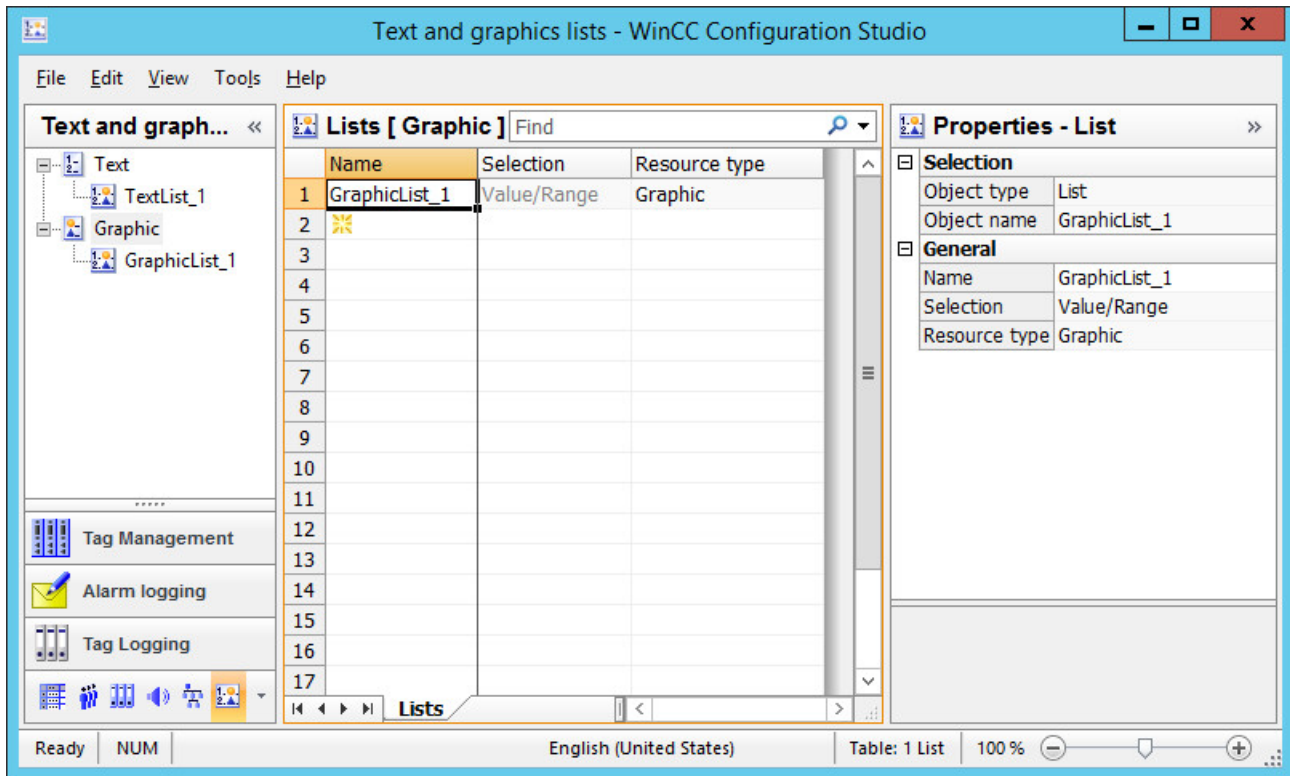

3. Select a graphic list in the navigation area.

- In the data area, select a graphic from the drop-down list in the "Basic picture" column. When you click on a graphic field in the "Properties - Graphic" area, you can see a preview of the selected graphic in the "What's This?" area.

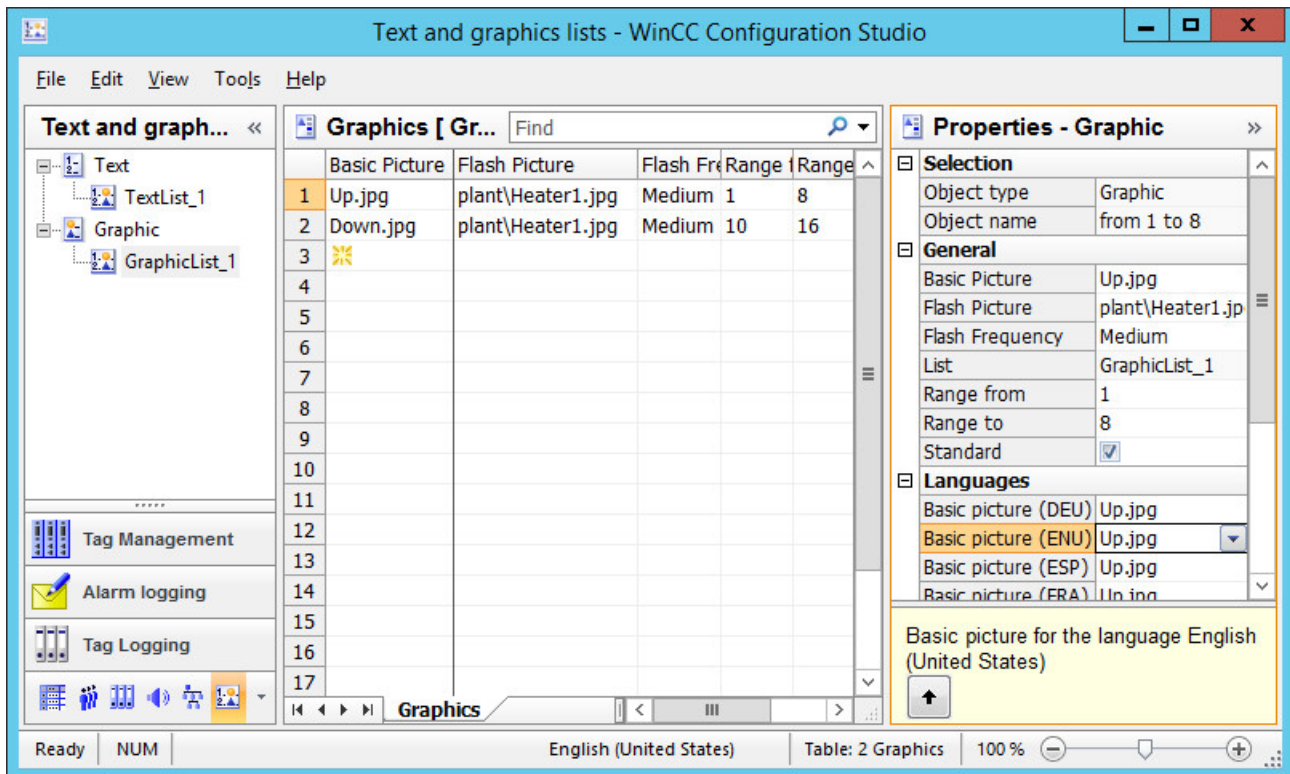

- If required, select the flash picture in the data area or in the "Properties - Graphic" area. "Languages" area: You can select different graphics for the Runtime languages.
- Set the flash frequency for the flash pictures.
- Define the desired value range for each graphic. The values must not overlap.
- Select the "Standard" option for a graphic that is displayed for all values that have not been assigned a graphic.
- In the Graphics Designer, select the "Status display" smart object in the configuration dialog from one of the configured graphic lists. The status list enters the selected graphic list.

See also

- How to create text lists (Page 449)
- How to configure a status display (Page 635)
- How to create text lists and graphics lists in faceplate types (Page 428)

3.8 Working with Objects

3.8.1 Working with Objects

Introduction

You will find the following information in this chapter:

- The basic functions of the Graphics Designer for working with objects
- The features of the single objects
- How to use objects to create process pictures
- How to specifically change object properties

Objects in Graphics Designer

"Objects" in the Graphics Designer are the predefined graphic elements that enable efficient creation of process pictures. You can easily insert all objects into a picture from the "Standard" selection window. The objects are made available in four object groups:

Standard objects	Smart objects	Windows objects	Tube objects
Line	Application window	Button	Polygon tube
Polygon	Picture window	Check box	T-piece
Polyline	Control	Radio box	Double T-piece
Ellipse	OLE object	Round button	Tube bend
Circle	I/O field	Slider object	
Ellipse segment	Bar		
Pie segment	Graphic object		
Ellipse arc	Status display		
Circular arc	Text list		
Rectangle	Multi-line text		
Rounded rectangle	Combo box		
Static text	List box		
Connector	Faceplate instance		
	.NET control		
	WPF control		
	3D bar		
	Group display		
	Status display (extended)		
	Analog display (extended)		
	DataSet		
	SVG object		

Combined Objects

You can combine the objects with one another by creating a "Group" or a "Faceplate type" from a multiple selection.

- You can prepare a faceplate type can for reuse as a faceplate instance in other process pictures or projects.
- You can insert a group into the project library and prepare it as a "Library object" for reusing in other process pictures or projects.

Note

Line display when zooming in "WinCC Classic" design

If you have set the "WinCC Classic" design, all occurrences of a dashed line with a line thickness of "1" are shown as a solid in the Graphics Designer when zooming over 100%.

This effect is dictated by the graphics system of Microsoft. The effect does not occur if the line thickness is greater than "1" or the zoom is less than 100% or if another design is defined.

See also

The "Object Properties" Window (Page 512)

How to change the default setting of object types (Page 457)

Basic Static Operations (Page 459)

Basic Dynamic Operations (Page 485)

The Properties of an Object (Page 511)

Working with Combined Objects (Page 709)

Working with Controls (Page 749)

3.8.2 How to change the default setting of object types

Introduction

In the Graphics Designer, the various object types have default properties.

If an object is inserted in a picture, the object adopts these default settings.

Note

Default setting only for current project

The default setting for the object types applies across the project.

The changed default settings only apply to the pictures of the currently opened WinCC project. The basic settings of the Graphics Designer are not changed here.

Basic procedure

You can adapt default settings for individual object types to your requirements.

We recommend that you make predefined settings for objects with multiple application before creating a process picture. This is how to limit the scope for later adaptation.

This section shows the general procedure to view the default setting for the object types. Changing the default properties is based on changing the individual attributes of an object.

You can find a detailed description for the changing of attributes in section "The Properties of an Object (Page 511)".

You can find a detailed description for saving the default settings in section "The Basic Settings of the Graphics Designer (Page 355)".

Global design and central color palette

You can also define the design and colors of object types for an entire project. You can find more information about this under:

- "The central color palette (Page 346)"
- "Working with projects > Global Design of the Objects (Page 158)"

Requirements

- A picture must be opened. This picture can also be empty.

Procedure

1. Right-click in the "Standard" selection window on the object type whose default settings you want to change.
2. Choose the "Properties" option from the shortcut menu.
The "Object properties" window opens. The name of the object type with the additional "Default" is displayed in the toolbar of this window.
3. Select the property group in the "Properties" tab that contains the attribute you want to change.
Changing attributes is described extensively in the section "Change attribute".

See also

Global Design of the Objects (Page 158)
The central color palette (Page 346)
The Basic Settings of the Graphics Designer (Page 355)
The Properties of an Object (Page 511)
How to Change an Attribute (Page 525)
Managing the default settings of objects (Page 366)
The "Object Properties" Window (Page 512)
Controls (Page 341)

Elements and Basic Settings of the Graphics Designer (Page 319)

Working with Objects (Page 456)

3.8.3 Basic Static Operations

3.8.3.1 Basic Static Operations

Introduction

To create a process picture, the required objects must first be inserted from the "Standard" selection window of the Graphics Designer into a picture. These objects are then dynamically linked suitably to a process to use the process picture to control and monitor processes.

This chapter introduces the basic static operations with which objects are inserted and arranged in the picture.

See also

How to position objects (Page 469)

Working with Objects (Page 456)

Basic Dynamic Operations (Page 485)

You can change the text contents of objects (Page 483)

How to change the tag connection of objects using linking (Page 499)

How to change the position of an object (Page 481)

How to duplicate objects (Page 480)

How to insert the contents of the clipboard (Page 479)

How to copy objects (Page 478)

How to cut objects (Page 477)

How to delete objects (Page 476)

How to rotate the objects (Page 475)

How to mirror the objects (Page 474)

How to scale an object (Page 472)

How to Align Multiple Objects (Page 471)

How to Select Multiple Objects (Page 467)

Multiple Selection of Objects (Page 465)

How to select an object (Page 464)

How to Rename Objects (Page 462)

How to insert an object into a picture (Page 460)

3.8.3.2 How to insert an object into a picture

Introduction

You insert the objects that map a process or a subprocess in a process picture in the Graphics Designer into a picture from the "Standard" selection window.

In the Graphics Designer, the various object types have default properties. When they are inserted the objects import these default properties (except for individual geometric properties). After insertion the properties of an object can be modified. In the same way the default settings for the object types can be modified as required.

When inserting an object, an object name is automatically assigned. The name of the object type is linked with a continuous number as the object name. No special characters are used in the object name. You change the object name using the "Object Name" attribute.

Requirements

- The display of the "Standard" window must be enabled.

Procedure

Using the standard object "Rectangle" here as an example, the following describes how to insert an object by dragging and dropping it into a picture. Some object types require additional steps. You can learn more about this in the detailed description of the single objects.

1. Open the picture into which you want to insert an object.
2. Click the standard object "Rectangle" in the "Standard" window.
3. Keeping the left mouse button pressed, drag the object in the desired area of the picture.
For most objects, you see a preview of the object here.
When you release the mouse button, the object is inserted into the corresponding place in the picture.
4. Drag the rectangle to the desired size.

Note

If you press the <Esc> key during drag-and-drop, the dragging action and the selection of the object is canceled.

Alternative operation

Double-click the required object in the "Standard" window. The new object is inserted close to the picture origin. The properties of the new object correspond to the default settings for the selected object type.

See also

How to Rename Objects (Page 462)
How to select an object (Page 464)
How to position objects (Page 469)
How to scale an object (Page 472)
How to delete objects (Page 476)
How to copy objects (Page 478)
How to copy objects to another picture (Page 394)
The Coordinate System of a Process Picture (Page 319)
The Coordinate System of an Object (Page 321)
The Rectangle Surrounding the Object (Page 323)
Controls (Page 341)
Basic Static Operations (Page 459)
Working with Objects (Page 456)

3.8.3.3 How to add a text from a WinCC editor as an object**Introduction**

When you drag-and-drop a text from a WinCC editor in the Graphics Designer, you can insert one of the following objects:

- Static text
- Combo box
- List box
- Multiple row text
- Check box
- Radio box

The inserted object contains the added text. The texts separated with <Tab> and <Return> are considered different texts. This inserts a separate "Static Text" object, for example, for each separated text. When a combo box is created, it contains the separated texts as single lines.

If the text cannot be dragged into the Graphics Designer, the source application does not support text in the "Unicode" format.

Note

"Undo" not possible.

After inserting an object using drag-and-drop, the configuration cannot be reversed using the "Undo" menu command in the Graphics Designer.

Requirement

- A process picture is open in the Graphics Designer.

Insert the "Static Text" object with drag-and-drop

1. Select a text from a WinCC editor or from another application.
2. Hold down the left mouse button while dragging the text to an empty area of a picture in the Graphics Designer.
3. Release the mouse button in the picture. The "Static Text" object with the text is inserted into the picture.

Inserting other objects with drag-and-drop

1. Select a text from a WinCC editor or from another application.
2. Hold down the right mouse button while dragging the text to an empty area of a picture in the Graphics Designer.
3. Release the mouse button in the picture. A shortcut menu is displayed in the Graphics Designer. Select an object in the shortcut menu. The selected object with the text is inserted into the picture.
4. If you drag text into an object already configured, in the shortcut menu you can select whether the existing text entries are to be overwritten or supplemented with new texts.

You can learn how to insert smart objects with tag connection on the page "Drag-and-drop to smart objects (Page 107)".

See also

Drag-and-drop from the Configuration Studio to other applications (Page 109)

3.8.3.4 How to Rename Objects

Introduction

The "Object Name" attribute specifies the name of an object in the picture. The object name is unique within a picture. The name of the object is used for example in configuring C actions to call the object.

When an object is inserted, the object name assigned as standard is the description of the object type with a consecutive number. This name can be changed using the "Object Name" attribute.

Note

Avoid special characters in object names of these object names are used in scripts.

Requirements

- Select an object of any type.

Procedure

1. Open the "Object Properties" window.
2. On the "Properties" tab select the entry for the selected object type to which the property groups of the object are subordinate.
3. Double-click the "Object name" attribute.
The "Text entry" dialog will open.
4. Enter the new name.
5. Click "OK" to confirm your entries.

See also

How to insert an object into a picture (Page 460)

How to select an object (Page 464)

Illegal Characters (Page 226)

Controls (Page 341)

Basic Static Operations (Page 459)

Working with Objects (Page 456)

3.8.3.5 How to select an object

Introduction

To change the properties of an object, you have to select the object.

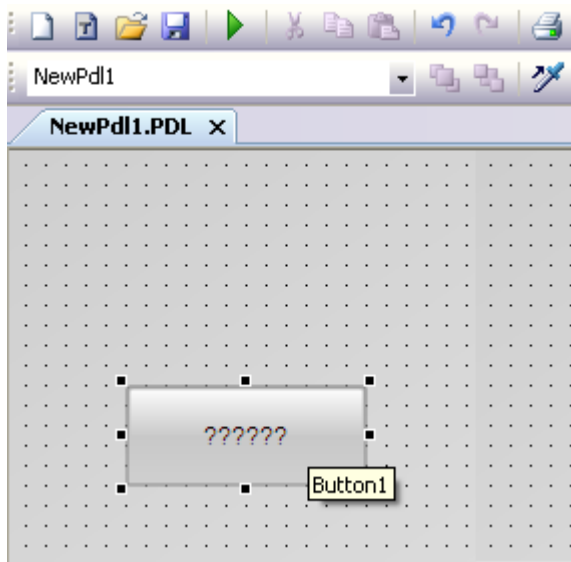

Requirements

- The active picture must contain at least one object.

Procedure

1. Position the cursor on the required object.
2. Click the object.
The mouse pointer changes to a crosshair with arrow points.
The handles of the rectangle surrounding the object appear.

Alternative procedure

1. Open the "Object Properties" window.
2. On the toolbar of the window, open the drop-down list field to select the object.
3. Select the required object.
The handles of the object are displayed.

See also

- How to select an object (Page 464)
- How to Select Multiple Objects (Page 467)

Multiple Selection of Objects (Page 465)

The Rectangle Surrounding the Object (Page 323)

Controls (Page 341)

The "Object Properties" Window (Page 512)

Basic Static Operations (Page 459)

Working with Objects (Page 456)

3.8.3.6 Multiple Selection of Objects

Introduction

In order to change the properties of several objects at the same time, you must select all desired objects. You do this using "Multiple selection".

All attributes of the selected objects are shown in the "Object properties" window for a multiple selection. For an attribute however, a value is only displayed if it is the same for all selected objects that have this attribute.

Along with "selection borders" and the "reference object", a multiple selection has two characteristics which play an important role, for example for the common alignment of the selected objects. These characteristics are however not visible in the Graphics Designer.

Selection Frame of a Multiple Selection

The selection border encloses all objects in a multiple selection, comparable to the rectangle surrounding individual objects. The selection border is known as a lasso.

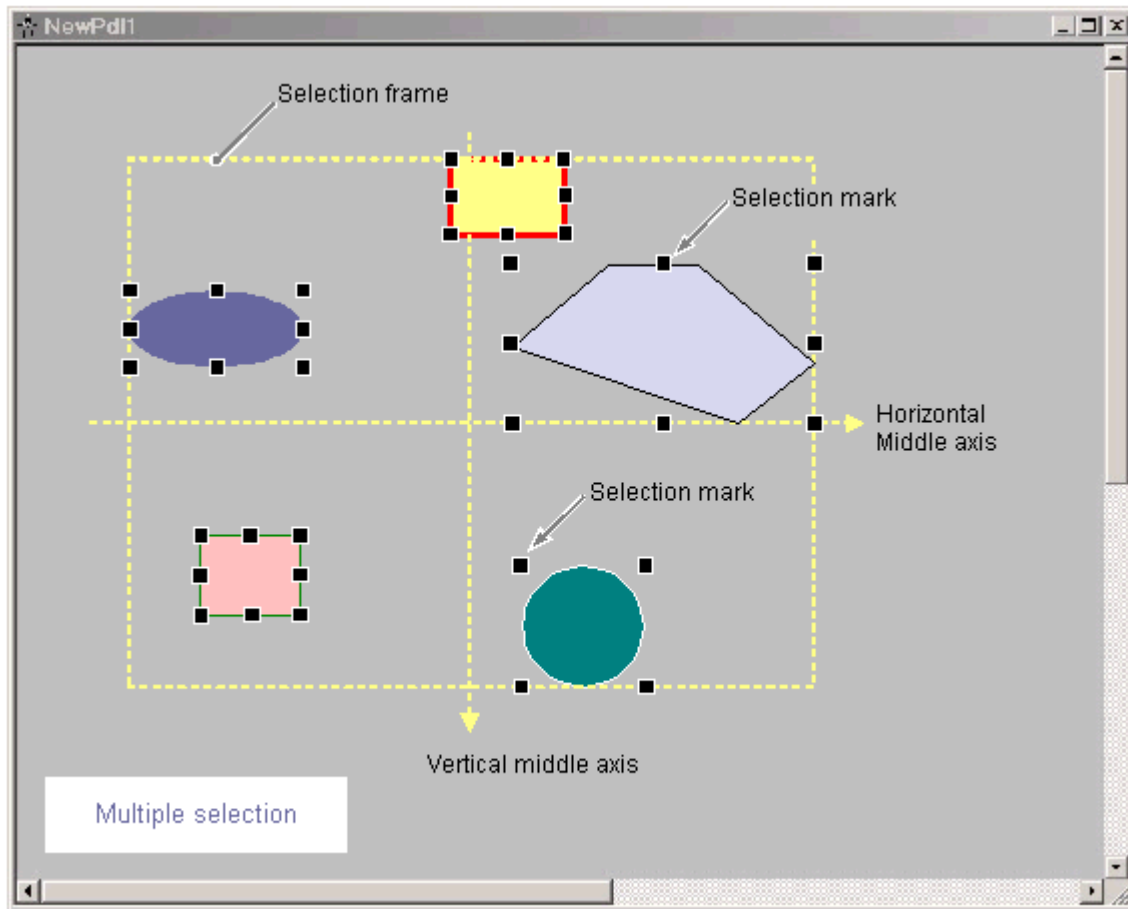

The position and size of the selection border are dependent on the position of the selected object. The midpoint of the selection border corresponds to the common midpoint of the selected objects. The limit line of the selection border touches the outer edges of those objects which have the greatest distance from the common midpoint.

The selection border is not visible. After finishing the multiple selection, only the handles of the individual objects will be shown.

Reference object of a multiple selection

One of the selected objects has to be used as a reference object for aligning objects of the multiple selection: For example, if the "Same width" function is selected in the Alignment palette, then all selected objects will be set to the same width as the respective reference object.

The object to be used as a reference object depends on the type of multiple selection and on the function selected in the alignment palette:

Selection type	Selection borders	<Shift> + left mouse button	<Ctrl + A>
Function	Reference object is:	Reference object is:	Reference object is:
Aligning	the outermost object	the object selected first	the reference object that is used until the selection; otherwise the outermost object
Center	the common center axis of the selected object		
Distribute	No reference object		
Match width or height	the object with the greatest width or height	the object selected first	the reference object used until the selection; otherwise the object with the greatest width or height
Match width and height	the first configured, therefore the oldest object in the multiple selection		

See also

How to Select Multiple Objects (Page 467)

How to Align Multiple Objects (Page 471)

Working with Combined Objects (Page 709)

Alignment palette (Page 328)

The Rectangle Surrounding the Object (Page 323)

3.8.3.7 How to Select Multiple Objects

Introduction

In order to change the properties of several objects at once, all of the objects to be changed must be selected. You can do this with a "Multiple selection".

In the Graphics Designer, you can make the multiple selection of objects as follows:

- Multiple selection by clicking on the objects while holding down the <Shift> or <Ctrl> key or both keys simultaneously
- Multiple selection by dragging a selection border with the mouse
- Multiple selection with key combination <Ctrl+A>

Note

You can remove an object that was selected in the multiple selection by mistake by clicking on it with the <Shift> or <Ctrl> key pressed.

If you press the <Esc> key during a multiple selection, the selection of objects is canceled.

Prerequisites

- The active picture contains at least two objects.

Multiple selection with <Shift> or <Ctrl>

1. Hold down the <Shift> or <Ctrl> key or both keys simultaneously.
2. Click the relevant objects, working in succession.
The handles of the rectangle surrounding the object appear for every selected object.
The mouse pointer will change to crosshairs with arrow points when it is positioned over a selected object.

Multiple selection with the mouse

Draw a frame around the desired objects with the left mouse button. The result of the selection depends on the setting of the object selection in the options of the Graphics Designer:

- "Surrounding object selection"
All objects inside the displayed frame are selected.
- "Touching object selection"
All objects touched by the frame will be selected, in addition to those inside of it.
- "Directional"
The mouse movement determines the behavior of the selection border:

Drag mouse	Object selection
From top left to bottom right	Surrounding
From top right to bottom left	
From bottom left to top right	Touching
From bottom right to top left	

Note

The "Touching object selection" setting in the options has a higher priority than the direction of the object selection. Regardless of the direction of the multiple selection, all objects that touch the frame are always selected.

Multiple selection with <Ctrl+A>

1. Select one or more objects.
2. Press <Ctrl+A>.
 - If no object was selected, all objects of the picture are selected.
 - If at least one object was selected, all objects of the same type are selected like the selected objects.

Reference object

The object to be used as a reference object depends on the type of selection and on the function selected in the alignment palette:

Selection type	Selection borders	<Shift> + click	<Ctrl + A>
Function	Reference object is:	Reference object is:	Reference object is:
Aligning	the outermost object	the object selected first	the reference object that is used until the selection; otherwise the outermost object
Center	the common center axis of the selected object		
Distribute	No reference object		
Match width or height	the object with the greatest width or height	the object selected first	the reference object used until the selection; otherwise the object with the greatest width or height
Match width and height	the first configured, therefore the oldest object in the multiple selection		

3.8.3.8 How to position objects

Introduction

The position of an object is defined by the coordinates of the object origin. The left upper corner of the rectangle surrounding the control is called the object origin.

You can position objects by:

- dragging the object to a new position
- moving the selected object with the aid of the arrow keys for cursor control
- Changing the "Position X" and "Position Y attributes"

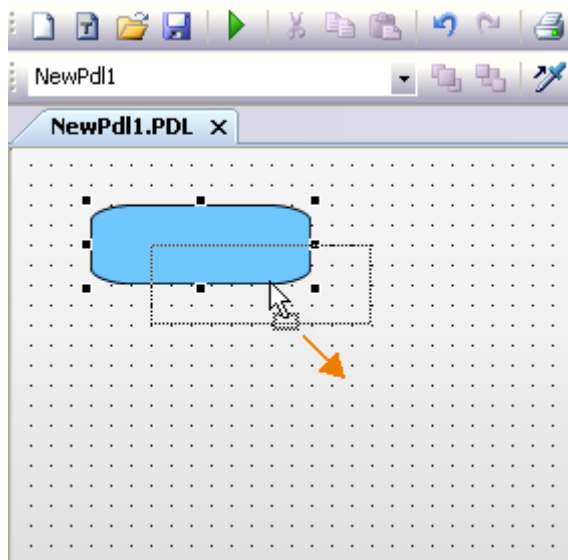

Multiple selection

You can move several selected objects at the same time.

Requirements

- Select an object of any type.

Procedure

1. Position the mouse pointer over the selected object.
The mouse pointer changes to a crosshair with arrow points.
2. Click the object and hold the left mouse button.
The cursor changes into an arrow with an outline icon (small rectangle with broken line).
3. Move the mouse pointer.
The rectangle surrounding the object is displayed as broken and shows a possible new position for the object.
The object itself initially keeps its original position.
4. Release the mouse button.
The object is moved to the position previously displayed by the broken line of the rectangle surrounding the object.
The mouse pointer turns into crosshairs with arrow points.

Alternative operation

Move the selected object using the arrow keys for cursor control or change the value for the geometric "Position X" and "Position Y" attributes in the "Object Properties" window.

Note

In the settings of the Graphics Designer if the "Snap to grid" function is activated, the object can only be positioned with the mouse according to the settings for the grid.

See also

- The Rectangle Surrounding the Object (Page 323)
- Working with Objects (Page 456)
- Basic Static Operations (Page 459)
- The Coordinate System of an Object (Page 321)
- The Coordinate System of a Process Picture (Page 319)
- How to Set the Grid (Page 356)
- How to position objects (Page 469)
- How to select an object (Page 464)

3.8.3.9 How to Align Multiple Objects

Introduction

You can arrange the objects of a multiple selection together in the picture by using the functions of the alignment palette. A detailed description of these functions can be found in the section "Alignment palette".



Align

The selected objects are aligned on the border line of the selection frame (up, down, left, right).

Center

The selected objects are centered on a middle axis of the selection frame (horizontally, vertically).

Distribute

The selected objects are distributed evenly across the height or width of the selection frame (horizontally, vertically).

Match

The size of the reference object is assigned to the selected objects (height, width or height and width).

Requirements

- Select at least two objects of any type.

Procedure

In the "Alignment Palette" click the required icon or in the "Arrange > Align" menu select the required entry.

The alignment or the size of the selected objects is changed.

See also

How to position objects (Page 469)

How to Select Multiple Objects (Page 467)

Alignment palette (Page 328)

Multiple Selection of Objects (Page 465)

The Coordinate System of a Process Picture (Page 319)

Basic Static Operations (Page 459)

Working with Objects (Page 456)

3.8.3.10 How to scale an object

Introduction

The size of an object is defined by the geometry of the rectangle surrounding the object. The rectangle surrounding the object is symbolized when selecting an object by showing the selection markers.

You can scale objects by:

- dragging the handle to a new position
- changing the values of the "Width" and "Height" attributes

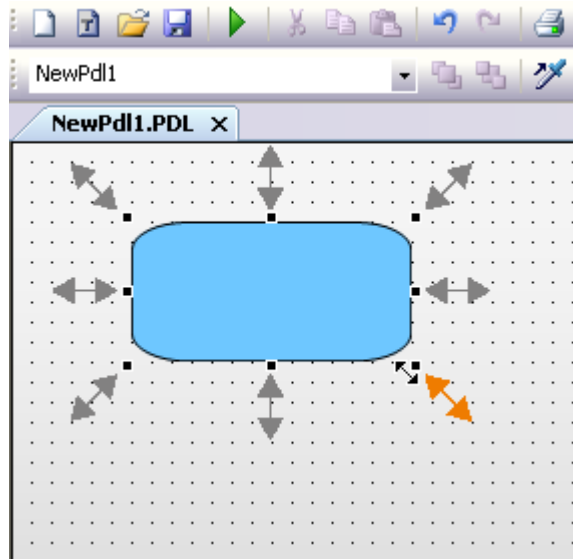

Multiple selection

You cannot scale several selected objects simultaneously using the mouse. To do this, the objects must be grouped.

Requirements

- Select an object of any type.

Procedure

1. Position the mouse pointer over a handle of the selected object.
The mouse pointer changes into a double arrow. The alignment of the double arrow indicates the directions in which you can move the handle:
 - "Horizontal double arrow"
The width of the object can be changed using the handles on the horizontal center axis.
 - "Vertical double arrow"
The handles on the vertical center axis can be used to change the height of the object.
 - "Diagonal double arrow"
The handles on the corners of the object can be used to change the height and width of the object.
2. Use the mouse to drag the handle to the position you want.
If the "Snap to grid" function is activated in the settings of the Graphics Designer, the object can only be scaled with the mouse according to the settings for the grid.

Alternative operation

Change the values for the geometric "Width" and "Height" attributes in the "Object Properties" window.

See also

How to select an object (Page 464)
How to position objects (Page 469)
How to Set the Grid (Page 356)
The Rectangle Surrounding the Object (Page 323)
Basic Static Operations (Page 459)
Working with Objects (Page 456)

3.8.3.11 How to mirror the objects

Introduction

You can mirror objects on their horizontal or vertical center axis. The mirroring of an object can cause its geometric attributes to change. Mirroring can also change the alignment of elements contained in the object such as text or check boxes.

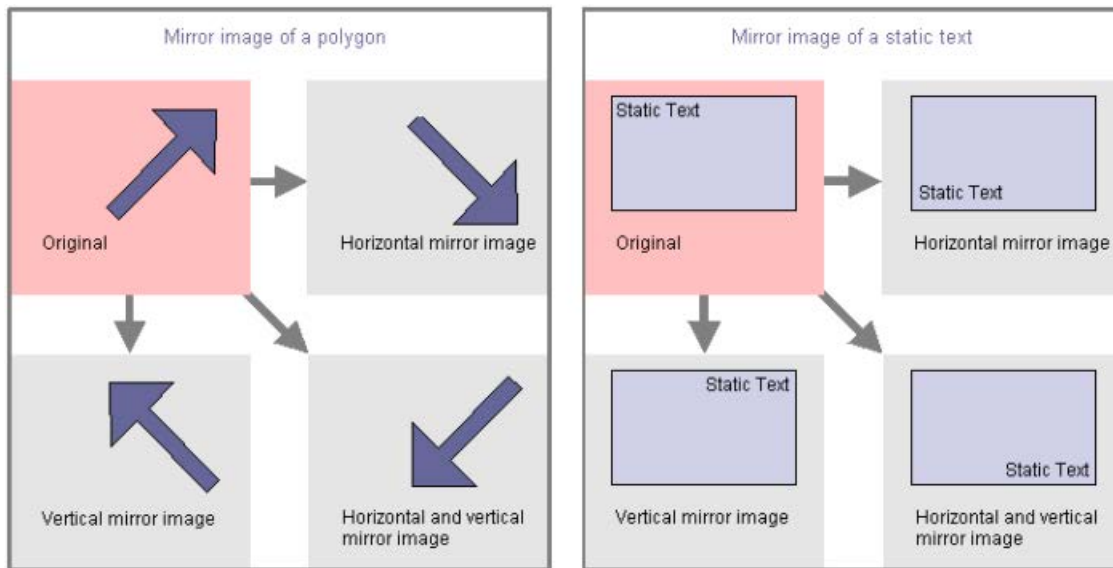

Multiple selection



You can mirror several selected objects at the same time. The mirroring occurs on the horizontal or vertical middle axis of the individual objects.

Requirements

- Select any type of object except circle, application window, picture window, Control, OLE object, status display, 3D bar, group display and round button.

Procedure

In the standard palette click the toolbar button

-  to mirror the selected object on its horizontal center axis
-  to mirror the selected object on its vertical center axis

Alternatively you can use the entries "Horizontal" and "Vertical" on the "Arrange / Mirror" menu.

3.8.3.12 How to rotate the objects

Introduction

You can rotate objects around their center point. The rotation is clockwise and in steps of 90 degrees.

The rotation of an object can cause its geometric attributes to change. Rotation can also change the alignment of elements in an object such as a text.

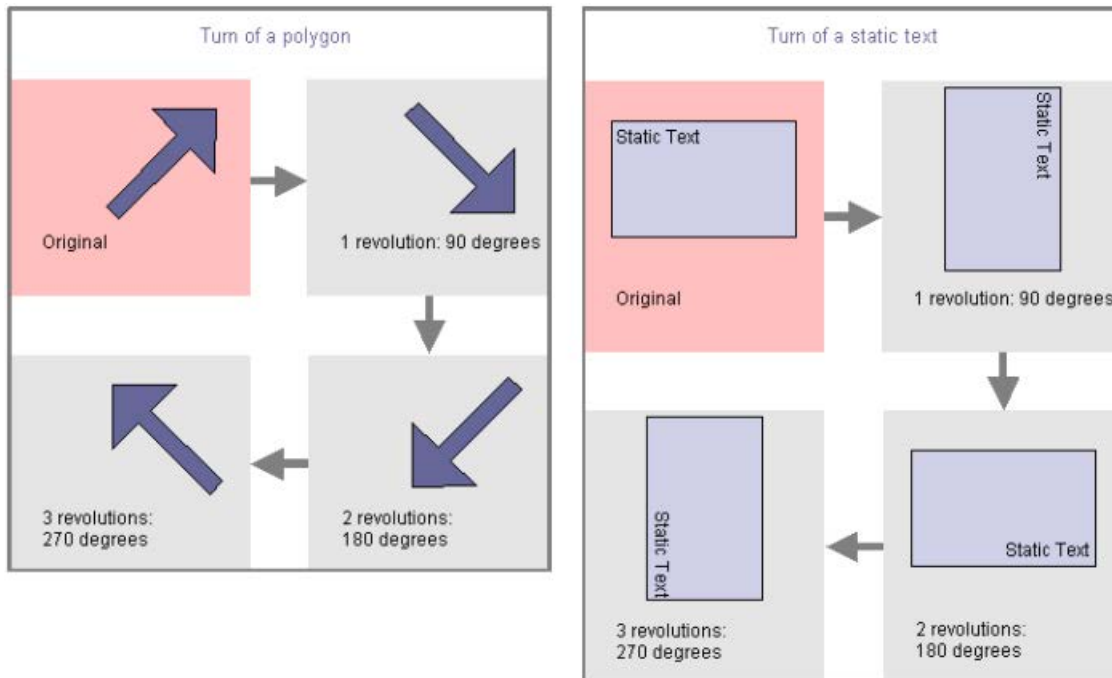

Multiple selection

You can rotate several selected objects at the same time. The objects are each rotated around their center point.

Requirements

- Select any type of object except circle, application window, picture window, Control, OLE object, status display, 3D bar, group display and round button.

Procedure

In the standard palette, click  to rotate the object clockwise around its center axis. It rotates 90 degrees.

Alternatively, you can select the "Rotate entry" in the "Arrange "menu.

3.8.3.13 How to delete objects

Introduction

The "Delete" command removes a selected object from a picture.

Multiple selection

You can delete several selected objects at the same time.

Requirements

- Select an object of any type.

Procedure

Press to remove the selected object from the picture.

Alternatively you can use the "Delete" entry on the popup menu or on the "Edit" menu.

Note

You can easily correct operating steps unintentionally carried out:

Click  in the standard palette to undo the last executed action. You can undo the last 30 editing steps by repeatedly clicking this button.

Use  in the standard palette to redo the last executed action.

See also

How to cut objects (Page 477)

How to copy objects (Page 478)

How to insert the contents of the clipboard (Page 479)

How to duplicate objects (Page 480)

How to insert an object into a picture (Page 460)

How to select an object (Page 464)

How to Select Multiple Objects (Page 467)

Basic Static Operations (Page 459)

Working with Objects (Page 456)

3.8.3.14 How to cut objects

Introduction

The "Cut command" copies a selected object into the clipboard of the operating system. The object itself is removed from the picture.

Multiple selection

You can cut out several selected objects at the same time.

Requirements

- Select an object of any type.

Procedure

Use the key combination <CTRL+X> to remove the selected object from the picture and copy it to the clipboard.

Alternatively, you can click  in the standard palette or use the "Cut" command in the context menu or in the "Edit" menu.

Note

You can easily correct operating steps unintentionally carried out:

Click  in the standard palette to undo the last executed action. You can undo the last 30 editing steps by repeatedly clicking this button.

Use  in the standard palette to redo the last executed action.

See also

Working with Objects (Page 456)

Basic Static Operations (Page 459)

How to Select Multiple Objects (Page 467)

How to select an object (Page 464)

How to insert an object into a picture (Page 460)

How to duplicate objects (Page 480)

How to insert the contents of the clipboard (Page 479)

How to copy objects (Page 478)

How to delete objects (Page 476)

3.8.3.15 How to copy objects

Introduction

The "Copy command" copies a selected object into the clipboard of the operating system. The advantage of copying to the clipboard is that you can insert the object several times, even into different pictures.

Multiple selection

You can copy several selected objects at the same time.

Note

When inserting a copied object, an object name is automatically assigned. The name of the original object is used as object name and linked with a continuous number. No special characters are used in the object name. You change the object name using the "Object Name" attribute.

Requirements

- Select an object of any type.

Procedure

Use the shortcut <CTRL+C> to copy the selected object to the clipboard.

Alternatively, you can click  in the standard palette or use the "Copy" command in the context menu or in the "Edit" menu.

See also

Working with Objects (Page 456)

How to copy objects to another picture (Page 394)

Basic Static Operations (Page 459)

How to Select Multiple Objects (Page 467)

How to select an object (Page 464)

How to insert the contents of the clipboard (Page 479)

How to cut objects (Page 477)

How to Rename Objects (Page 462)

How to duplicate objects (Page 480)

3.8.3.16 How to insert the contents of the clipboard

Introduction

You can use the "Paste" command to insert the current contents of the clipboard into the active picture as often as required. If an object was copied to the clipboard, for example, you can insert any number of copies of the object into different pictures using this command.

Requirements

- The clipboard must have contents.

Procedure

1. Press the shortcut <CTRL+V>.
The current contents of the clipboard are inserted into the active picture and selected.
2. Repeat this step to insert further copies of the contents.

Alternatively, you can click  in the standard palette or use the "Paste" command in the context menu or in the "Edit" menu.

Note

Objects from other applications can also be inserted via the clipboard of the operating system. Position X and Position Y of the inserted object are each 20 pixels higher than Position X and Y of the original object.

The inserted object receives the object name of the original object but is supplemented by a continuous number.

See also

How to copy objects (Page 478)
How to duplicate objects (Page 480)
How to cut objects (Page 477)
How to delete objects (Page 476)
How to select an object (Page 464)
How to Select Multiple Objects (Page 467)
Basic Static Operations (Page 459)
Working with Objects (Page 456)

3.8.3.17 How to duplicate objects

Introduction

Use the "Duplicate" command to make a copy of the selected objects directly in the active picture. The object itself is not modified. The selected object is not copied to the operating system clipboard.

Multiple selection

You can duplicate several selected objects at the same time.

Requirements

- Select an object of any type.

Procedure

Select "Duplicate" on the popup menu or on the "Edit" menu to make a copy of the selected object directly in the active picture.

Note

Position X and Position Y of the inserted duplicate are each 20 pixel greater than Position X and Y of the original object.

The duplicated object receives the object name of the original object but is supplemented by a continuous number.

See also

[How to copy objects \(Page 478\)](#)

[How to cut objects \(Page 477\)](#)

[How to insert the contents of the clipboard \(Page 479\)](#)

[How to delete objects \(Page 476\)](#)

[How to select an object \(Page 464\)](#)

[How to Select Multiple Objects \(Page 467\)](#)

[Basic Static Operations \(Page 459\)](#)

[Working with Objects \(Page 456\)](#)

3.8.3.18 How to change the position of an object

Introduction

In the Graphics Designer, a picture consists of 32 layers in which the objects can be inserted. By default the objects are inserted in the level predefined for the respective object type.

The position of the objects to one another can however also be changed within a level. This is important for example if several objects overlap and thereby over each other.

The position of the objects within one layer

Text list is on top of 3D bar

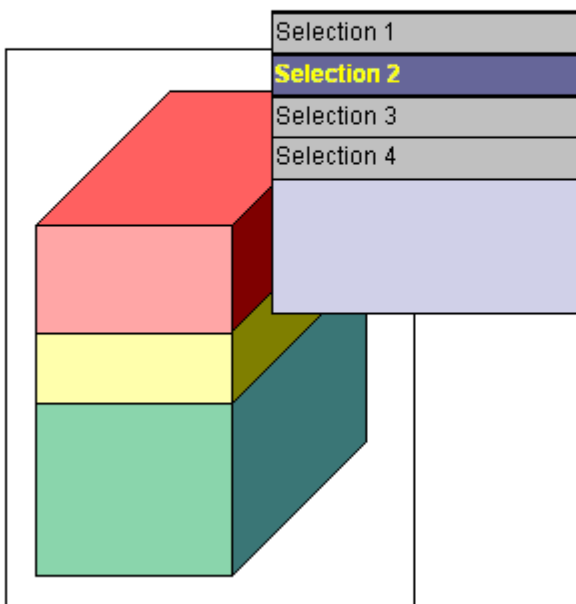

Text list is behind the 3D bar

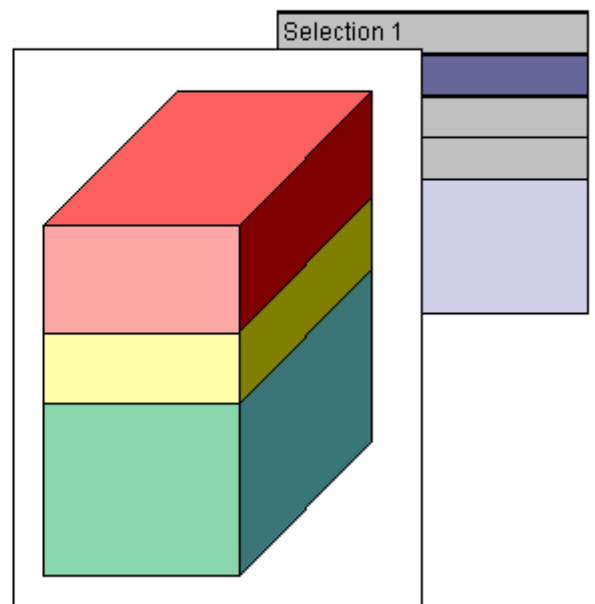

When creating a process picture the objects of a level are by default arranged in the order in which they were configured. The object inserted first lies at the very back of the level, each additional object is inserted one position toward the front.

Multiple selection

You can change the position of multiple selected objects simultaneously.

The modification always applies to the reference object relative to the position of the unselected objects. An individual position behind the reference object is assigned to each selected object.

Requirements



- The active picture should contain at least two objects of any type which partially overlap.
- Both objects must be on the same level.
- Select one of these objects.

Procedure

Use one of the following shortcuts to change the position of the selected object:

- <CTRL> and <+> = "All the way to the front"
The selected object is positioned in front of all the other objects contained in the picture.
- <CTRL> and <-> = "All the way to the back"
The selected object is positioned behind all the other objects contained in the picture.
- <+> = "one to the front"
The selected object moves up one position to the front.
- <-> = "one to the back"
The selected object moves back one position.

Alternative operation

- Select the required entry on the "Arrange / Within the Level" menu to change the position of the selected object.
- In the object palette, click  to position the selected object in the very front.
In the object palette, click  to position the selected object in the very back.

Note

Some objects of the "Control" type generally are in the foreground.

See also

Working with Objects (Page 456)

Basic Static Operations (Page 459)

Working with Layers (Page 388)

Layer palette (Page 330)

How to change the default setting of object types (Page 457)

How to Select Multiple Objects (Page 467)

How to select an object (Page 464)

3.8.3.19 You can change the text contents of objects

Introduction

The "Linking" command is used to reconfigure the text contents of attributes for all selected objects. All configured texts are listed in a dialog and can be edited directly or using the "Find" and "Replace" functions.

Open the "Find and Replace Texts" dialog.

Select all the objects whose text contents you want to change. If you do not select an object, all the objects in the active picture are evaluated.

In the "Edit" menu select "Linking / Text" or from the popup menu of the selection or of the active picture.

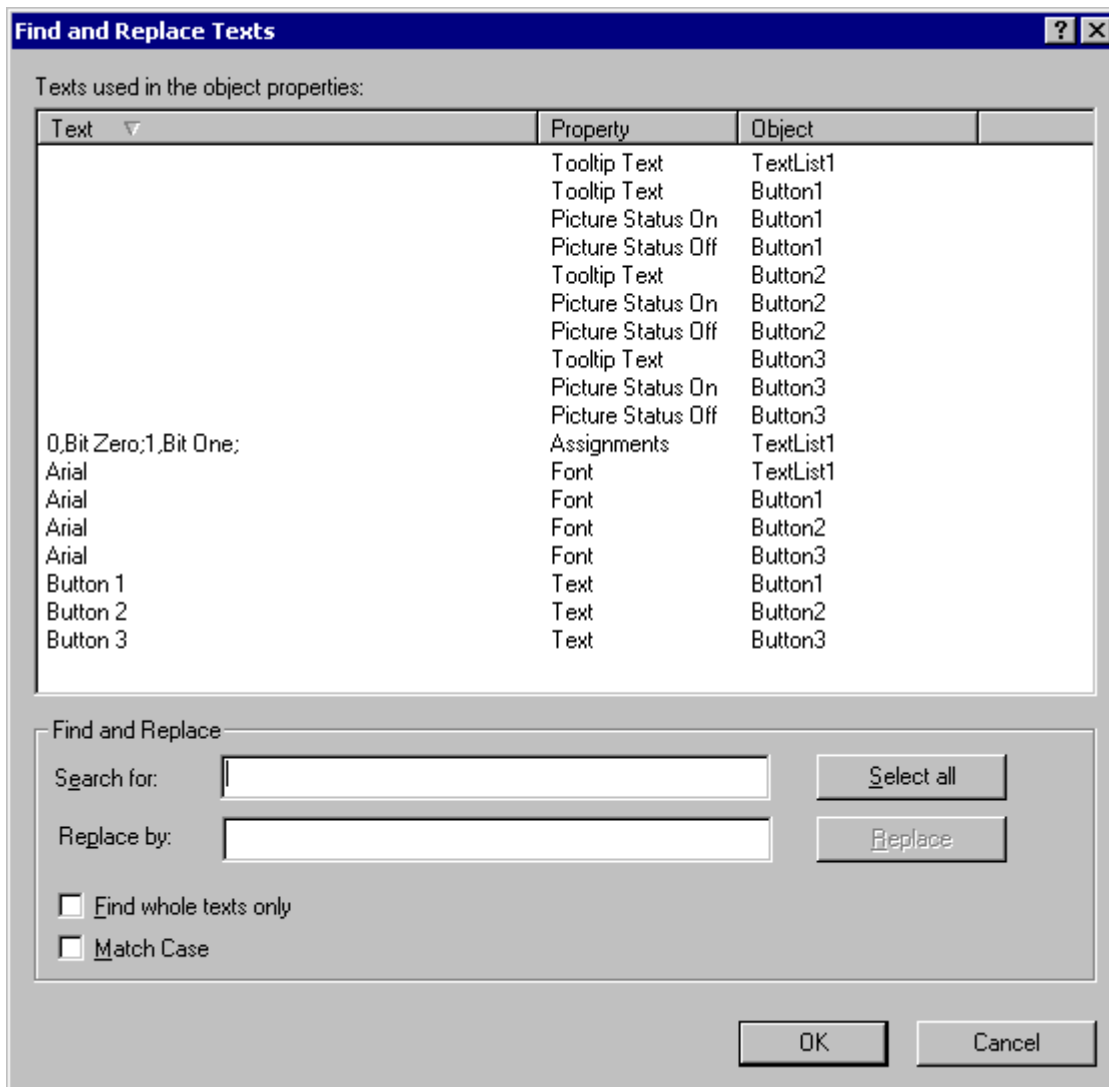

Sort text contents

The three-columned upper area of the dialog lists the texts configured in the objects selection and the associated attributes and objects.

Click the column name to sort the list according to texts, properties or objects.

Directly edit text contents

1. In the "Text" column, select the text contents to be changed.
2. Click the text once to activate the edit function.
3. Enter the new text contents and confirm this by pressing <ENTER>.

Find

You can select certain text contents using the "Find" function in the lower area of the dialog:

- Click "Select All" if you want to change the text contents displayed.
- Enter the text or parts of text you want to search for in the search field. You can also activate the options "Find whole words only" and "Match case". All text contents which do not meet the search criteria are hidden.

Replace

You can replace the selected text contents using the "Replace" function in the lower area of the dialog. Enter the new text in the field and click "Replace".

Note

The "Replace" function replaces only the part of the text contents displayed in the "Find" field.

Note

Grouped objects can only be linked if there are no grouped objects in the group itself.

See also

The "Texts" tab in the "Object Properties" window (Page 519)

How to change the tag connection of objects using linking (Page 499)

How to Select Multiple Objects (Page 467)

Basic Static Operations (Page 459)

Working with Objects (Page 456)

3.8.4 Basic Dynamic Operations

3.8.4.1 Basic Dynamic Operations

Introduction

To create a process picture, the required objects must first be inserted from the "Standard" selection window of the Graphics Designer into a picture.

These objects are then dynamically linked suitably to a process to use the process picture to control and monitor processes.

This chapter introduces the basic dynamic operations provided in the Graphics Designer to make objects dynamic:

- Dynamizing/animating attributes
- Configuring Events

There is an extensive description of this topic in the chapter "Making Process Pictures Dynamic".

The configuration of special displays in runtime, e.g. Rotation, is described in the following section: "Special Runtime Settings (Page 557)"

See also

Special Runtime Settings (Page 557)

The "Object Properties" Window (Page 512)

How to make attributes dynamic (Page 485)

How to configure events (Page 487)

How to configure a dynamic dialog (Page 489)

How to configure a C action (Page 494)

How to configure a VBS action (Page 495)

How to Configure a Tag Connection (Page 497)

How to change the tag connection of objects using linking (Page 499)

How to Configure a Direct Connection (Page 502)

Basic Static Operations (Page 459)

Working with Objects (Page 456)

3.8.4.2 How to make attributes dynamic

Introduction

You can make certain attributes dynamic in the "Object properties" dialog on the "Properties" tab.

By linking the attributes with dynamic dialogs, VBS actions, C actions or tags, the properties of an object can be dynamically adapted to the requirements of the processes to be displayed.

Certain attributes cannot be made dynamic because a change has no effect in runtime. These attributes have no dynamics icon.

Note

Global design

As soon as an attribute is defined with a global design, it is static and can no longer be made dynamic.

Pre-defined dynamics have no effect.

Runtime performance









To optimize the performance in runtime, check to see which dynamization is best suited for your requirements:

- Tag connections and animations usually offer a better Runtime performance than dynamization with scripts.
- Cyclic triggers and complex expressions can have a negative effect on the performance.

You can find additional recommendations for configuration under "Working with Projects > Dynamize process pictures > Configuration recommendations (Page 1165)".

Types of dynamics

The "Dynamic" column of the "Properties" tab displays the type of configured dynamics for the selected attribute and is marked by one of the following icons:

Icon	Type of dynamics
	No dynamics
	Dynamics with a tag
	Dynamics via a dynamic dialog
	Animation of the object via tag or script
	Dynamics with a VBS action
	Dynamics with a C action
	Dynamics with a C action not yet translated
	Faceplate type: Dynamization with an interface tag or structure tag

There is an extensive description of this topic in the chapter "Making Process Pictures Dynamic".

Prerequisites

- You have selected an object

Procedure

1. Open the "Object properties" dialog and select the "Properties" tab.
2. Select the property group containing the attribute to be made dynamic.
3. Right-click the Dynamic icon of the required attribute in the "Dynamics" column.
4. Select the required dynamics type on the popup menu.
The associated dialog box opens.
There is a brief description of the dynamics types under "Basic dynamic operations".

See also

Global Design of the Objects (Page 158)
The "Properties" Tab in the "Object Properties" Window (Page 514)
How to animate an object (Page 491)
How to Change an Attribute (Page 525)
Interface tags (Page 407)
Configuration recommendations (Page 1165)
How to configure a dynamic dialog (Page 489)
How to configure a C action (Page 494)
How to configure a VBS action (Page 495)
How to Configure a Tag Connection (Page 497)
How to change the tag connection of objects using linking (Page 499)
How to configure events (Page 487)
The "Object Properties" Window (Page 512)
Basic Dynamic Operations (Page 485)
Working with Objects (Page 456)

3.8.4.3 How to configure events

Introduction

The "Event" tag in the "Object Properties" window allows events to be configured.

By linking the events with direct connections, VBS actions or C actions, certain actions can be triggered in runtime by the operation of an object.

There are events which cannot be made dynamic because a change in runtime has no effect. They have no action icon.

Note

Runtime performance





To optimize the performance in runtime, check to see which dynamization is best suited for your requirements:

- Tag connections and animations usually offer a better Runtime performance than dynamization with scripts.
- Cyclic triggers and complex expressions can have a negative effect on the performance.

You can find additional recommendations for configuration under "Working with Projects > Dynamize process pictures > Configuration recommendations (Page 1165)".

Action types

The "Action" column of the "Event" tab displays the type of configured dynamics for the selected event and is marked by one of the following icons.

Icon	Type of dynamics
	There is no action for the event.
	There is an action via direct connection for the event.
	There is a VBS action for the event.
	There is a C action for the event.
	There is a C action not yet translated for the event.

There is an extensive description of this topic in the chapter "Making Process Pictures Dynamic".

Requirements

- Select an object.

Procedure

1. Open the "Object Properties" window and select the "Event" tab.
2. Select the event group containing the event to be configured.
3. Right-click the action icon of the required event in the Action column.
4. Select the required dynamics type on the popup menu.
The associated dialog box opens.
There is a brief description of the dynamics types under "Basic dynamic operations".

See also

"Events" tab in the "Object Properties" window (Page 517)

How to Change an Attribute (Page 525)

Configuration recommendations (Page 1165)
How to configure a C action (Page 494)
How to configure a VBS action (Page 495)
How to Configure a Direct Connection (Page 502)
How to make attributes dynamic (Page 485)
The "Object Properties" Window (Page 512)
Basic Dynamic Operations (Page 485)
Working with Objects (Page 456)

3.8.4.4 How to configure a dynamic dialog

Introduction

A dynamic dialog is used to achieve high Runtime performance when making attributes dynamic. A C action is automatically generated from the dynamic dialog. This can however be extended later. The advantage of higher Runtime performance is then lost.

A dynamic dialog is created with the "Value range" dialog which is described briefly here. More detailed information on this topic can be found under "Dynamics with the Dynamic dialog".

Opening the "Value range" dialog

Open the "Properties" tab in the "Object Properties" window. In the "Dynamics column", "select the "Dynamic Dialog" Box entry from the popup menu of the attribute to be made dynamic.

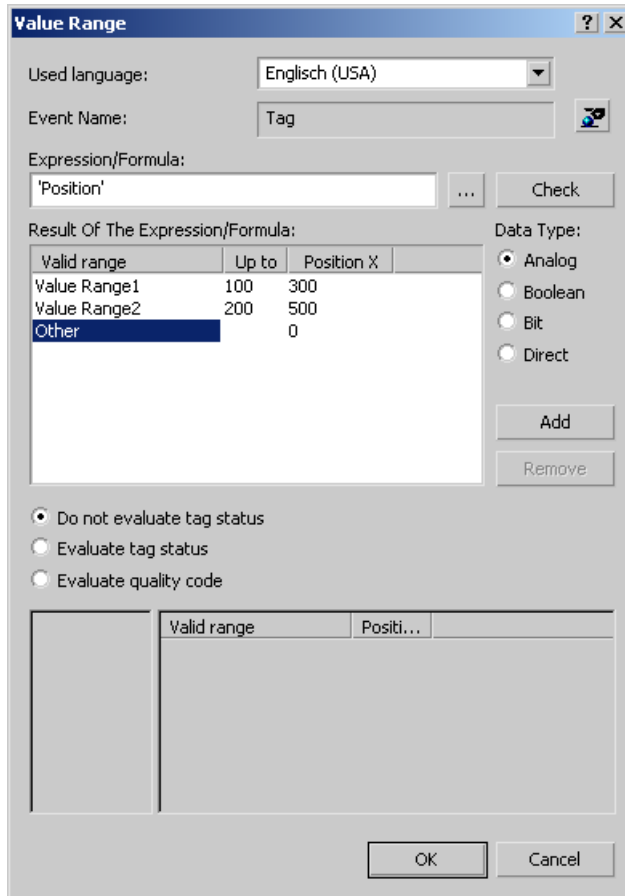

Event Name

The "Event Name" field displays the name of the selected trigger event which defines the update cycle for the value to be calculated.

The trigger event is configured using the "Change trigger" dialog. You can configure or rename the "Tag", "Default cycle", "Picture cycle" and "Window cycle" events in this dialog.

Click the button  to open the "Change trigger" dialog.

Expression/Formula

Specify the formula with which the new value of the attribute should be calculated in Runtime.

Click the button  in order to create the formula from the configured tags, global script functions and operators. Click "Check" to check the formula for errors.

Result of the Expression/Formula

This field displays the calculated value or value range. The evaluation of the event depends on the set data type.

Data type

Select the data type for the evaluation of the event. The options "Analog", "Bool", "Bit" and "Direct" are available.

Evaluate tag status

Activate this check box to view the current values of the tags in the formula.

Evaluate quality code

Activate this check box to monitor the quality code of a WinCC tag in Runtime.

See also

Dynamizing Using the Dynamic Dialog (Page 1204)

How to Configure Dynamization Using the Dynamic Dialog (Page 1205)

Creating Expressions (Page 1207)

Defining a Valid Range (Page 1211)

Monitoring Tag Status (Page 1215)

Monitoring Quality Code (Page 1216)

3.8.4.5 How to animate an object**Animation of objects**

The animation of objects allows you to dynamize multiple properties with a tag, for example, fast and clearly structured.

The following applies to animation of WinCC objects:

- You can animate most properties of the WinCC objects. The behavior depends on the respective WinCC object.
- You can only animate one object or one group at the time. Multiple selection is not possible.
- When you configure an animation for an object group, this animation applies to all individual objects that support this animation.
- You can change multiple object properties in runtime with one animation. Example: A rectangle gradually changes its fill color and starts flashing as of a defined value.

- When you copy an object and paste it into the same process picture, the configured animations are copied as well.
When it is copied to another process picture, the object loses the configured animations.
- Compared to the dynamization with scripts, animation usually offers a better Runtime performance.
Keep in mind, however, that cyclic triggers and complex expressions can have a negative effect on the performance.

You can find additional information on object animation under "Basic dynamic operations" and "The properties of an object":

- The "Animation" tab in the "Object Properties" window (Page 521)
- Example: How to animate a circle as signal light (Page 504)
- Example: How to animate the operability of a button (Page 508)

Procedure

1. Select the WinCC object in the process picture and the "Animation" tab in the "Object properties" window.

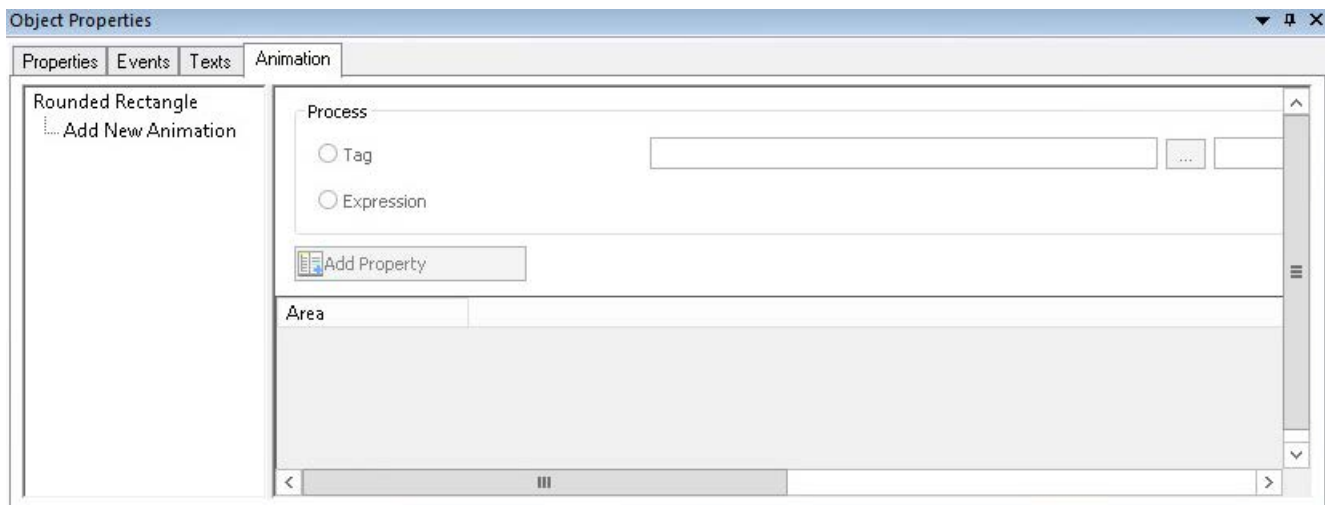

2. Double-click "Add New Animation".
To assign a meaningful name to the animation, select "Rename Animation" in the shortcut menu.
Alternatively, double-click the name or select <F2>.
To delete an animation, select "Delete row" from the shortcut menu.
3. Select a tag or or formulate an expression in the "Process" area.



4. To change the update cycle, click the following symbol: 

- In the "Settings" area, select the type of the value or the value range. When you change the type later, the configured animation steps are reset.

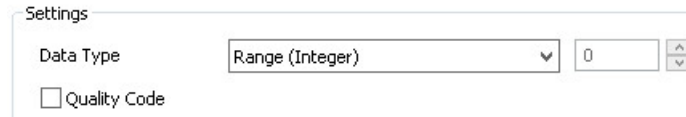

- To add the animation steps, click "Add" in the table. A new row is created and given a predefined default value. Depending on the selected type, animation steps are already created with the possible value ranges. No animation steps are created for the "Direct" type, because the tag value or expression is set as object property. To delete a row, select "Delete row" from the shortcut menu in the "Value" column.
- To change the value or the value range, double-click in the field. The values you can enter are specified by the selection of the value type in the "Type" area.
- To add the object property you want to animate, click "Add Property". The object property is added as column and predefined with the currently configured value. When you select a property that is already dynamized, a warning is shown. To maintain the original dynamization, select "No". To delete a property column, select "Delete property" from the shortcut menu in one of the cells in the column.
- To configure the value of the property for an animation step, double-click the table field. The configuration corresponds to the input in the "Properties" tab.

Result

The object property is marked as dynamized in the "Properties" tab: ⚡

You can jump directly to the corresponding animation by using the shortcut menu of the "Dynamic" column.

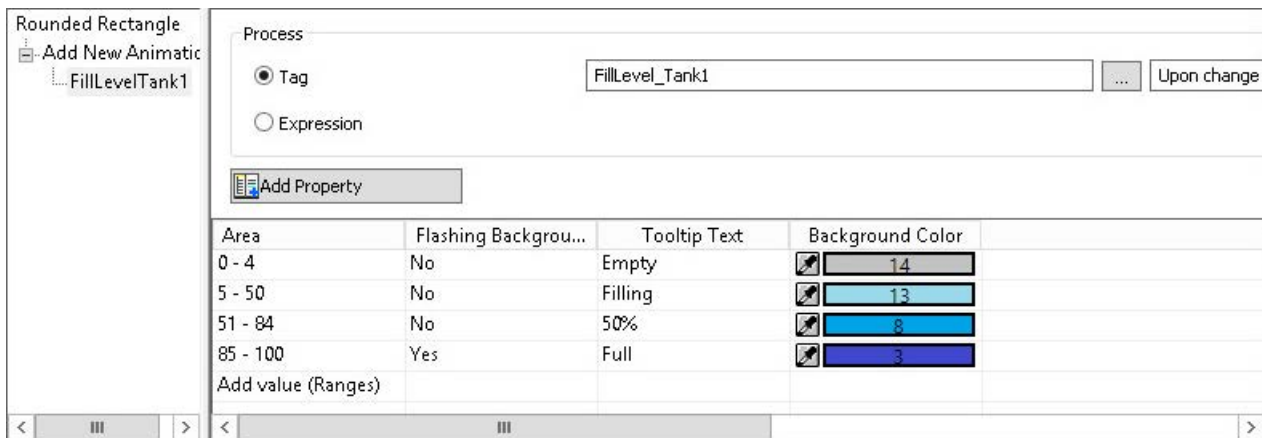

See also

Setting Up Rotation of Objects (Page 558)

The "Animation" tab in the "Object Properties" window (Page 521)

How to make attributes dynamic (Page 485)

Example: How to animate a circle as signal light (Page 504)

Example: How to animate the operability of a button (Page 508)

3.8.4.6 How to configure a C action

Introduction

You can use a C action to make attributes and events dynamic. The powerful script language ANSI-C opens almost endless options for dynamics.

However, the Runtime performance achieved is lower than with other dynamic types. Therefore, before using a C action check whether the required dynamics can also be implemented with another dynamic type, for example, by an animation.

A C action is created with the "Edit action" dialog which is briefly described here. More detailed information on this topic can be found under "Dynamics with a C Action".

Open "Edit action" dialog

Attribute

Open the "Properties" tab in the "Object Properties" window. In the "Dynamics" column, select the "C Action" entry from the popup menu of the attribute to be made dynamic.

Event

Open the "Event" tab in the "Object Properties" window. In the "Action" column, select the "C Action" entry from the pop-up menu of the event to be made dynamic.

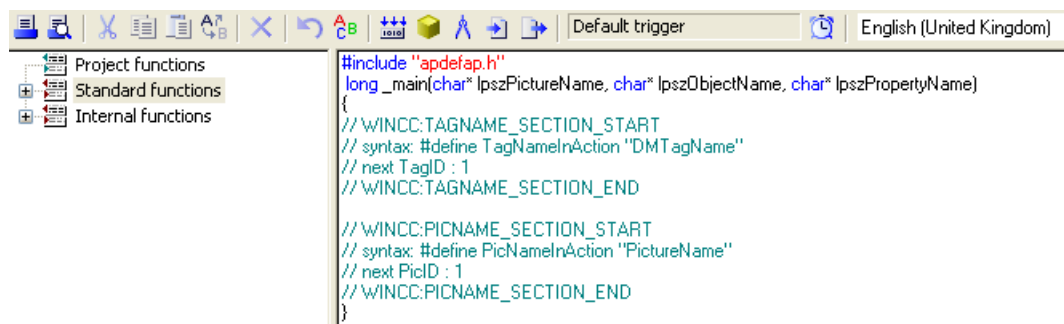





```
#include "apdefap.h"
long_main(char* lpszPictureName, char* lpszObjectName, char* lpszPropertyName)
{
//WINCC:TAGNAME_SECTION_START
// syntax: #define TagNameInAction "DMTagName"
// next TagID : 1
//WINCC:TAGNAME_SECTION_END

//WINCC:PICNAME_SECTION_START
// syntax: #define PicNameInAction "PictureName"
// next PicID : 1
//WINCC:PICNAME_SECTION_END
}
```

Toolbar

The toolbar of the "Edit action" dialog also contains the following buttons in addition to the familiar icons:

Icon	Name	Description
	Create Action	Checks the program codes of the C action for errors
	Tag selection	Selects tags which should be evaluated in the C action
	Selection of picture	Selects the picture in PDL format which is to be evaluated in the C action
	Import an Action	Imports an existing C action. C actions are saved in the ACT file format.
	Exporting an Action	Exporting the new or modified C action. C actions are saved in the file format ACT.

Event Name

The "Event Name" field displays the name of the selected trigger event which defines the update cycle for the value to be calculated.

The trigger event is configured using the "Change trigger" dialog. You can configure or rename the "Tag", "Standard cycle", "Picture cycle" and "Window cycle" events in this dialog.

Click  to open the "Change trigger" dialog.

Editor window

The editor window shows and edits the program code of the C action. Functions, tags and pictures can be inserted and modified at the respective current cursor position.

Function selection

The function selection shows the Global Script functions available in the project in the form of a directory tree. You can use these functions to create the C actions.

Double-click the required function to configure the contained parameters with the Set "Parameters" dialog. Confirm the new parameters by clicking "OK" to insert the function with the new values at the position of the cursor in the editor window.

See also

Dynamizing Using C Action (Page 1234)

3.8.4.7 How to configure a VBS action

Introduction

You can use a VBS action to make attributes and events dynamic. The script language of a VBS action is Visual Basic.

If you want to configure tag-triggered dynamizations, it may make more sense to use an animation. The Runtime performance of scripts is usually less than with tag connections.

A VBS action is created with the "Edit VBS action" dialog which is briefly described here. More detailed information on this topic can be found under "Dynamics with a VBS Action".

Open "Edit VBS action" dialog

Attribute

Open the "Properties" tab in the "Object Properties" window.

In the "Dynamics" column, select the "VBS Action" entry from the popup menu of the attribute to be made dynamic.

Event

Open the "Event" tab in the "Object Properties" window.

In the "Action" column, select the "VBS Action" entry from the pop-up menu of the event to be made dynamic.

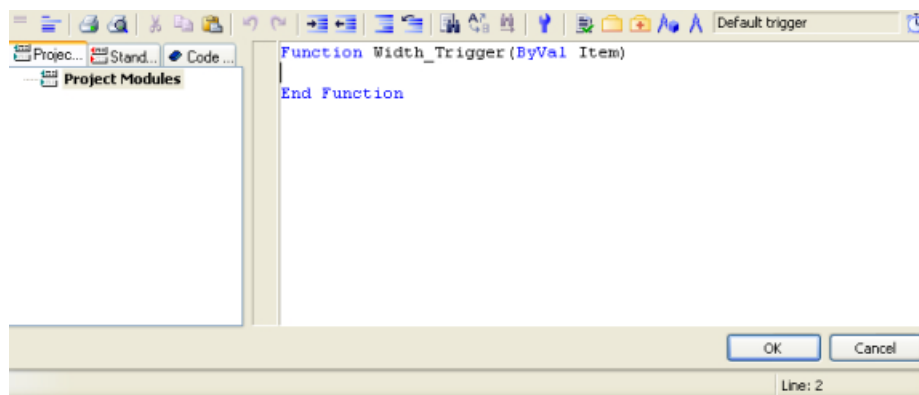





Toolbar

The toolbar of the "Edit VBS action" dialog also contains the buttons described below in addition to the familiar icons.

The composition of the icons on the toolbar varies according to the types of attribute or event for which a VBS action was configured.

Icon	Name	Description
	Hide declaration section	Hides the declaration section with "Option explicit"
	Show declaration section	Shows the declaration section with "Option explicit"
	Uncomment	Changes marked program lines into commentary lines
	Remove comment	Deletes the commentary marking of a program line
	Syntax Check	Checks the program codes of the VBS action for errors

Icon	Name	Description
	Tag dialog	Selects tag which is evaluated in the VBS action
	Tag dialog with extended return parameter	Tag selection in a dialog with extended return parameters
	Object selection	Select an object with a property that is evaluated in the VBS action
	Selection of picture	Selects a picture in "PDL" format that is evaluated in the VBS action

Event Name

The "Event Name" field displays the name of the selected trigger event that defines the update cycle for the value to calculate.

The trigger event is configured using the "Change trigger" dialog. You can configure or rename the "Tag", "Standard cycle", "Picture cycle" and "Window cycle" events in this dialog.

Click  to open the "Change trigger" dialog.

Editor window

The editor window shows and edits the program code of the VBS action.

Visual Basic modules, tags and pictures can be inserted and modified at the respective current cursor position.

Module selection

The module selection displays Visual Basic modules already available in the form of a directory tree.

There are three tabs in which "Project modules", "Standard modules" and "Code templates" are made available. You can use these modules to create the VBS actions.

3.8.4.8 How to Configure a Tag Connection

Introduction

You can make attributes dynamic using a tag connection. Connecting an attribute to a process tag for example enables the change of the measurement value to be displayed graphically.

All tags available in the project can be selected in the "Tags – Project: ..." dialog that is described briefly here. More detailed information on the topic can be found under "Making Dynamic using Tag Connection" and "under "Tag Management".

"Tags – Project:" dialog ..." Open

Open the "Properties" tab in the "Object Properties" window. In the "Dynamics" column, select the "Tag" entry from the shortcut menu of the attribute to be made dynamic.

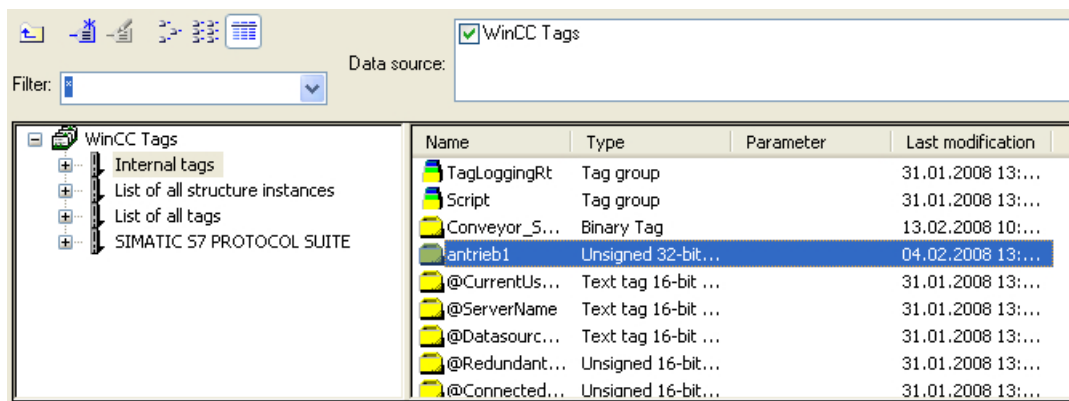

Filter

If there is a large number of configured tags, the search procedure can take some time. For instance, for 15,000 tags the search procedure takes about a minute.

By specifying a filter, you can narrow the scope of the search and reduce the duration of the search procedure. You can achieve a significant increase in efficiency if you configure tags with the aid of a tag prefix.

Data source

You can use the "Data Source" window to select the tags it is intended to display.

Tag groups

The selected tag group including its sub-folders is displayed in the left-hand area in the form of a folder tree.

Directories and subdirectories can be opened or closed by clicking on the "+" or "-" icons. The tags available for the selected entry are shown in the tag display.

Tag display

The right-hand area contains all the tags that are available for the entry. The tag display is divided into 4 columns showing the tag name, type and parameter, and the point in time at which the tag was last changed. Tags can be sorted by clicking on the respective column heading.

Procedure

1. Select the required filter. An asterisk means that no filter is to be used or no filter has been defined.
2. Select one or more data sources.
3. Open the desired tag group in the left-hand window area.

4. Select the desired tag from the right-hand window area.
5. Confirm your selection with "OK".
The dialog "Tags - project: ..." closes.
The selected tag is assigned to the selected object and you can continue with the configuration.

I/O field: Simplified tag connection

Use drag-and-drop to place the required tag from the tag selection dialog in the process picture. The Graphics Designer creates an I/O field with this tag connection.

See also

Dynamizing by Means of Tag Connection (Page 1195)

3.8.4.9 How to change the tag connection of objects using linking

Introduction

The "Linking" command is used to reconfigure the tag connection for all selected objects. The tag connections configured for the selection are listed in a dialog and can be linked directly or with the aid of the "Find" and "Replace" functions.

Open "Linking of the Tag Connection" dialog

Select all the objects whose tag connection contents you want to link.
From the "Edit" menu select "Linking / Tag Connection" or from the popup menu of the selection.

Linking tags at the places of use

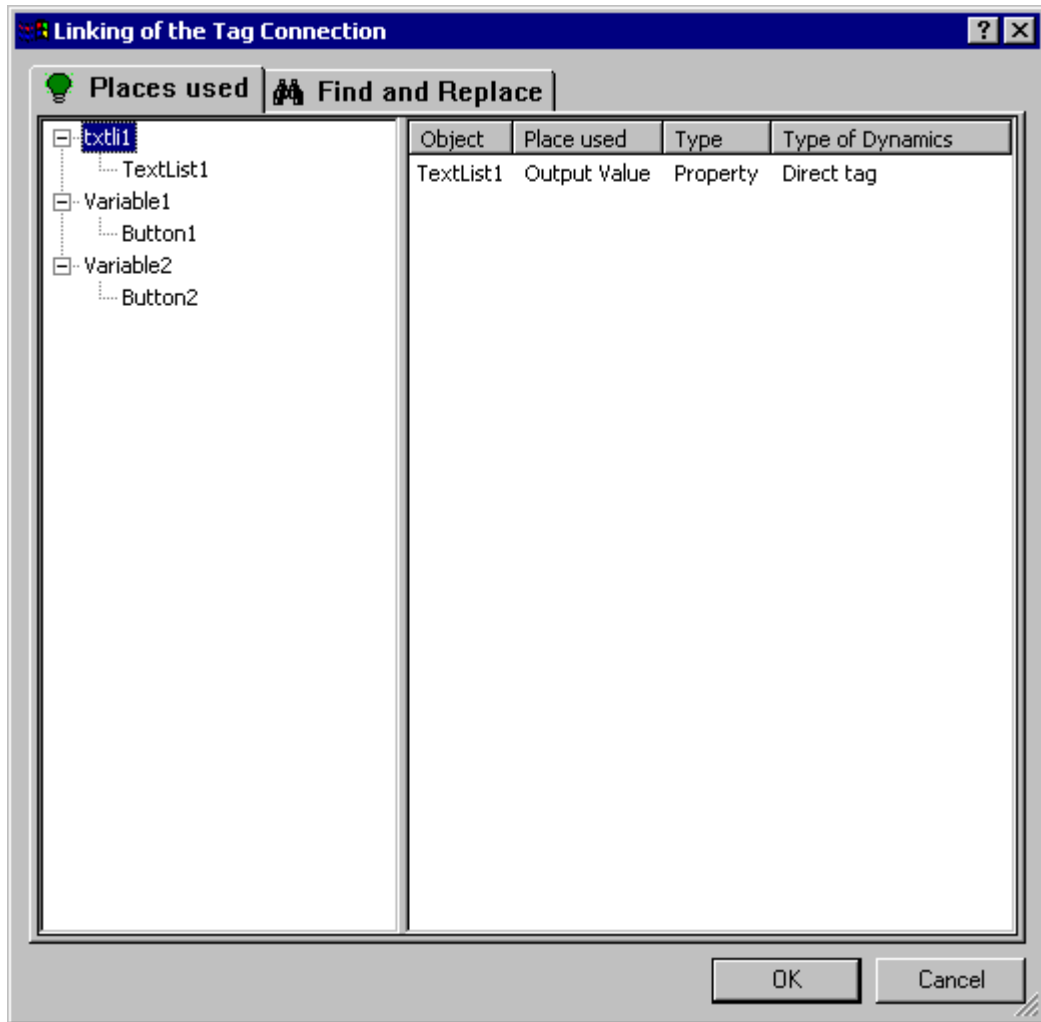

Tag selection

The left area of the "Places of Use" tab shows a list of the tags configured in the object selection. All objects are assigned to these tags in the form of a folder tree which contains the dynamics of the respective tag.

Select a tag or object. The detail view shows the current tag connections.

Detail view

The right area of the "Places of Use" tab shows the current tag connections for the selected tag or object. You can link these tag connections:

Right-click the required tag connection to call the "Linking" command. The "Linking a Tag" dialog opens.

Find

The left area of the "Find and Replace" tag shows the names of all tags configured in the object selection. There are three search options available to select certain tag names:

- Click "Select All" if you want to link the texts displayed.
- Select a tag name and click the button , if you only wish to change the connections to this tag. All remaining tag names are hidden.
- Enter the tag names or parts of names you want to search for in the search field. You can also activate the options "Find whole words only" and "Match case". All tags which do not meet the search criteria are hidden.

Replace

In the right area of the "Find and Replace" tab you can enter the name of the new tag with which the selected tag names should be replaced. Alternatively you can click the associated button to select the required tag.

Click "Preview" to view and check the planned replacement.

Click "Replace" to link the selected tag connections as in the preview.

Note

The "Replace" function replaces only the part of the tag names contents displayed in the "Find" text field of the area.

Note

Grouped objects can only be linked if there are no grouped objects in the group itself.

3.8.4.10 How to Configure a Direct Connection

Introduction

Events can be made dynamic using a direct connection. A direct connection offers the quickest dynamics in the picture and achieves the highest Runtime performance. However the direct connection can only be used within a process picture and only one connection can be created.

A direct connection is created with the "Direct Connection" dialog which is briefly described here. More detailed information on this topic can be found under "Dynamics with a Direct Connection".

Opening the "Direct Connection" dialog

Open the "Event" tab in the "Object Properties" window. In the "Action" column, select the "Direct Connection" entry from the popup menu of the event to be made dynamic.

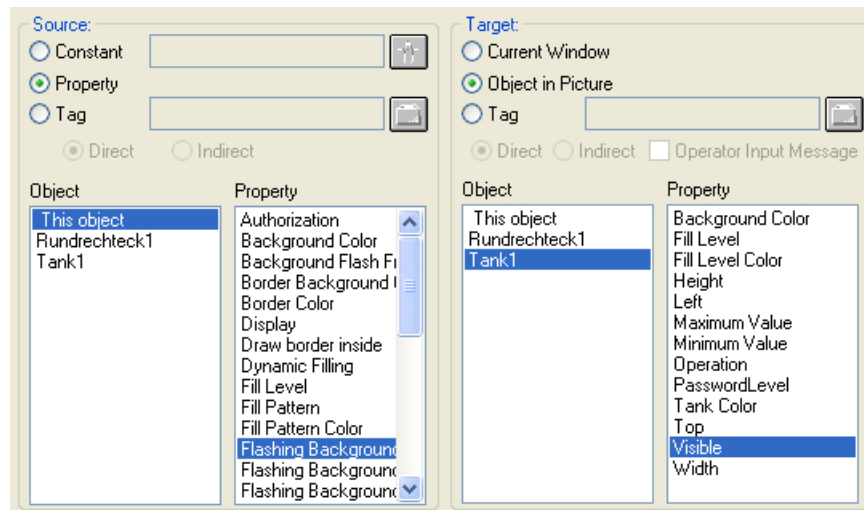

Source

You can select a constant, object property or a tag as the data source:

Constant

Click the associated button or select a picture of the PDL format which provides the constant.

Object property

Select the object and an attribute of the object whose value should be used as the data source.

Tag

Click the associated button and select the required tag. Define whether the update of the tags should be done permanently (directly) or only when called (indirectly).

Objective

You can select "Current window", "Object in Picture" or "Tag" as the target which should take the value of the data source:

Current window

Select this option if you want to assign the value of the data source to the active picture.

Object in the picture

Select the object and attribute of this object to which you want to assign the value of the data source.

Tag

Click the associated button and select the required tag which should take the value of the data source. Define whether the update of the tags should be done permanently (directly) or only when called (indirectly). If required, you can activate the output of a operator message.

See also

Dynamizing by Means of Direct Connection (Page 1198)

3.8.4.11 Example: How to animate a circle as signal light

"Signal light" animation

In this example you are configuring a circle as signal light:

- Depending on the tag value, the circle changes its vertical position.
- Depending on the tag value, the circle changes its color.
- As of the specific tag value, the circle will start flashing.
- The circle is shown in light gray for uncertain or bad tag status. A tooltip "inactive" is displayed.

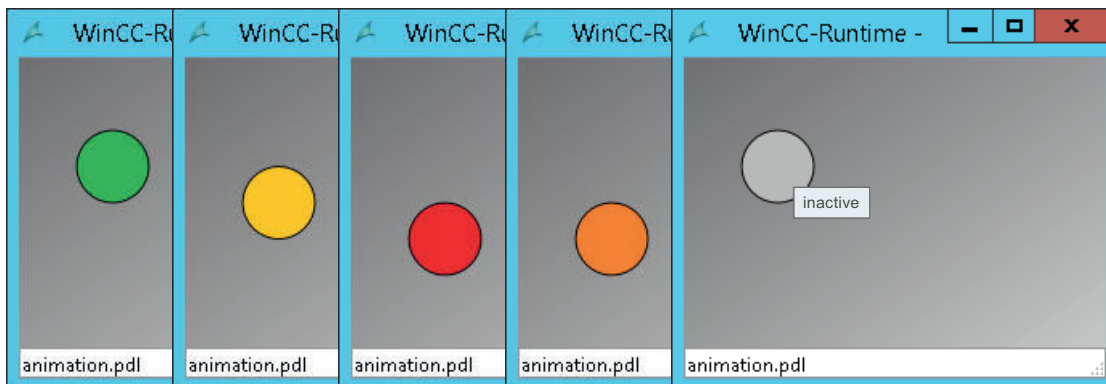

Requirement

- An internal tag "TCelsius" with the type "Unsigned 32-bit value" is created in the Tag Management.
- A standard object "Circle" with the following object properties is inserted in the "animation.pdl" process picture:

Property group	Attribute	Value in the "Static" column
Geometry	Position Y	50
	Radius	25
Colors	Background color	Central color palette "WinCC Standard", color 14 (light gray)
Layout	Global color scheme	No

Procedure

Configuring animations

1. Select the "Circle" object in the "animation.pdl" process picture.
2. To create the "Signal Light" animation, double-click the entry "Add New Animation" in the "Animation" tab.

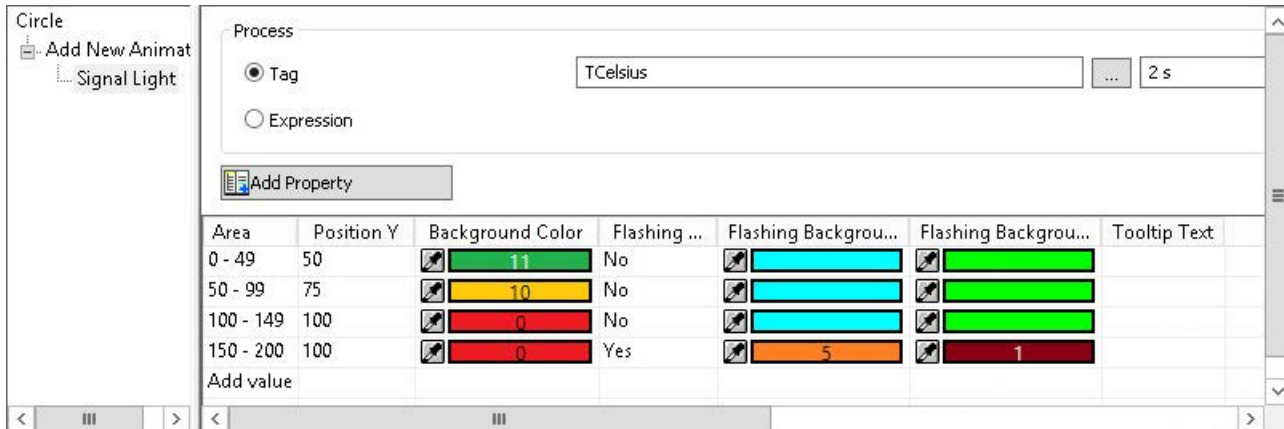

3. Select the tag "TCelsius" in the "Process" area.
4. Select the type "Range (Integer)" in the "Settings" area.
5. Click on the "Add Property" button to select the following object properties:
 - Change of position: "Position Y"
 - Color change: "Background color"
 - Flashing behavior: "Flashing Background Active", "Flashing Background Color On", "Flashing Background Color Off"
 - Tooltip for Quality Code: "Tooltip text"
6. To add the animation steps, double-click "Add" in the table four times.
7. Configure the value ranges of the four animation steps:
 - 0-49, 50-99, 100-149, 150-200

To prevent the values from overlapping, enter the range "0-49" last.
The sequence of the value ranges during configuring has no effect on the animation.

- To configure the behavior for each animation step, click in the fields of the object properties in the table.
Select the following values for the animation of the object properties:

Object property	Value: 0-49	Value: 50-99	Value: 100-149	Value: 150-200
Position Y	50	75	100	100
Background color ¹⁾	11 (green)	10 (yellow)	0 (red)	0 (red)
Flashing Background Active	No	No	No	Yes
Flashing Background Color "On" ¹⁾	(Default value)	(Default value)	(Default value)	5 (orange)
Flashing Background Color "OFF" ¹⁾	(Default value)	(Default value)	(Default value)	1 (dark red)
Tooltip text	-	-	-	-

1) The color numbers of the central color palette "WinCC Standard" are specified as colors in each case. To select the colors, switch to the "Color selection" dialog in the "Palette" tab.

- Save the process picture to apply the settings. The "Circle" object will lose its focus. You have configured the signal light animation and can test it in runtime.

Configuring tag status

- Click on the "Circle" object in the process picture and go to the "Properties" tab.
- In the "Miscellaneous" property group, configure the tooltip text "inactive".

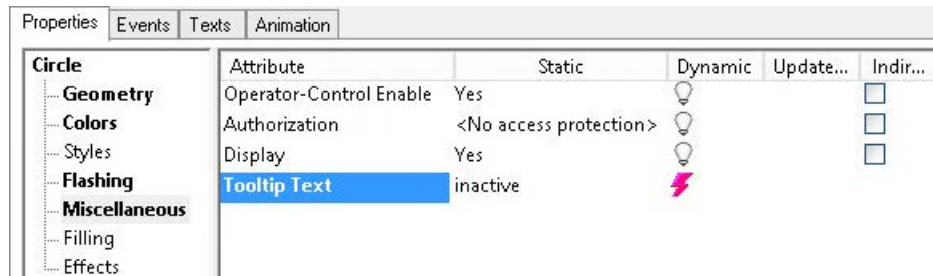

Because the four animation steps were saved prior to the tooltip input, the configured animation does not change.

- Go back to the "Animation" tab and activate the "Quality Code" option in the "Settings" area. A new first row is displayed.

4. To open the first table row and show the quality codes, click on the arrow: ▶
When selecting the tag status, the currently configured static values of the object properties were applied.
5. To highlight the quality code "bad (0x1C) out of service" in the process picture, for example, configure a separate animation step for it:
 - Flashing: Yes
 - Flashing Background Color On: 5 (orange)
 - Flashing Background Color Off: 14 (light gray)

Regardless of the current tag value, the circle is displayed as flashing in orange when the tag has the status "bad (0x1C) out of service".

Area	Posi...	Background Color	Flashin...	Flashing Ba...	Flashing Bac...	Tooltip Text
▼						
low limited	50		No			inactive
high limited	50		No			inactive
uncertain miscellaneous sta	50		No			inactive
uncertain (0x40) non-specifi	50		No			inactive
uncertain (0x44) last usable v	50		No			inactive
uncertain (0x48) substitute-s	50		No			inactive
uncertain (0x4C) initial value	50		No			inactive
uncertain (0x78) process rela	50		No			inactive
uncertain (0x56) engineering	50		No			inactive
uncertain (0x55) engineering	50		No			inactive
uncertain (0x54) engineering	50		No			inactive
uncertain (0x60) simulated v	50		No			inactive
uncertain (0x68) maintenanc	50		No			inactive
bad miscellaneous states	50		No			inactive
bad (0x2B) process related, r	50		No			inactive
bad (0x28) process related, s	50		No			inactive
bad (0x00) non-specific	50		No			inactive
bad (0x04) configuration err	50		No			inactive
bad (0x08) not connected	50		No			inactive
bad (0x0C) device failure	50		No			inactive
bad (0x14) no communicati	50		No			inactive
bad (0x18) no communicati	50		No			inactive
bad (0x1C) out of service	50		Yes			inactive
0 - 49	50		No			
50 - 99	75		No			
100 - 149	100		No			
150 - 200	100		Yes			
Add value (Ranges)						

Testing animation in runtime

To test the behavior in runtime, use the simulator "Tag simulation":

1. Configure the tag "TCelsius":
 - "Increment" function
 - End value = 200
 - Increment steps = 5
2. Activate the tag in the "Active" column.

3. Save the simulation.
4. Activate Runtime in the Graphics Designer and start the simulation in the simulator.

See also

How to animate an object (Page 491)

The "Animation" tab in the "Object Properties" window (Page 521)

Example: How to animate the operability of a button (Page 508)

3.8.4.12 Example: How to animate the operability of a button

"Button" animation

In this example you are configuring a button that can only be operated under specific conditions:

- Depending on the return value of the configured expression, the button is either shown or hidden.
In this example you are converting the tag value used as "degrees Celsius" into degrees Fahrenheit.
The button remains hidden as long as the temperature is below 100 degrees Fahrenheit. As soon as the temperature exceeds 100 degrees Fahrenheit, the button is shown.
- The button can be operated depending on a set bit.
- The logged on user is output as button label.

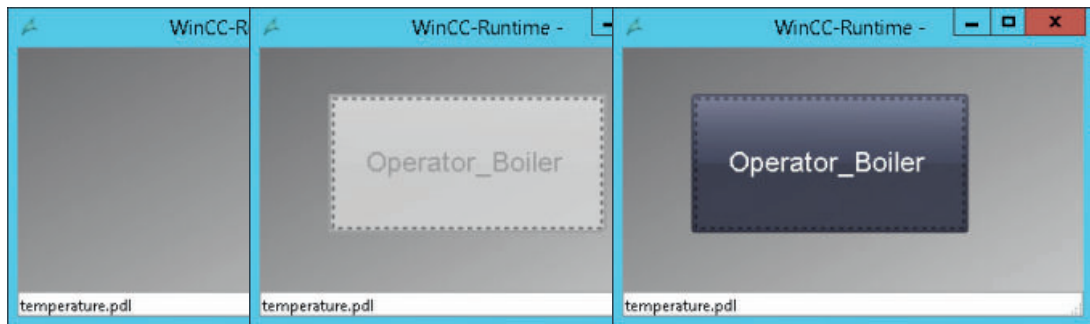

Requirement

- Tag Management:
An internal tag "TCelsius" with the type "Unsigned 32-bit value" is created.
An internal tag "Authorization_Tag" with the type "Unsigned 8-bit value" is created.
- User Administrator:
An "Operator_Boiler" user with the "Process control" authorization is created.

- Graphics Designer:
The two process pictures "animation.pdl" and "temperature.pdl" are created.
- A "Button" Windows object is added in the "temperature.pdl" process picture.
Select the following settings in the configuration dialog:
 - Change Picture on Mouse Click: animation.pdl
 - Authorization: Process control

Procedure

Show / hide button

1. Select the "Button" object in the process picture.
2. Create the "Show Button" animation in the "Animation" tab.

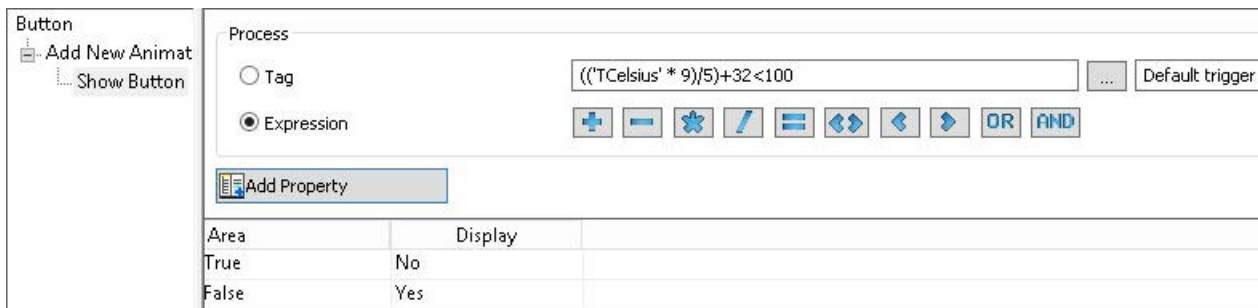

3. In the "Process" area, select the "Expression" option.
 - $((TCelsius * 9) / 5) + 32 < 100$

The return value "True" or "False" is determined in runtime:
The tag value is converted from Celsius to Fahrenheit. As long as the value is less than 100, the return value is "True".
4. Select "Boolean" as type.
The animation steps with the values "True" and "False" are created.
5. Use the "Add Property" button to select the "Display" object property.
6. Configure the two animation steps:
 - True: No
 - False: Yes

If the value matches the configured value "False", the button is shown.

Setting Operator-Control Enable

1. Select the "Button" object in the process picture.
2. Create the "Button Authorization" animation in the "Animation" tab.
3. In the "Process" area, select the "Authorization_Tag" tag.

4. Select "Bit" as type and "2" as bit number.



The animation is now checked to determine whether or not the second bit of the "Authorization_Tag" tag is set.

The animation steps with the values "0" and "1" are created.

5. Use the "Add Property" button to select the "Operator-Control Enable" object property.
6. Configure the two animation steps:
 - 0: Yes
 - 1: No

If the second bit of the "Authorization_Tag" tag is set, the user with the "Process control" authorization can operate the button in runtime.

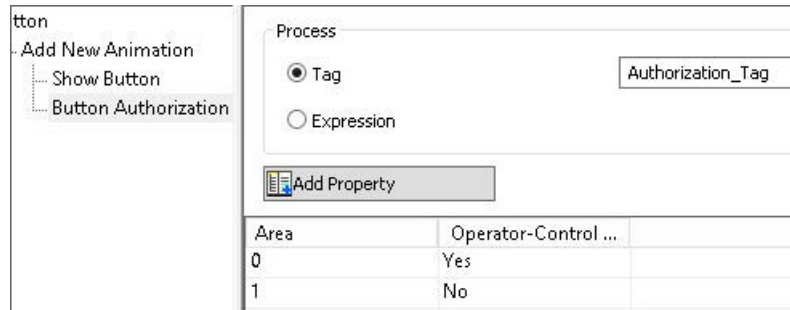

Displaying user name

1. Select the "Button" object in the process picture.
2. Create the "Username" animation in the "Animation" tab.
3. Select the system variable "@CurrentUserName" in the "Process" area.
4. Select "Direct" as type.

There are no animation steps because the tag value is set as object property in the animation.



5. Use the "Add Property" button to select the "Text" object property. The name of the logged on user is shown as button label in runtime.

Testing animation in runtime

To test the behavior in runtime, use the simulator "Tag simulation":

1. Configure the following tags and settings:
 - TCelsius: "Increment" function, end value = 200, increment steps = 5.
 - Authorization_Tag: "Sine" function
 - @CurrentUserName: "User input" function
2. Activate the tags in the "Active" column.
3. Save the simulation.
4. Activate Runtime in the Graphics Designer and start the simulation in the simulator.
5. To test the "@CurrentUserName" tag, enter the user name "Operator_Boiler" in the "Value set" field.

See also

Example: How to animate a circle as signal light (Page 504)

How to animate an object (Page 491)

The "Animation" tab in the "Object Properties" window (Page 521)

How to define the visibility of objects (Page 564)

3.8.5 The Properties of an Object

3.8.5.1 The Properties of an Object

Object properties

The properties of an object are described by a large number of attributes. Typical object properties are, for example, shape, appearance and visibility, position, process connection and operability of an object.

You configure these properties as required in the Graphics Designer. To change an object property, assign a new value to the associated attribute.

"Object Properties" window

The "Object Properties" window on the "Properties" tab contains all the attributes of a selected object or a multiple selection of objects.

The attributes are divided into property groups, such as "geometry" or "Colors". The type and number of the available property groups and attributes are dependent on the type of the selected objects. So, for example, the "Font" property group is only shown for the object types which can be displayed with text.

As an alternative to changing the attributes in the "Object properties" window, objects can also be adjusted with animations, the mouse and keyboard or by using the toolbar and palettes. However, in this way only certain object properties, such as the basic geometric size, color and line style, can be changed.

Editing multiple objects

With a multiple selection it is possible that individual property groups for one specific object type are summarized to a shared property group.

All attributes of the summarized property groups available in this group are contained under the "User defined" label.

See also

Elements and Basic Settings of the Graphics Designer (Page 319)

Working with Objects (Page 456)

Special Runtime Settings (Page 557)

Property Groups and Attributes (Page 530)

The "Object Properties" Window (Page 512)

The Start Screen of the Graphics Designer (Page 325)

3.8.5.2 The "Object Properties" Window

The "Object Properties" Window

Introduction

In the Graphics Designer, the "Object Properties" window represents the central dialog for changing object properties. Object properties are, for example, shape, appearance and visibility, position, process connection and operability of an object.

To show the window, click on an object in the process picture and select "Properties" from the shortcut menu. You can change the position and size of the window freely.

The "Object Properties" window is divided into the following tabs:

- Properties
- Events
- Texts
- Animation

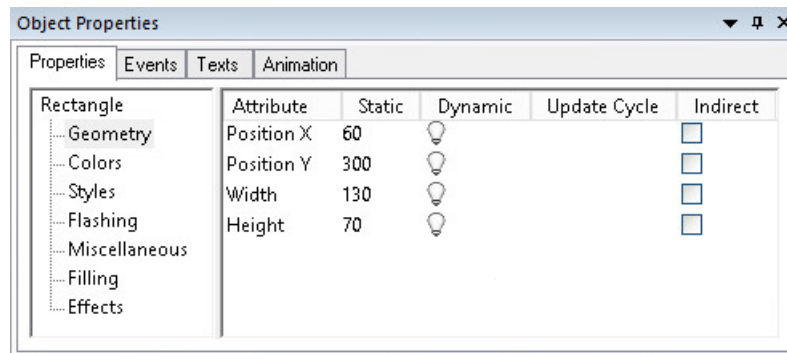

Working in the "Object Properties" window

Select a property group and an attribute to adjust the static value of an object property.

A description of the selected property is available through the "F1" key and the "Direct help" context menu.

Dynamizing object property

The "Object Properties" window allows process pictures to be made dynamic.

To dynamically adapt the properties of an object to the requirements of the process to be displayed, link an attribute to a tag or C actions, for example.

You can find a description of dynamizing under "Working with WinCC > Dynamize process pictures".

Arranging the "Object Properties" window

Click in the title bar of the window to arrange the "Object Properties" window as needed. Move the window to the desired position while keeping the mouse button pressed.

You can change the width of the window areas and the columns in the attribute display by moving the vertical separation lines.

You select the docking options using the arrow in the title bar of the window:

- Undock
Shows the window permanently in the foreground.
- Docking
- Document in tab format
- Automatically in background
- Hiding

See also

The "Animation" tab in the "Object Properties" window (Page 521)

The "Texts" tab in the "Object Properties" window (Page 519)

How to Change an Attribute (Page 525)

How to Transfer Object Properties (Page 529)

How to change the default setting of object types (Page 457)

The "Properties" Tab in the "Object Properties" Window (Page 514)

"Events" tab in the "Object Properties" window (Page 517)

The Properties of an Object (Page 511)

The "Properties" Tab in the "Object Properties" Window

Introduction

In the "Object Properties" window, the "Properties" tab represents the central dialog to change static values of a selected object.

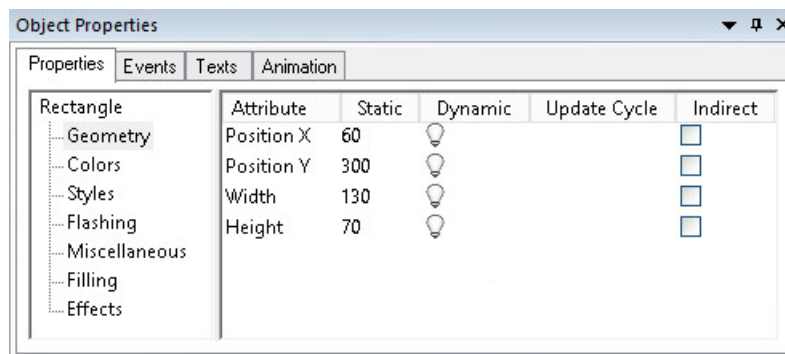

Properties folder

The left area shows the selected object with its property groups in a directory tree. The selected object is displayed as a directory. It is not possible to change the entries in the property directory.

If you select multiple objects or a user object, this directory only contains the shared property groups of the individual objects contained therein. For a selected group the common property groups are listed first followed by the individual objects with their property groups in subfolders.

You can open and close folders and subfolders by clicking the "+" or "-" symbols. The attributes available for the selected entry are shown in the attribute display.



Attribute display

The right-hand area contains all the attributes that are available for the entry.

The attribute display is divided into five columns that display the static values and the dynamic attributes of the selected object.







You can change the displayed values by double-clicking or opening the shortcut menu in the respective column.

Columns of the attribute display

Column	Function	Description
Attribute	Attribute name	All available attributes of the selected property group are displayed. The attribute name cannot be changed. You can change the static value of the attribute by double-clicking the name of the attribute.
Static	Static value of the attribute	The current value of the attribute is shown for the selected object. The value is displayed as a number, text or graphic display, depending on the type of attribute. Double-click the attribute to change its value or name. Additional icons are displayed for color and text attributes: <ul style="list-style-type: none"> • Colors:  By means of the color picker, you apply a color from an object in the process picture or a color that is displayed on the screen. The behavior depends on the clicked-on object in each case. • Texts:  When you double-click the text field, the button for opening the "Character map" dialog is displayed. When you edit a text in the "Text input" dialog, you open the character map with the "..." button. For more information, refer to the section "How to edit an attribute".
Dynamic	Dynamization of attribute	The type of dynamization is displayed and identified by symbols with different colors. You can right-click to open a shortcut menu context menu in which you can set the desired dynamization. You can more detailed information in the sections "Basic dynamic operations" and "Dynamize process pictures".
Update	Update cycle of the attribute	The setting for the update cycle is displayed when dynamization of the attribute is set. You can change the update cycle of the attribute by double-clicking the value.
Indir.	Indirect attribute addressing	You can dynamize an attribute directly or indirectly: <ul style="list-style-type: none"> • Direct: The attribute is dynamized directly with the content of the tag. • Indirectly: The attribute is linked to a tag of the type "String" that references another tag. The attribute is dynamized with the content of the referenced tag. You can activate indirect addressing of the attribute by double-clicking the check box, provided the attribute is dynamized with a tag. Further information can be found in chapter "Making Process Picture Dynamic".

Font styles to display dynamics and events

Dynamics and events are particularly highlighted with the aid of different font styles.

Attribute	Static	Dynamic
Border Color	 	 Chn_Tag.
Border Background Color	 	
Background Color	 	
Fill Pattern Color	 	

The following font styles are used:

- **Bold**
Once you have assigned a dynamic response or event to an attribute of the selected object, this attribute is displayed in bold in the attributes view.
The associated property group in the property folder and the selected object in object selection of the toolbar are also displayed in bold.
- **Italic**
The target of a direct connection that was configured for an event is displayed in italics in the attributes view.
The target object is also displayed in italics in the object selection of the toolbar.
- **Bold and italic**
If a selected dynamic object is the target of a direct connection, the attribute in the attributes view and the object in the object selection are displayed in bold and italics.

See also

How to make attributes dynamic (Page 485)

Types of Dynamization (Page 1163)

The "Texts" tab in the "Object Properties" window (Page 519)

The "Animation" tab in the "Object Properties" window (Page 521)

How to configure picture objects for more languages in the "Graphics Designer" editor (Page 2379)

Basic Dynamic Operations (Page 485)

How to Change an Attribute (Page 525)

How to Transfer Object Properties (Page 529)

How to change the default setting of object types (Page 457)

"Events" tab in the "Object Properties" window (Page 517)

The "Object Properties" Window (Page 512)

"Events" tab in the "Object Properties" window

Introduction

In the "Object Properties" window the "Event" tab represents the central dialog for configuring events. Configuring events is described extensively in the chapter "Making Process Pictures Dynamic".

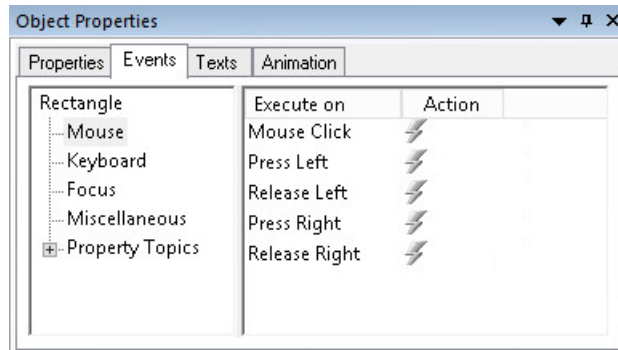

Event folder

The left area shows the selected object in a directory tree. This directory shows entries such as "Mouse" or "Keyboard" to configure events for the operation of the entire object.

The "Property Topics" displays all property groups of the selected object. You can also configure an event for each individual attribute of a property group. If several individual objects are contained in the selected object, this structure is repeated for each individual object.

It is not possible to change the entries in the event directory. You can open and close folders and subfolders by clicking the "+" or "-" symbols. The configurable events for the selected entry are shown in the event display.

Event display

The right-hand area contains all the events that are available for the entry. The event display is divided into two columns that show the events and the linked actions.

You can change the displayed actions by double-clicking or opening the shortcut menu in the "Action" column.

Columns of the event display

Column	Function	Description
Run at	Event type	Displays all events which are available for the selected object and are assigned to the selected entry. You cannot change the name of the event. You can change the configured action by double-clicking the name of the attribute.
Action	Action selection	The action that is executed when the event occurs is displayed. The selected action is marked by symbols with different colors: You change the configured action by double-clicking in the "Execute with" column or by opening the shortcut menu in the "Action" column. Further information can be found in chapter "Making Process Picture Dynamic".

Triggering events

Event	Execute with	Description
Mouse	Mouse click	Is triggered if the cursor is on the object when the mouse button is pressed and released.
Mouse	Click left/right	Is triggered when pressing the mouse button directly on the object.
Mouse	Release left/right	Is triggered when releasing the mouse button for the object the cursor was over when the mouse button was pressed.
Keyboard	Pressing	Is triggered when pressing a key on the keyboard. The keys <F10> and <ALT+PRINT> must not be used for process operation.
Keyboard	Releasing	Is triggered when releasing a key on the keyboard. The keys <F10> and <ALT+PRINT> must not be used for process operation.
Focus	Focus change	Occurs during focus reception and focus change, caused by C action, VBS action or selection of an object using (TAB sequence) or mouse click.
Miscellaneous	object change	Occurs if at least one object attribute changes.
Miscellaneous	Gesture	Assigns the object a gesture for touch operation.
Miscellaneous	Open Picture	Occurs when a process picture is opened in Runtime, for example, by a picture change.
Miscellaneous	Close Picture	Occurs when a process picture is closed in Runtime, for example, by a picture change.
Object attributes	Change	Most of the object attributes have the "Change" event so that it is possible to react specifically to the change of a specific attribute. The event occurs if the attribute value changes. The action linked to this event is logged on individually. With "Close Picture", all actions logged on at this point are logged off individually. This results in an increased system load. To keep the system load low, use this event type sparingly and only there where it is absolutely necessary to react to the change. This is the case for example when inputting a value in the I/O field.

See also

- How to configure events (Page 487)
- Types of Dynamization (Page 1163)

- Basic Dynamic Operations (Page 485)
- How to Change an Attribute (Page 525)
- How to Transfer Object Properties (Page 529)
- How to change the default setting of object types (Page 457)
- The "Properties" Tab in the "Object Properties" Window (Page 514)
- The "Object Properties" Window (Page 512)

The "Texts" tab in the "Object Properties" window

Introduction

You configure text attributes in the respective Runtime languages in the "Texts" tab of the "Object Properties" window.

The table contains all language-dependent texts that are not managed using the text library. When you export and translate these texts via the Text Distributor, the imported translations are shown here.

The object name is always created as language-neutral and cannot be changed in this dialog.

You can change the width of the table columns by moving the vertical separation lines.

Reference	English (United States)	German (Germany)	Spanish (Spai...
Start\Display name	Start	Startbild	Imagen inicia
Start\Button1\Tooltip Text	Next picture	Nächstes Bild	Imagen siguie
<input checked="" type="checkbox"/> Start\Button1\Text	<input checked="" type="checkbox"/> Picture Change	<input checked="" type="checkbox"/> Bildwechsel	<input checked="" type="checkbox"/> Cambio de im
Start\Boiler 01\Tooltip Text	Fill level	Füllstand	
Start\RadioBox1\Tooltip Text	TextList_Temp	TextList_Temp	TextList_Temp
Start\ListField\Tooltip Text	State	Zustand	Estado
<input checked="" type="checkbox"/> Start\ListField\Text(1)	<input checked="" type="checkbox"/> Process is active	<input checked="" type="checkbox"/> Prozess ist aktiv	<input checked="" type="checkbox"/> ☉
<input checked="" type="checkbox"/> Start\ListField\Text(2)	<input checked="" type="checkbox"/> Error	<input checked="" type="checkbox"/> Fehler	<input checked="" type="checkbox"/> !!
<input checked="" type="checkbox"/> Start\ListField\Text(3)	<input checked="" type="checkbox"/> Process is deactivated	<input checked="" type="checkbox"/> Prozess ist deaktiviert	<input checked="" type="checkbox"/> ●
Start\ValueTemp\Tooltip Text			
Start\Radio Box1\Tooltip Text	Temperature	Temperatur	Temperatura
<input checked="" type="checkbox"/> Start\Radio Box1\Text(1)	<input checked="" type="checkbox"/> Increase	<input checked="" type="checkbox"/> ??????1	<input checked="" type="checkbox"/> Increase
<input checked="" type="checkbox"/> Start\Radio Box1\Text(2)	<input checked="" type="checkbox"/> Decrease	<input checked="" type="checkbox"/> Reduzieren	<input checked="" type="checkbox"/> Decrease
<input checked="" type="checkbox"/> Start\Radio Box1\Text(3)	<input checked="" type="checkbox"/> Deactivate	<input checked="" type="checkbox"/> Deaktivieren	<input checked="" type="checkbox"/> Deactivate
Start\Rechteck1\Tooltip Text			

"Reference" column

The first column, "Reference", contains the object name and the name of the object property. In case of multiple selection, the selected objects are shown listed in the order in which they were added.

If no object is selected, all objects contained in the process picture are listed with their text attributes.

Newly added objects are shown at the bottom of the list.

Language columns

The table area shows all languages that are created in the text library.

In the table row of a text attribute, you configure the text in the corresponding language.

In the following cases the "Texts" tab already includes translated texts when you open it for the first time:

- The text was translated with the Text Distributor.
- A translation was already entered in the "Text input" dialog in the "Properties" tab.

Texts from the text library are not displayed.



"Text list" object property

You can link some smart objects and Windows objects to a configured text list from the "Text and graphic lists" editor.

The texts of these text lists are not configured in the object properties and are not displayed in the "Texts" window.

Formatting text

If you can change the layout of the text, a button for editing is displayed:

	The text format can be changed.
	The text format was changed for this language.

A dialog opens when you click on these buttons; in it, you can format the text.

You configure the matching font and formatting for the different languages and objects:

- Font
- Font size in points
- Format (bold, italic, underline)



Select a Cyrillic font for Russian, for example, or enlarge the font size for Chinese characters.

For object properties that contain multiple texts, all texts have the same format. Example: "Text" object property in the combo box.

To format the text for all languages, click on the button in the "Reference" column.

Inserting special characters

Use the character map to enter special characters:

1. Open the character map with the "Options > Character map" menu or using the button: 
2. Select the preferred font.
3. Insert the special characters in the text field with a double-click.
4. Copy the selected special characters to the clipboard using the button: 

5. To paste the special characters to the "Texts" tab, click in the text field of the desired language.
6. Navigate to the desired location in the text and select "Paste" in the shortcut menu.

Alternative procedure

1. In the object properties, switch to the "Properties" tab.
2. Double-click the object property.
3. Click in the language box in the "Text input" dialog.
4. To call the character map, click on the "..." button.
5. Select the preferred font.
6. Double-click the special characters to paste them to the text field and confirm with "OK".
The new text with the added special characters is displayed in the "Texts" tab.

See also

You can change the text contents of objects (Page 483)

The "Object Properties" Window (Page 512)

The "Properties" Tab in the "Object Properties" Window (Page 514)

How to Change an Attribute (Page 525)

How to configure picture objects for more languages in the "Graphics Designer" editor (Page 2379)

The "Animation" tab in the "Object Properties" window

Introduction

You configure animations of the graphic objects in the "Animation" tab in the "Object properties" window, for example:

- Move
- Zoom in and Zoom out
- Color change

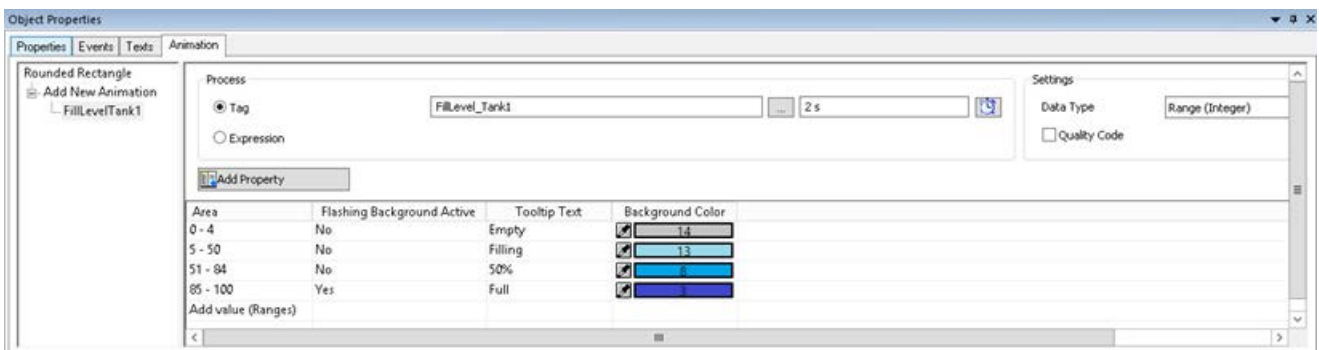

Navigation area

The left area shows the selected object.

You create animations in the directory with a double-click on "Add New Animation". The animations are shown with their names sorted alphabetically.

You can create multiple animations with different settings for each object.

Animation display

The right area shows the configuration of the selected animation:

- Linked dynamization:
 - Tag connection
 - Update cycle
 - Scripts / expression
- Value ranges for the animation steps
 - Type: Value type or value range
 - Evaluation of the tag status (Quality Code)
- Animation steps and their values
- Animated project properties

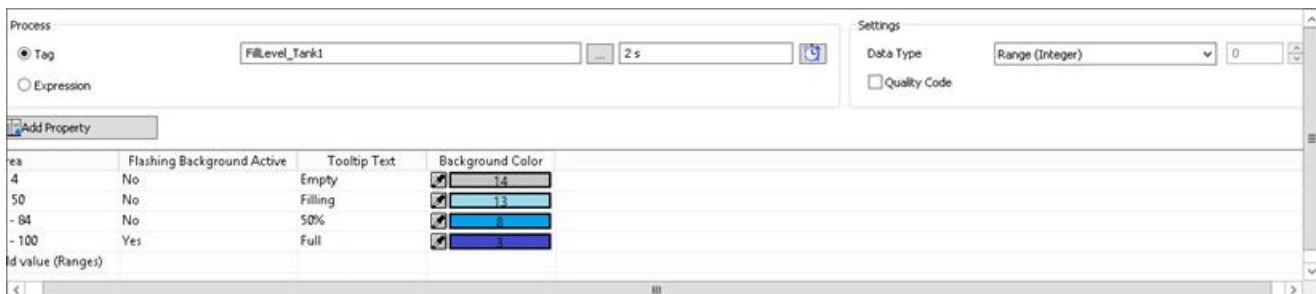

Value ranges of the animation steps

Depending on the linked tag or formulated expression, you configure different types of the value or value range.

This specification, in turn, determines the steps in which the animation progresses.

The following types are available for specifying the value range:

Type	Value range	Description
Range (Integer)	Value ranges of integers	<p>You configure integer value ranges of a tag or of an expression. A tag value or expression that is not an integer is either rounded up or down.</p> <p>You specify the corresponding values of the object property for each value range. The value ranges must not overlap.</p> <p>If the Runtime value is within a configured value ranges, the object property linked to it is dynamized.</p> <p>If the tag value is not assigned to an animation step, the static value of the object property is displayed.</p>
Range (Floating point)	Value ranges with floating-point numbers	<p>You configure value ranges of a tag or of an expression with floating-point numbers.</p> <p>The behavior corresponds to the "Range (Integer)" type.</p>
Binary	Bit numbers of the configured tag	<p>You configure one or more bit numbers of the selected tag as value.</p> <ul style="list-style-type: none"> • When the tag value matches one of the configured bit numbers in runtime, the linked object property is dynamized. • If the tag value does not match any of the bit numbers in the "Value" column, the static value of the object property is displayed.
Bit	0 / 1	<p>You select a bit of the tag that is to be monitored:</p> <ul style="list-style-type: none"> • 0 = The bit is set. • 1 = The bit is not set. <p>The linked value of the object property is displayed.</p>
Bool	True / False	<p>You configure a Boolean tag or an expression that contains a logical comparison.</p> <p>When the tag value or return value of the expression returns the value "True" or "False", the linked value of the respective object property is displayed.</p>
Direct	-	<p>The tag value of the configured tag or the return value of the configured expression is written directly to the object property.</p> <p>No animation steps are shown in the table.</p>

Evaluation of the tag status

The quality of the entire value transmission and value processing of the respective tag is summarized in the quality code.

If the "Tag status" option is selected, the quality code of the configured tag is checked before the animation is executed.

The evaluation of the quality code takes precedence over the defined value ranges. Only when the quality code of the tag is correct, are the configured values analyzed.

When you configure an expression, it can contain multiple tags. In this case the tags are evaluated according to their sequence in the expression from left to right.

List of the quality codes in the table area

After being activated, the list of available quality codes is shown in the table as first row. To configure the behavior, open the list.

This quality codes are sorted by descending priority.

Configuring the expression

You formulate an expression by using tags, VB scripts and arithmetic operands.

The value of the expression is obtained in runtime and compared to the configured value ranges.

The "Expression" option is only available for the following types:

- Range (Integer / Floating point)
- Bool
- Direct

Tags in the expression

With direct entry, write tag names in single quotation marks:

- 'tagname'

Boolean tags can be evaluated more easily:

- 'booltag1' AND NOT 'booltag2'

VBScript keywords and constants

- mod
- not
- and
- or
- xor
- eqv
- imp
- vbTrue
- vbFalse

Operands

Enter the operands directly or use the offered buttons:



Use the following manual input for "not equal to": !=

Note the following behavior:

	Value in the expression ¹⁾	Runtime value of a Boolean tag ¹⁾
TRUE	-1	1
FALSE	0	0

1) For the "Bool" type, Boolean tags are implicitly converted with the VB script function "CBool" to the VB script values "true" = -1 and "false" = 0.

Use the constants "vbTrue" and "vbFalse" for a unique synchronization in the expression.

See also

How to animate an object (Page 491)

Example: How to animate a circle as signal light (Page 504)

Example: How to animate the operability of a button (Page 508)

The "Object Properties" Window (Page 512)

The "Properties" Tab in the "Object Properties" Window (Page 514)

How to Change an Attribute (Page 525)

How to Change an Attribute

Introduction

The properties of an object are defined in the Graphics Designer with values which possess the attributes of the object.

Every change to an object made with the mouse, for example, changes the value of the accompanying attributes.

Configuring object properties

The "Object Properties" window on the "Properties" tab shows all the attributes of a selected object or a multiple selection of objects.

The attributes are assigned to so-called "property groups". The type and number of the available property groups and attributes are dependent on the type of the selected objects. So, for example, the "Font" property group is only shown for the object types which can be displayed with text.

You can change an object property by assigning a new value to its attribute.

	Processing	Examples
Switching values	Double-click changes the value, e.g. "Yes" / "No"	Display, dynamic filling
Assign color	A color value is applied from the process picture with the mouse pointer.	Frame color, font color, trend color

	Processing	Examples
"Value input" dialog	A dialog for entering a value opens.	Height, output value
"Text input" dialog	A dialog for entering a text opens.	Tooltip text, inscription
Selection dialog	A dialog for selection of a value opens.	List type, authorization
Configuration dialog	A configuration dialog opens.	Line type, server prefix, assignments (text list)

Dynamization / animation

When you dynamize an object property or link it to an animation, this object property is changed in runtime. The value change is, for example, caused by a process value, a script or an operator action.

For additional information, refer to "How to make attributes dynamic (Page 485)".

Procedure

1. Open the "Object Properties" window.
2. On the "Properties" tab, select the required property group.
3. Double-click on the desired attribute.
The reaction depends on the attribute type.

Switching between two values

If there are only two values available for an attribute, each double-click causes a switchover between these two values.

Alternatively, you can switch between the values by double-clicking the "Static" column.

Assign color

Select a color attribute. In the "Static" column, click on the "Color picker" button: .

Click the desired color of an object in the process picture or on the screen. The color is applied for the attribute.

"Value input" dialog

Enter a new value in the "Value input" dialog and confirm this by clicking "OK".

Alternatively, you can directly enter the new value by double-clicking on the "Static" column.

"Text input" dialog

Enter the new text in the required language in the dialog "Text Input".

Alternatively, you can also enter the new text directly after double-clicking the column "Static".

Inserting a line break

Depending on the object, you can generate a multi-line text with line break.

1. Open the "Text input" dialog with a double-click on the object property.
2. Use the key combination <Ctrl+Enter> or <Ctrl+M>.

The line break is displayed as character string "\r\n" in the column "Static".

Multilingual configuration of object properties

In the "Text Input" dialog, enter texts in all configurable languages that are configured in the Text Library.

No language switching is required for this.

Alternatively, you edit all text attributes of an object in the "Texts" tab of the "Object properties" dialog.

Entering special characters

In addition to the standard character map, WinCC offers additional fonts and special characters.

The "Character map" dialog shows you the installed fonts as well as a preview of the entered text:

Boiler 1

When you double-click a text field, a button for selection of special characters is shown: 

This button opens the "Character map" dialog:

1. Select the preferred font.
2. Enter the text in the text field.
3. To insert a special character in the text field, double-click this character.
4. To apply the content of the text field to the clipboard, click the button: 

You can copy the characters to other object properties, for example, or to the "Texts" tab. Use the copy function for the "Multiline Text" object to enter special characters for the "Text" object property.
5. Close the dialog by clicking "OK".

The example shows a "Radio Box" object with symbols of the font "FontAwesome":



In the object properties, the text is displayed with the selected font as preview:

Attribute	Static
Font	System
Font Size	12
Bold	No
Italic	No
Underline	No
X alignment	Left
Text	Start Runtime

Selection dialog

Selection in the form of buttons

Click on the buttons provided to specify the new value.

Alternatively, select the new value by double-clicking on the "Static" column from a drop-down list box.

Selection from a list

Click on the one of the rows to specify the new value.

Alternatively, you open the list with a double-click on the "Static" column.

Selecting a color

In the selection dialog, select one of the 16 standard colors or open the palette with the customized colors. In this palette, you can freely define additional colors.

Alternative procedures:

- Open the color selection with a double-click on the "Static" column.
- Use the buttons of the color palette.

Selecting a picture

Select a picture from the picture selection.

To add additional pictures to the picture selection, open a selection window using the "Find" button.

Confirm your selection with "OK".

Alternatively, double-click the "Static" column and enter the name of the picture.

Configuration dialog

Select the settings and confirm your input with "OK".

Alternatively, open the configuration dialog with a double-click on the "Static" column.

Some WinCC objects have their own configuration dialog, for example, the "Bar" smart object. You open this configuration dialog in the shortcut menu of the object.



See also

- The "Object Properties" Window (Page 512)
- The Start Screen of the Graphics Designer (Page 325)
- The "Properties" Tab in the "Object Properties" Window (Page 514)
- Property Groups and Attributes (Page 530)
- How to Transfer Object Properties (Page 529)
- How to make attributes dynamic (Page 485)
- How to configure events (Page 487)
- The "Texts" tab in the "Object Properties" window (Page 519)
- The "Animation" tab in the "Object Properties" window (Page 521)
- The central color palette (Page 346)

How to Transfer Object Properties

Introduction

The properties of an object can be transferred to another object with the "eyedropper". In the Graphics Designer, you can use the following buttons to transfer object properties:

- , to copy properties of the selected object
- , to apply copied properties to a selected object

These buttons are located in the "Object Palette" toolbar. Alternatively, these functions can be called via the "Edit/Properties" menu.

With the exception of the user object, you can copy the properties of any object using the eyedropper. You can also transfer the copied properties to any object such as to a multiple selection, a group or a user object. The properties are transferred without changing the geometric attributes of the object. With different object types, only those attributes which both object types possess are changed.

Color picker

To apply the colors of an object, use the "Color picker" button in the color palette or in the "Object Properties" window.

Password is not copied

When transferring the object properties between pictures or faceplate types, the property "Password Protection" is not copied.

You configure a separate password for each picture or for each faceplate type.

Procedure

1. Select the object whose properties you want to copy.
2. Click  in the object palette.
The properties of the selected object are copied.

3. Select the object to which you want to assign the copied properties.
4. Click  in the object palette.
The selected object is displayed with the new properties, but without changing its geometric attributes. With different object types, only those attributes which both object types possess are changed.

See also

- Color palette (Page 331)
- How to Change an Attribute (Page 525)
- How to change the default setting of object types (Page 457)
- The "Object Properties" Window (Page 512)

3.8.5.3 Property Groups and Attributes

Property Groups and Attributes

Introduction

On the "Properties" tab of the "Object properties" dialog all property groups are displayed which are available for the selected object. If you select one of these properties, the associated attributes for the selected object are listed in the attribute display.

You change the properties of an object by allocating the respective attributes with new values. If you make an attribute dynamic, it will be changed dynamically in runtime.

Note

As soon as an attribute is defined with a global design, it is static and can no longer be made dynamic. Pre-defined dynamics have no effect.

This chapter introduces all property groups and the associated attributes. The function of an attribute is described briefly and the object types for which the attribute is available are listed.

An extensive description of the individual attributes can be found in the "Direct help" which can be called from the pop-up menu of the required attribute.

See also

- "Geometry" Property Group (Page 542)
- "Colors" Property Group (Page 538)
- "Styles" Property Group (Page 552)
- "Font" Property Group (Page 547)
- "Flashing" Property Group (Page 535)
- "Miscellaneous" Property Group (Page 548)

"Filling" Property Group (Page 541)
 The "Display" property group (Page 537)
 "Picture" Property Group (Page 534)
 "Pictures" Property Group (Page 534)
 "Status" Property Group (Page 556)
 "Axis" Property Group (Page 531)
 "Limits" Property Group (Page 544)
 "Output / Input" Property Group (Page 532)
 "Message Types" Property Group (Page 545)
 "Lock" Property Group (Page 552)
 "Connected Objects" Property Group (Page 554)
 "Assignment" Property Group (Page 555)
 The Properties of an Object (Page 511)
 How to Change an Attribute (Page 525)

"Axis" Property Group

Introduction

The "Axis" property group contains attributes which you can use to change the properties of the bar.

Requirements

The "Axis" property group is only available for the "Bar" object.

Overview

The following table contains all attributes of the "Axis" property group and a brief description of their function.

Attribute	Function
Axis Section	Distance between the large tick marks (difference between two adjacent axis labels)
Alignment	Arrangement of the scale in relation to the bar (top/bottom or left/right)
Bar Scaling	Type of scale division (for example, linear or logarithmic)
Label Each	Number of labeled large tick marks (each, every other, every third, etc.)
Exponent Display	Permits numerical display with exponents

Attribute	Function
Large Tick Marks	Style for displaying the large tick marks of a scale (bold or normal)
Length of Large Tick Marks	Length of the large tick marks of a scale. The length of the short tick marks corresponds to 50% of the value set here. (Unit: Pixels)
Digits to the Right of the Decimal Point	Number of digits to the right of the decimal point for displaying numerical values in the scale
Zero Point	Position of the zero point in relation to the distance of the scale end values (Unit: Percentage)
Only Large Tick Marks	Specifies whether only the large tick marks are displayed in the scale or if the short tick marks are also displayed.
Scale	Permits the display of a scale for displaying the values
Scale Marks	Number of bar segments that are separated by the large tick marks of the scale
Digits to the Left of the Decimal Point	Number of digits to the left of the decimal point for displaying numerical values in the scale

See also

- How to Change an Attribute (Page 525)
- How to insert a bar (Page 623)
- The Properties of an Object (Page 511)
- Property Groups and Attributes (Page 530)

"Output / Input" Property Group

Introduction

The "Output / Input" property group contains attributes with which you can set the properties of input and output values.

Requirements

The "Output / Input" property group is only available for the following objects: I/O field, combo box, list box, text list, check box and radio box.

Overview

The following table shows all the attributes of the "Output / Input" property group. The function of an attribute is described briefly and the object types for which the attribute is available are listed.

Attribute	Function	Object type
Field type	Defines the function type of the field	I/O field, text list
Input value	Enables the display of the input value via direction connection, even after acceptance with "OK".	I/O field
Output value	Default value for the display in runtime if the associated tag is not linked or updated	I/O field, text list
Data Format	Data type of the field contents (binary, decimal, string, hexadecimal)	I/O field
Output Format	Format indication for the display of the output value	I/O field
Apply on Full Input	Defines whether the field is automatically exited and the data applied simultaneously as soon as the predefined number of characters have been entered	I/O field
Apply on Exit	Defines whether the specified data are applied on exiting the field.	I/O field, text list
Clear on New Input	Defines whether the existing field contents are deleted when the input field is activated	I/O field
Clear on Invalid Input	Defines whether the field content is automatically deleted if input is incorrect	I/O field
Hidden Input	Defines whether the input is visible immediately or replaced by ""	I/O field
List Type	Type of text list (binary, decimal, bit)	Text list
Assignments	Assignment between the output value and the output value to be actually output	Text list
Bit Number	Number of the relevant bit in the output value	Text list
Number of visible lines	Defines how many lines the selection list should contain	Text list
Text list	Specifies a text list created in the "Text and graphic list" editor in which the type of list and the assignments are configured.	Check box, combo box, list box, radio box, text list
Sorting of text list	Specifies the sorting in runtime for the "Text list" property.	Text list
Selected Boxes	Informs the system about which fields are active	Check box
Selected Box	Informs the system about which field is activated	Radio box

See also

How to Change an Attribute (Page 525)

How to insert an I/O field (Page 612)

How to add a text list (Page 639)

How to insert a check box (Page 686)

- How to insert an radio box (Page 688)
- The Properties of an Object (Page 511)
- Property Groups and Attributes (Page 530)

"Picture" Property Group

Introduction

The "Picture" property group contains attributes with which you can change the properties of the picture to be displayed.

Prerequisites

The "Picture" property group is only available for the objects "Graphic object" and "SVG object".

Overview

The following table shows all attributes of the "Picture" property group and brief description of their function.

Attribute	Function
Picture	Picture displayed in the Graphic Object
Picture referenced	Defines whether the picture itself or only a reference to the picture is incorporated
Picture Transparent Color	Defines which color of the picture is set to "transparent"
Picture Transparent Color On	Permits the "Transparent Color function"

See also

- How to Change an Attribute (Page 525)
- How to insert a graphic object (Page 631)
- The Properties of an Object (Page 511)
- Property Groups and Attributes (Page 530)

"Pictures" Property Group

Introduction

The "Pictures" property group contains attributes with which you can change the properties of the pictures to be displayed for different states.

Prerequisites

The "Pictures" property group is only available for the objects "Button" and "Round Button".

Overview

The following table shows all attributes of the "Pictures" properties group. The functionality of an attribute is described briefly and assigned to the object types for which the attribute is available.

Attribute	Function	Object type
Picture Off Referenced	For the "Off" state, defines whether the picture itself or only a reference to the picture are incorporated	Button, round button
Picture Off Transparent Color	For the "Off" state, defines which color of the picture is set to "Transparent"	Button, round button
Picture Off Transparent Color On	Permits the "Transparent Color" function for the "Off" state	Button, round button
Picture Deact. Referenced	For the "Deactivated" state, defines whether the picture itself or only a reference to the picture are incorporated	Round Button
Picture Deact. Transparent Color	For the "Deactivated" state, defines which color of the picture is set to "Transparent"	Round Button
Picture Deact. Transparent Color On	Permits the "Transparent Color" function for the "Deactivated" state	Round Button
Picture On Referenced	For the "On" state, defines whether the picture itself or only a reference to the picture are incorporated	Button, round button
Picture On Transparent Color	For the "On" state, defines which color of the picture is set to "Transparent"	Button, round button
Picture On Transparent Color On	Permits the "Transparent Color" function for the "On" state	Button, round button
Picture Status Off	Picture displayed for the "Off" state	Button, round button
Picture Status Deactivated	Picture displayed for the "Deactivated" state	Round Button
Picture Status On	Picture displayed for the "On" state	Button, round button
Picture alignment	Defines the picture alignment and scaling	Button, round button

See also

[How to Change an Attribute \(Page 525\)](#)

[How to insert a round button \(Page 691\)](#)

[The Properties of an Object \(Page 511\)](#)

[Property Groups and Attributes \(Page 530\)](#)

"Flashing" Property Group

Introduction

The "Flashing" property group contains attributes with which you can change the flashing of object elements. The settings of the "Flashing" property group can only be seen in Runtime.

Prerequisites

The "Flashing" property group is available for all objects except application windows, picture windows, multiline text, combobox, list box, control, OLE object and 3D bar.

If you have selected a global design in the project, it is possible to have the color attributes of the "Flashing" property group only become effective if the "Global color scheme" is set to "No" under "Display".

Overview

The following table shows all the attributes of the "Flashing" property group. The function of an attribute is described briefly and the object types for which the attribute is available are listed.

Attribute	Function	Object type
Flashing Background Active	Activates flashing of the background	Polygon, ellipse, circle, ellipse segment, pie segment, rectangle, rounded rectangle, static text, I/O field, bar, graphics object, SVG object, text list all Windows objects
Flashing Line Active	Activates flashing of the line	all standard objects, bar, graphics object, status display, SVG object all Windows objects
Flashing Border Active	Activates flashing of the border	I/O field, Text List
Flashing Text Active	Activates flashing of the font	Static text, I/O field, text list, button, check box, radio box
Flash frequency	Frequency for the flashing of the group display	Group Display
Background Flash Frequency	Frequency for the flashing of the background	Polygon, ellipse, circle, ellipse segment, pie segment, rectangle, rounded rectangle, static text, I/O field, bar, graphics object, SVG object, text list all Windows objects
Line Flash Frequency	Frequency for the flashing of the line	all standard objects, bar, graphics object, status display, SVG object all Windows objects
Border Flash Frequency	Frequency for the flashing of the border	I/O field, bar, text list
Text Flash Frequency	Frequency for the flashing of the text	Static text, I/O field, text list, button, check box, radio box

Attribute	Function	Object type
Flashing Background Color Off	Color for the flash state "Off"	Polygon, ellipse, circle, ellipse segment, pie segment, rectangle, rounded rectangle, static text, I/O field, bar, graphics object, SVG object, text list all Windows objects
Flashing Background Color On	Color for the flash state "On"	Polygon, ellipse, circle, ellipse segment, pie segment, rectangle, rounded rectangle, static text, I/O field, bar, graphics object, SVG object, text list all Windows objects
Flashing Line Color Off	Color for the flash state "Off"	all standard objects, bar, graphics object, status display, SVG object all Windows objects
Flashing Line Color On	Color for the flash state "On"	all standard objects, bar, graphics object, status display, SVG object all Windows objects
Flashing Border Color Off	Color for the flash state "Off"	I/O field, bar, text list
Flashing Border Color On	Color for the flash state "On"	I/O field, bar, text list
Flashing Text Color Off	Color for the flash state "Off"	Static text, I/O field, text list, button, check box, radio box
Flashing Text Color On	Color for the flash state "On"	Static text, I/O field, text list, button, check box, radio box

See also

How to Change an Attribute (Page 525)

The Properties of an Object (Page 511)

Property Groups and Attributes (Page 530)

The "Display" property group

Introduction

The "Display" property group contains attributes with which you can change the optical appearance of the objects.

Requirement

The "Display" properties group is available for all objects of the object palette besides the following Smart objects: application window, picture window, control, OLE object, faceplate instance, .NET control and WPF control.

Overview

The following table shows all attributes in the "Display" property group. The function of an attribute is described briefly and the object types for which the attribute is available are listed.

Attribute	Function	Object type
Global shadow	Takes over the global setting for a shadow underlying the object	Single objects, I/O Field, bar, graphic object, status display, text list, multiline text, combo-box, list box, 3D bar, group display, status display, analog display, SVG object, button, check box, radio box, round button, slider object, polygon tube, T-piece, double T-piece, tube bend
Global color scheme	Takes on the global color scheme	Single objects, I/O Field, bar, graphic object, text list, SVG object, check box, radio box, round button, slider object, polygon tube, T-piece, double T-piece, tube bend
Object transparency	Defines the transparency of the objects between 0 (not transparent) and 100 (completely transparent). 100% transparent or invisible objects can also be operated in Runtime.	Single objects, I/O Field, bar, graphic object, text list, SVG object, 3D bar, button, check box, radio box, round button, slider object, polygon tube, T-piece, double T-piece, tube bend
[V6.2] Windows Style	Shows the objects in the Windows style of WinCC V6.2	Button, Slider object
WinCC style	Defines the design of the objects	button, round button, slider object
Display options	Defines the type of display.	Button, round button

"Colors" Property Group

Introduction

The "Colors" property group contains attributes which you can use to change the color settings of objects.

Configuring color

Either define the color directly in the "Color selection" dialog or select an indexed color from the central color palette if a central color palette is defined.

The name of a configured color is displayed in the properties dialog as a tooltip.

Requirements

The "Colors" property group is available for all object types except:

- Application window
- Picture window
- Control
- OLE object
- Faceplate instance
- .NET Control
- WPF Control
- DataSet
- WinCC controls

The color properties are contained in the "Control properties" group.

If you have selected a global design in the project, it is possible to have certain attributes of the "Colors" property group only become effective if the "Global color scheme" is set to "No" under "Display".

Overview

The following table shows all attributes in the "Colors" property group. The function of an attribute is described briefly and the object types for which the attribute is available are listed.

Flashing colors are described in the "Flashing" property group.

Attribute	Function	Object type
3D Border Color Top	Color of the left and upper part of the 3D border	Button, round button
3D Shadow Color	Color of the right and lower part of the 3D border	Button, round button
List Background Color	Background color of the non-selected entries in the selection list	Text list
List Font Color	Font color of the non-selected entries in the selection list	Text list
Bar Color	Color of the bar to display the current value	Bar
Bar Background Color	Color of the bar background	Bar
High Limit Color	Color of the upper and right arrow key	Slider object
Low Limit Color	Color of the lower and left arrow key	Slider object
Fill pattern color	Color of the fill pattern	Picture object Polygon, ellipse, circle, ellipse segment, pie segment, rectangle, rounded rectangle, static text I/O field, bar, graphic object, text list, multiple row text, combo box, list box, 3D bar, SVG object All Windows objects

Attribute	Function	Object type
Background color	Fill color of the object	Picture object Polygon, ellipse, circle, ellipse segment, pie segment, rectangle, rounded rectangle, static text I/O field, bar, graphic object, text list, multiple row text, combo box, list box, 3D bar, group display, SVG object All Windows objects
Button Color	Color of the regulator	Slider object
Line color	Color of the line	All standard objects except static text Graphic object, status display, SVG object All Windows objects All tube objects
Line background color	Background color of line	All standard objects Graphic object, status display, SVG object All Windows objects
High Limit Background Color	Color of the upper and right slider surface	Slider object
Border color	Color of the border	Static text I/O field, bar, text list, multi-line text, combo box, list box, 3D bar All Windows objects
Border Background Color	Background color of the border	I/O field, bar, text list, multi-line text, combo box, list box All Windows objects
Grid Color	Work surface of the current process picture in the Graphics Designer: Color of the grid points	Picture object
Font color	Color of the text in an object	Static text I/O field, text list, multiple row text, combo box, list box All Windows objects except slider object
Selection Background Color	Background color in the selected entry of the selection list	Text list
Selection Font Color	Color of the font in the selected entry of the selection list	Text list
Scale Color	Color to display the scale and label	Bar
Trend Color	Color of the trend display which displays the trend of the measurement value in the form of a small arrow at the lower end of the bar	Bar
Dividing Line Color	Color of the dividing lines in the selection list	Text list

Attribute	Function	Object type
Dividing Line Background Color	Background color of the dividing lines in the selection list	Text list
Low Limit Background Color	Color of the lower and left slider surface	Slider object

See also

The central color palette (Page 346)

How to Change an Attribute (Page 525)

The Properties of an Object (Page 511)

Property Groups and Attributes (Page 530)

"Filling" Property Group

Introduction

The "Filling" property group contains attributes, which you can control the dynamic filling of objects.

Requirements

The "Filling" property group is available for all objects: Polygon, ellipse, circle, ellipse segment, circular segment, rectangle, round rectangle, static text, graphic object, SVG object, button, check box, option group, round button and slider.

Overview

The following table shows all the attributes of the "Filling" property group. The function of an attribute is described briefly and the object types for which the attribute is available are listed.

Attribute	Function	Object type
Dynamic filling	Permits dynamic filling of objects with closed border line	All the objects mentioned above
Fill level	Height of the object filling with closed border line as a percentage of the object height	All the objects mentioned above
Fill direction	Direction of the object filling with closed border line	All the objects mentioned above

See also

How to Change an Attribute (Page 525)

The Properties of an Object (Page 511)

Property Groups and Attributes (Page 530)

"Geometry" Property Group

Introduction

The "Geometry" property group contains attributes, which you can use to change the geometric properties of objects.

Requirements

The "Geometry" property group is available for all objects.

Overview

The following table shows all attributes in the "Geometry" property group. The function of an attribute is described briefly and the object types for which the attribute is available are listed.

Attribute	Function	Object type
Current value X	Horizontal position of the currently selected corner point, relative to the image origin. (Unit: Pixels)	Polygon, polyline, connector
Current value Y	Vertical position of the currently selected corner point, relative to the image origin. (Unit: Pixels)	Polygon, polyline, connector
Alpha	Depth angle Alpha for the 3D effect (Unit: Degree)	3D Bar
Start angle	Start angle for the display of segment or arc objects (Unit: Degree)	Ellipse arc, ellipse segment, circular arc, pie segment, tube bend
Number of corners	Number of corner points	Polygon, polyline, polygon tube
Number of boxes	Number of available selection fields	Check Box, Radio Box
Number of rows	Number of rows of text displayed	Combobox, list box
Alignment	Direction of movement of the slider control (Value: horizontal or vertical)	Slider
Bar Width	Width of the 3D bar (Unit: Pixels)	3D Bar
Bar Height	Height of the 3D bar (Unit: Pixels)	3D Bar
Bar direction	Direction of the positive bar axis (top, bottom, left, right)	Bar, 3D bar
Bar depth	Depth of the 3D bar (Unit: Pixels)	3D Bar
Base X	Horizontal distance from the right bar edge to the left object field edge	3D Bar
Base Y	Vertical distance from the lower bar edge to the upper object field edge	3D Bar
Beta	Depth angle Beta for the 3D effect (Unit: Degree)	3D Bar

Attribute	Function	Object type
Width	Distance between the left and right borderline of an object (Unit: Pixels)	All objects except application and picture windows
Width Button 1-8	Individual width for each of the eight buttons (1-8) (Unit: Pixels)	Group Display
Display axis	Coordinate axis on which the measurement values are displayed as 3D bars	3D Bar
Corner radius X	Radius of the corner rounding (Unit: Percentage)	Rounded rectangle
Corner radius Y	Radius of the corner rounding (Unit: Percentage)	Rounded rectangle
End angle	End angle for the display of segment or arc objects (Unit: Degree)	Ellipse arc, ellipse segment, circular arc, pie segment, tube bend
Window width	Distance between the left and right borderline (Unit: Pixels)	Application window, picture window
Window height	Distance between the top and bottom border line (Unit: Pixels)	Application window, picture window
Same size	Display type of the four buttons	Group display
Height	Distance between the top and bottom border line of an object (Unit: Pixels)	All objects except application and picture windows
Index	Number of the currently selected corner points	Polygon, polyline, connector, polygon tube
Position X	Horizontal distance of the object origin from the image origin (Unit: Pixels)	All objects
Position Y	Vertical distance of the object origin from the image origin (Unit: Pixels)	All objects
Radius	Radius of a circular object (Unit: Pixels)	Circle, circular arc, pie segment, round button
Radius X	Horizontal radius of an elliptical object (Unit: Pixels)	Ellipse, ellipse arc, ellipse segment, tube bend
Radius Y	Vertical radius of an elliptical object (Unit: Pixels)	Ellipse, ellipse arc, ellipse segment, tube bend
Rotation reference X	Horizontal coordinates of the reference point around which an object is shown to rotate in Runtime (Unit: Percentage)	Line, Polygon, Polyline, Static Text
Rotation reference Y	Vertical coordinates of the reference point around which an object is shown to rotate in Runtime (Unit: Percentage)	Line, Polygon, Polyline, Static Text
Rotation angle	Angle around which an object is shown to rotate in Runtime (Unit: Degree)	Line, Polygon, Polyline, Static Text
Rotation angle	Orientation of a T-piece upwards, left, downwards or right (unit: degrees). The values 0, 90, 180 and 270 are permitted. Other entries are rounded to the multiple of 90.	T-piece
Angle settings	Type of depth display for the 3D effect	3D Bar

See also

- How to Change an Attribute (Page 525)
- Setting Up Rotation of Objects (Page 558)
- The Properties of an Object (Page 511)
- Property Groups and Attributes (Page 530)

"Limits" Property Group

Introduction

The "Limits" property group contains attributes with which you can set limit values and the monitoring of limit values.

Requirements

The "Limits" property group is only available for the following objects. I/O field, bar and 3D bar

Overview

The following table shows all the attributes of the "Limits" property group. The function of an attribute is described briefly and the object types for which the attribute is available are listed.

Attribute	Function	Object type
Type (AH, WH, TH, RH4, RH5, AL, WL, TL, RL4, RL5)	Type of display for the specified limit value (percent or absolute)	Bar
Bar color (0 - 10)	Color the 3D bar takes when the specified limit is reached	3D bar
Bar color (AH, WH, TH, RH4, RH5, AL, WL, TL, RL4, RL5)	Color the bar takes when the specified limit is reached	Bar
Limit (0 – 10)	Value of the specified limit	3D bar
Limit Marker	Permits the display of the limit values on the scale	Bar
High Limit Value	Upper limit to display a value in the I/O field	I/O field
Upper limit (AH, WH, TH, RH4, RH5)	Value of the specified upper limit	Bar
Low Limit Value	Lower limit to display a value in the I/O field	I/O field
Lower limit (AL, WL, TL, RL4, RL5)	Value of the specified lower limit	Bar
Monitor (0 – 10)	Activates monitoring of the specified limit	3D bar
Monitor (AH, WH, TH, RH4, RH5, AL, WL, TL, RL4, RL5)	Activates monitoring of the specified limit	Bar

See also

How to Change an Attribute (Page 525)
How to insert an I/O field (Page 612)
How to insert a bar (Page 623)
How to Insert a 3D Bar (Page 659)
The Properties of an Object (Page 511)
Property Groups and Attributes (Page 530)

The "Background picture" property group

Introduction

The "Background picture" properties group contains attributes with which you can change the picture file used and the respective display for the background picture of the process picture.

Prerequisites

The "Background picture" property group is available for the process picture.

Overview

The following table shows all attributes in the "Background picture" property group. The functionality of the attribute is briefly described.

Attribute	Function
Picture	File name of the background picture Files of format EMF, WMF, DB, BMP, GIF, JPG, JPEG and ICO are suitable
Show as	Display of the picture in relation to the process picture and Runtime window

"Message Types" Property Group

Introduction

The "Message Types" property group contains attributes with which you can set the display of messages depending on message type and message class.

Requirements

The "Message Types" property group is only available for the object "Group Display".

Overview

The following table contains all attributes of the "Message Types" property group and brief description of their function.

Attribute	Function
Display Text	Label of buttons depending on the displayed message type
Went Out Unacknowledged – Background Flashing	Permits flashing background when a message goes out unacknowledged
Went Out Unacknowledged – Background Color Off	Background color for the flash state Off
Went Out Unacknowledged – Background Color On	Background color for the flash state On
Went Out Unacknowledged – Text Flashing	Permits flashing font when a message goes out unacknowledged
Went Out Unacknowledged – Text Color Off	Color of the text for the flash state Off
Went Out Unacknowledged – Text Color On	Color of the text for the flash state On
Came in – Background flashing	Permits flashing background when a message comes in
Came in – Background Color Off	Background color for the flash state Off
Came in – Background Color On	Background color for the flash state On
Came in – Text flashing	Permits flashing text when a message comes in
Came in – Text Color Off	Color of the text for the flash state Off
Came in – Text Color On	Color of the text for the flash state On
Came in acknowledged – Background flashing	Permits flashing background when a message comes in acknowledged
Came in acknowledged – Background Color Off	Background color for the flash state Off
Came in acknowledged – Background Color On	Background color for the flash state On
Came in acknowledged – Text flashing	Permits flashing text when a message comes in acknowledged
Came in acknowledged – Text Color Off	Color of the text for the flash state Off
Came in acknowledged – Text Color On	Color of the text for the flash state On
Message type	Defines the message type (for example AL, AH, WL, etc.) for which the attributes of the "Message Types" property group are configured

See also

How to Change an Attribute (Page 525)
 How to Insert a Group Display (Page 662)
 The Properties of an Object (Page 511)
 Property Groups and Attributes (Page 530)

"Font" Property Group**Introduction**

The "Font" property group contains attributes which you can use to change the appearance of text in objects.

Prerequisites

The "Font" property group is only available for the following objects: Static text, I/O field, bar, text list, group display, multiline text, combobox, list box, button, check box and radio box.

Overview

The following table shows all attributes in the "Font" property group. The function of an attribute is described briefly and the object types for which the attribute is available are listed.

Attribute	Function	Object type
Bold	Text is displayed in boldface	Static text, I/O field, bar, text list, group display, button, check box, radio box
Index	Number of the label field displayed in the dialog	Check box, radio box, combobox, list box
Italic	Text is displayed in italics	Static text, I/O field, text list, group display, button, check box, radio box
Text orientation	Horizontal or vertical arrangement of the text in the object	Static text, I/O field, text list, button, check box, radio box
Text	Object label for current index	Static text, button, check box, radio box, multiline text, combobox, list box
Underline	Text is displayed underlined	Static text, I/O field, text list, group display, button, check box, radio box

Attribute	Function	Object type
X alignment	Horizontal alignment of the text in the object	Static text, I/O field, text list, group display, button, check box, radio box
Y alignment	Vertical alignment of the text in the object	Static text, I/O field, text list, group display, button, check box, radio box
Font	Font of the text	Static text, I/O field, bar, text list, group display, multiline text, combobox, list box, button, check box, radio box
Font size	Font size of the text in points	Static text, I/O field, bar, text list, group display, multiline text, combobox, list box, button, check box, radio box

See also

- How to Change an Attribute (Page 525)
- The Properties of an Object (Page 511)
- Property Groups and Attributes (Page 530)

"Miscellaneous" Property Group

Introduction

The "Miscellaneous" property group contains attributes which you can use to change the miscellaneous settings of objects.

Requirements

The "Miscellaneous" property group is available for all objects.

The availability of the attributes depends on the type of selected objects. Only the attributes of the selected object are displayed.

Overview

The following table shows all attributes in the "Miscellaneous" property group. The function of an attribute is described briefly and the object types for which the attribute is available are listed.

Attribute	Function	Object type
Update cycle	Type and frequency of the update	Picture window, picture object
Display	Activates the display of an object	All objects
Display names	User-defined name of the process picture	Picture object
Display options	Specifies if a button is assigned to a graphic, text, or both	Button
Operator control enable	Release to operate an object	All objects except: <ul style="list-style-type: none"> • Application window • Picture window
Operator input message	Defines whether a message is output following operation	I/O field, text list, combo box, list box Check box, radio box, slider
Operator activities report	Defines whether the reason for an operation should be logged	I/O field, text list, combo box, list box Slider
Operation steps	Defines how many steps the slider is moved on the slider surface when the mouse is clicked	Slider
User for the electronic signature	Specifies which user can sign an operation	I/O field, text list, multiple row text, combo box, list box All Windows objects
User value 1-4	Any 32-Bit value which for example can be used for a script evaluation	Group display
Authorization	User-specific authorization to operate an object	All objects except: <ul style="list-style-type: none"> • Application window • Picture window • Control
Adapt picture	Permits adaptation of the picture size to the window size	Picture window
Picture name	Defines the name of the picture to be shown	Picture window
Picture offset X	Horizontal coordinate to define a picture section	Picture window
Picture offset Y	Vertical coordinate to define a picture section	Picture window
Picture Status Off	Defines the picture displayed when a button is not pressed	Button
Picture status on	Defines the picture displayed when a button is pressed	Button
Bit pattern group display	System-internal Output Value	Group display
Cursor mode	Specifies if a process picture is operated in runtime using the alpha cursor or the tab order cursor.	Picture object
Cursor control	Defines whether the Alpha cursor automatically jumps to the next field of the TAB order following input in a field	I/O field, text list
Date of last change	Indicates the date when the process picture was last saved.	Picture object
Immediate input	Defines whether when jumping to the object it should change directly to input mode	I/O field, text list

3.8 Working with Objects

Attribute	Function	Object type
Activate electronic signature	Determines whether a signature is required during operation in Runtime	I/O field, text list, multiple row text, combo box, list box All Windows objects
Extended operation	Defines whether the slider jumps to the minimum or maximum value when the mouse is clicked on the slider surface	Slider
Extended zooming	The view of the process picture in runtime may be zoomed in or out using the mouse wheel.	Picture object
Change color	Defines whether the color changes segment-by-segment or for the entire bar when the limit value is reached	Bar
Adapt size	Permits adaptation of the window size to the picture size	Picture window
Window mode	Defines the position and scaling of the picture window	Picture window
Sizeable	Permits the operator to change the window size	Application window, picture window
Hotkey	Defines a key or key combination as an alternative operation to a mouse action	Button
Hysteresis	Permits display with hysteresis	Bar
Hysteresis Range	Defines the hysteresis in percentage of the display range	Bar
Maximum value	Absolute value to display the largest value	Bar, 3D bar Slider
Maximizable	Permits the enlargement of a window to the maximum screen size	Application window, picture window
Menu/Toolbar configuration	Enables the assignment of an MTL file with the layout of menu and toolbars	Picture window
Minimum value	Absolute value to display the smallest value	Bar, 3D bar Slider
Average value	Forms an average value across the last 10 values	Bar
Monitor number	Defines the monitor, on which the picture window will be displayed	Picture window
Zero point value	Absolute value to display the zero point	Bar, 3D bar
Password protection	Specifies a password for the process picture or faceplate type	Picture object, faceplate type
Process driver connection	Default values for the display in runtime if the associated tag is not linked or updated	Bar, 3D bar Slider
Acknowledgment mask	Specifies which events require acknowledgment. Graphics objects which display an alarm flash for events that require acknowledgment and are steady on for events that do not require acknowledgment.	Group display Extended status display, extended analog display
Border	Display of a window with or without a border	Application window, picture window
Adapt border	Dynamic adaptation of the field border to the text size	Static text I/O field, text list Button, check box, radio box
Scroll bar	Permits a scroll bar in the window	Picture window
Scroll bar position X	Horizontal moving of picture scroll bar in picture window with scroll bar	Picture window

Attribute	Function	Object type
Scroll bar position Y	Vertical moving of picture scroll bar in picture window with scroll bar	Picture window
Group relevant	Defines the consideration to form a group display	Group display
Group value	Collect value of the current state of the active message classes	Group display
Closable	Permits a window to be closed	Application window, picture window
Selected box	Defines the number of the highlighted of displayed text field	Combo box, list box
Selected text	Shows certain text with the "Selected box" attribute	Combo box, list box
Server name	Display under which name an embedded object is registered in the operating system	Control, OLE object
Server prefix	Name of the server from which the picture to be shown is called	Picture window
Scaling factor	Zoom factor to display the picture in the window	Picture window
Scaling mode	Scaling and display of components of the faceplate instance or the internal objects of the user object	Faceplate instance, user object
Configured languages	Displays the languages configured for the selected object	Static text Text list, multiple row text, combo box, list box Button, check box, radio box, round button
Text reference	Defines whether the language-dependent assignment texts are managed in the text library or directly in the object	Text list
Title	Activates the title bar of a window	Application window, picture window
Tooltip text	Describing text which appears in runtime as soon as the cursor is positioned on the object	All objects except: <ul style="list-style-type: none"> • Application window • Control
Trend	Permits the display of the trend of a measurement value	Bar
Heading	Headline displayed in the title bar of the picture window	Picture window
Independent window	Defines whether the picture window can be used in position and scaling independent of the process picture	Picture window
Tag prefix	Name extension prefixed on all tag in the picture	Picture window
Visualize tag status	Determines of the object is grayed out when a bad quality code or tag status is detected.	I/O field, bar, text list, 3D bar, group display, status display (extended), analog display (extended)
Movable	Permits a window to be moved	Application window, picture window
Foreground	Defines whether a window is pinned on top	Application window, picture window

See also

How to Change an Attribute (Page 525)

How to configure the display of windows (Page 559)

How to Configure Logging and Operator Authorizations (Page 560)

The Properties of an Object (Page 511)

Property Groups and Attributes (Page 530)

"Lock" Property Group

Introduction

The "Lock" property group contains attributes with which you can change the properties to display locked measuring points.

Requirements

The "Lock" property group is only available for the object "Group Display".

Overview

The following table contains all attributes of the "Lock" property group and a brief description of their function.

Attribute	Function
Lock Display	Permits viewing a locked measuring point
Lock Display Text	Label of the buttons for a locked measuring point
Lock Background Color	Background color of the buttons for a locked measuring point
Lock Text Color	Font color of the buttons for a locked measuring point

See also

How to Change an Attribute (Page 525)

How to Insert a Group Display (Page 662)

The Properties of an Object (Page 511)

Property Groups and Attributes (Page 530)

"Styles" Property Group

Introduction

The "Styles" property group contains attributes which you can use to change the style for the appearance of objects.

Requirements

The "Styles" property group is available for all objects except application windows, picture windows, Control and OLE object.

Overview

The following table shows all attributes in the "Styles" property group. The function of an attribute is described briefly and the object types for which the attribute is available are listed.

Attribute	Function	Object type
3D border weight	Line weight of the 3D border (unit: pixel)	Group display button, round button
Bar pattern	Pattern to display the bar surface, for example solid or broken	Bar
Border weight	Width of the border of a slider control (unit: pixel)	Slider
Display as drop-down list	Display as single object with arrow button for drop-down	Text list
Corners	Representation of the corners of an object, e.g. round, flat or pointed (associated with the "Line style" attribute)	all standard objects, graphics object, status display, SVG object all Windows objects,
Latch down	Saves the last selected switch positioned ("Pressed" or "Not pressed")	Button, round button,
Box alignment	Arrangement of the buttons relative to the describing text	Check box, radio box
Fill pattern	Pattern for the display of background areas, for example solid or hatched	Polygon, ellipse, circle, ellipse segment, pie segment, rectangle, rounded rectangle, static text, I/O field, bar, graphics object, text list, combobox, list box, SVG object, all Windows objects
Pressed	Start position of the switch	Button, round button
Background	Display of the background	3D bar
Light effect	Display of the sides of a 3D bar with different brightness	3D bar
Line end	Representation of the line ends of an object, e.g. round, flat or pointed (associated with the "Line style" attribute)	all standard objects, graphics object, status display, SVG object all Windows objects,
Line style	Display type of a line, for example dotted or dashed	all standard objects, graphics object, status display, SVG object all Windows objects,
Line end style	Display type for the end points of a line	Line, polyline, connector
Line weight	Thickness of a line (Unit: pixel)	all standard objects, graphics object, status display, SVG object all Windows objects, all tube objects
Line connection type	Type of transition at a corner point	Polygon tube

Attribute	Function	Object type
Draw Border Inside		Ellipse, circle, ellipse segment, circular segment, ellipse arc, circle arc, rectangle, round rectangle, static text, graphic object, status display, SVG object, all Window objects
Border style	Display type of a border line, for example dotted or broken	I/O field, bar, multiline text, combo box, list box, multiline text, 3D bar
Border width	Thickness of a border line (unit: pixel)	I/O field, bar, multiline text, combo box, list box, multiline text, 3D bar
Dividing line style	Display type of the dividing lines of a selection list, for example dotted or broken	Text list
Dividing line weight	Thickness of the separation lines in a selection list (Unit: pixel)	Text list

See also

- How to Change an Attribute (Page 525)
- The Properties of an Object (Page 511)
- Property Groups and Attributes (Page 530)

"Connected Objects" Property Group

Introduction

The "Connected Objects" property group contains attributes which can be used to change the connection between two objects by means of the "Connector" object.

Requirements

The "Connected Objects" property group is only available for the "Connector" object.

Overview

The following table shows all attributes of the "Connected Objects" property group and a brief description of their function.

Attribute	Function
Object name of the source object	Specifies the object that is connected to the start of the connector
Connection point index of the source object	For the start of the connector, specifies at which connection point of the source object the connection is created

Attribute	Function
Object name of the target object	Specifies the object that is connected to the end of the connector
Connection point index of the target object	For the end of the connector, specifies at which connection point of the target object the connection is created
Change orientation	Reverses the definition of the connector "Start" and "End" with the current assignments
Connection Type	Specifies whether an automatic or basic direct connection should be created between the objects.

See also

How to Change an Attribute (Page 525)

How to use the connector (Page 595)

The Properties of an Object (Page 511)

Property Groups and Attributes (Page 530)

"Assignment" Property Group

Introduction

The "Assignment" property group contains attributes you use to assign message types to buttons of the group display object. The display of message types is configured in the "Message Types" property group.

Requirements

The "Assignment" property group is only available for the "Group Display" object.

Overview

The following table shows all attributes of the "Assignment" property group and a brief description of their function.

Attribute	Function
Message Types for Button 1	Specifies one or several message events for the first button of the group display object.
Message Types for Button 2	Specifies one or several message events for the second button of the group display object.
Message Types for Button 3	Specifies one or several message events for the third button of the group display object.
Message Types for Button 4	Specifies one or several message events for the fourth button of the group display object.
Message Types for Button 5	Specifies one or several message events for the fifth button of the group display object.

Attribute	Function
Message Types for Button 6	Specifies one or several message events for the sixth button of the group display object.
Message Types for Button 7	Specifies one or several message events for the seventh button of the group display object.
Message Types for Button 8	Specifies one or several message events for the eighth button of the group display object.

See also

- How to Change an Attribute (Page 525)
- How to Insert a Group Display (Page 662)
- The Properties of an Object (Page 511)
- Property Groups and Attributes (Page 530)

"Status" Property Group

Introduction

The "Status" property group contains attributes with which you can change the properties of the status display.

Requirements

The "Status" property group is only available for the object "Status Display".

Overview

The following table shows all attributes of the "Status" property group and brief description of their function.

Attribute	Function
Current status	Status set to display a basic picture or a flash picture
Flash Picture	Picture to be displayed as a flash picture
Flash Picture Referenced	Defines whether the picture itself or only a reference to the picture is incorporated
Flash Picture Transparent Color	Defines which color of the flash picture is set to "transparent"
Flash Picture Transparent Color On	Permits the "Transparent Color" function for the flash picture
Flashing Flash Picture Active	Activates flashing of the flash picture
Flash picture flash frequency	Frequency for the flashing of the flash picture
Graphics list	Specifies a graphics list created in the "Text and Graphic List" editor in which the assignments are configured.
Basic Picture	Picture to be displayed as basic picture

Attribute	Function
Basic Picture Referenced	Defines whether the picture itself or only a reference to the picture is incorporated
Basic Picture Transparent Color	Defines which color of the basic picture is set to "Transparent"
Basic Picture Transparent Color On	Permits the "Transparent Color" function for the basic picture

See also

How to Change an Attribute (Page 525)
 How to insert a status display (Page 633)
 The Properties of an Object (Page 511)
 Property Groups and Attributes (Page 530)

3.8.5.4 Special Runtime Settings**Special Runtime Settings****Introduction**

To display and operate individual objects in runtime, there are different attributes available whose change is only visible in runtime:

- Rotation of objects
- Display of windows
- Operation and logging
- Multiple picture windows

The objects can also be displayed as transparent right to invisible in runtime.

These settings are described extensively below.

See also

Property Groups and Attributes (Page 530)
 How to Configure Logging and Operator Authorizations (Page 560)
 How to configure the display of windows (Page 559)
 Setting Up Rotation of Objects (Page 558)
 How to support multiple picture windows (Page 562)
 How to define the visibility of objects (Page 564)
 How to animate an object (Page 491)
 Basic Dynamic Operations (Page 485)

Setting Up Rotation of Objects

Introduction

A rotation around a reference point can be configured for objects of the type line, polygon, polyline or static text.

The rotation of an object is only visible in Runtime.

The coordinates of the reference point and the configured start position are defined by the attributes "Rotation reference X", "Rotation reference Y" and "Rotation angle in the "Geometry" property group.

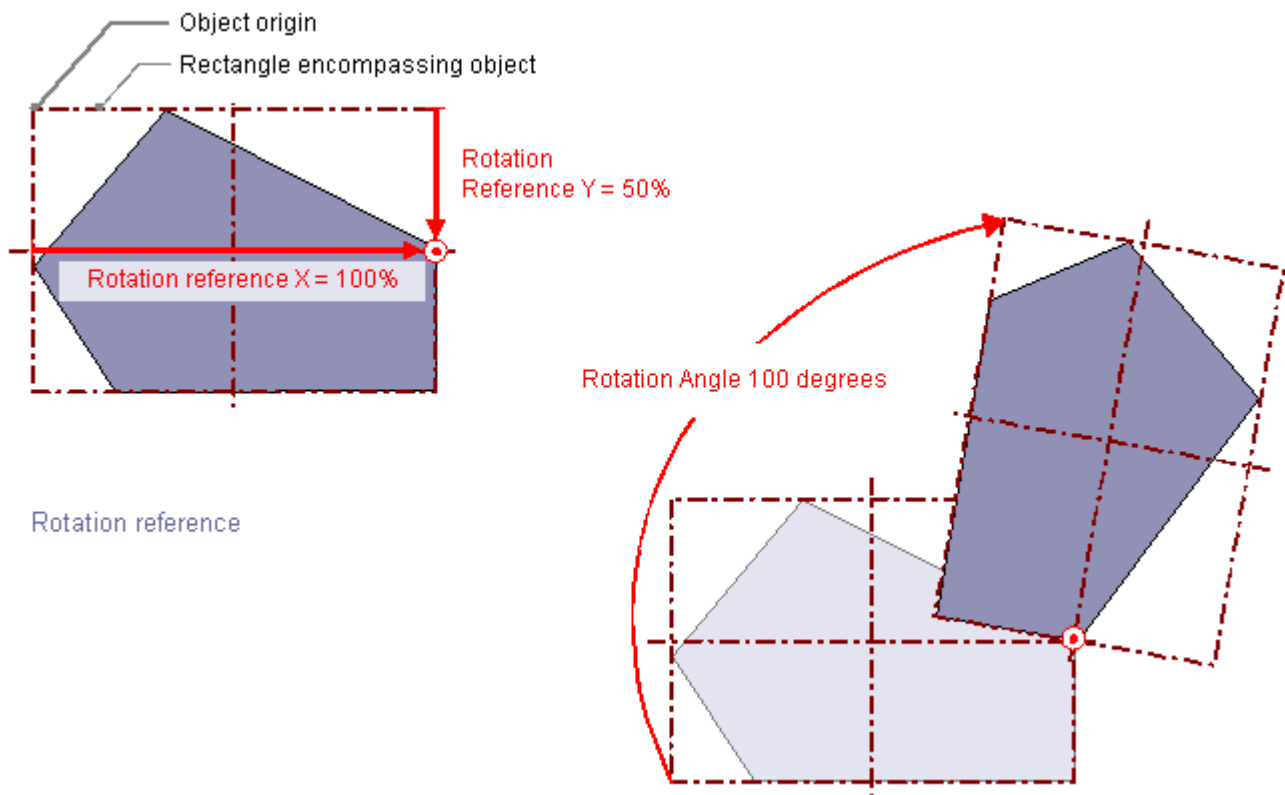

Rotation reference X, Rotation reference Y

The attribute "Rotation reference X" and "Rotation reference Y" define the horizontal and vertical distance of the reference point from the object origin.

The values are specified in percent. The object width or object height correspond to a value of 100%. The reference point value can be outside the selection rectangle. This means that both negative values and values higher than 100% are possible.

Rotation angle

The "Rotation Angle" attribute defines the rotation of an object around the reference point.

The Rotation Angle is specified in degrees. The configured start point corresponds to a value of 0°. The position of an object deviates from its configured start position by the value of the "Rotation Angle" attribute.

See also

The Properties of an Object (Page 511)

Special Runtime Settings (Page 557)

How to Draw a Polyline (Page 573)

How to Draw a Polygon (Page 570)

How to Draw a Line (Page 567)

How to animate an object (Page 491)

How to configure the display of windows

Introduction

The "Application Window" and "Picture Window" objects are displayed in Runtime as a window in a process picture. The properties of this window display can be changed as required with the attributes described here. Some of these attributes are available for other object types.

Adapt Size

The "Adapt Size" attribute specifies whether or not a picture window adapts to the size of the embedded picture in Runtime.

Sizeable

The "Sizeable" attribute specifies whether or not the size of a window can be changed in Runtime.

Border

The "Border" attribute specifies whether or not a window is displayed with a border.

Scroll Bar

The "Scroll Bar" attribute specifies whether or not a picture window is displayed with a scroll bar if required. A scrollbar is only visible in Runtime.

Can Be Closed

The "Can Be Closed" attribute specifies whether or not a window can be closed in Runtime.

Title

The "Title" attribute specifies whether a window is displayed in Runtime with or without a title bar.

Heading

The "Heading" attribute specifies which text appears in the title of a picture window.

Movable

The "Movable" attribute specifies whether or not a window can be moved in Runtime.

Foreground

The "Foreground" attribute specifies whether or not a window lies in the foreground. This setting is independent of the layer to which the window is assigned.

See also

- The Properties of an Object (Page 511)
- Special Runtime Settings (Page 557)
- "Miscellaneous" Property Group (Page 548)
- How to insert a picture window (Page 605)
- How to Insert an Application Window (Page 602)

How to Configure Logging and Operator Authorizations

Introduction

In WinCC to operate a process picture you can define user-specific authorization for the contained objects. Each Operation may be logged and sent to the message system. The associated settings can be changed with the attributes described here.

Display

The "Display" attribute specifies whether or not an object is displayed in Runtime.

Operator-Control Enable

The "Operator-Control Enable" attribute specifies whether or not an object can be operated in Runtime.

Operator Input Message

The "Operator Input Message" attribute specifies whether a message is displayed after an operation for some objects. The object must be connected to a tag. Following an operation, a message is generated, sent to the message system, and is archived. Using the message system, a message may be output in a message line, for example.

Operator Activities Report

The "Operator Activities Report" attribute specifies whether or not the reason for an operation is to be logged by the operator. The Operator Activities Report is archived in the message system.

Authorization

The User Administrator editor is used in WinCC to assign authorizations for the users. An authorization can be assigned for every object in the Graphics Designer. The object can only be operated by those users with the corresponding authorization.

Note

An object can only receive an operator authorization as a "Whole". A customized object can have an operator authorization but its subordinate objects cannot.

Cursor Control

The "Cursor Control" attribute specifies whether the Alpha Cursor automatically jumps to the next field in the TAB sequence after an entry has been made in a field. This function enables rapid input in different fields without having to use the tab key to jump.

Hotkey

As an alternative to operation with the mouse, a button can also be triggered using the keyboard. To do so, a hotkey must be set.

See also

The Properties of an Object (Page 511)

Special Runtime Settings (Page 557)

"Miscellaneous" Property Group (Page 548)

How to support multiple picture windows

Introduction

WinCC supports independent picture windows. Independent picture windows can be used and positioned absolutely without being connected to the respective process picture. With the respective hardware and the support of the operating system, you can control more monitors to handle processes with greater scope and differentiation.

For example, you can visualize the process on monitors 1 to 3 and use monitor 4 to display another view of the process with an Excel list.

The main window, in which you have configured the individual picture window, is no longer required. You can hide it to increase the impact of more independent runtime windows.

Note

WinCC/WebUX: No support of independent windows

The WinCC option WebUX does not support independent picture windows.

The configured independent windows behave like other picture windows in Runtime.

Procedure

1. Configure more picture windows with the desired process pictures in the start picture.
2. Open the properties for each picture window with a double click.
The "Object Properties" dialog is opened.

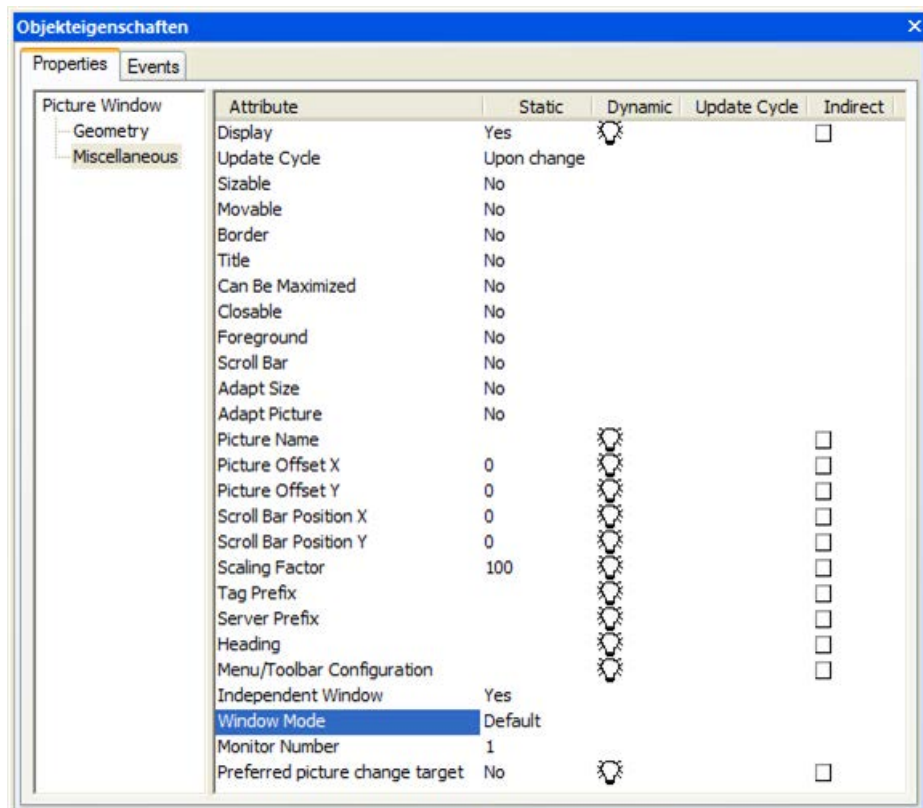

3. Set the attribute "Independent window" to "Yes".
4. Define the display for the configured picture window with window mode:
 - Standard: configured size in the configured position
 - Center: configured size in the central position
 - Maximize: display adapted to the size of the monitor
5. If you want to use more monitors:
Select the desired monitor for the picture window with the "Monitor number" attribute.
6. If you want to hide the main window:
Select "Properties" in the WinCC Explorer of the shortcut menu of the computer, select the respective computer and click on "Properties".
The "Computer Properties" dialog opens.
7. Activate check box "Hide main window" on the "Graphics Runtime" tab under "Independent picture window".

Result

In runtime, the selected process pictures appear in several picture windows that are to be controlled independent of one another.

See also

How to insert a picture window (Page 605)

How to define the visibility of objects

Introduction

The visibility of objects is controlled with the "Object transparency" property. The operability of an object does not depend on its visibility. Even a completely transparent, or invisible, object can be controlled in runtime.

Procedure

1. Select "Properties" in the shortcut menu.
The "Properties" dialog opens.
2. Define the object transparency as a percentage in the "Display" property group.
0% means no transparency, therefore complete visibility.
100% means complete transparency, therefore invisibility of the object.
The text and fields of the graphic objects are only transparent at 100%.

Note

The transparency of the object is shown in the Graphics Designer as well as later in runtime.

Finding objects again

A 100% transparent object cannot be seen in the project as well as in runtime. The selection marks for the rectangle surrounding the object are also not seen in the project.

Use the setting with the knowledge that operation of an invisible object is still possible.

In order to have an overview of which objects belong to the process picture in the project, select the "View Project Documentation" command in the "File" menu.

Existing, invisible objects are also included in the project documentation. The position of the objects in the process picture are indicated in the schematic overview graphic.

See also

Example: How to animate a circle as signal light (Page 504)

Example: How to animate the operability of a button (Page 508)

3.8.6 Working with Standard Objects

3.8.6.1 Working with Standard Objects



Introduction



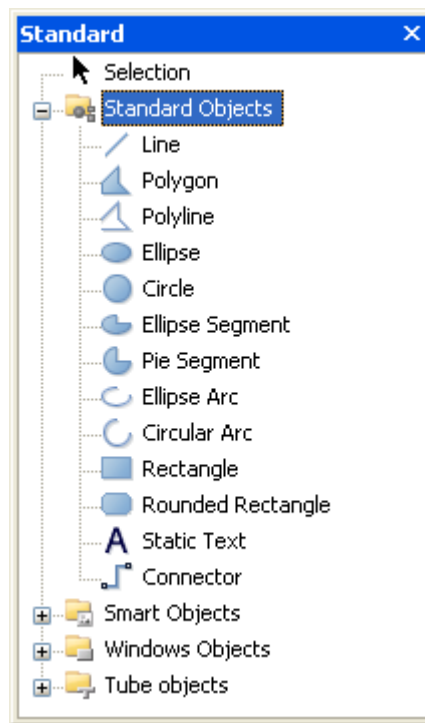







The standard objects include geometric shapes and static text. The geometric shapes draw the individual elements of the process picture. For example, static text can be used for labels.

In the Graphics Designer, the various object types have default properties. When they are inserted the objects import these default properties (except for individual geometric properties). After insertion the properties of an object can be modified. In the same way the default settings for the object types can be modified as required.



Overview

Icon	Object	Description
	Line	The line is an open object. The length and angle of a line are determined by the height and width of the rectangle around the object. The line ends, for example, can be shown as arrows or points.
	Polygon	The polygon is a closed object that can be filled with a color or pattern. A polygon can have any number of corners. The corners are numbered in their sequence of creation and can be modified individually or deleted.

Icon	Object	Description
	Polyline	The polyline is an open object. Even if the start and finish point have the same coordinates, the area cannot be filled. A polyline can have any number of corners. The corners are numbered in their sequence of creation and can be modified individually or deleted. The line ends of a polyline can for example be shown as arrows or points.
	Ellipse	The ellipse is a closed object that can be filled with a color or pattern. The height and width of an ellipse can be modified as desired to allow it to be aligned horizontally or vertically.
	Circle	A circle is a closed object that can be filled with a color or pattern. A circle can be resized at will.
	Ellipse segment	The ellipse segment is a closed object that can be filled with a color or pattern. The height and width of an ellipse segment can be modified as desired to allow it to be aligned horizontally or vertically.
	Pie segment	The pie segment is a closed object that can be filled with a color or pattern. A pie segment can be resized at will.
	Ellipse arc	The ellipse arc is an open object. The height and width of an ellipse arc can be modified as desired to allow it to be aligned horizontally or vertically.
	Circular arc	The circular arc is an open object. A circular arc can be resized at will.
	Rectangle	The rectangle is a closed object that can be filled with a color or pattern. The height and width of a rectangle can be modified as desired to allow it to be aligned horizontally or vertically.
	Rounded rectangle	The rounded rectangle is a closed object that can be filled with a color or pattern. The height and width of a rounded rectangle can be modified as desired to allow it to be aligned horizontally or vertically. The corners of a rounded rectangle can be rounded as much as desired.
	Static text	The field for static text is a closed object that can be filled with a color or pattern. The static text is entered into a field of any desired size. One-line or multiline text can be input for all design languages.
	Connector	The connector is a linear object whose ends can be connected with the connection points of other objects. The number and arrangement of the connection points depend on the specific object type. If connected objects are moved, the connector's length and direction are automatically adapted and the connection is retained.

See also

[How to Draw a Line \(Page 567\)](#)

[How to Draw a Polygon \(Page 570\)](#)

[How to Draw a Polyline \(Page 573\)](#)

[How to Draw an Ellipse \(Page 576\)](#)

[How to Draw a Circle \(Page 578\)](#)

How to draw an Ellipse Arc (Page 584)
How to Draw a Circular Arc (Page 587)
How to Draw an Ellipse Segment (Page 580)
How to Draw a Pie Segment (Page 582)
How to Draw a Rectangle (Page 589)
How to Draw a Rounded Rectangle (Page 590)
How to Insert Static Text (Page 593)
How to use the connector (Page 595)
How to change the default setting of object types (Page 457)
Basic Static Operations (Page 459)
Basic Dynamic Operations (Page 485)
Controls (Page 341)
The Coordinate System of a Process Picture (Page 319)
The Coordinate System of an Object (Page 321)
The Rectangle Surrounding the Object (Page 323)
Working with Combined Objects (Page 709)
Working with Objects (Page 456)

3.8.6.2 How to Draw a Line

Introduction

The line is an open object.

The length and angle of a line are determined by the height and width of the rectangle around the object.

The line ends, for example, can be shown as arrows or points.

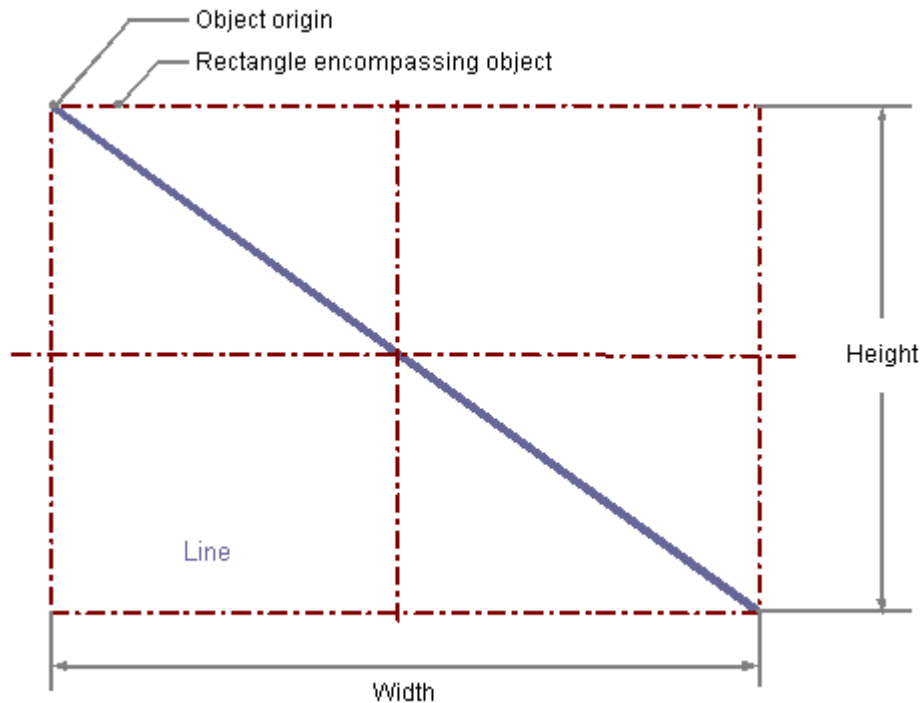

Drawing a line

1. Open the picture into which you want to insert a line.
2. Click the "Line" standard object in the "Standard" selection window.
3. Place the mouse pointer at the position in the picture where you want to insert a line. The mouse pointer changes into a crosshair with an object symbol attached.
4. Keeping the left mouse button pressed, drag the line to the desired length. As soon as you release the mouse button, the line is finished.

Alternative procedure

Double-click the line in the "Standard" selection window.

A line with default object properties is then inserted near the picture origin.

Changing a line

Select an object of the line type if you wish to carry out one of the following changes:

Actions with the mouse

Drag the rectangle surrounding the object to the new position in order to arrange the object in the picture.

Drag the handles on the rectangle surrounding the object to a new position in order to resize the object.

Palettes and toolbars

Use the elements of the object palette to mirror or rotate the object.

Use the color palette to change the colors.

Use elements of the style palette to change the display style for the object.

Attributes

Open the "Object Properties" window to change the current values of the required attributes.

Configuring the Line Style**Line style**

The "Line Style" attribute specifies the style in which a line appears. For example, a dotted or dashed representation is possible.

A line with line width of 1 pixel can be displayed in two colors.

To do so, you must select a broken line style and assign another color to the background of the line. If the line color is identical to the line background color in the "Colors" property group, breaks in the line are invisible.

Five line styles are available for selection.

Line ends

The "Line ends" attribute determines the appearance of the line ends. The definition of the attribute applies to both ends of the line.

Select one of the three following options:

- A round end sets the center of a circle at the end point of the line. The diameter of the circle adapts to the line width.
- A rectangular end sets the center of a square at the end point of the line. The width and the height of the square adapt to the line width.
- A flat end terminates the line at its end points.

Configuring line end style

The "Line End Style" attribute specifies the style of the ends of a line object.

The ends of a line object can have different shapes. For example, a line can begin with a dot and end with an arrow.

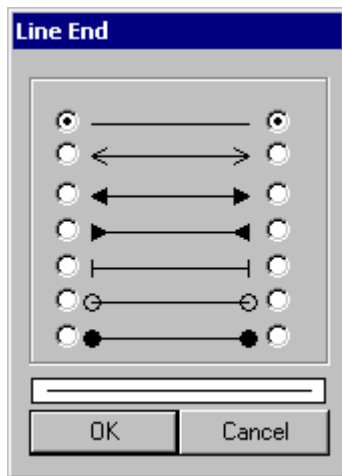

Configuring rotation in Runtime

The line can rotate around a reference point in Runtime.

The rotation is defined by the attributes "Rotation Reference X", "Rotation Reference Y" and "Rotation Angle".

See also

Setting Up Rotation of Objects (Page 558)

Basic Static Operations (Page 459)

Basic Dynamic Operations (Page 485)

The Properties of an Object (Page 511)

Working with Standard Objects (Page 565)

3.8.6.3 How to Draw a Polygon

Introduction

The polygon is a closed object that can be filled with a color or pattern.

A polygon can have any number of corners.

The corners are numbered in their sequence of creation and can be modified individually or deleted.

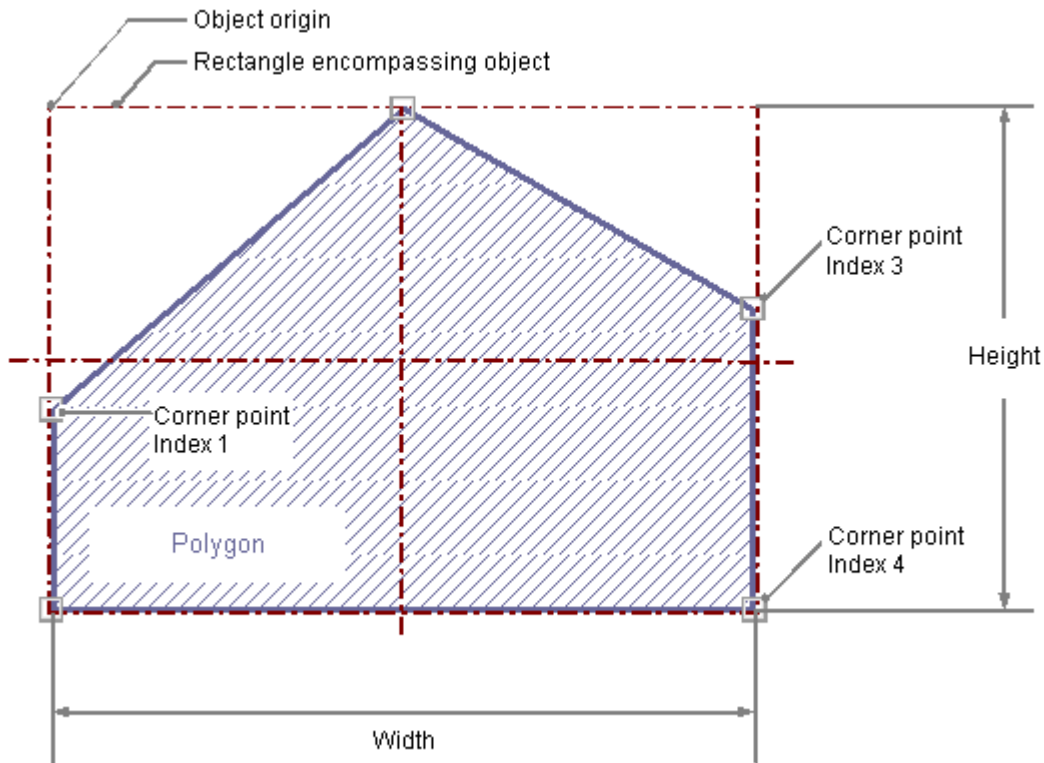

Drawing a polygon

1. Open the picture in which you want to insert a polygon.
2. Click the "Polygon" standard object in the "Standard" selection window.
3. Place the mouse pointer at the position in the picture where you want to insert a polygon. The mouse pointer changes into a crosshair with an object symbol attached.
4. Click the selected starting point with the left mouse button.
5. Click any other desired corner of the polygon with the left mouse button.
6. Click once with the right mouse button to correct the last drawn section of the polygon.
7. Finish the polygon by double-clicking the left mouse button.

Alternative procedure

Double-click the polygon in the "Standard" selection window.

A polygon with default object properties is then inserted near the picture origin.

Changing a polygon

Select an object of the polygon type if you wish to carry out one of the following changes:

Actions with the mouse

Drag the rectangle surrounding the object to the new position in order to arrange the object in the picture.

Drag the handles on the rectangle surrounding the object to a new position in order to resize the object.

Palettes and toolbars

Use the elements of the object palette to mirror or rotate the object.

Use the color palette to change the colors.

Use elements of the style palette to change the display style for the object.

Attributes

Open the "Object Properties" window to change the current values of the required attributes.

Changing corners

The positions of the corners can be changed with the attributes "Current Value X" and "Current Value Y" in the "Object Properties" window.

The position number of the current selected corner is shown by the "Index" attribute in the "Geometry" property group. Changing the value specified here enables targeted selection of a corner.

A change of the "Index" attribute for the current selected corner also changes the displayed value of the attributes "Current Value X" and "Current Value Y".

You can also change corners by actions with the mouse:

Moving corners

Position the mouse pointer on the corner that is to be moved and drag it to the desired position with the mouse button held down.

Inserting corners

Hold down the <ALT> key and insert another corner by double-clicking on a corner.

The additional corner is inserted between the clicked corner and the previously created corner.

Deleting corners

Position the mouse pointer on the corner that you want to delete.

Hold down the <CTRL> key and delete the corner by double-clicking on the left mouse button.

Configuring rotation in Runtime

The line can rotate around a reference point in Runtime.

The rotation is defined by the attributes "Rotation Reference X", "Rotation Reference Y" and "Rotation Angle".

See also

Setting Up Rotation of Objects (Page 558)

Basic Static Operations (Page 459)

Basic Dynamic Operations (Page 485)

The Properties of an Object (Page 511)

Working with Standard Objects (Page 565)

3.8.6.4 How to Draw a Polyline

Introduction

The polyline is an open object. Even if the start and finish point have the same coordinates, the area cannot be filled.

A polyline can have any number of corners.

The corners are numbered in their sequence of creation and can be modified individually or deleted.

The line ends of a polyline can for example be shown as arrows or points.

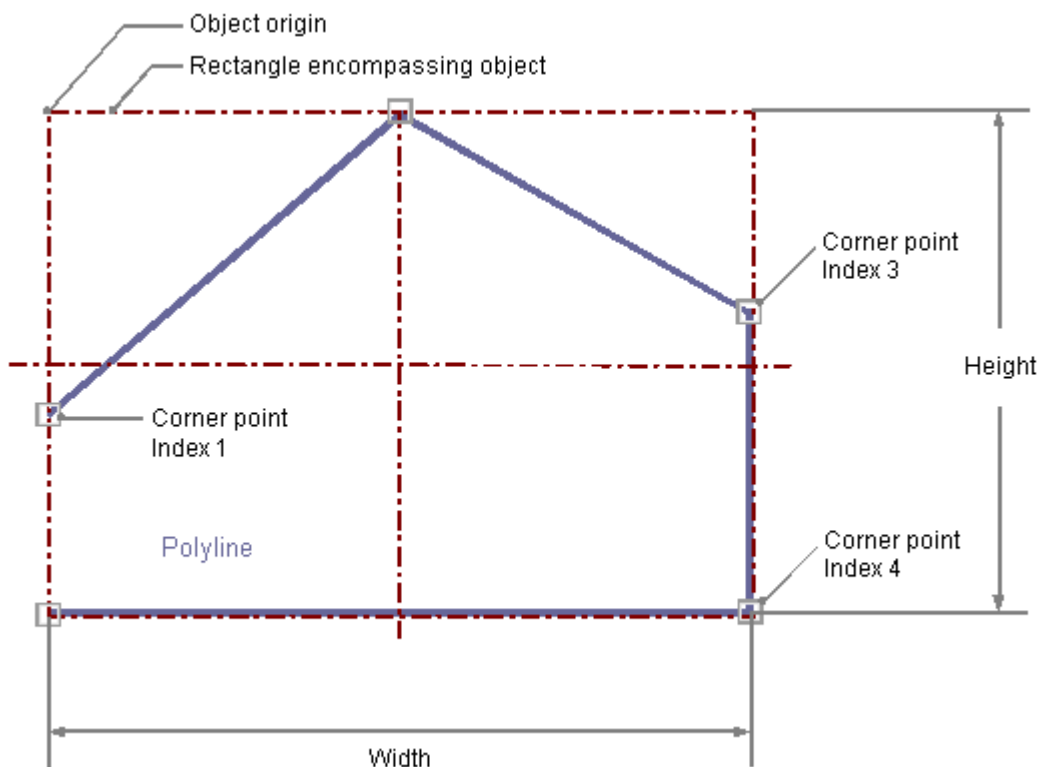

Drawing a polyline

1. Open the picture into which you want to insert a polyline.
2. Click the "Polyline" standard object in the "Standard" selection window.
3. Place the mouse pointer at the position in the picture where you want to insert a polyline. The mouse pointer changes into a crosshair with an object symbol attached.
4. Click the selected starting point with the left mouse button.
5. Click every other desired corner of the polyline with the left mouse button.
6. Click once with the right mouse button to correct the last drawn section of the polyline.
7. Finish the polyline by double-clicking the left mouse button.

Alternative procedure

Double-click the polyline in the "Standard" selection window.

A polyline with default object properties is then inserted near the picture origin.

Changing a polyline

Select an object of the polyline type if you wish to carry out one of the following changes:

Rectangle surrounding the object

Drag the rectangle surrounding the object to the new position in order to arrange the object in the picture.

Drag the handles on the rectangle surrounding the object to a new position in order to resize the object.

Palettes and toolbars

Use the elements of the object palette to mirror or rotate the object.

Use the color palette to change the colors.

Use elements of the style palette to change the display style for the object.

Attributes

Open the "Object Properties" window to change the current values of the required attributes.

Changing corners

The positions of the corners can be changed with the attributes "Current Value X" and "Current Value Y" in the "Object Properties" window.

The position number of the current selected corner is shown by the "Index" attribute in the "Geometry" property group. Changing the value specified here enables targeted selection of a corner.

A change of the "Index" attribute for the current selected corner also changes the displayed value of the attributes "Current Value X" and "Current Value Y".

You can also change corners by actions with the mouse:

Moving corners

Position the mouse pointer on the corner that is to be moved and drag it to the desired position with the mouse button held down.

Inserting corners

Hold down the <ALT> key and insert another corner by double-clicking on a corner.

The additional corner is inserted between the clicked corner and the previously created corner.

Deleting corners

Position the mouse pointer on the corner that you want to delete.

Hold down the <CTRL> key and delete the corner by double-clicking on the left mouse button.

Configuring the Line Style**Line style**

The "Line Style" attribute specifies the style in which a line appears. For example, a dotted or dashed representation is possible.

A line with line width of 1 pixel can be displayed in two colors.

To do so, you must select a broken line style and assign another color to the background of the line. If the line color is identical to the line background color in the "Colors" property group, breaks in the line are invisible.

Five line styles are available for selection.

Line ends

The "Line ends" attribute determines the appearance of the line ends. The definition of the attribute applies to both ends of the line.

Select one of the three following options:

- A round end sets the center of a circle at the end point of the line. The diameter of the circle adapts to the line width.
- A rectangular end sets the center of a square at the end point of the line. The width and the height of the square adapt to the line width.
- A flat end terminates the line at its end points.

Corners

The "Corners" attribute define the appearance of the corner intersections of where lines meet. The definition applies to all the corners of the object.

Select one of the three following options:

- A round corner sets the center of a circle at the intersection of two line ends. The diameter of the circle adapts to the line width.
- The two outer corner points of the line connection are linked by a straight line. This flattening effect causes the corners to appear beveled.
- A pointed corner corresponds to the real corner intersection of the meeting lines.

Configuring line end style

The "Line End Style" attribute specifies the style of the ends of a line object.

The ends of a line object can have different shapes. For example, a line can begin with a dot and end with an arrow.

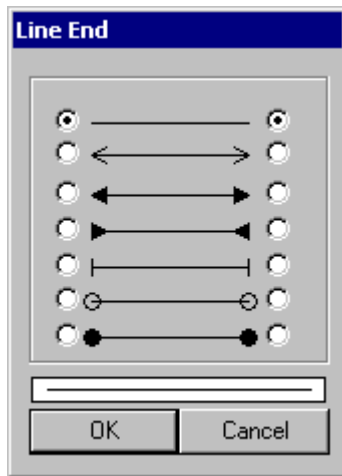

Configuring rotation in Runtime

The line can rotate around a reference point in Runtime.

The rotation is defined by the attributes "Rotation Reference X", "Rotation Reference Y" and "Rotation Angle".

See also

Setting Up Rotation of Objects (Page 558)

Basic Static Operations (Page 459)

Basic Dynamic Operations (Page 485)

The Properties of an Object (Page 511)

Working with Standard Objects (Page 565)

3.8.6.5 How to Draw an Ellipse

Introduction

The ellipse is a closed object that can be filled with a color or pattern.

The height and width of an ellipse can be modified as desired to allow it to be aligned horizontally or vertically.

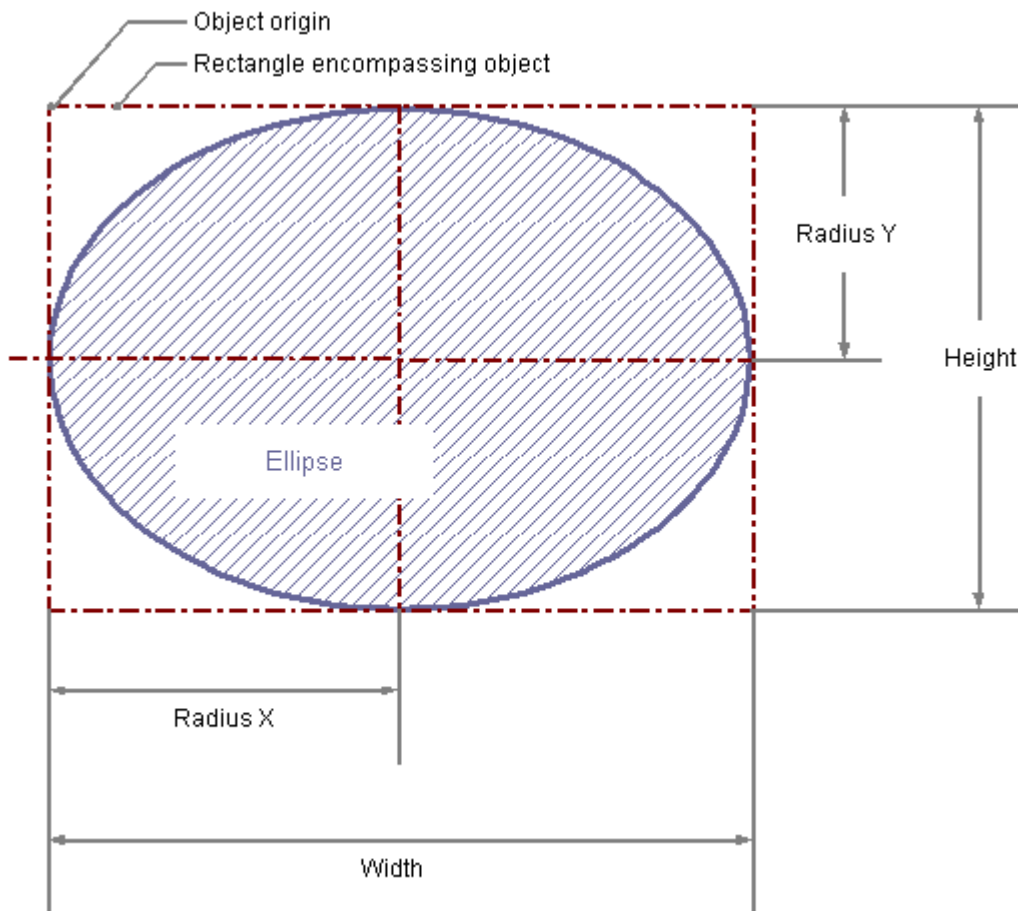

Drawing an ellipse

1. Open the picture into which you want to insert an ellipse.
2. Click the "Ellipse" standard object in the "Standard" selection window.
3. Place the mouse pointer at the position in the picture where you want to insert an ellipse. The mouse pointer changes into a crosshair with an object symbol attached.
4. Keeping the left mouse button pressed, drag the ellipse to the desired size. As soon as you release the mouse button, the ellipse is finished. If you hold down the <SHIFT> key while drawing, the "Ellipse" object is created in the shape of a circle.

Alternative procedure

Double-click the ellipse in the "Standard" selection window.

An ellipse with default object properties is then inserted near the picture origin.

Changing an ellipse

Select an object of the Ellipse type if you wish to carry out one of the following changes:

Rectangle surrounding the object

Drag the rectangle surrounding the object to the new position in order to arrange the object in the picture.

Drag the handles on the rectangle surrounding the object to a new position in order to resize the object.

Palettes and toolbars

Use the elements of the Object Palette to rotate the object.

Use the color palette to change the colors.

Use elements of the style palette to change the display style for the object.

Attributes

Open the "Object Properties" window to change the current values of the required attributes.

See also

Basic Static Operations (Page 459)

Basic Dynamic Operations (Page 485)

The Properties of an Object (Page 511)

Working with Standard Objects (Page 565)

3.8.6.6 How to Draw a Circle

Introduction

A circle is a closed object that can be filled with a color or pattern.

A circle can be resized at will.

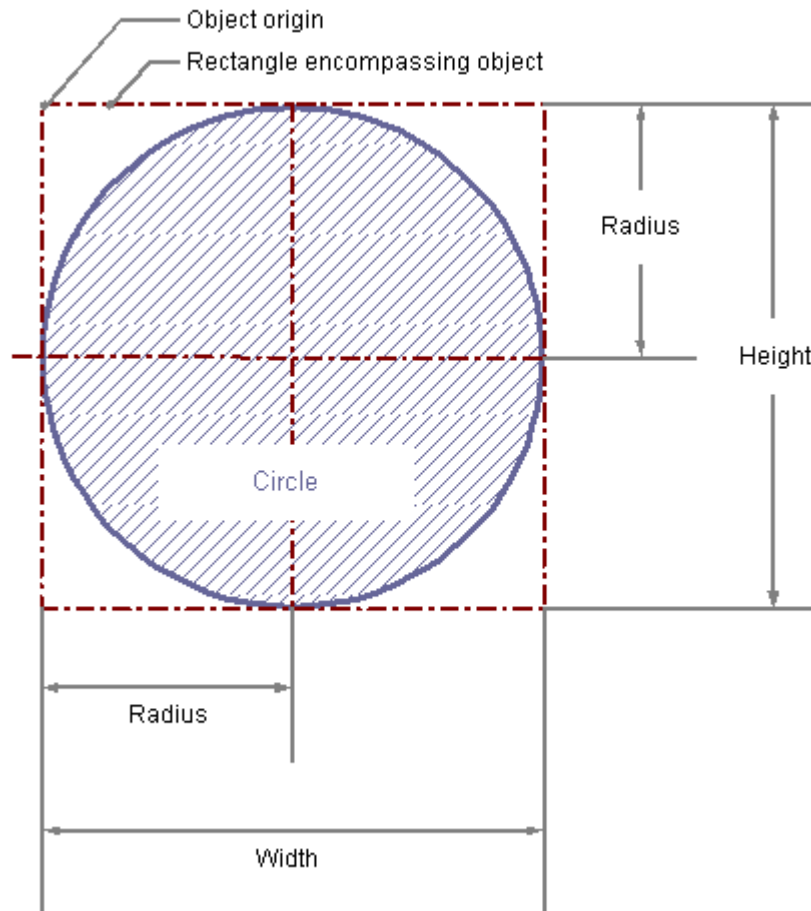

Drawing a circle

1. Open the picture into which you want to insert a circle.
2. Click the "Circle" standard object in the "Standard" selection window.
3. Place the mouse pointer at the position in the picture where you want to insert a circle. The mouse pointer changes into a crosshair with an object symbol attached.
4. Keeping the left mouse button pressed, drag the circle to the desired size. As soon as you release the mouse button, the circle is finished.

Alternative procedure

Double-click the circle in the "Standard" selection window.

A circle with default object properties is then inserted near the picture origin.

Changing a circle

Select an object of the circle type if you wish to carry out one of the following changes:

Rectangle surrounding the object

Drag the rectangle surrounding the object to the new position in order to arrange the object in the picture.

Drag the handles on the rectangle surrounding the object to a new position in order to resize the object.

Palettes and toolbars

Use the color palette to change the colors.

Use elements of the style palette to change the display style for the object.

Attributes

Open the "Object Properties" window to change the current values of the required attributes.

See also

Basic Static Operations (Page 459)

Basic Dynamic Operations (Page 485)

The Properties of an Object (Page 511)

Working with Standard Objects (Page 565)

3.8.6.7 How to Draw an Ellipse Segment

Introduction

The ellipse segment is a closed object that can be filled with a color or pattern.

The height and width of an ellipse segment can be modified as desired to allow it to be aligned horizontally or vertically.

An ellipse segment is by default a quarter ellipse and can be configured after it has been created. Even if the values of the start angle and end angle are identical, an ellipse segment does not turn into a closed ellipse.

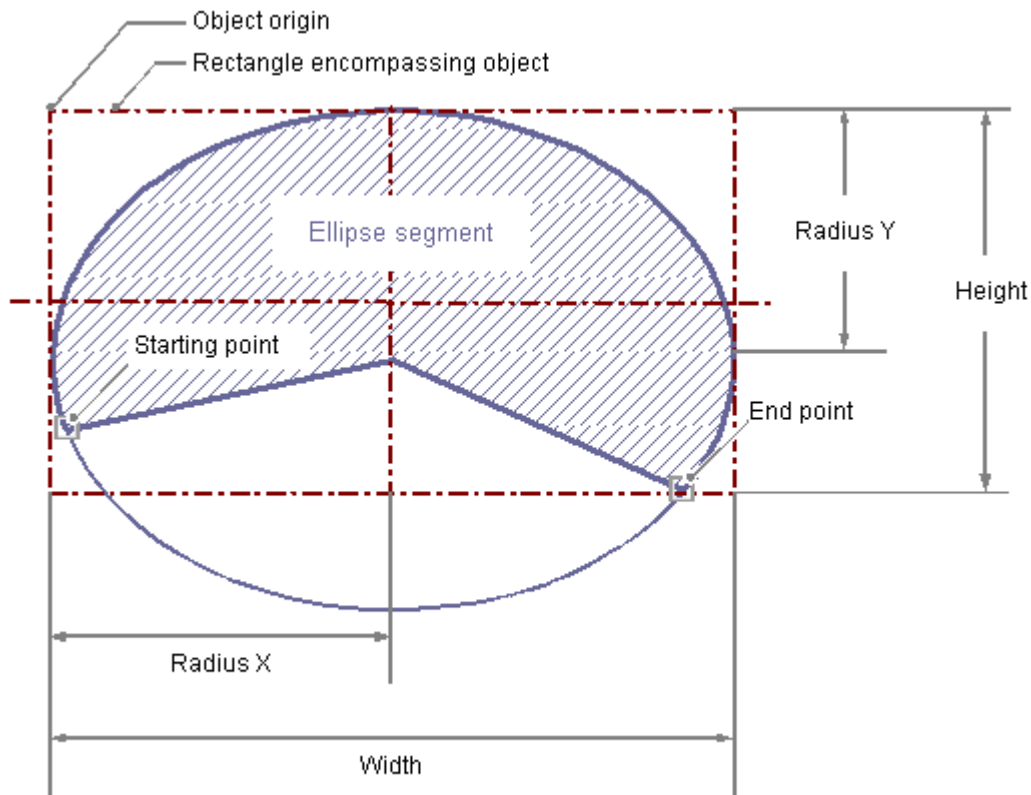

Drawing an ellipse segment

1. Open the picture in which you want to insert a ellipse segment.
2. Click the "Ellipse segment" standard object in the "Standard" selection window.
3. Place the mouse pointer at the position in the picture where the ellipse segment is to have its center point.
The mouse pointer changes into a crosshair with an object symbol attached.
4. Hold down the mouse button and drag the ellipse segment to the desired size.
As soon as you release the mouse button, the insertion process is finished.
If you hold down the <SHIFT> key while drawing, the "Ellipse Segment" object is created in the shape of a pie segment.
5. The start and end points of the ellipse segment are shown by small gray squares.
Place the mouse pointer on one of these squares.
The mouse pointer changes to a crosshair with A (start angle) or E (end angle) above it.
6. Drag the start or end point to the desired position while holding down the mouse button.

Alternative procedure

Double-click the ellipse segment in the "Standard" selection window.

An ellipse segment with default object properties is then inserted near the picture origin.

Changing an ellipse segment

Select an object of the ellipse segment type if you wish to carry out one of the following changes:

Rectangle surrounding the object

Drag the rectangle surrounding the object to the new position in order to arrange the object in the picture.

Drag the handles on the rectangle surrounding the object to a new position in order to resize the object.

Palettes and toolbars

Use the elements of the object palette to mirror or rotate the object.

Use the color palette to change the colors.

Use elements of the style palette to change the display style for the object.

Attributes

Open the "Object Properties" window to change the current values of the required attributes.

Adjusting the size of the ellipse segment

The length of the ellipse segment is set by the "Start Angle" and "End Angle" attributes. They specify the angle in degrees by which the start and end angle of the object deviate from the zero position (0°).

The start and end points of the ellipse segment are shown by small gray squares.

Place the mouse pointer on one of these squares. The mouse pointer changes to a crosshair with A (start angle) or E (end angle) above it.

Drag the start or end point to the desired position while holding down the mouse button.

See also

Basic Static Operations (Page 459)

Basic Dynamic Operations (Page 485)

The Properties of an Object (Page 511)

Working with Standard Objects (Page 565)

3.8.6.8 How to Draw a Pie Segment

Introduction

The pie segment is a closed object that can be filled with a color or pattern.

A pie segment can be resized at will.

A pie segment is by default a quarter circle and can be configured after it has been created. Even if the values of the start angle and end angle are identical, a pie segment does not turn into a closed circle.

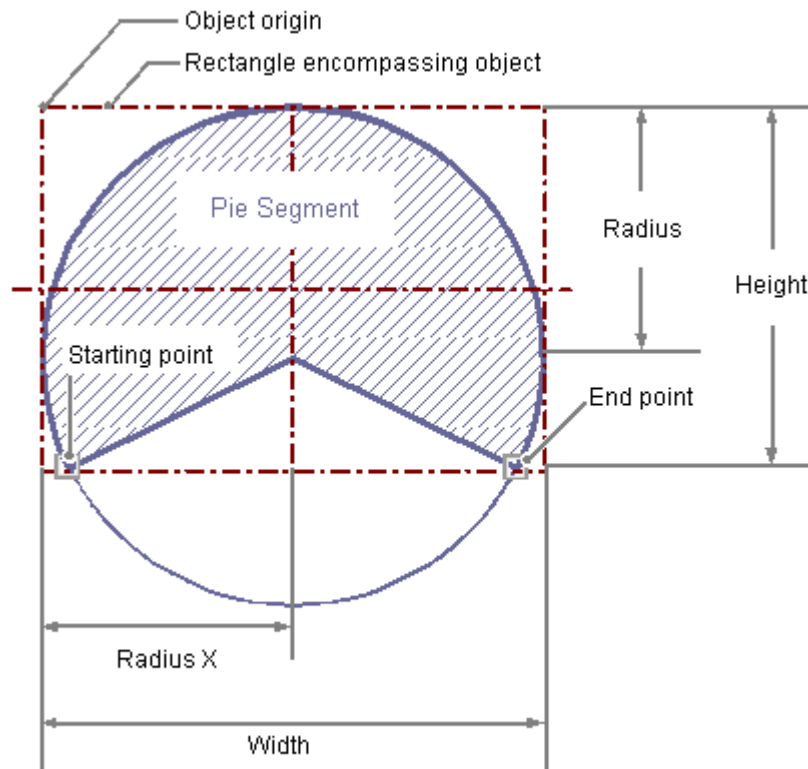

Drawing a pie segment

1. Open the picture in which you want to insert a pie segment.
2. Click the "Pie segment" standard object in the "Standard" selection window.
3. Place the mouse pointer at the position in the picture where the pie segment is to have its center point.
The mouse pointer changes into a crosshair with an object symbol attached.
4. Hold down the mouse button and drag the pie segment to the desired size.
As soon as you release the mouse button, the insertion process is finished.
5. The start and end points of the pie segment are shown by small gray squares.
Place the mouse pointer on one of these squares.
The mouse pointer changes to a crosshair with A (start angle) or E (end angle) above it.
6. Drag the start or end point to the desired position while holding down the mouse button.

Alternative procedure

Double-click the pie segment in the "Standard" selection window.

A pie segment with default object properties is then inserted near the picture origin.

Changing a pie segment

Select an object of the pie segment type if you wish to carry out one of the following changes:

Rectangle surrounding the object

Drag the rectangle surrounding the object to the new position in order to arrange the object in the picture.

Drag the handles on the rectangle surrounding the object to a new position in order to resize the object.

Palettes and toolbars

Use the elements of the object palette to mirror or rotate the object.

Use the color palette to change the colors.

Use elements of the style palette to change the display style for the object.

Attributes

Open the "Object Properties" window to change the current values of the required attributes.

Configuring size of the pie segment

The size of the pie segment is set by the "Start Angle" and "End Angle" attributes. They specify the angle in degrees by which the start and end angle of the object deviate from the zero position (0°).

The start and end points of the pie segment are shown by small gray squares.

Place the mouse pointer on one of these squares. The mouse pointer changes to a crosshair with A (start angle) or E (end angle) above it.

Drag the start or end point to the desired position while holding down the mouse button.

See also

How to change the default setting of object types (Page 457)

The Properties of an Object (Page 511)

Working with Standard Objects (Page 565)

3.8.6.9 How to draw an Ellipse Arc

Introduction

The ellipse arc is an open object. Even if the values of the start angle and end angle are identical, an ellipse arc does not turn into a closed ellipse.

The height and width of an ellipse arc can be modified as desired to allow it to be aligned horizontally or vertically.

An ellipse arc is by default a quarter ellipse and can be configured after it has been created.

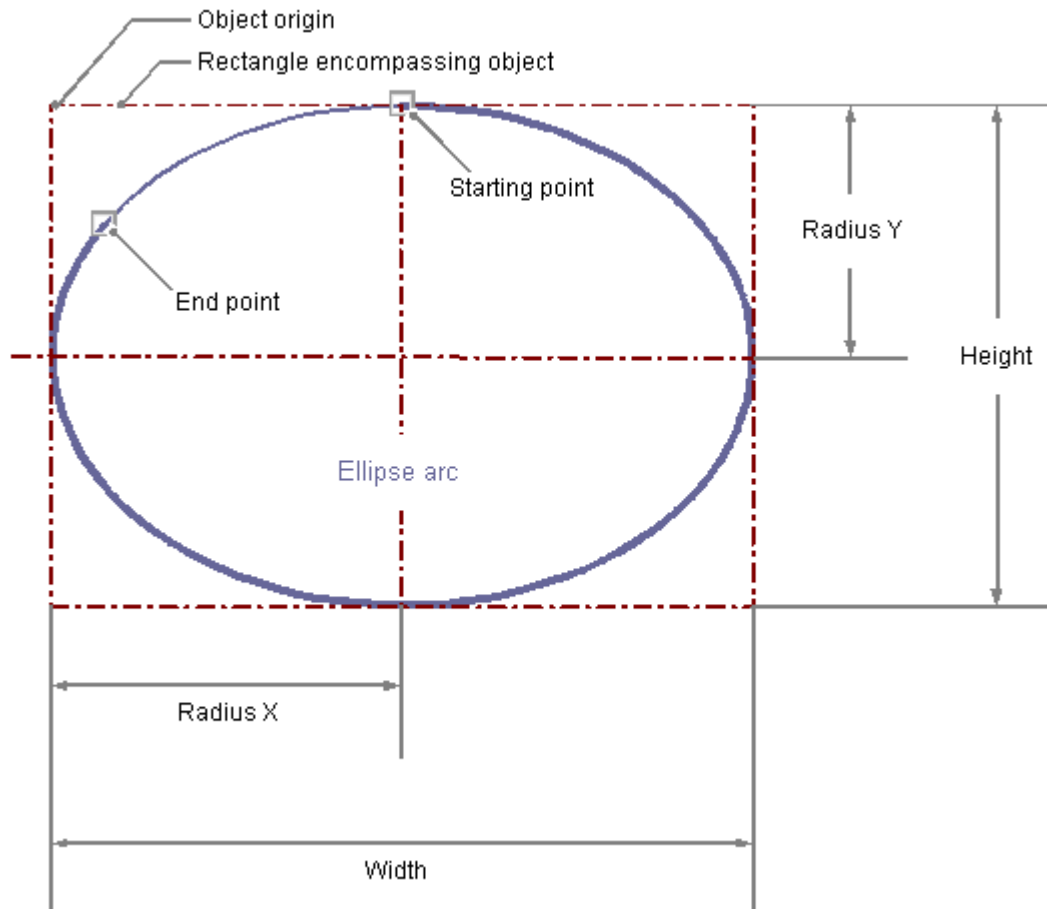

Drawing an ellipse arc

1. Open the picture in which you want to insert an ellipse arc.
2. Click the "Ellipse arc" standard object in the "Standard" selection window.
3. Place the mouse pointer at the position in the picture where the ellipse arc is to have its center point.
The mouse pointer changes into a crosshair with an object symbol attached.
4. Keeping the left mouse button pressed, drag the ellipse arc to the desired size.
As soon as you release the mouse button, the insertion process is finished.
If you hold down the <SHIFT> key while drawing, the "Ellipse Arc" object is created in the shape of a circular arc.
5. The start and end points of the ellipse arc are shown by small gray squares.
Place the mouse pointer on one of these squares.
The mouse pointer changes to a crosshair with A (start angle) or E (end angle) above it.
6. Drag the start or end point to the desired position while holding down the mouse button.

Alternative procedure

Double-click the ellipse arc in the "Standard" selection window.

An ellipse arc with default object properties is then inserted near the picture origin.

Changing an ellipse arc

Select an object of the Ellipse Arc type if you wish to carry out one of the following changes:

Rectangle surrounding the object

Drag the rectangle surrounding the object to the new position in order to arrange the object in the picture.

Drag the handles on the rectangle surrounding the object to a new position in order to resize the object.

Palettes and toolbars

Use the elements of the object palette to mirror or rotate the object.

Use the color palette to change the colors.

Use elements of the style palette to change the display style for the object.

Attributes

Open the "Object Properties" window to change the current values of the required attributes.

Setting the length of the ellipse arc

The length of the ellipse arc is set by the "Start Angle" and "End Angle" attributes. They specify the angle in degrees by which the start and end angle of the object deviate from the zero position (0°).

The start and end points of the ellipse arc are shown by small gray squares.

Place the mouse pointer on one of these squares. The mouse pointer changes to a crosshair with A (start angle) or E (end angle) above it.

Drag the start or end point to the desired position while holding down the mouse button.

See also

Basic Static Operations (Page 459)

Basic Dynamic Operations (Page 485)

The Properties of an Object (Page 511)

Working with Standard Objects (Page 565)

3.8.6.10 How to Draw a Circular Arc

Introduction

The circular arc is an open object. Even if the values of the start angle and end angle are identical, a circular arc does not turn into a closed circle.

A circular arc can be resized at will.

A circular arc is by default a quarter circle and can be configured after it has been created.

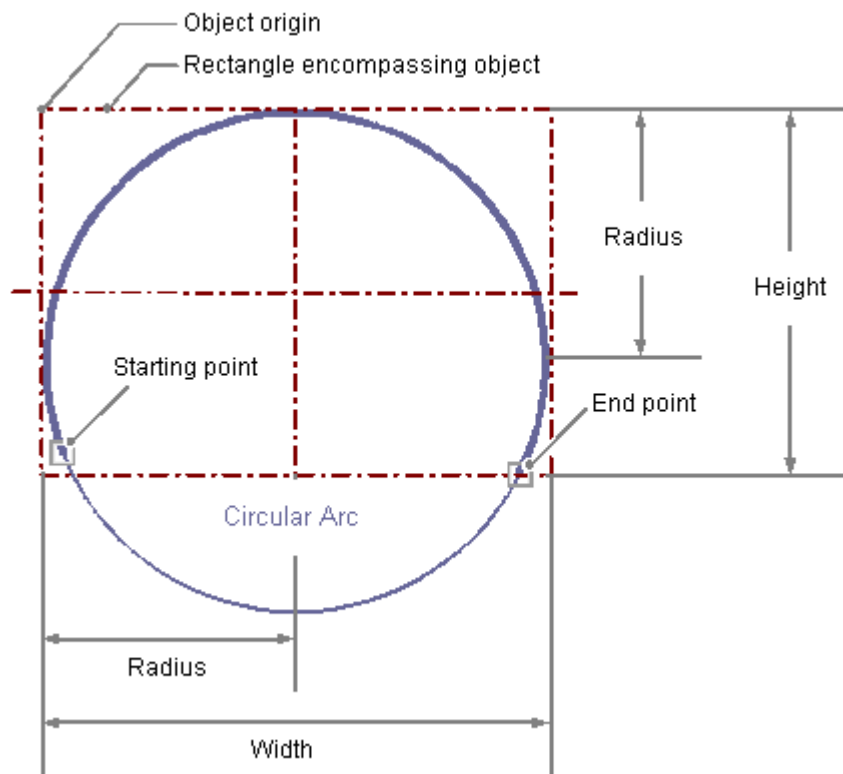

Drawing a circular arc

1. Open the picture into which you want to insert a circular arc.
2. Click the "Circular arc" standard object in the "Standard" selection window.
3. Place the mouse pointer at the position in the picture where the circular arc is to have its center point.
The mouse pointer changes into a crosshair with an object symbol attached.
4. Keeping the left mouse button pressed, drag the circular arc to the desired size.
As soon as you release the mouse button, the insertion process is finished.

5. The start and end points of the circular arc are shown by small gray squares.
Place the mouse pointer on one of these squares.
The mouse pointer changes to a crosshair with A (start angle) or E (end angle) above it.
6. Drag the start or end point to the desired position while holding down the mouse button.

Alternative procedure

Double-click the circular arc in the "Standard" selection window.

A circular arc with default object properties is then inserted near the picture origin.

Changing a circular arc

Select an object of the Circular Arc type if you wish to carry out one of the following changes:

Rectangle surrounding the object

Drag the rectangle surrounding the object to the new position in order to arrange the object in the picture.

Drag the handles on the rectangle surrounding the object to a new position in order to resize the object.

Palettes and toolbars

Use the elements of the object palette to mirror or rotate the object.

Use the color palette to change the colors.

Use elements of the style palette to change the display style for the object.

Attributes

Open the "Object Properties" window to change the current values of the required attributes.

Configuring the length of the circular arc

The length of the circular arc is set by the "Start Angle" and "End Angle" attributes. They specify the angle in degrees by which the start and end angle of the object deviate from the zero position (0°).

The start and end points of the circular arc are shown by small gray squares.

Place the mouse pointer on one of these squares. The mouse pointer changes to a crosshair with A (start angle) or E (end angle) above it.

Drag the start or end point to the desired position while holding down the mouse button.

See also

Basic Static Operations (Page 459)

Basic Dynamic Operations (Page 485)

The Properties of an Object (Page 511)

Working with Standard Objects (Page 565)

3.8.6.11 How to Draw a Rectangle

Introduction

The rectangle is a closed object that can be filled with a color or pattern.

The height and width of a rectangle can be modified as desired to allow it to be aligned horizontally or vertically.

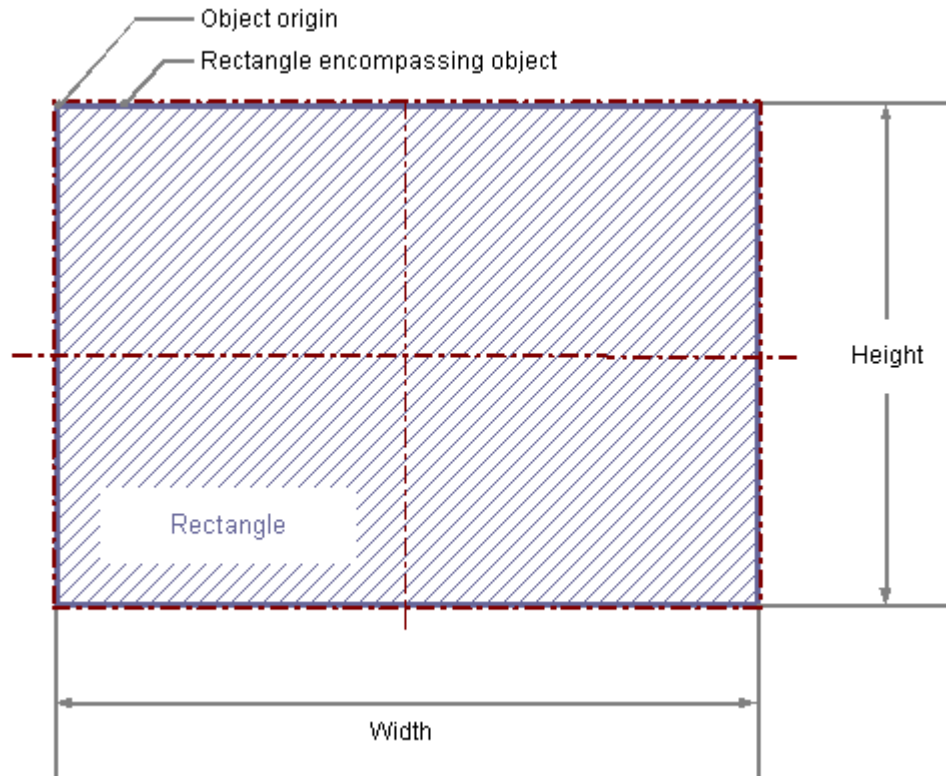

Drawing a rectangle

1. Open the picture into which you want to insert a rectangle.
2. Click the "Rectangle" standard object in the "Standard" selection window.
3. Place the mouse pointer at the position in the picture where you want to insert a rectangle. The mouse pointer changes into a crosshair with an object symbol attached.
4. Hold down the mouse button and drag the rectangle to the desired size. As soon as you release the mouse button, the rectangle is finished. If you hold down the <SHIFT> key while drawing, the "Rectangle" object is created in the shape of a square.

Alternative procedure

Double-click the rectangle in the "Standard" selection window.

A rectangle with default object properties is then inserted near the picture origin.

Changing a rectangle

Select an object of the Rectangle type if you wish to carry out one of the following changes:

Rectangle surrounding the object

Drag the rectangle surrounding the object to the new position in order to arrange the object in the picture.

Drag the handles on the rectangle surrounding the object to a new position in order to resize the object.

Palettes and toolbars

Use the elements of the object palette to mirror or rotate the object.

Use the color palette to change the colors.

Use elements of the style palette to change the display style for the object.

Attributes

Open the "Object Properties" window to change the current values of the required attributes.

See also

Basic Static Operations (Page 459)

Basic Dynamic Operations (Page 485)

The Properties of an Object (Page 511)

Working with Standard Objects (Page 565)

3.8.6.12 How to Draw a Rounded Rectangle

Introduction

The rounded rectangle is a closed object that can be filled with a color or pattern.

The height and width of a rounded rectangle can be modified as desired to allow it to be aligned horizontally or vertically.

The corners of a rounded rectangle can be rounded as much as desired.

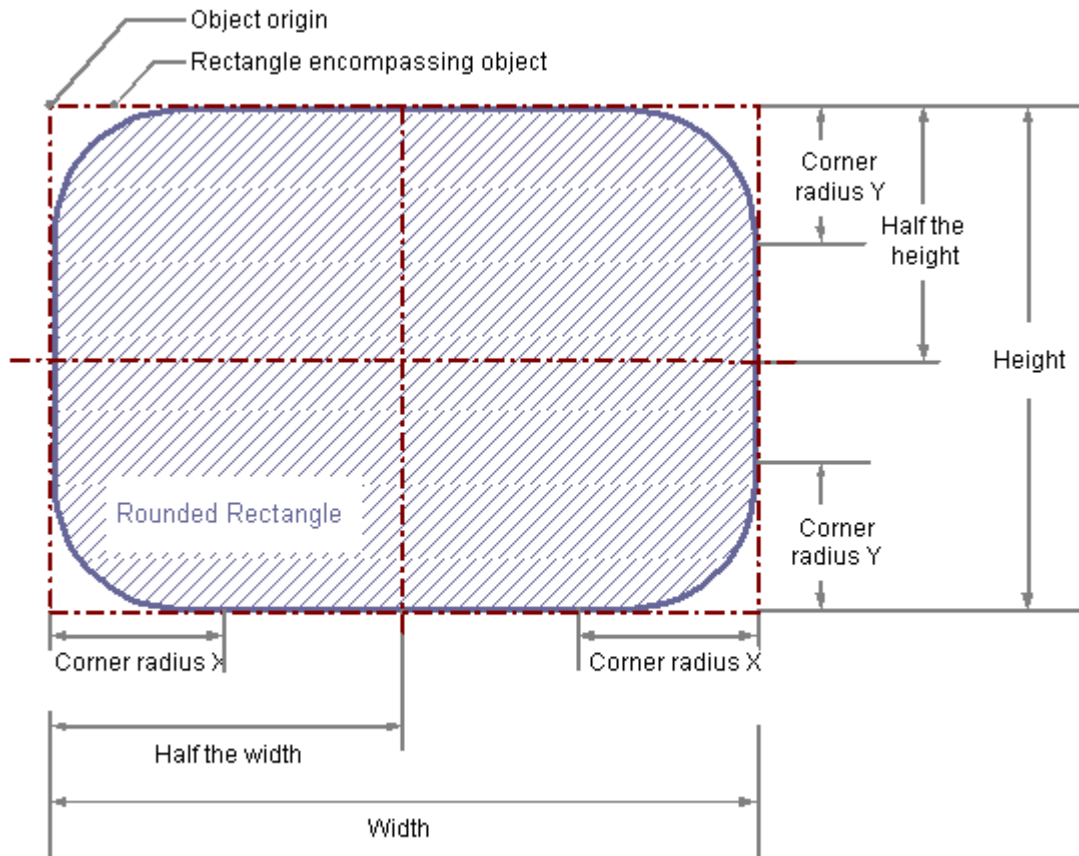

Drawing a rounded rectangle

1. Open the picture into which you want to insert a rounded rectangle.
2. Click the "Rounded rectangle" standard object in the "Standard" selection window.
3. Place the mouse pointer at the position in the picture where you want to insert a rounded rectangle.
The mouse pointer changes into a crosshair with an object symbol attached.
4. Hold down the mouse button and drag the rounded rectangle to the desired size.
As soon as you release the mouse button, the rectangle is finished.
If you hold down the <SHIFT> key while drawing, the "Rounded Rectangle" object is created in the shape of a square.

Alternative procedure

Double-click the rounded rectangle in the "Standard" selection window.

A rounded rectangle with default object properties is then inserted near the picture origin.

Changing a rounded rectangle

Select an object of the rounded rectangle type if you wish to carry out one of the following changes:

Rectangle surrounding the object

Drag the rectangle surrounding the object to the new position in order to arrange the object in the picture.

Drag the handles on the rectangle surrounding the object to a new position in order to resize the object.

Palettes and toolbars

Use the elements of the object palette to mirror or rotate the object.

Use the color palette to change the colors.

Use elements of the style palette to change the display style for the object.

Attributes

Open the "Object Properties" window to change the current values of the required attributes.

Changing corner radii

The radii for rounding the corners of the rounded rectangle are specified with the "corner radius X" and "corner radius Y" attributes.

They define the horizontal or vertical distance between the corners of the rectangle around the object and the starting point of the corner rounding.

The value is specified as a percentage of the half width and the half height of the object.

Corner radius "100%"

If the "Corner Radius X" and "Corner Radius Y" attributes are both set to the value 100%, the rounded rectangle is displayed as an ellipse or circle.

The rectangle is shown without rounded corners when either one of the two attributes is set to 0%.

See also

Basic Static Operations (Page 459)

Basic Dynamic Operations (Page 485)

The Properties of an Object (Page 511)

Working with Standard Objects (Page 565)

3.8.6.13 How to Insert Static Text

Introduction

The field for static text is a closed object that can be filled with a color or pattern.

The static text is entered into a field of any desired size.

One-line or multiline text can be input for all design languages.

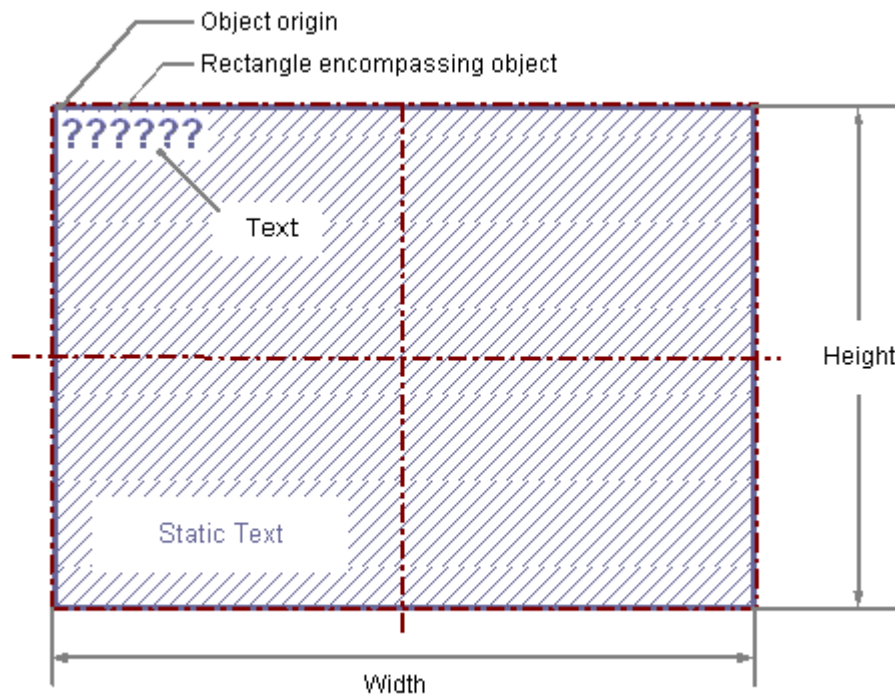

Inserting static text

1. Open the picture in which you want to insert static text.
2. Click the "Static text" standard object in the "Standard" selection window.
3. Place the mouse pointer at the position in the picture where you want to insert static text. The mouse pointer changes into a crosshair with an object symbol attached.
4. Keeping the left mouse button pressed, drag the text field to the desired size. As soon as you release the mouse button, the field for the static text is finished. Several highlighted question marks appear in the field. If you hold down the <SHIFT> key while drawing, the "Static Text" object is created in the shape of a square.

5. Overwrite the question marks with the desired text.
For a multiple row text, create a line break with key combination <SHIFT+ENTER> or <CTRL+M>.
6. Press <ENTER> to finish text input.

Alternative procedure

Double-click the static text in the "Standard" selection window.

A static text with default object properties is then inserted near the picture origin.

Changing static text

Select an object of the rounded rectangle type if you wish to carry out one of the following changes:

Rectangle surrounding the object

Drag the rectangle surrounding the object to the new position in order to arrange the object in the picture.

Drag the handles on the rectangle surrounding the object to a new position in order to resize the object.

Palettes and toolbars

Use the elements of the object palette to mirror and rotate the object.

Use the elements of the font palette to change the font display.

Use the color palette to change the colors.

Use elements of the style palette to change the display style for the object.

Attributes

Open the "Object Properties" window to change the current values of the required attributes.

Changing the Contents of the Static Text

Double-click the static text to open the input mode for text. The complete text is selected.

Position the insertion point with another click at the position in the text at which you want to change something.

Line breaks must be entered manually: Create a line break with key combination <SHIFT+ENTER> or <CTRL+M>.

A line brake is shown in the "Object Properties" window in the "Static" column as a control character.

Configuring rotation in Runtime

The static text can be rotated around a reference point in Runtime.

The rotation is defined by the attributes "Rotation Reference X", "Rotation Reference Y" and "Rotation Angle". The rotation is displayed in Graphics Designer during configuration.

Rotation of a group

In order to rotate static text in a group object, watch for the following:

The current position and the rotation angle of the object "Static text" in Runtime are always the result of the current values of properties "RotationReferenceX", "RotationReferenceY" and "Rotation Angle". The orientation of static text depends on the sequence in which these properties were applied.

If the rotation references refer to the group object, the display in Runtime may deviate from the display in the configuration system. This is caused by the fact that the sequence in which these properties are updated is not always the same due to system constraints.

You avoid unexpected display problems in Runtime, if you do not dynamize the properties RotationReferenceX, RotationReferenceY and RotationAngle directly at the group object. Instead, perform the dynamization directly at the respective object "Static Text" within the group object.

See also

Basic Static Operations (Page 459)

Basic Dynamic Operations (Page 485)

The Properties of an Object (Page 511)

Working with Standard Objects (Page 565)

3.8.6.14 How to use the connector

Introduction

The connector is a linear object whose ends can be connected with the connection points of other objects. Multiple connectors can also be connected together.

The number and arrangement of the connection points depend on the specific object type.

If connected objects are moved, the connector's length and direction are automatically adapted and the connection is retained.

You can choose between two connection types:

In the case of "Automatic" connection type, the connector is comprised of horizontal and vertical parts.

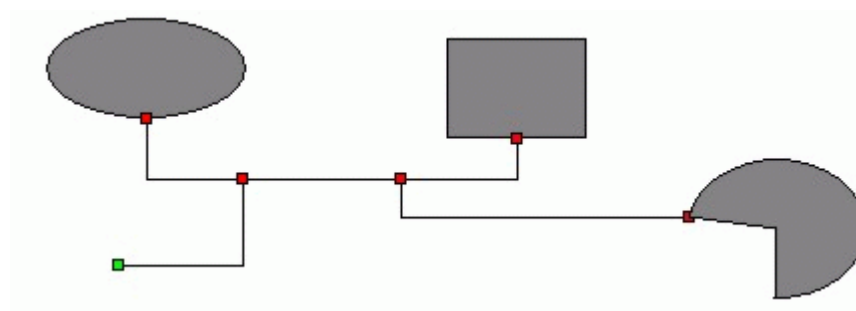

If the connection type "Simple" is selected, the connecting points are connected by a straight line.

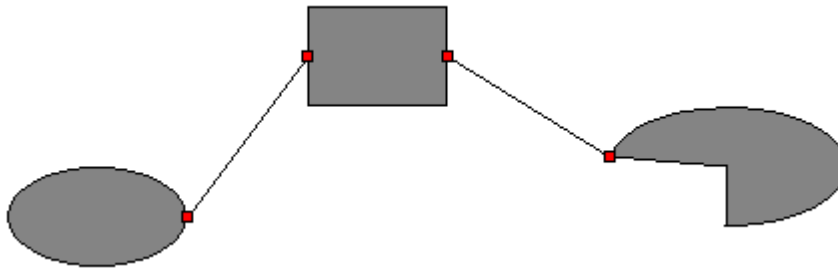

The start and end of a selected connector can be highlighted by small colored rectangles to show their status:

- Green rectangles identify unconnected ends
- Red rectangles identify connected ends

Inserting a connector

1. Open the picture in which you want to insert a connector.
2. Click the "Connector" standard object in the "Standard" selection window.
3. Place the mouse pointer at the position in the picture where you want to insert a connector. The mouse pointer changes into a crosshair with an object symbol attached.
4. Keeping the left mouse button pressed, drag the connector to the desired size. As soon as you release the mouse button, the insertion process is finished. The connector is displayed as a selected object with green ends.

Alternative procedure

Double-click the connector in the "Standard" selection window.

A connector with default object properties is then inserted near the picture origin.

Changing a connector

Select an object of the connector type if you wish to carry out one of the following changes:

Palettes and toolbars

Use the color palette to change the colors.

Use elements of the style palette to change the display style for the object.

Attributes

Open the "Object Properties" window to change the current values of the required attributes.

Connecting objects

1. Select the connector you want to use to connect two objects.
The start and end of the connector are symbolized by small green rectangles.
2. Drag the start of the connector to the first object to be connected without releasing the mouse button.
The red connection points of the object to be connected to the start are displayed.
3. Position the start of the connector on the desired connection point of the object.
As soon as you release the mouse button, the connection to the first object is established.
The start of the selected connector turns red and the other unconnected end is green.
4. Drag the end of the connector to the second object to be connected without releasing the mouse button.
The red connection points of the object to be connected to the end are displayed.

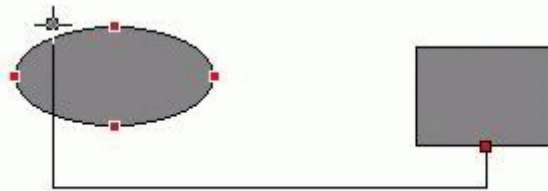

5. Position the end of the connector on the desired connection point of the second object.
As soon as you release the mouse button, the connection is finished.
The beginning and end of the selected connector are now symbolized by red rectangles.
The position of the connected objects can be changed as needed.

Changing a connection

Select the connector and drag one end of the connector to the new position.

For example, you can connect the end to another connection point of the same object, or to a connection point on a new object.

Alternatively you can change the attributes of the "Connected Objects" property group in the "Object Properties" window.

The type of connector can be changed within the "Connected objects" property group using the "Connection type" attribute. Select between the two connection types "Automatic" and "Simple".

Deleting a connection

Select the desired connector and press to delete the "Connector" object.

See also

"Connected Objects" Property Group (Page 554)

Basic Static Operations (Page 459)

Basic Dynamic Operations (Page 485)

The Properties of an Object (Page 511)

Working with Standard Objects (Page 565)

3.8.7 Working with Smart Objects





3.8.7.1 Working with Smart Objects











Introduction







Smart objects offer the option of building complex system pictures. The smart objects include items such as various windows, fields and bars, which offer a variety of dynamic options.

In the Graphics Designer, the various object types have default properties. When added, objects take on these defaults, with the exception of individual geometric properties. After inserting the properties you can modify the properties of an object. In the same way, you can adapt the default settings for the object types as required.

Overview

Icon	Object	Description
	Application window	The application window is an object that can be provided from applications of the global script and the logging system. In Runtime, these applications open an application window, transfer information and enable operation. The size and properties which an application window accepts in Runtime are defined in the Graphics Designer.
	Picture window	The picture window offers the option of displaying other pictures that were created with the Graphics Designer in the current picture. For example, with dynamics the contents of a picture window can be continuously updated. The size and properties that a picture window has in Runtime are defined in the Graphics Designer.
	Control	The Object Control provides the option to integrate system process control and monitoring elements into a picture. Controls are prefinished objects such as for example alarm windows, measurement value windows, selection dialogs or buttons. ActiveX Controls, WinCC Controls and controls from other manufacturers are available if they are registered in the operating system. These are changed as required and dynamically integrated into the process. The size and properties which a control accepts in Runtime are defined in the Graphics Designer.
	OLE object	The OLE object enables files created in other programs to be inserted into a picture. Therefore all OLE object registered in the operating system can be integrated. The size and properties which an OLE object accepts in Runtime are defined in the Graphics Designer. No changes can be made to OLE objects in Runtime.

Icon	Object	Description
	I/O field	The I/O Field can be defined as an input field, an output field or a combined input/output field. The following data formats are available: Binary, decimal, string and hexadecimal. Limit values such as "Hidden Input" or "Accept on complete input" can also be specified. The size and properties which an I/O Field accepts in Runtime are defined in the Graphics Designer.
	Bar	The bar offers the option of displaying values graphically. The values can also be displayed in a combined view as graphics with freely definable number scale. The size and properties which a bar accepts in Runtime are defined in the Graphics Designer.
	Graphic object	The graphic object enables graphics created in other programs to be inserted into a picture. Graphics and pictures of the following formats can be inserted: EMF, WMF, DIB, BMP (up to 32 Bit), GIF, JPEG, ICO and PNG ¹⁾ . The size and properties which a graphic object accepts in Runtime are defined in the Graphics Designer. ¹⁾ PNG: Not possible with the global design "WinCC Classic".
	Status display	The status display offers the option to display almost any number of different states of an object. The states are implemented via tags whose value corresponds to the respective state. The states are displayed via the assigned pictures. The size and properties which a status display accepts in Runtime are defined in the Graphics Designer.
	Text list	The text list offers the option of assigning specific values to a text. The text list can be defined as an input list, an output list or as a combined input/output list. The following data formats are available: Decimal, binary or bit. The size and properties which a text list has in Runtime are defined in the Graphics Designer.
	Multiple row text	The Multiline Text object makes it possible to display text over several lines in a rectangular, scrolling field and to edit it in runtime. The size and properties which a multiline text takes on in Runtime are defined in the Graphics Designer.
	Combo box	The combo box makes it possible to display a drop-down list of several values and to use the selection as the input. The size and properties which a combobox takes on in runtime are defined in the Graphics Designer.
	List box	The list box makes it possible to highlight a scrolling list of several values and to use the selection as an input. The size and properties which a list box accepts in Runtime are defined in the Graphics Designer.
	Faceplate instance	You can insert a faceplate instance into the picture with the faceplate instance object. Faceplate types must first be saved on your system. The size and properties which a faceplate instance has in runtime are defined in the Graphics Designer.
	.NET Control	You insert a .NET application (Assembly) as a control into your picture with the .NET control object. The size and properties which a .NET control takes on in runtime are defined in the Graphics Designer.

Icon	Object	Description
	WPF Control	The WPF control object makes it possible to insert a WPF file into your picture as a control. The size and properties which a WPF control accepts in Runtime are defined in the Graphics Designer.
	3D bar	The 3D bar graph enables values to be displayed graphically three-dimensionally. The size and properties which a 3D bar has in Runtime are defined in the Graphics Designer. The 3D bar is only available if the "Basic Process Control" optional package was installed with WinCC.
	Group Display	The group display enables the current states of certain message types to be displayed by hierarchy. Five buttons allow messages to be represented and operated. Using a group display, you can configure a quick change to represent an error source for example. The size and properties which a group display accepts in Runtime are defined in the Graphics Designer. The group display is only available if the "Basic Process Control" optional package was installed with WinCC.
	Status display (Ext.)	You can use an extended status display to assign "Came In" (+), "Came In Acknowledged" (+Q) and "Went Out Unacknowledged" (-) and "OK" picture statuses. The sizes and properties of the extended status display in runtime are defined in the Graphics Designer. Extended status display is available only when a PCS 7 OS is installed.
	Analog display (Ext.)	The extended analog display is used to display the value of a tag in different colors depending on the alarm status of a component. The sizes and properties of the extended analog display in runtime are defined in the Graphics Designer. Extended analog display is available only when a PCS 7 OS is installed.
	DataSet	DataSet serves as a container for the internal storage of data of the user objects or faceplate types. The object does not have a graphical user interface in Runtime. Create the object attributes in the configuration dialog.
	SVG object	The SVG object enables SVG graphics created in other programs to be inserted into a picture. The size and properties that a SVG object assumes in Runtime are defined in the Graphics Designer. The SVG object is not supported by the global design "WinCC Classic".

See also

- How to add an SVG object (Page 677)
- How to Insert an Application Window (Page 602)
- How to insert a picture window (Page 605)
- How to insert a control (Page 608)
- How to Insert an OLE Object (Page 610)
- How to insert an I/O field (Page 612)
- How to insert a bar (Page 623)
- How to insert a graphic object (Page 631)

How to insert a status display (Page 633)
How to add a text list (Page 639)
How to insert multiline text (Page 649)
How to insert a combobox (Page 651)
How to insert a list box (Page 653)
How to insert a Faceplate instance (Page 655)
How to insert a .NET control (Page 656)
How to insert a WPF control (Page 658)
How to Insert a 3D Bar (Page 659)
How to Insert a Group Display (Page 662)
How to change the default setting of object types (Page 457)
Basic Static Operations (Page 459)
Basic Dynamic Operations (Page 485)
Controls (Page 341)
The Coordinate System of a Process Picture (Page 319)
The Coordinate System of an Object (Page 321)
The Rectangle Surrounding the Object (Page 323)
Working with Combined Objects (Page 709)
Working with Objects (Page 456)

3.8.7.2 How to Insert an Application Window

Introduction

The application window is an object that is provided from applications of the global script and the logging system. In Runtime, these applications open an application window, transfer information and enable operation. The size and properties which an application window accepts in Runtime are defined in the Graphics Designer.

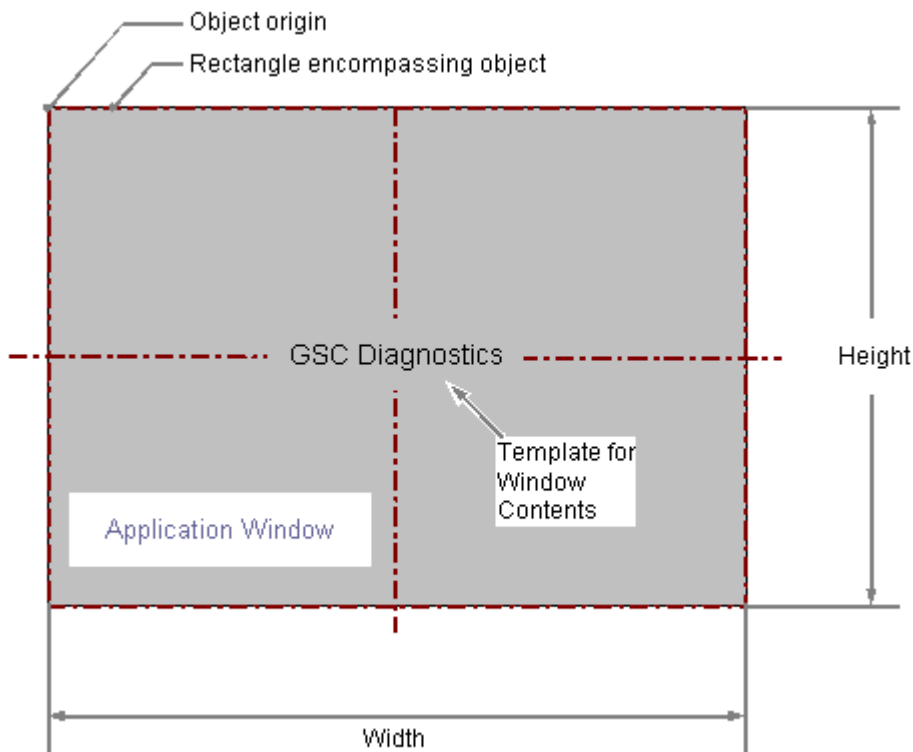

Inserting an application window

1. Open the picture in which you want to insert an application window.
2. Click the "Application window" smart object in the "Standard" selection window.
3. Keeping the left mouse button pressed, drag the object in the desired area of the picture to the desired size.
When you release the mouse button, the object is inserted into the corresponding location in the picture. The "Window Contents" dialog opens.

4. In the "Window Contents" dialog, select the required display option and confirm your entry with "OK".
The "Template" dialog opens.
5. In the "Template" dialog, select a template for the selected display option and confirm your entry with "OK".
The insertion of the "Application window" object is completed.

Alternatively, you can double-click the "Application window" smart object in the "Standard" selection window. An application window with the default object properties is then inserted near the picture origin. The "Window Contents" and "Template" dialogs open. The insertion process is finished when you confirm your inputs with "OK".

If you press and hold down <SHIFT> during the size change, the "Application window" object takes on the shape of a square.

Changing an application window

Select an object of the application window type if you wish to carry out one of the following changes:

Rectangle surrounding the object

Drag the rectangle surrounding the object to the new position in order to arrange the object in the picture.

Drag the handles on the rectangle surrounding the object to a new position in order to resize the object.

Attributes

Open the "Object Properties" window to change the current values of the required attributes.

Configuring the window contents and template

The contents of the application window are changed with the "Window Contents" and "Template" attributes.

The "Window Contents" attribute specifies for an application window which application is to be displayed. The "Template" attribute specifies the template for displaying the window contents. Depending on the value of the "Window Contents" attribute the following templates are available:

Window Contents = Global Script

- GSC Diagnostics
The application window is supplied by applications of the Global Script. The results of the diagnosis system are displayed.
- GSC Runtime
The application window is supplied by applications of the Global Script. The analysis results regarding characteristics in Runtime are displayed.

Window Contents = Print Jobs

- All Jobs
The application window is supplied by the report system. The available reports are displayed as a list.
- All Jobs – shortcut menu
The application window is supplied by the report system. The available reports are displayed as a list. The shortcut menu enables the selection of print options, display of a print preview as well as a printout of the log.
- Job Detail View
The application window is supplied by the report system. The available reports are displayed in a selection menu. Detailed information is displayed for the selected report.
- Selected Jobs - shortcut menu
The application window is supplied by the report system. The available reports are displayed as a list. This list only contains reports which you have activated the option "Mark for print job list" in the "Print Job Properties" dialog. The shortcut menu enables the selection of print options, display of a print preview as well as a printout of the log.

Window display in Runtime

The application window is displayed in Runtime as a separate window within a process picture. The characteristics of the window display can be configured with attributes of the "Miscellaneous" property group.

See also

- How to configure the display of windows (Page 559)
- Basic Static Operations (Page 459)
- Basic Dynamic Operations (Page 485)
- The Properties of an Object (Page 511)
- Working with Smart Objects (Page 598)

3.8.7.3 How to insert a picture window

Introduction

The picture window offers the option of displaying other pictures that were created with the Graphics Designer in the current picture. For example, you can continuously update the contents of a picture window with dynamics. The size and properties that a picture window has in runtime are defined in the Graphics Designer.

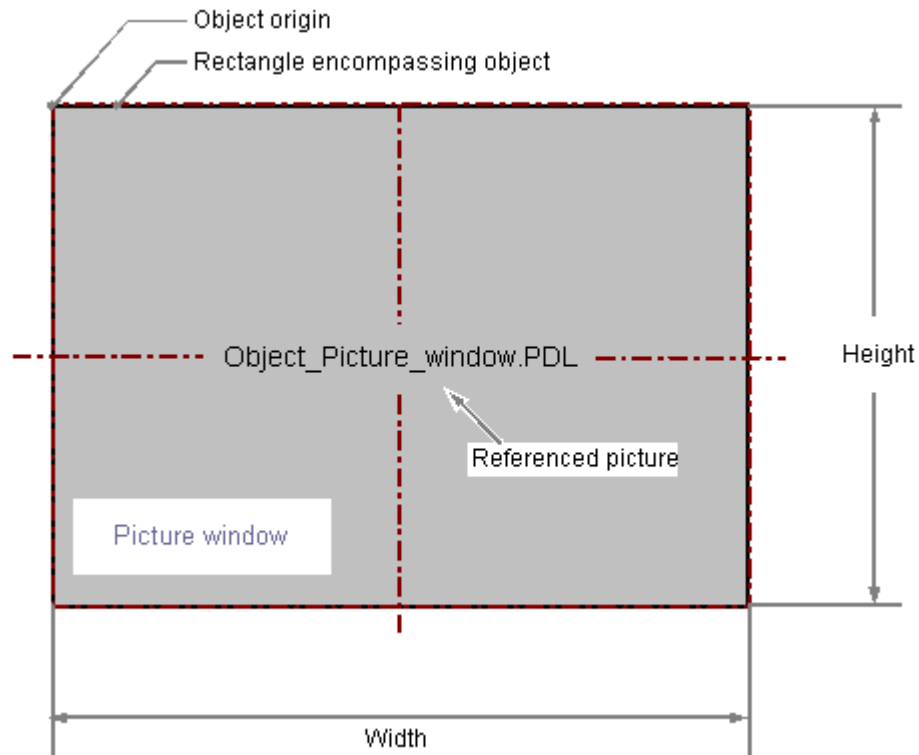

Inserting a picture window

1. Open the picture in which you want to insert a picture window.
2. Click the "Picture window" smart object in the "Standard" selection window.
3. Keeping the left mouse button pressed, drag the object in the desired area of the picture to the desired size.
When you release the mouse button, the object is inserted at the corresponding location in the picture.

Alternatively, you can double-click the "Picture window" object in the object palette. A picture window with default object properties is then inserted near the picture origin.

If you hold down the <Shift> key during insertion, the "Picture Window" object is created in the shape of a square.

Configuring picture windows

Double click to open the "Object properties" dialog, in which you define the picture to be displayed and the other attributes of the picture window.

Picture Name

Double-click the "Picture Name" attribute and select the "*.pdl" picture file that you want to display in the picture window.

The name is shown at the top of the picture window and the preview of the picture in the middle. If the picture does not exist, the "PDL" symbol appears. You can open the picture with <Ctrl + double-click>.

Open integrated picture

Use <Ctrl> and double click to immediately open the process picture integrated in the picture window.

Specify picture zoom area

To define the display of the picture in the picture window, activate one of the following properties:

- **Adapt Picture:**
The process picture is adapted to the size of the configured picture window.
- **Adapt Size:**
The picture window is adapted to the size of the contained picture. Take into account the size of the process picture in which the picture window is located.
If necessary, change the picture size using the scaling factor.
- **Scroll Bar:**
The picture is shown in its original size or with the selected scaling factor. If the configured picture window is smaller, scroll bars are displayed.

You can use the "Scaling factor" attribute to set the zoom factor for the display of the picture in the picture window.

You can display the integrated process picture in the picture window a zoom area (cut-out) as well. The origin of this zoom area is determined by the "Picture Offset X" and "Picture Offset Y" attributes.

You use the picture offset to define the fixed point for the scaling of the picture as well.

Picture offset X and picture offset Y

Original picture

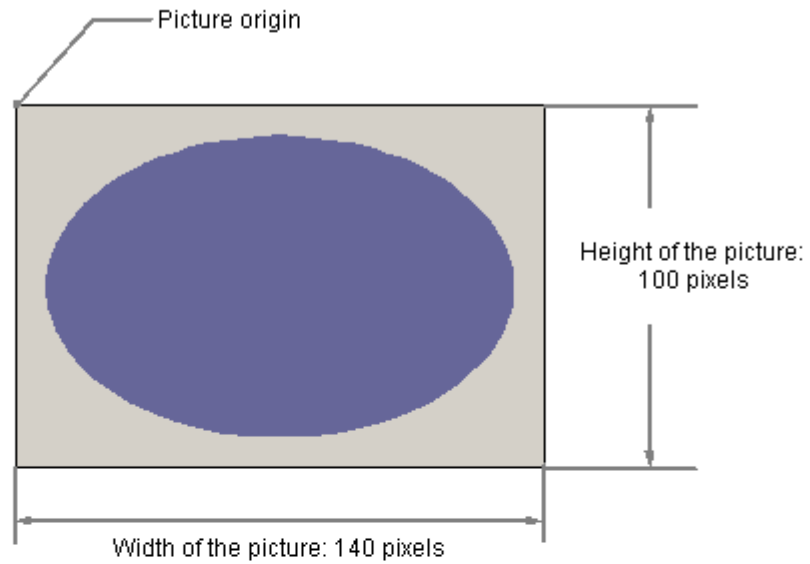

Original picture in Picture Window

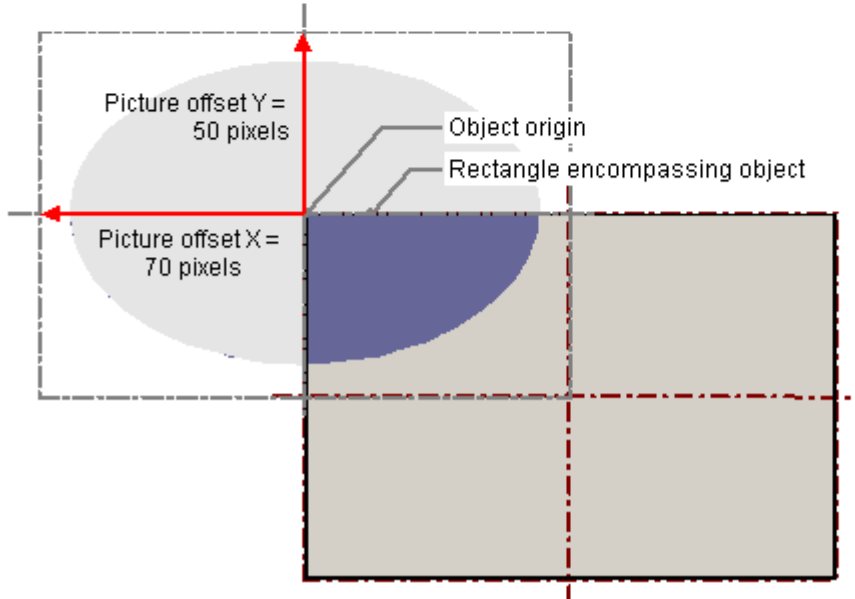

Independent picture window

WinCC supports many pictures windows and on several monitors. This requires attributes "Independent picture window", "Window mode" and "Monitor number". More information on this can be found under "How to support multiple picture windows".

Note

When using the Microsoft ListView Control in a picture window, use the event "MouseUp" instead of "ItemClick" to call a script.

3.8.7.4 How to insert a control

Introduction

The "Control" object offers the option of integrating system process control and monitoring elements into a picture. Controls are prefinished objects such as for example alarm windows, measurement value windows, selection dialogs or buttons. ActiveX Controls, WinCC Controls and controls from other manufacturers are available if they are registered in the operating system. These are changed as required and dynamically integrated into the process. The size and properties which a control accepts in Runtime are defined in the Graphics Designer.

For the detailed description of the controls and their configuration dialogs see "Working with Controls".

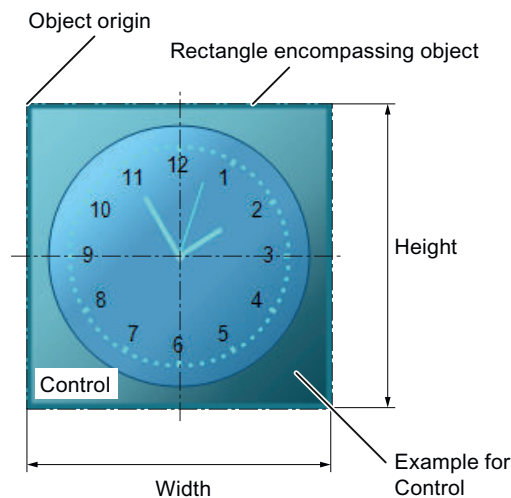

Requirements

- The use of the configuration dialogs is activated under "Tools > Settings..." on the "Options" tab.

Procedure

1. Open the picture in which you want to insert a control.
2. Click the "Control" smart object in the "Standard" selection window.
3. Keeping the left mouse button pressed, drag the object in the desired area of the picture to the desired size.
When you release the mouse button, the object is inserted into the corresponding location in the picture.
The "Control" dialog opens. The description of the dialog is located in the section "Working with controls".
4. Select one of the controls that are registered in the operating system and confirm your entry with "OK".
The associated configuration dialog now opens for some controls.
For the detailed description of the controls and their configuration dialogs see "Working with Controls".
5. Adapt the settings of the configuration dialog as required and confirm your entry with "OK".
The insertion of the "Control" object is completed.

Alternatively, you can select the required control directly in the "Control" tab in the "Standard" selection window.

You can press the <SHIFT> key while inserting to create a square "Control" object.

See also

Basic Static Operations (Page 459)

Basic Dynamic Operations (Page 485)

The Properties of an Object (Page 511)

Working with Smart Objects (Page 598)

Working with Controls (Page 749)

3.8.7.5 How to Insert an OLE Object

Introduction

The OLE object enables files created in other programs to be inserted into a picture. Therefore all OLE object registered in the operating system can be integrated. The size and properties which an OLE object accepts in Runtime are defined in the Graphics Designer. No changes can be made to OLE objects in Runtime.

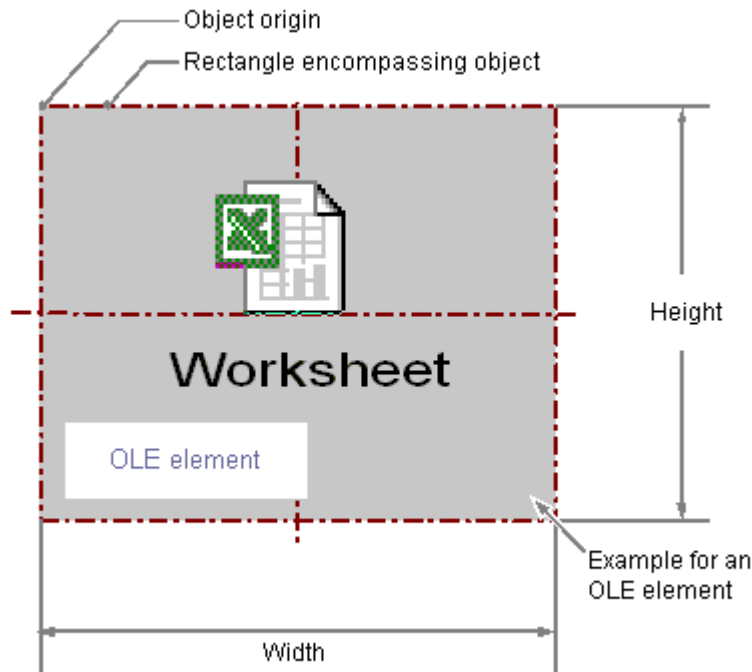

Requirements

- The desired file type must be registered in the operating system.

Inserting Ole object

1. Open the picture into which you want to insert an OLE object.
2. Click the "OLE object" smart object in the "Standard" selection window.
3. Keeping the left mouse button pressed, drag the object in the desired area of the picture to the desired size.
When you release the mouse button, the object is inserted into the corresponding location in the picture. The "Insert Object" dialog opens.
4. Select the option "Create from file" or "Create new".

Note

To prevent problems in Runtime, you have to insert a video object in the "AVI" format as a control object and not as an OLE object in a picture.

Creating an OLE object from file

With the option "Create from file", an already existing file is chosen for display in the selected OLE object. You edit the file in the OLE object with the program that is registered for editing the selected file type in the operating system.

1. Select the option "Create from file".
2. The "Insert Object" dialog shows an input field, the "Browse..." button and the "Link" check box.
3. Enter the directory path and the name of the required file in the input field.
Or click the "Browse..." button to select the required file with the "Browse" dialog.
4. Select the "Link" check box if the selected file is not copied to the OLE object but is only used as a reference.
5. Select the "As icon" check box if only an icon is displayed for the associated file type and not the contents of the selected file.
6. Confirm your entries with "OK".
The insertion of the OLE object is completed.

Creating a new OLE object

The "Create new" option selects a file type for a new file that is created in the selected OLE object. You edit the file in the OLE object with the program that is registered for editing the selected file type in the operating system.

1. Select the "Create new" option.
The "Insert Object" dialog shows a list of all file types registered in the operating system.
2. Select the object type for the file that you want to create in the selected OLE object.
3. Select the "As icon" check box if only an icon is displayed for the associated file type and not the contents of the selected file.
4. Confirm your entries with "OK".
The insertion of the OLE object is completed.
5. Double-click the OLE object to edit the embedded file in the OLE object.
The program registered in the operating system for editing the associated file type opens in the Graphics Designer.
6. Finish editing the embedded file by deselecting the OLE object.
The performed changes are saved.

Note

An OLE object that you want to edit in a picture must be in the original path. If the object does not exist there, double-clicking the OLE object may affect the operation of the Graphics Designer.

After processing an OLE object, it can occur that the toolbars of the Graphics Designer are no longer displayed. You can prevent this error after processing an OLE object if you first close the server application (for example Excel or Paint) before exiting the Graphics Designer.

To restore the display of toolbars, proceed as follows:

1. Select all available objects in the active picture.
 2. In the "View" menu, select the "Toolbars..." command.
 3. Click the "Reset" button in the "Toolbars" dialog.
-

Changing an OLE object

Select an object of the "OLE object" type if you wish to carry out one of the following changes:

Rectangle surrounding the object

Drag the rectangle surrounding the object to the new position in order to arrange the object in the picture.

Drag the selection marks for the rectangle surrounding the object to a new position in order to resize the object.

Attributes

Open the "Object Properties" window to change the current values of the required attributes.

See also

Quick Object Configuration (Page 703)

Basic Static Operations (Page 459)

Basic Dynamic Operations (Page 485)

The Properties of an Object (Page 511)

Working with Smart Objects (Page 598)

3.8.7.6 I/O Field

How to insert an I/O field

Introduction

The I/O Field can be defined as an input field, an output field or a combined input/output field.

The size and properties which an I/O Field accepts in Runtime are defined in the Graphics Designer.

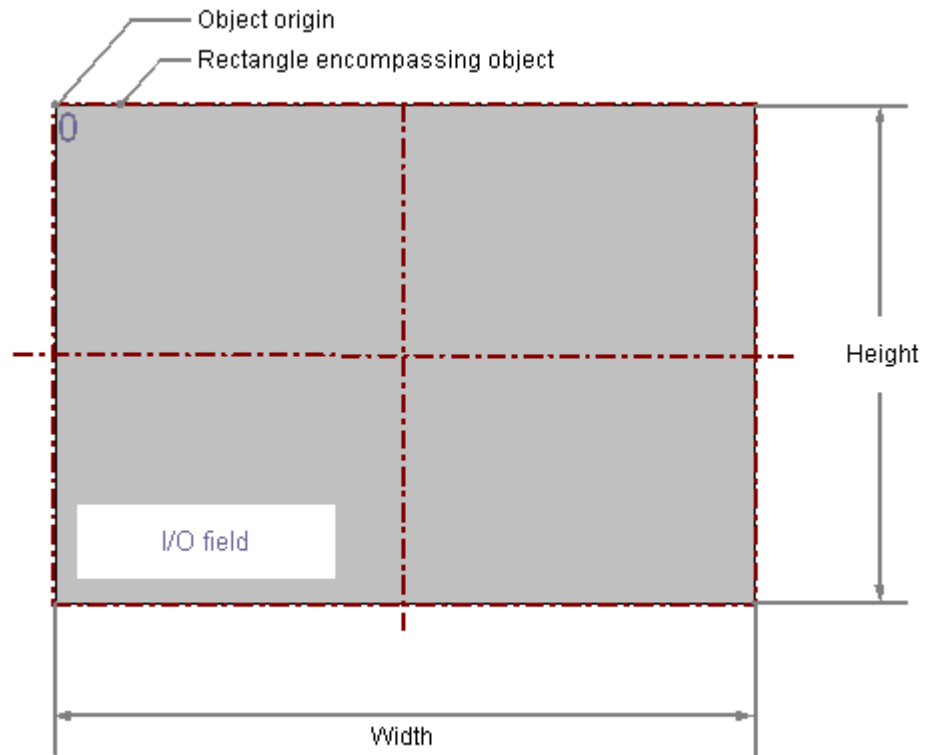

Configuration

Limit values such as "Hidden Input" or "Accept on complete input" can also be specified.

The following data formats are available:

Binary	Numerical values
Decimal	Numerical values
String	Texts
Hexadecimal	Numerical values
Date/time	Date and/or time or time span in ms
Date/Time (local)	Date and/or time or time span in ms UTC is converted to the local time zone of the respective client or server.

Requirements

- The use of configuration dialogs must be enabled in the "Options" tab of the "Tools / Settings..." menu.

Inserting an I/O Field

1. Open the picture in which you want to insert an I/O Field.
2. Click the "I/O field" smart object in the "Standard" selection window.
3. Keeping the left mouse button pressed, drag the object in the desired area of the picture to the desired size.
When you release the mouse button, the object is inserted into the corresponding location in the picture. The "I/O Field Configuration" dialog opens.
4. Enter the required values in the fields of the configuration dialog.
The description of the configuration dialog can be found in the next section.
5. Confirm your entries with "OK".
The insertion of the "I/O field" object is completed.

Alternatively, you can double-click the "I/O field" smart object in the "Standard" selection window. An I/O Field with default object properties is then inserted near the picture origin. The "I/O Field Configuration" dialog opens. The insertion is completed when you confirm your entries with "OK".

If you hold down the <SHIFT> key during insertion, the "I/O field" object is created in the shape of a square.

Inserting a tag as an I/O field

To access a specific tag value via an I/O field, you can insert the tag directly in the process picture via drag-and-drop.

Procedure

1. Select the required tag in the "Tag" window.
2. Drag the tag into the process picture.
This creates an I/O field that is connected to the tag.
3. Configure the properties of the I/O field.

Changing an I/O Field

Select an object of the I/O Field type if you wish to carry out one of the following changes:

Rectangle surrounding the object

Drag the rectangle surrounding the object to the new position in order to arrange the object in the picture.

Drag the handles on the rectangle surrounding the object to a new position in order to resize the object.

Palettes and toolbars

Use the elements of the object palette to mirror or rotate the object.

Use the font palette to change the font display.

Use the color palette to change the background color.

Use elements of the style palette to change the display style for the object.

Attributes

Open the "Object Properties" window to change the current values of the required attributes.

See also

How to configure an I/O Field (Page 615)

How to change limit values and type of value input of an I/O field (Page 617)

How to define the output format for the "Binary" data type (Page 618)

How to define the output format for the "Decimal" data type (Page 620)

How to define the output format for the "Hexadecimal" data type (Page 621)

How to define the output format for the "String" data type (Page 622)

Basic Static Operations (Page 459)

Basic Dynamic Operations (Page 485)

The Properties of an Object (Page 511)

Working with Smart Objects (Page 598)

How to configure an I/O Field

Introduction

The "I/O-Field Configuration" dialog opens after the insertion process if the use of configuration dialogs is enabled in the "Options" tab of the "Tools / Settings..." menu. It enables fast configuration of the important features of the I/O Field.

You can also open the configuration dialog with the object context menu. You change individual attributes in the "Object Properties" window.

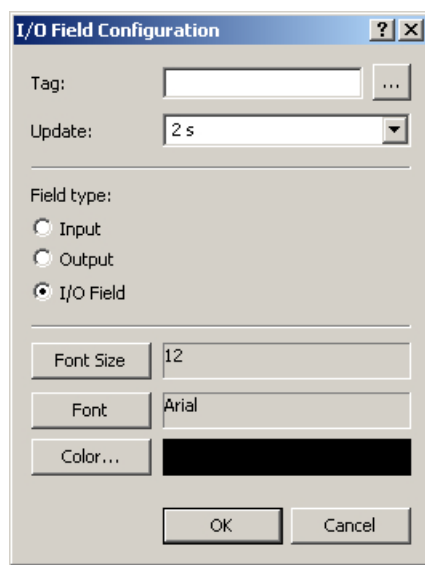

Tag

You can dynamize the I/O field by interconnecting a tag. Depending on the selected field type, the value of the tag is displayed as output or changed by an input.

Enter the name of the required tag or click  to open the "Tags" dialog. You can find a detailed description in the section "Quick configuration of objects > How to select a tag".

Alternatively, you can drag a tag from the tag selection dialog into a process image to create an I/O field with this tag connection.

Updating

Specify the frequency with which the display for the indicated output value is to be updated.

Enter the desired interval or select an interval from the drop down list. You can find a detailed description in the section "The Basic Settings of the Graphics Designer > How to change the default trigger".

Field type

The I/O field can be defined as a text box, an output field or a combined input/output field.

Specify the desired field type.

Font

You can change the font for displaying input and output values regardless of the selected field type.

Click on the buttons to open the associated dialogs.

See also

How to insert an I/O field (Page 612)

How to define the output format for the "String" data type (Page 622)

How to define the output format for the "Hexadecimal" data type (Page 621)

How to define the output format for the "Decimal" data type (Page 620)

How to define the output format for the "Binary" data type (Page 618)

How to change limit values and type of value input of an I/O field (Page 617)

Quick Object Configuration (Page 703)

Selecting a tag (Page 705)

Changing the default trigger (Page 368)

How to change limit values and type of value input of an I/O field

Introduction

You can define a value range for input and output of an I/O field using limit values. Values outside this value range cannot be displayed or input. You can make additional settings that offer protection against accepting incorrect values for the value input.

Setting Limit Values

The "High Limit Value" attribute defines the maximum limit value for input and output. The "Low Limit Value" attribute defines the minimum limit value for input and output. The specified value depends on the "data format" of the I/O field.

If a value is lower than the low limit value or higher than the high limit value, the following effects may occur in Runtime:

- Field type = "Input"
The "WinCC Runtime" dialog is opened and displays the error message "The entered value is outside the configured limits". Confirm the error message with "OK" and enter another value.
- Field type = "Output"
The display of the value is substituted by the character string "****".

You can change the "Data Format" and "Field Type" attributes in the "Output / Input" property group. You cannot specify a limit value for the "String" format.

Input value into an I/O Field

1. Double-click the I/O field.
The input mode opens. A placeholder is displayed for every character in accordance with the set output format. If a value has already been entered, it is displayed as marked.
2. Enter a new value.
3. Depending on the setting of the attributes of the I/O Field, the value is accepted on completion of input or the input must be finished by pressing <Enter> .

Specifying type of value input

Immediate Input

The "Immediate Input" attribute specifies for input fields whether a direct change is made into the input mode on jumping to the object.

Clear on New Input

The "Clear on New Input" attribute specifies whether the field contents are cleared when selecting the input field.

Clear on Invalid Input

The "Clear on Invalid Input" attribute can be used to prevent adoption of an incorrect input value when the field is left. For example, an input value that does not correspond to the predefined data format of the input field is incorrect.

Apply on Full

The "Apply on Full" attribute specifies when an input value is applied. If the attribute has the value "No", the input value is only applied when the input is confirmed with <Enter> . Otherwise the input value is automatically applied as soon as the preset number of characters has been entered.

Apply on Exit

The "Apply on Exit" attribute can also be enabled for a value input in the event that the I/O Field is exited without prior confirmation or reaching the required number of characters.

Hidden Input

The "Hidden Input" attribute specifies whether the input value is displayed during input as normal or encrypted. If this attribute has the value "Yes", every character input is replaced with the "*" character. The value entered and the data format of the value cannot be recognized.

Continue to show input value after <Enter>

After confirming the entry with <Enter>, the entered value is deleted. If you configure a direct connection between the "Input value" attribute and the "Output value" attribute, the input value continues to be shown after confirming with <Enter>.

See also

How to insert an I/O field (Page 612)

How to define the output format for the "String" data type (Page 622)

How to define the output format for the "Hexadecimal" data type (Page 621)

How to define the output format for the "Decimal" data type (Page 620)

How to define the output format for the "Binary" data type (Page 618)

How to configure an I/O Field (Page 615)

How to define the output format for the "Binary" data type

Introduction

Four different data formats are available for the input and output of values in an I/O field. Numerical values can be edited in binary, decimal or hexadecimal format. The "String" data format must be specified for the I/O field to display text.

Based on the specified data format different output formats can be selected or freely defined for displaying the field contents.

The definition for an output format can be rewritten as a sequence of formatting codes. The

formatting codes act as placeholders for a specific group of characters. For example, if a formatting code for which only the display of the numbers 0-9 is preset for a specific position in the display of an I/O field, only letters can be input at this position.

Note

If the value you want to display does not correspond exactly to the definition of the output format, only three asterisks are displayed. This applies for the length of the entire character string and also for the type and position of the individual characters.

Formatting codes - "Binary" data type

- 1 Placeholder for the binary values 0 and 1. The number of the formatting code "1" specifies the permissible number of positions for displaying a binary value.
- 0 If necessary a leading zero is placed before the binary value. The output format can therefore begin with the formatting code "0", but can only have this once.

Example - "Binary" data type

The 8-digit binary value 10011101 can be displayed as follows:

Output format	Allowed number of positions	Display
11	2	01
011	2 + leading zero	001
1111	4	1101
01111	4 + leading zero	01101
1111111	7	0011101
01111111	7 + leading zero	00011101
111111111	10	10011101
0111111111	10 + leading zero	010011101

See also

[How to insert an I/O field \(Page 612\)](#)

[How to define the output format for the "String" data type \(Page 622\)](#)

[How to define the output format for the "Hexadecimal" data type \(Page 621\)](#)

[How to define the output format for the "Decimal" data type \(Page 620\)](#)

[How to change limit values and type of value input of an I/O field \(Page 617\)](#)

[How to configure an I/O Field \(Page 615\)](#)

How to define the output format for the "Decimal" data type

Introduction

Four different data formats are available for the input and output of values in an I/O field. Numerical values can be edited in binary, decimal or hexadecimal format. The "String" data format must be specified for the I/O field to display text.

Based on the specified data format different output formats can be selected or freely defined for displaying the field contents.

The definition for an output format can be rewritten as a sequence of formatting codes. The formatting codes act as placeholders for a specific group of characters. For example, if a formatting code for which only the display of the numbers 0-9 is preset for a specific position in the display of an I/O field, only letters can be input at this position.

Note

If the value you want to display does not correspond exactly to the definition of the output format, only three asterisks are displayed. This applies for the length of the entire character string and also for the type and position of the individual characters.

Formatting codes - "Decimal" data type

- 9 Placeholder for the binary values 0 and 9. The number of the formatting code "9" specifies the permissible number of positions for displaying a decimal value. If the actual number of decimal places exceeds the number specified in the display format, the displayed value is rounded out.
- ,
- A comma defines the position for decimal point. The formatting code "," can be at any position in the output format, but can only be used once.
- s Positive decimal numbers are displayed with signs. The formatting code "s" must be at the first position of the output format and must be used only once.
- 0 Leading and following zeroes are displayed when the actual number of position before and after the decimal point is less that the number set in the display format. The formatting code "0" must be before the first "9" and must be used only once.
- e The decimal number is displayed in exponential format. The formatting code "e" must be at the last position of the output format and must be used only once.

Example - "Decimal" data type

The 6-digit decimal number 123.456 can be displayed as follows:

Output format	Allowed number of positions	Display
999	3	124
999.9	4	123.5
s999.9	4 + sign	+123.5
999.999	6	123.456
09999.9999	8 + zeroes	0123.4560

Output format	Allowed number of positions	Display
s09999.9999	8 + sign + zeroes	+0123.4560
1111111111	10	10011101
9.99999e	6	1.23456e+002

Note

If a floating point number is saved in the IEEE format of the S5, an output format that allows the sign and exponent should be used for display in an I/O Field (e.g. s0999.999e).

See also

How to configure an I/O Field (Page 615)

How to change limit values and type of value input of an I/O field (Page 617)

How to define the output format for the "Binary" data type (Page 618)

How to define the output format for the "Hexadecimal" data type (Page 621)

How to define the output format for the "String" data type (Page 622)

How to insert an I/O field (Page 612)

How to define the output format for the "Hexadecimal" data type**Introduction**

Four different data formats are available for the input and output of values in an I/O field. Numerical values can be edited in binary, decimal or hexadecimal format. The "String" data format must be specified for the I/O field to display text.

Based on the specified data format different output formats can be selected or freely defined for displaying the field contents.

The definition for an output format can be rewritten as a sequence of formatting codes. The formatting codes act as placeholders for a specific group of characters. For example, if a formatting code for which only the display of the numbers 0-9 is preset for a specific position in the display of an I/O field, only letters can be input at this position.

Note

If the value you want to display does not correspond exactly to the definition of the output format, only three asterisks are displayed. This applies for the length of the entire character string and also for the type and position of the individual characters.

Formatting codes - "Hexadecimal" data type

- f Placeholder for the letters A-F and a-f and the digits 0-9, which are used to display hexadecimal numbers. The allowed number of characters is defined by the number of the formatting code "f" in the output format.
- 0 Leading zeros of the hexadecimal value are displayed if the output format begins with the formatting code "0". The formatting code "0" must be included only once.

See also

How to configure an I/O Field (Page 615)

How to change limit values and type of value input of an I/O field (Page 617)

How to define the output format for the "Binary" data type (Page 618)

How to define the output format for the "Decimal" data type (Page 620)

How to define the output format for the "String" data type (Page 622)

How to insert an I/O field (Page 612)

How to define the output format for the "String" data type

Introduction

Four different data formats are available for the input and output of values in an I/O field. Numerical values can be edited in binary, decimal or hexadecimal format. The "String" data format must be specified for the I/O field to display text.

Based on the specified data format different output formats can be selected or freely defined for displaying the field contents.

The definition for an output format can be rewritten as a sequence of formatting codes. The formatting codes act as placeholders for a specific group of characters. For example, if a formatting code for which only the display of the numbers 0-9 is preset for a specific position in the display of an I/O field, only letters can be input at this position.

Note

If the value you want to display does not correspond exactly to the definition of the output format, only three asterisks are displayed. This applies for the length of the entire character string and also for the type and position of the individual characters.

Formatting codes - "String" data type

The allowed length of a character string is defined by the number of formatting codes used (exception "***").

* Input of a character string of any length

? Input of any character string

- a Lower-case letters, upper-case letters and digits are allowed
no separators or similar.
- A Upper-case letters and digits are allowed
no lower case letters, separators or similar.
- b Lower-case letters and upper-case letters are allowed
no digits, separators or similar.
- B Only upper-case letters are allowed
no lower case letters, digits, separators or similar.
- 1-9 The formatting codes "1", "2", ..., "9" are used as placeholders for digits.
The selected formatting code also defines the actual digits allowed: For example, if the "2" is specified, only the digits 0, 1 or 2 can be displayed. The formatting code "8" allows all digits except for the 9.
- h Only the digits 0-9 and the letters A-F or a-f are allowed.
The formatting code "h" allows only characters that are required to display hexadecimal numbers.
- t The formatting code "t" forces input of a separator at the specified position. These separators are valid: Slash, colon, comma, period and space.

See also

How to configure an I/O Field (Page 615)

How to change limit values and type of value input of an I/O field (Page 617)

How to define the output format for the "Binary" data type (Page 618)

How to define the output format for the "Decimal" data type (Page 620)

How to define the output format for the "Hexadecimal" data type (Page 621)

How to insert an I/O field (Page 612)

3.8.7.7 Bar

How to insert a bar

Introduction

The "Bar" object offers the option of displaying values graphically.

The values can also be displayed in a combined view as graphics with freely definable number scale.

The size and properties which a bar accepts in Runtime are defined in the Graphics Designer.

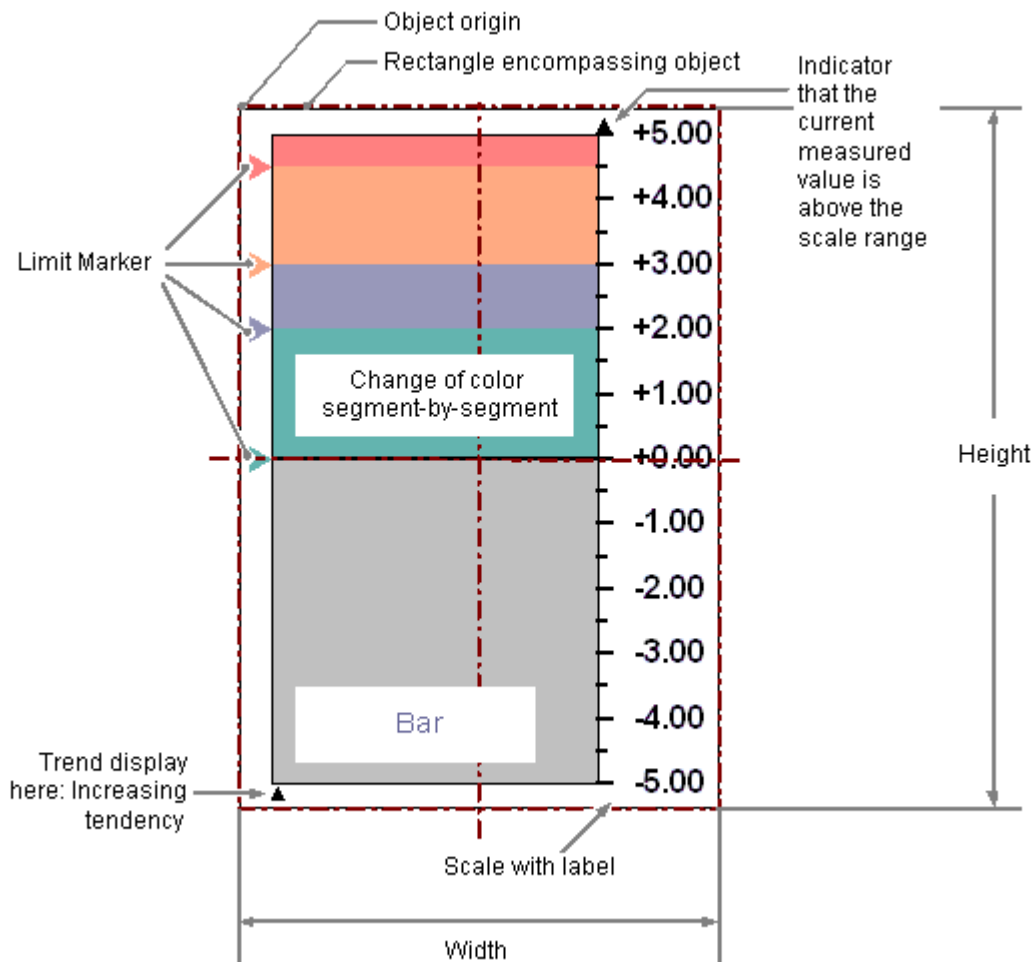

Requirements

- The use of configuration dialogs must be enabled in the "Options" tab of the "Tools / Settings..." menu.

Inserting bar

1. Open the picture in which you want to insert a bar.
2. Click the "Bar" smart object in the "Standard" selection window.
3. Keeping the left mouse button pressed, drag the object in the desired area of the picture to the desired size.
When you release the mouse button, the object is inserted at the corresponding location in the picture.
The "Bar Configuration" dialog opens.
If you keep the <SHIFT> key pressed while inserting, you create the "Bar" object in the shape of a square.

4. Enter the required values in the fields of the configuration dialog.
The description of the configuration dialog can be found in the next section.
5. Confirm your input with "OK".
The insertion of the "Bar" object is completed.

Alternative procedure

Double-click the "Bar" smart object in the "Standard" selection window.

A bar with default object properties is then inserted near the picture origin.

The "Bar Configuration" dialog opens. The insertion process is finished when you confirm your inputs with "OK".

Changing bar

Select an object of the bar type if you wish to carry out one of the following changes:

Rectangle surrounding the object

Drag the rectangle surrounding the object to the new position in order to arrange the object in the picture.

Drag the handles on the rectangle surrounding the object to a new position in order to resize the object.

Palettes and toolbars

Use the elements of the object palette to mirror and rotate the object.

Use the font palette to change the font display.

Use the color palette to change the colors.

Use elements of the style palette to change the display style for the object.

Attributes

Open the "Object Properties" window to change the current values of the required attributes.

See also

- How to configure a bar (Page 626)
- How to configure the limits of a bar (Page 627)
- How to configure the bar scale (Page 628)
- Basic Static Operations (Page 459)
- Basic Dynamic Operations (Page 485)
- The Properties of an Object (Page 511)
- Working with Smart Objects (Page 598)

How to configure a bar

Introduction

The "Bar Configuration" dialog opens after the insertion process if the use of configuration dialogs is enabled in the "Options" tab of the "Tools / Settings..." menu. It enables fast configuration of the important features of the bar.

You can also open the configuration dialog with the object context menu. You change individual attributes in the "Object Properties" window.

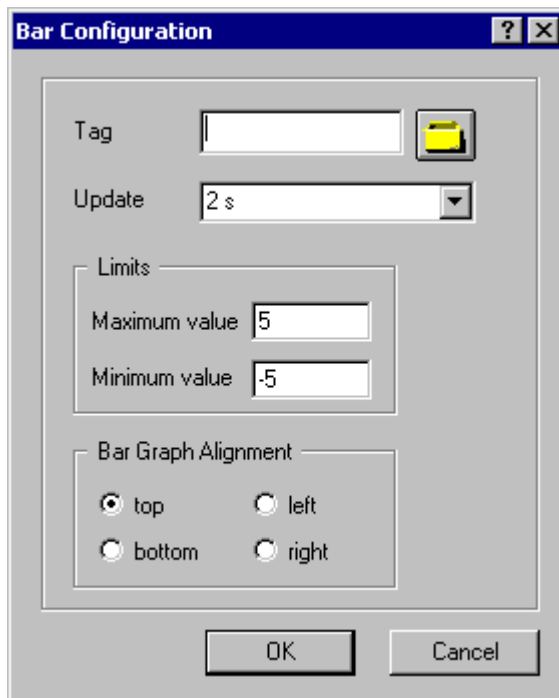

Tag

You can dynamize the display value of the bar by embedding a tag.

Enter the name of the required tag or click the tag icon to open the "Tags" dialog. You can find a detailed description in the section "Quick configuration of objects > How to select a tag".

Updating

Specify the frequency with which the display for the indicated bar value is to be updated.

Enter the desired interval or select an interval from the drop down list. You can find a detailed description in the section "The Basic Settings of the Graphics Designer > How to change the default trigger".

Limits

The two ends of the bar view are specified by the maximum value and the minimum value of the bar.

Enter the desired limits for the bar display. You can find a detailed description in the section "How to configure the limits of a bar".

Bar direction

Specify the direction of the coordinate axis, which the highest display value of the bar points to.

You can find a detailed description in the section "How to adapt the bar scale".

See also

Changing the default trigger (Page 368)

Selecting a tag (Page 705)

How to configure the limits of a bar (Page 627)

How to configure the bar scale (Page 628)

How to insert a bar (Page 623)

Quick Object Configuration (Page 703)

How to configure the limits of a bar

Introduction

For the "Bar" object, up to 5 limits can be defined, each of which has an upper (High) and a lower (Low) limit value. The limits are termed:

Name	Upper limit (High)	Lower limit (Low)
Alarm limit A	AH – Alarm High	AL – Alarm Low
Warning limit W	WH – Warning High	WL – Warning Low
Tolerance limit T	TH – Tolerance High	TL – Tolerance Low
Reserve 4 R4	RH4 – Reserve High 4	RL4 – Reserve Low 4
Reserve 5 R5	RH5 – Reserve High 5	RL5 – Reserve Low 5
General: Limit X	XH – High Limit Value of limit X	XL – Low Limit Value of limit X

Upper limit, Lower limit, type

The "Upper Limit XH" and "Lower Limit XL" attributes specify the limit values for the corresponding Limit X. The "Type X" attributes specify whether the specified limit values are displayed as absolute values or as percentage values.

Bar color, Change Color

The "Bar Color XH" and "Bar Color XL" attributes can be used to assign a color to any Limit X. The display value is shown in the corresponding color as soon as, starting from the zero point of the bar display, it is higher than the corresponding Upper Limit XH or lower than the Lower Limit XL. The "Change Color" attribute in the "Miscellaneous" property group specifies whether this color change is to take place segment-wise or for the entire display.

Monitoring, Limit Marker

The color change can only be displayed for a limit X if the "Monitoring X" attribute has the value "Yes". If the "Limit Marker" attribute has the value "Display", the configured and monitored limits are indicated by marking arrows. These limit markers receive the bar color of the corresponding limit and are displayed on the side of the bar opposite the scale.

Trend

The "Trend" attribute specifies whether or not the trend is displayed. The trend display enables a fast overview of changes for the bar. If the value displayed in the scale is exceeded, a small arrow is displayed beside the scale by default. The arrow indicates that the measured value cannot be displayed on the scale. Another scale can be shown on the other side of the bar to avoid having to wait for the next update. This arrow shows the trend of the current movement of the bar.

Hysteresis, Hysteresis Range

So that a color change is not triggered immediately in the case of a slight limit violation, the "Hysteresis" and "Hysteresis Range" attributes can be used to define a distribution range for the display of the value.

The "Hysteresis" attribute specifies for the "Bar" object whether the display with hysteresis is permitted or not.

The "Hysteresis Range" attribute specifies for the "Bar" object the hysteresis as a percentage of the display range.

See also

How to configure a bar (Page 626)

How to configure the bar scale (Page 628)

How to insert a bar (Page 623)

How to configure the bar scale

Introduction

The "Bar" object can be labeled by showing a scale. The layout and graduation of the scale and the size and format of the label can be configured by changing the relevant attributes as required.

Setting scale end values and zero point value

The attribute "Maximum value" defines the absolute value for the display of the highest value. The attribute "Minimum value" defines the absolute value for the display of the smallest value. The attribute "Zero point value" defines the absolute value for the zero value of the bar.

Specifying the arrangement the scale

The "Scale" attribute specifies for the "Bar" object whether the bar is labeled with a scale. The "Bar Direction" attribute specifies for the "Bar" object the direction of the coordinate axis, which the highest display value of the bar points to.

The "Alignment" attribute defines the arrangement of the scale relative to the bar for the "Bar" object. Depending on the setting for the "Bar Direction" attribute in the "Geometry" property group, the scale can be displayed to the left or right or above or below the bar.

Alignment of bar scale

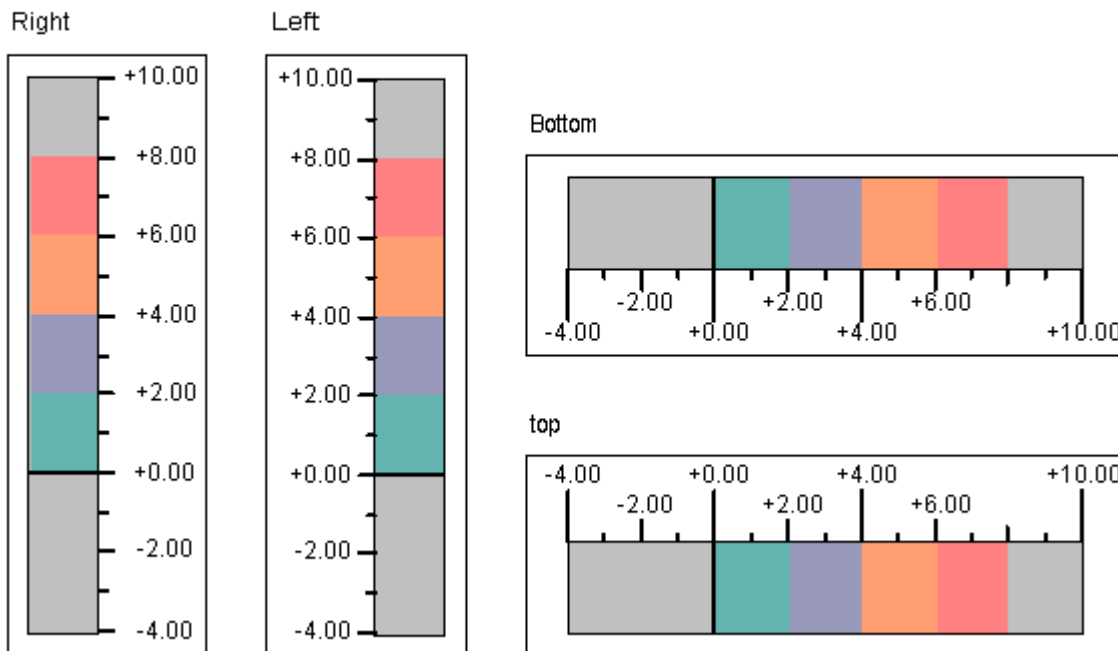

Defining bar segments

The "Scale Marks" attribute specifies the number of segments into which the bar is divided by the large tick marks of the scale.

The "Axis Section" attribute defines the distance between the large tick marks. The value is shown as the difference in value between two adjacent large tick marks.

Specifying scale division

The "Zero Point" attribute specifies for the representation of the bar in which position the zero point value is displayed. The value is specified relative to the spacing of the scale end values in %. For a value of 0 %, for example, the zero point value is shown at the height of the large tick mark with the lowest value. The zero point can also be outside of the range represented. The "Zero Point" attribute is only evaluated if the "Bar Scaling" attribute has the value "Automatic". The absolute value for the zero point is set with the "Zero Point Value" attribute in the "Miscellaneous" property group.

The "Bar Scaling" attribute specifies the type of scale division. By selecting suitable scale divisions, it is possible to emphasize a particular range of values in the bar display.

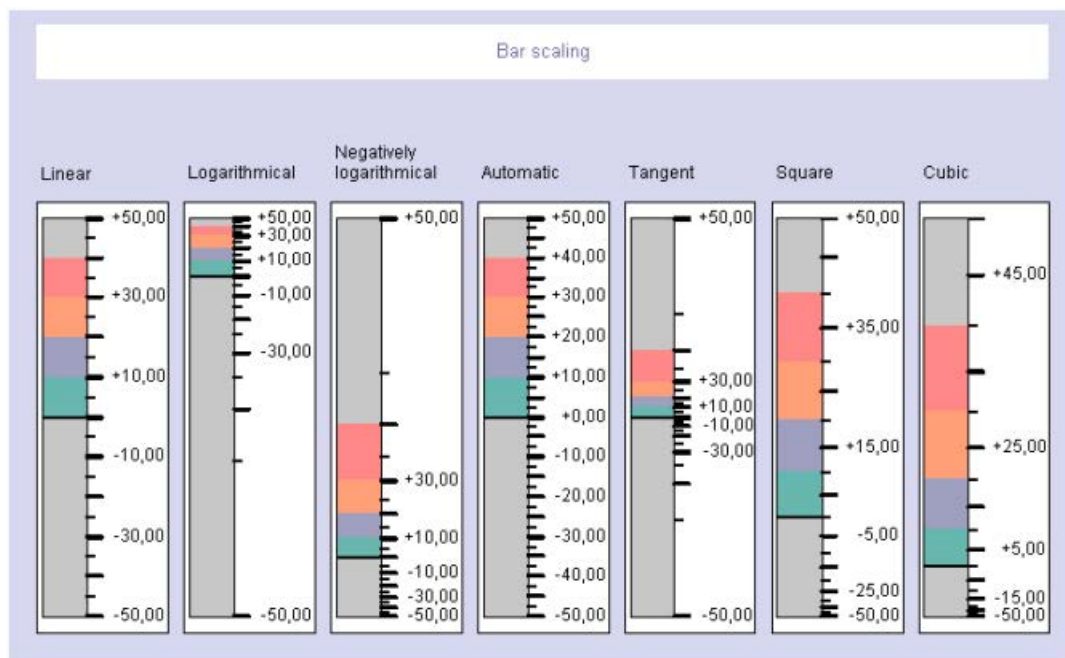

Specifying the format of tick marks

The "Large Tick Marks Length" attribute specifies for the "Bar" object whether the sections between the large tick marks in the scale of the bar are divided by shorter tick marks. The "Large Tick Marks" attribute specifies whether the large tick marks of the scale are shown in bold or normal. The "Length of Large Tick Marks" attribute specifies the length of the large tick marks. The length of the shorter tick marks corresponds to half of the value specified here. The values are specified in pixels.

Specifying the format of labeling

The "Label Each" attribute specifies the number of labeled large tick marks. If, for example, the attribute has the value "3", only every third large tick mark is labeled, starting with the large tick mark with the lowest value.

The "Exponent Display" attribute shows whether the numerical values of the scale are shown as exponents or as decimal values without exponents.

The "Decimal Places" attribute specifies the number of digits before the decimal point for the display of numerical values in the scale.

The "Decimal Places" attribute specifies the number of digits to the right of the decimal point for the numerical value display in the scale.

3.8.7.8 How to insert a graphic object

Introduction

The graphic object enables graphics created in other programs to be inserted into a picture. You can insert graphics or images with the following formats:

EMF, WMF, DIB, BMP (up to 32-bit), GIF, JPEG, ICO and PNG ¹⁾.

¹⁾ If you use the "WinCC Classic" global design, the format PNG is not available.

The size and properties that a graphic object has in runtime are defined in the Graphics Designer.

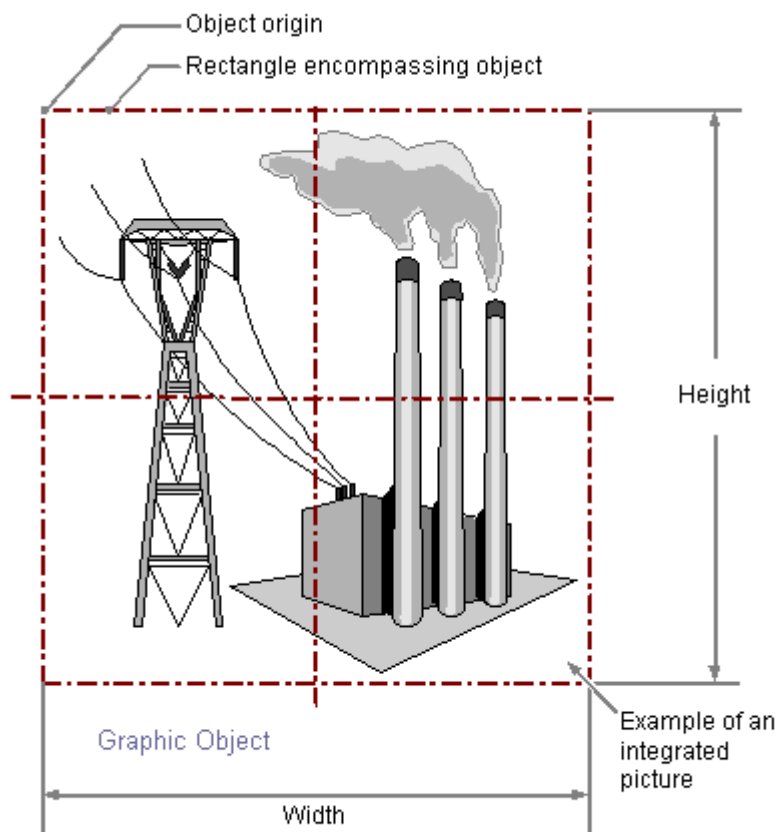

Requirements

- The use of the configuration dialogs is activated under "Tools > Settings..." on the "Options" tab.

Inserting Graphic Object

1. Open the picture in which you want to insert a graphic object.
2. Click the "Graphic object" smart object in the "Standard" selection window.
3. Keeping the left mouse button pressed, drag the object in the desired area of the picture to the desired size.
When you release the mouse button, the object is inserted into the corresponding location in the picture. The "Picture selection" dialog opens.

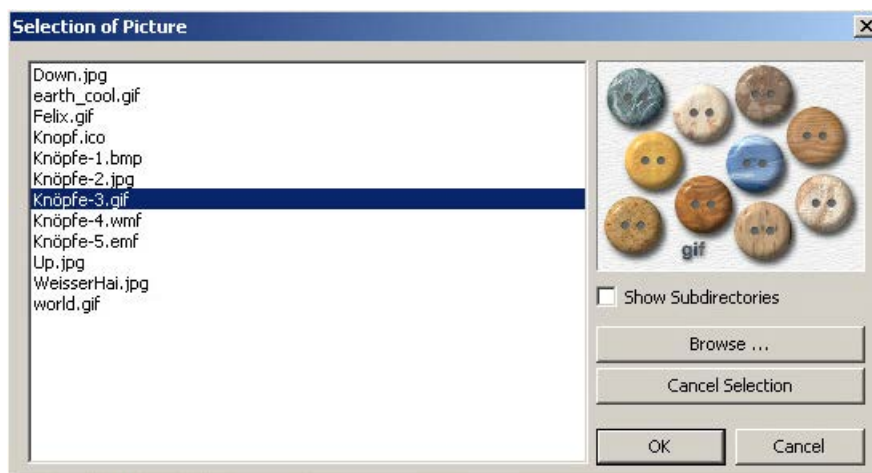

4. The picture selection shows all pictures in the EMF, WMF, DIB, BMP, GIF, JPEG, ICO and PNG formats that are in the graphics directory "GraCS" of the current WinCC project. Selection "Show subdirectories" when you want to display existing subdirectories of "GraCS" with the pictures they contain in the picture selection. Click on the "Browse..." button to insert additional pictures from the picture selection. To remove an existing assignment, click "Cancel Selection".
5. Select the picture that is displayed in the graphic object.
6. Confirm your entries with "OK".
The insertion of the "Graphic Object" is completed.

As an alternative, double-click the "Graphic object" smart object in the "Standard" selection window. A graphic object with default object properties is then inserted near the picture origin. The "Picture selection" dialog opens. The insertion process is finished when you confirm your inputs with "OK".

If you hold down the <Shift> key during insertion, the "Graphic object" object is created in the shape of a square.

Note

If the "Picture Transparent Color On" attribute has the value "Yes" for a graphic object, the available flash frequency is also reduced if necessary.

See also

Selecting pictures (Page 706)

Basic Static Operations (Page 459)

Basic Dynamic Operations (Page 485)

The Properties of an Object (Page 511)

Working with Smart Objects (Page 598)

3.8.7.9 Status display

How to insert a status display

Introduction

The status display offers the option to display almost any number of different states of an object. The states are implemented via tags whose value corresponds to the respective state. The states are displayed via the assigned pictures. The size and properties which a status display accepts in Runtime are defined in the Graphics Designer.

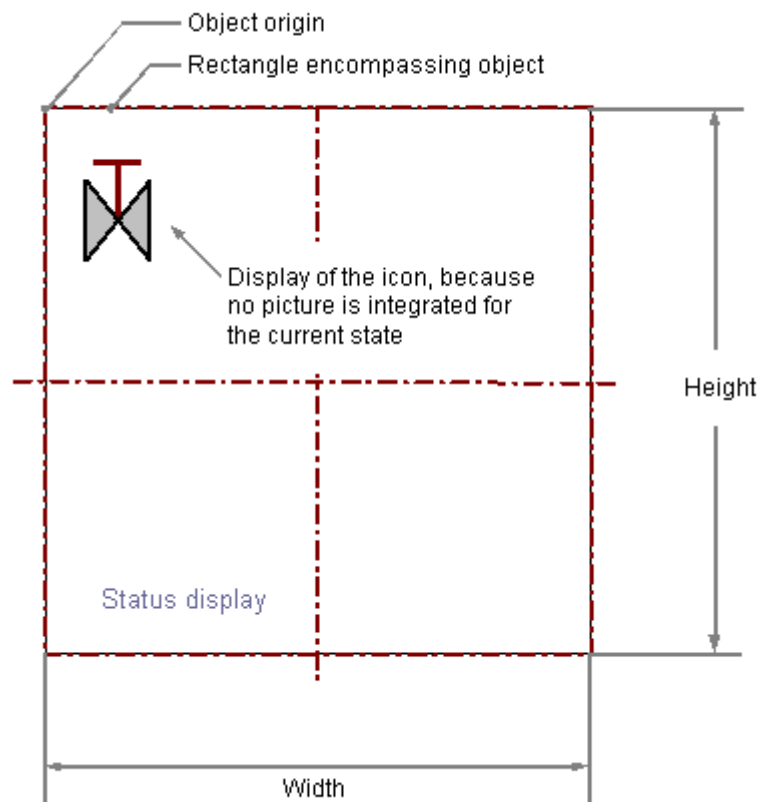

Requirements

- The use of configuration dialogs must be enabled in the "Options" tab of the "Tools / Settings..." menu.

Inserting a status display

1. Open the picture in which you want to insert a status display.
2. Click the "Status display" smart object in the "Standard" selection window.
3. Keeping the left mouse button pressed, drag the object in the desired area of the picture to the desired size.
When you release the mouse button, the object is inserted into the corresponding place in the picture. The "Status Display Configuration" dialog opens.
4. Enter the required values into the fields of the configuration dialog.
You will find the description of the configuration dialog in the next section.
5. Confirm the input with "OK".
The insertion process for the "Status display" object is finished.

As an alternative, double-click the "Status display" smart object in the "Standard" selection window. A line with default object properties is then inserted near the picture origin. The "Status Display Configuration" dialog opens. The insertion process is finished when you confirm your inputs with "OK".

You can press the <SHIFT> key while inserting to create a square "Status display" object.

Changing a status display

Select an object of the Status Display type if you wish to carry out one of the following changes:

Rectangle surrounding the object

Drag the rectangle surrounding the object to the new position in order to arrange the object in the picture.

Drag the selection marks for the rectangle surrounding the object to a new position in order to resize the object.

Palettes and toolbars

Use the color palette to change the frame color.

Use elements of the style palette to change the display style for the object.

Attributes

Open the "Object Properties" window to change the current values of the required attributes.

See also

How to configure a status display (Page 635)

How to configure states (Page 637)

Basic Static Operations (Page 459)

Basic Dynamic Operations (Page 485)

The Properties of an Object (Page 511)

Working with Standard Objects (Page 565)

How to configure a status display

Introduction

The "Status Display Configuration" dialog enables fast configuration of the important features of the status display. The use of configuration dialogs must be enabled in the "Options" tab of the "Tools / Settings..." menu.

You can also open the configuration dialog with the object context menu. You change individual attributes in the "Object Properties" window.

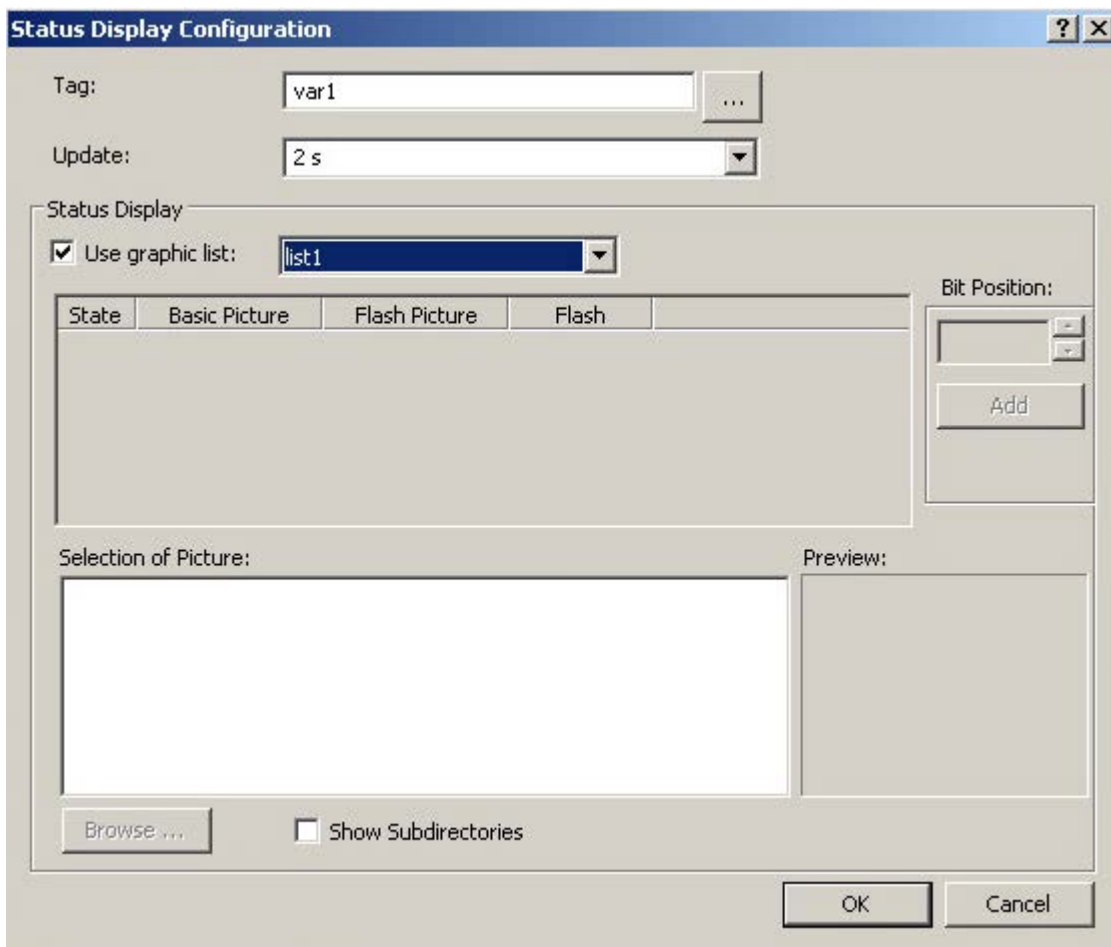

Tag

You can dynamize the value of the status to be displayed by embedding a tag.

Enter the name of the required tag or click "..." to open the "Tags" dialog.

Updating

Specify the frequency with which the status display is to be updated.

Enter the desired interval or select an interval from the drop down list. You can find a detailed description in the section "The Basic Settings of the Graphics Designer > How to change the default trigger".

Use graphic list

Enable the "Use graphic text" option to use one of the graphic lists already configured in the "Text and Graphic List" editor in the status display. You can learn how to create graphic lists in the "Text and Graphic List" editor in How to create graphic lists (Page 452)

Status list

If you do not want to use a graphics list already configured, you can link the states to pictures and set the flash frequency in the state list.

You can add states and change the settings using the shortcut menu. You can reference the pictures of the picture selection by dragging them with the mouse to the required position in the status list.

See the "How to configure states" section for the detailed description.

Bit position

If you do not want to use a graphics list already configured, you can assign a state a certain bit position of the tag.

Click the arrow key to select a bit position.

Click the field "Add" to enter the status of this bit position in the status list. Click the "Add" button again to insert the next higher bit position.

See the "How to configure states" section for the detailed description.

Preview

The picture selected in the picture selection is displayed as a preview.

Selection of picture

The picture selection shows all pictures in the graphics directory "GraCS" of the current WinCC project. You can insert graphics or images with the following formats: BMP, DIB, ICO, CUR, EMF, WMF, GIF and JPG.

Use the mouse to drag a picture of the picture selection to the desired position in the status list in order to assign it to a status as a basic picture or a flash picture. Click on the "Browse..." button to insert additional pictures from the picture selection.

How to configure states

Introduction

In Runtime the states are displayed via the assigned pictures.

If you have not set any picture for a state, the following is displayed depending on the configuration:

- You use a graphics list and have enabled the "Default" option there for a picture. In Runtime, the default picture is then displayed for each state that has not been configured.
- You have manually assigned states to the pictures in the "Status Display Configuration" dialog. In Runtime, the symbol of the status display appears as a placeholder for each state for which no picture is set. If a status that has not been configured occurs in Runtime, the pictures of the prior status are shown. The settings for the following status are shown if there was no prior status.

How to assign pictures to the states

You configure the states in the "Status Display Configuration" dialog.

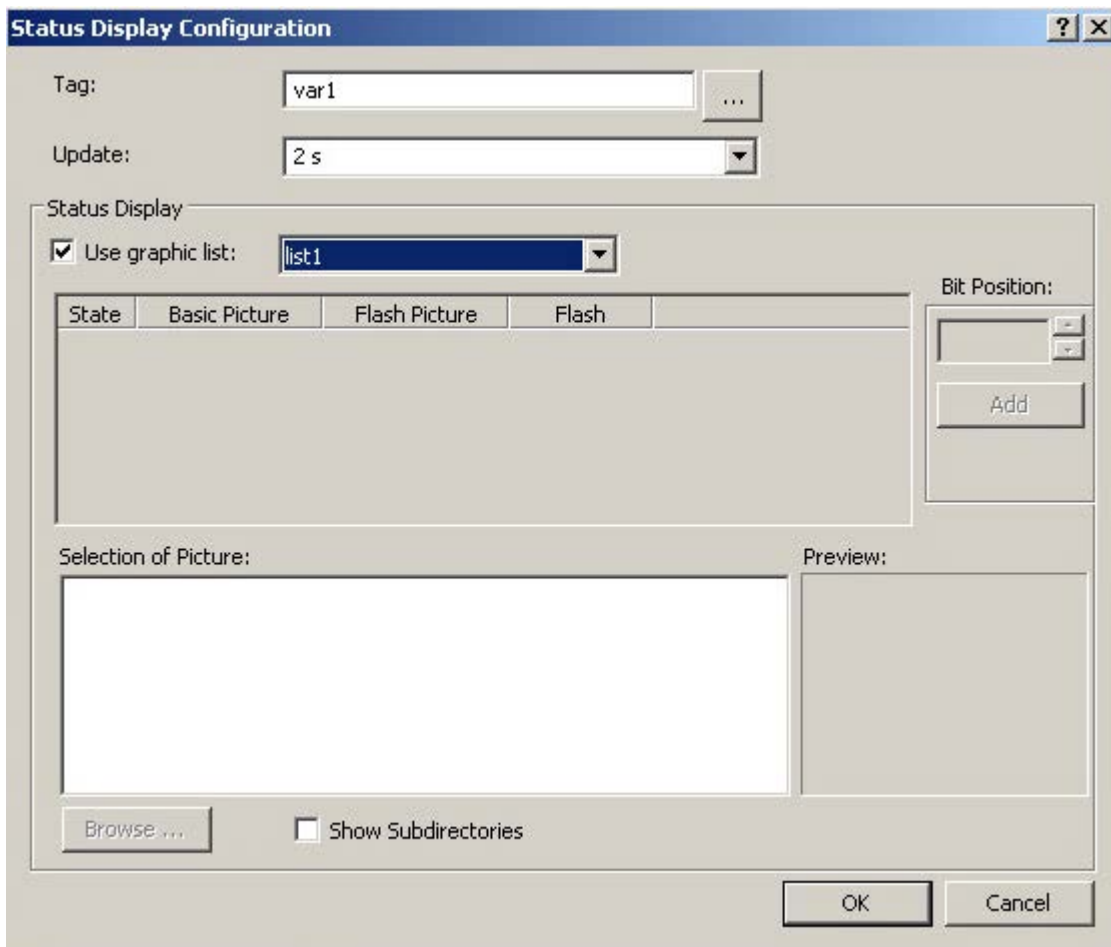

Two alternative procedures are possible:

- In the "Text and Graphics List" editor, you configure one or more graphic lists in which you assign pictures to the states. If you enable the "Use graphics list" option and select a graphic list, the assignments from the graphics list are used for status display. You can learn how to create graphic lists in the "Text and Graphic List" editor in How to create graphic lists (Page 452)
- You use a state list to manually configure the assignment of the pictures to the individual states. This procedure is described below.

Manual assignment of pictures

The status list is divided into four columns whose width can be changed. Every line of the status list shows the settings for a specific state. You configure the following settings through the context menu in the status list:

- State column:
Shows the value of the configured state. You can add or delete states. The command "Clear List" removes all states to which no picture is assigned.
- Basic picture column
Shows the name of the picture that is displayed in runtime when the state occurs. You can delete the basic picture of a status.
- Flash picture column
Shows the name of the picture that is displayed alternating with the basic picture, if a flash frequency is set for the flashing attribute. You can delete the flash picture of a status.
- Flashing attribute column
Displays the configured flash frequency. You can set the values "No flashing", "Slow", "Medium" and "Fast".

Inserting a status

Select the position in the "State" column at which you wish to insert a status. Select the entry "Add" in the context menu. The status for the next free position is inserted.

Inserting a status as a bit position

Click the arrow key to select a bit position. Click the field "Add" to enter the status of this bit position in the status list. The value selected as bit position is increased by one position. Click the "Add" button again to insert the next higher bit position.

Renaming status

Double-click the position in the state column at which you wish to rename a status. Enter the new value and confirm this by pressing <ENTER>. If the new value is already assigned, no change is made.

Deleting a status

Select the position in the state column at which you wish to delete a status. Select the entry "Remove" in the context menu. The status is deleted so long as at least one additional status is configured.

Clearing a status list

Open the pop-up menu at any status in the state column and select the entry "Clear List". All states to which no pictures are assigned are cleared.

Assigned pictures

Select the picture in the picture selection that you want to assign a status as basic picture or flash picture. Drag the picture to the desired position with the mouse. An existing picture is replaced by the new picture.

Delete pictures

Select the entry "Delete" in the pop-up menu of a configured picture to remove the picture from the status list.

Changing a flashing attribute

If a status is assigned only one basic picture, the associated flash automatically receives the "no flashing" attribute. If a basic picture and flash picture are assigned to a status, you can change the flash with the pop-up menu.

See also

How to configure a status display (Page 635)

How to insert a status display (Page 633)

3.8.7.10 Text list**How to add a text list****Introduction**

The text list offers the option of assigning specific values to a text.

You can use the text list:

- As an input list
- As an output list
- As a combined input / output list

The following data formats are available:

- Decimal
- Binary
- Bit.

The size and properties which a text list has in runtime are defined in the Graphics Designer.

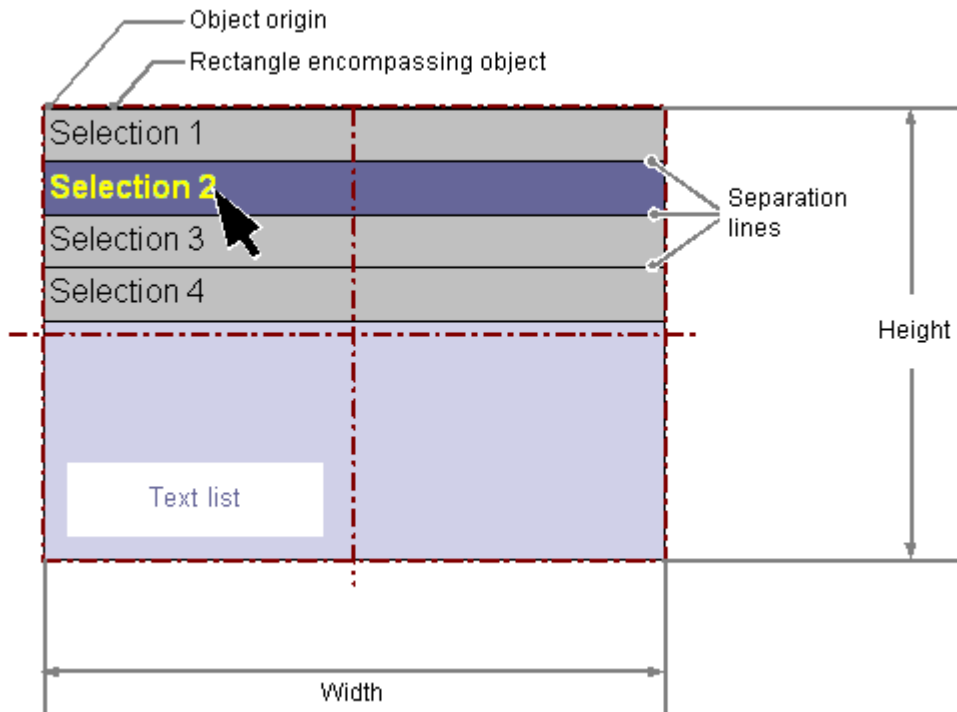

Requirements

- The use of configuration dialogs must be enabled in the "Options" tab of the "Tools / Settings..." menu.

Inserting a text list

1. Open the picture in which you want to insert a text list.
2. Click the "Text list" smart object in the "Standard" selection window.
3. Keeping the left mouse button pressed, drag the object in the desired area of the picture to the desired size.
When you release the mouse button, the object is inserted into the corresponding location in the picture.
The "Text List Configuration" dialog opens.
You can press the <SHIFT> key while inserting to create a square "Text list" object.
4. Enter the required values in the fields of the configuration dialog.
The description of the configuration dialog can be found in the next section.
5. Confirm your entries with "OK".
The insertion of the "Text list" object is completed.

Alternative procedure

Double-click the "Text list" smart object in the "Standard" selection window.

A text list with default object properties is then inserted near the picture origin.

The "Text List Configuration" dialog opens. The insertion process is finished when you confirm your inputs with "OK".

Changing a text list

Select an object of the text list type if you wish to carry out one of the following changes:

Rectangle surrounding the object

Drag the rectangle surrounding the object to the new position in order to arrange the object in the picture.

Drag the handles on the rectangle surrounding the object to a new position in order to resize the object.

Palettes and toolbars

Use the elements of the object palette to mirror or rotate the object.

Use the font palette to change the font display.

Use the color palette to change the colors.

Use elements of the style palette to change the display style for the object.

Attributes

Open the "Object Properties" window to change the current values of the required attributes.

See also

[How to configure a text list \(Page 641\)](#)

[How to configure apply values and display text of a text list \(Page 643\)](#)

[How to configure assignments for the "Decimal" type list \(Page 645\)](#)

[How to configure assignments for the "Binary" list type \(Page 647\)](#)

[How to configure assignments for the "Bit" list type \(Page 648\)](#)

[Basic Static Operations \(Page 459\)](#)

[Basic Dynamic Operations \(Page 485\)](#)

[The Properties of an Object \(Page 511\)](#)

[Working with Smart Objects \(Page 598\)](#)

How to configure a text list

Introduction

The "Text List Configuration" dialog opens after the insertion process if the use of configuration dialogs is enabled in the "Options" tab of the "Tools / Settings..." menu.

Alternatively, open the configuration dialog using the context menu of the object.

You change individual attributes in the "Object Properties" window.

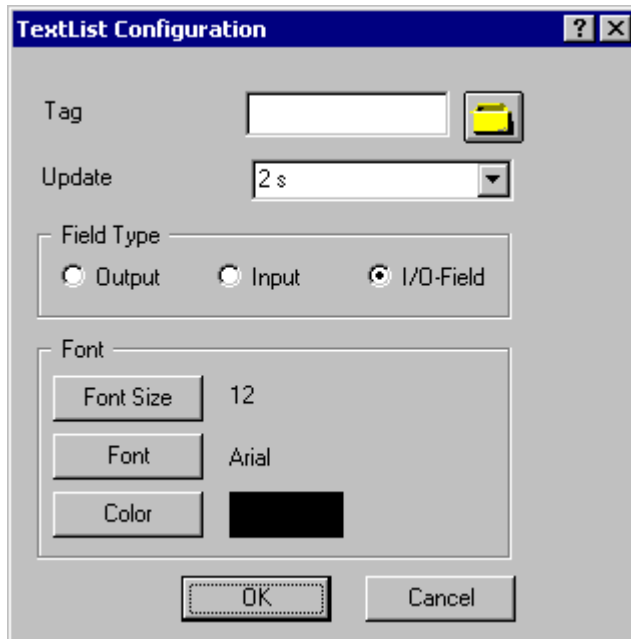

Tag

You can dynamize the text list by embedding a tag.

Depending on the selected field type, the value of the tag can be displayed as output or changed by an input.

Enter the name of the required tag or click  to open the "Tags" dialog. You can find a detailed description in the section "Quick configuration of objects > How to select a tag".

Maximum value range

The maximum value range corresponds to a signed 32-bit value. If the value is larger than "2 147 483 647" in runtime, the value is replaced by the string "****".

Updating

Specify the frequency with which the display for the indicated output value is to be updated.

Enter the desired interval or select an interval from the drop down list. You can find a detailed description in the section "The Basic Settings of the Graphics Designer > How to change the default trigger".

Field type

You can define the text list as an input list, an output list or as a combined input/output list.

Specify the desired field type.

Font

You can change the font for displaying input and output values regardless of the selected field type.

Click on the buttons to open the associated dialogs.

Display as drop-down list

You can display the text list as single object with arrow button for drop-down.

In the object properties, select the property "Display as drop-down list box" in the "Styles" group.

See also

[Changing the default trigger \(Page 368\)](#)

[Selecting a tag \(Page 705\)](#)

[How to configure apply values and display text of a text list \(Page 643\)](#)

[How to configure assignments for the "Decimal" type list \(Page 645\)](#)

[How to configure assignments for the "Binary" list type \(Page 647\)](#)

[How to configure assignments for the "Bit" list type \(Page 648\)](#)

[How to add a text list \(Page 639\)](#)

[Quick Object Configuration \(Page 703\)](#)

How to configure apply values and display text of a text list

Introduction

You can change the following attributes, among other things, for the "Text list" object using the object properties.

Changing an output value

The "Output Value" attribute specifies a start value for the output which is displayed in runtime in the case of a missing process driver connection or if an update has not yet taken place.

Activating apply values on exit

The "Apply on Exit" attribute specifies whether the input is applied when you exit the text list with <TAB> or by clicking the mouse.

Specifying a text reference

The "Text Reference" attribute specifies where the language-dependent assignment texts are stored.

The texts can be managed directly in the object or in the Text Library where the translation into other languages is made.

When you reference a configured text list, the assignment texts are always managed in the Text Library.

Defining the list type

The "List type" attribute determines the format for the assignment of the display texts to the output values.

If you use a configured text list with the "Text list" property, the "List type" property is grayed out.

Configuring assignments

The "Assignments" attribute in the "Input/Output" property group allows display texts to be specified. The display texts are displayed depending on the current "Output Value".

The number of texts and the type of assignment depends on the selected list type.

If you use a configured text list with the "Text list" property, the "Assignments" property is grayed out.

List Type	Assignment
Decimal	Display texts are assigned to values or value ranges. <ul style="list-style-type: none"> • Single value: Assignment to a single value • From value / to value: The text applies to all values greater than/equal to or less than/equal to the specified value. • From - to value: The text applies to all values of the value range. The maximum value range corresponds to a signed 32-bit value. Values that exceed "2 147 483 647" are not accepted.
Binary	Display texts are assigned to bit numbers. Up to 32 display texts can be defined. If a bit set in the output value is not assigned a display text, three asterisks appear in the list box.
Bit	A display text applies to the states of the bit that is set in the output value: <ul style="list-style-type: none"> • 1 - bit set • 0 - bit not set

Note

Text with semicolon can only be configured in "Text and graphic lists"

If you assign a text to a value in the text list, the text must not include a semicolon. The semicolon is a WinCC control character and is therefore automatically deleted in a text.

When configuring the text list in the "Text and graphic lists" editor, the text can also contain semicolons.

Using configured text list

To simplify the assignment of texts to specific values, configure a text list in the "Text and graphic lists" editor. This way you do not have to configure the assignment for each individual object in the object properties.

Select the name of a configured text list as "Text list" object property. The properties of the text list are applied to the "List type" and "Assignment" object properties.

You configure the sequence of the display texts in runtime with the "Sorting of text list" property.

You can learn how to create text lists in the "Text and graphic list" editor in "How to create text lists (Page 449)".

See also

How to configure a text list (Page 641)

How to configure assignments for the "Decimal" type list (Page 645)

How to configure assignments for the "Binary" list type (Page 647)

How to configure assignments for the "Bit" list type (Page 648)

How to add a text list (Page 639)

How to configure assignments for the "Decimal" type list

Introduction

The text list offers the option of assigning specific values or value ranges of a tag to a text.

Two alternative procedures are possible:

- In the "Text and graphic list" editor, you configure one or more text lists in which you assign texts to the values.
You can use the "Text list" object property to assign one of the configured text lists to the "Text list" smart object.
You can learn how to create text lists in the "Text and graphic list" editor in "How to create text lists (Page 449)".
- You use the "Assignments" attribute in the "Input/Output" property group to specify the display texts.
For the "Decimal" list type you can assign specific values or value ranges to display texts. This procedure is described below.

Procedure

1. Select the "Decimal" list type in the "Output/Input" property group.
2. Open the "Text list assignments (decimal)" dialog by double-clicking the "Assignments" attribute.

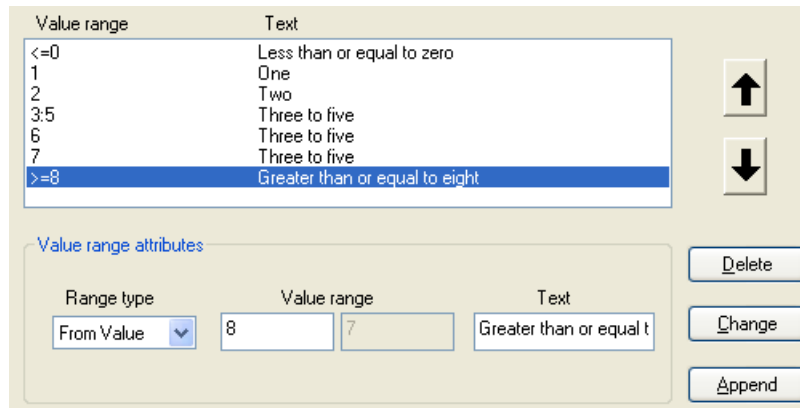

3. Select a range type from the drop-down list to specify the required value range:
 - Single value - a display text is assigned to a single value.
 - From value - a display text applies to all values greater than or equal to the specified value.
 - To value - a display text applies to all values less than or equal to the specified value.
 - From-to value - a display text applies to all values within the specified range of values.
4. Enter the desired value or value range.
5. Enter the text that you want to display for this value or value range. The text must not include a semicolon.
6. Click the "Append" button.
The new assignment is input into the assignments list.

Sorting assignments

Select the assignments that you want to sort.

Click the "Up" or "Down" button to move these assignments in the assignments list.

To sort configured text lists from the "Text and graphic list" editor, use the "Sorting of text list" object property.

Deleting assignments

Select the assignments that you want to delete in the assignments list and click the "Delete" button.

See also

- How to configure a text list (Page 641)
- How to configure apply values and display text of a text list (Page 643)
- How to configure assignments for the "Binary" list type (Page 647)
- How to configure assignments for the "Bit" list type (Page 648)
- How to add a text list (Page 639)

How to configure assignments for the "Binary" list type

Introduction

The text list offers the option of assigning specific bit numbers of a tag to a text.

Two alternative procedures are possible:

- In the "Text and graphic list" editor, you configure one or more text lists in which you assign texts to the bit numbers.
You can use the "Text list" object property to assign one of the configured text lists to the "Text list" smart object.
You can learn how to create text lists in the "Text and graphic list" editor in "How to create text lists (Page 449)".
- You use the "Assignments" attribute in the "Input/Output" property group to specify the display texts.
You can assign up to 32 display texts to the bit numbers for the "Binary" list type.
If a bit set in the output value is not assigned a display text, three asterisks appear in the list box.
This procedure is described below.

Procedure

1. Select the "Binary" list type in the "Output/Input" property group.
2. Open the "Text list assignments (binary)" dialog by double-clicking the "Assignments" attribute.

Bit no.	Text
0	Bit zero
1	Bit one
2	Bit two
3	Bit three

Value range attributes

Bit no.	Text
3	Bit three

3. Enter the bit number that you want to assign to a display text.

4. Enter the desired display text. The text must not include a semicolon.
5. Click the "Append" button.
The new assignment is input into the assignments list.

Sorting assignments

Select the assignments that you want to sort.

Click the "Up" or "Down" button to move these assignments in the assignments list.

To sort configured text lists from the "Text and graphic list" editor, use the "Sorting of text list" object property.

Deleting assignments

Select the assignments that you want to delete in the assignments list and click the "Delete" button.

See also

How to configure a text list (Page 641)

How to configure apply values and display text of a text list (Page 643)

How to configure assignments for the "Decimal" type list (Page 645)

How to configure assignments for the "Bit" list type (Page 648)

How to add a text list (Page 639)

How to configure assignments for the "Bit" list type

Introduction

The text list offers the option of assigning a bit of a tag to a text.

Two alternative procedures are possible:

- In the "Text and graphic list" editor, you configure one or more text lists in which you assign texts to the bits.
You can use the "Text list" object property to assign one of the configured text lists to the "Text list" smart object.
You can learn how to create text lists in the "Text and graphic list" editor in "How to create text lists (Page 449)".
- You use the "Assignments" attribute in the "Input/Output" property group to specify the display texts.
For the "Bit" list type you can assign one display text each for the states "1 - Bit set" and "0 - Bit not set" of the output value bit.
The "Bit Number" attribute specifies the number of the relevant bit in the output value.
This procedure is described below.

Procedure

1. Select the "Bit" list type in the "Output/Input" property group.
2. Open the "Text list assignments (bit)" dialog by double-clicking the "Assignments" attribute.

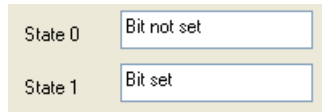

3. Enter the required display text for the states "0" and "1" and confirm the assignments with "OK". The display text must not include a semicolon.

See also

How to configure a text list (Page 641)

How to configure apply values and display text of a text list (Page 643)

How to configure assignments for the "Decimal" type list (Page 645)

How to configure assignments for the "Binary" list type (Page 647)

How to add a text list (Page 639)

3.8.7.11 How to insert multiline text

Introduction

The "Multiline Text" object makes it possible to display multiple lines of text in a rectangle in the picture.

If you enable operation, the operator can scroll and edit the text in Runtime.

By connecting variables, you can use the multilined text for entering or outputting text.

You define the size and properties of the "Multiline Text" object in the Graphics Designer. If the text is larger than the rectangle, WinCC automatically adds a scroll bar on the right-hand edge.

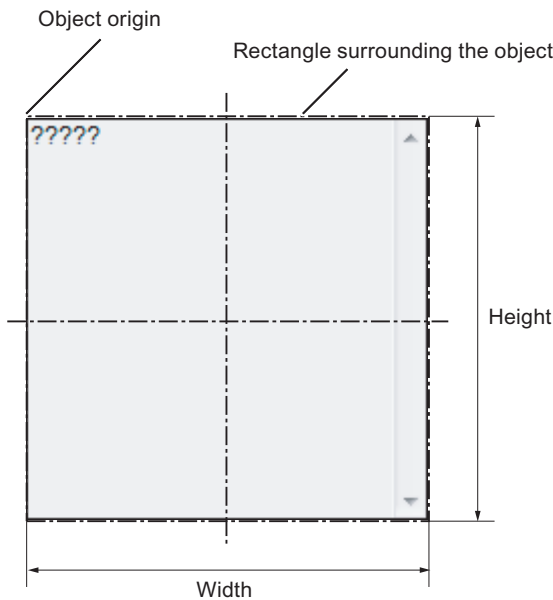

Insert multiline text

1. Open the picture into which you want to insert the object.
2. Click the "Multiline Text" smart object in the "Standard" selection window.
3. Keeping the left mouse button pressed, drag the object in the desired area of the picture to the desired size.
When you release the mouse button, the object is inserted at the corresponding location in the picture.
4. Use the color palette to change the colors.
5. Use elements of the Style Palette to change the display style for the object.

Alternative procedure

Double-click the "Multiple row text" smart object in the object palette.

The object with the default object properties is inserted near the picture origin.

Edit multiline text

Select the "Properties" menu command in the shortcut menu of the object and define the attributes of the "Multiline Text" object in the "Object properties" window.

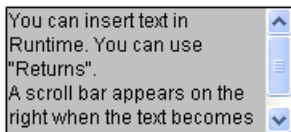

"Font" property group

You define the text and the respective display with the attributes under "Font".

Enter the text in the "Dialog" window.

"Miscellaneous" property group

If the attribute "Operator-Control Enable" is set to "Yes" and the operator has the access authorization, the operator can scroll the window and edit text in runtime.

Dynamization

If you connect tags to the "Text" attribute, you can use the "Multiline Text" object for entering and outputting text.

3.8.7.12 How to insert a combobox

Introduction

The combobox makes it possible to select one of many possible text records from a drop-down list for displaying and inserting in runtime.

You can define the texts with tags.

The size and properties which a combobox takes on in runtime are defined in the Graphics Designer.

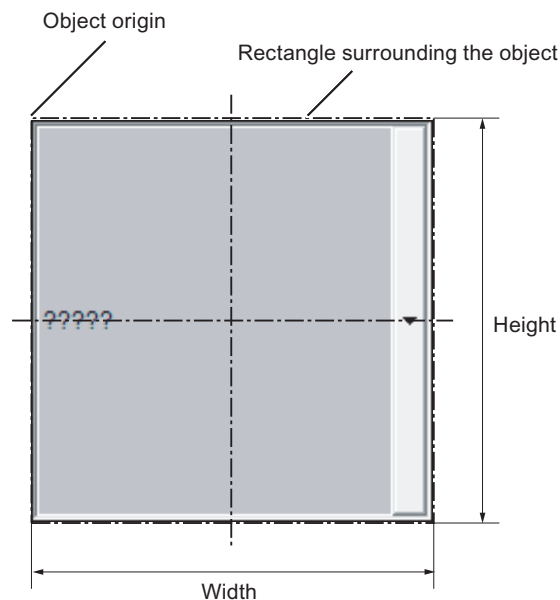

Insert combobox

1. Open the picture into which you want to insert a combobox.
2. Click the "Combobox" smart object in the "Standard" selection window.

3. Keeping the left mouse button pressed, drag the object in the desired area of the picture to the desired size.
When you release the mouse button, the object is inserted at the corresponding location in the picture.
4. Use the color palette to change the colors.
In runtime, the field that is active in each case is displayed with the background color specified for "Selected elements" in the operating system. This color cannot be changed in WinCC.
5. Use elements of the Style Palette to change the display style for the object.

Alternative procedure

Double-click the "Combo box" smart object in the object palette.

A combobox with default object properties is then inserted near the picture origin.

Edit combobox

Select the "Properties" menu command in the shortcut menu of the object and define the attributes of the combobox in the "Object properties" window.

"Geometry" property group

Use the "Number of rows" attribute to define the amount of lines shown in the combobox.

"Font" property group

You define the text and the respective display with the attributes under "Font".

Enter the respective text for each index from "1" to "Number of rows".

1. Double-click "Index" and enter the number.
2. Double-click "Text" and enter the corresponding display text.

The texts are saved for the object. Use the Text Distributor for translation.

Alternatively, link the object to a configured text list under "Output/Input".

"Miscellaneous" property group

The "Selected Box" attribute defines the index whose text is displayed in the combo box in runtime.

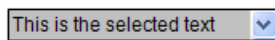

If the attribute "Operator-Control Enable" is set to "Yes" and the operator has the access authorization, the operator can drop the combobox down and select another text in runtime.

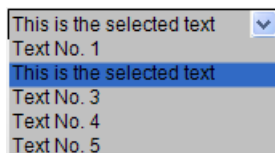

"Output/Input" property group

In the "Text list" attribute, select a text list that you have configured in the "Text and graphic lists" editor.

The "Text" and "Selected text" object properties apply the display text of the text list and are grayed out. The index assignment is also applied from the text list.

Dynamics

If you connect the respective tags, you can use the combobox:

- For the entry of a predefined text or the respective index.
- For the output of one or many predefined text records.

With other tags, you can predefine the text records dynamically yourself.

3.8.7.13 How to insert a list box**Introduction**

The list box make it possible to highlight one of many text records or select it for entry in runtime.

You define the size and properties that a list box has in runtime in the Graphics Designer. If the list is longer than the list box, scroll bars are added to the list box.

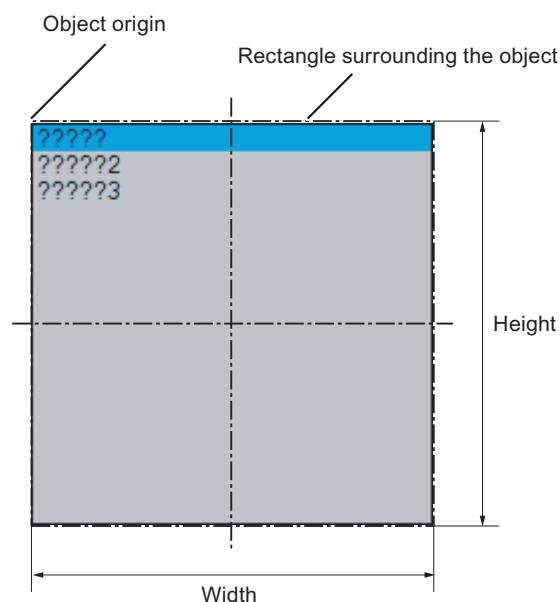
**Insert list box**

1. Open the picture into which you want to insert an list box.
2. Click the "List box" smart object in the "Standard" selection window.

3. Keeping the left mouse button pressed, drag the object in the desired area of the picture to the desired size.
When you release the mouse button, the object is inserted at the corresponding location in the picture.
4. Use the color palette to change the colors.
In runtime, the field that is active in each case is displayed with the background color specified for "Selected elements" in the operating system. This color cannot be changed in WinCC.
5. Use elements of the Style Palette to change the display style for the object.

Alternative procedure

Double-click the "List Box" smart object in the object palette.

A list box with default object properties is then inserted near the picture origin.

Edit list box

Select the "Properties" menu command in the shortcut menu of the object and define the attributes of the list box in the "Object properties" window.

"Geometry" property group

Use the "Number of rows" attribute to define the amount of entries that the list box has.

The number of displayed entries is defined by the height of the list box.

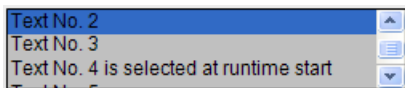

Make sure that the list box is wide enough for displaying the text.

Horizontal scrolling is not possible. Text that is too long will be cut off.

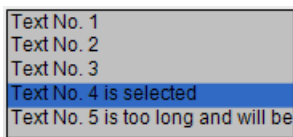

"Font" property group

You define the text and the respective display with the attributes under "Font".

Enter the respective text for each index from "1" to "Number of rows".

1. Double-click "Index" and enter the number.
2. Double-click "Text" and enter the corresponding display text.

The texts are saved for the object. Use the Text Distributor for translation.

Alternatively, link the object to a configured text list under "Output/Input".

"Miscellaneous" property group

The "Selected box" attribute defines the index, the text of which is highlighted in the list box when runtime is started.

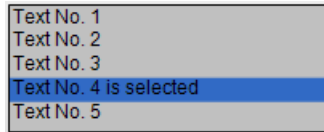

If the attribute "Operator-Control Enable" is set to "Yes" and the operator has the access authorization, the operator can select another text and highlight it in the list box in runtime.

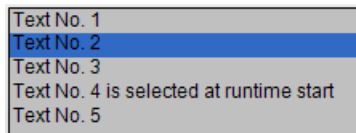
**"Output/Input" property group**

In the "Text list" attribute, select a text list that you have configured in the "Text and graphic lists" editor.

The "Text" and "Selected text" object properties apply the display text of the text list and are grayed out. The index assignment is also applied from the text list.

Dynamization

If you connect tags to the respective attributes, you can use the list box for the following:

- For inputting a predefined text or the respective index
- For outputting one of the predefined text records

You can also make the predefined text records dynamic with the respective text tags.

3.8.7.14 How to insert a Faceplate instance**Introduction**

You can insert a faceplate instance into your picture with the faceplate object. Faceplate types must first exist in the WinCC project.

Faceplates are preconfigured combinations of objects. You save such a combination as a faceplate type and can use them again and again as faceplate instances afterwards.

The size and properties that a faceplate instance takes on in runtime are defined in the Graphics Designer.

Insert faceplate instance

1. Open the picture in which you want to insert a faceplate instance.
2. Click the "Faceplate instance" smart object in the "Standard" selection window.

3. Keeping the left mouse button pressed, drag the object in the desired area of the picture to the desired size.
When you release the mouse button, the object is inserted into the corresponding location in the picture. The file selection dialog opens.
4. Select the desired FPT file.

As an alternative, double-click the "Faceplate instance" smart object in the "Default" selection window and select the faceplate type.

A faceplate instance with default object properties is then inserted near the picture origin.

Changing a faceplate instance

Select the "Properties" menu command in the shortcut menu of the faceplate instance and edit the attributes of the faceplate instance in the "Object properties" window.

The properties that you can change here depend on how the properties of the faceplate type are defined. Every faceplate type has two types of attributes:

- Type-specific attributes: You can change these attributes only in the faceplate type. After changes in the faceplate type, the changes are effective in the faceplate instance by reloading the picture.
- Instance-specific attributes: The attributes are predefined in the faceplate type and can be changed in the faceplate instance. A change in the faceplate type has no effects on already inserted Faceplate instances.

Other information on faceplate types are found in chapter "Working with Faceplate types".

See also

Working with Faceplate Types (Page 396)

3.8.7.15 How to insert a .NET control

Introduction

The .NET framework by Microsoft is also installed with WinCC. This makes it possible for you to integrate .NET applications (assemblies) as controls in your pictures.

When inserting the Smart object ".NET control" select the desired control in the "Insert control" dialog. Here, all controls that are available on your system are displayed.

Note

Possible problems when using third-party controls

The user of the software is responsible for problems caused by the deployment of external controls.

We recommend testing for safe operation before implementation.

At the end of the insertion process a configuration dialog is usually opened, in which you adapt the properties of the control. You can also open this dialog later by double-clicking the control.

WinCC uses the designation of the control linked with a sequential number as the object name by default. You can change this name with the "Object name" attribute in the "Object Properties" window.

Procedure

1. Click the ".NET Control" smart object in the "Standard" selection window.
2. Keeping the left mouse button pressed, drag the object in the desired area of the picture to the desired size.
When you release the mouse button, the object is inserted into the corresponding location in the picture.
3. The "Insert control" dialog is opened with the controls from the "Global assembly cache".

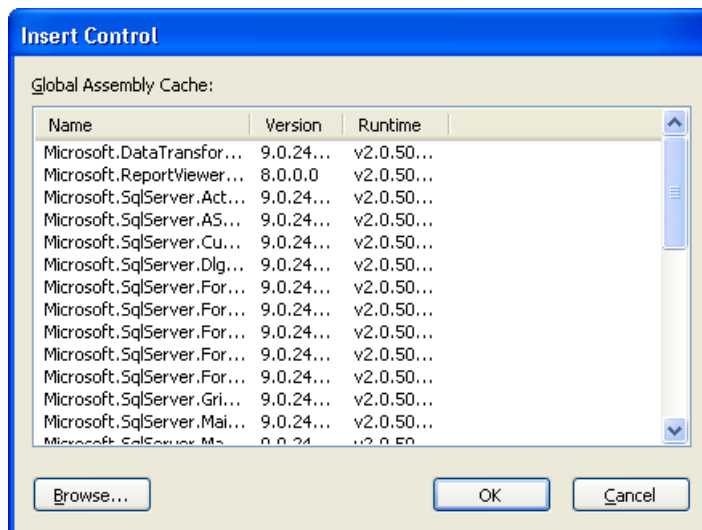

4. Select the required control and confirm with "OK".
5. Choose the desired type in the "Select type" dialog.
The associated configuration dialog now opens for some controls.
6. Adapt the settings of the configuration dialog as needed. Confirm your entries with "OK".
The insertion process for the ".NET control" object is finished.

As an alternative, double-click the ".NET control" smart object in the "Standard" selection window in order to insert it with the default properties into the process picture. Select the required control in the "Insert control" and "Insert type" dialogs.

Edit .NET Control

You open the "Object properties" dialog in the shortcut menu of the .NET control with "Properties". You can define the specific attributes of the selected controls in the "Control properties" properties group.

3.8.7.16 How to insert a WPF control

Introduction

Together with WinCC, the Microsoft .NET Framework 3.0 is also installed. A component of the framework is the "Windows Presentation Foundation (WPF)" which is used to describe user interfaces. This makes it possible to integrate WPF files as controls in your pictures.

When inserting the Smart object "WPF control", select the desired control. Here, all controls that are available on your system are displayed.

Note

Possible problems when using third-party controls

The user of the software is responsible for problems caused by the deployment of external controls.

We recommend testing for safe operation before implementation.

At the end of the insertion process a configuration dialog is usually opened, in which you adapt the properties of the control. You can also open this dialog later by double-clicking the control.

WinCC uses the designation of the control linked with a sequential number as the object name by default. You can change this name with the "Object name" attribute in the "Object Properties" window.

Procedure

1. Click the "WPF Control" smart object in the "Standard" selection window.
2. Keeping the left mouse button pressed, drag the object in the desired area of the picture to the desired size.
When you release the mouse button, the object is inserted into the corresponding location in the picture.
3. The "Insert control" dialog is opened with the "PresentationFramework 3.0" entry.

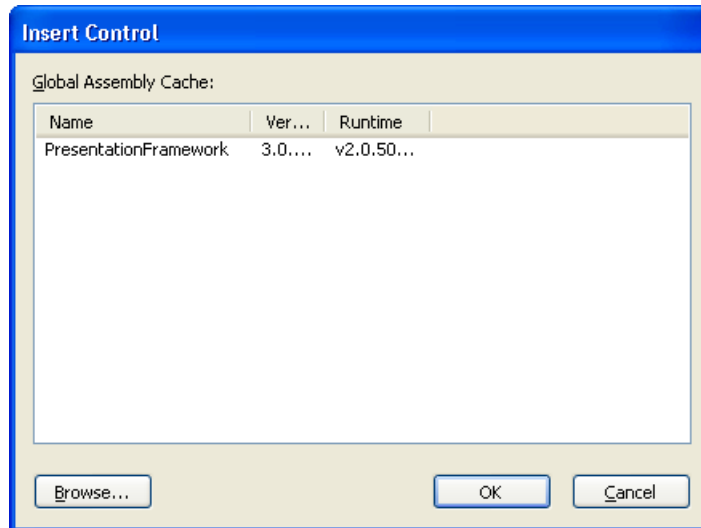

4. Select the "PresentationFramework 3.0" and confirm with "OK".

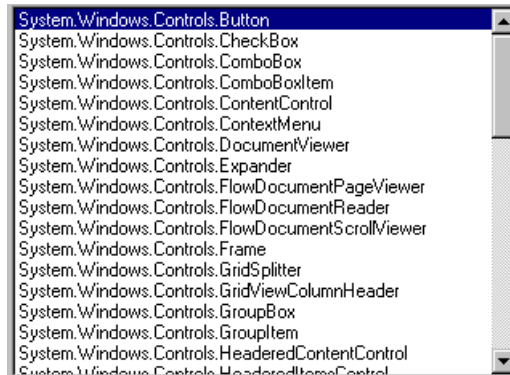

5. Choose the desired type in the "Select type" dialog.
The associated configuration dialog now opens for some controls.
6. Adapt the settings of the configuration dialog as needed. Confirm your entries with "OK".
The insertion process for the "WPF Control" object is finished.

As an alternative, double-click the "WPF Control" smart object in the "Standard" selection window in order to insert it with the default properties into the process picture. Select the required control in the "Insert control" and "Insert type" dialogs.

Edit WPF control

You open the "Object properties" dialog in the shortcut menu of the WPF control with "Properties". You can define the specific attributes of the selected controls in the "Control properties" properties group.

3.8.7.17 How to Insert a 3D Bar

Introduction

The 3D bar graph enables values to be displayed graphically three-dimensionally.

The size and properties which a 3D bar has in Runtime are defined in the Graphics Designer.

The 3D bar is only available if the "Basic Process Control" optional package was installed with WinCC.

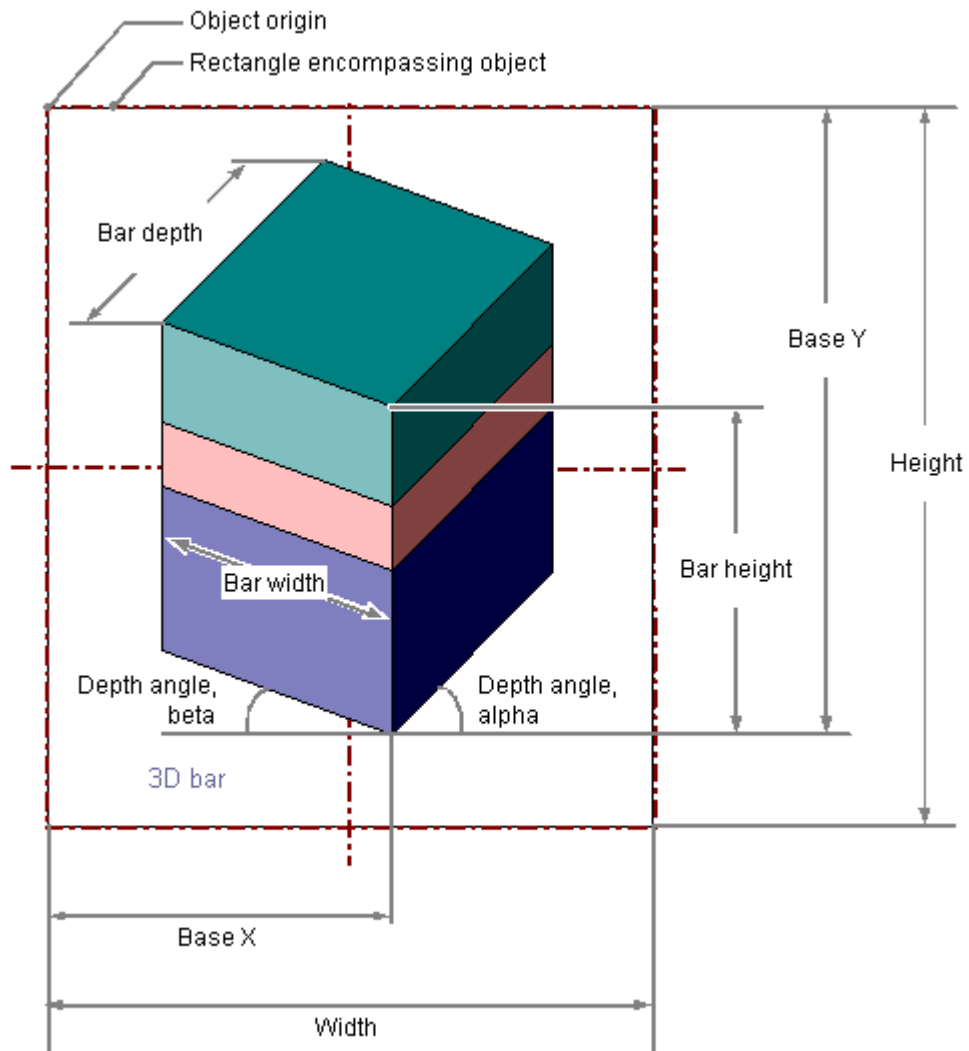

Inserting a 3D bar

1. Open the picture in which you want to insert a 3D bar.
2. Click the "3D bar" smart object in the "Standard" selection window.
3. Keeping the left mouse button pressed, drag the object in the desired area of the picture to the desired size.
When you release the mouse button, the object is inserted at the corresponding location in the picture.
If you keep the <SHIFT> key pressed while inserting, you create the "3D-Bar" object in the shape of a square.

Alternative procedure

Double-click the "3D-Bar" smart object in the "Standard" selection window.

A 3D bar with default object properties is then inserted near the picture origin.

Changing a 3D bar

Select an object of the 3D bar type if you wish to carry out one of the following changes:

Rectangle surrounding the object

Drag the rectangle surrounding the object to the new position in order to arrange the object in the picture.

Drag the handles on the rectangle surrounding the object to a new position in order to resize the object.

Palettes and toolbars

Use the color palette to change the colors.

Use elements of the style palette to change the display style for the object.

Attributes

Open the "Object Properties" window to change the current values of the required attributes.

Note

Avoid using black as the background color

The 3D bar is always surrounded by a rectangular frame.

Do not use a black background.

The arrows indicating that an area has been exceeded are not visible at this time.

Configuring limits of the 3D bar

You can define up to 11 limit values using the attributes "Limit N" (N = 0 to 10) for the "3D bar" object.

You can use the "Bar Color N" attributes to specify a color change for each limit value.

If the corresponding attribute "Monitoring N" has the value "Yes", the color setting is activated.

A display value is displayed in the "Bar Color N" as long as the value is lower than the value of the "Limit N".

A black arrow at the ends of the bar representation symbolizes display values that are lower than "Limit 0" or higher than "Limit 10".

See also

"Limits" Property Group (Page 544)

Basic Static Operations (Page 459)

Basic Dynamic Operations (Page 485)

The Properties of an Object (Page 511)

Working with Smart Objects (Page 598)

3.8.7.18 How to Insert a Group Display

Introduction

The group display enables the current states of certain message types to be displayed by hierarchy.

Up to eight buttons permit display and operation of messages.

Using a group display, it is possible for example to implement a quick change to represent an error source.

The size and properties which a group display accepts in Runtime are defined in the Graphics Designer.

Note

Autonomous group displays for ORing UP by means of the picture hierarchy

Group display objects that have been created automatically by the system for ORing UP must not be used in a group.

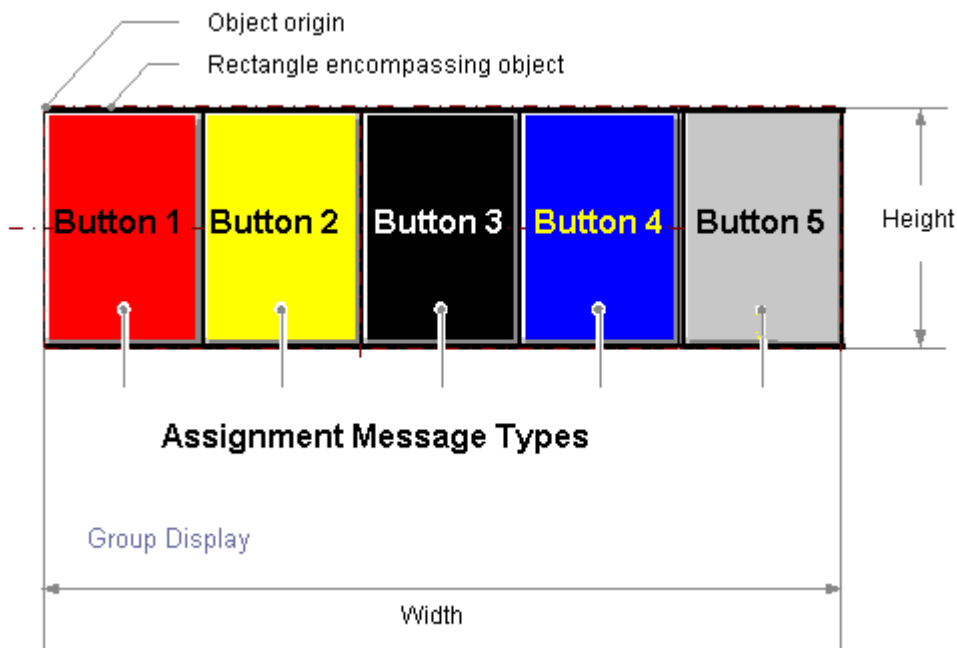

Inserting group display

1. Open the picture in which you want to insert a group display.
2. Click the "Group Display" smart object in the "Standard" selection window.
3. Keeping the left mouse button pressed, drag the object in the desired area of the picture to the desired size.
When you release the mouse button, the object is inserted at the corresponding location in the picture.
If you keep the <SHIFT> key pressed while inserting, you create a "Group Display" object in the shape of a square.

Alternative procedure

Double-click the "Group Display" smart object in the "Standard" selection window.

A group display with default object properties is then inserted near the picture origin.

Changing group display

Select an object of the group display type if you wish to carry out one of the following changes:

Rectangle surrounding the object

Drag the rectangle surrounding the object to the new position in order to arrange the object in the picture.

Drag the handles on the rectangle surrounding the object to a new position in order to resize the object.

Palettes and toolbars

Use the color palette to change the colors.

Use elements of the style palette to change the display style for the object.

Attributes

Open the "Object Properties" window to change the current values of the desired attributes.

Default settings of group display

If you insert a picture into the group display, the group display will have five buttons.

11 message types and their respective colors and texts are assigned to those five buttons.

You can change the assignment and can configure three additional buttons.

The default settings of graphic objects are changed by using the property dialog (right mouse button) of the default object selected in the "Standard" selection window.

Dynamizing the group display

The group display object is triggered by a tag which represents the message status.

You can use this tag to display the group display states in the other WinCC components .

Other types of dynamization are not possible.

Connect a group display with a PCS 7 measuring point

To configure the link to the tag, use the Dynamic Wizard "Link Group Display with PCS 7 Measuring Point".

Start the wizard and define the required settings.

The group display "Group value" attribute is linked to the "EventState" structure tag of the PCS 7 measuring point concerned.

The individual bits of this tag are interpreted in PCS 7 as follows:

Table 3-1 Status information of PCS 7 tag "EventState":

Bit in double word	Message class	Message type
Bit 31 (MS bit)	Alarm	AH
Bit 30	Alarm	AL
Bit 29	Warning	WH
Bit 28	Warning	WL
Bit 27	Tolerance	TH
Bit 26	Tolerance	TL
Bit 25	AS Process control message	Fault
Bit 24	AS Process control message	Error
Bit 23	Maintenance request	Maintenance request
Bit 22	Process message	PM
Bit 21	Not assigned	Not assigned
Bit 20	Operator request	OR
Bit 19	Operator message	OM
Bit 18	Status message	Automation system (AS) status
Bit 17	Status message	Status OS
Bit 16	Measuring point locked	X

Table 3-2 Acknowledgment information of PCS 7 tag "EventState":

Bit in double word	Message class	Message type
Bit 15	Alarm	AH acknowledged
Bit 14	Alarm	AL acknowledged
Bit 13	Warning	WH acknowledged
Bit 12	Warning	WL acknowledged
Bit 11	Tolerance does not require acknowledgment for PCS 7 *	TH acknowledged *
Bit 10	Tolerance does not require acknowledgment for PCS 7 *	TL acknowledged *
Bit 9	AS Process control message	Fault acknowledged
Bit 8	AS Process control message	Fault acknowledged
Bit 7	Maintenance request	MR acknowledged
Bit 6	Process message	PM acknowledged
Bit 5	Not assigned	Not assigned
Bit 4	Operator request acknowledgment not required for PCS 7	-

Bit in double word	Message class	Message type
Bit 3	Operator input message acknowledgment not required for PCS 7	-
Bit 2	Status message acknowledgment not required for PCS 7	-
Bit 1	Status message acknowledgment not required for PCS 7	-
Bit 0 (LS-bit)	Measuring point block acknowledgment not required for PCS 7	-

* With new projects as of WinCC V7.01, you can configure messages of the "Tolerance" message class as mandatory acknowledgement messages. The option is selected in the OS Project Editor.

You may assign any of the 16 message types to any bit and thereby change the default settings. Configuration is performed in the "Message type" property in "Message Types" property group.

The bit assignment to the message classes cannot be changed. You cannot view other message classes, such as OS process control messages, in the group display.

Connecting a group display with a custom tag

Independent of PCS 7, you may connect a group display with a tag. In this tag you assign individual bits on a need basis.

1. Open the group display shortcut menu and select "Properties".
2. Select "Miscellaneous" in the "Properties" tab.
3. Open the shortcut menu in the "Group value" line, "Dynamic" column and select "Tag...". The tag must be a signed 32-bit variable.
4. Select one of the tags from the process layer or from the internal tags in the "Select tag" window.
5. Activate the "Upon Change" update cycle in the "Current" column.

If an internal tag is used, it should have the start value 65535 (0x0000FFFF). In this manner, you can ensure that at the start - from the view of the group display - there are no unacknowledged messages.

For individually configured group displays, the supplied PCS7 settings for acknowledgment sample of "17" or "3089" is most likely not suitable for your project and must be adjusted.

You can thus influence the quitting pattern via the ""@EventQuit" tag.

Configuring Message Types

The "Message Types" property group contains attributes with which you can set the display of messages depending on the 16 message types.

For example, each message type may be visualized by an appropriate label and by color changes of the button.

Assigning message types to buttons

In the "Assignment" object property of the group display you assign message types to the buttons. Enter the respective bit numbers in the group value.

The buttons may have multiple assignments:

- with bit numbers corresponding to message classes. These are separated by ",".
- with bit numbers corresponding to message types. These are separated by ";".

The sequence of entries determines their priority. The earliest entry is displayed with the highest priority in case of concurrent events.

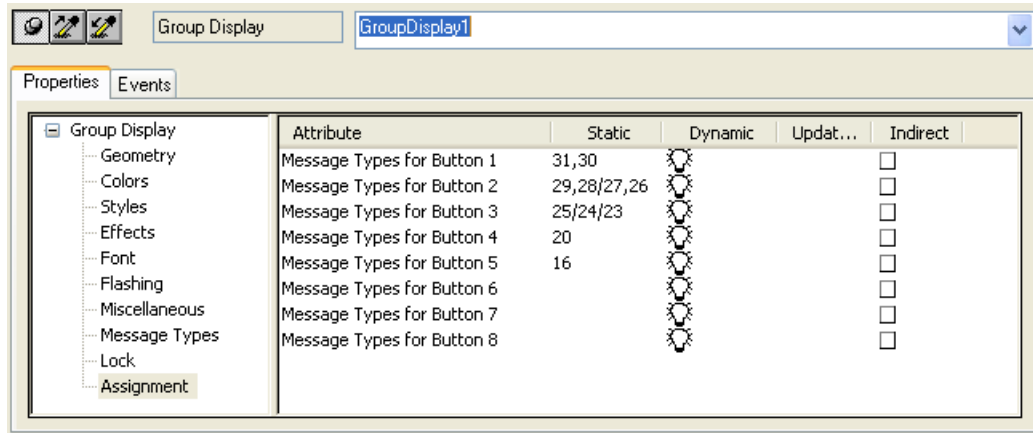

Lock display

The "Lock" property group contains attributes with which you can change the view of locked measuring points.

The "Lock display" attribute specifies for a group display whether or not a locked measuring point is displayed.

The lock applies to all buttons of the group display, independent of which other events in the hierarchy are pending.

In the default settings for the group display, the fifth button is reserved for display of status "Measuring point locked" by using "Group value bit 16". This allows to display not only pending events in the hierarchy but also those locked in subordinate measuring points.

See also

"Message Types" Property Group (Page 545)

"Lock" Property Group (Page 552)

Basic Static Operations (Page 459)

Basic Dynamic Operations (Page 485)

The Properties of an Object (Page 511)

Working with Smart Objects (Page 598)

3.8.7.19 How to Configure the Extended Status Display

Introduction

Extended status display is available only when a PCS 7 OS is installed.

You can use the extended status display to define statuses on the basis of the group value and/or up to four control tags. You assign pictures to the statuses.

The group value is triggered by a tag which represents the message status. Other types of dynamizing are not possible. The group value is usually interconnected with a PCS 7 EventState.

You can use any numerical tag from the WinCC Tag Management as a status tag.

The alarm status results from the evaluation of the bits of the group value. If the group value contains multiple bits, the priority determines which status is displayed. For the bits of the group value, you assign pictures for the "Came In" (+), "Came In Acknowledged" (+Q) and "Went Out Unacknowledged" (-) statuses. In addition, you can assign a basic picture and a flashing picture for the "OK" status.

Configuration steps

You configure the extended status display in several steps:

1. Specify how many tags you want to use. Connect these tags to the appropriate object properties "Status1" to "Status4" of the extended status display.
2. For status value generation, determine the bit assignment of the status value in accordance with a bit position of the utilized tags "Status1" to "Status4".
3. If you want to consider the alarm statuses of the group value, you determine the bits of the group value to be used. Connect the "Group value" property to a tag. In PCS 7, this is usually the "EventState" tag of a process tag.
4. Specify the priorities for the messaging characteristics in Runtime.
5. Assign basic and flashing pictures to the utilized bits of the status value or the combination of utilized bits from the status value and group value.

Procedure

1. Open the Graphics Designer, go to the Object Palette/Smart Objects and select the object "Status Display (extended)".
2. Move the object into the working area using a drag-and-drop operation. This opens the configuration dialog box for the extended status display.

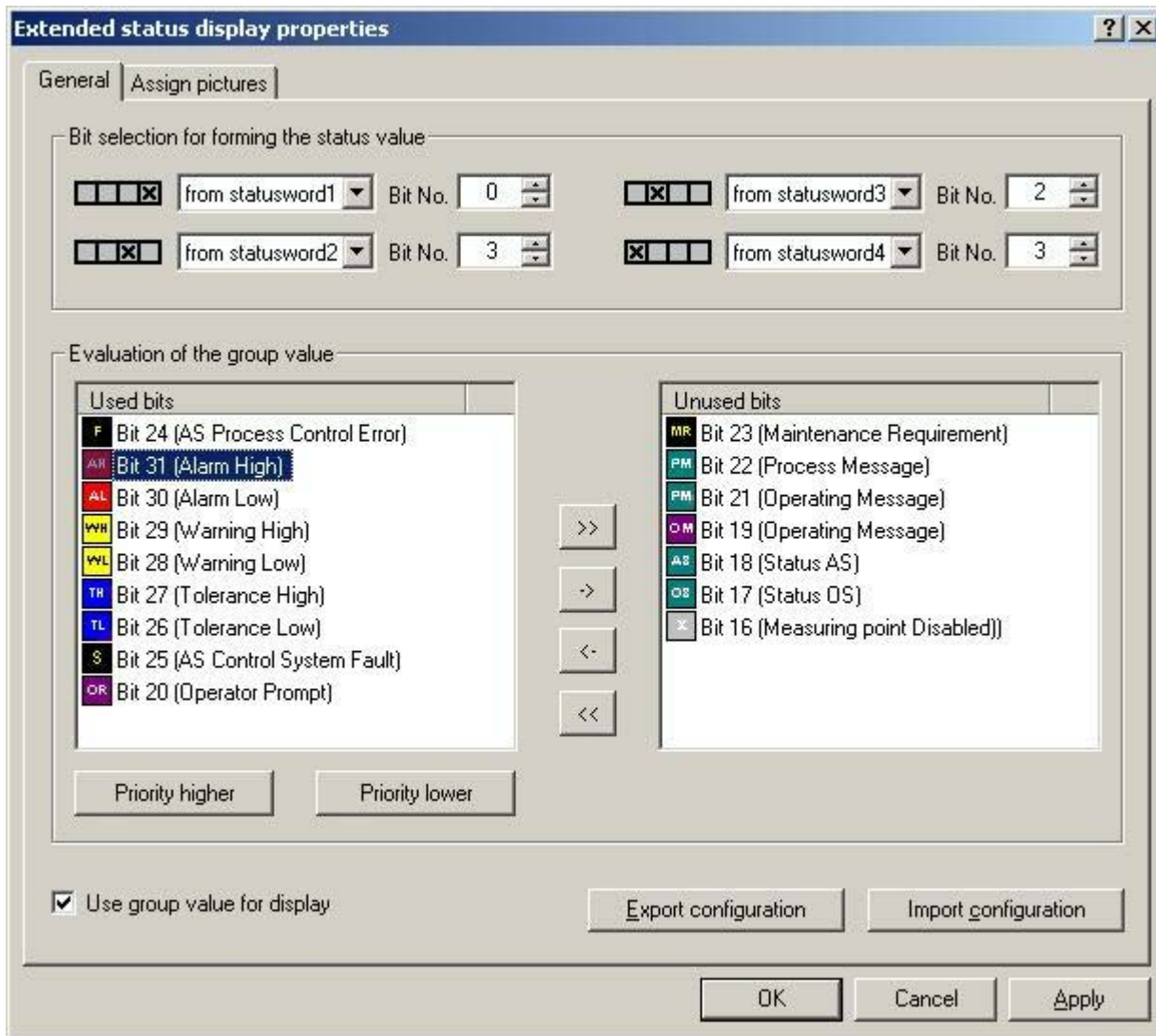

- In the "Bit selection" area, form an individual status value from a maximum of 4 interconnectable status words.

Example A: The status value is formed solely from the "two to the power of four" bit of the tag interconnected with the "Status1" property.

Example B: You want to use the inputs of the four binary variables "Status1" to "Status4" to form the status value.

- If you want to combine the status value formation with the alarm statuses of the group value, select the "Use group value for display" check box.
- Select the bits that you want to use for the extended status display from the group value. Use the arrow keys to move a selected bit between the two lists. The default allocation corresponds with the PCS7 standard.
- Specify the priority order of the utilized bits for the evaluation of the group value. The entries in the "Used Bits" list show the order of the priorities. The top entry has the highest priority (priority 1). Select one entry at a time in the "Used bits" list and change the priority by clicking "Priority higher" or "Priority lower". All entries in the "Unused bits" list have the priority "0". The icons in the "Used bits" and "Unused bits" lists always reflect the PCS 7 standard, regardless of any project-specific deviation.

- Assign the used bits in the "Assign pictures" tab. The Index is formed from the status value formation or the combination of status value and group value. You can specify the basic picture and flash picture for each combination. If a flash picture is configured, the basic picture and the flash picture will be displayed alternately in Runtime. You can use your own pictures, but these must be located in the "GraCS" directory of the project or in a subdirectory of "GraCS".

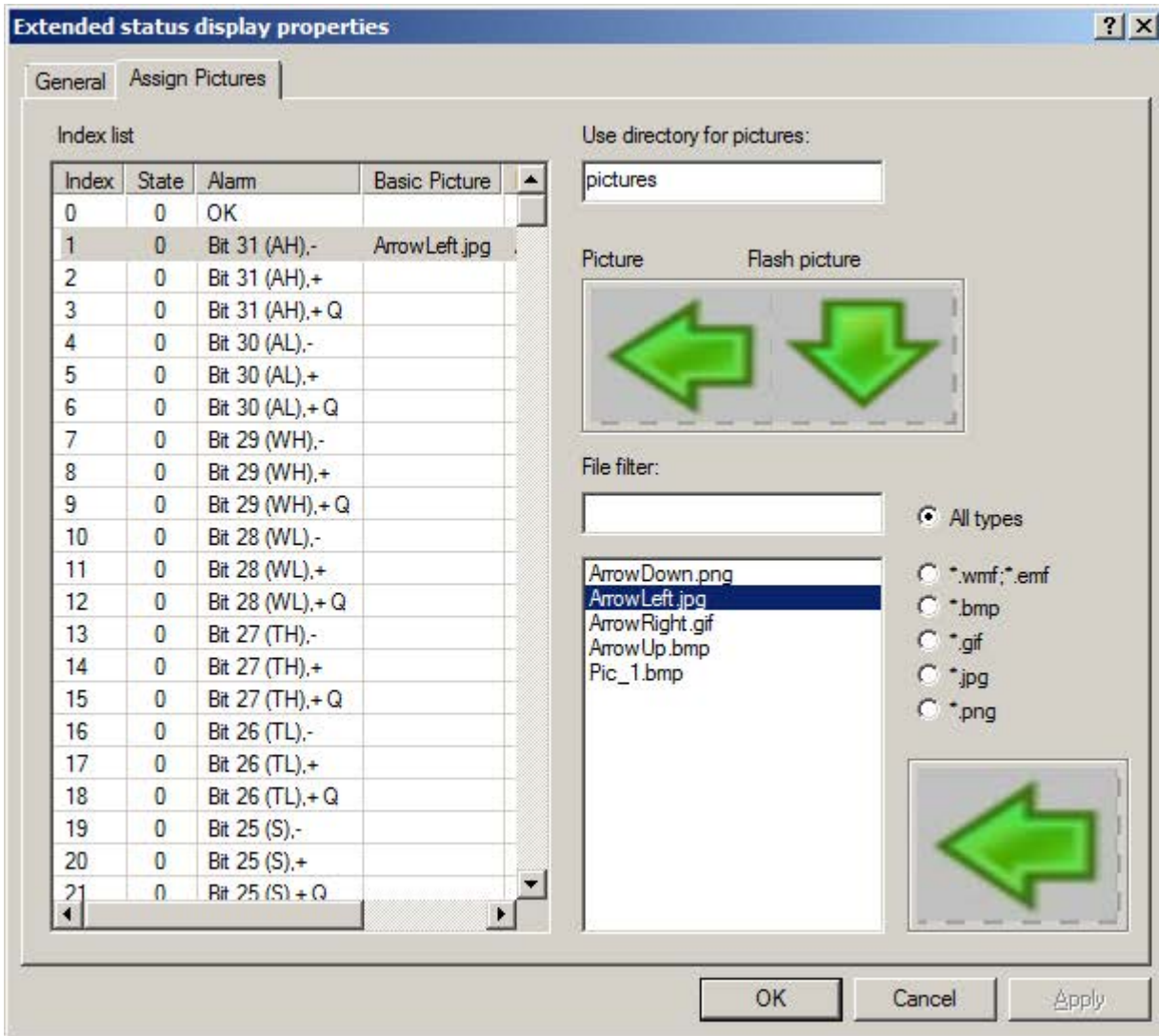

- In the index list, click the status to which you want to assign pictures.
- The file selection list shows the graphics files of the selected file type, either from the "GraCS" directory of the project or from the subdirectory specified in the "Use directory for pictures" field. If no subdirectory is specified or if the subdirectory does not include any pictures, the pictures in the "GraCS" directory are taken into consideration. Double-click on the required graphic file. You assign the basic picture with the first double-click, and the flash picture with the second double-click.

10. If you want to delete a picture from a status, select the status in the table and select the appropriate menu command from the shortcut menu.
11. Click on the "OK" or "Apply" button. The settings will be applied.
12. Connect the utilized tags to the extended status display. Open the object properties.
13. Select the property "Status1" in the properties group "Other". Select the "Tag..." command from the shortcut menu of the "Dynamic" column. Select the tag from the "Select tag" window. If using multiple tags, interconnect these with the "Status2" to "Status4" properties.
14. Connect the tag for the group value in the object properties of the extended status display. Select the property "Group value" in the properties group "Other". Select the "Tag..." command from the shortcut menu of the "Dynamic" column. The tag must be a signed 32-bit variable. Select one of the tags from the process layer or from the internal tags in the "Select tag" window.

Export/import configuration

You can save and forward the configured picture assignments for the extended status display by exporting the configuration as an XML file. This is also how you import an existing configuration. You cannot import a configuration of the extended status display that you have exported prior to WinCC V6.2.

Behavior of message priorities in Runtime

When a queued event is acknowledged, it goes to the background regardless of its priority. Events with lower priority that have not yet been acknowledged are displayed prior to events of higher priority that have already been acknowledged.

Lower priority events are not displayed so long as a higher priority event is displayed as "Unacknowledged Outgoing".

Special settings in the properties dialog box

The extended status display has been modified for optimum compatibility with how the group display behaves.

If the "Group Relevant" attribute is set to "Yes" in the object properties, the status tag interconnected under "Group value" enters into the ORing UP of the group display hierarchy. If the "Group Value" attribute is not interconnected, then you must set "Group Relevant" to "No". The process alarm "Group display: tag .EventState not found" would otherwise not be triggered in Runtime.

Property "Other/Acknowledgment mask"

To ensure consistent runtime response, we recommend that you configure the acknowledgment mask for the group display and the extended status display in exactly the same way.

For the extended status display, the supplied PCS7 setting of the acknowledgment mask with "17" or "3089" prior to WinCC V7.01 is possibly not suitable for your project and must be adjusted.

Property "Other/Outgoing state visible"

You use the "Outgoing state visible" property to specify whether an outgoing state is visible or not.

Note

If you change the status value formation or add or remove the group value for the display, this changes the possible statuses available on the "Assign pictures" configuration page. A notice warns you that all picture assignments configured so far will be lost. If you wish to retain the picture assignments, you must export and save the existing configuration.

3.8.7.20 How to Configure the Extended Analog Display

Introduction

Extended analog display is available only when a PCS 7 OS is installed.

The extended analog display enables you to display the value of a tag in runtime in various colors according to the alarm statuses of a block. The alarm status results from the evaluation of the bits of the group value. The group value is controlled by a tag. Other types of dynamizing are not possible. If the group value contains multiple bits, the priority determines which status is displayed.

Display options

The following display options are available for the bits of the group value with regard to the "Came In", "Came In Acknowledged" and "Went Out Unacknowledged" statuses:

- Background color
- Font color
- Flashing and color-flashing of the background and the text

For the "OK" and "Simulation" statuses, you can configure both a background color and a text color in the properties dialog or the configuration dialog. The flashing color is the same for both statuses. You specify whether or not both statuses are to exhibit flashing response in the "Flashing" property in the properties dialog box.

Configuration steps

You configure the extended status display in several steps:

1. Specify the bits of the group value to be used.
2. Specify the priorities for the messaging characteristics in Runtime.
3. If you do not want to accept the default settings, specify the display options of the message types for the utilized bits. Independent of the bits of the group value, you can configure the colors for the "OK" and "Simulation" statuses.
4. Connect the "Value" and "Group value" properties to one tag each.
5. If necessary, configure a simulation tag and the display options for the value of the tags.

Procedure

1. Open the Graphics Designer, go to the Object Palette/Smart Objects and select the object "Analog Display (Extended)."
2. Move the object into the working area using a drag-and-drop operation. This opens the configuration dialog box for the extended analog display.

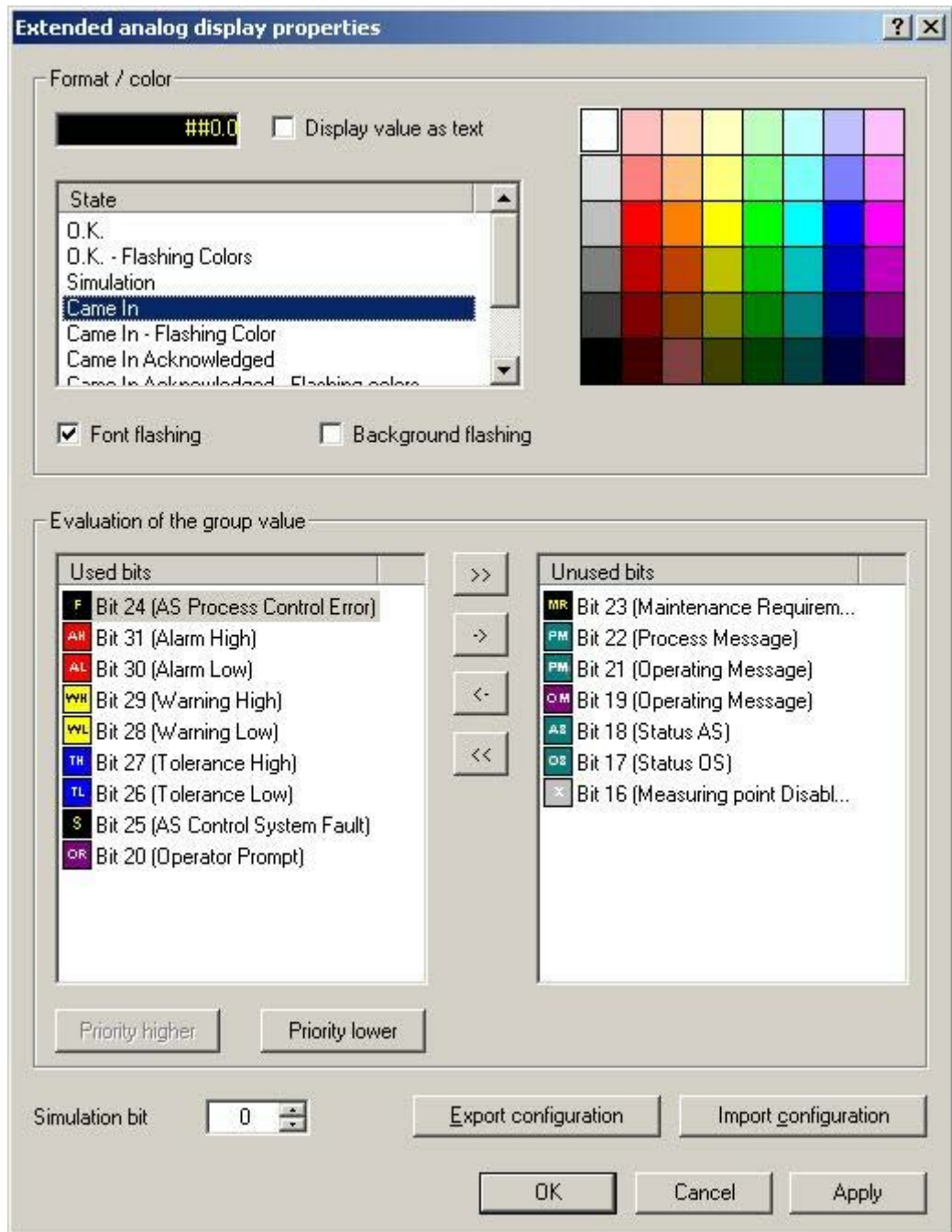

3. Select the bits that you want to use for the extended analog display from the group value. Use the arrow keys to move a selected bit between the two lists. The default allocation corresponds with the PCS7 standard.

4. Specify the priority order of the utilized bits for the evaluation of the group value. The entries in the "Used Bits" list show the order of the priorities. The top entry has the highest priority (priority 1). Select one entry at a time in the "Used bits" list and change the priority by clicking "Priority higher" or "Priority lower." All entries in the "Unused bits" list have the priority "0." The icons in the "Used bits" and "Unused bits" lists always reflect the PCS 7 standard, even if there are user-defined settings. These settings are indicated under "Format/color."
5. To configure the display for the statuses of a bit, you select the bit from the "Used bits" list. You then select the status from the "Status" list, for whose value you want to change the pre-configured color settings.
6. Click the desired color in the color matrix. The first click changes the background color and the second click changes the text color/foreground color.
7. If the value and/or the background to be displayed for the utilized bit and the selected status is to flash, select the appropriate check box. Specify the flashing colors, as appropriate.
8. If you want to change the format of the value to be displayed, open the object properties of the extended analog display. In the "Text" properties group, double-click the "Format" property and enter the desired format.
If you want to output the value as text, double-click "Value as text" in the properties group "Other", or activate the "Display value as text" check box in the configuration dialog box.
9. Configure the display options for additional bits.
10. Click "OK." The settings will be applied.
11. Connect the tags for the value that you want to display and for the group value in the object properties of the extended analog display.
12. Select the "Value" property in the "Other" properties group for this purpose. Select the "Tag..." command from the shortcut menu of the "Dynamic" column. Select the tag from the "Select tag" window.
13. Select the property "Group value" in the properties group "Other." Select the "Tag..." command from the shortcut menu of the "Dynamic" column. The tag must be a signed 32-bit variable. Select one of the tags from the process layer or from the internal tags in the "Select tag" window.

Configuring a simulation

You can configure a simulation for the purpose of replicating a specific situation using different text and background colors. The "Simulation" and "Simulation bit" properties will only be evaluated if the status is "O.K."

1. Select the "Simulation" property in the object properties of the extended analog display. Select the "Tag..." command from the shortcut menu of the "Dynamic" column. Select the tag from the "Select tag" window.
2. Double-click the "Simulation bit" property in the extended analog display "Other" properties group. In the edit box, enter the simulation tag bit that is to be evaluated.
3. In the "Colors" properties group, specify the text and background colors for the simulation.

Export/import configuration

You can forward the configured settings for the extended analog display by exporting the configuration as an XML file. This is also how you import existing configurations. You cannot import a configuration of the extended analog display that you have exported prior to WinCC V6.2.

Behavior of message priorities in Runtime

When a queued event is acknowledged, it goes to the background regardless of its priority. Events with lower priority that have not yet been acknowledged are displayed prior to events of higher priority that have already been acknowledged.

Lower priority events are not displayed so long as a higher priority event is displayed as "Unacknowledged Outgoing."

Special settings in the properties dialog box

The extended analog display has been modified for optimum compatibility with how the group display behaves.

If the "Group Relevant" attribute is set to "Yes" in the object properties, the status tag interconnected under "Group value" enters into the ORing UP of the group display hierarchy. If the "Group Value" attribute is not interconnected, then you must set "Group Relevant" to "No." The process alarm "Group display: tag .EventState not found" would otherwise not be triggered in Runtime.

Property "Other/Acknowledgment mask"

To ensure consistent runtime response, we recommend that you configure the acknowledgment mask for the group display and the extended analog display in exactly the same way.

For the extended analog status display, the supplied PCS7 settings for acknowledgment sample of "17" or "3089" prior to WinCC V7.01 is possibly not suitable for your project and must be adjusted.

Property "Other/Outgoing state visible"

You use the "Outgoing state visible" property to specify whether an outgoing state is visible or not.

Note

The quality code can only be evaluated by the extended analog display if the object property "Value" is made dynamic directly with a tag.

See also

Format Function of the Analog Display (Page 676)

3.8.7.21 Format Function of the Analog Display

Formatting options

You format the value of the tag that will be displayed in the extended analog display as follows:

Formatting characters	Display
No characters	Displays the number without formatting.
(0)	<p>Displays a digit or zero.</p> <p>If the expression contains a digit at a position that is occupied by a 0 in the format string, the digit is displayed. Otherwise a zero is output.</p> <p>If the number has less digits than the zeros in the format expression (on both sides of the decimal point), the leading or trailing zeros are displayed.</p> <p>If the number has more decimal places after the decimal point than the zeros in the format expression, the decimal places are rounded to the number of zeros.</p> <p>If the number has more places before the decimal point than zeros in the format expression, the additional places are displayed just as they are.</p>
(#)	<p>Displays a digit or no output.</p> <p>If the expression contains a digit at a position that is occupied by a # placeholder in the format string, the digit is displayed. Otherwise nothing is displayed at this position. This symbol behaves like a 0 placeholder. However, leading or trailing zeros are not displayed if the format expression contains more # placeholders before or after the decimal separator than there are digits in the number.</p>
(.)	<p>Placeholder for the decimal separator.</p> <p>In many locales a comma is used as decimal point, and in others a point is used. The placeholder for the decimal separator determines how many places are displayed to the left and right of the decimal separator.</p> <p>If the format expression contains only # placeholder to the left of this symbol, numbers smaller than 1 begin with a decimal character.</p> <p>If you require decimal numbers always to be displayed with a leading zero, you must specify a 0 placeholder for the first digit to the left of the decimal point. The character that is actually output as the decimal separator depends on the system settings for the number format.</p>
(%)	<p>Placeholder for percent.</p> <p>The expression is multiplied by 100. The percent sign (%) is inserted at the position it occupies in the format string.</p>
(,)	<p>Thousands separator</p> <p>In many locales a comma is used as the thousands separator, and in others a point is used. The thousands separator divides thousands from hundreds in a number containing four digits or more. A thousands separator is output if the format expression contains the appropriate placeholder and this placeholder is itself surrounded by placeholders for digits (0 or #). Two thousands separators in succession or a thousands separator immediately left of the decimal separator even if no decimal places are specified will cause the number to be divided by 1000 and rounded off.</p> <p>Example: You can use the format string "##0,," in order to output "100 million" as "100". Numbers smaller than 1 million are then shown as 0.</p> <p>Two consecutive placeholders for the thousands separator that are not placed immediately to the left of the decimal separator are interpreted as a normal thousands separator and output as such. The character that is actually output as the thousands separator depends on the system settings for the number format.</p>

Formatting characters	Display
((E- E+ e- e+)	<p>Scientific format.</p> <p>If the format expression contains at least one digit placeholder (0 or #) to the right of the symbol E-, E+, e- or e+, then the number is displayed in scientific notation or exponential notation. The letter E or e is inserted between the number and the exponent. The number of digit placeholders to the right of the symbol determines the number of places in the exponent. When the symbol is E- or e- a minus sign is output immediately alongside a negative exponent. When the symbol is E+ or e+ a minus sign is likewise output immediately alongside a negative exponent, but a plus sign is output beside a positive exponent.</p>
- + \$ ()	<p>Displaying a literal character</p> <p>If you want to output characters other than those specified here, you must enter a back slash (\) before the character concerned or enter the character in quote marks (" ").</p>
(\)	<p>Displaying the next character in the format string</p> <p>Many characters in the format expression have a special meaning and can only be displayed as literal characters if a back slash (\) is entered in front of them. The back slash is not displayed. A back slash has the same effect as enclosing the following character in quote marks. You indicate a back slash with two back slashes (\\).</p> <p>Examples of characters that cannot be displayed as literal characters are the letters for formatting the date and time (a, c, d, h, m, n, p, q, s, t, w, y, / and :) as well as the characters for formatting numbers (#, 0, %, E, e, comma and dot) and strings (@, &, <, > and !).</p>
(("ABC")	<p>Displays a character string in quote marks (" "). Before you can enter text from the code in the Format format string, you must enclose it in quotation marks with Chr(34). 34 is the character code for quotation marks ("").</p>

3.8.7.22 How to add an SVG object

Introduction

Scalable vector graphics (SVG) is a picture format for two-dimensional graphics that support interaction and animation. SVG pictures and the behavior of the graphics are defined in XML files and can be created and edited with any type of text editor.

Using a SVG object, you can insert pictures with scalable vector graphics in a process picture. The size and properties that a SVG object assumes in Runtime are defined in the Graphics Designer.

You can save the configured SVG objects to the SVG project library.

Requirements

- The use of the configuration dialogs is enabled in the "Options" tab under "Tools > Settings...".

Inserting an SVG object

1. Open the picture into which you want to insert an SVG object.
2. Click the "SVG object" smart object in the "Standard" selection window.

3. Keeping the left mouse button pressed, drag the object in the desired area of the picture to the desired size.
When you release the mouse button, the object is inserted into the corresponding location in the picture. The "Picture selection" dialog opens.

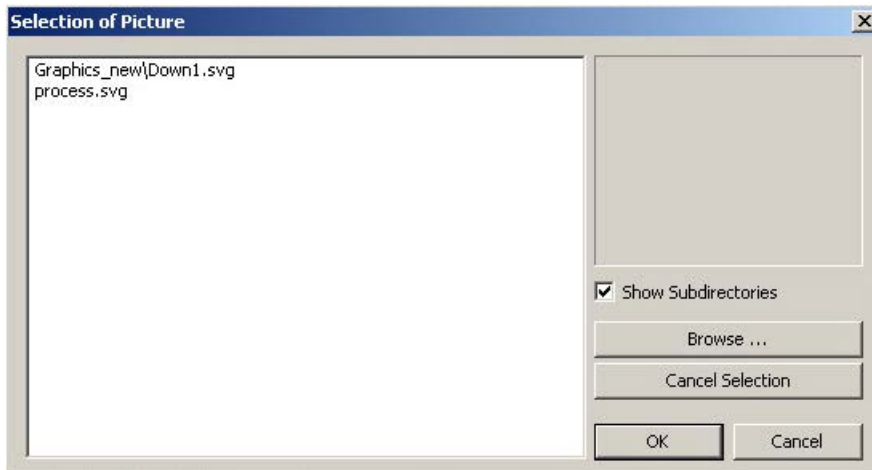

4. The picture selection shows all pictures with "svg" format contained in the SVG Library of the current WinCC project. Select "Show subdirectories" when you want to display existing subdirectories of "GraCS" with the SVG pictures they contain in the picture selection. Click on the "Browse..." button to insert additional pictures from the picture selection. To remove an existing assignment, click "Cancel Selection".
5. Select the picture that is displayed in the SVG object.
6. Confirm your entries with "OK".
The insertion process for the "SVG Control" object is finished.

You can press the <SHIFT> key while inserting to create a square "SVG object" object.

Alternatively, you can use drag-and-drop to insert an SVG file from the SVG library into the SVG object. The SVG object is then configured with this file in the "Picture" property.

Note

If the "Picture Transparent Color On" attribute has the value "Yes" for a SVG object, the available flash frequency is also reduced if necessary.

3.8.7.23 How to configure a DataSet object

DataSet

Serves as a container for internal storage of data of the customized objects or faceplate types. The object does not have a graphical user interface in Runtime.

You can link tags or configure events in the properties of the DataSet object:

- Create / delete object attribute: "Add" / "Remove" button
Maximum number: 255 attributes
- Changing a data type: Click in the "Type" column.
Possible data types (combo box): Bool, Int, Long, Double, String (language-neutral text), LanguageString (language-dependent text), Color, PasswordLevel.
- Changing attribute name: Double-click or <F2>
- Sorting display: Click on column heading "Name" or "Type"
Reset sorting: Click on column heading "Index"
- Change sequence: Use arrow keys on right
Requirement: The sorting is not changed or reset.

3.8.8 Working with Windows Objects

3.8.8.1 Working with Windows Objects



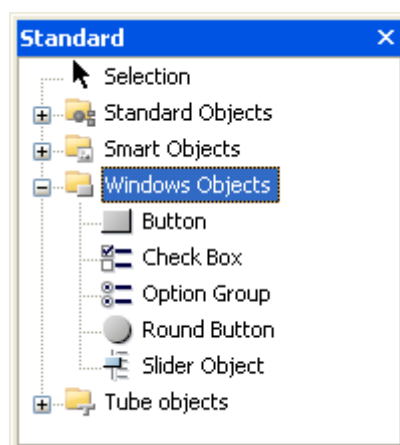

Introduction

The Windows objects are elements familiar from Windows applications: button, check box, radio box and slider. You can also configure a round button. The objects can be modified and made dynamic in many ways. They enable you to operate process events and to control processes.

In the Graphics Designer, the various object types have default properties. When they are inserted the objects import these default properties (except for individual geometric properties). After inserting the properties you can modify the properties of an object. In the same way, you can adapt the default settings for the object types as required.



Overview

Icon	Object	Description
	Button	The button enables process operation. It is used for example to acknowledge messages. A button has the two states "On" and "Off". In addition you can define whether a button should appear pressed by default, and whether it should latch when pressed. A button is integrated into the process by providing the corresponding attributes with dynamics.
	Check box	The check box enables the operator to select several options and to check the corresponding check boxes. It is also possible to activate the check box by default so that the operator only changes the predefined value as required. A check box is integrated into the process by providing the corresponding attributes with dynamics.
	Radio box	The option box enables the operator to selected one of the presented options and to activate the corresponding options field. It is also possible to activate the option boxes by default so that the operator only changes the predefined value as required. An option box is integrated into the process by providing the corresponding attributes with dynamics.
	Round button	The round button enables process operation. A round button has three states: "On", "Off" and "Deactivated". In addition you can define whether a round button should appear pressed by default, and whether it should latch when pressed. A round button is integrated into the process by making the corresponding attributes dynamic.
	Slider	The slider is a slide controller and can be used to control processes. For example, it can be used for infinitely variable changes to a value. A slider is integrated into the process by providing the corresponding attributes with dynamics.

See also

- How to insert a button (Page 681)
- How to insert a check box (Page 686)
- How to insert an radio box (Page 688)
- How to insert a round button (Page 691)
- How to insert a slider (Page 693)
- How to change the default setting of object types (Page 457)
- Basic Static Operations (Page 459)
- Basic Dynamic Operations (Page 485)
- Controls (Page 341)
- The Coordinate System of a Process Picture (Page 319)
- The Coordinate System of an Object (Page 321)
- The Rectangle Surrounding the Object (Page 323)
- Working with Combined Objects (Page 709)
- Working with Objects (Page 456)

3.8.8.2 Button

How to insert a button

Introduction

The button enables process operation.

A button is used for such actions as acknowledging messages or for navigation in Runtime.

A button has the two possible states "On" and "Off". In addition you can define whether a button should appear pressed by default, and whether it should latch when pressed.

A button is integrated into the process by providing the corresponding attributes with dynamics.

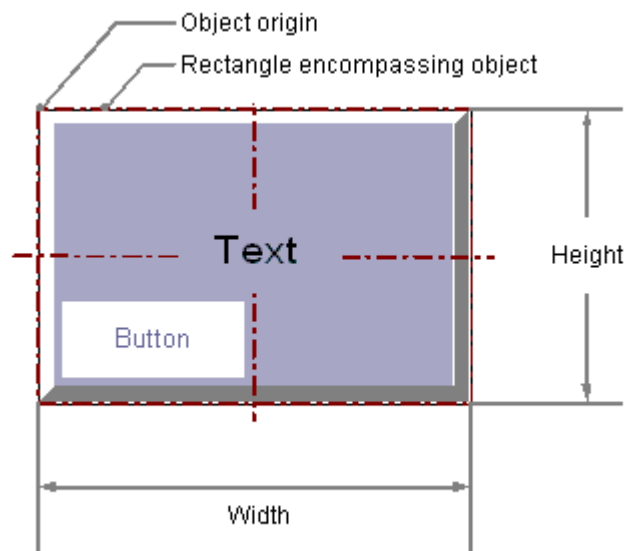

Inserting a button

1. Open the picture in which you want to insert a button.
2. Click the "Button" Windows object in the "Standard" selection window.
3. Keeping the left mouse button pressed, drag the object in the desired area of the picture to the desired size.

When you release the mouse button, the object is inserted at the corresponding location in the picture.

The "Button Configuration" dialog opens.

If you keep the <SHIFT> key pressed while inserting, you create the "Button" object in the shape of a square.

4. Enter the required values in the fields of the configuration dialog.
The description of the configuration dialog can be found in the next section.
5. Confirm your input with "OK".
The insertion process for the "Button" object is finished.

Alternative procedure

Double-click the "Button" Windows object in the "Standard" selection window.

A button with default object properties is then inserted near the picture origin.

The "Button Configuration" dialog opens. The insertion process is finished when you confirm your inputs with "OK".

Changing a button

Select an object of the button type if you wish to carry out one of the following changes:

Rectangle surrounding the object

Drag the rectangle surrounding the object to the new position in order to arrange the object in the picture.

Drag the handles on the rectangle surrounding the object to a new position in order to resize the object.

Palettes and toolbars

Use the "Rotate" element of the object palette to rotate the object.

Use the color palette to change the colors.

Use elements of the style palette to change the display style for the object.

Attributes

Open the "Object Properties" window to change the current values of the required attributes.

See also

How to configure a button (Page 683)

How to configure a hotkey for navigation in Runtime (Page 684)

Basic Static Operations (Page 459)

Basic Dynamic Operations (Page 485)

The Properties of an Object (Page 511)

Working with Windows Objects (Page 679)

How to configure a button

Introduction

The "Button Configuration" dialog opens at the end of the insertion process if the use of configuration dialogs is enabled in the "Options" tab of the "Tools / Settings..." menu. The dialog enables fast configuration of the important features of the button.

You can also open the configuration dialog with the object context menu. You change individual attributes in the "Object Properties" window.

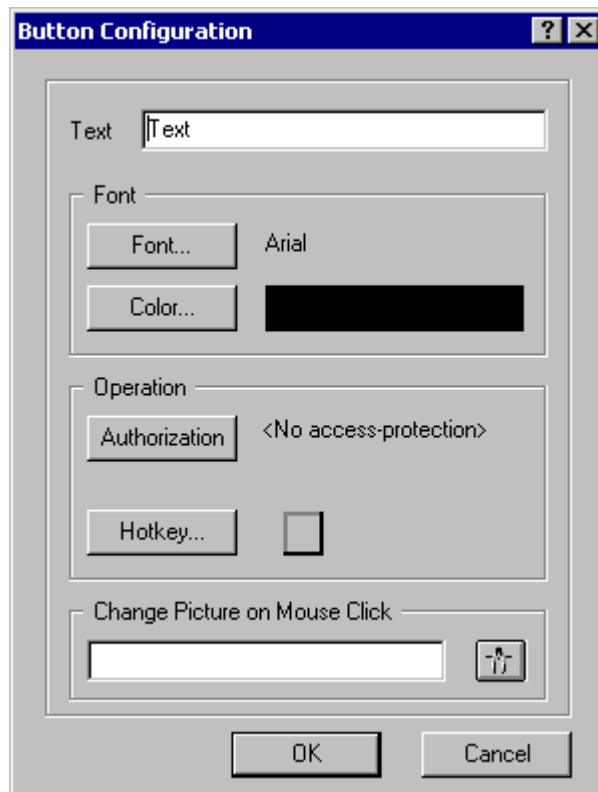

Text

The button can display a text that describes its function.

Enter the required text.

Only one text line is available in the configuration dialog. You can enter multiline text in the "Text" attribute in the "Object Properties" window. You can find the detailed description in the "Changing field labels with the "Text" attribute" section.

Font

Click the buttons to open the dialogs for font changes.

Operation

In order to operate the button you can assign an authorization and define a hotkey that allows operation with one key or shortcut.

Click on the buttons to open the associated dialogs. You can find the detailed description of the dialogs in the "How to define a hotkey for navigation in runtime" section.

Change Picture on Mouse Click

With this function you configure an event for the selected button. The specified process picture is displayed when you click the button in runtime.

Enter the name of the picture to be displayed or click  to open the "Pictures:" dialog to select a picture.

The "Pictures:" dialog shows all pictures in "PDL" format that are contained in the "GraCS" graphic folder of the current WinCC project. Pictures located in "GraCS" subfolders are shown at the bottom of the list.

You can find the detailed description in "Making Process Pictures Dynamic".

Note

Basic Process Control: No "Change Picture on Mouse Click"

You must not use the "Change Picture on Mouse Click" function in the Basic Process Control area.

Use the "SSMChangeWorkField" function for opening a picture in the working area.

Use the "SSMOpenTopField" function to open an additional picture window.

See also

Selecting a tag (Page 705)

How to configure a hotkey for navigation in Runtime (Page 684)

How to insert a button (Page 681)

Quick Object Configuration (Page 703)

How to configure a hotkey for navigation in Runtime

Introduction

The "Button" object is used to open a configured event. Objects of the "Button" type can, for example, be used for navigation between multiple pictures.

Configuring change picture

The picture change is configured with a constant for the "Mouse click" event as direct connection. If the button is clicked with the mouse, the display of the process picture specified here is opened.

You can configure the name of the picture that you want to display in the "Insert Button" dialog. Alternatively you can also change the configured direct connection in the "Events" tab of the "Object Properties" window. You can find the detailed description in "Making Process Pictures Dynamic".

Setting hotkeys

As an alternative to operation with the mouse, a button can also be triggered using the keyboard. You have to specify a hotkey for this purpose.

Double-click the "Hotkey" attribute in the "Miscellaneous" property group. Select one of the displayed function keys with the mouse or enter a key or shortcut. If a hotkey is defined for a button, an arrow is displayed in the object properties next to the "Hotkey" attribute.

Note

If a group is operated with a hotkey, the hotkey must only be assigned to the single object "Button" in the group. A hotkey that you assign to the entire group does not have any effect in Runtime.

Setting authorizations

The "User Administrator" editor is used in WinCC to assign authorizations for the users. You can assign an authorization for every object in the Graphics Designer. Meaning that only a user with the appropriate authorization can operate this object.

Double-click the "Authorization" attribute in the "Miscellaneous" property group. Select one of the available authorizations.

Note

To operate the button in Runtime, the "Operator-Control Enable" and "Display" attributes must have the value "Yes". The value of the "Authorization" attribute must contain the access authorization of the current user.

See also

How to configure a button (Page 683)

How to insert a button (Page 681)

3.8.8.3 How to insert a check box

Introduction

The check box enables the operator to select several options and to check the corresponding check boxes.

Check boxes can be activated by default so the user changes the default values only as required.

A check box is integrated into the process by providing the corresponding attributes with dynamics.

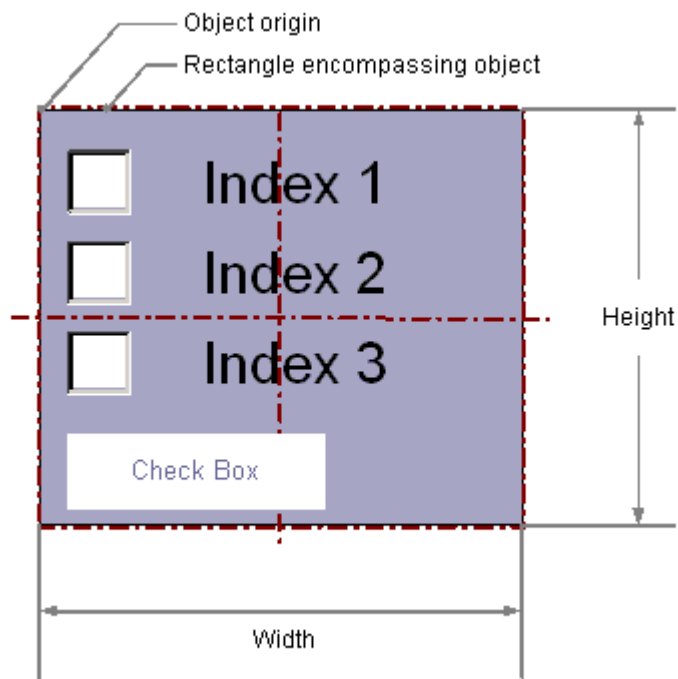

Inserting a check box

1. Open the picture in which you want to insert a check box.
2. Click the "Check box" Windows object in the "Standard" selection window.
3. Keeping the left mouse button pressed, drag the object in the desired area of the picture to the desired size.
When you release the mouse button, the object is inserted at the corresponding location in the picture.
If you keep the <SHIFT> key pressed while inserting, you create the "Check Box" object in the shape of a square.

Alternative procedure

Double-click the "Check Box" Windows object in the "Standard" selection window.

A check box with default object properties is inserted near the picture origin.

Changing a check box

Select an object of the check box type if you wish to carry out one of the following changes:

Rectangle surrounding the object

Drag the rectangle surrounding the object to the new position in order to arrange the object in the picture.

Drag the handles on the rectangle surrounding the object to a new position in order to resize the object.

Palettes and toolbars

Use the elements of the object palette to mirror and rotate the object.

Use the font palette to change the font display.

Use the color palette to change the colors.

Use elements of the style palette to change the display style for the object.

Attributes

Open the "Object Properties" window to change the current values of the required attributes.

Specifying the number of boxes

The "Number of Boxes" specifies the total number of boxes for the selected object. For each object, a maximum number of 64 boxes can be set.

At the same time, the value of the "Number of Boxes" attribute specifies the upper limit value for the "Index" attribute in the "Font" property group.

Changing the value can have the following effects:

Increasing the number

New fields are inserted under the field with the highest value in the "Index" attribute.

The default labeling of the new field can be changed using the "Text" attribute in the "Font" property group.

Reducing the number

All fields for which the value of the "Index" attribute is greater than the new number are deleted.

Specify Texts

You define the text and the respective display with the attributes under "Font".

Enter the respective text for each index from "1" to "Number of rows".

1. Double-click "Index" and enter the number.
2. Double-click "Text" and enter the corresponding display text.

The texts are saved for the object. Use the Text Distributor for translation.

Referencing a text list

Alternatively, link the object to a configured text list.

- In the "Text list" attribute, select a text list that you have configured in the "Text and graphic lists" editor.

The "Text" object property applies the display text of the text list and is grayed out. The index assignment is also applied from the text list.

Specifying selected boxes

The "Selected Boxes" attribute sets which fields in a check box are to be shown as enabled. Multiple boxes can be enabled simultaneously.

Each field is represented by a bit in a 32-bit word.

In order to activate a field, the corresponding bit must have the value "1".

The 32-bit word contains the information for all fields of the check box.

The value of the "Selected Boxes" attribute is specified in hexadecimals.

See also

Basic Static Operations (Page 459)

Basic Dynamic Operations (Page 485)

The Properties of an Object (Page 511)

Working with Windows Objects (Page 679)

3.8.8.4 How to insert an radio box

Introduction

The option box enables the operator to selected one of the presented options and to activate the corresponding options field.

One of the option groups can be activated by default so the user changes the default values only as required.

An option box is integrated into the process by providing the corresponding attributes with dynamics.

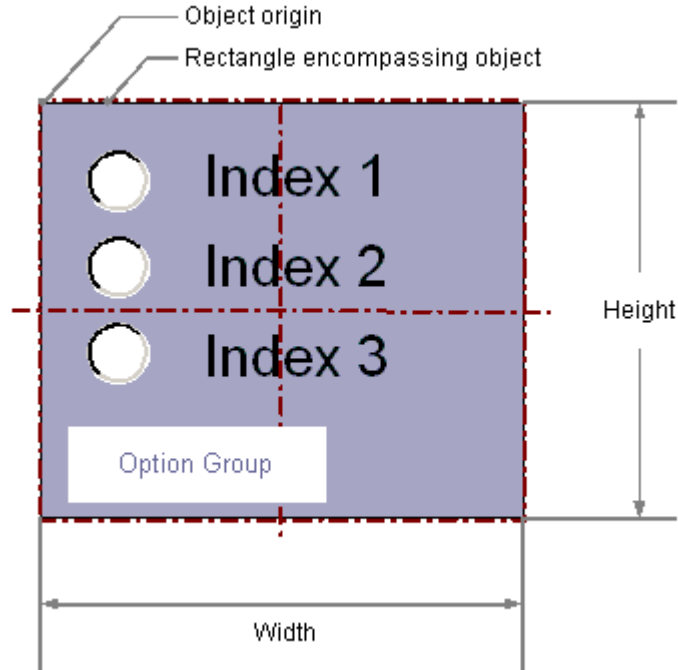

Inserting a radio box

1. Open the picture in which you want to insert an option group.
2. Click the "Radio box" Windows object in the "Standard" selection window.
3. Keeping the left mouse button pressed, drag the object in the desired area of the picture to the desired size.
When you release the mouse button, the object is inserted at the corresponding location in the picture.
If keep the <SHIFT> key pressed while inserting, you create the "Option Group" object in the shape of a square.

Alternative procedure

Double-click the "Option Group" Windows object in the "Standard" selection window.

An option group with default object properties is inserted near the picture origin.

Changing a radio box

Select an object of the option group type if you wish to carry out one of the following changes:

Rectangle surrounding the object

Drag the rectangle surrounding the object to the new position in order to arrange the object in the picture.

Drag the handles on the rectangle surrounding the object to a new position in order to resize the object.

Palettes and toolbars

Use the elements of the object palette to mirror and rotate the object.

Use the font palette to change the font display.

Use the color palette to change the colors.

Use elements of the style palette to change the display style for the object.

Attributes

Open the "Object Properties" window to change the current values of the required attributes.

Specifying the number of boxes

The "Number of Boxes" specifies the total number of boxes for the selected object. For each object, a maximum number of 64 boxes can be set.

At the same time, the value of the "Number of Boxes" attribute specifies the upper limit value for the "Index" attribute in the "Font" property group.

Changing the value can have the following effects:

Increasing the number

New fields are inserted under the field with the highest value in the "Index" attribute.

The default labeling of the new field can be changed using the "Text" attribute in the "Font" property group.

Reducing the number

All fields for which the value of the "Index" attribute is greater than the new number are deleted.

Specify Texts

You define the text and the respective display with the attributes under "Font".

Enter the respective text for each index from "1" to "Number of rows".

1. Double-click "Index" and enter the number.
2. Double-click "Text" and enter the corresponding display text.

The texts are saved for the object. Use the Text Distributor for translation.

Referencing a text list

Alternatively, link the object to a configured text list.

- In the "Text list" attribute, select a text list that you have configured in the "Text and graphic lists" editor.

The "Text" object property applies the display text of the text list and is grayed out. The index assignment is also applied from the text list.

Specifying selected boxes

The "Selected Box" attribute sets which option field in an option group is displayed as activated. Only one of the boxes can be enabled.

Each field is represented by a bit in a 32-bit word.

In order to activate a field, the corresponding bit must have the value "1".

The 32-bit word contains the information for all fields of the check box.

The value of the "Selected Box" attribute is specified in hexadecimals.

See also

Basic Static Operations (Page 459)

Basic Dynamic Operations (Page 485)

The Properties of an Object (Page 511)

Working with Windows Objects (Page 679)

3.8.8.5 How to insert a round button

Introduction

The round button enables process operation.

For example, it is used to acknowledge messages.

A round button has the three possible states "On", "Off" and "Deactivated". In addition you can define whether a round button should appear pressed by default, and whether it should latch when pressed.

A round button is integrated into the process by making the corresponding attributes dynamic.

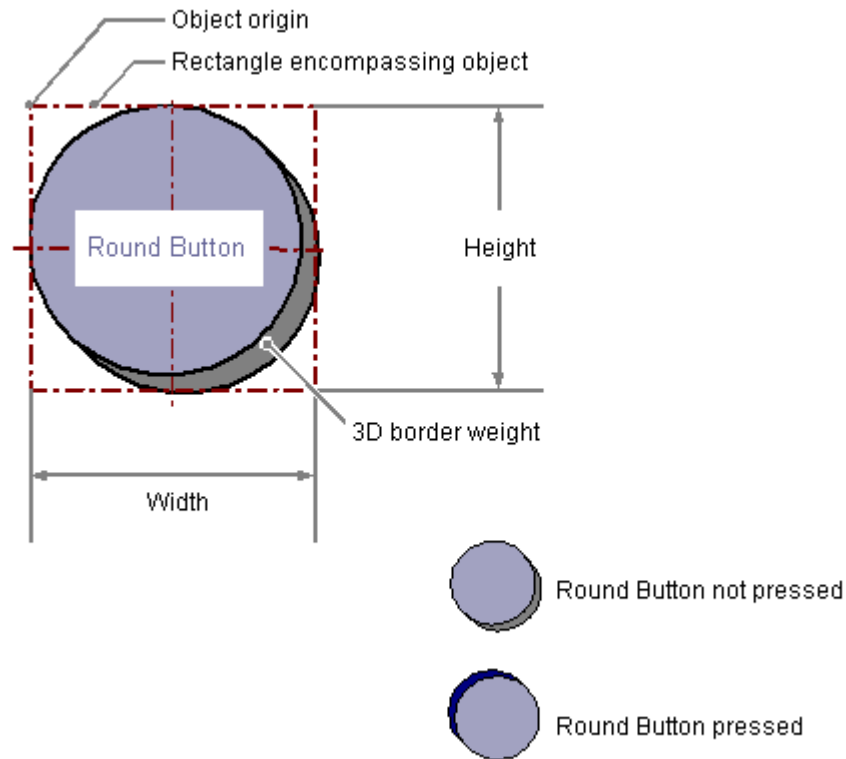

Inserting a round button

1. Open the picture in which you want to insert a round button.
2. Click the "Round button" Windows object in the "Standard" selection window.
3. Keeping the left mouse button pressed, drag the object in the desired area of the picture to the desired size.
When you release the mouse button, the object is inserted at the corresponding location in the picture.

Alternative procedure

Double-click the "Round button" Windows object in the "Standard" selection window.
A round button with default object properties is then inserted near the picture origin.

Changing a round button

Select an object of the round button type if you wish to carry out one of the following changes:

Rectangle surrounding the object

Drag the rectangle surrounding the object to a new position in order to arrange the object in the picture.

Drag the handles on the rectangle surrounding the object to a new position in order to resize the object.

Palettes and toolbars

Use the color palette to change the colors.

Use elements of the style palette to change the display style for the object.

Attributes

Open the "Object Properties" window to change the current values of the required attributes.

See also

Basic Static Operations (Page 459)

Basic Dynamic Operations (Page 485)

The Properties of an Object (Page 511)

Working with Windows Objects (Page 679)

3.8.8.6 Slider

How to insert a slider

Introduction

The slider is a slide controller and can be used to control processes.

You can, for example, use a slider for continuous and smooth changes to a value.

A slider is integrated into the process by providing the corresponding attributes with dynamics.

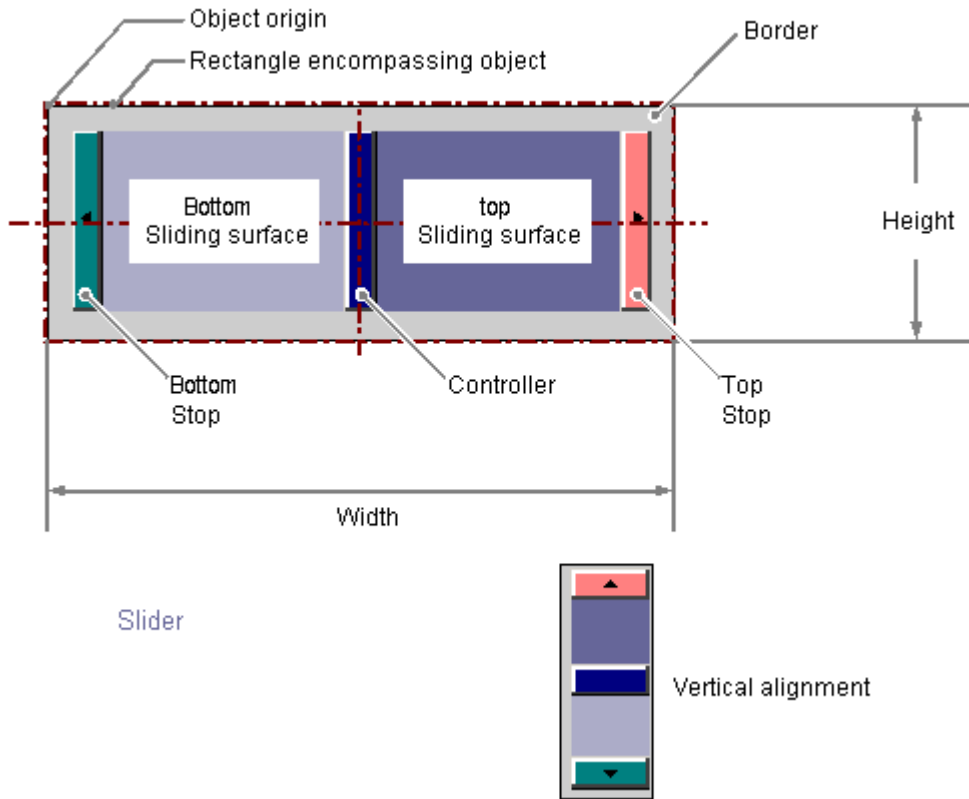

Inserting a slider

1. Open the picture in which you want to insert a slider.
2. Click the "Slider" Windows object in the "Standard" selection window.
3. Keeping the left mouse button pressed, drag the object in the desired area of the picture to the desired size.
When you release the mouse button, the object is inserted at the corresponding location in the picture.
The "Slider Configuration" dialog opens.
If keep the <SHIFT> key pressed while inserting, you create the "Slider" object in the shape of a square.
4. Enter the required values in the fields of the configuration dialog.
The description of the configuration dialog can be found in the next section.
5. Confirm your input with "OK".

Alternative procedure

Double-click the "Slider" Windows object in the "Standard" selection window.
A slider with default object properties is then inserted near the picture origin.
The "Slider Configuration" dialog opens. The insertion process is finished when you confirm your inputs with "OK".

Changing a slider

Select an object of the slider type if you wish to carry out one of the following changes:

Rectangle surrounding the object

Drag the rectangle surrounding the object to a new position in order to arrange the object in the picture.

Drag the handles on the rectangle surrounding the object to a new position in order to resize the object.

Palettes and toolbars

Use the "Rotate" element of the object palette to rotate the object.

Use the color palette to change the colors.

Use elements of the style palette to change the display style for the object.

Attributes

Open the "Object Properties" window to change the current values of the required attributes.

See also

How to configure a slider (Page 695)

How to configure the value range and operation of a slider (Page 697)

Basic Static Operations (Page 459)

Basic Dynamic Operations (Page 485)

The Properties of an Object (Page 511)

Working with Windows Objects (Page 679)

How to configure a slider

Introduction

The "Slider Configuration" dialog opens after the insertion process if the use of configuration dialogs is enabled in the "Options" tab of the "Tools / Settings..." menu. The dialog enables fast configuration of the important features of the slider.

You can also open the configuration dialog with the object context menu. You change individual attributes in the "Object Properties" window.

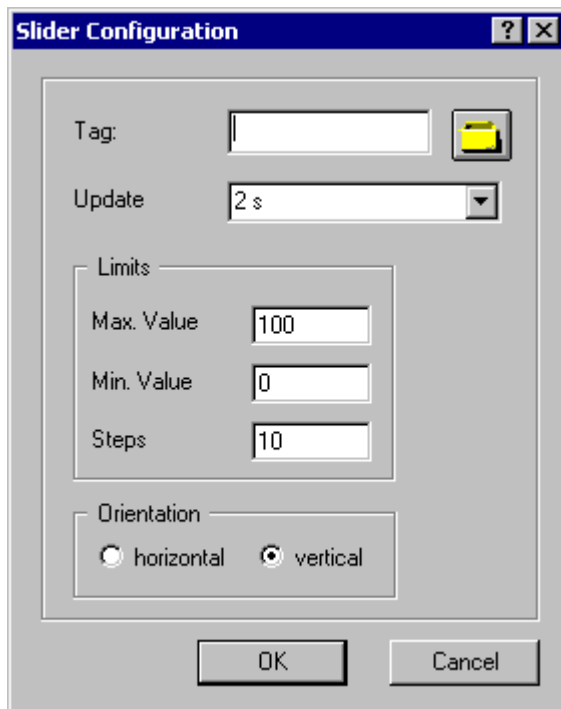

Tag

You can dynamize the slider by embedding a tag.

Enter the name of the required tag or click the tag icon to open the "Tags" dialog. You can find a detailed description in the section "Quick configuration of objects > How to select a tag".

Updating

Specify the frequency with which the display for the indicated slider value is to be updated.

Enter the desired interval or select an interval from the drop down list. You can find a detailed description in the section "The Basic Settings of the Graphics Designer > How to change the default trigger".

Limits

The two holders of the slider are specified by the maximum value and the minimum value of the slider. The specification of the operation steps attribute specifies the number of steps the slider is moved in the corresponding direction with one mouse-click the slide surface.

Enter the required limits and the number of operation steps for displaying the slider.

Alignment

Specify whether the slider is moved horizontally or vertically.

See also

Changing the default trigger (Page 368)

Selecting a tag (Page 705)

How to configure the value range and operation of a slider (Page 697)

How to insert a slider (Page 693)

Quick Object Configuration (Page 703)

How to configure the value range and operation of a slider

Introduction

You can configure the value range of the required operation steps and the appearance of the "Slider" object as required by changing the relevant attributes.

Setting scale end values and zero point value

- The "Maximum value" attribute specifies the absolute value for displaying the highest value.
- The "Minimum value" attribute specifies the absolute value for displaying the lowest value.
- The "Zero point value" attribute specifies the absolute value for the zero point of the bar.

Operation Steps

The "Operation Steps" attribute specifies for the slider the number of steps the slider is moved in the corresponding direction with one mouse-click the slide surface.

The number of times you have to click on the slide surface for it to move from one end to the other is calculated as follows: ("Maximum value" – "Minimum value") / "Operating steps".

Example:

Where maximum value = 100, minimum value = 0 and operation steps = 25 the slide surface must be clicked four times to move the slider from one end to the other.

Alignment

The "Alignment" attribute defines for the "Slider" object whether the movement of the slider is in a horizontal or vertical direction.

WinCC style

The "WinCC style" defines how the style for the display of the objects is set:

- User-defined in Graphics Designer
- Through the globally set design
- Through the default settings of the operating system

See also

How to insert a slider (Page 693)

How to configure a slider (Page 695)

3.8.9 Working with Tube Objects

3.8.9.1 Working with tube objects

Introduction

With WinCC you can recreate in your process pictures systems of interconnected tubes, tanks and other objects.

To do this, select suitable objects from the library and connect them with each other using the tube objects. Due to the provided fill pattern, the tubes appear three-dimensionally and thus allow the creation of intuitively well ascertainable pictures.

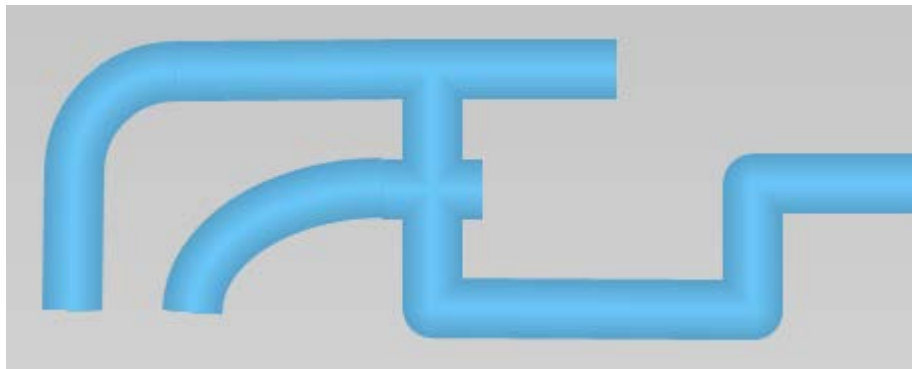

Tube objects

WinCC provides the following tube objects:

Tube objects		Function
Polygon Tube	—	Tube made of a polyline
T-piece	T	T-shaped branch in four possible orientations
Double T-piece	+	Cross-shaped connector
Tube Bend	↷	Cross- or elliptical-shaped bend of any radian

You create your system from these tube objects and the objects in the object library, e.g. tanks and valves.

See also

- How to insert a polygone tube (Page 699)
- How to insert a T-piece (Page 700)
- How to insert a double T-piece (Page 701)
- How to insert a tube bend (Page 702)

3.8.9.2 How to insert a polygone tube

Introduction

WinCC has tube objects for simulating pipe systems. Using the polygon tube, you create pipes with as many bends as is required. You can round off the corner points or display them as angled corners.

The polygon tube is an open polygon: Even if you select the same start and end point, the ends will not be connected with one another.

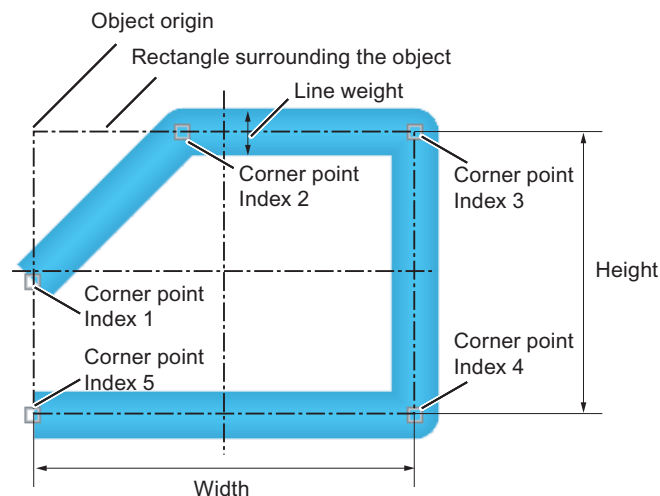

A polygon tube can have any number of corners. The corner points are numbered in the order of their creation. You can move them individually.

Procedure

1. Open the picture in which you want to insert a polygon tube.
2. Click the "Polygon tube" tube object in the "Standard" selection window.
3. Place the mouse pointer at the position in the picture where you want to begin the polygon tube.
The mouse pointer changes into a cross with arrows pointing inward.
4. Click the selected starting point with the left mouse button.
5. Click every other desired corner of the polygon tube with the left mouse button.
Click with the right mouse button to correct the last drawn section of the polygon tube.

6. In order to complete the polygon tube, double click on the desired end point.
7. In order to move an individual corner point at a later point in time, drag the small square next to the end point to the desired point.

Object properties

Use the "Line connection type" attribute in the "Styles" property group to set the type of corner display:

- Square: No rounding on the corner points
- Round: Arc-formed corner rounding

Use the "Line width" attribute to set the width of the tube display.

3.8.9.3 How to insert a T-piece

Introduction

WinCC has tube objects for simulating pipe systems. You can create a T-shaped tube connection with the T-piece.

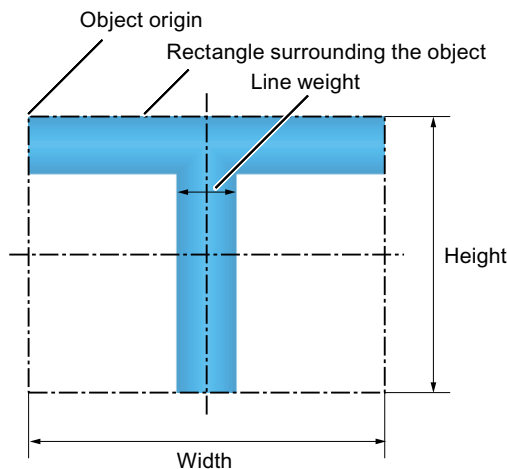

You can give the T-piece any of four possible orientations.

Procedure

1. Open the picture into which you want to insert a T-piece.
2. Click the "T-piece" tube object in the "Standard" selection window. The mouse pointer changes to a hollow T.
3. Position the mouse point at the position in the picture where you want to insert the T-piece and click on the desired position. The T-piece is inserted. You can change the position and size using the mouse. Change the orientation using the properties of the T-piece.

Object properties

Use the "Line width" attribute in the "Styles" property group to set the width of the tube display.

Set the orientation of the T-piece in degrees using the "Rotation Angle" attribute in the "Geometry" property group. This determines whether the "leg" of the "T" points downwards (0), to the left (90), upwards (180) or to the right (270). The entered value is automatically rounded to a multiple of "90".

3.8.9.4 How to insert a double T-piece

Introduction

WinCC has tube objects for simulating pipe systems. Use the double T-piece to construct a tube-crossing.

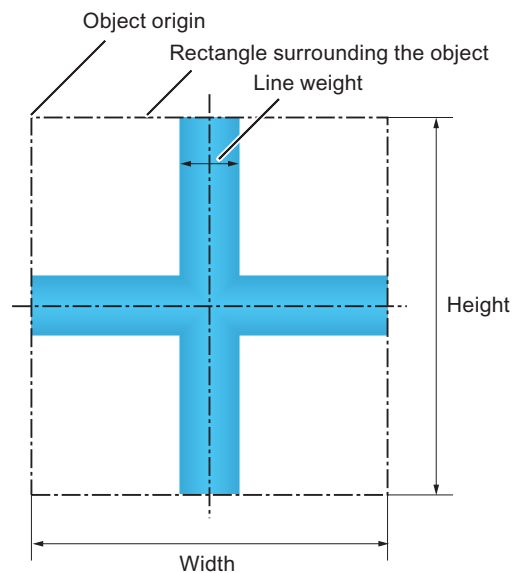

Procedure

1. Open the picture in which you want to insert a double T-piece.
2. In the "Standard" selection window, click the tube object "Double T-piece". The mouse pointer changes to a hollow cross.
3. Position the mouse pointer on the place in the picture that you want to put the double T-piece and click on the desired point. The double T-piece is inserted. You can adapt it in position and size.

Object properties

Use the "Line width" attribute in the "Styles" property group to set the width of the tube display.

3.8.9.5 How to insert a tube bend

Introduction

WinCC has tube objects for simulating pipe systems. Use the tube bend to create a bend in a piece of pipe.

You can set the size, the shape as a circular arc or elliptical arc and circular dimensions of the tube bend to your requirements.

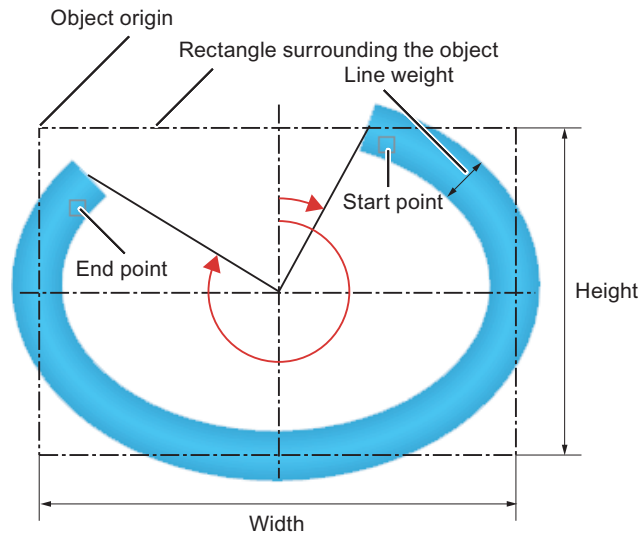

Procedure

1. Open the picture in which you want to insert a tube bend.
2. Click the "Tube bend" tube object in the "Standard" selection window.
3. Place the mouse pointer at the position in the picture where you want to insert the tube bend.
The mouse pointer changes to a hollow quarter-ellipse.
4. Click on the selected position.
The tube bend is inserted with certain start parameters: As a circular arc with equal width and height in the first quadrant with a circular dimension $90^\circ = \frac{1}{2} \pi$.
5. Adapt the tube bend in position, size and shape.
If the width and height are not equal, the circular arc becomes an elliptical arc.
6. Mirror or rotate the quarter bend to change the orientation.
7. To move the start or end point at a later point in time, drag the small square next to the affected point in the desired direction.
This changes the circular dimensions of the tube bend.

Object properties

Geometry of the tube bend

Define the size and shape of the tube bend with the attributes under "Geometry". The "Start angle" and "End angle" attributes determine the circular dimensions.

The attributes are independent from one another.

- If you change the "Width" and "Height", the "RadiusX" and "RadiusY" change with them automatically. Start and end angle remain.
- If the start and end angle change, the "Width" and "Height" change with them automatically. "RadiusX" and "RadiusY" remain.
- If you change "RadiusX" and "RadiusY", the "Width" and "Height" change with them automatically. Start and end angle remain.

Tube width

Use the "Line width" attribute in the "Styles" property group to set the width of the tube display.

3.8.10 Quick Object Configuration

3.8.10.1 Quick Object Configuration

Introduction

Configuration dialogs are provided in the Graphics Designer for the fast configuration of individual objects. The important features of an object can be set in the configuration dialogs.

If the use of configuration dialogs is enabled in the "Options" tab of the "Tools/Settings..." menu, the associated dialog opens when an object is inserted.

You can also open the "Configuration dialog" with the object context menu.

Different configuration dialogs are available for the following objects:

- I/O field
- Bar
- Graphic object
- Status display
- Text list
- Button
- Slider object

Brief description of features that can be set

Feature	Description	Object type
Updating	Specifies the frequency with which the display of the value shown is to be updated.	I/O field, bar, status display, text list, slider
Alignment	Specifies whether the slider is moved horizontally or vertically.	Slider
Bar direction	Specifies the direction of the coordinate axis to which the maximum value of the bar points.	Bar
Operation	Specifies an "authorization" for operation of the button. In addition you can define a "Hotkey" that allows operation with one key or shortcut.	Button
Bit position	Assigns a specific bit position of the tag to a state.	Status display
Picture change with preview	Shows all pictures in the "GraCS" graphic folder of the current WinCC project.	Graphic object, status display
Change Picture on Mouse Click	Configures an event for the selected button. The selected process picture is displayed when you click the button in Runtime.	Button
Field type	Specifies whether the selected object is used to input, output or input and output values.	I/O field, text list
Limits	Defines both ends of the bar display and both holders of the slider through the "Maximum value" and "Minimum value". Define the number of operating steps for the slider with which the slider is moved at a mouse click.	Bar, slider
Font	Change the font options for displaying the button and display values.	I/O field, text list, button
Text	Specifies the text for the button. You can enter multiline text by changing the "Text" attribute in the "Object Properties" window.	Button
Tag	Dynamizes the selected object by embedding a tag. With an I/O field and text list the value of the tag can be displayed as output or changed by an input depending on the selected field type.	I/O field, bar, status display, text list, slider
Status list	Shows the linked pictures and the specified flash frequency for all the configured states. You can add states and change settings using the context menu.	Status display

See also

- How to configure a slider (Page 695)
- How to configure a button (Page 683)
- How to configure a text list (Page 641)
- How to configure a status display (Page 635)
- How to insert a graphic object (Page 631)
- How to configure a bar (Page 626)
- How to configure an I/O Field (Page 615)
- Selecting pictures (Page 706)
- How to configure states (Page 637)
- Selecting a tag (Page 705)

3.8.10.2 Selecting a tag

Introduction

Tags are a central element for dynamizing process pictures. By linking a process tag to an object, such things as the change in a measured value can be represented graphically. More details about the use of tags can be found in the chapter called "Tag Management".

The "Tag" dialog contains all tags available in the project.

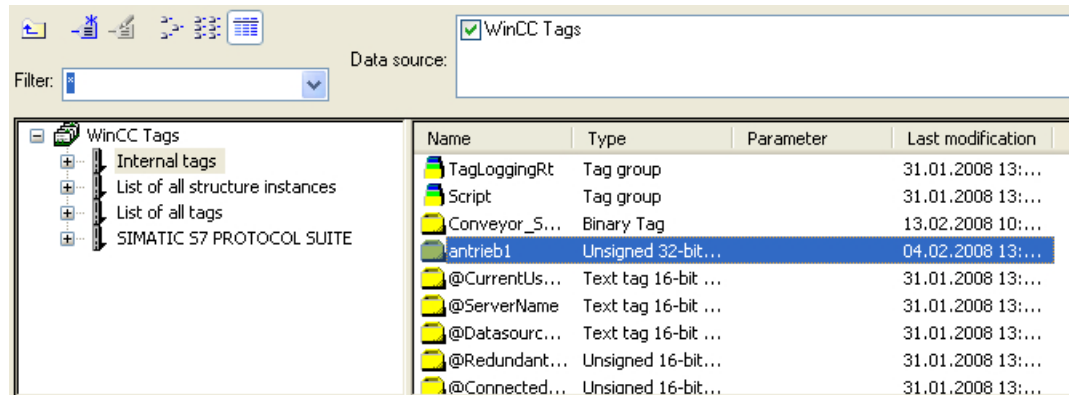

You can change the width of both window areas and the columns in the tag display by moving the vertical separation lines.

Filter

If there is a large number of configured tags, the search procedure can take some time. For instance, for 15,000 tags the search procedure takes about a minute.

You limit the scope of the search by specifying a filter. You can achieve a significant increase in efficiency if you configure tags with the aid of a tag prefix.

Data source

You can use the "Data source" window to select the tags to be displayed.

Tag groups

The selected tag group including its subfolders is displayed in the left-hand area in a directory tree.

You can open and close folders and subfolders by double-clicking or by clicking the "+" or "-" symbols. The tags available for the selected entry are shown in the tag display.

Tag display

The right-hand area contains all the tags that are available for the entry. The tag display includes, among other things, the tag name, the type and the time when the tag was last changed. Sort the tags by clicking the respective column header.

Procedure

1. Select the required filter. An asterisk means that no filter is used or no filter has been defined.
2. Select one or more data sources.
3. Open the desired tag group in the left-hand window area.
4. Select the desired tag from the right-hand window area.
5. Confirm your selection with "OK". The "Tag" dialog closes. The selected tag is assigned to the selected object.

See also

- Quick Object Configuration (Page 703)
- Working with Windows Objects (Page 679)
- Working with Smart Objects (Page 598)

3.8.10.3 Selecting pictures

Introduction

You can integrate pictures in some objects of the Graphics Designer. Depending on the object the integrated pictures have different file formats:

Object	Formats	How pictures are linked
Picture window	PDL	The "Picture Name" selection dialog is opened via the window "Object Properties" > "Miscellaneous" property group > "Picture Name" attribute
Graphic object	BMP, DIB, ICO, CUR, EMF, WMF, GIF, JPG	The "Picture Selection" selection dialog is opened via the window "Object Properties" > "Picture" property group > "Picture" attribute or the configuration dialog
Status display	BMP, DIB, EMF, WMF	The "Picture" selection dialog is opened via the window "Object Properties" > "Status" property group > "Basic picture" and "Flash picture" attribute or the configuration dialog
Button	BMP, DIB, ICO, CUR, EMF, WMF, GIF, JPG	The "Picture" selection dialog is opened via the "Object Properties" window, > "Miscellaneous" property group > "Picture Status On" and "Picture Status Off" attributes
Round button	BMP, DIB, ICO, CUR, EMF, WMF, GIF, JPG	The "Picture" selection dialog is opened via the "Object Properties" window, > "Pictures" property group > "Picture Status On", "Picture Status Off" and "Picture Status Deactivated" attributes
SVG object	SVG	The "Picture Selection" selection dialog is opened via the window "Object Properties" > "Picture" property group > "Picture" attribute or the configuration dialog

The "Picture Name" selection dialog

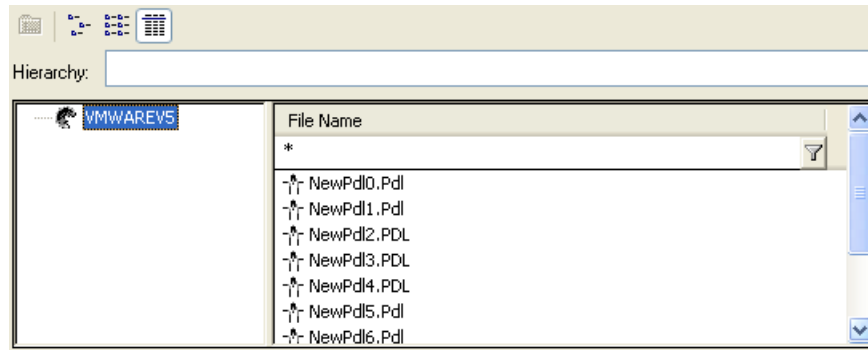

The "Picture Name" selection dialog displays all the PDL files in the current project. A file that you wish to integrate in the picture window must belong to the current WinCC project.

The "Picture" selection dialog

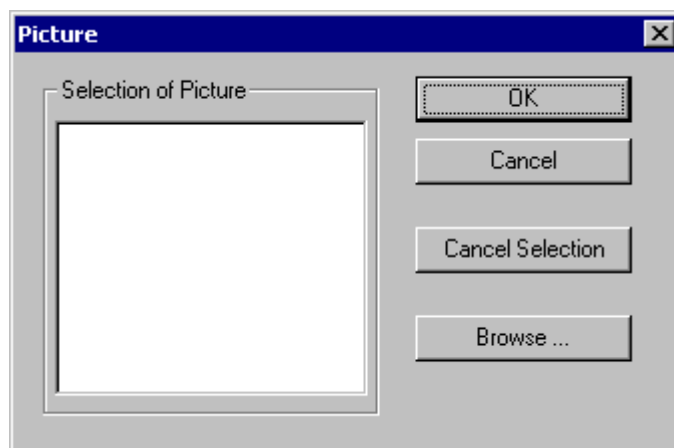

The "Picture" selection dialog lists the pictures that are available in the project. The pictures are located in the "GraCS" graphic folder of the current WinCC project. To add further pictures to the current project use the "Browse ..." button to open another selection dialog.

Configuration dialog

The appearance of a configuration dialog depends on the selected object. Here the configuration dialog of the graphic object as an example:

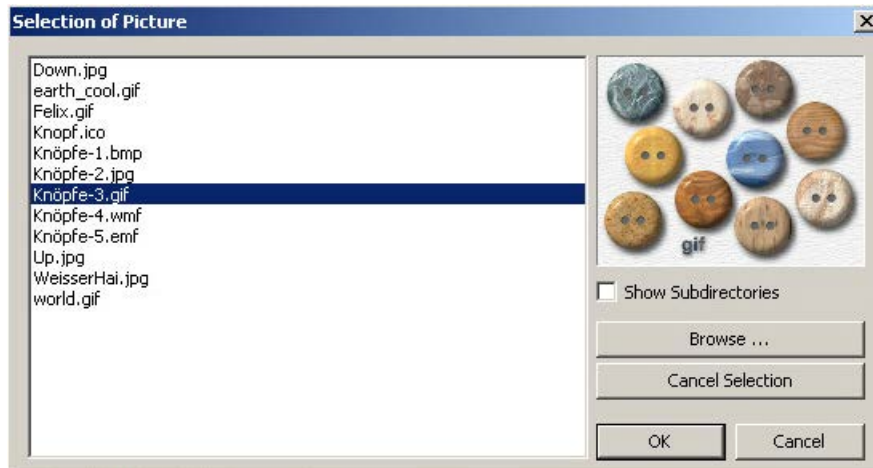

The picture selection lists the pictures that are available in the "GraCS" graphic folder of the current WinCC project. Select "Show subdirectories" to display existing subdirectories of "GraCS" with the pictures they contain in the picture selection.

To add further pictures to the current project use the "Browse ..." button to open another selection dialog.

Find Picture

You can use this dialog to switch to any folder in order to select one or more pictures and add them to the current project. The pictures are then displayed in the selection of pictures in the selection dialog.

Note

You have to copy referenced graphic files to the "GraCS" graphic folder for the current WinCC project in order for them to be available on a target computer. If you use the Browse ..." button in the picture selection, the selected graphic files are automatically copied to the "GraCS" graphic folder.

You select several pictures by holding down the <SHIFT> key and clicking the first and the last picture.

You select individual pictures by holding down the <CTRL> key and clicking the individual pictures.

See also

[Quick Object Configuration \(Page 703\)](#)

[Working with Windows Objects \(Page 679\)](#)

[Working with Smart Objects \(Page 598\)](#)

3.8.11 Working with Combined Objects

3.8.11.1 Working with Combined Objects

Introduction

You combine the objects in the Graphics Designer by forming a group or a customized object from a multiple selection.

In addition you can insert a group or a combined object into the project library. This makes the group or the combined object available as a library object for re-use in other process pictures or projects.

Alternatively, you can also use faceplate types: You create a process picture with the desired objects as a template. You use instances of the faceplate type in other process pictures similar to customized objects. You can find additional information under "Overview: Faceplate types (Page 396)".

Overview

Object	Description
Group	<p>You can combine a multiple selection of objects into a group.</p> <p>You can edit a group of objects like a single object in the Graphics Designer. In addition you can also edit the objects contained in the group individually.</p> <p>Unlike multiple selection, the selection marks of the individual objects are no longer shown for a group. The selection marks cover the entire group. The selection frame of the multiple selection becomes the rectangle around all the objects of the group.</p>
Customized object	<p>A customized object allows the properties and events that are displayed in the "Object Properties" window to be configured individually.</p> <p>You edit a customized object like an individual object in the Graphics Designer.</p> <p>As in a group, the selection marks of the individual objects are no longer shown after creation of a customized object. The selection marks surround the entire customized object. The selection frame of the multiple selection becomes the rectangle around all the objects of the customized object.</p>
Library object	<p>The library of the Graphics Designer is used for saving and managing graphic objects that can be used for creating process pictures.</p> <ul style="list-style-type: none"> • The "Global Library" offers a variety of pre-defined graphic objects that you can insert into a picture as library objects and configure as required. • The "Project Library" enables a project-specific library to be built.

See also

Working with the library (Page 737)

Working with Customized Objects (Page 713)

Multiple Selection of Objects (Page 465)

Working with Objects (Page 456)

Overview: Faceplate types (Page 396)

3.8.11.2 Working with Groups

How to group objects

Introduction

You combine the objects of a multiple selection into a group with the "Group" command.

Requirements

- Select at least two objects of any type, except for "Control" and "OLE objects".

Procedure

1. Open the pop-up menu of the multiple selection or the "Edit" menu.
2. Select the entry "Group / Grouping".
The selected objects are combined into a group. The selection frame of the multiple selection becomes the rectangle around the group. Selection marks are shown for the group only.

Note

You can combine single groups into larger groups with the "Group" command. This allows a group hierarchy to be built up. Groups can be ungrouped in the reverse order of grouping.

Autonomous group displays for ORing UP by means of the picture hierarchy

Group display objects that have been created automatically by the system for ORing UP must not be used in a group.

See also

Working with Objects (Page 456)

The Rectangle Surrounding the Object (Page 323)

Multiple Selection of Objects (Page 465)

How to ungroup a group (Page 712)

How to change the properties of a group (Page 710)

How to change the properties of a group

Introduction

You can edit a group in the Graphics Designer like all other objects.

The following elements are shown as components of the "Group" object type in the "Object Properties" window:

- Property groups and attributes that have at least one of the selected objects.
- All objects in the group with their own property groups and attributes.

Effects when a common object is changed

Changing a common group attribute affects all single objects that have this attribute.

For some attributes this effect has special rules that only apply to the group.

- If the origin of a group is moved, the values of the individual objects are adapted to the new coordinates. The attributes "Position X" and "Position Y" of the individual objects do not change relative to the origin of the group.
- If you change the size of a group, the "Height" and "Width" attributes of the individual objects are adjusted by percentage to match the resize.
- If you have specified a rotation for single objects of a group in Runtime, these settings are matched to the size of the group. The reference points for the rotation refer to the origin of the group, not the origin of the single object. In Runtime, the objects for which no rotation is specified remain unchanged.
- Linear objects that are in a group with surface objects always take the color that was last selected for the background color or the line color in the properties of the group.
- If a group is operated with a hotkey, the hotkey must only be assigned to the single object "Button" in the group. A hotkey assigned to the entire group will not work in Runtime.

Requirements

- Select a group.

Procedure

1. Open the "Object Properties" window.
2. Select the property group in the "Properties" tab that contains the attribute you want to change.

Note

You can also edit the objects included in a group individually by changing their attributes. The objects are displayed in the "Object Properties" window with their property groups as a component of the "Group" object type.

See also

How to group objects (Page 710)

How to ungroup a group (Page 712)

- The Properties of an Object (Page 511)
- Multiple Selection of Objects (Page 465)
- The Rectangle Surrounding the Object (Page 323)
- Working with Objects (Page 456)

How to ungroup a group

Introduction

Use the "Ungroup" command to split a group into its individual objects. The individual objects are then shown as a multiple selection.

Requirements

- Select a group.

Procedure

1. Open the pop-up menu or the "Edit" menu.
2. Select "Group / Ungroup".
 - The group selection marks are hidden.
 - The individual objects of the group are shown as a multiple selection.

Note

You can combine single groups into larger groups with the "Group" command. This allows a group hierarchy to be built up. Groups can be ungrouped in the reverse order of grouping.

See also

- How to group objects (Page 710)
- Multiple Selection of Objects (Page 465)
- The Rectangle Surrounding the Object (Page 323)
- Working with Objects (Page 456)
- Working with Combined Objects (Page 709)

3.8.11.3 Working with Customized Objects

Working with Customized Objects

Overview

A customized object allows the properties and events that are displayed in the "Object Properties" window to be configured individually.

You edit a customized object like an individual object in the Graphics Designer. The selection marks of the individual objects are no longer shown after creation of a customized object. The selection marks surround the entire customized object. The selection border of the multiple selection becomes the rectangle around all the objects of the customized object.

Special features of customized objects

- The "Undo" function is not available for editing a customized object.
- Configured events of the single objects are deleted when the customized object is created.
- If editing mode is exited without an object being selected, the customized object is deleted. When edit mode is exited, only the selected objects are imported into the customized object.
- You can have a separate tooltip text displayed for the customized object and for the contained object in Runtime. Select the attribute "Tooltip text" for the required objects in the configuration dialog. Configure the tooltip texts in the "Object properties" window. If no tooltip text is available for the selected Runtime language, the text of the Runtime default language is displayed. If no separate texts are configured for the contained objects, the tooltip text of the customized object is displayed in Runtime.
- Assigning shortcuts and specifying a TAB sequence for objects within the customized object is not supported.
- If you integrate a group display in a customized object, the attributes "group value", "group relevant" and "bit pattern group display" are available for the customized object to capture and acknowledge states.
- It is not possible to create an attribute name twice. These attributes are preassigned by the system (standard attributes). If you delete the attributes of a customized object, these attribute names cannot be used in a user-specific attribute. Additional information on standard attributes is available under "ScreenItem Object".
- User-specific attribute names of the customized object must not contain special characters.
- Use the "Configuration Dialog Customized Object" to display the properties for the customized object. If you delete a standard property in "Configuration Dialog Customized Object", this property is not displayed on the Graphics Designer user interface. Access to the property is still possible using VBS. This relates to the following properties: "ObjectName", "Layer", "Left", "Top", "Width", "Height", "Visible", "Enabled" and "PasswordLevel".
- Properties with the prefix "@" are not electronically numbered (enum) by VBA. Therefore, these properties are not edited by VBA either.
- Properties with the prefix "@" are not addressed by VBS.

- When addressing the user-specific properties of a customized object, the spelling used in the VBS must correspond to the spelling in the Configuration dialog. Particular attention must be paid to upper/lower case.
- The property name is dependent on the language set. In the case of customized objects with multi-language, user-specific properties, the language must be set in the "Configuration Dialog Customized Object" before editing the customized object. Then you can select the required language.

Note

You have to dynamize the text properties of the text object to allow changes from external sources so the language change can function.

See also

- How to create a customized object (Page 714)
- How to configure the property groups of the customized object (Page 718)
- How to add and delete attributes of a customized object (Page 719)
- How to configure the properties of attributes of the customized object (Page 721)
- Events of a customized object (Page 724)
- How to configure the events of a customized object (Page 725)
- How to edit a customized object (Page 726)
- How to delete a customized object (Page 727)
- Working with Objects (Page 456)
- Working with Combined Objects (Page 709)
- Example: How to create a compressor as a customized object (Page 728)
- Properties of a Customized Object (Page 716)
- Multiple Selection of Objects (Page 465)

How to create a customized object

Introduction

The objects of a multiple selection are combined into a customized object with the command "Customized Object / create..." in the context menu or the "Edit" menu. You can also create a customized object from a single object.

The following object types cannot be included in a customized object:

- Application window
- Picture window
- OLE object
- Group or other customized object

Requirements

- Select at least two objects in the picture.

Procedure

1. Open the pop-up menu or the "Edit" menu.
2. Select the entry "Customized object / create...".
The "Configuration Dialog Customized object" dialog is opened.
3. Configure the available properties and events of the customized object.
For more information on the configuration of a customized object see section "The Configuration of a Customized Object".
4. Confirm your configuration with "OK".
The selected objects are combined into a customized object.
The selection border of the multiple selection becomes the rectangle around the customized object.

See also

How to edit a customized object (Page 726)

How to delete a customized object (Page 727)

Example: How to create a compressor as a customized object (Page 728)

Working with Objects (Page 456)

Multiple Selection of Objects (Page 465)

Working with Customized Objects (Page 713)

Properties of a Customized Object (Page 716)

Properties of a Customized Object

Introduction

You define a selection of the available property groups and attributes in the "Properties" tab. You can edit the name and the configured language of an available attribute. Every attribute of the customized object can also be linked to attributes of the included single objects.

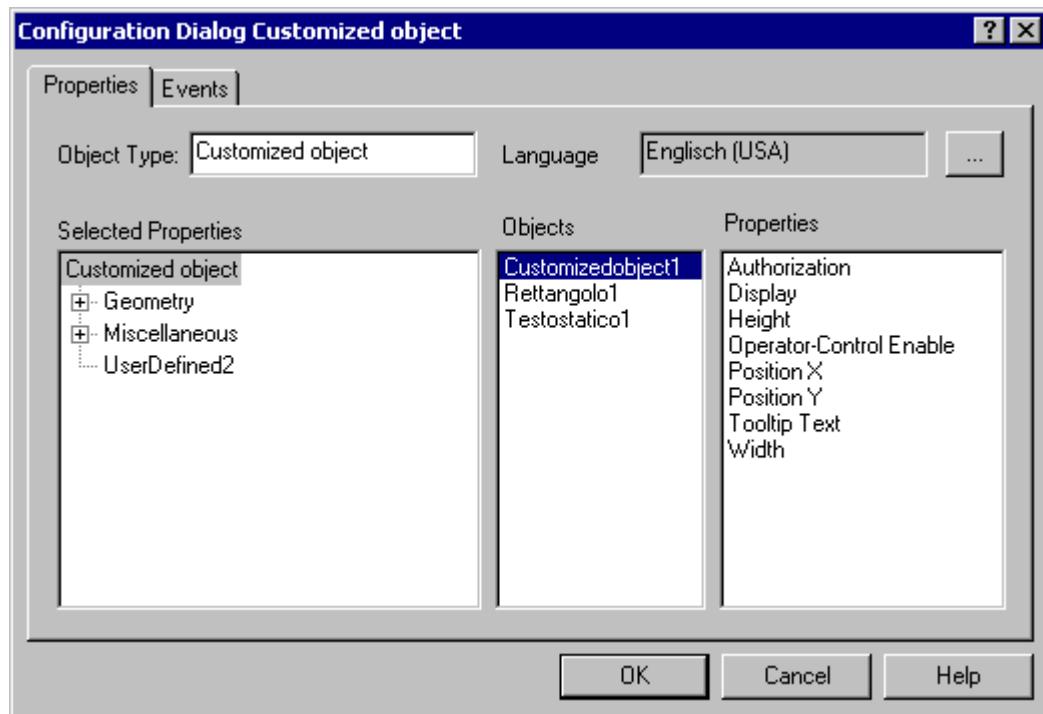

Configuration dialog

Object type

The type of the selected customized object is displayed. Enter the name you require.

Language

You can configure the customized object and the attributes of the selected properties for different languages.

Select the required attribute and click  to select one of the languages installed in WinCC.

Selected Properties

This area contains the property groups and attributes that are displayed as properties of the customized object in the "Object Properties" window. You can add or remove property groups and attributes from the selection as required.

Click the "+" or "-" symbols to show or hide subordinate entries.

The detailed description can be found in the following chapters: "Configuring property groups of a customized object" and "Configuring attributes of a customized object".

Objects

This area contains all objects included in the customized object. Select an object for which you want to show the available attributes in the "Properties" area.

Properties

This area contains all available attributes for the object selected in the "Objects" area. Double-click the required attribute to insert it into the assigned position in the "Selected Properties" area. The detailed description can be found in "Inserting or deleting attributes of a customized object".

Note

An object can only receive an operator authorization as a "Whole". A customized object can have an operator authorization but its subordinate objects cannot.

Object Properties dialog**"Inherit Status" attribute**

The statuses of the "Display" and "Operator-Control Enable" properties of the user object can be inherited by the individual objects of the customized object. The "Inherit status" property determines whether a change in the outer "Display" and "Operator-Control Enable" properties is passed on to the inner objects.

Example 1

You have configured the "Inherit status" properties for the customized object with "Yes" and "Display" as "Visible".

One object of the customized object has the property "invisible".

If the customized object is made invisible and then again visible, then all objects of the customized object are shown as visible even if one object of the customized object has the property "invisible".

Example 2

You have configured the "Inherit status" property for the customized object with "No" and "Display" as "Visible".

The customized object is now switched to invisible. If you then set the property of an inner object to "Visible", the inner object is not visible. The inner object only becomes visible if the customized object is changed to visible.

See also

How to configure the property groups of the customized object (Page 718)

How to add and delete attributes of a customized object (Page 719)

How to configure the properties of attributes of the customized object (Page 721)

How to configure the events of a customized object (Page 725)

Working with Customized Objects (Page 713)

Events of a customized object (Page 724)

How to configure the property groups of the customized object

Introduction

Only the property groups that are listed in the "Selected Properties" area are shown for the customized object in the "Object Properties" window. You configure the selection of the property groups with the "Theme Selection" dialog. You can change the predefined name of the user-defined property groups.

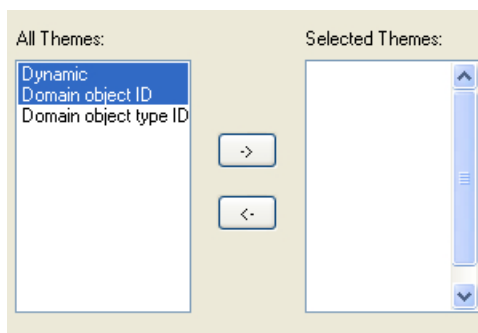

All Themes

All property groups that are made available for the customized object are listed in the left section of the dialog.

Selected Themes

All property groups that you have selected for the customized object are listed in the right section of the dialog.

Arrow buttons

Use the arrow buttons to move property groups in the direction of the arrow:



Moves the selected property groups from the left to the right section.



Moves the selected property groups from the right to the left section.

Requirements

- The "Properties" tab in the "Configuration Dialog Customized object" must be open for the selected customized object.
- There must be at least one property group in the "Selected Themes" area.

Selecting property groups

1. Select the "Theme Selection..." entry in the pop-up menu of the "Selected Properties" area". The "Theme Selection" dialog opens.
2. Select the desired property groups and move them with the arrow buttons.
3. Confirm your configuration with "OK".

Renaming property groups

You can also use user-defined property groups for a customized object. By default they contain the name "User-defined" and a sequential number that you can change.

1. Select "Rename" in the pop-up menu of the property group. The name of the property group can now be edited.
2. Enter the new name for the property group.
3. Confirm your entry with <ENTER>.

See also

[How to add and delete attributes of a customized object \(Page 719\)](#)

[How to configure the properties of attributes of the customized object \(Page 721\)](#)

[How to configure the events of a customized object \(Page 725\)](#)

[Working with Customized Objects \(Page 713\)](#)

[Properties of a Customized Object \(Page 716\)](#)

[Events of a customized object \(Page 724\)](#)

How to add and delete attributes of a customized object

Introduction

Attributes of the customized object that you want to show in the "Object Properties" window can be added or deleted from the selection in the "Selected Properties" area of the configuration dialog.

You can also configure the available properties of the lower-level objects in addition to the attributes of the customized object.

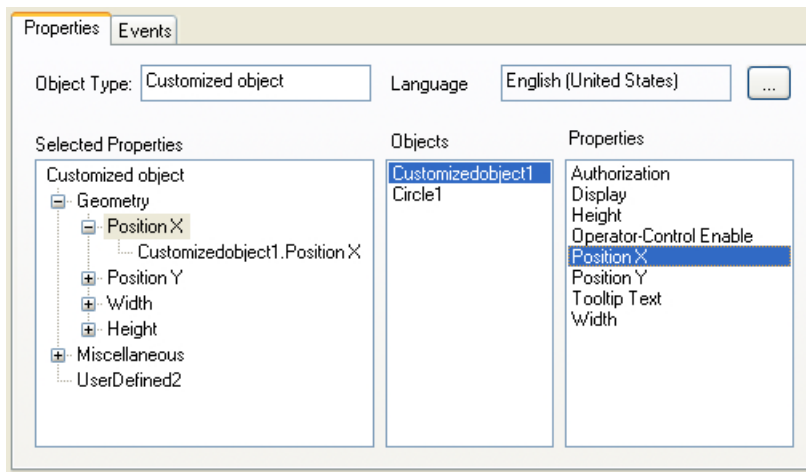

Requirements

- The "Properties" tab in the "Configuration Dialog Customized object" must be open for the selected customized object.

Adding attributes

1. Select an object in the "Objects" area from which you want to provide an attribute for the customized object.
The available attributes of the selected object are shown in the "Properties" area.
2. Double-click the required attribute in the "Properties" area.
The selected attribute is added at the selected position in the "Selected properties" area.
The attribute name is extended by the object name of the object.
3. Repeat steps 1 and 2 until all desired attributes are in the "Selected Properties" area.
If you select the same attribute for multiple objects, give the attributes a descriptive name if necessary. A serial number is added during the selection of the attribute names.
4. Close the configuration dialog.
Configure the attributes in the "Object properties" area of the Graphics Designer.

Alternative procedure

Alternatively you can drag attributes to the desired position in the "Selected Properties" area with the mouse.

Note

The attributes of the customized object are automatically assigned to the associated property group. The default assignments cannot be changed.

Deleting attributes

1. Select the attributes of the customized object that you want to delete in the "Selected Properties" area.
2. Select "Delete" in the pop-up menu of the selected attribute.
The selected attribute is removed from the selection.

See also

How to configure the property groups of the customized object (Page 718)

How to configure the properties of attributes of the customized object (Page 721)

How to configure the events of a customized object (Page 725)

Working with Customized Objects (Page 713)

Properties of a Customized Object (Page 716)

Events of a customized object (Page 724)

How to configure the properties of attributes of the customized object

Introduction

You can change the properties of the attributes available in the customized object for display in the "Object Properties" window. The properties of the attributes can be configured with the "Properties" dialog.

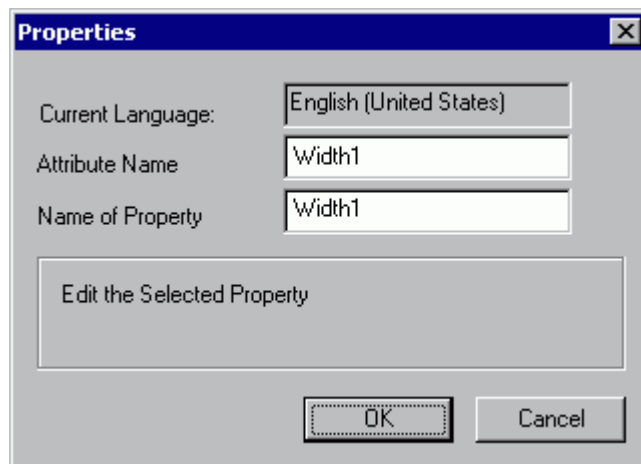

Current language

Displays the language for which the attribute is configured.

Attribute Name

Displays the attribute names under which the attribute is registered in WinCC. The "OLE Automation Name" must be unique. A change of the attribute name affects all languages configured for the attribute.

Name of Property

Property names with which the attribute is displayed in the "Object Properties" window.

Requirements

- The "Properties" tab in the "Configuration Dialog Customized object" must be open for the selected customized object.

Procedure

1. Select the attribute of the customized object whose properties you want to configure in the "Selected Properties" area.
2. Select "Properties..." in the pop-up menu of the selected attribute.
Opens the "Properties" dialog.
3. Change the settings and confirm your input with "OK".

See also

How to configure the property groups of the customized object (Page 718)

How to add and delete attributes of a customized object (Page 719)

How to configure the events of a customized object (Page 725)

Working with Customized Objects (Page 713)

Properties of a Customized Object (Page 716)

Events of a customized object (Page 724)

Linking a Customized Object with a Structure Tag

Introduction

Customized object may be linked with a structure tag with an open tag dialog in Graphics Designer simply by using Drag&Drop. Using the object properties of two text fields, structure type and unique identification of the object are characterized using the structure tag.

Prerequisites

- A structure type and at least one structure tag must be configured.
- In the customized object, you have added two objects "Static Text" with the property "Text" in "Selected Properties" to "UserDefined2".
- In Graphics Designer, the tag dialog must be open. Using the menu "View/Toolbars..." you activate the tag dialog.

Procedure

1. In "Configuration Dialog Customized Object" in the area "Selected Properties", select one of the static texts for the Customized Object.
2. In the dialog "Properties" for "Attribute Name", enter the name "StructureType".
3. In "Configuration Dialog Customized Object" in the area "Selected Properties", select the second static text for the Customized Object.
4. In the dialog "Properties" for "Attribute Name", enter the name "tagname".
5. Confirm your settings with "OK".
6. In the "Object Properties" dialog of the Customized Object, enter under attribute "StructureType" the name of the structure type as text.
7. Dynamize the desired properties with an element of a valid structure tag.
8. If you now select the Customized Object, the open tag dialog will only display the available tags of the assigned structure type.
9. Using Drag&Drop, you connect the desired structure tag from the tag dialog with the customized object. The structure tag is entered into the object property "tagname".

Duplicate customized object may be assigned a tag of the same structure type using Drag&Drop.

See also

How to add and delete attributes of a customized object (Page 719)

How to configure the properties of attributes of the customized object (Page 721)

Working with Customized Objects (Page 713)

Properties of a Customized Object (Page 716)

Events of a customized object

Introduction

You configure the events available for the customized object with the "Event" tab. You can also make "Object Events" available for the included single objects.

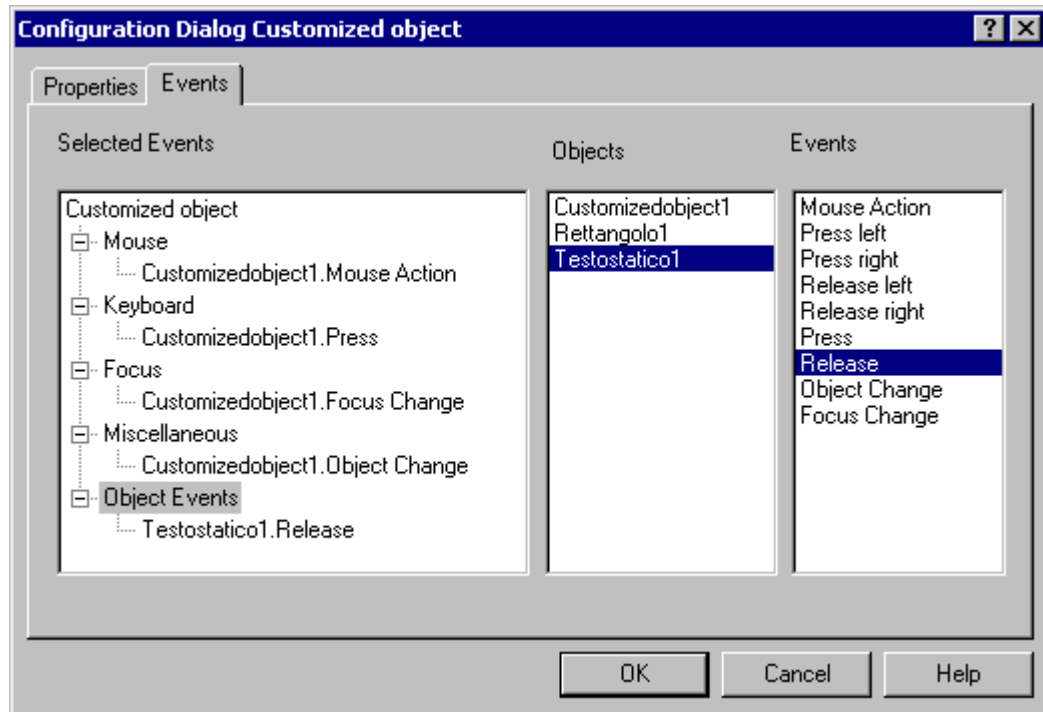

Selected Events

This area contains the event groups "Mouse", "Keyboard", "Focus", "Miscellaneous" and "Object Events". You assign the events configured for the customized object to these event groups. All events that you configure for the single objects in the customized object are assigned to the "Object Events" event group.

Click the "+" or "-" symbols to show or hide subordinate entries.

Objects

This area contains all objects included in the customized object.

Select an object for which you want to show the available events in the "Properties" area.

Event

This area contains all available events for the object selected in the "Objects" area.

Double-click the required event to insert it into the assigned position in the "Selected Events" area.

See also

Properties of a Customized Object (Page 716)

How to add and delete attributes of a customized object (Page 719)

How to configure the properties of attributes of the customized object (Page 721)

How to configure the events of a customized object (Page 725)

Working with Customized Objects (Page 713)

How to configure the property groups of the customized object (Page 718)

How to configure the events of a customized object

Introduction

The events available for the customized object are configured with the "Events" tab. You can also make "Object Events" available for the included single objects.

Requirements

- Select a customized object.
- Open the "Configuration Dialog Customized object" from the pop-up menu and select the "Events" tab.

Adding events

1. In the "Objects" area, select an object for which you want to configure an event in the customized object.
The events available for the selected object are displayed in the "Events" area.
2. Double-click the required event in the "Event" area.
The selected event is inserted into the respective event group in the "Selected Events" area. The event name is extended by the object name of the object.
3. Repeat steps 1 and 2 until all desired events are in the "Selected Events" area.
4. Confirm your configuration with "OK".

Alternatively you can drag events to the desired position in the "Selected events" area with the mouse.

Note

The events configured for the customized object are automatically assigned to the associated event group. The default assignments cannot be changed.

Deleting events

1. Select the event of the customized object that you want to delete in the "Selected Events" area.
2. Select "Delete" in the context menu of the selected event.
The selected event is removed from the selection.

See also

How to configure the property groups of the customized object (Page 718)

How to add and delete attributes of a customized object (Page 719)

How to configure the properties of attributes of the customized object (Page 721)

How to configure the events of a customized object (Page 725)

Working with Customized Objects (Page 713)

Properties of a Customized Object (Page 716)

Events of a customized object (Page 724)

How to edit a customized object

Introduction

The edit mode for the customized object is activated with the "Customized object / Edit ..." function. In edit mode the properties of all included single objects can be separately changed. Single objects can be added or deleted. A single object contained in a customized object is edited as described in "Working with objects".

The selection marks of the single objects are shown as gray squares with a white border in edit mode. When edit mode is exited, only the selected objects are imported into the customized object.

Prerequisites

- Select a customized object.

Activating edit mode

1. Open the pop-up menu or the "Edit" menu.
2. Select "Customized object / Edit...".
The Edit mode will be activated.
Like multiple selection of objects, selection marks for the single objects contained in the customized object are shown. The selection marks are shown as gray squares with a white border in edit mode.

Exit edit mode

1. Open the pop-up menu or the "Edit" menu.
2. Select "Customized object / Exit edit".
Edit mode is deactivated.
When edit mode is exited, only the selected objects are imported into the customized object.
If no object is selected, the customized object is discarded.

See also

- Working with Customized Objects (Page 713)
- Working with Objects (Page 456)
- How to delete a customized object (Page 727)
- How to create a customized object (Page 714)

How to delete a customized object

Introduction

A customized object can be split into its component objects with the command "Customized Object / Delete" in the pop-up menu or the "Edit" menu. The individual objects are then shown as a multiple selection.

Prerequisites

- Select a customized object.

Procedure

1. Open the pop-up menu or the "Edit" menu.
2. Select "Customized Object / Delete".
The selection marks of the customized object are hidden.
The individual objects of the customized object are shown as a multiple selection.

See also

- How to create a customized object (Page 714)
- Multiple Selection of Objects (Page 465)
- The Rectangle Surrounding the Object (Page 323)
- Working with Customized Objects (Page 713)
- Working with Combined Objects (Page 709)

Example: How to create a compressor as a customized object

Introduction

A customized object that can be used to display a compressor is to be prepared for a system design. Only specific properties should be configurable to allow multiple use of the "Compressor" customized object in the design.

The "Compressor" customized object should have the check-back messages "On", "Off", "Approach" and "Retract". The "On" and "Off" states must be visualized by a change in a background color. The "Approach" and "Retract" states must be displayed by flashing lines.

The following example implements this task step-by-step.

Procedure

1. Create a graphic to show the compressor.

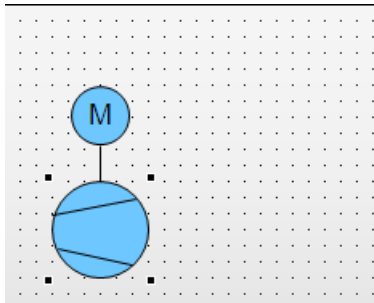

The compressor is created from the following standard objects: 2 circles, 3 lines and a static text.

2. Select all objects from which the customized object must be created. Select "Customized Object / Create..." in the multiple selection context menu.

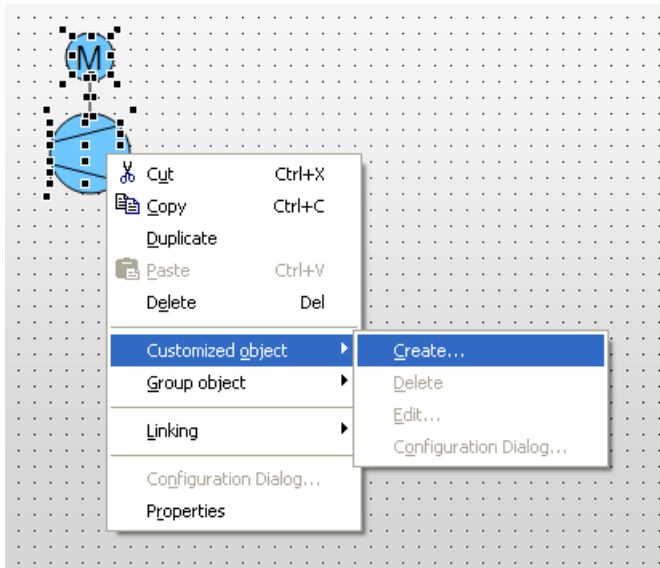

The "Configuration Dialog Customized object" dialog opens.

3. The "Configuration Dialog Customized Object" shows all the single objects contained in the customized object with their properties and events. Select the "Properties" tag.

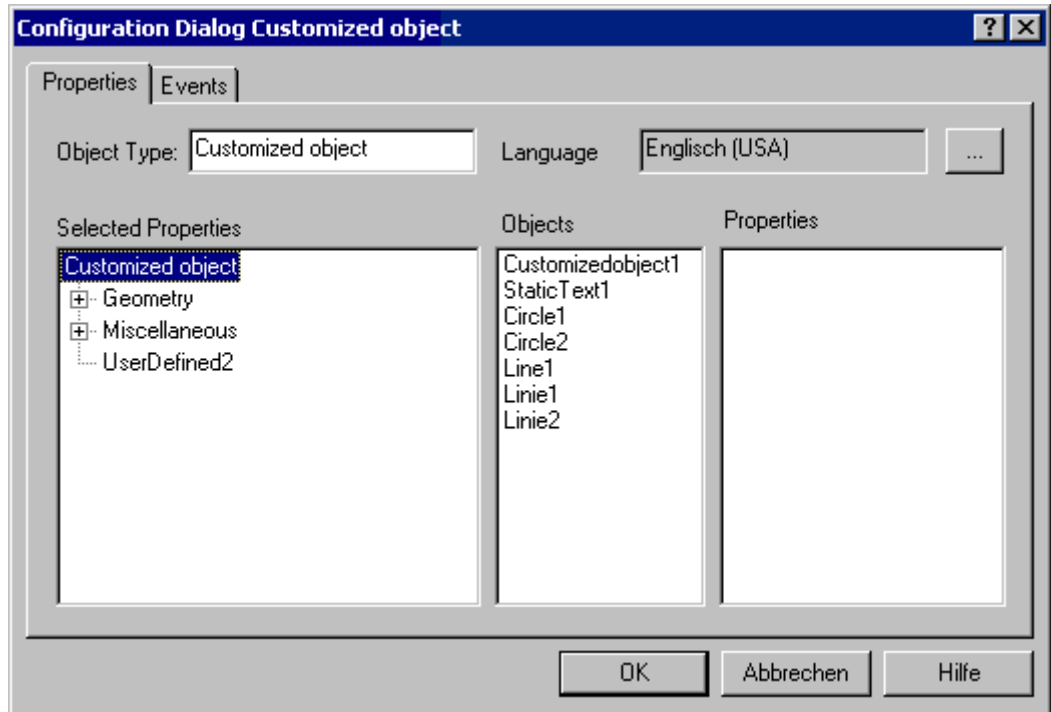

In this example the "UserDefined2" property group is used to define the desired properties and events of the customized object.

- 4. Select "Rename" in the shortcut menu of the "UserDefined2" property group.

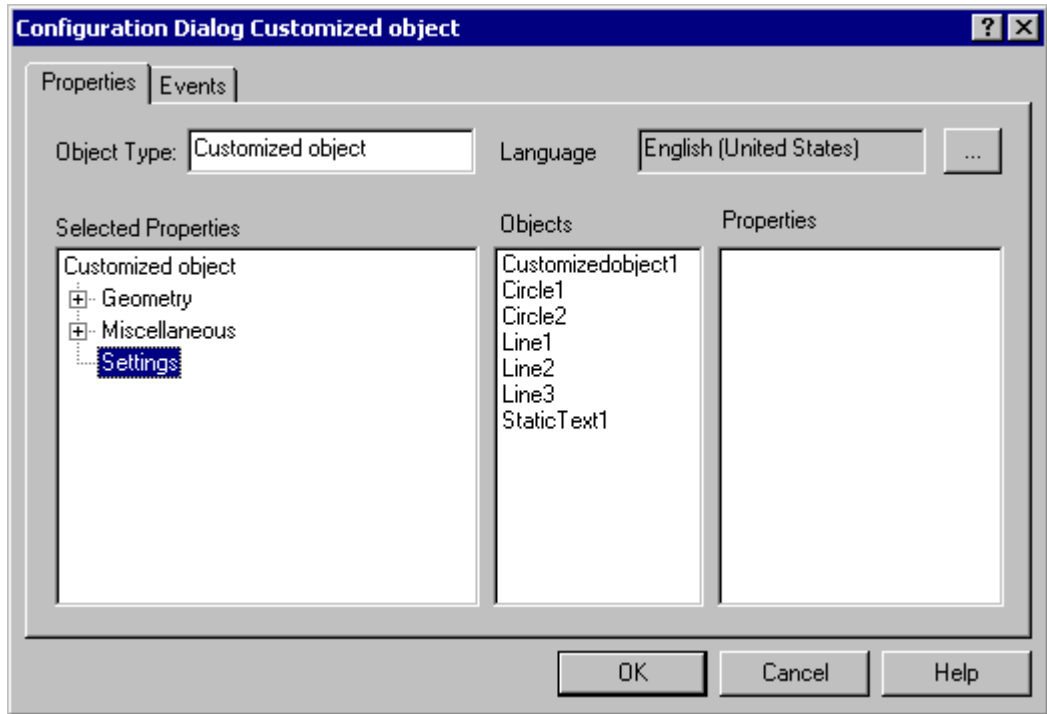

In this example the term "Settings" is entered as the new name of the "UserDefined2" property group.

- The "On" and "Off" states must be visualized by changing the background color of Circle1:
 Select the object "Circle1".
 Drag the "Background color" property by Drag&Drop to the "Settings" property group.

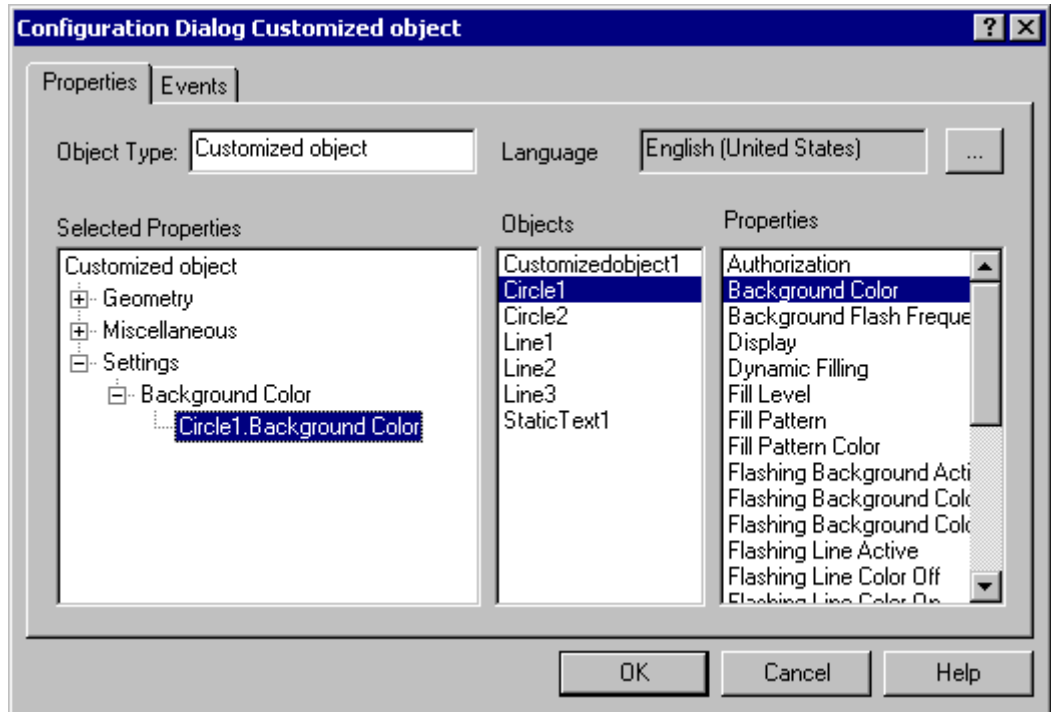

The customized object now has the "Circle1.Background Color" attribute in the "Settings / Background Color" property group.

- Select "Properties..." in the shortcut menu of the attribute "Circle1.Background color".
 The "Properties" dialog opens.

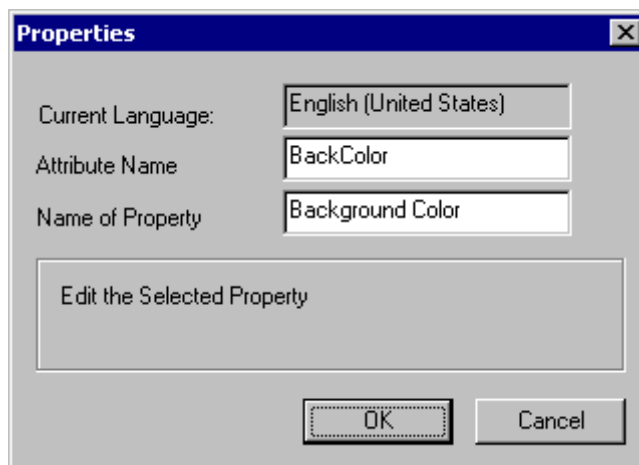

Enter a name for the dynamics of the attribute by C or VBS actions in the "Attribute Name" field. The "Name of Property" field contains the exact name of the attribute for the display in the "Object Properties" window and can also be changed.

- 7. The "Approach" and "Retract" states must be displayed by flashing lines:
The line colors of all objects, which flashing is to be configured for, can be combined into an attribute of the customized object.
Select the desired objects in sequence and drag the property "Line Color" via Drag&Drop into the property group ""Settings".

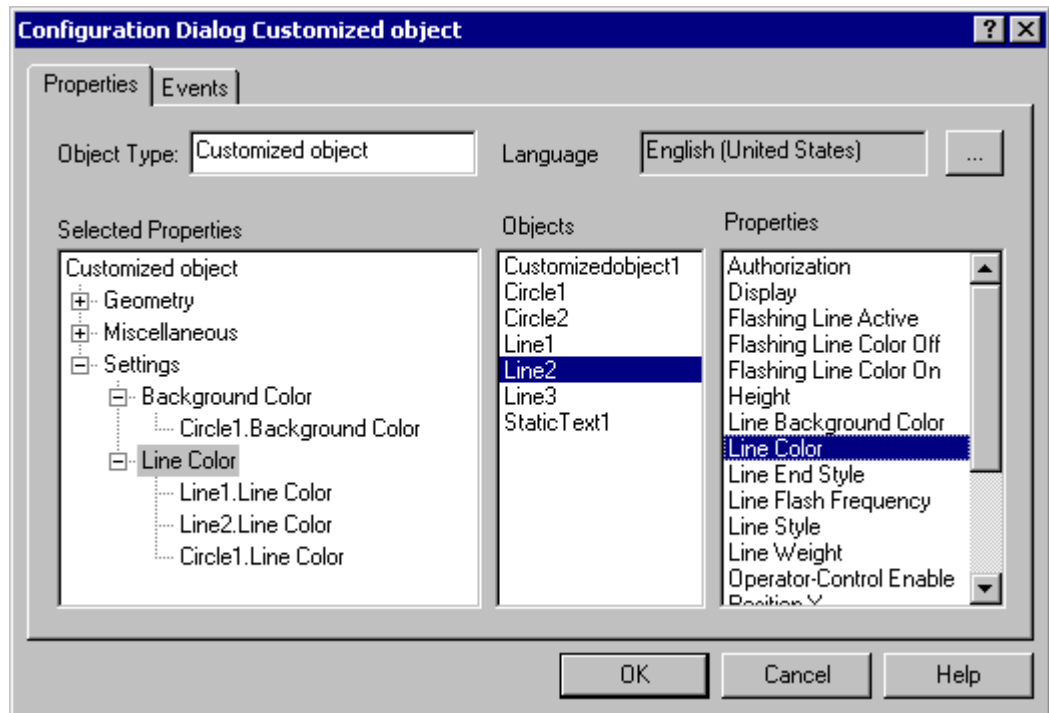

The customized object now has the "Object.Line Color" attributes in the "Settings / Line Color" property group.

- Repeat this process for all attributes that the customized object requires.

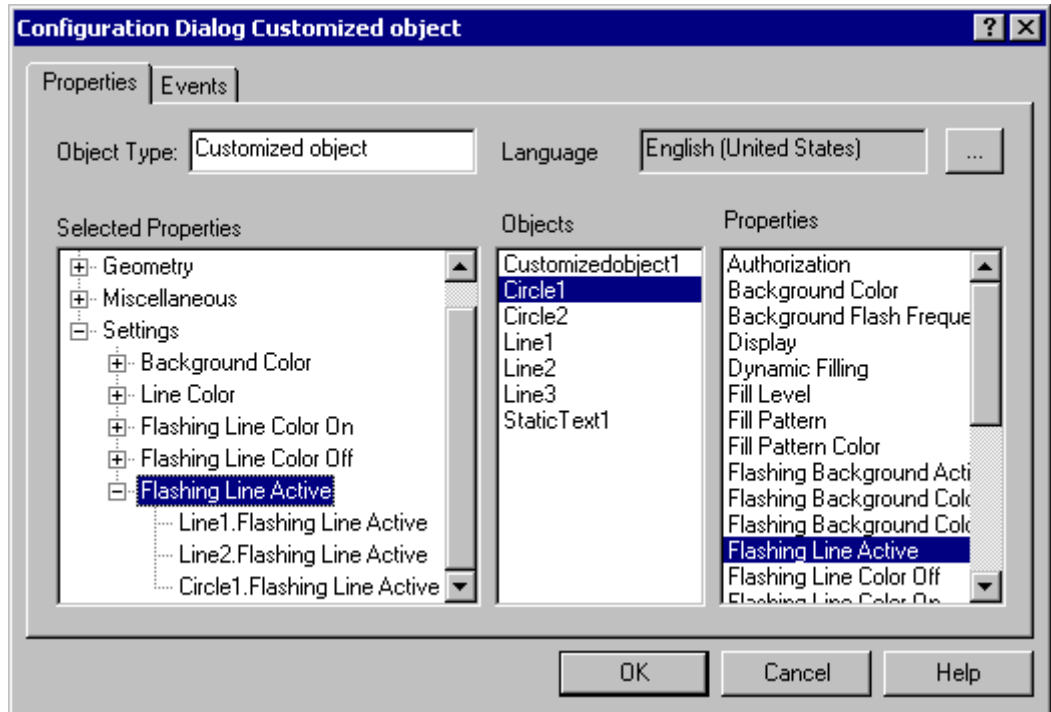

In this example the attributes "Flashing Line Color On", "Flashing Line Color Off" and "Flashing Line Active" are added to various single objects.

- 9. Select the "Events" tab to configure the required events for the customized object.

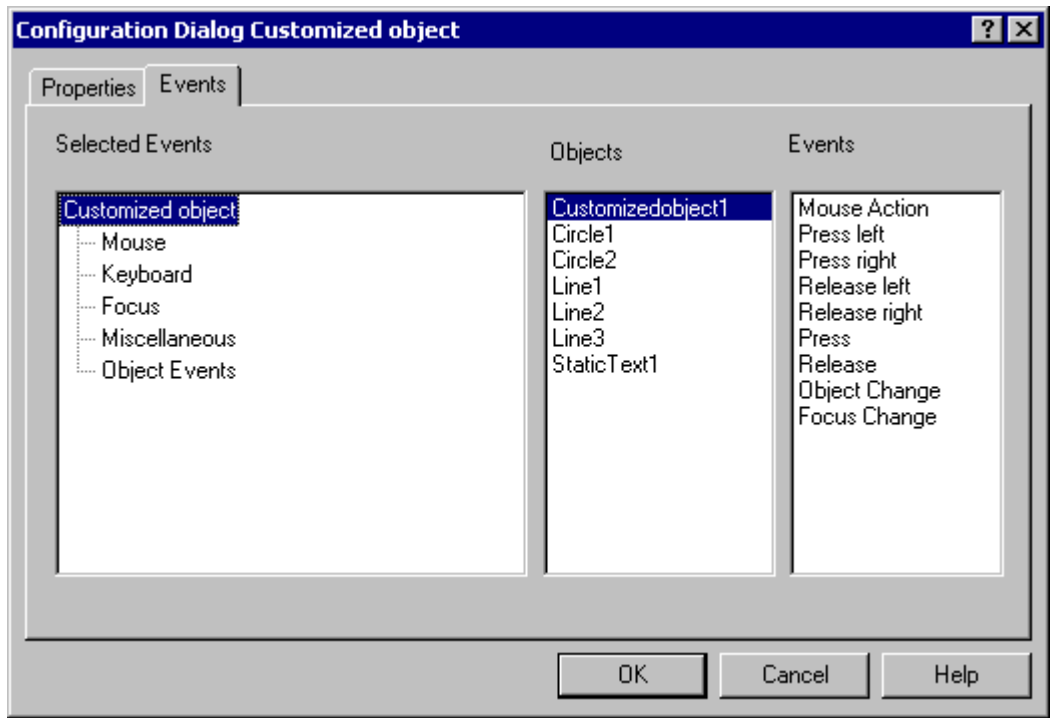

In this example only the "Mouse Action" event is configured.

10. Select the event "Mouse".

Select the "CustomizedObject1" object that is to respond to the desired event. If the event is to be configured for a contained single object, select the single object only.

Double-click the event "Mouse click".

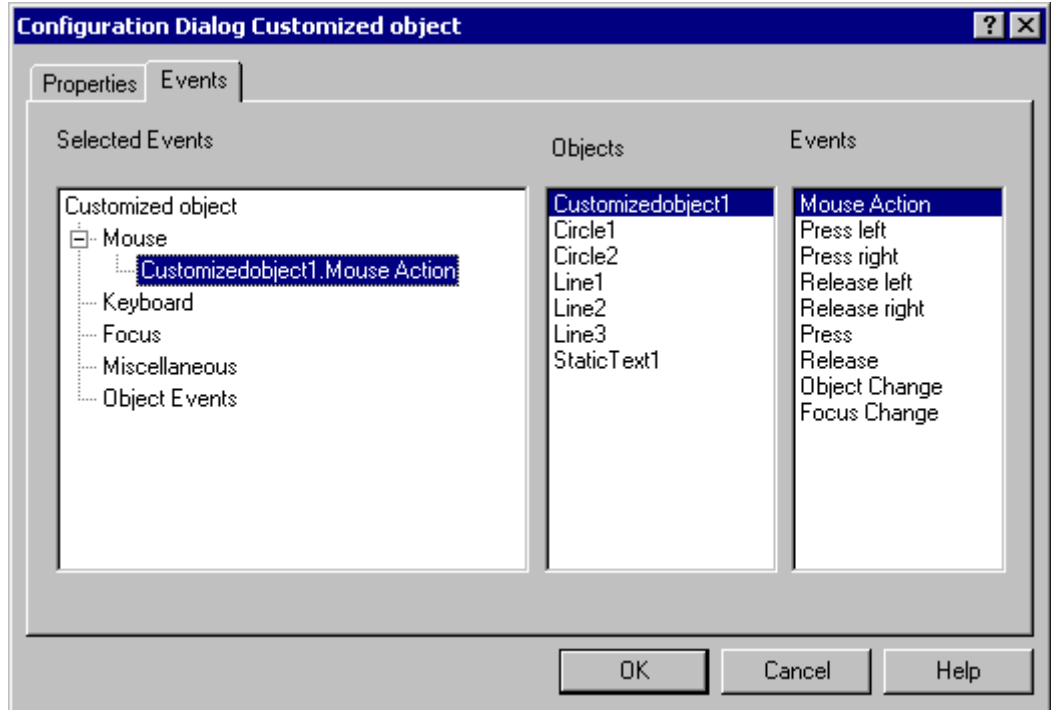

The customized object now has the "CustomizedObject1.Mouse Action" event in the "Mouse" event group.

Add more events in the same manner.

- 11. The customized object should have the name "myCompressor":
 - Select the "Properties" tab.
 - Enter the name "myCompressor" in the field "Object type".
 - Click the entry "Customized Object" in the "Selected Properties" area to accept the name.

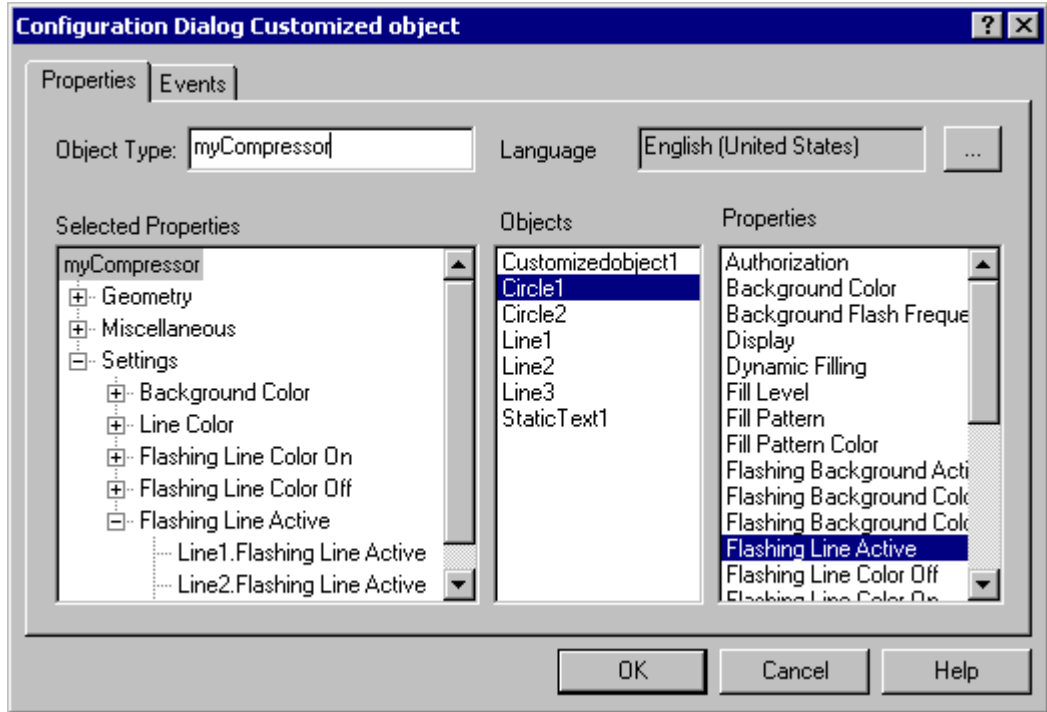

Confirm the configuration with "OK" to finish creating the "myCompressor" customized object.
The configuration dialog "Configuration Dialog Customized object" will be closed.

- 12. Select the new customized object in your process picture.
 - Open the window "Object Properties" to check the configuration of the customized object.

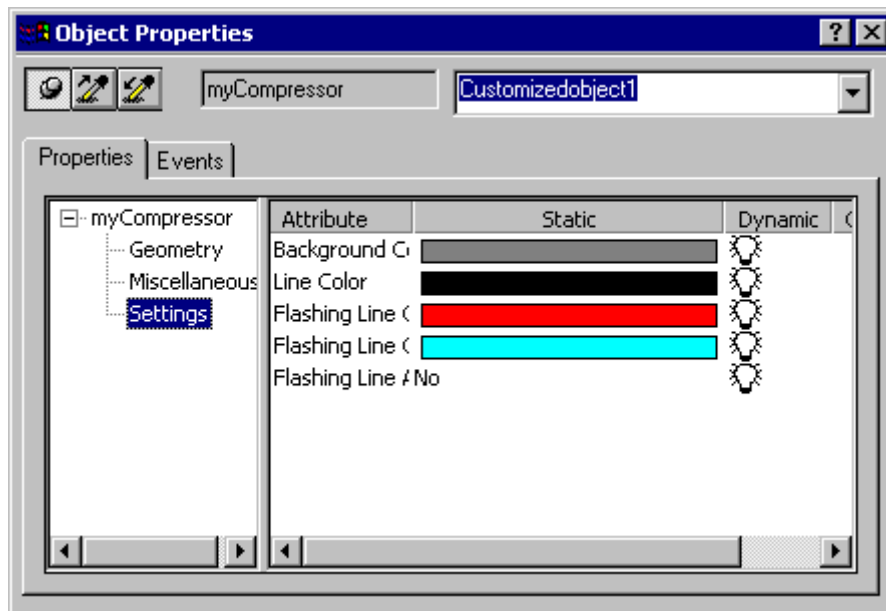

The "Settings" property group only shows the properties and events that you defined in the "Configuration Dialog Customized Object".

See also

- How to create a customized object (Page 714)
- How to configure the property groups of the customized object (Page 718)
- How to add and delete attributes of a customized object (Page 719)
- How to configure the properties of attributes of the customized object (Page 721)
- How to configure the events of a customized object (Page 725)
- How to edit a customized object (Page 726)
- How to delete a customized object (Page 727)
- Events of a customized object (Page 724)
- Properties of a Customized Object (Page 716)

3.8.12 Working with libraries

3.8.12.1 Working with the library

Introduction



The libraries of the Graphics Designer are a versatile tool to store and manage graphic objects.

In the symbol library, you manage customized objects and controls that you use to create process pictures.

In the SVG library, you manage SVG objects.

Open library

To show and hide libraries in the standard palette, use the following symbols in the toolbar of the Graphics Designer:

	Symbol library: Customized objects and controls
	SVG library: SVG graphics

The display of the library objects can be adapted with the elements of the toolbar.

Library directories

The libraries each contain two folders: the global library and the project library.

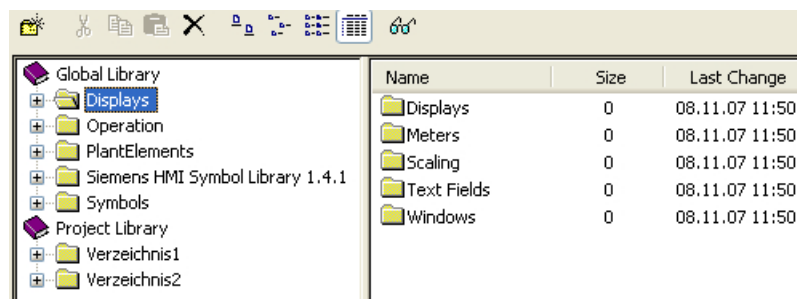

Global library

The "Global Library" offers a variety of pre-defined graphic objects that you can insert into a picture as library objects and configure as required. Graphic objects such as machines and plant components, measuring equipment, operator control elements and buildings are thematically organized in folders.

The "Siemens HMI Symbol Library" or "IndustryGraphicLibrary" contains a comprehensive symbol library with objects that are different from the other library objects.

You can add user-defined objects to the "Global Library" to make the objects available for other projects as well. These objects must not be linked with dynamics to prevent errors when embedding them in other projects.

Project Library

The "Project Library" enables a project-specific library to be built. The objects can be sorted by subjects by creating folders and subfolders.

You store user-defined objects here as a copy and make them available for multiple use.

Because the project library is only available for the current project, you can only include dynamized objects in this directory.

The names of user-defined objects inserted into the library can be freely selected.

Backup library objects

The project library is only available for the current project. If you have added user-defined objects to the Project Library, you have to back up the Project Library.

In WinCC the library objects are stored in different folder paths:

- All information on the global library is by default saved in the "\aplib" subfolder of the WinCC installation folder.
- Objects of the project library as components of the current project are stored in the "library" subfolder of the project folder.

To be able to use the user-defined configurations of the project library in other projects, you have to copy the contents of the relevant folder to the corresponding folder of the target project.

It is also recommended that you create a backup copy of the "library" folder and update it regularly.

Types of library objects

Different object types are used as library objects in the global library.

Accordingly a library object that has been inserted into a picture is changed in various configuration dialogs:

Customized objects

The folders "System Modules", "Displays", "Operation" and "Symbols" contain pre-defined customized objects.

If such a library object is inserted into a picture, changes can be executed in the "Object Properties" window and in the "Configuration Dialog Customized Object". Both dialogs can be opened from the pop-up menu of the inserted object.

Controls

The "Siemens HMI Symbol Library" folder contains an extensive symbol library whose elements you can also insert as a control into a picture.

When you insert such a library object into a picture, carry out the changes in the "Object Properties" window and in the "Properties of Siemens HMI Symbol Library" dialog. You open the "Properties of Siemens HMI Symbol Library" dialog by double-clicking the inserted object.

The detailed description of the "Siemens HMI Symbol Library" is available in the section "Working with Controls".

SVG objects

The "IndustryGraphicLibrary" contains pre-defined SVG graphics.

As of version 2.0 of the SVG library, selected properties of the SVG objects can be dynamized as object properties.

See also

The "Siemens HMI Symbol Library" Control (Page 764)

3.8.12.2 Working with the SVG Library

Introduction

The SVG Library of the Graphics Designer is a versatile tool for saving and managing SVG objects that can be used for creating process pictures.

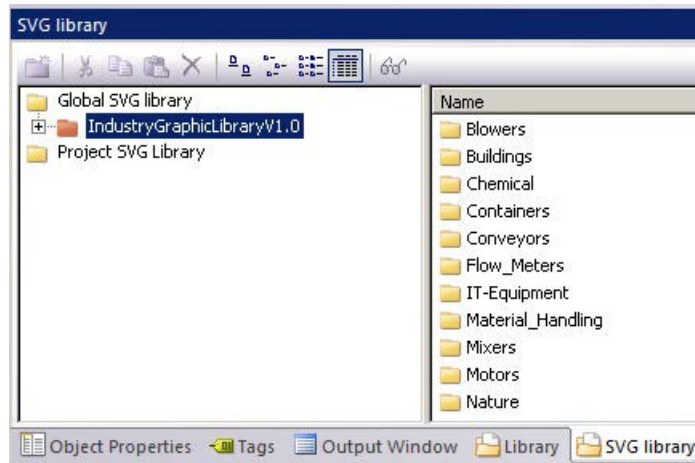

Global SVG library

The global SVG library contains read-only SVG libraries with pre-defined SVG graphics that are available as "zip" files under "SVGLibrary" in the WinCC installation folder.

WinCC installs a separate standard SVG library "IndustryGraphicLibrary". PCS 7 and other products can provide their own SVG libraries.

You can select the global SVG libraries individually and use them in your WinCC project. These libraries are copied uncompressed into the project folder under "GraCS/SVGLibrary" and added to the "Project SVG Library".

SVG libraries: Versions

The global SVG libraries contain version information. This enables you to distinguish modified libraries in the installation folder from libraries already used in the project.

When you open the Graphics Designer, you receive a message that newer versions of the global SVG libraries are available. You can decide whether you want to update these libraries for the project. You can prevent the display of the message under "Tools > Settings ...".

As of the version "IndustryGraphicLibraryV2.0", main object properties of the supplied SVG graphics can be dynamized.

Project SVG library

The Project SVG library enables a project-specific library to be set up. The objects in the library are stored in the project folder under "GraCS/SVGLibrary". The SVG project library also contains metadata ("PXL" files), which load the contents of the SVG objects.

Creating a project library

When you create a new WinCC project, the project SVG library is empty.

You manage the project SVG library using the shortcut menu. The objects can be sorted by subjects by creating folders and subfolders.

Editing a project library

To expand or change the libraries, you need to remove the write protection via the shortcut menu. You can recognize a read-only project library by the red color of the folder.

You store user-defined objects here as a copy and make them available for multiple use.

Because the project SVG library is only available for the current project, you can only include dynamized objects in this folder.

The names of user-defined objects inserted into the library can be freely selected.

You can export the library in ".zip" format using the "Export" shortcut menu.

Using library objects in the process picture

Using drag-and-drop, you insert objects of the SVG libraries into a process picture.

Insert SVG graphic as SVG object

If you insert the "SVG Object" smart object into the process picture, you can also select a graphic of the SVG library. For this purpose, the SVG graphic must be imported into the WinCC project.

To show all SVG graphics, activate the "Show Subdirectories" option.

Insert SVG graphic as "Picture" object property

You can use drag-and-drop to insert the SVG graphics in the objects of the Graphics Designer that have the "Picture" property. For example, a "Button", "Status display" or graphic object.

If you can assign multiple pictures to the object, e.g. "Status display" or "Button", a shortcut menu opens for selecting the target object.

See also

How to work with SVG project libraries (Page 743)

How to import library objects into a picture (Page 746)

3.8.12.3 Toolbar of the libraries

Introduction

You can make the following settings with the tools in the toolbar of the "Library" dialog:

- Creating and deleting folders for sorting the library objects by topic.
- Copying, moving and deleting library objects or inserting them into the current picture.

- Adding user-defined objects to the library.
- Adapting the display for the library objects.

Overview



Symbol	Name	Function
	New folder	Creates a new subdirectory in the selected directory. Directories can be renamed or deleted from their shortcut menu.
	Cut	A selected library element is copied to the operating system clipboard. The library object is removed from the library.
	Copying	A selected library element is copied to the operating system clipboard. The library object itself is not changed.
	Paste	The current contents of the clipboard can be inserted in the selected library directory as often as desired.
	Delete	A selected library object is removed from the current library directory.
	Extra Large Symbols	The library objects contained in the current directory are displayed as large symbols. Apart from the name of the object, no detailed information is shown. If the preview is activated, the symbol for the picture contents of the library object is used.
	Large Symbols	The library objects contained in the current directory are displayed as medium-sized symbols. Apart from the name of the object, no detailed information is shown. If the preview is activated, the symbol for the picture contents of the library object is used.
	Small Symbols	The library objects contained in the current directory are displayed as a list with small symbols. Apart from the name of the object, no detailed information is shown. If the preview is activated, the symbol for the picture contents of the library object is used.
	List	The library objects contained in the current directory are displayed as a list with small symbols. Apart from the name of the object, the file size and the date of the last modification are displayed as detailed information. If the preview is activated, the symbol for the picture contents of the library object is used.
	Preview	The picture contents of the library objects are used for the symbolic display of the library object. If the preview is not activated, a default symbol is shown.

3.8.12.4 How to work with SVG project libraries

Introduction

When you create a new WinCC project, the project SVG library is empty. To fill the project library with content, you have the following options:

- Transfer the global SVG libraries into the project SVG library.
- Create a new project library under "Project SVG Library" and add SVG objects or SVG pictures.
- Importing an SVG library

Editing project libraries

To expand or change the project libraries, you may need to remove the write protection via the shortcut menu.

You can make the following configurations in your project library:

- Copy, paste and removing entries
- Adding subfolders
- Inserting new SVG graphics
- Export the library in ".zip" format.
The exported library contains the SVG pictures and the meta-information.

How to insert your own SVG graphics in a project library is described under "How to insert objects into a library (Page 744)".

Procedure: Apply global SVG library

1. Select one or more ".zip" entries in the "Global SVG Library" folder.
2. Click "Use in project" in the shortcut menu.
The selected libraries are copied uncompressed into the project folder under "GraCS/SVGLibrary" and inserted into the "Project SVG Library".

Procedure: Create project library

1. Select the "Project SVG Library" folder.
2. Click "New Library" in the shortcut menu.
3. Enter a name for the project library in the dialog.
A new SVG library with an empty ".pxl" file is created and inserted below the project SVG library.

Procedure: Import SVG library

1. Select the "Project SVG Library" folder.
2. Click "Import" in the shortcut menu.
3. Select a compressed file in the dialog.
The imported SVG library is extracted and inserted below the "Project SVG library".

Procedure: Export SVG library

1. Select a project library under the "Project SVG Library" folder.
2. Click "Export" in the shortcut menu.
3. Select the storage path.
The project library is exported as ZIP file under the library name.

See also

How to import library objects into a picture (Page 746)

How to insert objects into a library (Page 744)

Working with the SVG Library (Page 740)

3.8.12.5 How to insert objects into a library

Introduction

You can add your own objects to WinCC libraries which you can then use in other process pictures of the project or in other WinCC projects.

Symbol library

You can add the objects contained in a picture to the library by dragging them with the mouse or by using the clipboard.

If required, create new folders and subfolders and assign a corresponding name to the inserted library object for easier repeated use in the future.

Global library

You can add user-defined objects to the "Global Library" to make the objects available for other projects as well.

These objects must not be linked with dynamics to prevent errors when embedding them in other projects.

Project library

You can also include dynamized objects in the "Project Library" because this project is only available for the current project.

SVG library

Your own SVG graphics can only be included in the project SVG library.

You use either the "SVG Object" smart object or the import function for this purpose.



Requirement

- A picture is open.
- A library is open.

Symbol library: Procedure

1. Select or create a subfolder of the global library or the project library in the left section of the dialog.
The library objects in this subfolder are shown in the right section of the dialog.
2. Select the object in the active picture that you want to add to the selected folder of the library.
3. Hold down the mouse button and drag the selected object into the library folder.
As soon as you release the mouse button, the insertion process is finished.
4. If you want to assign a name to the new library object, select "Rename" in the shortcut menu of the new library object.
The name of the library object becomes editable.
5. Enter the new name and confirm this by pressing <ENTER>.

Symbol library: Alternative procedure

1. Select or create a subfolder of the global library or the project library in the left section of the dialog.
The library objects in this subfolder are shown in the right section of the dialog.
2. Select the object in the active picture that you want to add to the selected folder of the library.
3. Click on the symbol  in the standard palette of the Graphics Designer.
The selected object is copied to the clipboard.
4. Click on the symbol  in the toolbar of the "Library" dialog.
The new library object is inserted into the selected library folder from the clipboard of the operating system.
5. If you want to assign a name to the new library object, select "Rename" in the shortcut menu of the new library object.
The name of the library object becomes editable.
6. Enter the new name and confirm this by pressing <ENTER>.

SVG library: Procedure

1. Insert the "SVG object" smart object in the process picture using drag-and-drop.
2. Configure the SVG object.

3. Use drag-and-drop to add an SVG object to the project SVG library or a subfolder of the library.
The SVG object is added to the library with its name.
4. To change the name, open the shortcut menu of the imported SVG graphic in the data area of the SVG library and select "Rename".

SVG library: Alternative procedure

1. Open the shortcut menu of the "Project SVG library" in the navigation area.
2. Select the "Import > Folder" command to import the SVG graphics of a folder.
If you have stored the graphics in a ZIP file, import the SVG graphics using "Import > From ZIP file".
You can also import individual files into the subfolder of a project library using "Import > SVG graphics".

See also

How to work with SVG project libraries (Page 743)

How to import library objects into a picture (Page 746)

Toolbar of the libraries (Page 741)

Working with the library (Page 737)

3.8.12.6 How to import library objects into a picture

Introduction

You can insert library objects in a picture by dragging them with the mouse or by using the clipboard.

When a library object is added to a picture, the object name is by default a combination of the name of the object type and a sequential number.

You can change the name with the "Object name" attribute in the "Object Properties" window.



Requirement

- A picture is open.
- A symbol library or an SVG library is open.

Procedure

1. Select a subdirectory of the global library or the project library in the navigation area of the dialog.
The library objects in this subfolder are shown in the right section of the dialog.
2. Select a library object and drag it with the mouse to the required position in the picture.
As soon as you release the mouse button, the insertion process is finished.
3. To change the object properties of the inserted library object, select the "Object Properties" window.
The properties to be dynamized are displayed in the "Control Properties" property group.

Alternative procedure

1. Select a subdirectory of the global library or the project library in the navigation area of the dialog.
The library objects in this subfolder are shown in the right section of the dialog.
2. Select the desired library object.
3. Click on the symbol  in the toolbar of the "Library" dialog.
The library element is copied to the operating system clipboard.
In an SVG library, this function is only available for objects of project libraries.
4. Click on the symbol  in the standard palette of the Graphics Designer.
The library object is inserted into the current picture from the clipboard.

See also

Working with the SVG Library (Page 740)
 How to work with SVG project libraries (Page 743)
 How to insert objects into a library (Page 744)
 How to Rename Objects (Page 462)
 Toolbar of the libraries (Page 741)
 Working with the library (Page 737)

3.8.12.7 How to insert an SVG graphic as a "Picture" object property

Introduction

You can use objects from the SVG library as pictures in the following objects:

Object	Object Properties
Graphic Object	Picture
Status Display	Basic Picture Flash Picture
SVG object	Graphic

Object	Object Properties
Button	Picture Status Off Picture Status On
Round Button	Picture Status Off Picture Status On Picture Status Deactivated

Requirement

- A picture is open.
- An SVG library is open.

Procedure

1. Insert a button, for example, into a process picture.
2. Select an object of the SVG library
3. Drag the library object with the mouse to the selected button in the process picture. As soon as you release the mouse button, the selection of the available object properties is displayed.

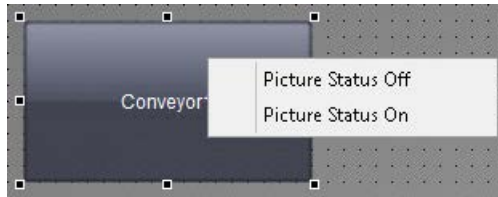

If only one object property can be selected in the object, the SVG graphic is added directly.

4. Select the desired object property, e.g. "Picture Status Off". The object property is connected to the SVG graphic.



3.9 Working with Controls

3.9.1 Working with Controls

Contents

ActiveX controls offer the option of integrating elements for controlling and monitoring system processes into a process picture. WinCC supports the following types of controls:

- **ActiveX controls**
ActiveX controls are control elements from any provider that can be used by other programs via a defined interface based on OLE.
- **.NET controls**
.NET controls are control elements from any supplier with the .NET Frameworks as of 2.0 from Microsoft.
- **WPF controls**
WPF Controls are control elements from any supplier with the .NET Frameworks as of 3.0 from Microsoft.

The size and properties that a control accepts in Runtime are defined in the Graphics Designer.

All ActiveX controls registered in the operating system and the .NET and WPF Controls on your system are available for use in WinCC.

However, this chapter only covers the use of ActiveX controls provided by WinCC. The ActiveX controls provided by WinCC can be changed as required and embedded dynamically in the process.

This chapter shows you:

- how to register ActiveX controls in the operating system
- how to embed and configure controls in process pictures with the Graphics Designer
- how to use controls.

3.9.2 Short Description of the WinCC Controls and Additional Controls

Introduction

Controls are used for the monitoring and visualization of measured values and system parameters. By appropriate dynamics they can be employed as control elements of the process control.

While installing WinCC, a number of ActiveX controls will also be installed: The WinCC controls.

Overview

Detailed descriptions of the following WinCC controls can be viewed via the links in the menu bar.

Control	Abbreviation	Function
Siemens HMI Symbol Library	Symbol Library	The Symbol Library contains a comprehensive collection of ready-made symbols for the display of systems and system components in process pictures.
WinCC AlarmControl	AlarmControl	The AlarmControl can be used to display messages during run-time.
WinCC Digital/Analog Clock Control	Clock Control	The Clock Control can be used to integrate a time display into a process picture.
WinCC FunctionTrendControl	FunctionTrendControl	The FunctionTrendControl can be used to display the values of tags as functions of other tags and compare the trend with the setpoint trend.
WinCC Gauge Control	Gauge Control	The Gauge Control can be used to display the monitored measurement values in the form of an analog measurement clock.
WinCC Media Control	Media Control	The Media Control can be used to play media files.
WinCC OnlineTableControl	OnlineTableControl	The OnlineTableControl can be used to display values from archive tags in tabular form.
WinCC OnlineTrendControl	OnlineTrendControl	The OnlineTrendControl can be used to display values from tags and archive tags as trends.
WinCC RulerControl	RulerControl	RulerControl displays the evaluation of process data in a statistics or ruler window.
WinCC Slider Control	Slider Control	The Slider Control can be used to display the monitored measurement values in the form of a slider control.
WinCC UserArchiveControl	UserArchiveControl	The UserArchiveControl provides options to access user archives and views of the user archives.
WinCC UserAdminControl	UserAdminControl	You can edit the user administration in Runtime using the WinCC UserAdminControl.
WinCC WebBrowser Control	Display function	The WinCC WebBrowser Control displays static Web contents or CHM documents in process pictures.
WinCC SysDiagControl	SysDiagControl	You can use the WinCC SysDiagControl to display the system diagnostics of the "SIMATIC S7-1200" and "SIMATIC S7-1500" controllers
WinCC BarChartControl	BarChartControl	The BarChartControl can be used to display values of archive tags in a bar chart.

See also

- How to Resize a Control (Page 756)
- How to Change the Properties of a Control (Page 763)
- This is how you change the registration of an ActiveX control (Page 761)
- How to configure the control selection (Page 758)
- How to Position a Control (Page 757)
- How to insert a control from the selection window (Page 754)
- This is how you insert an ActiveX control as a smart object: (Page 751)

The "WinCC Digital/Analog Clock" Control (Page 773)

The "WinCC Gauge" Control (Page 779)

The "WinCC Slider" Control (Page 793)

WinCC AlarmControl (Page 1372)

WinCC OnlineTrendControl (Page 1604)

WinCC FunctionTrendControl (Page 1688)

WinCC OnlineTableControl (Page 1560)

WinCC UserArchiveControl (Page 1945)

WinCC Media Control (Page 789)

The "Siemens HMI Symbol Library" Control (Page 764)

3.9.3 This is how you insert an ActiveX control as a smart object:

Introduction

You insert an ActiveX Control from the "Default" selection window into a process picture. You can insert controls as a smart object or from the "Controls" tab.

If you insert the ActiveX Control as a smart object, select the ActiveX Control from the "Insert a Control" dialog during the insertion process. The dialog shows all the ActiveX Controls that are registered in the operating system.

Note

The use of ActiveX Controls from third party providers can lead to errors as well as drops in performance or system blocks. The user of the software is responsible for problems caused by the deployment of external ActiveX Controls.

We recommend testing for safe operation before implementation.

ActiveX controls which have not been certified must operate in accordance with the Microsoft specification. In a conflict occurs, the user is obliged to submit evidence of compliance with the specification.

At the end of the insertion process a configuration dialog is usually opened, in which you adapt the properties of the control. You can also open this dialog later by double-clicking the control. Detailed description of the configuration dialog can be found in the descriptions of the related controls.

WinCC uses the designation of the control linked with a sequential number as the object name by default. You can change this name with the "Object name" attribute in the "Object Properties" window.

Procedure

1. In the Object Palette, click the smart object "Control".
2. Keeping the left mouse button pressed, drag the object in the desired area of the picture to the desired size.
When you release the mouse button, the object is inserted into the corresponding location in the picture.
The "Insert Control" dialog opens.



3. Select one of the ActiveX Controls that are registered in the operating system. Confirm your selection with "OK".
With some controls, the corresponding configuration dialog is automatically opened. In any case, you can open the configuration dialog with a double-click or via the shortcut menu.
4. Adapt the settings of the configuration dialog as needed. Confirm your entries with "OK".
The insertion process for the "Control" object is finished.

Alternative procedure

1. Double-click the "Control" smart object in the "Default" selection window in order to insert it with the default properties into the process picture.
2. Select the desired control in the "Insert a Control" dialog.

See also

- How to Change the Properties of a Control (Page 763)
- This is how you change the registration of an ActiveX control (Page 761)
- How to configure the control selection (Page 758)
- How to Position a Control (Page 757)
- How to Resize a Control (Page 756)
- How to insert a control from the selection window (Page 754)
- Short Description of the WinCC Controls and Additional Controls (Page 749)

3.9.4 This is how you insert a .NET or WPF control as a smart object

Introduction

Insert a .NET or WPF Control from the "Standard" selection window into a process picture. You can insert these controls as a smart object or from the "Controls" tab.

When inserting the control as a smart object, select the required control in the "Insert a Control" dialog. All the controls which were configured for selection are displayed here.

Note

Possible problems with third-party controls

The user of the software is responsible for problems caused by the deployment of external controls.

We recommend that you check for secure operation before using.

Configuration

At the end of the insertion process a configuration dialog is usually opened, in which you adapt the properties of the control. You can also open this dialog later by double-clicking the control.

WinCC uses the designation of the control linked with a sequential number as the object name by default. You can change this name with the "Object name" attribute in the "Object Properties" window.

Note

Some inserted WPF controls only work properly when the associated .dll files are in the "assemblies" folder.

The storage location, e.g. "C:\Program Files\Common Files\Siemens\assemblies", depends on the WinCC installation path and the operating system.

Procedure

1. Click the ".NET Control" or "WPF Control" smart object in the "Standard" selection window.
2. Keeping the left mouse button pressed, drag the object in the desired area of the picture to the desired size.
 When you release the mouse button, the object is inserted into the corresponding location in the picture.
 The "Insert a Control" dialog with the controls from the "Global Assembly Cache" is opened.

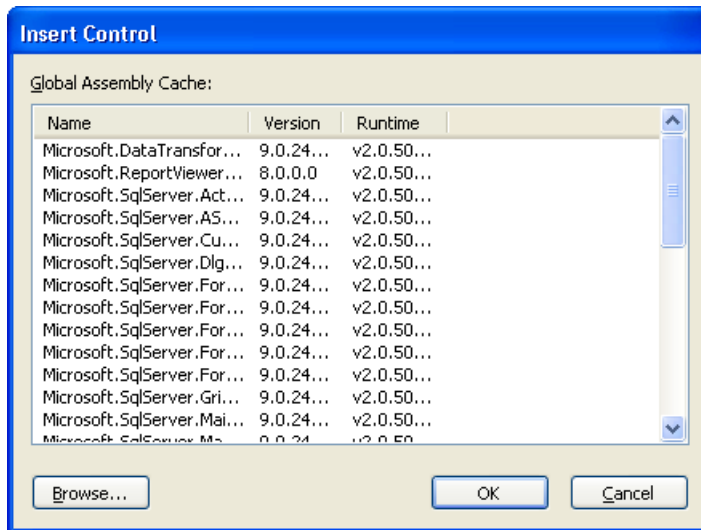

3. Select the required control and confirm with "OK".
4. Choose the desired type in the "Select type" dialog.
 The associated configuration dialog now opens for some controls.
5. Adapt the settings of the configuration dialog as needed. Confirm your entries with "OK".
 The insertion process for the ".NET Control" or "WPF Control" object is finished.

Alternative procedure

1. Double-click the ".NET Control" or "WPF Control" smart object in the "Standard" selection window in order to insert it with the default properties into the process picture.
2. Select the required control in the "Insert control" and "Insert type" dialogs.

3.9.5 How to insert a control from the selection window

Introduction

You insert a control into a process picture from the "Default" selection window as a smart object or from the "Controls" selection window. ActiveX controls, .NET controls and WPF controls are available.

After installation of WinCC the "Controls" selection window displays a default selection of WinCC controls under the ActiveX controls. No controls are initially listed under ".NET controls" and "WPF controls". You can configure this control selection if necessary.

At the end of the insertion process a configuration dialog is usually opened, in which you adapt the properties of the control. You can also open this dialog later by double-clicking the control.

WinCC uses the designation of the control linked with a sequential number as the object name by default. You can change the name with the "Object name" attribute in the "Object Properties" window.

Requirement

- You have display the "Controls" selection window with "View > Toolbars".

Procedure

1. Select the required control in the "Controls" selection window.
2. Keeping the left mouse button pressed, drag the control in the desired area of the picture. When you release the mouse button, the object is inserted into the corresponding location in the picture.
The associated configuration dialog opens for some controls.
3. Adapt the settings of the configuration dialog as required and confirm your entry with "OK". The insertion process for the selected control is finished.

Note

If you press the <Esc> key during drag-and-drop, the dragging action and the selection of the object is canceled.

See also

[How to Change the Properties of a Control \(Page 763\)](#)

[This is how you change the registration of an ActiveX control \(Page 761\)](#)

[How to configure the control selection \(Page 758\)](#)

[How to Position a Control \(Page 757\)](#)

[How to Resize a Control \(Page 756\)](#)

[This is how you insert an ActiveX control as a smart object: \(Page 751\)](#)

[Short Description of the WinCC Controls and Additional Controls \(Page 749\)](#)

3.9.6 How to Resize a Control

Introduction

The size of an object is defined by the geometry of the rectangle surrounding the object. The rectangle surrounding the control is symbolized when selecting an object by showing the handles.

Controls can be resized by:

- dragging the handle to a new position
- Changing the values of the "Width" and "Height" attributes in the window "Object properties"

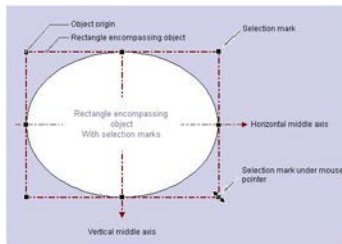

Requirements

- Select a control.

Procedure

1. Position the cursor on the handle of the selected control.
The mouse pointer will change to a double arrow. The alignment of the double arrow indicates the directions in which you can move the handle:
 - Horizontal double arrow
The handles on the horizontal center axis can be used to change the width of the control.
 - Vertical double arrow
The handles on the vertical center axis can be used to change the height of the control.
 - Diagonal double arrow
The handles on the corners of the control can be used to change the height and width of the control.
2. Use the mouse to drag the handle to the position you want.
In the settings of the Graphics Designer if the Snap to Grid function is activated, the control can only be scaled with the mouse according to the settings for the grid.

See also

This is how you change the registration of an ActiveX control (Page 761)

How to Change the Properties of a Control (Page 763)

How to configure the control selection (Page 758)

How to Position a Control (Page 757)

How to insert a control from the selection window (Page 754)

This is how you insert an ActiveX control as a smart object: (Page 751)

Short Description of the WinCC Controls and Additional Controls (Page 749)

3.9.7 How to Position a Control

Introduction

The position of a control is defined by the coordinates of the control origin. The left upper corner of the rectangle surrounding the control is called the object origin. Controls can be positioned by:

- dragging the control to a new position
- moving the selected control with the aid of the arrow keys for cursor control
- Changing the "Position X" and "Position Y" attributes in the "Object Properties" window

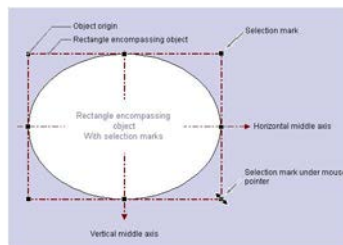

Requirements

- Select a control.

Procedure

1. Position the cursor on the selected control.
The mouse pointer changes to a crosshair with arrowheads.
2. Click the control and hold down the left mouse button.
The cursor changes into an arrow with an outline icon (small rectangle with broken line).
3. Move the cursor.
The rectangle surrounding the control is displayed as broken and shows a possible new position for the control. The control initially maintains its original position.
In the settings of the Graphics Designer if the Snap to Grid function is activated, the control can only be positioned with the mouse according to the settings for the grid.
4. Release the mouse button.
The control is moved to the position previously displayed by the broken line of the rectangle surrounding the object. The mouse pointer again changes into a crosshair with arrow ends.

See also

How to configure the control selection (Page 758)

How to Change the Properties of a Control (Page 763)

This is how you change the registration of an ActiveX control (Page 761)

How to Resize a Control (Page 756)

How to insert a control from the selection window (Page 754)

This is how you insert an ActiveX control as a smart object: (Page 751)

Short Description of the WinCC Controls and Additional Controls (Page 749)

3.9.8 How to configure the control selection

Introduction

The "Controls" tab in the "Standard" selection window of the Graphics Designer contains a selection of controls in the folders "ActiveX controls", ".NET controls" and "WPF controls". You can insert these controls directly into a picture.

You can configure the selection of controls available in the tab yourself:

- Change the selection of the ActiveX controls in the dialog "Select OCX Controls". You can add any of the ActiveX controls registered in the operating system to the list of controls and remove individual controls from the selection.
- Change the selection of the .NET controls in the dialog "Select .NET Object".
- Change the selection of the WPF controls in the dialog "Select WPF Object".

Note

The use of controls from third party providers can lead to errors as well as drops in performance or system blockage. The user of the software is responsible for problems caused by the deployment of external controls.

We recommend a thorough test before implementation.

Configuring ActiveX controls

1. Open the "Controls" tab and select the entry "Add/Remove" in the shortcut menu of the "ActiveX Controls" folder. The "Select OCX Controls" dialog is opened.

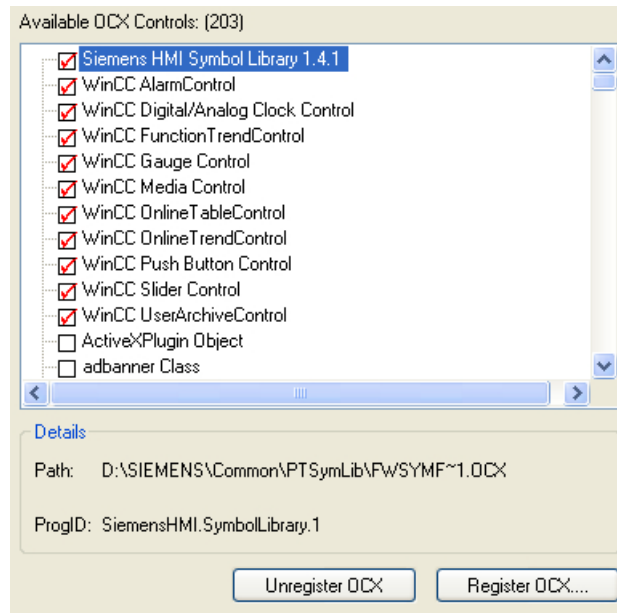

In the area "Available OCXs (Number)", the "Select OCX Controls" dialog shows all the ActiveX Controls that are registered in the operating system. The exact number is shown in the title of the area after the registration has been read in. A red check mark indicates those controls that are available in the "Controls" tab dialog of the Object Palette. The path and the program ID of the selected ActiveX Controls are displayed in the area "Details". You can open the "Select OCX Controls" dialog also from the WinCC Explorer. Click on the entry "Graphics Designer" in the navigation window and select the entry "Select ActiveX Control" in the shortcut menu.

2. To add an ActiveX control in the "Controls" tab, select the required control in the area "Available OCX Controls".
A red check mark indicates that the control is added to the "Controls" tab.
3. To remove an ActiveX control deactivate the control in question in the area "Available OCX Controls".
The red check mark disappears.
4. Confirm your changes by clicking "OK".

Configuring .NET objects and WPF objects

1. Open the "Controls" tab and select the entry "Add/Remove" in the shortcut menu of the ".NET Controls" folder or the "WPF Controls" folder.
The dialog "Select .NET Object" or "Select WPF Object" opens.

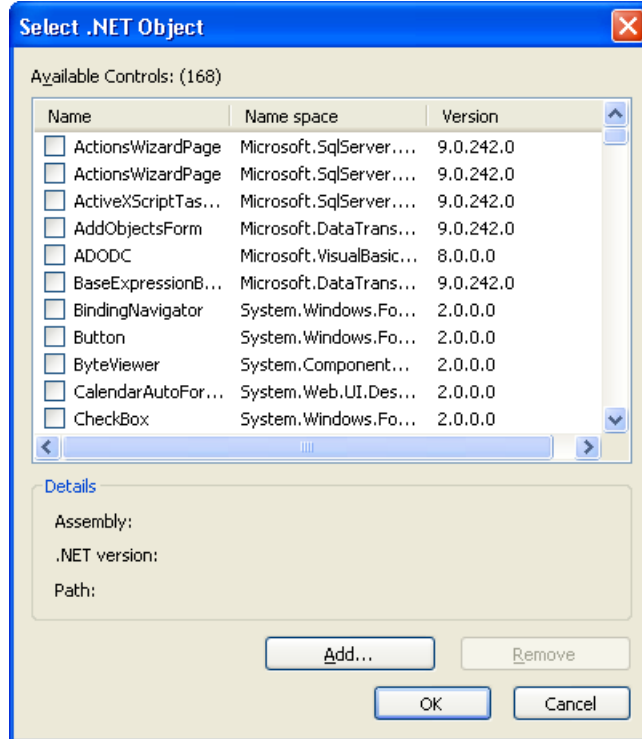

In the area "Available Controls (Number)", the dialog shows all the .NET objects or WPF objects on your computer. The precise number is displayed in the title of the area. A red check mark indicates those controls that are available in the "Controls" tab dialog of the Object Palette. The assembly, .NET version and path of the selected object are displayed in the area "Details".

2. To add a control in the "Controls" tab, select the required control in the area "Available Controls".
A red check mark indicates that the control is added to the "Controls" tab.
3. To remove a control deactivate the control in question in the area "Available Controls".
The red check mark disappears.
4. Confirm your changes by clicking "OK".

See also

How to Change the Properties of a Control (Page 763)

This is how you change the registration of an ActiveX control (Page 761)

How to Position a Control (Page 757)

How to Resize a Control (Page 756)

How to insert a control from the selection window (Page 754)

This is how you insert an ActiveX control as a smart object: (Page 751)

Short Description of the WinCC Controls and Additional Controls (Page 749)

.NET controls (Page 805)

WPF controls (Page 806)

3.9.9 This is how you change the registration of an ActiveX control

Introduction

ActiveX Controls must be configured in the operating system, in order to be available for applications. Normally the registration is a component of the installation procedure. For troubleshooting or also for upgrading of individual controls, you can also perform a registration or deregistration manually. In WinCC you can edit the registration in the following dialogs:

- Dialog "Select OCX Controls"
Use the button "Deregister OCX" and "Register OCX"
- Dialog "Insert a Control"
Use the buttons "Register..." and "Deregister".

The procedure for changing the registration is the same in both dialogs. We will describe it below in the example of the Insert a Control dialog.

Note

You can use these buttons to change the settings of the operating system. Changes are made immediately.

Before the deregistration of an ActiveX control, check in which path the related OCX file is saved on the hard disk. How to facilitate a repeated registration of this control.

Deregistering ActiveX Control

1. Insert a Control as a Smart Object.
The "Insert a Control" dialog is opened.
2. Select the desired Control in the selection list.

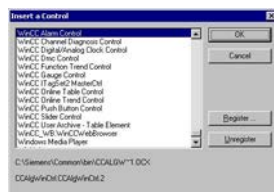

3. Check the details under the selection list (path and name).
4. Click on the button "Deregister".
The selected control is deregistered and deleted from the selection list. The related OCX file is maintained in the specified path on the hard disk.

Registering ActiveX Control

1. Insert a Control as a smart object.
The "Insert a Control" dialog opens.
2. Click the "Register..." button.
You can use the Open dialog to open a browser window for the selection of the desired OCX file.



3. Select the desired OCX file.
During the installation, WinCC Controls are normally copied into the folder "...\\Siemens WinCC\\BIN".
4. Click "OK" to confirm your choice.
The selected control is registered in the operating system and displayed in the selection list of the "Insert a Control" dialog.



See also

- How to Change the Properties of a Control (Page 763)
- How to configure the control selection (Page 758)
- How to Position a Control (Page 757)
- How to Resize a Control (Page 756)
- How to insert a control from the selection window (Page 754)
- This is how you insert an ActiveX control as a smart object: (Page 751)
- Short Description of the WinCC Controls and Additional Controls (Page 749)

3.9.10 How to Change the Properties of a Control

Introduction

The properties of a control can be adopted according to your needs by:

- Changing the attributes in the "Object Properties" dialog
- Changing the settings in the Configuration dialog

Opening the "Object Properties" Window

In the pop-up menu of a control select the entry "Properties", in order to open the "Object Properties" dialog. The change of an attribute is executed immediately.

The detailed description of the "Object Properties" dialog is found in chapter "The Window Object Properties".

Opening the Configuration Dialog

Double-click a control to open the related configuration dialog. Select a tab to carry out the desired changes. Click on "Accept" in order to assign the new settings to the control. Confirm your configuration with "OK" to close the dialog.

The configuration dialogs are explained in the detailed description of the related control.

See also

How to Resize a Control (Page 756)

This is how you change the registration of an ActiveX control (Page 761)

How to configure the control selection (Page 758)

How to Position a Control (Page 757)

How to insert a control from the selection window (Page 754)

This is how you insert an ActiveX control as a smart object: (Page 751)

Short Description of the WinCC Controls and Additional Controls (Page 749)

3.9.11 ActiveX controls

3.9.11.1 Siemens HMI Symbol Library

The "Siemens HMI Symbol Library" Control

Introduction

The control "Siemens HMI Symbol Library" contains a comprehensive collection of prepared symbols. These symbols can be used for the display of systems and system components in process pictures.

Inserting Symbols of the Symbol Library

The symbols of the Symbol Library are inserted into a picture as a control from the "Standard" selection window or from the library of the Graphics Designer:

- As a smart object
The "Control" smart object is inserted from the "Standard" tab. The Symbol Library is selected in the dialog "Insert a Control".
The selection of the desired symbol is done after the insertion procedure in the configuration dialog which is opened by double-clicking the control.
- From the "Controls" tab
The "Siemens HMI Symbol Library" control is inserted directly from the "Controls" tab.
The selection of the desired symbols is done after the insertion procedure in the configuration dialog which is opened by double-clicking the control.
- From the library of the Graphics Designer
The control Siemens HMI Symbol Library is integrated as a unique folder into the library of the Graphics Designer.
The desired symbol is selected directly and inserted from the library. The properties of the symbols can be changed in the configuration dialog, which is opened by double-clicking the symbol.

Changing the Symbols of the Symbol Library

The properties of the symbols of the Symbol Library can be changed in the window "Object Properties" and in the configuration dialog "Properties of Siemens HMI Symbol Library".

The window "Object Properties" is opened from the pop-up menu of the inserted object. The dialog "Properties of Siemens HMI Symbol Library" is opened by double-clicking the symbol to be changed.

See also

Short Description of the WinCC Controls and Additional Controls (Page 749)

How to Change the Colors (Page 770)

How to Change the Display Options (Page 768)

How to Change the Alignment (Page 766)

How to Select a Symbol from the Symbol Library (Page 765)

Working with the library (Page 737)

How to Select a Symbol from the Symbol Library

Introduction

You can use the "Symbols" tab in the Properties of Siemens HMI Symbol Library dialog to replace the displayed symbol with another. The picture contents of the selected symbols is changed by the selection of another symbol of the Symbol Library. The other properties of the selected symbols are not changed.

Requirements

- The "Properties of Siemens HMI Symbol Library" dialog is opened by double-clicking the symbol to be changed.
- Select the "Symbols" tab.

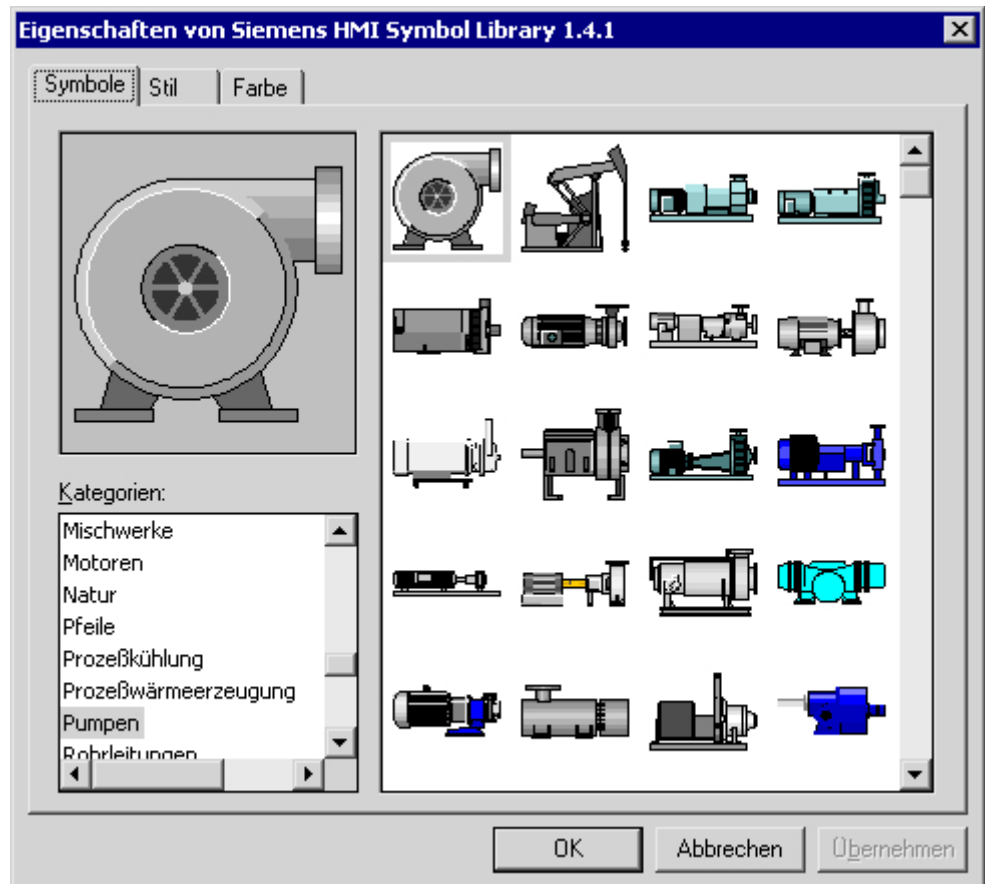

Preview

In the area at the top left, the symbol selected in the selection will be displayed. All settings of the "Siemens HMI Symbol Library" dialog are displayed in the preview.

Categories

In the area at the bottom left all categories containing symbols of the Symbol Library are displayed.

Select the category that contains the desired symbol. All symbols of the selected category are displayed in the selection.

Selection

The right area displays all the symbols available for the selected category.

Position the mouse pointer on a symbol, to show a short description.

Click on the desired symbol to select it. The selected symbol is displayed in the preview.

See also

[How to Change the Colors \(Page 770\)](#)

[The "Siemens HMI Symbol Library" Control \(Page 764\)](#)

[How to Change the Display Options \(Page 768\)](#)

[How to Change the Alignment \(Page 766\)](#)

How to Change the Alignment

Introduction

You can use the "Style" tab in the Properties of Siemens HMI Symbol Library dialog to set different options. The display and the alignment of the selected symbols can be customized.

In the area at the top left, the symbol selected in the "Symbols" tab is displayed. All settings of the "Siemens HMI Symbol Library" dialog are displayed in the preview.

Requirements

- The "Properties of Siemens HMI Symbol Library" dialog is opened by double-clicking the symbol to be changed.
- Select the "Style" tab.

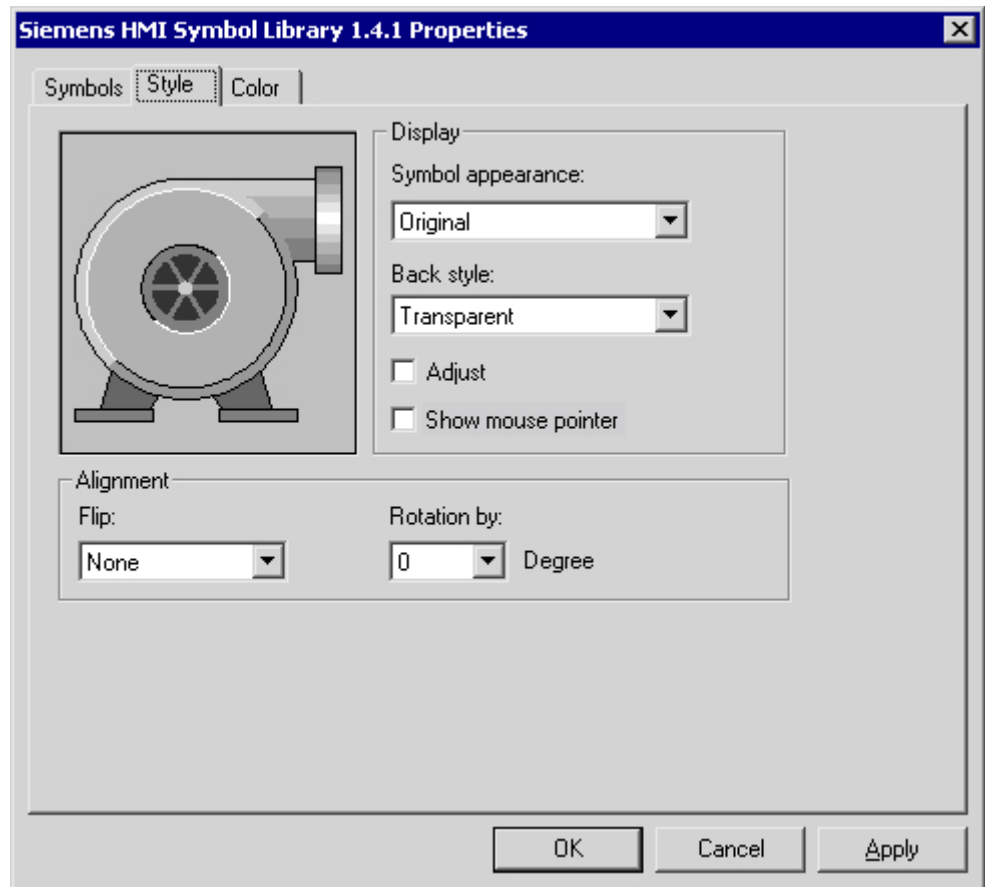

Alignment

In the bottom left area the alignment of the symbol in the current picture can be changed. The symbol can be mirrored and rotated.

Mirroring

Open the drop-down list box and select the desired mirroring type. The picture content is mirrored on the horizontal or vertical central axis of the symbol respectively. Objects can be mirrored both horizontally and vertically.

Rotation

Open the drop-down list box and select the desired angle for the rotation. The rotation of the picture contents is done around the central axis of the symbol. The rotation is done counter-clockwise in steps of 90, 180 and 270 degrees.

See also

The "Siemens HMI Symbol Library" Control (Page 764)

How to Change the Colors (Page 770)

How to Change the Display Options (Page 768)

How to Select a Symbol from the Symbol Library (Page 765)

How to Change the Display Options

Introduction

You can use the "Style" tab in the Properties of Siemens HMI Symbol Library dialog to set different options. The display and the alignment of the selected symbols can be customized.

In the area at the top left, the symbol selected in the "Symbols" tab is displayed. All settings of the "Siemens HMI Symbol Library" dialog are displayed in the preview.

Requirements

- The "Properties of Siemens HMI Symbol Library" dialog is opened by double-clicking the symbol to be changed.
- Select the "Style" tab.

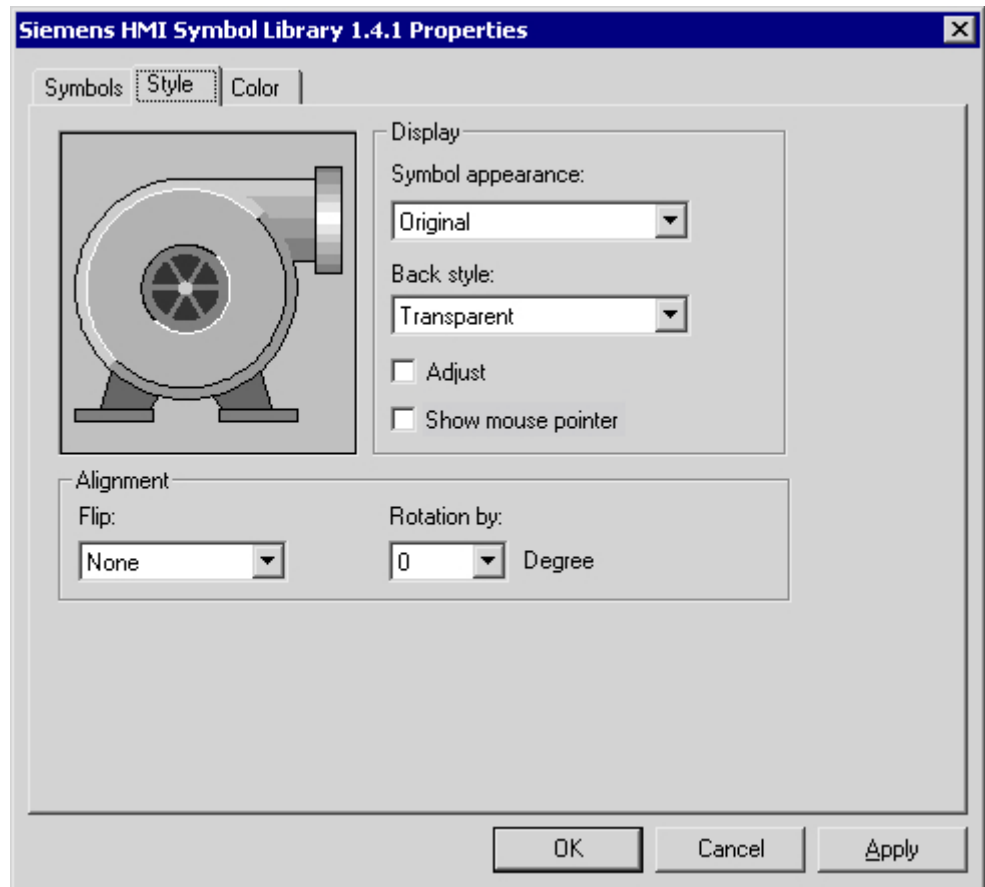

Display

Open the drop-down list box and select the desired appearance form for the picture contents.

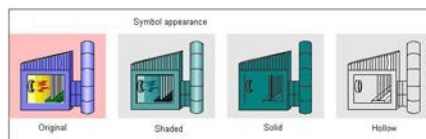

Original

The appearance form of the symbol corresponds to the multi-colored display in the selection of the "Symbols" tab.

Shadow

Lines of the color "Black" are maintained as contour lines. Elements of the symbols in other colors are displayed as light grades of the current foreground color.

Solid

Lines of the color "Black" are maintained as contour lines. All the elements of the symbol in other colors are assigned the color value of the current foreground color.

Outline

Lines of the color "Black" are maintained as contour lines. All the elements of the symbol in other colors are assigned the color value of the current background color.

Background

Open the drop-down list box and select the desired background type.
The background can be displayed either "Nontransparent" or "Transparent".

Adjusting

Click on the control box next to the "Adjust" option, in order to enable or to disable the option.
When selecting the "Adjust" option, the picture contents are adapted to the object size of the selected symbol.

Display Mouse Pointer

Click on the control box next to the "Show mouse pointer" option, in order to enable or to disable the option.
When selecting the "Show mouse pointer" option, the mouse pointer is not hidden in Runtime, if it is placed on the symbol.

See also

- The "Siemens HMI Symbol Library" Control (Page 764)
- How to Change the Colors (Page 770)
- How to Change the Alignment (Page 766)
- How to Select a Symbol from the Symbol Library (Page 765)

How to Change the Colors

Introduction

Using the "Color" tab in the Properties of Siemens HMI Symbol Library dialog you can set different color settings for the display of the selected symbol.

Requirements

- The "Properties of Siemens HMI Symbol Library" dialog is opened by double-clicking the symbol to be changed.
- Select the "Color" tab.

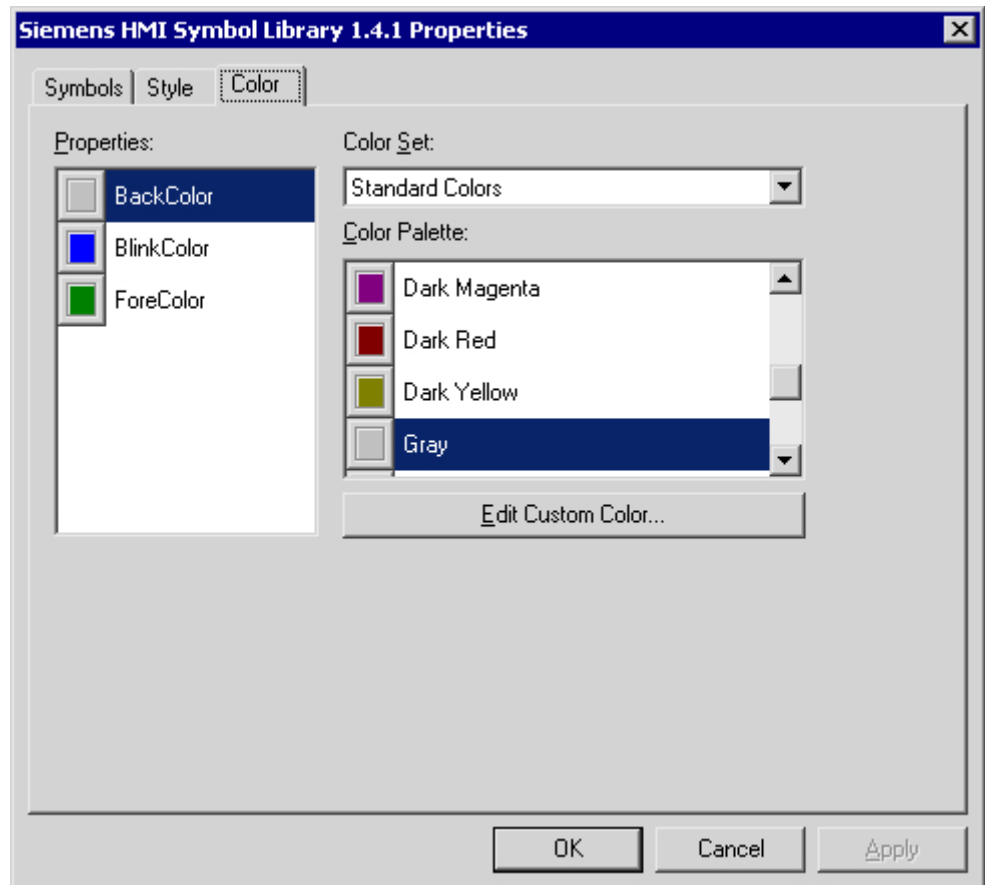

Properties

Select the color attribute you wish to change.

The "Flashing Color" acquires the symbol in the flashing status. The flashing is only visible in Runtime. With the "Background Color" you can display the background of the symbol for the background type "Nontransparent". In the appearance forms of "Shadow" and "Solid", the symbol is shown in the Foreground Color.

Color group

Select one of the color groups in the drop-down list box. The related colors are displayed in the "Color Palette" section.

The "Standard Colors" color group contains the 16 standard colors of the operating system. The "Windows System Colors" color group contains the colors which are set in the operating system currently as the display options at system start.

Color palette

Select the desired color. Click "Accept" in order to assign the new color to the selected color attribute.

Editing Custom Colors

Click this button to access the "Colors" dialog. Depending on the graphic settings of the operating system you can define the desired color freely.

See also

The "Siemens HMI Symbol Library" Control (Page 764)

How to Change the Display Options (Page 768)

How to Change the Alignment (Page 766)

How to Select a Symbol from the Symbol Library (Page 765)

3.9.11.2 WinCC AlarmControl

Overview

With the WinCC AlarmControl you can have the messages displayed in a message window in Runtime. Each message is displayed in a separate message line in the table. The content of the message line depends on the message blocks to be displayed.

For more information, refer to Display of messages during Runtime (Page 1372).

3.9.11.3 WinCC BarChartControl

Overview

With the WinCC BarChartControl you can display the values of archive tags in a bar chart. You have many options for configuring the appearance of the bar chart.

For more information refer to Outputting process values in bar chart form in process pictures (Page 1663)

3.9.11.4 WinCC Digital/Analog Clock Control

The "WinCC Digital/Analog Clock" Control'

Introduction

With the "WinCC Digital/Analog Clock Control" you can integrate a time display into a process picture. In Runtime the current system time of the operating system is displayed. The time can be displayed as analog or digital. In addition, the digital display contains the current date.

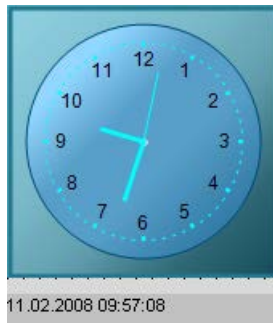

Inserting a Clock Control

The Clock Control is inserted from the "Standard" selection window into a picture:

- As a smart object
The "Control" smart object is inserted from the "Standard" tab. The Clock Control is selected in the dialog "Insert a Control".
- From the "Controls" tab
The Clock Control is inserted directly from the "Controls" tab.

The properties of the control are changed in the configuration dialog "Properties of the WinCC Digital/Analog Clock Control" or in the window "Object Properties".

See also

[Short Description of the WinCC Controls and Additional Controls \(Page 749\)](#)

[How to Change the Background Picture of the Clock Control \(Page 777\)](#)

[How to Change the Color of the Clock Control \(Page 776\)](#)

[How to Change the Font of the Digital Clock Control Display \(Page 775\)](#)

[How to Change the Appearance of the Clock Control \(Page 774\)](#)

How to Change the Appearance of the Clock Control

Introduction

In the "General" tab, you have the option to set the general appearance of the clock control. In addition, the geometry of the pointers can be changed.

Requirements

- Double-click the control to open the "Properties of WinCC Digital/Analog Control" dialog.
- Click on the "General" tab.

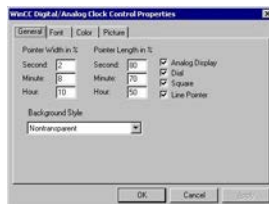

Pointer width in %

For the analog display you can set the width of the second, minute and hour pointer. The values are understood as percent share of the pointer length.

You can only set the pointer width in the classic design. The static values and the configured dynamic properties have no effect on the new design.

Pointer length in %

For the analog display you can set the length of the second, minute and hour pointer. The values are understood as percent share of the radius of the dial.

Analog display

Choose between analog and digital display of the clock.

Dial

Hide or unhide the hour marks for the analog display.

Square

Select whether the analog clock is to be displayed in square shape.

Line pointer

Specify whether for the analog display only the border or also the filling color of the pointer will be displayed.

Background style

Select "Nontransparent" in order to display the analog clock with a frame. With "Transparent border" the colored dial is displayed without a border. Select "Transparent", in order to display the analog clock without background.

See also

The "WinCC Digital/Analog Clock" Control' (Page 773)

How to Change the Background Picture of the Clock Control (Page 777)

How to Change the Color of the Clock Control (Page 776)

How to Change the Font of the Digital Clock Control Display (Page 775)

How to Change the Font of the Digital Clock Control Display

Introduction

You can use the "Font" tab to adapt the font to the digital display of the clock. This setting has no effect on the analog display of the Clock Control.

Requirements

- Double-click the control to open the "Properties of WinCC Digital/Analog Control" dialog.
- Select the "Font" tab.

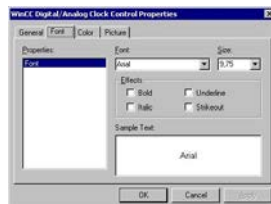

Properties

The currently selected property is shown.

Font

Select the desired font for the digital display of the clock from the drop-down list box. You can use any of the fonts registered in the operating system.

Font size

Select the desired font size for the digital display of the clock from the drop-down list box. Alternatively, enter the font size directly in the field. The value is specified in points (pt).

Display

Select one or more display options.

The selected font can be displayed in "Bold", "Italic", "Underline" and "Strikethrough".

Sample Text

The selected settings are displayed in a preview.

See also

The "WinCC Digital/Analog Clock" Control' (Page 773)

How to Change the Background Picture of the Clock Control (Page 777)

How to Change the Color of the Clock Control (Page 776)

How to Change the Appearance of the Clock Control (Page 774)

How to Change the Color of the Clock Control

Introduction

You can use the "Color" tab to adapt the color to the digital display of the clock. For the digital display of the Clock Controls only the color attribute "Foreground color" (font color) is relevant.

Requirements

- Double-click the control to open the "Properties of WinCC Digital/Analog Control" dialog.
- Select the "Color" tab.

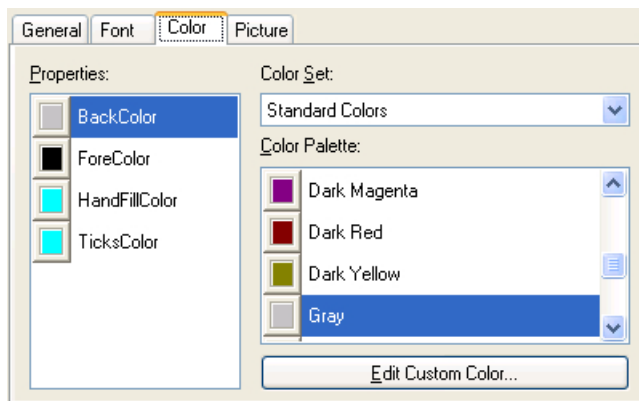

Properties

Select the color attribute you wish to change.

Color group

Select one of the color groups in the drop-down list box. The related colors are displayed in the "Color Palette" section.

The "Standard Colors" color group contains the 16 standard colors of the operating system. The "Windows System Colors" color group contains the colors which are set in the operating system currently as the display options at system start.

Color palette

Select the desired color. Click "Accept" in order to assign the new color to the selected color attribute.

Editing Custom Colors

Click this button to access the "Colors" dialog. Depending on the graphic settings of the operating system you can define the desired color freely.

See also

The "WinCC Digital/Analog Clock" Control' (Page 773)

How to Change the Background Picture of the Clock Control (Page 777)

How to Change the Font of the Digital Clock Control Display (Page 775)

How to Change the Appearance of the Clock Control (Page 774)

How to Change the Background Picture of the Clock Control

Introduction

You can use the "Picture" tab, to assign a background picture to the analog or digital display of the clock. The current picture is shown in the "Preview" area.

Requirements

- Double-click the control to open the "Properties of WinCC Digital/Analog Control" dialog.
- Select the "Picture" tab.



Browsing

Click the "Browse..." button to access the "Find Picture" dialog. Select the graphic file, to which you want to assign the selected property.

Pictures in the following formats can be inserted:
BMP, DIB, ICO, CUR, EMF, WMF, GIF and JPG.

Deleting

Click the "Clear" button to move on from the opening picture.

See also

The "WinCC Digital/Analog Clock" Control' (Page 773)

How to Change the Color of the Clock Control (Page 776)

How to Change the Font of the Digital Clock Control Display (Page 775)

How to Change the Appearance of the Clock Control (Page 774)

3.9.11.5 WinCC FunctionTrendControl

Overview

The WinCC FunctionTrendControl can be used to display the values of tags as functions of other tags and compare trends with a setpoint trend.

Additional information is available under Outputting process values as a function of other tags (Page 1688)

3.9.11.6 WinCC Gauge Control

The "WinCC Gauge" Control

Introduction

The "WinCC Gauge" control is used to display the monitored measurement values in the form of an analog measurement clock. Warning and danger areas as well as the extreme values of the pointer movement can be marked in colors.

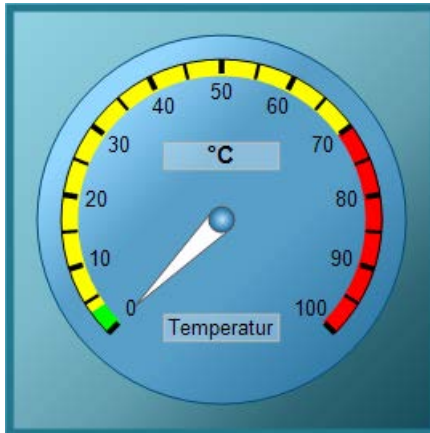

Inserting Gauge Control

The Gauge Control is inserted from the "Standard" selection window into a picture:

- As a smart object
The "Control" smart object is inserted from the "Standard" tab. The Control is selected in the dialog "Insert a Control".
- From the "Controls" tab
The Gauge Control is inserted directly from the "Controls" tab.

Changing Important Properties

The properties of the control are changed in the configuration dialog "Properties of the WinCC Gauge Control" or in the window "Object Properties".

The following attributes can be changed only in the window "Object Properties":

Labeling

Enter a text to be displayed, for example the type of the controlled value on the gauge. As a standard, you must enter the label "SIMATIC".

Unit text

Enter a text to display, for example, the physical unit of the displayed value on the gauge. By default, this field is blank.

Unit offset

Specify the position for the display of the physical unit on the gauge. The value is given in decimal format. The value is the percent share of the object height, starting from the topmost border line of the rectangle encompassing the object.

See also

How to Configure the Scale of the Gauge Control (Page 782)

Short Description of the WinCC Controls and Additional Controls (Page 749)

How to Assign Pictures to the Gauge Control (Page 788)

How to Change the Colors of the Gauge Control (Page 786)

How to Change the Font of the Gauge Control (Page 785)

How to Mark Special Value Ranges (Page 784)

How to change the Appearance of the Gauge Control (Page 780)

How to change the Appearance of the Gauge Control

Introduction

On the "General" tab, you have the option to adapt the general appearance of the Gauge Control.

Requirements

- Double-click the inserted control to open the "Properties of WinCC Gauge Control" dialog.
- Click the "General" tab.

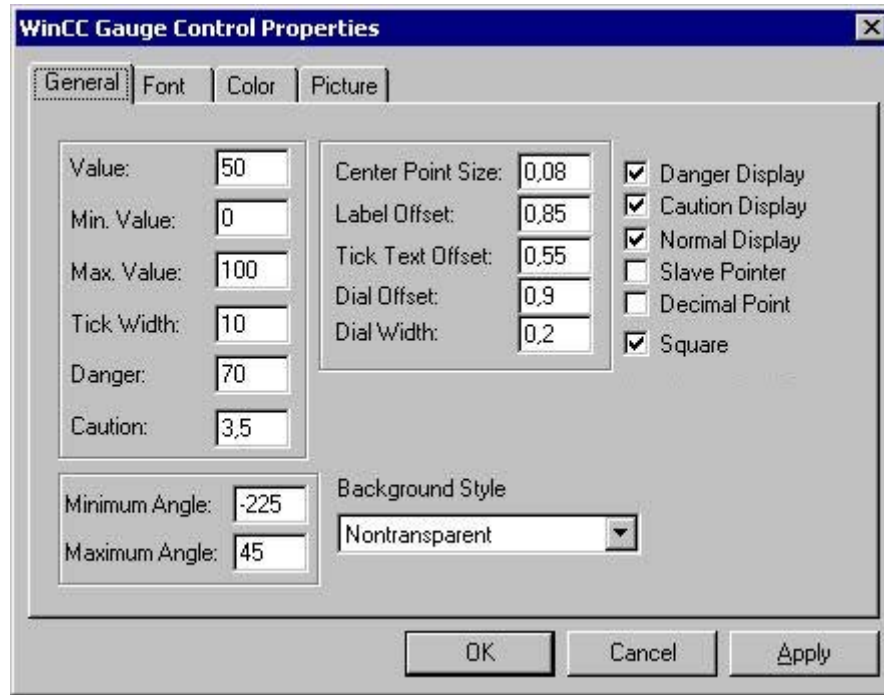

Center Point Size

Specify the radius for the display of the center point. The value is given in decimal format as percent share of the diameter of the gauge.

Labeling Offset

Specify the position for the labeling of the gauge. The value is given in decimal format. The value is the percent share of the object height, starting from the topmost border line of the rectangle encompassing the object.

Slave Pointer

For the maximum and the minimum pointer movement a marker function can be activated, which marks the real measurement area in Runtime with colored lines:

- A green line marks the minimum pointer movement.
- A red line marks the maximum pointer movement.

Square

Select whether the gauge is to be displayed in square shape.

Background Style

Select "Nontransparent" in order to display the gauge clock with a frame. "Transparent Border" hides the frame. With "Transparent", only the scale of the gauge will be displayed.

See also

- The "WinCC Gauge" Control (Page 779)
- How to Assign Pictures to the Gauge Control (Page 788)
- How to Change the Colors of the Gauge Control (Page 786)
- How to Change the Font of the Gauge Control (Page 785)
- How to Mark Special Value Ranges (Page 784)
- How to Configure the Scale of the Gauge Control (Page 782)

How to Configure the Scale of the Gauge Control

Introduction

On the "General" tab, you can set the measuring range to be monitored. In addition, you can configure the display of the scale.

Requirements

- Double-click the inserted control to open the "Properties of WinCC Gauge Control" dialog.
- Click on the "General" tab.

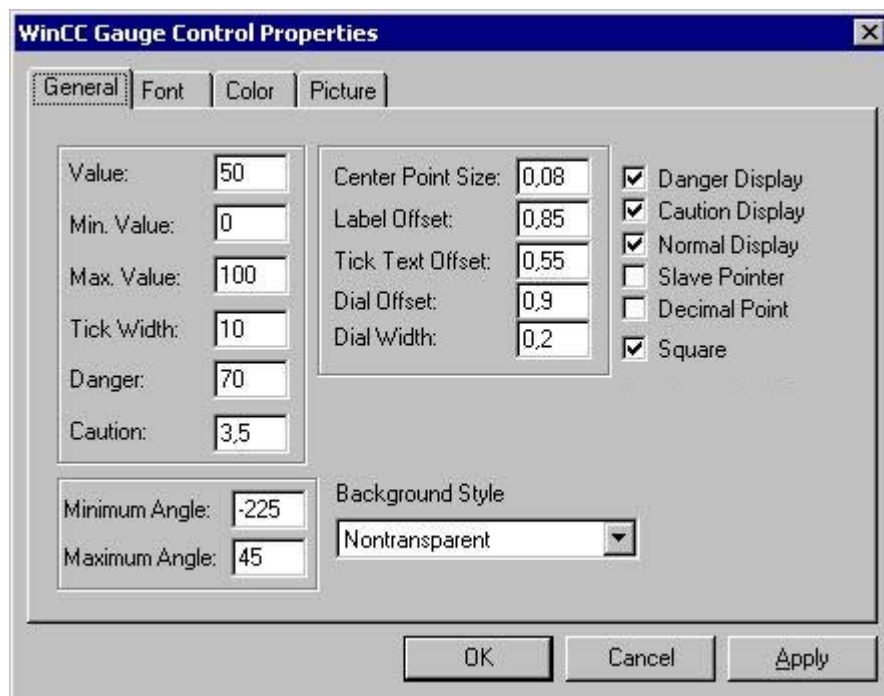

Minimum value

Enter the lower limit value of the measuring range. This value is shown as the min. scale value.

Maximum value

Enter the upper limit value of the measuring range. This value is shown as the max. scale value.

Value

Specify a start value for the pointer of the gauge. If process driver connections are missing, this value is shown in Runtime.

Minimum Angle

Enter the angle for the display at the scale start. The value is entered in degrees.

Maximum Angle

Enter the angle for the display at the scale end. The value is entered in degrees.

Tick Width

Enter the distance of the main tick marks as the difference of two neighboring measurements. The area between two main tick marks is divided by default by a wider tick mark of half the length.

Scale Width

Specify the length of the main tick marks and thus the width of the scale. The value is given in decimal format as percent share of the radius of the gauge.

Scale Offset

Specify the outer radius of the scale. The value is given in decimal format as percent share of the radius of the gauge.

Tick Text Offset

Specify the inner radius of the scale labeling. The value is given in decimal format as percent share of the radius of the gauge.

Decimal point

The values of the scale labeling can be displayed as whole numbers or as decimal numbers with one decimal place.

See also

How to Assign Pictures to the Gauge Control (Page 788)

How to Change the Colors of the Gauge Control (Page 786)

How to Change the Font of the Gauge Control (Page 785)

How to Mark Special Value Ranges (Page 784)

How to change the Appearance of the Gauge Control (Page 780)

How to Mark Special Value Ranges

Introduction

You can use the "General" tab to highlight special range of values in the scale in colors.

Requirements

- Double-click the inserted control to open the "Properties of WinCC Gauge Control" dialog.
- Click on the "General" tab.

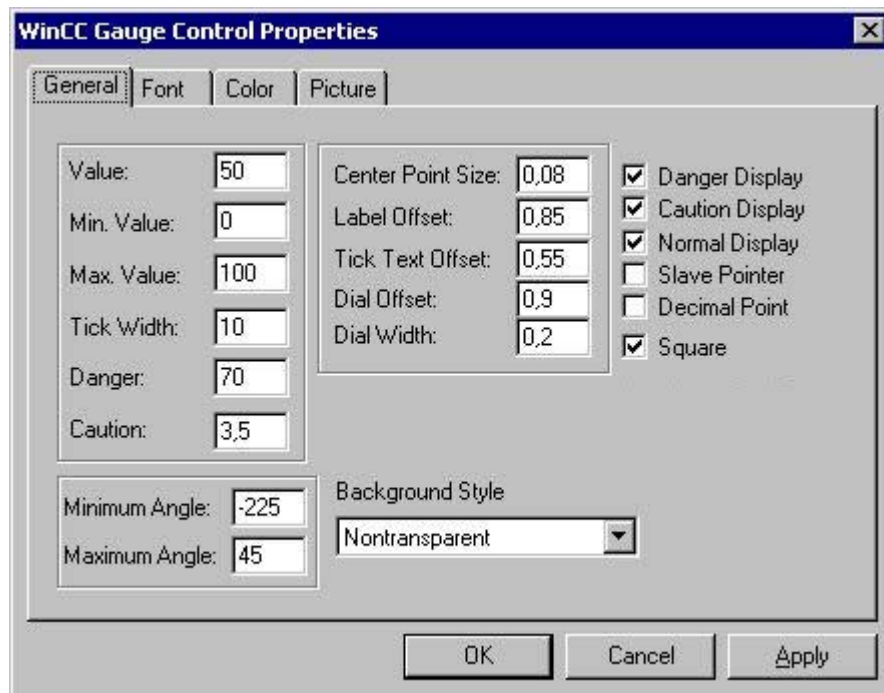

Danger

Set the limit value for the start of the danger area.

Warning

Set the limit value for the start of the warning area.

Danger Display

The scale area starting at the limit value "Danger" can be shown in the "Danger color" (default color: red).

Warning Display

The scale area starting at the limit value "Warning" can be shown in the "Warning color" (default color: yellow).

Normal Display

The scale area ending at the limit value "Warning" can be shown in the "Normal color" (default color: green).

See also

The "WinCC Gauge" Control (Page 779)

How to Assign Pictures to the Gauge Control (Page 788)

How to Change the Colors of the Gauge Control (Page 786)

How to Change the Font of the Gauge Control (Page 785)

How to Configure the Scale of the Gauge Control (Page 782)

How to change the Appearance of the Gauge Control (Page 780)

How to Change the Font of the Gauge Control

Introduction

You can use the tab "Font" to adapt the fonts for the different labeling elements of the gauge.

Requirements

- Double-click the inserted control to open the "Properties of WinCC Gauge Control" dialog.
- Select the "Font" tab.



Properties

Select the font attribute you wish to change.

Select "Labeling font", in order to change the font for the name of the gauge. "Unit font" changes the font for the display of the physical unit. You can configure the scale labeling with the "Scale text font".

Font

Select from the drop-down list box the desired font for the selected labeling attribute. You can use any of the fonts registered in the operating system.

Font size

Select from the drop-down list box the desired font size for the selected labeling attribute. Alternatively, enter the font size directly in the field. The value is specified in points (pt).

Display

Select one or more display options.

The selected font can be displayed in "Bold", "Italic", "Underline" and "Strikethrough".

Sample Text

The selected settings are displayed in a preview.

See also

The "WinCC Gauge" Control (Page 779)

How to Assign Pictures to the Gauge Control (Page 788)

How to Change the Colors of the Gauge Control (Page 786)

How to Mark Special Value Ranges (Page 784)

How to Configure the Scale of the Gauge Control (Page 782)

How to change the Appearance of the Gauge Control (Page 780)

How to Change the Colors of the Gauge Control

Introduction

You can use the "Color" tab to adapt the color for the display of the Gauge Control.

Requirements

- Double-click the inserted control to open the "Properties of WinCC Gauge Control" dialog.
- Select the "Color" tab.

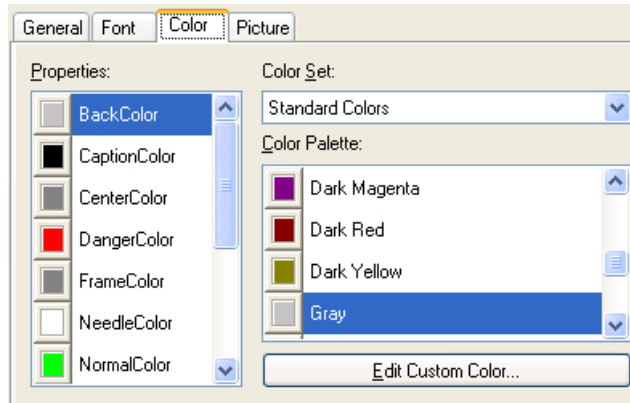

Properties

Select the color attribute you wish to change.

Color group

Select one of the color groups in the drop-down list box. The related colors are displayed in the "Color Palette" section.

The "Standard Colors" color group contains the 16 standard colors of the operating system. The "Windows System Colors" color group contains the colors which are set in the operating system currently as the display options at system start.

Color palette

Select the desired color. Click "Accept" in order to assign the new color to the selected color attribute.

Editing Custom Colors

Click this button to access the "Colors" dialog. Depending on the graphic settings of the operating system you can define the desired color freely.

See also

The "WinCC Gauge" Control (Page 779)

How to Assign Pictures to the Gauge Control (Page 788)

How to Change the Font of the Gauge Control (Page 785)

How to Mark Special Value Ranges (Page 784)

How to Configure the Scale of the Gauge Control (Page 782)

How to change the Appearance of the Gauge Control (Page 780)

How to Assign Pictures to the Gauge Control

Introduction

You can use the tab "Picture" to assign a background and a frame image to the Gauge.

Requirements

- Double-click the inserted control to open the "Properties of WinCC Gauge Control" dialog.
- Select the "Picture" tab.



Properties

Select the property for which you want to change the picture assignment. The current picture is shown in the "Preview" area.

With the "background picture" option you can assign an image to the circular background of the gauge. With the "Frame picture" option you can assign an image to the rectangular background of the Control.

Browsing

Click the "Browse..." button to access the "Find Picture" dialog. Select the graphic file, to which you want to assign the selected property.

Pictures in the following formats can be inserted:
BMP, DIB, ICO, CUR, EMF, WMF, GIF and JPG.

Deleting

Click the "Clear" button to move on from the opening picture.

See also

How to Change the Font of the Gauge Control (Page 785)

The "WinCC Gauge" Control (Page 779)

How to Change the Colors of the Gauge Control (Page 786)

How to Mark Special Value Ranges (Page 784)

How to Configure the Scale of the Gauge Control (Page 782)

How to change the Appearance of the Gauge Control (Page 780)

3.9.11.7 WinCC Media Control

WinCC Media Control

Introduction

You can use WinCC to also integrate multimedia files as controls into your pictures. This is what WinCC Media Control is used for.

The WinCC Media Control can display the following file formats: GIF, BMP, JPG, JPEG, PNG.

WinCC Media Control can be used conditionally to play back the following file formats: ASF, WMV, AVI, MPG, MPEG, MP4, QT, MOV. The control can only play the formats that the MediaPlayer plays.

Note

Video file requirements

To play back video files in Windows Server 2012 R2, install the Microsoft "Desktop Experience" feature.

For more information related to this topic, refer to the Microsoft documentation on the Internet.

Note

In addition to the data format, playback of multimedia files also depends on the video and audio codes installed on the computer.

Note

Data loss when coping the project

When copying the project to another computer, please note the following:

The files specified in the WinCC Media Control are not copied along with the project if they are linked dynamically and not specified with UNC path.

You will need to add the files to the project again.

Inserting WinCC Media Control

Insert the WinCC Media Control from the "Standard" selection window into a picture:

- Drag the smart object "Control" on the "Standard" tab into the picture and select the WinCC Media Control.
- Double-click "WinCC Media Control" on the "Controls" tab.

A placeholder for the WinCC Media Control is inserted in the picture.

Double-click the WinCC Media Control to open the related configuration dialog. Enter the required information on the file to be played and for display of the Media Control.

The WinCC Media Control will then be displayed differently:

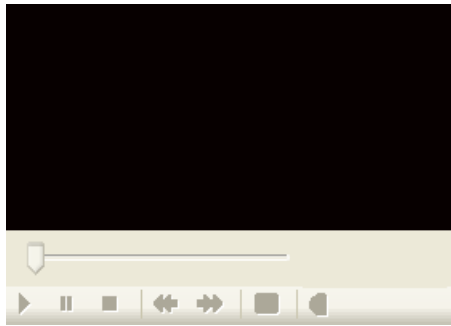

Runtime

The user can display or play the specified multimedia file with the help of the control elements in Runtime.

See also

Short Description of the WinCC Controls and Additional Controls (Page 749)

This is how you configure the WinCC Media Control:

Introduction

The WinCC Media Control can be used to display or play multimedia files in Runtime.

Note

Video file requirements

To play back video files in Windows Server 2012 R2, install the Microsoft "Desktop Experience" feature.

For more information related to this topic, refer to the Microsoft documentation on the Internet.

Procedure

1. Double-click the object "WinCC Media Control".
The "Properties of WinCC Media Control" dialog is opened.

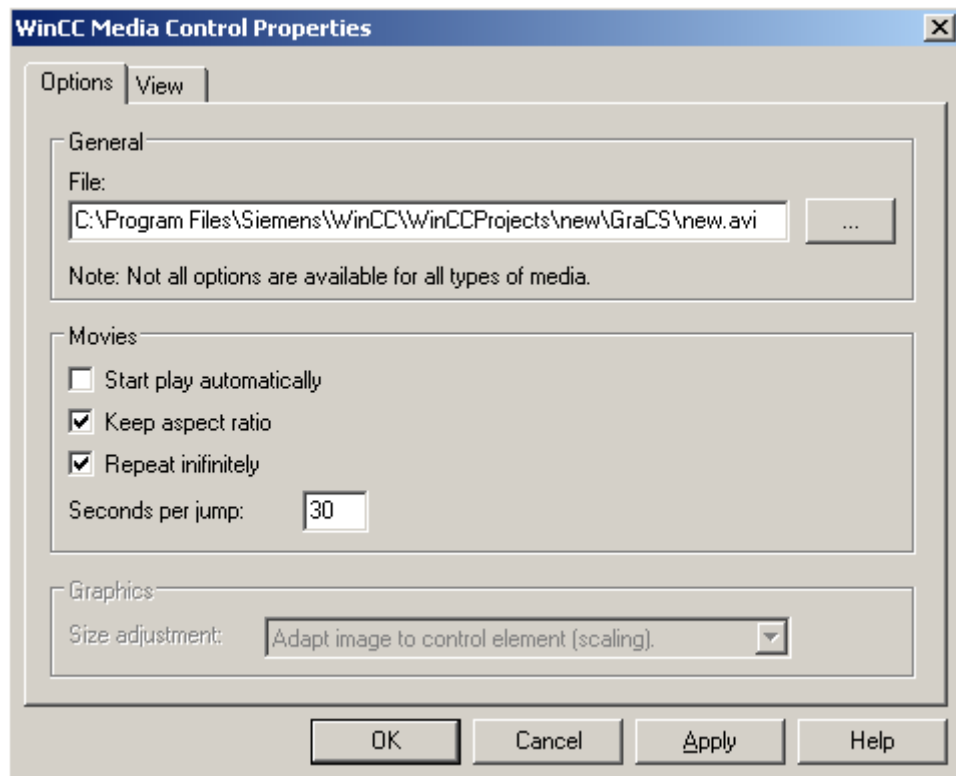

Note

If you want to dynamize the attributes, you have to open the object properties with the "Properties" entry in the shortcut menu.

2. Enter the path and file name of the file to be displayed or played under "General" or look for the file after clicking the button "...".
Depending on the media type entered, you can select different options.
3. For pictures, set whether the picture should be adapted to the control or whether the control should be adapted to the picture.

- 4. For films, set the playback format and playback options.
The option "Skip interval" is used to set the interval for forward or backward skip.

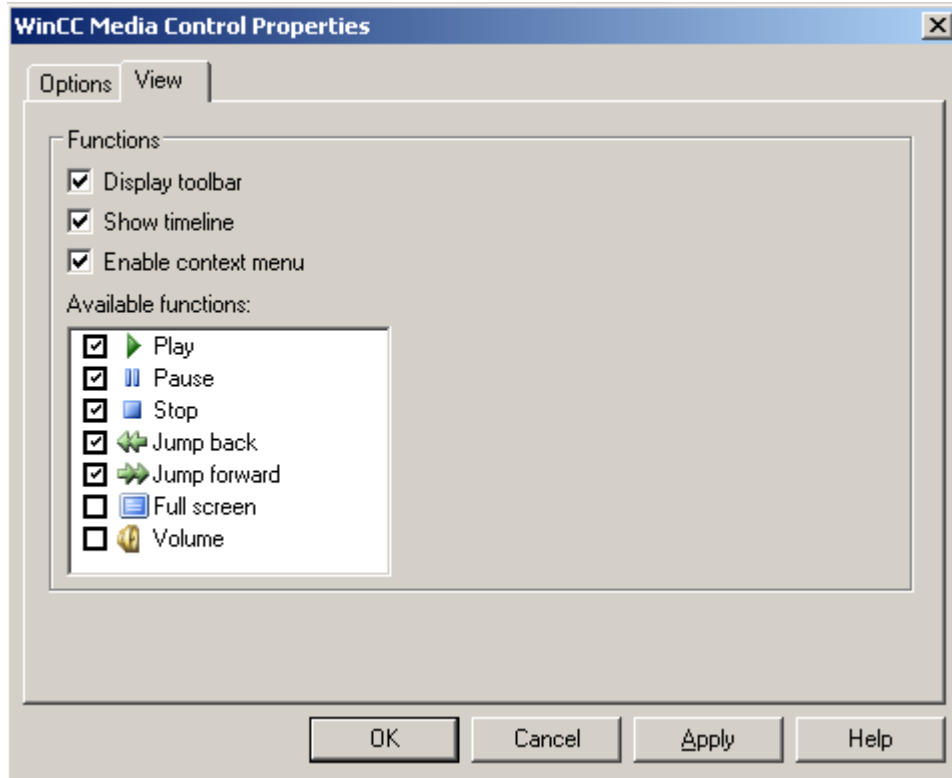

- 5. On the "View" tab, define the display of the WinCC Media Control for playing multimedia files.
In runtime the WinCC Media Control is displayed with the selected display and operator controls.

3.9.11.8 WinCC OnlineTableControl

Overview

With the WinCC OnlineTableControl you can have the values of tags and archive tags displayed in tables. You have many options of configuring the representation of the tables.

For more information refer to Outputting process values in table form in process pictures (Page 1560).

3.9.11.9 WinCC OnlineTrendControl

Overview

With the WinCC OnlineTrendControl you can have the values of tags and archive tags displayed as trends. You have many options of configuring the representation of the trends.

For more information refer to Outputting process values in trend form in process pictures (Page 1604).

3.9.11.10 WinCC RulerControl

Overview

With WinCC RulerControl the evaluation of process data is displayed in a statistics window or ruler window.

You can use the WinCC RulerControl with the following controls:

- WinCC OnlineTrendControl
- WinCC OnlineTableControl
- WinCC FunctionTrendControl

For more information refer to How to configure a ruler window / statistics window / statistics section window (Page 1575).

3.9.11.11 WinCC Slider Control

The "WinCC Slider" Control

Introduction

The "WinCC Slider" control can be used to display the monitored measurement values in the form of a slider control. The current value can be displayed under the slider and the controlled measurement area can be displayed as scale labeling.

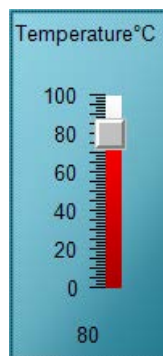

Inserting Slider Control

The Slider Control is inserted from the "Standard" selection window into a picture:

- As a smart object
The "Control" smart object is inserted from the "Standard" tab. The Slider Control is selected in the dialog "Insert a Control".
- From the "Controls" tab
The Slider Control is inserted directly from the "Controls" tab.

The properties of the control are changed in the configuration dialog "Properties of the WinCC Slider Control" or in the window "Object Properties".

See also

Short Description of the WinCC Controls and Additional Controls (Page 749)

How to Assign Pictures to the Slider Control (Page 800)

How to Change the Colors of the Slider Control (Page 799)

How to Change the Fonts of the Slider Control (Page 798)

How to Change the 3D Effects of the Slider Control (Page 797)

How to change the measuring range and the label of the Slider Control (Page 795)

How to Change the Appearance of the Slider Control (Page 794)

How to Change the Appearance of the Slider Control

Introduction

On the "General" tab, you have the option to adapt the general appearance of the Slider Control.

Requirements

- Double-click the inserted control to open the "WinCC Slider Control Properties" dialog.
- Click on the "General" tab.

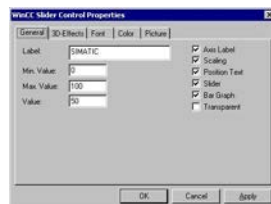

Axis Label

The tick marks of the scale can be labeled with measurement values. The step size is set depending on the specified measurement area and the size of the control automatically.

Scaling

On the left side of the slider tick marks can be shown for the display of a scale.

Position Text

The value of the current position of the slider can be displayed under the slider.

Slider

The slider can be hidden.

Bar Graph

The display of the sliding areas above and below the slider can be hidden.

Transparent

The background of the control can be displayed transparent. The configured background color is hidden.

See also

The "WinCC Slider" Control (Page 793)

How to Assign Pictures to the Slider Control (Page 800)

How to Change the Colors of the Slider Control (Page 799)

How to Change the Fonts of the Slider Control (Page 798)

How to Change the 3D Effects of the Slider Control (Page 797)

How to change the measuring range and the label of the Slider Control (Page 795)

How to change the measuring range and the label of the Slider Control

Introduction

On the "General" tab, you can set the measuring range to be monitored. In addition, you can also enter a function description as a label of the Slider Control.

Requirements

- Double-click the inserted control to open the "WinCC Slider Control Properties" dialog.
- Click on the "General" tab.



Labeling

Enter a text to be displayed, for example the type of the controlled value at the slider. As a standard, you must enter the label "SIMATIC".

Minimum value

Enter the lower limit value of the measuring range. This value is shown as the min. scale value of the slider control.

Maximum value

Enter the upper limit value of the measuring range. This value is shown as the max. scale value of the slider control.

Value

Specify a start value for the position of the slider gauge. If the Process Driver Connection is missing, the slider is displayed at this position in Runtime.

See also

The "WinCC Slider" Control (Page 793)

How to Assign Pictures to the Slider Control (Page 800)

How to Change the Colors of the Slider Control (Page 799)

How to Change the Fonts of the Slider Control (Page 798)

How to Change the 3D Effects of the Slider Control (Page 797)

How to Change the Appearance of the Slider Control (Page 794)

How to Change the 3D Effects of the Slider Control

Introduction

On the "3D Effects" tab, you can choose the style and width for the 3D display of borders and scales.

Requirements

- Double-click the inserted control to open the "WinCC Slider Control Properties" dialog.
- Select the "3D-Effects" tab.



Style

Select a style for the display of the inner and outer frame as well as the scale.

The border of the Slider Control consists of the three elements outer frame, border and inner frame. A 3D effect is created by the two-colored display of the outer and inner frames as well as the tick marks of the scaling.

The styles "Depressed" and "Raised" can be distinguished by the changed alignment of the two color attributes "Upper Frame color" and "Bottom Frame Color". The "Border" style for the scale has the effect that the elements are displayed single-colored.

Width

Enter a value for the width of the border elements in pixel(s).

See also

[How to Change the Fonts of the Slider Control \(Page 798\)](#)

[The "WinCC Slider" Control \(Page 793\)](#)

[How to Assign Pictures to the Slider Control \(Page 800\)](#)

[How to Change the Colors of the Slider Control \(Page 799\)](#)

[How to change the measuring range and the label of the Slider Control \(Page 795\)](#)

[How to Change the Appearance of the Slider Control \(Page 794\)](#)

How to Change the Fonts of the Slider Control

Introduction

You can use the tab "Font" to adapt the fonts for the different labeling elements of the Slider Control.

Requirements

- Double-click the inserted control to open the "WinCC Slider Control Properties" dialog.
- Select the "Font" tab.

Changing Configuration

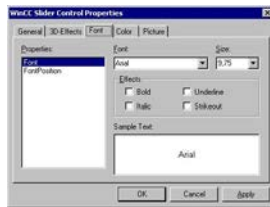

Properties

Select the font attribute you wish to change.

With the "Position font" option, you can change the display of the value, which is displayed by the current position of the slider. A change of the attribute "Font" affects the labeling of the control and the scale.

Font

Select from the drop-down list box the desired font for the selected labeling attribute. You can use any of the fonts registered in the operating system.

Font size

Select from the drop-down list box the desired font size for the selected labeling attribute. Alternatively, enter the font size directly in the field. The value is specified in points (pt).

Display

Select one or more display options.
The selected font can be displayed in "Bold", "Italic", "Underline" and "Strikethrough".

Sample Text

The selected settings are displayed in a preview.

See also

How to Change the Appearance of the Slider Control (Page 794)

The "WinCC Slider" Control (Page 793)

How to Assign Pictures to the Slider Control (Page 800)

How to Change the Colors of the Slider Control (Page 799)

How to Change the 3D Effects of the Slider Control (Page 797)

How to change the measuring range and the label of the Slider Control (Page 795)

How to Change the Colors of the Slider Control

Introduction

You can use the "Color" tab to adapt the color for the display of the Slider Control.

Requirements

- Double-click the inserted control to open the "WinCC Slider Control Properties" dialog.
- Select the "Color" tab.

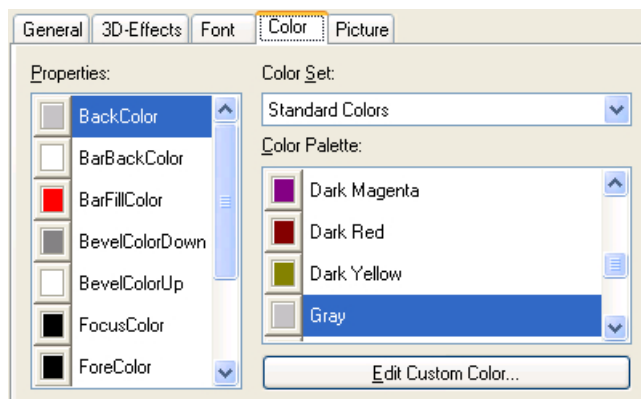

Properties

Select the color attribute you wish to change.

Color group

Select one of the color groups in the drop-down list box. The related colors are displayed in the "Color Palette" section.

The "Standard Colors" color group contains the 16 standard colors of the operating system. The "Windows System Colors" color group contains the colors which are set in the operating system currently as the display options at system start.

Color palette

Select the desired color. Click "Accept" in order to assign the new color to the selected color attribute.

Editing Custom Colors

Click this button to access the "Colors" dialog. Depending on the graphic settings of the operating system you can define the desired color freely.

See also

The "WinCC Slider" Control (Page 793)

How to Assign Pictures to the Slider Control (Page 800)

How to Change the Fonts of the Slider Control (Page 798)

How to Change the 3D Effects of the Slider Control (Page 797)

How to change the measuring range and the label of the Slider Control (Page 795)

How to Change the Appearance of the Slider Control (Page 794)

How to Assign Pictures to the Slider Control

Introduction

On the "Picture" tab, you can assign pictures to the Slider Control for the display of the background and the slider.

Requirements

- Double-click the inserted control to open the "WinCC Slider Control Properties" dialog.
- Select the "Picture" tab.

Changing Configuration



Properties

Select the property for which you want to change the picture assignment. The current picture is shown in the "Preview" area.

With the "Background picture" option, you can assign an image to the background of the Control. With "Slider picture", you have the option to display an image on the slider.

Browsing

Click the "Browse..." button to access the "Find Picture" dialog. Select the graphic file, to which you want to assign the selected property.

Pictures in the following formats can be inserted:
BMP, DIB, ICO, CUR, EMF, WMF, GIF and JPG.

Deleting

Click the "Clear" button to move on from the opening picture.

See also

The "WinCC Slider" Control (Page 793)

How to Change the Colors of the Slider Control (Page 799)

How to Change the Fonts of the Slider Control (Page 798)

How to Change the 3D Effects of the Slider Control (Page 797)

How to change the measuring range and the label of the Slider Control (Page 795)

How to Change the Appearance of the Slider Control (Page 794)

3.9.11.12 WinCC SysDiagControl

Overview

You can use the WinCC SysDiagControl in Runtime to display various views of the system diagnostics for the "SIMATIC S7-1200" and "SIMATIC S7-1500" controllers. You have many options for configuring the appearance of the views.

You can find more detailed information under System diagnostics with SysDiagControl

3.9.11.13 WinCC UserAdminControl

Overview

You can use and edit the user administration in Runtime via the WinCC UserAdminControl.

You have many options of configuring the representation of the tables. You will find additional information in the "What's This?" for the control.

Note

WinCC UserAdminControl in a redundant system

When you add a new user on a redundant server via the WinCC UserAdminControl, this information is not synchronized on the redundant partner.

Read the information on the User Administrator under "Configuration > Redundant systems > Configuring the redundant system > Configuration with the same function".

3.9.11.14 WinCC UserArchiveControl

Overview

The WinCC UserArchiveControl provides options to access user archives and views of the user archives in Runtime. You have many options of configuring the representation of the table.

For more information refer to WinCC UserArchiveControl (Page 1945).

3.9.11.15 WinCC WebBrowser Control

Overview

The WinCC WebBrowser Control displays static Web contents or CHM documents in process pictures.

Contents with scripting functionality are not supported.

Control properties

Object property	Description	
MyPage	Address path to the displayed content	
Enabled	Yes	The operator can change the address path.
	No	The address path cannot be changed in Runtime.
ShowStatus	Yes	The status bar is displayed in Runtime.
	No	The status bar is hidden in Runtime.
ShowNavigation	Yes	The toolbar is displayed in Runtime.
	No	The toolbar is hidden in Runtime. The user can only use the functions of the shortcut menu.
UseSimpleContextMenu	Yes	The shortcut menu of the content window contains only "Forward" and "Back".
	No	The shortcut menu is displayed with all functions. Some of the functions allow access to the operating system.

3.9.11.16 How to adapt table elements and buttons of the controls

Introduction

You can change the design of the standard configuration for the WinCC controls and adapt the following elements in their appearance:

- Size and design of buttons
- Custom symbols for table elements of the table controls, for example, in the Alarm Control or OnlineTableControl
- Style of the scroll bar

Overview

The standard installation of WinCC creates the folder "CCAxControlSkins" for the design of the WinCC controls in "C:\Program Files(x86)\Common Files\Siemens\bin\".

To use modified designs, you need to create different subfolders within the "CCAxControlSkins" folder. The number and the name of the folder are determined by the elements you want to adapt in the respective controls .

The design of a control can then be selected as a "style" property in the configuration dialog of the control in the "General" tab.

You can also use project-specific designs. You need to create the folder structure in the "GraCS" folder of the project, e.g. in "C:\WINCCProjects\TestProject\GraCS\CCAxControlSkins". When a design folder with the same name already exists in the installation folder and in the project folder, the design of the project folder used as the "Style".

In order for the created symbols for table elements of a control to be visible, the "Content as symbol" option must be enabled for the appropriate columns. The "Apply project settings" option must be disabled in Alarm Control.

You can learn how to adapt the WinCC Alarm Control in WinCC Runtime Professional under Customizing the WinCC Controls (<https://support.industry.siemens.com/cs/de/en/view/76327375>)

Note

When creating a new design, you do not have to create all the files. For all of the files that are not present, the standard settings of the controls are used.

How to adapt table elements

The procedure is described using the example of table elements in the Alarm Control.

1. In the "CCAxControlSkins" folder, create a sub-folder, for example, "Table symbols".
2. Create a subfolder in this folder for the control, for example, "AlarmControl".
3. In the folder of the control, create a subfolder, for example, "GridIcons".
4. Create a "GridIcons" folder for each column of the table in which you want to display icons. No icons can be displayed for the date and time columns.

5. Rename the folder to the name of the object property, for example, "State" for the "State" column/message block in the Alarm Control.
6. You must save the graphics in the "State" folder with the respective state names in English, for example, "ComeQuit".
For the state for which you have saved a graphic, the new symbol appears in the table cell when the state occurs.
7. To display symbols for message numbers, for example, you can assign a graphic to each numerical value. For example, the respective number is highlighted in a certain color. Then the graphic name in the folder is "Number", for example, "5.png" for the number "5".
If you want to define a symbol for a specific interval , e.g. for the interval "50 - 100", the graphic name is "50_100.png". The limits are contained in the interval.
8. To display only icons instead of the text of a message block/column, you must specify a graphics file for each occurring text.
For example "Fault location": If an error occurs in the tank, a tank symbol appears. If a fault occurs at the valve, the symbol of a valve is shown.
9. Select the corresponding design in the "General" tab of the "Style" property in the configuration dialog of the control.

How to adapt the buttons of the toolbar

1. Create the "Toolbar" subfolder in the "CCAxCtrlSkins" folder.
2. Create the file "IconsNormal.png" in this folder.
3. In this file, insert the individual graphics of the buttons side-by-side in a row. For disabled buttons, use the file "IconsDisabled.png".
4. To use new graphics, you must adapt these files. You can use any graphics program of your choice for this.
The control reads the file, cuts it into individual graphics and displays the cut parts on the corresponding buttons.

How to adapt the scroll bar

1. In the "CCAxCtrlSkins" folder, create a subfolder, for example, "Scroll bar".
2. Create two subfolders in this folder, "Horizontal" and "Vertical".
3. You need to create a number of individual files within this folder to form the scroll bar when the program at runtime.

3.9.12 .NET controls

Introduction

The .NET Framework 2.0 and 3.0 from Microsoft is installed together with WinCC. This makes it possible for you to integrate .NET applications (assemblies) as controls in your pictures. This is what the container for the .NET controls is used for.

Note

The user of the software is responsible for problems caused by the deployment of external controls.

We recommend testing for safe operation before implementation.

Inserting a .NET control

You insert a .NET control from the "Standard" selection window into a process picture. You can insert the control as a smart object or from the "Controls" tab.

- When inserting the control as a smart object, select the required control in the "Insert a Control" dialog. All the controls which were configured for selection are displayed here. After selecting the control, define the type.
At the end of the insertion process a configuration dialog is usually opened, in which you adapt the properties of the control. You can also open this dialog later by double-clicking the control.
- When you insert the control from the "Controls" tab, only the controls which you added to the "Controls" tab are available. Click the required control and draw a rectangular in the picture for the control. Then define the type.
Configure the control selection with the "Add .NET Object" dialog.

Note

For multi-user projects, the ".Net Control" must be saved locally on each client. You have saved a ".Net Control" on the server under "C:\Controls" and added a ".Net Control" to the project. Then you have to save the ".Net Control" to the associated clients under "C:\Controls" or under "C:\Program Files\Common Files\Siemens\Assemblies". Create the "Assemblies" folder.

See also

How to configure the control selection (Page 758)

3.9.13 WPF controls

Introduction

Together with WinCC, the Microsoft .NET Framework 3.0 is also installed. This enables you to integrate .WPF files as controls in your pictures. This is what the container for the WPF (Windows Presentation Foundation) controls is used for.

Note

The user of the software is responsible for problems caused by the deployment of external controls.

We recommend testing for safe operation before implementation.

Inserting a .WPF control

You insert a WPF control from the "Standard" selection window into a process picture. You can insert the control as a smart object or from the "Controls" tab.

- When inserting the control as a smart object, select the required control in the "Insert a Control" dialog. All the controls which were configured for selection are displayed here. Then define the type.
At the end of the insertion process a configuration dialog is usually opened, in which you adapt the properties of the control.. You can also open this dialog later by double-clicking the control.
- When you insert the control from the "Controls" tab, only the controls which you added to the "Controls" tab are available. Click the required control and draw a rectangular in the picture for the control. Then define the type.
Configure the control selection in the Object Palette with the "Add WPF Object" dialog.

Note

Some inserted WPF controls only work properly when the associated .dll files are in the "assemblies" folder. Depending on the WinCC installation path and the operating system, the storage path is, for example, "C:\Program Files\Common Files\Siemens\Assemblies". Create the "Assemblies" folder.

See also

How to configure the control selection (Page 758)

3.10 Process Pictures in Runtime

3.10.1 Process Pictures in Runtime

Introduction

The behavior of process pictures that you created and dynamized with the Graphics Designer can be tested in Runtime. Some object properties, such as the rotation or flashing of an object, can only be displayed in Runtime.

In this chapter, you will learn to

- activate and deactivate Runtime
- configure user-defined menus and toolbars
- configure the on-screen keyboard
- configure mouseless operation for Runtime
- which touch operation is supported in Runtime

See also

[Touch operation in Runtime \(Page 809\)](#)

[Activating Project \(Page 204\)](#)

[How to activate / deactivate Runtime \(Page 807\)](#)

[How to set up Runtime \(Page 180\)](#)

[How to set up a picture for mouseless operation \(Page 836\)](#)

[Virtual keyboard - General Information \(Page 831\)](#)

3.10.2 How to activate / deactivate Runtime

Introduction

Activate Runtime in WinCC Explorer or in Graphics Designer. When it is activated in WinCC Explorer, Runtime starts with the predefined start picture. If it is activated in Graphics Designer, the active picture is opened in Runtime. You can only deactivate Runtime in the WinCC Explorer.

Requirements

- A project must be opened.
- The local computer's name must be entered as the computer name in the project.

- A process picture, which is found in the project, must be defined as the start picture.
- Changes in a picture can only be displayed in Runtime if you save the picture before activating Runtime.

Activating runtime

Program modules additionally required for Runtime are loaded with the "Activate Runtime" command.

WinCC Explorer

Click  in the toolbar to open Runtime with the predefined start picture.

Alternatively select "Activate" in the "File" menu. When Runtime is activated this is indicated by a check mark in front of the entry "Activate".

Graphics Designer

Click  in the standard palette to open Runtime with the active picture.

Alternatively select "Activate Runtime" in the "File" menu.

Note

In Runtime, you can find out the name of the current picture and the graphic object. Press and hold down "Shift+Ctrl+Alt" and move the mouse pointer over a graphic object in the picture. A tooltip displays the picture name and the name of the graphic object. You cannot find out the name of an ActiveX control.

Deactivating Runtime

You can only deactivate Runtime in the WinCC Explorer.

Click  in the toolbar to deactivate Runtime.

The modules for the execution of Runtime are deactivated. The "WinCC Runtime" program window is closed.

Alternatively select "Activate" in the "File" menu. The check mark in front of the "Activate" entry is removed.

See also

How to set up Runtime (Page 180)

Process Pictures in Runtime (Page 807)

3.10.3 Touch operation

3.10.3.1 Touch operation in Runtime

In WinCC Runtime, you can use both touch gestures and user-configured multitouch operation.

The usual gestures on a touch screen are supported, e.g.:

- Change picture by swiping
- Zooming by dragging with two fingers (scaling)
- Opening a shortcut menu with a long tap on an object or link

A selection of gestures is available for the operation of WinCC controls. Note that not all WinCC controls support the same gestures.

You can find a detailed overview of the supported gestures under:

- Supported gestures in Runtime (Page 810)
- Supported gestures in WinCC Controls (Page 812)

Note

Touch operation is not approved for CS

Touch operations are only approved and practical in Runtime mode.

Touch operation is not supported for configuration in the WinCC editors.

Disable "Swipe" gesture

To prevent unwanted picture changes during operation, you can disable the following swipe gestures:

- Swipe left
- Swipe right
- Swipe down

Procedure

In the "Computer Properties" dialog box, disable the following option in the "Runtime" tab:

- Enable "Swipe" gesture control

The setting takes effect on the respective computer. This allows you to disable the swiping gestures, for example, at specific operator stations only.

Multitouch operation of process pictures

You have the option of configuring multi-finger operation in WinCC to increase security in Runtime. You require a screen that supports multitouch.

You can find additional information about configuration under:

- Two-handed operation of process pictures (Page 814)

See also

Two-handed operation of process pictures (Page 814)

Supported gestures in Runtime (Page 810)

Supported gestures in WinCC Controls (Page 812)

How to make computer-specific settings for runtime (Page 200)

3.10.3.2 Supported gestures in Runtime

You can use the usual gestures in WinCC Runtime.

A selection of gestures is available for the operation of WinCC controls. You can find an overview under:

- Supported gestures in WinCC Controls (Page 812)

Note

Touch operation is not approved for CS

Touch operations are only approved and practical in Runtime mode.

Touch operation is not supported for configuration in the WinCC editors.



No operation with three or more fingers



Use only one or two fingers to operate with touch gestures.

Using more than two fingers for touch gestures can result in operating errors.

Use multitouch operation with multiple fingers only at correspondingly configured objects.

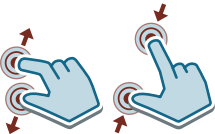
Supported gestures in WinCC Runtime

Icon	Gesture	Function
	Tap	To select an object, tap the appropriate point in the process picture.
	Drag	To scroll horizontally or vertically, drag the process image or object in the desired direction with one finger. By dragging diagonally in pictures, you can scroll horizontally and vertically at the same time.
	Scale	To zoom in or zoom out, drag with two fingers at the same time (zoom).

Icon	Gesture	Function
	Swipe	To switch between process pictures, swipe horizontally with one finger. You can disable this gesture in the computer properties.
	Press and hold	To open the shortcut menu, press on the object or the link for more than one second. The function corresponds to a right mouse click.
	Activation gesture	To open the WinCC system dialogs, quickly swipe vertically from top to bottom.

Supported gestures for user actions

You can assign supported gestures to your custom actions in WinCC.

The OnGesture event is defined as follows:

C action

```
void OnGesture(char* lpszPictureName, char* lpszObjectName,
ENUM_GESTURE_TYPE gestureType, GestureData pData)
```

```
//Enum for OnGesture events
```

```
typedef enum
{
    GESTURE_NO_GESTURE = 0,
    GESTURE_TAP = 1,
    GESTURE_PRESS_AND_HOLD = 2,
    GESTURE_SLIDE = 3,
    GESTURE_GESTURE_SWIPE = 4,
    GESTURE_PINCH = 5,
    GESTURE_STRETCH = 6,
    GESTURE_TURN = 7
}ENUM_GESTURE_TYPE;
```

```
typedef struct
{
    int pointX;
    int pointY;
    float translationX;
    float translationY;
    float rotation;
    float scale;
    float velocityX;
    float velocityY;
    float velocityAngular;
    float velocityExpansion;
    int tapCount;
}GestureData;
```

3.10 Process Pictures in Runtime

VBS action:

Sub OnGesture (ByVal Item, ByVal gestureInfo)

The following properties are available:

- GestureType
- Left
- Top
- TranslationX
- TranslationY
- Rotation
- Scale
- VelocityX
- VelocityY
- VelocityAngular
- VelocityExpansion
- TapCount

You can find additional information under "Events" tab in the "Object Properties" window (Page 517).

See also

Supported gestures in WinCC Controls (Page 812)

3.10.3.3 Supported gestures in WinCC Controls

A selection of gestures is available for the operation of WinCC controls. Note that not all WinCC controls support the same gestures.

Some of the gestures have different effects in WinCC controls than in process pictures.

You can find an overview of gestures for process pictures under:

- Supported gestures in Runtime (Page 810)

Note

Touch operation is not approved for CS

Touch operations are only approved and practical in Runtime mode.



Touch operation is not supported for configuration in the WinCC editors.

Adjusting the size of the toolbar

You can change the size of icons to facilitate operation in the toolbar of WinCC controls.

The "Key size in pixels" property allows a maximum of ten times magnification of the original size of 28 pixels.

Supported gestures in WinCC Controls

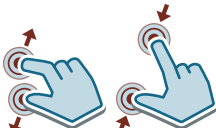
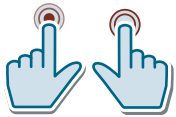
Icon	Gesture	Behavior	Supported WinCC controls
	Drag with two fingers	To move tables or trends and axes, drag with two fingers in the control window.	Trend window: <ul style="list-style-type: none"> • WinCC BarControl • WinCC FunctionTrendControl • WinCC OnlineTrendControl Table window: <ul style="list-style-type: none"> • WinCC AlarmControl • WinCC OnlineTableControl • WinCC SysDiagControl • WinCC UserAdminControl • WinCC UserArchiveControl Ruler window <ul style="list-style-type: none"> • WinCC RulerControl
	Drag with one finger	To move the x or y axis, you can drag the axis with one or two fingers.	Trend window: <ul style="list-style-type: none"> • WinCC BarControl • WinCC FunctionTrendControl • WinCC OnlineTrendControl
	Press and hold	To display the tooltip of the tapped value or object, press on the value or object longer than one second. The function corresponds to a right mouse click.	Trend window: <ul style="list-style-type: none"> • WinCC BarControl • WinCC FunctionTrendControl • WinCC OnlineTrendControl
	Scale	To zoom in or out of the trend display, drag with two fingers (zoom) in the control window.	Trend window: <ul style="list-style-type: none"> • WinCC BarControl • WinCC FunctionTrendControl • WinCC OnlineTrendControl
	Hold a finger and tap twice with the second finger	To reset a zoomed display to 100%, proceed as follows: <ul style="list-style-type: none"> • Hold the control with one finger • Tap twice on the control with the second finger. The operation is equivalent to clicking the icon "Original view" (1:1).	Trend window: <ul style="list-style-type: none"> • WinCC BarControl • WinCC FunctionTrendControl • WinCC OnlineTrendControl

See also

Supported gestures in Runtime (Page 810)

3.10.3.4 Two-handed operation of process pictures

Multitouch operation of process pictures

WinCC supports the two-handed operation of process pictures.

This enables safe operation of objects used to change critical system settings, for example, control variables with machine limits.

You can configure up to ten objects for simultaneous clicks to trigger an operation.

Requirement

Operating stations at which a process picture appears with two-handed operation must be technically equipped for multitouch.

Locking and unlocking operator controls

You define specific objects as locked operator controls for two-handed operation.

At least one object in the picture must be set as the release button. The release button can be any unlocked object.

As long as the locked operator controls are not unlocked, they cannot be operated in Runtime. The operator can only use these objects when the release button is pressed at the same time.

You can lock or unlock one or multiple operator controls at one time.

Picture window

The operator control enable is possible across picture windows.

Use a picture window with locked controls in the process picture. The corresponding enable button can be configured as follows:

- The enable button is located outside the picture window in the process picture.
- The enable button is located in another picture window.

Procedure

Configuration of two-handed operation:

- You configure objects that are displayed as locked operator controls.
- You configure an object that serves as a release button and unlocks the operator controls.

You can find additional information under "How to configure two-handed operation (Page 815)".

See also

Supported gestures in Runtime (Page 810)

How to configure two-handed operation (Page 815)

3.10.3.5 How to configure two-handed operation

Requirement

- The hardware used supports multitouch operation.
Operator stations at which the configured process picture is displayed must be technically equipped for multitouch.

Procedure

- Select the operator control that you want to lock, e.g. an "IOLock" IO field.
- Select the "No" option for the "Miscellaneous > Operator Control Enable" property.
- Select the object with which the operator control is unlocked, e.g. an "UnlockButton" button.
- Select the "Mouse > Press left" event. Open the "Direct connection" dialog in the shortcut menu.
- Configure the "Press left" event:

Area	Option / Field	Value
Source	Constant	1
Target	Object in the picture	-
Target	"Object" field	Operator control e.g. "IOLock" IO field
Target	"Property" field	Operator control enable

- Select the "Mouse > Release left" event. Open the "Direct connection" dialog in the shortcut menu.
- Configure the "Release left" event:

Area	Option / Field	Value
Source	Constant	0
Target	Object in the picture	-
Target	"Object" field	Operator control e.g. "IOLock" IO field
Target	"Property" field	Operator control enable

Result

The "IOLock" IO field is operable in Runtime as long as the "UnlockButton" button is pressed. If the button is not pressed at the same time, the operator control is locked in Runtime.

Alternative procedure

You can also configure the unlocking of an operator control via a script.

To do this, use the following properties or functions:

- VBScript: "Enabled" property
- ANSI C: "Operation" property, "GetPropBOOL" internal function
- VBA: "Operation" property

See also

Two-handed operation of process pictures (Page 814)

3.10.4 Menus and Toolbars

3.10.4.1 User-defined menus and toolbars

Introduction

In the "Menus and Toolbars" editor you can configure customized menus and toolbars.

The customized menus and toolbars can be displayed in the basic picture of a project and in picture windows.

You connect menu items and symbols using procedures from Global Script VBS.

Use

You used customized menus and toolbars, for e.g. to implement a picture navigation.

You can thus switch from any process picture to all pictures to which you have configured the picture change using menu commands and icons.

Other common functions that can be called via a menu command or an icon include:

- Deactivating runtime
- Changing the runtime language
- Login / Logout
- Calling system dialogs

Principle

You save the customized menus and toolbars in configuration files.

For each configuration file, you can:

- Save a menu
- Save any number of toolbars
- Connect a maximum of 1250 scripts to menu commands and icons

A maximum of 20 menus and toolbars can be loaded at the same time.

Configuration options

Configuring a start picture

If you have configured more than one configuration, you can define which configuration is displayed when runtime is activated.

The customized menus and toolbars are also displayed in WebNavigator.

Configuring picture windows

You can configure a separate configuration file for each picture window which is displayed instead of the start configuration.

Operator authorization

You can assign different authorizations to customized menus and toolbars as well as to individual items.

If a logged in user does not have the required authorization, the respective item is automatically disabled.

Inactive or invisible elements

Further, you can disable or hide customized menus and toolbars and their elements.

You can also exchange the configuration file, for e.g. in case of user change during runtime, if you save the modified functional scope in a new configuration file.

Online configuration

You can configure customized menus and toolbars while the project is active in runtime. However, the configuration changes are not immediately visible in runtime.

Changed configuration files are only updated in runtime when the configuration in the picture is loaded again:

- Menus and toolbars in the picture window:
 - Picture change
- Menus and toolbars in the basic picture:
 - Runtime restart
 - Close runtime window and open it again
 - Load a different configuration and then load the changed configuration again, e.g. via a script
- Changed VB script in a configuration file:
 - Runtime restart

Language-dependent configuring

In the "Menus and toolbars" editor, you configure language-dependent texts for menus and toolbars.

Click the item in the navigation tree and enter the texts in the respective runtime languages in the "Properties" area.

Exporting language-dependent texts

To translate the texts in an external editor, use the export and import via the Text Distributor. Activate the "Menus and toolbars" option in the Text Distributor.

You cannot edit the MTL files.

For further information please refer to "Working with WinCC > Configuring multilingual projects > Text export and text import with the Text Distributor (Page 2353)".

See also

Procedures and dynamization of menus and toolbars (Page 818)

How to configure menus and toolbars for runtime display (Page 827)

How to configure menus and toolbars in a picture window (Page 828)

Text export and text import with the Text Distributor (Page 2353)

3.10.4.2 Procedures and dynamization of menus and toolbars

Introduction

The menu items and toolbar items only have a function when they are connected with a VBScript procedure.

You can also configure the switch between two configurations in runtime with VBScript.

Configuring menus and toolbars with VBA

To further adapt the display in runtime, use VBA scripts. For example, save keyboard shortcuts or hide items when a condition is not met.

You can find additional information in the WinCC Information System under "Working with WinCC > VBA for Automated Configuration > VBA in the Graphics Designer > Adapting the Graphics Designer with VBA > Creating user-defined menus and toolbars".

Changing configuration in runtime

You can dynamize the "Menu/Toolbar configuration" property in a picture window.

To assign a different configuration file to the basic picture or the picture window, use the property "MenuToolBarConfig".

Sample procedure

The following example shows a procedure to which the configuration file to be loaded is transferred as parameter:

```
Sub ChangeMenuToolBarConfigFile (ByVal strMTConfigFile)
HMIRuntime.MenuToolBarConfig = strMTConfigFile
End Sub
```

Connect menu command or icon to procedure

Use the following syntax to connect a procedure from the global script to a menu item or icon:

```
Sub <Procedurename> (ByVal Item)
Tag declarations
'Instructions
End Sub
```

The transfer parameter "Item" shows the object that the user has clicked.

Use the "User Data" field in the "Menus and toolbars" editor to transfer a parameter to the procedure.

Sample procedure

The following example shows the "ActivateScreen" procedure that executes the picture change.

Enter the picture name in the "User Data" field:

```
Sub ActivateScreen (ByVal Item)
Dim objScreen
Dim strScreenName
' "UserData" contains the screen name specified
' in editor menus and toolbars.
strScreenName = Item.Userdata
HMIRuntime.BaseScreenName = strScreenName
End Sub
```

Applying procedure change to configuration

If you change a procedure in the VBS editor, this change is not immediately contained in the configuration files.

To update the procedure in a configuration file, follow these steps:

1. Open the configuration file in which the procedure is referenced in the "Menus and toolbars" editor.
2. Save the configuration.
It is only when saved that the information regarding the necessary project modules is transferred to the configuration file.

Change in runtime

A changed VB script that is connected with "Menus and toolbars" is only updated after Runtime is restarted.

See also

User-defined menus and toolbars (Page 816)

How to Create a Menu (Page 822)

How to Create a Toolbar (Page 825)

How to configure menus and toolbars for runtime display (Page 827)

How to configure menus and toolbars in a picture window (Page 828)

3.10.4.3 Configurable properties of menus and toolbars

In the "Menus and toolbars" editor, you configure the properties of the following items:

- No more than one menu per configuration
- Any number of toolbars
- Menu items
If a menu item contains further lower-level items, the menu item is only for navigation. Configured procedures are not executed.
- Toolbar items

Common features

The following properties are available for all items:

Properties	Function	Explanation
Object type	Currently selected object in the editor	Menu, menu item, toolbar, toolbar item
Name/object name	Internal name of item	Use the internal name to uniquely identify the item and address it via scripts, for example.
Text	Text that is displayed in the menu or toolbar	The text is language-dependent. The menu itself has no text, only a name.
Active	The item can be operated in runtime.	Use these settings in the following cases, for example:
Visible	The item is displayed in runtime.	<ul style="list-style-type: none"> • An item can only be operated or is only visible when a specific condition is met. • Online configuration: You have already configured the structure of the menus and toolbars, but not all items are functional.
Authorization	Authorization to operate the item in runtime	The item is only activated when the logged in user has the selected authorization.

Menus and toolbars

The following properties are available only for menus and toolbars:

Properties	Function	Explanation
Masking Color	Color of the icon to be replaced by the background color of the menu or toolbar	Use the masking color, for example, when you use round graphics or graphics that have a different background color as icons. To define the color coding, open the graphic in the Graphics Designer and use the "Color Selection" button.
Fixed ¹⁾	Anchors the toolbar	If the toolbar is not fixed, the user can move it to any margin of the window or display it as a separate window ("floating"/"docked").
Alignment ¹⁾	Position of toolbar	Possible positions: <ul style="list-style-type: none"> • Top/bottom/left/right Menus are always displayed in the top left margin.
Mode ¹⁾	Display of the item in the toolbar	Possible display types: <ul style="list-style-type: none"> • Picture • Text • Picture + text For the toolbar items, you configure only graphics as icons, only texts, or both, depending on the mode.
Picture size ¹⁾	Icon size in pixels	The selected graphic will be scaled to the specified size in runtime. In menus, the icons are always adapted to the font size.

1) Only applies to toolbars.

Menu commands and icons

The following properties are available only for menu items and toolbar items:

Properties	Function	Explanation
Tooltip (only toolbar)	Help text for the icon	The help text is displayed if the user points with the mouse on the icon.
Separator	Configuring the element as separator.	Use separators to optically demarcate the function groups from each other. Menus: You cannot use separators on the top level.
User data	Value that is transferred during procedure call	For example, you can enter the name of a process picture or an object that is transferred to the procedure as parameter.
Script	Procedure that is run when the item is clicked	To select a script, click the "..." button or enter the name.

Properties	Function	Explanation
Picture	Icon displayed for the item	Select a graphic from the drop-down list. To import graphics into the WinCC project, select the command "Import Graphics" in the shortcut menu of "Menus" or "Toolbars" in the navigation area.
Origin / Toolbar	Higher-level navigation item	For submenus and menu commands, the higher-level menu item is displayed. For icons, the higher-level toolbar is displayed.

See also

How to Create a Menu (Page 822)

How to Create a Toolbar (Page 825)

How to configure menus and toolbars for runtime display (Page 827)

3.10.4.4 How to Create a Menu

Introduction

In each picture, a menu is placed at the top margin. Toolbars may be displayed under the menu.

You can configure one menu with multiple hierarchy levels for each configuration file.

Configuration of a menu

The configuration options for a menu item depend on the position where the menu item is located in the menu structure.

The figure below shows a typical menu structure with different menu items:

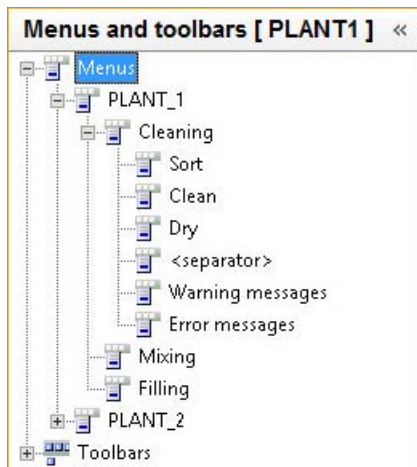

The following table explains the functions of the menu items shown in the figure:

Menu item	Function
PLANT_1 / PLANT_2	Menu bar: Top level of the menu On the top level, the menu commands are located next to one another without separators. The menu items only have the function of displaying submenus and menu commands.
Cleaning	Submenu In a submenu, you can insert menu commands, separators or further submenus. As soon as lower-level items are assigned to a menu item, this menu item only has a navigation purpose. Configured procedures are not executed and are grayed out in the data area of the editor.
<separator>	Separator: Horizontal line between menu commands You can only insert separators in submenus or between menu commands.
Mixing / Filling Sort / Clean / Dry / Warning messages / Error messages	Menu commands Assign a procedure that is run when you click on the menu command to a menu command. You can enter a parameter (e.g. a picture name) that is to be transferred to the procedure under "User Data".

Requirement

- The menu structure is yet to be planned.
- The required VBScript procedures are configured.

Procedure

1. Select the entry "Menus" in the navigation area.
Configure the properties in the "Properties - Menu" area.
If necessary, select an authorization for operating the menu.
2. To insert the menu items, select the item "New menu item" in the shortcut menu of "Menus".

3. Assign the menu items to the desired hierarchy levels.
To do this, use drag-and-drop or the shortcut menu of the item in the navigation tree:

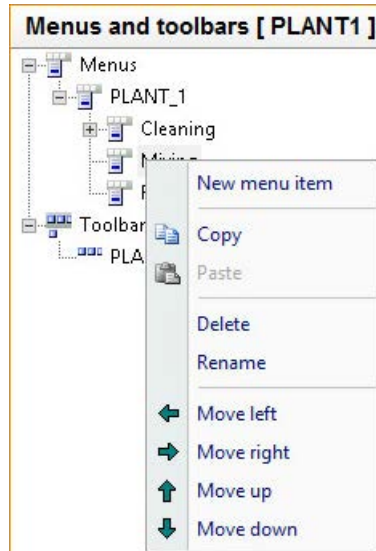

4. Enter a name and a text for each menu item.
If necessary, add the translations in the "Properties - Menu item" area.
5. Connect the menu item with a procedure and enter the parameters in the "User Data" field.
6. Configure the additional properties in the "Properties - Menu item" area.
If necessary, select an authorization for operating the individual items.
7. To group the menu commands, add menu items as "separators".
A separator is displayed as a horizontal line and has no other function.
8. Select "File > Save" to save the configuration.

Result

The figure below shows the example menu in runtime:



See also

Procedures and dynamization of menus and toolbars (Page 818)

Configurable properties of menus and toolbars (Page 820)

3.10.4.5 How to Create a Toolbar

Introduction

You can configure any number of tools for each configuration file.

For each toolbar you can define the placement position of the toolbar in the picture. In addition, you can define whether the user should be able to freely place a toolbar.

if you place multiple toolbars in the top margin, for example, the toolbars are displayed one under another.

Configuration of a toolbar

A toolbar has two object types:

- Toolbar
- Toolbar item

To display toolbar items as picture, text or picture and text, select the corresponding mode for the toolbar.

Requirement

- The toolbar structure is yet to be planned.
- The required VBScript procedures are configured.

Procedure

1. Select the command "New toolbar" in the shortcut menu of "Toolbars" in the navigation area.
2. Enter a name and a text for the toolbar in the "Properties - Toolbar" window.
If necessary, add the translations for other runtime languages in the "Text" area.
3. Configure the additional properties in the "Properties - Toolbar" area.
If necessary, select an authorization for operating the toolbar.
4. Select the toolbar in the navigation area.
In the data area, enter the names of the toolbar items.

5. Connect the toolbar item with a procedure and enter the parameters in the "User Data" field.

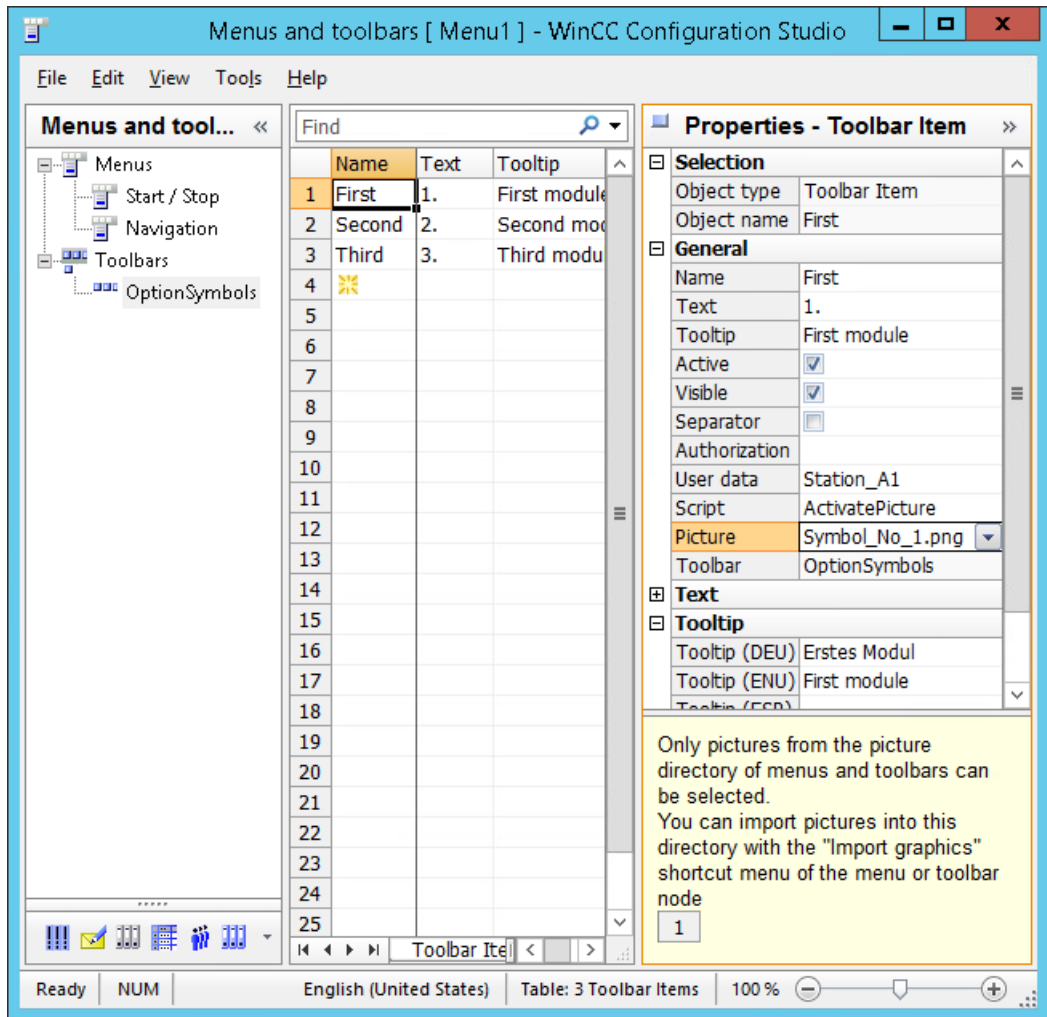

6. Configure the additional properties in the "Properties - Toolbar item" area.
If necessary, select an authorization for operating the individual items.
If necessary, add the translations for other runtime languages in the "Text" and "Tooltip" areas.
7. To group the icons, add toolbar items as "separators".
A separator is displayed as a vertical line and has no other function.
8. To change the order of the toolbar items, select the entire row.
Select "Move up" or "Move down" in the shortcut menu.
You can change the order of the toolbars in the navigation area with drag-and-drop.
9. Select "File > Save" in the menu to save the configuration.

Result

The figure below shows the toolbar in runtime under a user-defined menu bar:

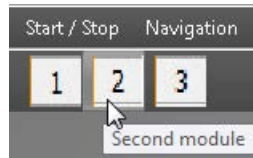

See also

Procedures and dynamization of menus and toolbars (Page 818)

Configurable properties of menus and toolbars (Page 820)

3.10.4.6 How to configure menus and toolbars for runtime display

Introduction

You can configure a configuration file as start configuration for every computer in the WinCC project. The configuration file of the local computer is marked as "Start configuration" in the Graphics Designer.

The customized menus and toolbars of the start configuration are displayed in runtime in each basic picture at the configured position.

If no start configuration is selected in the WinCC project, the basic pictures are displayed without customized menus or toolbars. If no configuration file is stored on a computer in a distributed system, the start configuration of the server is displayed.

Dynamization with VBScript

To load other configuration files in runtime, dynamize the property "MenuToolBarConfig".

You can, for example, load different menus and toolbars depending on the selected picture or the logged in user.

Procedure

1. Click the Computer component in the navigation window of the WinCC Explorer. WinCC displays the list of computers in the data window.
2. Choose the "Properties" command from the shortcut menu of the relevant computer. The "Computer properties" dialog will open.
3. Click "..." in the "Start configuration menu and toolbars" area of the "Graphics Runtime" tab.
4. Select the configuration file in the file selection dialog.
5. Click "OK" to close all dialogs.

Alternative procedure

If you only want to assign a configuration file to the local computer, follow these steps:

1. Click "Menus and toolbars" in the navigation window of WinCC Explorer.
The created configuration files are displayed in the data window.
2. In the shortcut menu of the desired configuration, choose the command "Set configuration as start configuration".
The configuration is marked as start configuration in the "Type" column.
In the local computer properties, the configuration is entered on the "Graphics Runtime" tab.

Result

When you activate a project, all customized menus and toolbars will be displayed in the basic picture of the project.

See also

Procedures and dynamization of menus and toolbars (Page 818)

User-defined menus and toolbars (Page 816)

Configurable properties of menus and toolbars (Page 820)

3.10.4.7 How to configure menus and toolbars in a picture window

Introduction

Customized menus and toolbars are not usually shown in a picture window.

However, you can configure a configuration for each picture window which is then shown in the picture window in runtime.

Requirements

- A picture window is configured in the process picture.

Procedure

1. Open the object properties of the configured picture window.
2. Select the "Others" property group.
3. Double-click the "Configuration of menu/toolbars" attribute and select the desired configuration file in the file selection dialog.
The "Configuration of menu/toolbars" attribute can be made dynamic using the "MenuToolBarConfig" name.

Result

The customized menus and toolbars of the selected configuration are displayed in the picture window in runtime.

See also

Procedures and dynamization of menus and toolbars (Page 818)
User-defined menus and toolbars (Page 816)

3.10.4.8 How to define the font for the various languages

Introduction

You can define the font and text size for the menus and toolbars for each language individually.

Requirements

- The WinCC Explorer is open.

Procedure

1. Select item "Font settings" command from the "Menus and Toolbars" context menu.
The "Font settings" dialog opens.

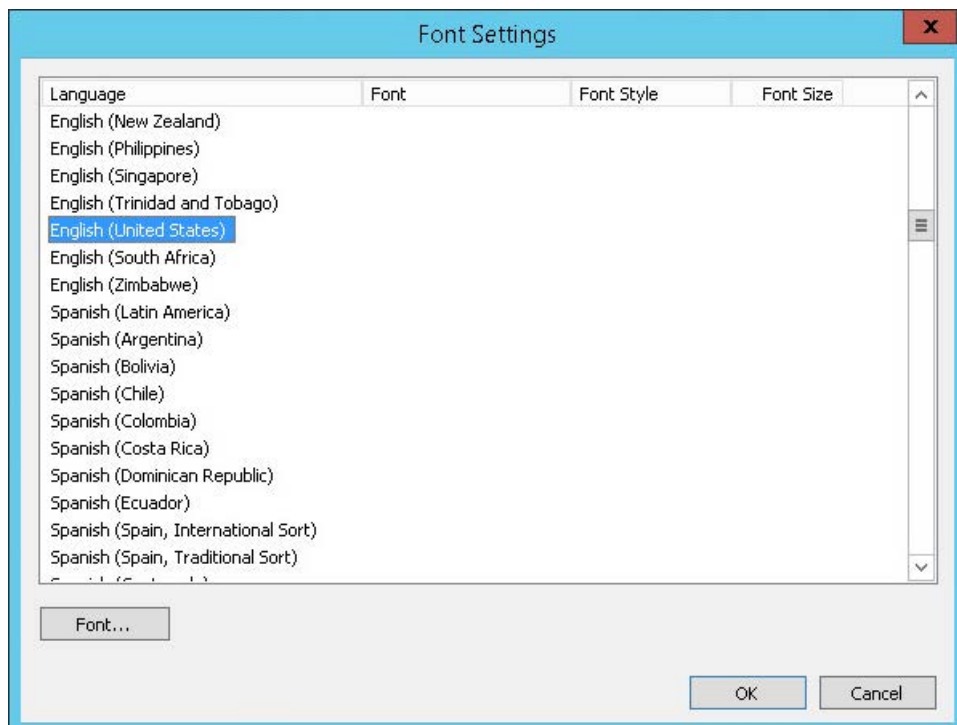

2. Select the language for which you want to define a font.

3.10 Process Pictures in Runtime

- 3. Click on "Font".
The "Font" dialog box will open.

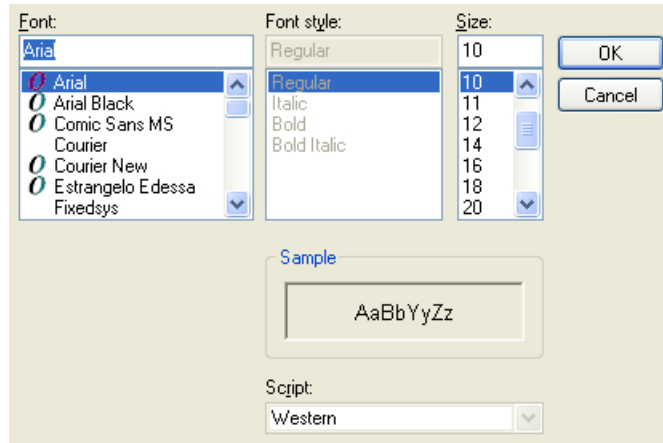

- 4. Select the font and text size.
- 5. Click "OK".
The changes that have been made are shown in the "Font settings" dialog.

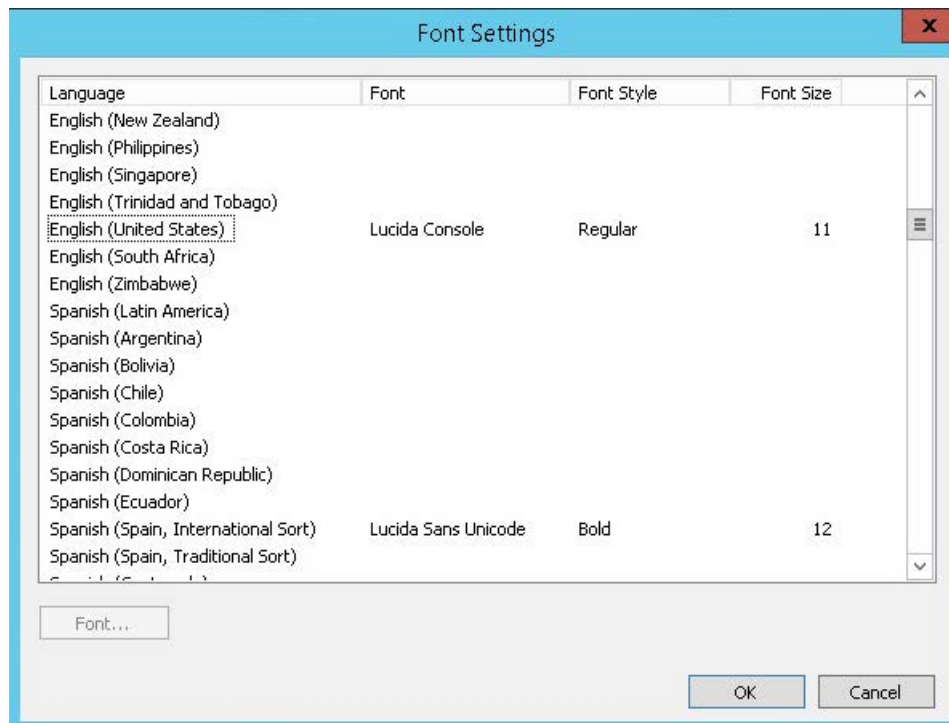

- 6. Repeat steps 2 to 5 for all languages for which you want to define the font.

3.10.5 Virtual keyboard

3.10.5.1 Virtual keyboard - General Information

Introduction

The monitor keyboard is a virtual keyboard on the screen of the HMI device.

The operator can click the keys shown on the screen, for example, to fill in an input field.

Note

Disable key combinations

Use the monitor keyboard provided in WinCC instead of the Windows "On-Screen Keyboard", for example, so that you can disable the <CTRL+ALT+DEL> keystrokes.

Properties of the monitor keyboard

- The monitor keyboard has keys for entering numerical or alphanumeric characters.
- The key labels shown on the monitor keyboard are set to agree with the Regional Settings in the Windows Control Panel. In other words, an English keyboard will not have any special characters for German or French. The layout of the letters on the keyboard is also in part different.

If several keyboard layouts are installed, you can change the keyboard with a click on the language display:

German (Germany)

- You cannot use the Menu button in WinCC Runtime: 
- The representation of the supplied monitor keyboard is determined by the global design settings, for example, the background color or the font color.

The illustration shows a German monitor keyboard for entering alphanumeric values.



Activating the monitor keyboard

The monitor keyboard can be either displayed automatically for an input or activated by the operator when needed by pressing a key.

The monitor keyboard can only be hidden using the "X" button in the monitor keyboard's title bar or by clicking on a place outside of an entry field.

Monitor keyboard - position on screen

The default position of the monitor keyboard is in the center of the screen.

The monitor keyboard can be positioned, maximized and minimized on the screen like any other window.

3.10.5.2 How to configure the activation of the virtual keyboard

Introduction

You can configure the behavior of the monitor keyboard as follows:

- The monitor keyboard is displayed automatically for an input and then hidden once the input is finished.
- The monitor keyboard is displayed via a script or by calling in the command line.
- The monitor keyboard can be displayed manually when the operator presses a key. The monitor keyboard can only be hidden using a button in its title bar.

Display monitor keyboard automatically for input

The monitor keyboard will always be shown in WinCC Runtime as soon as the operator has selected an input field.

Once the entry has been completed, the keyboard will be automatically hidden again.

Configuration

1. In WinCC Explorer double-click "Computer" and then right click in the project window on the right to open the shortcut menu with the properties of the computer.
2. On the "Runtime" tab, use the check box "Monitor keyboard".

Calling the monitor keyboard via script or command line

You can start the monitor keyboard via the command line or via a script:

- Enter the application name in the command line: "CCOnScreenKeyboard.exe".
- Use the C function "ProgramExecute" in the script.

Requirements for the call via C function

If you open the monitor keyboard using the C function "ProgramExecute", you must change the following settings in the Control Panel:

- User Accounts > Change User Account Control settings > Choose when to be notified about changes to your computer > "Never notify" setting
- Administrative Tools > Local Security Policy > Local Policies > Security Options > Disable policy: "User Account Control: Run all administrators in Admin Approval Mode"

Start parameters of the WinCC monitor keyboard

You can use the following start parameters when you start via the command line or using a script:

-NoInfo	The monitor keyboard is started without info dialog
-NumPadOn	The monitor keyboard is started in the numeric keypad view.
-NumPadOff	The monitor keyboard is started in the normal view.
-1 -ShowNumPad	Only the numeric keypad is displayed for entering numbers.
-1 -CtlEsc	<Ctrl+Esc> is approved.
-0 -CtlEsc	<Ctrl+Esc> is not executed.
-1 -AltEsc	<Alt+Esc> is approved.
-0 -AltEsc	<Alt+Esc> is not executed.
-1 -AltTab	<Alt+Tab> is approved.
-0 -AltTab	<Alt+Tab> is not executed.
-1 -CtlAltDel	<Ctrl+Alt+Del> is approved.
-0 -CtlAltDel	<Ctrl+Alt+Del> is not executed.

Press a key to display the monitor keyboard

In this configuration, the operator can call up the monitor keyboard and use it not only for making entries in WinCC Runtime, but also to work in other applications, such as Excel.

Connect the action for starting the monitor keyboard to a button in a WinCC picture.

If the operator clicks on the button in Runtime, the monitor keyboard will remain on the screen even after a switching to another application or exiting from WinCC.

To close it, the operator must use the button in the monitor keyboard's title bar.

Requirement

- A process picture is open in the Graphics Designer.

Procedure

1. Configure a button by dragging the Windows "Button" object from the "Standard" window into the picture.
Label the button in the Configuration dialog with the appropriate text.
2. Click the "Dynamic Wizard" tab and then the "System Functions" tab.
Double-click the "Start other applications" function. The configured button must be selected in the picture while you perform the above step.
3. In the Wizard, select a trigger which is to be used to start the monitor keyboard.
4. To select the application for starting the monitor keyboard, click the  button on the next page of the wizard.
The file selection dialog opens.

5. Go to the folder "<Programs (x86)>/Common Files/Siemens/bin".
Select the "CCOnScreenKeyboard.exe" application.
6. Exit from the Wizard and save the picture.

Result

The operator can use this button to display the monitor keyboard permanently.

To close it, the operator must use the button in the monitor keyboard's title bar.

If the "Use monitor keyboard" check box is selected in addition to display of the keyboard by means of the button, only users with administrator rights can access applications outside of WinCC Runtime by means of the monitor keyboard.

See also

How to operate the virtual keyboard (Page 834)

Virtual keyboard - General Information (Page 831)

3.10.5.3 How to operate the virtual keyboard

Entering alphanumeric values

To enter character strings and numerical values, WinCC automatically displays an alphanumeric monitor keyboard in Runtime as soon as you select an input field or double-click a cell or enter values in a WinCC Control in editing mode.

Once the entry has been completed, the keyboard will be automatically hidden again.

Keyboard levels

The alphanumeric monitor keyboard has several levels:

- the normal level
- the shifted level for entering uppercase and special characters
- the Alt Gr level for entering special characters
- the function key level for accessing the function keys F1 to F12



Alphanumeric values can be entered character by character using the monitor keyboard's buttons. You confirm the entered value with the enter key and the monitor keyboard is hidden.

Entering numerical values

To enter numerical values, click the "123" button to display the numeric monitor keyboard. Once the entry has been completed, the keyboard will be automatically hidden again.



Numerical values can be entered character by character using the monitor keyboard's buttons. You confirm the entered value with the enter key and the monitor keyboard is hidden.

Disable keys and key combinations

The following key combinations and keys can also be disabled for the monitor keyboard in WinCC:

- CTRL+ALT+DEL
 - CTRL+ESC
 - CTRL+SHIFT+ESC
 - ALT+TAB
 - Windows Buttons
1. In WinCC Explorer double-click "Computer" and then right click in the project window on the right to open the shortcut menu with the properties of the computer.
 2. In the "Parameters" tab, activate the check box "Disable Keys". This will disable all of the key-combinations described above and the keys on the monitor keyboard.

3.10.6 Setting up Mouseless Operation of a Picture

3.10.6.1 How to set up a picture for mouseless operation

Introduction

Graphic objects such as buttons or I/O fields must be operated in Runtime to influence the processes. Operation via the keyboard can be convenient and ensures that all necessary entries are made. The user moves from one graphic object to the next in a specified order in order to enter values, for example.

Requirement

- The graphic objects must be enabled for operation.
- Operator authorization must be assigned for the graphic objects.

Mouseless operation

Mouseless operation is specified using cursor mode:

- "Alpha cursor": The user jumps only to the "IO field", "Text list" and "Multiple row text" objects.
- "Tab order": The user jumps to defined object types in which entries are possible.

Cursor mode must be specified before starting Runtime for the process picture. However, you can toggle the mode in Runtime.

Combining the alpha and tab order cursors in a picture

The cursor mode can be toggled in Runtime if a hotkey has been specified for this. The operator can then switch between using the alpha or tab order cursor in Runtime. The tab sequence must be specified for both types of cursor.

Moving from one object to the next in Runtime

The tab sequence is used to specify the order in which graphic objects are operated in Runtime. You can display and, if necessary, change the tab sequence. Individual objects can be removed from or restored to the tab sequence.

By default, the cursor is moved with the <TAB> key or <SHIFT+TAB> for the reverse order. Operation via hotkeys can also be specified.

See also

Defining the Alpha cursor's tab sequence (Page 837)

Specifying the tab sequence of the tab order cursor (Page 839)

How to define hotkeys for operation and screen navigation (Page 191)

How to Assign Hotkeys in the Project (Page 174)

How to configure the cursor control in Runtime (Page 196)

How to set up Runtime (Page 180)

Virtual keyboard - General Information (Page 831)

Process Pictures in Runtime (Page 807)

3.10.6.2 Defining the Alpha cursor's tab sequence

Introduction

In mouseless operation in Runtime, the alpha cursor will only access I/O field and text list object types.

Procedure

1. In the Graphics Designer, select "Sequence" in menu "Edit/TAB Sequence/Alpha Cursor". If the "Sequence" entry is not active, the picture does not contain any I/O field or text list objects.
2. All I/O fields and text lists are automatically allocated a number in the top left corner. The numbers are displayed in a box in WinCC Classic design and in a circle in all other designs.
3. In the picture, click on the object that you want to move to first. Then click on the other objects according to the desired tab sequence.
4. To conclude the entry, click on the desktop.
5. Check whether the "Cursor Mode" property is set to "Alpha Cursor" for the process picture. To do this, click a free area in the picture and select the "Properties" entry in the pop-up menu. If necessary, change the "Cursor Mode" property to "Alpha Cursor" in the "Miscellaneous" property group.

Results

In the following example, in Runtime the cursor first moves to the I/O field (1) and then to the text list (2).

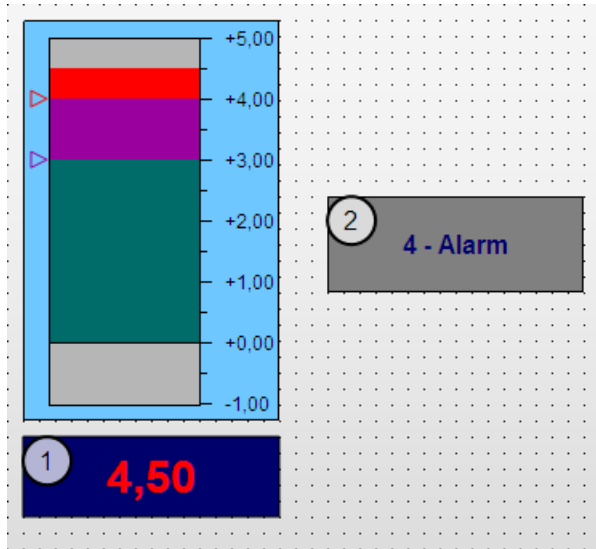

Changing the tab sequence

In order that you do not have to sort all objects again when changing the tab sequence, the Graphics Designer offers the following options:

- Specify new sequence
Press and hold down the <SHIFT> key while clicking on an object. Release the <SHIFT> key. The object is allocated the number "1" for the tab sequence. Then click on all the objects in the desired tab sequence.
- Change the sequence
Press and hold down the <CTRL> key while clicking on the object that should be allocated the number. Release the <CTRL> key. Now click on the object that should be next in the sequence.
- Remove an object from/restore an object to the sequence
Press and hold down the <SHIFT+CTRL> keys while clicking on an object. The object is removed from the tab sequence. The number of the object will be replaced by an asterisk. The objects with higher numbers will be automatically renumbered. Removed objects with an asterisk can be restored to the sequence using <SHIFT+CTRL>. The objects are allocated a number again.

See also

Specifying the tab sequence of the tab order cursor (Page 839)

How to set up a picture for mouseless operation (Page 836)

3.10.6.3 Specifying the tab sequence of the tab order cursor

Introduction

Every object can be accessed in Runtime with the tab order cursor.

Specifying object types

1. First specify which types of objects should be operable.
2. In the Graphics Designer, select "Settings" in menu "Edit/TAB Sequence/Tab Order".
3. In the "Object Types" dialog, activate the object types for the tab sequence.

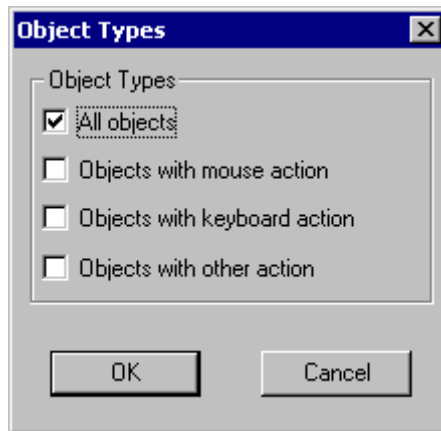

4. Click "OK".

Results

All activated object types are automatically allocated a number in the top left corner. The numbers are displayed in a box in WinCC Classic design and in a circle in all other designs. In the following example, in Runtime the cursor first moves to the I/O field (1), to the text list (2), and then to the bar (3).

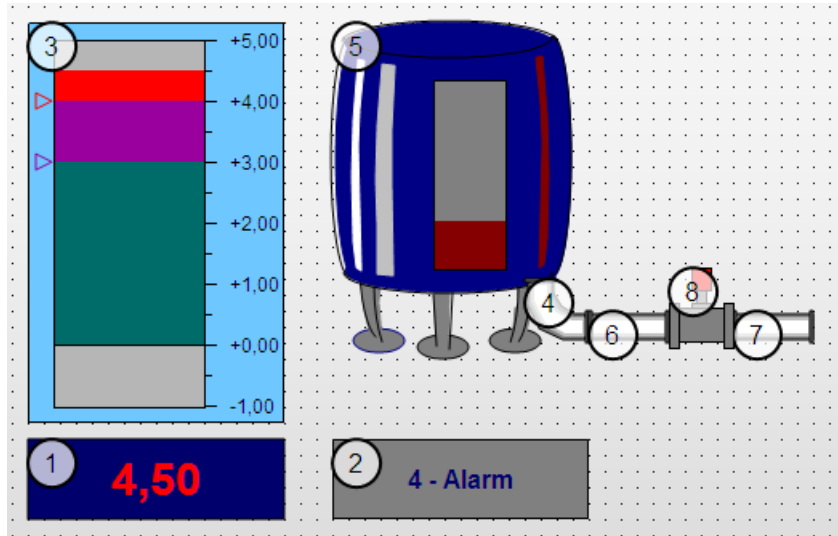

Specifying the sequence of the tab order cursor

1. In the Graphics Designer, select "Sequence" in menu "Edit/TAB Sequence/Tab Order". If the "Sequence" entry is not active, the picture does not contain any objects of the type that were specified in the "Object Types" dialog.
2. In the picture, click on the object that you want to move to first. Then click on the other objects according to the desired tab sequence.
3. To conclude the entry, click on the desktop.
4. Check whether the "Cursor Mode" property is set to "Tab Order" for the process picture. To do this, click a free area in the picture and select the "Properties" entry in the pop-up menu. If necessary, change the "Cursor Mode" property to "Tab Order" in the "Miscellaneous" property group.

Changing the tab sequence

In order that you do not have to sort all objects again when changing the tab sequence, the Graphics Designer offers the following options:

- **Specify new sequence**
Press and hold down the <SHIFT> key while clicking on an object. Release the <SHIFT> key. The object is allocated the number "1" for the tab sequence. Then click on all the objects in the desired tab sequence.
- **Change the sequence**
Press and hold down the <CTRL> key while clicking on the object that should be allocated the number. Release the <CTRL> key. Now click on the object that should be next in the sequence.
- **Remove an object from/restore an object to the sequence**
Press and hold down the <SHIFT+CTRL> keys while clicking on an object. The object is removed from the tab sequence. The number of the object will be replaced by an asterisk. The objects with higher numbers will be automatically renumbered. Removed objects with an asterisk can be restored to the sequence using <SHIFT+CTRL>. The objects are allocated a number again.

See also

Defining the Alpha cursor's tab sequence (Page 837)

How to set up a picture for mouseless operation (Page 836)

3.11 Object properties

3.11.1 "Axis" Property Group

3.11.1.1 Axis Section (AxisSection)

Axis Section (AxisSection)

The "Axis Section" attribute defines the distance between the large tick marks for the "Bar" object. The value is specified as the difference in value between two neighboring large tick marks.

There is a free choice of value. A meaningful limit is provided by the minimum value and maximum value of the scale.

0	The spacing between the large tick marks is set automatically according to the setting of the "Bar Scaling" attribute.
---	--

The "Axis Section" attribute can be made dynamic with the name "AxisSection".

3.11.1.2 Alignment

Alignment

The "Alignment" attribute defines the arrangement of the scale relative to the bar for the "Bar" object. Depending on the setting for the "Bar Direction" attribute in the "Geometry" property group, the scale can be displayed to the left or right or above or below the bar.

The possibilities for arrangement of the scale relative to the bar depend on the value of the "Bar Direction" attribute in the "Geometry" property group.

Above / Below	The scale is displayed above or below the bar.
Left / Right	The scale is displayed to the left or right of the bar.

The "Alignment" attribute can be made dynamic with the name "Alignment".

3.11.1.3 Bar Scaling (ScalingType)

Bar Scaling (ScalingType)

The "Bar Scaling" attribute specifies the type of scale division for the "Bar" object. By selecting suitable scale divisions, it is possible to emphasize a particular range of values in the bar display.

Linear	The large tick marks are evenly distributed across the scale. The spacing between the large tick marks corresponds to the value of the "Axis Section" attribute.
Logarithmic	The distribution of the large tick marks on the scale follows a logarithmic function. The representation of low values is strongly emphasized.
Negative logarithmic	The distribution of the large tick marks on the scale follows a negative logarithmic function. The representation of high values is strongly emphasized.
Automatic (linear)	The large tick marks are evenly distributed across the scale. The spacing between the large tick marks is set automatically.

Tangent	The distribution of the large tick marks on the scale emphasizes the representation of the low and high values.
Square	The distribution of the large tick marks on the scale follows a square function. The representation of high values is emphasized.
Cubic	The distribution of the large tick marks on the scale follows a cubic function. The representation of high values is emphasized.

The "Bar Scaling" attribute can be made dynamic with the name "ScalingType".

3.11.1.4 Label Each (LongStrokesText Each)

Label Each (LongStrokesText Each)

The "Label Each" attribute specifies the number of labeled large tick marks for the "Bar" object. If, for example, the attribute has the value "3", only every third large tick mark is labeled, starting with the large tick mark with the lowest value.

There is a free choice of value. A meaningful limit results from the number of large tick marks.

0	The large tick marks are not labeled
1	Each large tick mark is labeled
5	Every fifth large tick mark is labeled

The "Label Each" attribute cannot be made dynamic.

3.11.1.5 Exponent Display (Exponent)

Exponent Display (Exponent)

The "Exponent Display" attribute specifies for the "Bar" object whether the numerical values of the scale are shown exponentially or as decimal values without exponent.

The representation of decimal values can be defined with the attributes "Decimal Places" and "Digits to the Left of the Decimal Point".

Yes	The numerical values of the scale are displayed exponentially.
No	The numerical values of the scale are displayed as decimal values without exponent.

The "Exponent display" attribute can be made dynamic with the name "Exponent".

3.11.1.6 Large Tick Marks (LongStrokesBold)

Large Tick Marks (LongStrokesBold)

The "Large Tick Marks" attribute specifies for the "Bar" object whether the large tick marks of the scale are shown in bold or as normal.

Normal	The large tick marks of the scale are displayed normally.
Bold	The large tick marks of the scale are displayed in bold.

The "Large Tick Marks" attribute can be made dynamic with the name "LongStrokesBold".

3.11.1.7 Large Tick Marks Length (LongStrokesSize)

Large Tick Marks Length (LongStrokesSize)

The "Large Tick Marks Length" attribute specifies the length of the large tick marks for the "Bar" object. The length of the shorter tick marks corresponds to half of the value specified here. The values are specified in pixels.

If the "Only Large Tick Marks" attribute has the value "Yes", no shorter tick marks are displayed.

There is a free choice of value.

The "Only Large Tick Marks" attribute can be made dynamic with the name "LongStrokesSize".

3.11.1.8 Decimal Places (RightComma)

Decimal Places (RightComma)

The "Decimal Places" attribute specifies for the "Bar" object the number of digits after the decimal point for the display of numerical values in the scale.

0 - 20	The value can be chosen freely within the specified limits.
--------	---

The "Decimal Places" attribute can be made dynamic with the name "RightComma".

3.11.1.9 Zero Point (ZeroPoint)

Zero Point (ZeroPoint)

The "Zero Point" attribute specifies for the representation of the bar in which position the zero point value is displayed. The value is specified relative to the spacing of the scale end values in %. For a value of 0 %, for example, the zero point value is shown at the height of the large tick mark with the lowest value. The zero point can also be outside of the range represented.

The "Zero Point" attribute is only evaluated if the "Bar Scaling" attribute has the value "Automatic". The absolute value for the zero point is set with the "Zero Point Value" attribute in the "Miscellaneous" property group.

There is a free choice of value.

The "Zero Point" attribute can be made dynamic with the name "ZeroPoint".

3.11.1.10 Only Large Tick Marks (LongStrokesOnly)

Only Large Tick Marks (LongStrokesOnly)

The "Only Large Tick Marks" attribute specifies for the "Bar" object whether the sections between the large tick marks in the scale of the bar are divided by shorter tick marks.

The length of the large tick marks is specified with the "Large Tick Marks Length" attribute. The length of the shorter tick marks corresponds to half of the value specified here.

Yes	In the scale of the bar, only large tick marks are displayed.
No	In the scale of the bar, the sections between the large tick marks are divided by shorter tick marks.

The "Only Large Tick Marks" attribute can be made dynamic with the name "LongStrokesOnly".

3.11.1.11 Scale (Scaling)

Scale (Scaling)

The "Scale" attribute specifies for the "Bar" object whether the bar is labeled with a scale.

Yes	The bar is displayed with a scale.
No	The bar is displayed without a scale.

The "Scale" attribute can be made dynamic with the name "Scaling".

3.11.1.12 Scale Marks (ScaleTicks)

Scale Marks (ScaleTicks)

The "Scale Marks" attribute specifies for the "Bar" object the number of segments into which the bar is divided by the large tick marks of the scale.

0 - 100	The "Bar" object can be divided into a maximum of 100 segments.
= 0	The optimum number of segments is set automatically.

The "Scale Marks" attribute can be made dynamic with the name "ScaleTicks".

3.11.1.13 Digits to the Left of the Decimal Point (LeftComma)

Digits to the Left of the Decimal Point (LeftComma)

The "Digits to the Left of the Decimal Point" attribute specifies for the "Bar" object the number of digits before the decimal point for the display of numerical values in the scale.

0 - 20	The value can be chosen freely within the specified limits.
--------	---

The "Digits to the Left of the Decimal Point" attribute can be made dynamic with the name "LeftComma".

3.11.2 "Output / Input" Property Group

3.11.2.1 Number of Visible Lines (NumberLines)

Number of Visible Lines (NumberLines)

The "Number of Visible Lines" attribute specifies the number of lines displayed in the selection list of a text list. If the amount of configured text is larger than this value, the selection list receives a vertical scroll bar in Runtime.

There is a free choice of value.

The "Number of Visible Characters" attribute can be made dynamic with the name "NumberLines".

3.11.2.2 Output Format (OutputFormat)

Output Format (OutputFormat)

The "Output Format" attribute specifies the format for the display of an output value in the I/O field. The available format definitions depend on the value of the "Data Format" attribute.

The following data formats are available for the input and output of values in an I/O field:

- Numerical values can be processed in binary, decimal, or hexadecimal format.
- For the display of text, assign the "String" data format.
- For the "Date/Time" or "Date/Time (local)" data format, the date and/or time as well as the time span can be displayed in milliseconds.

The "Output Format" can be dynamized using the "OutputFormat" name.

3.11.2.3 Output Value (OutputValue)

Output Value (OutputValue)

The "Output Value" attribute specifies a start value for the output which is displayed in Runtime in the case of a missing process driver connection or if an update has not yet taken place.

It must be possible to display the output value with the format specifications specified with the "Output Format" attribute. If this is not the case, three asterisks are displayed instead of the output value.

There is a free choice of value.

The "Output Value" attribute can be made dynamic with the name "OutputValue".

3.11.2.4 Bit Number (BitNumber)

Bit Number (BitNumber)

The "Bit Number" attribute specifies the number of the relevant bit in the output value.

0 - 31	The value can be chosen freely within the specified limits.
--------	---

The "Bit Number" attribute can be made dynamic with the name "BitNumber".

3.11.2.5 Data Format (DataFormat)

Data Format (DataFormat)

The "Data Format" attribute defines the data type for a value to be displayed.

Six data formats are available for the input and output of values in an I/O field:

- Numerical values: Binary, decimal and hexadecimal format
- "String": Display of text
- "Date/time": Date and/or time or time span, dependent on "Output format" attribute
"Date/time (local)" takes into account the local time zone of the respective client or server.
UTC is converted to the local time zone.

It must be possible to display the output value with the format specified by means of "Output Format" attribute. If this is not the case, three asterisks are displayed instead of the output value.

The "Data Format" attribute cannot be made dynamic.

3.11.2.6 Input value

Input value

The "Input value" attribute defines the value to be entered in the I/O field by the user. The value is not displayed in the I/O field when the property is set.

If you want the value to be displayed in the I/O field after confirmation with the <Return> key, configure a direct connection between the properties "input value" and "output value". The direct connection is only practical when no tag is connected to the output value, but the user can nevertheless query the specified value, for example, through a script.

The "Input value" attribute can be made dynamic with the name "InputValue".

3.11.2.7 Field Type (BoxType)

Field Type (BoxType)

The "Field Type" attribute defines the application area for I/O fields or fields of a text list.

Input	The field is only used for the input of values.
Edition	The field is only used for the output of values.
Input/Output	The field can be used for the input and output of values.

The "Field Type" attribute can be made dynamic with the name "BoxType".

3.11.2.8 List Type (ListType)

List Type (ListType)

The "List Type" attribute defines the data type for the "Text List" object.

Depending on the selected list type, a distinction is made in the specification of display texts for test lists defined with the "Assignment" attribute.

Decimal	Display texts are assigned to specific value ranges.
Binary	Display texts are assigned to bit numbers.
Bit	Display texts are assigned to the states "1 - bit set" and "0 - bit not set".

If you use a configured text list with the "Text list" property, the object property is grayed out.

The "List Type" attribute cannot be made dynamic.

3.11.2.9 Clear on Invalid Input (ClearOnError)

Clear on Invalid Input (ClearOnError)

3.11 Object properties

The "Clear on Invalid Input" attribute can be used to prevent adoption of an incorrect input value when the field is left. An input value is bad, for example, when it does not correspond to the predefined data format of the input field.

Yes	An incorrect input value is deleted automatically on leaving the field.
No	An incorrect input value is not deleted automatically on leaving the field.

The "Clear on Invalid Input" attribute can be made dynamic with the name "ClearOnError".

3.11.2.10 Clear on New Input (ClearOnNew)

Clear on New Input (ClearOnNew)

The "Clear on New Input" attribute specifies whether the current field contents are automatically deleted when an input field is selected.

Yes	The field contents are deleted automatically when the field is selected.
No	The field contents not are deleted automatically when the field is selected.

The "Clear on New Input" attribute can be made dynamic with the name "ClearOnNew".

3.11.2.11 Selected Boxes (Process)

Selected Boxes (Process)

The "Selected Boxes" attribute sets which fields in a check box are to be shown as enabled. Each field is represented by a bit in a 32-bit word. In order to activate a field, the corresponding bit must have the value "1". The 32-bit word contains the information for all fields of the check box. The value of the "Selected Boxes" attribute is specified in hexadecimals.

The "Selected Boxes" attribute can be made dynamic with the name "Process".

3.11.2.12 Selected Box (Process)

Selected Box (Process)

The "Selected Box" attribute sets which option field in an option group is displayed as activated. Each field is represented by a bit in a 32-bit word. In order to activate a field, the corresponding bit must have the value "1". The 32-bit word contains the information for all fields of the check box. The value of the "Selected Box" attribute is specified in hexadecimals.

The "Selected Box" attribute can be made dynamic with the name "Process".

3.11.2.13 Sorting of the text list (TextListSort)

Sorting of the text list

When you use a text list from the "Text and Graphic List" editor, you can specify the sorting of texts for the WinCC object.

Value	Sort	Description
0	None	Original sorting of the text list in the "Text and Graphic List" editor
1	Value	Increasing in number according to configured value/range
2	Text	Alphabetically from A to Z according to configured text The setting depends on the language.

The attribute is only available for the "Text list" smart object. When no configured text list is linked in the object, the object property is grayed out.

The "Sorting of the text list" attribute can be made dynamic with the name "TextListSort".

3.11.2.14 Text list (Textlist)

Text list (Textlist)

You use the text list for the assignment of texts to specific values when configuring the following objects:

- Smart objects: Combo box, list box, text list
- Windows objects: Check box, radio box

Double-click the attribute and select the name of a text list that you have created in the "Text and Graphics Lists" editor.

To remove the link to the text list, double-click in the "Static" column and delete the name of the text list.

The display texts of the configured text list are then displayed in runtime in an input list and/or output list.

The "Text list" attribute can be made dynamic with the name "Textlist".

3.11.2.15 Apply on Exit (AssumeOnExit)

Apply on Exit (AssumeOnExit)

The "Apply on Exit" attribute can be used to activate application of a value if the user leaves the I/O field or the text list without prior confirmation or before the required number of characters is reached.

The "Apply on Exit" attribute has no effect if the "Apply on Full" attribute has the value "Yes" in the I/O field.

Yes	The field contents are accepted automatically when the field is selected.
No	The input value is only accepted when the input is confirmed by the ENTER (return) key.

The "Apply on Exit" attribute can be made dynamic with the name "AssumeOnExit".

3.11.2.16 Apply on Complete Input (AssumeOnFull)

Apply on Complete Input (AssumeOnFull)

The "Apply on Complete Input" attribute specifies when an input value is applied.

Yes	The input value is automatically applied as soon as the preset number of characters has been entered.
No	The entered value is only applied when the input is confirmed by the ENTER (return) key

The "Apply on Complete Input" attribute can be made dynamic with the name "AssumeOnFull".

3.11.2.17 Hidden Input (HiddenInput)

Hidden Input (HiddenInput)

The "Hidden Input" attribute specifies whether the input value is displayed during input as normal or encrypted.

Yes	Each entered character is replaced in the display with the "*" character. The value entered and the data format of the value cannot be recognized.
No	Each entered character is displayed as normal.

The "Hidden Input" attribute can be made dynamic with the name "HiddenInput".

3.11.2.18 Assignments (Assignments)

Assignments (Assignments)

Specification of display texts that are displayed depending on the current "Output Value" in the text list.

The display text must not include a semicolon ";". The semicolon is a WinCC control character and is therefore automatically deleted in a text. To use texts with semicolon, configure a text list in the "Text and graphic lists" editor.

The type of assignment depends on the selected "List Type".

List Type Decimal

- Display texts are assigned to values or value ranges.
 - Single value: Assignment to a single value
 - From value / to value: The text applies to all values greater than/equal to or less than/equal to the specified value.
 - From - to value: The text applies to all values of the value range.
- The maximum value range corresponds to a signed 32-bit value. Values that exceed "2 147 483 647" are not accepted.

List Type Binary

- Display texts are assigned to bit numbers. Up to 32 display texts can be defined.
- If a bit set in the output value is not assigned a display text, three asterisks appear in the list box.

List Type Bit

- A display text applies to the states of the bit that is set in the output value:
 - 1 - bit set
 - 0 - bit not set

If you use a configured text list with the "Text list" property, the "Assignments" property is grayed out.

The "Assignments" attribute cannot be made dynamic.

3.11.3 "Picture" Property Group

3.11.3.1 Picture (PictureName)

Picture (PictureName)

The "Picture" attribute specifies which picture is displayed in a graphic object or SVG object. Picture can be inserted in the graphic object in the following formats: BMP, DIB, ICO, CUR, EMF, WMF, GIF and JPG.

If no picture that you want to display is defined for a graphic object / SVG object, the symbol for the object is shown as a placeholder.

The graphic object /SVG object should be the same size as the selected picture; otherwise, its display is distorted.

In order to cancel an existing assignment, the "Cancel Selection" button must be clicked in the "Picture Selection" dialog.

The "Picture" attribute can be made dynamic with the name "PictureName".

3.11.3.2 Picture Referenced (PicReferenced)

Picture Referenced (PicReferenced)

The "Picture Referenced" attribute specifies whether the picture itself or only the reference in the form of a cross-reference to the picture is integrated.

Yes	Only the reference of the picture is integrated and saved.
No	The picture itself is integrated and saved.

The "Picture Referenced" attribute cannot be made dynamic.

3.11.3.3 Picture Transparent Color (PicTransparentColor)

Picture Transparent Color (PicTransparentColor)

3.11 Object properties

The "Picture Transparent Color" attribute specifies the transparent color of the picture to be displayed. A transparent color can only be displayed for pictures with the formats "BMP", "DIB" and "SVG". The "Picture Transparent Color On" attribute must have the value "Yes".

The "Picture Transparent Color" attribute can be assigned dynamic properties by means of the name "PicTransparentColor".

3.11.3.4 Picture Transparent Color On (PicUseTransparentColor)

Picture Transparent Color On (PicUseTransparentColor)

The "Picture Transparent Color On" attribute specifies whether the "Transparent Color" function is to be used for the picture to be displayed. A transparent color can only be displayed for pictures with the formats "BMP", "DIB" and "SVG".

Yes	The "Picture Transparent Color On" attribute is enabled.
No	The "Picture Transparent Color On" attribute is disabled.

The "Picture Transparent Color On" attribute can be assigned dynamic properties by means of the name "PicUseTransparentColor".

3.11.3.5 Keep aspect ratio

Keep aspect ratio

Specifies if the ratio is kept for the picture in a graphic object.

The attribute cannot be dynamized.

3.11.4 "Pictures" Property Group

3.11.4.1 Picture Off Referenced (PicUpReferenced)

Picture Off Referenced (PicUpReferenced)

The "Round button" object can have three different states: "On", "Off" or "Deactivated".

For each status, a picture to be displayed can be selected. The attributes "Picture Off Referenced", "Picture On Referenced" and "Picture Deact. Referenced" determine for the various states whether the pictures or only references to the pictures are integrated.

Yes	Only the reference of the picture is integrated and saved.
No	The picture itself is integrated and saved.

The "Picture Off Referenced" attribute cannot be made dynamic.

3.11.4.2 Picture Off Transparent Color (PicUpTransparent)

Picture Off Transparent Color (PicUpTransparent)

The "Picture Off Transparent Color" attribute specifies the transparent color of the picture to be displayed in "Off" state. Transparent colors can only be displayed for pictures in BMP or DIB format.

The "Picture Off Transparent Color On" attribute must have the value "Yes".

The "Picture Off Transparent Color" attribute can be assigned dynamic properties by means of the name "PicUpTransparent".

3.11.4.3 Picture Off Transparent Color On (PicUpUseTransColor)

Picture Off Transparent Color On (PicUpUseTransColor)

The "Picture Off Transparent Color On" attribute specifies whether the "Transparent Color" function is to be used for the picture to be displayed in "Off" state. Transparent colors can only be displayed for pictures in BMP or DIB format.

Yes	The "Picture Off Transparent Color On" attribute is enabled.
No	The "Picture Off Transparent Color On" attribute is disabled.

The "Picture Off Transparent Color On" attribute can be assigned dynamic properties by means of the name "PicUpUseTransColor".

3.11.4.4 Picture Deact. Referenced (PicDeactReferenced)

Picture Deact. Referenced (PicDeactReferenced)

The "Round button" object can have three different states: "On", "Off" or "Deactivated".

For each status, a picture to be displayed can be selected. The attributes "Picture Off Referenced", "Picture On Referenced" and "Picture Deact. Referenced" determine for the various states whether the pictures or only references to the pictures are integrated.

Yes	Only the reference of the picture is integrated and saved.
No	The picture itself is integrated and saved.

The "Picture Deact. Referenced" cannot be made dynamic.

3.11.4.5 Picture Deact. Transparent Color (PicDeactTransparent)

Picture Deact. Transparent Color (PicDeactTransparent)

The "Picture Deact. Transparent Color" specifies the transparent color for the picture to be displayed in "Deactivated" state. Transparent colors can only be displayed for pictures in BMP or DIB format.

The "Picture Deact. Transparent Color On" attribute must have the value "Yes".

The "Picture Deact. Transparent Color" attribute can be assigned dynamic properties by means of the name "PicDeactTransparent".

3.11.4.6 Picture Deact. Transparent Color On (PicDeactUseTransColor)

Picture Deact. Transparent Color On (PicDeactUseTransColor)

3.11 Object properties

The "Picture Deact. Transparent Color On" attribute specifies whether the "Transparent Color" function is to be used for the picture to be displayed in "Deactivated" state. Transparent colors can only be displayed for pictures in BMP or DIB format.

Yes	The "Picture Deact. Transparent Color On" attribute is enabled.
No	The "Picture Deact. Transparent Color On" attribute is disabled.

The "Picture Deact. Transparent Color On" attribute can be assigned dynamic properties by means of the name "PicDeactUseTransColor".

3.11.4.7 Picture On Referenced (PicDownReferenced)

Picture On Referenced (PicDownReferenced)

The "Round button" object can have three different states: "On", "Off" or "Deactivated".

For each status, a picture to be displayed can be selected. The attributes "Picture Off Referenced", "Picture On Referenced" and "Picture Deact. Referenced" determine for the various states whether the pictures or only references to the pictures are integrated.

Yes	Only the reference of the picture is integrated and saved.
No	The picture itself is integrated and saved.

The "Picture On Referenced" attribute cannot be made dynamic.

3.11.4.8 Picture On Transparent Color (PicDownTransparent)

Picture On Transparent Color (PicDownTransparent)

The "Picture On Transparent Color" attribute specifies the transparent color of the picture to be displayed in "On" state. Transparent colors can only be displayed for pictures in BMP or DIB format.

The "Picture On Transparent Color On" attribute must have the value "Yes".

The "Picture On Transparent Color" attribute can be assigned dynamic properties by means of the name "PicDownTransparent".

3.11.4.9 Picture On Transparent Color On (PicDownUseTransColor)

Picture On Transparent Color On (PicDownUseTransColor)

The "Picture On Transparent Color On" attribute specifies whether the "Transparent Color" function is to be used for the picture to be displayed in "On" state. Transparent colors can only be displayed for pictures in BMP or DIB format.

Yes	The "Picture On Transparent Color On" attribute is enabled.
No	The "Picture On Transparent Color On" attribute is disabled.

The "Picture On Transparent Color On" attribute can be assigned dynamic properties by means of the name "PicDownUseTransColor".

3.11.4.10 Picture Status Off (PictureUp)**Picture Status Off (PictureUp)**

A round button can have one of three statuses: "On", "Off" or "Deactivated".

For each status, a picture to be displayed can be selected. Pictures with the following formats can be inserted: BMP, DIB, ICO, CUR, EMF, WMF, GIF and JPG.

In order to cancel an existing assignment, the "Cancel Selection" button must be clicked in the "Picture Selection" dialog.

The "Picture Status Off" attribute can be made dynamic with the name "PictureUp".

3.11.4.11 Picture Status Deactivated (PictureDeactivated)**Picture Status Deactivated (PictureDeactivated)**

A round button can have one of three statuses: "On", "Off" or "Deactivated".

For each status, a picture to be displayed can be selected. Pictures with the following formats can be inserted: BMP, DIB, ICO, CUR, EMF, WMF, GIF and JPG.

The "Picture Status Deactivated" attribute can be made dynamic with the name "PictureDeactivated".

In order to cancel an existing assignment, the "Cancel Selection" button must be clicked in the "Picture Selection" dialog.

3.11.4.12 Picture Status On (PictureDown)**Picture Status On (PictureDown)**

A round button can have one of three statuses: "On", "Off" or "Deactivated".

For each status, a picture to be displayed can be selected. Pictures with the following formats can be inserted: BMP, DIB, ICO, CUR, EMF, WMF, GIF and JPG.

The "Picture Status On" attribute can be made dynamic with the name "PictureDown".

In order to cancel an existing assignment, the "Cancel Selection" button must be clicked in the "Picture Selection" dialog.

3.11.4.13 X picture alignment (PictAlignment)**Picture Alignment**

The "Picture alignment" attribute defines the position and scaling of the picture placed on the button or round button.

centered	The picture is positioned, centered in the original proportions.
Left justified	The picture is positioned with original proportions, with left justification on the left side of the button.
Right justified	The picture is positioned with original proportions, with right justification on the right side of the button.
Stretched	The picture is scaled to a square and is adapted to the size of the button.

The attribute "Picture alignment" can be made dynamic with the name "PictAlignment".

3.11.5 "Flashing" Property Group

3.11.5.1 Flashing (EnableFlashing)

Flashing (EnableFlashing)

The "Flashing" attribute shows whether the value for status "OK" and "Simulation" appears flashing or not in the extended analog display in Runtime.

So that the flashing is visible in Runtime, the font flashing color must be different to the background flashing color.

Yes	Flashing for status "OK" and "Simulation" in Runtime is enabled.
No	Flashing for status "OK" and "Simulation" in Runtime is disabled.

The "Flashing" attribute can be made dynamic with the name "EnableFlashing".

3.11.5.2 Flashing Background Active (FlashBackColor)

Flashing Background Active (FlashBackColor)

The "Flashing Background Active" attribute specifies whether in Runtime a background is to appear as flashing or not.

To make the flashing visible in Runtime, the flashing color of the status "On" must differ from the flashing color of the status "Off". In order to set flashing for a button or slider, the "Windows Style" attribute must be set to "No".

Yes	The background of the object flashes in Runtime.
No	The background of the object does not flash in Runtime.

The "Flashing Background Active" attribute can be made dynamic with the name "FlashBackColor".

3.11.5.3 Flashing Line Active (FlashBorderColor)

Flashing Line Active (FlashBorderColor)

The "Flashing Line Active" attribute specifies whether in Runtime a line is to appear as flashing or not.

To make the flashing visible in Runtime, the flashing color of the status "On" must differ from the flashing color of the status "Off". In order to activate flashing, the "Global color scheme" attribute must be set to "No" - except with Design WinCC Classic.

Yes	The line of the object flashes in Runtime.
No	The line of the object does not flash in Runtime.

The "Flashing Line Active" attribute can be made dynamic with the name "FlashBorderColor".

3.11.5.4 Flashing Border Active (FlashBorderColor)

Flashing Border Active (FlashBorderColor)

The "Flashing Border Active" attribute specifies whether in Runtime a border is to appear as flashing or not.

To make the flashing visible in Runtime, the flashing color of the status "On" must differ from the flashing color of the status "Off".

Yes	The border of the object flashes in Runtime.
No	The border of the object does not flash in Runtime.

The "Flashing Border Active" attribute can be made dynamic with the name "FlashBorderColor".

3.11.5.5 Flashing Text Active (FlashForeColor)

Flashing Text Active (FlashForeColor)

The "Flashing Text Active" attribute specifies whether in Runtime a text is to appear as flashing or not.

To make the flashing visible in Runtime, the flashing color of the status "On" must differ from the flashing color of the status "Off". In order to activate flashing, the "Global color scheme" attribute must be set to "No" - except with Design WinCC Classic.

Yes	The text in the object flashes in Runtime.
No	The text in the object does not flash in Runtime.

The "Flashing Text Active" attribute can be made dynamic with the name "FlashForeColor".

3.11.5.6 Flash Frequency (FlashRate)

Flash Frequency (FlashRate)

The "Flash Frequency" attribute defines at what speed the messages flash in the group display, the extended status display, and in the extended analog display in Runtime. The frequencies "slow", "medium" and "fast" can be set. The flash frequency depends on the system performance.

To make the flashing visible in Runtime, the flashing color of the status "On" must differ from the flashing color of the status "Off".

Slow	The messages flash slowly in Runtime.
Medium	The messages flash at medium speed in Runtime.
Fast	The messages flash quickly in Runtime.

The "Flash Frequency" attribute can be made dynamic with the name "FlashRate".

3.11.5.7 Background Flash Frequency (FlashRateBackColor)

Background Flash Frequency (FlashRateBackColor)

The "Background Flash Frequency" attribute specifies the speed at which a background flashes in Runtime. The frequencies "slow", "medium" and "fast" can be set. The flash frequency depends on the system performance.

3.11 Object properties

To make the flashing visible in Runtime, the flashing color of the status "On" must differ from the flashing color of the status "Off". In order to set flashing for a button or slider, the "Windows Style" attribute must be set to "No".

Slow	The background of the object flashes slowly in Runtime.
Medium	The background of the object flashes in Runtime at medium rate.
Fast	The background of the object flashes quickly in Runtime.

The "Background Flash Frequency" attribute can be made dynamic with the name "FlashRateBackColor".

3.11.5.8 Line Flash Frequency (FlashRateBorderColor)

Line Flash Frequency (FlashRateBorderColor)

The "Line Flash Frequency" attribute specifies the speed at which a line flashes in Runtime. The frequencies "slow", "medium" and "fast" can be set. The flash frequency depends on the system performance.

To make the flashing visible in Runtime, the flashing color of the status "On" must differ from the flashing color of the status "Off". In order to set flashing for a button or slider, the "Windows Style" attribute must be set to "No".

Slow	The line of the object flashes slowly in Runtime.
Medium	The line of the object flashes in Runtime at medium speed.
Fast	The line of the object flashes quickly in Runtime.

The "Line Flash Frequency" attribute can be made dynamic with the name "FlashRateBorderColor".

3.11.5.9 Border Flash Frequency (FlashRateBorderColor)

Border Flash Frequency (FlashRateBorderColor)

The "Border Flash Frequency" attribute specifies the speed at which a border flashes in Runtime. The frequencies "slow", "medium" and "fast" can be set. The flash frequency depends on the system performance.

To make the flashing visible in Runtime, the flashing color of the status "On" must differ from the flashing color of the status "Off".

Slow	The border of the object flashes slowly in Runtime.
Medium	The border of the object flashes in Runtime at medium speed.
Fast	The border of the object flashes quickly in Runtime.

The "Border Flash Frequency" attribute can be made dynamic with the name "FlashRateBorderColor".

3.11.5.10 Text Flash Frequency (FlashRateForeColor)

Text Flash Frequency (FlashRateForeColor)

The "Text Flash Frequency" attribute specifies the speed at which a text flashes in Runtime. The frequencies "slow", "medium" and "fast" can be set. The flash frequency depends on the system performance.

To make the flashing visible in Runtime, the flashing color of the status "On" must differ from the flashing color of the status "Off".

Slow	The text in an object flashes slowly in Runtime.
Medium	The text in an object flashes in Runtime at medium speed.
Fast	The text in an object flashes quickly in Runtime.

The "Text Flash Frequency" attribute can be made dynamic with the name "FlashRateForeColor".

3.11.5.11 Flashing Background Color Off (BackFlashColorOff)

Flashing Background Color Off (BackFlashColorOff)

The "Flashing Background Color Off" attribute specifies the color a background assumes in flash status "Off". The flashing is only visible in Runtime.

To make the flashing visible in Runtime, the flashing color of the status "On" must differ from the flashing color of the status "Off". In order to activate flashing, the "Global color scheme" attribute must be set to "No" - except with Design WinCC Classic. In order to set flashing for a button or slider object, the "[V6.2] Windows Style" attribute must be set to "No".

Either permanently define the color in the "Color selection" dialog or select an indexed color from the central color palette if a central color palette is defined.

The "Flashing Background Color Off" attribute can be made dynamic with the name "BackFlashColorOff".

3.11.5.12 Flashing Background Color On (BackFlashColorOn)

Flashing Background Color On (BackFlashColorOn)

The "Flashing Background Color On" attribute specifies the color a background assumes in flash status "On". The flashing is only visible in Runtime.

To make the flashing visible in Runtime, the flashing color of the status "On" must differ from the flashing color of the status "Off". In order to activate flashing, the "Global color scheme" attribute must be set to "No" - except with Design WinCC Classic. In order to set flashing for a button or slider object, the "[V6.2] Windows Style" attribute must be set to "No".

Either permanently define the color in the "Color selection" dialog or select an indexed color from the central color palette if a central color palette is defined.

The "Flashing Background Color On" attribute can be made dynamic with the name "BackFlashColorOn".

3.11.5.13 Flashing Line Color Off (BorderFlashColorOff)

Flashing Line Color Off (BorderFlashColorOff)

3.11 Object properties

The "Flashing Line Color Off" attribute specifies the color a line assumes in flash status "Off". The flashing is only visible in Runtime.

To make the flashing visible in Runtime, the flashing color of the status "On" must differ from the flashing color of the status "Off". In order to activate flashing, the "Global color scheme" attribute must be set to "No" - except with Design WinCC Classic.

Either permanently define the color in the "Color selection" dialog or select an indexed color from the central color palette if a central color palette is defined.

The "Flashing Line Color Off" attribute can be made dynamic with the name "BorderFlashColorOff".

3.11.5.14 Flashing Line Color On (BorderFlashColorOn)

Flashing Line Color On (BorderFlashColorOn)

The "Flashing Line Color On" attribute specifies the color a line assumes in flash status "On". The flashing is only visible in Runtime.

To make the flashing visible in Runtime, the flashing color of the status "On" must differ from the flashing color of the status "Off". In order to activate flashing, the "Global color scheme" attribute must be set to "No" - except with Design WinCC Classic.

Either permanently define the color in the "Color selection" dialog or select an indexed color from the central color palette if a central color palette is defined.

The "Flashing Line Color On" attribute can be made dynamic with the name "BorderFlashColorOn".

3.11.5.15 Flashing Border Color Off (BorderFlashColorOff)

Flashing Border Color Off (BorderFlashColorOff)

The "Flashing Border Color Off" attribute specifies the color a border assumes in flash status "Off". The flashing is only visible in Runtime.

To make the flashing visible in Runtime, the flashing color of the status "On" must differ from the flashing color of the status "Off".

Either permanently define the color in the "Color selection" dialog or select an indexed color from the central color palette if a central color palette is defined.

The "Flashing Border Color Off" attribute can be made dynamic with the name "BorderFlashColorOff".

3.11.5.16 Flashing Border Color On (BorderFlashColorOn)

Flashing Border Color On (BorderFlashColorOn)

The "Flashing Border Color On" attribute specifies the color a border assumes in flash status "On". The flashing is only visible in Runtime.

To make the flashing visible in Runtime, the flashing color of the status "On" must differ from the flashing color of the status "Off".

Either permanently define the color in the "Color selection" dialog or select an indexed color from the central color palette if a central color palette is defined.

The "Flashing Border Color On" attribute can be made dynamic with the name "BorderFlashColorOn".

3.11.5.17 Flashing Text Color Off (ForeFlashColorOff)

Flashing Text Color Off (ForeFlashColorOff)

The "Flashing Text Color Off" attribute specifies the color a text assumes in flash status "Off". The flashing is only visible in Runtime.

To make the flashing visible in Runtime, the flashing color of the status "On" must differ from the flashing color of the status "Off". In order to activate flashing, the "Global color scheme" attribute must be set to "No" - except with Design WinCC Classic. In order to set flashing for a button or slider object, the "[V6.2] Windows Style" attribute must be set to "No".

Either permanently define the color in the "Color selection" dialog or select an indexed color from the central color palette if a central color palette is defined.

The "Flashing Text Color Off" attribute can be made dynamic with the name "ForeFlashColorOff".

3.11.5.18 Flashing Text Color On (ForeFlashColorOn)

Flash Text Color On (ForeFlashColorOn)

The "Flashing Text Color On" attribute specifies the color a text assumes in flash status "On". The flashing is only visible in Runtime.

To make the flashing visible in Runtime, the flashing color of the status "On" must differ from the flashing color of the status "Off". In order to activate flashing, the "Global color scheme" attribute must be set to "No" - except with Design WinCC Classic. In order to set flashing for a button or slider object, the "[V6.2] Windows Style" attribute must be set to "No".

Either permanently define the color in the "Color selection" dialog or select an indexed color from the central color palette if a central color palette is defined.

The "Flashing Text Color On" attribute can be made dynamic with the name "ForeFlashColorOn".

3.11.6 The property group "Control Properties"

3.11.6.1 A

Activate property

Activate

3.11 Object properties

The data to be displayed in the message window are only requested from the message server if you set this attribute. Instead of setting this attribute, it is advisable to change the value dynamically in order to reduce picture activation times.

To differentiate the "Activate" property from the "Activate" method, the property is addressed via "Object".

Example

```
Dim ctrlSet  
ctrl = ScreenItems("Control")  
ctrl.Object.activate = true
```

The attribute can be assigned dynamic properties by means of the name **Activate** . The data type is BOOLEAN.

AllServer property

All servers - AllServer

Selects all servers whose packages were loaded and on which "Alarm Logging Runtime" is activated in the startup list.

Value	Explanation
TRUE	All servers are activated.
FALSE	Activates only the servers entered in "Server selection".

The attribute can be assigned dynamic properties by means of the name **AllServer**. The data type is BOOLEAN.

Appearance property

Appearance

Specifies the appearance of the table in WinCC UserAdminControl.

Value	Explanation
0	The table is displayed normally.
1	The table is displayed in button style.

The attribute can be assigned dynamic properties using the name **Appearance**. The data type is SHORT.

ApplyProjectSettings property

Apply project settings - ApplyProjectSettings

Activates the project settings derived from "Alarm Logging".

Value	Explanation
TRUE	The "Apply project settings" check box is selected. The message blocks configured in "Alarm Logging" and their properties are activated in AlarmControl. The message blocks are displayed with these properties in the message window.
FALSE	The "Apply project settings" check box is deactivated. You can add or remove message blocks, or edit their properties.

The attribute can be assigned dynamic properties by means of the name **ApplyProjectSettings**. The data type is BOOLEAN.

ArchiveName property

Name - ArchiveName

Specifies the user archive or view to be displayed. Open the "Package Browser" dialog for configuring an archive or a view by clicking the button.

The attribute can be assigned dynamic properties by means of the name **ArchiveName**. The data type is STRING.

ArchiveType property

Type - ArchiveType

Specifies whether the selected user archive is an archive or a view. The field cannot be edited.

The attribute can be assigned dynamic properties by means of the name **ArchiveType**. The data type is LONG.

AspectRatio property

AspectRatio

Specifies if the aspect ratio is kept in movies.

The attribute can be assigned dynamic properties by means of the name **AspectRatio**. The data type is BOOLEAN.

Stretch

Stretch

Specifies the stretch for the icon.

Value	Explanation
TRUE	The screen content is set to fit the object size of the selected icon.
FALSE	The screen content is not set to fit the object size of the selected icon.

The attribute can be assigned dynamic properties by means of the name **Stretch**. The data type is BOOLEAN.

AutoCompleteColumns property

Show empty columns - AutoCompleteColumns

Adds empty columns if the Control width is greater than the width of columns configured.

Value	Explanation
TRUE	Enables the display of empty columns.
FALSE	Disables the display of empty columns.

The attribute can be assigned dynamic properties by means of the name **AutoCompleteColumns**. The data type is BOOLEAN.

AutoCompleteRows property

Show empty rows - AutoCompleteRows

Enables the insertion of empty rows if the Control length is greater than the number of rows configured.

Value	Explanation
TRUE	Enables the display of empty rows.
FALSE	Disables the display of empty rows.

The attribute can be assigned dynamic properties by means of the name **AutoCompleteRows**. The data type is BOOLEAN.

AutoPosition property

Automatic positioning - AutoPosition

Defines whether to position the RulerControl exactly below the source control.

The following settings are available:

Value	Explanation
TRUE	The RulerControl is positioned exactly below the source control.
FALSE	The RulerControl is displayed in accordance with your configuration of the control position.

The attribute can be assigned dynamic properties by means of the name **AutoPosition**. The data type is BOOLEAN.

AutoScroll property

Auto scrolling - AutoScroll

Defines the behavior of the message window after a new message events.

You can only select message lines if "Auto scrolling" is disabled.

Value	Explanation
TRUE	If "AutoScroll" is activated, a new activated message is appended to the list displayed in the message window and selected automatically. The visible area of the message window is shifted as required.
FALSE	New message events are not selected if "Autoscroll" is disabled. The visible area of the message window is not changed.

The attribute can be assigned dynamic properties by means of the name **AutoScroll**. The data type is BOOLEAN.

AutoSelectionColors property

Automatic selection coloring - AutoSelectionColor

Enables the display of default system colors as selection color for cells and rows.

Value	Explanation
TRUE	The system colors are in use.
FALSE	The custom colors are used.

The attribute can be assigned dynamic properties by means of the name **AutoSelectionColors**. The data type is BOOLEAN.

AutoSelectionRectColor property

Automatic color assignment - AutoSelectionRectColor

Defines a system color for the selection border.

Value	Explanation
TRUE	The system color is in use.
FALSE	The custom color is used.

3.11 Object properties

The attribute can be assigned dynamic properties by means of the name **AutoSelectionRectColors**. The data type is BOOLEAN.

AutoShow property

Show/hide automatically - AutoShow

Enables/disables automatic activation of the RulerControl on the display if you selected the button functions for the ruler, statistics range and for statistics in the source control.

The RulerControl is hidden again if you are no longer using the ruler, statistics range and statistics functions.

Value	Explanation
TRUE	The RulerControl is displayed automatically.
FALSE	The RulerControl is not displayed automatically.

The attribute can be assigned dynamic properties by means of the name **AutoShow**. The data type is BOOLEAN.

Autostart property

Autostart

Specifies if movies are started automatically.

The attribute can be assigned dynamic properties by means of the name **Autostart**. The data type is BOOLEAN.

3.11.6.2 B

BackColor property

Background - BackColor

Specifies the background color of the control. The button opens the "Color selection" dialog.

The attribute can be assigned dynamic properties by means of the name **BackColor**. The data type is LONG.

Bar

BarAdd property

New - BarAdd

Creates a new diagram.

The attribute can be assigned dynamic properties using the name **BarAdd**. The data type is STRING.

BarBarGradientColor property

Fill pattern color – BarFillPatternColor

The "Fill Pattern Color" attribute defines the color of the pattern that is displayed on a filled area.

The attribute can be assigned dynamic properties by means of the name BarFillPatternColor. The data type is LONG.

BarBarGradientPattern property

Fill pattern - BarBarGradientPattern

The "Fill Pattern" attribute specifies the pattern for the display of bars.

So that the fill pattern becomes visible, the color of the fill pattern must differ from the background color.

49 fill patterns are available for selection:

- Fill pattern 1 "Solid" fills the object with the set background color.
- Fill pattern 2 "Transparent" means neither a background nor a fill pattern is displayed.

The attribute can be assigned dynamic properties using the name **BarBarGradientPattern**. The data type is LONG.

BarBarWindow property

Diagram window - BarBarWindow

Specifies the diagram window in which the selected diagram will be displayed. You specify the available diagram windows on the "Diagram window" tab.

The attribute can be assigned dynamic properties using the name **BarWindow**. The data type is STRING.

BarColor property

Border color - BarColor

Indicates the border color of the bar. Use the button to open the "Color selection" dialog to select the color.

The attribute can be assigned dynamic properties using the name **BarColor**. The data type is LONG.

BarCount property

BarCount

Specifies the number of configured diagrams.

The attribute can be assigned dynamic properties using the name **BarCount**. The data type is LONG.

BarFillColor property

Bar color - BarFillColor

Indicates the fill color of the bars. For the "Bars with value" diagram type, the text background color is specified.

Use the button to open the "Color selection" dialog to select the color.

The attribute can be assigned dynamic properties using the name **BarFillColor**. The data type is LONG.

BarIndex property

BarIndex

References a configured diagram. Using this attribute, you can assign the values of other attributes to a specific diagram. The index must always be set before you change the properties of a diagram in Runtime.

Valid values for "BarIndex" are between 0 and "BarCount" minus 1. The "BarCount" attribute specifies the number of configured diagrams.

The "BarIndex" attribute can be assigned dynamic properties using the attribute **BarRepos**. The data type is LONG.

BarLabel property

Label - BarLabel

Specifies the label of the selected diagram. The label is displayed in Runtime when the "UseBarNameAsLabel" attribute has the value "FALSE".

The attribute can be assigned dynamic properties using the name **BarLabel**. The data type is STRING.

BarLineStyle property

Border style - BarLineStyle

Specifies which border type is used to represent the border of the bar.

The following settings are available:

Value	Description	Explanation
0	Solid	The border is displayed as a solid border.
1	Dashed	The border is displayed as a dashed border.
2	Dotted	The border is displayed as a dotted line.
3	Dash dot	The border is displayed as a dash-dot line.
4	Dash-dot-dot	The border is displayed as a dash-dot-dot line.

The attribute can be assigned dynamic properties using the name **BarLineStyle**. The data type is LONG.

BarChartType property

Diagram type - BarChartType

Specifies how the diagram will be displayed.

The following settings are available:

Value	Description	Explanation
0	Bar diagram	A diagram with bars will be displayed.
1	Bars with value	In addition to the bars, the values will be displayed in the diagram. The display of values conforms to the configuration of the "Alignment" property and the write direction of the bars.

The attribute can be assigned dynamic properties using the name **BarChartType**. The data type is LONG.

BarLineWidth property

Border width - BarLineWidth

Specifies the border width of the bar.

The attribute can be assigned dynamic properties using the name **BarLineWidth**. The data type is LONG.

BarLowerLimit property

BarLowerLimit

Specifies the low limit of a tag. If the tag value is less than "BarLowerLimit", the values are designated with the color set in "BarLowerLimitColor". This setting is enabled when the "BarLowerLimitColoring" attribute has the value "TRUE".

The attribute can be assigned dynamic properties using the name **BarLowerLimit**. The data type is DOUBLE.

BarLowerLimitColor property

BarLowerLimitColor

Specifies the color for designating tag values below the value at "BarLowerLimit". The setting is enabled when the "BarLowerLimitColoring" attribute has the value "TRUE".

The attribute can be assigned dynamic properties using the name **BarLowerLimitColor**. The data type is LONG.

BarLowerLimitColoring property

BarLowerLimitColoring

Specifies whether the "BarLowerLimitColor" attribute is used for designating tag values that are lower than the value at "BarLowerLimit".

Value	Explanation
TRUE	The "BarLowerLimitColor" attribute is enabled.
FALSE	The "BarLowerLimitColor" attribute is disabled.

The attribute can be assigned dynamic properties using the name **BarLowerLimitColoring**. The data type is BOOLEAN.

BarName property**Object name - BarName**

Specifies the name of the selected diagram.

The "BarName" attribute can be assigned dynamic properties using the attribute **BarRename**.

BarProvider property**Data source - BarProvider**

Specifies the data source of the selected diagram.

The following settings are available:

Value	Description	Explanation
0	None	No data source configured to create a connection in Runtime by means of a script.
1	Archive tags	Data source with archive tags of a process value archive.

The attribute can be assigned dynamic properties using the name **BarProvider**.

BarProviderCLSID property**BarProviderCLSID**

Displays the data source of the selected diagram.

Value	Explanation
	No data source configured to create a connection in Runtime by means of a script.
{416A09D2-8B5A-11D2-8B81-006097A45D48}	Data source with archive tags of a process value archive.

The attribute can be assigned dynamic properties using the name **BarProviderCLSID**. The data type is STRING.

BarRemove property**Remove - BarRemove**

Removes the selected diagram from the list.

The attribute can be assigned dynamic properties using the name **BarRemove**. The data type is STRING.

BarRename property

BarRename

Renames the diagram that is referenced using the "BarIndex" attribute.

The attribute can be assigned dynamic properties using the name **BarRename**. You can use "BarRename" to also assign dynamic properties to the "BarName" attribute. The data type is STRING.

BarRepos property

Up/down - BarRepos

Changes the order of the selected diagrams in the diagram window. "Up" and "Down" move the selected diagrams up and down in the list. As a result, the diagram is displayed further in the foreground or background in runtime.

The attribute can be assigned dynamic properties using the name **BarRepos**. The data type is LONG.

BarSelectTagName property

BarSelectTagName

Opens a dialog for selecting the tag name for the data source of the diagram. Programmers can set this attribute to allow users to select a tag name using a button, for example.

The attribute can be assigned dynamic properties using the name **BarSelectTagName**. The data type is BOOLEAN.

BarTagName property

Tag name - BarTagName

Displays the tag name of the connected tag. With the button you open a dialog for selecting an archive tag.

The attribute can be assigned dynamic properties using the name **BarTagName**. The data type is STRING.

BarTimeAxis property

Time axis - BarTimeAxis

Specifies which time axis will be used for the selected diagram. You specify the available time axes on the "Time axes" tab.

The attribute can be assigned dynamic properties using the name **BarTimeAxis**. The data type is STRING.

BarUncertainColor property

BarUncertainColor

Values have an uncertain status if the initial value is unknown when Runtime starts or if a substitute value is used. You can use the "BarUncertainColor" attribute to specify the color used for identifying these values. The "BarUncertainColoring" attribute determines whether or not this setting is evaluated.

The attribute can be assigned dynamic properties using the name **BarUncertainColor**. The data type is LONG.

BarUncertainColoring property

BarUncertainColoring

Values have an uncertain status if the initial value is unknown when Runtime starts or if a substitute value is used. You can use the "BarUncertainColoring" attribute to enable identification of such values based on the color set in "BarUncertainColor".

Value	Explanation
TRUE	The setting for the "BarUncertainColor" attribute is enabled.
FALSE	The setting for the " BarUncertainColor " attribute is disabled.

The attribute can be assigned dynamic properties using the name **BarUncertainColoring**. The data type is BOOLEAN.

BarUpperLimitColoring property

BarUpperLimitColoring

Specifies whether the "BarUpperLimitColor" attribute is used for designating tag values that are higher than the value at "BarUpperLimit".

Value	Explanation
TRUE	The setting for the "BarUpperLimitColor" attribute is enabled.
FALSE	The setting for the "BarUpperLimitColor" attribute is disabled.

The attribute can be assigned dynamic properties using the name **BarUpperLimitColoring**. The data type is BOOLEAN.

BarUpperLimitColor property

BarUpperLimitColor

Specifies the color for designating tag values above the value at "BarUpperLimit". The setting is enabled when the "BarUpperLimitColoring" attribute has the value "TRUE" hat.

The attribute can be assigned dynamic properties using the name **BarUpperLimitColor**. The data type is LONG.

BarUpperLimit property

BarUpperLimit

Specifies the high limit of a tag. If the tag value is higher than "BarUpperLimit", the values are designated with the color set in "BarUpperLimitColor". This setting is enabled when the "BarUpperLimitColoring" attribute has the value "TRUE".

The attribute can be assigned dynamic properties using the name **BarUpperLimit**. The data type is DOUBLE.

BarValueAlignment property

Alignment - BarValueAlignment

Specifies the alignment of the displayed values for the "Bars with value" diagram type.

The following settings are available depending on the write direction of the bars:

- The write direction of bars is "From the right" or "From the left"

Value	Description	Explanation
0	Bottom	The values are displayed at the bottom of the diagram window.
1	Centered	The values are displayed at the center of the diagram window.
2	Top	The values are displayed at the top of the diagram window.

- The write direction of bars is "From the top" or "From the bottom"

Value	Description	Explanation
0	Left	The values are displayed at the left of the diagram window.
1	Centered	The values are displayed at the center of the diagram window.
2	Right	The values are displayed at the right of the diagram window.

The attribute can be assigned dynamic properties using the name **BarValueAlignment**. The data type is LONG.

BarValueAxis property

Value axis - BarValueAxis

Specifies which value axis will be used for the selected diagram. You specify the available value axes on the "Value axes" tab.

The attribute can be assigned dynamic properties using the name **BarValueAxis**. The data type is STRING.

BarValueUnit property

Unit - BarValueUnit

Specifies a unit of the values that will be appended to the value to be displayed for the "Bars with value" diagram type. e.g. "%" or "°C"

The attribute can be assigned dynamic properties using the name **BarValueUnit**. The data type is STRING.

BarVisible property

Diagram - BarVisible

The list shows the diagrams you have created.

Select the diagrams in the list that you want to display in the diagram windows.

Click on a diagram in the list to adapt the properties and to assign axes and diagram windows to the diagram.

The attribute can be assigned dynamic properties using the name **BarVisible**. The data type is BOOLEAN.

BarWindowAdd property

New - BarWindowAdd

Creates a new diagram window.

The attribute can be assigned dynamic properties using the name **BarWindowAdd**. The data type is STRING.

BarWindowCoarseGrid property

Main scaling - BarWindowCoarseGrid

Enables the display of grid lines for the main scale.

Value	Explanation
TRUE	Enables the display of grid lines for the main scale.
FALSE	Disables the display of grid lines for the main scale.

The attribute can be assigned dynamic properties using the name **BarWindowCoarseGrid**. The data type is BOOLEAN.

BarWindowCoarseGridColor property

Color main scale - BarWindowCoarseGridColor

Specifies the color of the grid lines for the main scale. Use the button to open the "Color selection" dialog to select the color.

The attribute can be assigned dynamic properties using the name **BarWindowCoarseGridColor**. The data type is LONG.

BarWindowCount property

BarWindowCount

Specifies the number of configured diagrams.

The attribute can be assigned dynamic properties using the name **BarWindowCount**. The data type is LONG.

BarWindowFineGrid property

Secondary scaling - BarWindowFineGrid

Specifies whether the grid lines are displayed for the secondary scale.

Value	Explanation
TRUE	Enables the display of grid lines for the secondary scale.
FALSE	Disables the display of grid lines for the secondary scale.

The attribute can be assigned dynamic properties using the name **BarWindowFineGrid**. The data type is BOOLEAN.

BarWindowFineGridColor property**Color secondary scale - BarWindowFineGridColor**

Specifies the color of the grid lines for the secondary scale. Use the button to open the "Color selection" dialog to select the color.

The attribute can be assigned dynamic properties using the name **BarWindowFineGridColor**. The data type is LONG.

BarWindowForegroundBarGrid property**For foreground diagram only - BarWindowForegroundBarGrid**

Specifies whether the grid lines for the foreground diagram only will be displayed in the selected diagram window.

Value	Explanation
TRUE	The grid lines for the foreground diagram are displayed in the diagram window.
FALSE	The grid lines for all diagrams are displayed in the diagram window.

The attribute can be assigned dynamic properties using the name **BarWindowForegroundBarGrid**. The data type is BOOLEAN.

BarWindowGapWidth property**Gap width - BarWindowGapWidth**

Specifies the gap between two bars of a bar diagram in % of the bar width.

The attribute can be assigned dynamic properties using the name **BarWindowGapWidth**. The data type is LONG.

BarWindowGridInBarColor property**In diagram color - BarWindowGridInBarColor**

Specifies whether the grid lines for the main scaling will be displayed in the color of the bars.

Value	Explanation
TRUE	The grid lines are displayed in the color of the bars.
FALSE	The grid lines are displayed with the color set in the "Color" field.

The attribute can be assigned dynamic properties using the name **BarWindowGridInBarColor**. The data type is BOOLEAN.

BarWindowHorizontalGrid property

For value axes - BarWindowHorizontalGrid

Enables the display of horizontal grid lines for value axes.

Value	Explanation
TRUE	Display of horizontal grids for value axes is enabled.
FALSE	Display of horizontal grid lines for value axes is disabled.

The attribute can be assigned dynamic properties using the name **BarWindowHorizontalGrid**.

BarWindowIndex property

BarWindowIndex

References a configured diagram. Using this attribute, you can assign the values of other attributes to a specific diagram.

Valid values for "BarWindowIndex" are between 0 and "BarWindowCount" minus 1. The "BarWindowCount" attribute specifies the number of configured diagrams.

The "BarWindowIndex" attribute can be assigned dynamic properties using the attribute **BarWindowRepos**. The data type is LONG.

BarWindowName property

Object name - BarWindowName

Specifies the name of the selected diagram window.

The "BarWindowName" attribute can be assigned dynamic properties using the attribute **BarWindowRename**. The data type is STRING.

BarWindowRemove property

Remove - BarWindowRemove

Removes the selected diagram window from the list.

The attribute can be assigned dynamic properties using the name **BarWindowRemove**. The data type is STRING.

BarWindowRename property

BarWindowRename

Renames the diagram window, which is referenced using the "BarWindowIndex" attribute.

The attribute can be assigned dynamic properties using the name **BarWindowRename**. You can use "BarWindowRename" to also assign dynamic properties to the "BarWindowName" attribute. The data type is STRING.

BarWindowRepos property

Up/down - BarWindowRepos

Changes the order of the diagram windows. "Up" and "Down" move the selected diagram windows up and down in the list.

The order in the list determines the position in the Control. The first diagram window is displayed at the bottommost position, the last diagram window is displayed at the topmost position.

The attribute can be assigned dynamic properties using the name **BarWindowRepos**. The data type is LONG.

BarWindowSeriesOverlap property

Overlap - BarWindowBarOverlap

Specifies the overlap of various bars of a time instant in % of the bar width.

The attribute can be assigned dynamic properties using the name **BarWindowBarOverlap**. The data type is LONG.

BarWindowSpacePortion property

Proportional area - BarWindowSpacePortion

Specifies the portion of the selected diagram window for the display in the control.

The attribute can be assigned dynamic properties using the name **BarWindowSpacePortion**. The data type is LONG.

BarWindowVerticalGrid property

For time axes- BarWindowVerticalGrid

Enables the display of vertical grid lines for time axes.

Value	Explanation
TRUE	Display of vertical grid lines for time axes is enabled.
FALSE	Display of vertical grid lines for time axes is disabled.

The attribute can be assigned dynamic properties using the name **BarWindowVerticalGrid**.

BarWindowVisible property

Diagram window - BarWindowVisible

The list shows the diagram windows you have created.

Select the diagram windows in the list that you want to display in the control.

Click on an entry in the list to adapt the properties of the bar display and the grid lines.

The attribute can be assigned dynamic properties using the name **BarWindowVisible**. The data type is BOOLEAN.

BarChartAlignment property

Alignment - BarChartAlignment

Specifies the alignment of the bar in the diagram.

The following settings are available depending on the write direction of the bars:

- The write direction of bars is "From the right" or "From the left"

Value	Description	Explanation
0	Left	The bars are shown left justified on the graph.
1	Centered	The bars are centered in the graph.
2	Right	The bars are shown right justified on the graph.

- The write direction of bars is "From the top" or "From the bottom"

Value	Description	Explanation
0	Top	The bars are shown at the top of the graph.
1	Centered	The bars are centered in the graph.
2	Bottom	The bars are shown at the bottom of the graph.

The attribute can be dynamized with the **BarChartAlignment** name. The data type is LONG.

Flash Color (BlinkColor)

Flash Color (BlinkColor)

Specifies the icon color in flashing state by means of "Color selection" dialog.

The attribute can be assigned dynamic properties by means of the name **BlinkColor**. The data type is LONG.

Flash rate (BlinkSpeed)

Flash rate (BlinkSpeed)

Specifies the length of the icon flash interval in Runtime.

The following settings are available:

Value	Description	Comments
250	Fast	Flash interval of 250 ms.
500	Medium	Flash interval of 500 ms.
1000	Slow	Flash interval of 1000 ms.

The attribute can be assigned dynamic properties by means of the name **BlinkSpeed**. You can also use other values. The data type is LONG.

Flash mode (BlinkMode)

Flash mode (BlinkMode)

Specifies the flash mode of the icon in runtime.

The following settings are available:

Value	Description	Comments
0	No flashing	The icon does not flash.
1	Hidden	The icon flashes in the background color.
2	Shadow	The icon flashes with shading in the foreground color.
3	Solid	The icon flashes in the foreground color.

The attribute can be assigned dynamic properties by means of the name **BlinkMode**. The data type is LONG.

BlockAlign property

Block alignment - BlockAlign

Defines the mode of aligning the caption of blocks in column headers.

The following settings are available:

Value	Description	Explanation
0	left	The block caption is left justified.
1	centered	The block caption is aligned to center.
2	right	The block caption is right justified.

The attribute can be assigned dynamic properties by means of the name **BlockAlign**. The data type is LONG.

BlockAutoPrecisions property

Decimal places automatic - BlockAutoPrecisions

Enables automatic setting of the decimal precision.

Value	Explanation
TRUE	The decimal precision is defined automatically. The value in the "Decimal places" field is disabled.
FALSE	The value in the "Decimal places" field is enabled.

The attribute can be assigned dynamic properties by means of the name **BlockAutoPrecisions**. The data type is BOOLEAN.

BlockCaption property

Caption - BlockCaption

Defines the caption of the column header in the control for the selected message block.

The caption is active in all Runtime languages.

The attribute can be assigned dynamic properties by means of the name **BlockCaption**. The data type is STRING.

BlockCount property

BlockCount

Specifies the number of blocks to be made available as columns for the control.

The attribute can be assigned dynamic properties by means of the name **BlockCount**. The data type is LONG.

BlockDateFormat property

Date format - BlockDateFormat

Defines the date format for visualization.

The following date formats are available:

Value	Explanation
Automatic	The date format is set automatically.
dd.MM.yy	Day.Month.Year, e.g. 24.12.07.
dd.MM.yyyy	Day.Month.Year, e.g. 24.12.2007.
dd/MM/yy	Day/Month/Year, e.g. 24/12/07.
dd/MM/yyyy	Day/Month/Year, e.g. 24/12/2007.

The attribute can be assigned dynamic properties by means of the name **BlockDateFormat**. The data type is STRING.

BlockDurationTimeFormat

BlockDurationTimeFormat

Defines which duration format will be used for the display in the block.

To change the setting, the option "Take from source" must be deactivated or "BlockUseSourceFormat" must be set to "FALSE".

The following time duration formats are available:

Value	Explanation
Automatic	The time duration format is determined automatically.
d H:mm:ss	Day Hours:Minutes:Seconds Example: 1 2:03:55
H:mm:ss.	Hours:Minutes:Seconds Example: 26:03:55
m:ss	Minutes:Seconds Example: 1563:55
s	Seconds Example: 93835
d H:mm:ss.ms	Day Hours:Minutes:Seconds.Milliseconds Example: 1 2:03:55.150
H:mm:ss.ms	Hours:Minutes:Seconds.Milliseconds Example: 26:03:55.150
m:ss.ms	Minutes:Seconds.Milliseconds Example: 1563:55.150
s.ms	Seconds.Milliseconds Example: 2.150

The attribute can be assigned dynamic properties by means of the name **BlockDurationTimeFormat**. The data type is STRING.

BlockExponentialFormat property

Exponential notation - BlockExponentialFormat

Specifies exponential notation for the display of values of a selected block.

Value	Explanation
TRUE	The values are displayed with exponential notation.
FALSE	The values are displayed with decimal notation.

The attribute can be assigned dynamic properties by means of the name **BlockExponentialFormat**. The data type is BOOLEAN.

BlockHideText property

Content as text - BlockHideText

Enables the textual display of the content of a selected block.

Value	Explanation
TRUE	The content is not displayed in text format. The option is disabled.
FALSE	The content is displayed in text format. The option is enabled.

The attribute can be assigned dynamic properties by means of the name **BlockHideText**. The data type is BOOLEAN.

BlockHideTitleText property

Title as text - BlockHideTitleText

Enables the display of the header of a selected block in text format.

Value	Explanation
TRUE	The header is not displayed in text format. The option is disabled.
FALSE	The header is displayed in text format. The option is enabled.

The attribute can be assigned dynamic properties by means of the name **BlockHideTitleText**. The data type is BOOLEAN.

BlockId property

BlockId

Default assignment of the ID number and of the block in WinCC RulerControl:

Value	Description
0	No block
1	Name
2	Index
3	Designation
4	Display
5	Tag name Y
6	Tag name X
7	Y value
8	X value/time stamp
9	Y value (LL)
10	Time stamp (LL)
11	Y value (UL)
12	Time stamp (UL)

Value	Description
13	Minimum
14	Minimum - Time stamp
15	Maximum
16	Maximum - Time stamp
17	Average
18	Standard deviation
19	Integral
20	Weighted mean value
21	Duration
22	Number of values

The attribute can be assigned dynamic properties by means of the name **BlockID**. The data type is LONG.

BlockIndex property

BlockIndex

References a block. Using this attribute you can assign the values of other attributes to a specific block.

Values between 0 and "BlockCount" minus 1 are valid for "BlockIndex". Attribute "BlockCount" defines the number of available blocks.

The attribute can be assigned dynamic properties by means of the name **BlockIndex**. The data type is LONG.

BlockLength property

Length in characters - BlockLength

Specifies the column width for a selected block.

The attribute can be assigned dynamic properties by means of the name **BlockLength**. The data type is LONG.

BlockName property

Object name - BlockName

Displays the name of the block selected. You cannot edit this name.

The attribute can be assigned dynamic properties by means of the name **BlockName**. The data type is STRING.

BlockPrecisions property

Decimal places - BlockPrecisions

Specifies the number of decimal places of the values in the selected column. You can only enter the value if the "Automatic" option is disabled.

The attribute can be assigned dynamic properties by means of the name **BlockPrecisions**. The data type is SHORT.

BlockShowDate property

Display date - BlockShowDate

Specifies if the "Time" block is displayed with time and date in a field.

Value	Explanation
TRUE	The date and time are displayed. The date format is defined in the "Date format" field.
FALSE	The time is displayed.

The attribute can be assigned dynamic properties by means of the name **BlockShowDate**. The data type is BOOLEAN.

BlockShowIcon property

Content as icon - BlockShowIcon

Enables the display of the content of a selected block as icon. This function is only available in WinCC Alarm Control.

Value	Explanation
TRUE	The content is visualized as icon.
FALSE	The content is not visualized as icon.

The attribute can be assigned dynamic properties by means of the name **BlockShowIcon**. The data type is BOOLEAN.

BlockShowTitleIcon property

Title as icon - BlockShowTitleIcon

Enables the display of the header of a selected block as icon. This function is only available in WinCC Alarm Control.

Value	Explanation
TRUE	The header is displayed as icon.
FALSE	The header is not displayed as icon.

The attribute can be assigned dynamic properties by means of the name **BlockShowTitleIcon**. The data type is BOOLEAN.

BlockTimeFormat property

Time format - BlockTimeFormat

Defines the time format to be used for visualization.

The following time formats are available:

Value	Explanation
Automatic	The time format is set automatically.
HH:mm:ss.ms	Hours:Minutes:Seconds, e.g. 15:35:44.240.
hh:mm:ss tt	Hours:Minutes:Seconds AM/PM, e.g. 03:35:44 PM.
hh:mm:ss.ms tt	Hours:Minutes:Seconds.Milliseconds AM/PM, e.g. 03:35:44.240 PM.

The attribute can be assigned dynamic properties by means of the name **BlockTimeFormat**. The data type is STRING.

BlockUseSourceFormat property

Use source format - BlockUseSourceFormat

Specifies that the format is inherited from the interconnected control. Here the size of the control, the zoom factor and the value range are taken into consideration to display the optimal number of decimal places.

Value	Explanation
TRUE	The formats are derived from the interconnected control.
FALSE	The formats configured in Ruler Control are used, for example, the display of a precisely specified number of decimal places.

The attribute can be assigned dynamic properties by means of the name **BlockUseSouceFormat**. The data type is BOOLEAN.

BorderColor property

Border color - BorderColor

Specifies the border color. The button opens the "Color selection" dialog.

The attribute can be assigned dynamic properties by means of the name **BorderColor**. The data type is LONG.

BorderWidth property

Border width - BorderWidth

Specifies the line weight of the border in pixels.

The attribute can be assigned dynamic properties by means of the name **BorderWidth**. The data type is LONG.

3.11.6.3 C

Caption property

Text - Caption

Defines the text of the window caption.

The attribute can be assigned dynamic properties by means of the name **Caption**. The data type is STRING.

CellCut property

Shorten contents - CellCut

Shortens cell contents if the cell width is insufficient.

Value	Explanation
TRUE	Enables shortening of cell contents.
FALSE	Disables shortening of cell contents.

The attribute can be assigned dynamic properties by means of the name **CellCut**. The data type is BOOLEAN.

CellSpaceBottom property

CellSpaceBottom

Defines the bottom margin of the table cells.

The attribute can be assigned dynamic properties by means of the name **CellSpaceBottom**. The data type is LONG.

CellSpaceLeft property

CellSpaceLeft

Defines the left indent of the table cells.

The attribute can be assigned dynamic properties by means of the name **CellSpaceLeft**. The data type is LONG.

CellSpaceRight property**CellSpaceRight**

Defines the right indent of the table cells.

The attribute can be assigned dynamic properties by means of the name **CellSpaceRight** . The data type is LONG.

CellSpaceTop property**CellSpaceTop**

Defines the top margin of the table cells.

The attribute can be assigned dynamic properties by means of the name **CellSpaceTop** . The data type is LONG.

Closeable property**Closeable**

Defines whether the control can be closed in Runtime.

Value	Explanation
TRUE	The control can be closed in Runtime.
FALSE	The control cannot be closed in Runtime.

The attribute can be assigned dynamic properties by means of the name **Closeable**. The data type is BOOLEAN.

Column**ColumnAdd property****Apply - ColumnAdd**

Copies the selected column from the list of existing columns to the list of selected columns.

The attribute can be assigned dynamic properties by means of the name **ColumnAdd**. The data type is STRING.

ColumnAlias property

ColumnAlias

Defines the alias specified in the user archive for the column name.

The attribute can be assigned dynamic properties by means of the name **ColumnAlias**. The data type is STRING.

ColumnAlign property

Alignment - ColumnAlign

Specifies the mode of alignment of a selected column.

The following settings are available:

Value	Description	Explanation
0	left	The selected column is aligned left.
1	centered	The selected column is aligned to center.
2	right	The selected column is aligned right.

The attribute can be assigned dynamic properties by means of the name **ColumnAlign**. The data type is LONG.

ColumnAutoPrecisions property

Decimal places automatic - ColumnAutoPrecisions

Enables automatic setting of the decimal precision.

Value	Explanation
TRUE	The decimal precision is defined automatically. The value in the "Decimal places" field is disabled.
FALSE	The value in the "Decimal places" field is enabled.

The attribute can be assigned dynamic properties by means of the name **ColumnAutoPrecisions**. The data type is BOOLEAN.

ColumnCaption property

Caption - ColumnCaption

Sets the caption for a selected column.

The attribute can be assigned dynamic properties by means of the name **ColumnCaption**. The data type is STRING.

ColumnCount property

ColumnCount

Defines the number of columns configured.

The attribute can be assigned dynamic properties by means of the name **ColumnCount**. The data type is LONG.

ColumnDateFormat property

Date format - ColumnDateFormat

Defines the date format for visualization.

The following date formats are available:

Value	Explanation
Automatic	The date format is set automatically.
dd.MM.yy	Day.Month.Year, e.g. 24.12.07.
dd.MM.yyyy	Day.Month.Year, e.g. 24.12.2007.
dd/MM/yy	Day/Month/Year, e.g. 24/12/07.
dd/MM/yyyy	Day/Month/Year, e.g. 24/12/2007.

The attribute can be assigned dynamic properties by means of the name **ColumnDateFormat**. The data type is STRING.

ColumnDMVarName property

ColumnDMVarName

Defines the name of the tag you assigned to the column in the user archive.

The attribute can be assigned dynamic properties by means of the name **ColumnDMVarName**. The data type is STRING.

ColumnExponentialFormat property

Exponential notation - ColumnExponentialFormat

Sets exponential notation for the display of values of a selected column.

Value	Explanation
TRUE	The values are displayed with exponential notation.
FALSE	The values are displayed with decimal notation.

The attribute can be assigned dynamic properties by means of the name **ColumnExponentialFormat**. The data type is BOOLEAN.

ColumnFlagNotNull property

ColumnFlagNotNull

Specifies whether the user archive field assigned to the column must have a value.

Value	Explanation
Yes	The column must have a value.
No	The column can have a value.

The attribute cannot be dynamized.

ColumnFlagUnique property

ColumnFlagUnique

Specifies whether the user archive field assigned to the column must have a unique value. Values in this column must not be redundant.

Value	Explanation
TRUE	The column must have a unique value.
FALSE	The column must not have a unique value.

The attribute cannot be dynamized.

ColumnHideText property

Content as text - ColumnHideText

Defines textual display of the contents of a selected column.

Value	Explanation
TRUE	The content is not displayed in text format. The option is disabled.
FALSE	The content is displayed in text format. The option is enabled.

The attribute can be assigned dynamic properties by means of the name **ColumnHideText**. The data type is BOOLEAN.

ColumnHideTitleText property

Text header - ColumnHideTitleText

Sets textual display of the header of a selected column.

Value	Explanation
TRUE	The header is not displayed in text format. The option is disabled.
FALSE	The header is displayed in text format. The option is enabled.

The attribute can be assigned dynamic properties by means of the name **ColumnHideTitleText**. The data type is BOOLEAN.

ColumnId property

ColumnId

Default assignment of the ID number and column in the WinCC control:

The attribute can be assigned dynamic properties by means of the name **ColumnId**. The data type is LONG.

ColumnIndex property

ColumnIndex

References a control column. Using this attribute you can assign the values of other properties to a specific column.

Values between 0 and "ColumnCount" minus 1 are valid for "ColumnIndex"; the attribute "ColumnCount" defines the number of available columns.

The "ColumnIndex" attribute can be assigned dynamic properties by means of attribute **ColumnIndex**. The data type is LONG.

ColumnInspectorView property

ColumnInspectorView

Specifies whether the diagnostic data in the detail view are displayed in columns instead of rows.

The attribute can be assigned dynamic properties using the name **ColumnInspectorView**. The data type is BOOLEAN.

ColumnLeadingZeros property

With leading zeros - ColumnLeadingZeros

Enables the display of values with leading zeros for the column selected. Use "Number of digits" or "ColumnLeadingZeros" to specify the number of leading zeros. The maximum number is "11". No leading zeros are displayed with the value "0". The "With leading zeros" option is deactivated.

The attribute can be assigned dynamic properties by means of the name **ColumnLeadingZeros**. The data type is LONG.

ColumnLength property

Length in Characters - ColumnLength

Specifies the width of a selected column.

The attribute can be assigned dynamic properties by means of the name **ColumnLength**. The data type is LONG.

ColumnMaxValue property

ColumnMaxValue

Defines the maximum column value specified in the user archive.

The attribute can be assigned dynamic properties by means of the name **ColumnMaxValue**. The data type is STRING.

ColumnMinValue property

ColumnMinValue

Defines the minimum column value specified in the user archive.

The attribute can be assigned dynamic properties by means of the name **ColumnMinValue**. The data type is STRING.

ColumnName property

ColumnName

Defines the name of the column which is referenced by means of "ColumnIndex" attribute.

The attribute can be assigned dynamic properties by means of the name **ColumnName**. The data type is STRING.

ColumnPosition property

ColumnPosition

Displays the field position defined in the user archive.

The attribute can be assigned dynamic properties by means of the name **ColumnPosition**. The data type is LONG.

ColumnPrecisions property

Decimal places - ColumnPrecisions

Specifies the number of decimal places of the values in the selected column. You can only enter the value if the "Automatic" option is disabled.

The attribute can be assigned dynamic properties by means of the name **ColumnPrecisions**. The data type is SHORT.

ColumnReadAccess property

ColumnReadAccess

Defines authorizations for read access to the column as specified in the user archive. The number corresponds with the number assigned to the authorization in the "User Administrator" editor.

The attribute cannot be dynamized.

ColumnReadonly property

Write protected - ColumnReadonly

Sets the write protection of a selected column.

Value	Explanation
TRUE	This column is write protected.
FALSE	This column is not write protected. You can edit the column values in Runtime by activating the "Change" option in the General" tab.

The attribute can be assigned dynamic properties by means of the name **ColumnReadonly**. The data type is BOOLEAN.

ColumnRemove property

Remove - ColumnRemove

Cuts selected columns from the list of selected columns and pastes these to the list of available columns.

The attribute can be assigned dynamic properties by means of the name **ColumnRemove**. The data type is STRING.

ColumnRepos property

Up/Down - ColumnRepos

Changes the order of columns. "Up" and "Down" move the column selected up or down in the list. This moves the column towards the front or towards the back.

The attribute can be assigned dynamic properties by means of the name **ColumnRepos**. The data type is LONG.

ColumnResize property

Width can be resized - ColumnResize

Enables changes to the width of columns.

Value	Explanation
TRUE	You can change the width of the columns.
FALSE	You cannot change the width of the columns.

The attribute can be assigned dynamic properties by means of the name **ColumnResize**. The data type is BOOLEAN.

ColumnScrollbar property

Column scroll bars - ColumnScrollbar

Enables the display of column scroll bars.

The following settings are available:

Value	Description	Explanation
0	No	Column scroll bars are not displayed.
1	as required	Column scroll bars are displayed if vertical space requirements of the control are greater than the actually available display area.
2	always	Column scroll bars are always displayed.

The attribute can be assigned dynamic properties by means of the name **ColumnScrollbar**. The data type is LONG.

ColumnShowDate property

Display date - ColumnShowDate

Specifies if the "Time" block is displayed with time and date in a field.

Value	Explanation
TRUE	The date and time are displayed. The date format is defined in the "Date format" field.
FALSE	The time is displayed.

The attribute can be assigned dynamic properties by means of the name **ColumnShowDate**. The data type is BOOLEAN.

ColumnShowIcon property

Content as icon - ColumnShowIcon

Enables the display the contents of a selected column by means of icon. This function is only available in WinCC Alarm Control.

Value	Explanation
TRUE	The content is visualized as icon.
FALSE	The content is not visualized as icon.

The attribute can be assigned dynamic properties by means of the name **ColumnShowIcon**. The data type is BOOLEAN.

ColumnShowTitleIcon property

Header as icon - ColumnShowTitleIcon

Specifies the display of the header of a selected column by means of icon. This function is only available in WinCC Alarm Control.

Value	Explanation
TRUE	The header is displayed as icon.
FALSE	The header is not displayed as icon.

The attribute can be assigned dynamic properties by means of the name **ColumnShowTitleIcon**. The data type is BOOLEAN.

ColumnsMoveable property

ColumnsMoveable

Specifies whether the user can move the columns of the control in runtime.

The attribute can be assigned dynamic properties using the name **ColumnsMoveable**. The data type is BOOLEAN.

ColumnSort property

ColumnSort

Defines the sorting order of the user archive column referenced in the "ColumnIndex" attribute.

The following settings are available:

Value	Description	Explanation
0	No	No sorting
1	Ascending	Ascending order, starting at the lowest value.
2	Descending	Descending order, starting at the highest value.

The attribute can be assigned dynamic properties by means of the name **ColumnSort** . The data type is LONG.

ColumnSortIndex property

ColumnSortIndex

Defines the sorting order of the column referenced in "ColumnIndex". The sorting criterion is removed from "ColumnSort" if you set a "0" value..

The attribute can be assigned dynamic properties by means of the name **ColumnSortIndex**. The data type is LONG.

ColumnStartValue property

ColumnStartValue

Defines the column start value specified in the user archive.

The attribute can be assigned dynamic properties by means of the name **ColumnStartValue**. The data type is STRING.

ColumnStringLength property

ColumnStringLength

Displays the string length of the column as defined in the user archive.

The attribute can be assigned dynamic properties by means of the name **ColumnStringLength**. The data type is LONG.

ColumnTimeFormat property

Time format - ColumnTimeFormat

Defines the time format to be used for visualization.

The following time formats are available:

Value	Explanation
Automatic	The time format is set automatically.
HH:mm:ss.ms	Hours:Minutes:Seconds, e.g. 15:35:44.240.
hh:mm:ss tt	Hours:Minutes:Seconds AM/PM, e.g. 03:35:44 PM.
hh:mm:ss.ms tt	Hours:Minutes:Seconds.Milliseconds AM/PM, e.g. 03:35:44.240 PM.

The attribute can be assigned dynamic properties by means of the name **ColumnTimeFormat**. The data type is STRING.

ColumnTitleAlign property

Column title alignment - ColumnTitleAlign

Specifies the type of column title alignment.

The following settings are available:

Value	Description	Explanation
0	left	The column titles are left justified.
1	centered	The column titles are centered.
2	right	The column titles are right justified.
3	Same as table content	The column titles are justified to fit the corresponding column content.

The attribute can be assigned dynamic properties by means of the name **ColumnTitleAlign**. The data type is LONG.

ColumnTitles property

Show column title - ColumnTitles

Enables the display of the column header.

Value	Explanation
TRUE	The column header is displayed.
FALSE	The column header is not displayed.

The attribute can be assigned dynamic properties by means of the name **ColumnTitles**. The data type is BOOLEAN.

ColumnType property

Type - ColumnType

Displays the data type set in the user archive for a selected column.

The attribute can be assigned dynamic properties by means of the name **ColumnType**. The data type is LONG.

ColumnType property

ColumnType

Indicates the associated view of the selected column in the SysDiagControl.

The attribute can be assigned dynamic properties using the name **ColumnType**. The data type is LONG.

ColumnVisible property

ColumnVisible

Enables the display of a column referenced by means of "ColumnIndex" attribute.

Value	Explanation
TRUE	The column is displayed.
FALSE	The column is not displayed.

The attribute can be assigned dynamic properties by means of the name **ColumnVisible** . The data type is BOOLEAN.

ColumnWriteAccess property

ColumnWriteAccess

Defines authorizations for write access to the column as specified in the user archive. The number corresponds with the number assigned to the authorization in the "User Administrator" editor.

The attribute cannot be dynamized.

ConnectBarWindows property

Connected diagram window - ConnectBarWindows

Specifies whether the configured diagram windows are connected. You must have configured several diagram windows for this.

The connected diagram windows have the following properties:

- They can have a common X axis.
- They have a scroll bar.
- The zoom functions for a diagram window affect the connected diagram windows.

Value	Description
TRUE	All configured diagram windows are connected.
FALSE	The diagram windows are displayed separately.

The attribute can be assigned dynamic properties using the name **ConnectBarWindows**. The data type is BOOLEAN.

ConnectTrendWindows property

Connect trend windows - ConnectTrendWindows

Enables the connection of trend windows configured. You must have configured several trend windows.

The connected trend windows have the following properties:

- They can have a common X axis.
- They have a scroll bar.
- They have a ruler.
- The zoom functions for a trend window affect the connected trend windows.

Value	Description
TRUE	All trend windows configured are connected.
FALSE	The trend windows are displayed separately.

The attribute can be assigned dynamic properties by means of the name **ConnectTrendWindows**. The data type is BOOLEAN.

3.11.6.4 D

DefaultMsgFilterSQL property

DefaultMsgFilterSQL

Defines an SQL statement for a fixed selection of messages.

The SQL statements of "DefaultMsgFilterSQL" and "MsgFilterSQL" are linked logically by "AND" operation if you define additional custom selections by means of "MsgFilterSQL" attribute.

3.11 Object properties

The attribute can be assigned dynamic properties by means of the name **DefaultMsgFilterSQL**. The data type is STRING.

DefaultSort property

Default sorting order - DefaultSort

Defines the default sorting order in table columns.

The following settings are available:

Value	Description	Explanation
0	Ascending	The list is updated starting with the bottom line.
1	Descending	The list is updated starting with the top line.

The attribute can be assigned dynamic properties by means of the name **DefaultSort**. The data type is LONG.

DefaultSort2 property

DefaultSort2

Use this function to define the sorting method in table columns if not using the default "Date/time/number" sorting order. Instead, you defined a message block in the "DefaultSort2Column" object property to sort the columns based on the "message block/date/time/number" order.

The following settings are available:

Value	Description	Explanation
0	Ascending	The list is updated starting with the bottom line.
1	Descending	The list is updated starting with the top line.

The attribute can be assigned dynamic properties by means of the name **DefaultSort2**. The data type is LONG.

DefaultSort2Column property

DefaultSort2Column

Use this function to define the sorting method in table columns if not using the default "Date/time/number" sorting order.

Define a message block by its object name.

The table columns are now sorted based on the "message block/date/time/number" order.

The attribute can be assigned dynamic properties by means of the name **DefaultSort2Column**. The data type is STRING.

DiagnosticsContext property**DiagnosticsContext**

The attribute is only used internally in conjunction with WinCC SysDiagControl for system diagnostics of an S7-1200/1500 controller.

DisplayOptions property**Show messages - DisplayOptions**

Select the messages to be displayed.

The following selection options are available:

Value	Designation
0	All messages
1	Only displayed messages
2	Only hidden messages

The attribute can be assigned dynamic properties by means of the name **DisplayOptions**. The data type is LONG.

DoubleClickAction property**Action on double-click - DoubleClickAction**

Specifies the action to be executed in Runtime by double-clicking on a message line.

The following settings are available:

Value	Description	Explanation
0	none	No action.
1	Loop-in-alarm	Calls the "Loop-in-alarm" function.
2	Open comments dialog	Calls the "Comments dialog" button function.
3	Open Info text dialog	Calls the "Info text dialog" button function.
4	Column-dependent	The action is determined by the column in which you double-clicked.

The attribute can be assigned dynamic properties by means of the name **DoubleClickAction**. The data type is LONG.

Rotation (Rotation)**Rotation (Rotation)**

Specifies anticlockwise rotation around the icon center.

3.11 Object properties

The following settings are available:

Value	Comments
0	The icon is not rotated.
90	The icon is rotated by 90 degrees.
180	The icon is rotated by 180 degrees.
270	The icon is rotated by 270 degrees.

The attribute can be assigned dynamic properties by means of the name **Rotation**. The data type is LONG.

3.11.6.5 E

EnableDelete property

Delete - EnableDelete

Enables deletion of data from the user archive in Runtime.

Value	Explanation
TRUE	You can delete data from the user archive in Runtime.
FALSE	You cannot delete data from the user archive in Runtime.

The attribute can be assigned dynamic properties by means of the name **EnableDelete**. The data type is BOOLEAN.

EnableEdit property

Modify - EnableEdit

Enables editing of the data displayed during runtime.

Value	Explanation
TRUE	Enables editing of data during runtime.
FALSE	Disables editing of data during runtime.

The attribute can be assigned dynamic properties by means of the name **EnableEdit**. The data type is BOOLEAN.

EnableInsert property

Add - EnableInsert

Enables insertion of data in the user archive in Runtime.

Value	Explanation
TRUE	You can add data to the user archive in Runtime.
FALSE	You cannot add data to the user archive in Runtime.

The attribute can be assigned dynamic properties by means of the name **EnableInsert**. The data type is BOOLEAN.

EnablePopupMenu property

EnablePopupMenu

Specifies if the pop-up menu is enabled in the control.

The attribute can be assigned dynamic properties by means of the name **EnablePopupMenu**. The data type is BOOLEAN.

EnableUserAutoLogout property

Automatic user logout - EnableUserAutoLogout

Specifies for the WinCC UserAdminControl whether the settings in the User Administrator for user logout are inherited from the group or are user-specific.

Value	Name	Explanation
FALSE	Inherit from group	Automatic user logout is inherited from the group.
TRUE	User-specific	The user has his/her own logout.

If you are using the "SIMATIC Logon" option, you will only be able to use automatic logout for the group. The setting will automatically be applied to each user in this group. Automatic logout is deactivated if a user logs on with a chip card.

The attribute can be assigned dynamic properties using the name **EnableUserAutoLogout**. The data type is BOOL.

EnableUserPermissions property

Operator authorizations of the user - EnableUserPermissions

Defines whether user-specific operator authorizations can be configured for WinCC UserAdminControl.

Value	Explanation
FALSE	"Inherit from group" The operating authorizations are always inherited by the group. The "Authorization levels" button is disabled.
TRUE	"User-specific" When the user is created, the user authorizations of the group are transferred. You can change the user's authorizations in the "Authorization levels" window.

The attribute can be assigned dynamic properties using the name **EnableUserPermissions**. The data type is BOOL.

EnableUserWebOptions property

Web options of the user - EnableUserWebOptions

Specifies for the WinCC UserAdminControl whether the settings in the User Administrator for the Web options of the user are inherited from the group or are user-specific.

The settings for the Web options refer to the WinCC options WinCC/WebNavigator, WinCC/DataMonitor and WinCC/WebUX.

Value	Name	Explanation
FALSE	Inherit from group	The settings for the Web options are inherited from the group.
TRUE	User-specific	The user has his/her own settings for the Web options.

The attribute can be assigned dynamic properties using the name **EnableUserWebOptions**. The data type is BOOL.

ExportDirectoryChangeable property

Directory can be changed - ExportDirectoryChangeable

Enables changing of the directory for data export in Runtime.

Value	Explanation
TRUE	The data export directory can be changed in Runtime.
FALSE	The data export directory cannot be changed in Runtime.

The attribute can be assigned dynamic properties by means of the name **ExportDirectoryChangeable**. The data type is BOOLEAN.

ExportDirectoryname property**Directory - ExportDirectoryname**

Defines the directory to which the exported Runtime data is written.

You can select or create the directory using the selection button.

The attribute can be assigned dynamic properties by means of the name **ExportDirectoryname**. The data type is STRING.

ExportFileExtension property**ExportFileExtension**

Defines the extension of the export file.

Only the file name extension "csv" is currently supported.

The attribute can be assigned dynamic properties by means of the name **ExportFileExtension**. The data type is STRING.

ExportFilename property**File name - ExportFilename**

Defines the name of the file which is to receive the exported Runtime data.

The attribute can be assigned dynamic properties by means of the name **ExportFilename**. The data type is STRING.

ExportFilenameChangeable property**File can be renamed - ExportFilenameChangeable**

Enables renaming of the export file in Runtime.

Value	Explanation
TRUE	The export file can be renamed in Runtime.
FALSE	The export file cannot be renamed in Runtime.

The attribute can be assigned dynamic properties by means of the name **ExportFilenameChangeable**. The data type is BOOLEAN.

ExportFormatGuid property

ExportFormatGuid

Default assignment of the ID number and export provider.

The attribute can be assigned dynamic properties by means of the name **ExportFormatGuid**.
The data type is STRING.

ExportFormatName property

Format - ExportFormatName

Defines the export file format.

Only the "csv" file format is currently available for the export.

The attribute can be assigned dynamic properties by means of the name **ExportFormatName**.
The data type is STRING.

ExportParameters property

ExportParameters

Specifies the parameters of the selected format by means of the properties dialog.

The attribute can be assigned dynamic properties by means of the name **ExportParameters**.
The data type is VARIANT.

ExportSelection property

Scope of data export - ExportSelection

Specifies the control's Runtime data to be exported.

The following settings are available:

Value	Description	Explanation
0	all	All Runtime data of the control is exported.
1	Selection	Selected Runtime data of the control is exported.

The attribute can be assigned dynamic properties by means of the name **ExportSelection**. The data type is LONG.

ExportShowDialog property

Show dialog - ExportShowDialog

Enables the display of the export dialog during runtime.

Value	Explanation
TRUE	The dialog is displayed during runtime.
FALSE	The dialog is not displayed during runtime.

The attribute can be assigned dynamic properties by means of the name **ExportShowDialog**. The data type is BOOLEAN.

ExportXML property

ExportXML

Only used internally.

The attribute can be assigned dynamic properties by means of the name **ExportXML**.

3.11.6.6 F

FeatureFullscreen property

FeatureFullscreen

Specifies if the "Full screen" function is available in the control.

The attribute can be assigned dynamic properties by means of the name **FeatureFullscreen**. The data type is BOOLEAN.

FeaturePause property

FeaturePause

Specifies if the "Pause" function is available in the control.

The attribute can be assigned dynamic properties by means of the name **FeaturePause**. The data type is BOOLEAN.

FeaturePlay property

FeaturePlay

Specifies if the "Play" function is available in the control.

3.11 Object properties

The attribute can be assigned dynamic properties by means of the name **FeaturePlay**. The data type is BOOLEAN.

FeatureStepBackward property

FeatureStepBackward

Specifies if the "Step backward" function is available in the control.

The attribute can be assigned dynamic properties by means of the name **FeatureStepBackward**. The data type is BOOLEAN.

FeatureStepForward property

FeatureStepForward

Specifies if the "Step forward" function is available in the control.

The attribute can be assigned dynamic properties by means of the name **FeatureStepForward**. The data type is BOOLEAN.

FeatureStop property

FeatureStop

Specifies if the "Stop" function is available in the control.

The attribute can be assigned dynamic properties by means of the name **FeatureStop**. The data type is BOOLEAN.

FeatureVolume property

FeatureVolume

Specifies if the "Volume" function is available in the control.

The attribute can be assigned dynamic properties by means of the name **FeatureVolume**. The data type is BOOLEAN.

FileName property

FileName

Specifies the file whose content you want to display or play.

The attribute can be assigned dynamic properties by means of the name **FileName**. The data type is STRING.

FilterSQL property

FilterSQL

Defines an SQL statement for a selection of data in the user archive.

The attribute can be assigned dynamic properties by means of the name **FilterSQL**. The data type is STRING.

Font property

Name - Font

Sets the font.

The attribute cannot be dynamized.

3.11.6.7 G

GraphDirection property

Write direction - GraphDirection

Defines the direction of the update of axis values.

Value	Description	Explanation
0	From the right	The updated values are displayed starting at the right in the control.
1	From the left	The updated values are displayed starting at the left in the control.
2	From the top	The updated values are displayed starting at the top in the control.
3	From the bottom	The updated values are displayed starting at the bottom in the control.

If you select for the "From the top" or "From the bottom" setting for the write direction, you must use True-Type fonts within the window. Only this setting ensures legibility of the labeling of the vertical axis.

The attribute can be assigned dynamic properties by means of the name **GraphDirection**. The data type is LONG.

GridLineColor property

Color of the row divider / content - GridLineColor

Defines the color of row/column dividers in table contents. The button opens the "Color selection" dialog.

The attribute can be assigned dynamic properties by means of the name **GridLineColor**. The data type is LONG.

GridLineWidth property

Width of dividers - GridLineWidth

Defines the line weight of the row/column dividers in pixels.

The attribute can be assigned dynamic properties by means of the name **GridLineWidth**. The data type is LONG.

GridVisible property

GridVisible

Specifies whether or not the grid is visible in the table of the WinCC UserAdminControl.

The attribute can be assigned dynamic properties using the name **GridVisible**. The data type is BOOLEAN.

GroupEditMode property

Edit mode groups - GroupEditMode

Specifies which editing options the user has in WinCC UserAdminControl regarding group properties of the User Administrator.

Value	Name	Explanation
0	Read	The user can only read the group properties.
1	Change	The user can change the group properties.
2	Full access	The user can access the group properties without restrictions.

The attribute can be assigned dynamic properties using the name **GroupEditMode**. The data type is LONG.

3.11.6.8 H

HeaderFont property

HeaderFont

Specifies the font of the table header in WinCC UserAdminControl.

The attribute cannot be dynamized.

Background style (BackStyle)

Background style (BackStyle)

Specifies the style of the background.

The following settings are available:

Value	Description	Comments
0	Transparent	The background is transparent.
1	Opaque	The background is displayed in the specified background color.

The attribute can be assigned dynamic properties by means of the name **BackStyle**. The data type is LONG.

Background Color (BackColor)

Background Color (BackColor)

Specifies the icon background color in the "Color selection" dialog. The background color is displayed in "opaque" style.

The attribute can be assigned dynamic properties by means of the name **BackColor**. The data type is LONG.

HitlistColumnAdd property

HitlistColumnAdd

Transfers the selected message block from the list of available message blocks to the list of selected message blocks.

The attribute can be assigned dynamic properties by means of the name **HitlistColumnAdd**. The data type is STRING.

HitlistColumnAutoAdjust property

HitlistColumnAutoAdjust

Automatically optimizes the width of the columns in the hit list in Runtime. If the configured column is not sufficient for the displayed text, the column width is increased.

If the user changes the width of columns in Runtime, the width is only optimized again when the picture is opened again.

The attribute can be assigned dynamic properties using the name **HitlistColumnAutoAdjust**. The data type is BOOLEAN.

HitlistColumnCount property

HitlistColumnCount

Specifies the number of message blocks displayed in the hitlist in Runtime.

The attribute can be assigned dynamic properties by means of the name **HitlistColumnCount** . The data type is LONG.

HitlistColumnIndex property

HitlistColumnIndex

References a message block selected for the hitlist. Using this attribute you can assign the values of other attributes to a specific message block of the hitlist.

Values between 0 and "HitlistColumnCount" minus 1 are valid for "HitlistColumnIndex". Attribute "HitlistColumnCount" defines the number of message blocks selected for the hitlist.

The "HitlistColumnIndex" attribute can be assigned dynamic properties by means of attribute **HitlistColumnRepos**. The data type is LONG.

HitlistColumnName property

HitlistColumnName

Displays the name of the message block of the hitlist which is referenced with attribute "HitlistColumnIndex". You cannot edit this name.

The attribute can be assigned dynamic properties by means of the name **HitlistColumnName** . The data type is STRING.

HitlistColumnRemove property

HitlistColumnRemove

Cuts the marked message block from the list of selected message blocks and pastes it to the list of available message blocks.

The attribute can be assigned dynamic properties by means of the name **HitlistColumnRemove**. The data type is STRING.

HitlistColumnRepos

Up/Down - MessageColumnRepos/HitlistColumnRepos

Resorts the message blocks. The "Up" and "Down" commands move the selected message block accordingly in the list. This moves the message block in Runtime Control towards the front or towards the back.

The attribute for the hitlist can be assigned dynamic properties by means of the name **HitlistColumnRepos** .

The attribute for the message list can be assigned dynamic properties by means of the name **MessageColumnRepos**.

The data type is LONG.

HitlistColumnSort property

HitlistColumnSort

Defines the sorting order of the message block referenced in "HitlistColumnIndex" for the hitlist.

The following settings are available:

Value	Description	Explanation
0	none	No sorting
1	Ascending	Ascending order, starting at the lowest value.
2	Descending	Descending order, starting at the highest value.

The attribute can be assigned dynamic properties by means of the name **HitlistColumnSort** .
The data type is LONG.

HitlistColumnSortIndex property

HitlistColumnSortIndex

Defines the sorting order of the message block referenced in "HitlistColumnIndex" in the hitlist. The sorting criterion is removed from "HitlistColumnSort" if you set a "0" value..

The attribute can be assigned dynamic properties by means of the name **HitlistColumnSortIndex**. The data type is LONG.

HitlistColumnVisible

Selected message blocks - MessageColumnVisible/HitlistColumnVisible

Selected message blocks of message list or hitlist that are displayed in Runtime. Defines whether the message block referenced in "MessageColumnIndex" or "HitlistColumnIndex" is displayed.

3.11 Object properties

The attribute for the message list can be assigned dynamic properties by means of the name **MessageColumnVisible**.

The attribute for the hitlist can be assigned dynamic properties by means of the name **HitlistColumnVisible**.

The data type is BOOLEAN.

HitlistDefaultSort property

HitlistDefaultSort

Defines the default sorting order in the table columns of the hitlist.

The following settings are available:

Value	Description	Explanation
0	Ascending	The list is sorted in ascending order based on frequency.
1	Descending	The list is sorted in descending order based on frequency.

The attribute can be assigned dynamic properties by means of the name **HitlistDefaultSort**. The data type is LONG.

HitListMaxSourceItems property

Maximum number of data records - HitListMaxSourceItems

Defines the maximum number of data records for statistics.

The attribute can be assigned dynamic properties by means of the name **HitListMaxSourceItems** . The data type is LONG.

HitListMaxSourceItemsWarn property

Warning when maximum is reached - HitListMaxSourceItemsWarn

Enables the output of a warning notice after the valid number of data records was reached.

Value	Explanation
TRUE	A warning is output after the valid maximum number of data records was reached.
FALSE	A warning is not output after the valid maximum number of data records was reached.

The attribute can be assigned dynamic properties by means of the name **HitListMaxSourceItemsWarn**. The data type is BOOLEAN.

HitListRelTime property**Time range for statistics - HitListRelTime**

Sets a time range for the statistics.

Value	Explanation
TRUE	The time range set for statistics is used if this range was not defined in the selection.
FALSE	The time range is not used.

The attribute can be assigned dynamic properties by means of the name **HitListRelTime**. The data type is BOOLEAN.

HitListRelTimeFactor property**Time range - HitListRelTimeFactor**

Defines the factor for calculating the time range. Only integer factors are valid.

The attribute can be assigned dynamic properties by means of the name **HitListRelTimeFactor**. The data type is LONG.

HitListRelTimeFactorType property**Time range - HitListRelTimeFactorType**

Defines the time unit for calculating the time range.

The following time units are available:

Value	Description
0	Minute
1	Hour
2	Day
3	Week
4	Month

The attribute can be assigned dynamic properties by means of the name **HitListMaxRelTimeFactorType**. The data type is LONG.

HorizontalGridLines property

Horizontal - HorizontalGridLines

Defines whether horizontal separating lines will be displayed.

Value	Explanation
TRUE	Enables the display of horizontal dividers.
FALSE	Disables the display of horizontal dividers.

The attribute can be assigned dynamic properties by means of the name **HorizontalGridLines**. The data type is BOOLEAN.

3.11.6.9 I

IconSpace property

IconSpace

Defines the spacing between the icons and text in the table cells. The value is active if and icon and text are displayed.

The attribute can be assigned dynamic properties by means of the name **IconSpace**. The data type is LONG.

IgnoreGlobalSettings property

IgnoreGlobalSettings

Determines whether the central settings for the alarm logging from the "PCS 7 Alarm Configuration Editor" are to be used.

Value	Explanation
TRUE	The configured settings in the "PCS 7 Alarm Configuration Editor" are not used.
FALSE	The configured settings in the "PCS 7 Alarm Configuration Editor" are used.

3.11.6.10 L

LineColor property

Color of window dividers - LineColor

Specifies the color of the window dividers. The button opens the "Color selection" dialog.

The attribute can be assigned dynamic properties by means of the name **LineColor**. The data type is LONG.

LineWidth property

Line weight of window dividers - LineWidth

Defines the line weight of the window dividers in pixels.

The attribute can be assigned dynamic properties by means of the name **LineWidth**. The data type is LONG.

ListType property

List - ListType

Specifies which of the following lists is displayed in WinCC UserAdminControl.

Value	Name	Explanation
0	Users	The user list is displayed.
1	Groups	The group list is displayed.

The attribute can be assigned dynamic properties using the name **ListType**. The data type is LONG.

LoadDataImmediately property

Load archive data - LoadDataImmediately

Defines whether the tag values for the time range to be displayed are loaded from the archives when the picture is called.

Value	Explanation
TRUE	Loads archived values on picture calls.
FALSE	Loads only current values on picture calls.

The attribute can be assigned dynamic properties by means of the name **LoadDataImmediately**. The data type is BOOLEAN.

LongTermArchiveConsistency property

LongTimeArchiveConsistency

If "LongTimeArchiveConsistency" is set to "No", 1000 messages are displayed in the long-term archive list on the single-user system, server or client for each server, or for each redundant server pair.

3.11 Object properties

If the "LongTimeArchiveConsistency" is set to "yes", the most recent 1000 messages are displayed on the client of all servers or redundant server pair in the long-term archive list.

The attribute can be assigned dynamic properties by means of the name **LongTimeArchiveConsistency** . The data type is BOOLEAN.

3.11.6.11 M

Mouse pointer (Cursor)

Mouse pointer (Cursor)

Specifies whether or not to display the mouse pointer on the icon at runtime.

Value	Explanation
TRUE	The mouse pointer is shown at runtime if positioned on the icon.
FALSE	The mouse pointer is hidden at runtime if positioned on the icon.

The attribute can be assigned dynamic properties by means of the name **Cursor**. The data type is BOOLEAN.

MessageBlock

MessageBlockAlign property

Alignment - MessageBlockAlign

Aligns the contents of a selected message block in the table.

To change the alignment, the option "Apply project settings" must be deactivated or "ApplyProjectSettings" must be set to "FALSE".

The following settings are available:

Value	Description	Explanation
0	left	Aligns the contents of a selected message block to the left.
1	centered	Aligns the contents of a selected message block to the center.
2	right	Aligns the contents of a selected message block to the right.

The attribute can be assigned dynamic properties by means of the name **MessageBlockAlign**. The data type is LONG.

MessageBlockAutoPrecisions property**Automatic decimal places - MessageBlockAutoPrecisions**

Enables automatic setting of the number of decimal places.

Value	Explanation
TRUE	The number of decimal places is set automatically. The value in the "Decimal places" field is disabled.
FALSE	The value in the "Decimal places" field is enabled.

The attribute can be assigned dynamic properties by means of the name **MessageBlockAutoPrecisions**. The data type is BOOLEAN.

MessageBlockCaption property**Label - MessageBlockCaption**

Defines the label of the column title in the message window for the selected message block. The label specified is active in all Runtime languages.

To change the label, the option "Apply project settings" must be deactivated or "ApplyProjectSettings" must be set to "FALSE".

The attribute can be assigned dynamic properties by means of the name **MessageBlockCaption**. The data type is STRING.

MessageBlockCount property**MessageBlockCount**

Defines the number of message blocks which are available for the message list and the hitlist.

The attribute can be assigned dynamic properties by means of the name **MessageBlockCount**. The data type is LONG.

MessageBlockDateFormat property**Date format - MessageBlockDateFormat**

Defines the date format for displaying messages.

To change the date format, the option "Apply project settings" must be deactivated or "ApplyProjectSettings" must be set to "FALSE".

The following date formats are available:

Value	Explanation
Automatic	The date format is set automatically.
dd.MM.yy	Day.Month.Year, e.g. 24.12.07.

3.11 Object properties

Value	Explanation
dd.MM.yyyy	Day.Month.Year, e.g. 24.12.2007.
dd/MM/yy	Day/Month/Year, e.g. 24/12/07.
dd/MM/yyyy	Day/Month/Year, e.g. 24/12/2007.

The attribute can be assigned dynamic properties by means of the name **MessageBlockDateFormat**. The data type is STRING.

MessageBlockExponentialFormat property

Exponential notation - MessageBlockExponentialFormat

Specifies the exponential notation for visualization of the values of a selected message block.

Value	Explanation
TRUE	The values are displayed with exponential notation.
FALSE	The values are displayed with decimal notation.

The attribute can be assigned dynamic properties by means of the name **MessageBlockExponentialFormat**. The data type is BOOLEAN.

MessageBlockFlashMode property

Flash mode - MessageBlockFlashMode

Specifies how the content of the selected message block flashes in Runtime when a message appears. The "Flashing on" option must be selected.

To change the setting, the option "Apply project settings" must be deactivated or "ApplyProjectSettings" must be set to "FALSE".

Value	Description	Explanation
0	Standard	The text color switches between the standard color and the flash color when flashing
1	Switch background color/text color	The color of the background and the text color switch during flashing. You configure the message colors for the type of message in the alarm logging editor.
2	Switch message color/table color	The message colors and the configured table colors switch during flashing. You configure the message colors for the type of message in the alarm logging editor. Set the table colors in the "Layout" tab in the AlarmControl.

The attribute can be assigned dynamic properties by means of the name **MessageBlockFlashMode**. The data type is LONG.

MessageBlockFlashOn property

Flashing on - MessageBlockFlashOn

Enables flashing of the selected message block in Runtime after a message was activated.

To change the setting, the option "Apply project settings" must be deactivated or "ApplyProjectSettings" must be set to "FALSE".

Value	Explanation
TRUE	Flashing message block content.
FALSE	No flashing message block content.

The attribute can be assigned dynamic properties by means of the name **MessageBlockFlashOn**. The data type is BOOLEAN.

MessageBlockHideText property

Content as text - MessageBlockHideText

Enables the textual display of the content of a selected message block.

Value	Explanation
TRUE	The content is not displayed in text format. The option is disabled.
FALSE	The content is displayed in text format. The option is enabled.

The attribute can be assigned dynamic properties by means of the name **MessageBlockHideText**. The data type is BOOLEAN.

MessageBlockHideTitleText property

Title as text - MessageBlockHideTitleText

Enables the display of the header of a selected message block in text format.

Value	Explanation
TRUE	The header is not displayed in text format. The option is disabled.
FALSE	The header is displayed in text format. The option is enabled.

The attribute can be assigned dynamic properties by means of the name **MessageBlockHideTitleText**. The data type is BOOLEAN.

MessageBlockId property

MessageBlockId

Default assignment of the ID number and message block in WinCC AlarmControl.

The attribute can be assigned dynamic properties by means of the name **MessageBlockID**. The data type is LONG.

MessageBlockIndex property

MessageBlockIndex

References an existing message block. Using this attribute, you can assign a specific message block values for other attributes.

Values between 0 and "MessageBlockCount" minus 1 are valid for "MessageBlockIndex". Attribute "MessageBlockCount" defines the number of available message blocks.

The attribute can be assigned dynamic properties by means of the name **MessageBlockIndex**. The data type is LONG.

MessageBlockInvertUseMessageColor property

MessageBlockInvertUseMessageColor

Specifies for the message block whether or not the message colors are displayed, contrary to the central setting for the AlarmControl . For example, the "UseMessageColor" property is set to "FALSE" for the AlarmControl. You have set the "MessageBlockInvertUseMessageColor" property to "TRUE" for a message block. This causes the message colors to be displayed for this message block in Runtime.

Value	Explanation
TRUE	Contrary to the central setting in "UseMessageColor", the message colors are displayed or not displayed for the message block.
FALSE	Just like the central setting in "UseMessageColor", the message colors are displayed or not displayed for the message block.

The attribute can be assigned dynamic properties by means of the name **MessageBlockInvertUseMessageColor**. The data type is BOOLEAN.

MessageBlockLeadingZeros property

Number of digits - MessageBlockLeadingZeros

Defines the number of leading zeros for the message block content. The maximum number is "11". A "0" value deactivates the "With leading zeros" option.

To change the setting, the option "Apply project settings" must be deactivated or "ApplyProjectSettings" must be set to "FALSE".

The attribute can be assigned dynamic properties by means of the name **MessageBlockLeadingZeros**. The data type is LONG.

MessageBlockLength property

Length in characters - MessageBlockLength

Defines the length of the message block selected based on the number of characters.

To change the length, the option "Apply project settings" must be deactivated or "ApplyProjectSettings" must be set to "FALSE".

The attribute can be assigned dynamic properties by means of the name **MessageBlockLength**. The data type is LONG.

MessageBlockName property

Object name - MessageBlockName

Displays the object name of the message block selected. You cannot edit this name.

The data type is STRING.

MessageBlockPrecisions property

Decimal places - MessageBlockPrecisions

Specifies the decimal precision of the values of a selected message block. You can only enter the value if the "Automatic" option is disabled.

The attribute can be assigned dynamic properties by means of the name **MessageBlockPrecisions**. The data type is SHORT.

MessageBlockSelected property

Available message blocks - MessageBlockSelected

The available message blocks are blocks that can be used in Runtime for the message list or hitlist.

Select the "Message blocks" tab to activate existing message blocks as required in the Control. Select the "Hitlist" and "Message list" tabs to configure the hitlist and message list based on the available blocks.

To change the setting, the option "Apply project settings" must be deactivated or "ApplyProjectSettings" must be set to "FALSE".

The attribute can be assigned dynamic properties by means of the name **MessageBlockSelected**. The data type is BOOLEAN.

MessageBlockShowDate property

Show date - MessageBlockShowDate

Enables the display of a date in the "Time" message block in addition to the time.

Value	Explanation
TRUE	Date and time are displayed.
FALSE	The time is displayed.

The attribute can be assigned dynamic properties by means of the name **MessageBlockShowDate**. The data type is BOOLEAN.

MessageBlockShowIcon property

Content as icon - MessageBlockShowIcon

Enables the display of the content of a selected message block as icon.

Value	Explanation
TRUE	The content is visualized as icon.
FALSE	The content is not visualized as icon.

The attribute can be assigned dynamic properties by means of the name **MessageBlockShowIcon**. The data type is BOOLEAN.

MessageBlockShowTitleIcon property

Title as icon - MessageBlockShowTitleIcon

Enables the display of the title of a selected message block as icon.

Value	Explanation
TRUE	The header is displayed as icon.
FALSE	The header is not displayed as icon.

The attribute can be assigned dynamic properties by means of the name **MessageBlockShowTitleIcon**. The data type is BOOLEAN.

MessageBlockTextId property

Text ID - MessageBlockTextId

Specifies the caption of the selected message block using a Text ID which was derived from the text library. The caption is adapted automatically if a user changes the Runtime language.

To change the setting, the option "Apply project settings" must be deactivated or "ApplyProjectSettings" must be set to "FALSE".

The attribute can be assigned dynamic properties by means of the name **MessageBlockTextId**. The data type is LONG.

MessageBlockTimeFormat property

MessageBlockTimeFormat

Defines which time format or duration format is used for displaying the messages.

To change the setting, the option "Apply project settings" must be deactivated or "ApplyProjectSettings" must be set to "FALSE".

The following time formats are available:

Value	Explanation
Automatic	The time format is set automatically.
HH:mm:ss	Hours:Minutes:Seconds, e.g. 15:35:44
HH:mm:ss.ms	Hours:Minutes:Seconds.Milliseconds, e.g. 15:35:44.240.
hh:mm:ss tt	Hours:Minutes:Seconds AM/PM, e.g. 03:35:44 PM.
hh:mm:ss.ms tt	Hours:Minutes:Seconds.Milliseconds AM/PM, e.g. 03:35:44.240 PM.

The following time duration formats are available:

Value	Explanation
Automatic	The time duration format is determined automatically.
d H:mm:ss	Day Hours:Minutes:Seconds, e.g. 1 2:03:55.
H:mm:ss.	Hours:Minutes:Seconds, e.g. 26:03:55.
m:ss	Minutes:Seconds, Example: 1563:55.
s	Seconds, e.g. 93835.

The attribute can be made dynamic by means of the name **MessageBlockTimeFormat**. The data type is STRING.

MessageBlockType property

MessageBlockType

Displays the association of the message block.

The following settings are available:

Value	Description	Explanation
0	System block	The message block belongs to the system block category.
1	Text block	The message block belongs to the user text block category.
2	Process value block	The message block belongs to the process value block category.
3	Hitlist block	The message block belongs to the message blocks of the hitlist.

3.11 Object properties

The attribute can be assigned dynamic properties by means of the name **MessageBlockType** . The data type is LONG.

MessageColumnAdd property

MessageColumnAdd

Adds the selected message block from the list of existing message blocks to the list of selected message blocks.

The attribute can be assigned dynamic properties by means of the name **MessageColumnAdd** . The data type is STRING.

MessageColumnAutoAdjust property

MessageColumnAutoAdjust

Automatically optimizes the width of the columns in the WinCC AlarmControl in Runtime. If the configured column is not sufficient for the displayed text, the column width is increased.

If the user changes the width of columns in Runtime, the width is only optimized again when the picture is opened again.

The attribute can be assigned dynamic properties using the name **MessageColumnAutoAdjust** . The data type is BOOLEAN.

MessageColumnCount property

MessageColumnCount

Specifies the number of message blocks to be displayed in the message list in Runtime.

The attribute can be assigned dynamic properties by means of the name **MessageColumnCount** . The data type is LONG.

MessageColumnIndex property

MessageColumnIndex

References a message block selected for the message list. Using this attribute you can assign the values of other attributes to a specific message block of the message list.

Values between 0 and "MessageColumnCount" minus 1 are valid for "MessageColumnIndex". Attribute "MessageColumnCount" defines the number of message blocks selected for the message list.

The "MessageColumnIndex" attribute can be assigned dynamic properties by means of attribute **MessageColumnRepos**. The data type is LONG.

MessageColumnName property

MessageColumnName

Displays the name of the message block of the message list which is referenced with attribute "MessageColumnIndex". You cannot edit this name.

The attribute can be assigned dynamic properties with the name **MessageColumnName**. The data type is STRING.

MessageColumnRemove property

MessageColumnRemove

Cuts the marked message block from the list of selected message blocks and pastes it to the list of available message blocks.

The attribute can be assigned dynamic properties by means of the name **MessageColumnRemove**. The data type is STRING.

MessageColumnRepos property

Up/Down - MessageColumnRepos/HitlistColumnRepos

Resorts the message blocks. The "Up" and "Down" commands move the selected message block accordingly in the list. This moves the message block in Runtime Control towards the front or towards the back.

The attribute for the hitlist can be assigned dynamic properties by means of the name **HitlistColumnRepos**.

The attribute for the message list can be assigned dynamic properties by means of the name **MessageColumnRepos**.

The data type is LONG.

MessageColumnSort property

MessageColumnSort

Defines the sorting order of the message block referenced in "MessageColumnIndex".

The following settings are available:

Value	Description	Explanation
0	no	No sorting
1	Ascending	Ascending order, starting at the lowest value.
2	Descending	Descending order, starting at the highest value.

3.11 Object properties

The attribute can be assigned dynamic properties by means of the name **MessageColumnSort** . The data type is LONG.

MessageColumnSortIndex property

MessageColumnSortIndex

Defines the sorting order of the message block referenced in "MessageColumnIndex". The sorting criterion is removed from "MessageColumnSort" if you set a "0" value.

The attribute can be assigned dynamic properties by means of the name **MessageColumnSortIndex**. The data type is LONG.

MessageColumnVisible property

Selected message blocks - MessageColumnVisible/HitlistColumnVisible

Selected message blocks of message list or hitlist that are displayed in Runtime. Defines whether the message block referenced in "MessageColumnIndex" or "HitlistColumnIndex" is displayed.

The attribute for the message list can be assigned dynamic properties by means of the name **MessageColumnVisible**.

The attribute for the hitlist can be assigned dynamic properties by means of the name **HitlistColumnVisible**.

The data type is BOOLEAN.

MessageListType property

Active list on picture call - MessageListType

Selection field for defining the active list for picture calls.

Value	Description	Explanation
0	Message list	The currently active messages are displayed after a picture was called.
1	Short-term archive list	A short-term archive list displays the logged messages after the picture was called. The display is updated immediately on activation of new messages.
2	Long-term archive list	A long-term archive list displays the logged messages after a picture was called.
3	Lock list	Only the currently locked messages are displayed after a picture was called.
4	Hitlist	The configured statistics data is displayed after a picture was called.
5	List of messages to be hidden	The messages to be hidden are displayed at the call of a picture.

The attribute can be assigned dynamic properties by means of the name **MessageListType**. The data type is LONG.

Moveable Property

Movable

Defines whether the control can be moved in Runtime.

Value	Explanation
TRUE	The control can be moved in Runtime.
FALSE	The control cannot be moved in Runtime.

The attribute can be assigned dynamic properties by means of the name **Moveable**. The data type is BOOLEAN.

MsgFilterSQL property

MsgFilterSQL

Defines one or several SQL statements for the custom selection of messages. Multiple user-defined selections are logically linked by "OR" operation. The SQL statements of "DefaultMsgFilterSQL" and "MsgFilterSQL" are linked logically by "AND" operation if you define a default selection by means of "DefaultMsgFilterSQL".

The attribute can be assigned dynamic properties by means of the name **MsgFilterSQL**. The data type is STRING.

3.11.6.12 N

NavigationPathFont property

NavigationPathFont

Specifies the font used for the header (path) in the diagnostic overview.

The attribute cannot be dynamized.

NavigateTo property

NavigateTo

This attribute is only used internally and is used to open the diagnostic overview of a controller for which an AS alarm is displayed in the AlarmControl.

3.11.6.13 O

Online property

Starting refresh - Online

Enables a refresh of displayed values when calling a picture in Runtime.

Value	Description
TRUE	Enables the refresh of values on picture calls.
FALSE	Disables the refresh of values on picture calls.

The attribute can be assigned dynamic properties by means of the name **Online**. The data type is BOOLEAN.

OperatorMessageID property

OperatorMessageID

Default assignment of the ID number and trigger event in WinCC OnlineTableControl:

Value	Description	Explanation
5	EditValue	Trigger event "Change archive value"
6	InsertValue	Trigger event "Generate archive value"

The attribute can be assigned dynamic properties by means of the name **OperatorMessageID**. The data type is LONG.

OperatorMessageIndex property

OperatorMessageIndex

References the event of an archive value change for an operator message. Using this attribute you can assign the values of other attributes to a specific operator message.

The following values are available:

Value	Explanation
0	Trigger event "Change archive value"
1	Trigger event "Generate archive value"

The attribute can be assigned dynamic properties by means of the name **OperatorMessageIndex**. The data type is LONG.

OperatorMessageName property

Object name - OperatorMessageName

Displays the name that is referenced with the attribute "OperatorMessageIndex" for message events for operator messages. You cannot edit this name.

The following names are available for message events:

Value	Explanation
Lock	Message event "Lock"
Unlock	Message event "Enable"
Hide	Message event "Hide"
Unhide	Message event "Unhide"
Quit	Message event "Ackn."

The attribute can be assigned dynamic properties by means of the name **OperatorMessageName** . The data type is STRING.

OperatorMessageNumber property

Message number - OperatorMessageNumber

Define a message number for the selected operator message event if you do not want to use the operator message of WinCC.

The attribute can be assigned dynamic properties by means of the name **OperatorMessageNumber**. The data type is LONG.

OperatorMessageSelected property

Operator messages for - OperatorMessageSelected

Activate the message events which trigger operator messages in the list.

The attribute can be assigned dynamic properties by means of the name **OperatorMessageSelected**. The data type is BOOLEAN.

OperatorMessageSource1 property

Source - OperatorMessageSource1

Define the message block of an operated message to be added to "Process value block 1" of the operator message configured in Source.

An operator message is to be generated to indicate that a message was locked. The contents of "User text block 1" of the locked message, e.g. "Motor faulty", is to be displayed in "Process value block 1" of the operator message. Select "1" at process value as the message lock of the operated message "User text block 1".

3.11 Object properties

The attribute can be assigned dynamic properties by means of the name **OperatorMessageSource1**. The data type is STRING.

OperatorMessageSource2 property

Source - OperatorMessageSource2

Define the message block of an operated message to be added to "Process value block 2" of the operator message configured in Source.

An operator message is to be generated to indicate that a message was locked. The contents of "User text block 1" of the locked message, e.g. "Motor faulty", is to be displayed in "Process value block 2" of the operator message. Select "2" at process value as the message lock of the operated message "User text block 1".

The attribute can be assigned dynamic properties by means of the name **OperatorMessageSource2**. The data type is STRING.

OperatorMessageSource3 property

Source - OperatorMessageSource3

Define the message block of an operated message to be added to "Process value block 3" of the operator message configured in Source.

An operator message is to be generated to indicate that a message was locked. The contents of "User text block 1" of the locked message, e.g. "Motor faulty", is to be displayed in "Process value block 3" of the operator message. Select "3" at process value as the message lock of the operated message "User text block 1".

The attribute can be assigned dynamic properties by means of the name **OperatorMessageSource3**. The data type is STRING.

OperatorMessageSource4 property

Source - OperatorMessageSource4

Define the message block of an operated message to be added to "Process value block 4" of the operator message configured in Source.

An operator message is to be generated to indicate that a message was locked. The contents of "User text block 1" of the locked message, e.g. "Motor faulty", is to be displayed in "Process value block 4" of the operator message. Select "4" at process value as the message lock of the operated message "User text block 1".

The attribute can be assigned dynamic properties by means of the name **OperatorMessageSource4**. The data type is STRING.

OperatorMessageSource5 property

Source - OperatorMessageSource5

Define the message block of an operated message to be added to "Process value block 5" of the operator message configured in Source.

An operator message is to be generated to indicate that a message was locked. The contents of "User text block 1" of the locked message, e.g. "Motor faulty", is to be displayed in "Process value block 5" of the operator message. Select "5" at process value as the message lock of the operated message "User text block 1".

The attribute can be assigned dynamic properties by means of the name **OperatorMessageSource5**. The data type is STRING.

OperatorMessageSource6 property

Source - OperatorMessageSource6

Define the message block of an operated message to be added to "Process value block 6" of the operator message configured in Source.

An operator message is to be generated to indicate that a message was locked. The contents of "User text block 1" of the locked message, e.g. "Motor faulty", is to be displayed in "Process value block 6" of the operator message. Select "6" at process value as the message lock of the operated message "User text block 1".

The attribute can be assigned dynamic properties by means of the name **OperatorMessageSource6**. The data type is STRING.

OperatorMessageSource7 property

Source - OperatorMessageSource7

Define the message block of an operated message to be added to "Process value block 7" of the operator message configured in Source.

An operator message is to be generated to indicate that a message was locked. The contents of "User text block 1" of the locked message, e.g. "Motor faulty", is to be displayed in "Process value block 7" of the operator message. Select "7" at process value as the message lock of the operated message "User text block 1".

The attribute can be assigned dynamic properties by means of the name **OperatorMessageSource7**. The data type is STRING.

OperatorMessageSource8 property

Source - OperatorMessageSource8

Define the message block of an operated message to be added to "Process value block 8" of the operator message configured in Source.

An operator message is to be generated to indicate that a message was locked. The contents of "User text block 1" of the locked message, e.g. "Motor faulty", is to be displayed in "Process value block 8" of the operator message. Select "8" at process value as the message lock of the operated message "User text block 1".

The attribute can be assigned dynamic properties by means of the name **OperatorMessageSource8**. The data type is STRING.

OperatorMessageSource9 property

Source - OperatorMessageSource9

Define the message block of an operated message to be added to "Process value block 9" of the operator message configured in Source.

An operator message is to be generated to indicate that a message was locked. The contents of "User text block 1" of the locked message, e.g. "Motor faulty", is to be displayed in "Process value block 9" of the operator message. Select "9" at process value as the message lock of the operated message "User text block 1".

The attribute can be assigned dynamic properties by means of the name **OperatorMessageSource9**. The data type is STRING.

OperatorMessageSource10 property

Source - OperatorMessageSource10

Define the message block of an operated message to be added to "Process value block 10" of the operator message configured in Source.

An operator message is to be generated to indicate that a message was locked. The contents of "User text block 1" of the locked message, e.g. "Motor faulty", is to be displayed in "Process value block 10" of the operator message. Select "10" at process value as the message lock of the operated message "User text block 1".

The attribute can be assigned dynamic properties by means of the name **OperatorMessageSource10**. The data type is STRING.

OperatorMessageSourceType1 property

Transfer as - OperatorMessageSourceType1

Specifies the format of the source content for the transfer.

The following formats are available:

Value	Description	Explanation
0	Text	Transfer the source content in text format.
1	Value	Transfer the source content as value.

The attribute can be assigned dynamic properties by means of the name **OperatorMessageSourceType1**. The data type is LONG.

OperatorMessageSourceType2 property

Transfer as - OperatorMessageSourceType2

Specifies the format of the source content for the transfer.

The following formats are available:

Value	Description	Explanation
0	Text	Transfer the source content in text format.
1	Value	Transfer the source content as value.

The attribute can be assigned dynamic properties by means of the name **OperatorMessageSourceType2**. The data type is LONG.

OperatorMessageSourceType3 property

Transfer as - OperatorMessageSourceType3

Specifies the format of the source content for the transfer.

The following formats are available:

Value	Description	Explanation
0	Text	Transfer the source content in text format.
1	Value	Transfer the source content as value.

The attribute can be assigned dynamic properties by means of the name **OperatorMessageSourceType3**. The data type is LONG.

OperatorMessageSourceType4 property

Transfer as - OperatorMessageSourceType4

Specifies the format of the source content for the transfer.

3.11 Object properties

The following formats are available:

Value	Description	Explanation
0	Text	Transfer the source content in text format.
1	Value	Transfer the source content as value.

The attribute can be assigned dynamic properties by means of the name **OperatorMessageSourceType4**. The data type is LONG.

OperatorMessageSourceType5 property

Transfer as - OperatorMessageSourceType5

Specifies the format of the source content for the transfer.

The following formats are available:

Value	Description	Explanation
0	Text	Transfer the source content in text format.
1	Value	Transfer the source content as value.

The attribute can be assigned dynamic properties by means of the name **OperatorMessageSourceType5**. The data type is LONG.

OperatorMessageSourceType6 property

Transfer as - OperatorMessageSourceType6

Specifies the format of the source content for the transfer.

The following formats are available:

Value	Description	Explanation
0	Text	Transfer the source content in text format.
1	Value	Transfer the source content as value.

The attribute can be assigned dynamic properties by means of the name **OperatorMessageSourceType6**. The data type is LONG.

OperatorMessageSourceType7 property

Transfer as - OperatorMessageSourceType7

Specifies the format of the source content for the transfer.

The following formats are available:

Value	Description	Explanation
0	Text	Transfer the source content in text format.
1	Value	Transfer the source content as value.

The attribute can be assigned dynamic properties by means of the name **OperatorMessageSourceType7**. The data type is LONG.

OperatorMessageSourceType8 property

Transfer as - OperatorMessageSourceType8

Specifies the format of the source content for the transfer.

The following formats are available:

Value	Description	Explanation
0	Text	Transfer the source content in text format.
1	Value	Transfer the source content as value.

The attribute can be assigned dynamic properties by means of the name **OperatorMessageSourceType8**. The data type is LONG.

OperatorMessageSourceType9 property

Transfer as - OperatorMessageSourceType9

Defines the format for transferring the source.

The following formats are available:

Value	Description	Explanation
0	Text	Transfer the source as text.
1	Value	Transfer the source as value.

The attribute can be assigned dynamic properties by means of the name **OperatorMessageSourceType9**. The data type is LONG.

OperatorMessageSourceType10 property

Transfer as - OperatorMessageSourceType10

Specifies the format of the source content for the transfer.

3.11 Object properties

The following formats are available:

Value	Description	Explanation
0	Text	Transfer the source content in text format.
1	Value	Transfer the source content as value.

The attribute can be assigned dynamic properties by means of the name **OperatorMessageSourceType10**. The data type is LONG.

3.11.6.14 P

PageMode property

Enable paging - PageMode

Enables paging is in the long-term archive list. Allows you to display all messages of the short-term archive in the long-term archive list. Use the "Messages per page" or "PageModeMessageNumber" property to determine the number of messages displayed per page.

The page up/down buttons of the toolbar can be used if paging is enabled.

Value	Explanation
TRUE	Paging is enabled for the long-term archive list.
FALSE	Paging is disabled for the long-term archive list.

The attribute can be assigned dynamic properties by means of the name **PageMode**. The data type is BOOLEAN.

PageModeMessageNumber property

Messages per page - PageModeMessageNumber

Defines the number of messages shown per page when paging the long-term archive list.

The attribute can be assigned dynamic properties by means of the name **PageModeMessageNumber**. The data type is LONG.

Picture

Picture

Call the configuration dialog for selecting icons.

PercentageAxis property

PercentageAxis

Specifies whether an axis with percentage scaling will be displayed in addition to the value axes in the trend window or diagram window.

Value	Explanation
TRUE	The display of an axis with percentage scaling is enabled.
FALSE	The display of an axis with percentage scaling is disabled.

The attribute can be assigned dynamic properties by means of the name **PercentageAxis**. The data type is BOOLEAN.

PercentageAxisAlign property

PercentageAxisAlign

Specifies the alignment of the axis with percentage scaling in the trend window or diagram window.

The following settings are available:

Value	Description	Explanation
0	left	The axis with percentage scaling is aligned left.
1	right	The axis with percentage scaling is aligned right.

The attribute can be assigned dynamic properties by means of the name **PercentageAxisAlign**. The data type is LONG.

PercentageAxisColor property

PercentageAxisColor

Specifies the color of an axis with percentage scaling. The button opens the "Color selection" dialog to select the color.

The attribute can be assigned dynamic properties by means of the name **PercentageAxisColor**. The data type is LONG.

PictureSizeMode property

PictureSizeMode

Specifies the size adjustment between picture and control.

Value	Designation	Explanation
0	Fit size to content	The control is adapted to the picture size.
1	Fit content to size	The picture is adapted or scaled to the control.

The attribute can be assigned dynamic properties by means of the name **PictureSizeMode**. The data type is LONG.

PlayEndless property

PlayEndless

Specifies if movies are played endlessly in the control.

The attribute can be assigned dynamic properties by means of the name **PlayEndless**. The data type is BOOLEAN.

PrintJobName property

Current print job view - PrintJobName

Defines the print job triggered by the print function of the "Print" toolbar button. The recommended print job is set for the control by default.

Open the "Select Print Job" dialog using the selection button.

The attribute can be assigned dynamic properties by means of the name **PrintJobName**. The data type is STRING.

3.11.6.15 R

RowScrollbar property

Row scroll bars - RowScrollbar

Enables the display of row scroll bars.

The following settings are available:

Value	Description	Explanation
0	No	No row scroll bars.
1	as required	Row scroll bars are displayed if horizontal space requirements of the control are greater than the actually available display area.
2	always	Row scroll bars are always displayed.

The attribute can be assigned dynamic properties by means of the name **RowScrollbar**. The data type is LONG.

RowTitleAlign property

Row label alignment - RowTitleAlign

Specifies the type of row label alignment.

The following settings are available:

Value	Description	Explanation
0	left	The row headers are aligned left.
1	centered	The row headers are aligned to center.
2	right	The row headers are aligned right.

The attribute can be assigned dynamic properties by means of the name **RowTitleAlign**. The data type is LONG.

RowTitles property

Show row labels - RowTitles

Enables the display of row labels.

Value	Explanation
TRUE	The row labels are displayed.
FALSE	The row labels are not displayed.

The attribute can be assigned dynamic properties by means of the name **RowTitles**. The data type is BOOLEAN.

RTPersistence property

Online configuration at the next picture change - RTPersistence

Enables retention of the online configurations of the control after a picture change.

3.11 Object properties

The following settings are available:

Value	Description	Explanation
0	Discard	The current online configurations are discarded at the next picture change.
1	Retain	The current online configurations are retained at the next picture change.
2	Reset	All online configurations made are lost. The picture is set to the contents found in the configuration system.

The attribute can be assigned dynamic properties by means of the name **RTPersistence**. The data type is LONG.

RTPersistencePasswordLevel property

Operator authorization for online configuration - RTPersistencePasswordLevel

Displays the authorization for online configuration. You can edit the authorization using the selection button. Authorizations are configured in the "User Administrator" editor.

The attribute can be assigned dynamic properties by means of the name **RTPersistencePasswordLevel** . The data type is LONG.

RTPersistenceType property

Online configuration - RTPersistenceType

Defines how to retain online configurations of WinCC.

The following settings are available:

Value	Description	Explanation
0	Do not retain	Online configurations are not retained. These are lost at the next picture change.
1	Retain during runtime	Online configurations are retained during runtime. These are lost on exiting.
2	Retain permanently	Online configurations are retained permanently. These are also available after restart.

The attribute cannot be dynamized.

RulerType property

Window - RulerType

Specifies window to be displayed during runtime. Depending on the window type, only certain blocks can be used as columns of the WinCC RulerControl.

The following window types can be selected:

Value	Description	Explanation
0	"Ruler" window	The ruler window shows the coordinate values of the trends on a ruler or values of a selected row in the table.
1	"Statistics area" window	The statistics area window shows the values of the low and high limit of trends between two rulers, or displays the selected range in the table.
2	"Statistics" window	The statistics window shows the statistic evaluation of trends between two rulers, or it displays the selected values in the table.

The attribute can be assigned dynamic properties by means of the name **RulerType**. The data type is LONG.

3.11.6.16 S

Font size unit

Font size unit - FontSizeUnit

You use this attribute to specify the unit on which the font size is based.

- Font size unit = pixels (0)
The font size is specified in pixels.
- Font size unit = points (1)
The font size is specified in points.

For dynamization by a script, use the value in the brackets.

The attribute can be dynamized with the name **FontSizeUnit**.

SelectArchiveName property

SelectArchiveName

Opens the dialog for selecting the user archive.

Programmers can set this attribute to allow users to select a user archive by means of a button, for example.

The attribute can be assigned dynamic properties by means of the name **SelectArchiveName**. The data type is BOOLEAN.

SelectedCellColor property

Background color of selected cell - SelectedCellColor

Specifies the background color of a selected cell. The button opens the "Color selection" dialog.

3.11 Object properties

The attribute can be assigned dynamic properties by means of the name **SelectedCellColor**.
The data type is LONG.

SelectedCellForeColor property

Font color of the selected cell - SelectedCellForeColor

Specifies the font color of the selected cell. The button opens the "Color selection" dialog.

The attribute can be assigned dynamic properties by means of the name **SelectedCellForeColor**. The data type is LONG.

SelectedRowColor property

Background color of the selected row - SelectedRowColor

Specifies the background color of the selected line. The button opens the "Color selection" dialog.

The attribute can be assigned dynamic properties by means of the name **SelectedRowColor**.
The data type is LONG.

SelectedRowForeColor property

Font color of the selected row - SelectedRowForeColor

Specifies the font color of the selected row. The button opens the "Color selection" dialog.

The attribute can be assigned dynamic properties by means of the name **SelectedRowForeColor**. The data type is LONG.

SelectedTitleColor property

Background selection color - SelectedTitleColor

Specifies the background color of a selected table header. The button opens the "Color selection" dialog.

The setting is only active in Runtime if the "Selection color" or "UseSelectedTitleColor" option is activated.

The attribute can be assigned dynamic properties by means of the name **SelectedTitleColor**.
The data type is LONG.

SelectedTitleForeColor property**Font selection color - SelectedTitleForeColor**

Specifies the font color of the table header selected. The button opens the "Color selection" dialog.

The setting is only active in Runtime if the "Selection color" or "UseSelectedTitleColor" option is activated.

The attribute can be assigned dynamic properties by means of the name **SelectedTitleForeColor**. The data type is LONG.

SelectionColoring property**Selection colors for - SelectionColoring**

Enables the use of selection colors for cells or rows.

The following settings are available:

Value	Description	Explanation
0	None	No selection colors for cells and rows.
1	Cell	Selection color for cell.
2	Row	Selection color for row.
3	Cell and row	Selection colors for cell and row.

The attribute can be assigned dynamic properties by means of the name **SelectionColoring**. The data type is LONG.

SelectionRect property**Selection border- SelectionRect**

Enables the use of a selection border for selected cells or rows.

The following settings are available:

Value	Description	Explanation
0	None	No selection border is drawn for selected cells or rows.
1	Cell	A selection border is drawn for the selected cell.
2	Row	A selection border is drawn for the selected row.

The attribute can be assigned dynamic properties by means of the name **SelectionRect**. The data type is LONG.

SelectionRectColor property

Color of the selection border - SelectionRectColor

Specifies the color of the selection border. The button opens the "Color selection" dialog.

The attribute can be assigned dynamic properties by means of the name **SelectionRectColor**.
The data type is LONG.

SelectionRectWidth property

Line weight of the selection border - SelectionRectWidth

Defines the line weight of the selection border in pixels.

The attribute can be assigned dynamic properties by means of the name **SelectionRectWidth**.
The data type is LONG.

SelectionType property

Selectable rows - SelectionType

Defines the number of lines you can select. The following settings are available:

Value	Description	Explanation
0	None	No row selection.
1	Single selection	One row can be selected.
2	Multiple selection	Multiple rows can be selected.

The attribute can be assigned dynamic properties by means of the name **SelectionType**. The data type is LONG.

ServerNames property

Server selection - ServerNames

Defines from which servers within a distributed system the message window obtains the display data.

The attribute can be assigned dynamic properties by means of the name **ServerNames**. The data type is STRING.

ShareSpaceWithSourceControl property

ShareSpaceWithSourceControl

Defines whether the size of the source control in the picture window is adapted so that the WinCC RulerControl is also displayed in a small picture window.

Value	Explanation
TRUE	The source control in the picture window is adapted.
FALSE	The source control in the picture window is not adapted.

The attribute can be assigned dynamic properties by means of the name **ShareSpaceWithSourceControl**. The data type is BOOLEAN.

ShowBarIcon property

ShowBarIcon

Enables the display of an icon below the value axes. The symbol indicates the diagram currently displayed in the foreground.

The attribute can be assigned dynamic properties using the name **ShowBarIcon**. The data type is BOOLEAN.

ShowMilliseconds property

ShowMilliseconds

Specifies whether milliseconds are displayed in the diagnostic buffer view.

The attribute can be assigned dynamic properties using the name **ShowMilliseconds**. The data type is BOOLEAN.

ShowRuler property

Show ruler - ShowRuler

Enables the display of a ruler for scanning the coordinate points on picture calls.

Value	Explanation
TRUE	Enables the display of a ruler for scanning the coordinate points.
FALSE	Disables the display of a ruler for scanning the coordinate points.

The attribute can be assigned dynamic properties by means of the name **ShowRuler**. The data type is BOOLEAN.

ShowRulerInAxis property

ShowRulerInAxis

Enables the display of rulers in the time axis.

Value	Explanation
TRUE	Enables the display of rulers in the time axes.
FALSE	Disables the display of rulers in the time axes.

The attribute can be assigned dynamic properties by means of the name **ShowRulerInAxis**. The data type is BOOLEAN.

ShowScrollbars property

Scroll bars - ShowScrollbars

Enables the display of scroll bars.

The following settings are available:

Value	Description	Explanation
0	No	The display of scroll bars is disabled.
1	as required	Scroll bars are displayed if space requirements of the control are greater than the actual display area.
2	always	The scroll bars are always displayed.

The attribute can be assigned dynamic properties by means of the name **ShowScrollbars**. The data type is LONG.

ShowSlider property

ShowSlider

Specifies if a time slider is displayed in the control.

The attribute can be assigned dynamic properties by means of the name **ShowSlider**. The data type is BOOLEAN.

ShowSortButton property

Use sorting button - ShowSortButton

Enables the display of a sorting button above the vertical scroll bar. Click this sorting button to sort the selected column based on the configured sorting criteria. The sorting button is not displayed if the table does not contain a vertical scroll bar.

Value	Explanation
TRUE	Enables sorting of a selected column by means of sorting button.
FALSE	The sorting button is not displayed.

The attribute can be assigned dynamic properties by means of the name **ShowSortButton**. The data type is BOOLEAN.

ShowSortIcon property

Show sorting icon - ShowSortIcon

Enables the display of the sorting icon.

Value	Explanation
TRUE	Enables the display of the sorting icon.
FALSE	Disables the display of the sorting icon.

The attribute can be assigned dynamic properties by means of the name **ShowSortIcon**. The data type is BOOLEAN.

ShowSortIndex property

Show sorting index - ShowSortIndex

Enables the display of a sorting icon.

Value	Explanation
TRUE	Enables the display of a sorting index.
FALSE	Disables the display of a sorting index.

The attribute can be assigned dynamic properties by means of the name **ShowSortIndex**. The data type is BOOLEAN.

ShowStatisticRuler property

ShowStatisticRuler

Enables the display of rulers in the statistics field on picture calls.

Value	Explanation
TRUE	Enables the display of rulers in the statistics field.
FALSE	Disables the display of rulers in the statistics field.

The attribute can be assigned dynamic properties by means of the name **ShowStatisticRuler**. The data type is BOOLEAN.

ShowTitle property

Window title - ShowTitle

Defines representation the Control window header.

Value	Designation	Explanation
0	No	No window title.
1	Normal	The window title consists of a WinCC icon and text. The text is entered in the "Text" field.
2	Narrow	The window title consists only of text. The text is entered in the "Text" field.

The attribute can be assigned dynamic properties by means of the name **ShowTitle**. The data type is LONG.

ShowToolbar property

ShowToolbar

Specifies if a toolbar is displayed in the control.

The attribute can be assigned dynamic properties by means of the name **ShowToolbar**. The data type is BOOLEAN.

ShowTrendIcon property

ShowTrendIcon

Enables the display of an icon below the value axes. The icon indicates the trend currently displayed in the foreground.

The attribute can be assigned dynamic properties by means of the name **ShowTrendIcon**. The data type is BOOLEAN.

Sizeable property

Sizeable

Enables resizing of the control during runtime.

Value	Explanation
TRUE	The control can be resized during runtime.
FALSE	The control cannot be resized during runtime.

The attribute can be assigned dynamic properties by means of the name **Sizeable**. The data type is BOOLEAN.

SkinName property

Style - SkinName

The control style can be defined in this selection field.

The following settings are available:

Value	Designation	Explanation
	Project setting	The style corresponds to the project settings in WinCC Explorer.
0	Simple	"Classic" WinCC style up to WinCC V6.2
1	Standard	Standard style as of WinCC V7
	Basic Process Control	The style is reserved for internal use with Basic Process Control.

If you have saved new designs for the controls in the following folders, you can select these designs in the selection field:

- Below the folder "C:\Programme(x86)\Common Files\Siemens\bin\CCAxControlSkins"
- Project-specific, for example in "C:\WINCCProjects\TestProject\GraCS\CCAxControlSkins"

The attribute can be assigned dynamic properties by means of the name **SkinName**. The data type is STRING.

SortSequence property

Sorting order by mouse click - SortSequence

Specifies how to change the sorting order by mouse click.

The following sorting orders are available:

Value	Description	Explanation
0	Up/down/none	You can toggle between ascending, descending and no sorting by means of mouse click.
1	Up/down	You can toggle between ascending and descending sorting order by means of mouse click.

The attribute can be assigned dynamic properties by means of the name **SortSequence**. The data type is LONG.

SourceControl property

Source - SourceControl

Defines the control to be interconnected with WinCC RulerControl.

The attribute can be assigned dynamic properties by means of the name **SourceControl**. The data type is STRING.

SourceControlType property

Type - SourceControlType

Defines the type of control that is interconnected with the WinCC RulerControl in the "Source" field.

Value	Designation	Explanation
0	None	The RulerControl is not connected to any source.
1	OnlineTrend Control	The RulerControl is connected with an OnlineTrendControl.
2	OnlineTable Control	The RulerControl is connected with an OnlineTableControl.
3	FunctionTrend Control	The RulerControl is connected with a FunctionTrendControl.

The attribute can be assigned dynamic properties by means of the name **SourceControlType**. The data type is LONG.

Flip (Flip)

Flip (Flip)

Specifies flipping of the icon at runtime.

The following settings are available:

Value	Description	Comments
0	None	The icon is not flipped.
1	Horizontal	The object is flipped along the horizontal center axis.
2	Vertical	The object is flipped along the vertical center axis.
3	Both	The object is flipped along the horizontal and vertical center axes.

The attribute can be assigned dynamic properties by means of the name **Flip**. The data type is LONG.

SplittedViewRatio property

SplittedViewRatio

With a split display, this specifies the portion of the "Diagnostic overview" area is shown compared to the "Detail view" area.

The attribute can be assigned dynamic properties using the name **SplittedViewRatio**. The data type is DOUBLE.

StepSeconds property

StepSeconds

Specifies the interval for step forward or step backward in movies.

The attribute can be assigned dynamic properties by means of the name **StepSeconds**. The data type is LONG.

Status bar

StatusbarAlignment property

Alignment - StatusbarAlignment

Specifies the alignment of the status bar in the control.

The following settings are available:

Value	Description	Explanation
0	Top	The status bar is aligned to the top edge.
1	Below	The status bar is aligned to the bottom edge.
2	Left	The status bar is aligned to the left edge.
3	Right	The status bar is aligned to the right edge.

The attribute can be assigned dynamic properties using the name **StatusbarAlignment**. The data type is LONG.

StatusbarBackColor property

Background color - StatusbarBackColor

Defines the background color of the status bar. The button opens the "Color selection" dialog to select the color.

For the setting to become active, the "Display" or "StatusbarUseBackColor" option must be activated.

3.11 Object properties

The attribute can be assigned dynamic properties by means of the name **StatusbarBackColor**. The data type is LONG.

StatusbarElementAdd property

New - StatusbarElementAdd

Defines a new, user-defined status bar element. The name set by WinCC can be edited in the "Object name" field.

The attribute can be assigned dynamic properties by means of the name **StatusbarElementAdd**. The data type is STRING.

StatusbarElementAutoSize property

Automatic - StatusbarElementAutoSize

Enables autosizing of the width of a status bar element selected.

Value	Explanation
TRUE	The width of the selected element is set automatically.
FALSE	The width of the selected element is not set automatically.

The attribute can be assigned dynamic properties by means of the name **StatusbarElementAutoSize**. The data type is BOOLEAN.

StatusbarElementCount property

StatusbarElementCount

Defines the number of configurable status bar elements.

The attribute can be assigned dynamic properties by means of the name **StatusbarElementCount**. The data type is LONG.

StatusbarElementIconId property

StatusbarElementIconId

Default assignment of the ID number and icon of a status bar element.

The attribute for custom status bar elements can be made assigned dynamic properties by means of the name **StatusbarElementIconId**. The data type is LONG.

StatusbarElementID property

Object ID - StatusbarElementID

Unique ID of the status bar element selected. WinCC assigns this read only ID number.

The attribute can be assigned dynamic properties by means of the name **StatusbarElementID**. The data type is LONG.

StatusbarElementIndex property

StatusbarElementIndex

References a status bar element. Using this attribute you can assign the values of other attributes to a specific status bar element.

Values between 0 and "StatusbarElementCount" minus 1 are valid for "StatusbarElementIndex". Attribute "StatusbarElementCount" defines the number of configurable status bar elements.

The "StatusbarElementIndex" attribute can be assigned dynamic properties by means of attribute **StatusbarElementIndex**. The data type is LONG.

StatusbarElementName property

Object name - StatusbarElementName

Displays the object name of the status bar element selected. You can rename the objects of custom status bar elements.

The "StatusbarElementName" attribute can be assigned dynamic properties by means of attribute **StatusbarElementRename**. The data type is STRING.

StatusbarElementRemove property

Remove - StatusbarElementRemove

Removes the selected status bar element. You can only remove user-defined status bar element from the list.

The attribute can be assigned dynamic properties by means of the name **StatusbarElementRemove**. The data type is STRING.

StatusbarElementRename property

StatusbarElementRename

Renames a custom status bar element which is referenced by means of "StatusbarElementIndex" attribute.

The attribute for custom elements can be assigned dynamic properties by means of the name **StatusbarElementRename**. "StatusbarElementRename" also sets a dynamic attribute "StatusbarElementName". The data type is STRING.

StatusbarElementRepos property

Up/Down - StatusbarElementRepos

Changes the sorting order of button functions. "Up" and "Down" moves the selected status bar element up or down in the list. This moves the status bar element of the Control towards the front or towards the back in Runtime.

The attribute can be assigned dynamic properties by means of the name **StatusbarElementRepos**. The data type is LONG.

StatusbarElementText property

StatusbarElementText

Defines the text to be displayed for the status bar element. You can edit the "StatusbarElementText" attribute for custom elements.

The attribute for custom elements can be assigned dynamic properties by means of the name **StatusbarElementText**. The data type is STRING.

StatusbarElementTooltipText property

StatusbarElementTooltipText

Defines the tooltip text for the custom status bar element.

The attribute can be assigned dynamic properties by means of the name **StatusbarElementTooltipText**. The data type is STRING.

StatusbarElementVisible property

Status bar elements - StatusbarElementVisible

Activate the elements in the list of status bar elements for their display in Runtime.

Click a list entry to adapt the properties, or to change its position in the status bar of the Control by means of the "Up" and "Down" buttons.

Value	Explanation
TRUE	The status bar element is displayed.
FALSE	The status bar element is not displayed.

The attribute can be assigned dynamic properties by means of the name **StatusbarElementVisible**. The data type is BOOLEAN.

StatusbarElementUserDefined property

StatusbarElementUserDefined

Indicates whether the project engineer has added the status bar element as a new custom element.

Value	Explanation
TRUE	The status bar element is user-defined.
FALSE	The status bar element is defined by the system.

The attribute can be assigned dynamic properties by means of the name **StatusbarElementUserDefined**. The data type is BOOLEAN.

StatusbarElementWidth property

Width in pixels - StatusbarElementWidth

Shows the width of the status bar element selected in pixels. You can define the width if the "Automatic" option is not activated.

The attribute can be assigned dynamic properties by means of the name **StatusbarElementWidth**. The data type is LONG.

StatusbarFont property

StatusbarFont

Defines the font of the text in the status bar.

The attribute cannot be dynamized.

StatusbarFontColor property

Font color - StatusbarFontColor

Defines the color of the text in the status bar.

3.11 Object properties

The attribute can be assigned dynamic properties by means of the name **StatusbarFontColor**. The data type is LONG.

StatusbarShowTooltips property

Tooltips - StatusbarShowTooltips

Enables the display of tooltips for the status bar elements in Runtime.

Value	Explanation
TRUE	Enables the display of tooltips.
FALSE	Disables the display of tooltips.

The attribute can be assigned dynamic properties by means of the name **StatusbarShowTooltips**. The data type is BOOLEAN.

Attribute "StatusbarElementTooltipText" defines the tooltip text.

StatusbarText property

StatusbarText

Default text in the status bar.

The attribute can be assigned dynamic properties by means of the name **StatusbarText**. The data type is STRING.

StatusbarUseBackColor property

Display background color - StatusbarUseBackColor

Sets a background color for the status bar.

Value	Explanation
TRUE	Enables the display of the background color of the status bar.
FALSE	Disables the display of a background color for the status bar.

The attribute can be assigned dynamic properties by means of the name **StatusbarUseBackColor**. The data type is BOOLEAN.

StatusbarVisible property

Show status bar - StatusbarVisible

Enables the display of the status bar of a control.

Value	Explanation
TRUE	Enables the display of a status bar.
FALSE	Disables the display of a status bar.

The attribute can be assigned dynamic properties by means of the name **StatusbarVisible** .
The data type is BOOLEAN.

3.11.6.17 T

TableColor property

Row background color 1 - TableColor

Defines the background color of the rows. The button opens the "Color selection" dialog.

The attribute can be assigned dynamic properties by means of the name **TableColor**. The data type is LONG.

TableColor2 property

Row background color 2 - TableColor2

Specifies the background color of "Row color 2". The button opens the "Color selection" dialog.

The setting is only active in Runtime if the "Row color 2" or "UseTableColor2" option is activated. The background colors of "Row color 2" and "Row color 1" are used alternately in this case.

The attribute can be assigned dynamic properties by means of the name **TableColor2**. The data type is LONG.

TableForeColor property

Row font color 1 - TableForeColor

Specifies the font color of the rows. The button opens the "Color selection" dialog.

The attribute can be assigned dynamic properties by means of the name **TableForeColor**. The data type is LONG.

TableForeColor2 property

Row font color 2 - TableForeColor2

Specifies the font color of "Row color 2". The button opens the "Color selection" dialog.

The setting is only active in Runtime if the "Row color 2" or "UseTableColor2" option is activated. The font colors of "Row color 2" and "Row color 1" are used alternately in this case.

The attribute can be assigned dynamic properties by means of the name **TableForeColor2**.
The data type is LONG.

TableStyle property

TableStyle

Specifies the appearance of the fields in the table in WinCC UserAdminControl.

Value	Description	Explanation
0	Flat	The fields of the table are displayed normally.
1	Button	The fields of the table are displayed in button style.

The attribute can be assigned dynamic properties using the name **TableStyle**. The data type is LONG.

TimeAxis

TimeAxisActualize property

Refresh - TimeAxisActualize

Enables refreshing of the time axis selected.

Value	Explanation
TRUE	Enables updates of the trend window assigned to the time axis or diagram window.
FALSE	Disables updates of the trend window assigned to the time axis or diagram window. This setting can be useful when comparing an archived trend with a current trend or diagram.

The attribute can be assigned dynamic properties by means of the name **TimeAxisActualize**.
The data type is BOOLEAN.

TimeAxisAdd property

New - TimeAxisAdd

Creates a new time axis.

The attribute can be assigned dynamic properties by means of the name **TimeAxisAdd**. The data type is STRING.

TimeAxisAlign property

Alignment - TimeAxisAlign

Specifies the mode of alignment of a selected time axis.

The following settings are available:

Value	Description	Explanation
0	Bottom	The selected time axis is displayed below the trend or diagram.
1	Top	The selected time axis is displayed above the trend or diagram.

The attribute can be assigned dynamic properties by means of the name **TimeAxisAlign**. The data type is LONG.

TimeAxisBarWindow property

Diagram window - TimeAxisBarWindow

Specifies the diagram window in which the selected time axis will be used. You can specify the available diagram window in the "Diagram window" tab or using "BarWindowAdd".

The attribute can be assigned dynamic properties using the name **TimeAxisBarWindow**. The data type is STRING.

TimeAxisBeginTime property

Start time - TimeAxisBeginTime

Defines the start of the time range for a selected time axis.

The attribute can be assigned dynamic properties by means of the name **TimeAxisBeginTime**. The data type is Date.

Use the "yyyy-mm-dd hh:mm:ss" format when setting a dynamic time range.

TimeAxisColor property

Time axis color - TimeAxisColor

Specifies the color of the time axis. The button opens the "Color selection" dialog to select the color.

The setting is only active if the "Use trend color" or "Use diagram color" option is disabled or if "ValueAxisInTrendColor" is "FALSE".

3.11 Object properties

The attribute can be assigned dynamic properties by means of the name **TimeAxisColor**. The data type is LONG.

TimeAxisCount property

TimeAxisCount

Defines the number of time axes configured.

The attribute can be assigned dynamic properties by means of the name **TimeAxisCount**. The data type is LONG.

TimeAxisDateFormat property

Date format - TimeAxisDateFormat

Defines the date format for visualizing a selected time axis.

The following date formats are available:

Value	Explanation
Automatic	The date format is set automatically.
dd.MM.yy	Day.Month.Year, e.g. 24.12.07.
dd.MM.yyyy	Day.Month.Year, e.g. 24.12.2007.
dd/MM/yy	Day/Month/Year, e.g. 24/12/07.
dd/MM/yyyy	Day/Month/Year, e.g. 24/12/2007.

The attribute can be assigned dynamic properties by means of the name **TimeAxisDateFormat**. The data type is STRING.

TimeAxisEndTime property

End time - TimeAxisEndTime

Defines the end of the time range of a selected time axis.

The attribute can be assigned dynamic properties by means of the name **TimeAxisEndTime**. The data type is Date.

Use the "yyyy-mm-dd hh:mm:ss" format when setting a dynamic time range.

TimeAxisInBarColor property

In diagram color - TimeAxisInBarColor

Specifies whether the selected time axis will be displayed in the diagram color. If there is more than one diagram in the diagram window, the color of the first diagram will be used. You specify the order of the diagrams on the "Diagrams" tab.

Value	Explanation
TRUE	The selected time axis is displayed in the diagram color. The setting in the "Color" or "TimeAxisColor" field is disabled.
FALSE	The selected time axis is displayed in the color set in the "Color" or "TimeAxisColor" field.

The attribute can be assigned dynamic properties using the name **TimeAxisInBarColor**. The data type is BOOLEAN.

TimeAxisIndex property

TimeAxisIndex

References a configured time axis. Using this attribute you can assign the values of other attributes to a specific time axis.

Values between 0 and "TimeAxisCount" minus 1 are valid for "TimeAxisIndex". The "TimeAxisCount" attribute defines the number of configured time axes.

The "TimeAxisIndex" attribute can be assigned dynamic properties by means of attribute **TimeAxisRepos**. The data type is LONG.

TimeAxisInTrendColor property

Use trend color - TrendAxisInTrendColor

Sets a trend color for displaying the time axis selected. The color of the first trend is activated if several trends are displayed in the trend window. Define the order of trends on the "Trends" tab.

Value	Explanation
TRUE	The trend color is used to display the time axis selected. The setting in the "Color" or "TimeAxisColor" field is disabled.
FALSE	The time axis selected is displayed in the color set in the "Color" or "TimeAxisColor" field.

The attribute can be assigned dynamic properties by means of the name **TimeAxisInTrendColor**. The data type is BOOLEAN.

TimeAxisLabel property

Label - TimeAxisLabel

Defines the label text for a time axis.

The attribute can be assigned dynamic properties by means of the name **TimeAxisLabel**. The data type is STRING.

TimeAxisMeasurePoints property

Number of measurement points - TimeAxisMeasurePoints

Defines the number of measurement points to be displayed at the time axis selected.

The attribute can be assigned dynamic properties by means of the name **TimeAxisMeasurePoints**. The data type is LONG.

TimeAxisName property

Object name - TimeAxisName

Specifies the name of a selected time axis.

The "TimeAxisName" attribute can be assigned dynamic properties by means of attribute **TimeAxisRename**. The data type is STRING.

TimeAxisRangeType property

Time range setting - TimeAxisRangeType

Specifies the time range for the time axis selected.

Value	Description	Explanation
0	Time range	Defines the start time and the time range for the time axis.
1	Start to end time	Defines the start and end time for the time axis.
2	Number of measurement points	Defines the start time and the number of measurement points for the time axis.

The attribute can be assigned dynamic properties by means of the name **TimeAxisRangeType**. The data type is LONG.

TimeAxisRemove property

Remove - TimeAxisRemove

Removes the selected time axis from the list.

The attribute can be assigned dynamic properties by means of the name **TimeAxisRemove**. The data type is STRING.

TimeAxisRename property

TimeAxisRename

Renames a time axis which is referenced by means of "TimeAxisIndex" attribute.

The attribute can be assigned dynamic properties by means of the name **TimeAxisRename**. "TimeAxisRename" also sets a dynamic attribute "TimeAxisName". The data type is STRING.

TimeAxisRepos property

Up/Down - TimeAxisRepos

Changes the order of the time axes. "Up" and "Down" move the selected time axis up or down in the list.

The list order determines the time axis position in the trend window or diagram window in runtime. If the orientation is the same and the time axis is further above, the time axis is shown at a more remote position of the curve or diagram.

The attribute can be assigned dynamic properties by means of the name **TimeAxisRepos**. The data type is LONG.

TimeAxisShowDate property

Show date - TimeAxisShowDate

Enables the display of the date and time at the time axis selected.

Value	Explanation
TRUE	Date and time are displayed. The date format is defined in the "Date format" field.
FALSE	The date is not displayed. Only the time is displayed.

The attribute can be assigned dynamic properties by means of the name **TimeAxisShowDate**. The data type is BOOLEAN.

TimeAxisTimeFormat property

Time format - TimeAxisTimeFormat

Defines the time format for visualizing a selected time axis.

3.11 Object properties

The following time formats are available:

Value	Explanation
Automatic	The time format is set automatically.
hh:mm:ss.ms	Hours:Minutes:Seconds, e.g. 15:35:44.240.
hh:mm:ss tt	Hours:Minutes:Seconds AM/PM, e.g. 03:35:44 PM.
hh:mm:ss.ms tt	Hours:Minutes:Seconds.Milliseconds AM/PM, e.g. 03:35:44.240 PM.

The attribute can be assigned dynamic properties by means of the name **TimeAxisTimeFormat**. The data type is STRING.

TimeAxisTimeRangeBase property

Time range - TimeAxisTimeRangeBase

Defines the time unit for calculating the time range.

The following time units are available:

Value	Description
500	500 ms
1000	1 second
60000	1 minute
3600000	1 hour
86400000	1 day

The attribute can be assigned dynamic properties by means of the name **TimeAxisTimeRangeBase**. The data type is LONG.

TimeAxisTimeRangeFactor property

Time range - TimeAxisTimeRangeFactor

Defines the factor for calculating the time range. Only integer factors are valid.

The attribute can be assigned dynamic properties by means of the name **TimeAxisTimeRangeFactor**. The data type is SHORT.

TimeAxisTrendWindow property

Trend window - TimeAxisTrendWindow

Specifies the trend window for displaying the time axis selected. Define the available trend windows in the "Trend window" or "TrendWindowAdd" tab.

The attribute can be assigned dynamic properties by means of the name **TimeAxisTrendWindow**. The data type is STRING.

TimeAxisVisible property

Time axis - TimeAxisVisible

The list shows all time axes you created. Click a time axis entry in the list to adapt the properties and to assign a trend window or diagram window to the time axis.

Select the time axes in the list that you want to display in the trend windows or diagram windows.

Defines whether the selected time axis is displayed.

Value	Explanation
TRUE	The time axis is displayed.
FALSE	The time axis is not displayed.

The attribute can be assigned dynamic properties by means of the name **TimeAxisVisible**. The data type is BOOLEAN.

TimeBase property

Time base - TimeBase

This selection field is used to define the time base for the time stamp in the control.

Value	Designation
0	Local time zone
1	Coordinated Universal Time (UTC)
2	Project setting

The attribute can be assigned dynamic properties by means of the name **TimeBase**. The data type is LONG.

TimeColumn

TimeColumnActualize property

TimeColumnActualize

Enables the update of values in the selected column.

Value	Explanation
TRUE	The time column is updated.
FALSE	The time column is not updated. This setting can be useful when comparing tables.

The attribute can be assigned dynamic properties by means of the name **TimeColumnActualize**. The data type is BOOLEAN.

TimeColumnAdd property

New - TimeColumnAdd

Creates a new time column.

The attribute can be assigned dynamic properties by means of the name **TimeColumnAdd**.
The data type is STRING.

TimeColumnAlign property

Alignment - TimeColumnAlign

Defines the mode of alignment of the time column selected.

The following settings are available:

Value	Description	Explanation
0	left	The time column selected is displayed on the left.
1	Centered	The time column selected is aligned to center.
2	right	The time column selected is displayed on the right.

The attribute can be assigned dynamic properties by means of the name **TimeColumnAlign**.
The data type is LONG.

TimeColumnBackColor property

Background color - TimeColumnBackColor

Specifies the background color of the time column selected. Use the button to open the "Color selection" dialog.

The setting is useful if:

- The "Use value column colors" option is not activated or "TimeColumnUseValueColumnColors" is "FALSE".
- The "Background color" option is activated or "UseColumnBackColor" is "TRUE" in the "Use column color" field of the "General" tab".

The attribute can be assigned dynamic properties by means of the name **TimeColumnBackColor**. The data type is LONG.

TimeColumnBeginTime property

Start time - TimeColumnBeginTime

Defines the start of the time range for a selected time column.

The attribute can be assigned dynamic properties by means of the name **TimeColumnBeginTime**. The data type is Date.

Use the "yyyy-mm-dd hh:mm:ss" format when setting a dynamic time range.

TimeColumnCaption property

Caption - TimeColumnCaption

Defines the caption of the time column.

The attribute can be assigned dynamic properties by means of the name **TimeColumnCaption**. The data type is STRING.

TimeColumnCount property

TimeColumnCount

Defines the number of time columns configured.

The attribute can be assigned dynamic properties by means of the name **TimeColumnCount**. The data type is LONG.

TimeColumnDateFormat property

Date format - TimeColumnDateFormat

Defines the date format for visualizing a selected time column.

The following date formats are available:

Value	Explanation
Automatic	The date format is set automatically.
dd.MM.yy	Day.Month.Year, e.g. 24.12.07.
dd.MM.yyyy	Day.Month.Year, e.g. 24.12.2007.
dd/MM/yy	Day/Month/Year, e.g. 24/12/07.
dd/MM/yyyy	Day/Month/Year, e.g. 24/12/2007.

The attribute can be assigned dynamic properties by means of the name **TimeColumnDateFormat**. The data type is STRING.

TimeColumnEndTime property

End time - TimeColumnEndTime

Defines the end of the time range of a selected time column.

3.11 Object properties

The attribute can be assigned dynamic properties by means of the name **TimeColumnEndTime**. The data type is Date.

Use the "yyyy-mm-dd hh:mm:ss" format when setting a dynamic time range.

TimeColumnForeColor property

Font color - TimeColumnForeColor

Specifies the font color of the time column selected. Use the button to open the "Color selection" dialog.

The setting is useful if:

- The "Use value column colors" option is not activated or "TimeColumnUseValueColumnColors" is "FALSE".
- The "Font color" option is activated or "UseColumnForeColor" is "TRUE" in the "Use column color" field of the "General" tab.

The attribute can be assigned dynamic properties by means of the name **TimeColumnForeColor**. The data type is LONG.

TimeColumnHideText property

TimeColumnHideText

Sets text format for displaying the content of a time column.

Value	Explanation
TRUE	The content is not displayed in text format.
FALSE	The content is displayed in text format.

The attribute can be assigned dynamic properties by means of the name **TimeColumnHideText**. The data type is BOOLEAN.

TimeColumnHideTitleText property

TimeColumnHideTitleText

Sets text format for displaying the time column header.

Value	Explanation
TRUE	The header is not displayed in text format.
FALSE	The header is displayed in text format.

The attribute can be assigned dynamic properties by means of the name **TimeColumnHideTitleText**. The data type is BOOLEAN.

TimeColumnIndex property

TimeColumnIndex

References a configured time column. Using this attribute you can assign the values of other attributes to a specific time column.

Values between 0 and "TimeColumnCount" minus 1 are valid for "TimeColumnIndex". Attribute "TimeColumnCount" defines the number of time columns configured.

The "TimeColumnIndex" attribute can be assigned dynamic properties by means of attribute **TimeColumnRepos**. The data type is LONG.

TimeColumnLength property

Length in characters - TimeColumnLength

Specifies the width of a selected time column.

The attribute can be assigned dynamic properties by means of the name **TimeColumnLength**. The data type is LONG.

TimeColumnMeasurePoints property

Number of measurement points - TimeColumnMeasurePoints

Defines the number of measurement points to be displayed in the time column selected.

The attribute can be assigned dynamic properties by means of the name **TimeColumnMeasurePoints**. The data type is LONG.

TimeColumnName property

Object name - TimeColumnName

Specifies the name of a selected time column.

The "TimeColumnName" attribute can be assigned dynamic properties by means of attribute **TimeColumnRename**. The data type is STRING.

TimeColumnRangeType property

Time range setting - TimeColumnRangeType

Defines the time range setting for the time column selected.

Value	Description	Explanation
0	Time range	Defines the start time and time range of the time column.
1	Start to end time	Defines the start and end time for the time column.
2	Number of measurement points	Defines the start time and the number of measurement points for the time column.

The attribute can be assigned dynamic properties by means of the name **TimeColumnRangeType**. The data type is LONG.

TimeColumnRemove property

Remove - TimeColumnRemove

Removes the selected time column from the list.

The attribute can be assigned dynamic properties by means of the name **TimeColumnRemove**. The data type is STRING.

TimeColumnRename property

TimeColumnRename

Renames a time column which is referenced by means of "TimeColumnIndex" attribute.

The attribute can be assigned dynamic properties by means of the name **TimeColumnRename**. "TimeColumnRename" also sets a dynamic attribute "TimeColumnName". The data type is STRING.

TimeColumnRepos property

Up/Down - TimeColumnRepos

Repositions the order of time columns and of corresponding value columns. "Up" and "Down" move the time column selected up or down in the list. This moves the time column and corresponding value columns in the table towards the front or towards the back.

The attribute can be assigned dynamic properties by means of the name **TimeColumnRepos**. The data type is LONG.

TimeColumnShowDate property**Show date - TimeColumnShowDate**

Enables the display of the date and time in the time column selected.

Value	Explanation
TRUE	Date and time are displayed. The date format is defined in the "Date format" field or by using "TimeColumnDateFormat".
FALSE	The date is not displayed. Only the time is displayed.

The attribute can be assigned dynamic properties by means of the name **TimeColumnShowDate**. The data type is BOOLEAN.

TimeColumnShowIcon property**TimeColumnShowIcon**

Enables the display of time column contents as icon. This function is only available in WinCC Alarm Control.

Value	Explanation
TRUE	The content is visualized as icon.
FALSE	The content is not visualized as icon.

The attribute can be assigned dynamic properties by means of the name **TimeColumnShowIcon**. The data type is BOOLEAN.

TimeColumnShowTitleIcon property**TimeColumnShowTitleIcon**

Enables display of the time column header as icon. This function is only available in WinCC Alarm Control.

Value	Explanation
TRUE	The header is displayed as icon.
FALSE	The header is not displayed as icon.

The attribute can be assigned dynamic properties by means of the name **TimeColumnShowTitleIcon**. The data type is BOOLEAN.

TimeColumnSort property**TimeColumnSort**

Defines the sorting order of the time column referenced in "TimeColumnIndex" .

3.11 Object properties

The following settings are available:

Value	Description	Explanation
0	No	No sorting
1	Ascending	Ascending order, starting at the lowest value.
2	Descending	Descending order, starting at the highest value.

The attribute can be assigned dynamic properties by means of the name **TimeColumnSort** . The data type is LONG.

TimeColumnSortIndex property

TimeColumnSortIndex

Defines the sorting order of the time column referenced in "TimeColumnIndex". The sorting criterion is removed from "TimeColumnSort" if you set a "0" value..

The attribute can be assigned dynamic properties by means of the name **TimeColumnSortIndex**. The data type is LONG.

TimeColumnTimeFormat property

Time format - TimeColumnTimeFormat

Defines the time format for visualizing a selected time column.

The following time formats are available:

Value	Explanation
Automatic	The time format is set automatically.
HH:mm:ss.ms	Hours:Minutes:Seconds, e.g. 15:35:44.240.
hh:mm:ss tt	Hours:Minutes:Seconds AM/PM, e.g. 03:35:44 PM.
hh:mm:ss.ms tt	Hours:Minutes:Seconds.Milliseconds AM/PM, e.g. 03:35:44.240 PM.

The attribute can be assigned dynamic properties by means of the name **TimeColumnTimeFormat**. The data type is STRING.

TimeColumnTimeRangeBase property

Time range - TimeColumnTimeRangeBase

Defines the time unit for calculating the time range.

The following time units are available:

Value	Description
500	500 ms
1000	1 second

Value	Description
60000	1 minute
3600000	1 hour
86400000	1 day

The attribute can be assigned dynamic properties by means of the name **TimeColumnTimeRangeBase**. The data type is LONG.

TimeColumnTimeRangeFactor property

Time range - TimeColumnTimeRangeFactor

Defines the factor for calculating the time range. Only integer factors are valid.

The attribute can be assigned dynamic properties by means of the name **TimeColumnTimeRangeFactor**. The data type is SHORT.

TimeColumnUseValueColumnColors property

Use value column colors - TimeColumnUseValueColumnColors

Defines whether the selected time column will be displayed in the value column colors.

Value	Explanation
TRUE	The colors of the value column are used to display a selected time column. The settings in the "Font color" and "Background color" fields are disabled.
FALSE	The colors defined in the "Font color" and "Background color" fields are used to display the selected time column.

The attribute can be assigned dynamic properties by means of the name **TimeColumnUseValueColumnColors**. The data type is BOOLEAN.

TimeColumnVisible property

Time columns - TimeColumnVisible

The list shows the time columns you created. Click a time column entry in the list to adapt the properties and to define the time range of the time column.

Select the time columns to be displayed in the table from the list.

Defines whether the selected time column is displayed.

The attribute can be assigned dynamic properties by means of the name **TimeColumnVisible**. The data type is BOOLEAN.

TimeStepBase property

Precision - TimeStepBase

Defines the precision of the time stamp displayed in a table.

Calculate the precision by multiplying the factor with the time unit. Enter factor "3" and time unit "1s" to display all values which were generated within 3 seconds in the same row, for example.

Value	Description	Explanation
0	Exact	Only values with precisely the same time stamp are displayed in a table row.
100	100 ms	All values generated within 100 milliseconds are grouped in a table row.
250	250 ms	All values generated within 250 milliseconds are grouped in a table row.
500	500 ms	All values generated within 500 milliseconds are grouped in a table row.
1000	1 s	All values generated within 1 second are grouped in a table row.

The attribute can be assigned dynamic properties by means of the name **TimeStepBase**. The data type is LONG.

TimeStepFactor property

Precision - TimeStepFactor

Defines the precision of the time stamp displayed in a table.

Calculate the precision by multiplying the factor with the time unit. Enter factor "3" and time unit "1s" to display all values which were generated within 3 seconds in the same row.

The factor entered is disabled if "Exact" is selected for the time unit or "0" is selected for "TimeStepBase".

The attribute can be assigned dynamic properties by means of the name **TimeStepFactor**. The data type is LONG.

TitleColor property

Table header background - TitleColor

Specifies the background color of the table headers. The button opens the "Color selection" dialog.

The attribute can be assigned dynamic properties by means of the name **TitleColor**. The data type is LONG.

TitleCut property**Shorten contents - TitleCut**

Truncates the content of column headers if the column is insufficient.

Value	Explanation
TRUE	The column headers are truncated.
FALSE	The column headers are not truncated.

The attribute can be assigned dynamic properties by means of the name **TitleCut** . The data type is BOOLEAN.

TitleDarkShadowColor property**Dark shading color - TitleDarkShadowColor**

Specifies the color of the dark side of shading. The button opens the "Color selection" dialog.

The setting is only active if the "Shading Color" option or "TitleStyle" is activated.

The attribute can be assigned dynamic properties by means of the name **TitleDarkShadowColor**. The data type is LONG.

TitleForeColor property**Table header font color - TitleForeColor**

Specifies the color of the table header. The button opens the "Color selection" dialog.

The attribute can be assigned dynamic properties by means of the name **TitleForeColor**. The data type is LONG.

TitleGridLineColor property**Color of the divider / header - TitleGridLineColor**

Defines the color of row/column dividers in the table header. The button opens the "Color selection" dialog.

The attribute can be assigned dynamic properties by means of the name **TitleGridLineColor**. The data type is LONG.

TitleLightShadowColor property**Bright shading color - TitleLightShadowColor**

Specifies the color of the bright side of shading. The button opens the "Color selection" dialog.

3.11 Object properties

The setting is only active if the "Shading Color" option or "TitleStyle" is activated.

The attribute can be assigned dynamic properties by means of the name **TitleLightShadowColor**. The data type is LONG.

TitleSort property

Sort by column title- TitleSort

Defines how to trigger sorting by column title. You can only sort by column title if the "Auto-scrolling" option is deactivated.

Value	Description	Explanation
0	No	Sorting by column title is not possible.
1	With click	Sorting is triggered by clicking in the column header.
2	With double-click	Sorting is triggered by double-clicking in the column title.

The attribute can be assigned dynamic properties by means of the name **TitleSort**. The data type is LONG.

TitleStyle property

Shading color - TitleStyle

Specifies whether to set a shading color for the table header.

Value	Description	Explanation
0	Flat	Disables the use of shading colors. Flat header style.
1	Button	Enables the use of shading colors. 3D representation of the header.

The attribute can be assigned dynamic properties by means of the name **TitleStyle**. The data type is LONG.

Toolbar

ToolbarAlignment property

Alignment - ToolbarAlignment

Defines the orientation of the Control toolbar.

The following settings are available:

Value	Description	Explanation
0	Top	The toolbar is aligned to the top edge.
1	Bottom	The toolbar is aligned to the bottom edge.

Value	Description	Explanation
2	left	The toolbar is aligned to the left edge.
3	right	The toolbar is aligned to the right edge.

The attribute can be assigned dynamic properties by means of the name **ToolbarAlignment**. The data type is LONG.

ToolbarBackColor property

Background color - ToolbarBackColor

Specifies the background color of the toolbar. Open the "Color selection" dialog by clicking the button.

The background color you configured is only displayed if the "Display" option is activated or "ToolbarUseBackColor" is "TRUE".

The attribute can be assigned dynamic properties by means of the name **ToolbarBackColor**. The data type is LONG.

ToolbarButtonActive property

Active - ToolbarButtonActive

Activates a button function in Runtime. Clicking the button in Runtime triggers the corresponding function.

Value	Explanation
TRUE	The button function is enabled.
FALSE	The button function is disabled. You can assign custom functions to the button by means of scripting.

The attribute can be assigned dynamic properties by means of the name **ToolbarButtonActive**. The data type is BOOLEAN.

ToolbarButtonAdd property

New - ToolbarButtonAdd

Creates a new, user-defined button function. The name set by WinCC can be edited in the "Object name" field.

The attribute can be assigned dynamic properties by means of the name **ToolbarButtonAdd**. The data type is STRING.

ToolBarButtonBeginGroup property

Separator - ToolBarButtonBeginGroup

Inserts a leading separator (vertical line) for the selected button function on the toolbar. These separators can be used to group the icons of the button functions.

Value	Explanation
TRUE	A separator prefix is inserted for the button function selected.
FALSE	A separator prefix is not inserted for the button function selected.

The attribute can be assigned dynamic properties by means of the name **ToolBarButtonBeginGroup**. The data type is BOOLEAN.

ToolBarButtonClick AlarmControl property

ToolBarButtonClick

Triggers the function linked to the toolbar button. The respective button function is called via the "ID".

The attribute can be assigned dynamic properties by means of the name **ToolBarButtonClick**. The data type is LONG.

ID / Button function	ID / Button function
1 = Help	21 = Next message
2 = Configuration dialog	22 = Last message
3 = Message list	23 = Info text dialog
4 = Short-term archive list	24 = Comments dialog
5 = Long-term archive list	25 = Loop in Alarm
6 = Lock list	26 = Lock message
7 = Hit list	27 = Enable message
8 = List of messages to be hidden	28 = Hide message
9 = Acknowledge central signaling device	29 = Unhide message
10 = Single acknowledgment	30 = Sort dialog
11 = Group acknowledgment	31 = Time base dialog
12 = Autoscroll	32 = Copy rows
13 = Selection dialog	33 = Connect backup
14 = Display options dialog	34 = Disconnect backup
15 = Lock dialog	35 = Export data
16 = -	36 = First page
17 = Print	37 = Previous page
18 = Emergency acknowledgment	38 = Next page
19 = First message	39 = Last page
20 = Previous message	40 = Display alarm help text
	as of 1001 = User-defined

ToolBarButtonClick BarChartControl property

ToolBarButtonClick

Triggers the function connected to the toolbar button. The respective button function is called via the "ID".

The attribute can be assigned dynamic properties by means of the name **ToolBarButtonClick**. The data type is LONG.

ID / Button function	ID / Button function
1 = Help	14 = Original view
2 = Configuration dialog	15 = Select data connection
3 = First data record	16 = Select diagram
4 = Previous data record	17 = Select time range
5 = Next data record	18 = Previous diagram
6 = Last data record	19 = Next diagram
7 = -	20 = Start/Stop
8 = Zoom area	21 = Print
9 = Zoom +/-	24 = Connect backup
10 = Zoom time axis +/-	25 = Disconnect backup
11 = Zoom value axis +/-	26 = Export data
12 = Move diagram area	as of 1001 = User-defined
13 = Move axis range	

ToolBarButtonClick FunctionTrendControl property

ToolBarButtonClick

Triggers the function linked to the toolbar button. The respective button function is called via the "ID".

The attribute can be assigned dynamic properties by means of the name **ToolBarButtonClick**. The data type is LONG.

ID / Button function	ID / Button function
1 = Help	11 = Select data connection
2 = Configuration dialog	12 = Select trends
3 = Ruler	13 = Select time range
4 = Zoom area	14 = Previous trend
5 = Zoom +/-	15 = Next trend
6 = Zoom X axis +/-	16 = Start/Stop
7 = Zoom Y axis +/-	17 = Print
8 = Move trend range	18 = Connect backup
9 = Move axis range	19 = Disconnect backup
10 = Original view	20 = Export data
	as of 1001 = User-defined

ToolBarButtonClick OnlineTableControl property

ToolBarButtonClick

Triggers the function linked to the toolbar button. The respective button function is called via the "ID".

The attribute can be assigned dynamic properties by means of the name **ToolBarButtonClick**. The data type is LONG.

ID / Button function	ID / Button function
1 = Help	13 = Next column
2 = Configuration dialog	14 = Start/stop
3 = First data record	15 = Print
4 = Previous data record	16 = Define statistics area
5 = Next data record	17 = Calculate statistics
6 = Last data record	18 = Connect backup
7 = Edit	19 = Disconnect backup
8 = Copy rows	20 = Export data
9 = Select data connection	21 = Create archive value
10 = Select columns	22 = Select filter
11 = Select time range	as of 1001 = User-defined
12 = Previous column	

ToolBarButtonClick OnlineTrendControl property

ToolBarButtonClick

Triggers the function linked to the toolbar button. The respective button function is called via the "ID".

The attribute can be assigned dynamic properties by means of the name **ToolBarButtonClick**. The data type is LONG.

ID / Button function	ID / Button function
1 = Help	15 = Select data connection
2 = Configuration dialog	16 = Select trends
3 = First data record	17 = Select time range
4 = Previous data record	18 = Previous trend
5 = Next data record	19 = Next trend
6 = Last data record	20 = Start/Stop
7 = Ruler	21 = Print
8 = Zoom area	22 = Set statistics range
9 = Zoom +/-	23 = Calculate statistics
10 = Zoom time axis +/-	24 = Connect backup
11 = Zoom value axis +/-	25 = Disconnect backup
12 = Move trend range	26 = Export data
13 = Move axis range	27 = Relative axis
14 = Original view	as of 1001 = User-defined

ToolBarButtonClick RulerControl property

ToolBarButtonClick

Triggers the function linked to the toolbar button. The respective button function is called via the "ID".

The attribute can be assigned dynamic properties by means of the name **ToolBarButtonClick**. The data type is LONG.

ID / Button function	ID / Button function
1 = Help	5 = Statistics
2 = Configuration dialog	6 = Print
3 = Ruler window	7 = Export data
4 = Statistics area	as of 1001 = User-defined

ToolBarButtonClick SysdiagControl property

ToolBarButtonClick

Triggers the function linked to the toolbar button. The respective button function is called via the "ID".

3.11 Object properties

The attribute can be assigned dynamic properties using the name **ToolBarButtonClick**. The data type is LONG.

ID / Button function	ID / Button function
1 = Help	6 = Overview
2 = Configuration dialog	7 = Back
3 = Sort dialog	8 = Open
4 = Print	9 = Diagnostic buffer
5 = Export data	10 = Update diagnostic buffer
	as of 1001 = User-defined

ToolBarButtonClick UserAdminControl property

ToolBarButtonClick

Triggers the function linked to the toolbar button. The respective button function is called via the "ID".

The attribute can be assigned dynamic properties using the name **ToolBarButtonClick**. The data type is LONG.

ID / Button function	ID / Button function
1 = Help	9 = Log on
2 = Configuration dialog	10 = Log off
3 = Group list	11 = Change password
4 = User list	12 = Import user administration
5 = Edit	13 = Export user administration
6 = Add	14 = Sort dialog
7 = Authorization levels	15 = Print
8 = Delete	16 = Export data
	as of 1001 = User-defined

ToolBarButtonClick UserArchiveControl property

ToolBarButtonClick

Triggers the function linked to the toolbar button. The respective button function is called via the "ID".

The attribute can be assigned dynamic properties by means of the name **ToolBarButtonClick**. The data type is LONG.

ID / Button function	ID / Button function
1 = Help	12 = Read tags
2 = Configuration dialog	13 = Write tags
3 = Select data connection	14 = Import archive
4 = First row	15 = Export archive
5 = Previous row	16 = Sort dialog
6 = Next row	17 = Selection dialog
7 = Last row	18 = Print
8 = Delete rows	19 = Time base dialog
9 = Cut rows	20 = Export data
10 = Copy rows	as of 1001 = User-defined
11 = Paste rows	

ToolBarButtonCount property

ToolBarButtonCount

Defines the number of configurable button functions.

The attribute can be assigned dynamic properties by means of the name **ToolBarButtonCount**. The data type is LONG.

ToolBarButtonEnabled property

ToolBarButtonEnabled

Enables operation of custom toolbar buttons.

The attribute can be assigned dynamic properties by means of the name **ToolBarButtonEnabled**. The data type is BOOLEAN.

ToolBarButtonHotKey property

Hotkey - ToolBarButtonHotKey

Shows the hotkey for a button function selected.

You create or edit a hotkey by clicking in the "Hotkey" field and pressing the button or key shortcut required.

The attribute can be assigned dynamic properties by means of the name **ToolBarButtonHotKey**. The data type is LONG.

ToolBarButtonID property

Object ID - ToolBarButtonID

Unique ID number for the selected button function. WinCC assigns this read only ID number.

The attribute can be assigned dynamic properties by means of the name **ToolBarButtonID**.

The data type is LONG.

ToolBarButtonIndex property

ToolBarButtonIndex

References a button function. Using this attribute you can assign the values of other attributes to a specific button function.

Values between 0 and "ToolBarButtonIndex" minus 1 are valid for "ToolBarButtonCount".

Attribute "ToolBarButtonCount" defines the number of configurable button functions.

The "ToolBarButtonIndex" attribute can be assigned dynamic properties by means of attribute **ToolBarButtonRepos**. The data type is LONG.

ToolBarButtonLocked property

ToolBarButtonLocked

Enables/disables the display of the pressed state of a user-defined toolbar button.

The attribute can be assigned dynamic properties by means of the name

ToolBarButtonLocked. The data type is BOOLEAN.

ToolBarButtonName property

Object name - ToolBarButtonName

Shows the name for the selected button function. You rename user-defined button functions.

The "ToolBarButtonName" attribute can be assigned dynamic properties by means of attribute **ToolBarButtonRename**. The data type is STRING.

ToolBarButtonPasswordLevel property

Operator authorization - ToolBarButtonPasswordLevel

Shows the authorization for a button function selected. You can edit the authorization using the selection button.

Authorizations are configured in the "User Administrator" editor.

The attribute can be assigned dynamic properties by means of the name **ToolBarButtonPasswordLevel**. The data type is LONG.

ToolBarButtonRemove property

Remove - ToolBarButtonRemove

Removes the selected button function from the list. Only user-defined button functions can be removed.

The attribute can be assigned dynamic properties by means of the name **ToolBarButtonRemove**. The data type is STRING.

ToolBarButtonRename property

ToolBarButtonRename

Renames a custom toolbar element which is referenced by means of "ToolBarButtonIndex" attribute.

The attribute for custom elements can be assigned dynamic properties by means of the name **ToolBarButtonRename**. "ToolBarButtonRename" also sets a dynamic attribute "ToolBarButtonName". The data type is STRING.

ToolBarButtonRepos property

Up/Down - ToolBarButtonRepos

Changes the sorting order of button functions. "Up" and "Down" move the button function selected up or down in the list. This moves the button function in the toolbar of a Control towards the front or towards the back.

The attribute can be assigned dynamic properties by means of the name **ToolBarButtonRepos**. The data type is LONG.

ToolBarButtonSize property

Button size in pixels - ToolBarButtonSize

Defines the size of the buttons in the toolbar.

With the maximum value of 280 pixels, the button size can be ten times larger than the original size of 28 pixels.

The following behavior results for the button size depending on the configured value:

Value of the button size	Behavior
Value < 0	Invalid value. The most recent valid value is used.
$0 \leq \text{value} \leq \text{original size of button}$	The original size of the button is used. "ToolBarButtonSize" is set to the default (= 0).

3.11 Object properties

Value of the button size	Behavior
Original size of the button < value ≤ maximum value	The configured value is used.
Maximum value < value	Invalid value. The most recent valid value is used.

With a large button size, please note that in some cases not all buttons may be displayed in the control. To show all activated buttons in Runtime, you must therefore extend the control or activate fewer buttons as required.

You can create a dedicated button to zoom in or out of the toolbar in Runtime. For instructions, refer to the example "How to configure a user-defined toolbar button with a self-created selection dialog" in the documentation "VBS for Creating Procedures and Actions".

The attribute can be assigned dynamic properties by means of the name **ToolbarButtonSize** . The data type is LONG.

ToolbarButtonTooltipText property

ToolbarButtonTooltipText

Specifies the tooltip text for the button.

The attribute can be assigned dynamic properties by means of the name **ToolbarButtonTooltipText**. The data type is STRING.

ToolbarButtonUserDefined property

ToolbarButtonUserDefined

Indicates whether the project engineer has added a new user-defined toolbar button.

Value	Explanation
TRUE	The toolbar button is assigned a user-defined function.
FALSE	The toolbar button is defined by the system.

The attribute can be assigned dynamic properties by means of the name **ToolbarButtonUserDefined**. The data type is BOOLEAN.

ToolbarButtonVisible property

Button functions - ToolbarButtonVisible

Select the button functions to be displayed in the toolbar from the list.

Click a list entry to adapt the properties, or to change the position in the status bar of the Control by means of the "Up" and "Down" buttons.

The attribute can be assigned dynamic properties by means of the name **ToolbarButtonVisible** . The data type is BOOLEAN.

ToolbarShowTooltips property**Tooltips - ToolbarShowTooltips**

Enables the display of tooltips for the button functions in Runtime.

Value	Explanation
TRUE	Enables the display of tooltips.
FALSE	Disables the display of tooltips.

The attribute can be assigned dynamic properties by means of the name **ToolbarShowTooltips**. The data type is BOOLEAN.

Attribute "ToolbarButtonTooltipText" defines the tooltip text.

ToolbarUseBackColor property**Show background color - ToolbarUseBackColor**

Enables the display of the background color for a toolbar.

Value	Explanation
TRUE	Enables the display of the background color of a toolbar.
FALSE	Disables the display of the background color of a toolbar.

The attribute can be assigned dynamic properties by means of the name **ToolbarUseBackColor**. The data type is BOOLEAN.

ToolbarUseHotKeys property**Hotkeys - ToolbarUseHotKeys**

Activates the hotkeys for button functions in Runtime. Insert the hotkeys for button functions in the "Hotkey" field.

Value	Explanation
TRUE	The hotkeys are activated.
FALSE	The hotkeys are deactivated.

The attribute can be assigned dynamic properties by means of the name **ToolbarUseHotKeys**. The data type is BOOLEAN.

ToolbarVisible property

Show toolbar - ToolbarVisible

Enables the display of the Control toolbar.

Value	Explanation
TRUE	Enables the display of the toolbar.
FALSE	Disables the display of the toolbar.

The attribute can be assigned dynamic properties by means of the name **ToolbarVisible** . The data type is BOOLEAN.

Trend

TrendActualize property

Update -TrendActualize

Enables the update of a selected trend.

Value	Explanation
TRUE	Enables updates of the trend selected.
FALSE	Disables updates of the trend selected. This setting can be useful when comparing a logged trend with a current trend.

The attribute can be assigned dynamic properties by means of the name **TrendActualize**. The data type is BOOLEAN.

TrendAdd property

New - TrendAdd

Creates a new trend.

The attribute can be assigned dynamic properties by means of the name **TrendAdd**. The data type is STRING.

TrendAutoRangeBeginTagName property

TrendAutoRangeBeginTagName

This attribute sets the low limit tag for the range of values if the range of values is calculated automatically by means of online tags.

The attribute can be assigned dynamic properties by means of the name **TrendAutoRangeBeginTagName**. The data type is STRING.

TrendAutoRangeBeginValue property**TrendAutoRangeBeginValue**

This attribute sets the low limit tag for the range of values if the range of values is calculated based on the configuration of high and low limits.

The attribute can be assigned dynamic properties by means of the name **TrendAutoRangeBeginValue**. The data type is DOUBLE.

TrendAutoRangeEndTagName property**TrendAutoRangeEndTagName**

This attribute sets the high limit tag for the range of values if the range of values is calculated automatically by means of online tags.

The attribute can be assigned dynamic properties by means of the name **TrendAutoRangeEndTagName**. The data type is STRING.

TrendAutoRangeEndValue property**TrendAutoRangeEndValue**

This attribute sets the high limit tag for the range of values if the range of values is calculated based on the configuration of high and low limits.

The attribute can be assigned dynamic properties by means of the name **TrendAutoRangeEndValue**. The data type is DOUBLE.

TrendAutoRangeSource property**TrendAutoRangeSource**

Defines the mode for automatic calculation of the range of values of trend data.

Value	Description	Explanation
0	Display data	The range of values is calculated automatically based on the data displayed.
1	Value range	The range of values is defined based on its configured low and high limit. The low and high limits are emulated in the "TrendAutoRangeBeginValue" and "TrendAutoRangeEndValue" attributes.
2	Online tags	The low and high limits of the range of values are derived from the values of connected online tags. The low and high limits are emulated in the "TrendAutoRangeBeginTagName" and "TrendAutoRangeEndTagName" attributes.

The attribute can be assigned dynamic properties by means of the name **TrendAutoRangeSource**. The data type is LONG.

TrendBeginTime property

Start time - TrendBeginTime

Defines the start time of the time range for data transfer to the selected trend.

The attribute can be assigned dynamic properties by means of the name **TrendBeginTime**. The data type is Date.

TrendColor property

Trend color - TrendColor

Specifies the trend color. Open the "Color selection" dialog by clicking the button.

The attribute can be assigned dynamic properties by means of the name **TrendColor**. The data type is LONG.

TrendCount property

TrendCount

Defines the number of configured trends.

The attribute can be assigned dynamic properties by means of the name **TrendCount**. The data type is LONG.

TrendEndTime property

End time - TrendEndTime

Defines the end of the time range for data connections of a selected trend.

The attribute can be assigned dynamic properties by means of the name **TrendEndTime**. The data type is Date.

TrendExtendedColorSet property

Extended - TrendExtendedColorSet

Enables configuration of the point and fill colors and the display of colors in Runtime.

Value	Explanation
TRUE	The "Point color" and "Fill color" field settings can be configured and are active in Runtime.
FALSE	The "Point color" and "Fill color" field settings cannot be configured and are inactive in Runtime.

The attribute can be assigned dynamic properties by means of the name **TrendExtendedColorSet**. The data type is BOOLEAN.

TrendFill property

Filled - TrendFill

Specifies if the area beneath the trend is to be filled.

Value	Explanation
TRUE	The area beneath the trend is shown filled. You can define the trend color as fill color if the "Advanced" option is deactivated. The text background is displayed in the trend color for the trend type "Values". The background color of the control is used as text color.
FALSE	The trend is not visualized with fill color.

The attribute can be assigned dynamic properties by means of the name **TrendFill**. The data type is BOOLEAN.

TrendFillColor property

Fill color - TrendFillColor

Specifies the fill color of the trend. The text fill color is specified for the trend type "Values".

The fill color is used if the "Filled" option is activated or "TrendFill" is "TRUE". Open the "Color selection" dialog by clicking the button.

The configuration is only possible if the "Advanced" option is activated or "TrendExtendedColorSet" is "TRUE".

The attribute can be assigned dynamic properties by means of the name **TrendFillColor**. The data type is LONG.

TrendIndex property

TrendIndex

References a configured trend. Using this attribute you can assign the values of other attributes to a specific trend. The index must always be set before you change the properties of a trend in runtime.

Values between 0 and "TrendIndex" minus 1 are valid for "TrendCount". Attribute "TrendCount" defines the number of trends configured.

The "TrendIndex" attribute can be assigned dynamic properties by means of attribute **TrendRepos**. The data type is LONG.

TrendLabel property

Label - TrendLabel

Defines the label of the trend selected. The label is displayed in Runtime if the value at attribute "UseTrendNameAsLabel" is "FALSE".

The attribute can be assigned dynamic properties by means of the name **TrendLabel**. The data type is STRING.

TrendLineStyle property

Line style - TrendLineStyle

Defines the line style for trend visualization.

The following settings are available:

Value	Description	Explanation
0	Solid	The trend is visualized as solid line.
1	Dashed	The trend is visualized as dashed line.
2	Dotted	The trend is visualized as dotted line.
3	Dash dot	The trend is visualized as dot-dash line.
4	Dash Dot Dot	The trend is visualized as dash-dot-dot line.

The attribute can be assigned dynamic properties by means of the name **TrendLineStyle**. The data type is LONG.

TrendLineType property

Trend type - TrendLineType

Defines how to visualize a trend.

The following settings are available:

Value	Description	Explanation
0	None	Only the dots are displayed.
1	Connect dots linearly	Visualizes a trend with linear interconnection of points.
2	Stepped	Visualizes a stepped trend and its interconnected points.
3	Values	Can only be configured with OnlineTrendControl. A value is displayed at each time stamp or at the main grid line of the time axis instead of trend points.

The attribute can be assigned dynamic properties by means of the name **TrendLineType**. The data type is LONG.

TrendLineWidth property

Line weight - TrendLineWidth

Defines the line weight of the line displayed.

The attribute can be assigned dynamic properties by means of the name **TrendLineWidth**. The data type is LONG.

TrendLowerLimit property

TrendLowerLimit

Specifies the low limit of a tag. The values are identified based on the color set in "TrendLowerLimitColor" if the tag value is less than "TrendLowerLimit". This setting is only active if the value at attribute "TrendLowerLimitColoring" is "TRUE".

The attribute can be assigned dynamic properties by means of the name **TrendLowerLimit**. The data type is DOUBLE.

TrendLowerLimitColor property

TrendLowerLimitColor

Specifies the color of tag values which are less than the value at "TrendLowerLimit". This setting is only active if the value at attribute "TrendLowerLimitColoring" is "TRUE".

The attribute can be assigned dynamic properties by means of the name **TrendLowerLimitColor**. The data type is LONG.

TrendLowerLimitColoring property

TrendLowerLimitColoring

Enables the "TrendLowerLimitColor" attribute for identifying tag values which are less than the value at "TrendLowerLimitValue".

Value	Explanation
TRUE	Attribute "TrendLowerLimitColor" is active.
FALSE	Attribute "TrendLowerLimitColor" is inactive.

The attribute can be assigned dynamic properties by means of the name **TrendLowerLimitColoring**. The data type is BOOLEAN.

TrendMeasurePoints property

Number of measurement points - TrendMeasurePoints

Defines the number of measurement points for visualization of selected trends.

Defines the number of value pairs provided to the trend from a user archive.

The attribute can be assigned dynamic properties by means of the name **TrendMeasurePoints**. The data type is LONG.

TrendName property

Object name - TrendName

Displays the name of the selected trend. The name is defined on the "Trends" tab.

The "TrendName" attribute can be assigned dynamic properties by means of attribute **TrendRename**. The data type is STRING.

TrendPointColor property

Point color - TrendPointColor

Defines the color of trend points. Open the "Color selection" dialog by clicking the button.

The configuration is only possible if the "Advanced" option is activated or "TrendExtendedColorSet" is "TRUE".

The attribute can be assigned dynamic properties by means of the name **TrendPointColor**. The data type is LONG.

TrendPointStyle property

Dot type - TrendPointStyle

Defines the dot style for trend visualization.

The following settings are available:

Value	Description	Explanation
0	None	The dots are not displayed.
1	Dots	The trend dots are visualized with a size of one pixel. The setting in the "Dot width" field is deactivated.
2	Squares	The dots are displayed as square. The setting in the "Dot width" field is active.
3	Circles	The dots are displayed as circles. The setting in the "Dot width" field is active.

The attribute can be assigned dynamic properties by means of the name **TrendPointStyle**. The data type is LONG.

TrendPointWidth property

Dot width - TrendPointWidth

Sets the dot width in pixels. You can only define the dot width for the "square" and "circular" type.

The attribute can be assigned dynamic properties by means of the name **TrendPointWidth**. The data type is LONG.

TrendProvider property

Data source - TrendProvider

Specifies the data source for a selected trend.

The following settings are available:

Value	Description	Explanation
0	None	No data source configured for implementation in Runtime by means of script.
1	Archive tags	Data source with archive tags of a process value archive.
2	Online tags	Data source with online tags derived from tag management.
3	User archive	Data source with columns of a user archive.

The attribute can be assigned dynamic properties by means of the name **TrendProvider**. The data type is LONG.

TrendProviderCLSID_FunctionTrend property

TrendProviderCLSID_FunctionTrend

Indicates the data source of the trend selected.

Value	Explanation
	No data source configured for implementation in Runtime by means of script.
{416A09D2-8B5A-11D2-8B81-006097A45D48}	Data source with archive tags of a process value archive.
{A3F69593-8AB0-11D2-A440-00A0C9DBB64E}	Data source with online tags derived from tag management.
{2DC9B1C8-4FC1-41B1-B354-3E469A13FBFD}	Data source with columns of a user archive.

The attribute can be assigned dynamic properties by means of the name **TrendProviderCLSID**. The data type is STRING.

TrendProviderCLSID_OnlineTrend property

TrendProviderCLSID_OnlineTrend

Indicates the data source of the trend selected.

Value	Explanation
	No data source configured for implementation in Runtime by means of script.
{416A09D2-8B5A-11D2-8B81-006097A45D48}	Data source with archive tags of a process value archive.
{A3F69593-8AB0-11D2-A440-00A0C9DBB64E}	Data source with online tags derived from tag management.

The attribute can be assigned dynamic properties by means of the name **TrendProviderCLSID**. The data type is STRING.

TrendRangeType property

Time range setting - TrendRangeType

Defines the time range for providing data to the selected trend.

You can only define the number of measuring points if you select user archives as the data source.

The following configuration options are available:

Value	Description	Explanation
0	Time range	Defines the start time and the time range for the data connection.
1	Start to end time	Defines the start and end time for the data connection.
2	Number of measurement points	Defines the start time and the number of measurement points for the data connection.

The attribute can be assigned dynamic properties by means of the name **TrendRangeType**. The data type is LONG.

TrendRemove property

Remove - TrendRemove

Removes selected trends from the list.

The attribute can be assigned dynamic properties by means of the name **TrendRemove**. The data type is STRING.

TrendRename property

TrendRename

Renames a trend which is referenced by means of "TrendIndex" attribute.

The attribute can be assigned dynamic properties by means of the name **TrendRename**. "TrendRename" also sets a dynamic attribute "TrendName". The data type is STRING.

TrendRepos property

Up/Down - TrendRepos

Repositions the trend in the trend window. "Up" and "Down" move the selected trend up or down in the list. This moves the trend towards the foreground or background for visualization in Runtime.

The attribute can be assigned dynamic properties by means of the name **TrendRepos**. The data type is LONG.

TrendSelectTagName property

TrendSelectTagName

Opens a dialog for selecting the tag name for the source of Y axis data in WinCC OnlineTrendControl. Programmers can set this attribute to allow users to select a tag name by means of a button, for example.

The attribute can be assigned dynamic properties by means of the name **TrendSelectTagName**. The data type is BOOLEAN.

TrendSelectTagNameX property

TrendSelectTagNameX

Opens a dialog for selecting the tag name for the source of X axis data in WinCC FunctionTrendControl. Programmers can set this attribute to allow users to select a tag name by means of a button, for example.

The attribute can be assigned dynamic properties by means of the name **TrendSelectTagNameX**. The data type is BOOLEAN.

TrendSelectTagNameY property

TrendSelectTagNameY

Opens a dialog for selecting the tag name for the source of Y axis data in WinCC FunctionTrendControl. Programmers can set this attribute to allow users to select a tag name by means of a button, for example.

The attribute can be assigned dynamic properties by means of the name **TrendSelectTagNameY**. The data type is BOOLEAN.

TrendShowAlarms property

Displaying alarms - TrendShowAlarms

If you have connected online tags and activate the "Show alarms" option, you can have the assigned message displayed as a symbol and tooltip for the trend values with limit violation. Limit monitoring must be configured in the alarm logging for the online tag for this.

The red symbol indicates a high or low limit violation. The tooltip contains the message text and information text of the message. If you have configured "Loop in Alarm" with the "OpenPicture" function for the message, you can jump to the assigned picture by double-clicking this symbol.

The attribute can be assigned dynamic properties by means of the name **TrendShowAlarms**. The data type is BOOLEAN.

TrendState property

TrendState

Shows the status of the data link of the selected curve in Runtime.

The attribute can be made dynamic with the name **TrendState**. The data type is LONG.

TrendTagName property

Tag name - TrendTagName

Displays the name of connected tags. Use the Open button to open a dialog for selecting an online or archive tag.

The attribute can be assigned dynamic properties by means of the name **TrendTagName**. The data type is STRING.

TrendTagNameX property**Tag Name X / Column X - TrendTagNameX**

Shows the name of interconnected tags or of the column for the X axis. Using the selection button, select a tag or a column for the data source you configured.

The attribute can be assigned dynamic properties by means of the name **TrendTagNameX**. The data type is STRING.

TrendTagNameY property**Tag Name Y / Column Y - TrendTagNameY**

Shows the name of interconnected tags or of the column for the Y axis. Using the selection button, select a tag or a column for the data source you configured.

The attribute can be assigned dynamic properties by means of the name **TrendTagNameY**. The data type is STRING.

TrendTimeAxis property**Time axis - TrendTimeAxis**

Defines the time axis to be used for the trend selected. Define the available time axes in the "Time axes" tab.

The attribute can be assigned dynamic properties by means of the name **TrendTimeAxis**. The data type is STRING.

TrendTimeRangeBase property**Time Range - TrendTimeRangeBase**

Defines the time unit for calculating the time range.

The following time units are available:

Value	Description
500	500 ms
1000	1 second
60000	1 minute
3600000	1 hour
86400000	1 day

The attribute can be assigned dynamic properties by means of the name **TrendTimeRangeBase**. The data type is LONG.

TrendTimeRangeFactor property

Time range - TrendTimeRangeFactor

Defines the factor for calculating the time range. Only integer factors are valid.

The attribute can be assigned dynamic properties by means of the name **TrendTimeRangeFactor**. The data type is SHORT.

TrendTrendWindow property

Trend window - TrendTrendWindow

Defines the trend window for visualizing the trend selected. Define the available trend windows in the "Trend window" tab.

The attribute can be assigned dynamic properties by means of the name **TrendTrendWindow**. The data type is STRING.

TrendUncertainColor property

TrendUncertainColor

Value are in uncertain state if the initial value is unknown after runtime has been activated, or if a substitute value is used. Set attribute "TrendUncertainColor" to define the color identifier of these values. The "TrendUncertainColoring" attribute determines whether or not this setting is evaluated.

The attribute can be assigned dynamic properties by means of the name **TrendUncertainColor**. The data type is LONG.

TrendUncertainColoring property

TrendUncertainColoring

Value are in uncertain state if the initial value is unknown after runtime has been activated, or if a substitute value is used. The "TrendUncertainColoring" attribute is used to enable identification of such values based on the color set in "TrendUncertainColor".

Value	Explanation
TRUE	The settings of the "TrendUncertainColor" attribute are active.
FALSE	The settings of the "TrendUncertainColor" attribute are inactive.

The attribute can be assigned dynamic properties by means of the name **TrendUncertainColoring**. The data type is BOOLEAN.

TrendUpperLimit property

TrendUpperLimit

Specifies the high limit of a tag. If the tag exceeds the value of the "TrendUpperLimit, the values are marked with the color set in "TrendUpperLimitColor". This setting is only active if the value at attribute "TrendUpperLimitColoring" is "TRUE".

The attribute can be assigned dynamic properties by means of the name **TrendUpperLimit**. The data type is DOUBLE.

TrendUpperLimitColor property

TrendUpperLimitColor

Specifies the color for designating tag values that are above the value of "TrendLowerLimit". This setting is only active if the value at attribute "TrendUpperLimitColoring" is "TRUE".

The attribute can be assigned dynamic properties by means of the name **TrendUpperLimitColor**. The data type is LONG.

TrendUpperLimitColoring property

TrendUpperLimitColoring

Specifies whether the attribute "TrendUpperLimitColor" is used to identify tag values that are above the limit of the TrendUpperLimit".

Value	Explanation
TRUE	The setting of the "TrendUpperLimitColor" attribute is active.
FALSE	The setting of the "TrendUpperLimitColor" attribute is inactive.

The attribute can be assigned dynamic properties by means of the name **TrendUpperLimitColoring**. The data type is BOOLEAN.

TrendValueAlignment property

Alignment - TrendValueAlignment

Specifies the alignment of the displayed values for the trend type "Values".

The following settings are available depending on the writing direction of the trend:

- The writing direction of the trend is "from right" or "from left"

Value	Description	Explanation
0	Bottom	The values are displayed at the bottom in the trend window.
1	Centered	The values are displayed centered in the trend window.
2	Top	The values are displayed at the top in the trend window.

- The writing direction of the trend is "from top" or "from bottom"

Value	Description	Explanation
0	Left	The values are displayed on the left in the trend window.
1	Centered	The values are displayed centered in the trend window.
2	Right	The values are displayed on the right in the trend window.

The attribute can be assigned dynamic properties by means of the name **TrendValueAlignment**. The data type is LONG.

TrendValueAxis property

Value axis - TrendValueAxis

Defines the value axis to be used for the trend selected. Define the available value axes in the "Value axes" tab.

The attribute can be assigned dynamic properties by means of the name **TrendValueAxis**. The data type is STRING.

TrendValueUnit property

Unit - TrendValueUnit

Specifies a unit for the trend type "Values" that is appended to the displayed value, e.g., "%" or "°C".

The attribute can be assigned dynamic properties by means of the name **TrendValueUnit**. The data type is STRING.

TrendVisible property

Trends - TrendVisible

The list shows all trends you created.

Select the trends to be displayed in the trend window from the list.

Click a trend entry in the list to adapt the properties and to assign axes and trend windows to the trend.

The attribute can be assigned dynamic properties by means of the name **TrendVisible**. The data type is BOOLEAN.

TrendXAxis property**X axis - TrendXAxis**

Defines the X axis to be used for the trend selected. Define the available X axes inn the "X Axes" tab.

The attribute can be assigned dynamic properties by means of the name **TrendXAxis**. The data type is STRING.

TrendYAxis property**Y axis - TrendYAxis**

Defines the Y axis to be used for the trend selected. Define the available Y axes inn the "Y Axes" tab.

The attribute can be assigned dynamic properties by means of the name **TrendYAxis**. The data type is STRING.

TrendWindow**TrendWindowAdd property****New - TrendWindowAdd**

Creates a new trend window.

The attribute can be assigned dynamic properties by means of the name **TrendWindowAdd**. The data type is STRING.

TrendWindowCoarseGrid property**Main grid lines - TrendWindowCoarseGrid**

Enables the display of grid lines for the main scale.

Value	Explanation
TRUE	Enables the display of grid lines for the main scale.
FALSE	Disables the display of grid lines for the main scale.

The attribute can be assigned dynamic properties by means of the name **TrendWindowCoarseGrid**. The data type is BOOLEAN.

TrendWindowCoarseGridColor property

Color of main scale - TrendWindowCoarseGridColor

Specifies the grid color of the main scale. Open the "Color selection" dialog by clicking the button.

The attribute can be assigned dynamic properties by means of the name **TrendWindowCoarseGridColor**. The data type is LONG.

TrendWindowCount property

TrendWindowCount

Defines the number of configured trend views.

The attribute can be assigned dynamic properties by means of the name **TrendWindowCount**. The data type is LONG.

TrendWindowFineGrid property

Secondary grid lines - TrendWindowFineGrid

Enables the display of grid lines for the secondary scale.

Value	Explanation
TRUE	Enables the display of grid lines for the secondary scale.
FALSE	Disables the display of grid lines for the secondary scale.

The attribute can be assigned dynamic properties by means of the name **TrendWindowFineGrid**. The data type is BOOLEAN.

TrendWindowFineGridColor property

Color of secondary scale - TrendWindowFineGridColor

Specifies the grid color of the main scale. Open the "Color selection" dialog by clicking the button.

The attribute can be assigned dynamic properties by means of the name **TrendWindowFineGridColor**. The data type is LONG.

TrendWindowForegroundTrendGrid property**Only for foreground trend - TrendWindowForegroundTrendGrid**

Enables the display of grid lines only for the foreground trend in the trend window.

Value	Explanation
TRUE	Enables the display of grid lines for the foreground trend in the trend window.
FALSE	Enables the display of grid lines for all trends in the trend window.

The attribute can be assigned dynamic properties by means of the name **TrendWindowForegroundTrendGrid**. The data type is BOOLEAN.

TrendWindowGridInTrendColor property**Use trend color - TrendWindowGridInTrendColor**

Sets the trend color for the visualization of the grid lines for the main scale.

Value	Explanation
TRUE	The grid is displayed in the trend color.
FALSE	The grid is displayed with the color set in the "Color" field.

The attribute can be assigned dynamic properties by means of the name **TrendWindowGridInTrendColor**. The data type is BOOLEAN.

TrendWindowHorizontalGrid property**For X axis - TrendWindowVerticalGrid**

Enables the display of horizontal grid lines.

Value	Explanation
TRUE	The display of horizontal grid lines is enabled.
FALSE	The display of horizontal grid lines is disabled.

The attribute can be assigned dynamic properties by means of the name **TrendWindowHorizontalGrid**. The data type is BOOLEAN.

TrendWindowIndex property**TrendWindowIndex**

References a configured trend view. Using this attribute you can assign the values of other attributes to a specific trend view.

3.11 Object properties

Values between 0 and "TrendWindowIndex" minus 1 are valid for "TrendWindowCount". Attribute "TrendWindowCount" defines the number of trend views configured.

The "TrendWindowIndex" attribute can be assigned dynamic properties by means of attribute **TrendWindowRepos**. The data type is LONG.

TrendWindowName property

Object name - TrendWindowName

Defines the name of the trend window selected.

The "TrendWindowName" attribute can be assigned dynamic properties by means of attribute **TrendWindowRename**. The data type is STRING.

TrendWindowRemove property

Remove - TrendWindowRemove

Removes the selected trend window from the list.

The attribute can be assigned dynamic properties by means of the name **TrendWindowRemove**. The data type is STRING.

TrendWindowRename property

TrendWindowRename

Renames a trend view which is referenced by means of "TrendWindowIndex" attribute.

The attribute can be assigned dynamic properties by means of the name **TrendWindowRename**. "TrendWindowRename" also sets a dynamic attribute "TrendWindowName". The data type is STRING.

TrendWindowRepos property

Up/Down - TrendWindowRepos

Changes the sorting order of the trend windows. "Up" and "Down" move the selected trend up or down in the list.

The sorting order in the list defines the position in the Control. The first trend window is displayed at the last position, while the last is displayed at the top position.

The attribute can be assigned dynamic properties by means of the name **TrendWindowRepos**. The data type is LONG.

TrendWindowRulerColor property

Ruler color - TrendWindowRulerColor

Specifies the ruler color. Open the "Color selection" dialog by clicking the button.

The color can be configured and displayed if "1 - graphic" is set for display of the ruler or "TrendWindowRulerStyle".

The attribute can be assigned dynamic properties by means of the name **TrendWindowRulerColor**. The data type is LONG.

TrendWindowRulerLayer property

Ruler layer - TrendWindowRulerLayer

Defines the representation layer of a ruler in the trend window.

The following settings are available:

Value	Description	Explanation
0	Under grid	The ruler is visualized on a layer under the grid.
1	Between grid and trend	The ruler is positioned on top of the trend and under the grid.
2	On top of trend	The ruler is positioned on top of the trend.

The attribute can be assigned dynamic properties by means of the name **TrendWindowRulerLayer**. The data type is LONG.

TrendWindowRulerStyle property

Ruler - TrendWindowRulerStyle

Defines the appearance of the ruler.

The following settings are available:

Value	Description	Explanation
0	Simple	The ruler is displayed as basic black line.
1	Graphic	The ruler is displayed based on the "color" and "weight" configured.

The attribute can be assigned dynamic properties by means of the name **TrendWindowRulerStyle**. The data type is LONG.

TrendWindowRulerWidth property

Ruler width - TrendWindowRulerWidth

Defines the width of the ruler in pixels.

3.11 Object properties

The width can be configured and displayed if "1 - graphic" is set for display of the ruler or "TrendWindowRulerStyle".

The attribute can be assigned dynamic properties by means of the name **TrendWindowRulerWidth**. The data type is LONG.

TrendWindowSpacePortion property

Proportional area - TrendWindowSpacePortion

Specifies the proportion of the trend widow to be used for the selected curve.

The attribute can be assigned dynamic properties by means of the name **TrendWindowSpacePortion**. The data type is LONG.

TrendWindowStatisticRulerColor property

Color of ruler for statistics area - TrendWindowStatisticRulerColor

Specifies the color of the ruler for the statistics area. The button opens the "Color selection" dialog to select the color.

The color can be configured and displayed if "1 - graphic" is set for display of the ruler for the statistics area or "TrendWindowStatisticRulerStyle".

The attribute can be assigned dynamic properties by means of the name **TrendWindowStatisticRulerColor**. The data type is LONG.

TrendWindowStatisticRulerStyle property

Ruler for statistics area - TrendWindowStatisticRulerStyle

Enables the display of a ruler for defining the statistics area.

The following settings are available:

Value	Description	Explanation
0	Simple	The ruler is displayed as basic black line.
1	Graphic	The ruler is displayed based on the "color" and "weight" configured.

The attribute can be assigned dynamic properties by means of the name **TrendWindowStatisticRulerStyle**. The data type is LONG.

TrendWindowStatisticRulerWidth property

Width of ruler for statistics area - TrendWindowStatisticRulerWidth

Defines the width of the ruler for the statistics area in pixels.

The width of the ruler can be configured and displayed if "1 - graphic" is set for display of the ruler for the statistics area or "TrendWindowStatisticRulerStyle".

The attribute can be assigned dynamic properties by means of the name **TrendWindowStatisticRulerWidth**. The data type is LONG.

TrendWindowVerticalGrid property

for Y axis - TrendWindowVerticalGrid

Enables the display of vertical grid lines.

Value	Explanation
TRUE	The display of vertical grid lines is enabled.
FALSE	The display of vertical grid lines is disabled.

The attribute can be assigned dynamic properties by means of the name **TrendWindowVerticalGrid**. The data type is BOOLEAN.

TrendWindowVisible property

Trend window - TimeAxisTrendWindow

The list shows all trend windows you created.

Select the trend windows to be displayed in the control from the list.

Click a list entry to adapt the ruler and grid line properties.

The attribute can be assigned dynamic properties by means of the name **TrendWindowVisible**. The data type is BOOLEAN.

3.11.6.18 U

UseColumnBackColor property

Use column color / background - UseColumnBackColor

Specifies the settings to be activated for the background colors of columns.

Value	Explanation
TRUE	The background color settings are active in the "Time columns" or "TimeColumnBackColor" tabs and in the "Value columns" or "ValueColumnBackColor" tabs.
FALSE	The background color settings are active in the "Display" tab.

The attribute can be assigned dynamic properties by means of the name **UseColumnBackColors**. The data type is BOOLEAN.

UseColumnForeColor property

Use column color / font - UseColumnForeColor

Defines the active font color settings for the columns.

Value	Explanation
TRUE	The font color color settings are active in the "Time columns" or "TimeColumnForeColor" tabs and in the "Value columns" or "ValueColumnForeColor" tabs.
FALSE	The font color settings are active in the "Display" tab.

The attribute can be assigned dynamic properties by means of the name **UseColumnForeColors**. The data type is BOOLEAN.

UserEditMode property

Edit mode user - UserEditMode

Specifies which editing options the user has in WinCC UserAdminControl regarding user properties.

Value	Name	Explanation
0	Read	The user can only read the user properties.
1	Change	The user can change the user properties.
2	Full access	The user can change the user properties without restrictions.

The attribute can be assigned dynamic properties using the name **UserEditMode**. The data type is LONG.

UseHeaderFont property

UseHeaderFont

Specifies whether the font defined in the "HeaderFont" attribute is used for the table header of WinCC UserAdminControl.

The attribute can be assigned dynamic properties using the name **UseHeaderFont**. The data type is BOOLEAN.

UseMessageColor property

Show message colors - UseMessageColor

Sets the outputs of messages with colors as agreed by handshake.

Value	Explanation
TRUE	The message colors are displayed.
FALSE	The message colors are not displayed. Instead, the color settings defined for the table content are activated on the "Display" tab.

The attribute can be assigned dynamic properties by means of the name **UseMessageColor**. The data type is BOOLEAN.

UseSelectedTitleColor property

Selection color - UseSelectedTitleColor

Specifies whether to use a selection color for the headers of selected table cells.

Value	Explanation
TRUE	A selection color is used. The "Background" or "SelectedTitleColor" and "Font" or "SelectedTitleForeColor" settings are active in Runtime.
FALSE	Selection color is not used. The "Background" and "Font" settings are disabled in Runtime.

The attribute can be assigned dynamic properties by means of the name **UseSelectedTitleColor**. The data type is BOOLEAN.

UseSourceBackColors property

Apply background colors - UseSourceBackColors

Sets the background color derived from the control defined in the "Source" field.

Value	Explanation
TRUE	The background color from the interconnected control is used.
FALSE	The background color from the interconnected control is not used. The settings on the "Layout" tab are used.

The attribute can be assigned dynamic properties by means of the name **UseSourceBackColors**. The data type is BOOLEAN.

UseSourceForeColors property

Apply font colors - UseSourceForeColors

Sets the font colors derived from the control defined in the "Source" field.

Value	Explanation
TRUE	The font color of the interconnected control is activated.
FALSE	The font color from the connected control is not used. The settings on the "Layout" tab are used.

The attribute can be assigned dynamic properties by means of the name **UseSourceForeColors**. The data type is BOOLEAN.

UseTableColor2 property

Row Color 2 - UseTableColor2

Specifies whether to use a second row color for the representation of the table.

Value	Explanation
TRUE	"Row color 2" and "Row color 1" are used alternately.
FALSE	The "Row color 1" settings are used for all rows.

The attribute can be assigned dynamic properties by means of the name **UseTableColor2**. The data type is BOOLEAN.

UseTrendNameAsLabel property

UseTrendNameAsLabel

Sets the "TrendName" or "TrendLabel" attribute for labeling the trend in Runtime.

Value	Explanation
TRUE	Sets the "TrendName" attribute for labeling the trend in Runtime.
FALSE	Sets the "TrendLabel" attribute for labeling the trend in Runtime.

The attribute can be assigned dynamic properties by means of the name **UseTrendNameAsLabel**. The data type is BOOLEAN.

3.11.6.19 V

ValueAxis**ValueAxisAdd** property**New - ValueAxisAdd**

Creates a new value axis.

The attribute can be assigned dynamic properties by means of the name **ValueAxisAdd**. The data type is STRING.

ValueAxisAlign property**Alignment - ValueAxisAlign**

Specifies the mode of alignment of a selected value axis.

The following settings are available:

Value	Description	Explanation
0	left	The selected value axis is displayed on left side of the trend or diagram.
1	right	The selected value axis is displayed on right side of the trend or diagram.

The attribute can be assigned dynamic properties by means of the name **ValueAxisAlign**. The data type is LONG.

ValueAxisAutoPrecisions property**Decimal places automatic - ValueAxisAutoPrecisions**

Enables automatic setting of the decimal precision.

Value	Explanation
TRUE	The decimal precision is defined automatically. The value in the "Decimal places" or "ValueAxisPrecisions" field is disabled.
FALSE	The value in the "Decimal places" or "ValueAxisPrecisions" field is active.

The attribute can be assigned dynamic properties by means of the name **ValueAxisAutoPrecisions**. The data type is BOOLEAN.

ValueAxisAutoRange property

Value range automatic - ValueAxisAutoRange

Enables automatic calculation of the range of values.

Value	Explanation
TRUE	The range of values is calculated automatically.
FALSE	The range of values is calculated based on the values configured in the "from" and "to" or "ValueAxisBeginValue" and "ValueAxisEndValue" fields.

The attribute can be assigned dynamic properties by means of the name **ValueAxisAutoRange**. The data type is BOOLEAN.

ValueAxisBarWindow property

Diagram window - ValueAxisBarWindow

Specifies the diagram window in which the selected value axis will be used. You can specify the available diagram window in the "Diagram window" tab or using "BarWindowAdd".

The attribute can be assigned dynamic properties using the name **ValueAxisBarWindow**. The data type is STRING.

ValueAxisBeginValue property

Value range from - ValueAxisBeginValue

Specifies the start value of the value axis selected. You can configure the value if the "Automatic" option is disabled or "ValueAxisAutoRange" is "FALSE".

The attribute can be assigned dynamic properties by means of the name **ValueAxisBeginValue**. The data type is DOUBLE.

ValueAxisColor property

Value axis color - ValueAxisColor

Specifies the color of the time axis. The button opens the "Color selection" dialog to select the color.

The setting is only active if the "Use trend color" or "Use diagram color" option is disabled or if "ValueAxisInTrendColor" is "FALSE".

The attribute can be assigned dynamic properties by means of the name **ValueAxisColor**. The data type is LONG.

ValueAxisCount property

ValueAxisCount

Defines the number of value axes configured.

The attribute can be assigned dynamic properties by means of the name **ValueAxisCount**. The data type is LONG.

ValueAxisEndValue property

Value range to - ValueAxisEndValue

Specifies the end value of the value axis selected. You can configure the value if the "Automatic" option is disabled or "ValueAxisAutoRange" is "FALSE".

The attribute can be assigned dynamic properties by means of the name **ValueAxisEndValue**. The data type is DOUBLE.

ValueAxisExponentialFormat property

Exponential notation - ValueAxisExponentialFormat

Sets exponential notation for the display of values of a value axis selected.

Value	Explanation
TRUE	The values are displayed with exponential notation.
FALSE	The values are displayed with decimal notation.

The attribute can be assigned dynamic properties by means of the name **ValueAxisExponentialFormat**. The data type is BOOLEAN.

ValueAxisInBarColor property

In diagram color - ValueAxisInBarColor

Specifies whether the selected value axis will be displayed in the diagram color. If there is more than one diagram in the diagram window, the color of the first diagram will be used. You specify the order of the diagrams on the "Diagrams" tab.

Value	Explanation
TRUE	The selected value axis is displayed in the diagram color. The setting in the "Color" or "ValueAxisColor" field is disabled.
FALSE	The value axis selected is displayed in the color set in the "Color" or "ValueAxisColor" field.

The attribute can be assigned dynamic properties using the name **ValueAxisInBarColor**. The data type is BOOLEAN.

ValueAxisIndex property

ValueAxisIndex

References a value axis. Using this attribute you can assign the values of other attributes to a specific value axis.

Values between 0 and "ValueAxisCount" minus 1 are valid for "ValueAxisIndex". Attribute "ValueAxisCount" defines the number of value axes configured.

The "ValueAxisIndex" attribute can be assigned dynamic properties by means of attribute **ValueAxisRepos**. The data type is LONG.

ValueAxisInTrendColor property

Use trend color - ValueAxisInTrendColor

Sets the trend color for displaying the value axis selected. The color of the first trend is activated if several trends are displayed in the trend window. Define the order of trends on the "Trends" tab.

Value	Explanation
TRUE	The selected value axis is displayed in the trend color. The setting in the "Color" or "ValueAxisColor" field is disabled.
FALSE	The value axis selected is displayed in the color set in the "Color" or "ValueAxisColor" field.

The attribute can be assigned dynamic properties by means of the name **ValueAxisInTrendColor**. The data type is BOOLEAN.

ValueAxisLabel property

Label - ValueAxisLabel

Specifies the label of a value axis selected.

The attribute can be assigned dynamic properties by means of the name **ValueAxisLabel**. The data type is STRING.

ValueAxisName property

Object name - ValueAxisName

Specifies the name of a value axis selected.

The "ValueAxisName" attribute can be assigned dynamic properties by means of attribute **ValueAxisRename**. The data type is STRING.

ValueAxisPrecisions property

Decimal places - ValueAxisPrecisions

Specifies the decimal precision for displaying the value axis selected. The value can be configured and is active in Runtime, if the "Automatic" option is disabled or "ValueAxisAutoPrecisions" is "FALSE".

The attribute can be assigned dynamic properties by means of the name **ValueAxisPrecisions**. The data type is SHORT.

ValueAxisRemove property

Remove - ValueAxisRemove

Removes the selected value axis from the list.

The attribute can be assigned dynamic properties by means of the name **ValueAxisRemove**. The data type is STRING.

ValueAxisRename property

ValueAxisRename

Renames a value axis which is referenced by means of "ValueAxisIndex" attribute.

The attribute can be assigned dynamic properties by means of the name **ValueAxisRename**. "ValueAxisRename" also sets a dynamic attribute "ValueAxisName". The data type is STRING.

ValueAxisRepos property

Up/Down - ValueAxisRepos

Changes the order of value axes. "Up" and "Down" move the value axis selected up or down in the list.

The list order determines the value axis position in the trend window or diagram window in runtime. If the orientation is the same and the value axis of the list is further above, the value axis is shown at a more remote position of the curve or diagram.

The attribute can be assigned dynamic properties by means of the name **ValueAxisRepos**. The data type is LONG.

ValueAxisScalingType property

Scaling - ValueAxisScalingType

Specifies the scaling mode for a selected value axis.

The following settings are available:

Value	Description	Explanation
0	Linear	Enables linear scaling of a value axis selected.
1	Logarithmic	Enables logarithmic scaling of a value axis selected.
2	Logarithmically negated	Enables scaling of a selected value value axis with logarithmic negation.

The attribute can be assigned dynamic properties by means of the name **ValueAxisScalingType**. The data type is LONG.

ValueAxisTrendWindow property

Trend window - ValueAxisTrendWindow

Specifies the trend window for displaying the value axis selected. Define the available trend windows in the "Trend window" tab.

The attribute can be assigned dynamic properties by means of the name **ValueAxisTrendWindow**. The data type is STRING.

ValueAxisVisible property

Value axes - ValueAxisVisible

The list shows all value axes you created. Click a value axis entry in the list to adapt the properties and to assign a trend window or diagram window to the value axis.

Select the value axes in the list that you want to display in the trend windows or diagram windows.

The attribute can be assigned dynamic properties by means of the name **ValueAxisVisible** . The data type is BOOLEAN.

ValueColumn

ValueColumnAdd property

New - ValueColumnAdd

Creates a new value column.

The attribute can be assigned dynamic properties by means of the name **ValueColumnAdd**. The data type is STRING.

ValueColumnAlign property

Alignment - ValueColumnAlign

Defines the mode of alignment of a selected value column.

The following settings are available:

Value	Description	Explanation
0	left	The selected value column is displayed on the left.
1	Centered	The selected value column is aligned to center.
2	right	The selected value column is displayed on the right.

The attribute can be assigned dynamic properties by means of the name **ValueColumnAlign**. The data type is LONG.

ValueColumnAutoPrecisions property

Automatic - ValueColumnAutoPrecisions

Enables automatic setting of the decimal precision.

Value	Explanation
TRUE	The decimal precision is defined automatically. The value in the "Decimal places" or "ValueColumnPrecisions" field is disabled.
FALSE	The value in the "Decimal places" or "ValueColumnPrecisions" field is active.

The attribute can be assigned dynamic properties by means of the name **ValueColumnAutoPrecisions**. The data type is BOOLEAN.

ValueColumnBackColor property

Background color - ValueColumnBackColor

Specifies the background color of the value column selected. Use the button to open the "Color selection" dialog.

The setting is only active if the "Background color" option is set or "UseColumnBackColor" is "TRUE" in the "Use column color" field of the "General" tab.

The attribute can be assigned dynamic properties by means of the name **ValueColumnBackColor**. The data type is LONG.

ValueColumnCaption property

Description - ValueColumnCaption

Defines the label of the value column selected.

3.11 Object properties

The attribute can be assigned dynamic properties by means of the name **ValueColumnCaption**. The data type is STRING.

ValueColumnCount property

ValueColumnCount

Defines the number of value columns configured.

The attribute can be assigned dynamic properties by means of the name **ValueColumnCount**. The data type is LONG.

ValueColumnExponentialFormat property

Exponential notation - ValueColumnExponentialFormat

Sets exponential notation for the display of values of a value column selected.

Value	Explanation
TRUE	Display with exponential notation.
FALSE	Display with decimal notation.

The attribute can be assigned dynamic properties by means of the name **ValueColumnExponentialFormat**. The data type is BOOLEAN.

ValueColumnForeColor property

Font color - ValueColumnForeColor

Specifies the font color of the value column selected. Use the button to open the "Color selection" dialog.

The setting is only active if the "Font color" option is set or "UseColumnForeColor" is "TRUE" in the "Use column color" field of the "General" tab.

The attribute can be assigned dynamic properties by means of the name **ValueColumnForeColor**. The data type is LONG.

ValueColumnHideText property

ValueColumnHideText

Sets text format for displaying the content of a value column.

Value	Explanation
TRUE	The content is not displayed in text format.
FALSE	The content is displayed in text format.

The attribute can be assigned dynamic properties by means of the name **ValueColumnHideText**. The data type is BOOLEAN.

ValueColumnHideTitleText property

ValueColumnHideTitleText

Sets text format for displaying the value column header.

Value	Explanation
TRUE	The header is not displayed in text format.
FALSE	The header is displayed in text format.

The attribute can be assigned dynamic properties by means of the name **ValueColumnHideTitleText**. The data type is BOOLEAN.

ValueColumnIndex property

ValueColumnIndex

References a configured value column. Using this attribute you can assign the values of other attributes to a specific value column.

Values between 0 and "ValueColumnCount" minus 1 are valid for "ValueColumnIndex". Attribute "ValueColumnCount" defines the number of value columns configured.

The "ValueColumnIndex" attribute can be assigned dynamic properties by means of attribute **ValueColumnRepos**. The data type is LONG.

ValueColumnLength property

Length in characters - ValueColumnLength

Specifies the width of a selected value column.

The attribute can be assigned dynamic properties by means of the name **ValueColumnLength**. The data type is LONG.

ValueColumnName property

Object name - ValueColumnName

Specifies the name of a selected value column.

The "ValueColumnName" attribute can be assigned dynamic properties by means of attribute **ValueColumnRename**. The data type is STRING.

ValueColumnPrecisions property

Decimal places - ValueColumnPrecisions

Specifies the decimal precision for displaying the data of a value column selected. The value can be entered if the "Automatic" option is disabled or "ValueColumnAutoPrecisions" is "FALSE".

The attribute can be assigned dynamic properties by means of the name **ValueColumnPrecisions**. The data type is SHORT.

ValueColumnProvider property

Data source - ValueColumnProvider

Specifies the data source for a selected value column.

The following settings are available:

Value	Description	Explanation
1	Archive tags	Data source with archive tags of a process value archive.
2	Online tags	Data source with online tags derived from tag management.

The attribute can be assigned dynamic properties by means of the name **ValueColumnProvider**. The data type is LONG.

ValueColumnProviderCLSID property

ValueColumnProviderCLSID

Indicates the data source of the value column selected.

Value	Explanation
{416A09D2-8B5A-11D2-8B81-006097A45D48}	Data source with archive tags of a process value archive.
{A3F69593-8AB0-11D2-A440-00A0C9DBB64E}	Data source with online tags derived from tag management.

The attribute can be assigned dynamic properties by means of the name **ValueColumnProviderCLSID**. The data type is STRING.

ValueColumnRemove property

Remove - ValueColumnRemove

Removes the selected value column from the list.

The attribute can be assigned dynamic properties by means of the name **ValueColumnRemove**. The data type is STRING.

ValueColumnRename property

ValueColumnRename

Renames a value column which is referenced by means of "ValueColumnIndex" attribute.

The attribute can be assigned dynamic properties by means of the name **ValueColumnRename**. "ValueColumnRename" also sets a dynamic attribute "ValueColumnName". The data type is STRING.

ValueColumnRepos property

Up/Down - ValueColumnRepos

Changes the sorting order of the value columns. "Up" and "Down" move the value column selected up or down in the list.

The sorting order in the list determines the order of value columns after the time column if several value columns are assigned to the same time column. Higher positions of the value column in the list moves it to closer proximity towards the time column.

You change the order of time columns and their assigned value columns in the "Time columns" tab.

The attribute can be assigned dynamic properties by means of the name **ValueColumnRepos**. The data type is LONG.

ValueColumnSelectTagName property

ValueColumnSelectTagName

Opens a dialog for selecting the tag name for the data source of the value column in WinCC OnlineTableControl. Programmers can set this attribute to allow users to select a tag name by means of a button, for example.

The attribute can be assigned dynamic properties by means of the name **ValueColumnSelectTagName**. The data type is BOOLEAN.

ValueColumnShowIcon property

ValueColumnShowIcon

Enables the display of value column contents as icon.

Value	Explanation
TRUE	The content is visualized as icon.
FALSE	The content is not visualized as icon.

The attribute can be assigned dynamic properties by means of the name **ValueColumnShowIcon**. The data type is BOOLEAN.

ValueColumnShowTitleIcon property

ValueColumnShowTitleIcon

Enables display of the value column header as icon.

Value	Explanation
TRUE	The header is displayed as icon.
FALSE	The header is not displayed as icon.

The attribute can be assigned dynamic properties by means of the name **ValueColumnShowTitleIcon**. The data type is BOOLEAN.

ValueColumnSort property

ValueColumnSort

Defines the sorting order of the value column referenced in "ValueColumnIndex" .

The following settings are available:

Value	Description	Explanation
0	No	No sorting
1	Ascending	Ascending order, starting at the lowest value.
2	Descending	Descending order, starting at the highest value.

The attribute can be assigned dynamic properties by means of the name **ValueColumnSort** . The data type is LONG.

ValueColumnSortIndex property

ValueColumnSortIndex

Defines the sorting order of the value column referenced in "ValueColumnIndex". The sorting criterion is removed from "ValueColumnSort" if you set a "0" value..

The attribute can be assigned dynamic properties by means of the name **ValueColumnSortIndex**. The data type is LONG.

ValueColumnState property

ValueColumnState

Displays the data connection status of a selected value column in Runtime.

The attribute can be assigned dynamic properties by means of the name **ValueColumnState**. The data type is LONG.

ValueColumnTagName property

Tag name - ValueColumnTagName

Displays the name of connected tags. You can change the tag connection using the selection button.

The attribute can be assigned dynamic properties by means of the name **ValueColumnTagName**. The data type is STRING.

ValueColumnTimeColumn property

Time column - ValueColumnTimeColumn

Specifies the time column for displaying the value column selected. Define the available time columns in the "Time columns" tab.

The attribute can be assigned dynamic properties by means of the name **ValueColumnTimeColumn**. The data type is STRING.

ValueColumnVisible property

Value columns - ValueColumnVisible

The list shows all value columns you created. Click a value column entry in the list to adapt the properties, to assign the value column, and to define the data connection.

Select the value columns to be displayed in the table from the list. Value columns are displayed if interconnected with a time column.

The attribute can be assigned dynamic properties by means of the name **ValueColumnVisible**. The data type is BOOLEAN.

VerticalGridLines property

Vertical - VerticalGridLines

Enables the display of vertical dividers.

Value	Explanation
TRUE	Enables the displays of vertical dividers.
FALSE	Disables the display of vertical dividers.

The attribute can be assigned dynamic properties by means of the name **VerticalGridLines**. The data type is BOOLEAN.

Foreground color (ForeColor)

Foreground color (ForeColor)

Specifies the foreground color of the icon in the "Color selection" dialog. The icon is displayed in the foreground color if the "Shadow" and "Solid" foreground mode is set.

The attribute can be assigned dynamic properties by means of the name **ForeColor**. The data type is LONG.

Foreground mode (SymbolAppearance)

Foreground mode (SymbolAppearance)

Specifies the appearance of the icon.

The following settings are available:

Value	Description	Comments
0	Original	The appearance of the icon corresponds to the multi-color representation in the selection of the "Icons" tab.
1	Shadow	"Black" lines are maintained as contour lines. Elements of the symbols in other colors are displayed as brightness grades of the current foreground color.
2	Solid	"Black" lines are maintained as contour lines. All icon elements of other colors are assigned the color value of the current foreground color.
3	Outline	Lines of the color "Black" are maintained as contour lines. All the elements of the symbol in other colors are assigned the color value of the current background color.

The attribute can be assigned dynamic properties by means of the name **SymbolAppearance**. The data type is LONG.

3.11.6.20 X/Y

X/YAxisAdd property

New - X/YAxisAdd

Creates a new X or Y axis.

The X axis attribute can be assigned dynamic properties by means of the name **XAxisAdd** .

The Y axis attribute can be assigned dynamic properties by means of the name **YAxisAdd** .

The data type is STRING.

X/YAxisAlign property

Alignment - X/YAxisAlign

Defines the alignment mode for a selected axis.

The following settings are available for the X axis:

Value	Description	Explanation
0	Bottom	The X axis selected is displayed below the trend.
1	Top	The X axis selected is displayed above the trend.

The X axis attribute can be assigned dynamic properties by means of the name **XAxisAlign**.
The data type is LONG.

The following settings are available for the Y axis:

Value	Description	Explanation
0	left	The X axis selected is displayed on left side of the trend.
1	right	The X axis selected is displayed on right side of the trend.

The Y axis attribute can be assigned dynamic properties by means of the name **YAxisAlign**.
The data type is LONG.

X/YAxisAutoPrecisions property

Decimal places automatic - X/YAxisAutoPrecisions

Enables automatic setting of the decimal precision.

Value	Explanation
TRUE	The number of decimal places is set automatically. The value in the "Decimal places" or "X/YAxisPrecisions" field is disabled.
FALSE	The value in the "Decimal places" or "X/YAxisPrecisions" field is active.

The X axis attribute can be assigned dynamic properties by means of the name **XAxisAutoPrecisions**.

The Y axis attribute can be assigned dynamic properties by means of the name **YAxisAutoPrecisions**.

The data type is BOOLEAN.

X/YAxisAutoRange property

Value range automatic - X/YAxisAutoRange

Enables automatic calculation of the value range of the axis selected.

Value	Explanation
TRUE	The range of values is calculated automatically.
FALSE	The range of values is calculated based on the values configured in the "from" and "to" or "X/YAxisBeginValue" and "X/YAxisEndValue" fields.

The X axis attribute can be assigned dynamic properties by means of the name **XAxisAutoRange**.

3.11 Object properties

The Y axis attribute can be assigned dynamic properties by means of the name **YAxisAutoRange**.

The data type is BOOLEAN.

X/YAxisBeginValue property

Value range from - X/YAxisBeginValue

Specifies the lower range of values of the axis selected. You can configure the value if the "Automatic" option is disabled or "X/YAxisAutoRange" is "FALSE".

The X axis attribute can be assigned dynamic properties by means of the name **XAxisBeginValue**.

The Y axis attribute can be assigned dynamic properties by means of the name **YAxisBeginValue**.

The data type is DOUBLE.

X/YAxisColor property

Color XY axis - X/YAxisColor

Specifies the color of the axis selected. The button opens the "Color selection" dialog to select the color.

The setting is only active if the "Use trend color" field is disabled or "X/YAxisInTrendColor" is "FALSE".

The X axis attribute can be assigned dynamic properties by means of the name **XAxisColor**.

The Y axis attribute can be assigned dynamic properties by means of the name **YAxisColor**.

The data type is LONG.

X/YAxisEndValue property

Value range to - X/YAxisEndValue

Specifies the upper range of values of the axis selected. You can configure the value if the "Automatic" option is disabled or "X/YAxisAutoRange" is "FALSE".

The X axis attribute can be assigned dynamic properties by means of the name **XAxisEndValue**.

The Y axis attribute can be assigned dynamic properties by means of the name **YAxisEndValue**.

The data type is DOUBLE.

X/YAxisExponentialFormat property

Exponential notation - X/YAxisExponentialFormat

Enables the exponential notation for visualization of a selected axis.

Value	Explanation
TRUE	The values are displayed with exponential notation.
FALSE	The values are displayed with decimal notation.

The X axis attribute can be assigned dynamic properties by means of the name **XAxisExponentialFormat**.

The Y axis attribute can be assigned dynamic properties by means of the name **YAxisExponentialFormat**.

The data type is BOOLEAN.

X/YAxisInTrendColor property

Use trend color - X/YAxisInTrendColor

Enables the display of an axis selected in the trend color. The color of the first trend is activated if several trends are displayed in the trend window. Define the order of trends on the "Trends" tab.

Value	Explanation
TRUE	The axis selected is displayed in the trend color. The setting in the "Color" or "X/YAxisColor" field is disabled.
FALSE	The axis selected is displayed in the color set in the "Color" or "X/YAxisColor" field.

The X axis attribute can be assigned dynamic properties by means of the name **XAxisInTrendColor**.

The Y axis attribute can be assigned dynamic properties by means of the name **YAxisInTrendColor**.

The data type is BOOLEAN.

X/YAxisLabel property

Label - X/YAxisLabel

Defines the label text for a selected axis.

The X axis attribute can be assigned dynamic properties by means of the name **XAxisLabel**.

The Y axis attribute can be assigned dynamic properties by means of the name **YAxisLabel**.

The data type is STRING.

X/YAxisName property

Object name - X/YAxisName

Specifies the name of a selected axis.

Attribute "XAxisName" can be assigned dynamic properties for the X axis by means of **XAxisRename** attribute.

Attribute "YAxisName" can be assigned dynamic properties for the Y axis by means of **YAxisRename** attribute.

The data type is STRING.

X/YAxisPrecisions property

Decimal places - X/YAxisPrecisions

Specifies the decimal precision for displaying the axis selected. The value can be configured and is active in Runtime, if the "Automatic" option is disabled or "X/YAxisAutoPrecisions" is "FALSE".

The X axis attribute can be assigned dynamic properties by means of the name **XAxisPrecisions**.

The Y axis attribute can be assigned dynamic properties by means of the name **YAxisPrecisions**.

The data type is SHORT.

X/YAxisRemove property

Remove - X/YAxisRemove

Removes the selected axis from the list.

The X axis attribute can be assigned dynamic properties by means of the name **XAxisRemove** .

The Y axis attribute can be assigned dynamic properties by means of the name **YAxisRemove** .

The data type is STRING.

X/YAxisRepos property

Up/Down - X/YAxisRepos

Changes the sorting order of the axes. "Up" and "Down" move the axis selected up or down in the list.

The list order determines the axis position in the trend window. The axis output position is moved away from the trend if the axis is moved further up in the list and the orientation is the same.

The X axis attribute can be assigned dynamic properties by means of the name **XAxisRepos**.

The Y axis attribute can be assigned dynamic properties by means of the name **YAxisRepos**.

The data type is LONG.

X/YAxisScalingType property

Scaling - X/YAxisScalingType

Defines the scaling mode for a selected axis.

The following settings are available:

Value	Description
0	Linear
1	Logarithmic
2	Logarithmically negated

The X axis attribute can be assigned dynamic properties by means of the name **XAxisScalingType**.

The Y axis attribute can be assigned dynamic properties by means of the name **YAxisScalingType**.

The data type is LONG.

X/YAxisTrendWindow property

Trend window - X/YAxisTrendWindow

Specifies the trend window for a selected axis. Define the available trend windows in the "Trend window" tab.

The X axis attribute can be assigned dynamic properties by means of the name **XAxisTrendWindow**.

The Y axis attribute can be assigned dynamic properties by means of the name **YAxisTrendWindow**.

The data type is STRING.

X/YAxisVisible property

X/Y axes - X/YAxisVisible

The list shows all axes you created. Click an axis entry in the list to adapt the properties and to assign the axis to a trend window.

3.11 Object properties

Activate the axes to be displayed in the trend windows in the list.

The X axis attribute can be assigned dynamic properties by means of the name **XAxisVisible** .

The Y axis attribute can be assigned dynamic properties by means of the name **YAxisVisible** .

The data type is BOOLEAN.

XAxisCount property

XAxisCount

Defines the number of X axes configured.

The attribute can be assigned dynamic properties by means of the name **XAxisCount**. The data type is LONG.

XAxisIndex property

XAxisIndex

References a configured X axis. Using this attribute you can assign the values of other attributes to a specific X axis.

Values between 0 and "XAxisCount" minus 1 are valid for "Index"; the attribute "XAxisCount" defines the number of configured X axes.

The "XAxisIndex" attribute can be assigned dynamic properties by means of attribute **XAxisRepos**. The data type is LONG.

XAxisRename property

XAxisRename

Renames the X axis which is referenced by means of "XAxisIndex" attribute.

The attribute can be assigned dynamic properties by means of the name **XAxisRename**. "XAxisRename" also sets a dynamic attribute "XAxisName". The data type is STRING.

YAxisCount property

YAxisCount

Defines the number of Y axes configured.

The attribute can be assigned dynamic properties by means of the name **YAxisCount**. The data type is LONG.

YAxisIndex property

YAxisIndex

References a configured Y axis. Using this attribute you can assign the values of other attributes to a specific Y axis.

Values between 0 and "YAxisCount" minus 1 are valid for "Index". Attribute "YAxisCount" defines the number of configured Y axes.

The "YAxisIndex" attribute can be assigned dynamic properties by means of attribute **YAxisRepos**. The data type is LONG.

YAxisRename property

YAxisRename

Renames the Y axis which is referenced by means of "YAxisIndex" attribute.

The attribute can be assigned dynamic properties by means of the name **YAxisRename**. "YAxisRename" also sets a dynamic attribute "YAxisName". The data type is STRING.

3.11.7 The "Display" property group

3.11.7.1 Display Options (DisplayOptions)

Display Options (DisplayOptions)

The "Display options" attribute defines what can be displayed in the object.

Picture or text	Either pictures or text can be displayed in the object.
Picture and text	Pictures and text can be displayed in the object.
Text only	Only text can be displayed in the object.
Picture only	Only pictures can be displayed in the object.

The "Display Options" attribute can be made dynamic with the name "DisplayOptions".

3.11.7.2 Global Shadow

Global Shadow (GlobalShadow)

The "Global shadow" attribute defines whether the object will be displayed with the shadowing defined in the active design.

yes	Uses the global shadowing defined for this object type.
no	No shadowing.

The attribute "Global shadow" can be made dynamic with the name "GlobalShadow".

3.11 Object properties

3.11.7.3 Global Color Scheme

Global Color Scheme (GlobalColorScheme)

The "Global color scheme" attribute defines whether the colors defined for the current design in the global color scheme will be used for this object.

yes	Uses the colors from the global color scheme defined for this type of object.
no	Uses the colors from the color scheme defined for this type of object under "Colors".

The attribute "Global color scheme" can be made dynamic with the name "GlobalColorScheme".

3.11.7.4 Object Transparency

Object Transparency (Transparency)

The "Transparency" attribute defines the percentage to which the object will become transparent.

0 - 100 (integer)	Defines the percentage of transparency. 0 = no transparency; 100 = complete transparency (invisible)
----------------------	---

The text and fields of the graphic objects are only transparent at "100."

In runtime, a completely transparent object (invisible) is also functional.

The attribute "Transparency" can be made dynamic with the name "Transparency".

3.11.7.5 [V6.2] Windows Style

[V6.2] Windows Style (WindowsStyle)

The attribute "[V6.2] Windows Style" defines whether the object will be shown in Windows style by WinCC version 6.2. It can only be selected if "WinCC Classic" is chosen as the current design.

yes	Shows the object using the Windows style from WinCC version 6.2.
no	Shows the object not using the Windows style from WinCC version 6.2.

The "[V6.2] Windows style" attribute can be made dynamic with the name "WindowsStyle".

The WinCC V6.2 standard design "WinCC Classic" which, for compatibility reasons, is available for migrated projects. The design supports only a portion of the functions that were introduced as of WinCC V7.0: For example, you cannot use any SVG graphics.

3.11.7.6 WinCC style

WinCC style (WinCCStyle)

The attribute "WinCC Style" defines the style in which the object will be displayed.

User-defined	Shows the object according to the respective settings.
Global	Shows the object in a globally defined design.
Windows Style	Shows the object in Windows style.

The attribute "WinCC Style" can be made dynamic with the name "WinCCStyle".

3.11.8 "Colors" Property Group

3.11.8.1 Colors - 3D to H

3D Border Color Top (BorderColorTop)

3D Border Color Top (BorderColorTop)

The "3D Border Color Top" attribute defines the color for the left and upper part of a 3D border.

Either permanently define the color in the "Color selection" dialog or select an indexed color from the central color palette if a central color palette is defined.

The "3D Border Color Top" attribute can be made dynamic with the name "BorderColorTop".

3D Border Color Bottom (BorderColorBottom)

3D Border Color Bottom (BorderColorBottom)

The "3D Shadow Color" attribute defines the color for the right and lower part of a 3D border.

Either permanently define the color in the "Color selection" dialog or select an indexed color from the central color palette if a central color palette is defined.

The "3D Shadow Color" attribute can be made dynamic with the name "BorderColorBottom".

List Background Color (UnselBGColor)

List Background Color (UnselBGColor)

The "List Background Color" attribute defines for the "Text list" object the color with which the entries not selected in the selection list of the background are displayed.

Either permanently define the color in the "Color selection" dialog or select an indexed color from the central color palette if a central color palette is defined.

The "List Background Color" attribute can be made dynamic with the name "UnselBGColor".

List Font Color (UnselTextColor)

List Font Color (UnselTextColor)

The "List Font Color" attribute defines for the "Text list" object the color with which the text not selected in the selection list of the background is displayed.

3.11 Object properties

Either permanently define the color in the "Color selection" dialog or select an indexed color from the central color palette if a central color palette is defined.

The "List Font Color" attribute can be made dynamic with the name "UnselTextColor".

Bar Color (BackColor2)

Bar Color (BackColor2)

The "Bar Color" attribute defines the color with which the current value is displayed for the "Bar" object.

Either permanently define the color in the "Color selection" dialog or select an indexed color from the central color palette if a central color palette is defined.

The "Bar color" attribute can be made dynamic with the name "BackColor2".

Bar Background Color (BackColor3)

Bar Background Color (BackColor3)

The "Bar Background Color" attribute defines the color with which the background of the bar is displayed for the "Bar" object.

Either permanently define the color in the "Color selection" dialog or select an indexed color from the central color palette if a central color palette is defined.

The "Bar background color" attribute can be made dynamic with the name "BackColor3".

High Limit Color (HighLimitColor)

High Limit Color (HighLimitColor)

The "High Limit Color" attribute defines the color with which the upper or right arrow key is displayed for the "Slider object" object. The position of the slider is set using the "Alignment" attribute in the "Geometry" property group.

Either permanently define the color in the "Color selection" dialog or select an indexed color from the central color palette if a central color palette is defined.

The "High Limit Color" attribute can be made dynamic with the name "HighLimitColor".

Low Limit Color (LowLimitColor)

Low Limit Color (LowLimitColor)

The "Low Limit Color" attribute defines the color with which the lower or left arrow key is displayed for the "Slider object" object. The position of the slider is set using the "Alignment" attribute in the "Geometry" property group.

Either permanently define the color in the "Color selection" dialog or select an indexed color from the central color palette if a central color palette is defined.

The "Low Limit Color" attribute can be made dynamic with the name "LowLimitColor".

Fill Pattern Color (FillColor)

Fill Pattern Color (FillColor)

The "Fill Pattern Color" attribute defines the color of the pattern that is displayed on the picture background.

Either permanently define the color in the "Color selection" dialog or select an indexed color from the central color palette if a central color palette is defined.

The selected color is only effective if the "Global color scheme" is set to "No" under "Display".

The "Fill Pattern Color" attribute can be made dynamic with the name "FillColor".

Fill Pattern Color (FillColor)

Fill Pattern Color (FillColor)

The "Fill Pattern Color" attribute defines the color of the pattern that is displayed on a filled area.

The "Fill Pattern Color" attribute can be made dynamic with the name "FillColor".

Background Flash Color (BackColor)

Background Flash Color (BackColor)

The "Background Flash Color" attribute defines the color used to display the background of the picture when flashing.

Either permanently define the color in the "Color selection" dialog or select an indexed color from the central color palette if a central color palette is defined.

The "Background Flash Color" attribute can be made dynamic with the name "BackColor".

Background flashing fill color (OK, simulation) (BackFillColor)

Background flashing fill color (OK, simulation) (BackFillColor)

The "Background flashing fill color (OK, simulation)" attribute defines the background color of the flashing picture.

Either define a permanent color directly in the "Color selection" dialog, or select an indexed color from the central color palette if a central color palette is defined.

The "Background flashing fill color (OK, simulation)" attribute can be assigned dynamic properties by means of the name "BackFillColor".

Background flashing fill pattern (OK, simulation) (BackFillStyle)

Background flashing fill pattern (OK, simulation) (BackFillStyle)

The "Background flashing fill pattern (OK, simulation)" attribute defines the background pattern of the flashing picture.

There is a choice of 50 fill patterns. "Solid" fill pattern 0 fills the object with the set background color; "Transparent" fill pattern 1 disables the display of a background and of a fill pattern.

3.11 Object properties

The "Background flashing fill pattern (OK, simulation)" attribute can be assigned dynamic properties by means of the name "BackFillColor".

Background Color (BackColor)

Background Color (BackColor)

The "Background Color" attribute defines the color used to display the background.

Either permanently define the color in the "Color selection" dialog or select an indexed color from the central color palette if a central color palette is defined.

The selected color is only effective if the "Global color scheme" is set to "No" under "Display".

The "Background Color" attribute can be made dynamic with the name "BackColor".

Background Color (BackColor)

Background Color (BackColor)

The "Background Color" attribute defines the color used to display a filled area.

The "Background Color" attribute can be made dynamic with the name "BackColor".

Background Color (OK) (BackColor_OK)

Background Color (OK) (BackColor_OK)

The "Background Color (OK)" attribute defines the color used to display the background with the status "OK".

Either permanently define the color in the "Color selection" dialog or select an indexed color from the central color palette if a central color palette is defined.

The "Background Color (OK)" attribute can be made dynamic with the name "BackColor_OK".

Background Color (Simulation) (BackColor_Simulation)

Background Color (Simulation) (BackColor_Simulation)

The "Background Color (Simulation)" attribute defines the color used to display the background with the status "Simulation".

Either permanently define the color in the "Color selection" dialog or select an indexed color from the central color palette if a central color palette is defined.

The "Background Color (Simulation)" attribute can be made dynamic with the name "BackColor_Simulation".

Background fill color (OK) (BackColor_OK)

Background fill color (OK) (BackColor_OK)

The "Background fill color (OK)" attribute defines the background color used to indicate the "OK" state.

Either define a permanent color directly in the "Color selection" dialog, or select an indexed color from the central color palette if a central color palette is defined.

The "Background fill color (OK)" attribute can be assigned dynamic properties by means of the name "BackFillColor_OK".

Background fill color (simulation) (BackColor_Simulation)

Background fill color (simulation) (BackColor_Simulation)

The "Background fill color (simulation)" attribute defines the background color used to indicate the active "Simulation" state.

Either define a permanent color directly in the "Color selection" dialog, or select an indexed color from the central color palette if a central color palette is defined.

The "Background fill color (simulation)" attribute can be assigned dynamic properties by means of the name "BackFillColor_Simulation".

Background fill pattern (OK) (BackColor_OK)

Background fill pattern (OK) (BackColor_OK)

The "Background fill pattern (OK)" attribute defines the background pattern used to indicate the "OK" state.

There is a choice of 50 fill patterns. "Solid" fill pattern 0 fills the object with the set background color; "Transparent" fill pattern 1 disables the display of a background and of a fill pattern.

The "Background fill pattern (OK)" attribute can be assigned dynamic properties by means of the name "BackFillStyle_OK".

Background fill pattern (simulation) (BackColor_Simulation)

Background fill pattern (simulation) (BackColor_Simulation)

The "Background fill pattern (simulation)" attribute defines the background pattern used to indicate the "Simulation" state.

There is a choice of 50 fill patterns. "Solid" fill pattern 0 fills the object with the set background color; "Transparent" fill pattern 1 disables the display of a background and of a fill pattern.

The "Background fill pattern (simulation)" attribute can be assigned dynamic properties by means of the name "BackFillStyle_Simulation".

3.11.8.2 Colors - I to R

Button Color (ButtonColor)

Button Color (ButtonColor)

The "Button Color" attribute defines the color of a "Slider object" object.

Either permanently define the color in the "Color selection" dialog or select an indexed color from the central color palette if a central color palette is defined.

The "Button Color" attribute can be made dynamic with the name "ButtonColor".

Line Color (BorderColor)

Line Color (BorderColor)

The "Line Color" attribute defines the color for representation of a line.

Either permanently define the color in the "Color selection" dialog or select an indexed color from the central color palette if a central color palette is defined.

The "Line Color" attribute can be made dynamic with the name "BorderColor".

Line Background Color (BorderBackColor)

Line background color (BorderBackColor)

The "Line Background Color" attribute defines the color used to display the background of a broken line.

Either permanently define the color in the "Color selection" dialog or select an indexed color from the central color palette if a central color palette is defined.

In the WinCC Classic design, the background color is only visible when the line weight is "1". With line weight of "2" or greater, the intermediate areas are shown as being transparent.

The "Line Background Color" attribute can be made dynamic with the name "BorderBackColor".

High Limit Background Color (BackColorTop)

High Limit Background Color (BackColorTop)

The "High Limit Background Color" attribute defines the color with which the upper or right area of the slide surface is displayed for the "Slider object" object. The range depends on the "Alignment" attribute in the "Geometry" property group.

Either permanently define the color in the "Color selection" dialog or select an indexed color from the central color palette if a central color palette is defined.

The "High Limit Background Color" attribute can be made dynamic with the name "BackColorTop".

Border Color (BorderColor)

Border Color (BorderColor)

The "Border Color" attribute defines the color for representation of a border line.

Either permanently define the color in the "Color selection" dialog or select an indexed color from the central color palette if a central color palette is defined.

The "Border Color" attribute can be made dynamic with the name "BorderColor".

Border Background Color (BorderBackColor)

Border Background Color (BorderBackColor)

The "Border Background Color" attribute defines the color used to display the background of a broken border line.

Either permanently define the color in the "Color selection" dialog or select an indexed color from the central color palette if a central color palette is defined.

The "Border Background Color" attribute can be made dynamic with the name "BorderBackColor".

Grid Color

Grid Color

The "Grid Color" attribute defines the color used to display the grid in the workspace of the current picture.

The grid is a utility of the Graphics Designer which makes it easier to position objects in a process picture precisely. The grid lines of the grid are symbolized by display of the intersection points.

Either permanently define the color in the "Color selection" dialog or select an indexed color from the central color palette if a central color palette is defined.

The "Grid Color" attribute cannot be made dynamic.

Grid Color with Quality Code: "bad" (PaintColor_QualityCodeBad)

Grid color for quality code: "bad" (PaintColor_QualityCodeBad)

The "Grid Color with Quality Code: "bad"" attribute defines the color that the grid will be shown in when a poor status exists, e.g. if the connection to the server is broken.

Either permanently define the color in the "Color selection" dialog or select an indexed color from the central color palette if a central color palette is defined.

The "Grid Color with Quality Code: "bad"" attribute can be made dynamic with the name "PaintColor_QualityCodeBad".

Grid Color with Quality Code: "uncertain" (PaintColor_QualityCodeUnCertain)

Grid color for quality code: "uncertain" (PaintColor_QualityCodeUnCertain)

The "Grid Color with Quality Code: "uncertain"" attribute defines the color that indicates that the grid in an uncertain status.

Either permanently define the color in the "Color selection" dialog or select an indexed color from the central color palette if a central color palette is defined.

The "Grid Color with Quality Code: "uncertain"" attribute can be made dynamic with the name "PaintColor_QualityCodeUnCertain".

3.11.8.3 Colors - S to Z

Font Flash Color (ForeColor)

Font Flash Color (ForeColor)

The "Font Flash Color" attribute defines the color of a text when flashing. The flashing is only visible in Runtime.

Either permanently define the color in the "Color selection" dialog or select an indexed color from the central color palette if a central color palette is defined.

The "Flashing Text Color Off" attribute can be made dynamic with the name "ForeColor".

Font Color (ForeColor)

Font Color (ForeColor)

The "Font Color" attribute defines the color of the text in the object.

Either permanently define the color in the "Color selection" dialog or select an indexed color from the central color palette if a central color palette is defined.

The selected color is only effective if the "Global color scheme" is set to "No" under "Display".

The "Font Color" attribute can be made dynamic with the name "ForeColor".

Font Color (OK) (ForeColor_OK)

Font Color (OK) (ForeColor_OK)

The "Font Color (OK)" attribute defines the color in which the foreground is displayed with the status "OK".

Either permanently define the color in the "Color selection" dialog or select an indexed color from the central color palette if a central color palette is defined.

The "Font Color (OK)" attribute can be made dynamic with the name "ForeColor_OK".

Font Color (Simulation) (ForeColor_Simulation)

Font Color (Simulation) (ForeColor_Simulation)

The "Font Color (Simulation)" attribute defines the color in which the foreground is displayed with the status "Simulation".

Either permanently define the color in the "Color selection" dialog or select an indexed color from the central color palette if a central color palette is defined.

The "Font Color (Simulation)" attribute can be made dynamic with the name "ForeColor_Simulation".

Selection Background Color (SelBGColor)

Selection Background Color (SelBGColor)

The "Selection Background Color" attribute defines for the "Text list" object the color with which the background of the entry selected in the selection list is displayed.

Either permanently define the color in the "Color selection" dialog or select an indexed color from the central color palette if a central color palette is defined.

The "Selection Background Color" attribute can be made dynamic with the name "SelBGColor".

Selection Font Color (SelTextColor)

Selection Font Color (SelTextColor)

The "Selection Font Color" attribute defines for the "Text list" object the color with which the text selected in the selection list of the background is displayed.

Either permanently define the color in the "Color selection" dialog or select an indexed color from the central color palette if a central color palette is defined.

The "Selection Font Color" attribute can be made dynamic with the name "SelTextColor".

Scale Color (ScaleColor)

Scale Color (ScaleColor)

The "Scale Color" attribute defines the color with which the scale and the label are displayed for the "Bar" object.

Either permanently define the color in the "Color selection" dialog or select an indexed color from the central color palette if a central color palette is defined.

The "Scale Color" attribute can be made dynamic with the name "ScaleColor".

Trend Color (TrendColor)

Trend Color (TrendColor)

The "Trend Color" attribute defines the color with which the trend display is shown for the "Bar" object. The trend display shows the tendency of the measured value in the form of a small arrow at the lower end of the bar.

Either permanently define the color in the "Color selection" dialog or select an indexed color from the central color palette if a central color palette is defined.

The "Trend Color" attribute can be made dynamic with the name "TrendColor".

Dividing Line Color (ItemBorderColor)

Dividing Line Color (ItemBorderColor)

The "Dividing Line Color" attribute defines the color with which the dividing line in the selection list is displayed for the "Text list" object.

Either permanently define the color in the "Color selection" dialog or select an indexed color from the central color palette if a central color palette is defined.

The "Dividing Line Color" attribute can be made dynamic with the name "ItemBorderColor".

Dividing Line Background Color (ItemBorderBackColor)

Dividing Line Background Color (ItemBorderBackColor)

The "Dividing Line Background Color" attribute defines for the "Text list" object the color with which the background of a broken line in the selection list is displayed.

Either permanently define the color in the "Color selection" dialog or select an indexed color from the central color palette if a central color palette is defined.

The "Dividing Line Background Color" attribute can be made dynamic with the name "ItemBorderBackColor".

Low Limit Background Color (BackColorBottom)

Low Limit Background Color (BackColorBottom)

The "Low Limit Background Color" attribute defines the color with which the lower or left area of the slide surface is displayed for the "Slider object" object. The range depends on the "Alignment" attribute in the "Geometry" property group.

Either permanently define the color in the "Color selection" dialog or select an indexed color from the central color palette if a central color palette is defined.

The "Low Limit Background Color" attribute can be made dynamic with the name "BackColorBottom".

3.11.9 "Filling" Property Group

3.11.9.1 Dynamic Filling (Filling)

Dynamic Filling (Filling)

The "Dynamic Filling" attribute specifies whether an object with a closed border line can be filled.

Yes	The object can be filled.
No	The object cannot be filled.

The "Dynamic Filling" attribute can be made dynamic with the name "Filling".

3.11.9.2 Fill Level (FillingIndex)

Fill Level (FillingIndex)

The "Fill Level" attribute specifies the height up to which an object is filled. The value is entered as a percentage, in relation to the object height.

The fill level is displayed according to the value of the "Background Color" attribute in the "Colors" property group. The non-filled background is displayed as "transparent".

0% - 100%	The value can be chosen freely within the specified limits.
-----------	---

The "Fill Level" attribute can be made dynamic with the name "FillingIndex".

3.11.9.3 Filling direction (FillingDirection)

Filling direction (FillingDirection)

The "Filling direction" attribute specifies the filling direction for an object enclosed in a frame line.

Bottom to top	The object is filled from bottom to top.
Top to bottom	The object is filled from top to bottom.
Left to right	The object is filled from left to right.
Right to left	The object is filled from right to left.

The attribute can be assigned dynamic properties by means of the name FillingDirection. The data type is LONG.

3.11.10 "Geometry" Property Group

3.11.10.1 Geometry - A to B

Current Value X (ActualPointLeft)

Current Value X (ActualPointLeft)

The "Current Value X" attribute specifies the horizontal position of the currently selected corner. The value stands in relation to the picture origin and specifies in pixels the distance of the corner from the left picture border.

The currently selected corner is uniquely determined by the "Index" attribute. In order to display the current value X of another corner, the value of the "Index" attribute must be modified.

There is a free choice of value. A meaningful limit results from the picture size.

The "Current Value X" attribute can be made dynamic with the name "ActualPointLeft".

Current Value Y (ActualPointTop)

Current Value Y (ActualPointTop)

The "Current Value Y" attribute specifies the vertical position of the currently selected corner. The value stands in relation to the picture origin and specifies in pixels the distance of the corner from the top picture border.

The currently selected corner is uniquely determined by the "Index" attribute. In order to display the current value Y of another corner, the value of the "Index" attribute must be modified.

The value can be selected. A useful limit is determined by the picture size.

The "Current Value Y" attribute can be made dynamic with the name "ActualPointTop".

Alpha (AngleAlpha)

Alpha (AngleAlpha)

3.11 Object properties

The "Alpha" attribute specifies the depth angle Alpha for the 3D display of the right side of a 3D bar. The values are specified in degrees.

0° - 90°	There is a free choice of value for the depth angle Alpha within the specified limits.
----------	--

The "Alpha" attribute can be made dynamic with the name "AngleAlpha".

Start Angle (StartAngle)

Start Angle (StartAngle)

For segment or arc objects, the "Start Angle" attribute specifies the angle by which the starting point of the object deviates from the zero position (0°). The values are specified in degrees.

The start angle can be chosen freely. A meaningful limit results from the definition of a circle.

The "Start Angle" attribute can be made dynamic with the name "StartAngle".

Number of Corners (PointCount)

Number of Corners (PointCount)

The "Number of Corners" specifies the total number of corners for the selected object. The minimum number of three corners is given.

Changing the "Number of Corners" attribute has the following effects:

Increasing the number: All new corners are placed on the corner with the highest value for the "Index" attribute. The exact position can be set by dragging with the mouse or changing the individual position values.

Reducing the number: All corners are removed for which the value of the "Index" attribute is higher than the new number of corners.

There is a free choice of value. The minimum number of corners is 3.

The "Number of Corners" attribute can be assigned dynamic properties with the name "PointCount".

Number of Boxes (BoxCount)

Number of Boxes (BoxCount)

The "Number of Boxes" specifies the total number of boxes for the selected object. For each object, a maximum number of 64 boxes can be set.

At the same time, the value of the "Number of Boxes" attribute specifies the upper limit value for the "Index" attribute in the "Font" property group. Changing the value can have the following effects:

- Increasing the number: New fields are inserted under the field with the highest value in the "Index" attribute. The standard labeling of the new box can be changed using the "Text" attribute in the "Font" property group.
- Reducing the number: All fields are removed for which the value of the "Index" attribute is higher than the new number.

1 - 64	There is a free choice of value within the specified value range.
--------	---

The "Number of Boxes" attribute can be made dynamic with the name "BoxCount".

Number of rows

Number of rows

The "Number of rows" attribute defines the number of text lines for a combination field and a list field. You can define a maximum of 32 000 lines.

At the same time, the value of the "Number of rows" attribute specifies the upper limit value for the "Index" attribute in the "Font" property group. Changing the value can have the following effects:

- Increasing the number: New lines are added at the bottom. The standard labeling of the new filed can be changed using the "Text" attribute in the "Font" property group.
- Reducing the number: All lines are removed for which the value of the "Index" attribute is higher than the new number.

1 - 32 000	There is a free choice of value within the specified value range.
------------	---

The attribute can be made dynamic with the name "NumberLines".

Alignment (Direction)

Alignment (Direction)

The "Alignment" attribute defines for the "Slider" object whether the movement of the slider is in a horizontal or vertical direction.

Horizontal	The movement of the slider is in horizontal direction.
Vertical	The movement of the slider is in vertical direction.

The "Alignment" attribute can be made dynamic with the name "Direction".

Bar Width (BarWidth)

Bar Width (BarWidth)

The "Bar Width" attribute defines for 3D bars the distance between the vertical limitation lines of the front bar area. The values are specified in pixels.

There is a free choice of value. A meaningful limit results from the object size.

= 0	The representation of the 3D bar is reduced to a vertical line.
-----	---

The "Bar Width" attribute can be made dynamic with the name "BarWidth".

Bar Height (BarHeight)

Bar Height (BarHeight)

3.11 Object properties

The "Bar Height" attribute defines for 3D bars the distance between the horizontal limitation lines of the front bar area. The values are specified in pixels.

There is a free choice of value. A meaningful limit results from the object size.

= 0	The representation of the 3D bar is reduced to a horizontal line.
-----	---

The "Bar Height" attribute can be made dynamic with the name "BarHeight".

Bar Direction (Direction)

Bar Direction (Direction)

The "Bar Direction" attribute specifies for the "Bar" object the direction of the coordinate axis in which the highest display value of the bar points.

Up	The highest display value of the bar points upwards.
Down	The highest display value of the bar points downwards (negative direction).
Left	The highest display value of the bar points to the left (negative direction).
Right	The highest display value of the bar points to the right.

The "Bar Direction" attribute can be made dynamic with the name "Direction".

Bar Direction (Direction)

Bar Direction (Direction)

The "Bar Direction" attribute specifies for the "3D bar" object whether the highest display value of the bar points in the positive or negative direction of the coordinate axis. The position of the 3D bar in the coordinate system is specified using the "Display Axis" attribute.

Positive	The highest display value of the 3D bar points towards the positive coordinate axis.
Negative	The highest display value of the 3D bar points towards the negative coordinate axis.

The "Bar Direction" attribute can be made dynamic with the name "Direction".

Bar Depth (BarDepth)

Bar Depth (BarDepth)

The "Bar Depth" attribute defines for the 3D bar the length of the oblique lines for the depth display. The values are specified in pixels.

There is a free choice of value. A meaningful limit results from the object size.

= 0	The representation of the 3D bar appears in two dimensions.
-----	---

The "Bar Depth" attribute can be made dynamic with the name "BarDepth".

Base X (BaseX)

Base X (BaseX)

The "Base X" attribute defines for the 3D bar the distance between the left object border and the right limitation line of the front bar area. The values are specified in pixels.

There is a free choice of value. A meaningful limit results from the object size.

The "Base X" attribute can be made dynamic with the name "BaseX".

Base Y (BaseY)

Base Y (BaseY)

The "Base Y" attribute defines for the 3D bar the distance between the top object border and the bottom limitation line of the front bar area. The values are specified in pixels.

There is a free choice of value. A meaningful limit results from the object size.

The "Base Y" attribute can be made dynamic with the name "BaseY".

Beta (AngleBeta)

Beta (AngleBeta)

The "Beta" attribute specifies the depth angle Beta for the 3D display of the left side of a 3D bar. The values are specified in degrees.

0° - 90°	There is a free choice of value for the depth angle Beta within the specified limits.
----------	---

The "Start Angle" attribute can be made dynamic with the name "AngleBeta".

Picture Width (Width)

Picture Width (Width)

The "Picture Width" attribute defines the width of a process picture. The default value corresponds to the vertical component of the current screen resolution and is specified in pixels.

If the value for the picture width exceeds the screen resolution, scroll bars appear in Runtime to enable movement of the picture.

1 to 10500 pixels	The value can be chosen freely within the specified limits. A meaningful limit results from the screen resolution.
-------------------	--

The "Picture Width" attribute can be made dynamic with the name "Width".

Picture Height (Height)

Picture Height (Height)

The "Picture Height" attribute defines the height of a process picture. The default value corresponds to the horizontal component of the current screen resolution and is specified in pixels.

3.11 Object properties

If the value for the picture height exceeds the screen resolution, scroll bars appear in Runtime to enable movement of the picture.

1 - 10000 pixels	The value can be chosen freely within the specified limits. A meaningful limit results from the screen resolution.
------------------	--

The "Picture Height" attribute can be made dynamic with the name "Height".

Width (Width)

Width (Width)

The "Width" attribute defines the horizontal distance between the left and right limitation line of an object. The values are specified in pixels.

In the case of the objects "Group Display", "Button" and "Round Button", changing the object size may make it necessary to adapt the "3D Border Width" attribute in the "Styles" property group.

0 - 10000	The value can be chosen freely within the specified limits.
-----------	---

The "Width" attribute can be made dynamic with the name "Width".

With the object "Connector", the attribute "Width" cannot be made dynamic.

Button 1 Width (Button1Width)

Button 1 Width (Button1Width)

The "Button 1 Width" attribute defines for the "Group Display" object the width of the first button from the left. The values are specified in pixels.

There is a free choice of value. If the button should not be visible, set the width to "0".

Different values for the buttons are only displayed if the "Same Size" attribute has the value "No".

The "Button 1 Width" attribute can be made dynamic with the name "Button1Width".

Button 2 Width (Button2Width)

Button 2 Width (Button2Width)

The "Button 2 Width" attribute defines for the "Group Display" object the width of the second button from the left. The values are specified in pixels.

There is a free choice of value. If the button should not be visible, set the width to "0".

Different values for the buttons are only displayed if the "Same Size" attribute has the value "No".

The "Button 2 Width" attribute can be made dynamic with the name "Button2Width".

Button 3 Width (Button3Width)

Button 3 Width (Button3Width)

The "Button 3 Width" attribute defines for the "Group Display" object the width of the third button from the left. The values are specified in pixels.

There is a free choice of value. If the button should not be visible, set the width to "0".

Different values for the buttons are only displayed if the "Same Size" attribute has the value "No".

The "Button 3 Width" attribute can be made dynamic with the name "Button3Width".

Button 4 Width (Button4Width)

Button 4 Width (Button4Width)

The "Button 4 Width" attribute defines for the "Group Display" object the width of the fourth button from the left. The values are specified in pixels.

There is a free choice of value. If the button should not be visible, set the width to "0".

Different values for the buttons are only displayed if the "Same Size" attribute has the value "No".

The "Button 4 Width" attribute can be made dynamic with the name "Button4Width".

Button 5 Width (Button5Width)

Button 5 Width (Button5Width)

The "Button 5 Width" attribute defines the width of the fifth button from the left for the "Group Display" object. The values are specified in pixels.

There is a free choice of value. If the button should not be visible, set the width to "0".

Different values for the buttons are only displayed if the "Same Size" attribute has the value "No".

The "Button 5 Width" attribute can be made dynamic with the name "Button5Width".

Button 6 Width (Button6Width)

Button 6 Width (Button6Width)

The "Button 6 Width" attribute defines the width of the sixth button from the left for the "Group Display" object. The values are specified in pixels.

There is a free choice of value. If the button should not be visible, set the width to "0".

Different values for the buttons are only displayed if the "Same Size" attribute has the value "No".

The "Button 6 Width" attribute can be made dynamic with the name "Button6Width".

Button 7 Width (Button7Width)

Button 7 Width (Button7Width)

The "Button 7 Width" attribute defines the width of the seventh button from the left for the "Group Display" object. The values are specified in pixels.

3.11 Object properties

There is a free choice of value. If the button should not be visible, set the width to "0".

Different values for the buttons are only displayed if the "Same Size" attribute has the value "No".

The "Button 7 Width" can be made dynamic with the name "Button7Width".

Button 8 Width (Button8Width)

Button 8 Width (Button8Width)

The "Button 8 Width" attribute defines the width of the eighth button from the left for the "Group Display" object. The values are specified in pixels.

There is a free choice of value. If the button should not be visible, set the width to "0".

Different values for the buttons are only displayed if the "Same Size" attribute has the value "No".

The "Button 8 Width" attribute can be made dynamic with the name "Button8Width".

3.11.10.2 Geometry - C to Z

Display Axis (Axe)

Display Axis (Axe)

The "Display Axis" attribute defines the position of the 3D bar in the coordinate system.

X axis	The representation of the 3D bar takes place on the X axis.
Y axis	The representation of the 3D bar takes place on the Y axis.
Z axis	The representation of the 3D bar takes place on the Z axis.

The "Display Axis" attribute can be made dynamic with the name "Axe".

Corner radius (CornerRadius)

Corner radius (CornerRadius)

The "Corner radius" attribute defines the rounding radius of the rectangles which enclose objects in the extended analog display. The values are defined in pixels.

The range of values which can be displayed for the corner radius depends on the values set for the "height" and "width" attributes. The maximum corner radius value which can be displayed is equivalent to 50% of the lower one of the "height" or "width" values. The maximum value is used if higher values are entered.

The "Corner Radius" attribute can be assigned dynamic properties by means of the name "CornerRadius".

Corner Radius X (RoundCornerHeight)

Corner Radius X (RoundCornerHeight)

The "Corner Radius X" attribute defines for a rounded rectangle the horizontal distance between the corner of the rectangle around the object and the starting point of a rounded corner. The value is specified as a percentage of half the object width.

If the "Corner Radius X" and "Corner Radius Y" attributes are both set to the value 100%, the rounded rectangle is displayed as an ellipse or circle. The rectangle is shown without rounded corners when either one of the two attributes is set to 0%.

0% - 100%	The value can be chosen freely within the specified limits.
0	No rounded corners; the rounded rectangle has the appearance of a normal rectangle.
100	The Corner Radius X corresponds to half the width of the rounded rectangle. The start point of the curved section is located at the vertical center line of the object. Both horizontal limitation lines are displayed as arcs.

The "Corner Radius X" attribute can be made dynamic with the name "RoundCornerHeight".

Corner Radius Y (RoundCornerWidth)

Corner Radius Y (RoundCornerWidth)

The "Corner Radius Y" attribute defines for a rounded rectangle the vertical distance between the corner of the rectangle around the object and the starting point of a rounded corner. The value is specified as a percentage of half the object height.

If the "Corner Radius X" and "Corner Radius Y" attributes are both set to the value 100%, the rounded rectangle is displayed as an ellipse or circle. The rectangle is shown without rounded corners when either one of the two attributes is set to 0%.

0% - 100%	The value can be chosen freely within the specified limits.
0	No rounded corners; the rounded rectangle has the appearance of a normal rectangle.
100	The Corner Radius Y corresponds to half the height of the rounded rectangle. The start point of the curved section is located at the vertical center line of the object. Both vertical limitation lines are displayed as arcs.

The "Corner Radius Y" attribute can be made dynamic with the name "RoundCornerWidth".

End Angle (EndAngle)

End Angle (EndAngle)

For segment or arc objects, the "End Angle" attribute specifies the angle by which the end point of the object deviates from the zero position (0°). The values are specified in degrees.

There is a free choice of value. A meaningful limit results from the definition of a circle.

The "End Angle" attribute can be made dynamic with the name "EndAngle".

Window Width (Width)

Window Width (Width)

3.11 Object properties

The "Window Width" attribute defines the horizontal distance between the left and right limitation line of an object. The values are specified in pixels.

0 - 10000	The value can be chosen freely within the specified limits.
-----------	---

The "Window Width" attribute can be made dynamic with the name "Width".

Window Height (Height)

Window Height (Height)

The "Window Height" attribute defines the vertical distance between the top and bottom limitation line of an object. The values are specified in pixels.

0 - 10000	The value can be chosen freely within the specified limits.
-----------	---

The "Window Height" attribute can be made dynamic with the name "Height".

Same Size (SameSize)

Same Size (SameSize)

The "Same Size" attribute defines whether the buttons of a group display will have the same width or whether the widths can be defined individually for each button.

Yes	All buttons that have the "Button ... Width" attribute defined as unequal to "0" will be set to the same size within the overall width of the "Group Display" object. Changing the overall width of the object changes the width of the all buttons that have a width unequal to 0.
No	The width of the buttons can be defined individually using the "Button ... Width" attributes.

The "Same Size" attribute can be made dynamic with the name "SameSize".

Height (Height)

Height (Height)

The "Height" attribute defines the vertical distance between the top and bottom limitation line of an object. The values are specified in pixels.

In the case of the objects "Group Display", "Button" and "Round Button", changing the object size may make it necessary to adapt the "3D Border Width" attribute in the "Styles" property group.

0 - 10000	The value can be chosen freely within the specified limits.
-----------	---

The "Height" attribute can be made dynamic with the name "Height".

With the object "Connector", the attribute "Height" cannot be made dynamic.

Index (Index)

Index (Index)

The "Index" attribute indicates the item number of the currently selected corner. Changing the value specified here enables targeted selection of a corner.

Changing the "Index" attribute also changes the displayed value of the "Current Value X" and "Current Value Y" attributes. The display of these three attributes only applies to the currently selected corner in each case.

1 - "Number of Corners"	The value can be chosen freely within the specified limits.
-------------------------	---

The "Index" attribute can be made dynamic with the name "Index".

Position X (Left)

Position X (Left)

The "Position X" attribute defines the horizontal distance of the object origin from the left picture border. The values are specified in pixels.

There is a free choice of value. A meaningful limit results from the picture size.

The "Position X" attribute can be made dynamic with the name "Left".

With the object "Connector", the value can only be changed with unlinked ends.

Position Y (Top)

Position Y (Top)

The "Position Y" attribute defines the vertical distance of the object origin from the top picture border. The values are specified in pixels.

There is a free choice of value. A meaningful limit results from the picture size.

The "Position Y" attribute can be made dynamic with the name "Top".

With the object "Connector", the value can only be changed with unlinked ends.

Radius (Radius)

Radius (Radius)

The "Radius" attribute defines the radius of circular objects. The values are specified in pixels.

0 - 5000	The value can be chosen freely within the specified limits.
----------	---

The "Radius" attribute can be made dynamic with the name "Radius".

Radius X (RadiusWidth)

Radius X (RadiusWidth)

The "Radius X" attribute defines the horizontal radius of elliptical objects. The values are specified in pixels.

0 - 5000	The value can be chosen freely within the specified limits.
----------	---

The "Radius X" attribute can be made dynamic with the name "RadiusWidth".

Radius Y (RadiusHeight)

Radius Y (RadiusHeight)

The "Radius Y" attribute defines the vertical radius of elliptical objects. The values are specified in pixels.

0 - 5000	The value can be chosen freely within the specified limits.
----------	---

The "Radius Y" attribute can be made dynamic with the name "RadiusHeight".

Grid On

Grid On

The "Grid On" attribute specifies whether a grid is shown in the workspace of the current picture.

The grid is a utility of the Graphics Designer which makes it easier to position objects in a process picture precisely. The grid lines of the grid are symbolized by display of the intersection points.

If the additional option "Snap to Grid" is enabled, all objects are automatically aligned

Grid Height

Grid Height

The "Grid Height" attribute is used to specify the vertical distance for the grid lines of the grid. The value is specified in pixels.

The grid is a utility of the Graphics Designer which makes it easier to position objects in a process picture precisely. The grid lines of the grid are symbolized by display of the intersection points.

The minimum grid height that can be displayed on the screen is 10 pixels. A low value can be specified, but only the intersection points with a spacing of at least 10 pixels are displayed on the screen.

With a grid height of 4 pixels, only each third intersection is displayed. The objects can however also be aligned to the two grid lines between them.

Grid Width

Grid Width

The "Grid Width" attribute is used to specify the horizontal distance for the grid lines of the grid. The value is specified in pixels.

The grid is a utility of the Graphics Designer which makes it easier to position objects in a process picture precisely. The grid lines of the grid are symbolized by display of the intersection points.

The minimum grid width that can be displayed on the screen is 10 pixels. A low value can be specified, but only the intersection points with a spacing of at least 10 pixels are displayed on the screen.

With a grid width of 4 pixels, only each third intersection is displayed. The objects can however also be aligned to the two grid lines between them.

Rotation Reference X (ReferenceRotationLeft)

Rotation Reference X (ReferenceRotationLeft)

The "Rotation Reference X" attribute defines the horizontal coordinates of the reference point around which the object rotates in Runtime. The value describes the horizontal distance between the reference point and the origin of the object. The value is indicated in percentages, whereby the object width corresponds to 100%.

The reference point value can be outside the selection rectangle. This means that both negative values and values higher than 100% are possible.

The rotation of an object is visible only in Runtime. The direction of rotation depends on the value of the "Rotation Angle" attribute.

There is a free choice of value. Both negative values and values greater than 100% are permitted.

Examples:

-100%	The reference point lies to the left of the object origin (distance = one object width).
0%	The vertical coordinates of the reference point and object origin are the same.
50%	The reference point lies on the vertical center axis of the object.
100%	The reference point lies to the right of the object origin (distance = one object width).
200%	The reference point lies to the right of the object origin (distance = two object widths).

The "Rotation Reference X" attribute can be made dynamic with the name "ReferenceRotationLeft".

Rotation Reference Y (ReferenceRotationTop)

Rotation Reference Y (ReferenceRotationTop)

The "Rotation Reference Y" attribute defines the vertical coordinates of the reference point around which the object rotates in Runtime. The value describes the vertical distance between the reference point and the origin of the object. The value is indicated in percentages, whereby the object width corresponds to 100%.

The reference point value can be outside the selection rectangle. This means that both negative values and values higher than 100% are possible.

The rotation of an object is visible only in Runtime. The direction of rotation depends on the value of the "Rotation Angle" attribute.

There is a free choice of value. Both negative values and values greater than 100% are permitted.

Examples:

-100%	The reference point lies above the object origin (distance = one object width).
0%	The horizontal coordinates of the reference point and object origin are the same.
50%	The reference point lies on the horizontal center axis of the object.
100%	The reference point lies below the object origin (distance = one object width).
200%	The reference point lies below the object origin (distance = two object widths).

3.11 Object properties

The "Rotation Reference Y" attribute can be made dynamic with the name "ReferenceRotationTop".

Rotation Angle (RotationAngle)

Rotation Angle (RotationAngle)

The "Rotation Angle" attribute defines the rotation of an object around a reference point. The value of the rotation angle is specified in degrees; the starting value corresponds to a value of 0°.

The position of the object deviates from its configured start position by the value of the "Rotation Angle" attribute. The changed orientation of the object is only visible in Runtime.

The coordinates of the reference point are defined with the "Rotation Reference X" and "Rotation Reference Y" attributes.

-360° - 360°	The value can be chosen freely within the specified limits.
< 0°	The object is rotated counterclockwise.
= 0°	The object is not rotated (display of the configured start position).
> 0°	The object is rotated clockwise.

The "Rotation Angle" attribute can be made dynamic with the name "RotationAngle".

Rotation Angle (RotationAngle)

Rotation Angle (RotationAngle)

The "Rotation Angle" attribute defines the orientation of a T-piece. The attribute can have one of four values that are specified in degrees.

The orientation is produced by rotating the T-piece clockwise around the center point by the specified number of degrees.

If you enter another value, it is automatically converted to modulus 360 and rounded up or down to the closest permissible value.

0	The standard position of the T-piece is the shape of the letter "T"
90	The "leg" of the "T" points towards the left
180	The "leg" of the "T" points upwards
270	The "leg" of the "T" points to the right

The "Rotation Angle" attribute can be made dynamic with the name "RotationAngle".

Angle Settings (PredefinedAngles)

Angle Settings (PredefinedAngles)

The "Angle Settings" attribute offers three predefined variants for the depth display of a 3D bar. A fourth variant enables free setting of the two depth angles Alpha and Beta.

If the "Angle Settings" attribute is changed, the "Alpha" and "Beta" attributes receive predefined values.

Cavalier	Depth display with the values: Alpha = 45° and Beta = 0°
Isonometric	Depth display with the values: Alpha = Beta = 45°
Axonometric	Depth display with the values: Alpha = 10° and Beta = 42°
Freely Defined	There is a free choice of values for Alpha and Beta.

The "Angle Settings" attribute can be made dynamic with the name "PredefinedAngles".

3.11.11 "Limits" Property Group

3.11.11.1 Limits - A

Type AH (TypeAlarmHigh)

Type AH (TypeAlarmHigh)

The "Type AH" attribute specifies for the "Bar" object whether the value of the Limit AH is displayed as an absolute value or as a percentage value, starting from the zero point of the bar display.

For the "Bar" object, up to 5 limits can be defined, each of which has an upper (High) and a lower (Low) limit value. The limits are termed:

The "Upper Limit XH" and "Lower Limit XL" attributes specify the limit values for the corresponding Limit X. The "Type X" attributes specify whether the specified limit values are displayed as absolute values or as percentage values.

The "Bar Color XH" and "Bar Color XL" attributes can be used to assign a color to any Limit X. The display value is shown in the corresponding color, starting from the zero point of the bar display, as soon as it is higher than the corresponding Upper Limit XH or lower than the Lower Limit XL. The "Change Color" attribute in the "Miscellaneous" property group specifies whether this color change is to take place segment by segment or for the entire bar display.

The color change can only be displayed for a Limit X if the "Monitoring X" attribute has the value "Yes". If the "Limit Marker" attribute has the value "Display", the configured and monitored limits are indicated by marking arrows. These limit markers are shown in the bar color of the corresponding limit and are displayed on the side of the bar opposite the scale.

Absolute	The value of limit AH is accepted as an absolute value in the representation of the bar.
%	The value of limit AH is displayed as a percentage value, starting from the zero point of the bar display.

The "Type AH" attribute can be made dynamic with the name "TypeAlarmHigh".

Type AL (TypeAlarmLow)

Type AL (TypeAlarmLow)

3.11 Object properties

The "Type AL" attribute specifies for the "Bar" object whether the value of the Alarm Low Limit AL is displayed as an absolute value or as a percentage value, starting from the zero point of the bar display.

For the "Bar" object, up to 5 limits can be defined, each of which has an upper (High) and a lower (Low) limit value. The limits are termed:

The "Upper Limit XH" and "Lower Limit XL" attributes specify the limit values for the corresponding Limit X. The "Type X" attributes specify whether the specified limit values are displayed as absolute values or as percentage values.

The "Bar Color XH" and "Bar Color XL" attributes can be used to assign a color to any Limit X. The display value is shown in the corresponding color, starting from the zero point of the bar display, as soon as it is higher than the corresponding Upper Limit XH or lower than the Lower Limit XL. The "Change Color" attribute in the "Miscellaneous" property group specifies whether this color change is to take place segment by segment or for the entire bar display.

The color change can only be displayed for a Limit X if the "Monitoring X" attribute has the value "Yes". If the "Limit Marker" attribute has the value "Display", the configured and monitored limits are indicated by marking arrows. These limit markers are shown in the bar color of the corresponding limit and are displayed on the side of the bar opposite the scale.

Absolute	The value of Alarm Low Limit AL is accepted as an absolute value in the representation of the bar.
%	The value of Alarm Low Limit AL is displayed as a percentage value, starting from the zero point of the bar display.

The "Type AL" attribute can be made dynamic with the name "TypeAlarmLow".

Type RH4 (TypeLimitHigh4)

Type RH4 (TypeLimitHigh4)

The "Type RH4" attribute specifies for the "Bar" object whether the value of the High Limit RH4 is displayed as an absolute value or as a percentage value, starting from the zero point of the bar display.

For the "Bar" object, up to 5 limits can be defined, each of which has an upper (High) and a lower (Low) limit value. The limits are termed:

The "Upper Limit XH" and "Lower Limit XL" attributes specify the limit values for the corresponding Limit X. The "Type X" attributes specify whether the specified limit values are displayed as absolute values or as percentage values.

The "Bar Color XH" and "Bar Color XL" attributes can be used to assign a color to any Limit X. The display value is shown in the corresponding color, starting from the zero point of the bar display, as soon as it is higher than the corresponding Upper Limit XH or lower than the Lower Limit XL. The "Change Color" attribute in the "Miscellaneous" property group specifies whether this color change is to take place segment by segment or for the entire bar display.

The color change can only be displayed for a Limit X if the "Monitoring X" attribute has the value "Yes". If the "Limit Marker" attribute has the value "Display", the configured and monitored

limits are indicated by marking arrows. These limit markers are shown in the bar color of the corresponding limit and are displayed on the side of the bar opposite the scale.

Absolute	The value of High Limit RH4 is accepted as an absolute value in the representation of the bar.
%	The value of High Limit RH4 is displayed as a percentage value, starting from the zero point of the bar display.

The "Type RH4" attribute can be made dynamic with the name "TypeLimitHigh4".

Type RH5 (TypeLimitHigh5)

Type RH5 (TypeLimitHigh5)

The "Type RH5" attribute specifies for the "Bar" object whether the value of the High Limit RH5 is displayed as an absolute value or as a percentage value, starting from the zero point of the bar display.

For the "Bar" object, up to 5 limits can be defined, each of which has an upper (High) and a lower (Low) limit value. The limits are termed:

The "Upper Limit XH" and "Lower Limit XL" attributes specify the limit values for the corresponding Limit X. The "Type X" attributes specify whether the specified limit values are displayed as absolute values or as percentage values.

The "Bar Color XH" and "Bar Color XL" attributes can be used to assign a color to any Limit X. The display value is shown in the corresponding color, starting from the zero point of the bar display, as soon as it is higher than the corresponding Upper Limit XH or lower than the Lower Limit XL. The "Change Color" attribute in the "Miscellaneous" property group specifies whether this color change is to take place segment by segment or for the entire bar display.

The color change can only be displayed for a Limit X if the "Monitoring X" attribute has the value "Yes". If the "Limit Marker" attribute has the value "Display", the configured and monitored limits are indicated by marking arrows. These limit markers are shown in the bar color of the corresponding limit and are displayed on the side of the bar opposite the scale.

Absolute	The value of High Limit RH5 is accepted as an absolute value in the representation of the bar.
%	The value of High Limit RH5 is displayed as a percentage value, starting from the zero point of the bar display.

The "Type RH5" attribute can be made dynamic with the name "TypeLimitHigh5".

Type RL4 (TypeLimitLow4)

Type RL4 (TypeLimitLow4)

The "Type RL4" attribute specifies for the "Bar" object whether the value of the Low Limit RL4 is displayed as an absolute value or as a percentage value, starting from the zero point of the bar display.

For the "Bar" object, up to 5 limits can be defined, each of which has an upper (High) and a lower (Low) limit value. The limits are termed:

The "Upper Limit XH" and "Lower Limit XL" attributes specify the limit values for the corresponding Limit X. The "Type X" attributes specify whether the specified limit values are displayed as absolute values or as percentage values.

3.11 Object properties

The "Bar Color XH" and "Bar Color XL" attributes can be used to assign a color to any Limit X. The display value is shown in the corresponding color, starting from the zero point of the bar display, as soon as it is higher than the corresponding Upper Limit XH or lower than the Lower Limit XL. The "Change Color" attribute in the "Miscellaneous" property group specifies whether this color change is to take place segment by segment or for the entire bar display.

The color change can only be displayed for a Limit X if the "Monitoring X" attribute has the value "Yes". If the "Limit Marker" attribute has the value "Display", the configured and monitored limits are indicated by marking arrows. These limit markers are shown in the bar color of the corresponding limit and are displayed on the side of the bar opposite the scale.

Absolute	The value of Low Limit RL4 is accepted as an absolute value in the representation of the bar.
%	The value of Low Limit RL4 is displayed as a percentage value, starting from the zero point of the bar display.

The "Type RL4" attribute can be made dynamic with the name "TypeLimitLow4".

Type RL5 (TypeLimitLow5)

Type RL5 (TypeLimitLow5)

The "Type RL5" attribute specifies for the "Bar" object whether the value of the Low Limit RL5 is displayed as an absolute value or as a percentage value, starting from the zero point of the bar display.

For the "Bar" object, up to 5 limits can be defined, each of which has an upper (High) and a lower (Low) limit value. The limits are termed:

The "Upper Limit XH" and "Lower Limit XL" attributes specify the limit values for the corresponding Limit X. The "Type X" attributes specify whether the specified limit values are displayed as absolute values or as percentage values.

The "Bar Color XH" and "Bar Color XL" attributes can be used to assign a color to any Limit X. The display value is shown in the corresponding color, starting from the zero point of the bar display, as soon as it is higher than the corresponding Upper Limit XH or lower than the Lower Limit XL. The "Change Color" attribute in the "Miscellaneous" property group specifies whether this color change is to take place segment by segment or for the entire bar display.

The color change can only be displayed for a Limit X if the "Monitoring X" attribute has the value "Yes". If the "Limit Marker" attribute has the value "Display", the configured and monitored limits are indicated by marking arrows. These limit markers are shown in the bar color of the corresponding limit and are displayed on the side of the bar opposite the scale.

Absolute	The value of Low Limit RL5 is accepted as an absolute value in the representation of the bar.
%	The value of Low Limit RL5 is displayed as a percentage value, starting from the zero point of the bar display.

The "Type RL5" attribute can be made dynamic with the name "TypeLimitLow5".

Type TH (TypeToleranceHigh)

Type TH (TypeToleranceHigh)

The "Type TH" attribute specifies for the "Bar" object whether the value of the Limit TH is displayed as an absolute value or as a percentage value, starting from the zero point of the bar display.

For the "Bar" object, up to 5 limits can be defined, each of which has an upper (High) and a lower (Low) limit value. The limits are termed:

The "Upper Limit XH" and "Lower Limit XL" attributes specify the limit values for the corresponding Limit X. The "Type X" attributes specify whether the specified limit values are displayed as absolute values or as percentage values.

The "Bar Color XH" and "Bar Color XL" attributes can be used to assign a color to any Limit X. The display value is shown in the corresponding color, starting from the zero point of the bar display, as soon as it is higher than the corresponding Upper Limit XH or lower than the Lower Limit XL. The "Change Color" attribute in the "Miscellaneous" property group specifies whether this color change is to take place segment by segment or for the entire bar display.

The color change can only be displayed for a Limit X if the "Monitoring X" attribute has the value "Yes". If the "Limit Marker" attribute has the value "Display", the configured and monitored limits are indicated by marking arrows. These limit markers are shown in the bar color of the corresponding limit and are displayed on the side of the bar opposite the scale.

Absolute	The value of limit TH is accepted as an absolute value in the representation of the bar.
%	The value of limit TH is displayed as a percentage value, starting from the zero point of the bar display.

The "Type TH" attribute can be made dynamic with the name "TypeToleranceHigh".

Type TL (TypeToleranceLow)

Type TL (TypeToleranceLow)

The "Type TL" attribute specifies for the "Bar" object whether the value of the Limit TL is displayed as an absolute value or as a percentage value, starting from the zero point of the bar display.

For the "Bar" object, up to 5 limits can be defined, each of which has an upper (High) and a lower (Low) limit value. The limits are termed:

The "Upper Limit XH" and "Lower Limit XL" attributes specify the limit values for the corresponding Limit X. The "Type X" attributes specify whether the specified limit values are displayed as absolute values or as percentage values.

The "Bar Color XH" and "Bar Color XL" attributes can be used to assign a color to any Limit X. The display value is shown in the corresponding color, starting from the zero point of the bar display, as soon as it is higher than the corresponding Upper Limit XH or lower than the Lower Limit XL. The "Change Color" attribute in the "Miscellaneous" property group specifies whether this color change is to take place segment by segment or for the entire bar display.

The color change can only be displayed for a Limit X if the "Monitoring X" attribute has the value "Yes". If the "Limit Marker" attribute has the value "Display", the configured and monitored limits are indicated by marking arrows. These limit markers are shown in the bar color of the corresponding limit and are displayed on the side of the bar opposite the scale.

Absolute	The value of limit TL is accepted as an absolute value in the representation of the bar.
%	The value of limit TL is displayed as a percentage value, starting from the zero point of the bar display.

The "Type TL" attribute can be made dynamic with the name "TypeToleranceLow".

Type WH (TypeWarningHigh)

Type WH (TypeWarningHigh)

The "Type WH" attribute specifies for the "Bar" object whether the value of the Limit WH is displayed as an absolute value or as a percentage value, starting from the zero point of the bar display.

For the "Bar" object, up to 5 limits can be defined, each of which has an upper (High) and a lower (Low) limit value. The limits are termed:

The "Upper Limit XH" and "Lower Limit XL" attributes specify the limit values for the corresponding Limit X. The "Type X" attributes specify whether the specified limit values are displayed as absolute values or as percentage values.

The "Bar Color XH" and "Bar Color XL" attributes can be used to assign a color to any Limit X. The display value is shown in the corresponding color, starting from the zero point of the bar display, as soon as it is higher than the corresponding Upper Limit XH or lower than the Lower Limit XL. The "Change Color" attribute in the "Miscellaneous" property group specifies whether this color change is to take place segment by segment or for the entire bar display.

The color change can only be displayed for a Limit X if the "Monitoring X" attribute has the value "Yes". If the "Limit Marker" attribute has the value "Display", the configured and monitored limits are indicated by marking arrows. These limit markers are shown in the bar color of the corresponding limit and are displayed on the side of the bar opposite the scale.

Absolute	The value of limit WH is accepted as an absolute value in the representation of the bar.
%	The value of limit WH is displayed as a percentage value, starting from the zero point of the bar display.

The "Type WH" attribute can be made dynamic with the name "TypeWarningHigh".

Type WL (TypeWarningLow)

Type WL (TypeWarningLow)

The "Type WL" attribute specifies for the "Bar" object whether the value of the Limit WL is displayed as an absolute value or as a percentage value, starting from the zero point of the bar display.

For the "Bar" object, up to 5 limits can be defined, each of which has an upper (High) and a lower (Low) limit value. The limits are termed:

The "Upper Limit XH" and "Lower Limit XL" attributes specify the limit values for the corresponding Limit X. The "Type X" attributes specify whether the specified limit values are displayed as absolute values or as percentage values.

The "Bar Color XH" and "Bar Color XL" attributes can be used to assign a color to any Limit X. The display value is shown in the corresponding color, starting from the zero point of the bar display, as soon as it is higher than the corresponding Upper Limit XH or lower than the Lower Limit XL. The "Change Color" attribute in the "Miscellaneous" property group specifies whether this color change is to take place segment by segment or for the entire bar display.

The color change can only be displayed for a Limit X if the "Monitoring X" attribute has the value "Yes". If the "Limit Marker" attribute has the value "Display", the configured and monitored

limits are indicated by marking arrows. These limit markers are shown in the bar color of the corresponding limit and are displayed on the side of the bar opposite the scale.

Absolute	The value of limit WL is accepted as an absolute value in the representation of the bar.
%	The value of limit WL is displayed as a percentage value, starting from the zero point of the bar display.

The "Type WL" attribute can be made dynamic with the name "TypeWarningLow".

3.11.11.2 Limits - Bar color

Bar Color 0 (Layer00Color)

Bar Color 0 (Layer00Color)

The "Bar Color 0" attribute defines for the "3D bar" object the color for the representation of a display value that is lower than the value of the "Limit 0" attribute.

You can define up to 11 limit values for the "3D bar" object by means of the "Limit N" (N = 0 to 10) attributes. For each limit value, the "Bar Color N" attributes can be used to specify a color change. This color setting is activated if the corresponding "Monitoring N" attribute has the value "Yes".

A display value is output in the Bar Color N as long as it is less than the value of Limit N. A black arrow at the ends of the bar display symbolizes display values that are less than Limit 0 or greater than Limit 10.

The "Bar Color 0" attribute can be made dynamic with the name "Layer00Color".

Bar Color 1 (Layer01Color)

Bar Color 1 (Layer01Color)

The "Bar Color 1" attribute defines for the "3D bar" object the color for the representation of a display value that is lower than the value of the "Limit 1" attribute.

You can define up to 11 limit values for the "3D bar" object by means of the "Limit N" (N = 0 to 10) attributes. For each limit value, the "Bar Color N" attributes can be used to specify a color change. This color setting is activated if the corresponding "Monitoring N" attribute has the value "Yes".

A display value is output in the Bar Color N as long as it is less than the value of Limit N. A black arrow at the ends of the bar display symbolizes display values that are less than Limit 0 or greater than Limit 10.

The "Bar Color 1" attribute can be made dynamic with the name "Layer01Color".

Bar Color 2 (Layer02Color)

Bar Color 2 (Layer02Color)

The "Bar Color 2" attribute defines for the "3D bar" object the color for the representation of a display value that is lower than the value of the "Limit 2" attribute.

You can define up to 11 limit values for the "3D bar" object by means of the "Limit N" (N = 0 to 10) attributes. For each limit value, the "Bar Color N" attributes can be used to specify a

3.11 Object properties

color change. This color setting is activated if the corresponding "Monitoring N" attribute has the value "Yes".

A display value is output in the Bar Color N as long as it is less than the value of Limit N. A black arrow at the ends of the bar display symbolizes display values that are less than Limit 0 or greater than Limit 10.

The "Bar Color 2" attribute can be made dynamic with the name "Layer02Color".

Bar Color 3 (Layer03Color)

Bar Color 3 (Layer03Color)

The "Bar Color 3" attribute defines for the "3D bar" object the color for the representation of a display value that is lower than the value of the "Limit 3" attribute.

You can define up to 11 limit values for the "3D bar" object by means of the "Limit N" (N = 0 to 10) attributes. For each limit value, the "Bar Color N" attributes can be used to specify a color change. This color setting is activated if the corresponding "Monitoring N" attribute has the value "Yes".

A display value is output in the Bar Color N as long as it is less than the value of Limit N. A black arrow at the ends of the bar display symbolizes display values that are less than Limit 0 or greater than Limit 10.

The "Bar Color 3" attribute can be made dynamic with the name "Layer03Color".

Bar Color 4 (Layer04Color)

Bar Color 4 (Layer04Color)

The "Bar Color 4" attribute defines for the "3D bar" object the color for the representation of a display value that is lower than the value of the "Limit 4" attribute.

You can define up to 11 limit values for the "3D bar" object by means of the "Limit N" (N = 0 to 10) attributes. For each limit value, the "Bar Color N" attributes can be used to specify a color change. This color setting is activated if the corresponding "Monitoring N" attribute has the value "Yes".

A display value is output in the Bar Color N as long as it is less than the value of Limit N. A black arrow at the ends of the bar display symbolizes display values that are less than Limit 0 or greater than Limit 10.

The "Bar Color 4" attribute can be made dynamic with the name "Layer04Color".

Bar Color 5 (Layer05Color)

Bar Color 5 (Layer05Color)

The "Bar Color 5" attribute defines for the "3D bar" object the color for the representation of a display value that is lower than the value of the "Limit 5" attribute.

You can define up to 11 limit values for the "3D bar" object by means of the "Limit N" (N = 0 to 10) attributes. For each limit value, the "Bar Color N" attributes can be used to specify a color change. This color setting is activated if the corresponding "Monitoring N" attribute has the value "Yes".

A display value is output in the Bar Color N as long as it is less than the value of Limit N. A black arrow at the ends of the bar display symbolizes display values that are less than Limit 0 or greater than Limit 10.

The "Bar Color 5" attribute can be made dynamic with the name "Layer05Color".

Bar Color 6 (Layer06Color)

Bar Color 6 (Layer06Color)

The "Bar Color 6" attribute defines for the "3D bar" object the color for the representation of a display value that is lower than the value of the "Limit 6" attribute.

You can define up to 11 limit values for the "3D bar" object by means of the "Limit N" (N = 0 to 10) attributes. For each limit value, the "Bar Color N" attributes can be used to specify a color change. This color setting is activated if the corresponding "Monitoring N" attribute has the value "Yes".

A display value is output in the Bar Color N as long as it is less than the value of Limit N. A black arrow at the ends of the bar display symbolizes display values that are less than Limit 0 or greater than Limit 10.

The "Bar Color 6" attribute can be made dynamic with the name "Layer06Color".

Bar Color 7 (Layer07Color)

Bar Color 7 (Layer07Color)

The "Bar Color 7" attribute defines for the "3D bar" object the color for the representation of a display value that is lower than the value of the "Limit 7" attribute.

You can define up to 11 limit values for the "3D bar" object by means of the "Limit N" (N = 0 to 10) attributes. For each limit value, the "Bar Color N" attributes can be used to specify a color change. This color setting is activated if the corresponding "Monitoring N" attribute has the value "Yes".

A display value is output in the Bar Color N as long as it is less than the value of Limit N. A black arrow at the ends of the bar display symbolizes display values that are less than Limit 0 or greater than Limit 10.

The "Bar Color 7" attribute can be made dynamic with the name "Layer07Color".

Bar Color 8 (Layer08Color)

Bar Color 8 (Layer08Color)

The "Bar Color 8" attribute defines for the "3D bar" object the color for the representation of a display value that is lower than the value of the "Limit 8" attribute.

You can define up to 11 limit values for the "3D bar" object by means of the "Limit N" (N = 0 to 10) attributes. For each limit value, the "Bar Color N" attributes can be used to specify a color change. This color setting is activated if the corresponding "Monitoring N" attribute has the value "Yes".

A display value is output in the Bar Color N as long as it is less than the value of Limit N. A black arrow at the ends of the bar display symbolizes display values that are less than Limit 0 or greater than Limit 10.

The "Bar Color 8" attribute can be made dynamic with the name "Layer08Color".

Bar Color 9 (Layer09Color)

Bar Color 9 (Layer09Color)

The "Bar Color 9" attribute defines for the "3D bar" object the color for the representation of a display value that is lower than the value of the "Limit 9" attribute.

You can define up to 11 limit values for the "3D bar" object by means of the "Limit N" (N = 0 to 10) attributes. For each limit value, the "Bar Color N" attributes can be used to specify a color change. This color setting is activated if the corresponding "Monitoring N" attribute has the value "Yes".

A display value is output in the Bar Color N as long as it is less than the value of Limit N. A black arrow at the ends of the bar display symbolizes display values that are less than Limit 0 or greater than Limit 10.

The "Bar Color 9" attribute can be made dynamic with the name "Layer09Color".

Bar Color 10 (Layer10Color)

Bar Color 10 (Layer10Color)

The "Bar Color 10" attribute defines for the "3D bar" object the color for the representation of a display value that is lower than the value of the "Limit 10" attribute.

You can define up to 11 limit values for the "3D bar" object by means of the "Limit N" (N = 0 to 10) attributes. For each limit value, the "Bar Color N" attributes can be used to specify a color change. This color setting is activated if the corresponding "Monitoring N" attribute has the value "Yes".

A display value is output in the Bar Color N as long as it is less than the value of Limit N. A black arrow at the ends of the bar display symbolizes display values that are less than Limit 0 or greater than Limit 10.

The "Bar Color 10" attribute can be made dynamic with the name "Layer10Color".

Bar Color AH (ColorAlarmHigh)

Bar Color AH (ColorAlarmHigh)

The "Bar Color AH" attribute defines for the "Bar" object the color for the representation of a display value that is higher than the value of the upper limit "Alarm High".

For the "Bar" object, up to 5 limits can be defined, each of which has an upper (High) and a lower (Low) limit value. The limits are termed:

The "Upper Limit XH" and "Lower Limit XL" attributes specify the limit values for the corresponding Limit X. The "Type X" attributes specify whether the specified limit values are displayed as absolute values or as percentage values.

The "Bar Color XH" and "Bar Color XL" attributes can be used to assign a color to any Limit X. The display value is shown in the corresponding color as soon as, starting from the zero point of the bar display, it is higher than the corresponding Upper Limit XH or lower than the Lower Limit XL. The "Change Color" attribute in the "Miscellaneous" property group specifies whether this color change is to take place segment-wise or for the entire display.

The color change can only be displayed for a limit X if the "Monitoring X" attribute has the value "Yes". If the "Limit Marker" attribute has the value "Display", the configured and monitored limits are indicated by marking arrows. These limit markers receive the bar color of the corresponding limit and are displayed on the side of the bar opposite the scale.

The "Bar Color AH" attribute can assigned dynamic properties by means of the name "ColorAlarmHigh".

Bar Color AL (ColorAlarmLow)

Bar Color AL (ColorAlarmLow)

The "Bar Color AL" attribute defines for the "Bar" object the color for the representation of a display value that is lower than the value of the lower limit Alarm Low".

For the "Bar" object, up to 5 limits can be defined, each of which has an upper (High) and a lower (Low) limit value. The limits are termed:

The "Upper Limit XH" and "Lower Limit XL" attributes specify the limit values for the corresponding Limit X. The "Type X" attributes specify whether the specified limit values are displayed as absolute values or as percentage values.

The "Bar Color XH" and "Bar Color XL" attributes can be used to assign a color to any Limit X. The display value is shown in the corresponding color as soon as, starting from the zero point of the bar display, it is higher than the corresponding Upper Limit XH or lower than the Lower Limit XL. The "Change Color" attribute in the "Miscellaneous" property group specifies whether this color change is to take place segment-wise or for the entire display.

The color change can only be displayed for a limit X if the "Monitoring X" attribute has the value "Yes". If the "Limit Marker" attribute has the value "Display", the configured and monitored limits are indicated by marking arrows. These limit markers receive the bar color of the corresponding limit and are displayed on the side of the bar opposite the scale.

The "Bar Color AL" attribute can assigned dynamic properties by means of the name "ColorAlarmLow".

Bar Color RH4 (ColorLimitHigh4)

Bar Color RH4 (ColorLimitHigh4)

The "Bar Color RH4" attribute defines for the "Bar" object the color for the representation of a display value that is higher than the value of the upper limit "Reserve High 4".

For the "Bar" object, up to 5 limits can be defined, each of which has an upper (High) and a lower (Low) limit value. The limits are termed:

The "Upper Limit XH" and "Lower Limit XL" attributes specify the limit values for the corresponding Limit X. The "Type X" attributes specify whether the specified limit values are displayed as absolute values or as percentage values.

The "Bar Color XH" and "Bar Color XL" attributes can be used to assign a color to any Limit X. The display value is shown in the corresponding color as soon as, starting from the zero point of the bar display, it is higher than the corresponding Upper Limit XH or lower than the Lower Limit XL. The "Change Color" attribute in the "Miscellaneous" property group specifies whether this color change is to take place segment-wise or for the entire display.

3.11 Object properties

The color change can only be displayed for a limit X if the "Monitoring X" attribute has the value "Yes". If the "Limit Marker" attribute has the value "Display", the configured and monitored limits are indicated by marking arrows. These limit markers receive the bar color of the corresponding limit and are displayed on the side of the bar opposite the scale.

The "Bar Color RH4" attribute can assigned dynamic properties by means of the name "ColorAlarmHigh4".

Bar Color RH5 (ColorLimitHigh5)

Bar Color RH5 (ColorLimitHigh5)

The "Bar Color RH5" attribute defines for the "Bar" object the color for the representation of a display value that is higher than the value of the upper limit "Reserve High 5".

For the "Bar" object, up to 5 limits can be defined, each of which has an upper (High) and a lower (Low) limit value. The limits are termed:

The "Upper Limit XH" and "Lower Limit XL" attributes specify the limit values for the corresponding Limit X. The "Type X" attributes specify whether the specified limit values are displayed as absolute values or as percentage values.

The "Bar Color XH" and "Bar Color XL" attributes can be used to assign a color to any Limit X. The display value is shown in the corresponding color as soon as, starting from the zero point of the bar display, it is higher than the corresponding Upper Limit XH or lower than the Lower Limit XL. The "Change Color" attribute in the "Miscellaneous" property group specifies whether this color change is to take place segment-wise or for the entire display.

The color change can only be displayed for a limit X if the "Monitoring X" attribute has the value "Yes". If the "Limit Marker" attribute has the value "Display", the configured and monitored limits are indicated by marking arrows. These limit markers receive the bar color of the corresponding limit and are displayed on the side of the bar opposite the scale.

The "Bar Color RH5" attribute can assigned dynamic properties by means of the name "ColorAlarmHigh5".

Bar Color RL4 (ColorLimitLow4)

Bar Color RL4 (ColorLimitLow4)

The "Bar Color RL4" attribute defines for the "Bar" object the color for the representation of a display value that is lower than the value of the lower limit "Reserve Low 4".

For the "Bar" object, up to 5 limits can be defined, each of which has an upper (High) and a lower (Low) limit value. The limits are termed:

The "Upper Limit XH" and "Lower Limit XL" attributes specify the limit values for the corresponding Limit X. The "Type X" attributes specify whether the specified limit values are displayed as absolute values or as percentage values.

The "Bar Color XH" and "Bar Color XL" attributes can be used to assign a color to any Limit X. The display value is shown in the corresponding color as soon as, starting from the zero point of the bar display, it is higher than the corresponding Upper Limit XH or lower than the Lower Limit XL. The "Change Color" attribute in the "Miscellaneous" property group specifies whether this color change is to take place segment-wise or for the entire display.

The color change can only be displayed for a limit X if the "Monitoring X" attribute has the value "Yes". If the "Limit Marker" attribute has the value "Display", the configured and monitored limits are indicated by marking arrows. These limit markers receive the bar color of the corresponding limit and are displayed on the side of the bar opposite the scale.

The "Bar Color RL4" attribute can assigned dynamic properties by means of the name "ColorAlarmLow4".

Bar Color RL5 (ColorLimitLow5)

Bar Color RL5 (ColorLimitLow5)

The "Bar Color RL5" attribute defines for the "Bar" object the color for the representation of a display value that is lower than the value of the lower limit "Reserve Low 5".

For the "Bar" object, up to 5 limits can be defined, each of which has an upper (High) and a lower (Low) limit value. The limits are termed:

The "Upper Limit XH" and "Lower Limit XL" attributes specify the limit values for the corresponding Limit X. The "Type X" attributes specify whether the specified limit values are displayed as absolute values or as percentage values.

The "Bar Color XH" and "Bar Color XL" attributes can be used to assign a color to any Limit X. The display value is shown in the corresponding color as soon as, starting from the zero point of the bar display, it is higher than the corresponding Upper Limit XH or lower than the Lower Limit XL. The "Change Color" attribute in the "Miscellaneous" property group specifies whether this color change is to take place segment-wise or for the entire display.

The color change can only be displayed for a limit X if the "Monitoring X" attribute has the value "Yes". If the "Limit Marker" attribute has the value "Display", the configured and monitored limits are indicated by marking arrows. These limit markers receive the bar color of the corresponding limit and are displayed on the side of the bar opposite the scale.

The "Bar Color RL5" attribute can assigned dynamic properties by means of the name "ColorLimitLow5".

Bar Color TH (ColorToleranceHigh)

Bar Color TH (ColorToleranceHigh)

The "Bar Color TH" attribute defines for the "Bar" object the color for the representation of a display value that is higher than the value of the upper limit "Tolerance High".

For the "Bar" object, up to 5 limits can be defined, each of which has an upper (High) and a lower (Low) limit value. The limits are termed:

The "Upper Limit XH" and "Lower Limit XL" attributes specify the limit values for the corresponding Limit X. The "Type X" attributes specify whether the specified limit values are displayed as absolute values or as percentage values.

The "Bar Color XH" and "Bar Color XL" attributes can be used to assign a color to any Limit X. The display value is shown in the corresponding color as soon as, starting from the zero point of the bar display, it is higher than the corresponding Upper Limit XH or lower than the Lower Limit XL. The "Change Color" attribute in the "Miscellaneous" property group specifies whether this color change is to take place segment-wise or for the entire display.

The color change can only be displayed for a limit X if the "Monitoring X" attribute has the value "Yes". If the "Limit Marker" attribute has the value "Display", the configured and monitored limits are indicated by marking arrows. These limit markers receive the bar color of the corresponding limit and are displayed on the side of the bar opposite the scale.

The "Bar Color TH" attribute can assigned dynamic properties by means of the name "ColorToleranceHigh".

Bar Color TL (ColorToleranceLow)

Bar Color TL (ColorToleranceLow)

The "Bar Color TL" attribute defines for the "Bar" object the color for the representation of a display value that is lower than the value of the lower limit "Tolerance Low".

For the "Bar" object, up to 5 limits can be defined, each of which has an upper (High) and a lower (Low) limit value. The limits are termed:

The "Upper Limit XH" and "Lower Limit XL" attributes specify the limit values for the corresponding Limit X. The "Type X" attributes specify whether the specified limit values are displayed as absolute values or as percentage values.

The "Bar Color XH" and "Bar Color XL" attributes can be used to assign a color to any Limit X. The display value is shown in the corresponding color as soon as, starting from the zero point of the bar display, it is higher than the corresponding Upper Limit XH or lower than the Lower Limit XL. The "Change Color" attribute in the "Miscellaneous" property group specifies whether this color change is to take place segment-wise or for the entire display.

The color change can only be displayed for a limit X if the "Monitoring X" attribute has the value "Yes". If the "Limit Marker" attribute has the value "Display", the configured and monitored limits are indicated by marking arrows. These limit markers receive the bar color of the corresponding limit and are displayed on the side of the bar opposite the scale.

The "Bar Color TL" attribute can be assigned dynamic properties by means of the name "ColorToleranceLow".

Bar Color WH (ColorWarningHigh)

Bar Color WH (ColorWarningHigh)

The "Bar Color WH" attribute defines for the "Bar" object the color for the representation of a display value that is higher than the value of the upper limit "Warning High".

For the "Bar" object, up to 5 limits can be defined, each of which has an upper (High) and a lower (Low) limit value. The limits are termed:

The "Upper Limit XH" and "Lower Limit XL" attributes specify the limit values for the corresponding Limit X. The "Type X" attributes specify whether the specified limit values are displayed as absolute values or as percentage values.

The "Bar Color XH" and "Bar Color XL" attributes can be used to assign a color to any Limit X. The display value is shown in the corresponding color as soon as, starting from the zero point of the bar display, it is higher than the corresponding Upper Limit XH or lower than the Lower Limit XL. The "Change Color" attribute in the "Miscellaneous" property group specifies whether this color change is to take place segment-wise or for the entire display.

The color change can only be displayed for a limit X if the "Monitoring X" attribute has the value "Yes". If the "Limit Marker" attribute has the value "Display", the configured and monitored limits are indicated by marking arrows. These limit markers receive the bar color of the corresponding limit and are displayed on the side of the bar opposite the scale.

The "Bar Color WH" attribute can be assigned dynamic properties by means of the name "ColorWarningHigh".

Bar Color WL (ColorWarningLow)

Bar Color WL (ColorWarningLow)

The "Bar Color WL" attribute defines for the "Bar" object the color for the representation of a display value that is lower than the value of the lower limit "Warning Low".

For the "Bar" object, up to 5 limits can be defined, each of which has an upper (High) and a lower (Low) limit value. The limits are termed:

The "Upper Limit XH" and "Lower Limit XL" attributes specify the limit values for the corresponding Limit X. The "Type X" attributes specify whether the specified limit values are displayed as absolute values or as percentage values.

The "Bar Color XH" and "Bar Color XL" attributes can be used to assign a color to any Limit X. The display value is shown in the corresponding color as soon as, starting from the zero point of the bar display, it is higher than the corresponding Upper Limit XH or lower than the Lower Limit XL. The "Change Color" attribute in the "Miscellaneous" property group specifies whether this color change is to take place segment-wise or for the entire display.

The color change can only be displayed for a limit X if the "Monitoring X" attribute has the value "Yes". If the "Limit Marker" attribute has the value "Display", the configured and monitored limits are indicated by marking arrows. These limit markers receive the bar color of the corresponding limit and are displayed on the side of the bar opposite the scale.

The "Bar Color WL" attribute be assigned dynamic properties by means of the name "ColorWarningLow".

3.11.11.3 Limits - Bar fill color

Bar fill color 0 (Layer00FillColor)

Bar fill color 0 (Layer00FillColor)

The "Layer00FillColor" attribute defines the color with which the bar is filled in relation to "Limit 0".

The "Layer00FillColor" attribute can be made dynamic with the name "Layer00FillColor".

Layer01FillColor

Layer01FillColor

The "Layer01FillColor" attribute defines the color with which the bar is filled in relation to "Limit 1".

The "Layer01FillColor" attribute can be made dynamic with the name "Layer01FillColor".

Layer02FillColor

Layer02FillColor

The "Layer02FillColor" attribute defines the color with which the bar is filled in relation to "Limit 2".

The "Layer02FillColor" attribute can be made dynamic with the name "Layer02FillColor".

Layer03FillColor

Layer03FillColor

The "Layer03FillColor" attribute defines the color with which the bar is filled in relation to "Limit 3".

The "Layer03FillColor" attribute can be made dynamic with the name "Layer03FillColor".

Layer04FillColor

Layer04FillColor

The "Layer04FillColor" attribute defines the color with which the bar is filled in relation to "Limit 4".

The "Layer04FillColor" attribute can be made dynamic with the name "Layer04FillColor".

Layer05FillColor

Layer05FillColor

The "Layer05FillColor" attribute defines the color with which the bar is filled in relation to "Limit 5".

The "Layer05FillColor" attribute can be made dynamic with the name "Layer05FillColor".

Layer06FillColor

Layer06FillColor

The "Layer06FillColor" attribute defines the color with which the bar is filled in relation to "Limit 6".

The "Layer06FillColor" attribute can be made dynamic with the name "Layer06FillColor".

Layer07FillColor

Layer07FillColor

The "Layer07FillColor" attribute defines the color with which the bar is filled in relation to "Limit 7".

The "Layer07FillColor" attribute can be made dynamic with the name "Layer07FillColor".

Layer08FillColor

Layer08FillColor

The "Layer08FillColor" attribute defines the color with which the bar is filled in relation to "Limit 8".

The "Layer08FillColor" attribute can be made dynamic with the name "Layer08FillColor".

Layer09FillColor

Layer09FillColor

The "Layer09FillColor" attribute defines the color with which the bar is filled in relation to "Limit 9".

The "Layer09FillColor" attribute can be made dynamic with the name "Layer09FillColor".

Layer10FillColor

Layer10FillColor

The "Layer10FillColor" attribute defines the color with which the bar is filled in relation to "Limit 10".

The "Layer10FillColor" attribute can be made dynamic with the name "Layer10FillColor".

3.11.11.4 Limits - Bar fill style

Layer00FillStyle

Layer00FillStyle

The "Layer00FillStyle" attribute defines the style of the bar in relation to "Limit 0". For the fill pattern to become visible, "bar fill color 0" must differ from "bar color 0".

There is a choice of 50 fill styles. The 0 "Solid" fill style fills the object with the set background color. The 1 "Transparent" fill style means neither a background nor a fill pattern is displayed.

The "Layer00FillStyle" attribute can be made dynamic with the name "Layer00FillStyle".

Layer01FillStyle

Layer01FillStyle

The "Layer01FillStyle" attribute defines the style of the bar in relation to "Limit 1". For the fill pattern to become visible, "bar fill color 1" must differ from "bar color 1".

There is a choice of 50 fill styles. The 0 "Solid" fill style fills the object with the set background color. The 1 "Transparent" fill style means neither a background nor a fill pattern is displayed.

The "Layer01FillStyle" attribute can be made dynamic with the name "Layer01FillStyle".

Layer02FillStyle

Layer02FillStyle

The "Layer02FillStyle" attribute defines the style of the bar in relation to "Limit 2". For the fill pattern to become visible, "bar fill color 2" must differ from "bar color 2".

There is a choice of 50 fill styles. The 0 "Solid" fill style fills the object with the set background color. The 1 "Transparent" fill style means neither a background nor a fill pattern is displayed.

The "Layer02FillStyle" attribute can be made dynamic with the name "Layer02FillStyle".

Layer03FillStyle

Layer03FillStyle

The "Layer03FillStyle" attribute defines the style of the bar in relation to "Limit 3". For the fill pattern to become visible, "bar fill color 3" must differ from "bar color 3".

There is a choice of 50 fill styles. The 0 "Solid" fill style fills the object with the set background color. The 1 "Transparent" fill style means neither a background nor a fill pattern is displayed.

The "Layer03FillStyle" attribute can be made dynamic with the name "Layer03FillStyle".

Layer04FillStyle

Layer04FillStyle

The "Layer04FillStyle" attribute defines the style of the bar in relation to "Limit 4". For the fill pattern to become visible, "bar fill color 4" must differ from "bar color 4".

There is a choice of 50 fill styles. The 0 "Solid" fill style fills the object with the set background color. The 1 "Transparent" fill style means neither a background nor a fill pattern is displayed.

The "Layer04FillStyle" attribute can be made dynamic with the name "Layer04FillStyle".

Layer05FillStyle

Layer05FillStyle

The "Layer05FillStyle" attribute defines the style of the bar in relation to "Limit 5". For the fill pattern to become visible, "bar fill color 5" must differ from "bar color 5".

There is a choice of 50 fill styles. The 0 "Solid" fill style fills the object with the set background color. The 1 "Transparent" fill style means neither a background nor a fill pattern is displayed.

The "Layer05FillStyle" attribute can be made dynamic with the name "Layer05FillStyle".

Layer06FillStyle

Layer06FillStyle

The "Layer06FillStyle" attribute defines the style of the bar in relation to "Limit 6". For the fill pattern to become visible, "bar fill color 6" must differ from "bar color 6".

There is a choice of 50 fill styles. The 0 "Solid" fill style fills the object with the set background color. The 1 "Transparent" fill style means neither a background nor a fill pattern is displayed.

The "Layer06FillStyle" attribute can be made dynamic with the name "Layer06FillStyle".

Layer07FillStyle

Layer07FillStyle

The "Layer07FillStyle" attribute defines the style of the bar in relation to "Limit 7". For the fill pattern to become visible, "bar fill color 7" must differ from "bar color 7".

There is a choice of 50 fill styles. The 0 "Solid" fill style fills the object with the set background color. The 1 "Transparent" fill style means neither a background nor a fill pattern is displayed.

The "Layer07FillStyle" attribute can be made dynamic with the name "Layer07FillStyle".

Layer08FillStyle

Layer08FillStyle

The "Layer08FillStyle" attribute defines the style of the bar in relation to "Limit 8". For the fill pattern to become visible, "bar fill color 8" must differ from "bar color 8".

There is a choice of 50 fill styles. The 0 "Solid" fill style fills the object with the set background color. The 1 "Transparent" fill style means neither a background nor a fill pattern is displayed.

The "Layer08FillStyle" attribute can be made dynamic with the name "Layer08FillStyle".

Layer09FillStyle

Layer09FillStyle

The "Layer09FillStyle" attribute defines the style of the bar in relation to "Limit 9". For the fill pattern to become visible, "bar fill color 9" must differ from "bar color 9".

There is a choice of 50 fill styles. The 0 "Solid" fill style fills the object with the set background color. The 1 "Transparent" fill style means neither a background nor a fill pattern is displayed.

The "Layer09FillStyle" attribute can be made dynamic with the name "Layer09FillStyle".

Layer10FillStyle

Layer10FillStyle

The "Layer10FillStyle" attribute defines the style of the bar in relation to "Limit 10". For the fill pattern to become visible, "bar fill color 10" must differ from "bar color 10".

There is a choice of 50 fill styles. The 0 "Solid" fill style fills the object with the set background color. The 1 "Transparent" fill style means neither a background nor a fill pattern is displayed.

The "Layer10FillStyle" attribute can be made dynamic with the name "Layer10FillStyle".

3.11.11.5 Limits - C to T

Limit 0 (Layer00Value)

Limit 0 (Layer00Value)

The "Limit 0" attribute defines for the "3D bar" object the limit value up to which a display value is displayed with Bar Color 0.

For the "3D bar" object, up to 11 limit values can be defined using the attributes "Limit N" (N = 0 to 10). For each limit value, the "Bar Color N" attributes can be used to specify a color change. If the corresponding attribute "Monitoring N" has the value "Yes", the color setting is activated.

A display value is displayed in the bar color N as long as it is lower than the value of the Limit N. A black arrow at the ends of the bar display symbolizes display values that are lower than Limit 0 or higher than Limit 10.

There is a free choice of value. A meaningful limit results from the value range that is to be displayed with the object "3D bar".

The "Limit 0" attribute can be made dynamic with the name "Layer00Value".

Limit 1 (Layer01Value)

Limit 1 (Layer01Value)

The "Limit 1" attribute defines for the "3D bar" object the limit value up to which a display value is displayed with Bar Color 1.

For the "3D bar" object, up to 11 limit values can be defined using the attributes "Limit N" (N = 0 to 10). For each limit value, the "Bar Color N" attributes can be used to specify a color change. If the corresponding attribute "Monitoring N" has the value "Yes", the color setting is activated.

A display value is displayed in Bar Color N as long as it is lower than the value of Limit N. A black arrow at the ends of the bar display symbolizes display values that are lower than Limit 0 or higher than Limit 10.

There is a free choice of value. A meaningful limit results from the value range that is to be displayed with the object "3D bar".

The "Limit 1" attribute can be made dynamic with the name "Layer01Value".

Limit 2 (Layer02Value)

Limit 2 (Layer02Value)

The "Limit 2" attribute defines for the "3D bar" object the limit value up to which a display value is displayed with Bar Color 2.

For the "3D bar" object, up to 11 limit values can be defined using the attributes "Limit N" (N = 0 to 10). For each limit value, the "Bar Color N" attributes can be used to specify a color change. If the corresponding attribute "Monitoring N" has the value "Yes", the color setting is activated.

A display value is displayed in Bar Color N as long as it is lower than the value of Limit N. A black arrow at the ends of the bar display symbolizes display values that are lower than Limit 0 or higher than Limit 10.

There is a free choice of value. A meaningful limit results from the value range that is to be displayed with the object "3D bar".

The "Limit 2" attribute can be made dynamic with the name "Layer02Value".

Limit 3 (Layer03Value)

Limit 3 (Layer03Value)

The "Limit 3" attribute defines for the "3D bar" object the limit value up to which a display value is displayed with Bar Color 3.

For the "3D bar" object, up to 11 limit values can be defined using the attributes "Limit N" (N = 0 to 10). For each limit value, the "Bar Color N" attributes can be used to specify a color change. If the corresponding attribute "Monitoring N" has the value "Yes", the color setting is activated.

A display value is displayed in Bar Color N as long as it is lower than the value of Limit N. A black arrow at the ends of the bar display symbolizes display values that are lower than Limit 0 or higher than Limit 10.

There is a free choice of value. A meaningful limit results from the value range that is to be displayed with the object "3D bar".

The "Limit 3" attribute can be made dynamic with the name "Layer03Value".

Limit 4 (Layer04Value)

Limit 4 (Layer04Value)

The "Limit 4" attribute defines for the "3D bar" object the limit value up to which a display value is displayed with Bar Color 4.

For the "3D bar" object, up to 11 limit values can be defined using the attributes "Limit N" (N = 0 to 10). For each limit value, the "Bar Color N" attributes can be used to specify a color change. If the corresponding attribute "Monitoring N" has the value "Yes", the color setting is activated.

A display value is displayed in Bar Color N as long as it is lower than the value of Limit N. A black arrow at the ends of the bar display symbolizes display values that are lower than Limit 0 or higher than Limit 10.

There is a free choice of value. A meaningful limit results from the value range that is to be displayed with the object "3D bar".

The "Limit 4" attribute can be made dynamic with the name "Layer04Value".

Limit 5 (Layer05Value)

Limit 5 (Layer05Value)

The "Limit 5" attribute defines for the "3D bar" object the limit value up to which a display value is displayed with Bar Color 5.

For the "3D bar" object, up to 11 limit values can be defined using the attributes "Limit N" (N = 0 to 10). For each limit value, the "Bar Color N" attributes can be used to specify a color change. If the corresponding attribute "Monitoring N" has the value "Yes", the color setting is activated.

A display value is displayed in Bar Color N as long as it is lower than the value of Limit N. A black arrow at the ends of the bar display symbolizes display values that are lower than Limit 0 or higher than Limit 10.

There is a free choice of value. A meaningful limit results from the value range that is to be displayed with the object "3D bar".

The "Limit 5" attribute can be made dynamic with the name "Layer05Value".

Limit 6 (Layer06Value)

Limit 6 (Layer06Value)

The "Limit 6" attribute defines for the "3D bar" object the limit value up to which a display value is displayed with Bar Color 6.

For the "3D bar" object, up to 11 limit values can be defined using the attributes "Limit N" (N = 0 to 10). For each limit value, the "Bar Color N" attributes can be used to specify a color change. If the corresponding attribute "Monitoring N" has the value "Yes", the color setting is activated.

A display value is displayed in Bar Color N as long as it is lower than the value of Limit N. A black arrow at the ends of the bar display symbolizes display values that are lower than Limit 0 or higher than Limit 10.

There is a free choice of value. A meaningful limit results from the value range that is to be displayed with the object "3D bar".

The "Limit 6" attribute can be made dynamic with the name "Layer06Value".

Limit 7 (Layer07Value)

Limit 7 (Layer07Value)

The "Limit 7" attribute defines for the "3D bar" object the limit value up to which a display value is displayed with Bar Color 7.

For the "3D bar" object, up to 11 limit values can be defined using the attributes "Limit N" (N = 0 to 10). For each limit value, the "Bar Color N" attributes can be used to specify a color change. If the corresponding attribute "Monitoring N" has the value "Yes", the color setting is activated.

A display value is displayed in Bar Color N as long as it is lower than the value of Limit N. A black arrow at the ends of the bar display symbolizes display values that are lower than Limit 0 or higher than Limit 10.

There is a free choice of value. A meaningful limit results from the value range that is to be displayed with the object "3D bar".

The "Limit 7" attribute can be made dynamic with the name "Layer07Value".

Limit 8 (Layer08Value)

Limit 8 (Layer08Value)

The "Limit 8" attribute defines for the "3D bar" object the limit value up to which a display value is displayed with Bar Color 8.

For the "3D bar" object, up to 11 limit values can be defined using the attributes "Limit N" (N = 0 to 10). For each limit value, the "Bar Color N" attributes can be used to specify a color

change. If the corresponding attribute "Monitoring N" has the value "Yes", the color setting is activated.

A display value is displayed in Bar Color N as long as it is lower than the value of Limit N. A black arrow at the ends of the bar display symbolizes display values that are lower than Limit 0 or higher than Limit 10.

There is a free choice of value. A meaningful limit results from the value range that is to be displayed with the object "3D bar".

The "Limit 8" attribute can be made dynamic with the name "Layer08Value".

Limit 9 (Layer09Value)

Limit 9 (Layer09Value)

The "Limit 9" attribute defines for the "3D bar" object the limit value up to which a display value is displayed with Bar Color 9.

For the "3D bar" object, up to 11 limit values can be defined using the attributes "Limit N" (N = 0 to 10). For each limit value, the "Bar Color N" attributes can be used to specify a color change. If the corresponding attribute "Monitoring N" has the value "Yes", the color setting is activated.

A display value is displayed in Bar Color N as long as it is lower than the value of Limit N. A black arrow at the ends of the bar display symbolizes display values that are lower than Limit 0 or higher than Limit 10.

There is a free choice of value. A meaningful limit results from the value range that is to be displayed with the object "3D bar".

The "Limit 9" attribute can be made dynamic with the name "Layer09Value".

Limit 10 (Layer10Value)

Limit 10 (Layer10Value)

The "Limit 10" attribute defines for the "3D bar" object the limit value up to which a display value is displayed with Bar Color 10.

For the "3D bar" object, up to 11 limit values can be defined using the attributes "Limit N" (N = 0 to 10). For each limit value, the "Bar Color N" attributes can be used to specify a color change. If the corresponding attribute "Monitoring N" has the value "Yes", the color setting is activated.

A display value is displayed in Bar Color N as long as it is lower than the value of Limit N. A black arrow at the ends of the bar display symbolizes display values that are lower than Limit 0 or higher than Limit 10.

There is a free choice of value. A meaningful limit results from the value range that is to be displayed with the object "3D bar".

The "Limit 10" attribute can be made dynamic with the name "Layer10Value".

Limit Marker (Marker)

Limit Marker (Marker)

3.11 Object properties

The "Limit Marker" attribute specifies for the "Bar" object whether the configured and monitored limits are indicated by marking arrows. These limit markers are shown in the bar color of the corresponding limit and are displayed on the side of the bar opposite the scale.

Display elements	The configured and monitored limits are marked by marking arrows.
Do Not Display	The configured and monitored limits are not marked by marking arrows.

The "Limit Marker" attribute can be made dynamic with the name "Marker".

High Limit Value (LimitMax)

High Limit Value (LimitMax)

The "High Limit Value" attribute defines for the "I/O field" object the maximum limit value for input and output. The specified value depends on the "data format" of the I/O field.

If a value is higher than the upper limit value, the following effects are possible in Runtime:

Field type = "Input": The "WinCC Runtime" dialog is opened and displayed the error message "The entered value is outside the configured limits".

Confirm the error message with "OK" and enter another value.

Field type = "Output": The display of the value is substituted by the character string "****".

The "Data Format" and "Field Type" attributes can be changed in the "Output / Input" property group.

There is a free choice of value depending on the "data format" of the I/O field.

The "High Limit Value" attribute can be made dynamic with the name "LimitMax".

Limit AH (AlarmHigh)

Limit AH (AlarmHigh)

The "Limit AH" attribute defines for the "Bar" object the upper limit value for the alarm limit "Alarm High". If the display value exceeds the value specified here, it is displayed in the Bar Color AH.

For the "Bar" object, up to 5 limits can be defined, each of which has an upper (High) and a lower (Low) limit value. The limits are termed:

The "Upper Limit XH" and "Lower Limit XL" attributes specify the limit values for the corresponding Limit X. The "Type X" attributes specify whether the specified limit values are displayed as absolute values or as percentage values.

The "Bar Color XH" and "Bar Color XL" attributes can be used to assign a color to any Limit X. The display value is shown in the corresponding color as soon as, starting from the zero point of the bar display, it is higher than the corresponding Upper Limit XH or lower than the Lower Limit XL. The "Change Color" attribute in the "Miscellaneous" property group specifies whether this color change is to take place segment-wise or for the entire display.

The color change can only be displayed for a limit X if the "Monitoring X" attribute has the value "Yes". If the "Limit Marker" attribute has the value "Display", the configured and monitored limits are indicated by marking arrows. These limit markers receive the bar color of the corresponding limit and are displayed on the side of the bar opposite the scale.

There is a free choice of value. A meaningful limit results from the value range that is to be displayed with the object "Bar".

The "Limit AH" attribute can be made dynamic with the name "AlarmHigh".

High Limit RH4 (LimitHigh4)

High Limit RH4 (LimitHigh4)

The "High Limit RH4" attribute defines for the "Bar" object the upper limit value for the limit "Reserve High 4". If the display value exceeds the value specified here, it is displayed in the Bar Color RH4.

For the "Bar" object, up to 5 limits can be defined, each of which has an upper (High) and a lower (Low) limit value. The limits are termed:

The "Upper Limit XH" and "Lower Limit XL" attributes specify the limit values for the corresponding Limit X. The "Type X" attributes specify whether the specified limit values are displayed as absolute values or as percentage values.

The "Bar Color XH" and "Bar Color XL" attributes can be used to assign a color to any Limit X. The display value is shown in the corresponding color, starting from the zero point of the bar display, as soon as it is higher than the corresponding Upper Limit XH or lower than the Lower Limit XL. The "Change Color" attribute in the "Miscellaneous" property group specifies whether this color change is to take place segment by segment or for the entire bar display.

The color change can only be displayed for a Limit X if the "Monitoring X" attribute has the value "Yes". If the "Limit Marker" attribute has the value "Display", the configured and monitored limits are indicated by marking arrows. These limit markers are shown in the bar color of the corresponding limit and are displayed on the side of the bar opposite the scale.

There is a free choice of value. A meaningful limit results from the value range that is to be displayed with the object "Bar".

The "High Limit RH4" attribute can be made dynamic with the name "LimitHigh4".

High Limit RH5 (LimitHigh5)

High Limit RH5 (LimitHigh5)

The "High Limit RH5" attribute defines for the "Bar" object the upper limit value for the limit "Reserve High 5". If the display value exceeds the value specified here, it is displayed in the Bar Color RH5.

For the "Bar" object, up to 5 limits can be defined, each of which has an upper (High) and a lower (Low) limit value. The limits are termed:

The "Upper Limit XH" and "Lower Limit XL" attributes specify the limit values for the corresponding Limit X. The "Type X" attributes specify whether the specified limit values are displayed as absolute values or as percentage values.

The "Bar Color XH" and "Bar Color XL" attributes can be used to assign a color to any Limit X. The display value is shown in the corresponding color, starting from the zero point of the bar display, as soon as it is higher than the corresponding Upper Limit XH or lower than the Lower Limit XL. The "Change Color" attribute in the "Miscellaneous" property group specifies whether this color change is to take place segment by segment or for the entire bar display.

The color change can only be displayed for a Limit X if the "Monitoring X" attribute has the value "Yes". If the "Limit Marker" attribute has the value "Display", the configured and monitored limits are indicated by marking arrows. These limit markers are shown in the bar color of the corresponding limit and are displayed on the side of the bar opposite the scale.

There is a free choice of value. A meaningful limit results from the value range that is to be displayed with the object "Bar".

The "High Limit RH5" attribute can be made dynamic with the name "LimitHigh5".

Limit TH (ToleranceHigh)

Limit TH (ToleranceHigh)

The "Limit TH" attribute defines for the "Bar" object the upper limit value for the tolerance limit "Tolerance High". If the display value exceeds the value specified here, it is displayed in the Bar Color TH.

For the "Bar" object, up to 5 limits can be defined, each of which has an upper (High) and a lower (Low) limit value. The limits are termed:

The "Upper Limit XH" and "Lower Limit XL" attributes specify the limit values for the corresponding Limit X. The "Type X" attributes specify whether the specified limit values are displayed as absolute values or as percentage values.

The "Bar Color XH" and "Bar Color XL" attributes can be used to assign a color to any Limit X. The display value is shown in the corresponding color, starting from the zero point of the bar display, as soon as it is higher than the corresponding Upper Limit XH or lower than the Lower Limit XL. The "Change Color" attribute in the "Miscellaneous" property group specifies whether this color change is to take place segment by segment or for the entire bar display.

The color change can only be displayed for a Limit X if the "Monitoring X" attribute has the value "Yes". If the "Limit Marker" attribute has the value "Display", the configured and monitored limits are indicated by marking arrows. These limit markers are shown in the bar color of the corresponding limit and are displayed on the side of the bar opposite the scale.

There is a free choice of value. A meaningful limit results from the value range that is to be displayed with the object "Bar".

The "Limit TH" attribute can be made dynamic with the name "ToleranceHigh".

Limit WH (WarningHigh)

Limit WH (WarningHigh)

The "Limit WH" attribute defines for the "Bar" object the upper limit value for the warning limit "Warning High". If the display value exceeds the value specified here, it is displayed in the Bar Color WH.

For the "Bar" object, up to 5 limits can be defined, each of which has an upper (High) and a lower (Low) limit value. The limits are termed:

The "Upper Limit XH" and "Lower Limit XL" attributes specify the limit values for the corresponding Limit X. The "Type X" attributes specify whether the specified limit values are displayed as absolute values or as percentage values.

The "Bar Color XH" and "Bar Color XL" attributes can be used to assign a color to any Limit X. The display value is shown in the corresponding color, starting from the zero point of the

bar display, as soon as it is higher than the corresponding Upper Limit XH or lower than the Lower Limit XL. The "Change Color" attribute in the "Miscellaneous" property group specifies whether this color change is to take place segment by segment or for the entire bar display.

The color change can only be displayed for a Limit X if the "Monitoring X" attribute has the value "Yes". If the "Limit Marker" attribute has the value "Display", the configured and monitored limits are indicated by marking arrows. These limit markers are shown in the bar color of the corresponding limit and are displayed on the side of the bar opposite the scale.

There is a free choice of value. A meaningful limit results from the value range that is to be displayed with the object "Bar".

The "Limit WH" attribute can be made dynamic with the name "WarningHigh".

3.11.11.6 Limits - U to Z

Monitoring 0 (Layer00Checked)

Monitoring 0 (Layer00Checked)

For the "3D bar" object, the "Monitoring 0" attribute activates the monitoring of Limit 0.

For the "3D bar" object, up to 11 limit values can be defined using the attributes "Limit N" (N = 0 to 10). For each limit value, the "Bar Color N" attributes can be used to specify a color change. If the corresponding attribute "Monitoring N" has the value "Yes", the color setting is activated.

A display value is displayed in Bar Color N as long as it is lower than the value of Limit N. A black arrow at the ends of the bar display symbolizes display values that are lower than Limit 0 or higher than Limit 10.

Yes	Limit 0 is monitored. The display value is displayed with bar color 0 until Limit 0 is exceeded.
No	Limit 0 is not monitored. A color change only takes place when the next monitored limit is exceeded.

The "Monitoring 0" attribute can be made dynamic with the name "Layer00Checked".

Monitoring 1 (Layer01Checked)

Monitoring 1 (Layer01Checked)

For the "3D bar" object, the "Monitoring 1" attribute activates the monitoring of limit 1.

For the "3D bar" object, up to 11 limit values can be defined using the attributes "Limit N" (N = 0 to 10). For each limit value, the "Bar Color N" attributes can be used to specify a color change. If the corresponding attribute "Monitoring N" has the value "Yes", the color setting is activated.

A display value is displayed in Bar Color N as long as it is lower than the value of Limit N. A black arrow at the ends of the bar display symbolizes display values that are lower than Limit 0 or higher than Limit 10.

Yes	Limit 1 is monitored. The display value is displayed with bar color 1 until Limit 1 is exceeded.
No	Limit 1 is not monitored. A color change only takes place when the next monitored limit is exceeded.

The "Monitoring 1" attribute can be made dynamic with the name "Layer01Checked".

Monitoring 2 (Layer02Checked)

Monitoring 2 (Layer02Checked)

For the "3D bar" object, the "Monitoring 2" attribute activates the monitoring of limit 2.

For the "3D bar" object, up to 11 limit values can be defined using the attributes "Limit N" (N = 0 to 10). For each limit value, the "Bar Color N" attributes can be used to specify a color change. If the corresponding attribute "Monitoring N" has the value "Yes", the color setting is activated.

A display value is displayed in Bar Color N as long as it is lower than the value of Limit N. A black arrow at the ends of the bar display symbolizes display values that are lower than Limit 0 or higher than Limit 10.

Yes	Limit 2 is monitored. The display value is displayed with bar color 2 until Limit 2 is exceeded.
No	Limit 2 is not monitored. A color change only takes place when the next monitored limit is exceeded.

The "Monitoring 2" attribute can be made dynamic with the name "Layer02Checked".

Monitoring 3 (Layer03Checked)

Monitoring 3 (Layer03Checked)

For the "3D bar" object, the "Monitoring 3" attribute activates the monitoring of limit 3.

For the "3D bar" object, up to 11 limit values can be defined using the attributes "Limit N" (N = 0 to 10). For each limit value, the "Bar Color N" attributes can be used to specify a color change. If the corresponding attribute "Monitoring N" has the value "Yes", the color setting is activated.

A display value is displayed in Bar Color N as long as it is lower than the value of Limit N. A black arrow at the ends of the bar display symbolizes display values that are lower than Limit 0 or higher than Limit 10.

Yes	Limit 3 is monitored. The display value is displayed with bar color 3 until Limit 3 is exceeded.
No	Limit 3 is not monitored. A color change only takes place when the next monitored limit is exceeded.

The "Monitoring 3" attribute can be made dynamic with the name "Layer03Checked".

Monitoring 4 (Layer04Checked)

Monitoring 4 (Layer04Checked)

For the "3D bar" object, the "Monitoring 4" attribute activates the monitoring of limit 4.

For the "3D bar" object, up to 11 limit values can be defined using the attributes "Limit N" (N = 0 to 10). For each limit value, the "Bar Color N" attributes can be used to specify a color change. If the corresponding attribute "Monitoring N" has the value "Yes", the color setting is activated.

A display value is displayed in Bar Color N as long as it is lower than the value of Limit N. A black arrow at the ends of the bar display symbolizes display values that are lower than Limit 0 or higher than Limit 10.

Yes	Limit 4 is monitored. The display value is displayed with bar color 4 until Limit 4 is exceeded.
No	Limit 4 is not monitored. A color change only takes place when the next monitored limit is exceeded.

The "Monitoring 4" attribute can be made dynamic with the name "Layer04Checked".

Monitoring 5 (Layer05Checked)

Monitoring 5 (Layer05Checked)

For the "3D bar" object, the "Monitoring 5" attribute activates the monitoring of limit 5.

For the "3D bar" object, up to 11 limit values can be defined using the attributes "Limit N" (N = 0 to 10). For each limit value, the "Bar Color N" attributes can be used to specify a color change. If the corresponding attribute "Monitoring N" has the value "Yes", the color setting is activated.

A display value is displayed in Bar Color N as long as it is lower than the value of Limit N. A black arrow at the ends of the bar display symbolizes display values that are lower than Limit 0 or higher than Limit 10.

Yes	Limit 5 is monitored. The display value is displayed with bar color 5 until Limit 5 is exceeded.
No	Limit 5 is not monitored. A color change only takes place when the next monitored limit is exceeded.

The "Monitoring 5" attribute can be made dynamic with the name "Layer05Checked".

Monitoring 6 (Layer06Checked)

Monitoring 6 (Layer06Checked)

For the "3D bar" object, the "Monitoring 6" attribute activates the monitoring of limit 6.

For the "3D bar" object, up to 11 limit values can be defined using the attributes "Limit N" (N = 0 to 10). For each limit value, the "Bar Color N" attributes can be used to specify a color change. If the corresponding attribute "Monitoring N" has the value "Yes", the color setting is activated.

A display value is displayed in Bar Color N as long as it is lower than the value of Limit N. A black arrow at the ends of the bar display symbolizes display values that are lower than Limit 0 or higher than Limit 10.

Yes	Limit 6 is monitored. The display value is displayed with bar color 6 until Limit 6 is exceeded.
No	Limit 6 is not monitored. A color change only takes place when the next monitored limit is exceeded.

The "Monitoring 6" attribute can be made dynamic with the name "Layer06Checked".

Monitoring 7 (Layer07Checked)

Monitoring 7 (Layer07Checked)

For the "3D bar" object, the "Monitoring 7" attribute activates the monitoring of limit 7.

3.11 Object properties

For the "3D bar" object, up to 11 limit values can be defined using the attributes "Limit N" (N = 0 to 10). For each limit value, the "Bar Color N" attributes can be used to specify a color change. If the corresponding attribute "Monitoring N" has the value "Yes", the color setting is activated.

A display value is displayed in Bar Color N as long as it is lower than the value of Limit N. A black arrow at the ends of the bar display symbolizes display values that are lower than Limit 0 or higher than Limit 10.

Yes	Limit 7 is monitored. The display value is displayed with bar color 7 until Limit 7 is exceeded.
No	Limit 7 is not monitored. A color change only takes place when the next monitored limit is exceeded.

The "Monitoring 7" attribute can be made dynamic with the name "Layer07Checked".

Monitoring 8 (Layer08Checked)

Monitoring 8 (Layer08Checked)

For the "3D bar" object, the "Monitoring 8" attribute activates the monitoring of limit 8.

For the "3D bar" object, up to 11 limit values can be defined using the attributes "Limit N" (N = 0 to 10). For each limit value, the "Bar Color N" attributes can be used to specify a color change. If the corresponding attribute "Monitoring N" has the value "Yes", the color setting is activated.

A display value is displayed in Bar Color N as long as it is lower than the value of Limit N. A black arrow at the ends of the bar display symbolizes display values that are lower than Limit 0 or higher than Limit 10.

Yes	Limit 8 is monitored. The display value is displayed with bar color 8 until Limit 8 is exceeded.
No	Limit 8 is not monitored. A color change only takes place when the next monitored limit is exceeded.

The "Monitoring 8" attribute can be made dynamic with the name "Layer08Checked".

Monitoring 9 (Layer09Checked)

Monitoring 9 (Layer09Checked)

For the "3D bar" object, the "Monitoring 9" attribute activates the monitoring of limit 9.

For the "3D bar" object, up to 11 limit values can be defined using the attributes "Limit N" (N = 0 to 10). For each limit value, the "Bar Color N" attributes can be used to specify a color change. If the corresponding attribute "Monitoring N" has the value "Yes", the color setting is activated.

A display value is displayed in Bar Color N as long as it is lower than the value of Limit N. A black arrow at the ends of the bar display symbolizes display values that are lower than Limit 0 or higher than Limit 10.

Yes	Limit 9 is monitored. The display value is displayed with bar color 9 until Limit 9 is exceeded.
No	Limit 9 is not monitored. A color change only takes place when the next monitored limit is exceeded.

The "Monitoring 9" attribute can be made dynamic with the name "Layer09Checked".

Monitoring 10 (Layer10Checked)

Monitoring 10 (Layer10Checked)

For the "3D bar" object, the "Monitoring 10" attribute activates the monitoring of limit 10.

For the "3D bar" object, up to 11 limit values can be defined using the attributes "Limit N" (N = 0 to 10). For each limit value, the "Bar Color N" attributes can be used to specify a color change. If the corresponding attribute "Monitoring N" has the value "Yes", the color setting is activated.

A display value is displayed in Bar Color N as long as it is lower than the value of Limit N. A black arrow at the ends of the bar display symbolizes display values that are lower than Limit 0 or higher than Limit 10.

Yes	Limit 10 is monitored. The display value is displayed with bar color 10 until Limit 10 is exceeded.
No	Limit 10 is not monitored. There is no color change.

The "Monitoring 10" attribute can be made dynamic with the name "Layer10Checked".

Monitoring AH (CheckAlarmHigh)

Monitoring AH (CheckAlarmHigh)

The "Monitoring AH" attribute defines for the "Bar" object the monitoring of the alarm limit "Alarm High".

For the "Bar" object, up to 5 limits can be defined, each of which has an upper (High) and a lower (Low) limit value. The limits are termed:

The "Upper Limit XH" and "Lower Limit XL" attributes specify the limit values for the corresponding Limit X. The "Type X" attributes specify whether the specified limit values are displayed as absolute values or as percentage values.

The "Bar Color XH" and "Bar Color XL" attributes can be used to assign a color to any Limit X. The display value is shown in the corresponding color, starting from the zero point of the bar display, as soon as it is higher than the corresponding Upper Limit XH or lower than the Lower Limit XL. The "Change Color" attribute in the "Miscellaneous" property group specifies whether this color change is to take place segment by segment or for the entire bar display.

The color change can only be displayed for a Limit X if the "Monitoring X" attribute has the value "Yes". If the "Limit Marker" attribute has the value "Display", the configured and monitored limits are indicated by marking arrows. These limit markers are shown in the bar color of the corresponding limit and are displayed on the side of the bar opposite the scale.

Yes	Limit AH is monitored. The display value is displayed with the bar color AH as soon as it exceeds the Limit AH.
No	Limit AH is not monitored. No color change takes place.

The "Monitoring AH" attribute can be made dynamic with the name "CheckAlarmHigh".

Monitoring AL (CheckAlarmLow)

Monitoring AL (CheckAlarmLow)

The "Monitoring AL" attribute defines for the "Bar" object the monitoring of the alarm limit "Alarm Low".

3.11 Object properties

For the "Bar" object, up to 5 limits can be defined, each of which has an upper (High) and a lower (Low) limit value. The limits are termed:

The "Upper Limit XH" and "Lower Limit XL" attributes specify the limit values for the corresponding Limit X. The "Type X" attributes specify whether the specified limit values are displayed as absolute values or as percentage values.

The "Bar Color XH" and "Bar Color XL" attributes can be used to assign a color to any Limit X. The display value is shown in the corresponding color, starting from the zero point of the bar display, as soon as it is higher than the corresponding Upper Limit XH or lower than the Lower Limit XL. The "Change Color" attribute in the "Miscellaneous" property group specifies whether this color change is to take place segment by segment or for the entire bar display.

The color change can only be displayed for a Limit X if the "Monitoring X" attribute has the value "Yes". If the "Limit Marker" attribute has the value "Display", the configured and monitored limits are indicated by marking arrows. These limit markers are shown in the bar color of the corresponding limit and are displayed on the side of the bar opposite the scale.

Yes	Limit AL is monitored. The display value is displayed with the bar color AL as soon as it falls below the Alarm Low Limit AL.
No	Limit AL is not monitored. No color change takes place.

The "Monitoring AL" attribute can be made dynamic with the name "CheckAlarmLow".

Monitoring RH4 (CheckLimitHigh4)

Monitoring RH4 (CheckLimitHigh4)

The "Monitoring RH4" attribute defines for the "Bar" object the monitoring of the limit "Reserve High 4".

For the "Bar" object, up to 5 limits can be defined, each of which has an upper (High) and a lower (Low) limit value. The limits are termed:

The "Upper Limit XH" and "Lower Limit XL" attributes specify the limit values for the corresponding Limit X. The "Type X" attributes specify whether the specified limit values are displayed as absolute values or as percentage values.

The "Bar Color XH" and "Bar Color XL" attributes can be used to assign a color to any Limit X. The display value is shown in the corresponding color, starting from the zero point of the bar display, as soon as it is higher than the corresponding Upper Limit XH or lower than the Lower Limit XL. The "Change Color" attribute in the "Miscellaneous" property group specifies whether this color change is to take place segment by segment or for the entire bar display.

The color change can only be displayed for a Limit X if the "Monitoring X" attribute has the value "Yes". If the "Limit Marker" attribute has the value "Display", the configured and monitored limits are indicated by marking arrows. These limit markers are shown in the bar color of the corresponding limit and are displayed on the side of the bar opposite the scale.

Yes	Limit RH4 is monitored. The display value is displayed with the bar color RH4 as soon as it exceeds the High Limit RH4.
No	Limit RH4 is not monitored. A color change only takes place when the next monitored limit is exceeded.

The "Monitoring RH4" attribute can be made dynamic with the name "CheckLimitHigh4".

Monitoring RH5 (CheckLimitHigh5)

Monitoring RH5 (CheckLimitHigh5)

The "Monitoring RH5" attribute defines for the "Bar" object the monitoring of the limit "Reserve High 5".

For the "Bar" object, up to 5 limits can be defined, each of which has an upper (High) and a lower (Low) limit value. The limits are termed:

The "Upper Limit XH" and "Lower Limit XL" attributes specify the limit values for the corresponding Limit X. The "Type X" attributes specify whether the specified limit values are displayed as absolute values or as percentage values.

The "Bar Color XH" and "Bar Color XL" attributes can be used to assign a color to any Limit X. The display value is shown in the corresponding color, starting from the zero point of the bar display, as soon as it is higher than the corresponding Upper Limit XH or lower than the Lower Limit XL. The "Change Color" attribute in the "Miscellaneous" property group specifies whether this color change is to take place segment by segment or for the entire bar display.

The color change can only be displayed for a Limit X if the "Monitoring X" attribute has the value "Yes". If the "Limit Marker" attribute has the value "Display", the configured and monitored limits are indicated by marking arrows. These limit markers are shown in the bar color of the corresponding limit and are displayed on the side of the bar opposite the scale.

Yes	Limit RH5 is monitored. The display value is displayed with the bar color RH5 as soon as it exceeds the High Limit RH5.
No	Limit RH5 is not monitored. A color change only takes place when the next monitored limit is exceeded.

The "Monitoring RH5" attribute can be made dynamic with the name "CheckLimitHigh5".

Monitoring RL4 (CheckLimitLow4)

Monitoring RL4 (CheckLimitLow4)

The "Monitoring RL4" attribute defines for the "Bar" object the monitoring of the limit "Reserve Low 4".

For the "Bar" object, up to 5 limits can be defined, each of which has an upper (High) and a lower (Low) limit value. The limits are termed:

The "Upper Limit XH" and "Lower Limit XL" attributes specify the limit values for the corresponding Limit X. The "Type X" attributes specify whether the specified limit values are displayed as absolute values or as percentage values.

The "Bar Color XH" and "Bar Color XL" attributes can be used to assign a color to any Limit X. The display value is shown in the corresponding color, starting from the zero point of the bar display, as soon as it is higher than the corresponding Upper Limit XH or lower than the Lower Limit XL. The "Change Color" attribute in the "Miscellaneous" property group specifies whether this color change is to take place segment by segment or for the entire bar display.

The color change can only be displayed for a Limit X if the "Monitoring X" attribute has the value "Yes". If the "Limit Marker" attribute has the value "Display", the configured and monitored

3.11 Object properties

limits are indicated by marking arrows. These limit markers are shown in the bar color of the corresponding limit and are displayed on the side of the bar opposite the scale.

Yes	Limit RL4 is monitored. The display value is displayed with the bar color RL4 as soon as it falls below the Low Limit RL4.
No	The limit RL4 is not monitored. A color change only takes place when the value falls below the next monitored limit.

The "Monitoring RL4" attribute can be made dynamic with the name "CheckLimitLow4".

Monitoring RL5 (CheckLimitLow5)

Monitoring RL5 (CheckLimitLow5)

The "Monitoring RL5" attribute defines for the "Bar" object the monitoring of the limit "Reserve Low 5".

For the "Bar" object, up to 5 limits can be defined, each of which has an upper (High) and a lower (Low) limit value. The limits are termed:

The "Upper Limit XH" and "Lower Limit XL" attributes specify the limit values for the corresponding Limit X. The "Type X" attributes specify whether the specified limit values are displayed as absolute values or as percentage values.

The "Bar Color XH" and "Bar Color XL" attributes can be used to assign a color to any Limit X. The display value is shown in the corresponding color, starting from the zero point of the bar display, as soon as it is higher than the corresponding Upper Limit XH or lower than the Lower Limit XL. The "Change Color" attribute in the "Miscellaneous" property group specifies whether this color change is to take place segment by segment or for the entire bar display.

The color change can only be displayed for a Limit X if the "Monitoring X" attribute has the value "Yes". If the "Limit Marker" attribute has the value "Display", the configured and monitored limits are indicated by marking arrows. These limit markers are shown in the bar color of the corresponding limit and are displayed on the side of the bar opposite the scale.

Yes	Limit RL5 is monitored. The display value is displayed with the Bar Color RL5 as soon as it falls below the Low Limit RL5.
No	Limit RL5 is not monitored. A color change only takes place when the value falls below the next monitored limit.

The "Monitoring RL5" attribute can be made dynamic with the name "CheckLimitLow5".

Monitoring TH (CheckToleranceHigh)

Monitoring TH (CheckToleranceHigh)

The "Monitoring TH" attribute defines for the "Bar" object the monitoring of the tolerance limit "Tolerance High".

For the "Bar" object, up to 5 limits can be defined, each of which has an upper (High) and a lower (Low) limit value. The limits are termed:

The "Upper Limit XH" and "Lower Limit XL" attributes specify the limit values for the corresponding Limit X. The "Type X" attributes specify whether the specified limit values are displayed as absolute values or as percentage values.

The "Bar Color XH" and "Bar Color XL" attributes can be used to assign a color to any Limit X. The display value is shown in the corresponding color, starting from the zero point of the bar display, as soon as it is higher than the corresponding Upper Limit XH or lower than the Lower Limit XL. The "Change Color" attribute in the "Miscellaneous" property group specifies whether this color change is to take place segment by segment or for the entire bar display.

The color change can only be displayed for a Limit X if the "Monitoring X" attribute has the value "Yes". If the "Limit Marker" attribute has the value "Display", the configured and monitored limits are indicated by marking arrows. These limit markers are shown in the bar color of the corresponding limit and are displayed on the side of the bar opposite the scale.

Yes	Limit TH is monitored. The display value is displayed with the Bar Color TH as soon as it exceeds the Limit TH.
No	Limit TH is not monitored. A color change only takes place when the next monitored limit is exceeded.

The "Monitoring TH" attribute can be made dynamic with the name "CheckToleranceHigh".

Monitoring TL (CheckToleranceLow)

Monitoring TL (CheckToleranceLow)

The "Monitoring TL" attribute defines for the "Bar" object the monitoring of the tolerance limit "Tolerance Low".

For the "Bar" object, up to 5 limits can be defined, each of which has an upper (High) and a lower (Low) limit value. The limits are termed:

The "Upper Limit XH" and "Lower Limit XL" attributes specify the limit values for the corresponding Limit X. The "Type X" attributes specify whether the specified limit values are displayed as absolute values or as percentage values.

The "Bar Color XH" and "Bar Color XL" attributes can be used to assign a color to any Limit X. The display value is shown in the corresponding color, starting from the zero point of the bar display, as soon as it is higher than the corresponding Upper Limit XH or lower than the Lower Limit XL. The "Change Color" attribute in the "Miscellaneous" property group specifies whether this color change is to take place segment by segment or for the entire bar display.

The color change can only be displayed for a Limit X if the "Monitoring X" attribute has the value "Yes". If the "Limit Marker" attribute has the value "Display", the configured and monitored limits are indicated by marking arrows. These limit markers are shown in the bar color of the corresponding limit and are displayed on the side of the bar opposite the scale.

Yes	Limit TL is monitored. The display value is displayed with the Bar Color TL as soon as it falls below the Limit TL.
No	Limit TL is not monitored. A color change only takes place when the value falls below the next monitored limit.

The "Monitoring TL" attribute can be made dynamic with the name "CheckToleranceLow".

Monitoring WH (CheckWarningHigh)

Monitoring WH (CheckWarningHigh)

The "Monitoring WH" attribute defines for the "Bar" object the monitoring of the warning limit "Warning High".

3.11 Object properties

For the "Bar" object, up to 5 limits can be defined, each of which has an upper (High) and a lower (Low) limit value. The limits are termed:

The "Upper Limit XH" and "Lower Limit XL" attributes specify the limit values for the corresponding Limit X. The "Type X" attributes specify whether the specified limit values are displayed as absolute values or as percentage values.

The "Bar Color XH" and "Bar Color XL" attributes can be used to assign a color to any Limit X. The display value is shown in the corresponding color, starting from the zero point of the bar display, as soon as it is higher than the corresponding Upper Limit XH or lower than the Lower Limit XL. The "Change Color" attribute in the "Miscellaneous" property group specifies whether this color change is to take place segment by segment or for the entire bar display.

The color change can only be displayed for a Limit X if the "Monitoring X" attribute has the value "Yes". If the "Limit Marker" attribute has the value "Display", the configured and monitored limits are indicated by marking arrows. These limit markers are shown in the bar color of the corresponding limit and are displayed on the side of the bar opposite the scale.

Yes	Limit WH is monitored. The display value is displayed with the Bar Color WH as soon as it exceeds the Limit WH.
No	Limit WH is not monitored. A color change only takes place when the next monitored limit is exceeded.

The "Monitoring WH" attribute can be made dynamic with the name "CheckWarningHigh".

Monitoring WL (CheckWarningLow)

Monitoring WL (CheckWarningLow)

The "Monitoring WL" attribute defines for the "Bar" object the monitoring of the warning limit "Warning Low".

For the "Bar" object, up to 5 limits can be defined, each of which has an upper (High) and a lower (Low) limit value. The limits are termed:

The "Upper Limit XH" and "Lower Limit XL" attributes specify the limit values for the corresponding Limit X. The "Type X" attributes specify whether the specified limit values are displayed as absolute values or as percentage values.

The "Bar Color XH" and "Bar Color XL" attributes can be used to assign a color to any Limit X. The display value is shown in the corresponding color, starting from the zero point of the bar display, as soon as it is higher than the corresponding Upper Limit XH or lower than the Lower Limit XL. The "Change Color" attribute in the "Miscellaneous" property group specifies whether this color change is to take place segment by segment or for the entire bar display.

The color change can only be displayed for a Limit X if the "Monitoring X" attribute has the value "Yes". If the "Limit Marker" attribute has the value "Display", the configured and monitored limits are indicated by marking arrows. These limit markers are shown in the bar color of the corresponding limit and are displayed on the side of the bar opposite the scale.

Yes	Limit WL is monitored. The display value is displayed with the Bar Color WL as soon as it falls below the Limit WL.
No	Limit WL is not monitored. A color change only takes place when the value falls below the next monitored limit.

The "Monitoring WL" attribute can be made dynamic with the name "CheckWarningLow".

Low Limit Value (LimitMin)

Low Limit Value (LimitMin)

The "Low Limit Value" attribute defines for the "I/O field" object the minimum limit value for input and output. The specified value depends on the "data format" of the I/O field.

If a value is lower than the low limit value, the following effects are possible in Runtime:

Field type = "Input": The "WinCC Runtime" dialog is opened and displayed the error message "The entered value is outside the configured limits".

Confirm the error message with "OK" and enter another value.

Field type = "Output": The display of the value is substituted by the character string "****".

The "Data Format" and "Field Type" attributes can be changed in the "Output / Input" property group.

There is a free choice of value depending on the "data format" of the I/O field.

The "Low Limit Value" attribute can be made dynamic with the name "LimitMin".

Alarm Low Limit AL (AlarmLow)

Alarm Low Limit AL (AlarmLow)

The "Alarm Low Limit AL" attribute defines for the "Bar" object the lower limit value for the alarm limit "Alarm Low". If the display value falls below the value specified here, it is displayed in bar color AL.

For the "Bar" object, up to 5 limits can be defined, each of which has an upper (High) and a lower (Low) limit value. The limits are termed:

The "Upper Limit XH" and "Lower Limit XL" attributes specify the limit values for the corresponding Limit X. The "Type X" attributes specify whether the specified limit values are displayed as absolute values or as percentage values.

The "Bar Color XH" and "Bar Color XL" attributes can be used to assign a color to any Limit X. The display value is shown in the corresponding color as soon as, starting from the zero point of the bar display, it is higher than the corresponding Upper Limit XH or lower than the Lower Limit XL. The "Change Color" attribute in the "Miscellaneous" property group specifies whether this color change is to take place segment-wise or for the entire display.

The color change can only be displayed for a limit X if the "Monitoring X" attribute has the value "Yes". If the "Limit Marker" attribute has the value "Display", the configured and monitored limits are indicated by marking arrows. These limit markers receive the bar color of the corresponding limit and are displayed on the side of the bar opposite the scale.

There is a free choice of value. A meaningful limit results from the value range that is to be displayed with the object "Bar".

The "Alarm Low Limit AL" attribute can be made dynamic with the name "AlarmLow".

Low Limit RL4 (LimitLow4)

Low Limit RL4 (LimitLow4)

The "Low Limit RL4" attribute defines for the "Bar" object the lower limit value for the limit "Reserve Low 4". If the display value falls below the value specified here, it is displayed in bar color RL4.

For the "Bar" object, up to 5 limits can be defined, each of which has an upper (High) and a lower (Low) limit value. The limits are termed:

The "Upper Limit XH" and "Lower Limit XL" attributes specify the limit values for the corresponding Limit X. The "Type X" attributes specify whether the specified limit values are displayed as absolute values or as percentage values.

The "Bar Color XH" and "Bar Color XL" attributes can be used to assign a color to any Limit X. The display value is shown in the corresponding color, starting from the zero point of the bar display, as soon as it is higher than the corresponding Upper Limit XH or lower than the Lower Limit XL. The "Change Color" attribute in the "Miscellaneous" property group specifies whether this color change is to take place segment by segment or for the entire bar display.

The color change can only be displayed for a Limit X if the "Monitoring X" attribute has the value "Yes". If the "Limit Marker" attribute has the value "Display", the configured and monitored limits are indicated by marking arrows. These limit markers are shown in the bar color of the corresponding limit and are displayed on the side of the bar opposite the scale.

There is a free choice of value. A meaningful limit results from the value range that is to be displayed with the object "Bar".

The "Low Limit RL4" attribute can be made dynamic with the name "LimitLow4".

Low Limit RL5 (LimitLow5)

Low Limit RL5 (LimitLow5)

The "Limit RL5" attribute defines for the "Bar" object the lower limit value for the limit "Reserve Low 5". If the display value falls below the value specified here, it is displayed in bar color RL5.

For the "Bar" object, up to 5 limits can be defined, each of which has an upper (High) and a lower (Low) limit value. The limits are termed:

The "Upper Limit XH" and "Lower Limit XL" attributes specify the limit values for the corresponding Limit X. The "Type X" attributes specify whether the specified limit values are displayed as absolute values or as percentage values.

The "Bar Color XH" and "Bar Color XL" attributes can be used to assign a color to any Limit X. The display value is shown in the corresponding color, starting from the zero point of the bar display, as soon as it is higher than the corresponding Upper Limit XH or lower than the Lower Limit XL. The "Change Color" attribute in the "Miscellaneous" property group specifies whether this color change is to take place segment by segment or for the entire bar display.

The color change can only be displayed for a Limit X if the "Monitoring X" attribute has the value "Yes". If the "Limit Marker" attribute has the value "Display", the configured and monitored limits are indicated by marking arrows. These limit markers are shown in the bar color of the corresponding limit and are displayed on the side of the bar opposite the scale.

There is a free choice of value. A meaningful limit results from the value range that is to be displayed with the object "Bar".

The "Low Limit RL5" attribute can be made dynamic with the name "LimitLow5".

Limit TL (ToleranceLow)

Limit TL (ToleranceLow)

The "Limit TL" attribute defines for the "Bar" object the lower limit value for the tolerance limit "Tolerance Low". If the display value falls below the value specified here, it is displayed in bar color TL.

For the "Bar" object, up to 5 limits can be defined, each of which has an upper (High) and a lower (Low) limit value. The limits are termed:

The "Upper Limit XH" and "Lower Limit XL" attributes specify the limit values for the corresponding Limit X. The "Type X" attributes specify whether the specified limit values are displayed as absolute values or as percentage values.

The "Bar Color XH" and "Bar Color XL" attributes can be used to assign a color to any Limit X. The display value is shown in the corresponding color, starting from the zero point of the bar display, as soon as it is higher than the corresponding Upper Limit XH or lower than the Lower Limit XL. The "Change Color" attribute in the "Miscellaneous" property group specifies whether this color change is to take place segment by segment or for the entire bar display.

The color change can only be displayed for a Limit X if the "Monitoring X" attribute has the value "Yes". If the "Limit Marker" attribute has the value "Display", the configured and monitored limits are indicated by marking arrows. These limit markers are shown in the bar color of the corresponding limit and are displayed on the side of the bar opposite the scale.

There is a free choice of value. A meaningful limit results from the value range that is to be displayed with the object "Bar".

The "Limit TL" attribute can be made dynamic with the name "ToleranceLow".

Limit WL (WarningLow)

Limit WL (WarningLow)

The "Limit WL" attribute defines for the "Bar" object the lower limit value for the warning limit "Warning Low". If the display value falls below the value specified here, it is displayed in bar color WL.

For the "Bar" object, up to 5 limits can be defined, each of which has an upper (High) and a lower (Low) limit value. The limits are termed:

The "Upper Limit XH" and "Lower Limit XL" attributes specify the limit values for the corresponding Limit X. The "Type X" attributes specify whether the specified limit values are displayed as absolute values or as percentage values.

The "Bar Color XH" and "Bar Color XL" attributes can be used to assign a color to any Limit X. The display value is shown in the corresponding color, starting from the zero point of the bar display, as soon as it is higher than the corresponding Upper Limit XH or lower than the Lower Limit XL. The "Change Color" attribute in the "Miscellaneous" property group specifies whether this color change is to take place segment by segment or for the entire bar display.

The color change can only be displayed for a Limit X if the "Monitoring X" attribute has the value "Yes". If the "Limit Marker" attribute has the value "Display", the configured and monitored limits are indicated by marking arrows. These limit markers are shown in the bar color of the corresponding limit and are displayed on the side of the bar opposite the scale.

There is a free choice of value. A meaningful limit results from the value range that is to be displayed with the object "Bar".

The "Limit WL" attribute can be made dynamic with the name "WarningLow".

3.11.12 The "Background picture" property group

3.11.12.1 BackPictureName

BackPictureName

The "Picture" attribute defines the name of the file that is used as the background image in the process picture. The file must exist in the project path in the "GraCS" folder or in a subfolder.

If you assign the attribute in the properties dialog, you can select it from any directory. The selection creates a copy in the "GraCS" folder.

Files of format EMF, WMF, DB, BMP, GIF, JPG, JPEG and ICO are suitable.

The "Picture" attribute can be made dynamic with the name "BackPictureName".

3.11.12.2 Show as (Back Picture Alignment)

Show as (Back Picture Alignment)

The "Show as" attribute defines the method of displaying the background image of the process picture.

Normal	The background picture is centered in the original size. When opening the picture in runtime, it remains in the location.
Stretched (window)	The background picture is scaled to the runtime window and process picture of the larger of the two windows. In runtime, it is scaled to the size of the runtime window and is scaled when you resize the picture.
Tiled	Graphics Designer and process picture are exhibited with the picture in its original size.
Stretched (picture)	The background picture is scaled to the configured size of the process picture. When opening the picture in runtime, it retains its size.

The "Show as" attribute can be made dynamic with the name "BackPictureAlignment".

3.11.13 "Message Types" Property Group

3.11.13.1 Display Text (MCText)

Display Text (MCText)

The "Display Text" attribute is used to specify the type of text for the representation of a message of the selected "Message Type".

The "Display Text" attribute can be made dynamic with the name "MCText".

3.11.13.2 Went Out Unacknowledged - Background Flashing (GNQBackFlash)

Went Out Unacknowledged - Background Flashing (GNQBackFlash)

The "Went Out Unacknowledged - Background Flashing" attribute specifies for the selected message type and the status "Went Out Unacknowledged" whether the background of the value to be displayed flashes when a message goes out unacknowledged.

Yes	When a message goes out unacknowledged, the background of value to be displayed flashes.
No	When a message goes out unacknowledged, the background of the displayed value flashes.

The "Went Out Unacknowledged - Background Flashing" attribute can be made dynamic using the name "GNQBackFlash."

3.11.13.3 Went Out Unacknowledged - Background Flashing (MCGUBackFlash)

Went Out Unacknowledged - Background Flashing (MCGUBackFlash)

The "Went Out Unacknowledged - Background Flashing" attribute specifies for the selected message type whether the background of the button flashes when a message goes out unacknowledged.

Yes	When a message goes out unacknowledged, the background of the button flashes.
No	When a message goes out unacknowledged, the background of the button does not flash.

The "Went Out Unacknowledged - Background Flashing" attribute can be made dynamic using the name "MCGUBackFlash".

3.11.13.4 Went Out Unacknowledged - Background Color Off (GNQBackColorOff)

Went Out Unacknowledged - Background Color Off (GNQBackColorOff)

The "Went Out Unacknowledged - Background Color Off" attribute specifies for the selected message type and the status "Went Out Unacknowledged" which color the background of the value to be displayed assumes for flashing status "Off" when a message goes out unacknowledged.

The "Went Out Unacknowledged - Background Color Off" attribute can be made dynamic using the name "GNQBackColorOff".

3.11.13.5 Went Out Unacknowledged - Background Color Off (MCGUBBackColorOff)

Went Out Unacknowledged - Background Color Off (MCGUBBackColorOff)

The "Went Out Unacknowledged - Background Color Off" attribute specifies for the selected message type which color the background of the button assumes for the flashing status "Off" when a message goes out unacknowledged.

The "Went Out Unacknowledged - Background Color Off" attribute can be made dynamic using the name "MCGUBBackColorOff".

3.11.13.6 Went Out Unacknowledged - Background Color On (GNQBackColorOn)

Went Out Unacknowledged - Background Color On (GNQBackColorOn)

The "Went Out Unacknowledged - Background Color On" attribute specifies for the selected message type and the status "Went Out Unacknowledged" which color the background of the value to be displayed assumes for flashing status "On" when a message goes out unacknowledged.

The "Went Out Unacknowledged - Background Color On" attribute can be made dynamic using the name "GNQBackColorOn".

3.11.13.7 Went Out Unacknowledged - Background Color On (MCGUBackColorOn)

Went Out Unacknowledged - Background Color On (MCGUBackColorOn)

The "Went Out Unacknowledged - Background Color On" attribute specifies for the selected message type which color the background of the button assumes for the flashing status "On" when a message goes out unacknowledged.

The "Went Out Unacknowledged - Background Color On" attribute can be made dynamic using the name "MCGUBackColorOn".

3.11.13.8 Went Out Unacknowledged - Text Flashing (GNQTextFlash)

Went Out Unacknowledged - Text Flashing (GNQTextFlash)

The "Went Out Unacknowledged - Text Flashing" attribute specifies for the selected message type and the status "Went Out Unacknowledged" whether the text of the value to be displayed flashes when a message goes out unacknowledged.

Yes	When a message goes out unacknowledged, the text of the message flashes.
No	When a message goes out unacknowledged, the text of the message does not flash.

The "Went Out Unacknowledged - Text Flashing" attribute can be made dynamic using the name "GNQTextFlash."

3.11.13.9 Went Out Unacknowledged - Text Flashing (MCGUTextFlash)

Went Out Unacknowledged - Text Flashing (MCGUTextFlash)

The "Went Out Unacknowledged - Text Flashing" attribute specifies for the selected message type whether the text of the button flashes when a message goes out unacknowledged.

Yes	When a message goes out unacknowledged, the text of the button flashes.
No	When a message goes out unacknowledged, the text of the button does not flash.

The "Went Out Unacknowledged - Text Flashing" attribute can be made dynamic using the name "MCGUTextFlash".

3.11.13.10 Went Out Unacknowledged - Text Color Off (GNQTextColorOff)

Went Out Unacknowledged - Text Color Off (GNQTextColorOff)

The "Went Out Unacknowledged - Text Color Off" attribute specifies for the selected message type and the status "Went Out Unacknowledged" which color the text of the button assumes for flashing status "Off" when a message goes out unacknowledged.

The "Went Out Unacknowledged - Text Color Off" attribute can be made dynamic using the name "GNQTextColorOff".

3.11.13.11 Went Out Unacknowledged - Text Color Off (MCGUTextColorOff)

Went Out Unacknowledged - Text Color Off (MCGUTextColorOff)

The "Went Out Unacknowledged - Text Color Off" attribute specifies for the selected message type which color the text of the button assumes for the flashing status "Off" when a message goes out unacknowledged.

The "Went Out Unacknowledged - Text Color Off" attribute can be made dynamic using the name "MCGUTextColorOff".

3.11.13.12 Went Out Unacknowledged - Text Color On (GNQTextColorOn)

Went Out Unacknowledged - Text Color On (GNQTextColorOn)

The "Went Out Unacknowledged - Text Color On" attribute specifies for the selected message type and the status "Went Out Unacknowledged" which color the text of the button assumes for flashing status "On" when a message goes out unacknowledged.

The "Went Out Unacknowledged - Text Color On" attribute can be made dynamic using the name "GNQTextColorOn".

3.11.13.13 Went Out Unacknowledged - Text Color On (MCGUTextColorOn)

Went Out Unacknowledged - Text Color On (MCGUTextColorOn)

The "Went Out Unacknowledged - Text Color On" attribute specifies for the selected message type which color the text of the button assumes for the flashing status "On" when a message goes out unacknowledged.

The "Went Out Unacknowledged - Text Color On" attribute can be made dynamic using the name "MCGUTextColorOn".

3.11.13.14 Came In - Background Flashing (CBackFlash)

Came In - Background Flashing (CBackFlash)

The "Came In - Background Flashing" attribute specifies for the selected message type and status "Came In" whether the background of the value to be displayed flashes.

Yes	When the message comes in, the background of the displayed value flashes.
No	When the message comes in, the background of the displayed value does not flash.

The "Came In - Background Flashing" attribute can be made dynamic using the name "CBackFlash".

3.11.13.15 Came In - Background Flashing (MCKOBackFlash)

Came In - Background Flashing (MCKOBackFlash)

The "Came In - Background Flashing" attribute specifies for the selected message type whether the background of the button flashes when a message comes in.

Yes	When the message comes in, the background of the button flashes.
No	When the message comes in, the background of the button does not flash.

The "Came In - Background Flashing" attribute can be made dynamic using the name "MCKOBackFlash".

3.11.13.16 Came In - Background Color Off (CBackColorOff)

Came In - Background Color Off (CBackColorOff)

The "Came In - Background Color Off" attribute specifies for the selected message type which color the background of the value to be displayed assumes for flashing status "Off" when a message comes in.

The "Came In - Background Color Off" attribute can be made dynamic using the name "CBackColorOff".

3.11.13.17 Came In - Background Color Off (MCKOBackColorOff)

Came In - Background Color Off (MCKOBackColorOff)

The "Came In - Background Color Off" attribute specifies for the selected message type which color the background of the button assumes for the flashing status "Off" when a message comes in.

The "Came In - Background Color Off" attribute can be made dynamic using the name "MCKOBackColorOff".

3.11.13.18 Came In - Background Color On (CBackColorOn)

Came In - Background Color On (CBackColorOn)

The "Came In - Background Color On" attribute specifies for the selected message type which color the background of the value to be displayed assumes for flashing status "On" when a message comes in.

The "Came In - Background Color On" attribute can be made dynamic using the name "CBackColorOn".

3.11.13.19 Came In - Background Color On (MCKOBackColorOn)

Came In - Background Color On (MCKOBackColorOn)

The "Came In - Background Color On" attribute specifies for the selected message type which color the background of the button assumes for the flashing status "On" when a message comes in.

The "Came In - Background Color On" attribute can be made dynamic using the name "MCKOBackColorOn".

3.11.13.20 Came In - Text Flashing (CTextFlash)

Came In - Text Flashing (CTextFlash)

The "Came In - Text Flashing" attribute specifies for the selected message type and status "Came In" whether the text of the value to be displayed flashes.

Yes	When the message comes in, the text of the value to be displayed flashes.
No	When the message comes in, the text of the value to be displayed does not flash.

The "Came In - Text Flashing" attribute can be made dynamic using the name "CTextFlash".

3.11.13.21 Came In - Text Flashing (MCKOTextFlash)

Came In - Text Flashing (MCKOTextFlash)

The "Came In - Text Flashing" attribute specifies for the selected message type whether the text of the button flashes when a message comes in.

Yes	When the message comes in, the text of the button flashes.
No	When the message comes in, the text of the button does not flash.

The "Came In - Text Flashing" attribute can be made dynamic using the name "MCKOTextFlash".

3.11.13.22 Came In - Text Color Off (CTextColorOff)

Came In - Text Color Off (CTextColorOff)

The "Came In - Text Color Off" attribute specifies for the selected message type which color the text of the button assumes for flashing status "Off" when a message comes in.

The "Came In - Text Color Off" attribute can be made dynamic using the name "CTextColorOff".

3.11.13.23 Came In - Text Color Off (MCKOTextColorOff)

Came In - Text Color Off (MCKOTextColorOff)

The "Came In - Text Color Off" attribute specifies for the selected message type which color the text of the button assumes for the flashing status "Off" when a message comes in.

The "Came In - Text Color Off" attribute can be made dynamic using the name "MCKOTextColorOff".

3.11.13.24 Came In - Text Color On (CTextColorOn)

Came In - Text Color On (CTextColorOn)

The "Came In - Text Color On" attribute specifies for the selected message type which color the text of the button assumes for flashing status "On" when a message comes in.

The "Came In - Text Color On" attribute can be made dynamic using the name "CTextColorOn".

3.11.13.25 Came In - Text Color On (MCKOTextColorOn)

Came In - Text Color On (MCKOTextColorOn)

The "Came In - Text Color On" attribute specifies for the selected message type which color the text of the button assumes for the flashing status "On" when a message comes in.

The "Came In - Text Color On" attribute can be made dynamic using the name "MCKOTextColorOn".

3.11.13.26 Came In Acknowledged - Background Flashing (CQBackFlash)

Came In Acknowledged - Background Flashing (CQBackFlash)

The "Came In Acknowledged - Background Flashing" attribute specifies for the selected message type and the status "Came In Acknowledged" whether the background of the value to be displayed flashes when the arrival of a message is acknowledged.

Yes	The background of the value to be displayed flashes when the arrival of a message is acknowledged.
No	The background of the value to be displayed does not flash when the arrival of a message is acknowledged.

The "Came In Acknowledged - Background Flashing" attribute can be made dynamic using the name "CQBackFlash".

3.11.13.27 Came In Acknowledged - Background Flashing (MCKQBackFlash)

The "Came In Acknowledged - Background Flashing" attribute specifies for the selected message type whether the background of the button flashes when the arrival of a message is acknowledged.

Yes	The background of the button flashes when the arrival of a message is acknowledged.
No	The background of the button does not flash when the arrival of a message is acknowledged.

The "Came In Acknowledged - Background Flashing" attribute can be made dynamic using the name "MCKQBackFlash".

3.11.13.28 Came In Acknowledged - Background Color Off (CQBackColorOff)

Came In Acknowledged - Background Color Off (CQBackColorOff)

The "Came In Acknowledged - Background Color Off" attribute specifies for the selected message type and the status "Came In Acknowledged" which color the background of the value to be displayed assumes for flashing status "Off" when the arrival of a message is acknowledged.

The "Came In Acknowledged - Background Color Off" attribute can be made dynamic using the name "CQBackColorOff".

3.11.13.29 Came In Acknowledged - Background Color Off (MCKQBackColorOff)

Came In Acknowledged - Background Color Off (MCKQBackColorOff)

The "Came In Acknowledged - Background Color Off" attribute specifies for the selected message type which color the background of the button assumes for the flashing status "Off" when the arrival of a message is acknowledged.

The "Came In Acknowledged - Background Color Off" attribute can be made dynamic using the name "MCKQBackColorOff".

3.11.13.30 Came In Acknowledged - Background Color On (CQBackColorOn)

Came In Acknowledged - Background Color On (CQBackColorOn)

The "Came In Acknowledged - Background Color On" attribute specifies for the selected message type and the status "Came In Acknowledged" which color the background of the value to be displayed assumes for flashing status "On" when the arrival of a message is acknowledged.

The "Came In Acknowledged - Background Color On" attribute can be made dynamic using the name "CQBackColorOn".

3.11.13.31 Came In Acknowledged - Background Color On (MCKQBackColorOn)

Came In Acknowledged - Background Color On (MCKQBackColorOn)

The "Came In Acknowledged - Background Color On" attribute specifies for the selected message type which color the background of the button assumes for the flashing status "On" when the arrival of a message is acknowledged.

The "Came In Acknowledged - Background Color On" attribute can be made dynamic using the name "MCKQBackColorOn".

3.11.13.32 Came In Acknowledged - Text Flashing (CQTextFlash)

Came In Acknowledged - Text Flashing (CQTextFlash)

The "Came In Acknowledged - Text Flashing" attribute specifies for the selected message type and the status "Came In Acknowledged" whether the text of the value to be displayed flashes when the arrival of a message is acknowledged.

Yes	The text of the value to be displayed flashes when the arrival of a message is acknowledged.
No	The text of the value to be displayed does not flash when the arrival of a message is acknowledged.

The "Came In Acknowledged - Text Flashing" attribute can be made dynamic using the name "CQTextFlash".

3.11.13.33 Came In Acknowledged - Text Flashing (MCKQTextFlash)

Came In Acknowledged - Text Flashing (MCKQTextFlash)

3.11 Object properties

The "Came In Acknowledged - Text Flashing" attribute specifies for the selected message type whether the text of the button flashes when the arrival of a message is acknowledged.

Yes	The text of the button flashes when the arrival of a message is acknowledged.
No	The text of the button does not flash when the arrival of a message is acknowledged.

The "Came In Acknowledged - Text Flashing" attribute can be made dynamic using the name "MCKQTextFlash".

3.11.13.34 Came In Acknowledged - Text Color Off (CQTextColorOff)

Came In Acknowledged - Text Color Off (CQTextColorOff)

The "Came In Acknowledged - Text Color Off" attribute specifies for the selected message type and the state "Came In Acknowledged" which color the text of the value to be displayed assumes for flashing status "Off" when the arrival of a message is acknowledged.

The "Came In Acknowledged - Text Color Off" attribute can be made dynamic using the name "CQTextColorOff".

3.11.13.35 Came In Acknowledged - Text Color Off (MCKQTextColorOff)

Came In Acknowledged - Text Color Off (MCKQTextColorOff)

The "Came In Acknowledged - Text Color Off" attribute specifies for the selected message type which color the text of the button assumes for the flashing status "Off" when the arrival of a message is acknowledged.

The "Came In Acknowledged - Text Color Off" attribute can be made dynamic using the name "MCKQTextColorOff".

3.11.13.36 Came In Acknowledged - Text Color On (CQTextColorOn)

Came In Acknowledged - Text Color On (CQTextColorOn)

The "Came In Acknowledged - Text Color On" attribute specifies for the selected message type and the status "Came In Acknowledged" which color the text of the value to be displayed assumes for flashing status "On" when the arrival of a message is acknowledged.

The "Came In Acknowledged - Text Color On" attribute can be made dynamic using the name "CQTextColorOn".

3.11.13.37 Came In Acknowledged - Text Color On (MCKQTextColorOn)

Came In Acknowledged - Text Color On (MCKQTextColorOn)

The "Came In Acknowledged - Text Color On" attribute specifies for the selected message type which color the text of the button assumes for the flashing status "On" when the arrival of a message is acknowledged.

The "Came In Acknowledged - Text Color On" attribute can be made dynamic using the name "MCKQTextColorOn".

3.11.13.38 Using global alarm classes (UseGlobalAlarmClasses)

Using global alarm classes (UseGlobalAlarmClasses)

Defines whether to use ob globally configured alarm classes to visualize message events. The property is only relevant to PCS7 projects.

Yes	Activates the global settings made in PCS7 alarm editor for visualizing the message events.
No	Visualization of the message events is defined locally for each message class.

The property cannot be assigned dynamic functionality.

3.11.13.39 Message Type (MessageClass)

Message Type (MessageClass)

The "Message Type" attribute shows all message types that can be configured for the group display and the extended analog and status display. They configure the type of message using a bit in the group value.

For each message type, you can configure the following attributes for the statuses "Came in", "Came in acknowledged" and "Went unacknowledged":

- Font color
- Background color
- Flashing text
- Flashing background

A change of attribute applies to the selected message type.

The "Message Type" attribute can be made dynamic with the name "MessageClass".

3.11.14 The "Object" Property Group

3.11.14.1 Layer (Layer)

Layer (Layer)

The "Layer" attribute specifies the position of an object in the picture.

In the Graphics Designer, a picture consists of 32 layers in which the objects can be inserted. Objects of the layer 0 are located at the screen background, while objects of the layer 32 are located in the foreground.

Depending on certain events, the Layer object can be used with VBScript to obtain access to the properties of a complete layer in order, for example, to hide or unhide a layer with operating elements according to the operator authorization. More information is available in the VBS Reference in the Information System.

0 - 31	There is a free choice of layer for each object.
--------	--

The "Layer" attribute cannot be changed in Runtime. However, layers can be hidden or unhidden in Runtime.

3.11 Object properties

The following WinCC controls are displayed in separate windows and cannot be integrated in the picture layer system:

- WinCC OnlineTableControl
- WinCC OnlineTrendControl
- WinCC UserArchiveControl
- WinCC AlarmControl
- WinCC FunctionTrendControl
- WinCC RulerControl
- .Net Control
- WinCC Web Control
- Application window

You can assign a layer to these controls, but this setting will be ignored in Runtime.

3.11.14.2 Faceplate Type FPT

Faceplate Type FPT

The "Faceplate type" attribute shows the file name of the respective faceplate type.

The attribute is defined by selecting the faceplate type and cannot be changed.

The "Faceplate type" attribute cannot be made dynamic.

3.11.14.3 Window Contents (Application)

Window Contents (Application)

The "Window Contents" attribute specifies for an application window which application is to be displayed. Application windows can be supplied from applications of the Global Script and the report system. In Runtime, these applications open an application window, transfer information and enable operation.

Global Scripts	The application window is supplied by applications of the Global Script.
Print Jobs	The application window is supplied by the report system.

The "Window Contents" attribute cannot be made dynamic.

3.11.14.4 Object Name (ObjectName)

Object Name (ObjectName)

The "Object Name" attribute specifies the name of an object in the picture. The object name is unique within a picture and, for example, is used in the project engineering of C actions for the call instruction of the object.

When an object is inserted, the object name assigned as standard is the description of the object type with a consecutive number. This name can be changed using the "Object Name" attribute.

There is a free choice of object name and it can have a length of up to 128 characters without restriction.

The "Object Name" attribute cannot be made dynamic.

3.11.14.5 Template (Template)

Template (Template)

The "Template" attribute specifies for an application window which template is to be used for display of the window contents. The available templates depend on the value of the "Window Contents" attribute.

Application windows can be supplied from applications of the Global Script and the report system.

GSC Diagnostics	The application window is supplied by applications of the Global Script. The results of the diagnosis system are displayed.
GSC Runtime	The application window is supplied by applications of the Global Script. The analysis results regarding characteristics in Runtime are displayed.
All Jobs	The application window is supplied by the report system. The available reports are displayed as a list.
All Jobs – Shortcut Menu	The application window is supplied by the report system. The available reports are displayed as a list. The shortcut menu enables the selection of print options, display of a print preview as well as a printout of the log.
Job Detail View	The application window is supplied by the report system. The available reports are displayed in a selection menu. Detailed information is displayed for the selected report.
Selected Jobs - Shortcut Menu	The application window is supplied by the logging system. The available reports are displayed as a list. This list only contains reports which you have activated the option "Mark for print job list" in the "Print Job Properties" dialog. The shortcut menu enables the selection of print options, display of a print preview as well as a printout of the log.

The "Template" attribute cannot be made dynamic.

3.11.15 "Font" Property Group

3.11.15.1 Bold (FontBold)

Bold (FontBold)

The "Bold" attribute specifies whether or not the text in an object is displayed as bold.

Yes	The text is displayed in bold face.
No	The text is not displayed in bold face.

The "Bold" attribute can be made dynamic with the name "FontBold".

3.11.15.2 Format (Format)

Format (Format)

3.11 Object properties

The "Format" attribute shows in which format the value of the analog display is displayed.

No Character	Displays the number without formatting.
(0)	Displays a digit or a zero.
(#)	Displays a digit or no output.
(.)	Placeholder for decimal character.
(%)	Placeholder for percentage.
(,)	Thousand separator.
((E- E+ e- e+)	Scientific format.
- + \$ ()	Display of a literal character.
(\)	Display the next character in the format character sequence.
(("ABC")	Displays the string in inverted commas (" ").

The "Format" attribute can be made dynamic with the name "Format".

3.11.15.3 Index (Index)

Index (Index)

The "Index" attribute is a help attribute that is used in the "Object properties" dialog for accessing text of fields or lines of the object.

- The number of the fields of an object is defined with the "Number of Boxes" attribute in the "Geometry" properties group to determine the supply of values for the "Index" attribute.
- The number of the lines of an object is defined with the "Number of rows" attribute in the "Geometry" properties group to determine the supply of values for the "Index" attribute.

Use the "Index" attribute to set the position number of the field or the line that you want to display or edit. The content of the field or the line is shown as a value of the "Text" attribute. Changing the "Index" attribute also changes the displayed value of the "Text" attribute.

1 - "Number of Boxes"	Check Box, Radio Box
1 - "Number of rows"	Combination field, List field

The "Index" attribute can be made dynamic with the name "Index".

3.11.15.4 Italic (FontItalic)

Italic (FontItalic)

The "Italic" attribute specifies whether or not the text in an object is displayed in italics.

Yes	The text is displayed in italic.
No	The text is not displayed in italic.

The "Italic" attribute can be made dynamic with the name "FontItalic".

3.11.15.5 Text Orientation (Orientation)**Text Orientation (Orientation)**

The "Text Orientation" attribute specifies whether a text appears with a vertical or horizontal orientation. Changing the attribute only changes the position of the text within an object, while the object itself remains unchanged.

Horizontal	The orientation of the text is from left to right.
Vertical	The orientation of the text is from top to bottom.

The "Text Orientation" attribute can be made dynamic with the name "Orientation".

3.11.15.6 Text (Text)**Text (Text)**

The "Text" attribute specifies the text for a text field. Here, for example, buttons can be labeled. In the case of the objects "Check Box" and "Option Group", each text field is selected individually via the "Index" attribute.

Line breaks must be entered manually: You can create a line break with either <SHIFT+ENTER> or <CTRL+M>.

A line brake is shown in the "Object Properties" window in the "Static" column as a control character.

A text of any length can be entered. A meaningful limit results from the object size.

The "Text" attribute can be made dynamic with the name "Text".

3.11.15.7 Underline (FontUnderline)**Underline (FontUnderline)**

The "Underline" attribute specifies whether or not the text in an object is displayed as underlined.

Yes	The text is displayed as underlined.
No	The text is not displayed as underlined.

The "Underline" attribute can be made dynamic with the name "FontUnderline".

3.11.15.8 X alignment (AlignmentLeft)**X alignment (AlignmentLeft)**

The "X Alignment" attribute specifies the horizontal alignment of a text in an object. Changing the attribute only changes the position of the text within an object, while the object itself remains unchanged.

On left	The text is aligned to the left in the object.
centered	The text is centered horizontally in the object.
right	The text is aligned to the right in the object.

The "X Alignment" attribute can be made dynamic with the name "AlignmentLeft".

3.11.15.9 Y alignment (AlignmentTop)

Y alignment (AlignmentTop)

The "Y Alignment" attribute specifies the vertical alignment of a text in an object. Changing the attribute only changes the position of the text within an object, while the object itself remains unchanged.

top	The text is aligned to the top of the object.
centered	The text is centered vertically in the object.
bottom	The text is aligned to the bottom of the object.

The "Y Alignment" attribute can be made dynamic with the name "AlignmentTop".

3.11.15.10 Font (FontName)

Font (FontName)

The "Font" attribute specifies in which font a text appears. You can use every font that is installed in the Windows operating system.

If a selected font is not available on a system, the text is automatically displayed in "Arial".

Any of the fonts installed in the Windows operating system can be selected.

The "Font" attribute can be made dynamic with the name "Font Name".

3.11.15.11 Font Size (FontSize)

Font Size (FontSize)

The "Font Size" attribute specifies in which font size a text appears. The values are specified in points.

The "Font Size" attribute can be made dynamic with the name "FontSize".

3.11.16 "Miscellaneous" Property Group

3.11.16.1 Others - A to B

Update Cycle (UpdateCycle)

Update Cycle (UpdateCycle)

The "Update Cycle" attribute defines the type and the frequency for updating a process picture.

The value specified here corresponds to the "picture cycle", which can be set as the update cycle for individual objects. In this case, the display of these objects will be updated at the same time as the display of the process picture.

The "Update Cycle" attribute cannot be made dynamic.

Update Cycle (UpdateCycle)

Update Cycle (UpdateCycle)

The "Update Cycle" defines the type and the frequency of the update for a picture window.

The "Update Cycle" attribute cannot be made dynamic.

Display (Visible)

Display (Visible)

The "Display" attribute specifies whether or not a process picture is displayed in Runtime.

Yes	The process picture is displayed in Runtime.
No	The process picture is not displayed in Runtime.

The "Display" attribute can be made dynamic with the name "Visible".

Display (Visible)

Display (Visible)

The "Display" attribute specifies whether or not an object is displayed in Runtime.

Yes	The object is displayed in Runtime.
No	The object is not displayed in Runtime.

The "Display" attribute can be made dynamic with the name "Visible".

Display name (DisplayName)

Display name (DisplayName)

Specifies the user-defined name of the process picture. The attribute is of type "Multilingual String". You can specify names for all languages installed in WinCC.

The logon name is displayed in the following cases:

WinCC Explorer	"Details" view in the data window	"Display name" column
	"Large Icons" view in the data window	Process picture preview
WinCC Runtime	"Favorites" system dialog	Process picture preview
	Picture Tree	Container name

The "Display name" attribute cannot be made dynamic.

Display Options (DisplayOptions)

Display Options (DisplayOptions)

3.11 Object properties

The "Display Options" attribute specifies whether a button will be allocated with a picture or text or both.

0	Picture or text: If a picture exists, the button is assigned with the picture, otherwise it is assigned with text.
1	Picture and text
2	Text only
3	Picture only

The "Display Options" attribute can be made dynamic with the name "DisplayOptions".

Assembly Info

Assembly Info

Displays the information of the object registered in the Global Assembly Cache. The information is made up of "Assembly", "Version", "Culture" and "PublicKeyToken".

If the object is not registered in the Global Assembly Cache, the path of the object is only displayed in "Assembly".

The "Assembly Info" attribute cannot be made dynamic.

Operator-Control Enable (Operation)

Operator-Control Enable (Operation)

The "Operator-Control Enable" attribute specifies whether or not a process picture can be operated in Runtime.

In order to be able to operate a process picture, the operator must have the relevant authorization. You specify this with the "Authorization" attribute.

Yes	The process picture can be operated in Runtime.
No	The process picture cannot be operated in Runtime.

The "Operator-Control Enable" attribute can be made dynamic with the name "Operation".

Operator-Control Enable (Operation)

Operator-Control Enable (Operation)

The "Operator-Control Enable" attribute specifies whether or not an object can be operated in Runtime.

In order to be able to operate an object, the operator must have the relevant authorization. You specify this with the "Authorization" attribute.

Yes	The object can be operated in Runtime.
No	The object cannot be operated in Runtime.

The "Operator-Control Enable" attribute can be made dynamic with the name "Operation".

Operator Message (OperationMessage)

Operator Message (OperationMessage)

The "Operator Input Message" attribute specifies whether or not a message is displayed after operation of the object. The object must be connected to a tag.

If the attribute "Operator Input Message" has been set to "yes", a message is generated upon operation, sent to the message system and archived. Using the message system, a message may be output in a message line, for example.

So that the operator can enter a reason for the operation after its completion, the "Operator Activities Report" attribute must be enabled. The reason for the operator input is displayed as a comment for the operator input message in the long-term archive list.

Yes	An operator output message is displayed.
No	An operator output message is not displayed.

The "Operator Message" attribute can be made dynamic with the name "OperationMessage".

Operator Activities Report (OperationReport)

Operator Activities Report (OperationReport)

The "Operator Activities Report" attribute specifies whether the reason for an operation will be logged by the operator. The operator activities report is archived in the message system. The reason for the operator input is displayed as a comment for the operator input message in the long-term archive list.

Yes	The reason for the operation is logged. On operation of the object, a dialog opens in Runtime in which the operator can enter a text.
No	The reason for the operation is not logged.

The "Operator Activities Report" attribute can be made dynamic with the name "OperationReport".

Operation Steps (SmallChange)

Operation Steps (SmallChange)

The "Operation Steps" attribute specifies for the slider the number of steps the slider is moved in the corresponding direction with one mouse-click on the slide surface.

The number of times to click on the slider surface for the slider to move from one end to the other is calculated as follows: ("maximum value" - "minimum value") / "operation steps".

Example: Where maximum value = 100, minimum value = 0, operation steps = 25 the slider surface must be clicked four times to move the slider from one end to the other.

With one mouse-click on the slide surface, the slider can be set to the minimum or maximum value if the "Extended Operation" attribute has the value "Yes".

There is a free choice of value.

The "Operation Steps" attribute can be made dynamic with the name "SmallChange".

User for the electronic signature (AuthorizedGroups)

User for the electronic signature (AuthorizedGroups)

The attribute "User for the electronic signature" specifies which user can sign an operation.

In Runtime, the configured user authenticates him or herself with the password during operation. The user has the option to enter a comment which is saved with the triggered system message.

In the "Selection" dialog, select the users in the "User group" column. To activate the drop-down list, select the empty row in the "Group" column.

The "User for the electronic signature" attribute can be dynamized with the "AuthorizedGroups" name.

WinCC/Audit: Additional options

With WinCC/Audit, you can select multiple users and group them via operands and parentheses.

The option "Later" allows signing after the operation.

User Value (UserValue1)

User Value (UserValue1)

The "User Value 1" to "User Value 4" attributes make it possible to enter sample values for a group display. Any values can be entered and, for example, evaluated in a script. In Runtime, the entered user values are neither displayed nor evaluated.

0 (232-1)	The value can be chosen freely within the specified limits.
-----------	---

The "User Value 1" attribute can be made dynamic with the name "UserValue1".

The "User Value 2" attribute can be made dynamic with the name "UserValue2", etc.

Authorization (PasswordLevel)

Authorization (PasswordLevel)

The User Administrator editor is used in WinCC to assign authorizations for the users. In the Graphics Designer, an authorization can be assigned for each process picture, which means that this process picture can only be operated by those users who have the corresponding authorization.

So that a process picture can be operated, the "Operator-Control Enable" attribute must have the value "Yes".

The "Authorization" attribute can be made dynamic with the name "PasswordLevel".

Authorization (PasswordLevel)

Authorization (PasswordLevel)

The User Administrator editor is used in WinCC to assign authorizations for the users. In the Graphics Designer, an authorization can be assigned for each object, which means that this object can only be operated by those users who have the corresponding authorization.

So that an object can be operated, the "Operator-Control Enable" attribute must have the value "Yes".

The "Authorization" attribute can be made dynamic with the name "PasswordLevel".

Preferred picture target (PreferredTarget)

Preferred picture target (PreferredTarget)

The "Preferred picture target" attribute specifies where the picture change is carried out by the Favorites browser.

Yes	The picture change is carried out in this picture window. In the case of nested picture windows, the picture change is carried out in the innermost picture window with the "Yes" setting.
No	The picture change is carried out in the main screen.

The "Preferred picture target" attribute can be made dynamic with the name "PreferredTarget".

Adapt Picture (AdaptPicture)

Adapt Picture (AdaptPicture)

The "Adapt Picture" attribute specifies whether or not the picture displayed in a picture window adapts to the size of the picture window in Runtime.

Yes	The picture adapts to the size of the picture window in Runtime.
No	The picture does not adapt to the size of the picture window in Runtime.

The "Adapt Picture" attribute cannot be made dynamic.

Picture Status Off (PictureUp)

Picture Status Off (PictureUp)

A button can have one of two statuses: "On" or "Off".

For each status, a picture to be displayed can be selected. Pictures with the following formats can be inserted: BMP, DIB, ICO, CUR, EMF, WMF, GIF and JPG.

In order to cancel an existing assignment, the "Cancel Selection" button must be clicked in the "Picture Selection" dialog.

The "Picture Status Off" attribute can be made dynamic with the name "PictureUp".

Picture Status On (PictureDown)

Picture Status On (PictureDown)

A button can have one of two statuses: "On" or "Off".

For each status, a picture to be displayed can be selected. Pictures with the following formats can be inserted: BMP, DIB, ICO, CUR, EMF, WMF, GIF and JPG.

3.11 Object properties

In order to cancel an existing assignment, the "Cancel Selection" button must be clicked in the "Picture Selection" dialog.

The "Picture Status On" attribute can be made dynamic with the name "PictureDown".

Picture Name (PictureName)

Picture Name (PictureName)

The "Picture Name" attribute specifies which picture is displayed in a picture window. Only pictures of the format PDL that belong to the current project can be inserted.

If no picture to be displayed is defined for a picture window, the picture window is not displayed in Runtime.

In the Graphics Designer, the picture appears in the picture window above the name and in the center of the preview. If the picture does not exist, the "PDL" symbol appears.

The "Picture Name" attribute can be made dynamic with the name "PictureName".

Picture Offset X (OffsetLeft)

Picture Offset X (OffsetLeft)

A process picture that is embedded in a picture window can only be displayed as a zoom area. The origin of this zoom area is determined by the "Picture Offset X" and "Picture Offset Y" attributes.

The "Picture Offset X" specifies the horizontal coordinates for the origin of the zoom area. The values are specified in pixels.

There is a free choice of value. A meaningful limit results from the size of the integrated picture.

The "Picture Offset X" attribute can be made dynamic with the name "OffsetLeft".

Picture Offset Y (OffsetTop)

Picture Offset Y (OffsetTop)

A process picture that is embedded in a picture window can only be displayed as a zoom area. The origin of this zoom area is determined by the "Picture Offset X" and "Picture Offset Y" attributes.

The "Picture Offset Y" specifies the vertical coordinates for the origin of the zoom area. The values are specified in pixels.

There is a free choice of value. A meaningful limit results from the size of the integrated picture.

The "Picture Offset Y" attribute can be made dynamic with the name "OffsetTop".

Picture scaling mode

Picture scaling mode

Specifies how the picture window reacts to zooming. If the image resolution of the computer is different in Runtime, this can result in different picture sizes, because the picture window zooms with a fixed aspect ratio.

Uniform	The content is zoomed to the smallest page. The picture can be fully viewed in the picture window. When the aspect ratio differs, the picture does not fill the picture window.
Uniformly filled	The content is zoomed to the largest page. The picture fills the picture window. When the aspect ratio differs, parts of the picture are cropped.

The "Picture scaling mode" attribute cannot be assigned dynamic properties.

Bit Pattern Group Display (SignificantMask)

Bit Pattern Group Display (SignificantMask)

The value of the attribute is an internal system output value. The value is updated if the group display is clicked for a loop-in-alarm.

The "Bit Pattern Group Display" attribute should not be made dynamic by the user.

3.11.16.2 Others - C to O

Control Type

Control Type

Displays the name space of the control.

The "Control type" attribute cannot be made dynamic.

Cursor Mode

Cursor mode

The "Cursor Mode" attribute specifies whether a process picture is operated in Runtime by means of an "Alpha Cursor" or a "Tab Order".

The cursor mode can be toggled in Runtime if a hotkey is configured for the toggle.

Alpha-Cursor	Operation in Runtime is by means of the Alpha Cursor.
Tab order cursor	Operation in Runtime is by means of Tab Order.

The "Cursor Mode" attribute cannot be made dynamic.

Cursor Control (CursorControl)

Cursor Control (CursorControl)

The "Cursor Control" attribute specifies whether the Alpha Cursor automatically jumps to the next field in the TAB sequence after an entry has been made in a field. This function enables rapid input in different fields without having to use the tab key to jump.

Yes	The cursor automatically jumps to the next field of the TAB sequence after the input has been made.
No	The cursor does not automatically jump to the next field of the TAB sequence after the input has been made.

The "Cursor Control" attribute can be made dynamic with the name "CursorControl".

Date of Last Change

Date of last change

The "Date of Last Change" attribute shows the date on which the process picture was last saved.

The "Date of Last Change" attribute cannot be made dynamic.

Immediate Input (EditAtOnce)

Immediate Input (EditAtOnce)

The "Immediate Input" attribute specifies for input fields whether or not a direct change is made into the input mode on jumping to the object.

Yes	When the focus moves to the object, the input mode is immediately active.
No	When the focus moves to the object, the input mode is not immediately active.

The "Immediate Input" attribute can be made dynamic with the name "EditAtOnce".

Limited cursor movement (RestrictedCursorMovement)

Limited cursor movement (RestrictedCursorMovement)

The "Limited cursor movement" attribute specifies whether the cursor is fixed on the left-hand side in the I/O field. This corresponds to the default setting when opening the I/O field. As a result, negative values are always displayed correctly. You enter the values with decimal places regardless of the cursor position. You no longer have any possibility to change the position during the entry. The decimal place shown in the I/O field is hidden during the entry of a decimal place.

Yes	The cursor movement is restricted in the I/O field. The cursor is fixed on the left-hand side.
No	The cursor movement is not restricted in the I/O field.

The "Limited cursor movement" attribute can be made dynamic with the "RestrictedCursorMovement" name.

Activate electronic signature (ElectronicSignature)**Activate electronic signature (ElectronicSignature)**

The "Activate electronic signature" attribute determines whether a signature is required during operation in Runtime. With the "User for the electronic signature" property, you define which user can sign the operation.

Yes	An electronic signature is required when the object or control is operated.
No	Operation is possible without an electronic signature.

The "Activate electronic signature" attribute can be made dynamic with the name "ElectronicSignature".

Extended Operation (ExtendedOperation)**Extended Operation (ExtendedOperation)**

The "Extended Operation" attribute specifies whether the slider jumps on the slide surface in one step to the minimum value or maximum value when clicked.

Yes	With one mouse-click on the slide surface, the slider jumps to the minimum value or maximum value.
No	With a mouse-click on the slide surface, the slider is moved in the corresponding direction by the value set in the "Operation Steps" attribute.

The "Extended Operation" attribute can be made dynamic with the name "ExtendedOperation".

Extended Zooming (ExtendedZoomingEnable)**Extended Zooming (ExtendedZoomingEnable)**

The "Extended Zooming" specifies whether the picture can be zoomed in on or out of for the selected process picture with the mouse wheel. Requirements for using the zoom function:

- a mouse driver by Logitech or Microsoft Intellimouse
- the mouse wheel must be set to "Autoscroll".
- The "Extended Zooming" function must be enabled in the "Graphics Runtime" tab of the "Computer Properties" dialog for all process pictures.

Yes	The mouse wheel can be used to zoom in on or out of the picture. Press the <CTRL> key in Runtime, while you turn the mouse wheel. If you turn the mouse wheel away from the palm of your hand, you increase the zoom factor.
No	Rotating the mouse wheel does not zoom in on or out of the picture, even if extended zooming is enabled for all process pictures.

The "Extended Zooming" attribute can be made dynamic with the name "ExtendedZoomingEnable".

Change Color (ColorChangeType)**Change Color (ColorChangeType)**

3.11 Object properties

The "Change Color" attribute specifies for the "Bar" object whether a color change is run segment-wise or for the entire bar. With segment-wise display, for example, it is possible to visualize which limits are exceeded by the displayed value.

Total	When a limit is reached, the entire bar changes color.
Segment	When a limit is reached, the bar changes segment by segment. The color allocation takes place in accordance with the settings in the "Limits" property group.

The "Change Color" attribute can be made dynamic with the name "ColorChangeType".

Adapt Size (AdaptSize)

Adapt Size (AdaptSize)

The "Adapt Size" attribute specifies whether or not the picture window adapts to the size of the embedded picture in Runtime.

Yes	The picture window adapts to the size of the picture in Runtime.
No	The picture window does not adapt to the size of the picture in Runtime.

The "Adapt Size" attribute cannot be made dynamic.

Windows Position Mode

Windows Position Mode

The "Window mode" attribute defines the position and scaling of the picture window on the screen.

It is only effective if the "Independent window" attribute is set to "Yes".

- Standard The picture window is positioned in its original size in the configured position on the screen.
- Center The picture window is positioned in its original size, centered on the screen.
- Maximize The picture window is scaled to the size of the screen.

Constraint

In WebUX Runtime the attribute does not have any effect on the picture window display since this WinCC option does not support independent windows.

Outgoing State Visible (AlarmGoneVisible)

Outgoing State Visible (AlarmGoneVisible)

The attribute "Outgoing State Visible" defines for an object whether an outgoing state is visible or not.

Yes	The outgoing state is visible
No	The outgoing state is suppressed

The "Outgoing State Visible" attribute can be made dynamic with the name "AlarmGoneVisible".

Sizeable (Sizeable)**Sizeable (Sizeable)**

The "Sizeable" attribute specifies whether or not the size of a window can be changed in Runtime.

Yes The size of the window can be changed in Runtime.

No The size of the window cannot be changed in Runtime.

The "Sizeable" attribute cannot be made dynamic.

Hotkey (Hotkey)**Hotkey (Hotkey)**

As an alternative to operation with the mouse, a button can also be triggered using the keyboard.

To do so, a hotkey must be set.

If a hotkey has been defined for a button, an arrow is displayed in the object properties beside the "Hotkey" attribute.

The "Hotkey" attribute cannot be made dynamic.

Hysteresis (Hysteresis)**Hysteresis (Hysteresis)**

So that a color change is not triggered immediately in the case of a slight limit violation, the "Hysteresis" and "Hysteresis Range" attributes can be used to define a distribution range for the display of the value.

The "Hysteresis" attribute specifies for the "Bar" object whether the display with hysteresis is permitted or not.

Set the hysteresis value with the "Hysteresis Range" attribute.

Yes	Display with hysteresis.
No	Display without hysteresis.

The "Hysteresis" attribute can be made dynamic with the name "Hysteresis".

Hysteresis Range (HysteresisRange)**Hysteresis Range (HysteresisRange)**

So that a color change is not triggered immediately in the case of a slight limit violation, the "Hysteresis" and "Hysteresis Range" attributes can be used to define a distribution range for the display of the value.

The "Hysteresis Range" attribute specifies for the "Bar" object the hysteresis as a percentage of the display range.

The "Hysteresis Range" attribute can be made dynamic with the name "HysteresisRange".

Maximum Value (Max)

Maximum Value (Max)

The "Maximum Value" attribute specifies the absolute value for display of the largest value for bars, 3D bars and sliders.

The hysteresis range is only taken into account if the "Hysteresis" attribute has the value "Yes".

There is a free choice of value.

The "Maximum Value" attribute can be made dynamic with the name "Max".

Can Be Maximized (MaximizeButton)

Can Be Maximized (MaximizeButton)

The "Can Be Maximized" attribute specifies whether or not a window can be enlarged to the maximum screen size in Runtime.

The attributes "Can Be Maximized" and "Can Be Closed" are displayed in the title bar; if one of the attributes has the value "Yes", the "Title" attribute is automatically assigned the value "Yes".

Yes	The window can be maximized in Runtime.
No	The window cannot be maximized in Runtime.

The "Can Be Maximized" attribute cannot be made dynamic.

Menu/Toolbar Configuration (MenuToolBarConfig)

Menu/Toolbar Configuration

Defines the configuration file using the user-defined menus and toolbars that are displayed in the picture screen.

The "Menu/Toolbar Configuration" attribute can be made dynamic using the ""MenuToolBarConfig"" name.

Minimum Value (Min)

Minimum Value (Min)

The "Minimum Value" attribute specifies the absolute value for display of the smallest value for bars, 3D bars and sliders.

There is a free choice of value.

The "Minimum Value" attribute can be made dynamic with the name "Min".

Average Value (Average)

Average Value (Average)

The "Average Value" attribute specifies whether or not a mean value of the last 10 values is formed for the "Bar" object. A value has to change for a new average value to be formed. The average value is reset when you change the picture. If only one value exists after you change

the picture, for example, the following average value is formed: $(5+0+0+0+0+0+0+0+0+0)/10=0,5$.

Yes	An average value of the last 10 values is formed.
No	An average value is not formed.

The "Average Value" attribute can be made dynamic with the name "Average".

Monitor number (WindowMonitorNumber)

Monitor number (WindowMonitorNumber)

The "Monitor number" attribute specifies the monitor that displays the picture window. This requires that your system supports more than one monitor.

The attribute is only effective if the "Independent window" attribute is set to "Yes".

1-n	The number of the monitor in the operating system on which the picture window is displayed.
-----	---

Constraint

In WebUX Runtime the attribute does not have any effect on the picture window display since this WinCC option does not support independent windows.

Zero Point Value (ZeroPointValue)

Zero Point Value (ZeroPointValue)

The "Zero Point Value" attribute specifies the absolute value for the zero point of bars or 3D bars.

The display of the zero point value on the scale is specified using the "Zero Point" attribute in the "Axis" property group.

There is a free choice of value within the limits of "minimum value" and "maximum value".

The "Zero Point Value" attribute can be made dynamic with the name "ZeroPointValue".

Folder for pictures (PictureDirectory)

Directory for pictures (PictureDirectory)

Specifies the name of the subdirectory that is created in the "GraCS" directory of the WinCC project.

If pictures are stored in the subdirectory, they are available for the extended status display. If no subdirectory is specified or the subdirectory does not contain any pictures, the pictures in the "GraCS" directory are taken into consideration.

The "Directory for pictures" attribute can be dynamized with the name "PictureDirectory".

3.11.16.3 Others - P to S

Password protection

The "Password protection" attribute can be assigned to any process picture or faceplate type.

enabled	The process picture or faceplate type is protected by password.
disabled	The process picture or faceplate type is not protected by password.

The "Password protection" attribute cannot be assigned dynamic properties.

Process Driver Connection (Process)

Process Driver Connection (Process)

If an object of the type "Bar", "3D Bar" or "Slider" is not embedded using a tag in the process, the object accesses a preset value in Runtime and displays this value.

The "Process Driver Connection" attribute specifies the default setting for the value to be displayed.

There is a free choice of value.

The "Process Driver Connection" attribute can be made dynamic with the name "Process".

Acknowledgment Sample (EventQuitMask)

Acknowledgment Sample (EventQuitMask)

The events "Operator request" and "Measuring point blocked" are not acknowledgeable events in the PCS 7 environment. Using the "@EventQuit" tag and the "Acknowledgment mask" attribute of the group display in Runtime, these events are automatically indicated as acknowledged to prevent flashing during the calculation of the group displays and the display of the area overview. The start value of the attribute is then 0x00000011 (17). The value of the "Acknowledgment mask" attribute should be identical for all group display objects, extended analog display and extended status display, and for the "@EventQuit" tag.

You can set the acknowledgment behavior of "Tolerance" in the OS Project Editor.

By setting other acknowledgment bits, you can indicate other events as being acknowledged as well with the display of the group display object and the extended analog and status display.

In the projects prior to WinCC V7.01 the events "ToleranceLow", "ToleranceHigh", "Operator Request" and "Measuring point blocked" are not acknowledgeable events in the PCS 7 environment. By default the tag has the start value 0x00000C11 (3089). These are precisely the acknowledgment bits for "ToleranceLow", "ToleranceHigh", "Operator Request" and "Measuring point blocked."

Border (WindowBorder)

Border (WindowBorder)

The "Border" attribute specifies whether or not an application window or picture window is to be displayed with a border.

If the "Sizeable" attribute for a window is set to the value "Yes", the "Border" attribute automatically assumes the value "Yes".

So that the picture window is displayed in Runtime, a picture must be embedded.

Yes	The window is displayed with a border.
No	The window is displayed without a border.

The "Border" attribute cannot be made dynamic.

Adapt Border (AdaptBorder)

Adapt Border (AdaptBorder)

The "Adapt Border" attribute defines for objects that contain text whether the field border adapts dynamically to the text size.

The dynamic change of the text in the field can cause the field size to change continuously in Runtime.

The performance in Runtime is higher if the "Adapt Border" attribute has the value "No".

Yes	The field border resizes dynamically to fit the text size.
No	The field border retains its size regardless of the text.

The "Flash Picture" attribute cannot be made dynamic.

Scroll Bars (ScrollBars)

Scroll Bars (ScrollBars)

The "Scroll Bars" attribute specifies whether or not a picture window is displayed with a scroll bar if required. This setting is only visible in Runtime.

The "Scroll Bars", "Adapt Size" and "Adapt Picture" attributes can influence one another.

Yes	The picture window is displayed in Runtime with scroll bars if the picture to be displayed does not fit in the picture window.
No	The picture window is always displayed in Runtime without scroll bars, even if the picture to be displayed does not fit in the picture window.

The "Scroll Bars" attribute cannot be made dynamic.

Scroll Bar Position X (ScrollPositionX)

Scroll Bar Position X (ScrollPositionX)

The "Scroll Bar Position X" attribute specifies the horizontal movement of the scroll bar position in a picture window with the scroll bar. The values are specified in pixels.

There is a free choice of value. A meaningful limit results from the size of the integrated picture.

The "Scroll Bar Position X" can be made dynamic with the name "ScrollPositionX".

Scroll Bar Position Y (ScrollPositionY)

Scroll Bar Position Y (ScrollPositionY)

The "Scroll Bar Position Y" attribute specifies the vertical movement of the scroll bar position in a picture window with the scroll bar. The values are specified in pixels.

There is a free choice of value. A meaningful limit results from the size of the integrated picture.

The "Scroll Bar Position Y" attribute can be made dynamic with the name "ScrollPositionY".

Group Relevant (Relevant)

Group Relevant (Relevant)

All displays in a class can be grouped hierarchically into a group display. This makes possible a rapid overview of alarms, warnings and malfunctions.

The "Group Relevant" attribute specifies for the object whether or not the object is taken into account for the formation of the group, extended analog or status display.

Yes	The object is taken into account for the formation of the group display.
No	The object is not taken into account for the formation of the group display.

The "Group Relevant" attribute can be made dynamic with the name "Relevant".

Collect Value (CollectValue)

Collect Value (CollectValue)

All displays in a class can be grouped hierarchically into a group display. This makes possible a rapid overview of alarms, warnings and malfunctions.

The "Collect Value" attribute specifies as an initial value the current status of the active message classes in each case.

So that an object of the group display type is taken into account for the formation of the group, extended analog or status display, the "Group Relevant" attribute must have the value "Yes". When a new group display is inserted, it has the collect value 65535 as start value. In this manner, you can ensure that at the start - from the view of the group display - there are no unacknowledged messages.

The group value is controlled by a tag. Other types of dynamization are not possible.

Use Group Value for Display (UseEventState)

Use Group Value for Display (UseEventState)

The "Use Group Value for Display" attributed defines for the extended status display whether the group value is evaluated for the display of the statuses.

If the group value is used, you can assign pictures for the individual alarm statuses.

Yes	The group value is taken into consideration for the display of the extended status display.
No	The group value is not taken into consideration for the display of the extended status display.

The attribute "Use Group Value for Display" can be made dynamic with the name "UseEventState".

Can be Closed (CloseButttton)

Can be Closed (CloseButttton)

The "Can Be Closed" attribute specifies whether or not a window can be closed in Runtime.

The attributes "Can Be Maximized" and "Can Be Closed" are displayed in the title bar; if one of the attributes has the value "Yes", the "Title" attribute is automatically assigned the value "Yes".

Yes	The window can be closed in Runtime.
No	The window cannot be closed in Runtime.

The "Can Be Closed" attribute cannot be made dynamic.

Selected text (SelText)

Selected text (SelText)

The "Selected text" attribute shows the text defined with the "Selected box" attribute, which is highlighted in the object.

You cannot directly change the "Selected text" attribute. You change the "Selected text" attribute by changing the "Selected box" attribute or the text itself in the "Font" properties group.

The "Selected text" attribute can be made dynamic with the name "SelText".

Selected box (SelIndex)

Selected box (SelIndex)

The "Selected box" attribute defines the index, the text of which is highlighted in the combination field or the list field.

1 - Number of rows	Index of the highlighted field
--------------------	--------------------------------

The "Selected Box" attribute can be made dynamic with the name "SelIndex".

Server Prefix (ServerPrefix)

Server Prefix (ServerPrefix)

Pictures that are embedded can be stored on any server in a multi-client system. Either the server is specified directly on embedding a picture, or assigned later via the object properties of the picture window.

The "Server Prefix" attribute specifies on which server the picture to be displayed in the picture window is located.

Changes to the server prefix only take effect when the picture is loaded once again. When the picture is changed, this occurs automatically, otherwise the picture name must be reassigned.

The "Server Prefix" attribute can be made dynamic with the name "ServerPrefix".

ServerName (ServerName)

ServerName (ServerName)

The "ServerName" attribute indicates under which name an embedded object is registered in the Windows operating system. A change of the registration is not possible in the Graphics Designer.

The "ServerName" attribute cannot be made dynamic.

Simulation (Simulation)

Simulation (Simulation)

With the "Simulation" attribute, you define the linking with any tag which is used for simulation.

The "Simulation" attribute can be made dynamic with the name "Simulation".

Simulation Bit (SimulationBit)

Simulation Bit (SimulationBit)

The "Simulation Bit" attribute shows the bit position of the linked simulation tags that are used for evaluation.

The value of the simulation tag is only evaluated with the alarm status "OK".

The "Simulation Bit" attribute can be made dynamic with the name "SimulationBit".

Scaling Factor (Zoom)

Scaling Factor (Zoom)

The "Scaling Factor" attribute sets the zoom factor for the display of the picture in the picture window. The values are specified as a percentage.

2 - 800	The value can be chosen freely within the specified limits.	
---------	---	--

The "Scaling Factor" attribute can be made dynamic with the name "Zoom".

Customized object scaling mode (ScalingMode)

Scaling mode (ScalingMode)

The "Scaling mode" attribute specifies how the internal objects of the customized object are displayed when the customized object is scaled.

proportional	The internal objects are scaled proportionally with respect to size, font size, and position. Controls do not support proportional scaling.
Not proportional	The internal objects are only repositioned with their size. The font size is not scaled. (default setting)

The "Scaling mode" attribute cannot be dynamized.

Note

The scaling mode is not taken into consideration in editing mode. The customized object is displayed in its original size.

Faceplate scaling mode (ScalingMode)**Scaling Mode**

The "Scaling mode" attribute defines the size to display the objects of the faceplate instance.

proportional	The faceplate type is scaled in proportion with the size of the faceplate instance.
1 : 1	The faceplate type is displayed in its original size when you insert a faceplate instance if the scaling mode of the default faceplate instance is set to "1 : 1".
Not proportional	The faceplate type is not scaled in proportion to the size of the faceplate instance.

The "Scaling mode" attribute cannot be made dynamic.

Configured Languages (DataLanguage)**Configured Languages (DataLanguage)**

The "Configured Languages" attribute specifies in which language variant an entry in a text object is displayed.

The "Configured Languages" attribute can only be modified if the individual languages have been set beforehand in the "View" "Languages" menu. With the "Configured Languages" attribute, configured languages can only be deleted, not added.

The "Configured Languages" attribute cannot be made dynamic.

Status (ProcessValue)**Status (ProcessValue)**

With the "Status" attribute, you define the linking with any tag.

The "Status" attribute can be made dynamic with the name "ProcessValue".

Status1 (Process)**Status1 (Process)**

In the "Status1" attribute, you can preset the first tag used for the calculation of the status value for the extended status display. In the configuration dialog of the extended status display, you can define the bit position taken into account for the status value calculation of this tag. This results in the statuses, to which you can then assign pictures.

The "Status1" attribute can be made dynamic with the name "Process".

Status2 (Process1)**Status2 (Process1)**

3.11 Object properties

In the "Status2" attribute, you can preset the second tag used for the calculation of the status value for the extended status display. In the configuration dialog of the extended status display, you can define the bit position taken into account for the status value calculation of this tag. This results in the statuses, to which you can then assign pictures.

The "Status2" attribute can be made dynamic with the name "Process1".

Status3 (Process2)

Status3 (Process2)

In the "Status3" attribute, you can preset the third tag used for the calculation of the status value for the extended status display. In the configuration dialog of the extended status display, you can define the bit position taken into account for the status value calculation of this tag. This results in the statuses, to which you can then assign pictures.

The "Status3" attribute can be made dynamic with the name "Process2".

Status4 (Process3)

Status4 (Process3)

In the "Status4" attribute, you can preset the fourth tag used for the calculation of the status value for the extended status display. In the configuration dialog of the extended status display, you can define the bit position taken into account for the status value calculation of this tag. This results in the statuses, to which you can then assign pictures.

The "Status4" attribute can be made dynamic with the name "Process3".

3.11.16.4 Others - T to Z

Tag (tag)

Tag (tag)

The "Tag" attribute is used for the Tool Graphic Object Update Wizard and is not evaluated for the object.

The "Tag" attribute can be made dynamic with the name "tag".

Tagname (tagname)

Tagname (tagname)

The attribute "Tag Name" is used for the Tool Graphic Object Update Wizard and is not evaluated for the object.

The "Tag Name" attribute can be made dynamic with the name "tagname."

Tagtype (tagtype)

Tagtype (tagtype)

The "Tag Type" attribute is used for the Tool Graphic Object Update Wizard and is not evaluated for the object.

The "Tag Type" attribute can be made dynamic with the name "tagtype."

Text Reference (LanguageSwitch)

Text Reference (LanguageSwitch)

The "Text Reference" attribute specifies where the language-dependent assignment texts are stored:

Yes	The texts are managed in the text library. They are translated into other languages in the text library.
No	The texts are managed directly in the object.

The "Text Reference" attribute cannot be made dynamic.

Title (Caption)

Title (Caption)

The "Title" attribute specifies whether a window is displayed in Runtime with or without a title bar.

The attributes "Can Be Maximized" and "Can Be Closed" are displayed in the title bar; if one of the attributes has the value "Yes", the "Title" attribute is automatically assigned the value "Yes".

Yes	In Runtime, the window is displayed with a title bar.
No	In Runtime, the window is displayed without a title bar.

The "Title" attribute cannot be made dynamic.

Tooltip text (ToolTipText)

Tooltip text (ToolTipText)

The "Tooltip text" attribute specifies the tooltip text to display in Runtime by positioning the mouse pointer on the object. The tooltip text can be entered for all available languages.

To define a tooltip text which contains the special character "&", enter three successive commercial ampersands, e.g. Save &&& Close

Two "&" have the effect of underlining the next character. This is only possible for one character per tooltip text. If you use the "&&" several times in a text, only the character after the last use of "&&" is underlined.

One "&" has no function.

The "Tooltip text" attribute can be assigned dynamic properties by means of the name "ToolTipText".

Trend (trend)

Trend (trend)

3.11 Object properties

The attribute "Trend" is used for the Tool Graphic Object Update Wizard and is not evaluated for the object.

The "Trend" attribute can be made dynamic with the name "trend."

Trend (Trend)

Trend (Trend)

The trend display enables a fast overview of changes for the bar. As standard, when the values shown in the scale are exceeded, a small arrow is displayed beside the scale to indicate that the measured value cannot be displayed on the scale. In order to avoid having to wait for the next update, an additional arrow can be shown on the other side of the bar to show the trend of the current movement of the bar.

The "Trend" attribute specifies whether or not the trend is displayed.

Yes	The trend is displayed.
No	The trend is not displayed.

The "Trend" attribute can be made dynamic with the name "Trend".

Header (CaptionText)

Header (CaptionText)

The "Header" attribute specifies which text appears in the title of a picture window.

The "Header" attribute can be made dynamic with the name "CaptionText".

Independent window

Independent window

The "Independent window" attribute defines whether the display of the picture window in runtime depends on the process picture in which the picture window was configured.

Yes	Size and position of the picture window are independent of the process picture and only defined by the "Window mode" attribute
No	Size and position of the picture window change with the shift or scaling of the process picture

Constraint

In WebUX Runtime the attribute does not have any effect on the picture window display since this WinCC option does not support independent windows.

Tag Prefix (TagPrefix)

Tag Prefix (TagPrefix)

WinCC offers a wide variety of possibilities to define and structure tags. For a picture window, a tag prefix can be assigned to precede all tags that are used in the picture. In this way, a picture that is embedded in a picture window retains access to its own tags while another accesses other tags.

The "Tag Prefix" attribute specifies the prefix that is placed before all tags present in the picture.

Changes to the tag prefix only take effect when the picture is loaded once again. When the picture is changed, this occurs automatically, otherwise the picture name must be reassigned.

The prefix can be freely defined, but must match the name of the structure tags. It must end with a period, for example "Structure2."

The "Tag Prefix" attribute can be made dynamic with the name "TagPrefix".

The TagPrefix property is not available for the controls.

No additional tag prefix can be specified in the child picture window

If a picture window is configured in a referenced picture of a picture window, the tag prefix of the parent picture window is adopted in the child picture window. You should not specify an additional tag prefix in the child picture window, since bundled structure tags are not supported in WinCC. The interpretation "TagPrefix1.TagPrefix2.TagName" cannot be used for dynamization.

Visualize tag status (ShowBadTagState)

Visualize tag status (ShowBadTagState)

The "Visualize tag status" attribute defines whether the graphic object is grayed out when a bad QualityCode or tag status is detected. For the two objects "extended analog display" and "extended status display", the attribute determines whether the settings for the attributes "Grid Color with Quality code: "bad" and "Grid Color with Quality code: "uncertain" are used.

Yes	If the quality code or the the tag status are poor, the object is grayed out or the settings for the grid color are used.
No	If the quality code or the the tag status are poor, the object is not grayed out or the settings for the grid color are not used.

The "Visualize tag status" attribute can be made dynamic with the name "ShowBadTagState".

Movable (Moveable)

Movable (Moveable)

The "Movable" attribute specifies whether or not a window can be moved in Runtime.

Yes	The window can be moved in Runtime.
No	The window can not be moved in Runtime.

The "Movable" attribute cannot be made dynamic.

Foreground (OnTop)

Foreground (OnTop)

The "Foreground" attribute specifies whether or not a window lies in the foreground. This setting is independent of the layer in which the window lies.

3.11 Object properties

If two windows overlap, and they both have the value "Yes" for the "Foreground" attribute, the settings exclude one another.

Yes	The window is always in the foreground.
No	The window is not always in the foreground.

The "Foreground" attribute cannot be made dynamic.

Web-enabled

Web-enabled

Identifies the picture object or faceplate type as executable in the Web browser.

Value (OutputValue)

Value (OutputValue)

With the attribute "Value", you define the linking with any analog/text tag. The analog display represents the value of this tag in the configured colors depending on the alarm state.

The "Value" attribute can be made dynamic with the name "OutputValue".

Value as Text (UseValueText)

Value as Text (UseValueText)

The attribute "Value as Text" shows whether a text tag is linked instead of a formatted analog value.

Yes	The value is linked with a text tag.
No	The value is not linked with a text tag

The "Value as Text" attribute can be made dynamic with the name "UseValueText".

Inherit status [WinCC V6]

Inherit status [WinCC V6]

The statuses of the "Display" and "Operator-Control Enable" properties of the user object can be inherited by the individual objects of the customized object.

Example: You have configured the "Inherit status" properties for the customized object with "Yes" and "Display" as "Visible". One object of the customized object has the property "invisible". If the customized object is now made invisible and then visible again, then all objects of the customized object are shown as visible even if one object of the customized object has the property "invisible".

The "Inherit Status" attribute cannot be made dynamic.

3.11.17 "Lock" Property Group

3.11.17.1 Lock Display (LockStatus)

Lock Display (LockStatus)

The "Lock Display" attribute defines for the marked group display whether a locked measuring point should be displayed. The lock applies to all the buttons of the group display.

The attributes "Lock Display Text", "Lock Text Color" and "Lock Background Color" are only evaluated if the attribute "Lock Display" has the value "Yes".

Yes	A locked measuring point is displayed as locked.
No	A locked measuring point is not displayed as locked. The queued message classes are displayed normally.

The "Lock Display" attribute can be made dynamic with the name "LockStatus".

3.11.17.2 Lock Display Text (LockText)

Lock Display Text (LockText)

The "Lock Display Text" attribute specifies the text that is displayed as button label for a locked measuring point. The value applies to all the buttons of the selected group display.

The "Lock Display Text" attribute is only evaluated if the "Lock Display" attribute has the value "Yes".

The "Lock Display Text" attribute can be made dynamic with the name "LockText".

3.11.17.3 Lock Background Color (LockBackColor)

Lock Background Color (LockBackColor)

The "Lock Background Color" attribute specifies the background color that the buttons assume for a locked measuring point. The value applies to all the buttons of the selected group display.

The "Lock Background Color" attribute is only evaluated if the "Lock Display" attribute has the value "Yes".

The "Lock Background Color" attribute can be made dynamic with the name "LockBackColor".

3.11.17.4 Lock Text Color (LockTextColor)

Lock Text Color (LockTextColor)

The "Lock Text Color" attribute specifies the color that the button labels assume for a locked measuring point. The value applies to all the buttons of the selected group display.

The "Lock Text Color" attribute is only evaluated if the "Lock Display" attribute has the value "Yes".

The "Lock Text Color" attribute can be made dynamic with the name "LockTextColor".

3.11.18 "Styles" Property Group

3.11.18.1 3D Border Width (BackBorderWidth)

3D Border Width (BackBorderWidth)

The "3D Border Width" attribute defines the line width of a 3D border. The values are specified in pixels.

= 0	The object has no 3D border.
> 0	There is a free choice of value depending on the object size.

The "3D Border Width" attribute can be made dynamic with the name "BackBorderWidth".

3.11.18.2 Bar Pattern (FillStyle2)

Bar Pattern (FillStyle2)

The "Bar Pattern" attribute specifies the fill pattern for display of the bar area.

So that the fill pattern becomes visible, the color of the fill pattern must differ from that of the background. The "Solid" fill pattern fills the object with the set background color; the "Transparent" fill pattern defines that neither a background nor a fill pattern are displayed.

There is a choice of 45 fill patterns.

The "Bar Pattern" attribute can be made dynamic with the name "FillStyle2".

3.11.18.3 Border Weight (BackBorderWidth)

Border Weight (BackBorderWidth)

The "Border Weight" attribute defines the width of the border of a slider. The values are specified in pixels.

= 0	The object has no border.
> 0	There is a free choice of value depending on the object size.

The "Border Width" attribute can be made dynamic with the name "BackBorderWidth".

3.11.18.4 Display as DropDownList

Display as drop-down list

The "Display as DropDownList" attribute displays all entries of the text box in a drop-down box.

The "Display as DropDownList" attribute cannot be made dynamic.

3.11.18.5 Latch Down (Toggle)

Latch Down (Toggle)

The "Latch Down" attribute specifies whether or not a button or round button latches down. The setting of the "Latch Down" attribute is only visible in runtime.

The initial position of the button can be set using the "Pressed" attribute.

Yes	The button latches down in the new switch setting when pressed. In order to release it, it must be pressed again.
No	On pressing, the button jumps back to the initial position.

The "Latch Down" attribute can be made dynamic with the name "Toggle".

3.11.18.6 Box Alignment (BoxAlignment)

Box Alignment (BoxAlignment)

The "Box Alignment" attribute defines the arrangement of the buttons in a check box or option group. The buttons can be arranged to the right or left of the descriptive text.

The descriptive text of the buttons can be aligned using the "Text Orientation", "X Alignment" and "Y Alignment" attributes in the "Font" property group.

Aligned Left The buttons appear in the field aligned left.

Aligned Right The buttons appear in the field aligned right.

The "Box Alignment" attribute can be made dynamic with the name "BoxAlignment".

3.11.18.7 Fill Pattern (FillStyle)

Fill Pattern (FillStyle)

The "Fill Pattern" attribute specifies the pattern for display of the picture background. So that the fill pattern becomes visible, the color of the fill pattern must differ from that of the background.

There is a choice of 49 fill patterns. The "Solid" fill pattern 1 fills the object with the set background color; the "Transparent" fill pattern 2 defines that neither a background nor a fill pattern are displayed.

The "Fill Pattern" attribute can be made dynamic with the name "FillStyle".

3.11.18.8 Fill Pattern (FillStyle)

Fill Pattern (FillStyle)

The "Fill Pattern" attribute specifies the pattern for display of the background areas. So that the fill pattern becomes visible, the color of the fill pattern must differ from that of the background.

There is a choice of 49 fill patterns. The "Solid" fill pattern 1 fills the object with the set background color; the "Transparent" fill pattern 2 defines that neither a background nor a fill pattern are displayed.

The "Fill Pattern" attribute can be made dynamic with the name "FillStyle".

3.11.18.9 Pressed (Pressed)

Pressed (Pressed)

3.11 Object properties

The "Pressed" attribute specifies whether a button or round button is displayed in the initial position as "pressed" or "not pressed".

The "Latch Down" attribute specifies whether or not a button latches down when pressed.

Yes	The button or round button has the initial position "pressed".
No	The button or round button has the initial position "not pressed".

The "Pressed" attribute can be made dynamic with the name "Pressed".

3.11.18.10 Background (Background)

Background (Background)

The "Background" attribute specifies whether a 3D bar is displayed with or without a background.

Yes	The background of the 3D bar is visible.
No	The background of the 3D bar is not visible.

The "Background" attribute can be made dynamic with the name "Background".

3.11.18.11 Light Effect (LightEffect)

Light Effect (LightEffect)

The "Light Effect" attribute specifies whether or not the 3D bar is displayed as illuminated.

Yes	The 3D bar is displayed spatially by means of a bright/dark contrast.	
No	The 3D bar is displayed as normal.	

The "Light Effect" attribute can be made dynamic with the name "LightEffect".

3.11.18.12 Line Style (BorderStyle)

Line Style (BorderStyle)

The "Line Style" attribute specifies the style in which a line appears. For example, a dotted or dashed representation is possible.

A line with line width of 1 pixel can be displayed in two colors. To do so, you must select a broken line style and assign another color to the background of the line. If the line color is identical to the line background color in the "Colors" property group, breaks in the line are invisible.

There is a choice of 5 line styles.

The "Line Style" attribute can be made dynamic with the name "BorderStyle".

Line termination

The "Line termination" attribute determines the appearance of the line termination. The definition of the attribute applies to both ends of the line. Select one of the three following options:

- A round termination sets the center of a circle at the end point of the line. The diameter of the circle adapts to the line width.
- A rectangular termination set the center of a square at the end point of the line. The width and height of the square adapts to the line width.
- A flat termination ends the line at its end points.

Corners

The "Corners" attribute define the appearance of the corner intersections of where lines meet. The definition applies to all the corners of the object. Select one of the three following options:

- A round corner sets the center of a circle at the intersection of two line ends. The diameter of the circle adapts to the line width.
- The two outer corner points of the line connection are linked by a straight line. This flattening effect causes the corners to appear beveled.
- A pointed corner corresponds to the real corner intersection of the meeting lines.

The "Line termination" and "Corners" attributes cannot be dynamized.

3.11.18.13 Line End Style (BorderEndStyle)**Line End Style (BorderEndStyle)**

The "Line End Style" attribute specifies in which style the ends of a line appear. The ends of a line can be designed differently. It is possible, for example, that a line begins with a dot and ends with an arrow.

There is a choice of 7 line end styles.

The "Line End Style" attribute can be made dynamic with the name "BorderEndStyle".

3.11.18.14 Line Weight (BorderWidth)**Line Weight (BorderWidth)**

The "Line Weight" attribute specifies the width of a line. The value is specified in pixels.

In order to display a line in two colors, select the broken line style and assign the "Line color" and "Line background color" attributes with different colors. In Design WinCC Classic, only one line can be displayed with a 1 pixel line weight.

0 - 100	There is a free choice of value within the limits. With line weight 0, no line is visible.
---------	--

The "Line weight" attribute can be made dynamic with the name "BorderWidth".

3.11.18.15 Line connection type (LineJoinStyle)**Line connection type (LineJoinStyle)**

3.11 Object properties

The "Line connection type" attribute defines the way that corners are displayed in a tube polygon.

Angle	The tubes are joined at corner points without rounding
Round	The tubes are rounded at the outside corner points.

The attribute "Line connection type" can be made dynamic with the name "LineJoinStyle".

3.11.18.16 Pattern alignment (Fill Style Alignment)

Pattern alignment (Fill Style Alignment)

The "Pattern alignment" attribute defines the alignment of the fill pattern for the process picture.

Normal	The fill pattern refers to the process picture. In runtime, no scaling is performed when opening the picture.
Stretched (window)	The fill pattern refers to the window in the Graphics Designer. In runtime, scaling is performed when opening the picture.

The "Pattern alignment" attribute can be made dynamic with the name "FillStyleAlignment".

3.11.18.17 Draw Border Inside (DrawInsideFrame)

Draw Border Inside (DrawInsideFrame)

For all line thicknesses greater than 1, the "Draw Border Inside" attribute defines whether the border lines are to be drawn inside the object frame or symmetrically on the frame.

The following objects have the "Draw Border Inside" attribute:

Ellipse, circle, ellipse segment, circular segment, ellipse arc, circle arc, rectangle, round rectangle, static text, graphic object, status display, button, checkbox, radio box, slider object.

Yes	The border lines are drawn inside the object frame.
No	The border lines are drawn symmetrically on the object frame.

The "Draw Border Insider" attribute cannot be made dynamic.

3.11.18.18 Border Style (BorderStyle)

Border Style (BorderStyle)

The "Border Style" attribute specifies the style in which a border appears. For example, a dotted or dashed representation is possible.

A border with border width 1 pixel can be displayed in two colors. To do so, you must select a broken border style and assign another color to the background of the border. If the border color is identical to the border background color in the "Colors" property group, breaks in the border are invisible.

There is a choice of 5 border styles.

The "Border Style" attribute can be made dynamic with the name "BorderStyle".

3.11.18.19 Border Width (BorderWidth)

Border Width (BorderWidth)

The "Border Width" attribute specifies the width of a border. The values are specified in pixels.

A border with border width 1 pixel can be displayed in two colors. To do so, you must select a broken border style and assign another color to the background of the border. If the border color is identical to the border background color in the "Colors" property group, breaks in the border are invisible.

0 - 100	There is a free choice of value within the limits. With border width 0, no border is visible.
---------	--

The "Border Width" attribute can be made dynamic with the name "BorderWidth".

3.11.18.20 Dividing Line Style (ItemBorderStyle)

Dividing Line Style (ItemBorderStyle)

The "Dividing Line Style" attribute specifies in which style the separation lines in a selection list appear. For example, a dotted or dashed representation is possible. The setting of the "Dividing Line Style" attribute is only visible in runtime.

If a broken dividing line style (e.g. dashed, dotted) is chosen, only the dividing line weights 0 pixel and 1 pixel can be displayed.

There is a choice of 5 dividing line styles.

The "Dividing Line Style" attribute can be made dynamic with the name "ItemBorderStyle".

3.11.18.21 Dividing Line Weight (ItemBorderWidth)

Dividing Line Weight (ItemBorderWidth)

The "Dividing Line Weight" attribute specifies the width of a dividing line. The values are specified in pixels. The setting of the "Dividing Line Weight" attribute is only visible in Runtime.

If a broken dividing line style (e.g. dashed, dotted) is chosen, only the dividing line weights 0 pixel and 1 pixel can be displayed.

0 - 10	There is a free choice of value within the limits. With dividing line weight 0, no dividing line is visible.
--------	--

The "Dividing Line Weight" attribute can be made dynamic with the name "ItemBorderWidth".

3.11.18.22 Windows Style (WindowsStyle)

Windows Style (WindowsStyle)

The "Windows Style" attribute specifies for the "Button" or "Slider" objects whether the style for the display of the objects in the Graphics Designer is set or taken from the default settings of the Windows operating system.

3.11 Object properties

A change to the "Border Width" or "Background Color" attributes sets the value of the "Windows Style" attribute to "No" if the new values do not match the default settings

Yes	The objects are displayed according to the default settings of the Windows operating system. Attributes that do not match the Windows style are ignored.
No	The objects are displayed according to the settings of the Graphics Designer.

The "Windows Style" attribute can be made dynamic with the name "WindowsStyle".

3.11.19 "Connected Objects" Property Group

3.11.19.1 Connection point index of source object (TopConnectedConnectionPointIndex)

Index of the Connection Point of the First Object Connected (TopConnectedConnectionPointIndex)

The "Index of the Connection Point of the First Object Connected" attribute specifies for the start of the connector at which connection point of the object the connection is formed.

The "Index of the Connection Point of the First Object Connected" attribute can be made dynamic with the name "TopConnectedConnectionPointIndex".

3.11.19.2 Connection point index of target object (BottomConnectedConnectionPointIndex)

Index of the Connection Point of the Object Connected at the End (BottomConnectedConnectionPointIndex)

The "Index of the Connection Point of the Object Connected at the End" attribute specifies for the end of the connector at which connection point of the object the connection is formed.

The "Index of the Connection Point of the Object Connected at the End" attribute can be made dynamic with the name "BottomConnectedConnectionPointIndex".

3.11.19.3 Object name of source object (TopConnectedObjectName)

Object Name of the First Object Connected (TopConnectedObjectName)

The "Object Name of the First Object Connected" attribute specifies the object that is connected to the start of the connector.

The "Object Name of the First Object Connected" attribute can be made dynamic with the name "TopConnectedObjectName".

3.11.19.4 Object name of target object (BottomConnectedObjectName)

Object Name of the Object Connected at the End (BottomConnectedObjectName)

The "Object Name of the Object Connected at the End" attribute specifies the object that is connected to the end of the connector.

The "Object Name of the Object Connected at the End" attribute can be made dynamic with the name "BottomConnectedObjectName".

3.11.19.5 Change Orientation (Orientation)

Change Orientation (Orientation)

The "Change Orientation" attribute reverses the definition of "Start" and "End" of the connector, including the current assignments

The "Change Orientation" attribute can be made dynamic with the name "Orientation".

3.11.19.6 Connection Type (ConnectorType)

Connection Type (ConnectorType)

The "Connection Type" attribute defines the type of connector. It is possible to select between two connection types.

Automatic	Both objects are connected by a polyline made up of horizontal and vertical parts.
Simple	Both objects are connected by a straight line between the connecting points.

The "Connection Type" can be dynamized with the name "ConnectorType".

3.11.20 "Assignment" Property Group

3.11.20.1 Using global settings (UseGlobalSettings)

Using global settings (UseGlobalSettings)

Specify whether to use global settings to assign message events to the buttons visualized in the group view. Configure the display of message events in the "Message types" property group. The property is only relevant to PCS7 projects.

Yes	Activates the settings made in PCS7 alarm editor for the assignment of message events to the buttons in the group display. The bit numbers in the group value are assigned to the respective buttons.
No	The message type are assigned locally to the buttons in the group display.

The sequence of the assignment defines the priority. If there are more than one selected event for one button, the event that has been entered first is displayed.

The same event can be visualized simultaneously in several buttons.

The property cannot be assigned dynamic functionality.

3.11.20.2 Message Types for Button 1 (Button1MessageClasses)

Message Types for Button 1 (Button1MessageClasses)

Define one or more message events for displaying the first button in the group display. This is done by entering the numbers of the bits in the collect value. The display of the message events is configured in the "Message Types" property group.

If you want to assign several message events, separate the numbers with a comma. The sequence of the assignment defines the priority. If there are more than one selected event for one button, the event that has been entered first is displayed.

3.11 Object properties

One event can be displayed simultaneously in more than one button.

The "Message Types for Button 1" attribute can be assigned dynamic properties with the name "Button1MessageClasses".

3.11.20.3 Message Types for Button 2 (Button2MessageClasses)

Message Types for Button 2 (Button2MessageClasses)

For displaying both buttons, define one or more message events in the group display. This is done by entering the number of the bit in the collect value. The display of the message events is configured in the "Message Types" property group.

If you want to assign several message events, separate the numbers with a comma. The sequence of the assignment defines the priority. If there are more than one selected event for one button, the event that has been entered first is displayed.

The same event can be visualized simultaneously in several buttons.

The "Message Types for Button 2" attribute can be assigned dynamic properties with the name "Button2MessageClasses".

3.11.20.4 Message Types for Button 3 (Button3MessageClasses)

Message Types for Button 3 (Button3MessageClasses)

For displaying the third button, define one or more message events in the group display. This is done by entering the number of the bit in the collect value. The display of the message events is configured in the "Message Types" property group.

If you want to assign several message events, separate the numbers with a comma. The sequence of the assignment defines the priority. If there are more than one selected event for one button, the event that has been entered first is displayed.

The same event can be visualized simultaneously in several buttons.

The "Message Types for Button 3" attribute can be assigned dynamic properties with the name "Button3MessageClasses".

3.11.20.5 Message Types for Button 4 (Button4MessageClasses)

Message Types for Button 4 (Button4MessageClasses)

For displaying the fourth button, define one or more message events in the group display. This is done by entering the number of the bit in the collect value. The display of the message events is configured in the "Message Types" property group.

If you want to assign several message events, separate the numbers with a comma. The sequence of the assignment defines the priority. If there are more than one selected event for one button, the event that has been entered first is displayed.

The same event can be visualized simultaneously in several buttons.

The "Message Types for Button 4" attribute can be assigned dynamic properties with the name "Button4MessageClasses".

3.11.20.6 Message Types for Button 5 (Button5MessageClasses)

Message Types for Button 5 (Button5MessageClasses)

For displaying the fifth button, define one or more message events in the group display. This is done by entering the number of the bit in the collect value. The display of the message events is configured in the "Message Types" property group.

If you want to assign several message events, separate the numbers with a comma. The sequence of the assignment defines the priority. If there are more than one selected event for one button, the event that has been entered first is displayed.

The same event can be visualized simultaneously in several buttons.

The "Message Types for Button 5" attribute can be assigned dynamic properties with the name "Button5MessageClasses".

3.11.20.7 Message Types for Button 6 (Button6MessageClasses)

Message Types for Button 6 (Button6MessageClasses)

For displaying the sixth button, define one or more message events in the group display. This is done by entering the number of the bit in the collect value. The display of the message events is configured in the "Message Types" property group.

If you want to assign several message events, delimit the numbers with a comma. The order of assignment defines the priority. If there are more than one selected event for one button, the event that has been entered first is displayed.

The same event can be visualized simultaneously in several buttons.

The "Message Types for Button 6" attribute can be assigned dynamic properties with the name "Button6MessageClasses".

3.11.20.8 Message Types for Button 7 (Button7MessageClasses)

Message Types for Button 7 (Button7MessageClasses)

For displaying the seventh button, define one or more message events in the group display. This is done by entering the number of the bit in the collect value. The display of the message events is configured in the "Message Types" property group.

If you want to assign several message events, delimit the numbers with a comma. The order of assignment defines the priority. If there are more than one selected event for one button, the event that has been entered first is displayed.

The same event can be visualized simultaneously in several buttons.

The "Message Types for Button 7" attribute can be assigned dynamic properties with the name "Button7MessageClasses".

3.11.20.9 Message Types for Button 8 (Button8MessageClasses)

Message Types for Button 8 (Button8MessageClasses)

3.11 Object properties

For displaying the eighth button, define one or more message events in the group display. This is done by entering the number of the bit in the collect value. The display of the message events is configured in the "Message Types" property group.

If you want to assign several message events, delimit the numbers with a comma. The order of assignment defines the priority. If there are more than one selected event for one button, the event that has been entered first is displayed.

The same event can be visualized simultaneously in several buttons.

The "Message Types for Button 8" attribute can be assigned dynamic properties with the name "Button8MessageClasses".

3.11.21 "Status" Property Group

3.11.21.1 Current Status (Index)

Current Status (Index)

The "Current Status" attribute shows the identification number of the currently selected status. Changing the value specified here selects the individual statuses of a status display to specify the settings of the other attributes in the "Status" property group.

4,294,967,296 different states can be shown for a status display. The permitted value range is from 0 to 4.294.967.295 (= $2^{32} - 1$).

The "Current Status" attribute can be made dynamic with the name "Index".

3.11.21.2 Bit Selection 0 (BitSelect0)

Bit Selection 0 (BitSelect0)

"Bit Selection 0" indicates the status tag that you have defined for the first bit of the status value. The tags are defined in the "Miscellaneous" property group under "Status1" to "Status4".

0	The first bit of the status value is not evaluated. No status tag is used.
1	Status tag "Status1" is used for the status value of the first bit.
2	Status tag "Status2" is used for the status value of the first bit.
3	Status tag "Status3" is used for the status value of the first bit.
4	Status tag "Status4" is used for the status value of the first bit.

The "Bit Selection 0" attribute can be made dynamic with the name "BitSelect0".

3.11.21.3 Bit Selection 1 (BitSelect1)

Bit Selection 1 (BitSelect1)

"Bit Selection 1" indicates the status tag that you have defined for the second bit of the status value. The tags are defined in the "Miscellaneous" property group under "Status1" to "Status4".

0	The second bit of the status value is not evaluated. No status tag is used.
1	Status tag "Status1" is used for the status value of the second bit.
2	Status tag "Status2" is used for the status value of the second bit.
3	Status tag "Status3" is used for the status value of the second bit.
4	Status tag "Status4" is used for the status value of the second bit.

The "Bit Selection 1" attribute can be made dynamic with the name "BitSelect1".

3.11.21.4 Bit Selection 2 (BitSelect2)

Bit Selection 2 (BitSelect2)

"Bit Selection 2" indicates the status tag that you have defined for the third bit of the status value. The tags are defined in the "Miscellaneous" property group under "Status1" to "Status4".

0	The third bit of the status value is not evaluated. No status tag is used.
1	Status tag "Status1" is used for the status value of the third bit.
2	Status tag "Status2" is used for the status value of the third bit.
3	Status tag "Status3" is used for the status value of the third bit.
4	Status tag "Status4" is used for the status value of the third bit.

The "Bit Selection 2" attribute can be made dynamic with the name "BitSelect2".

3.11.21.5 Bit Selection 3 (BitSelect3)

Bit Selection 3 (BitSelect3)

"Bit Selection 3" indicates the status tag that you have defined for the fourth bit of the status value. The tags are defined in the "Miscellaneous" property group under "Status1" to "Status4".

0	The fourth bit of the status value is not evaluated. No status tag is used.
1	Status tag "Status1" is used for the status value of the fourth bit.
2	Status tag "Status2" is used for the status value of the fourth bit.
3	Status tag "Status3" is used for the status value of the fourth bit.
4	Status tag "Status4" is used for the status value of the fourth bit.

The "Bit Selection 3" attribute can be made dynamic with the name "BitSelect3".

3.11.21.6 Flash Picture

Flash picture

The "Flash Picture" attribute specifies which flash picture is to be displayed for the currently selected status. Pictures with the following formats can be inserted: EMF, WMF, DIB, BMP.

If no flash picture has been defined for the selected status, the symbol for the status display is shown as a placeholder during flashing. The flashing is only visible in Runtime.

The "Flashing Flash Picture Active" attribute must have the value "Yes".

3.11 Object properties

The flash picture should have the same picture size as the basic picture, otherwise, its display is distorted.

In order to cancel an existing assignment, the "Cancel Selection" button must be clicked in the "Picture Selection" dialog.

The "Flash Picture" attribute cannot be made dynamic.

3.11.21.7 Flash Picture (FlashPicture)

Flash Picture (FlashPicture)

The "Flash Picture" attribute specifies which flash picture is to be displayed for the currently selected status. Pictures with the following formats can be inserted: EMF, WMF, BMP, GIF, JPG.

The flashing is only visible in Runtime.

The flash picture should have the same picture size as the basic picture, otherwise, its display is distorted.

The "Flash Picture" attribute can be made dynamic with the name "FlashPicture".

3.11.21.8 Flash Picture Referenced (FlashPicReferenced)

Flash Picture Referenced (FlashPicReferenced)

The "Status Display" object can have an almost infinite number of different statuses.

For each status, you can choose a basic picture and a flash picture. The "Flash Picture Referenced" attribute specifies whether the flash picture for the selected status itself or only the reference in the form of a cross-reference to the picture is integrated.

Yes	Only the reference of the picture is integrated and saved.
No	The picture itself is integrated and saved.

The "Flash Picture Referenced" attribute cannot be made dynamic.

3.11.21.9 Flash Picture Transparent Color (FlashPicTransparentColor)

Flash Picture Transparent Color (FlashPicTransparentColor)

The "Flash Picture Transparent Color" attribute specifies the transparent color of the flashing picture. Transparent colors can only be displayed for pictures in BMP or DIB format.

The "Flash Picture Transparent Color" attribute can be assigned dynamic properties by means of the name "FlashPicTransparentColor".

3.11.21.10 Flash Picture Transparent Color On (FlashPicUseTransparentColor)

Flash Picture Transparent Color On (FlashPicUseTransparentColor)

The "Flash Picture Transparent Color On" attribute specifies whether the "Transparent Color" function is to be used for the picture to be displayed. Transparent colors can only be displayed for pictures in BMP or DIB format.

Yes	The "Flash Picture Transparent Color On" attribute is enabled.
No	The "Flash Picture Transparent Color On" attribute is disabled.

The "Flash Picture Transparent Color On" attribute can be assigned dynamic properties by means of the name "FlashPicUseTransColor".

3.11.21.11 Flashing Flash Picture Active (FlashFlashPicture)

Flashing Flash Picture Active (FlashFlashPicture)

The "Flashing Flash Picture Active" attribute specifies whether in runtime only the basic picture is displayed or the basic picture and the flash picture alternate in the display.

If no flash picture has been defined, a symbol is displayed as placeholder in runtime.

Yes	In Runtime, the basic picture and flash picture alternate in the display.
No	Only the basic picture is displayed in Runtime.

The "Flashing Flash Picture Active" attribute can be made dynamic with the name "FlashFlashPicture".

3.11.21.12 Flash Picture Flash Frequency(FlashRateFlashPic)

Flash Picture Flash Frequency(FlashRateFlashPic)

The "Flash Picture Flash Frequency" attribute specifies how quickly the basic picture and flash picture alternate in Runtime. The frequencies "slow", "medium" and "fast" can be set. The flash frequency depends on the system performance.

The "Flashing Flash Picture Active" attribute must have the value "Yes".

Slow	In Runtime, the basic picture and flash picture alternate slowly.
Medium	In Runtime, the basic picture and flash picture alternate at medium speed.
Fast	In Runtime, the basic picture and flash picture alternate quickly.

The "Flash Picture Flash Frequency" attribute can be made dynamic with the name "FlashRateFlashPic".

3.11.21.13 Graphic list (Graphiclist)

Graphic list (Graphiclist)

The graphics list is used for the picture selection when configuring the "status display" smart object. A graphic lists facilitates the configuration of graphics and its flashing characteristics for the various states.

Enter the name of a graphic list that you created in the WinCC Configuration Studio in the "Text and Graphics Lists" editor.

The "Graphics list" attribute can be made dynamic with the name "Graphiclist".

3.11.21.14 Basic Picture (BasePicture)

Basic Picture (BasePicture)

The "Basic Picture" attribute specifies which picture is to be displayed for the currently selected status. Pictures with the following formats can be inserted: EMF, WMF, DIB, BMP.

If no picture that you want to display is defined for a status, the symbol for the status display is shown as a placeholder.

In order to cancel an existing assignment, the "Cancel Selection" button must be clicked in the "Picture Selection" dialog.

The "Basic Picture" attribute cannot be made dynamic.

3.11.21.15 Basic Picture (BasePicture)

Basic Picture (BasePicture)

The "Basic Picture" attribute shows which picture is to be displayed for the currently selected status. Pictures with the following formats can be inserted: EMF, WMF, BMP, GIF, JPG.

If no picture that you want to display is defined for a status, the symbol for the status display is shown as a placeholder.

The "Basic Picture" attribute can be made dynamic with the name "BasePicture".

3.11.21.16 Basic Picture Referenced (BasePicReferenced)

Basic Picture Referenced (BasePicReferenced)

The "Status Display" object can have an almost infinite number of different statuses.

For each status, you can choose a basic picture and a flash picture. The "Basic Picture Referenced" attribute specifies whether the basic picture for the selected status itself or only the reference in the form of a cross-reference to the picture is integrated.

Yes	Only the reference of the picture is integrated and saved.
No	The picture itself is integrated and saved.

The "Basic Picture Referenced" attribute cannot be made dynamic.

3.11.21.17 Basic Picture Transparent Color (BasePicTransColor)

Basic Picture Transparent Color (BasePicTransColor)

The "Basic Picture Transparent Color" attribute specifies the transparent color of a picture. Transparent colors can only be displayed for pictures in BMP or DIB format.

The "Basic Picture Transparent Color" attribute can be assigned dynamic properties by means of the name "BasePicTransColor".

3.11.21.18 Basic Picture Transparent Color On (BasePicUseTransColor)**Basic Picture Transparent Color On (BasePicUseTransColor)**

The "Basic Picture Transparent Color On" attribute specifies whether the "Transparent Color" function is to be used for the picture to be displayed. Transparent colors can only be displayed for pictures in BMP or DIB format.

Yes	The "Basic Picture Transparent Color On" attribute is enabled.
No	The "Basic Picture Transparent Color On" attribute is disabled.

The "Basic Picture Transparent Color On" attribute can be assigned dynamic properties by means of the name "BasePicUseTransColor".

3.11.21.19 Highest Index (MaxIndex)**Highest Index (MaxIndex)**

The "Highest Index" attribute shows the highest index of all configurable alarm and status combinations.

The "Highest Index" attribute can be made dynamic with the name "MaxIndex".

3.11.21.20 Index (Index)**Index (Index)**

The "Index" attribute shows the index of the currently selected state. By changing the value specified here, you can define the object properties for this index in the property group "Status".

The "Index" attribute can be made dynamic with the name "Index".

3.11.21.21 Priority Bit 16 (PrioBit16)**Priority Bit 16 (PrioBit16)**

The "Priority Bit 16" indicates the priority of bit 16 (measuring point locked) in the collect value for the alarm evaluation for the extended analog and status display. The alarm evaluation starts at the highest priority (priority 1). Bits that are not used for the alarm evaluation are assigned priority 0.

If several bits are queued in the collect value, the status is determined by the priority.

The "Priority Bit 16" attribute can be made dynamic with the name "PrioBit16".

3.11.21.22 Priority Bit 17 (PrioBit17)**Priority Bit 17 (PrioBit17)**

The "Priority Bit 17" indicates the priority of bit 17 (OS status) in the collect value for the alarm evaluation for the extended analog and status display. The alarm evaluation starts at the highest priority (priority 1). Bits that are not used for the alarm evaluation are assigned priority 0.

If the group value contains multiple bits, the priority determines which status is displayed.

The "Priority Bit 17" attribute can be made dynamic with the name "PrioBit17".

3.11.21.23 Priority Bit 18 (PrioBit18)

Priority Bit 18 (PrioBit18)

The "Priority Bit 18" indicates the priority of bit 18 (AS status) in the collect value for the alarm evaluation for the extended analog and status display. The alarm evaluation starts at the highest priority (priority 1). Bits that are not used for the alarm evaluation are assigned priority 0.

If the group value contains multiple bits, the priority determines which status is displayed.

The "Priority Bit 18" attribute can be made dynamic with the name "PrioBit18".

3.11.21.24 Priority Bit 19 (PrioBit19)

Priority Bit 19 (PrioBit19)

The "Priority Bit 19" indicates the priority of bit 19 (operator input message) in the collect value for the alarm evaluation for the extended analog and status display. The alarm evaluation starts at the highest priority (priority 1). Bits that are not used for the alarm evaluation are assigned priority 0.

If the group value contains multiple bits, the priority determines which status is displayed.

The "Priority Bit 19" attribute can be made dynamic with the name "PrioBit19".

3.11.21.25 Priority Bit 20 (PrioBit20)

Priority Bit 20 (PrioBit20)

The "Priority Bit 20" indicates the priority of bit 20 (operator instruction) in the collect value for the alarm evaluation for the extended analog and status display. The alarm evaluation starts at the highest priority (priority 1). Bits that are not used for the alarm evaluation are assigned priority 0.

If the group value contains multiple bits, the priority determines which status is displayed.

The "Priority Bit 20" attribute can be made dynamic with the name "PrioBit20".

3.11.21.26 Priority Bit 21 (PrioBit21)

Priority Bit 21 (PrioBit21)

The "Priority Bit 21" indicates the priority of bit 21 (system message) in the collect value for the alarm evaluation for the extended analog and status display. The alarm evaluation starts at the highest priority (priority 1). Bits that are not used for the alarm evaluation are assigned priority 0.

If the group value contains multiple bits, the priority determines which status is displayed.

The "Priority Bit 21" attribute can be made dynamic with the name "PrioBit21".

3.11.21.27 Priority Bit 22 (PrioBit22)**Priority Bit 22 (PrioBit22)**

The "Priority Bit 22" indicates the priority of bit 22 (process message) in the collect value for the alarm evaluation for the extended analog and status display. The alarm evaluation starts at the highest priority (priority 1). Bits that are not used for the alarm evaluation are assigned priority 0.

If the group value contains multiple bits, the priority determines which status is displayed.

The "Priority Bit 22" attribute can be made dynamic with the name "PrioBit22".

3.11.21.28 Priority Bit 23 (PrioBit23)**Priority Bit 23 (PrioBit23)**

The "Priority Bit 23" indicates the priority of bit 23 (maintenance instruction) in the collect value for the alarm evaluation for the extended analog and status display. The alarm evaluation starts at the highest priority (priority 1). Bits that are not used for the alarm evaluation are assigned priority 0.

If the group value contains multiple bits, the priority determines which status is displayed.

The "Priority Bit 23" attribute can be made dynamic with the name "PrioBit23".

3.11.21.29 Priority Bit 24 (PrioBit24)**Priority Bit 24 (PrioBit24)**

The "Priority Bit 24" indicates the priority of bit 24 (AS control technology error) in the collect value for the alarm evaluation for the extended analog and status display. The alarm evaluation starts at the highest priority (priority 1). Bits that are not used for the alarm evaluation are assigned priority 0.

If the group value contains multiple bits, the priority determines which status is displayed.

The "Priority Bit 24" attribute can be made dynamic with the name "PrioBit24".

3.11.21.30 Priority Bit 25 (PrioBit25)**Priority Bit 25 (PrioBit25)**

The "Priority Bit 25" indicates the priority of bit 25 (AS control technology fault) in the collect value for the alarm evaluation for the extended analog and status display. The alarm evaluation starts at the highest priority (priority 1). Bits that are not used for the alarm evaluation are assigned priority 0.

If the group value contains multiple bits, the priority determines which status is displayed.

The "Priority Bit 25" attribute can be made dynamic with the name "PrioBit25".

3.11.21.31 Priority Bit 26 (PrioBit26)**Priority Bit 26 (PrioBit26)**

3.11 Object properties

The "Priority Bit 26" indicates the priority of bit 26 (tolerance low) in the collect value for the alarm evaluation for the extended analog and status display. The alarm evaluation starts at the highest priority (priority 1). Bits that are not used for the alarm evaluation are assigned priority 0.

If the group value contains multiple bits, the priority determines which status is displayed.

The "Priority Bit 26" attribute can be made dynamic with the name "PrioBit26".

3.11.21.32 Priority Bit 27 (PrioBit27)

Priority Bit 27 (PrioBit27)

The "Priority Bit 27" indicates the priority of bit 27 (tolerance high) in the collect value for the alarm evaluation for the extended analog and status display. The alarm evaluation starts at the highest priority (priority 1). Bits that are not used for the alarm evaluation are assigned priority 0.

If the group value contains multiple bits, the priority determines which status is displayed.

The "Priority Bit 27" attribute can be made dynamic with the name "PrioBit27".

3.11.21.33 Priority Bit 28 (PrioBit28)

Priority Bit 28 (PrioBit28)

The "Priority Bit 28" indicates the priority of bit 28 (warning low) in the collect value for the alarm evaluation for the extended analog and status display. The alarm evaluation starts at the highest priority (priority 1). Bits that are not used for the alarm evaluation are assigned priority 0.

If the group value contains multiple bits, the priority determines which status is displayed.

The "Priority Bit 28" attribute can be made dynamic with the name "PrioBit28".

3.11.21.34 Priority Bit 29 (PrioBit29)

Priority Bit 29 (PrioBit29)

The "Priority Bit 29" indicates the priority of bit 29 (warning high) in the collect value for the alarm evaluation for the extended analog and status display. The alarm evaluation starts at the highest priority (priority 1). Bits that are not used for the alarm evaluation are assigned priority 0.

If the group value contains multiple bits, the priority determines which status is displayed.

The "Priority Bit 29" attribute can be made dynamic with the name "PrioBit29".

3.11.21.35 Priority Bit 30 (PrioBit30)

Priority Bit 30 (PrioBit30)

The "Priority Bit 30" indicates the priority of bit 30 (alarm low) in the collect value for the alarm evaluation for the extended analog and status display. The alarm evaluation starts at the highest priority (priority 1). Bits that are not used for the alarm evaluation are assigned priority 0.

If the group value contains multiple bits, the priority determines which status is displayed.

The "Priority Bit 30" attribute can be made dynamic with the name "PrioBit30".

3.11.21.36 Priority Bit 31 (PrioBit31)

Priority Bit 31 (PrioBit31)

The "Priority Bit 31" indicates the priority of bit 31 (alarm high) in the collect value for the alarm evaluation for the extended analog and status display. The alarm evaluation starts at the highest priority (priority 1). Bits that are not used for the alarm evaluation are assigned priority 0.

If the group value contains multiple bits, the priority determines which status is displayed.

The "Priority Bit 31" attribute can be made dynamic with the name "PrioBit31".

3.11.21.37 Status Word Bit 0 (BitPosition0)

Status Word Bit 0 (BitPosition0)

The "Status Word Bit 0" indicates the bit position of the selected tag for bit 0 of the status value. The content is only evaluated, if a tag is selected for bit selection 0. The tags are defined in the "Miscellaneous" property group under "Status1" to "Status4".

Enter a value from 0 to 31. Each value can only be assigned once.

The "Status Word Bit 0" attribute can be made dynamic with the name "BitPosition0".

3.11.21.38 Status Word Bit 1 (BitPosition1)

Status Word Bit 1 (BitPosition1)

The "Status Word Bit 1" indicates the bit position of the selected tag for bit 1 of the status value. The content is only evaluated, if a tag is selected for bit selection 1. The tags are defined in the "Miscellaneous" property group under "Status1" to "Status4".

Enter a value from 0 to 31. Each value can only be assigned once.

The "Status Word Bit 1" attribute can be made dynamic with the name "BitPosition1".

3.11.21.39 Status Word Bit 2 (BitPosition2)

Status Word Bit 2 (BitPosition2)

The "Status Word Bit 2" indicates the bit position of the selected tag for bit 2 of the status value. The content is only evaluated, if a tag is selected for bit selection 2. The tags are defined in the "Miscellaneous" property group under "Status1" to "Status4".

Enter a value from 0 to 31. Each value can only be assigned once.

The "Status Word Bit 2" attribute can be made dynamic with the name "BitPosition2".

3.11.21.40 Status Word Bit 3 (BitPosition3)

Status Word Bit 3 (BitPosition3)

The "Status Word Bit 3" indicates the bit position of the selected tag for bit 3 of the status value. The content is only evaluated, if a tag is selected for bit selection 3. The tags are defined in the "Miscellaneous" property group under "Status1" to "Status4".

Enter a value from 0 to 31. Each value can only be assigned once.

The "Status Word Bit 3" attribute can be made dynamic with the name "BitPosition3".

Process Picture Dynamics

4.1 Types of Dynamization

Introduction

WinCC offers various ways of dynamizing the objects of a process picture.

Basically, there are two types of dynamization.

- Dynamic objects change their appearance and position depending on, for example, a process value. An example of a dynamic object is a bar whose length is influenced by a current temperature, a pointer instrument with a moving pointer, or an object which changes color depending on the position of a workpiece.
- Operator-controllable objects react to events, e.g. a mouse-click, and enable the operator to actively intervene in the process. Operator-controllable objects can be, for example, buttons, sliders, or I/O fields used for entering certain process parameters.

Note

If you copy a dynamized object in the Graphics Designer, the dynamics are also copied. The copied object will then be affected by the dynamics in just the same way as the original object.

Graphics Designer will permit identical object names in a picture which differ only in lower and upper case letters. For dynamization of objects in a picture, however, you must assign a unique nomenclature. Differentiation of object names by upper and lower cases alone shall not be sufficient.



Dynamizing by Means of Direct Tag Connection

When a tag is connected to a property of an object, the value of the tag is transferred directly to the object property. This means, for example, that the value of a tag can be directly influenced by an I/O field.

Dynamization by means of tag connection is indicated in the Object Properties dialog with the  icon and the name of the tag.

Dynamizing by Means of Indirect Tag Connection

When a tag is connected to a property of an object, the value of the tag is interpreted as the tag name. The value of this tag is transferred to the object property. You configure an indirect tag connection by double-clicking the box in the "Indirect" column of the "Object Properties" dialog.

Dynamization by means of tag connection is indicated in the Object Properties dialog with the  icon and the name of the tag. The indirect tag connection is indicated with the icon  in the "Indirect" column of the "Object Properties" dialog.

Dynamizing by Means of Direct Connection

Direct connection is used for reacting to events. If the event occurs in Runtime, the value of a source element is used for a target element. The values of the source element and target element can be defined by:

- a constant
- a WinCC tag
- the value of an object property

Dynamizing by means of direct connection is indicated in the Object Properties dialog with the  icon.

Dynamizing Using Dynamic Dialog

The Dynamic dialog is used for dynamizing an object property. You should use the Dynamic dialog if you want to map the value of a tag to a value which can be interpreted by the operator. For example, you can use the Dynamic dialog to map the value range of a tag to color values.

When no value is specified for the tag, the value for "other" is used as a default value for the object property. For example, the default text is "??????" for the "Button" object. In the Dynamic dialog this text is used as the default value for "other".

Dynamizing using the Dynamic dialog is indicated in the Object properties dialog with the  icon.

Dynamizing Using VBS Action

VBS actions are used to dynamize an object property or to react to events. You should use VBS actions if, for example, you want to process several input parameters in one action or you want to execute conditional instructions (if ... then ...).

Dynamization with a VBS action is indicated with the  icon in the "Object Properties" dialog.

Dynamizing Using C Action

C actions are used to dynamize an object property or to react to events. You should use C actions if, for example, you want to process several input parameters in one action or you want to execute conditional instructions (if ... then ...).

Dynamization with a C action is indicated with the  icon in the "Object Properties" dialog.

See also

"Events" tab in the "Object Properties" window (Page 517)

The "Properties" Tab in the "Object Properties" Window (Page 514)

4.2 Configuration recommendations

4.2.1 Configuration recommendations for dynamization

The following factors may have a strong influence on the performance of your WinCC system:

- Configuration / hardware:
 - Server / Client PC
 - Data source/ communication channel
- Structure and size of the WinCC project
- Global project scripts and utilization through central project functions, e.g. Tag Logging
- Number and type of the dynamizations
- Nested screen windows
- Complex screen navigation

This section focuses on the dynamization and configuration of process pictures.

Configuration recommendations

You can use different types of dynamization when configuring the process pictures. Depending on the project structure and configuration, it makes sense to use or avoid specific methods.

You can find the corresponding recommendations in the following sections:

- Configuration recommendations: Cycle times (Page 1166)
- Configuration recommendations: Dynamizing object properties (Page 1167)
- Configuration recommendations: Faceplate types (Page 1171)
- Configuration recommendations: Tags and tag triggers (Page 1169)

Additional recommendations

You can find additional information on improving the performance in the WinCC Information System under:

Chapter	Contents
"Working with WinCC > Working with Projects > Making Settings for Runtime > System Diagnostics with Performance Tags (Page 176)"	Information on system tags with which, for example, the time behavior during reading or writing of tags is analyzed.
"Configurations > Multi-User Systems > Configuration Limits and Performance"	The notes on configuration in this section apply to all project types.
"Performance data"	Technical specifications and performance limits as well as typical configurations.

4.2 Configuration recommendations

Chapter	Contents
"Release Notes > Notes on operation"	Information about the compatibility and the usage of virus scanners.
"Working with WinCC > Working with Projects > Making Settings for Runtime > Effect of External Applications on Runtime (Page 175)"	Information on applications that can affect system resources.

See also

- Effect of External Applications at Runtime (Page 175)
- Preparation to Create a Project (Page 115)
- System diagnostics with performance tags (Page 176)

4.2.2 Configuration recommendations: Cycle times

Cyclic triggers guarantee a high updating rate of the system but require a high system load.

Cycle times in WinCC projects

Ensure that cycle times in the WinCC project are synchronized in order to achieve even load distribution:

Cycle type	Component	Use
Acquisition cycle	Tag Management	Read tag values
Triggers	Global script (VBScript / ANSI-C)	Read / write values via scripts
Archiving cycle	Tag Logging	Archive tag values
Updating cycle	Graphics Runtime	Update process picture
Update cycle	Report system	Start print jobs
Segment change	Tag Logging / Alarm Logging	Closing or swapping out of an archive segment and creation of a new segment A segment change can result in delayed display of archive values.

Cyclic tag updating:

Select an update cycle that is as long as possible for the cyclic updating of process tags.

If many, frequently updated tags with a short update cycle are configured in the WinCC project, avoid the permanent display of these tag values in the process screen.

Scripts in process screens

Ensure that the processing time of all scripts with the same cycle is not longer than the configured cycle time.

Avoid the "SetTagWait" and "GetTagWait" functions in cyclic C actions.

Ensure that the "Output performance warnings" option is activated on the "Options" tab in the "Settings" dialog in Graphics Designer.

User Archive

Avoid many cyclic changes in user archives.

Cyclic print jobs

Configure cyclic print jobs so that the print jobs are started consecutively and not at the same time.

See also

Configuration recommendations for dynamization (Page 1165)

Configuration recommendations: Tags and tag triggers (Page 1169)

Configuration recommendations: Dynamizing object properties (Page 1167)

4.2.3 Configuration recommendations: Dynamizing object properties

The selected dynamization of object properties can have a great effect on the performance.

The following cases are considered in this section:

- Dynamizing several object properties
- Graphic object: Read / write properties via scripts
- Dynamizing object properties with the "Item" object

Dynamization via scripts (VBScript / ANSI-C)

Note that a large number of scripts in a process picture can always adversely affect performance.

If possible, use the dynamization type "Animation" or tag connections.

Dynamizing several object properties

Task

Trigger modification of several object properties via the same event.

Recommended procedure

Create an animation in which the object properties are dynamized via tag connection or expression.

Constraint:

- Cyclic triggers and complex expressions can have a negative effect on the performance.

Alternative procedure

Dynamize properties via scripts.

Result:

- If many object properties are dynamized, worse Runtime performance may result than at the animation.

Additional information

- Working with WinCC > Creating Process Pictures > Working with Objects > Dynamic Basic Operations > Animating an Object (Page 491)

Graphic object: Read / write properties via scripts

Task

Setting values of object properties in graphic objects.

Recommended procedure

Setting properties using VBScript, see example VBS122:

```
Dim objScreenSet  
objScreen = HMIRuntime.Screens("ScreenWindow1")  
objScreen.FillStyle = 131075  
objScreen.FillColor = RGB(0, 0, 255)
```

Alternative procedure

Setting properties using the "SetProperty" function.

Result:

- If you use the "SetProperty" function within a C action, the picture is reloaded every time a value changes (Redraw). The performance is reduced when opening a picture.

Additional information

- Working with WinCC > VBS for Creating Procedures and Actions > VBScript Examples > Examples in WinCC > Example: Defining the color of objects

Dynamizing object properties with the "Item" object

Task

Dynamize multiple object properties of the same object.

Recommended procedure

Use the "Item" object.

To reference to the current object once, use the "Item" object in the VBScript actions, for example:

```
Item.Width
```

Alternative procedure

Addressing objects using the object model, e.g.:

```
HMIRuntime.Screens("Screen1").ScreenItem("Polygon1").Width
```

Result:

- Entering the path multiple times in a function reduces the performance when executing the function.

Additional information

- Working with WinCC > VBS for Creating Procedures and Actions > VBS Reference > Objects and Lists > Item object

See also

How to animate an object (Page 491)

Configuration recommendations for dynamization (Page 1165)

Configuration recommendations: Cycle times (Page 1166)

4.2.4 Configuration recommendations: Tags and tag triggers

The following cases are considered in this section:

- Reading tags via script
- Triggering actions by tag trigger

Script: Read tags

Task

Read many tags in a script.

Recommended procedure

Use the object "TagSet" (list).

The object "TagSet" enables simultaneous access to several tags in one call.

Alternative procedure

Single access to various tags.

Result:

- Reduced performance and high communication load in the WinCC project.

Additional information

- Working with WinCC > VBS for Creating Procedures and Actions > VBS Reference > Objects and Lists > TagSet object (list)

Trigger actions by tag trigger

Task

Trigger actions by tag trigger.

Recommended procedure

Preferably use the tag trigger "Upon change". The tags are queried in the update cycle "1 second".

Advantage:

- The tag trigger only executes the action if a change in the value of the tag has been detected. This reduces the load on the system and increases performance.
- When reading from the process image, the tag is logged on and, from that moment, polled cyclically from the PLC. When a picture is selected, all of the tags contained in tag triggers are known.
Since all tags are requested at once, the best possible optimization can be achieved by the channel. The duration of the call does not depend on the bus-load or on the AS.

Constraint:

- When the tags change very rapidly, the increased trigger frequency of the action can result in a higher system load.
This applies, for example, for WinCC diagnostics tags that can change very rapidly.

Alternative procedure

Use cyclic tag triggering with brief trigger periods.

Result:

- Increased system load and reduced performance in Runtime.

Exception:

- When the tags change rather frequently, you may want to use a cyclic tag trigger, for example, for WinCC diagnostics tags.

Additional information

- Working with WinCC > Dynamize process pictures > Trigger Types (Page 1175)
- Working with WinCC > VBS for Creating Procedures and Actions:
 - Creating and Editing Actions > Trigger
 - VBS Reference > Methods > Read Method
- Working with WinCC > ANSI-C for Creating Functions and Actions
 - Creating and Editing Actions > Trigger
 - Internal F > tag > get > GetTag functions, function principle

See also

- Configuration recommendations for dynamization (Page 1165)
- Configuration recommendations: Cycle times (Page 1166)
- Trigger Types (Page 1175)

4.2.5 Configuration recommendations: Faceplate types

When creating a faceplate type as a reusable template, you define instance-specific properties of the individual objects.

For a high-performance dynamization of the faceplate instance in the process picture, link the instance-specific properties with interface tags or structure tags.

Faceplate tags and scripts in the faceplate types and faceplate instances may reduce the performance in Runtime.

The following cases are considered in this section:

- Dynamization in faceplate types
- Many faceplate instances with the same dynamization

Additional information

- Working with WinCC > Creating Process Pictures > Working with Faceplate Types (Page 396)

Dynamization in faceplate types

Task

Configure dynamization in faceplate types

Recommended procedures

- Link object properties with interface tags.
- Link object properties with structure types.
- Link instance-specific properties directly with the properties of the objects.
- Distribute many complex faceplate instances to multiple process pictures.
When the faceplate instances contain many scripts or are linked to many faceplate tags, the performance is reduced when opening a picture.

Alternative procedure

Link instance-specific properties with faceplate tags.

Result:

- The linking of faceplate tags to instance-specific properties reduces the performance in Runtime.

Many faceplate instances with the same dynamization

Task

Create many faceplate instances with the same dynamizations.

Recommended procedure

Link object properties in the faceplate type with prepared structure types and structure type elements.

In the process picture insert the structure instance from the Tag Management into the process picture instead of a faceplate instance. The instance of the faceplate type selected in the process is linked automatically with the structure tags.

Alternative procedure

Dynamization of the individual faceplate instances via interface tags or instance-specific properties.

Result:

- Elaborate configuring of the individual faceplate instances.
- The selected dynamization may reduce the performance in Runtime.

See also

Configuration recommendations for dynamization (Page 1165)

Working with Faceplate Types (Page 396)

4.3 Using tag prefixes and server prefixes

Introduction

WinCC offers a wide variety of possibilities to define and structure tags. For a picture window, a tag prefix can be assigned to precede all tags that are used in the picture.

Pictures that are embedded can be stored on any server in a multi-user system. Either the server is specified directly on embedding a picture with the server prefix, or assigned later via the object properties of the picture window. Tags can also be requested from other servers with the server prefix.

TagPrefix Property

Use "TagPrefix" to define or return the tag prefix that is added to all tags, which are contained in the picture window object, or that returns a tag prefix. In this way, a picture that is embedded in a picture window retains access to its own tags while another picture accesses other tags.

Example: In a picture window the "temperature" tag is requested on an object. If the "Motor1." tag prefix is assigned to the picture window, the tag "Motor1.Temperature" is requested.

Note

Do not specify an additional tag prefix in the child picture window

If a picture window is configured in a referenced picture of a picture window, the tag prefix of the parent picture window is applied to the child picture window of the tag prefix. You should not specify an additional tag prefix in the child picture window, because WinCC does not support bundled structure tags. The interpretation "Tag_prefix1.Tag_prefix2.Tag_name" cannot be used for dynamization.

ServerPrefix Property

Use "ServerPrefix" to determine in a multi-user system:

- the server where the picture to be displayed in the picture window is located.
- the server, from which the tags are read.

Note

No check is made as to whether the server prefix matches the server which is actually available.

When changing the computer name of the server, you need to adapt the server prefix manually. When changing a computer name, you should retain the symbolic computer name that was set when the package was created. This makes it easier to manually adapt the server prefix.

Requesting tags without prefix

The example below shows a reason for requesting tags without prefix.

4.3 Using tag prefixes and server prefixes

You want to read the local user using the "@CurrentUser" tag. In a multi-user system, or if the faceplate technology is used, the tag names are always preceded by a server prefix or a tag prefix. You can use the following tag add-ons to switch off the prefix in order to read the "@CurrentUser" tag.

- "@NOTP" switches off the tag prefix.
- "@NOSP" switches off the server prefix.
- "@NOP" switches off the tag prefix and the server prefix.

The add-ons cannot be used in the "TagPrefix" or "ServerPrefix" properties of a picture window or basic picture.

The add-ons are available in all dynamization types. It only makes sense to switch off the server prefix in the case of clients with their own project.

If a standard server is set up on a multi-user system, you cannot use the "@NOP" and "@NOSP" add-ons.

Tag prefixes will only function for tags.

Example

The following VBScript reads the "@CurrentUser" tag without tag prefix and outputs the content as a trace in a diagnostics window.

```
'VBS311
Dim tag
tag = HMIRuntime.Tags("@NOTP::@CurrentUser").Read
HMIRuntime.Trace "CurrentUser: " & tag & vbNewLine
```

Note

The setting of the prefix only becomes effective when newly supplying the picture name. This means you must either set the prefix before picture selection or newly supply the picture name if the picture is not changed.

4.4 Trigger Types

4.4.1 Trigger Types

Introduction

Triggers are used to execute actions at runtime. To do this, a trigger is linked to an action, forming the triggering event for calling the action. Actions without triggers will not be carried out.

The following triggers are available for the dynamization of objects:

- Cyclic Triggers
- Cyclic Triggers Based on Window Cycle
- Cyclic Triggers Based on Picture Cycle
- Tag triggers
- Event-Driven Triggers

Note

It is important to remember that the cycle time has a major effect on the performance of the project. All the actions of a picture must be completed within their cycle time. Apart from the runtimes of the actions, the times required for requesting the tag values and the reaction times of the automation systems must also be taken into consideration. You should only set trigger events with a cycle time under one second if variables which change rapidly have to be queried.

4.4.2 Cyclic Triggers

Introduction

Cyclic triggers are a means of processing periodic actions in WinCC. In the case of a cyclic trigger, the action is executed when the trigger event occurs, e.g. every 20 seconds.

Principle of Operation

When actions with a cyclical trigger are configured in a picture, each tag is requested individually following selection of the picture.

The start of the first time interval coincides with the start of Runtime. The length of the interval is determined by the cycle. Cycles between 250 ms and 1 h can be selected. Self-defined user cycles are also available.

4.4 Trigger Types

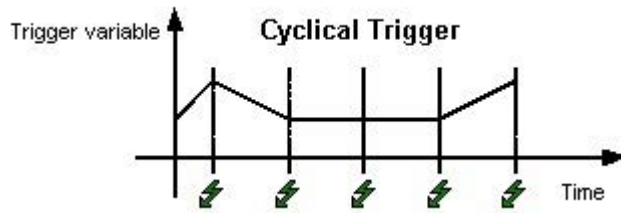

The action is always executed when the triggering event occurs.

Note

Depending on the system, it cannot be guaranteed that an action with a cyclic trigger is carried out at exactly the specified time.

Cyclic Triggers Based on Window Cycle

A cyclic trigger is used as the trigger. The cycle time is defined by the object property Update Cycle of the Picture Window object. This cycle provides the option of defining the cycles of all the actions used in a picture window centrally.

Cyclic Triggers Based on Picture Cycle

A cyclic trigger is used as the trigger. The cycle time is defined by the object property Update Cycle of the picture object. This cycle provides the option of defining the cycles of all the actions used in a picture centrally.

Recommendation

In order that the WinCC project has a high level of performance, it is advantageous to dispense with actions which have a cyclical trigger and to realize periodic actions in the automation system.

4.4.3 Tag Triggers

Introduction

Tag triggers consist of one or more specified tags. The action which is connected to such a trigger is executed if a change in the value of one of these tags was detected when the query was launched.

Principle of Operation

When actions with tag triggers are configured in a picture, all the tag triggers related to an action are requested block by block when the picture is selected.

The beginning of the first interval coincides with the point at which the picture is first selected. The length of the interval is determined by the cycle. Query cycles between 250 ms and 1 h can be selected. Self-defined user cycles are also available.

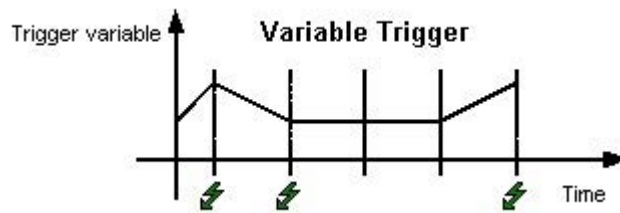

The action is only executed when the value of the tag triggers has changed.

Note

If a tag briefly changes within a query cycle and then resumes its original value, the action is not executed.

Note

Reaction in case of non-existing variables

A C/VBS action is not executed after screen selection if a non-existing tag is requested. The object is shown regardless. However, a dynamic dialog is executed once after screen selection. The object is not shown.

Upon change

You can also configure a tag trigger so that the action is executed whenever the tag value is changed.

The "On change" mode setting for process tags corresponds to a cyclic read request with a cycle time of 1 second.

Note

If the WinCC diagnostics tags are used as action triggers, this form of the tag trigger should not be used. Diagnostics tags can change very quickly. Since every change could trigger the action, it can lead to high system utilization.

Recommendation

Tag triggers should be used in order that the WinCC project has a high performance level:

- With cyclic actions, the action is always executed, e.g. every 2 seconds. The tag trigger only executes the action if a change in the value of the tag has been detected. This reduces the load on the system and increases performance.
- When a picture is selected, all of the tags contained in tag triggers are known and can be requested all at the same time by the automation system. The best possible optimization can thus be achieved from the channel.

4.4.4 Event-Driven Triggers

Introduction

Actions which are connected to an event are executed whenever this event occurs. Events can be, for example, mouse control, keyboard control, or changes in focus.

If the "Mouse Action" event is connected to an action, this action is also triggered by a configured hotkey.

Mode of Operation

The action is only executed when the object's triggering event is triggered. If the event occurs, all the tags contained in the action are registered. Process tags are subsequently updated at a cycle time of 1 s.

Recommendation

Event-driven triggers are not suitable for bulk configuration in the case of dynamizing with C-actions because each action must be logged on and off individually by the action control.

4.5 Dynamic Wizard

4.5.1 Dynamizing Using Dynamic Wizard

Introduction

With the Dynamic Wizard, you can dynamize an object using C actions. When you execute a wizard, preconfigured C actions and trigger events are defined and transferred to the object properties. If necessary, you can change the C actions in the object properties using the Events tab.

Dynamic Wizard

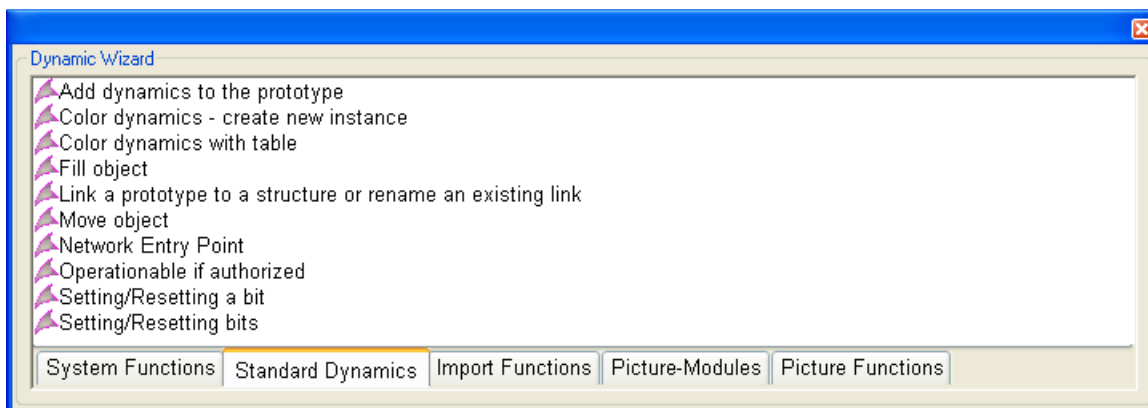

The preconfigured C actions are divided into the following groups:

- System functions
- Standard dynamics
- Picture components
- Import functions
- Picture functions
- SFC

The available groups and the wizards contained in the groups depend on the WinCC installation type, the project type, and the selected object.

Note

You can use the "Toolbars..." item in the "View" menu of the Graphics Designer to show or hide the Dynamic Wizard.

See also

- SFC (Page 1193)
- System Functions (Page 1192)
- Standard Dynamics (Page 1185)
- Import Functions (Page 1184)
- Picture Components (Page 1183)
- Picture Functions (Page 1180)

4.5.2 Picture Functions

Updating Picture Objects

This wizard updates all user objects with type identification contained in the current WinCC picture or in the project.

The wizard is part of the Graphic Object Update functionality.

Note

The Wizard functionality is only available in a PCS7-OS.

Changing User Object Connection

This wizard is used to change the individual connections of user objects at a later stage, e.g. connection to a different AS block instance.

The wizard is part of the Graphic Object Update functionality.

Note

The Wizard functionality is only available in a PCS7-OS.

Picture Selection in Process Window

With this wizard you can create an action used to change a picture in the process window. The name of the picture to be displayed is specified in the wizard.

Note

This wizard is only available if the WinCC Basic Process Control and SFC Visualization option is installed and the project has been processed with the OS Project Editor.

Picture Selection Via Measurement Point

With this wizard you can create an action used to select a picture by means of a measurement point which you must select. The name of the measurement point and of the picture to be displayed is specified in the wizard.

Note

This wizard is only available if the WinCC Basic Process Control and SFC Visualization option is installed and the project has been processed with the OS Project Editor.

Picture Selection Via Group Display

With this wizard you can create an action used to select a picture by means of a group display. If an alarm occurs in Runtime, the location (graphic) of this alarm is displayed.

Note

This wizard is only available if the WinCC Option Basic Process Control is installed, the project has been processed with the OS Project Editor, and a group display has been selected.

Picture Navigation

This wizard creates an action which performs the selected picture navigation when the trigger occurs at the selected object.

The following picture navigation functions can be selected:

- Display Start Picture
- Display Previous Picture
- Display Next Picture
- Display Stored Picture
- Store Picture

Note

This wizard is only available if the project has not been processed with the OS - Project Editor.

Picture Change in Working Area

With this wizard you can create an action used to change a picture in the working area. The name of the picture to be displayed is specified in the wizard.

Note

This wizard is only available if the WinCC Basic Process Control is installed and the project has been processed with the OS Project Editor.

▲ Picture Change in Window

This wizard is used to change the content of a window object in a Graphics Designer picture.

Note

This wizard is only available if the project has not been processed with the OS - Project Editor.

▲ Simple Picture Change

With this wizard you can create an action used to change a picture. The name of the picture to be displayed is specified in the wizard.

Note

This wizard is only available if the project has not been processed with the OS - Project Editor.

Picture Object Export

This wizard exports user objects with type identifier contained in the current picture and in the project into an Excel table (.csv format). Information such as the object type and connection information is exported.

The wizard is part of the Graphic Object Update functionality.

Note

The Wizard functionality is only available in a PCS7-OS.

▲ Display Error Box

The wizard creates an action which displays a dialog. The type of dialog, info box, question box, or emergency box, and the title and text of the dialog must be specified in the wizard.

The action which calls the error box is not resumed until the box has been closed. Other actions which have been configured under the same trigger type in the same application are not triggered while the box is open.

If one of the buttons in the dialog is clicked in Runtime, the action is given a return value which you can evaluate in your script:

Button	Return value
OK	1
Cancel	2
Yes	6
No	7

Note

This wizard is only available if the project has not been processed with the OS - Project Editor.

**PCS
7** **Picture Object Import**

This wizard imports user objects into WinCC pictures. The required information is normally read from a file that has earlier been generated and modified using the Dynamic Wizard "Export Picture Objects".

The wizard is part of the Graphic Object Update functionality.

Note

The Wizard functionality is only available in a PCS7-OS.

 **Display WinCC Dialog**

With this wizard you can display any picture of the Graphics Designer in a picture window. The name of the picture to be displayed and the appearance of the picture window is set in the wizard.

Note

This wizard is only available if the project has not been processed with the OS - Project Editor.

See also

Dynamizing Using Dynamic Wizard (Page 1179)

4.5.3 Picture Components

 **Creating faceplate as type - V 1.14**

This wizard is used to configure the assignment between the object properties of the picture and the structural components of a structured data type.

- Supply output value of an I/O field every second with .actual value
- Provide data to the process connection of a bar graph at intervals of two seconds.
Temperature

Here .actual value and .temperature are components of a structured data type

The original picture has become a type picture.

Note

This wizard is only available if the project has not been processed with the OS - Project Editor.
The WebNavigator does not support the basic faceplate technology of the wizard.

▲ Creating instances in the plant picture - V 1.14

With this wizard you can create a picture window in a parent picture and then call a type picture in this picture window. When doing so, you specify which tag of a structured data type the picture window works with and at which position the picture window is placed. The instance wizard enables the positioning of picture windows in several ways:

- as a fixed component in the picture
- as a displayable component which can be called using a button
- as several displayable components which can each be called using a button
- as a fixed component with a selectable name .he name of the component can be pre-assigned with a tag.

Note

This wizard is only available if the project has not been edited using the OS - Project Editor.
The WebNavigator does not support the basic faceplate technology of the wizard.

Picture Module Technology

The documentation concerning the Picture module technology explains the WinCC screen-in-screen technology. An example project illustrates how to create and modify a picture module.

See also

Dynamizing Using Dynamic Wizard (Page 1179)

4.5.4 Import Functions

▲ Import Messages

With this wizard you can import a COROS LS-B message list into WinCC. You will find further information in the WinCC Information System under WinCC Documentation, Smart Tools, Migration of COROS LS-B to WinCC.

▲ Import S5L, Tag Only

With this wizard you can import a COROS LS-B tag list into WinCC. You will find further information in the WinCC Information System under WinCC Documentation, Smart Tools, Migration of COROS LS-B to WinCC.

▲ Import S7 S5 ASLI

With this wizard you can read the assignment list of STEP 5 and STEP 7 into WinCC. You will find further information in the WinCC Information System under WinCC Documentation, Smart Tools, Importing Assignment List.

See also

Dynamizing Using Dynamic Wizard (Page 1179)

4.5.5 Standard Dynamics

▲ Operative with Authorization

With this Wizard you may generate an action to check the authorization level of a user.

Link picture component with measuring point

Using the "Link Picture Component with Measuring Point" wizard you can link an existing picture component with the measuring points existing in the project.

Perform the following steps to establish such a link:

1. Open a picture with the desired picture component in Graphics Designer.
2. Select this picture component (mark the header, not the object contained within the picture component).
3. Select the "Standard Dynamics" tab in the "Dynamic Wizard" and start the wizard by double clicking it.
4. Follow the instructions in the Dynamic Wizard dialogs.
5. Using the tag selection dialog, the wizard will offer you all measuring points corresponding to the structure tag of the selected picture component. Select the desired measuring point.
6. Start the action by clicking the Finish button.

The wizard will link the objects of the picture component with the structure tags of the selected measuring point.

Note

The Wizard function is only available in a PCS 7 OS. One block icon must have been selected.

▲ Set/Reset Bit

Using this wizard you may create an action to set or reset the bit of a tag. The tag to be changed as well as the bit number will be displayed during the wizard run

▲ Color Dynamics - Create a New Instance

Dynamizations done using the "Color dynamics with table" wizard can also contain references to structure tags. For example: there can be a reference to a structure tag "Engine1" for a user object to display an engine. To copy this object, for e.g. for displaying another engine, then the references to the structure tag "Engine1" are to be modified.

The wizard does the required changes by switching all references to "Engine1" to the new structure instance that is to be mentioned. This affects all dynamizations established through tag links or scripts. Excluded are dynamizations established through Dynamic Dialog.

Note

This wizard is only available if the project has not been edited using the OS Project Editor.

▲ Color Dynamics With Table

Color attributes of graphics objects may be controlled during runtime by using a table. Each table entry may be assigned a color and a logical expression. The logical expression is a link of bit information of one or several tags from the WinCC Tag Management. The table is prioritized. The top table entry has the highest priority, the lowest table entry the lowest priority. If several expressions are valid during Runtime, the one with the highest priority will be used.

After selecting a graphics object in Graphics Designer the wizard is ready to start. Initially the wizard lists all object properties from which a dynamic color property may be selected. Afterwards the update timer for the tag trigger is set. All used tags are entered as triggers. Upon reselection of the wizard, the settings for any color dynamization previously made are displayed again.

Note

This wizard is only available if the project has not been edited using the OS Project Editor.

▲ Set/Reset Several Bits

Using this wizard you may create an action to set or reset several bits of a tag. The tag to be changed as well as the number of the bits will be displayed during the wizard run.

▲ Network Entry Point

Using this wizard you may implement a direct network entry point during runtime, triggered by an object event to be configured.

If the event occurs the program editor is started from STEP 7. At the same time a direct entry is made into the respective network.

In order to use the wizard, the following prerequisites must be met:

- the WinCC project with the picture to which entry is supposed to be made and the STEP 7 project must be on the same computer
- the WinCC project must be created as a subdirectory of the STEP 7 project (STEP 7-Project \wincproj\WinCC project)
- the S7 tags are mapped onto the WinCC tags

For the current object you specify an event which will trigger the entry. For e.g. "Click with the left mouse key" on a button. In addition, the selected WinCC tag will be linked with an attribute of the current object, for example the background color of the button. This attribute is controlled by the contents of the WinCC tag upon modification of tag value.

Once the triggering event occurs on the respective object during runtime, e.g., click with the left mouse button, the program editor (KOP, FUP, AWL) is started from STEP 7 and direct entry is made into the network defined by the selected tag.

Note**Not all operator authorizations are displayed after the language is changed**

The operator authorization is set up for each language in multi-language projects and errors may occur when you change the language. Restart WinCC Explorer and User Administrator to ensure the correct display of operator authorizations.

▲ Move Object

The object properties "Position X" and "Position Y" can be linked with tags in the course of the wizard so that the position of the object can be dynamized.

Note

This wizard is only available if the project has not been edited using the OS Project Editor.

▲ Fill Object

With this wizard you may create an action to dynamize the fill level of an object through a tag. During the wizard run you may also define the tags as well as upper and lower limits for fill levels 0% and 100%.

Note

This wizard is only available if the project has not been edited using the OS Project Editor.

▲ Dynamize Prototype

With this wizard you may dynamize the object properties through a structure tag element.

Dynamic Entity of Prototype

You can use this wizard to link an object property or user object edited using "Dynamize Prototype" in Runtime with a tag of a structured data type.

The wizard can only be used if the selected object has the "tagname" property in the correct upper and lower case.

You can only use the wizard together with the "Link Prototype with Structure or Rename Existing Ones" wizard.

Link Prototype with Structure or Rename Existing Ones

With this wizard you may link object properties to a structure or may rewire the link with a structure.

The following options may be selected:

- Change Object Name: The structure name is assumed as the object name.
- Check Structures: Checks if the stated structure is known.
- Remove Server Prefix: Removes server prefix from tag name.

This wizard makes all necessary changes by modifying all references to the new structure entity. This affects all dynamizations established through actions, direct links, or dynamic dialog.

You can only use the wizard together with the "Dynamic Entity of Prototype" wizard.

Link Group Display with Picture

The wizard is only offered for selection if a picture component or group display is marked in Graphics Designer.

With this wizard you may link the selected group display to a picture which is linked to additional group displays/picture components. In the selected group display in Runtime, you will see a display of the message states for the linked picture.

Note

This wizard is only available if the WinCC Basic Process Control is installed, the project has been processed with the OS Project Editor, and a group display has been selected.

Connect a group display with a PCS 7 process tag

The wizard is only offered for selection if a picture component or group display is marked in Graphics Designer.

With this wizard you may link an existing group display to the measuring points available in the project.

Note

This wizard is only available if the WinCC Basic Process Control is installed, the project has been processed with the OS Project Editor, and a group display has been selected.

▲ Actual Value Bar

Issues the tag content as actual value on a bar. Cycle time, tag name, minimum and maximum value, and zero of the bar display may be entered during the wizard run.

Note

This wizard is only available if a bar has been selected.

See also

Color Dynamics with Table (Page 1189)

Dynamizing Using Dynamic Wizard (Page 1179)

4.5.6 Color Dynamics with Table

Dialog for the Creation of Color Dynamics

This dialog is used to define color changes which are controlled by tag states. The color can be determined by a single tag or by the logical combination of several tags.

AND and OR conditions are available as logical operations.

A maximum of 10 color definitions are possible. These are then processed in the listed sequence. Entries which are at the top of the table have a higher priority than entries which are at the bottom of the table. The last entry in the table is always the "Default" entry. Its priority cannot be changed.

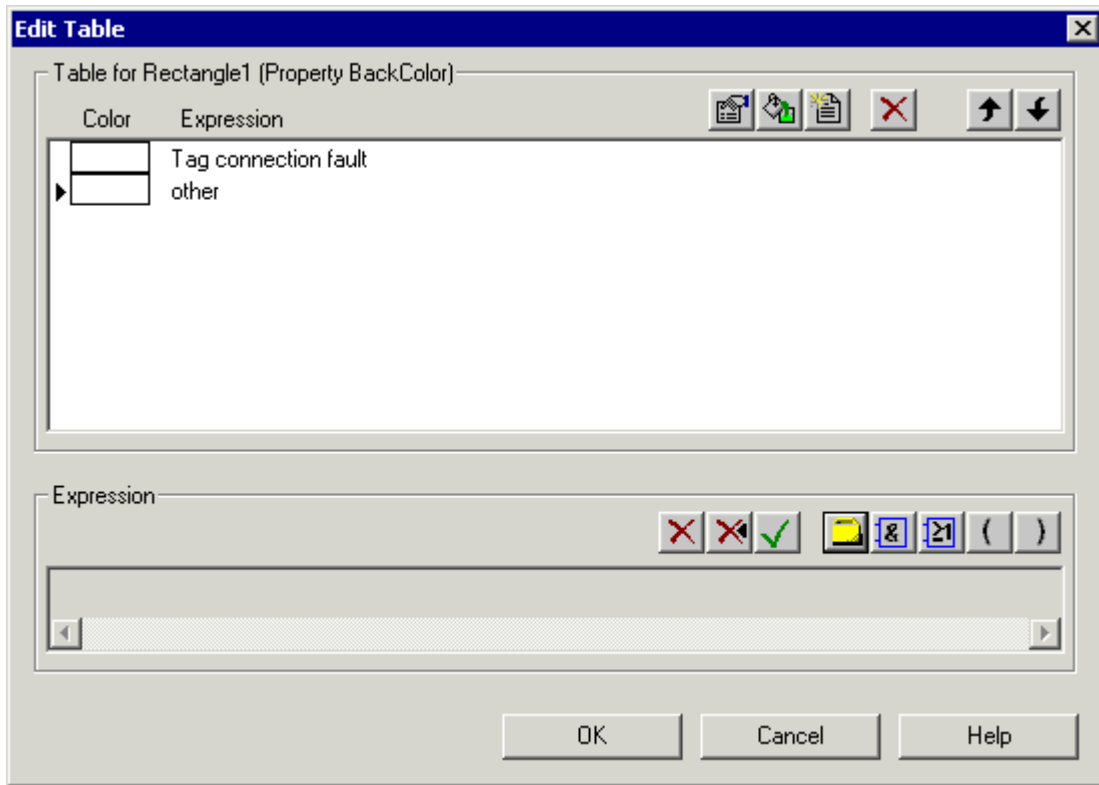

Creating Color Change Table

Before new color conditions can be added, a new row must be inserted using the "New" button. The empty entry is then automatically highlighted and can be changed in the editing area for expressions. The editing area is below the table.

"Properties" button. All the bit masks in the selected row are displayed in sequence. They can be changed.

"Color" button. This button opens the color selection dialog. The color selection dialog can also be opened by double-clicking the selected row.

"New List Entry" button. This button inserts a new row in the table.

"Delete List" button. All entries in the table are deleted, except for the entry "Other" (table area).

"Delete Highlighted Entry" button. The highlighted row is deleted.

"Up" button. The selected row is moved up in the table and is thus given a higher priority.

"Down" button. The selected row is moved down in the table and is thus given a lower priority.

Editing Expression

"Delete Entire Expression" button. Deletes the entire expression.

"Delete the Last Part of the Expression" button. Deletes the last part of the expression.

 "Accept Expression in the Table" button. Transfers the expression into the highlighted table row.

 "Tag Selection" button. Opens the tag selection dialog. All tags of the Bit, Byte, Word, and DWord type are displayed. When the tags have been selected, the tag bit mask appears in which the bits to be checked are set.

 "And" button. If permitted syntactically, a logical AND operation is attached to the expression.

 "Or" button. If permitted syntactically, a logical OR operation is attached to the expression.

 "Open Parenthesis" button. If permitted syntactically, an opening parenthesis is attached to the expression.

 "Close Parenthesis" button. If permitted syntactically, a closing parenthesis is attached to the expression.

Note

It is not possible to edit the expression manually.

Dialog for Creating Tag Bit Mask

This dialog is used to enter the tag bits to be checked.

Up to four bytes (only one bit in the case of binary tags) of the tag value are displayed. The states to be checked are entered here. An 'x' means that the bit is ignored.

If '0' or '1' is entered, the state of the bits concerned is checked accordingly.

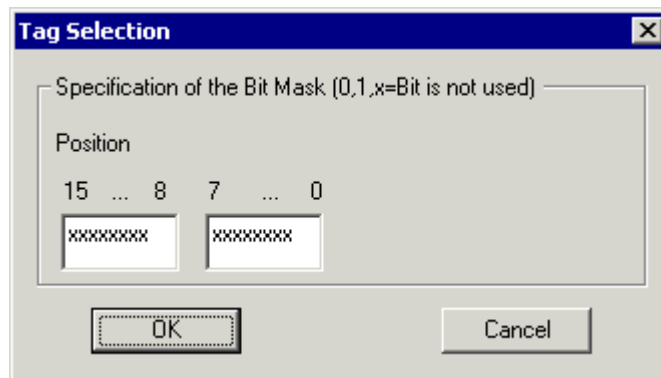

See also

Dynamizing Using Dynamic Wizard (Page 1179)

4.5.7 System Functions

▲ Start Other Applications

With this wizard you can create an action which starts another application. The path and name of the application to be started is entered in the wizard.

▲ Hardcopy

With this wizard you can create an action for making a hardcopy of the screen.

▲ Set Up Redundant Connection

With this wizard you can create an action for SIMATIC S7 Protocol Suite which performs a dynamic connection switch.

Further information can be found in the description of S7 Protocol Suite.

Note

This wizard is only available if the project has not been edited using the OS Project Editor.

▲ Language Switch

With this function you can create an action which switches the Runtime language.

▲ Exit WinCC

With this wizard you can create an action which closes WinCC. The action only acts on the computer on which the action is executed (this also applies to multi-user systems).

Note

This wizard is only available if the project has not been edited using the OS Project Editor.

▲ Exit WinCC or Windows

With this wizard you can create an action which closes WinCC or the operating system. You can specify how the operating system is to be closed (Exit, Restart, Relogin). The action only acts on the computer on which the action is executed (this also applies to multi-user systems).

Exit WinCC Runtime

With this wizard you can create an action which closes Runtime. The action only acts on the computer on which the action is executed (this also applies to multi-user systems).

Note

This wizard is only available if the project has not been edited using the OS Project Editor.

See also

Dynamizing Using Dynamic Wizard (Page 1179)

4.5.8 SFC

Introduction

The Sequential Function Chart (SFC) is a process control which is used to control the sequence of processes.

The "SFC Visualization" software pack can be used in the WinCC configurations for SFC visualization. It can also be used in Runtime to operate and monitor SFC plans and SFC instances.

The help is only available after SFC is installed.

A printable version of the SFC manual is available in the Windows program group "Siemens Automation > Documentation".

The "SFCenu.chm" file is also available in the installation path under \SIEMENS\WinCC\bin.

Note

You can find information about the Dynamic Wizard and SFC in the SFC documentation by searching for "Dynamic Wizard".

Configuring SFC Control

You can use this wizard to link an existing "PCS 7 SFC Control" with a SFC-Plan or SFC-Instance existing in the project.

Requirement

- A "PCS 7 SFC Control" has been selected

Procedure

1. Open a picture with a "PCS 7 SFC Control" in Graphics Designer and select this control.
2. Select the "SFC" tab in the "Dynamic Wizard" and start the wizard by double clicking "Configure SFC Control".
3. Follow the instructions in the Dynamic Wizard dialogs.
4. The wizard offers all the available SFCs via the SFC selection dialog. Select an SFC.
5. Select the required representation for this SFC.
6. Start the action by clicking the "Next" button and confirm it by clicking "Finish". The wizard connects "PCS 7 SFC Control" with the selected SFC.

Note

The Wizard functionality is only available in a PCS7-OS.

Configuring SFC Browser

You can use this wizard to dynamize a graphic object, say a button, to open the SFC browser at runtime using configured operations and to select and display a SFC plan or a SFC instance.

For additional information, see "SFC Visualization" in the PCS 7 description.

Note

The Wizard functionality is only available in a PCS7-OS.

Configuring SFC Button

You can use this wizard to dynamize a graphic object, say a button, to select and display a SFC plan or a SFC instance during runtime using configured operations.

For additional information, see "SFC Visualization" in the PCS 7 description.

Note

The Wizard functionality is only available in a PCS7-OS.

See also

Dynamizing Using Dynamic Wizard (Page 1179)

4.6 Dynamizing by Means of Tag Connection

4.6.1 Dynamizing by Means of Tag Connection

Introduction

When a tag is connected to a property of an object, the value of the tag is transferred directly to the object property. This means, for example, that the value of a tag can be directly influenced by an I/O field.

You should always use this type of dynamization if you want to transfer the value of a tag directly to an object property.

See also

Example: Dynamic Filling of Rectangle (Page 1196)

How to Configure a Tag Connection (Page 1195)

Types of Dynamization (Page 1163)

4.6.2 How to Configure a Tag Connection

Requirement

- Start Graphics Designer and open a picture.

Procedure

1. Open the Object Properties dialog of the object to be dynamized.
2. Click the Properties tab.
3. In the left-hand window area, select the property group to which the property you want to dynamize belongs.
4. In the right-hand window area, select the property which you want to dynamize.

5. Right-click the  icon belonging to this property and select the Tag... command in the pop-up menu.

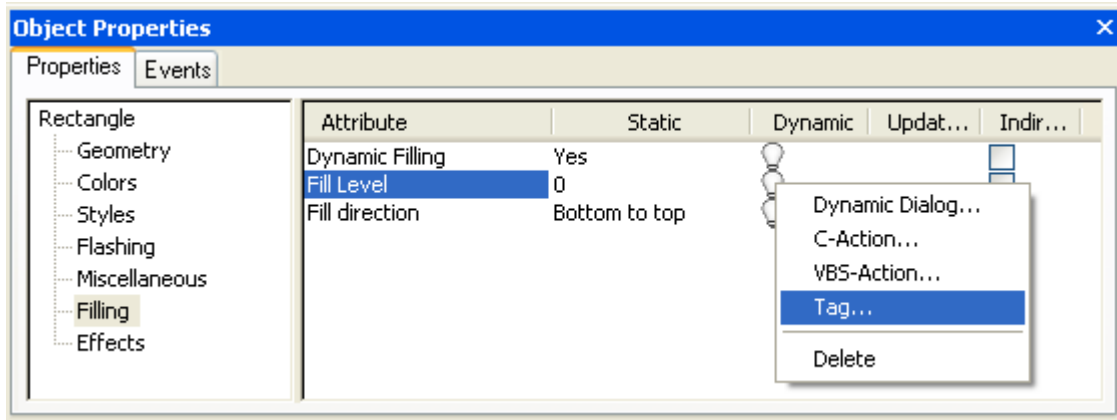

The tag selection dialog is displayed.

6. Select the tag which you want to link to the property.
7. Close the tag selection dialog using the OK button.
Dynamization by means of tag connection is indicated in the Object Properties dialog by the  icon and the name of the tag. The default trigger set in the Graphics Designer is used as the update cycle.
8. Check the update cycle and, if necessary, make changes using the pop-up menu.

Alternative Operation

You can also configure a tag connection by dragging a tag from the Tags toolbar onto the  icon.

You can also configure a tag connection by double-clicking the  icon. The name of the tag can then be entered directly in the entry field.

You can also configure a tag connection to the Output Value object property by dragging a tag from the Tags toolbar onto the object in the Graphics Designer picture.

See also

- Example: Dynamic Filling of Rectangle (Page 1196)
- Dynamizing by Means of Tag Connection (Page 1195)

4.6.3 Example: Dynamic Filling of Rectangle

Introduction

A process tag directly influences the fill level of a rectangle. In the example, the process tag is simulated by an internal tag whose values you can change by means of an I/O field.

Requirement



- Configure a "FillLevel" tag of data type "Unsigned 8-Bit Value".
- Start Graphics Designer and open a picture.
- Insert an I/O field into the picture and connect it to the "FillLevel" tag.
- Insert a rectangle into the picture.

Procedure

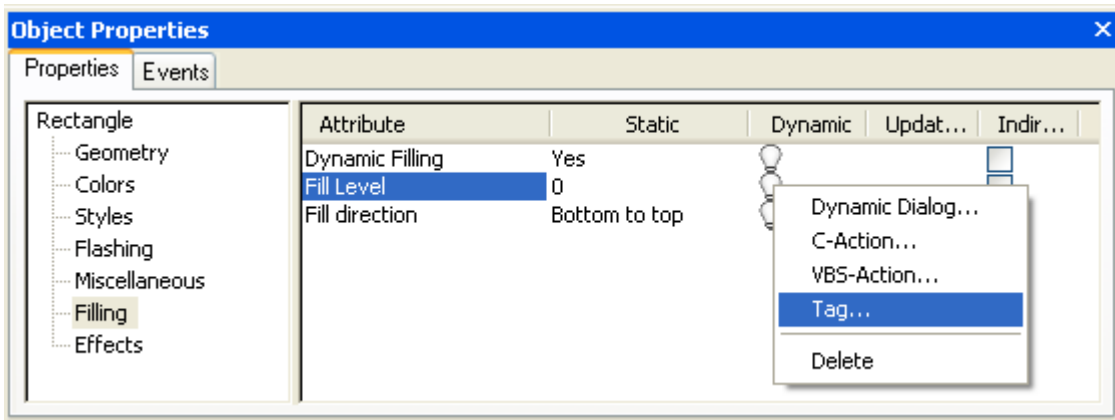
1. Open the "Object Properties" dialog of the rectangle and click the "Properties" tab.
2. In the left-hand window area, select the "Filling" property group.
3. In the right-hand window area, double-click the "Dynamic Filling" property. "Yes" now appears in the "Static" column.
4. Right-click the  symbol belonging to the "Fill Level" property and select the "Tag..." command in the context menu.



The tag selection dialog is displayed.

5. In the tag selection dialog, select the "FillLevel" tag and close the tag selection dialog using the "OK" button.
6. Dynamization by means of tag connection is indicated in the "Object Properties" dialog with the  symbol and the name of the tag. The default trigger set in the Graphics Designer is used as the update cycle.
7. Save the picture and activate Runtime using the  button.
8. In Runtime you can change the value of the tag using the I/O field. If, for example, you enter the value 30 in the I/O field, the bottom third of the rectangle is filled with the background color of the rectangle. The top two thirds of the rectangle are transparent.

See also

Dynamizing by Means of Tag Connection (Page 1195)

4.7 Dynamizing by Means of Direct Connection

4.7.1 Dynamizing by Means of Direct Connection

Introduction

Direct connection can be used as a reaction to events. If the event occurs in Runtime, the 'value' of a source element (Source) is used for a target element (Target).

Constants, tags, or the attributes of the objects in the picture are available as sources.

Tags or the dynamizable attributes of objects and windows or tags can be used as targets.

The advantages of direct connection are the simple configuration and the time response in Runtime. Direct connection has the best performance of all dynamization types.

Copying Objects

If in the Graphics Designer you copy an object whose properties are dynamized with a direct connection, the dynamizations are also copied.

If the direct connection in the original object relates to an object property of this object, the direct connection in the copied object relates to the corresponding property of the copied object.

If the direct connection in the original object relates to an object property of a third object, this third object is influenced by the direct connection of the copied object in exactly the same way as the direct connection of the original object.

See also

Example: Picture Change in Picture Window (Page 1201)

How to Configure a Direct Connection (Page 1200)

Application Examples of Direct Connection (Page 1198)

Types of Dynamization (Page 1163)

4.7.2 Application Examples of Direct Connection

Constants As Source of Direct Connection

If a constant is selected as the source of the direct connection, a character string can be entered in the entry field.

The table below explains the effect that the entries have on various target elements.

Source	Objective	Explanation
"picture1.pdl"	Current window / picture name	If the event occurs, a picture change is performed. The picture with the name "picture1.pdl" is displayed in the window.
"picture1"	Button1 / text	If the event occurs, the object "Button1" is labeled "picture1".
50	Rectangle1 / width	If the event occurs, the object "Rectangle1" is displayed with a width of 50 pixels.
50	Tag, direct with operator message	If the event occurs, the tag is assigned the value 50. An operator message is sent at the same time.

Note

You can also use the  button to configure a picture change. This button opens the picture selection dialog in which all configured pictures are displayed.

Object Properties As Source of Direct Connection

The table below explains the effects of various direct connections when an object property is used as the source.

Source	Objective	Explanation
Circle1 / fill pattern	Rectangle1 / fill pattern	If the event occurs, the fill pattern of the object "Rectangle1" is adapted to the fill pattern of the object "Circle1".
Circle / width	Current window / width	If the event occurs, the width of the window is adapted to the width of the object "Circle1".
Bar1 / height	Tag, direct	If the event occurs, the height of the object "Bar1" is assigned to the tag.

Note

The list of objects contains the entry "This object". If you use properties of the currently selected object as the source or target of the direct connection, this entry is used automatically when the dialog is closed. The dynamics are also copied when an object is copied. The direct connection of the object created during copying therefore refers to "This object". The newly created object is therefore used as the source or target of the direct connection.

Tags As Source of Direct Connection

The table below explains the effects of various direct connections when a tag is used as the source.

Source	Objective	Explanation
Tag1, direct	Tag2, indirect with operator message	If the event occurs, the tag whose name is stored in Tag2 is given the value of Tag1. An operator message is also sent.
Tag1, direct	Circle1 / radius	If the event occurs, the radius of the object "Circle1" is changed according to the value of the tag.

See also

Example: Picture Change in Picture Window (Page 1201)

How to Configure a Direct Connection (Page 1200)

Dynamizing by Means of Direct Connection (Page 1198)

4.7.3 How to Configure a Direct Connection

Requirement

- Start the Graphics Designer and open a picture.

Procedure

1. Open the Object Properties dialog of the object for which you want to configure an action.
2. Click the Event tab.
3. In the left-hand window area, select the event trigger, e.g. mouse, background color, ...

- In the right-hand window area, double-click the event type: e.g. mouse click, change, ...
The Direct Connection dialog opens.

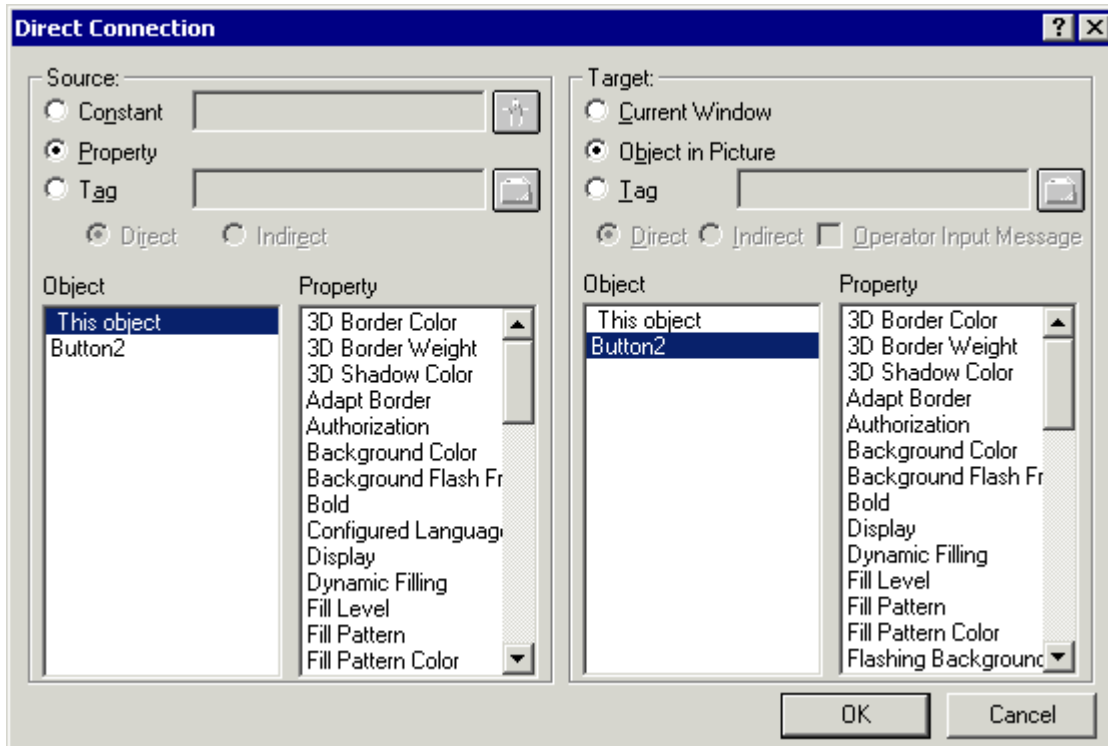

- Set the source of the direct connection.
- Set the target of the direct connection.
- In the "Direct Connection" dialog, click the "OK" button. Dynamizing by means of direct connection is indicated in the Object Properties dialog with the  icon.

See also

- Example: Picture Change in Picture Window (Page 1201)
- Application Examples of Direct Connection (Page 1198)
- Dynamizing by Means of Direct Connection (Page 1198)

4.7.4 Example: Picture Change in Picture Window

Introduction

In a picture window, a picture change is executed by means of a direct connection.

Requirement

- Start the Graphics Designer.
- Create two pictures "NewPDL1.pdl" and "NewPDL2.pdl". These pictures should contain objects which allow a distinction to be made between the objects.
- Insert a button into a new picture.
- Insert a picture window into the picture. Enter the picture name "NewPDL1.pdl" in the "Picture Name" object property.

Procedure

1. Open the "Object Properties" dialog of the button and click the "Event" tab.
2. In the left-hand window area, select the mouse as the event trigger.
3. In the right-hand window area, select Mouse Control as the event type.
4. Right-click the  symbol belonging to the "Action" and select the "Direct connection..." command in the context menu.

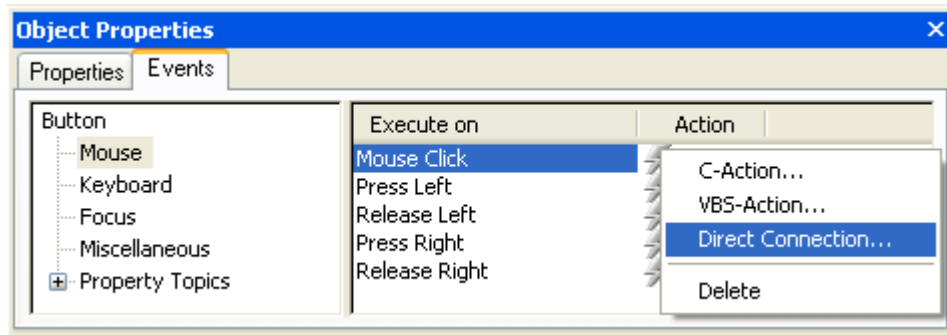



The "Direct Connection" dialog opens.

5. In the "Source" area, select a constant as the source of the direct connection. Click the  button and double-click the picture "NewPdl2.pdl" in the picture selection dialog.

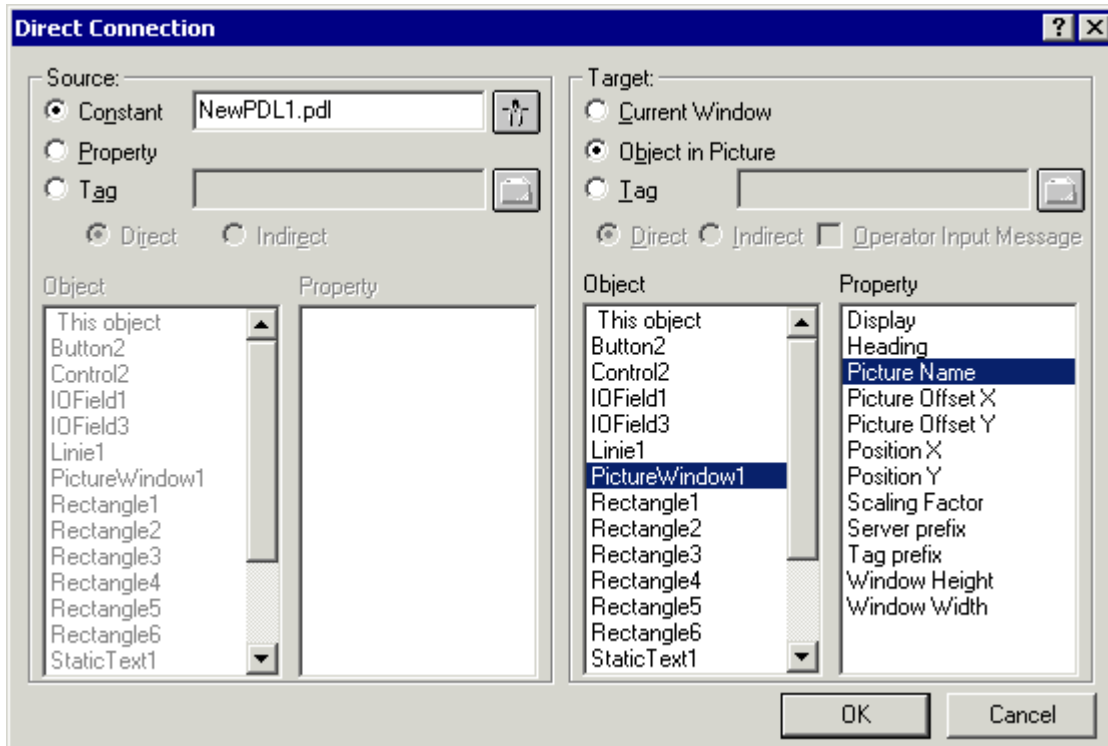
6. In the "Target" area, select the object "PictureWindow1" and the property "Picture Name".



7. In the "Direct Connection" dialog, click the "OK" button. Dynamizing by means of direct connection is indicated in the "Object Properties" dialog with the  symbol.
8. Save the picture and activate Runtime using the  button.
9. In Runtime, the picture "NewPdl1.pdl" is displayed in the picture window. If you click the "Button" object, a picture change to the picture "NewPdl2.pdl" takes place in the picture window.

See also

Dynamizing by Means of Direct Connection (Page 1198)

4.8 Dynamizing Using the Dynamic Dialog

4.8.1 Dynamizing Using the Dynamic Dialog

Introduction

The Dynamic Dialog is used to dynamize object properties. In Dynamic Dialog you formulate an expression by using tags, functions, and arithmetic operands. The value of the expression, the status as well as the quality code of tags used within the expression are used to form the object property value in Runtime.

The Dynamic Dialog may be used for the following purposes:

- Map the value ranges of a tag into colors
- Monitor single tag bits and map bit value onto colors or texts
- Monitor a Boolean tag and map bit value onto colors or texts
- Monitor tag status
- Monitor tag quality code

Note

If you divide two tags in a dynamic dialog, the decimal places are removed in the result. In the generated C code, a "LONG" is erroneously placed before the "GetTagDouble".

Remove the "LONG" so that the result of the division is output correctly.

Note

When using several tags or operands, the essential performance advantage of Dynamic Dialog is lost.

Convert to C Action

An action created with Dynamic Dialog is indicated in the "Object Properties" dialog with the  icon.

The code of this action is displayed if you use the right mouse button to click the  icon in the "Object Properties" dialog and select the command "C Action..." in the pop-up menu. This converts the dynamization created with Dynamic Dialog into a C action.

If you save the action or modify the code of the action, the action may no longer be modified by using the Dynamic Dialog.

Note

The "check_limits" feature generated during conversion of the Dynamic Dialog is reserved for the Dynamic Wizards.

See also

Example: Color Change Depending on Position (Page 1220)

Monitoring Quality Code (Page 1216)

Monitoring Tag Status (Page 1215)

Defining a Valid Range (Page 1211)

Creating Expressions (Page 1207)

How to Configure Dynamization Using the Dynamic Dialog (Page 1205)

4.8.2 How to Configure Dynamization Using the Dynamic Dialog

Requirement

- Start the Graphics Designer and open a picture.

Note**Specifying triggers**

If you do not set a trigger, the trigger event is defaulted by the system. The default values are dependent upon the contents of the formulated expression.

Output value in the I/O field

The direct connection to a text tag as output value of the I/O field cannot be dynamized using "Direct" data type in the Dynamic dialog.

Case sensitive tag name

Please note that the tag name is case sensitive.

Procedure

1. Open the "Object properties" dialog of the object to be dynamized.
2. Click the "Properties" tab.
3. In the left window area, select the property group which contains the property to be dynamized.
4. In the right window area, select the property to be dynamized.

- With the right mouse button, click the  symbol belonging to the property and select the "Dynamic Dialog..." command in the pop-up menu.

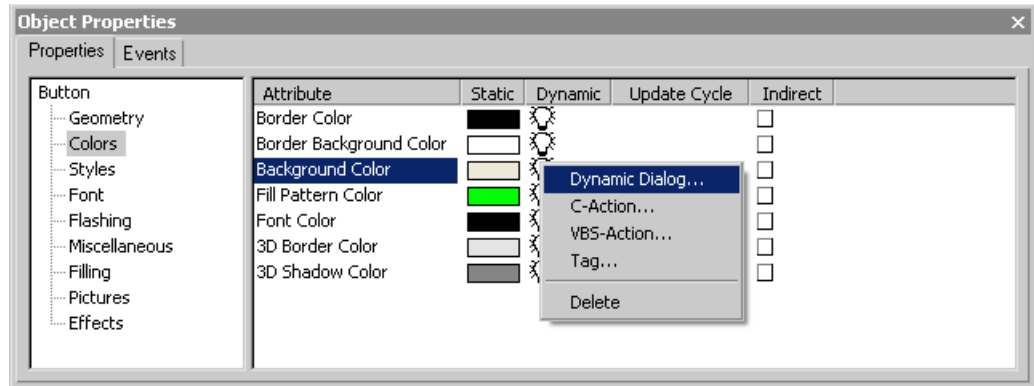

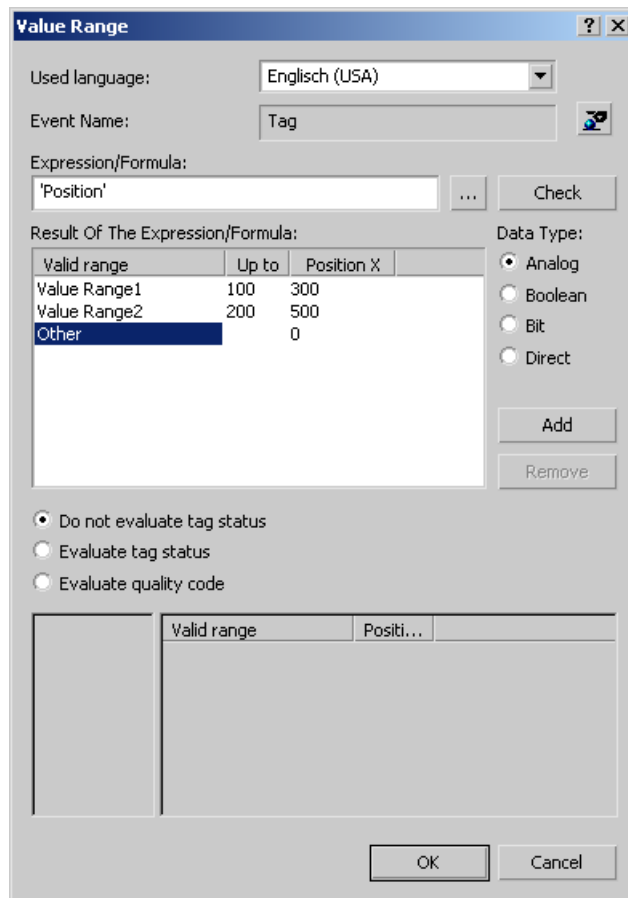

- The Dynamic dialog opens.



- In the "Language used" section set the corresponding code page for the scripts to be generated. You can select "Dynamic: Project setting" as the language setting for scripts. C scripts will then not only use the string transfer parameters with the given code page setting, for example, French (France), but will react dynamically to the project setting. You can specify the project setting in the "Project Properties" dialog in the WinCC Explorer.

- Click the  button and specify the trigger.

9. Specify the data type of the expression result in the "Result Of The Expression/Formula" area.
The data type determines the options for specifying the expression and defining value ranges.
10. In the "Expression/Formula" area, specify the expression which is to influence the value of the object property.
You may enter the expression either directly or add tags, functions and operands to your expression by using the  button.
11. Click the button "Check" to check the syntax of your expression.
12. Specify the valid ranges in the "Result of Expression/Formula" area.
13. Assign a value to the object properties of each valid range.
14. Specify whether or not to perform an analysis of the tag status of quality code of a tag.
Assign values to the object properties of the desired status or quality codes, if any.
15. Close the tag selection dialog by clicking the "Apply" button.
Dynamizing using the Dynamic dialog is indicated in the "Object properties" dialog with the  symbol.

See also

Example: Color Change Depending on Position (Page 1220)

Monitoring Quality Code (Page 1216)

Monitoring Tag Status (Page 1215)

Defining a Valid Range (Page 1211)

Creating Expressions (Page 1207)

Dynamizing Using the Dynamic Dialog (Page 1204)

4.8.3 Creating Expressions

Introduction

In Dynamic Dialog you formulate an expression by using tags, functions, and arithmetic operands. The value of the expression is used to formulate the value of the object property during Runtime.

The options to formulate the expression are dependent upon the desired data type of the printout result.

Formulating the Expression for Analog, Boolean, Direct Data Types

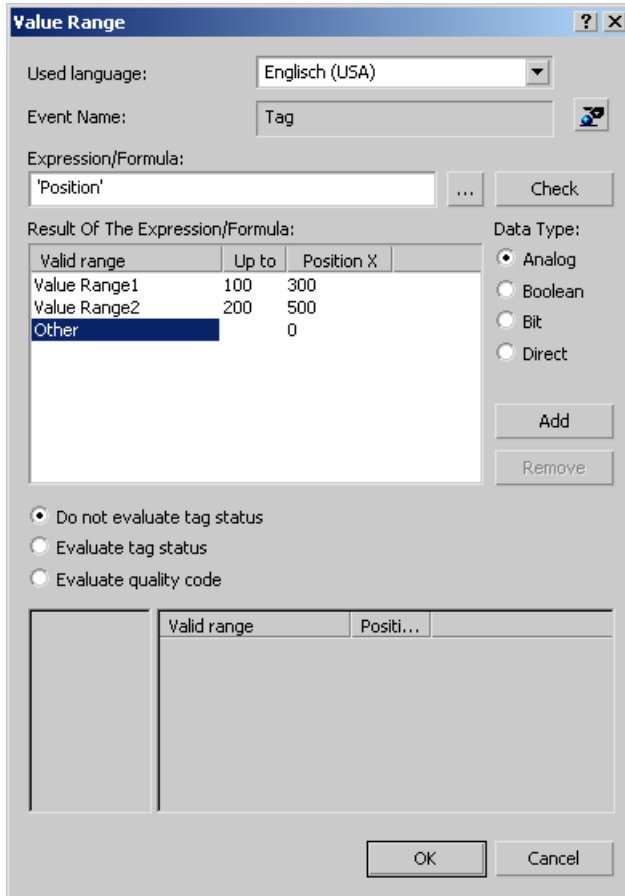

Tags

Tags may be entered either directly or by clicking the  button and using the tag selection dialog. For direct entry, make sure that tag names are included in single quotation marks.

Note

If you enter the name of a tag which cannot be found, the "Missing tags" dialog appears.

Click the "OK" button to define a new tag with this name. Click the "Cancel" button to edit the tag name.

Click the "Ignore" button to link the attribute with a nonexistent tag. This is useful, for example, if you work with structure tags in a picture window or subsequently wish to import tags. Check prior to commissioning that the respective tag is actually found in the system.

Functions

Functions may be entered either directly or by using the  button and the function browser. You may use all C functions of the Global Script within an expression.

Operands

Operands may be entered either directly or by using the  button. Within an expression, operands may be used for addition, subtraction, multiplication or division.

Decimal numbers may be entered directly. Only a period is permissible as the decimal point.

Note

When using several tags or operands, the essential performance advantage of Dynamic Dialog is lost.

Creating an Expression for Bit Data Types

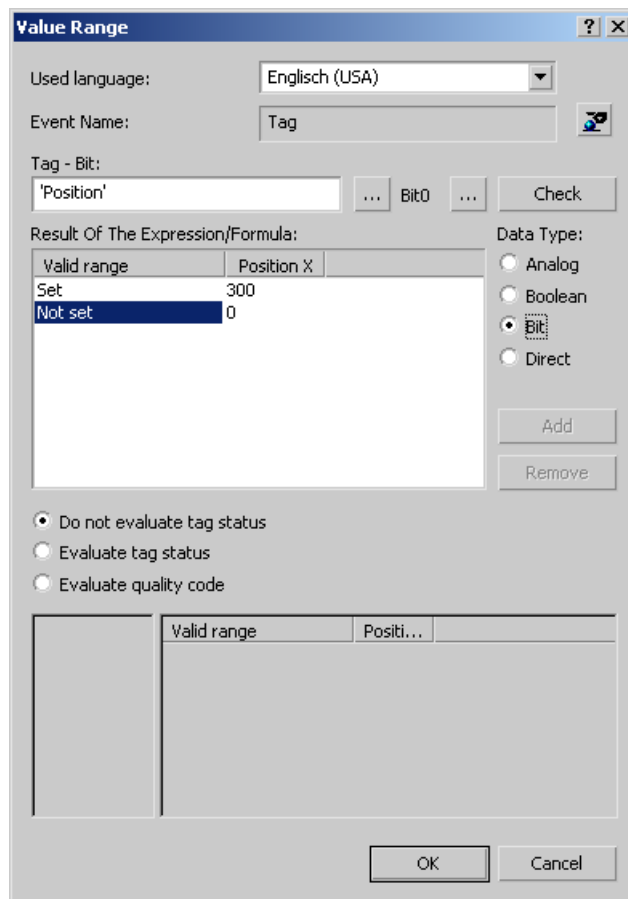

The Value Range dialog box is used to define the valid range for a bit data type. It includes the following fields and options:

- Used language: Englisch (USA)
- Event Name: Tag
- Tag - Bit: 'Position' (with a selection button), Bit0 (with a selection button), and a Check button.
- Result Of The Expression/Formula: A table with two columns: Valid range and Position X.

Valid range	Position X
Set	300
Not set	0
- Data Type: Radio buttons for Analog, Boolean, Bit (selected), and Direct. Includes Add and Remove buttons.
- Evaluation options:
 - Do not evaluate tag status
 - Evaluate tag status
 - Evaluate quality code
- Bottom section: A table with columns for Valid range and Positi... (truncated).
- Buttons: OK and Cancel.

Tags

Tags may be entered either directly or by clicking the  button and using the tag selection dialog. For direct entry, make sure that tag names are included in single quotation marks.

Masking Relevant Bits

For 8-bit, 16-bit and 32-bit tags, clicking the  button will open a dialog to mask the relevant bits.

Checking the Expression Syntax

Clicking the "Check" or "Apply" buttons, the syntax of the expression will be checked. You will receive an error message if the expression contains an error.

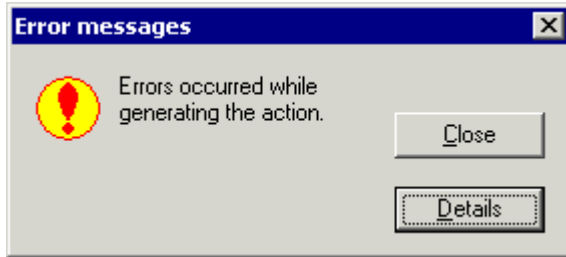

Clicking the "Details" button, you will receive additional information on the error message.

Note

Clicking the "Check" or "Apply" buttons will sort the list of value ranges "Result of the Expression/Formula" in ascending order by range upper limit.

See also

Example: Color Change Depending on Position (Page 1220)

Monitoring Quality Code (Page 1216)

Monitoring Tag Status (Page 1215)

Defining a Valid Range (Page 1211)

How to Configure Dynamization Using the Dynamic Dialog (Page 1205)

Dynamizing Using the Dynamic Dialog (Page 1204)

4.8.4 Defining a Valid Range

Value Ranges for an Expression of Data Type Analog

Value Range

Used language: Englisch (USA)

Event Name: Tag

Expression/Formula: 'Position'

Result Of The Expression/Formula:

Valid range	Up to	Position X
Value Range1	100	300
Value Range2	200	500
Other		0

Data Type:

Analog

Boolean

Bit

Direct

Do not evaluate tag status

Evaluate tag status

Evaluate quality code

Buttons: Add, Remove, OK, Cancel

For an expression of data type "Analog", you may specify several value ranges. Use the "Add" button to create new value ranges. A new value range is always created between the most recently defined value range and the range "Other".

The upper limit of a value range is changed by double-clicking the respective value in column "Up to".

The applicable value of an object property in a value range is changed by double-clicking the respective value in the column of the object property.

Settings shown in the picture have the following effect:

- If the value of the tag "Position" is less than or equal to 100, the property "Position X" is set to 300.
- If the value of the tag "Position" is greater than 100 and less than or equal to 200, the property "Position X" is set to 500.
- If the value of the tag "Position" is greater than 200, the property "Position X" is set to 0.

Value Ranges for an Expression of Data Type Boolean

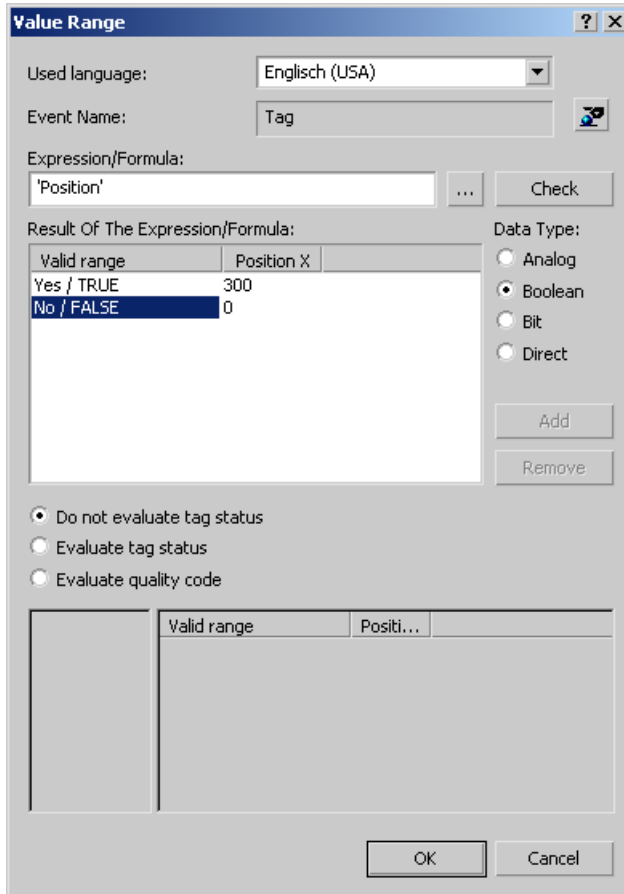

The applicable value of an object property in a value range is changed by double-clicking the respective value in the column of the object property.

Settings shown in the picture have the following effect:

- If the tag "Position" equals TRUE, the property "Position X" is set to 300.
- If the tag "Position" equals FALSE, the property "Position X" is set to 0.

Value Ranges for an Expression of Data Type Bit

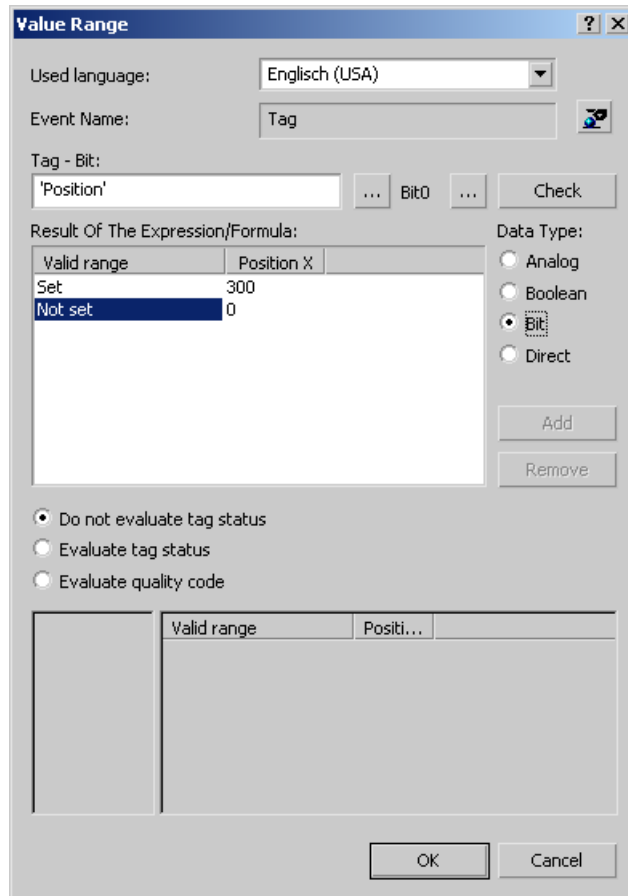

The applicable value of an object property in a value range is changed by double-clicking the respective value in the column of the object property.

Settings shown in the picture have the following effect:

- If Bit4 of the tag "Position" is set, the property "Position X" is set to 300.
- If Bit4 of the tag "Position" is not set, the property "Position X" is set to 0.

Value Ranges for an Expression of Data Type Direct

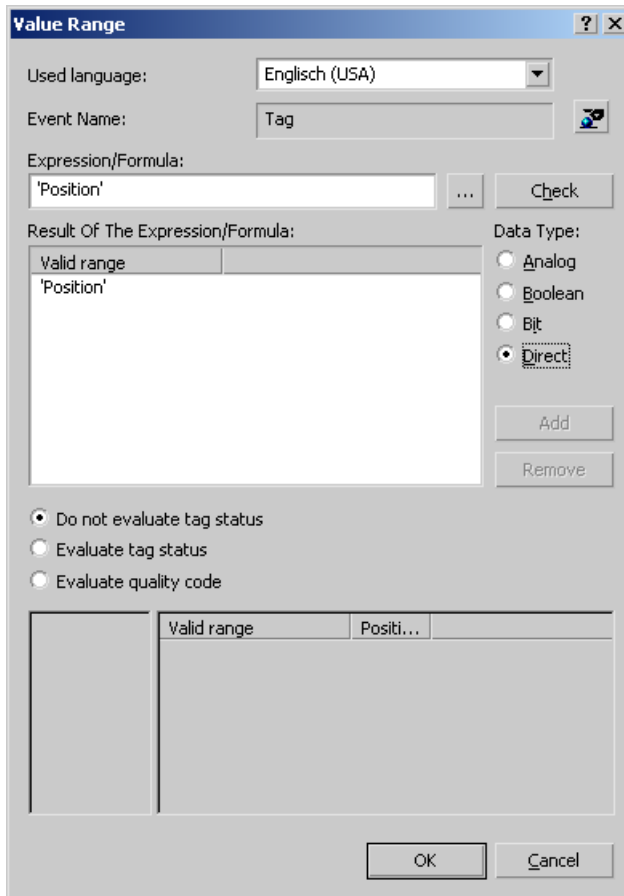

Settings shown in the picture have the following effect:

- The value of tag "Position" is divided by 10. The result of this calculation is accepted as the value for the object property to be dynamized.

See also

Defining a Valid Range (Page 1211)

Example: Color Change Depending on Position (Page 1220)

Monitoring Quality Code (Page 1216)

Monitoring Tag Status (Page 1215)

Creating Expressions (Page 1207)

How to Configure Dynamization Using the Dynamic Dialog (Page 1205)

Dynamizing Using the Dynamic Dialog (Page 1204)

4.8.5 Monitoring Tag Status

Introduction

Dynamizing by using the Dynamic Dialog may also be used to monitor the status of a WinCC tag in Runtime. Monitoring the tag status will also allow for conclusions on the status of associated links for external tags.

If you activate the check box "Tag status", the Dynamic Dialog is extended.

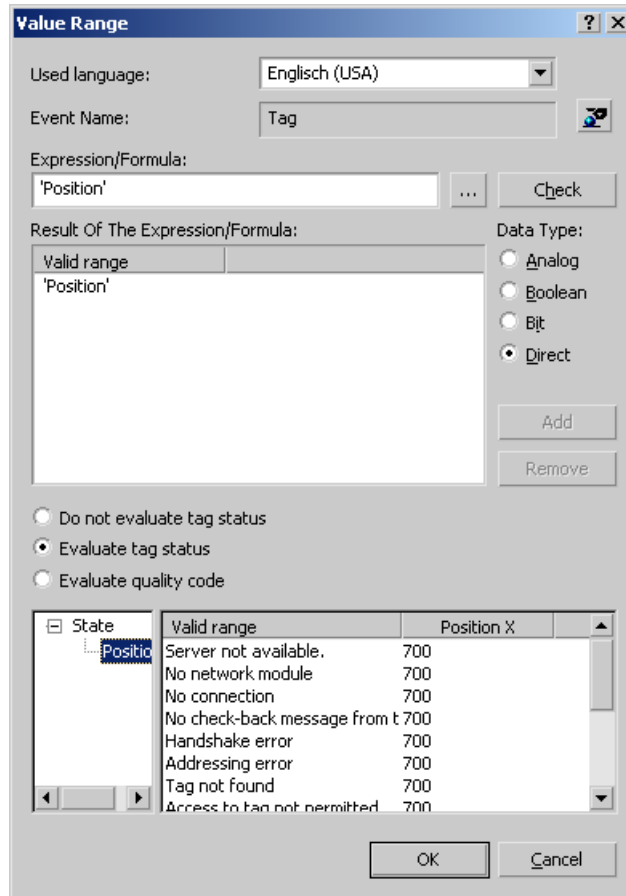

The left subarea will display all tags used in the expression.

In the right subarea, you may assign a value for each tag status of the object property to be dynamized. The applicable value of an object property for a tag status is changed by double-clicking the respective value in the column of the object property.

Note

If definitions for the value of an object property in the areas "Result of the Expression/Formula" and "Tag status" contradict each other, the value of the object property is determined by the definition in area "Tag status".

See also

- Example: Color Change Depending on Position (Page 1220)
- Monitoring Quality Code (Page 1216)
- Defining a Valid Range (Page 1211)
- Creating Expressions (Page 1207)
- How to Configure Dynamization Using the Dynamic Dialog (Page 1205)
- Dynamizing Using the Dynamic Dialog (Page 1204)

4.8.6 Monitoring Quality Code

Introduction

Dynamizing by using the Dynamic Dialog may also be used to monitor the quality code of a WinCC tag in Runtime. Monitoring the quality code of external tags will also allow for conclusions on the quality of associated tags during the process.

If you activate the checkbox "Quality Code", the Dynamic Dialog is extended.

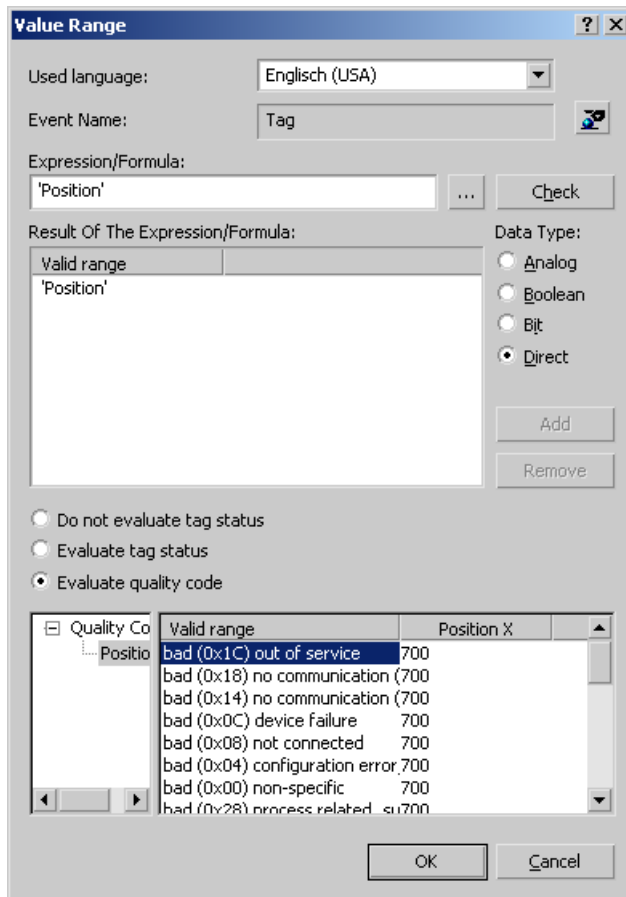

The left subarea will display all tags used in the expression.

In the right subarea, you may assign a value for each quality code of the object property to be dynamized. The applicable value of an object property in a quality code is changed by double-clicking the respective value in the column of the object property.

Note

If definitions for the value of an object property in the "Result of the Expression/Formula" and "Quality Code" areas contradict each other, the value of the object property is determined by the definition in "Quality Code" area.

Quality Codes that can be evaluated

In the right-hand portion of the Dynamic dialog, the selection of the supported Quality Codes is shown. All quality codes are data managers that are not available in the Dynamic dialog are summarized under the collective signal "bad miscellaneous state" and "uncertain miscellaneous states".

The Quality Codes that are offered in the Dynamic dialog are found in the following table. This list of Quality Codes is ordered by descending priority. If an expression is comprised of several tags, the expression contains the Quality Code of the tags for which the Quality Code is highest in the table.

Quality Code (Hex)	
0x1C	bad (0x1C) out of service
0x18	bad (0x18) no communication (no usable value)
0x14	bad (0x14) no communication (last usable value)
0x0C	bad (0x0C) device failure
0x08	bad (0x08) not connected
0x04	bad (0x04) configuration error, value not accepted
0x00	bad (0x00) non specific
0x28	bad (0x28) process related, substitute value
0x2B	bad (0x2B) process related, no maintenance
remaining codes from data manager with "bad" quality	bad miscellaneous states
0x68	uncertain (0x68) maintenance demanded
0x60	uncertain (0x60) simulated value
0x54	uncertain (0x54) engineering unit range violation, no limits set
0x55	uncertain (0x55) engineering unit range violation, low limits set
0x56	uncertain (0x56) engineering unit range violation, high limits set
0x78	uncertain (0x78) process related, no maintenance
0x4C	uncertain (0x4C) initial value
0x48	uncertain (0x48) substitute set
0x44	uncertain (0x44) last usable value
0x40	uncertain (0x40) non specific

Quality Code (Hex)	
remaining codes from data manager with "uncertain" quality	uncertain miscellaneous states
0x02	high limited (0x02)
0x01	low limited (0x01)

See also

- Example: Color Change Depending on Position (Page 1220)
- Editing Triggers (Page 1218)
- Monitoring Tag Status (Page 1215)
- Defining a Valid Range (Page 1211)
- Creating Expressions (Page 1207)
- How to Configure Dynamization Using the Dynamic Dialog (Page 1205)
- Dynamizing Using the Dynamic Dialog (Page 1204)

4.8.7 Editing Triggers

Introduction

If you do not set a trigger, the trigger event is defaulted by the system. The default setting depends on the content of the formulated expression in the Dynamic dialog.

- If the expression contains one or more tags, a tag trigger with the standard cycle set in the Graphics Designer is used as the trigger. All tags contained in the expression are entered in the tag list.
- If the expression does not contain any tags, a cyclic trigger with the standard cycle set in the Graphics Designer is used as the trigger.

Trigger Events

The following trigger events are available in the Dynamic dialog.

- Tag: A tag trigger is used as the trigger. The query can be performed either when a change is made or cyclically. Query cycles between 250 ms and 1 h can be selected. Self-defined user cycles are also available.
- Standard cycle: A cyclic trigger is used as the trigger. Cycle times between 250 ms and 1 h can be selected. Self-defined user cycles are also available.

- Picture cycle: A cyclic trigger is used as the trigger. The cycle time is defined by the object property Update Cycle of the picture object. This cycle provides the option of defining the cycles of all the actions used in a picture centrally.
- Window cycle: A cyclic trigger is used as the trigger. The cycle time is defined by the object property Update Cycle of the Picture Window object. This cycle provides the option of defining the cycles of all the actions used in a picture window centrally.

Note

It is important to remember that the cycle time has a major effect on the performance of the project. All the actions of a picture must be completed within their cycle time. Apart from the runtimes of the actions, the times required for requesting the tag values and the reaction times of the automation systems must also be taken into consideration. You should only set trigger events with a cycle time under one second if variables which change rapidly have to be queried.

Requirement

- Open the Dynamic dialog

Procedure

1. Click the  button in the "Event Name" area.
2. The Change Trigger dialog opens.

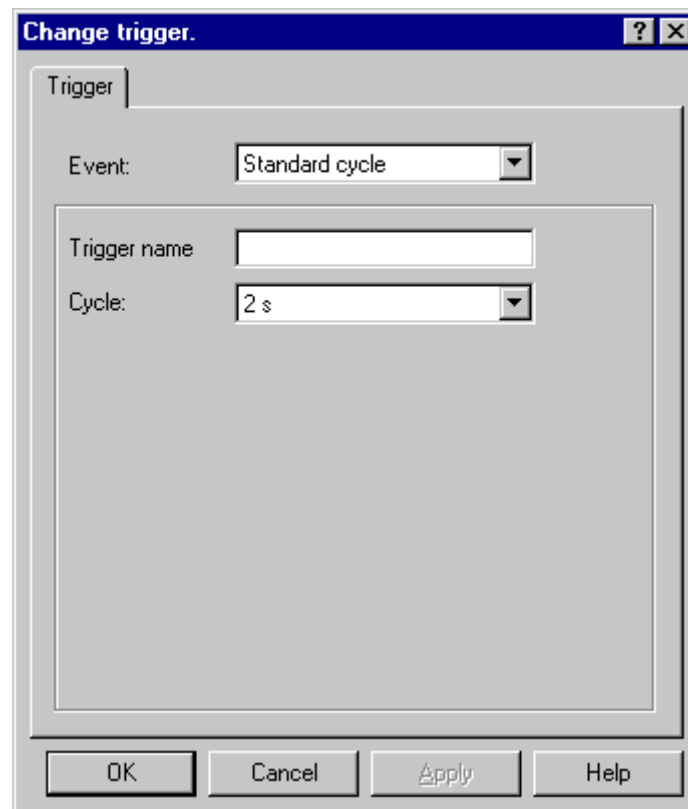

4.8 Dynamizing Using the Dynamic Dialog

3. Select the desired trigger event in the Event section.
4. Select the desired cycle time in the Cycle section.
5. For the trigger events Standard Cycle, Picture Cycle, and Window Cycle, you can enter a specific name for your trigger in the Trigger Name field.
6. Click "OK".

See also

How to Configure Dynamization Using the Dynamic Dialog (Page 1205)

Dynamizing Using the Dynamic Dialog (Page 1204)

4.8.8 Example: Color Change Depending on Position

Introduction

The position of a workpiece is to influence the background color of the workpiece. In the example, the workpiece is simulated by a rectangle and the position by an internal tag. The position may be changed by using an I/O field.

Requirement

- Configure a "Position" tag of data type "Unsigned 16-Bit Value".
- Start Graphics Designer and open a picture.
- Insert an I/O field into the picture and connect it to the "Position" tag.
- Insert a rectangle into the picture. Dynamize the "Position X" object property by means of a tag connection to the "Position" tag.

Procedure

1. Open the "Object properties" dialog of the rectangle and click the "Properties" tab, unless already activated.
2. In the left-hand window area, select the "Colors" property group.

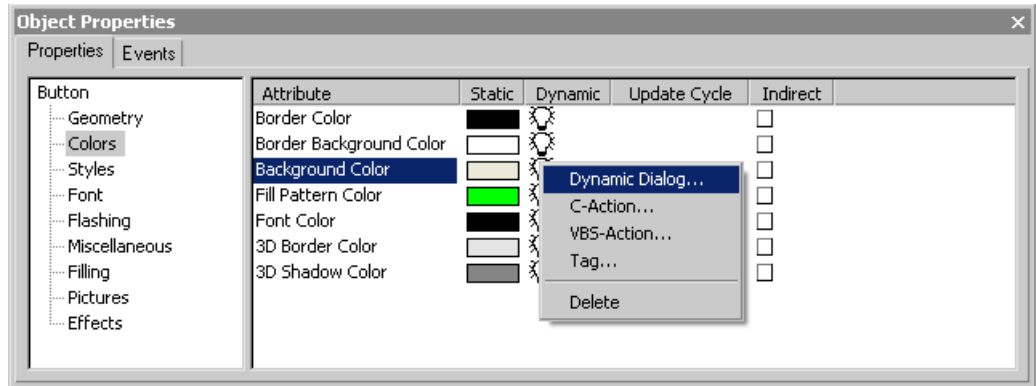

- Use the right mouse button to click the  button next to the property Background color. From the pop-up menu, select the command "Dynamic Dialog...".

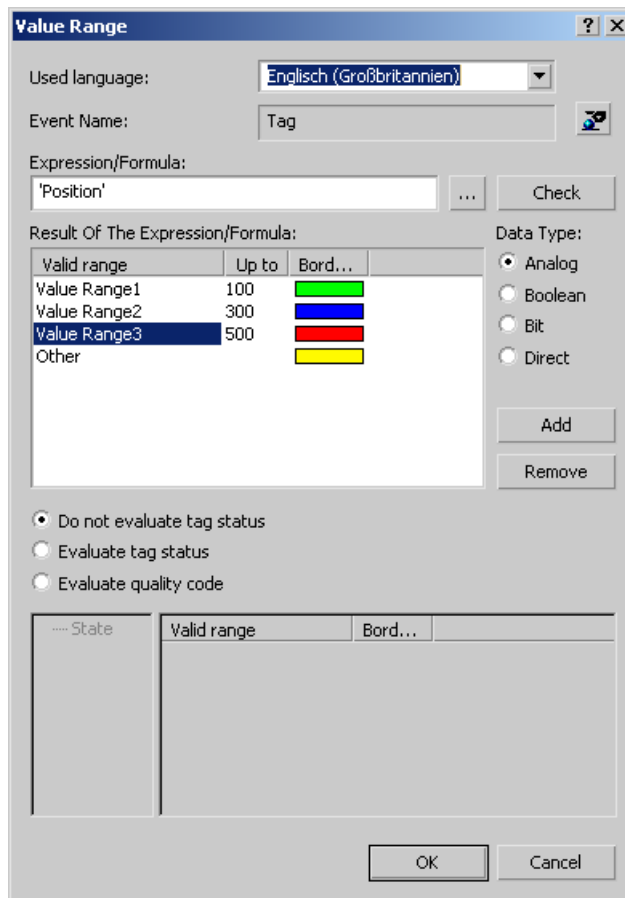

- The Dynamic dialog opens.



- In the Expression/Formula area, left-click the  button and select the Tag... command. The tag selection dialog opens.
- In the tag selection dialog, select the "Position" tag and close the tag selection dialog using the "OK" button.
- Click the Add button in the Result of Expression / Formula area. The first value range is created.

8. In the Background color column, double-click the color bar and select green as the background color.
9. Click the Add button in the Result of Expression / Formula area.
The second value range is created.
10. In the Background color column, double-click the color bar and select yellow as the background color.
11. Double-click the value "200" in the "to" column. Enter "300" in the value entry dialog.
12. Click the Add button in the Result of Expression / Formula area.
The third value range is created.
13. In the Background color column, double-click the color bar and select red as the background color.
14. Click the "Accept" button.
15. Dynamizing using the Dynamic dialog is indicated in the Object properties dialog with the  icon. A tag trigger with the standard cycle set in the Graphics Designer is used as the trigger.
16. Save the picture and activate Runtime using the  button.
17. In Runtime, you may change the X position of the rectangle by using the I/O field. Four value ranges (0-100, 101-300, 301-500, 501-...) have been defined by Dynamic Dialog dynamization. The background color of the rectangle changes according to the value range in which the left-hand edge of the rectangle is located.

See also

- Monitoring Quality Code (Page 1216)
- Monitoring Tag Status (Page 1215)
- Defining a Valid Range (Page 1211)
- Creating Expressions (Page 1207)
- How to Configure Dynamization Using the Dynamic Dialog (Page 1205)
- Dynamizing Using the Dynamic Dialog (Page 1204)

4.9 Dynamizing Using VBS Action

4.9.1 Dynamizing Using VBS Action

Introduction

Apart from the dynamization options using direct connection, C action, and tags, WinCC also offers VBS actions for dynamizing graphic objects in Runtime.

You should use VBS actions if

- you want to process several input parameters in an action
- you want to execute conditional instructions (if ... then ...)
- you want to change several object properties in an action
- you want to access selection dialogs of the operating system, e.g. file selection dialog or color selection dialog

You create VBS actions in the VBS action editor of the Graphics Designer. The action editor offers a similar range of functions to the VBS editor Global Script. From the Graphics Designer you can also access procedures which you have created in Global Script.

Actions which you create in the Graphics Designer are always stored with the picture in which they have been configured. In addition to all configured object properties, the configured VBS actions are also documented in the project documentation of the Graphics Designer. All of the VBS actions configured in this picture are displayed if you select a picture in the WinCC Explorer and call up the Properties dialog using the pop-up menu.

Further information on VBS actions can be found in the chapter "Creating Procedures and Actions Using VBScript".

Application Scenarios

VBS Action for Dynamizing Object Properties

You use VBS actions for dynamizing an object property. You can dynamize the value of the object property in Runtime depending on a trigger, a tag, or the status of other object properties. You should use a VBS action if the options provided by tag connection or the Dynamic dialog are not sufficient to solve the task in question.

Note

"Date/Time" data type

When the value of an object property reads a tag of the data type "Date/Time" through a VBS action, only the time component of the tag is displayed in Runtime until the start value of the tag changes.

VBS Action for Events

You can use a VBS action to react to an event which occurs at a graphic object. You should use a VBS action if the options provided by tag connection or the Dynamic dialog are not sufficient to solve the task in question.

The use of actions to react to changes to object properties influences performance in Runtime.

The event occurs if the value of the object property changes. The action associated with the event is then started. When a picture is closed, all of the started actions are stopped one by one. This can cause high system loads.

See also

[Editing Triggers \(Page 1232\)](#)

[How to Configure a VBS Action \(Page 1230\)](#)

[Working in Action Editor \(Page 1228\)](#)

[Action Editor in Graphics Designer \(Page 1225\)](#)

[Working with VBS Actions \(Page 1224\)](#)

[Types of Dynamization \(Page 1163\)](#)

4.9.2 Working with VBS Actions

Introduction

If you create VBS actions in the Graphics Designer, it is important to note the following differences compared to actions in Global Script:

- An action in the Graphics Designer is always saved with the picture.
- If you copy a graphic object for which you have configured an action, the action is copied together with the properties of the graphic object.
- Actions can only be saved in the Graphics Designer if they have the correct syntax. Therefore use the syntax check before you save an action.
- You cannot create globally applicable procedures in the Graphics Designer.

Working with Actions

The editor for VBS actions in the Graphics Designer provides the following options:

- Before you save an action, check it to make sure that it is syntactically correct. To do so, click the  button in the toolbar or select the appropriate command from the pop-up menu in the VBS dialog.
- You delete actions from object properties by selecting the corresponding command from the shortcut menu in the "Object properties" dialog of the graphic object:

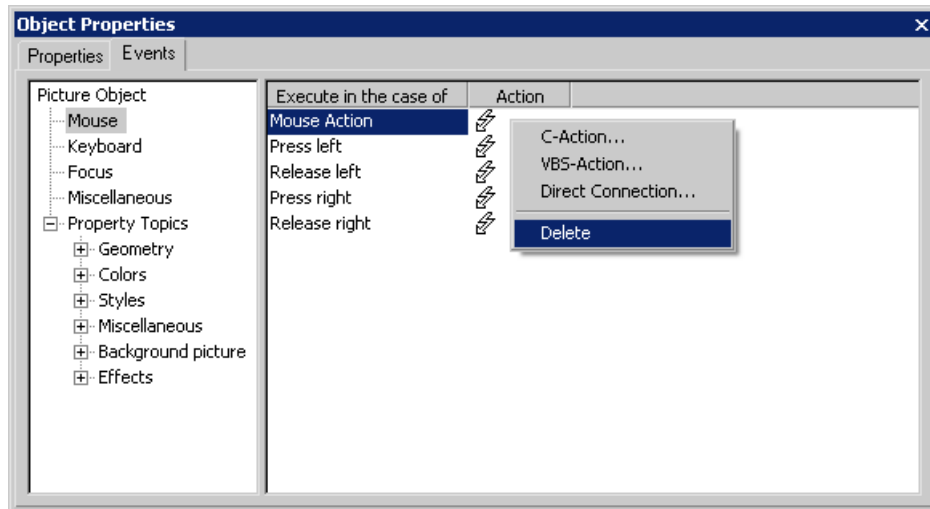

If you configure a different type of dynamization at a property or an event, the dynamization configured previously is automatically deleted.

See also

- Editing Triggers (Page 1232)
- How to Configure a VBS Action (Page 1230)
- Working in Action Editor (Page 1228)
- Action Editor in Graphics Designer (Page 1225)
- Dynamizing Using VBS Action (Page 1223)

4.9.3 Action Editor in Graphics Designer

Introduction

You create and process VBS actions at graphic objects in the editor for VBS actions in the Graphics Designer. The action editor offers a similar range of functions to the VBS editor Global Script.

Calling Action Editor

You start the editor for VBS actions from the "Object Properties" dialog of a graphic object in the Graphics Designer. If you configure an action to dynamize an object property, you call the dialog in the Properties tab. Place the mouse pointer in the "Dynamic" column and select the "VBS Action" command from the pop-up menu:

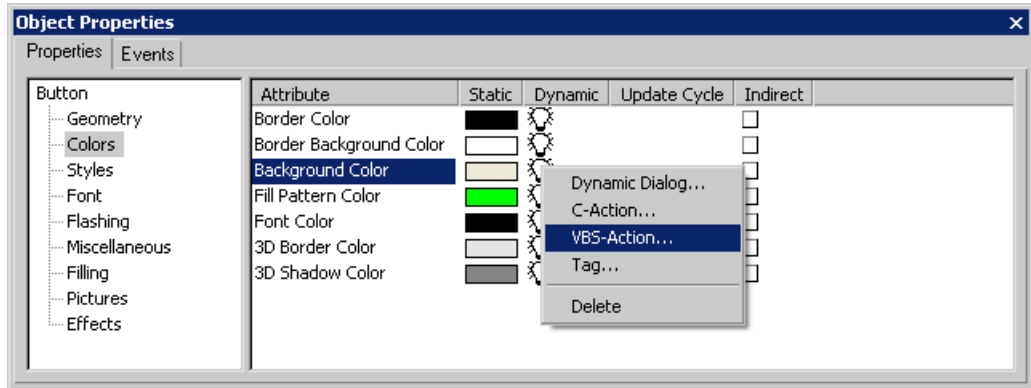

If you want to react to an event at a graphic object using an action, you call the dialog in the Event tab. Place the mouse pointer in the "Action" column and select the "VBS Action" command from the pop-up menu:

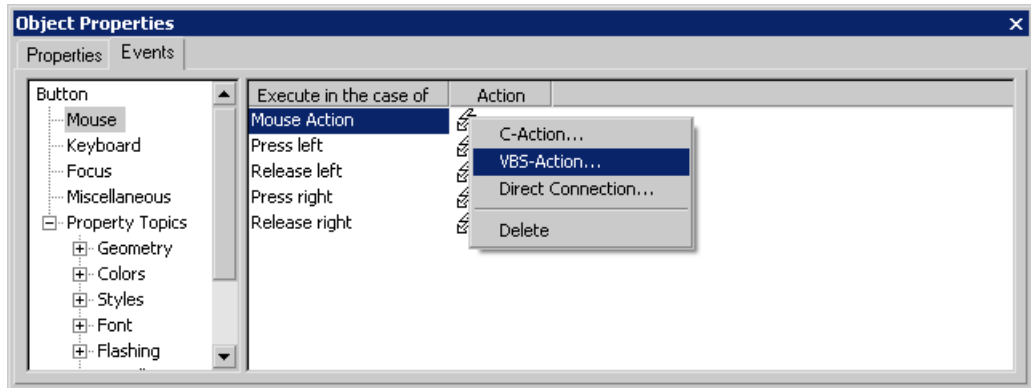

Layout of Action Editor

The editor for VBS actions offers a similar range of functions to the VBS editor Global Script.

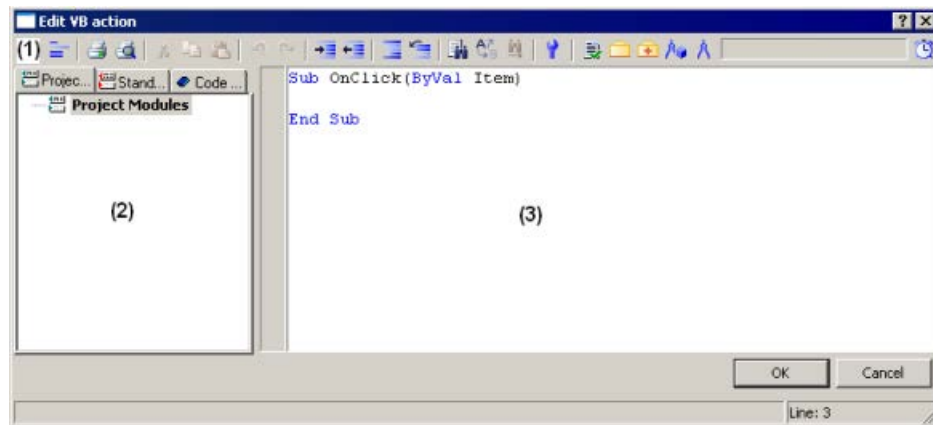

Toolbar (1)

In the toolbar you will find all the commands needed to create actions.

Navigation window (2)

You manage your actions in the navigation window. Here you will also find:

- Project and standard procedures which you have created in Global Script and which you can insert into your action code (drag and drop).
- Code templates which you can insert into your action or procedure (drag and drop).

Editor window (3)

You write and edit your actions in the Editor window.

See also

[Editing Triggers \(Page 1232\)](#)

[How to Configure a VBS Action \(Page 1230\)](#)

[Working with VBS Actions \(Page 1224\)](#)

[Dynamizing Using VBS Action \(Page 1223\)](#)

[Working in Action Editor \(Page 1228\)](#)

4.9.4 Working in Action Editor

Declaration Area in Actions

If you create actions in Graphics Designer, you can display the declaration area of the action using the  button. When creating a new action, the "Option explicit" instruction is automatically entered in the declaration area and cannot be deleted. The instruction is necessary as it prevents errors caused by the incorrect notation of tags without declaration.

The instruction requires that tags are always defined in your code with the "Dim" instruction.

Do not use the instruction "Option explicit" in your code as this can cause runtime errors.

In the declaration area, you can also make general settings which you want to use globally for the current picture, e.g.:

- Tag Definitions
- Procedures which you only want to use in this picture

In the declaration area of the actions, you may define global tags independent of each other in the areas "Event" and "Properties" of an object. There is no link between global tags of identical names in both areas.

Note

Always make sure that the procedures in the declaration area have correct syntax, i.e. with "Sub" - "End Sub". Do not create directly executable codes in the declaration area as this can cause runtime errors.

Please note that when creating a tag, it must not contain a value (Value = VT_EMPTY). Initialize the tags after declaration with the corresponding value.

In the general declaration part of screens, no check is made whether a procedure or function name has already been assigned. Therefore, a name could occur several times and it is not defined which function will be executed. This is standard behavior of the MS Scripting Engine.

Intellisense and Highlight Syntax

During text entry, context-sensitive lists appear containing the properties, methods, and objects possible at the current code position. If you insert an element from the list, the required syntax is also indicated automatically.

Note

Full intellisense for all objects can only be utilized in the Graphics Designer if the list is accessed using the object name and the result is assigned to a tag. Otherwise, you are only offered a list of standard properties.

Example of full intellisense:

Dim Tag

Set Variable = ScreenItems ("Circle1")

Variable.<Intellisense selection>

If picture window limits are exceeded during addressing, it is once again only the standard properties which are offered since the picture of the picture window is not loaded.

General VBS Functions

Using the pop-up menu in the Editor window you can view a list of the possible VBS standard functions, e.g. Abs, Array, ... , Year.

Lists of Objects, Properties and Methods

Using the pop-up menu in the editing window you can view a list of the possible objects by calling the "Object List" command in Graphics Designer.

Use the "Properties/Methods" pop-up menu command to call in a list of possible properties and methods.

The same lists can be called in with the key combination <CTRL + SPACEBAR> but according to the context of the script.





Code Templates

In the Code templates tab in the Navigation window of the Editor, you will find a selection of frequently used instructions, e.g. for loops and conditional instructions. You can insert these templates into your process code by dragging and dropping or by double-clicking.

If you insert a code template into your code, it is important to note that, for example, conditions in the templates are identified by "_XYZ_". You must replace these placeholders with the appropriate information.

Selection Dialogs

If you use WinCC tags or picture objects in the code, you can open the following selection dialogs:

-  Opens the tag selection dialog and gives the selected tag name as the return value.
-  Opens a tag selection dialog and returns the tag name with an associated reference.
-  Opens a picture/object browser in which you can select a picture/object whose name is then used for the return value.
-  Opens a picture selection dialog for pictures and returns the picture name with the server prefix, if necessary.

Syntax Check

The Action Editor supports you by providing a syntax check which you can perform after the code has been created. Syntax errors in the code are displayed in the output window of the editor. You can move to the erroneous point in the code directly by double-clicking the error in the output window.

Note

The syntax check can only detect syntax errors in the code. Programming errors, such as missing references, only become visible in Runtime. You should therefore also always check your scripts in the Runtime environment.

See also

- Editing Triggers (Page 1232)
- How to Configure a VBS Action (Page 1230)
- Working with VBS Actions (Page 1224)
- Action Editor in Graphics Designer (Page 1225)
- Dynamizing Using VBS Action (Page 1223)

4.9.5 How to Configure a VBS Action

Introduction

In the Graphics Designer you configure VBS actions to

- dynamize an object property. You can, for example, display a fill level according to a tag value, implement a color change if a tag value is exceeded, or create cyclic actions (e.g. flashing).
- react to an event which is triggered on an object: This can involve the execution of actions, for example, on clicking the mouse or a color change following the change of an object property.

The procedure is basically the same for both types of action.

Executing Actions in Runtime

An action which you have configured for an event is executed whenever the triggering event (e.g. mouse click) occurs.

Actions which you have used to dynamize object properties always need a trigger for execution. Actions without trigger are not executed in Runtime.

Procedure

1. Open the "Object Properties" dialog of the object for which you want to configure an action.
2. Activate the Properties tab if you want to dynamize an object property.
Activate the Event tab if you want to react to an event with an action.
3. Highlight the "Dynamic" column of the object property which you want to dynamize, or the "Action" column of the event to which you want to react. Select the command "VBS Action" from the pop-up menu.
The editor for VBS actions is opened.
4. Create the VBS action.
5. Check your action with <F7>. If your action contains syntax errors, they are displayed in an output window. Correct the code and check it again.
6. If your action is syntactically correct, exit the dialog with OK.

Note

Actions can only be saved in the Graphics Designer if they have the correct syntax. To save an erroneous action temporarily, you must first remove the comment from the action.

Result

The action is displayed in the Object Properties dialog of the object with the following symbol:



See also

- Editing Triggers (Page 1232)
- How to Configure a VBS Action (Page 1230)
- Working in Action Editor (Page 1228)
- Action Editor in Graphics Designer (Page 1225)
- Working with VBS Actions (Page 1224)
- Dynamizing Using VBS Action (Page 1223)

4.9.6 Editing Triggers

Introduction

If you configure an action for an event, you do not have to configure a trigger. The event is the trigger for the action. You have to assign triggers if you configure an action for dynamizing an object property.

A cyclic trigger with the standard cycle set in the Graphics Designer is used by default as the trigger.

Trigger Events

The following trigger events are available in the editor for VBS actions.

- **Tag:** A tag trigger is used as the trigger. The query can be performed either when a change is made or cyclically. Query cycles between 250 ms and 1 h can be selected. Self-defined user cycles are also available.
- **Standard cycle:** A cyclic trigger is used as the trigger. Cycle times between 250 ms and 1 h can be selected. Self-defined user cycles are also available. Note that the configured user cycles are based on a 250 ms time pattern.
- **Picture cycle:** A cyclic trigger is used as the trigger. The cycle time is defined by the object property Update Cycle of the picture object. This cycle provides the option of defining the cycles of all the actions used in a picture centrally.
- **Window cycle:** A cyclic trigger is used as the trigger. The cycle time is defined by the object property Update Cycle of the Picture Window object. This cycle provides the option of defining the cycles of all the actions used in a picture window centrally.

Note

It is important to remember that the cycle time has a major effect on the performance of the project. All the actions of a picture must be completed within their cycle time. Apart from the runtimes of the actions, the times required for requesting the tag values and the reaction times of the automation systems must also be taken into consideration. You should only set trigger events with a cycle time under one second if variables which change rapidly have to be queried.

Automatic Ending of Actions

After a change of picture, busy scripts are automatically stopped 1 minute after the change of picture.

Scripts that are still busy when Runtime is closed are stopped after 5 seconds.

Requirement

- Open the editor for VBS actions.

Procedure

1. In the toolbar, click the  button.
The Change Trigger dialog opens.

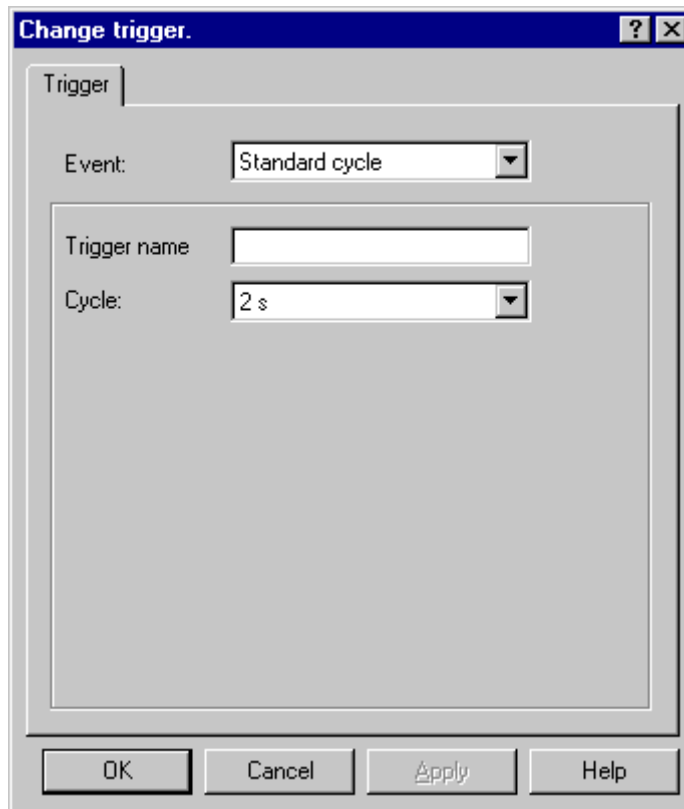

2. Select the trigger event in the "Event" section.
3. Select the cycle time in the "Cycle" section.
4. In the "Trigger Name" field, you can assign a specific name to your trigger for the "Default Cycle", "Picture Cycle", and "Window Cycle" trigger events.
5. Click "OK".

See also

- How to Configure a VBS Action (Page 1230)
- Working in Action Editor (Page 1228)
- Action Editor in Graphics Designer (Page 1225)
- Working with VBS Actions (Page 1224)
- Dynamizing Using VBS Action (Page 1223)
- Trigger Types (Page 1175)

4.10 Dynamizing Using C Action

4.10.1 Dynamizing Using C Action

Introduction

C actions are used to dynamize an object property or to react to events. When object properties are dynamized, the value of the object property is determined by the return value of the C function.

Use C actions if, for example, you want to process several input parameters in one action or you want to execute conditional instructions (if ... then ...). It is advisable to use C actions especially if in the case of recipes, for example, you want to access several tags in the automation system at the same time.

Application Scenarios

C Action for Dynamizing Object Properties

You use C actions for dynamizing an object property. You can dynamize the value of the object property in Runtime depending on a trigger, a tag, or the status of other object properties. You should use a C action if the options provided by tag connection or the Dynamic dialog are not sufficient to solve the task in question.

C Action As Reaction to Events

You can use C actions to react to an event which occurs at a graphic object. You should use a C action if the options provided by tag connection or the Dynamic dialog are not sufficient to solve the task in question.

The use of actions to react to changes to object properties influences performance in Runtime.

The event occurs if the value of the object property changes. The action associated with the event is then started. When a picture is closed, all of the started actions are stopped one by one. This can cause high system loads.

Note

If C scripts are linked to ActiveX Control events, ensure that the event name in question has at least 5 characters. If the name is shorter than 5 characters, the C script is not executed.

See also

Types of Dynamization (Page 1163)

Importing and Exporting Actions (Page 1241)

Editing Triggers (Page 1240)

How to Apply Functions in the Action Code (Page 1238)

How to Configure a C Action (Page 1236)

Working with C Actions (Page 1235)

4.10.2 Working with C Actions

Introduction

If you create C actions in the Graphics Designer, it is important to note the following differences compared to actions in Global Script:

- An action in the Graphics Designer is always saved with the picture.
- If you copy a graphic object for which you have configured an action, the action is copied together with the properties of the graphic object.
- Actions can be saved in the Graphics Designer if they can be compiled without error.
- You cannot create functions in the Graphics Designer; you can only call functions in actions which you have created in Global Script.

Layout of Editor for C Actions

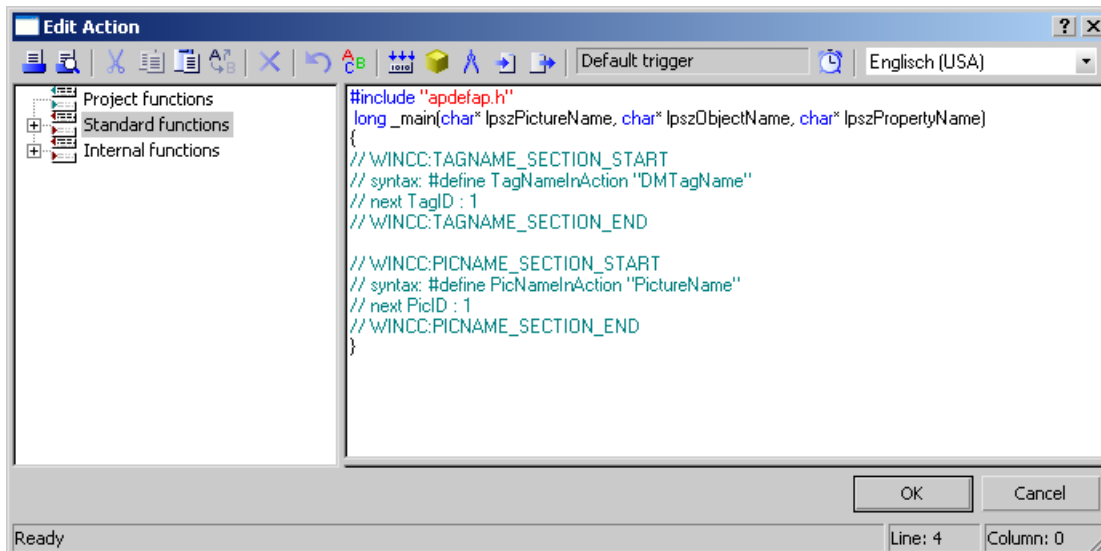

Toolbar

In the toolbar you will find the commands needed to create actions.

Navigation window

The navigation window enables you to access the existing C functions. You can apply these functions to the function code by double-clicking.

Edit Window

You write and edit your C actions in the Editor window.

In order to utilize the functions of the "Cross Reference" editor used to locate where tag and picture names are used, the tag and picture names used in a C action must first be declared. This is done in the areas "WINCC:TAGNAME_SECTION" and "WINCC:PICNAME_SECTION". More detailed information can be found under "WinCC Coding Rules"

See also

Importing and Exporting Actions (Page 1241)

Editing Triggers (Page 1240)

How to Apply Functions in the Action Code (Page 1238)

How to Configure a C Action (Page 1236)

Dynamizing Using C Action (Page 1234)

4.10.3 How to Configure a C Action

Introduction

In the Graphics Designer you configure C actions to

- dynamize an object property. You can, for example, display a fill level according to a tag value, implement a color change if a tag value is exceeded, or create cyclic actions (e.g. flashing).
- react to an event which is triggered on an object: This can involve the execution of actions, for example, on clicking the mouse or a color change following the change of an object property.

The procedure is basically the same for both types of action.

Processing of Actions in Runtime

An action which you have configured for an event is executed whenever the triggering event (e.g. mouse click) occurs.

Actions which you have used to dynamize object properties always need a trigger for execution. Actions without trigger are not executed in Runtime.

Requirement

- Start the Graphics Designer and open a picture.

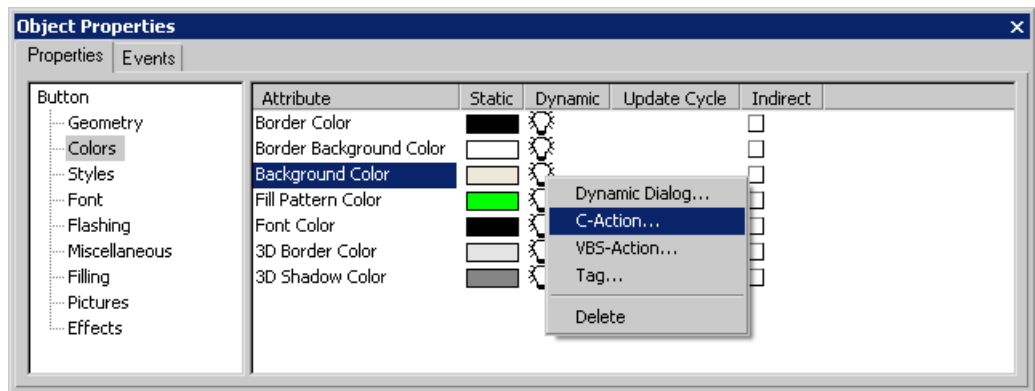

Procedure

1. Open the Object Properties dialog of the object to be dynamized.
2. To dynamize an object property: In the left window area, select the property group. In the right window area, select the property.
3. To configure a reaction to an event: In the left-hand window area, select the event trigger, e.g. mouse, background color, etc. In the right window area, select the type of the event: e.g. mouse click, change, etc.
4. Right-click the associated  button and select the command C Action... in the pop-up menu.



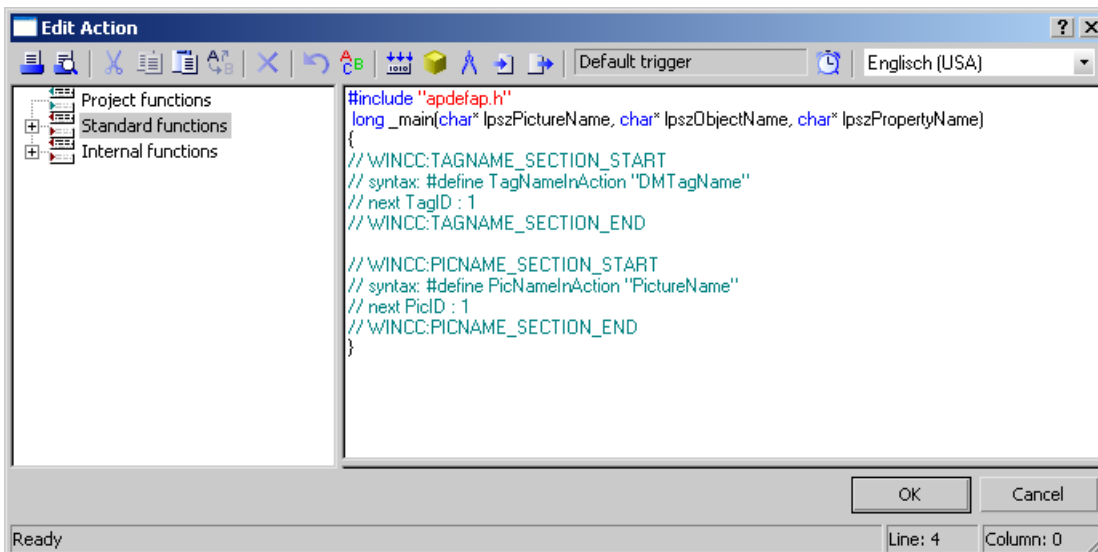

5. The editor for C actions opens.

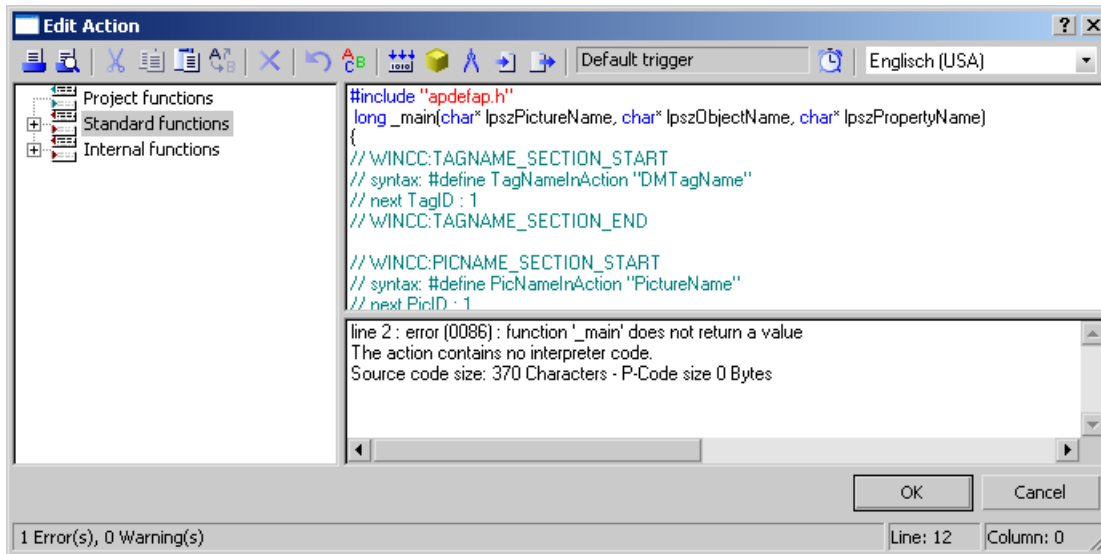

6. Formulate the C function.
7. Click the  button and specify the trigger.
8. Select the language for C compilation from the toolbar.
9. Click . The function is compiled. This process is indicated in the status bar of the dialog by the message "Compile Action...".

- 10.If compilation has been completed without error, the message 0 Error(s), 0 Warning(s) is displayed in the status bar. Click on the OK button. The "Edit Action" dialog is closed. Dynamization with C action is indicated in the "Object Properties" dialog by means of the  icon.
- 11.If compilation has not been completed without error, the number of errors and warnings is displayed in the status bar. More detailed information about the errors is shown at the bottom of the Editor window.



- 12.Correct all errors. Recompile the function. Click "OK" to close the dialog. Dynamization with C action is indicated in the "Object Properties" dialog by means of the  icon.

See also

- Importing and Exporting Actions (Page 1241)
- Editing Triggers (Page 1240)
- Working with C Actions (Page 1235)
- Dynamizing Using C Action (Page 1234)
- How to Apply Functions in the Action Code (Page 1238)

4.10.4 How to Apply Functions in the Action Code

Introduction

You can use internal functions, standard functions, or project functions within your action. The function is always inserted in the action code at the cursor position.

Requirement

- Open the editor for C actions.

How to Export an Action

1. Place the cursor at the point at which the function is to be inserted.
2. In the navigation window, double-click the function to be inserted.
3. If the function to be inserted has parameters, the Set Parameters dialog opens.

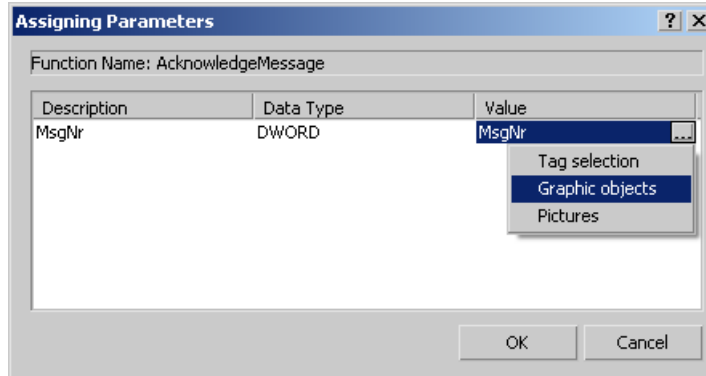

4. This dialog shows a list of all parameters belonging to the function to be inserted, and allows you to set parameters for this function.
5. In the Value column, click the parameter which you want to set.
6. You can enter tags either directly or using the "..." button and the tag selection dialog. You can enter objects and object properties either directly or using the "..." button and the selection dialog for pictures, objects, and object properties. You can enter pictures either directly or using the "..." button and the picture selection dialog. If you make direct entries, make sure that you put names within quotation marks.
7. Click the "OK" button.
The parameter assignment dialog is closed and the function is inserted in the action code at the cursor position.

Alternative Operation

You can also open the Set Parameters dialog using the commands Apply or Parameter Assignment in the shortcut menu of the functions in the navigation window.

Notes on special functions

The " SetProperty " function should not be used within a C action because it initiates a 'Redraw' of the picture.

See also

Working with C Actions (Page 1235)

Dynamizing Using C Action (Page 1234)

4.10.5 Editing Triggers

Introduction

If you configure an action for an event, you do not have to configure a trigger. The event is the trigger for the action.

You have to assign a trigger if you configure an action for dynamizing an object property. A cyclic trigger with the standard cycle set in the Graphics Designer is used by default as the trigger.

Trigger Events

The following trigger events are available in the Edit C Action dialog.

- **Tag:** A tag trigger is used as the trigger. The query can be performed either when a change is made or cyclically. Query cycles between 250 ms and 1 h can be selected. Self-defined user cycles are also available.
- **Standard cycle:** A cyclic trigger is used as the trigger. Cycle times between 250 ms and 1 h can be selected. Self-defined user cycles are also available. Note that the configured user cycles are based on a 250 ms time pattern.
- **Picture cycle:** A cyclic trigger is used as the trigger. The cycle time is defined by the object property Update Cycle of the picture object. This cycle provides the option of defining the cycles of all the actions used in a picture centrally.
- **Window cycle:** A cyclic trigger is used as the trigger. The cycle time is defined by the object property Update Cycle of the Picture Window object. This cycle provides the option of defining the cycles of all the actions used in a picture window centrally.

Note

It is important to remember that the cycle time has a major effect on the performance of the project. All the actions of a picture must be completed within their cycle time. Apart from the runtimes of the actions, the times required for requesting the tag values and the reaction times of the automation systems must also be taken into consideration. You should only set trigger events with a cycle time under one second if variables which change rapidly have to be queried.

Requirement

- Open the editor for C actions in the Graphics Designer.

Procedure

1. In the toolbar, click the  button.

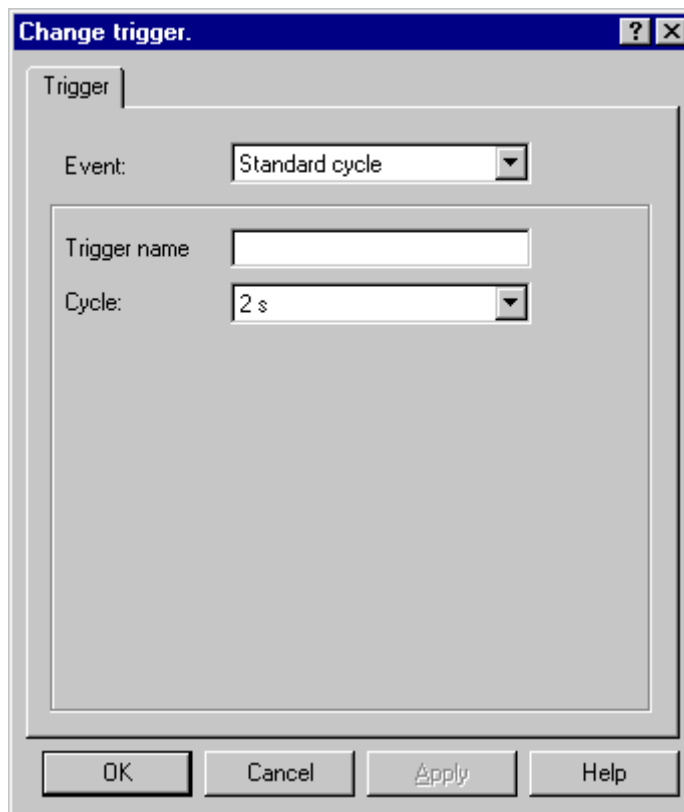

2. Select the trigger event in the "Event" section.
3. Select the cycle time in the "Cycle" section.
4. In the "Trigger Name" field, you can assign a specific name to your trigger for the "Default Cycle", "Picture Cycle", and "Window Cycle" trigger events.
5. Click "OK".

See also

- How to Configure a C Action (Page 1236)
- Working with C Actions (Page 1235)
- Dynamizing Using C Action (Page 1234)

4.10.6 Importing and Exporting Actions

Introduction

In order to transfer an action to a different object or object property, you can export and then import the function code.

When exporting, no check is performed to determine whether or not the function code can be compiled without error.

Requirement

- Open the editor for C actions.

How to Export an Action

1. In the toolbar, click the  button.
2. The file selection dialog opens.
Enter an appropriate name for the exported file. Click "OK".

How to Import an Action

1. In the toolbar, click the  button.
2. The file selection dialog opens.
Select the file containing the function code to be imported. Click "OK".

See also

Working with C Actions (Page 1235)

Dynamizing Using C Action (Page 1234)

Setting up a Message System

5.1 WinCC Alarm Logging

Content

The message system

- Provides access to comprehensive information about error and operating states
- Allows for the early detection of critical situations
- Enables the prevention or reduction of downtimes
- Enables quality improvement
- Allows for targeted documentation of error and operating states

With the "Alarm Logging" editor, you configure

- Preparation of messages
- Display of messages in runtime
- Acknowledgment of messages
- Archiving of messages

5.2 Message System in WinCC

Introduction

The message system processes results from functions that monitor actions in the process, on the automation level and in the WinCC System. The message system indicates detected alarm events both visually and acoustically and archives them electronically and on paper. Direct access to the messages and supplementary information on individual messages and help for handling the messages ensures that faults are localized and cleared quickly.

Archiving

Changes in the message status are written to configurable archives. The respective message must be created accordingly.

Archiving takes place in the message archive. Various parameters, such as archive size, time range, and switchover time, are specified for this. If one of the configured criteria is exceeded, the oldest messages in the archive at the time are overwritten. The backup of the archiving databases is specified through additional settings.

Display of messages saved in a message archive takes place in a long-term archive list or a short-term archive list. Display of messages in the short-term archive list is updated immediately upon receipt of a new incoming message.

Hiding Messages

Hiding messages reduces the information load for the system user. You can select whether the messages are to be displayed in the message list, short-term archive list and long-term archive list. The display depends on the activated "Display Options" option in the dialog. The possible options are:

- Display All Messages
- Display visible messages (default setting)
- Display Hidden Messages

The hidden messages are displayed in the list of messages to be hidden and can be shown again.

You can hide messages in two ways:

- Automatic hide: Messages are hidden and shown again later depending on a certain status of the hide tag. You can configure the condition for hiding or showing using the hide mask in the message.
- Manual hide: In the message window, you can use a button to define whether you want to hide a message and, if so, at what time. You can also show the messages again using another button. The system displays the messages again after a configurable time.

Operator message

An operation in the process can trigger an operator message.

Single acknowledgment, group acknowledgment

A pending message can be acknowledged in two different ways:

- Messages that are not assigned the "Group Acknowledgment" attribute must be acknowledged individually.
- Group acknowledgment can be used to collectively acknowledge all messages with the "Group Acknowledgment" attribute that are visible in the message window.

The message acknowledgment can be logged with information on the acknowledging user and computer used. This requires that you insert the "User Name" and "Computer Name" system blocks in the message line of a message in the WinCC AlarmControl. Upon acknowledgment of a message, the user name and computer name are not displayed in the message line of the incoming message but rather are displayed in the operator message of the acknowledgment in the short-term archive list and the long-term archive list. The operator message must be activated in the WinCC AlarmControl in the "Operator messages" tab.

Events

The message system distinguishes between binary events and monitoring events:

- Binary events are state changes of internal or external tags.
- Monitoring events are not supported directly by Alarm Logging. Monitoring events include overflow of archives and hard disks, printer messages, server failure and faulty process communication.

Initial Value Message, New Value Message

- The initial value message is a message of a message class with single-mode acknowledgment, which is highlighted as the first message of the message class by flashing in the message window.
- The new value message is a message of a message class with single-mode acknowledgment or dual-mode acknowledgment, highlighted by flashing in the message window.

Message types, message classes

- Message classes comprise several message types. The following message classes are preconfigured in Alarm Logging: "Error", "System, Requires Acknowledgment", and "System, Without Acknowledgment". You can define up to 16 message classes.
- Messages with the same acknowledgment philosophy are combined into one message type. All messages of a message type have the same color and background in Runtime. The display can be adapted separately for each message type. You can create up to 16 message types for each message class. Message types are already configured in the preconfigured message classes.

Message blocks

The state change of a message is displayed in a message line in Runtime. You define the information you want to have displayed in the message line during configuration of the message blocks:

- System blocks allow for the specification of predefined information that is not freely utilizable, such as date, time, duration, comment. The value of the message block (for example, the time) is displayed in the message line.
- User text blocks enable you to assign a message to up to ten different freely definable texts. The message line will display the content of the text you defined. The message text of a user text block can display process values. You define the output format for this.
- Using process value blocks, you can display the values of tags in the message line. The formatting that is used for this cannot be user-defined. You specify the associated tags for the process value blocks.

With use in multi-user systems, the content of a message can be displayed on a client by configuring the message blocks in the same way on all servers.

Message blocks in multilingual projects

In Runtime, the texts from the text library are displayed.

WinCC client with its own project

In the "Properties" dialog of the WinCC AlarmControl, you configure the behavior of a client with its own project in the "Message blocks" tab:

Settings	Behavior
The "Apply project properties" option is activated.	The text from the text library of the WinCC server is displayed.
The "Apply project properties" option is deactivated. The text ID from the text library is entered.	The text from the local text library of the WinCC client is displayed.
The "Apply project properties" option is deactivated. The text ID "0" is entered for the message block.	The text entered in the "Name" field is displayed.

Message event, message status

- Message events refer to the "coming in", "going out", and "acknowledging" of messages. All message events are stored in the message archive.
- Message states are the possible states of a message: "Came In", "Went Out", "Acknowledged".

Message window

In Runtime, the changes in message states are indicated in a message window. You can configure the appearance and operating options of the message window in the Graphics Designer.

A message window shows a table with all messages that have yet to be displayed. Each message to be displayed appears in its own line – the message line.

The content of the message window can be influenced by a user-defined filter, for example, sorting according to message blocks.

Depending on the source of the messages displayed in the message window, a distinction is made between six types of message windows.

- Message lists are used for displaying currently pending messages.
- Short-term archive lists are used to display messages that are stored in a message archive. The display of messages is immediately updated when a new message arrives.
- Long-term archive lists are used to display messages that are stored in a message archive.
- All messages in the system that have been locked are displayed in the lock list. Locked messages can be unlocked by means of a button in the toolbar.
- The hit list contains statistical information on the messages.
- The list of hidden messages shows all messages that to be hidden due to automatic or manual hide in the message list, in the short-term archive list or the long-term archive list.

Message, message group

WinCC Alarm Logging distinguishes between two message forms:

- Messages
Each event is assigned a separate message.
- Message groups combine messages. At the same time, message classes and message types represent message groups containing messages assigned to them. You can use your user-defined message groups to combine any of the messages into message groups, which can then be combined to form higher-level message groups. Up to six layers of lower-level message groups are permitted. You need a user-defined message group to hide a message automatically.

Messages

The message system is used to chronologically signal and archive events that occur sporadically during the process via messages at a central location. A message can be caused by an event or a frame.

The message system distinguishes between three messages:

- Operating messages indicate a status in the process.
- Fault messages indicate an error in the process.
- System messages indicate error messages from other applications.

In Alarm Logging, messages with similar behavior, for example, with the same acknowledgment philosophy or color assignment of message states, are grouped into message types.

Frames

Frames originate from either the process or from the process-control monitoring system. They are exchanged between the controller or the monitoring application and Alarm Logging. Frames Attributes are saved in raw data tags.

Message texts

Message text reflects information about a message, that provides the operator with support for handling the message.

You can configure the following message texts:

- User text blocks: Explanatory texts, for example, information about the cause of a fault or the fault location in order to localize the fault
- Info text: Additional information about the message
- Support: The texts provide information about using the message, for example, about the required reaction time

Message tag

In the bit message procedure, the controller signals the occurrence of an event in the process by means of the message tag. Several messages can be masked via one message tag. A bit of the message tag can only be used for a single message.

Message procedure

The message procedure is a result of the configuration of the message. Alarm Logging supports multiple message procedures:

- In the bit message procedure, the controller signals the occurrence of an event by means of a message tag. The time stamp (date and time) of the message is assigned by Alarm Logging.
- With chronological reporting, the controller transmits a frame with the message data when the event occurs. This is evaluated in Alarm Logging. The time stamp (date and time) of the message is assigned by the controller.
-If the "Acknowledgment-Triggered Messaging" (QTM) procedure is activated on an AS S7-400, not every signal change is transmitted to the OS. With the QTM procedure, when messages occur frequently due to sensor chatter, the AS does not send a new message about a signal change until the last signaled positive signal change (incoming message) has been acknowledged in the OS.
- Limit monitoring can be used to monitor the course of an analog tag for violation of the high and low limits or for agreement with comparison values.

Message line

In a message window, each message is displayed in its own message line. The content of the message line depends on the message blocks to be displayed:

- In the case of system message blocks, the value of the message block is displayed, for example, date and time.
- In the case of process and user text blocks, the content is displayed, for example, the text you have defined.

Logging

There are two options available in WinCC AlarmControl for logging messages:

- With message sequence reports, all state changes (came in, went out, acknowledged) from all currently pending messages are output to a printer.
- The messages in the individual message lists can be printed out directly via Print Current View button in WinCC AlarmControl.

Locking and unlocking messages

In order to reduce the number of message events, known recurring messages can be locked and unlocked again. The message system distinguishes between active and passive locking/unlocking of messages. For active locking, the message source must support the locking/unlocking of messages with confirmation and a valid date/time stamp. In addition, a general query of the source must return the currently locked messages. If the message source meets these requirements, the messages are actively locked/unlocked; otherwise, the messages of WinCC are locked/unlocked passively.

- In the case of active locking, a lock request is sent to the message source (for example, the AS). The message is locked in WinCC only after the source confirms that the message as locked. Messages are unlocked in the same way. Only messages that have been configured chronologically on the AS level are locked/unlocked in active mode.
- In the case of passive locking, the message is locked/unlocked in the alarm server of WinCC. The message source is not involved in this process.

Acknowledgment philosophy

Acknowledgment philosophy refers to the manner in which a message is to be displayed and processed from the time it "Came In" to the time it "Went Out". Different acknowledgment philosophies can be implemented in Alarm Logging:

- Single message without acknowledgment
- Single message with incoming acknowledgment
- Single message with dual-mode acknowledgment
- Initial-value message with single-mode acknowledgment
- New-value message with single-mode acknowledgment
- New-value message with dual-mode acknowledgment

- Message without "Went Out" status and without acknowledgment
- Message without "Went Out" status and with acknowledgment

Acknowledgment tag

The acknowledgment tag contains the "Acknowledgment Status". A central signaling device can be controlled using the acknowledgment tag.

Status tag

The "Came In/Went Out" status and an identifier for messages requiring acknowledgment are stored in the status tag.

5.3 Principles of the Message System

5.3.1 Principles of the Message System

Introduction

Messages inform the operator about operating states and error states in the process. They help identify critical situations early so that downtimes can be avoided.

Structure of a Message

The messages are displayed as lines in a table in Runtime. An individual message is composed of information that is shown in the fields of the table. These individual pieces of information are referred to as message blocks.

The message blocks are subdivided into three groups:

- System blocks with system data, for example, date, time, message number and status
- Process value blocks with process values, for example, current fill levels, temperatures or rotational speeds
- User text blocks with explanatory texts, for example, the message text containing information on the location and cause of a fault

While the contents of the system blocks are fixed, you can modify the contents of process value blocks and user text blocks. Selections in system blocks affect only the data display but not the logging.

Configuration

You make basic settings (input language, color scheme) for all editors in the main menu.

You find basic, frequently recurring procedures in the description "Working with projects".

You configure messages in Alarm Logging.

You configure the message window for displaying messages in Runtime in the form of an ActiveX control in the Graphics Designer. You can freely configure the appearance and operating options of the message window according to your requirements.

The Report Designer is used to configure the printout of messages in chronological order and to log message archives.

Display of messages in Runtime

In runtime, Alarm Logging records, evaluates, and archives the events coming from the controllers or process control system and then displays them in a message window.

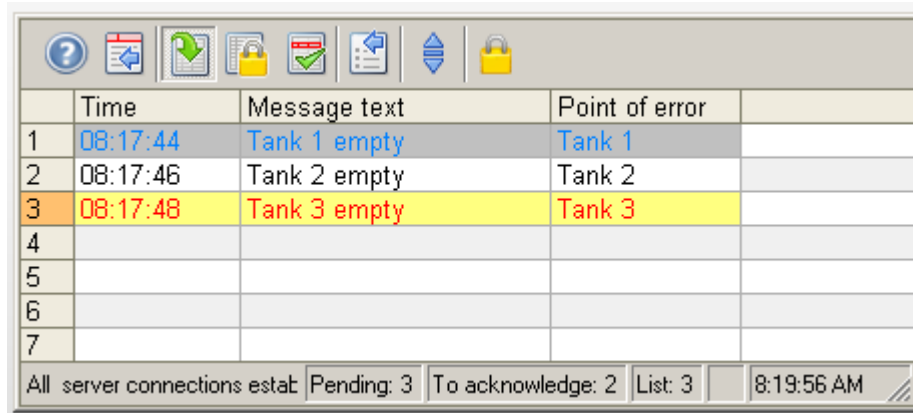

	Time	Message text	Point of error	
1	08:17:44	Tank 1 empty	Tank 1	
2	08:17:46	Tank 2 empty	Tank 2	
3	08:17:48	Tank 3 empty	Tank 3	
4				
5				
6				
7				

All server connections estat: Pending: 3 To acknowledge: 2 List: 3 8:19:56 AM

5.3.2 "Alarm Logging" editor

You configure the messages and the message archive in Alarm Logging.

You start the editor with a double-click on the "Alarm Logging" entry in the WinCC Explorer.

Structure of the Alarm Logging editor

The Alarm Logging editor has three areas:

- **Navigation area**
 - Tree view showing objects as folders
 - Navigation bar for switching between the editors
- **Table area**
 - Creation and editing of multiple objects
- **Properties area**
 - Properties of a selected object
 - "What's this?" for the selected property

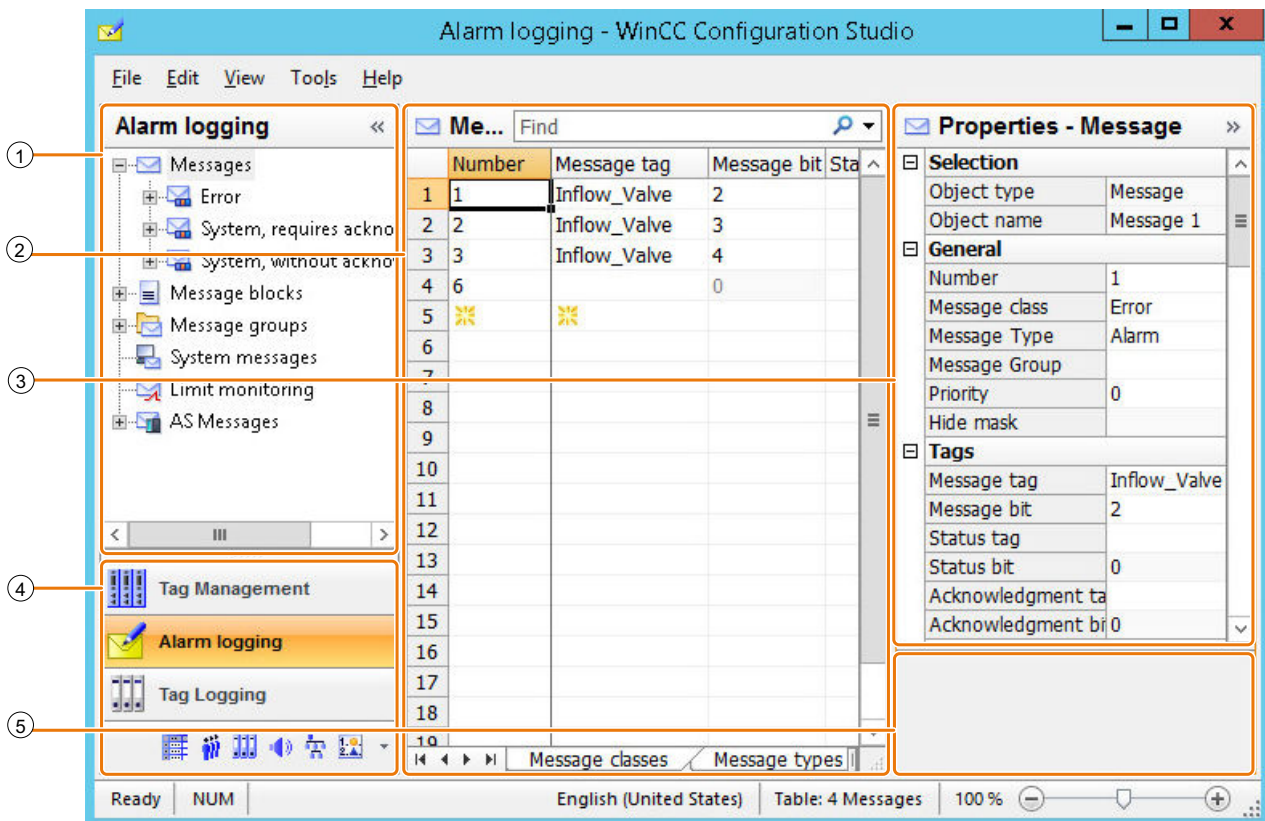

① Navigation area

The navigation area displays the Alarm Logging objects as a tree view.

The folders of the top level are:

- Messages
The message classes and message types are located below this folder.
- Message blocks
- Message groups
- System messages
- Limit monitoring
- AS messages

The elements assigned to a selected folder are displayed in the table area, e.g. messages, message blocks.

A shortcut menu is available for each folder. The shortcut menu provides commands for the folder as well as general commands such as "Copy / Paste" and "Export".

Discrete alarms, system messages, limit monitoring and AS messages can be hidden.

② Table area

The table displays the elements that are assigned to the folder selected in the tree view. You can, for example, display all messages or only messages of a selected message class or message type.

You create new messages, message groups and limit monitoring in the table area.

Message blocks are selected in the table for display in messages. You can edit the properties of messages and message blocks in the table.

Note

Inconsistent entries have a colored background in the table window.

In the event of inconsistent configuration, a note is displayed which describes the incorrect configuration.

Tabs

Depending on the selected structure level, you can display the lower-level elements in tables using tabs.

Navigation keys allow you to scroll through tabs. You select a tab by clicking on it, with the navigation keys, or from the shortcut menu of the navigation keys.

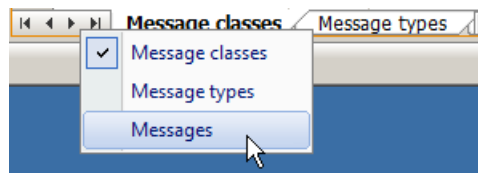

③ Properties

The properties of a selected object are displayed.

To display the properties of a message class, message type or message group, select it in the tree view.

To display the properties of individual messages, message blocks or limit messages, select them in the table view.

You edit the properties of a data record. However, some properties are only displayed and can not be edited.

④ Selection of the editors

The navigation bar is displayed in the area below the tree view; it provides access to additional WinCC editors.

⑤ What's this?

Displays an explanation of the selected property.

Status bar



The status bar at the bottom edge of the editor includes the following information, among other things:

- Number of data records in the displayed data area, for example, message classes, message types, messages, message blocks, message groups, limits, system alarms, text lists.
- Number of selected data records when table cells are selected.

5.3.3 Working in the Alarm Logging areas

You work and navigate in the "Alarm Logging" editor as you would in the entire Configuration Studio. Configuration is user-friendly and supports the configuring engineer during editing. The handling is similar to that of a spreadsheet program.

Detailed information on operating the Configuration Studio is available in the WinCC Information System under "Working with WinCC > Working with projects > WinCC Configuration Studio".

Working in the navigation area

Shortcut menus with additional functions are offered for individual structure levels. You can create new message classes, message types or message groups, for example, with the shortcut menu.

Displaying additional messages

To show or hide specific messages in the table area, select the "Selection" command in the shortcut menu of the top structure level "Messages".

The following messages can be shown or hidden:

- Discrete alarms
- Limit monitoring messages
- AS messages
- System messages

Working in the table area

Creating a new object

You create new messages in the table area. You can also create additional objects, such as message classes, message types or message groups, in the table area as an option.

To create a new object, you edit the first empty cell. The cell is identified by a yellow icon: ✖

Enter the required text, for example, a number as message number or the name of a message group.

8	8	Störung
9	✖	

Note

Creating tags with open tag selection

If you want to specify a message tag in Alarm Logging and have not created it in Tag Management yet, you can create it in Tag Management while the dialog for tag selection is displayed.

Inconsistent entries

If an entered value is faulty or inconsistent, you will see a corresponding note, for example:

- Invalid entries are created when you edit several entries by dragging a cell.

The cell for the message number may have a red background in the table area and in the "Properties" area, for example:

- A message was deleted even though it is still being used as limit message.

Filtering messages in the search field

Use the "Search in" search field to filter entries according to the specifications in a column.

You make the settings for the search in the menu of the search field.

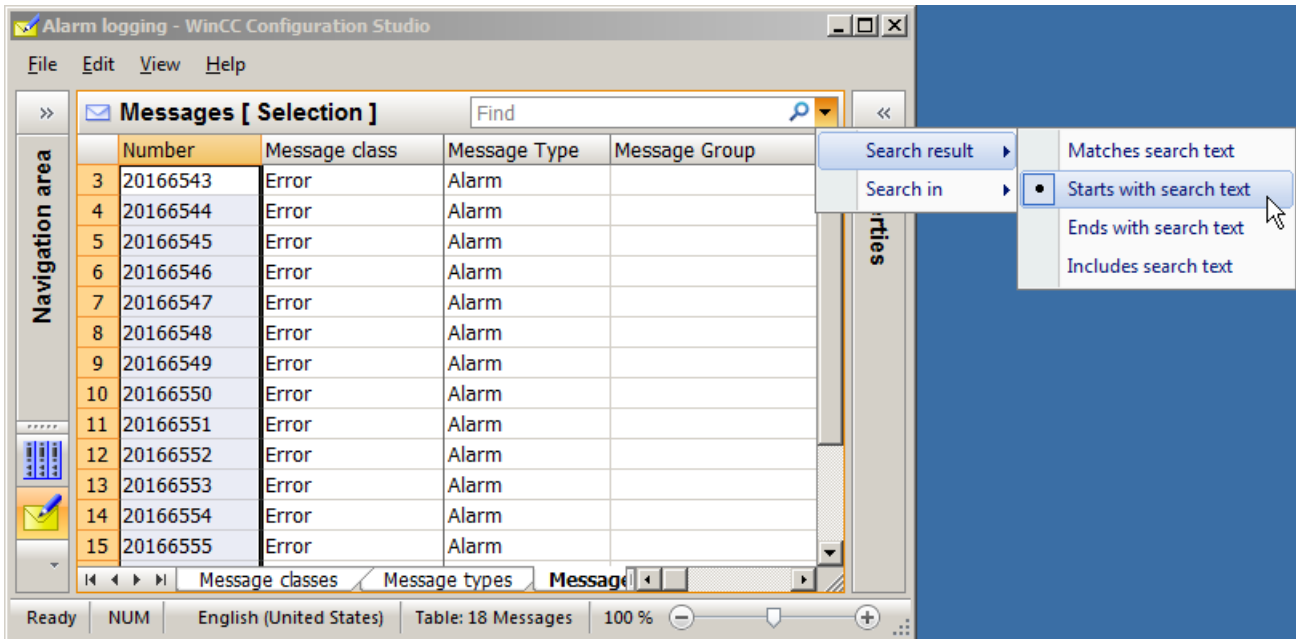

You can, for example, display all messages that start with the number 20 or all limit messages that monitor a tag ending in "_level".

Delete the filter by clicking the button .

Use the "Search in" command to select the properties (table columns) to which the filter is applied.

5.3.4 Tips and tricks

Efficient configuration with Alarm Logging

Below are some tips from the real world. These will help you configure with the WinCC Configuration Studio.

Find next free message number

To find the next free message number:

1. In the navigation area, select the folder with the message type to which the new message is assigned.
2. Copy a message row in the table area.
3. Paste the row to the top free row as a new message
The message is automatically given the next free recipe message number.
4. Edit the properties of the message if required.

No translation

If you change the input language during configuration, the entries for the texts already configured may not be available in the new input language. This is indicated by the note "Empty text" in the corresponding properties fields of the user text blocks. This information reminds you that translations are not available for the current input language. The "Empty text" message only appears in the editor and not in Runtime.

Find and replace

If you want to find entries in the entire table, select the "Find" option in the shortcut menu of the table. If you have already selected an area of the table, the search is limited to this area.

Use the "Find and replace" function to change specific entries in a selected area. You can, for example, display messages of a range with the "Find" field and then change the message groups to which selected messages belong in a highlighted area.

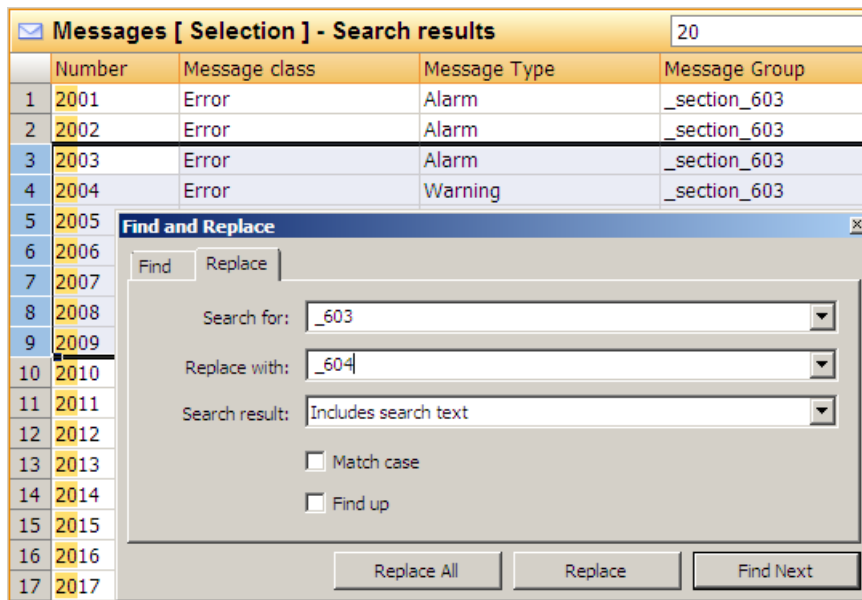

Please keep in mind that the corresponding object (the message group "Plant_unit_604" in the example) may need to be configured beforehand.

Select all - Deselect all

The shortcut menu in the column header of some properties allows you to select an option for all objects.

Examples:

- System messages - You can select (use) or deselect all system messages from the shortcut menu.
- Message blocks - You can select (use) or deselect all message blocks from the shortcut menu.
- Message groups - You can select or deselect the property "Shared message" for all messages in a message group.

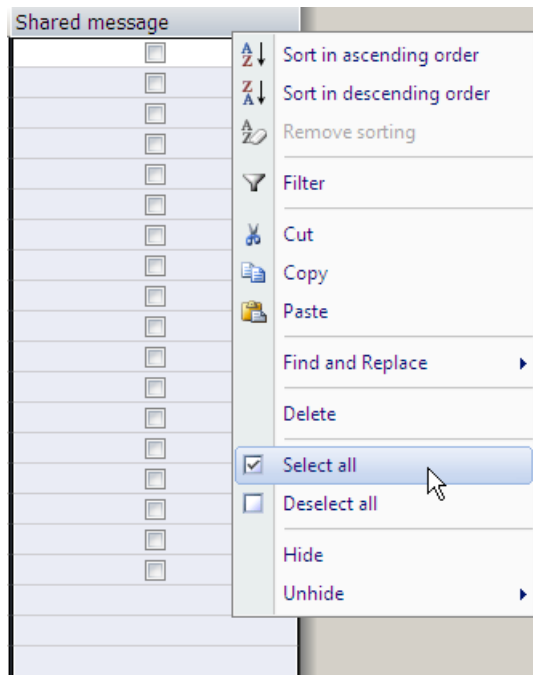

Note

Multi-selection possible

If you have first selected multiple cells, the command is executed for all selected cells.

5.4 Configuring the Message System

5.4.1 Configuring the Message System

Introduction

In Alarm Logging, you can specify the messages and content to be displayed in the message window. You specify how and where messages are archived.

Basic procedure

The following steps enable efficient configuration:

1. Configure the message blocks in accordance with your requirements.
2. Configure the message classes, message groups and message types.
3. Configure the single messages.
4. Configure the system messages and limit monitoring.
5. Configure the data archiving method.

Regardless of this sequence, you can adapt any existing configuration, add additional configurations or delete existing ones at any time.

5.4.2 Working with Message Blocks

5.4.2.1 Working with Message Blocks

Introduction

The content of a message consists of message blocks. In Runtime, each message block corresponds to one column in the tabular display of the message window.

There are three groups of message blocks:

- System blocks with system data, for example, date, time, message number, and status
- User text blocks with explanatory texts, for example, message text with information about the cause of an error or location of the error, maximum 10 per message.
- Process value blocks are used to link the messages to process values, for example, current fill levels, temperatures, or speeds, maximum 10 per message.

Configuring Message Blocks

- Select the message blocks for use.
- Edit the properties of the message blocks.

General Properties of Message Blocks

You can display a message requiring acknowledgment or single message blocks as flashing in Runtime. To do this, the following conditions must be satisfied:

- The "Flashing On" property must be activated in the message type to which the message is assigned. You configure the property for a selected message type either in the table area or in the "Properties" area.
- The "Flashing" property must also be enabled in the message block. You configure the property for a selected message block either in the table area or in the "Properties" area. If several message blocks or all message blocks in a message are to be displayed flashing, this property must be enabled in each message block.
- The status texts of the messages are displayed in the "Status" system block. The number of characters for this system block must be sufficient for the status texts to be displayed in full.

Maximum number of characters

User text blocks can contain a maximum number of 255 characters.

The display of process value blocks is restricted during runtime to the following:

- Maximum of 32 characters for chronological reporting
- Maximum of 255 characters for bit messaging

5.4.2.2 Description of System Blocks

Introduction

System blocks allow for the display of predefined information that cannot be freely used, such as date, time and duration.

The value of the message block (for example, the time) is displayed in the message line.

Overview

System block	Description	Default number of characters
Date	Date for the "incoming", "outgoing" and "acknowledged" states of a message.	-
Time	Time of day for "incoming", "outgoing" and "acknowledged". Accuracy of the WinCC time stamp: 1 s. Display accuracy: 10 ms.	-

System block	Description	Default number of characters
Duration	<p>Period of time between the "incoming" and "outgoing" states and the acknowledgment of a message. There is only one column for duration:</p> <ul style="list-style-type: none"> • The column remains blank for messages with "came in" status. • For messages with "gone out" status , the time that elapses between "came in" and "went out" is displayed. • When the message is acknowledged, the time between "came in" and "acknowledged" is displayed. 	-
Daylight Saving Time/Standard Time	An "X" in this system block indicates whether daylight saving time applies.	1
Status	Message status, for example, "Came In" or "Went Out". The status texts displayed in this system block are configured in the message type and depend on the window type of the message window.	1
Acknowledgment Status	Indicates whether a message has been acknowledged. The status texts displayed in this system block are configured in the message type and depend on the window type of the message window.	1
Number	Message number	3
Class	One of 16 message classes. The text is user-defined.	8
Type	One of 16 message types per message class. The text is user-defined.	2
AS/CPU-Number	Number of the CPU and AS in which the message is triggered. During runtime, the value of this system block is not taken from the AS but rather is taken from the configured data of the single message. The value has no function in the communication with the AS.	2
Tag	Tag name for operator message from I/O field (and similar objects that can output operator messages)	1
Archiving	Indicates whether the message will be archived.	1
Logging	Each message is logged. Logging cannot be changed or removed.	1
Comment	The "Comment" system block indicates whether there is a comment for this message. A comment is an entry made by the user in the event of a message occurrence, for example, "This message occurred today because...".	1
Info text	Information texts for the message, limited to a maximum of 255 characters, for example, "Message could occur if...". The system block indicates whether an info text is available for this message. Info text cannot be edited in Runtime.	1
Loop in Alarm	This field is marked with an "X" when the "Loop In Alarm" function is activated.	1

System block	Description	Default number of characters
Computer name	<p>Indicates the name of the computer:</p> <ul style="list-style-type: none"> The name of the computer used by the operator is shown in the short-term archive list and the long-term archive list, provided that the user has entered a comment in the long-term archive list and has changed windows. After acknowledgment of a message, the computer on which this has message was acknowledged is shown in the operator input message in the short-term and long-term archive lists. The operator input message must be activated in WinCC Alarm Control on the "Message Lists" tab. 	10
User name	<p>Indicates the name of the user (login name):</p> <ul style="list-style-type: none"> The user name is shown the short-term archive list and the long-term archive list if the user has entered a comment in the long-term archive list and has changed windows. After acknowledgment of a message, the user who was logged on to WinCC at time of acknowledgment is identified in the operator input message in the short-term archive list and the long-term archive list. The operator input message must be activated in WinCC Alarm Control on the "Message Lists" tab. 	10
Priority	<p>Displays the priority of the message. You can sort the display of messages by priority. By sorting according to priority, you can ensure that, in single-line message view, the most important message (that is, the message with highest priority) is shown. A message with a lower priority is not displayed, even if the message is more recent.</p> <p>WinCC does not specify which value corresponds to the highest priority. When using Basic Process Control or PCS 7, reserve priority "16" for the messages with the highest priority.</p>	3
Class priority	<p>Used only by PCS 7.</p> <p>Displays the priority of a message class. You can sort the display of messages by class priority. If messages are sorted according to priority, the message of the highest-priority message class appears first in the display area in a single-line message display.</p>	3

Note

If the "ISO 8601-Force format for all components" setting is activated in the "Computer properties" dialog, the formats configured for system blocks "Date" and "Time" are affected.

5.4.2.3 How to select message blocks for use

Introduction

You select message blocks that are required for the display and archiving of messages.

Requirement

- The "Alarm Logging" editor is open.

Procedure

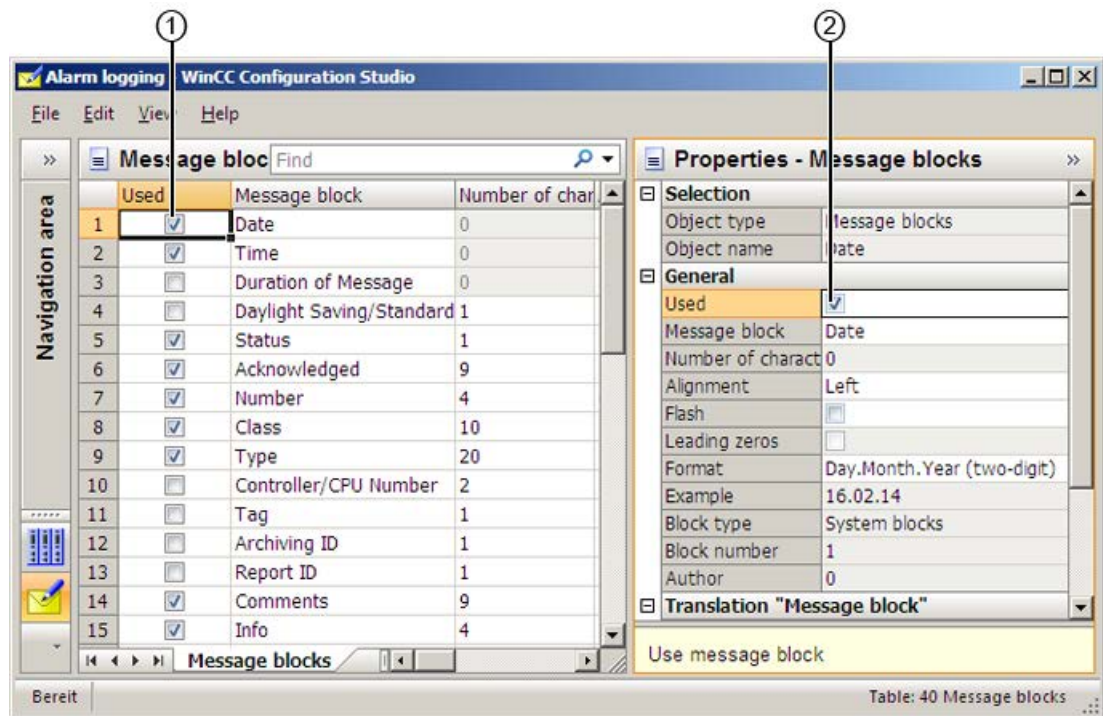

1. Select the "Message blocks" folder in the navigation area.
2. Set a check mark for the "Used" property for each message block you are using. Edit in the table area (1) or in the "Properties" area (2).
3. Click the box again to remove the check mark. The message block is no longer available.

5.4.2.4 How to change properties of a message block

Properties of message blocks

The properties of a message block determine how the message is displayed in Runtime.

Procedure

You change the properties of a message block either in the table area or in the "Properties" area.

Depending on the selected object, individual properties cannot be edited or only to a limited extent. Properties that cannot be edited have a colored background in the "Properties" area.

1. In the navigation area, select the "Message blocks" folder or one of the lower-level folders.
2. Select the message block in the table area to edit it in the "Properties" area.
3. You edit a property by clicking the respective box.

Note

All available properties of a selected message block are displayed in the "Properties" area. Individual properties could be hidden in the table area.

Overview of properties

Property	Description
Used	Indicates whether the message block is used.
Message block	Name of the message block The name is displayed as property during configuration of a message.
Number of characters	Number of characters that are available for display of the message block in Runtime
Alignment	Left, centered, right
Flashing	Indicates whether the message block is displayed as flashing in Runtime.
Leading zeros	Only for numerical message blocks: Indicates whether leading zeros are displayed.
Format	Only for date and time: Selection of display
Example	Display: Example of date representation
Block type	Display - not editable
Block number	Display - not editable
Creator	Display - not editable

Translation

Displays the name of the message block in the available languages.

You can edit the text here.

Recommendation: You can also edit the texts that are not available in the input language in the "Text Library" editor.

5.4.3 Working with Message Classes

5.4.3.1 Working with Message Classes

Introduction

Message classes combine message types in groups. Message classes provide a clear and structured display.

As of V7.3, the message types assume all the properties of the message classes. The message classes are retained as the parent of the message types and may continue to be used with their group tags. These properties can thus be used more flexibly in the message types.

Overview

WinCC provides 16 message classes and two preset system message classes. The following standard message classes are available:

- Error
- System, requires acknowledgment
- System, without acknowledgment

You configure the following settings for message classes:

- Message types assigned to the message class
- Group tags

Basic Process Control: Message classes in the group display

When you are using Basic Process Control, you can use the "Group display" object.

However, you can only assign the predefined message classes to the group display. You can find additional information in the WinCC Information System under:

- Working with WinCC > Creating Process Pictures > Working with Objects > Working with Smart Objects > How to Insert a Group Display (Page 662)
- Options > Options for Process Control > Process Control Runtime > Group Display

See also

How to Insert a Group Display (Page 662)

5.4.3.2 How to Add Message Classes

Introduction

You add additional message classes to the message system to combine message types in groups.

Requirement

- The "Alarm Logging" editor is open.

Procedure

1. Select the "Messages" folder in the navigation area.

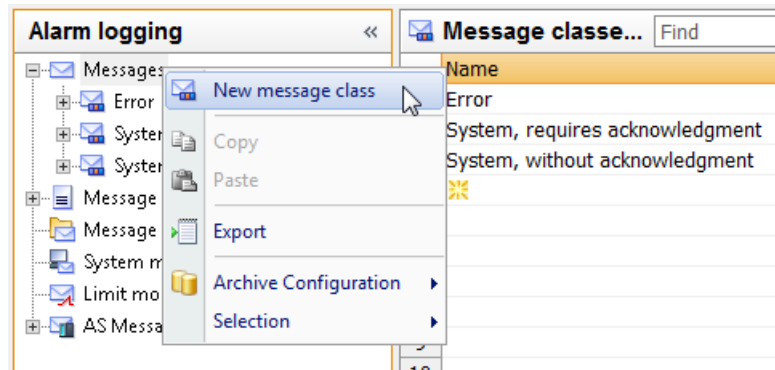

2. Select "New message class" in the shortcut menu.
A new message class appears as a folder in the tree view.

Alternative procedure

1. Select the "Messages" folder in the navigation area.
2. Click the "Message classes" tab below the table area.
3. Click in the top free cell of the "Name" column.
4. Enter the name for the message class.
A new message class has been created.

Note

Adding all message classes

To add all message classes at once, drag down the selection by more than 16 rows. This adds all available message classes.

5.4.3.3 How to insert the copy of a message class

Procedure

1. Select the folder for a message class in the navigation area.
2. Select "Copy" from the shortcut menu.
3. Select the "Messages" folder in the navigation area.
4. Select "Paste" in the shortcut menu.
A copy of the message class is created in the tree view.

Alternative procedure

1. Select the "Messages" folder in the navigation area.
2. Click the "Message classes" tab below the table area.
3. Select a line and select "Copy" from the shortcut menu.
4. Select the top free line and select "Paste" from the shortcut menu.
A copy of the message class is pasted.

5.4.3.4 How to change the properties of a message class

Introduction

You configure the following basic settings for message classes:

- Name of message class
- Tags

Requirement

- You have added the message classes to the message system.

Procedure

1. Select the folder of the message class in the navigation area.
2. Edit the properties of the message class in the "Properties" area.

Properties of a message class

You can freely assign the name of the message class. You can also change the name in the shortcut menu of the tree view with the "Rename" command.

Message classes use tags such as message groups as group tags.

See also: "Working with Message Groups (Page 1302)".

Translation

Displays the name of the message class in the available languages.

You can edit the text here.

Recommendation: You can also edit the texts that are not available in the input language in the "Text Library" editor.

5.4.3.5 How to Delete Message Classes

Introduction

You remove a message class from the message system when you no longer need it for the configured messages.

Requirement

- The "Alarm Logging" editor is open.

Procedure

1. Select the folder of the message class in the navigation area.
2. Select "Delete" in the shortcut menu.

Note

All messages assigned to the message class are deleted.

You cannot remove the "System, requires acknowledgment" and "System, without acknowledgment" message classes.

5.4.3.6 System Message Classes

Introduction

System messages are messages that are generated internally by the system, such as messages from operator inputs or on system failures.

WinCC provides system message classes for the processing of system messages. You cannot expand system message classes. The acknowledgment philosophy of the assigned message types is preset.

You specify which of the provided system messages are used. See section "Working with system messages (Page 1313)".

System Message Class Requiring Acknowledgment

The following message types are assigned to the message class "System, requires acknowledgment":

- Process control system: Messages are generated by the process control system, for example, during system startup.
- System messages: Messages are generated by the system, for example, when a system component fails.

An incoming message that is assigned to the system message class that requires acknowledgment must be acknowledged in order to remove it from the queue. The message disappears immediately following an acknowledgment.

Note

The "Went Out" status is not registered or stored in the archive.

System Message Class Without Acknowledgment

The following message types are assigned to the message class "System, without acknowledgment":

- Process control system: Messages are generated by the process control system, for example, during system startup.
- Operator input messages: Messages are generated by the operator input, for example, through operation of a component.

A message that is assigned to the system message class not requiring acknowledgment is not acknowledged.

Note

Keep in mind that an erroneous operator input will also be logged in an operator input message.

5.4.4 Working with message types

5.4.4.1 Working with message types

Introduction

Message types combine messages with the same acknowledgment philosophy and the same color display.

You configure messages within a message type. Message types also combine messages into groups.

As of V7.3, the message types assume all the properties of the message classes. The message classes are retained as the parent of the message types and may continue to be used with their group tags. These properties can thus be used more flexibly in the message types.

Overview

You can configure up to 16 message types in each message class.

WinCC provides the following message types for a new project:

- "Alarm", "Warning" and "Failure" in the message class "Error".
These message types can be edited or deleted.
- "Process control system" and "System messages" in the message class "System, requires acknowledgment".
- "Process control system" and "Operator input messages" in the message class "System, without acknowledgment"
You cannot delete the message types of the system message classes. The acknowledgment theory is preset. You cannot configure any additional message types in the system message classes.

5.4.4.2 How to Add Message Types for the Message Class

Introduction

Message classes combine messages with the same acknowledgment philosophy and the same color display.

You configure the message types within a message class.

Requirement

- The "Alarm Logging" editor is open.

Procedure

1. In the navigation area, select the folder with the message class to which the new message type is assigned.
2. Select "New message type" in the shortcut menu.
A new message type appears as a folder in the tree view.

Note

You cannot add message types to the "System, requires acknowledgment" and "System, without acknowledgment" message classes.

Alternative procedure

1. In the navigation area, select the folder with the message class to which the message type is added.
2. Click the "Message types" tab below the table area.
3. Click in the top free cell of the "Name" column.
4. Enter the name for the message type.
A new message class has been created.

Note

Adding all message types

To add all message types at once, drag down the selection by more than 16 rows. This adds all available message types.

5.4.4.3 How to insert copies of a message type

Introduction

If you need several message types for your project whose properties are more or less identical, create a copy of a message type.

Messages already assigned to the message type are not copied.

Requirement

A message type has been created.

Procedure

1. Select the folder for a message type in the navigation area.
2. Select "Copy" from the shortcut menu.
3. In the navigation area, select the folder of the message class to which the copy is added.
4. Select "Paste" in the shortcut menu.
A copy of the message type is created in the tree structure.

Alternative procedure

1. In the navigation area, select the folder with the message class to which the copy of the message type is added.
2. Click the "Message types" tab below the table area.
3. Select a line and select "Copy" from the shortcut menu.
4. Select the top free line and select "Paste" from the shortcut menu.
A copy of the message type is pasted.

5.4.4.4 How to change the properties of a message type

Introduction

You configure the properties of a message type in the "Properties" area.

Requirement

- You have added a message type to a message class.

Procedure

1. Select the folder of the message type in the navigation area.
2. Edit the properties of the message type in the "Properties" area.

Properties of a message type

- General information
"Name" and "ID" can be edited.
- Acknowledgment philosophy, central signaling device
See "How to Configure the Acknowledgment of a Message Type (Page 1273)"
- Status texts
See "How to Configure the Status Texts of a Message Type (Page 1275)"
- Tags
See "AUTOHOTSPOT"
- Colors
See "How To Configure Colors for the Display (Page 1277)"
- Translations
Displays the name and the status texts in the available languages.
You can edit texts.

Recommendation: You can also edit the texts that are not available in the input language in the "Text Library" editor.

5.4.4.5 How to Configure the Acknowledgment of a Message Type

Introduction

For the acknowledgment of a message, you specify how the message is to be displayed and processed during runtime from "Incoming" status to "Outgoing" status. All messages assigned to a message type use the same acknowledgment philosophy.

Requirement

- You have selected a message type in the navigation area.
- The properties of the message type are displayed in the "Properties" area.
- You can also select the "Messages" folder or the folder of a message class in the navigation area and select the "Message types" tab in the table area.

Basic procedure

In the "Properties" area, you configure the acknowledgment philosophy of a message and the acknowledgment of a message using the central signaling device.

You can choose between different states for the acknowledgment of a message:

- Single message without acknowledgment
- Single message with incoming acknowledgment
- Single message with dual-mode acknowledgment
- Initial-value message with single-mode acknowledgment
- New-value message with single-mode acknowledgment
- New-value message with dual-mode acknowledgment
- Message without "Went Out" status and with acknowledgment
- Message without "Went Out" status and without acknowledgment

Acknowledgment Theory Options

Acknowledgment Theory	
Acknowledgment "came in"	<input checked="" type="checkbox"/>
Acknowledgment "went out"	<input type="checkbox"/>
Flash On	<input type="checkbox"/>
Only for initial value	<input type="checkbox"/>
Without status "went out"	<input type="checkbox"/>
Unique user	<input type="checkbox"/>
Comment	<input type="checkbox"/>

Some options cannot be combined with other options. To select one of these options, you first have to undo the previously defined selection.

Option	Description
Acknowledgment came in	Select the option for a single message that must be acknowledged when it comes in. The message remains pending until it is acknowledged.
Acknowledgment went out	Select the option for a single message with dual-mode acknowledgment. Outgoing messages of this message class must be acknowledged.
Flashing On	Select the option for a new-value message with single-mode or dual-mode acknowledgment. The messages of this message class are displayed flashing in the message window. In order for a message block of a message to flash in runtime, flashing must be enabled in the properties of the respective message block.
Only for initial value	Select the option for an initial value message with single-mode acknowledgment. Only the first message of this message type is displayed flashing in the message window. The "Flashing On" check box must be selected.
Without status "went Out"	Select the option for a message without "Went Out" status and with or without acknowledgment. If this option is selected, the messages do not have "Went Out" status. If the message only recognizes the "Came In" status, it is not entered in the message window and is only archived.

Option	Description
Unique user	If you select the option, the comments in the message window are assigned to the logged-on user. The user is entered in the "User Name" system block. If no comment has yet been entered, any user can enter the first comment. After the first comment has been entered, all other users have only read access to this comment.
Comment	If you select the option, the comment of the incoming message is always displayed in the user text blocks with the dynamic components "@100%s@", "@101%s@", "@102%s@" and "@103%s@". The display then depends on the status of the message in the message list.

Note

If a message type does not need to be acknowledged and is not assigned a "Went Out" status, it is not displayed in the message window. The message is only archived. If such a message is used within a message group, the status bit of the message group is no longer affected when the message occurs.

Acknowledgment of a central signaling device

Central signaling device	
Acknowledgment key	<input checked="" type="checkbox"/>
Tag for central signaling device	

Option	Description
Acknowledge button	Central signaling devices that are triggered when a message comes in are acknowledged by the user by means of a separate acknowledgment button in the toolbar or by means of a keyboard entry. The acknowledgment button must be configured in the message window. The separate acknowledgment button is always available, even if the "Single acknowledgment" option has been selected in the properties of the message.
Tag for central horn	The central signaling device is controlled by the tag.
	Opens the "Select Tag" dialog so that a tag can be selected for the central horn.

5.4.4.6 How to Configure the Status Texts of a Message Type

Introduction

Message status texts of a message are displayed in the message line in the "Status" and the "Acknowledgment Status" system blocks.

Requirement

- You have selected a message type in the navigation area.
- The properties of the message type are displayed in the "Properties" area.

Display in the message window

The display of customizable status texts depends on the type of the selected message window:

Window Type	System block	Display of the status texts from the field
Message list	Status	"Came In", or "Came In and Went Out"
Message list	Acknowledgment Status	"Acknowledged"
Archive List	Status	"Came In", "Acknowledged" or "Went Out"
Archive List	Acknowledgment Status	No text is displayed.
Lock list	Status	No text can be configured. Locked messages are labeled with "Lock". The lock cannot be configured.
Lock list	Acknowledgment Status	No text can be configured. No text is displayed.

Note

The system generates the display of status texts "Ackn System" (system-acknowledged messages) and "Ackn Reset" (messages acknowledged using emergency acknowledgment).

Configuration of status texts

You configure the texts for individual message states in the "Properties" area.

Status Texts	
Text "came in"	+
Text "went out"	-
Text "acknowledged"	*
Text "came in and went out"	+/-

Option	Description
Came In	Text for "incoming" messages when there is a change to the signaling operating state
Went Out	Text for "outgoing" messages when there is a change from the signaling operating state
Acknowledged	Text for acknowledged messages
Came In and Went Out	Text for message that has come in and gone out

Note

Status texts are displayed in the message line only up to the number of characters configured in the system block properties. Therefore, a system block should be long enough for the longest status text to be displayed.

Translation

The bottom part of the properties includes the display of the status texts in the available languages.

You can edit the text here.

Recommendation: You can also edit the texts that are not available in the input language in the "Text Library" editor.

5.4.4.7 How To Configure Colors for the Display

Introduction

You configure the properties of a message type in the "Properties" area or in the table area.

The selected colors are used to display the assigned messages. Either permanently define the color in the "Color selection" dialog or select an indexed color from the central color palette if a central color palette is defined.

Requirement

- You have added a message type to a message class.

Procedure

1. Select the folder of the message type in the navigation area.
2. Edit the properties of the message type in the "Properties" area.

Color selection

For each message type, select the colors with which the assigned messages are displayed in Runtime. Font color and background color are specified for the states:

- Came in
- Went out
- Acknowledged

Colors	
Font color "came in"	255; 0; 0
Background color "came in"	192; 192; 192
Font color "went out"	255; 0; 0
Background color "went out"	192; 192; 192
Font color "acknowledged"	255; 0; 0
Background color "acknowledged"	192; 192; 192

1. Click on one of the property boxes for the color.
2. Click the  button.
The dialog for color selection opens.
3. Alternatively, you can use the keyboard to enter color values:
 - Enter three values separated by semicolons. The values between 0 and 255 each determine the RGB value of the color.
 - Enter a single numerical value. The value is interpreted as a hexadecimal value.
 - Enter an index value of the project portfolio.

The selected color is displayed in front of the numerical values. The selected color is used for the display of messages of the message type in Runtime.

5.4.4.8 How to delete message types

Introduction

If you no longer need a message type, you can delete it.
Assigned messages are also deleted.

Requirement

- The "Alarm Logging" editor is open.

Procedure

1. Select the folder for a message type in the navigation area.
2. Select "Delete" in the shortcut menu.

Note

You cannot remove the "Process control system", "System messages", and "Operator messages" message types from the "System" message classes.

5.4.5 Working with messages

5.4.5.1 Working with messages

Introduction

Each message is assigned to an event.
A message is made up of defined message blocks.

You can combine messages in a message group.

Requirement

You have configured message types to which you have assigned messages.

Configuring messages

You can configure messages in the table area of Alarm Logging:

- Create and copy messages
- Delete messages

You edit the properties of a message either

- In the table area
- In the "Properties" area

Displaying messages

Messages are displayed in the table area.

- To display all messages, select the "Messages" folder in the tree view in the navigation area.
Note that discrete alarms, messages from the limit monitoring, AS messages and system messages may be hidden. You can hide or display these messages from the shortcut menu of the "Messages" folder using the "Selection" command.
- To display messages of a message class, a message type or a message group, select the corresponding folder in the tree view in the navigation area.
- To display the system messages, select the folder "System Messages".
- To display the messages of limit monitoring, select the folder "Limit monitoring".
- To display the AS messages, select the "AS messages" folder. This folder is only shown if AS messages are available in the project.

Make sure that you have selected the "Messages" tab below the table area.

Shortcut menu in the table area

Use the shortcut menu of the table header (top row) to adjust the display of the table.

Shortcut menu table header

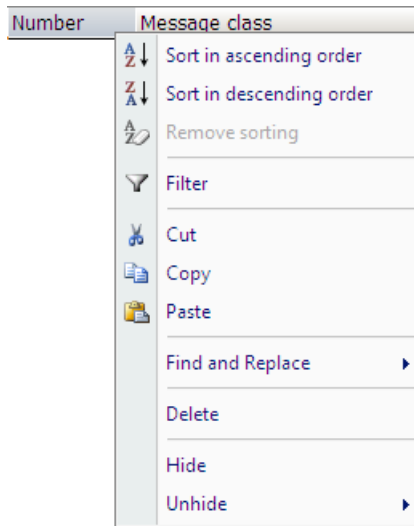

- Sort the table according to the entries of a column.
- Hide the entries for a specific time by setting a filter.
- Hide or show individual table columns.
- Other functions are available, for example Cut, Copy, Paste, Delete etc.

Shortcut menu row number

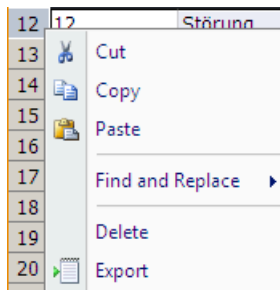

You edit the message with the shortcut menu of the first table column (sequential row number):

- Copy the messages to create similar messages.
- Delete messages that are no longer required.
- Export selected messages.

5.4.5.2 The properties of a message

Introduction

You specify the properties of a message either in the table area or in the "Properties" area.

You can create and edit a large number of messages in the table area. You can show or hide individual columns. You can sort or filter messages according to a column.

The "Properties" area displays all parameters of a message clearly arranged.

Requirement

- Required message classes and message types have been configured.
- Tags you are going to use have been created.
- Message blocks have been configured.

Display of parameters in the "Properties" area

1. Select a message in the table area by clicking any cell of the message.

Selection

Property	Description
Object type	Not editable
Object name	Message number Even if several messages are selected in the table area, only one message is edited in the "Properties" area.

General information

Property	Description
Number	Number of the message. Letters, spaces and special characters are not accepted in message numbers. Many numbers are reserved for WinCC system messages, other components and WinCC options. You can use numbers in the following ranges: <ul style="list-style-type: none"> • 1 - 999.999 • 1.020000 - 1.899.999 • 3.000.000 - 3.999.999 • 5.000.000 - 12.508.140 • 12.508.142 - 536.870.911 Message numbers of the above number range may already be assigned by the use of options.
Message class	Message class of the message. Selection from a drop-down list is possible. You can only select from message classes that have already been created.
Message type	Message type of the message. Selection from a drop-down list is possible. You can only select message types that have been assigned to the selected message class.

Property	Description
Message group	Assignment of the message to a user-defined message group. Selection from a drop-down list is possible. You can only select user-defined message groups that have already been configured. The field remains empty if the message is not assigned to a user-defined message group.
Priority	Defines the message priority. Messages can be selected and sorted based on their priority. The range of values is "0" to "16". WinCC does not specify which value corresponds to the highest priority. The value 16 corresponds to the highest priority in the PCS7 environment.
Hide mask	Defines the condition for hiding the message. If the value of the hide tag number corresponds to a system status in Runtime, the message is automatically hidden in the message list and in the short-term or long-term archive list. The message must be assigned to a message group and a hide tag must be configured for the message group.

Tags

Property	Description
Message tag	The message tag contains the bit which is used to trigger the currently selected message.
Message bit	Number of the message tag bit which is used to trigger the currently selected message.
Status tag	Tag in which the states of the message ("Came In / Went Out" and acknowledgment status) are stored.
Status bit	Number of the status tag bit which indicates the message status. The bit for mandatory acknowledgment is determined automatically.
Acknowledgment tag	Tag that is used as acknowledgment tag.
Acknowledgment bit	Number of the acknowledgment tag bit that is used to acknowledge the message.

You select tags in the "Tag Selection" dialog. A message appears if you select a tag that is already in use somewhere else. The input is not accepted. The bit is selected from a drop-down list. Only available bits are offered for selection.

Parameter

Property	Description
Single acknowledgment	The message must be acknowledged separately. It cannot be acknowledged using a group acknowledgment button.
Central signaling device	The message controls a central signaling device.
Archived	The message is saved to the archive.
Falling edge	For the discrete alarm procedure, you can specify whether the message is generated at the rising or at the falling signal edge. For all other message procedures, the message is always generated at the rising signal edge. For messages with falling edge, configure the message tag with start value "1".

Property	Description
Triggers an action	The message triggers the default function "GMsgFunction" which you can edit using the "Global Script" editor. The function is available at "Standard Functions/Alarm" in the function browser of Global Script.
Extended associated value data	<p>The option controls the evaluation of message events from message blocks via raw data tags.</p> <p>Option is activated: The process values are evaluated in Alarm Logging according to the data types of the accompanying values defined in the dynamic text parts and are archived or displayed in the message.</p> <p>The 12 bytes of the accompanying value can be combined from the following data types:</p> <ul style="list-style-type: none"> • Byte(Y), • WORD(W), DWORD(X), • Integer(I), Integer(D), • BOOL(B), CHAR(C), REAL(R). <p>Example: @1Y%d@, @2W%d@, @3W%d@, @3X%d@, @5W%d@, @6Y%d@. "@2W%d@" references the second associated value as "WORD".</p> <p>Regardless of the option, system values can be displayed for specific message blocks in process value block "10".</p>
Support	If the option is enabled, you can configure texts that provide the operator help for handling the message.

You select a parameter by clicking in the option button and thus setting the checkmark .

Extended

Property	Description
Format DLL	If the message tag is a raw data tag, select the corresponding compiler program in this field.
Loop In Alarm	A WinCC function is started when the message is output.
Function name	<p>Select the function that is called, for example, to link the message with a picture.</p> <p>Default: "OpenPicture"</p> <p>You can select any other function.</p>
Function parameter	<p>Call parameter, depending on the selected function, freely editable.</p> <p>Example: Name of a picture that is displayed when called.</p>
AS number	<p>Number of the AS (sublevel controller - PLC) which triggers the message.</p> <p>The value is displayed in the message block of the message in Runtime and does not have any function in the communication with the AS.</p>
CPU number	<p>Number of the CPU which triggers the message.</p> <p>The value is displayed in the message block of the message in Runtime and does not have any role in the communication with the AS or CPU.</p>
The following properties are only relevant for messages of an S7 Plus AS	
Address	Address of the message.
Version	Version of the message.
Author ID	ID of the author

Property	Description
Connection	Name of the connection to the AS that can trigger the message.
Author	Display: Author of the message

User text blocks

Property	Description
Message text	Freely editable, maximum 255 characters. Enter the text in the text field. To add process values to the text, click in the table area in the field for "Message text", "Point of error" or a user text block. Then click the "Edit" menu option in the shortcut menu.
Point of error	
Info text	

Help (language-neutral)

Property	Description
Reaction time	Required reaction time after the message is triggered. Time format: "Day Hour: Minute:Second"
Description	Description of the message.
Reasons	Possible reasons for triggering the message.
Action	Recommended action of the operator.
Effect	Effect if the operator does not react within the required reaction time.

Translation

The bottom part of the properties includes the display of the configured user text blocks in the available languages.

You can edit the text here.

Recommendation: You can also edit the texts that are not available in the input language in the "Text Library" editor.

5.4.5.3 How to Create a Message

Introduction

You create a message in the table area by entering a number in the top free line of the "Number" column.

Requirement

- The "Alarm Logging" editor is open.

Create new message

1. In the navigation area, select the folder with the message type to which the new message is assigned.
2. Click in the next empty line of the "Number" column in the table area.

Messages [Message type]		
	Number	Message tag
1	1001	
2	1002	
3	1003	
4	1004	
5	<input type="text"/>	<input type="text"/>
6		

3. Enter a number for the message.
The message is created as soon as you click the mouse on another location.
If you enter a number that is already assigned to a message, a corresponding message appears. The input is not accepted.

Note

The numbers "1000000" to "1019999" are reserved for WinCC system messages. You can use the following numbers:

- "1" to "999999"
- "1020000" to "536870911" (0x1FFFFFFF)

4. Alternatively, select a tag in the top free row of the "Message tag" column. This field is also marked by the yellow icon.
The message is created with the next available message number as soon as you have selected the message tag.
5. Edit the properties of the message either in the "Properties" area or in the table area.

Create copied message

1. In the table window, select the line number of the messages you want to copy.
2. Select the "Copy" command in the shortcut menu.
Alternative: Press "Ctrl+C".
3. Select the top empty line.
4. Select the "Paste" command in the shortcut menu.
Alternative: Press "Ctrl+V".
5. Copied messages are pasted. The numbers are adapted according to the existing numbers.
6. Edit the properties of the copied messages.

Creating several messages

You can create a large number of messages in the table area based on an existing message.

1. Select the "Number" cell of the lowest entry in the table area.
2. Drag down the bottom right corner of the selection while keeping the mouse button pressed.

25	125	XYZ-Klasse
26	126	XYZ-Klasse
27		
28		
29		

New messages are created. The message number is incremented according to the selected message.

5.4.5.4 How to Edit Multiple Messages

Introduction

A selection of messages can be edited simultaneously.

Requirement

- The "Alarm Logging" editor is open.

Possible actions

Messages displayed in the table area can be edited at the same time. Each individual property (e.g. message type, message group membership, message text) can be changed or assigned for multiple messages.

If messages that are edited together must be displayed in the table area below one another, use the following options:

- Create several consecutive messages by "pulling down" the message number.
- Sort or filter the table by property using the shortcut menu of the column header.
- Filter the display using the "Find" search box.

You also have the following options:

- Selection of a message type, message class or message group in the tree view. The assigned messages are displayed in the table area.
- Multiple selection in the table area: To select multiple lines, press the Shift button (selection of consecutive lines) or the "Ctrl" button (selection of independent areas) while clicking a line number.

You can apply the functions of the shortcut menu (Copy, Export, etc.) to the selection.

Procedure

1. Select the cell with the property of a message that is to be applied to the next messages. You can select several properties at the same time.
2. Drag the selection at the bottom right corner of the box across the messages below. The messages apply the property from the selection. Numerical values (e.g., message bits) are incremented, if necessary.

5.4.5.5 How to Delete a Message

Introduction

You delete a message in the table area.

Requirement

- The "Alarm Logging" editor is open.

Procedure

1. In the table area, select the lines containing the messages you want to delete. Click the line number to do so. If you only select individual cells of a message, only the input for the respective property is deleted.
2. Select "Delete" in the shortcut menu. Alternatively, press the "Del" key. The message is deleted and removed from the table. System messages are not deleted. The use of system messages is canceled.

5.4.5.6 Tags of a Single Message

The message tag of a message

Introduction

A message is triggered by means of the message tag. The tag must be of an unsigned tag type. The structure of message tags is not specified.

You have the following options of configuring message tags:

- Configuring separate message tags for each message.
- Triggering several messages using one message tag. The messages are distinguished by the message bit. A message tag bit can only be used for a single message.

Procedure

1. Select the message in the table area.
2. Select the tag in the table area or in the "Properties" area. See "The properties of a message (Page 1280)"

Note

Do not combine any bits of the message tag with other tags of the message, for example, with a status tag.

Using one tag for multiple messages

1. Create the messages that use one tag below one another in the table area.
2. Select the tag for the first message and usually the message bit 0.
3. Select the cell with the tag and drag the selection down with the mouse.
The selected tag is applied to the messages below. The message bit is incremented accordingly.

The status tag of a message

Introduction

There are two important message statuses for a message:

- The "Came In / Went Out" status indicates whether the message is incoming or outgoing.
- The acknowledgment status indicates whether the message requires acknowledgment and has not yet been acknowledged.

Both statuses of the message are stored in a status tag. Depending on the data type of the tag, up to 16 messages can be logged to a status tag. Each message occupies 2 bits in the status tag.

"Acknowledgment bit"

The acknowledgment bit in the status tag changes to "1" as soon as a message requiring acknowledgment has come in and has not yet been acknowledged. The acknowledgment bit changes to "0" as soon as a message requiring acknowledgment has been acknowledged.

Position of the bits

The position of the bit for "Incoming/Outgoing" status in the status tag is identified by the status bit. The position of the "acknowledgment bit" depends on the data type of the status tag. The distance to the bit with the "Came In / Went Out" status is:

- 4 bits for the "8 bit unsigned" tag
- 8 bits for the "16 bit unsigned" tag
- 16 bits for the "32 bit unsigned" tag

Status tag of data type "32 Bit Unsigned"

If the status tag is of data type "32 bit unsigned" and the status bit = 9,

- bit 9 of the status tag indicates the "Came In / Went Out" state of the message.
- bit 25 of the status tag indicates whether this message requires acknowledgment.

Bits "0-15" correspond accordingly to bits "16-31" of a "32-bit" status tag.

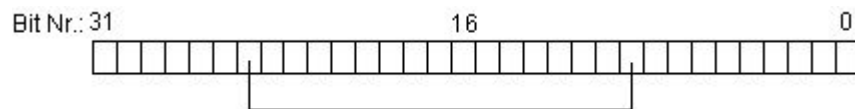

Status tag of data type "16 Bit Unsigned"

If the status tag is of data type "16 bit unsigned" and the status bit = 3,

- bit 3 of the status tag indicates the "Came In / Went Out" state of the message.
- bit 11 of the status tag indicates whether this message requires acknowledgment.

Bits "0-7" correspond accordingly to bits "8-15" of a "16-bit" status tag.

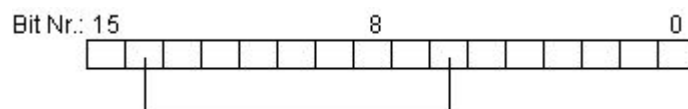

Status tag of data type "8 Bit Unsigned"

If the status tag is of data type "8 bit unsigned" and the status bit = 3,

- bit 3 of the status tag indicates the "Came In / Went Out" state of the message.
- bit 7 of the status tag indicates whether this message requires acknowledgment.

Bits "0-3" correspond accordingly to bits "4-7" in an "8-bit" status tag.

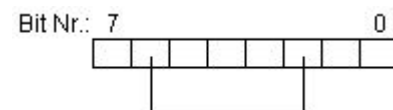

Configuring the status tags

1. Select the message in the table area.
2. Select the tag in the table area or in the "Properties" area. See "The properties of a message (Page 1280)"

Note

Do not combine any bits of the status tag with other tags of the message, for example, with an acknowledgment tag.

Using one tag for multiple messages

1. Create the messages that use one tag below one another in the table area.
2. Select the tag for the first message and usually the message bit 0.
3. Select the cell with the tag and drag the selection down with the mouse.
The selected tag is applied to the messages below. The message bit is incremented accordingly.

The acknowledgment tag of a message

Introduction

One bit of the acknowledgment tag in messages is used to trigger the acknowledgment and to display the status. The following rules apply:

- The message was acknowledged if the corresponding acknowledgment bit has the value "1".
- The message has not yet been acknowledged if the corresponding acknowledgment bit has the value "0".

This acknowledgment bit is set when a message is acknowledged in Runtime.

The structure of the acknowledgment tag is not specified. The tags must be an unsigned tag type. You have the following options of configuring message tags:

- Configuring a separate acknowledgment tag for each message.
- Grouping several messages in a single acknowledgment tag. Messages are distinguished by means of the acknowledgment bit.

Note

For the acknowledgment of the message using the WinCC Alarm Control, the acknowledgment bit assigned to the message is set. The acknowledgment bit is reset by user actions, for example, by clicking a button in the WinCC process picture or by means of a program in the AS.

Configuring acknowledgment tags

1. Select the message in the table area.
2. Select the tag in the table area or in the "Properties" area. See "The properties of a message (Page 1280)"

Note

Do not combine any acknowledgment bits of the message with other tags of the message, for example, with a status tag.

Using one tag for multiple messages

1. Create the messages that use one tag below one another in the table area.
2. Select the tag for the first message and usually the message bit 0.
3. Select the cell with the tag and drag the selection down with the mouse.
The selected tag is applied to the messages below. The message bit is incremented accordingly.

5.4.5.7 How to specify the text of a message

Introduction

You configure message texts, info texts and texts for support in order to provide further information on the messages or advice on how to handle the message.

Overview

User text blocks

You can configure texts for up to ten user text blocks. The names of the first two blocks are preset as "Message text" and "Point of error".

The texts can be up to 255 characters in length.

In the user text block, you can display the field contents of the comment dialog of the message using format specifications, for example:

- @100%s@ = Computer name
- @101%s@ = Application name (max. 32 characters)
- @102%s@ = User name (max. 16 characters)
- @103%s@ = Comment (max. 255 characters) of message in long-term archive list. For this, a comment must have been entered in the message.

Info text

In addition to the user texts, you can define additional information for the "Info text" message block.

The texts can be up to 255 characters in length. The information text also supports format instructions.

The info texts cannot be changed in Runtime.

Texts for support

You can make the following help text available to support the operator in handling the message.

- Reaction time - required reaction time after the message is triggered.
The time format is: "Day Hour: Minute:Second"
- Description - Description of the message
- Reasons - Possible reasons for triggering the message
- Action - Recommended operator actions
- Effect - Effect if the operator does not react within the required reaction time

The texts can be more than 400 characters long and multiline. Format instructions are not supported.

The texts can be configured as multilingual. The language-specific texts are configured in the Alarm Logging. The texts are not displayed in the text library and cannot be edited there. You can import and export the multilingual texts via the Text Distributor.

The texts cannot be used in Runtime for message filtering or sorting.

In WinCC AlarmControl, the most recent text is always displayed with the key function "Display alarm help", even if the text when the message had another text when it was triggered, for example.

Requirement

- You have already created messages.

Configuring user text blocks and info text of a message

You define the message texts in the "Properties" area or table area. You can find the input fields in the "Properties" area under "User text blocks".

1. Click in the input box, for example "Message text", "Info text".
2. Enter the text.
3. To insert process values into the user text block, select the "Edit" command from the shortcut menu of the corresponding input field in the table area.
The dialog for process value block selection and formatting opens. See "AUTOHOTSPOT".
4. Close the dialog by clicking "OK".

Configure texts for help on a message

1. Enable the "Help" option for the parameters in the "Properties" area.
2. Enter the language-neutral texts in the "Help (language-neutral)" input boxes.
3. If you want to use multilingual texts, enter the texts for the help of the installed languages in the "Translation" area.

You can see the entered text in the tooltip text of the text boxes.

Translation of user text blocks and info texts

The bottom part of the properties includes the display of the activated and used user text blocks in the available languages.

You can edit the text here.

Recommendation: You can also edit the texts that are not available in the input language in the "Text Library" editor.

No translation

If you change the input language during configuration, the entries for the texts already configured may not be available in the new input language. This is indicated by the note "Empty text" in the corresponding properties fields of the user text blocks. This information reminds you that translations are not available for the current input language. The "Empty text" message only appears in the editor and not in Runtime.

5.4.5.8 How to Insert Process Values in User Text Blocks

Introduction

You can insert the value of a process variable in a user text block. The maximum number of characters is 255.

Settings for configuring process values

You assign the process value to a user block in the dialog for editing a message text.

You make the following settings:

Input	Description
Process value block	Select the process variable, the value of which you want to insert. You are offered to select: <ul style="list-style-type: none"> • The process value blocks selected for use • Computer name • Application name • User name • Comment
Type	Specifies the format type of the process value to be inserted. The following selections can be made: <ul style="list-style-type: none"> • Text • Fixed point number (decimal, octal, hexadecimal) • Floating point number
Number of digits	Defines the number of digits reserved in the user text for the process value.
Accuracy	Defines how many digits of the process value are to be inserted in the user text.
Align Left	If the number of digits in the process value to be inserted is less than the number of digits reserved, this function is used to specify whether the process value is aligned right or left when it is inserted in the user text.
Pad with 0	If this function is activated, floating point numbers are filled in with "0" until the number of digits specified in the "Precision" text field is reached.
Data output	Input field for text.
Inserting process value	Inserts the selected process value in the selected formatting in the output at the position where the input cursor is located.
< < > (arrow keys)	Place the input cursor in the process value block you want to move in the user block. Click an arrow key to move the process value block within the output.
Example	Shows an example of a message text.

Requirement

- You have already created messages.
- You have selected at least one process value block to be used.

Procedure

1. In the table area, select the corresponding user text block, for example, "Message text", "Point of error, etc.
2. Select the "Edit" command from the shortcut menu of the input field. The dialog for selection and formatting a process value block opens.

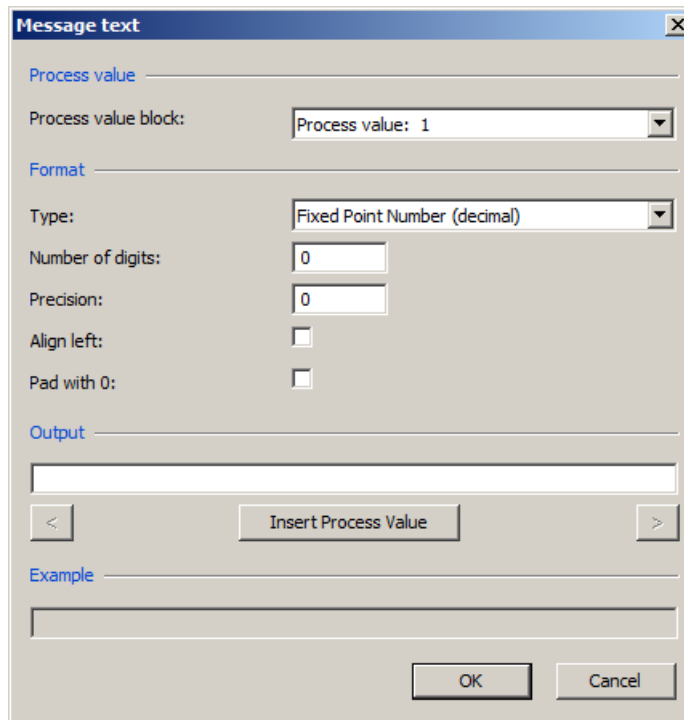

3. Specify the settings and confirm them with "OK".

5.4.5.9 How to Link a Picture to a Message

Introduction

You can display a graphic for a message in Runtime that represents the plant unit of the process where the message occurred.

To do this, assign the name of the graphic to a picture function that is triggered in the message window:

Note

The default setting for the picture function is the WinCC standard function "OpenPicture". You can specify any function and specify another file as the transfer parameter.

If you wish to use a different function, you should note the following:

- Use a function that accepts a transfer parameter of the type char*, for example: void MyFunction(char* NameOwnData).
 - Use only functions whose return parameter corresponds to the "unsigned char", "short int", "long int", "float", "double", "bool", or "void" types.
-

Requirement

- You have already created messages.
- You have configured a graphic in the Graphics Designer.

Procedure

1. Select the message in the table area.
2. Activate the option "Loop In Alarm" in the "Properties" area, section "Extended". The "OpenPicture" function is the default setting.
3. Select the graphic you want to display as a "function parameter".

5.4.5.10 How to Configure the Hiding of Messages

Introduction

Hiding messages reduces the information load for the system user.

You as user can concentrate better on the messages only if selected messages are shown.

Properties of hidden messages

Hidden messages are:

- In the message list, short-term archive list and long-term archive list, you can select whether the hidden messages are to be displayed. The display depends on the activated option in the "Display Options" dialog.
- They are included in the list of messages to be hidden and displayed there.
- They are archived.
- They do not trigger the alarm in Basic Process Control.
- The central messaging tag is not set in WinCC.

- You can manually or automatically unhide messages that are hidden.
- Manual hiding forces you to acknowledge messages that need acknowledgment and triggers an operator input message.
- Automatic hiding does not force you to acknowledge and therefore it also does not trigger an operator input message.
- In the period when messages requiring confirmation are hidden, the system acknowledges the outgoing messages.
If a message does not have the "gone" status, the system acknowledges it immediately.

Procedure for hiding

You have the following options to hide messages:

- **Automatic hide:**
Messages are hidden and shown again later depending on a certain system status of the hide tag.
 - You need to create a user-defined message group with a hide tag.
 - You add the messages that you want to hide in Runtime to the message group.
 - You can configure the system states for hiding or showing for each message using the hide mask.
- **Manual hide:**
In the message window, you can use a button to define when you want to hide a message from one of the three message lists.
 - You can also show the messages again using another button in the Message window.
 - The system displays the messages again after a configurable time.

You trigger manual hiding with operator messages. When an operator message is configured, the operator must give a reason for hiding.

Configuring hiding

You can configure automatic hide and the duration for manual hide in Alarm Logging.

You configure the button for manual hide in WinCC Alarm Control in the Graphics Designer.

You can find additional information on the configuration and operation in Runtime under "AUTOHOTSPOT".

Requirement

- The "Alarm Logging" editor is open.

Procedure for automatic hiding

You configure automatic hiding using a user-defined message group.

1. Create a user-defined message group.
2. Select the respective folder in the navigation area.
The properties of the user-defined message group are displayed.

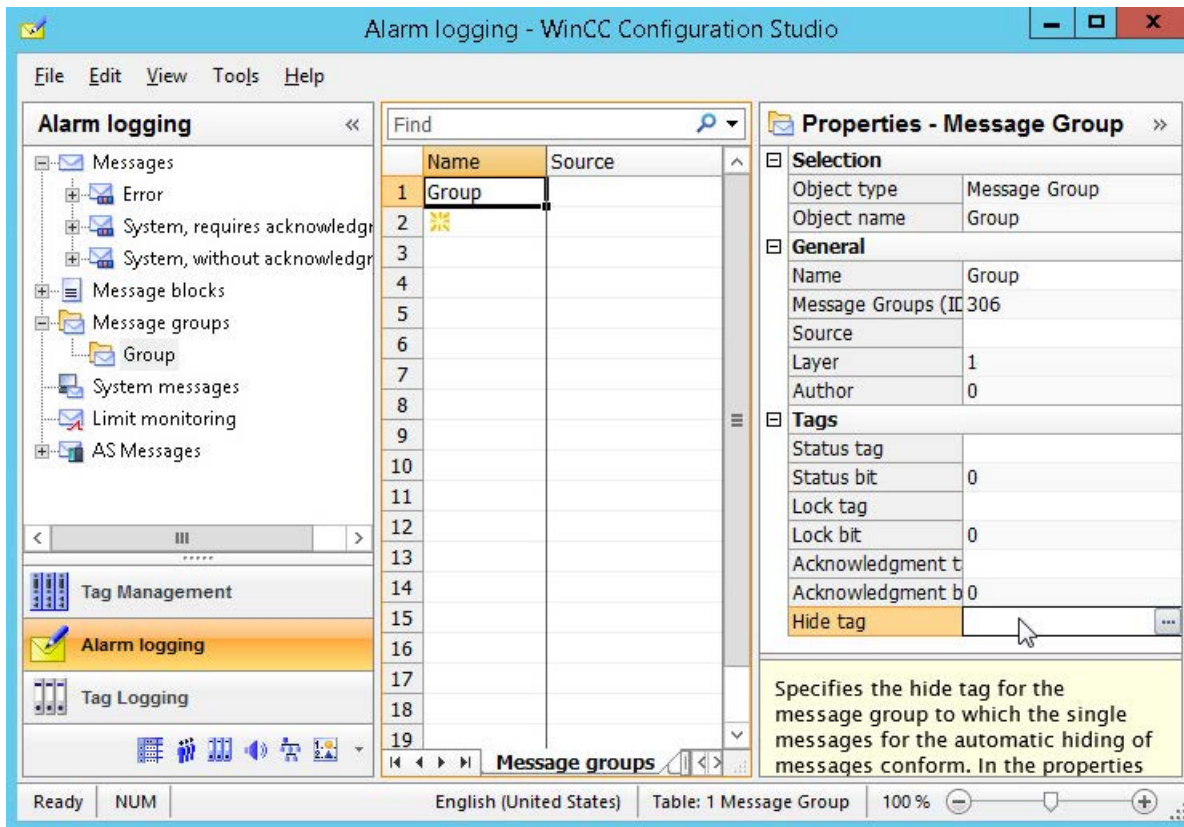

3. Click in the "Hide tag" box under "Tags".
4. Click the button.
5. Choose the hide tag via the tag selection dialog.
You can use an unsigned 8 bit, 16 bit or 32 bit value as a hide tag.
6. Add the messages that you want to hide automatically to the message group.

7. Define the hide condition for each message of the user-defined message group.
Edit the "Hide mask" property under "General".
This way you determine the system statuses of the hide tag for which the message is hidden.
8. Click .
The "Hide at the following process cell states" dialog opens.

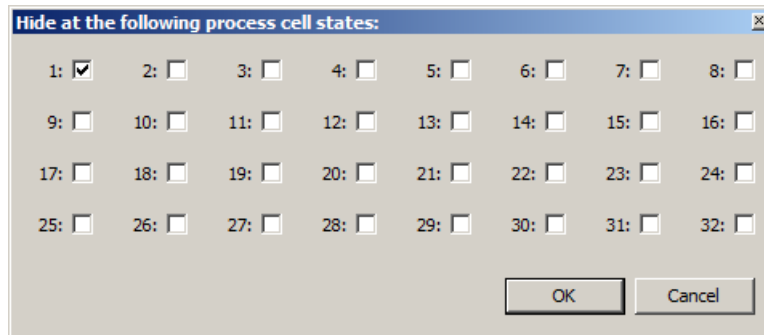

Select the system statuses. The selected system statuses are displayed in the "Hide mask" box.
You can also enter the numerical values separated by semicolons in the "Hide mask" field.

Procedure for hiding manually

If the messages are hidden manually, define the duration for hiding messages from the messages list in the "Alarm Logging" editor.

1. Select the "Messages" folder in the navigation area.
The properties available for manual hiding are displayed in the "Properties" area under "Hiding manually".

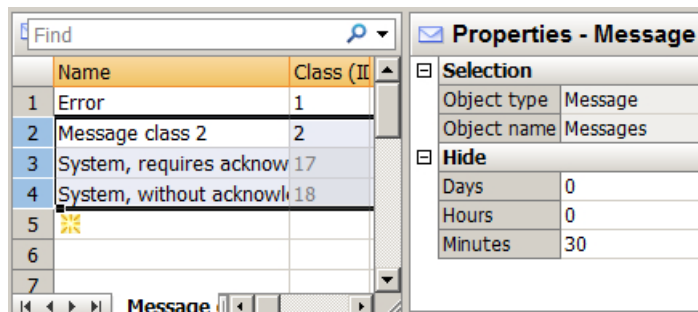

2. Enter the required duration.
The period is interpreted internally in minutes.
The default for minimum timeout is 30 minutes.
You can enter a maximum of 9 days, 23 hours and 59 minutes. This is equal to 239 hours and 59 minutes or 14399 minutes.

See also

- How to configure operator messages (Page 1394)
- How to Hide and Unhide Messages (Page 1421)

5.4.5.11 Importing and Exporting Messages

How to Export Messages

Introduction

You can select and export messages as you please. The exported messages are either saved as a text file (*.txt) or as Excel workbook (*.xlsx).

Requirement

- The "Alarm Logging" editor is open.

Preparation for export

- Select the "Messages" folder if you want to export all messages.
- Select a folder if you want to export all messages of a message class, a message type or a message group.
- Select individual messages you want to export in the table area.
To do so, select the line numbers of the messages.
Press the Shift key to select consecutive messages.
Press the Ctrl key to select non-consecutive messages.

Procedure

1. Select the messages you want to export.
2. Select "Export" in the shortcut menu.
3. Select the file format (text or Excel workbook).
The selected messages are written to a file.
A message confirms that the export was completed successfully.

Note

Select the "Edit > Export" command in the main menu to export the entire configured Alarm Logging (all messages, message blocks and limit monitoring).

Structure of the export file

The format of the export file is either Unicode text or an Excel workbook. All dependencies are also exported.

Unicode text

The individual properties are separated by tabs; the lines are separated by line breaks (CR-LF).

Depending on the selected export, the file lists message classes, message types, messages, etc. with all properties.

You can open and edit the file in spreadsheet programs (such as MS Excel).

Excel workbook

Messages, message types and message classes are represented on separate worksheets in Microsoft Excel 2010 format.

How to Import Messages

Introduction

You can import previously exported messages in Alarm Logging. You can import messages from other projects.

Requirement

- The "Alarm Logging" editor is open.
- A text file with messages is available.

Procedure

1. Select the "Import" command in the "Edit" main menu. A dialog for selecting an import file opens.
2. Select an import file.
3. Click "Import" to import the messages into the message system. A message confirms that import is complete.

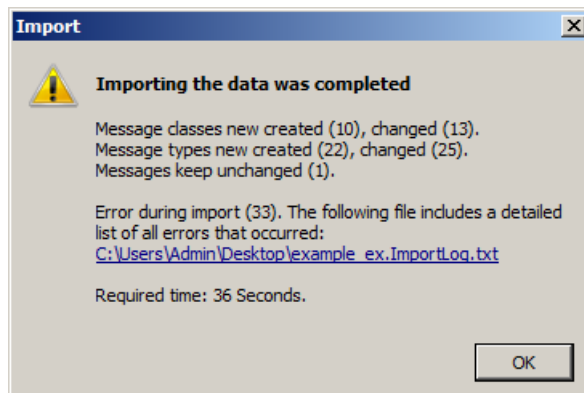

If errors occurred during the import, the message includes a link to the log file in which the errors are listed

5.4.6 Working with Message Groups

5.4.6.1 Message groups

Introduction

Message groups are used for higher-level queries and control of a defined number of messages.

Configuration

In WinCC, there are two types of message groups:

- User-defined message groups
The user-defined message groups are configured using the "Message groups" folder in the navigation area.
- The groups "Message classes" and "Message types" are already defined.
You configure these message groups by editing the properties of the message class or message type.

5.4.6.2 Working with Message Groups

Introduction

For message groups consisting of message classes and message types, the associated messages are the result of the general message configuration. Because the structure of the message classes and message types is hierarchical and the message class always represents the top folder for the message types listed below, the resulting message affiliation is as follows.

- All messages that are configured below a message class are part of this group.
- All messages that are configured below a message type are part of this group.
- You can determine the affiliation for user-defined message groups yourself.
The user-defined message groups can be hierarchically structured in six lower-level layers.
Keep in mind that a message can only be assigned to one user-defined message group.

You can use these options to form a wide variety of groups.

The message groups only include tags that process the status and control of the associated messages as group formation or group control.

Assignment of Tags

The following tags can be assigned to each message group, message class and message type:

- The **status tag** represents the group formation of the message states of all lower-level messages. The status bit indicates that at least one message has "Came in" status. It is not reset until all messages have the status "Went out". The acknowledgment bit of the status tags indicates that at least one message came in which requires acknowledgment. This bit is not reset until all messages have been acknowledged.
The message status can also be queried by other WinCC components using the status tag.
- Use the **lock tag** to evaluate the lock of the message group. The lock tag is by default controlled by the lock dialog in Runtime to lock the message group. The lock status can also be queried by other WinCC components by means of the lock tag.
- Use the **acknowledgment tag** to define the acknowledgment of the message group. You can use the acknowledgment tag to acknowledge the messages of the entire message group. The acknowledgment can also be controlled by other WinCC components by means of the acknowledgment tag.
- **Hide tags** only exist with user-defined message groups. Use the hide tag of a user-defined message group to define the conditions for single messages of the message group - when should a message be automatically hidden from the message list, short-term archive list and long-term archive list.

5.4.6.3 How to Create a User-Defined Message Group

Introduction

You have the following options for creating user-defined message groups:

- Creating a new user-defined message group
- Creating a lower-level, user-defined message group for a user-defined message group

Requirement

- The "Alarm Logging" editor is open.

Procedure

1. Select the "Message groups" folder in the navigation area.
If you want to subordinate a user-defined message group, select a message group that you have already created.
2. Select "New Group" in the shortcut menu.
A new user-defined message group is created.
3. Enter a name for the message group.
4. Configure the tags you need for the message group.

Alternative procedure

1. Select the "Message groups" folder in the navigation area.
If you want to subordinate a user-defined message group, select a message group that you have already created.
2. Click in the top empty line of the "Name" column in the table area.
3. Enter the name of the new message group in the "Name" input field.
A new message group is created.
4. To subordinate the user-defined message group to an existing user-defined message group, select the required message group for the "Origin" property.
5. Configure the tags you need for the message group.

5.4.6.4 How to Change the Properties of a Message Group

Introduction

The properties and the assigned tags determine the behavior of the message groups.

Properties of the message groups

General information

Property	Description
Name	Enter text as required. The names of a user-defined message groups can only be configured in one language.
Message group (ID)	Display of ID
Source	Higher-level message group. Empty if the message group is on the top layer. Can only be edited for user-defined message group. The message group can be assigned to a user-defined message group you have already created.
Layer	Only for user-defined message groups: Indicates the nesting depth. "1" is displayed if the message group is on the top layer.
Author	Display

Tags

Property	Description
Status tag	Tag in which the states of the message group ("Came In / Went Out" and acknowledgment status) are stored.
Status bit	The two bits of the status tag in which the states of the currently selected message group are stored.
Lock tag	If you lock a message group via the lock dialog during runtime, the relevant bit is set in this tag.

Property	Description
Lock bit	If you use a lock tag for several message groups, you specify the assignment to a message group using a lock bit.
Acknowledgment tag	Tag that is used as acknowledgment tag.
Acknowledgment bit	Acknowledgment tag bit that is used to acknowledge the message.

Requirement

- The "Alarm Logging" editor is open.

Procedure

1. Select a message group in the navigation area.
2. Edit the properties in the table area or in the "Properties" area.

5.4.6.5 Tags of a message group

Tags of a message group

Supply of tags in a message group

Each user-defined message group, message class and message type provides tags. The value of one of these group tags is the result of a logical OR operation of the corresponding tags of the lower-level messages and message groups.

Tags of a message group can, for example, be evaluated by scripts. The status and acknowledgment status of a group can be determined in this way. The lock tag is supplied by the lock dialog in runtime. The hide tag can be used to automatically show or hide messages in user-defined message groups.

Status Tag of a Message Group

Introduction

The status tag of a message group describes two message states:

- The "Came In / Went Out" status indicates whether one of the subordinate messages came in or went out. This can also be another message group.
- The acknowledgment status indicates whether the triggering message of the message group requires acknowledgment and has not yet been acknowledged.

Both states of the message group are stored in the tag. Depending on the data type of the tag, up to 16 message groups can be logged to a status tag. Each message group occupies 2 bits in the status tag.

If a status bit of a lower-level layer is set in user-defined message groups, the status bit of all levels above this one is set as well. This means the status is ORed up. The same applies to the acknowledgment bit.

"Acknowledgment bit"

The acknowledgment bit in the status tag changes to the status "1" as soon as at least one message that belongs to the message group and that requires acknowledgment came in and was not acknowledged. The acknowledgment bit changes to the status "0" as soon as all messages that belong to the message group and that require acknowledgment have been acknowledged.

Position of the bits

The position of the bit for "Incoming/Outgoing" status in the status tag is identified by the status bit. The position of the "acknowledgment bit" depends on the data type of the status tag.

The distance to the bit with the "Came in / Went Out" status is:

- 4 bits for the "8 bit unsigned" tag.
- 8 bits for the "16 bit unsigned" tag.
- 16 bits for the "32 bit unsigned" tag.

Status tag of data type "32 Bit Unsigned"

If the status tag is of data type "32 bit unsigned" and the status bit = 9,

- bit 9 of the status tag indicates the "Came In / Went Out" state of the message group.
- bit 25 of the status tag indicates whether the message group contains a message requiring acknowledgment that has not yet been acknowledged.

Bits "0-15" correspond accordingly to bits "16-31" of a "32-bit" status tag.

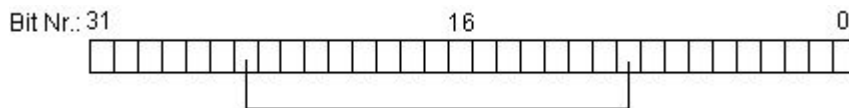

Status tag of data type "16 Bit Unsigned"

If the status tag is of data type "16 bit unsigned" and the status bit = 3,

- bit 3 of the status tag indicates the "Came In / Went Out" state of the message group.
- bit 11 of the status tag indicates whether the message group contains a message requiring acknowledgment that has not yet been acknowledged.

Bits "0-7" correspond accordingly to bits "8-15" of a "16-bit" status tag.

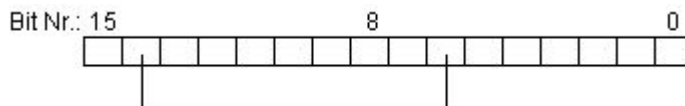

Status tag of data type "8 Bit Unsigned"

If the status tag is of data type "8 bit unsigned" and the status bit = 3,

- bit 3 of the status tag indicates the "Came In / Went Out" state of the message group.
- bit 7 of the status tag indicates whether the message group contains a message requiring acknowledgment that has not yet been acknowledged.

Bits "0-3" correspond accordingly to bits "4-7" in an "8-bit" status tag.

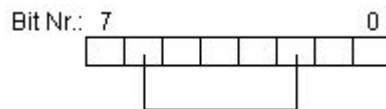

Configuration of the status tags for message groups

1. Select the message group in the navigation area.
2. You specify the status tag and the status bit in the "Properties" area.

Note

Do not mix any status tag bits with other tags of the message, such as an acknowledgment tag.

Note

After the message has occurred for the first time, the status tag configured for the message is set. The status tag is not changed again when the message has one of the two properties below:

- Without acknowledgment "Came in"
- Without status "Went Out"

Lock Tag of a Message Group

Introduction

The lock tag of a message group is used to evaluate the locked status of the message group. Define a lock bit in the lock tag for this purpose.

The structure of the lock tag is not specified. The tags must be an unsigned tag type. You have the following options of configuring lock tags:

- Configure a separate lock tag for each message group.
- Group several message groups in a single lock tag. Message groups are identified by means of the lock bit.

If a message group is locked in Runtime by means of the lock dialog, the associated lock bit is set in the configured tag.

The lock bits are passed down to the layers below. If one layer is locked, all layers below this layer are locked as well.

Configuration of the lock tag for message groups

1. Select the message group in the navigation area.
2. Specify the lock tag and the lock bit in the "Properties" area.

Note

Do not mix any lock tag bits of the message with other tags of the message, such as a status tag.

Acknowledgment Tag of a Message Group

Introduction

The acknowledgment tag of a message group is used to acknowledge all of its single messages. Define an acknowledgment bit in the acknowledgment tag for this purpose.

The structure of the acknowledgment tag is not specified. The tags must be an unsigned tag type. You have the following options of configuring acknowledgment tags:

- Configuring a separate acknowledgment tag for each message group.
- Group several message groups in a single acknowledgment tag. Message groups are distinguished by means of the acknowledgment bit.

The corresponding acknowledgment bit is set to acknowledge the message group in Runtime. The acknowledgment bit is acknowledged or reset by user actions, for example, by clicking a button in the WinCC process picture or by means of a program in the AS. The acknowledgment bit of a layer also acknowledges all lower-level layers.

Note

The acknowledgment bit does not display an acknowledgment via WinCC Alarm Control in case of a message from a message group.

Configuration of acknowledgment tags for message groups

1. Select the message group in the navigation area.
2. Specify the acknowledgment tag and the acknowledgment bit in the "Properties" area.

Note

Do not combine any acknowledgment tag bits of the message with other tags of the message, for example, with a status tag.

Hide Tag of a User-Defined Message Group

Introduction

You use the hide tag of a user-defined message group to automatically hide messages that are assigned to the message group. In the hide mask of the tag, you specify the system statuses for which the message of the user-defined message group is hidden.

Overview

Select the hide tag of the message group in the "Properties" area.

In the properties of the message, you use the hide mask to specify the system statuses for hiding the message. Select the process cell states in the "Hide at the following process cell states" dialog.

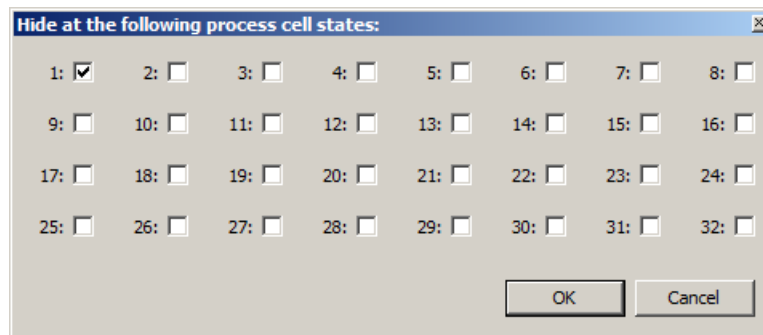

The selected system statuses are entered in the "Hide mask" field.

If the value of the hide tag number corresponds to a system status in runtime, the message is automatically hidden in the message list and in the short-term or long-term archive list. The hidden messages are added to the list of hidden messages.

Relation between hide tag and hide mask

The hide mask is made up of configurable system statuses. The hide tag must accept the value of the system status so that the message can be hidden. You can hide several messages for a system status, if you configure the hide masks accordingly.

In the following sections you will see five examples for 8, 16 and 32-bit values of the hide tag. The value of the hide tag corresponds to the respective process cell state.

- Hide mask empty (zero). Hiding is deactivated. The message is never hidden.

1: <input type="checkbox"/>	2: <input type="checkbox"/>	3: <input type="checkbox"/>	4: <input type="checkbox"/>	5: <input type="checkbox"/>	6: <input type="checkbox"/>	7: <input type="checkbox"/>	8: <input type="checkbox"/>
9: <input type="checkbox"/>	10: <input type="checkbox"/>	11: <input type="checkbox"/>	12: <input type="checkbox"/>	13: <input type="checkbox"/>	14: <input type="checkbox"/>	15: <input type="checkbox"/>	16: <input type="checkbox"/>
17: <input type="checkbox"/>	18: <input type="checkbox"/>	19: <input type="checkbox"/>	20: <input type="checkbox"/>	21: <input type="checkbox"/>	22: <input type="checkbox"/>	23: <input type="checkbox"/>	24: <input type="checkbox"/>
25: <input type="checkbox"/>	26: <input type="checkbox"/>	27: <input type="checkbox"/>	28: <input type="checkbox"/>	29: <input type="checkbox"/>	30: <input type="checkbox"/>	31: <input type="checkbox"/>	32: <input type="checkbox"/>

- Hide mask 1. If the hide tag assumes the value "1", the message is hidden.

1: <input checked="" type="checkbox"/>	2: <input type="checkbox"/>	3: <input type="checkbox"/>	4: <input type="checkbox"/>	5: <input type="checkbox"/>	6: <input type="checkbox"/>	7: <input type="checkbox"/>	8: <input type="checkbox"/>
9: <input type="checkbox"/>	10: <input type="checkbox"/>	11: <input type="checkbox"/>	12: <input type="checkbox"/>	13: <input type="checkbox"/>	14: <input type="checkbox"/>	15: <input type="checkbox"/>	16: <input type="checkbox"/>
17: <input type="checkbox"/>	18: <input type="checkbox"/>	19: <input type="checkbox"/>	20: <input type="checkbox"/>	21: <input type="checkbox"/>	22: <input type="checkbox"/>	23: <input type="checkbox"/>	24: <input type="checkbox"/>
25: <input type="checkbox"/>	26: <input type="checkbox"/>	27: <input type="checkbox"/>	28: <input type="checkbox"/>	29: <input type="checkbox"/>	30: <input type="checkbox"/>	31: <input type="checkbox"/>	32: <input type="checkbox"/>

- Hide mask 1, 3, 4. If the hide tag assumes the value "1", "3" or "4", the message is hidden.

1: <input checked="" type="checkbox"/>	2: <input type="checkbox"/>	3: <input checked="" type="checkbox"/>	4: <input checked="" type="checkbox"/>	5: <input type="checkbox"/>	6: <input type="checkbox"/>	7: <input type="checkbox"/>	8: <input type="checkbox"/>
9: <input type="checkbox"/>	10: <input type="checkbox"/>	11: <input type="checkbox"/>	12: <input type="checkbox"/>	13: <input type="checkbox"/>	14: <input type="checkbox"/>	15: <input type="checkbox"/>	16: <input type="checkbox"/>
17: <input type="checkbox"/>	18: <input type="checkbox"/>	19: <input type="checkbox"/>	20: <input type="checkbox"/>	21: <input type="checkbox"/>	22: <input type="checkbox"/>	23: <input type="checkbox"/>	24: <input type="checkbox"/>
25: <input type="checkbox"/>	26: <input type="checkbox"/>	27: <input type="checkbox"/>	28: <input type="checkbox"/>	29: <input type="checkbox"/>	30: <input type="checkbox"/>	31: <input type="checkbox"/>	32: <input type="checkbox"/>

- Hide mask 4, 32. If the hide tag assumes the value "4" or "32", the message is hidden.

1: <input type="checkbox"/>	2: <input type="checkbox"/>	3: <input type="checkbox"/>	4: <input checked="" type="checkbox"/>	5: <input type="checkbox"/>	6: <input type="checkbox"/>	7: <input type="checkbox"/>	8: <input type="checkbox"/>
9: <input type="checkbox"/>	10: <input type="checkbox"/>	11: <input type="checkbox"/>	12: <input type="checkbox"/>	13: <input type="checkbox"/>	14: <input type="checkbox"/>	15: <input type="checkbox"/>	16: <input type="checkbox"/>
17: <input type="checkbox"/>	18: <input type="checkbox"/>	19: <input type="checkbox"/>	20: <input type="checkbox"/>	21: <input type="checkbox"/>	22: <input type="checkbox"/>	23: <input type="checkbox"/>	24: <input type="checkbox"/>
25: <input type="checkbox"/>	26: <input type="checkbox"/>	27: <input type="checkbox"/>	28: <input type="checkbox"/>	29: <input type="checkbox"/>	30: <input type="checkbox"/>	31: <input type="checkbox"/>	32: <input checked="" type="checkbox"/>

- Hide mask 0xFFFFFFFF. If the hide tag has a value greater than zero, the message is hidden.

1: <input checked="" type="checkbox"/>	2: <input checked="" type="checkbox"/>	3: <input checked="" type="checkbox"/>	4: <input checked="" type="checkbox"/>	5: <input checked="" type="checkbox"/>	6: <input checked="" type="checkbox"/>	7: <input checked="" type="checkbox"/>	8: <input checked="" type="checkbox"/>
9: <input checked="" type="checkbox"/>	10: <input checked="" type="checkbox"/>	11: <input checked="" type="checkbox"/>	12: <input checked="" type="checkbox"/>	13: <input checked="" type="checkbox"/>	14: <input checked="" type="checkbox"/>	15: <input checked="" type="checkbox"/>	16: <input checked="" type="checkbox"/>
17: <input checked="" type="checkbox"/>	18: <input checked="" type="checkbox"/>	19: <input checked="" type="checkbox"/>	20: <input checked="" type="checkbox"/>	21: <input checked="" type="checkbox"/>	22: <input checked="" type="checkbox"/>	23: <input checked="" type="checkbox"/>	24: <input checked="" type="checkbox"/>
25: <input checked="" type="checkbox"/>	26: <input checked="" type="checkbox"/>	27: <input checked="" type="checkbox"/>	28: <input checked="" type="checkbox"/>	29: <input checked="" type="checkbox"/>	30: <input checked="" type="checkbox"/>	31: <input checked="" type="checkbox"/>	32: <input checked="" type="checkbox"/>

Configuring the hide tags

1. Select the user-defined message group in the navigation area.
2. Select the tag under "Hide tag" in the "Properties" area.
3. Select individual messages of the message group.
4. Click in the "Hide mask" box in the "Properties" area.
The "System status" dialog opens.
5. Specify the value of the hide mask by clicking the corresponding option boxes.
You can also enter the corresponding numerical values separated by commas in the "Hide mask" field.

5.4.6.6 How to Add a Message to a User-Defined Message Group

Requirement

- The "Alarm Logging" editor is open.
- You have already created a user-defined message group.

Procedure

1. Select a message in the table area.
It does not matter if a message class or a message type is selected in the "Messages" folder of the tree view.
2. Select the required user-defined message group for the "Message group" property.
Only user-defined message groups that have already been created are available for selection.

How to assign multiple messages to a user-defined message group

1. Display all messages you want to assign to a user-defined message group one after the other in the table area.
Use the options to filter the view or sort by columns.
2. Assign the top message to the required user-defined message group.
3. Drag down the selection of the cell with the "Message group" property in the table area.
All messages that you include in your selection are assigned to the message group.

5.4.6.7 How to add another user-defined message group to a user-defined message group

Requirement

- The "Alarm Logging" editor is open.
- You have already created a user-defined message group.

Assigning a user-defined message group to a user-defined message group

User-defined message groups can be combined into a higher-level, user-defined message group.

How to assign a user-defined message group to an existing message group

1. Select the user-defined message group you want to assign to an existing message group in the table area.
2. Select the required message group for the "Origin" property.
Only user-defined message groups that have already been created are available for selection.
The "Layer" property shows the current layer in the tree structure.

5.4.6.8 How to Remove a Message from a User-Defined Message Group

Requirement

- The "Alarm Logging" editor is open.
- You have already assigned messages to a user-defined message group.

Procedure

1. Select a message in the table area.
It does not matter if a message class or a message type is selected in the "Messages" folder of the tree view.
2. To assign the message to no user-defined group, delete the content of the "Message group" property.
The message is retained. The message is not assigned to a user-defined message group.
3. Select "Delete" from the shortcut menu or press the Delete key.
The message is deleted.
4. To assign the message to another user-defined message group, select another user-defined message group for the "Message group" property.
Only user-defined message groups that have already been created are available for selection.
The message is retained and assigned to a user-defined message group.

How to remove several messages from a user-defined message group

1. Display all messages with an assignment you wish to change one after the other in the table area.
Use the options to filter the view or sort by columns.
2. Assign the top message to the required user-defined message group or to no message group.
3. Drag down the selection of the cell with the "Message group" property in the table area.
All messages that you include in your selection are reassigned.

Note

You can also edit several messages with the "Replace" dialog.

See also

Filtering using the filter list box (Page 86)

5.4.6.9 How to Delete a User-Defined Message Group

Requirement

- The "Alarm Logging" editor is open.
- You have created a user-defined message group.

Procedure

Note

All assigned messages and subordinated, user-defined message groups are deleted when you delete a user-defined message group.

To undo the deletion, press Ctrl+Z.

1. In the navigation area, select the user-defined message group you want to delete.
2. Select "Delete" in the shortcut menu.
The user-defined message group with its associated messages is deleted.

5.4.7 Working with system messages

5.4.7.1 How To Use System Messages

Introduction

System messages are triggered by different WinCC components in Runtime. WinCC provides system messages for this purpose. The WinCC installation directory includes language-specific files with special system messages, e.g. "LTMDatenEnu.CSV". The system messages are available in all WinCC installation languages. System messages must be selected for use when you configure the message system.

System messages are displayed under the separate folder "System messages" and below the folders of the system message classes.

System messages used are also displayed under the "Messages" folder if "System messages" are selected in the shortcut menu of the folder under "Selection".

The operator message with message number 1250841 is always provided and used in a new project.

Note

System messages from languages installed at a later time

When you install a language at a later time and are already using WinCC system messages, you must update the system messages.

Incorporating new system messages after a system update or migration

You have to update the system messages following a system update or migration.

Requirement

- The "Alarm Logging" editor is open.
- The "System messages" folder is selected in the navigation area.

Selecting the user text block and language

A user text block is required for displaying system message texts. Select a user text block.

- Select the input language with the "View > Input language" command in the main menu of WinCC.
- Select the "System messages" folder in the navigation area.
- Under "Message block for message text" in the properties area, select the user text block in which the message texts are to be entered.
- Under "Language for texts" in the Properties area, select one of the installed languages. The texts of the selected language are used for the current input language.

Using all system messages

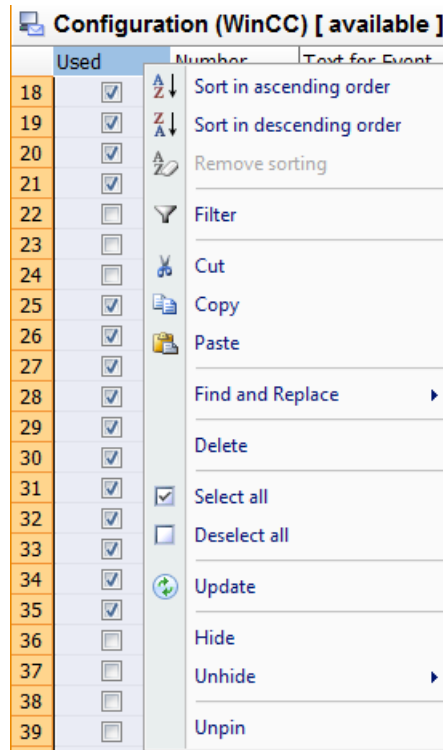

1. Select the "Used" column in the table area.
2. Select the "Select all" command in the shortcut menu of the "Used" column.
All system messages are applied. This process takes some time.
The system messages obtain texts from the language selected for the selected user text block.

Note

You can edit the properties of system messages to a limited extent.
You cannot edit the numbers of system messages.

Using individual system messages

	Used	Number	Text for Event	Requires acknow
1	<input checked="" type="checkbox"/>	1000000	WCCRT:@100%ε	<input type="checkbox"/>
2	<input checked="" type="checkbox"/>	1000001	WCCRT:@100%ε	<input type="checkbox"/>
3	<input checked="" type="checkbox"/>	1000002	WCCRT:@100%ε	<input type="checkbox"/>
4	<input type="checkbox"/>	1000003	WCCRT:@100%ε	<input type="checkbox"/>
5	<input type="checkbox"/>	1000004	WCCRT:@100%ε	<input type="checkbox"/>
6	<input type="checkbox"/>	1000005	WCCRT:@100%ε	<input type="checkbox"/>
7	<input type="checkbox"/>	1000006	WCCRT:@100%ε	<input type="checkbox"/>
8	<input type="checkbox"/>	1000100	WCCRT:@100%ε	<input type="checkbox"/>
9	<input type="checkbox"/>	1000200	WCCRT:@100%ε	<input type="checkbox"/>
10	<input type="checkbox"/>	1000201	WCCRT:@100%ε	<input type="checkbox"/>
11	<input type="checkbox"/>	1000202	WCCRT:@100%ε	<input type="checkbox"/>
12	<input type="checkbox"/>	1000203	WCCRT:@100%ε	<input type="checkbox"/>

1. Select the "System messages" folder in the navigation area.
2. Select the "Configuration (WinCC) tab in the table area.
3. To use a system message, enable the option "Used".
Used system messages are displayed under the "Messages" tab and below the folders of the system classes.

Using multiple system messages

1. Select the system message lines that you want to use.
 2. From the shortcut menu, select the "Select all" command.
- If required, you also deselect system messages using the shortcut menu.

Note

When you delete a system message in the table area in the "Messages" tab, it is no longer used.

Updating used system messages

You can update the system messages to the latest version after installing a new language, after a system update or after migration. System messages that do not correspond to the template are highlighted in red in the table area.

1. In the table area, select the system messages that you want to refresh.
If you want to refresh all system messages, select the column "Used".
2. Select the "Update" command in the shortcut menu.
The selected system messages are updated. The system messages obtain texts from the language selected for the selected user text block.

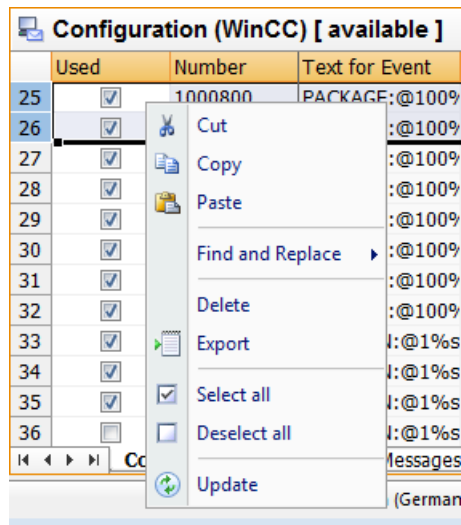

See also

Operator messages (Page 1348)

5.4.7.2 Description of WinCC System Messages

Introduction

The system messages are listed below.

System messages are assigned to the default message type when you use a system message class.

Note

When you assign system messages to a user-defined message class and message type, the message class and message type must have the same properties as the system message class.

Note

You can obtain additional information on the system messages in the system message block "Comment" for the message.

WinCC system messages

Number	Error Message / Description
1000000	WCCRT:Error
1000001	WCCRT:Error loading the object engine

Number	Error Message / Description
1000002	WCCRT:Channel could not be loaded
1000003	WCCRT:Tag - Violated low limit
1000004	WCCRT:Tag value of the high limit is exceeded
1000005	WCCRT:Format error of tag
1000006	WCCRT:Scale error of tag
1000100	WCCRT:Drive error
1000200	WCCRT:Status
1000201	WCCRT:Object Engine was loaded
1000202	WCCRT:Runtime has been activated
1000203	WCCRT:Runtime has been deactivated
1000204	WCCRT:Connection not established
1000205	WCCRT:Connection established
1000206	WCCRT:Client connection established
1000207	WCCRT: Client connection disconnected
1000208	WCCRT:Client connection broken
1000209	WCCRT:Connection deleted
1000210	WCCRT:Connection modified
1000211	WCCRT:Connection reestablished
1000300	WCCRT:Driver state
1000301	WCCRT: Legitimization of connection has failed. The password is incorrect!
1000302	WCCRT: The PLC is protected. You must configure a password for the connection.
1000303	WCCRT: Legitimization of connection has failed. The password is blocked. Please unblock locally (e.g. on the display).
1000800	PACKAGE:Import
1000801	PACKAGE:Export
1000802	PACKAGE>Delete
1000803	PACKAGE:New
1000804	PACKAGE:Reload
1000805	PACKAGE:DefaultServer
1000806	PACKAGE:Implicit update
1000807	PACKAGE:Update
1000900	PERFMON: is low
1000901	PERFMON: is OK
1000902	PERFMON: is high
1000903	PERFMON: is OK
1000904	PERFMON: is low
1000905	PERFMON: is OK
1000906	PERFMON: is high
1000907	PERFMON: is OK
1000908	PERFMON: is low
1000909	PERFMON: is OK
1000910	PERFMON: is high
1000911	PERFMON: is OK

Number	Error Message / Description
1000912	PERFMON: Redundancy loss of the terminal adapter
1000913	PERFMON: Redundancy of the terminal adapter restored
1000914	PERFMON: Terminal adapter connected
1000915	PERFMON: Terminal adapter disconnected
1001000	PDLRT: General error
1001001	PDLRT: Operator action not active
1001002	PDLRT: Wrong picture format
1001003	PDLRT: Picture not found
1001004	PDLRT: No dynamic active in picture
1001005	PDLRT: Tag could not be written
1001006	PDLRT: Dynamic Actions not active
1002000	TLGRT: General error
1002001	TLGRT: Error during initialization
1002002	TLGRT: Error during loading of run-time data
1002003	TLGRT: Error during language switch
1002004	TLGRT: Error during access to database
1002005	TLGRT: Error during creation of run-time objects
1002006	TLGRT: Error during on-line configuration
1002007	TLGRT: Error in client/server environment
1002008	TLGRT: Error in memory management
1002009	TLGRT: Error compiling measured values
1002010	TLGRT: Error processing measured values
1002011	TLGRT: Error archiving measured values
1002012	TLGRT: Error in Format DLL
1002013	TLGRT: Error with user archive option
1002014	TLGRT: Error in process controlled archiving
1002015	TLGRT: Error in the API
1002016	TLGRT: Error with the application window
1002017	TLGRT: System error
1002018	TLGRT: Database queue overflow
1002019	TLGRT: Notification queue overflow
1002020	TLGRT: Norm DLL queue overflow - data is lost!
1002021	TLGRT: Problems with the connection to the central archive server.
1002022	TLGRT: The problem with the connection to the central archive server was fixed.
1002023	TLGRT:Archive value processed - Archive tag=@10@s@ Time stamp=@1@s@ New value=@2@s@ Old value=@3@s@
1002024	TLGRT:Archive value generated - Archive tag=@10@s@ Time stamp=@1@s@ Value=@2@s@
1003018	ALGRT:Message does not require acknowledgment. An attempt was made to acknowledge a message that does not require acknowledgment.
1003019	ALGRT:Message has already been acknowledged An attempt was made to acknowledge a message that has already been acknowledged.
1003020	ALGRT:Message class for the message not found The message class associated with the message does not exist.

Number	Error Message / Description
1003021	ALGRT:Message status cannot be processed The message status (Came In, Went Out, Acknowledged, ...) could not be interpreted.
1003022	ALGRT:Message is locked This message occurs if you attempt to trigger a locked message via the API.
1003023	ALGRT:Message date/time-stamp invalid The date/time stamp from the AS could not be interpreted.
1003032	ALGRT:Message window template name unknown This error is generated if you delete a message window that is already configured in Graphics Design. In client/server projects, this message could also be triggered by a communication error in the network.
1003033	ALGRT:Message window could not be created
1003034	ALGRT:Message window data invalid The configuration data are faulty.
1003048	ALGRT:Bit is outside the tag range. For example, an attempt was made to trigger the 18th bit of a 16-bit tag.
1003049	ALGRT:No tag change
1003050	ALGRT:Message tag (bit) already occupied by a message The bit of the message tag has already been interconnected to a message.
1003051	ALGRT:Acknowledgment tag(bit) already used The acknowledgment tag bit has already been interconnected to a message.
1003052	ALGRT:Status tag already occupied by message The bit of the status tag has already been interconnected to a message.
1003053	ALGRT:Error during conversion of the variant data type
1003054	ALGRT:Message tag (bit) already occupied-->different type
1003055	ALGRT:Event tag or tag type invalid The data type of the message tag is invalid. A tag with sign was used, for example.
1003056	ALGRT: Acknowledgment tag or tag type invalid The data type of the acknowledgment tag is invalid. A tag with sign was used, for example.
1003057	ALGRT:Status tag or tag type invalid The data type of the status tag is invalid. A tag with sign was used, for example.
1003058	ALGRT:Handle invalid This error message can occur during accesses via the API.
1003059	ALGRT: Selection criteria invalid This error message can occur during accesses via the API.
1003060	ALGRT: Resources DLL for language not found One of the language-dependent files is missing.
1003061	ALGRT:Error while creating the memory mapped file This internal error indicates a problem involving the memory.
1003062	ALGRT:Error while creating the synchronization mechanism. This error occurs when the operating system is overloaded.
1003063	ALGRT:Wrong parameter This error message can occur during accesses via the API.
1003064	ALGRT:Transfer buffer too small This error message can occur during accesses via the API.

Number	Error Message / Description
1003065	ALGRT:This function is not available at this time This error message can occur during accesses via the API.
1003066	ALGRT:Format DLL send data cannot be evaluated.
1003067	ALGRT:Format DLL. Do not execute function
1003068	ALGRT:No message blocks in the report Check the message sequence report.
1003069	ALGRT:Invalid log
1003070	ALGRT:Report printout is already active An attempt was made to restart an active report.
1003071	ALGRT:Message system Runtime <Server> not installed The server reports that the project was activated without the Runtime component of Alarm Logging.
1003072	ALGRT:Printout of the message report could not be started.
1003073	ALGRT:Printout of the short-term archive not started.
1003074	ALGRT:Printout of the sequence archive report not started.
1003075	ALGRT:Max. Number of messages configurable online The maximum number of messages that can be configured online (default setting is 600) has been exceeded.
1003076	NRMS7:Parameter error for S7 message frame A parameter error has occurred on the interface to S7.
1003077	NRMS7:Parameter error for ALGRT A parameter error has occurred on the interface to ALGRT.
1003078	NRMS7:Invalid parameter TLGRT A parameter error has occurred on the interface to TLGRT.
1003079	NRMS7:Invalid process value blocks The additional data of the messages are faulty.
1003080	NRMS7:Parameter error at AR_SEND The structure of the AR-SEND user data is faulty.
1003081	NRMS7:General error An internal error of unknown cause has occurred.
1003082	NRMS7:Message loss on the automation system
1003083	NRMS7:Link-up and update on PLC active
1003084	NRMS7:Link-up and update on PLC finished
1003085	NRMS7:System modification in RUN (CiR) active
1003086	NRMS7:System modification in RUN (CiR) inactive
1003087	NRMS7:Error while logging on to receive message
1003098	ALGRT:Message archiving overflow - messages will be lost
1003099	ALGRT:[Computer Name]:Locked messages [message number] [message text of locked message] This message occurs when a message is locked.
1003100	ALGRT:[Computer Name]:Message [message number] unlocked [message text of unlocked message] This message occurs when a message is unlocked.
1003101	ALGRT:Acknowledgment request for message [message number] was issued This message occurs when a message is acknowledged.
1003102	ALGRT:[Computer Name]:Message group [message group number] locked This message occurs when a message group is locked.

Number	Error Message / Description
1003103	ALGRT:[Computer Name]:Message group [message group number] unlocked This message occurs when a message group is unlocked.
1003104	ALGRT:[Computer Name]:Message archive overflow ended - no more messages will be lost
1003105	ALGRT:[Computer Name]:message input queue reaches critical number
1003106	ALGRT:[Computer Name]:message input queue reaches uncritical number
1003107	ALGRT:[Computer Name]:Message [Message Number] hidden:@1@s@
1003108	ALGRT:[Computer Name]:Message [Message Number] shown:@1@s@
1003109	ALGRT:[Computer name]: The connection to the master was interrupted
1003110	ALGRT:[Computer name]: Incomplete configuration data for message [message number] detected
1003111	ALGRT:[Computer name]: The queued message was removed by user
1003300	NRMS7PLUS: Modified configuration data for message detected.
1003301	NRMS7PLUS: Error while logging on to receive message.
1003302	NRMS7PLUS: Not all messages could be acknowledged due to temporary resource bottleneck. Repeat the acknowledgment.
1003303	NRMS7PLUS: Does not support automatic updating for message texts.
1003310	OPCUACHN: Number of queries increases to @1%d@. Load on "OPC UA" channel is too high.
1003320	OPCCHN: Number of queries increases to @1%d@. Load on "OPC" channel is too high.
1004000	RPTRT:General error
1004001	RPTRT:PRT_OUT-Folder full.
1004002	RPTRT:Spool folder full
1004003	RPTRT:Report was not printed. PRT_OUT directory full
1004004	RPTRT:Report was not printed. Spool folder full
1004005	RPTRT:Message sequence report is reprinted.
1004006	RPTRT:Spool folder full
1004007	RPTRT:Hardcopy was not printed. Spool folder full
1005000	TXTRT:General error
1005001	TXTRT: Error while logging off Runtime applications.
1005002	TXTRT:Error during connection of the Runtime applications.
1005003	TXTRT:Error during initialization of the MMF. A memory error has occurred.
1005004	TXTRT:Error while loading the MMF. Error during access to database.
1005005	TXTRT:Error while opening the MMF. A memory error has occurred.
1005006	TXTRT:An error occurred while creating the Service window.
1005007	TXTRT:No language found.
1005008	TXTRT:Text ID not found. The requested Text ID could not be found in the text library.
1005009	TXTRT:MMF Read access refused.
1005010	TXTRT:Language not found. The requested language has not been configured in the text library.

Number	Error Message / Description
1005011	TXTRT:Language table could not be opened. Either the data are faulty or the table is locked in the database.
1005012	TXTRT:Text table could not be opened. Either the data are faulty or the table is locked in the database.
1005013	TXTRT:Invalid Language specified. The Language ID specified is invalid.
1005014	TXTRT:DBConnect error No connection to the database could be set up.
1006000	GSCRT:Error
1007000	SCRIPT:Overflow Overload: either there are too many actions running in a cycle that is too small, or an action is suspended (endless loop, dialog output). All the other actions are in the queue and cannot be processed.
1007001	SCRIPT:Action error One of the following errors has occurred: <ul style="list-style-type: none"> • Exception in the action (exact cause unknown) • Exception upon access to the return result (char* associated memory invalid) • Stack overflow upon execution of the action • The action contains a division by 0 • The action contains an access to a non-existing symbol • The action contains an access violation In WinCC version 4.0 and higher, you can integrate the OnErrorExecute function in your script, which allows for a detailed analysis of errors.
1007002	SCRIPT:Overflow Internal lists have overflowed.
1007003	SCRIPT:Connection error The connection to the server is broken.
1007004	SCRIPT:Action error 1 The called function is not known. Check the spelling in the function call and the implementation of the function.
1007005	SCRIPT:Action error 2 This error can have several causes: <ul style="list-style-type: none"> • The action does not contain a P code. Recompile the action. • The function could not be loaded because, for example, the function name is incorrect. • The type of the returned value of the function is invalid. In WinCC version 4.0 and higher, you can integrate the OnErrorExecute function in your script, which allows for a detailed analysis of errors.
1007006	SCRIPT:Tag error A requested tag was not supplied by WinCC Explorer within 10 s. Check the spelling of the tag name. In the case of external tags, there may be a communication problem between the WinCC Explorer and the controller. In WinCC version V4.0 and higher, you have the option to incorporate the OnErrorExecute function into your script, which allows for a detailed analysis of the error.
1007007	SCRIPT: Info Additional information under "Diagnostics of WinCC / Runtime Monitoring for Actions".
1007009	SCRIPT:Error in Thread Additional information under "Diagnostics of WinCC / Runtime Monitoring for Actions".

Number	Error Message / Description
1008000	USERT:Connection to chip card reader paused
1008001	USERT:Incorrect login name/password
1008002	USERT:Incorrect login name/password by chip card
1008003	USERT:Manual Login
1008004	USERT:Login by chipcard
1008005	USERT:Manual Logout
1008006	USERT:Logout by chipcard
1008007	USERT:Automatic Logout by timeout
1008008	USERT: Authorizations of Service users/group effective
1009000	LBMRT:Error
1009999	LBMRT:tag does not exist
1010000	STRRT:Error
1011000	CSIG:Group display error at start up
1011001	CSIG:Group display hierarchy not updated
1011002	Group display: Connection fault
1011003	Group display: Tag does not exist
1011101	PTM: Error during startup
1011201	SSM: Error during startup
1011202	The fill level of the project drive is over 80%
1011203	The project was created with the wrong WinCC version
1012001	SYNC:Switched to master operation
1012002	SYNC:Cannot issue time message frame
1012003	SYNC:Time receipt service: Poor or failed signal
1012004	SYNC:Cannot receive time message frame
1012005	SYNC:Cannot receive any time message frame on redundant bus
1012006	SYNC:No time message frame. Switch to redundant device
1012007	SYNC:Can issue time message frame properly
1012008	SYNC:Time reception service functions properly
1012009	SYNC:Can receive time message frame properly
1012010	SYNC:Can receive time message frame properly on redundant bus
1012011	SYNC:Switched to slave operation
1012012	SYNC:Time synchronization deactivated
1012013	SYNC:Time synchronization activated
1012014	SYNC:DCF77 client service has failed
1012015	SYNC:DCF77 client service is working properly
1012016	SYNC:Device switched to master operation
1012017	SYNC:Device switched to slave operation
1012018	SYNC:Device cannot issue time message frame
1012019	SYNC:Device can issue time message frame properly
1012020	SYNC:Device sets local time
1012021	SYNC:LAN sync: Time synchronization fault on PC
1012022	SYNC:LAN sync: Time synchronization set on PC
1012023	SYNC:LAN sync: Time synchronization established with PC

Number	Error Message / Description
1012024	SYNC:Configured device name for the time synchronization does not agree with PC installation
1012025	SYNC:LAN sync: Cannot acquire time from the connected WinCC server
1012026	SYNC:Time jump - switched to permanent slave mode
1012027	SYNC:Time jump - time synchronization permanently deactivated
1012028	SYNC:Time reception service not started
1012029	SYNC:Time reception service
1012030	SYNC:Time synchronization is disabled
1012200	REDRT:Partner station has failed
1012201	REDRT:Partner station restarted
1012202	REDRT:Projects are not functionally identical
1012203	REDRT:Archive synchronization failed
1012204	REDRT:Internal error in Redundancy
1012205	REDRT:Connection to partner disturbed
1012206	REDRT:Connection to the partner has been reestablished
1012207	REDRT:Partner server - WinCC has not been started
1012208	REDRT:Archive synchron - ization starts
1012209	REDRT:Synchronization finished
1012210	REDRT:Tag Logging is being synchronized
1012211	REDRT:Tag Logging synchronization finished
1012212	REDRT:Alarm Logging is being synchronized
1012213	REDRT:Alarm Logging synchronization finished
1012214	REDRT>User Synchronization launched
1012215	REDRT>User Archive synchronization finished
1012216	REDRT:Synchronization was paused
1012217	REDRT:Partner Server-Project has not been activated
1012218	SWITCH:Client has been switched automatically
1012219	SWITCH:Client has been switched manually
1012220	REDRT:Synchronization is not ready for all User Archives
1012221	REDRT:Synchronization is ready for all User Archives
1012222	SWRED:Main connection disturbed
1012223	SWRED:Main connection operational
1012224	SWRED:Backup connection disturbed
1012225	SWRED:Backup connection operational
1012226	REDRT:Partner Server-Project has been activated
1012227	REDRT>Error: Partner computer is not a server
1012228	REDRT:CAS: Archive synchronization launched
1012229	REDRT: CAS: Archive synchronization finished
1012240	REDRT:RedundancyControl error triggered switching
1012241	REDRT:RedundancyControl: Switch to status
1012242	DELTALoader:Delta loading was started
1012243	DELTALoader:Delta loading ended
1012244	REDRT:Overload during Alarm Logging online update
1012245	REDRT:RedundancyControl: Loss of serial connection

Number	Error Message / Description
1012246	REDRT:RedundancyControl: Serial connection reestablished
1012247	REDRT: OS server (standby) redundancy error
1012248	REDRT: OS server (standby) redundancy reestablished
1012250	AM:Archive database inconsistency possible
1012251	AM:Internal error
1012252	AM:Backup:Error on writing to backup path
1012253	AM:Backup:Insufficient storage space on destination drive
1012254	AM:No connection to WriteArchiveServer
1012255	AM:No connection to Microsoft Message Queue
1012256	AM:No connection to WinCC project
1012257	AM:No connection to the database
1012258	AM:No connection to text library
1012259	AM:Error on generating TagLogging data
1012260	AM:Error on generating AlarmLogging data
1012261	AM:Caution! Backup will be delayed until restart of partner server.
1012265	AM:Data base verification failed
1012301	CA:No access to SQL Server (loss of data possible)
1012348	AM:Insufficient free memory space on project drive
1012349	REDRT:RedundancyControl: Connection of network card (MAC) address lost
1012350	REDRT:RedundancyControl: Connection via network card (MAC) address established again
1012351	REDRT:RedundancyControl: System blockage detected. Switch to Fault status.
1012352	REDRT:RedundancyControl: System blockage detected. Restart the computer as soon as possible.
1012354	RedundancyControl: Status changed to FAULT, but server isolation is not activated.
1012355	RedundancyControl: Status changed to FAULT, but server isolation is disabled by @1@s@. Reason: @2@s@
1012356	RedundancyControl: Status changed to FAULT => server is isolated
1012357	RedundancyControl: Status changed to FAULT, but automatic restart is not activated.
1012358	RedundancyControl: Status changed to FAULT, but automatic restart is disabled because network adapter is disconnected and DHCP is enabled.
1012359	RedundancyControl: Computer restart disabled by @1@s@. Reason: @2@s@
1012360	RedundancyControl: Computer restart canceled because the previous restart took place less than @1@s@ s ago
1012361	RedundancyControl: Computer restart canceled because no additional restart is permitted for @2@s@ s after @1@s@ restarts
1012362	RedundancyControl: Computer will be restarted in @1@s@ s
1012363	RedundancyControl: "ERROR" state reset until the partner has reached a stable state
1012400	WEBRT:WebClient connection established
1012401	WEBRT: WebClient connection disconnected
1012500	PHRDY:Start recovery for Process Historian
1012501	PHRDY:Recovery for Process Historian is complete
1012502	PHRDY:Communication with Process Historian is not available
1012503	PHRDY:Communication with Process Historian disrupted
1012504	PHRDY:Communication with Process Historian is restored
1012505	PHRDY:Process Historian Server offline since @1@s@

Number	Error Message / Description
1012506	PHRDY:@100%:@:Buffer limit channel @1%#@ exceeded
1012507	PHRDY:@100%:@:Buffer limit channel @1%#@ normal
1012508	PHRDY:@100%:@:Less than @1%#@ GB storage space free on data medium '@2%#@' for communication with Process Historian.
1012509	PHRDY:@100%:@:Communication of Process Historian terminated. Less than @1%#@ GB free memory on data carrier '@2%#@'.
1012510	PHRDY:@100%:@:Connection to Process Historian could not be established (check configuration).
1012600	Process Historian:Data memory occupied to @1%#@%
1012601	Process Historian:System at full capacity
1012602	Process Historian:@1%#@ @2%#@
1012603	PH:@100%:@:Redundancy restored
1012604	PH:@100%:@:License volume exceeded. Shutdown in @1%#@ days
1012605	PH:@100%:@:PH-Ready @1%#@ failed
1012606	PH:@100%:@:An automatic redundancy switchover of the Process Historian server has taken place.
1012607	PH:@100%:@:Less than @1%#@ GB free storage space for Process Historian database.
1012608	PH:@100%:@:Less than @1%#@ GB free storage space for 'tempdb' database.
1012609	PH:@100%:@:Less than @1%#@ GB free storage space for disaster recovery.
1012610	PH:@100%:@:Creation of a new backup for disaster recovery failed due to lack of storage space.
1012611	PH:@100%:@:An unspecified error occurred during the creation of a backup for disaster recovery.
1012612	PH:@100%:@:Storage path @1%#@ not accessible for disaster recovery.
1012613	PH:@100%:@:The emergency threshold for drive @1%#@ was reached. Process Historian is therefore locked.
1012614	PH:@100%:@:None of the prepared segments exist. Checking the Process Historian is necessary.
1012615	PH:@100%:@:Not all of the prepared segments were created.
1012700	Self-diagnostics: Value @7%#@ of station @10%#@ is invalid.
1012701	Self-diagnostics: Value @7%#@ of station @10%#@ violated the HIGH error limit.
1012702	Self-diagnostics: Value @7%#@ of station @10%#@ violated the LOW error limit.
1012703	Self-diagnostics: Value @7%#@ of station @10%#@ violated the HIGH warning limit.
1012704	Self-diagnostics: Value @7%#@ of station @10%#@ violated the LOW warning limit.
1012705	Self-diagnostics: Value @7%#@ of station @10%#@ no longer violates the error limit.
1012706	Self-diagnostics: Value @7%#@ of station @10%#@ is OK.
1012707	Self-diagnostics: Station @10%#@ causes @2%#@.
1012708	Self-diagnostics: @100%:@: Value @7%#@ of station @10%#@ is invalid.
1012800	WEBRT:WebUX @1%#@connected (User=@2%#@)
1012801	WEBRT:WebUX @1%#@disconnected (User=@2%#@)
1016000	IDB: Provider initialization failed for connection:@2%#@
1016001	IDB: Consumer initialization failed for connection:@2%#@
1016002	IDB: Provider data transfer failed for connection:@2%#@
1016003	IDB: Consumer data transfer failed for connection:@2%#@
1016004	IDB: Provider initialization database failed for connection:@2%#@
1016005	IDB: Consumer initialization database failed for connection:@2%#@
1016006	IDB: Provider data transfer database failed for connection:@2%#@
1016007	IDB: Consumer data transfer database failed for connection:@2%#@
1016008	IDB: Provider initialization dynamic database failed for connection:@2%#@

Number	Error Message / Description
1016009	IDB: Consumer initialization dynamic database failed for connection:@2@s@
1016010	IDB: Provider data transfer dynamic database failed for connection:@2@s@
1016011	IDB: Consumer data transfer dynamic database failed for connection:@2@s@
1016100	EnS: Archiving error: @1@s@
1016101	EnS: @1@s@: Loss of data possible
1016102	EnS: Archiving resumes
1016103	EnS: Connection to @1@s@ disconnected
1016104	EnS: Connection to @1@s@ established
1900000	ESIG:@1@s@:Electronic signature of user @2@s@ accepted.
1900001	ESIG:@1@s@:Electronic signature of user @2@s@ not accepted.
1900002	ESIG:@1@s@:Electronic signature of user @2@s@ canceled.
1900003	ESIG: Single electronic signing with one global ID:@1@s@:Electronic signature @2@s@ successful.
1900004	ESIG: Multiple electronic signing with one global ID:@1@s@:Electronic signature @2@s@ successful.
1900010	Audit: Provider service not started.
1900011	Audit: Provider service started.
1900012	Audit: Trial service not started.
1900013	Audit: Trial service started.
1900014	Audit: @1@s@: Provider service is not available.
1900015	Audit: @1@s@: Trial service is not available.
1900018	Audit: @1@s@: Audit Trail is connected to project.
12508141	WinCC operator message

5.4.8 Working with the Limit Monitoring

5.4.8.1 Working with the Limit Monitoring

Introduction

Specify limits or comparison values for the tags and have them monitored. If there is a high or low limit violation, or if the conditions of the comparison values are met, a message is generated in runtime.

Limit monitoring in Alarm Logging

Limit monitoring is available in the tree view in the navigation area.

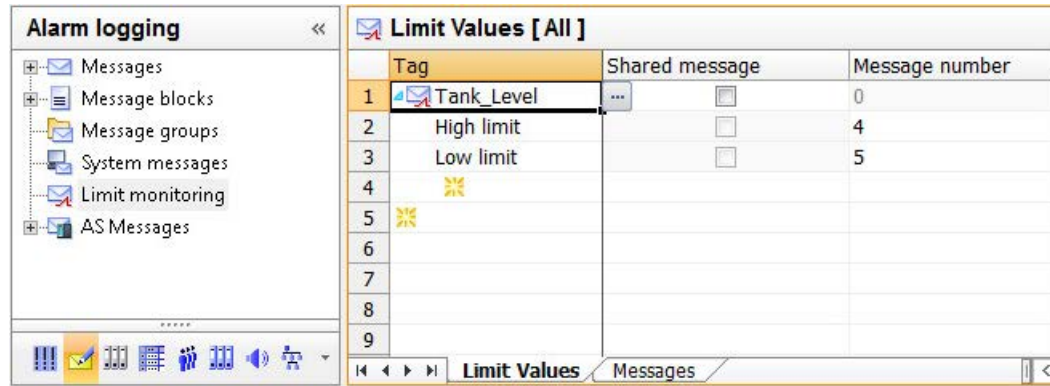

Configuring limit monitoring

1. Specification of the tag to be monitored
2. Assigning a message
3. Specifying limits or comparison values
4. Specifying other properties

5.4.8.2 Messages of the Limit Monitoring

Message of limit monitoring

Each limit monitoring is assigned the number of a message as property. This message is output if the criteria of the limit monitoring are met.

You can use an existing message if a message tag has not been configured at this message. You can also enter a message number that has not been assigned yet. A message with this message number is then created.

If different values are monitored for a tag, you can assign a shared message for these events.

Note

The values of the limit value, hysteresis, and trigger value are stored in process value blocks 1 to 3. The process value blocks 4 to 10 must not be used for a limit monitoring message.

5.4.8.3 How to Create Limit Monitoring

Requirement

- Tags you are going to monitor have been created.

Procedure

1. Select the "Limit monitoring" folder in the navigation area.
2. Click in the top empty line of the "Tag" column in the table area.
3. Click the  button.
The "Tag selection" dialog opens.
4. Select a tag and confirm with "OK".
The dialog closes. A new limit monitoring has been created.
5. Select one or more events for limit monitoring from the selection list in the "Tag" column below the tags:
 - High limit: Limit is exceeded.
 - Low limit: Limit is undershot.
 - Value is same: Limit has been reached.
 - Value is different: Limit is greater than or less than
6. Enable the "Shared message" property, if you want to create a message with the same message number for all events of the monitoring limit.
7. Specify a new message number that has not yet been used, or enter the message number of an existing message for which a message tag has not yet been configured.
8. Set the comparison value in the table or in the properties of the limit.

Note

Cells with a red background in the table area alert you to the fact that inconsistent data is present. Edit the respective properties.

5.4.8.4 How to Use Message Blocks for Limit Monitoring

Message blocks of limit monitoring

The limit monitoring can supply two message blocks with content. Message blocks can be supplied with a message text of the limit monitoring and of the monitored tag. You specify the format of the data content in the selected message block in the message.

Requirement

- Message blocks have been selected for use and configured.

How to select the message blocks for supply by means of limit monitoring

1. Select the "Limit monitoring" folder in the navigation area.
The "Message block for message text" and "Message block for tag" selection fields for the message blocks are displayed under "General" in the "Properties" area.
2. Select the message block from the drop-down list that the limit monitoring is to use for display of the message text and the monitored tag.

To not display a message text or tag, double-click the input field and delete all characters in the input field.

Select the same message block for both properties to display the message text and the tag together.

Example: "Test10 Limit @1%f@ exceeded: @3%f@".

Note

These message blocks are only used if a new message is created in the limit monitoring "Messages" tab. If a message is assigned that is already configured, the properties and message blocks configured for the message are applied. They are also used for shared messages.

Messages that were imported from previous versions do not display the tag.

5.4.8.5 How to Configure Limit Monitoring

Introduction

You edit the properties of a limit monitoring either in the table area or in the "Properties" area. Individual columns may be hidden in the table area.

Configuring limit monitoring

The properties determine which tag is monitored. Specify the corresponding values. Specify which message is output when a limit is exceeded, undershot or reached.

Properties of limit monitoring

Limit

Property	Description
Tag	The tag which is monitored. The tag must already be available. Click the box to open the selection dialog.
Shared message	Creates a message with the same message number for all events that occur for the tag.

Property	Description
Delay time	Specifies the time between occurrence of the event and generation of the message. The message is only triggered if the corresponding condition has been met for the entire time period of the delay time. The delay time can be between 250 milliseconds and 24 hours. Enter the value "0" for "No delay time".
Unit	Unit for input of the delay time.

Comparison

Property	Description
Comparison value	Numerical value for the event of the tag (cannot be edited when the "Indirect" option is set).
Comparison tag	Selection of a tag that is compared to the current value (can only be edited when "Indirect" option is set).
Indirect	Option not set: The tag is compared with a numerical value. Option set: The tag is compared with the current value of another tag.

Hysteresis

Property	Description
Hysteresis	Value for the hysteresis
Hysteresis in percent	Option set: The hysteresis value is a percentage value. Option not set: The hysteresis value is an absolute numerical value.
Hysteresis with "Came In"	The hysteresis is taken into consideration when the message comes in.
Hysteresis with "Went out"	The hysteresis is taken into consideration when the message goes out.

If a hysteresis has been defined, messages are not triggered immediately when the limit is reached. Instead, they are triggered when the actual tag value exceeds or falls below the limit by the amount of the hysteresis.

You can specify the hysteresis either as an absolute deviation or as a percentage deviation from the limit. Depending on the selected setting, the hysteresis will become effective while a message is generated or revoked.

Message

Property	Description
Message number	Number of the message that is output by the limit monitoring.
Consider quality code	When the option is enabled, a value change of the tag is only checked for a limit violation with a quality code equal to "GOOD". When selecting the option, a limit message is not created, for example, when there is a bad connection to the automation system.

5.4.8.6 How to Display the Messages of the Limit Monitoring

Limit monitoring messages

You can display all messages which are output by the limit monitoring in the table area.

Procedure

1. Select the "Limit monitoring" folder in the navigation area.
2. Select the "Messages" tab in the table area.
All messages which are output by the limit monitoring are displayed in the table area.

Alternative procedure

The messages of the limit monitoring can also be displayed under the "Messages" folder.

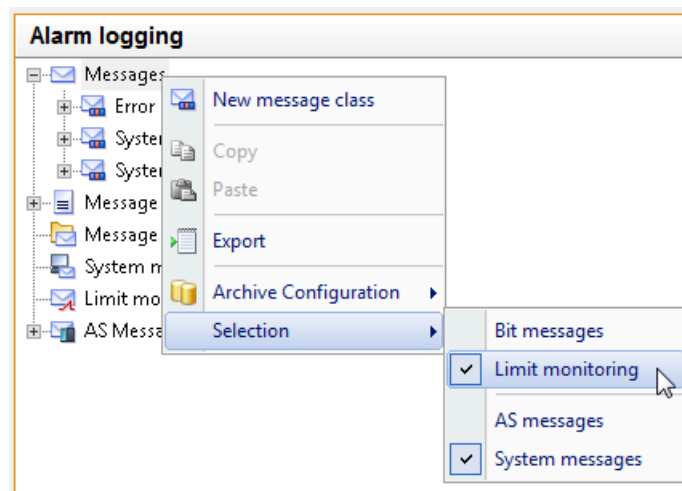

1. Select the "Messages" folder in the navigation area.
2. Select the "Selection" command in the shortcut menu of the "Messages" folder.
3. Activate the selection "Limit monitoring".
The "Messages" tab also displays the messages of the limit monitoring.

5.4.8.7 How to Delete the Limit Monitoring

Introduction

How to delete limit monitoring

Deleting limit monitoring

1. Select the "Limit monitoring" folder in the navigation area.
2. Select the "Limits" tab in the table area.

3. In the table area, select the line number of the limit monitoring you want to delete. You can make multiple selections.
4. Select "Delete" from the shortcut menu or press the Delete key. The limit monitoring is deleted. Tags or messages are not deleted.

5.4.8.8 Examples of Configuring a Limit Value

Introduction

The following examples illustrate how the configuration of limits affects the behavior of limit monitoring.

Example: High limit and "Absolute hysteresis"

The screenshot shows a dialog box titled "Properties - Limit" with a collapse/expand icon (two right-pointing arrows) in the top right corner. The dialog is organized into several sections, each with a collapse/expand icon (a square with a minus sign) on the left:

- Selection**
 - Object type: Limit
 - Object name: var_1
- Limit**
 - Tag: var_1
 - Shared message:
 - Delay time: 0
 - Unit: Milliseconds
- Comparison**
 - Comparison value: 200
 - Comparison value tag:
 - Indirect:
- Hysteresis**
 - Hysteresis: 20
 - Hysteresis in percent:
 - Hysteresis during "incoming":
 - Hysteresis during "outgoing":
- Message**
 - Message number: 4
 - Consider quality code:

Message no. 4 is triggered (arrives) when the tag to be monitored has exceeded the value 220, because the "Hysteresis ...with came in" is activated here and the comparison value + hysteresis applies (200+20=220).

Message no. 4 is revoked when the tag to be monitored drops below the value 200, because "Hysteresis ...with went out" is not activated here.

Example: Low limit and "Hysteresis in percentage"

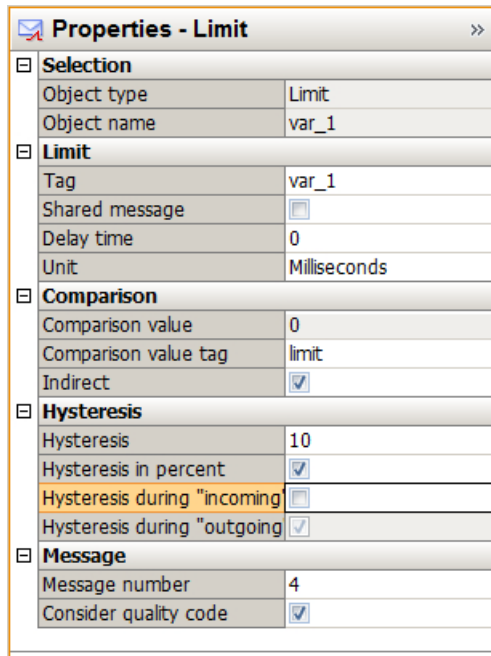

Message No. 4 is triggered (arrives) when the tag to be monitored exceeds the value in the "limit" comparison tag.

Message No. 4 is revoked when the tag to be monitored drops below the value of the "limit" comparison tag by 10%.

5.4.9 Working with AS messages

5.4.9.1 AS messages

Displaying AS messages

At the following channels, you load the controller alarms of the automation system into the WinCC project:

Communication channel	Controller	Supported functions
SIMATIC S7-1200, S7-1500 Channel	S7-1500 ¹⁾	Load from file Load from AS Automatic update Export of AS messages: *.bin
SIMATIC S7 Protocol Suite	S7-300 S7-400	Load from file

1) The S7-1200 does not support AS messages.

Imported messages

The following controller alarms are imported with all texts in Alarm Logging:

- System diagnostics
- Process diagnostics
- Program messages

Maximum length of message texts

If an AS message consists of more than 400 characters, only the first 400 characters are imported.

AS messages in the "Alarm Logging" editor

The controller alarms are integrated into WinCC Alarm Logging as "AS messages".

The "AS messages" folder with the connections of an S7-1500 or an S7-300 or S7-400 is displayed in the navigation area.

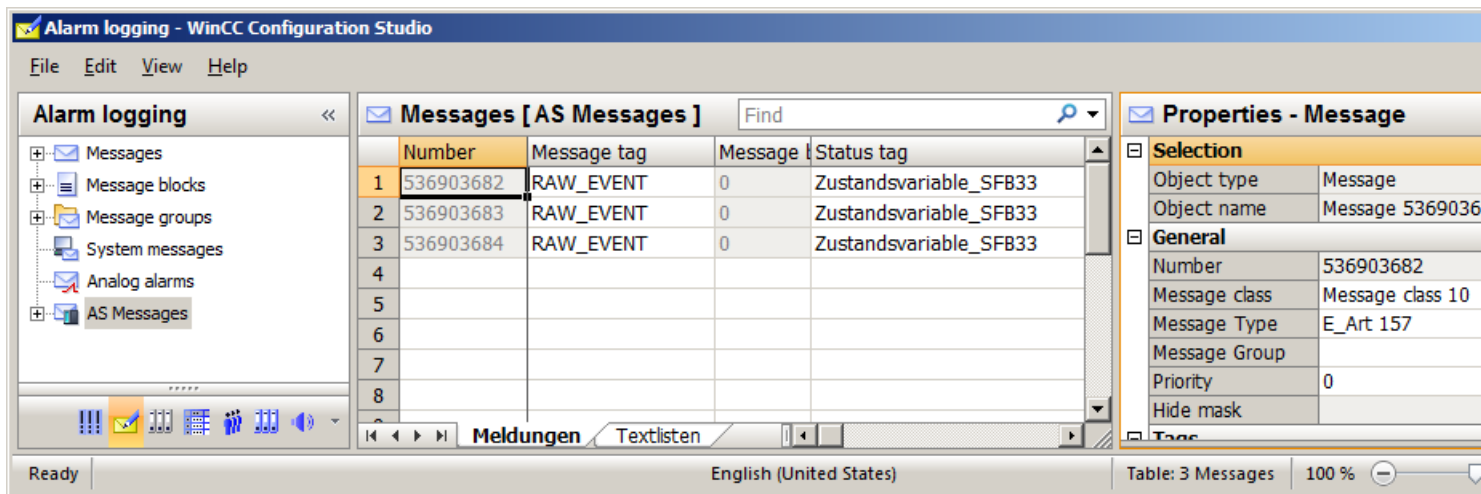

"Messages" and "Text lists" tabs

The AS messages or AS text lists integrated in Alarm Logging are displayed in the "Messages" and "Text lists" tabs in the table area.

If you are not using AS messages or AS text lists in the WinCC project yet, the table area is empty.

"AS Messages" and "AS Text lists" tabs

When you download the messages from the controller or from a file, the "AS Messages" and "AS Text lists" tabs are shown.

These tabs contain the messages and text lists downloaded from the controller. To integrate messages and text lists in the WinCC project, select the "Used" field.

For additional information on the download from the controller, refer to "How to download AS alarms from the controller (Page 1339)".

AS messages / messages

The AS messages downloaded from the controller are displayed.

Imported languages

Messages are imported in the project languages that are configured as a user interface language on the AS.

The number of imported languages depends on the AS that is used.

Automatic update

To have AS messages automatically updated in Alarm Logging after message changes, configure "Automatic update". For additional information, refer to "How to configure the automatic update of S7-1500 alarms (Page 1346)".

Used	Modified	Nummer in AS	Name	Meldeklasse	Type	Infotext (DEU)
<input type="checkbox"/>	<input type="checkbox"/>	1	SDIAG_ALCAT_CPU_INFO_MSG_000F	No Acknowledgement	Notify AP	Kurzbezeichnung
<input type="checkbox"/>	<input type="checkbox"/>	2	SDIAG_ALCAT_CPU_ERR_MSG_0010	No Acknowledgement	Notify AP	Kurzbezeichnung
<input type="checkbox"/>	<input type="checkbox"/>	3	SDIAG_ALCAT_CPU_ERR_MSG_0110	No Acknowledgement	Info Report AP	Kurzbezeichnung
<input type="checkbox"/>	<input type="checkbox"/>	4	SDIAG_ALCAT_CPU_MD_MSG_0011	No Acknowledgement	Notify AP	Kurzbezeichnung
<input type="checkbox"/>	<input type="checkbox"/>	5	SDIAG_ALCAT_CPU_MD_MSG_0111	No Acknowledgement	Info Report AP	Kurzbezeichnung
<input type="checkbox"/>	<input type="checkbox"/>	6	SDIAG_ALCAT_CPU_MR_MSG1_0012	No Acknowledgement	Notify AP	Kurzbezeichnung
<input type="checkbox"/>	<input type="checkbox"/>	7	SDIAG_ALCAT_CPU_MR_MSG1_0112	No Acknowledgement	Info Report AP	Kurzbezeichnung
<input type="checkbox"/>	<input type="checkbox"/>	8	SDIAG_ALCAT_CPU_TMPERR_MSG_0013	No Acknowledgement	Notify AP	Kurzbezeichnung
<input type="checkbox"/>	<input type="checkbox"/>	9	SDIAG_ALCAT_RACK_MSG_0004	No Acknowledgement	Notify AP	Kurzbezeichnung
<input type="checkbox"/>	<input type="checkbox"/>	10	SDIAG_ALCAT_RACK_MSG_0104	No Acknowledgement	Info Report AP	Kurzbezeichnung
<input type="checkbox"/>	<input type="checkbox"/>	11	SDIAG_ALCAT_DEVICE_MSG_0005	No Acknowledgement	Notify AP	Kurzbezeichnung
<input type="checkbox"/>	<input type="checkbox"/>	12	SDIAG_ALCAT_DEVICE_MSG_0105	No Acknowledgement	Info Report AP	Kurzbezeichnung
<input type="checkbox"/>	<input type="checkbox"/>	13	SDIAG_ALCAT_IDSYSTEM_MSG_0006	No Acknowledgement	Notify AP	Kurzbezeichnung
<input type="checkbox"/>	<input type="checkbox"/>	14	SDIAG_ALCAT_IDSYSTEM_MSG_0106	No Acknowledgement	Info Report AP	Kurzbezeichnung
<input type="checkbox"/>	<input type="checkbox"/>	15	SDIAG_ALCAT_MODUL_MSG_0003	No Acknowledgement	Notify AP	Kurzbezeichnung
<input type="checkbox"/>	<input type="checkbox"/>	16	SDIAG_ALCAT_MODUL_MSG_0103	No Acknowledgement	Info Report AP	Kurzbezeichnung
<input type="checkbox"/>	<input type="checkbox"/>	17	SDIAG_ALCAT_SUBMODUL_MSG_0002	No Acknowledgement	Notify AP	Kurzbezeichnung
<input type="checkbox"/>	<input type="checkbox"/>	18	SDIAG_ALCAT_SUBMODUL_MSG_0102	No Acknowledgement	Info Report AP	Kurzbezeichnung
<input type="checkbox"/>	<input type="checkbox"/>	19	SDIAG_ALCAT_CPU_OST_MSG_0000	No Acknowledgement	Notify AP	Kurzbezeichnung
<input type="checkbox"/>	<input type="checkbox"/>	20	SDIAG_ALCAT_CPU_OST_MSG_0100	No Acknowledgement	Info Report AP	Kurzbezeichnung
<input type="checkbox"/>	<input type="checkbox"/>	21	SDIAG_ALCAT_FLIC_MSG_00FF	No Acknowledgement	Notify AP	Kurzbezeichnung
<input type="checkbox"/>	<input type="checkbox"/>	22	SDIAG_ALCAT_CONFIG_REPORT_0029	No Acknowledgement	Notify AP	Kurzbezeichnung
<input type="checkbox"/>	<input type="checkbox"/>	23	SDIAG_ALCAT_USER_MSG_00B0	No Acknowledgement	Notify AP	Kurzbezeichnung
<input type="checkbox"/>	<input type="checkbox"/>	24	SDIAG_ALCAT_SECU_EV_MSG_005E	No Acknowledgement	Notify AP	Kurzbezeichnung
<input type="checkbox"/>	<input type="checkbox"/>	25	SDIAG_ALCAT_SECU_EV_INFO_005F	No Acknowledgement	Notify AP	Kurzbezeichnung
<input type="checkbox"/>	<input type="checkbox"/>	26	SDIAG_ALCAT_SUB_ERR_MSG_001E	No Acknowledgement	Notify AP	Kurzbezeichnung
<input type="checkbox"/>	<input type="checkbox"/>	27	SDIAG_ALCAT_SUB_ERR_MSG_011E	No Acknowledgement	Info Report AP	Kurzbezeichnung
<input type="checkbox"/>	<input type="checkbox"/>	28	SDIAG_ALCAT_SUB_MD_MSG_0021	No Acknowledgement	Notify AP	Kurzbezeichnung
<input type="checkbox"/>	<input type="checkbox"/>	29	SDIAG_ALCAT_SUB_MD_MSG_0121	No Acknowledgement	Info Report AP	Kurzbezeichnung
<input type="checkbox"/>	<input type="checkbox"/>	30	SDIAG_ALCAT_SUB_MR_MSG_0024	No Acknowledgement	Notify AP	Kurzbezeichnung
<input type="checkbox"/>	<input type="checkbox"/>	31	SDIAG_ALCAT_SUB_MR_MSG_0124	No Acknowledgement	Info Report AP	Kurzbezeichnung
<input type="checkbox"/>	<input type="checkbox"/>	32	SDIAG_ALCAT_CH_ERR_MSG_0015	No Acknowledgement	Notify AP	Kurzbezeichnung
<input type="checkbox"/>	<input type="checkbox"/>	33	SDIAG_ALCAT_CH_ERR_MSG_0115	No Acknowledgement	Info Report AP	Kurzbezeichnung
<input type="checkbox"/>	<input type="checkbox"/>	34	SDIAG_ALCAT_CH_MD_MSG_0018	No Acknowledgement	Notify AP	Kurzbezeichnung
<input type="checkbox"/>	<input type="checkbox"/>	35	SDIAG_ALCAT_CH_MD_MSG_0118	No Acknowledgement	Info Report AP	Kurzbezeichnung
<input type="checkbox"/>	<input type="checkbox"/>	36	SDIAG_ALCAT_CH_MR_MSG_001B	No Acknowledgement	Notify AP	Kurzbezeichnung
<input type="checkbox"/>	<input type="checkbox"/>	37	SDIAG_ALCAT_CH_MR_MSG_011B	No Acknowledgement	Info Report AP	Kurzbezeichnung
<input type="checkbox"/>	<input type="checkbox"/>	38	SDIAG_ALCAT_CONFIG_INFO_0028	No Acknowledgement	Notify AP	Kurzbezeichnung
<input type="checkbox"/>	<input type="checkbox"/>	39	SDIAG_ALCAT_CONFIG_INFO_0128	No Acknowledgement	Info Report AP	Kurzbezeichnung
<input type="checkbox"/>	<input type="checkbox"/>	40	SDIAG_ALCAT_ESUB_ERR_MSG_001F	No Acknowledgement	Notify AP	Kurzbezeichnung
<input type="checkbox"/>	<input type="checkbox"/>	41	SDIAG_ALCAT_ESUB_ERR_MSG_011F	No Acknowledgement	Info Report AP	Kurzbezeichnung
<input type="checkbox"/>	<input type="checkbox"/>	42	SDIAG_ALCAT_ESUB_ERR_MSG_0037	No Acknowledgement	Notify AP	Kurzbezeichnung
<input type="checkbox"/>	<input type="checkbox"/>	43	SDIAG_ALCAT_ESUB_ERR_MSG_0137	No Acknowledgement	Info Report AP	Kurzbezeichnung

AS text lists / text lists

The text lists downloaded from STEP 7 or the controller are displayed.

AS text lists contain additional texts for the messages, e.g.:

- Texts that were created in integrated projects by the AS/OS Engineering Tool "Mapper"
- PLC message text lists for system diagnostics

Translation of text lists

In the text library you can rewrite or translate the referenced texts for display in the runtime languages.

You cannot change the text displayed as "Object name" from the AS.

Used	Modified	Bibliothek ID	Textlist Name	Textlist ID	Text ENU
<input type="checkbox"/>	<input type="checkbox"/>	2	SYSTEM_SDiag57P_CPUTextLib	513	No retentive data
<input type="checkbox"/>	<input type="checkbox"/>	2	SYSTEM_SDiag57P_CPUTextLib	514	Real-time clock initialized
<input type="checkbox"/>	<input type="checkbox"/>	2	SYSTEM_SDiag57P_CPUTextLib	515	Retentive data used
<input type="checkbox"/>	<input type="checkbox"/>	2	SYSTEM_SDiag57P_CPUTextLib	544	Power-on mode set: No startup \n
<input type="checkbox"/>	<input type="checkbox"/>	2	SYSTEM_SDiag57P_CPUTextLib	545	Power-on mode set: COLD RESTART to RUN \n
<input type="checkbox"/>	<input type="checkbox"/>	2	SYSTEM_SDiag57P_CPUTextLib	546	Power-on mode set: WARM RESTART to RUN \n
<input type="checkbox"/>	<input type="checkbox"/>	2	SYSTEM_SDiag57P_CPUTextLib	547	Power-on mode set: COLD RESTART to RUN (if CPU was in RUN
<input type="checkbox"/>	<input type="checkbox"/>	2	SYSTEM_SDiag57P_CPUTextLib	548	Power-on mode set: WARM RESTART to RUN (if CPU was in RUN
<input type="checkbox"/>	<input type="checkbox"/>	2	SYSTEM_SDiag57P_CPUTextLib	576	Switch position: RUN
<input type="checkbox"/>	<input type="checkbox"/>	2	SYSTEM_SDiag57P_CPUTextLib	577	Switch position: RUN-P
<input type="checkbox"/>	<input type="checkbox"/>	2	SYSTEM_SDiag57P_CPUTextLib	578	Switch position: STOP
<input type="checkbox"/>	<input type="checkbox"/>	2	SYSTEM_SDiag57P_CPUTextLib	579	Switch position: MRES
<input type="checkbox"/>	<input type="checkbox"/>	2	SYSTEM_SDiag57P_CPUTextLib	608	Completed successfully
<input type="checkbox"/>	<input type="checkbox"/>	2	SYSTEM_SDiag57P_CPUTextLib	609	Up-to-date (operating mode dependent)
<input type="checkbox"/>	<input type="checkbox"/>	2	SYSTEM_SDiag57P_CPUTextLib	610	No update file available
<input type="checkbox"/>	<input type="checkbox"/>	2	SYSTEM_SDiag57P_CPUTextLib	611	Multiple update files
<input type="checkbox"/>	<input type="checkbox"/>	2	SYSTEM_SDiag57P_CPUTextLib	612	Bad update file
<input type="checkbox"/>	<input type="checkbox"/>	2	SYSTEM_SDiag57P_CPUTextLib	613	Invalid hardware version
<input type="checkbox"/>	<input type="checkbox"/>	2	SYSTEM_SDiag57P_CPUTextLib	614	Invalid firmware version
<input type="checkbox"/>	<input type="checkbox"/>	2	SYSTEM_SDiag57P_CPUTextLib	615	Inconsistent update data for a subcomponent
<input type="checkbox"/>	<input type="checkbox"/>	2	SYSTEM_SDiag57P_CPUTextLib	616	Error in update log or on the module
<input type="checkbox"/>	<input type="checkbox"/>	2	SYSTEM_SDiag57P_CPUTextLib	617	Subcomponent update stopped
<input type="checkbox"/>	<input type="checkbox"/>	2	SYSTEM_SDiag57P_CPUTextLib	618	Internal error
<input type="checkbox"/>	<input type="checkbox"/>	2	SYSTEM_SDiag57P_CPUTextLib	619	Firmware for hardware component unchanged
<input type="checkbox"/>	<input type="checkbox"/>	2	SYSTEM_SDiag57P_CPUTextLib	620	Firmware successfully downloaded and activated for use after re
<input type="checkbox"/>	<input type="checkbox"/>	2	SYSTEM_SDiag57P_CPUTextLib	621	Firmware successfully downloaded, activated and booted with re
<input type="checkbox"/>	<input type="checkbox"/>	2	SYSTEM_SDiag57P_CPUTextLib	624	Started for CPU
<input type="checkbox"/>	<input type="checkbox"/>	2	SYSTEM_SDiag57P_CPUTextLib	625	Completed successfully
<input type="checkbox"/>	<input type="checkbox"/>	2	SYSTEM_SDiag57P_CPUTextLib	626	Invalid memory card type
<input type="checkbox"/>	<input type="checkbox"/>	2	SYSTEM_SDiag57P_CPUTextLib	627	Invalid memory card size
<input type="checkbox"/>	<input type="checkbox"/>	2	SYSTEM_SDiag57P_CPUTextLib	640	Diagnostics buffer entries reduced due to power-down save funct
<input type="checkbox"/>	<input type="checkbox"/>	2	SYSTEM_SDiag57P_CPUTextLib	641	Corrupt diagnostics buffer initialized
<input type="checkbox"/>	<input type="checkbox"/>	2	SYSTEM_SDiag57P_CPUTextLib	642	Channel diagnostics overflow for HW ID= @4W%Su@
<input type="checkbox"/>	<input type="checkbox"/>	2	SYSTEM_SDiag57P_CPUTextLib	643	Component diagnostics overflow for HW ID= @4W%Su@
<input type="checkbox"/>	<input type="checkbox"/>	2	SYSTEM_SDiag57P_CPUTextLib	644	No diagnostics buffer entries for interrupt/error OEs locked by use
<input type="checkbox"/>	<input type="checkbox"/>	2	SYSTEM_SDiag57P_CPUTextLib	645	No time synchronization with time master
<input type="checkbox"/>	<input type="checkbox"/>	2	SYSTEM_SDiag57P_CPUTextLib	646	Connection to preferred time synchronization master lost
<input type="checkbox"/>	<input type="checkbox"/>	2	SYSTEM_SDiag57P_CPUTextLib	672	New O8 requests for all O8 classes
<input type="checkbox"/>	<input type="checkbox"/>	2	SYSTEM_SDiag57P_CPUTextLib	673	New O8 requests for O8 class @3W%u@
<input type="checkbox"/>	<input type="checkbox"/>	2	SYSTEM_SDiag57P_CPUTextLib	674	New O8 requests for O8 @3W%u@
<input type="checkbox"/>	<input type="checkbox"/>	2	SYSTEM_SDiag57P_CPUTextLib	768	Unformatted memory card
<input type="checkbox"/>	<input type="checkbox"/>	2	SYSTEM_SDiag57P_CPUTextLib	769	Deprogram-card (external load memory)

Editing AS messages without a connection to the controller

You can configure offline independently of a connection to the controller.

To do so, you save the loaded AS messages in a file.

1. Select the connection in the "AS messages" folder.
2. Select "AS messages > Save to file" from the shortcut menu of the connection.

You then load the AS messages to Alarm Logging in the offline project.

1. Select the connection in the "AS messages" folder.
2. Select "AS messages > Load from file" from the shortcut menu of the connection.

You can find additional information about offline configuration under "How to download AS messages/text lists offline (Page 1343)".

See also

How to download AS messages/text lists offline (Page 1343)

How to download AS alarms from the controller (Page 1339)

How to configure the automatic update of S7-1500 alarms (Page 1346)

How to export AS messages (Page 1347)

5.4.9.2 How to download AS alarms from the controller

You import controller alarms of an S7-1500 controller into the WinCC project in the "Alarm Logging" editor.

For the "SIMATIC S7 Protocol Suite" channel, you can only load AS messages offline via the "Load from file" function.

Requirement

- The channel "SIMATIC S7-1200, S7-1500 Channel" must be integrated in the project.
- A connection must be created in the "OMS+" channel unit.
- The connection must be established in Runtime.

Procedure

1. Select the connection in the "AS messages" folder.
2. Select the "Load from AS" connection from the shortcut menu.
All available messages and texts of the controller are loaded into the "AS messages" or "AS Text lists" tab in the table area.

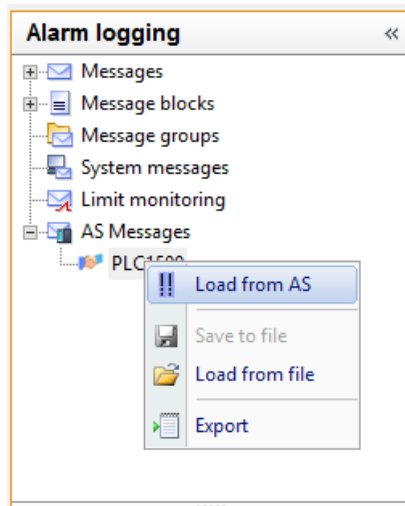

5.4 Configuring the Message System

- To configure the assignment of message classes, select "AS messages" in the navigation area.
In the "Properties - AS messages" area, select the corresponding WinCC message types for the AS classes.

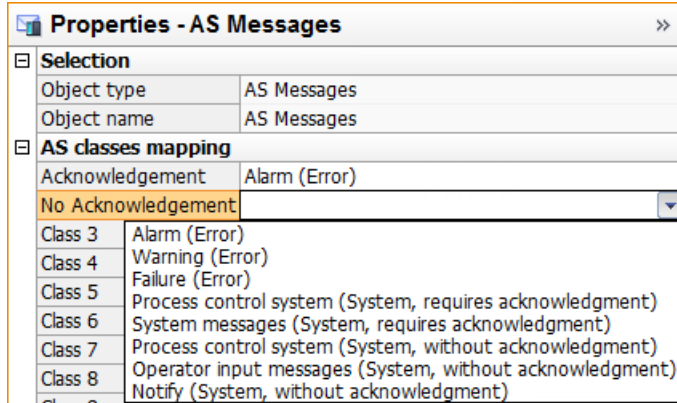

- To assign the AS message texts to the WinCC message texts, select the connection in the navigation area.
In the "Properties - connection" area, select the corresponding WinCC message texts under "Assignment of the alarm texts".

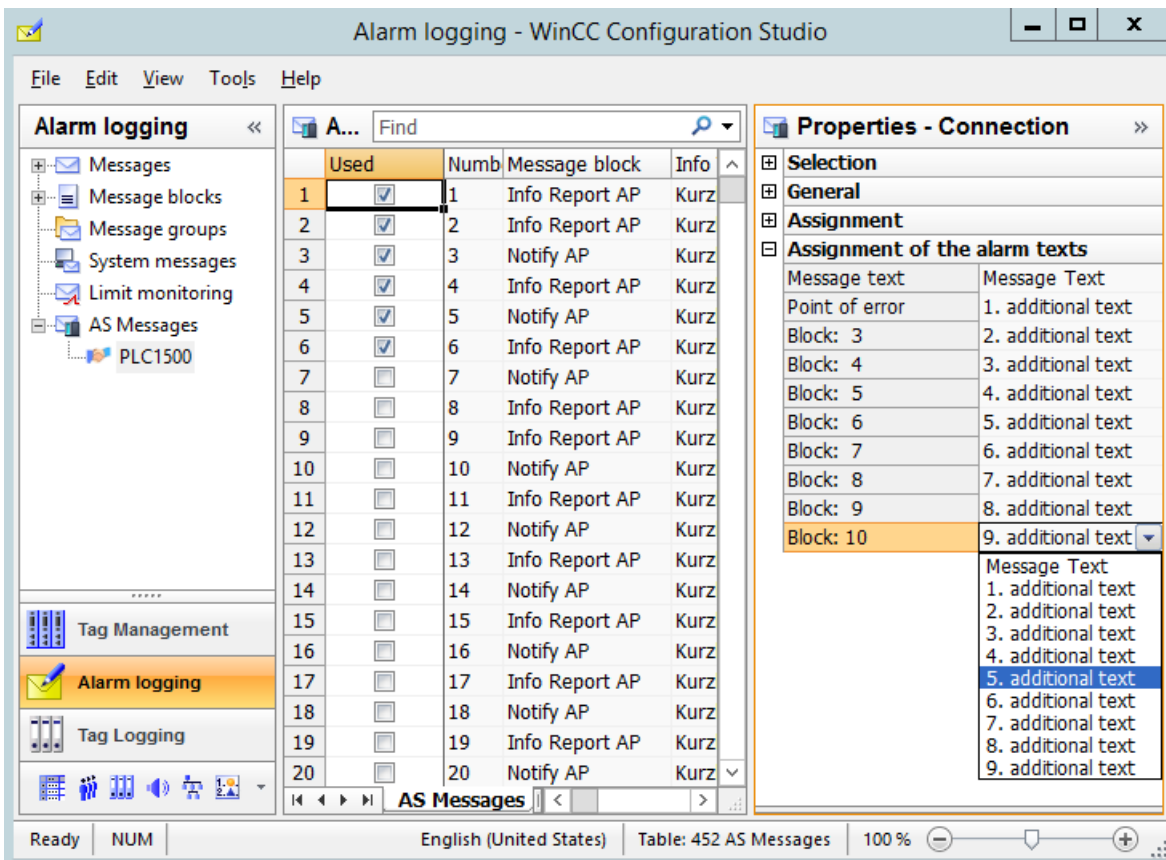

5. The messages are not automatically included in Alarm Logging.
To transfer the required messages to the "Messages" tab, activate the "Used" option in each case in the "AS Text Lists" tab.

	Used	Modified	Number	Message block	Info Text (DEU)
1	<input checked="" type="checkbox"/>	<input type="checkbox"/>	1	Info Report AP	Kurzbezeichnung: @6W%
2	<input checked="" type="checkbox"/>	<input type="checkbox"/>	2	Info Report AP	Kurzbezeichnung: @6W%
3	<input checked="" type="checkbox"/>	<input type="checkbox"/>	3	Notify AP	Kurzbezeichnung: @6W%
4	<input checked="" type="checkbox"/>	<input type="checkbox"/>	4	Info Report AP	Kurzbezeichnung: @6W%
5	<input checked="" type="checkbox"/>	<input type="checkbox"/>	5	Notify AP	Kurzbezeichnung: @6W%
6	<input checked="" type="checkbox"/>	<input type="checkbox"/>	6	Info Report AP	Kurzbezeichnung: @6W%
7	<input type="checkbox"/>	<input type="checkbox"/>	7	Notify AP	Kurzbezeichnung: @6W%
8	<input type="checkbox"/>	<input type="checkbox"/>	8	Info Report AP	Kurzbezeichnung: @6W%
9	<input type="checkbox"/>	<input type="checkbox"/>	9	Info Report AP	Kurzbezeichnung: @6W%
10	<input type="checkbox"/>	<input type="checkbox"/>	10	Notify AP	Kurzbezeichnung: @6W%
11	<input type="checkbox"/>	<input type="checkbox"/>	11	Info Report AP	Kurzbezeichnung: @6W%
12	<input type="checkbox"/>	<input type="checkbox"/>	12	Notify AP	Kurzbezeichnung: @6W%
13	<input type="checkbox"/>	<input type="checkbox"/>	13	Info Report AP	Kurzbezeichnung: @6W%
14	<input type="checkbox"/>	<input type="checkbox"/>	14	Notify AP	Kurzbezeichnung: @6W%
15	<input type="checkbox"/>	<input type="checkbox"/>	15	Info Report AP	Kurzbezeichnung: @6W%
16	<input type="checkbox"/>	<input type="checkbox"/>	16	Notify AP	Kurzbezeichnung: @6W%
17	<input type="checkbox"/>	<input type="checkbox"/>	17	Info Report AP	Kurzbezeichnung: @6W%
18	<input type="checkbox"/>	<input type="checkbox"/>	18	Notify AP	Kurzbezeichnung: @6W%
19	<input type="checkbox"/>	<input type="checkbox"/>	19	Info Report AP	Kurzbezeichnung: @6W%

6. To apply the AS text lists to the text library, activate the "Used" option in each case in the "AS Text Lists" tab.
The texts and their translations are transferred to the text library.
7. If necessary, check the assignment of message class and message type in the "Properties OS" area in the "Properties - AS message" area.
When the assignment is missing, both fields are marked in red.

Result

The messages and text lists of the S7-1500 controller are integrated in Alarm Logging and are displayed in the "Messages" or "Text lists" tab.

The activated messages remain in the "Messages" tab even when the Alarm Logging editor is closed.

After the "Alarm Logging" editor is closed, the "AS Messages" and "AS Text Lists" tabs are hidden once again.

If you want to add additional messages after opening the Alarm Logging editor again, download the messages once again from the AS.

Number	Message tag	Message bit	Status tag
1	1023410177	0	
2	1023410178	0	
3	1023410179	0	
4	1023410180	0	
5	1023410181	0	
6	1023410182	0	
7			
8			
9			
10			
11			
12			
13			
14			
15			
16			
17			
18			
19			

New download from the AS

If you assigned the AS message texts to the WinCC message texts for the first download, the assignment is maintained when the message texts are downloaded again from the AS.

If the AS message texts or the assignment of the WinCC message texts have been modified, the "Modified" option of the corresponding message is activated.

To apply modifications in the "Messages" tab, deactivate the "Modified" option.

Assignment of an empty WinCC message text

If a WinCC message text is empty and assigned to an AS message text, the "Modified" option of the corresponding message is not activated.

Existing message texts are not overwritten by an empty message text.

To apply the change nevertheless, remove the message and import the message in Alarm Logging again:

1. Select the corresponding message and deactivate the "Used" option.
2. Then activate the option "Used" again.

See also

AS messages (Page 1335)

How to configure the automatic update of S7-1500 alarms (Page 1346)

How to download AS messages/text lists offline (Page 1343)

How to export AS messages (Page 1347)

5.4.9.3 How to download AS messages/text lists offline

Introduction

You can configure the following S7 channels offline:

- SIMATIC S7 Protocol Suite
- SIMATIC S7-1200, S7-1500 Channel: S7-1500 controllers
S7-1200 controllers do not support AS messages.

To do this, the data records must be exported from an existing TIA Portal project and loaded in the corresponding WinCC project.

"SIEMENS SIMATIC SCADA Export" for TIA Portal

To export data records from a TIA Portal project, use the "SIEMENS SIMATIC SCADA Export" tool.

In the TIA Portal project, select the "Export to SIMATIC SCADA" entry in the shortcut menu of the PLC.

The tool for the various TIA Portal versions is available for download in the Industry Online Support:

- "SIMATIC SCADA Export" download (ID 109748955) (<https://support.industry.siemens.com/cs/ww/en/view/109748955>)
- "SIMATIC SCADA Export" documentation (ID 101908495) (<https://support.industry.siemens.com/cs/ww/en/view/101908495>)

Raw data tag for S7 Protocol Suite

If you load AS messages from an S7-400 controller, the raw data tag "<ConnectionName>#RawEvent" must be created in the Tag Management.

The tag is used as a message tag and acknowledgment tag for the imported AS messages.

To create the tag, proceed as follows:

1. Select the connection of the "SIMATIC S7 Protocol Suite" communication channel in the Tag Management.
2. Create a tag with the following name:
<Connection_name>#RawEvent
3. Select "Raw data type" as data type.
4. Select the "Events" raw data type in the "Address Properties" dialog.

Requirement

- The AS was compiled in the TIA Portal.
- The PLC configuration data is exported as zip file.
- The communications processor and associated hardware driver are installed in the WinCC project.

- A connection is created in the "SIMATIC S7-1200, S7-1500 Channel" or "SIMATIC S7 Protocol Suite".
- The raw data tag "<Connectionname>#RawEvent" is created for SIMATIC S7 Protocol Suite.
- The "Alarm Logging" editor is open.

Procedure

1. Select the "Load from file" command from the shortcut menu of the created connection.

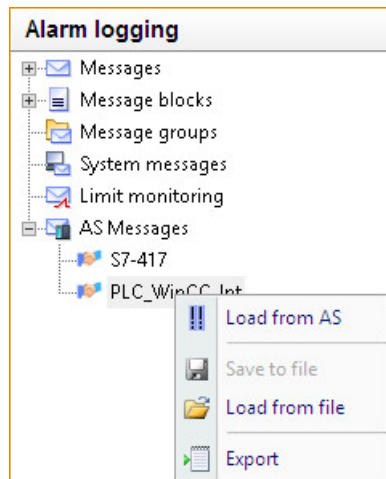

2. Select the desired .zip file to be loaded.

3. If necessary, select one of the AS offered with configurations you want to import.

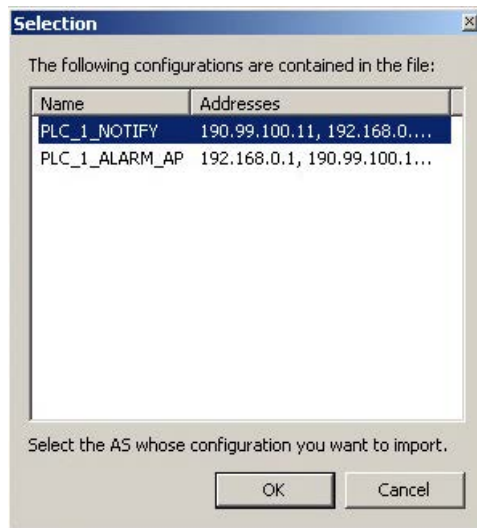

Note

Configuration selection

The configuration selection is only available when multiple configurations are contained in the file, and none of them matches the IP address.

If there is only one configuration in the file or any of the configurations contained in the file matches the IP address, it is automatically selected.

The "AS Messages" and "AS Text Lists" tabs are created.

4. To create WinCC messages from the found controller messages, select the "Used" option. The loaded messages are displayed on the "Messages" tab.

Result

The configuration has been imported.

After the "Alarm Logging" editor is closed, the "AS Messages" and "AS Text Lists" tabs are hidden once again.

If you want to add additional messages after opening the Alarm Logging editor again, download the messages once again from the AS.

New download from the AS

If you assigned the AS message texts to the WinCC message texts for the first download, the assignment is maintained when the message texts are downloaded again from the AS.

If the AS message texts or the assignment of the WinCC message texts have been modified, the "Modified" option of the corresponding message is activated.

To apply modifications in the "Messages" tab, deactivate the "Modified" option.

See also

How to download AS alarms from the controller (Page 1339)

How to export AS messages (Page 1347)

"SIMATIC SCADA Export" documentation (ID 101908495) (<https://support.industry.siemens.com/cs/ww/en/view/101908495>)

"SIMATIC SCADA Export" download (ID 109748955) (<https://support.industry.siemens.com/cs/ww/en/view/109748955>)

5.4.9.4 How to configure the automatic update of S7-1500 alarms

For S7-1500 controllers, you have the AS messages automatically updated in Alarm Logging after modifications to the messages.

Automatic update of the controller alarms

The "Automatic update" option is selected by default in the S7-1500 controller. Firmware version 2.0 or higher is required.

You have the following options in the WinCC project:

- Select the "Automatic update" option in Alarm Logging.
The AS messages are displayed with the current properties in runtime after message changes, e.g. after a change of the message text.
However, the AS messages are not integrated in the Alarm Logging of the WinCC project.
- Download the AS messages and AS text lists from the controller.
You must load the AS messages again after a configuration change in the controller.
If you do not load the messages again, they are displayed in runtime with the previous properties, for example, with an outdated message text.

Principle

No message configuration is performed in Alarm Logging for this controller. Configured messages of this controller are removed from Alarm Logging.

1. The controller alarms send an ID of the message class.
2. The matching message class in WinCC is selected in the Alarm Logging based on the ID. When you activate the "Automatic update" option, the additional message classes 29 - 48 are created in the WinCC project:
 - The message classes 29 - 32 are used for system diagnostics.
 - Message classes 33 - 48 according to the ID from the AS.

You configure the assignment of the WinCC message classes in Alarm Logging.

3. The acknowledgment philosophy of the message classes is taken from the controller.

Requirement

- The "Central message management" option is selected in the controller. This activates the automatic update in the controller.
- The controller alarms have been configured in STEP 7.
- A connection must be created in the "OMS+" channel unit below the "SIMATIC S7-1200, S7-1500 Channel".

Procedure

1. Select the S7-1500 connection in the navigation tree below the "AS messages" folder.
2. Enable the "Automatic update" option in the "Properties" area.
3. In Alarm Logging under "Properties - AS messages > Assignment AS classes", select the corresponding WinCC message types.

Result

The latest AS messages are always displayed in the WinCC project.

When a message is changed in the controller, this change is applied during the next reading in the WinCC project.

See also

How to download AS alarms from the controller (Page 1339)

5.4.9.5 How to export AS messages

Exporting AS messages

You can export AS messages from an S7-1500 controller as binary data. The S7-1200 does not support AS messages.

You use the export files for the offline configuration.

Requirement

- In the "SIMATIC S7-1200, S7-1500 Channel" communication channel, a connection to an S7-1500 is created.
- You have loaded AS project data and configured it in WinCC.

Procedure: Exporting binary data

1. Select the connection under "AS messages" in the Alarm Logging.
2. Select the "Save to file" option from the shortcut menu.
The "Save" dialog opens.
3. Select the storage path and enter a file name.
Close the dialog with the "Save" button.
The configuration data is exported as a binary data set to a .bin file.

See also

How to download AS alarms from the controller (Page 1339)

How to download AS messages/text lists offline (Page 1343)

5.4.10 Working with operator messages

5.4.10.1 Operator messages

Operator messages

An operation in the process can trigger an operator message.

The configuration of an operator message depends on the object being operated and the type of operation.

Typical operator messages

Message number	Component	System message
12508141	Graphics Runtime	WinCC operator message during operator control of objects in the process picture
1003099	Alarm Logging	A message is locked.
1003100	Alarm Logging	A locked message is released.
1003101	Alarm Logging	A message is acknowledged.
1003107	Alarm Logging	A message is hidden.
1003108	Alarm Logging	A hidden message is shown.

Comment of an operator message

The comment of an operator message may be up to 254 characters long.

Depending on the operator message, the comment field also contains automatically added information, such as the message number of the hidden message or the computer name.

You open the "Comment" dialog in the long-term archive list, depending on the configuration of the WinCC AlarmControl:

- The "Comment" message block is displayed in the message list:
In the "Comment" column of the operator message, double-click the icon: 
- The key function "Comments dialog" is selected in the toolbar:
Select the operator message and click the button in the toolbar.

Objects with the property "Operator message"

You can activate the "Operator message" property for the respective object in the Graphics Designer to control certain objects, such as the input of a value in an I/O field.

The operator message 12508141 is triggered in Runtime.

The basic principle is as follows:

- The object must be connected to a tag.
- The structure of the operator message 12508141 cannot be edited.
- By activating the "Operator Activities Report" attribute, the user can enter the reason for an operation as a comment on the message in a dialog after performing the operation.
- The operator message contains the value before the operation (old value) in process value block 2, and the modified value (new value) in process value block 3.
Old value and new value are displayed in the comment of operator message 12508141.

Own operator message as action

For operating optional graphic WinCC objects, you can configure your own operator message as a C action or as a VBS action.

C action

Execute the respective C action as a reaction to the operation event.

In this case, the operation event can be the mouse click on the WinCC object, for example.

Configure your own operator message with the "GCreateMyOperationMsg" default function from the "Alarms" function group.

VBS action

Execute the respective VBS action as a reaction to the operation event.

In this case, the operation event can be the mouse click on the WinCC object, for example.

Configure your own operator message with the "HMIRuntime.Alarms" object.

Operation of a message

For operation of a message, an operator message is configured in WinCC Alarm Logging.

To do so, use of the WinCC system messages must be enabled in Alarm Logging.

Trigger event

The triggering events for an operator message are activated in the WinCC AlarmControl in the "Operator Messages" tab, for example, acknowledging or locking a message.

Content of the operator message

An operator message contains information on the logged-on user and current computer.

To configure the content of the operator message yourself, select the "Operator Messages" tab in the WinCC AlarmControl configuration. In the "Process values of the operator message" area, you specify which message blocks are written to the process values.

Operator message on manual hiding

When the operator message is enabled, the operator must give a reason for hiding in the "Hide Manually" dialog. In addition, the operator can add a hide comment with a maximum length of 232 characters.

In WinCC AlarmControl, the selected reason and the comment in the "Comment" dialog is displayed in the long-term archive list.

For additional information, refer to "How to Hide and Unhide Messages (Page 1421)".

See also

How to configure operator messages (Page 1394)

How to Hide and Unhide Messages (Page 1421)

How To Use System Messages (Page 1313)

5.5 Message Archiving

5.5.1 Message Archiving in WinCC

Introduction

With the archive management feature in WinCC, you archive process values and messages for the documentation of operational and fault statuses. The Microsoft SQL Server is used for archiving.

Messages configured in Alarm Logging are output during runtime when the corresponding event occurs, for example, a fault or a limit violation. Messages are archived if events known as message events occur, for example:

- when the message occurs
- when the status of the message changes (e.g., from "Message Came In" to "Message Acknowledged")

You can save the message events in an archive database and archive it as a message report on paper. The messages archived in the database can, for example, be output in a message window in runtime.

Archived Message Data

All data associated with a message, including the configuration data, is saved in the message archives. You can read out all properties of a message from the archives, including its message type, time stamp, and texts. A subsequent change to the configuration data of a message results in the creation of a new archive with the new configuration data. This ensures that the change has no effect on messages that were archived before the change was made.

Note

The time stamp on archived messages is always in standard UTC format (Coordinated Universal Time).

Because messages are configured on a language-dependent basis, archives contain a table with the configuration data for each configured language.

Quantity structure

The following table shows the number of messages that WinCC can process. The actual number depends on the server in use. The information in the table refers to the following server configuration:

- Intel Pentium III with 1.4 GHz
- 512 MB RAM
- 40 GB hard disk
- Maximum of 16 clients

	Server	Special archive server
Sustained message load (per second)	10 messages	100 messages
Message flow (per 10 seconds)	2,000 messages	15,000 messages

Note

The values for message flow apply only to archiving. For further processing in Alarm Logging, additional time must be planned: five minutes must elapse before a new message overload can be created.

Memory requirements of messages

Configuration data of a message for a single language:

- Theoretical minimum value: approx. 198 bytes
- Theoretical maximum value: approx. 5062 bytes

This value is stored in a segment each time.

Runtime data of a message:

- Message without associated values or comment => Minimum value: approx. 172 bytes
- Messages with maximum associated values and comment => Maximum value: approx. 4012 bytes

5.5.2 Configuration of Message Archiving

5.5.2.1 Configuration of Message Archiving

Introduction

To archive messages, WinCC uses short-term archives of configurable size, which you can configure with or without backup.

Storing archive files

Archive files are always stored so that they are local to the computer in the associated project.

Properties of message archives

A WinCC message archive consists of multiple individual segments. You can configure both the size of the message archive and the size of the individual segments in WinCC:

- The size of the message archive or individual segments, for example: 100 MB message archive size, 32 MB per individual segment.
- The archiving period of the message archive or individual segments, for example: The message archive archives all messages which occur within one week, each individual segment archives the messages which occur within one day. The configuration of the archiving period is called archive partitioning.

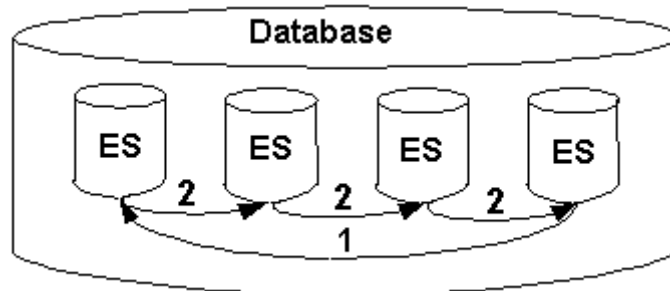

You can always configure both conditions at the same time. If either of the two criteria is exceeded, the following happens:

1. Criterion for message archive (Database) is exceeded: the oldest messages (i.e. the oldest individual segment) are deleted.
2. Criteria for individual segment is exceeded: a new individual segment (ES) is created.

A new individual segment is also created when you configure message data online.

Note

When starting Runtime, the system checks whether the configured size of the individual segment has been calculated to a sufficient size. If the configured size is too small, the system automatically adapts the segment to the minimum size.

Backing up archived messages

The data of the message archives can be stored in a backup.

5.5.2.2 How to Configure Messages for Archiving

Introduction

You decide when you configure a message if it is archived.

Note

The default setting for new messages is that they are archived. If you do not want to archive messages, you have to specify it.

Requirement

The message system is configured.

Procedure

1. Open the "Alarm Logging" editor.
2. Select the message you wish to archive in the table area.
3. Select the "Archived" option in the "Properties" area.
4. Disable the option for messages that are not to be archived.

5.5.2.3 How to Configure a Message Archive

Introduction

You have the option to configure the message archive in Alarm Logging.

Note

Make sure that the archive size does not exceed the free memory space available. The archive manager does not check the selected settings for plausibility. A high number of linked database segments can lead to longer waiting periods in the system when starting and ending Runtime.

Example of memory requirements calculation

The following example shows how to calculate memory requirements for messages across all segments and for individual segments. For this purpose, you need information about how many messages come in per second on average. Approximately 4000 bytes per message is included in the calculation of memory requirements.

General rule: Number of messages/s * 4000 bytes * 60 s/min * 60 min/h * 24 h/day * 31 days/month * y months.

A rate of 1 message/sec is assumed in the example:

- The approximate maximum size for all segments across a period of 2 months is derived as follows:
 $20 \text{ GB} (1 \text{ message/s} * 4000 \text{ bytes / message} * 60 \text{ s/min} * 60 \text{ min/h} * 24 \text{ h/day} * 31 \text{ days/ month} * 2 \text{ month})$
- The resultant value for each segment is a daily rate of:
approximately 330 MB $(1 \text{ message/s} * 4000 \text{ bytes / message} * 60 \text{ s/min} * 60 \text{ min/h} * 24 \text{ h/ day} * 1 \text{ day})$

You should explicitly set this limit to a higher level, e.g. 700 MB, to achieve an appropriate daily storage even in the case of a possible message surge.

Configure your message archives accordingly.

Procedure

1. Open the "Alarm Logging" editor.
2. Select the "Messages" folder in the navigation area.

3. Select "Archive" > "Properties..." in the shortcut menu.

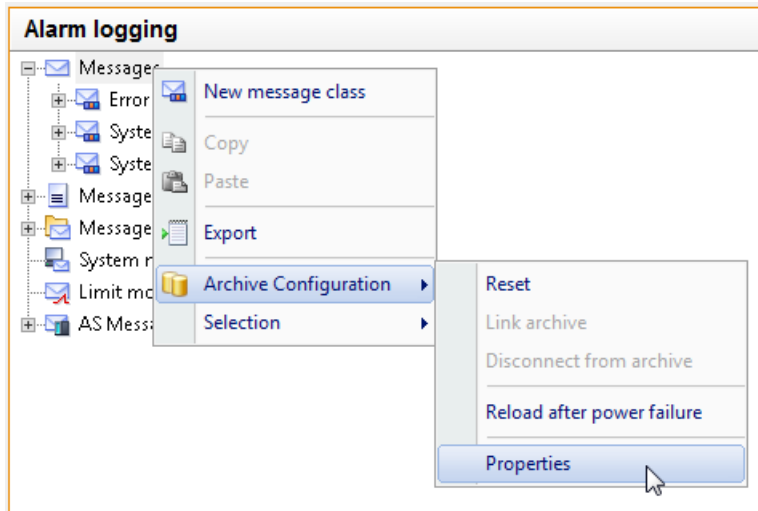

The "AlarmLogging" dialog is opened.

Note

Automatically adjusting the configuration at the start of Runtime

The maximum size of a single segment is automatically adjusted at the start of Runtime if necessary if the specified size is not sufficient.

AlarmLogging

Archive Configuration | Backup Configuration

Archive size

Time period of all segments: 1 Week(s)

Max. size of all segments: 100 Megabyte(s)

Time period covered by a single segment: 1 Day(s)

Max. size of a single segment: 10 Megabyte(s)

Time of the segment change

Month: January Year: 2009 Day of the month: 17

Weekday: Saturday Hour: 23 Minute: 59

OK Cancel Apply

4. Make the following settings for the archive:
 - Time period of all segments and its maximum size. This specification defines the size of the archive database. If one of the criteria is exceeded, a new segment is started and the oldest segment is deleted.
 - The time period in which messages are archived in an individual segment and its maximum size. If either of these criteria is exceeded, a new individual segment is started. When the criterion for "Time period of all segments" is exceeded, the oldest individual segment is also deleted.
5. In the "Time of the segment change" field, enter the start date and time for the first segment change.
When a new individual segment begins, the configuration of the time of the segment change is taken into account.
6. Click "OK" to confirm your entry.

Note

Displaying configuration changes

Changes in Alarm Logging are not visible in Runtime until a segment has been changed.

A segment change is delayed by 30 seconds after the last change in Alarm Logging. After a maximum of 2 minutes, messages are written into the new archive segment with the changed configuration data. This means that read access to the changes in the archive will not be active until this action has been completed. Alternatively, you can deactivate and reactivate Runtime.

If you modify the archiving size (time range) in Runtime, such modifications take effect only upon the next segment change.

Example

In the above screen shot, the segment changes for the first time on January 17 at 23:59. The next time-related segment change occurs at the configured time in the cycle defined in "Time period covered by a single segment". With the above cycle setting "1 day", the change is made every day at 23:59. If the cycle is set to "1 month", for example, the segment change takes place on the 17th day of the next month at 23:59.

The segment is also changed if the configured size ("Max. size of all segments") is exceeded after the start of Runtime. In this case, the oldest individual segment is also deleted.

Note

After selecting the "Reset" command in the shortcut menu, the Runtime data is deleted from the archives.

5.5.2.4 How to Configure the Archive Backup

Principle

Create regular backups of your archive data to ensure seamless documentation of your process.

Note

Starting the backup

The backup normally starts 15 minutes after the first time-related segment change.

If the start of backup and start of segment should be synchronous with the start of Runtime, define the start time for the segment change prior to the start of Runtime.

Changing archived messages in Runtime

You can change the displayed message in Runtime using WinCC Alarm Control.

If the location of the archive segment where the message is stored has already been changed, then the modified comment is not accepted in the swapped-out archive. The change is limited to the local archive segment.

If the archive segment has not yet been swapped out, then the changed comment is accepted permanently.

Backup behavior with redundant system

Only the current master server swaps out to a local drive.

Procedure

1. Open Alarm Logging in the WinCC Explorer.
2. Select the "Messages" folder in the navigation area.
3. Select "Archive" > "Properties..." in the shortcut menu.
The "AlarmLogging" dialog is opened.

4. Select the "Backup Configuration" tab.

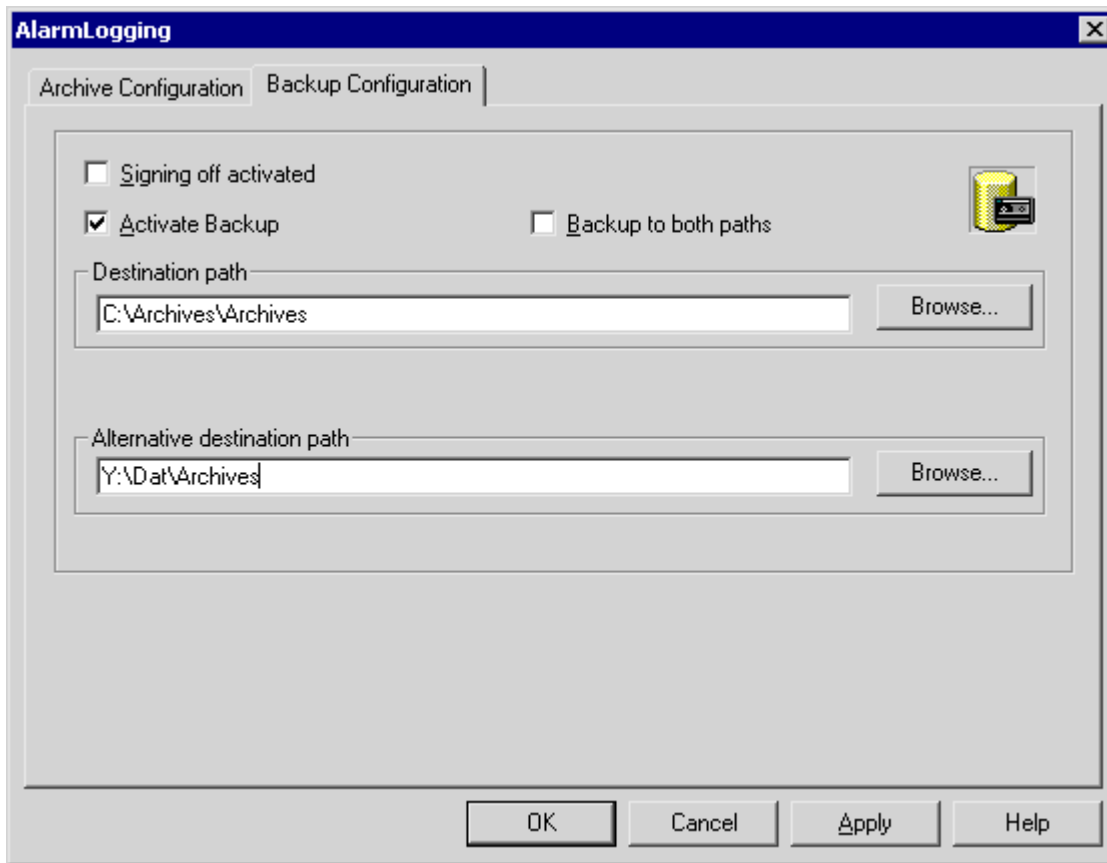

5. Select the "Signing off activated" check box, if the swapped archive data are to receive a signature. When reconnected with WinCC, the signature allows the system to determine whether any modifications have been made to the archive backup file after its swap-out.
6. Select the "Activate Backup" check box, if the archived data are to be backed up. In addition, select the "Backup to both paths" check box, if the archived data are to be saved in both directories, "Destination path" and "Alternative destination path".
7. Enter the destination path in which the backup files are to be stored. Network paths are also valid as destination paths. The "Alternative destination path" is used in the following cases, for example:
 - The storage space of a backup medium is full.
 - The original destination path is not available, for example, due to a network failure.After the corresponding system messages have been configured, the messages are output if the specified destination path is not available.
8. Click "OK" to confirm your entry.

Result

The archive backup is stored in the specified destination path.

Structure of the archive backup file

An archive backup consists of two files, with the extensions LDF and MDF. To transfer an archive backup, for example to another computer, copy the corresponding LDF and MDF files.

The file name is composed as follows:

"<Computername>_<Projectname>_<Type>_<Period_from>_<Period_until>". The type identification of the message archive is "ALG". The time period is specified in format `yyyymmddhhmm`, for example 200212021118 for December 2, 2002, 11:18 hours. Underscores ("_") in the project name are displayed as "#".

Signing of archive backup files

If signing and backup are activated, each archive backup file is signed when it is swapped out. It is thus possible to determine upon reconnection of the file with WinCC whether or not the file has been changed after swapping.

In order to verify the data, the "Signing activated" check box must be selected.

If you use archive signing-off, the maximum size of a single segment may not exceed 200 MB.

5.5.2.5 How to link an archive

Introduction

To access data in an archive backup during Runtime, link the associated database files to the project. You can link an archive yourself using the Alarm Logging and WinCC AlarmControl or have the connection established automatically. The archived messages are displayed in the message display in Runtime.

Requirement

- The corresponding LDF file and MDF file of the archive backup are in a local directory on the configuration computer, e.g. hard drive or DVD.
- The project is loaded on the configuring computer and is in Runtime.
- You can only link the archive files on the server.

Note

The messages are only displayed in Runtime if the time range in the message display has been configured accordingly. Example: You have configured a time range to display only the messages of the past 24 hours. If you link up to an archive backup containing messages that are older than 24 hours, these messages are not included in the message display.

Connecting an archive via the "Alarm Logging" editor

1. Open Alarm Logging in the WinCC Explorer.
2. Select the "Messages" folder in the navigation area.

5.5 Message Archiving

3. Select "Archive" > "Link archive..." in the shortcut menu.
The dialog for file selection opens.
4. Select the database file and click "Open".
After selecting the file, the message archive is linked to the project.

If signing is activated and you link a modified or unsigned archive file to the project, acknowledge the link to these files, as the archive files are otherwise not linked. A WinCC system message is generated and an entry is added to the Windows event log in the "Application" section.

Note

After having connected an archive in the Alarm Logging Editor, you may not close the editor until the "Archive Successfully Connected" dialog is displayed.

Linking the archive with WinCC AlarmControl

1. Click  in the WinCC AlarmControl toolbar.
2. In the dialog, use the "..." button to navigate to the path in which the archive files are located.
3. Select the required archive file under "Backups" and click "OK". After selecting the file, the message archive is linked to the project.

Automatic Linking to an Archive

1. Add the archive files to the "ProjectName\CommonArchiving" directory.
2. In Runtime, the message archive is automatically linked to the project.

If signing has been activated, modified, signed off archive files are not automatically linked. A WinCC system message is generated and an entry is added to the Windows event log in the "Application" section.

Linking an Archive Using a Script

You can link the archive files with the WinCC project by using a script via the VBS object "AlarmLogs". The archive segments are copied with the "Restore method" to the Common Archiving directory of the Runtime project. You can find additional information in the sections "VBS Object AlarmLogs" and "VBS Method Restore".

5.5.2.6 How to disconnect an archive

Introduction

If you no longer wish to access the data in an archive during Runtime, disconnect the associated database files from the project.

You can disconnect an archive with the "Alarm Logging" editor or WinCC AlarmControl. You must delete linked archives from the "Project name\CommonArchiving" directory or have it removed by a script with the VBS object "AlarmLogs".

Requirement

- Archive backup files are linked.
- The project is loaded on the configuring computer and is in Runtime.
- You can only disconnect linked archive files on the server.

Disconnecting an archive with the "Alarm Logging" editor

1. Open Alarm Logging in the WinCC Explorer.
2. Select the "Messages" folder in the navigation area.
3. Select "Archive" > "Disconnect from archive..." in the shortcut menu.
The dialog for database selection opens.
4. Select the archive file and click "OK".
The archive is no longer linked with the project.

Disconnecting the archive with WinCC AlarmControl

1. Click  in the WinCC AlarmControl toolbar.
2. Select the required archive file in the dialog and click "OK".

Result

The link to the archive file is disconnected. Access is no longer possible to the archived messages in Runtime.

5.5.3 Output of Message Archive Data

5.5.3.1 Output of Message Archive Data in Runtime

General procedure

Messages stored in message archives can be output in Runtime in the following ways:

- Display the archived messages in a message window; in the event of a power failure, the messages queued for loading from the archive to the message system are loaded with the correct time stamp (reloading after power failure).
- Print archive report.
- Access to message archive database via OLE-DB for output of archived messages.
- Access to the message data via the OPC O&I server.
- If you use the WinCC/DataMonitor, you can evaluate and display archive data with the DataMonitor.

- Access via ODK.
- Access by means of suitable client applications.

See also

Direct Access to the Archive Database (Page 1369)

How to Configure a Message Archive Report (Page 1367)

How to Configure Reloading of Messages Following a Power Failure (Page 1366)

How to Display Archived Messages in Runtime (Page 1364)

5.5.3.2 How to Display Archived Messages in Runtime

Introduction

You cannot only display the latest messages with WinCC AlarmControl in Runtime but also call up messages from the archive. You have the option to display archive messages in a short-term archive list or long-term archive list. The short-term archive list also contains current messages.

Requirement

All archived data displayed in Runtime must be stored locally on the archive server. The SQL server does not permit access to backup files that are located on another computer in the network, for example.

For additional information on this topic, refer to chapter "Message Server" in this documentation.

Procedure

The following procedure describes just the principle steps for the display of archived messages in Runtime. The exact procedure for configuration of WinCC AlarmControls is described in the online help under "Setting up a message system/Displaying messages in Runtime".

1. Insert a WinCC AlarmControl into the desired picture in the Graphics Designer.
2. Double-click the control to open the "WinCC AlarmControl Properties" dialog.

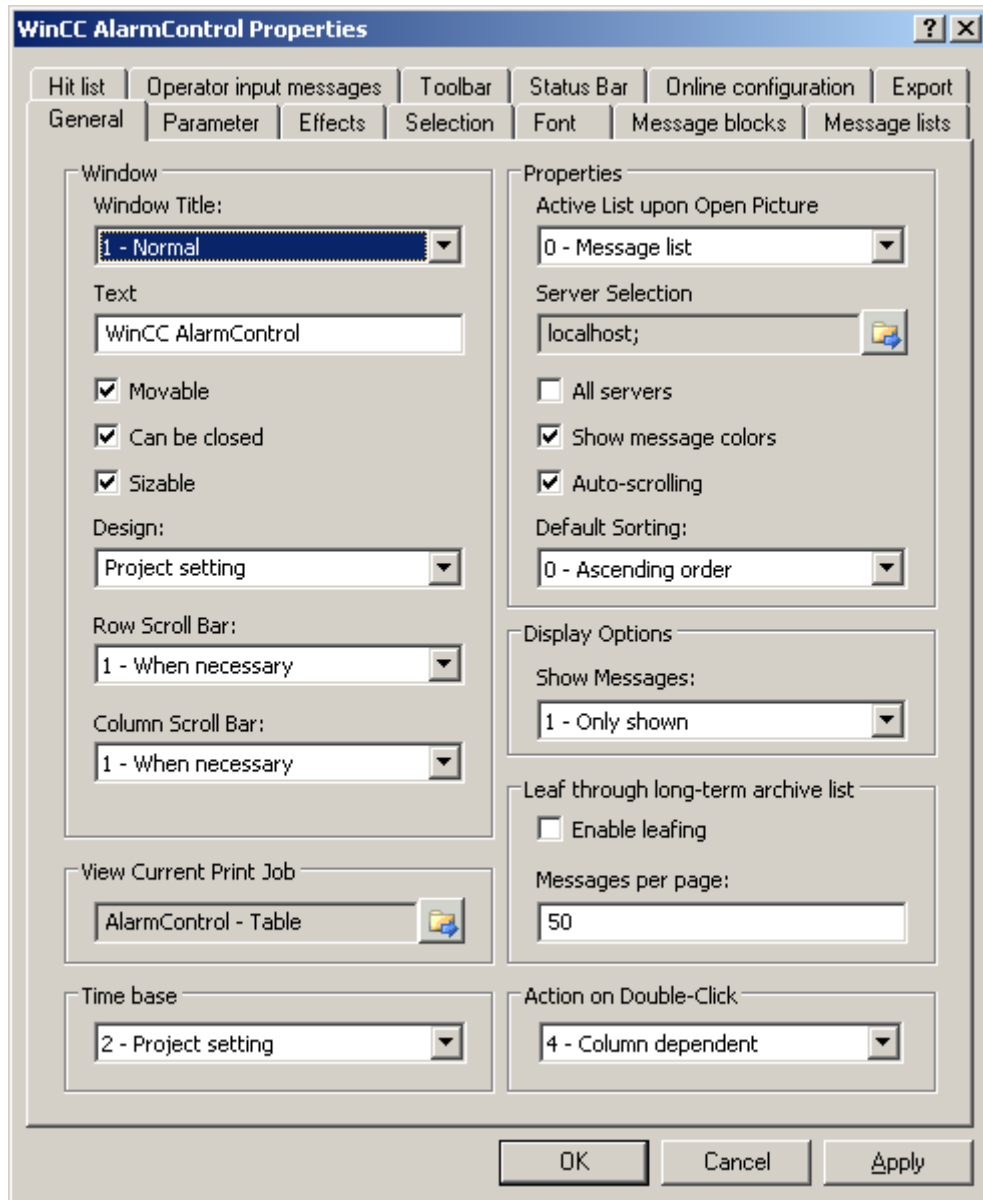



3. In the "General" tab, select which list will be shown when the picture opens in the "Properties" area. To display archived messages, select "Short-term archive list" or "Long-term archive list".

4. If you want to only display messages from a certain server in a distributed system, deactivate the "All servers" checkbox. Click on  to select a server. Confirm with "OK".
5. Go to the "Toolbar" tab. Activate the "Display toolbar" check box. Select at least button function "Short-term archive list" or "Long-term archive list". Confirm with "OK".

Note

When displaying messages in the short-term archive list, the system immediately updates new incoming messages. This is not the case when the long-term archive list is selected.

Result

In Runtime, click  or  to display messages from the archive in the message list. You can filter messages from the archive to only display messages of the "Fault" type, for example, or only messages at specific parts of the plant.

See also

- Direct Access to the Archive Database (Page 1369)
- How to Configure a Message Archive Report (Page 1367)
- How to Configure Reloading of Messages Following a Power Failure (Page 1366)
- Output of Message Archive Data in Runtime (Page 1363)

5.5.3.3 How to Configure Reloading of Messages Following a Power Failure

Principle

To display the most recent messages in Runtime following a power failure, configure the "Reload after power failure" function in the Alarm Logging. In the event of a power failure, a user-defined number of messages is read from the message archive to reconstruct the most recent process image.

Procedure

1. Select the "Messages" folder in the navigation area.
2. Select "Archive" > "Reload after power failure..." in the shortcut menu. The dialog for "Reload after power failure" opens.

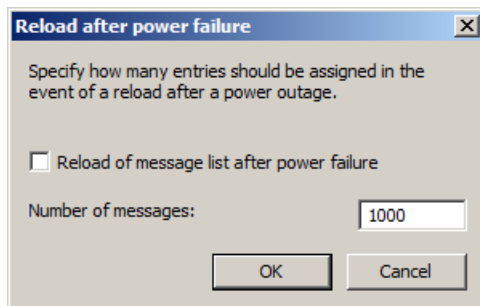

3. Enter the number of messages to be reloaded after a power failure.
4. Select the "Reload Message List After Power Failure" check box so that the message list is reloaded in Runtime after the system has rebooted.
5. Click "OK" to confirm your entry.

5.5.3.4 How to Configure a Message Archive Report

Introduction

You can output archived messages on a printer and as a file. You configure the log for the message archive in the Report Designer.

Overview

WinCC provides you with a pre-configured system layout for the log, which you can adjust to suit your specific needs. You can also create your own log layouts. You have three alternatives to configure the layout for a message archive:

- Configuration with the layout of the "WinCC Control Runtime Print Provider". The layouts are available with WinCC V7 and higher. Either the message archive list is printed out in table format with all messages, or the current display of the message archive list in AlarmControl is printed out. The output of the archive report is only possible via WinCC AlarmControl and the "Print" key.
- Configuration with the "WinCC Alarm Control (Classic)" layout. You start printing with the "Print" key in WinCC Alarm Control. You can also start output of the archive report outside of Alarm Control.
- Configuration with the layout "Alarm Logging RT". You start the print job outside of Alarm Control.

Configuration with the layout of the "WinCC Control Runtime Print Provider"

1. Open the Report Designer in the WinCC Explorer. Open either the "@Alarm Control - Table_ENU.RPL" layout in the "English (USA)" language folder for a table printout or the "@Alarm Control - Picture_ENU.RPL" layout to print out the current display.
2. Double click on "WinCC Control Runtime Print Provider.Table" or "WinCC Control Runtime Print Provider.Picture" in the open layout. The "Object properties" dialog opens.
3. Configure the layout of the table in the "Properties" tab.
4. Save the configuration in the Report Designer.
5. The layouts of the "WinCC Control Runtime Printprovider" are linked with the matching print jobs "@AlarmControl - Table" or "@AlarmControl - Picture". Select one of these print jobs in the "General" tab of the Graphics Designer in the picture with the AlarmControl . If you click "Print" in Runtime, the messages are printed out according to the configured layout.

Configuration with the "WinCC Alarm Control (Classic)" layout

1. Open the Report Designer in the WinCC Explorer. Open the "@CCAlarmCtrl-CP_ENU.RPL" layout, for example, in the language folder "English (USA)".
2. In the open layout double-click the "WinCC Alarm Control (Classic) table". The "Object properties" dialog opens.
3. Configure the layout of the table in the "Properties" tab.
4. Change the output options for the WinCC Alarm Control. For more detailed information, refer to Modify output options for WinCC Alarm Control (Page 2255).
5. Save the configuration in the Report Designer.
6. The "@CCAlarmCtrl-CP_ENU.RPL" layout is linked with the "@Report AlarmControl-CP" print job. Select this print job in the Graphics Designer in the picture with the AlarmControl in the "General" tab. If you click the "Print" key in Runtime, the messages of the selected message list are printed out in form of a table.
7. You can also define a print job outside of the Alarm Control, for example, by configuring a cyclic log output. If all archiving data is to be logged, the output cycles are not to be shorter than the configured archiving period. For more detailed information, refer to Print Job Properties (Page 2032).

Configuration with the layout "Alarm Logging RT"

1. Open the Report Designer in the WinCC Explorer. Open the "@CCAlgRtSequenceArchive_ENU.RPL" layout, for example, in the language folder "English (USA)".
2. Double click the table "Alarm Logging RT Archive Log" in the open layout. The "Object properties" dialog opens.
3. Configure the layout of the table in the "Properties" tab.
4. Change the output options for the archive log. For more detailed information, refer to Changing Output Options for Message Reports from Alarm Logging (Page 2261).
5. Save the configuration in the Report Designer.
6. The "@CCAlgRtSequenceArchive_ENU.RPL" layout is linked with the "@Report Alarm Logging RT Sequence archive New" print job. Configure this print job to specify the output of the archive report. You can, for example, configure a cyclic report output. If all archiving data is to be logged, the output cycles are not to be shorter than the configured archiving period. For more detailed information, refer to How to create print jobs for the Runtime documentation (Page 2072).

See also

- Direct Access to the Archive Database (Page 1369)
- How to Configure Reloading of Messages Following a Power Failure (Page 1366)
- How to Display Archived Messages in Runtime (Page 1364)
- Output of Message Archive Data in Runtime (Page 1363)
- Print Job Properties (Page 2032)

How to create print jobs for the Runtime documentation (Page 2072)

Changing Output Options for Message Reports from Alarm Logging (Page 2261)

Modify output options for WinCC Alarm Control (Page 2255)

5.5.3.5 Direct Access to the Archive Database

Introduction

Various providers offer interfaces that you can use to access databases. These interfaces also enable you to directly access the WinCC archive databases. Direct access lets you read process values, for example, for editing in spreadsheet programs.

Access to archive databases with ADO/OLE DB

The process values are partially saved in compressed format to the archive databases. Use the WinCC OLE DB Provider to access such compressed process values. You can use the Visual Basic or Visual C++ programming languages, for example.

Note

Note that the table structure may vary in a new WinCC version when directly accessing the archive database using ADO/OLE DB.

For additional information, refer to the Microsoft MSDN Library "Win32 and COM Development > Data Access and Storage > Windows Data Access Components SDK" available on the Internet at:

- <http://msdn.microsoft.com/en-us/library/default.aspx> (<http://msdn.microsoft.com/en-us/library/default.aspx>)

Access to the archive database using OPC

OPC (OLE for Process Control) provides interfaces for communication with process automation systems. The OPC interface enables harmonized interconnection of devices and applications from different manufacturers. You can use WinCC as an OPC client to access process data or messages of an OPC server. WinCC can be used as OPC server to manage archive data.

For additional information, refer to:

- "WinCC Information System", "Communication" > "OPC",
- "WinCC Information System", "System Overview" > "Open Source"
- On the Internet at "<http://www.opcfoundation.org>"

Access to the archive database using C-API/ODK

You can use the "WinCC Open Development Kit" option to access WinCC data and functions by means of open source programming interfaces.

For additional information, refer to:

- Documentation on the WinCC Open Development Kit

See also

How to Configure a Message Archive Report (Page 1367)

How to Configure Reloading of Messages Following a Power Failure (Page 1366)

How to Display Archived Messages in Runtime (Page 1364)

Output of Message Archive Data in Runtime (Page 1363)

<http://msdn.microsoft.com/en-us/library/default.aspx> (<http://msdn.microsoft.com/en-us/library/default.aspx>)

5.5.4 Message Server

Introduction

When using WinCC to configure a client/server system, you have the option to configure different scenarios for message archiving.

Archiving on WinCC Servers

The messages are archived on every server (2) in a client/server system. All Runtime applications including archiving run on each server. The clients (1) have access to the message archives on the servers.

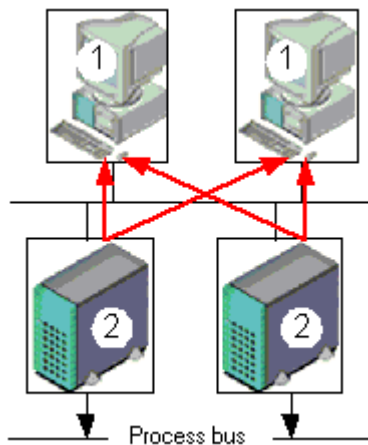

Use this configuration, if each server is dedicated to a certain section of the plant. Each server thereby monitors a specific section of the plant, and manages its own messaging and archiving system.

Archiving on archive servers without a process driver connection (server/server communication)

Archiving on a central archive server (3) on which the message archives (and process value archives, if any) are stored. The only programs run on the archive server are the archiving applications. The archive server receives the data to be archived from the servers (2). The clients (1) access the archive server (3) to display archived data. All other Runtime data is provided by the servers (2):

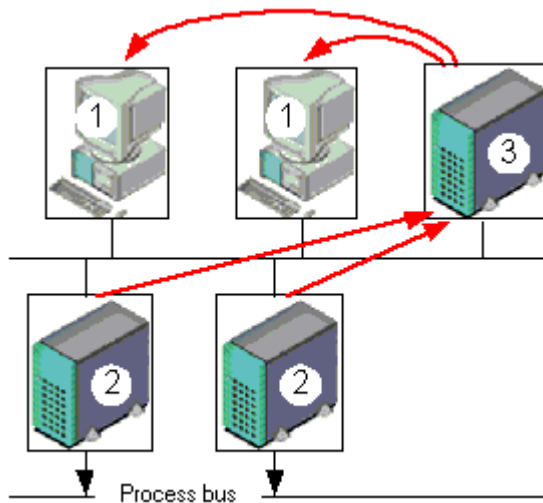

Note

This configuration cannot be implemented for message archives in a PCS7 environment, as messages are generated separately on each server and cannot be brought together on a single server.

For additional information, refer to the WinCC documentation "Client/Server Systems" and "Redundancy".

See also

Output of Message Archive Data in Runtime (Page 1363)

Configuration of Message Archiving (Page 1352)

Message Archiving in WinCC (Page 1351)

5.6 Display of Messages during Runtime

5.6.1 WinCC AlarmControl

Introduction

WinCC AlarmControl is a message window used to display message events. All messages are displayed in a separate message line. The content of the message line depends on the message blocks to be displayed.

Lists in the message window

You have the option of viewing six different lists in the message window:

- Message list to view currently activated messages.
- Short-term archive list, to view archived messages. The display is updated immediately after activation of new messages.
- Long-term archive list, to view archived messages.
- Lock list, to view currently locked messages.
- Hitlist, to view statistics data.
- List of messages to be hidden, to view hidden archived messages.

The figure below shows an example of a message list:

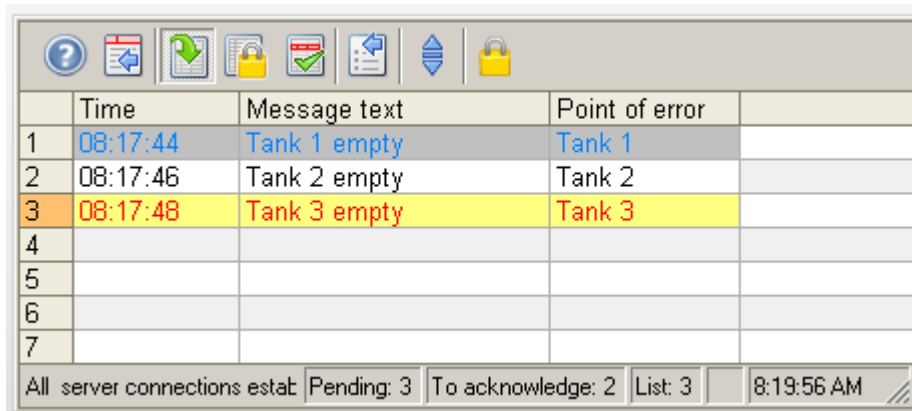

	Time	Message text	Point of error	
1	08:17:44	Tank 1 empty	Tank 1	
2	08:17:46	Tank 2 empty	Tank 2	
3	08:17:48	Tank 3 empty	Tank 3	
4				
5				
6				
7				

All server connections estat Pending: 3 To acknowledge: 2 List: 3 8:19:56 AM

Note

A message is shown with a crossed-out date and time stamp in the message list if any of the following events are triggered:

- A locked message is released again. The date and time stamp shows the OS time. This also applies to chronological reporting.
Associated values for a message are shown as "??" after they are unlocked.
 - A message is reloaded after power failure. This only applies to chronological reporting.
 - The AS is restarted. This only applies to chronological reporting.
-

See also

Short Description of the WinCC Controls and Additional Controls (Page 749)

5.6.2 Configuring the AlarmControl

5.6.2.1 How to configure the AlarmControl

Introduction

The messages are displayed in a message window in runtime.

You can configure a corresponding WinCC AlarmControl in Graphics Designer.

Requirement

- A message system has been set up using the "Alarm Logging" editor.
- You configured the necessary message blocks, message classes and the message types according to requirements configured in "Alarm logging".
- You configured the necessary single messages and message groups and their properties in "Alarm logging".

Configuration steps

1. Insert the WinCC AlarmControl into a picture of the Graphics Designer.
2. Configure the basic properties of the AlarmControl in the "General" tab.
 - The message window properties
 - The general properties of the control
 - The time base of the control
 - The default sorting order in the table
 - Properties of the long-term archive list
 - The action to be triggered by double-clicking in the message line
3. Configure the content of the message lines in the message window.
The content of the message line depends on the configuration of the message blocks.
Go to the "Message blocks" tab.
4. Select the "Message lists" tab to define the message blocks to be shown as columns in the message window.
Use the selection dialog to define the messages to be displayed in the message window.
5. Configure the layout and properties of the message window in the "Parameter", "Effects" and "Selection" tabs.
6. Configure the toolbar and the status bar of the message window.
7. Configure a hitlist if you want to view message statistics.
8. Configure the display for the operator input messages to adapt these as required.
9. Save your configuration data.

See also

How to determine the selection in the message window (Page 1379)

How to determine the sorting in the message window (Page 1382)

5.6.2.2 How to configure the message blocks

Introduction

The message content to be displayed in the message line depends on the message blocks configured. The message blocks configured in the "Alarm logging" editor can be applied without changes, or be configured in AlarmControl.

Requirements

- You created a message system using the "Alarm Logging" editor.
- In "Alarm logging", you configured the message blocks to be used in the message line.

Configuring existing message blocks

1. Go to the "Message blocks" tab in AlarmControl. All of the message blocks configured in the "Alarm logging" editor are listed in "Available message blocks". The message blocks for the hitlist are also listed.

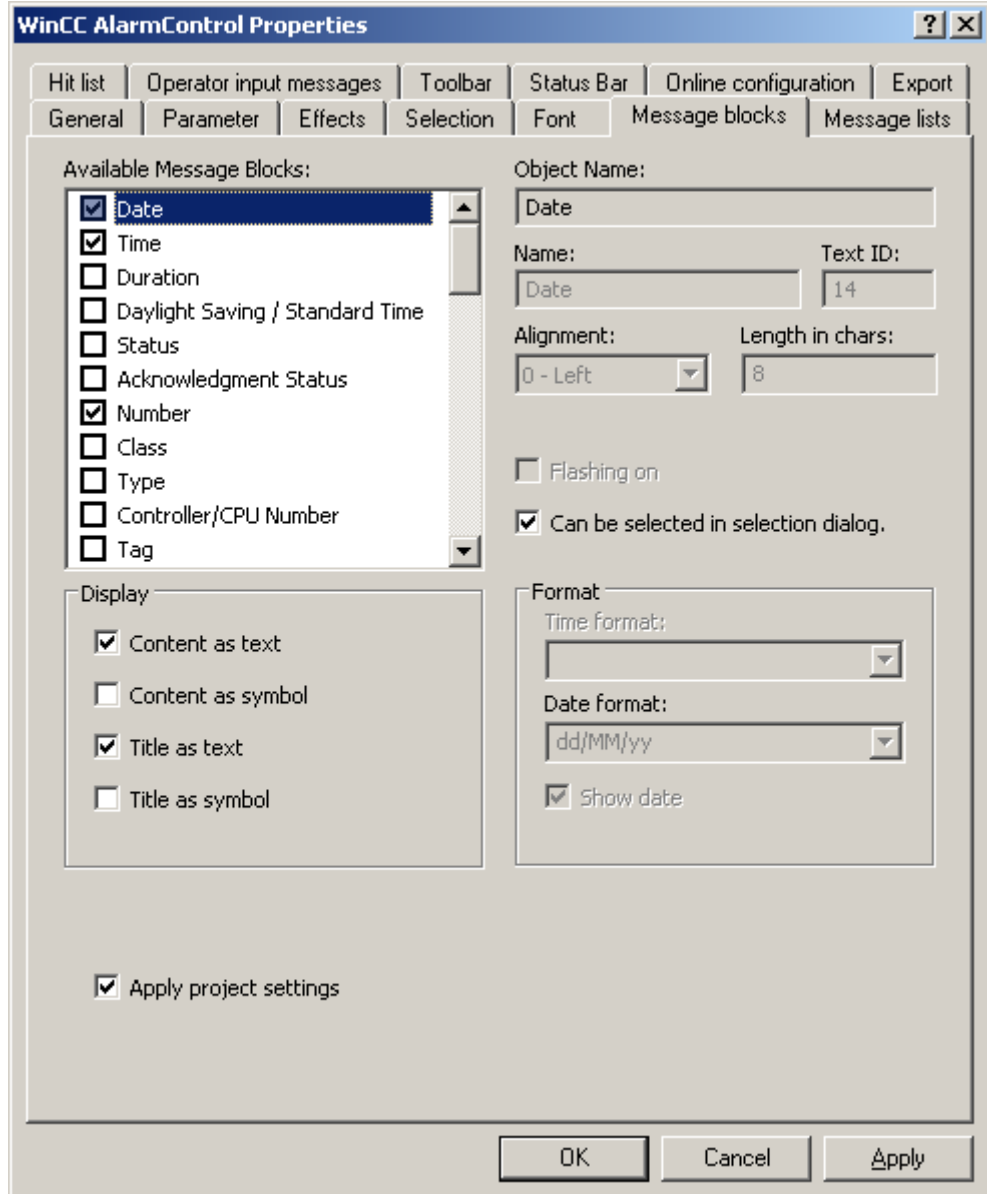

2. If the "Apply project settings" option is activated, the message blocks and their properties you configured in "Alarm logging" are activated in the AlarmControl. The message blocks are displayed with these properties in the message window and can only be changed by means of the Alarm logging. The message blocks of the hitlist depend on "Alarm logging". You can configure these message blocks as required.
3. Deactivate the "Apply project settings" option to let you add or remove message blocks for the message lists, or to configure message block properties. The changed properties are stored in the picture. Changes to properties made in "Alarm logging" are ignored in this control.

5.6 Display of Messages during Runtime

4. Activate the check box next to the name of a message block to be used in the message window in the "Available message blocks" list.
5. A selected message block can be set as criterion in the selection dialog by activating the "Selectable in selection dialog" option for this message block.

Message block names

1. You can assign the message blocks custom names for the column header in the message window. Remove the text ID and enter a name in the "Name" field. The name is saved to the picture in the currently active language.
2. Use a corresponding entry from the text library for multi-lingual functions and for the message block names in all pictures. Enter an existing text ID from the text library in the "Text ID" field. The text ID stored in the text library is entered in the "Name" field. In the "Alarm Logging" editor, the text ID is displayed in the "Message block (ID)" field.

Displaying message blocks

1. Resize the message block width in the message window as required. Enter a value in the "Length in chars" field.
2. Use the "Display message colors" to determine whether or not to display the message block colors as in the central setting for the AlarmControl, or otherwise.
3. With activated "Flashing on" option, you can specify that the content of a message block flashes when a message is output at runtime.
4. Certain message block can also display the content and heading in the column of the message view as icon. The content of the "Status" message block, for example, can be displayed using the "Came In", "Came In/Went Out" und "Came In/Acknowledged" icons, etc. Specify how these message blocks are displayed in the "Display" field. The text and icons can be displayed in parallel.
5. You can format certain message blocks. Select the message block from the "Available message blocks" list. Define the format in the "Format" field.
6. Save the configuration.

5.6.2.3 How to specify message window contents

Introduction

All messages are displayed in a separate message line in the message windows.

The content of the message window is determined by the message blocks and messages selected.

On the "Message lists" tab, define the content of the message window.

Requirement

- You created a message system using the "Alarm Logging" editor.
- You configured the message blocks to be used in the message line.

Select message blocks

1. Go to the "Message lists" tab.

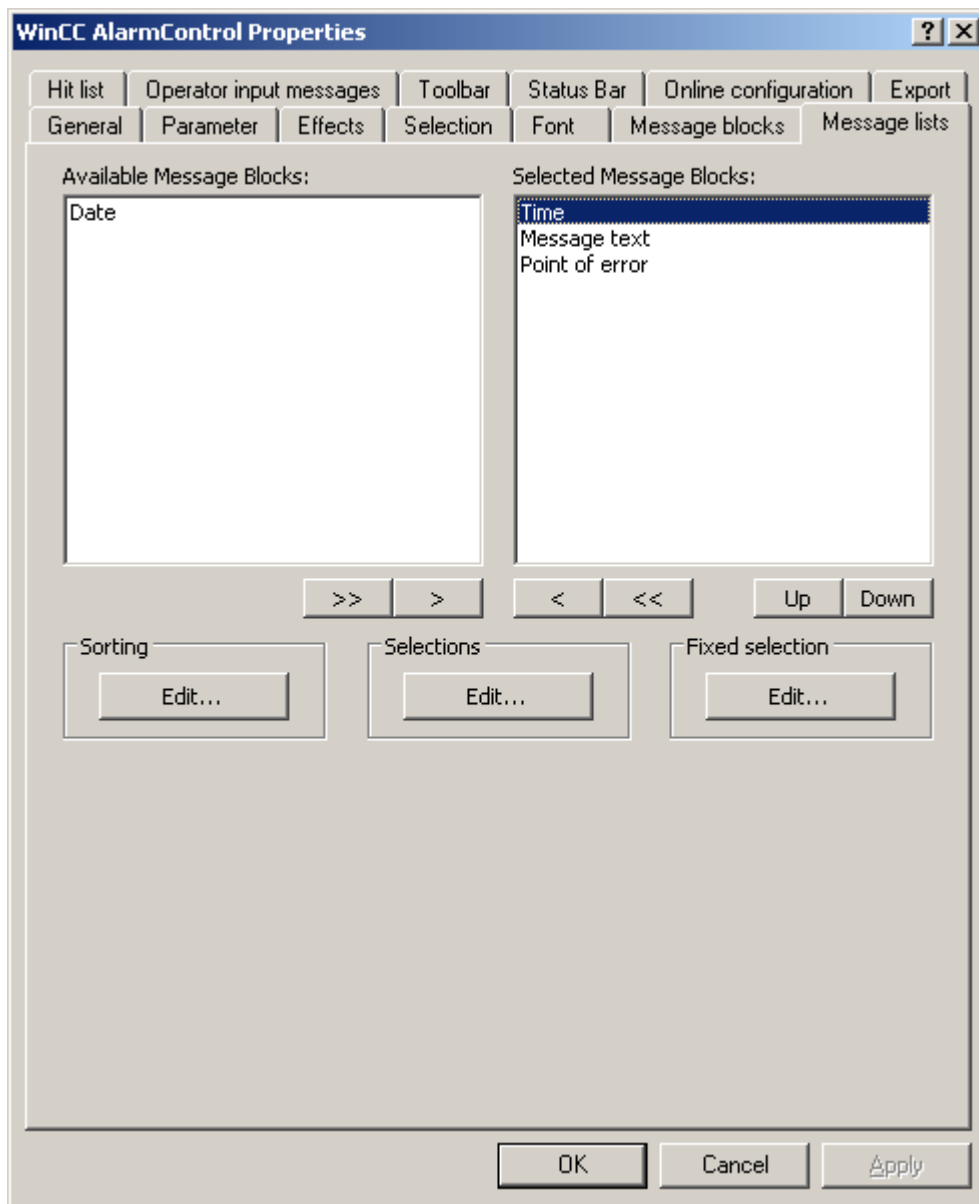

2. Select the "Available message blocks" list and select the configured message blocks to be displayed in the message lists:
Use the arrow buttons to move these message blocks to the "Selected message blocks" list.
Using the arrow buttons, you can cut selected message blocks from the message lists and paste these to the "Available message blocks" list.
3. You can define the sorting order of selected message blocks in the message lists and move these using the "Up" and "Down" buttons.
4. Save the configuration.

Result

You have specified the content of the message window.

Information on user-defined filters and on the sorting order is available at:

- How to determine the selection in the message window (Page 1379)
- How to determine the sorting in the message window (Page 1382)

See also

How to select messages in Runtime (Page 1412)

How to Sort the Display of Messages (Page 1418)

How to determine the selection in the message window (Page 1379)

How to determine the sorting in the message window (Page 1382)

5.6.2.4 How to determine the selection in the message window

Configuring selections

All messages are displayed in a separate message line in the message windows. The message blocks are displayed in the columns.

To display only selected messages in the message list, configure the user-defined filter in the Selection dialog.

The filters define which message blocks criteria must be fulfilled to display the message.

Select the configured selections during runtime using the toolbar. You can also create new selections or edit existing selections.

Fixed and user-defined selections

You can configure one fixed selection and several user-defined selections:

- The configured "fixed selection" is always used in the message list in Runtime. The fixed selection applies only to the configured AlarmControl.
- A user-defined selection is only used during runtime if the selection is enabled. The user-defined selections are created project-wide and can be selected for all AlarmControls.

Linking of fixed and user-defined selections

Any activated custom selection used is logically linked with the fixed selection you are using by means of "AND" operation.

Make sure that the criteria of the fixed selection are more general than the criteria of the user-defined selections.

Importing user-defined selections

You can import user-defined selections from another WinCC project. Importing selections does not require an export.

The import is used, for example, to reuse selections made by the user in other projects or to supply clients with the selections of the server project.

Note

Import overwrites existing selections

Previously created selections in the WinCC project are overwritten by the imported selections.

The originally created selections are then deleted.

Procedure

1. In the "Selections" dialog, click "Import".
2. In the selection dialog, select the WinCC project folder from which you want to import the selection.
3. Confirm with OK.
The selections of the selected WinCC project are displayed.
4. Click "OK" to import the selections.
Previously created selections are overwritten in the open WinCC project.
To cancel the import, click "Cancel". The previously created selections are retained.

Authorizations for selection processing

When you create a user-defined selection you can specify the user authorization required for editing the selection.

This selection can only be changed or deleted during runtime by authorized user with the corresponding authorization level.

Prerequisite

- You created a message system using the "Alarm Logging" editor.
- You configured the message blocks to be used in the message line.
- You have configured the display of the message blocks.

Procedure

1. On the "Message lists" tab, click "Edit" in the "Selection" area.
The "Selections" dialog opens.

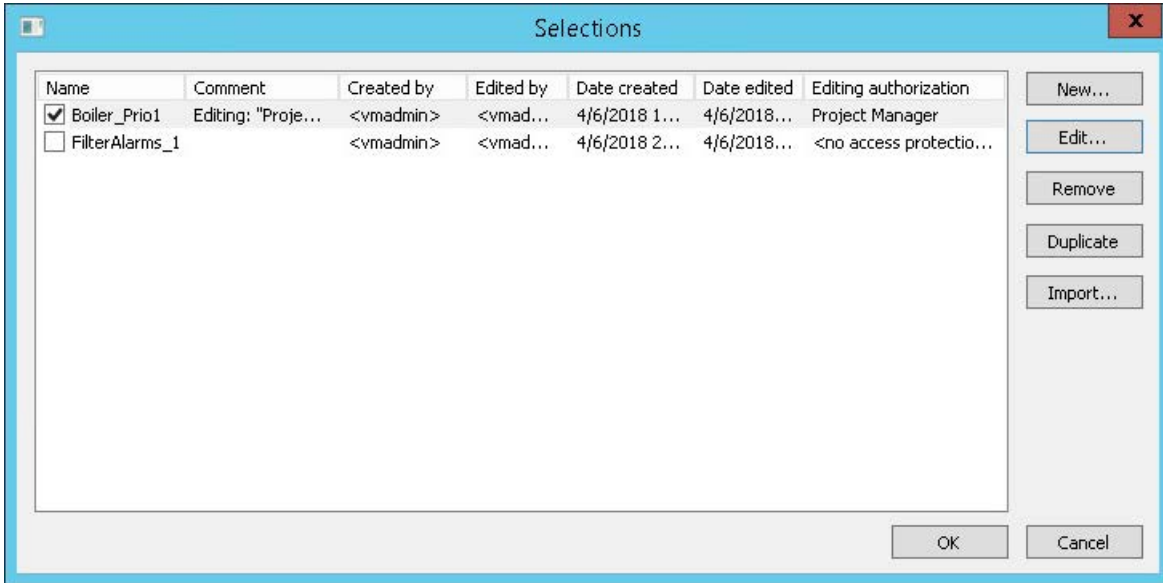

2. To create a selection, click "New".
The "Selection" dialog opens.

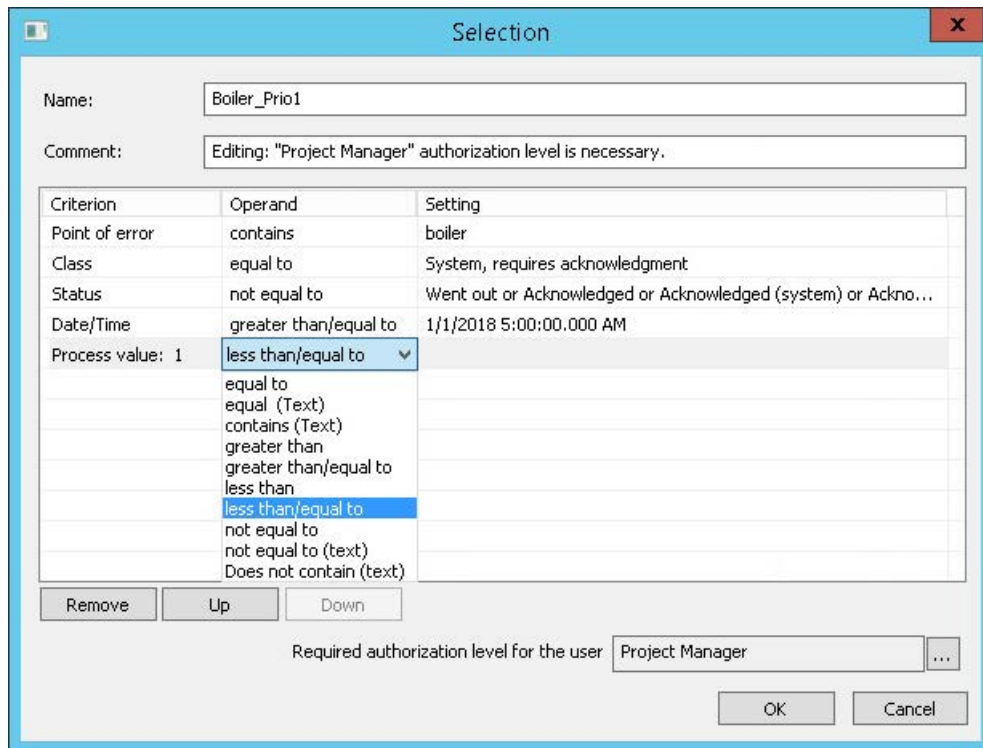

3. Enter a descriptive name for the selection and add a comment if required.

4. Configure the selection criteria:
 - In the "Criterion" column, select the relevant message blocks.
 - Select an operand in each case.
 - In the "Setting" column, enter a text or a value, or select an option.
5. If required, select an authorization level for editing the selection.
In runtime, only users with the appropriate authorization may change the selection.
6. Click "OK" to save the selection.
The selection is saved in the selections table.
7. Activate the required selections and confirm with "OK".
The activated selections are included in the message window at the start of runtime.
For more information on messages during runtime, refer to "How to select messages in Runtime (Page 1412)".
8. To create or edit a fixed selection, click "Edit" in the "Fixed selection" area.
The "Selection" dialog opens.
9. Configure the fixed selection:
 - Select the message blocks.
 - Select an operand in each case.
 - In the "Setting" column, enter a text or a value, or select an option.
10. Press "OK" to save the fixed selection and close the selection dialog.
The fixed selection is included in the message window at the start of runtime.
To change the view, the user can also enable a user-defined selection during runtime.

See also

How to select messages in Runtime (Page 1412)

How to specify message window contents (Page 1376)

How to configure the AlarmControl (Page 1373)

SQL statements for filtering messages in AlarmControl (Page 1401)

How to determine the sorting in the message window (Page 1382)

5.6.2.5 How to determine the sorting in the message window

Sorting message lists

All messages are displayed in a separate message line in the message windows. The message blocks are displayed in the columns.

With default sorting the messages are sorted in descending sequence by date, time and message number during runtime. The most recent message is displayed at the top.

To change the sequence, configure a user-defined sorting. You can also sort by message blocks that are not displayed in the message window.

Sorting in Runtime

In Runtime you have the following options for sorting the message lists:

- Opening the Sort dialog via keyboard functions in the toolbar
- Double-click the column header

Sorting when Autoscroll is enabled

When the "Autoscroll" option is selected, the default sorting is applied during runtime.

To use the configured sorting even when Autoscroll is enabled, select the "Always" option in the sort dialog in the "Apply sorting" area.

Change default sorting

You can change the default sorting order by "date/time/number" to "message block/date/time/number".

Configure the "DefaultSort2Column" and "DefaultSort2" object properties accordingly:

- Define a message block and its object name in the "DefaultSort2Column" object property.
- Define the ascending or the descending sorting order in the "DefaultSort2" object property.

Prerequisite

- You created a message system using the "Alarm Logging" editor.
- You configured the message blocks to be used in the message line.

Procedure

1. Go to the "Message lists" tab.
2. Click "Edit" in the "Sorting" area.
The sorting dialog opens.

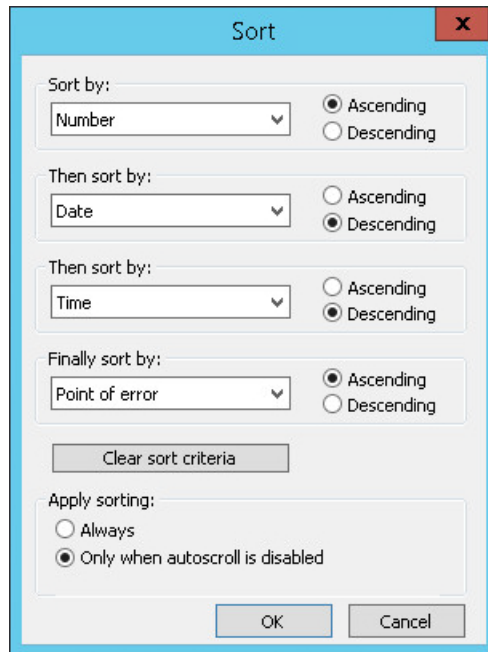

3. To define a sorting sequence, select the message blocks according to which sorting takes place.
For further information on sorting messages, refer to "How to Sort the Display of Messages (Page 1418)".
4. Click "OK" to close the sorting dialog.

See also

- How to Sort the Display of Messages (Page 1418)
- How to specify message window contents (Page 1376)
- How to configure the AlarmControl (Page 1373)
- How to determine the selection in the message window (Page 1379)

5.6.2.6 How to configure the display for the table

How to configure the properties of the table elements

Introduction

You can adjust the properties of the table elements in the WinCC controls to suit requirements.

Prerequisite

- You opened Graphics Designer and configured a picture with a WinCC control.
- The configuration dialog of the WinCC control is open.

Procedure

1. Go to the "Parameter" tab.

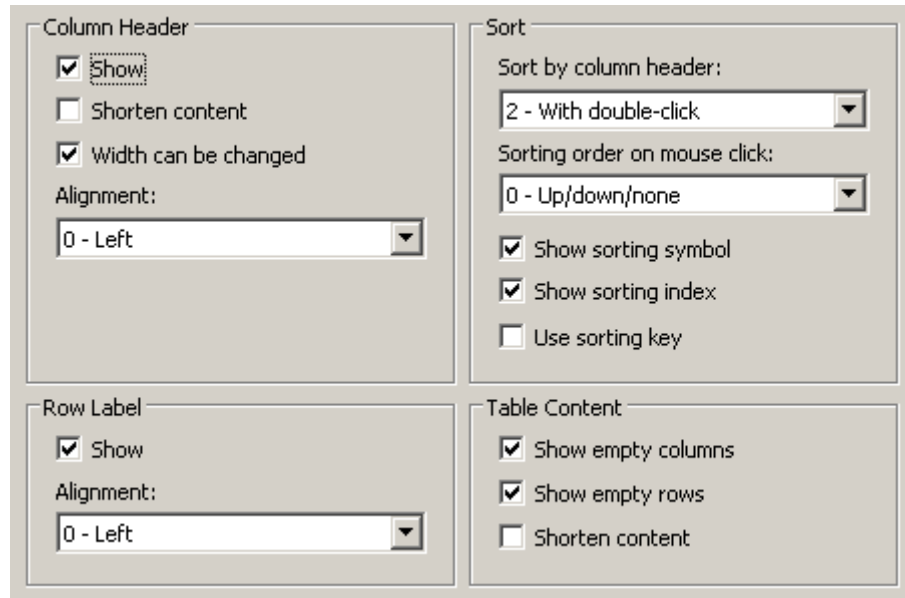

2. Specify the properties for
 - Column Header
 - Row label
 - Sorting
 - Table Content
3. Save the configuration.

How to configure the colors of the table elements

Introduction

You can adjust the colors of the table elements in the WinCC controls to suit requirements.

Requirement

- You opened Graphics Designer and configured a picture with a WinCC control.
- The configuration dialog of the WinCC control is open.

Procedure

1. Go to the "Effects" tab.



2. Define the colors for the background or text here for:
 - Table content. You can define different colors for even and odd line numbers to improve differentiation between both.
 - Contents of the table header
 - Separating lines in the table and for table headers
3. Define the color and the line weight in the "General" area in terms of:
 - Control borders
 - Window dividers for control elements
4. Save the configuration.

How to configure the marking of the selected cells and lines

Introduction

You can customize the marking of the selected cells and rows in the WinCC control to suit requirements.

Prerequisite

- You opened Graphics Designer and configured a picture with a WinCC control.
- The configuration dialog of the WinCC control is open.

Procedure

1. Go to the "Selection" tab.

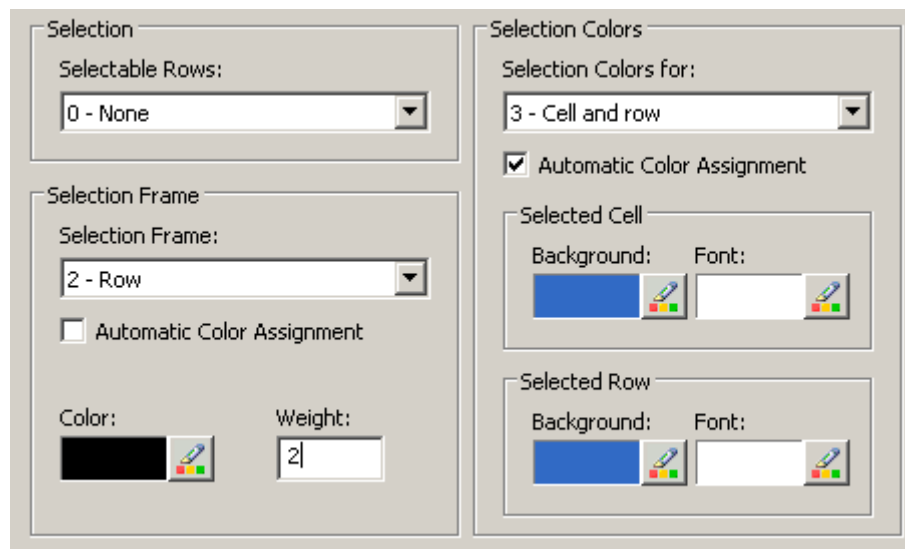

2. Define whether to select rows or only cells using the mouse.
3. Configure the properties of the selection rectangle that can be displayed around selected table cells or rows.
4. Configure the marking color for selectable cells and/or rows. The system colors are used for marking with "Automatic coloring" property.
5. Save the configuration.

How to configure sorting via the column heading

Introduction

You can adjust the sorting order by means of table column header in the WinCC controls to suit requirements.

Prerequisite

- You opened Graphics Designer and configured a picture with a WinCC control.
- The configuration dialog of the WinCC control is open.

Procedure

1. Go to the "Parameter" tab.

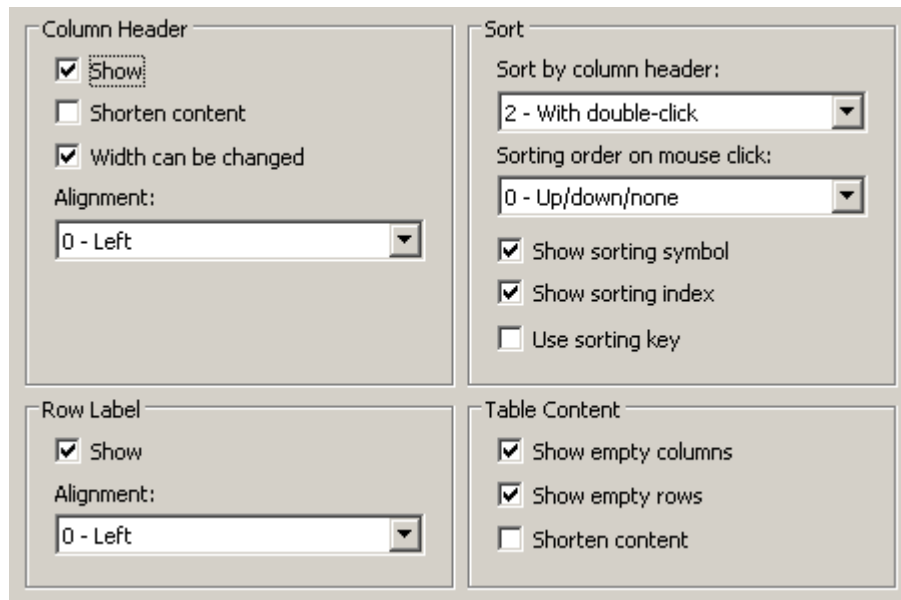

2. Define whether to enable sorting and the sorting method by column header. In WinCC AlarmControl, you can only sort by column header if the "Auto-scrolling" is disabled. You can deactivate "Auto-scrolling" either in the "General" tab, or using the "Autoscroll" toolbar icon of the WinCC AlarmControl.
3. Determine the sorting order by mouse click on the column header. Select ascending, descending or no sorting order.
4. Configure the sorting icon and index to be displayed in the column header with right justification. These show the sorting order and sequence of the columns.
5. Activate the "Use sorting key" to display the sorting icon as sorting button above the vertical scroll bar. Click this sorting key to activate a configured sorting order for the column selected. The sorting key is not displayed if a vertical scroll bar is missing.
6. Save the configuration.

5.6.2.7 How to configure the toolbar and the status bar

Introduction

The WinCC controls are operated at runtime using the functions of the toolbar buttons. The status bar contains information pertaining to the current status of the WinCC control. You can adapt the toolbar and the status bar for all WinCC controls when configuring, or at runtime.

Requirement

- A picture showing a WinCC control is opened in Graphics Designer when configuring.
- The WinCC control is assigned the "Configuration dialog" button function for opening the configuration dialog in Runtime.
- The configuration dialog of the WinCC control is open.

How to configure the toolbar

1. Go to the "Toolbar" tab. In the WinCC AlarmControl, for example:

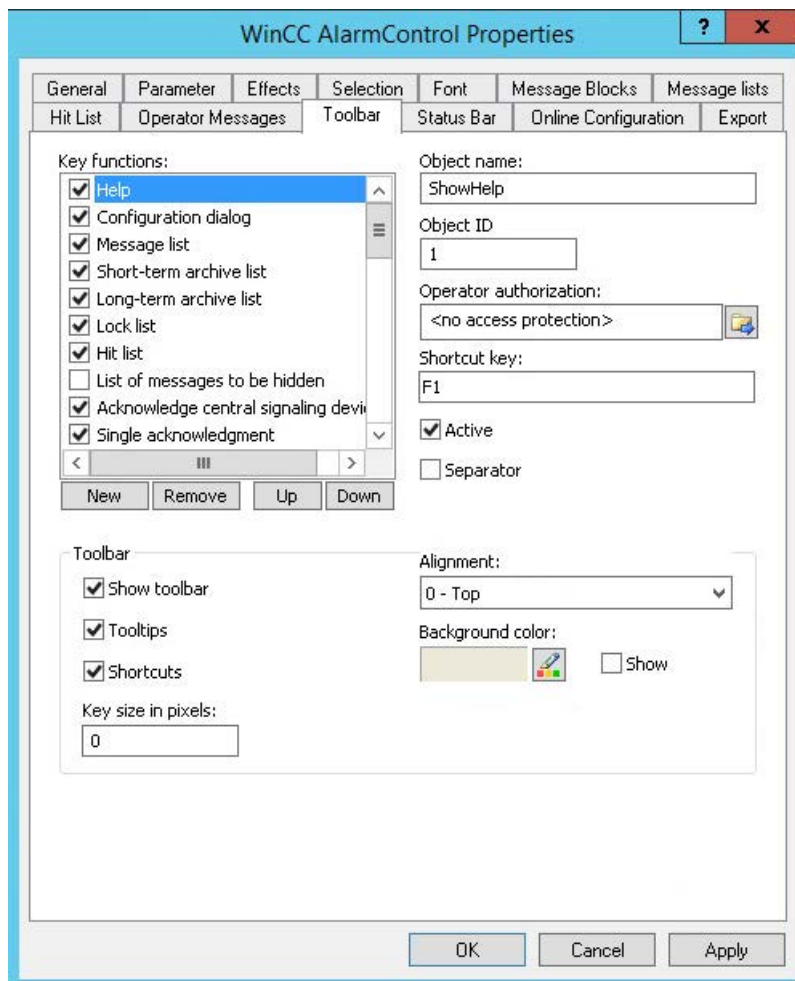

2. In the list, activate the button functions you require for operating the WinCC control in Runtime. For information on the button functions, refer to the description of the corresponding WinCC control at "Operation in runtime".
3. Determine the sorting order for displaying the button functions in the toolbar. Select the button functions from the list and the move the functions using the "Up" and "Down" buttons.
4. Define a shortcut key for the functions of the toolbar buttons.
5. Any button functions assigned operator authorizations are only available in Runtime to authorized users.

5.6 Display of Messages during Runtime

- 6. An activated button function is displayed during runtime if you deactivate its "Active" option, however, it cannot be operated.
- 7. You can set separators between the button functions. Activate the "Separator" option for the button function to be restricted by separator.
- 8. Configure the general properties of the toolbar, e.g. alignment or background color.
- 9. Change the button size as required. The standard setting is "0" and corresponds to the original size of 28 pixels. You can specify 280 pixels as maximum value.
The following behavior results for the button size depending on the configured value:

Value of the button size	Behavior
Value < 0	Invalid value. The most recent valid value is used.
$0 \leq \text{value} \leq \text{original size of button}$	The original size of the button is used. The value is set to the default (= 0).
Original size of the button < value \leq maximum value	The configured value is used.
Maximum value < value	Invalid value. The most recent valid value is used.

With a large button size, please note that in some cases not all buttons may be displayed in the control. To show all activated buttons in Runtime, you must therefore extend the control or activate fewer buttons as required.

How to configure the status bar

1. Go to the "Status Bar" tab. In the WinCC AlarmControl, for example:

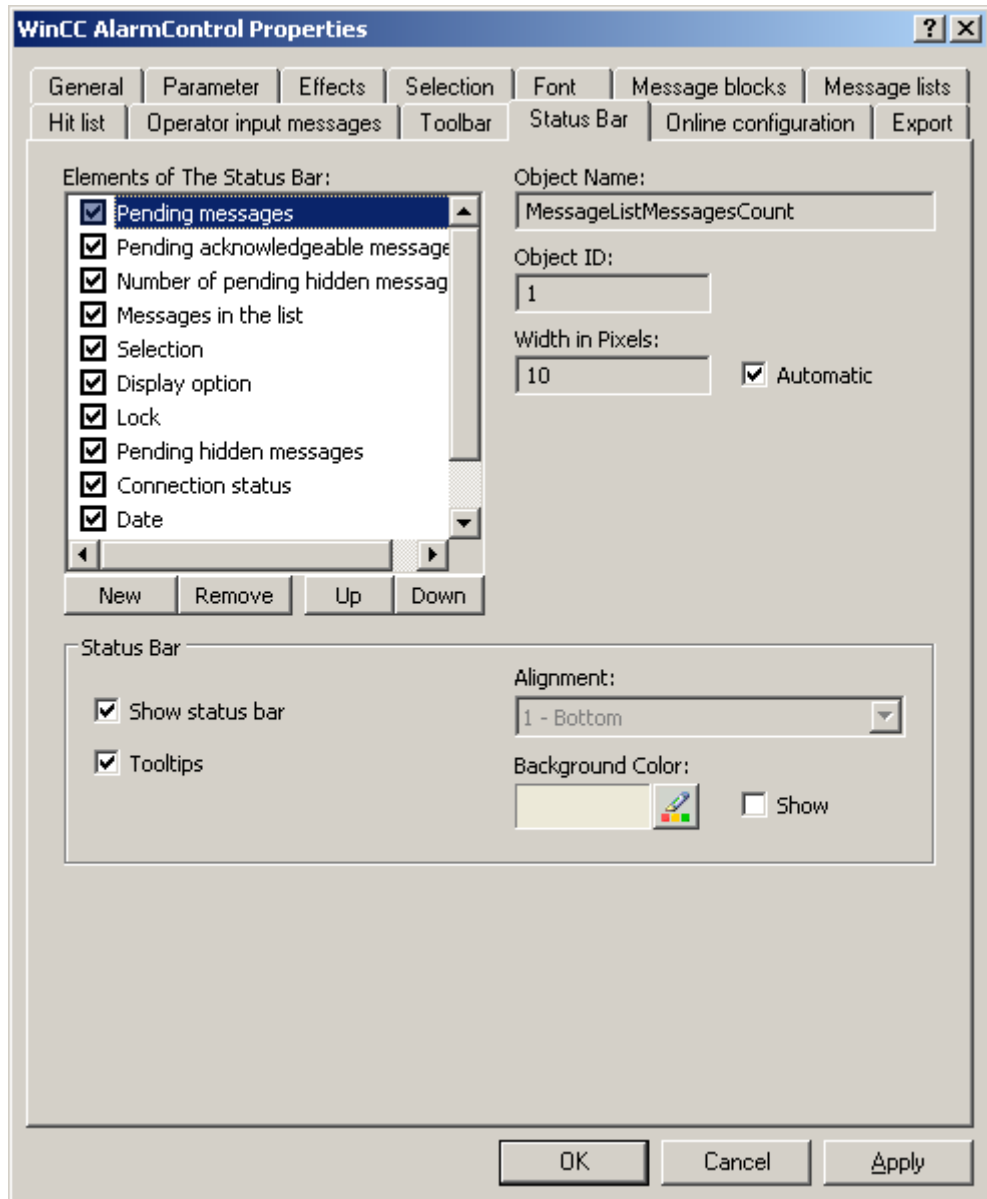

2. Activate the elements required during runtime in the list of status bar elements. For further information on status bar elements, refer to the descriptions of the corresponding WinCC control at "Operation in runtime".
3. Determine the sorting order for displaying of the status bar elements. Select the elements from the list and move these using the "Up" and "Down" buttons.
4. To resize the width of a status bar element, deactivate the "Automatic" option and enter a pixel value for the width.
5. Configure the general properties of the status bar, e.g. alignment or background color.

5.6.2.8 How to Configure a Hit List of Messages

Introduction

The hit list displays statistic calculations for archived messages in the message window. In addition to statistics, the hit list can display configured message blocks. Modifiable contents with the format specifications "@...@" are not shown in the user text blocks.

Overview

Customize the hit list columns which consist of message blocks and statistics data.

The following statistic calculations are available for messages:

- Frequency of a message number. The frequency is only increased if the archive contains a message with "Came In" state. If the frequency of a message number in the selected message range is "0", an entry does not exist for this message number in statistics data.
- The cumulative duration of a message number for the status:
 - "Came In/Came In" (Message block: Sum +/+)
 - "Came In/Went Out" (Message block: Sum +/-)
 - "Came In/Initial Acknowledgment" (message block: Sum +/*1)
 - "Came In/Second Acknowledgment" (message block: Sum +/*2).
- The average duration of a message number for the states:
 - "Came In/Came In" (Message block: average +/+),
 - "Came In/Went Out" (Message block: Average +/-),
 - "Came In/Initial Acknowledgment" (message block: average +/*1)
 - "Came In/Second Acknowledgment" (message block: average +/*2).

Only the "Acknowledgment", "System Acknowledgment" and "Emergency Acknowledgment" states are included in the statistics calculation of acknowledgment times.

Note

Messages with "Acknowledgment", "System Acknowledgment", "Emergency Acknowledgment" and "Went Out" states are only included in the calculation of statistic data if the events available for statistics calculation include a corresponding, previous message with "Came In" state.

If only one acknowledgment is triggered for a message with initial or second acknowledgment, the acknowledgment time is included in the calculation of the cumulative and average duration of the "Came In/Initial Acknowledgment" and "Came In/Second Acknowledgment" states.

If Runtime is stopped/restarted several times and a message is pending during this time, for example, due to the external discrete alarm procedures or chronological reporting, then the message is entered several times in the archive with "Came In" state and included several times in the calculation.

Requirement

- You opened a picture which contains the AlarmControl in Graphics Designer.
- You configured the message blocks to be included in the hit list.
- You activated the "Hit List" button function on the "Toolbar" tab of the AlarmControl.

Procedure

1. Go to the "Hit list" tab.

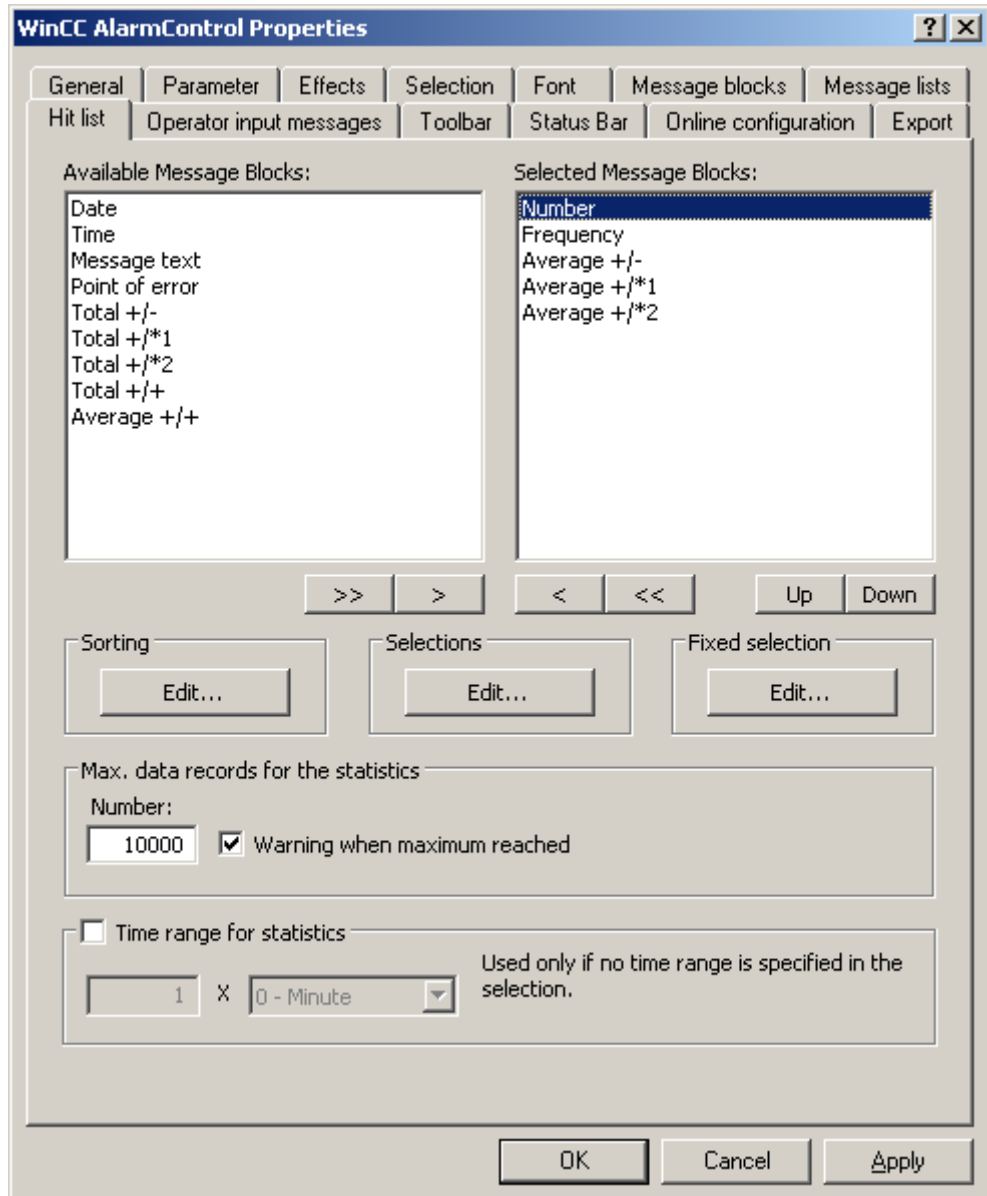

2. Select the message blocks to be displayed in the hit list from the list of available message blocks. Use the arrow buttons to move these message blocks to the "Selected message blocks" list. You can cut message blocks from the hit list and paste these to the "Available message blocks" list using the arrow buttons.

3. You can define the sorting order of message blocks in the hit list by selecting and then moving these using the "Up" or "Down" buttons.
4. Specify the criteria to be used for displaying messages in the hit list, such as a specific message class or a specific time range in the "Selection" area of the tab. All times are included in the calculation of average values if you have not specified a time range. Note that a long-range selection can adversely affect performance. Click the "Edit..." button to configure a selection or import it. The imported selection replaces the existing selection in this case. Importing selections does not require an export. You can also define selection criteria for the hit list in Runtime using the "Selection dialog" button. For further information on the selection of messages, refer to "How to select messages".
5. Define the sorting criteria for the hit list columns in the "Sorting" area of the tab, for example, first descending by date and then ascending by message number. Click the "Edit..." button to configure a sorting order. You can also define the sorting criteria for the hit list in Runtime by means of the "Sort dialog" button.
6. In the lower portion of the tab, define the settings in terms of quantity and time limits for the creation of statistics data.
7. Save the configuration.

Result

The hit list is configured for display in the message window. Call the hit list in Runtime by clicking  in the toolbar.

The values in the hit list are sorted by frequency in descending order if you have not set any sorting criteria.

New activated messages are not automatically included in the hit list. To include them, you must reselect the hit list.

5.6.2.9 How to configure operator messages

Introduction

Operation of a message can trigger an operator message.

Operator messages can be triggered at the following events:

- Lock message
- Release message
- Acknowledge message
- Hide message
- Unhide message

Configure operator messages in WinCC AlarmControl:

- If you want to use and adapt the default operator messages of WinCC
- If you want to use custom operator messages

Note**Operator messages: Message classes**

It is recommend to use message class "System, without acknowledgment" for all operator messages.

Always use message classes that are configured as "without status Went Out".

Archiving operator messages

Operator messages can only be logged if corresponding system messages are set up in the message archive.

Operator message triggering upon locking and unlocking a message

Operator messages triggered by locking and unlocking messages are always assigned

- a time stamp
- name of the logged on user
- the computer name in the message archive of the alarm server concerned

The time stamp for the message is derived from:

- the message source (e.g., AS), in the case of active locking and unlocking
- the alarm server (OS), in the case of passive locking and unlocking

Actively locked messages are visible and operable on all WinCC servers and clients.

Prerequisite

- You have enabled the use of WinCC system messages in the "Alarm Logging" editor.
- In the "Alarm logging" editor, you configured the messages editor to be used as operator messages in WinCC Alarm control.
- You opened Graphics Designer and configured a picture with a WinCC AlarmControl.
- The configuration dialog of the AlarmControl is open.

Procedure

1. Go to the "Operator input messages" tab.

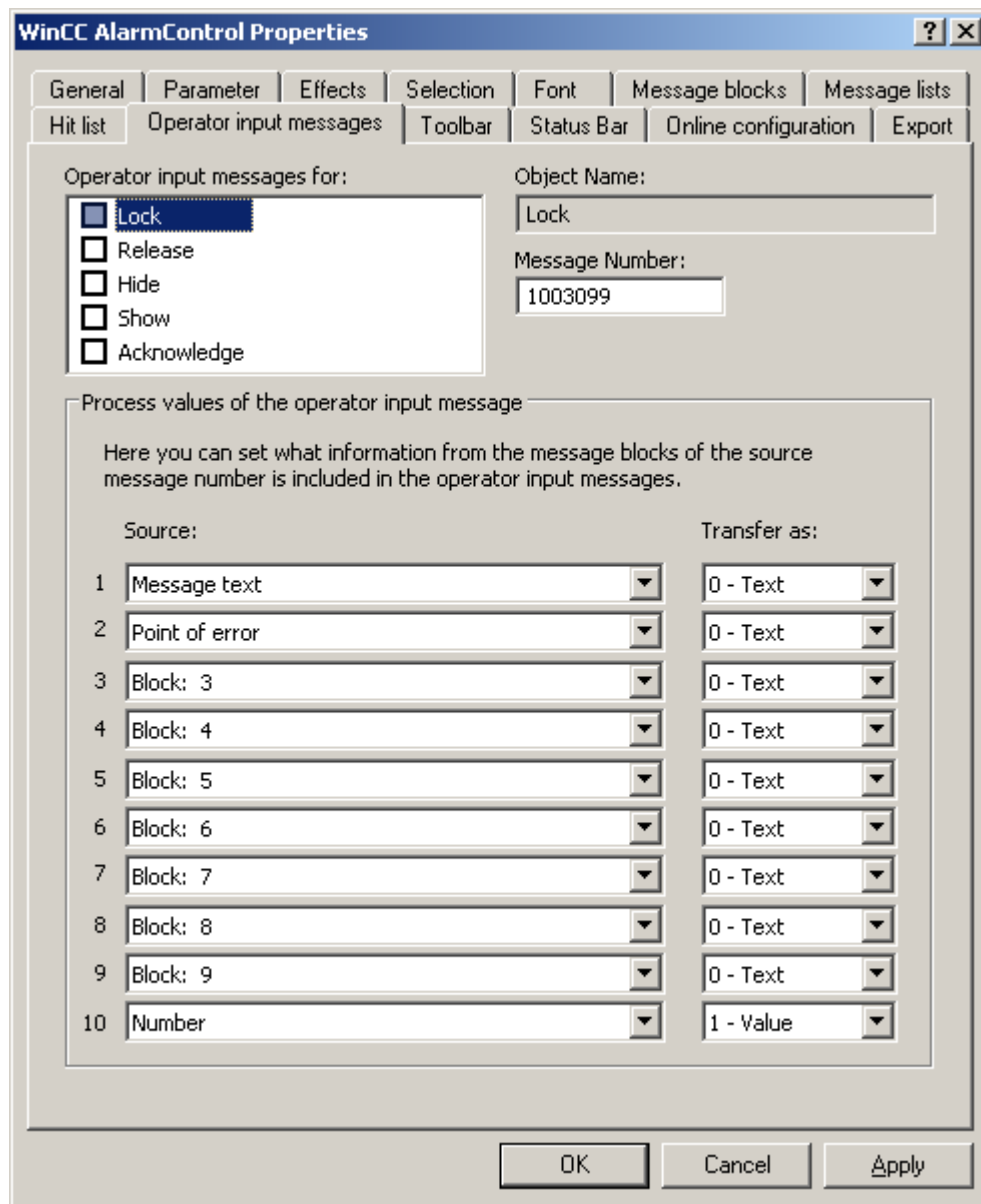

2. In the "Operator messages for:" list, activate the events that trigger an operator message.
3. If not using the operator messages from WinCC, enter the message number of the configured message for every event.
4. Assign the message blocks of the operated message to the process value blocks of the operator message.
The message blocks must be activated in the "Message Blocks" tab.
5. Define whether the contents are transferred as text or value.

Example

An operator message is to be generated on locking a message.

The content of "User text block 1" of the locked message, e.g. "Motor faulty", is to be displayed in "Process value block 1" of the operator message.

This requires that you select "1" under process value as the message block of operated message "User text block 1".

Results

The contents of operated messages are displayed in the updated process value blocks of the operator message.

The process value blocks must have been selected in the "Message Lists" tab to enable the display of process value blocks of the operator message.

The hitlist displays statistic data of the operator messages.

See also

How to Configure the Hiding of Messages (Page 1296)

How to Hide and Unhide Messages (Page 1421)

Operator messages (Page 1348)

5.6.2.10 How to export runtime data

Introduction

The runtime data shown in the WinCC controls can be exported using a button function. Set up operation of the data export during runtime in the configuration dialog.

Requirement

- A picture showing a WinCC control is opened in Graphics Designer when configuring.
- The configuration dialog of the WinCC control is open.

How to configure the operation of the data export

1. Go to the "Export" tab.

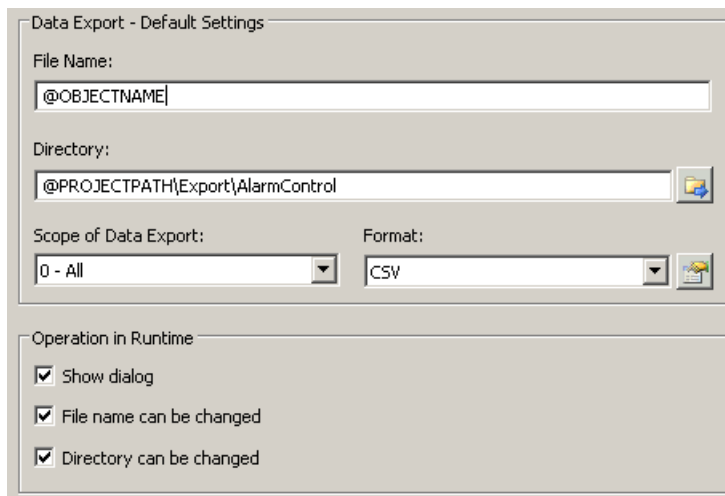

2. A standard file name and a standard directory are already entered in the "Data export default settings". In this case for AlarmControl. If necessary, define a file name and a directory for the export file.
The file name can be made up of the freely defined name and the following placeholder:
@OBJECTNAME - Object name of the controls
@CURRENTDATE - Current date
@CURRENTTIME - Current time
3. CSV is currently available as data format. Click  to specify the delimiter and data format in the CSV file.
4. Define the scope of the data export:
 - All runtime data is exported
 - Selected runtime data is exported. This data export is only possible in WinCC controls with tabular display.
5. Configure the operation of the data export during runtime. Define:
 - whether users are allowed to rename the file, or change the directory.
 - whether to display the "Data export default settings" dialog in Runtime.
6. If "Show dialog" is deactivated, the data for operation of the "Export data" button function is immediately exported to the defined export file.
7. Save the configuration.
8. Go to the "Toolbar" tab to activate the "Export data" button function for runtime.

Results

You can export all or selected data to a defined file at runtime using the  button function.

5.6.2.11 How to define the effect of the online configuration

Introduction

Users can parameterize the WinCC controls in Runtime. You must define the Runtime effects of the online configuration.

Changes configured in Runtime are saved for the specific user separately from the picture in the configuration system. The original picture configuration is retained in the configuration system.

Note

The picture is also replaced at Runtime if you save it in Graphics Designer, or when loading deltas in online mode. All online changes are lost.

The different configurations are only activated for new users after you performed a picture change.

Requirement

- A picture showing a WinCC control is opened in Graphics Designer when configuring.
- The configuration dialog of the WinCC control is open.

Procedure

1. Go to the "Online configuration" tab. For example, in OnlineTrendControl:

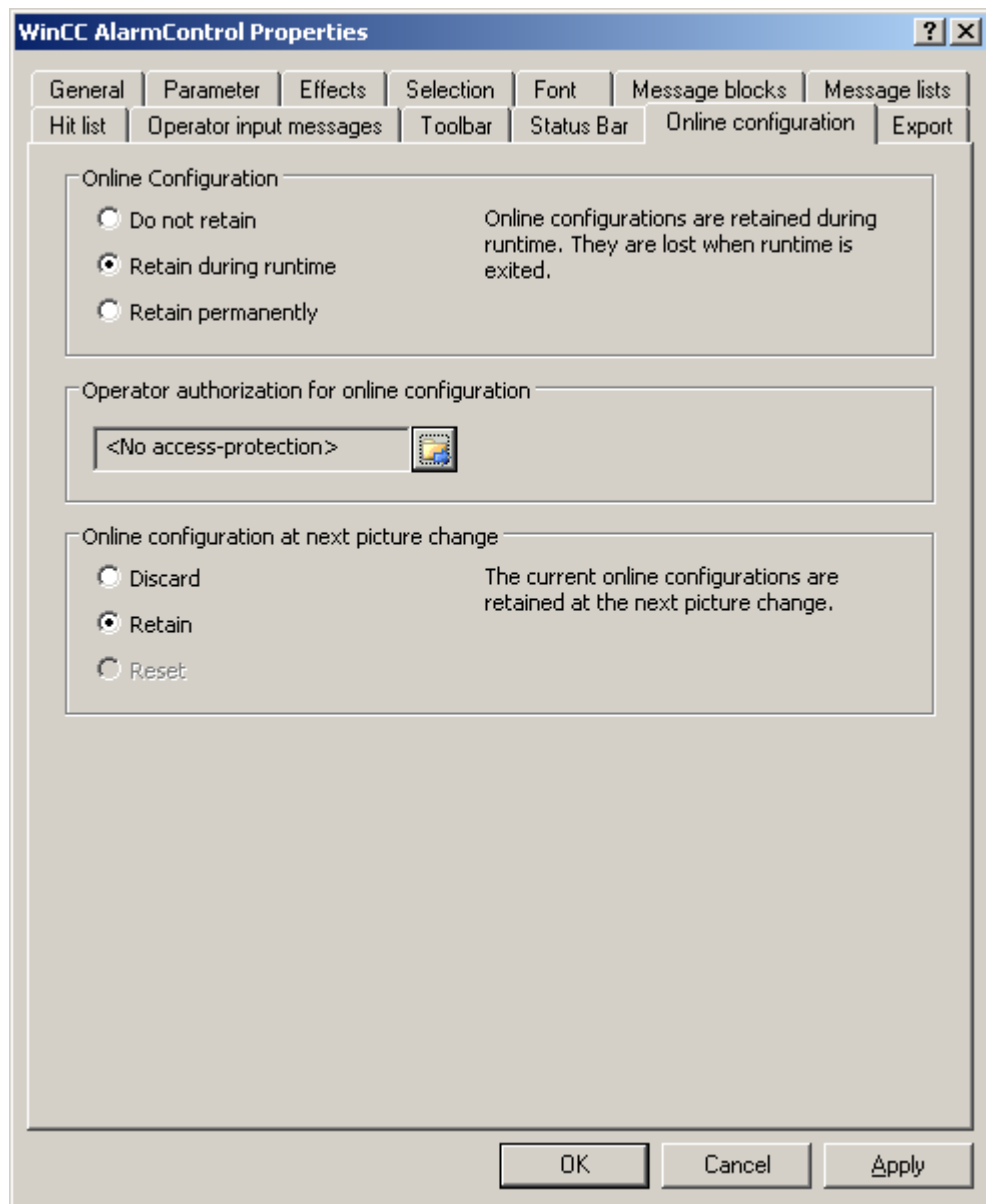

2. The option buttons of the "Online configuration" field for setting online configuration defaults are only available in the configuration system. The option buttons are not available in Runtime.

Select one of the three effects of the online configuration:

- "Do not retain". The online configurations are not retained in Runtime. This default setting disables all options for Runtime users. Online configurations are lost at the next picture change and on activation/deactivation of the project.

- "Retain during Runtime". This default setting enables the "discard", "retain" or "reset" options for Runtime users. Online configurations are retained at the next picture change if the "retain" option is enabled, however, these are lost on activation/deactivation of the project.
 - "Retain permanently". This default setting enables the "discard", "retain" or "reset" options for Runtime users. Online configurations are retained at the next picture change and on activation/deactivation of the project if the "retain" option is enabled.
3. Define corresponding user authorizations for online configuration.
 4. The option buttons of the "Online configuration on next picture change" can be enabled for operation in the configuration system and at Runtime by setting the "retain at Runtime" and "retain permanently" defaults. The "reset" operation is only available in Runtime, because the configuration system contains the original configuration.
Select one of three effects of the online configuration at the next picture change:
 - Select "discard" if to discard the online configuration at the next picture change.
 - Activate "retain" to activate the online configuration based on default settings at the next picture change or on activation/deactivation of the project.
 - Activate "Reset" if you want to apply the picture saved in the configuration system in Runtime. All online changes are lost.
 5. Save the configuration.

5.6.2.12 SQL statements for filtering messages in AlarmControl

Introduction

WinCC AlarmControl only supports SQL statements which can also be generated using the selection dialog of the message window. The following conditions apply to WinCC:

- The structure consists of "Field", "Operand", and "Value", with the individual parameters separated by blanks. For example: DATETIME >= '2007-12-21 00:00:00' AND MSGNR >= 100 (as of 2007-12-21, all messages with message number greater than and equal to 100).
- Strings, date, and time must be passed in single quotation marks.
- In the "DATETIME" argument, the date and time of day are separated by a blank. Regardless of the time base setting in the object properties, the output of "DATETIME" is based on the time base "Local Time". The "UTC" setting of the time base is an exception; the output is then based on the "UTC" time base.

Valid arguments

Name	SQL name	Type	Data	Example
Date/time	DATETIME	Date	'YYYY-MM-DD hh:mm:ss.ms'	DATETIME >= '2007-12-03 16:00:00.000' Outputs messages as of 12/03/2007, 16.00 hours.
Number	MSGNR	Integer	Message number	MSGNR >= 10 AND MSGNR <= 12 Outputs the messages with message numbers 10 - 12.
Class	Class	Integer	Message class ID 1-16 and system message classes 17 + 18	Class = 1 Outputs messages of message class 1. Class IN (1,2) Outputs messages of message class 1 and message class 2.
Type	Type	Integer	Message type ID 1-256 and system message types 257, 258, 273, 274	Type = 1 Outputs messages of message type 1. Type IN (1,2,3) Outputs messages of message type 1, message type 2 and message type 3.
State	State	Integer	Valid values: 1 = activated messages 2 = deactivated messages 3 = acknowledged messages 4 = blocked messages 10 = hidden messages 11 = displayed messages 16 = messages acknowledged by the system 17 = Emergency-acknowledged messages 18 = ackn. central signaling devices	State = 1 State IN(1,2,3,16,17)
Computer name	ComputerName	Text	Search text for the computer name	Computer name LIKE 'PC1234' Outputs messages whose computer name corresponds to "PC1234". Computer name LIKE '%C12%' Outputs messages whose computer name corresponds to "C12".
User name	UserName	Text	Search text for the user name	User name LIKE 'User123' Outputs the messages whose user name corresponds to "User123". User name LIKE '%er12%' Outputs messages whose user name corresponds to "er12".
Priority	Priority	Integer	Message priority 0 - 16	Priority >= 1 AND Priority <= 5 Outputs messages that have a priority between 1 and 5.
AS number (AS/CPU number)	AGNR	Integer	AS Number	AGNR >= 2 AND AGNR <= 2 Outputs messages with the AS number 2.

Name	SQL name	Type	Data	Example
CPU number (AS/CPU number)	CPU__NR	Integer	AS subnumber	CPU__NR >= 5 AND CPU__NR <= 5 Outputs messages with AS subnumber 5.
Instance	Instance	Text	Instance	-
Block: 1 ... block: 10	Textxx	Text	Search text for block: 1 - Block: 10	Text2 LIKE 'Fault' Outputs message whose block: 2 corresponds to "Fault". Text2 LIKE '%Fault%' Outputs message whose block: 2 contains the "Fault" entry.
Process value: 1 ... process value: 10	PValuexx	Double	Search value for process value: 1 - Process value: 10	PValue1 >= 0 AND PValue1 <= 50 Outputs messages with process value between 0 and 50.

Valid operands

- >=, <=, =, >, <, NOT
- IN(...): Several values as an array, separated by commas, e.g.: Class IN(1, 2, 3) AND Type IN(1, 2, 19, 20, 37,38)
- LIKE: The message text must match the string. The message text must only contain the string if this string is enclosed with "%" characters. The "LIKE" operand is only valid for "Textxx" arguments.

Invalid arguments and operands

Only the arguments defined in the table and the operands from the list are valid.

Grouping arguments, for example with brackets, is not permitted.

Note

If using SQL statements of versions older than WinCC V7 in the new WinCC AlarmControl V7, you possibly have to convert the operands and contents for "Textxx" arguments. Only the "LIKE" operand is used for "Textxx" arguments.

See also

How to determine the selection in the message window (Page 1379)

5.6.2.13 How to make the toolbar for the AlarmControl dynamic

Introduction

The default functions for operating the WinCC AlarmControl are no longer supported in the new WinCC AlarmControl for WinCC V7.0 or higher. However, you can use the dynamic methods of WinCC to operate the function of a toolbar button by means of script.

Overview

WinCC Controls V7.0 or higher no longer requires special functionality for operating the control by means of dynamic toolbar. The default functions "AXC_OnBtn..." and "OnBtn..." used previously are no longer supported.

If you do not want to operate the message window using the toolbar, you can set the "ID" of a button to the "ToolBarButtonClick" object property using any dynamic mode.

Determine a toolbar button "ID":

- using the table on page "Operation of the AlarmControl in Runtime".
- by means of the "Object ID" field of the "Toolbars" tab in the configuration dialog of the AlarmControl.

Example: Open the control configuration dialog

The following options of assigning dynamic properties are available for opening the control configuration dialog:

- VBScript:
 - `ScreenItems("Control1").ToolBarButtonClick = 2`
 - As an alternative to the "ToolBarButtonClick" property, you can use the VBS methods for operating the toolbar: `ScreenItems("Control1").ShowPropertyDialog`
 - Or, with the following notation and support of "Intellisense":

```
Dim obj
Set obj = ScreenItems("Control1")
obj.ShowPropertyDialog
```
- C script:
 - `SetPropWord(lpszPictureName, "Control1", "ToolBarButtonClick", 2);`
- Direct connection
 - Enter "2" as source constant in the direct connection dialog.
 - Select the "ToolBarButtonClick" property for the "Control1" object as the "Object in picture" target.

See also

Operating the AlarmControl in runtime (Page 1406)

5.6.2.14 How to adapt table elements and buttons of the controls

Introduction

You can change the design of the standard configuration for the WinCC controls and adapt the following elements in their appearance:

- Size and design of buttons
- Custom symbols for table elements of the table controls, for example, in the Alarm Control or OnlineTableControl
- Style of the scroll bar

Overview

The standard installation of WinCC creates the folder "CCAxControlSkins" for the design of the WinCC controls in "C:\Program Files(x86)\Common Files\Siemens\bin\".

To use modified designs, you need to create different subfolders within the "CCAxControlSkins" folder. The number and the name of the folder are determined by the elements you want to adapt in the respective controls .

The design of a control can then be selected as a "style" property in the configuration dialog of the control in the "General" tab.

You can also use project-specific designs. You need to create the folder structure in the "GraCS" folder of the project, e.g. in "C:\WINCCProjects\TestProject\GraCS\CCAxControlSkins". When a design folder with the same name already exists in the installation folder and in the project folder, the design of the project folder used as the "Style".

In order for the created symbols for table elements of a control to be visible, the "Content as symbol" option must be enabled for the appropriate columns. The "Apply project settings" option must be disabled in Alarm Control.

You can learn how to adapt the WinCC Alarm Control in WinCC Runtime Professional under Customizing the WinCC Controls (<https://support.industry.siemens.com/cs/de/en/view/76327375>)

Note

When creating a new design, you do not have to create all the files. For all of the files that are not present, the standard settings of the controls are used.

How to adapt table elements

The procedure is described using the example of table elements in the Alarm Control.

1. In the "CCAxControlSkins" folder, create a sub-folder, for example, "Table symbols".
2. Create a subfolder in this folder for the control, for example, "AlarmControl".
3. In the folder of the control, create a subfolder, for example, "GridIcons".
4. Create a "GridIcons" folder for each column of the table in which you want to display icons. No icons can be displayed for the date and time columns.

5. Rename the folder to the name of the object property, for example, "State" for the "State" column/message block in the Alarm Control.
6. You must save the graphics in the "State" folder with the respective state names in English, for example, "ComeQuit".
For the state for which you have saved a graphic, the new symbol appears in the table cell when the state occurs.
7. To display symbols for message numbers, for example, you can assign a graphic to each numerical value. For example, the respective number is highlighted in a certain color. Then the graphic name in the folder is "Number", for example, "5.png" for the number "5".
If you want to define a symbol for a specific interval, e.g. for the interval "50 - 100", the graphic name is "50_100.png". The limits are contained in the interval.
8. To display only icons instead of the text of a message block/column, you must specify a graphics file for each occurring text.
For example "Fault location": If an error occurs in the tank, a tank symbol appears. If a fault occurs at the valve, the symbol of a valve is shown.
9. Select the corresponding design in the "General" tab of the "Style" property in the configuration dialog of the control.

How to adapt the buttons of the toolbar

1. Create the "Toolbar" subfolder in the "CCAxControlSkins" folder.
2. Create the file "IconsNormal.png" in this folder.
3. In this file, insert the individual graphics of the buttons side-by-side in a row. For disabled buttons, use the file "IconsDisabled.png".
4. To use new graphics, you must adapt these files. You can use any graphics program of your choice for this.
The control reads the file, cuts it into individual graphics and displays the cut parts on the corresponding buttons.

How to adapt the scroll bar

1. In the "CCAxControlSkins" folder, create a subfolder, for example, "Scroll bar".
2. Create two subfolders in this folder, "Horizontal" and "Vertical".
3. You need to create a number of individual files within this folder to form the scroll bar when the program at runtime.

5.6.3 Operation during runtime

5.6.3.1 Operating the AlarmControl in runtime

Introduction

You operate the message window at runtime using the toolbar buttons.











If you do not want to operate the message window using the toolbar, you can set the "ID" of a button to the "ToolBarButtonClick" object property using any dynamic mode.

Overview















The overview shows all symbols in "standard" style.





If you want to create a design of the controls with "single" style, the display of the symbols corresponds to the AlarmControl before WinCC V7.

You can find an overview on the page: "Before WinCC V7: Display of Messages during Runtime > Operation during Runtime > Operation of Alarm Control during Runtime".

Icon	Description	ID
	"Help" Calls the WinCC AlarmControl help.	1
	"Configuration dialog" Opens the configuration dialog for editing the properties of the AlarmControl.	2
	"Message list" Lists currently active messages.	3
	"Short-term archive list" Lists the archived messages of the short-term archive list.	4
	"Long-term archive list" Shows the messages saved to the long-term archive list. In this view, you can display or edit the comments of the messages.	5
	"Lock list" Shows all messages locked in the system.	6
	"Hitlist" Displays the message blocks and the statistic data you configured on the Hitlist tab of the AlarmControl.	7
	"List of messages to be hidden" Shows all messages which were hidden automatically or manually in the message list.	8
	"Ackn. central signaling devices" Acknowledges a visual or acoustic signal generator.	9
	"Single acknowledgment" Acknowledgment of a selected and visible single message. If using the multiple selection, the selected messages which require single acknowledgment are not acknowledged.	10
	"Group acknowledgment" Acknowledges all active, visible messages which require acknowledgment in the message window, unless these require single acknowledgment. If you use the multiple selection, all marked messages are acknowledged, even if the messages are hidden.	11

	<p>"Emergency acknowledgment"</p> <p>Emergency acknowledgement of a message requiring acknowledgement. This function transfers the acknowledgment signal of a selected single message directly to the AS, even if this message is not activated. Acknowledgment of inactive messages only refers to messages which were configured in proper chronological order.</p>	18
	<p>"Selection dialog"</p> <p>Specifies the selection criteria for messages to be displayed in the message window. The messages which do not meet these criteria are not displayed but are nevertheless archived.</p>	13
	<p>"Display options dialog"</p> <p>Specifies the messages to be displayed in the message window. If the "All messages" option is activated, the message windows shows the hidden as well as displayed messages. If the "Only displayed messages" option is activated, only shown messages are displayed in the message window. If the "Only hidden messages" option is activated, only hidden messages are displayed in the message window.</p>	14
	<p>"Lock dialog"</p> <p>Defines the locking criteria. All messages that meet these criteria are neither displayed, nor archived.</p>	15
	<p>"Print"</p> <p>Start printing of the messages of the selected list. The print job used for printing is defined in the configuration dialog in the "General" tab.</p>	17
	<p>"Export data"</p> <p>Use this button to export all or selected runtime data to a CSV file. If the option "Display dialog" is enabled, a dialog opens in which you can view the export settings and start the export. With the relevant authorizations, you are also allowed to select the file and the directory for the export. If a dialog is displayed, the export of the data to the predefined file starts immediately.</p>	35
	<p>"Autoscroll"</p> <p>If "Autoscroll" is activated, the last message in chronological order is selected in the message window. The visible range of the message window is moved if necessary. Default setting is "enabled". New messages are not selected if "Autoscroll" is disabled. The visible range of the message window is not modified. Messages can only be selected explicitly if "Autoscroll" is disabled.</p>	12
	<p>"First message"</p> <p>The first of the currently active messages is selected. The visible range of the message window is moved if necessary. The button is only available if "Autoscroll" is disabled.</p>	19
	<p>"Previous message"</p> <p>The message activated previously to the currently selected message is selected. The visible range of the message window is moved if necessary. The button is only available if "Autoscroll" is disabled.</p>	20









	<p>"Next message"</p> <p>The next message relative to the currently selected message is selected. The visible range of the message window is moved if necessary. The button is only available if "Autoscroll" is disabled.</p>	21
	<p>"Last message"</p> <p>The last of the currently active messages is selected. The visible range of the message window is moved if necessary. The button is only available if "Autoscroll" is disabled.</p>	22
	<p>"Infotext dialog"</p> <p>Opens a dialog for viewing infotexts.</p>	23
	<p>"Comments dialog"</p> <p>Opens a text editor for entering comments</p>	24
	<p>"Loop-in-alarm"</p> <p>Shows a picture for the selected message or triggers a script.</p>	25
	<p>"Lock message"</p> <p>The selected message is locked in the message list and in the message archive list.</p>	26
	<p>"Release message"</p> <p>Enables messages selected in the lock list.</p>	27
	<p>"Hide message"</p> <p>Hides the message you selected in the message list, or in short-term or long-term archive list. The message is entered in the "List of messages to be hidden". When an operator message is triggered during hiding, the operator must give a reason for hiding.</p>	28
	<p>"Unhide messages"</p> <p>Reactivates the display of messages you selected in the "List of messages to be hidden" in the message list, or in the short-term or long-term archive list. The message is removed from the "List of messages to be hidden".</p>	29
	<p>"Sort dialog"</p> <p>Opens a dialog for setting custom sorting criteria for displayed messages.</p>	30
	<p>"Time base dialog"</p> <p>Opens a dialog for setting the time base for times displayed in the messages.</p>	31
	<p>"Copy rows"</p> <p>Copies the selected messages. You can paste the copy to the table editor or text editor.</p>	32
	<p>"Connect backup"</p> <p>Use this button to open a dialog for interconnecting selected backup files with WinCC Runtime.</p>	33
	<p>"Disconnect backup"</p> <p>Use this button to open a dialog for disconnecting selected backup files from WinCC Runtime.</p>	34
	<p>"First page"</p> <p>Returns you to the first page of the long-term archive list. The button is only available if paging is enabled in the long-term archive list. You can activate this setting in the "General" tab of the configuration dialog.</p>	36

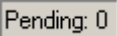

	<p>"Previous page"</p> <p>Returns you to the previous page of the long-term archive list. The button is only available if paging is enabled in the long-term archive list.</p> <p>You can activate this setting in the "General" tab of the configuration dialog.</p>	37
	<p>"Next page"</p> <p>Opens the next page of the long-term archive list. The button is only available if paging is enabled in the long-term archive list.</p> <p>You can activate this setting in the "General" tab of the configuration dialog.</p>	38
	<p>"Last page"</p> <p>Opens the last page of the long-term archive list. The button is only available if paging is enabled in the long-term archive list.</p> <p>You can activate this setting in the "General" tab of the configuration dialog.</p>	39
	<p>"Display alarm help"</p> <p>Displays the texts for the help that have been configured in the property of a message.</p> <p>The "Help" option must be enabled in the parameters of the message.</p>	40
	<p>"User-defined 1"</p> <p>Shows the first button function created by the user.</p> <p>The button function is user-defined.</p>	1001

Available status bar elements

The following elements can be output to the status bar of the message window:



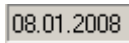
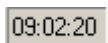



Icon	Name	Description
	Pending messages	Shows the number of current messages in the message list. The count includes messages hidden in the message list.
	Pending acknowledgeable messages	Shows the number of pending messages requiring acknowledgment.
	Number of pending hidden messages	Shows the number of pending messages that are hidden.
	Messages in the list	Shows the number of messages in the current message window.
	Selection	A message selection exists.
	Display option	The filter criteria is active. The "Display all messages" or "Show hidden messages only" option is currently active.
	Locked	The lock is set on messages.
	Pending hidden messages	There are hidden messages pending.

Icon	Name	Description
	Connection status	Shows the status of the connection to the alarm servers: <ul style="list-style-type: none"> • No connection errors • Faulty connections exist • All connections are faulty
	Date	Shows the system date.
	Time	Shows the system time.
	Time base	Shows the time base used for displaying times.











Possible symbols in the message lists

You can display symbols in the message list to represent certain message blocks. An overview of meaning of these symbols is provided below.





Symbols in the message list in the "Status" and "Acknowledge status" message blocks:

Icon	Meaning
	Message came in in the "Status" message block
	Message came in/went out in the "Status" message block
	Message came in/acknowledged in the "Status" message block
	Message acknowledged in the "Acknowledge status" message block

Icons in the short-term archive list in message block "Status":

Icon	Meaning
	Message came in
	Message went out
	Message acknowledged
	Message acknowledged by system
	Message is hidden
	Hidden message came in
	Hidden message went out
	Hidden message acknowledged
	Message is displayed again
	Emergency acknowledgment of message
	Message locked

Icons in the message lists of certain system blocks:

Icon	Meaning
	Indicates whether a system block property has been activated.
	The "Comment" system block indicates whether there is a comment for this message.
	The "Infotext" system block indicates whether there is an infotext for this message.
	Indicates whether Loop in Alarm has been activated at system block "Loop in Alarm"

5.6.3.2 How to select messages in Runtime

Introduction

You can use the selection dialog in Runtime to specify the messages to be displayed in the message window.

You define new selection criteria in the selection dialog, or select an already existing selection.

Unsupported acknowledgment states

Selection based on the "Acknowledged (emergency)" state is not supported for chronological reporting.

Selection based on the "Acknowledged (central signaling device)" state is not supported.

Selection dialog

The Selection dialog provides the following functions:

- Concise input of selection criteria.
- The "*" and "?" wildcards are supported for setting a criterion.
- Saving a selection enables reuse of the selection without having to reenter the selection criteria.
- Creating several selections.
- Duplicating a configured selection
- Linking specific selections in terms of a logical "OR" operation.
- A fixed selection is available that cannot be changed in Runtime.
The fixed selection and the active user-defined selections are logically linked by "AND" operation.
- All users are granted full access to all user-defined selections.
Selections can be protected against unintentional change in Runtime by assigning an authorization level.
- The SQL statements you created by means of scripting, or entered in the object property "MsgFilterSQL", are written to the list of selections and provided with a comment.

Testing a selection

Use the "Apply" button in Runtime to check the selection:

- Test all selections separately and before linking these, and then test the linked selections.
- Check that all expected messages are also displayed in combination.

This ensures that all selections are displayed in the AlarmControl.

NOTICE

Ensuring the display of all messages

Observe the proper use of criteria, operands and settings of selections.

Incorrectly linked criteria can lead to important messages not being displayed in the AlarmControl.

Note

Displaying messages from Process Historian

To display messages from Process Historian in WinCC AlarmControl, you must specify a time range in the Selection dialog.

If you did not specify a time range, only messages from the server are displayed.

Requirement

- You configured the "Selection dialog" button function on the "Toolbar" tab of the AlarmControl.
- You activated the message blocks that are available as the selection criteria on the "Message blocks" tab using the "Selectable in selection dialog" option.

Procedure

1. Click on  in runtime.
The "Selections" dialog opens.
2. Click "New..." to create a selection.
Alternatively, you can activate existing selections by clicking in the check box in front of the selection name.
3. When creating a new selection, assign a name to the selection and an expressive comment to distinguish it from other selections.
4. Click in the first empty row of the "Criterion" column.
The list with the selectable system blocks, configured user text blocks and process value blocks is displayed.
Select the message block.
5. Select the suitable operand using the "Operand" column.
6. Click in the corresponding row of the "Setting" column.
Depending on the text block, enter a text or a value, or select an option.

5.6 Display of Messages during Runtime

7. Click "OK".
The selection is saved and is listed in the table of selections.
You can create other selections or edit, remove or duplicate existing selections in the selection dialog.
If a fixed selection is configured, other activated selections and the fixed selection are logically linked by "AND" operation.
8. In the table, activate the selections to be included in the message window.
9. Click "Apply".
The message window shows the selected messages.
10. Click "OK" to close the selection dialog.

See also

How to determine the selection in the message window (Page 1379)

5.6.3.3 How to Lock and Unlock Messages

Introduction

Message locking suppresses the display and archiving of messages. You can set a lock for the following:

- Messages
- Message types
- Message classes
- Message groups

Authorizations in the User Administrator

Users who are authorized to lock and enable messages must have been granted both authorizations in the User Administrator, and these authorizations must be configured directly one below the other.

This is necessary because the authorization level defined below the authorization for "Lock Messages" in the User Administrator is used automatically as the authorization for enabling.

Note

S7-1500: AS messages not supported

Messages of a "SIMATIC S7-1500" controller cannot be locked.

Alarm_D- and Alarm_S messages not supported

The following Alarm_D and Alarm_S alarms cannot be locked:

- SFC 17 "ALARM_SQ" and SFC 18 "ALARM_S"
- SFC 107 "ALARM_DQ" and SFC 108 "ALARM_D"

Additional information is available in the manual titled "System Software for S7-300/400 System and Standard Functions".

Persistence of message locking



- The lock of messages is not persistent. Locked messages are unlocked automatically at the restart of WinCC Runtime. Exceptions are messages that are locked directly in the AS by means of data blocks (locking via source).
- The locking of message classes and message types remains in force even after a restart of WinCC Runtime.

Requirement

- You configured the relevant button functions on the "Toolbar" tab of the AlarmControl.

Locking and enabling selected messages using key functions

Lock and enable selected messages using the "Lock message" and "Enable message" button functions.

1. In the message list, select the message row which contains the message to be locked.
2. Click the "Lock message" button .
The message is removed from the message list.
3. You can view the locked message by clicking the "Lock list" button .
You can enable the selected message again by clicking the "Enable message" button .
The message is removed from the lock list.

Note

Locking/enabling single messages of an ALARM_8P

If locking/enabling a single message of an Alarm_8P using S7PMC, you lock/enable all 8 messages of this block.

Locking and enabling single messages using the message number

1. Click the "Lock dialog" button .
The "Configure Lock List" dialog opens.
2. Click a server in the server list, or click the local computer in the case of a single-user projects.

3. Click the "Add" button. Enter the message number to be locked in the next dialog.

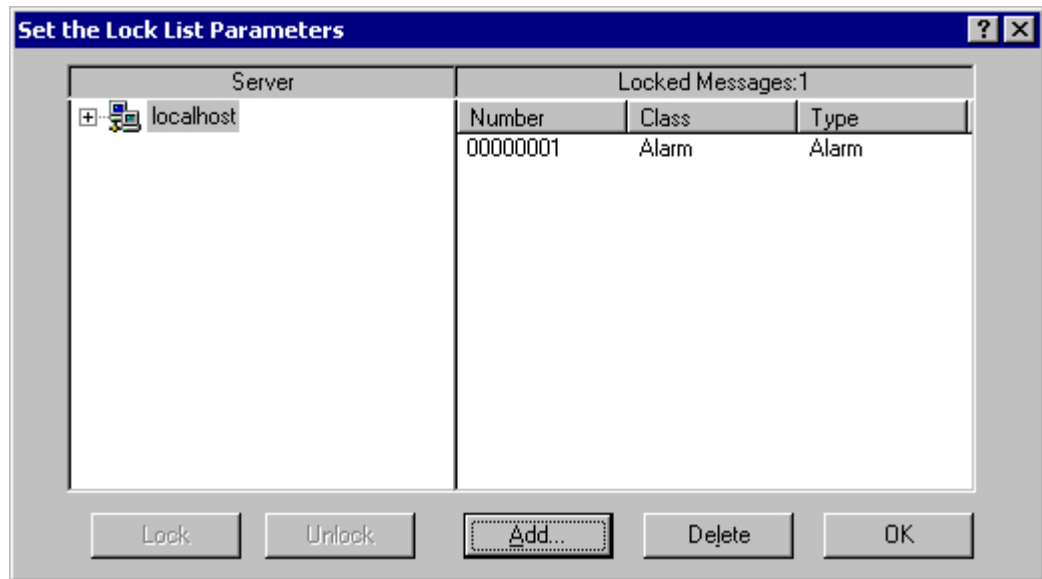

4. You can lock several messages simultaneously.
To do this, enter the message numbers separated by commas.
To select the a range of message numbers, enter a range in the form "5-10".
Only uninterrupted message ranges are locked. If there are gaps in the specified range, the message "Invalid Range" is returned.
5. To enable a locked message, select the message from the list of locked messages and then click the "Delete".

Note

You can lock and enable up to 50 messages simultaneously.

Locking and enabling of messages based on message class, message type, or message group

1. Click the "Lock dialog" button .
The "Configure Lock List" dialog opens.
2. Click a server in the server list, or click the local computer in the case of a single-user projects.

- In the tree view, select a message class, a message type or a message group you want to lock.
Click the "Lock" button.
All messages of the specified message class, message type or message group are locked.

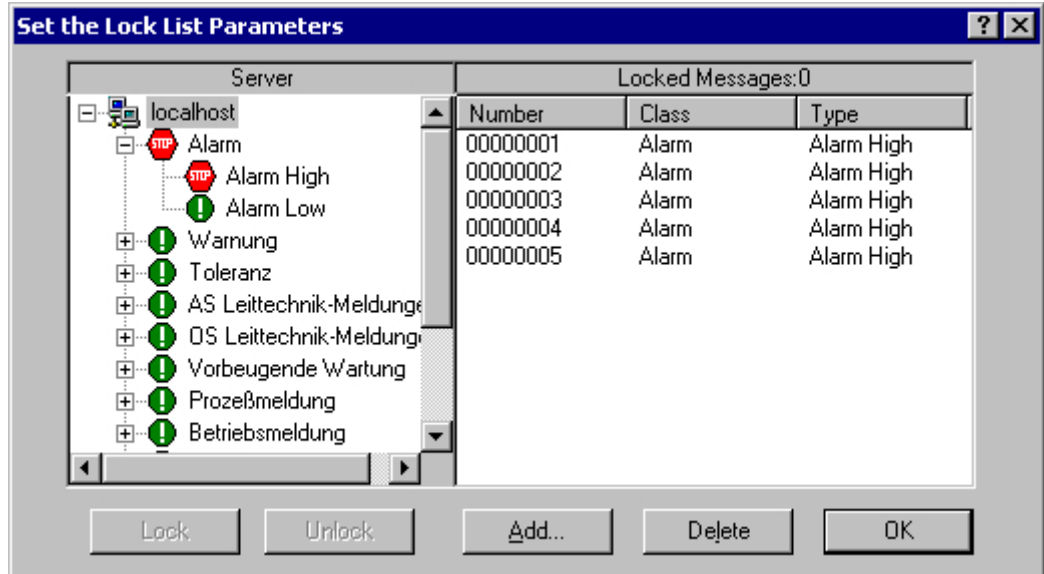

- To enable the locked messages, select the message class, message type or message group and then click the "Enable" button.

Note

The server list contains only those server projects whose "Packages" are loaded on the computer containing the project where you are configuring the control.

5.6.3.4 How to Perform an Emergency Acknowledgement

Introduction

In exceptional cases, a message can be acknowledged on the basis of its message number. In this case, the acknowledgment signal is also transferred to the AS if the message is currently inactive. Acknowledgment of inactive messages only refers to messages which were configured in proper chronological order.

Note

The emergency acknowledgment function is not intended for general acknowledgment. The function may only be used in extreme emergency situations.

Prerequisite

- You configured the "Emergency Acknowledgment" button function on the "Toolbar" tab of the AlarmControl.

Procedure

1. Click the "Emergency acknowledgment" button . The "Emergency acknowledgment of messages" dialog opens.
2. Select a server. In the "Message number" input field, enter the number of the message to be acknowledged.

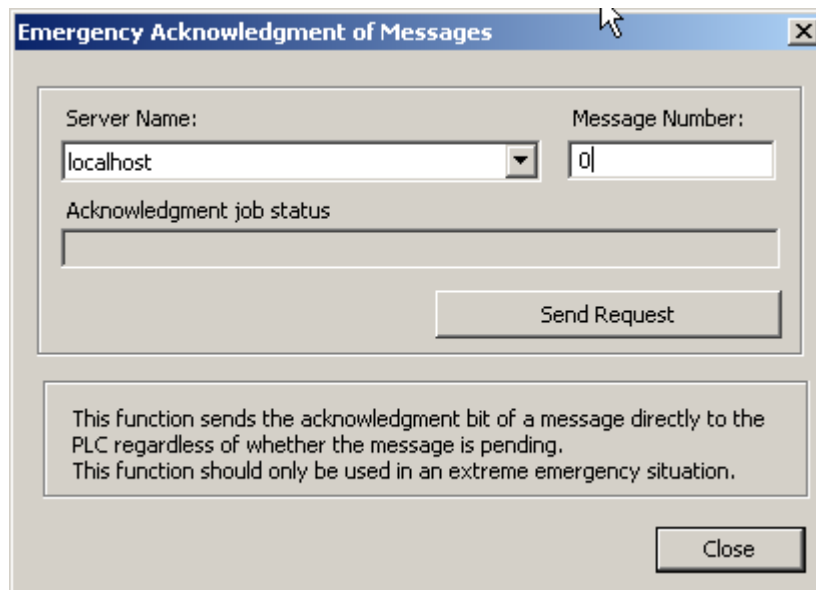

3. Click the "Send request" button. In the message window, the message now appears in the color that you specified for an acknowledged message.

Note

In the dialog for the selection of the servers, only server projects are shown whose "Package" is loaded onto the computer.

5.6.3.5 How to Sort the Display of Messages

Introduction

During runtime, you can sort the messages in the message window on the basis of message blocks.

You sort the message blocks either via the "Sort Dialog" keyboard function or directly via the column headers of the message blocks.

Sorting - Examples

Examples of message sorting:

- Descending by date, time and message number.
The most recent message is displayed at the top. This is the default descending setting.
- Messages are displayed based on their priority.
To apply this sorting method, you must have specified the priorities of messages in the "Alarm logging" editor and configured the "Priority" message block in the WinCC AlarmControl.
As a result, in a single-line message view, only the top-priority message appears in the message window. The messages are usually shown in chronological order.
- Display of messages in ascending or descending order based on various message blocks, allowing for user-defined sorting during runtime.
- The "Status" message block is sorted according to the status type and not according to the configured status texts.
If sorting is in ascending order, the messages are sorted in the following order: "Came In", "Went Out", "Acknowledged", "Locked", "Released", "System Acknowledgement", "Emergency Acknowledgement" and "Came In/Went Out".

Configuring sorting in the Graphics Designer

You can already define the sorting criteria during the configuration of the WinCC AlarmControl:

1. Select the "Message lists" tab.
For the hit list, select the "Hit list" tab.
2. Click "Edit" in the "Sorting" area.
3. Configure the sorting in the "Sort" dialog.
4. You configure the sorting criteria for the hit list in the "Hit list" tab.

Sorting when Autoscroll is enabled

When the "Autoscroll" option is selected, the standard sorting is applied in runtime.

To use the configured sorting even when Autoscroll is enabled, select the "Always" option in the sort dialog in the "Apply sorting" area.

Requirement

- You have configured the button function "Sort dialog" on the "Toolbar" tab of the AlarmControl.

Procedure

1. Click the "Sort Dialog" button .
2. In the "Sort By" field, select the message block by which to sort first.
You can also select message blocks as sorting criterion which are not displayed in runtime.
3. Select the relevant check box to specify sorting in ascending or descending order.

4. If you want to sort by more than one message block, select the other message blocks in the following lists.

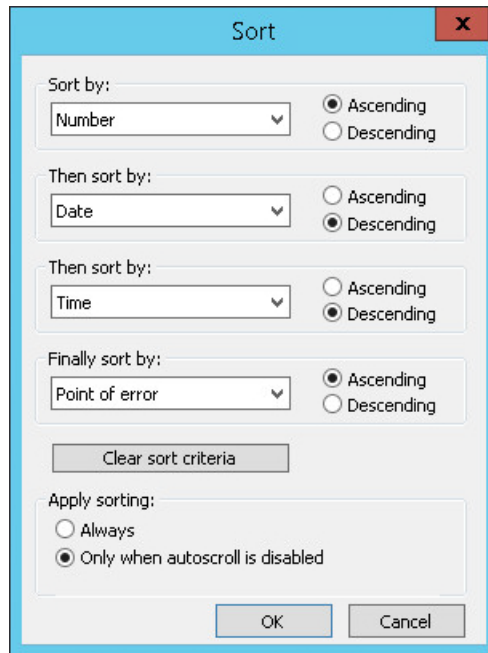

5. Specify whether the configured sorting is to also be applied when "Auto Scrolling" is activated.

Sorting message blocks by column header

When sorting using the column header, you are able to specify the sort order for more than four message blocks.

A sorting icon and sorting index, displayed with right-justification in the column heading, show sorting order and sorting sequence of the message blocks.

Requirement

- You have permitted the sorting in the list field "Sorting with column heading" by clicking or double clicking on the WinCC AlarmControl on the "Parameter" tab.
- You have activated the "Show sorting icon" and "Show sorting index" check boxes.
- You have deactivated the button function "Autoscroll" in the toolbar or option "Auto-scrolling" on the "General" tab.

Procedure

1. Click the column header of the message block you want to sort by first. The sorting index "1" is displayed, and the sorting icon points upwards for ascending sort order.
2. If you want to sort in descending order, click the column header again.

3. If the sorting order has been defined with "up/down/none", you can undo the sorting of the message block with a third click.
4. If you want to sort on the basis of several message blocks, click the header columns of the respective message blocks in the desired sequence.

See also

How to determine the sorting in the message window (Page 1382)

5.6.3.6 How to Hide and Unhide Messages

Introduction

Manual hiding of messages puts lesser information load on the user of the system.

You as user can concentrate better on the messages only if lesser important messages are not shown.

Hide manually

During manual hide, you as user will decide whether to hide a message by using a button in the message window.

The operator can show the message again by using a button. If the operator does not intervene, the system displays the messages again after a configurable time.

Operator message on manual hiding

You can arrange for operator messages to be triggered during manual showing and hiding.

If the operator message is configured, you can only hide individual messages. Multiple selection is not possible.

The operator message contains the following information:

Field	Description
Number	Message number of the operator message
Date/time	Time stamp of hiding
Author	User who triggers the hiding
Computer	Computer name of the alarm server

Field	Description
Reason	<p>Possible reasons for hiding:</p> <ul style="list-style-type: none"> • Chattering or fleeting behavior • Invalid for current process state • False indication of an abnormal condition • No operator action can be taken • Duplicates another alarm for the same cause. • Set aside to address more critical alarms • Others
Comment:	<p>Information on hidden message:</p> <ul style="list-style-type: none"> • Message number of hidden message • If required, additional operator information <p>The entered hide comment can have a maximum of 232 characters. A maximum of 254 characters are displayed in the "Comment" field. If available, the comment of the hidden message is shown as well. You can edit or delete the original message comment, for example, to write a longer hide comment. This change only affects the comment of the operator message. The comment of the hidden message is not changed.</p>

Show comment

To show the details in Runtime, open the "Comment" dialog in the long-term archive list.

The procedure depends on the configuration of the WinCC AlarmControl:

- The "Comment" message block is displayed in the message list:
 In the "Comment" column of the operator message, double-click the comment icon: 
- The key function "Comments dialog" is selected in the toolbar:
 Select the operator message and click the button in the toolbar.

You can find additional information on operator messages under "Operator messages (Page 1348)".

Manual and automatic hiding in Runtime

Using the manual and automatic hide functions during Runtime has an effect on both the hide modes.

If the message is hidden automatically, you can display it again by clicking "Unhide message".



Automatic hiding takes priority over manual hiding:

- If a message has the status of the hide tag for automatic hiding, the message remains hidden, even if the time period for manual hiding has elapsed.
- If the status of the hiding tag occurs for automatic hiding of the message, the message is shown again, even if the time period for manual hiding has not yet elapsed.

Requirement

- You have configured the following button functions in the "Toolbar" tab of the WinCC AlarmControl:
 - List of messages to be hidden
 - Hide message
 - Unhide message
- Runtime has been activated and the WinCC AlarmControl is displayed.

Procedure

1. Select the message you want to hide in the message list, short-term archive list or long-term archive list.
2. Click the "Hide message"  button.
The message is no longer displayed in the list and is added to the list of messages to be hidden.
3. If an operator message is configured, the "Hide manually" dialog opens.
Select the reason for hiding from the drop-down list.
If required, enter a comment.
The operator message of the hidden comment is displayed in the long-term archive list.
4. To show the hidden messages, click on the "List of messages to be hidden"  button.
5. To show a message again, select the message in the "List of messages to be hidden".
6. Click the "Unhide messages"  button.
The message is removed from the "List of messages to be hidden" and displayed back in the original list.
If you do not take any action to show the hidden messages, the configured duration will decide when the system has to display back a message and remove it from the "List of messages to be hidden".

See also

How to configure operator messages (Page 1394)

Operator messages (Page 1348)

5.6.4 AlarmControl example project

5.6.4.1 Examples of configuring an AlarmControl

Introduction

The following example shows the configuration of a WinCC Alarm Control and the display of messages in runtime.

Requirement

- A message system has been set up using the "Alarm Logging" editor.

Basic procedure

Alarm Logging

1. Configure the required message blocks, message classes and message types according to your requirements.
2. Configure the messages and message groups that you require.

Graphics Designer

1. Link the WinCC AlarmControl to a Graphics Designer picture and change the properties of the control.
2. For the example, configure buttons to trigger and acknowledge messages in the Graphic Designer.

5.6.4.2 How to Configure the Message System

Introduction

If you have created a message system, you configure the message system in Alarm Logging according to your requirements.

The following settings are configured for the AlarmControl example:

- Number of displayable characters in the "Message Text" user text block
- Acknowledgment philosophy for the message type
- Coloring of message states for the "Alarm" and "Warning" message classes

Requirement

- The "Alarm Logging" editor is open.

Procedure

1. Select the "User text blocks" folder in the navigation area. The folder is a subfolder of the "Message blocks" folder.
2. Select the respective message block in the "Table area".

3. Edit the property "Number of characters" in the "Properties" area.

Properties - Message blocks >>	
[-] Selection	
Object type	Message blocks
Object name	Message text
[-] General	
Used	<input checked="" type="checkbox"/>
Message block	Message text
Number of characters	20
Alignment	Left
Flash	<input type="checkbox"/>
Leading zeros	<input type="checkbox"/>
Format	
Example	
Block type	User text blocks
Block number	1
Author	0
[-] Translation "Message block"	
Specifies the number of characters and thus the width of the message block.	

4. Select the folder of the corresponding message type ("Alarm" and "Error") in the navigation area.

5. Activate the "Acknowledgment Came In" option in the "Properties" area under "Acknowledgment philosophy".

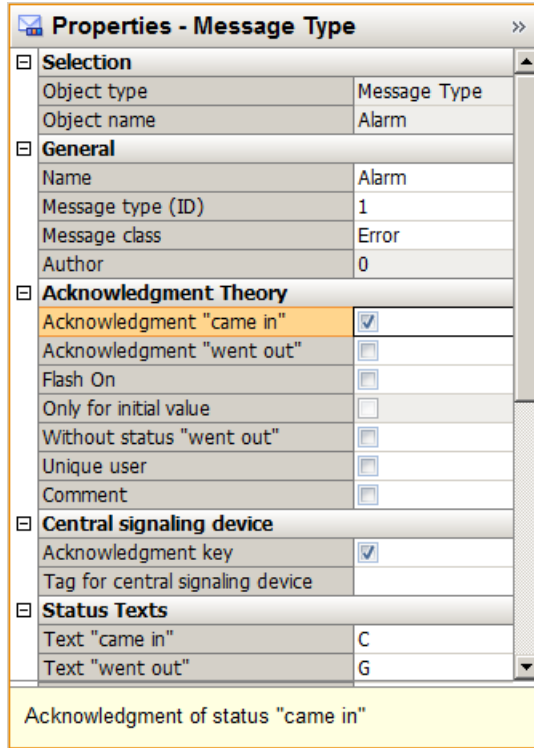

6. Select the text and background colors for the message statuses in the "Properties" area under "Colors".

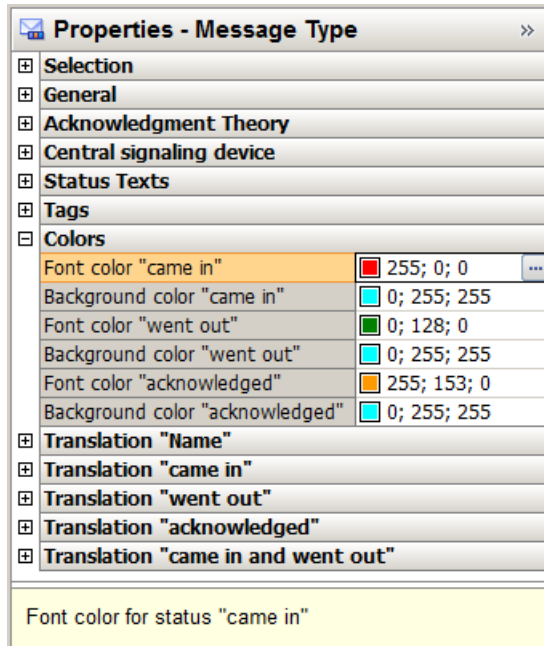

5.6.4.3 How to Configure Single Messages

Introduction

In the example, four message are displayed during runtime. You configure these message in Alarm Logging with the following settings:

No.	Class	Type	Message tag	Message text	Point of error
1	Fault	Alarm	Tank1	Tank 1 empty	Tank 1
2	Fault	Alarm	Tank2	Tank 2 empty	Tank 2
3	Fault	Alarm	Tank3	Tank 3 empty	Tank 3

Requirement

- Configure the three "Binary" type tags "Tank1", "Tank2" and "Tank3" in the Tag Management.
- The "Alarm Logging" editor is open.

Procedure

1. Select the folder of the "Alarm" message type in the "Error" message class in the navigation area.
2. Create three new messages in the table area of Alarm Logging. The messages are assigned to the "Alarm" message type.

3. The following properties are specified by assigning the "Alarm" message type:

- Acknowledgment philosophy - Acknowledgment Came In
- Central signaling device - Acknowledgment button

This way you can acknowledge the message with an acknowledgment button in the example project.

4. Specify the following properties for each message in the "Properties" area:

- Message tag = "Tank1" (Tank2, Tank3).
- Message text = "Tank 1 empty" (Tank 2 empty, Tank 3 empty)
- Point of error = Tank 1 (Tank 2, Tank 3)

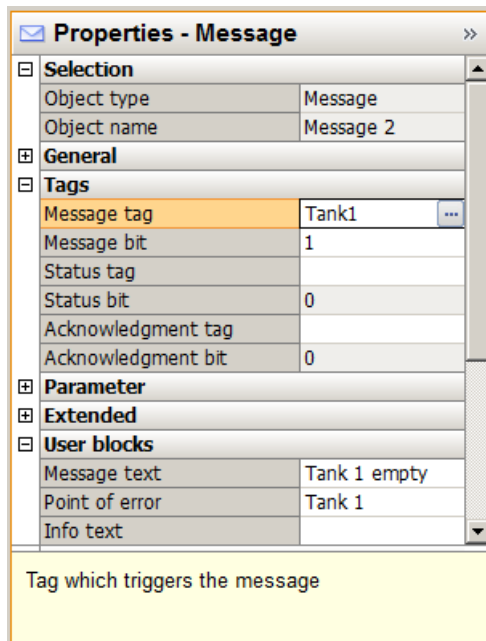

5.6.4.4 How to configure the AlarmControl in the Graphics Designer

Introduction

Messages are displayed in runtime in WinCC AlarmControl. Configure the AlarmControl in the Graphics Designer.

The following settings are configured for the example project:

- Key functions in the toolbar
- Selection in the message window
- Selection and order of the message blocks that are displayed in the message window

Procedure

1. Start Graphics Designer and open a new picture.
2. On the object palette, double-click the "WinCC AlarmControl" on the "Controls tab".
The Control is inserted into the picture.
Click the Control at the drag point and drag it to the desired size.
3. Double-click the Control.
The "Properties of WinCC AlarmControl" is opened with the "General" tab.
4. "Normal" is already selected as the window heading.
Enter the desired window name in the "Text" input field.

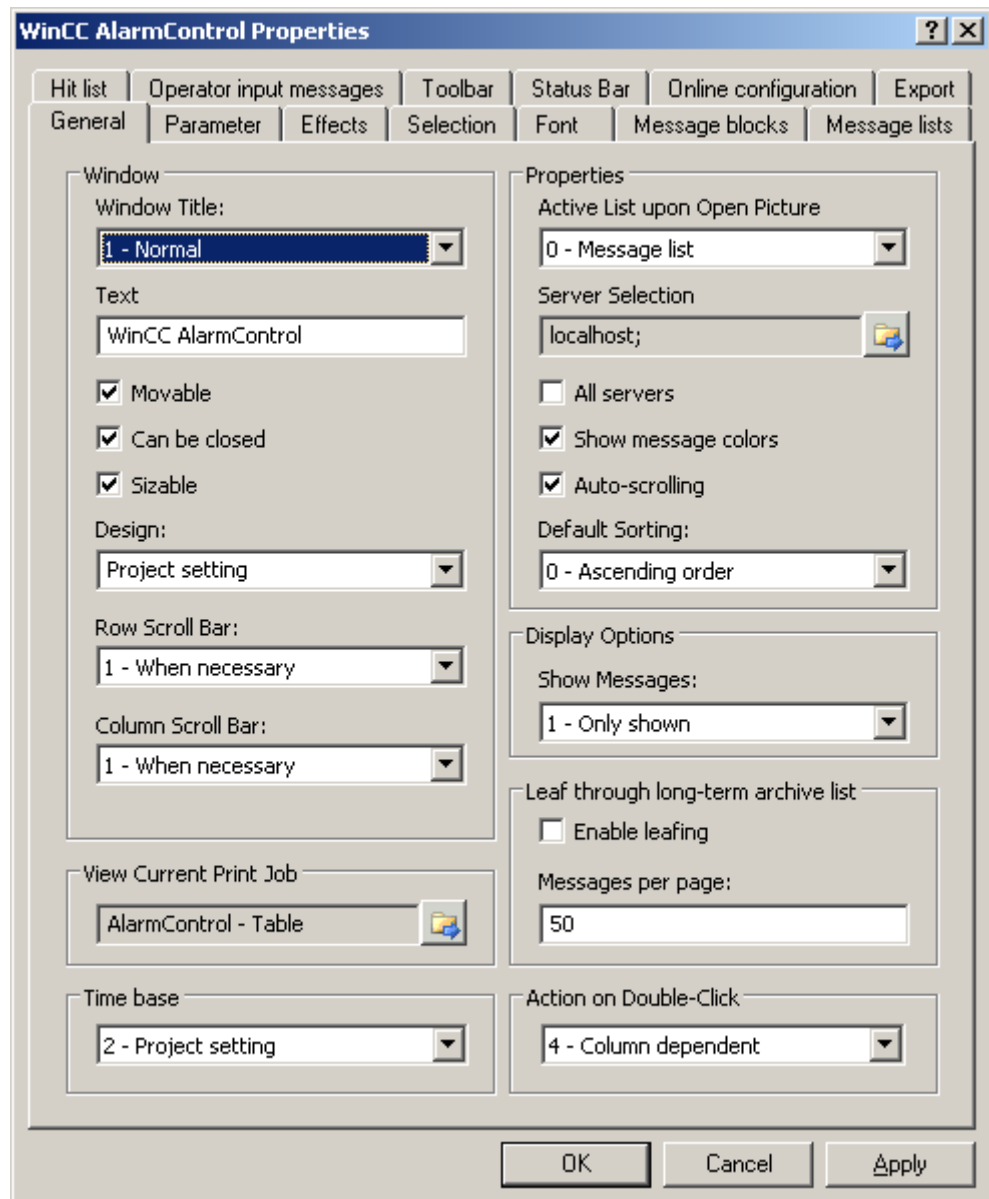

5. On the "Toolbar" tab, select the "Display Toolbar" check box. Select the key functions that you require for the examples:
 - Configuration dialog
 - Message list
 - Lock list
 - Single acknowledgment
 - Selection dialog
 - AutoScroll
 - Lock message
 - Enable message

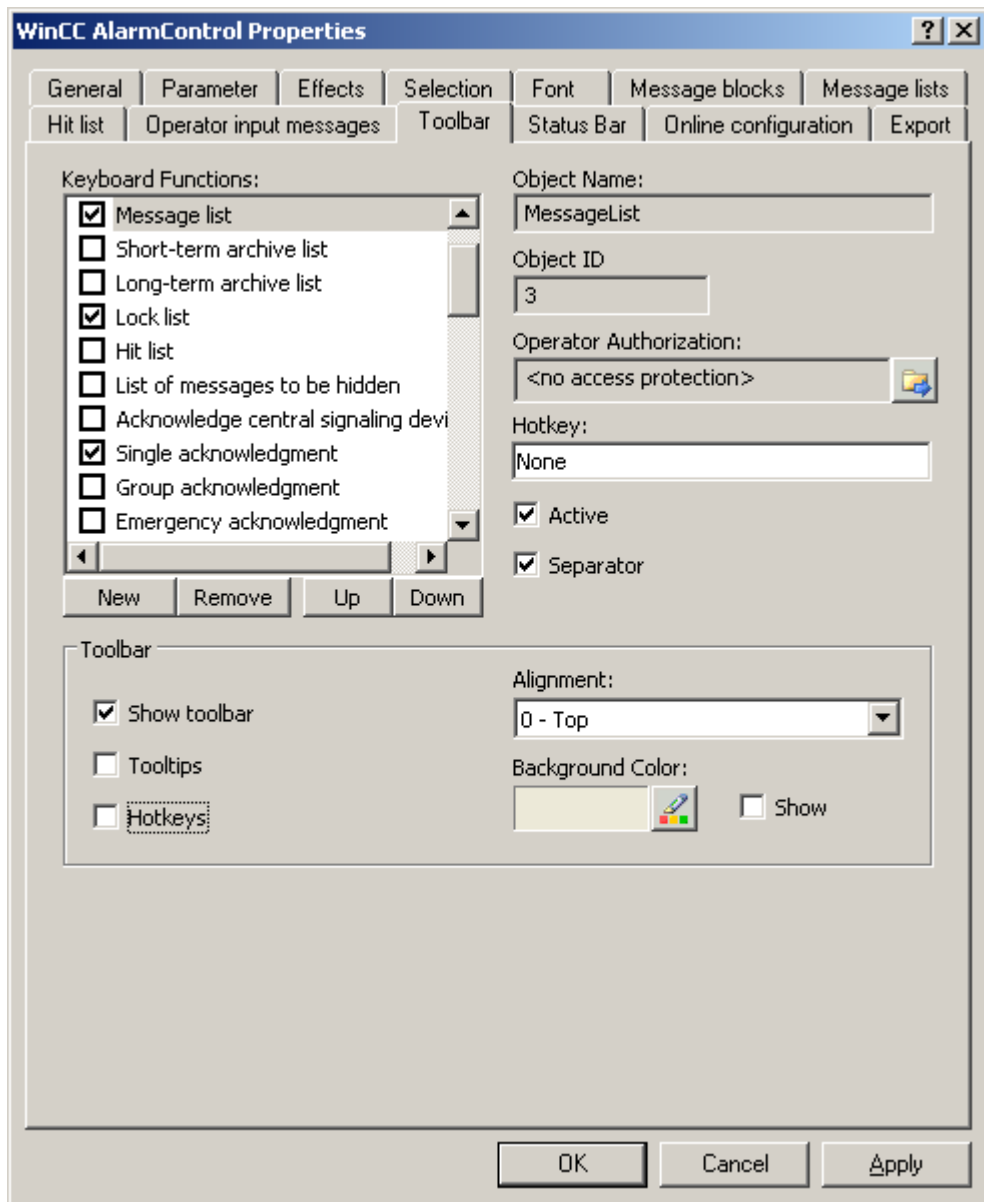

6. Select the following settings in the "Selection" tab:

- Selectable rows: "Single selection"
- Selection border: "Row"

Define the marking colors as you wish.

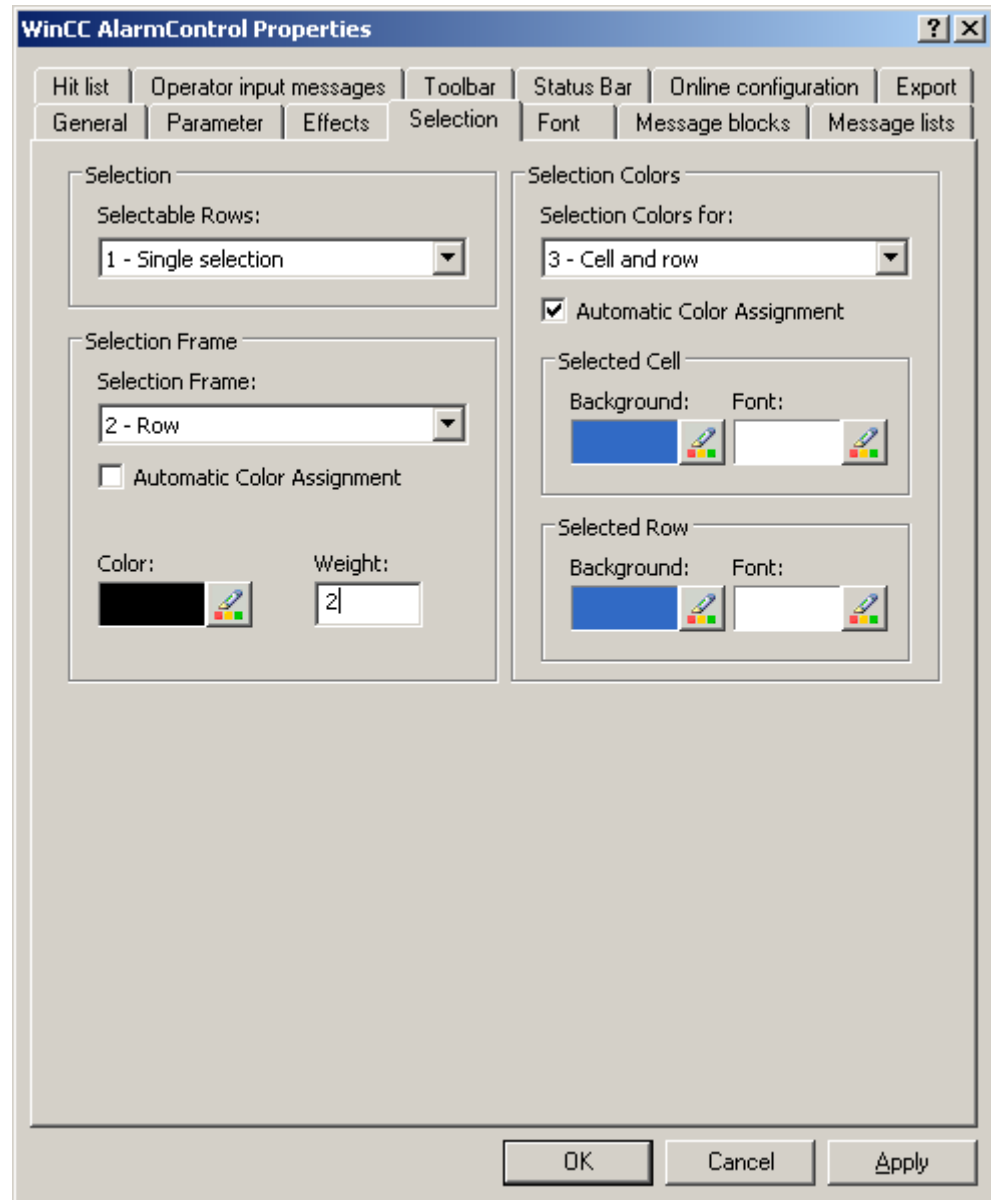

7. Define the other display options as you like on the "Parameter" and "Display" tabs.

8. To change the format and the label, select the following message blocks in the "Message blocks" tab:
 - Time of day
 - User text block 1
 - User text block 2

To change the message blocks you must disable the option "Apply project settings". Select the desired format in the "Format" field for "Time".

For "User text block 1", the name "Message text" and for "User text block 2" the name "Fault location" are already entered.

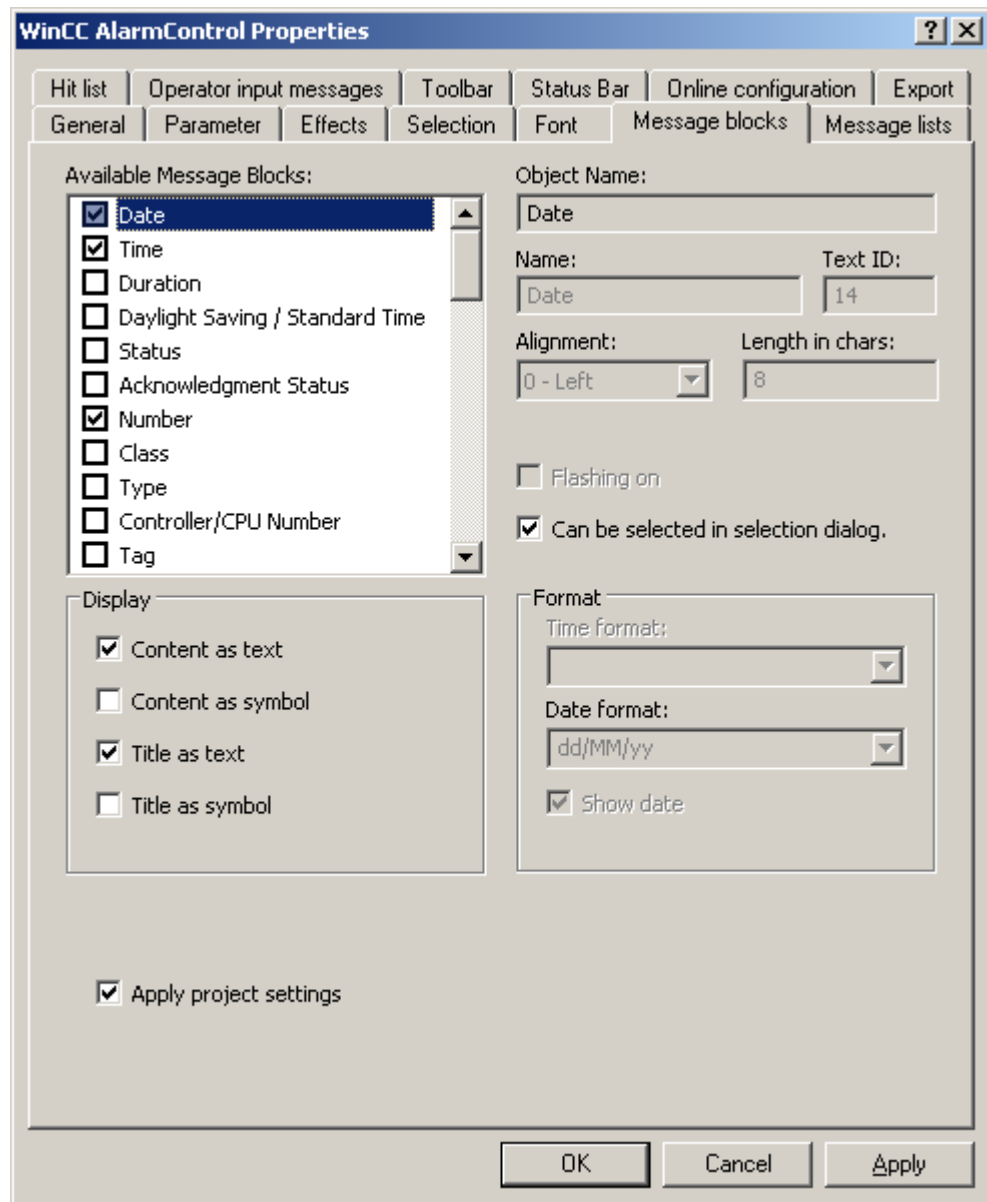

- Define the message blocks and the sequence as columns on the "Message lists" tab. Using the arrow keys, move the selected message blocks from the list of "Available message blocks" to the list of "Selected message blocks". Change the order by selecting a message block and clicking "Up" or "Down".

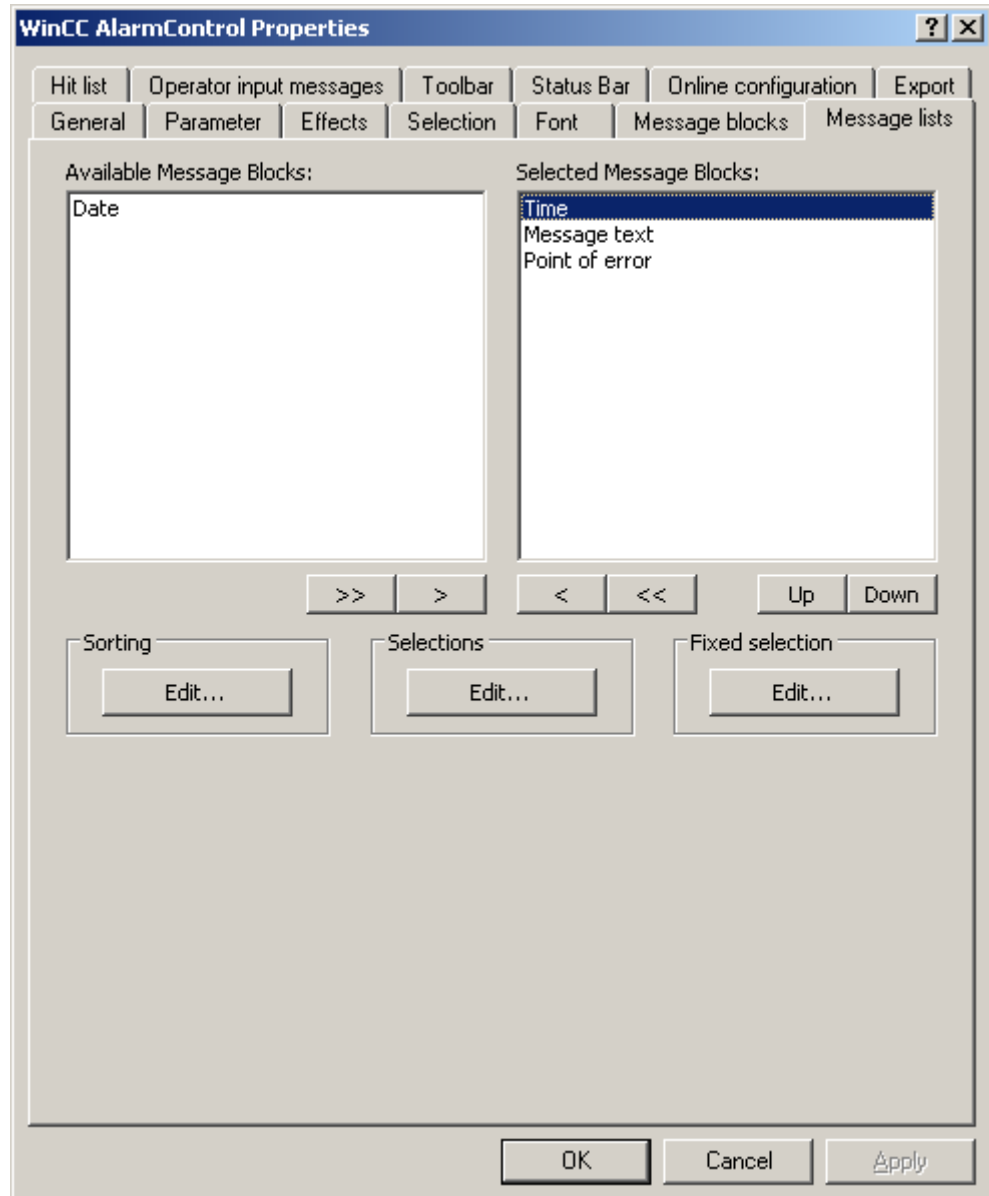

- Click "OK" to close the dialog, and save your settings in the Graphics Designer.

Results

The WinCC AlarmControl is configured for the example.

If you have activated button function "Configuration dialog" on the "Toolbar" tab, you can change the display of tables in the control at any time in runtime.

5.6.4.5 How to Configure Buttons for Changing Message Tags

Introduction

You have configured three single messages in Alarm Logging. In order to reproduce the example for the Alarm Control, you configure three buttons in the Graphics Designer that you use during runtime to set and reset the binary message tags of the individual messages. The message window shows the message statuses with the configured colors.

Procedure

1. In the object palette of the Graphics Designer, select the "Standard" tab and click the "Button" object in the "Windows Object" group. Position the cursor in the picture to the spot where you want to insert the button, and enter the text "Tank1".
2. Select "Properties" in the shortcut menu.
3. Make the "Press left" event dynamic by establishing a direct link between the constant "1" and the tag "Tank1".

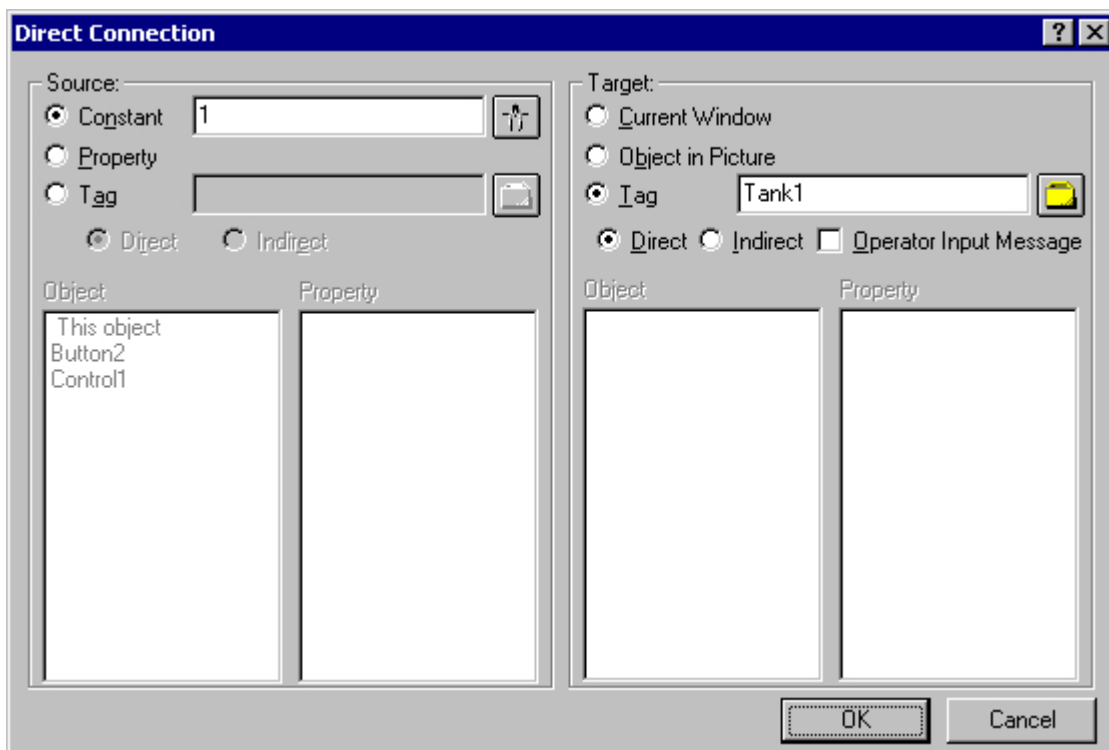

4. Make the "Press right" event dynamic by establishing a direct link between the constant "0" and the tag "Tank1".
5. Likewise, configure two additional buttons with "Tank2" and "Tank3".
6. Save your settings in the Graphics Designer.

5.6.4.6 Example of making the toolbar of the AlarmControl dynamic

Introduction

In order to operate a button function of the toolbar of the WinCC AlarmControl from another location, you must provide the "ToolBarButtonClick" property with the respective "ID".

In principle, any object can be used to operate the AlarmControl. In the following example, the standard object "Button" is used to acknowledge a message.

Requirement

- You have configured the example project for AlarmControl.
- You have opened the picture with the configured AlarmControl in the Graphics Designer.

Procedure

1. Determine the object name of the AlarmControl based on the object properties of the control, for example, "Control1".
2. Insert a button object from the Windows objects of the object palette into the picture. Enter a button text, e.g. "Acknowledge".
3. In order to make the button object dynamic, open the shortcut menu for the properties of the button object. In the "Event" tab, select the "Mouse" property. Make the attribute "Mouse click" dynamic with a C action.
4. Select "C action..." with the right mouse button. The "Edit action" window is opened.
5. Insert the following into the right window area:
 - // activate toolbar button single acknowledgement (ID: 10)
 - SetPropertyWord(IpszPictureName, "Control1", "ToolBarButtonClick", 10);
6. Select the language for C compilation from the toolbar.
7. Compile and save the C action.
8. Save your settings in the Graphics Designer.

5.6.4.7 How to operate the example on AlarmControl

Requirement

- You have saved the configured picture in the Graphics Designer.
- You have entered the configured picture as the start screen in the "Computer properties" dialog on the "Graphics Runtime" tab.
- You have activated "Graphics Runtime", "Alarm Logging Runtime" and "Global Script Runtime" applications in the startup list of WinCC Explorer using the "Computer properties" dialog.

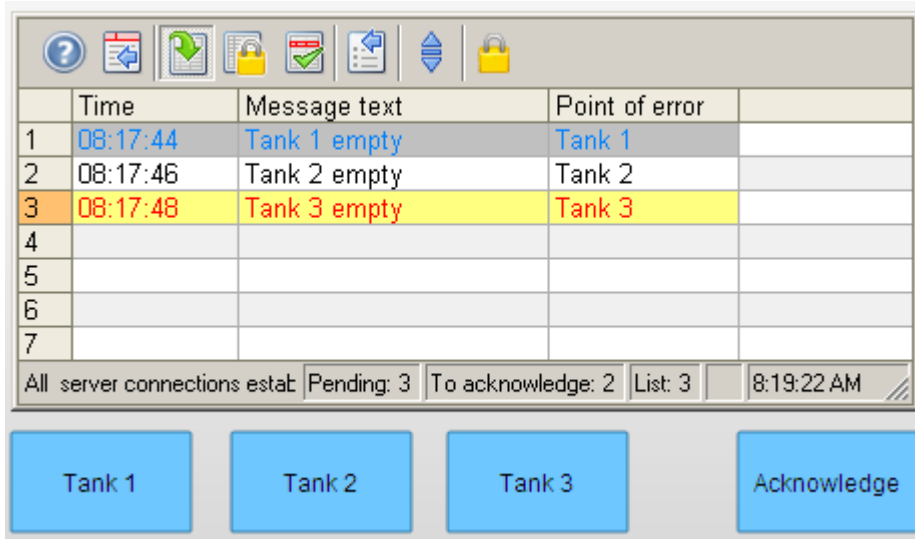

Activating and deactivating Runtime

1. Activate runtime by clicking the relevant button in the toolbar or selecting the relevant menu option in WinCC Explorer.
2. Click on the three buttons with the left mouse button. The respective messages are incoming and are displayed.
3. Click on the "Tank 1" button with the right mouse button for example. The message is outgoing. The message status changes, indicated by the changed color.



4. After you have tested other control capabilities, e.g. locking messages, deactivate runtime. You can deactivate Runtime using the toolbar or the menu bar of WinCC Explorer.

Locking and enabling messages

1. In the message list, select the message line containing the message to be locked, for example, "Tank1".
2. Click on the  button. The message is removed from the message list.
3. If you click the button , you will see the locked message in the lock list.
4. You can unlock the selected message in the lock list again by clicking button . The message is removed from the lock list.

Acknowledging a message using the acknowledgment button

1. Mark one of the messages that has the "Activated" state, e.g. the message "Tank 3 empty".
2. Now click on the dynamic acknowledgment button. The message is acknowledged. The message status changes, indicated by the changed color.

5.7 Before WinCC V7: Display of Messages during Runtime

5.7.1 WinCC Alarm Control

Introduction

WinCC Alarm Control is used as a message window for displaying message events.

Lists in the Message Window

You have the option to view six different lists in the message window:

- Message list showing the currently pending messages.
- Short-term archive list showing archived messages. The display is updated immediately when new incoming messages occur.
- Long-term archive list showing archived messages.
- Lock list showing the currently locked messages.
- Hit list showing statistics.
- List of hidden messages to show messages that have been archived but are not displayed.

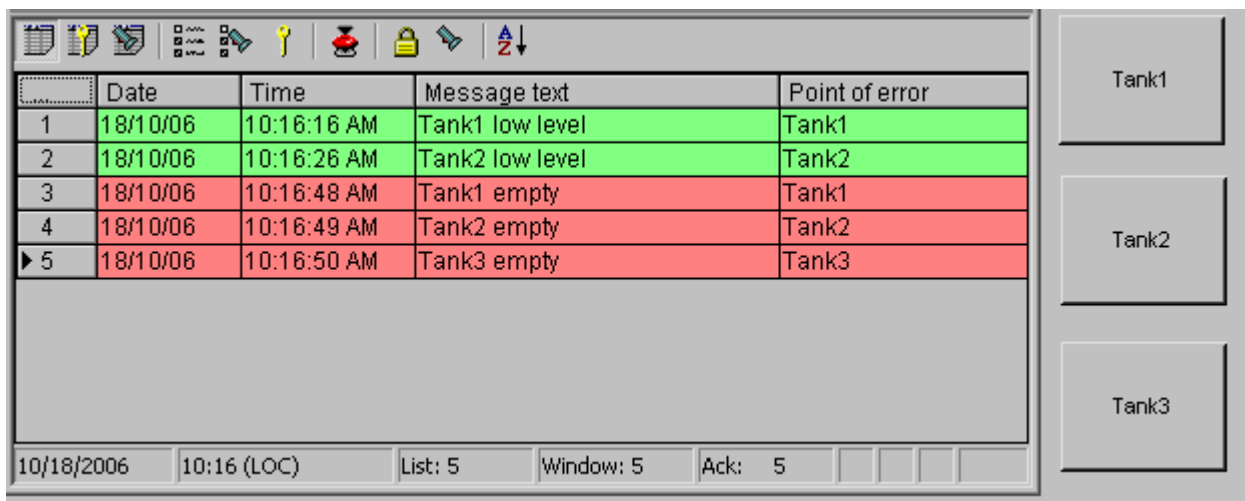

	Date	Time	Message text	Point of error
1	18/10/06	10:16:16 AM	Tank1 low level	Tank1
2	18/10/06	10:16:26 AM	Tank2 low level	Tank2
3	18/10/06	10:16:48 AM	Tank1 empty	Tank1
4	18/10/06	10:16:49 AM	Tank2 empty	Tank2
▶ 5	18/10/06	10:16:50 AM	Tank3 empty	Tank3

10/18/2006 10:16 (LOC) List: 5 Window: 5 Ack: 5

Note

A message is shown with a crossed-out date and time stamp in the message list when any of the following occur:

- A locked message is unlocked.
- A message is reloaded after a power failure. This applies only to chronological messaging.
- The AS is restarted. This applies only to chronological messaging.

See also

Configuration of the WinCC Alarm Control (Page 1438)

How to Configure Single Messages (Page 1441)

5.7.2 Configuration of the Alarm Control

5.7.2.1 Configuration of the WinCC Alarm Control

Introduction

Using an example, you will see how to display messages during runtime WinCC Alarm Control.

Requirement

- You have created a message system with the "Alarm Logging" editor.

Basic procedure

In Alarm Logging

1. Configure the required message blocks, message classes and message types according to your requirements.
2. Configure the single messages and message groups that you require.

In Graphics Designer

1. Link the WinCC Alarm Control to a Graphics Designer picture and change the properties of the Control.
2. In order to reproduce the message window settings for the example, you must configure buttons for setting and resetting the message tags in the Graphics Designer.

Note

Standard functions can be used to control the message window. If you do not want to use the toolbar functions to operate the message window, you can make any of the Graphics Designer objects dynamic using the appropriate functions.

See also

Standard Functions for Operation of WinCC Alarm Control (Page 1473)

How to Configure the Alarm Control in the Graphics Designer (Page 1443)

How to Configure Single Messages (Page 1441)

How to Configure the Message System (Page 1439)

Configuring the Message System (Page 1260)

5.7.2.2 How to Configure the Message System

Introduction

If you have created a message system in Alarm Logging, you configure the message system in Alarm Logging according to your requirements.

The following settings are configured for the Alarm Control example::

- Number of displayable characters in the "Message Text" user text block
- Acknowledgement theory for message class "Error".
- Color assignment for the message statuses of message types "Alarm" and "Warning"

Requirement

- The "Alarm Logging" editor is open.

Procedure

1. Select "Properties" in the shortcut menu of the "Message Text" user text block, and change the length of the message block.

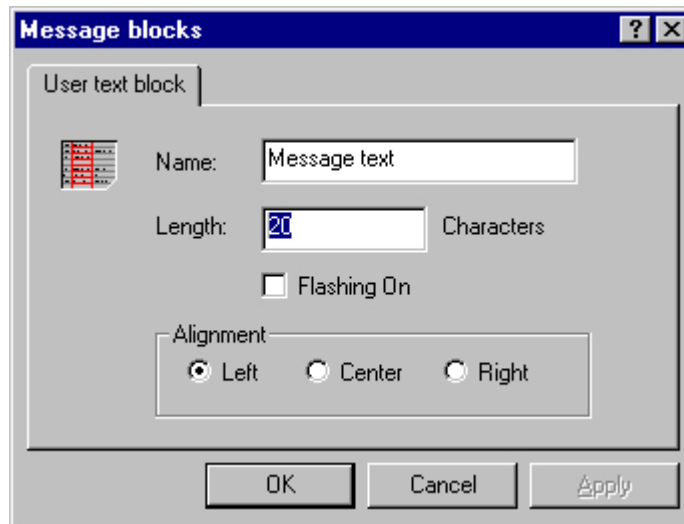

2. Select "Properties" in the shortcut menu of the "Error" message class, and select the "Acknowledgement Came In" check box on the "Acknowledgement" tab.

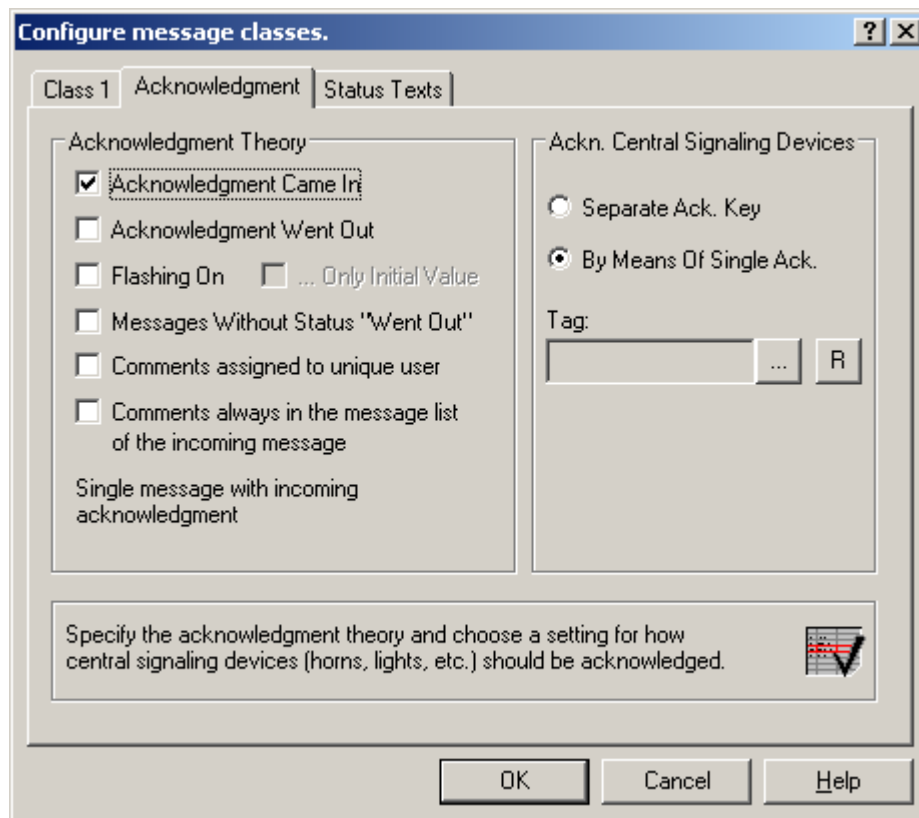

3. Select the "Properties" command in the shortcut menus of message type "Alarm" or "Warning," respectively, and select the text color and background color for the message statuses.

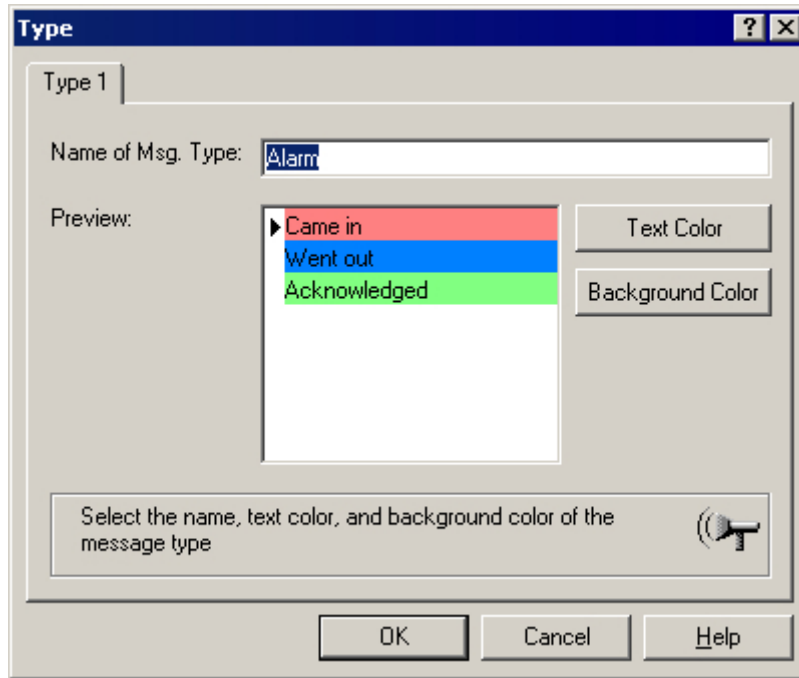

4. Save the settings in Alarm Logging.

See also

How to Configure the Alarm Control in the Graphics Designer (Page 1443)

How to Configure Single Messages (Page 1441)

Configuring the Message System (Page 1260)

5.7.2.3 How to Configure Single Messages

Introduction

In the example, four message are displayed during runtime. You configure these message in Alarm Logging with the following settings:

No.	Class	Type	Message tag	Message text	Location of fault
1	Fault	Alarm	Tank1	Tank 1 empty	Tank 1
2	Fault	Alarm	Tank2	Tank 2 empty	Tank 2
3	Fault	Alarm	Tank3	Tank 3 empty	Tank 3
4	Fault	Warning	Motor	Motor on	

Requirement

- Configure the four "Binary"-type tags "Tank1", "Tank2", "Tank3" and "Motor" in the Tag Management.
- The "Alarm Logging" editor is open.

Procedure

1. In the Alarm Logging table window, add a new line for each message using the shortcut menu.
2. Select "Properties" in the shortcut menu of the created message.
3. On the "Parameters" tab of the "Single Message" dialog, select the class and type indicated above and connect the message to the respective message tag.

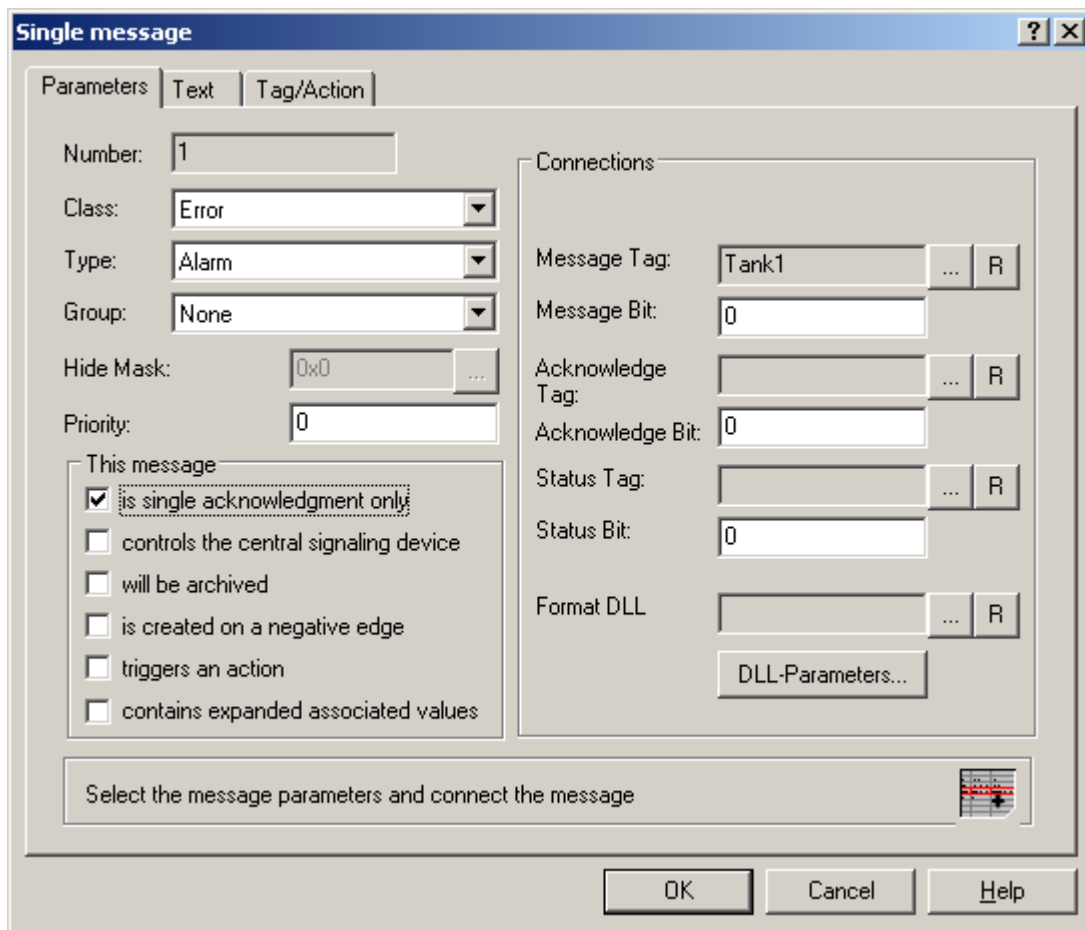

4. On the "Text" tab of the "Single Message" dialog, enter the text indicated above for "Message Text" and "Point of Error".
5. Likewise, configure three additional messages with "Tank2", "Tank3" and "Motor".
6. Save the settings in Alarm Logging.

Note

You can create the tags used as message tags either in the Tag Management of WinCC Explorer or directly by selecting the message tag on the "Parameters" tab of Alarm Logging.

See also

How to Configure the Message System (Page 1439)

Configuring the Message System (Page 1260)

5.7.2.4 How to Configure the Alarm Control in the Graphics Designer

Introduction

During runtime, the message events are displayed in an ActiveX Control, which is inserted and configured in a picture in the Graphics Designer.

The following settings are configured for the example project:

- Keyboard functions in the toolbar
- Selection in the message window
- Selection and order of the message blocks that are displayed in the message window

Procedure

1. Start Graphics Designer and open a new picture.
2. In the object palette on the "Controls" tab, double-click "WinCC Alarm Control".

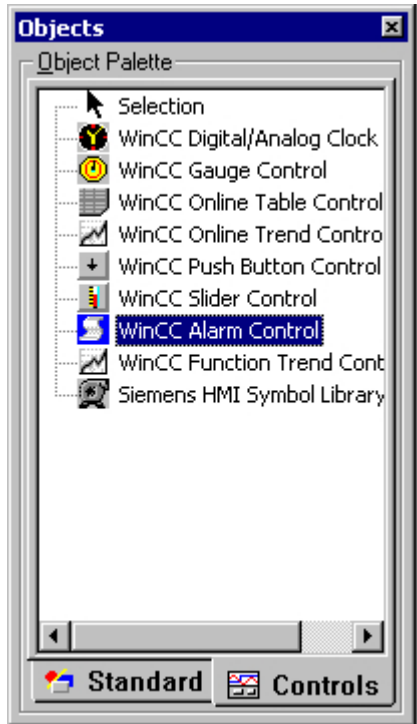

3. The Control is inserted into the picture. Click the Control at the drag point and drag it to the desired size.

4. Double-click the Control to open the "WinCC Alarm Control Properties" dialog. Enter a name for the window in the "Window Header" box and select the "Window Header" check box in order to display the window name during runtime.

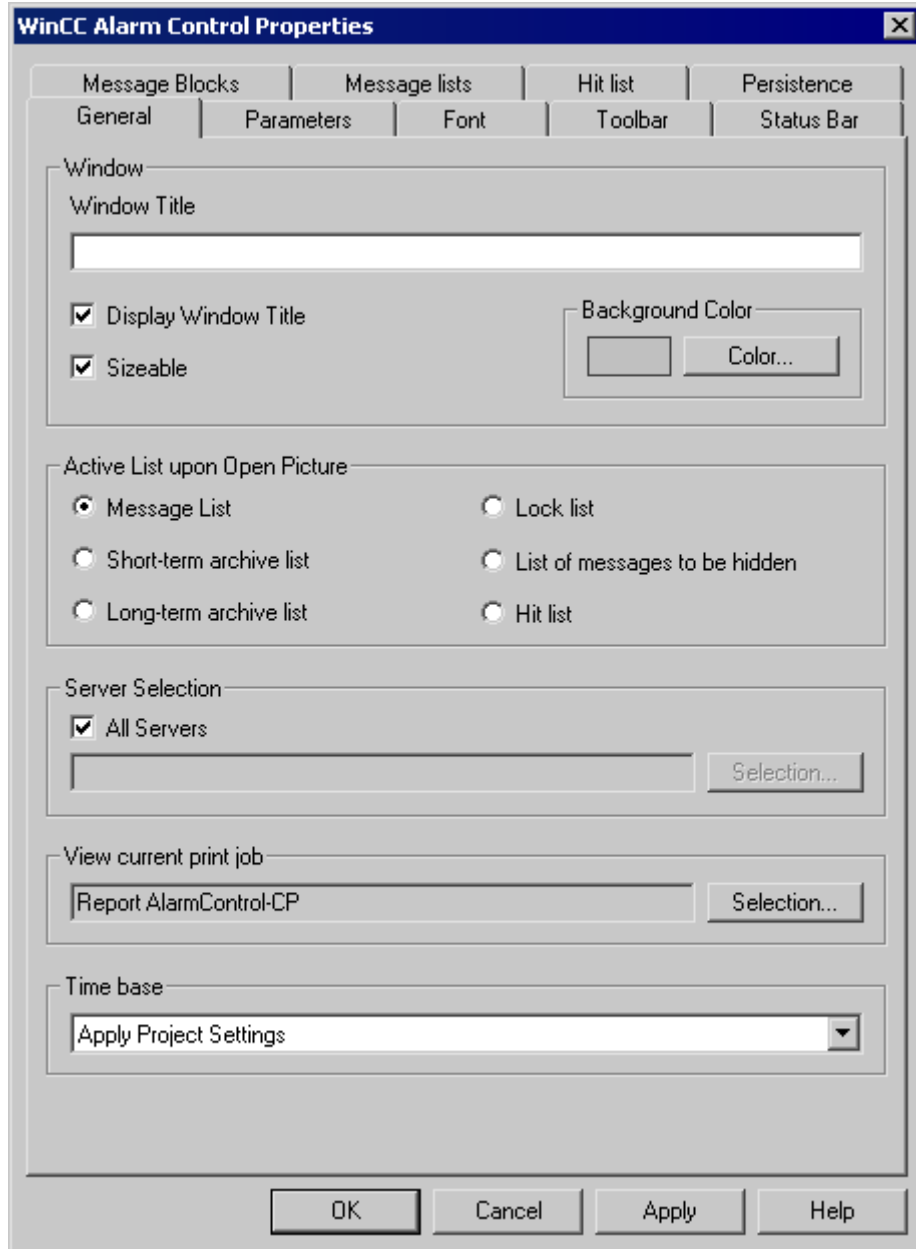

5. On the "Toolbar" tab, select the "Display Toolbar" check box. Select the keyboard functions you require. For the examples, you need the following keyboard functions: "Message List", "Lock List", "Selection Dialog", "Lock Dialog", "Emergency Acknowledgement", "Lock/Unlock Message" and "Sort Dialog".

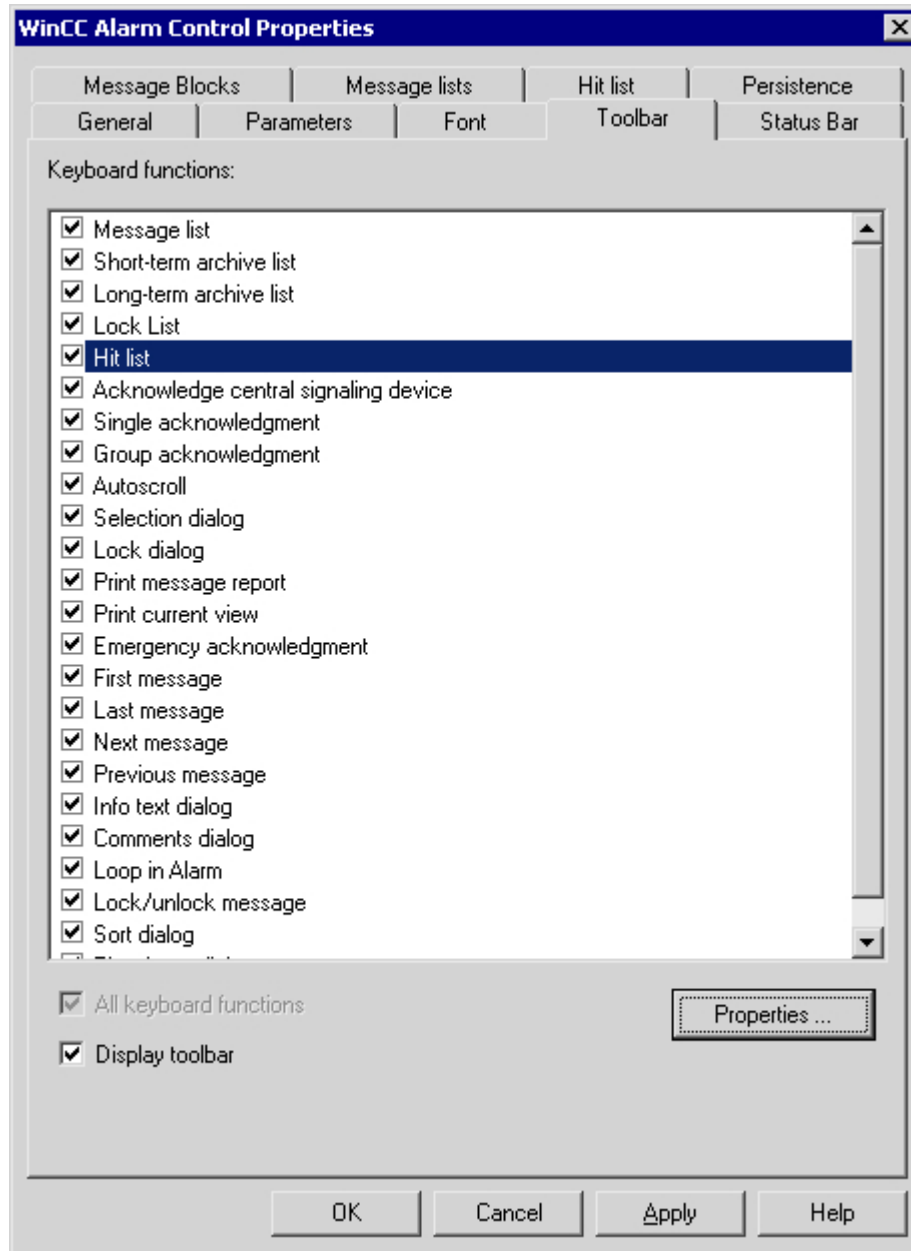

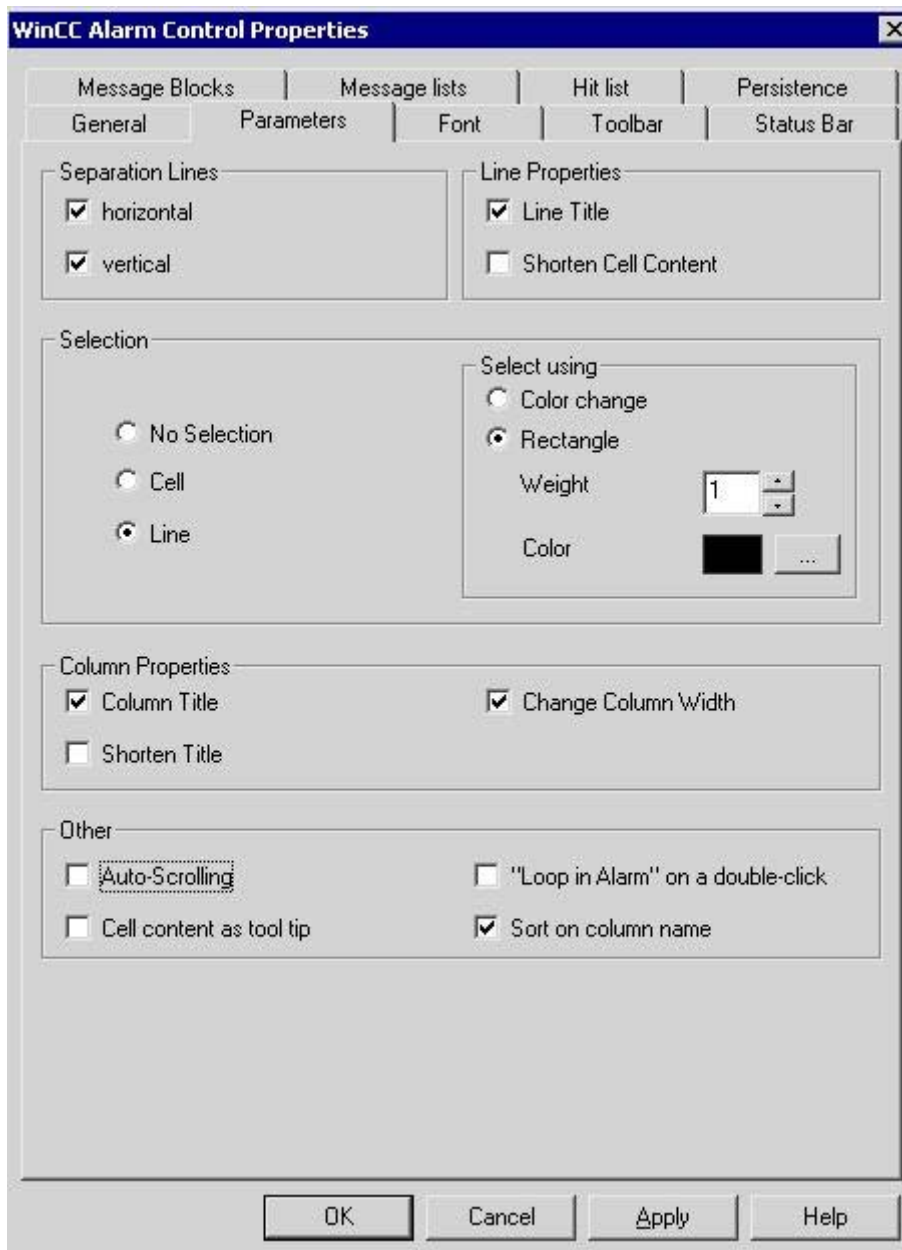

6. In the "Selection" group of the "Parameters" tab, select the "Line" option.

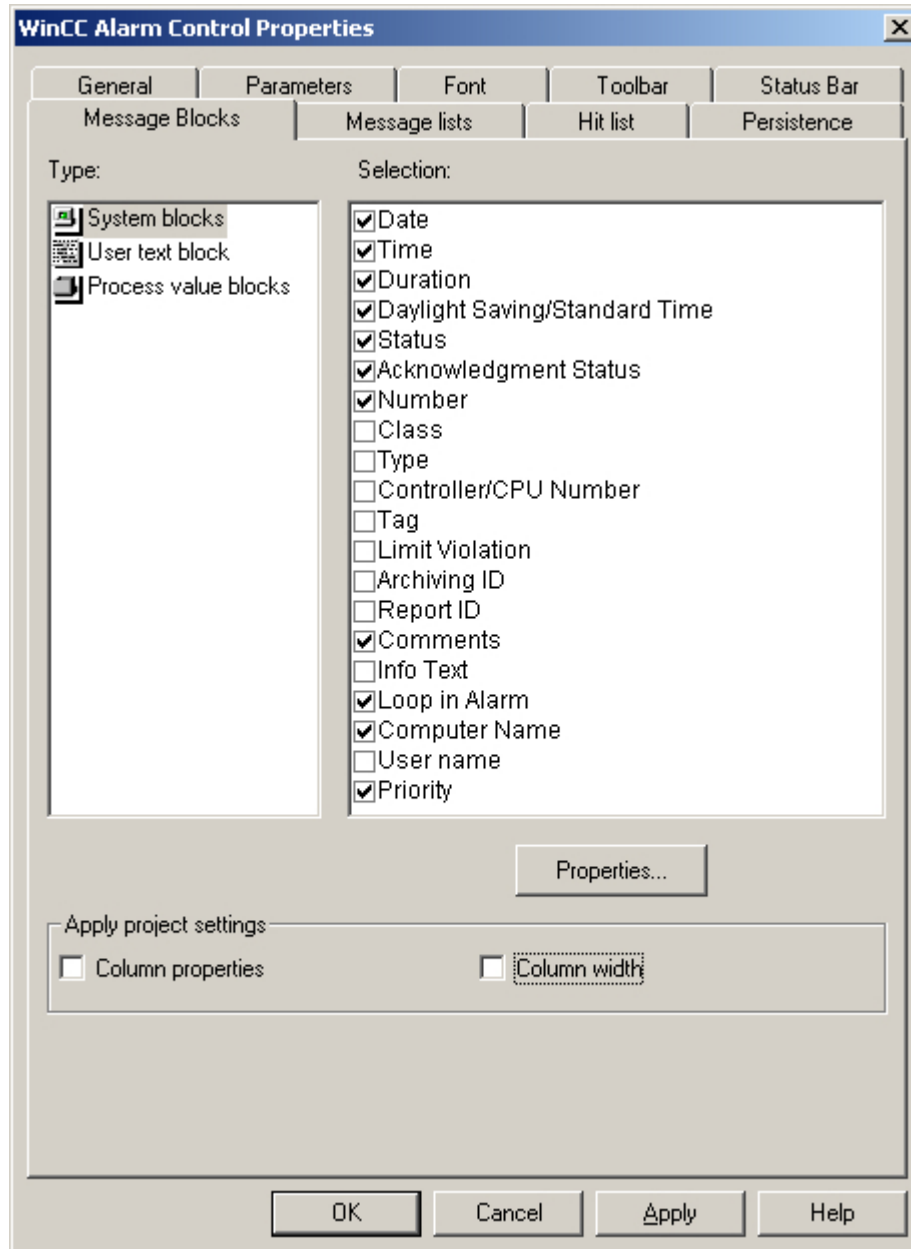

7. On the "Message Blocks" tab, select the "Time" system block and the two user text blocks "Message Text" and "Point of Error".



8. On the "Message Lists" tab, specify the message blocks and the order in which they are to be displayed in the message window. Using the arrow keys, move the selected message blocks from the list of "Existing Message Blocks" to the list of "Selected message blocks". Change the order by selecting a message block and clicking  or .

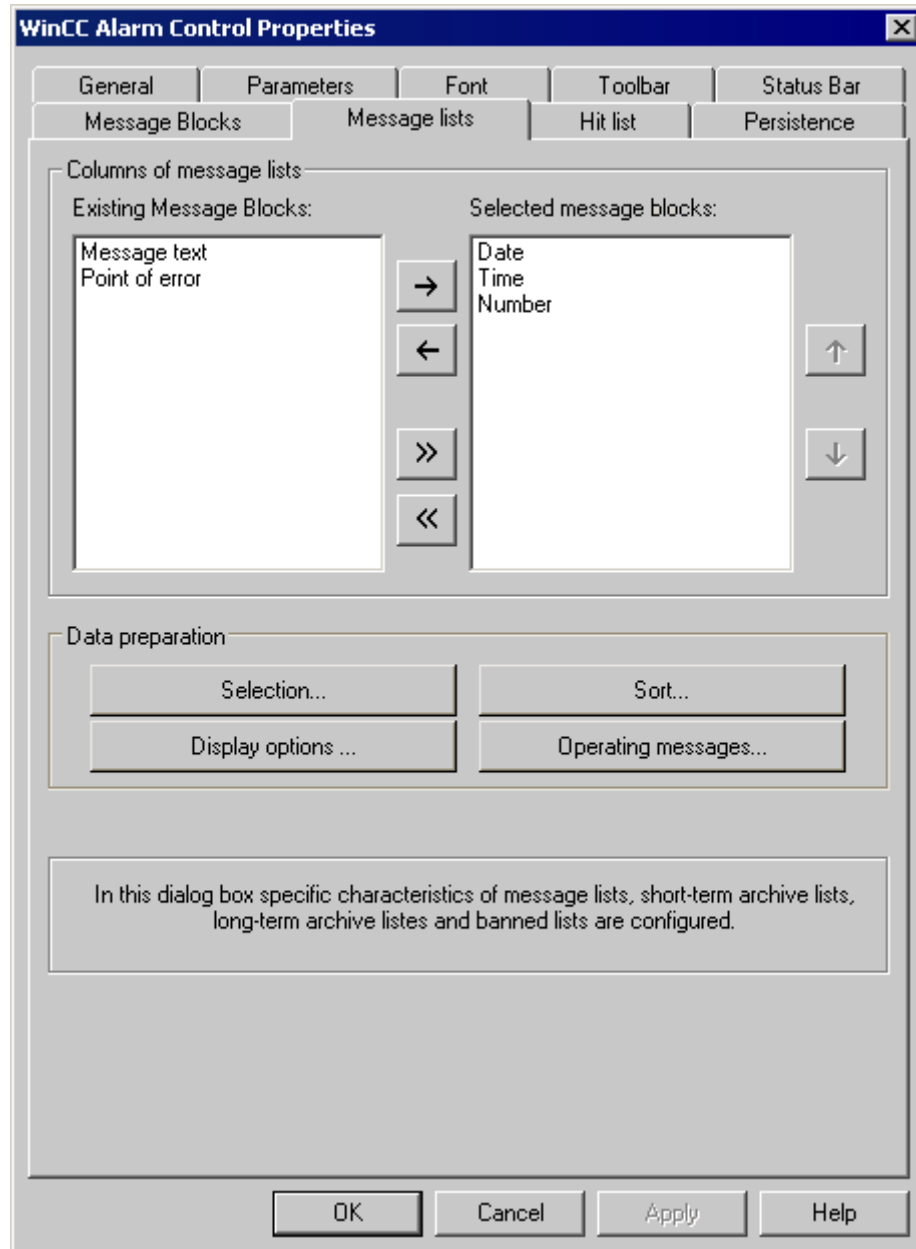

9. Click "OK" to close the dialog, and save your settings in the Graphics Designer.

See also

- How to Configure Buttons for Changing Message Tags (Page 1450)
- Configuration of the WinCC Alarm Control (Page 1438)

5.7.2.5 How to Configure Buttons for Changing Message Tags

Introduction

You have configured four single messages in Alarm Logging. In order to reproduce the example for the Alarm Control, you configure four buttons in the Graphics Designer that you use during runtime to set and reset the binary message tags of the individual messages. The message window shows the message statuses with the configured colors.

Procedure

1. In the object palette of the Graphics Designer, select the "Standard" tab and click the "Button" object in the "Windows Object" group. Position the cursor on the image at the spot where you want to insert the button, and enter the text "Tank1".
2. Select "Properties" in the shortcut menu.
3. Make the "Left-click" event dynamic by establishing a direct link between the constant "1" and the tag "Tank1".

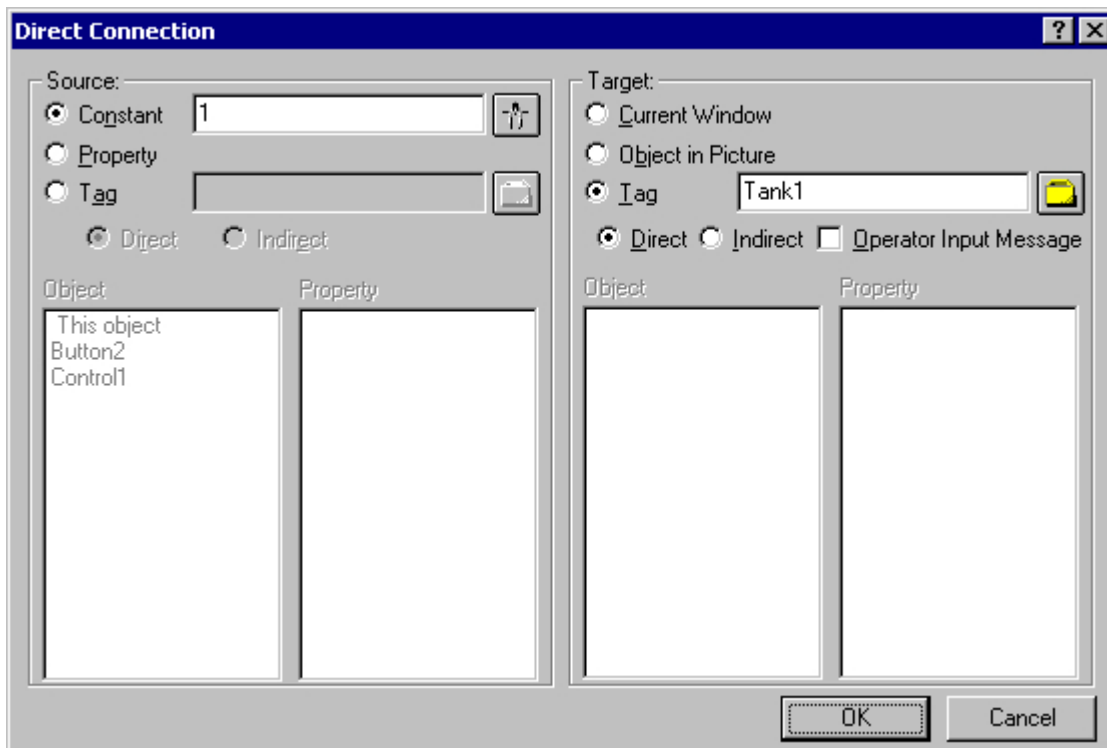

4. Make the "Right-click" event dynamic by establishing a direct link between the constant "0" and the tag "Tank1".
5. Likewise, configure three additional buttons with "Tank2", "Tank3" and "Motor".
6. Save your settings in the Graphics Designer.

See also

How to Configure the Alarm Control in the Graphics Designer (Page 1443)

Configuration of the WinCC Alarm Control (Page 1438)

5.7.2.6 How to Configure a Hit List of Messages

Introduction

The hit list displays statistics for the archived messages in the message window. In addition to statistics, a limited selection of configured message blocks can also be displayed in the hit list. In the case of variable contents, the message blocks display the data for the last incoming message.

You assemble the columns of the hit list yourself, which consist of the message blocks and the statistics.

The following statistical calculations are available for messages:

- Frequency of a message number. The frequency is only increased, if a message with status "Came In" is included in the archive. If the frequency of a message number in the selected message range is "0", no entry is made in the statistics for this message number.
- The cumulative duration of a message number in seconds for status "Came In/Came In"(+/+), "Came In/Went Out"(+/-), the status "Came In/Initial Acknowledgment"(+/*1) or the status "Came In/Second Acknowledgment"(+/*2).
- The average duration of a message number in seconds for status "Came In/Came In"(+/+), "Came In/Went Out"(+/-), the status "Came In/Initial Acknowledgment"(+/*1) or the status "Came In/Second Acknowledgment"(+/*2).

Only the "Acknowledgment", "System Acknowledgment" and "Emergency Acknowledgment" acknowledgment states are included in the statistics calculation of acknowledgment times.

Note

Messages with the states "Acknowledgment", "System acknowledgment", "Emergency acknowledgment" and "Went out" are only used for statistics calculation if the results available for statistics formation show a matching message issued at a preceding time period with the state "Came in".

If only one acknowledgment shows up with single-mode acknowledgment or dual-mode acknowledgment, the acknowledgment time for calculation of the cumulated and average duration for both states "Came In/Initial acknowledgment and "Came In/Second acknowledgment" are taken into consideration.

If Runtime was deactivated and activated several times and a message was pending during this time, e.g. due to the external discrete alarm or the chronological order alarm, the message is entered multiple times in the archive with the state "Came In" and is also counted several times during calculation.

Requirement

- You have opened the Graphics Designer is opened and linked an Alarm Control.
- You have selected the message blocks you want to incorporate in the hit list on the "Message Blocks" tab.
- You have specified the properties of the message blocks that you want to incorporate in the hit list.
- You have activated the keyboard function "Hit List" on the "Toolbar" tab of the Alarm Control.

Procedure

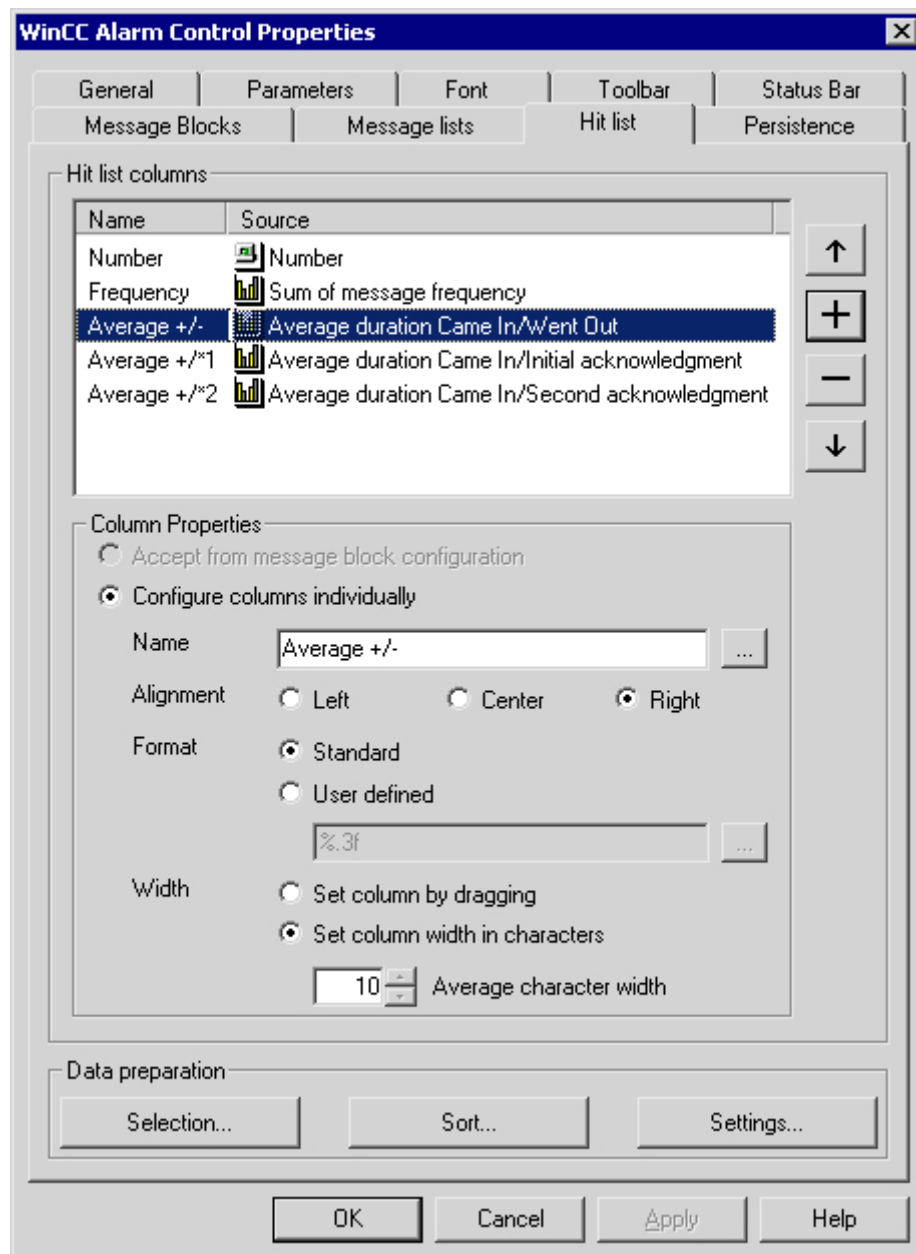

1. Double-click the Control. Select the "Hit List" tab.

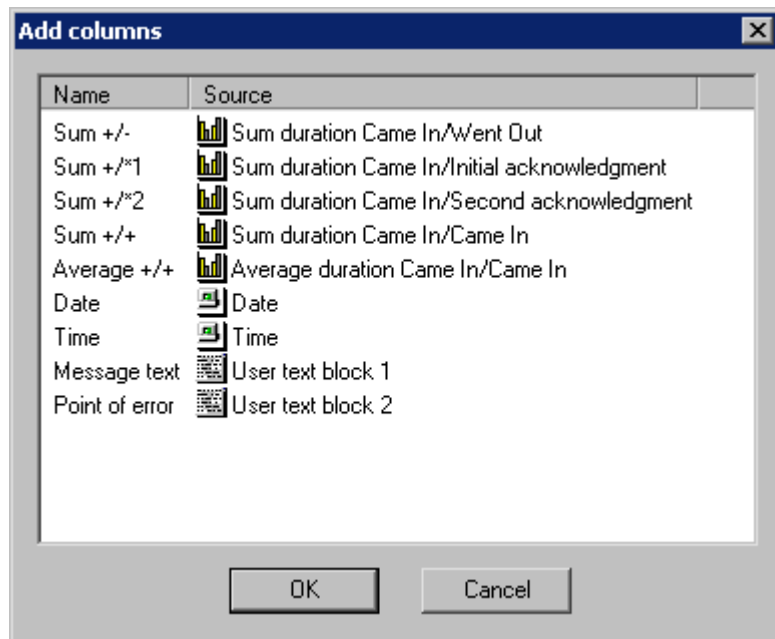

2. Select the columns you want to display in the hit list. To do so, click . The "Add Columns" dialog opens.



The dialog contains all statistical calculations that are available, as well as a limited number of configured message blocks. You add the columns to the hit list by making one or more selections and clicking "OK". If you want to remove a column from the hit list, select the relevant columns in the "Hit List Columns" list and click .

3. You can change the order in which the columns are displayed in the hit list by selecting the column and clicking  or  to move it within the list.
4. Configure the column properties for the statistics data columns. You can rename the column, change the alignment and the format of the values in the column, and adjust the width of the column.
5. Columns can be named in two ways: If you are assigning a column name that is identical every runtime language, enter a name in the edit box. If you want to use multiple languages, use a text entry in the text library. Click  to select an existing text ID from the text library.

6. If you want to configure the format of the column, select the "User Defined" check box. Enter the desired format specification in the edit box or click . If you have selected the column for "Frequency" or a summation, the "Integer Formatting Help" dialog opens. For formatting the averaging calculation, the "Formatting Help Floating-Point Number" dialog opens.

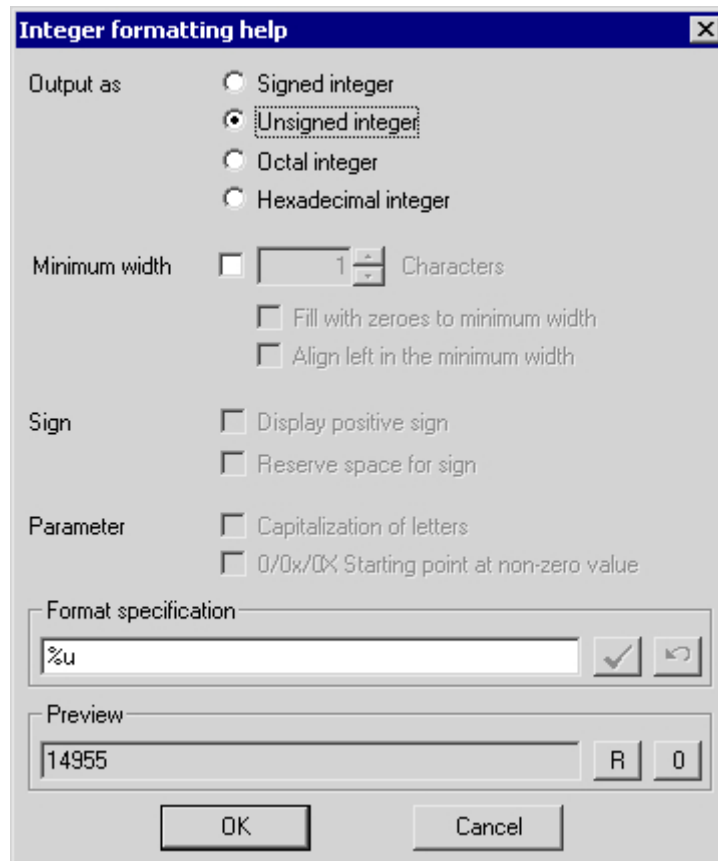

Specify the format settings. The preview shows the effect of your column format settings. In the Format Specification box you can enter additional text in front of and behind the formatting specification. Click  to confirm your entry. Click "OK" to confirm the format specification.

7. Using the "Selection" button, specify the criteria to be used for displaying messages in the hit list, such as a specific message class or a specific time range. If no time range is specified, all times are taken into account in calculating average values. Note that a long-range selection can adversely affect performance. Alternatively, you can specify the selection criteria for the hit list during runtime.
8. Using the "Sort..." button, specify the criteria to be used for sorting the columns in the hit list, for example, first descending by date and then ascending by message number. Alternatively, you can define the sort criteria for the hit list during runtime using the Sort dialog or "Sort by Column Header" function.

- Using the "Settings..." button, specify limitations regarding the number of messages and the time range to be taken into account in the statistical calculations for the hit list. This enables you to avoid adverse impacts on performance.

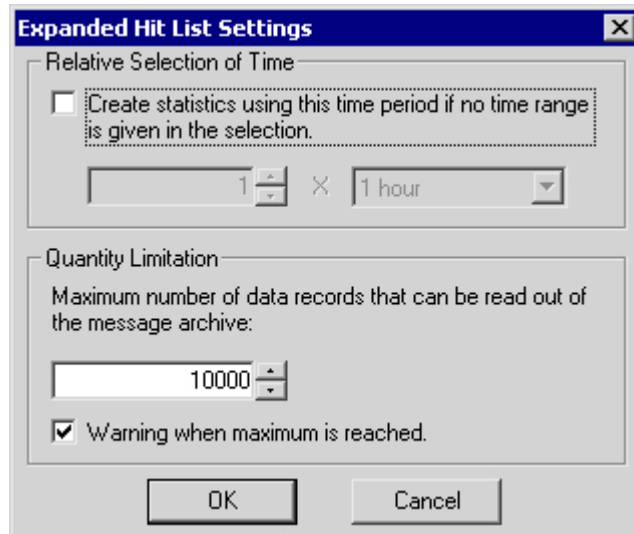

If no time range is specified in the selection dialog, you can select the relevant check box and enter a time factor and a time type to be used to generate the statistics. If the check box is not selected, the time factor is set to "0" and no time filter is applied.

In the "Quantity Limitation" field, specify the maximum number of data records from the message archive that are to be used to generate the hit list.

Example: You have specified the "Message Class Alarm High" filter in the selection dialog. For the compilation of the hit list, all alarm messages that meet this criteria are retrieved from the message server. From this group, the number of data records that is taken into account in the statistics is limited to the amount you specified in the quantity limitation.

When the maximum number of records is reached, a warning can be issued.

- Click "OK" or "Apply" to confirm the settings for the hit list. The hit list is now compiled. You can access the hit list during runtime by clicking  in the toolbar.

If no sort criteria are specified, the values in the hit list are sorted in descending order of frequency.

New incoming messages are not automatically included in the hit list. To include them, you must reselect the hit list.

See also

How to Configure the Alarm Control in the Graphics Designer (Page 1443)

Configuration of the WinCC Alarm Control (Page 1438)

5.7.2.7 How to Activate the Example for Alarm Control

Requirement

Prior to activating the example for the WinCC Alarm Control, you must

- Activate "Graphics Runtime" and "Alarm Logging Runtime" in the startup list of WinCC Explorer using the "Computer Properties" dialog
- Save the picture you configured in the Graphics Designer and enter it as the startup picture on the "Graphics Runtime" tab of the "Computer Properties" dialog.

Procedure

1. Activate runtime by clicking the relevant button in the toolbar or selecting the relevant menu option in WinCC Explorer.
2. Click the four buttons. The corresponding messages are displayed. If you now right-click the "Tank 2" button, the message status changes as indicated by the color assignment.

The screenshot shows the WinCC Alarm Control interface. At the top is a toolbar with various icons. Below it is a table with five rows of alarm messages. The first two rows are highlighted in green, and the last three rows are highlighted in red. To the right of the table are three buttons labeled 'Tank1', 'Tank2', and 'Tank3'. At the bottom of the interface, there are several status fields: '10/18/2006', '10:16 (LOC)', 'List: 5', 'Window: 5', and 'Ack: 5'.

	Date	Time	Message text	Point of error
1	18/10/06	10:16:16 AM	Tank1 low level	Tank1
2	18/10/06	10:16:26 AM	Tank2 low level	Tank2
3	18/10/06	10:16:48 AM	Tank1 empty	Tank1
4	18/10/06	10:16:49 AM	Tank2 empty	Tank2
▶ 5	18/10/06	10:16:50 AM	Tank3 empty	Tank3











3. Deactivate runtime by clicking the relevant button in the toolbar or selecting the relevant menu option in WinCC Explorer.















5.7.3 Operation during runtime





5.7.3.1 Operation of Alarm Control during Runtime

Introduction

The buttons on the toolbar are used to operate the message window during runtime. If you do not want to use the toolbar to operate the message window, you can use the functions available in the "Standard Functions/Alarm" group of the "Global Script" editor.





	"Message list" Shows the currently pending messages.
	"Short-term archive list" Shows the archived messages in the short-term archive list.
	"Long-term archive list" Shows the archived messages in the long-term archive list
	"Lock List" Shows all messages blocked in the system.
	"Hit List" Displays the message blocks and the static information that you have configured on the hit list tab of Alarm Control.
	"Ackn. Central Signaling Devices" Acknowledges a visual or audio messenger
	"Single acknowledgment" Acknowledges a selected single message
	"Group acknowledgement" Acknowledges all pending visible messages in the message window that require acknowledgement, unless they require single acknowledgment
	"Autoscroll" If "Autoscroll" has been activated, the latest modified message is selected in the message window. The visible range of the message window is moved, if necessary. If "Autoscroll" is not activated, a new message that appears is not selected. The visible range of the message window is not modified. Message rows can be selected in a targeted manner only if "Autoscroll" is activated.
	"Selection dialog" Specifies the selection criteria for the messages to be displayed in the message window. The messages that meet these criteria are not displayed but are nevertheless archived.
	"Display options dialog" Defines which messages are to be displayed in the message window. If the "Display all messages" option has been activated, the message windows shows the hidden as well as displayed messages. If the "Display shown messages only" option is activated, only shown messages are displayed in the message window. If the "Display hidden messages only" option is activated, only hidden messages are displayed in the message window.

	<p>"Lock dialog"</p> <p>Defines the blocking criteria. All messages that meet these criteria are neither displayed nor archived.</p>
	<p>"Print message report"</p> <p>Function for generating documentation containing a user-defined selection of messages</p>
	<p>"Print current view"</p> <p>Starts the printout of the messages displayed in the message window. Print job used during printing can be specified in the control properties on the "General" tab. In the Parameter dialog of the layouts linked to the print order, select the list of messages you want to print.</p>
	<p>"Emergency acknowledgement"</p> <p>Emergency acknowledgement of a message requiring acknowledgement. This function is used to send the acknowledgment signal of a selected single message directly the the AS, even when the message is not queued. The acknowledgment of unqueued messages only relates to messages configured in correct chronological order.</p>
	<p>"First message"</p> <p>The first of the currently pending messages is selected. The visible range of the message window is moved, if necessary. The button is only available if "Auto scrolling" is deactivated.</p>
	<p>"Last message"</p> <p>The last of the currently pending messages is selected. The visible range of the message window is moved, if necessary. The button is only available if "Auto scrolling" is deactivated.</p>
	<p>"Next message"</p> <p>The next message (relative to the currently selected one) is selected. The visible range of the message window is moved, if necessary. The button is only available if "Auto scrolling" is deactivated.</p>
	<p>"Previous message"</p> <p>The previous message (relative to the currently selected one) is selected. The visible range of the message window is moved, if necessary. The button is only available if "Auto scrolling" is deactivated.</p>
	<p>"Info text dialog"</p> <p>Opens a dialog where you can display info texts</p>
	<p>"Comments dialog"</p> <p>Opens a text editor where you can enter comments This button is only available in the long-term archive window. The configuration of this function therefore has an effect on the Alarm Control properties only for this window type.</p>
	<p>"Loop in alarm"</p> <p>Shows a picture related to the selected message, or triggers a script. The function can also be started by double-clicking a message.</p>
	<p>"Enable message"</p> <p>Click this button to unlock a message selected in the lock list.</p>
	<p>"Lock message"</p> <p>A selected message is locked in the current message list and in the message archive list.</p>
	<p>"Sort dialog"</p> <p>Opens a dialog for setting user-defined sort criteria for the displayed messages. User-defined sort criteria override the sort criteria resulting from the "MsgCtrlFlags" attribute.</p>

	"Time base dialog" Opens a dialog for setting the time base for the time data displayed in the messages.
	"List of hidden messages" The list of hidden messages shows all messages that are not visible due to automatic or manual hide in the message list, in the short-term archive list or the long-term archive list.
	"Hide messages" Hides the message you have selected in the message list, short-term archive list or long-term archive list. The message is entered in the list of hidden messages.
	"Unhide messages" Shows again the message you have selected in the "List of hidden messages" in the message list, short-term archive list or long-term archive list. The message is removed from the list of hidden messages.

Possible elements of the status bar



Icon	Description
Date	System date
Time of day	System time
List:	Number of current messages in the message list. The count includes messages hidden in the message list.
Window:	Number of messages in the window
Ackn:	Number of pending messages requiring acknowledgement
	Selection has been made.
	Filter criterion is effective, i.e. the "Display all messages" or "Display hidden messages only" option is currently active.
	Lock is set.
	There are hidden messages pending.

See also

Standard Functions for Operation of WinCC Alarm Control (Page 1473)

Configuration of the WinCC Alarm Control (Page 1438)

5.7.3.2 How to Select Messages

Introduction

You can use selection criteria during runtime to define which messages you want to display in the message window. In the example below, only messages that contain message text "Motor on" are displayed.

Requirements

- You have configured the relevant keyboard functions on the "Toolbar" tab of the Alarm Control.

Procedure

1. Click the "Selection Dialog" button  during runtime. The "Selection" dialog opens.
2. Double-click the "Text Blocks" folder in the tree structure, and click "Message Text". In the right pane, select the "Search Text" check box and double-click the "Search Text" selection.

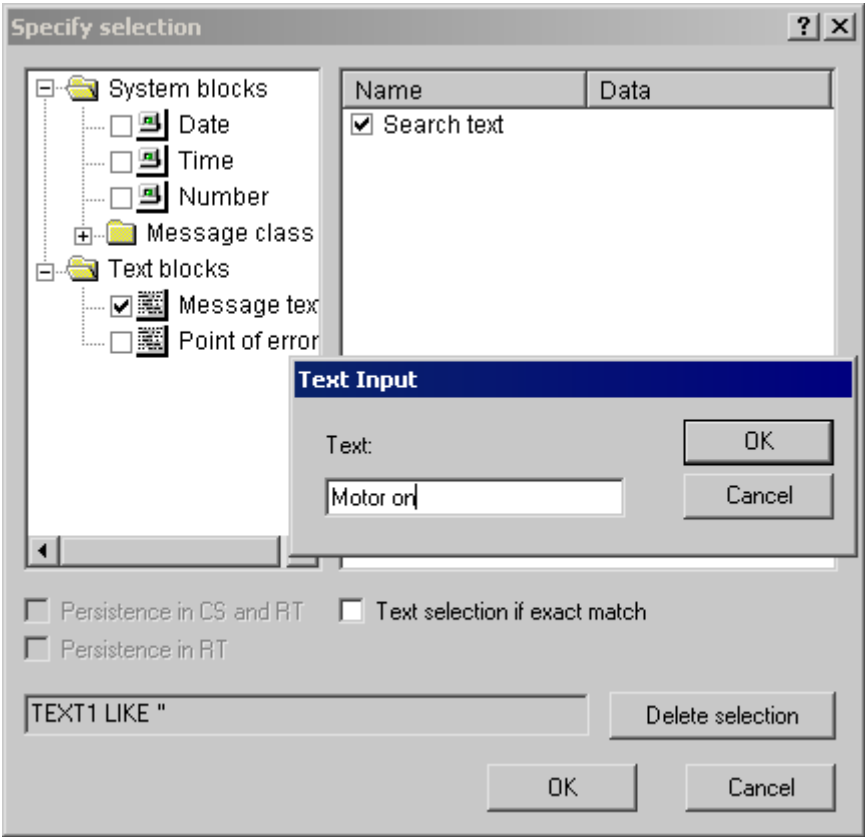

3. The "Text Input" dialog opens. Enter the search text "Tank 1" and click "OK" to confirm.
4. Click "OK" to close the "Specify Selection" dialog. The message window now shows only the selected messages.

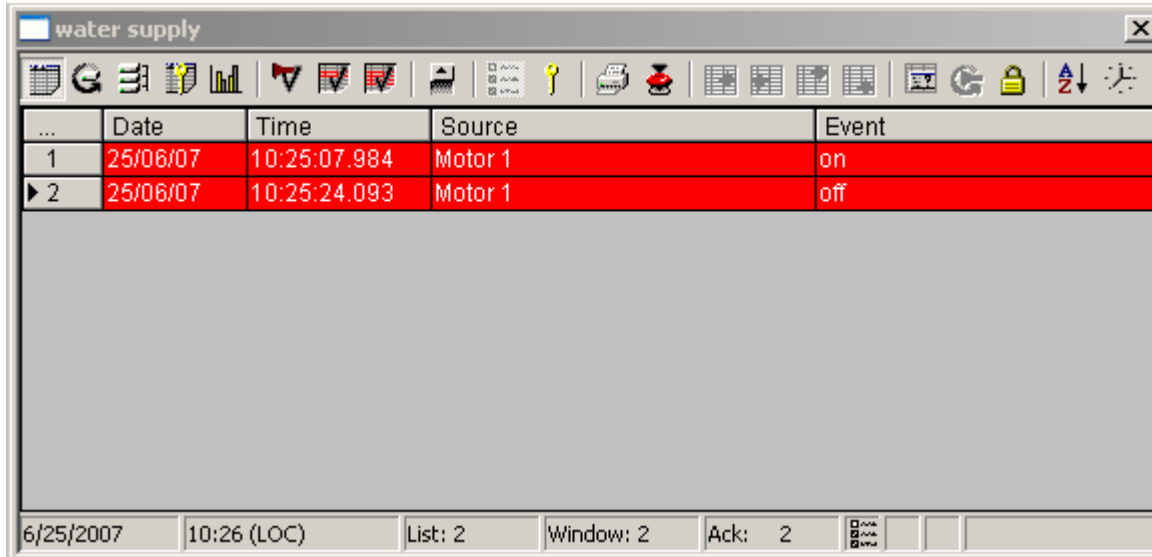

Notes on defining the dialog

For certain message blocks, such as the date and time-of-day system blocks, you specify the start and end times or a search text in the dialog. The entry must conform to the format required in the dialog.

In the "Specify Selection" dialog, you can make the following settings:

Array	Description
Text selection if exact match	If the "Text selection if exact match" check box is not selected, all text blocks containing the search string are selected. If the "Text selection if exact match" check box is selected, all text blocks correspond exactly to the search string are selected.
Persistence in RT	If the "Persistent in RT" check box is selected, changes in the search criteria are retained even after a picture change.
Persistence in CS and RT	If the "Persistent in RT and CS" check box is selected, the modified settings are also applied to the configuration system. To do this, you must open the picture in Graphics Designer and save it once again. The changed settings are also used when the project is reactivated. Changes to the control properties in Runtime are not persistently accepted in CS with PCS 7 projects or TIA projects. When you completely load the ES to the OS, the changed settings on the OS will be overwritten. Configure the properties of the controls on the ES.
Delete selection	Click this button to delete all configured selection criteria.

Note

It is not possible to enter text as a selection criterion for a process value. If you want to select based on the text of a process value block or the displayed process tags, proceed as follows:

- 1) Insert this process value as a message text of a user text block in a message.
- 2) During runtime, select the messages based on the text in the "Message Text" text block.

In multi-user systems, you must ensure that contents displayed in the selection dialog on a client are named identically on all servers.

To select based on the time of day, start and stop values are not automatically adjusted when the time base of the Alarm Control is changed. For example, a computer located in time zone "UTC + 1h" has the "Local Time Zone" time base specified in the Control. A selection criterion based on the time of day 10:00 a.m. to 11:00 a.m. is then applied. If the time base of the Control is now switched to "UTC" and you want to display the same messages in the Control as before, the start and stop values of the selection must be changed to 9:00 a.m. and 10:00 a.m., respectively.

See also

Operation of Alarm Control during Runtime (Page 1458)

Configuration of the WinCC Alarm Control (Page 1438)

5.7.3.3 How to Lock and Unlock Messages**Introduction**

Message locking suppresses the display and archiving of messages. You can set a lock for the following:

- Single messages
- Single messages with multiple instances. The selected instance of the message will be locked.
- Message types
- Message classes
- User-defined message groups



Persistence of message locking

- The locking of single messages is not persistent. Locked single messages are automatically unlocked when WinCC Runtime restarts. Exception: messages that are locked directly in the AS by means of data blocks (locking at source).
- The locking of message classes and message types remains in force even after a restart of WinCC Runtime.

Requirement

- You have configured the relevant keyboard functions on the "Toolbar" tab of the Alarm Control.

Locking and Unlocking Selected Messages using Keyboard Function "Lock/Unlock Message"

1. In the message list, select the message line containing the message to be locked, for example, "Tank1".
2. Click the "Lock/Enable message" button . The message is removed from the message list.
3. You can view the locked message by clicking the "Lock list" button . You can unlock the selected message again by clicking the "Lock/Enable message" button . The message is removed from the lock list.

Note

If a user is authorized to lock and unlock messages, this user must have both authorizations in the User Administrator, and these authorizations must be configured directly one below the other. This is necessary, since the unlock authorization for locked messages automatically uses the authorization level defined in the authorization for "Lock Messages" in the User Administration.

Note

Locking/unlocking of a single message of an Alarm_8(P) using S7PMC always results in the locking/unlocking of all 8 single messages of this block.

Locking and enabling single messages using the message number

1. Click the "Lock dialog" button . The "Configure Lock List" dialog opens.
2. Click a server in the server list, or click the local computer in the case of a single-user projects.

- Click the "Add" button. Enter the message number to be locked in the next dialog.

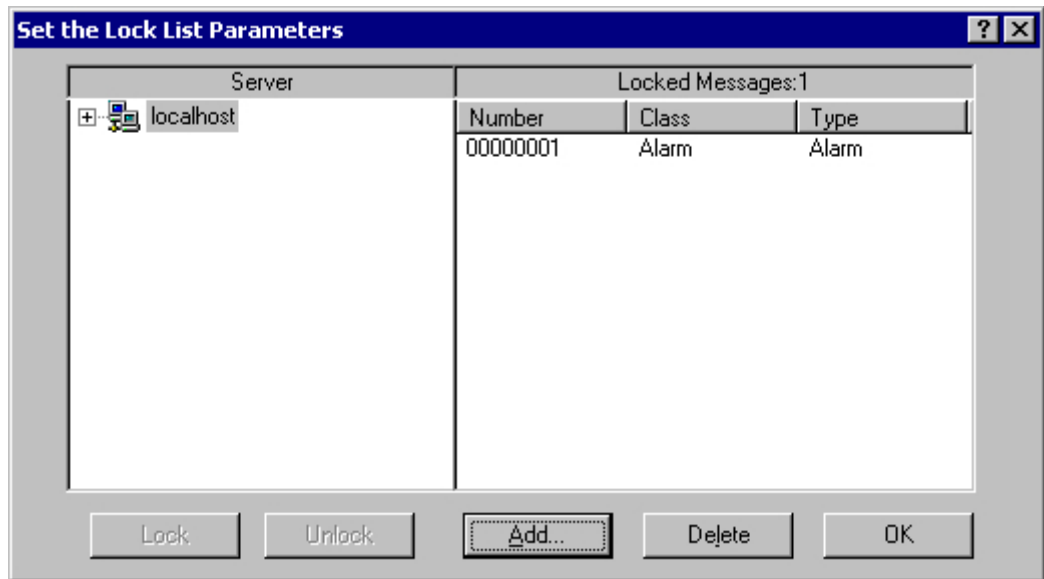

- You can lock several messages simultaneously. To do this, enter the message numbers separated by commas. To select a range of message numbers, enter a range in the form "5-10". Only uninterrupted message ranges are locked. If there are gaps in the specified range, the message "Invalid Range" is returned.
- To enable a locked message, select the message from the list of locked messages and then click the "Delete".

Note

You can lock and unlock a maximum of 50 messages simultaneously.

Locking and enabling messages using the message class, message type or user-defined group message

- Click the "Lock dialog" button . The "Configure Lock List" dialog opens.
- Click a server in the server list, or click the local computer in the case of a single-user projects.

3. In the tree structure, select a message class, message type or user-defined message group that you want to lock. Click the "Lock" button. All messages of the specified message class, message type or user-defined message group are locked.

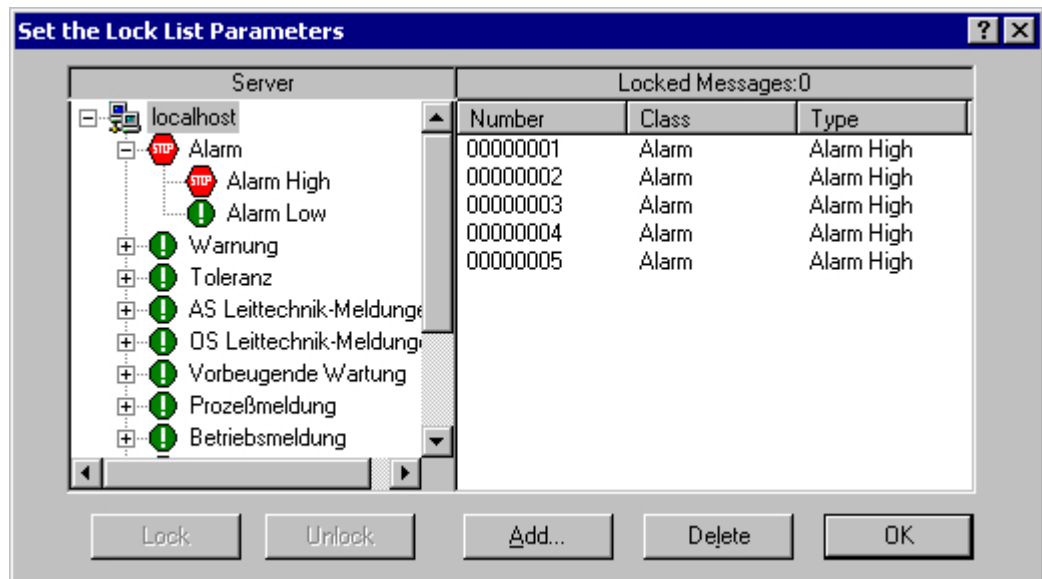

4. To enable the locked messages, select the relevant message class, message type or user-defined message group and click the "Enable" button.

Note

The server list contains only those server projects whose "Packages" are loaded on the computer containing the project where you are configuring the Control.

Operator Message upon Locking a Message

In the Alarm Control, you can specify whether an operator message is generated when a message is locked or unlocked. You can configure the operator message yourself. It contains the following information, by default:

- Time stamp
- Logged-on user
- Name of the computer in the message archive of the relevant alarm server

The time stamp for the message comes from the following:

- The message source (e.g., AS), in the case of active locking
- The alarm server (OS), in the case of passive locking

Actively locked messages are visible and operable on all WinCC servers and clients.

Procedure

1. On the "Message Lists" tab in the properties dialog for the Alarm Control, click the "Operator Messages..." button.
2. In the "Operator Messages" dialog, select the relevant check boxes if an operator message is to be triggered when messages are locked or unlocked.
3. If you want to configure the content of the operator message yourself, click . In the configuration dialog, enter the number of a message that you have configured previously in Alarm Logging. You assign the message blocks of the locked message to the process value blocks of the operator message. These message blocks must be selected on the "Message Blocks" tab. Click "OK" to confirm your settings.

Note

Operator messages can only be archived if system messages are set up in the message archive.

See also

Operation of Alarm Control during Runtime (Page 1458)

Configuration of the WinCC Alarm Control (Page 1438)

5.7.3.4 How to Hide and Show Messages

Introduction

Manual hiding of messages puts lesser information load on the user of the system. You as user can concentrate better on the messages only if lesser important messages are not shown.

Properties of Hidden Messages

Hidden messages are:

- In the message list, short-term archive list and long-term archive list, you can select whether the hidden messages are to be displayed. The display depends on the activated option in the "Display Options" dialog.
- They are included in the list of hidden messages and displayed there.
- They are archived.
- They do not trigger the alarm in Basic Process Control.
- You can again show messages that are hidden manually or automatically.
- In manual hide, they are displayed again after a certain defined period.
- Manual hiding forces you to acknowledge messages that need acknowledgement and triggers an operator input message.

- Automatic hiding does not force you to acknowledge and therefore it also does not trigger an operator input message.
- In the period when messages requiring confirmation are hidden, the system acknowledges the outgoing messages. If a message does not have the "gone" status, the system acknowledges it immediately.

Hide process

During manual hide, you as user will decide whether to hide a message by using a button in the message window. You can show the message again using a button or the system will show the message after a configurable period. Operator input messages can be triggered in Manual Hide.



Configuring Message Hiding in Alarm Logging

You can configure automatic hide and the duration for manual hide in Alarm Logging. The configuration process is described in the chapter "How to Configure the Hiding of Messages".

Requirement

- You have configured the key functions "Hide/Show Message" and "List of Hidden Messages" in the "Toolbar" tab in WinCC Alarm Control.
- Runtime has been activated and the WinCC Alarm Control is displayed.

Procedure

1. Select the message you want to hide in the message list, short-term archive list or long-term archive list.
2. Click the "Hide/Show message"  button. The message is no longer displayed in the list and is added to the list of hidden messages.
3. Click the "List of Hidden Messages"  button to display the hidden messages.
4. To show these messages again, display the "List of Hidden Messages". Select a message and click the "Hide/Show Message"  button. The message is removed from the "List of Hidden Messages" and displayed back in the original list.
5. If you do not take any action to show the hidden messages, the configured duration will decide when the system has to display back a message and remove it from the "List of Hidden Messages".

Runtime Behavior in Manual and Automatic Hiding of Messages

Using the manual and automatic hide functions during runtime has an effect on both the hide types:

- If the message is hidden automatically, you can display it again by clicking "Hide/Show Message".
- You have manually hidden the message using the "Hide/Show Message" button. The message is shown again when the hide tag reaches the state for automatic display. The period for manual hide should not have elapsed.
- You have manually hidden the message using the "Hide/Show Message" button. Further, the message has the status of the hide tag for automatic hiding. If the period for manual hide has expired, this message remains hidden.

See also

How to Configure the Hiding of Messages (Page 1296)

5.7.3.5 How to Perform an Emergency Acknowledgement

Introduction

In exceptional cases, a message can be acknowledged on the basis of its message number. In this case, the acknowledgment signal is sent to the AS even if the message is currently not pending. Acknowledging messages that are not pending only refers to messages that are configured in chronological order.

For this reason, the function should only be used in extreme emergency situations.

Requirement

- You have configured the keyboard function "Emergency Acknowledgment" on the "Toolbar" tab of the Alarm Control.

Procedure

1. Click the "Emergency acknowledgment" button . The "Emergency Acknowledgment for Messages" dialog opens.
2. Select a server. In the "Message Number" box, enter the number of the message to be acknowledged. Click the "Request" button. In the message window, the message now appears in the color that you specified for an acknowledged message.

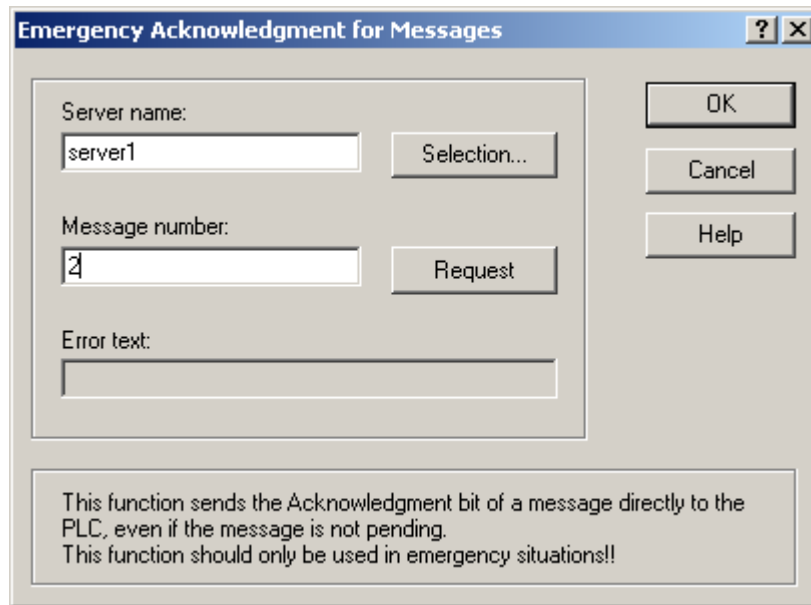

Note

In the dialog for the selection of the servers, only server projects are shown whose "Package" is loaded onto the computer.

See also

- Operation of Alarm Control during Runtime (Page 1458)
- Configuration of the WinCC Alarm Control (Page 1438)

5.7.3.6 How to Sort the Display of Messages

Introduction

During runtime, you can sort the messages in the message window on the basis of message blocks. You sort the message blocks either via the "Sort Dialog" keyboard function or directly via the column headers of the message blocks.

Examples for sorting messages:

- Display of messages in descending order by date, time and message number. The most recent message is displayed at the top.
- Display of messages according to priority. To apply this sorting method, you must have specified the priorities of messages in Alarm Logging and configured the "Priority" message block in the Alarm Control. As a result, in a single-line message view, only the top-priority message appears in the message window. A message with a lower priority is not displayed, even if it is more recent. Normally, the messages are shown in chronological order.
- Display of messages in ascending or descending order based on various message blocks, allowing for user-defined sorting during runtime.
- The "Status" message block is sorted according to the status type and not according to the configured status texts. If sorting is in ascending order, the messages are sorted in the following order: Came In, Went Out, Acknowledged, Locked, Unlocked, System Acknowledgement, Emergency Acknowledgement, Came In/Went Out.

Note

You can also specify the sort criteria during configuration in the Alarm Control by clicking the "Sorting..." button on the "Message Lists" tab. You configure the sort criteria for the hit list on the "Hit List" tab.

Sorting Using the Sort Dialog

Requirement

- You have configured the "Sort Dialog" keyboard function on the "Toolbar" tab of the Alarm Control.

Procedure

1. Click the "Sort Dialog" button .
2. In the "Sort By" field, select the message block by which to sort first. Select the relevant check box to specify sorting in ascending or descending order. If you want to sort by more than one message block, select the other message blocks in the desired order in the "Then By" lists.

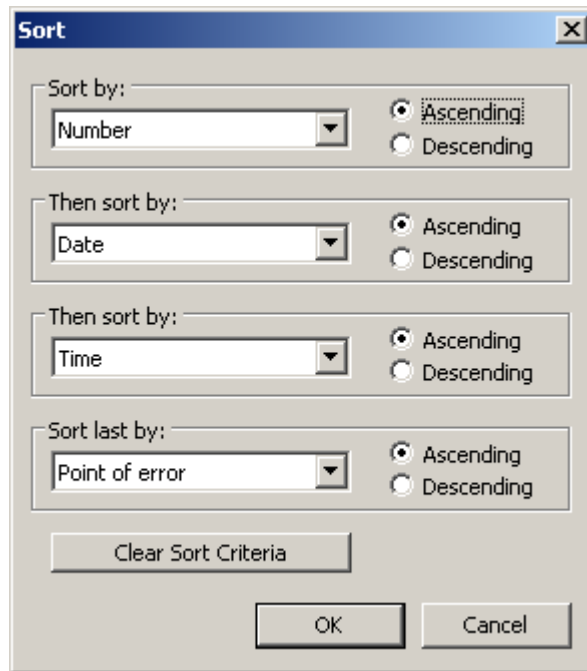

Sorting Using the Column Headers of Message Blocks

When sorting using the column header, you can specify the sort order for more than four message blocks. An arrow and a number are shown in the column header (right-justified). The arrow indicates the sort direction, i.e. ascending or descending. The number beside the arrow indicates the sort order of the message blocks.

Requirement

- You have selected the "Sort by Column Header" check box on the "Parameters" tab of the Alarm Control.
- You have deactivated the "Autoscroll" keyboard function.

Procedure

1. Click the column header of the message block you want to sort by first. The number "1" is displayed, and the arrow points upwards for ascending sort order.
2. If you want to sort in descending order, click the column header again.

3. If you want to clear the sorting of the message block, click the column header a third time.
4. If you want to sort on the basis of several message blocks, click the header columns of the respective message blocks in the desired sequence.

Note

Sorting is not affected by events or changes in the message block configuration. If you have defined a message block as a sort criterion in the sort dialog and you subsequently delete this block from the message line, the specified sort order remains in place. In the sort dialog, a blank field is displayed instead of the deleted message block. If you have not specified another sort order and the deleted message block is included again in the message block configuration of the Control, the messages are again shown in the original sort order.

See also

Operation of Alarm Control during Runtime (Page 1458)

Configuration of the WinCC Alarm Control (Page 1438)

5.7.3.7 Standard Functions for Operation of WinCC Alarm Control

Introduction

If you do not want to use the toolbar to operate the message window, you can use the functions available in the "Standard Functions/Alarm" group of the "Global Script" editor.

Function	Description
AXC_OnBtnAlarmHidingList	Function used to switch the message window to show the list of hidden messages.
AXC_OnBtnArcLong	This function is used to switch the message window to show the messages in the long-term archive list.
AXC_OnBtnArcShort	This function is used to switch the message window to show the messages in the short-term archive list.
AXC_OnBtnComment	This function opens the dialog for entry of a message comment.
AXC_OnBtnEmergAckn	This function is used for an emergency acknowledgement of a message.
AXC_OnBtnHideUnhideMsg	The function hides the selected message or displays again the hidden message.
AXC_OnBtnHit	This function is used to switch the message window to show the messages in the hit list.
AXC_OnBtnHornAckn	This function can be used to acknowledge a central signaling device assigned to the selected message.
AXC_OnBtnInfo	This function opens an information window showing the stored information text.
AXC_OnBtnLoop	You can use this function to change the picture to the configured loop-in alarm picture of the selected message.

Function	Description
AXC_OnBtnMsgFirst	This function selects the first message and shifts the visible range in the message window, if necessary.
AXC_OnBtnMsgLast	This function selects the last message and shifts the visible range in the message window, if necessary.
AXC_OnBtnMsgNext	This function selects the next message and shifts the visible range in the message window, if necessary.
AXC_OnBtnMsgPrev	This function selects the previous message and shifts the visible range in the message window, if necessary.
AXC_OnBtnMsgWin	This function is used to switch the message window to show the messages in the message list.
AXC_OnBtnPrint	Depending on the current display type (message list, short-term archive list, long-term archive list), this function is used to generate a printout of the currently pending or archived messages that meet the selection criteria. The print layout depends on the type of the message window.
AXC_OnBtnProtocol	This function starts a printout of the current view of the Control. All messages meeting the selection criteria are printed.
AXC_OnBtnScroll	This function can be used to change the Autoscroll behavior of the message window.
AXC_OnBtnSelect	This function opens the selection dialog.
AXC_OnBtnSinglAckn	This function is used for acknowledgement of a selected single message.
AXC_OnBtnSortDlg	This function opens the dialog for creating a user-defined sort criteria for the displayed messages.
AXC_OnBtnTimeBase	This function opens the dialog for setting the time base for the time data displayed in the messages.
AXC_OnBtnVisibleAckn	This function is used for acknowledgement of all messages visible in the message window.
AXC_OnBtnLock	This function opens the dialog where messages can be locked.
AXC_OnBtnLockWin	This function activates the lock list view.
AXC_OnBtnLockUnlock	This function locks the currently selected message in Alarm Control in the message list, short-term archive list and long-term archive list views. If the lock list view is selected, this function is used to unlock the currently selected message.
AXC_SetFilter	This function can be used to define a filter for selection of messages to be displayed in the message window. The filter criteria must be defined within the action script.

See also

- Example of the Use of Standard Functions (Page 1475)
- Operation of Alarm Control during Runtime (Page 1458)
- Configuration of the WinCC Alarm Control (Page 1438)

5.7.3.8 Example of the Use of Standard Functions

Introduction

In order to operate the WinCC Alarm Control by means a function, you must configure the corresponding function. This is done by making objects dynamic with standard functions of Global Script in the Graphics Designer.

In principle, any object can be used to operate the Alarm Control. In order to achieve similarity with the toolbar of a message window, the following example will insert a graphic object for acknowledging a message.

Requirement

- You have configured the example project for Alarm Control.
- You have opened the picture containing the configured Alarm Control in the Graphics Designer.

Procedure

1. Determine the object name of the Alarm Control based on the object properties of the Control, for example, "OLE-Control1".
2. Insert a graphic object from the smart objects of the object palette into the picture. Use the mouse to resize the graphic object to the desired size. In the configuration dialog, select  picture to be displayed, for example,



3. In order to make the graphic object dynamic, open the Properties dialog for the object via the shortcut menu of the graphic object. On the "Events" tab, select the "Mouse" object and use a C-Action to make the "Mouse Action" attribute dynamic.

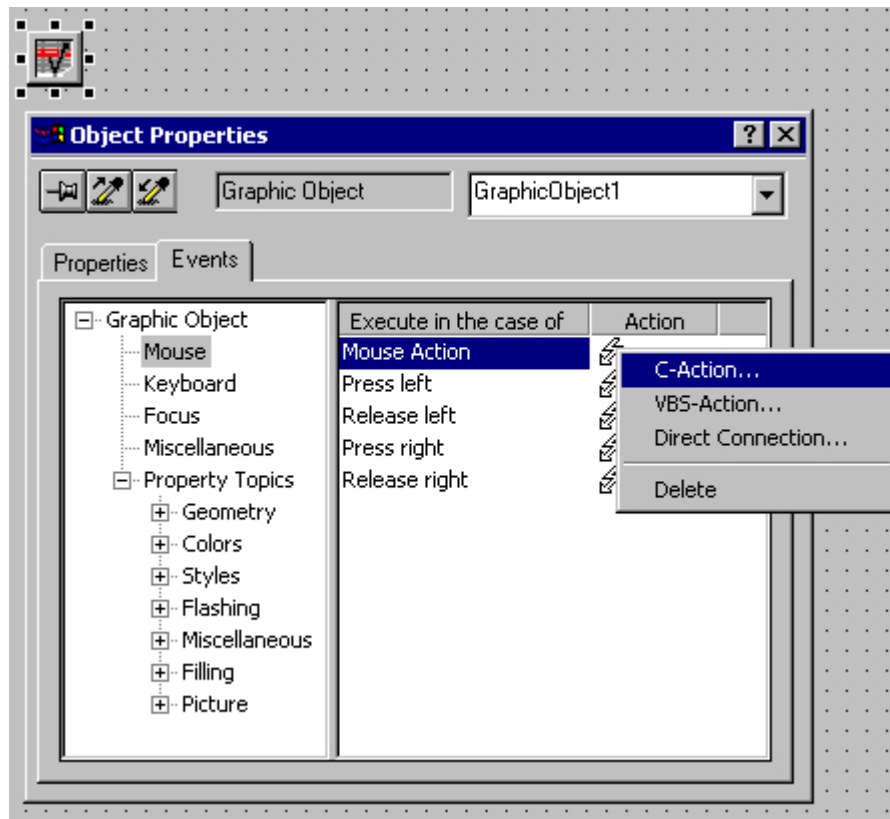

- In order to enable a single acknowledgement of messages, you must select the "AXC_OnBtnSinglAckn" function from the "Alarm" standard functions group in the "Edit Action" window. To do so, double-click the function.

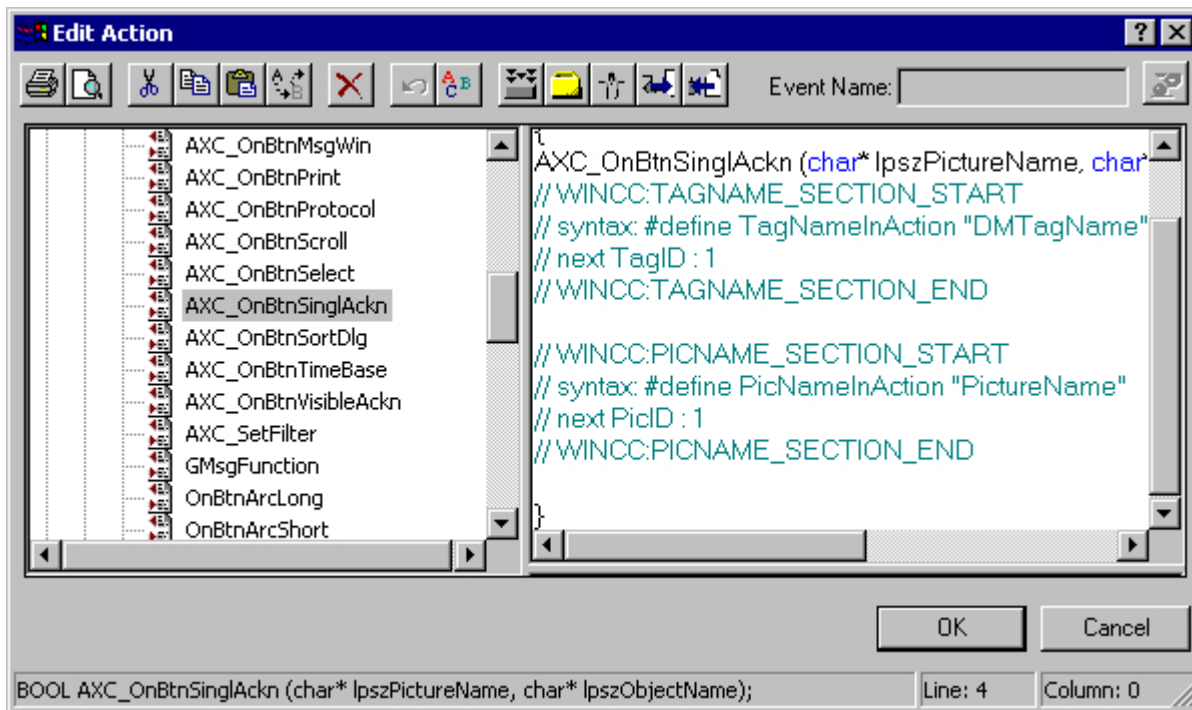

- The "Set Parameters" window opens. Click "OK" to close the window without changes.

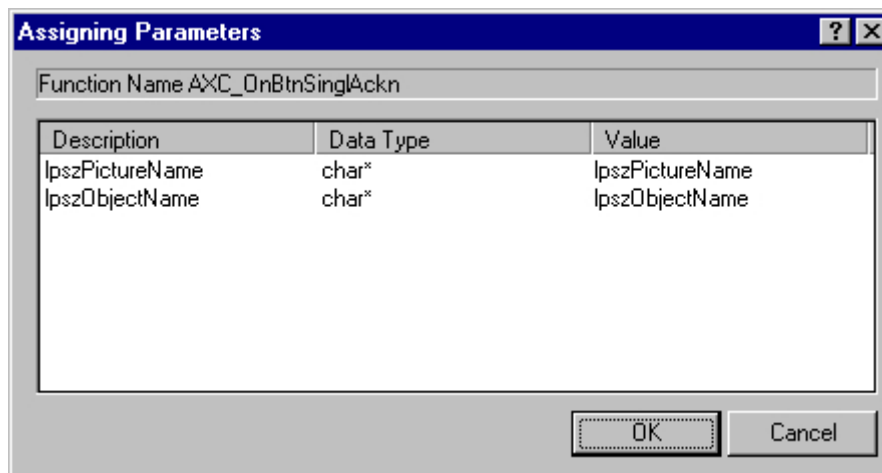

6. In the "Edit Action" window, replace the string "IpszObjectName" with the object name of the Alarm Control. In the example, the string is replaced with "OLE-Control1". After successful creation of the action, click "OK" to close the window.

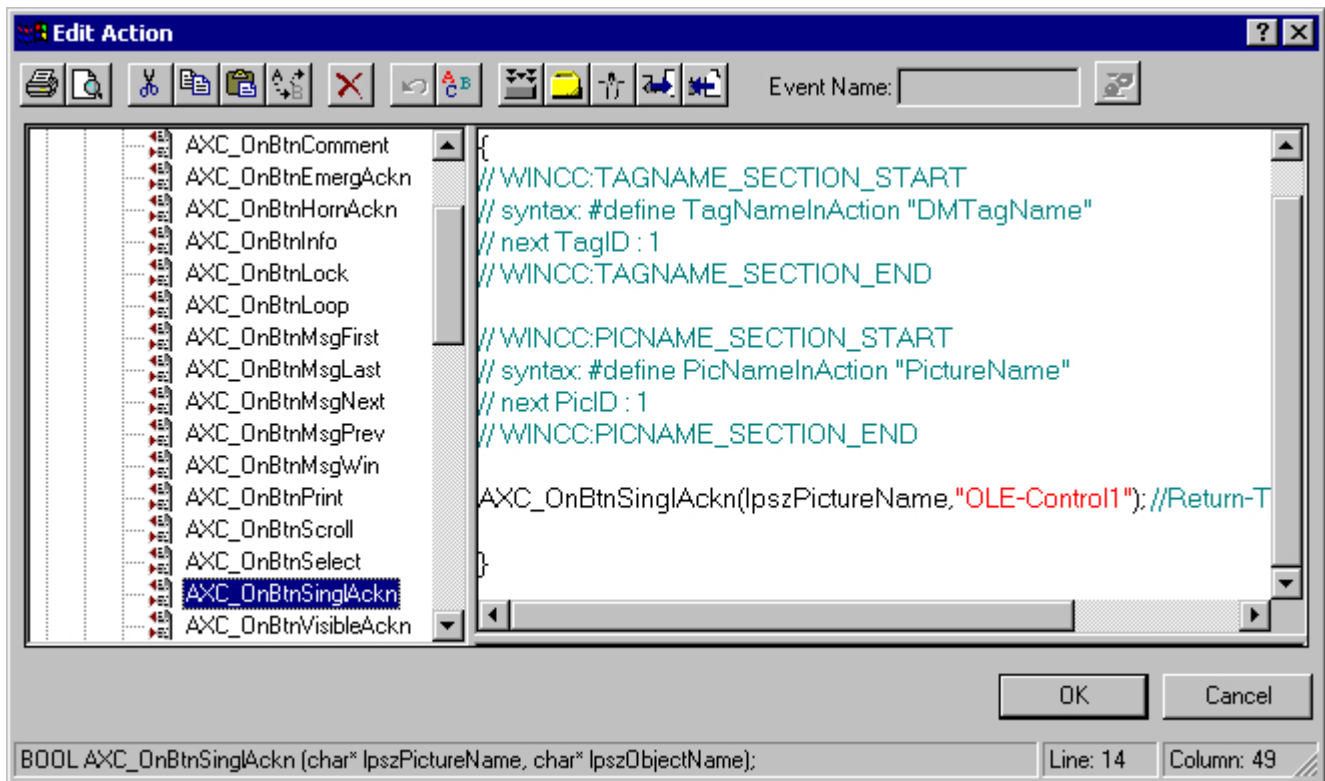

7. Save your settings in the Graphics Designer.
8. Start Runtime. Click the "Tank 1" button to generate a message. Now, click . The message is acknowledged, and the color of the message changes.

See also

- How to Configure Buttons for Changing Message Tags (Page 1450)
- Configuration of the WinCC Alarm Control (Page 1438)
- Standard Functions for Operation of WinCC Alarm Control (Page 1473)

5.7.4 SQL Statements for Filtering of Messages in Alarm Control

Introduction

In WinCC Alarm Control, only the SQL statements that can also be generated using the selection dialog of the message window are permitted. The following conditions apply to WinCC:

- The structure consists of "Field", "Operand", and "Value", with the individual parameters separated by blanks. E.g.: DATETIME >= '2006-12-21 00:00:00' AND MSGNR >= 100 (all messages as of 12/21/2006 with a message number greater than and equal to 100)
- Character strings, date, and time must be passed in single quotation marks.
- In the "DATETIME" argument, the date and time of day are separated by a blank. Regardless of the time base setting in the object properties, the output of "DATETIME" is based on the time base "Local Time". The "UTC" setting of the time base is an exception; the output is then based on the "UTC" time base.
- The length of the SQL statement in WinCC AlarmControl is limited to 4096 characters.
- Only the SQL statements that can also be generated using the selection dialog of the message window are permitted.

Valid arguments

Name	SQL name	Type	Data	Example
Date/time	DATETIME	Date	'YYYY-MM-DD hh:mm:ss.msmsms'	DATETIME >= '2007-05-03 16:00:00.000' Outputs messages as of 05/03/2007, 16:00 hours.
Number	MSGNR	Integer	Message number	MSGNR >= 10 AND MSGNR <= 12 Outputs the messages with message numbers 10 - 12.
Class/type	CLASS IN AND TYPE IN	Integer	- Message class ID 1-16 and sys- tem message classes 17 + 18 - Message type ID 1-256 and sys- tem message types 257, 258, 273, 274	CLASS IN (1) AND TYPE IN (2) Outputs messages of message class 1, message type 2.
State	STATE	Integer	Value "ALARM_STATE_xx" Only the operands "=" and "IN(...)" are permitted. ALARM_STATE_1 ALARM_STATE_2 ALARM_STATE_3 ALARM_STATE_4 ALARM_STATE_10 ALARM_STATE_11 ALARM_STATE_16 ALARM_STATE_17	STATE IN(1,2,3) Outputs all messages that came in, went out and were acknowledged. Possible value: 1 = incoming messages 2 = outgoing messages 3 = acknowledged messages 4 = locked messages 10 = hidden messages 11 = shown messages 16 = messages acknowledged by the system 17 = Emergency-acknowledged mes- sages

Name	SQL name	Type	Data	Example
Priority	PRIORITY	Integer	Message priority 0 - 16	PRIORITY >= 1 AND PRIORITY <= 5 Outputs messages that have a priority between 1 and 5.
AS Number	AGNR	Integer	AS Number	AGNR >= 2 AND AGNR <= 2 Outputs messages with the AS number 2.
CPU Number	AGSUBNR	Integer	AG subnumber	AGSUBNR >= 5 AND AGSUBNR <= 5 Outputs messages with AG subnumber 5.
Instance	INSTANCE	Text	Instance	-
Block: 1 ... Block: 10	TEXTxx	Text	Search text for Text1 - Text10	TEXT2 = "Error" Outputs the messages whose Text2 corresponds with "Error". TEXT2 IN ('Error','Fault') Outputs the messages whose Text2 corresponds with the text "Error" or "Fault". TEXT2 LIKE 'Error' Outputs the messages whose Text2 includes the text "Error".
Process value: 1 ... Process value: 10	PVALUExx	Double	Search value for PVALUE1-PVALUE10	PVALUE1 >= 0 AND PVALUE1 <= 50 Outputs process value 1 with start value 0 and stop value 50.

Valid operands

- >= , <= , = , > , <
- **IN(...)** : Several values as an array, separated by commas, e.g.: CLASS IN(1 ,2 ,3) AND TYPE IN(1 ,2 ,19 ,20 ,37 ,38)
- **LIKE** : Text must contain string, e.g.: TEXT1 LIKE 'Error' relays message where Text1 contains the search text "Error". The operand LIKE is only permitted for Text arguments.

Invalid arguments and operands

Only the arguments indicated in the table and operands from the list are valid.

The following are not valid:

- The "OR" operand
- Multiple use of the same "Textxx" argument, e.g. "Text1"
- Grouping of arguments, e.g. by means of parentheses.

Archiving Process Values

6.1 Archiving Process Values

Content

WinCC offers the following options:

- Process and archive process values from a plant
- Output process values in the picture or as a log

You configure archives in the "Tag Logging" editor.

This chapter shows you:

- The basics of process value archiving
- How to configure the process value archiving
- How to output process values

6.2 Process Value Archiving in WinCC

Introduction

The archive system is used for the archiving of process values in Runtime.

The archiving system processes the process values cached in the Runtime database and writes them to the archive database.

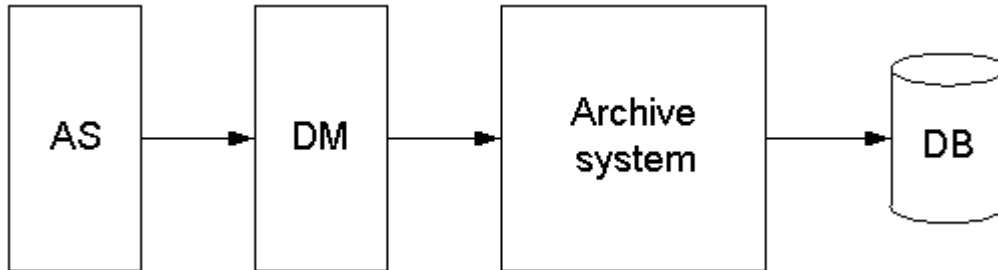

The following WinCC subsystems are involved in the process value archiving:

- Automation system (AS): saves the process values that are sent to WinCC via communication drivers.
- Data manager (DM): processes the process values and returns them to the archive system via process tags.
- Archive system: Processes the acquired process values, for example, by forming the average value. The method of processing depends on the configuration of the archive.
- Runtime database (DB): saves the process values that are to be archived.

Term definitions of archiving

The question of whether and when process values are acquired and archived is dependent on a variety of parameters.

The parameters to be configured for your project depend on the applied archiving method.

- Acquisition cycle: determines when the value of a process tag is read out in the automation system. You might configure an acquisition cycle, for example, for the continuous cyclic archiving of process values.
- Archiving cycle: determines when the processed process value is saved in the archive database. You might configure an archiving cycle, for example, for the continuous cyclic archiving of process values.
- Start event: starts process value archiving when a specific event occurs, for example, when the plant is turned on. You might configure a start event, for example, for a selective cyclic archiving of process values.

- **Stop event:**
stops process value archiving when a specific event occurs, for example, when the plant is turned off.
You might configure a stop event, for example, for a selective cyclic archiving of process values.
- **Event-controlled archiving:**
Process values are archived if a change takes place in a tag value or in the return value of a script.
You can configure event-controlled archiving in acyclic archiving of process values.
- **Archiving process values during changes:**
Process values are archived only when they have been changed.
You can configure the archiving in acyclic archiving of process values.

Term definitions of archive configuration

The following two archive types are available for archive configuration:

- **TagLogging Slow**
All archive tags with a cycle time of more than one minute are automatically archived by WinCC in TagLogging Slow.
- **TagLogging Fast**
All archive tags with a cycle time of less than one minute are automatically archived by WinCC in TagLogging Fast.
In the archive configuration you can assign different archive tags to the TagLogging Fast, for example, process-controlled measured values.

You change the default cycle time for the archive types in the archive configuration of TagLogging Fast.

6.3 Basics of Process Values Archiving

6.3.1 Basics of Process Values Archiving

Introduction

The process value archiving serves for compiling, processing and archiving of process data from an industrial plant.

The process data gained can be filtered according to important economic and technical criteria relating to the operating status of a plant.

Principle of operation

The process values to be archived are compiled, processed and saved in the archive database in Runtime.

Current or previously archived process values can be output in Runtime as a table, trend or bar diagram.

You can display archived texts in tables.

In addition, it is possible to print out archived process values as a protocol.

Configuration

You configure the archive system in the "Tag Logging" editor.

- Creating process value archives and compressed archives
- Defining acquisition cycles and archiving cycles
- Selecting process values to be archived

You configure WinCC controls for displaying process data in runtime in Graphics Designer:

- In table form
- In trend form
- In bar form

The report output of archived process data is configured as a report in Report Designer.

- In tables
- In trends
- In bar diagrams

Usage

The process value archiving can, for example, be used for the following tasks:

- Early detection of danger and fault conditions
- Increase of productivity
- Increase of product quality
- Optimization of maintenance cycles
- Documentation of the progress of process values

6.3.2 Process Value Archiving for Multi-User Projects

Introduction

In multi-user projects, process values can be archived by various servers.

The following client-server scenarios illustrate possible configurations.

Client/Server Scenarios

Scenario 1

Process value archiving runs on several servers (2).

Clients (1) can access the process value archives on the available servers:

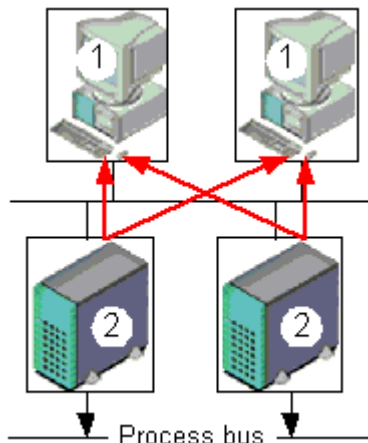

Scenario 2

Message and process value archiving runs on one server (3), together with process communication.

All other servers (2) deal with process-oriented tasks (e.g. displaying pictures).

Clients (1) can access all available servers:

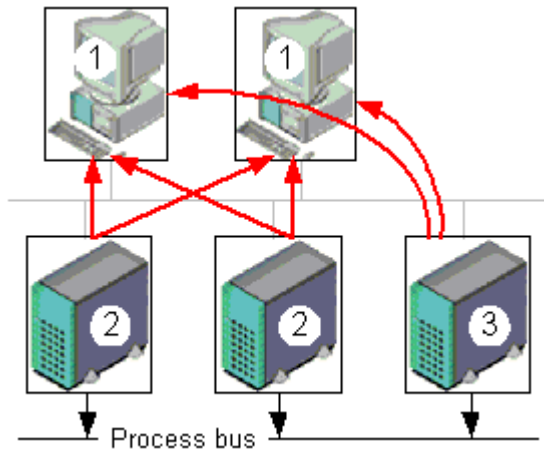

Scenario 3

A server (3) without a process driver connection deals solely with message and process value archiving.

The server (3) collects the data from all other servers (2) through server-server communication and distributes it to the clients (1):

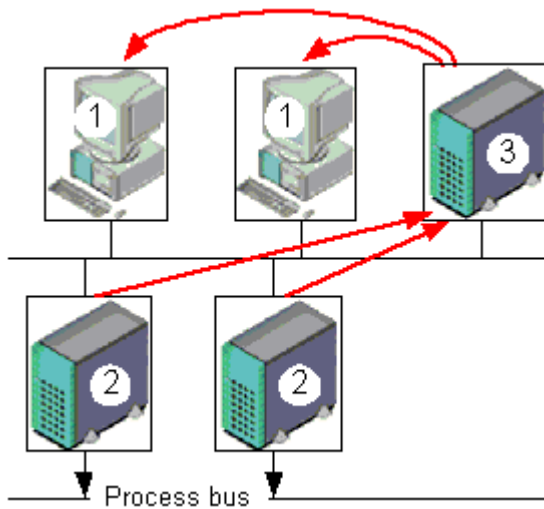

6.3.3 Process Values and Tags

6.3.3.1 Process Values and Tags

Principle

Process values

Process values are data stored in the memory of one of the connected automation systems.

Process values represent the status of a plant or parts thereof, for example, temperatures, fill levels or states (e.g. motor off).

Process tags

To work with the process tags, you define tags in WinCC.

The link between WinCC and the automation systems is provided by process tags, which correspond to a certain process value in the memory of an automation system.

The value of a process tag is obtained by reading out the process value from the memory of the automation system.

On the other hand, a process value can also be written back to the memory of the automation system.



6.3.3.2 External and Internal Tags

Introduction

External tags

External tags are used to acquire process values in WinCC.

They access a memory address in the connected automation system. External tags are therefore referred to as process tags.

Internal tags

Internal tags do not have a process link and only carry values within WinCC.

External and internal tags can be stored in archive tags in the process value archive.

Note

Documentation for the archiving system

As the primary task of process value archiving is the archiving of external tag values, this documentation refers only to process tags.

Archive Tags

Process values are stored in archive tags in the process value archive.

The system distinguishes between the following types of archive tags:

- Analog archive tag:
Stores numerical process values, e.g. the fill level of a tank.
- Binary archive tag:
Stores binary process values, e.g. whether a motor was switched on or off.
- Process-driven tag
Stores process values that have been sent to the archive system as frames, e.g. process values in a series of measurements.
- Text tag (8-bit and 16-bit):
Stores the product IDs or batch names, for example.

Compressed tags

Archived process values can be compressed.

This compression is achieved through the application of mathematical functions (e.g. averaging).

Compressed process values of this type are stored in compressed tags in a compressed archive.

6.3.3.3 Process-controlled tags

Raw data tags

Process-controlled tags (frame tags) are needed for the acquisition of quickly changing process values, or if you want to combine several measuring points from one system.

Process-controlled tags are of the "raw data type" in WinCC and are therefore also referred to as "raw data tags".

Principle

In the automation system the process values are written to a binary file, and are sent as a frame to WinCC where they are stored in a raw data tag.

Archiving process-controlled tags

If you want the acquired process values belonging to a raw data tag to be archived, you need to configure a process-controlled tag in the process value archive.

To enable the archive system to process the frame in the process-controlled tag, select a format DLL.

The format DLL is supplied with the automation system that you are using and dismantles the frame (e.g. to ascertain the process values). The process values are then written to the archive database.

A format DLL for the SIMATIC S7 is included as standard in the scope of delivery of WinCC.

6.3.3.4 Structure of a Telegram with Raw Data Tags

Introduction

A frame for the transfer of raw data tags consists of two parts:

- Frame header
- Frame body

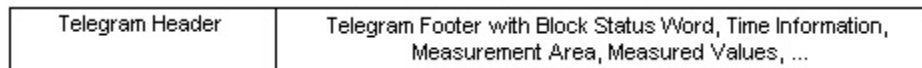

Frame header

The frame header contains general data, e.g. length of the frame.

The high byte of data word 0 is not used by the system and might thus be assigned by the user as required.

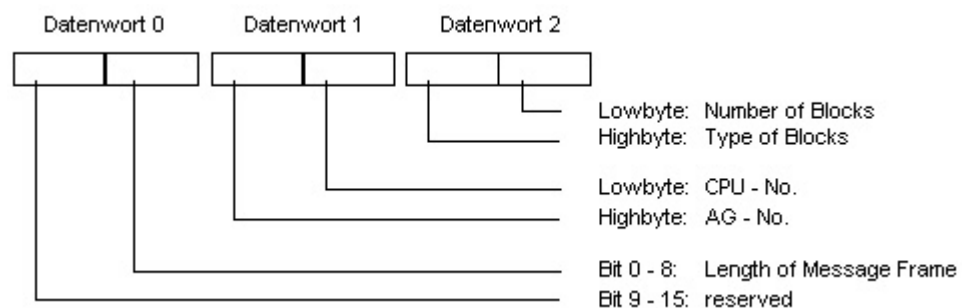

Frame body

In the block status word, the format of the measurement values and the format of the measurement areas, among other things, are defined.

Bit 10 is reserved. The bit is used for switching daylight saving and standard times (daylight saving time = 1).

6.3 Basics of Process Values Archiving

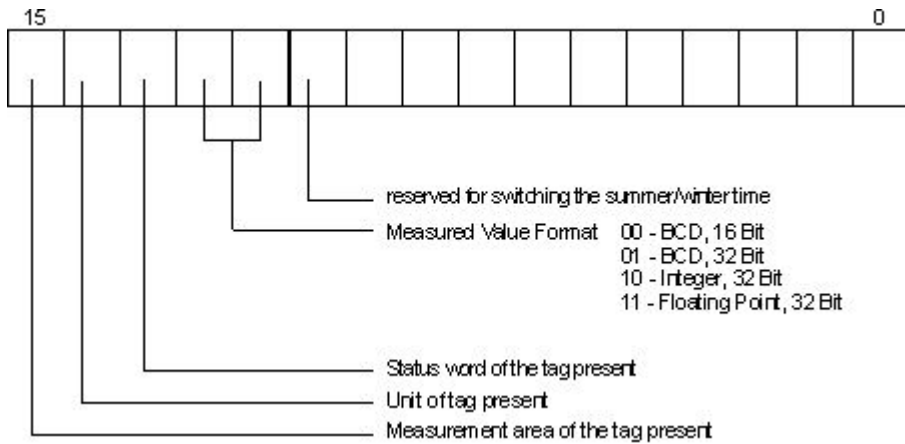

Time and date are structured in accordance with the definition of the sequential time indication.

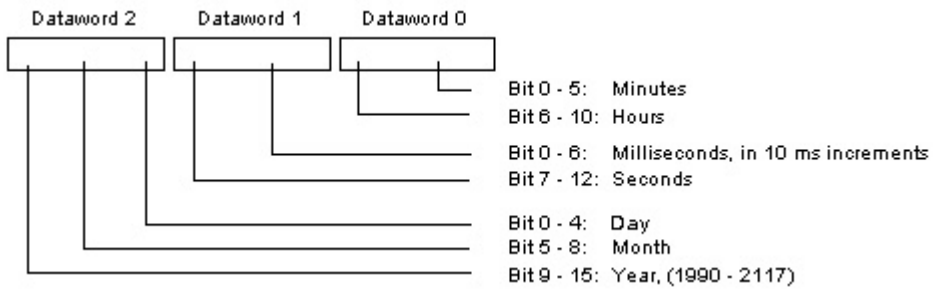

To transfer a measurement area, 8 data words are necessary. In these words, the upper and lower limits of the tag and the archive are specified.

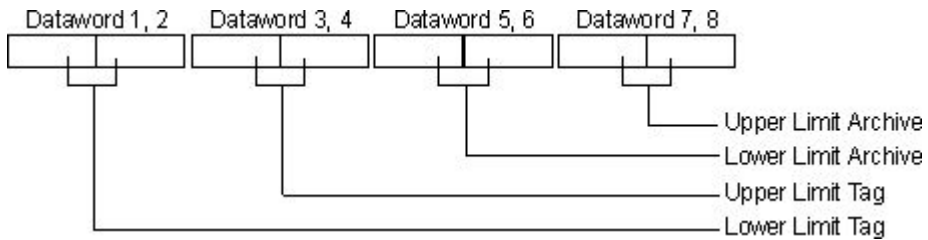

The following section contains a number of sample frame types.

Type 1

Measured value of a process tag + date and time

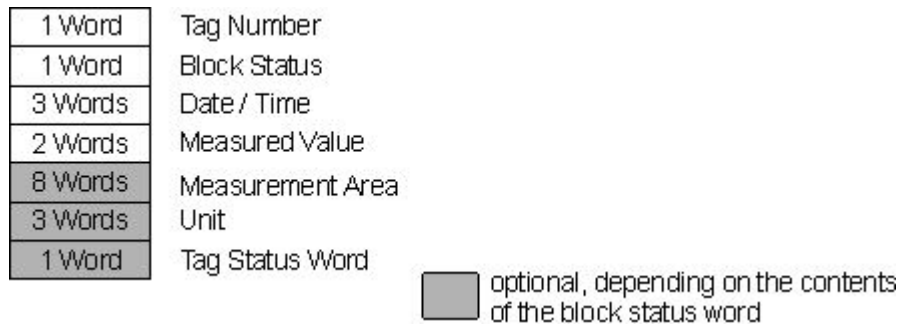

Type 2

n measured values of a process tag + date and time of each measured value

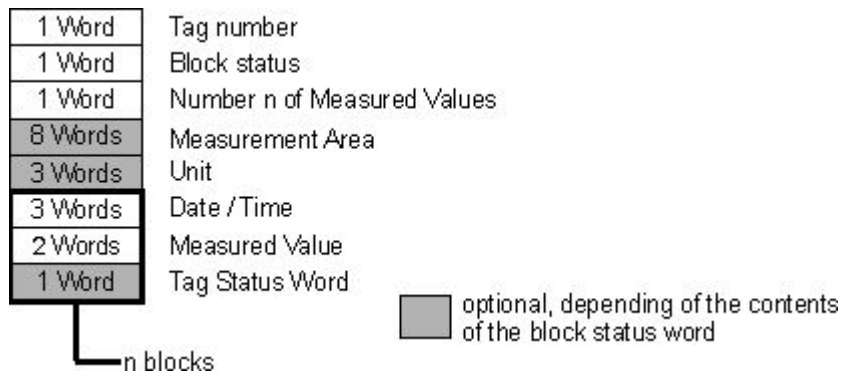

Type 3

n measured values of a process tag with date and time, and sampling cycle

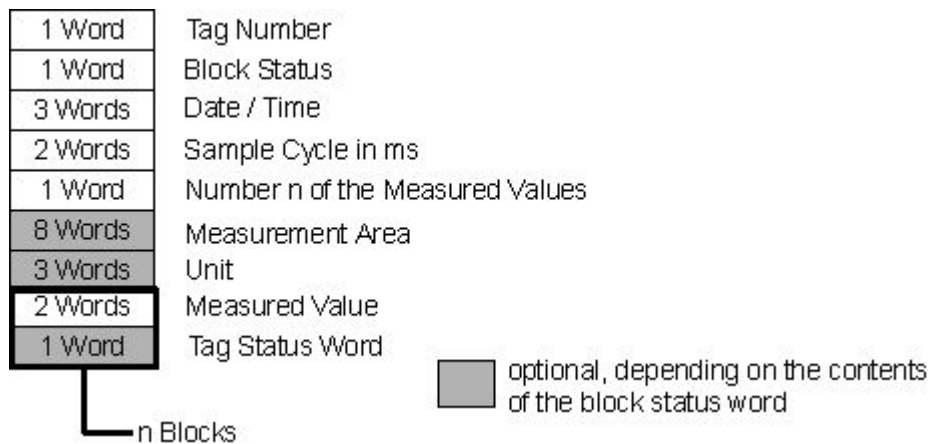

Type 4

n measured values of various process tags with time and date

6.3 Basics of Process Values Archiving

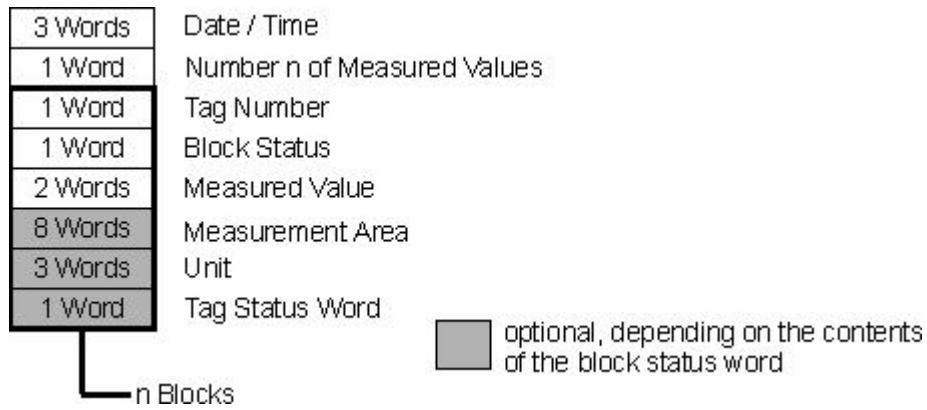

Type 5

n measured values of various process tags without time and date

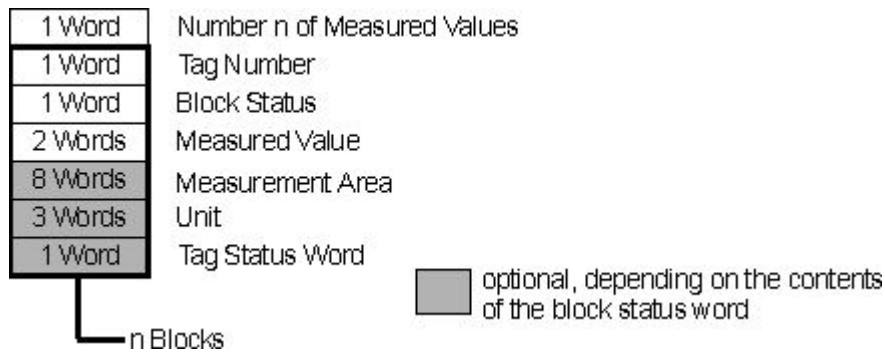

6.3.3.5 Diagnostic Tags of Tag Logging Runtime

Tag logging has some diagnostics tags which enable the current archiving rate of the system to be established.

Diagnostic tags are created as internal tags in the WinCC Explorer and are part of the "TagLoggingRT" tag group.

@TLGRT_TAGS_PER_SECOND

The tag specifies the average archiving rate of Tag Logging cyclically as an archive tag per second.

@TLGRT_AVARAGE_TAGS_PER_SECOND

The tag specifies the arithmetic average value of the average archiving rate of Tag Logging cyclically as an archive tag per second since Runtime as started.

@TLGRT_SIZEOF_NOTIFY_QUEUE

This tag contains the current number of entries in the ClientNotify queue. All local trend and table windows receive their current data from this queue.

@TLGRT_SIZEOF_NLL_INPUT_QUEUE

This tag contains the current number of entries in the queue for the format DLL. This queue archives values that are transmitted by the raw data tag.

6.3.4 Properties in Tag Logging**6.3.4.1 Properties of a cycle time**

A cycle time is calculated on a basis that is multiplied with an integer factor.

Example: Base time "1 minute" x factor 90 starts archiving every 90 minutes.

Cycle times are independent of the current time. Time series, on the other hand, refer to the calendar and result in daily or annual archiving, for example, at the specific time.

In WinCC Configuration Studio, you determine the properties of a cycle time in the navigation area or in the "Properties" area of the Tag Logging editor.

General

Property	Description
Last change	Display only: Last change to the properties of the cycle time

Timers**Note****Archiving when activating / deactivating Runtime**

An archiving cycle is not always executed each time Runtime is shut down or started up.

If you archive acyclically, for example, archiving only takes place once a value has changed by a set amount.

In such a case, the value in the archive is not up-to-date when Runtime is shut down.

To prevent this from happening, you have the option of additional archiving upon system startup and shutdown.

Property	Description
Timer name	Enter a meaningful name for the cycle. A meaningful name can be helpful later.
At system startup	Option activated: Archiving is carried out each time Runtime is started.
At system shutdown	Option activated: Archiving is always carried out when Runtime is shut down.

Property	Description
Start time	Option activated: The cycle is first triggered at the specified time. Archiving is carried out at the start time.
Month, day, hour, minute, second	This information determines the first time the acquisition or archiving cycle is triggered. If the selection for "Day" does not apply in a given month, archiving is carried out on the last day of the month. Example: "31" selected, November: Archiving on November 30

Cycle times

Property	Description
Time factor	Factor by which the time base is multiplied.
Time base	Drop-down list with default base times: <ul style="list-style-type: none"> • 500 ms • Second • Minute • Hour • Day

See also

Times for acquisition and archiving (Page 1531)

6.3.4.2 Properties of a time series

Time series are based on the calendar.

The acquisition and archiving based on a time series takes place daily or yearly, for example, at a specific time. Cycle times, on the other hand, refer to a period independent of the current time.

In WinCC Configuration Studio, you determine the properties of a time series in the navigation area or in the "Properties" area of the Tag Logging editor.

General

Property	Description
Last change	Display only: Last change to the properties of the cycle time

Timers

Note

Archiving when activating / deactivating Runtime

An archiving cycle is not always executed each time Runtime is shut down or started up.

If you archive acyclically, for example, archiving only takes place once a value has changed by a set amount.

In such a case, the value in the archive is not up-to-date when Runtime is shut down.

To prevent this from happening, you have the option of additional archiving upon system startup and shutdown.

Property	Description
Timer name	Enter a meaningful name for the cycle. A meaningful name can be helpful later.
At system startup	Option activated: Archiving is carried out each time Runtime is started.
At system shutdown	Option activated: Archiving is always carried out when Runtime is shut down.
Start time	Option activated: The cycle is first triggered at the specified time. Archiving is carried out at the start time.
Month, day, hour, minute, second	This information determines the first time the acquisition or archiving cycle is triggered. If the selection for "Day" does not apply in a given month, archiving is carried out on the last day of the month. Example: "31" selected, November: Archiving on November 30

Time series

Property	Description
Time series base	Drop-down list with default base intervals: <ul style="list-style-type: none"> • Daily • Weekly • Monthly • Yearly
Every (n) days, weeks, months	Factor that determines the series. Examples: <ul style="list-style-type: none"> • Base "Daily" and "9": Archiving is performed every 9 days. • Base "Weekly" and "1" and "Weekday(s)" is "Monday": Archiving is performed every Monday. • Base "Monthly" and "3" and "Day of month" is "7": Archiving is performed on the 3rd day of every 7th month. • Base "Annually" and "Day of month" is "5" and "Month" is February: Archiving is performed every February 5th.
Weekday(s)	Weekly: Selection of the weekday for time series base
Day in month	Monthly and yearly: Specification of day for time series base
Month	Yearly: Selection of the month for time series base

See also

Times for acquisition and archiving (Page 1531)

6.3.4.3 Properties of a process value archive

In WinCC Configuration Studio, you determine the properties of a process value archive in the navigation area or in the "Properties" area of the Tag Logging editor.

General

Comment	Enter text as required.
Archiving disabled	Option activated: The archive is not described and remains unchanged.
Relevant long term	Option activated: Archive tag is considered to be "relevant long term" by the archive server.

Manual input permitted	Option activated: In Runtime, archived values can be changed or new values can be added manually to the archive. The values can be changed using the WinCC OnlineTableControl or external interfaces, such as ODK or OPC. If manual input is not permitted, no values can be written to the archive in Runtime.
Last change	Display only: Time stamp of last change

General archive properties

Archive name	The name can be edited and can be changed at any time. You may be notified of illegal characters during the input.
Server name	If you are working with a multi-user system, select the server.
Action at archive start / enable	Opens the dialog for selecting a WinCC function. This function is triggered when the archiving process is started. See section "AUTOHOTSPOT" for more information.

Memory location

Memory location	Select between "Hard disk" and "Main memory". See section "AUTOHOTSPOT" for more information.
Size in data records	If the archive is saved in the main memory, you can specify the archive size here.
Size in kB/tags	Display only: Size results from the information for "Size in data records".

6.3.4.4 Properties of a compressed archive

In WinCC Configuration Studio, you determine the properties of a compressed archive in the navigation area or in the "Properties" area of the Tag Logging editor.

General properties

Comment	Enter text as required.
Archiving disabled	Option activated: The archive is not described and remains unchanged.

6.3 Basics of Process Values Archiving

Manual input permitted	<p>Option activated:</p> <p>In Runtime, archived values can be changed or new values can be added manually to the archive.</p> <p>The values can be changed using the WinCC OnlineTableControl or external interfaces, such as ODK or OPC.</p> <p>If manual input is not permitted, no values can be written to the archive in Runtime.</p>
Last change	<p>Display only:</p> <p>Time stamp of last change</p>

General archive properties

Archive name	<p>The name can be edited and can be changed at any time.</p> <p>You may be notified of illegal characters during the input.</p>
Server name	<p>If you are working with a multi-user system, select the server.</p>
Action at archive start / enable	<p>Opens the dialog for selecting a WinCC function.</p> <p>This function is triggered when the archiving process is started.</p> <p>See section "AUTOHOTSPOT" for more information.</p>

Compression properties

Processing method	<p>Specify what is to happen to the archived process values after compression.</p> <p>See section "AUTOHOTSPOT" for more information.</p>
Compression time period	<p>All times created in Tag Logging that are "greater than 1 minute" are available as compression time periods.</p> <p>If the required compression time period is not available, configure a new time in Tag Logging and then set the compression time period.</p>
Recalculation with manual input	<p>Select this option if you want newly created or manually changed values in Runtime to be applied for the relevant period.</p> <p>Settings of the individual compressed tags overwrite the settings for the compressed archive.</p>

Weighted quality code

Quality code bad	<p>Enter a percentage value to specify the percentage value as of which the respective status of the process values is archived in the compressed tag.</p>
Quality code uncertain	
Quality code good (Cascade)	
Quality code good (Non-Cascade)	

6.3.4.5 Properties of archive tags (binary, analog, text)

Properties of archive tags

General

Comment	Enter text as required. If a comment exists for the process tag to be archived, this comment is entered here.
Archiving disabled	Option activated: Process values are not archived for this tag.
Relevant long term	Option activated: The archive tag is considered to be "relevant long term" by the archive server.
Manual input permitted	Option activated: In Runtime, archived values can be changed or new values can be added manually to the archive. The values can be changed using the WinCC OnlineTableControl or external interfaces, such as ODK or OPC. If manual input is not permitted, no values can be written to the archive in Runtime.
Last change	Display only: Time stamp of last change

General archive properties

Here, the name of the archive containing the configured archive tag is displayed.

General tag properties

Process tag	Tag whose values are saved in the archive tag.
Tag type	Display: Binary / analog / text
Tag name	Name of the archive tag, can be edited. Default: Name of the process tag.
Tag supply	Selection: <ul style="list-style-type: none"> • Manual: Tag value is entered manually. • System: Tag value is applied automatically.
Also in tag	You can also write the value of the archive tag in an internal tag to continue using the archived values for other purposes. Click on the cell and then on the  button to open the dialog for tag selection.

Archiving

Acquisition type	<p>Selection:</p> <ul style="list-style-type: none"> • acyclic - event controlled Archiving is controlled by start and stop events only. Time-based archiving does not take place in this case. • acyclic - in case of change Stop event or stop tag are taken into consideration. Tags which change more frequently than every second cannot be archived this way. • acyclic - on demand • cyclic - continuous • cyclic - selective You must specify a start and stop event. <p>Depending on this selection, some properties may not be relevant in this section and therefore cannot be edited.</p>
Acquisition cycle	<p>Drop-down list with all configured timers. Determines how often process values are acquired.</p>
Factor for acquisition cycle	<p>Factor by which the acquisition cycle is multiplied. The result determines the archiving cycle.</p>
Archiving/display cycle	<p>Drop-down list with all configured timers. Determines how often process values are archived and how often the displays are updated in Runtime.</p>
Number of values, leader	<p>Input of integer number. This number of values is acquired in the leader but not archived.</p>
Number of values, trailer	<p>Input of integer number. This number of values is acquired in the trailer but not archived.</p>
Start event	<p>Opens the dialog for selecting a WinCC function. The function must return the Boolean values "TRUE" or "FALSE". Archiving starts as soon as the selected function returns the value "TRUE".</p>
Stop event	<p>Opens the dialog for selecting a WinCC function. The function must return the Boolean values "TRUE" or "FALSE". Archiving stops as soon as the selected function returns the value "TRUE".</p>
Start tag	<p>Opens the dialog for selecting a binary tag. Archiving starts as soon as the selected tag has the value "1".</p>
Stop tag	<p>Opens the dialog for selecting a binary tag. Archiving stops as soon as the selected tag has the value "1".</p>
Archive after segment change	<p>Option activated: The value is archived even if it has not changed in case of a segment change.</p>
Hysteresis	<p>Input of a value for hysteresis. If a value is input, process values are only archived if they deviate by this value (absolute or relative) from the value archived last.</p>
Hysteresis type	<p>Selection: relative / absolute.</p>

Parameter

Archiving on	(only with binary tags) Selection of the signal change that triggers archiving. The option "Always" results in a permanently up-to-date trend display of the value. The value is archived even if there is no signal change.
Processing	(only with analog tags) Processing function for the values acquired since the last archiving. The following selections can be made: <ul style="list-style-type: none"> • Actual value Archives the currently acquired value. • Mean value • Sum • Minimum value • Maximum value • Action Permits running of a script for processing the archived values. • Difference • Difference for ascending values • Difference for descending values
Unit	Input name of any unit.
Action for processing	Opens the dialog for selecting a script. The selected script processes the values acquired since the last archiving.
Save on error	Selection which value is archived in case of an error: last value / substitute value.
Counter limit high	Specifies the high limit of the counter when the "Difference for ascending values" and "Difference for descending values" processing functions are used. The overflow of values is taken into consideration when the counter low limit or the counter high limit is reached. See example in: Compressed Archive (Page 1518)
Counter limit low	Specifies the low limit of the counter when the "Difference for ascending values" and "Difference for descending values" processing functions are used. The overflow of values is taken into consideration when the counter low limit or the counter high limit is reached.

Display

Scaling tag low limit	Input of a factor. The factors define a high and a low limit for display of the tags. Values that violate the high or low limit are not displayed.
Scaling tag high limit	

Compression

Compression activated	Option activated: "Swinging Door algorithm" is applied for effective archiving
Tmin (ms)	Positive integer: Minimum period between two archived values
Tmax (ms)	Positive integer: Maximum period between two archived values
Deviation absolute / in %	Selection determines type of deviation: absolute / in percent
Deviation value	Positive floating-point number: Absolute or relative value of the deviation that is permitted when calculating the gradient using the algorithm; base value is the last process value saved.
Low limit	Consistent positive or negative integer: The value range is specified by the high and low limit of the compression distribution; relevant only with relative (in percent) deviation. The input of limit values is deactivated in the case of absolute deviation.
High limit	

See also

Compressed Archive (Page 1518)

6.3.4.6 Properties of process-controlled tags

Properties of process-controlled tags

Process-driven tags (frame tags) are referred to as "Raw data tag" in WinCC.

General

Relevant long term	Option activated: Archive tag is considered to be "relevant long term" by the archive server.
Manual input permitted	Option activated: In Runtime, archived values can be changed or new values can be added manually to the archive. The values can be changed using the WinCC OnlineTableControl or external interfaces, such as ODK or OPC. If manual input is not permitted, no values can be written to the archive in Runtime.
Comment	Enter text as required. If a comment exists for the raw data tag to be archived, enter this comment here.
Last change	Display only: Time stamp of last change

General archive properties

Here, the name of the archive containing the configured archive tag is displayed.

General tag properties

Tag type	Display: Process: Raw data tag
Tag name	Internal name of the archive tag. The name is specified after selection of the format DLL and block ID. Depending on the format DLL used, IDs can be input for identification of the tags. If no archive tag name was specified as alias, the internal tag name is used for management in the process archive and for addressing the archive tags.

Properties of process-controlled tag

Raw data tag	Selection of raw data tag whose values are saved in the archive tag.
Archive tag name	Enter text as required: Alias name of the tag The archive tag name is used for management in the process archive and for addressing the archive tags. If no alias is entered, WinCC uses the internal tag name.
Format DLL	Selection of the format DLL. The default is "nrms7pmc.nll".
Block Id	"AR_ID" with "nrms7pmc.nll": "Tag ID" with "s5std.nll"
Subnumber	"AR_ID subnumber" with "nrms7pmc.nll":

6.3.4.7 Properties of compressed tags**Properties of compressed tags****General**

Comment	Enter text as required.
Archiving disabled	Option activated: Compressed values are not archived for this tag.
Relevant long term	Option activated: Archive tag is considered to be "relevant long term" by the archive server.
Manual input permitted	Option activated: In Runtime, archived values can be changed or new values can be added manually to the archive. The values can be changed using the WinCC OnlineTableControl or external interfaces, such as ODK or OPC. If manual input is not permitted, no values can be written to the archive in Runtime.
Last change	Display only: Time stamp of last change

General archive properties

Here, the name of the archive containing the configured archive tag is displayed.

General tag properties

Tag name	Name of the compressed tag
Tag supply	Selection: <ul style="list-style-type: none"> • Manual: Tag value is entered manually. • System: Tag value is applied automatically.

Compression properties

Recalculation with manual input	Option activated: Values changed manually or created in Runtime are taken into consideration.
---------------------------------	--

Parameter

Processing	Processing function for the values acquired since the last archiving. The following selections can be made: <ul style="list-style-type: none"> • Mean value • Weighted mean value • Sum • Minimum value • Maximum value • Difference • Difference for increasing values • Difference for decreasing values
Unit	Input name of any unit.
Counter high limit	Specifies the high limit of the counter when the "Difference for increasing values" and "Difference for decreasing values" processing functions are used. The overflow of values is taken into consideration when the counter low limit or the counter high limit is reached. See example in: Compressed Archive (Page 1518)
Counter low limit	Specifies the low limit of the counter when the "Difference for increasing values" and "Difference for decreasing values" processing functions are used. The overflow of values is taken into consideration when the counter low limit or the counter high limit is reached.

Properties of a compressed tag

Source tag	Archive tag whose value is saved in the compressed tag.
Source archive	Display only: Archive in which the source tag is archived.

Weighted quality code

Quality code bad	Enter a percentage value to specify the percentage value as of which the respective status of the process values is archived in the compressed tag.
Quality code uncertain	
Quality code good (Cascade)	
Quality code good (Non-Cascade)	

See also

Compressed Archive (Page 1518)

6.3.5 Archiving Methods**6.3.5.1 Archiving Methods****Introduction**

Various archiving methods are available for archiving process values. You can therefore monitor a single process value at any point in time, for example, and make the monitoring dependent on certain events. You can archive process values that change relatively quickly without increasing the system load in doing so. You can compress process values already archived to reduce the data volume.

Archiving methods

The following archiving methods are available in Runtime:

- Cyclical, continuous process value archiving:
Continuous process value archiving, for example, for monitoring a process value.
- Cyclical, selective process value archiving:
Action-driven, continuous process value archiving, for example, for monitoring a process value within a specific period of time.
- Acyclic process value archiving:
Event-driven process value archiving, for example, archiving a current process value when a critical limit value is exceeded.
- Archiving process values After every change:
Process values are archived in a acyclic manner only when they have been changed.
- Process value archiving on demand:
Continuous process value archiving in which tag values are read as soon as an archiving cycle is triggered.
This reads and archives the current tag value.
Conditions:
 - For acquisition cycle and archive cycle: ≥ 1 hour
 - Archiving function = actual value

6.3 Basics of Process Values Archiving

- Process-controlled process value archiving:
Archiving of several process tags or of rapidly changing process values.
- Swinging Door algorithm:
Compression of archive values through linear interpolated tag values.
- Compressed archive:
Compression of individual archive tags or of entire process value archives, for example, the hourly averaging of process values archived every minute.

See also

Process value archiving "When necessary" (Page 1512)

6.3.5.2 Cycles and Events

Introduction

Process value archiving is controlled by cycles and events.

The acquisition cycles and archiving cycles enable continuous acquisition and archiving of process values.

Furthermore, process value archiving can also be triggered or ended by events and actions.

Cycles and events may be combined: A process value is for example acquired regularly; archiving is however only triggered by a binary event.

Differentiation from Graphics Runtime

In Graphics Designer, the "Update cycle" of the WinCC project is specified that triggers the update of the process pictures in Runtime.

Acquisition cycle

The acquisition cycle determines the interval at which the process value of a process tag is read.

The shortest possible value is 500 ms. All other values are integer multiples of this value.

The starting point of an acquisition cycle is determined by the run-up time of the WinCC Runtime.

Note

Improving performance

A short acquisition cycle may lead to a high system load.

Use process-controlled tags where there are frequent or fast process value changes.

Archiving cycle

The archiving cycle determines when a process value is saved in the archive data bank.

The archiving cycle is always an integer multiple of the acquisition cycle.

Note**Same cycle for acquisition and archiving**

If the same cycle is used for acquisition and archiving, it does not necessarily mean that acquisition and archiving are started simultaneously.

There might be a system delay of up to the length of an acquisition cycle between acquisition and archiving.

Starting point

For standard timers, the starting point of the archiving cycle depends on either the startup time of WinCC Runtime or the starting point of the timer used.

The starting point for calendar-based timers is set in the time series configuration.

Specifying the start point means that the values are logged with a delay and that the logging load is distributed.

Here are two examples:

Example 1: Archiving every minute

Process values are archived in three cycles:

- every minute
- every two minutes
- every three minutes

This causes a high archiving load every six minutes.

Assign a different starting point to each of the three cycles. Trigger archiving as follows, for example:

- every minute at the 15th second
- every two minutes at the 30th second
- every three minutes at the 45th second

The archiving load is thus distributed.

Example 2: Every 10 seconds

Many process values must be archived every ten seconds.

In order to distribute the archiving load you can, for example, configure two "10 second" cycles with different starting points.

Archiving takes place at second 0 or at second 5.

Parameter: Archiving function

All process values read from the process tags during the time period between acquisition and archiving will be processed by the archiving function.

In the process value archive, you can use only one of the following archiving functions:

Actual value	Saves the last acquired process value.
Sum	Saves the sum of all acquired process values.
Maximum value	Saves the highest of all acquired process values.
Minimum value	Saves the lowest of all acquired process values.
Average value	Saves the mean of all acquired process values.
Difference	Saves the difference between the process values of two archiving cycles
Action	The most recently acquired process value is calculated, using a function created in Global Script.

Start/Stop Events and Actions

Events start and stop process value archiving.

Conditions which trigger an event can be linked to a tag or to scripts (C, VBS).

In WinCC, events / actions are differentiated as follows:

- Binary action:
Response to changes in a Boolean process tag.
Example: turning on a motor might start the archiving of a process value.
- Limit value event:
Triggered by a limit value being exceeded or reached.
Limit value events might be in absolute or scaled numbers.
Example: temperature fluctuations of more than 2% might trigger archiving.
- Time-controlled event:
Triggered when a fixed point in time is reached, or a defined period of time from the start time of the process value archiving has elapsed.
Example: a report is generated after each shift change.

See also

Process value archiving "When necessary" (Page 1512)

6.3.5.3 Continuous cyclic process value archiving

Introduction

Continuous cyclic process value archiving begins when Runtime is started.

The process values are acquired at fixed cycles and stored in the archive database.

Continuous cyclic process value archiving ends when Runtime is terminated.

How it works

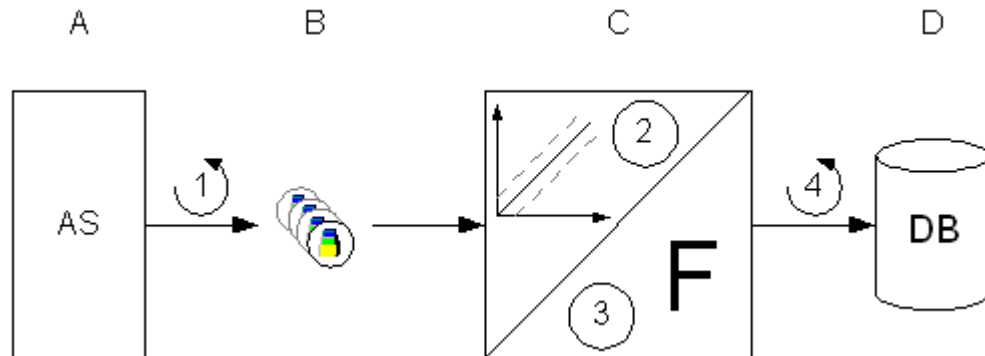

Each process tag in WinCC (B) corresponds to a certain process value in the memory of one of the connected automation systems (A).

The acquisition cycle (1) controls when the process value is read from the memory of the connected automation system.

The Runtime component of the archive system (C) processes the process value:

- Whether the process value is archived at all depends on the way you have configured the system.
The process value must change by a certain amount or percentage (2).
- The archiving function (3) determines how the acquired process values are processed, for example, by averaging.

The archiving cycle (4) determines when the processed process value is written to the archive database (D).

Note

WinCC controls: Updating the display

The update of the WinCC controls is based on the archiving cycle.

If you have configured a fast acquisition cycle but a slow archiving cycle, you may get the impression when displaying the values that no values are archived.

If you want the values in the controls to be updated with the acquisition cycle, activate the option "Refresh cyclic values" in the "Tag Logging" editor.

To do so, select the "Tag Logging" folder in the navigation area.

See also

Process value archiving "When necessary" (Page 1512)

6.3.5.4 Cyclic-Selective Process Value Archiving

Introduction

The cyclic-selective process value archiving is started in Runtime as soon as a start event occurs.

The process values are subsequently acquired at fixed cycles and stored in the archive database.

Cyclic process value archiving ends:

- When a stop event occurs
- When you terminate Runtime
- When the start event no longer exists

Start event and stop event are determined by the value of the configured tag or by the return value of a script.

You configure the tags or scripts in Tag Logging in the properties of the process value tags in the "Archiving" area.

How it works

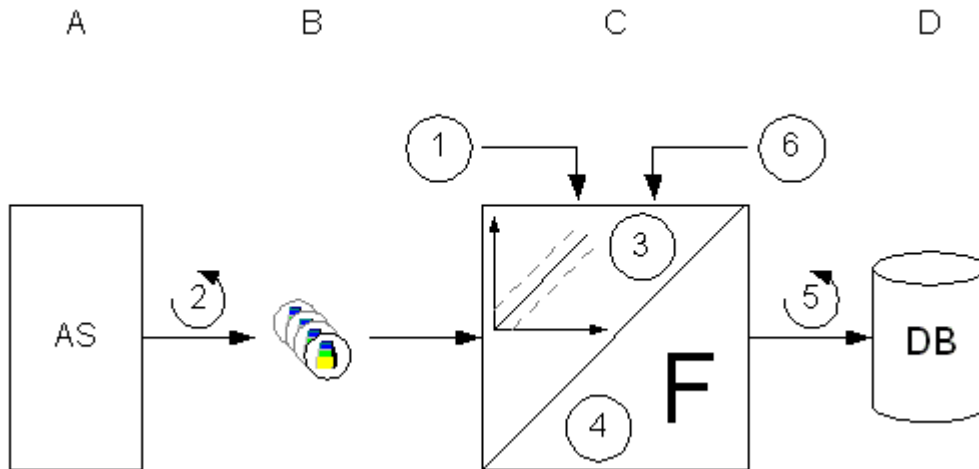

Each process tag in WinCC (B) corresponds to a certain process value in the memory of one of the connected automation systems (A).

Process value archiving begins on the occurrence of the start event (1).

The acquisition cycle (2) controls when the process value is read from the memory of the automation system.

The Runtime component of the archive system (C) processes the process value:

- Whether the process value is archived at all depends on the way you have configured a hysteresis.
The process value must be changed by a certain amount or percentage (3).
- The processing method (4) determines how the acquired process values are processed, for example, by averaging.

Until the occurrence of the Stop event (6), the archiving cycle (5) determines when the processed process value is written to the archive database (D).

See also

Process value archiving "When necessary" (Page 1512)

6.3.5.5 Acyclic Process Value Archiving

Introduction

With acyclic process value archiving, a process value is saved when it changes or depending on an event in the archive database.

Archiving of the process value is triggered in the following cases:

- With every change of a process value
- In case of event-driven acquisition
 - Via a tag
 - Binary tag: Change of the value (0 / 1)
 - Analog tag: Rising / falling edge
 - Via a script
 - Trigger: The return value changes in comparison to the last call of the function.
 - The value "TRUE" must be returned at the first script call.

How it works

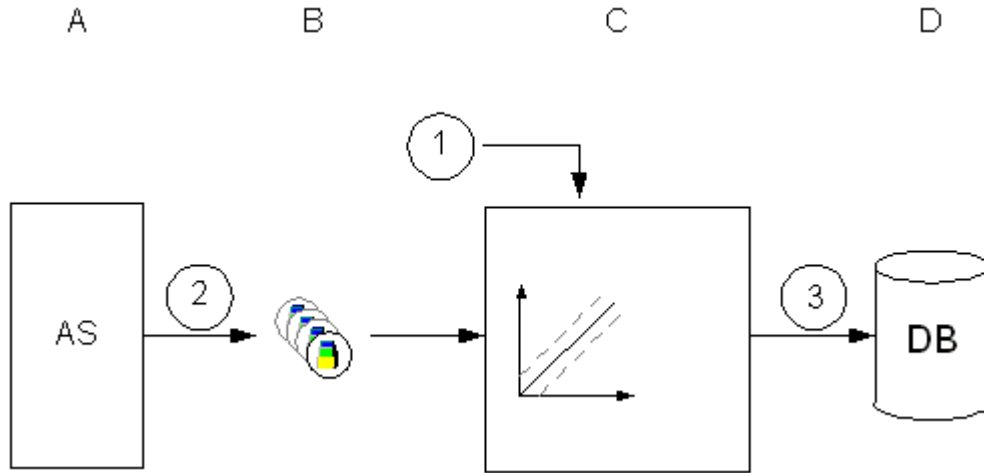

Each process tag in WinCC (B) corresponds to a certain process value in the memory of one of the connected automation systems (A).

Upon change:

- Every change of the process value is read from the memory of the connected automation system (2).
- If you only want to archive a value when it changes to "1" or "TRUE", you must configure the "signal change 0 -> 1" for archiving of a binary tag.

Event-driven:

- The process value is archived if the tag assumes the value "1" and then the value "0" once again for a configured event or the script receives the return value "TRUE" and then the return value "FALSE" once again (1).

The Runtime component of the archive system (C) processes the process value.

The actual value of the process value is then written to the archive database (D) (3).

Acyclic process value archiving ends when Runtime is terminated.

See also

Process value archiving "When necessary" (Page 1512)

6.3.5.6 Process value archiving "When necessary"

Introduction

With cyclic process value archiving "When necessary", a process value is archived regularly at longer intervals.

Generally speaking, the following settings apply:

- The actual value of the archive tag is acquired.
In the event of a fault, you can select whether the last acquired value or the substitute value is archived.
- The shortest acquisition cycle is based on a cycle time with the base time "1 hour".
- Archiving either starts during system startup or when a start event occurs.
- Cyclic process value archiving ends when Runtime is terminated.
- The acquisition type is not available for binary tags.
Binary tags always have the acquisition cycle "500 ms". For binary tags, the current value is always archived.

How it works

1. Process value archiving begins on the occurrence of the start event.
2. The current process value is read from the memory of the automation system cyclically.
Following acquisition cycles are possible:
 - Hourly or multiple of one hour
 - Daily or multiple of one day
 - A time series or multiple of a time series
3. The Runtime component of the archive system processes the process value.
4. The archiving cycle determines when the processed process value is written to the archive database.
5. Acquisition ends when Runtime is deactivated.

See also

Cycles and Events (Page 1506)

Archiving Methods (Page 1505)

Continuous cyclic process value archiving (Page 1508)

Cyclic-Selective Process Value Archiving (Page 1510)

Acyclic Process Value Archiving (Page 1511)

Process-Controlled Process Value Archiving (Page 1514)

Compressed Archive (Page 1518)

Storing Process Values (Page 1521)

Configuration of Process Value Archiving (Page 1527)

6.3.5.7 Process-Controlled Process Value Archiving

Introduction

Process-controlled process value archiving is used for archiving several process tags or rapidly changing process values.

The process values are written to a process-controlled tag, which is decoded by the archive system. Process-driven tags (frame tags) are referred to as "Raw data tag" in WinCC.

The process values obtained in this way are then stored in the archive database.

How it works

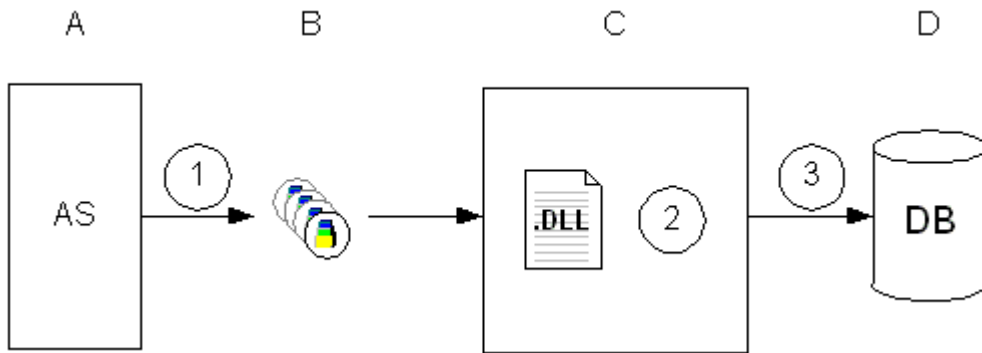

Each process tag in WinCC (B) corresponds to a certain process value in the memory of one of the connected automation systems (A).

At the start of runtime, the process values of the selected process tags are read out (1) and written to the configured process-controlled tag as binary data.

The runtime component of the archive system (C) processes the process-controlled tag:

- The format DLL (2) is part of the archive system and decodes the binary data of the process-controlled tag.

The decoded process values are then written to the archive database (D) (3).

See also

Process value archiving "When necessary" (Page 1512)

6.3.5.8 Swinging Door algorithm for process value archiving

Introduction

Note

When compression is activated, the standard parameters for the archiving are deactivated.

Process values are compressed with the "Swinging Door Algorithm".

With optimum parameter assignment, process values are saved more effectively with the Swinging Door algorithm than with cyclic acquisition.

The compression is achieved by not saving all the values. The compression therefore involves some degree of data loss. The values that are actually saved are those that are regarded as relevant based on the parameter assignment of the algorithm. The values that are not saved are those that fall within a specified time interval within calculated limits.

Optimum parameter assignment is determined through the following specifications:

- Required accuracy of the archived data
- Required compression

Because the value range and the sampling rate differ in various use cases, only general information regarding the parameter assignment can be given here.

The advantage of compression is lost if values are archived too frequently.

The display of the value trend is less accurate if a larger deviation is selected.

Mode of Operation

The first value saved in the process value archive is the base value. If values have already been stored in the archive, the last archived value is used as the base value.

Values that fall within a continuously recalculated value range are not saved. Only if a value falls outside this range is the value saved and used as the base point for another calculation of the value range. In order to regularly save values even when the trend characteristic is smooth, use the T_{\max} parameter to specify the maximum duration for which no values are saved.

Continuously calculated value range - compression distribution

Values that fall within the value range are not saved. The compression of the data is achieved in this manner.

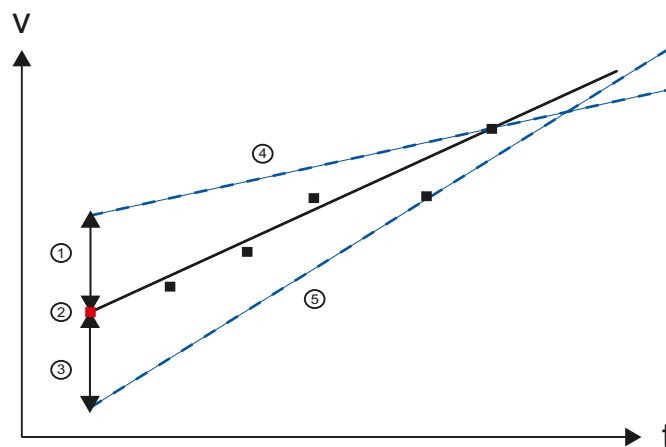

- (1, 3) Deviation above, below
 (2) Last archive value, base value for calculating the value range
 (4, 5) Continuously recalculated limits of the last archive value

The value range corresponds to a triangle that is recalculated with each newly acquired value. The basis for the value range is the last saved value (2) plus your specified deviation (1,3). The high limit (4) and the low limit (5) are adapted based on the measured values.

If the value range can no longer be determined because the calculated limits no longer intersect (triangle is no longer possible), the last valid value (value just prior to the value that violated the conditions) is saved and applied as the starting value for the calculation of the following value range.

Minimum and maximum time

By specifying the minimum time T_{min} and maximum time T_{max} , you can adapt the accuracy of the archiving to the sampling rate of the values.

If more than one value is measured within the specified minimum time, only the last value is considered.

A value is always saved after the maximum time.

Notes on parameter assignment

If necessary, select parameters initially in such a way that only slight compression is achieved but with high accuracy (small T_{max} , small deviation). In this way, you ensure that the data lost through compression is kept to a minimum. If you find out that unneeded values are being archived, you can adapt the parameters in such a way that fewer values are saved, thus optimizing the compression rate.

For more information refer to the following application example in Product Support:

- "Compressing of process value archives with the Swinging Door algorithm in PCS 7 (<https://support.industry.siemens.com/cs/ww/en/view/109739594/en>)".

Parameter

You can specify the following process tag properties for the configuration of the Swinging Door compression algorithm:

Parameter	Unit	Description	Tips on parameter assignment
T min	Milliseconds	Time period for which measured values are ignored. Starts at the last acquired value. Values within this time period are neither saved nor used for calculating the value range.	In most use cases, set T_{min} to the smallest possible value. When a minimum time is specified, data may be lost. Use this parameter if values are frequently acquired and you are sure that you can ignore them.
T max	Milliseconds	Maximum period between two archived values. Starts at the last saved value. After this time, the following value is always archived. This value is used as the starting value for calculating the current value range.	Select a multiple of the sampling rate for the value of T_{max} . This parameter ensures that values are archived periodically and not just depending on the process.

Parameter	Unit	Description	Tips on parameter assignment
Deviation	Process value unit	Absolute or relative value of the deviation that is permitted when calculating the value range; base value is the last process value saved.	Preferably, you should select a percentage value. In many use cases, the use of small percentage deviations provides a good compromise between compression and accuracy. In any case, always select a deviation less than 50%. With absolute values, the deviation must be less than half the value range.
Value range	Process value unit	Specified by the high and low limit of compression distribution; relevant only with relative (percentile) deviation. The input of limit values is deactivated in the case of absolute deviation.	

You make these settings in the "Compression" area in the "Properties" area of the archive tag.

Example of a value trend

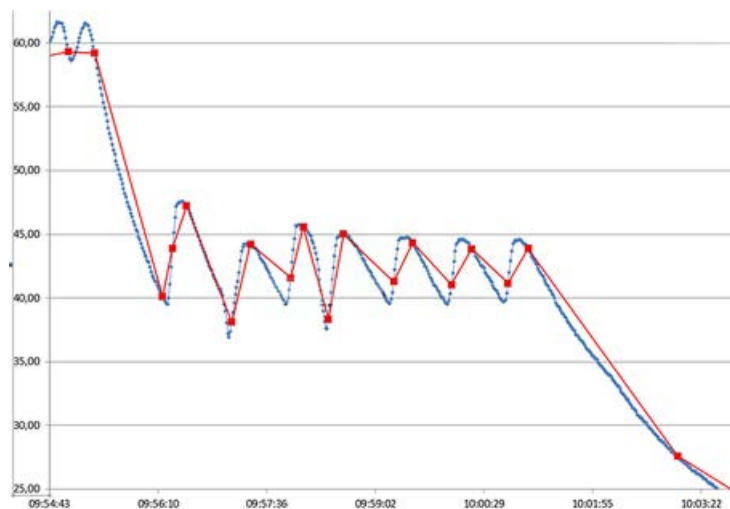

The graphic shows two trends as an example:

- blue - process values actually measured
- red - values saved with the Swinging Door algorithm

They values used for this example are:

Deviation = 2.5(%) $T_{\max} = 120$ s corresponds to 120 times the sampling time.

See also

Compressed Archive (Page 1518)

6.3.5.9 Compressed Archive

Introduction

In order to reduce the volume of data in the archive database, the archive tags for a specified period can be compressed.

To do this a compressed archive is created, which stores each archive tag in a compressed tag. The archive tags are retained and can be copied, moved or deleted.

The compressed archive is stored in the archive database in the same way as the process value archive.

Processing (compressed tag)

For compression, one of the following functions is applied to the archived process values in a specified period of time:

Sum

The sum of all process values is saved in the compressed tag.

Minimum value

The lowest process value is saved in the compressed tag.

Maximum value

The highest process value is saved in the compressed tag.

Average value

The average process value is saved in the compressed tag.

Weighted average value

Saves the weighted average value of the process values in the compressed tag. The time span in which a recorded value has the same value is considered in the calculation of the weighted average value.

Difference

Saves the difference between the process values of two archiving cycles in the compressed tag.

Difference for ascending values

Saves the difference that results from ascending process values of two archiving cycles in the compressed tag.

The overflow of values is taken into consideration when the counter low limit or the counter high limit is reached. See example below.

To correctly determine the difference, you must observe the following:

- The total value range of the counter must not be undershot during an archiving cycle. It may therefore be necessary to adjust the duration of the archiving cycle.
- Only an overflow between two archiving cycles is taken into consideration.
- The counter may only have an increment of "1".

Difference for descending values

Saves the difference that results from descending process values of two archiving cycles in the compressed tag.

The same conditions as for "Difference for ascending values" apply to this function.

Processing method (compressed archive)

What happens to the existing archived process values after compression depends on which method of compression is used.

The process values of the archive tags of the specified period are processed as follows:

Calculate

- Reading
- Compression

The process values of the archive tags are retained.

Calculate and copy

- Reading
- Compression
- Copy to compressed archive

Calculate and delete

- Reading
- Compression
- Delete

Calculate, copy, and delete

- Reading
- Compression
- Move to compressed archive

The process values of the archive tags are deleted when they are copied to the compressed archive.

Time stamp for a compressed archive

A compressed archive contains the following time stamp, depending on the archiving function used, when archiving the process value:

- For maximum and minimum values, the time stamp of the respective maximum and minimum value is archived.
- The time stamp of the compression period is archived for mean value, sum and difference.

Quality codes of tags in the compressed archive

The quality code of tags apply in the compressed archive as follows:

- In standard mode, a tag is always archived with its worst quality code. The status "Bad" will always be archived in the compressed tag if even just one of the process values has the status "Bad".
- When weighted quality codes are used, you can specify a percentage for the status of the quality codes as of which the respective status of the process values will be archived in the compressed tag. For example, 80% of the values must have the "Good" status to be stored as "Good" in the compressed tag.

You can configure weighted quality codes for the complete compressed archive or for individual compressed tags.

The compression tag settings overwrite the settings for the compression archive.

Substatus of the quality codes

The weighting you define is also valid for the substatus of the quality codes.

The substatauses are reduced to the main status in each case.

For example, an archive tag with quality code "Uncertain" and status "4C" becomes quality code "40" in the compressed tag.

Examples

The following examples illustrate the way that the compressed archive works:

Average value

A process value is archived once every minute and returns 60 values in one hour.

The compression with the average value is performed over a period of one hour.

Every hour, the average value is formed from the 60 values and is stored in the compressed tag.

What happens to the 60 values depends on the compression method described above.

Weighted average value

A process value is acquired every second and returns 60 values in one minute.

The value is "50" for 40 seconds, the value is "60" for 20 seconds.

The compression with the weighted average value is performed over a period of one minute.

Every minute, the weighted average value of 60 values is archived, therefore:

- $40 \times 50 + 20 \times 60 / 60 = 53.33$.

Difference for ascending values

An electricity meter, for example, always counts up.

The value range is limited between the counter low limit "0" and the counter high limit "9999".

In the case of a change between the archiving cycles from "9995" to "5", this method results in a difference of "+ 10".

With the normal difference method, the resulting difference would be "- 9990" which does not make sense for a counter that only counts up.

See also

Process value archiving "When necessary" (Page 1512)

Swinging Door algorithm for process value archiving (Page 1514)

6.3.6 Storing Process Values

Introduction

Process values can be stored either on hard disk in the archive database or in the main memory of Tag Logging Runtime.

Storing in Archive Database

The process values to be archived are stored in two separate cyclic archives (A, B) in the archive database. Each short-term archive consists of a configurable number of data buffers. The data buffer is defined in terms of size in MB, and a period of time (e.g., one day).

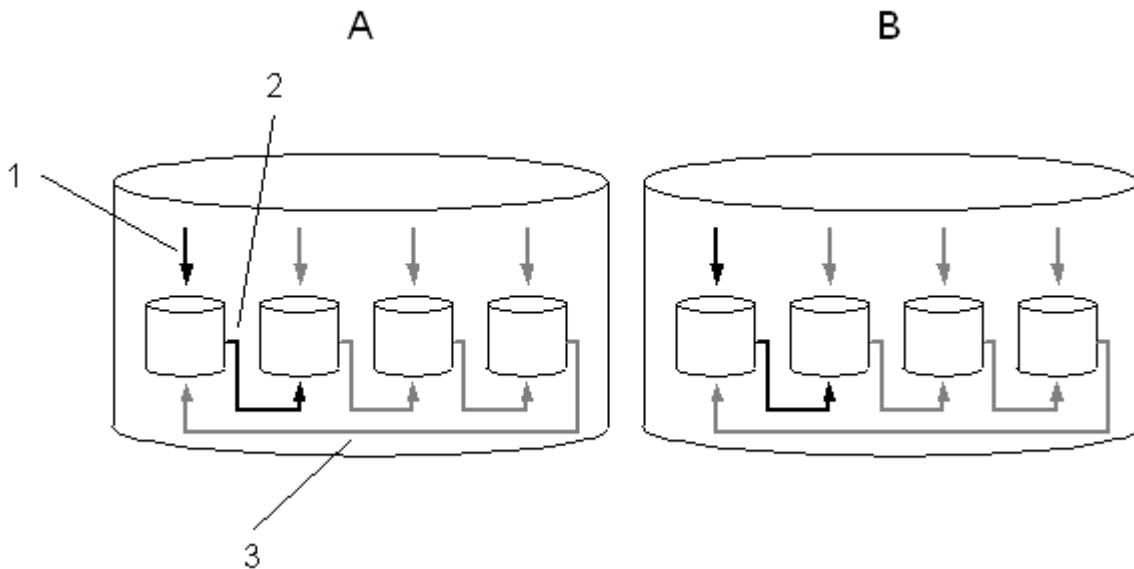

The process values are written continuously in the data buffers (1). When the configured size of the data buffer is reached or the time periods exceeded, the system switches to the next one (2). When all the data buffers are full, the process data in the first data buffer is overwritten (3). In order that process data is not destroyed by the overwritten process, it can be swapped (exported).

Tag Logging Fast

Short-term archive A stores the process values whose acquisition cycle is less than or equal to one minute. These process values are initially saved and compressed in a binary file. When the binary file has reached a specific size, it is stored in the short-term archive.

Tag Logging Slow

Short-term archive B stores process values whose acquisition cycle is greater than one minute and compressed archives. The data is written immediately in the short-term archive and not compressed.

You can adapt the archive configuration to suit your needs.

Note

When starting Runtime, the system tests whether the configured size of a data buffer has been calculated to a sufficient size. If the configured size is too small, the system automatically adapts to the minimum size.

Saving in Main Memory

In contrast with storage in the archive database, process values archived in the main memory are only available for as long as Runtime is active. Storing in the main memory has the advantage, however, that the values can be written and read out very quickly. The process values stored in the main memory cannot be swapped out.

Note

Compressed archives cannot be saved in the main memory.

See also

Process value archiving "When necessary" (Page 1512)

6.3.7 Swapping Out Process Values

Introduction

You can swap out process values from the archive database as a backup. All process values contained in a data puffer are swapped out. The time of the swapping-out can be configured as you wish.

Principle

You configure process value swapping in Tag Logging in the shortcut menu of the "Archive" folder with the "Archive configuration" command. The swapping-out takes place separately for "Tag Logging Fast" and "Tag Logging Slow".

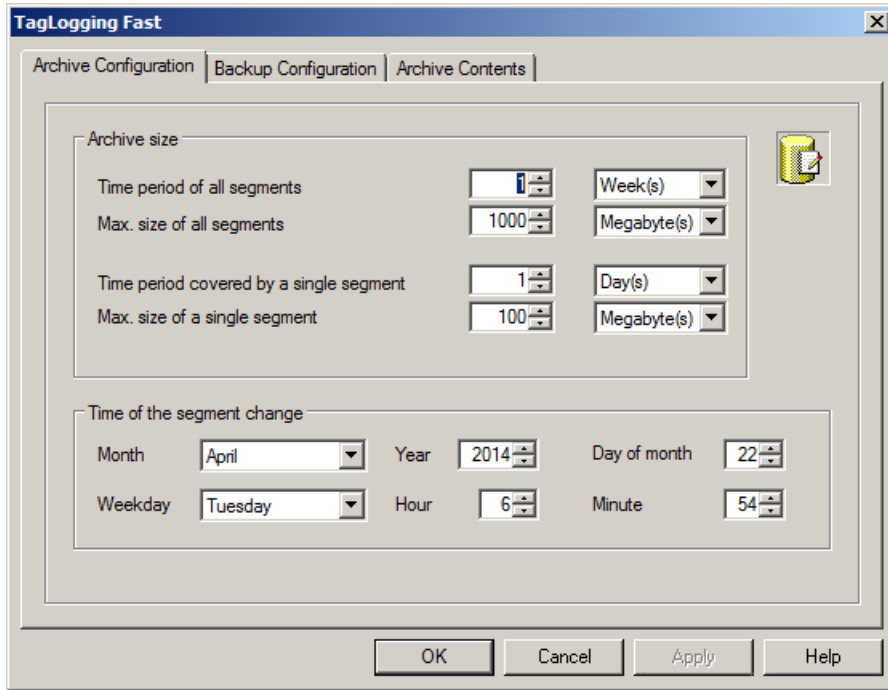

On the "Archive Configuration" tab, configure the settings of the individual data buffers and specify what time period is to be contained in the archive.

On the "Backup Configuration" tab, specify whether you want to create a backup of the archived process values and where the backup is to be stored.

Note

In Runtime you can change a displayed process value with the OnlineTableControl.

If the location of the archive segment where the process value is stored has already been changed, then the modified value is not accepted in the shifted archive. The change is limited to the local archive segment.

If the archive segment has not yet been moved out, then the changed value is accepted permanently.

Archive server

An archive server is used for backing up process value archives. Swap files can be accessed in three different ways:

- Copy swap files onto the configuration computer on which Runtime is run. Link the swap files to the project in the Alarm Logging or Tag Logging. The archived values are displayed in Runtime.
- Access via OLE-DB
- Access via DataMonitor Web Edition

6.3.8 Significance of Archive Value Flags

For each value written to the archive, Tag Logging will set a flag which provides information on the tag state.

Representation of this flag is in the form of a 2-word value, coded in decimal form and listed in the 3rd column of the database archive. This flag must be converted to its hexadecimal representation for analysis purposes.

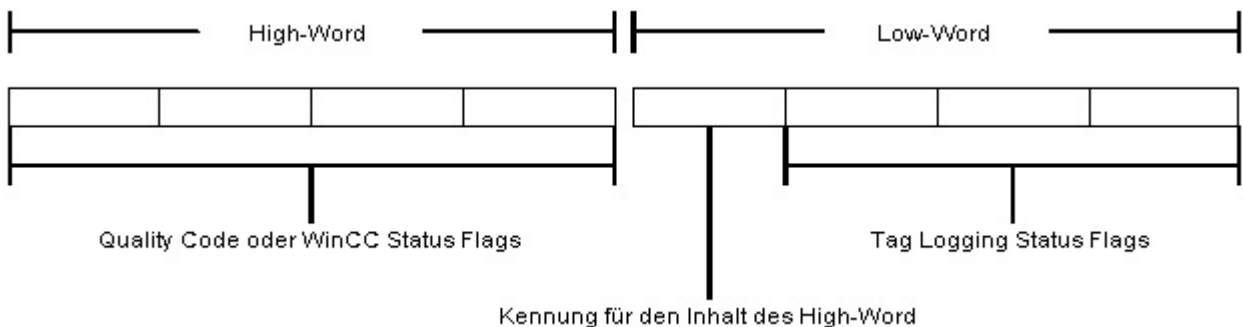

The high word contains the WinCC status flag or quality code and the low word contains the Tag Logging status flags as well as a code for the content of the high word.

Code for High Word Content:

	Meaning
0x0	High word contains WinCC status flags
0x1	High word contains quality code

Quality Code

You can find information about the Quality Code under:

- "Communication > Communication Diagnostics > Quality of tags > Tag Quality Codes"

WinCC Status Flags

You can find information on WinCC Status Flags under:

- "Communication > Communication Diagnostics > Quality of tags > Tag status"

Tag Logging Status Flags

Name of flag	Value	Meaning
PDE_RT_DAYLIGHT	0x001	Daylight saving time
PDE_RT_SUBSTITUTION	0x002	Substitute value
PDE_RT_TIME_BEVOR_JUMP	0x004	Value prior to time jump
PDE_RT_TIME_BEHIND_JUMP	0x008	Value after time jump
PDE_RT_TIME_OVERLAPPED	0x010	Values during time overlap
PDE_RT_LOAD_SYSTEM	0x020	First value archived after creation of the archive
PDE_RT_RELOAD_SYSTEM	0x040	Initial value after archiving of RT
PDE_RT_CMPCOPY	0x080	Compressed value
PDE_RT_TIME_CHANGED	0x100	Time change took place
PDE_RT_HAND	0x200	Manual tag supply

Examples

Value in database	16842753
Hexadecimal representation	0101 0001
Coding for high word	0: High word contains WinCC status flag
Tag logging status flag	001: Daylight saving time
WinCC status flag	0101: Link to partner not established; tag initialization value

Value in database	266242
Hexadecimal representation	0004 1002
Coding for high word	1: High word contains quality code
Tag logging status flag	002: Substitute value
Quality code	0004: Configuration error, value not accepted

6.4 Configuration of Process Value Archiving

6.4.1 Configuration of Process Value Archiving

Introduction

The process value archiving is configured in the "Tag Logging" editor. Specify which process values are to be archived at what time. WinCC provides you with the process value archive and the compressed archive for the archiving of process values.

Basic procedure

The configuration procedure for process value archives consists of the following steps:

1. Configure the process value archive: In the "Tag Logging" table area, create a process value archive and select the process tags. Configure the properties of the archive in the "Properties" area.
2. Specify the tags whose values are saved in the archive. Specify the archiving method in the properties.
3. Specify the format DLL and the archive tag name for process-controlled tags.
4. Configure compressed archives, if necessary.
5. Specify the configuration for the archive backup.

6.4.2 Tag Logging editor

In the "Tag Logging" editor, the archives, the process values to be archived and the times for the acquisition and archiving cycles are configured.

You configure the configuration of the data buffer on the hard disk and the swapping out of process values in Tag Logging.

You start the editor with a double-click on the "Tag Logging" entry in the WinCC Explorer.

Structure of the Tag Logging editor

The Tag Logging editor has three areas:

- **Navigation area**
 - Tree view showing objects as folders
 - Navigation bar for switching between the editors
- **Table area**
 - Creation and editing of multiple objects
- **Properties area**
 - Properties of a selected object
 - "What's this?" for the selected property

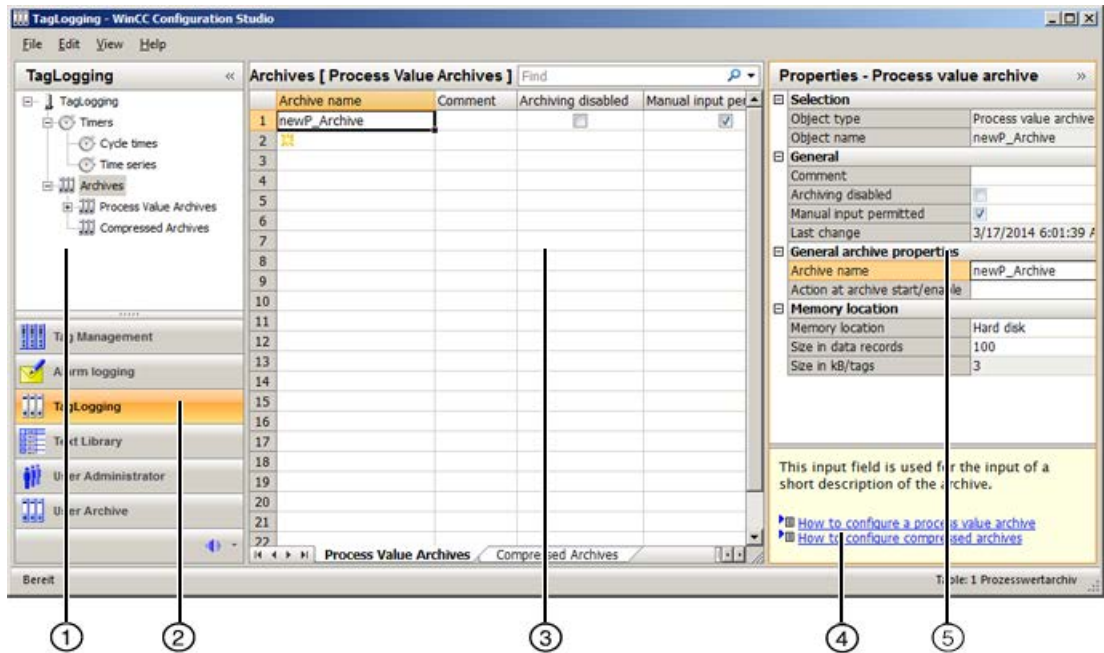

① Navigation area

Times and archives are displayed in the tree view.

The elements assigned to a selected folder are displayed in the table area, e.g. cycle time, archives, tags.

② Selection of the editors

The navigation bar is displayed in the area below the tree view; it provides access to additional WinCC editors.

③ Table area

The table displays the elements that are assigned to the folder selected in the tree view.

- Cycle times and time series are displayed and created here.
- Process value archives and compressed archives are displayed. New archives are created in the table area.
- Archive tags or compressed tags are displayed. You can change the properties of the displayed tags here or add a new archive tag or compressed tag.

Note

Inconsistent entries have a colored background in the table window.

In the event of inconsistent configuration, a note is displayed which describes the incorrect configuration.

Tabs

Depending on the selected structure level, you can display the lower-level elements in tables using tabs.

Navigation keys allow you to scroll through tabs. You select a tab by clicking on it or from the shortcut menu of the navigation keys.

④ What's this?

Displays an explanation of the selected property.

⑤ Properties

The properties of a selected object are displayed.

You edit the properties of a data record. However, some properties are only displayed and can not be edited.

Status bar

The status bar at the bottom edge of the editor includes the following information, among other things:

- Number of data records in the displayed data area, for example, timers, archives, tags.
- Number of selected data records when table cells are selected.

6.4.3 Working in the Tag Logging areas

You work and navigate in the "Tag Logging" editor as you would in the entire Configuration Studio. Configuration is user-friendly and supports the configuration engineer during editing. The handling is similar to that for a spreadsheet program.

Detailed information on operating the Configuration Studio is available in the WinCC Information System under "Working with WinCC > Working with projects > WinCC Configuration Studio".

Note

Undo is not possible

The functions "Undo" and "Restore" are not available in the "Tag Logging" editor.

Working in the navigation area

The archive configuration is configured in the navigation area using the shortcut menu.

Shortcut menus with additional functions are offered for individual folders.

Working in the table area

Creating a new object

You create new archives and archive tags in the table area.

To create a new object, you edit the first empty cell. The cell is identified by a yellow icon: ✖

Enter the required text, for example, the name of the archive, or select a tag from the selection dialog.



Inconsistent entries

If an entered value is faulty or inconsistent, you will see a corresponding note, for example:

- Invalid entries are created when you edit several entries by dragging a cell.

Editing several objects

You enter recurring texts by selecting an entry and dragging down the bottom right corner of the selection while keeping the left mouse button pressed.

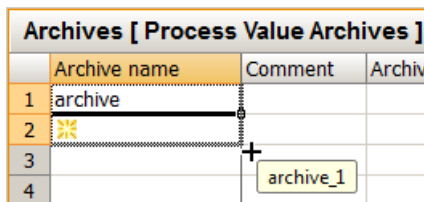

The cells are automatically filled with the respective entry:

- Numerical entries are automatically incremented.
- A numerical suffix which is automatically incremented is appended to text entries.
- Option boxes apply the selected option of the marked cell.

Tag names ending in a number are automatically incremented. When the name of a tag does not end with a number, the same tag is used for all entries when you drag down the selection.

To create multiple entries of a tag with numerical suffix without incrementing them, press <Ctrl> while you drag down the selection.

Archives [archive]		
	Process tag	Tag type
1	var_1002	alog
2		
3		
4		
5		

6.4.4 Cycle times and time series

6.4.4.1 Times for acquisition and archiving

Times for acquisition and archiving

The acquisition and archiving cycles in Tag Logging are based on previously configured times.

Frequently used time cycles are already created by WinCC when you create a new project. If necessary, you can configure and use a total of 96 time cycles.

WinCC distinguishes between cycle times and time series.

Cycle time

A new cycle time is calculated on a basis that is multiplied with an integer factor.

Cycle times are independent of the current time.

The acquisition and archiving based on a cycle time is started as configured and repeated cyclically thereafter.

Base times are:

- 1 day
- 1 hour
- 1 minute
- 1 second
- 500 ms (half a second)

Time series

Time series are based on the calendar.

The acquisition and archiving based on a time series takes place daily, weekly, monthly or yearly.

The day can be specified as day of the week or fixed calendar date.

The time of the acquisition or archiving on the respective day can either be specified or depend on the system start.

See also

How to configure a new time series (Page 1533)

6.4.4.2 How to Configure a New Cycle Time

Introduction

The cyclical acquisition and archiving cycles are based on these timers.

Frequently used time intervals are provided by WinCC when you create a new project. If you wish to use timers that deviate from these standard timers, you can configure new timers.

A new time cycle is calculated on a basis that is multiplied with an integer factor.

- Cycle time = time factor x base time.

Procedure

1. Select the "Cycle times" folder under the "Timers" folder in the navigation area of the "Tag Logging" editor.
All configured time cycles are displayed in the table area.
You can use these time cycles to configure the acquisition and archiving cycles.
2. To create a new timer, click the top empty cell and enter a name in the "Timer name" column of the table area.
A new timer is created.
3. Edit the properties of the timer in the "Properties" area.

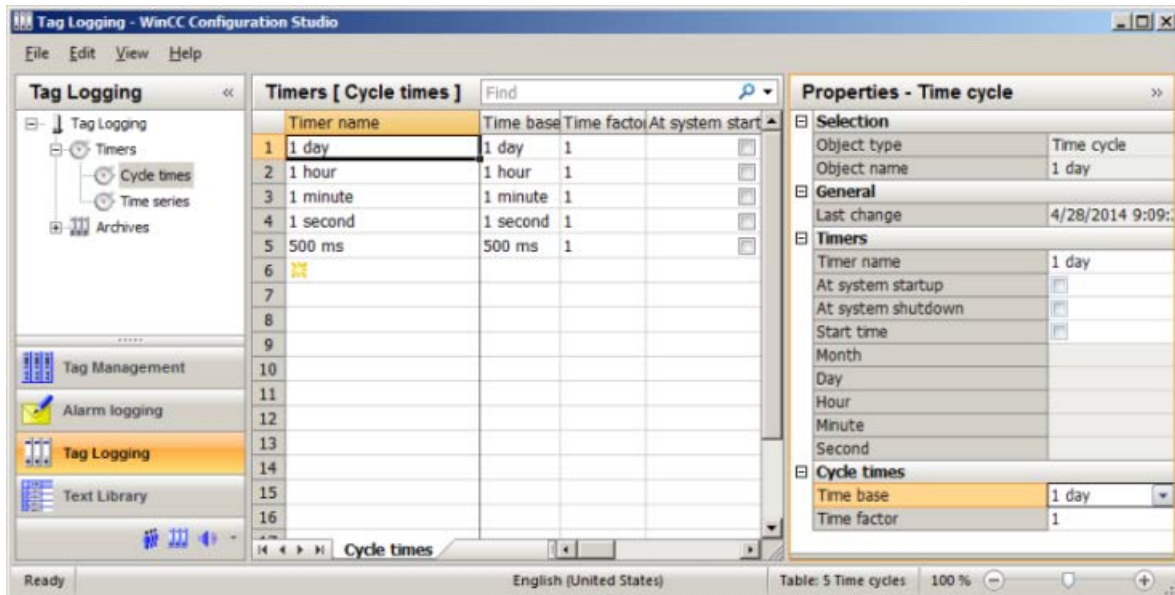

6.4.4.3 How to configure a new time series

Introduction

Time series are based on the calendar and the time.

Acquisition and archiving take place at regular intervals depending on the calendar date, the day of the week or the time of day.

Procedure

1. Select the "Time series" folder under the "Timers" folder in the navigation area of the "Tag Logging" editor.
All configured time series are displayed in the table area.
You can use these time series to configure the acquisition and archiving cycles.
2. To create a new timer, click the top empty cell and enter a name in the "Timer name" column of the table area.
A new timer is created.
3. Edit the properties of the timer in the "Properties" area.

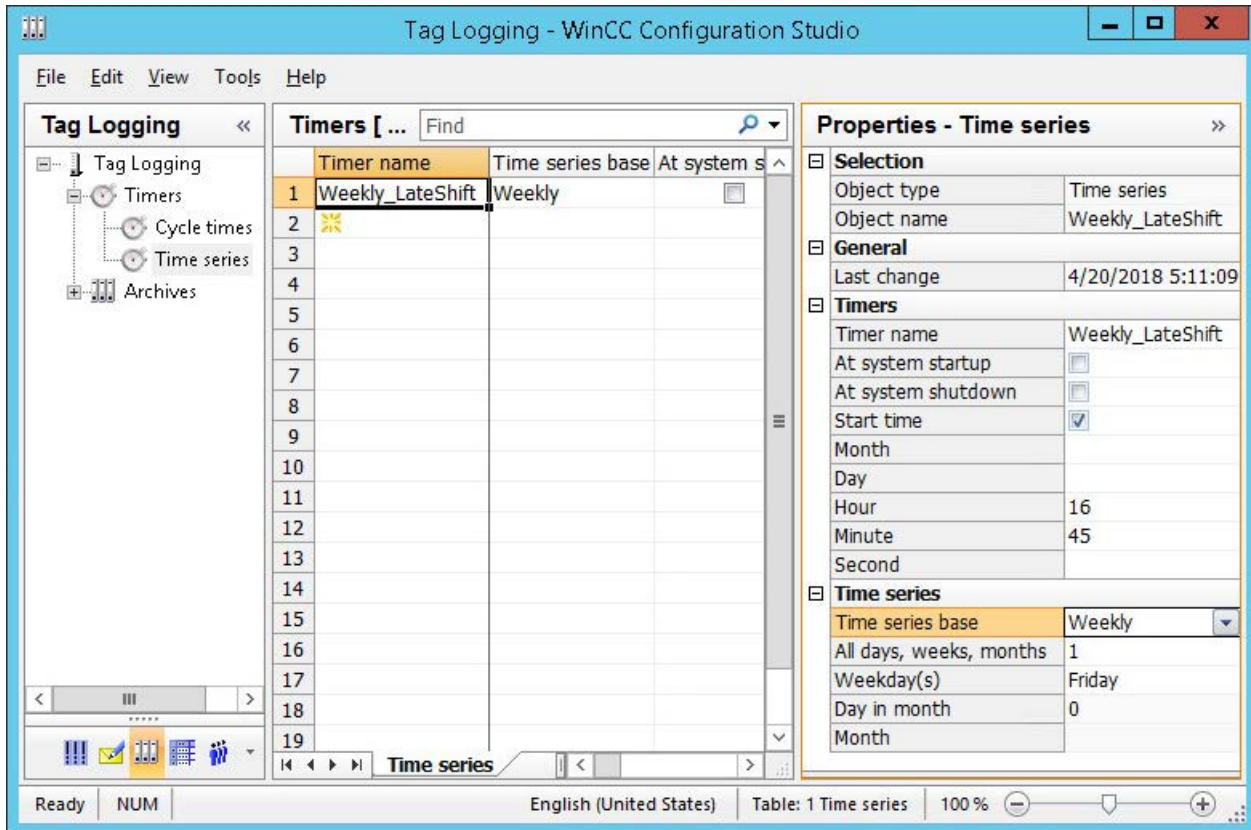

See also

Properties of a time series (Page 1494)

6.4.5 Configuring Archives

6.4.5.1 Configuring Archives

Principle

For the configuration of archives, the system distinguishes between the following archive types:

- A process value archive stores process values in archive tags. When configuring the process value archive you select the process tags that are to be archived and the storage location.
- A compressed archive compresses archive tags from process value archives. When configuring the compressed archive you select a calculation method and the compression time period.

6.4.5.2 How to Configure a Process Value Archive

Introduction

The procedure for configuring a process value archive is broken down into the following steps:

1. Creating process value archive: Create the new process value archive and select the tags that are to be archived.
2. Configuring the process value archive: Configure the process value archive by selecting the memory location, etc.

Procedure

Creating process value archive

Note

The following signs cannot be used in archive names:

ä ö ü - Ä Ö Ü # <space>.

1. Select the "Process Value Archives" folder in the navigation area of the Tag Logging editor.
2. Click the top empty line in the "Archive name" column of the table area and enter the name of the archive.

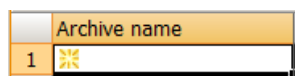

You have created the process value archive.

Configuring process value archive

You edit the properties of the archive either in the "Properties" area or in the table area:

1. Select the folder of the archive in the navigation area.
Edit the properties of the archive, for example:
 - Action at archive start / enable
 - Memory location (hard disk / main memory)
 - Size in data records
2. In the table area, add the tags to the archive that are to be saved in the archive:
 - Select the "Tags" tab in the table area to add binary or analog tags to the archive.
 - Select the "Process-controlled tags" tab to add raw data tags (frame tags).
You must select the format DLL and an archive tag for these tags.
3. Select the line of a tag in the table area.
Edit the properties of the tag in the "Properties" area.

6.4.5.3 How to configure the data buffer

Introduction

In the case of a process value archive, it is possible to define whether the data buffer should be stored on the hard disk or in the main memory.

In contrast to storage in the logging database, process values logged in main memory are only available for as long as Runtime is active. Storing in the main memory has the advantage, however, that the values can be written and read out very quickly. The process values stored in the main memory cannot be swapped out.

Procedure

Note

Compressed archives can only be stored on the hard disk.

1. Select the process value archive whose data buffer you wish to configure in the navigation area.
2. Edit the information in the "Memory location" section in the "Properties" area.
3. If you select "Main memory" as the storage location, enter the "Size in data records" for the data buffer.

6.4.5.4 How to Configure Compressed Archives

Introduction

The procedure for the configuration of a compressed archive consists of the following steps:

1. Creating compressed archive: Create the new compressed archive and select the tags to be archived.
2. Configuring compressed archive: Configure the compressed archive by selecting the memory location, calculation method, etc.
3. Assigning the source tags to a compressed tag: Select the archive tags to be included in the compressed archive.

Procedure

Creating compressed archive

Note

The following signs cannot be used in archive names:

ä ö ü - Ä Ö Ü # <space>.

1. Select the "Compressed archives" folder in the navigation area of the Tag Logging editor.
2. Click the top empty line in the "Archive name" column of the table area and enter the name of the archive.

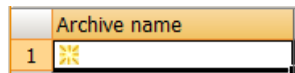

You have created the compressed archive.

Configuring compressed archive

1. You edit the properties of the archive in the "Properties" area or in the table area, for example:
 - Action at archive start / enable
 - Compression properties
 - Weighting of the quality codes
2. Select an archive tag as source tag and assign it to a compressed tag.
See also: "How to configure the properties of a compressed tag (Page 1544)".

6.4.6 Creating Archive Tags

6.4.6.1 Creating Archive Tags

Principle

Process values are archived in archive tags. Different archive tags can be used in a process value archive:

- Binary process values are stored in a binary archive tag.
- An analog archive tag is used for storing numerical process values.
- A process-controlled tag is used for storing process values which have been sent to the archive system as a frame.
- A text tag (8-bit and 16-bit) can save the product IDs or batch name, for example.

In a compressed archive each compressed process value is stored in a separate compressed tag.

Several tags can be archived in one archive.

Note

You may suffer data loss if you change the type of process tag to be archived after assigning it to an archive.

Create a new process tag with a different tag type and assign this process tag to the archive tag.

Basic procedure

With binary or analog archive tags and text tags, you configure the archiving type (e.g., cyclic) as well as acquisition and archiving cycles. Depending on the archiving type, select events and actions which trigger or end archiving. Depending on the type of archive tag, configure the display limits and parameters for processing the process value.

Select the format DLL for process-controlled tags.

Select a compression function when configuring a compressed tag.

Note

In Tag Logging, if you delete, save and subsequently recreate a tag with the same name as the deleted tag, the values of the deleted tag can no longer be accessed for display or archiving. Reason: The newly created archive tag is assigned a new ID. The ID of a deleted archive tag is no longer accessible.

6.4.6.2 How to create an archive tag

Introduction

You create an archive tag in a previously configured process value archive. You assign a name for the archive tag and select the process tag that is to be archived. You determine the type of archiving by editing the properties of the archive tag.

Requirements

- A process value archive is configured.
- Tags whose values are to be archived have been configured.

Creating the archive tag

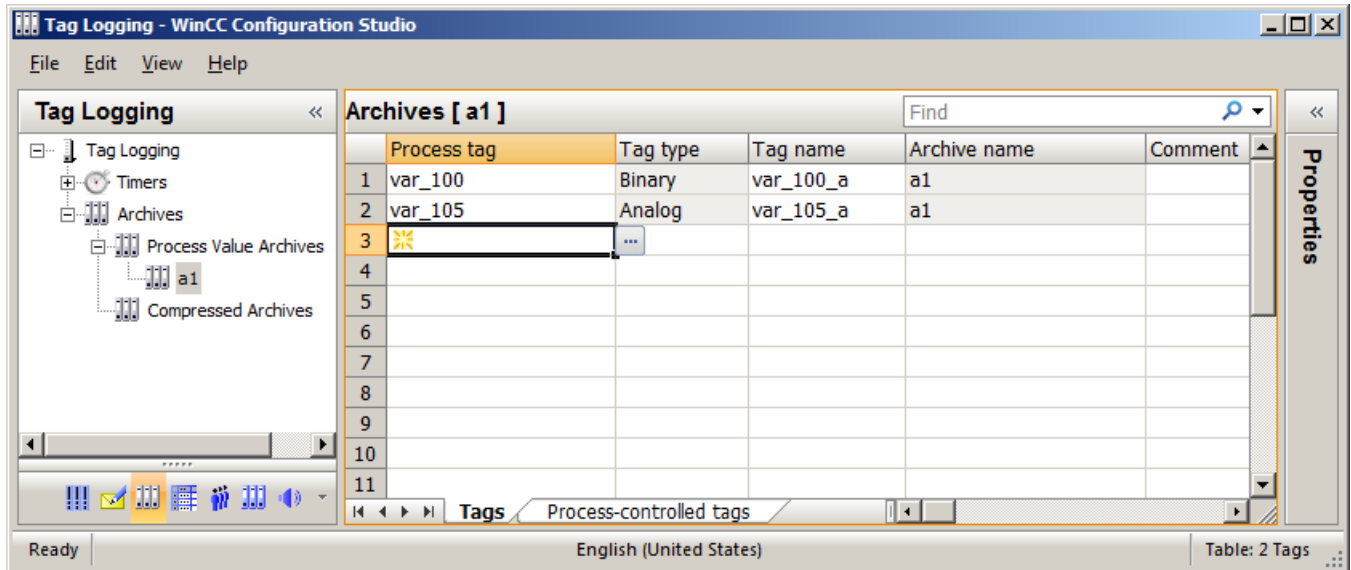

1. Select the folder of the process value archive in which you want to create the archive tag in the navigation area.
2. Select the "Tags" tab in the table area.
3. Click in the top empty cell of the "Process tag" column in the table area and then on . The dialog for tag selection opens.
4. Select the tag whose values are to be saved in the archive tag.
5. Close the dialog by clicking "OK".
The archive tag has been created. It receives the name of the process value tag. You can change this name.
The "Tag type" column indicates if the tag is a binary or an analog tag.
6. Now edit the properties of the archive tag.

6.4.6.3 How to configure the properties of an archive tag

Type of archiving

The properties of the archive tag determine how and how often the process values are archived.

Note

The properties of a tag take precedence over properties of the process value archive with the same name.

Editing properties

1. Select the folder of the archive in which the archive tag is saved in the navigation view.
2. Select the "Tags" tab in the table area.
3. Select the row with the tag whose properties you wish to edit in the table area.
4. Edit the properties in the "Properties" area.

Note

You can also edit the properties in the table area. However, individual columns may be hidden in the table area. The table area lets you edit several entries at once. Read the general information on editing in the section "The WinCC Configuration Studio (Page 54)".

Note

If you change the acquisition method for archive tags in Runtime, from "cyclic" to "acyclic", for example, archiving of these archive tags will be stopped. After deactivation and reactivation of Runtime, archiving is resumed with the modified settings.

6.4.6.4 How to Create a Process-Controlled Tag

Introduction

For acquisition and archiving of process values that change quickly or of process values from several measuring points, the values are transmitted from the AS to WinCC via a raw data tag. Archiving in archive tags takes place via a process-controlled tag by assigning the raw data tags to the archive tag.

Structure of the Archive Tag Name

When the process-controlled tag is configured, WinCC generates an internal archive tag name. You can specify an alias in the "Archive tag name" box. If you do not enter an alias, the internal archive tag name is used for management in the process value archive and addressing the archive tags in WinCC.

The structure of the internal archive tag name depends on the selected format DLL. The format DLL depends on the used PLC.

Procedure

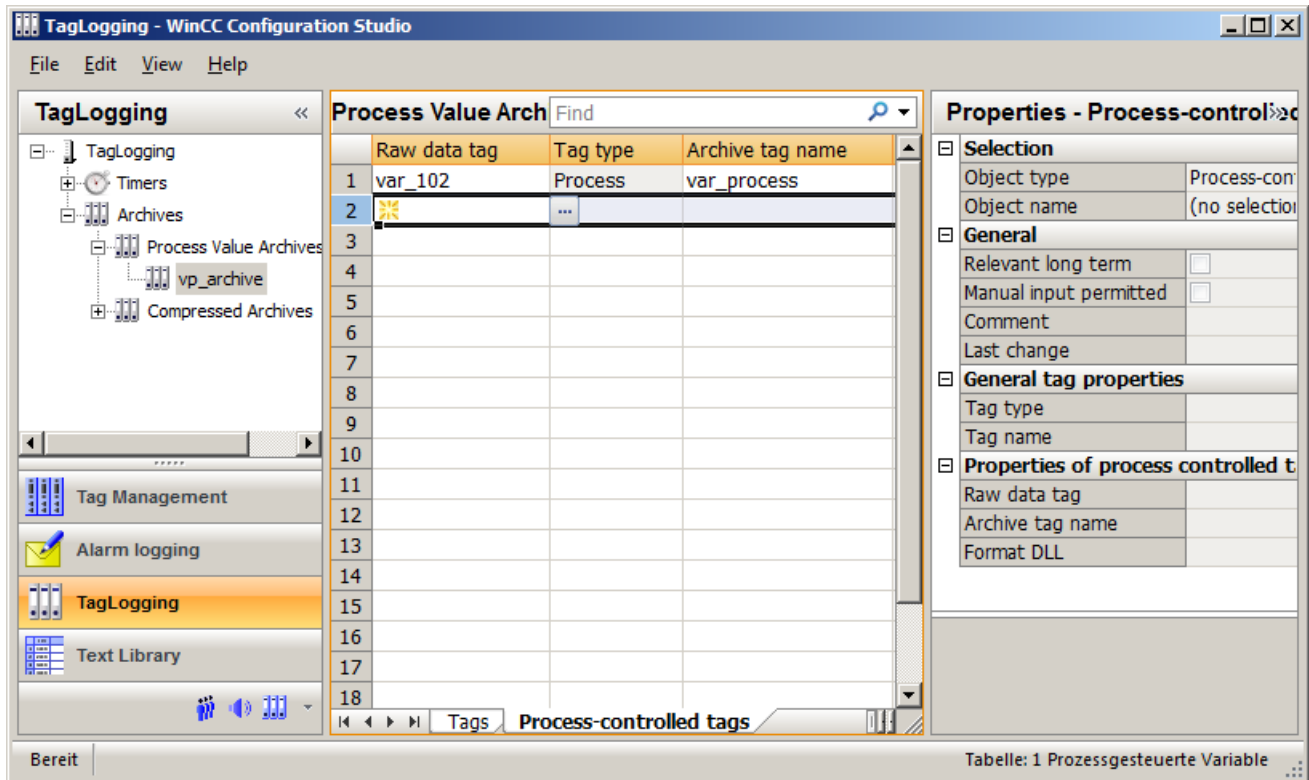

1. Select the folder of the process value archive in which you want to create the archive tag in the navigation area.
2. Select the "Process-controlled tags" tab in the table area.
3. Click in the top empty line of the "Raw data tag" column in the table area and then on the  button.
The dialog for tag selection opens.
4. Select the tag whose values are to be saved in the archive tag.
5. Close the dialog by clicking "OK".
The archive tag has been created.
6. Now edit the properties of the tag.

6.4.6.5 How to configure the properties of a process-controlled tag

Type of archiving

Process-controlled tags are archived if the process supplies new values in a raw data tag. Raw data tags are compiled by a format DLL for archiving in archive tags.

For the format DLLs "nrms7pmc.nll" and "s5std.nll", internal tag names are generated automatically after specification of the parameters.

Note

The properties of a tag take precedence over properties of the process value archive with the same name.

Note

You can also edit the properties in the table area. However, individual columns may be hidden in the table area. The table area lets you edit several entries at once. Read the general information on editing in the section "The WinCC Configuration Studio (Page 54)".

Editing properties

1. Select the folder of the archive in which the archive tag is saved in the navigation view.
2. Select the "Process-controlled tags" tab in the table area.
3. Select the row with the tag whose properties you wish to edit in the table area.
4. Edit the properties in the "Properties" area.
5. The format DLL "nrms7pmc.nll" is set by default. You can also select "s5std.nll".
6. If you have selected "nrms7pmc.nll", enter the "AR_ID" in "Block Id". If a subnumber is being used, enter the "AR_ID subnumber" in "Subnumber". The name of the archive tag is generated and entered in the "Tag name" property.
7. If you have selected "s5std.nll", enter the "Tag ID" in "Block Id". The name of the archive tag is generated and entered in the "Tag name" property.
8. If required, you can specify an alias for the name of the archive tag using the "Archive tag name" property. If no alias is used, the internal tag name in WinCC will be used.
9. If you are using another format DLL, you must configure the parameters in a dialog window via the "Tag name" column.

6.4.6.6 How to Create a Compressed Tag

Introduction

You create a compressed tag in a previously configured compressed archive. You assign a name for the compressed tag and select the archive tag that is to be saved in compressed form. You determine the type of compression by editing the properties of the compressed tag.

Requirement

- Process value archives with archive tags are available.
- A compressed archive has been created.

Procedure

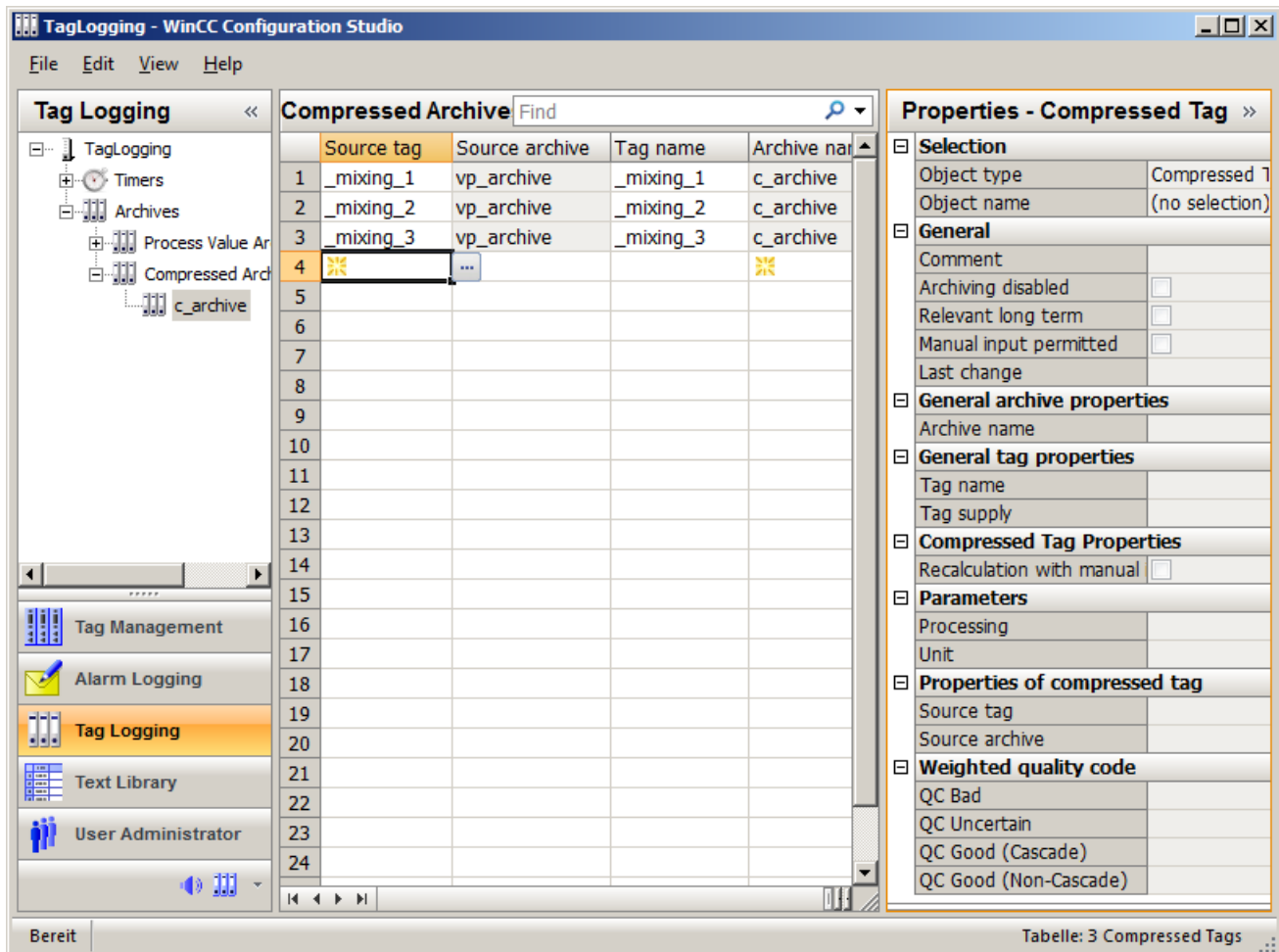

1. Select the folder of the compressed archive in which you want to create the compressed tag in the navigation area.
2. Click in the top empty line of the "Source tag" column in the table area and then on the  button.
The dialog for tag selection opens.

3. Click on the entry of an archive.
All archive tags saved in the archive are displayed.

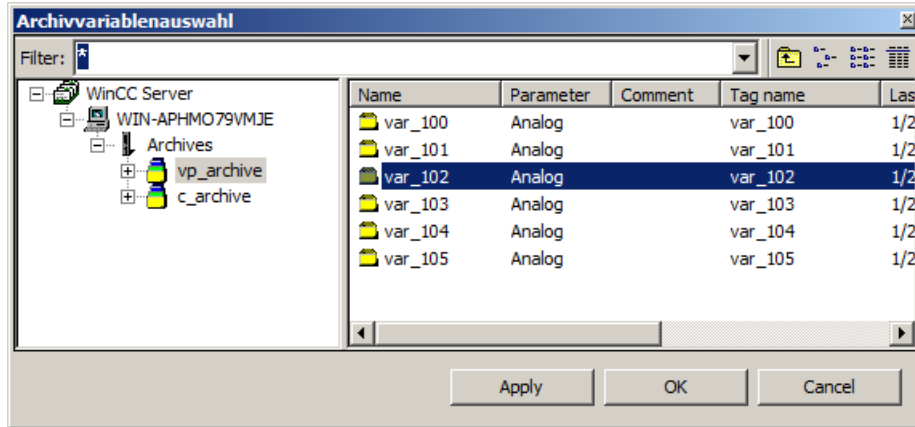

4. Select the tag whose values are to be saved in the compressed tag.
5. Close the dialog by clicking "OK".
The compressed tag is created by assigning a source tag. The name of the compressed tag is the same as the source tag when it is created.
Edit the name of the compressed tag either in the table area or in the "Properties" area.
6. Edit the properties of the compressed tag in the "Properties" area.

6.4.6.7 How to configure the properties of a compressed tag

Editing properties

Note

The properties of a tag take precedence over properties of the compressed archive with the same name.

Note

You can also edit the properties in the table area. However, individual columns may be hidden in the table area. The table area lets you edit several entries at once. Read the general information on editing in the section "The WinCC Configuration Studio (Page 54)".

1. Select the folder of the archive in which the compressed tag is saved in the navigation view.
2. Select the row with the tag whose properties you wish to edit in the table area.
3. Edit the properties in the "Properties" area.

6.4.7 Configuring archives

6.4.7.1 Calculating memory requirements

Introduction

The calculation of memory requirements serves as orientation for the archive configuration of TagLogging Fast and TagLogging Slow.

- TagLogging Fast logs archive tags at a cycle time of less than one minute.
- TagLogging Slow logs archive tags at a cycle time of more than one minute.

Calculating memory requirements

You need information about how many archive tags are logged per second on average.

Formula for general calculation of the memory requirement:

Memory requirement = Number of archive values/s * x bytes * 60 s/min * 60 min/h * 24 h/day * 31 days/month * y months

x $\hat{=}$ bytes across all segments

y $\hat{=}$ time period in months

Standard practice is to specify a daily or weekly period per segment. A segment change at a rate faster than 1 day has a negative impact on performance.

Example of TagLogging Fast

You are planning on implementing a period of 2 months. You have calculated a mean rate of 750 archive values/s for TagLogging Fast.

- The maximum size for all segment is derived as follows:
 - For a memory requirement of 16 bytes per process value:
ca. 60 GB (750 [archive values/s] * 16 [bytes/value] * 60 [s/min] * 60 [min/h] * 24 [h/day] * 30 [days/month] * 2 [months])
 - For a memory requirement of 6 bytes per process value:
ca. 22 GB (750 [archive values/s] * 6 [bytes/value] * 60 [s/min] * 60 [min/h] * 24 [h/day] * 30 [days/month] * 2 [months])
- Daily value per segment:
 - For a memory requirement of 16 bytes per process value:
ca. 1 GB (750 [archive values/s] * 16 [bytes/value] * 60 [s/min] * 60 [min/h] * 24 [h/day] * 1 [day])
 - For a memory requirement of 6 bytes per process value:
ca. 370 MB (750 [archive values/s] * 6 [bytes/value] * 60 [s/min] * 60 [min/h] * 24 [h/day] * 1 [day])

Configure your message archives accordingly for the "TagLogging Fast" archive configuration.

Example of TagLogging Slow

You are planning on implementing a period of 2 months. You have calculated a mean rate of 100 archive values/s for TagLogging Slow.

- The maximum size for all segment is derived as follows:
 - For a memory requirement of 16 bytes per process value:
ca. 8 GB ($100 \text{ [archive values/s]} * 16 \text{ [bytes/value]} * 60 \text{ [s/min]} * 60 \text{ [min/h]} * 24 \text{ [h/day]} * 30 \text{ [days/month]} * 2 \text{ [months]}$)
 - For a memory requirement of 6 bytes per process value:
ca. 3 GB ($100 \text{ [archive values/s]} * 6 \text{ [bytes/value]} * 60 \text{ [s/min]} * 60 \text{ [min/h]} * 24 \text{ [h/day]} * 30 \text{ [days/month]} * 2 \text{ [months]}$)
- Daily value per segment:
 - For a memory requirement of 16 bytes per process value:
ca. 130 MB ($100 \text{ [archive values/s]} * 16 \text{ [bytes/value]} * 60 \text{ [s/min]} * 60 \text{ [min/h]} * 24 \text{ [h/day]} * 1 \text{ [day]}$)
 - For a memory requirement of 6 bytes per process value:
ca. 50 MB ($100 \text{ [archive values/s]} * 6 \text{ [bytes/value]} * 60 \text{ [s/min]} * 60 \text{ [min/h]} * 24 \text{ [h/day]} * 1 \text{ [day]}$)

Configure your message archives accordingly for the "TagLogging Slow" archive configuration.

6.4.7.2 How to Configure Archive

Introduction

You configure the two archive types "TagLogging Fast" and "TagLogging Slow".

- TagLogging Fast archives archive tags with a cycle time of less than or equal to one minute.
- TagLogging Slow logs archive tags at a cycle time of more than one minute.

You can adapt this setting to suit your needs.

Note

The archive size is not to exceed the available memory. The archive manager does not check the selected settings for plausibility. A high number of linked database segments can lead to waiting times when starting and ending Runtime.

Note

If you modify the time range under Archiving size in Runtime, the modification does not take effect until the next segment change.

Procedure

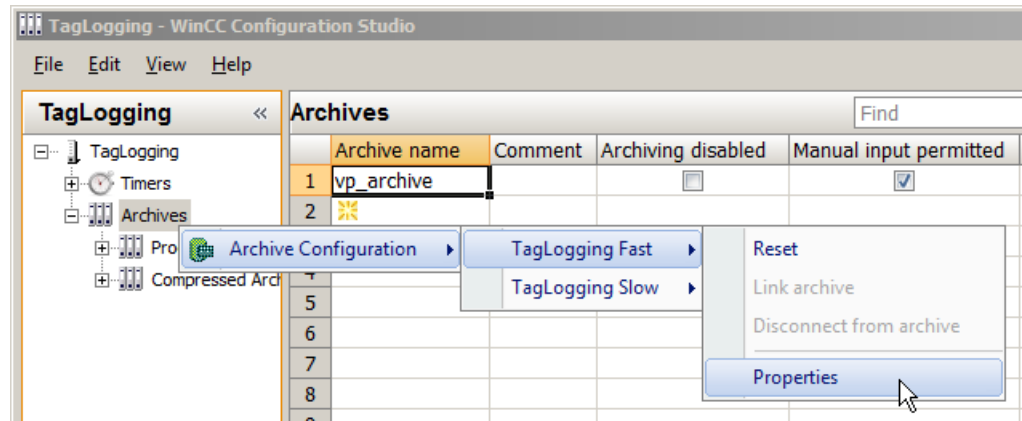

1. Select the "Archives" folder in the navigation area.
2. Select "Archive configuration" > "TagLogging Fast" > "Properties" in the shortcut menu. The "TagLogging Fast" dialog is opened:

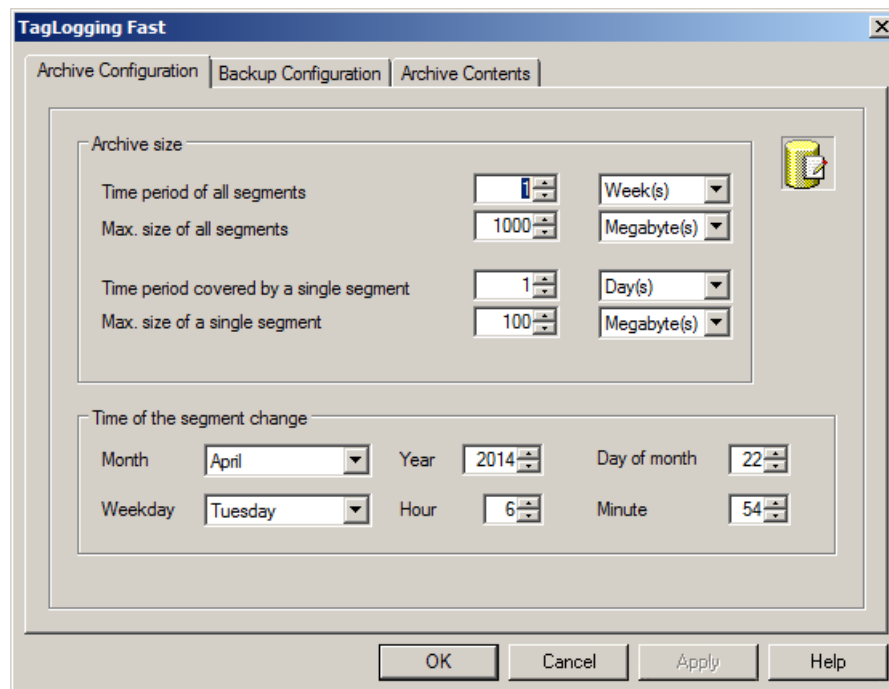

3. Make the following settings for the archives:
 - Time period across all segments and their maximum size.
This specification defines the size of the archive database. If one of the criteria is exceeded, a new segment is started and the oldest segment is deleted.
 - The time period in which process values are to be archived in an individual segment and its maximum size.
If either of these criteria is violated, a new individual segment is started. When the criterion for "Time period of all segments" is exceeded, the oldest individual segment is also deleted.

4. Enter the following under "Time of segment change":
 - Start date and start time for the first segment change.
5. Click "OK" to confirm your entries.

Example

In the above screen shot, the segment changes for the first time on April 22 2014 at 06:54. The next time-related segment change occurs at the configured time in the cycle defined in "Time period covered by a single segment". The segment is also changed when the configured size of all segments and one single segment is exceeded. The oldest single segment is only deleted if the configured size of all segments or the time period of all segments has been exceeded.

Changing the archive type

The cycle time of archive tags must not be changed in Runtime to exceed the aforementioned limits. The change of an archive tag from "TagLogging Fast" to "TagLogging Slow" and vice versa is not possible in Runtime.

If you save tags in a different archive type following a cycle change or reconfiguration, the tags are read from the valid archive. Previous archive values of this tag are not accessible in Runtime.

If tags are no longer archived in "Tag Logging Fast" but in "Tag Logging Slow" after a change, the size of the databases required for these tags may increase considerably.

Note

Runtime data in archives are deleted during a reset in the archive configuration of Tag Logging. Only previously swapped-out databases remain intact.

6.4.7.3 How to Assign Archive Tags to Archive Types

Introduction

Process value archiving uses the archive types "TagLogging Fast" and "TagLogging Slow" to save data.

Archive tags are automatically assigned to the respective archive type by WinCC.

You can make global changes for both types of archive.

In Runtime, the setting is not applied until the project is deactivated and runtime is restarted.

Procedure

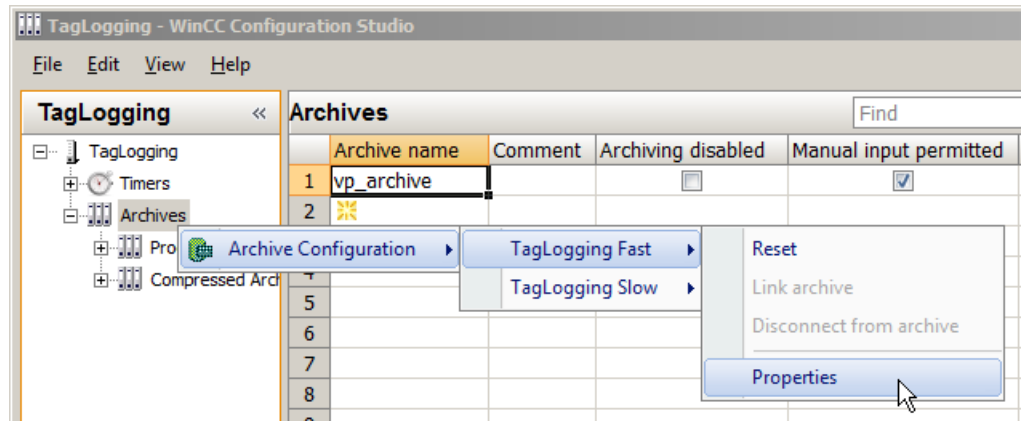

1. Select the "Archives" folder in the navigation area.
2. Select "Archive configuration" > "TagLogging Fast" > "Properties" in the shortcut menu. The "TagLogging Fast" dialog is opened:
3. Click the "Archive Contents" tab.

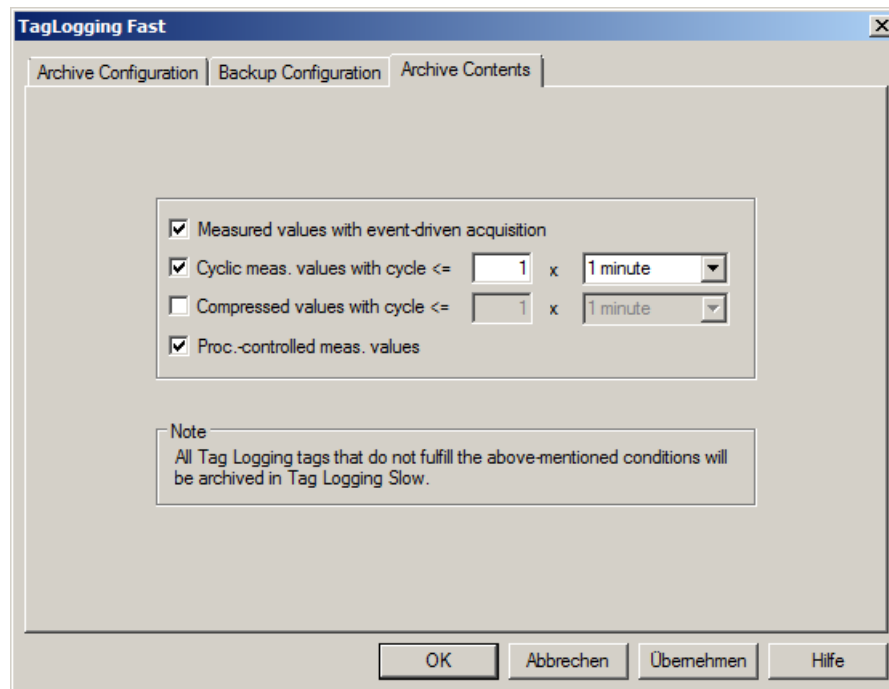

4. Select the options that you want to specify as conditions for archiving of archive tags in TagLogging Fast:
 - acyclic archiving for event-controlled acquisition of process values.
 - cyclic archiving of the process values with an archiving cycle less than or equal to a specified limit.
 - compressed measured values with an archiving cycle less than or equal to a specified limit.
 - Process-controlled measured values
5. Enter a value for the upper limit of the archiving cycle for cyclical and compressed measured values.

Result

All archive tags to which these settings apply are archived in the "Tag Logging Fast" archive. The archive tags to which these settings do not apply are archived in the "Tag Logging Slow" archive.

6.4.8 Archive backup

6.4.8.1 How to Configure an Archive Backup

Introduction

Create regular backups of your archive data to ensure seamless documentation of your process.

Note

Starting the backup

The backup normally starts 15 minutes after the first time-related segment change.

If the start of backup and start of segment should be synchronous with the start of Runtime, define the start time for the segment change prior to the start of Runtime.

Changing archived process value in Runtime

In Runtime you can change a displayed process value using WinCC OnlineTableControl.

If the location of the archive segment where the process value is stored has already been changed, then the modified value is not accepted in the shifted archive. The changed process value is only stored in the local archive segment.

If the archive segment has not yet been moved out, then the changed value is accepted permanently.

Backup behavior with redundant system

Only the current master server swaps out to a local drive.

Procedure

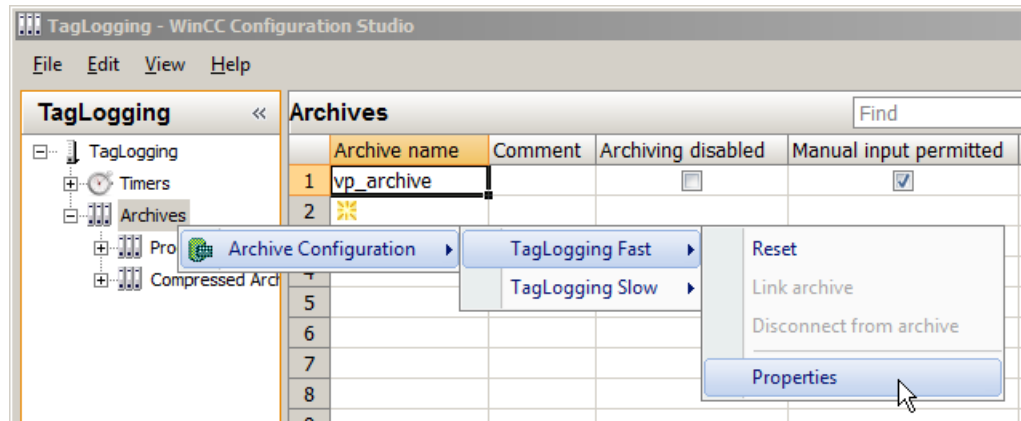

1. Select the "Archives" folder in the navigation area.
2. Select "Archive configuration" > "TagLogging Fast" / "TagLogging Slow" > "Properties" in the shortcut menu.
The "TagLogging ..." dialog is opened:
3. Click the "Backup Configuration" tab.

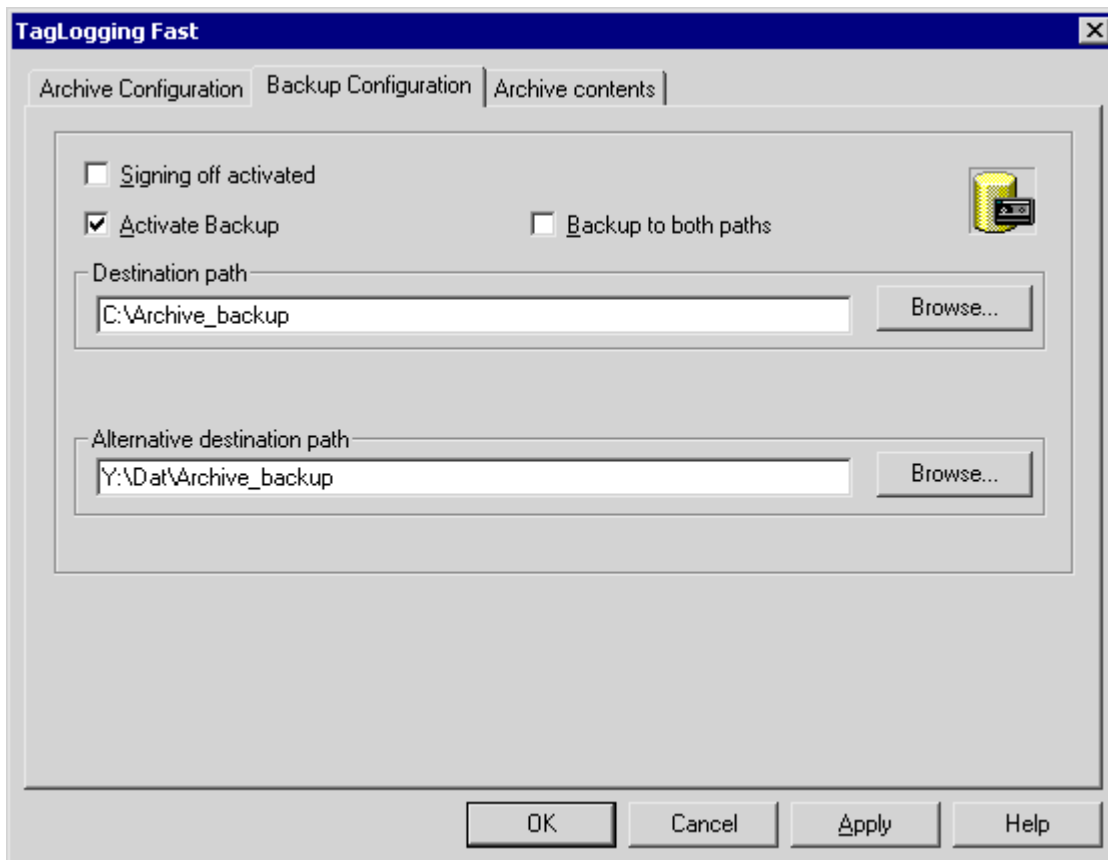

4. Activate the "Signing activated" option if the archive backup files are supposed to contain a signature. When reconnected with WinCC, the signature allows the system to determine whether the archive backup file was changed after its swap-out.
5. Select the "Activate backup" option, if the archived data are to be backed up. In addition, select the "Backup to both paths" option, if the archived data are to be saved in both directories, "Destination path" and "Alternative destination path".
6. Enter the destination path in which the backup files are to be stored. Network paths are also permitted as destination paths. The "Alternative destination path" is used in the following cases, for example:
 - The storage space of a backup medium is full.
 - The original destination path is not available, for example, due to a network failure. After the corresponding system messages have been configured, the messages are output if the specified destination path is not available.
7. Click "OK" to confirm your entries.

Result

The archive backup is stored in the specified destination path.

Structure of the archive backup file

An archive backup consists of two files, with the extensions LDF and MDF. To transfer an archive backup to another computer, for example, copy the corresponding LDF and MDF files.

The file name is composed as follows:

"<Computername>_<Projectname>_<Type>_<Period_from>_<Period_until>". The type is defined by the archive type:

- TLG_F: "Tag Logging Fast" process value archive
- TLG_S: "Tag Logging Slow" process value archive

The time period is specified in the following format: `yyyymmddhhmm`, e.g., 200212021118 (for December 2, 2002, 11:18 AM). Underscores ("_") in the project name are displayed as "#".

Signing of archive backup files

If signing and backup are activated, each archive backup file is signed off when swapped out. It is thus possible to determine upon reconnection of the file with WinCC whether or not the file has been changed after swapping.

In order to verify the data, the "Signing activated" check box must be selected.

Note

No segment change may take place while you deactivate signing, for example, to establish a fast connection to the backup files.

After the connection has been established, you need to reactivate signing off so that the data to be archived receives a signature.

Tag Logging Slow

Longer verification times result from connecting "Tag Logging Slow" archives. The "Link archive" menu entry is gray-shaded for the duration of the connection.

For Tag Logging Slow you must expect longer picture selection times than with Tag Logging Fast.

Configuration limits

If you use archive signing-off, the size of a single segment may not exceed 200 MB.

You can find additional information on the archiving of signed data in the WinCC Information System under "Performance data > Archive system".

6.4.8.2 How to Link an Archive Backup

Introduction

Connect the database files once again with the project to access an archive backup in runtime. You can link an archive using the "Tag Logging" editor and WinCC Controls or have the connection created automatically.

Requirement

- The LDF file and MDF file of the archive backup are in a local directory on the configuration computer, for example, on the hard drive.
- The project is loaded on the configuration computer and is located in Runtime.
- You can only link the archive files on the server. How you start an action on the server from a client with a script, is described in the section "Example: How to start an action on the server (Logging object)".

Displaying the Process Values in Runtime

The archived process values are inserted in runtime in the configured display according to the time stamp.

Alternative access options to backups

You can use OLE-DB or the DataMonitor Web editor to directly access the archive server.

Link archive

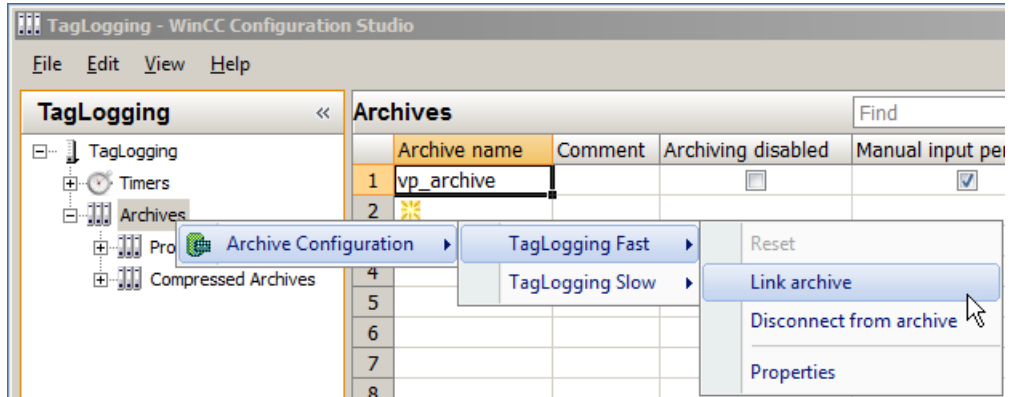

1. Select the "Archives" folder in the navigation area.
2. Select "Archive configuration" > "TagLogging Fast" / "TagLogging Slow" > "Link archive" in the shortcut menu.
The dialog for selecting a file is displayed.
3. Select the database file and click "Open".
The database file is connected with the project. The process values can be displayed directly in Runtime.

If signing off is activated and you link a modified or unsigned archive backup file to the project, you must acknowledge the link to these files, as the archive backup files are otherwise not linked. A WinCC system message is generated and an entry is added to the Windows event log in the "Application" section.

Longer verification times result from connecting "Tag Logging Slow" archives. The "Link archive" menu entry is gray-shaded for the duration of the connection.

Linking the archive with WinCC Controls

1. Click  on the WinCC Control toolbar.
2. In the dialog use the "..." button to navigate to the path in which the backup files are located.
3. Select the required backup file under "Backups" and click "OK".
The database file is connected with the project. The process values can be displayed directly in Runtime.

Automatic Linking to an Archive

1. Add the archive backup files to the "ProjectName\CommonArchiving" directory.
2. In Runtime, the process value archive is automatically linked to the project.

If signing off has been activated, modified, signed off archive backup files are not automatically linked. A WinCC system message is generated and an entry is added to the Windows event log in the "Application" section.

Linking an Archive Using a Script

You can link the archive backup files with the WinCC project by using a script via the VBS object "DataLogs". The archive segments are copied with the "Restore method" to the Common Archiving directory of the Runtime project. You can find more information under "DataLogs VBS Object" and "VBS Method 'Restore'".

6.4.8.3 How to Disconnect an Archive Backup

Introduction

If you no longer wish to access the data in an archive backup during Runtime, disconnect the database files from the project.

You can disconnect an archive with the "Tag Logging" editor or WinCC Controls. You must delete connected archives from the "Project name\CommonArchiving" directory or have it removed by a script with the VBS object "DataLogs".

Requirement

- Archive backup files are linked.
- The project is loaded on the configuration computer and is located in Runtime.
- You can only disconnect linked archive files on the server. How you start an action on the server from a client with a script, is described in the section "Example: How to start an action on the server (Logging object)".

Disconnect from archive

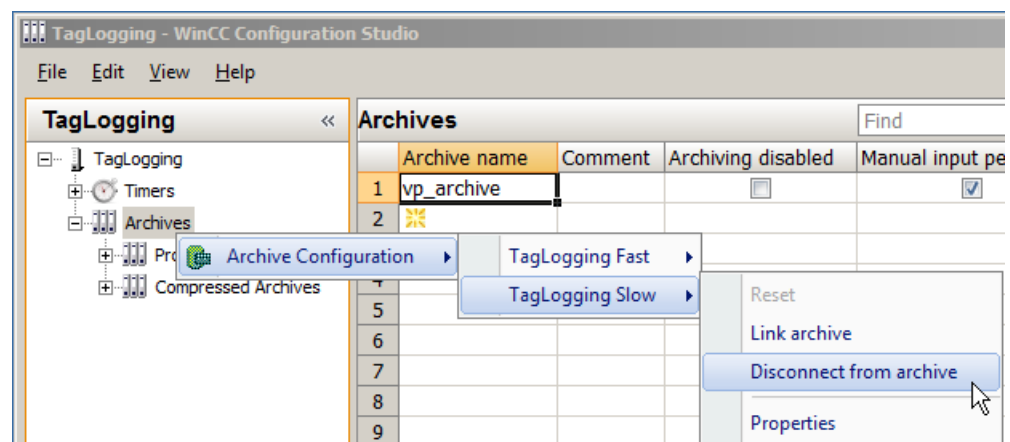

6.4 Configuration of Process Value Archiving

1. Select the "Archives" folder in the navigation area
2. Select "Archive configuration" > "TagLogging Fast" / "TagLogging Slow" > "Disconnect from archive" in the shortcut menu.
The dialog for selecting a file is displayed.
3. Select the database file and click "Open".
The link to the archive file is disconnected. You will no longer have access to the archived process values in Runtime.

Disconnecting the archive with a WinCC control

1. Click  on the WinCC Control toolbar.
2. Select the required archive file in the dialog and click "OK".

6.5 Output of Process Values

6.5.1 Output of Process Values

Introduction

You can output process values in process displays and as a report. You can also directly access the archive database via various interfaces.

Process Value Output in Process Pictures

You can output process values in table form, trend form, or bar form in runtime. To do this you can load process values from the archive database or monitor the running process directly.

Process Value Output in Reports

You can print out process values from the archive database as a report. You can select among table, trend, and bar for this output form, as well. In the Report Designer, both output forms are available as predefined layouts in Report Designer.

Direct Access to the Archive Database

Interfaces are available from various providers that you can make use of for accessing archive databases:

- Access to the archive database using OPC
- Access to the archive database using C-API/ODK
- Access to archive databases using ADO/OLE DB

See also

Process value output in reports (Page 1728)

Configuration of Process Value Archiving (Page 1527)

Basics of Process Values Archiving (Page 1484)

6.5.2 Process Value Output in Process Pictures

6.5.2.1 Process value output in process pictures

Introduction

You have the option to display archived and current process values in Runtime. Use ActiveX Controls in WinCC for this purpose, which you insert in a process picture as a table windows, trend window or bar diagram.

Note

Maximum data sizes with OnlineTableControl and OnlineTrendControl

The maximum amount of data sent by the Tag Logging server to the controls is 134,217,728 bytes.

When a process value includes 20 bytes, approximately 6.7 million values can be displayed in the OnlineTableControl or exported to a ".csv" file.

Long screen opening times with OnlineTableControl and OnlineTrendControl

If you link a large number of archives to the project at the start of Runtime, it may take longer to open and update pictures by means of OnlineTableControl and OnlineTrendControl.

Process Value Output in a Table

To display process values in table format in Runtime, use the WinCC OnlineTableControl. You can connect the values in the table with archive tags or process tags.

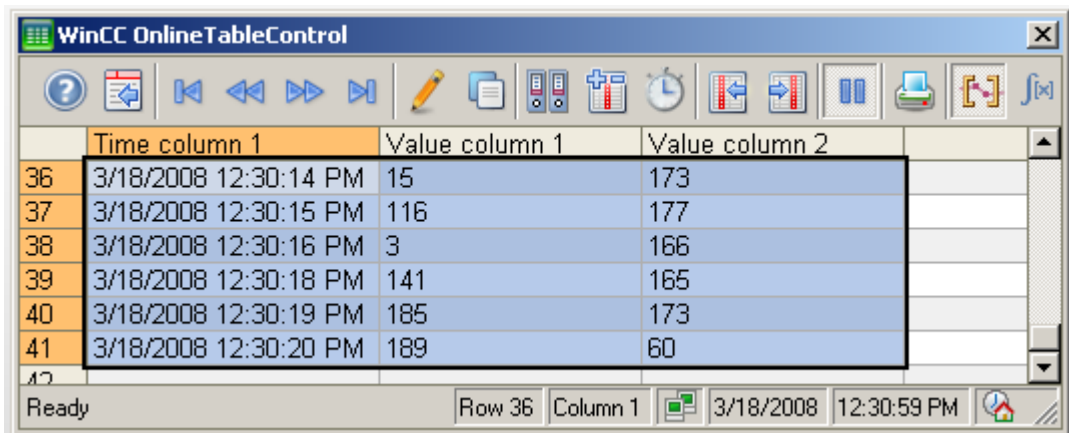

	Time column 1	Value column 1	Value column 2	
36	3/18/2008 12:30:14 PM	15	173	
37	3/18/2008 12:30:15 PM	116	177	
38	3/18/2008 12:30:16 PM	3	166	
39	3/18/2008 12:30:18 PM	141	165	
40	3/18/2008 12:30:19 PM	185	173	
41	3/18/2008 12:30:20 PM	189	60	

Ready Row 36 Column 1 3/18/2008 12:30:59 PM

Process value output in trends

To display process values in trend format in Runtime, use the WinCC OnlineTrendControl. You can connect the values in the trend with archive tags or process tags.

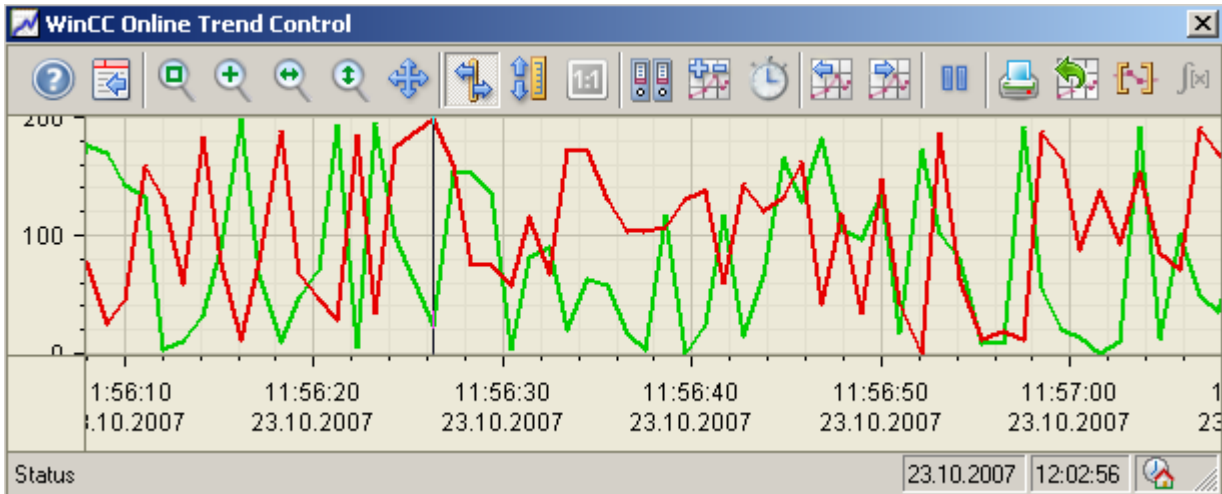

Process value output as a function of another tag in trends

To output process values as a function of another tag, use the WinCC FunctionTrendControl.

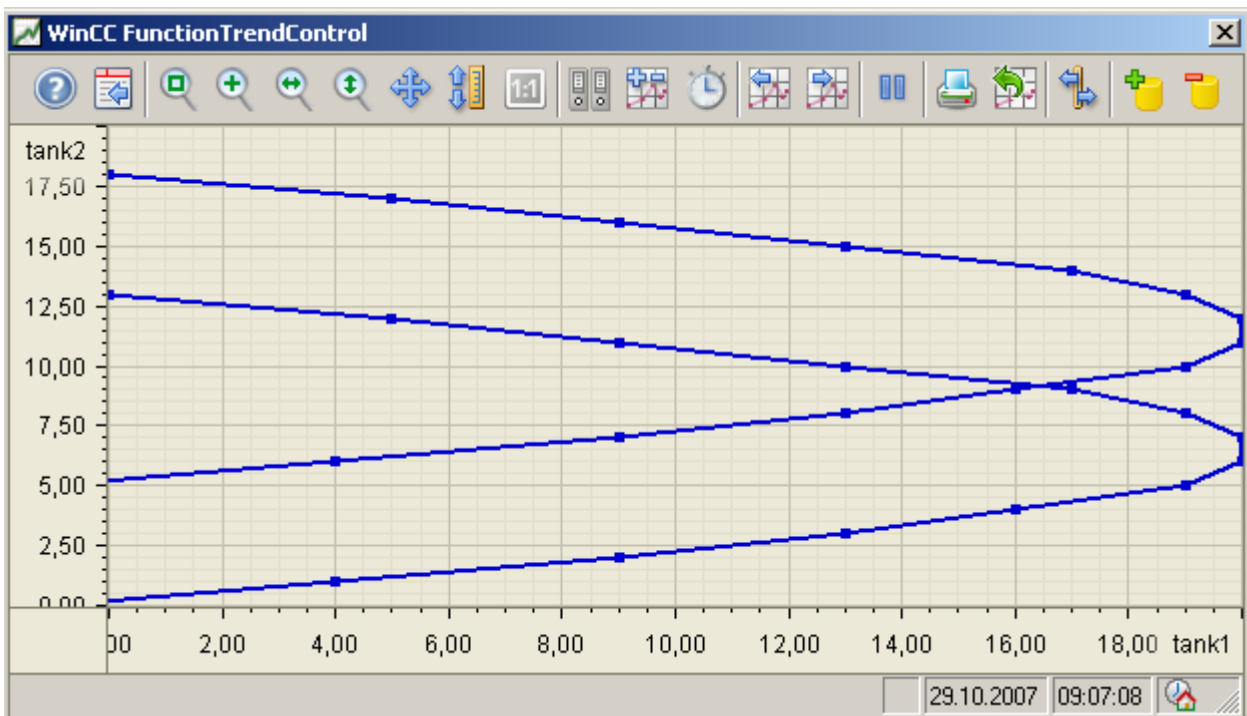

Process value output in a bar diagram

To display archived process values in a bar diagram in runtime, use the WinCC BarChartControl.

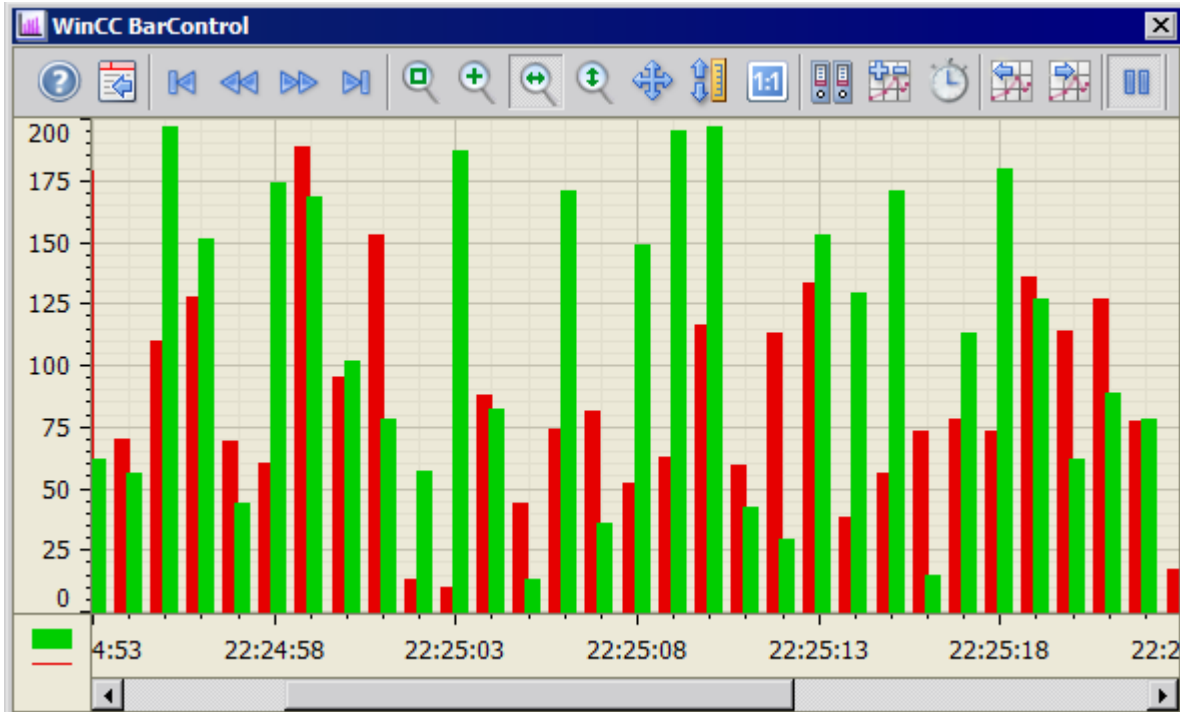

6.5.2.2 Process Value Output in Table Format

WinCC OnlineTableControl

Overview

Current process values or archived values and texts are displayed in a table with WinCC OnlineTableControl. The process data is represented in online tags, archive values in archive tags.

You can arrange the display of the table as you wish.

You can create statistics from them in runtime or you can export the data for further processing.

	Time column 1	Value column 1	Value column 2
36	3/18/2008 12:30:14 PM	15	173
37	3/18/2008 12:30:15 PM	116	177
38	3/18/2008 12:30:16 PM	3	166
39	3/18/2008 12:30:18 PM	141	165
40	3/18/2008 12:30:19 PM	185	173
41	3/18/2008 12:30:20 PM	189	60

See also

Short Description of the WinCC Controls and Additional Controls (Page 749)

Configuring the OnlineTableControl

How to configure the OnlineTableControl:

Introduction

The values in the table are shown in runtime in an ActiveX control.

You can configure a WinCC OnlineTableControl for this in the Graphics Designer.

Configuration steps

1. Link the WinCC OnlineTableControl to a Graphics Designer picture.
2. Configure the basic properties for the OnlineTableControl on the "General" tab.
3. Configure one or more time columns with the time ranges for the table.
4. Configure one or more value columns.
 - Assign time columns to the value columns.
 - Every value column configured must be connected with an online tag or archive tag.
 - Define the data connection for each value column.
 - Specify the color for limit violations for each value column as required.
5. Configure the display and properties of the table on the "Parameter", "Display" and "Marker" tabs.
6. Configure the toolbar and status bar of the table window.

7. If you want to show the statistics values, configure a statistics window as well. Connect the statistics window with the OnlineTableControl.
8. Save the configurations.

How to configure the time columns for the table

Introduction

You configure the time range in the table display with time columns. A table can have separate time columns for several value columns or a common time column.

Time range of a table

Basically, there are two different time references in the table:

- **Static display.** The time range of the table is determined by a pre-defined, fixed time interval, independent of the current system time.



- **Dynamic display.** The time range of the table is determined retrospectively from the most current values. The display is continuously updated. The configured time range follows the current system time.

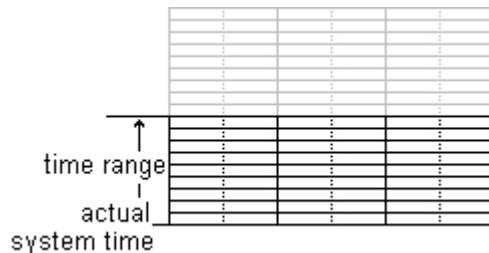

You have three different ways to define the time range of a time column for each of the two time references:

- The table values are displayed within a defined time interval. You define a start time and an end time. In a dynamic display, the end time corresponds with the current system time. The time difference between the start time and the end time is the time range for the table.
- The table values are displayed from a start time throughout a defined time range, e.g. 30 minutes from the start time. In the dynamic display, the defined time range up to the current system time is used, e.g. 30 minutes to the current system time.
- Starting from a start time, a defined number of values are shown, e.g. 100 values from the start time. With the dynamic display, the last values up to the current system time are shown.

Requirement

- You have opened the picture with the WinCC OnlineTableControl in the Graphics Designer.

Procedure

1. Define one or more time columns with the "New" button on the "Time columns" tab. The sequence in the list determines the arrangement of the columns in the table.

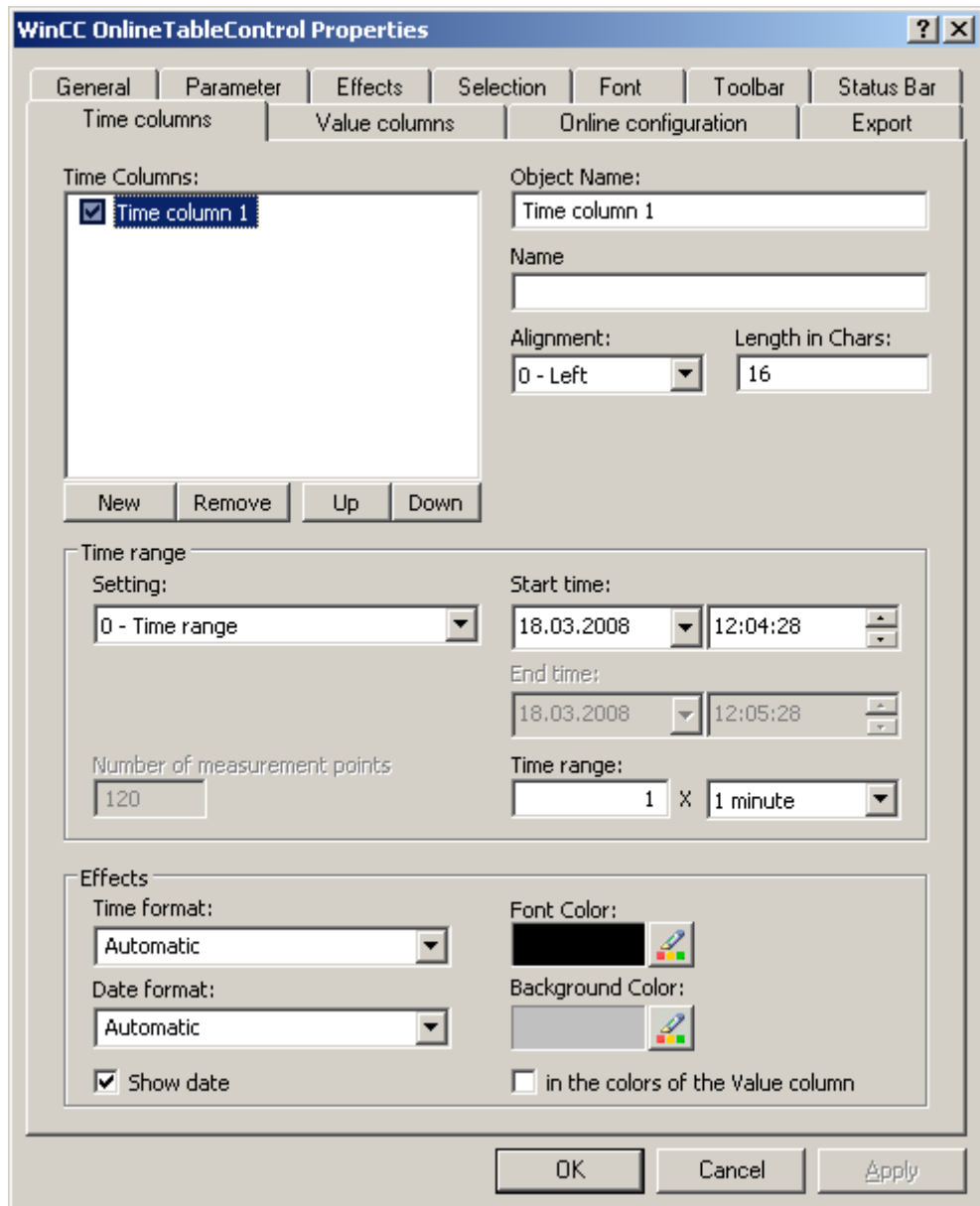

2. If you do not want to show a time column in the table, deactivate the time column by clicking on the checkbox in front of the name in the list. During runtime, you can show it again by activating the time column in the table.
3. Configure the properties and the formats for time and date for every time column.

4. Configure a time range for every time column. If you want a dynamic display, activate the "Refresh started" option in the "Open picture" area in the "General" tab.
 5. Set the time range:
 - If you want to define a fixed time interval, select setting "Start to end time" Enter the date and time for each.
 - If you want to define a time period, select the setting "Time range". Define the date and time for the start time. The time range is the result of a multiplication of the "Factor" and "Time unit", e.g. 30 times "1 minute" for a time range of 30 minutes. Enter the factor and the time unit in the "Time range" field.
 - If you want to display a certain number of values, select the setting "Number of measurement points". Define the date and time for the start time. Enter the desired number of measurement points in the input field.
 6. Save the configuration.
-

Note

Upon starting Runtime the values to be displayed are either read from the archive or are set to zero. Define whether the update will start upon opening the picture on the "General" tab.

How to configure the value columns for the table

Introduction

You can display several value columns in a table.

Every value column is connected with a time column. The value columns can have a common time column.

Color coding of a limit violation

To highlight limit violations and uncertain values, configure different text colors and background colors for the values:

- **Low limit:**
Whenever a table value displayed is less than the value defined in the "Value" input field, the value and the cell are shown in the configured color.
The same applies for the second low limit value.
- **High limit:**
Whenever a table value displayed is greater than the value defined in the "Value" input field, the value and the cell are shown in the configured color.
The same applies for the second high limit value.
- **Value with uncertain status:**
Values whose start values are unknown after runtime is activated or for which the substitute values are being used, have an uncertain status.
You can only highlight values with uncertain status for text tags.

Requirement

- You have opened the picture with the WinCC OnlineTableControl in the Graphics Designer.
- You have defined time columns.

Procedure

1. Define one or more value columns with the "New" button on the "Value columns" tab. The sequence in the list determines the arrangement of the value columns in the table relative to the assigned time axis.

2. Assign time columns that have been configured already to the value columns. If more than one value column is to use a common time column, assign the same time column to these value columns.
3. If you do not want to show a value column in the table, deactivate the value column by clicking on the check box in front of the name in the list. You can use key function "Column On/Off/Move" in runtime to display the value column in the table again.
4. Configure the properties and the display for each value column.
5. Define the data source for each value column. Your options are:
 - Data source with archive tags of a process value archive
 - Data source with online tags from the tag management

6. Click on  to select a tag.
7. Configure the representation of the value columns.
8. To create a text filter for a value column, click "Edit" in the "Selection" area.
In the "Select filter" dialog, select a value column that is linked to an archive tag of the tag type "Text".
To specify the criteria, open the "Selection" dialog with the "Select filter" button.
You activate the created filters in Runtime with the "Select filter" button.
For additional information, refer to "Operation in Runtime > How to filter texts in value columns (Page 1597)".
9. Save the configuration.

Configuring color coding of a limit violation

1. Click the "Limit values" button if you want limit value violations in a value column to be highlighted in color.
This will open the "Limit values" dialog.



2. Select "Use" for the limit values for which you want color identification.
3. Set the limit value, the background color for the cell and the font color for each limit value monitoring function.
The table cells of the values are displayed in the configured colors.
4. Save the configuration.

See also

How to filter texts in value columns (Page 1597)

How to configure the display for the table

How to configure the properties of the table elements

Introduction

You can adjust the properties of the table elements in the WinCC controls to suit requirements.

Prerequisite

- You opened Graphics Designer and configured a picture with a WinCC control.
- The configuration dialog of the WinCC control is open.

Procedure

1. Go to the "Parameter" tab.

Section	Property	Value
Column Header	Show	<input checked="" type="checkbox"/>
	Shorten content	<input type="checkbox"/>
	Width can be changed	<input checked="" type="checkbox"/>
	Alignment	0 - Left
Sort	Sort by column header	2 - With double-click
	Sorting order on mouse click	0 - Up/down/none
	Show sorting symbol	<input checked="" type="checkbox"/>
	Show sorting index	<input checked="" type="checkbox"/>
	Use sorting key	<input type="checkbox"/>
Row Label	Show	<input checked="" type="checkbox"/>
	Alignment	0 - Left
Table Content	Show empty columns	<input checked="" type="checkbox"/>
	Show empty rows	<input checked="" type="checkbox"/>
	Shorten content	<input type="checkbox"/>

2. Specify the properties for
 - Column Header
 - Row label
 - Sorting
 - Table Content
3. Save the configuration.

How to configure the colors of the table elements

Introduction

You can adjust the colors of the table elements in the WinCC controls to suit requirements.

Requirement

- You opened Graphics Designer and configured a picture with a WinCC control.
- The configuration dialog of the WinCC control is open.

Procedure

1. Go to the "Effects" tab.

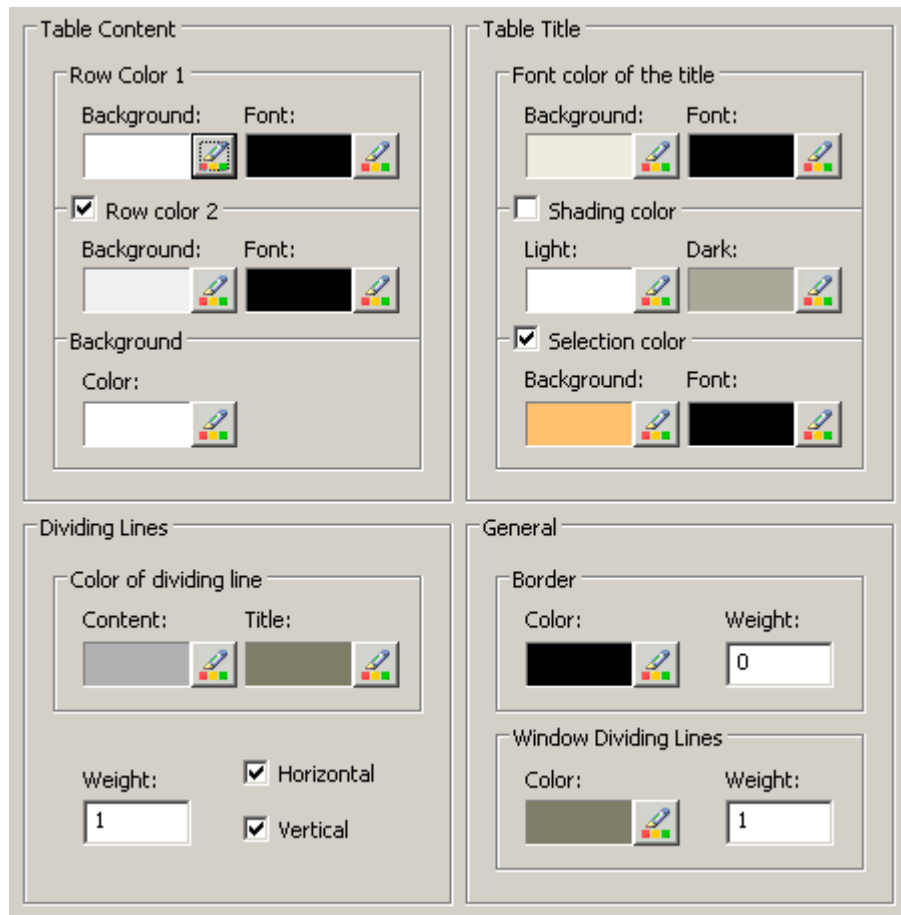

2. Define the colors for the background or text here for:
 - Table content. You can define different colors for even and odd line numbers to improve differentiation between both.
 - Contents of the table header
 - Separating lines in the table and for table headers

3. Define the color and the line weight in the "General" area in terms of:
 - Control borders
 - Window dividers for control elements
4. Save the configuration.

How to configure the marking of the selected cells and lines

Introduction

You can customize the marking of the selected cells and rows in the WinCC control to suit requirements.

Prerequisite

- You opened Graphics Designer and configured a picture with a WinCC control.
- The configuration dialog of the WinCC control is open.

Procedure

1. Go to the "Selection" tab.

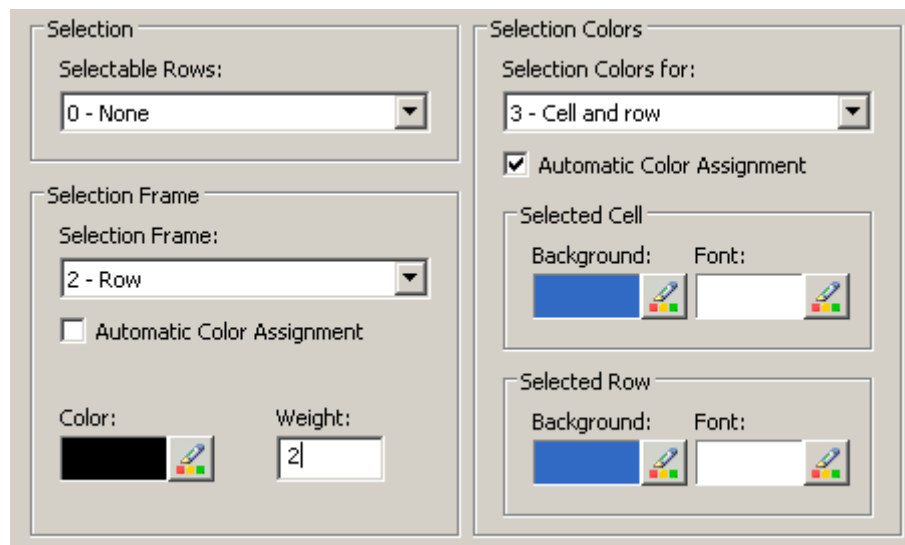

2. Define whether to select rows or only cells using the mouse.
3. Configure the properties of the selection rectangle that can be displayed around selected table cells or rows.
4. Configure the marking color for selectable cells and/or rows. The system colors are used for marking with "Automatic coloring" property.
5. Save the configuration.

How to configure sorting via the column heading

Introduction

You can adjust the sorting order by means of table column header in the WinCC controls to suit requirements.

Prerequisite

- You opened Graphics Designer and configured a picture with a WinCC control.
- The configuration dialog of the WinCC control is open.

Procedure

1. Go to the "Parameter" tab.

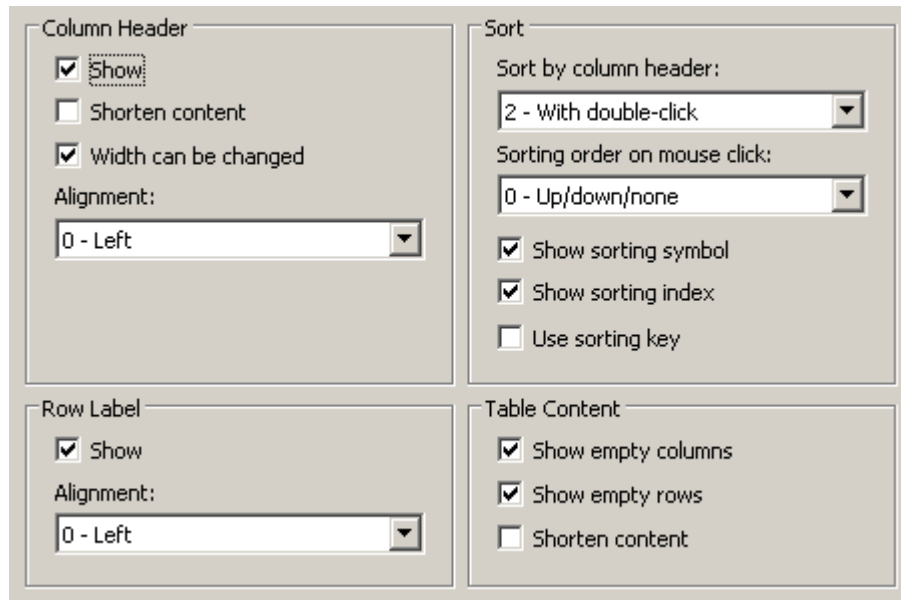

2. Define whether to enable sorting and the sorting method by column header. In WinCC AlarmControl, you can only sort by column header if the "Auto-scrolling" is disabled. You can deactivate "Auto-scrolling" either in the "General" tab, or using the "Autoscroll" toolbar icon of the WinCC AlarmControl.
3. Determine the sorting order by mouse click on the column header. Select ascending, descending or no sorting order.
4. Configure the sorting icon and index to be displayed in the column header with right justification. These show the sorting order and sequence of the columns.
5. Activate the "Use sorting key" to display the sorting icon as sorting button above the vertical scroll bar. Click this sorting key to activate a configured sorting order for the column selected. The sorting key is not displayed if a vertical scroll bar is missing.
6. Save the configuration.

How to configure the toolbar and the status bar

Introduction

The WinCC controls are operated at runtime using the functions of the toolbar buttons. The status bar contains information pertaining to the current status of the WinCC control. You can adapt the toolbar and the status bar for all WinCC controls when configuring, or at runtime.

Requirement

- A picture showing a WinCC control is opened in Graphics Designer when configuring.
- The WinCC control is assigned the "Configuration dialog" button function for opening the configuration dialog in Runtime.
- The configuration dialog of the WinCC control is open.

How to configure the toolbar

1. Go to the "Toolbar" tab. In the WinCC AlarmControl, for example:

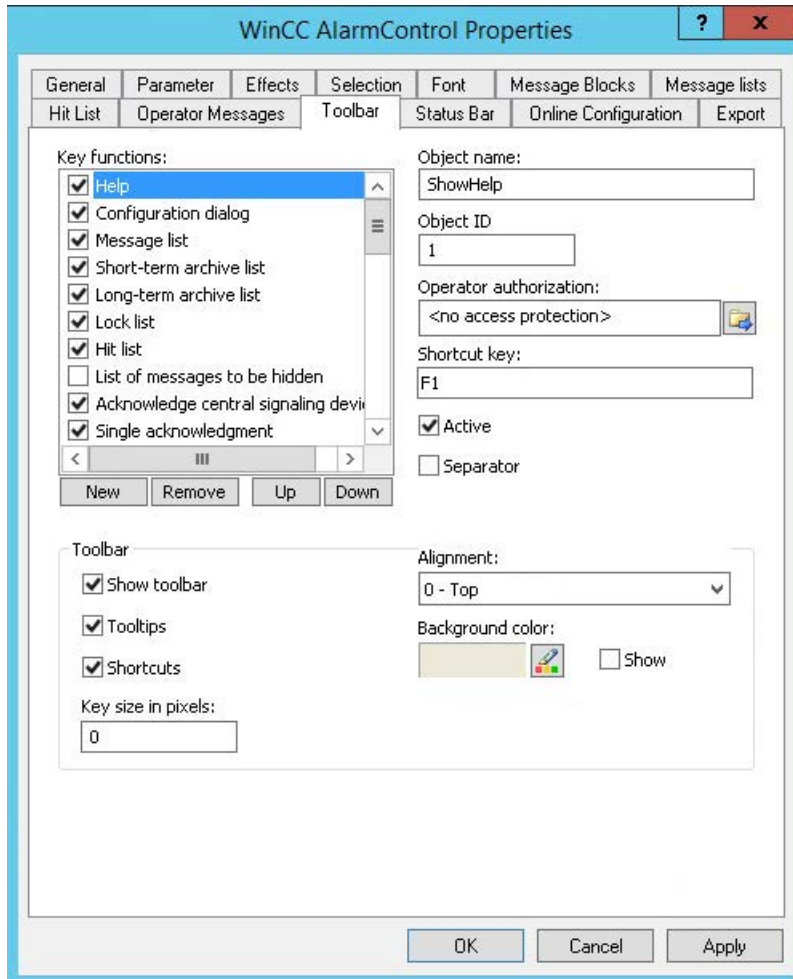

2. In the list, activate the button functions you require for operating the WinCC control in Runtime. For information on the button functions, refer to the description of the corresponding WinCC control at "Operation in runtime".
3. Determine the sorting order for displaying the button functions in the toolbar. Select the button functions from the list and the move the functions using the "Up" and "Down" buttons.
4. Define a shortcut key for the functions of the toolbar buttons.
5. Any button functions assigned operator authorizations are only available in Runtime to authorized users.
6. An activated button function is displayed during runtime if you deactivate its "Active" option, however, it cannot be operated.
7. You can set separators between the button functions. Activate the "Separator" option for the button function to be restricted by separator.

8. Configure the general properties of the toolbar, e.g. alignment or background color.
9. Change the button size as required. The standard setting is "0" and corresponds to the original size of 28 pixels. You can specify 280 pixels as maximum value.
The following behavior results for the button size depending on the configured value:

Value of the button size	Behavior
Value < 0	Invalid value. The most recent valid value is used.
$0 \leq \text{value} \leq \text{original size of button}$	The original size of the button is used. The value is set to the default (= 0).
Original size of the button < value \leq maximum value	The configured value is used.
Maximum value < value	Invalid value. The most recent valid value is used.

With a large button size, please note that in some cases not all buttons may be displayed in the control. To show all activated buttons in Runtime, you must therefore extend the control or activate fewer buttons as required.

How to configure the status bar

1. Go to the "Status Bar" tab. In the WinCC AlarmControl, for example:

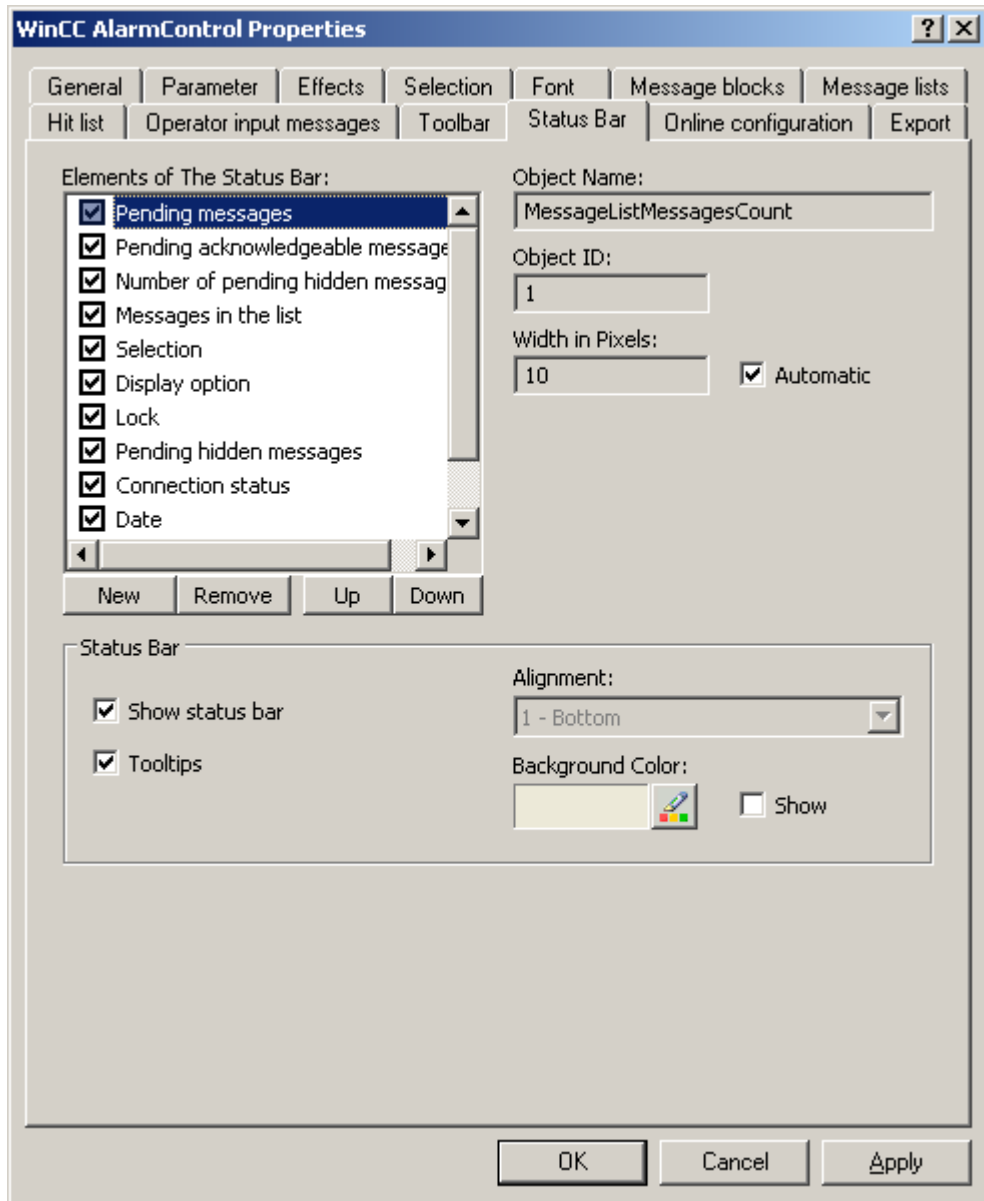

2. Activate the elements required during runtime in the list of status bar elements. For further information on status bar elements, refer to the descriptions of the corresponding WinCC control at "Operation in runtime".
3. Determine the sorting order for displaying of the status bar elements. Select the elements from the list and move these using the "Up" and "Down" buttons.
4. To resize the width of a status bar element, deactivate the "Automatic" option and enter a pixel value for the width.
5. Configure the general properties of the status bar, e.g. alignment or background color.

How to configure the Ruler window/Statistics window/Statistics area window

Introduction

Evaluated data and statistics are shown in a table in a ruler window, statistics window or a statistics area window. The ruler window/statistics window/statistics area window are configured in the WinCC RulerControl.

Overview of the WinCC RulerControl

The RulerControl can be connected with the following controls:

- WinCC OnlineTrendControl
- WinCC OnlineTableControl
- WinCC FunctionTrendControl

Depending on the data evaluation, there are three different types of windows for displaying values. The following window types are available:

- The ruler window displays the coordinate values of trends on the ruler.
- The statistics area window shows the values of the lower limit and upper limit of the trends between two rulers or the selected area in the table. The statistics area window is not planned for the WinCC FunctionTrendControl.
- The statistics window shows the statistic evaluation of the trends between two rulers or the selected values in the table. The statistics window is not planned for the WinCC FunctionTrendControl.

All windows can also display additional information on the connected trends or columns.

Requirement

- You have opened a picture with an OnlineTrendControl, OnlineTableControl or FunctionTrendControl in the Graphics Designer.

Procedure

1. Insert RulerControl into the picture from the WinCC object palette.
2. Double click on the RulerControl to open the configuration dialog.

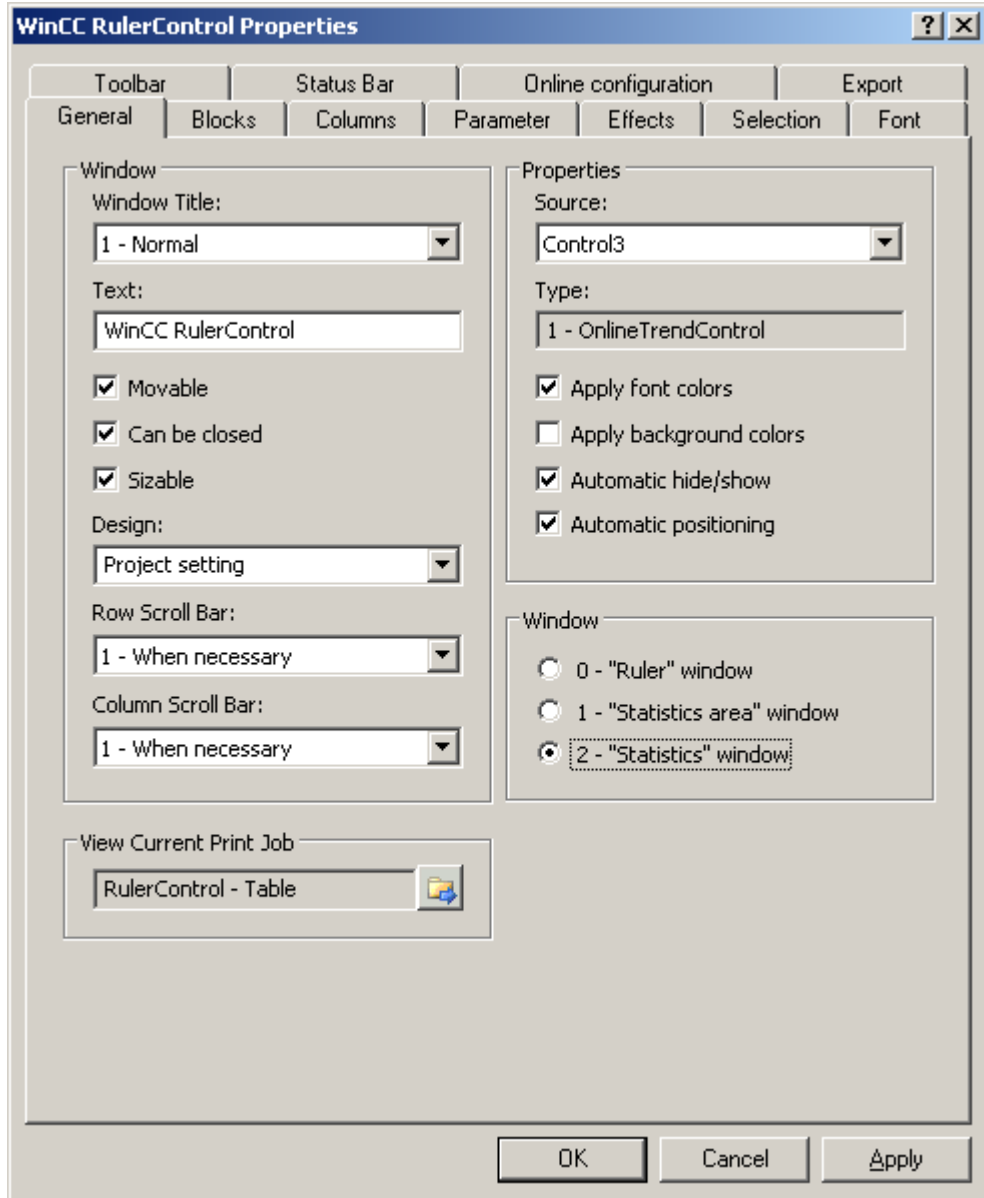

3. Configure the properties of the control on the "General", "Toolbar" and "Status bar" tabs.
4. Go to the "General" tab in the field "Source" and select the object name of the control that is already configured. The type of control is displayed in the "Type" field.
5. Set the window type in the "Window" field. If the key function "Configuration dialog" can be operated in runtime, you can change the window type in runtime.

6. Go to the "Columns" tab.

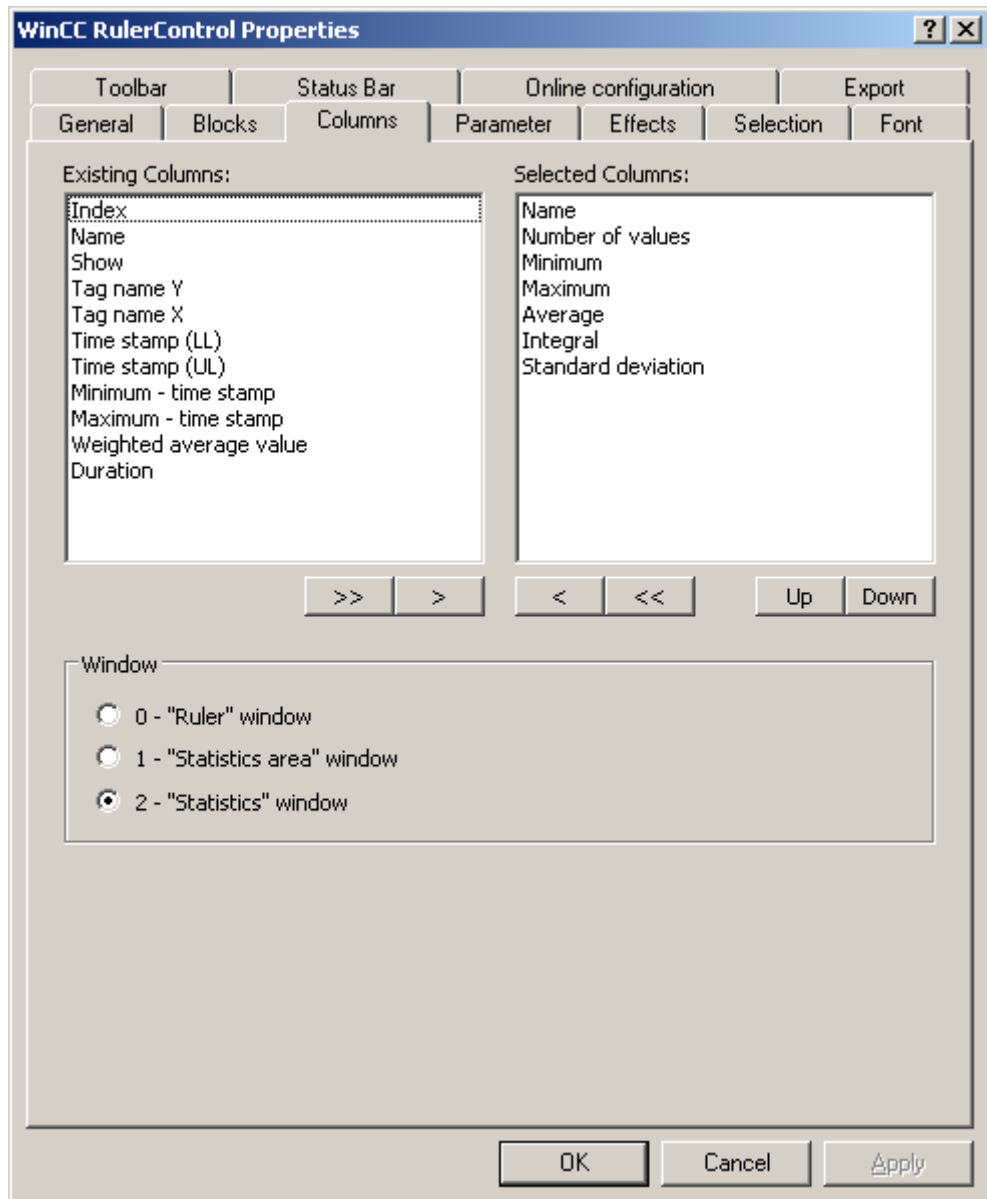

7. Use the arrow keys to select the column of the window type that you want to display for the assigned control. Columns for the basic data and columns that are only for the selected window type or the assigned control are available. Define the column sequence with buttons "Up" and "Down".

- 8. Go to the "Blocks" tab.

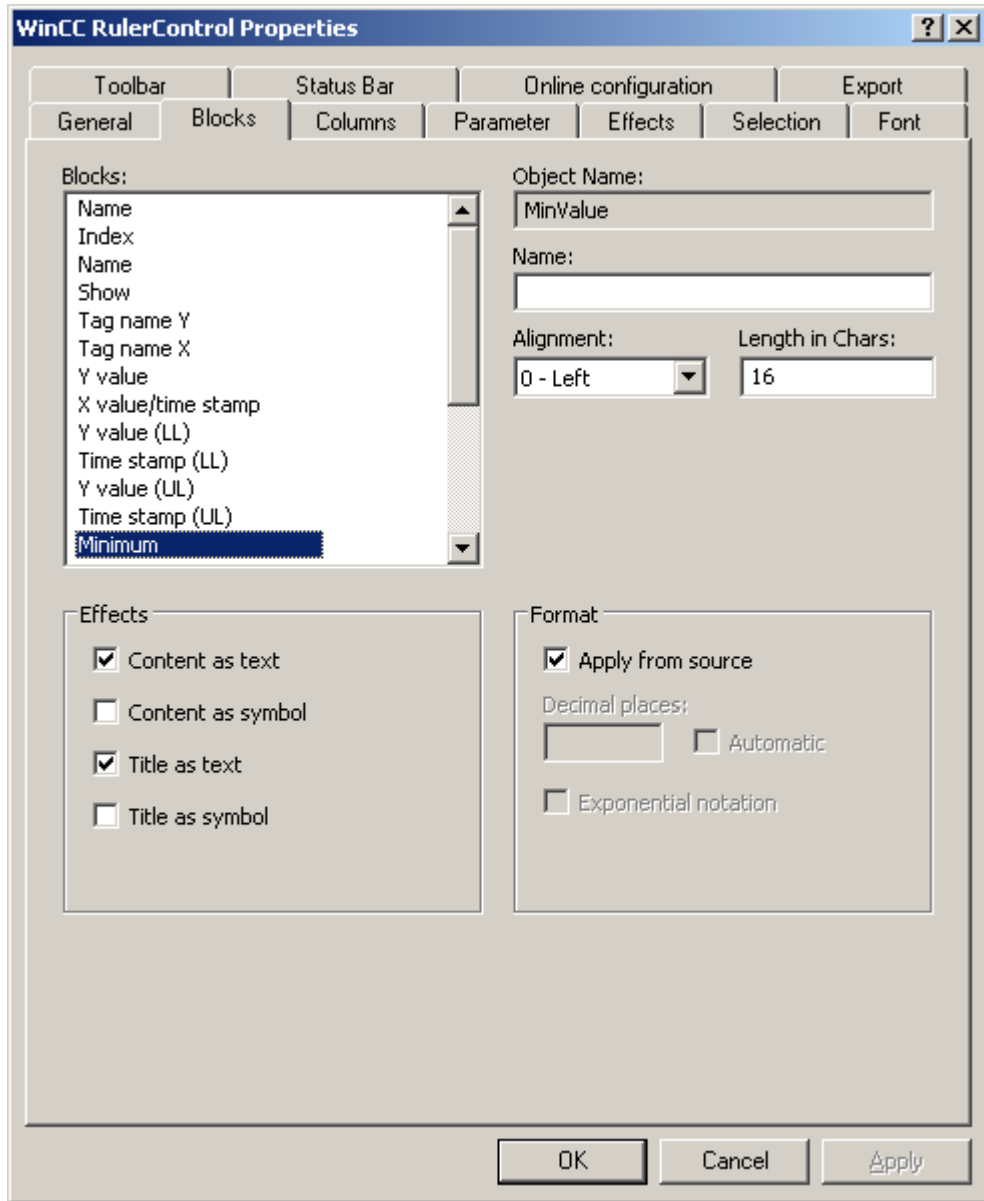

Every column corresponds with a block. In order to define the properties for the selected columns, click on the respective blocks.

- 9. If a special format exists for a block, you can configure the format of the block. Deactivate the option "Apply from source" if the format settings of the connected control are not to apply in this case. Define the desired format.
- 10. Define whether the data for the column and the column heading is to be displays as text or as an icon in the table under "Display".
- 11. Save the configuration.

12. Configure the properties and the display of the table for the RulerControl in the "Parameter," "Effects" and "Selection" tabs.
For details on configuring the table display, please refer to "Configuration of OnlineTableControl > How to configure the table display" in the WinCC OnlineTableControl documentation.
13. You can export the evaluated data. This requires activating the "Export data" key function on the "Toolbar" tab.
For details on data export, please refer to "Configuration of OnlineTableControl > How to export runtime data" in the WinCC OnlineTableControl documentation.
14. Configuring the TrendRulerControl is possible in runtime.
For more detailed information, please refer to "Configuration of OnlineTableControl > How to apply online configuration" in the WinCC OnlineTableControl documentation.

See also

- How to define the effect of the online configuration (Page 1583)
- How to export runtime data (Page 1581)
- How to configure the display for the table (Page 1567)

How to configure operator input messages for archive value changes

Introduction

You can specify that operator input messages are to be triggered when an archive value is changed or create manually in runtime. You will need to configure corresponding operator input messages.

An operator input message can display the following information on manual input of an archive value:

- Time stamp
- Old value
- New value
- Archive tag

Requirement

- You have opened the Graphics Designer and configured a picture with WinCC OnlineTableControl.
- The configuration dialog of OnlineTableControl is open.

Procedure

1. Go to the "Operator input messages" tab.

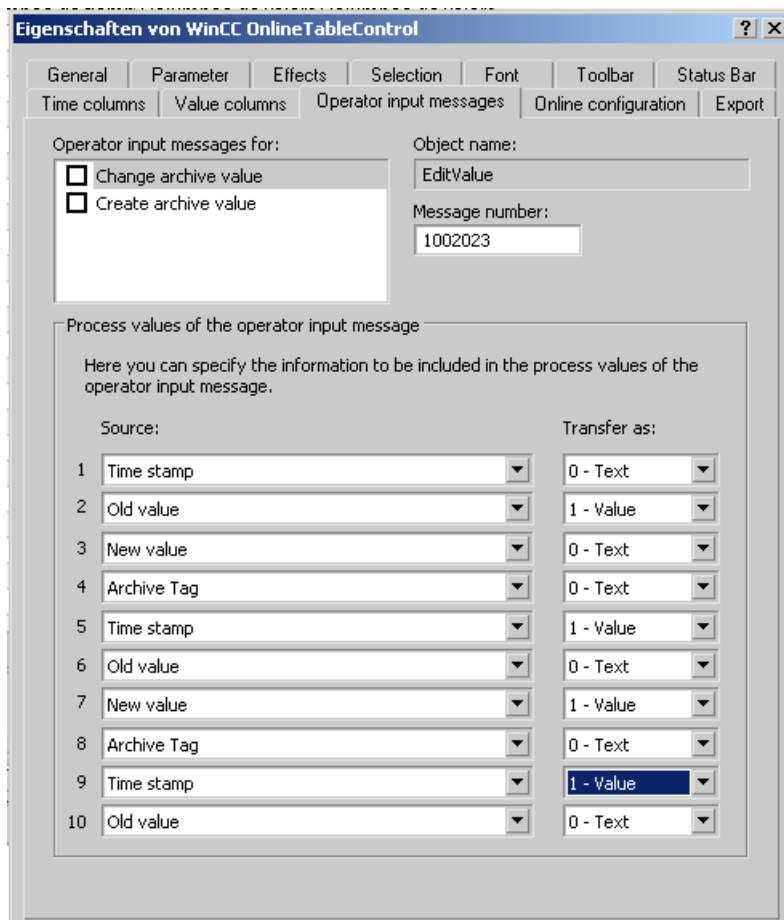

2. In the list, activate "Operator input messages for:" the events which trigger operator input messages.
3. If you are not using the WinCC operator input messages, enter the message number of the configured message for each event.
4. Assign the required information on manual input to the process value blocks of the operator input message.
5. Specify whether the contents are to be transferred as a text or value.

Example

You want an operator input message with the name of the archive tags and the new value to be generated when an archive value is changed.

1. Select "Change archive value".
2. The name of the archive tag will be displayed in "Process value block 1" of the operator input message. Select "Archive tag" as source under process value "1". Select "Text" under "Transfer as:".
3. The new value will be displayed in "Process value block 2" of the operator input message. Select "New value" as source under process value "2". Select "Value" under "Transfer as:".

Result

The relevant information on manual input will now be displayed in the configured process value blocks of the operator input message.

Note

Operator input messages can only be archived if corresponding system messages have been created in the message archive.

How to export runtime data

Introduction

The runtime data shown in the WinCC controls can be exported using a button function. Set up operation of the data export during runtime in the configuration dialog.

Requirement

- A picture showing a WinCC control is opened in Graphics Designer when configuring.
- The configuration dialog of the WinCC control is open.

How to configure the operation of the data export

1. Go to the "Export" tab.

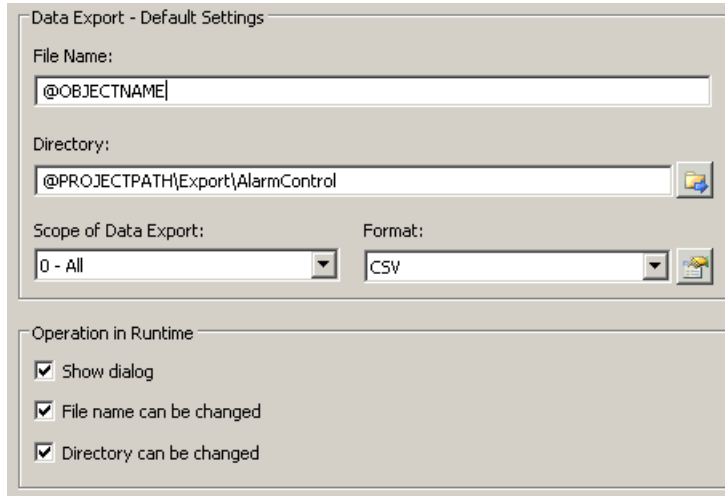

2. A standard file name and a standard directory are already entered in the "Data export default settings". In this case for AlarmControl. If necessary, define a file name and a directory for the export file.
The file name can be made up of the freely defined name and the following placeholder:
@OBJECTNAME - Object name of the controls
@CURRENTDATE - Current date
@CURRENTTIME - Current time
3. CSV is currently available as data format. Click  to specify the delimiter and data format in the CSV file.
4. Define the scope of the data export:
 - All runtime data is exported
 - Selected runtime data is exported. This data export is only possible in WinCC controls with tabular display.
5. Configure the operation of the data export during runtime. Define:
 - whether users are allowed to rename the file, or change the directory.
 - whether to display the "Data export default settings" dialog in Runtime.
6. If "Show dialog" is deactivated, the data for operation of the "Export data" button function is immediately exported to the defined export file.
7. Save the configuration.
8. Go to the "Toolbar" tab to activate the "Export data" button function for runtime.

Results

You can export all or selected data to a defined file at runtime using the  button function.

How to define the effect of the online configuration

Introduction

Users can parameterize the WinCC controls in Runtime. You must define the Runtime effects of the online configuration.

Changes configured in Runtime are saved for the specific user separately from the picture in the configuration system. The original picture configuration is retained in the configuration system.

Note

The picture is also replaced at Runtime if you save it in Graphics Designer, or when loading deltas in online mode. All online changes are lost.

The different configurations are only activated for new users after you performed a picture change.

Requirement

- A picture showing a WinCC control is opened in Graphics Designer when configuring.
- The configuration dialog of the WinCC control is open.

Procedure

1. Go to the "Online configuration" tab. For example, in OnlineTrendControl:

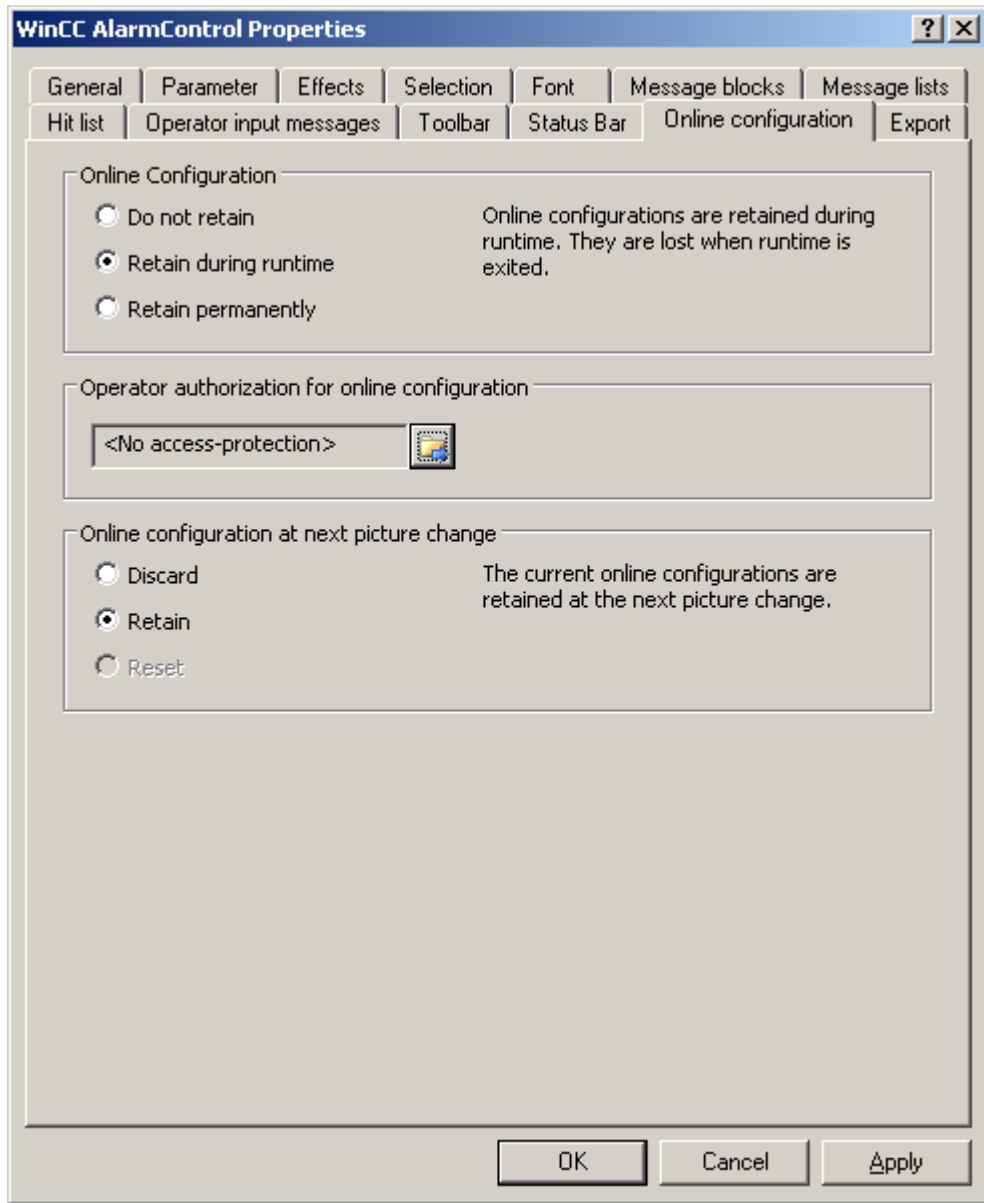

2. The option buttons of the "Online configuration" field for setting online configuration defaults are only available in the configuration system. The option buttons are not available in Runtime.

Select one of the three effects of the online configuration:

- "Do not retain". The online configurations are not retained in Runtime. This default setting disables all options for Runtime users. Online configurations are lost at the next picture change and on activation/deactivation of the project.

- "Retain during Runtime". This default setting enables the "discard", "retain" or "reset" options for Runtime users. Online configurations are retained at the next picture change if the "retain" option is enabled, however, these are lost on activation/deactivation of the project.
 - "Retain permanently". This default setting enables the "discard", "retain" or "reset" options for Runtime users. Online configurations are retained at the next picture change and on activation/deactivation of the project if the "retain" option is enabled.
3. Define corresponding user authorizations for online configuration.
 4. The option buttons of the "Online configuration on next picture change" can be enabled for operation in the configuration system and at Runtime by setting the "retain at Runtime" and "retain permanently" defaults. The "reset" operation is only available in Runtime, because the configuration system contains the original configuration.
Select one of three effects of the online configuration at the next picture change:
 - Select "discard" if to discard the online configuration at the next picture change.
 - Activate "retain" to activate the online configuration based on default settings at the next picture change or on activation/deactivation of the project.
 - Activate "Reset" if you want to apply the picture saved in the configuration system in Runtime. All online changes are lost.
 5. Save the configuration.

How to make the toolbar for the OnlineTableControl dynamic

Introduction

The default functions for operating the WinCC OnlineTableControl are no longer supported for the new WinCC OnlineTableControl as of WinCC V7.0. You can use the WinCC types of dynamics to e.g. operate a key function of the toolbar with a script.

Overview

With WinCC Controls as of V7.0 you do not need special functions to implement operation of the control by assigning dynamic properties to the toolbar. The previously used standard functions "TlgTableWindowPress..." are no longer supported.

If you do not want to operate the control via the toolbar, you can write the "ID" for the desired button in the "ToolbarButtonClick" object property with an optional type of dynamics.

The "ID" of a button of the toolbar can be determined:

- with the table on page "Operation of the OnlineTableControl in Runtime".
- in the configuration dialog of the OnlineTableControl on the "Toolbars" tab via field "Object ID".

Example: Opening the control configuration dialog

The following options of assigning dynamic properties are available for opening the control configuration dialog:

- VBScript:
 - ScreenItems("Control1").ToolBarButtonClick = 2
 - As an alternative to the "ToolBarButtonClick" property, you can use the VBS methods for operating the toolbar: ScreenItems("Control1").ShowPropertyDialog
 - Or, with the following notation and support of "Intellisense":
Dim obj
Set obj = ScreenItems("Control1")
obj.ShowPropertyDialog
- C script:
 - SetPropWord(IpszPictureName, "Control1", "ToolBarButtonClick", 2);
- Direct connection
 - In the dialog of the direct connection, enter "2" as a constant for the source.
 - Select the property "ToolBarButtonClick" for the object "Control1" for the target "Object in picture".

See also

Operating the OnlineTableControl in runtime (Page 1588)

How to adapt table elements and buttons of the controls

Introduction

You can change the design of the standard configuration for the WinCC controls and adapt the following elements in their appearance:

- Size and design of buttons
- Custom symbols for table elements of the table controls, for example, in the Alarm Control or OnlineTableControl
- Style of the scroll bar

Overview

The standard installation of WinCC creates the folder "CCAxControlSkins" for the design of the WinCC controls in "C:\Program Files(x86)\Common Files\Siemens\bin".

To use modified designs, you need to create different subfolders within the "CCAxControlSkins" folder. The number and the name of the folder are determined by the elements you want to adapt in the respective controls .

The design of a control can then be selected as a "style" property in the configuration dialog of the control in the "General" tab.

You can also use project-specific designs. You need to create the folder structure in the "GraCS" folder of the project, e.g. in "C:\WINCCProjects\TestProject\GraCS\CCAxControlSkins". When a design folder with the same name already exists in the installation folder and in the project folder, the design of the project folder used as the "Style".

In order for the created symbols for table elements of a control to be visible, the "Content as symbol" option must be enabled for the appropriate columns. The "Apply project settings" option must be disabled in Alarm Control.

You can learn how to adapt the WinCC Alarm Control in WinCC Runtime Professional under Customizing the WinCC Controls (<https://support.industry.siemens.com/cs/de/en/view/76327375>)

Note

When creating a new design, you do not have to create all the files. For all of the files that are not present, the standard settings of the controls are used.

How to adapt table elements

The procedure is described using the example of table elements in the Alarm Control.

1. In the "CCAxControlSkins" folder, create a sub-folder, for example, "Table symbols".
2. Create a subfolder in this folder for the control, for example, "AlarmControl".
3. In the folder of the control, create a subfolder, for example, "GridIcons".
4. Create a "GridIcons" folder for each column of the table in which you want to display icons. No icons can be displayed for the date and time columns.
5. Rename the folder to the name of the object property, for example, "State" for the "State" column/message block in the Alarm Control.
6. You must save the graphics in the "State" folder with the respective state names in English, for example, "ComeQuit".
For the state for which you have saved a graphic, the new symbol appears in the table cell when the state occurs.
7. To display symbols for message numbers, for example, you can assign a graphic to each numerical value. For example, the respective number is highlighted in a certain color. Then the graphic name in the folder is "Number", for example, "5.png" for the number "5".
If you want to define a symbol for a specific interval, e.g. for the interval "50 - 100", the graphic name is "50_100.png". The limits are contained in the interval.
8. To display only icons instead of the text of a message block/column, you must specify a graphics file for each occurring text.
For example "Fault location": If an error occurs in the tank, a tank symbol appears. If a fault occurs at the valve, the symbol of a valve is shown.
9. Select the corresponding design in the "General" tab of the "Style" property in the configuration dialog of the control.

How to adapt the buttons of the toolbar

1. Create the "Toolbar" subfolder in the "CCAxControlSkins" folder.
2. Create the file "IconsNormal.png" in this folder.
3. In this file, insert the individual graphics of the buttons side-by-side in a row. For disabled buttons, use the file "IconsDisabled.png".
4. To use new graphics, you must adapt these files. You can use any graphics program of your choice for this.
The control reads the file, cuts it into individual graphics and displays the cut parts on the corresponding buttons.

How to adapt the scroll bar

1. In the "CCAxControlSkins" folder, create a subfolder, for example, "Scroll bar".
2. Create two subfolders in this folder, "Horizontal" and "Vertical".
3. You need to create a number of individual files within this folder to form the scroll bar when the program at runtime.

Operation in Runtime



Operating the OnlineTableControl in runtime













Introduction











In Runtime, the table window is operated by means of the toolbar buttons. If you do not want to operate the table window via the toolbar, you can write the "ID" for the desired button in the "ToolbarButtonClick" object property with an optional type of dynamics.

Overview

The overview shows all symbols in "standard" style. If you create a design of the controls with the "Simple" style, the representation of the symbols is the same as with OnlineTableControl before WinCC V7. You can find an overview on the page "Before WinCC V7: Output process values as tables in process pictures > Operation in Runtime > Operation of Online Table Control in Runtime".

Icon	Description	ID
	"Help" Calls up the help on WinCC Online TableControl.	1
	"Configuration dialog" Opens the configuration dialog, in which you can change the properties of the Online TableControl.	2





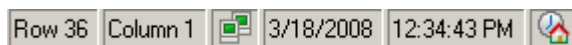

	<p>"First Data Record"</p> <p>This button displays the tag trend over time in the table window, starting with the first archived value and extending over a defined time range.</p> <p>The button is only available if the values originate from a process value archive.</p>	3
	<p>"Previous Data Record"</p> <p>This button displays the tag trend of the previous time interval in the table window, starting from the currently displayed time interval.</p> <p>The button is only available if the values originate from a process value archive.</p>	4
	<p>"Next Data Record"</p> <p>This button displays the tag trend of the following time interval in the table window, starting from the currently displayed time interval.</p> <p>The button is only available if the values originate from a process value archive.</p>	5
	<p>"Last Data Record"</p> <p>This button displays the tag trend over time in the table window, ending with the last archived value and extending over a defined time range.</p> <p>The button is only available if the values originate from a process value archive.</p>	6
	<p>"Edit"</p> <p>After the activation, you can double-click any table field to change its content. This requires stopping the updated display.</p>	7
	<p>"Create archive value"</p> <p>This button opens a dialog for entering a new value and a time stamp. You must first stop the updated display.</p>	21
	<p>"Copy lines"</p> <p>Copies the content of the selected lines to the clipboard. This requires stopping the updated display.</p>	8
	<p>"Select data connection"</p> <p>This button opens a dialog for the archive selection and tag selection.</p>	9
	<p>"Select columns"</p> <p>This button opens the dialog for toggling the visible and invisible column view. You can also change the sequence of the columns in the table.</p>	10
	<p>"Select time range"</p> <p>This button opens the dialog where you can specify the time range to be displayed in a table window.</p>	11
	<p>"Previous column"</p> <p>This button is used to move the value column in front of the previous value column. The function refers to the value columns that are assigned with a time axis.</p>	12
	<p>"Next column"</p> <p>This button is used to move the value column in behind of the next value column. The function refers to the value columns that are assigned with a time axis.</p>	13

	<p>"Stop"</p> <p>The updated display is stopped.</p> <p>The data is saved to the clipboard and added to the table when the button is clicked again.</p>	14
	<p>"Start"</p> <p>Resume updated display.</p>	14
	<p>"Print"</p> <p>Start the print-out of the values shown in the table. The print job used for printing is defined in the configuration dialog in the "General" tab.</p>	15
	<p>"Export data"</p> <p>This button is used to export all or the selected runtime data into a "CSV" file.</p> <p>If the option "Display dialog" is active, a dialog opens in which you can view the settings for exporting and can start the export. With the respective authorization, you are also allowed to select the file and the directory for the export.</p> <p>If a dialog is displayed, the export of the data to the predefined file starts immediately.</p>	20
	<p>"Define statistics area"</p> <p>This button is used to define the time range for calculating the statistics in the table window.</p>	16
	<p>"Calculate Statistics"</p> <p>The button shows the statistical values in the statistics window. The displayed values refer to a selected column with the configured calculation time range.</p> <p>The button is only functional if a statistics window is connected with the OnlineTableControl.</p>	17
	<p>"Connect backup"</p> <p>This button opens a dialog in which you can connect selected archives with WinCC Runtime.</p>	18
	<p>"Disconnect backup"</p> <p>This button opens a dialog in which you can disconnect selected archives from WinCC Runtime.</p>	19
	<p>"Select filter"</p> <p>Opens a selection dialog to filter text tags for a string.</p> <p>This requires stopping the updated display. When the update is active again, the filter is reset.</p> <p>The button is only available if the values originate from a process value archive.</p>	22
	<p>"User-defined 1"</p> <p>Shows the first button function created by the user. The function of the button is user-defined.</p>	1001

Possible elements of the status bar

The following elements can appear in the status bar of the table window:



Icon	Name	Description
	Connection status	Shows the status of the data connections: <ul style="list-style-type: none"> • No faulty connections • Faulty connections • All connections are faulty
	Selected Row	Shows the number of the selected line.
	Selected column	Shows the number of the selected column.
	Date	Shows the system date.
	Time	Shows the system time.
	Time base	Shows the time base used in the display of times.

Double click on the icon for the connection status to open the window "Status of the data connections", in which the name, status and tag name of the data connection are listed.

Online configuration of the OnlineTableControl

Introduction

In runtime, you can configure online and change the display of the WinCC OnlineTableControl. Configuring the WinCC OnlineTableControl defines how to proceed with a picture change or after ending runtime with online configurations.

Overview

The following buttons functions make online configuration possible in OnlineTableControl:

- With key function "Configuration dialog"
- With key function "Select data connection"
- With key function "Select columns"
- With key function "Select time range"

Key function "Configuration dialog"

Use the key function "Configuration dialog"  to access the configuration dialog tabs, for example to change the display of the table.

The key function "Select data connection"

Use the key function "Select data connection"  to select the archive tags or online tags for the value columns which you want to show in the table:

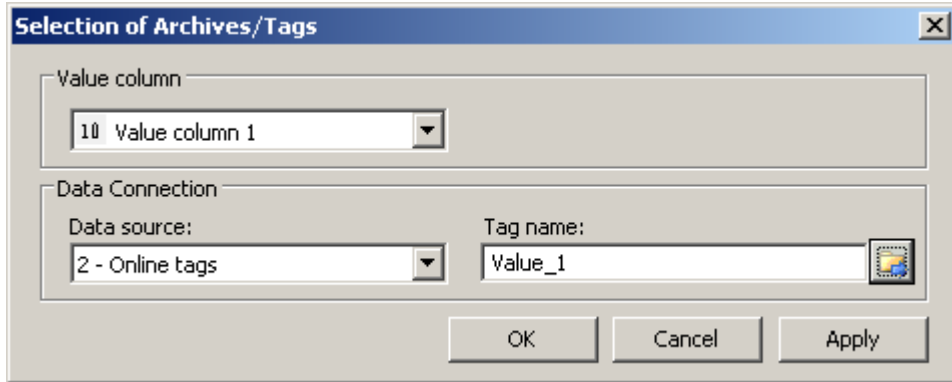

Field	Description
Value column	Choose the configured value column for which you want to change the data connection.
Data source	Define whether the selected value column is supplied with an archive tag or online tag.
Tag name	Select the tag name for the data connection.

The key function "Select column"

The key function "Select column"  opens a dialog for showing or hiding columns. You can change the sequence of the value columns that are assigned with a time column. The value columns can only be moved in reference to the anchored time column.

Note

The first column of a table window cannot be hidden.

The key function "Select time range"

Select the time range to be displayed for the time columns with key function "Select time range" . If the columns of a table window are to be displayed with a common time axis, the specified time range applies to all columns.

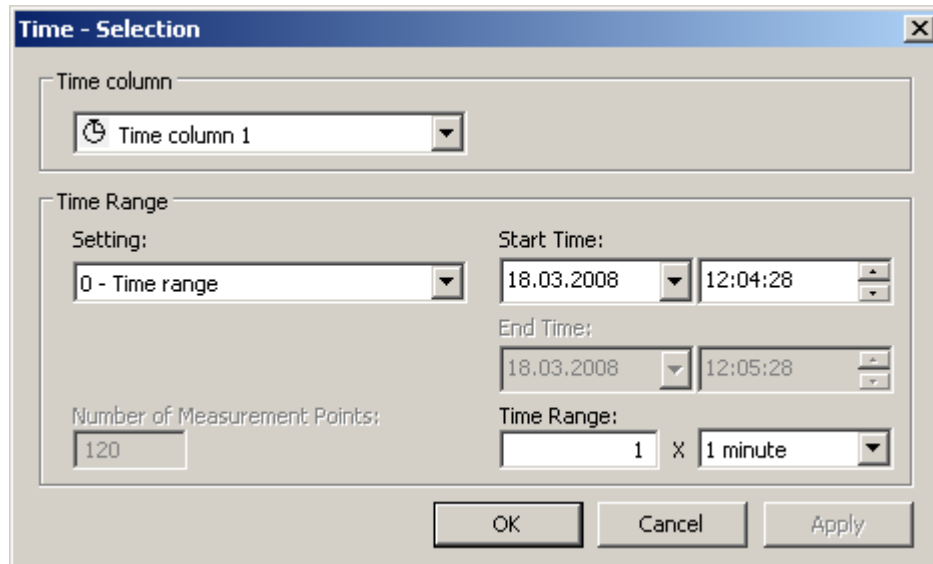

Field	Description
Time column	Select the configured time column for which you want to define a time range.
Time range	Specify the time range: <ul style="list-style-type: none"> • If you want to define a fixed time interval, select setting "Start to end time". Enter the date and time for each. • If you want to define a time period, select the setting "Time range". Define the date and time for the start time. The length of the time interval to be displayed is determined by multiplying the "Factor" by the "Time unit". • If you want to display a certain number of values, select the setting "Number of measurement points". Define the date and time for the start time. Enter the required number of measurement points in the input field.

The entry format of the date and time depends on the Runtime language used.



Starting and Stopping Update

Introduction

The update of the column in the table window can be started and stopped with the "Start/Stop" key function.

Certain key functions, e.g. "Define statistics area", stop the update automatically.

The appearance of the button indicates whether the update is stopped or not:

- : Update has been stopped. Click on the button to continue updating.
- : Update has been started. Click on the button to stop updating.

How to edit a table field in runtime

Introduction

You can change archived values and create new values in OnlineTableControl manually with the key functions "Edit" and "Create archive value".



The modified values are marked with a flag and archived.

You can configure operator input messages to be triggered when an archive value is changed or created.

Requirement

- You have configured an OnlineTableControl.
- You have activated the key function "Edit" or "Create archive value" for the Control toolbar.
- You have enabled manual input for the linked archive or for individual archive tags in the "Tag Logging" editor.
- You have activated runtime.

Procedure

1. In OnlineTableControl, click on .
The updated display is stopped, the process data continues being archived.
2. Click on  to change an archive value.
3. Double click on the desired table field of a value column.
Change the value of the cell.

- Click  to create an archive value.
The "Create archive value" dialog will appear.
The drop-down list shows the value columns that can be selected. The symbol "10" is always displayed in the text color of the value column.

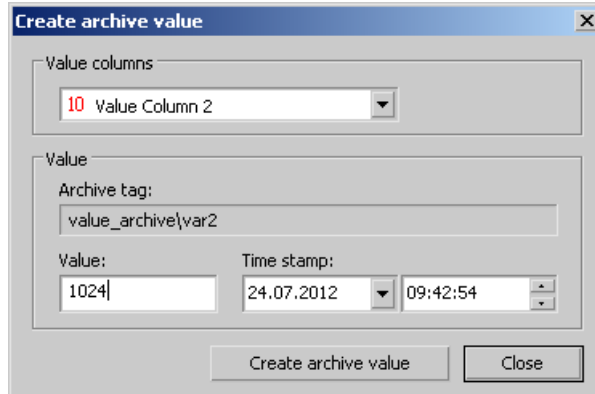

- Select a value column the is linked to an archive tag.
- Enter a value and a time stamp.
Click the "Create archive value" button.
The system checks whether the value is within the valid range before adding it.
- To continue with the display of runtime data in OnlineTableControl, click .

Result

The modified or newly created values are now marked and archived.

"m" for manual input is displayed in the value column.

The values in the compressed archives for the relevant time range will be recalculated provided you have enable recalculation in the "Tag Logging" editor.

A tooltip with detailed information will appear if you right-click on the cell.

See also

How to configure operator input messages for archive value changes (Page 1579)

Moving columns in the table

Introduction

The time column is always shown in the first column in the table. The value columns that are assigned with this time column are displayed next. If there are more than one time columns configured, the second time column follows with the assigned value columns.



How to change the sequence of the columns in runtime

You can change the sequence of the value columns that are assigned with a time column in runtime. The value columns can only be moved in reference to the anchored time column. The sequence of the time columns with the assigned value columns must be defined on the "Time axes" tab.

Requirement

- You have configured key functions "Select columns", "Previous column" and "Next column".

Procedure

-  changes the sequence of the columns in the dialog. Deactivate the check box in front of the column name if you do not want to display the column.
-  is used to move the value column behind the next value column. The function refers to the value columns that are assigned with a time axis.
-  is used to move the value column in front of the previous value column. The function refers to the value columns that are assigned with a time axis.

Show archived values

Introduction

Use the buttons in the toolbar of a table window or the corresponding key combinations to browse through an archive.

The values archived for a tag will be displayed within a time interval. You define the time interval:

- In the configuration dialog of the Online TableControl on the "Time columns" tab.
- During runtime using the  button.

Buttons for Archived Values



The table displays the tag values within a specified time range, beginning with the first archived value.



The table displays the tag values within the previous time interval, based on the currently displayed time interval.



The table displays the tag values within the next time interval, based on the currently displayed time interval.



The table displays the tag values within the specified time interval, ending with the last archived value.

Note

The WinCC Online Table Control displays a maximum of 1000 values within a selected time range.

How to filter texts in value columns

In WinCC OnlineTableControl, you can filter the texts of archived text tags.

To only show the desired text values, select the filter criteria in a selection dialog after stopping the update.

For each value column in which the values of an archive tag with the tag type "Text" are shown, you can also create a selection in the configuration dialog.

Requirement

- Archive tags are configured in the process value archive that are linked to text tags.
- Value columns are configured for these archive tags in WinCC OnlineTableControl.
- The button function "Select filter" is enabled in the WinCC OnlineTableControl toolbar.

Procedure

1. To stop the updated display in Runtime, click "Stop".
The "Select filter" button is enabled.



2. To open the selection dialog, click on the "Select filter" button.
The drop-down list shows the value columns that are linked to an archive tag of the type "Text".
The symbol "10" is always displayed in the text color of the value column.
The archive tag of the value column is shown in the bottom field.

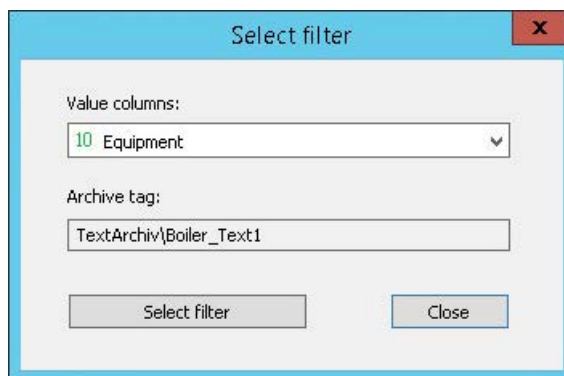

3. Select the desired value column from the list.

- 4. Click the "Select filter" button.
The selected value column is shown in the "Criterion" column in the "Selection" dialog.
If a selection has already been created for the value column in the configuration dialog, the selected filter criteria are displayed. You can change the filter criteria in Runtime as needed.

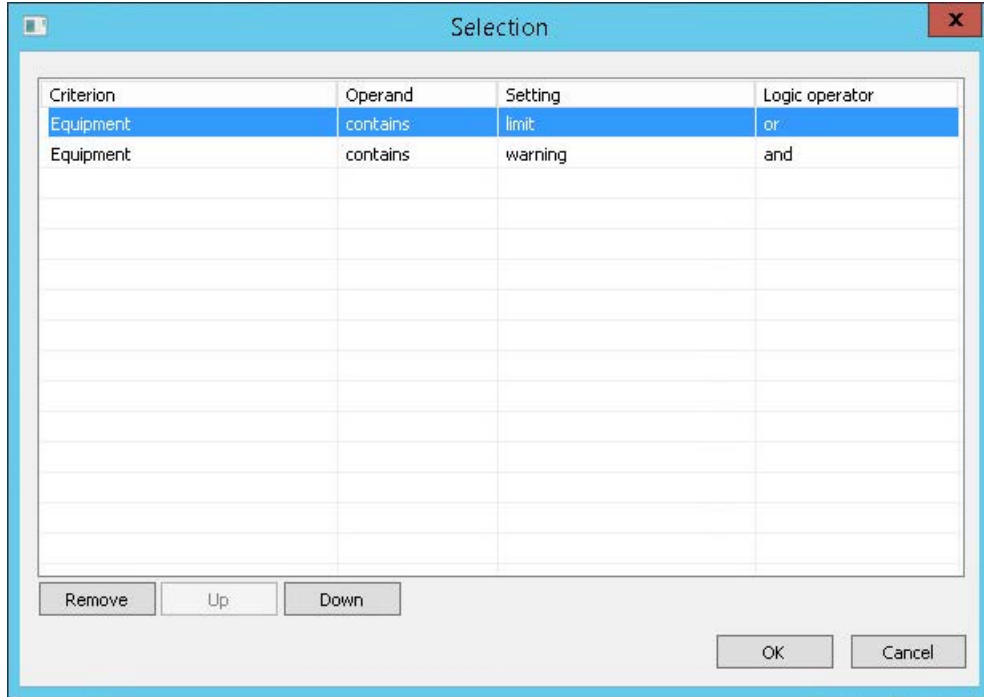

- 5. In the first line, select the required operand:
 - Equal to
 - Not equal to
 - Contains...
 - Does not contain...
- 6. In the "Setting" column, enter the text you are looking for as string in the value column.
- 7. To link an additional criterion to the first one, click the "Criterion" field in the next row.
- 8. Select the operand and the filter text of the second criterion.

9. Select the desired logic operation:

- And: Both criteria must be met.
- Or: One of the two criteria must be met.

The logic operation always refers to the link with the next row.

The "And" logic operation is higher order and groups the combined criteria.

Example:

- Criterion 1 and 2 are linked with an "Or" logic operation.
- Criterion 2 and 3 are linked with an "And" logic operation.
- Result: The value column shows texts that either meet criterion 2 and 3 or criterion 1.

10. Close the dialog by clicking "OK".

In the data window, the filter is applied to the selected value column.

Select an additional value column in the "Select filter" dialog, if necessary, to also filter the texts of this column.

Result

Only the text values that meet the criteria are shown in the filtered value column in the data window.

The text is hidden in all other rows.

Deactivate "Stop"

When you continue the updated display, the filter is deactivated.

The filter settings per value column are persistent in Runtime.

When you stop the updated display once again, you can apply the created filters once again.

Deactivate Runtime

The filters are reset during a restart of Runtime.

Only the filters that were created in the configuration dialog are available after activating the project once again.

See also

How to configure the value columns for the table (Page 1564)

How to Generate Statistics of Runtime Data

Introduction

You can generate an evaluation of runtime process data in the table window. The evaluated data is shown in a separate WinCC RulerControl.

Overview

Depending on the data evaluation, there are three different types of windows for displaying values. The following window types are available:

- The ruler window shows the values of a selected line in the table.
- The statistics area window shows the values of the lower limit and upper limit of the selected area in the table.
- The statistics window shows the statistical evaluation of the selected values in the table. Among other things, the statistics include:
 - Minimum
 - Maximum
 - Average
 - Standard deviation
 - Integral

All windows can also show additional information on the values of the connected columns.

Requirement

- You have configured a WinCC OnlineTableControl.
- You have configured a WinCC RulerControl and connected it with the OnlineTableControl.
- You have selected the window in the RulerControl which shows the desired data.
- You have configured key functions "Set statistics range", "Calculate statistics" and "Start/ Stop". If a display of the values in a ruler window is sufficient, you do not need key functions "Select statistics area" and "Calculate statistics".
- You require key function "Select time range", if you wish to choose a statistics area outside of the time range displayed in the table.
- You require key function "Configuration dialog" of the RulerControl if you want to switch between the statistics window and the ruler window.
- You have activated runtime.

How to show the data in a ruler window

1. In OnlineTableControl, click on . The updated display is stopped, the process data continues being archived.
2. Select an line. Data in the columns that you have configured is shown in the ruler window.

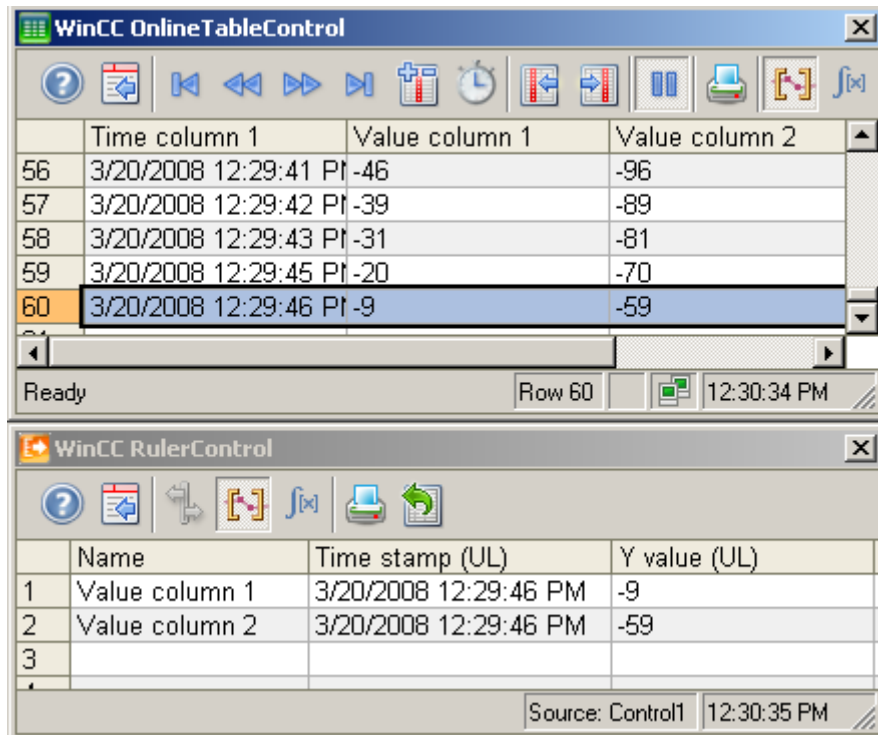

3. To continue with the display of runtime data in OnlineTableControl, click .

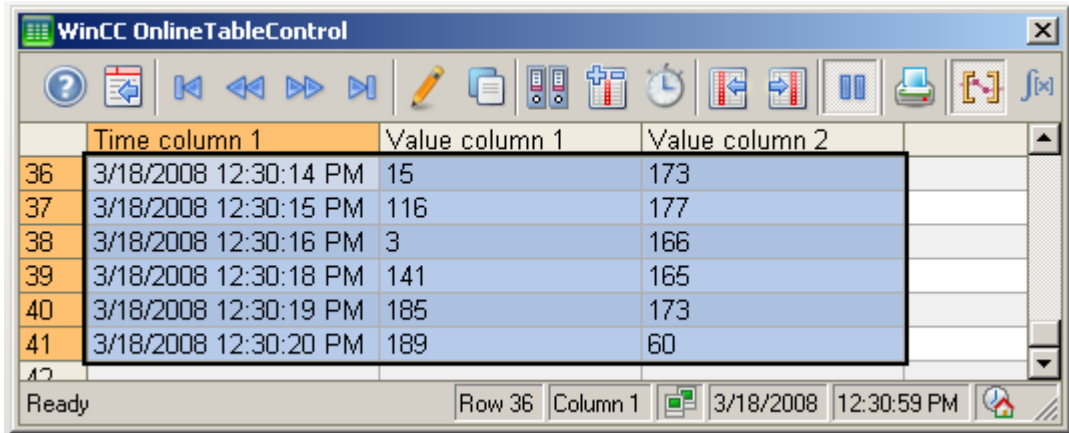

How to display the data in a statistics area window

1. In OnlineTableControl, click on . The updated display is stopped, the process data continues being archived.
2. In order to specify the time period for the calculation, use the mouse to select the table lines for the desired time frame. For different columns with different time frames you can select different time ranges for the calculation of statistics.



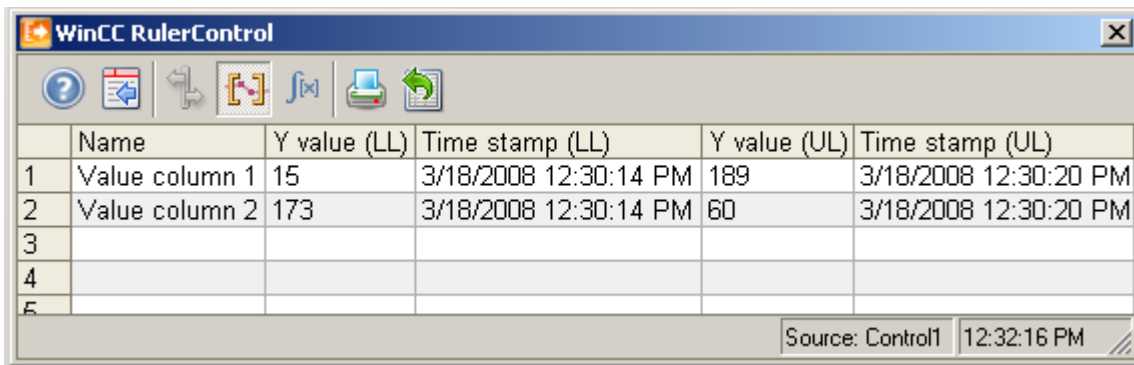

3. Click  in the toolbar. The evaluated data is displayed in the columns that you have configured in the statistics area window.



4. If you want an evaluation of data that is not displayed in OnlineTableControl, click on . Enter the desired time range for the selected time column in the "Time selection" dialog. The data for the defined time range is displayed. You can now evaluate this data.
5. To continue with the display in OnlineTableControl, click on .

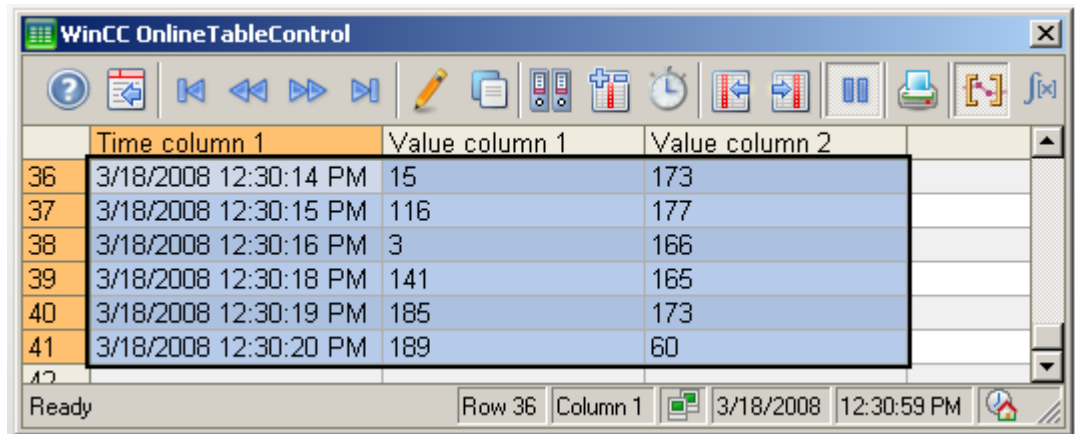

How to display the data in a statistics window

1. In OnlineTableControl, click on . The updated display will be stopped but the process data will continue to be archived.
2. Click on . In order to specify the time period for the calculation, use the mouse to select the table lines for the desired time frame. For different columns with different time frames you can select different time ranges for the calculation of statistics.



3. Click on . The evaluated data is displayed in the columns that you have configured in the statistics window.

	Name	Number of values	Minimum	Maximum	Average	Integral	Standard deviation
1	Value column 1	6	3	189	108.17	558.33	81.63
2	Value column 2	6	60	177	152.33	811.66	45.47
3							
4							

4. If you want an evaluation of process data that is not displayed in OnlineTableControl, click on . Enter the desired time range for the selected time column in the "Time selection" dialog. The process data for the defined time range is displayed. You can now evaluate this data.
5. To continue with the display in OnlineTableControl, click on .

Note

For additional statistical analysis of process data and archiving of results you can write the scripts yourself.

6.5.2.3 Process Value Output in the Form of Trends in Process Pictures

WinCC OnlineTrendControl

Overview

With the WinCC OnlineTrendControl you can have current and archived process values displayed in trends. The trend display can be configured as you wish.

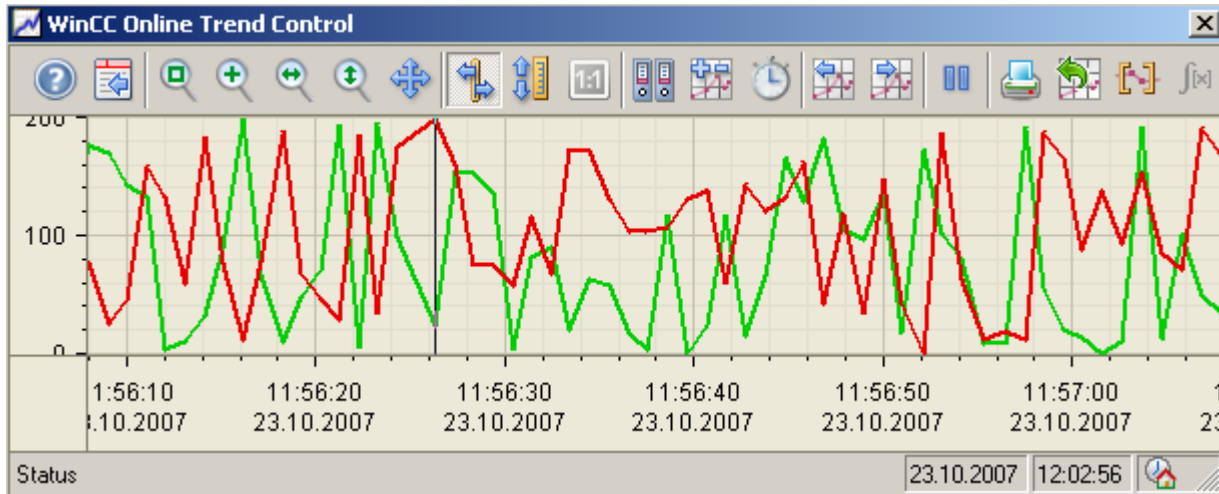

Displaying the limit monitoring messages in a trend

If you have configured limit monitoring for values from online tags, you can have the assigned message displayed as a symbol and tooltip for trend values with a limit violation.

The red symbol indicates a limit violation (high or low). If you have configured "Loop in Alarm" for the message, you can jump to the assigned picture by double-clicking this symbol.

The tooltip contains the message number, message text and information text of the message. If you have configured "Loop in Alarm" for the message, the tooltip also displays the symbol for "Loop in Alarm".

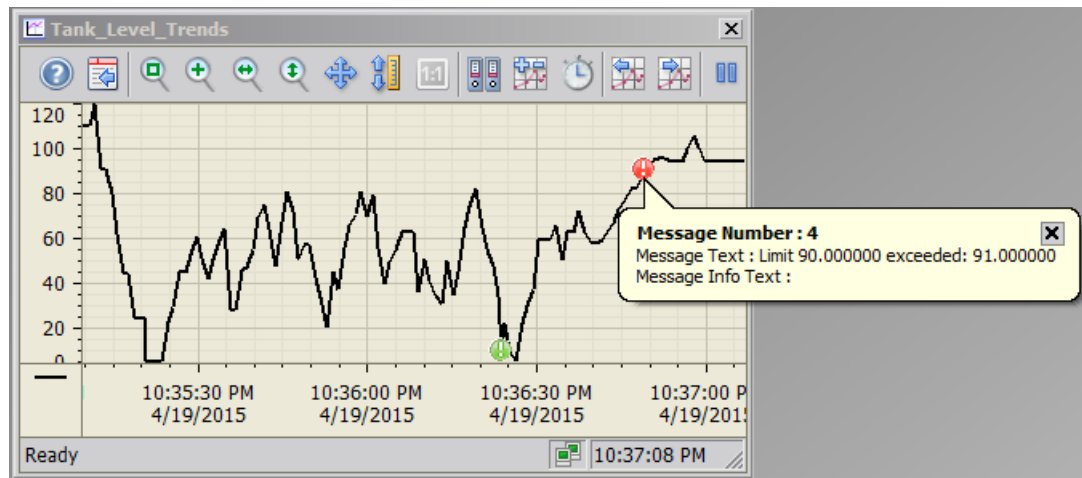

Requirement

The following requirements apply to the display of trends in WinCC Online Trend Control:

- In a WinCC Online Trend Control any number of trends can be displayed in one or more trend windows. Displaying a maximum of 8 trends is recommended.
- Up to 6 million value pairs can be represented in total in the configured trends. Depending on the screen resolution and the settings, the display might vary, however. The response time depends on the performance of the system.
- In order to display tags as a function of other tags, use the WinCC Function Trend Control.

Resolution of Trend Display

The number of trend values that can be displayed on the screen is limited by the screen resolution and selected size of the trend window. Therefore, when displaying trends, it is possible that fewer values are displayed in the trend window than actually exist.

If, for example, in an area of 100 pixels 200 measured values are archived, each pixel represents 2 measured values. The value shown on the screen is that of the most recent data (most recent time stamp).

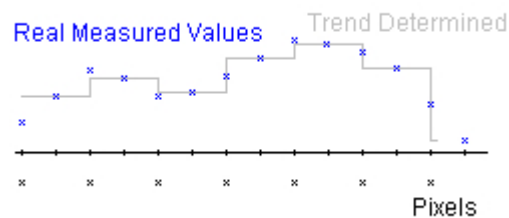

Note

If you have selected too large a time for the graph representation and the random access memory is not sufficient, a message is displayed in the status line in OnlineTrendControl. Decrease the values to be displayed by using compression archives.

See also

Short Description of the WinCC Controls and Additional Controls (Page 749)

Representation Trend Lines

Representation Trend Lines

Introduction

The WinCC OnlineTrendControl has many ways of displaying the progress of a trend.

Representation formats

Four representation formats are available to display values graphically:

- No trend
The values are shown as dots. The display of the points can be configured as you wish.

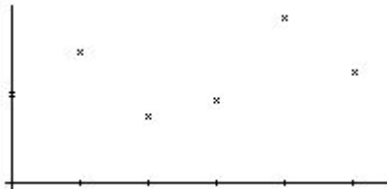

- Connect dots linearly
The trend line is interpolated on a linear basis from the point values. The display of the lines and points can be configured as you wish.

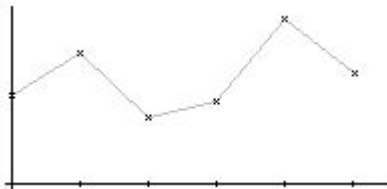

- **Stepped trend**
The progress of the trend line is determined from the values as a stepped trend. The display of the lines and points can be configured as you wish.

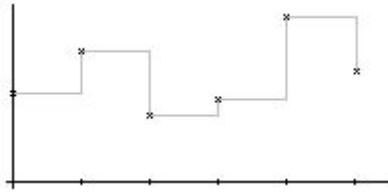

- **Representing values**
The values are displayed as text at each time stamp or at every main gridline on the time axis. A unit can also be displayed in addition to the values.

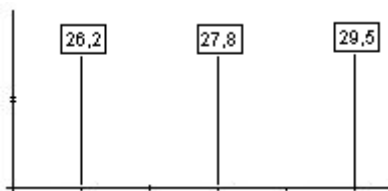

The display of the trend can be configured on the "Trends" tab of the OnlineTrendControl.

Write direction

With the write direction option, you can specify where the current values for all trend windows are to be entered. Normally, the current values are written in the trend window from the right. All four write directions can be configured. The write direction is configured on the "General" tab of the OnlineTrendControl.

Representation Using Common Axes

Introduction

When displaying more than one trend in a trend window, you can assign every trend with its own axes or use a common time axis and/or value axis for all trends.

Representation Using Different Axes

If the values to be displayed in a trend window differ greatly, a common value axis makes no sense. The values can be read more easily if different axial scales are used. Individual axes can be hidden if required.

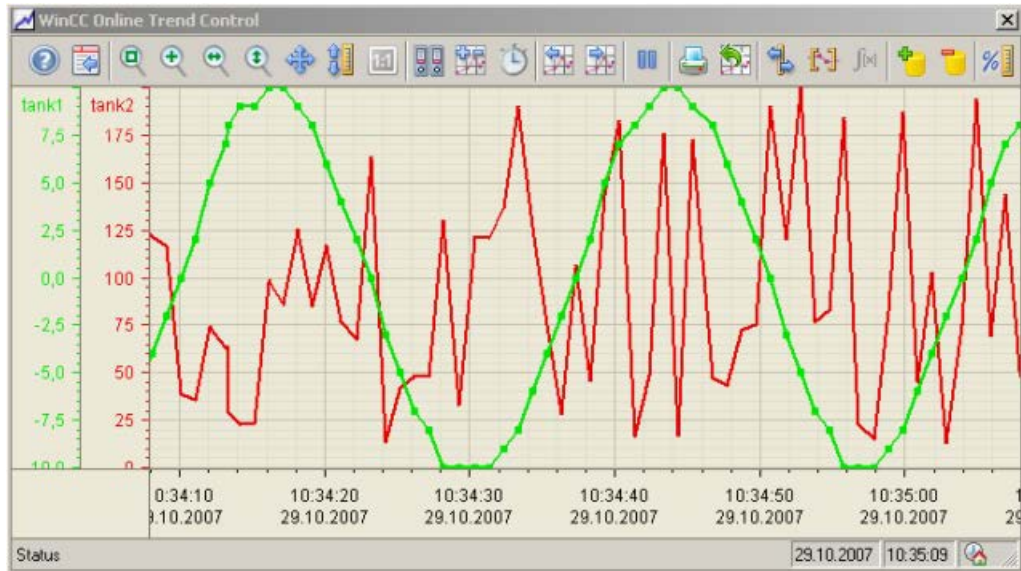

Representation Using Common Axes

If the comparability of the trend lines is important, common axes in a trend window is sensible. Connected trend windows can have a common time axis.

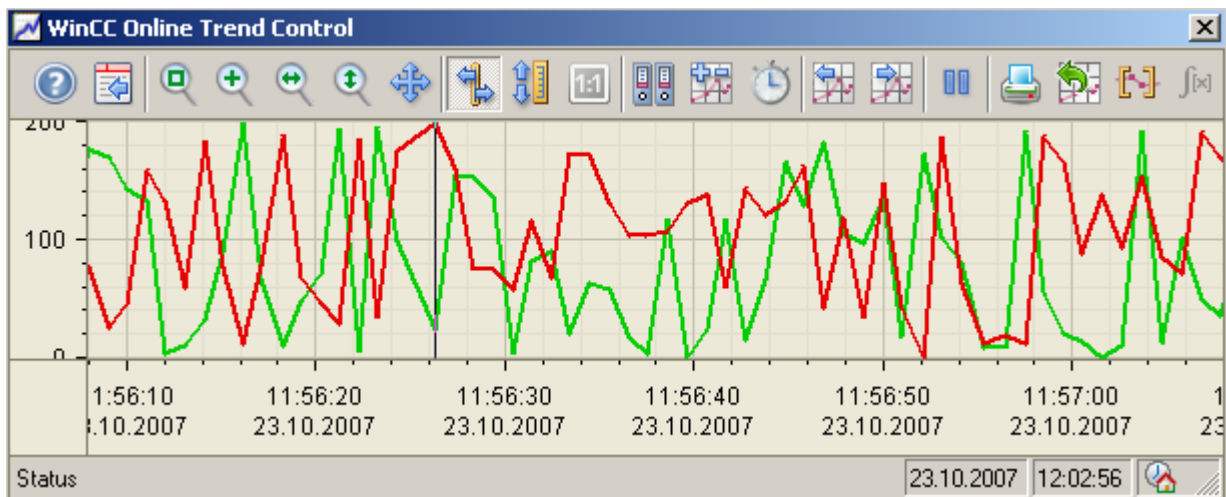

Configuring

The axes are configured on the "Value axis" and "Time axis" tabs of OnlineTrendControl. The assignment of the axes for the trends can be configured on the "Trends" tab. In this case, you can assign the individual trends to the same axes.

Note

In OnlineTrendControl, only tags with the same update cycles should be displayed for more than one trend with a common time axis. In the case of different updating cycles, the length of the time axis is not identical for all tags. Since the trends are updated at different times due to the different updating cycles, a minimal different in the end time for the time axis occurs on each change. As a result, the trends displayed skip slightly to and fro on each change.

Configuring the OnlineTrendControl

How to configure the OnlineTrendControl

Introduction

In runtime, the trends are displayed in an ActiveX control. You can configure a WinCC OnlineTrendControl for this in the Graphics Designer.

Configuration steps

1. Insert the OnlineTrendControl into a picture of the Graphics Designer.
2. Configure the basic properties for the OnlineTrendControl on the "General" tab:
 - the window properties of the control
 - the display of the control
 - the write direction of the trend values
 - the time base of the control
3. Define one or more trend windows.
4. Configure one or more time axes and value axes with their respective properties. Assign the axes to the trend windows.
5. Define trends that you want to display in the trend windows. Assign the trends to the trend windows. The value axis of a trend can only be the value axis of the assigned trend window. Assign the trends with one or more time axes.
6. Every configured trend must be connected with an online tag or an archive tag. Define the data connection for each trend.
7. Configure the display for each trend.
8. Configure the toolbar and status bar of the trend window.

9. If you want to display coordinates or statistic values, configure a ruler window, statistics window or statistics area window as well. Connect the ruler window/statistics window/statistics area window with the OnlineTrendControl.
10. Save the configurations.

How to create trend windows in OnlineTrendControl

Introduction

The WinCC OnlineTrendControl can contain one or more trend windows. The trend window provides an area to display trends in.

Overview of the trend window

The trend window has the following properties:

- Every trend window is assigned with at least one trend, which has one time axis and one value axis.
- The value axis of the trend determines the trend window, in which the trend will be displayed.
- A trend can only be assigned to one trend window.
- Several trends can be displayed in a trend window.
- A trend window can display value axes, independent of the displayed trends. Value axes and time axes can be hidden in runtime.
- The sequence of the configured trend window is determined by the position in OnlineTrendControl. The first trend window in the list of trend windows is displayed in the lower position, the last trend window is shown in the top position.
- If more than one trend window is configured, the trend windows can be connected. The connected trend windows have the following properties:
 - They can have a common time axis.
 - They have a scroll bar.
 - They have a ruler.
 - The zoom functions for a trend window affect the connected trend windows.

Procedure

1. Define one or more trend windows with the "New" button on the "trend windows" tab.

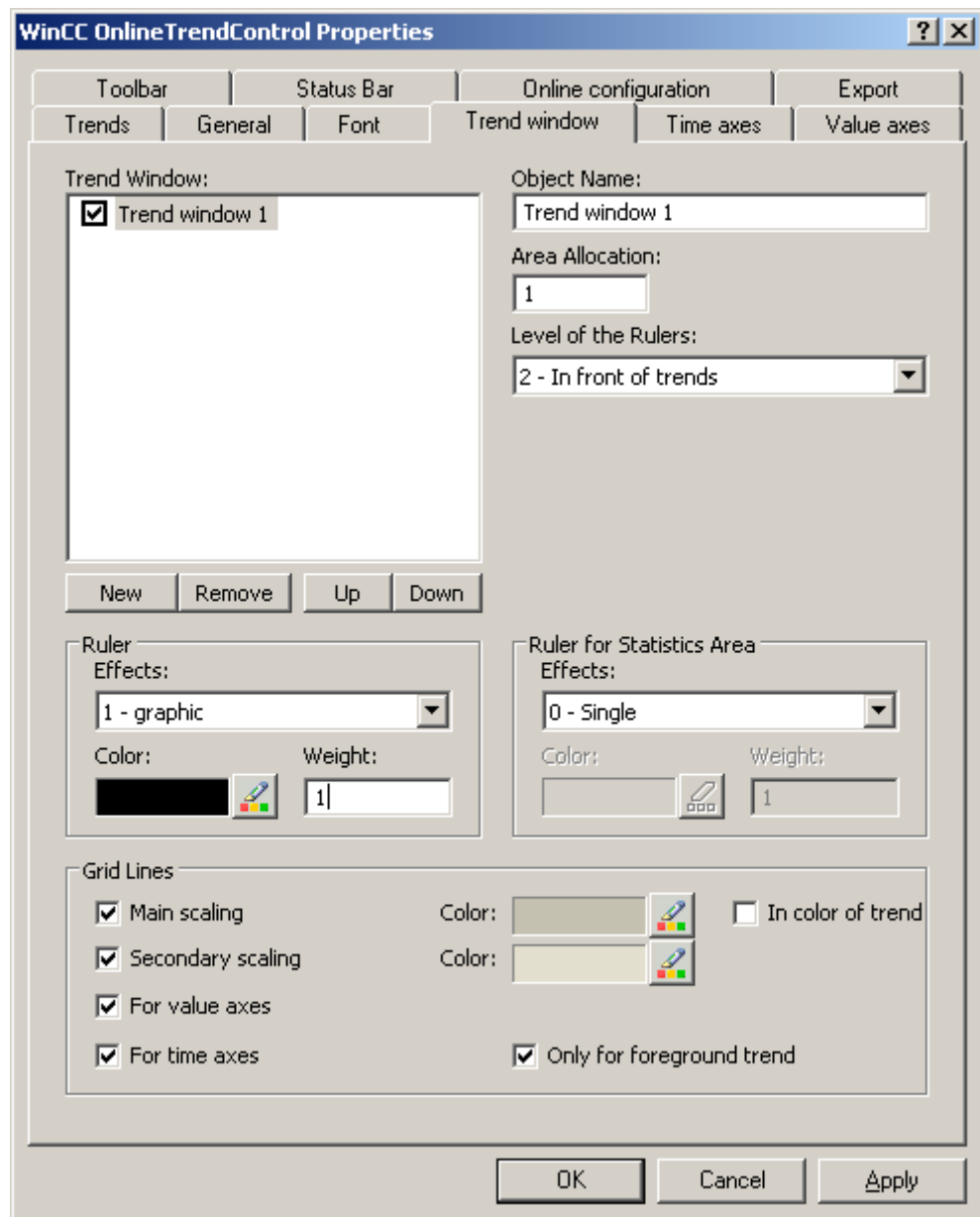

2. If you have defined more than one trend window, more configurations are possible:
 - Assign every trend window with an area selection in the displayed OnlineTrendControl.
 - Define the position of the trend windows with the "Up" and "Down" buttons.
 - Define whether the trend window will be connected on the "General" tab.
3. If you want to hide a trend window in runtime, deactivate the checkbox in front of the name of the trend window in the list. The respective axes are then hidden as well.
4. Configure the gridlines for every trend window.

5. Configure the display of the ruler. If you want to use a statistics area window, configure the ruler that will be used with the statistics area as well.
6. If you use "Graphic" for the display of the ruler, you can configure the color and the line weight of the ruler.
7. Define the level on which to display the ruler in the trend window.
8. Save the configuration.

How to configure the time axes of trend windows

Introduction

The time range for trend display is configured with time axes. Several time axes can be assigned with one or more trend windows. Connected trend windows may have a common time axis.

Time range of the trend display

Basically, there are two different time references in the trend display:

- Static display. The time range of the trend display is determined by a pre-defined, fixed time interval, independent of the current system time.

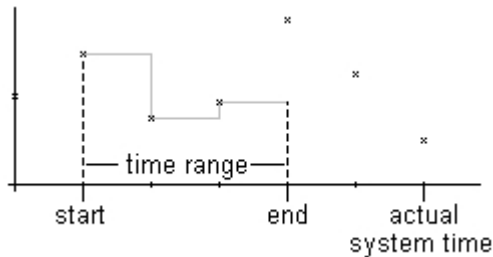

- Dynamic display. The time range of the trend display is determined retrospectively from the most current values. The display is continuously updated. The configured time range follows the current system time.

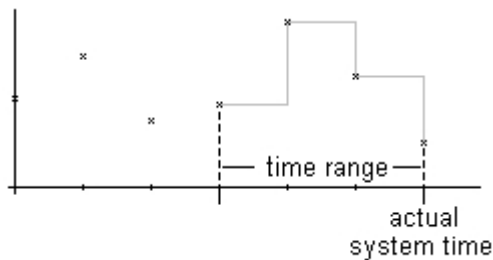

You have three different ways to define the time range of a time range for each of the two time references:

- The trend is displayed within a defined time interval. You define a start time and an end time. In a dynamic display, the end time corresponds with the current system time. The time between the start time and the end time is the time range for the trend display.
- The trend is displayed from a start time throughout a defined time range, e.g. 30 minutes from the start time. In the dynamic display, the defined time range up to the current system time is used, e.g. 30 minutes to the current system time.
- Starting from a start time, a defined number of values are shown, e.g. 100 values from the start time. With the dynamic display, the last values up to the current system time are shown.

Requirement

- You have opened a picture with the OnlineTrendControl in the Graphics Designer.
- You have defined one or more trend windows.

Procedure

1. Define one or more time axes with the "New" button on the "Time axes" tab.

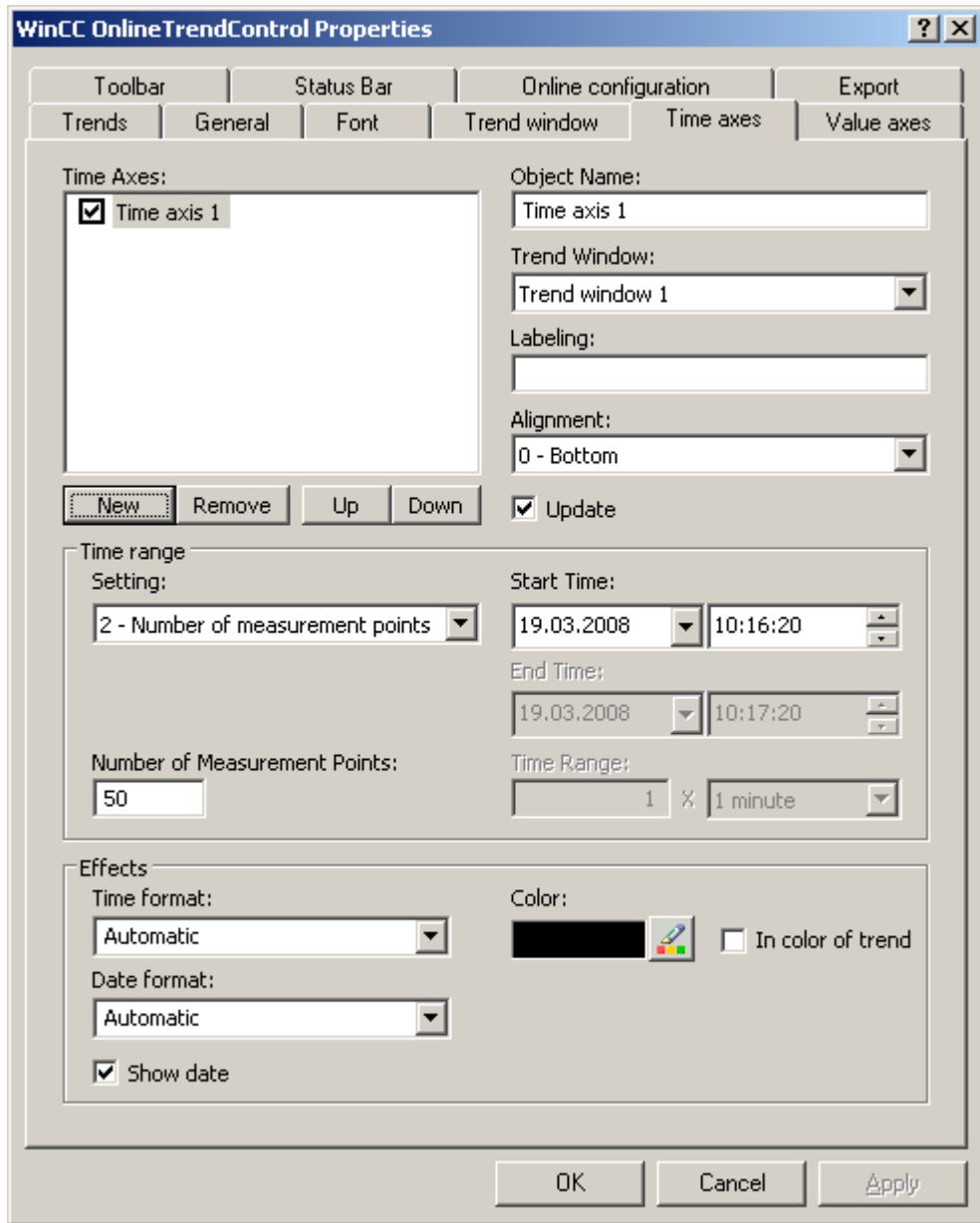

2. Define the positioning of the configured time axes for a trend window. The sequence in the list of time axes determines the positioning in the trend window. If several time axes are arranged on the same page of a trend window, the first time axis in the list assumes the position in the bottom left and the last time axis in the list then assumes the position at the top right.
3. Assign the time axes to the configured trend windows.
4. If you want to hide a time axis in the trend window, click on the checkbox in front of the name of the time axis in the list. You can display the axes again in runtime with the key functions.

5. Configure the properties and the formats for time and date for every time axis.
6. If the trends in the trend window assigned to the time axis are always updated, activate the "Update" option. If you e.g. want to compare a current trend display with an earlier trend display, deactivate the "Update" option for the time axis of the comparison trend.
7. Configure the time range for every time axis:
 - If you want to define a fixed time interval, select setting "Start to end time". Enter the date and time for each.
 - If you want to define a time period, select the setting "Time range". Define the date and time for the start time. The time range is the result of a multiplication of the "Factor" and "Time unit", e.g. 30 times "1 minute" for a time range of 30 minutes. Enter the factor and the time unit in the "Time range" field.
 - If you want to display a certain number of values, select the setting "Number of measurement points". Define the date and time for the start time. Enter the desired number of measurement points in the input field.
8. Save the configuration.

Note

Upon opening the picture of a trend window in runtime, the trend values to be displayed are either read from the archive or are set to zero. Define what is to be done via the "Load archive data" option on the "General" tab.

How to configure the value axes of trend windows

Introduction

You can configure several value axes that you will assign to one or more trend windows. Configure the value range and the scaling for every value axis.

If you have defined a value axis, the value range and the scaling are pre-configured as follows:

- The value range is based on the current values of the assigned trend.
- The value axis scale is linear to the value range.

Requirement

- You have opened the picture with the OnlineTrendControl in the Graphics Designer.
- You have defined trend windows.

Procedure

1. Define one or more value axes with the "New" button on the "value axes" tab.

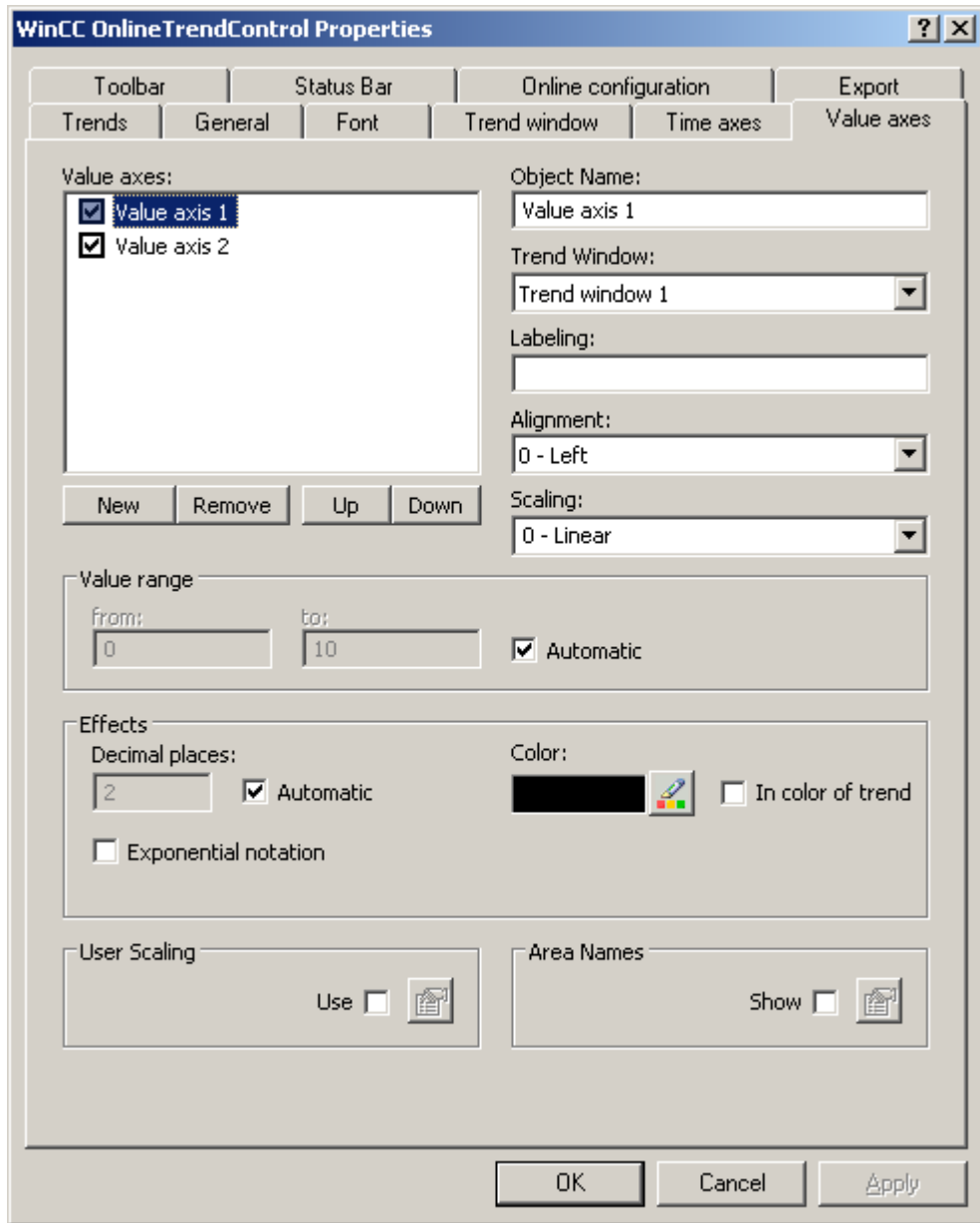

2. Assign the value axes to the configured trend windows.
3. If you want to hide a value axis in the trend window, click on the checkbox in front of the name of the value axis in the list. You can display the value axes again in runtime with the key functions.
4. Configure the orientation and the scaling for every value axis.
5. Configure the display of the value axis in trend windows.
6. Deactivate the "Automatic" option in "Value range" if you want to define a fixed value range for the value axis.

7. In the "From:" and "To:" input fields enter the minimum and maximum value of the value range.
8. If you want to define the scaling of the value axis yourself, activate the "Use" option in field "User scaling". Click on  to open the "User scaling" dialog.
9. Click "Add" to define an area. You must define segments without gaps for the entire configured value range and assign areas on the value axis. If you have defined a value range of "0 - 100000" you can divide this value range e.g. into three sections that you can display as follows on the value axis:

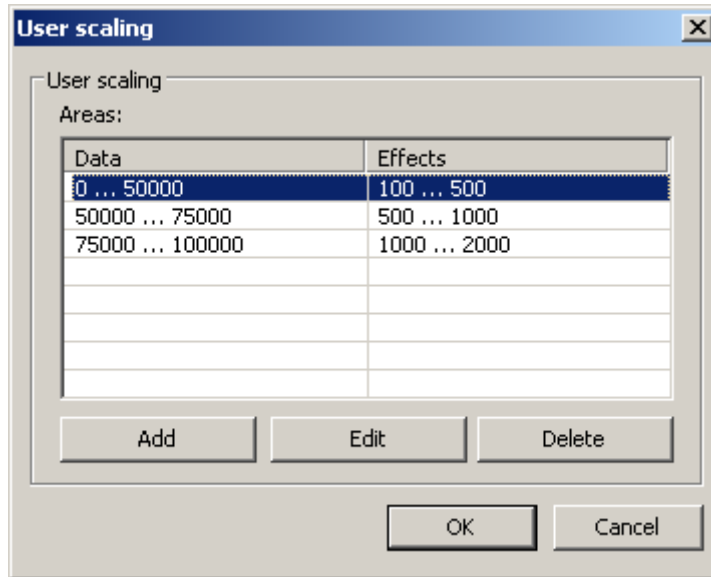

E.g. value range "0 - 50000" is displayed in runtime on the value axis in the "100 - 500" range.

10. In a ruler window, the key function "Ruler" displays e.g. measurement values. You can have a name shown as well in the "Y value" of the ruler window next to the measurement value and the status display "i" and "u". Area names can be assigned for certain value ranges.
11. If you want to display area names, activate the "Display" option in the "Area names" field. Click on  to open the "Area names" dialog.

12. Click "Add" to define ranges with the respective names.

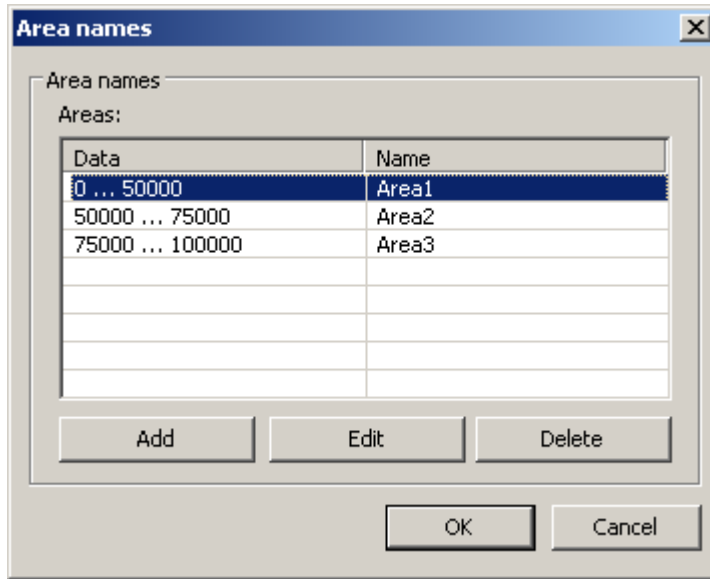

13. Save the configuration for the value axis.

How to create trends for the trend window

Introduction

Every trend is assigned with a time axis and a value axis. The value axis assigned to the trend determines the trend window, in which the trend will be displayed.

Requirement



- You have inserted the OnlineTrendControl into a picture of the Graphics Designer.
- You have configured time axes, value axes and trend windows.
- The following prerequisites apply for the data source:
 - If you want to connect data of online tags, you have to have defined process values in the tag management.
 - If you want to connect the data from archive tags, you have to have configured a process value archive with archive tags.
 - If you want to supply the trend values with data in runtime with scripts, you require a script via the API interface.

Procedure

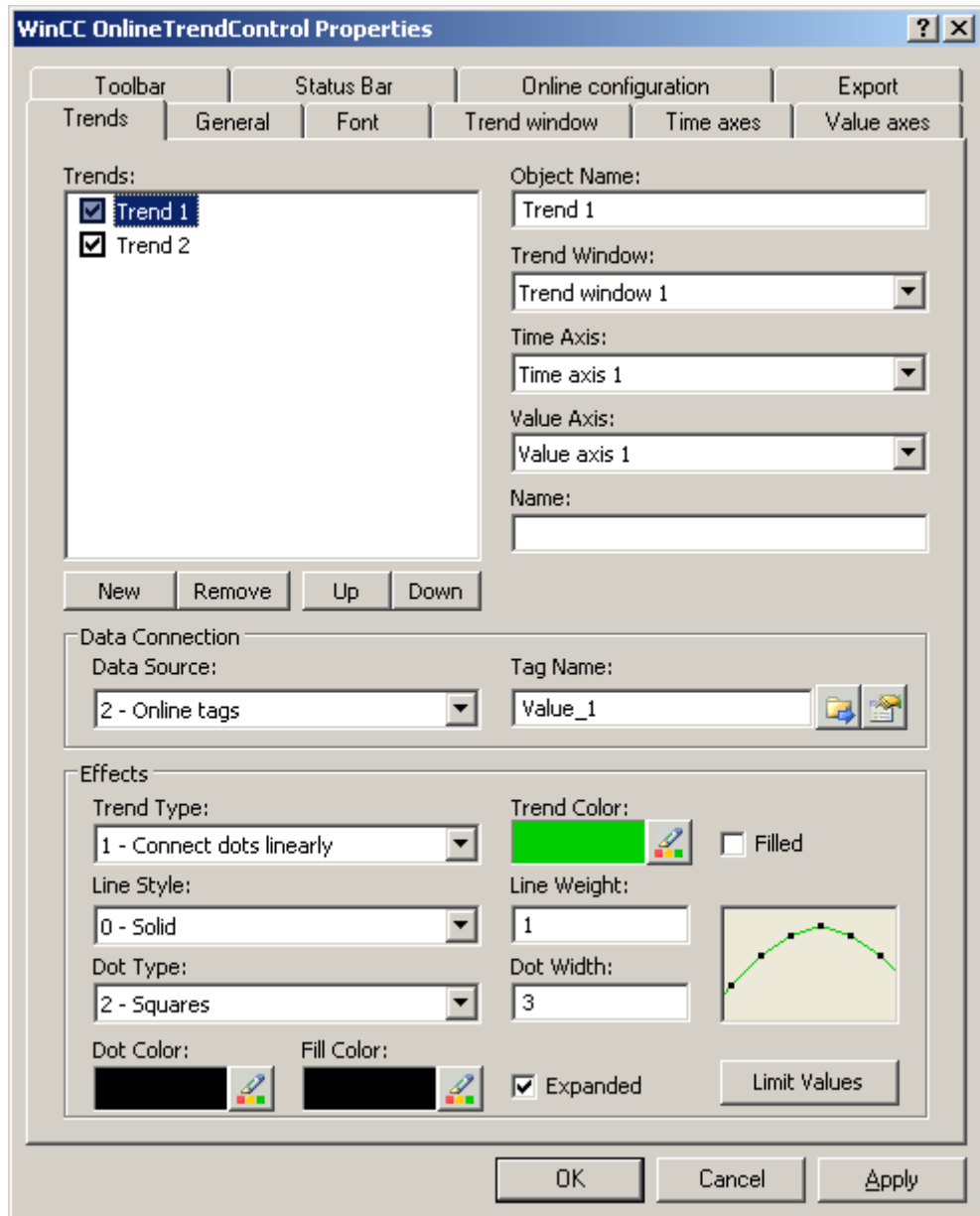
1. Go to the "Trends" tab.



2. Use the "New" button to define the desired number of trends.
3. Define the sequence of trends in the trend window using "Up" and "Down" keys.
4. Assign each trend of trend window with a time axis and a value axis.
5. Define the data source for each trend. You can select the following:
 - Archive tags of a process value archive
 - Online tags from the tag management
 - No configured data source to establish a connection in runtime via a script.

6. Click on  to select a tag for the trend.
7. If you have connected online tags and activate the "Display alarms" option, you can have the assigned message displayed as a symbol and tooltip for the trend values with limit violation. Limit monitoring must be configured in the alarm logging for the online tag for this. The red symbol indicates a limit violation (high or low). The tooltip contains the message text and information text of the message. If you have configured "Loop in Alarm" with "OpenPicture" function for the message, you can jump to the assigned picture by double-clicking this symbol.
8. Configure the value range for the data in which the trend will be displayed. Click the  button in the "Data connection" field. The dialog "Automatic value range" will be opened.

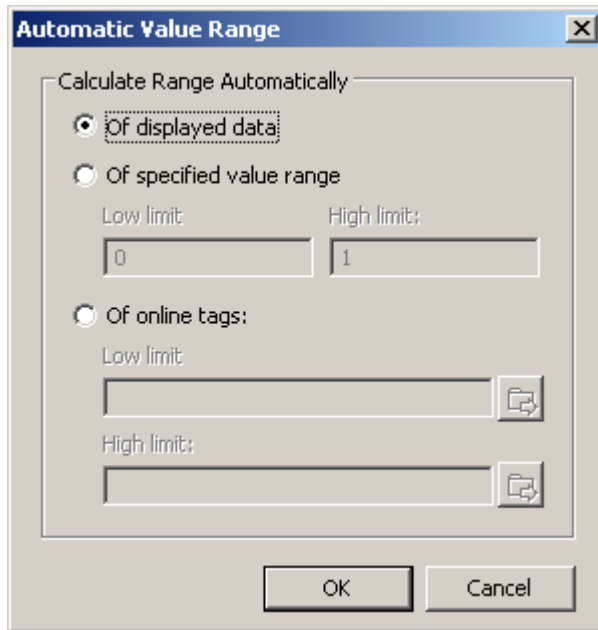

Choose how the value range is defined from the following possibilities:

- Automatically from the displayed data.
- From the defined value range. Enter the values for the lower limit and the upper limit of the value range.
- From online tags. The lower limit and the upper limit of the value range are made from the values from connected online tags. Enter a tag name for the lower limit and the upper limit.

9. Configure the display for each trend. More information can be found on page "How to configure the display of trends".
10. Save the configuration.

How to configure the display of trends

Introduction

You can adjust the display of trends to suit your requirements in the WinCC controls. The following WinCC controls are shown in trends:

- WinCC OnlineTrendControl
- WinCC FunctionTrendControl

Overview

The following trends features can be configured:

- The types of trends and trend lines
- The properties of trend lines
- The colors of the trends, the trend points and the fill color
- Color identification for a limit value violation

Note

Depending on the window size of the control and the line weight, the line style can be represented differently regardless of the configured line style.

Requirement

- You have opened the Graphics Designer and configured a picture with the above mentioned WinCC control.
- The configuration dialog of the WinCC control is opened.

Configuring the types of trends and trend lines

1. Go to the "Trends" tab. Here e.g. in WinCC OnlineTrendControl.

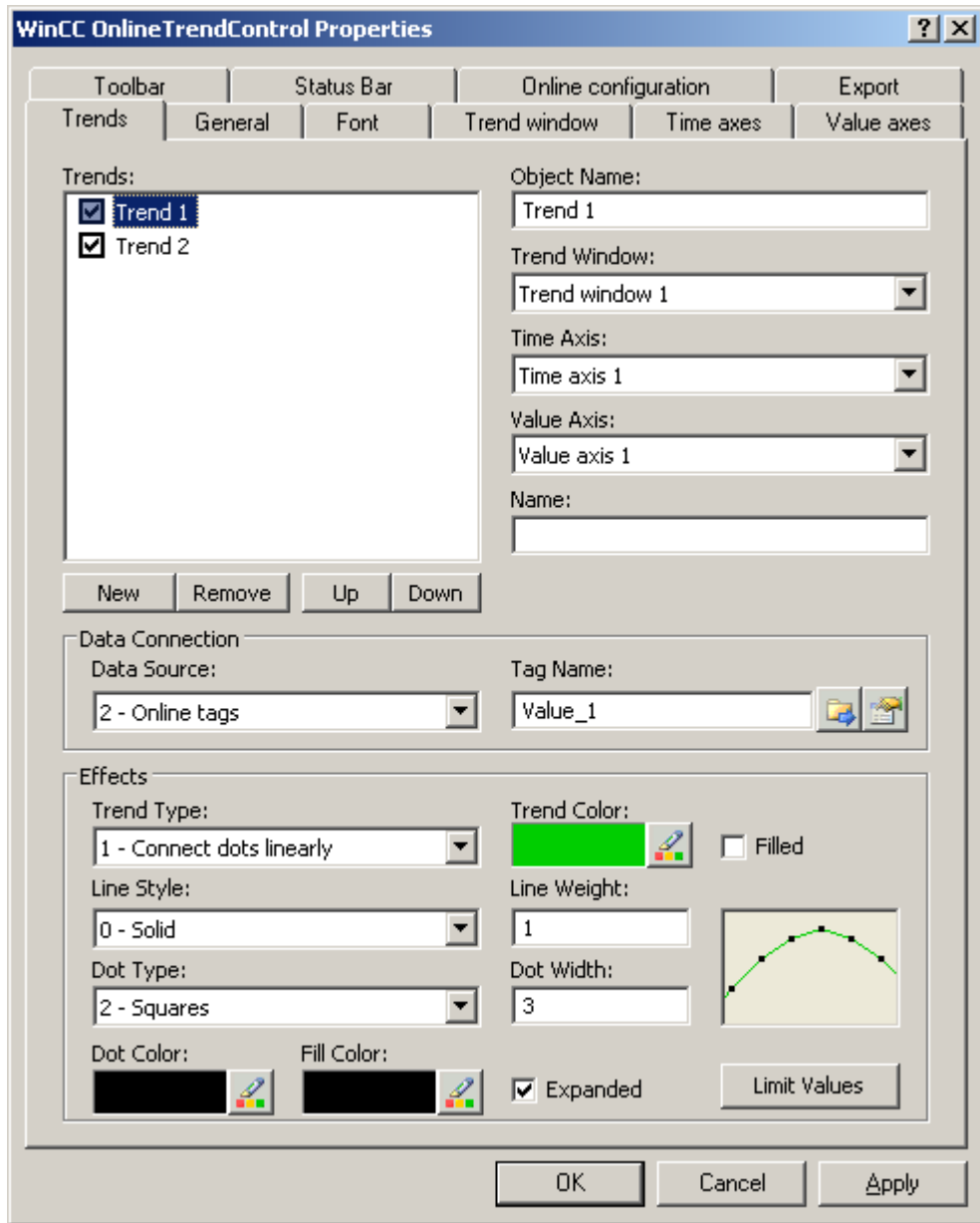

2. Choose a trend under "Trends".
3. Define the type of the trends and trend lines in the "Display" area.
4. If you want to highlight the display of the area under the trend, activate the "Filled" option.
5. In the small picture in the right-hand margin of the "Display" area, the result of the configuration is shown.
6. Save the configuration.

Configuring the properties of trend lines

1. Choose a trend under "Trends".
2. Define the properties of the trend lines in the "Display" area.
3. Define the line weight and the properties of the trend points.
4. In the small picture in the right-hand margin of the "Display" area, the result of the configuration is shown.
5. Save the configuration.

Configuring the colors of the trends, the trend points and the fill color

1. Choose a trend under "Trends".
2. Define the colors in the "Display" area.
3. If you want to configure the colors of the trend points and the fill color, activate the "Extended" option.
4. In the small picture in the right-hand margin of the "Display" area, the result of the configuration is shown.
5. Save the configuration.

Configuring the color identification for a limit value violation

1. Choose a trend under "Trends".
2. Click in the "Display" area on the "Limit values" button. This will open the "Limit values" dialog.

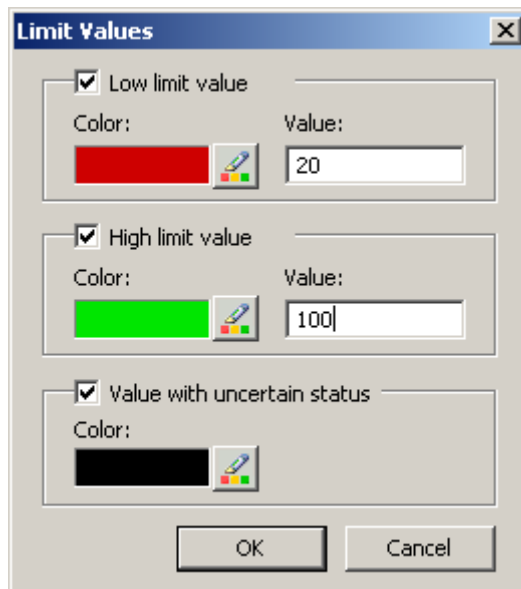

3. Activate the limit values, for which you want a colored identification.
4. Define the color for every activated option.

5. The colored identification has the following effect:
 - Low limit value. Whenever a displayed trend value is below the value defined in the "Value" input field, the value is shown in the configured color.
 - High Limit Value. Whenever a displayed trend value is above the value defined in the "Value" input field, the value is shown in the configured color.
 - Value with uncertain status. Values, whose start value is unknown on activating runtime or for which a substitute value is used, have an uncertain status. These values are displayed in the configured colors.
6. Save the configuration.

Note

In WinCC V7 or higher, the display of trend values with uncertain status in trend controls differs to their display in trend controls in earlier versions of WinCC V7: The trend values with uncertain status will not be displayed in the control until they have returned to a reliable state.

How to configure the toolbar and the status bar

Introduction

The WinCC controls are operated at runtime using the functions of the toolbar buttons. The status bar contains information pertaining to the current status of the WinCC control. You can adapt the toolbar and the status bar for all WinCC controls when configuring, or at runtime.

Requirement

- A picture showing a WinCC control is opened in Graphics Designer when configuring.
- The WinCC control is assigned the "Configuration dialog" button function for opening the configuration dialog in Runtime.
- The configuration dialog of the WinCC control is open.

How to configure the toolbar

1. Go to the "Toolbar" tab. In the WinCC AlarmControl, for example:

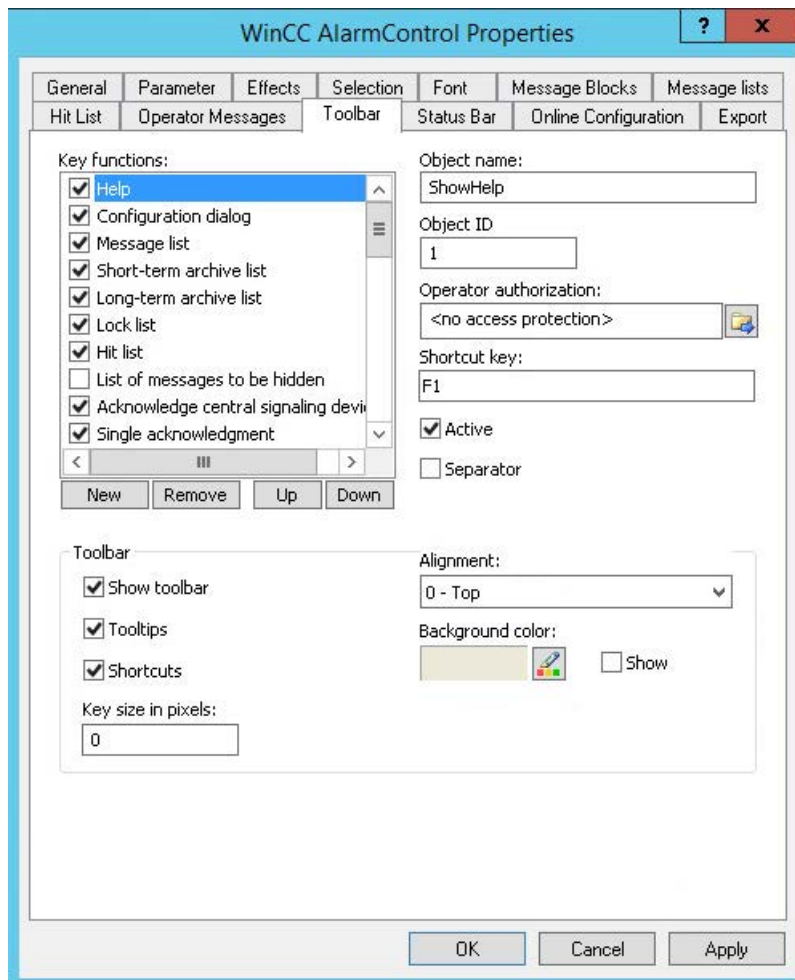

2. In the list, activate the button functions you require for operating the WinCC control in Runtime. For information on the button functions, refer to the description of the corresponding WinCC control at "Operation in runtime".
3. Determine the sorting order for displaying the button functions in the toolbar. Select the button functions from the list and the move the functions using the "Up" and "Down" buttons.
4. Define a shortcut key for the functions of the toolbar buttons.
5. Any button functions assigned operator authorizations are only available in Runtime to authorized users.
6. An activated button function is displayed during runtime if you deactivate its "Active" option, however, it cannot be operated.
7. You can set separators between the button functions. Activate the "Separator" option for the button function to be restricted by separator.

- 8. Configure the general properties of the toolbar, e.g. alignment or background color.
- 9. Change the button size as required. The standard setting is "0" and corresponds to the original size of 28 pixels. You can specify 280 pixels as maximum value.
The following behavior results for the button size depending on the configured value:

Value of the button size	Behavior
Value < 0	Invalid value. The most recent valid value is used.
$0 \leq \text{value} \leq \text{original size of button}$	The original size of the button is used. The value is set to the default (= 0).
Original size of the button < value \leq maximum value	The configured value is used.
Maximum value < value	Invalid value. The most recent valid value is used.

With a large button size, please note that in some cases not all buttons may be displayed in the control. To show all activated buttons in Runtime, you must therefore extend the control or activate fewer buttons as required.

How to configure the status bar

1. Go to the "Status Bar" tab. In the WinCC AlarmControl, for example:

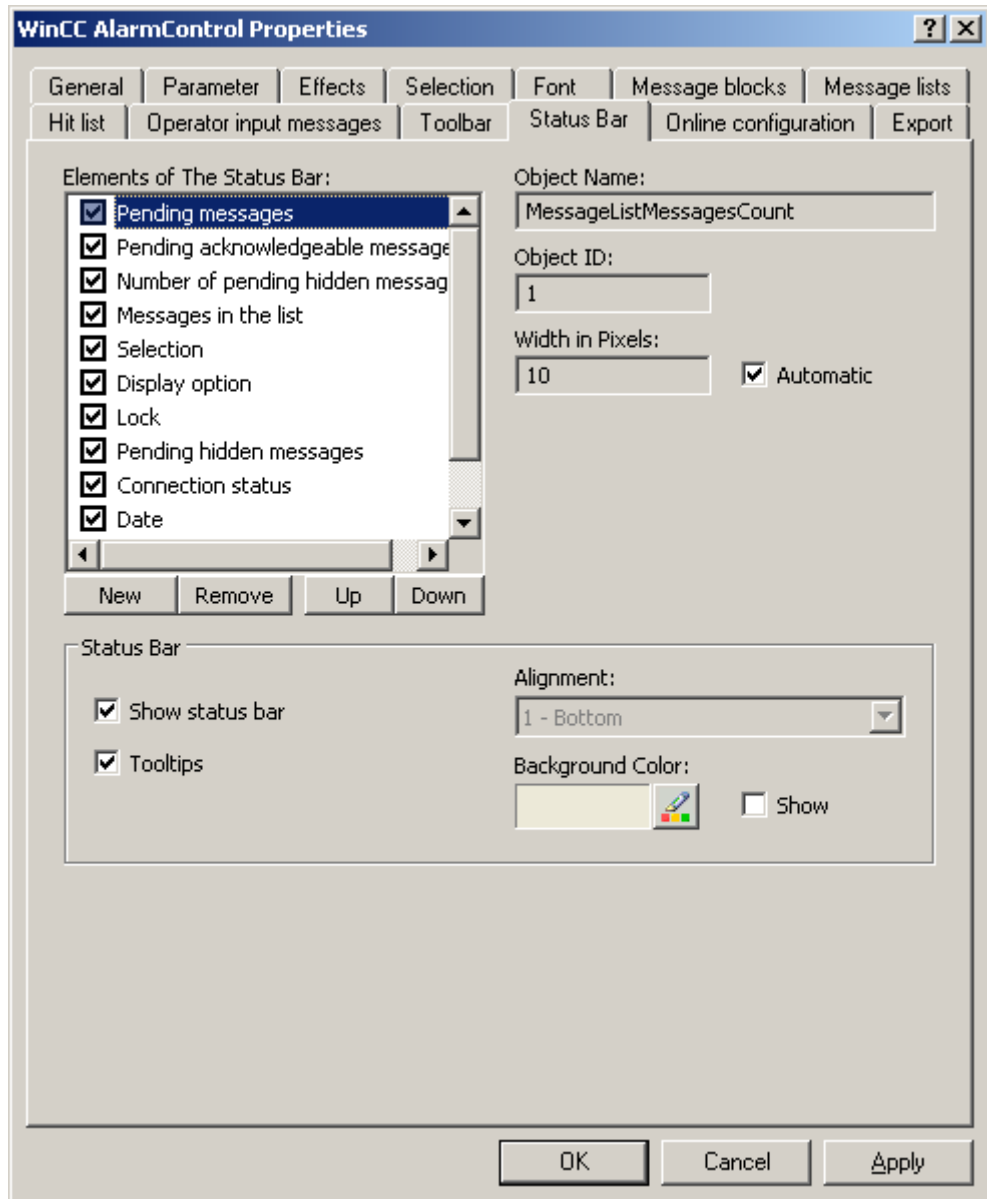

2. Activate the elements required during runtime in the list of status bar elements. For further information on status bar elements, refer to the descriptions of the corresponding WinCC control at "Operation in runtime".
3. Determine the sorting order for displaying of the status bar elements. Select the elements from the list and move these using the "Up" and "Down" buttons.
4. To resize the width of a status bar element, deactivate the "Automatic" option and enter a pixel value for the width.
5. Configure the general properties of the status bar, e.g. alignment or background color.

How to configure the Ruler window/Statistics window/Statistics area window

Introduction

Evaluated data and statistics are shown in a table in a ruler window, statistics window or a statistics area window. The ruler window/statistics window/statistics area window are configured in the WinCC RulerControl.

Overview of the WinCC RulerControl

The RulerControl can be connected with the following controls:

- WinCC OnlineTrendControl
- WinCC OnlineTableControl
- WinCC FunctionTrendControl

Depending on the data evaluation, there are three different types of windows for displaying values. The following window types are available:

- The ruler window displays the coordinate values of trends on the ruler.
- The statistics area window shows the values of the lower limit and upper limit of the trends between two rulers or the selected area in the table. The statistics area window is not planned for the WinCC FunctionTrendControl.
- The statistics window shows the statistic evaluation of the trends between two rulers or the selected values in the table. The statistics window is not planned for the WinCC FunctionTrendControl.

All windows can also display additional information on the connected trends or columns.

Requirement

- You have opened a picture with an OnlineTrendControl, OnlineTableControl or FunctionTrendControl in the Graphics Designer.

Procedure

1. Insert RulerControl into the picture from the WinCC object palette.
2. Double click on the RulerControl to open the configuration dialog.

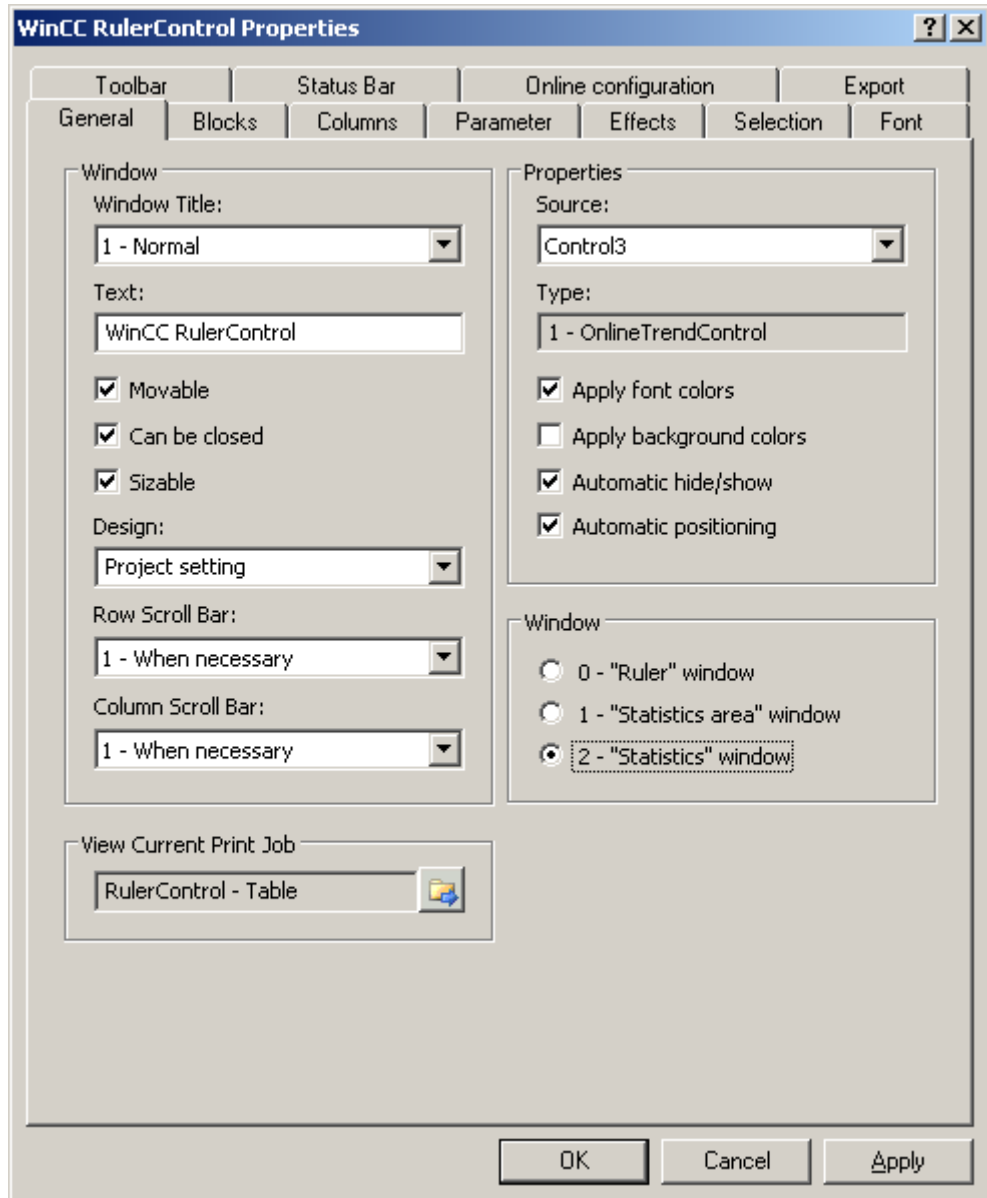

3. Configure the properties of the control on the "General", "Toolbar" and "Status bar" tabs.
4. Go to the "General" tab in the field "Source" and select the object name of the control that is already configured. The type of control is displayed in the "Type" field.
5. Set the window type in the "Window" field. If the key function "Configuration dialog" can be operated in runtime, you can change the window type in runtime.

- 6. Go to the "Columns" tab.

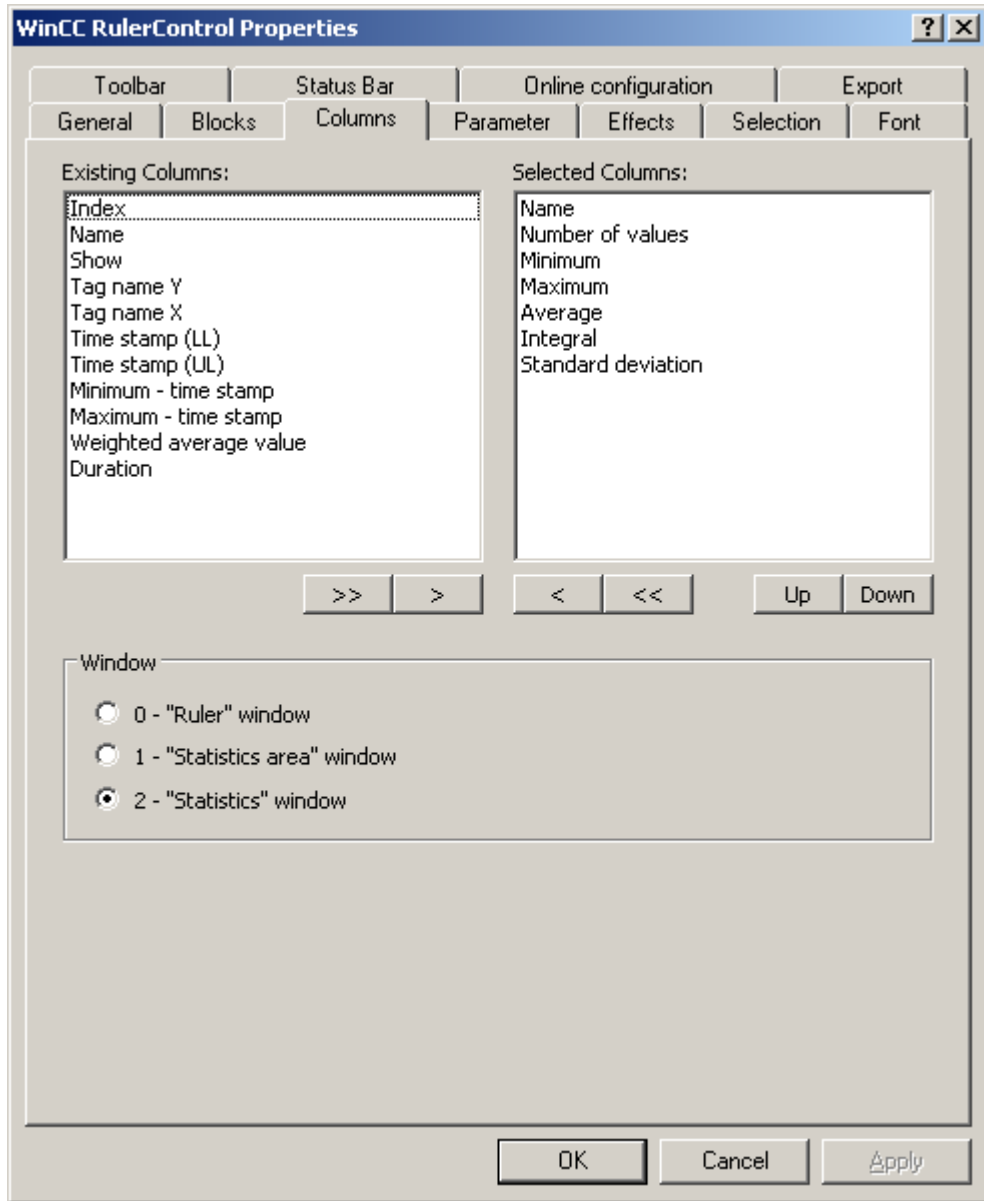

- 7. Use the arrow keys to select the column of the window type that you want to display for the assigned control. Columns for the basic data and columns that are only for the selected window type or the assigned control are available. Define the column sequence with buttons "Up" and "Down".

8. Go to the "Blocks" tab.

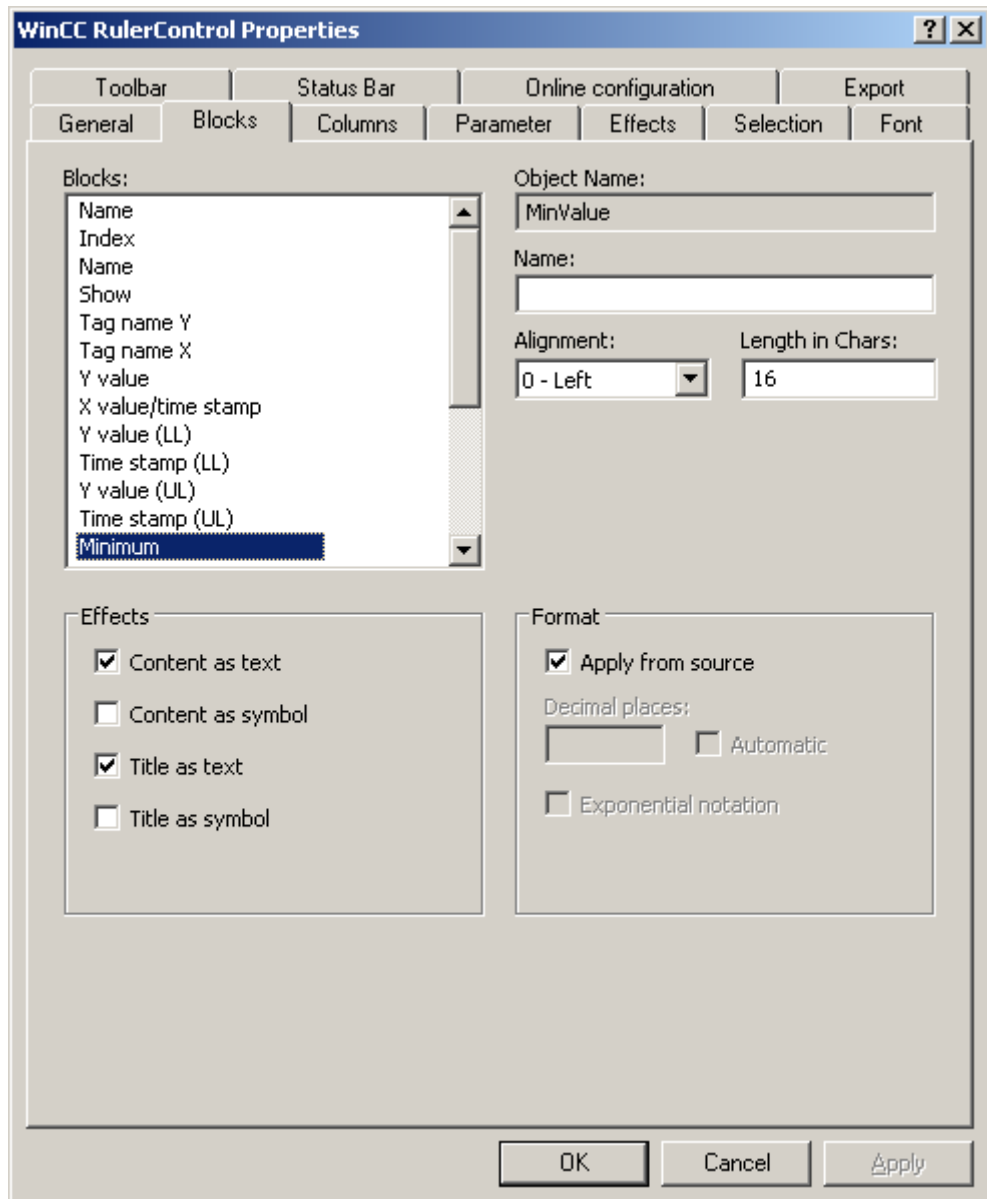

Every column corresponds with a block. In order to define the properties for the selected columns, click on the respective blocks.

9. If a special format exists for a block, you can configure the format of the block. Deactivate the option "Apply from source" if the format settings of the connected control are not to apply in this case. Define the desired format.
10. Define whether the data for the column and the column heading is to be displays as text or as an icon in the table under "Display".
11. Save the configuration.

12. Configure the properties and the display of the table for the RulerControl in the "Parameter," "Effects" and "Selection" tabs.
For details on configuring the table display, please refer to "Configuration of OnlineTableControl > How to configure the table display" in the WinCC OnlineTableControl documentation.
13. You can export the evaluated data. This requires activating the "Export data" key function on the "Toolbar" tab.
For details on data export, please refer to "Configuration of OnlineTableControl > How to export runtime data" in the WinCC OnlineTableControl documentation.
14. Configuring the TrendRulerControl is possible in runtime.
For more detailed information, please refer to "Configuration of OnlineTableControl > How to apply online configuration" in the WinCC OnlineTableControl documentation.

See also

How to export runtime data (Page 1632)

How to define the effect of the online configuration (Page 1634)

How to configure the display of trends (Page 1621)

How to export runtime data

Introduction

The runtime data shown in the WinCC controls can be exported using a button function. Set up operation of the data export during runtime in the configuration dialog.

Requirement

- A picture showing a WinCC control is opened in Graphics Designer when configuring.
- The configuration dialog of the WinCC control is open.

How to configure the operation of the data export

1. Go to the "Export" tab.

Data Export - Default Settings

File Name:
@OBJECTNAME

Directory:
@PROJECTPATH\Export\AlarmControl

Scope of Data Export: 0 - All Format: CSV

Operation in Runtime

- Show dialog
- File name can be changed
- Directory can be changed

2. A standard file name and a standard directory are already entered in the "Data export default settings". In this case for AlarmControl. If necessary, define a file name and a directory for the export file.
The file name can be made up of the freely defined name and the following placeholder:
@OBJECTNAME - Object name of the controls
@CURRENTDATE - Current date
@CURRENTTIME - Current time
3. CSV is currently available as data format. Click  to specify the delimiter and data format in the CSV file.
4. Define the scope of the data export:
 - All runtime data is exported
 - Selected runtime data is exported. This data export is only possible in WinCC controls with tabular display.
5. Configure the operation of the data export during runtime. Define:
 - whether users are allowed to rename the file, or change the directory.
 - whether to display the "Data export default settings" dialog in Runtime.
6. If "Show dialog" is deactivated, the data for operation of the "Export data" button function is immediately exported to the defined export file.
7. Save the configuration.
8. Go to the "Toolbar" tab to activate the "Export data" button function for runtime.

Results

You can export all or selected data to a defined file at runtime using the  button function.

How to define the effect of the online configuration

Introduction

Users can parameterize the WinCC controls in Runtime. You must define the Runtime effects of the online configuration.

Changes configured in Runtime are saved for the specific user separately from the picture in the configuration system. The original picture configuration is retained in the configuration system.

Note

The picture is also replaced at Runtime if you save it in Graphics Designer, or when loading deltas in online mode. All online changes are lost.

The different configurations are only activated for new users after you performed a picture change.

Requirement

- A picture showing a WinCC control is opened in Graphics Designer when configuring.
- The configuration dialog of the WinCC control is open.

Procedure

1. Go to the "Online configuration" tab. For example, in OnlineTrendControl:

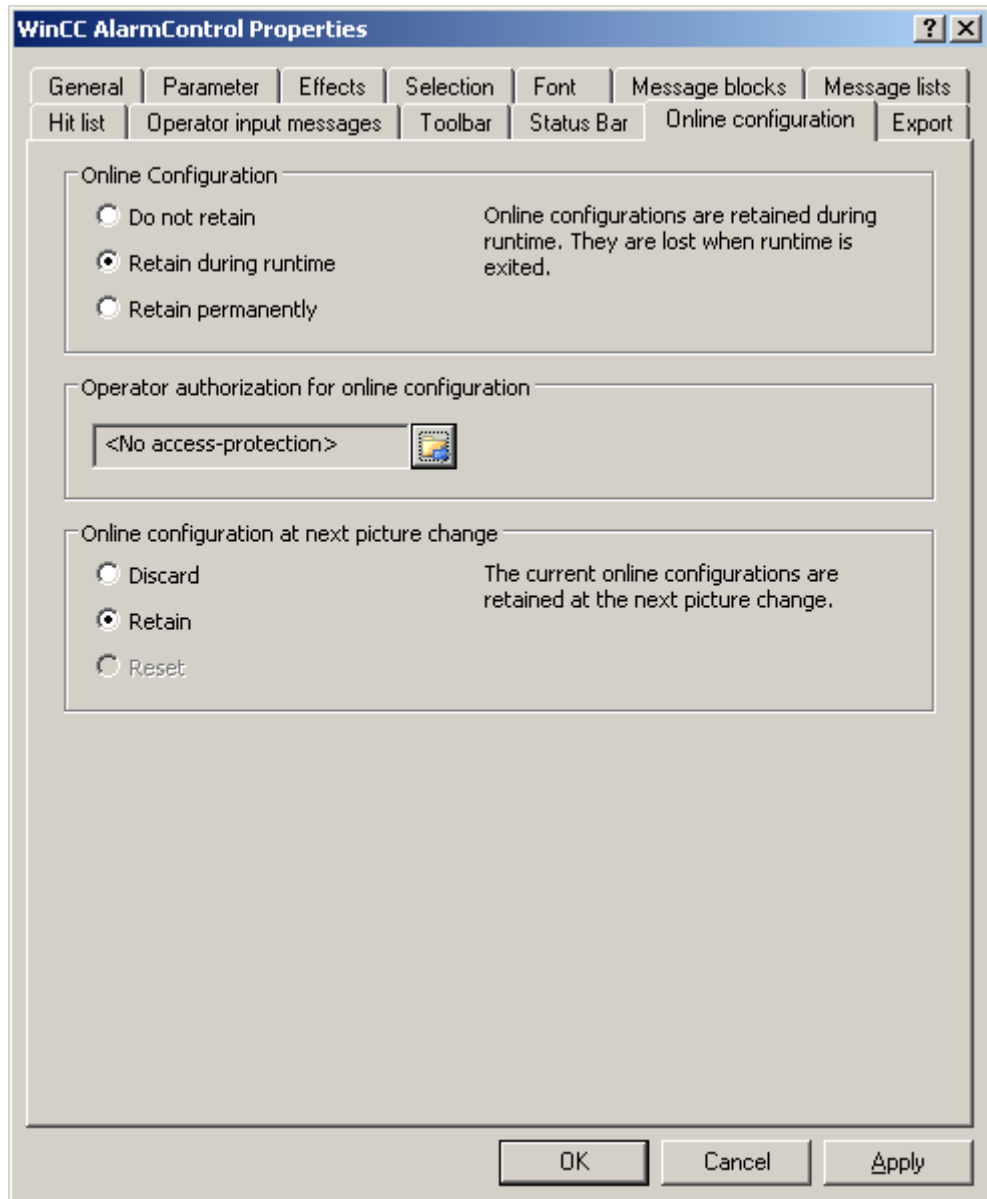

2. The option buttons of the "Online configuration" field for setting online configuration defaults are only available in the configuration system. The option buttons are not available in Runtime.
Select one of the three effects of the online configuration:
 - "Do not retain". The online configurations are not retained in Runtime. This default setting disables all options for Runtime users. Online configurations are lost at the next picture change and on activation/deactivation of the project.

- "Retain during Runtime". This default setting enables the "discard", "retain" or "reset" options for Runtime users. Online configurations are retained at the next picture change if the "retain" option is enabled, however, these are lost on activation/deactivation of the project.
 - "Retain permanently". This default setting enables the "discard", "retain" or "reset" options for Runtime users. Online configurations are retained at the next picture change and on activation/deactivation of the project if the "retain" option is enabled.
3. Define corresponding user authorizations for online configuration.
 4. The option buttons of the "Online configuration on next picture change" can be enabled for operation in the configuration system and at Runtime by setting the "retain at Runtime" and "retain permanently" defaults. The "reset" operation is only available in Runtime, because the configuration system contains the original configuration.
Select one of three effects of the online configuration at the next picture change:
 - Select "discard" if to discard the online configuration at the next picture change.
 - Activate "retain" to activate the online configuration based on default settings at the next picture change or on activation/deactivation of the project.
 - Activate "Reset" if you want to apply the picture saved in the configuration system in Runtime. All online changes are lost.
 5. Save the configuration.

How to make the toolbar for the OnlineTrendControl dynamic

Introduction

The default functions for operating the WinCC OnlineTrendControl are no longer supported for the new WinCC OnlineTrendControl as of WinCC V7.0. You can use the WinCC types of dynamics to e.g. operate a key function of the toolbar with a script.

Overview

With WinCC Controls as of V7.0 you do not need special functions to implement operation of the control by assigning dynamic properties to the toolbar. The previously used standard functions "TlgTrendWindowPress..." and "TrendToolbarButton" are no longer supported.

If you do not want to operate the control via the toolbar, you can write the "ID" for the desired button in the "ToolbarButtonClick" object property with an optional type of dynamics.

The "ID" of a button of the toolbar can be determined:

- with the table on page "Operation of the OnlineTrendControl in Runtime".
- in the configuration dialog of the OnlineTrendControl on the "Toolbar" tab via field "Object ID".

Example: Opening the control configuration dialog

The following options of assigning dynamic properties are available for opening the control configuration dialog:

- VBScript:
 - `ScreenItems("Control1").ToolBarButtonClick = 2`
 - As an alternative to the "ToolBarButtonClick" property, you can use the VBS methods for operating the toolbar: `ScreenItems("Control1").ShowPropertyDialog`
 - Or, with the following notation and support of "Intellisense":
`Dim obj`
`Set obj = ScreenItems("Control1")`
`obj.ShowPropertyDialog`
- C script:
 - `SetPropWord(IpszPictureName, "Control1", "ToolBarButtonClick", 2);`
- Direct connection
 - In the dialog of the direct connection, enter "2" as a constant for the source.
 - Select the property "ToolBarButtonClick" for the object "Control1" for the target "Object in picture".

See also

Operating the OnlineTrendControl in runtime (Page 1639)

How to adapt table elements and buttons of the controls

Introduction

You can change the design of the standard configuration for the WinCC controls and adapt the following elements in their appearance:

- Size and design of buttons
- Custom symbols for table elements of the table controls, for example, in the Alarm Control or OnlineTableControl
- Style of the scroll bar

Overview

The standard installation of WinCC creates the folder "CCAxControlSkins" for the design of the WinCC controls in "C:\Program Files(x86)\Common Files\Siemens\bin\".

To use modified designs, you need to create different subfolders within the "CCAxControlSkins" folder. The number and the name of the folder are determined by the elements you want to adapt in the respective controls .

The design of a control can then be selected as a "style" property in the configuration dialog of the control in the "General" tab.

You can also use project-specific designs. You need to create the folder structure in the "GraCS" folder of the project, e.g. in "C:\WINCCProjects\TestProject\GraCS\CCAxControlSkins". When a design folder with the same name already exists in the installation folder and in the project folder, the design of the project folder used as the "Style".

In order for the created symbols for table elements of a control to be visible, the "Content as symbol" option must be enabled for the appropriate columns. The "Apply project settings" option must be disabled in Alarm Control.

You can learn how to adapt the WinCC Alarm Control in WinCC Runtime Professional under Customizing the WinCC Controls (<https://support.industry.siemens.com/cs/de/en/view/76327375>)

Note

When creating a new design, you do not have to create all the files. For all of the files that are not present, the standard settings of the controls are used.

How to adapt table elements

The procedure is described using the example of table elements in the Alarm Control.

1. In the "CCAxControlSkins" folder, create a sub-folder, for example, "Table symbols".
2. Create a subfolder in this folder for the control, for example, "AlarmControl".
3. In the folder of the control, create a subfolder, for example, "GridIcons".
4. Create a "GridIcons" folder for each column of the table in which you want to display icons. No icons can be displayed for the date and time columns.
5. Rename the folder to the name of the object property, for example, "State" for the "State" column/message block in the Alarm Control.
6. You must save the graphics in the "State" folder with the respective state names in English, for example, "ComeQuit".
For the state for which you have saved a graphic, the new symbol appears in the table cell when the state occurs.
7. To display symbols for message numbers, for example, you can assign a graphic to each numerical value. For example, the respective number is highlighted in a certain color. Then the graphic name in the folder is "Number", for example, "5.png" for the number "5".
If you want to define a symbol for a specific interval, e.g. for the interval "50 - 100", the graphic name is "50_100.png". The limits are contained in the interval.
8. To display only icons instead of the text of a message block/column, you must specify a graphics file for each occurring text.
For example "Fault location": If an error occurs in the tank, a tank symbol appears. If a fault occurs at the valve, the symbol of a valve is shown.
9. Select the corresponding design in the "General" tab of the "Style" property in the configuration dialog of the control.

How to adapt the buttons of the toolbar

1. Create the "Toolbar" subfolder in the "CCAxControlSkins" folder.
2. Create the file "IconsNormal.png" in this folder.
3. In this file, insert the individual graphics of the buttons side-by-side in a row. For disabled buttons, use the file "IconsDisabled.png".
4. To use new graphics, you must adapt these files. You can use any graphics program of your choice for this.
The control reads the file, cuts it into individual graphics and displays the cut parts on the corresponding buttons.

How to adapt the scroll bar

1. In the "CCAxControlSkins" folder, create a subfolder, for example, "Scroll bar".
2. Create two subfolders in this folder, "Horizontal" and "Vertical".
3. You need to create a number of individual files within this folder to form the scroll bar when the program at runtime.

Operation in Runtime

Operating the OnlineTrendControl in runtime

Introduction



The trend window is operated in runtime via the buttons in the toolbar.













If you do not want to operate the trend window via the toolbar, you can write the "ID" for the desired button in the "ToolbarButtonClick" object property with an optional type of dynamics.















Overview

The overview shows all symbols in "standard" style.

If you create a design of the controls with the "Simple" style, the representation of the symbols is the same as with OnlineTrendControl before WinCC V7. You can find an overview on the page "Before WinCC V7: Output process values as trends in process pictures > Operation in Runtime > Operation of Online Trend Control in Runtime".

Icon	Description	ID
	"Help" Calls up the help on WinCC OnlineTrendControl.	1
	"Configuration dialog" Opens the configuration dialog, in which you can change the properties of the OnlineTrendControl.	2

	<p>"First Data Record"</p> <p>This button displays the tag trend over time in the trend window, starting with the first archived value and extending over a defined time range. The button is only available if the values originate from a process value archive.</p>	3
	<p>"Previous Data Record"</p> <p>This button displays the tag trend of the previous time interval in the trend window, starting from the currently displayed time interval. The button is only available if the values originate from a process value archive.</p>	4
	<p>"Next Data Record"</p> <p>This button displays the tag trend of the following time interval in the trend window, starting from the currently displayed time interval. The button is only available if the values originate from a process value archive.</p>	5
	<p>"Last Data Record"</p> <p>This button displays the tag trend over time in the trend window, ending with the last archived value and extending over a defined time range. The button is only available if the values originate from a process value archive.</p>	6
	<p>"Zoom area"</p> <p>Define an area by dragging with the mouse in the trend window. This cut-out of the trend window is made larger. The "Original view" button brings back the original size of the view.</p> <p>If the symbol is enabled, the updated display is stopped and the "Stop" symbol is enabled.</p>	8
	<p>"Zoom +/-"</p> <p>Zooms in on or out off the trends in the trend window. The left mouse button increases the size of the trends. By holding the "Shift" button down, the left mouse button zooms out of the trends. The "Original view" button brings back the original size of the view.</p>	9
	<p>"Zoom time axis +/-"</p> <p>Zooms in on or out off the time axes in the trend window. The left mouse button increases the size of the time axes. By holding the "Shift" button down, the left mouse button zooms out of the time axes. The "Original view" button brings back the original size of the view.</p>	10
	<p>"Zoom value axis +/-"</p> <p>Zooms in on or out off the value axes in the trend window. The left mouse button increases the size of the value axes. By holding the "Shift" button down, the left mouse button zooms out of the value axes. The "Original view" button brings back the original size of the view.</p>	11
	<p>"Move trend area"</p> <p>This button moves the trends along the time axis and the value axis in the trend window.</p>	12
	<p>"Move axes area"</p> <p>This button moves the trends along the value axis in the trend window.</p>	13
	<p>"Original view"</p> <p>This button exit the zoomed trend display back to the original view.</p>	14
	<p>"Select data connection"</p> <p>This button opens a dialog for the archive selection and tag selection.</p>	15
	<p>"Select trends"</p> <p>This button opens the dialog for toggling between visible and invisible trends. You can also define which trend is displayed in the foreground.</p>	16

	<p>"Select time range"</p> <p>This button opens a dialog where you can specify the time range to be displayed in a trend window.</p>	17
	<p>"Previous trend"</p> <p>This button is used to display the previous trend of the trend window in the foreground.</p>	18
	<p>"Next trend"</p> <p>This button is used to display the next trend of the trend window in the foreground.</p>	19
	<p>"Stop"</p> <p>The updated display is stopped. The data is saved to the clipboard and added when the button in the trend window is clicked again.</p>	20
	<p>"Start"</p> <p>Resume updated display.</p>	20
	<p>"Print"</p> <p>Click this button to print the trend shown in the trend window. The print job used for printing is defined in the configuration dialog on the "General" tab.</p>	21
	<p>"Export data"</p> <p>This button is used to export all or the selected runtime data to a "CSV" file. If the option "Display dialog" is active, a dialog will open in which you can view the export settings and start the export. You can select the export file and directory, provided you have the relevant authorizations. The data will be exported immediately to the default file if this dialog is not displayed.</p>	26
	<p>"Ruler"</p> <p>The coordinate points of a trend are queried with this button. The trend data is displayed in the ruler window.</p>	7
	<p>"Define statistics area"</p> <p>This button is used to define the time range for calculating the statistics in the trend window.</p>	22
	<p>"Calculate Statistics"</p> <p>The button shows the statistical values in the statistics window. The displayed values refer to a selected trend with the configured calculation time range. The button is only functional if a statistics window is connected with the OnlineTrendControl.</p>	23
	<p>"Connect backup"</p> <p>This button opens a dialog in which you can connect selected archives to WinCC Runtime.</p>	24
	<p>"Disconnect backup"</p> <p>This button opens a dialog in which you can disconnect selected archives from WinCC Runtime.</p>	25
	<p>"Relative axis"</p> <p>Switches from displaying the absolute values to the percentage display of value axis. The high and low limits for the trend correspond with a range of 0 to 100%.</p>	27
	<p>"User-defined 1"</p> <p>Shows the first key function created by the user. The function of the button is user-defined.</p>	1001

Possible elements of the status bar

The following elements can appear in the status bar of the trend window:



Icon	Name	Description
	Connection status	Shows the status of the data connections: <ul style="list-style-type: none">No faulty connectionsFaulty connectionsAll connections are faulty
	Date	Shows the system date.
	Time	Shows the system time.
	Time base	Shows the time base used in the display of times.

Double-click on the icon for the connection status to open the window "Status of the data connections", which lists the name, status and tag name of the data connection.

Note

Display of values in runtime

Whole numbers are represented as decimal figures, as the interpolation of two values within a time range can produce a number with decimal places.

The values displayed for a time can fluctuate as plotting continues. This is a result of the interpolation of values along the x-axis. To prevent fluctuation of the values, select a larger time range, for example an hour.

Online configuration of the OnlineTrendControl

Introduction

In runtime, you can configure online and change the display of the WinCC OnlineTrendControl. Configuring the OnlineTrendControl defines how to proceed with a picture change or after ending runtime with online configurations.

Overview

The following buttons functions make online configuration possible in OnlineTrendControl:

- With key function "Configuration dialog"
- With key function "Select data connection"
- With key function "Select trends"
- With key function "Select time range"

Key function "Configuration dialog"

Use the key function "Configuration dialog" to access to the configuration dialog tab, e.g. for changing the display of the trend.

The key function "Select data connection"

With key function "Select data connection" you select the archive tags or online tags for the value axes, which you want to show in the trend.

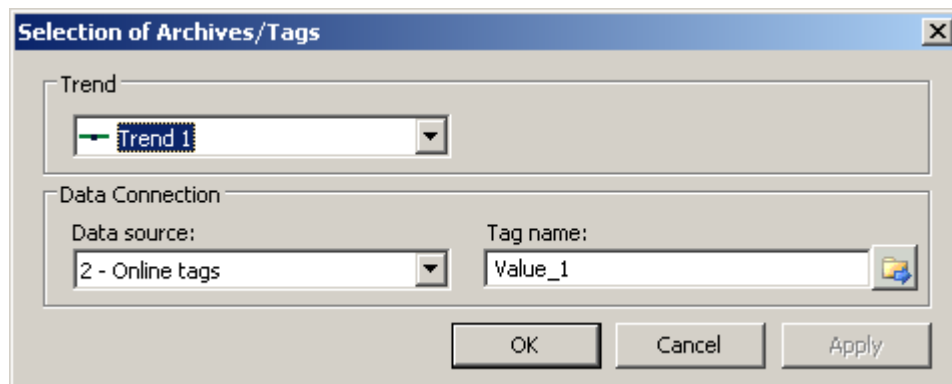

Field	Description
Trends	Choose one of the configured trends.
Data source	Define whether the selected trend is supplied with an archive tag or online tag.
Tag name	Select the tag name for the data connection.

Key function "Select trends"

The key function "Select trends"  opens a dialog in which you show or hide trends. You bring trends to the foreground by changing the order of the trends.

Note

The first trend of a trend window can not be hidden.

Key function "Select time range"

Select the time range to be displayed for the time axes using the key function "Select time range" . If the trends in a trend window are to be displayed with a common time axis, the specified time range applies to all trends.

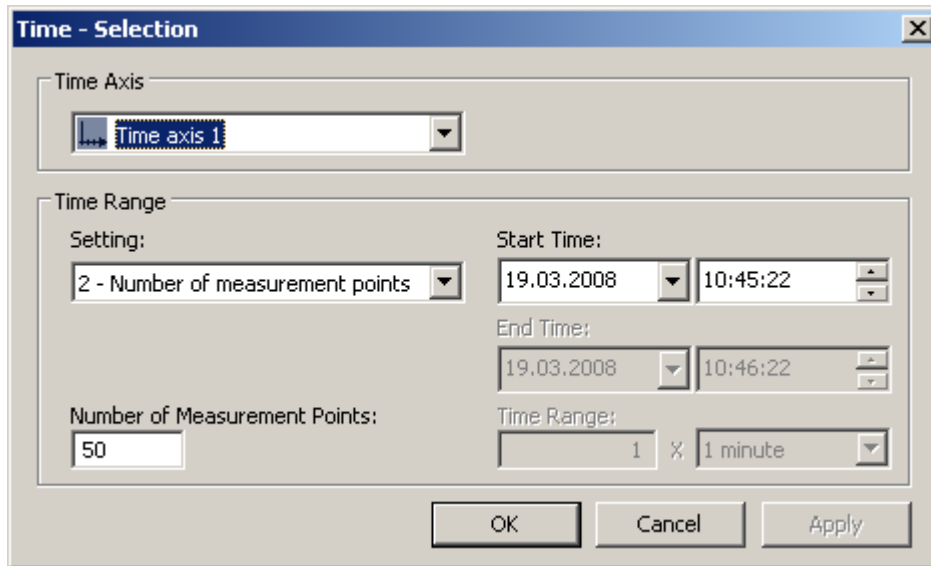

Field	Description
Time axis	Select the configured time axis for which you want to define a time range.
Time range	Specify the time range: <ul style="list-style-type: none"> • If you want to define a fixed time interval, select setting "Start to end time". Enter the date and time for each. • If you want to define a time period, select the setting "Time range". Define the date and time for the start time. The length of the time interval to be displayed is determined by multiplying the "Factor" by the "Time unit". • If you want to display a certain number of values, select the setting "Number of measurement points". Define the date and time for the start time. Enter the required number of measurement points in the input field.



The input format of the date and time depends on the Runtime language used.

Starting and Stopping Update

Introduction

With the "Start/Stop" button function you can start or stop the update of trends and bars in the trend window or diagram window.

The button indicates whether the update is stopped or not:

- : The update is stopped. Click on the button to continue updating.
- : The update is started. Click on the button to stop updating.

How to display the trend in the foreground



Introduction

If more than one trend are to be displayed in a trend window, you can use key functions to define which trends will be displayed in the foreground.

Requirement

- You have configured key functions "Select trends", "Previous trend" and "Next trend".

Procedure

-  is used to open a dialog for displaying or hiding trends. You can also define which trend is in the foreground.
-  is used to display the next trend of the trend window in the foreground.
-  is used to display the previous trend of the trend window in the foreground.

How to Determine the Coordinates of a Point



Introduction

Key function "Ruler" is used for using a ruler to determine the coordinates of a point on the trend. You can zoom in on an area of the trend to make coordinate finding easier. If you right-click on the trend, some of the trend parameters are displayed in the tooltip of the trend window.

Requirement

- You have configured a WinCC OnlineTrendControl. In order to highlight the ruler in the trend window, you can increase the line weight of the ruler on the "Trend window" tab and configure the color.
- You have configured the "Ruler" key function. If you want to zoom in on a section of the trend, configure key functions "Zoom area" and "Original view".
- You have configured a WinCC RulerControl and connected it with the OnlineTrendControl.
- You have selected the ruler window in the RulerControl which shows the coordinates.
- You have activated runtime.

How to display the coordinates

1. In OnlineTrendControl, click on .
2. Move the ruler to the desired position with the mouse.
3. If you want to zoom in on an area, click on . Move the ruler to the desired position with the mouse.
4. If you want to return to the original view, click on .

Result

A ruler appears in the trend window. In the ruler window, besides the X value/time stamp and the Y value, the data that you have configured in WinCC RulerControl is shown in the columns. For example, you can have the area name displayed that you have specified for the value range of the Y value in the OnlineTrendControl.

The displayed values can be assigned an additional attribute in the form of a letter:

- Letter "i." : The displayed value is an interpolated value.
- Letter "u." : The displayed value has an uncertain status. The value is not certain if the initial value is not known after runtime has been activated, or when a substitute value is used.

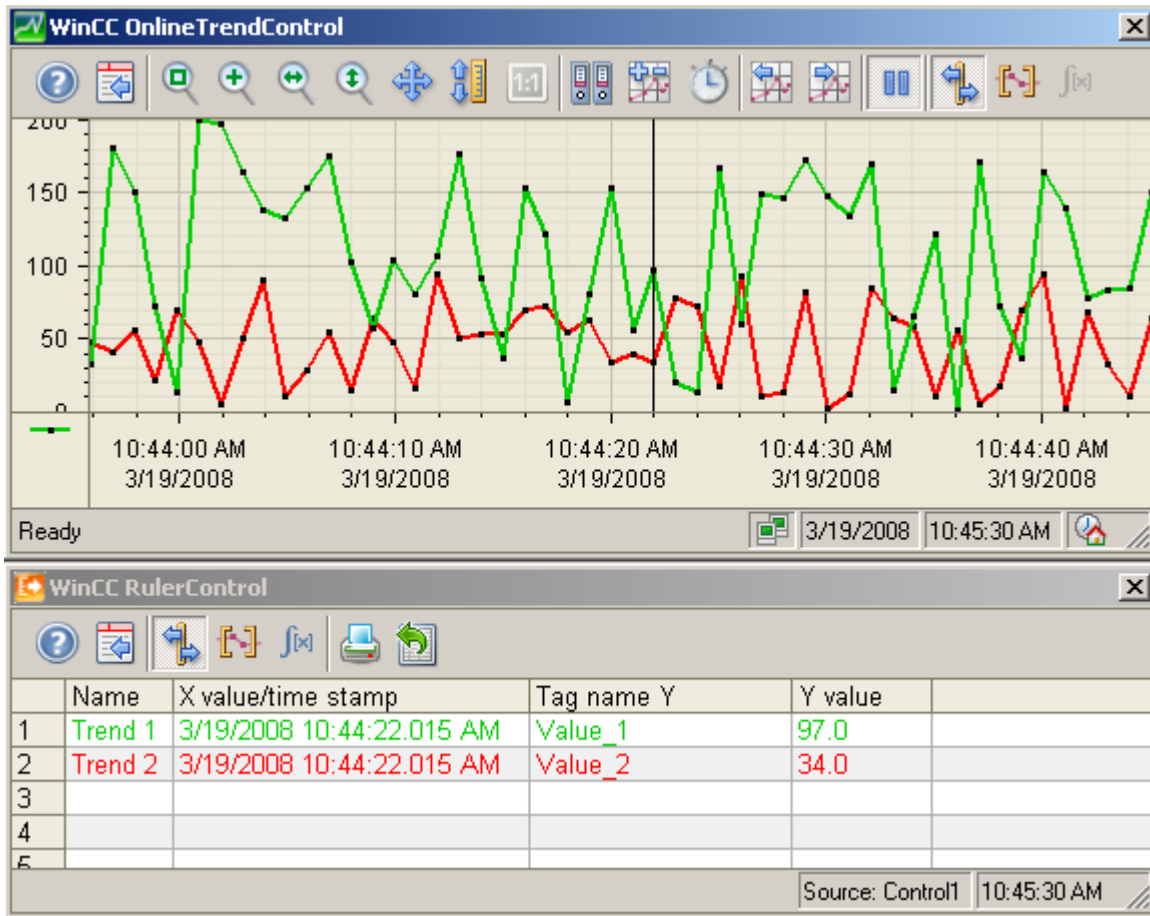

Other values can be determined by positioning the mouse pointer on the ruler and moving it to the desired position while holding the left mouse button pressed.

Note

The "uncertain" status of a value can also be indicated in the displayed trend characteristic. You must activate the "Value with uncertain status" option on the "Trends" tab under "Limit values".

How to use the zoom functions in trend windows

Introduction

Key functions can be used for zooming in on, zooming out of and returning to the original view for trends, axes and various zoom areas of the trend window.

Overview



The following zoom functions are available in the trend window:

- "Zoom area"
- "Original view"
- "Zoom +/-"
- "Zoom time axis +/-"
- "Zoom value axis +/-"
- "Move trend area"

Requirement



- You have configured a WinCC OnlineTrendControl.
- You have configured the buttons for the required zoom functions for the toolbar.
- You have activated runtime.

How to zoom in on a segment of a trend window

1. Click on . The updated display is stopped.
2. In the trend window, click one corner of the area that you wish to enlarge.
3. Hold down your left mouse button and drag the area you want to enlarge until it reaches the desired size. If the highlighted area contains at least two measured values, the selected trend area is displayed in the trend window.
4. Release the left mouse button. The selected segment is magnified. If you want to increase the size further, repeat the process.
5. Click on . The trend window is shown in the originally configured view again.
6. Click on  to restart the update. The values that have been defined earlier are used for the X axis and the Y axis.

How to zoom in and zoom out of the trends





1. Click on . The updated display is stopped.
2. Click in the trend window with the left mouse button to zoom in on the trends in the trend window. If you want to increase the size further, repeat the process.

3. If you want to zoom out of the trends, press the "Shift" button while clicking with the left mouse button.
4. While zooming in or zooming out with trends, the 50% value of the trends is always in the middle of the value axes.
5. Click on . The trend window is shown in the original view again.
6. Click on  to restart the update. The values that have been defined earlier are used for the X axis and the Y axis.



Note

If you change the value area of a value axis on the "Value Axis" tab in the configuration dialog while zooming, the visible zoom area is set to the new value area.

How to zoom with time axes and value axes

1. Click on  to zoom in on time axes or on  to zoom in on value axes. The updated display is stopped.
2. Click in the trend window with the left mouse button to zoom in on the time axes or value axes. If you want to increase the size further, repeat the process.
3. If you want to zoom out of the time axes or value axes, press the "Shift" button while clicking with the left mouse button.
4. While zooming with axes, the 50% value of the trend is always in the middle of the axes.
5. Click on . The trend window is shown in the original view again.
6. Click on  to restart the update. The values that have been defined earlier are used for the X axis and the Y axis.

How to move the trend area

1. Click on . The updated display is stopped.
2. While holding the left mouse button down, move the cursor in the desired direction in the trend window. The displayed area in the trend window is adapted on the time axis and on the value axis.
3. If you click on  again, the trend window is displayed in the original view again.

How to Generate Statistics of Runtime Data

Introduction

You can generate an evaluation of runtime process data in the trend window. The evaluated data is shown in the WinCC RulerControl.

Overview

Depending on the data evaluation, there are three different types of windows for displaying values. The following window types are available:



- The ruler window shows the coordinates of a trend on the ruler.
- The statistics area window shows the values of the lower limit and upper limit of the trends.
- The statistics window shows the statistical evaluation of the trends. Among other things, the statistics include:
 - Minimum
 - Maximum
 - Average
 - Standard deviation
 - Weighted average value: The time span for which a recorded value has the same value is included in the calculation of the weighted average value.
 - Integral: Calculates the area between each trend and the zero line.

All windows can also show additional information on the values of the connected trends.

Requirement

- You have configured a WinCC OnlineTrendControl. In order to highlight the ruler defining the statistics area, you can increase the line weight of the ruler on the "Trend window" tab and configure the color.
- You have configured a WinCC RulerControl and connected it with the OnlineTrendControl.
- You have selected the window in the RulerControl which shows the desired data.
- You have configured key functions "Set statistics range", "Calculate statistics" and "Start/Stop". If a display of the values in a ruler window is sufficient, you do not need key functions "Select statistics area" and "Calculate statistics".
- You require key function "Select time range", if you wish to choose a statistics area outside of the time range displayed in the trend window.
- You require key function "Configuration dialog" if you want to switch between the statistics windows and the ruler window.
- You have activated runtime.

How to display the data in a statistics area window

1. Click on  in OnlineTrendControl if the updated display is to be stopped.
2. Click on . The updated display is stopped, process data continue to be archived. Two vertical lines are displayed at the left and right edge of the trend window.
3. Move the ruler until the desired area is selected.

6.5 Output of Process Values

- The evaluated data is displayed in the columns that you have configured in the statistics area window.

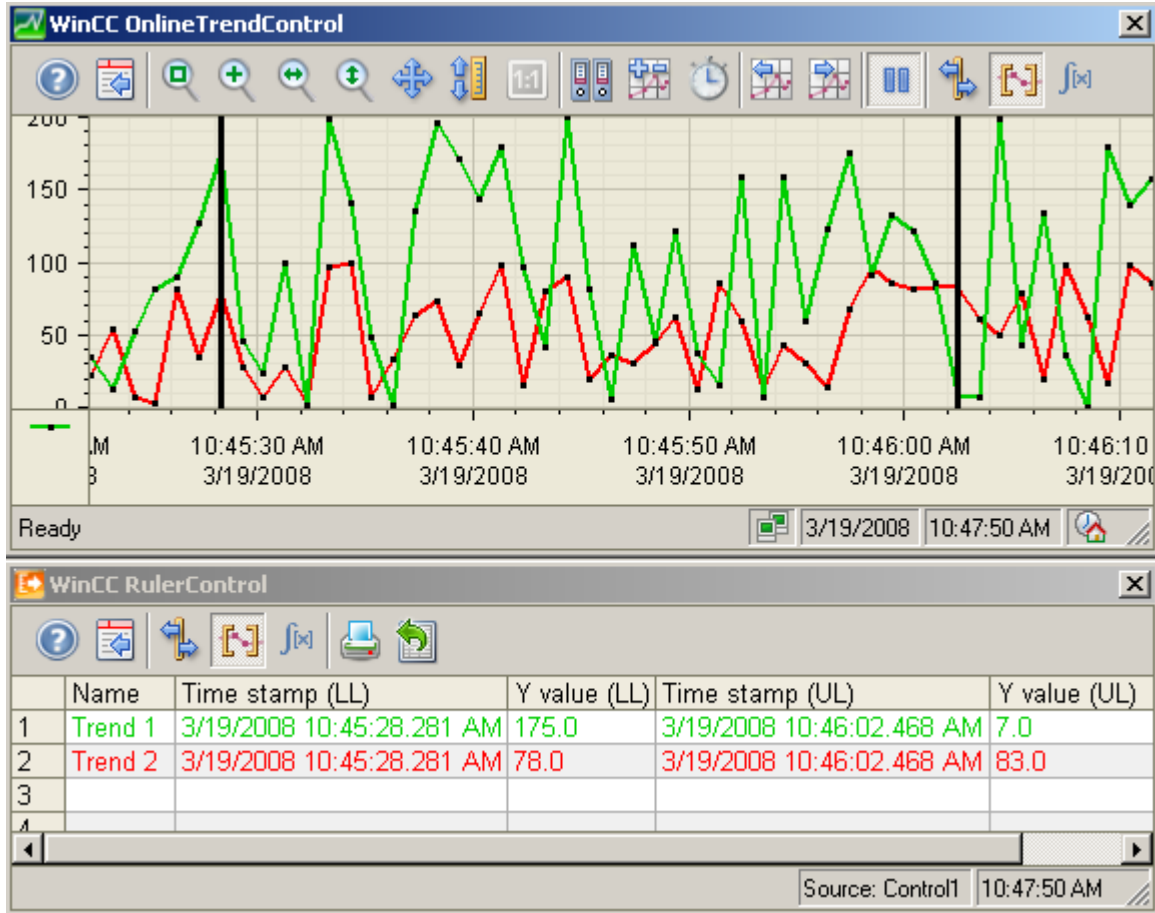



- If you want an evaluation of data that is not displayed in OnlineTrendControl, click on . Enter the desired time range for the selected time axis in the "Time selection" dialog. The data for the defined time range is displayed. You can now evaluate this data.
- To continue with the display in OnlineTrendControl, click on .

How to display the data in a statistics window

- In OnlineTrendControl, click on . The updated display will be stopped but the process data will continue to be archived.
- Click on . The updated display is stopped, process data continue to be archived. Two vertical lines are displayed at the left and right edge of the trend window.
- Move the ruler until the desired area is selected.

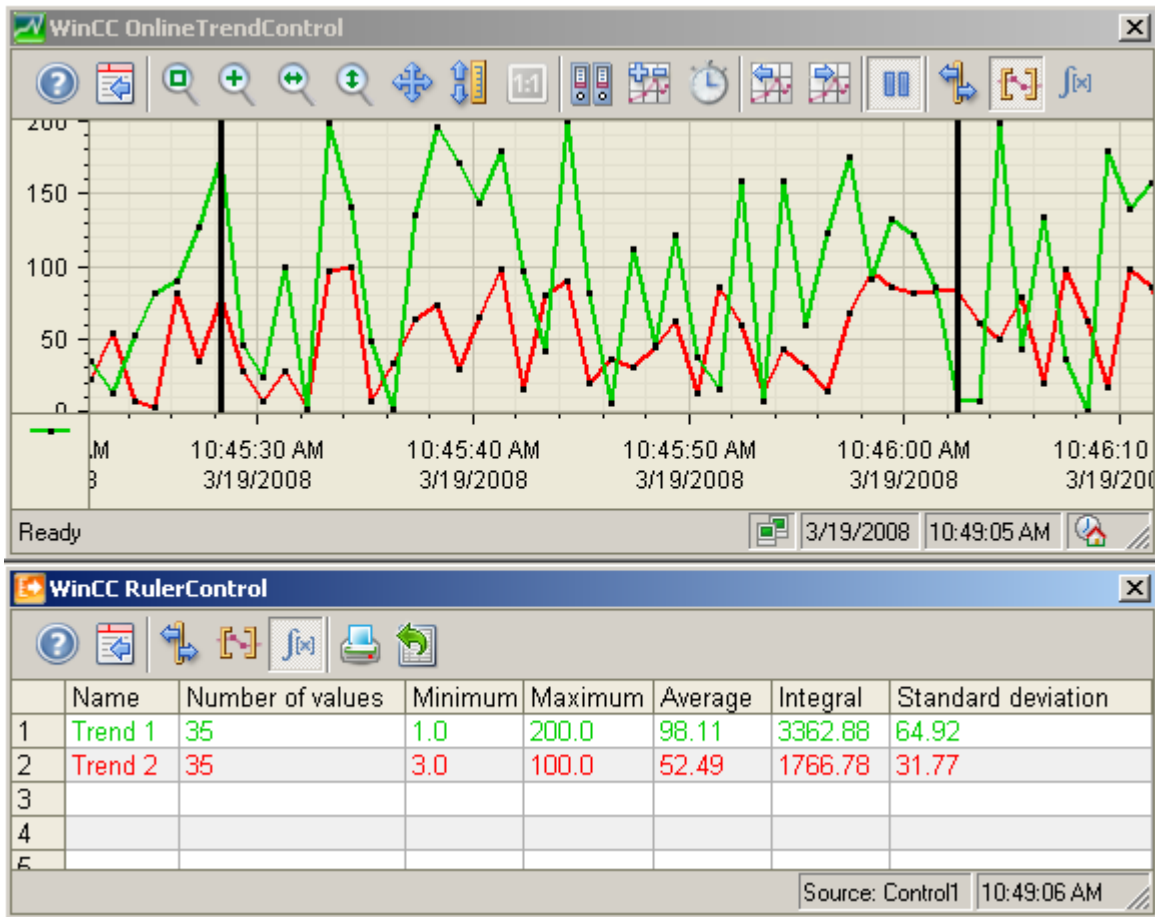
4. Click on . The evaluated data is displayed in the columns that you have configured in the statistics window.



5. If you want an evaluation of data that is not displayed in OnlineTrendControl, click on . Enter the desired time range for the selected time axis in the "Time selection" dialog. The data for the defined time range will be displayed. You can now evaluate this data.
6. To continue with the display in OnlineTrendControl, click on .

Note

The displayed values can be assigned an additional attribute in the form of a letter:

- Letter "i." : The displayed value is an interpolated value.
- Letter "u." : The displayed value has an uncertain status. The value is not certain if the initial value is not known after runtime has been activated, or when a substitute value is used.

Note

For additional statistical analysis of process data and archiving of results you must write the scripts yourself.

How to display archived values

Introduction





You can browse within an archive using the buttons in the toolbar or the corresponding shortcut keys.

The archived values of a tag within a time interval are displayed in the control. The time interval is defined by entering a time range or by entering a start and end time.

Requirement

- The buttons for browsing in archive are available only if data is supplied through archive tags.
- You have defined a time range or a start and end time.

Buttons for Archived Values

	The history of a tag within the defined time is displayed starting with the first archived value.
	The history of a tag within the previous time interval is displayed starting from the currently displayed time interval.
	The history of a tag within the next time interval is displayed starting from the currently displayed time interval.
	The history of a tag within the defined time is displayed ending with the last archived value.

Example project for OnlineTrendControl

Example configuration of an OnlineTrendControl

Introduction

The following example shows the configuration of a WinCC OnlineTrendControl with two trends and the display in runtime. With key function "Configuration dialog" in runtime, you can change the display of the trends at any time and view the effects immediately.

Configuration steps

1. Insert the OnlineTrendControl into a picture of the Graphics Designer.
2. Configure the OnlineTrendControl properties.
3. Create a trend window.

4. Configure a time axis with the respective properties. Assign the time axes to the trend window.
5. Configure two value axis with the respective properties. Assign the value axes to the trend window.
6. Define two trends and assign the trends to the trend windows. Assign the trends with the time axis and the value axes.
7. Connect the two trends with an online tag for each.
8. Configure the display for each trend.
9. Save the picture with the OnlineTrendControl in the Graphics Designer.
10. Define the picture as a start picture with the example project.
11. Start runtime.
12. Start the tag simulator to supply the trends with data.
13. Deactivate runtime if you want to end the example project.

How to configure the trend window

Introduction

The example has a trend window embedded in a WinCC OnlineTrendControl. This chapter shows the configuration of the properties of the control and the trend window.

Requirement

- You have opened a picture in the Graphics Designer.

Procedure

1. Insert a WinCC OnlineTrendControl into the picture from the object palette in the Graphics Designer. Use the mouse to drag the control to the desired size.
2. Double-click in the control. The configuration dialog opens.

3. Go to the "General" tab.

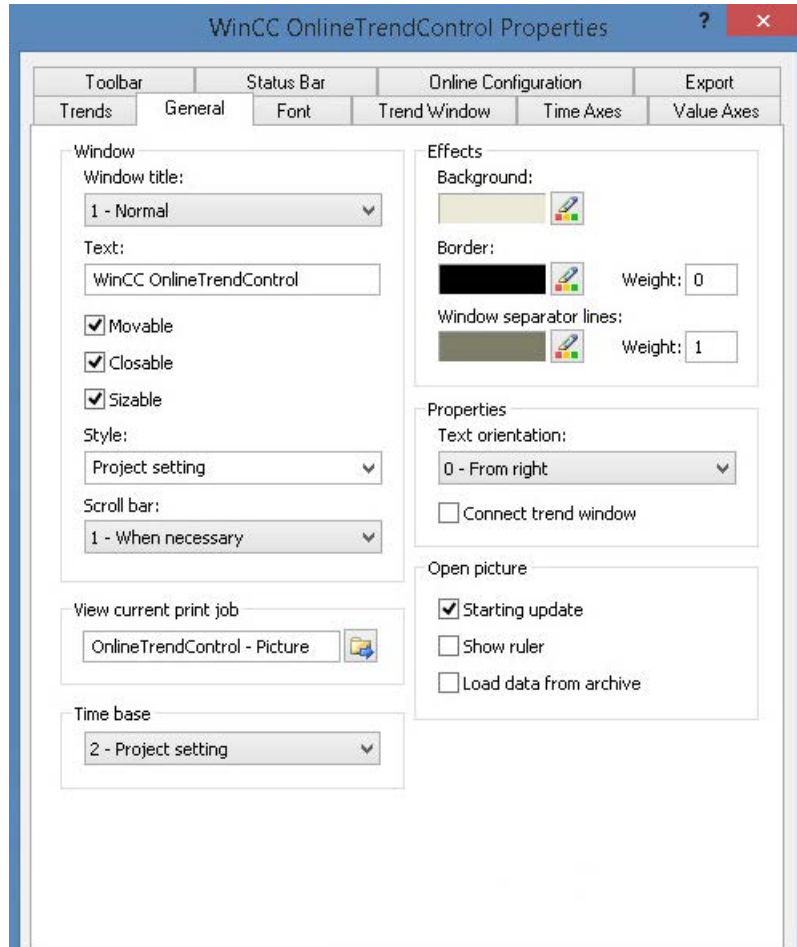

4. Select the "Normal" window heading. Activate the "Moveable", "Can Be Closed" and "Sizeable" options. "From the right" is defined as the writer orientation and updating will start when the picture is opened.
5. Save the configuration.
6. Go to the "Trend windows" tab. Define a trend window with the "New" button. The gridlines are displayed during runtime.
7. Configure the display of the ruler. If you use "Graphic" for the display of the ruler, you can configure the color and the line weight of the ruler.
8. Save the configuration.
9. Go to the "Toolbar" tab. You require the following key functions to test the example:
 - Configuration Dialog
 - All key functions for zooming and moving
 - Original view
 - Ruler
10. Save the configuration.

How to configure the axes of the OnlineTrendControl

Introduction

The trend window of the example has a time axis and two value axes. The last 50 values of the trend in relation to the current time are shown in the trend window.

Requirement

- You have defined a trend window.

Procedure

1. Go to the "Time axes" tab. Define a time axis with the "New" button.

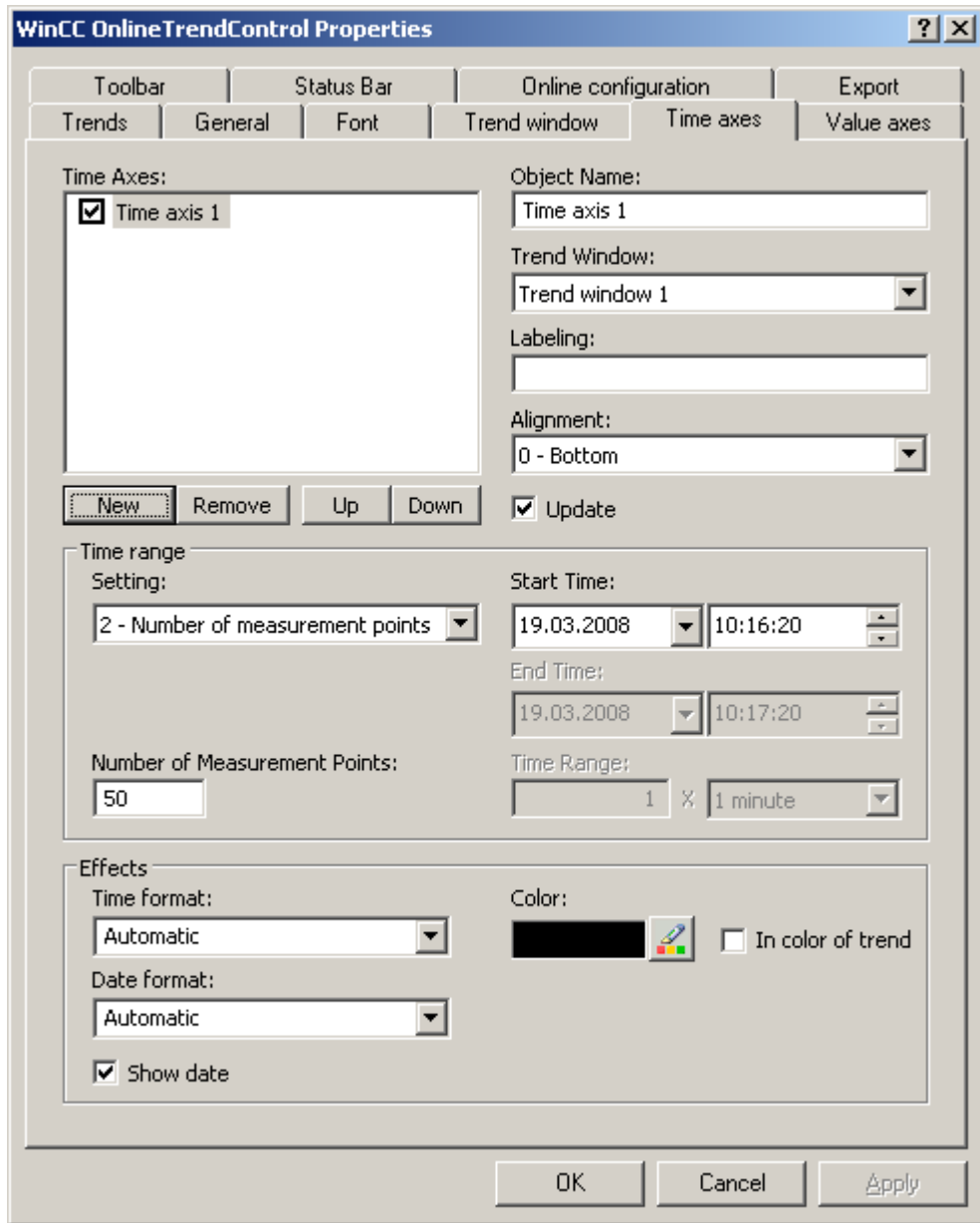

2. Assign the time axis to the configured trend window. Select "Bottom" for the alignment of the time axis.
3. Activate the "Update" option to display the values in relation to the current time.
4. Select setting "Number of measurement points" in the "Time range" area. You do not have to define the start time because the last 50 values in relation to the current time will be displayed in the example. Enter "50" for the number of measurement points in the input field.
5. Configure the desired format for time and date.

6. Save the configuration.
7. Go to the "Value axes" tab. Define two value axes with the "New" button.

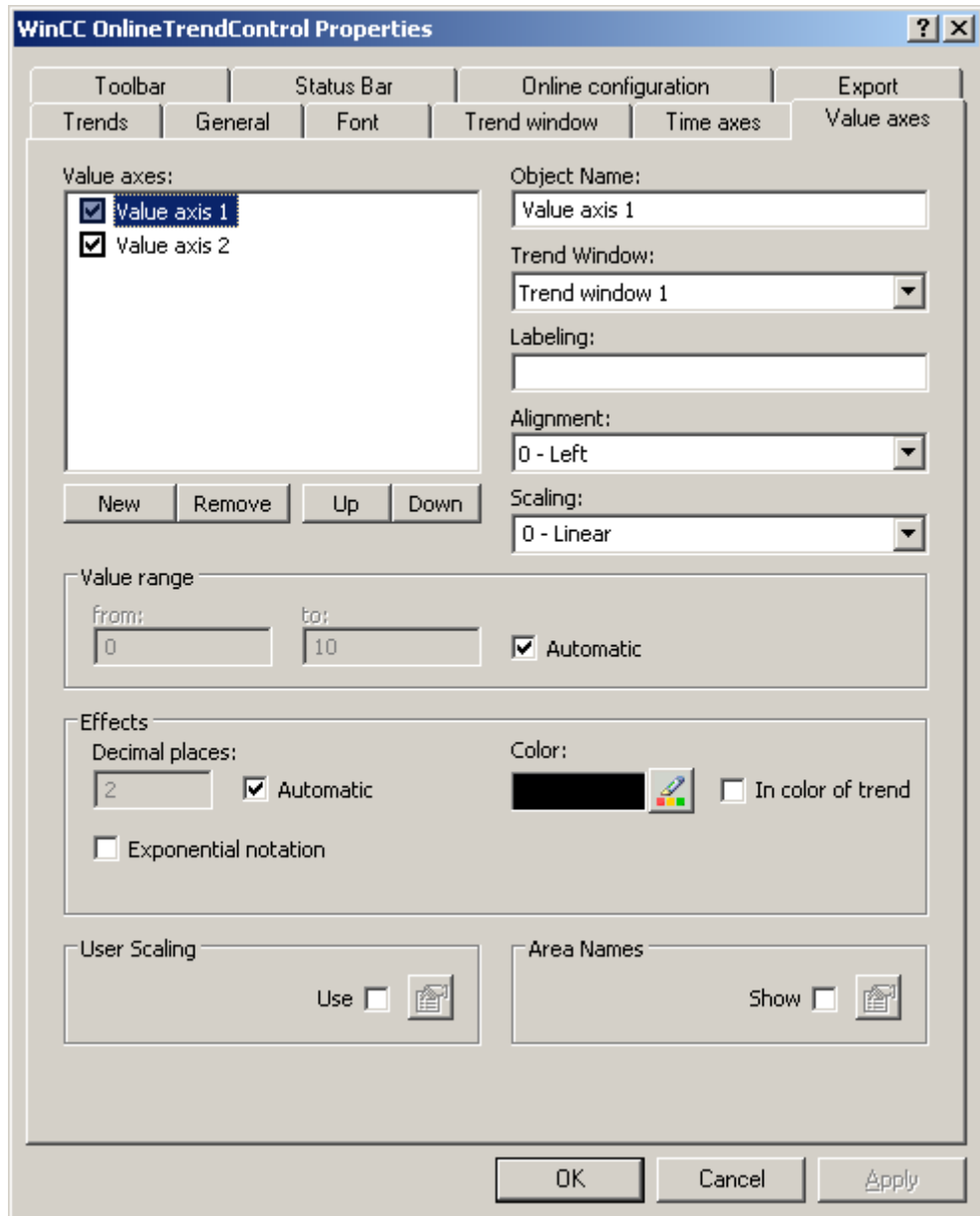

8. Assign the value axes to the configured trend window.
9. Configure the alignment for each value axis. The first value axis should be left-justified, the second right-justified.
10. Select "Linear" for the scaling.
11. The option "Automatic" is activated for both value axes in the "Value range" area. The value range for the value axes is based on the tag values.
12. Save the configuration.

How to configure the trends

Introduction

The trend window in the example shows two trends with a common time axis. Each trend has its own value axis. The trends receive their data from online tags. The customer display can be configured individually.

Requirement

- You have defined a trend window.
- You have configured a time axis and two value axes.
- You have created two non-binary tags in tag management.

Procedure

1. Go to the "Trends" tab. Define two trends with the "New" button.

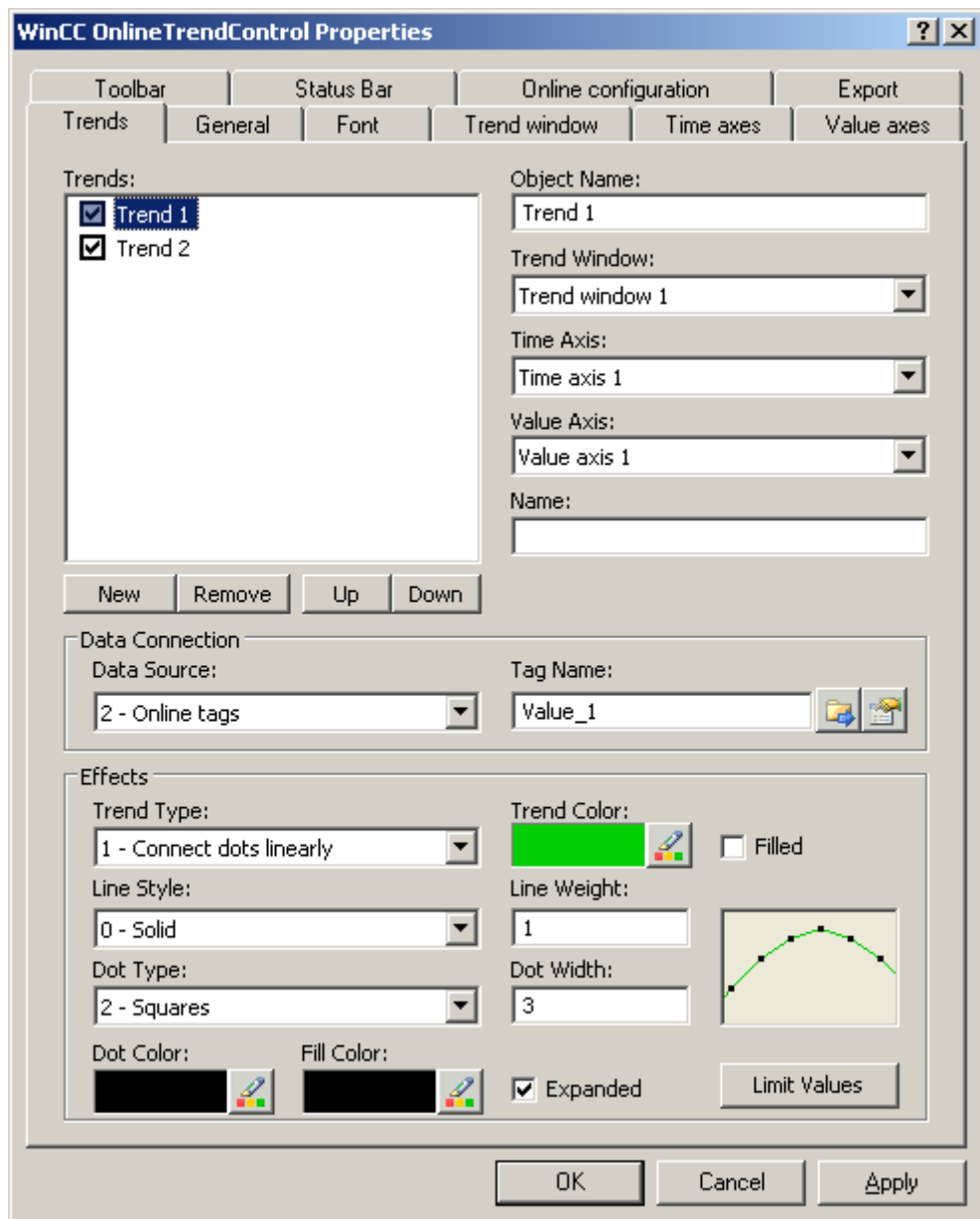

2. Assign each trend with the configured trend window and the time axes. Trend1 is assigned with ValueAxis1 and Trend2 with ValueAxis2.
3. Define the data connection for each trend. Select "Online tags".
4. Click on , to select the tags for the trends.
5. Configure the display for each trend as desired. More information on configuration can be found on page How to configure the display of trends (Page 1621).
6. Save the configuration.

See also

How to configure the display of trends (Page 1621)

How to start the example on OnlineTrendControl

Introduction

In order to test the example of the OnlineTrendControl in runtime, you must made many settings in the project.

Requirement

- You have saved the configured picture in the Graphics Designer.
- You have defined the picture in the WinCC Explorer as the start picture via the shortcut menu.

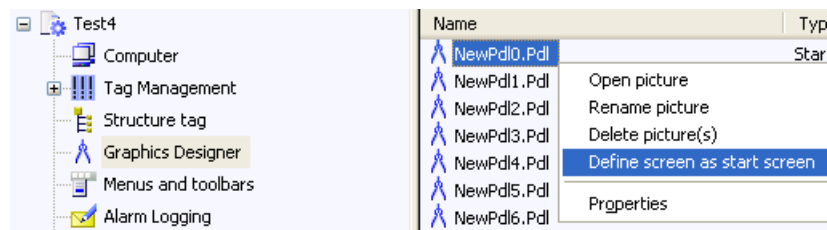

- You have checked for whether "Graphics Runtime" and "Tag Logging Runtime" are activated in the "Computer properties" dialog.

Procedure

1. Activate runtime by clicking the relevant button in the toolbar or selecting the relevant menu bar.
2. Start the tag simulator to test the WinCC OnlineTrendControl with the tags.
3. Go to "Start/SIMATIC/WinCC/Tools" on your computer.
4. Select the "WinCC Tag Simulator". The simulation program will open.
5. Define two tags that you have connected in OnlineTrendControl.
6. Assign the tag with property "Random" and click on the "Active" option.
7. Save the settings in each case.
8. Click the "Start Simulation" button. The simulation is started and the trend supplied with data.
9. Deactivate runtime if you want to end the example project.

Result

The trends are displayed in runtime with the values that create the tag simulator.

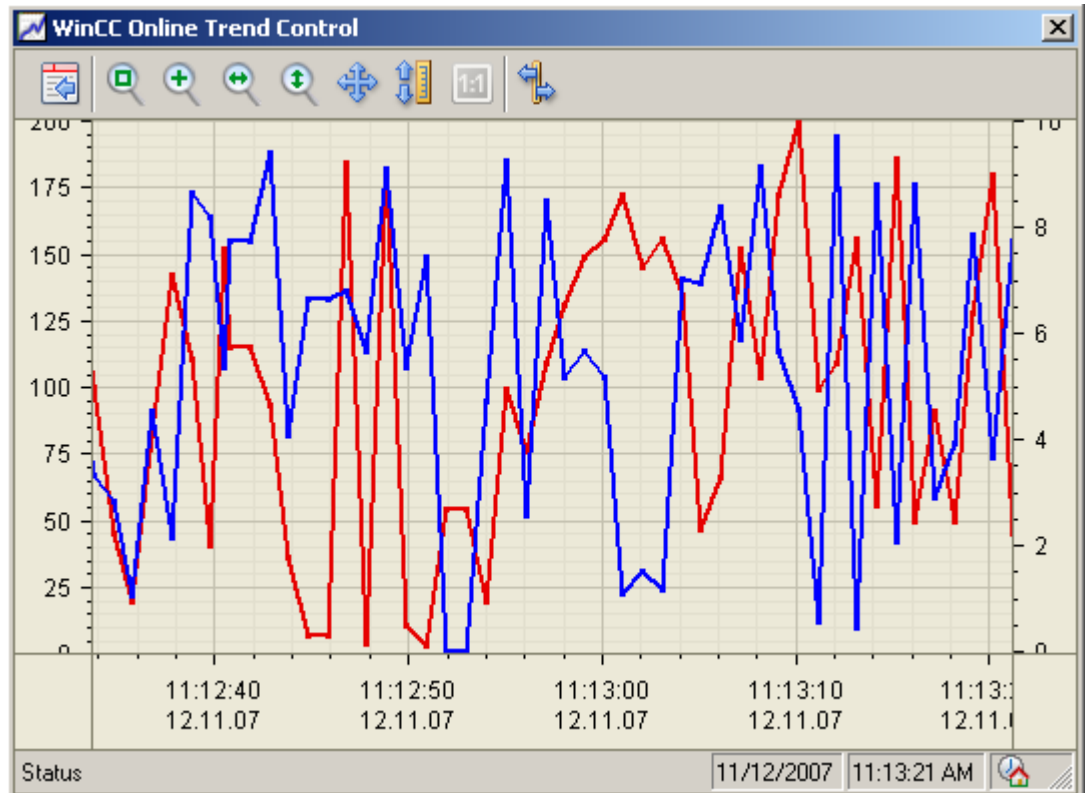

The  button takes you to the configuration dialog, where you can change the display of the trends as required on the "Trends" tab. You will immediately see the results of your configuration.

Test all functions for zooming and move the trend or the axes. More information is found under How to use the zoom functions in trend windows (Page 1647) .

More information on operating the OnlineTrendControl in runtime is found under Operating the OnlineTrendControl in runtime (Page 1639) .

You can expand the OnlineTrendControl with a ruler window for example. More information can be found under How to Generate Statistics of Runtime Data (Page 1648) and How to configure the Ruler window/Statistics window/Statistics area window (Page 1628) .

6.5.2.4 Displaying process values in bar form in process pictures

WinCC BarChartControl

Overview

For graphical processing of archive data, WinCC provides the option of displaying process values in bar diagrams with WinCC BarChartControl.

You can have one or more diagram windows displayed in one WinCC BarChartControl. Each diagram window can display multiple diagrams.

The display of the diagrams in the control is user-configurable.

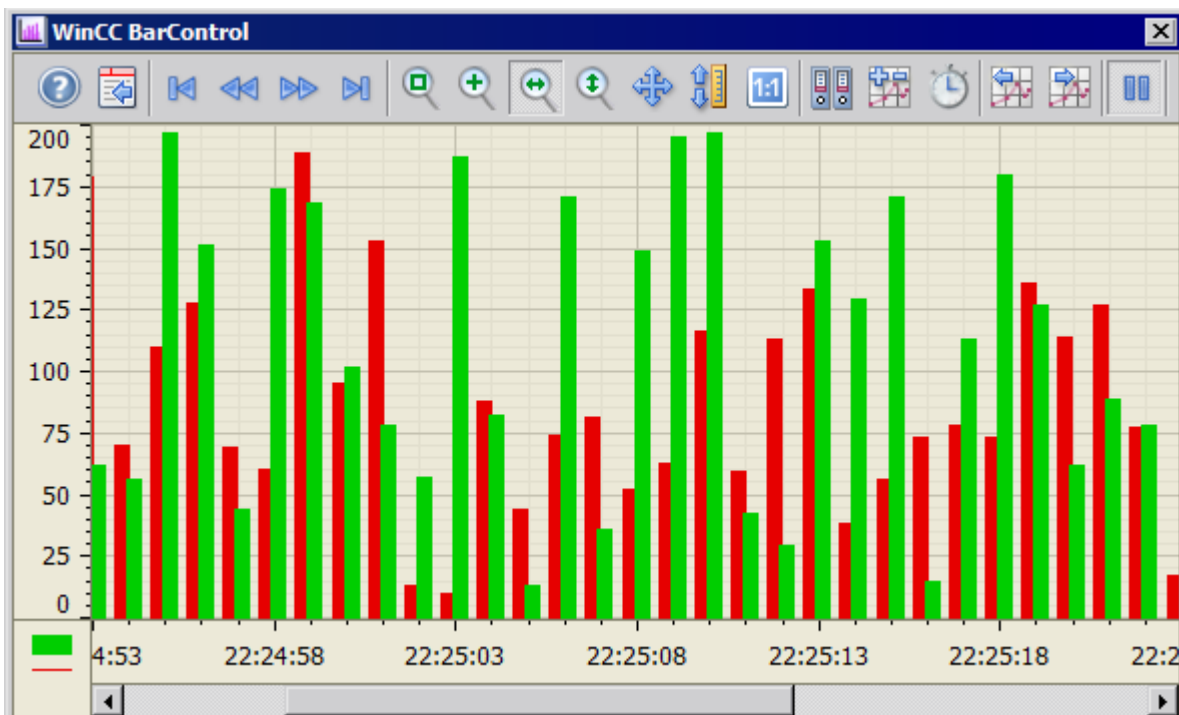

Diagram types:

Two diagram types are available:

- Bar diagram: Only the bars are displayed
- Bars with value display: The values for the bars are displayed as text. A unit can also be displayed.

Write direction

Using the write direction, you can specify where the values for all diagram windows are entered. Normally, the values are written in the diagram window from the right. All four write directions can be configured. You configure the write direction on the "General" tab of the BarChartControl.

Displaying the axes

When more than one diagram is displayed in a diagram window, you can assign every diagram with its own axes or use a common time axis and/or value axis for all diagrams.

- If the values to be displayed in a diagram window differ greatly, a common value axis is not appropriate. The values can be read off easily when different axial scales are used. Individual axes can be hidden if required.
- If the comparability of the diagrams is important, the use of common axes in one diagram window is appropriate. Connected diagram windows can have a common time axis.

Display of bars when using acyclic archive tags

In Runtime, the width of the bars can change dynamically depending on the time difference of the displayed archived values. The maximum possible width of the bars is calculated based on the time difference of all archived values in the displayed time range. The smallest time difference is used to calculate the bar width so that the bars do not overlap.

When you enlarge the bars, the width of the bars changes depending on the number of bars in the displayed time range. When you enlarge only one bar, the bar is displayed in the size "1".

See also

WinCC BarChartControl (Page 772)

Configuring the BarChartControl

How to configure the BarChartControl

Introduction

The bar diagram is displayed in an ActiveX Control in runtime. You configure a WinCC BarChartControl in Graphics Designer for this.

Configuring steps

1. Insert the BarChartControl into a picture of Graphic Designer.
2. Configure the basic properties of the BarChartControl on the "General" tab.
 - the window properties of the control
 - the display of the control
 - the print job of the control
 - the time base of the control
3. Create one or more diagram windows.
4. Configure one or more time axes and value axes with their respective properties. Assign the axes to the diagram windows.
5. Create the bar diagrams that you want to display in the diagram windows. Assign the bar diagrams to the diagram windows. The value axis of a bar diagram can only be the value axis of the assigned diagram window. Assign one or more time axes to the bar diagrams.
6. Every configured bar diagram must be connected to an archive tag. Define the data connection for each bar diagram.
7. Configure the display for each bar diagram.
8. Configure the toolbar and status bar of the diagram window.
9. Save your configuration data.

See also

[How to create a diagram window in the BarChartControl \(Page 1664\)](#)

[How to configure the time axes of diagram windows \(Page 1666\)](#)

[How to configure the value axes of diagram windows \(Page 1668\)](#)

[How to create a bar diagram \(Page 1670\)](#)

[How to configure the display of the bar diagram \(Page 1671\)](#)

How to create a diagram window in the BarChartControl

Introduction

The WinCC BarChartControl can contain one or more diagram windows. The diagram window provides an area to display the bar diagrams in.

Overview of the diagram window

The diagram window has the following properties:

- Every diagram window is assigned at least one bar diagram, which has one time axis and one value axis.
- The value axis of the bar diagram determines which diagram window the bar diagram is displayed in.
- A bar diagram can only be assigned to one diagram window.
- Several bar diagrams can be displayed in one diagram window.
- A diagram window can display value axes, independent of the displayed bar diagrams. Value axes and time axes can be hidden in runtime.
- The order of the configured diagram windows determines the position in the BarControl. The first diagram window in the list of diagram windows is displayed at the bottommost position, the last diagram window is displayed at the topmost position.
- If more than one diagram window is configured, the diagram windows can be connected. The connected diagram windows have the following properties:
 - They can have a common time axis.
 - They have a scroll bar.
 - The zoom functions for a diagram window affect the connected diagram windows.
- The distance between the bars and overlapping of the bars can be different for each diagram window. For bar diagrams that are connected to acyclic tag archives, the distance and the overlap are not displayed in proportion.

Procedure

1. Create one or more diagram windows with the "New" button on the "Diagram window" tab.
2. If you have created more than one diagram window, more configurations are possible:
 - Assign a portion of the area in the displayed BarChartControl to each diagram window.
 - Define the position of the diagram windows with the "Up" and "Down" buttons.
 - Specify whether the diagram windows will be connected on the "General" tab.
3. If you want to hide a diagram window in runtime, clear the check box in front of the name of the diagram window in the list. The respective axes are then hidden as well.
4. Use the "Gap width" property to specify the distance between two bars of a bar diagram in % of the bar width.
5. Use the "Overlap" property to specify the overlapping of various bars of a time instant in % of the bar width.
6. Configure the grid lines for every diagram window.
7. Save the configuration.

See also

How to create a bar diagram (Page 1670)

How to configure the time axes of diagram windows (Page 1666)

How to configure the value axes of diagram windows (Page 1668)

How to configure the time axes of diagram windows

Introduction

You configure the time range for bar diagrams using time axes. You can assign multiple time axes to one or more diagram windows. Connected diagram windows can have a common time axis.

Time range of the bar diagram

A basic distinction must be made between two time references of the bar diagram:

- **Static display.** The time range of the bar diagram is determined by a fixed preset time interval, independent of the current system time.

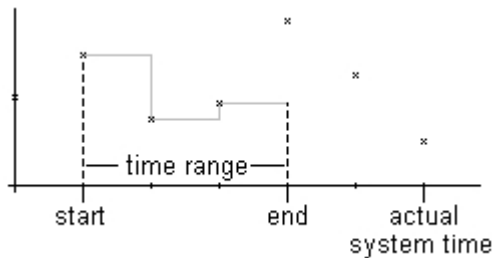

- **Dynamic display.** The time range of the bar diagram is determined retrospectively from the most current archived values. The display is continuously updated. The configured time range follows the current system time.

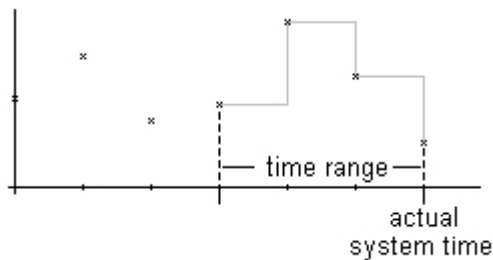

You have three options for defining the time range of a time axis for each of the two time references:

- The bars are displayed within a defined time interval. You define a start time and an end time. In a dynamic display, the end time corresponds to the current system time. The time between the start time and end time is then the time range for the display of the bars.
- The bars are displayed from a start time over a defined time period, e.g. 30 minutes from the start time. In the dynamic display, the defined time period up to the current system time is used, e.g. 30 minutes up to the current system time.
- Starting from a start time, a defined number of values is displayed, e.g. 100 values from the start time. With the dynamic display, the last values up to the current system time are displayed.

Requirements

- You have opened a picture with the BarChartControl in Graphics Designer.
- You have created one or more diagram windows.

Procedure

1. Define one or more time axes with the "New" button on the "Time axes" tab.
2. Define the positioning of the configured time axes for a diagram window. The order in the list of time axes determines the positioning in the diagram window. If several time axes are positioned on the same side of a diagram window, the first time axis in the list assumes the position in the bottom left and the last time axis in the list then assumes the position at the top right.
3. Assign the time axes to the configured diagram windows.
4. If you want to hide a time axis in the diagram window, click the check box in front of the name of the time axis in the list. You can display the axes again in runtime using button functions.
5. Configure the properties and the formats for time and date for every time axis.
6. If the bar diagrams in the diagram window assigned to the time axis will be continuously updated, activate the "Update" option. If you e.g. want to compare a current bar diagram with an earlier bar diagram, deactivate the "Update" option for the time axis of the comparison trend.

7. Configure the time range for every time axis:
 - If you want to define a fixed time interval, select the "Start to end time" setting. Enter the date and time for each.
 - If you want to define a time period, select the "Time range" setting. Define the date and time for the start time. The time period is the result of a multiplication of the "Factor" and "Time unit", e.g. 30 times "1 minute" for a time range of 30 minutes. Enter the factor and the time unit in the "Time range" field.
 - If you want to display a certain number of values, select the "Number of measurement points" setting. Define the date and time for the start time. Enter the required number of measurement points in the input field.
8. Save the configuration.

Note

When a diagram window is opened in runtime, the values to be displayed are either read from the archive or are set to zero. You specify this behavior using the "Load archive data" option on the "General" tab.

Display of the time axis

- Use only tags with the same update cycle for multiple diagrams with a common time axis. If you want to display multiple diagrams in a shared time axis that are supplied by tags with different archiving cycles, the subdivision of the time axis conforms to the selected diagram with the minimum archiving cycle. Since the diagrams are updated at different times due to the different archiving cycles, a slightly different end time results for the time axis at each change. As a result, the displayed diagrams jump back and forth slightly at each change.
- The configured time range of the time axis must be greater than or equal to the archiving cycle of the selected archive tags. This ensures the correct display of the time axis.
- The width of the bars changes depending on the time range of the time axis. The width of the bars becomes smaller the longer the time range configured on the time axis.

See also

How to create a bar diagram (Page 1670)

How to create a diagram window in the BarChartControl (Page 1664)

How to configure the value axes of diagram windows

Introduction

You can configure several value axes that you assign to one or more diagram windows. Configure the value range and the scaling for every value axis.

If you have created a value axis, the value range and the scaling are pre-configured as follows:

- The value range conforms automatically to the currently displayed values of the assigned bar diagram. The value range always starts with "0".
- The value axis scale conforms linearly to the value range.

Requirements

- You have opened the picture with the BarChartControl in Graphics Designer.
- You have created a diagram window.

Procedure

1. Define one or more value axes with the "New" button on the "Value axes" tab.
2. Assign the value axes to the configured diagram windows.
3. If you want to hide a value axis in the diagram window, click the check box in front of the name of the value axis in the list. You can display the value axes again in runtime using button functions.
4. Configure the alignment and the scaling for every value axis.
5. Configure the display of the value axis in diagram window.
6. Deactivate the "Automatic" option in "Value range" if you want to define a fixed value range for the value axis.
7. Enter the minimum value and maximum value of the value range in the "from:" and "to:" input fields.
8. If you want to define the scaling of the value axis yourself, activate the "Use" option in the "User scaling" field. Click on  to open the "User scaling" dialog.

- 9. Click "Add" to define an area. You must define segments without gaps for the entire configured value range and assign areas on the value axis. If you have defined a value range of "0 - 100000" you can divide this value range e.g. into three segments that are displayed on the value axis as follows:

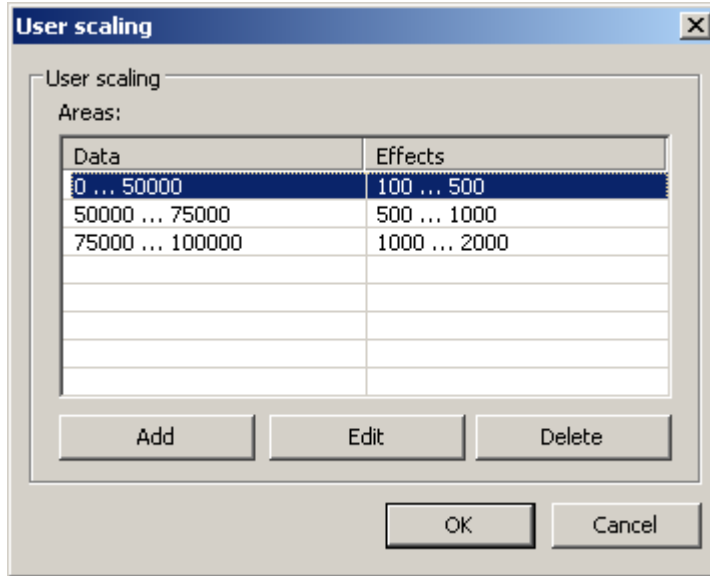

E. g. value range "0 - 50000" is displayed in runtime on the value axis in the "100 - 500" area.

- 10. Save the configuration for the value axis.

See also

How to create a bar diagram (Page 1670)

How to create a diagram window in the BarChartControl (Page 1664)

How to create a bar diagram

Introduction

Every bar diagram is assigned a time axis and a value axis. The value axis assigned to the bar diagram determines the diagram window in which the bars will be displayed.

Requirements

- You have inserted the WinCC BarChartControl into a picture of Graphics Designer.
- You have configured time axes, value axes and diagram windows.
- You have configured a process value archive with archive tags.

Procedure

1. Go to the "Diagrams" tab.
2. Use the "New" button to create the desired number of bar diagrams.
3. Define the order of the bar diagrams in the diagram window using the "Up" and "Down" keys.
4. Assign each bar diagram a diagram window, time axis, and value axis.
5. Define the data source with an archive tag of a process value archive for each bar diagram.
6. Click on  to select the tag for the bar diagram.
7. Configure the display for each bar diagram. More information can be found on page "How to configure the display of the bar diagram".
8. Save the configuration.

See also

How to create a diagram window in the BarChartControl (Page 1664)

How to configure the time axes of diagram windows (Page 1666)

How to configure the value axes of diagram windows (Page 1668)

How to configure the display of the bar diagram (Page 1671)

How to configure the display of the bar diagram

Overview

The following features of the bars can be configured in a BarChartControl:

- Bar diagram or bars with value display
- The colors of the bars and the border
- The fill pattern and fill pattern color of the bars
- The color coding of a limit violation

Note

If many bars are displayed in a diagram, not all values may be visible for bars with value display. If you want to see all values, you must either use the zoom functions or change the time range.

Requirements

- You have opened the Graphics Designer and configured a picture with a BarChartControl.
- The configuration dialog of BarChartControl is open.

Configuring of the type and properties of the bars

1. Go to the "Diagrams" tab.
2. Select a diagram under "Diagrams".
3. Define the type of diagram, the colors and the border properties in the "Display" area.
4. If necessary, specify a fill pattern for the bars.
5. In the small picture on the right edge of the "Display" area, you see the result of the configuration.
6. Save the configuration.

Configuring the color coding of a limit violation

1. Select a diagram under "Diagrams".
2. Click on the "Limit values" button in the "Effects" area. The "Limit values" dialog opens.

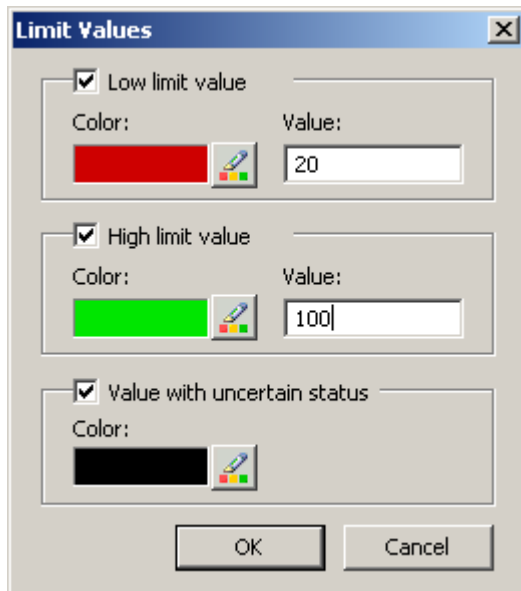

3. Select the limit values, for which you want a color coding.
4. Define the color for every activated option.
5. The color coding acts as follows:
 - Low limit value. Whenever a displayed bar value falls below the value defined in the "Value" input field, the value is shown in the configured color.
 - High limit value. Whenever a displayed bar value exceeds the value defined in the "Value" input field, the value is shown in the configured color.
 - Value with uncertain status. Values whose start valued are unknown after runtime is activated or for which the substitute values are being used, have an uncertain status. These values are displayed in the configured color.
6. Save the configuration.

See also

How to create a bar diagram (Page 1670)

How to configure the toolbar and the status bar

Introduction

The WinCC controls are operated at runtime using the functions of the toolbar buttons. The status bar contains information pertaining to the current status of the WinCC control. You can adapt the toolbar and the status bar for all WinCC controls when configuring, or at runtime.

Requirement

- A picture showing a WinCC control is opened in Graphics Designer when configuring.
- The WinCC control is assigned the "Configuration dialog" button function for opening the configuration dialog in Runtime.
- The configuration dialog of the WinCC control is open.

How to configure the toolbar

1. Go to the "Toolbar" tab. In the WinCC AlarmControl, for example:

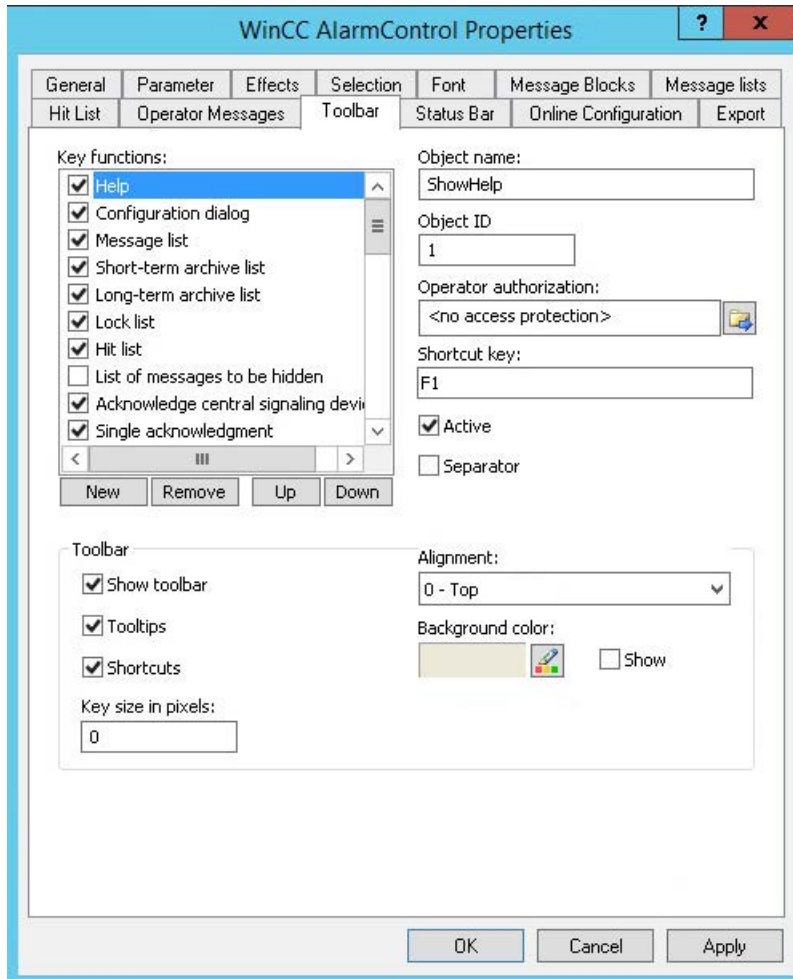

2. In the list, activate the button functions you require for operating the WinCC control in Runtime. For information on the button functions, refer to the description of the corresponding WinCC control at "Operation in runtime".
3. Determine the sorting order for displaying the button functions in the toolbar. Select the button functions from the list and the move the functions using the "Up" and "Down" buttons.
4. Define a shortcut key for the functions of the toolbar buttons.
5. Any button functions assigned operator authorizations are only available in Runtime to authorized users.
6. An activated button function is displayed during runtime if you deactivate its "Active" option, however, it cannot be operated.
7. You can set separators between the button functions. Activate the "Separator" option for the button function to be restricted by separator.

8. Configure the general properties of the toolbar, e.g. alignment or background color.
9. Change the button size as required. The standard setting is "0" and corresponds to the original size of 28 pixels. You can specify 280 pixels as maximum value.
The following behavior results for the button size depending on the configured value:

Value of the button size	Behavior
Value < 0	Invalid value. The most recent valid value is used.
$0 \leq \text{value} \leq \text{original size of button}$	The original size of the button is used. The value is set to the default (= 0).
Original size of the button < value \leq maximum value	The configured value is used.
Maximum value < value	Invalid value. The most recent valid value is used.

With a large button size, please note that in some cases not all buttons may be displayed in the control. To show all activated buttons in Runtime, you must therefore extend the control or activate fewer buttons as required.

How to configure the status bar

1. Go to the "Status Bar" tab. In the WinCC AlarmControl, for example:

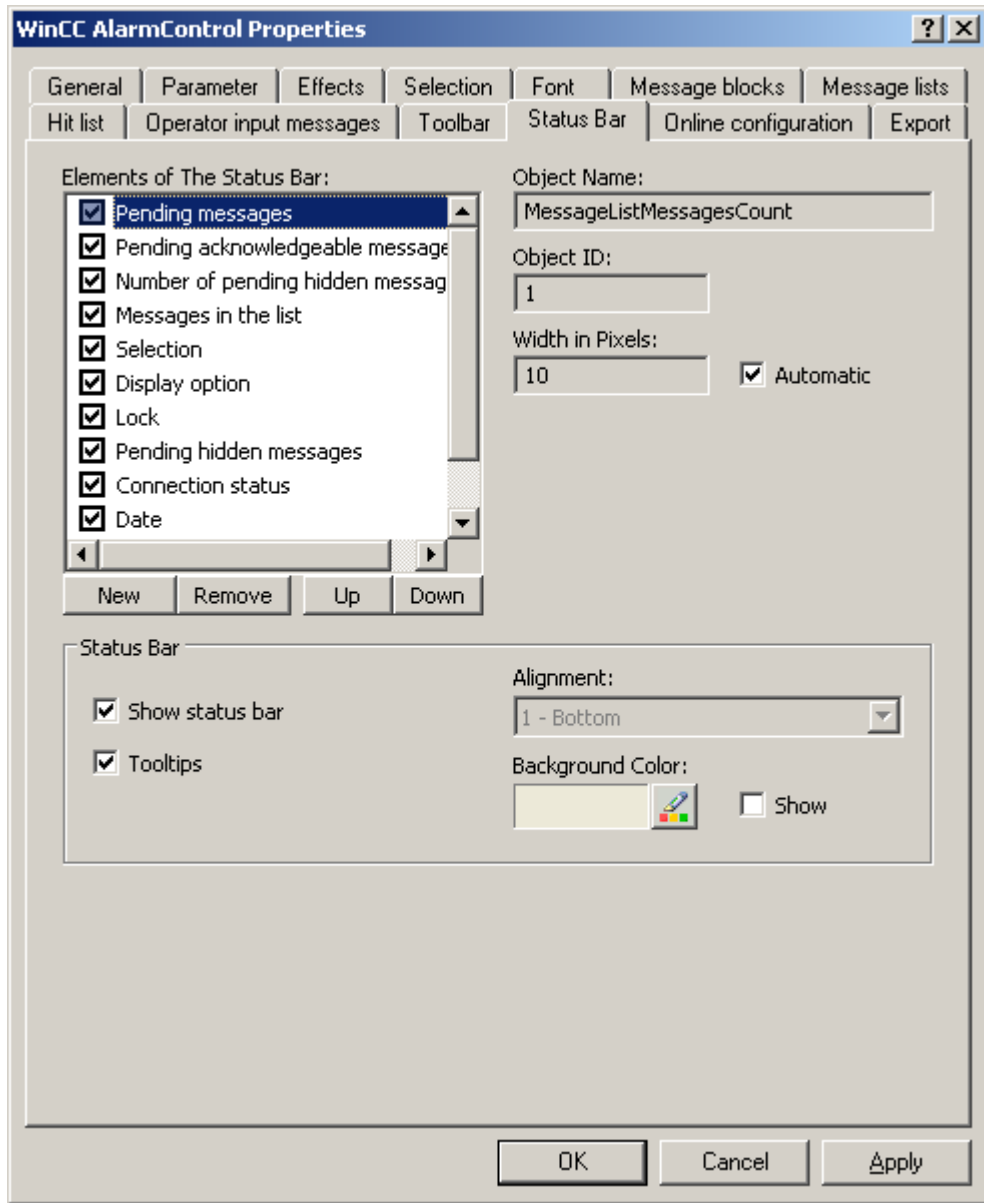

2. Activate the elements required during runtime in the list of status bar elements. For further information on status bar elements, refer to the descriptions of the corresponding WinCC control at "Operation in runtime".
3. Determine the sorting order for displaying of the status bar elements. Select the elements from the list and move these using the "Up" and "Down" buttons.
4. To resize the width of a status bar element, deactivate the "Automatic" option and enter a pixel value for the width.
5. Configure the general properties of the status bar, e.g. alignment or background color.

How to export runtime data

Introduction

The runtime data shown in the WinCC controls can be exported using a button function. Set up operation of the data export during runtime in the configuration dialog.

Requirement

- A picture showing a WinCC control is opened in Graphics Designer when configuring.
- The configuration dialog of the WinCC control is open.

How to configure the operation of the data export

1. Go to the "Export" tab.

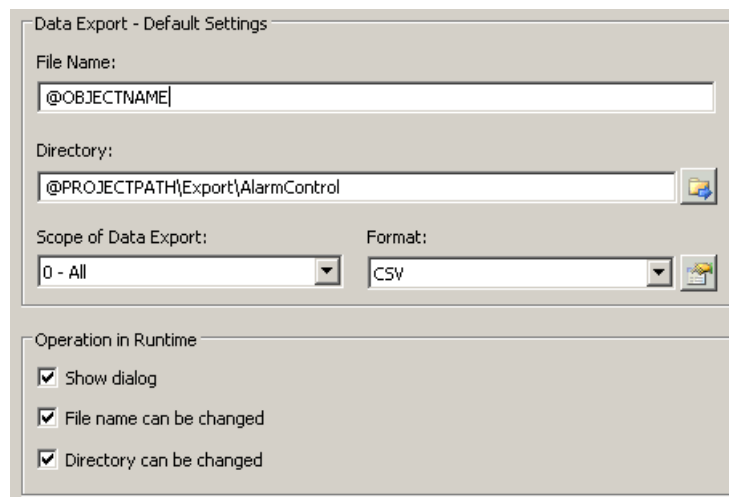

2. A standard file name and a standard directory are already entered in the "Data export default settings". In this case for AlarmControl. If necessary, define a file name and a directory for the export file.
The file name can be made up of the freely defined name and the following placeholder:
@OBJECTNAME - Object name of the controls
@CURRENTDATE - Current date
@CURRENTTIME - Current time
3. CSV is currently available as data format. Click  to specify the delimiter and data format in the CSV file.
4. Define the scope of the data export:
 - All runtime data is exported
 - Selected runtime data is exported. This data export is only possible in WinCC controls with tabular display.

5. Configure the operation of the data export during runtime. Define:
 - whether users are allowed to rename the file, or change the directory.
 - whether to display the "Data export default settings" dialog in Runtime.
6. If "Show dialog" is deactivated, the data for operation of the "Export data" button function is immediately exported to the defined export file.
7. Save the configuration.
8. Go to the "Toolbar" tab to activate the "Export data" button function for runtime.

Results

You can export all or selected data to a defined file at runtime using the  button function.

How to define the effect of the online configuration

Introduction

Users can parameterize the WinCC controls in Runtime. You must define the Runtime effects of the online configuration.

Changes configured in Runtime are saved for the specific user separately from the picture in the configuration system. The original picture configuration is retained in the configuration system.

Note

The picture is also replaced at Runtime if you save it in Graphics Designer, or when loading deltas in online mode. All online changes are lost.

The different configurations are only activated for new users after you performed a picture change.

Requirement

- A picture showing a WinCC control is opened in Graphics Designer when configuring.
- The configuration dialog of the WinCC control is open.

Procedure

1. Go to the "Online configuration" tab. For example, in OnlineTrendControl:

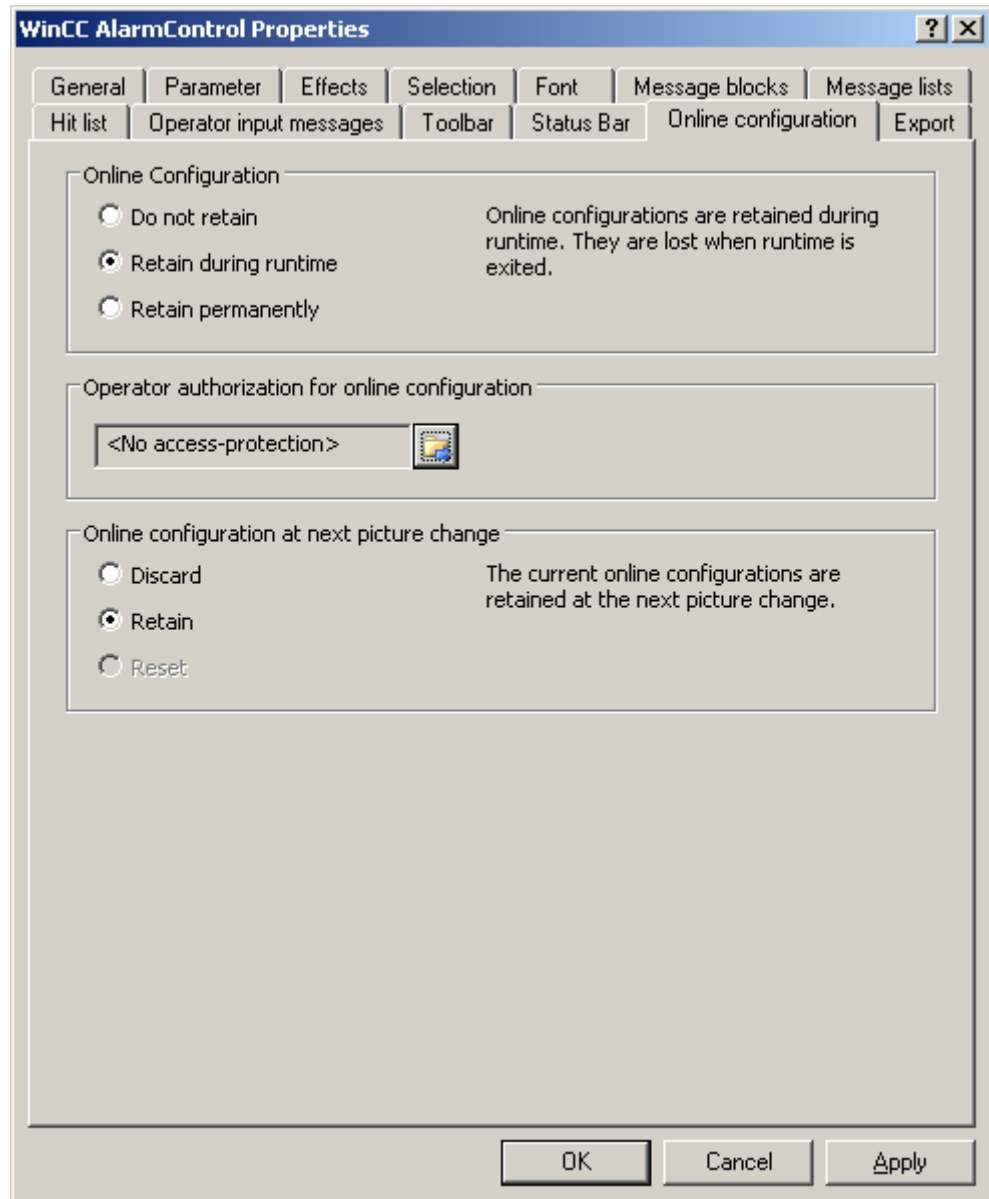

2. The option buttons of the "Online configuration" field for setting online configuration defaults are only available in the configuration system. The option buttons are not available in Runtime.
Select one of the three effects of the online configuration:
 - "Do not retain". The online configurations are not retained in Runtime. This default setting disables all options for Runtime users. Online configurations are lost at the next picture change and on activation/deactivation of the project.

- "Retain during Runtime". This default setting enables the "discard", "retain" or "reset" options for Runtime users. Online configurations are retained at the next picture change if the "retain" option is enabled, however, these are lost on activation/deactivation of the project.
 - "Retain permanently". This default setting enables the "discard", "retain" or "reset" options for Runtime users. Online configurations are retained at the next picture change and on activation/deactivation of the project if the "retain" option is enabled.
3. Define corresponding user authorizations for online configuration.
 4. The option buttons of the "Online configuration on next picture change" can be enabled for operation in the configuration system and at Runtime by setting the "retain at Runtime" and "retain permanently" defaults. The "reset" operation is only available in Runtime, because the configuration system contains the original configuration.
 Select one of three effects of the online configuration at the next picture change:
 - Select "discard" if to discard the online configuration at the next picture change.
 - Activate "retain" to activate the online configuration based on default settings at the next picture change or on activation/deactivation of the project.
 - Activate "Reset" if you want to apply the picture saved in the configuration system in Runtime. All online changes are lost.
 5. Save the configuration.

Operation in runtime



Operation of the BarChartControl in runtime













Introduction









The diagram window is operated in runtime via the buttons in the toolbar.

If you would like to operate the diagram window not using the toolbar, you can write the "ID" of the desired button in the "ToolBarButtonClick" object property using any dynamization method.

Overview

Icon	Description	ID
	"Help" Calls the help for WinCC BarChartControl.	1
	"Configuration dialog" Opens the configuration dialog in which you change the properties of the BarChartControl.	2
	"First data record" This button is used to display in the diagram window the history of a tag within the defined time range starting from the first archived value.	3



	<p>"Previous data record"</p> <p>This button is used to display in the diagram window the history of a tag within the previous time interval starting from the currently displayed interval.</p>	4
	<p>"Next data record"</p> <p>This button is used to display in the diagram window the history of a tag within the next time interval starting from the currently displayed interval.</p>	5
	<p>"Last data record"</p> <p>This button is used to display in the diagram window the history of a tag within the specified time range ending with the last archived value.</p>	6
	<p>"Zoom area"</p> <p>You define an area by dragging with the mouse in the diagram window. This area of the diagram window is made larger. The "Original view" button is used to restore the original view.</p> <p>If the symbol is enabled, the updated display is stopped and the "Stop" symbol is enabled.</p>	8
	<p>"Zoom +/-"</p> <p>Zooms in on or out from the bars in the diagram window. You zoom in on the bars with the left mouse button. If you hold down the "Shift" key, you zoom out from the bars with the left mouse button. The "Original view" button is used to restore the original view.</p>	9
	<p>"Zoom time axis +/-"</p> <p>Zooms in on or out from the time axes in the diagram window. The left mouse button increases the size of the time axes. If you hold down the "Shift" key, you zoom out from the time axes with the left mouse button. The "Original view" button is used to restore the original view.</p>	10
	<p>"Zoom value axis +/-"</p> <p>Zooms in on or out from the value axes in the diagram window. You zoom in on the value axes with the left mouse button. If you hold down the "Shift" key, you zoom out from the value axes with the left mouse button. The "Original view" button is used to restore the original view.</p>	11
	<p>"Move diagram area"</p> <p>With this button you move the bars in the diagram window along the time axis and value axis.</p>	12
	<p>"Move axis area"</p> <p>With this button you move the bars in the diagram window along the value axis.</p>	13
	<p>"Original view"</p> <p>With this button you return from the zoomed-in display back to the original view.</p>	14
	<p>"Select data connection"</p> <p>With this button you open a dialog for the archive selection and tag selection.</p>	15
	<p>"Select diagram"</p> <p>With this button you open a dialog for making diagrams visible and invisible. You can also define which diagram is displayed in the foreground.</p>	16
	<p>"Select time range"</p> <p>With this button you open a dialog where you set the time range displayed in the diagram window.</p>	17

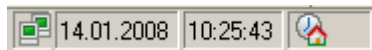

	"Previous diagram" With this button you display the previous diagram of the diagram window in the foreground.	18
	"Next diagram" With this button you display the next diagram of the diagram window in the foreground.	19
	"Stop" The updated display is stopped. The data is saved to the clipboard and added the next time you click on the button in the diagram window.	20
	"Start" Resume updated display.	20
	"Print" Starts the printout of the bars displayed in the diagram window. You define the print job used for printing on the "General" tab of the configuration dialog.	21
	"Export data" With this button you exporting all, or selected, runtime data to a "CSV" file. If the "Display dialog" is option is selected, a dialog opens in which you can view the settings for exporting and start the export. You can also select the file and the directory for the export, provided you have the corresponding authorizations. If no dialog is displayed, the export of the data to the preset file is started immediately.	26
	"Connect backup" With this button you open a dialog in which you connect selected archives to WinCC Runtime.	24
	"Disconnect backup" With this button you open a dialog in which you disconnect selected archives from WinCC Runtime.	25
	"User-defined 1" Shows the first button function created by the user. The function of the button is user-defined.	1001

Possible elements of the status bar

The following elements may appear in the status bar of the diagram window:

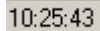

Icon	Name	Description
	Connection status	Shows the status of the data connections: <ul style="list-style-type: none"> • No faulty connections • Faulty connections • All connections are faulty
	Date	Shows the system date.

Icon	Name	Description
	Time	Shows the system time.
	Time base	Shows the time base used for the display of times.

Double-clicking the connection status element opens the "Status of the data connections" window, which lists the name, status and tag name of the data connection.

Online configuration of the BarChartControl

Introduction

You can configure online in runtime and thus change the display of the WinCC BarChartControl. During configuration of the BarChartControl, it was specified how online configurations are to be handled at a change of picture or after completion of runtime.

Overview

An online configuration in the BarChartControl is possible using the following button functions:

- With key function "Configuration dialog"
- With key function "Select data connection"
- With button function "Select diagram"
- With key function "Select time range"

Key function "Configuration dialog"

With button function "Configuration dialog" you have access to the tabs of the configuration dialog, for example to change the diagram display.

The key function "Select data connection"

With button function "Select data connection" you select the archive tags that you want to display in the diagram window for the value axes.

Field	Description
Diagram	Select one of the configured diagrams.
Data source	Specify whether the selected diagram is supplied by an archive tag or by no tag.
Tag name	Select the tag name for the data connection.

Button function "Select diagram"

The button function "Select diagram"  opens a dialog in which you show or hide diagrams. You bring diagrams to the foreground by changing the order of the diagrams.

Key function "Select time range"

Select the time range to be displayed for the diagrams using the button function "Select time range" . If the diagrams will be displayed in one diagram window with a common time axis, the specified time range applies to all diagrams.

Field	Description
Diagrams	Select the diagram for which you want to define a time range.
Time range	Specify the time range: <ul style="list-style-type: none"> • If you want to define a fixed time interval, select setting "Start to end time". Enter the date and time for each. • If you want to define a time period, select the setting "Time range". Define the date and time for the start time. The length of the time interval to be displayed is determined by multiplying the "Factor" by the "Time unit". • If you want to display a certain number of values, select the setting "Number of measurement points". Define the date and time for the start time. Enter the required number of measurement points in the input field.



The input format of the date and time depends on the Runtime language used.

Starting and Stopping Update

Introduction

With the "Start/Stop" button function you can start or stop the update of trends and bars in the trend window or diagram window.

The button indicates whether the update is stopped or not:

- : The update is stopped. Click on the button to continue updating.
- : The update is started. Click on the button to stop updating.

How to display a diagram in the foreground



Introduction

If more than one diagram is to be displayed in a diagram window, you can use button functions to define which diagram will be displayed with its bars in the foreground.

Requirements

- You have selected the "Select diagram", "Previous diagram" and "Next diagram" button functions on the "Toolbar" tab.

Procedure

- Use  to open a dialog for displaying and hiding diagrams. You can also define which diagram is in the foreground with its bars.
- Use  to display the bars of the next diagram in the foreground.
- Use  to display the bars of the previous diagram in the foreground.

How to use the zoom functions in the diagram windows

Introduction

You can use button functions to zoom in on and zoom out from bars, axes, and any sections of the diagram window and to return to the original view.

Overview



The following zoom functions are available in the diagram window:

- "Zoom area"
- "Original view"
- "Zoom +/-"
- "Zoom time axis +/-"
- "Zoom value axis +/-"
- "Move diagram area"



Requirements

- You have configured a WinCC BarChartControl.
- You have configured the buttons for the required zoom functions for the toolbar.
- You have activated runtime.

How to zoom in on a section of the diagram window

1. Click on . The updated display is stopped.
2. In the diagram window, click one corner of the area that you want to zoom in on.
3. While holding down the left mouse button, drag to select the size of the area you to be zoomed in on. If the selected area contains at least two measured values, the section of the diagram is displayed in the diagram window.
4. Release the left mouse button. The selected section is shown enlarged. If you want to zoom in further, repeat the procedure.
5. Click on . The diagram window is shown in the originally configured view again.
6. Click on  to restart the update. The values preassigned for the X axis and Y axis are applied.





How to zoom in on and zoom out from diagrams

1. Click on . The updated display is stopped.
2. Click in the diagram window with the left mouse button to zoom in on the diagrams in the diagram window. If you want to zoom in further, repeat the procedure.
3. If you want to zoom out from the diagrams, press the "Shift" key while clicking with the left mouse button.
4. When zooming in to or zooming out from trends, the 50% value of the diagrams is always in the center of the value axes.
5. Click on . The diagram window is shown in the originally view again.
6. Click on  to restart the update. The values preassigned for the X axis and Y axis are applied.



Note

If you change the value range of a value axis on the "Value Axis" tab of the configuration dialog while zooming, the visible zoom area is set to the new value range.

How to use the zoom function on the time axis and value axis

1. Click on  to zoom in on the time axes or on  to zoom in on the value axes. The updated display is stopped.
2. Click in the diagram window with the left mouse button to zoom in on the time axes or value axes. If you want to zoom in further, repeat the procedure.
3. If you want to zoom out from the time axes or value axes, press the "Shift" key while clicking with the left mouse button.
4. When using the zoom function on the axes, the 50% value of the diagram is always in the center of the axes.
5. Click on . The diagram window is shown in the originally view again.
6. Click on  to restart the update. The values preassigned for the X axis and Y axis are applied.

How to move the diagram area

1. Click on . The updated display is stopped.
2. While holding the left mouse button down, move the cursor in the desired direction in the diagram window. The displayed area in the diagram window on the time axis and on the value axis is adjusted.
3. If you click on  again, the diagram window is displayed in the original view again.

How to display archived values

Introduction





You can browse within an archive using the buttons in the toolbar or the corresponding shortcut keys.

The archived values of a tag within a time interval are displayed in the control. The time interval is defined by entering a time range or by entering a start and end time.

Requirement

- The buttons for browsing in archive are available only if data is supplied through archive tags.
- You have defined a time range or a start and end time.

Buttons for Archived Values

	The history of a tag within the defined time is displayed starting with the first archived value.
	The history of a tag within the previous time interval is displayed starting from the currently displayed time interval.
	The history of a tag within the next time interval is displayed starting from the currently displayed time interval.
	The history of a tag within the defined time is displayed ending with the last archived value.

6.5.2.5 Process Value Output as a Function of Another Tag

WinCC FunctionTrendControl

Introduction

For a graphic processing of tags, WinCC FunctionTrendControl in WinCC offers the option of displaying one tag as a function of another tag. For example, temperature may be shown as a function of pressure.

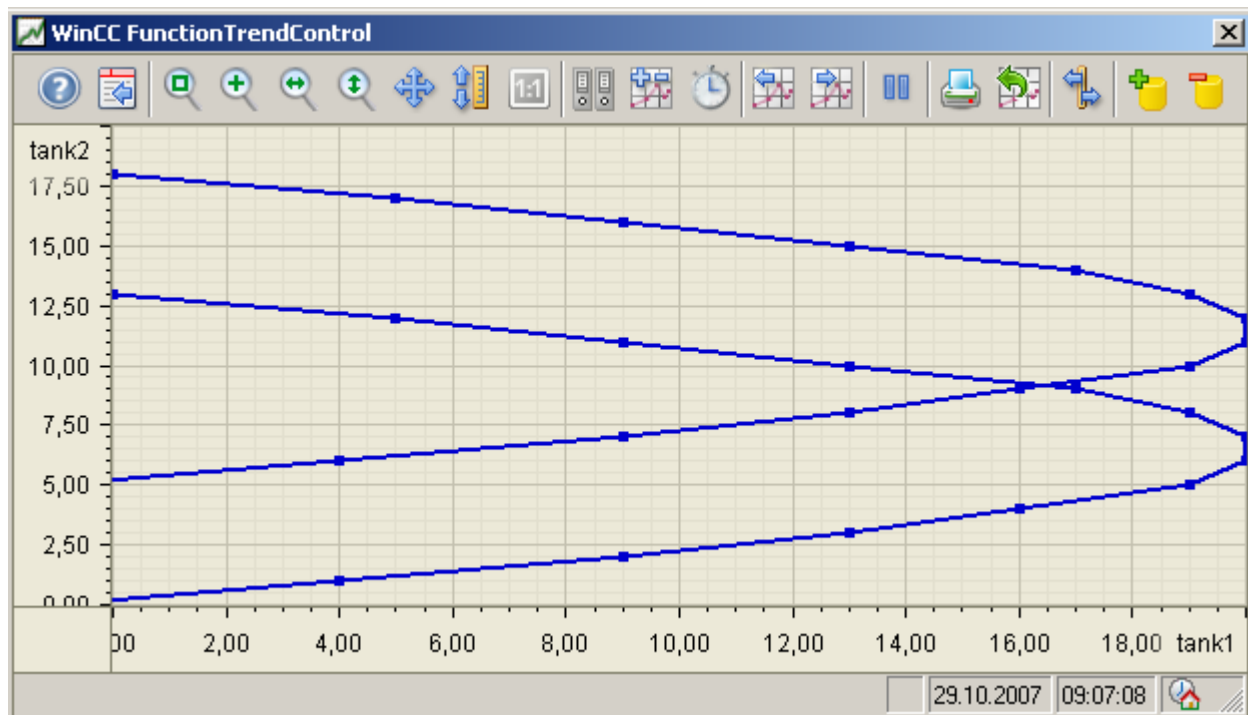

Requirement

For the display of trends in WinCC FunctionTrendControl the following prerequisites apply:

- You can display as many trends as you need in a WinCC FunctionTrendControl. Configuring a maximum of 8 trends is recommended.
- A trend can represent a maximum of 10000 value pairs.
- You can use online tags, archive tags or data from user archives for the trends.
- The online tags of a trend must have the identical update cycle.
- The archive tags of a trend must have the same update cycle and must be recorded in a continuous cycle.
- The representation of tags in the form of functions over time is only possible, if the values of the trend are supplied through the API interface. In order to display tags as time functions, use the WinCC OnlineTrendControl.

Resolution of Trend Display

The number of trend values that can be displayed on the screen is limited by the screen resolution and selected size of the trend window. Therefore, when displaying trends, it is possible that fewer values are displayed in the trend window than are actually archived.

If, for example, in an area of 100 pixels 200 measured values are archived, each pixel represents 2 measured values. The value shown on the screen is that of the most recent data (most recent time stamp).

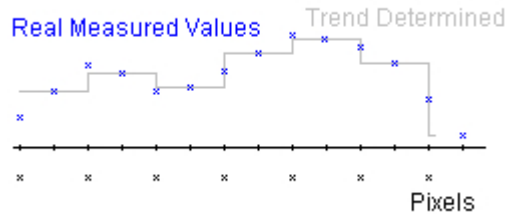

See also

Short Description of the WinCC Controls and Additional Controls (Page 749)

Display of Trends

Representing Trend Lines

Introduction

The WinCC FunctionTrendControl has many ways of displaying the progress of a trend.

Representation formats

To display values graphically, three basic representation types are available:

- No trend
The values are shown as dots. The display of the points can be configured as you wish.

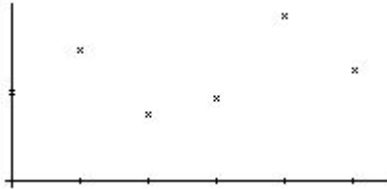

- Connect dots linearly
The trend line is interpolated on a linear basis from the point values. The display of the lines and points can be configured as you wish.

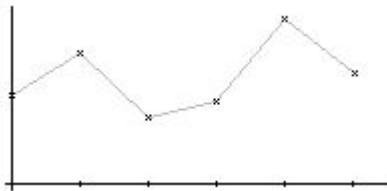

- Stepped trend
The progress of the trend line is determined from the values as a stepped trend. The display of the lines and points can be configured as you wish.

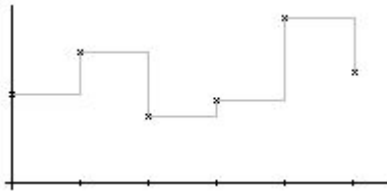

The display of the trend can be configured on the "Trends" tab of the FunctionTrendControl.

Write direction

With the write direction option, you can specify where the current values for all trend windows are to be entered. Normally, the current values are written in the trend window from the right. All four write directions can be configured. The write direction is configured on the "General" tab of the FunctionTrendControl.

Displaying the trends with logarithmic axes

The axes in the trend window can be scaled on either a logarithmic or a linear basis. No negative values can be displayed in the display with logarithmic axes. No positive values can be displayed in the display with negative logarithmic axes. The display with logarithmic axes is configured on the "X axes" and "Y axes" tabs of the FunctionTrendControl.

Display with common axes

Introduction

When displaying more than one trend in a trend window, you can assign every trend with its own axes or use a common time X axis or Y axis.

Representation Using Different Axes

If the values to be displayed in a trend window differ greatly, a common axis makes no sense. The values can be read more easily if different axial scales are used. Individual axes can be hidden if required.

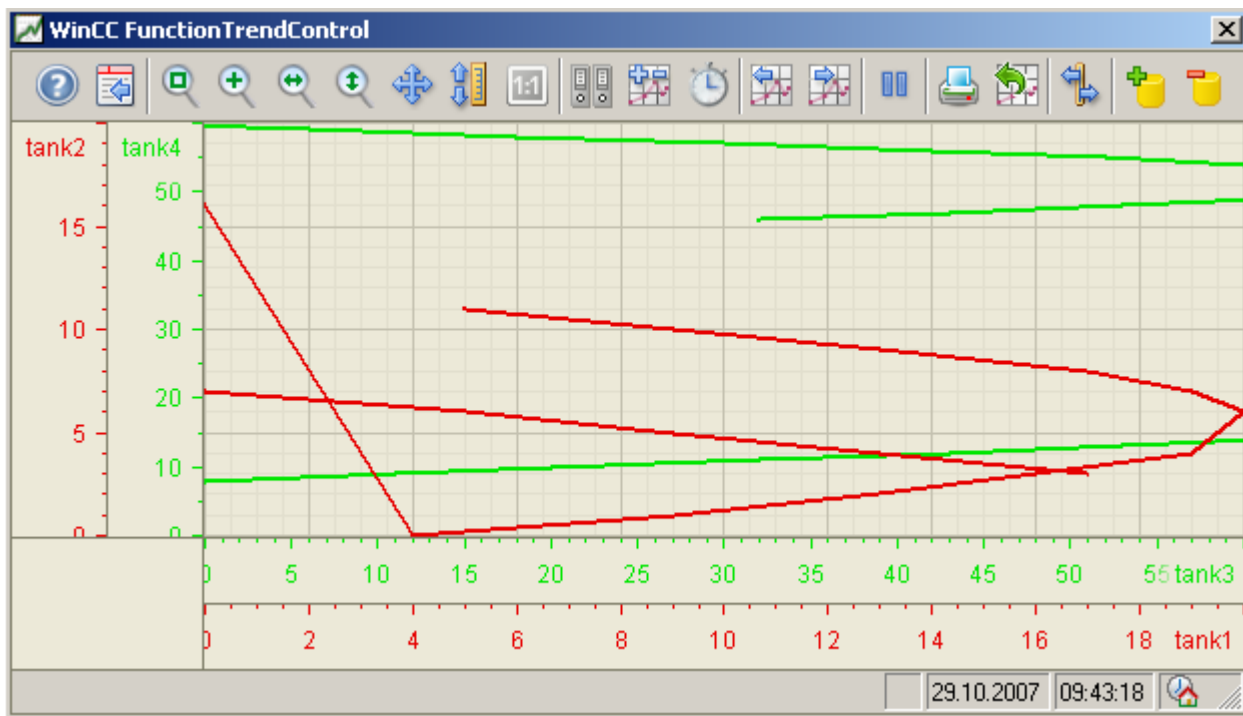

Representation Using Common Axes

If the comparability of the trend lines is important, common axes in a trend window is sensible. Connected trend windows can have a common axis.

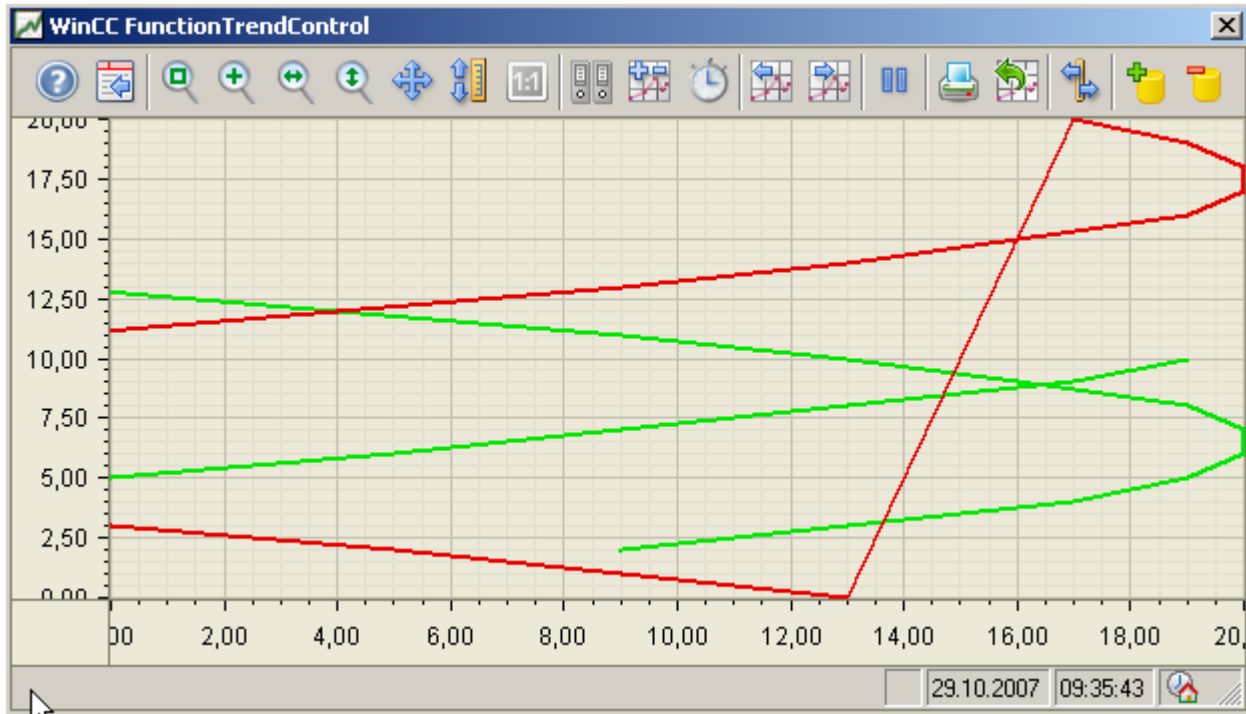

Configuring

The axes are configured on the "X axis" and "Y axis" tabs of the FunctionTrendControl. The assignment of the axes for the trends can be configured on the "Trends" tab. In this case, you can assign the individual trends to the same axes.

Configuring the FunctionTrendControl

How to configure the FunctionTrendControl

Introduction

Process values of a tag can be displayed depending on the process values of another tag in trends. You can configure a WinCC FunctionTrendControl for this in the Graphics Designer.

Configuration steps

1. Insert the FunctionTrendControl into a picture of the Graphics Designer.
2. Configure the basic properties for the FunctionTrendControl on the "General" tab:
 - the window properties of the control
 - the display of the control
 - the write direction of the trend values
 - the time base of the control
3. Define one or more trend windows.
4. Configure one or more X axes and Y axes with their respective properties. Assign the axes to the trend windows.
5. Define trends that you want to display in the trend windows. Assign the trends to the trend windows. Assign each trend an X axis and a Y axis that belong to the respective trend window.
6. Configure the display for each trend.
7. Every configured trend must be connected with an online tag, archive tag or a user archive via the X axis and Y axis. Define the data supply for the axes of each trend.
8. Configure the toolbar and status bar of the trend window.
9. If you want to display the coordinates of the trends, configure a ruler window as well. Connect the ruler window with the FunctionTrendControl.
10. Save the configurations.

How to create the trend window in FunctionTrendControl

Introduction

The WinCC FunctionTrendControl can contain one or more trend windows. The trend window provides an area to display trends in.

Overview of the trend window

The trend window has the following properties:

- Every trend window is assigned with at least one trend, which has one X axis and one Y axis.
- A trend can only be assigned to one trend window.
- Several trends can be displayed in a trend window.
- A trend window can display X axes and Y axes independent of the displayed trends. X axes and Y axes can be hidden in runtime.

6.5 Output of Process Values

- The sequence of the configured trend window is determined by the position in FunctionTrendControl. The first trend window in the list of trend windows is displayed in the lower position, the last trend window is shown in the top position.
- If more than one trend window is configured, the trend windows can be connected. The connected trend windows have the following properties:
 - They can have a common X axis.
 - They have a scroll bar.
 - They have a ruler.
 - The zoom functions for a trend window affect the connected trend windows.

Procedure

1. Define one or more trend windows with the "New" button on the "trend windows" tab.

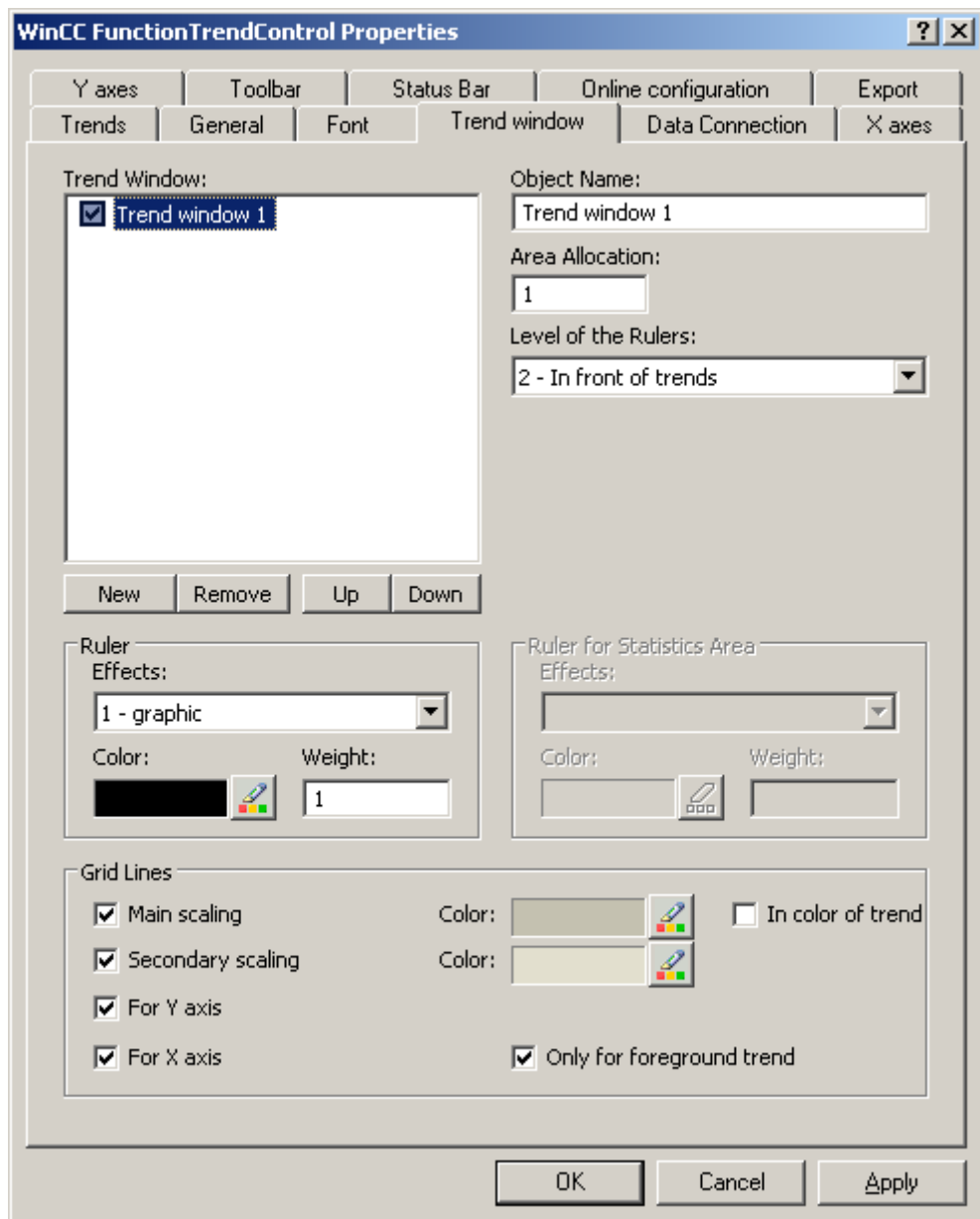

2. If you have defined more than one trend window, more configurations are possible:
 - Assign every trend window with an area selection in the displayed FunctionTrendControl.
 - Define the position of the trend windows with the "Up" and "Down" buttons.
 - Define whether the trend window will be connected on the "General" tab.
3. If you want to hide a trend window in runtime, deactivate the checkbox in front of the name of the trend window in the list. The respective axes are then hidden as well.
4. Configure the gridlines for every trend window.

5. Configure the display of the ruler. If you use "Graphic" for the display of the ruler, you can configure the color and the line weight of the ruler.
6. Define the level on which to display the ruler in the trend window.
7. Save the configuration.

How to configure the axes of trend windows

Introduction

You can configure several X axes and Y axes that you assign to one or more trend windows. Configure the value range and the display for each X axis and Y axis.

Requirement

- You have opened the picture with the FunctionTrendControl in the Graphics Designer.
- You have defined trend windows.

Procedure

1. Define one or more axes with the "New" button on the "X axes" and "Y axes" tabs. Here e.g. tab "X axes":

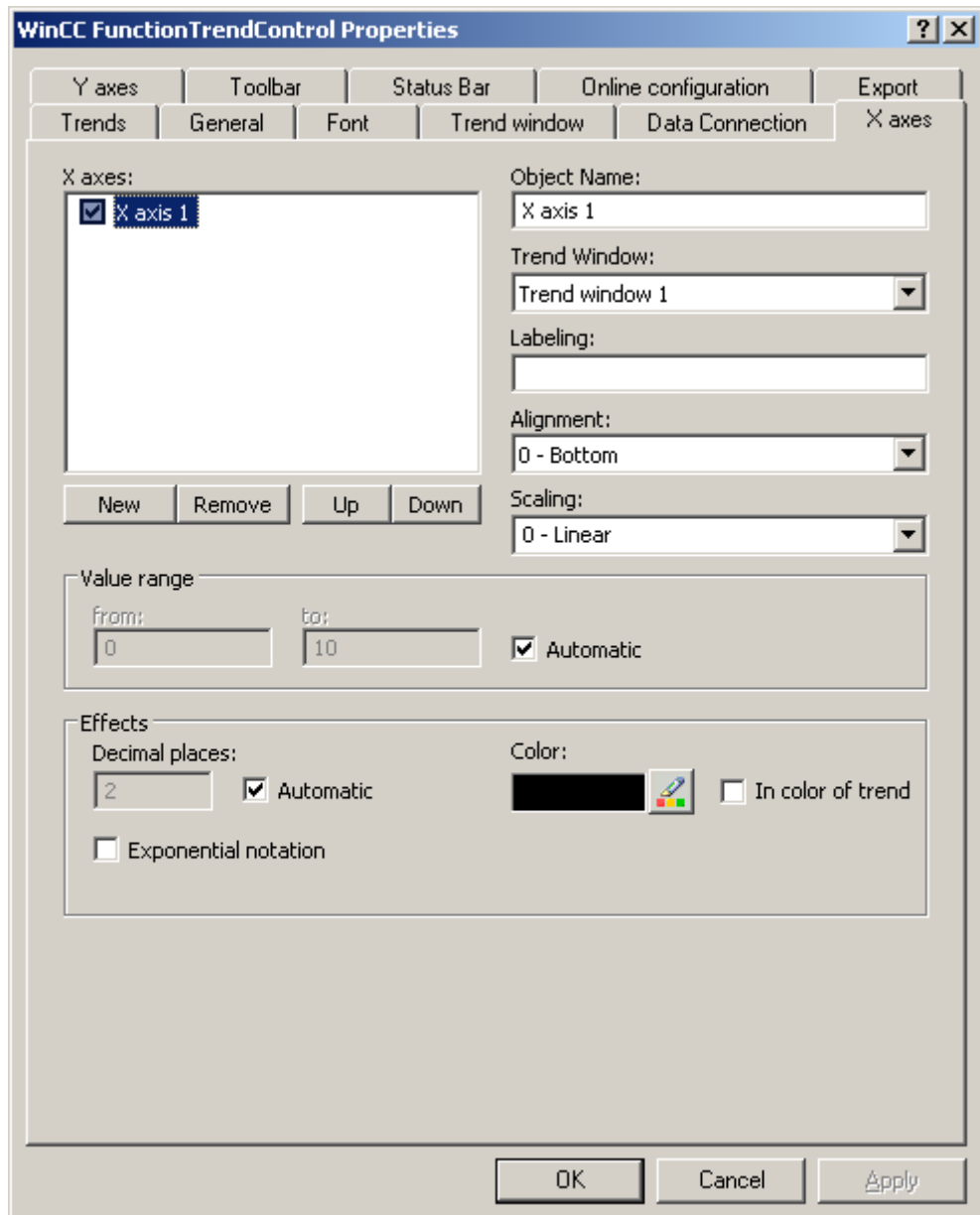

2. Assign the X axes and Y axes to the configured trend windows.
3. If you want to hide an X axis or Y axis in the trend window, click on the checkbox in front of the name of the axis in the list. You can display the axes again in runtime with the key functions.
4. Configure the orientation and scaling for each X axis and Y axis.
5. Configure the display of the axes in trend windows.

6.5 Output of Process Values

6. Deactivate the "Automatic" option in "Value range" if you want to define a fixed value range for the X axis or Y axis.
7. In the "From:" and "To:" input fields enter the minimum and maximum value of the value range.
8. Save the configuration.

How to create trends for the trend window

Introduction

Every trend is displayed in a trend window with an X axis and a Y axis. The trends can use the same axes in a trend window.

Requirement

- You have inserted the FunctionTrendControl into a picture of the Graphics Designer.
- You have configured X axes, Y axes and trend window.

Procedure

1. Go to the "Trends" tab.

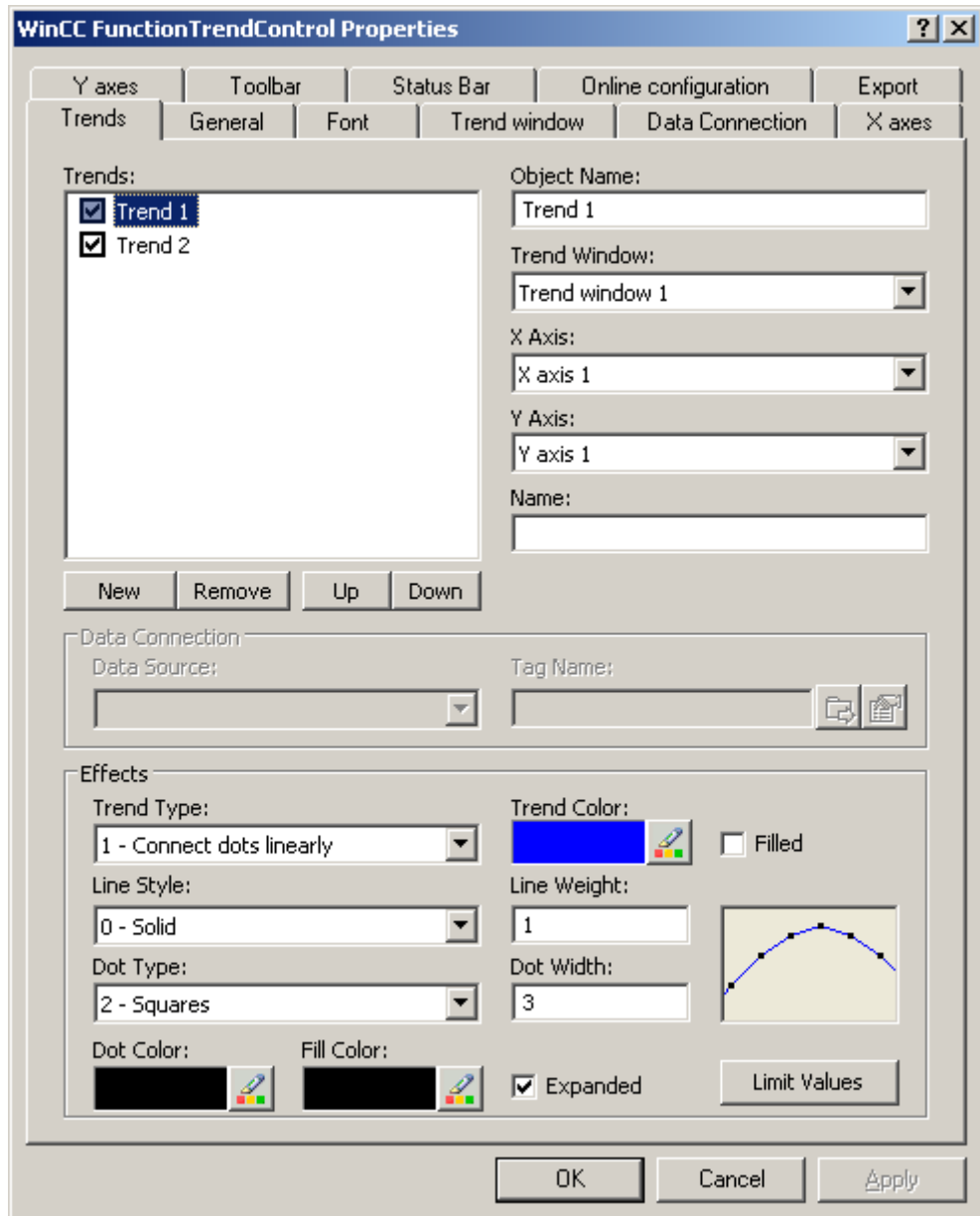

2. Use the "New" button to define the desired number of trends.
3. Define the sequence of trends in the trend window using "Up" and "Down" keys.
4. Assign every trend to a trend window. Several trends can be assigned to one trend window.
5. Assign an X axis and a Y axis to every trend. You can only use the axes that belong to the assigned trend window for the trend.
6. Configure the display for each trend. More information can be found on page "How to configure the display of trends".

7. The data connection of the trends are configured on the "Data connection" tab. More information can be found on page "How to configure the data connection of trends".
8. Save the configuration.

How to configure the display of trends

Introduction

You can adjust the display of trends to suit your requirements in the WinCC controls. The following WinCC controls are shown in trends:

- WinCC OnlineTrendControl
- WinCC FunctionTrendControl

Overview

The following trends features can be configured:

- The types of trends and trend lines
- The properties of trend lines
- The colors of the trends, the trend points and the fill color
- Color identification for a limit value violation

Note

Depending on the window size of the control and the line weight, the line style can be represented differently regardless of the configured line style.

Requirement

- You have opened the Graphics Designer and configured a picture with the above mentioned WinCC control.
- The configuration dialog of the WinCC control is opened.

Configuring the types of trends and trend lines

1. Go to the "Trends" tab. Here e.g. in WinCC OnlineTrendControl.

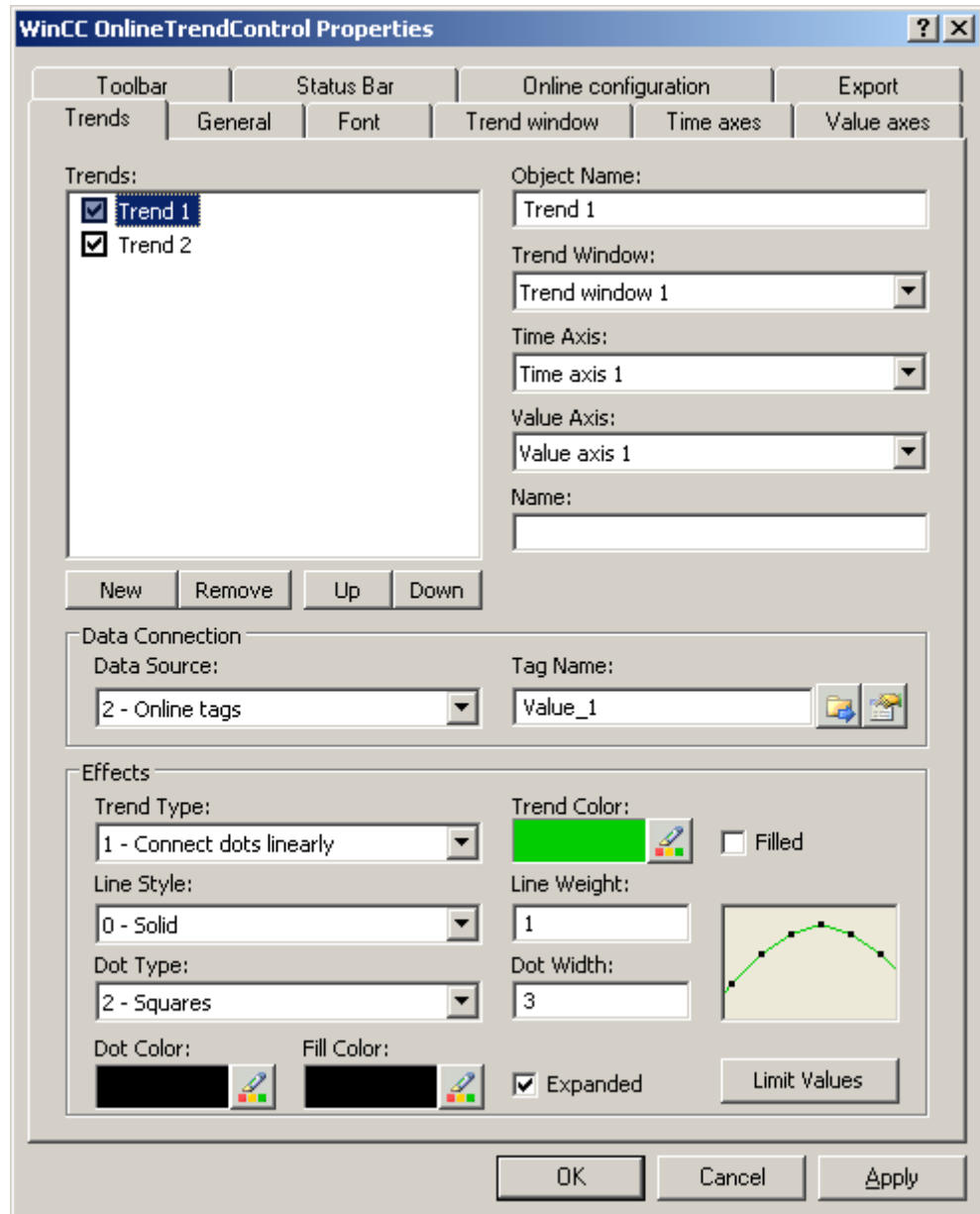

2. Choose a trend under "Trends".
3. Define the type of the trends and trend lines in the "Display" area.
4. If you want to highlight the display of the area under the trend, activate the "Filled" option.
5. In the small picture in the right-hand margin of the "Display" area, the result of the configuration is shown.
6. Save the configuration.

Configuring the properties of trend lines

1. Choose a trend under "Trends".
2. Define the properties of the trend lines in the "Display" area.
3. Define the line weight and the properties of the trend points.
4. In the small picture in the right-hand margin of the "Display" area, the result of the configuration is shown.
5. Save the configuration.

Configuring the colors of the trends, the trend points and the fill color

1. Choose a trend under "Trends".
2. Define the colors in the "Display" area.
3. If you want to configure the colors of the trend points and the fill color, activate the "Extended" option.
4. In the small picture in the right-hand margin of the "Display" area, the result of the configuration is shown.
5. Save the configuration.

Configuring the color identification for a limit value violation

1. Choose a trend under "Trends".
2. Click in the "Display" area on the "Limit values" button. This will open the "Limit values" dialog.

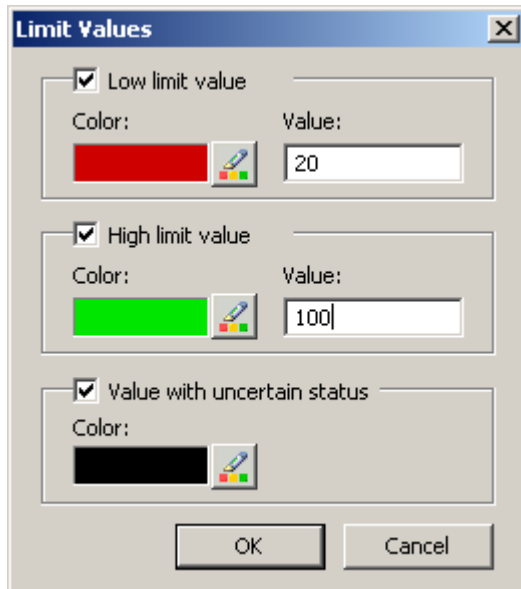

3. Activate the limit values, for which you want a colored identification.
4. Define the color for every activated option.

5. The colored identification has the following effect:
 - Low limit value. Whenever a displayed trend value is below the value defined in the "Value" input field, the value is shown in the configured color.
 - High Limit Value. Whenever a displayed trend value is above the value defined in the "Value" input field, the value is shown in the configured color.
 - Value with uncertain status. Values, whose start value is unknown on activating runtime or for which a substitute value is used, have an uncertain status. These values are displayed in the configured colors.
6. Save the configuration.

Note

In WinCC V7 or higher, the display of trend values with uncertain status in trend controls differs to their display in trend controls in earlier versions of WinCC V7: The trend values with uncertain status will not be displayed in the control until they have returned to a reliable state.

How to Configure the Data Connection of Trends

Introduction

The trends are provided with values from various tags to display a tag as a function of another tag in a certain time range. The values of the trends can also originate from a user archive independent of time, to e.g. display a setpoint trend.

Time range of the trend display

Basically, there are two different time references in the trend display:

- **Static display.** The time range of the trend display is determined by a pre-defined, fixed time interval, independent of the current system time.

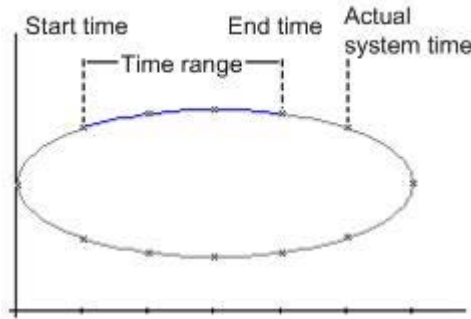

- **Dynamic display.** The time range of the trend display is determined retrospectively from the most current values. The display is continuously updated. The configured time range follows the current system time.

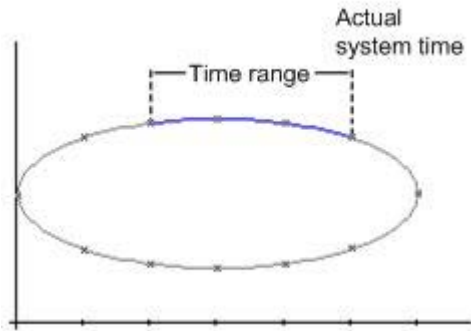

You have three different ways to define the time range of a time range for each of the two time references:

- The trend is displayed within a defined time interval. You define a start time and an end time. In a dynamic display, the end time corresponds with the current system time. The time difference between the start time and the end time is the time range for the trend display.
- The trend is displayed from a start time throughout a defined time range, e.g. 30 minutes from the start time. In the dynamic display, the defined time range up to the current system time is used, e.g. 30 minutes to the current system time.
- Starting from a start time, a defined number of values are shown, e.g. 100 values from the start time. With the dynamic display, the last values up to the current system time are shown.

Requirement

- You have opened a picture with the FunctionTrendControl in the Graphics Designer.
- You have defined one or more trends.
- The following prerequisites apply for the basic data:
 - If you want to connect data of online tags, you have to have defined process values in the tag management.
 - If you want to connect the data from archive tags, you have to have configured a process value archive with archive tags.
 - If you want to connect the data from an archive tag, you have to have configured a user archive with columns.
 - If you want to use a script to supply the trend values with data in runtime, you will require a script through the API interface. E.g. the display of a tag as a time function if you do not want to use the WinCC OnlineTrendControl.

Procedure

1. Go to the "Data connection" tab.

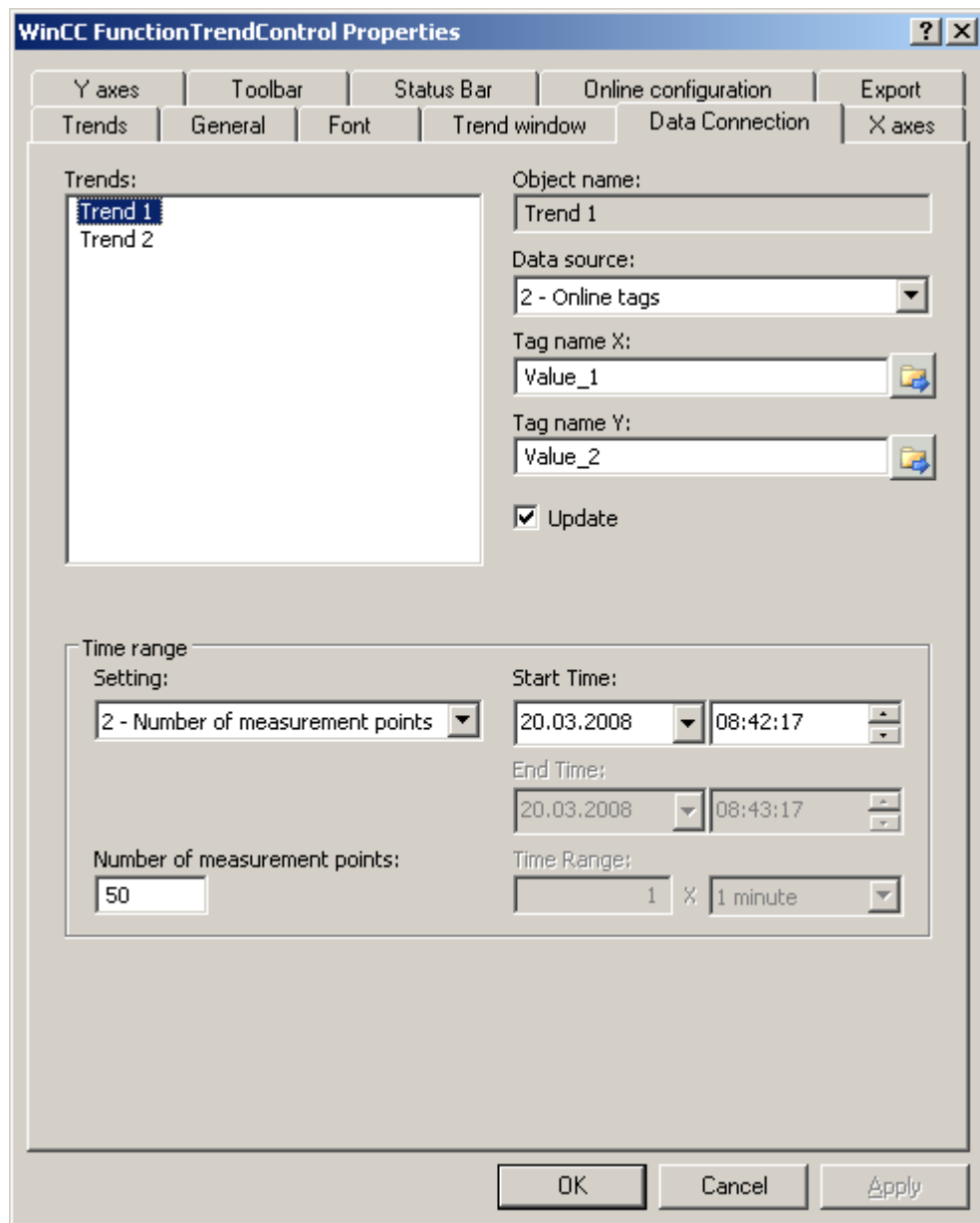

2. Define the data source for each trend. You can select the following:
 - Archive tags of a process value archive
 - Online tags from the tag management
 - User archive columns
 - No configured data source to establish a connection in runtime via a script.
3. Click on  to select the tags for the X axis and the Y axis. The online tags connected to a trend must have the identical update cycle. The archive tags connected with a trend must originate from the process archive of a server and be acquired in a continuous cycle.

4. If the data is connected with a user archive, select columns of the user archive for the X axis and Y axis. Define the "ID" for each column, starting from which the values of the column will be used.
5. If the trends in the trend window are always updated, activate the "Update" option. If you e.g. want to compare a current trend display with an earlier trend display, deactivate the "Update" option for the comparison trend.
6. Configure the time range in which the trend will be displayed:
 - If you want to define a fixed time interval, select setting "Start to end time". Enter the date and time for each.
 - If you want to define a time period, select the setting "Time range". Define the date and time for the start time. The time range is the result of a multiplication of the "Factor" and "Time unit", e.g. 30 times "1 minute" for a time range of 30 minutes. Enter the factor and the time unit in the "Time range" field.
 - If you want to display a certain number of values, select the setting "Number of measurement points". Define the date and time for the start time. Enter the desired number of measurement points in the input field.
 - If the trend will be provided via a user archive, define the number of value pairs for the area to be displayed. Enter the desired number in the "Number of measurement points" field.
7. Save the configuration.

How to configure the toolbar and the status bar

Introduction

The WinCC controls are operated at runtime using the functions of the toolbar buttons. The status bar contains information pertaining to the current status of the WinCC control. You can adapt the toolbar and the status bar for all WinCC controls when configuring, or at runtime.

Requirement

- A picture showing a WinCC control is opened in Graphics Designer when configuring.
- The WinCC control is assigned the "Configuration dialog" button function for opening the configuration dialog in Runtime.
- The configuration dialog of the WinCC control is open.

How to configure the toolbar

1. Go to the "Toolbar" tab. In the WinCC AlarmControl, for example:

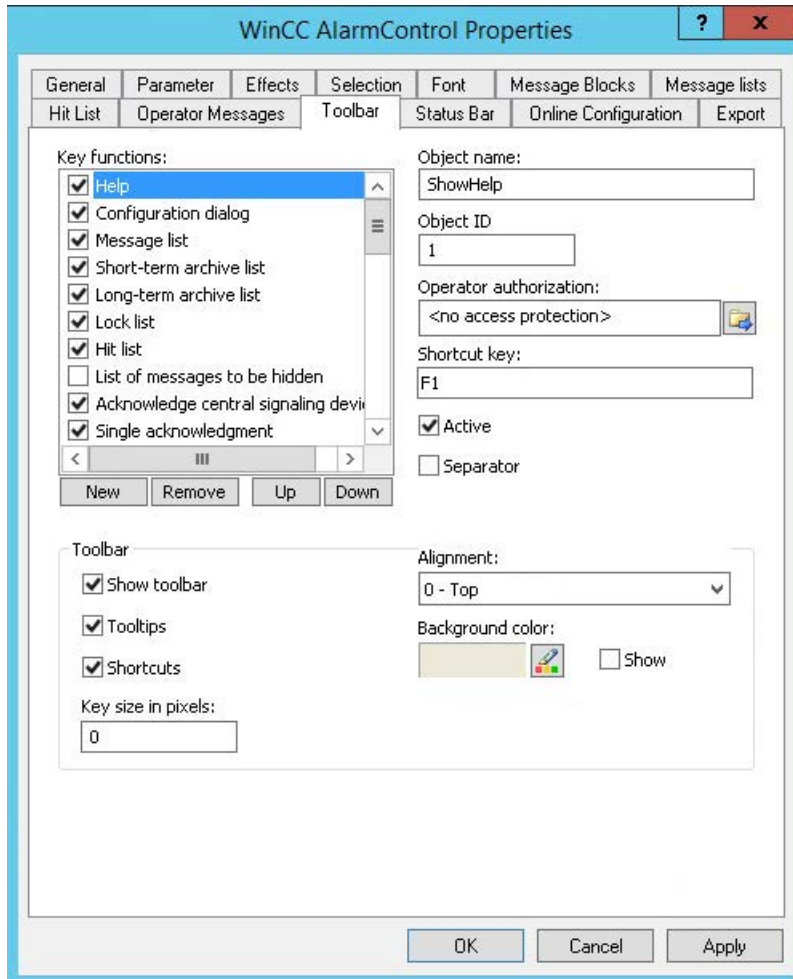

2. In the list, activate the button functions you require for operating the WinCC control in Runtime. For information on the button functions, refer to the description of the corresponding WinCC control at "Operation in runtime".
3. Determine the sorting order for displaying the button functions in the toolbar. Select the button functions from the list and the move the functions using the "Up" and "Down" buttons.
4. Define a shortcut key for the functions of the toolbar buttons.
5. Any button functions assigned operator authorizations are only available in Runtime to authorized users.
6. An activated button function is displayed during runtime if you deactivate its "Active" option, however, it cannot be operated.
7. You can set separators between the button functions. Activate the "Separator" option for the button function to be restricted by separator.

8. Configure the general properties of the toolbar, e.g. alignment or background color.
9. Change the button size as required. The standard setting is "0" and corresponds to the original size of 28 pixels. You can specify 280 pixels as maximum value.
The following behavior results for the button size depending on the configured value:

Value of the button size	Behavior
Value < 0	Invalid value. The most recent valid value is used.
$0 \leq \text{value} \leq \text{original size of button}$	The original size of the button is used. The value is set to the default (= 0).
Original size of the button < value \leq maximum value	The configured value is used.
Maximum value < value	Invalid value. The most recent valid value is used.

With a large button size, please note that in some cases not all buttons may be displayed in the control. To show all activated buttons in Runtime, you must therefore extend the control or activate fewer buttons as required.

How to configure the status bar

1. Go to the "Status Bar" tab. In the WinCC AlarmControl, for example:

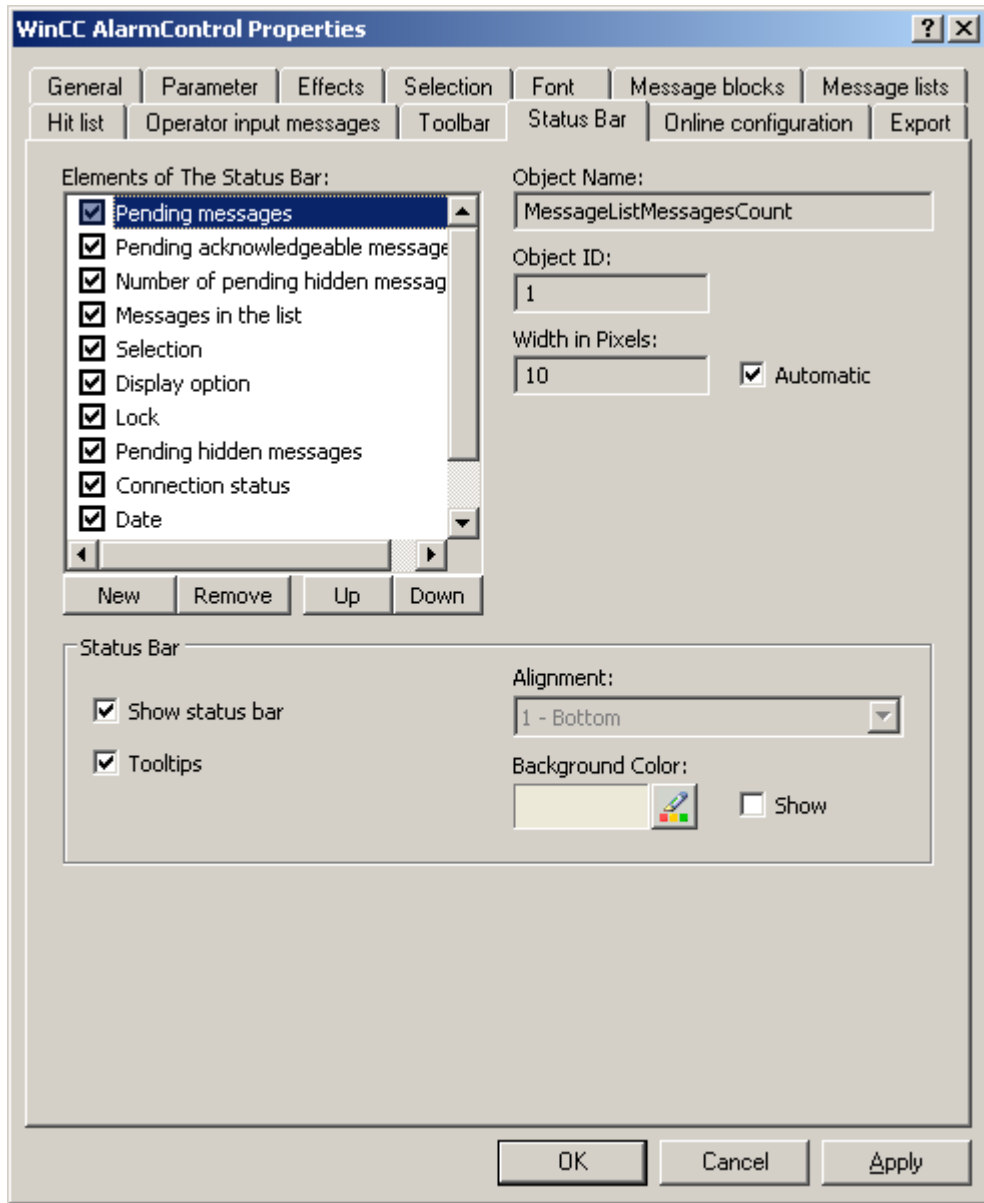

2. Activate the elements required during runtime in the list of status bar elements. For further information on status bar elements, refer to the descriptions of the corresponding WinCC control at "Operation in runtime".
3. Determine the sorting order for displaying of the status bar elements. Select the elements from the list and move these using the "Up" and "Down" buttons.
4. To resize the width of a status bar element, deactivate the "Automatic" option and enter a pixel value for the width.
5. Configure the general properties of the status bar, e.g. alignment or background color.

How to configure the Ruler window/Statistics window/Statistics area window

Introduction

Evaluated data and statistics are shown in a table in a ruler window, statistics window or a statistics area window. The ruler window/statistics window/statistics area window are configured in the WinCC RulerControl.

Overview of the WinCC RulerControl

The RulerControl can be connected with the following controls:

- WinCC OnlineTrendControl
- WinCC OnlineTableControl
- WinCC FunctionTrendControl

Depending on the data evaluation, there are three different types of windows for displaying values. The following window types are available:

- The ruler window displays the coordinate values of trends on the ruler.
- The statistics area window shows the values of the lower limit and upper limit of the trends between two rulers or the selected area in the table. The statistics area window is not planned for the WinCC FunctionTrendControl.
- The statistics window shows the statistic evaluation of the trends between two rulers or the selected values in the table. The statistics window is not planned for the WinCC FunctionTrendControl.

All windows can also display additional information on the connected trends or columns.

Requirement

- You have opened a picture with an OnlineTrendControl, OnlineTableControl or FunctionTrendControl in the Graphics Designer.

Procedure

1. Insert RulerControl into the picture from the WinCC object palette.
2. Double click on the RulerControl to open the configuration dialog.

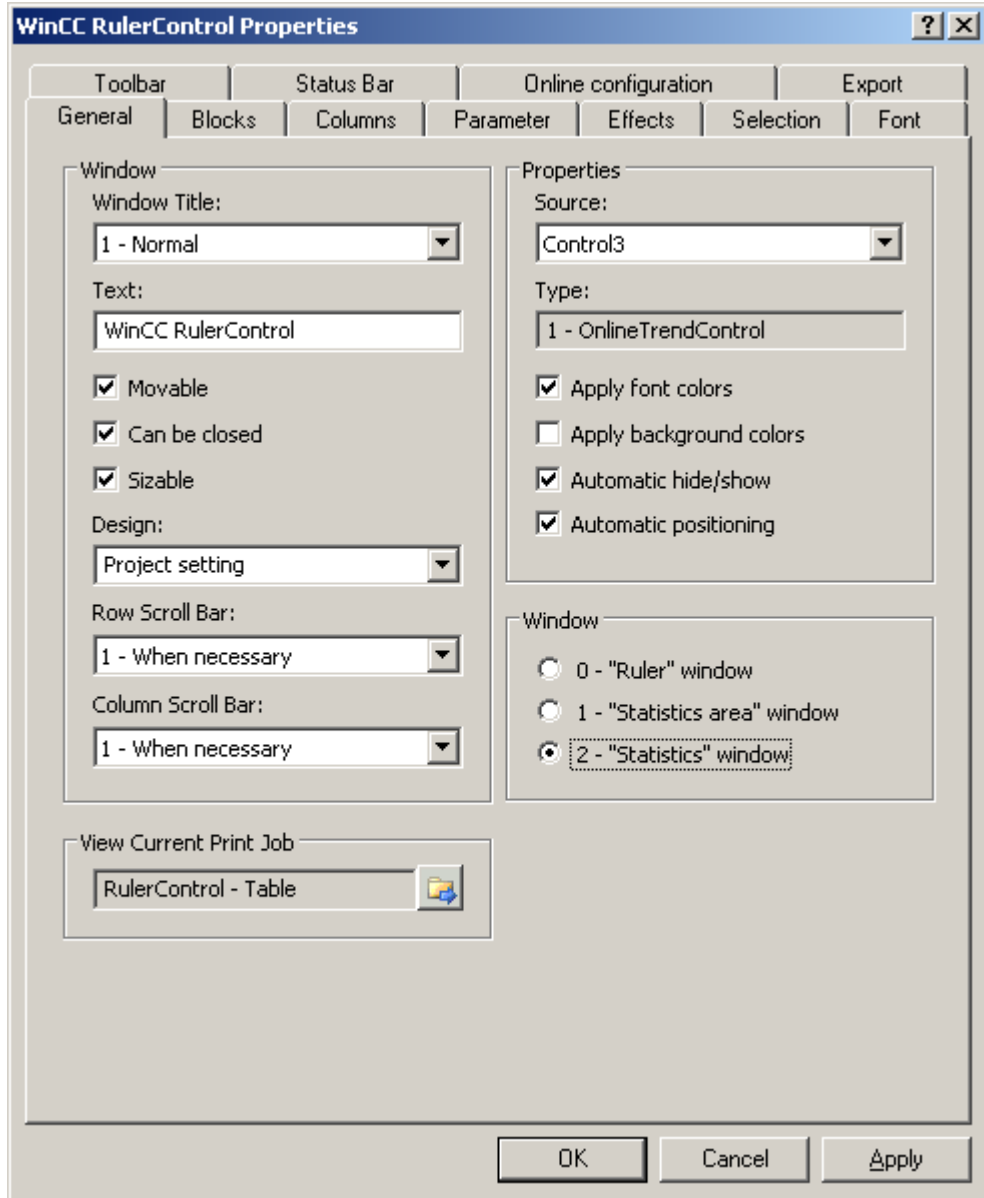

3. Configure the properties of the control on the "General", "Toolbar" and "Status bar" tabs.
4. Go to the "General" tab in the field "Source" and select the object name of the control that is already configured. The type of control is displayed in the "Type" field.
5. Set the window type in the "Window" field. If the key function "Configuration dialog" can be operated in runtime, you can change the window type in runtime.

6. Go to the "Columns" tab.

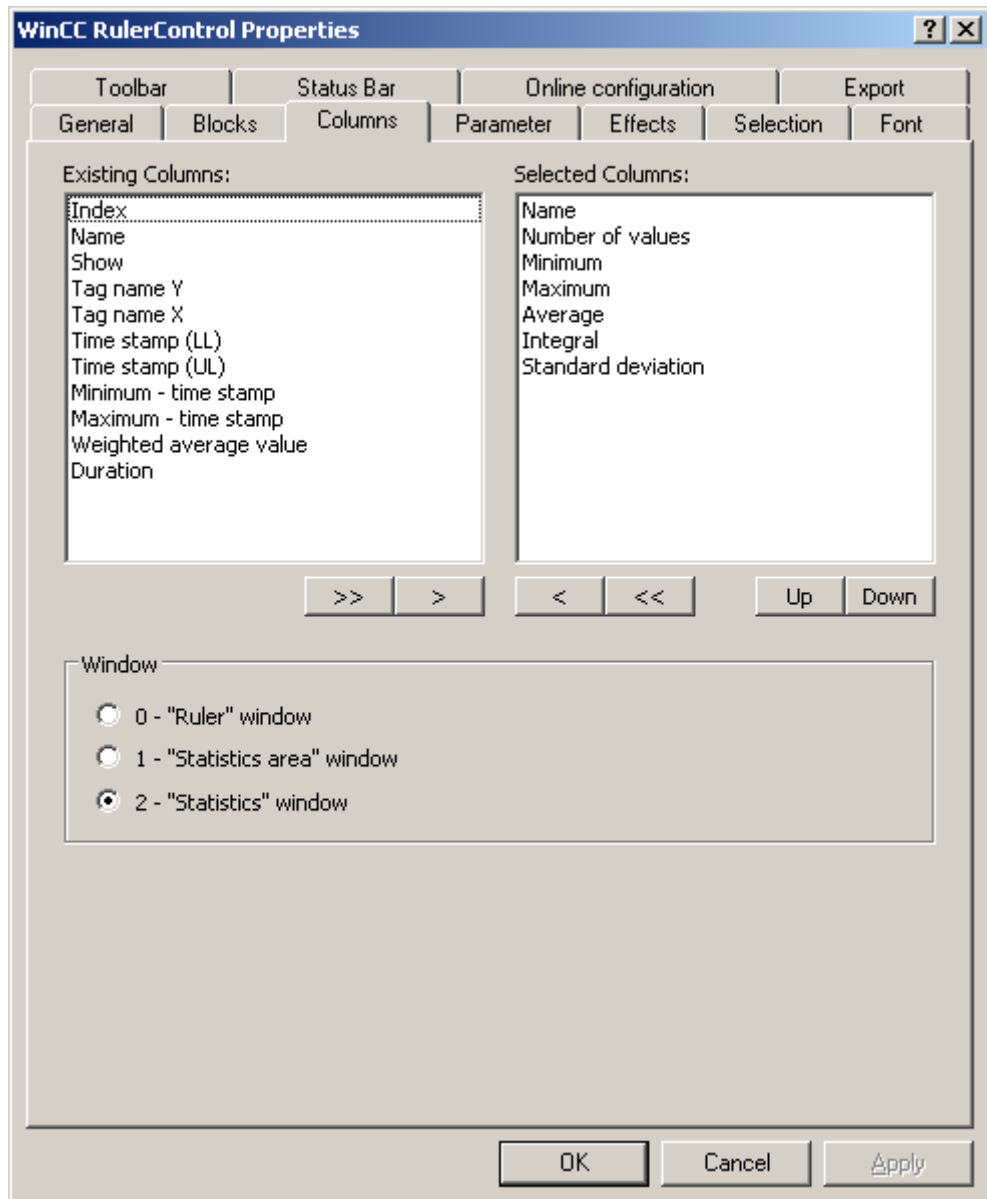

7. Use the arrow keys to select the column of the window type that you want to display for the assigned control. Columns for the basic data and columns that are only for the selected window type or the assigned control are available. Define the column sequence with buttons "Up" and "Down".

- 8. Go to the "Blocks" tab.

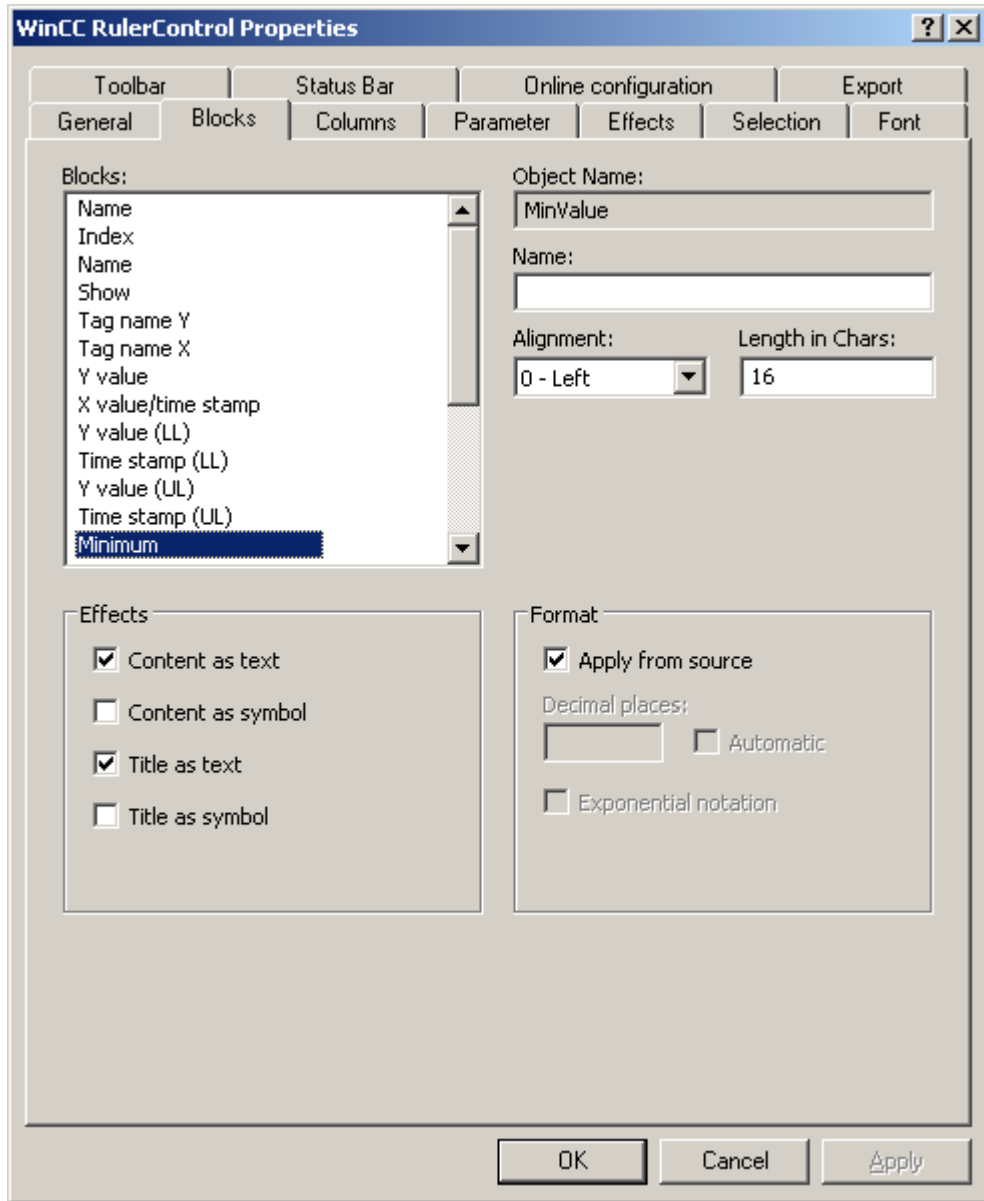

Every column corresponds with a block. In order to define the properties for the selected columns, click on the respective blocks.

- 9. If a special format exists for a block, you can configure the format of the block. Deactivate the option "Apply from source" if the format settings of the connected control are not to apply in this case. Define the desired format.
- 10. Define whether the data for the column and the column heading is to be displays as text or as an icon in the table under "Display".
- 11. Save the configuration.

12. Configure the properties and the display of the table for the RulerControl in the "Parameter," "Effects" and "Selection" tabs.
For details on configuring the table display, please refer to "Configuration of OnlineTableControl > How to configure the table display (Page 1567)" in the WinCC OnlineTableControl documentation.
13. You can export the evaluated data. This requires activating the "Export data" key function on the "Toolbar" tab.
For details on data export, please refer to "Configuration of OnlineTableControl > How to export runtime data (Page 1581)" in the WinCC OnlineTableControl documentation.
14. Configuring the TrendRulerControl is possible in runtime.
For more detailed information, please refer to "Configuration of OnlineTableControl > How to apply online configuration (Page 1583)" in the WinCC OnlineTableControl documentation.

See also

- How to export runtime data (Page 1581)
- How to define the effect of the online configuration (Page 1583)
- How to configure the display for the table (Page 1567)

How to export runtime data

Introduction

The runtime data shown in the WinCC controls can be exported using a button function. Set up operation of the data export during runtime in the configuration dialog.

Requirement

- A picture showing a WinCC control is opened in Graphics Designer when configuring.
- The configuration dialog of the WinCC control is open.

How to configure the operation of the data export

1. Go to the "Export" tab.

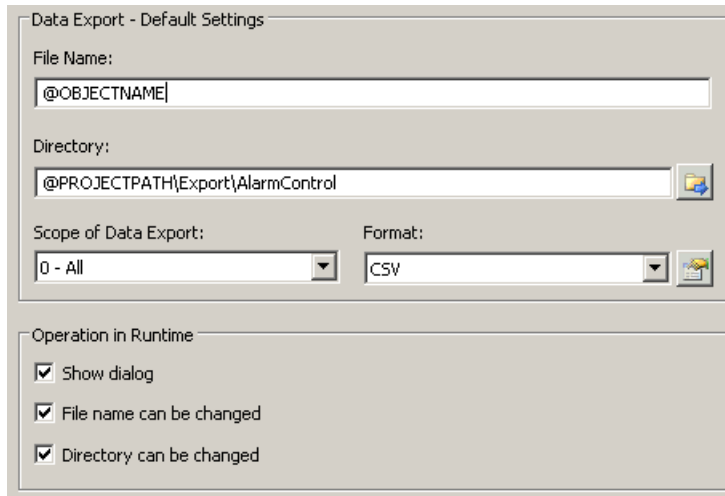

2. A standard file name and a standard directory are already entered in the "Data export default settings". In this case for AlarmControl. If necessary, define a file name and a directory for the export file.

The file name can be made up of the freely defined name and the following placeholder:

@OBJECTNAME - Object name of the controls

@CURRENTDATE - Current date

@CURRENTTIME - Current time

3. CSV is currently available as data format. Click  to specify the delimiter and data format in the CSV file.
4. Define the scope of the data export:
 - All runtime data is exported
 - Selected runtime data is exported. This data export is only possible in WinCC controls with tabular display.
5. Configure the operation of the data export during runtime. Define:
 - whether users are allowed to rename the file, or change the directory.
 - whether to display the "Data export default settings" dialog in Runtime.
6. If "Show dialog" is deactivated, the data for operation of the "Export data" button function is immediately exported to the defined export file.
7. Save the configuration.
8. Go to the "Toolbar" tab to activate the "Export data" button function for runtime.

Results

You can export all or selected data to a defined file at runtime using the  button function.

How to define the effect of the online configuration

Introduction

Users can parameterize the WinCC controls in Runtime. You must define the Runtime effects of the online configuration.

Changes configured in Runtime are saved for the specific user separately from the picture in the configuration system. The original picture configuration is retained in the configuration system.

Note

The picture is also replaced at Runtime if you save it in Graphics Designer, or when loading deltas in online mode. All online changes are lost.

The different configurations are only activated for new users after you performed a picture change.

Requirement

- A picture showing a WinCC control is opened in Graphics Designer when configuring.
- The configuration dialog of the WinCC control is open.

Procedure

1. Go to the "Online configuration" tab. For example, in OnlineTrendControl:

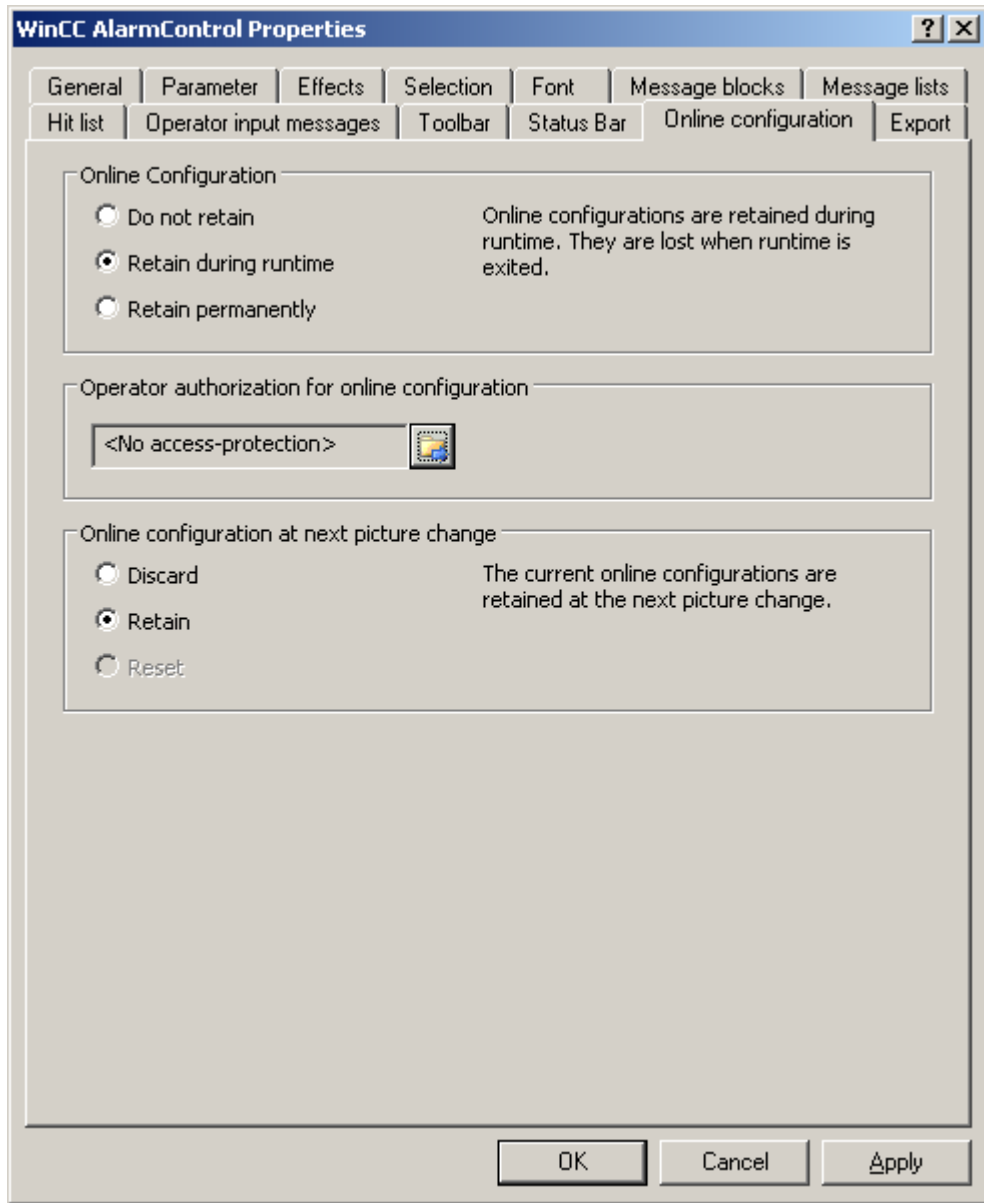

2. The option buttons of the "Online configuration" field for setting online configuration defaults are only available in the configuration system. The option buttons are not available in Runtime.

Select one of the three effects of the online configuration:

- "Do not retain". The online configurations are not retained in Runtime. This default setting disables all options for Runtime users. Online configurations are lost at the next picture change and on activation/deactivation of the project.

- "Retain during Runtime". This default setting enables the "discard", "retain" or "reset" options for Runtime users. Online configurations are retained at the next picture change if the "retain" option is enabled, however, these are lost on activation/deactivation of the project.
 - "Retain permanently". This default setting enables the "discard", "retain" or "reset" options for Runtime users. Online configurations are retained at the next picture change and on activation/deactivation of the project if the "retain" option is enabled.
3. Define corresponding user authorizations for online configuration.
 4. The option buttons of the "Online configuration on next picture change" can be enabled for operation in the configuration system and at Runtime by setting the "retain at Runtime" and "retain permanently" defaults. The "reset" operation is only available in Runtime, because the configuration system contains the original configuration.
Select one of three effects of the online configuration at the next picture change:
 - Select "discard" if to discard the online configuration at the next picture change.
 - Activate "retain" to activate the online configuration based on default settings at the next picture change or on activation/deactivation of the project.
 - Activate "Reset" if you want to apply the picture saved in the configuration system in Runtime. All online changes are lost.
 5. Save the configuration.

How to make the toolbar for the FunctionTrendControl dynamic

Introduction

The default functions for operating the WinCC FunctionTrendControl are no longer supported for the new WinCC FunctionTrendControl as of WinCC V7.0. You can use the WinCC types of dynamics to e.g. operate a key function of the toolbar with a script.

Overview

With WinCC Controls as of V7.0 you do not need special functions to implement operation of the control by assigning dynamic properties to the toolbar. The previously used standard functions "TrendToolbarButton" are no longer supported.

If you do not want to operate the control via the toolbar, you can write the "ID" for the desired button in the "ToolbarButtonClick" object property with an optional type of dynamics.

The "ID" of a button of the toolbar can be determined:

- with the table on page "Operation of the FunctionTrendControl in runtime".
- in the configuration dialog of the FunctionTrendControl on the "Toolbar" tab via field "Object ID".

Example: Open the configuration dialog for the control

In order to open the configuration dialog of the control, dynamics are possible as follows:

- VBScript:
 - ScreenItems("Control1").ToolBarButtonClick = 2
 - As an alternative to the property "ToolBarButtonClick", there are also methods in VBS for operating the toolbar: ScreenItems("Control1").ShowPropertyDialog
 - Or, with the following notation with the support of "Intellisense":
Dim obj
Set obj = ScreenItems("Control1")
obj.ShowPropertyDialog
- C script:
 - SetPropWord(lpszPictureName, "Control1", "ToolBarButtonClick", 2);
- Direct connection
 - In the dialog for the direct connection for the source, enter "2" as a constant
 - Select the property "ToolBarButtonClick" for the object "Control1" for the target "Object in picture"

See also

Operating the FunctionTrendControl in runtime (Page 1720)

Operation in Runtime

Operating the FunctionTrendControl in runtime

Introduction

The trend window is operated in runtime via the buttons in the toolbar.















If you do not want to operate the trend window via the toolbar, you can write the "ID" for the desired button in the "ToolBarButtonClick" object property with an optional type of dynamics.







Overview

The overview shows all symbols in "standard" style.

If you create a design of the controls with the "Simple" style, the representation of the symbols is the same as with FunctionTrendControl before WinCC V7. You can find an overview on the page "Before WinCC V7: Output process values as function of another tag > Operation in Runtime > Operation of Function Trend Control in Runtime".

Icon	Description	ID
	"Help" Calls up the help on WinCC FunctionTrendControl.	1





	"Configuration dialog" Opens the configuration dialog, in which you can change the properties of the FunctionTrendControl.	2
	"Zoom area" Define an area by dragging with the mouse in the trend window. This cut-out of the trend window is made larger. The "Original view" button brings back the original size of the view. If the symbol is enabled, the updated display is stopped and the "Stop" symbol is enabled.	4
	"Zoom +/-" Enlarges or reduces the trends in the trend window. The left mouse button increases the size of the trends. By holding the "Shift" button down, the left mouse button zooms out of the trends. The "Original view" button brings back the original size of the view.	5
	"Zoom X axis +/-" Zooms in on or out off the X axis in the trend window. The left mouse button increases the size of the X axis. By holding the "Shift" button down, the left mouse button zooms out of the X axis. The "Original view" button brings back the original size of the view.	6
	"Zoom Y axis +/-" Zooms in on or out off the Y axis in the trend window. The left mouse button increases the size of the Y axis. By holding the "Shift" button down, the left mouse button zooms out of the Y axis. The "Original view" button brings back the original size of the view.	7
	"Move trend area" The button moves the trend along the X axis and Y axis in the trend window.	8
	"Move axis area" This button moves the trends along the value axis in the trend window.	9
	"Original view" This button exits the zoomed trend display and restores the original view.	10
	"Select data connection" This button opens a dialog for the archive selection and tag selection.	11
	"Select trends" This button opens the dialog for toggling between visible and invisible trends. You can also define which trend is displayed in the foreground.	12
	"Select time range" This button opens a dialog where you can specify the time range to be displayed in a trend window.	13
	"Previous trend" This button is used to display the previous trend of the trend window in the foreground.	14
	"Next trend" This button is used to display the next trend of the trend window in the foreground.	15
	"Stop" The updated display is stopped. The data is saved to the clipboard and added the next time you click on the button in the trend window.	16

	"Start" Resume updated display.	16
	"Print" Click this button to print the trend shown in the trend window. The print job used for printing is defined in the configuration dialog on the "General" tab.	17
	"Export data" This button is used to export all or the selected runtime data to a "CSV" file. If the option "Display dialog" is active, a dialog will open in which you can view the export settings and start the export. You can also select the export file and directory, provided you have the required authorizations. If no dialog is displayed, the export of data to the preset file will be started immediately.	20
	"Ruler" The coordinate points of a trend are queried with this button. The trend data is displayed in the ruler window. The button is only functional if a ruler window is connected with the FunctionTrendControl.	3
	"Connect backup" This button opens a dialog in which you can connect selected archives to WinCC Runtime.	18
	"Disconnect backup" This button opens a dialog in which you can disconnect selected archives from WinCC Runtime.	19
	"User-defined 1" Shows the first key function created by the user. The function of the button is user-defined.	1001

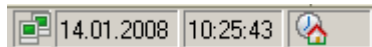
Possible elements of the status bar

The following elements can appear in the status bar of the trend window:



Icon	Name	Description
	Connection status	Shows the status of the data connections: <ul style="list-style-type: none"> • No faulty connections • Faulty connections • All connections are faulty
	Date	Shows the system date.
	Time	Shows the system time.
	Time base	Shows the time base used in the display of times.

Double click on the icon for the connection status to open the window "Status of the data connections", in which the name, status and tag name of the data connection are listed.

Online configuration of the FunctionTrendControl

Introduction

In runtime, you can configure online and change the display of the WinCC FunctionTrendControl. Configuring the WinCC FunctionTrendControl defines how to proceed with a picture change or after ending runtime with online configurations.

Overview

The following buttons functions make online configuration possible in FunctionTrendControl:

- With key function "Configuration dialog"
- With key function "Select trends"
- With key function "Select time range"

Key function "Configuration dialog"

Use the key function "Configuration dialog"  to access the configuration dialog tabs, for example to change the trend display.

Key function "Select trends"

The key function "Select trends"  opens a dialog in which you show or hide trends. You bring trends to the foreground by changing the order of the trends.

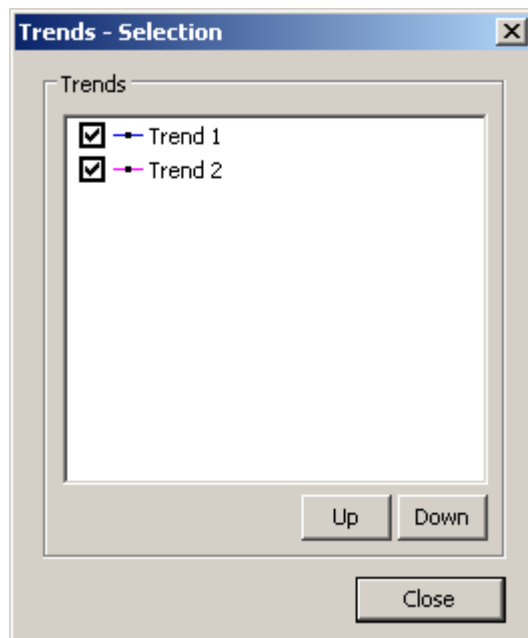

Key function "Select time range"

Select the time range in which the trend is to be displayed with the key function "Select time range" .

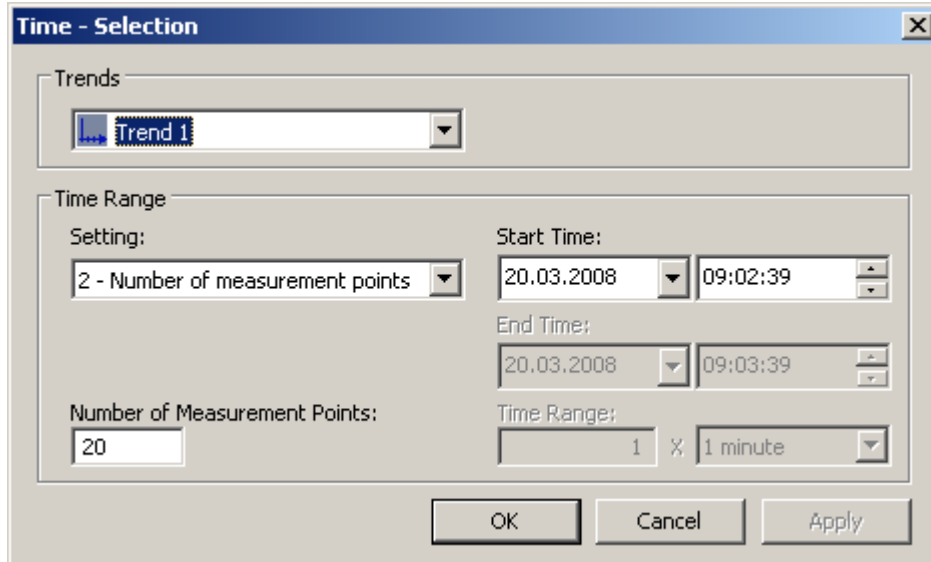

Field	Description
Trends	Select the trend for which you want to define a time range.
Time range	Specify the time range: <ul style="list-style-type: none"> • If you want to define a fixed time interval, select setting "Start to end time". Enter the date and time for each. • If you want to define a time period, select the setting "Time range". Define the date and time for the start time. The length of the time interval to be displayed is determined by multiplying the "Factor" by the "Time unit". • If you want to display a certain number of values, select the setting "Number of measurement points". Define the date and time for the start time. Enter the required number of measurement points in the input field.



The input format of the date and time depends on the Runtime language used.

Starting and Stopping Update

Introduction

With the "Start/Stop" button function you can start or stop the update of trends and bars in the trend window or diagram window.

The button indicates whether the update is stopped or not:

- : The update is stopped. Click on the button to continue updating.
- : The update is started. Click on the button to stop updating.

How to display the trend in the foreground



Introduction

If more than one trend are to be displayed in a trend window, you can use key functions to define which trends will be displayed in the foreground.

Requirement

- You have configured key functions "Select trends", "Previous trend" and "Next trend".

Procedure

-  is used to open a dialog for displaying or hiding trends. You can also define which trend is in the foreground.
-  is used to display the next trend of the trend window in the foreground.
-  is used to display the previous trend of the trend window in the foreground.

How to Determine the Coordinates of a Point



Introduction

Key function "Ruler" is used for defining the coordinates of a point on the trend with cross-hairs or the rulers. You can zoom in on an area of the trend to make coordinate finding easier. You can also read many trend parameters in the trend window with the mouse on the trend.

Requirement

- You have configured a WinCC FunctionTrendControl. In order to highlight the ruler in the trend window, you can increase the line weight on the "Trend window" tab and configure the color.
- You have configured the "Ruler" key function. If you want to zoom in on a section of the trend, configure key functions "Zoom area" and "Original view".
- You have configured a WinCC RulerControl as a ruler window and connected it with the FunctionTrendControl.
- You have activated runtime.

How to display the coordinates

1. In FunctionTrendControl, click on .
2. Move the cross-hairs or the ruler to the desired position with the mouse.
3. If you want to zoom in on an area, click on . Move the ruler to the desired position with the mouse.
4. If you want to return to the original view, click on .

Result

Two rulers or the cross-hairs appear in the trend window. In the ruler window, besides the X value and the Y value, the data that you have configured in WinCC RulerControl is shown in the columns.

The displayed values can be assigned an additional attribute in the form of a letter:

- Letter "i." : The displayed value is an interpolated value.
- Letter "u." : The displayed value has an uncertain status. The value is not certain if the initial value is not known after runtime has been activated, or when a substitute value is used.

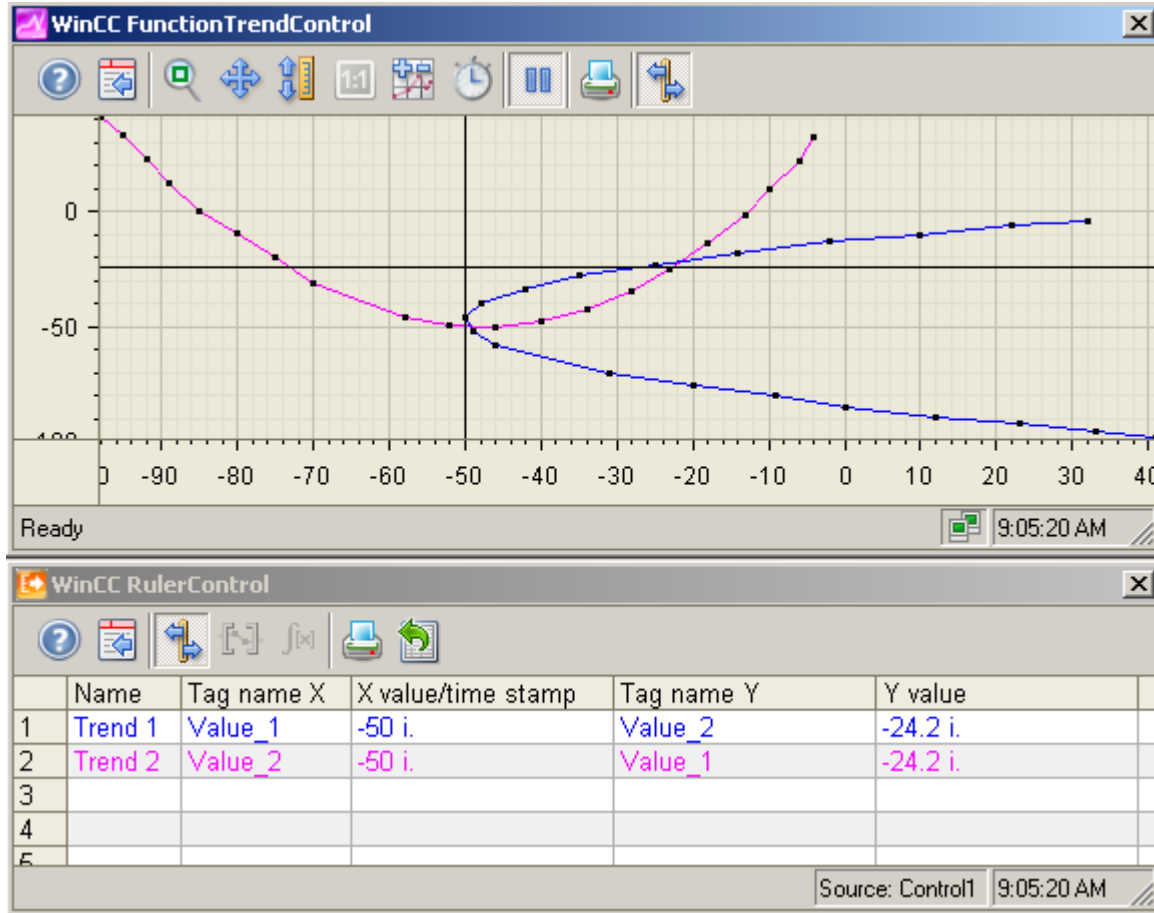

Other values can be determined by positioning the mouse pointer on the cross-hairs or the ruler and moving it to the desired position while holding the left mouse button pressed.

Note

The "uncertain" status of a value can also be indicated in the displayed trend characteristic. You must activate the "Value with uncertain status" option on the "Trends" tab under "Limit values".

How to use the zoom functions in trend windows

Introduction

Key functions can be used for zooming in on, zooming out of and returning to the original view for trends, axes and various zoom areas of the trend window.

Overview



The following zoom functions are available in the trend window:

- "Zoom area"
- "Original view"
- "Zoom +/-"
- "Zoom X axis +/-"
- "Zoom Y axis +/-"
- "Move trend area"

Requirement

- You have configured a WinCC FunctionTrendControl.
- You have configured the buttons for the required zoom functions for the toolbar.
- You have activated runtime.

How to zoom in on a segment of a trend window

1. Click on .
2. In the trend window, click one corner of the area that you wish to enlarge.
3. Hold down your left mouse button and drag the area you want to enlarge until it reaches the desired size. If the highlighted area contains at least two measured values, the selected trend area is displayed in the trend window.
4. Release the left mouse button. The selected segment is magnified. If you want to increase the size further, repeat the process.
5. Click on . The trend window is shown in the originally configured view again.

How to zoom in and zoom out of the trends



1. Click on .
2. Click in the trend window with the left mouse button to zoom in on the trends in the trend window. If you want to increase the size further, repeat the process.
3. If you want to zoom out of the trends, press the "Shift" button while clicking with the left mouse button.

4. While zooming in or zooming out with trends, the 50% value of the trends is always in the middle of the value axes.
5. Click on . The trend window is shown in the original view again.



Note

If you change the value area on the "X Axes" or "Y Axes" tab in the configuration dialog while zooming, the visible zoom area is set to the new value area.

How to zoom the X axis and the Y axis

1. Click on  to zoom in on the X-axis or on  to zoom in on the Y-axis.
2. Click in the trend window with the left mouse button to zoom in on the X axis or Y axis. If you want to increase the size further, repeat the process.
3. If you want to zoom out of the X axis or Y axis, press the "Shift" button while clicking with the left mouse button.
4. While zooming with axes, the 50% value of the trend is always in the middle of the axes.
5. Click on . The trend window is shown in the original view again.

How to move the trend area

1. Click on .
2. While holding the left mouse button down, move the cursor in the desired direction in the trend window. The displayed area in the trend window is adapted on the X axis and on the Y axis.
3. If you click on  again, the original trend window view will be restored.

6.5.3 Process value output in reports

6.5.3.1 Process value output in reports

Introduction

You have the option to output process values in the form of a report. At the end of each shift, you can for example load the achieved production figures from the process value archive and print them out in report format. You create reports in the Report Designer.

Report Designer:

The Report Designer contains a number of preset layout templates that you can change to suit your needs. The Report Designer is also used to create print jobs to initiate the output.

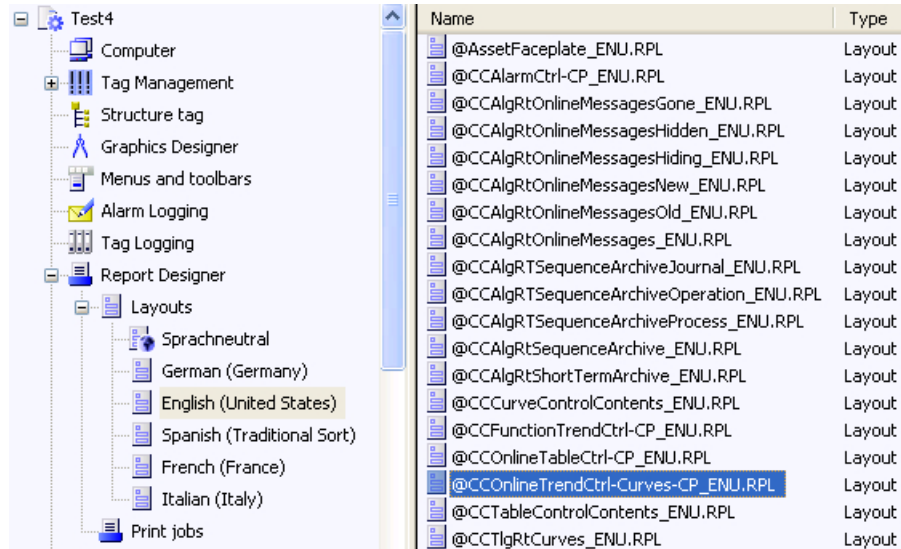

For the output of process values in report format, you can make use of many preset layout templates.

Layouts on the basis of WinCC Controls as of WinCC V7

Use the new layouts that are based on the "WinCC Control Runtime Printprovider" layout templates in WinCC V7 or higher. The output of the report object depends on the layout of the control in Runtime.

- @Online Table Control - Picture.RPL and @Online Table Control - Table.RPL: Process value output on the basis of WinCC Online Table Control.
- @Online Trend Control - Picture.RPL: Process value output on the basis of WinCC OnlineTrendControl.
- @Function Trend Control - Picture.RPL: Process value output on the basis of WinCC FunctionTrendControl.

Layouts on the basis of WinCC Controls prior to WinCC V7

You have detailed parameterization options in the following layouts. You can configure many setting options of the tabs and the dynamizable parameters of the WinCC Controls prior to WinCC V7.

- @CCOnlineTableCtrl-CP.RPL: Process value output on the basis of WinCC Online Table Control.
- @CCOnlineTrendCtrl-Curves-CP.RPL: Process value output on the basis of WinCC Online Trend Control.
- @CCFunctionTrendCtrl-CP.RPL: Process value output on the basis of WinCC Function Trend Control.

General Procedure

The configuration procedure for reports consists of the following steps:

1. Selection of process data and adjustment layout: Select the process data that will be displayed in the report. If necessary, modify the report layout.
2. Configuring the Print Job Configure the print output of the report by defining the time period, the number of pages and the output medium.

See also

Output of Process Values (Page 1557)

How to Configure the Static Parameters of WinCC Online Table Control (Page 2241)

How to Configure the Dynamic Parameters of WinCC Online Table Control (Page 2244)

How to Configure the Static Parameters of WinCC Online Trend Control (Page 2246)

How to Configure the Dynamic Parameters of the WinCC Online Trend Control (Page 2249)

How to Configure the Static Parameters of WinCC Function Trend Control (Page 2251)

Configuring the dynamic parameters of the WinCC Function Trend Control (Page 2253)

Introduction to Runtime Documentation (Page 2066)

How to create print jobs for the Runtime documentation (Page 2072)

6.5.4 Process value output before WinCC V7

6.5.4.1 Process value output in process pictures before WinCC V7

Introduction

You have the option to output archived and current process values in Runtime. For this, WinCC provides two ActiveX Control that can be inserted into a process picture, which consists of a table or trend window.

Process Value Output in Tables

To output process values in table format in Runtime, use the WinCC Online Table Control. You can display the archive tags:

Date/Time	Tank 1	Tank 2	Tank 3
15.03.99 16:34:09.9	200.00	55.00	10.00
15.03.99 16:34:10.4	200.00	55.00	10.00
15.03.99 16:34:10.9	171.00	54.00	14.00
15.03.99 16:34:11.4	171.00	54.00	14.00
15.03.99 16:34:11.9	152.00	62.00	20.00
15.03.99 16:34:12.4	152.00	62.00	20.00
15.03.99 16:34:12.9	152.00	66.00	26.00
15.03.99 16:34:13.4	152.00	66.00	26.00
15.03.99 16:34:13.9	170.00	62.00	26.00
15.03.99 16:34:14.4	170.00	62.00	26.00
15.03.99 16:34:14.9	200.00	61.00	30.00

Update stopped!

Process Value Output as Trends

To output process values in trend format in Runtime, use the WinCC Online Trend Control. You can then fill the table with archived or process tags:

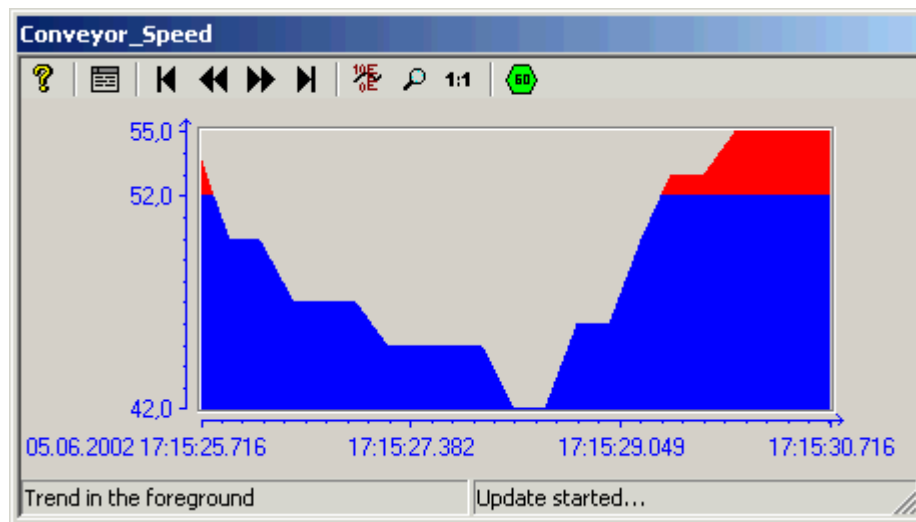

Use the WinCC Online Trend Control to display process trends, etc. You also have the option to show more than one trends in a window, and to highlight areas that are outside the limit range in a different color.

6.5.4.2 Before WinCC V7: Process Value Output in Table Format

WinCC Online Trend Control

Introduction

In order to process data in table form, WinCC uses Online Table Control to offer the option of displaying process data in a table. You have the option to display either current or archived values.

Display of tag values during Runtime takes place in ActiveX Control, inserted and configured in a picture in Graphics Designer. In order to facilitate access to the tags to be displayed, process value archives and the tags contained therein must be configured in Tag Logging.

Date/Time	Tank 1	Tank 2	Tank 3
15.03.99 16:34:09.9	200.00	55.00	10.00
15.03.99 16:34:10.4	200.00	55.00	10.00
15.03.99 16:34:10.9	171.00	54.00	14.00
15.03.99 16:34:11.4	171.00	54.00	14.00
15.03.99 16:34:11.9	152.00	62.00	20.00
15.03.99 16:34:12.4	152.00	62.00	20.00
15.03.99 16:34:12.9	152.00	66.00	26.00
15.03.99 16:34:13.4	152.00	66.00	26.00
15.03.99 16:34:13.9	170.00	62.00	26.00
15.03.99 16:34:14.4	170.00	62.00	26.00
15.03.99 16:34:14.9	200.00	61.00	30.00

Requirement

The following prerequisites apply to the display of trends in WinCC Online Table Control:

- Only archive tags can be used for tables.
- Each table can contain maximum 30,000 values.
- Archive tags in a table must originate from the same process value archive of a server, must have the same update cycle, and must be recorded in a continuous cycle.

Representation Formats

Introduction

Two basic display types are available for displaying tag values in tabular format.

Shared time column

In this display type, the table contains only one time column. This column displays the archived times of the tag output in the first column. A table to display the values of three tags will therefore consist of four columns in Runtime.

Note

The display of tags with different acquisition times in a table with a shared time column is problematic, since the tag values might not correspond to the indicated archived times of the time column. These values are displayed as crossed out.

Separate time columns

In this display type, the archived times of each tag are displayed in separate columns. A table to display the values of three tags will therefore consist of six columns in Runtime.

Configuration

The table display type to be used is specified on the "General" tab of the "Properties of WinCC Online Table Control" dialog.

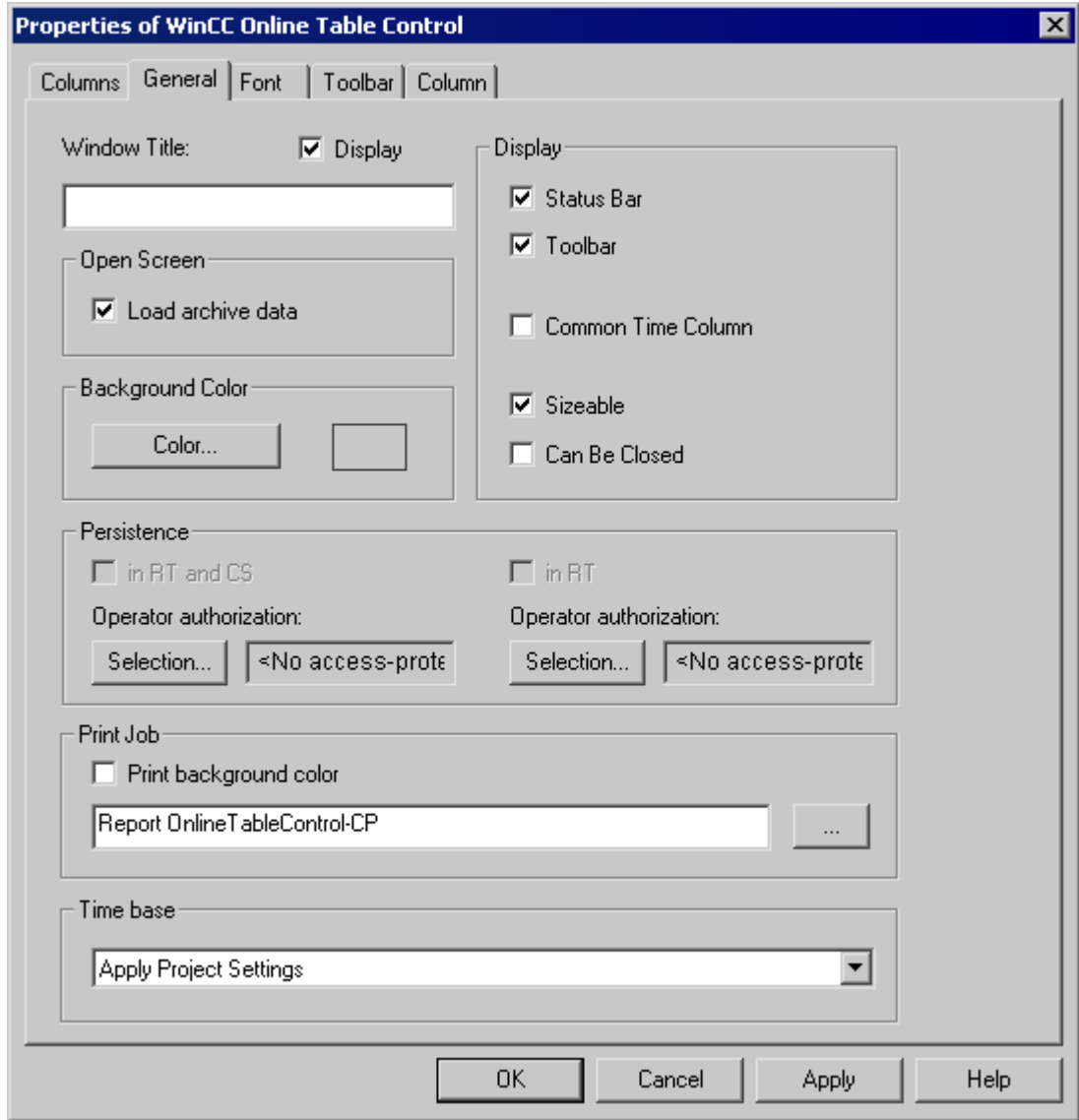

See also

Time Range of a Table Display (Page 1735)

Time Range of a Table Display

Introduction

With respect to time ranges to be displayed, the table display of tags can be shown in various ways:

Static Display

In a static display the archived tag values are shown for a defined time period.

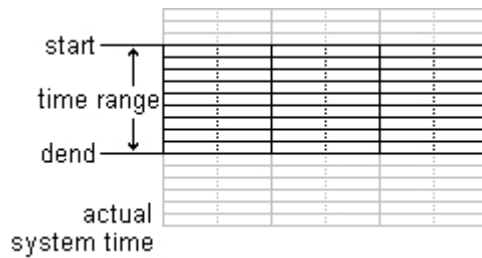

In the "Column" tab of the "WinCC Online Table Controls" property dialog, the static display type is configured by deactivating the "Update" option. The time range to be displayed is set either

- by entering a start time and a time range.
- by entering a start time and an end time.

The screenshot shows the 'WinCC Online Table Controls' property dialog, 'Column' tab. The dialog is divided into three main sections:

- Time display:**
 - Format:
 - Orientation: Left Centered Right
- Value display:**
 - Decimal places:
 - Orientation: Left Centered Right
- Selection of Time:**
 - Update
 - Date: Time:
 - From: To:
 - Time range:
 - Factor: Area:

Dynamic Display

In a dynamic display the end time in a table always corresponds to the current system time. New measurement values coming in will be included in the display.



In the "Column" tab of the property dialog of "WinCC Online Table Controls" the dynamic display type is configured by activating the "Update" option. The time range to be displayed is set either

- by entering a time range.
- by the time difference between the specified start and end times.

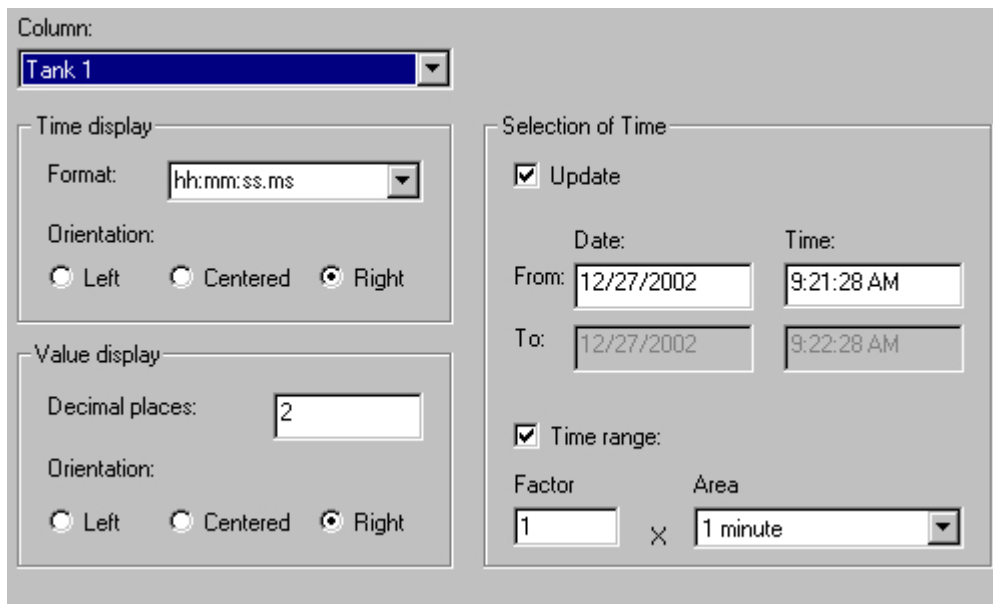

Note

Upon starting Runtime the tag values to be displayed are either read from the archive or are set to zero. This function is set in the "General" tab of the "Properties" dialog.

See also

Representation Formats (Page 1732)

Configuration

Configuration of WinCC Online Table Control

Introduction

In order to display process values in Runtime using WinCC Table Control, you must execute the following steps:

In Tag Logging

1. Use the Archive Wizard to create a process value archive.
2. Configure the process value tags it will contain.

In Graphics Designer

1. Link the WinCC Table Control to a Graphics Designer picture.
2. Link the columns to be displayed in Table Control to the tags of the process value archive.

Note

The table window can be influenced by means of standard functions. If you do not wish to use the toolbar functions to operate the table window, any Graphics Designer objects can be made dynamic using the appropriate functions.

See also

How to Create a Process Value Archive (Page 1738)

How to Insert the Online Table Control in a Picture (Page 1737)

How to Insert the Online Table Control in a Picture

Introduction

Tags are displayed in runtime in an ActiveX Control, which is inserted in a picture and configured with the aid of the Graphics Designer.

Procedure

1. Start Graphics Designer and open a new picture.
2. Click the "WinCC Online Table Control" object on the "Controls" tab in the object palette.

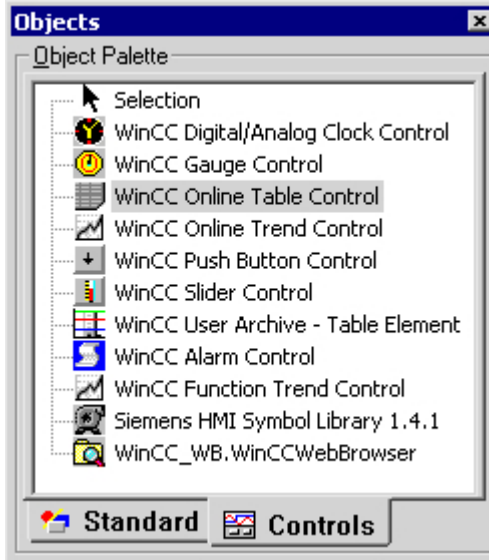

3. Place the mouse pointer at the position in the picture where you want to insert the control. The mouse pointer changes into a crosshair with an object symbol attached.
4. Drag the control to the desired size. The "Insert a Control" dialog is opened.
5. Select the WinCC Online Table Control and confirm your selection by clicking "OK". The "Properties of WinCC Online Table Control" quick configuration dialog box opens.
6. Configure the table properties according to your specifications.
7. Close the dialog with the "OK" button.

See also

How to Display Process Value Tags (Page 1739)

How to Create a Process Value Archive

Introduction

In order to display tags in a WinCC Online Table Control, you must configure a process value archive. A process value archive is created most easily with the help of the Archive wizard.

Procedure

1. Start Tag Logging and select the "Archive Wizard ...". command in the archive pop-up menu.

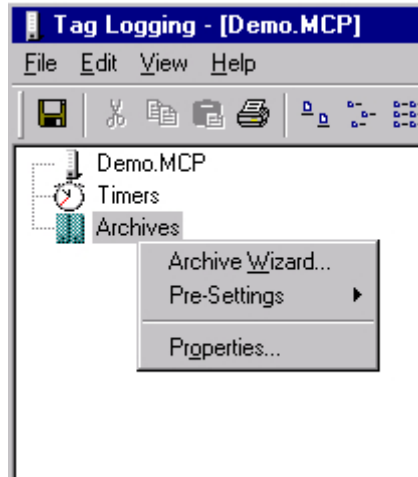

2. In the second step of the Archive Wizard, assign a meaningful name to the process value archive.
3. In the third step of the Archive Wizard, include the desired tags in the process value archive.
4. Close the Wizard by clicking "Apply".

Note

Provided that the process tags contained in an archive were not defined within the Archive Wizard, new tags can be added by using the pop-up menu of a process value archive.

See also

Configuration of WinCC Online Table Control (Page 1737)

How to Display Process Value Tags

Requirement

- Configure tags of data type "Signed 16-bit value".
- Create a process value archive using the configured tags as process value tags.
- Insert the Online Table Control in a picture of Graphics Designer.

Procedure

1. Open a picture in Graphics Designer using Online Table Control.
2. Double-click the Online Table Control.

3. Click the "Columns" tab.

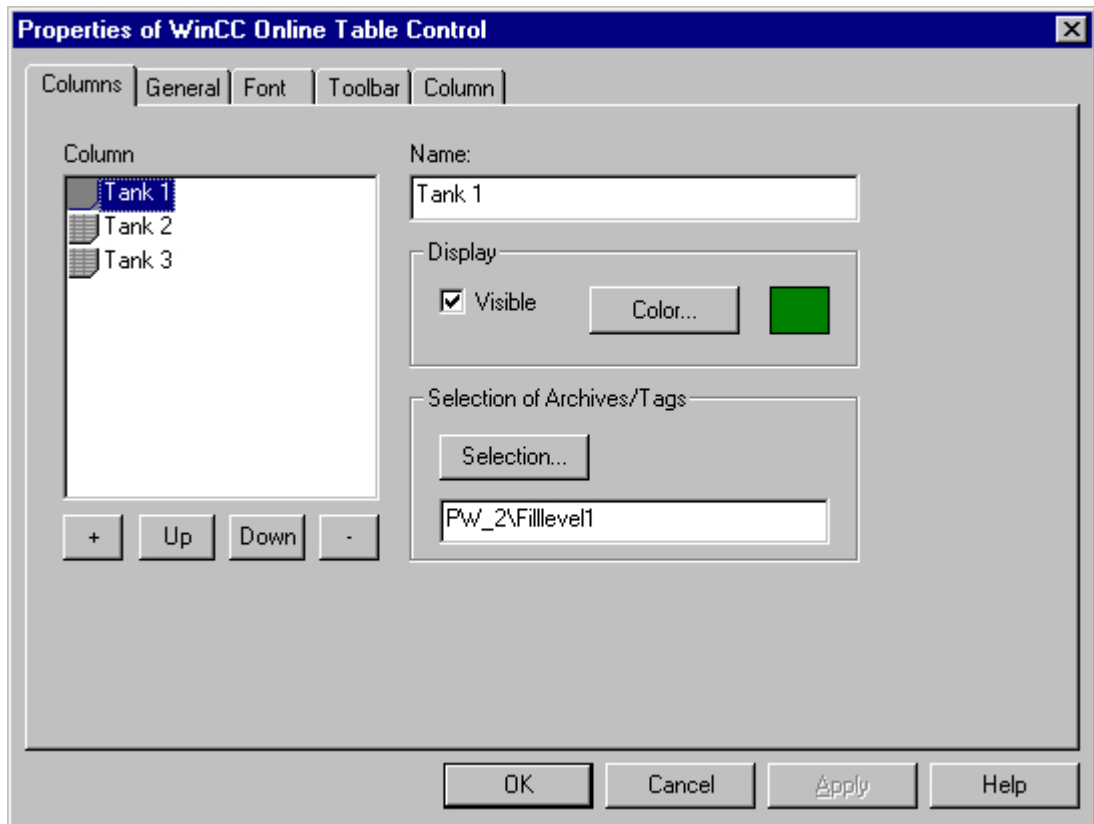

4. In the "Archive/Tag Selection" section, use the "Selection" button to select the process value tag for the selected column.

5. Click the "General" tab.

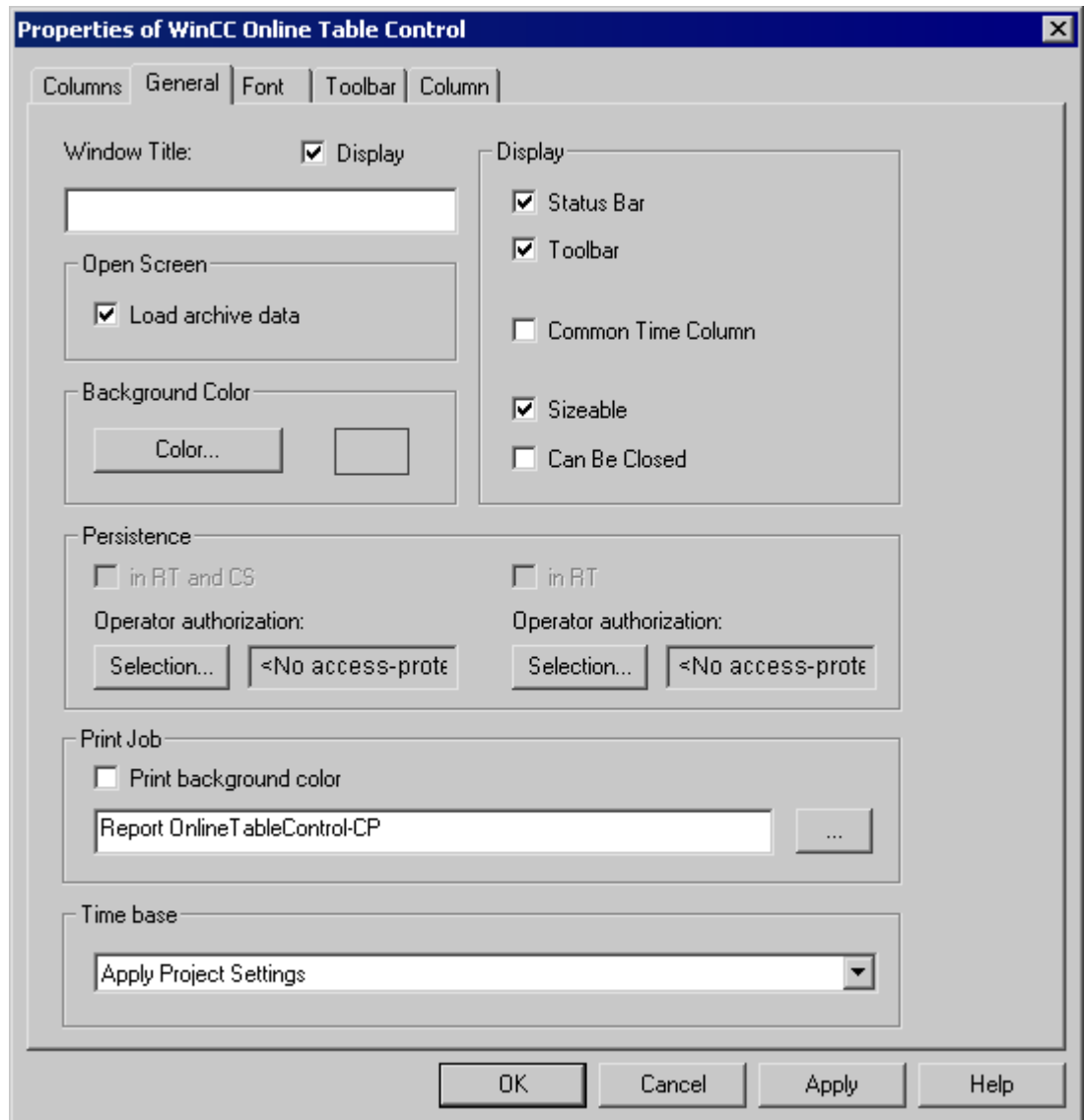

6. Define the behavior of the control in Runtime.
7. Configure additional properties using the "Control" tabs.
8. Close the dialog with the "OK" button.
9. Save the picture.

See also

- How to Insert the Online Table Control in a Picture (Page 1737)
- How to Create a Process Value Archive (Page 1738)

Operation in Runtime

Operation of Online Table Control in Runtime

Introduction

In Runtime, the table window is operated by means of the toolbar buttons.



"Online Help System"

Calls up the online help



"Open the Configuration Dialog"

Select dialog to assign display parameters.



"First Data Record"

The table displays the tag values within a specified time range, beginning with the first archived value.



"Previous Data Record"

The table displays the tag values within the previous time interval, based on the currently displayed time interval.



"Next Data Record"

The table displays the tag values within the next time interval, based on the currently displayed time interval.



"Last Data Record"

The table displays the tag values within the specified time interval, ending with the last archived value.



"Edit"

Upon activating this button, you can double-click any table cell to edit its contents. This will stop the updated display.



"Dialog for Archive and Tag Selection"

This button will open the dialog for archive and tag selection.



"Dialog for Selecting Columns"

This button will open the dialog for toggling visible and invisible column view.



"Select Time Range"

This button will open the dialog to specify the time range displayed in a table window.



"Previous Column to Front"

This button allows you to display the current last column of the table window as the first data column of the table. In a joint selection the corresponding archived times are displayed in the time column. In a joint selection the corresponding archived times are displayed in the time column.



"Next Column to Front"

This button allows you to display the current last column of the table window as the first data column of the table. In a joint selection the corresponding archived times are displayed in the time column. In a joint selection the corresponding archived times are displayed in the time column



"Start/Stop the Update"

The updating for the display is stopped. The values are stored in interim memory and resupplied after reactivating the button.



"Start/Stop the Update"

Resume display.



"Print Log"

Initiates printing of columns displayed in table window. Print job used during printing can be specified in the control properties on the "General" tab.



"Select Statistics Area"

Enables mouse-based specification of time frame for calculation of statistics in table window.



"Calculate Statistics"

Opens a statistics window to display minimum, maximum, average and standard deviation for a specified time frame and a specified column.

See also

Starting and Stopping Update (Page 1748)

How to Generate Statistics of Runtime Data (Page 1751)

Display Column in Front (Page 1748)

How to Edit a Table Cell in Runtime (Page 1749)

Online Configuration for Online Table Control (Page 1743)

Online Configuration for Online Table Control

Introduction

In order to change the configuration of Online Table Control in Runtime, you have four options available.

Key function "Open the Parameter Dialog"

The key function "Open Set Configuration Dialog"  provides access to all essential settings for table display.

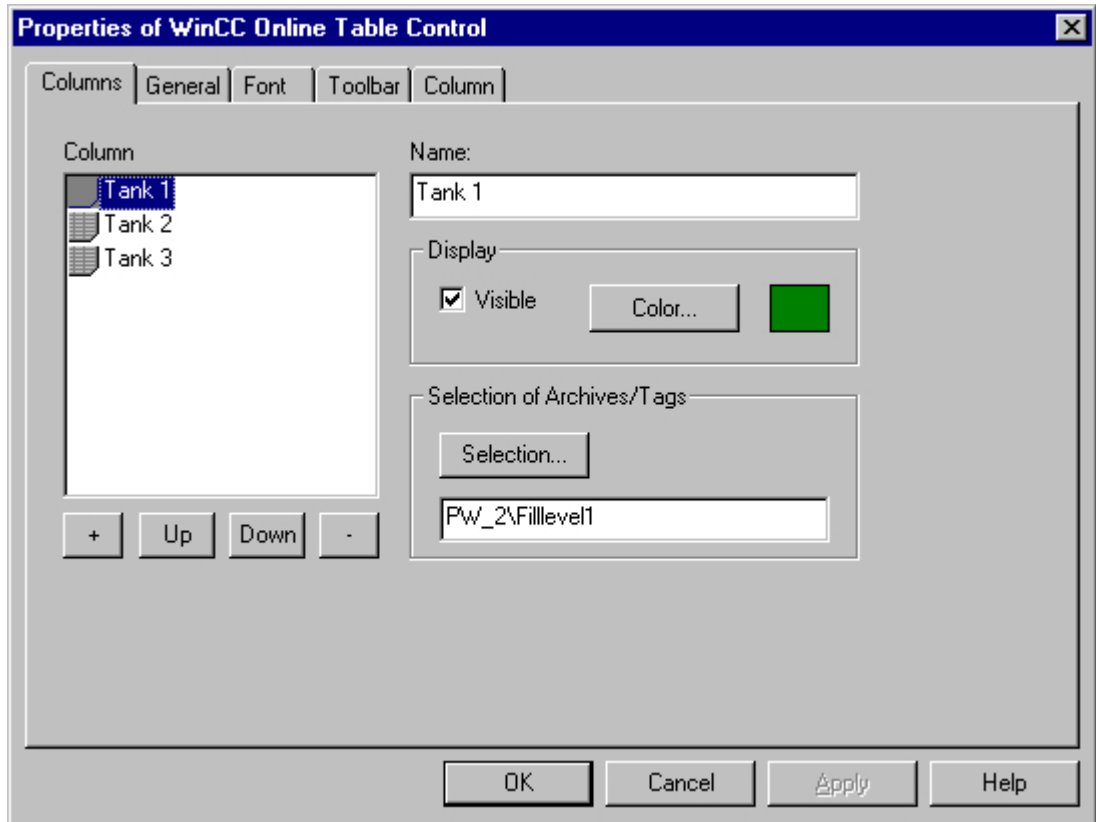

Key function "Dialog for Archive and Tag Selection"

The key function "Dialog for Archive and Tag Selection"  allows for the specification of the tags linked to the columns of a table window.

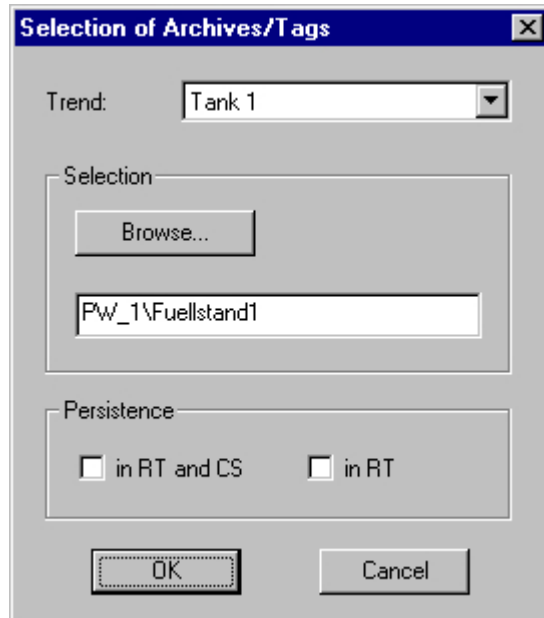

Array	Description
Column	Here, you can select one of the configured columns.
Selection	Using the "Selection" button, you open the dialog to select an archive and the tags contained therein.
Persistence	<p>If the "Persistence in RT and CS" option is not activated, any changes made to the settings are only effective within Runtime. Whether or not any changed settings remain effective after a picture change depends on the "Persistence in RT" option.</p> <p>If the "Persistence in RT and CS" option is activated, any changed settings are also transferred to the configuration system. To do this, you must open the picture in Graphics Designer and save it once again. The changed settings are also used when the project is reactivated.</p> <p>Changes to the control properties in Runtime are not persistently accepted in CS with PCS 7 projects or TIA projects. When you completely load the ES to the OS, the changed settings on the OS will be overwritten.</p> <p>Configure the properties of the controls on the ES.</p>

Key Function "Dialog for Selecting Trends"

The key function "Dialog for Selecting Columns"  opens the dialog for toggling between visible and invisible columns.

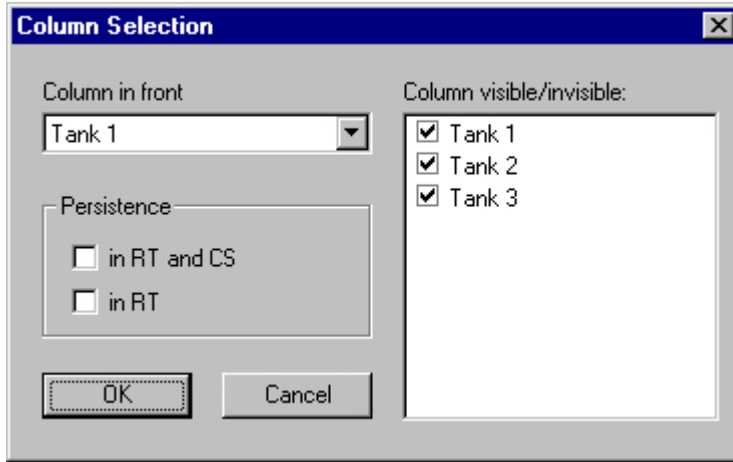

Array	Description
Column to Front	If a shared time column is used, the archived timers of the first column of the table will be displayed. The first column can be changed either in this dialog or by using the "Previous column in the front" and "Next column in the front" buttons in the toolbar.
Column visible/invisible	In this area, you can specify which configured columns are not to be shown.
Persistence	<p>If the "Persistence in RT and CS" option is not activated, any changes made to the settings are only effective within Runtime. Whether or not any changed settings remain effective after a picture change depends on the "Persistence in RT" option.</p> <p>If the "Persistence in RT and CS" option is activated, any changed settings are also transferred to the configuration system. To do this, you must open the picture in Graphics Designer and save it once again. The changed settings are also used when the project is reactivated.</p> <p>Changes to the control properties in Runtime are not persistently accepted in CS with PCS 7 projects or TIA projects. When you completely load the ES to the OS, the changed settings on the OS will be overwritten.</p> <p>Configure the properties of the controls on the ES.</p>

Note

The first column of a table window cannot take the "invisible" attribute.

Key Function "Select Time Range"

The key function "Select Time Range"  opens a dialog to specify the time range to be displayed. If the columns of a table window are to be displayed with a common time axis, the specified time range applies to all columns.

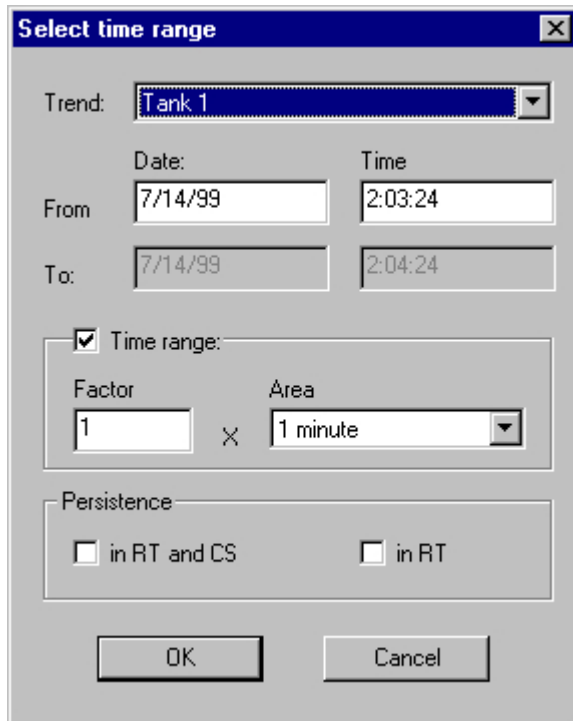

Array	Description
Column	Here, you can select one of the configured columns.
Time Selection	<p>The time interval to be displayed in the table window can be set</p> <ul style="list-style-type: none"> • by entering a start and an end point (the "Time Range" setting not activated). • by entering a start time and a time range. ("Time Range" setting activated). The length of the time interval to be displayed is determined by multiplying the "Factor" by the "Range".
Persistence	<p>If the "Persistence in RT and CS" option is not activated, any changes made to the settings are only effective within Runtime. Whether or not any changed settings remain effective after a picture change depends on the "Persistence in RT" option.</p> <p>If the "Persistence in RT and CS" option is activated, any changed settings are also transferred to the configuration system. To do this, you must open the picture in Graphics Designer and save it once again. The changed settings are also used when the project is reactivated.</p> <p>Changes to the control properties in Runtime are not persistently accepted in CS with PCS 7 projects or TIA projects. When you completely load the ES to the OS, the changed settings on the OS will be overwritten.</p> <p>Configure the properties of the controls on the ES.</p>

The entry format of the date and time depends on the Runtime language used.

Note

The WinCC Online Table Control cannot display more than 1000 values within a selected time range. This has to be taken into account when setting the time range.

See also

Configuration of WinCC Online Table Control (Page 1737)



Operation of Online Table Control in Runtime (Page 1742)

Starting and Stopping Update

Introduction

With the key function "Start/Stop Update", you can stop or continue the updates of the columns contained in the table window. When updates are stopped, you can change the displayed time frame and therefore display measurement values from the process value archive in the table window.

When updates are stopped, you can change the displayed time frame and therefore display measurement values from the process value archive in the table window.

- : When updates are stopped, you can change the displayed time frame and therefore display measurement values from the process value archive in the table window.
- : When updates are started, you can change the displayed time frame and therefore display measurement values from the process value archive in the table window.

See also



Operation of Online Table Control in Runtime (Page 1742)

Display Column in Front

Introduction

If a shared time column is used, the archived times of the first column of the table will be displayed in the time column.

The sequence of columns in the table window can be changed in Runtime:

- using the  button (key function "Dialog for Column Selection")
- using the  button: (key function "Next Column to Front")
- using the  button: (key function "Previous Column to Front")

Configuration

The sequence of columns is configured on the "Column" tab of the "Properties of WinCC Online Table Control" dialog. It can be changed via the "Up" and "Down" buttons.

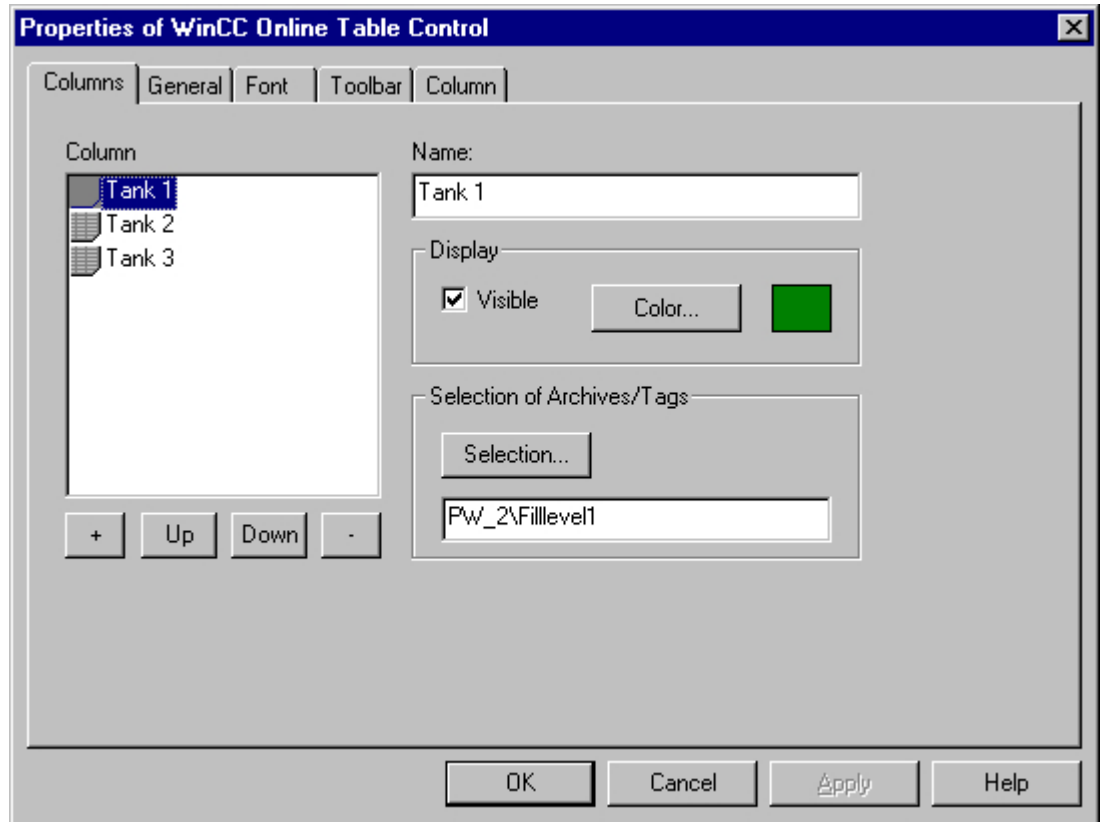

See also

Operation of Online Table Control in Runtime (Page 1742)

How to Edit a Table Cell in Runtime

Introduction

With the key function "Edit" you have the option of manually inserting laboratory or correction values into a process value archive.

Requirement

- Configuration of Online Table Control.
- Configure the display of a toolbar by using the "Edit" key function.
- Start Runtime.

Procedure

By clicking the "Edit" button , the table display is halted. Double-click any cell in the table to change the content of that cell. Values that occur during the edit process are archived.

Note

Values occurring during the edit process can be viewed in the static display. The static display is configured on the "Column" tab of the "Properties" dialog by deactivating the "Update" option.

If the time stamp for a joint selection is changed by editing, the new value will only be written in the first column of the database. The time stamp for the other columns will remain unchanged.

Return to the table display in Runtime mode by clicking the "Edit" button again.

See also

Operation of Online Table Control in Runtime (Page 1742)

Display of Archived Values

Introduction

The buttons in the toolbar of a table window and the respective keyboard shortcuts allow you to "page" through the archive.

In the table window, the values archived for a tag will be displayed within a time interval. The width of this interval is determined by the time range to be displayed or results from the time difference of entered start and end times.

Buttons for Archived Values



The table displays the tag values within a specified time range, beginning with the first archived value.



The table displays the tag values within the previous time interval, based on the currently displayed time interval.



The table displays the tag values within the next time interval, based on the currently displayed time interval.



The table displays the tag values within the specified time interval, ending with the last archived value.

Note

The WinCC Online Table Control cannot display more than 1000 values within a selected time range.

See also

- Operation of Online Table Control in Runtime (Page 1742)
- Online Configuration for Online Table Control (Page 1743)
- Configuration of WinCC Online Table Control (Page 1737)

How to Generate Statistics of Runtime Data

Introduction



You can generate a statistical evaluation of Runtime process data in the table window. The following results are displayed in a statistics window for all selected columns and a specified time frame:

- Minimum
- Maximum
- Average
- Standard deviation

Requirement

- Configuration of Online Table Control.
- Configure the display of a toolbar by using the key functions "Select statistics area", "Calculate statistics" and "Start/stop update". If you wish to calculate statistics for all values of a table, you do not need the key function "Select statistics area".
- Configure the display by using the key function "Select time range" if you wish to choose a statistics area outside of the time range displayed in the columns.
- You can specify the font for the table that is displayed with the key function "Calculate statistics" in the "Font" tab and via the property "StatisticsFont".
- Start Runtime.

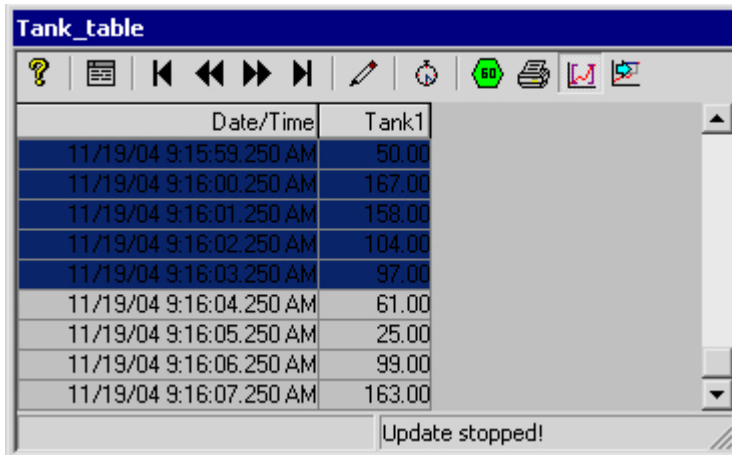

Procedure

1. In the toolbar, click the  button. If you wish to calculate statistics for all table values, click . The updated display is stopped, while process data archiving is continued.
2. In order to specify the time period for the calculation, use the mouse to select the table lines for the desired time frame. For different columns with different time frames you can select different time ranges for the calculation of statistics.



3. In the toolbar, click the  button.
4. The "Statistics" window opens with results of the calculation for the specified time frame of one column.

Column	Minimum	Maximum	Average	Standard deviation	Duration	blue numt	Time (UG	Tim
Tank1	11.00 11/19/04 9:55:46.390 AM	147.00 11/19/04 9:55:45.390 AM	93.43	48.90	10:00:06.0	7	4 9:55:43	4 9:

5. If you wish to display the results of additional table columns, select the appropriate column in the "Column" field.
6. In order to continue with the display of Runtime data in the table, close the statistics window and click the  button in the toolbar.
7. If you require a statistical analysis of process data not displayed in the table window, click the  button. Enter the desired time frame in the "Select time range" dialog. The process data will be displayed for the specified time frame, and statistics can be calculated.

Note

For additional statistical analysis of process data and archiving of results you must write the scripts yourself.

See also

Operation of Online Table Control in Runtime (Page 1742)
Online Configuration for Online Table Control (Page 1743)
Configuration of WinCC Online Table Control (Page 1737)

6.5.4.3 Before WinCC V7: Process Value Output in the Form of Trends in Process Pictures

WinCC Online Trend Control

Introduction

In order to process data in graphic form, WinCC uses Online Trend Control to offer the option of displaying process data as a trend. The trend type to be used can be selected. Furthermore you have the option of displaying current or archived values.

Display of tag values during Runtime takes place in ActiveX Control, inserted and configured in a picture in Graphics Designer.

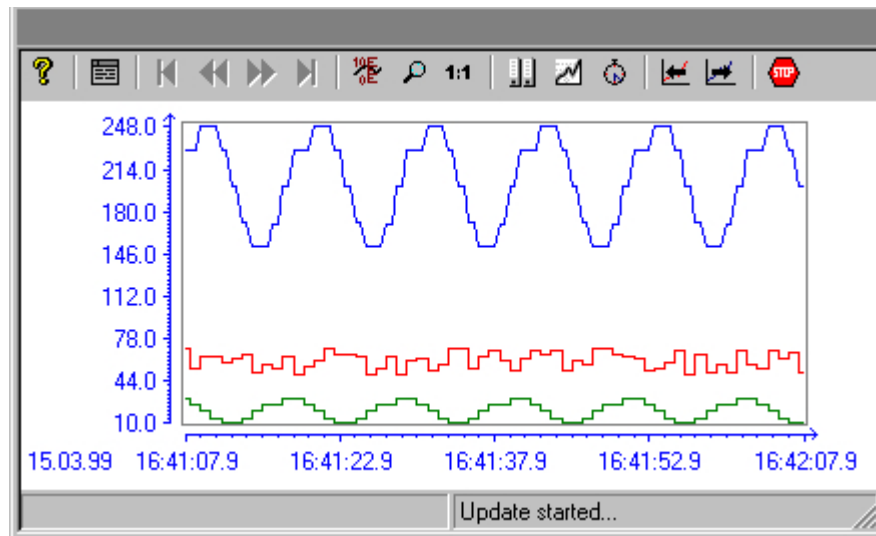

Requirement

The following requirements apply to the display of trends in WinCC Online Trend Control:

- In a WinCC Online Trend Control any number of trends can be displayed. However, it is recommended to configure no more than 8 trends.
- A trend can represent a maximum of 30000 value pairs. Depending on the screen resolution and the settings, the display might however vary.
- The trends can be based on online tags or archived tags.

- Online tags of a trend must have the identical update cycle.
- In order to display tags as a function of other tags, you should use the WinCC Function Trend Control.

Resolution of Trend Display

The number of trend values that can be displayed on the screen is limited by the screen resolution and selected size of the trend window. Therefore, when displaying trends, it is possible that fewer values are displayed in the trend window than are actually archived.

If, for example, in an area of 100 pixels 200 measured values are archived, each pixel represents 2 measured values. The value shown on the screen is that of the most recent data (most recent time stamp).

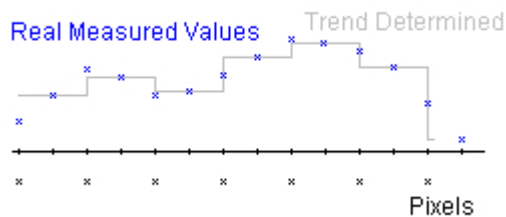

Representation Trend Lines

Representation Trend Lines

Introduction

WinCC Online Trend Control has a multitude of options to display a trend.

See also

- Representation of Staggered Trends (Page 1758)
- Identification of Time Jumps and Time Overlaps (Page 1761)
- Time Range of Trend Display (Page 1759)
- Write direction (Page 1758)
- Representation Using Common Axes (Page 1756)
- Representation formats (Page 1755)

Representation formats

Introduction

Three basic trend format are available for the graphic display of tag values.

Single Values

Value of measurement points are shown as dots.

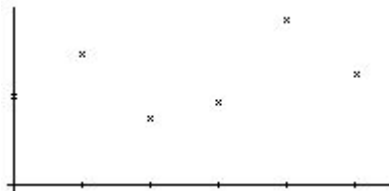

Linear Interpolation

The trend line is interpolated on a linear basis from values of measurement points. The trend is represented as either a solid line or a dashed line. The area under the curve can also be displayed in a solid color.

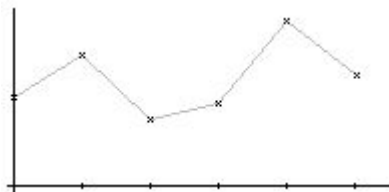

Stepped trend

The trend line is interpolated as a stepped curve from the values of measurement points. The trend is represented as either a solid line or a dashed line. The area under the curve can also be displayed in a solid color.

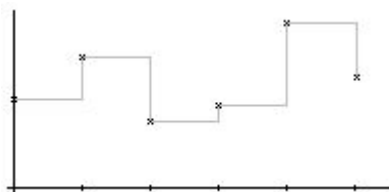

Configuration

You configure the trends in the Graphics Designer in the Properties dialog on WinCC Online Trend Control in the Trends tab.

See also

Representation Trend Lines (Page 1754)

Representation Using Common Axes

Introduction

If multiple trends are to be displayed in a trend window, you have the choice of using individual axes for each trend or using shared X/Y axes for all trends.

Representation Using Different Axes

If the tag values to be displayed in a tag window differ greatly, the use of shared axes for the trend display is not recommended. The tag values can be read more easily if different axial scales are used. You can singly display the Y-axis for the trend in the foreground.

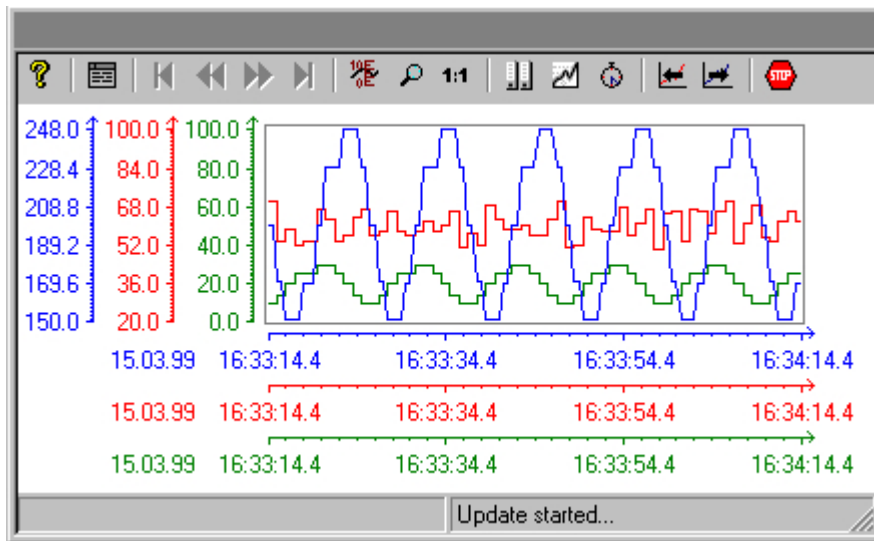

Representation Using Common Axes

If comparison of trend characteristics is important, it is recommended to display trends with common axes. You can assign a color for the common X-axis.

You can determine the exact tag values Runtime through zoom or coordinate inquiry.

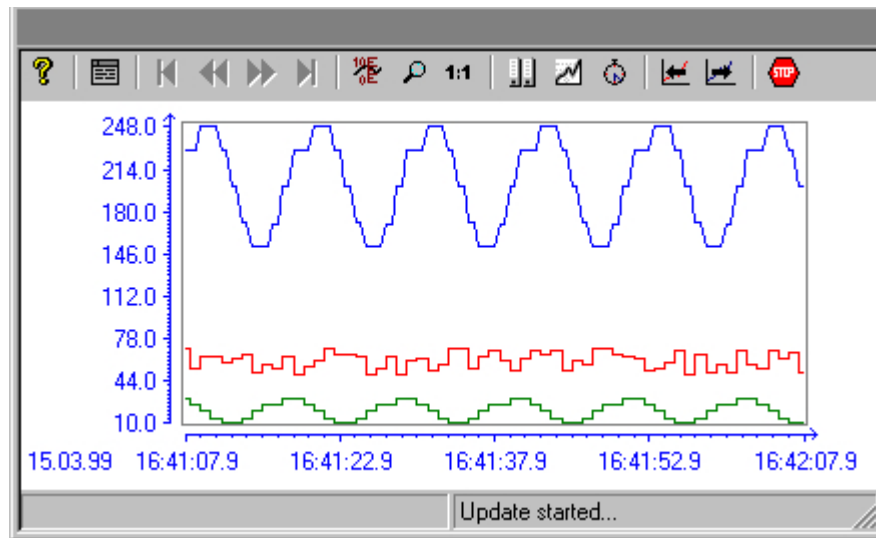

Configuration

You configure the display options of the axes in the Graphics Designer in the Properties dialog on WinCC Online Trend Control in the General tab.

Note

When configuring an Online Trend Control, only tags with an identical updating cycle should be displayed in a trend window in the case of several trends with a common time axis. In the case of tags with different updating cycles, the length of the time axis is not identical for all tags. Since the tag trends are updated at different times due to the different updating cycles, a minimal different in the end time for the time axis occurs on each change. As a result, the trends displayed skip slightly to and fro on each change.

See also

Representation Trend Lines (Page 1754)

Representation of Staggered Trends

Introduction

In a staggered display, the trends are displayed offset over each other in the trend window. For each trend, the value range to be displayed can be set for the Y axis.

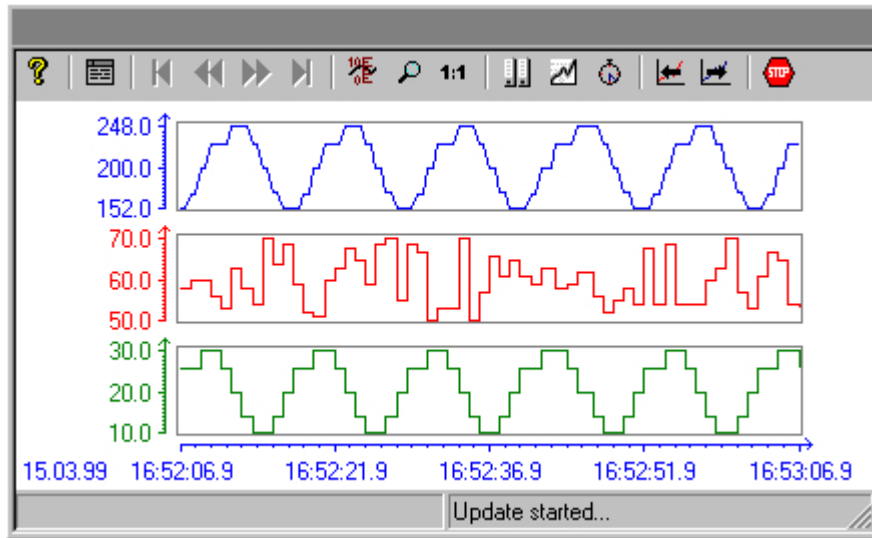

Configuration

You configure the display of the staggered curves in the Graphics Designer in the Properties dialog on WinCC Online Trend Control in the General tab.

See also

Representation Trend Lines (Page 1754)

Write direction

Introduction

With the "Write Direction" option, you can specify where the current measurement values are to be displayed. Setting "From the bottom" means that the current measurement values are processed from downward.

If you select for the write direction the "From the top" or "From the bottom" setting, you must use a True-Type font for the best display of the time axes labels in the trend window.

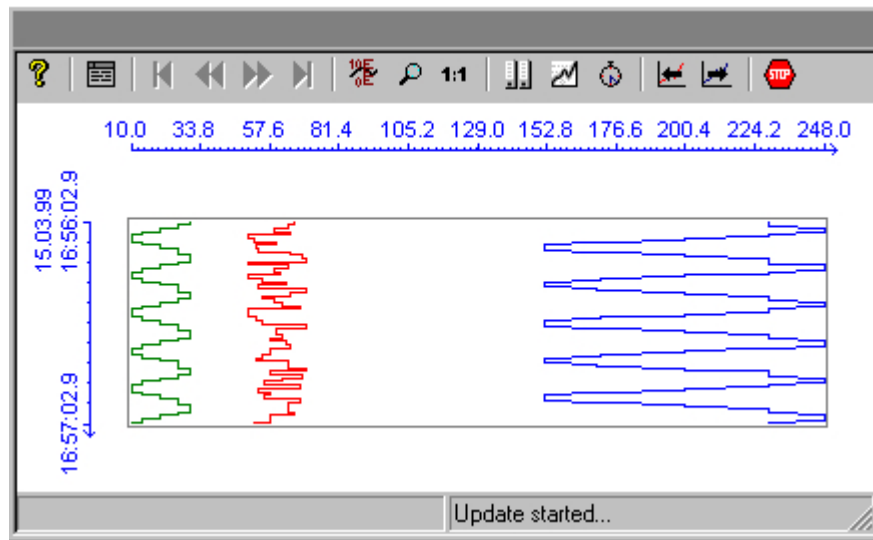

Configuration

You configure the write direction of the data in the Graphics Designer in the Properties dialog on WinCC Online Trend Control in the General tab.

See also

Representation Trend Lines (Page 1754)

Time Range of Trend Display

Introduction

With regard to the time ranges to be displayed, there are a number of ways to present a trend display of tags:

Static Representation of a Trend

Static representation presents the course of a tag within a defined time interval, based on the archived values.

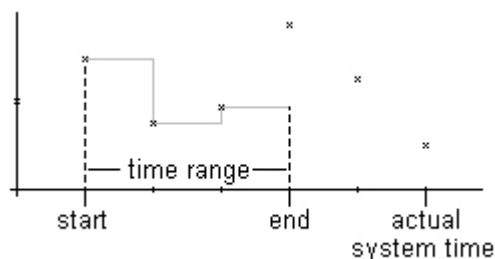

The static display is configured on the "Time Axis" tab of the "Properties" dialog by deactivating the "Update" option. The time range to be displayed is set either

- by entering a start time and a time range.
- by entering a start time and an end time.
- by entering a start time and the number of measurement points to be displayed.

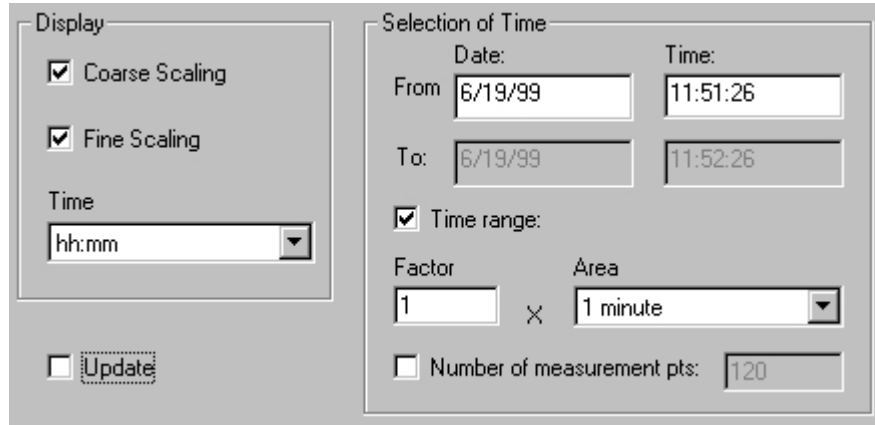

Note

This type of display can only be used for archive tags.

Dynamic Representation of a Trend

In a dynamic display, the end time of a trend always corresponds to the current system time. New measurement values coming in are included in the display.

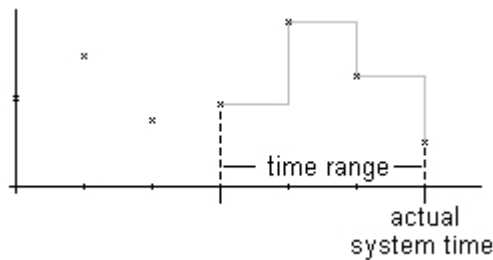

The static display is configured on the "Time Axis" tab of the "Properties" dialog by deactivating the "Update" option. The time range to be displayed is set either

- by entering a time range.
- by entering the number of measurement points to be displayed.
- by the time difference between the specified start and end times.

The screenshot shows a dialog box with two main sections: 'Display' and 'Selection of Time'.
In the 'Display' section:
- 'Coarse Scaling' is checked.
- 'Fine Scaling' is checked.
- 'Time' is set to 'hh:mm' in a dropdown menu.
- 'Update' is checked.
In the 'Selection of Time' section:
- 'From' date is 6/19/99 and time is 11:51:26.
- 'To' date is 6/19/99 and time is 11:52:26.
- 'Time range' is checked.
- 'Factor' is 1.
- 'Area' is '1 minute'.
- 'Number of measurement pts' is 120.

Note

Upon opening the trend window in Runtime, the tag values to be displayed are either read from the archive or are set to zero. This function is set in the "General" tab of the "Properties" dialog.

See also

How to Dynamize a Time Range in a Sript (Page 1768)

Representation Trend Lines (Page 1754)

Identification of Time Jumps and Time Overlaps

Introduction

By changing the time, e.g. by switching from daylight saving to standard time or vice versa, time jumps or time overlaps may occur in the archive.

In a trend display of archived values, the time axis labeling is modified and marked with a vertical line in the presence of time gaps or time overlaps.

6.5 Output of Process Values

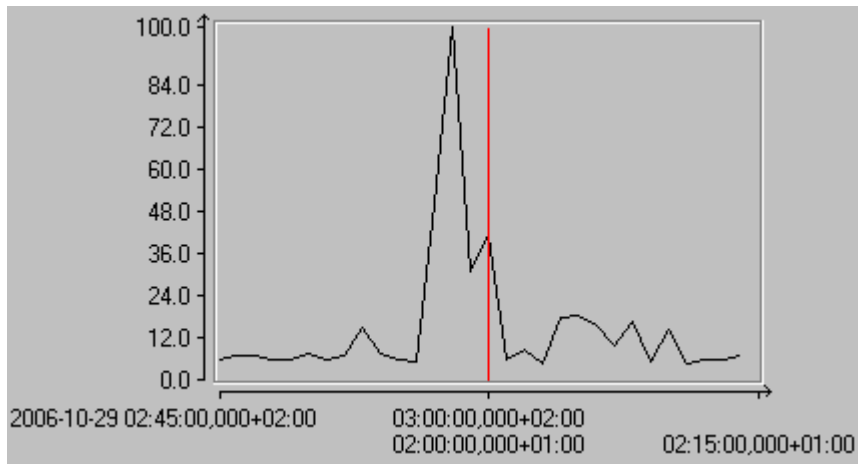
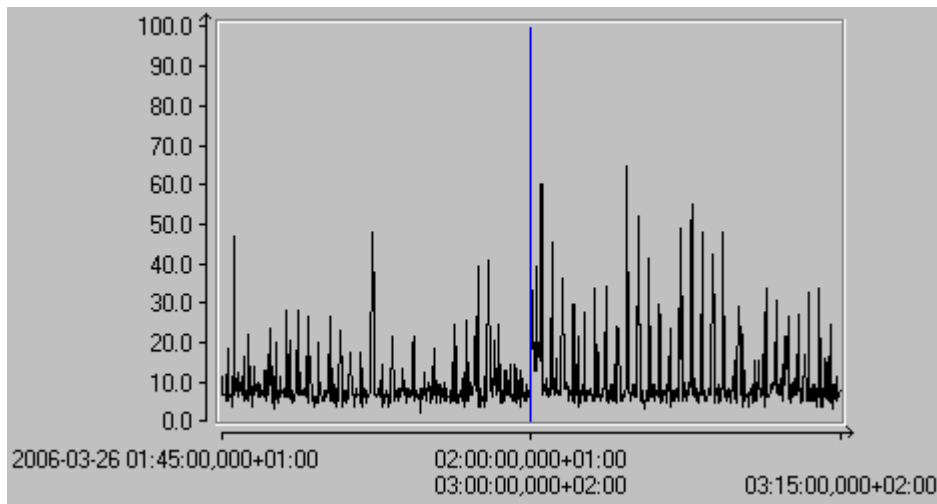

Configuration

On the "Limit Values" tab of the "Properties of WinCC Online Trend Control" dialog, the marker line can be assigned a color.

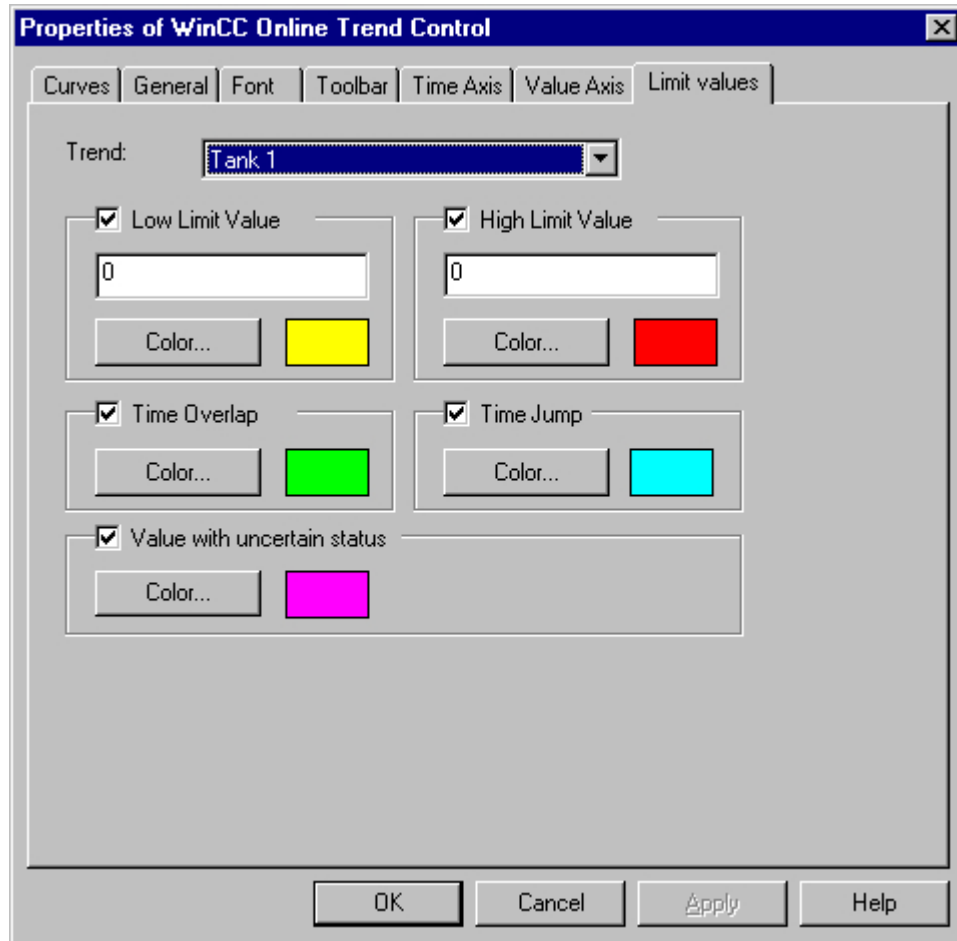

See also

Representation Trend Lines (Page 1754)

Configuration

Configuration of WinCC Online Trend Control

Introduction

The steps necessary for configuration of WinCC Online Trend Control depend on the tags you wish to display.

Display of Online Tags

1. The tags you wish to display need to be configured in WinCC Explorer.
2. Link WinCC Online Trend Control to a picture in Graphics Designer and modify the properties of ActiveX Control.

Display of Archive Tags

1. The tags you wish to display need to be configured in WinCC Explorer.
2. Use the Archive Wizard to create a process value archive.
3. Configure the process value tags it is to contain.
4. Link WinCC Online Trend Control to a picture in Graphics Designer and modify the properties of ActiveX Control.

See also

[How to Insert an Online Trend Control in a Picture \(Page 1764\)](#)

[How to Configure Trends in Online Trend Control \(Page 1766\)](#)

[How to Dynamize a Time Range in a Sript \(Page 1768\)](#)

[How to Activate the Example for Online Trend Control \(Page 1771\)](#)

How to Insert an Online Trend Control in a Picture

Introduction

The trends are displayed during Runtime in an ActiveX Control that you can configure in Graphics Designer.

Procedure

1. Start Graphics Designer and open a new picture.
2. Click the "WinCC Online Trend Control" object on the "Controls" tab in the object palette.

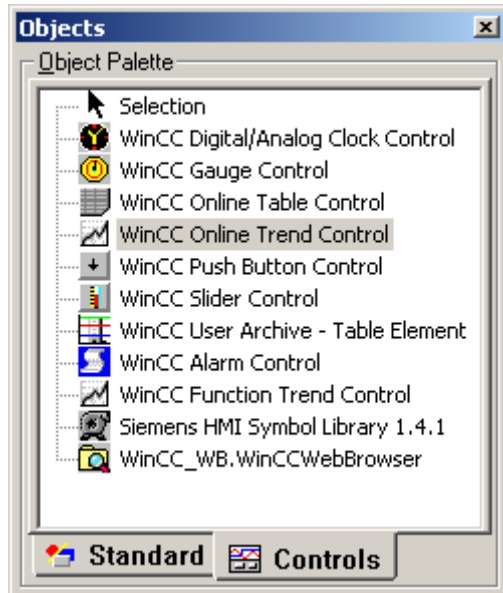

3. Place the mouse pointer at the position in the picture where you want to insert the control. The mouse pointer changes into a crosshair with an object symbol attached.
4. Drag the control to the desired size. The "Properties of WinCC WinCC Online Trend Control" quick configuration dialog is opened.

- 5. Configure the properties of WinCC Online Trend Control in the General tab.

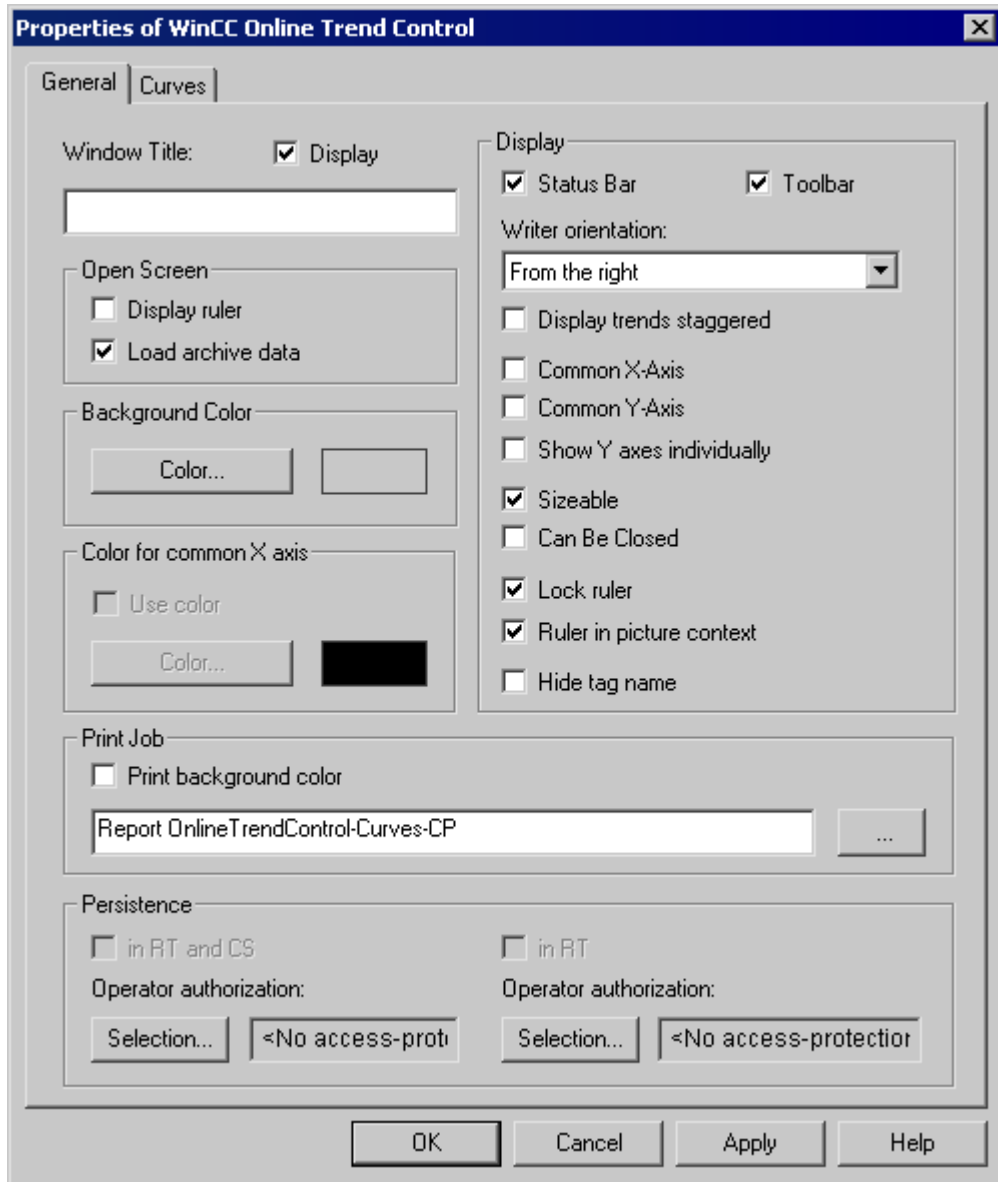

- 6. Close the dialog with the "OK" button.

See also

How to Configure Trends in Online Trend Control (Page 1766)

How to Configure Trends in Online Trend Control

Introduction

Define the trend properties in the tabs of the WinCC Online Trend Control configuration dialog.

Requirement

- You have inserted the tags for data supply to the trends in Tag Management.
- You have configured the process value archive while supplying archive tags as data.
- You have inserted WinCC Online Trend Control in a picture in Graphics Designer and defined the properties of Control.

Procedure

1. Double-click WinCC Online Trend Control.
2. Click the "Curves" tab.

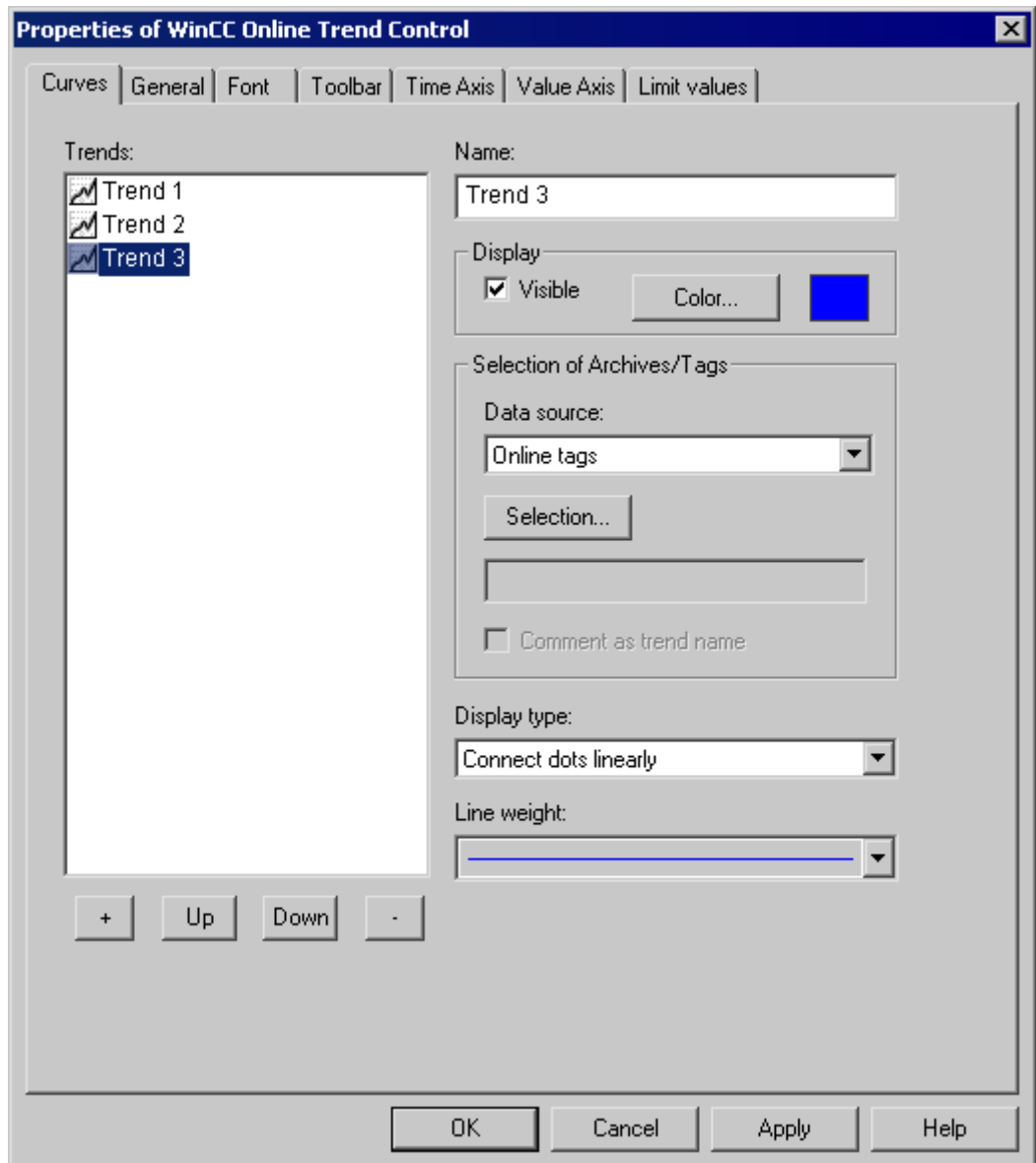

3. Use "+" key to define the desired number of trends.

4. Define the sequence of trends in control using "Up" and "Down" keys.
5. Select in the Trends section: one trend to define the trend properties and data supply.
6. In the "Archive/ Tag selection" define the data supply to the trend. In the "Data supply" field, define whether the data is to be provided online or from an archive. Select the corresponding tag via the "Selection" button.
7. Specify the display type and line weight of the trend.
8. Configure additional properties of the trend on the WinCC Online Trend Control tab.
 - In the Time Axis tab, you can define the time range for accessing the archived values.
 - In the Value Axis tab define the value range properties, for e.g. scaling.
9. Close the dialog with the "OK" button. Configuration of WinCC Online Trend Control is saved.

See also

How to Configure the Value Range of Trends (Page 1769)

How to Dynamize a Time Range in a Sript

Introduction

With WinCC Online Graph Control, the properties for "EndTime" and "BeginTime" can be dynamically configured using a C script.

In the example, the values for EndTime and BeginTime are defined in two I/O fields. The entry is of the following format: "dd.mm.yyyy hh.mm.ss" e.g. 04.09.2002 10:20:00.

The time range in WinCC Online Trend Control is updated using a C script. The C script is triggered by clicking the button control. To update the time range, the C script deactivates and reactivates the WinCC Online Trend Control.

Procedure

1. In Tag Management, configure the tags "strVar_1" and "strVar_2" of data type "text tag 8-bit value" and the tag "TagLog" of data type "unsigned 16-bit value".
2. Start Tag Logging and create a process value archive by using the Archive Wizard and configure the process value tag contained therein.
3. Start Graphics Designer and open a picture. Insert a WinCC Online Trend Control into the picture and link it to the process value tag.
4. Insert two I/O fields into the picture and link it to the tags "strVar_1" and "strVar_2", respectively. In object properties "Output/Input" of the I/O fields, enter "String" as data format and "*" as output format.
5. Insert a button into the picture and save the picture as "NewPDL0.PDL".
6. Open the "Object Properties" dialog of the button and click the "Event" tab.
7. In the left pane, select "Mouse click" as the trigger of the event.

8. Right-click the "Mouse click" event and select the "C Action..." command from the pop-up menu.
9. The StartTime and EndTime properties are dynamized with the following script. Copy this script into the edit field of the "Edit Action" dialog and click "OK".

```
//Set index for Trend1
SetPropWord("NewPdl0.Pdl","Control1","Index",0); //return type :BOOL
    SetPropBOOL("NewPdl0.PDL","Control1","Online",FALSE);
    SetPropBOOL("NewPdl0.PDL","Control1","TimeRange",FALSE);
    SetPropBOOL("NewPdl0.PDL","Control1","Activate",FALSE);
//Sets BeginTime Parameter: dd.mm.yyyy hh:mm:ss
SetPropChar("NewPdl0.PDL","Control1","BeginTime",GetTagChar("strVar_1"));
//Sets EndTime Parameter: dd.mm.yyyy hh:mm:ss
SetPropChar("NewPdl0.PDL","Control1","EndTime",GetTagChar("strVar_2"));
//Set Index for Trend2
SetPropWord("NewPdl0.Pdl","Control1","Index",1); //return type :BOOL
SetPropBOOL("NewPdl0.PDL","Control1","Online",FALSE);
    SetPropBOOL("NewPdl0.PDL","Control1","TimeRange",FALSE);
    SetPropBOOL("NewPdl0.PDL","Control1","Activate",FALSE);
//Sets BeginTime Parameter: dd.mm.yyyy hh:mm:ss
SetPropChar("NewPdl0.PDL","Control1","BeginTime",GetTagChar("strVar_1"));
//Sets EndTime Parameter: dd.mm.yyyy hh:mm:ss
SetPropChar("NewPdl0.PDL","Control1","EndTime",GetTagChar("strVar_2"));
//Activate BeginTime and EndTime at Trend Control
SetPropBOOL("NewPdl0.PDL","Control1","Activate",TRUE);
```
10. Save the picture and start Runtime.
11. In the I/O fields, enter the values for "EndTime" and "StartTime" in format "dd.mm.yyyy hh.mm.ss". Confirm each entry with "Enter".
12. By clicking the button, the time range is updated in WinCC Online Trend Control.

See also

- How to Activate the Example for Online Trend Control (Page 1771)
- Time Range of Trend Display (Page 1759)

How to Configure the Value Range of Trends

Introduction

For each trend, you can customize the value range and the scaling for the trend display in the Value Axis tab of the Configuration Dialog of WinCC Online Trend Control.

When you have inserted a trend, the value range and the scaling to be displayed is pre-configured as follows:

- The value range is automatically based on the minimum and maximum value of the selected curve. If you use a common value axis, the minimum and maximum values of all trends of the trend window are determined.
- The value axis scale is linear to the value range.

Requirement

- You have inserted the trends and configured the data supply.

Procedure

1. Click the configuration dialog of WinCC Online Trend Control on the Value Axis tab.

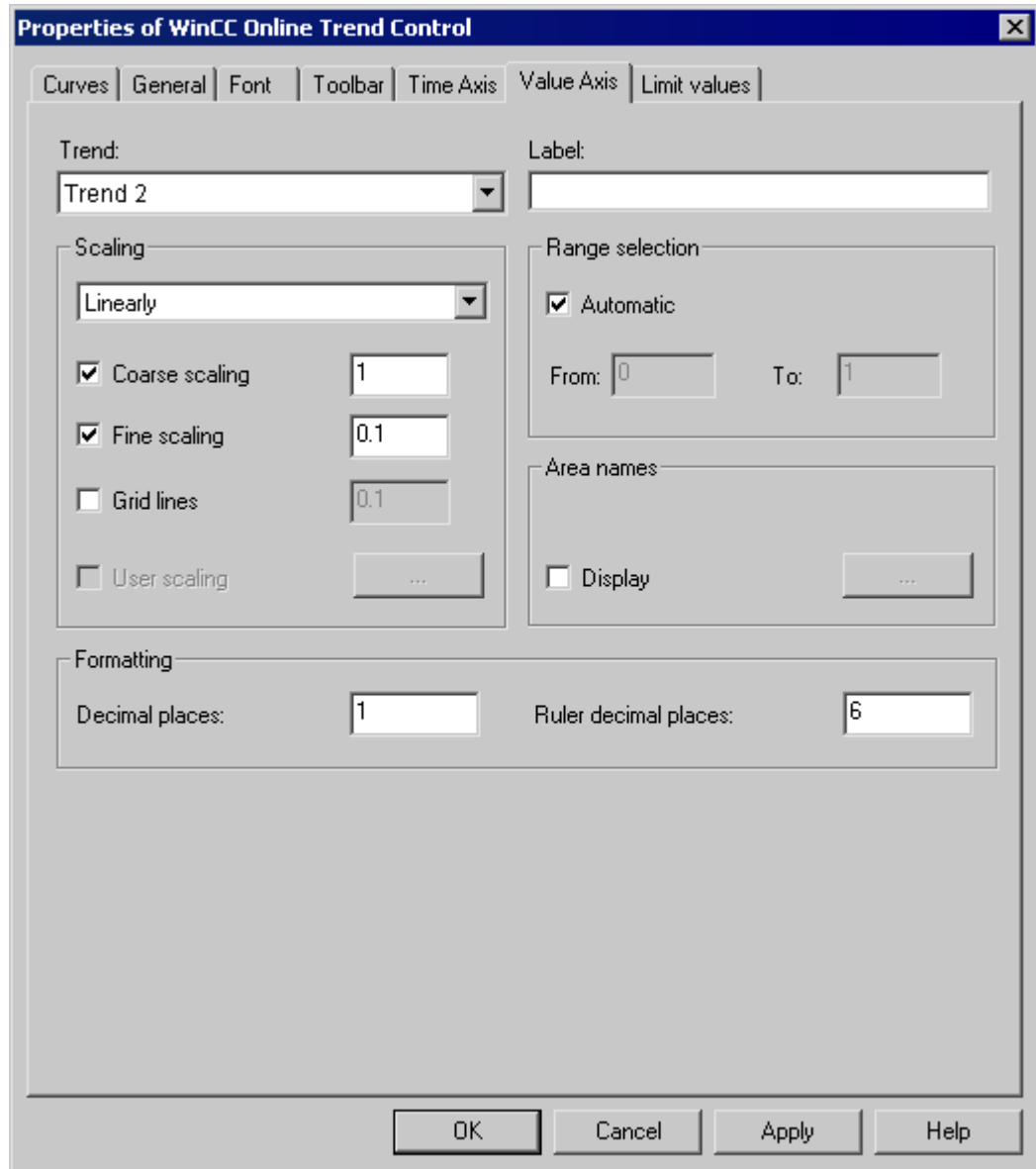

1. In Trend: select the trend whose value axis you want to change.
2. In the Range Selection, deactivate the Automatic option button if you want to define a fixed value range and a separate scaling of the value axis.
3. In the "From:" and "To:" input fields enter the minimum and maximum value of the value range.

4. For configuring the scaling, activate the User Scaling option button. Click "..." to define a scaling for the selected value range.
5. You must define segments without gaps for the entire value range and assign areas on the value axis. If you have defined a value range, say "0 - 100000" you can divide this value range into three sections that you can display as follows on the value axis:

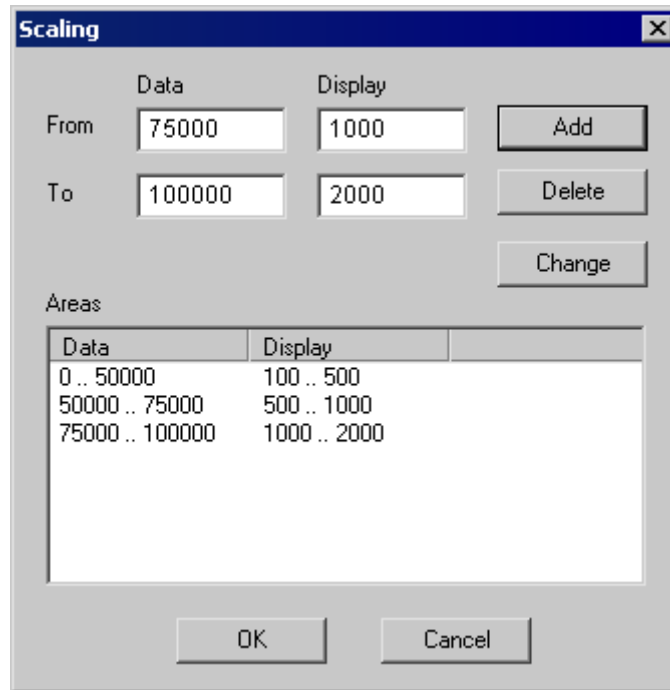

For e.g. value range "0 - 50000" is displayed during Runtime on the value axis in the "100 - 500" range if the User Scaling option box is activated.

How to Activate the Example for Online Trend Control

Requirement

Before activating the WinCC Online Trend Control example, you must complete the following steps:

- Save the picture configure by you.
- Use the pop-up menu in the WinCC Explorer to select the stored picture as the start picture.

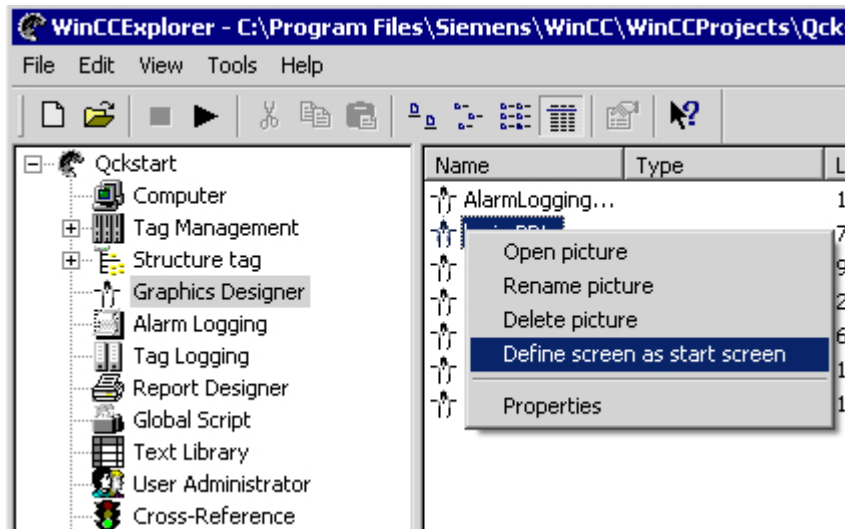

- Check whether "Graphics Runtime" and "Tag Logging Runtime" are selected in the startup list of WinCC Explorer ("Computer Properties" dialog).

Procedure

You have several options to start Runtime:

- From the toolbar of the WinCC Explorer
- From the menu bar of the WinCC Explorer

During configuration you can call individual pictures in Runtime:

- From the toolbar of the Graphics Designer
- From the menu bar of the Graphics Designer

How to apply the configuration of trend parameters from PCS 7

Introduction

In PCS 7, you can use the SIMATIC Manager to configure the properties of tags that have an effect on the display in Trend Controls. The specified parameters can be transferred to WinCC Online Trend Control.

Automatic configuration of trend parameters from PCS 7 data

In WinCC Online Trend Control, the properties for tags planned in PCS 7 are applied as trend parameters. The following parameters are configured automatically:

- The low limit of the trend range
- The high limit of the trend range
- The units of measurement for the trend

In runtime, the tag values are shown as a trend within these limits. The unit of measurement is shown on the "Y axis".

Procedure

1. Add a new trend in WinCC Online Trend Control.
2. Select an archive tag or online tag that has already been configured in PCS 7. If the properties indicated above are configured for these tags, the following parameters are configured in the "Value Axis" tab:
 - The "Label" field contains the unit of measurement for the tag. You can change the label.
 - In the "Range selection" area, the "Apply the properties of the tag display" option is activated and the "Automatic" option is deactivated.
 - The tag names for the high limit and the low limit of the variables are entered in the fields "From" and "To" in the "Range selection" area. These limits cannot be changed.
 - The "User Scaling" option is deactivated in the "Scaling" area.
3. If you want to change the limits for the trend range and configure a user scale, deactivate the "Apply tag properties" option.





Operation in Runtime















How to Operate Online Trend Control in Runtime





Introduction

The trend window is operated in runtime via the buttons in the toolbar.

Overview

	"Online-Help-System" Opening the online help
	"Open the Configuration Dialog" Selecting the dialog to assign display parameters.
	"First Data Record" Click this button to display the tag trend in the trend window, starting with the first archived tag.
	"Previous Data Record" Click this button to display the tag trend of the previous time interval in the trend window, based on the currently displayed time interval.
	"Next Data Record" Click this button to display the tag trend of the next time interval in the trend window, based on the currently displayed time interval.

	<p>"Online-Help-System" Opening the online help</p>
	<p>"Last Data Record"</p> <p>Click this button to display the tag trend ending with the last archived value in the trend window, based on the currently selected time interval.</p>
	<p>"Display Value at this Position"</p> <p>Click this button to query the coordinate points of a trend.</p>
	<p>"Zoom Area"</p> <p>Click this button to zoom in on any section of the trend window.</p>
	<p>"Activate Original View"</p> <p>Click this button to return to the configured normal view (after zooming).</p>
	<p>"Dialog for Archive and Tag Selection"</p> <p>This button opens the dialog for archive and tag selection.</p>
	<p>"Dialog for Trend Selection"</p> <p>Click this button to open the dialog for the selection of visible and invisible trends.</p>
	<p>"Select Time Range"</p> <p>Click this button to open the dialog where you can specify the time range to be displayed in a trend window.</p>
	<p>"Previous trend in foreground"</p> <p>Click this button to display the previous trend in the foreground of the trend window.</p>
	<p>"Next trend in the front"</p> <p>Click this button to display the next trend in the foreground of the trend window.</p>
	<p>"Start/Stop update"</p> <p>The updated display is stopped. The values are buffered and updated when the button is clicked again.</p>
	<p>"Start/Stop update"</p> <p>Resume display.</p>
	<p>"Print Log"</p> <p>Click this button to print the trend shown in the trend window. Print job used during printing can be specified in the control properties on the "General" tab.</p>
	<p>"Select Statistics Area"</p> <p>Click this button to define the time period for the calculation of statistics in trend window using vertical lines.</p>
	<p>"Calculate Statistics"</p> <p>Click this button to open the statistics window where the minimum, maximum, average and standard deviation for a specified time frame and trend are shown.</p>

	<p>"Online-Help-System" Opening the online help</p>
	<p>"Save report" Saves the current data of the control for the displayed trends in the time frame indicated. The updated display must be stopped. The report will be saved as a ".csv" file in the WinCC project directory under "Export/TagLogging". The file name consists of window title of Control and the timestamp. If you import the file into MS Excel, the local language settings are used. The "List separator" and the "Comma sign" can then lead to an incorrect display. In order to ensure a correct display, give the ".csv" file the extension "*.txt". You then have the ability to select the "List separator" and the "Comma sign" manually during the import.</p>
	<p>"Zoom out" Decreases the zoom factor.</p>
	<p>"Zoom in" Increases the zoom factor.</p>
	<p>"Relative scale" Switches from displaying the absolute values to the percentage display of value axis. The high and low limits for the trend correspond with a range of 0 to 100%. The following requirements apply to the "Relative scale" keyboard function:</p> <ul style="list-style-type: none"> • All trends displayed are assigned a fixed value range. • The trends have no user scaling. • The trends are scaled linearly.
Right-click trend	<p>When the update is stopped, right-click the trend to display the archive name, the tag name and the coordinates of the respective point.</p>

Note

Click the "Display value at this position" button in the toolbar to display the coordinate points of a trend. The displayed tag values can be assigned an additional attribute in the form of a letter. Where:

- Letter "i" : The displayed tag value is interpolated.
- Letter "u" : The displayed value is of uncertain status. This attribute is displayed when the initial value is not known after Runtime has been activated, or when a substitute value is used.

The "Page" buttons in archives are only available, if the trend to be displayed originates in a process value archive.

See also

How to Generate Statistics of Runtime Data (Page 1787)

Starting and Stopping Update (Page 1781)

Trend to Front (Page 1781)

How To Enlarge a Segment of a Trend (Page 1785)

How to Determine the Coordinates of a Point (Page 1783)

Online Configuration of Online Trend Control (Page 1776)

Online Configuration of Online Trend Control

Introduction

There are four options available to change the configuration of the Online Table Control in Runtime:

Key function "Open the Parameter Dialog"

The "Open Set Configuration Dialog"  key function provides access to all essential settings for trend display.

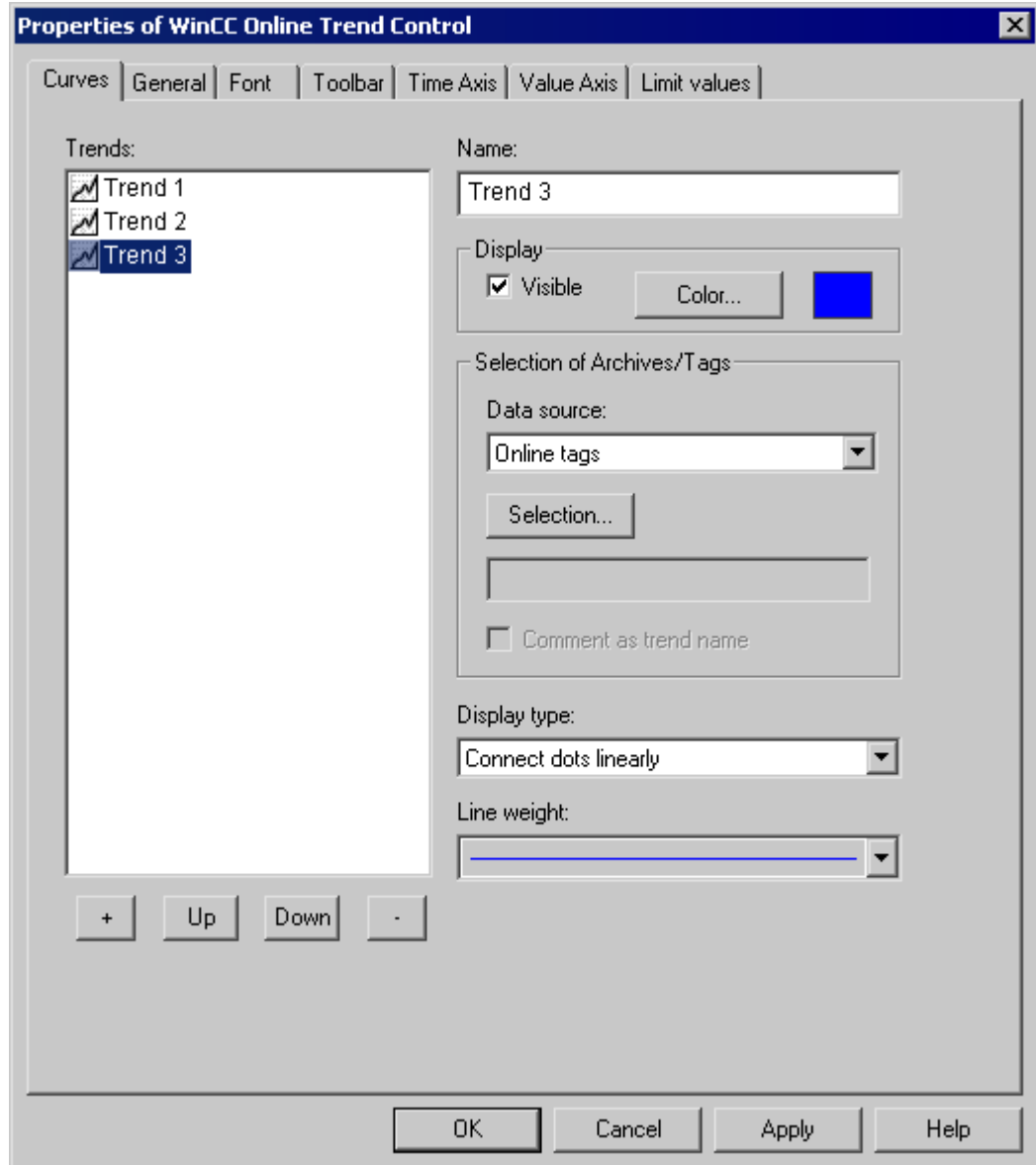

Key function "Dialog for Archive and Tag Selection"

The "Dialog for Archive and Tag Selection"  key function allows for the specification of the tags linked to the trends in a trend window.

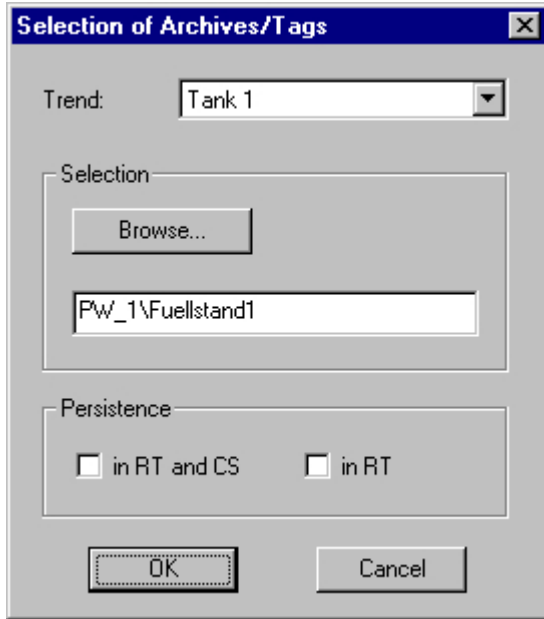

Array	Description
Trend	Select a configured trend.
Selection	Use the Selection button to open the dialog for selecting the linked tags.
Persistence	<p>If the "Persistence in RT and CS" option is not activated, any changes made to the settings are only effective within Runtime. Whether or not any changed settings remain effective after a picture change depends on the "Persistence in RT" option.</p> <p>If the "Persistence in RT and CS" option is activated, all changed settings are also transferred to the configuration system. To do this, you must open the picture in Graphics Designer and save it once again. The changed settings are also used when the project is reactivated.</p> <p>Changes to the control properties in Runtime are not persistently accepted in CS with PCS 7 projects or TIA projects. When you completely load the ES to the OS, the changed settings on the OS will be overwritten.</p> <p>Configure the properties of the controls on the ES.</p>

Key Function "Dialog for Selecting Trends"

The "Dialog for Trend Selection"  key function opens the dialog for the selection of visible and invisible trends.

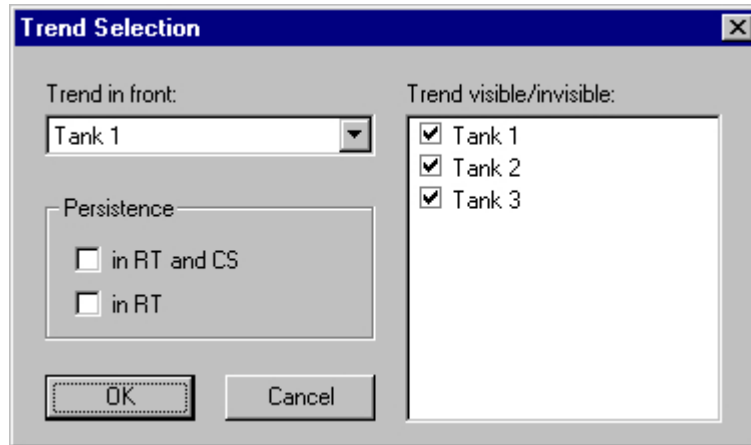

Array	Description
Trend in the foreground	If a common axis is used, the settings for the display of the first trend are applied for the display of the axis. You can configure a uniform color for the common X-axis. The first trend can be changed either in this dialog or by using the "Previous trend in foreground" and "Next trend in the front" buttons in the toolbar.
Trend visible/invisible:	In this area, you can specify the trends that are not to be shown.
Persistence	<p>If the "Persistent in RT and CS" option is not activated, any changes made to the settings are only effective within Runtime. Whether or not any changed settings remain effective after a picture change depends on the "Persistence in RT" option.</p> <p>If the "Persistence in RT and CS" option is activated, all changed settings are also transferred to the configuration system. To do this, you must open the picture in Graphics Designer and save it once again. The changed settings are also used when the project is reactivated.</p> <p>Changes to the control properties in Runtime are not persistently accepted in CS with PCS 7 projects or TIA projects. When you completely load the ES to the OS, the changed settings on the OS will be overwritten.</p> <p>Configure the properties of the controls on the ES.</p>

Note

The first trend in a trend window cannot be made "invisible".

Key Function "Select Time Range"

The key function "Select Time Range"  opens a dialog to specify the time range to be displayed. If the trends in the trend window are to be displayed with a common time axis, the specified time range applies to all trends.

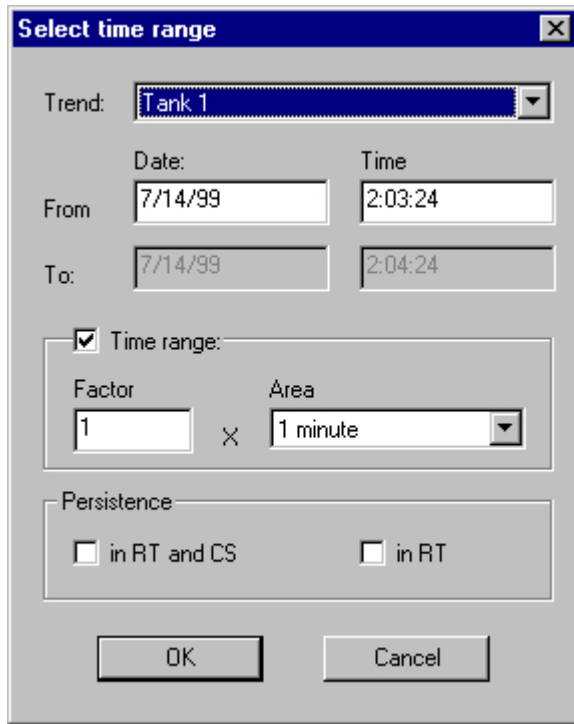

Array	Description
Trend	Select a configured trend.
Time Selection	The time interval to be displayed in the trend window can be set by entering a start and an end point (the "Time Range" setting not activated). by entering a start time and a time range. ("Time Range" setting activated). The length of the time interval to be displayed is determined by multiplying the "Factor" by the "Range".
Persistence	If the "Persistent in RT and CS" option is not activated, any changes made to the settings are only effective within Runtime. Whether or not any changed settings remain effective after a picture change depends on the "Persistence in RT" option. If the "Persistence in RT and CS" option is activated, all changed settings are also transferred to the configuration system. To do this, you must open the picture in Graphics Designer and save it once again. The changed settings are also used when the project is reactivated. Changes to the control properties in Runtime are not persistently accepted in CS with PCS 7 projects or TIA projects. When you completely load the ES to the OS, the changed settings on the OS will be overwritten. Configure the properties of the controls on the ES.

The entry format of the date and time depends on the Runtime language used.

See also

Configuration of WinCC Online Trend Control (Page 1763)

How to Generate Statistics of Runtime Data (Page 1787)

How to Operate Online Trend Control in Runtime (Page 1773)

Starting and Stopping Update

Introduction



The update of the trend window can be started and stopped with the "Start/Stop" key function.

If updating has stopped, you can:

- change the displayed time range and thus display the measured values from the process value archive in the trend window.
- save the data of the displayed trends for the displayed time range in a report.

Certain functions, such as the "Zoom Area" keyboard function automatically stop the update of value of measurement points.

You will recognize the status of the update by the appearance of the button.

- : When updates are stopped, you may change the displayed time frame and therefore display measurement values from the process value archive in the table window.
- : When updates are started, you may change the displayed time frame and therefore display measurement values from the process value archive in the table window.



See also

How to Operate Online Trend Control in Runtime (Page 1773)

Trend to Front

Introduction

You can modify the trend displayed on top in runtime:

- by clicking the  button ("Dialog for Trend Selection" key function)
- by clicking the  button: ("Next trend to Front" key function)
- by clicking the  button: ("Previous Trend to Front")

If common axes are used, the settings for the trend displayed in the foreground are used for displaying the axes. You can however configure a uniform color for the common X-axis.

Configuration

You define the sequence of the trends in the Trends tab of the Properties dialog in WinCC Online Trend Control. Select a trend and click "Up" or "Down" button.

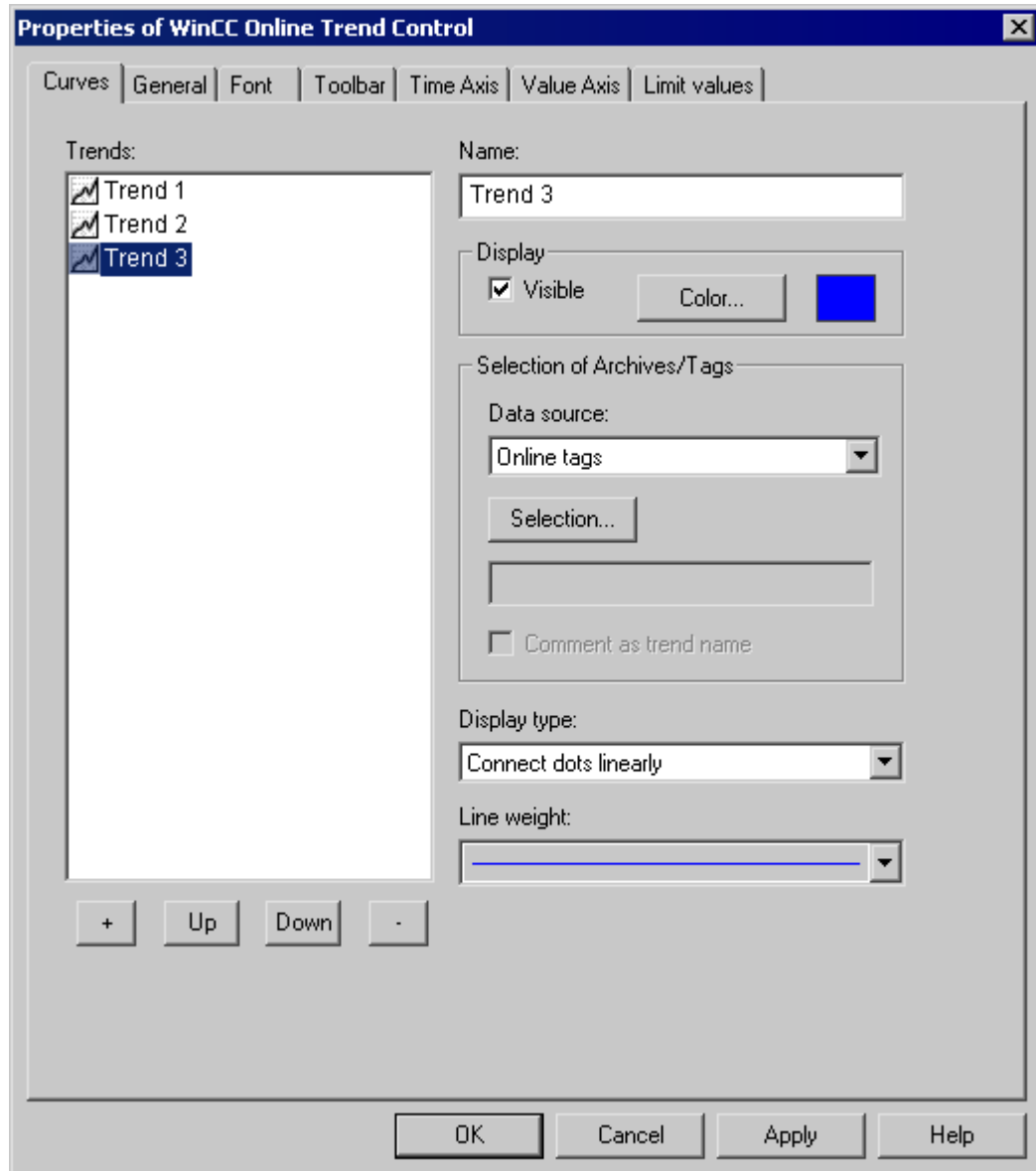

See also

How to Operate Online Trend Control in Runtime (Page 1773)

How to Determine the Coordinates of a Point

Introduction

You can use the "Display Value at this Position" key function to determine the coordinates of a point in the trend. To make it easier to determine the coordinates, you can also enlarge a particular segment of the trend lines.

Requirement

- Configure the Online Trend Control.
- Configure the display of a toolbar, using the key functions "Zoom Area" and "Activate Original View".
- You can specify the font for the tag value table that is displayed with the key function "Display value here" in the "Font" tab and via the property "RulerFont".
- Start Runtime.

Procedure

When activating the  button for "Display Value at This Position" a vertical line, a ruler, is added to the trend window. Below the trend window, the X and Y coordinates of the measured value are displayed together with the archive and tag names.

The displayed tag values can be assigned an additional attribute in the form of a letter. Where:

- Letter "i" : The displayed tag value is interpolated.
- Letter "u" : The displayed value is of uncertain status. This attribute is displayed when the initial value is not known after Runtime has been activated, or when a substitute value is used.

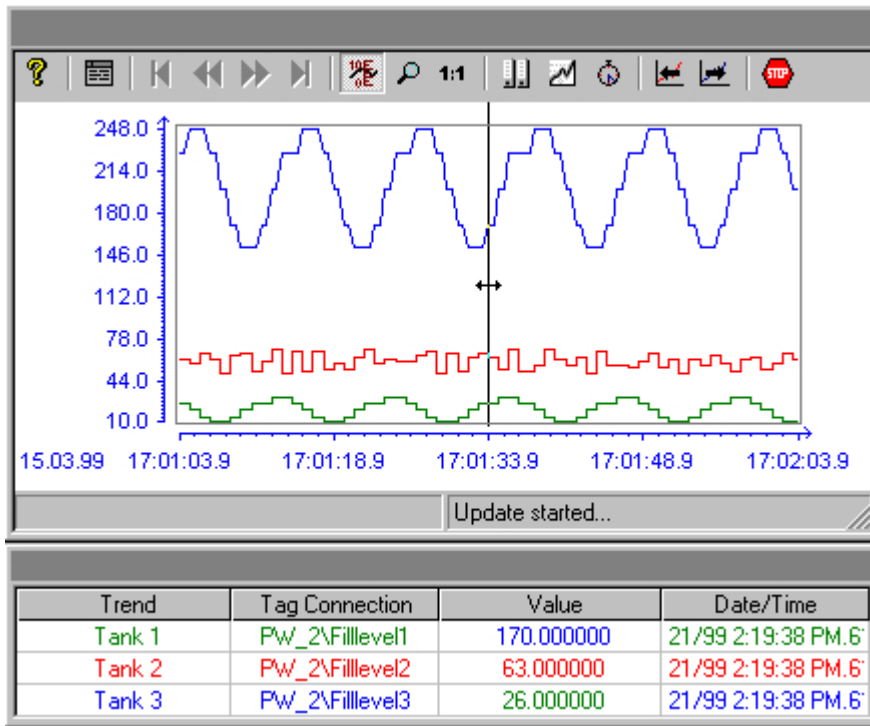

Other measurement values can be determined by positioning the mouse pointer on the ruler and moving it – while keeping the left mouse button pressed – to the desired position.

Note

The "uncertain" status of a tag value can also be identified in the displayed trend characteristic. To do this, you must activate the "Value with uncertain status" option on the "Limit Values" tab of the "Properties of WinCC Online Trend Control" dialog.

If you do not wish to display the tag link in the table, you must set "HideTagNames" in the object property dialog to "Yes".

See also

How to Operate Online Trend Control in Runtime (Page 1773)

How To Enlarge a Segment of a Trend



Introduction

You can use the "Enlarge Area" key function to zoom in on any segment of the trend window. You may then find that the keyboard function "Display Value at this Position" is easier to use within the enlarged display to determine the coordinates of a particular measurement point. Use the "Activate Original View" key function to switch back from an enlarged display to normal display mode.

Requirement

- Configure the Online Trend Control.
- Configure the display of a toolbar, using the buttons assigned to key functions "Zoom Area" and "Activate Original View".
- Start Runtime.

Procedure

1. Click the "Enlarge Area"  button in the toolbar.
The display stops being updated and the mouse pointer changes to a cross-hair.
2. In the trend window, click one corner of the area that you wish to enlarge.
3. Hold down your left mouse button and drag the area you want to enlarge until it reaches the desired size. If the highlighted area contains at least two measured values, the selected trend area is displayed in the trend window.
4. Release the left mouse button.
The section you selected is now shown enlarged.
5. Click the "Activate Original View" button  in the toolbar.
The trend window is displayed again in normal view as originally configured.
6. Click the "Start/Stop the Update" button in the toolbar to restart updating the display in the trend window. For the value ranges of the X and Y axes, the preset values is used by default.

See also

How to Operate Online Trend Control in Runtime (Page 1773)

Expanded zoom functions

Introduction

Using the "Zoom area", "Zoom in" and "Zoom out" keyboard functions, a segment of the trend window can be made larger or smaller in WinCC Online Trend Control.

"Zoom in" and "Zoom out" keyboard functions

Updating the trend values is stopped when zooming with the "Zoom area" keyboard function.

The trend values can be updated while zooming as well by activating the "Zoom in" and "Zoom out" keyboard functions.

Requirement

The following requirements apply to "Zoom in" and "Zoom out".

- All trends displayed are assigned a fixed value range.
- The trends have no user scaling.
- The trends are scaled linearly.

"Zoom in", "Zoom out" and original view buttons

The following buttons have been added to the toolbar of WinCC Online Trend Control for new keyboard functions:

 Zoom in. Increases the zoom factor.

 Zoom out. Decreases the zoom factor.

While zooming in or zooming out, the 50% value of the trend is always shown in the center of the value axis.

If you change the limits in the "Value Axis" tab in the configuration dialog while zooming, the visible zoom area is set to the new limits.

If you want to view the trend window in the original configured view again, click "Activate original view" in the tool bar:

 Activate original view.

Display of archived values

Introduction





Use the buttons in the toolbar of a trend window or the corresponding key combinations to browse through an archive.

The values archived of a tag are thereby displayed within a time interval in the trend window. The width of this interval is determined by the time range to be displayed or results from the time difference of entered start and end times.

Requirement

The buttons for browsing in archive are available only if data is supplied through archive tags.

Buttons for Archived Values

	The trend displays the tag values within a specified time range, beginning with the first archived value.
	The trend displays the tag values within the previous time interval, based on the currently displayed time interval.
	The trend displays the tag values within the next time interval, based on the currently displayed time interval.
	The trend displays the tag values within a specified time range, ending with the last archived value.

See also

- How to Operate Online Trend Control in Runtime (Page 1773)
- Online Configuration of Online Trend Control (Page 1776)
- Configuration of WinCC Online Trend Control (Page 1763)

How to Generate Statistics of Runtime Data

Introduction

You can generate a statistical evaluation of Runtime process data in the trend window. The following results are displayed in a statistics window for all displayed trends and a specified time frame:

- Minimum
- Maximum
- Average
- Standard deviation

Requirement

- Configure the Online Trend Control.
- Configure the display of a toolbar by using the key functions "Select statistics area", "Calculate statistics" and "Start/stop update".
- Configure the display with the "Select Time Range" keyboard function, if you wish to choose a statistics area outside of the time range displayed in the columns.
- You can specify the font for the tables that is displayed with the key functions "Select statistics range" and "Calculate statistics" in the "Font" tab and via the property "StatisticsFont".
- Start Runtime.

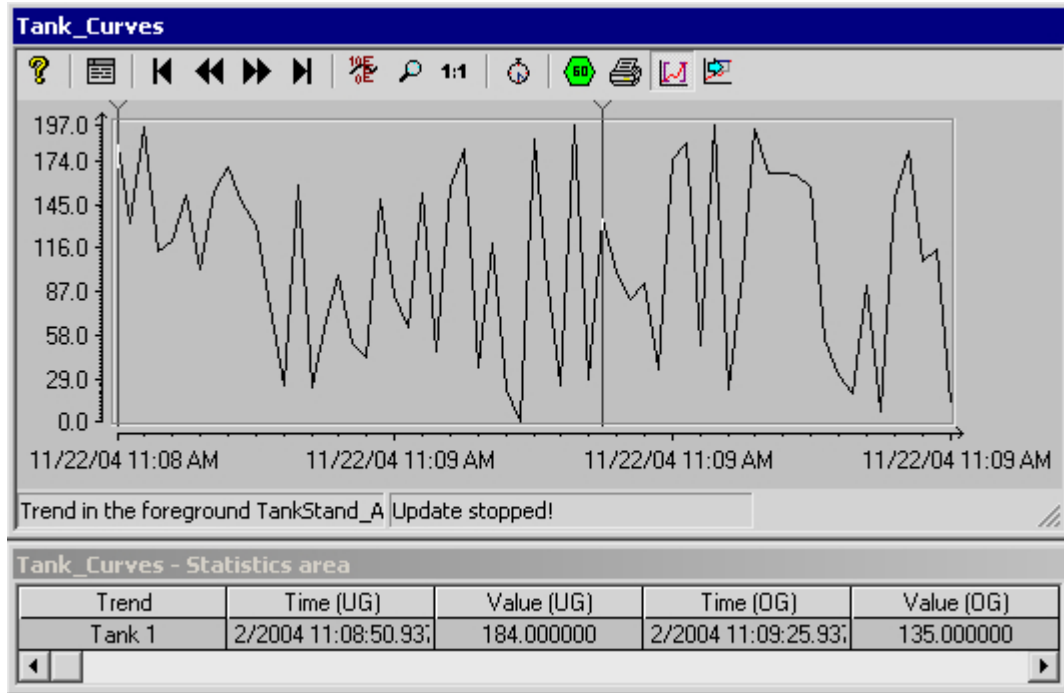

Procedure

1. In the toolbar, click the  button.
The updated display is stopped; process data continues to be archived. The updated display is stopped, process data continue to be archived. Two vertical lines are displayed at the left and right edge of the trend window. A window containing the statistics area shows the current upper (OG) and lower (UG) limits of the trends.
2. Specify the time frame for calculation by dragging both lines to their desired x axis position, using the mouse.



3. In the toolbar, click the  button.
4. The "Statistics" window opens showing the results of the calculation for the specified time frame of one trend.

Trend	Minimum	Maximum	Average	Standard deviation	Duration	Number of values
Tank 1	1.00 11/22/2004 11:19:34.937 AM	190.00 11/22/2004 11:19:47.937 AM	108.39	60.60	0:01:00.t	28

5. If you wish to display the results of an additional trend in the trend window, select the appropriate trends in the "Trends" field.
6. In order to continue with the display of Runtime data in trends, close the statistics window and click the  button in the toolbar.
7. If you require a statistical analysis of process data that are not displayed in the trend window, click the  button. Enter the desired time frame in the "Select time range" dialog. The process data are displayed for the specified time frame, and statistics can be calculated.

To view the process value and the X/Y coordinates of a point in the trend, right-click it. The information is shown in a tooltip window.

Note

For additional statistical analysis of process data and archiving of results you must write the scripts yourself.

See also

How to Operate Online Trend Control in Runtime (Page 1773)

Online Configuration of Online Trend Control (Page 1776)

Configuration of WinCC Online Trend Control (Page 1763)

6.5.4.4 Before WinCC V7: Process Value Output as a Function of Another Tag

WinCC Function Trend Control

Introduction

For a graphic processing of tags, Function Trend Control in WinCC offers the option of displaying one tag as a function of another tag. For example, temperature may be shown as a function of pressure. Furthermore, trends may be compared to target trends.

Display of trends during Runtime takes place in ActiveX Control, inserted and configured in a picture in Graphics Designer.

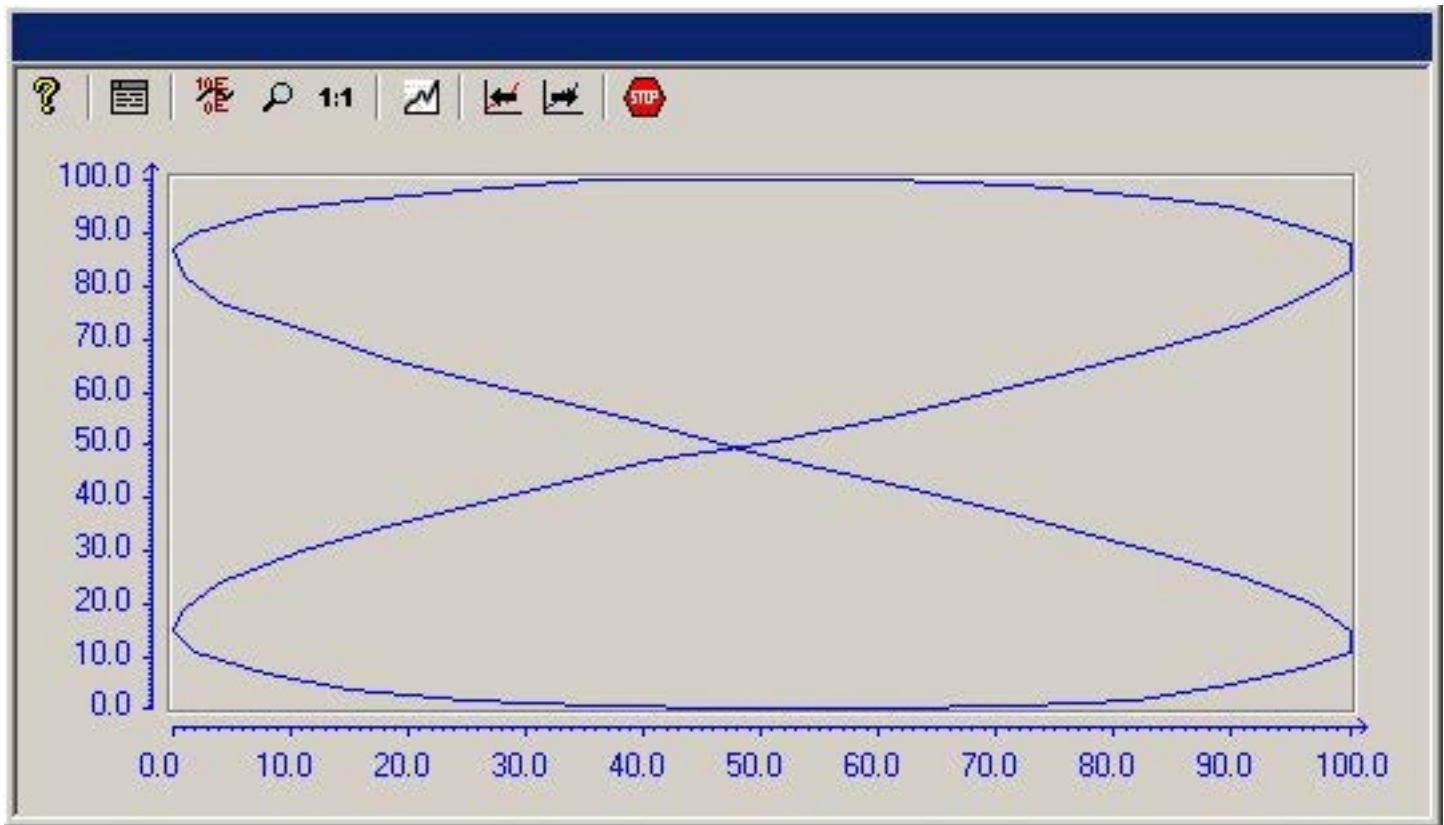

Requirement

For the display of trends in WinCC Function Trend Control the following prerequisites apply:

- In a WinCC Function Trend Control any number of trends may be displayed. However, it is recommended to configure no more than 8 trends.
- A trend can represent a maximum of 10000 value pairs.
- For these trends, either online tags, archive tags or data from user archives may be used.
- Online tags of a trend must have the identical update cycle.
- Archive tags of a trend must have the same update cycle and must be recorded in a continuous cycle.
- Data from user archives can be used for target trends.
- The representation of tags in the form of functions over time is only possible, if the values of the trend are supplied through the API interface. In order to display tags as a function of time, you should use the WinCC Online Trend Control.

Resolution of Trend Display

The number of trend values that can be displayed on the screen is limited by the screen resolution and selected size of the trend window. Therefore, when displaying trends, it is possible that fewer values are displayed in the trend window than are actually archived.

If, for example, in an area of 100 pixels 200 measurement values are archived, each pixel will represent 2 measurement values. The value shown on the screen is that of the most recent data (most recent time stamp).

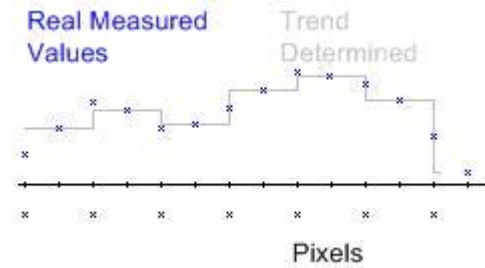

Display of Trends

Representing Trend Lines

Introduction

WinCC Function Trend Control provides a number of options for representing a trend line.

See also

- Comparison with an Ideal Trend (Page 1805)
- Identification of Special Values (Page 1804)
- Time Range of Trend Display (Page 1802)
- Write Direction (Page 1800)
- Display of Staggered Trends (Page 1798)
- Display with Logarithmic Axes (Page 1796)
- Display with common axes (Page 1794)
- Forms of Display (Page 1791)

Forms of Display

Introduction

To graphically display tag values, three basic representation types are available.

Single Values

Value of measurement points are shown as dots.

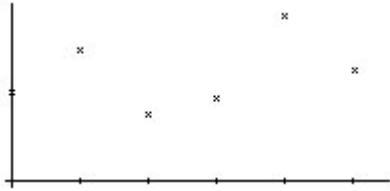

Linear Interpolation

The trend line is interpolated on a linear basis from values of measurement points. The trend is represented as either a solid line or a dashed line. The area under the curve can also be displayed in a solid color.

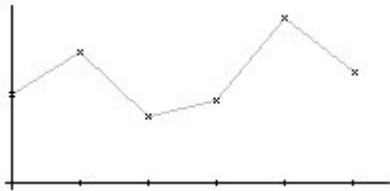

Stepped Trend

The trend line is interpolated as a stepped curve from the values of measurement points. The trend is represented as either a solid line or a dashed line. The area under the curve can also be displayed in a solid color.

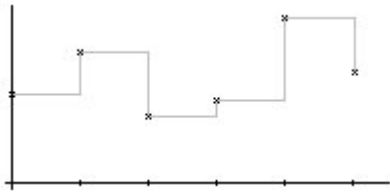

Configuration

The display of trends is configured on the General tab of the Properties of WinCC Online Trend Control dialog.

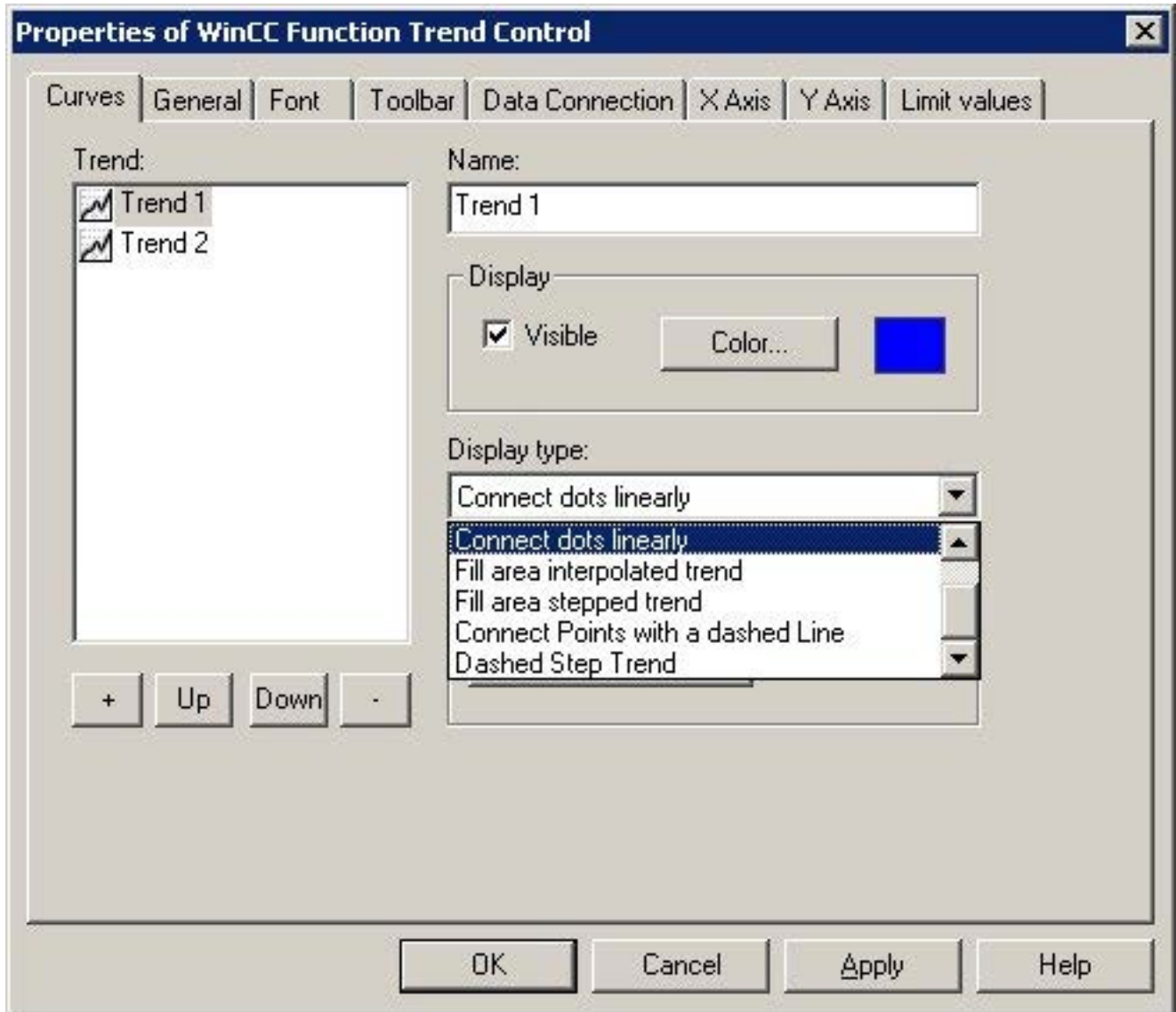

See also

Properties of Function Trend Control - Trends Tab (Page 1836)

Representing Trend Lines (Page 1791)

Display with common axes

Introduction

If multiple trends are to be displayed in a trend window, you have the choice of using individual axes for each trend or using shared X/Y axes for all trends.

Display with Different Axes

If the tag values to be displayed in a tag window differ greatly, the use of shared axes for the trend display is not recommended. The tag values can be read more easily if different axial scales are used.

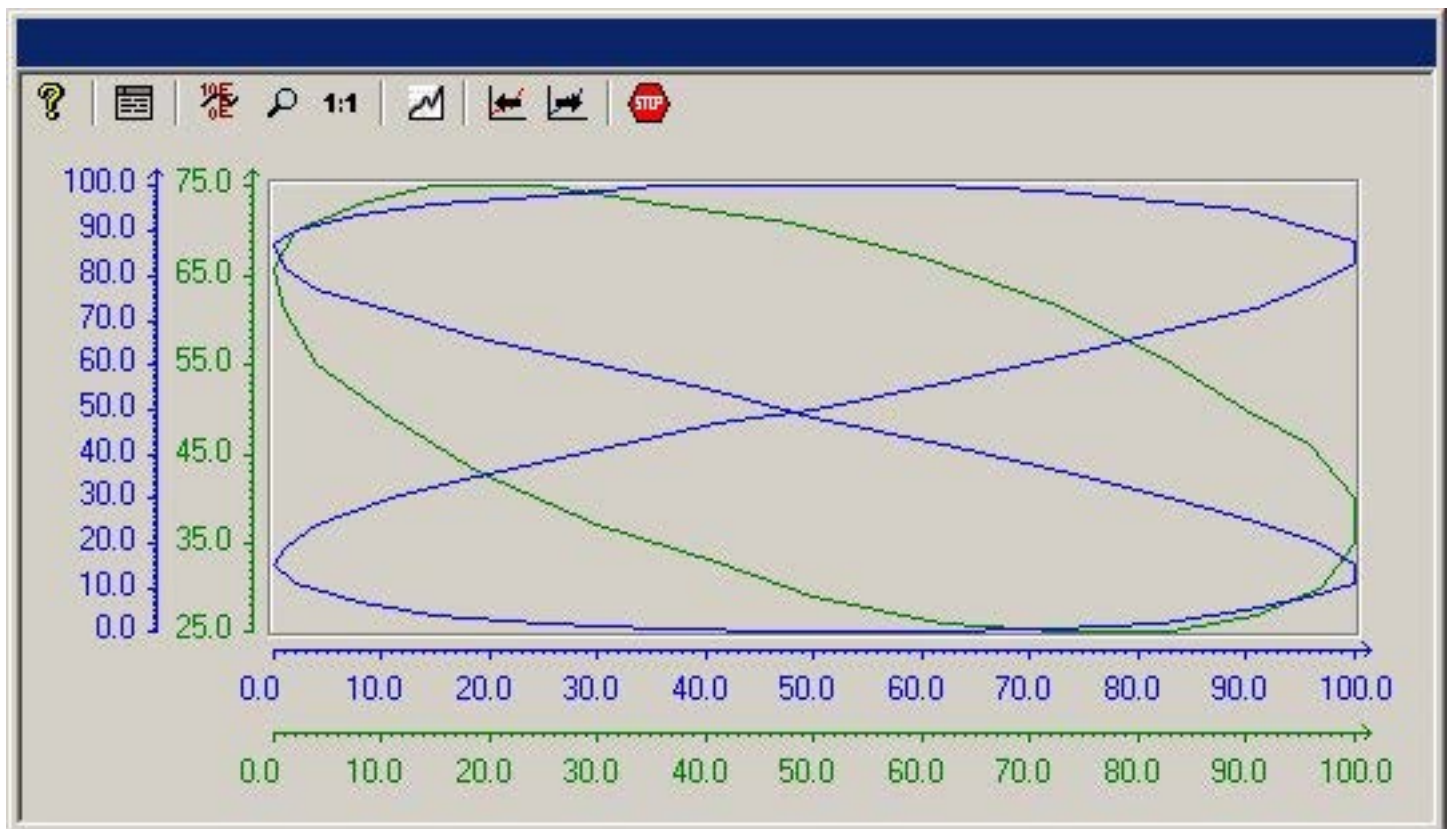

Display with Common Axes

If comparison of trend characteristics is important, it is recommended to display trends with common axes. The exact tag values may be determined in Runtime through zoom or coordinate inquiry.

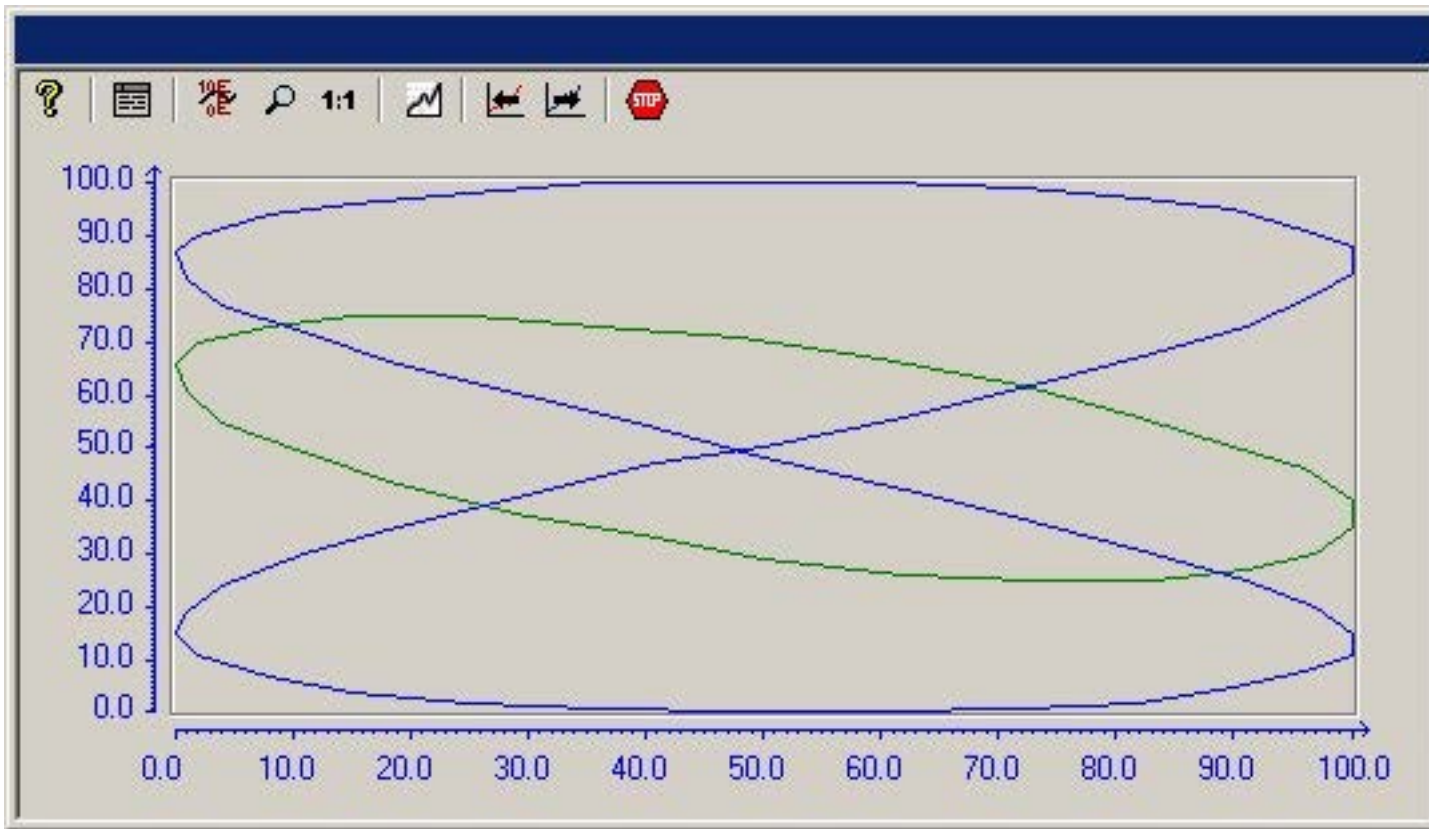

Configuration

The display of common axes is configured in the General tab of the Properties of WinCC Function Trend Control dialog.

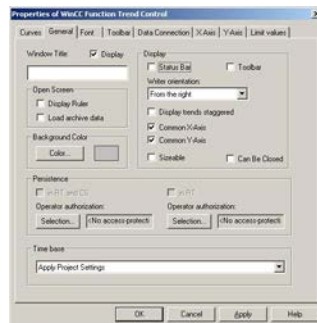

See also

Properties of Function Trend Control - General Tab (Page 1832)

Representing Trend Lines (Page 1791)

Display with Logarithmic Axes

Introduction

The axes in the trend window can be scaled on either a logarithmic or a linear basis. Representation using logarithmic axes means that no negative values can be displayed, and representation using negative logarithmic axes means that no positive values can be displayed.

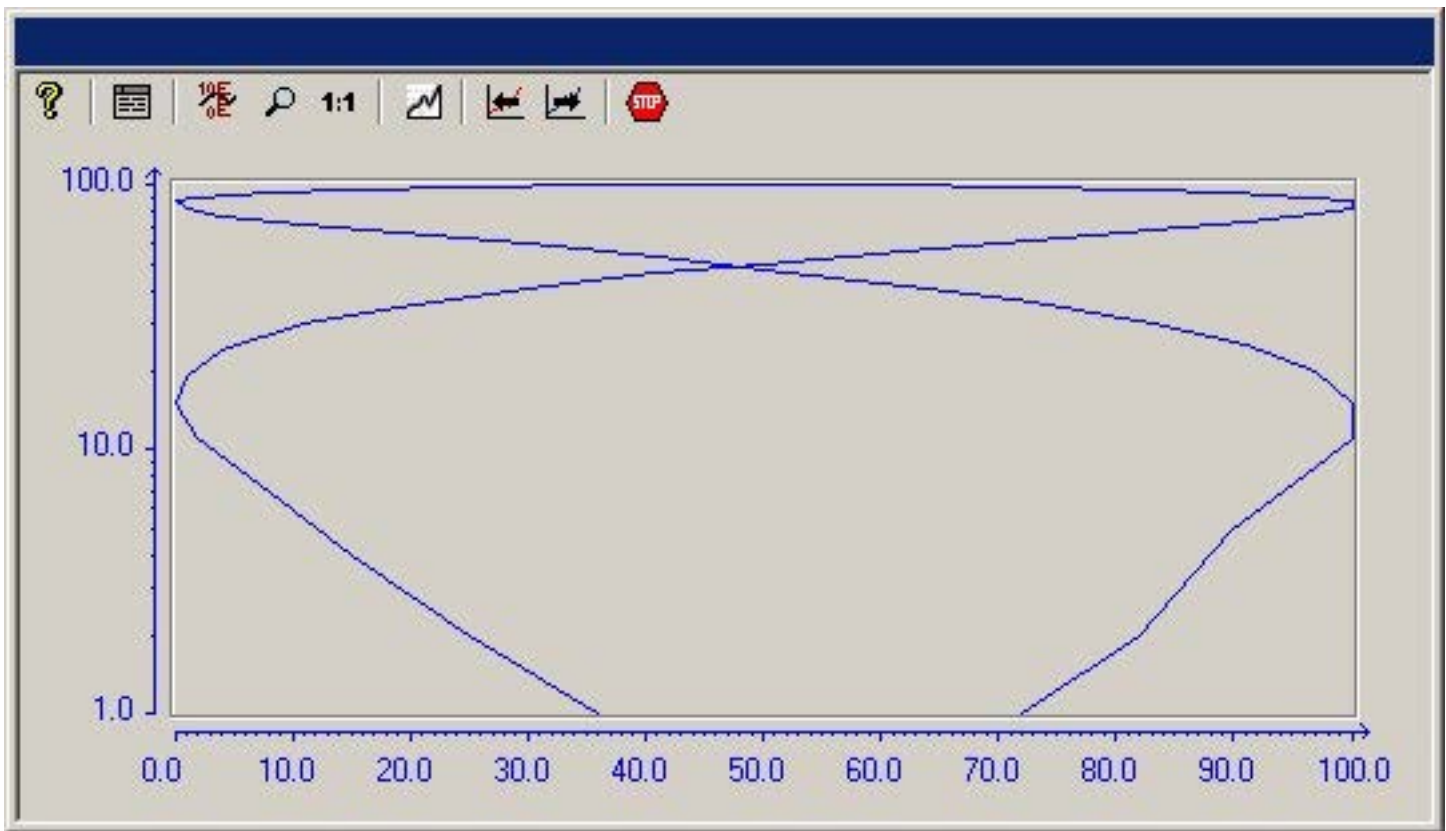

Configuration

Representations using logarithmic axes are configured in the X axis or Y axis tab of the Properties of WinCC Function Trend Control dialog.



See also

Representing Trend Lines (Page 1791)

Display of Staggered Trends

Introduction

In a staggered display, the trends are displayed offset over each other in the trend window. For each trend, the value range to be displayed can be set for the Y axis.

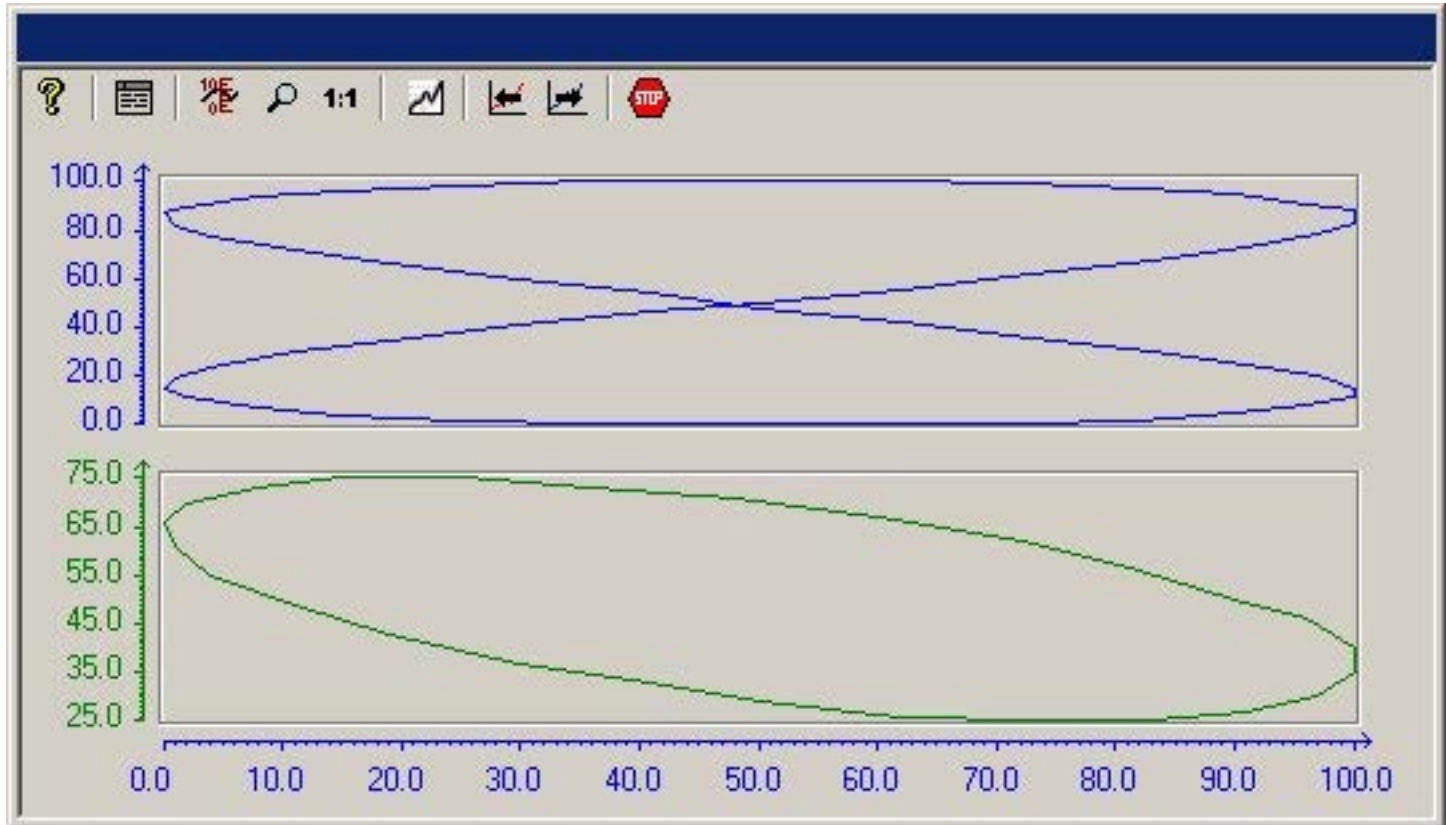

Configuration

The display of staggered trends is configured in the General tab of the Properties of WinCC Online Trend Control dialog.

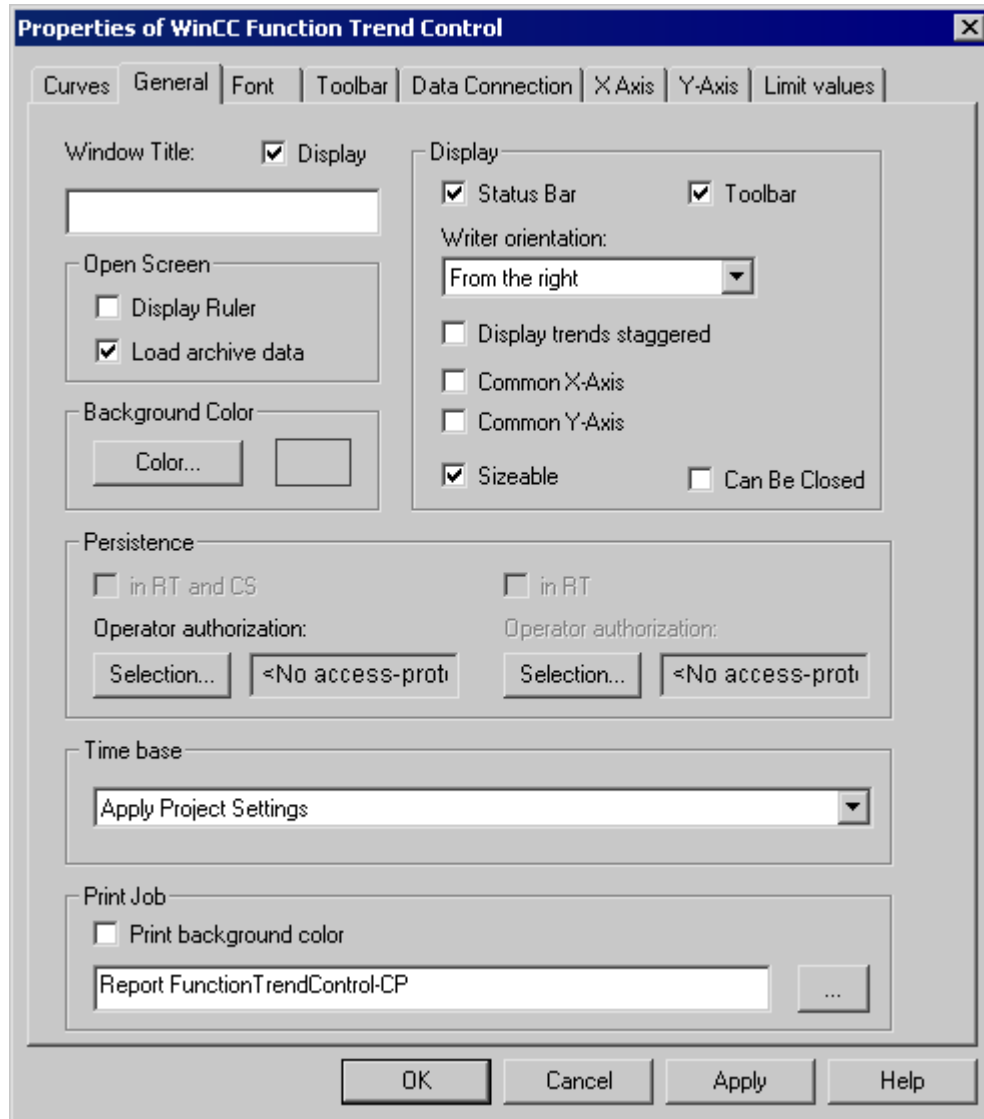

See also

Properties of Function Trend Control - General Tab (Page 1832)

Representing Trend Lines (Page 1791)

Write Direction

Introduction

The write direction defines the direction in which the positive values on the axes are depicted. Thus the setting from the bottom means that positive values on the Y axis will be shown in the downward direction.

If a setting of From the top or From the bottom is selected for the write direction, only True-Type fonts should be used inside the Trend window to ensure a clear display of labels on the vertical axis.

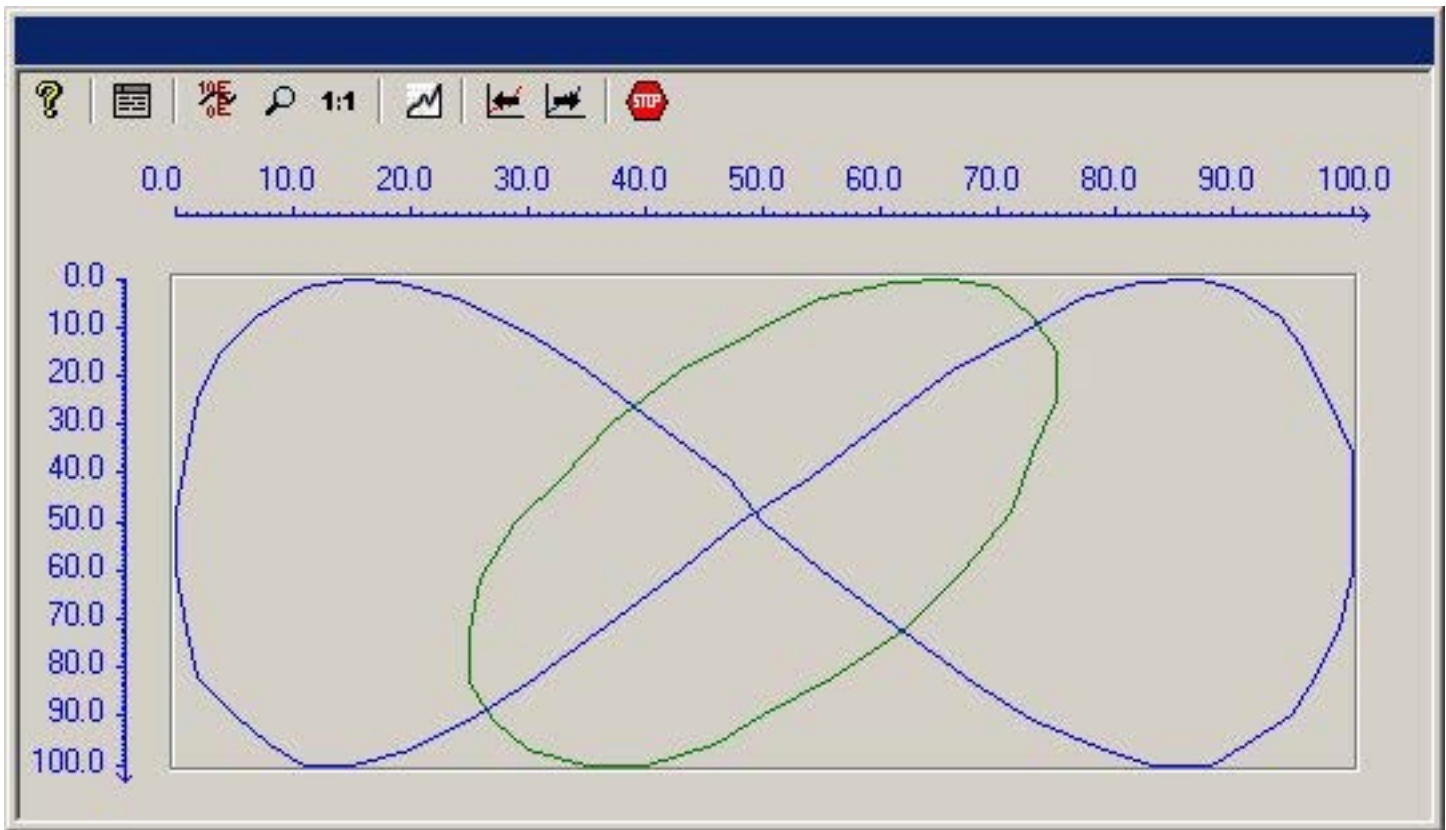

Configuration

The write direction configured in the General tab of the Properties of WinCC Function Trend Control dialog.

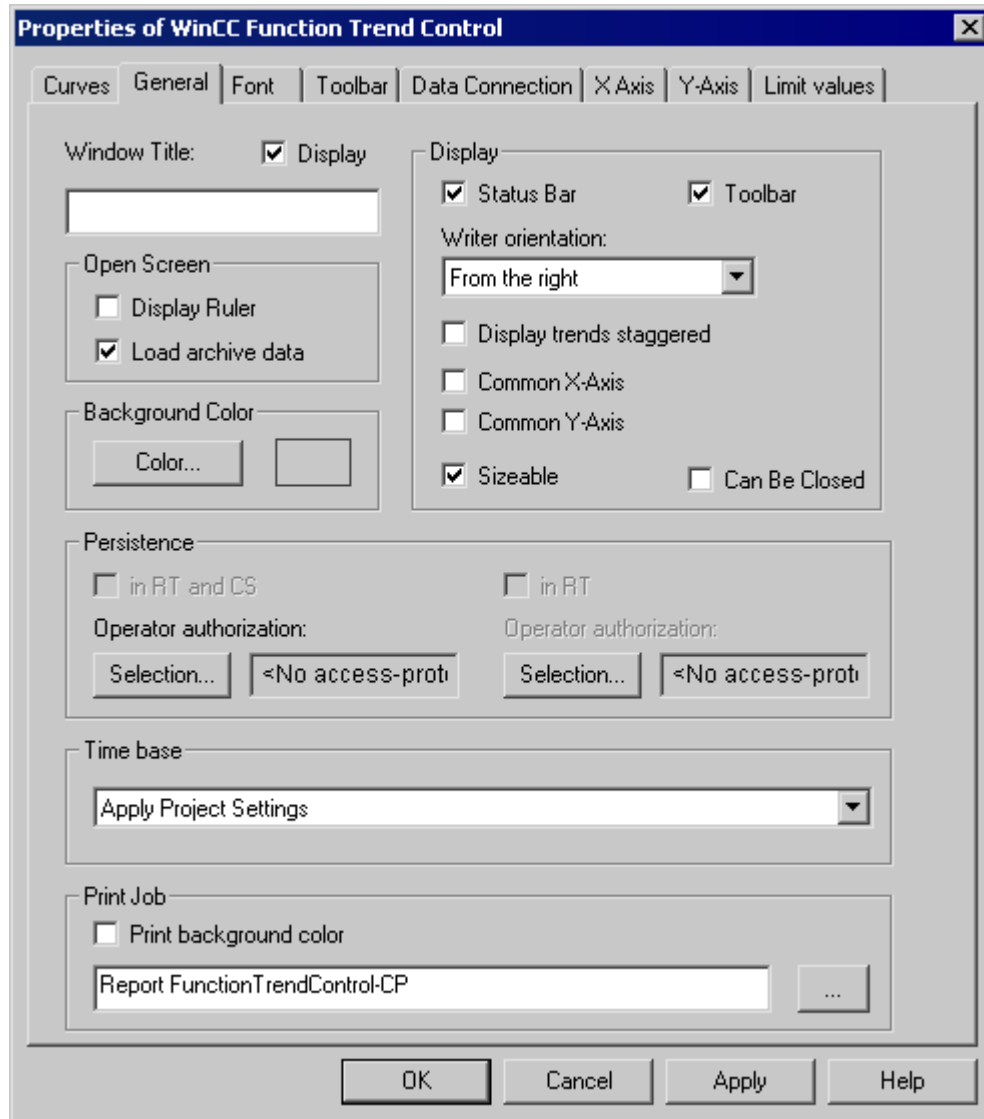

See also

Properties of Function Trend Control - General Tab (Page 1832)
Representing Trend Lines (Page 1791)

Time Range of Trend Display

Introduction

With regard to the time ranges to be displayed, there are a number of ways to present a trend display of tags:

Static Representation of a Tag

Static representation presents the course of a tag within a defined time interval, based on the archived values.

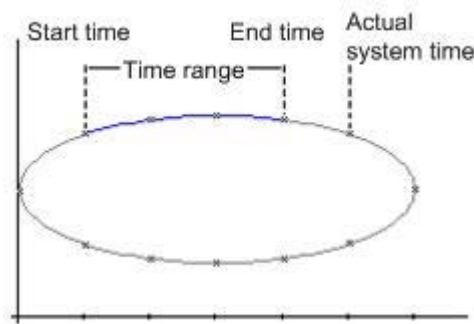

If display updating is stopped in runtime, the Data Linking tab of the Properties of WinCC Function Trend Control dialog can be used to configure the time range that needs to be represented. This time range is derived either by defining a starting time and end time or by defining a starting time and the number of value pairs to be represented.

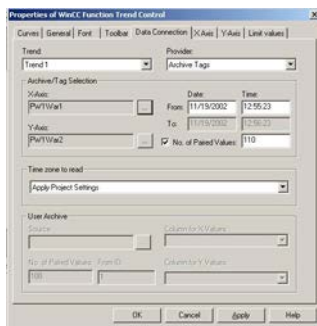

Dynamic Display of Tags

When displaying one tag as a function of another tag in dynamic mode, the value of measurement point associated with the current system time changes along the function graph. New measurement values coming in will be included in the display.

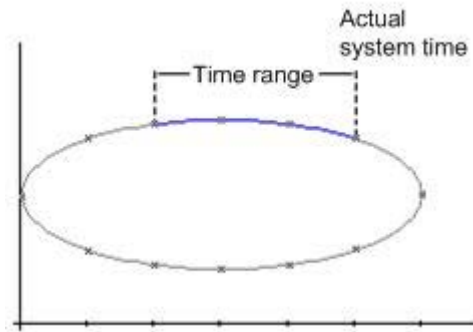

The time range to be represented is configured in the Data Linking tab of the Properties of WinCC Function Trend Control dialog. This time range is derived either by defining a starting time and end time or by defining the number of value pairs to be represented.

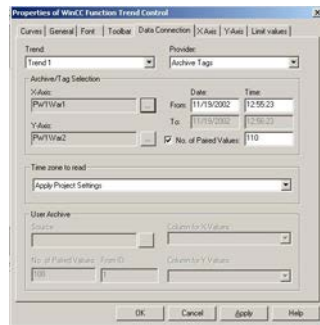

See also

Representing Trend Lines (Page 1791)

Identification of Special Values

Introduction

In any trend, values may occur which are above or below a limiting value, or which have an uncertain status. Such special values can be highlighted in color. Values with an uncertain status are those whose initial value is not known after runtime has been activated, or for which a substitute value is used.

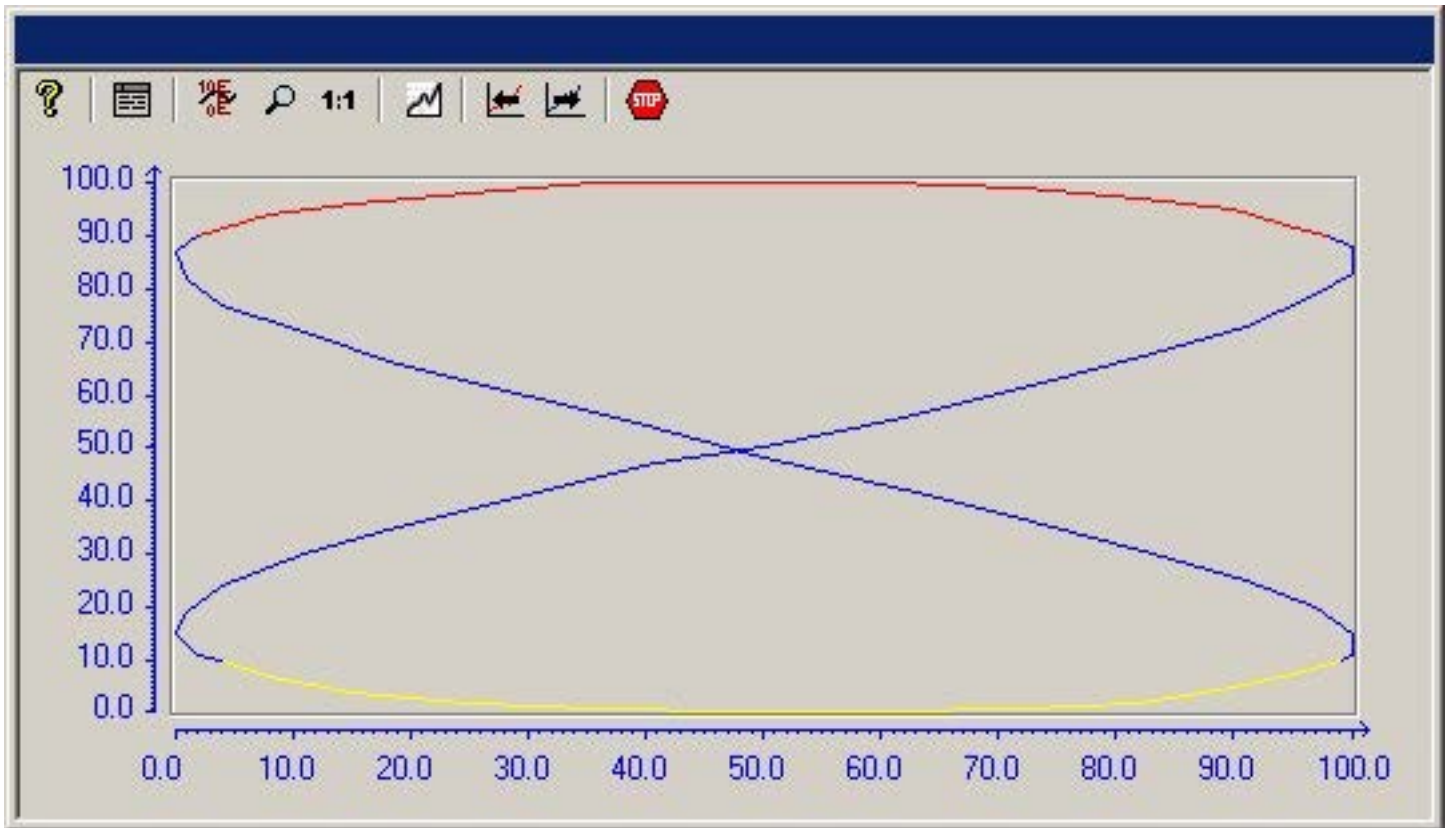

Configuration

Color-coded identification of special values is configured in the Limiting Values tab of the Properties of WinCC Function Trend Control dialog.

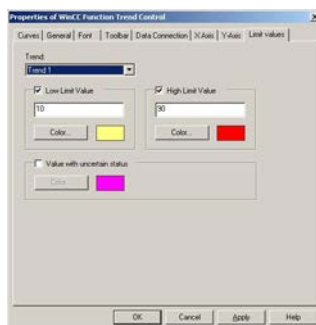

See also

Representing Trend Lines (Page 1791)

Comparison with an Ideal Trend

Introduction

Any trend can be configured with an ideal trend. It is then possible to make an effective comparison between the actual trend line and the specified ideal trend. The values for the ideal trend must be held in a user archive. You can create user archives with the aid of WinCC option User Archives.

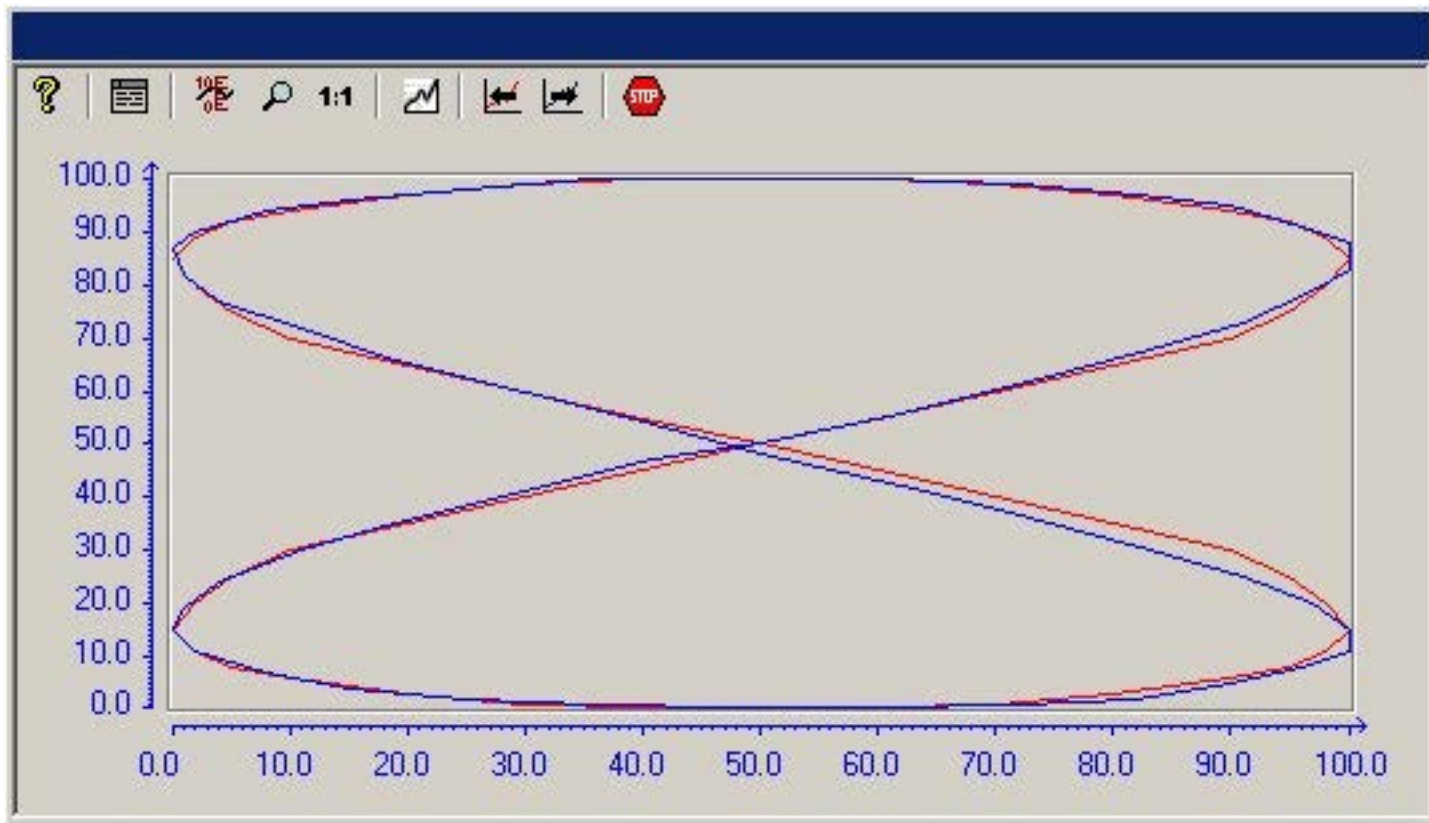

Configuration

The values for the ideal trend are configured in a user archive.

The display for an ideal trend is configured in the Trends tab of the Properties of WinCC Function Trend Control dialog box.

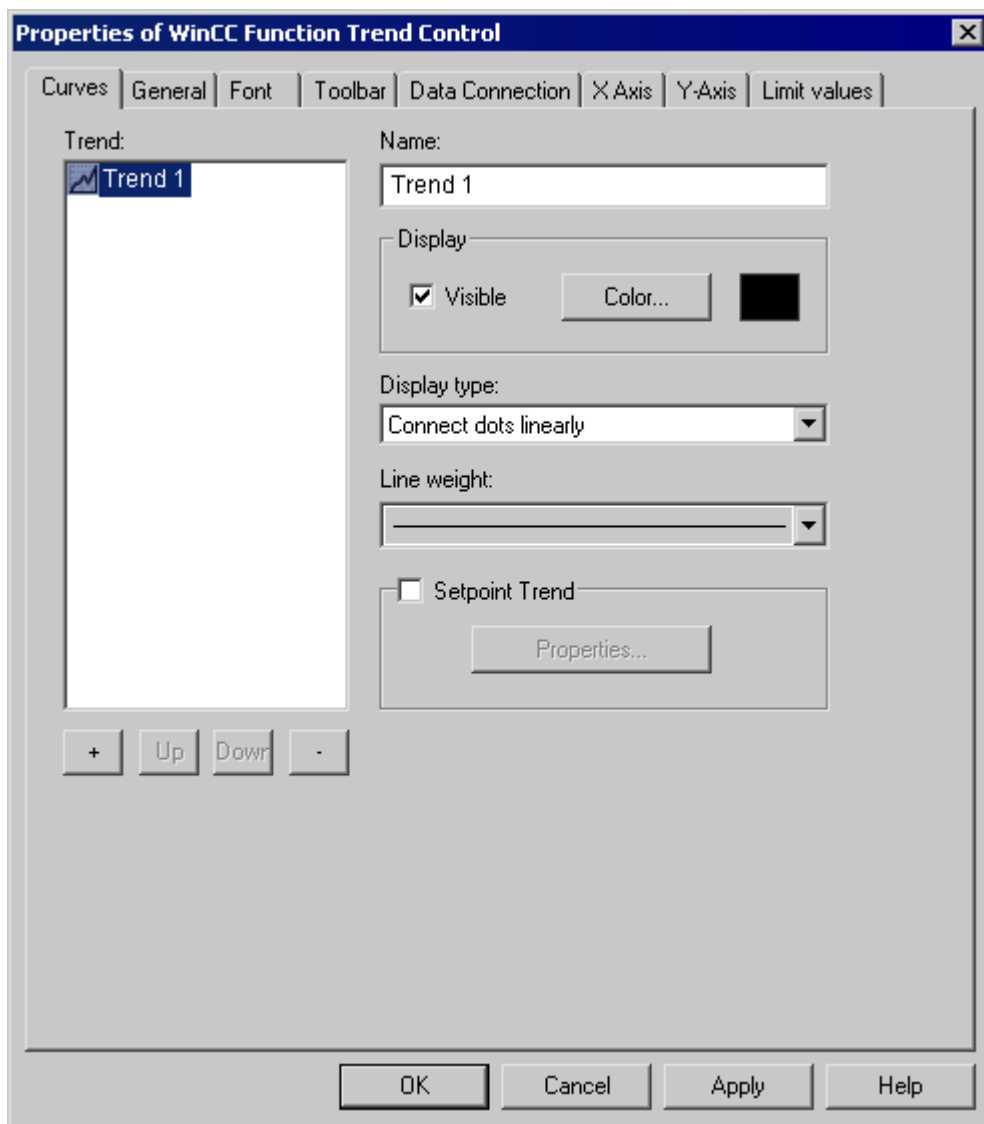

See also

Properties of Function Trend Control - Trends Tab (Page 1836)

Representing Trend Lines (Page 1791)

Configuration

Configuration of WinCC Online Trend Control

Introduction

The steps you need to take in order to configure WinCC Function Trend Control are dependent on the tags you wish to display.

Display of Online Tags

1. The tags you wish to display need to be configured in WinCC Explorer.
2. Link the WinCC Function Trend Control to a Graphics Designer picture and edit the properties of the ActiveX Control.

Display of Archive Tags

1. The tags you wish to display need to be configured in WinCC Explorer.
2. Use the Archive Wizard to create a process value archive.
3. Configure the process value tags it will contain.
4. Link the WinCC Function Trend Control to a Graphics Designer picture and edit the properties of the ActiveX Control.

Display of Values from User Archive

1. Create a user archive.
2. Configure the fields it will contain.
3. Link the WinCC user archive table element to a Graphics Designer picture and edit the properties of the ActiveX Control.
4. Link the WinCC Function Trend Control to a Graphics Designer picture and edit the properties of the ActiveX Control.
5. Enable runtime and input the display values into the user archive or import them from a csv file.

Comparison with an Ideal Trend

1. Create a user archive.
2. Configure the fields it will contain.
3. Link the WinCC user archive table element to a Graphics Designer picture and edit the properties of the ActiveX Control.
4. Link the WinCC Function Trend Control to a Graphics Designer picture and edit the properties of the ActiveX Control.
5. Enable runtime and input the ideal trend values into the user archive or import them from a csv file.

See also

- How to Display Archive Tags (Page 1809)
- How to Compare Tag Values with an Ideal Trend (Page 1812)
- How to Display Data from User Archives (Page 1810)
- How to Display Online Tags (Page 1808)
- How to Insert Function Trend Control in a Picture (Page 1808)

How to Insert Function Trend Control in a Picture

Introduction

Tags are displayed in runtime in an ActiveX Control, which is inserted in a picture and configured with the aid of the Graphics Designer.

Procedure

1. Start Graphics Designer and open a new picture.
2. In the Object Palette Default tab, click the smart object Control.
3. Place the mouse pointer at the position in the picture where you want to insert the control. The mouse pointer changes into a crosshair with an object symbol attached.
4. Drag the control to the desired size. The Insert a Control dialog is opened.
5. Select WinCC Function Trend Control and confirm your selection by clicking OK. The Properties of WinCC Function Trend Control quick configuration dialog box opens.
6. Click OK to close the dialog.

See also

- How to Compare Tag Values with an Ideal Trend (Page 1812)
- How to Display Data from User Archives (Page 1810)
- How to Display Online Tags (Page 1808)
- How to Display Archive Tags (Page 1809)

How to Display Online Tags

Requirement

- Configure two tags (Tag1, Tag2) with data type signed 16-bit value.
- Insert the Function Trend Control into a Graphics Designer picture.

Procedure

1. In Graphics Designer, open a picture using Function Trend Control.
2. Double-click the Function Trend Control.
3. Click the "Data Linking" tab.
4. For "Data Source", select the "Online Tags" setting.
5. In the "Select Archive/Tag" area, use the button marked "..." and select Tag1 for the X axis.
6. In the "Select Archive/Tag" area, use the button marked "..." and select Tag2 for the Y axis.
7. To define the time range you wish to display, specify a starting time and the number of value pairs to be represented.

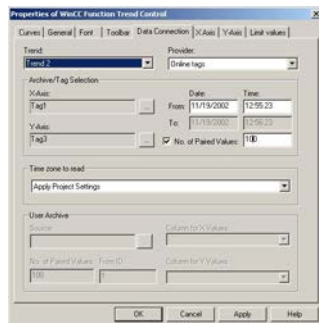

8. Close the dialog with the "OK" button.
9. Save the picture.
10. Enable runtime and start the WinCC Tag Simulator.

Note

The tags to be displayed within a trend must have the same updating cycle.

See also

How to Use the Simulator (Page 1817)

How to Insert Function Trend Control in a Picture (Page 1808)

How to Display Archive Tags

Requirement

- Configure two tags (Tag1, Tag2) with data type signed 16-bit value.
- Create a process value archive containing Tag1 and Tag2.
- Insert the Function Trend Control into a Graphics Designer picture.

Procedure

1. In Graphics Designer, open a picture using Function Trend Control.
2. Double-click the Function Trend Control.
3. Click the "Data Linking" tab.
4. For "Data Source", select the "Archive Tags" setting.
5. In the "Select Archive/Tag" area, use the button marked "..." and select Tag1 stored in process value archive PW1 for the X axis.
6. In the "Select Archive/Tag" area, use the button marked "..." and select Tag2 stored in process value archive PW2 for the Y axis.
7. To define the time range you wish to display, specify a starting time and the number of value pairs to be represented.

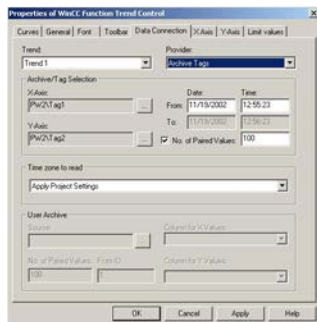

8. Close the dialog with the "OK" button.
9. Save the picture.
10. Enable runtime and start the WinCC Tag Simulator.

Note

The tags to be displayed in a trend must originate from an archive on a server and be acquired in a continuous cycle.

See also

- How to Use the Simulator (Page 1817)
- How to Insert Function Trend Control in a Picture (Page 1808)
- How to Create a Process Value Archive (Page 1828)

How to Display Data from User Archives

Introduction

You can use WinCC Function Trend Control to display value pairs from user archives. You can create user archives with the aid of WinCC option User Archives.

Requirement

- Configure a user archive with the columns "Setpoint X" and "Setpoint Y".
- In runtime, input values for "Setpoint X" and "Setpoint Y".
- Insert the Function Trend Control into a Graphics Designer picture.

Procedure

1. In Graphics Designer, open a picture using Function Trend Control.
2. Double-click the Function Trend Control.
3. Click the "Data Linking" tab.
4. Go to "Provider" and select the setting "User Archive".
5. In the "User Archive" area, use the button marked "..." and select user archive UA1.
6. In the "Column for X Values" area, select the "Setpoint X" column.
7. In the "Column for Y Values" area, select the "Setpoint Y" column.
8. To define the time range you wish to display, specify the number of value pairs to be represented and the ID of the first value pair.

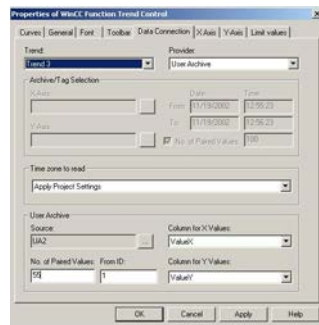

9. Close the dialog with the "OK" button.
10. Save the picture.
11. Enable runtime and start the WinCC Tag Simulator.

See also

- How to Use the Simulator (Page 1817)
- How to Insert Function Trend Control in a Picture (Page 1808)
- How to Create a User Archive (Page 1829)

How to Compare Tag Values with an Ideal Trend

Requirement

- Configure a user archive with the columns "Setpoint X" and "Setpoint Y".
- In runtime, input values for "Setpoint X" and "Setpoint Y".
- Insert the Function Trend Control into a Graphics Designer picture.
- Configure the data linking for the Function Trend Control.

Procedure

1. In Graphics Designer, open a picture using Function Trend Control.
2. Double-click the Function Trend Control.
3. Click the "Trends" tab.
4. Select the "Ideal Trend" check box.
5. Click the "Properties..." button.
The "Properties of the Ideal Trend" dialog box opens.
6. In the "User Archive" area, use the button marked "..." and select user archive UA1.
7. In the "Column for X Values" area, select the "Setpoint X" column.
8. In the "Column for Y Values" area, select the "Setpoint Y" column.

9. To define the time range you wish to display, specify the number of value pairs to be represented and the ID of the first value pair.

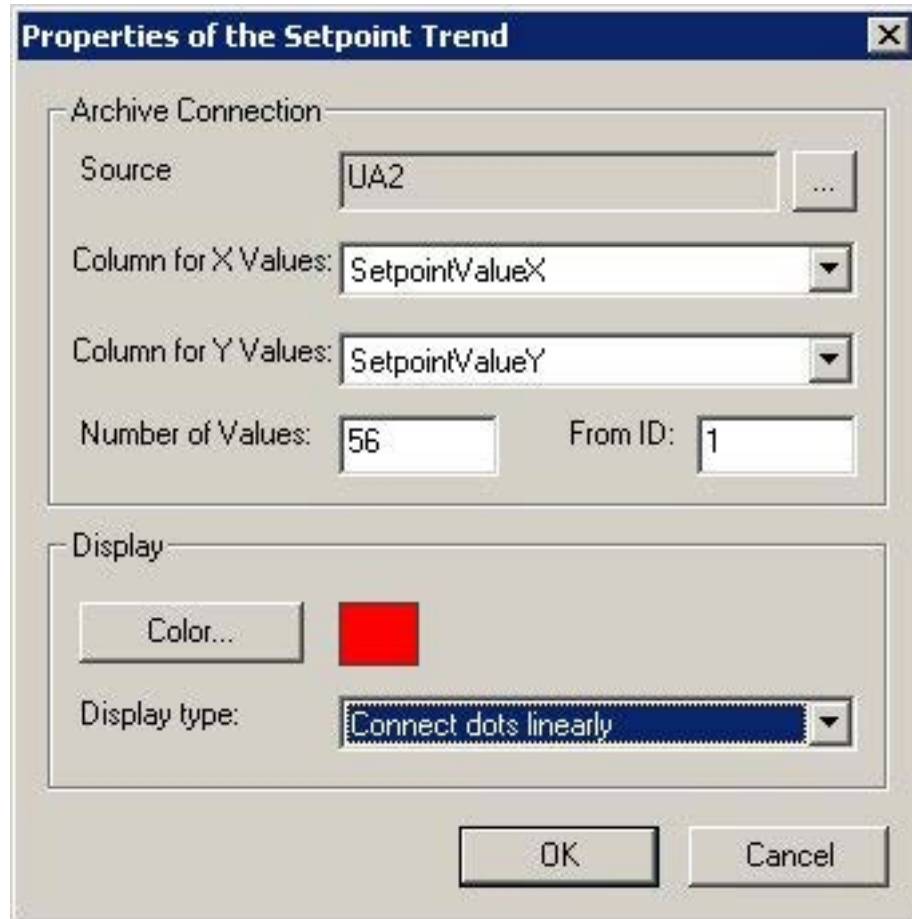

10. Select the color and representation type for the ideal trend.
11. Click "OK" to close all open dialogs.
12. Save the picture.
13. Enable runtime and start the WinCC Tag Simulator.

See also

- How to Use the Simulator (Page 1817)
- How to Insert Function Trend Control in a Picture (Page 1808)
- How to Create a User Archive (Page 1829)
- How to Create a Process Value Archive (Page 1828)

How to Display a Tag as a Function of Time

Introduction

You can also use Function Trend Control to display tags as a function of time. However, this is only possible if the data source for the trends is connected over the application programming interface (API). For this the setting none must be selected (as Provider) in the Data Linking tab of the Properties of WinCC Function Trend Control dialog box.

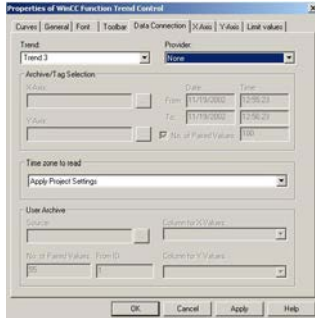

Note

In order to display tags as a function of time, you should use the WinCC Online Trend Control.

Example

The example shows the supply of values for a trend using the API interface. The third trend (index = 2) of Control1 in a picture is supplied with data. This results in a sine curve, consisting of 1440 value pairs:

```
// Definitions for the calculation of sine
#define NUMVALUES 1440 // Number of value pairs
#define PI 3.14159265359 // PI
// Variant for supply of DataXY property
VARIANT vtDataXY;
// Variant that contains a single data pair
VARIANT vtPair;
// Represents the X value of a data pair
VARIANT vtDataX;
// Represents the Y value of a data pair
VARIANT vtDataY;
// For faster access to the SAFEARRAY data that is contained in the
Variants.
VARIANT* pvtDataXY = NULL;
```

```
VARIANT* pvtPair = NULL;
int i = 0;
long lIndex = 0;
double dAngle = 0;
HRESULT hr = 0;
SAFEARRAYBOUND rgsabound[1];
// Initializing of the DataXY Variant
VariantInit( &vtDataXY );
// Creation of the SAFEARRAY for the DataXY property
rgsabound[0].cElements = NUMVALUES; // NUMVALUES - value pairs
rgsabound[0].lLbound = 0;
vtDataXY.u.parray = SafeArrayCreate( VT_VARIANT, 1, rgsabound );
if( vtDataXY.u.parray )
{
    vtDataXY.vt = (VARTYPE)( VT_ARRAY | VT_VARIANT );
}
else
{
    // No memory left
    return;
}
// Set the trend index
SetPropBOOL( lpszPictureName, Controll, Index, 2 );
// Delete all trend data
SetPropBOOL( lpszPictureName, Controll, DeleteData, TRUE );
// Obtain direct access to values of the DataXY-SAFEARRAYS
hr = SafeArrayAccessData( vtDataXY.u.parray, &pvtDataXY );
if( hr == 0 && pvtDataXY )
{
    for( i = 0; i < NUMVALUES; ++i )
    {
        // Initializing of the Variants in order to fill the DataXY-
SAFEARRAY
        VariantInit( &vtPair );
        VariantInit( &vtDataX );
    }
}
```

```

VariantInit( &vtDataY );
// Generation of a single value pair SAFEARRAY
// Always two values, respectively for the X and Y value.
rgsabound[0].cElements = 2;
vtPair.u.parray = SafeArrayCreate( VT_VARIANT, 1, rgsabound );
if( vtPair.u.parray )
{
    vtPair.vt = (VARTYPE)(VT_ARRAY | VT_VARIANT );
    // Obtain direct access to the data of the DataXY-SAFEARRAY
    SafeArrayAccessData( vtPair.u.parray, &pvtPair );
    if( pvtPair )
    {
        // Set the X value
        vtDataX.vt = VT_R8;
        vtDataX.u.dblVal = (double)( i - NUMVALUES/2 );
        dAngle = ( i - NUMVALUES/2 ) * 2 * PI / 360;
        // Set the Y value
        vtDataY.vt = VT_R8;
        vtDataY.u.dblVal = sin( dAngle );
        // Write values into the value pair SAFEARRAY
        VariantCopy( &pvtPair[0], &vtDataX );
        VariantCopy( &pvtPair[1], &vtDataY );

        // Re-enable the value pair SAFEARRAY data
        SafeArrayUnaccessData( vtPair.u.parray );
        pvtPair = NULL;
        // Copy the value pair into DataXY-SAFEARRAY
        VariantCopy( &pvtDataXY[i], &vtPair );
    }
}
// Enable the used SAFEARRAYs
VariantClear( &vtDataX );
VariantClear( &vtDataY );
VariantClear( &vtPair );
}

```

```
        // Enable access to the DataXY-SAFEARRAY data.
        SafeArrayUnaccessData( vtDataXY.u.parray );

        // Set the DataXY property
        PDLRTSetPropEx( PDLRT_AM_DEFAULT, lpszPictureName, Control1,
DataXY,
VT_VARIANT, (void*)&vtDataXY, NULL, NULL, 0, NULL, NULL );

        // Add value pairs at the end
        SetPropBOOL( lpszPictureName, Control1, InsertData, TRUE );
    }

    VariantClear( &vtDataXY );
```

How to Use the Simulator

Introduction

To familiarize yourself with the functionality of the WinCC Function Trend Control in runtime, you can use the Tag Simulator to simulate the tags configured in the examples.

Requirement

- Configure a WinCC Function Trend Control in the Graphics Designer.
- Enable runtime.
- Start the Tag Simulator.

Procedure

1. In the Edit menu, click the New Tag command.
2. Select Tag 1 and confirm your selection by clicking OK.
3. Click the Properties tab and input the following values for Tag 1.
Amplitude: 50
Offset: 50
Vibration period: 25
4. Click the Tags tab.
5. In the Edit menu, click the New Tag command.
6. Select Tag 1 and confirm your selection by clicking OK.
7. Click the Properties tab and input the following values for Tag 1.
Amplitude: 50
Offset: 50
Vibration period: 50
8. Click the Tags tab.

- 9. Click the Start Simulation button.
- 10. In WinCC runtime, track the display of the tags in the WinCC Function Trend Control.

Operation in Runtime

How to Operate Function Trend Control in Runtime

Introduction

The trend window is operated in runtime via the buttons in the toolbar.



"Online-Help-System"
Calling up the Online help



"Open the Configuration Dialog"
Selecting the dialog to assign display parameters.



"Display Value at this Position"
Click this button to query the coordinate points of a trend.



"Zoom Area"
Click this button to zoom in on any section of the trend window.



"Activate Original View"
Click this button to return to the configured normal view (after zooming).



"Opens the dialog for selecting a trend"
Opens a dialog to configure the settings for the selected trends



"Previous trend in foreground"
Click this button to display the previous trend in the foreground of the trend window



"Next trend in the front"
Click this button to display the next trend in the foreground of the trend window



"Start/Stop update"
Updates are stopped/started and can be continued/stopped by clicking the button.



"Print Log"
Click this button to print the trend shown in the trend window. Print job used during printing can be specified in the control properties on the "General" tab.

See also

Properties of Function Trend Control - Toolbar Tab (Page 1830)

Starting and Stopping Update (Page 1821)

Displaying a Trend on Top (Page 1822)

How To Enlarge a Segment of a Trend (Page 1826)

How to Determine the Coordinates of a Point (Page 1824)

Online Configuration of Function Trend Control (Page 1819)

Online Configuration of Function Trend Control

Introduction

There are two possible methods by which you can modify the configuration of the Function Trend Control in runtime.

Keyboard function Open the Parameter Dialog

Keyboard function Open the Configuration Dialog allows you to access virtually all Function Trend Control settings including data linking for the trends that are to be displayed. Only the input privileges configured for persistence cannot be amended in runtime.

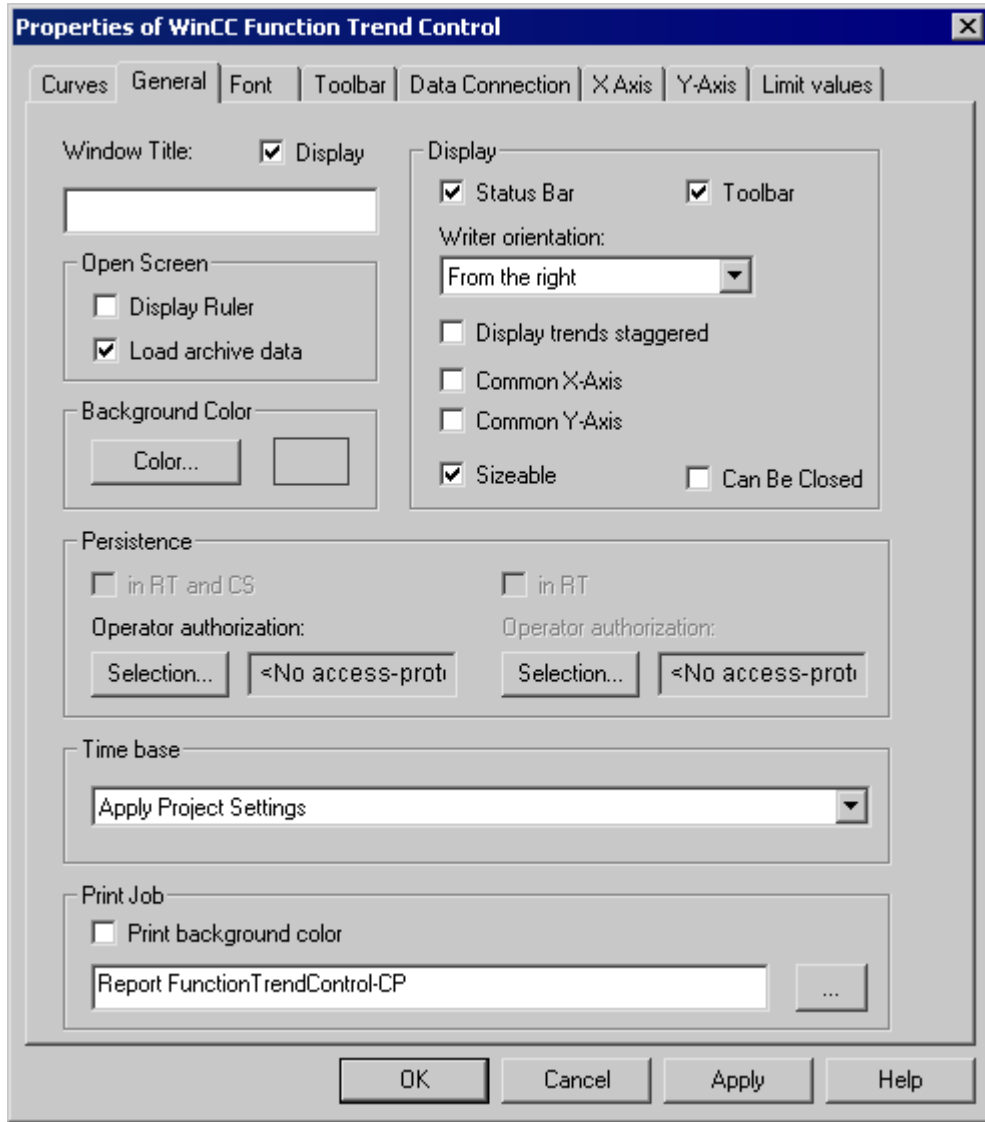

Keyboard function Opens the dialog for selecting a trend

Keyboard function Opens the dialog for selecting a trend allows you to access certain Function Trend Control settings.

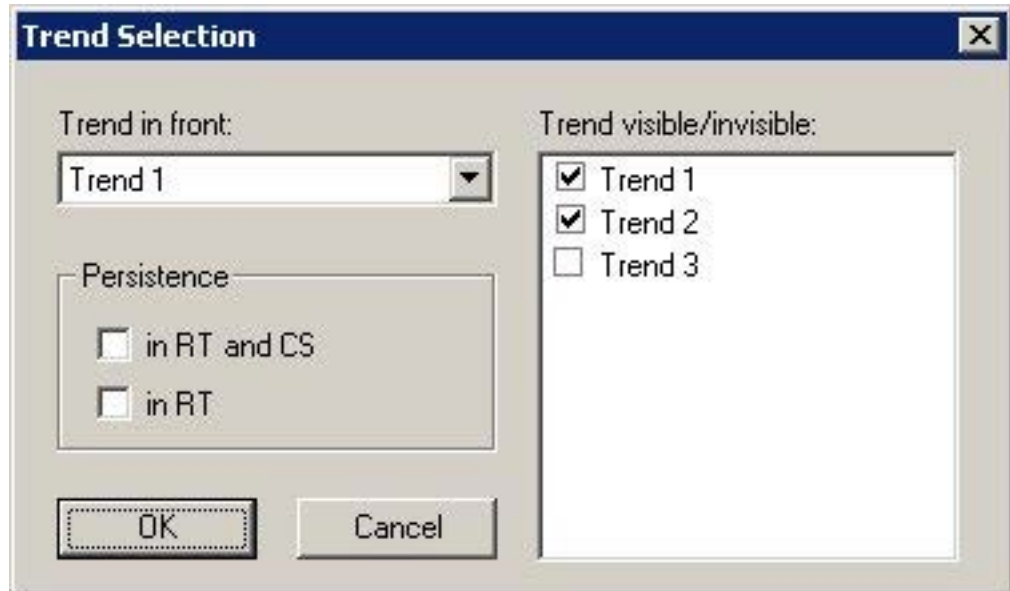

See also

How to Operate Function Trend Control in Runtime (Page 1818)

Starting and Stopping Update

Introduction

You can use keyboard function Start/Stop the Update to halt or restart the update in the trend window. When the update is stopped you can modify the time range being displayed, and display value of measurement points from the process value archive in the trend window. Certain functions, such as keyboard function Enlarge Area automatically stop the update of value of measurement points.

When updates are stopped, you may change the displayed time frame and therefore display measurement values from the process value archive in the table window.



: When updates are stopped, you may change the displayed time frame and therefore display measurement values from the process value archive in the table window.



: When updates are started, you may change the displayed time frame and therefore display measurement values from the process value archive in the table window.

See also



How to Operate Function Trend Control in Runtime (Page 1818)

Displaying a Trend on Top

Introduction

If a common axis is used, the settings for the trend displayed displaying the axis.

You can modify the trend displayed on top in runtime:

- with the  button: (keyboard function Opens the dialog for selecting a trend)
- with the  button: (keyboard function Next trend on top)
- with the  button: (keyboard function Previous trend on top)

Configuration

The sequence to be used for the trends is configured in the Limiting Value tab of the Properties of WinCC Function Trend Control dialog box. It can be changed via the Up and Down buttons.

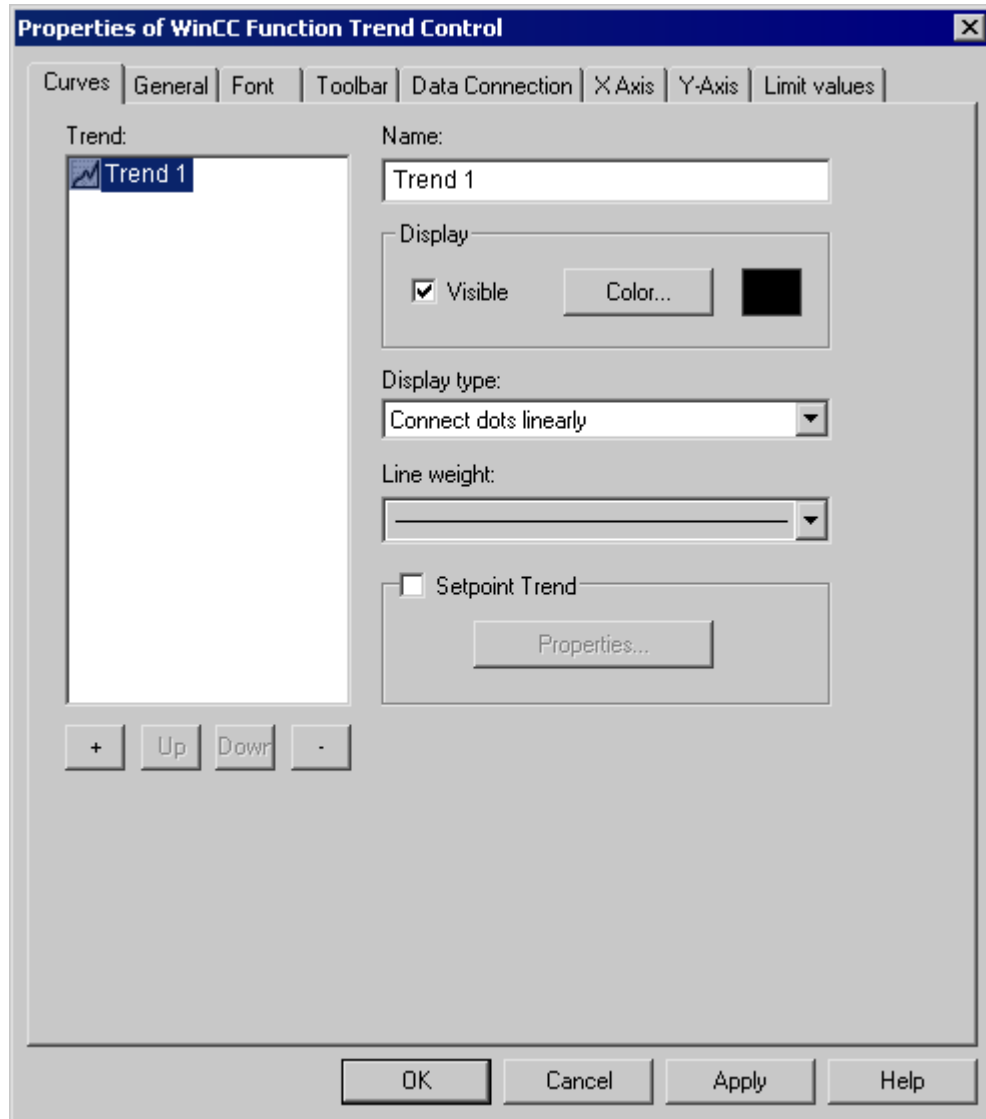

See also

How to Operate Function Trend Control in Runtime (Page 1818)

How to Determine the Coordinates of a Point

Introduction

You can use the "Display Value at this Position" key function to determine the coordinates of a point in the trend. To make it easier to determine the coordinates, you can also enlarge a particular segment of the trend lines.

Requirement

- Configure a Function Trend Control.
- Configure the display of a toolbar, using the buttons assigned to key functions "Zoom Area" and "Activate Normal View".
- You can specify the font for the tag value table that is displayed with the key function "Display value here" in the "Font" tab and via the property "RulerFont".
- Start Runtime.

Procedure

1. In the toolbar, click the "Display Value at this Position" button.
A cross-hair appears in the trend window. The coordinates for the center point of the crosshair are displayed below the trend window.
2. Move the mouse over one of the axes or the center point of the crosshair.
3. Hold down your left mouse button and drag the center point of the crosshair to the position of the value of measurement point whose coordinates you wish to know.

4. Release the left mouse button.

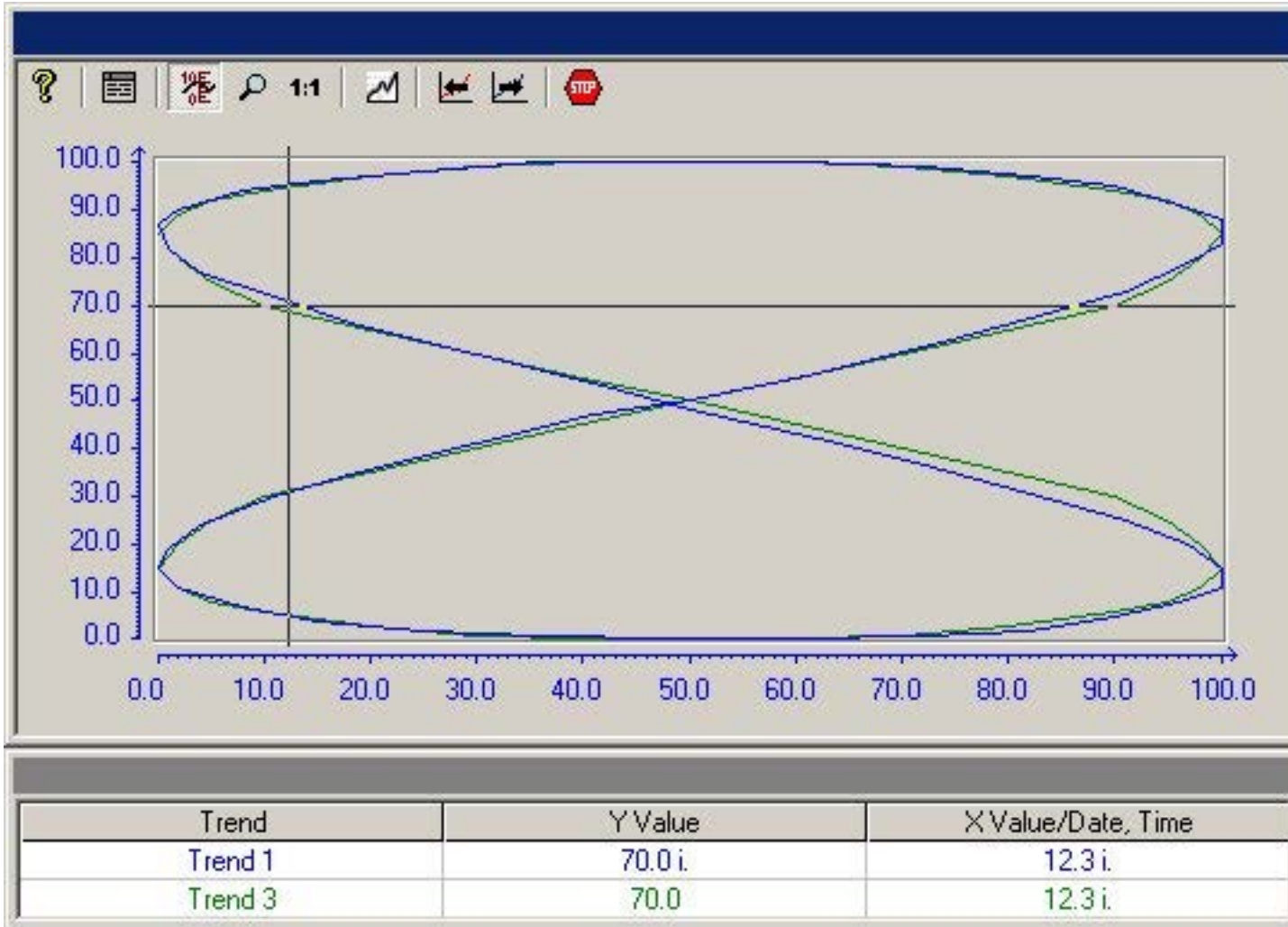

5. Read off the coordinates for the value of measurement point from the area below the trend window.
6. In the toolbar, click the "Display Value at this Position" button. The cross-hair disappears.

Note

Points which lie between two measured value pairs and have therefore interpolated are identified with an "i".

See also

How to Operate Function Trend Control in Runtime (Page 1818)

How To Enlarge a Segment of a Trend

Introduction

You can use the "Enlarge Area" key function to zoom in on any segment of the trend window. You may then find that the keyboard function "Display Value at this Position" is easier to use within the enlarged display to determine the coordinates of a particular measurement point. Use the "Activate Original View" key function to switch back from an enlarged display to normal display mode.

Requirement

- Configure a Function Trend Control.
- Configure the display of a toolbar, using the buttons assigned to key functions "Zoom Area" and "Activate Normal View".
- Start Runtime.

Procedure

1. Click the "Enlarge Area" button in the toolbar.
The display stops being updated and the mouse pointer changes to a cross-hair.
2. In the trend window, click one corner of the area that you wish to enlarge.

3. Hold down your left mouse button and drag the area you want to enlarge until it reaches the desired size.

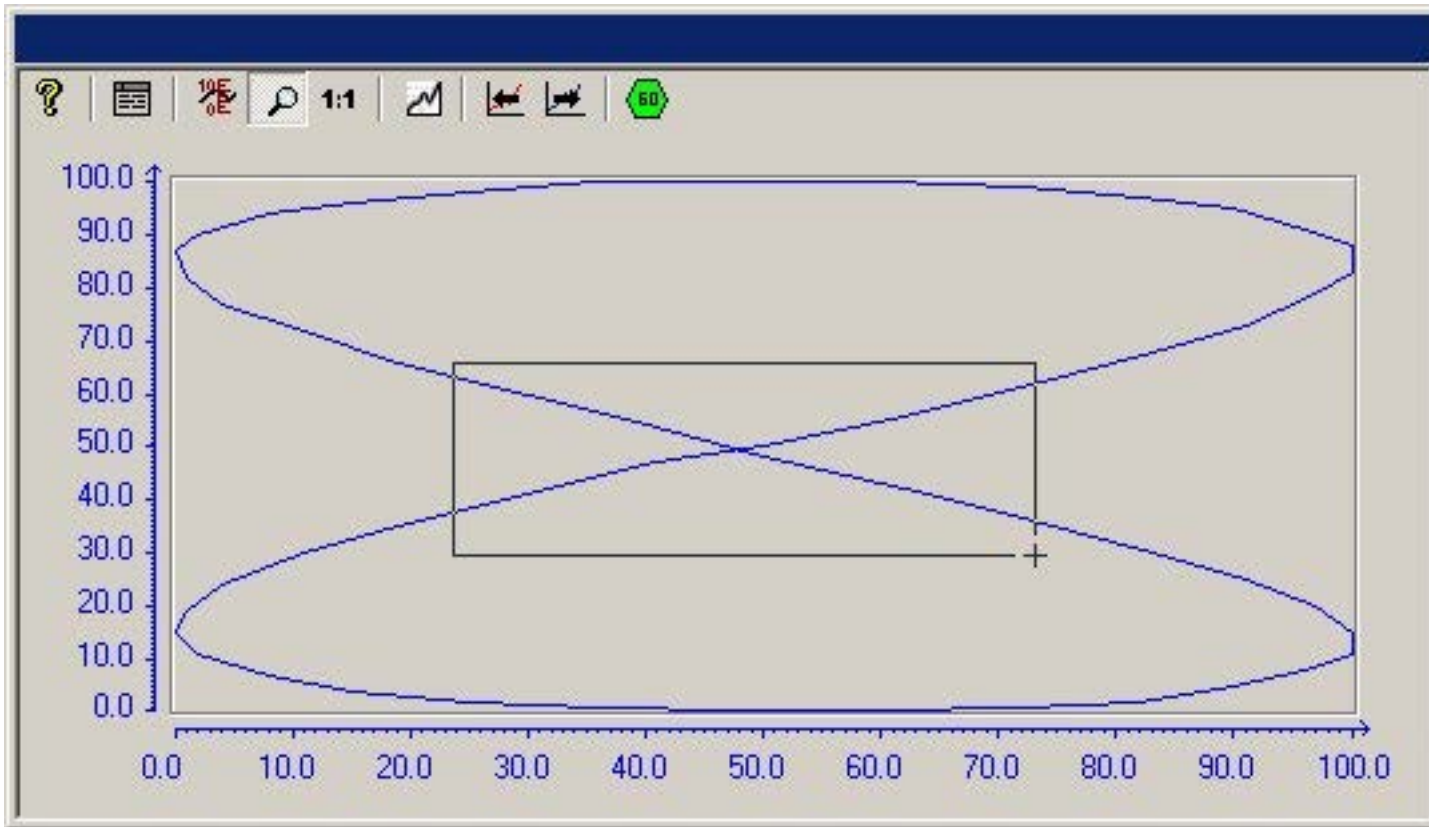

4. Release the left mouse button.
The section you selected is now shown enlarged.
5. Click the "Activate Original View" button in the toolbar.
The trend window is once more displayed in normal view as originally configured.
6. Click on the "Start/Stop the Update" button in the toolbar to restart updating the display in the trend window.

See also

How to Operate Function Trend Control in Runtime (Page 1818)

Appendix

How to Create a Process Value Archive

Introduction

In order to display archive tags in a WinCC Function Trend Control, you must configure a process value archive. A process value archive is created most easily with the help of the Archive wizard.

Procedure

1. Start Tag Logging and select the "Archive Wizard ...". command in the archive pop-up menu.



2. In the second step of the Archive Wizard, assign a meaningful name to the process value archive.
3. In the third step of the Archive Wizard, include the desired tags in the process value archive.
4. Close the Wizard by clicking "Apply".

Note

For the other examples of Function Trend Control, you require process value archive PW1 with the three tags Tag 1, Tag 2 and Tag 3, each with data type signed 16-bit value.

See also

How to Display Archive Tags (Page 1809)

How to Create a User Archive

Introduction

To display ideal trends or values from user archives in a WinCC Function Trend Control, you need to configure a user archive. You can create user archives with the aid of WinCC option User Archives.

Procedure

1. Start User Archives and from the Archives pop-up menu select the command New Archive.

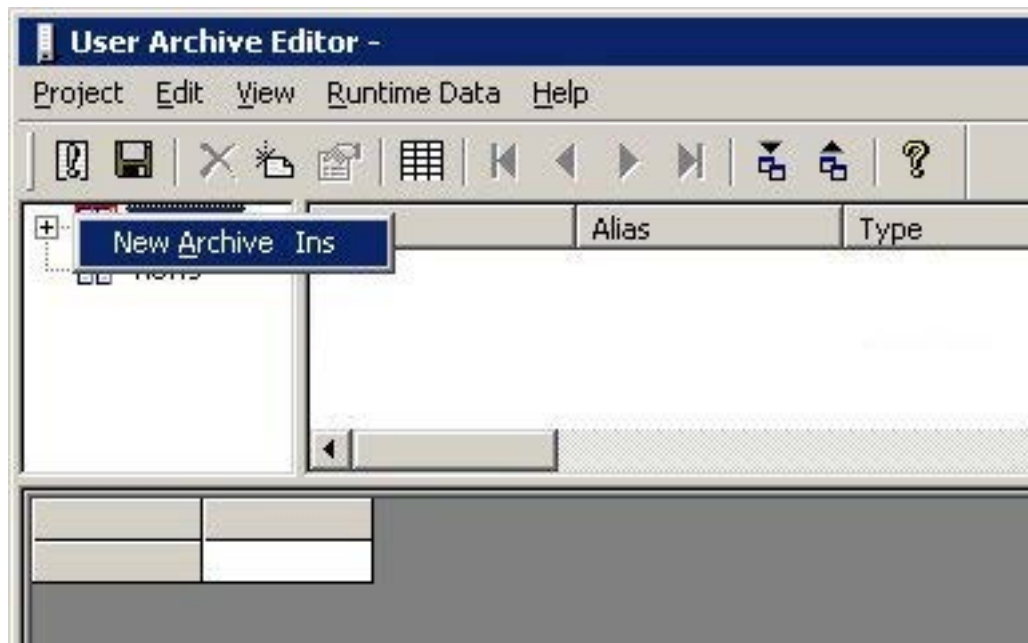

2. Give the user archive a meaningful name and click the Finish button.
3. Answer the question about creating a field in the archive with Yes.
4. Give the first field a meaningful name and click the Finish button.
5. Answer the question about creating another field in the archive with Yes.
6. Give the second field a meaningful name and click the Finish button.
7. Answer the question about creating another field with No.
8. Answer the question about creating another archive with No.
9. Click the Save button in the toolbar.

Note

For the other examples of Function Trend Control, you require user archive UA1 with columns Setpoint X and Setpoint Y.

See also

- How to Insert the User Archive Table Element into a Picture (Page 1835)
- How to Compare Tag Values with an Ideal Trend (Page 1812)
- How to Display Data from User Archives (Page 1810)

Properties of Function Trend Control - Toolbar Tab

Introduction

On the Toolbar tab, define the toolbar buttons which may be used to operate the trend window in runtime.

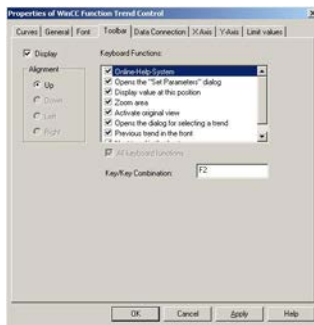

Display

Defines whether a toolbar can be used to operate the trend window in runtime.

Alignment

Defines at which edge of the trend window the toolbar will be displayed.

Keyboard Functions

This attribute defines which keyboard functions will be displayed as buttons in the toolbar and be available for operating the trend window.



Online-Help System







Open the Configuration Dialog



Display Value at this Position



Enlarge Area

	Activate Original View
	Opens the dialog for selecting a trend
	Next Trend to the Front
	Previous Trend to the Front
	Start/Stop the Update

Key, Hot Key

Specifies the hot key with which a chosen keyboard function can be triggered.

See also

How to Operate Function Trend Control in Runtime (Page 1818)
Properties of the Function Trend Control (Page 1837)

Properties of Function Trend Control - Font Tab

Introduction

On the Font tab, you can set the font to be used in the trend window. If you select either from the top or from the bottom as the direction to be written, you should use True-Type fonts within the trend window to ensure a clean display of the X axis labeling.

Note

The appearance of this tab and the names of the different fields depend on other installed programs.

Font

Specifies the name of the character set which is to be used.

Font Size

Sets the size of the selected character set.

Display

Sets the font style for the selected character set (e.g. bold, italic, underline).

Sample Text

Shows a preview using the chosen settings.

See also

Properties of the Function Trend Control (Page 1837)

Properties of Function Trend Control - General Tab

Introduction

On the General tab, you can define the general appearance and behavior of the trend window.



Window Title - Display

Defines whether the title bar of the trend window will be displayed in Runtime.

Window Title - Input Field

Defines the text that will be displayed in the title bar of the trend window in Runtime.

Background Color

Defines the background color that will be used in the trend window in Runtime.

Open Picture - Display Ruler

Defines whether the ruler for querying the coordinate points will automatically be displayed in the trend window every time there is a picture exchange in Runtime.

Open Picture - Load archive data

Defines whether archived values should be loaded or currently occurring values should be displayed when the picture is opened.

Display - Status Bar

Defines whether the status bar of the trend window will be displayed in Runtime.

Display - Toolbar

Defines whether the toolbar of the trend window will be displayed in Runtime.

Display - Write Direction

Defines the direction in which the positive values on the axes are depicted.

From the Right Positive values run to the right and upwards.

From the Left Positive values run to the left and upwards.

From the Top Positive values run to the right and upwards.

From the Bottom Positive values run to the right and downwards.

Display - Common X Axis

Defines whether the common X axis will be used for all the trends in the trend window. The first trend in the list of trend window elements (Trends tab) determines the color and the range of the axis.

Display - Common Y Axis

Defines whether the common Y axis will be used for all the trends in the trend window. The first trend in the list of trend window elements (Trends tab) determines the color and the range of the axis.

Display - Sizable

Defines whether the size of the trend window can be changed in Runtime.

Display - Can Be Closed

Defines whether the trend window can be closed in Runtime.

Persistence in RT

Specifies in Runtime whether changes made to the Function Trend Control settings should also be effective after a picture exchange.

In the Configuration System you can use the "Selection..." button to select one of the authorizations configured in the User Administrator. Should you assign an operator authorization, the persistence setting can only be changed in runtime if the logged in user has the authorization to do so.

Persistence in RT and CS

Specifies in runtime whether changes made to the Function Trend Control settings will also be applied to the Configuration System and be used when the project is reactivated.

In the Configuration System you can use the "Selection..." button to select one of the authorizations configured in the User Administrator. Should you assign an operator authorization, the persistence setting can only be changed in runtime if the logged in user has the authorization to do so.

Changes to the control properties in Runtime are not persistently accepted in CS with PCS 7 projects or TIA projects. When you completely load the ES to the OS, the changed settings on the OS will be overwritten.

Configure the properties of the controls on the ES.

Time Base

Defines the base for the time setting in WinCC.

See also

Properties of the Function Trend Control (Page 1837)

Setting Time in WinCC (Page 130)

Quick Configuration of Function Trend Control

Introduction

After inserting a Function Trend Control into a picture in the Graphics Designer, the Quick Configuration dialog box opens. This simplifies the configuration task by bringing together the main features of Function Trend Control in a single dialog box.



See also

Properties of the Function Trend Control (Page 1837)

How to Insert the User Archive Table Element into a Picture

Introduction

To display ideal trends or values from user archives in a WinCC Function Trend Control, you need to configure a user archive. You can create user archives with the aid of WinCC option User Archives. Values are entered in the user archive in runtime in the WinCC User Archive - Table Element, which is inserted in a picture and configured with the aid of the Graphics Designer.

Requirement

- Configure a user archive UA1 with the columns Setpoint X and Setpoint Y.

Procedure

1. Start Graphics Designer and open a new picture.
2. In the Object Palette, Controls tab, click the object WinCC User Archive - Table Element.
3. Place the mouse pointer at the position in the picture where you want to insert the control. The mouse pointer changes into a crosshair with an object symbol attached.
4. Hold down the mouse button and drag the control to the desired size.
5. Double-click the User Archive - Table Element.
6. In the Source area, click the Select button.
7. Select the user archive.
8. Click OK to close the dialog.
9. Save the picture.
10. Enable runtime and enter values in the Setpoint X and Setpoint Y columns.

See also

How to Compare Tag Values with an Ideal Trend (Page 1812)

How to Display Data from User Archives (Page 1810)

How to Create a User Archive (Page 1829)

Properties of Function Trend Control - Trends Tab

Introduction

On the Trends tab, you can define the tags you wish to display and the appearance of the trends.

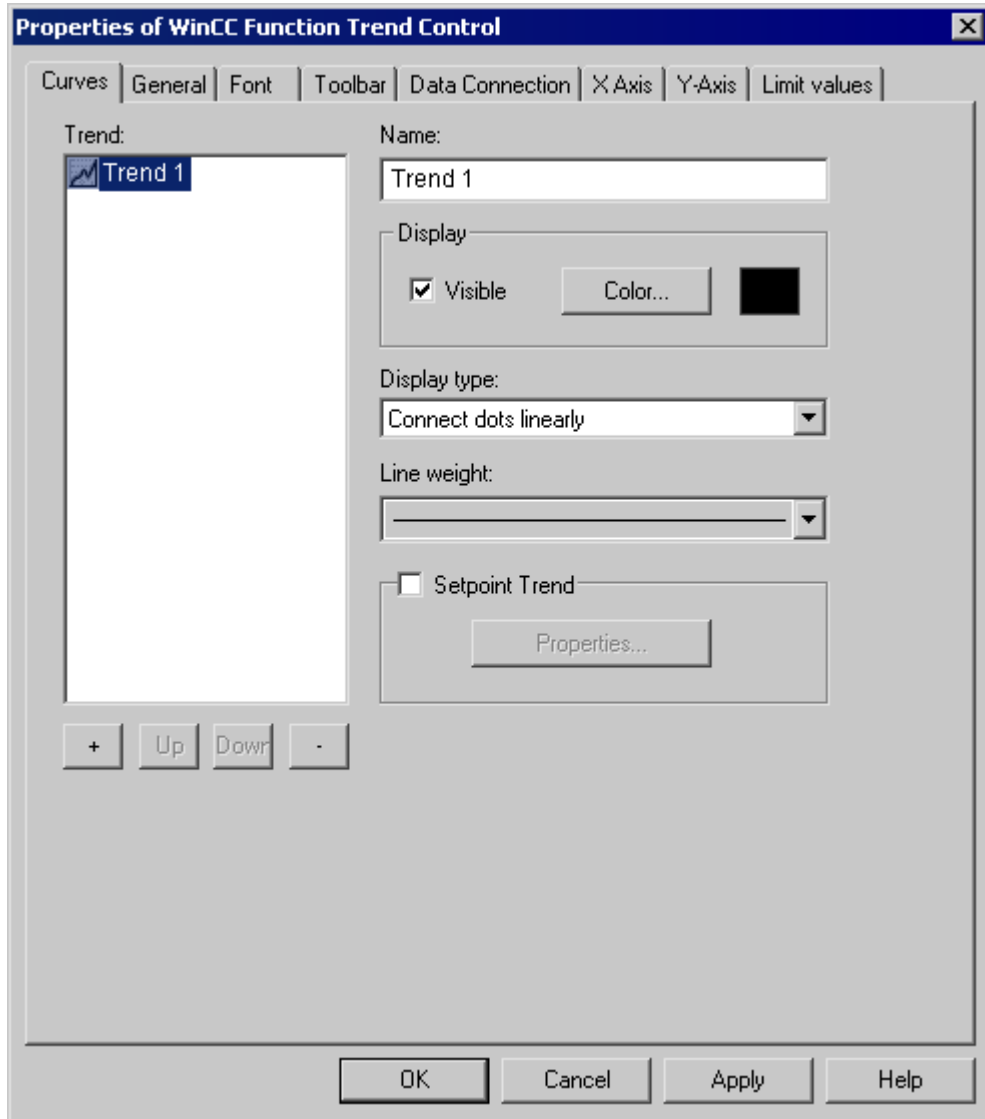

Trends

Defines the trends to be displayed. Use the + and - buttons to add new or delete existing trends. Use the Up and Down buttons to change the order of the trends. The order of the trends is analyzed in runtime by the keyboard functions Previous trend on top and Next trend on top. When using shared axes, the first trend in the list determines the color and value range of the axes.

Name

Defines the name of the trend. This name is used in the list of elements.

Display - Visible

Defines whether the trend selected in the list of elements is to be displayed in runtime. With this setting, you can suppress the display of configured trends without actually having to delete them.

Display - Color

Defines the color with which the trend selected in the list of elements and its associated axes will be displayed in runtime.

Ideal Trend

Defines whether an ideal trend is to be displayed with the trend selected in the list of elements. Use the Properties button to set the properties of the ideal trend.

See also

Displaying a Trend on Top (Page 1822)

Properties of the Function Trend Control - Setpoint Trend Properties (Page 1838)

Properties of the Function Trend Control (Page 1837)

Properties of the Function Trend Control

Introduction

The properties of WinCC Function Trend Control can be modified by using either the Quick Configuration dialog, the Configuration dialog or the Properties.

Quick Configuration

The Quick Configuration dialog box opens automatically when you insert a Function Trend Control into a picture in the Graphics Designer.

Configuration Dialog

The Configuration dialog box opens when you double-click or use the Configuration dialog... command in the Function Trend Control pop-up menu.

Properties

The Properties dialog box opens when you use the Properties command in the Function Trend Control pop-up menu.

See also

- Properties of Function Trend Control - Font Tab (Page 1831)
- Properties of Function Trend Control - Toolbar Tab (Page 1830)
- Properties of Function Trend Control - Trends Tab (Page 1836)
- Properties of Function Trend Control - General Tab (Page 1832)
- Quick Configuration of Function Trend Control (Page 1834)

Properties of the Function Trend Control - Setpoint Trend Properties

Introduction

In the Setpoint Trend Properties dialog, select the color, layout and data basis of the setpoint trend.

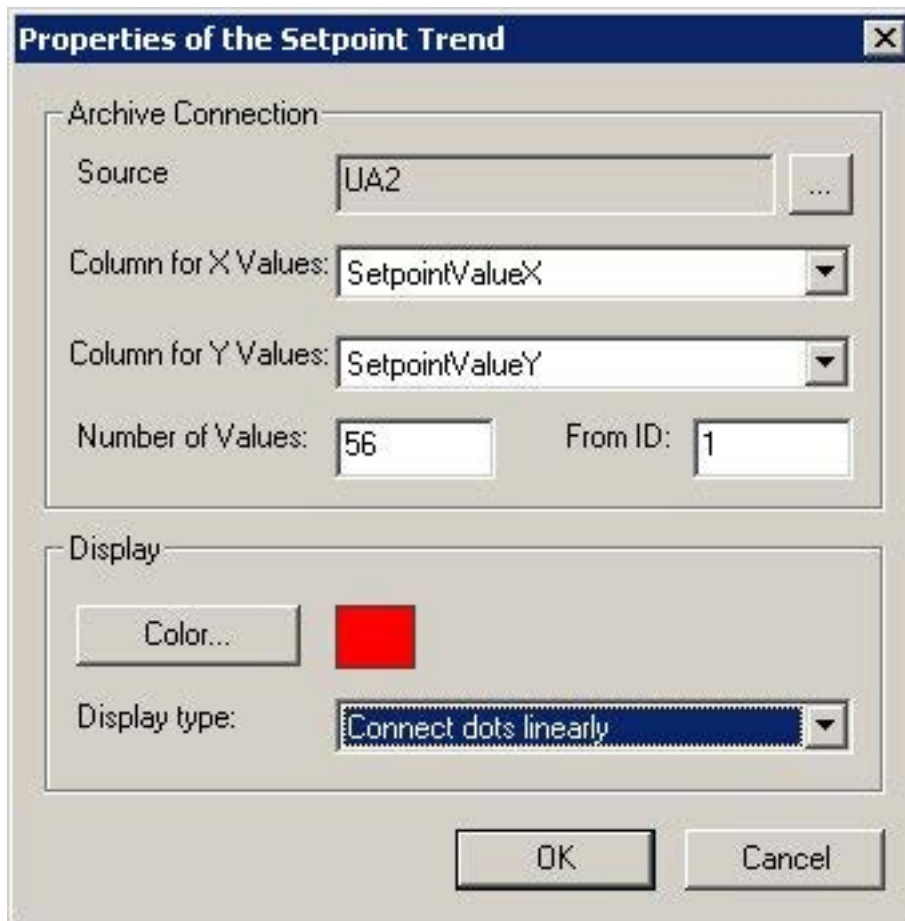

Archive Linking - Source

Defines the name of the user archive in which the value pairs of the setpoint trend are stored. Click ... to select a configured user archive.

Archive Linking - Column for X-Values

Defines the column in the user archive that contains the X coordinates of the value pairs for the setpoint trend.

Archive Linking - Column for Y-Values

Defines the column in the user archive that contains the Y coordinates of the value pairs for the setpoint trend.

Archive Linking - Number of Values

Defines the number of values on which the setpoint trend is based.

Archive Linking - from ID

Defines the record in the user archive in which the value pairs of the setpoint trend are stored.

Display - Color

Defines the color in which the trend is displayed in runtime.

Display of Format

Defines the format in which the trend is displayed in runtime.

See also

Properties of the Function Trend Control (Page 1837)

6.6 Direct Access to the Archive Database

Introduction

Various providers offer interfaces that you can use to access databases. These interfaces also enable you to directly access the WinCC archive databases. Direct access lets you, for example, read process values for editing in spreadsheet programs.

Requirement

The project is loaded on the configuration computer and is located in Runtime.

Access to archive databases with ADO/OLE DB

The process values are partially saved in compressed format to the archive databases. Use the WinCC OLE DB Provider to access such compressed process values. You can use the Visual Basic or Visual C++ programming languages, for example.

Note

Note that the table structure may vary in a new WinCC version when directly accessing the archive database using ADO/OLE DB.

For additional information, refer to the Microsoft MSDN Library at "Win32 and COM Development > Data Access and Storage > Windows Data Access Components SDK" on the Internet:

- <http://msdn.microsoft.com/en-us/library/default.aspx> (<http://msdn.microsoft.com/en-us/library/default.aspx>)

Access to the archive database using OPC

OPC (OLE for Process Control) provides interfaces for communication with process automation systems. The OPC interface enables harmonized interconnection of devices and applications from different manufacturers. You can use WinCC as an OPC client to access process data or messages of an OPC server. WinCC can be used as OPC server to manage archive data.

For further information, refer to:

- "WinCC Information System", "Communication" > "OPC",
- "WinCC Information System", "System Overview" > "Open Source"
- On the Internet at "http://www.opcfoundation.org"

Access to the archive database using C-API/ODK

You can use the "WinCC Open Development Kit" option to access WinCC data and functions by means of open source programming interfaces.

For further information, refer to:

- Documentation of the WinCC Open Development Kit

See also

<http://msdn.microsoft.com/en-us/library/default.aspx> (<http://msdn.microsoft.com/en-us/library/default.aspx>)

6.7 Function Call Templates

6.7.1 Function Call Templates

In different dialogs of the Tag Logging" configuration system, you can specify functions to be executed when certain events occur. These functions must be developed by you in the Global Script editor and must comply with the nomenclature of the respective template.

The following templates for function calls are available in WinCC:

- Function During Start of Archiving
- Function for Conversion of Tag Values
- Function to Start Archiving
- Function to Stop Archiving

See also

Function to Stop Archiving (Page 1844)

Function to Start Archiving (Page 1844)

Function for Conversion of Tag Values (Page 1843)

Function During Start of Archiving (Page 1842)

6.7.2 Function During Start of Archiving

`void function name (Boolean fFlag);`

Description

This function is triggered during the start of an archiving process. It can be assigned on the "General" tab in the "Properties" dialog in the Archiving group.

Parameters

fFlag

TRUE Lock Archive

FALSE Unlock Archive

Application Example

You can for example use this function to obtain information on the status of an archive.

6.7.3 Function for Conversion of Tag Values

```
double function name (double doLmtValue,  
                     double doValue,  
                     int dwCount,  
                     int Archiving);
```

Description

This function can be used to convert a tag value prior to archiving.

The value of the process tag (here: doValue) can be recalculated according to the requirements.

The result is returned as a return value of the function to Tag Logging for archiving.

The function is assigned under Edit/Action in the Properties Process Tag dialog in the Parameter tab .

Parameters

doLmtValue: Return value of the function that was triggered in the last acquisition cycle

doValue: Currently acquired value

dwCount: Number of acquisition cycles since the last archiving process

Archiving: TRUE, when archiving is performed

Application Example

The current process value should be divided by 10 and archived.

```
double Norm_PDE(double doLmtValue, double doValue, int dwCount, int  
Archiving)  
{  
return (doValue/10);  
}
```

Note

Note that the transfer parameter is declared in exactly the same way as in this example. The parameters are transferred from Tag Logging to the function.

What happens within an action is the responsibility of the user.

6.7.4 Function to Start Archiving

```
int function name ( );
```

Description

The function must return value "0" (corresponds to FALSE) or "1" (corresponds to TRUE). Other values are not permissible. An archiving process is triggered, depending on the archiving method and the value returned by the function.

For cyclic archiving, the archiving is always triggered, if the return value of the function is "1".

For acyclic archiving, the archiving is always triggered, if the returned value has changed since the last function call. The first function call must return value "1".

The function is assigned in the Properties Process Tag dialog in the Archiving tab in the Actions group.

6.7.5 Function to Stop Archiving

```
int function name ( );
```

Description

The function must return value "0" (FALSE) or "1" (TRUE). Upon a return value of "1" a running archiving process can be stopped.

The function is assigned in the Properties Process Tag dialog in the Archiving tab in the Actions group.

6.7.6 Appendix

6.7.6.1 Action for Swap-Out

```
void function name (  
LPTSTR IpszArchivName  
LPTSTR IpszVariablenName,  
DWORD dwNumberOfRecords);
```

Description

With this function you can specify how to swap out your short-term archive.

Upon reaching the upper limit of your short-term archive, this function is called for each tag of the archive.

Once the function is triggered, the call to this function is cyclic whenever the respective tag writes new values to the short-term archive.

This function can be assigned on the "Archive Parameters" tab in the "Process Value Archive Properties" dialog.

Parameters

IpszArchivName

Pointer on Name of Archive.

IpszVariablenName

Pointer on Name of Tag.

dwNumberOfRecords

Number of measured values saved in short-term archive.

Note

The function is also executed if the archive is locked.

6.7.6.2 Action upon Sending

```
void function name (  
    bool fFlag);
```

Description

This function is triggered after a tag is sent. It can be assigned on the "Raw Data Tag" tab of the "User Archive Properties" dialog.

Parameters

fFlag

The parameter has the value "FALSE" and is reserved for future extensions.

Application example

This function can be used to ensure that a message is displayed when a raw data tag is sent.

6.7.6.3 Action upon Reception

```
void function name (  
    bool fFlag);
```

Description

This function is triggered after a tag is received. It can be assigned on the "Raw Data Tag" tab of the "User Archive Properties" dialog.

Parameters

fFlag

The parameter has the value "FALSE" and is reserved for future extensions.

Application example

This function can be used, for example, to evaluate a raw data tag immediately after it is received.

User archive

7.1 Basics

7.1.1 Introduction to archives/user archives

Introduction

User archives allow you to assemble data resulting from production or machine parameter assignment. The data records are transferred between user archives and the automation system continuously or upon demand.

You can use the "User Archive" editor to define the structure of the user archive. You configure views to combine data from different user archives.

Using user archives

User archives can be used in the following scenarios:

- The user archive sends modified recipes or production parameters to the automation system online with the press of a button.
- The batch data or data for product quality is continuously recorded in the user archive to fulfill legal requirements for complete documentation.
- The operating data of the automation system is analyzed via the user archive.
- You can import production data stored in an external database into the user archive in Runtime via a CSV file and then transfer it to the automation system.
- The data of the user archive is selected with SQL to represent a selection in a view.
- The data of the user archive is shown as reference trends in a WinCC Function Trend Control to enable setpoints to be compared to values from the process value archive.

Configuring a user archive

Once you have defined the structure of the user archive, you configure the user archive in the "User Archive" editor:

- You create and edit the user archive and the associated data fields.
- You configure the communication and control between the archive and automation system.
- You enter new data records or import the values from a CSV file. If necessary, modify existing Runtime data.
- If you want to merge user archives, you configure a view.

Alternatively, you can use user archive scripts to configure user archives or operate them in Runtime.

Displaying and changing Runtime data from user archives

The WinCC UserArchiveControl displays the data from the user archive or the view in table form in a process picture. You configure the UserArchiveControl in the "Graphics Designer" editor. In the UserArchiveControl, you can change the data or create new data records which are then copied into the user archive.

Note

Prior to WinCC V7, the display of the user archives was configured in a user archives table element.

7.1.2 Properties of a user archive

In WinCC Configuration Studio, you edit the properties of a user archive in the "Properties" area of the "User Archive" editor.

General properties

Name	The first character must be a letter. The name can only include numeric and alphabetic characters and the underscore character "_". National special characters, for example umlauts or Asian characters are not permitted.
Alias	Any Unicode characters can be used as alias.
Multilingual alias	Option selected: The alias is copied into the TextLibrary. When the language is changed in Runtime, the alias of the archive name is also displayed in the corresponding language. The fields can be edited in the "Translation Alias" section. Translations are displayed here.
Type	The "Limited" option can be used to restrict the number of data records in the archive.
Max. number	Number of data records in the archive if "Limited" is selected as type.
Last change	Display only: Time stamp of last change

Communication

Communication type	Raw data tag: <ul style="list-style-type: none"> • Enter a freely selectable "PLCID" as unique name of the user archive. • Select a raw data tag under "Tag name". Data manager tags: <ul style="list-style-type: none"> • Configure the assignment of tags when creating the user archive fields.
PLCID	The "PLCID" must consist of exactly 8 ASCII characters and must be unique within the WinCC project. The "PLCID" is required in order for the automation system to send the process data back to the correct user archive. Do not use the "R_ID" configured in the raw data tag, since "R_ID" is only relevant for communication with the automation system.
Tag name	Selection of the raw data tag in communication type "Raw data tag"

Authorizations and flags

Read rights	By default, the user archive has no access protection.
Write rights	Here you configure the access rights for read and write access to the user archive. Select an authorization provided by the "User Administrator" from the drop-down list. If you want to use a separate authorization, you must first create the authorization in the User Administrator. Access protection for the user archive is queried in Runtime on opening the screen of a UserArchiveControl.
Field - last access	Option activated: In the archive, a field is generated where the time stamp of the last access is stored. The field is displayed in the table area under "Archive data". The field values and properties cannot be edited. If the user archive is synchronized through a redundant system, the "Field - last access" option must be selected.
Field - Last user	Option selected: In the archive, a field is generated where the name of the last user is stored. The field is displayed in the table area under "Archive data". The field values and properties cannot be edited.

Sequence

The property "Position" cannot be edited.

Control tags

Control tags	Function	Data type
ID	The data record number of the user archive	Signed 32-bit value
Job	The following jobs are possible: "6" = Read a data record from the tags in the user archive "7" = Write a data record from the user archive to the tags "8" = Delete a data record in the user archive After the job has been carried out, an error ID can be seen in "Request": "0" = No error "-1" = Error	Signed 32-bit value
Field	The specific field of the user archive	Text tag, 8-bit
Value	The value of a particular user archive field	Text tag, 8-bit

Additional combinations of the control tags "ID" and "Job":

ID	Job = "6"	Job = "7"	Job = "8"
-1	Attach data record	-	Delete data record with the lowest ID
-6	Read data record with the lowest ID	Write data record with the lowest ID	Delete data record with the lowest ID
-9	Read data record with the highest ID	Write data record with the highest ID	Delete data record with the highest ID

Translation Alias

If the option "Alias multilingual" is selected under "Properties" - "General", the translated texts for the "Alias" are displayed here. You can edit the texts here.

The field "Alias(ID)" displays the ID of the text for the input language alias in the "Text Library" editor.

7.1.3 Properties of a user archive field

In WinCC Configuration Studio, you edit the properties of a user archive field in the "Properties" area of the "User Archive" editor.

General properties

Name	The first character must be a letter. The name can only include numeric and alphabetic characters and the underscore character "_". National special characters, for example umlauts or Asian characters are not permitted.
Alias	Any Unicode characters can be used as alias.
Multilingual alias	Option selected: The alias is copied into the TextLibrary. When the language is changed in Runtime, the alias is also displayed in the corresponding language. The fields can be edited in the "Translation Alias" section. Translations are displayed here.
Type	Selection of the data type from a drop-down list: <ul style="list-style-type: none"> • Number (integer): Signed 32-bit value • Number (float): Floating-point number 32-bit IEEE 754 • Number (double): Floating-point number 64-bit IEEE 754 • Character string: Text tag, 8-bit • Date/time: The input format or output format depends on the project setting.
Length	Only for "Character string" data type: Length of the character string.
Last change	Display only: Time stamp of last change
Archive	Display only: Name of the archive in which the field was created.

Values

Minimum value	Only if "Number" is selected as data type under "Type": Lowest/highest value that can be stored in the field.
Maximum value	

Start value	Start value for the field when Runtime is started. For tags of the "Character string" type, you can, for example, enter a text to be displayed when Runtime is started.
Tag name	Only if the property "Communication Type" - "Data Manager Tags" is selected for the archive: Selection of the tags through which the field communicates with the AS.

Authorizations and flags

Read rights	By default, the user archive field has no access protection.
Write rights	Here you configure the access rights for read and write access to the user archive field. Select an authorization provided by the "User Administrator" from the drop-down list. If you want to use a separate authorization, you must first create the authorization in the User Administrator. Access protection for the user archive field is queried in Runtime on opening the screen of a User-ArchiveControl.
Value required	Option selected: The field must not be empty.
Unique value	Option selected: A value cannot be assigned more than once. The value for the field must differ from the values for other fields.
with index	Option selected: The field is supported by an index for quick searches.

Sequence

Displays the position of the field.

The position may be changed by using the shortcut menu of the row header.

When this column is shown in the table area, the "Position" property can be used to sort and filter.

Translation Alias

If the option "Alias multilingual" is selected under "Properties" - "General", the translated texts for the "Alias" are displayed here. You can edit the texts here.

The field "Alias(ID)" displays the ID of the text for the alias in the "Text Library" editor.

7.1.4 Properties of a view

In WinCC Configuration Studio, you edit the properties of a user archive view in the "Properties" area of the "User Archive" editor.

General properties

Name	The first character must be a letter. The name can only include numeric and alphabetic characters and the underscore character "_". National special characters, for example umlauts or Asian characters are not permitted.
Alias	Any Unicode characters can be used as alias.
Multilingual alias	Option selected: <ul style="list-style-type: none"> • The alias is copied into the TextLibrary. • When the language is changed in Runtime, the alias is also displayed in the corresponding language. The fields can be edited in the "Translation Alias" section. Translations are displayed here.
Last change	Display only: Time stamp of last change

Relation

Relation	Here, you establish a link between fields of various user archives. Define the relations of the field contents. The fields that are related to each other must be of the same data type. Enter the relation in SQL.
----------	---

Sequence

The property "Position" cannot be edited.

Translation Alias

If the option "Alias multilingual" is selected under "Properties" - "General", the translated texts for the "Alias" are displayed here. You can edit the texts here.

The field "Alias(ID)" displays the ID of the text for the alias in the "Text Library" editor.

7.1.5 Properties of a user archive column

In WinCC Configuration Studio, you edit the properties of the column of a user archive in the "Properties" area of the "User Archive" editor.

General properties

Name	The first character must be a letter. The name can only include numeric and alphabetic characters and the underscore character "_". National special characters, for example umlauts or Asian characters are not permitted.
Alias	Any Unicode characters can be used as alias.

Multilingual alias	Option selected: The alias is copied into the TextLibrary. When the language is changed in Runtime, the alias is also displayed in the corresponding language. The fields can be edited in the "Translation Alias" section. Translations are displayed here.
Archive	Selection from a drop-down list: User archive where the linked field is defined.
Field	Selection from a drop-down list: Field whose data are copied to the view.
Last change	Display only: Time stamp of last change
View	Display only: View containing the user archive column.

Sequence

Displays the position of the user archive column.

The position may be changed by using the shortcut menu of the row header.

When this user archive column is shown in the table area, the "Position" property can be used to sort and filter.

Translation Alias

If the option "Alias multilingual" is selected under "Properties" - "General", the translated texts for the "Alias" are displayed here. You can edit the texts here.

The field "Alias(ID)" displays the ID of the text for the alias in the "TextLibrary" editor.

7.1.6 User archives and redundancy

Introduction

You can integrate user archives in a redundant system using WinCC redundancy. With parallel operation of two servers, if one server fails, the data of the user archives is synchronized online. Find out more about the operation and configuration of WinCC redundancy for user archives in the chapters on "Redundant Systems" in the WinCC Information System .

Requirements for the use of redundant user archives

- The user archives are only synchronized if WinCC components are used, for example, functions of the UA API, control tags, WinCC UserArchiveControl. The user archives are not synchronized if the database is accessed through ODBC and the Connectivity Pack.
- The user archives to be synchronized require the same structure on both servers. The configuration of the user archives and the properties must therefore be identical. You can ensure this by exporting and importing the configuration data.

- The archive property "Field - last access" must be activated for online synchronization. You activate the option in the user archive under the "Authorizations and Flags" property in the "Properties" area of the archive.
- When raw data tags are used for communication of the user archives, the name of the raw data tags used must be identical on both servers.
- Configuration changes can only be saved during Runtime when no redundancy synchronization is being performed at that time in the user archives.

7.1.7 Overview of unusable names

Introduction

The following conditions apply for the names of archives, views and fields in the user archive:

- The first character must always be a letter.
- The names may only contain letters, numbers and “_”. National special characters, for example umlauts or Asian characters are not permitted.
- The names may not exceed a length of 25 characters.

You may not use the following names:

- Archives
- View
- Field
- ViewCol

Overview of SQL keywords

You may not use the following keywords or reserved words in SQL as the names in the user archive:

Keywords used in SQL			
add	all	alter	and
any	as	asc	begin
between	binary	break	by
call	cascade	cast	char
char_convert	character	check	checkpoint
close	comment	commit	connect
constraint	continue	convert	create
cross	current	cursor	date
dba	dbspace	deallocate	dec
decimal	declare	default	delete
desc	distinct	do	double

Keywords used in SQL			
drop	else	elseif	encrypted
end	endif	escape	exception
exec	execute	exists	fetch
first	float	for	foreign
from	full	goto	grant
group	having	holdlock	identified
if	in	index	inner
inout	insert	instead	int
integer	into	is	isolation
join	key	left	like
lock	long	match	membership
message	mode	modify	named
natural	noholdlock	not	null
numeric	of	Off	on
open	option	Options	or
order	others	out	outer
passthrough	precision	prepare	primary
Print	privileges	proc	procedure
raiserror	readtext	Real	reference
references	release	remote	rename
resource	restrict	return	revoke
right	rollback	save	savepoint
schedule	select	set	share
smallint	some	sqlcode	sqlstate
start	stop	subtrans	subtransaction
synchronize	syntax_error	table	temporary
then	time	tinyint	to
tran	trigger	truncate	tsequal
union	unique	unknown	update
user	using	validate	values
varbinary	varchar	variable	varying
view	when	where	while
with	work	writetext	

7.2 Configurations in the user archive

7.2.1 The "User Archive" editor

In the "User Archive" editor you create user archives or views. The archive is supplied with the configured data.

You start the editor with a double-click on the "User Archive" entry in the WinCC Explorer.

Detailed information on operating the Configuration Studio is available in the WinCC Information System under "Working with WinCC > Working with projects > WinCC Configuration Studio".

Note

Undo is not possible

The functions "Undo" and "Restore" are not available in the "User Archive" editor.

Structure of the "User Archive" editor

The "User Archive" editor is divided into three working areas:

- **Navigation area**
 - Tree view showing objects as folders
 - Navigation bar for switching between the editors
- **Table area**
 - Creation and editing of multiple objects
 - View and input of archive data
- **Properties area**
 - Properties of a selected object
 - "What's this?" for the selected property.

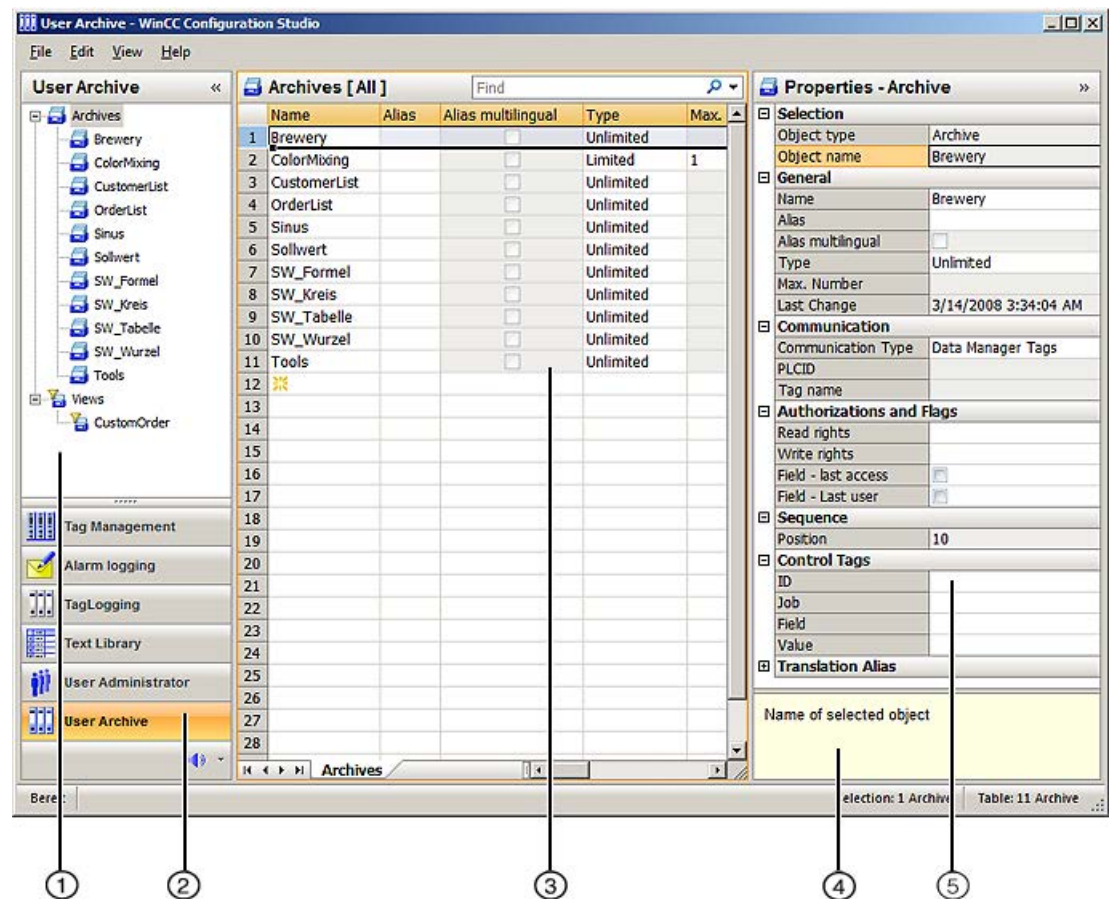

① Navigation area

In the navigation area, the objects of the "User Archive" are displayed in a tree view.

The folders of the top level are:

- Archives
- Views

The elements (e.g. archives, views, fields...) assigned to a selected folder are displayed in the table area.

② Selection of the editors

The navigation bar is displayed in the area below the tree view; it provides access to additional WinCC editors.

③ Table area

The table displays the elements that are assigned to the folder selected in the tree view. You can, for example, choose to have all fields of an archive displayed.

You create new fields in the table area. You can enter or edit data directly here.

Tabs

Depending on the selected structure level, you can display the lower-level elements in tables using tabs.

Navigation keys allow you to scroll through tabs. You select a tab by clicking on it, with the navigation keys, or from the shortcut menu of the navigation keys.

④ What's this?

Displays an explanation of the selected property.

⑤ Properties

The properties of a selected object are displayed.

You edit the properties of a data record. However, some properties are only displayed and can not be edited.

Status bar

The status bar at the bottom edge of the editor includes the following information, among other things:

- Number of data records in the displayed data area, for example, timers, archives, fields, archive data, views, columns, view data.
- Number of selected data records when table cells are selected.

See also

Interface (Page 55)

7.2.2 Configuration of a User Archive

7.2.2.1 How to create a user archive

Introduction

In WinCC Configuration Studio, you create a user archive in the table area of the "User Archive" editor.

Procedure

Note

You may not use keywords or reserved words in SQL as the archive name.

1. Select the "Archive" folder in the navigation area of the "User Archive" editor.
2. Click in the top empty cell of the "Name" column in the table area. The cell is marked by a yellow symbol.

	Name	Alias
1	archive_1	Archive 1
2	archive_2	Archive 2
3	archive_3	Archive 3
4	archive_4	Archive 4
5	*	
6		

3. Enter an archive name:
 - The first character must be a letter.
 - The name can only include numeric and alphabetic characters and the underscore character "_".
 - National special characters, for example umlauts or Asian characters are not permitted.

Create a multilingual alias to represent archive names in all project languages in a user-friendly way.
4. Edit the properties of the archive.
5. If you select the "Limited" option for the "Type" property, you can determine the maximum number of data records in the user archive.

Creating multiple archives

1. Create a new archive.
2. Select the cell in the "Name" column.
3. Drag down the selection at the bottom right corner while keeping the left mouse button pressed.
A new archive is created in each row over which you drag the selection.

7.2.2.2 How to edit properties of a user archive

Introduction

The properties of archives are displayed in the table area and in the "Properties" area of the "User Archive" editor.

Procedure

1. Select the "Archives" folder in the navigation area.
2. In the table area, select the row of the archive whose properties you wish to display and edit.
3. Edit the properties in the table area or in the "Properties" area.

Fields highlighted in color cannot be edited. Whether you can edit properties may depend on the activation or deactivation of individual options or a selection for another property.

In the table area, you can use the shortcut menu of a column header to show or hide specific columns (and therefore properties). You can display archives in a user-friendly manner using filtering and sorting options. The table area allows you to edit a large number of archives at the same time. To do this you can use, for example, the "Select and pull selection down" function or the shortcut menu commands "Deselect all" and "Select all".

The "Properties" area shows all the properties of the archive which is selected in the table area.

7.2.2.3 How to configure the communication to tags

Introduction

By configuring the communication, you define how data are transferred between WinCC tags or the automation system and the user archive. You can configure one connection to the automation system per user archive.

The following types of communication are possible:

- No communication with the user archive.
- Whole data records are transferred between the automation system and user archive via a WinCC raw data tag.
- Individual data fields of a data record are transferred via WinCC tags.

Procedure

1. Select the archive in the navigation area or in the table area.
2. Edit the properties of the archive in the "Communication" section in the "Properties" area.
 - Select a communication type.
If you select the "Via a raw data tag" option, enter a freely selectable "PLCID" as a unique name for the user archive. The "PLCID" must consist of exactly 8 ASCII characters and must be unique within the WinCC project. The "PLCID" is required in order for the automation system to send the process data back to the correct user archive. You cannot use the "R_ID" configured in the raw data tag, since "R_ID" is only relevant for communication with the automation system. Multiple user archives can also be supplied by the same raw data tag.
 - Select a raw data tag using .
 - If you select the "Data Manager Tags" option, you configure the assignment of tags when creating the user archive fields using the "Values/Tag name" property.

7.2.2.4 How to configure the control tags

Introduction

You use the control tags to access user archive fields in a user archive. If you use control tags, you always have to configure all four control tags.

The control tags provide two methods to access the user archives:

- You can use the control tags of the data record ID and job to read, write or delete specific target values in a data record.
- You can use the control tags of the archive field and the value of the archive field to find a data record. You can use the control tag of the job to write, read or delete selected data records.

Procedure

Note

The data type of the control tags may not be changed.

1. Select the archive in the navigation area or in the table area.
2. Edit the properties of the archive in the "Control Tags" section in the "Properties" area.
3. Select a tag using the tag selection dialog. Pay attention to the data type you need to use:
 - ID and job: Signed 32-bit value
 - Field and value: Text tag, 8-bit

The control tags are created in the form @UA_[archive name]_ID, @UA_[archive name]_Job etc.

7.2.2.5 Example for the use of control tags

Introduction

The following example depicts the use of control tags for the communication between the internal WinCC tags and the user archive. A WinCC UserArchivControl represents the content of the user archive. I/O fields are used to enter or output the values of the control tags and WinCC tags.

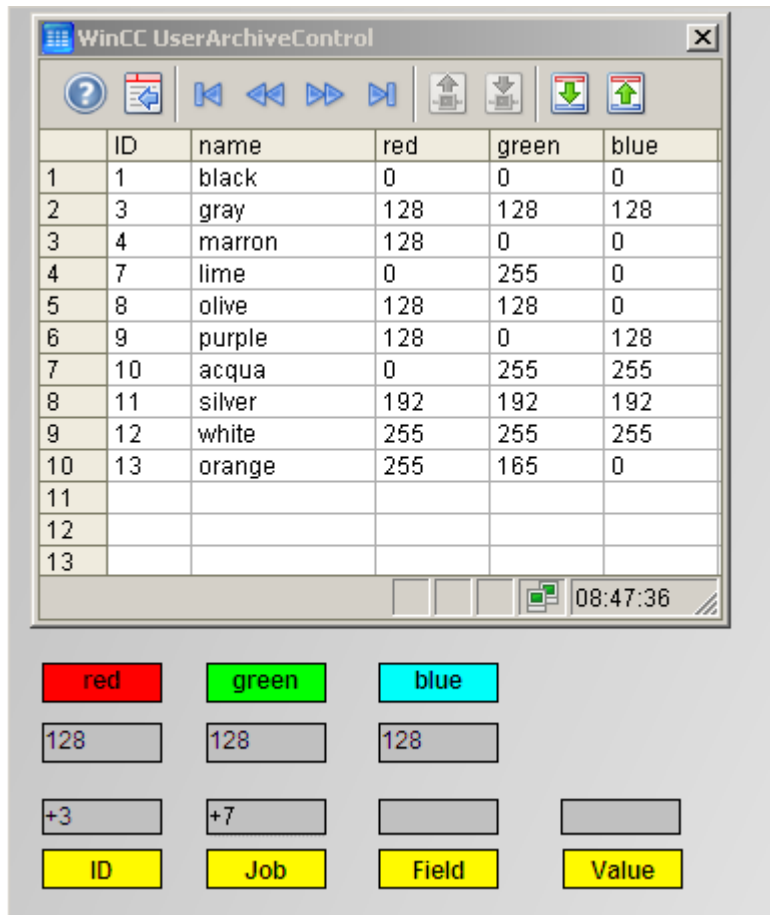

Requirement

- You are familiar with the fundamentals of the "User Archive" and "Graphics Designer" editors.

Configurations in the user archive

1. Create a user archive. Select "Data Manager Tags" as communication type.
2. Create the control tags and select them.
3. Create the "Name" field ("string" type) and the fields "red," "green," "blue" ("integer" type) for the user archive.

4. In the "Values" field property, create an internal tag with the data type "Unsigned 8-bit value" for the fields "red," "green," "blue."
5. Then save the configured user archive.

Configurations in the Graphics Designer

1. Open a new screen and create a WinCC UserArchiveControl.
2. Link the control on the "General" tab in the "Properties of WinCC UserArchiveControl" dialog with the configured user archive. Enable the access types "Change," "Insert" and "Delete."

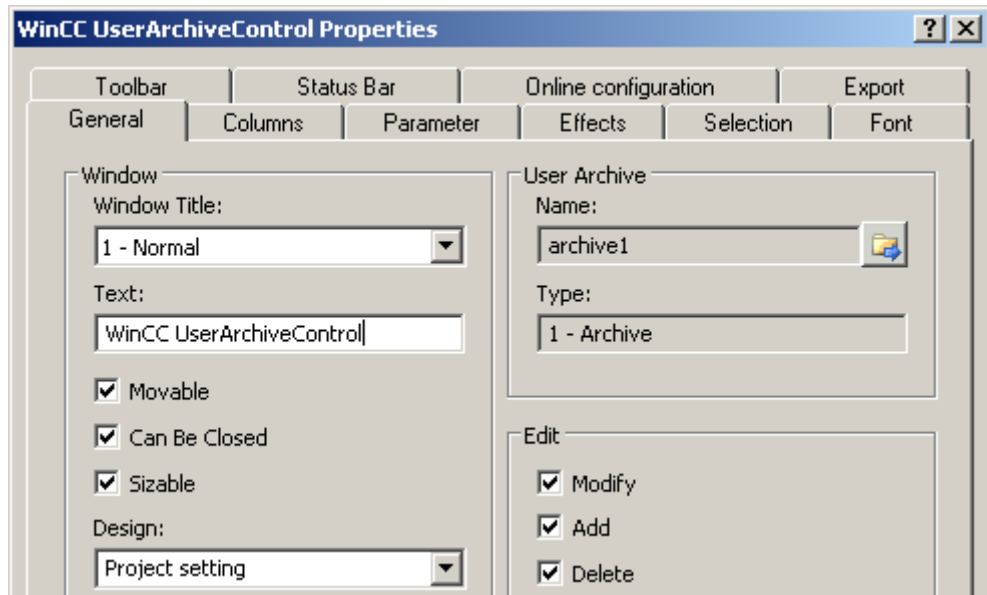

3. Configure additional control properties as desired. Close the dialog.

7.2 Configurations in the user archive

- For the configured fields "red," "green," "blue," add a "static text" object for the label and an I/O field to the screen. Select the internal tag from the I/O field configuration dialog linked with the corresponding archive field. Select the "With change" property in the "Update" field.

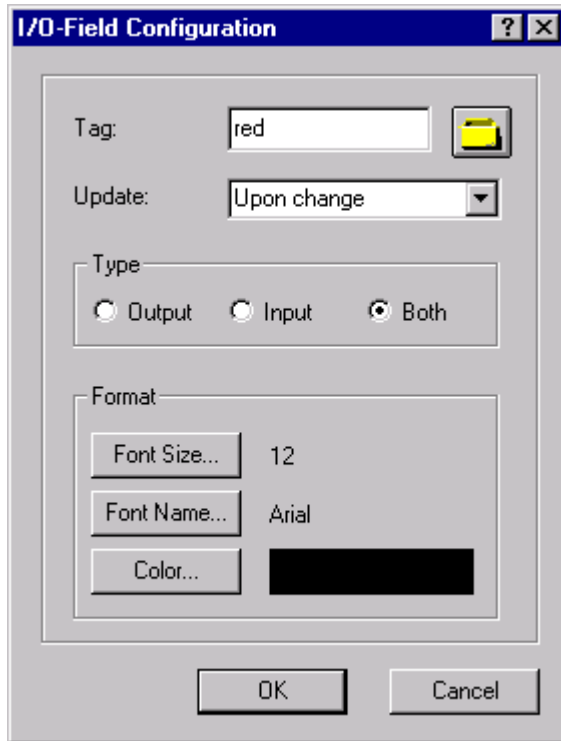

- For the configured control tags, add a "static text" object for the labels and an I/O field to the screen. Now select the corresponding control tag from the I/O field configuration dialog. Select the "With change" property in the "Update" field. Specify the following settings in the "Output/Input" property group:

Control tag	Data Format	Output format
@UA_xx_ID	Decimal	s999
@UA_xx_Job	Decimal	S9
@UA_xx_Field	String	*
@UA_xx_Value	String	*

- Save the configured screen.

Operator input in Runtime

- Activate WinCC Runtime.
- In the UserArchiveControl, enter several data blocks as depicted in the example shown above.
- Test the following examples and additional combinations of the "ID" and "Job" control tag.

Writing a data block to the tags

1. Enter "3" into the "ID" I/O field and "7" into the "Job" I/O field.
2. Click the "Enter" key.
The values of the data block with "ID 3" are written to the tags and output in the linked "red," "green," "blue" I/O fields.
If the action was successful, the error number "0" is displayed in the "Job" I/O field. In case of an error, the error number "-1" is displayed.

Writing a specific data block to the tags

1. Enter "Name" into the "Field" I/O field and for example "silver" into the "Value" I/O field.
2. Enter the value "7" into the "Job" I/O field.
The control tag "ID" is not needed. This is why "0" must be entered into the "ID" I/O field.
The data block with the value "silver" is written to the tags and output in the corresponding I/O fields.

Changing an existing data block by reading the tags

1. Change the values in the "red," "green," "blue" I/O fields.
2. For example, enter "5" into the "ID" I/O field and "6" into the "Job" I/O field.
The changes values are written from the I/O fields of the archive fields and the linked tags to the data block with the "ID" "5." The values previously contained in this data block are overwritten.

Adding data block by reading the tags

1. Enter values into the "red," "green," "blue" I/O fields.
2. Enter "1" into the "ID" I/O field and "6" into the "Job" I/O field.
The values of "red," "green" and "blue and the linked tags are appended to the end of the table of the user archive and depicted as the last data block in the UserArchiveControl.

7.2.2.6 How to specify the authorizations for the archive

Introduction

By default, a user archive has no access protection. The "Authorizations and Flags" properties determine the access rights for the user archive. Access protection for an archive in Runtime is queried on opening the screen of a UserArchiveControl. You configure access protection for the control tags of a protected archive through the object properties in the Graphics Designer, for example, the I/O field.

Procedure

1. Select the archive in the navigation area or in the table area of the "User Archive" editor.
2. Edit the properties of the archive in the "Authorizations and Flags" section in the "Properties" area.

Note

If the user archive is synchronized through a redundant system, the "Field - last access" option must be selected.

7.2.2.7 How to create user archive fields

Introduction

In WinCC Configuration Studio, you create the fields for a user archive in the table area of the "User Archive" editor.

Note

You can create 500 fields for each user archive.

You may not use special characters or reserved words in SQL as the field name.

If you change the properties of the user archive fields after completing configuration, data can be lost in the following circumstances:

- When a modified consistency condition can no longer be fulfilled for existing data, for example, the "Field must have a value" option.
 - When you change a field name.
 - When data from the source can no longer be converted due to a new data type.
-

Note

Limitation by the SQL database

The maximum size of a data record in bytes is limited by the lower-level database system.

An archive data record corresponds to a series. Maximum number of bytes per series: 8060.

You receive an error message if this limit is exceeded.

Procedure

1. Select the folder of an archive in the navigation area of the "User Archive" editor.
2. Select the "Fields" tab in the table area.
3. Click in the top empty cell of the "Name" column in the table area. The cell is marked by a yellow symbol.
4. Enter a name:
 - The first character must be a letter.
 - The name can only include numeric and alphabetic characters and the underscore character "_".
 - National special characters, for example umlauts or Asian characters are not permitted.

5. Edit the properties of the field.
6. If you specify an alias, the alias is used in Runtime as the column name. You can now select the option "Alias multilingual" to specify the alias in the respective languages in the "Translation Alias" section.
7. If you created several user archive fields, you can fix the sequence of the fields in the user archive using the "Sequence/Position" property.
Alternatively, you can also select one or more rows with the fields and change their positions using the following shortcut menu commands: "Move up", "Move down".
The columns are shown in the specified sequence of the fields in the WinCC UserArchiveControl. The order affects the assignment of indices for access via the functions of the WinCC script language.

Creating multiple fields

1. In the case of an already created field, select the cell in the "Name" column.
2. Drag down the selection at the bottom right corner while keeping the left mouse button pressed.
A new user archive field is created in each row over which you drag the selection.

7.2.2.8 How to edit properties of a user archive field

Introduction

The properties of user archive fields are displayed in the table area and in the "Properties" area of the "User Archive" editor.

Procedure

Fields highlighted in color cannot be edited. Whether you can edit properties may depend on the activation or deactivation of individual options or a selection for another property.

1. Select the folder of a user archive in the navigation area.
2. Select the "Fields" tab in the table area.
3. Select the row of a field.
4. Edit the properties in the table area or in the "Properties" area.

In the table area, you can use the shortcut menu of a column header to show or hide specific columns (and therefore properties). You can display user archive fields in a user-friendly manner using filtering and sorting options. The table area allows you to edit a large number of user archive fields at the same time. To do this you can use, for example, the "Select and pull selection down" function or the shortcut menu commands "Deselect all" and "Select all".

The "Properties" area shows all the properties of the user archive field whose column is selected in the table area.

7.2.2.9 How to edit the position of a user archive field

You edit the position of a user archive field in the "User Archive" editor using the shortcut menu in the table area.

The position determines the sequence in which the fields are displayed in Runtime.

Procedure

1. Select the folder of an archive in the navigation area.
2. Select the "Fields" tab in the table area.
3. Select the row header of a field.
4. Select "Move up" or "Move down" command in the shortcut menu.
The field is moved by one position.

7.2.2.10 How to configure multilingual text

Introduction

When naming user archive fields, you are restricted by the requirements of the database. To be able to organize the display and the input of data in a user-friendly way, you can create the "Alias" name of a field in all project languages.

Procedure

Note

For client projects, you need to use the same text ID for the text in the text library of the server and client. Otherwise, an incorrect text will appear on the client in Runtime.

1. Enter an alias for the field under "Properties" - "General". You can enter all Unicode characters.
2. Select the option "Alias multilingual".
3. Enter the texts for the alias under "Properties" - "Translation Alias".
4. Alternatively, enter the texts in the "TextLibrary" editor.
Alias (ID): You can find the entries in the TextLibrary under this ID.

If you change the language in Runtime, the corresponding text is displayed in the selected language.

7.2.2.11 How to make changes in the user archive

Introduction

If you want to modify or extend a user archive, existing data can be lost in the archive. This is especially true for changes to the structure of a user archive or changes to the properties of a field.

Changes are applied directly. Not all changes can be reversed in the editor.

Procedure

In order to avoid data loss, follow these steps:

1. Select the folder you wish to modify in the navigation area.
2. Select "Export" in the shortcut menu.
3. Select a descriptive name for the export file and a storage location in the "Export" dialog.
To backup all archives, select the command "Edit" > "Export" in the main menu of WinCC Configuration Studio.
The format is irrelevant for re-import to WinCC.
The data of the selected folder are backed up in an export file.
4. To restore archives, select the command "Edit" > "Import" in the main menu of WinCC Configuration Studio.

7.2.3 Configuring a view

7.2.3.1 How to create a view

Introduction

A view assembles data from multiple user archives. For example, you can create links via the fields of various user archives with SQL to see Runtime relationships in a single view. The linked user archives must then have at least one common data field.

In WinCC Configuration Studio, you create a view in the table area of the "User Archive" editor.

Procedure

1. Select the "Views" folder in the navigation area.
2. Click in the top empty cell of the "Name" column in the table area. The cell is marked by a yellow symbol.

7.2 Configurations in the user archive

3. Enter a name:
 - The first character must be a letter.
 - The name can only include numeric and alphabetic characters and the underscore character "_".
 - National special characters, for example umlauts or Asian characters are not permitted.A new view has been created.
4. Edit the properties of the view.
5. Add columns to the view.

7.2.3.2 How to edit properties of a view

Introduction

The properties of a view are displayed in the table area and in the "Properties" area of the "User Archive" editor.

Procedure

Fields highlighted in color cannot be edited. Whether you can edit properties may depend on the activation or deactivation of individual options or a selection for another property.

1. To display all views in the table area, select the "Views" folder in the navigation area.
To display the properties of a view, select the view in the table area.
2. Alternatively, select the folder of a view in the navigation area.
The properties of the selected view are displayed in the "Properties" area.
3. Edit the properties in the "Properties" area.

In the table area, you can use the shortcut menu of a column header to show or hide specific columns (and therefore properties). You can obtain a user-friendly display of views using filtering and sorting options. The table area allows you to edit a large number of views at one time. To do this you can use, for example, the "Select and pull selection down" function or the shortcut menu commands "Deselect all" and "Select all".

7.2.3.3 How to create the user archive columns of a view

Introduction

In WinCC Configuration Studio, you create columns of a view in the table area of the "User Archive" editor.

A user archive column uses the values of a field from a configured user archive. Each user archive column can be linked to a different user archive.

Procedure

1. Select the folder of a view in the navigation area.
2. Select the "Columns" tab in the table area.
3. Click in the top empty cell of the "Name" column in the table area. The cell is marked by a yellow symbol.
4. Enter a name:
 - The first character must be a letter.
 - The name can only include numeric and alphabetic characters and the underscore character "_".
 - National special characters, for example umlauts or Asian characters are not permitted.A new user archive column has been created.
5. Edit the properties of the user archive column.

7.2.3.4 How to edit properties of a user archive column

Introduction

The properties of a user archive column are displayed in the table area and in the "Properties" area of the "User Archive" editor.

Procedure

Fields highlighted in color cannot be edited. Whether you can edit properties may depend on the activation or deactivation of individual options or a selection for another property.

1. Select the folder of a view in the navigation area.
2. Select the "Columns" tab in the table area.
3. Select the row of a user archive column in the table area.
4. Edit the properties of the selected user archive column in the "Properties" area.

In the table area, you can use the shortcut menu of a column header to show or hide specific table columns (and therefore properties). You can display properties in a user-friendly manner using filtering and sorting options. The table area allows you to edit a large number of properties at the same time. To do this you can use, for example, the "Select and pull selection down" function or the shortcut menu commands "Deselect all" and "Select all".

7.2.3.5 How to edit the position of a user archive column

You edit the position of a user archive column in the "User Archive" editor using the shortcut menu in the table area.

The position determines the sequence in which the columns are displayed in Runtime.

Procedure

1. Select the folder of a view in the navigation area.
2. Select the "Columns" tab in the table area.
3. Select the row header of a user archive column.
4. Select "Move up" or "Move down" command in the shortcut menu.
The user archive column is moved by one position.

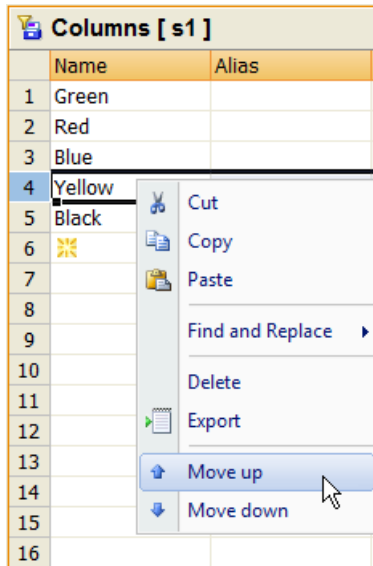

7.2.3.6 How to display the data of a view

In WinCC Configuration Studio, you display the data of a view in the table area of the "User Archive" editor.

Requirement

- You configured at least two user archives.
- You have configured a view. The view contains user archive columns which are linked to fields of the user archives.
- The fields of the user archives contain values.

Procedure

1. Select the folder of a view in the navigation area.
2. Select the "View data" tab in the table area
The data of the view are displayed in the table area.
No data can be edited in this view.
Use the commands from the shortcut menus, e.g. Sort, Filter, Hide Column, to adjust the display.

7.2.3.7 Example for relation

Example for relation

2 archives were configured with the names `Archive1` and `Archive2`:

`Archive1` has the fields named `A1Field1`, `A1Field2` and `A1Field3`.

`Archive2` has the fields named `A2Field1` and `A2Field2`.

2 views were configured with the names `View1` and `View2`:

`View 1` has a column that is linked to field `A1Field3` and a column that is linked to `A2Field2`.

Here, you can set up the following relation, for example:

- `~Archive1.A1Field3 >= ~Archive2.A2Field1`

`View 2` has a column that linked to field `A1Field1` and a column that points to `A2Field2`.

Here, you can set up the following relation, for example:

- `~Archive1.A1Field1 < ~Archive2.A2Field2` and `~Archive2.A2Field2 > ~Archive1.A1Field1`

7.2.4 Export and import

7.2.4.1 How to export the configuration data of the user archive

Introduction

You can export user archives and views of the open WinCC project in order to, for example, use the data in other projects or make a backup.

Procedure

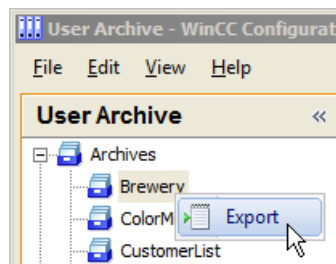

1. Select the folder you wish to export in the navigation area:
 - the "Archives" folder to export all archives
 - the folder of an archive to export the archive
 - the "Views" folder to export all views
 - the folder of a view to export the view

Select one or several rows in the table area to export the selected entries.

2. Select "Export" in the shortcut menu.
To backup all archives, select the command "Edit" > "Export" in the main menu of WinCC Configuration Studio.
3. Select a descriptive name for the export file and a storage location in the "Export" dialog.
4. Select the format:
 - Unicode text (*.txt)
 - Excel workbook (*.xlsx)

The selected data are backed up in an export file.

7.2.4.2 How to import the configuration data of the user archive

Introduction

The data for user archives and views that were exported from a WinCC project can be re-imported to a WinCC project.

Note

Existing data are supplemented during an import; that is, archives, views or fields that are configured in the editor remain if they do not exist in the export file.

Items of data with identical names are overwritten, i.e. archives, views or fields that are configured are overwritten by the export file data item if it has the same name.

Procedure

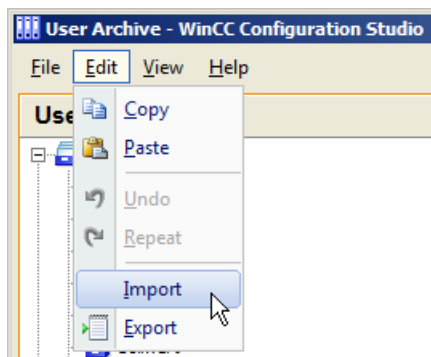

1. To import data, select the command "Edit" > "Import" in the main menu of WinCC Configuration Studio.
2. Select the export file in the "Import" dialog. Once the import is complete, a dialog is displayed for confirmation including a link to the log file. Any errors are listed in the log file.

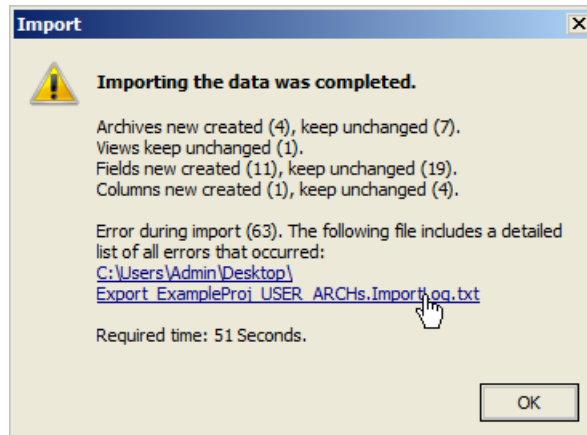

7.2.5 Runtime data

7.2.5.1 How to edit the Runtime data in the user archive

Introduction

The Runtime data of a user archive are displayed in the table area of the "User Archive" editor. You can modify or supplement values here as required.

Requirement

- You have created at least one user archive.
- You have configured fields for the user archive.

Procedure

1. Select the folder of the user archive in the navigation area.
2. Select the "Archive data" tab in the table area.
The Runtime data of the user archive are displayed. Each table column corresponds to one field.
3. Edit the displayed values.
4. To create a new data record, click in the top free cell of a column. Input fields are marked with a yellow symbol.
Creation of a new data record is complete once a value has been entered for a field.

7.2.5.2 How to export runtime data of the user archive

Introduction

You can export the Runtime data of a selected user archive in order to, for example, edit the data in a spreadsheet program or make a backup.

Requirement

- You have created at least one user archive.
- You have configured fields for the user archive.

Note

Date fields when exporting Runtime data

During further processing of the exported Runtime data, the date fields must always be changed into the language and format in which the date fields will be exported. Otherwise, an import of the data into the user archive can no longer be performed.

Procedure

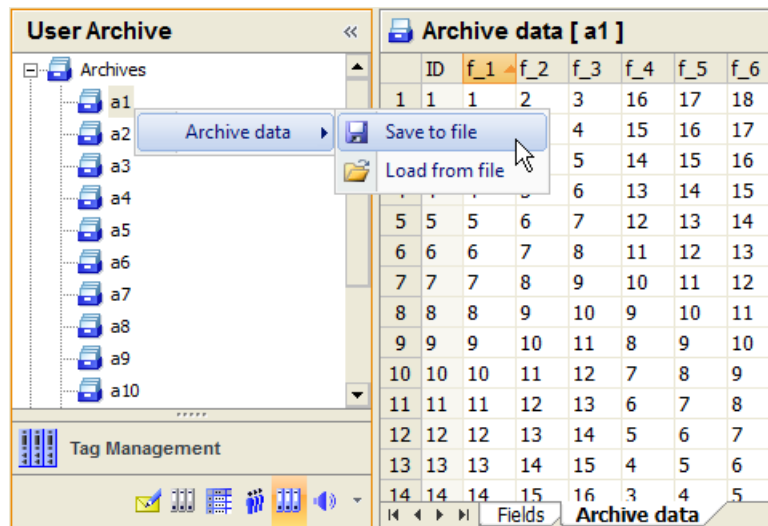

1. Select the "Archive data" tab in the table area of the "User Archive" editor.
2. Select the folder of an archive in the navigation area.
3. Select the "Archive data" > "Save to file" command in the folder shortcut menu.
The current archive data are stored in a file with the format **CSV*.

Note

If, in the case of a client-server project, the user archive is located on the server, for example under "C:\Projects\Test\UA", the archive will be shared under this default path. The client maps the share via a network drive e.g. "I:\Test\UA". Thereafter, the standard path of the User Archive is "I:\Test\UA" on the client. However, there is no directory on the server with this designation. If you want to export user archive data to the server, you have to change the default path on the client, for example to "C:\Projects\Test\UA".

Note**Exporting configuration data from user archives and views**

To export configuration data of user archives and views, select the corresponding folder in the navigation area and select the "Export" command from the shortcut menu.

7.2.5.3 How to import runtime data of the user archive

Introduction

You can import Runtime data originating from a WinCC database back to a user archive.

Data record IDs are entered for the export data during export, in order to provide clear mapping of the imported data for the import. If WinCC detects during the import that one of the IDs to be imported already exists in the user archive, an error message is generated and an entry is made in the "UALogFile.txt" log file. The data with a new data record ID are added as new data records into the user archive.

Requirement

- The file which you wish to import does not contain information about the data type and number of the fields. Therefore, the structure of import data and the target archive must match.
- Alternatively, you can import data into the user archive from which you have previously exported data.

Note

You have edited the exported Runtime data of a user archive outside WinCC and you now want to overwrite the data of this user archive. If you want to import the changed data, you must first delete all data records of the user archive. Otherwise, you will get error messages during the import because of identical data record IDs.

Note

If, in the case of a client-server project, the user archive is located on the server, for example under "C:\Projects\Test\UA", the archive will be shared under this default path. The client maps the share via a network drive e.g. "I:\Test\UA". Thereafter, the standard path of the User Archive is "I:\Test\UA" on the client. However, there is no directory on the server with this designation. If you want to import user archive data to the client, you have to change the default path on the client, for example to "C:\Projects\Test\UA".

Procedure

1. Select the "Archive data" tab in the table area of the "User Archive" editor.
2. Select the folder of an archive in the navigation area.
3. Select the "Archive data" > "Load from file" command in the folder shortcut menu.
4. Select the csv file containing the data in the "Import" dialog.
The data are loaded to the user archive.

Note

Importing the configuration data from user archives and views

To import configuration data and views, select the command "Edit" > "Import" in the main menu of WinCC Configuration Studio.

7.3 Data communication with automation systems

7.3.1 SIMATIC interfaces

Introduction

Runtime data can be exchanged between the user archive and S5/S7 automation systems via WinCC tags and also via raw data tags with S7-400. All SIMATIC interfaces are available, with the exception of the AS511 programming interface.

Data communication via WinCC tags

Data communication via WinCC tags with S5 or S7 automation systems is simple. You should be aware that only certain data types of the WinCC Tag Management can be used for user archives.

For the data types "Integer", "Double", "String" and "Date/Time" in the user archive, the following data types of the tag management must be used.

Selection in the User Archive editor	WinCC tag in the Tag Management
Number (integer)	Signed 32-bit value
Number (float)	Floating-point number 32-bit IEEE 754
Number (double)	Floating-point number 64-bit IEEE 754
Character string (string)	Text tag, 8-bit character set
Date/time	Date/time

The following pages provide a detailed description of data communication via raw data tags.

7.3.2 Data communication with S7 via raw data tags

7.3.2.1 How to configure data communication via raw data tags

Introduction

The "BSEND/BRCV" function of S7 communication is used for data communication between the user archive and the automation system via WinCC raw data tags. The raw data tags are sent from the automation system as an active partner.

Principle

The message frames of the raw data tags include one or more read or write jobs for the user archive. In response to these requests, WinCC sends back the requested data and a processing acknowledgment. This is why a "BRCV" must always be configured in the STEP 7 program.

Since the automation system is the active partner, a user-initiated job must be triggered directly in the automation system, for example, by an external WinCC tag. The "Request type" parameter used in the job header and acknowledgment header of the message frame cannot be used for triggering functions of the automation system, since the request type is only used for user archive functions.

Requirement

- You have background information on raw data tags.
- You have configured the STEP 7 program for the automation system.
- The "SIMATIC S7 Protocol Suite" channel is integrated in the WinCC project.

Procedure

1. Create a new connection for a channel unit in the "SIMATIC S7 Protocol Suite", for example, "Industrial Ethernet" in the "Tag Management" editor. You can also use an existing connection.
2. Select the command "Connection Parameters" in the connection shortcut menu.

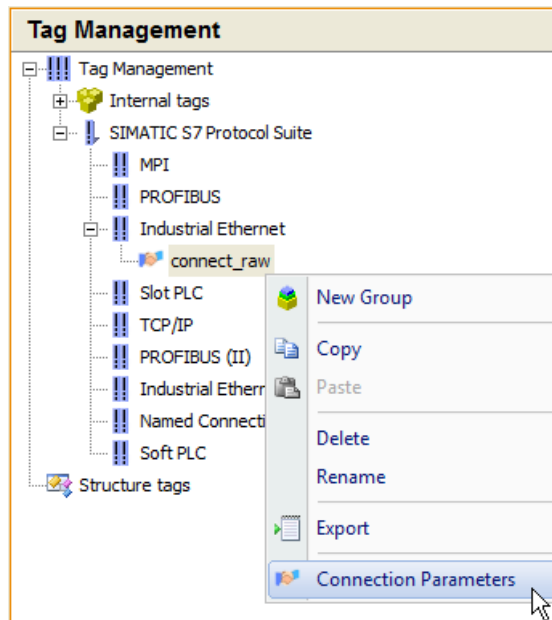

This opens the "Connection properties" dialog.

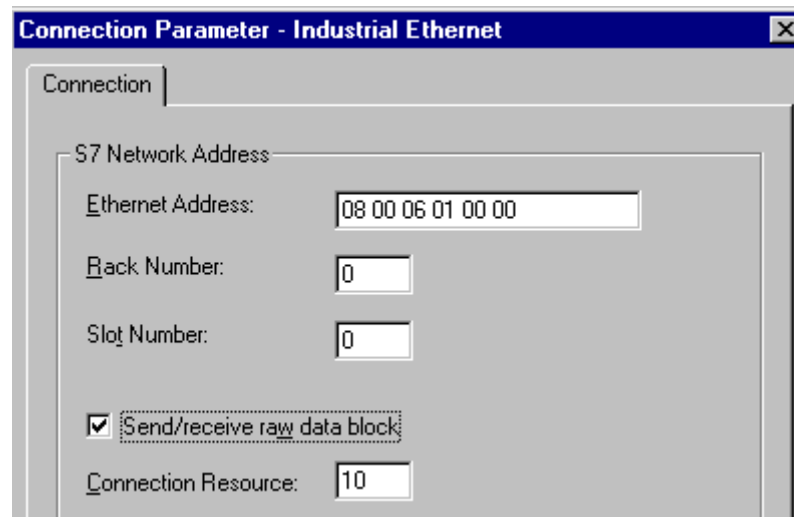

3. Enter the parameters and select the "Send/receive raw data block" check box. Use the hexadecimal value from the STEP 7 configuration as the "Connection resource".
4. Create a new tag with the data type "Raw data type" for the connection.
 - To do so, assign a name to the tag in the table area of the "Tag Management" editor.
 - In the tag properties, select the data type "Raw data type" under "General".

5. Click in the field for the "Address" property under "General".
6. In the field, click on the button  to open the "Tag properties" dialog.

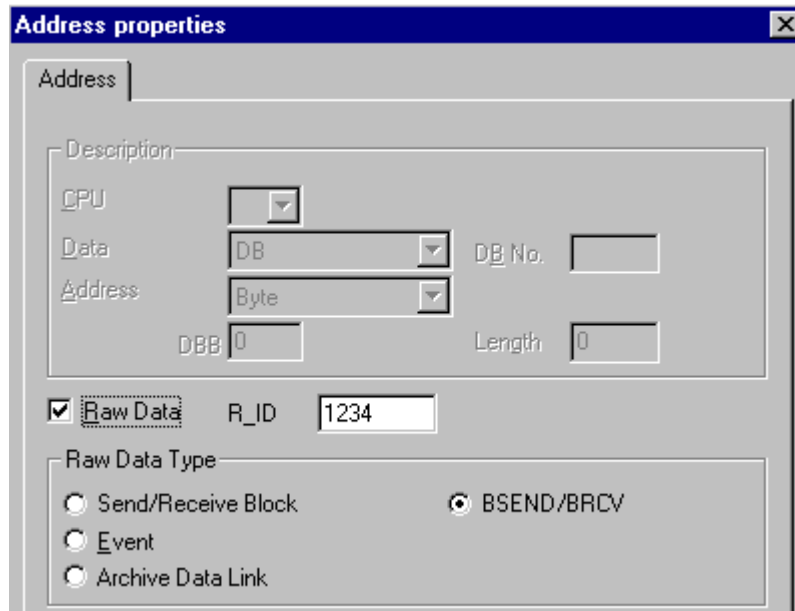

7. Select the "BSEND/BRCV" option as "Raw data type".
8. Select the option "Raw data". Use the "R_ID" from the STEP 7 configuration. The same "R_ID" must always be configured in the STEP 7 program with regard to "BSEND" and "BRCV" for the user archive.
9. Save the configuration.

Note

Always use the "BSEND/ BRCV" option as the raw data type, not the "Send/receive block" option.

7.3.2.2 Data format differences between WinCC and S5/S7

Introduction

The data formats in WinCC differ fundamentally from data formats in the S7 automation systems. You need to take this into consideration to avoid errors.

WinCC keeps to the data formats of Intel and Microsoft, in which the least significant bytes are stored first and most significant bytes last. This data format is very common and is known as the "Intel format".

Intel format

With the Intel format, the decimal number 300 is stored as follows:

Bit	15	14	13	12	11	10	9	8	7	6	5	4	3	2	1	0
Binary	0	0	0	0	0	0	0	1	0	0	1	0	1	1	0	0

Hex	0	1	2	C
-----	---	---	---	---

According to the Intel format, the decimal number "300" corresponds to the hexadecimal number "12C" ($1 \cdot 256 + 2 \cdot 16 + 12$).

SIMATIC format

In the SIMATIC format the least significant bytes are stored on most significant places. In the SIMATIC format, the decimal number "300" is stored as follows:

Bit	15	14	13	12	11	10	9	8	7	6	5	4	3	2	1	0
Binary	0	0	1	0	1	1	0	0	0	0	0	0	0	0	0	1

Hex	2	C	0	1
-----	---	---	---	---

According to the SIMATIC format, the decimal number "300" corresponds to the hexadecimal number "2C01". If "2C01" is erroneously interpreted according to the Intel format, you would get "11265" as a decimal number.

For the automation systems, there are function block available which can carry out corresponding data conversions. You must always call the function blocks before and after data transfer between S7 and WinCC. You can download the function blocks at "<http://support.automation.siemens.com/>".

Enter "Function blocks ANSI_S5" as the search term. The compressed file "ANSI_S5.EXE" is offered for download. The file contains the function block "IEEE:GP".

Active sending is described in the reference manuals of the PLCs or the "Communication Processors".

7.3.2.3 Sending jobs and data from S7 to WinCC

Structure of the raw data tag

Below you can see the structure of the raw data tags, which are used to send jobs and data from the S7 automation system to the WinCC user archive. The data is configured in the PLC by STEP 7.

Message frame from S7 to WinCC user archive
Message frame header
Job header 1
Data of the job 1

Possible job header 2
Possible data of the job 2
Job n

7.3.2.4 Receiving data and processing acknowledgment in S7

Structure of the raw data tag

Below you can see the structure of the raw data tags, which are used to receive processing acknowledgments and data from the WinCC user archive to the S7 automation system. The data is configured in the PLC by STEP 7.

Raw data tag for receiving in S7
Processing acknowledgement
Acknowledgement header
Acknowledgement data

7.3.2.5 Structure of the message frame header

Structure of the message frame header

The message frame header consists of the following individual parts (distribution in bytes):

Function of the field	Comment
Message frame length in bytes LSB *)	Length of the field 4 bytes
.	Max. length 4091 bytes
.	(due to S7 transport)
Message frame length in bytes MSB **)	.
Transfer type	1 from WinCC, 2 from the PLC
Reserved	
Number of jobs in the message frame LSB	Length of the field 2 bytes
Number of jobs in the message frame MSB	.
PLCID 1.character	Name in ASCII
.	Length of the field 8 bytes
.	.
.	.
.	.
.	.
.	.
PLCID 8th character	.

*) LSB = Least Significant Byte (lowest value byte)

***) MSB = Most Significant Byte (highest value byte)

7.3.2.6 Job Header

Structure of the job header

The job header consists of the following individual parts (distribution in bytes):

Function of the field	Comment
Job length in bytes LSB *)	Length of the field 2 bytes
Job length in bytes MSB**)	.
Job type	See description of the job types
Reserved	
Field number LSB	Length of the field 2 bytes
Field number MSB	.
Data record number LSB	Length of the field 4 bytes
.	.
.	.
Data record number MSB	.
Selection Criterion LSB	Selected according to field number, if you want to use a selection.
Selection criterion MSB	Selected according to field number, if you want to use a selection.
Data of the selection criterion LSB	Selected according to field content, if you want to use a selection.
Data of the selection criterion MSB	Selected according to field content, if you want to use a selection.

*) LSB = Least Significant Byte (lowest value byte)

***) MSB = Most Significant Byte (highest value byte)

7.3.2.7 Data of the job

Data of the job

Depending on the job type, the data of the job corresponds to the contents of a data record or of an addressed field.

Note the following:

- Text fields are not \0-terminated.
- The numbers must be transferred in Intel format, LSB first, MSB last.

7.3 Data communication with automation systems

- A field with data type "Integer" has a length of 4 bytes, "Float" has 4 bytes and "Double" has 8 bytes.
- If you want to use a selection criterion in the job header, shift the data of the job back by 2 bytes for the field number plus the number of bytes for the field contents.
 For example, the data records are selected according to the field number with "Integer" data type. The data of the job is then shifted back by 2 bytes for the field number plus 4 bytes for the integer.
 If you not want to use selection criteria, omit "Selection criteria" and "Data of the selection criterion" in the job header. The data of the job then starts directly after the data record number of the job header.

7.3.2.8 The acknowledgement header

Structure of the acknowledgment header

The acknowledgment header consists of the following individual parts (distribution in bytes):

Function of the field	Comment
Message frame length in bytes LSB*)	Length of the field 4 bytes
.	.
.	.
Message frame length in bytes MSB**)	.
Transfer type	1 from WinCC, 2 from the PLC
Reserved	
Error code	See description of the error codes
Job type	See description of the job types
Reserved	
Reserved	
Field number LSB	Length of the field 2 bytes
Field number MSB	.
Data record number LSB	Length of the field 4 bytes
.	.
.	.
Data record number MSB	.
PLCID 1.character	Name in ASCII
.	Length of the field 8 bytes
.	.
.	.
.	.
.	.
.	.
PLCID 8th character	.

*) LSB = Least Significant Byte (lowest value byte)

***) MSB = Most Significant Byte (highest value byte)

Data of the Acknowledgement

The acknowledgement contains either the data record or the addressed field (during a read request) or it is empty (write job, archive job).

7.3.2.9 Description of the job types

Description of the job types

Below, the jobs with which you can access the user archive are listed:

Type	Description
4	Check if user archive exists
5	Delete all of the records in the User Archive
6	Read data set
7	Write data record
8	Delete record
9	Read data record field
10	Write data record field

7.3.2.10 Description of the error codes

Description of the error codes

Below, the error codes that can occur when jobs are executed are listed:

Group	No.	Description	Possible fault causes
General	0	The function has been executed	--
archive	2	Data not available	No archive is configured with this PLCID
Data record	101	Data not allowed	- Data record layout does not match, e.g. number or data type of fields - Adding or updating data records failed, for example because the archive has the type "limited", or a minimum or maximum value is configured for a field - The filter criterion is incorrect
Data record	102	Data not available	(only for job type 6) - No data available - The filter criterion is incorrect
Field	201	Data not allowed	(only for job type 10) The filter criterion is incorrect, for example because the field does not exist or a minimum or maximum value is configured for a field

7.3 Data communication with automation systems

Field	202	Data not available	(only for job type 9) The filter criterion is incorrect or no field was found which meets the filter criterion
General	254	Function not available	--
General	255	Undefined error	--

7.4 User archive functions

7.4.1 General information

Introduction

You use the functions for user archives to configure user archives and to operate archives in runtime. WinCC provides a number of standard functions that enable the user to implement user archives in a flexible manner.

Overview

The standard functions require handles that are returned by the functions "uaQueryConfiguration", "uaConnect", "uaQueryArchive" and "uaOpen".

All functions for user archives begin with "ua", for example, "uaConnect". The runtime functions always begin with "uaArchive", for example, "uaArchiveOpen".

A distinction is made between two prefixes for the API calls:

- "ua" for scripts, such as Global Script and programming of actions.
- "UA" for programs that run outside of WinCC. If you use calls for user archives in a Dynamic Wizard, you have to use the "UA" prefix.

Note

When a data record is created, no check is made for completeness or correctness of the data record. In particular, a field must not be left blank.

Within a script, it must be ensured that the data is up-to-date.

In the following scenario, the script is not informed of changes, for example. A script has opened a user archive. A data record has been inserted into or deleted from the user archive via UserArchiveControl or via a "User Archive" editor. The changes in the script become known only after a "requery".

7.4.2 How to use the functions of the user archive

Introduction

To efficiently use the functions of the user archive in runtime for configuration of user archives, you must consider the relationship of the functions.

7.4 User archive functions

You must always comply to the following levels of connection to user archives when using runtime functions:

- uaConnect <--> uaDisconnect
- uaQueryArchiveByName or uaQueryArchive <--> uaReleaseArchive
- uaArchiveOpen <--> uaArchiveClose

After the three-step opening of the connections, you have access to the user archive with the runtime functions. Then, you must close the open connections again in three steps.

Functions for configuring user archives

The "uaQueryConfiguration" function introduces the section of the configuration and returns the handle "UAHCONFIG" for the configuration functions. The handle is used, for example, to call the "uaAddArchive" or "uaAddField" functions in order to create a new user archive or a new data field. The configuration section must be closed with the "uaReleaseConfiguration" function.

Establishing a connection to the user archive for runtime functions

To access in runtime, you need to call the "uaConnect" function in order to establish a connection to "User Archive". "uaConnect" creates the "UAHCONNECT" handle, which is needed to open the user archive. You have to close the connection to "User Archive" again with the "uaDisconnect" function.

Opening a user archive for the runtime functions

A configured user archive is required to use runtime functions. The "uaQueryArchive" or "uaQueryArchiveByName" functions establish a connection to the current user archive and provide a handle for the runtime functions. You can use the runtime functions after opening the user archive with the "uaArchiveOpen" function.

After access with the runtime functions, you first need to close the user archive using the "uaArchiveClose" function. Then close the connection to the current user archive with the "uaReleaseArchive" function.

Using runtime functions

You use the runtime functions to operate the user archives in runtime, as the following example with "uaArchiveSetFieldValueLong" shows. A unique assignment to a data record of the user archive is generated via the "hArchive" handle. The assignment also allows indirect addressing, for example, for the user interface.

The "uaArchiveNext", "uaArchivePrevious", "uaArchiveFirst" and "uaArchiveLast" functions move the pointer. The "uaArchiveUpdate" function stores the temporary data record in the user archive and overwrites the data record to which the pointer is currently pointing. The data record must previously be read by the "uaArchiveNext", "uaArchivePrevious", "uaArchiveFirst" or "uaArchiveLast" functions.

Example of a runtime function

```

#include "apdefap.h"
void OnClick(char* lpszPictureName, char* lpszObjectName, char*
lpszPropertyName)
{
    UAHCONNECT hConnect = 0;
    UAHARCHIVE hArchive = 0;
    if ( uaConnect( &hConnect ) )
    {
        if ( uaQueryArchiveByName( hConnect, "VarTest", &hArchive ) )
        {
            if ( uaArchiveOpen( hArchive ) )
            {
                //-----
                uaArchiveSetFieldValueLong( hArchive, 1,
GetTagSDWord("UA_VarTest_Int1"));
                uaArchiveSetFieldValueLong( hArchive, 2,
GetTagSDWord("UA_VarTest_Int2"));
                if (! uaArchiveInsert( hArchive ) )
                {
                    printf("Error (%d) with uaArchiveInsert\r
\n",uaGetLastError() );
                }
                //-----
                uaArchiveClose( hArchive );
            }
            else
            {
                printf( "Open failed.<%d>\r\n",uaGetLastError() );
            }

            uaReleaseArchive( hArchive );
        }
        else
        {
            printf( "Query failed.<%d>\r\n",uaGetLastError() );
        }

        uaDisconnect( hConnect );
    }
    else
    {
        printf( "Connect failed.<%d>\r\n",uaGetLastError() );
    }
}

```

7.4.3 Example of a user archive script

Introduction

The following is an example of a script that uses some of the standard functions of user archives. The example includes functions for reading and writing a user archive in runtime which can be accessed by clicking the buttons:

- The "UAReadFromArchive" function reads the first record of the user archive.
- The "UAWriteToArchive" function writes a data record to the user archive.

The data is displayed in the WinCC UserArchiveControl and the script output is shown in the diagnostic window.

The image shows two overlapping windows from a WinCC environment. The top window, titled "WinCC UserArchiveControl", displays a table of user archive data. The table has columns for ID, name, red, green, and blue. Below the table are "read" and "write" buttons, and a status bar showing "Ready", "Archive: color", and the time "9:41:23 AM".

	ID	name	red	green	blue
1	1	black	0	0	0
2	3	gray	128	128	128
3	4	marron	128	0	0
4	7	lime	0	255	0
5	8	olive	128	128	0
6	9	purple	128	0	128
7	10	acqua	0	255	255
8	11	silver	192	192	192
9	12	white	255	255	255
10	13	darkgray	105	105	105



The bottom window, titled "Global Script - Diagnostics", shows diagnostic information for a script execution. It lists the number of fields (5) and provides details for two fields: Field 1 (String, Value: darkgray, Length: 10) and Field 2 (Integer, Value: 105, Length: 4). The status bar shows the date "11.05.09" and time "09:41:23".

Requirement

- You are familiar with the fundamentals of the "User Archive", "Graphics Designer" and "Global Script" editors.
- You have created a user archive, for example, "color", from the example on the page "Example for the use of control tags".

- You have opened the Graphics Designer and configured a screen with a WinCC UserArchiveControl, for example, from the example on the page "Example for the use of control tags."
- You have enabled the "Global Script Runtime" option in the startup list in the WinCC properties of the computer.

Procedure

1. Open the C editor of "Global Script" in the WinCC Explorer.
2. Click on the "New Project Function" command in the "File" menu of the editor.
3. Copy one of the example scripts below into the editor window. Click on  to compile the function.
4. Click  to save the compiled, error-free function with the name "UARReadFromArchive".
5. Proceed with the second script using the same procedure.
6. Insert the "Application window" smart object from the object palette into the screen in the Graphics Designer. The application window serves as a diagnostic window for the scripts.
7. In the "Window Contents" dialog, select the entry "Global Script" and select "GSC Diagnostics" as a template. Set all the properties to "yes" in the "Miscellaneous" tab in the properties of the application window.
8. Create the "Read" and "Write" buttons with the "Button" object from the object palette under "Windows Objects".
9. Right-click on the "Read" button and select the "Properties" menu item.
10. Open the "Event" tab. Click "Mouse".
11. At "Mouse click", right-click in the "Action" column and select "C-action". The "Edit action" window opens.
12. In the editor window, click in the "OnClick" action between "{" and "}".
13. Double-click on "UARReadFromArchive" in the "Project functions" directory in the navigation window.
14. Click  and then "OK" at the bottom right. The example script is now integrated in the action for the mouse click on the button.
15. Proceed with the "Write" button using the same procedure.
16. Save the screen in Graphics Designer.
17. Activate the example project for runtime.

Example script "UARReadFromArchive"

```
#include "apdefap.h"
void UARReadFromArchive()
{
    UAHCONNECT hConnect = 0;
    UAHARCHIVE hArchive = 0;
    LONG IndexArchive;
    LONG FieldLength;
```

```

LONG FieldType;
LONG NumberOfFields;
LONG Index;
long IntValue;
float FloatValue;
double DoubleValue;
char ArchivName[255], StringField[255];
SYSTEMTIME SysDate;
//***** Connect to Component User Archives
*****
if (uaConnect( &hConnect ) == FALSE )
{
printf("uaConnect error: %d\n", uaGetLastError() );
return;
}
if (hConnect == NULL)
{
printf("Handle UAHCONNECT equals NULL\n" );
return;
}
//***** Connect to Archive via Archive Name
*****
if (uaQueryArchiveByName( hConnect, "color", &hArchive ) == FALSE )
{
printf("uaQueryArchive Error: %d\n", uaGetLastError() );
goto finish;
}
//***** Opens Archive
*****
if ( uaArchiveOpen( hArchive ) == FALSE )
{
printf("uaArchive Open Error\n" );
goto finish;
}
//***** Move to first record set
*****
if (uaArchiveMoveFirst(hArchive) == FALSE )
{
printf("uaArchiveMoveFirst Error = %d\n" , uaGetLastError() );
goto finish;
}
//***** Get Number of Fields
*****
NumberOfFields = uaArchiveGetFields( hArchive );
printf("Number of Fields = %u\n", NumberOfFields );
//***** Read and show Data Fields
*****
for ( Index = 1; Index < NumberOfFields; Index++ )
{
printf("Data of Field %u: \n", Index );
FieldType = uaArchiveGetFieldType( hArchive, Index );
switch ( FieldType )

```

```

{
case UA_FIELDTYPE_INTEGER :
printf("Field Type = Integer\n");
if ( uaArchiveGetFieldValueLong ( hArchive, Index, &IntValue ) ==
TRUE )
printf( "Field Value = %u\n", IntValue );
else
printf("Error callinguaArchiveGetFieldValueLong: %d\n",
uaGetLastError() );
break;
case UA_FIELDTYPE_FLOAT :
printf("Field Type = Float\n");
if (uaArchiveGetFieldValueFloat ( hArchive, Index, &FloatValue ) ==
TRUE )
printf("Field Value = %f\n", FloatValue );
else
printf("Error callinguaArchiveGetFieldValueFloat: %d\n",
uaGetLastError() );
break;
case UA_FIELDTYPE_DOUBLE :
printf("Field Type = Double\n");
if (uaArchiveGetFieldValueDouble (hArchive, Index, &DoubleValue ) ==
TRUE )
printf("Field Value = %g\n", DoubleValue );
else
printf("Error calling uaArchiveGetFieldValueDouble: %d\n",
uaGetLastError() );
break;
case UA_FIELDTYPE_STRING :
printf("Field Type = String\n");
if (uaArchiveGetFieldValueString ( hArchive, Index, StringField,
20 ) == TRUE )
printf("Field Value = %s\n", StringField );
else
printf("Error callinguaArchiveGetFieldValueString: %d\n",
uaGetLastError() );
break;
case UA_FIELDTYPE_DATETIME :
printf("Field Type = Date & Time\n");
if (uaArchiveGetFieldValueDate ( hArchive, Index, &SysDate ) ==
TRUE )
printf("%d.%d.%d\n ", SysDate.wDay, SysDate.wMonth, SysDate.wYear );
else
printf("Error calling uaArchiveGetFieldValueLong: %d\n",
uaGetLastError() );
break;
case -1 :
default:
printf("Error executing uaArchiveGetFieldType\n");
}
//***** Read and show Field Length
*****

```

```

FieldLength = uaArchiveGetFieldLength( hArchive, Index );
if ( FieldLength != -1 )
printf("Field Length = %u\n", FieldLength );
else
printf("Error executing uaArchiveGetFieldLength\n");
}
//***** Close all handles and connections
*****
finish;;
//***** Close Archive
*****
if( NULL != hArchive )
{
if (uaArchiveClose ( hArchive ) == FALSE )
{
printf("error on closing archive\n" );
}
}
//***** Release Connection to Archive
*****
if( NULL != hArchive )
{
if (uaReleaseArchive ( hArchive ) == FALSE )
{
printf("error on releasing archive\n" );
}
}
hArchive = 0;
}
//***** Disconnect to Component User Archives
*****
if( NULL != hConnect )
{
if (uaDisconnect ( hConnect ) == FALSE )
{
printf("error on disconnection\n" );
}
}
hConnect = 0;
}
}

```

Example script "UAWriteToArchive"

```

#include "apdefap.h"
void UAWriteToArchive()
{
UAHCONNECT hConnect = 0;
UAHARCHIVE hArchive = 0;
LONG IndexArchive;
LONG FieldLength;
LONG FieldType;
LONG NumberOfFields;
LONG Index;
}

```

7.4 User archive functions

```

long IntValue;
char StringField[255];
SYSTEMTIME SysDate;
//***** Connect to Component User Archives
*****
if (uaConnect( &hConnect ) == FALSE )
{
printf("uaConnect error: %d\n", uaGetLastError() );
return;
}
if (hConnect == NULL)
{
printf("Handle UAHCONNECT equals NULL\n" );
return;
}
//***** Connect to Archive via Name *****
if (uaQueryArchiveByName( hConnect, "color", &hArchive ) == FALSE )
{
printf("uaQueryArchive Error: %d\n", uaGetLastError() );
goto finish;
}
//***** Opens Archive
*****
if ( uaArchiveOpen( hArchive ) == FALSE )
{
printf("uaArchive Open Error\n" );
goto finish;
}
//***** Get Number of Fields
*****
NumberOfFields = uaArchiveGetFields( hArchive );
printf("Number of Fields = %u\n", NumberOfFields );
//***** Read Last Data Set
*****
if (uaArchiveMoveLast( hArchive ) == TRUE )
printf("Number of Fields = %u\n", NumberOfFields );
else
{
printf("uaArchiveMoveLast Error: %d\n", uaGetLastError() );
goto finish;
}
//***** Write into Data Fields
*****
IntValue = 105;//RGB for darkgray
strcpy(StringField, "darkgray" );
GetSystemTime( &SysDate );
for ( Index = 1; Index < NumberOfFields; Index++ )
{
printf("Data of Field %u: \n", Index );
FieldType = uaArchiveGetFieldType( hArchive, Index );
switch ( FieldType )
{

```



```

case UA_FIELDTYPE_INTEGER :
printf("Field Type = Integer\n");
if (uaArchiveSetFieldValueLong ( hArchive, Index, IntValue ) ==
TRUE )
printf( "Field Value = %u\n", IntValue );
else
printf("Error callinguaArchiveSetFieldValueLong: %d\n",
uaGetLastError() );
break;
case UA_FIELDTYPE_FLOAT :
printf("Field Type = Float\n");
if (uaArchiveSetFieldValueFloat ( hArchive, Index, FloatValue ) ==
TRUE )
printf("Field Value = %f\n", FloatValue );
else
printf("Error callinguaArchiveSetFieldValueFloat: %d\n",
uaGetLastError() );
break;
case UA_FIELDTYPE_DOUBLE :
printf("Field Type = Double\n");
if (uaArchiveSetFieldValueDouble (hArchive, Index, DoubleValue ) ==
TRUE )
printf("Field Value = %g\n", DoubleValue );
else
printf("Error calling uaArchiveSetFieldValueDouble: %d\n",
uaGetLastError() );
break;
case UA_FIELDTYPE_STRING :
printf("Field Type = String\n");
if (uaArchiveSetFieldValueString ( hArchive, Index, StringField ) ==
TRUE )
printf("Field Value = %s\n", StringField );
else
printf("Error callinguaArchiveSetFieldValueString: %d\n",
uaGetLastError() );
break;
case UA_FIELDTYPE_DATETIME :
printf("Field Type = Date & Time\n");
if (uaArchiveSetFieldValueDate ( hArchive, Index, &SysDate ) ==
TRUE )
printf("%d.%d.%d\n ",SysDate.wDay, SysDate.wMonth, SysDate.wYear );
else
printf("Error calling uaArchiveSetFieldValueLong: %d\n",
uaGetLastError() );
break;
case -1 :
default:
printf("Error executing uaArchiveSetFieldType\n");
}
FieldLength = uaArchiveGetFieldLength( hArchive, Index );
if ( FieldLength != -1 )
printf("Field Length = %u\n", FieldLength );

```

```
else
printf("Error executing uaArchiveGetFieldLength\n");
}
// ***** Update Archive *****
if (uaArchiveUpdate(hArchive) == FALSE )
{
printf("uaArchiveUpdate Error:\n" );
}
//***** Close all handles and connections
*****
finish;;
//***** Close Archive
*****
if( NULL != hArchive )
{
if (uaArchiveClose ( hArchive ) == FALSE )
{
printf("error on closing archive\n" );
}
}
//***** Release Connection to Archive
*****
if( NULL != hArchive )
{
if (uaReleaseArchive ( hArchive ) == FALSE )
{
printf("error on releasing archive\n" );
}
}
hArchive = 0;
}
//***** Disconnect to Component User Archives
*****
if( NULL != hConnect )
{
if (uaDisconnect ( hConnect ) == FALSE )
{
printf("error on disconnection\n" );
}
}
hConnect = 0;
}
}
```

7.4.4 Functions for Configuring User Archives

7.4.4.1 Functions for Configuring User Archives

Overview

To configure user archives, you must first call the "uaQueryConfiguration" function that creates the "UAHCONFIG" handle. The handle enables you to use the following functions. You need to call "uaReleaseConfiguration" after completing configuration.

Function	Description
uaAddArchive	Add a new user archive
uaAddField	Add a new field
uaGetArchive	Read archive configuration
uaGetField	Read field configuration
uaGetNumArchives	Read number of archives created
uaGetNumFields	Read number of fields
UaQueryConfiguration	Establish a connection to the user archive configuration
uaReleaseConfiguration	Close connection after configuration
uaRemoveAllArchives	Delete all archives
uaRemoveAllFields	Delete all fields
uaRemoveArchive	Delete particular archive
uaRemoveField	Delete particular field
uaSetArchive	Write archive configuration
uaSetField	Write field configuration

7.4.4.2 uaAddArchive

Description

Creates a new user archive. This corresponds to the configuration of a new user archive using the "User Archive" editor.

```
LONG uaAddArchive (
    UAHCONFIG hConfig,
    UACONFIGARCHIVE* pArchive )
```

Parameter

```
UAHCONFIG hConfig,
```

Handle for configuration of a user archive. The handle is set up with "uaQueryConfiguration".

```
UACONFIGARCHIVE* pArchive
```

Pointer to the buffer for storing the user archive configuration.

Return value

Index of the new user archive. "-1" in the case of an error.

See also

Structure of the user archive configuration "uaCONFIGARCHIVE" (Page 1910)

7.4.4.3 uaAddField

Description

Adds a new data field.

```
LONG uaAddField (  
    UAHCONFIG hConfig,  
    long lArchive,  
    UACONFIGFIELD* pField )
```

Parameter

UAHCONFIG hConfig,

Configuration handle of the user archive. The handle is set up with "uaQueryConfiguration".

long lArchive,

Archive Index (0 to (uaGetNumArchives()-1))

UACONFIGFIELD* pArchive

Pointer to the buffer of the field configuration.

Return value

Index of the new data field. "-1" in the case of an error.

See also

Structure of the field configuration "uaCONFIGFIELD" (Page 1910)

7.4.4.4 uaGetArchive

Description

Reads the user archive configuration.

```
BOOL uaGetArchive (  
    UAHCONFIG hConfig,
```

```
long lArchive,  
UACONFIGARCHIVE* pArchive )
```

Parameter

UAHCONFIG hConfig,
Configuration handle of the user archive. The handle is set up with "uaQueryConfiguration".

long lArchive,
Archive Index (0 to (uaGetNumArchives()-1))

UACONFIGARCHIVE* pArchive
Pointer to the buffer for receiving the user archive configuration.

Return value

TRUE: Access to the user archive was successful
FALSE: Error

See also

Structure of the user archive configuration "uaCONFIGARCHIVE" (Page 1910)

7.4.4.5 uaGetField

Description

Reads the field configuration.

```
BOOL uaGetField (  
UAHCONFIG hConfig,  
long lArchive,  
long lField,  
UACONFIGFIELD* pField )
```

Parameter

UAHCONFIG hConfig,
Configuration handle of the user archive. The handle is set up with "uaQueryConfiguration".

long lArchive,
Archive Index (0 to (uaGetNumArchives()-1))

long lField,
The field number, where "lField = 0" addresses the first field.

7.4 User archive functions

UACONFIGFIELD* pArchive

Pointer to the buffer for receiving the field configuration.

Return value

TRUE: Access to the user archive was successful

FALSE: Error

See also

Structure of the field configuration "uaCONFIGFIELD" (Page 1910)

7.4.4.6 uaGetNumArchives

Description

Reads the number of user archives currently configured.

```
LONG uaGetNumArchives (  
    UAHCONFIG hConfig )
```

Parameter

UAHCONFIG hConfig

Configuration handle of the user archive. The handle is set up with "uaQueryConfiguration".

Return value

Number of user archives currently configured. "-1" in the case of an error.

7.4.4.7 uaGetNumFields

Description

Supplies the number of the configured fields. The "ID", "Last User" and "Last Access" fields are not included. The indexes are specified with "0 to uaGetNumFields() -1" in the configuration calls.

```
LONG uaGetNumFields (  
    UAHCONFIG hConfig,  
    long lArchive )
```

Parameter

UAHCONFIG hConfig,
Configuration handle of the user archive. The handle is set up with "uaQueryConfiguration".
long lArchive,
Archive Index (0 to (uaGetNumArchives()-1))

Return value

Number of the configured fields. "-1" in the case of an error.

7.4.4.8 UaQueryConfiguration**Description**

Establishes the connection to the user archive for the configuration.

```
BOOL uaQueryConfiguration (  
UAHCONFIG* phConfig )
```

Parameter

UAHCONFIG* phConfig,
Pointer to the handle of the archive.

Return value

TRUE: Access to the user archive was successful
FALSE: Error

7.4.4.9 uaReleaseConfiguration**Description**

Closes the connection after configuration of the user archive.

```
BOOL uaReleaseConfiguration (  
UAHCONFIG hConfig,  
BOOL bSave )
```

Parameter

UAHCONFIG hConfig
Configuration handle of the user archive. The handle is set up with "uaQueryConfiguration".

BOOL bSave

Saves the configuration changes before closing the connection to the user archive.

TRUE: Save changes

FALSE: Discard changes

Note

You can only use the "BSAVE = TRUE" command when WinCC Runtime is not active!

Check if runtime is active using the "uIsActive" function.

Return value

TRUE: Connection successfully closed

FALSE: Error

See also

uIsActive (Page 1914)

7.4.4.10 uaRemoveAllArchives

Description

Deletes all user archives that are not used in views.

```
BOOL uaRemoveAllArchives
```

```
( UAHCONFIG hConfig )
```

Parameter

```
UAHCONFIG hConfig
```

Configuration handle of the user archive. The handle is set up with "uaQueryConfiguration".

Return value

TRUE: Successful deletion

FALSE: Error

Note

After calling the function, you can use "uaGetNumArchives()" to query whether all archives were deleted.

7.4.4.11 uaRemoveAllFields

Description

Deletes all data fields of a user archive.

```
BOOL uaRemoveAllFields (  
    UAHCONFIG hConfig,  
    long lArchive )
```

Parameter

```
UAHCONFIG hConfig,  
Configuration handle of the user archive. The handle is set up with "uaQueryConfiguration".  
long lArchive,  
Archiv Index (0 to (uaGetNumArchives()-1))
```

Return value

TRUE: Data fields successfully deleted
FALSE: Error

7.4.4.12 uaRemoveArchive

Description

Deletes the specified user archive.

```
BOOL uaRemoveArchive (  
    UAHCONFIG hConfig,  
    long lArchive )
```

Parameter

```
UAHCONFIG hConfig,  
Configuration handle of the user archive. The handle is set up with "uaQueryConfiguration".  
long lArchive,  
Archive Index (0 to (uaGetNumArchives()-1))
```

Return value

TRUE: User archive has been deleted successfully
FALSE: Error

7.4.4.13 uaRemoveField

Description

Removes a specific data field of a user archive.

```
BOOL uaRemoveField (  
    UAHCONFIG hConfig,  
    long lArchive,  
    long lField )
```

Parameter

UAHCONFIG hConfig,

Configuration handle of the user archive. The handle is set up with "uaQueryConfiguration".

long lArchive,

Archive Index (0 to (uaGetNumArchives()-1))

long lField,

The field number, where "lField = 0" addresses the first data field.

Return value

TRUE: Field has been deleted successfully

FALSE: Error

7.4.4.14 uaSetArchive

Description

Sets the configuration of a user archive.

```
BOOL uaSetArchive (  
    UAHCONFIG hConfig,  
    long lArchive,  
    UACONFIGARCHIVE* pArchive  
    )
```

Parameter

UAHCONFIG hConfig,

Configuration handle of the user archive. The handle is set up with "uaQueryConfiguration".

long lArchive,

Archive Index (0 to (uaGetNumArchives()-1))

UACONFIGARCHIVE* pArchive

Pointer to the buffer of the user archive configuration.

Return value

TRUE: Access to the user archive was successful

FALSE: Error

See also

Structure of the user archive configuration "uaCONFIGARCHIVE" (Page 1910)

7.4.4.15 uaSetField

Description

Sets the data field configuration.

```
BOOL uaSetField (  
    UAHCONFIG hConfig,  
    long lArchive,  
    long lField,  
    UACONFIGFIELD* pField )
```

Parameter

UAHCONFIG hConfig,

Configuration handle of the user archive. The handle is set up with "uaQueryConfiguration".

long lArchive,

Archive Index (0 to (uaGetNumArchives()-1))

long lField,

The field number, where "lField = 0" addresses the first field.

UACONFIGFIELD* pField

Pointer to the buffer of the field configuration.

Return value

TRUE: Access to the user archive was successful.

FALSE: Error

See also

Structure of the field configuration "uaCONFIGFIELD" (Page 1910)

7.4.4.16 Structure of the field configuration "uaCONFIGFIELD"

Structure "uaCONFIGFIELD"

```
typedef struct tagUACONFIGFIELD
{
    LONG lArchiveId; // Unique ID of the user archive
    LONG lFieldId; // Unique ID of the data field
    LONG lPosition; // Position of the user archive
    CHAR szName[UA_MAXLEN_NAME+1]; // Archive name max. 20 characters
    CHAR szAlias[UA_MAXLEN_ALIAS+1]; // Alias name max 50 characters
    LONG lType; //Archive type
    LONG lLength; /* Maximum number of characters if the data field is of STRING type; else
    not used */
    LONG lPrecision; // Is used internally; need not be populated
    CHAR szMinValue[UA_MAXLEN_VALUE+1]; /* Minimum for data fields that are not
    STRING or DATE type; else not used */
    CHAR szMaxValue[UA_MAXLEN_VALUE+1]; /* Maximum for data fields that are not
    STRING or DATE type; else not used */
    CHAR szStartValue[UA_MAXLEN_VALUE+1]; // Start value
    CHAR szDMVarName[UA_MAXLEN_DMVARNAME+1]; /* Tag from the Data Manager (is used
    for archives with communication via WinCC tags) */
    DWORD dwReadRight; // Read access rights
    DWORD dwWriteRight; // Write access rights
    DWORD dwFlags; // Last access
} UACONFIGFIELD;
```

See also

uaAddField (Page 1902)

7.4.4.17 Structure of the user archive configuration "uaCONFIGARCHIVE"

Structure type "uaCONFIGARCHIVE"

```
typedef struct tagUACONFIGARCHIVE
```

```

{
LONG lArchiveId; // Unique ID of the user archive
LONG lPosition; // Position of the user archive
CHAR szName[UA_MAXLEN_NAME+1]; // Archive name max. 20 characters
CHAR szAlias[UA_MAXLEN_ALIAS+1]; // Alias name max 50 characters
LONG lType; UA_ARCHIVETYPE_UNLIMITED // Archive type "unlimited"
UA_ARCHIVETYPE_LIMITED // Archive type "limited"
LONG lNumRecs; // max. number of data sets
LONG lCommType;
UA_COMMTYPE_NONE // no communication
UA_COMMTYPE_RAW // Communication via raw data
UA_COMMTYPE_DIRECT // Communication via Data Manager tags
CHAR szPLCID[UA_MAXLEN_PLCID+1]; // PLCID of raw data tags
CHAR szDMVarName[UA_MAXLEN_DMVARNAME+1]; // Name of the raw data tags
CHAR szIDVar[UA_MAXLEN_DMVARNAME+1]; // Control tag "ID"
CHAR szJobVar[UA_MAXLEN_DMVARNAME+1]; // Control tag "Job"
CHAR szFieldVar[UA_MAXLEN_DMVARNAME+1]; // Control tag "Field"
CHAR szValueVar[UA_MAXLEN_DMVARNAME+1]; // Control tag "Value"
DWORD dwReadRight; // Read access rights
DWORD dwWriteRight; // Write access rights
DWORD dwFlags; UA_ARCHIVEFLAG_ACCESS // "Last access" flag
UA_ARCHIVEFLAG_USER // "Last user" flag
} UACONFIGARCHIVE;

```

Note**LONG lArchiveId; //Unique ID of the user archive**

With "0", a unique ID is automatically used and returned for "uaGetArchive". This returned "ID" is then specified for "uaSetField". If ID "-1" is returned, the archive was not created.

See also

uaAddArchive (Page 1901)

7.4.5 General runtime functions

7.4.5.1 General runtime functions

Overview

The general Runtime functions are used for opening and closing user archives in Runtime.

You must first call the "uaConnect" function for access in Runtime. "uaConnect" creates the "UAHCONNECT" handle, which is needed to open the user archive. The handle enables you to use the following functions. You have to close the connection to "User Archive" again with the "uaDisconnect" function.

The "uaQueryArchive" or "uaQueryArchiveByName" functions create the "UAHARCHIVE" handle. The handle is required for using the "uaArchiveOpen" function. The user archive is opened in Runtime with "uaArchiveOpen".

After access with the Runtime functions, you first need to close the user archive using the "uaArchiveClose" function. Then close the connection to the current user archive with the "uaReleaseArchive" function.

Function	Description
uaConnect	Establish a connection to the user archive. This connection is valid for all user archives in Runtime
uaDisconnect	Closes the connection to the user archive
uaGetLocalEvents	Reads local events
ualsActive	Determines, if Runtime is active
uaOpenArchives	Determines the number of user archives open
uaOpenViews	Determines the number of open views
uaQueryArchive	Establishes a connection to a user archive
uaQueryArchiveByName	Establishes a connection to a user archive via the archive name
uaReleaseArchive	Closes the connection to the user archive.
uaSetLocalEvents	Sets local events
uaUsers	Finds the number of active connections or active users

7.4.5.2 uaConnect

Description

Establishes a connection to user archives in runtime.

```
BOOL uaConnect (
    UAHCONNECT* phConnect )
```

Parameter

```
UAHCONNECT* phConnect
```

Pointer to handle for the connected user archives.

Return value

TRUE: Connection to user archive successful

FALSE: Error

7.4.5.3 uaDisconnect**Description**

If a connection exists to user archives in runtime, it is closed.

```
BOOL uaDisconnect (  
    UAHCONNECT hConnect )
```

Parameter

UAHCONNECT hConnect

Handle for the connected user archives in runtime. The handle is set up with "uaConnect".

Return value

TRUE: Connection to user archive successfully closed

FALSE: Error

7.4.5.4 uaGetLocalEvents**Description**

The local events are read.

```
BOOL uaGetLocalEvents  
( UAHCONNECT hConnect )
```

Parameter

UAHCONNECT hConnect

Handle for the connected user archives in runtime. The handle is set up with "uaConnect".

Return value

The local event "bLocalEvents"

7.4.5.5 ualsActive

Description

Checks whether the user archive is active in runtime.

```
BOOL uaIsActive (  
    UAHCONNECT hConnect )
```

Parameter

UAHCONNECT hConnect

Handle for the connected user archives in runtime. This handle is set up with "uaConnect".

Return value

TRUE: The user archive is active in runtime

FALSE: The user archive is not active in runtime

7.4.5.6 uaOpenArchives

Description

Queries how many user archives are open in runtime.

```
LONG uaOpenArchives (  
    UAHCONNECT hConnect )
```

Parameter

UAHCONNECT hConnect

Handle for the connected user archives in runtime. This handle is set up with "uaConnect".

Return value

Number of user archives currently open

7.4.5.7 uaOpenViews

Description

Queries how many views are open in runtime.

```
LONG uaOpenViews (  
    UAHCONNECT hConnect )
```

Parameter

UAHCONNECT hConnect

Handle for the connected user archives in runtime. This handle is set up with "uaConnect".

Return value

Number of views currently open

7.4.5.8 uaQueryArchive**Description**

Establishes the connection to a user archive. "uaQueryArchive" creates the handle "UAHARCHIVE".

```
BOOL uaQueryArchive (  
    UAHCONNECT hConnect,  
    LONG lArchive,  
    UAHARCHIVE* phArchive )
```

Parameter

UAHCONNECT hConnect

Handle for the connected user archives in runtime. The handle is set up with "uaConnect".

LONG lArchive

Archive ID (1... uaGetNumArchives). A continuous numbering of the archive IDs cannot be ensured, because there may be gaps during ID assignment, e.g., by deleting archives.

UAHARCHIVE* phArchive

Pointer to handle for the connected user archive.

Return value

TRUE: Successful generation of the handle to the user Archive

FALSE: Error

Note

If you use user archive functions in a client project which views redundant server pairs, the user archive connection does not automatically switch to the new master when masters change. In this case, all user archive calls return the error "UA_ERROR_SERVER_UNKNOWN = 1004". You have to call the functions "uaQueryArchive" or "uaQueryArchiveByName" and "uaArchiveOpen" again.

7.4.5.9 uaQueryArchiveByName

Description

Establishes the connection to a user archive via the archive name. "uaQueryArchiveByName" creates the handle "UAHARCHIVE".

```
BOOL uaQueryArchiveByName (
    UAHCONNECT hConnect,
    LPCSTR pszName,
    UAHARCHIVE* phArchive )
```

Parameter

UAHCONNECT hConnect

Handle for the connected user archives in runtime. The handle is set up with "uaConnect".

LPCSTR pszName

Name of the user archive. If the standard server is not used in a client project, you can add a server prefix and "::" to the archive name.

UAHARCHIVE* phArchive

Pointer to handle for the connected user archive.

Return value

TRUE: Handle to the user archive has been generated successfully

FALSE: Error

Note

If you use user archive functions in a client project which views redundant server pairs, the user archive connection does not automatically switch to the new master when masters change. In this case, all user archive calls return the error "UA_ERROR_SERVER_UNKNOWN = 1004". You have to call the functions "uaQueryArchive" or "uaQueryArchiveByName" and "uaArchiveOpen" again.

7.4.5.10 uaReleaseArchive

Description

Closes the connection to the currently connected user archive.

```
BOOL uaReleaseArchive (
    UAHARCHIVE hArchive )
```

Parameter

UAHARCHIVE hArchive

Handle of the User Archive. This handle is generated with "uaQueryArchive" or "uaQueryArchiveByName".

Return value

TRUE: Connection to user archive successfully closed.

FALSE: Error

Note

You must set the handle "hArchive" to "ZERO" once the connection is successfully closed. This ensures that the error "UA_ERROR_INVALID_HANDLE" will be generated if the handle that is no longer valid continues to be used. This avoids unnecessary memory load.

7.4.5.11 uaSetLocalEvents**Description**

Sets local events.

```
void uaSetLocalEvents (
    UAHCONNECT hConnect
    BOOL bLocalEvents )
```

Parameter

UAHCONNECT hConnect

Handle for the connected user archives in runtime. This handle is set up with "uaConnect".

BOOL bLocalEvents

Local Event

7.4.5.12 uaUsers**Description**

Returns the number of all users connected to the user archive using "uaConnect". Note that this will also include internal WinCC calls to the user archive, in addition to calls initiated by the user (for example, from scripts).

```
LONG uaUsers (
    UAHCONNECT hConnect )
```

Parameter

UAHCONNECT hConnect

Handle for the connected user archives in runtime. This handle is set up with "uaConnect".

Return value

Number of active connections or users

7.4.6 Archive-specific runtime functions

7.4.6.1 Archive-specific runtime functions

Overview

After opening a user archive with the "uaArchiveOpen" function, you can use the following functions for operating the user archive in runtime.

The "uaQueryArchive" or "uaQueryArchiveByName" general runtime functions create the "UAHARCHIVE" handle. The handle is required for using the "uaArchiveOpen" function.

After access with the runtime functions, you need to close the user archive using the "uaArchiveClose" function. Then close the connection to the current user archive with the "uaReleaseArchive" general runtime function.

Note

You can use the "uaArchiveSetSort" and "uaArchiveSetFilter" functions without opening the user archive with "uaArchiveOpen".

Function	Description
uaArchiveClose	Closes the connection to the current user archive
uaArchiveDelete	Deletes a data record from the current user archive
uaArchiveExport	Exports the current user archive
uaArchiveGetCount	Reads the number of data records.
uaArchiveGetFieldLength	Reads the length of the current field
uaArchiveGetFieldName	Reads the name of the current field
uaArchiveGetFields	Reads the number of fields
uaArchiveGetFieldType	Reads the type of the current field
uaArchiveGetFieldValueDate	Reads date and time of the current data field
uaArchiveGetFieldValueDouble	Reads the double value of the current data field
uaArchiveGetFieldValueFloat	Reads the float value of the current data field
uaArchiveGetFieldValueLong	Reads the long value of the current data field
uaArchiveGetFieldValueString	Reads the string of the current data field

uaArchiveGetFilter	Reads the filter of the current data field
uaArchiveGetID	Reads the ID of the current data field
uaArchiveGetName	Reads the name of the current data field
uaArchiveGetSort	Reads the sorting of the current data field
uaArchiveImport	Imports the user archive
uaArchiveInsert	Inserts a new data record into the user archive
uaArchiveMoveFirst	Goes to the first data record
uaArchiveMoveLast	Goes to the last data record
uaArchiveMoveNext	Goes to the next data record
uaArchiveMovePrevious	Goes to the previous data record
uaArchiveOpen	Establishes a connection to the current user archive
uaArchiveReadTagValues	Reads the tag values
uaArchiveReadTagValuesByName	Reads the tag values based on the name
uaArchiveRequery	New Query
uaArchiveSetFieldValueDate	Writes the current data field
uaArchiveSetFieldValueDouble	Writes the double value of the current data field
uaArchiveSetFieldValueFloat	Writes the float value of the current data field
uaArchiveSetFieldValueLong	Writes the long value of the current data field
uaArchiveSetFieldValueString	Writes the sting of the current data field
uaArchiveSetFilter	Sets the filter
uaArchiveSetSort	Sets the sort criterion
uaArchiveUpdate	Updates the user archive which is open.
uaArchiveWriteTagValues	Writes the values of the current data record to the tag
uaArchiveWriteTagValuesByName	Writes the values of the current data record to the tag based on the name

7.4.6.2 uaArchiveClose

Description

Closes the currently open user archive.

```
BOOL uaArchiveClose (
    UAHARCHIVE hArchive )
```

Parameter

```
UAHARCHIVE hArchive
```

Handle of the User Archive. This handle is generated with "uaQueryArchive" or "uaQueryArchiveByName".

Return value

TRUE: User archive has been closed successfully

FALSE: Error

7.4.6.3 uaArchiveDelete

Description

Deletes the data from a user archive. The configured user archive is retained.

```
BOOL uaArchiveDelete (  
    UAHARCHIVE hArchive,  
    LPCSTR pszWhere )
```

Parameter

UAHARCHIVE hArchive

Handle of the User Archive. This handle is generated with "uaQueryArchive" or "uaQueryArchiveByName".

LPCSTR pszWhere

String with the SQL selection of data records to be deleted. The string corresponds to the SQL statement "DELETE FROM <archive> WHERE pszWhere".

Note

If "pszWhere" is empty, the entire user archive is deleted.

Return value

TRUE: User archive has been deleted successfully

FALSE: Error

7.4.6.4 uaArchiveExport

Description

Exports the current user archive to a CSV file.

```
BOOL uaArchiveExport (  
    UAHARCHIVE hArchive,  
    LPCSTR pszDestination,  
    LONG lType,  
    LONG lOptions )
```

Parameter

UAHARCHIVE hArchive

Handle of the User Archive. This handle is generated with "uaQueryArchive" or "uaQueryArchiveByName".

LPCSTR pszDestination

Name of the destination file. When calling the function on clients, the path specification refers to the server computer.

LONG lType

Data format of the destination file. Two formats are available:

- "UA_FILETYPE_DEFAULT = 0": The default file format "CSV".
- "UA_FILETYPE_CSV = 1": CSV file format

LONG lOptions

Options reserved for future expansion. "lOptions" must have the value "0".

Return value

TRUE: User archive has been exported successfully

FALSE: Error

7.4.6.5 uaArchiveGetCount**Description**

Reads the number of data records.

```
LONG uaArchiveGetCount (
    UAHARCHIVE hArchive,
    LONG * plCount )
```

Parameter

UAHARCHIVE hArchive

Handle of the User Archive. This handle is generated with "uaQueryArchive" or "uaQueryArchiveByName".

LONG plCount

Pointer to a tag in which the number of data records is to be stored.

Return value

Number of data records. With "0", the archive is empty or an error has occurred. The "uaGetLastError" query is required.

7.4.6.6 uaArchiveGetFieldLength

Description

Reads the length of a field in the current data record.

```
LONG uaArchiveGetFieldLength(  
    UAHARCHIVE hArchive,  
    LONG lField )
```

Parameter

UAHARCHIVE hArchive

Handle of the User Archive. This handle is generated with "uaQueryArchive" or "uaQueryArchiveByName".

LONG lField

The field number, where "lField = 1" addresses the first configured field. "lField = 0" addresses the "ID" field.

Return value

Length of the current field

7.4.6.7 uaArchiveGetFieldName

Description

Reads the name of a field in the current data record.

```
VOID uaArchiveGetFieldName (  
    UAHARCHIVE hArchive,  
    LONG lField,  
    LPCSTR pszName,  
    LONG cMaxLen )
```

Parameter

UAHARCHIVE hArchive

Handle of the User Archive. This handle is generated with "uaQueryArchive" or "uaQueryArchiveByName".

LONG lField

The field number, where "lField = 1" addresses the first configured field. "lField = 0" addresses the "ID" field.

LPCSTR pszName

Field Name

LONG cMaxLen

Maximum Length

7.4.6.8 uaArchiveGetFields

Description

Reads the number of configured data fields. The "ID", "Last user" and "Last access" fields are included. In the runtime calls, the indices of the configured fields are indicated with "1" to "N". The "ID" field has the index "0". The "Last user" and "Last access" fields are appended to the end of the configured fields.

```
LONG uaArchiveGetFields (  
    UAHARCHIVE hArchive )
```

Parameter

UAHARCHIVE hArchive

Handle of the User Archive. This handle is generated with "uaQueryArchive" or "uaQueryArchiveByName".

Return value

Number of the configured fields.

7.4.6.9 uaArchiveGetFieldType

Description

Reads the type of a field in the current data record.

```
LONG uaArchiveGetFieldType (  
    UAHARCHIVE hArchive,  
    LONG lField )
```

Parameter

UAHARCHIVE hArchive

Handle of the User Archive. This handle is generated with "uaQueryArchive" or "uaQueryArchiveByName".

LONG lField

The field number, where "lField = 1" addresses the first configured field. "lField = 0" addresses the "ID" field.

Return value

Type of the current field.

The symbolic definitions of the field types are:

- UA_FIELDTYPE_INTEGER
- UA_FIELDTYPE_FLOAT
- UA_FIELDTYPE_DOUBLE
- UA_FIELDTYPE_STRING
- UA_FIELDTYPE_DATETIME

7.4.6.10 uaArchiveGetFieldValueDate

Description

Reads the date and time of a field in the current data record.

```
BOOL uaArchiveGetFieldValueDate (  
    UAHARCHIVE hArchive,  
    LONG lField,  
    LPSYSTEMTIME pstDateTime )
```

Parameter

UAHARCHIVE hArchive

Handle of the User Archive. This handle is generated with "uaQueryArchive" or "uaQueryArchiveByName".

LONG lField

The field number, where "lField = 1" addresses the first configured field. "lField = 0" addresses the "ID" field.

LPSYSTEMTIME pstDateTime

Pointer to the tag of the "SYSTEMTIME" type

Return value

TRUE: Successful reading of date and time

FALSE: Error

7.4.6.11 uaArchiveGetFieldValueDouble

Description

Reads the "double" value of a field in the current data record.

```
BOOL uaArchiveGetFieldValueDouble (  
    UAHARCHIVE hArchive,  
    LONG lField,  
    double* pdValue )
```

Parameter

UAHARCHIVE hArchive

Handle of the User Archive. This handle is generated with "uaQueryArchive" or "uaQueryArchiveByName".

LONG lField

The field number, where "lField = 1" addresses the first configured field. "lField = 0" addresses the "ID" field.

double* pdValue

Pointer to the tag of the current field content.

Return value

TRUE: Value successfully read.

FALSE: Error

7.4.6.12 uaArchiveGetFieldValueFloat

Description

Reads the "float" value of a field in the current data record.

```
BOOL uaArchiveGetFieldValueFloat (  
    UAHARCHIVE hArchive,  
    LONG lField,  
    FLOAT* pfValue )
```

Parameter

UAHARCHIVE hArchive

Handle of the User Archive. This handle is generated with "uaQueryArchive" or "uaQueryArchiveByName".

7.4 User archive functions

LONG lField

The field number, where "lField = 1" addresses the first configured field. "lField = 0" addresses the "ID" field.

FLOAT* pfValue

Pointer to the tag of the current field content.

Return value

TRUE: Value successfully read

FALSE: Error

7.4.6.13 uaArchiveGetFieldValueLong

Description

Reads the "long" value of a field in the current data record.

```
BOOL uaArchiveGetFieldValueLong (  
    UAHARCHIVE hArchive,  
    LONG lField,  
    LONG* pdValue )
```

Parameter

UAHARCHIVE hArchive

Handle of the User Archive. This handle is generated with "uaQueryArchive" or "uaQueryArchiveByName".

LONG lField

The field number, where "lField = 1" addresses the first configured field. "lField = 0" addresses the "ID" field.

LONG* pdValue

Pointer to the tag of the current field content.

Return value

TRUE: Value successfully read.

FALSE: Error

7.4.6.14 uaArchiveGetFieldValueString

Description

Reads the string of a field in the current data record.

```
BOOL uaArchiveGetFieldValueString (  
    UAHARCHIVE hArchive,  
    LONG lField,  
    LPSTR pszString,  
    LONG cMaxLen )
```

Parameter

UAHARCHIVE hArchive

Handle of the User Archive. This handle is generated with "uaQueryArchive" or "uaQueryArchiveByName".

LONG lField

The field number, where "lField = 1" addresses the first configured field. "lField = 0" addresses the "ID" field.

LPCSTR pszString

Value as string.

LONG cMaxLen

Maximum length of the string.

Return value

TRUE: Value successfully read

FALSE: Error

7.4.6.15 uaArchiveGetFilter

Description

Reads the selection criteria of the current data record.

```
VOID uaArchiveGetFilter (  
    UAHARCHIVE hArchive,  
    LPSTR pszFilter,  
    LONG cMaxLen )
```

Parameter

UAHARCHIVE hArchive

Handle of the User Archive. This handle is generated with "uaQueryArchive" or "uaQueryArchiveByName".

LPSTR pszFilter

Selection criterion in SQL.

LONG cMaxLen

Maximum length.

7.4.6.16 uaArchiveGetID

Description

Reads the "ID" of the user archive.

```
LONG uaArchiveGetID (
    UAHARCHIVE hArchive )
```

Parameter

UAHARCHIVE hArchive

Handle of the User Archive. This handle is generated with "uaQueryArchive" or "uaQueryArchiveByName".

Return value

"ID" of the user archive

7.4.6.17 uaArchiveGetName

Description

Reads the name of the user archive.

```
VOID uaArchiveGetName (
    UAHARCHIVE hArchive,
    LPSTR pszName,
    LONG cMaxLen )
```

Parameter

UAHARCHIVE hArchive

Handle of the User Archive. This handle is generated with "uaQueryArchive" or "uaQueryArchiveByName".

LPSTR pszName

Pointer to the buffer for the user archive name.

LONG cMaxLen

Maximum length.

Example

```
char tank [40];
uaArchiveGetName( hArchive, tank, 39 );
```

7.4.6.18 uaArchiveGetSort

Description

Reads the sorting criteria of the user archive.

```
VOID uaArchiveGetSort (
    UAHARCHIVE hArchive,
    LPSTR pszSort,
    LONG cMaxLen )
```

Parameter

UAHARCHIVE hArchive

Handle of the User Archive. This handle is generated with "uaQueryArchive" or "uaQueryArchiveByName".

LPCSTR pszSort

Selection criteria in SQL.

LONG cMaxLen

Maximum length.

7.4.6.19 uaArchiveImport

Description

Imports a user archive with the CSV data format. The structure of the target archive must be identical to the imported CSV archive.

```
BOOL uaArchiveImport (
    UAHARCHIVE hArchive,
```

7.4 User archive functions

```
LPCSTR pszSource,  
LONG lType,  
LONG lOptions )
```

Parameter

UAHARCHIVE hArchive

Handle of the User Archive. This handle is generated with "uaQueryArchive" or "uaQueryArchiveByName".

LPCSTR pszSource

File name of the source archive.

LONG lType

Data format of the source archive. Two formats are available:

- "UA_FILETYPE_DEFAULT = 0": The default file format "CSV".
- "UA_FILETYPE_CSV = 1": CSV file format

LONG lOptions

Options reserved for future expansion. "lOptions" must have the value "0".

Return value

TRUE: User archive has been imported successfully

FALSE: Error

7.4.6.20 uaArchiveInsert

Description

Inserts the local data record buffer into the archive. To have useful data in the new data record, you need to fill the fields of the local data record buffer using "uaArchiveSetFieldValue..." functions before calling "uaArchiveInsert".

You need to fill the internal "ID" field with an ID not yet used in the archive or with 0 using the "uaArchiveSetFieldValueLong" function.

```
BOOL uaArchiveInsert (  
UAHARCHIVE hArchive )
```

Parameter

UAHARCHIVE hArchive

Handle of the User Archive. This handle is generated with "uaQueryArchive" or "uaQueryArchiveByName".

Return value

TRUE: Successful insertion of the data record

7.4.6.21 uaArchiveMoveFirst**Description**

Goes to the first data record.

```
BOOL uaArchiveMoveFirst (  
    UAHARCHIVE hArchive )
```

Parameter

UAHARCHIVE hArchive

Handle of the User Archive. This handle is generated with "uaQueryArchive" or "uaQueryArchiveByName".

Return value

TRUE: Successful jump in the user archive

FALSE: Error

7.4.6.22 uaArchiveMoveLast**Description**

Goes to the last data record.

```
BOOL uaArchiveMoveLast (  
    UAHARCHIVE hArchive )
```

Parameter

UAHARCHIVE hArchive

Handle of the User Archive. This handle is generated with "uaQueryArchive" or "uaQueryArchiveByName".

Return value

TRUE: Successful jump in the user archive

FALSE: Error

7.4.6.23 uaArchiveMoveNext

Description

Goes to the next data record.

```
BOOL uaArchiveMoveNext (  
    UAHARCHIVE hArchive )
```

Parameter

UAHARCHIVE hArchive

Handle of the User Archive. This handle is generated with "uaQueryArchive" or "uaQueryArchiveByName".

Return value

TRUE: Successful jump in the user archive

FALSE: Error

7.4.6.24 uaArchiveMovePrevious

Description

Goes to the previous data record.

```
BOOL uaArchiveMovePrevious (  
    UAHARCHIVE hArchive )
```

Parameter

UAHARCHIVE hArchive

Handle of the User Archive. This handle is generated with "uaQueryArchive" or "uaQueryArchiveByName".

Return value

TRUE: Successful jump in the user archive

FALSE: Error

7.4.6.25 uaArchiveOpen

Description

Opens an existing user archive. Calling "uaArchiveOpen" is required if you use read or write operations in the user archive, for example before calling the functions "uaArchiveMoveNext", "uaArchiveDelete" or "uaArchiveUpdate".

```
BOOL uaArchiveOpen (  
    UAHARCHIVE hArchive )
```

Parameter

UAHARCHIVE hArchive

Handle of the User Archive. This handle is generated with "uaQueryArchive" or "uaQueryArchiveByName".

Return value

TRUE: User archive has been opened successfully

FALSE: Error

7.4.6.26 uaArchiveReadTagValues

Description

Reads the current value from the field tag.

```
BOOL uaArchiveReadTagValues (  
    UAHARCHIVE hArchive,  
    LONG* pnFields,  
    LONG cFields,  
    LONG lOptions )
```

Parameter

UAHARCHIVE hArchive

Handle of the User Archive. This handle is generated with "uaQueryArchive" or "uaQueryArchiveByName".

LONG* pnFields

Reserved for later expansions. "pnFields" must have the value "0".

LONG cFields

Number of transferred field indices. Corresponds to the size of the array "pnFields". Reserved for later expansions. "cFields" must have the value "0".

LONG lOptions

Options. Reserved for later expansions. "IOptions" must have the value "0". For all other values of "IOptions", the data is inserted at the position of the pointer.

Return value

TRUE: Successful reading in the user archive

FALSE: Error

7.4.6.27 uaArchiveReadTagValuesByName

Description

Reads the tag values in the current data.

```
BOOL uaArchiveReadTagValuesByName (  
    UAHARCHIVE hArchive,  
    LPCSTR pszFields,  
    LONG lOptions )
```

Parameter

UAHARCHIVE hArchive

Handle of the User Archive. This handle is generated with "uaQueryArchive" or "uaQueryArchiveByName".

LPCSTR pszFields

Reserved for later expansions. "pszFields" must have the value "ZERO".

LONG lOptions

Options. Reserved for later expansions. "IOptions" must have the value "0".

Return value

TRUE: Successful reading in the user archive

FALSE: Error

7.4.6.28 uaArchiveRequery

Description

After calling "uaArchiveSetFilter" and "uaArchiveSetSort", you need to reload the user archive using "uaArchiveRequery".

Also call "uaArchiveRequery":

- If you have entered values in the UserArchiveControl.
- If you have entered values in the "User Archive" editor which were applied in the table window.

Note

You can use the "uaArchiveSetSort" and "uaArchiveSetFilter" functions without opening the user archive with "uaArchiveOpen". In case, do not call the "uaArchiveRequery" function.

```
BOOL uaArchiveRequery(  
UAHARCHIVE hArchive )
```

Parameter

UAHARCHIVE hArchive

Handle of the User Archive. This handle is generated with "uaQueryArchive" or "uaQueryArchiveByName".

Return value

TRUE: Data successfully queried

FALSE: Error

7.4.6.29 uaArchiveSetFieldValueDate

Description

Writes the date and time into a field of the current data record.

```
BOOL uaArchiveSetFieldValueDate (  
UAHARCHIVE hArchive,  
LONG lField,  
LPSYSTEMTIME pstDateTime )
```

Parameter

UAHARCHIVE hArchive

7.4 User archive functions

Handle of the User Archive. This handle is generated with "uaQueryArchive" or "uaQueryArchiveByName".

LONG lField

The field number, where "lField = 1" addresses the first configured field. "lField = 0" addresses the "ID" field.

LPSYSTEMTIME pstDateTime

Date and time for the particular field.

Return value

TRUE: Successful writing of date and time

FALSE: Error

7.4.6.30 uaArchiveSetFieldValueDouble

Description

Writes a "double" value into a field of the current data record.

```
BOOL uaArchiveSetFieldValueDouble (  
    UAHARCHIVE hArchive,  
    LONG lField,  
    double dValue )
```

Parameter

UAHARCHIVE hArchive

Handle of the User Archive. This handle is generated with "uaQueryArchive" or "uaQueryArchiveByName".

LONG lField

The field number, where "lField = 1" addresses the first configured field. "lField = 0" addresses the "ID" field.

double dValue

Value for the particular field.

Return value

TRUE: Value successfully written

FALSE: Error

7.4.6.31 uaArchiveSetFieldValueFloat

Description

Writes a "float" value into a field of the current data record.

```
BOOL uaArchiveSetFieldValueFloat (  
    UAHARCHIVE hArchive,  
    LONG lField,  
    float fValue )
```

Parameter

UAHARCHIVE hArchive

Handle of the User Archive. This handle is generated with "uaQueryArchive" or "uaQueryArchiveByName".

LONG lField

The field number, where "lField = 1" addresses the first configured field. "lField = 0" addresses the "ID" field.

float fValue

Value for the particular field.

Return value

TRUE: Value successfully written

FALSE: Error

7.4.6.32 uaArchiveSetFieldValueLong

Description

Writes a "long" value into a field of the current data record.

```
BOOL uaArchiveSetFieldValueLong (  
    UAHARCHIVE hArchive,  
    LONG lField,  
    LONG dValue )
```

Parameter

UAHARCHIVE hArchive

Handle of the User Archive. This handle is generated with "uaQueryArchive" or "uaQueryArchiveByName".

7.4 User archive functions

LONG lField

The field number, where "lField = 1" addresses the first configured field. "lField = 0" addresses the "ID" field.

LONG dValue

Value for the particular field.

Return value

TRUE: Value successfully written

FALSE: Error

7.4.6.33 uaArchiveSetFieldValueString

Description

Writes a String into a field of the current data record.

```
BOOL uaArchiveSetFieldValueString (  
    UAHARCHIVE hArchive,  
    LONG lField,  
    LPCSTR pszString )
```

Parameter

UAHARCHIVE hArchive

Handle of the User Archive. This handle is generated with "uaQueryArchive" or "uaQueryArchiveByName".

LONG lField

The field number, where "lField = 1" addresses the first configured field. "lField = 0" addresses the "ID" field.

LPCSTR pszString

String for the particular field.

Return value

TRUE: String successfully written

FALSE: Error

7.4.6.34 uaArchiveSetFilter

Description

Sets the selection criteria for the user archive. You can also call the function without opening the archive using "uaArchiveOpen".

Note

If you have opened the user archive using "uaArchiveOpen", reload it after filtering it with "uaArchiveRequery".

```
VOID uaArchiveSetFilter (  
    UAHARCHIVE hArchive,  
    LPSTR pszFilter )
```

Parameter

UAHARCHIVE hArchive

Handle of the User Archive. This handle is generated with "uaQueryArchive" or "uaQueryArchiveByName".

LPSTR pszFilter

Selection criterion in SQL.

7.4.6.35 uaArchiveSetSort

Description

Sets the sorting of the user archive. You can also call the function without opening the archive using "uaArchiveOpen".

Note

If you have opened the user archive using "uaArchiveOpen", reload it after sorting it with "uaArchiveRequery".

```
BOOL uaArchiveSetSort (  
    UAHARCHIVE hArchive,  
    LPSTR pszSort )
```

Parameter

UAHARCHIVE hArchive

7.4 User archive functions

Handle of the User Archive. This handle is generated with "uaQueryArchive" or "uaQueryArchiveByName".

LPCSTR pszSort

Selection criteria in SQL.

Return value

TRUE: Sorting successful

FALSE: Error

7.4.6.36 uaArchiveUpdate

Description

Updates the user archive which is open.

All data changes in the current data record of a user archive are applied in the database. The data record must be read in beforehand by one of the following functions:

- uaArchiveNext
- uaArchivePrevious
- uaArchiveFirst
- uaArchiveLast

The configuration of the user archive remains unchanged.

```
BOOL uaArchiveUpdate (  
    UAHARCHIVE hArchive )
```

Parameter

UAHARCHIVE hArchive

Handle of the User Archive. This handle is generated with "uaQueryArchive" or "uaQueryArchiveByName".

Return value

TRUE: User archive successfully updated

FALSE: Error "Update_failed = 106". The error occurs at a consistency violation. For example when the "Field must possess a value" option is set for a field, but there is no value in the field.

7.4.6.37 uaArchiveWriteTagValues

Description

Writes the values of the current data record to the tag. The execution of subsequent scripts only continues when this synchronous write request has been processed.

```
BOOL uaArchiveWriteTagValues (  
    UAHARCHIVE hArchive,  
    LONG* pnFields,  
    LONG cFields,  
    LONG lOptions )
```

Parameter

UAHARCHIVE hArchive

Handle of the User Archive. This handle is generated with "uaQueryArchive" or "uaQueryArchiveByName".

LONG* pnFields

Reserved for later expansions. "pnFields" must have the value "0".

LONG cFields

Number of transferred field indices. Corresponds to the size of the array "pnFields". Reserved for later expansions. "cFields" must have the value "0".

LONG lOptions

Options. Reserved for later expansions. "lOptions" must have the value "0".

Return value

TRUE: Writing to the user archive successfully completed

FALSE: Error

7.4.6.38 uaArchiveWriteTagValuesByName

Description

Writes the values of the current data record to the tag.

```
BOOL uaArchiveWriteTagValuesByName (  
    UAHARCHIVE hArchive,  
    LPCSTR pszFields,  
    LONG lOptions )
```

Parameter

UAHARCHIVE hArchive

Handle of the User Archive. This handle is generated with "uaQueryArchive" or "uaQueryArchiveByName".

LPCSTR pszFields

Reserved for later expansions. "pszFields" must have the value "ZERO".

LONG lOptions

Options. Reserved for later expansions. "lOptions" must have the value "0".

Return value

TRUE: Writing to the user archive successfully completed

FALSE: Error

7.4.7 Troubleshooting functions

7.4.7.1 uaGetLastError

Description

Many users archive functions return a BOOL value. The "TRUE" value means error-free execution of the function. If the "FALSE" value is returned, the error of the most recently used function can be read with the "uaGetLastError()" and "uaGetLastHResult" functions.

If "uaGetLastError" is called after several functions have been executed, it returns the error that occurred last. In order to know exactly with which function the error occurred, you need to call the "uaGetLastError" and "uaGetLastHResult" functions after each call to a function with a BOOL value.

Example

```
if ( uaArchiveGetFieldValueLong ( hArchive, Index, &IntValue ) ==
TRUE )
printf( "Field Value = %u\n", IntValue );
else
printf("Error calling uaArchiveGetFieldValueLong: %d / %08lx\n",
uaGetLastError(), uaGetLastHResult());
```

For functions that do not return a value (VOID), you must in any case call the "uaGetLastError" function:

```
uaArchiveGetFilter(hArchive, pszFilter, cMaxLen);
INT nUAEError = uaGetLastError ( );
```

```
if ( UA_ERROR_SUCCESS != nUAEError)
{
    printf( "Filter = [%s]\n", pszFilter );
}
else
{
    printf("Error calling uaArchiveGetFilter: %d, hr=0x%08lX\n",
nUAEError, uaGetLastHRESULT());
}
INT uaGetLastError()
```

Return value

Error status of the last function executed. The error constants and the "Predefines" of the user archive functions are located in "CCUACAPI.H".

The following errors can be returned with "uaGetLastError":

- UA_ERROR_SUCCESS
- UA_ERROR_GENERIC
- UA_ERROR_CONNECT_FAILED
- UA_ERROR_OPEN_FAILED
- UA_ERROR_CLOSE_FAILED
- UA_ERROR_REQUERY_FAILED
- UA_ERROR_MOVE_FAILED
- UA_ERROR_INSERT_FAILED
- UA_ERROR_UPDATE_FAILED
- UA_ERROR_DELETE_FAILED
- UA_ERROR_IMPORT_FAILED
- UA_ERROR_EXPORT_FAILED
- UA_ERROR_READ_FAILED
- UA_ERROR_WRITE_FAILED
- UA_ERROR_GET_FAILED
- UA_ERROR_SET_FAILED
- UA_ERROR_INVALID_NAME
- UA_ERROR_INVALID_TYPE
- UA_ERROR_INVALID_NUMRECS
- UA_ERROR_INVALID_COMMTYPE
- UA_ERROR_INVALID_LENGTH

7.4 User archive functions

- UA_ERROR_INVALID_PRECISION
- UA_ERROR_NULL_POINTER
- UA_ERROR_INVALID_POINTER
- UA_ERROR_INVALID_HANDLE
- UA_ERROR_INVALID_INDEX
- UA_ERROR_SERVER_UNKNOWN

7.4.7.2 uaGetLastHResult

Description

Reads the COM error which occurred most recently. The function is used primarily for diagnostics of incompatibilities in the employed COM implementation or for detecting registration and communication problems. This function should also be used in addition to "UaGetLastError", when a user archive function returns a "FALSE".

`LONG uaGetLastHResult()`

Return value

Most recently occurred COM error

7.5 WinCC UserArchiveControl

7.5.1 WinCC UserArchiveControl

Functional scope

The WinCC UserArchiveControl provides access capability to archives and views of user archives. In Runtime, you can:

- Create, delete or modify new data records
- Browsing in user archives
- Read and write tags for direct tag link
- Import and export user archive
- Define selection criteria to display a certain portion of the user archive only
- Define sorting conditions for the displayed user archive columns

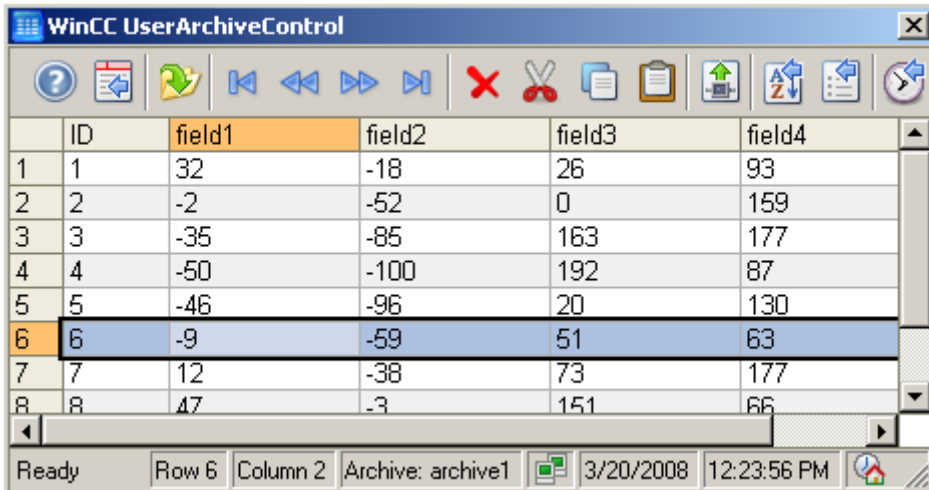

	ID	field1	field2	field3	field4
1	1	32	-18	26	93
2	2	-2	-52	0	159
3	3	-35	-85	163	177
4	4	-50	-100	192	87
5	5	-46	-96	20	130
6	6	-9	-59	51	63
7	7	12	-38	73	177
8	8	47	-3	151	66

Ready | Row 6 | Column 2 | Archive: archive1 | 3/20/2008 | 12:23:56 PM

Properties

You connect a UserArchiveControl with a selected user archive or a view in the configuration. For access, the user archive or the view must be enabled. If you remove the access protection, you must connect the WinCC UserArchiveControl with the user archive again in the configuration dialog.

Access protection for a user archive or field is queried on opening a screen of the UserArchiveControl:

- If the user has no authorization for reading the user archive, no data are shown but the column headings in the table are shown.
- If the user has no read access to a field, the respective user archive column is not shown in the table.

7.5 WinCC UserArchiveControl

- If the user has no authorization for writing in the user archive, the user cannot edit the data in the table.
- If the user has no write access to a field, the user cannot edit the respective user archive column in the table.

Access protection for the control tag of a protective archive must be configured separately with the object properties e.g. a picture, an IO field or a button.

See also

Short Description of the WinCC Controls and Additional Controls (Page 749)

7.5.2 Configuring the UserArchiveControl

7.5.2.1 How to configure the UserArchiveControl

Introduction

The values of the user archive are shown in runtime in an ActiveX control. You can configure a WinCC UserArchiveControl for this in the Graphics Designer.

Requirements

- You have configured an archive or a view in the user archive.

Configuration steps

1. Link the WinCC UserArchiveControl to a Graphics Designer picture.
2. Configure the basic properties for the UserArchiveControl on the "General" tab.
 - The table window properties
 - The general properties of the control
 - The time base of the control
 - The editing capabilities of the contents in control

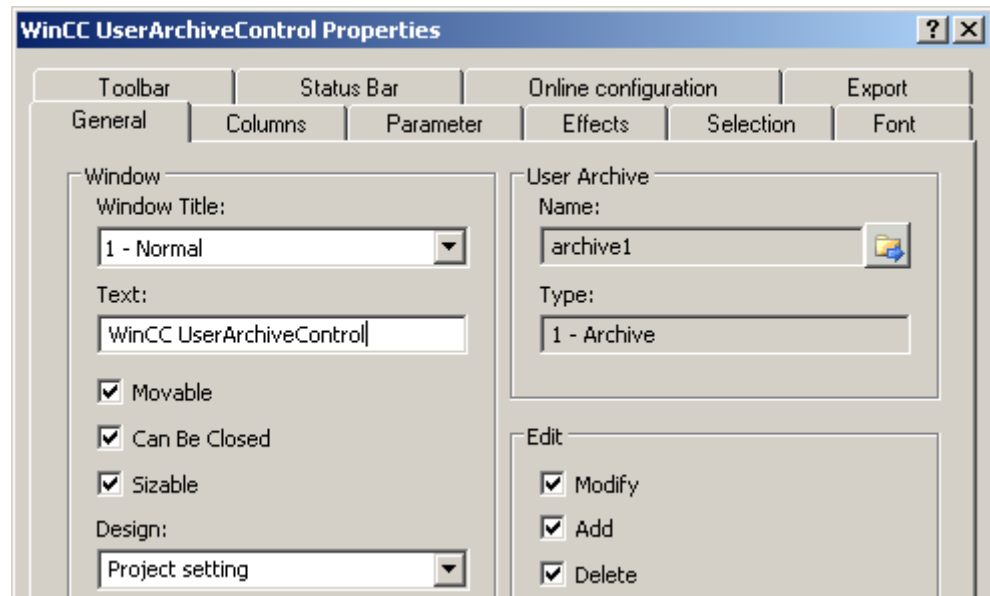

3. Connect the UserArchiveControl with an archive or a view of the user archive.
4. Define the content of the table of the UserArchiveControl, in which you configure the selected columns from the user archive.
5. Configure the display and properties of the table on the "Parameter", "Display" and "Marker" tabs.
6. Configure the toolbar and the status bar of the table window on the respective tabs
7. Save the configuration.

7.5.2.2 How to define the contents of the UserArchiveControl

Introduction

The WinCC UserArchiveControl shows the data of the connected user archive in a table. The displayed content of the table is determined by the selected columns of the user archive and the selection of column content.

Requirement

- You have created one or more user archives or views.
- You have connected the UserArchiveControl with a user archive or a view.

Configures the columns of the user archive.

1. Go to the "Columns" tab.

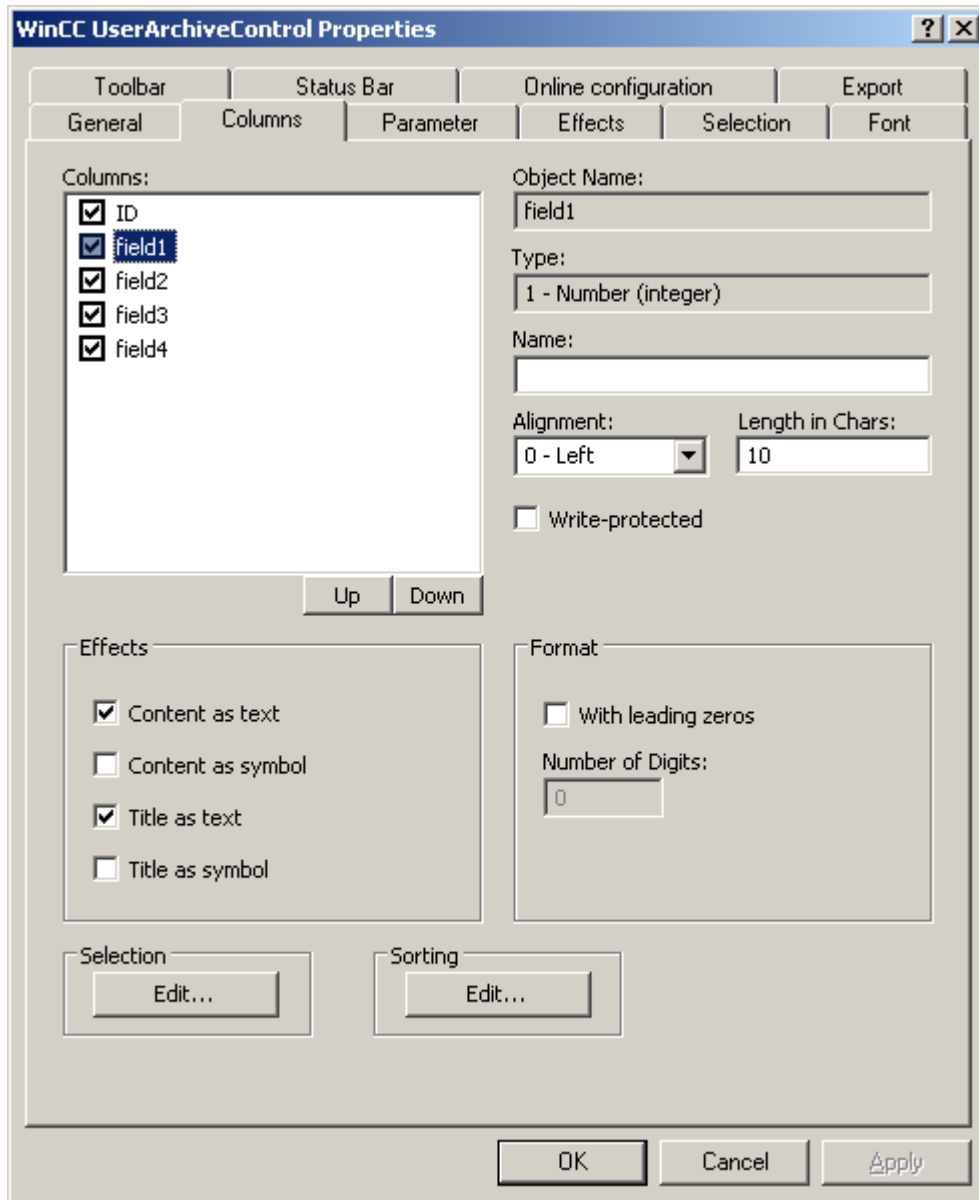

2. In the "Columns" list, you will see the fields of the connected archive or view. If a checkmark is set in the column in front of the name, the column is displayed in the table. Deactivate the check box if you do not want it to appear.
3. Determine the order of the columns in the table using the "Up" and "Down" buttons.

4. Select a column to configure the properties and the format.
5. If necessary, change the width of the column in the table. Enter a value in the "Length in chars" field.
6. Some columns can also show the content and the header as a symbol. Determine how these columns are displayed in the "Display" field. Text and symbols can be displayed at the same time.
7. Save the configuration.

Selection of column content that will be displayed in the table

Configure criteria used to display the content in the columns in the "Selection" area.

Procedure

1. Click "Edit...". The selection dialog is opened.

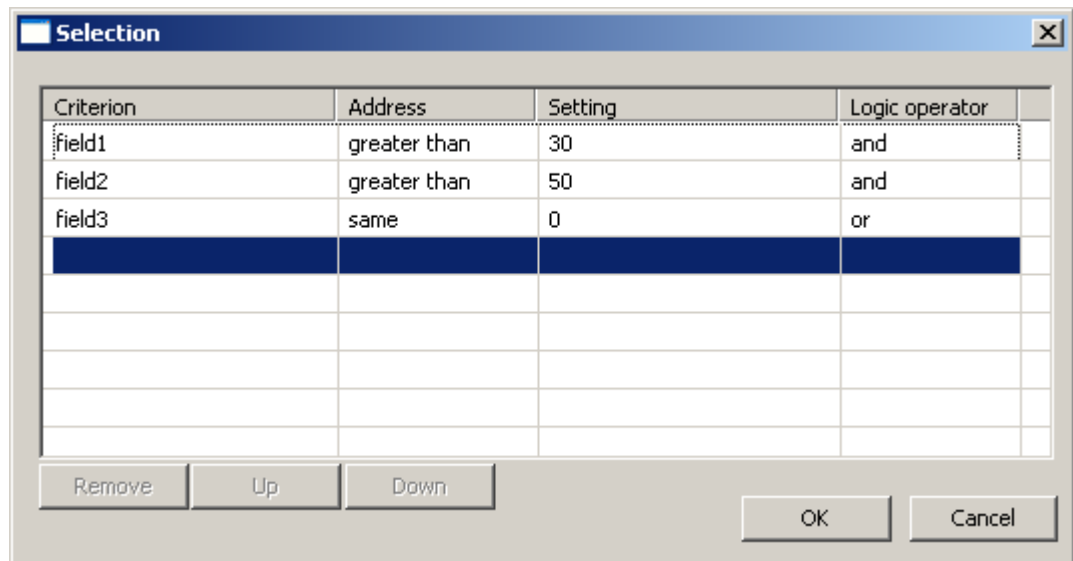

2. Specify the criteria for the display. More information on the selection of columns can be found under AUTOHOTSPOT.
3. Click "OK" to close the selection dialog. The selection is applied at runtime start in the table of the UserArchiveControl.

Configuring the Sorting of Columns

You configure the sorting of the columns in the table of the UserArchiveControl in the "Sorting" area. You can also specify the sorting criteria in runtime using the key functions.

1. Click "Edit...". The sorting dialog opens.

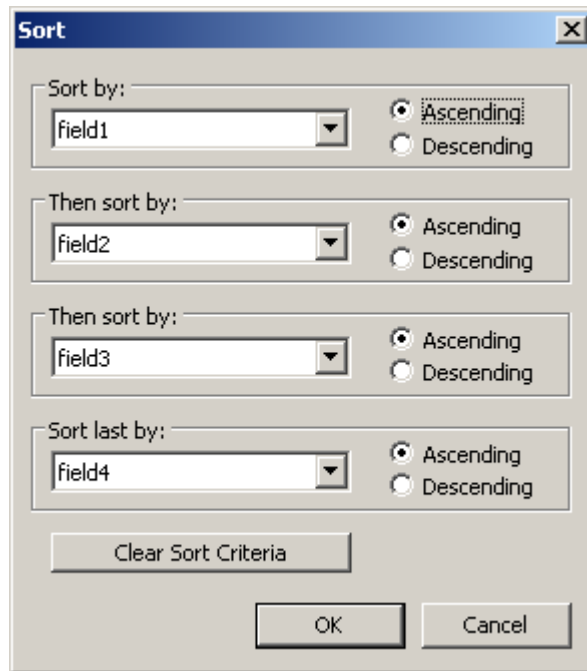

2. Set a sorting sequence. More information on the sorting of columns can be found under AUTOHOTSPOT.
3. Click "OK" to close the sorting dialog.
4. Save the configuration of the content of the UserArchiveControl.

7.5.2.3 How to configure the display for the table

How to configure the properties of the table elements

Introduction

You can adjust the properties of the table elements in the WinCC controls to suit requirements.

Prerequisite

- You opened Graphics Designer and configured a picture with a WinCC control.
- The configuration dialog of the WinCC control is open.

Procedure

1. Go to the "Parameter" tab.

The screenshot shows the configuration dialog for the WinCC UserArchiveControl. It is divided into four sections:

- Column Header:**
 - Show
 - Shorten content
 - Width can be changed
 - Alignment:
- Sort:**
 - Sort by column header:
 - Sorting order on mouse click:
 - Show sorting symbol
 - Show sorting index
 - Use sorting key
- Row Label:**
 - Show
 - Alignment:
- Table Content:**
 - Show empty columns
 - Show empty rows
 - Shorten content

2. Specify the properties for
 - Column Header
 - Row label
 - Sorting
 - Table Content
3. Save the configuration.

How to configure the colors of the table elements

Introduction

You can adjust the colors of the table elements in the WinCC controls to suit requirements.

Requirement

- You opened Graphics Designer and configured a picture with a WinCC control.
- The configuration dialog of the WinCC control is open.

Procedure

1. Go to the "Effects" tab.

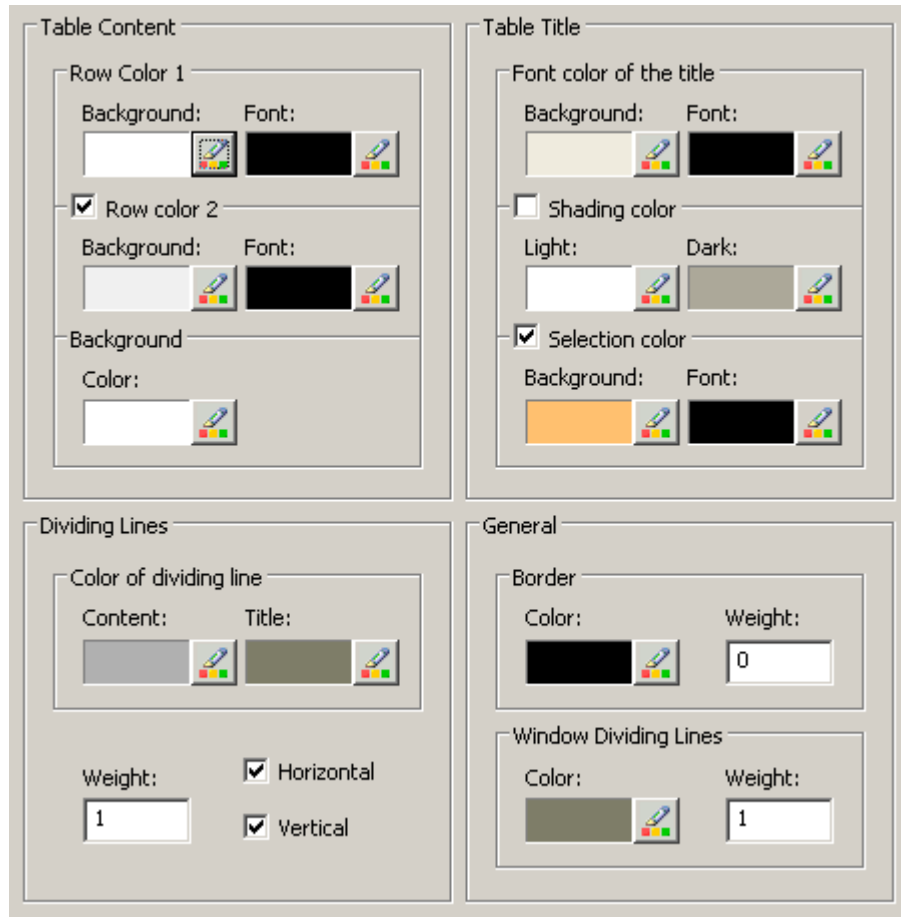

2. Define the colors for the background or text here for:
 - Table content. You can define different colors for even and odd line numbers to improve differentiation between both.
 - Contents of the table header
 - Separating lines in the table and for table headers
3. Define the color and the line weight in the "General" area in terms of:
 - Control borders
 - Window dividers for control elements
4. Save the configuration.

How to configure the marking of the selected cells and lines

Introduction

You can customize the marking of the selected cells and rows in the WinCC control to suit requirements.

Prerequisite

- You opened Graphics Designer and configured a picture with a WinCC control.
- The configuration dialog of the WinCC control is open.

Procedure

1. Go to the "Selection" tab.

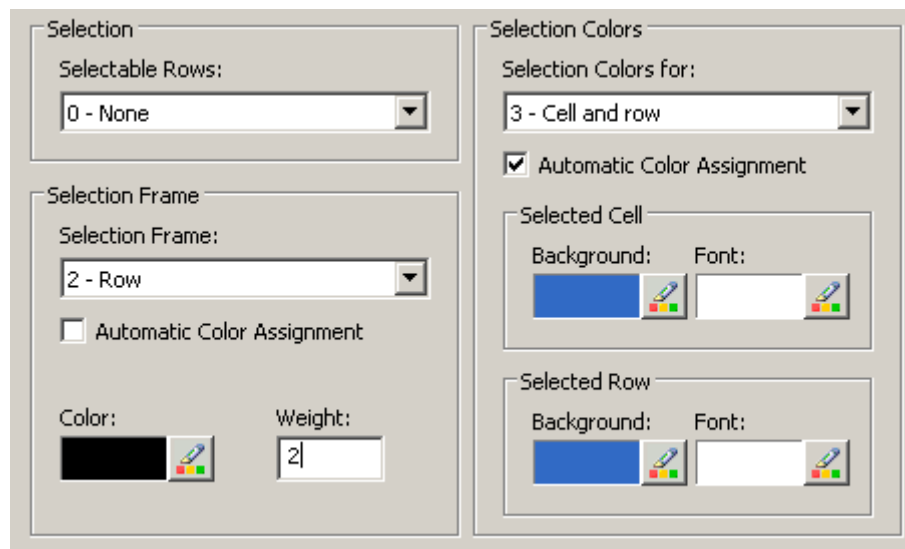

2. Define whether to select rows or only cells using the mouse.
3. Configure the properties of the selection rectangle that can be displayed around selected table cells or rows.
4. Configure the marking color for selectable cells and/or rows. The system colors are used for marking with "Automatic coloring" property.
5. Save the configuration.

How to configure sorting via the column heading

Introduction

You can adjust the sorting order by means of table column header in the WinCC controls to suit requirements.

Prerequisite

- You opened Graphics Designer and configured a picture with a WinCC control.
- The configuration dialog of the WinCC control is open.

Procedure

1. Go to the "Parameter" tab.

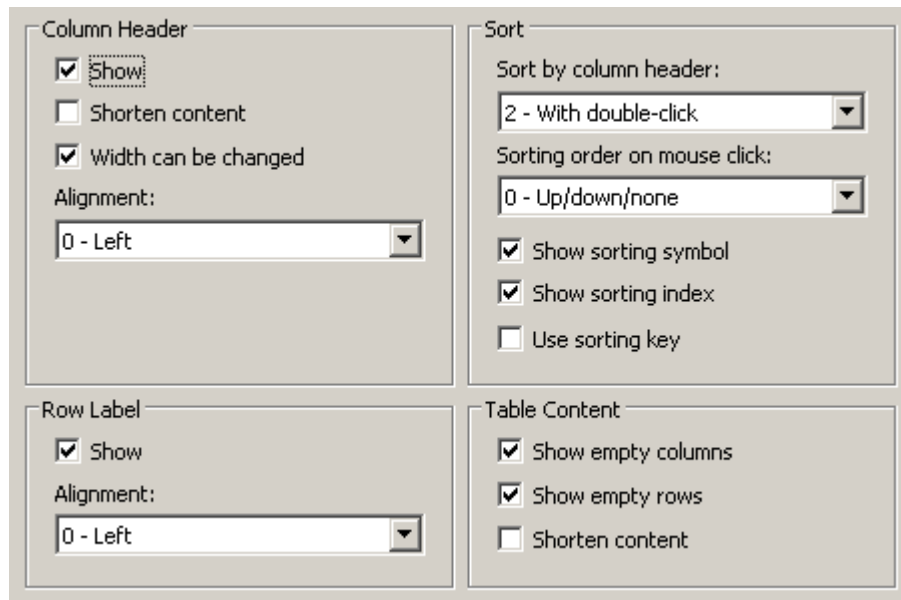

2. Define whether to enable sorting and the sorting method by column header. In WinCC AlarmControl, you can only sort by column header if the "Auto-scrolling" is disabled. You can deactivate "Auto-scrolling" either in the "General" tab, or using the "Autoscroll" toolbar icon of the WinCC AlarmControl.
3. Determine the sorting order by mouse click on the column header. Select ascending, descending or no sorting order.
4. Configure the sorting icon and index to be displayed in the column header with right justification. These show the sorting order and sequence of the columns.
5. Activate the "Use sorting key" to display the sorting icon as sorting button above the vertical scroll bar. Click this sorting key to activate a configured sorting order for the column selected. The sorting key is not displayed if a vertical scroll bar is missing.
6. Save the configuration.

7.5.2.4 How to configure the toolbar and the status bar

Introduction

The WinCC controls are operated at runtime using the functions of the toolbar buttons. The status bar contains information pertaining to the current status of the WinCC control. You can adapt the toolbar and the status bar for all WinCC controls when configuring, or at runtime.

Requirement

- A picture showing a WinCC control is opened in Graphics Designer when configuring.
- The WinCC control is assigned the "Configuration dialog" button function for opening the configuration dialog in Runtime.
- The configuration dialog of the WinCC control is open.

How to configure the toolbar

1. Go to the "Toolbar" tab. In the WinCC AlarmControl, for example:

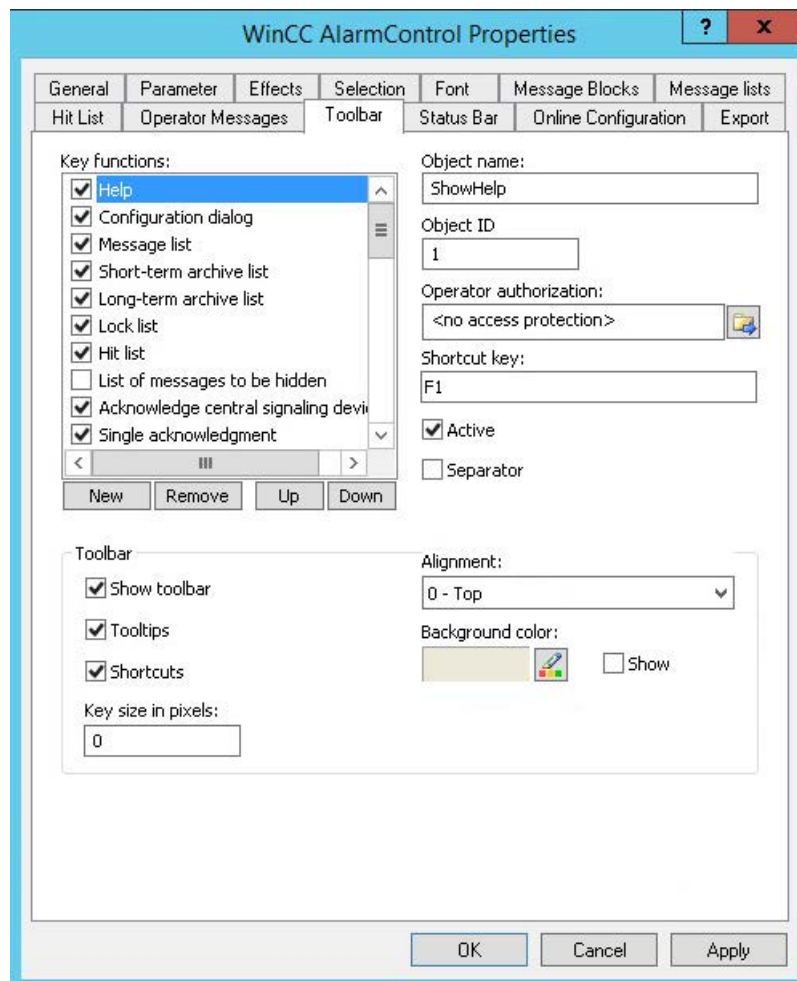

2. In the list, activate the button functions you require for operating the WinCC control in Runtime. For information on the button functions, refer to the description of the corresponding WinCC control at "Operation in runtime".
3. Determine the sorting order for displaying the button functions in the toolbar. Select the button functions from the list and move the functions using the "Up" and "Down" buttons.
4. Define a shortcut key for the functions of the toolbar buttons.
5. Any button functions assigned operator authorizations are only available in Runtime to authorized users.

6. An activated button function is displayed during runtime if you deactivate its "Active" option, however, it cannot be operated.
7. You can set separators between the button functions. Activate the "Separator" option for the button function to be restricted by separator.
8. Configure the general properties of the toolbar, e.g. alignment or background color.
9. Change the button size as required. The standard setting is "0" and corresponds to the original size of 28 pixels. You can specify 280 pixels as maximum value.
The following behavior results for the button size depending on the configured value:

Value of the button size	Behavior
Value < 0	Invalid value. The most recent valid value is used.
$0 \leq \text{value} \leq \text{original size of button}$	The original size of the button is used. The value is set to the default (= 0).
Original size of the button < value \leq maximum value	The configured value is used.
Maximum value < value	Invalid value. The most recent valid value is used.

With a large button size, please note that in some cases not all buttons may be displayed in the control. To show all activated buttons in Runtime, you must therefore extend the control or activate fewer buttons as required.

How to configure the status bar

1. Go to the "Status Bar" tab. In the WinCC AlarmControl, for example:

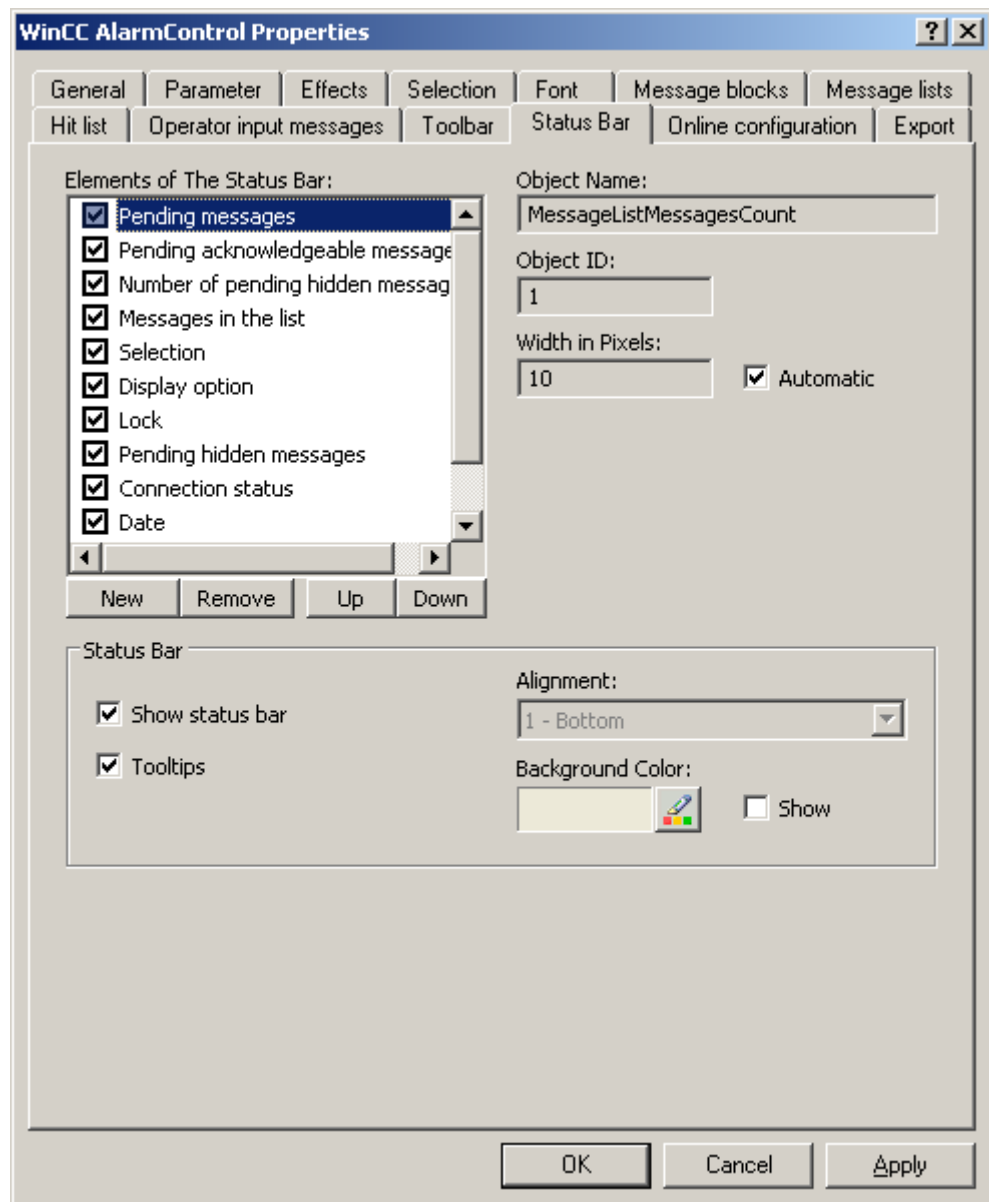

2. Activate the elements required during runtime in the list of status bar elements. For further information on status bar elements, refer to the descriptions of the corresponding WinCC control at "Operation in runtime".
3. Determine the sorting order for displaying of the status bar elements. Select the elements from the list and move these using the "Up" and "Down" buttons.
4. To resize the width of a status bar element, deactivate the "Automatic" option and enter a pixel value for the width.
5. Configure the general properties of the status bar, e.g. alignment or background color.

7.5.2.5 How to export runtime data

Introduction

The runtime data shown in the WinCC controls can be exported using a button function. Set up operation of the data export during runtime in the configuration dialog.

Requirement

- A picture showing a WinCC control is opened in Graphics Designer when configuring.
- The configuration dialog of the WinCC control is open.

How to configure the operation of the data export

1. Go to the "Export" tab.

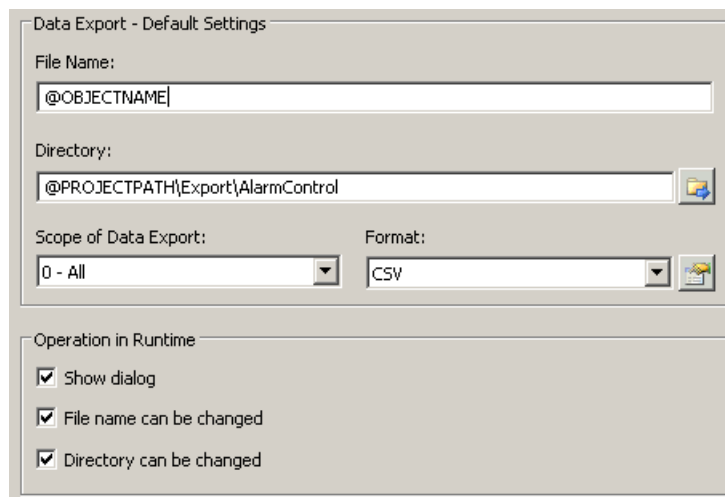

2. A standard file name and a standard directory are already entered in the "Data export default settings". In this case for AlarmControl. If necessary, define a file name and a directory for the export file.
The file name can be made up of the freely defined name and the following placeholder:
@OBJECTNAME - Object name of the controls
@CURRENTDATE - Current date
@CURRENTTIME - Current time
3. CSV is currently available as data format. Click  to specify the delimiter and data format in the CSV file.
4. Define the scope of the data export:
 - All runtime data is exported
 - Selected runtime data is exported. This data export is only possible in WinCC controls with tabular display.

5. Configure the operation of the data export during runtime. Define:
 - whether users are allowed to rename the file, or change the directory.
 - whether to display the "Data export default settings" dialog in Runtime.
6. If "Show dialog" is deactivated, the data for operation of the "Export data" button function is immediately exported to the defined export file.
7. Save the configuration.
8. Go to the "Toolbar" tab to activate the "Export data" button function for runtime.

Results

You can export all or selected data to a defined file at runtime using the  button function.

7.5.2.6 How to define the effect of the online configuration

Introduction

Users can parameterize the WinCC controls in Runtime. You must define the Runtime effects of the online configuration.

Changes configured in Runtime are saved for the specific user separately from the picture in the configuration system. The original picture configuration is retained in the configuration system.

Note

The picture is also replaced at Runtime if you save it in Graphics Designer, or when loading deltas in online mode. All online changes are lost.

The different configurations are only activated for new users after you performed a picture change.

Requirement

- A picture showing a WinCC control is opened in Graphics Designer when configuring.
- The configuration dialog of the WinCC control is open.

Procedure

1. Go to the "Online configuration" tab. For example, in OnlineTrendControl:

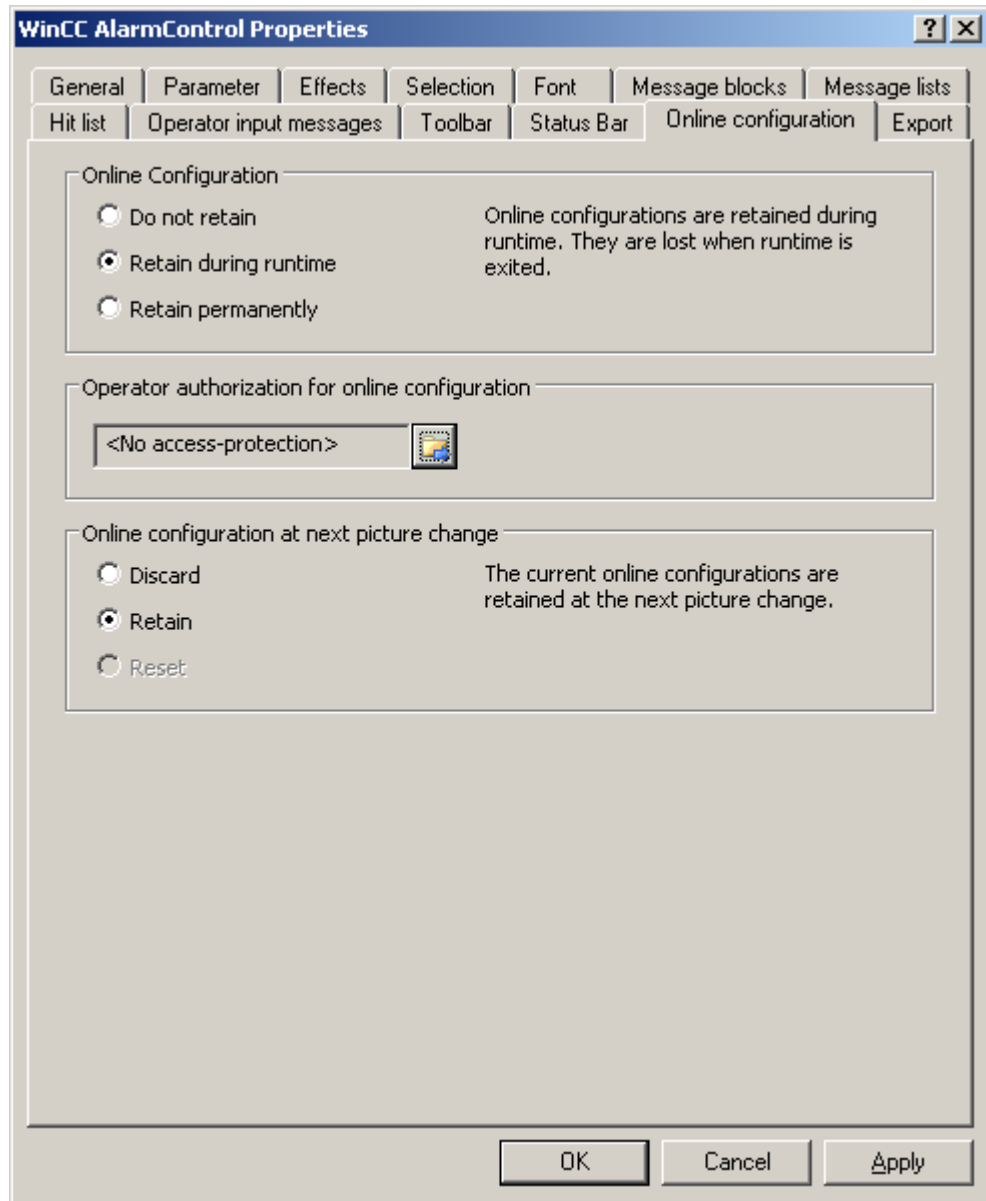

2. The option buttons of the "Online configuration" field for setting online configuration defaults are only available in the configuration system. The option buttons are not available in Runtime.

Select one of the three effects of the online configuration:

- "Do not retain". The online configurations are not retained in Runtime. This default setting disables all options for Runtime users. Online configurations are lost at the next picture change and on activation/deactivation of the project.

- "Retain during Runtime". This default setting enables the "discard", "retain" or "reset" options for Runtime users. Online configurations are retained at the next picture change if the "retain" option is enabled, however, these are lost on activation/deactivation of the project.
 - "Retain permanently". This default setting enables the "discard", "retain" or "reset" options for Runtime users. Online configurations are retained at the next picture change and on activation/deactivation of the project if the "retain" option is enabled.
3. Define corresponding user authorizations for online configuration.
 4. The option buttons of the "Online configuration on next picture change" can be enabled for operation in the configuration system and at Runtime by setting the "retain at Runtime" and "retain permanently" defaults. The "reset" operation is only available in Runtime, because the configuration system contains the original configuration.
Select one of three effects of the online configuration at the next picture change:
 - Select "discard" if to discard the online configuration at the next picture change.
 - Activate "retain" to activate the online configuration based on default settings at the next picture change or on activation/deactivation of the project.
 - Activate "Reset" if you want to apply the picture saved in the configuration system in Runtime. All online changes are lost.
 5. Save the configuration.

7.5.2.7 How to make the toolbar for the UserArchiveControl dynamic

Introduction

The default functions for operating the WinCC UserArchiveControl are no longer supported for the new WinCC UserArchiveControl as of WinCC V7.0. You can use the WinCC types of dynamics to e.g. operate a key function of the toolbar with a script.

Overview

With WinCC controls as of V7.0, special functions are no longer required for operating the control with toolbar dynamics. The previously used standard functions "Tlg..." are no longer supported.

If you do not want to operate the control via the toolbar, you can write the "ID" for the desired button in the "ToolbarButtonClick" object property with an optional type of dynamics.

The "ID" of a button of the toolbar can be determined:

- with the table on page "Operation of the UserArchiveControl in runtime".
- in the configuration dialog of the UserArchiveControl on the "Toolbar" tab via field "Object ID".

Example: Open the configuration dialog for the control

In order to open the configuration dialog of the control, dynamics are possible as follows:

- VBScript:
 - ScreenItems("Control1").ToolBarButtonClick = 2
 - As an alternative to the property "ToolBarButtonClick", there are also methods in VBS for operating the toolbar: ScreenItems("Control1").ShowPropertyDialog
 - Or, with the following notation with the support of "Intellisense":
Dim obj
Set obj = ScreenItems("Control1")
obj.ShowPropertyDialog
- C script:
 - SetPropWord(IpszPictureName, "Control1", "ToolBarButtonClick", 2);
- Direct connection
 - In the dialog for the direct connection for the source, enter "2" as a constant
 - Select the property "ToolBarButtonClick" for the object "Control1" for the target "Object in picture"

See also

Operating the UserArchiveControl in runtime (Page 1962)

7.5.3 Operation in runtime

7.5.3.1 Operating the UserArchiveControl in runtime

Introduction

The buttons on the toolbar are used to operate the WinCC UserArchiveControl during runtime. If you do not want to operate the table window via the toolbar, you can write the "ID" for the desired button in the "ToolBarButtonClick" object property with an optional type of dynamics.

Note

If the "Error while connecting the data!" error message appears when you start runtime, the UserArchiveControl is not connected to a user archive or a view. Check the following potential error sources:

- Is the connection specified correctly?
 - Has the configuration been changed?
 - Does the associated user archive or view still exist?
-











Navigation in the table of the WinCC UserArchiveControl











You can navigate in the table as follows:

- You enter the next cell with the "ENTER" key or with the "Right" cursor key.
- You enter the previous cell with "SHIFT+ENTER" key or with the "Left" cursor key.
- You enter the next line by clicking with the mouse in the line or with the "Down" cursor key.
- You enter the previous line by clicking with the mouse in the line or with the "Up" cursor key.

Overview

The overview shows all symbols in "standard" style. If you want to create a design of the controls with "Simple" style, the representation of the symbols corresponds to the UserArchiveControl prior to WinCC V7. You can find an overview on the page, "Before WinCC V7: WinCC User Archives Table Element > User Archives Table Elements in Runtime > The toolbar of the user archive table element".





Symbol	Description	ID
	"Help" Calls up the help on WinCC UserArchiveControl.	1
	"Configuration dialog" Opens the configuration dialog, in which you can change the properties of the UserArchiveControl.	2
	"Select data connection" Opens a dialog box in which you can select a user archive. The content of the selected user archive is displayed in the table of the UserArchiveControl.	3
	"First line" The first value of the user archive is displayed in the table via the button.	4
	"Previous line" The previous value of the user archive is displayed in the table via the button.	5
	"Next line" The next value of the user archive is displayed in the table via the button.	6
	"Last line" The last value of the user archive is displayed in the table via the button.	7
	"Delete lines" The content of the marked lines are deleted.	8
	"Cut lines" The content of the marked lines are cut out.	9
	"Copy lines" The content of the marked lines are copied.	10
	"Insert lines" The content of the copied or cut-out lines is inserted starting from the marked line.	11

	<p>"Read tags"</p> <p>This button is used for reading the content of the connected WinCC tags and writing to the columns. In order to use the button, the communication type "Communication via WinCC tags" must be activated in the user archive. The columns must be connected with tags.</p>	12
	<p>"Write tags"</p> <p>This button is used for writing the content of the columns into the connected WinCC tags. In order to use the button, the communication type "Communication via WinCC tags" must be activated in the user archive. The columns must be connected with tags.</p>	13
	<p>"Import Archive"</p> <p>The content of a user archive is imported into the table of the UserArchiveControl with the button. The user archive must exist as a CSV file in the "ua" directory of the project folder.</p>	14
	<p>"Export archive"</p> <p>This button exports the content of the table of the UserArchiveControl. The user archive exists as a CSV file in the "ua" directory of the project folder.</p>	15
	<p>"Sort dialog"</p> <p>Opens a dialog for setting user-defined sort criteria for the displayed user archive columns.</p>	16
	<p>"Selection dialog"</p> <p>Defining selection criteria for the columns of the user archive to be displayed in the table.</p>	17
	<p>"Print"</p> <p>Starts the printout of the displayed values. The print job used for printing is defined in the configuration dialog on the "General" tab.</p>	18
	<p>"Export data"</p> <p>This button is used for exporting all or the selected runtime data into a "CSV" file. If the option "Display dialog" is active, a dialog opens in which you can view the settings for exporting and can start the export. You can also select the export file and directory, provided you have the corresponding authorizations.</p> <p>If no dialog is displayed, the export of the data to the preset file is started immediately.</p>	20
	<p>"Time base dialog"</p> <p>Opens a dialog for setting the time base for the times used in the user archive.</p>	19
	<p>"User-defined 1"</p> <p>Shows the first key function created by the user. The function of the button is user-defined.</p>	1001

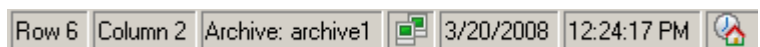
Possible elements of the status bar

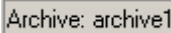
The following elements can appear in the status bar of the UserArchiveControl:

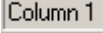
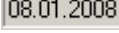
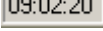

Symbol	Name	Description
	Archive name	Displays the name of the selected user archive.
	Row	Shows the number of the marked line.
	column	Shows the number of the marked column.
	Date	Shows the system date.
	Time	Shows the system time.
	Time Base	Shows the time base used in the display of times.

7.5.3.2 To process the data in the UserArchiveControl:

Introduction

You can edit data in the WinCC UserArchiveControl. The following options are available:

- Enter new data
- Change existing data
- Delete lines
- Cut-out, copy and insert lines



Requirement

- You have permitted editing in the configuration dialog on the "General" tab.
- You have deactivated the "Write-protected" property for the column to be edited in the configuration dialog on the "Columns" tab.
- The "ID" column cannot be edited.
- If the UserArchiveControl is connected with a view, you cannot delete or cut out a line.



Entering new data in the table.

1. Click on  to move to the last line. The line is marked.
2. Double-click on the first cell of the marked line. You can also press on "F2", "Alt+Enter" or "Ctrl+Enter" in the cell.
3. You enter the values in the cells one after the other and confirm each time by pressing Enter. After you have entered all values in the line and have marked another line, the new data record is written to the user archive. You move to another line by clicking with the mouse, with the "ENTER" key or with the "Up" and "Down" cursor keys.
4. You can copy the data of a marked line with "CTRL+C" or "CTRL+X" into the clipboard. The copied data is inserted into a marked line with "CTRL+V".





Changing existing data in the table

1. Click on  or  to move to the desired line. You can also use the scrollbars to move to the desired line.
2. Double-click on the desired cell of the marked line. You can also press on "F2", "Alt+Enter" or Ctrl+Enter" in the cell.
3. You enter the values in the cells one after the other and confirm each time by pressing Enter. After you have entered all values in the line and have marked another line, the changed data record is written to the user archive.

Deleting a line in the table

1. Click on  or  to move to the desired line. You can also use the scrollbars to move to the desired line.
2. Click on  to delete the marked line.

Cutting, copying and inserting lines

1. Click on  or  to move to the desired line. You can also use the scrollbars to move to the desired line.
2. Click on  or  to cut or copy the data of the line. As an alternative, you can also use key combination "CTRL+ALT+X" or "CTRL+ALT+C".
3. Go to the desired line into which you want to copy the data. Click on  to insert the cut-out or copied data. If you do not want to overwrite the data of the marked line, move into the last line to insert the data.

7.5.3.3 How to select the data of the user archive

Introduction

The content of the user archive that you want to display or export into the table of the WinCC UserArchiveControl can be defined in runtime via the selection dialog. You define the selection criteria concerning the displayed user archive columns in the selection dialog.

Requirement

- You have configured the button function "Selection dialog" on the "Toolbar" tab of the UserArchiveControl.

Procedure

1. Click on  in runtime. The "Selection" dialog opens.

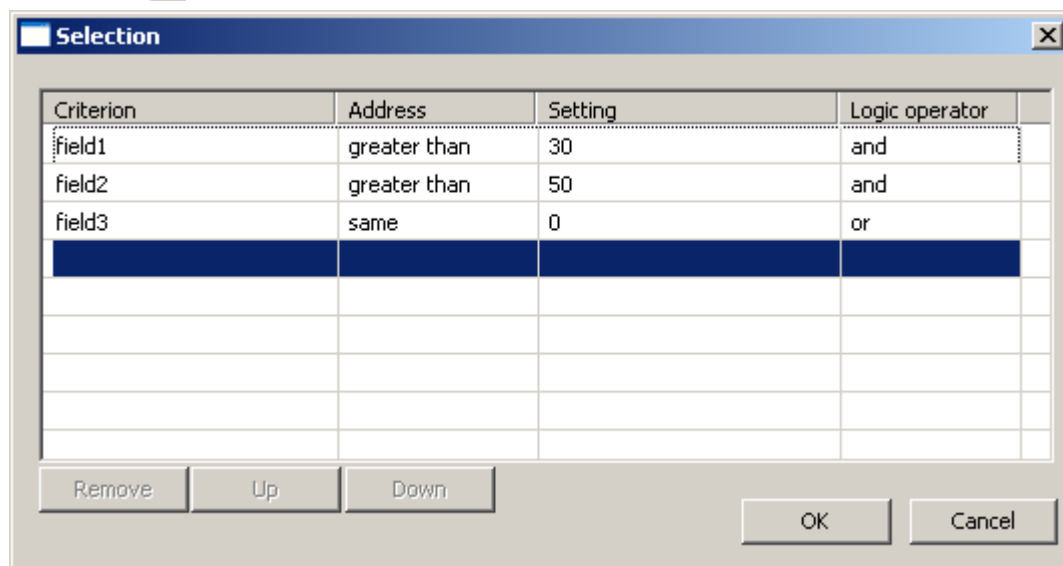

2. Double-click in the first empty line in the "Criteria" column. The list with the columns of the user archive is displayed. Select the desired columns, e.g. "field1".
3. Double-click in the "Operand" column to select an operand.
4. Double-click in the "Setting" column to enter a comparison value.
5. Double click in the "Logic operator" column to select an "AND" or "OR" function.
6. Repeat the procedure if you want to define further criteria.
7. Click "OK" to close the selection dialog. The selection is displayed in the table of the UserArchiveControl.

Note

Ensuring the display of column content

Make sure of proper use of the settings and connections of criteria.

Incorrect links can lead to data of the connected user archive not being displayed in the UserArchiveControl.

Each criteria must be tested separately and then each of the linked criteria needs to be tested before linking criteria. Check that all expected contents are also displayed in combination.

This ensures that the selection is completely displayed in the UserArchiveControl.

7.5.3.4 How to sort the display of user archive data

Introduction

During runtime, you can sort the data in the UserArchiveControl by column. You sort the columns either via the "Sort dialog" button function or directly via the column headers.

Note

You can also specify the sort criteria during configuration in the UserArchiveControl by clicking the "Edit..." button under "Sorting" on the "Columns" tab.

How to sort with the Sort dialog

Requirement

- You have configured the button function "Sort dialog" on the "Toolbar" tab of the UserArchiveControl.

Procedure

1. Click the "Sort Dialog" button .
2. In the "Sort By" field, select the column of the connected user archive, by which to sort first. Select the relevant check box to specify sorting in ascending or descending order. If you want to sort by more than one column, select the other columns in the desired order in the "Then sort by" lists.

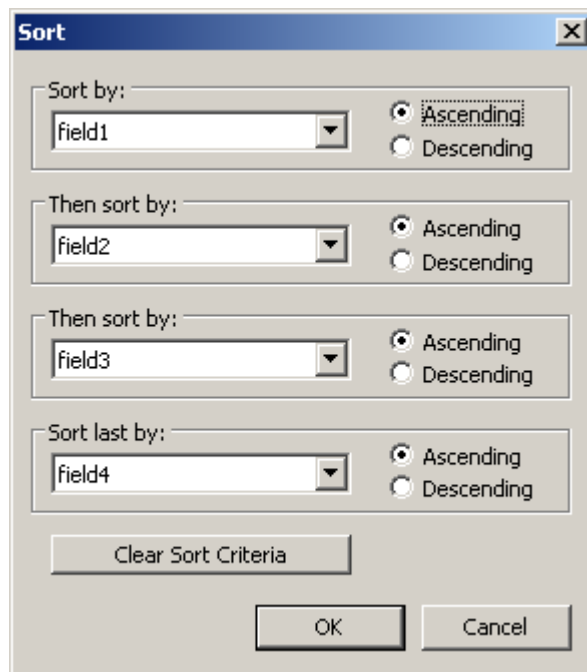

How to sort the column contents with the column heading

When sorting using the column header, you are able to specify the sort order for more than four columns. A sorting icon and sorting index, displayed with right-justification in the column heading, show sorting order and sorting sequence of the column contents.

Requirement

- You have permitted the sorting in the list field "Sorting with column heading" by clicking or double clicking on the WinCC UserArchiveControl on the "Parameter" tab.
- You have activated the "Show sorting icon" and "Show sorting index" checkboxes.

Procedure

1. Click the column header of the column you want to sort as first column. The sorting index "1" is displayed, and the sorting icon points upwards for ascending sort order.
2. If you want to sort in descending order, click the column header again.
3. If the sorting order has been defined with "up/down/none", you can undo the sorting of the column with a third click.
4. If you want to sort several message blocks, click the respective header columns in the desired sequence.

7.6 Before WinCC V7: WinCC User Archives Table Element

7.6.1 Functionality

Functional scope

The User Archives Table element provides options to access user archives and views of the user archives. Using the User Archives Table Element, in Runtime you can:

- Create, delete or modify new data records
- Browse in user archive
- Read and write tags for direct tag link
- Import and export user archive and
- Define filter and sorting conditions

The screenshot displays the WinCC User Archives Table Element in two views. The top view is a table with the following data:

ID	Recipes	Water	sugar	Caffeine	Color_7	Phosphoric_acid
1	Calif Coke	90	10	10	10	15
2	Coke	80	30	15	20	20

The bottom view is an input mask titled "Input mask Coke" with the following fields:

ID	1	Water	90
Recipes	Calif Coke	sugar	10
LastAccess	18.05.99 16:49:50	Caffeine	10
		Coloring7	10
		Phosphoric_acid	15

Navigation icons are visible above both views. The bottom status bar shows "Finished", "Rec 1/5", "Row 1", and "Col 1".

Views

The User Archives Table Element offers two views: the table view and the form view.

- **The Table View**
The Table View is used for a tabular display of the User Archive. Each record occupies one row, the data fields of a record are displayed as columns.
- **The Form View**
The Form View offers a user interface that can be designed by the user. The Form View of User Archives offers three field types: static texts, input fields and buttons.

Note

During configuration, a User Archives Table Element is connected to a selected user archive or form and can then only access that user archive or form. For access, the user archive / form must be enabled (access protection). Specific authorizations can be assigned to the control in the User Administrator.

If this access protection is canceled, the control must be reconnected in the Graphics Designer to the user archive so that control detects the canceled access protection.

Access protection for an archive or field is queried on opening a screen of a User Archive Table Elements. Access protection for the control tags of a protected archive must be implemented separately via the object properties, e.g. of the picture, I/O field or button.

See also

Configuring a User Archives Table Element (Page 1971)

7.6.2 Configuration of User Archives Table Element

7.6.2.1 Configuring a User Archives Table Element

Procedure

To configure a WinCC User Archives Table Element, proceed as follows:

1. Configure a user archive using the Editor User Archives or by using the functions of the WinCC script language. In the description of the Editors User Archives, you can know how the user archive "Cola" has been configured.
2. Place a new User Archives Table Element in an image of the Graphic Designer.
3. Configure the properties of the User Archives Table Element.
4. Configure a User Archives Form View.

See also

Working with Controls (Page 749)

7.6.2.2 Place the User Archive Table Element in a process screen

Procedure

To set up a User Archives Table Element in a process screen, you need to configure it in the Graphics Designer. This is done through the following steps:

1. Select the "Smart Objects" object group from the object palette.
2. Click the "Control" object and drag a window of an adequate size into the image area.
3. In the "Add Control" selection dialog that is now displayed, select the "WinCC User Archive Table Element" option and confirm the selection with OK.

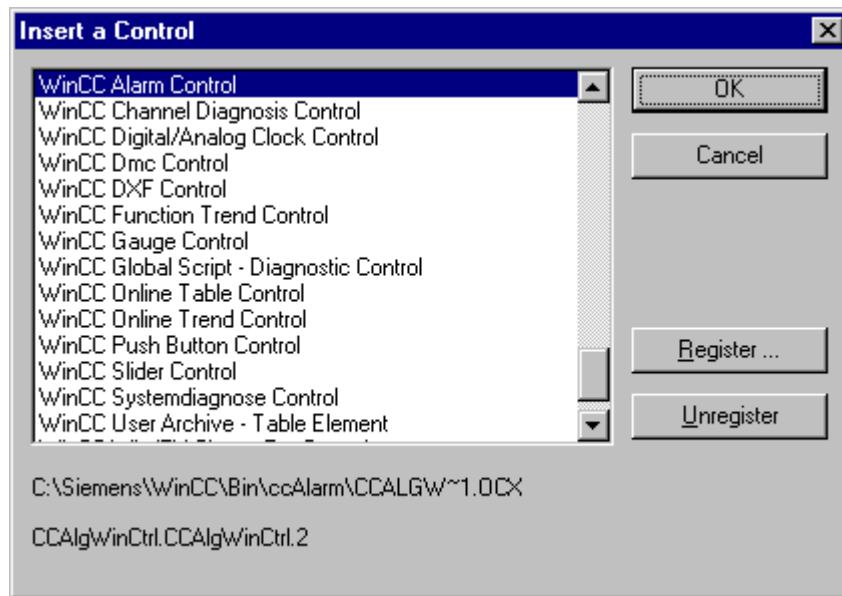

Alternative Procedure

- In the "Controls" tab of the object palette, some standard controls will be displayed to you for selection in the Object Palette window.
- Select the WinCC User Archive Table Element.

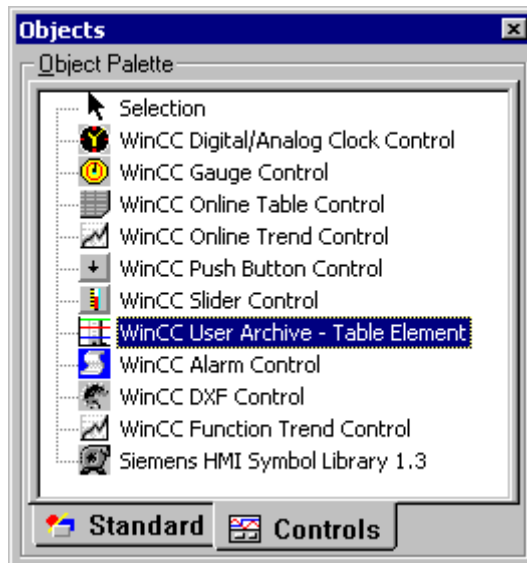

See also

Define properties of the User Archives Table Element (Page 1974)

Working with Controls (Page 749)

7.6.2.3 Define properties of the User Archives Table Element

Procedure

The following guideline gives you details of how you can configure a User Archives Table Element for the user archive "Cola" in the Graphics Designer using the "Properties of WinCC User Archive Table Element" dialog box.

1. Double-click in the area of the "WinCC User Archive Table Element". You will see the "WinCC User Archive Table Element Properties" dialogbox with the "General" tab.

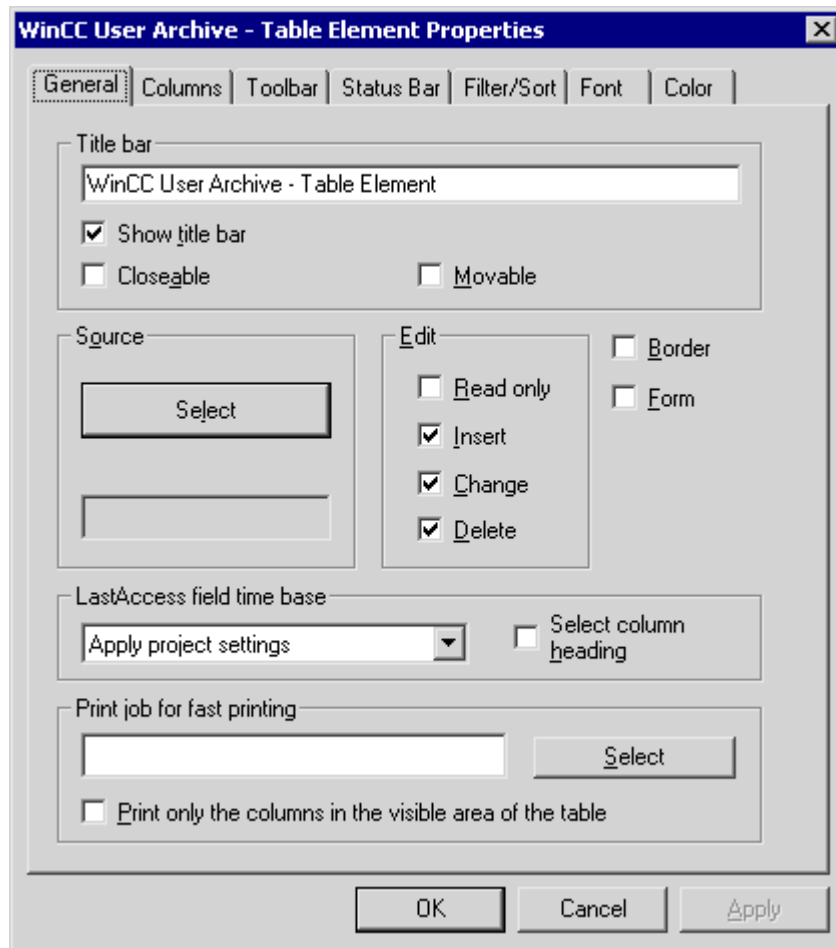

2. In the Source input field, define the archive or the view that is to be displayed in the Control. Click "Select" and select the user archive "Cola" in the Package Browser dialog.
3. You can define the access type during runtime in the Edit field. The "Add", "Modify" and "Delete" access types are enabled by default. Instead, you can also activate "Ready-Only".
4. Using the "Border" checkbox you can define whether the Control dialog is to be displayed with or without frame. Activate these options.
5. You can accept all the pre-settings in the other tabs without making any changes.

See also

"General" tab (Page 1977)

Delete the User Archives Table Element (Page 1975)

Working with Controls (Page 749)

7.6.2.4 Delete the User Archives Table Element**Procedure**

The User Archives Table Element is deleted in two steps in the Graphic Designer:

1. Click to select the User Archives Table Element to be deleted
2. Press Delete key or select "Edit - Delete" menu.

Note

The delete action is executed immediately without any warning! You can undo the delete action only using "Edit - Undo" menu or "Ctrl+Z".

7.6.3 Properties of WinCC User Archives Table Element**7.6.3.1 Properties of WinCC User Archives Table Element****Procedure**

1. You can modify the attributes of a User Archives Table Element by right-clicking the object and selecting the "Properties" menu item from the pop-up menu which opens.
You can edit the statics of the Filter, Form, PressTButton and Sort attributes. To avoid inconsistencies in the database, make changes to the other object properties via the "Properties of WinCC User Archive - Table Element" dialog box (double-click Control).
2. In the "Properties" tab of the opened "Object Properties" box, select the group "Control Properties".

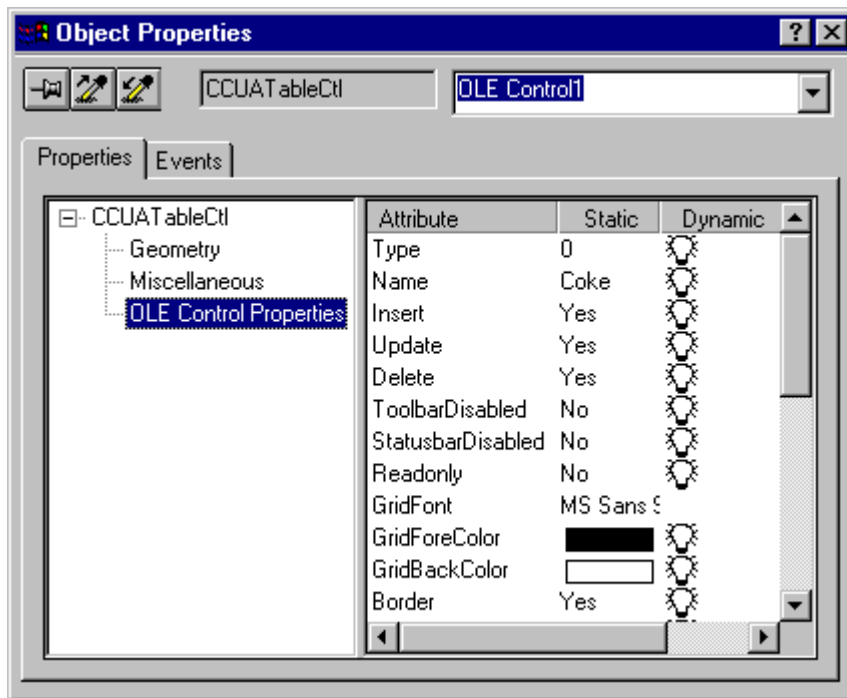

The User Archives Table Element is normally configured in the Graphics Designer by double-clicking one of the controls. You can make the desired changes in the dialog box that opens. As the existing user archives, views, tags, etc. in the dialog boxes of the different tabs are offered for selection, you can easily and safely make all the changes.

See also

Configuring a User Archives Table Element (Page 1971)

7.6.3.2 "General" tab

Configuration

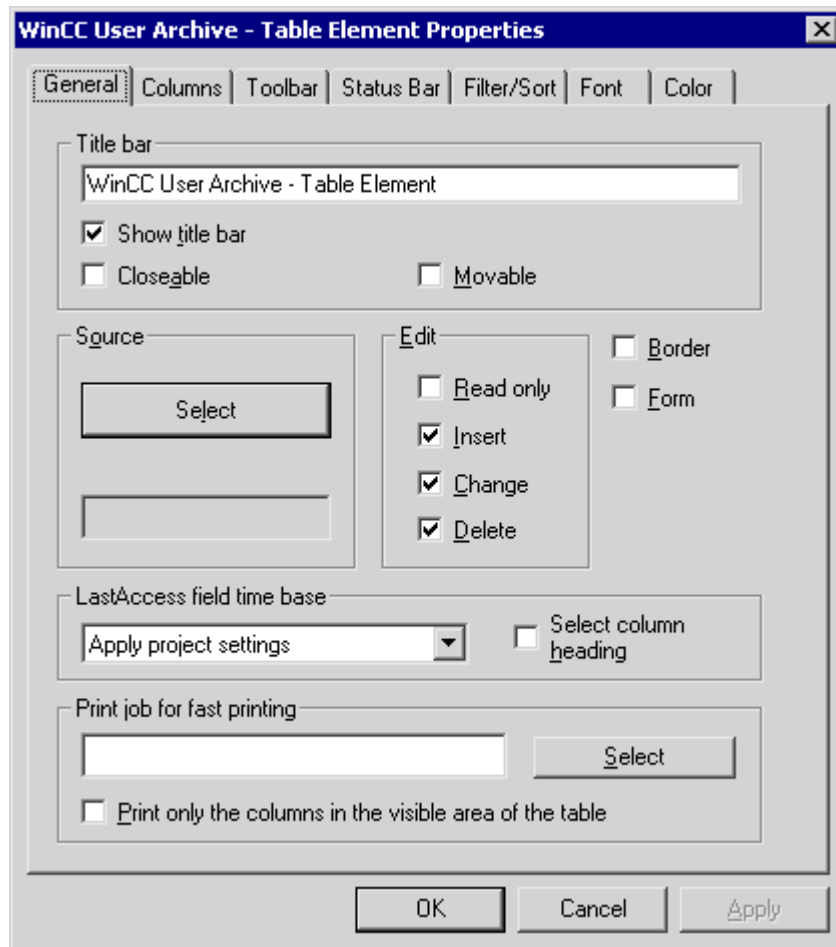

Icon	Description
Title Bar	Define the window title in the "Title bar" field. You define here whether the title bar can be displayed, the window can be closed or moved.
Source	Click the "Select" button to go to the Package Browser where you can select a user archive or view that has been configured earlier.
Edit	You can define the access type during runtime in the Edit field. The access types "Add", "Modify" and "Delete" are released for the user archives when you uncheck the "Read-Only" checkbox. For views, only the "Modify" checkbox is released.
Border	Using the "Border" checkbox you can define whether the Control dialog is to be displayed with or without frame.
Form	Use this checkbox to define whether the form view should be the start view in the control window.

Icon	Description
Time base for the Last Access field	In this selection field you define the time basis for the time display in the Last Access field.
Print job for quick printing	In this field you define the print job that is to be used for printing the displayed data.

Note

If the configuration of the user archive is changed in the Editor User Archives, for e.g. the access protection is removed, then the Control in the Graphics Designer must be linked again to this user archive. The Control can then detect the modified archive configuration.

The Package Browser

The Package Browser is activated by clicking the Select button in the Properties dialog of the User Archives Table Element. You can select from the user archives and views that have already been configured.

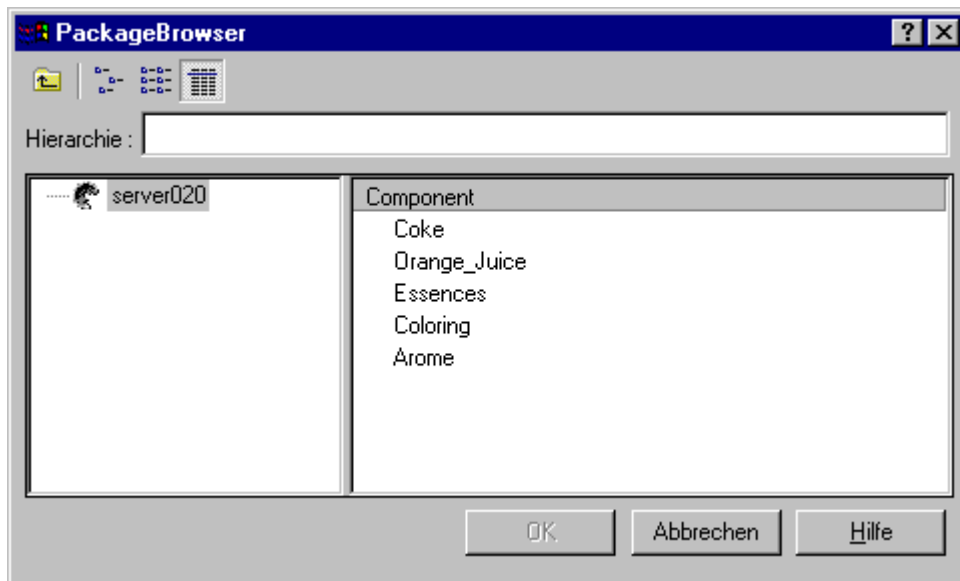

In a WinCC client, you can select in the Navigation field of the Package Browser those servers whose packages have been loaded and where a user archive has been configured using tags. In a project of the WinCC client, you can access the user archives of all the servers linked in the project. Some user archives are not meant for WinCC Client. The path to the selected server is displayed in the Hierarchy area. It can be edited so that you can manually enter the path to the desired server.

If the required server is not in the default list, a package of this server must be loaded by using the server data function. You can find additional information about WinCC Client functionalities in the WinCC Explorer Help.

Note

If the Control is not linked to an existing user archive or view, then the error message "Error while connecting the data!" is displayed when you change to Runtime.

See also

List of properties for the User Archives Table Element (Page 2000)

7.6.3.3 "Columns" tab

Configuration

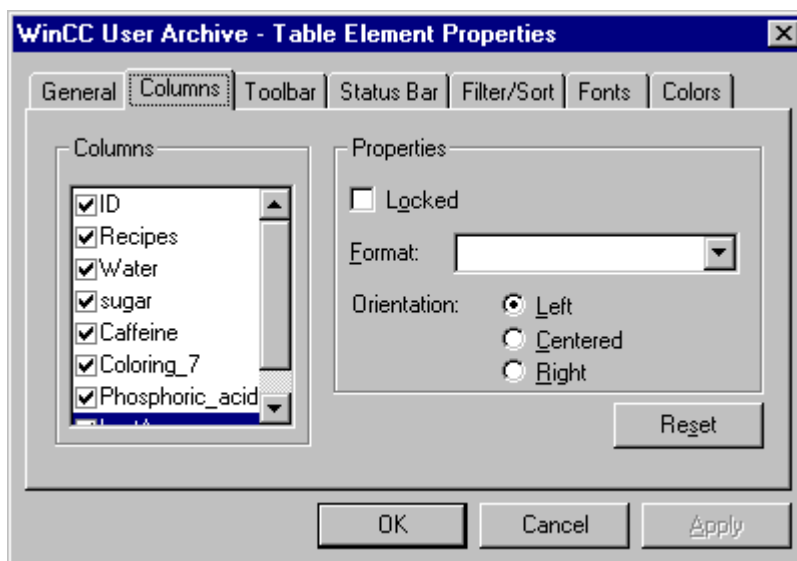

Icon	Description
Columns	In the Columns input field you can define which fields inserted in the Editor User Archives are to be displayed in the process screen.
Properties	In the Properties input field, you can define the properties of the field currently selected in the Columns field.
Blocked	You can use the Blocked checkbox to protect the select field from being overwritten.

Icon	Description
Format	Use the Format field to define the way the values are displayed: <ul style="list-style-type: none">• Fixed (Fixed point number "%.2f")• Scientific (Exponential display "%e")• Date (only date output "%x")• Time (only time output "%X")• TimeStamp (Output date and time "%c") A date field is displayed in the date format that is set in the operating system.
Alignment	In the "Alignment" field you can select between Left, Centered and Right.
Reset	Use Reset button to reestablish the previous setting.

Note

In the Format field you can also format the decimal places (for e.g. "%.3f" for three decimal lplaces) or the hexa-decimal format "%x" for integer values.

See also

List of properties for the User Archives Table Element (Page 2000)

7.6.3.4 "Toolbar" Tab

Configuration

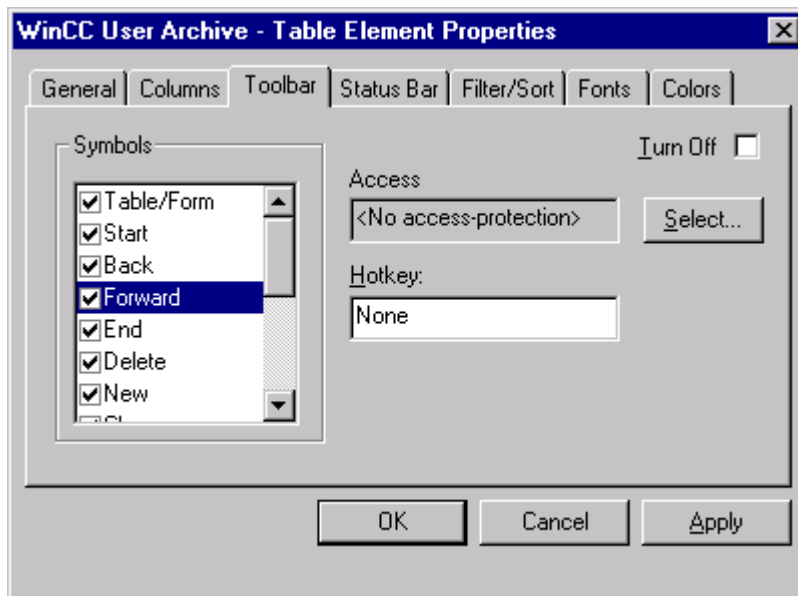

Icon	Description
Icons	Under "Icons" you define the icons that are to be included in the toolbar.
Access rights	The access rights for the selected symbol are displayed in the "Access Rights" field.
Selection	Click the "Selection" button to display the "Authorizations" dialog box where you can define the desired access.
Switch off	The "Turn Off" field is used to turn or turn off the toolbar display.
Hotkey	You can assign hotkeys to individual functions in the Hotkey field.

Authorizations

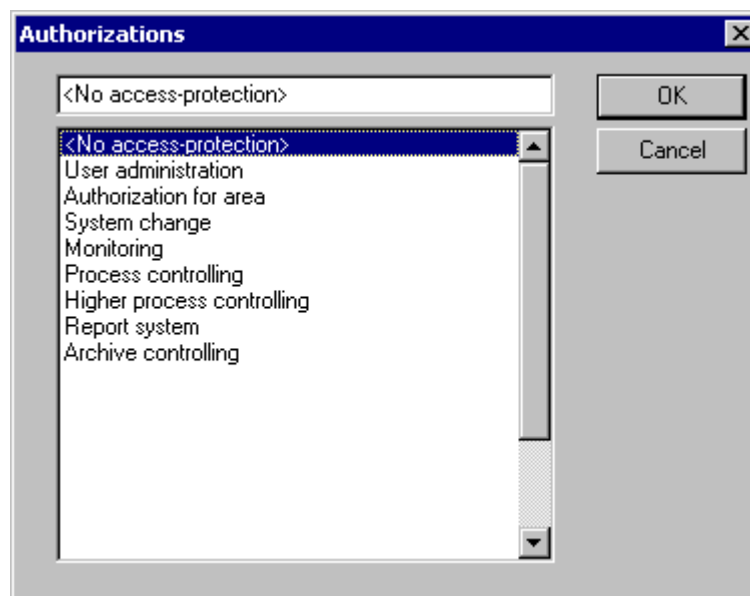

You can define the desired authorizations in the Authorizations dialog box. The authorizations displayed in the dialog have earlier been configured in the User Administrator.

See also

List of properties for the User Archives Table Element (Page 2000)

7.6.3.5 "Status Bar" Tab

Configuration

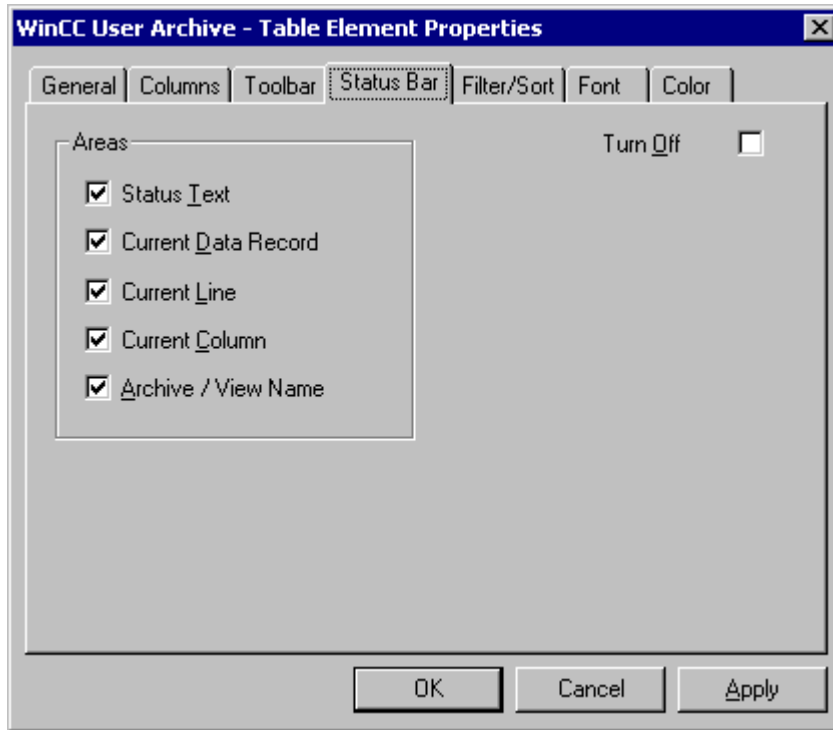

Icon	Description
Areas	In the "Ranges" checkbox you can define which elements are to be included in the status bar of the control.
Switch off	The "Turn Off" field is used to turn or turn off the status bar display.

The status bar is displayed as follows when all the areas of the status bar are activated:



See also

List of properties for the User Archives Table Element (Page 2000)

7.6.3.6 "Filter/ Sorting" tab

Configuration

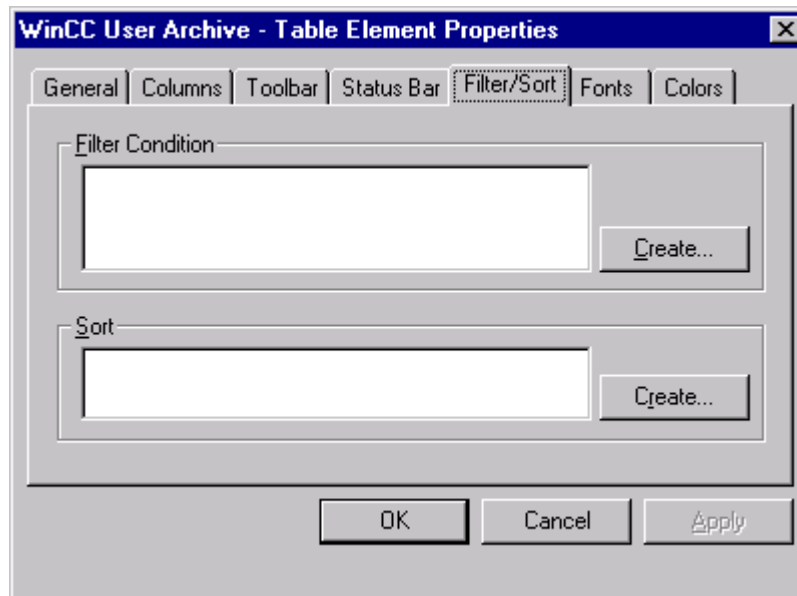

Filter criterion

You define the filter criteria in the "Filter Criterion" dialog. Enter directly the rules for the filter criteria. The conditions are formulated in the database programming language SQL (Structured Query Language). You will find a description of the SQL with many practical examples in the Appendix.

Example: `FieldC > 100`

All data sets which have a value greater than 100 in the "FieldC" column are selected.

When you click the "Create..." button you will get an automated filter screen where you can define the filter criteria.

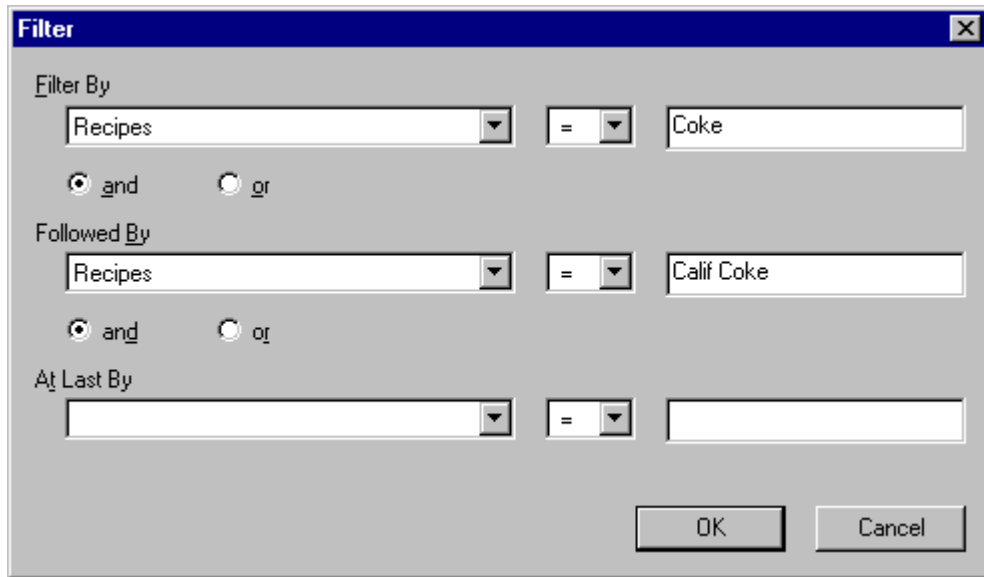

In the "Filter by" row you can define the filter criteria; in the left selection field you will see a display of all data fields of the user archive. You can use the "Followed by" and "Lastly after" rows to define the following filter criteria. The filters are processed in this sequence.

Sort order

You define the sort criteria in the "Sort..." dialog. Enter the sorting rules directly in the database programming language SQL.

When you click the "Create..." button you will get an automated filter screen where you can define the sort criteria.

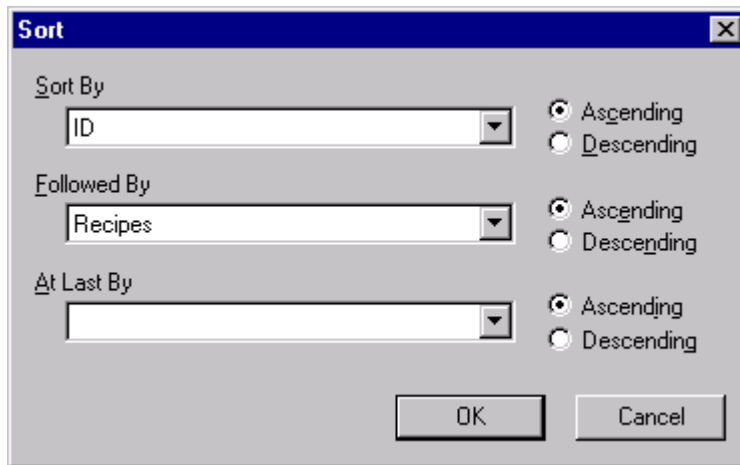

In the "Sort By" selection field you can define the sort criteria; all data fields of the user archive are offered for selection. You can use the "Followed by" and "Lastly after" selection fields to define the following sort criteria. The filters are processed in this sequence. Sorting is done in an ascending order when you click "Ascending"; in a descending order when you click "Descending".

See also

List of properties for the User Archives Table Element (Page 2000)

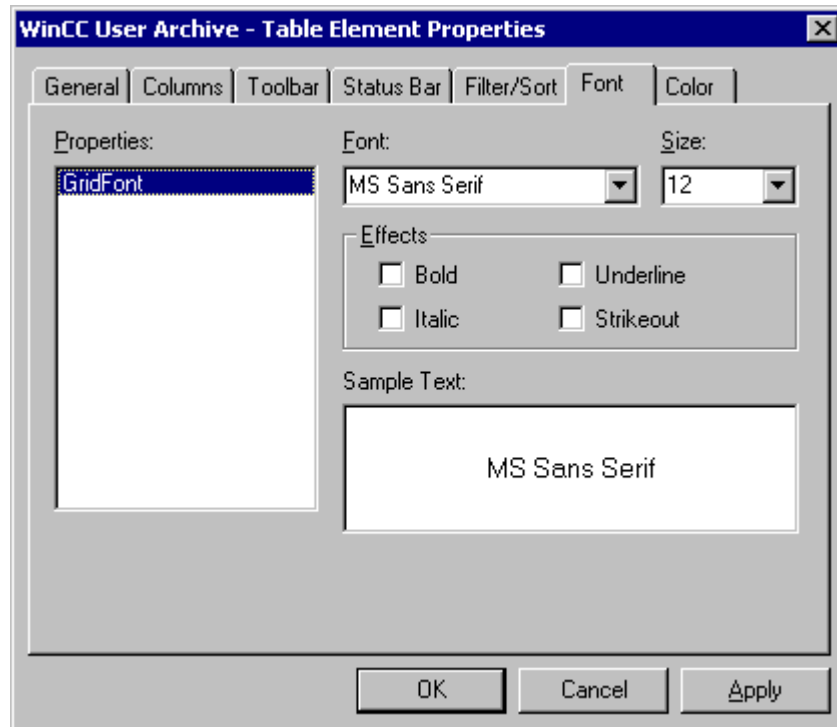
7.6.3.7 "Fonts" Tab**Configuration**

In the "Fonts" tab you define the font to be used in the Control.

See also

List of properties for the User Archives Table Element (Page 2000)

7.6.3.8 "Colors" tab

Configuration

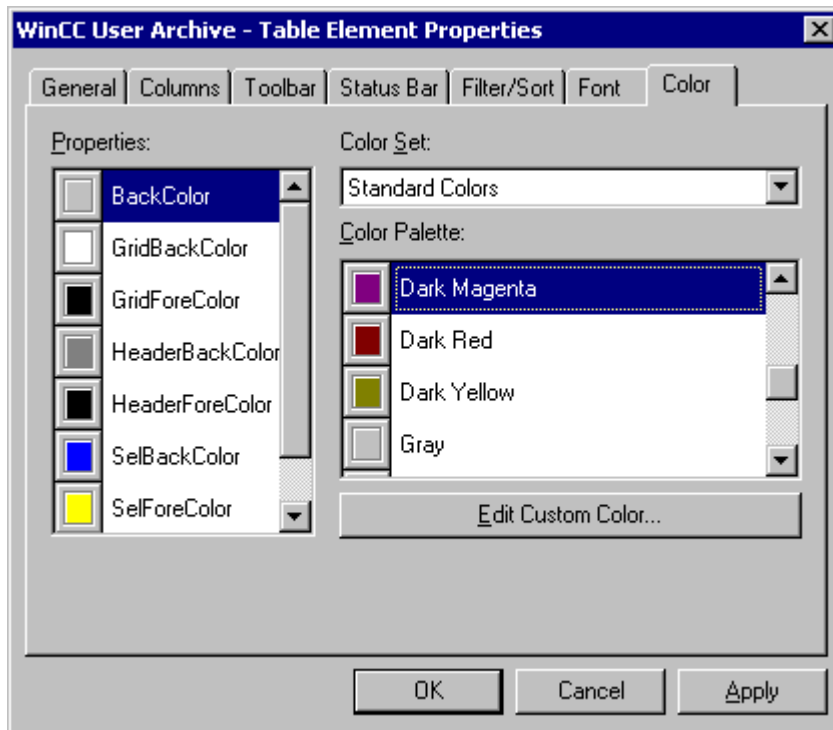

In the "Colors" tab you define the colors to be used in the Control.

See also

List of properties for the User Archives Table Element (Page 2000)

7.6.4 Configuring a Form View

7.6.4.1 Configuring a Form View

Procedure

The form of the User Archive Table Element may be configured by the user himself in Graphics Designer and is used for editing and displaying user archive data in Runtime.

A configured User Archives Table Element is a prerequisite for creating a form view.

The following guideline will show you the configuration of a new form view in the Graphics Designer.

1. Press the Control key and simultaneously double-click the User Archives Table Element. You will get a table view of the Controls. You can now define the width of the individual columns for Runtime.



2. Use the  icon to switch between form and table view. Click this icon to go to the form view.

You can now start configuring a form.

We will now create a form:

Input mask Coke

ID	<input type="text" value="1"/>	Water	<input type="text" value="90"/>
Recipes	<input type="text" value="Calif Coke"/>	sugar	<input type="text" value="10"/>
LastAccess	<input type="text" value="18.05.99 16:49:50"/>	Caffeine	<input type="text" value="10"/>
		Coloring7	<input type="text" value="10"/>
		Phosphoric_acid	<input type="text" value="15"/>

Note

With a right-click in the empty form you can use the function "Create, all" from the pop-up menu to automatically generate the form fields for all the data fields existing in the user archive. For each data field, a text field with the corresponding alias name is also inserted for each data field. The "Create, selected" option is used to generate form fields only for the columns that are selected in the "Columns" tab.

Note

The User Archive Table Element does not support zooming functionality. The configuration of the zoom functionality can lead to display problems in runtime.

7.6.4.2 Insert "Text" form field

Procedure

1. Open the Form view if you haven't already done so.
2. To insert a new "Text" form field, click with the right mouse key in the working area of the User Archives Table Element in the Graphics Designer at the place where you want to position the text. You will see the following list box:

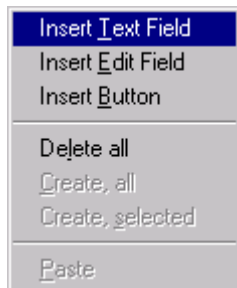

3. When you select "Add Text Field" you will go to the "Text Field Properties" dialog box.

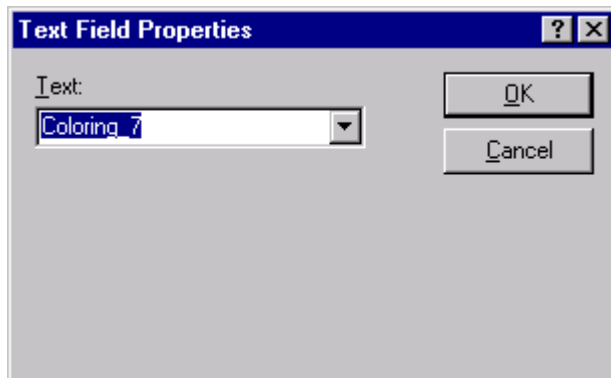

4. You can enter the desired text in the Text field. Enter here text "Input form Cola" as title for the form.

Note

If you expand the selection field via "Text" you will get a display of all field names of an archive as static text. If text references for language switching have already been entered as Text References in the Text library, the same are offered for selection.

See also

Insert "Edit" form field (Page 1989)

7.6.4.3 Insert "Edit" form field**Procedure**

1. Open the Form view if you haven't already done so.
2. To insert a new "Edit" form field, click with the right mouse key in the working area of the User Archives Table Element in the Graphics Designer at the place where you want to position the Edit field. You will see the following list box:



3. When you select "Add Edit Field" you will go to the "Edit Field Properties" dialog box:

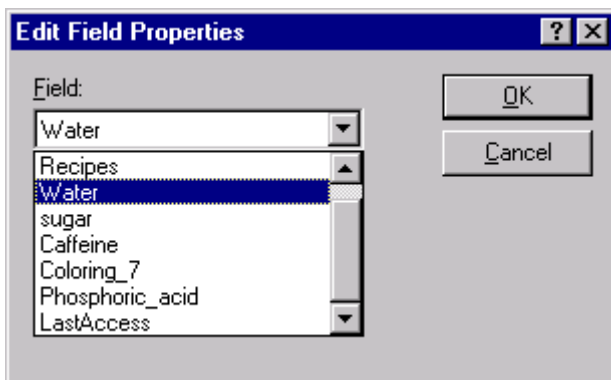

In the dialog of the selection field, you can select from all the configured fields of the user archive.

4. Select "Water". You can now insert other editing fields such as Sugar, Dyestuff 7, Caffeine and Phosphoric Acid.

See also

Insert "Button" form field (Page 1990)

7.6.4.4 Insert "Button" form field

Procedure

1. Open the Form view if you haven't already done so.
2. To insert a new "Button", click with the right mouse key in the working area of the User Archives Table Element in the Graphics Designer at the place where you want to position the button. You will see the following list box:

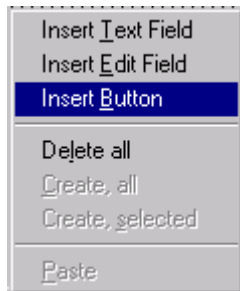

3. When you select "Add Button" you will go to the "Button Properties" dialog box:

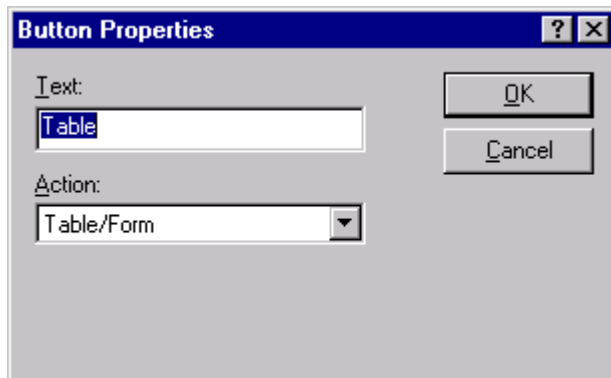

4. In the Text field you can define the text that is to be displayed as label on the new button. Enter the text "Table View".
5. In the Action field you can select an icon of the Form view. Your newly configured button will execute the same action as the corresponding icon in the toolbar. Select "Form" to switch to table view.

Note

You can link all functions of the toolbar from the form view to a button. You can also design the size and layout of the buttons to operate some functions of the toolbar via a touch screen.

See also

Edit form fields subsequently (Page 1991)

7.6.4.5 Edit form fields subsequently**Procedure**

1. To subsequently modify a form field, click the pre-configured form field with the right mouse key and then click the "Properties" button.
or
Double-click the pre-configured form field.

You will see the corresponding dialog for modifying the form field as described in the chapters on Text, Edit and Button form fields.

See also

Delete form fields (Page 1991)

7.6.4.6 Delete form fields**Procedure**

	ID	Recipes	Water	sugar	Caffeine	Coloring7	Phosph
1	1	Calif Coke	90	10	10	10	15
2	2	Coke	80	30	15	20	20
3	3	Standard	100	50	20	20	20
4	4	CokeLight	100	20	30	20	20
5	5	CherryCoke	100	80	50	5	10
...							

Finished Rec 1/5 Row 1 Col 1

7.6.5 Us

7.6.5.1 Ta

Application

The table and form window of the control is operated using the toolbar:



Processing inside a table takes place in the same way as the processing of the table window in the Editor User Archive.

Note

If one or more values are changed in the control table, you must exit the data record, i.e. change to another table cell or row so the value is accepted into the database and be updated in other

See also

7.6.5.2

The

Application

Input mask Coke			
ID	<input type="text" value="1"/>	Water	<input type="text" value="90"/>
Recipes	<input type="text" value="Calif Coke"/>	sugar	<input type="text" value="10"/>
LastAccess	<input type="text" value="18.05.99 16:49:50"/>	Caffeine	<input type="text" value="10"/>
		Coloring7	<input type="text" value="10"/>
		Phosphoric_acid	<input type="text" value="15"/>

Finished Rec 1/5 Row 1 Col 1

Note

If you change one or more values in a user archive table element form, then you must scroll to another record after completing the data entry so that the value is accepted in the database and updated in other displays.

7.6.5.3 Toolbar of WinCC User Archives Table Element

Functions

The toolbar offers the following options:



The screenshot shows a toolbar with various icons for table management and data entry. Below the toolbar is a form titled "Input mask Coke" with the following fields:

ID	<input type="text" value="1"/>	Water	<input type="text" value="90"/>
Recipes	<input type="text" value="Calif Coke"/>	sugar	<input type="text" value="10"/>
LastAccess	<input type="text" value="18.05.99 16:49:50"/>	Caffeine	<input type="text" value="10"/>
		Coloring7	<input type="text" value="10"/>
		Phosphoric_acid	<input type="text" value="15"/>

At the bottom of the form, there is a status bar with the following information:

Finished	Rec 1/5	Row 1	Col 1
----------	---------	-------	-------

Icon	Description
	Switching
	Delete record
	Insert a new record
	Modify existing field
	Browse in Table window
	Read and write tags
	Import and export user archive
	Define filter criterion
	Define sort criterion
	Time base for the "LastAccess" field

Icon	Description
	Printing
	Request Help

Switching

Use the icon to switch between form and table view.

Delete record

The selected record is deleted.

Insert a new record

You enter the values of the data fields one after the other and confirm each time by pressing Enter. After entering all data fields, the new record is created with the inserted values.

Modify existing field

After clicking this icon, click the field you want to modify. This will display the text marker - you can now see that the field can be edited. As soon as the "Modify existing field" is active, you can modify the Used Archives Table Element in the Modify mode. You can then move the cursor in the table and make the changes immediately. If the "Modify" mode is switched off, you can make changes only by pressing the F2 hotkey or double-clicking the field to be modified.

Browse in Table window

You can use these buttons to scroll or browse backward and forward in the table window and jump to the start or end of the user archive.

Read and write tags

These buttons are used to read and write WinCC tags.

While setting up the user archive in the "Communication" tab of the "Archive Properties" dialog box, you can select the communication type "Communication via WinCC tags".

Import and export archives

After clicking one of these buttons, the user archives are imported or exported in CSV format (Coma Seperated Value).

Note

Before reading them in Excel, you need to specify data type as CSV because otherwise Excel will not read the CSV file exported from WinCC correctly.

Note

With a multi-user project the following has to be considered: If there is a user archive on the server, e.g. at "c:\Projects\Test\UA", it is enabled with this specified path. The client maps the enablement via a network drive e.g. "I:\Test\UA". Thereafter, the standard path of the User Archive is on the client "I:\Test\UA". However, this directory does not exist on the server with this description. If you want to import / export user archive data, you have to change the standard path on the client, in our example to "C:\Projects\Test\UA".

Define filter criterion

Use this option to enter filter criteria. All displayed data is exported. To export a subset, you need to formulate the filter criteria in such a way that only the desired data is displayed. You can then export this filtered data.

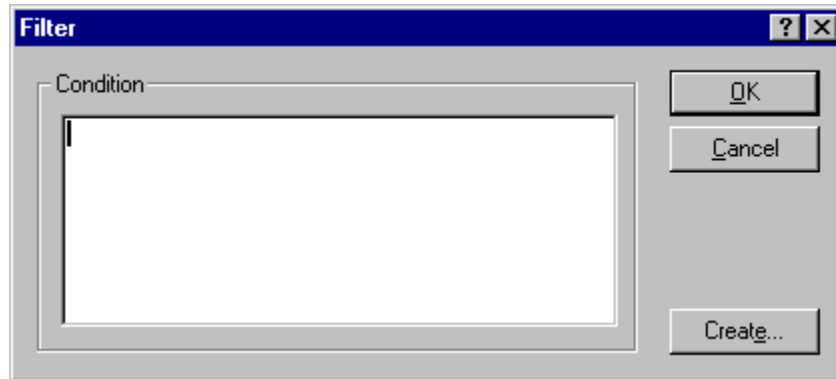

The conditions are formulated in the database programming language SQL (Structured Query Language). You will find a description of the SQL with many practical examples in the Appendix. For more details refer concerned technical literature.

Example: ID < 100

Only data fields with IDs 1 to 99 are selected; all other data fields are not displayed.

When you click the "Create..." button you will get an automated filter screen where you can define the filter criteria.

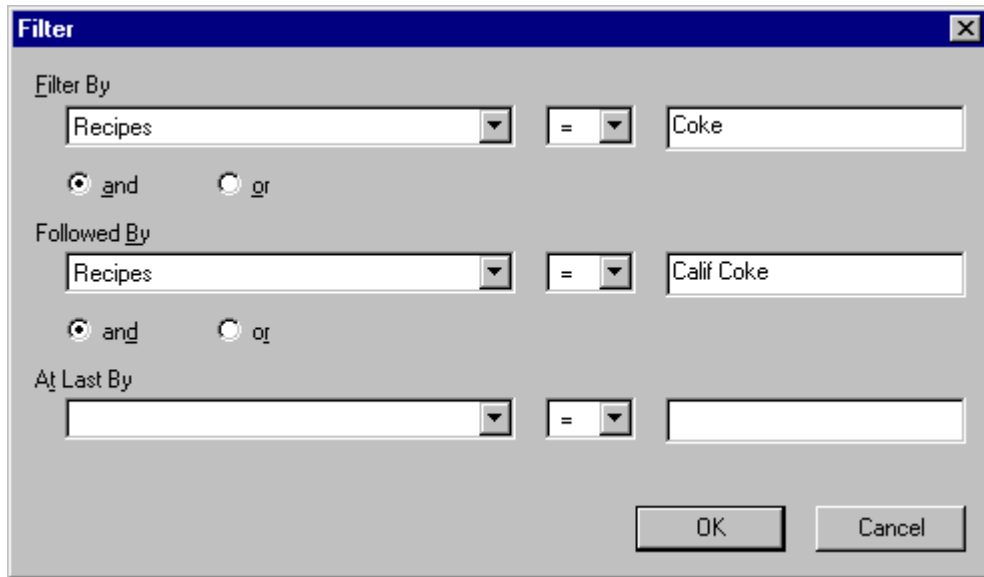

In the "Filter by" row you can define the filter criteria; in the left selection field you will see a display of all data fields of the user archive. You can use the "Followed by" and "Lastly after" rows to define the following filter criteria. The filters are processed in this sequence.

Note

The filter conditions defined here are temporary, i.e. after building up a fresh screen, the filter criteria defined in the Properties dialog are again valid.

Define sort criterion

Use this option to enter sort criteria.

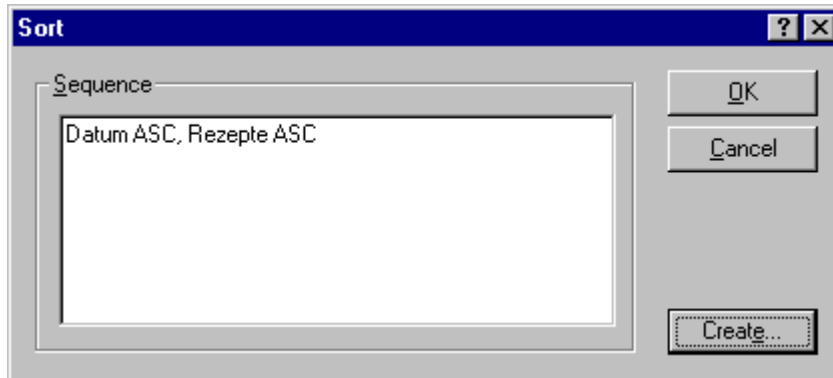

The rules for sorting are directly specified in the database programming language SQL.

Also refer the description of SQL in the Appendix. For more details refer concerned technical literature.

When you click the "Create..." button you will get an automated filter screen where you can define the sort criteria.

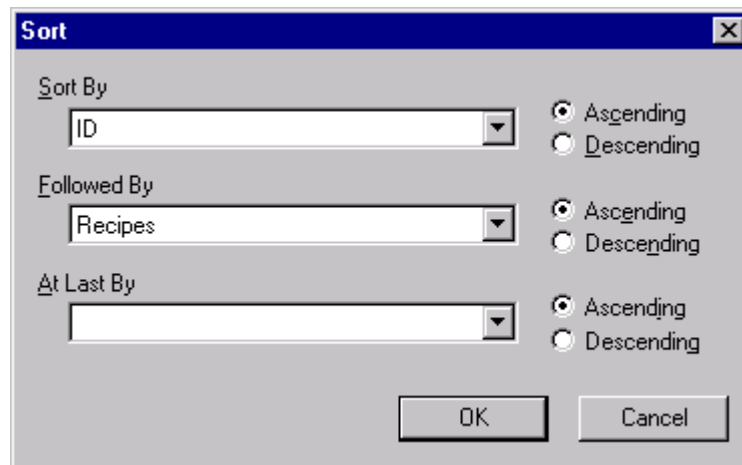

In the "Sort By" selection field you can define the sort criteria; all data fields of the user archive are offered for selection. You can use the "Followed by" and "Lastly after" selection fields to define the following sort criteria. The filters are processed in this sequence. Sorting is done in an ascending order when you click "Ascending"; in a descending order when you click "Descending".

Note

The sort conditions defined here are temporary, i.e. after building up a fresh screen, the filter criteria defined in the Properties dialog are again valid.

Time base for the Last Access field

You can use this option to change the time base for the "Last Access" field.

Printing

This option starts printing the displayed values.

Request Help

Click the Help button to request Help for the User Archives Table Element.

7.6.5.4 Operating the Control using Dynamized Objects

Operating options

The User Archives Table Element offers you the option of shifting the functions of all the toolbar buttons to self-defined buttons or I/O fields. You can define the size and appearance of each of the buttons so that you can operate the Table Element say by using a touch screen.

Example for using the "Press TB Button" attribute

You need to run the following steps to connect the User Archives Table Element with a button:

1. Create a button in the Graphics Designer and call it by right-clicking the object properties.
2. In the "Event" tab, select the Mouse option. Click in the right window to select "Mouse click". After right-clicking the arrow in the "Action" column, you see a dialog box; select the "Direct Connection" option.

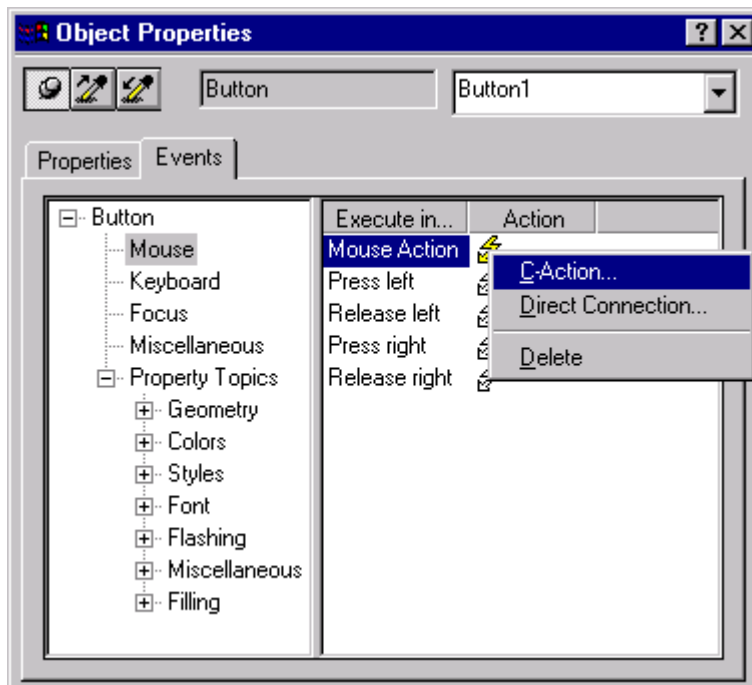















3. In the "Source" area, select "Constants" and enter a constant here, for e.g. "Form" (see further below for an overview of the constants available for the User Archives Table Element).
4. In the "Target" area, click the "Object in Image" option and select the table element to be linked in the Object Selection field. In the Properties box, select "PresstBButton" and confirm the dialog by clicking OK.
5. Save the picture in the Graphics Designer and go to Runtime. When you now activate the configured button "Form", the control display changes from the table view to the form view and vice-versa.

Constants for direct link to the User Archives Table Element

For the above direct links to the User Archives Table Element you have one constant for each button of the control. You can assign the individual buttons according to the following table.

Constant	Corresponding button
Form	
Delete	

Constant	Corresponding button
New	
Edit	
First	
Previous	
Next	
Load	
WriteVar	
ReadVar	
Import	
Export	
Filter	
Sort	
Timezone	
Print	
Help	

Note

While operating the table window using the keyboard, the cell cursor for the selected record cell is no longer visible when you press the keys "Tab" and "Position 1". To bring back the display to the last edited record, insert a button according to the steps mentioned above and select the "VTB_Focus" constant. When you press this button, the cell cursor jumps back to its last position.

See also

List of properties for the User Archives Table Element (Page 2000)

7.6.5.5 List of properties for the User Archives Table Element

Overview

You can set the following properties for the user archives table control:

Attribute	Description	can be made dynamic
BackColor	Defines the background color of the table window in the user archives table element. In order to avoid inconsistencies in the database, the static of this attribute should only be edited in the dialog box of the property dialog. In the tab "Colors" you can edit these settings.	no
Border	Determines whether the form view of the User Archives Table Elements in Runtime is displayed with or without a border. In order to avoid inconsistencies in the database, the static of this attribute should only be edited in the dialog box of the property dialog. In the tab "General" you can edit these settings.	no
Buttons	Defines that the pointers generated by the software of the buttons activated in the toolbar are output. In order to avoid inconsistencies in the database, the static of this attribute must not be edited.	no
Caption	Defines the labeling of the title bar in the user archives table element.	no
Closable	Determines whether the user archives table element can be closed via the "X" in the title bar.	no
Delete	Determines whether deletion processes are allowed in the user archives table element in Runtime. In order to avoid inconsistencies in the database, the static of this attribute should only be edited in the dialog box of the property dialog. There is a checkbox for this in the area "Edit" on the "General" tab.	no
Filter	Defines filter conditions for the database. The conditions are formulated in the database programming language SQL (Structured Query Language). Example: FieldC>100 All data sets, which have a value greater than 100 in the "FieldC" column, are selected. You can also enter these filter conditions in the tab "Filter/Sort".	yes, with the name Filter
Form	Defines the view of the user archives table elements when starting in Runtime: Status "Yes": Outputs the form view Status "No": outputs the table view. You can also change these settings in the "General" tab	yes, with the name Form
GridBackColor	Defines the background color of the data set in the user archives table element. In order to avoid inconsistencies in the database, the static of this attribute should only be edited in the dialog box of the property dialog. In the tab "Colors" you can edit these settings.	no
GridFont	Defines the font in the user archives table element. In order to avoid inconsistencies in the database, the static of this attribute should only be edited in the dialog box of the property dialog. In the tab "Fonts" you can edit these settings.	no

7.6 Before WinCC V7: WinCC User Archives Table Element

Attribute	Description	can be made dynamic
GridForeColor	Defines the font color of the data set in the user archives table element. In order to avoid inconsistencies in the database, the static of this attribute should only be edited in the dialog box of the property dialog. In the tab "Colors" you can edit these settings.	no
HeaderBackColor	Defines the background color of the header and the column with the consecutive line number in the user archives table element. In order to avoid inconsistencies in the database, the static of this attribute should only be edited in the dialog box of the property dialog. In the tab "Colors" you can edit these settings.	no
HeaderForeColor	Defines the font color of the header and the column with the consecutive line number in the user archives table element. In order to avoid inconsistencies in the database, the static of this attribute should only be edited in the dialog box of the property dialog. In the tab "Colors" you can edit these settings.	no
Insert	Defines whether entries can be made in the user archives table element. In order to avoid inconsistencies in the database, the static of this attribute should only be edited in the dialog box of the property dialog. There is a checkbox for this in the area "Edit" on the "General" tab.	no
LocaleSpecificSettings	Defines the language-specific response of the texts and fonts, which you configure in the properties dialog. Value = "Yes": You can assign separate texts and fonts for each Runtime language. To do so, select a language in the "View/Language" menu of the Graphics Designer and choose the desired font in the controls. Value = "No": You cannot define language-specific texts and fonts. The configuration of the control always applies to all available Runtime languages.	yes, with the name LocaleSpecificSettings
Movable	Defines whether the user archives table element can be moved.	no
Name	Defines which user archive or which view is displayed. In order to avoid inconsistencies in the database, the static of this attribute should only be edited in the dialog box of the property dialog. In the area "Source" of the tab "General" you will see a selection of all configured user archives and views.	no
PressTBButton	Connects all buttons of the toolbar of the table elements with self-defined buttons or I/O fields.	yes, with the name Press TB Button
PrintJob	Specifies which layout should be used for the print output.	no
PrintVisColsOnly	Defines whether only the currently visible columns should be printed in draft print mode.	no
Read only	Defines whether the user archives table element can be edited or only read in Runtime. In order to avoid inconsistencies in the database, the static of this attribute should only be edited in the dialog box of the property dialog. There is a checkbox for this in the area on the "General" tab.	no
SelBackColor	Defines the background color of the selected data set in the user archives table element. In order to avoid inconsistencies in the database, the static of this attribute should only be edited in the dialog box of the property dialog. In the tab "Colors" you can edit these settings.	no

7.6 Before WinCC V7: WinCC User Archives Table Element

Attribute	Description	can be made dynamic
SelForeColor	Defines the font color of the selected data set in the user archives table element. In order to avoid inconsistencies in the database, the static of this attribute should only be edited in the dialog box of the property dialog. In the tab "Colors" you can edit these settings.	no
SelectedID	Displays the ID of the data set selected in the control window. SelectedID = "0": if no valid data set has been selected, e.g. during the connection error SelectedID = "-1", if the edit line is selected.	no
Sort	Defines the sorting conditions for the database. The conditions are formulated in the database programming language SQL (Structured Query Language). You can also enter your filter conditions in the "Filter/Sort" Tab.	yes, with the name Sort
StatusbarDisabled	Defines whether the status bar in the user archives table element is activated in Runtime. In order to avoid inconsistencies in the database, the static of this attribute should only be edited in the dialog box of the property dialog. There is a checkbox "Turn Off" for this in the area on the "Status Bar" tab.	no
StatusbarShowArc	Defines whether the archive name is shown in the status bar of the user archives table element.	yes, with the name StatusbarShowArc
StatusbarShowCol	Defines whether the consecutive number of the currently selected data set column is shown in the user archives table element status bar. In order to avoid inconsistencies in the database, the static of this attribute should only be edited in the dialog box of the property dialog. You can change this setting in "Current column" in the "Status Bar" tab.	no
StatusbarShowRecord	Defines whether the field coordinates of the currently selected data set column is shown in the user archives table element status bar. In order to avoid inconsistencies in the database, the static of this attribute should only be edited in the dialog box of the property dialog. You can change this setting in "Current Data Record" in the "Status Bar" tab.	no
StatusbarShowRow	Defines whether the consecutive number of the currently selected data record line is shown in the user archives table element status bar. In order to avoid inconsistencies in the database, the static of this attribute should only be edited in the dialog box of the property dialog. You can change this setting in "Current Line" in the "Status Bar" tab.	no
StatusbarShowText	Defines whether the current status of the database is shown in the user archives table element status bar. In order to avoid inconsistencies in the database, the static of this attribute should only be edited in the dialog box of the property dialog. You can change this setting in "Status text" in the "Status Bar" tab.	no
Titleline	Defines whether the title bar is shown in the user archives table element.	no
TimeZone	Determines the time base used for the display of times in Runtime. The time base is set via the following numeric values: Value = 0: Apply project settings Value = 1: Server's time zone Value = 2: Local time zone Value = 3: Coordinated Universal Time (UTC) We recommend applying the default configuration "Apply Project Settings". This means that the display is operated at same time zone as the rest of the project.	no

Attribute	Description	can be made dynamic
TimeZoneMark	Determines whether the column heading of the LastAccess field should include the set time zone. The following acronyms are used for the time zone: LOC: Local time zone UTC: Coordinated universal time SVR: Server's time zone	no
ToolbarDisabled	Defines whether the toolbar in the user archives table element is activated in Runtime. In order to avoid inconsistencies in the database, the static of this attribute should only be edited in the dialog box of the property dialog. There is a checkbox "Turn Off" for this in the area on the "Toolbar" tab.	no
Type	Defines whether a user archive or a view is displayed in the user archives table element Value Type= 0: Stands for a user archive Value Type= 1: Stands for a view. In order to avoid inconsistencies in the database, the static of this attribute should only be edited in the dialog box of the property dialog. In the area "Source" of the tab "General" you will see a selection of all configured user archives and views.	no
Update	Defines whether changes can be made in the user archives table element. In order to avoid inconsistencies in the database, the static of this attribute should only be edited in the dialog box of the property dialog. There is a checkbox for this in the area "Edit" on the "General" tab.	no

7.6.5.6 Overview of the dynamizable properties in the layout

Filter

You can use the "Filter" property to define filter conditions for the database. The conditions must be formulated in the database programming language SQL.

Format: SQL text

Tag type: Text Tag

Sort

You can use the "Sort" property to define sorting criteria for the database. The criteria must be formulated in the database programming language SQL.

Format: SQL text

Tag type: Text Tag

TimeZone

Determines the time base used for the display of times in runtime.

Format: Number

Value	Description
0	Local time zone
1	Server Time Zone
2	Coordinated Universal Time (UTC)
3	Apply project Settings

Variable type: All tag types, except binary, text and raw data tags

Working with Cross Reference

8.1 The functionality of Cross Reference

Introduction

The "Cross Reference" editor provides an overview of the following elements that you have used in your project:

- Tags
- Pictures
- Functions
- Layouts
- Texts created in the Text Library

When you open the editor, updated lists will be generated automatically.

The search for tags takes place in the following editors:

- Graphics Designer
- Alarm Logging
- Tag Logging
- Global Script
- Report Designer
- User Archive
- Horn

Overview

Cross Reference offers the following functions:

- All referenced objects of the WinCC project are referenced in the list of project objects.
- You use filters to limit the display of project objects.
- The places of use of project objects are displayed in the list of places used.
- You can directly access the place of use of a project object to change or delete the object there.
- For tags in pictures, you can use the "Link" function to change the names of one or several tags, without any inconsistencies occurring in the project. You can search for and replace individual characters in the tag names.
- You can search for the places of use of non-existing tags to change or delete the places of use.

8.1 The functionality of Cross Reference

- You can find relationships between the existing process pictures of a project in order to apply the existing structure of the process visualization for a project extension.
- You can print the list of the project objects and the places of use, or export or copy list entries for further processing.
- If you change the configuration in the WinCC editors while Cross Reference is open, you can update the lists manually.
- You can insert missing text IDs with the rows into the Text Library again.

List of project objects

The listed project objects are differentiated by name, type and status.

The following types will be displayed:

- Process tags and internal tags
- Pictures, picture windows and WinCC controls
- Actions in pictures (C and VBS)
- Layouts (RPL files)

Project objects can have the following status:

Status of the project objects	Description
Used	Project objects that exist and are used in an object.
Not used	Project objects that exist but are not referenced in any object. Unused, existing tags are not displayed in the list of places used.
Non-existing	Project objects that have a reference to a non-existent object. For example, a deleted tag that is referenced in a picture.

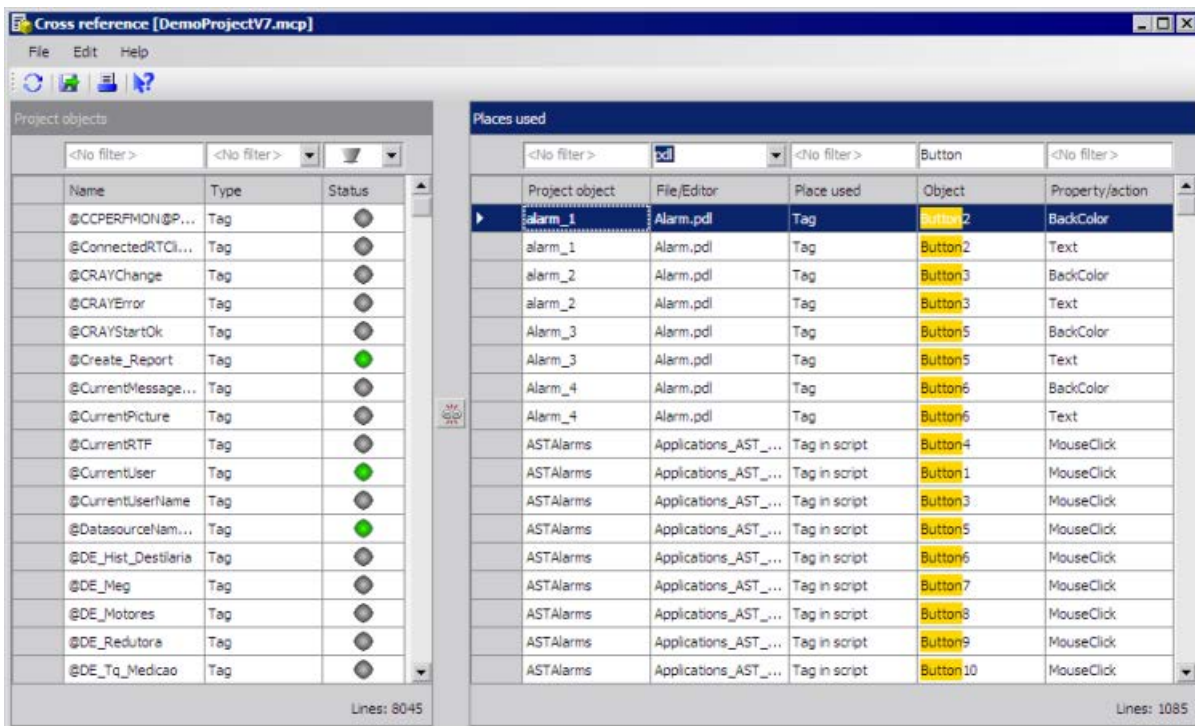

List of the places of use

The list contains:

- Names of the project objects
- WinCC editors and file names of pictures and scripts.
- Places of use in the files and editors
- Used objects in the files and editors.
- Properties and actions used in the files and editors. For pictures, the name of the property is the "WinCC Automation Name" that you use to dynamize the property.

Adding missing text IDs to the Text Library again

1. In the project object list, select the "Text" filter in the "Type" column. All text IDs existing in the Text Library are displayed with the texts.
2. Select all text objects in the list that have the status "does not exist".
3. Select the "Create text" command in the shortcut menu. The missing text IDs with their rows are once again inserted in the Text Library. However, the missing text entries are not restored.

Limitations for project objects

- In Cross Reference, configured messages will be searched for used variables. The search for messages is not supported.
- The tags in the scripts are found only if they conform to the configuration rules for tag and picture names. The configuration rule also applies to the linking of tags in C actions in pictures.
- Cross Reference displays the places of use of objects exclusively in the context of WinCC. Mapped WinCC tags are also displayed.
- The listing of standard objects, such as lines, and Windows objects in pictures is not supported.

Note

Converting project data of pictures and layouts for projects prior to WinCC V7.3

Before you start Cross Reference, you have to convert certain data for projects that were created prior to V7.3. In the WinCC Explorer, select the menu command "Convert project data" in the "Options" menu. Select the check boxes "Pictures and faceplates" and "Page and line layouts". Click "OK".

You can no longer use the XFC files.

The reference lists saved in the XFC files are no longer supported. They are not displayed in WinCC Explorer. Create new filters and save these filters.

8.2 How to filter the lists of the Cross Reference

Introduction

The lists of all project objects and all places of use are displayed after the start of "Cross Reference". You use filter and selection to limit the listed objects.



How to filter list entries

Above the lists, an input box for the filter criterion is available for each column. The default setting is "No filter" or .

1. Start by filtering the list of project objects. Enter a letter string in the "Name" column and press "Enter". The letter string you are looking for is highlighted in the listed names.
2. Limit the display of project objects further with the type or status.
3. If necessary, limit the entries in the list of places used further.
4. If you do not want to filter directly according to specific names in the list of places used, use "File/Editor" to limit the display. Select an editor or enter a file name and press "Enter".

How to display the places of use for selected project objects

You can use a selection of project objects to define the entries in the list of places used. Only the used objects are displayed in the list of places used.

1. In the list of project objects, select the entries whose places of use you want to display. Use the mouse and keyboard to access all selection options in a list, for example:
 - Select eight lines in a row
 - Select the first and the fourth line with <CTRL> and the mouse
 - Select all entries with <CTRL + A>.
2. Click on  between the tables. In the list of places used, only the entries of the selected project objects will be displayed. Use the columns of the list to filter and further delimit the list entries.
3. Click "Connect"  to once again display the complete or filtered list of places used.

Note

Number of maximum selected lines

To connect the selected entries, you cannot select more than 1,000 lines in the list of project objects.

8.3 How to jump to a place of use

Introduction

In the list of places used, you can jump to the corresponding WinCC editor of the project object.

Overview

The following table shows which editor is opened when jumping to the place of use:

Place of use	Editor	Action during jump to the place of use
Process value archive	WinCC Configuration Studio / Tag Logging	Start of the editor. No further action
User archive	WinCC Configuration Studio / User Archive	Start of the editor. No further action
Message Limit monitoring	WinCC Configuration Studio / Alarm Logging	Start of the editor. No further action
Project function Standard function	Global Script	Start of the editor and display of the function
Picture object OCX control	Graphics Designer	Start of the editor and focusing of the object
Layout	Report Designer	Start of the editor. No further action
Message Assignment Signal Assignment	WinCC Configuration Studio / Horn	Start of the editor. No further action

Procedure

1. Select the appropriate project object in the list of places used.
2. In the shortcut menu, select the "Go to" command or press the <F4> key. The corresponding editor opens.

8.4 How to link tags in the pictures

Introduction

Use the linking function to change the names of the tags in the places of use of the project without inconsistencies arising in the names of the tags used.

Only the names of tags in pictures can be changed.

You search for and replace individual or multiple characters in the tag names.

Note

Maximum number of selected lines

Do not select more than 10,000 lines in the list of places used for linking.

Tags used in object properties

If you link a tag that is used in several object properties of an object, note the following behavior:

The tag will be changed in all properties of this object and not just at the selected place of use.

How to replace a tag name with another name

1. In the list of places used, select the tag name that you want to replace.
2. Select the "Link" command in the shortcut menu or in the "Edit" menu. The link dialog opens. The selected tag is displayed in the "Tag name" column. The name is copied to the "Search for" input box.

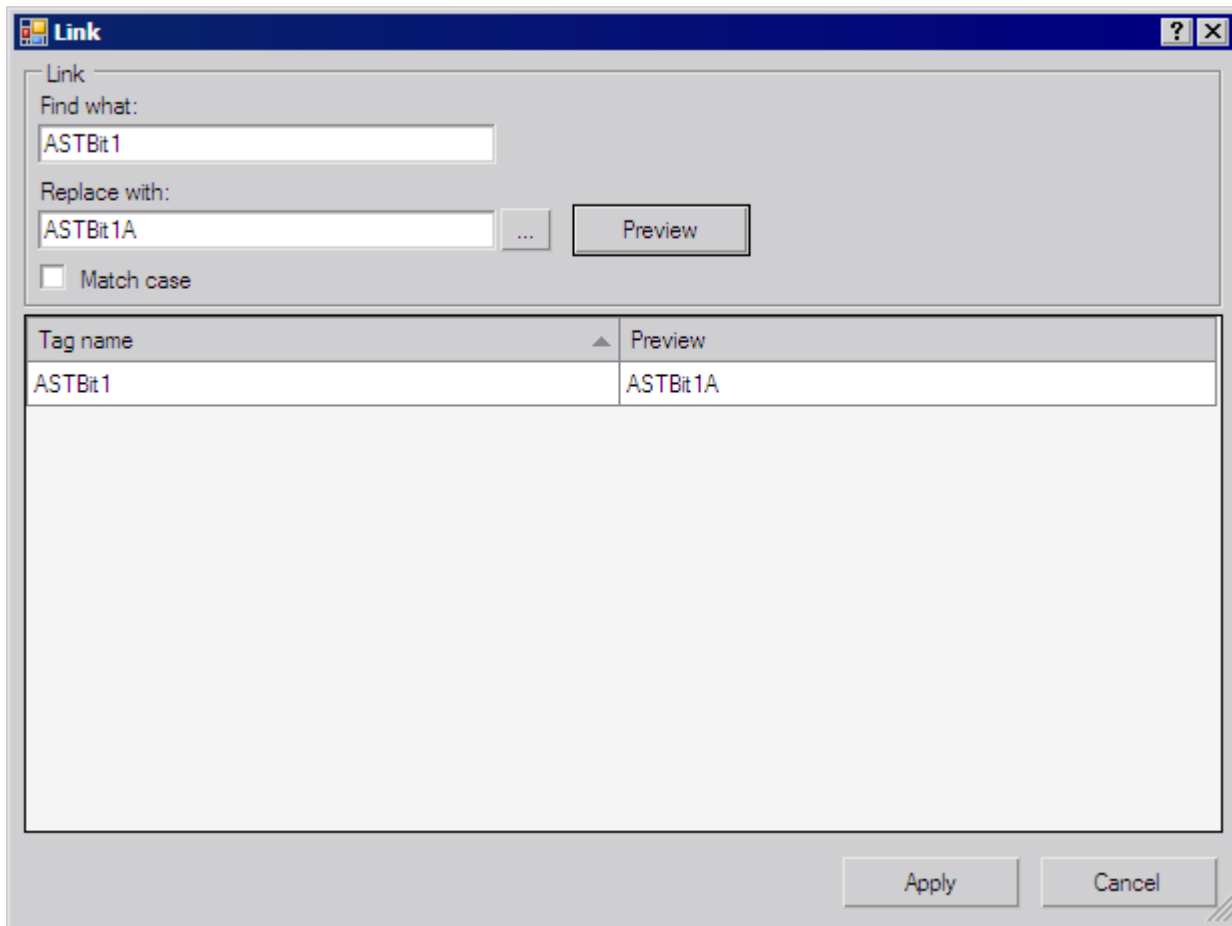

3. Enter the new name in the "Replace with" input box. Alternatively, click  to select a tag from the tag management in the tag selection dialog.
4. Click "Preview". The new tag name is displayed in the "Preview" column.
5. To replace the name, click the "Apply" button. The linking of the tags is applied in the project. If the new tag does not exist in the tag management yet, you must subsequently create the tag.

How to replace individual characters in multiple tag names

1. In the list of places used, select the tag names in which you want to replace characters.
2. Select the "Link" command in the shortcut menu or in the "Edit" menu. The link dialog opens. The selected tags are displayed in the "Tag name" column.

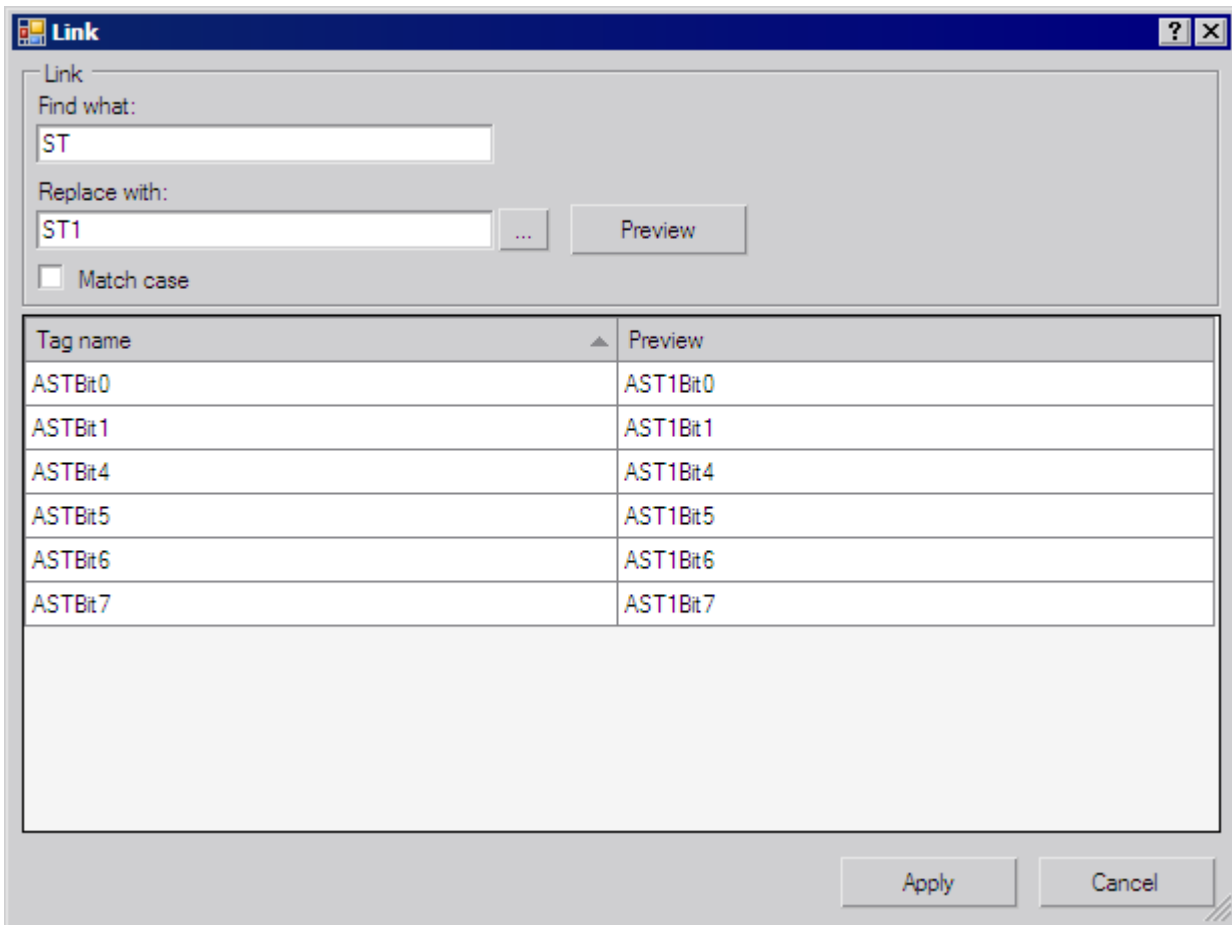

3. In the "Search for" input box, select the characters that you want to replace. You are not permitted to use wildcard characters.
4. Enter the new characters in the "Replace with" input box.
5. Click "Preview". The new tag names are displayed in the "Preview" column.
6. To replace the names, click the "Apply" button. The linking of the tags is applied in the project. If the new tags do not yet exist in the tag management, you must subsequently create the tags.

8.5 How to export the lists of Cross Reference

Introduction

You can use the lists of Cross Reference in the editors outside of WinCC. Cross Reference provides two options for this:

- You can export the lists in the "csv", "xml" or "xls" formats.
- Copying the selection of list entries.

How to export the lists

1. Click  and select the menu command "Edit > Export".

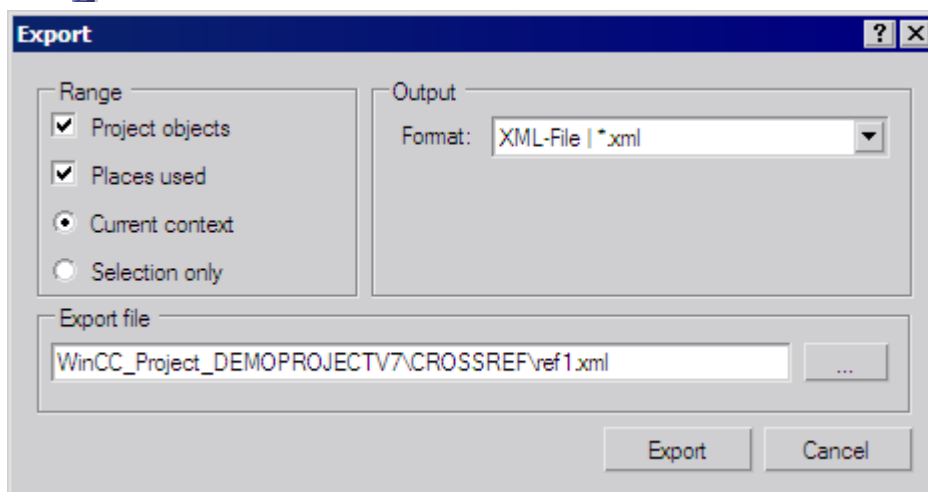

2. Select the options for the scope of export:
 - Project objects: The list of project objects is exported.
 - Places used: The list of places used is exported.
 - Current context: The exports includes the entries that you have delimited via the filter.
 - Selection only: Only the selected entries are exported.
3. Specify the format of the export file.
4. Use  to select the folder in which you want to save the export file. Enter an appropriate name for the file.
5. Click "Export". The exported list is saved in the specified folder.

How to copy a selection of list entries

1. In one of the lists, select the entries that you want to copy. You can use all selection options in a table with mouse and keyboard, for example, all columns, the first and the fourth column, or the third row and the eighth row.
2. Select the "Copy" command in the shortcut menu.
3. Open an editor, such as Excel, and paste the copied data.

Note

Number of maximum selected lines

Do not select more than 100,000 lines in the list of places used for copying.

8.6 Example: Filtering and jumping to places of use

Introduction

The following example shows how you can use the filtering and the jump to place of use functions to quickly modify the configuration. The example uses the WinCC demo project, but customers can use other WinCC projects.

Initial situation

The demo project contains numerous project objects. For the example, you will use an application from the project. In runtime you can find the application under "Applications/AST2/ Mining".



An explanatory text for the I/O fields is displayed in the picture. The display of the texts is dynamized and you want to change the assigned tag. The objective is to use the filter to find this tag with all places of use and to change a specific assignment of the tag there.

You can download the demo project at the following URL:



- WinCC demo project (<https://support.industry.siemens.com/cs/ww/en/>)

In the "Search for product information" field, search for the search term "WinCC demo project".

Requirement

- You have opened the demo project.
- Alternatively, you can for example use one of your own WinCC projects and adapt the procedure accordingly.

Procedure

1. Open the "Cross Reference" editor. The updated lists show all of the project objects and places of use of the project.
2. In the list of projects, write the text "tag" in the filter input box above the "Type" column.
3. Select "Used"  as filter for the status.
4. Click in the left table and press <CTRL + A>. All used tags are selected.
5. Click on . The places used for all used tags are displayed in the list of places used.
6. In the list of places used, write the picture name in the filter input box above the "File/Editor" column and press "Enter".
7. Write "StaticText" in the filter input box above the "Object" column and press "Enter". The names of the tags and all places of use are displayed by the filtering.

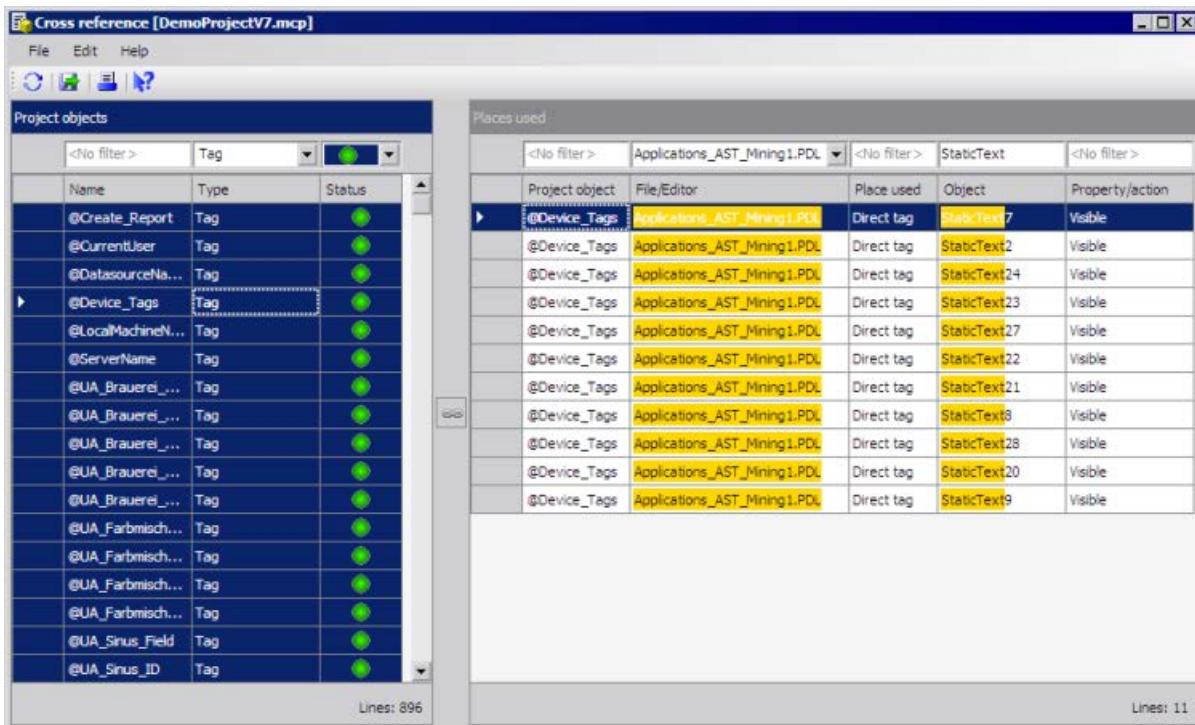

The screenshot shows the WinCC Cross Reference editor window titled "Cross reference [DemoProjectV7.mcp]". It contains two main tables: "Project objects" on the left and "Places used" on the right.

Project objects table:

Name	Type	Status
@Create_Report	Tag	Used
@CurrentUser	Tag	Used
@DataSourceNa...	Tag	Used
@Device_Tags	Tag	Used
@LocalMachineN...	Tag	Used
@ServerName	Tag	Used
@UA_Brauerel_...	Tag	Used
@UA_Brauerel_...	Tag	Used
@UA_Brauerel_...	Tag	Used
@UA_Brauerel_...	Tag	Used
@UA_Brauerel_...	Tag	Used
@UA_Brauerel_...	Tag	Used
@UA_Farbmisch...	Tag	Used
@UA_Farbmisch...	Tag	Used
@UA_Farbmisch...	Tag	Used
@UA_Farbmisch...	Tag	Used
@UA_Sinus_Field	Tag	Used
@UA_Sinus_ID	Tag	Used

Places used table:

Project object	File/Editor	Place used	Object	Property/action
@Device_Tags	Applications_AST_Mining1.PDL	Direct tag	StaticText7	Visible
@Device_Tags	Applications_AST_Mining1.PDL	Direct tag	StaticText2	Visible
@Device_Tags	Applications_AST_Mining1.PDL	Direct tag	StaticText24	Visible
@Device_Tags	Applications_AST_Mining1.PDL	Direct tag	StaticText23	Visible
@Device_Tags	Applications_AST_Mining1.PDL	Direct tag	StaticText27	Visible
@Device_Tags	Applications_AST_Mining1.PDL	Direct tag	StaticText22	Visible
@Device_Tags	Applications_AST_Mining1.PDL	Direct tag	StaticText21	Visible
@Device_Tags	Applications_AST_Mining1.PDL	Direct tag	StaticText8	Visible
@Device_Tags	Applications_AST_Mining1.PDL	Direct tag	StaticText28	Visible
@Device_Tags	Applications_AST_Mining1.PDL	Direct tag	StaticText20	Visible
@Device_Tags	Applications_AST_Mining1.PDL	Direct tag	StaticText9	Visible

The status bar at the bottom indicates "Lines: 896" for the Project objects table and "Lines: 11" for the Places used table.

8. Make a selection in the list of places used, for example, the first entry.

8.6 Example: Filtering and jumping to places of use

- In the shortcut menu, select the "Go to" command or press the <F4> button. The Graphics Designer opens. The static text selected in the list will be selected in the picture. The affected property is displayed in the object properties.

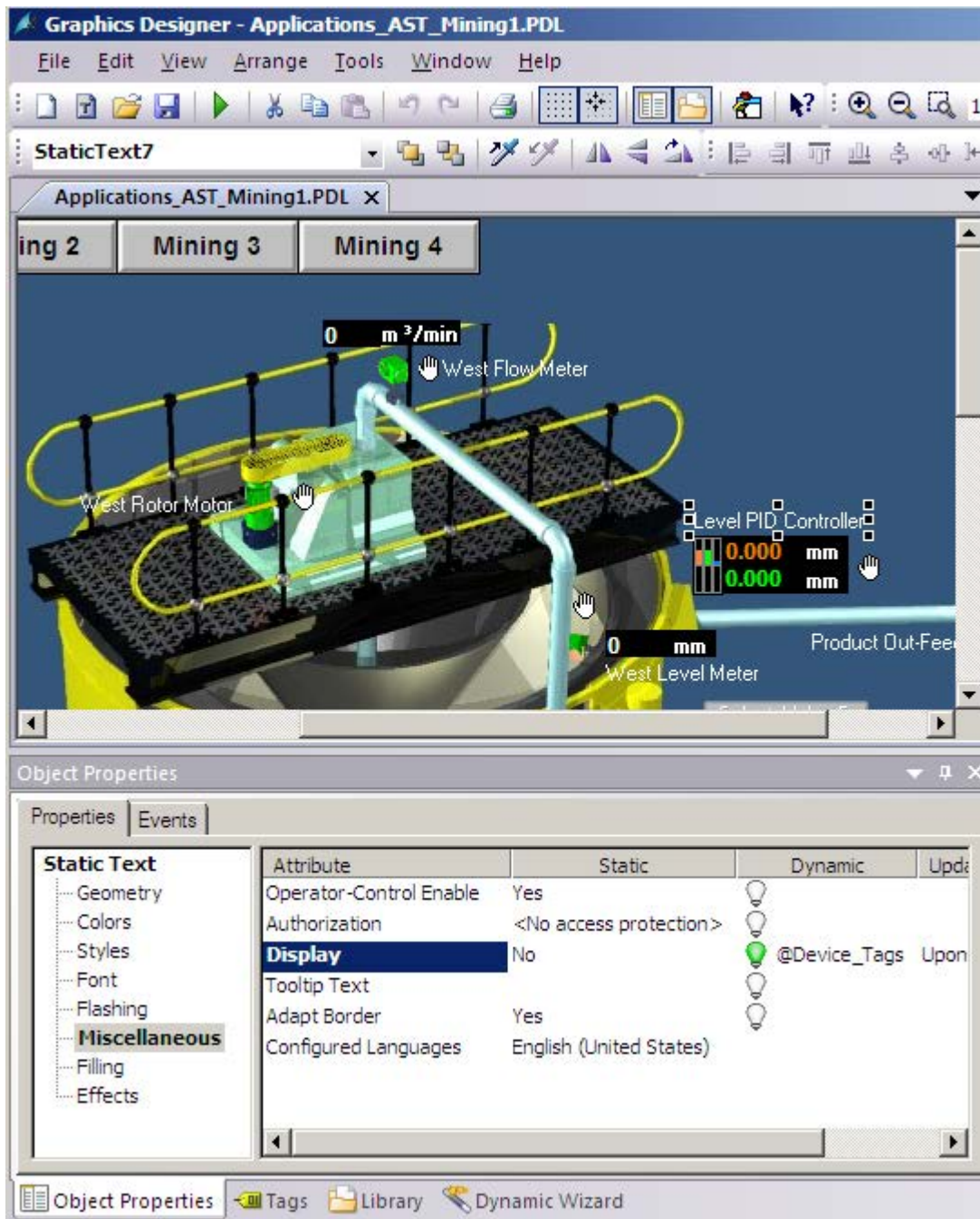

- The green lamp in the object properties indicates the dynamics of the property via a tag.
- Right-click on the green lamp. Select the command "Tag..." to select a different tag already created in the tag selection dialog.
- The new tag is now linked to the text at this place of use.

See also

Internet: Service and Support (<https://support.industry.siemens.com/cs/ww/en/>)

8.7 Example: Linking of tags

Introduction

The following example shows the linking of tags in the WinCC demo project. Customers can use this example or other WinCC projects.

Initial situation

The demo project contains numerous tags. To get a better overview of which tag belongs to which picture in the project, the tag names should contain a part of the picture name. Using the example of the demo page for "tag persistence", we want to change the name of the tags "Data_Tag_1" to "Data_Tag_6 " in all places of use. The new names are "Data_Tag_Persistence_1" etc.

You can download the demo project at the following URL:



- WinCC demo project (<https://support.industry.siemens.com/cs/ww/en/>)

In the "Search for product information" field, search for the search term "WinCC demo project".

Requirement

- You have opened the demo project.
- Alternatively, you can, for example, use one of your own WinCC projects and adapt the procedure accordingly.

Procedure

1. Open the "Cross Reference" editor. The updated lists show all of the project objects and places of use of the project.
2. In the list of projects, write the text "tag" in the filter input box above the "Type" column.
3. Select "Used"  as filter for the status.
4. To find the entries with the tag name you are looking for, enter a part of the file name as a filter using the "Name" column and press "Enter".
5. Select all entries with "Data_Tag_x".
6. Click on . The places of use for these tags are displayed in the list of places used.

7. Click in the right table and press <CTRL + A>. All tags with "Data_Tag_x" will be selected.

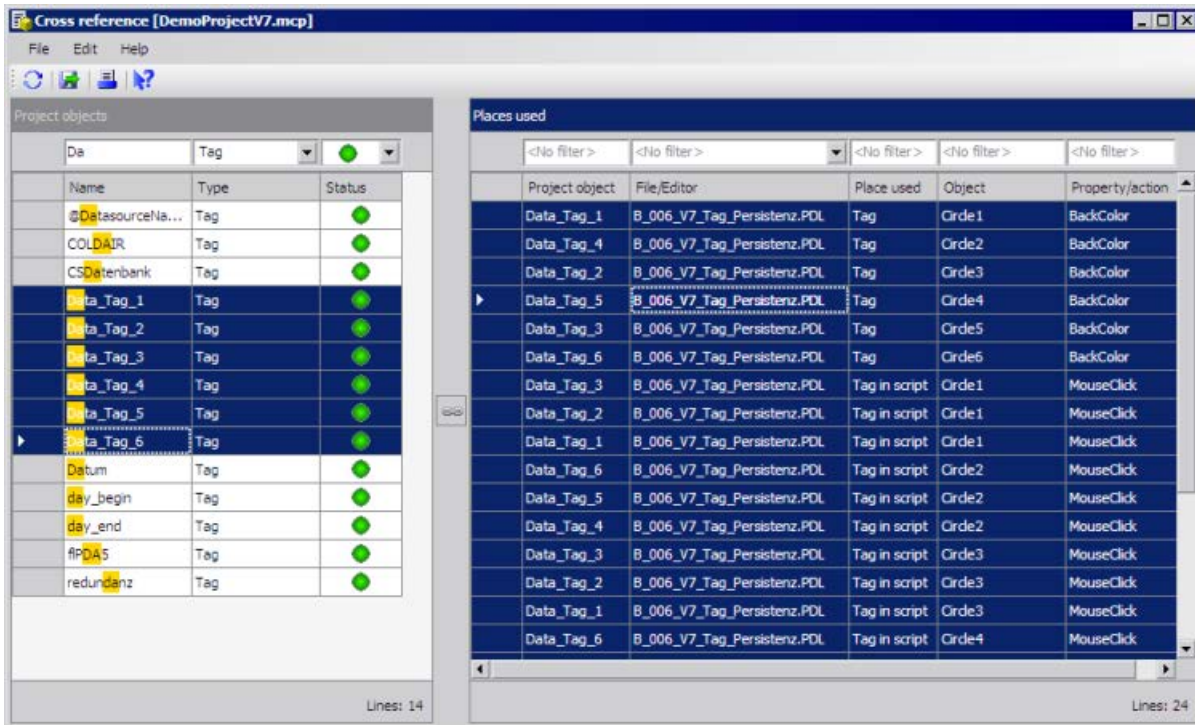

8. Select the "Link" command in the shortcut menu. The link dialog opens. The selected tags are displayed in the "Tag name" column.

9. Enter the string "Tag" in the "Search for" input box.

10. Enter the string "Tag_Persistence" in the "Replace with" input box.

11. Click "Preview". The new tag names are displayed in the "Preview" column.

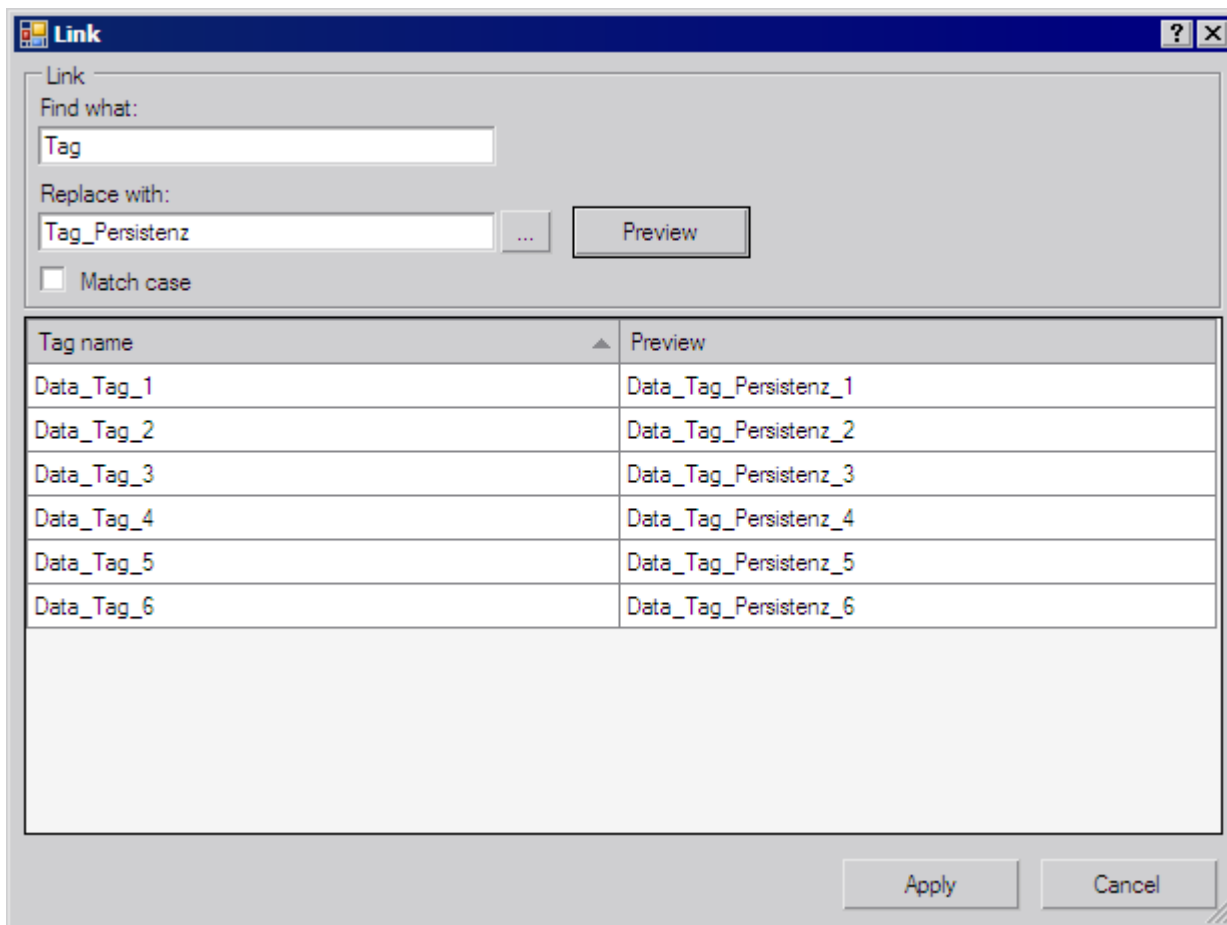

12. The linking of tags is applied in the project by means of the "Apply" button. If the new tags do not exist in the tag management yet, you must create them subsequently.

See also

Internet: Service and Support (<https://support.industry.siemens.com/cs/ww/en/>)

8.8 Configuration instructions for tags and picture names in actions

Introduction

In Cross Reference you can filter the tags and picture names used in actions.

In the pictures you can also link the tags in the actions. To do this, you must structure scripts as follows.

Overview

At the start of the script, declare all used tags and picture names in two sections.

The sections are structured as follows:

```
// WINCC:TAGNAME_SECTION_START
// syntax: #define TagNameInAction "DMTagName"
// next TagID : 4// to enter the next free ID
#define TAG_1 "name_1" // where "name_1" is the original tag name
#define TAG_2 "name_2"
#define TAG_3 "name_3"
// WINCC:TAGNAME_SECTION_END
// WINCC:PICNAME_SECTION_START
// syntax: #define PicNameInAction "PicName"
// next PicID : 4
#define PIC_1 "pict1.pdl"
#define PIC_2 "pict2.pdl"
#define PIC_3 "pict3.pdl"
// WINCC:PICNAME_SECTION_END
```

The standard functions for the reading or writing of the tags are called via the defined tags and pictures.

```
GetTagDWord (TAG_1);
OpenPicture (PIC_1)
SetPictureName ( PIC_2, "Picture Window1",PIC_3);
```

When you create a new action in the Graphics Designer, the corresponding prepared sections will be inserted into the script.

You supplement existing scripts accordingly. The SmartTool "WinCC CrossReferenceAssistant" supports you in this.

Documentation of Configuration and Runtime Data

9.1 Documentation of Configuration and Runtime Data

Introduction

Reports and logs are created in WinCC to document the configuration data and runtime data. The layouts supplied by WinCC cover most of the cases in which you need to document data. You can edit the supplied layouts or create new ones with the Report Designer.

The documentation of the configuration data and runtime data is language-dependent and must be observed for multi-lingual WinCC projects. For more information see the chapter "Logs for multi-lingual projects".

Overview

The documentation of configuration data or the project documentation serves to output configuration data of a WinCC project in a report. You can output the reports in all Runtime languages for multi-lingual projects.

The documentation of Runtime data or Runtime documentation serves to output process data in a log in Runtime. For multi-lingual projects, the log is output in the currently set Runtime language.

The dynamic objects of the Report Designer are used for the Runtime documentation. These dynamic objects are associated with the corresponding applications. The dynamic objects are supplied with the current values during output of the logs.

Selection of data for output is application-dependent and is carried out when the layout is created, when the print job is created, or when printing is initiated. The current view or the table content is output in the WinCC V7 controls and the corresponding layouts and print jobs.

Report Designer makes print jobs available for outputting the reports and logs. The scheduling, output medium and extent of the output is defined in the print jobs.

Output Media

The reports and logs can be output:

- To a printer
- To a file
- To the screen

Output Formats

The reports and logs can be output:

- with a page layout,
- with a line layout for the message sequence report.

Editors for the Layouts

Report Designer provides the page layout editor for editing page layouts. Both the page layouts for the project documentation reports and the logs for Runtime documentation are configured in the page layout editor.

Report Designer provides the line layout editor for editing line layouts. You configure the output of the message sequence report in the line layout editor.

See also

Introduction to Runtime Documentation (Page 2066)

Introduction to Project Documentation (Page 2041)

How to Create Reports in Line Layout (Page 2029)

How to Set Up Reports in the Page Layout (Page 2027)

Reports for Multilingual Projects (Page 2383)

9.2 How to Set Up Reports in the Page Layout

How the Areas of a Page Layout Are Divided Up

Page layouts are divided up geometrically into a number of different areas. The page range corresponds to the total area of the layout. The print margins can be specified for this area. It makes sense to begin by configuring the margins of the printable area for the header, footer or a company logo and only then to configure the rest of the printable area for the output of report data. The printable area inside the margins is referred to as the "body of the page".

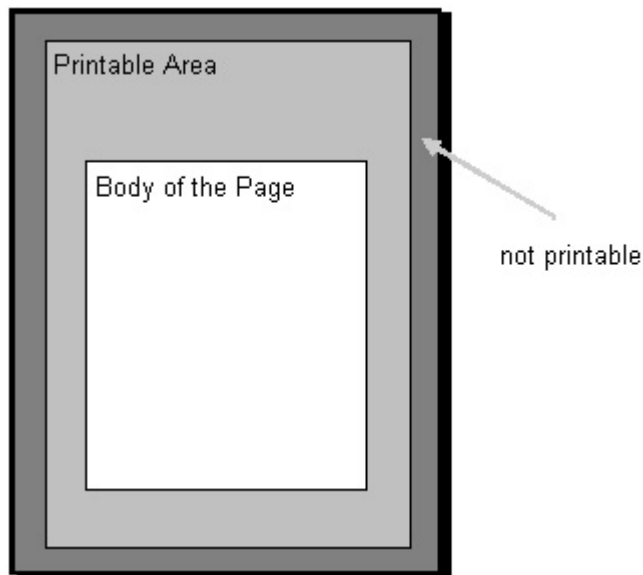

The report and log layout contain a static layer and a dynamic layer. The static layer contains the header and footer of a layout for outputting the company name, company logo, project name, layout name, page number, time, etc. The dynamic layer contains the dynamic objects for outputting the configuration and Runtime data.

In the static layer, only static and system objects can be inserted. In the dynamic layer, static and dynamic objects can be inserted.

Objects that are inserted in the dynamic part of a page layout are extended dynamically, if required. If an object of the type dynamic table is supplied with data, for example, this table is extended to allow all data in the table to be output. If there are other objects in the dynamic part of the layout, these are moved accordingly. Objects that are to have a fixed position must therefore be inserted in the static part of the layout.

Pages in the Page Layout

Each page layout consists of three pages:

- Cover sheet
- Report contents
- Final page

Cover sheet	The cover sheet is a fixed component of a page layout. It is therefore possible to design a separate cover sheet for each report.
Report contents	The structure and contents of the report for output are defined in this part of the page layout. system objects available for defining the report contents. The report contents have a static and a dynamic component (configuration layer). If necessary, the dynamic part of the contents of the report is spread across the various subsequent pages at output, since it is not known until the time of output how much data there is.
Final page	The final page is a fixed part of a page layout. It is therefore possible to design a separate final page for each report.

The creation and output of the cover sheet and final page are optional. By default, a cover sheet is output, but a final page is not output. You edit a page layout in the page layout editor.

The cover sheet and final page also have a static and a dynamic component (configuration layer).

Important:

If you use dynamic objects on the cover sheet or final page, only some of this data may be included at output. This happens when the data of dynamic objects do not fit on a single page. The cover sheet and final page only ever consist of a single page and never contain a page break.

Displaying Layout Properties

You can display the properties of a page layout in WinCC Explorer.

1. If you select the Report Designer entry in the navigation window of WinCC Explorer, the Layouts and Print Job subentries are displayed.
2. If you select the Layouts entry, all available layouts are displayed in the data window.
3. Select the Properties command from the pop-up menu of the relevant page layout. The creation date and the data of the last change are displayed. If the layout is opened in the page layout editor, the message "Currently being edited" is displayed.

See also

How to Create Reports in Line Layout (Page 2029)

Print Jobs in WinCC (Page 2031)

Introduction to Runtime Documentation (Page 2066)

Introduction to Project Documentation (Page 2041)

9.3 How to Create Reports in Line Layout

How the Areas of a Line Layout Are Divided Up

Line layouts are divided up geometrically into a number of different areas. The page range corresponds to the total layout area. The print margins can be defined for this area. It makes sense to begin by configuring the margins of the printable area for the header and footer or for a company logo and only then to configure the rest of the printable area for the output of the log data. The printable area inside the margins is referred to as the "body of the page".

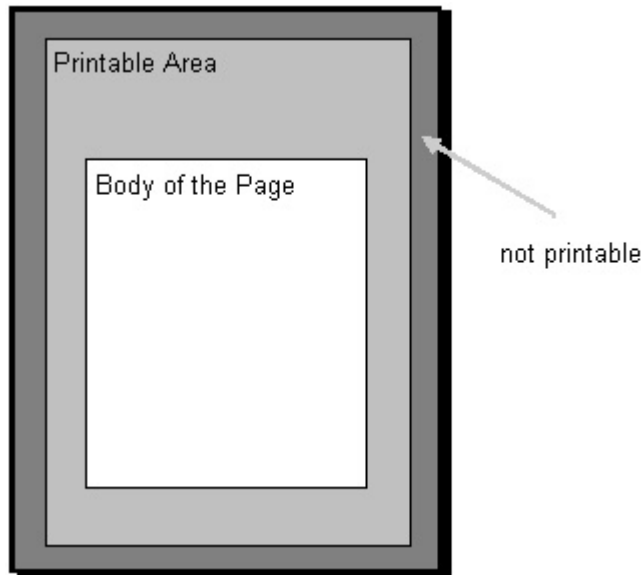

The line layouts contain a static layer and a dynamic layer. The static layer contains the header and footer for outputting the company name, project name, layout name, etc. as pure text. The dynamic layer contains a dynamic table for outputting Alarm Logging messages.

How a Page Is Divided Up

Each line layout consists of three areas:

- Header
- Log contents (table)
- Page footer

Header	The header is a fixed component of a line layout that is output together with every page. A header in the line layout can consist of up to 10 lines. Graphics cannot be inserted.
Log content (table)	The structure and contents of the log for output are defined in this part of the line layout. The Alarm Logging selection options and filter criteria for defining the contents of the log are available to you for alarm output. The design depends on the width of the individual columns and of the font size set.
Page footer	The footer is a fixed component of a line layout that is output together with every page. A footer in the line layout can consist of up to 10 lines. Graphics cannot be inserted.

9.3 How to Create Reports in Line Layout

The creation and output of a header and footer are optional. By default, 3 lines each are output for the header and footer.

Use of the Line Layout

The layout in line format is used exclusively for the message sequence report. You edit it in the line layout editor. For a line layout there is only one valid print job, which is integrated in the WinCC on a fixed basis. In order to be output, the message sequence report must be activated in the startup list of the computer carrying out the logging.

Displaying Layout Properties

You can display the properties of a line layout in WinCC Explorer.

1. If you select the Report Designer entry in the navigation window of WinCC Explorer, the Layouts and Print Job subentries are displayed.
2. If you select the Layouts entry, all available layouts are displayed in the data window.
3. Choose the Properties command from the pop-up menu of the relevant line layout. The creation date and the data of the last change are displayed. If the layout is opened in the line layout editor, the message "Currently being edited" is displayed.

See also

How to Output Online Data with Message Sequence Report (Page 2086)

Print Jobs in WinCC (Page 2031)

How to Create a User-Defined Message Sequence Report (Page 2089)

9.4 Print Jobs in WinCC

9.4.1 Print Jobs in WinCC

Introduction

Print jobs in WinCC are of central importance to the output of project and Runtime documentation. In the layouts you configure the external appearance and data supply for output. In the print jobs you configure the output medium, how much is to be printed, the time at which printing is to start, and other output parameters.

For the output, each layout has to be linked to a print job. Various print jobs are provided in WinCC for the purpose of project documentation. These system print jobs are already associated with the corresponding WinCC applications. The system print jobs can therefore not be deleted. If necessary, you can rename the system print jobs.

You can create new print jobs in WinCC Explorer in order to output new page layouts. A special print job is provided in WinCC for outputting line layouts. Line layouts can only be output using this print job. It is not possible to create a new print job for a line layout.

See also

[Introduction to Runtime Documentation \(Page 2066\)](#)

[Introduction to Project Documentation \(Page 2041\)](#)

[How to Change Output Options in Runtime \(Page 2074\)](#)

[How to Change an Existing Print Job \(Page 2048\)](#)

[How to Create a New Print Job \(Page 2045\)](#)

[Print Job Properties \(Page 2032\)](#)

[Defining a Printer \(Page 2037\)](#)

[Selecting the Print Range \(Page 2035\)](#)

9.4.2 Print Job Properties

Introduction

You enter the name, the layout used, and the start parameters on the "General" tab. You also set additional options that determine what happens when the print job is called on the "General" tab.

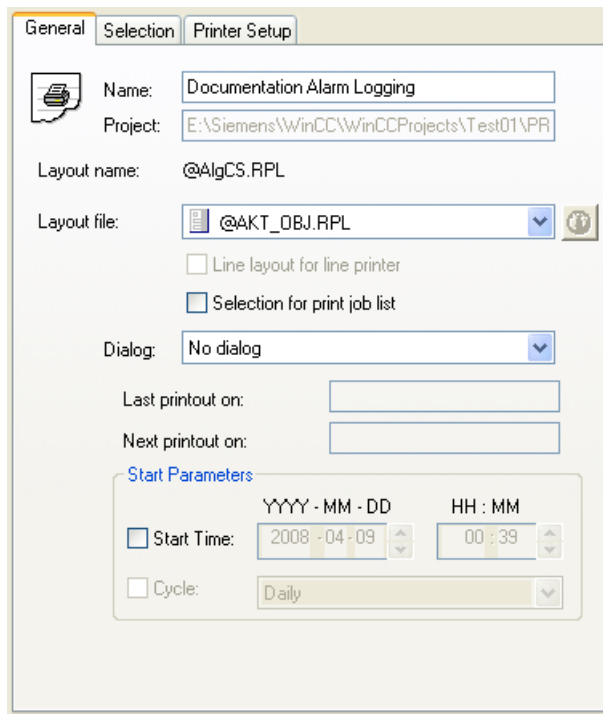

Name of the Print Job

The name of the print job is displayed in the "Name:" field. You can rename a print job you have just created in the "Name:" field. You cannot rename the system print jobs provided with the product because they are associated directly with the different applications of WinCC.

Layout

There are line layouts and page layouts. In the "Layout file:" selection field you can select the desired layout for the output.

Page layout

There are language-neutral and language-dependent line layouts. Further information can be found in the "Creating Page Layouts" and "Setting Up Multilingual Projects" documents.

Line layout

You can only select a line layout in the "@Report Alarm Logging RT Message sequence" print job. Line layouts do not contain language-dependent text; thus, no language-dependent layout files are needed.

Only in this job can the Line Layout for Line Printer option be selected. If the check box is checked, then the message sequence report is output to the locally installed line printer. If the check box is not checked, the message sequence report is output to a selectable printer in page format.

The system print jobs provided and the layouts set in them are for outputting the project documentation. Do not connect the system print jobs with other layouts, since otherwise the project documentation will no longer function correctly.

Selection for print job list

The "Graphics Designer" editor contains an application window belonging to the reporting system, the print job list. If this print job list is integrated into a WinCC picture, then the print jobs for the configurations are displayed in Runtime and you can start the output. In the print job list you can set the display of print jobs. The following views are available for selection:

- All print jobs
- System print jobs only
- User-defined jobs only
- Print jobs for which Selection for print job list option is selected

The "Selection for print job list" option allows you to compile a list of print jobs that you require in Runtime.

Displaying the Parameter Dialog

To make Runtime documentation more flexible, a number of log parameters have been dynamized. This allows you to change log output in Runtime. To do this, select the "Display Parameter Dialog" option in the "Dialog" field. When the print job is called in Runtime, a parameter dialog is called, in which you can change the parameters for output in Runtime. This dialog also allows you to select or change the printer for output. You find more information and a list of the relevant log objects in chapter Changing Output Options in Runtime.

Note

The system layouts and the self-configured layouts based on the "WinCC Control Runtime Printprovider" layout have no protocol parameters that can be made dynamic. Thus, you cannot edit the parameters of these layouts with the parameter dialog.

Calling the Printer Setup Options

To output logs in a page layout, you can change the printer for output in Runtime. To do this, select the Printer Setup option in the Dialog field. When the print job is called in Runtime, a dialog is called for selecting the printer.

Setting Start Parameter

In the Start Parameter area, you can set the start time and an output cycle. This setting is used primarily to output logs regularly in Runtime documentation (e.g. for shift reports). The start parameters are not required for project documentation, since project documentation is not executed cyclically. The following print jobs are indicated by a different symbol in the list of print jobs in WinCC Explorer:

- Print jobs for which start parameters are configured.
- Print orders for which a cyclical call is configured.

See also

[How to Change Output Options in Runtime \(Page 2074\)](#)

[How to Change an Existing Print Job \(Page 2048\)](#)

[How to Create a New Print Job \(Page 2045\)](#)

[Defining a Printer \(Page 2037\)](#)

[Selecting the Print Range \(Page 2035\)](#)

[Print Jobs in WinCC \(Page 2031\)](#)

9.4.3 Selecting the Print Range

Introduction

On the Selection tab you can specify how much is to be printed. You can specify a selection of the page range or a time range for the data to be output.

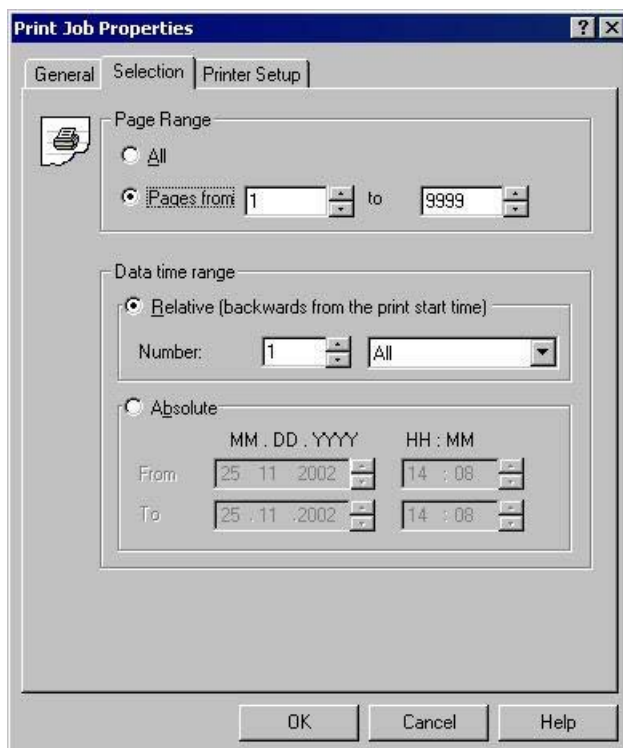

Note

If you print out online data using a message sequence log, all settings on the Selection tab are deactivated.

Selecting a Page Range

In the Page Range area you can specify how much is to be printed at output. You can output individual pages, a page range, or all pages.

Selecting a Time Range for the Data

You can use the Relative option to specify a relative time range for output (going back from the print start time). For the relative time range, you have the following time intervals available: All, Years, Months, Weeks, Days and Hours.

The Absolute option allows you to specify an absolute time range for the data to be output.

Note

If the time range is configured in the layout of a print job, this setting has priority over the settings in the print job. The selection of a time range is only relevant to Runtime documentation in Alarm Logging and Tag Logging.

If filter criteria can be set for the selection of the output data, these filter criteria are taken into account in addition to the settings in the Print Job Properties dialog. Exception: If filter criterion DATETIME is used, the time range settings in the print job are ignored.

If the @ReportAlarmLoggingRT... print jobs are started via the button in the Alarm Control, the settings from the layout and the print job are ignored, since the selection of the output data is transferred from the Alarm Control.

See also

[How to Change Output Options in Runtime \(Page 2074\)](#)

[How to Change an Existing Print Job \(Page 2048\)](#)

[How to Create a New Print Job \(Page 2045\)](#)

[Defining a Printer \(Page 2037\)](#)

[Print Job Properties \(Page 2032\)](#)

[Print Jobs in WinCC \(Page 2031\)](#)

9.4.4 Defining a Printer

Introduction

On the Printer Setup tab you can specify the printer or printers for output. You can use the lists in the Printer Priorities area to specify the order in which they are to be used. You also specify the settings for the print buffer and for output to a file here.

The screenshot shows the 'Printer Setup' tab of a configuration dialog. It features a printer icon and a 'Print Output To...' section with a checked 'Printer' option. Below this is a 'Printer Priorities' section with three dropdown menus: 1.) <Standard Printer>, 2.) <NONE>, and 3.) <NONE>. There are two identical sections for 'Minimum space required on the hard disk in MB', each containing 'Generate warnings' (150) and 'Discard trigger for logging' (100). At the bottom, there are checkboxes for 'File (*.emf)' and 'PDF', and a 'Tray:' label followed by two text input fields containing file paths: 'PRT_OUT_YYYYMMDDhhmmssmmm\...' and 'PRT_OUT_YYYYMMDDhhmmssmmm.pdf'.

Output to a Printer

On the Printer Setup tab you can specify the printer or printers for output. The printers are arranged in order of priority. Reports and logs are output to the printer set under 1.). If this printer fails, they are automatically output to the printer set under 2.). The same procedure applies to a third printer. If no printer is found that is ready for operation, the print data is saved to a file on the hard disk. The files are stored in the project directory in the PRT_OUT folder. In the event of a printer failure, the operating system outputs an error message. In this case, you have the following options:

1. Ignoring error message (Recommended)
Once printer is operational again, the pending messages (print jobs still in the spooler) will be printed automatically.
2. Repeat
If the Repeat button is clicked, the operating system tries to output the print jobs in the spooler again. This is only useful if the printer is ready for operation.
3. Cancel
If the Cancel button is clicked, the print job causing the error will be deleted. The print data is thus lost. The operating system then tries to print the next print job in the spooler.

Note

It is strongly recommended that you acknowledge the message from the operating system by clicking the Ignore button. If you click the Cancel button, all pending print jobs of the printer that has failed are lost.

In the event of a fault affecting the line printer for the message sequence report, you can disable the printer by clicking Cancel. You may have to restart the WinCC project to enable the printer again.

The time taken to detect a printer failure depends on the configured timeout setting for the printer connection. The timeout can be set by means of the properties for the printer connection in the operating system.

Two substitute printers can also be configured for the line-based message sequence report. The line printers must be connected to and installed on the computer carrying out the logging. The switchover is takes place as described above. If no printer is found that is ready for operation, a WinCC dialog is displayed in addition to the operating system message. The dialog provides information on the status of the print job and outputs the printer's fault. The message sequence report can be switched off in this dialog. If the message sequence report is switched off in this dialog, it is switched on again automatically as soon as one of the configured printers is ready for operation again.

Output to a File

If you like, you can output the reports and logs to a file. You can find additional information in section "How to Create a New Print Job (Page 2045)".

Note

If you print a message sequence log in line layout, the output as a file is deactivated.

Setting a Minimum Value for Disk Space

For log output there is a buffer area for output to a printer and a buffer area for output to a file. On the Printer Setup tab you can configure two limit values for the free space on a disk for each buffer area. If the limit values are violated, the following actions are triggered:

Limit value	Triggered Action
Generate warnings	If the free disk space on the hard disk being used is below the value set here, an entry is created in the WinCC_SStart_01.log file. If Runtime is activated, a system message is generated. The message informs you about the imminent resource bottleneck.
Discard trigger for logging	If the free disk space on the hard disk being used falls under the value set here, log triggering is rejected. In addition, an entry is created in the WinCC_SStart_01.log file. If Runtime is activated, a system message is generated that brings your attention to the lost log.

Recommendations and Limiting Conditions

- The timeouts for the printers should be kept low (approx. 10 seconds).
- Only one printer can be installed on each LPT port.
- When a computer is used for the line-based message sequence report, the substitute printer must be configured in the print job of the message sequence report.
- Mixed use of line- and page-based message sequence reports is not supported. The substitute printers must also be line printers.

Effect of the Printer Driver

When a report or a log is printed, the printout can be affected by the properties of the printer driver used. If you have just installed a printer, it is advisable to check the first few printouts in the preview.

Behavior and Time Requirements for Print Jobs

If there is a problem communicating with a WinCC component, a print job may hang at the stage of reading data from the application, and it may not be possible for the user to cancel it. A hung print job that is to print Runtime data is canceled after a waiting time of 30 minutes. Data preparation for project documentation can take considerably longer. Project documentation is therefore not canceled automatically.

If a print job stays in the printer spooler for longer than the specified time when there is an error (no paper, for example), the output is automatically redirected to the next printer in accordance with the specified printer priorities. The basic setting for the waiting time is 5 minutes. If there is no substitute printer configured or ready, the output is redirected to a file. The file is stored in the project directory under Prt_Out\$_<Jobname><DateTime>.

If a print job remains in the print spooler for longer than 13 minutes without its status changing, it is assigned an error status. Automatic print redirection is then initiated after a further 5 minutes.

See also

How to Change an Existing Print Job (Page 2048)

How to Change Output Options in Runtime (Page 2074)

How to Create a New Print Job (Page 2045)

Selecting the Print Range (Page 2035)

Print Job Properties (Page 2032)

Print Jobs in WinCC (Page 2031)

9.5 Project Documentation

9.5.1 Introduction to Project Documentation

Introduction

In order to create project documentation in WinCC, you can start the output of the reports from within the various WinCC editors. For this purpose, the editors are associated with print jobs, which call a predefined layout for output. Default parameters for output are already set in the predefined layouts. You can find more information on the output parameters in the project documentation of the various WinCC components.

Components from which project documentation can be called

You can start project documentation directly from the following components of WinCC:

- WinCC Explorer
- Graphics Designer
- Tag Management - WinCC Configuration Studio
- Alarm Logging - WinCC Configuration Studio
- Tag Logging - WinCC Configuration Studio
- Text Library - WinCC Configuration Studio
- User Administrator - WinCC Configuration Studio
- Horn - WinCC Configuration Studio
- Picture Tree - WinCC Configuration Studio
- Global Script
- Cross Reference
- Time Synchronization
- Lifebeat Monitoring
- OS Project Editor
- Component List Editor

9.5 Project Documentation

The reports for project documentation are output by the user. You can the following entries for this in the File menu of the various WinCC components:

Menu command	Function	Special features
Print Project Documentation Project Documentation - Print	Prints a report immediately. The layout set in the print job will be used as the layout. The printout is sent to the printer/file that is configured in the "Print Job Properties" dialog.	A printer selection dialog is not displayed; printing starts immediately. Depending on the size of the project, this process can take some time. The process cannot be canceled while the data is being read from the system.
Preview Project Documentation Project Documentation - Preview	Opens a preview of the report to be output.	Depending on the size of the project, this process can take some time. The process cannot be canceled while the data is being read from the system.
Set Up Project Documentation Project Documentation - Setup	Opens the "Print Job Properties" dialog to set the following: <ul style="list-style-type: none"> • The layout to be used • The printer or file for printing • The pages to be printed 	You can find more information in sections Print Jobs in WinCC and Changing an Existing Print Job.

See also

- How to Create a New Print Job (Page 2045)
- How to Change an Existing Print Job (Page 2048)
- Print Jobs in WinCC (Page 2031)
- How to Output Project Documentation (Page 2042)
- How to Set Up Reports in the Page Layout (Page 2027)

9.5.2 How to Output Project Documentation

Introduction

The basic procedure for outputting project documentation is described below. You can use the page layouts provided with the product for project documentation.

Procedure

1. Open the desired WinCC editor in the WinCC Explorer.
2. Select the "Print Project Documentation" or "Project Documentation - Print" command from the File menu in the editor

Alternative operation

If the print job used is known, you can start the project documentation directly:

1. Select the "Report Designer" entry in the navigation window of WinCC Explorer. The layouts and print job are displayed in the data window.
2. Double-click the "Print Jobs" entry. All available print jobs are displayed.
3. Open the pop-up menu of the desired print job, and choose the Print the Print Job command.

Note

A printer selection dialog is not displayed by default; printing starts immediately. Depending on the size of the project, this process can take some time. The process cannot be canceled while the data is being read from the system.

In some editors the output of project documentation from the application differs from the output of project documentation that is started directly via the print job in WinCC Explorer. You can find more information on this in sections Project Documentation... for the various WinCC editors.

Changing the output options

To change the printer or file for output, or to output a particular page range, you have to change the settings in the Print Job Properties dialog. To do this, choose the Project Documentation Setup... command from the File menu in the relevant editor. You can find more information on this in section Changing an Existing Print Job.

To make changes to the contents of a report, you can edit or create page layouts and call them in a print job. This allows you to design project documentation to suit your requirements. You can find more information on this in section Changing Predefined Layouts.

See also

System Layouts for Project Documentation (Page 2112)

How to Change an Existing Print Job (Page 2048)

Project Documentation in the Component List Editor (Page 2064)

Project Documentation in the OS Project Editor (Page 2063)

Project Documentation in Lifebeat Monitoring (Page 2062)

Project documentation in the Picture Tree (Page 2061)

Project documentation in the horn (Page 2060)

Project Documentation in the Time Synchronization Editor (Page 2060)

Project Documentation in the User Administrator (Page 2058)

Project Documentation in the Text Library (Page 2057)

Project Documentation in Global Script (Page 2055)

Project Documentation in Tag Logging (Page 2054)

Project Documentation in Alarm Logging (Page 2053)

Project Documentation in the Graphics Designer (Page 2050)

Project documentation in the WinCC Explorer/Tag Management (Page 2049)

9.5.3 How to Open a Project Documentation Preview

Introduction

You can open project documentation reports in a preview. This enables you to check that the report meets your requirements before you print it.

Procedure

1. Open the desired WinCC editor in the WinCC Explorer.
2. Select the "Preview Project Documentation" or "Project Documentation - Preview" command from the File menu in the editor

Alternative operation

1. Select the "Report Designer" entry in the navigation window of WinCC Explorer. The layouts and print job are displayed in the data window.
2. Double-click the "Print Jobs" entry. All available print jobs are displayed.
3. Open the pop-up menu of the desired print job, and choose the Preview Print Job command. The preview is opened.

Printing from the Preview

In the preview window you can print the report directly by clicking the Print... button. The print settings from the associated print job are used for this.

See also

Project Documentation in the Text Library (Page 2057)

System Layouts for Project Documentation (Page 2112)

Project Documentation in the Component List Editor (Page 2064)

Project Documentation in the OS Project Editor (Page 2063)

Project Documentation in Lifebeat Monitoring (Page 2062)

Project documentation in the Picture Tree (Page 2061)

Project documentation in the horn (Page 2060)

Project Documentation in the Time Synchronization Editor (Page 2060)

Project Documentation in the User Administrator (Page 2058)

Project Documentation in Global Script (Page 2055)

Project Documentation in Tag Logging (Page 2054)

Project Documentation in Alarm Logging (Page 2053)

Project Documentation in the Graphics Designer (Page 2050)

Project documentation in the WinCC Explorer/Tag Management (Page 2049)

9.5.4 How to Create a New Print Job

Introduction

In order to output a report to a printer or a file, associate the page layout used with a print job.

The options for output are specified in the print job.

The screenshot shows the 'General' tab of a print job configuration dialog. The fields are as follows:

- Name:** Documentation Alarm Logging
- Project:** E:\Siemens\WinCC\WinCCProjects\Test01\PR
- Layout name:** @AlgCS.RPL
- Layout file:** @AKT_OBJ.RPL (with a file selection icon)
- Line layout for line printer
- Selection for print job list
- Dialog:** No dialog
- Last printout on:** (empty text box)
- Next printout on:** (empty text box)
- Start Parameters:**
 - Start Time: 2008-04-09 00:39
 - Cycle: Daily

Display in WinCC Explorer

The print job is labeled with the following symbol in WinCC Explorer.

	A start time is configured in the print job.
	A cycle is configured in the print job.

Output options

Page range

On the "Selection" tab you can specify under "Page Range" whether you want to output all pages or only some of the pages.

Output format



The output format of the report is indicated in the file window of WinCC Explorer in the "Type" column by the abbreviation (F), (F, P) or (P).

(F)	Output to a file
(P)	Output to a printer
(F, P)	Output to a file and a printer

Page layout identification

In the "Print Job Properties" dialog, select the desired page layout using the "Layout file" drop-down list.

The layouts are identified with the following symbols:

	Layout is language-dependent. Layout files are available in all runtime languages. No language-neutral layout file exists.
	Layout is language-dependent. Layout files are not available in all runtime languages. You can use the layout. When you change to a runtime language for which there is no layout file available, the English layout file is used.
	The layout is language-neutral. The language-neutral layout is always printed in runtime, regardless of whether there are also language-specific layout files for the selected layout.

Output to a file

If you select output to a file, the data is saved in the form of EMF files.

You can use the "WinCC Documentation Viewer" SmartTool to display and print these files.

Storing the EMF file

If you select output to a file, define a folder name in the "Tray" entry field.

The "PRT_OUT" folder is created in the project path of the WinCC project. A folder with the name you entered is then created in this folder. A creation date and time are added to the folder name.

When output is started, the report is saved in this folder page by page in the form of emf files.

Storing the EMF files with a client without its own project

In multi-user systems, EMF files are saved to the "Windows-Temp\PRT_OUT\<Tray>_<Date +Time>" directory of the client in the case of a client without its own project.

After an EMF file is created, an attempt is made to move this file to the project directory on the server. In redundant systems, the file is moved to the current master. The file is deleted on the client.

If the file could not be moved to the server, it remains in the Windows Temp directory of the client. After the next EMF file has been created, an attempt is made to move all EMF files present in the directory.

In addition, the OS process control message "1004003" is generated following an unsuccessful move. The process control message specifies the directory of the client containing the EMF file. If the client is disconnected from all servers, this process control message can no longer be generated on a server. In this case, the message is located in the diagnostics file "WinCC_Sys_XX.log".

Requirements

- You must have specified a page layout that can output the desired data. This can be a predefined WinCC layout or a layout you have created or edited yourself in which the desired objects are integrated for data output.

Procedure

1. Select the Report Designer entry in the navigation window of WinCC Explorer. The "Layouts" and "Print Job" entries are displayed in the data window.
2. Select the Print Jobs entry. Choose the New Print Job command from the pop-up menu of the print job.
A new print job called "Print Job001" is created. The number in the print job name is incremented each time a new print job is created.
After the print job is created, all existing print jobs are displayed in the data window.
3. Select the newly created print job in the file window. Open the "Print Job Properties" dialog using the shortcut menu.
4. In the "Name" text box you can change the name of the print job.
When you click "OK" to apply the input, the print job is renamed. The print job with the previous name is overwritten.
5. Select the desired page layout from the selection box under "Layout file:".
6. Switch to the "Printer Setup" tab. Select output to a printer or a file.
It is also possible to select both output types at the same time.
If you select output to a file, you have to specify a folder name in the Location text box.
7. Click the OK button to apply the settings.
8. Select the print job in the file window. Start the output using the shortcut menu.

See also

Defining a Printer (Page 2037)

9.5.5 How to Change an Existing Print Job

Introduction

The layouts provided with WinCC are already associated with print jobs. The print jobs have basic settings. The output options of these print jobs can be changed.

If a print job is renamed, the original print job is overwritten. Changes therefore cannot be undone. A print job cannot be copied. It is therefore advisable to create a new print job to prevent any unwanted changes being made to a system print job.

The screenshot shows the 'Print Job Properties' dialog box with the 'General' tab selected. The dialog has three tabs: 'General', 'Selection', and 'Printer Setup'. The 'General' tab contains the following fields and options:

- Name:** Documentation Alarm Logging
- Project:** E:\Siemens\WinCC\WinCCProjects\Test01\PR
- Layout name:** @AlgCS.RPL
- Layout file:** @AKT_OBJ.RPL (with a selection icon)
- Line layout for line printer
- Selection for print job list
- Dialog:** No dialog
- Last printout on:** (empty text box)
- Next printout on:** (empty text box)
- Start Parameters:**
 - Start Time: 2008-04-09 00:39
 - Cycle: Daily

Procedure

1. Select the Report Designer entry in the navigation window of WinCC Explorer. The Layouts and Print Jobs entries are displayed in the data window.
2. Double-click the "Print Job" entry in the data window. All existing print jobs are displayed in the data window. Choose the Properties command from the pop-up menu of the desired print job. The Print Job Properties dialog is displayed.
3. In the Name text box you can change the name of the print job. When you click OK to apply the change, the print job is renamed and the previous name overwritten.
4. On the General tab, select the desired layout under Layout by using the selection dialog.
5. Change to the Printer Setup tab, and select output to a printer or a file. It is also possible to select both output types at the same time.

6. If you select output to a file, you have to specify a folder name in the Location text box. The folder PRT_OUT is created in the project path of the WinCC project. A folder with the name you entered is created in this folder, and a creation date and time are added to the folder name. When output is started, the report is saved in this folder page by page in the form of emf files.
7. Click the OK button to apply the settings.
8. Select the print job in the file window, and use the pop-up menu to start output.

To change the print job properties for project documentation, you can use the File/Project Documentation Setup... command in the editor to call the integrated print job directly.

Note

If you select output to a file, the data is saved in the form of EMF files. A documentation viewer is provided for these files with the WinCC Smart Tools.

Output options

On the Selection tab you can specify under Page Range whether you want to output all or only some of the pages.

On the Printer Setup tab you can specify a number of printers for output. If the first printer cannot be reached, the second printer is used. If this cannot be reached either, the third printer is used.

9.5.6 Project documentation in the WinCC Explorer/Tag Management

Introduction

WinCC Explorer is prepared for project documentation.

The following commands are available in the "File" menu of the WinCC Explorer for this purpose:

- Print Project Documentation
- Preview Project Documentation
- Project Documentation - Setup...

The following commands are available in the "File" menu in the "Tag Management - WinCC Configuration Studio" for this purpose:

- Project Documentation - Setup
- Project Documentation - Preview
- Project Documentation - Print

Data for output

The following data are available for project documentation in WinCC Explorer:

Object	Output options	Function
Computer	-	Serves to output the name of the computer whose data is to be documented.
Tags	Selection of tags Selection of tag groups Selection of tag parameters Format	Serves to output tags, tag groups, and tag parameters from the tag management system. Formats the tag list.
Connections	Selection of connections in a selection dialog.	Serves to output the configured connections to subordinate controllers.

Elements of the standard project documentation

A predefined page layout and a print job are supplied with for the project documentation.

Print job	Layout used	Objects contained
@Documentation Control Center	@mcpcs.RPL	Computers, tags, connections

Changing the output options

You can find more information on how to create a report in sections Working with Layouts and Working with Objects.

See also

How to Output Project Documentation (Page 2042)

9.5.7 Project Documentation in the Graphics Designer

Introduction

Graphics Designer is prepared for project documentation. The following commands are available in the File menu for this purpose:

- Print Project Documentation
- View Project Documentation
- Project Documentation Setup...

The print jobs for project documentation can be started from the menu of the WinCC component or directly in WinCC Explorer. However, there is an important difference to note in the case of Graphics Designer project documentation. When a print job is started in Graphics Designer, the data of the open picture are output. If the print job is started in WinCC Explorer, the data of all Graphics Designer pictures in the project are output. This applies to all documentable parameters of Graphics Designer pictures.

Data for Output

The following data are available for project documentation in Graphics Designer:

Actions in Graphics Designer

Object	Output options	Function
Info	The object is available for: - Actions on the property - Actions on the object	Serves to output general information such as the picture name, object name, and property name.
Trigger description	The object is available for: - Actions on the property	Serves to output the trigger type.
Source text	The object is available for: - Actions on the property - Actions on the object	Serves to output the source text of an action.

Graphics Designer Picture Data

Object	Output options	Function
General display	Selecting Elements: All available elements The selected element	Serves to output the view of a Graphics Designer picture in a report.
Picture statistics	Selection of statistics data for the picture	Serves to output statistics data on a Graphics Designer picture.
Attributes	Selection of attributes Selection of table data	Serves to output the attributes of a Graphics Designer picture
Embedded objects	Object selection	Serves to output the embedded objects in a Graphics Designer picture.
Actions	Selection of action types	Serves to output the actions in a Graphics Designer picture.
Trigger	Object selection Selection of actions	Serves to output the triggers for the actions in a Graphics Designer picture.
Source text	Selection of actions	Serves to output the source text of actions in a Graphics Designer picture.
Direct connections	Selecting Elements: All available elements The selected element	Serves to output the direct connections in a Graphics Designer picture.

Graphics Designer Object Data

Object	Output options	Function
Object statistics	Object selection Selection of statistics on the object	Serves to output statistics data on objects in a Graphics Designer picture.
Attributes	Object selection Selection of attributes Selection of table data	Serves to output the attributes of objects in a Graphics Designer picture.

Object	Output options	Function
Actions	Object selection Selection of actions	Serves to output the actions on objects in a Graphics Designer picture.
Trigger	Object selection Selection of actions	Serves to output the triggers for the actions on objects in a Graphics Designer picture.
Source text	Object selection Selection of actions	Serves to output the source text of actions for the selected objects.
Direct connection	Object selection	Serves to output the direct connections of objects

Points to Note About Object Data Output

- Control-Object slider:
The following applies to the PictureBack and PictureThumb attributes in project documentation:
If there is no picture entered, a hyphen (-) is output in the project documentation.
If a picture is entered, "none" is output.

Elements of Standard Project Documentation

Predefined page layouts and print jobs are provided with WinCC for project documentation.

Print job	Layout used	Objects contained
@Documentation Graphics Designer Dynamics	@PDLPicDyn.RPL	Nested layout for outputting the dynamization data of a Graphics Designer picture.
@Documentation Graphics Designer Overview	@PDLPicOvr.RPL	Picture statistics, general display.
@Documentation Graphics Designer	@PDLPic.RPL	Nested layout for outputting the general display, statistics data, objects in the picture, picture attributes, actions on the picture, direct connections to the picture, object statistics, attributes of the objects, actions on the objects, and direct connections to objects. The data is output on a separate page for each picture.

Changing the Output Options

You find more information on how to create a report in chapters Working with Layouts and Working with Objects.

See also

How to Output Project Documentation (Page 2042)

9.5.8 Project Documentation in Alarm Logging

Introduction

The Alarm Logging editor is prepared for project documentation.

The following commands are available in the "File" menu in the "Alarm Logging - WinCC Configuration Studio" for this purpose:

- Project Documentation - Setup
- Project Documentation - Preview
- Project Documentation - Print

Data for output

The following data are available for project documentation in Alarm Logging:

Object	Output options	Function
Message classes	-	Serves to output the existing message classes with their properties.
Messages	Selection of messages	Serves to output the selected messages with their properties.
Archives	-	Serves to output the existing message archives with their properties.

Data of the message blocks:

Object	Output options	Function
System blocks	-	Serves to output the existing system blocks with their properties.
User text blocks	-	Serves to output the existing user text blocks with their properties.
Process value blocks	-	Serves to output the existing process value blocks with their properties.

Data of the message groups

Object	Output options	Function
Message class	-	Serves to output the message groups of message classes.
Message groups	-	Serves to output message groups.

Elements of the standard project documentation

A predefined page layout and a print job are supplied with for the project documentation.

Print job	Layout used	Objects contained
@Documentation Alarm Logging	@AlgCS.RPL	Message blocks, message classes, messages, message groups, archives, and logs

Changing the output options

You can find more information on how to create a report in sections Working with Layouts and Working with Objects. You can find a description of the selection of messages in section "Changing Output Options for Messages from Alarm Logging CS".

9.5.9 Project Documentation in Tag Logging

Introduction

The Tag Logging editor is prepared for project documentation.

The following commands are available in the "File" menu in the "Tag Logging - WinCC Configuration Studio" for this purpose:

- Project Documentation - Setup
- Project Documentation - Preview
- Project Documentation - Print

Data for output

The following data are available for project documentation in the Tag Logging editor:

Object	Output options	Function
Timers	-	Serves to output the existing timers with their properties.

Data of the archives

Object	Output options	Function
Process value archive	Archive names Process value archive data	Serves to output the configuration data of process value archives
Compressed archive	Archive names Process value archive data	Serves to output the configuration data of compressed archives

Object	Output options	Function
Process value archive tag	Tag Tag data	Serves to output configuration data of the selected process value archive tags
Compressed archive tag	Tag Tag data	Serves to output configuration data of the selected compressed archive tags

Elements of the standard project documentation

A predefined page layout and a print job are supplied with for the project documentation.

Print job	Layout used	Objects contained
@Documentation Tag Logging	@tlgcs.RPL	Message blocks, message classes, single messages, group messages, archives, and logs

Changing the output options

You can find more information on how to create a report in sections Working with Layouts and Working with Objects.

See also

How to Output Project Documentation (Page 2042)

9.5.10 Project Documentation in Global Script

Introduction

There are two editors available in Global Script, the C editor and the VBS editor. Both of these editors are prepared for project documentation. If you open an action, a function, or a module in one of these editors, the following commands are available to you in the File menu of the editor:

- Print Project Documentation
- View Project Documentation
- Project Documentation - Setup...

The output applies to the open function, action, or module.

Documentation of all actions, project functions, and standard functions can be output by means of three of the print jobs listed below. The output is started in WinCC Explorer.

The same predefined layouts are used to output the project documentation in the C editor and the VBS editor. The identifier Language: C Script or Language: VB Script is output in the

9.5 Project Documentation

information box at output. This indicates which of the two editors the documentation comes from.

Note

The documentation of all actions, functions, and modules can be very extensive. To check the number of pages, open the print preview of the print job, and check the page number there (format: page 1 of x).

Data for Output

The following data are available for project documentation in the Global Script editor:

Object	Output options	Function
Info	The object is available for: - Actions - Standard functions - Project functions - Standard modules - Project modules	Serves to output general information such as who it was created/changed by, the creation date, data of change, version, and a comment.
Trigger description	The object is available for: - Actions	Serves to output the trigger type.
Source text	The object is available for: - Actions - Standard functions - Project functions - Standard modules - Project modules	Serves to output the source text of an action/function or a module.

Elements of Standard Project Documentation

Predefined page layouts and print jobs are provided with WinCC for project documentation.

Print job	Layout used	Objects contained
@Documentation Global Script Project Function	@GSC_RPFC.RPL	Nested layout for outputting the information and source text of the project functions. Output is started in WinCC Explorer.
@Documentation Global Script Standard Function	@GSC_RSFC.RPL	Nested layout for outputting the information and source text of the standard functions. Output is started in WinCC Explorer.
@Internal Global Script Action	@GSC_ACT.RPL	Layout for outputting information, a trigger description and the source text for an action open in the C editor or VBS editor or a module open in the VBS editor.

Print job	Layout used	Objects contained
@Internal Global Script Project Function	@GSC_PFC.RPL	Layout for outputting information and the source text for a project function open in the Global Script editor.
@internal Global Script Standard Function	@GSC_SFC.RPL	Layout for outputting information and the source text for a standard function open in the Global Script editor.

Changing the Output Options

You find more information on how to create a report in chapters Working with Layouts and Working with Objects.

See also

How to Output Project Documentation (Page 2042)

9.5.11 Project Documentation in the Text Library

Introduction

The Text Library is prepared for project documentation.

The following commands are available in the "File" menu in the "Text Library - WinCC Configuration Studio" for this purpose:

- Project Documentation - Setup
- Project Documentation - Preview
- Project Documentation - Print

Data for output

The following data are available for project documentation in the Text Library:

Object	Output options	Function
General data	-	Serves to output the configuration data of the Text Library.
Text table	Language selection for selecting the languages for output	Serves to output the texts from the Text Library.

Elements of the standard project documentation

Predefined page layouts and print jobs are provided with WinCC for project documentation.

Print job	Layout used	Objects contained
@Documentation Text Library	@Textlibrary.RPL	General data and text table. The texts of the different languages are output line by line one after the other.

Changing the output options

You can find more information on how to create a report in sections Working with Layouts and Working with Objects.

See also

How to Output Project Documentation (Page 2042)

9.5.12 Project Documentation in the User Administrator

Introduction

The User Administrator editor is prepared for project documentation.

The following commands are available in the "File" menu in the "User Administrator - WinCC Configuration Studio" for this purpose:

- Project Documentation - Setup
- Project Documentation - Preview
- Project Documentation - Print

Data for output

The following data are available for project documentation in the User Administrator editor:

Object	Output options	Function
Groups	-	Serves to output the user groups from the User Administrator.
functions	-	Serves to output the texts from the configured functions from the User Administrator.

Elements of the standard project documentation

A predefined page layout and a print job are supplied with for the project documentation.

Print job	Layout used	Objects contained
@Documentation User Administration	@UACS.RPL	Groups and functions

Changing the output options

You can find more information on how to create a report in sections Working with Layouts and Working with Objects.

See also

How to Output Project Documentation (Page 2042)

9.5.13 Project documentation in the Cross Reference

Introduction

The "Cross Reference" editor supports project documentation. The following commands are available in the File menu for this purpose:

- Print Project Documentation
- Project Documentation view
- Set up project documentation

Set the focus on the list in the Cross Reference that you want to print out.

Note

Do not call print jobs directly from the WinCC Explorer

The system print jobs are designed only for internal use. Do not call these print jobs directly from the WinCC Explorer, as the required data supply is missing. Select "Print" or "Print project documentation" in the Cross Reference.

Elements of Standard Project Documentation

The following predefined page layouts and print jobs are provided with WinCC for project documentation.

Print job	Layout used	Objects contained
@XREFPrintSrc	@XREFPRINTSRC.RPL	Entries in the list of project objects
@XREFPrintRef	@XREFPrintRef.RPL	Entries in the list of places of use

See also

How to Create a New Print Job (Page 2045)

How to Open a Project Documentation Preview (Page 2044)

9.5.14 Project Documentation in the Time Synchronization Editor

Introduction

The Time Synchronization editor is prepared for project documentation. The following buttons are available in the editor's dialog:

- Printing
- Preview
- Setup

Data for Output

The following data are available for project documentation in the Time Synchronization editor:

Object	Output options	Function
Devices	-	Serves to output the devices and services used.
General	-	Serves to output the general settings in the Time Synchronization editor.

Elements of Standard Project Documentation

A predefined page layout and a print job are supplied with for the project documentation.

Print job	Layout used	Objects contained
@Documentation Time Synchronization	@TimeSync(landscape).RPL	HornTags, general settings, horn signals, and additional reset tags.

Changing the Output Options

You find more information on how to create a report in chapters Working with Layouts and Working with Objects.

See also

How to Output Project Documentation (Page 2042)

9.5.15 Project documentation in the horn

Introduction

The horn is prepared for project documentation.

The following commands are available in the "File" menu in the "Horn - WinCC Configuration Studio" for this purpose:

- Project Documentation - Setup
- Project Documentation - Preview
- Project Documentation - Print

Data for output

The following data are available for project documentation in the horn:

Object	Output options	Function
HornTags	-	Serves to output the assignment of tag and message class.
General settings	-	Serves to output the general settings in the Audio Alarm Editor.
Horn signals	-	Serves to output the assignment of signals or signal modules to tags.
Additional reset tags	-	Serves to output multiple acknowledgment via additional acknowledgment tags.

Elements of the standard project documentation

A predefined page layout and a print job are supplied with for the project documentation.

Print job	Layout used	Objects contained
@Documentation Horn	@Horn(landscape).RPL	HornTags, general settings, horn signals, and additional reset tags.

Changing the output options

You can find more information on how to create a report in sections Working with Layouts and Working with Objects.

See also

How to Output Project Documentation (Page 2042)

9.5.16 Project documentation in the Picture Tree

Introduction

The "Picture Tree" editor is prepared for project documentation.

The following commands are available in the File menu for this purpose:

- Project Documentation - Setup
- Project Documentation - Preview
- Project Documentation - Print

Data for Output

The following data are available for project documentation in Picture Tree:

Object	Output options	Function
PTM table	-	Serves to output the configured container hierarchy and the pictures it contains.

Elements of Standard Project Documentation

Predefined page layouts and print jobs are provided with WinCC for project documentation.

Print job	Layout used	Objects contained
@Documentation Picture Tree Manager	@ptmcs.RPL	Picture Tree Manager table

Changing the Output Options

You find more information on how to create a report in chapters Working with Layouts and Working with Objects.

See also

How to Output Project Documentation (Page 2042)

9.5.17 Project Documentation in Lifebeat Monitoring

Introduction

The Lifebeat Monitoring editor is prepared for project documentation. The following commands are available on the File menu for this purpose:

- Printing
- View
- Printer Setup...

Data for Output

The following data are available for project documentation in the Lifebeat Monitoring editor:

Object	Output options	Function
Lifebeat Monitoring table	-	Serves to output the configuration data from Lifebeat Monitoring.

Elements of Standard Project Documentation

A predefined page layout and a print job are supplied with for the project documentation.

Print job	Layout used	Objects contained
@Documentation Lifebeat Monitoring	@lbmcs.RPL	Lifebeat Monitoring table

Changing the Output Options

You find more information on how to create a report in chapters Working with Layouts and Working with Objects.

9.5.18 Project Documentation in the OS Project Editor

Introduction

The OS Project Editor is prepared for project documentation. The following buttons are available for it on the General tab:

- Printing
- View
- Printer Setup...

Data for Output

The following data are available for project documentation in the OS Project Editor:

Object	Output options	Function
ProjectEditor table	-	Serves to output the coordinate settings of the monitor, overview area, working area, and key area.
TopField table	-	Serves to output the settings for the display of circular pictures in the Runtime window.
TopfieldConfig2 table	-	Serves to output the settings for the display of group pictures and general pictures in the Runtime window.
TopfieldConfig3 table	-	Serves to output the settings for the display of trend groups in the Runtime window.
AlarmConfig table	-	Serves to output the settings for the display of the small alarm window.

Object	Output options	Function
AreaButton table	-	Serves to output the settings for the buttons for switching between areas.
HiddenArea table	-	Serves to output the settings for hidden areas.
RestData table	-	Serves to output the general settings in the OS Project Editor.

Elements of Standard Project Documentation

A predefined page layout and a print job are supplied with for the project documentation.

Print job	Layout used	Objects contained
@Documentation OS Projecteditor	@Projecteditor.RPL	ProjectEditor table, TopField table, TopfieldConfig2 table, TopfieldConfig3 table, AlarmConfig table, AreaButton table, HiddenArea table, and RestData table.

Changing the Output Options

You find more information on how to create a report in chapters Working with Layouts and Working with Objects.

9.5.19 Project Documentation in the Component List Editor

Introduction

The Component List Editor is prepared for project documentation. The following commands are available in the File menu for this purpose:

- Project Documentation Setup...
- View Project Documentation
- Print Project Documentation

Data for Output

The following data are available for project documentation in the Component List Editor:

Object	Output options	Function
Attribute table	-	Serves to output information on the connections between internal IDs and texts for display in the Component List Editor.
Measuring point table	-	Serves to output the type, entry point picture (Loop In Alarm), and area assignments of a component and their designations.

Elements of Standard Project Documentation

A predefined page layout and a print job are supplied with for the project documentation.

Print job	Layout used	Objects contained
@Documentation LTO Component List	@LTO Bausteinliste(landscape).RPL	Attribute table, measuring point table

Changing the Output Options

You find more information on how to create a report in chapters Working with Layouts and Working with Objects.

9.6 Runtime Documentation

9.6.1 Introduction to Runtime Documentation

Introduction

A number of options are available for logging Runtime data in WinCC. The WinCC controls have a button for output of the runtime data logs. You can also output runtime data outside of the WinCC controls, for example, data from the user archives with the "CCAxUserArchiveControl" report object.

Overview

The following WinCC controls have a configurable interface for the log output:

- WinCC OnlineTableControl
- WinCC OnlineTrendControl
- WinCC FunctionTrendControl
- WinCC BarChartControl
- WinCC RulerControl
- WinCC AlarmControl
- WinCC UserAdminControl
- WinCC UserArchiveControl
- WinCC SysDiagControl

Note

As of WinCC V7, the "Print message report" button is no longer available in the AlarmControl.

For the independent logging of Runtime data, you must configure the corresponding layouts in Reports Designer and connect them with a print job.

For the "WinCC Control Runtime Printprovider" layout, you configure only the basic properties of the layout in Report Designer. The report parameters for the output are determined by properties of the WinCC control and cannot be made dynamic. Configure the static and dynamic report parameters for all other runtime documentation layouts.

You specify scheduling and how much is to be printed in the print job associated with the layout. You can re-use one layout for several print jobs, for example, for output on different media or with a different time selection of the data.

The print jobs can be called up as follows:

- with a configurable button in WinCC controls
- with a configurable button in a WinCC picture
- with the "print job list" application window in a WinCC picture

- with a configured cycle in the print job
- with configured start parameters in the print job
- with a script function

Report objects for the runtime documentation

You can output the runtime data with the following WinCC report objects:

WinCC Control Runtime Printprovider

Report object	Function
Table	The entire contents of the table of the control is output in the table. The output of the report object depends on the display of the control in Runtime and is only initiated using the button in the control. You cannot dynamize report parameters.
Text	In addition to the "Table" and "Picture" report objects, the window caption, the name and the picture name of the control is output.
Picture	The current control display is output in the picture. The output of the report object depends on the display of the control in Runtime and is only initiated using the button in the control. You cannot dynamize report parameters.

Note

The Runtime data of a WinCC RulerControl and of an interconnected WinCC control can be output in a single report. To do this, insert two report objects of the "WinCC Control Runtime Printprovider" into one page layout. for example, a "picture" for the OnlineTrendControl and a "table" for the RulerControl. In the properties of the RulerControl report object you must activate the "WinCC RulerControl" option on the "Link" tab.

CCAxAlarmControl

Report object	Function
Table	The table outputs the contents of the alarm control from outside the WinCC Alarm-Control. You configure the properties of the control and the dynamic parameters for output in the Report Designer.

CCAxFunctionTrendControl

Report object	Function
Picture	The contents of the FunctionTrendControl from outside the WinCC FunctionTrend-Control are output in the picture. You configure the properties of the control and the dynamic parameters for output in the Report Designer.

CCAXOnlineTableControl

Report object	Function
Table	The table outputs the contents of the OnlineTableControl from outside the WinCC OnlineTableControl. You configure the properties of the control and the dynamic parameters for output in the Report Designer.

CCAXOnlineTrendControl

Report object	Function
Picture	The contents of the OnlineTrendControl from outside the WinCC OnlineTrendControl are output in the picture. ### You configure the properties of the control and the dynamic parameters for the output in the Report Designer.

CCAXBarChartControl

Report object	Function
Picture	The contents of the BarChartControl from outside the WinCC BarChartControl are output in the picture. You configure the properties of the control and the dynamic parameters for output in the Report Designer.

CCAXUserAdminControl

Report object	Function
Table	The table outputs the contents of the User Administrator from outside the WinCC UserAdminControl. You configure the properties of the control and the dynamic parameters for output in the Report Designer.

CCAxUserArchiveControl

Report object	Function
Table	The table outputs the contents from the user archives outside the WinCC UserArchiveControl. You configure the properties of the WinCC UserArchiveControl and the dynamic parameters for output in the Report Designer.

WinCC Online Table Control (Classic)

Report object	Function
Table	The table contains the contents of the tags from the process value archives and compressed archives. You configure the static and dynamic parameters of the WinCC Online Table Control (Classic) for output in the Report Designer.

WinCC Online Trend Control (Classic)

Report object	Function
Picture	The contents of the tags from process value archives and compressed archives are output in trend form in the picture. You configure the static and dynamic parameters of the WinCC Online Trend Control (Classic) for output in the Report Designer.

WinCC Function Trend Control (Classic)

Report object	Function
Picture	The picture shows the process values as a function of another tag from process value archives, compressed archives or user archives in trend format. You configure the static and dynamic parameters of the WinCC Function Trend Control (Classic) for the output in the Report Designer.

WinCC Alarm Control (Classic)

Report object	Function
Table	The message lists are output in the table. In contrast to the "Message report" and "Archive report" report object, all message lists are accessed. You configure the static and dynamic parameters of the WinCC Alarm Control (Classic) for output in the Report Designer.

User archive runtime

Report object	Function
Table	The table contains the contents of the user archives.

Alarm Logging Runtime

Report object	Function
Message Report	The message report outputs all messages in the current message list in Alarm Logging.
Archive report	The archive log serves to output messages that are stored in the message archive.

Further Runtime Documentation Options**Logging of CSV Files**

Report object	Function
CSV provider table	The CSV provider table logs data from a file in CSV format. The data is output in table form.
CSV provider trend	The CSV provider trend logs data from a file in CSV format. The data is output in trend form.

Logging Data by Means of ODBC

Report object	Function
ODBC database field	Serves to output data from a data source field by means of ODBC. The data is output as text.
ODBC database table	Serves to output data from a data source table by means of ODBC. The data is output in table form.

Logging of Own COM Servers

Report object	Function
COM server	The COM server object allows you to integrate your own COM object in WinCC and log the data from this object. The COM object can be in the form "Text", "Table" or "Picture".

Output of a Hard Copy

Report object	Function
Hard copy	Serves to output the current screen content, a part of it or a currently selected picture window.

The hardcopy can also be output with the "PrintScreen" application. You find more information in chapter How to Output a Hard Copy.

Note

Simultaneous printing of identical log objects

When you create a layout with the same log objects of the Runtime documentation, you must open the properties dialog for each of the same log objects, set the required parameters and confirm your entries with "OK". This action ensures that all identical log objects are printed simultaneously.

Dynamic log parameters

You can influence the logging of runtime data before the output by using dynamic logging parameters, for example, through scripts. In addition to a configured value, you can configure WinCC tags from which the parameters are taken for output in Runtime.

To change the parameters for output immediately before you start printing, a dialog for changing the log parameters can be displayed. The display of this dialog can be controlled by the respective print job. The Configuration Dialog option must be set in the Dialog field on the General tab.

See also

[How to Create Layouts for Runtime Documentation \(Page 2070\)](#)

[How to Create Reports in Line Layout \(Page 2029\)](#)

[How to Set Up Reports in the Page Layout \(Page 2027\)](#)

9.6.2 How to Create Layouts for Runtime Documentation

Introduction

You create new layouts or adapt existing ones for Runtime documentation. First you save a layout supplied by WinCC under a new name before you change the layout. This way you can always access these layouts again.

Specify in the layouts,

- which data is logged in Runtime.
- the output form.
- whether the output can be changed before printing starts.

Note

The system layouts and system print jobs included in the scope of delivery are used by the WinCC components. This means you may not delete the system print jobs. If necessary, you can rename the system print jobs. Changes to the dynamic part of system layouts affect logging in Runtime. The system layouts can be identified by the prefix "@" in the layout name.

Editing a Layout

1. Select the Report Designer entry in the navigation window of WinCC Explorer. The Layouts and Print Jobs entries are displayed.
2. First double-click the "Layouts" entry in the file window and then the desired language. All existing layouts for the language are displayed in the file window.
3. Select a layout according to the required output. Double-click to use the pop-up menu to open the layout. The page layout editor is opened to allow you to edit the layout. You find a list of the layouts provided for Runtime documentation in the appendix.
4. Select the first report object in the open layout and open the properties dialog by double-clicking it or using the pop-up menu.
5. In the properties dialog, select the "Connect" tab and then the report object in the left window. The list of things you can do is displayed on the right.
6. As of WinCC V7 use the "WinCC Control Runtime Printprovider" layout for output of the data form the controls. The output depends on the representation of the controls in Runtime. Define the control elements for the "Table" and "Picture" report objects to be excluded from printing in the "Connect" tab. If you want to output a RulerControl via the report object, activate the "WinCC RulerControl" option.
7. If you use the report objects prior to WinCC V7, open the dialogs for setting parameters and dynamization on the "Connect" tab. You find a description of the possible output options for the various objects in chapter Working with Objects for Runtime Documentation.
8. Select the next report object in the layout and repeat steps 4 to 7.
9. Modify the external form of the object, if necessary, by changing the attribute values on the "Properties" tab.
10. Save the changes and close the layout.
11. Then edit the associated print job.

Please also note the behavior of dynamic tables during output. You find more information on this in chapter Changing Predefined Layouts.

Alternative Procedure

You can also create new layouts for Runtime documentation and use them for logging. A newly created layout must be connected with a print job for the output. You can use an existing print job or create a new one. The system print jobs provided are used for the log functions integrated in WinCC. This means you should only use a system print job if you want to use a self-defined layout instead of the preset system layout.

See also

System Layouts and Print Jobs for Runtime Documentation (Page 2115)

How to create print jobs for the Runtime documentation (Page 2072)

How to Change Output Options in Runtime (Page 2074)

Changing Predefined Layouts (Page 2158)

9.6.3 How to create print jobs for the Runtime documentation

Introduction

Predefined print jobs are provided with WinCC for logging Runtime data. These system print jobs are used by various WinCC components for Runtime documentation. The system print jobs can therefore not be deleted. If necessary, you can rename the system print jobs.

When you use system print jobs for Runtime documentation, you can specify output options, how much is to be printed, and the layout to be used. Additional information can be found in the chapter "Print Jobs in WinCC".

For user-defined Runtime documentation you can create new print jobs and configure their calls. In this way, you can output Runtime data without negatively affecting the preset log functions.

Procedure

1. Select the Report Designer entry in the navigation window of WinCC Explorer. The Layouts and Print Jobs entries are displayed.
2. Double-click the Print Jobs entry in the data window. All existing print jobs are displayed in the data window. Choose the Properties command from the pop-up menu of the desired print job. The Print Job Properties dialog is displayed. You find a list of the print jobs provided for Runtime documentation in the appendix.

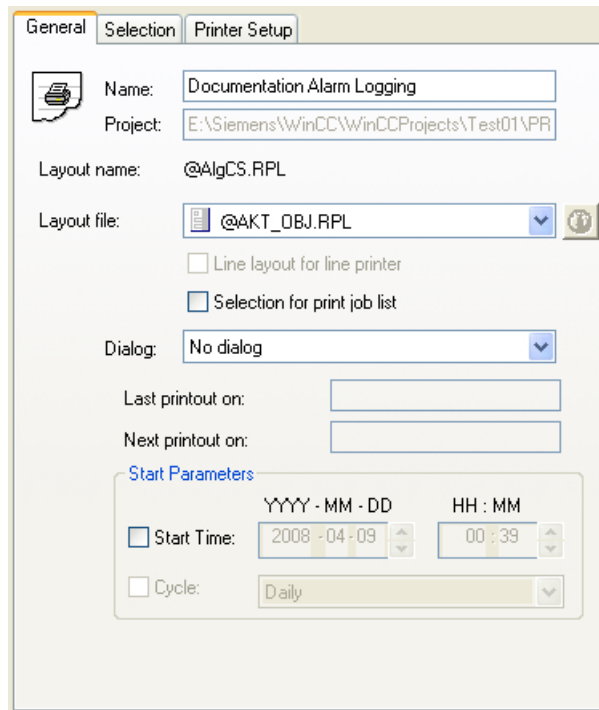

3. Use the three tabs in the dialog to set the parameters of the print job. Additional information can be found in the chapter "Print Jobs in WinCC".
4. To create a new print job, select the Print Jobs entry in the navigation window of WinCC Explorer, and choose the New Print Job command from the pop-up menu. A new print job is created with a consecutive number in its name. To assign parameters, proceed as described above.

Online Logs for a Client Without Project

If you wish to output Runtime logs in a distributed system using a client without its own project, you must activate the option Report Runtime in the startup list of this client.

In addition, you must set the parameter /CLIENT for Report Runtime. In the startup list, select the application Report Runtime and click the Edit... button. Add the necessary parameters in the Parameters entry field.

If cyclic print jobs are supposed to be excluded from the output, add the /NO_CYCLE parameter to the Parameters entry fields.

See also

Reporting Messages in Runtime (Page 2084)

Print Jobs in WinCC (Page 2031)

System Layouts and Print Jobs for Runtime Documentation (Page 2115)

Reporting Data from Other Data Sources (Page 2093)

Reporting Process Values in Runtime (Page 2090)

How to Change Output Options in Runtime (Page 2074)

How to Output Online Data with Message Sequence Report (Page 2086)

9.6.4 How to Change Output Options in Runtime

Introduction

To make Runtime documentation more flexible, a number of log parameters can be dynamized. This way you can change the report output in Runtime.

The report parameters for output from the WinCC V7 controls are determined by the properties of the WinCC Control and cannot be dynamized in the Report Designer. You can also output Runtime data outside of WinCC controls, for example, data from the user archives with the "CCAxUserArchiveControl" report object. You can change the properties and the dynamic parameters in the Report Designer for this purpose.

How to change the parameters for report objects

You can change the parameters in two different ways:

- Connect the dynamizable parameters with WinCC tags. For a print job, the assigned WinCC tags are provided with the current values in Runtime. You configure the value supply of the WinCC tags with:
 - Scripts
 - Input fields and output fields in a WinCC picture
 - Configured buttons with fixed values
 - Process-controlled actions
 - The supply through other applications of WinCC.

An overview of the Runtime documentation parameters that can be dynamized is included in chapter Dynamizable Parameters for Runtime Documentation.

- When starting a print job you can open a parameterization dialog that lists all dynamic report elements. A configuration dialog appears when you double-click a parameter; in it you can change the settings for the current output. If WinCC tags are configured to the report objects, the tags are read out and the values entered in the associated fields of the static parameters. The tag fields themselves are deactivated and cannot be changed in Runtime.

How to dynamize the parameters for report objects

1. Open the desired layout in the page layout editor and call the object properties dialog of the log object.
2. In the Object Properties dialog, select the Connect tab and then the log object in the left section of the tab. The list of things you can do is displayed on the right.
3. Double-click to open the Dynamizable Parameters configuration dialog. The object properties that can be dynamized are shown in the parameter list.
4. In the list of properties, select the parameter you want to dynamize.
5. Click the tag selection symbol on the upper right side. The tag selection dialog is displayed.
6. Select the desired tag, or create a new tag. Edit the properties of the tag in the tag selection dialog. If necessary, specify a start value for the tag.
7. Apply the settings by clicking OK and save the layout.
8. Before the log is started in Runtime, the WinCC tag must be supplied with values.

How to dynamize the parameters with other report objects of Runtime documentation

1. Open the required layout in the page layout editor.
2. Call up the object properties dialog of the report object.
3. Activate the "Connect" tab in the object properties dialog and select the report object in the left window. The list of things you can do is displayed on the right.
4. In the list of things you can do, open the configuration dialog by means of a double-click or the pop-up menu.
5. Select the Tag check box for the parameter to be dynamized, and click the folder button. The tag selection dialog is displayed.
6. Select the desired tag, or create a new tag. Edit the properties of the tag in the tag selection dialog. If necessary, specify a start value for the tag.
7. Accept the changes with "OK" and save the layout.
8. Before the log is started in Runtime, the WinCC tag must be supplied with values.

How to dynamize the report parameters with the configuration dialog

You can change the report parameters in Runtime in the configuration dialog. The configuration dialog displays the object names of the report objects. Assign meaningful names to the report objects. Otherwise, the objects are displayed in the configuration dialog with the standard names assigned by WinCC, e.g. "Dynamic table 1". A numbered selection of dynamic tables is then displayed in the configuration dialog, which is not suitable if the user wants to make a specific selection.

1. Select the required print job in WinCC Explorer.
2. Open the properties dialog with the pop-up menu.
3. Activate the "Configuration dialog" option in the "Dialog" selection field on the "General" tab.

4. Accept the change with "OK". If the print job is started, the configuration dialog is displayed with the linked report objects.
5. Use a double-click to open the configuration dialog of the desired log object, and then set the output options.

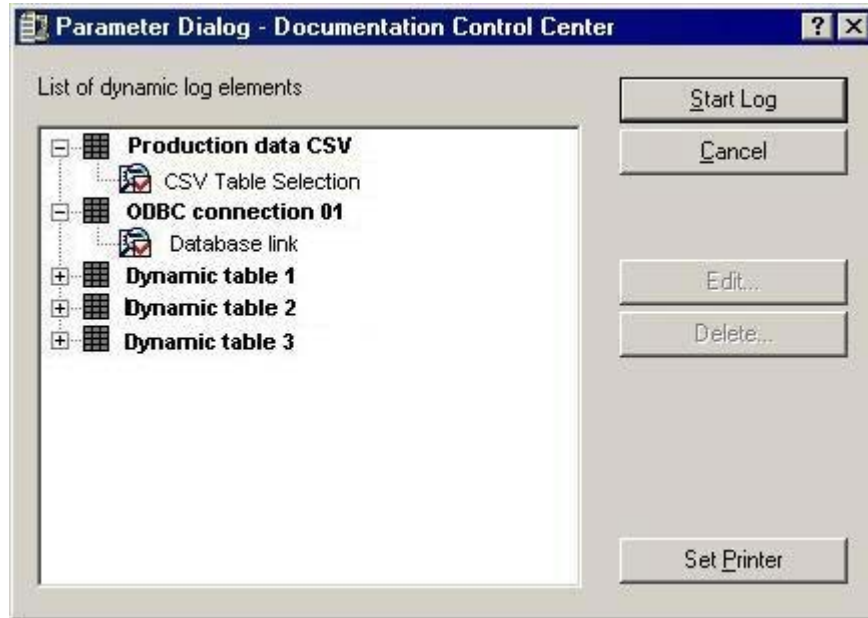

6. You can change the selected printer using the "Printer Setup" button.
7. You can delete a selection you have made using the "Delete" button.
8. You can start the report after selecting the report element in the table.

How to select the printer in Runtime

You can configure the printer selection with the print job. If the default settings in the "Print Job Properties" dialog remain unchanged, you cannot change the printer in Runtime. It is possible to select the printer in Runtime by activating the option "Printer Selection Dialog". The option must be configured separately for each print job.

1. Select the required print job in WinCC Explorer and use the pop-up menu to open the properties dialog.
2. On the General tab, select the Printer Selection Dialog option in the Dialog field.
3. Click OK to apply the change.
4. If the print job is started, the printer selection dialog is displayed with the available printers.
5. Use the dialog to specify the printer for the output. If necessary, change the order of priority of the printers. You can also print to a file.
6. Confirm the selection with "OK". Printing is started.

See also

System Layouts and Print Jobs for Runtime Documentation (Page 2115)
 Reporting Data from Other Data Sources (Page 2093)
 Dynamizable Parameters for Runtime Documentation (Page 2077)
 How to Configure the Dynamic Parameters of WinCC Online Table Control (Page 2244)
 How to Configure the Dynamic Parameters of the WinCC Online Trend Control (Page 2249)
 Configuring the dynamic parameters of the WinCC Function Trend Control (Page 2253)
 How to Configure the Dynamic Parameters of WinCC Alarm Control (Page 2257)
 How to Change the Output Options for Message Reports from Alarm Logging Runtime (Page 2261)
 How to Change the Output Options for User Archive Tables (Page 2267)

9.6.5 Dynamizable Parameters for Runtime Documentation**Introduction**

To make Runtime documentation more flexible, a number of report object parameters can be dynamized. The tables below show the parameters that can be dynamized.

CCAxAlarmControl

Dynamizable parameters	Explanation
MsgFilterSQL	Selection of messages by means of SQL statements
ServerNames	Server selection in distributed systems
TimeBase	Time base of message lists

CCAxBarChartControl

Dynamizable parameters	Explanation
BackColor	Background color of bar chart
GraphDirection	Direction of current values in bar chart
TimeBase	Time base of the bar chart
TimeAxisLabel	Label of the time axis
TimeAxisRangeType	Setting for the time range of the time axis
TimeAxisTimeRangeFactor	Factor for determining the time range.
TimeAxisTimeRangeBase	Time unit for determining the time range.
TimeAxisBeginTime	Start time of the time range for the time axis
TimeAxisEndTime	End time of the time range for the time axis
TimeAxisMeasurePoints	Number of measurement points for the time axis
ValueAxisLabel	Label of the value axis

Dynamizable parameters	Explanation
ValueAxisBeginValue	Start value of the value axis
ValueAxisEndValue	End value of the value axis
ValueAxisExponentialFormat	Representation of value axis in exponential format

CCAxFunctionTrendControl

Dynamizable parameters	Explanation
BackColor	Background color of trend view
GraphDirection	Direction of current values in trend view
TimeBase	Time base of trend view
X/YAxisLabel	Label of the X axis or Y axis
X/YAxisAutoRange	Automatic determination of the value range of the selected axis
X/YAxisBeginValue	Start value of the selected axis
X/YAxisEndValue	End value of the selected axis
X/YAxisExponentialFormat	Representation of the selected axis in exponential format
TrendLabel	Label of the trend
TrendVisible	Displayed trend
TrendColor	Trend color
TrendLineType	Trend type
TrendLineStyle	Line type:
TrendLineWidth	Line weight
TrendProvider	Data supply of the trend
TrendTagNameX/Y	Tag name of the connected tag.
TrendRangeType	Time range of the trend
TrendTimeRangeFactor	Factor for determining the time range.
TrendTimeRangeBase	Time unit for determining the time range.
TrendBeginTime	Start time of the time range for the trend
TrendEndTime	End time of the time range for the trend
TrendMeasurePoints	Number of measurement points for the trend

CCAxOnlineTableControl

Dynamizable parameters	Explanation
BackColor	Background color of the table
TimeBase	Time base of the table
TimeStepBase	Time unit for the precision of the time stamp
TimeStepFactor	Factor for the precision of the time stamp
TimeColumnCaption	Name of the time column
TimeColumnVisible	Displayed time column
TimeColumnAlign	Alignment of time column
TimeColumnBackColor	Background color of the time column
TimeColumnForeColor	Font color of the time column

Dynamizable parameters	Explanation
TimeColumnRangeType	Setting for the time range of the time column
TimeColumnTimeRangeFactor	Factor for determining the time range.
TimeColumnTimerangeBase	Time unit for determining the time range.
TimeColumnBeginTime	Start time of the time range for the time column
TimeColumnEndTime	End time of the time range for the time column
TimeColumnMeasurePoints	Number of measurement points for the time column
TimeColumnTimeFormat	Time format of the time column
TimeColumnDateFormat	Date format of the time column
ValueColumnCaption	Name of the value column
ValueColumnVisible	Displayed value column
ValueColumnBackColor	Background color of the value column
ValueColumnForeColor	Font color of the value column
ValueColumnPrecisions	Sets the number of decimal places.
ValueColumnAutoPrecisions	Automatic setting of decimal places
ValueColumnExponentialFormat	Representation of value column in exponential format
ValueColumnTagName	Tag name of the connected tag.

CCAxOnlineTrendControl

Dynamizable parameters	Explanation
BackColor	Background color of trend view
GraphDirection	Direction of current values in trend view
TimeBase	Time base of trend view
TimeAxisLabel	Label of the time axis
TimeAxisRangeType	Time range of the time axis
TimeAxisTimeRangeFactor	Factor for determining the time range.
TimeAxisTimeRangeBase	Time unit for determining the time range.
TimeAxisBeginTime	Start time of the time range for the time axis
TimeAxisEndTime	End time of the time range for the time axis
TimeAxisMeasurePoints	Number of measurement points for the time axis
ValueAxisLabel	Label of the value axis
ValueAxisBeginValue	Start value of the value axis
ValueAxisEndValue	End value of the value axis
ValueAxisExponentialFormat	Representation of value axis in exponential format
TrendLabel	Label of the trend
TrendVisible	Displayed trend
TrendColor	Trend color
TrendLineType	Trend type
TrendLineStyle	Line type:
TrendLineWidth	Line weight
TrendTagName	Tag name of the connected tag.

CCAxUserArchiveControl

Dynamizable Parameters	Explanation
FilterSQL	Filter criteria for database access by means of SQL statements
ColumnSort	Sort criteria for database access by means of SQL statements
TimeBase	Time base of the table

Parameters of report objects for WinCC Controls created in a version older than WinCC V7 which support dynamization

WinCC Alarm Control (Classic)

Dynamizable Parameters	Explanation
MsgFilterSQL	Selection of messages by means of SQL statements
ServerNames	Server selection in distributed systems
TimeBase	Time base of message lists

WinCC Online Table Control (Classic)

Dynamizable Parameters	Explanation
Archives	Archive linked to a column
BackColor	Background color of the table
BeginTime	Start time of the column time range If the "Update" checkbox is activated in the "Column" tab, the start time will refer to the current time. The previous values are then output in the defined time interval.
Color	Color of the column
CommonTime	Common time column to be used for the table
EndTime	End time of the column time range The "Time range" checkbox in the "Column" tab must be deactivated. The value depends on TimeAxisX.
ItemVisible	Hide/show column
Name	Name in column header
Precisions	Number of decimal places in a value column
TimeColumnAlignment	Alignment of time column
TimeFormat	Format of time in column
TimeRangeBase	Time range of a column. The time range is calculated by multiplying TimeRangeBase with TimeRangeFactor. The "TimeRangeBase" and "TimeRangeFactor" properties are only evaluated when the "Time range" checkbox in the "Column" tab is activated.Format:
TimeRangeFactor	Repeat rate of the column time range. The time range is calculated by multiplying TimeRangeBase with TimeRangeFactor. The "TimeRangeBase" and "TimeRangeFactor" properties are only evaluated when the "Time range" checkbox in the "Column" tab is activated.Format:
TimeZone	Time base of the table

Dynamizable Parameters	Explanation
ValueColumnAlignment	Alignment of value column
Tag	Archive tag linked to a column

WinCC Online Trend Control (Classic)

Dynamizable Parameters	Explanation
BackColor	Background color of trend view
BeginTime	Start time of a trend. If the "Update" checkbox is activated in the "Time axis" tab, the start time will refer to the current time. The previous values are then displayed for a fixed time range or for a fixed number of measured points. If CommonX is set to Yes, the set BeginTime applies to all trends.
BeginValue	Lower limit of value of the range of a trend. Only available if Autorange option is deactivated.
Color	Color of the trend
CommonX	Shared X axis of the trend graphic
CommonY	Shared Y axis of the trend graphic
CurveForm	Representation of measurements in the form of a trend
EndTime	End time of a trend. The "Time Range" and "Number of Measuring Points" checkboxes on the "Time Axis" tab must be unchecked.
EndValue	Upper limit of value of the range of a trend. Only available if Autorange option is deactivated.
GraphDirection	Direction of current values in trend view
ItemVisible	Hide/show trend
LineWidth	Line width of trend
MeasurePoints	The number of measuring points that are output since start time. The "Time range" checkbox in the "Time Axis" tab must be unchecked.
Relay Curves	Staggered display of trends
TagName	Tags linked by a trend
TimeRangeBase	Time range of a trend. The time range is calculated by multiplying TimeRangeBase with TimeRangeFactor. The "TimeRangeBase" is evaluated only when the "Time range" checkbox in the "Time Axis" tab is activated.
TimeRangeFactor	Repeat rate of the time range of a trend. The time range is calculated by multiplying TimeRangeBase with TimeRangeFactor. The "TimeRangeFactor" is evaluated only when the "Time range" checkbox in the "Time Axis" tab is activated.
TimeZone	Time base of trend view

WinCC Function Trend Control (Classic)

Dynamizable Parameters	Explanation
AutorangeX	Automatic selection of value range along X axis
AutorangeY	Automatic selection of value range along Y axis
BackColor	Background color of trend view

Dynamizable Parameters	Explanation
BeginX	Low limit of the value range of the X axis. "AutorangeX" must be set to "no". The value range is determined by CommonX.
BeginY	Low limit of the value range of the Y axis. "AutorangeY" must be set to "no". The value range is determined by CommonY.
Color	Color of the trend
CommonX	Shared X axis of the trend graphic
CommonY	Shared Y axis of the trend graphic
CurveForm	Representation of measurements in the form of a trend
DesiredCurveColor	Color of setpoint trend of a trend. The value depends on DesiredCurveVisible.
DesiredCurveCurveForm	Representation of measurements of setpoint trend of a trend. The value depends on DesiredCurveVisible.
DesiredCurveSourceNumberOfUAValues	Number of values of a setpoint trend of trend that can be loaded from the user archive. The value depends on DesiredCurveVisible.
DesiredCurveSourceUAArchive	Name of the user archive to which the setpoint trend of a trend is linked. The value depends on DesiredCurveVisible.
DesiredCurveSourceUAArchiveStartID	ID of the record of the user archive from which values are to be loaded to the setpoint trend of a trend. The value depends on DesiredCurveVisible.
DesiredCurveSourceUAColumnX	Column of the user archive from where the X values of a setpoint trend of a trend are to be read. The value depends on DesiredCurveVisible.
DesiredCurveSourceUAColumnY	Column of the user archive from where the Y values of a setpoint trend of a trend are to be read. The value depends on DesiredCurveVisible.
DesiredCurveVisible	Hide/show setpoint trend
EndX	High limit of the value range of the X axis. "AutorangeX" must be set to "no". The value range is determined by CommonX.
EndY	High limit of the value range of the Y axis. "AutorangeY" must be set to "no". The value range is determined by CommonY.
GraphDirection	Direction of positive values in trend graphic
ItemVisible	Hide/show trend
LabelX	Label of X axis of a trend. The value depends on Time-AxisX.
LabelY	Label of Y axis of a trend
Name	Name of a trend
Relay Curves	Staggered display of trends
SourceBeginTime	Start time of a trend.
SourceEndTime	End time of a trend. The "Time range" checkbox in the "X-Axis" tab must be checked.
SourceNumberOfUAValues	Number of value pairs of a trend that are loaded from the user archive

Dynamizable Parameters	Explanation
SourceNumberOfValues	Number of value pairs of a trend that are retrieved from archive tags. The "Time range" checkbox in the "X-Axis" tab must be unchecked.
SourceTagNameX	Archive tag linked to the X axis of a trend
SourceTagNameY	Archive tag linked to the Y axis of a trend
SourceUAArchive	Name of user archive linked to a trend
SourceUAArchiveStartID	ID of the record of the user archive from which values are to be loaded to a trend.
SourceUAColumnX	Column of the user archive from where the X values of a trend are to be read.
SourceUAColumnY	Column of the user archive from where the Y values of a trend are to be read.
TimeAxisX	Use time range of the X axis for a trend
TimeZone	Time base of trend view

Dynamizable Parameters for other Report Objects

Report object	Dynamizable Parameters
Message reports	Selected servers Filter criterion for alarm output
User archives table	Archive name/view name Filter condition Sorting
ODBC database field	ODBC data source Users Password SQL statement
ODBC database table	ODBC data source Users Password SQL statement
Hard copy	Range selection Size and position of a subarea
CSV provider table	CSV file name
CSV provider trend	CSV file name

See also

How to Configure the Dynamic Parameters of WinCC Online Table Control (Page 2244)

How to Configure the Dynamic Parameters of the WinCC Online Trend Control (Page 2249)

Configuring the dynamic parameters of the WinCC Function Trend Control (Page 2253)

How to Configure the Dynamic Parameters of WinCC Alarm Control (Page 2257)

9.6.6 Reporting Messages in Runtime

9.6.6.1 Reporting Messages in Runtime

Overview

You can log all messages occurring in the system using the WinCC reporting system. The following options are available:

- Output of Runtime data from the message lists.
- Output of a message sequence report.

You print the messages from the message lists directly via a configurable interface in the WinCC AlarmControl. The messages from the archive lists are output in accordance with the selection configured in the WinCC Alarm Control.

To output messages, you have to do the following things:

- Configure the button in the WinCC AlarmControl for starting the report in Runtime.
- Select "Alarm Logging Runtime" and "Graphics Runtime" in the startup list of the WinCC project.
- Select the project, and start the log.

You have the option of logging messages with a selection independent of the WinCC AlarmControl. The report system provides layouts, in which you can determine parameters that can be made dynamic. For more information, refer to:

- AUTOHOTSPOT
- AUTOHOTSPOT
- AUTOHOTSPOT

Note

Color conversion when printing messages

You can use the "Options" tab in the project properties dialog of the WinCC project to define the color properties for messages to be printed. If the "Color conversion when printing messages" option is activated, the settings in the "AlgLoggingPrinterColorConversion.XML" file will be taken into account. Black-white is the default setting. If the "Color conversion when printing messages" option is deactivated, the settings in AlarmLogging will be used.

Points to Note About the Message Sequence Report

The message sequence report outputs the messages that occur in the system in chronological order in accordance with the specified selection criteria. To this end, the message sequence report in the startup list of the WinCC project must be activated. The message sequence report is generally output to a line printer, but it can also be output page by page.

See also

How to Create a User-Defined Message Sequence Report (Page 2089)

How to Output Online Data with Message Sequence Report (Page 2086)

How to Output Runtime Data from the Message Lists (Page 2085)

How to Configure the Static Parameters of WinCC Alarm Control (Page 2255)

How to Configure the Dynamic Parameters of WinCC Alarm Control (Page 2257)

9.6.6.2 How to Output Runtime Data from the Message Lists

Introduction

In WinCC AlarmControl, you configure a button for the report call for the output of the messages from the message lists. In Runtime, you must activate the desired message list in AlarmControl and press the "Print" button. You determine how the data is output using the print job in AlarmControl.

Overview

When messages from the message archive lists are output, you must select the messages (e.g. all messages of the last shift) before outputting the report. When outputting a report without selection of messages, the scope of the output can be too great and the system can become overloaded.

For the output of the messages, the "@Alarm Control - Picture.RPL" or "@ Alarm Control - Table.RPL" system layouts are provided with the WinCC V7 AlarmControl. If you want to output the messages in WinCC V6.2 and in the Classic Controls of WinCC V7, use the "@CCAlarmCtrl-CP.RPL" system layout.

However, you can create a new layout to configure desired settings (e.g. landscape format, other aspects of the layout). In this case, you must link the print job to the layout.

Further information on the layouts and print jobs of the WinCC AlarmControl can be found under System Layouts and Print Jobs for Runtime Documentation (Page 2115).

Procedure

1. Open the WinCC picture with the WinCC AlarmControl in Graphics Designer.
2. Double-click the control to open the properties dialog.
3. Go to the "Toolbar" tab and activate the "Print" button function.
4. Go to the "General" tab. A print job is set for output in the "View current print job" field. If you want to use a different print job, select the desired print job using the  button.
5. Confirm the setting with "OK". Save and close the WinCC picture.
6. Select the "Graphics Runtime" and "Alarm Logging Runtime" options in the computer's startup list.

7. Activate the project.
8. Click the "Print" button in the WinCC AlarmControl for the print output. The current view or the full contents of the selected message list of the WinCC AlarmControl is output on the printer set in the print job.

Note

When the application starts log output, the system print jobs are used. The system print jobs cannot be deleted. If necessary, you can rename the system print jobs.

In the WinCC Alarm Control before WinCC V7, you can also activate the "Print message report" key function. In this case, the  button is displayed in Runtime. This button is for outputting logs with a standard layout from WinCC V5 and has been retained in the system for compatibility reasons. The contents of this log depend on the configuration settings in the layout called and the selection made in the WinCC Alarm Control. When messages from the message archive lists are output, you must select the messages (e.g. all messages of the last shift) before outputting the report. When outputting a report without selection of messages, the scope of the output can be too great and the system can become overloaded.

See also

System Layouts and Print Jobs for Runtime Documentation (Page 2115)

Reporting Data from Other Data Sources (Page 2093)

Reporting Process Values in Runtime (Page 2090)

How to Change Output Options in Runtime (Page 2074)

9.6.6.3 How to Output Online Data with Message Sequence Report

Introduction

The message sequence report allows you to output a chronological list of all messages that occur in a project. It is generally output on a line printer. The messages are output in the order in which they occur.

If a line printer is used for output, it must be connected locally to the logging computer. The Line layout for Line Printer check box in the print job must be selected. However, the message sequence report can also be output in a page layout.

The printer does not have to be connected locally to the logging computer in order to output the report with a page layout. A message sequence report in a page layout can also be output on a network printer. Upon output in page layout, the printout is generated when incoming messages have filled a page or if you initiate the printout of the page by clicking the operation button.

Print Job and Layout

For the message sequence report there is a set print job that also has to be used for a message sequence report you define yourself. It is not possible to create your own print job for a line layout.

Print job	Layout	Remarks
@Report Alarm Logging RT Message Sequence	@CCAlgRtSequence.RP1	System print job for a message sequence report in line format.
@Report Alarm Logging RT Message Sequence	@CCAlgRtOnlineMessages.RPL	Print job for the printing of a message sequence log in the page layout

Creating a Line Layout

Before a message sequence report is output in a line layout, the layout has to be adjusted. You edit a line layout in the line layout editor.

1. Select the Report Designer entry in the navigation window of WinCC Explorer. The Layouts and Print Jobs entries are displayed.
2. Double-click the Layouts entry in the file window. All existing layouts are displayed in the file window.
3. Double click on line layout "@CCAlgRtSequence.RP1". The layout is opened in the line layout editor.
4. In the Page Size area, specify the number of lines per page and the number of columns (characters per line).
5. In the Margins section, specify the number of characters for the width of the margins.
6. Edit the contents of the header and footer. These are output on every page.
7. Click the Selection button to open the Log Tables Selection dialog. Use the dialog to specify the data for output. You find more information in chapter "Changing Output Options for Message Reports from Alarm Logging". When you close the dialog, the selected columns and their widths are displayed in characters per line in the Table area. If the number of characters per line is too large, a message to this effect is displayed.
8. Save the changes to the line layout, and close the editor.

Prerequisites for Output

- The line printer on which the message sequence report is output must be connected locally to the computer carrying out the logging.
- The message sequence report must be activated in the startup list of the computer carrying out the logging.

Starting the Message Sequence Report

The message sequence report must be activated in the startup list of the computer carrying out the logging. The message sequence report is started automatically when the WinCC project is activated.

Interrupting the Message Sequence Report

To interrupt the output of the message sequence report on a line printer, proceed as follows:

- Suspend the output of the message sequence report by calling the MSRTActivateMProt(False,Null) function.

To resume output of the message sequence report, proceed as follows:

- Restart output of the message sequence report by calling the MSRTActivateMProt(TRUE,NULL) function.

Note

If the message sequence report is interrupted, the incoming messages for the message sequence report are lost.

Printout of Message Sequence Log in Page Layout

Before a message sequence report is output in a page layout, the print job has to be adjusted.

1. Select the Report Designer entry in the navigation window of WinCC Explorer. The Layouts and Print Jobs entries are displayed.
2. Double-click the Print Jobs entry. All existing print jobs are displayed in the file window.
3. Double click on print job "@Report Alarm Logging RT Message sequence" marked in yellow. The Print Job Properties dialog is displayed.
4. Clear the Line Layout for Line Printer check box on the General tab.
5. From the list of layouts, select layout "@CCAlgRtOnlineMessages.RPL".
6. Select the "Printer Setup" tab. Acknowledge the displayed dialog window "CcPJobApi" with "OK".
7. In the "Print output to..." section, select the default printer and the substitute printer. Click "OK". After closing the dialog, the yellow marking for the print job "@Report Alarm Logging RT Message sequence" disappears in the file window.

The message sequence log in page layout will be printed automatically as soon as the incoming messages have filled a page. If you wish to print a page before it is filled, proceed as follows:

- With a call to function MSRTPrintMProt (pointer to page number, pointer on error message), start the message sequence log printout.
- If you use Basic Process Control, the key set of the message lists include a printer button with which you can print out a page that is not full.

For troubleshooting instructions, refer to chapter Printer Setup.

See also

Defining a Printer (Page 2037)

System Layouts and Print Jobs for Runtime Documentation (Page 2115)

Reporting Data from Other Data Sources (Page 2093)

Reporting Process Values in Runtime (Page 2090)

How to create print jobs for the Runtime documentation (Page 2072)

9.6.6.4 How to Create a User-Defined Message Sequence Report

Introduction

To create a user-defined message sequence report, you can create a new line layout or page layout or save an existing layout with a new name and edit it. Always use the @Report Alarm Logging RT Message Sequence print job to output the message sequence report.

Output in a Line Layout

1. Select the Report Designer entry in the navigation window of WinCC Explorer. The Layouts and Print Job entries are displayed.
2. Select the Layouts entry, and use the pop-up menu to create a new line layout. A blank layout is created and stored under Layouts. The layout is saved with the name "NewRP100.RP1". If several layouts are created, the number in the layout name is incremented each time a new one is created.
3. Open the new line layout by means of a double-click in the line layout editor.
4. Configure the layout as described in chapter How to Output Online Data with Message Sequence Report.
5. Save and close the layout.

Output in a Page Layout

The message sequence report can also be output in a page layout.

1. Create a new page layout, and open it in the page layout editor.
2. In the object palette on the Runtime Documentation tab, select the Message Report object, and drag it to the desired size in the working area.
3. Open the Object Properties dialog by double-clicking the object, and select the Connect tab.
4. In the list of possible things to do, double-click Selection. The Alarm Logging Runtime: Report Table Selection dialog is opened.
5. Use the dialog to specify the data for output. You find more information in chapter Changing Output Options for Message Reports from Alarm Logging.

Editing the Print Job

There is only one print job for the message sequence report, so you have to call the line layout or page layout you have created in this print job.

1. Select the Report Designer entry in the navigation window of WinCC Explorer. The Layouts and Print Jobs entries are displayed.
2. Double-click the Print Jobs entry in the file window. All existing print jobs are displayed in the file window.
3. Open the @Report Alarm Logging RT Message Sequence print job by double-clicking it. The Print Job Properties dialog is displayed.
4. On the General tab, select the layout you have created in the Layout field.
5. If you are using a line layout, select the Line layout for Line Printer check box on the General tab. If you are using a page layout, clear this check box.
6. On the Printer Setup tab, specify the printer to be used for output, and then close the dialog.

See also

Print Jobs in WinCC (Page 2031)

How to Output Online Data with Message Sequence Report (Page 2086)

System Layouts and Print Jobs for Runtime Documentation (Page 2115)

Reporting Data from Other Data Sources (Page 2093)

Reporting Process Values in Runtime (Page 2090)

9.6.7 Reporting Process Values in Runtime

Introduction

You can output process values from the Logging tag using the WinCC report system. The following options are available:

- Output of process values in table form from process value archives and compressed archives via the WinCC OnlineTableControl.
- Output of process values in trend curve form from process value archives and compressed archives via the WinCC OnlineTrendControl.
- Output of process values in trend curve form as a function of another tag from process value archives, compressed archives and user archives via the WinCC FunctionTrendControl.

The data can be output directly in the relevant WinCC control using the "Print" button.

Overview

For the output of the data, the new WinCC V7 controls provide new system layouts for each WinCC control. If you output the process values outside of the WinCC controls and you want to dynamize the report parameters, continue to use the previous system layouts of the respective WinCC control.

However, you can create a new layout to configure desired settings (e.g. landscape format, other aspects of the layout). In this case, you must link the print job to the layout.

Further information on the layouts and print jobs of the controls can be found under AUTOHOTSPOT.

Procedure

1. Open the WinCC picture with one of the aforementioned WinCC controls in Graphics Designer.
2. Double-click the control to open the properties dialog.
3. Go to the "Toolbar" tab and activate the "Print" button function.
4. Go to the "General" tab. A print job is set for output in the "View current print job" field. If you want to use a different print job, select the desired print job using the  button.
5. Confirm the setting with "OK". Save and close the WinCC picture.
6. Select the "Graphics Runtime" and "Tag Logging Runtime" options in the computer's startup list.
7. Activate the project.
8. Click the "Print" button in the displayed WinCC AlarmControl for the print output. The current view or the trend curves or the full contents of the table is output on the printer set in the print job.

Note

When the application starts report output, the system print jobs are used. The system print jobs can therefore not be deleted. If necessary, you can rename the system print jobs.

See also

[How to Output Data from User Archives \(Page 2092\)](#)

[How to Configure the Dynamic Parameters of WinCC Online Table Control \(Page 2244\)](#)

[How to Configure the Dynamic Parameters of the WinCC Online Trend Control \(Page 2249\)](#)

[Configuring the dynamic parameters of the WinCC Function Trend Control \(Page 2253\)](#)

9.6.8 How to Output Data from User Archives

Introduction

You authorize output of the table of the WinCC UserArchiveControl in Runtime using the "Print" button. You determine how the data is output using the print job in the WinCC control. You can also arrange the output of the user archive data outside of the control.

Overview

For output of the data, the "@User Archive Control - Picture.RPL" or "@User Archive Control - Table.RPL" system layouts are provided with the WinCC UserArchiveControl.

If you want to output the user archive data outside of the WinCC UserArchiveControl, use the "CCAxUserArchiveControl" layout in the Reports Designer. Additional information on configuration is available at How to Change Output Options in Runtime (Page 2074).

However, you can create a new layout to configure desired settings (e.g. landscape format, other aspects of the layout). In this case, you must link the print job to the layout.

Further information on the layouts and print jobs of the WinCC UserArchiveControl can be found under System Layouts and Print Jobs for Runtime Documentation (Page 2115).

Procedure

1. Open the WinCC picture with the WinCC UserArchiveControl in Graphics Designer.
2. Double-click the control to open the properties dialog.
3. Go to the "Toolbar" tab and activate the "Print" button function.
4. Go to the "General" tab. A print job is set for output in the "View current print job" field. If you want to use a different print job, select the desired print job using the  button.
5. Confirm the setting with "OK". Save and close the WinCC picture.
6. Select the Graphics Runtime option in the computer's startup list.
7. Activate the project.
8. Click the "Print" button in the WinCC UserArchiveControl for the print output. The current view or the full contents of the table of the WinCC UserArchiveControl is output on the printer set in the print job.

Note

When the application starts report output, the system print jobs are used. The system print jobs can therefore not be deleted. If necessary, you can rename the system print jobs.

See also

Reporting Data from Other Data Sources (Page 2093)

System Layouts and Print Jobs for Runtime Documentation (Page 2115)

Reporting Messages in Runtime (Page 2084)

How to Change Output Options in Runtime (Page 2074)

9.6.9 Reporting Data from Other Data Sources

9.6.9.1 Reporting Data from Other Data Sources

Overview

The WinCC reporting system also allows you to log data that do not come from a WinCC project. There are various log objects available for integrating this kind of data in a WinCC log. In addition, WinCC provides a hard copy log object, by means of which the screen or a section of the screen showing the current Runtime status can be output in a report.

The following log objects are available for output:

ODBC database field	Serves to output data from a database field in a WinCC log by means of ODBC.
ODBC database tables	Serves to output data from a database table in a WinCC log by means of ODBC.
CSV table	Serves to output data from a file in CSV format in a WinCC log. The data is output in tabular form.
CSV trend	Serves to output data from a file in CSV format in a WinCC log. The data is output in the form of a trend.
Hard copy object	Serves to output a view of the screen or a section of the screen in a WinCC log.
COM server object	Permits the integration of a user-specific COM server to output its data in a WinCC log.

Detailed knowledge is required in order to configure these logs. Creating a COM server, in particular, requires appropriate background knowledge. Information on database accesses by means of ODBC, COM servers, and CSV files is not provided here. You find more information on these subjects in the relevant technical literature.

See also

How to Output Data from a COM Server in a Report (Page 2110)

How to Output a Hard Copy by Means of a Log Object (Page 2102)

How to Output Data from a CSV Table in a Log (Page 2095)

How to Output Data from an ODBC Database in a Report (Page 2094)

9.6.9.2 How to Output Data from an ODBC Database in a Report

Introduction

Special log objects are provided in the reporting system for integrating data from user-specific data sources. It is possible to use two of these log objects to access data sources by means of ODBC and to output the data that is read out in a WinCC log. These report objects allow for access to these data and output in a WinCC log. This gives the reports and logs uniformity, even if the data do not come from WinCC. If WinCC tags are integrated, the selection of the data can be dynamized. In other words, the data selection can be changed online before output.

Available ODBC Log Objects

Database field	Serves to output data from a field of a data source by means of ODBC.
Database table	Serves to output data from a table of a data source by means of ODBC.

Requirements

- Knowledge of how to create layouts and insert report objects
- Knowledge of how to access data sources by means of ODBC
- Access authorization for the ODBC data source
- Knowledge of SQL
- If WinCC tags are used for dynamization, the WinCC project must be activated for testing and output.

Procedure

1. Create a new page layout, and open it in the page layout editor.
2. In the object palette on the Standard Objects tab, select the log object Database Field or Database Table, depending on your requirements, and drag it to the required size in the working area.
3. Open the object properties dialog by double-clicking the object, and select the Connect tab.
4. In the list of possible things to do, double-click Database Link. The Data Connection dialog is displayed.
5. In the ODBC Data Source area of the selection dialog, select an existing data source, or enter a data source in the text box.
6. Edit the other text boxes in accordance with the requirements of your data source.
7. Click "OK" to close the dialog and save the layout.
8. Create a print job, and select the configured page layout there.
9. Start output by means of the print job in WinCC Explorer or by means of a configured call in a WinCC picture, for example.

Output options

You can use any SQL statement to select the data. Enter it in the SQL Statement field. You can use WinCC tags to dynamize the selection of data by means of a SQL statement. For full dynamization, select the Tag check box, and integrate a tag. You can also dynamize a substring of the SQL statement. To do this, use the Insert Tag button. Select the tag you require from the tag selection dialog that is displayed. The tag will be inserted at the current cursor position in the text box. The syntax for this is \$tagname\$.

You can use the Test SQL Statement button to check whether the SQL statement is correct. Access to the data source is required in order to carry out the test. If there are WinCC tags in the SQL statement, WinCC must be activated for the test. The result of the test is displayed in a dialog. If the test is successful, the number of fields is entered automatically for a data table.

Errors that occur in Runtime are written to a log file.

You find more information in chapters Changing Output Options for the ODBC Database Field and Changing Output Options for the ODBC Database Table.

NOTICE
The SQL statements are not subject to any constraints. If you do the wrong thing, it is possible to destroy or delete the data source.

9.6.9.3 How to Output Data from a CSV Table in a Log

Introduction

Two log objects are provided in the reporting system for the integration of data in CSV format. These report objects allow for access to these data and output in a WinCC log. This gives the reports and logs uniformity, even if the data do not come from WinCC. If WinCC tags are integrated, the selection of the data can be dynamized. In other words, the data selection can be changed in Runtime before output.

Available CSV Log Objects

CSV provider tableServes to output data from a file in CSV format. The data is output in tabular form.

CSV provider trendServes to output data from a file in CSV format. The data is output in the form of a trend.

Requirements

- Knowledge of how to create layouts and insert report objects
- Knowledge of the structure of CSV tables.
- If WinCC tags are used for dynamization, the WinCC project must be activated for testing and output.

Procedure

1. Create a new page layout, and open it in the page layout editor.
2. In the object palette on the Runtime Documentation tab, select the log object CSV-Provider Table or CSV-Provider Trend, depending on your requirements, and drag it to the desired size in the working area.
3. Open the object properties dialog by double-clicking the object, and select the Connect tab.
4. In the list of possible things to do, select CSV Table Selection or CSV Trend Selection. A dialog is displayed in which you can select the data source.
5. In CSV File Name area of the selection dialog, select an existing data source, or enter a data source in the text box.
6. Click "OK" to close the dialog and save the layout.
7. Create a print job, and select the configured page layout there.
8. Start output by means of the print job in WinCC Explorer or by means of a configured call in a WinCC picture, for example.

Using the Data Source

To output the log correctly, the data must be stored in the CSV file used on the basis of a predefined structure. If current data are to be output, the CSV file must be created before output is started. The user is responsible for deleting the CSV file after output. You find more information in chapter Requirements to Be Met by a CSV File for Logging.

See also

Requirements to be Met by a CSV File for Reporting (Page 2099)
Example of the Output of CSV Files in a Report (Page 2096)

9.6.9.4 Example of the Output of CSV Files in a Report

Introduction

To illustrate the output of CSV files in a WinCC log, an example is provided of output in tabular form, and another is provided of output in the form of a trend. The notation must be rigorously adhered to. If the CSV file is created using a spreadsheet program, please check the notation before outputting it for the first time. To this end, open the CSV file in a text editor and check the contents. You find more information on this in chapters How to Output Data from a CSV Table in a Log and Requirements to Be Met by a CSV File for Logging.

Procedure

1. Create a CSV file in which the data are stored as in the examples described below.
2. Configure a page layout for the output. Proceed in the same way as for configuration described in chapter How to Output Data from a CSV Table in a Log.

3. Create a print job, and associate it with the page layout. Proceed in the same way as for configuration described in chapter Creating Print Jobs for Runtime Documentation.
4. Start the print job. The log is output.
5. Delete the CSV file after output.

Example of Output in Tabular Form

Contents of the CSV file to be printed:

#Table; Name; Columns; Font; Font size

"testfile";4;"Arial";14

#Column; Num; Header; Width; Alignment

0;"Date";10;C

1;"Time";10;C

2;"Number";6;L

3;"Status";16;R

#Data; Color; Col1; Col2; Col3; Col4;

0xFF00FF;"05/06/02";"15.55.52";85;"+/-"

0xFF00FF;"05/06/02";"15.55.53";86;"+/-"

0x32b400;"05/06/02";"15.55.54";87;"+/-"

0x32b400;"05/06/02";"15.55.55";88;"+/-"

0xFFFFFFFF;"05/06/02";"15.55.56";89;"+/-"

0xFFFFFFFF;"05/06/02";"15.55.57";90;"+/-"

0x0000FF;"05/06/02";"15.57.12";100;"+/-"

0x0000FF;"05/06/02";"15.58.01";85;"+/-"

0xFF0000;"05/06/02";"15.58.02";86;"+/-"

0xFF0000;"05/06/02";"15.58.03";87;"+/-"

Output file

Date	Time	Number	State
05/06/02	15.55.52	85	+/-
05/06/02	15.55.53	86	+/-
05/06/02	15.55.54	87	+/-
05/06/02	15.55.55	88	+/-
05/06/02	15.55.56	89	+/-
05/06/02	15.55.57	90	+/-
05/06/02	15.57.12	100	+/-
05/06/02	15.58.01	85	+/-
05/06/02	15.58.02	86	+/-
05/06/02	15.58.03	87	+/-

Example of Output in the Form of a Trend

Contents of the CSV file to be printed:

```
#Trend_T; Name; Curves; DateFrom; DateTo; Common Y-Axis; Font; Fontsize
"TrendControl1";3;"2001-10-10 16:30:00.000";"2001-10-10 16:40:00.000";0;"Arial";10
#Curve; Num; Name; Count; dMin; dMax; Color; Weight; CurveType; Filling
0;"Temperature";3;10;30;0x00ff0000;1;STEP;0
1;"Pressure"; 5; 0;50;0x0000ff00;2;DOTS;0
2;"Force"; 10; 0;50;0x000000ff;5;LINE;1
#Data; Num; Date; Value; Flags; Color
0;"2001-10-10 16:30:00.000";22;0;0x000000FF
0;"2001-10-10 16:31:00.000";24;0;
0;"2001-10-10 16:32:00.000";27;0;
1;"2001-10-10 16:30:00.000";10;0;0x0000FF00
1;"2001-10-10 16:30:30.000";20;0;
1;"2001-10-10 16:31:00.000";20;0;
1;"2001-10-10 16:31:30.000";30;0;
1;"2001-10-10 16:32:00.000";10;0;
2;"2001-10-10 16:30:00.000";20;0;
2;"2001-10-10 16:31:00.000";27;0;
2;"2001-10-10 16:32:00.000";34;0;0x00FF00FF
2;"2001-10-10 16:33:00.000";45;0;0x00FF0000
```



```

2;"2001-10-10 16:34:00.000";20;0;
2;"2001-10-10 16:35:00.000";27;0;
2;"2001-10-10 16:36:00.000";34;0;0x00FF00FF
2;"2001-10-10 16:37:00.000";45;0;0x00FF0000
2;"2001-10-10 16:38:00.000";20;0;
2;"2001-10-10 16:39:00.000";10;0;
2;"2001-10-10 16:40:00.000";25;0;

```

Output file

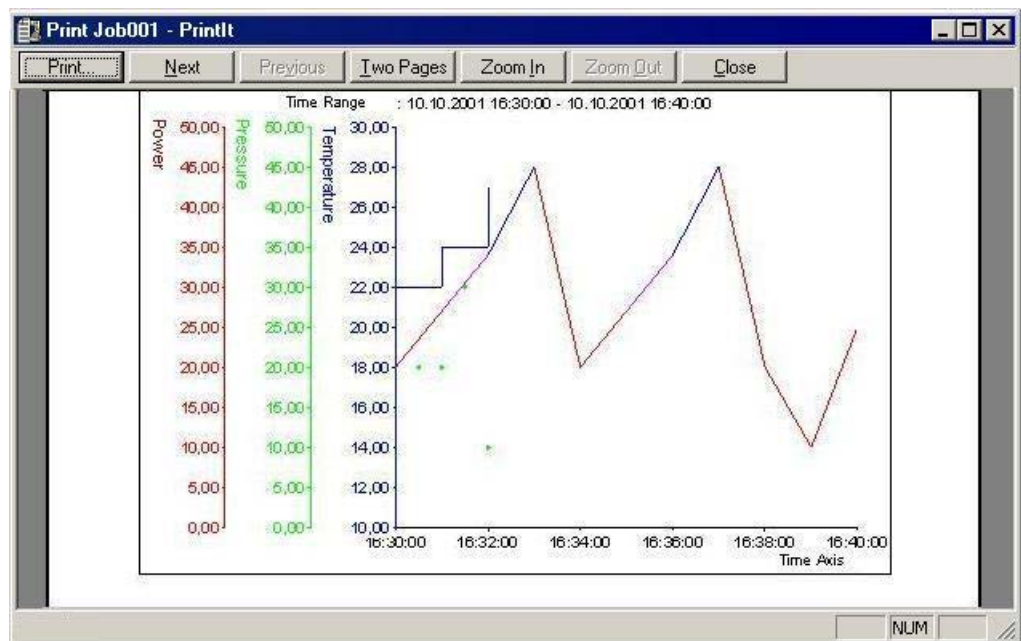

See also

Requirements to be Met by a CSV File for Reporting (Page 2099)

How to Output Data from a CSV Table in a Log (Page 2095)

9.6.9.5 Requirements to be Met by a CSV File for Reporting

Introduction

To permit the data from a CSV file to be output in a WinCC log, the data must correspond to a set structure. The data in a CSV file are prepared by the user. You find more information in chapters How to Output Data from a CSV Table in a Log and Example of the Output of CSV Files in a Report.

Requirements for CSV File to be Output in Tabular Form

Each section must begin with the name of the corresponding file structure, followed by one or more lines containing the elements of the file structure. All parameters must be separated by a semicolon (;), regardless of country-specific settings. The following file structures are defined:

File Structure for Output in Tabular Form

The table, columns, and data must be defined as follows:

#Table; Name; Columns; Font; Font size

- Name = name of the table control or file
- Columns = number of columns
- Font = font of the table
- Font size = font size of the table

#Column; Num; Header; Width; Alignment

- Num = number of the column
- Header = header of the column
- Width = width of the column in characters
- Alignment = left aligned/centered/right aligned

#Data; Color; Col1; Col2; Col3; Col4; ...

- Color = color attribute of the line (0xbbggrr)
- Col1 = data of column 1
- Col2 = data of column 2
- etc.

Points to Note About the Data in the CSV File

The control characters for colors, alignment, etc. are always at the beginning of the output text and can be combined with each other (e.g. "<U>output text"). No distinction is drawn between upper and lower case.

The Width parameter indicates the relative width of the columns. The effective width of the column in the table is calculated as follows:

[Table width as a number of characters] x [relative width of the column in %] / [sum of all relative widths of the column]

The line defined for tables in the CSV file contains one more column than the data lines. If a spreadsheet program such as Excel is used to edit the data, the columns for the headings and the data will no longer match up. To prevent this from happening, you can enter a semicolon (;) as the first character in the data lines of the CSV file. The data blocks of the CSV file may not contain blanks. When you open the CSV in Excel, the data columns are shifted one column to the right. The columns for the headings and data will then match up. If the first column does not contain anything, you have to insert a blank (;blank;first data value;...).

Control Characters for Table Output

<END>	Concludes the interpretation of control sequences. The rest of the text is accepted as specified.
<COLOR=#rrggbb>	Font color in hexadecimal notation (default = as set for the table)
<BGCOLOR=#rrggbb>	Background color in hexadecimal notation (default = as set for the table)
	Bold
<U>	Underlined
<I>	Italic
<STRIKE>	Strike-through
<ALIGN=left>	Left aligned
<ALIGN=center>	Centered
<ALIGN=right>	Right aligned

Note

The definition of the Color attribute conforms to the Intel byte format. The notation is 0xbbggrr (hex blue blue green green red red). The control characters for formatting the table cells conform to the HTML standard. The notation for <color=> is #rrggbb.

Each section must begin with the name of the corresponding file structure, followed by one or more lines containing the elements of the file structure. The following file structures are defined:

File Structure for Output in the Form of a Trend f(t)

#Trend_T; Name; Curves; DateFrom; DateTo; Common Y-Axis; Font; Fontsize

- Name = name of the trend control or file
- Curves = number of trends
- DateFrom = start of time range, notation: 2000-10-30 10:15:00.000
Number of digits: year(4); month(2); day(2); hours(2); minutes(2); seconds(2); milliseconds(3).
- DateTo = end of time range, notation: 2000-10-30 10:15:00.000
Number of digits: year(4); month(2); day(2); hours(2); minutes(2); seconds(2); milliseconds(3).
- Common Y-Axis = common y-axis
- Font = font
- Fontsize = font size

#Curve; Num; Name; Count; dMin; dMax; Color; Weight; CurveType; Filling

- Num = number of the trend
- Name = trend name
- Count = number of values

- dMin = lower limit of the trend (for scaling)
- dMax = upper limit of the trend (for scaling)
- Color = color attribute of the trend (0xbbggrr)
- Weight = line weight in points (e.g. 1.5)
- CurveType = trend type (LINE, DOTS, STEP)
- Filling = filling color for areas (0=no, 1=yes). The Filling parameter is currently not in use.

#Data; Num; Date; Value; Flags; Color

- Num = number of the trend
- Date = X coordinate of the trend, notation: 2000-10-30 10:15:00.000
Number of digits: year(4); month(2); day(2); hours(2); minutes(2); seconds(2); milliseconds(3).
- Value = y coordinate of the trend
- Flags = limit values/time overlap etc.
- Color (if an empty string is specified here, the color is taken from #Curve ...)

9.6.9.6 How to Output a Hard Copy by Means of a Log Object

Introduction

For outputting a hard copy in a log, the page layout editor provides the Hardcopy log object. This log object allows you to create a hard copy of the entire screen, a section of the screen, or the current window. In contrast to output by means of a key combination, this can be output in a defined page layout. It is also possible to insert the log object in a different log and output it together with other data.

Available Hard Copy Log Object

Hard copy	Serves to output current screen views.
-----------	--

Requirements

- Knowledge of how to create layouts and insert report objects
- If WinCC tags are used for dynamization, the WinCC project must be activated for testing and output.

Creating a Hard Copy Using the Hardcopy Log Object

1. Create a new page layout, and open it in the page layout editor.
2. In the object palette on the Standard Objects tab, select the Hardcopy log object. In the working area, drag it to the required size.

3. Open the object properties dialog by double-clicking the object, and select the Connect tab.
4. In the list of possible things to do, double-click Area Selection. A dialog that allows you to select the part of the screen to be output is displayed.
5. Select your preferred option in the Areas section of the selection dialog. If you select Copy of a Subarea, you have to specify the position of the upper-left corner and the size of the section in pixels in the corresponding text boxes.
6. Click "OK" to close the dialog and save the layout.
7. Create a print job, and select the configured page layout there.
8. Start output by means of the print job in WinCC Explorer or by means of a configured call in a WinCC picture, for example.

Output options

The selection of the area and the position and size specifications can also be dynamized by means of WinCC tags. To do this, select the relevant Tag check box, and use the folder button to select a tag from the Tag Selection dialog. If you know the tag name, you can enter it directly instead.

You configure tag supply in Graphics Designer.

See also

[How to Output a Hard Copy by Means of a Key Combination \(Page 2103\)](#)

[How to Change Output Options in Runtime \(Page 2074\)](#)

9.6.9.7 How to Output a Hard Copy by Means of a Key Combination

Introduction

In WinCC Explorer you can use the project properties to specify a key combination for outputting a hard copy. It is possible to create a hard copy of the entire screen, a section of the screen, or the current window. For this purpose, command-line parameters have to be transferred to the executing application PrintScreen. In contrast to output of a hard copy via a log object, output via PrintScreen is directly to the default printer. A defined page layout is not used. Output can be started in two ways:

1. By means of a configured key combination in the project properties
2. By starting the PrintScreen application in the computer's startup list

In the startup list you can pass parameters for output. The parameters are taken into account in both of the above ways of starting output. If a hot key has been configured both in the project properties and in the parameters in the startup list, the hot key from the project properties is used. Additional output parameters from the startup list are nevertheless still taken into account.

Configuring a Key Combination in the Project Properties

The output of a hard copy via a key combination can be set globally in WinCC. The output is directly to the default printer. For the output, the PrintScreen application is used instead of a layout from the logging system.

1. Select the name of the project in the navigation window of WinCC Explorer, and use the pop-up menu to open the Project Properties dialog.
2. Select the HotKeys tab, and then select Hard Copy in the Actions area.

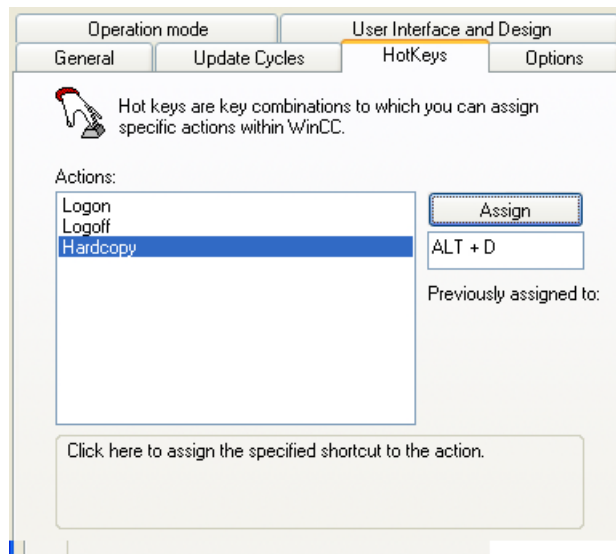

3. Click in the text box below the Assign button, and enter the key combination. The key combination is displayed in the text box.
4. Apply the setting by clicking the Assign button, and close the dialog.
5. The hard copy is output by entering the specified key combination.

Starting the Print Screen Application in the Startup List

The PrintScreen application is entered in the computer's startup list under Additional Tasks/ Applications. The application can be supplied with parameters in command-line format that specify the output. You find an overview of the parameters and the applicable conditions in chapter Output Parameters for Hard Copies.

1. Select Computer in the navigation window of WinCC Explorer. In the data window, select the computer on which you want the hard copy to be output. Use the pop-up menu to open the Computer Properties dialog.
2. Select the Startup tab.

3. Click the Add... button. The Add Application dialog is displayed.

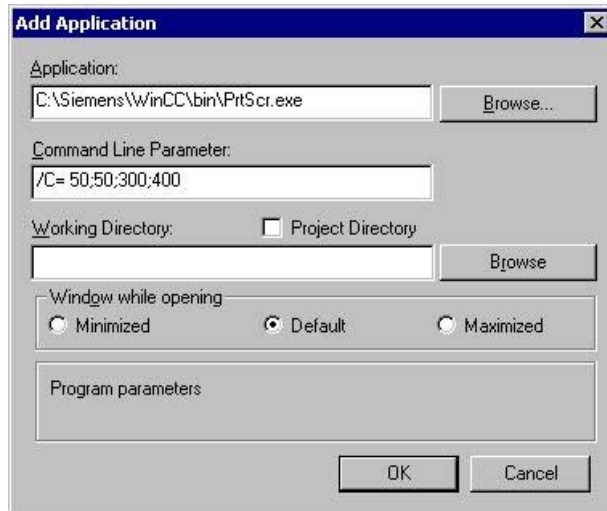

4. Click the Browse... button, and navigate to the bin folder in the WinCC installation directory. Select the PrtScr.exe application, and click Open.
5. Enter the desired parameters in the Parameters field.
6. The Working Directory and Window at Open fields are not required for PrintScreen.
7. Confirm your entries with "OK."

The PrintScreen application can also be called by means of a script. The parameters for output also apply when a script is used.

See also

[Output Parameters for Hard Copy \(Page 2105\)](#)

[How to Output a Hard Copy by Means of a Log Object \(Page 2102\)](#)

9.6.9.8 Output Parameters for Hard Copy

Introduction

When you output a hard copy by means of a key combination or a WinCC Script, you can pass parameters for the output. If the output is to be started by means of a key combination, this does not have to be specified in the project properties. The key combination can also be passed as a parameter.

Parameter for Output

The following parameters can be passed:

No parameters	The PrtScr.exe application is started and waits for the key combination for the printout to be pressed. In this case, the key combination must be specified in the project properties.
-end	Terminates a current instance of PrtScr.exe
-hardcopy	Starts PrtScr.exe, starts a hard copy immediately, and then waits for the key combination for the next printout to be pressed.
-nomcp	Starts PrtScr.exe, starts a hard copy immediately, and then terminates PrtScr.exe.
-C= left;top;right;bot- tom	Starts PrtScr.exe, immediately starts a hard copy for the specified area, and then terminates PrtScr.exe (the blank after -C= is important!). Example: prtscr.exe -C= 50;50;300;400 (Starting position 50 pixels from top, 50 pixels from left, End position 300 pixels from right, 400 pixels from bottom).
-l	Prints the hard copy in landscape format.
-ininit	Serves as a parameter for starting PrtScr.exe on a system without WinCC (e.g. a Web client). The key combination for the printout and the parameters for the printout are not obtained from the WinCC project; instead, they are passed in the command line. The PrtScr.exe application is started and waits for the key combination for the printout to be pressed. The parameters are passed once only at startup. If you want to change the parameters, you have to terminate the PrtScr.exe application and restart it with the changed parameters.
-SpoolerLevels= a,b	a = SpoolerLevelWarning, b= SpoolerLevelStop. Defines the limit value at which a warning is generated or the print job is rejected, if the required spooler capacity is not available. If no parameters is specified, the limit values are 150 MB for warnings and 100 MB for rejection of print job. Example: -SpoolerLevels= 50,30. If the available capacity of the spooler is less than 50 MB, system message 1004006 Spool full is generated. If less than 30 MB are available, the print job is rejected. System message 1004007 No hard copy printed. Spool full is generated.
-hotkey=x	Parameters for specifying the key combination for starting the output. The following key combinations are permitted: {<ALT>, <SHIFT>, <CTRL>} + {0-9, A-Z, 0xXX} The parameters must be entered in upper casing. The keys <ALT>, <SHIFT> and <CTRL> can be combined with each other, but it is not essential. By means of the hexadecimal value 0xXX, all virtual key codes can be expressed for XX. See the table below.

The parameters must be separated by blanks. In addition, a distinction must be drawn between upper and lower case.

Examples of the "-hotkey" parameter:

-hotkey=<CTRL+P>	Key combination CTRL and P
-hotkey=0x2C	Print screen (sometimes referred to as the Print key)
-hotkey=<ALT>+0x2C	Key combination of ALT and Print

Each time a key combination is pressed, PrtScr.exe prints a hard copy of the section of the screen specified (at program startup) on the default printer.

Parameter Combinations for Hard Copy Output on a Web Client

One-Time Starting

PrtScr.exe -inifit -hot-key="<Alt>+p"	Starts PrtScr and waits for key combination <ALT+P>. If the key combination is triggered, the entire screen is printed.
PrtScr.exe -inifit -hot-key="<Alt>+p" -C=10;10;100;100	Starts PrtScr and waits for key combination <ALT+P>. If the key combination is triggered, the selected partial area is printed.

Starting in a Script

PrtScr.exe -nomcp	Starts PrtScr, starts a hard copy immediately, and then terminates PrtScr.
PrtScr.exe -C=10;10;100;100	Starts PrtScr, starts a hard copy of the specified subarea immediately, and then terminates PrtScr.

The parameter -l can be added to any parameter combination.

Virtual Key Codes

The following table shows the symbolic constant names, hexadecimal values, and keyboard equivalents for the virtual-key codes used by the Microsoft Windows CE operating system. The codes are listed in numeric order.

Symbolic constant name	Value (hexadecimal)	Touch screen or keyboard equivalent
VK_LBUTTON	01	Touch screen
VK_CANCEL	03	Control-break processing
--	05-07	undefined
VK_BACK	08	BACKSPACE key
VK_TAB	09	TAB key
--	0A-0B	undefined
VK_CLEAR	0C	CLEAR key
VK_RETURN	0D	ENTER key
--	0E-0F	undefined
VK_SHIFT	10	SHIFT key
VK_CONTROL	11	CTRL key
VK_MENU	12	ALT key
VK_CAPITAL	14	CAPS LOCK key
--	15-19	Reserved for Kanji systems
--	1A	undefined
VK_ESCAPE	1B	ESC key
--	1C-1F	Reserved for Kanji systems
VK_SPACE	20	SPACEBAR key

9.6 Runtime Documentation

Symbolic constant name	Value (hexadecimal)	Touch screen or keyboard equivalent
VK_PRIOR	21	PAGE UP key
VK_NEXT	22	PAGE DOWN key
VK_END	23	END key
VK_HOME	24	HOME key
VK_LEFT	25	LEFT ARROW key
VK_UP	26	UP ARROW key
VK_RIGHT	27	RIGHT ARROW key
VK_DOWN	28	DOWN ARROOW key
VK_SELECT	29	SELECT key
--	2A	Original equipment manufacturer-specific (OEM-specific)
VK_EXECUTE	2B	EXECUTE key
VK_SNAPSHOT	2C	PRINT SCREEN key for Windows 3.0 and later
VK_HELP	2F	HELP key
VK_0	30	0 key
VK_1	31	1 key
VK_2	32	2 key
VK_3	33	3 key
VK_4	34	4 key
VK_5	35	5 key
VK_6	36	6 key
VK_7	37	7 key
VK_8	38	8 key
VK_9	39	9 key
--	3A-40	undefined
VK_A	41	A key
VK_B	42	B key
VK_C	43	C key
VK_D	44	D key
VK_E	45	E key
VK_F	46	F key
VK_G	47	G key
VK_H	48	H key
VK_I	49	I key
VK_J	4A	J key
VK_K	4B	K key
VK_L	4C	L key
VK_M	4D	M key
VK_N	4E	N key
VK_O	4F	O key
VK_P	50	P key
VK_Q	51	Q key
VK_R	52	R key

Symbolic constant name	Value (hexadecimal)	Touch screen or keyboard equivalent
VK_S	53	S key
VK_T	54	T key
VK_U	55	U key
VK_V	56	V key
VK_W	57	W key
VK_X	58	X key
VK_Y	59	Y key
VK_Z	5A	Z key
--	5B-5F	undefined
VK_NUMPAD0	60	Numeric keypad 0 key
VK_NUMPAD1	61	Numeric keypad 1 key
VK_NUMPAD2	62	Numeric keypad 2 key
VK_NUMPAD3	63	Numeric keypad 3 key
VK_NUMPAD4	64	Numeric keypad 4 key
VK_NUMPAD5	65	Numeric keypad 5 key
VK_NUMPAD6	66	Numeric keypad 6 key
VK_NUMPAD7	67	Numeric keypad 7 key
VK_NUMPAD8	68	Numeric keypad 8 key
VK_NUMPAD9	69	Numeric keypad 9 key
VK_MULTIPLY	6A	Asterisk (*) key
VK_ADD	6B	Plus sign (+) key
VK_SEPARATOR	6C	Separator key
VK_SUBTRACT	6D	Minus sign (-) key
VK_DECIMAL	6E	Period (.) key
VK_DIVIDE	6F	Slash mark (/) key
--	88-8F	unassigned
--	92-B9	unassigned
--	BA-C0	OEM-specific
--	C1-DA	unassigned
--	DB-E4	OEM-specific
--	E5	unassigned
--	E6	OEM-specific
--	E7-E8	unassigned
--	E9-F5	OEM-specific
VK_ATTN	F6	
VK_CRSEL	F7	
VK_EXSEL	F8	
VK_EREOF	F9	
VK_PLAY	FA	
VK_ZOOM	FB	
VK_NONAME	FC	
VK_PA1	FD	
VK_EM_CLEAR	FE	

Symbolic constant name	Value (hexadecimal)	Touch screen or keyboard equivalent
VK_LWIN	5B	
VK_RWIN	5C	
VK_APPS	5D	
VK_LSHIFT	A0	
VK_RSHIFT	A1	
VK_LCONTROL	A2	
VK_RCONTROL	A3	
VK_LMENU	A4	
VK_RMENU	A5	

9.6.9.9 How to Output Data from a COM Server in a Report

Introduction

To integrate user-specific data in a WinCC log, you can integrate a COM server in the reporting system. This COM server makes a log object available in the object palette that can be selected in the page layout editor and inserted in a page layout. The COM object then provides the user-specific data for output in the log. You find more information in section COM Provider in the Page Layout Editor.

Available Log Objects

COM object defined by the user	Serves to output data from data sources of the user in a WinCC log.
--------------------------------	---

Requirements

- Knowledge of how to create layouts and insert log objects

Procedure

1. Create a new page layout, and open it in the page layout editor.
2. In the object palette on the COM Server tab, select a COM object integrated by the user, and drag it to the desired size in the working area.
3. The creator of the COM object makes specifications available on the connection and selection of the data.
4. Configure the COM object in accordance with the specifications made there.
5. Save the layout.
6. Create a print job, and select the configured page layout there.
7. Start output by means of the print job in WinCC Explorer or by means of a configured call in a WinCC picture, for example.

Output Options

You receive information on possible output options from whoever wrote the COM object.

9.7 Appendix

9.7.1 System Layouts for Project Documentation

Introduction

WinCC provides you with a number of system layouts that have fixed associations with print jobs and are used for project documentation.

Print jobs and layouts in the basic WinCC system

You can start project documentation in the application or by starting the corresponding print job in WinCC Explorer.

Name of the print job	Layout name
@Documentation Alarm Logging Used for the output of the configuration data of the Alarm Logging.	@AlgCS.RPL (P)
@Documentation Alarm Center Used for the output of the configuration data of the WinCC Explorer.	@MCPCS.RPL (P)
@Documentation Global Script Actions Used for the output of the Global Script actions.	@GSC_RACT.RPL (P)
@Documentation Global Script Project function Used for the output of the Global Script project functions.	@GSC_RPFC.RPL (P)
@Documentation Global Script Standard function Used for the output of the Global Script standard functions.	@GSC_RSFC.RPL (P)
@Documentation Graphics Designer Used for the output of the configuration data of the Graphics Designer.	@pdlpic.RPL (P)
@Documentation Graphics Designer Dynamics Used for the output of the dynamization data of Graphics Designer pictures.	@pdlpicDyn.RPL (P)
@Documentation Graphics Designer Overview Used for the output of the picture statistics and the general display of Graphics Designer pictures.	@pdlpicOvr.RPL (P)
@Documentation Tag Logging Used for the output of the configuration data of the Tag Logging.	@TlgCS.RPL (P)
@Documentation Text Library Used for the output of the configuration data of the Text Library.	@Textlibrary.RPL (P)

Name of the print job	Layout name
@Documentation User Administrator Used to output the configuration data of the User Administrator.	@UACS.RPL (P)
@Internal Global Script Actions This print job is started internally.	@gsc_act.RPL (P)
@Internal Global Script Project-function This print job is started internally.	@gsc_pfc.RPL (P)
@Internal Global Script Standard-function This print job is started internally.	@gsc_sfc.RPL (P)
@Internal Graphics Designer Actions at the object This print job is started internally.	@akt_obj.RPL (P)
@Internal Graphics Designer Actions at the property This print job is started internally.	@akt_prop.RPL (P)
@XREFPrintSrc This print job is started internally.	@XREF-PRINTSRC.RPL
@XREFPrintRef This print job is started internally.	@XREFPrintRef.RPL

Print jobs and layouts of the WinCC option Basic Process Control

Name of the print job	Layout name
@Documentation Horn Used for the output of the configuration data of the horn editor.	@Horn(landscape).RPL (P)
@Documentation Lifebeat Monitoring Used for the output of the configuration data of the Lifebeat Monitoring.	@LBMCS.RPL (P)
@Documentation LTO Component List Used for the output of the configuration data of the component list editor.	@LTOBausteinliste(landscape).RPL (P)
@Documentation OS Project Editor Used to print the configuration data of the OS project editor.	@Projecteditor.RPL (P)
@Documentation Picture Tree Manager Is used to output the configuration data of the Picture Tree.	@PTMCS.RPL (P)
@Documentation Signal Collection Used for the output of the configuration data of the signal collection.	@SCollect.RPL (P)
@Documentation Time Synchronization	@TimeSync(landscape).RPL (P)

Internal system page layouts

The page layouts listed in the table below are involved in the standard project documentation and should not be edited. If you change these layouts, it affects project documentation.

Note

These system print jobs have fixed associations with the applications. The system print jobs can therefore not be deleted. If necessary, you can rename the system print jobs.

Name of the print job	Layout name
Involved in project documentation	@Global Script single Action (landscape).RPL
Involved in project documentation	@Global Script single Project Function (landscape).RPL
Involved in project documentation	@Global Script single Standard Function (landscape).RPL
Involved in project documentation	@gscract.RPL
Involved in project documentation	@gscrfc.RPL
Involved in project documentation	@gscrsfc.RPL
Involved in project documentation	@INC-PDL object actions.RPL
Involved in project documentation	@INC-PDL object attributes.RPL
Involved in project documentation	@INC-PDL object direct interconnections.RPL
Involved in project documentation	@INC-PDL object statistics.RPL
Involved in project documentation	@INC-PDL picture actions.RPL
Involved in project documentation	@INC-PDL picture attributes.RPL
Involved in project documentation	@INC-PDL picture direct interconnections.RPL
Involved in project documentation	@INC-PDL picture drawing.RPL
Involved in project documentation	@INC-PDL picture embedded objects.RPL
Involved in project documentation	@INC-PDL picture single action.RPL
Involved in project documentation	@INC-PDL picture statistics.RPL
Involved in project documentation	@INC-PDLOBJ object actions.RPL
Involved in project documentation	@INC-PDLOBJ object attributes.RPL
Involved in project documentation	@INC-PDLOBJ object direct interconnections.RPL
Involved in project documentation	@INC-PDLOBJ object single action.RPL
Involved in project documentation	@INC-PDLOBJ object statistics.RPL
Involved in project documentation	@PDL object actions.RPL
Involved in project documentation	@PDL object attributes.RPL
Involved in project documentation	@PDL object direct interconnections.RPL
Involved in project documentation	@PDL object statistics.RPL
Involved in project documentation	@PDL picture actions.RPL
Involved in project documentation	@PDL picture attributes.RPL
Involved in project documentation	@PDL picture direct interconnections.RPL
Involved in project documentation	@PDL picture drawing.RPL
Involved in project documentation	@PDL picture embedded objects.RPL
Involved in project documentation	@PDL picture statistics.RPL
Involved in project documentation	@PDLOBJLT.RPL

Name of the print job	Layout name
Involved in project documentation	@PDLPICLT.RPL
Involved in project documentation	@ptmcs (landscape).RPL

9.7.2 System Layouts and Print Jobs for Runtime Documentation

Introduction

WinCC provides you with a number of system layouts that have fixed associations with print jobs and are used to log Runtime data.

Print jobs and layouts in the basic WinCC system

Name of the print job	Function of the print job	Layout name
@AlarmControl - Picture	Output the current display of the AlarmControl in Runtime (WinCC V7 or higher).	@Alarm Control - Picture.RPL
@AlarmControl - Table	Output all messages of the select list in a table from the AlarmControl in Runtime (WinCC V7 or higher).	@Alarm Control - Table.RPL
@FunctionTrendControl	Output the current display of the Function-TrendControl in Runtime (WinCC V7 or higher).	@Function Trend Control - Picture.RPL
@OnlineTableControl - Picture	Output the current display of the OnlineTableControl in Runtime (WinCC V7 or higher).	@Online Table Control - Picture.RPL
@OnlineTableControl - Table	Output of all values in a table from the OnlineTableControl in Runtime (WinCC V7 or higher).	@Online Table Control - Table.RPL
@OnlineTrendControl - Picture	Output the current display of the OnlineTrendControl in Runtime (WinCC V7 or higher).	@Online Trend Control - Picture.RPL
@BarChartControl - Picture	Output of the current display of the BarChartControl in runtime	@Bar Chart Control - Picture.RPL
@Report Alarm Logging RT Locked Messages	Output the locked messages	@CCAlgRtOnline MessagesLocked.RPL
@Report Alarm Logging RT Message Sequence	Output the message sequence report on a line printer (WinCC V5.0 SP2 or higher).	@CCAlgRtSequence.RPL
@Report Alarm Logging RT OnlineMessages	Output the current messages	@CCAlgRtOnline Messages.RPL
@Report Alarm Logging RT Revolving archive	Output the revolving archive (prior to WinCC V5.0 SP2).	@ALRtUmA.RPL
@Report Alarm Logging RT Sequence archive	Output the sequence archive (prior to WinCC V5.0 SP2).	@ALRtFoA.RPL
@Report Alarm Logging RT Sequence archive New	Output the sequence archive (as of WinCC V5.0 SP2).	@CCAlgRtSequence Archive.RPL
@Report Alarm Logging RT Short Term archive New	Output the revolving archive (as of WinCC V5.0 SP2).	@CCAlgRtShortTerm Archive.RPL

Name of the print job	Function of the print job	Layout name
@Report AlarmControl-CP	Output the messages of Alarm Control in Runtime (in WinCC V6.2 and Classic Controls).	@CCAlarmCtrl-CP.RPL
@Report Curve Control Contents	Is started internally and is based on a CSV Provider (as of WinCC V6.2 as standard print job, replaced by @Report OnlineTrendControl-Curves-CP).	@CCCurveControlContents (P).RPL
@Report FunctionTrendControl-CP	Output the trends of Function Trend Control in Runtime (in WinCC V6.2 and Classic Controls).	@CCFunctionTrendCtrl-CP.RPL
@Report OnlineTableControl-CP	Output the tables of Online Table Control in Runtime (in WinCC V6.2 and Classic Controls).	@CCOnlineTableCtrl-CP.RPL
@Report OnlineTrendControl-Curves-CP	Output the trends of Online Trend Control in Runtime (in WinCC V6.2 and Classic Controls; replaces the @Report Curve Control Contents as standard print job).	@CCOnlineTrendCtrl-Curves-CP.RPL
@Report Runtime Message List	Output the current message list in Runtime	@Runtime Message List.RPL
@Report Table Control Contents	Is started internally based on a CSV Provider.	@CCTableControlContents (P).RPL
@Report Tag Logging RT Curves New	Output Tag Logging Trends in Runtime (as of WinCC V5.0 SP2).	@CCTIgtRtCurves.RPL
@Report Tag Logging RT Tables New	Output Tag Logging Tables in Runtime (as of WinCC V5.0 SP2).	@CCTIgtRtTables.RPL
@RulerControl - Picture	Output the current display of the RulerControl in Runtime (WinCC V7 or higher).	@Ruler Control - Picture.RPL
@RulerControl - Table	Output all values in a table by the RulerControl in Runtime (WinCC V7 or higher).	@Ruler Control - Table.RPL
@UserAdminControl - Picture	Output the current display of the UserAdminControl in Runtime (WinCC V7.3 or higher).	@User Admin Control - Picture.RPL
@UserAdminControl - Table	Output all values in a table from the UserAdminControl in Runtime (WinCC V7.3 or higher).	@User Admin Control - Table.RPL
@UserArchiveControl - Picture	Output the current display of the UserArchiveControl in Runtime (WinCC V7 or higher).	@User Archive Control - Picture.RPL
@UserArchiveControl - Table	Output all values in a table from the UserArchiveControl in Runtime (WinCC V7 or higher).	@User Archive Control - Table.RPL
@SysDiagControl - Picture	Output the current display of the SysDiagControl in Runtime	@SysDiag Control - Picture.RPL
@SysDiagControl - Table	Output all diagnostic values to a table from the SysDiagControl in Runtime	@SysDiag Control - Table.RPL

Print jobs and layouts of the WinCC option Basic Process Control

Note

The system print jobs provided with the WinCC scope of delivery may not be deleted. If necessary, you can rename the system print jobs. These system print jobs have fixed associations with the applications.

Name of the print job	Function of the print job	Layout name
@Report Alarm Logging RT OnlineMessages Active	Output list of active messages	@CCAlgRtOnlineMessagesActive.RPL (P)
@Report Alarm Logging RT OnlineMessages Gone	Output messages of the Gone Out List	@CCAlgRtOnlineMessagesGone.RPL (P)
@Report Alarm Logging RT OnlineMessages Hidden	Output Hidden Messages	@CCAlgRtOnlineMessagesHidden.RPL (P)
@Report Alarm Logging RT OnlineMessages Hiding	Output messages to be hidden	@CCAlgRtOnlineMessagesHiding.RPL (P)
@Report Alarm Logging RT OnlineMessages New	Output messages of the New List	@CCAlgRtOnlineMessagesNew.RPL (P)
@Report Alarm Logging RT OnlineMessages Old	Output messages of the Old List	@CCAlgRtOnlineMessagesOld.RPL (P)
@Report Alarm Logging RT Sequence archive Journal	Output messages of the Journal List	@CCAlgRtSequenceArchiveJournal.RPL (P)
@Report Alarm Logging RT Sequence archive Operation	Output messages of the Operation List	@CCAlgRtSequenceArchiveOperation.RPL (P)
@Report Alarm Logging RT Sequence archive Process	Output messages of the Process List	@CCAlgRtSequenceArchiveProcess.RPL (P)
@Report Asset Faceplate	Output diagnostics results of Faceplates	@AssetFaceplate.RPL (P)

9.7.3 Filter criteria for alarm output

Introduction

The filter criteria for alarm output are transferred with the transfer of the selection criteria from the selection dialog in the "Filter criteria for alarm output" area.

The filter criteria can be edited.

Notes on configuring the filter criteria are available in the following section:

- "Creating page layouts > Working with objects for Runtime documentation > Changing output options for alarm logs from Alarm Logging > Selection of data for an alarm log (Page 2263)".

Conditions

When filtering messages, note the following:

- The structure consists of "Field", "Operand", and "Value", with the individual parameters separated by blanks.
Example: DATETIME >= '2006-12-21 00:00:00' AND MSGNR >= 100
(all messages as of 21/12/2006 with a message number greater than or equal to 100)
- Strings, date, and time must be passed in single quotation marks.
- In the DATETIME argument, the date and time of day are separated by a blank.
Regardless of the time base setting in the object properties, the output of DATETIME is based on the time base Local Time.
Exception: UTC is set as the time base: in this case, the output is based on time base UTC.

Valid operands

Arguments and operands other than those mentioned below are not permitted.

- >=
- <=
- =
- >
- <
- IN(...)
Several values as an array, separated by commas.
Example: CLASS IN(1 ,2 ,3) AND TYPE IN(1 ,2 ,19 ,20 ,37 ,38)
- LIKE
Text must contain string only.
The operand LIKE is only permissible for TEXT arguments.
Example: TEXT1 LIKE 'Error' relays message where Text1 contains the search text Error.

Valid arguments

Name	Type	data	Example:
MsgFilterSQL:	Integer	Maximum number of messages to be output	MsgFilterSQL: 10000 Up to 10000 messages are output. MsgFilterSQL: 10000\MSGNR >= 1 Up to 10000 messages starting with message number 1 are output.
DATETIME	Date	'YYYY-MM-DD hh:mm:ss.msmsms'	DATETIME >= '2007-05-03 16:00:00' Output of message from 05.03.2007 16:00 hours.
MSGNR	Integer	Message number	MSGNR >= 10 AND MSGNR <= 12 Output of messages with message numbers 10 - 12.

Name	Type	data	Example:
CLASS IN AND TYPE IN	Integer	- Message class ID 1-16 and system message classes 17, 18 - Message type ID 1-256 and system message types 257, 258, 273, 274	CLASS IN (1) AND TYPE IN (2) Output of messages of message class 1 message type 2.
STATE	Integer	Value of ALARM_STATE_xx Only the operands "=" and "IN(...)" are permitted ALARM_STATE_1 ALARM_STATE_2 ALARM_STATE_3 ALARM_STATE_4 ALARM_STATE_5 ^(*) ALARM_STATE_6 ^(*) ALARM_STATE_7 ^(*) ALARM_STATE_10 ALARM_STATE_11 ALARM_STATE_16 ALARM_STATE_17	STATE IN(1,2,3) Output of all message that came in, went out and were acknowledged. Possible values: 1 = Came In messages 2 = Went Out messages 3 = acknowledged messages 4 = locked message 5 = released messages 6 = messages that came in and have been acknowledged 7 = messages that came in and went out 10 = hidden messages 11 = displayed messages 16 = messages acknowledged by the system 17 = emergency-acknowledged messages ^(*) The "ALARM_STATE_5", "ALARM_STATE_6" and "ALARM_STATE_7" states can only be output via the "Alarm Logging Runtime" layout. These states cannot be selected in the AlarmControl.
PRIORITY	Integer	Message priority 0 - 16	PRIORITY >= 1 AND PRIORITY <= 5 Outputs messages that have a priority between 1 and 5.
AGNR	Integer	PLC number	AGNR >= 2 AND AGNR <= 2 Output of messages with AG number = 2.
AGSUBNR	Integer	AG sub-number	AGSUBNR >= 5 AND AGSUBNR <= 5 Outputs messages with AG sub-number 5.
TEXTxx	Text	Search text for 'Text1'-'Text10'	TEXT2 = "Error" Outputs the messages whose Text2 corresponds with "Error". TEXT2 IN ('Error','Fault') Outputs the messages whose Text2 corresponds with the text "Error" or "Fault". TEXT2 LIKE 'Error' Outputs the messages whose Text2 includes the text "Error".
PVALUExx	Double	Search text for PVALUE1- PVALUE10	PVALUE1 >= 0 AND PVALUE1 <= 50 Output of process value 1 with start value 0 and stop value 50.

See also

Selection of the Data for a Message Report (Page 2263)

Creating Page Layouts

10.1 Creating Page Layouts

Contents

The page layout editor is a component of the Report Designer and is used to create and dynamize page layouts for the output of reports. The page layout editor can only be used for the project currently open in the WinCC Explorer. The layouts are saved are the basis of their projects.

This online help will show you

- how to set up the page layout editor
- how to create and edit page layouts
- how to use objects in the object palette
- how to adapt the object properties to the requirements of your project

how to change the output options for reports and logs

10.2 How to Start the Page Layout Editor

Introduction

The page layout editor can be opened in several standard Windows ways. The page layout editor can only be used for the project currently open in the WinCC Explorer.

Requirement

- A project must be opened in WinCC Explorer.

Opening the Page Layout Editor

The page layout editor is called from the WinCC Explorer. The following options are available:

Navigation Window/Data Window of WinCC Explorer:

Select the Report Designer entry. The "Layouts" and "Print Jobs" subentries are displayed.

Double-click the "Layouts" entry in the navigation window or select "Layouts" in either the navigation or data windows in WinCC and select "Open Page Layout" from the context menu.

The page layout editor is started and a new layout is opened.

WinCC Explorer Data Window:

Select the Report Designer entry. The "Layouts" and "Print Jobs" subentries are displayed.

In the navigation window, select "Layouts". The available layouts are displayed in the data window. Double-click a page layout or select "Open Page Layout" from the context menu.

The page layout editor starts and the selected page layout is opened.

See also

The Page Layout Editor (Page 2123)

10.3 The Page Layout Editor

10.3.1 The Page Layout Editor

Introduction

The page layout editor offers objects and tools for creating page layouts. Start the page layout editor in WinCC Explorer.

Structure of the Page Layout Editor

The page layout editor follows the conventions set by Windows. It possesses a workspace, toolbars, menu bar, status bar and various palettes. After opening the page layout editor, the workspace is displayed with the default settings. You can arrange the palettes and bars to your liking and also hide them.

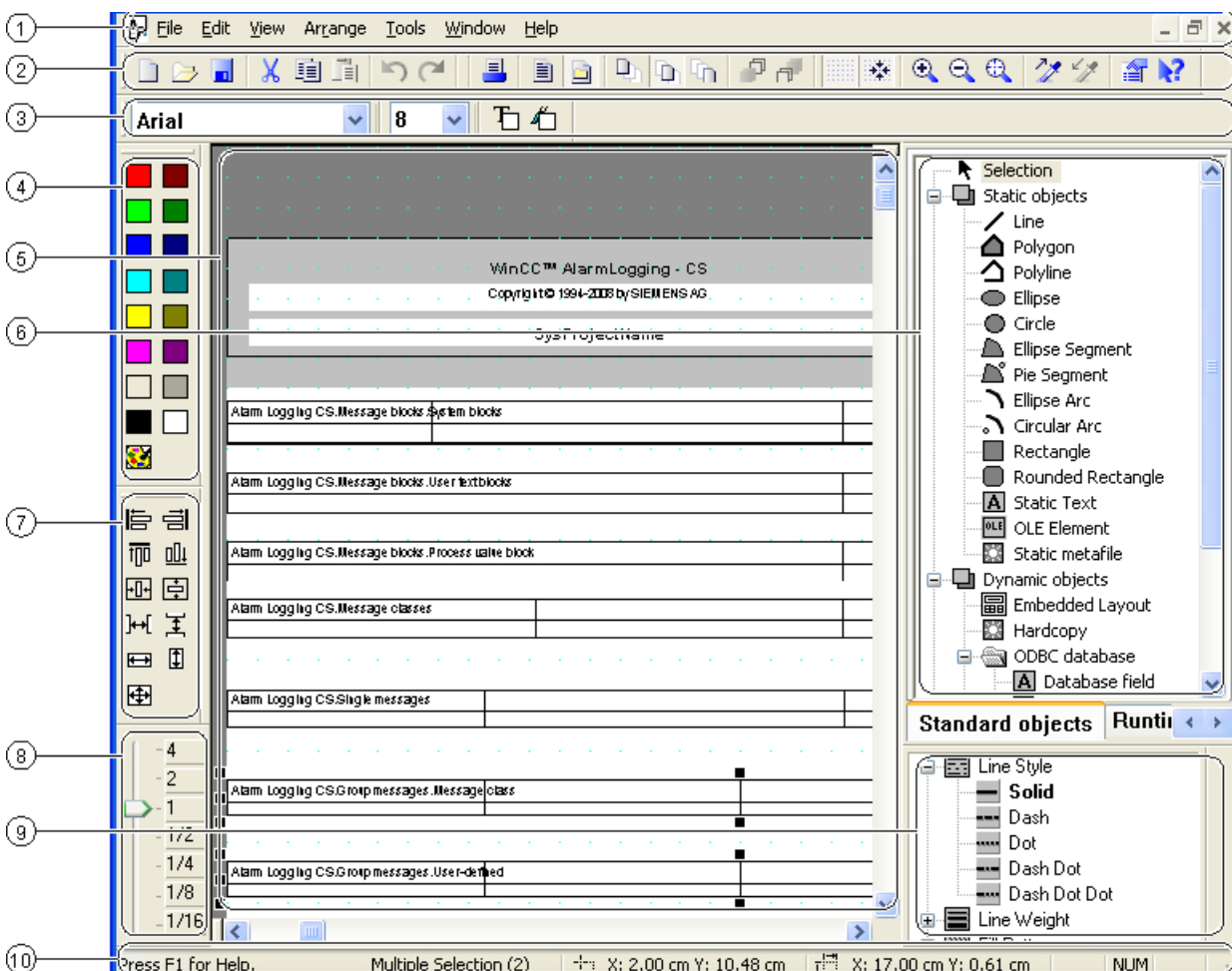

(1) The Menu Bar

The menu bar is always visible. Depending on the context, the functions in the menus are active or inactive.

(2) The Toolbar

The toolbar provides buttons to quickly perform common commands of the page layout editor. The toolbar can be hidden if required or moved to any location on the screen.

(3) The Font Palette

The font palette is used to change font type, size and color of text objects as well as the line color of standard objects.

(4) The Color Palette

The color palette is used to color selected objects. In addition to the 16 standard colors, custom colors can be defined.

(5) The Workspace

The gray area represents the printable area, the white area the page body. Each screen in the workspace represents a layout and is saved as a separate rpl file. The layouts can be enlarged and reduced according to the Windows standard.

(6) The Object Palette

The object palette contains the standard objects, objects for the runtime documentation, COM server objects and objects for the project documentation. The objects are used to form a layout.

(7) The Alignment Palette

The alignment palette is used to change the absolute position of one or more objects, change the position of selected objects relative to each other or unify the height and width of several objects.

(8) The Zoom Palette

The zoom palette offers two options to enlarge or reduce the objects of the active layout: either via buttons of the standard zoom factors or via a slider.

(9) The Style Palette

The style palette is used to change the appearance of a selected object. Depending on the object, the line type, line strength or fill pattern can be changed.

(10) The Status Bar

The status bar is located at the bottom of the screen and can be hidden if required. Among other things, it displays tips, information about the position of the selected objects and the keyboard setting.

See also

- The Alignment Palette (Page 2136)
- The Status Bar (Page 2141)
- The Color Palette (Page 2139)
- The Zoom Palette (Page 2138)
- The Style Palette (Page 2135)
- The Object Palette (Page 2127)
- The Font Palette (Page 2140)
- The Standard Toolbar (Page 2125)

10.3.2 The Standard Toolbar







Usage



















The toolbar is located in its default position under the menu bar, on the upper edge of the page layout editor. The buttons arranged on the toolbar allow quick and comfortable access to the offered functionality of the page layout editor.



Contents

The standard toolbar contains buttons with the following functions:

Button	Function	Key combination
	Creates a new page layout.	<CTRL+N>
	Opens an existing page layout.	<CTRL+O>
	Saves the current page layout.	<CTRL+S>
	Cuts out the highlighted object (text or drawing object) and copies it to the clipboard. Therefore the function is only available when an object is highlighted.	<CTRL+X>
	Copies the highlighted object (text or drawing object) to the clipboard. Therefore the function is only available when an object is highlighted	<CTRL+C>
	Pastes the contents of the clipboard at the location of the cursor. This function is only available, when the clipboard is not empty.	<CTRL+V>

Button	Function	Key combination
	Undoes the last actions (maximum of 30). This function is only available when an action has been carried out.	<CTRL+Z>
	Redoes the last undone action. This function is only available when an action has been undone.	<CTRL+A>
	Prints the contents of the current page layout. Therefore, the function is only available when a page layout is open.	<CTRL+P>
	Makes the static part of a layout active and the dynamic part inactive. If the static part is already active, it remains active. The static part can be individually defined for the cover sheet, the succeeding pages and for the closing page. The same static part will be repeated on all of the succeeding pages.	-
	Makes the dynamic part of a layout active and the static part inactive. If the dynamic part is already active, it remains active.	-
	Makes the cover sheet of a layout active and the contents of the report and the closing page inactive. If the cover sheet page type is already active, it remains active.	-
	Makes the report contents of a layout active and the cover sheet and closing page inactive. If the report contents page type is already active, it remains active.	-
	Makes the closing page of a log active and the cover sheet and report contents inactive. If the closing page page type is already active, it remains so.	-
	Puts the highlighted objects in the layer in the foreground of the layout. The objects in the foreground cover objects which lie under them.	-
	Puts the highlighted objects in the layer in the background of the layout. Objects in the background are covered by objects lying in front of them.	-
	Switches the grid in the active window on or off.	-
	Switches the "Snap to Grid" function on or off.	-
	Increases the zoom factor in steps of 50%; the layout is shown enlarged. This function is only active until the largest zoom factor (400%) has been reached.	-
	Decreases the zoom factor in steps of 50%; the layout is shown smaller. This function is only active until the smallest zoom factor (6.25%) has been reached.	-
	Zooms to any picture section you choose. This will be adjusted to fit the picture window.	-
	Copies the properties of an object to apply them to another object.	-
	Applies the previously copied properties of an object to another object. The function is only active when properties have been previously copied.	-
	Opens a window in which the properties of the highlighted object or object group are displayed.	-
	Activates the direct help (What's this?).	<SHIFT+F1>

Characteristics

The toolbar can be hidden or shown. It can be attached under the menu bar. When it is not attached it can be positioned anywhere on the screen with the mouse.

See also

How to Change the Standard Toolbar (Page 2144)

How to Show and Hide the Toolbar and Palettes (Page 2143)

How to Arrange the Toolbar and Palettes (Page 2143)

10.3.3 The Object Palette

10.3.3.1 The Object Palette

Usage

The object palette contains object types that can be inserted into the page layout. Static objects and system objects are available for the visual construction of the page layout. Dynamic objects are available for data output.

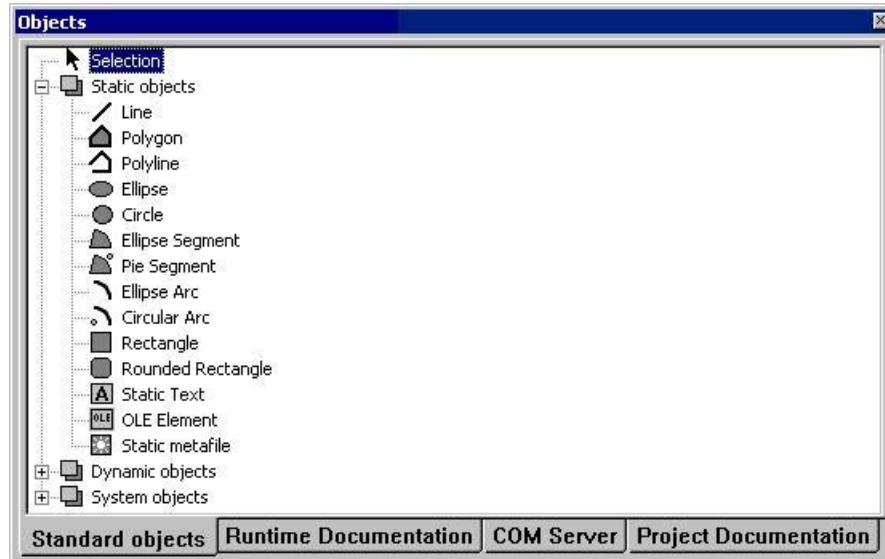

Contents

The objects in the object palette can be summarized in the following 4 object groups:

- Standard objects: static objects, dynamic objects and system objects
- Objects of the runtime documentation: for example Alarm Logging RT, user archive runtime, CSV provider, etc.

- COM server objects
- Project documentation objects: for example actions in the Graphics Designer, Alarm Logging CS, Global Script, etc.

Operation

Click one of the tabs and select the object you want.

Characteristics

The object palette can be shown and hidden. It can be moved anywhere on the screen with the mouse.

See also

Standard Objects (Page 2128)

Objects for the Project Documentation (Page 2134)

COM Server Objects (Page 2134)

Objects for the Runtime Documentation (Page 2132)

10.3.3.2 Standard Objects

Standard Objects

Usage

Standard objects contain object types that are used to visually construct the page layout. Dynamic object types can also be used for this, unlike objects for runtime documentation and project documentation, which are not connected to the WinCC components.



Overview

Standard objects can be divided into three object classes:

- Static objects are used for the visual creation of a page layout. You can insert static objects into both the static and dynamic parts of a page layout.
- Dynamic objects can be connected with data sources which have a valid data format for the current object. That way these data can be output in a WinCC layout. You can only insert dynamic objects in the dynamic part of the page layout.
- System objects are used as placeholders for the system time, the current page number and the project and layout names. You can only use system objects in the static part of the page layout. The required entries are described in the "Format" attribute in the "Miscellaneous" property of the system object.

Shared Properties

- The object properties (e.g. geometry, color) of the individual standard objects are preset. However, these defaults can be changed. The objects are displayed with the standard object properties.
- The properties of the displayed objects can be changed at any time.

See also

[How to Change an Attribute \(Page 2181\)](#)

[Working with Standard Objects \(Page 2194\)](#)

[Overview of the System Objects \(Page 2131\)](#)

[Overview of the Dynamic Objects \(Page 2130\)](#)



[Overview of the Static Objects \(Page 2129\)](#)

Overview of the Static Objects

Introduction

Static objects are used for the visual creation of a page layout. You can insert standard objects in both the static and dynamic parts of a page layout.

Overview

Icon	Object	Description
	Line	The line is an open object. The length and angle of a line are determined by the height and width of the rectangle around the object.
	Polygon	The polygon is a closed object that can be filled with a color or pattern. A polygon can have any number of corner points; these are numbered in the order of their creation and can be changed individually, or even deleted.

Icon	Object	Description
	Polyline	The polyline is an open object. Even if the start and finish point have the same coordinates, the area cannot be filled. A polyline can have any number of corner points; these are numbered in the order of their creation and can be changed individually, or even deleted.
	Ellipse	The ellipse is a closed object that can be filled with a color or pattern. The height and width of an ellipse can be modified as desired to allow it to be aligned horizontally or vertically.
	Circle	A circle is a closed object that can be filled with a color or pattern. A circle can be resized at will.
	Ellipse segment	The ellipse segment is a closed object that can be filled with a color or pattern. The height and width of an ellipse segment can be modified as desired to allow it to be aligned horizontally or vertically.
	Pie segment	The pie segment is a closed object that can be filled with a color or pattern. A pie segment can be resized at will.
	Ellipse arc	The ellipse arc is an open object. The height and width of an ellipse arc can be modified as desired to allow it to be aligned horizontally or vertically.
	Circular arc	The circular arc is an open object. A circular arc can be resized at will.
	Rectangle	The rectangle is a closed object that can be filled with a color or pattern. The height and width of a rectangle can be modified as desired to allow it to be aligned horizontally or vertically.
	Rounded rectangle	The rounded rectangle is a closed object that can be filled with a color or pattern. The height and width of a rounded rectangle can be modified as desired to allow it to be aligned horizontally or vertically. The corners of a rounded rectangle can be rounded as much as desired.
	Static text	The field for static text is a closed object that can be filled with a color or pattern. The static text is entered into a field of any desired size. The text can be entered on one or more lines.
	OLE object	You can import the contents of a file or new object into a layout with any data type, e.g. an Adobe Acrobat document.
	Static metafile	You can insert graphic data into a layout with the "Static Metafile" object. The graphic files must be in the *.emf (Enhanced Meta File) format.

See also

Overview of the System Objects (Page 2131)

Overview of the Dynamic Objects (Page 2130)





Standard Objects (Page 2128)

Overview of the Dynamic Objects

Introduction

With dynamic objects, you can set the data you want to output in a report/log from different data sources. You can only insert dynamic objects in the dynamic part of the page layout.

Overview

Icon	Object	Description
	Embedded layout	Layouts for the project documentation can be nested with the "Embedded Layout" dynamic object. The object is only used for the project documentation in ready-made layouts for WinCC.
	Hard copy	With the "Hard Copy" object type, you can output a picture of the current screen, contents or a defined section of it, in a log. You can also output a currently selected picture window.
	ODBC database field	With the "ODBC Database Field" object type, you can output texts from some data sources into a log via the ODBC interface.
	ODBC database table	With the "ODBC Database Table" object type, you can output tables from some data sources into a log via the ODBC interface.
	Tag	Output the "Variable" values in runtime with the Tag object type. Tag values can only be output if the project is activated. In runtime you can also call a script for the output.

See also

Overview of the System Objects (Page 2131)

Overview of the Static Objects (Page 2129)





Standard Objects (Page 2128)

Overview of the System Objects

Introduction

System objects are used as placeholders for the system time, current page number of the report and project and layout names. You can only use system objects in the static part of the page layout.

Overview

Icon	Object	Description
	Date/time	Insert a placeholder for the date and time of the output in the page layout with the "Date/Time" system object. During printing, the system date and time are added by the computer.
	Page number	Insert a placeholder for the current page number of the report or log in the page layout with the "Page Number" system object.
	Project name	Insert a placeholder for the project name in the page layout with the "Project Name" system object.
	Layout name	Insert a placeholder for the layout name in the page layout with the "Layout Name" system object.

See also

- Standard Objects (Page 2128)
- Overview of the Static Objects (Page 2129)
- Overview of the Dynamic Objects (Page 2130)

10.3.3.3 Objects for the Runtime Documentation

Usage

The runtime documentation objects are for outputting logs of the runtime data. The output options can be configured using the "Object Properties" dialog. The data for the logs are taken from the linked data sources at the time of the output. You can only insert the runtime documentation objects in the dynamic part of the page layout.

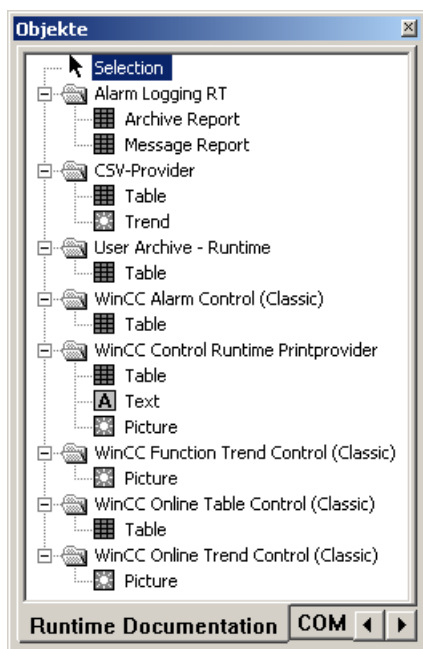

Overview

Object	Description
Alarm Logging RT Archive Log	The "Archive Report" object is connected to the message system and outputs the messages saved in the message archive to a table.
Alarm Logging RT Message Log	The "Message Report" object is connected to the message system and outputs the current messages in the message list to a table.
User archive Runtime Table	The "User Archive Runtime Table" object is connected to the User Archive and outputs the runtime data from the user archives and views to a table.
CSV provider table	The "CSV Provider Table" object can be linked to a CSV file. The data contained in the file are output to a table. The data must be in a predefined structure.

Object	Description
CSV Provider Trend	The "CSV Provider Trend" object can be linked to a CSV file. The data contained in the file are output in a curve. The data must be in a predefined structure.
WinCC Alarm Control Table	The "WinCC Alarm Control/Table" object is used to output the message lists in a tabular format. You configure the static and dynamic parameters of the control for the output in Reports Designer.
WinCC Control Runtime Printprovider Table	The entire contents of the table of a WinCC control is output in the table. The report object is not available for the WinCC OnlineTrendControl and WinCC FunctionTrendControl. The report can only be output via the button in the WinCC control.
WinCC Control Runtime Printprovider Picture	The current control display is output in the picture. The report can only be output via the button in the WinCC control.
WinCC Function Trend Control Picture	The "WinCC Function Trend Control/Picture" object is used to output process data as function of another tag from the process value, compression and user archives in the form of a trend. You configure the static and dynamic parameters of the control for the output in Reports Designer.
WinCC Online Table Control Table	The "WinCC Online Table Control/Table" object is used to output process data from the associated process value archives and compressed archives in a tabular format. You configure the static and dynamic parameters of the control for the output in Reports Designer.
WinCC Online Trend Control Picture	The "WinCC Online Trend Control/Picture" object is used to output process data from the associated process value archives and compressed archives in trend curve format. You configure the static and dynamic parameters of the control for the output in Reports Designer.

Shared Properties

- The object properties (e.g. font) of the individual objects are preset. However, these defaults can be changed. The objects are displayed with the default object properties.
- The properties of the displayed objects can be changed at any time.

See also

How to Change an Attribute (Page 2181)

Working with Objects for the Project Documentation (Page 2275)

Working with Objects for the Runtime Documentation (Page 2240)

10.3.3.4 COM Server Objects

Usage

In order to use a COM server object, a COM server projector must be integrated into WinCC. This COM server makes the object for logging data available. This way, it is possible to integrate user-specific data in a WinCC log. The form and properties of a COM server object are determined by the COM server writer. The description of the COM server object is delivered with the COM server writer. The options for selecting the output data are determined by the current COM server object. The COM server objects can only be inserted into the dynamic part of a page layout. Additional information can be found in chapter "Working with COM Server Objects".

10.3.3.5 Objects for the Project Documentation

Usage

The project documentation objects are provided for the report output of configured data. The objects for project documentation can only be inserted into the dynamic part of a page layout.



The objects for project documentation are closely connected with the WinCC components. The object types are fixed. Depending on the type and size of the configuration data for the output, the "Static Text", "Dynamic Metafile" or "Dynamic Table" object types are used. A detailed description of the objects used and the output data can be found in chapter "Outputting Project Documentation".

For some of the objects used with the "Dynamic Metafile" and "Dynamic Table" object types, you can change the selection of the configuration data for output. Additional information can be found in chapter "Working with Objects for Project Documentation".

Shared Properties

- The object properties (e.g. font) of the individual objects are preset. However, these defaults can be changed. The objects are displayed with the default object properties.
- The properties of the displayed objects can be changed at any time.

See also

How to Change an Attribute (Page 2181)

Working with Objects for the Runtime Documentation (Page 2240)

Working with Objects for the Project Documentation (Page 2275)

10.3.4 The Style Palette

Usage

The line type, line weight and background pattern of the selected object can be changed with the style palette. Depending on the object type, different style forms are available.



Contents

- The "Line Type" style group contains different line types, such as dashed, dotted, etc.
- The "Line Weight" style group contains different line weights. The line weight is given in pixels. 1 mm = 4.73 pixels.
- The "Fill Pattern" style group contains fill patterns for the background of closed objects, such as transparent, checkered, diagonal lines, etc.

Displaying the Current Settings

The currently selected settings are displayed in "bold" font.

Characteristics

The style palette can be shown or hidden. It can be placed anywhere on the screen with the mouse.

See also

How to Show and Hide the Toolbar and Palettes (Page 2143)

How to Arrange the Toolbar and Palettes (Page 2143)

10.3.5 The Alignment Palette

Usage

The alignment palette is used to:

- change the absolute position of one or more objects
- change the position of the selected objects relative to one another
- align the heights and widths of several objects.

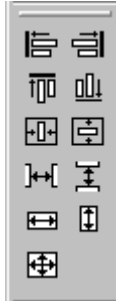





Requirements

The palette buttons are enabled when at least two objects are highlighted.

Overview

Button	Function
	Align objects left. The type of selection determines which object is used as reference for alignment. If the objects are selected with a selection frame (lasso), the object lying farthest out will be used as reference. If the objects are selected with the left mouse button, the object selected first will be used as reference for alignment.
	Align objects right. See section "Align Objects Left" to determine which object will be used as reference for alignment.
	Align objects top. See section "Align Objects Left" to determine which object will be used as reference for alignment.
	Align objects bottom. See section "Align Objects Left" to determine which object will be used as reference for alignment.
	Align objects on horizontal center. The objects are moved to be aligned along a common central horizontal axis.
	Align objects on vertical center. The objects are moved to be aligned along a common central vertical axis.
	Distribute objects evenly in horizontal direction. The objects maintain the same horizontal distance from one another.. The location of the outer objects remains unchanged.

Button	Function
	Distribute objects evenly in vertical direction. The objects maintain the same vertical distance from one another.. The position of the upper and lower objects remains unchanged.
	Standardize width of objects. If the objects were selected with the left mouse button, they receive the width of the first object selected. The width of lines remains however unchanged. If the objects were selected using a selection frame (lasso), the widths will be adjusted to the largest width in the group.
	Standardize heights of objects. If the objects were selected with the left mouse button, they receive the height of the first object selected. If the objects were selected using a selection frame (lasso), the heights will be adjusted to the largest height in the group.
	Standardize width and height of objects. The objects receive the width and height of the first object configured in the group.

Characteristics

The alignment palette can be show and hidden. It can be placed anywhere on the screen with the mouse.

See also

How to Select Multiple Objects (Page 2172)

How to Align Multiple Objects (Page 2173)

How to Show and Hide the Toolbar and Palettes (Page 2143)

How to Arrange the Toolbar and Palettes (Page 2143)

10.3.6 The Zoom Palette

Usage

The zoom factor for the objects in the active layout is set with the zoom palette. The current zoom factor is displayed under the slider. The zoom palette offers two options for enlarging or reducing the objects:

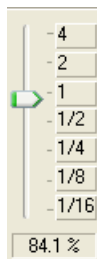

- using buttons with standard zoom factors (e.g. 8, 1/2)
- using a slider.



Characteristics

The zoom palette can be shown and hidden. It can be placed anywhere on the screen with the mouse.

Note

The zoom factor can also be set incrementally using the  and  buttons in the standard toolbar.

See also

How to Show and Hide the Toolbar and Palettes (Page 2143)

How to Arrange the Toolbar and Palettes (Page 2143)

10.3.7 The Color Palette

Usage

Selected objects can be assigned one of the 16 standard colors, a primary color or a self-defined color with the color palette. For example, one mouse click in the color palette can change:

- the fill color for area objects (e.g. rectangle),
- the line color for line objects (e.g. polyline),
- the background color of text objects.

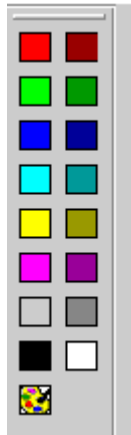

Characteristics

The color palette can be shown and hidden. It can be placed anywhere on the screen with the mouse.

See also

The Colors Property Group (Page 2185)

How to Create Custom Colors (Page 2142)

How to Show and Hide the Toolbar and Palettes (Page 2143)

How to Arrange the Toolbar and Palettes (Page 2143)





10.3.8 The Font Palette

Usage

A new text object or another object which contains text will be created with preset text properties. The font palette contains tools for changing the font, size and color of text objects, as well as the line color of standard objects, at any time.



Overview

Button	Description
	Changing font
	Change font size
	Change font color
	Change line color. For area objects, this function influences the color of the borderline and for line objects it influences the line color.

Characteristics

The font palette can be shown and hidden. It can be placed anywhere on the screen with the mouse.

Note

Additional text properties, such as orientation, italic, bold, underline, are changed in the "Object Properties" window.

See also

The Font Property Group (Page 2189)

How to Show and Hide the Toolbar and Palettes (Page 2143)

How to Arrange the Toolbar and Palettes (Page 2143)

10.3.9 The Status Bar

Usage

The status bar provides you with the following information:

- help text for a selected functions, menu commands and buttons
- information about the name, position and size of a highlighted object
- information about the keyboard status (e.g. the NUM LOCK key).

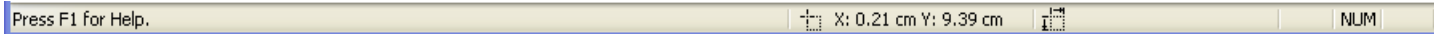

Characteristics

The status bar can be shown or hidden.

See also

How to Show and Hide the Toolbar and Palettes (Page 2143)

10.3.10 Customizing the Working Environment

10.3.10.1 Customizing the Working Environment

Operator Elements of the Page Layout Editor

You can adjust the following operator elements to your personal needs:

- The toolbars can be shown and hidden.
- Icons can be added to and removed from the standard toolbar.
- Changes to the standard toolbar can be blocked or allowed.
- Toolbars and palettes can be arranged elsewhere on the screen.
- The appearance of the toolbar can be changed.
- The display of the keyboard shortcuts in the menus can be switched off.

Basic Page Layout Editor Settings

You can adjust the following functions in the page layout editor to your personal needs:

- Snap objects to the grid or not
- Hide or show the grid
- Grid width and height in pixels, centimeters or inches
- Defining the type of object selection surrounding or touching

- Object types in the object palette can be selected or deselected according to the insertion of an object
- Configuration settings for the page layout editor can be saved or not when quitting the program
- Storage type and path for the objects' default settings

See also

The Basic Settings of the Page Layout Editor (Page 2146)

How to Change the Appearance of the Toolbar and Palettes (Page 2150)

How to Change the Standard Toolbar (Page 2144)

How to Arrange the Toolbar and Palettes (Page 2143)

How to Show and Hide the Toolbar and Palettes (Page 2143)

10.3.10.2 How to Create Custom Colors

Introduction

In addition to the 16 basic colors from the Color Palette, you are free to define other colors.



Procedure

1. On the color palette, click . The "Colors" dialog is opened.
2. Click the primary color that comes closest to the color to be created.
3. To change the selected color, open the color matrix using the "Define Colors" button.
4. Change the brightness of the selected color with the slider to the right of the color matrix.
5. Change the saturation of the selected color by vertically moving the cross.
6. Change the color by horizontally moving the cross.
7. To define the properties of the color more precisely, enter the values for the color, saturation, brightness, and the red, green and blue amounts.
8. To accept the color in the user-defined palette, click the "Add Colors" button.
9. Close the dialog by clicking "OK". The newly defined color is saved.

See also

The Colors Property Group (Page 2185)

The Color Palette (Page 2139)

10.3.10.3 How to Show and Hide the Toolbar and Palettes

Introduction

Normally, the standard toolbar and palettes are shown. In order to obtain a larger working area, you can hide palettes that you do not need and the standard toolbar and show them again as required.

Procedure

1. Open the "View" menu and select the "Toolbars..." option. The "Toolbars" dialog is opened.
2. Clear the check box for the toolbar to be hidden. Alternatively, select the check box for the toolbar to be shown.
3. If the dialog should remain open so that you can make additional settings on other tabs, click "Apply".
4. If you would like to restore the most recently saved settings, click the "Restore" button.
5. Apply the new settings with "OK". The settings will be saved and the dialog is closed.

See also

How to Change the Appearance of the Toolbar and Palettes (Page 2150)

How to Change the Standard Toolbar (Page 2144)

How to Arrange the Toolbar and Palettes (Page 2143)

10.3.10.4 How to Arrange the Toolbar and Palettes

Introduction

The standard toolbar and the palettes are normally arranged along the edge of the screen. You can remove them from their anchoring, change their size and move them anywhere you like. The toolbar and palettes can be reanchored in any location.

Special features

- The size of a palette can only be changed when it is not anchored.
- When you reanchor a palette, its size will not be adjusted to the free space on the edge of the screen. Therefore, you must adjust the size of the palette to fit the free space before anchoring it.
- When you close the page layout editor, the changed palette positions are saved and used again the next time the program is started.

How to Undock the Palette

1. Click on the narrow, outer edge of the palette, hold down the mouse button and drag the palette into the working area. Now you can resize the palette as desired in the normal Windows way.

Procedure for Restoring the Original Position

1. Open the toolbar dialog by selecting the menu "View" > "Toolbars...".
2. Click the "Restore" button.

Procedure for Docking the Palette

1. Adjust the size of the palette to the free space on the edge of the screen.
2. Click on the title bar of the palette, hold down the mouse button and drag the palette to the free space on the edge of the screen. The position of the cursor determines the place where the palette will be anchored. If the palette is to be moved between two others, the cursor should be placed on the lower edge of the upper palette.

Note

The changes in position can be undone, so long as the page layout editor is open; changes you have made will be saved when the program is closed.

See also

How to Change the Appearance of the Toolbar and Palettes (Page 2150)

How to Show and Hide the Toolbar and Palettes (Page 2143)

10.3.10.5 How to Change the Standard Toolbar

Usage

You can use drag and drop to adjust the standard toolbar to your requirements, that is adding, removing or rearranging buttons.

Requirements

On the "Menu/Toolbars" tab in the "Settings" window of the "Tools" menu, all of the checkboxes in the "Standard Toolbar" area must be marked.

Procedure for Removing Buttons

1. Hold down the "Alt" key.
2. Use the mouse to drag the button from the toolbar.

Procedure for moving buttons

1. Hold down the "Alt" key.
2. Use the mouse to drag the button to another place on the toolbar.

Procedure for Adding/Removing Buttons

1. Hold down the "Alt" key.
2. Double-click a button. The "Customize Toolbar" window opens.

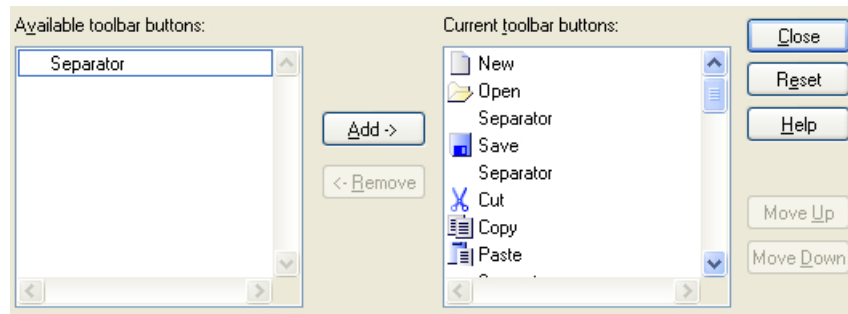

3. Add: Drag the desired button from the Available buttons list to the Current Buttons list.
Remove: Drag the desired button from the Current Buttons list to the Available Buttons list.
4. Set the order of the buttons on the toolbar using the "Move up" and "Move down" buttons in this dialog.
5. You can restore the original state by clicking on the "Reset" button.
6. The changes will be applied and the dialog closed when you click on the "Close" button.

See also

How to Arrange the Toolbar and Palettes (Page 2143)

How to Show and Hide the Toolbar and Palettes (Page 2143)

How to Change the Appearance of the Toolbar and Palettes (Page 2150)

10.3.10.6 The Basic Settings of the Page Layout Editor

The Basic Settings of the Page Layout Editor

Usage

In the Settings window, you can make basic settings in order to adjust the appearance and behavior of the page layout editor to meet your needs. The settings will be saved and retained when you open the page layout editor again.

Calling:

The window can be called

- from the menu Tools > Settings and
- from the menu View > Grid.

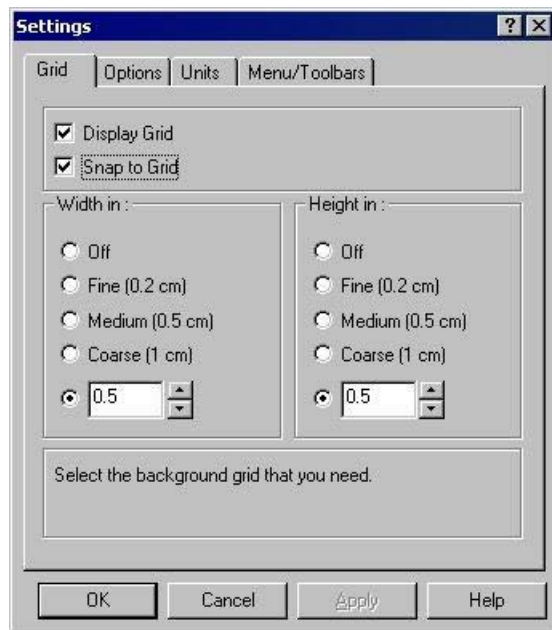

Setting Options

Tab	Description
Grid	This is where you can set: <ul style="list-style-type: none">• whether the objects should snap to the grid,• whether the grid should be visible,• the distance between the grid points
Options	This is where the fundamental program settings are changed, for example what should happen with altered program settings when the program is closed, or how objects should be selected and edited.

Tab	Description
Units	This is where you choose which units of measurement you would like to use for entering the size of coordinates, text height and line width.
Menu / Toolbars	This is where the appearance and properties for the menu bar, toolbar and palettes can be set, for example whether the standard toolbar should be configurable, whether the keyboard shortcuts should be shown, etc.

See also

How to Paste an Object into a Layout (Page 2167)

How to Set the Options for the configuration settings (Page 2148)

How to Set the Grid (Page 2147)

How to Set the Grid

Usage

In order to be able to work precisely in the working area, you can show a grid on the working area with the "Display Grid" function. If you also have the "Snap to Grid" function switched on, all newly created objects will be automatically aligned to the grid points.



Possible settings

- Snap to Grid** Determines whether the objects should be positioned anywhere on the drawing area or aligned to the grid.
- Display grid** Determines whether the grid should be visible or not. If the grid is invisible, objects still align to it when the "Snap to Grid" option is switched on.
- Width in/ Height in** Changes the distance between grid points as necessary. Set the units for the size entry in the "Units" tab. The grid width to be set is oriented to the size and variety of objects and to the desired positioning precision.

Procedure

1. In the "Options" menu, select the "Settings" entry. The "Settings" dialog opens.
2. Change the individual settings as required by marking or clearing the check boxes.

3. If you want to keep the dialog open to make changes in other tabs, confirm the changes you have made with the "Apply" button.
4. Save the settings with "OK".

Note

The minimum grid separation that can be displayed on the screen is 10 pixels. If you set a smaller value (e.g. 6 pixels), you can still align your objects to this grid, but the next even numbered multiple of this value > 10 pixels will be displayed on the screen (in this case 12 pixels).

See also

How to Set the Options for the configuration settings (Page 2148)

How to Change the Appearance of the Toolbar and Palettes (Page 2150)

How to Set the Options for the configuration settings

Usage

On the options tab, you can set whether the configuration settings in this dialog are saved when the program is closed. This is also where you can choose the method of selecting objects.

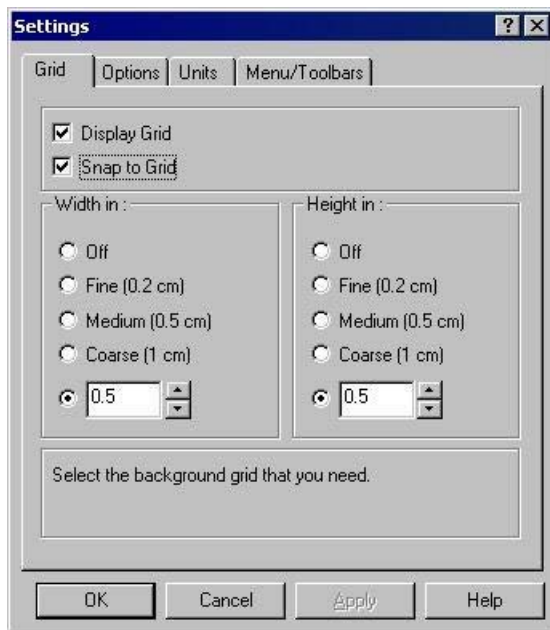

Possible settings

Save settings on exit	Determines whether the settings for the page layout editor are saved when the program closes.
Object selection Surrounding/touching	Surrounding: A frame will be drawn when the left mouse button is held down, so that all objects that are completely within this frame will be selected. Touching: A frame will be drawn when the left mouse button is held down, so that all objects touched by this frame will be selected.
Always reset object type selection	If this option is enabled, an object will be deselected as soon as it is pasted into the layout. If the option is disabled, the object will remain selected after it has been pasted into the layout. With this method, you can paste the same object several times without having to reselect the object.

Procedure

1. In the "Options" menu, select the "Settings" entry. The "Settings" dialog opens.
2. Click the Options tab.
3. Change the individual settings as required by marking or clearing the check boxes.
4. If you want to keep the dialog open to make changes in other tabs, confirm the changes you have made with the "Apply" button.
5. Save the settings with "OK".

See also

How to Change the Appearance of the Toolbar and Palettes (Page 2150)
How to Set the Grid (Page 2147)

How to Change the Appearance of the Toolbar and Palettes

Usage

The appearance of the standard toolbar and the palettes in the page layout editor can be adjusted to meet your requirements and preferences.

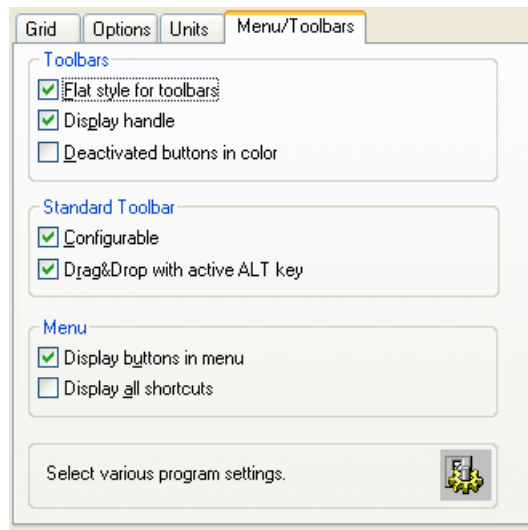

Possible settings

Flat style for toolbars	Determines whether the buttons on the toolbar and palettes are displayed with a border or without.
Display move handles	Determines whether the buttons on the toolbar and palettes are displayed with move handles or without.
Display buttons in the menu	Determines whether the buttons on the toolbar will be shown in the menus on the menu bar.
Display all shortcuts	Determines whether the keyboard shortcuts for the menu commands will be shown in the menus on the menu bar.
Deactivated buttons in color	Determines whether deactivated buttons on the toolbar and palettes are displayed in color or grayed out.
Standard toolbar: customizable	Determines whether the standard toolbar can be changed. If this option is enabled, the "Toolbar" dialog can be opened with [ALT+double-click].
Standard toolbar: Drag&drop with ALT key active	If this option is enabled, the icons on the toolbar can be moved or removed with the mouse by holding down the ALT key.

Procedure

1. In the "Options" menu, select the "Settings" entry. The "Settings" dialog opens.
2. Click the Menu/Toolbars tab.
3. Change the individual settings as required by marking or clearing the check boxes.

4. If you want to keep the dialog open to make changes in other tabs, confirm the changes you have made with the "Apply" button.
5. Save the settings with "OK".

See also

How to Change the Standard Toolbar (Page 2144)

How to Arrange the Toolbar and Palettes (Page 2143)

How to Show and Hide the Toolbar and Palettes (Page 2143)

The Standard Toolbar (Page 2125)

How to Set the Options for the configuration settings (Page 2148)

How to Set the Grid (Page 2147)

10.4 Working with Layouts

10.4.1 Working with Layouts

Introduction

The difference between a layout in the sense of a file and a layout as an object must be clearly understood. In this chapter, we will describe dealing with a layout in the form of a file. A layout opened in the page layout editor is treated as an object. The layout object has object properties and can be edited accordingly. Additional information can be found in the chapter "Working with the layout object".

In this chapter we will show you how to create layouts, display the properties of layouts and how to work with several layouts. WinCC comes with several ready-made layouts for most standard applications. So it is often simpler and less time consuming to save one of these layouts under a new name and adapt it to your own requirements, than to create a new layout.

Note

Language-Neutral and Language-Dependent Layouts

There are language-neutral and language-dependent layouts. Language-neutral layouts have the following designation: "<Name of the layout>.rpl". Language-neutral layouts are saved in folder "\\<Name of system on which the layout was created>\Project name\PRT".

Language-dependent page layouts contain layout files with the following designation: "<Name of the layout>_XXX.rpl". "XXX" stands for the language code of the layout file. The language-specific layout file is saved in a language-specific folder in folder "\\<Name of the system on which the layout was created>\Project name\PRT".

Create layout files in all Runtime languages for a language-dependent layout. When the layout file of a Runtime language is missing, the English layout file is used.

The following table shows the language code and the designations of the folders in folder "\\<Name of the system on which the layout was created>\Project name".

Language	Language ID in file names	Language-specific folder
Language-neutral		\PRT
German	DEU	\PRT\DEU
English	ENU	\PRT\ENU
French	FRA	\PRT\FRA
Italian	ITA	\PRT\ITA
Spanish	ESP	\PRT\ESP
Chinese (simplified)	CHS	\PRT\CHS
Chinese (traditional)	CHT	\PRT\CHT
Korean	KOR	\PRT\KOR
Japanese	JPN	\PRT\JPN

Configuration steps

1. Create a new page layout.
2. Design the outward appearance in the static part of the layout and save the newly designed layout as a template.
3. Apply the design in the layout for the output.

Editing Options

In order to configure quickly, use the various program functions such as:

- Save Layout under New Name
- Applying Object Properties to Other Objects
- Coping or Transferring Objects in Other Layouts
- Adopting Fully Designed Objects and Layouts from Other Projects

Note

This path of the layouts is retained when you duplicate a project or load it on a target machine. While printing, the system first tries to load the layout using the entered path. If that is not possible, the system searches the layout in the project path of the local computer.

See also

- Working with Objects (Page 2163)
- Working with Multiple Layouts (Page 2160)
- Changing Predefined Layouts (Page 2158)
- How to Display the Layout Properties (Page 2157)
- Layout File Operations (Page 2153)

10.4.2 Layout File Operations

Introduction

Because layouts are saved as independent files with the extension .rpl, you can carry out the usual file operations in the page layout editor or in WinCC Explorer. Many file operations can be carried out in the page layout editor and the WinCC Explorer. Layouts are saved as separate files.

Layout files of language-neutral layouts

The layout file of a language-neutral layout is saved in the "PRT" folder of the WinCC project.

Layout files of language-dependent layouts

You must create layout files in the Runtime languages for a language-dependent layout. The name of the layout file contains the language code, e.g. NewRPL01_ENU.RPL and NewRPL01_ESP.RPL.

The "PRT" folder of the WinCC project contains a folder for each language installed with WinCC. The language-specific layout files must be saved in the corresponding language-specific folder. The current Runtime language determines which layout file is used.

1. Single-language configuration

You are making configurations in English for English-speaking operators.

New layouts are saved e.g. under the file name "NewRPL01_ENU.RPL". The layout file is saved in folder "\\<Name of computer>\Project name\PRT".

Alternatively, create your own new layouts as language-neutral layouts.

2. Multilingual configuration

You are making configurations for English-speaking and Spanish-speaking operators. The "NewRPL01" layout must be saved in 2 layout files:

- NewRPL01_ENU.RPL" in folder "\\<Name of the computer>\Project name\PRT\ENU"
- NewRPL01_ESP.RPL" in folder "\\<Name of the computer>\Project name\PRT\ESP"

In the case of multi-language configurations, be sure to make all changes, copies and deletions to all layout files of a layout.

You can also create language-neutral layouts.

Adding a Layout Language

If you need reports and documentation in other languages, you must create language-dependent layouts. To do this, you must add the language.

1. Select the "Report Designer" editor in WinCC Explorer.

The entries "Layouts" and "Print Jobs" appear in the data window.

2. Select the "Layouts" entry and open its context menu.

3. Select the "Add Language ..." command.

4. Select the desired layout language from the list.

In WinCC <V7.2 you can only add language-specific folders that use the same code page. If you need to edit layout files in languages that need another codepage, you must set up the associated system locale (operating system language) in the system control of your operating system.

WinCC as of V7.2 supports Unicode. This means that you can edit layout files in languages that belong to different system locales.

The new language folder is created under the "Layouts" entry. Layout files of the current language are listed in the right window.

Creating Layout

To create a new report, you first have to create a new layout. Page layouts contain layout files with ending ".rpl".

1. Select the "Report Designer" editor in WinCC Explorer.
The entries "Layouts" and "Print Jobs" appear in the data window.
2. Select the "Layouts" entry and open its context menu.
3. If necessary, create a new layout language with the "Add Language ..." command.
The layout files of the current language are listed in the right window.
4. Select the desired layout language or the "Language neutral" entry.
5. Select the command "New page layout" from the context menu. A new file with the name "NewRPLxx.RPL" is created. The numbers in the file names increase consecutively.
6. In order to open the file select "Open page layout" from the layout context menu.
7. The newly created layout is opened in the page layout editor.

Alternative Operation

You can also create a new layout file in the open page layout editor. To do this, select "New" from the "File" menu. The page layout editor creates an empty layout file. Save the layout file under the desired name and in the correct folder.

Saving Layout

Note

Language Code in the Layout File

When saving the file, enter the correct language code in the file name, e.g. NewRPL01_ENU.RPL. Save the layout file in the correct language folder.

1. Select "Save as..." from the "File" menu in the page layout editor.
2. If you choose "Save as...", a dialog will open.
 - Navigate to the correct folder.
 - Enter a file name and a language code and save the layout file.
3. The layout file receives extension .rpl.

Opening Layout

1. Select the "Report Designer" editor in WinCC Explorer.
The entries "Layouts" and "Print Jobs" appear in the data window.
2. Select the "Layouts" entry.
The existing language directories are displayed in WinCC Explorer.

3. Select the desired language folder and open its context menu.
The layout files of the current language are listed in the right window.
4. Select the desired layout file and select the "Open page layout" command from the context menu.

Alternative Operation

If the page layout editor has already been started, you can select "Open" from the "File" menu. In the file selection dialog, navigate to the desired language directory. Select the desired layout file and then click on "Open".

Copying a Layout File

You can save layout files under other names and thus copy them, for example to create variants.

1. Open the layout file to be copied in the page layout editor.
2. To do this, select "Save As..." from the "File" menu.
The Save As... dialog opens.
3. Give the layout file a new name and save the layout file.

Renaming a Layout File

1. Select the "Report Designer" editor in WinCC Explorer.
The entries "Layouts" and "Print Jobs" appear in the data window.
2. Select the "Layouts" entry in the data window.
The existing language folders are displayed in WinCC Explorer.
3. Select the desired language folder.
All project layout files in the selected language are listed.
4. Select the desired layout file and select the "Rename page layout" command from the context menu.
The "New Name:" dialog opens.
5. Change the name of the selected layout file and click on the "OK" button. Please pay attention to the note below.

Deleting a Layout File

1. Select the "Report Designer" editor in WinCC Explorer.
The entries "Layouts" and "Print Jobs" appear in the data window.
2. Select the "Layouts" entry in the data window.
The existing language folders are displayed in WinCC Explorer.
3. Select the desired language folder.
All project layout files in the selected language are listed.
4. Select the desired layout file and select the "Delete page layout" command from the context menu. The layout file will be deleted without a confirmation.

Note

The system layouts supplied with WinCC are integrated into the project documentation. To use one of the system layouts for your own purposes, simply save it under a new name. You can recognize the system layouts by the "@" suffix in the file name. Do not use this symbol to name custom layouts.

If you wish to create a page layout using the SIMATIC Manager, you cannot rename or delete this layout in WinCC Explorer. This also applies to a page layout created in WinCC and subsequently imported into SIMATIC Manager using the function "Import WinCC Object". This import transforms the WinCC object into a TIA object.

If you copy a page layout using the Report Designer, the copy is created as a WinCC object. You may rename or copy this copy as a WinCC object.

See also

Working with Multiple Layouts (Page 2160)
Changing Predefined Layouts (Page 2158)
How to Display the Layout Properties (Page 2157)
Working with Layouts (Page 2152)

10.4.3 How to Display the Layout Properties

Usage

For each layout file, you can call the creation date, the date of last change and the file size.

Requirements

The WinCC project must be open.

Procedure

1. Select the "Report Designer" editor in WinCC Explorer.
The entries "Layouts" and "Print Jobs" appear in the data window.
2. Select the "Layouts" entry in the data window.
The existing language folders are displayed in WinCC Explorer.
3. Select the desired language folder.
All project layout files in the selected language are listed.
4. Select the desired layout file and select the "Properties" entry from the context menu.
The "Properties" window opens.

See also

Working with Multiple Layouts (Page 2160)

Changing Predefined Layouts (Page 2158)

Working with Layouts (Page 2152)

Layout File Operations (Page 2153)

10.4.4 Changing Predefined Layouts

Introduction

You can change the predefined layouts in order to fit your needs better. It is advisable to save an existing layout file with a new name first and only then to edit the layout file. If you do this, you can always fall back on the layouts provided with WinCC if you need to.

The system layouts and system print jobs delivered with WinCC are used by the WinCC components when the report output is triggered (e.g. project documentation in the Graphics Designer). The system print jobs can therefore not be deleted. If necessary, you can rename the system print jobs.

The system files are located in the WinCC directory in the language-specific folders under folder ".\WinCC\systlay". The language-specific folders in a new project are copied to the corresponding project directory in the ".\<Project name>\PRT" folder the first time it is accessed.

The system layouts and system print jobs are created for every new project.

How to Make Changes to the Static Part of a Layout

The header and footer are defined in the static part of a page layout. You can also change the appearance of the report without changing the dynamic properties of the layout. The static part of a page in the page layout extends across the entire printable area of the report. You can individually define the static part for the cover sheet, the report contents and the closing page. Static objects and system objects are available to you for the design.

The same static part will be repeated on all the succeeding pages of the report contents.

How to activate the static report part:

1. Select "Static Part" from the "View" menu.
Or
activate the static report part using the toolbar.
2. Next add static objects or system objects.

Changes in the dynamic part of a layout

You put together the structure and content of the report for output in this part of the page layout. There are static, dynamic, and system objects available for defining the report contents. If necessary, the dynamic part of the contents of the report is spread across the various subsequent pages at output, since it is not known until the time of output how much data there is. The first object in the vertical direction in a layout is automatically moved to the upper dynamic edge during output.

Important:

During the definition of a page layout, you can not predict with absolute certainty on how many pages the dynamic part will require. The size of the dynamic tables and text fields is determined by the data which is used at the moment of output. Succeeding objects are moved downward according to the dynamic size changes.

Generally no line breaks are provided for the output of data in table cells. However, you can output large amounts of data in a table cell without the data being cut off by:

1. Select the output of the report in landscape format.
2. Select the "Vertical" table format in the table object properties.
3. Set the relative column width of all columns as narrowly as possible.
4. Use the smallest font size possible.

Static objects which are pasted into the static part of a page layout are in a layer below the dynamic objects. Thus, it can happen that the static objects will be covered by the dynamic objects, especially by the dynamic extension of a table.

How to enable the report contents for editing:

1. Select "Dynamic Part" from the "View menu".
Or
activate the dynamic report part using the toolbar.
2. Next add static, dynamic or system objects.
3. For dynamic objects, then select the data for output from the "Connect" tab in the "Properties" dialog.

Note

If you use the "WinCC Control Runtime Printprovider" layout as of WinCC V7, the dynamic portion of the report is determined by the underlying control. In the "Link" tab, configure the properties of the picture or table in the layout.

Editing the Objects

Objects in the layout are edited using the "Object properties" dialog. This can be opened using the toolbar, the pop-up menu for the objects or by double-clicking an object. Please see "Working with Objects" for more information.

See also

Changing Predefined Layouts (Page 2158)

How to Display the Layout Properties (Page 2157)

Working with Layouts (Page 2152)

Layout File Operations (Page 2153)

10.4.5 Working with Multiple Layouts

Introduction

The page layout editor offers you some options for efficient configuration. In order not to have to keep repeating the same configuration steps, you can

- Save Layout under New Name
- Applying Object Properties to Other Objects
- Coping or Transferring Objects in Other Layouts
- Adopting Fully Designed Objects and Layouts from Other Projects

Note

Language-Neutral and Language-Dependent Layouts

There are language-neutral and language-dependent layouts.

Language-neutral layouts have the following designation: "<Name of the layout>.rpl".

Language-neutral layouts are saved in folder "\\<Name of system on which the layout was created>\Project name\PRT".

Language-dependent page layouts contain layout files with the following designation:

"<Name of the layout>_XXX.rpl". "XXX" stands for the language code of the layout file.

The language-specific layout file is saved in a language-specific folder in folder "\\<Name of the system on which the layout was created>\Project name\PRT".

In the case of multi-language configurations, be sure to make all changes, copies and deletions to all layout files of a layout.

See section " Working with Layouts (Page 2152) " for further instructions.

Save Layout under New Name

If you want to configure several projects, it is recommended that you first save a layout as a template. Set the elements which remain the same, such as headers and footers, in this layout. Set the page format and the orientation. Set the print margins and the dynamic margins. Save the finished layouts as often as you want under new names. Then you can add the log objects you want to the individual layouts and set their parameters. You will find more information in the "Layout File Operations" chapter.

Applying Object Properties to Other Objects

If you have an object with certain properties in a layout, then you can easily apply these properties to another object. Use the eyedropper function for this. You will find more information in the "Transferring Object Properties" chapter.

Coping or Transferring Objects in Other Layouts

This is a very useful function in order to paste already configured objects or object groups into another layout. In this way, you can, for example, design a complete header and transfer it to other layouts.

In order to copy an object or object group, highlight the object(s) and copy the selection to the operating system clipboard. Next open the target layout and paste in the contents of the clipboard. The contents of the clipboard can be pasted into as many other layouts as desired. The next time an object is copied, the data in the clipboard will be overwritten.

In order to transfer an object or object group, highlight the object(s) and cut the selection out. The selection will be copied to operating system clipboard. Then you can proceed with this selection as with copying.

Adopting Fully Designed Objects and Layouts from Other Projects

If you have already created a project with WinCC, then you can transfer existing layouts to the new project. You can also transfer objects from an existing layout to a layout in the new project.

There are two options for transferring a complete layout:

1. Navigate to the root directory of the old project using Windows Explorer. Open the "PRT" folder.
 - For language-neutral layouts:
Copy the desired layout file and add it to the folder "PRT" of the new project.
 - For language-dependent layouts:
Open the desired language-dependent folder. Copy the desired layout file and add it to the language-dependent folder in folder "PRT" of the new project.
Repeat the process for all Runtime languages, if necessary.
2. Open the page layout editor in the new project and click the folder button in the toolbar. The "Open" dialog will appear.
 - For language-neutral layouts:
Use this dialog to navigate to the "PRT" folder of the old project. Open the desired layout file in the page layout editor. Save the layout file in the "PRT" folder of the new project using the "Save" or "Save as..." function.
 - For language-dependent layouts:
Use this dialog to navigate to the language-dependent folder in the "PRT" folder of the old project. Open the desired layout file in the page layout editor. Save the layout in the language-dependent folder in the "PRT" folder of the new project using the "Save" or "Save as..." function.
Repeat the process for all Runtime languages, if necessary.

Requirements

In order to transfer a fully defined object from another project, open the layout which contains this object in one of the two ways described above. Select the object or group of objects that you want and copy the selection to the clipboard. Open the target layout and paste in the contents of the clipboard.

Note

If you are copying system layouts, we recommend creating a backup copy of the new system layout before overwriting it in the "PRT" folder.

See also

[How to Transfer Object Properties \(Page 2182\)](#)

[Changing Predefined Layouts \(Page 2158\)](#)

[How to Display the Layout Properties \(Page 2157\)](#)

[Layout File Operations \(Page 2153\)](#)

10.5 Working with Objects

10.5.1 Working with Objects

Introduction

In this chapter, you will learn

- which basic functions of the page layout editor can be used for working with objects
- what characteristics the individual objects have
- how to use objects to create layouts
- how to specifically change object properties

You will find a description of the available objects in the chapter on the "Object Palette".

See also

The Properties of an Object (Page 2175)

Working with Objects for the Project Documentation (Page 2275)

Working with Objects for the Runtime Documentation (Page 2240)

Working with Standard Objects (Page 2194)

The Object Palette (Page 2127)

10.5.2 The coordinate system in the Report Designer

Introduction

The basis for the definition of position and size entries in the page layout editor is a two-dimensional coordinate system. The two axes of the coordinate system, x-axis and y-axis, are perpendicular to one another and intersect at the coordinate origin. The coordinate origin lies with the coordinates (X = 0 / Y = 0) in the top left corner of the desktop. Extending from the coordinate origin, the horizontal X-axis runs in the positive direction to the right edge of the working area, and the vertical Y-axis runs in the positive direction to the lower edge of the working area. Thus the values for X and Y displayed in the status bar of the page layout editor increase when the mouse is moved from the upper left to the lower right of the working area. Coordinates are displayed in the units set in the "Tools/Settings" menu in the "Units" tab.

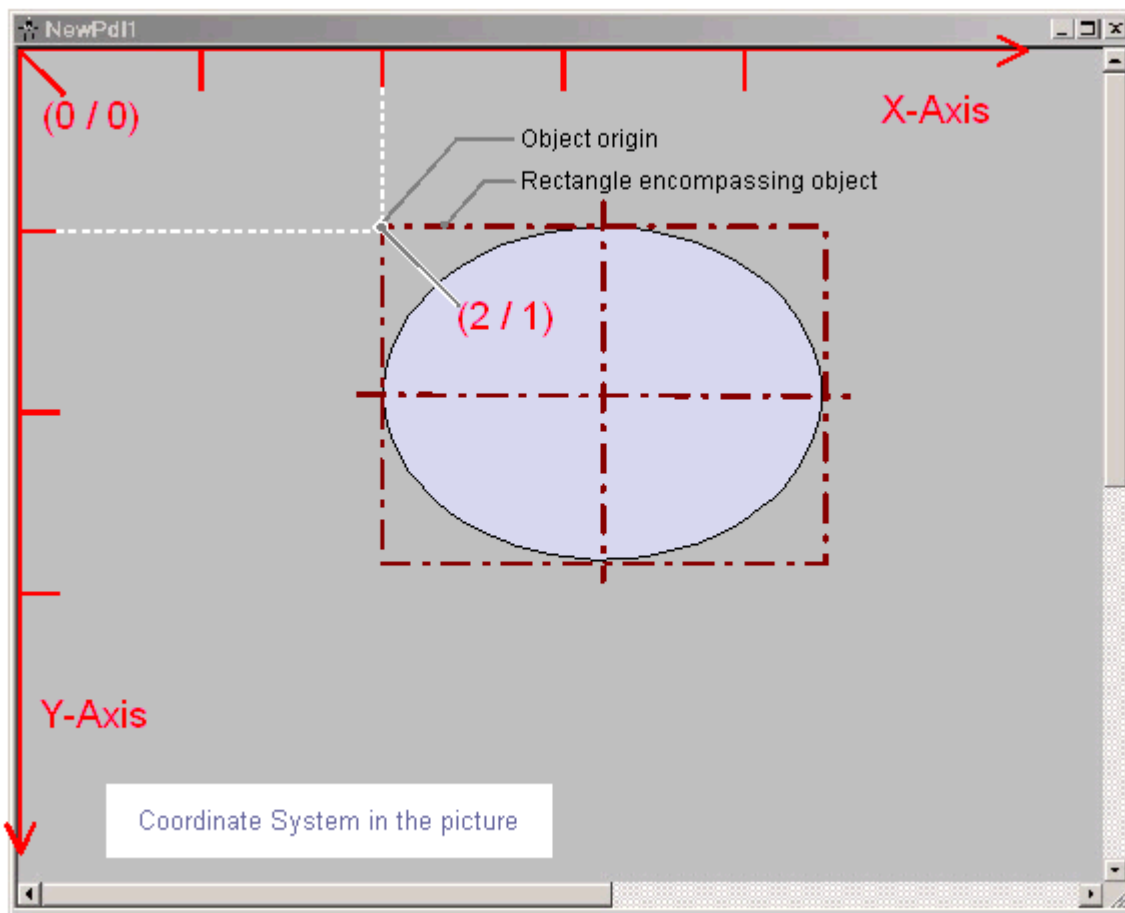

The position and size of objects in a layout are determined by the coordinates which an object has in the coordinate system. For example, the position of the object origin is determined by the attributes "Position X" and "Position Y"; thus, it has the coordinates (X = "Position X"/Y = "Position Y"). The values of these attributes describe the distance of the object origin from the coordinate axes.

Definition of Origin

The "origin" is defined as the point of an area or an object that is used as the reference point for entering position and size specifications. For creating a layout in the page layout editor, the following reference points are significant:

- **Coordinate system origin (X = 0/Y = 0)**
= Top left corner of the working area
- **Picture origin (X = 0/Y = 0)**
= Top left corner of the layout
- **Object origin (X = "Position X"/Y = "Position Y")**
= Top left corner of the rectangle surrounding the object

Internal Coordinate System of an Object

The validity of the normal coordinate system is canceled for displays within an object. The following special form is used for the internal coordinate system of an object:

The positive direction of the Y-axis points downward, the positive direction of the X-axis points to the right.

See also

The Status Bar (Page 2141)

The Rectangle Surrounding the Object (Page 2166)

10.5.3 The Rectangle Surrounding the Object

Introduction

The "rectangle surrounding an object" is defined as a rectangular frame which lies on the outer borders of an object. The rectangle surrounding an object is not visible in the page layout editor. When an object is selected, however, the handles which are used to grab an object for changing its size are shown. These handles identify the central axes and corner points of the rectangle surrounding the object.

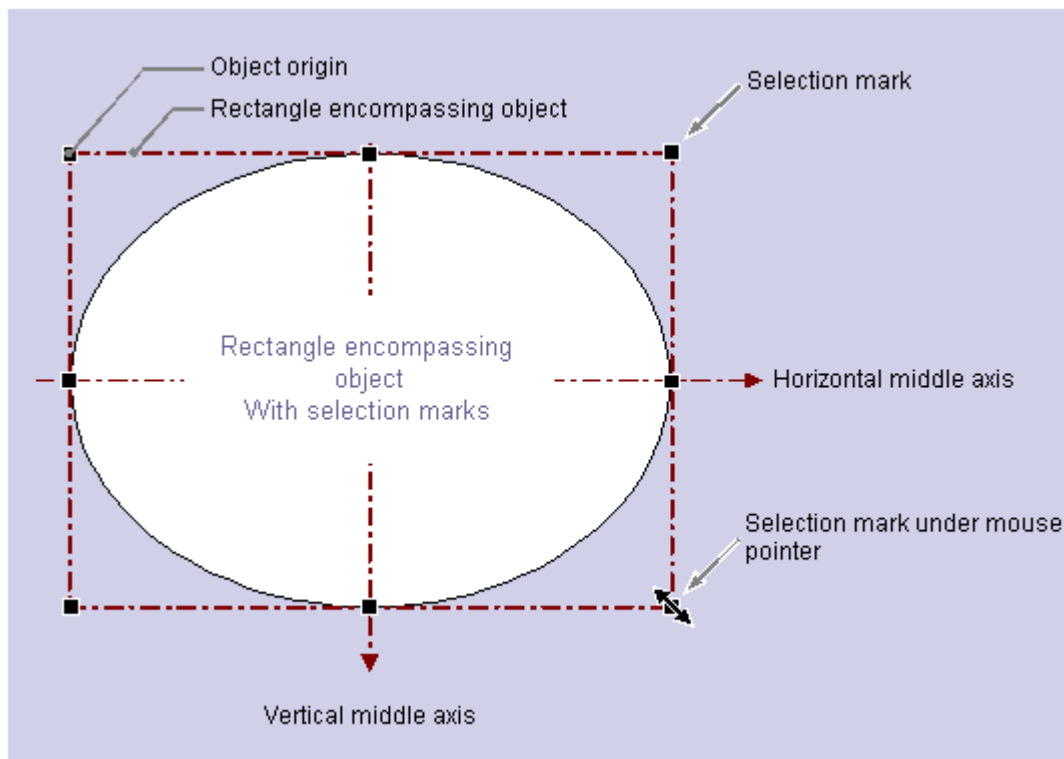

The special significance of the rectangle surrounding the object for determining the position can be illustrated with a circular or ellipse-shaped object as an example:
 The position of an object is defined by means of the position of its origin relative to the coordinate system. The object origin has the coordinates ("Position X"/"Position Y") and is defined as the upper left corner of the rectangle surrounding the object. Specified in this way, the position of a circular or ellipse-shaped object can be set clearly.

The handles of the rectangle surrounding the object

The handles of the rectangle surrounding the object appear as soon as an object is selected. By dragging with the mouse, the size of an object can be modified by shifting a handle to a new position.

If the mouse pointer is positioned on a handle, it turns into a double arrow. The alignment of the double arrow indicates the directions in which the handle can be moved:

- **Horizontal double arrow:** The handles on the horizontal center axis can be used to change the width of the object.
- **Vertical double arrow:** The handles on the vertical center axis can be used to change the width of the object.
- **Diagonal double arrow:** The handles on the corners of the object can be used to change the height and width of the object.

Note

Circular objects can only be changed in terms of their whole size; they do not have handles for their center axes.

See also

- Multiple Selection of Objects (Page 2170)
- How to Paste an Object into a Layout (Page 2167)
- The coordinate system in the Report Designer (Page 2164)
- How to Edit Objects (Page 2168)

10.5.4 How to Paste an Object into a Layout

Introduction

A layout is created in the page layout editor by pasting objects from the object palette into a layout.

In the page layout editor, the various object types have predefined properties. When added, objects take on these defaults, with the exception of individual geometric properties. After insertion the properties of an object can be modified. In the same way the default settings for the object types can be modified as required.

When an object is inserted, the object name assigned as standard is the description of the object type with a consecutive number. This name can be changed using the "Object Name" attribute.

Requirement

The display of the object palette must be enabled.

Procedure

The "Rectangle" standard object is shown here as an example for the general procedure for pasting an object into a layout. Some object types require additional steps. You can learn more about these additional steps in the detailed description of the individual objects.

1. Open the layout in which you want to insert an object.
2. Click the "Rectangle" standard object in the object palette.
3. Place the mouse pointer at the position in the layout where you want to insert the rectangle. The mouse pointer changes into a crosshair with an object symbol attached.
4. Hold down the mouse button and drag the rectangle to the required size. As soon as you release the mouse, the rectangle is added.

Alternative Operation

Using the "Paste" command, the current contents of the clipboard can be pasted into the active layout as often as you like. If an object has been copied to the clipboard, this command can be used to paste as many copies of the object as you like, also into different layouts. The "Paste" command can be executed via the button in the toolbar, via the context menu, using the key combination "CTRL+V" or by selecting "Edit/Paste" in the menu bar.

See also

[The Properties of an Object \(Page 2175\)](#)

[Working with Objects for the Project Documentation \(Page 2275\)](#)

[Working with Objects for the Runtime Documentation \(Page 2240\)](#)

[Working with Standard Objects \(Page 2194\)](#)

[The Object Palette \(Page 2127\)](#)

[How to Edit Objects \(Page 2168\)](#)

10.5.5 How to Edit Objects

Introduction

You can select, position, scale, delete, cut, copy, duplicate and change the properties of objects in a layout.

Selecting Objects

Select an object of any type by clicking it. As an alternative, you can select the object you want from the object selection list in the "Object Properties" window.



Positioning Objects

1. Select the object you want.
2. The mouse pointer changes to a crosshair with arrowheads.
The handles of the rectangle surrounding the object appear as soon as an object is selected.
3. Hold down the mouse button and move the object to the desired position.

You can also select the object using the arrow keys or by changing the values for the geometric attributes "Position X" and "Position Y" in the "Object Properties" window.

Scaling objects

1. Select the object you want.
2. Position the mouse pointer on one of the handles of the object. The mouse pointer will change to a double arrow. The orientation of the double arrow indicates the direction in which you can move the handles.
3. Use the mouse to drag the handle to the position you want.

You can also resize the object by changing the values for the geometric attributes "Width" and "Height" in the "Object Properties" window.

Deleting Objects

1. Select the object you want.
2. Press the "DEL" key. The selected object is deleted.

You can also delete the selected object by selecting "Delete" from the context menu or by selecting "Edit/Delete" from the menu bar.

Cutting Objects

1. Select the object you want.
2. Click the  button in the toolbar. The selected object will be cut from the layout and copied to the clipboard.

You can also cut the selected object using the "Cut" command in the context menu, the key combination "CTRL+X" or by selecting "Edit/Cut" from the menu bar.

Copying Objects

1. Select the object you want.
2. Click the  button in the toolbar. The selected object will be copied to the clipboard.

You can also copy the selected object using the "Copy" command in the context menu, the key combination "CTRL+C" or by selecting "Edit/Copy" from the menu bar.

Duplicating Objects

1. Select the object you want.
2. Select "Duplicate" from the context menu. A copy of the selected object will be created directly in the active layout. Position X and Position Y of the copy are approximately 20 pixels higher than Position X and Y of the original object.

You can also duplicate the selected object by selecting "Edit/Duplicate" from the menu bar.

See also

Multiple Selection of Objects (Page 2170)

The Rectangle Surrounding the Object (Page 2166)

10.5.6 Multiple Selection of Objects

10.5.6.1 Multiple Selection of Objects

Introduction

In order to change the properties of several objects at once, all of the objects to be changed must be selected. This procedure is called "multiple selection".

During a multiple selection, the attributes held by at least one of the selected objects are displayed in the "Object properties" window. The value of an attribute will only be displayed, however, if it is the same for all selected objects.

Along with "selection frames" and the "reference object", a multiple selection has two characteristics which play an important role, for example for the common alignment of the selected objects. However, these characteristics are not visibly displayed in the page layout editor.

Making multiple selections

The multiple selection of objects can be made in several ways in the page layout editor:

- Multiple selection while pressing the Shift key. Click the objects you want, one after the other, while holding down the Shift key.
- Multiple selection by dragging a selection frame with the mouse. While dragging, a frame will be shown to help with orientation. The selection is dependent on the type of object selection set in the page layout editor. For "surrounding object selection", all objects which are inside the displayed frame are selected. For "touching object selection", all objects touched by the frame will be selected, in addition to those inside of it.

Selection Frame of a Multiple Selection

The selection frame encloses all objects in a multiple selection, comparable to the rectangle surrounding individual objects.

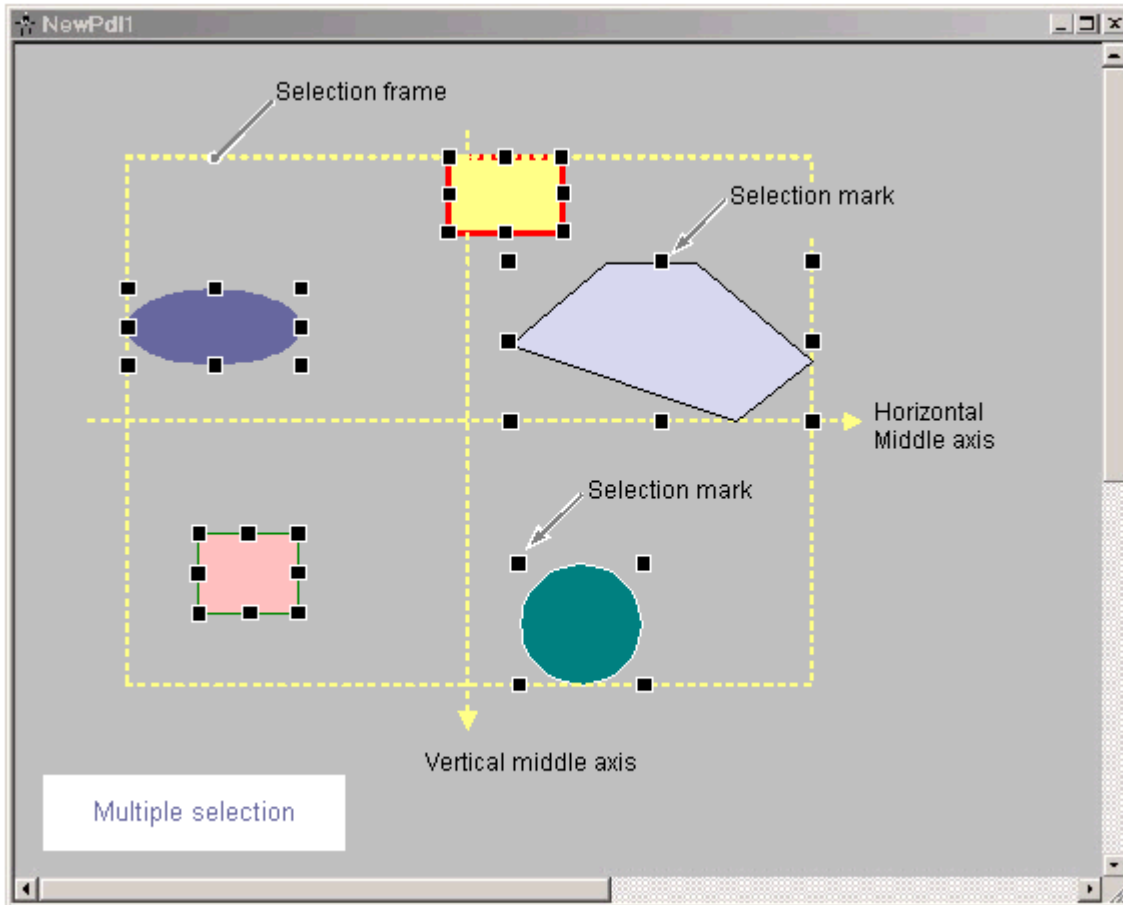

The position and size of the selection frame are dependent on the position of the selected object. The midpoint of the selection frame corresponds to the common midpoint of the selected objects. The limit line of the selection frame touches the outer edges of the objects which have the greatest distance from the common midpoint.

The selection frame is not visible. After finishing the multiple selection, only the handles of the individual objects will be shown.

Reference Object of a Multiple Selection

During a multiple selection, one of the selected objects will be set as a reference object. For example, if the "Same width" function is selected in the Alignment palette, then all selected objects will be set to the same width as the reference object.

If the multiple selection is made by dragging a frame, the first object created is set as the reference object.

If the multiple selection is made with the Shift key, the first object selected is set as the reference object.

See also

The Rectangle Surrounding the Object (Page 2166)

The Alignment Palette (Page 2136)

How to Align Multiple Objects (Page 2173)

How to Select Multiple Objects (Page 2172)

10.5.6.2 How to Select Multiple Objects

Introduction

In order to change the properties of several objects at once, all of the objects to be changed must be selected. This procedure is called "multiple selection".

Requirements

The layout must contain at least two objects.

Procedure

1. On the keyboard hold down the SHIFT key.
2. With the mouse, click the objects you want, one after the other.
The handles of the rectangle surrounding the object appear for every selected object.
The mouse pointer will change to a crosshair with arrow points when it is positioned over a selected object.

The reference object in this type of multiple selection is the object that was selected first.

Note

If an object has been selected accidentally, it can be removed from the multiple selection by clicking it again while holding down the Shift key.

Alternative Procedure

The multiple selection can also be made by dragging a selection frame with the mouse. The objects will be selected in accordance with the setting for the type of object selection. The procedure described here is for the "surrounding object selection" type.

1. Hold down the mouse button and drag a frame around the objects you want.
2. As soon as you release the mouse button, the handles for the rectangles surrounding the objects will be shown for every selected object.

The reference object in this type of multiple selection is the object that was created first.

See also

The Rectangle Surrounding the Object (Page 2166)

Multiple Selection of Objects (Page 2170)

How to Set the Options for the configuration settings (Page 2148)

How to Align Multiple Objects (Page 2173)

10.5.6.3 How to Align Multiple Objects

Introduction

The objects in a multiple selection can be edited together using the functions of the Alignment palette. These functions can also be called from the "Arrange / Align" menu.

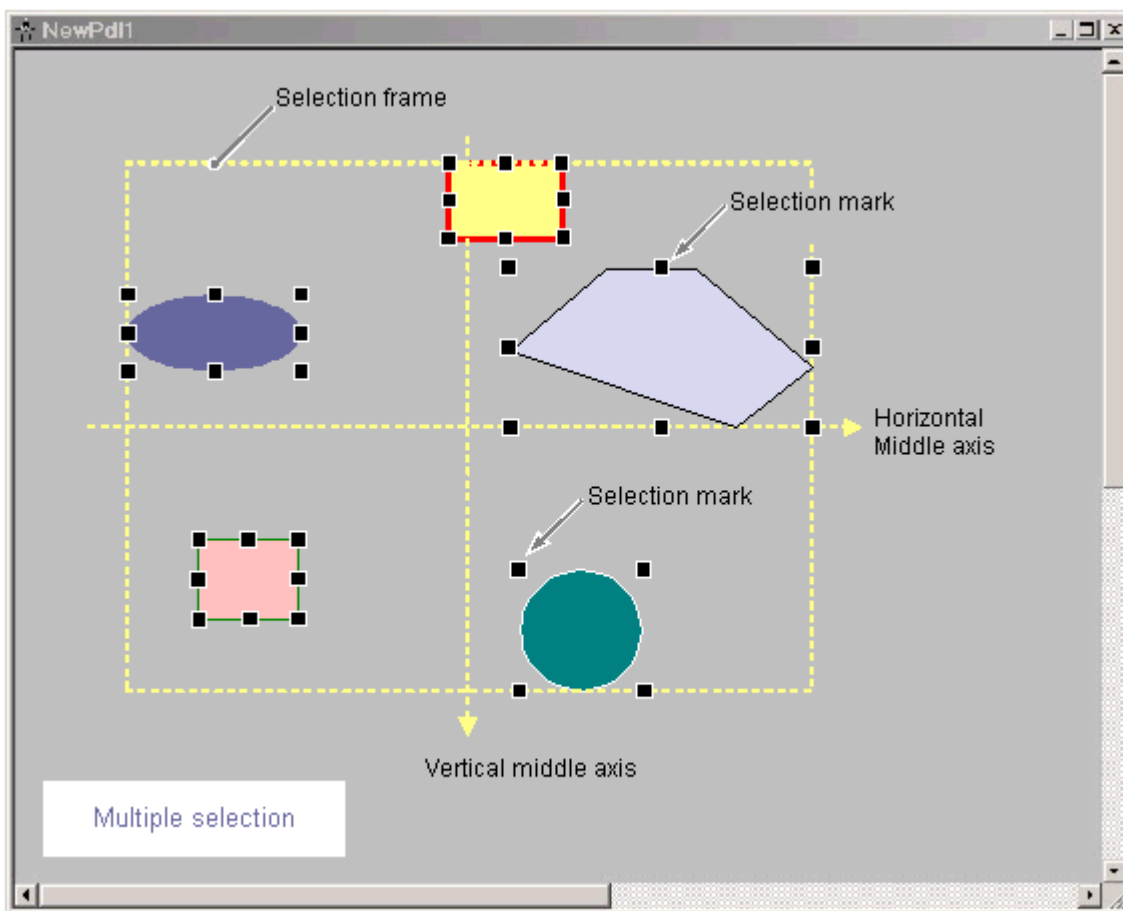

The Alignment Palette contains the following functions for processing the objects in a multiple selection:



- **Align:**The selected objects are aligned on the border line of the selection frame (up, down, left, right).
- **Center:**The selected objects are centered on a middle axis of the selection frame (horizontally, vertically).
- **Space:** The selected objects are distributed evenly across the height or width of the selection frame (horizontally, vertically).
- **Align:** The size of the reference object is assigned to the selected objects (height, width or height and width).

A detailed description of these functions can be found in the section "The Alignment palette".

Requirement

Select at least two objects of any type.

Procedure

1. Click the icon you want in the Alignment Palette.
The alignment or the size of the selected objects changes.

Alternative Procedure

1. Select the entry you want from the Arrange / Align menu.
The alignment or the size of the selected objects changes.

See also

Multiple Selection of Objects (Page 2170)

The Alignment Palette (Page 2136)

How to Select Multiple Objects (Page 2172)

10.5.7 The Properties of an Object

10.5.7.1 The Properties of an Object

Introduction

The shape, appearance, position and application linking of an object are set by the "Object Properties". These properties can be changed in the page layout editor as needed.

The properties of an object are described by a large number of "attributes". An object property can be changed by assigning a new value to its attribute.

The Properties tab of the "Object Properties" window contains all the attributes of a selected object or objects in a multiple selection. The attributes are divided into property groups, such as "Geometry" or "Colors". The type and number of the available property groups and attributes are dependent on the type of the selected objects. So, for example, the "Font" property group is only shown for the object types which can be displayed with text.

As an alternative to changing the attributes in the "Object Properties" window, objects can also be adjusted with the mouse and keyboard or by using the toolbar and palettes. However, in this way only certain object properties, such as the basic geometric size, color and line style, can be changed.

See also

[How to Change an Attribute \(Page 2181\)](#)

[How to Transfer Object Properties \(Page 2182\)](#)

[The Object Palette \(Page 2127\)](#)

[How to Access the Object Properties Window \(Page 2176\)](#)

[The Object Properties Window \(Page 2175\)](#)

10.5.7.2 The Object Properties Window

The Object Properties Window

Introduction

The "Object Properties" window represents the central dialog for changing object properties in the page layout editor.

For creating a layout, it is first important to adjust the static values of the attributes, in order, for example, to set the form, appearance or position of an object. Change the static values on the Properties tab.

With dynamic report objects, you can edit the selection of data for output using the "Object Properties" dialog. You can open the dialogs for editing on the link tab.

The "Object Properties" Window

As an example, the "Object Properties" window can have the following appearance for a rectangle with the object name "Rectangle1":

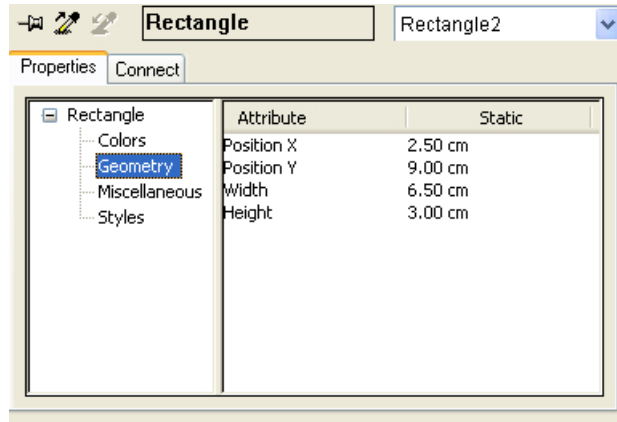

The "Object Properties" window can be kept in the foreground of the page layout editor. The position and size of the window can be changed as you like.

The "Object Properties" window is subdivided into the Elements toolbar, and the Properties and Link tabs. You can find more about these elements in their detailed description.

Keeping the "Object Properties" window in the foreground

By activating the button, the "Object Properties" window can be set so that it is always in the foreground of the page layout editor. Clicking the button again deactivates the function.

See also

[How to Access the Object Properties Window \(Page 2176\)](#)

[The Link tab in the Object Properties Window \(Page 2180\)](#)

[The Properties tab in the Object Properties window \(Page 2178\)](#)

[The Toolbar in the Object Properties Window \(Page 2177\)](#)

[The Properties of an Object \(Page 2175\)](#)

How to Access the Object Properties Window

Introduction

The Properties tab of the "Object Properties" window contains all the attributes of a selected object or objects in a multiple selection. The changes are made to an object property by assigning a new value to accompanying attribute.

Requirement

Select an object of any type.

Procedure

You can open the "Object Properties" window in the following ways:

- In the standard toolbar, click the  button.
- Double-click the selected object.
- Select "Properties" from the context menu of the object.
- Select "Properties" from the "View" menu.

Note

If you want to make changes to several objects, you can lock the display of the "Object Properties" window with the .

See also

[How to Change an Attribute \(Page 2181\)](#)

[The Link tab in the Object Properties Window \(Page 2180\)](#)

[The Properties tab in the Object Properties window \(Page 2178\)](#)

[The Toolbar in the Object Properties Window \(Page 2177\)](#)

[The Object Properties Window \(Page 2175\)](#)

[The Properties of an Object \(Page 2175\)](#)

The Toolbar in the Object Properties Window

Introduction



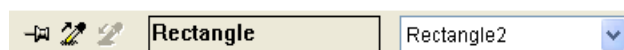

You can make the following settings with the toolbar in the "Object Properties" window:

- The display of the "Object Properties" window can be kept in the foreground of the page layout editor.
- Object properties can be transferred.
- Individual objects in the active layout can be selected.

As an example, the toolbar can have the following appearance for a rectangle with the object name "Rectangle1":

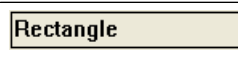
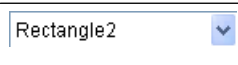

Elements of the toolbar in the "Object Properties" window

Icon	Name	Function
 	Pin activated/deactivated	Deactivate: The "Object Properties" window will be closed as soon as the mouse is clicked outside the selected object. Activate: The "Object Properties" window stays in the foreground at all times. Different objects can be edited without having to open the window again.
	Eyedropper Copy properties	The properties of a selected object are copied.
	Eyedropper Assign properties	The previously copied properties are transferred to the selected object without changing its geometric attributes. For different object types, only those attributes which both object types have are transferred.
	Object type	Displays the object type of the selected object. When several objects are selected, a multiple selection and the number of objects selected is displayed here.
	Object selection	Displays the name of the selected object. Another object can be selected using the selection list. If the dynamic part of the layout is enabled, the selection list contains the names of all objects in the dynamic part of the layout. This is also the case for the static part of the layout.

See also

- How to Transfer Object Properties (Page 2182)
- How to Change an Attribute (Page 2181)
- The Link tab in the Object Properties Window (Page 2180)
- The Properties tab in the Object Properties window (Page 2178)
- How to Access the Object Properties Window (Page 2176)
- The Object Properties Window (Page 2175)
- The Properties of an Object (Page 2175)

The Properties tab in the Object Properties window

Introduction

In the "Object Properties" window, the Properties tab represents the central dialog for changing the static values of a selected object.

As an example, the Properties tab can have the following appearance for a rectangle with the object name "Rectangle1":

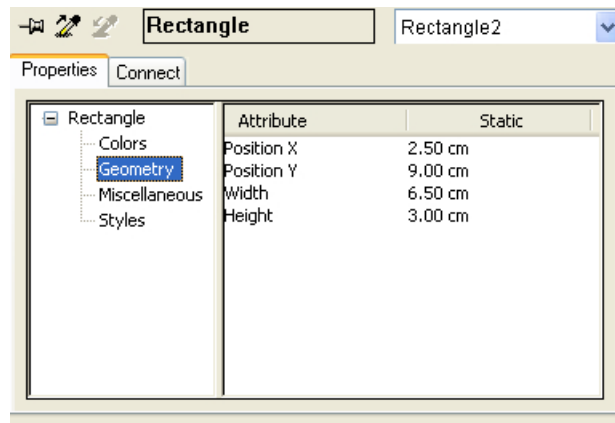

The Properties tab is divided into two areas:

- Properties display:** In the left-hand area, the selected object is displayed with its property groups in the form of a directory tree. The selected object is displayed as a directory. With a multiple selection or a user object, this folder only receives the shared property groups of the contained individual objects. For a selected property group, the value of an attribute will only be displayed if the value is the same for all selected objects or if the attribute belongs to only one of the selected objects. The name of the property groups cannot be changed. Directories and subdirectories can be opened or closed by clicking on the "+" or "-" icons.
- Attribute display:** The right-hand area contains all attributes which are available for the selected property group. The attribute display is divided into two columns in which the static values of the selected object are displayed. The displayed values can be changed by double-clicking or opening the context menu in the "Static" column.

The width of the two window areas and the columns in the attribute display can be changed by moving the vertical dividing lines.

Attribute Display Columns

Column	Description
Attribute	<p>Name of the attribute. All of the attributes from the selected property group that are available for the selected object will be shown.</p> <p>The name of the attribute cannot be changed. The static value of the attribute can be changed by double-clicking the attribute name.</p>
Static	<p>Static value of the attribute. The current value of the attribute for the selected object is displayed. The value will be displayed as a number, text or graphic display, depending on the type of attribute.</p> <p>The static value of the attribute can be changed by double-clicking the attribute name. Further information can be found in chapter "Change Attribute".</p>

See also

- The Object Properties Window (Page 2175)
- How to Transfer Object Properties (Page 2182)
- How to Change an Attribute (Page 2181)
- The Link tab in the Object Properties Window (Page 2180)
- The Toolbar in the Object Properties Window (Page 2177)
- How to Access the Object Properties Window (Page 2176)
- The Properties of an Object (Page 2175)

The Link tab in the Object Properties Window

Introduction

The Link tab represents the central dialog for configuring links in the "Object Properties" window.

The dynamic objects are already linked with the corresponding applications. Some of the dynamic objects have one or more dialogs for selecting data for output.

For example, the Link tab in the "Object Properties" window for a database table with object name "Dynamic Table 1" might look like this:

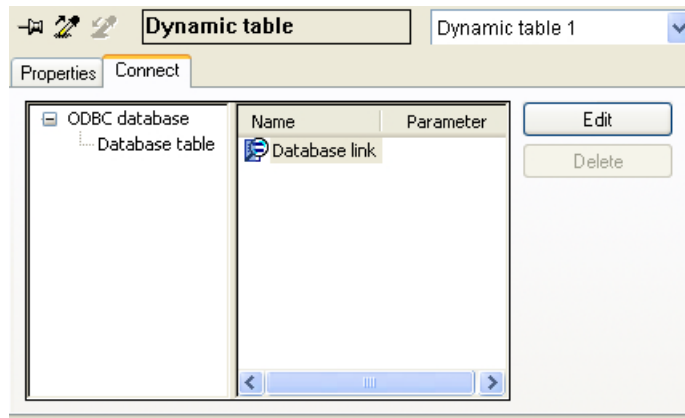

The Link tab is divided into two areas:

- In the left-hand area, the linked applications from which the data to be output are taken are shown in the form of a directory tree.
- In the right-hand area, the editing options and, if they exist, the formatting options, are shown in the "Name" column. You can open the appropriate configuration dialog with the "Edit..." button.

The configured selections are reset with the "Delete..." button. The selection options remain.

The width of the two window areas and the columns in the event display can be changed by moving the vertical dividing lines.

See also

- How to Transfer Object Properties (Page 2182)
- How to Change an Attribute (Page 2181)
- The Properties tab in the Object Properties window (Page 2178)
- The Toolbar in the Object Properties Window (Page 2177)
- How to Access the Object Properties Window (Page 2176)
- The Object Properties Window (Page 2175)
- The Properties of an Object (Page 2175)

10.5.7.3 How to Change an Attribute

Introduction

The properties of an object are defined in the page layout editor by the values of the object attributes. Any change that is made to an object, for example using the mouse or via a configuration dialog, automatically changes the value of the corresponding attributes.

The Properties tab of the "Object Properties" window displays all the attributes of a selected object or objects in a multiple selection. The attributes are assigned to "property groups". The type and number of available property groups and attributes depend on the type of object selected. So, for example, the "Font" property group is only shown for the object types which can be displayed with text.

An object property can be changed by assigning a new value to its attribute. Information about changing a specific attribute can be found in the detailed description of the relevant attribute.

Procedure

1. Open the "Object Properties" window.
2. In the Properties tab, select the desired property group.
3. Double-click on the desired attribute. A dialog opens where you can change the attribute. Enter a new value according to the table below.
4. Click "OK" to confirm your entries.

Alternatively, a dialog where you can change the attribute can also be called directly by double-clicking in the "Static" column. You can call up direct help for each attribute by right-clicking on it in the "Attribute" column.

Dialogs for changing attributes

The table provides information about the possible dialogs for changing attributes and contains an example for calling each dialog.

Dialog	Procedure
Value input	Enter a new value in the line. Example: Object: Static text; property group: Geometry; attribute: Width.
Text input	Click in the text field to edit the text or enter a new text. Example: Object: Static text; property group: Font; attribute: Text.
Switchover	Double-click to switch between the two available values. Example: Object: Static text; property group: Font; attribute: Bold.
Selection dialog in the form of a button	Click on the buttons provided to specify the new value. Example: Object: Static text; property group: Font; attribute: X alignment.
Color selection	Select one of the 16 standard colors or open the palette with the user-defined colors. In this palette, you can freely define additional colors. Example: Object: Static text; property group: Colors; attribute: Font color.
Picture selection	Select a picture from the selection dialog or, using the "Search in" dialog, search for a directory containing additional pictures that can be selected. Example: Object: Static metafile; property group: Miscellaneous; attribute: Metafile name.

See also

The Styles Property Group (Page 2192)

The Miscellaneous Property Group (Page 2191)

The Font Property Group (Page 2189)

The Geometry Property Group (Page 2186)

The Colors Property Group (Page 2185)

How to Rename Objects (Page 2183)

How to Transfer Object Properties (Page 2182)

10.5.7.4 How to Transfer Object Properties

Introduction

The properties of an object can be transferred to another object with the "eyedropper". The following buttons can be used to transfer object properties in the page layout editor:



to copy properties of the selected object



to apply copied properties to a selected object

These buttons are in the standard toolbar and in the "Object Properties" toolbar. Alternatively, these functions can be called via the "Edit/Properties" menu.

The properties of any object can be copied with the eyedropper. You can apply the copies to any object or multiple selection. The properties are transferred without changing the geometric attributes of the object. For different object types, only the attributes held by both the original and target objects will be changed.

Password is not copied

When transferring the object properties between pictures or faceplate types, the property "Password Protection" is not copied.

You configure a separate password for each picture or for each faceplate type.

Procedure

1. Select the object whose properties you want to copy.
2. In the standard toolbar, click . The properties of the selected object are copied.
3. Select the object to which you want to assign the copied properties.
4. In the standard toolbar, click . The selected object will be displayed with the new properties, but without changing its geometric attributes.

See also

The Styles Property Group (Page 2192)

The Miscellaneous Property Group (Page 2191)

The Font Property Group (Page 2189)

The Geometry Property Group (Page 2186)

The Colors Property Group (Page 2185)

How to Rename Objects (Page 2183)

How to Change an Attribute (Page 2181)

10.5.7.5 How to Rename Objects

Introduction

The "Object Name" attribute specifies the name of an object in the layout. The object name is unique within a layout.

When an object is inserted, the object name assigned as standard is the description of the object type with a consecutive number. This name can be changed using the "Object Name" attribute.

The allocation of unique names is important when using objects whose output parameters can be changed online. You can find more information in chapter "Changing Output Options in Runtime".

Requirement

Select an object of any type.

Procedure

1. Open the "Object Properties" window.
2. In the Properties tab, select the entry for the selected object type to which the property groups of the object are subordinate.

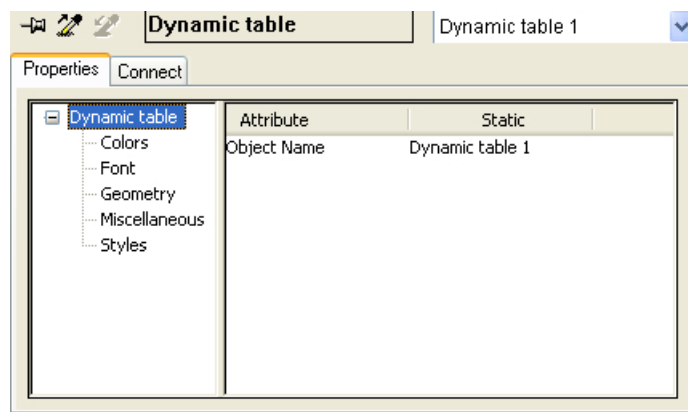

3. Double-click the "Object Name" attribute. The "Text Entry" dialog opens.
4. Enter the new name.
5. Click "OK" to confirm your entries.

Value area

The object name is freely selectable and can contain up to 128 characters. When entering the name, please make note of the list of characters which are not permitted.

10.5.7.6 The Colors Property Group

The Colors Property Group

Introduction

The "Colors" property group contains attributes which you can use to change the color settings of objects.

Requirement

The "Colors" property group is available for all object types.

The availability of the attributes is dependent on the type of object selected. Only the attributes which the selected object has will be displayed.

Overview

The following table shows all attributes in the "Colors" property group. The function of an attribute is described briefly and the object types for which the attribute is available are listed.

Attribute	Function	Object type
Fill pattern color	Color of the fill pattern	Polygon, ellipse, circle, ellipse segment, pie segment, rectangle, rounded rectangle, static text, static metafile, all dynamic objects, all system objects, all objects for runtime documentation and project documentation and the layout object.
Background color	Background color of the object	Polygon, ellipse, circle, ellipse segment, pie segment, rectangle, rounded rectangle, static text, static metafile, all dynamic objects, all system objects, all objects for runtime documentation and project documentation and the layout object.
Line color	Color of a line	All standard objects except static text, all dynamic objects, all system objects, all objects for the runtime documentation and the project documentation and the layout object.
Line background color	Background color of a line	All standard objects except static text, all dynamic objects, all system objects, all objects for the runtime documentation and the project documentation.
Font color	Color of the text in an object	Static text, all dynamic objects except embedded layout and hard copy, all system objects, all logs and tables in the objects for runtime documentation, all objects for the project documentation

See also

Working with the Colors Property Group (Page 2186)

How to Change an Attribute (Page 2181)

The Properties of an Object (Page 2175)

The Color Palette (Page 2139)

Working with the Colors Property Group

Introduction

In the "Colors" property group you can change the color settings for the background, lines, fill pattern and font of an object. The following example "Changing the Background Color" explains how to work with this property group.

Requirement

Select an object of any type.

Procedure

1. Open the "Object Properties" window, for example using the context menu.
2. In the Properties tab, select the "Colors" property group.
3. Double-click the "Background Color" attribute. A selection dialog opens.
4. Select one of the 16 standard colors or open the palette with the user-defined colors. In this palette, you can freely define additional colors.

See also

Working with the Colors Property Group (Page 2186)

How to Change an Attribute (Page 2181)

The Properties of an Object (Page 2175)

The Color Palette (Page 2139)

10.5.7.7 The Geometry Property Group

The Geometry Property Group

Introduction

The "Geometry" property group contains attributes, which you can use to change the geometric properties of objects.

Requirement

The "Geometry" property group is available for all objects.

The availability of the attributes is dependent on the type of object selected. Only the attributes which the selected object has will be displayed.

Overview

The following table shows all attributes in the "Geometry" property group. The function of an attribute is described briefly and the object types for which the attribute is available are listed.

Attribute	Function	Object type
Current value X	Horizontal position of the currently selected corner point, relative to the image origin.	Polygon, polyline
Current value Y	Vertical position of the currently selected corner point, relative to the image origin.	Polygon, polyline
Start angle	Start angle for the display of segment or arc objects in "degrees".	Ellipse arc, ellipse segment, circular arc, pie segment
Number of corners	Number of corner points	Polygon, polyline
Width	Distance between the left and right borders of an object, for the layout object the width of the layout.	All objects
Corner radius X	Radius of the corner rounding	Rounded rectangle
Corner radius Y	Radius of the corner rounding	Rounded rectangle
End angle	End angle for the display of segment or arc objects in "degrees".	Ellipse arc, ellipse segment, circular arc, pie segment
Height	Distance between the upper and lower borders of an object, for the layout object the height of the layout	All objects
Index	Number of the currently selected corner points	Polygon, polyline
Left print margin	Determines the width of the left print margin	Layout object
Left dynamic margin	Determines the left margin of the dynamic layout part.	Layout object
Top print margin	Determines the width of the top print margin	Layout object
Top dynamic margin	Determines the top margin of the dynamic layout part.	Layout object
Orientation	Determines the orientation of the printout in portrait or landscape format.	Layout object
Position X	Horizontal distance of the object origin from the image origin	All objects
Position Y	Vertical distance of the object origin from the image origin	All objects
Radius	Radius of a circular object	Circle, circular arc, pie segment
Radius X	Horizontal radius of an elliptical object	Ellipse, ellipse arc, ellipse segment
Radius Y	Vertical radius of an elliptical object	Ellipse, ellipse arc, ellipse segment
Right print margin	Determines the width of the right print margin	Layout object
Right dynamic margin	Determines the right margin of the dynamic layout part.	Layout object
Page format	Determines the paper format of the printout	Layout object

Attribute	Function	Object type
Columns	Number and width of the columns in a table	All table objects in the object palette, recognizable by the  icon.
Bottom print margin	Determines the width of the bottom print margin	Layout object
Bottom dynamic margin	Determines the bottom margin of the dynamic layout part.	Layout object

See also

- Working with the Geometry Property Group (Page 2188)
- How to Change an Attribute (Page 2181)
- The Rectangle Surrounding the Object (Page 2166)
- The coordinate system in the Report Designer (Page 2164)
- The Properties of an Object (Page 2175)

Working with the Geometry Property Group

Introduction

You can change the geometric properties of an object in the "Geometry" property group. The following example "Changing the Width" explains how to work with this property group.

Requirement

Select an object of any type. You have already set the units of the coordinates (e.g. centimeters) in the Tools/Settings/Units menu.

Procedure

1. Open the "Object Properties" window, for example using the context menu.
2. In the Properties tab, select the "Geometry" property group.
3. Double-click the "Width" attribute. The "Value Input" dialog opens.
4. Enter the new value.
5. Click "OK" to confirm your entries.

Alternative Operation

Change the object size with the mouse by dragging one of the handles on the rectangle surrounding the object to the width you want.

See also

- How to Change an Attribute (Page 2181)
- The Properties of an Object (Page 2175)
- The Rectangle Surrounding the Object (Page 2166)
- The coordinate system in the Report Designer (Page 2164)
- The Geometry Property Group (Page 2186)

10.5.7.8 The Font Property Group

The Font Property Group

Introduction

The "Font" property group contains attributes which you can use to change the appearance of text in objects.

Requirement

The "Font" property group is available for all objects. Static object "Static Text", dynamic objects "ODBC Database" and "Tags", system objects and objects for online and project documentation.

The availability of the attributes is dependent on the type of object selected. Only the attributes which the selected object has will be displayed.

Overview

The following table shows all attributes in the "Font" property group. The function of an attribute is described briefly and the object types for which the attribute is available are listed.

Attribute	Function	Object type
Bold	Text is displayed in boldface	Static text, dynamic objects "ODBC Database" and "Tags", system objects and objects for online and project documentation
Italic	Text is displayed in italics	Static text, dynamic objects "ODBC Database" and "Tags", system objects and objects for online and project documentation
Text	The object text	Static text
Underline	Text is displayed underlined	Static text, dynamic objects "ODBC Database" and "Tags", system objects and objects for online and project documentation
X alignment	Horizontal orientation of the text in the object	Static text, dynamic objects "ODBC Database" and "Tags", system objects and objects for online and project documentation which contain dynamic text
Y alignment	Vertical orientation of the text in the object	Static text, dynamic object "Tag", system objects

Attribute	Function	Object type
Font	Font of the text	Static text, dynamic objects "ODBC Database" and "Tags", system objects and objects for online and project documentation
Font size	Font size of the text in points	Static text, dynamic objects "ODBC Database" and "Tags", system objects and objects for online and project documentation
Text wrap	Automatic line wrapping during output of the text	Static text, dynamic objects "ODBC Database" and "Tags", system objects and objects for online and project documentation which contain dynamic text

See also

- How to Change an Attribute (Page 2181)
- The Properties of an Object (Page 2175)
- Working with the Font Property Group (Page 2190)

Working with the Font Property Group

Introduction

You can change the text display attributes of an object in the "Font" property group. The following example "Changing the Font" explains how to work with this property group.

Requirement

Select one of the following objects: Static object "Static Text", dynamic objects "ODBC Database" and "Tags", system objects and objects for online and project documentation.

Procedure

1. Open the "Object Properties" window, for example using the context menu.
2. In the Properties tab, select the "Font" property group.
3. Double-click the "Font" attribute. The "Font Selection" dialog opens.
4. Select the font you want in the dialog.
5. Click "OK" to confirm your entries.

See also

- How to Change an Attribute (Page 2181)
- The Properties of an Object (Page 2175)
- Working with the Font Property Group (Page 2190)

10.5.7.9 The Miscellaneous Property Group

The Miscellaneous Property Group

Introduction

The "Miscellaneous" property group contains attributes which you can use to change the miscellaneous settings of objects.

Requirement

The "Miscellaneous" property group is available for all objects.

The availability of the attributes is dependent on the type of object selected. Only the attributes which the selected object has will be displayed.

Overview

The following table shows all attributes in the "Miscellaneous" property group. The function of an attribute is described briefly and the object types for which the attribute is available are listed.

Attribute	Function	Object type
Output format	sets the appearance of the output value	Dynamic object "Tag"
Output value	sets the tags for the output	Dynamic object "Tag"
Calculation	calls a script for further editing of the tag value	Dynamic object "Tag"
Data type	sets the data type of the tags	Dynamic object "Tag"
Cover sheet	Sets whether a cover sheet should be output	Layout object
Format	sets the appearance of the output value	all system objects
Layout file	sets the layout to be embedded	Embedded layout
Metafile name	sets the name of the embedded file	Static metafile
Final page	Sets whether a closing page should be output	Layout object
Page break	inserts a page break in front of the object.	All objects
Polling list	If the output data is output in a single column per line, this attribute can be used to output multiple columns per line. The data will be written from left to right in the table cells.	All table objects in the object palette, recognizable by the  icon.

See also

How to Change an Attribute (Page 2181)

The Properties of an Object (Page 2175)

Working with the Miscellaneous Property Group (Page 2192)

Working with the Miscellaneous Property Group

Introduction

You can change various properties of an object in the "Miscellaneous" property group. The following example "Changing the Page Break" explains how to work with this property group.

Requirement

Select an object of any type.

Procedure

1. Open the "Object Properties" window, for example using the context menu.
2. In the Properties tab, select the "Miscellaneous" property group.
3. Double-click the "Page Break" attribute. The entered value changes, for example from "No" to "Yes". With "Yes", a page break is inserted in front of the object. The default setting is "Yes".

See also

[How to Change an Attribute \(Page 2181\)](#)

[The Properties of an Object \(Page 2175\)](#)

[Working with the Miscellaneous Property Group \(Page 2192\)](#)

10.5.7.10 The Styles Property Group

The Styles Property Group

Introduction

The "Styles" property group contains attributes which you can use to change the style for the appearance of objects.

Requirement

The "Styles" property group is available for all objects.

The availability of the attributes is dependent on the type of object selected. Only the attributes which the selected object has will be displayed.

Overview

The following table shows all attributes in the "Styles" property group. The function of an attribute is described briefly and the object types for which the attribute is available are listed.

Attribute	Function	Object type
Corners	Representation of the corners of an object, for example round, flat or pointed (associated with the "Line Style" attribute)	all objects
Fill pattern	Pattern for the display of background areas, for example solid or hatched	Polygon, ellipse, circle, ellipse segment, pie segment, rectangle, rounded rectangle, static text, static metafile, all dynamic objects, all system objects, all objects for runtime documentation and project documentation and the layout object.
Line termination	Representation of the line ends of an object, e.g. round, flat or pointed (associated with the "Line Style" attribute)	all objects
Line type	Display type of a line, for example dotted or dashed	all objects
Line weight	Width of a line in points	all objects

See also

How to Change an Attribute (Page 2181)

The Properties of an Object (Page 2175)

Working with the Styles Property Group (Page 2193)

Working with the Styles Property Group

Introduction

In the "Styles" property group, you can change the style for the display of objects. The following example "Changing the Fill Pattern" explains how to work with this property group.

Requirement

Select an object of any type.

Procedure

1. Open the "Object Properties" window, for example using the context menu.
2. In the Properties tab, select the "Styles" property group.
3. Double-click the "Fill Pattern" attribute. The "Fill Pattern Selection" dialog opens.

4. Select the fill pattern you want in the dialog.
5. Click "OK" to confirm your entries.

Alternative Operation

You can also change the fill pattern with the style palette.

See also

[How to Change an Attribute \(Page 2181\)](#)

[The Properties of an Object \(Page 2175\)](#)

[Working with the Styles Property Group \(Page 2193\)](#)

10.5.8 Working with Standard Objects

10.5.8.1 Working with Standard Objects

Introduction

Standard objects include geometric shapes, static text, OLE objects, static metafiles, the dynamic objects and the system objects. You can use static objects to design the layout for the output. System objects can be used, as an example, to inscribe the project name and page numbers in the static part of the report.

In the page layout editor, the various object types have predefined properties. When they are inserted the objects import these default properties, with the exception of individual geometric properties. After insertion the properties of an object can be modified. In the same way the default settings for the object types can be modified as required.

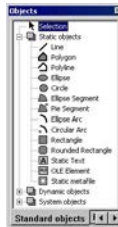

See also

[Working with System Objects \(Page 2237\)](#)

[Working with Dynamic Standard Objects \(Page 2224\)](#)

[Working with Static Objects \(Page 2195\)](#)

[How to Transfer Object Properties \(Page 2182\)](#)

How to Change an Attribute (Page 2181)

The Properties of an Object (Page 2175)

10.5.8.2 Working with Static Objects

Working with Static Objects

Introduction

In this chapter, you will learn the details of the static objects available in the page layout editor. You will learn how to work with the objects, and what are the basic conditions for each object.

Usage

Static objects are used for the visual design of a report. The static objects can be pasted into the static and dynamic parts of a layout.

See also

How to Paste an Object into a Layout (Page 2167)

How to Transfer Object Properties (Page 2182)

How to Change an Attribute (Page 2181)

The Rectangle Surrounding the Object (Page 2166)

The Properties of an Object (Page 2175)

Overview of the Static Objects (Page 2129)

How to Draw a Line

Introduction

The line is an open object. The length and angle of a line are determined by the height and width of the rectangle around the object. Different line types, such as dashed or dotted, are available.

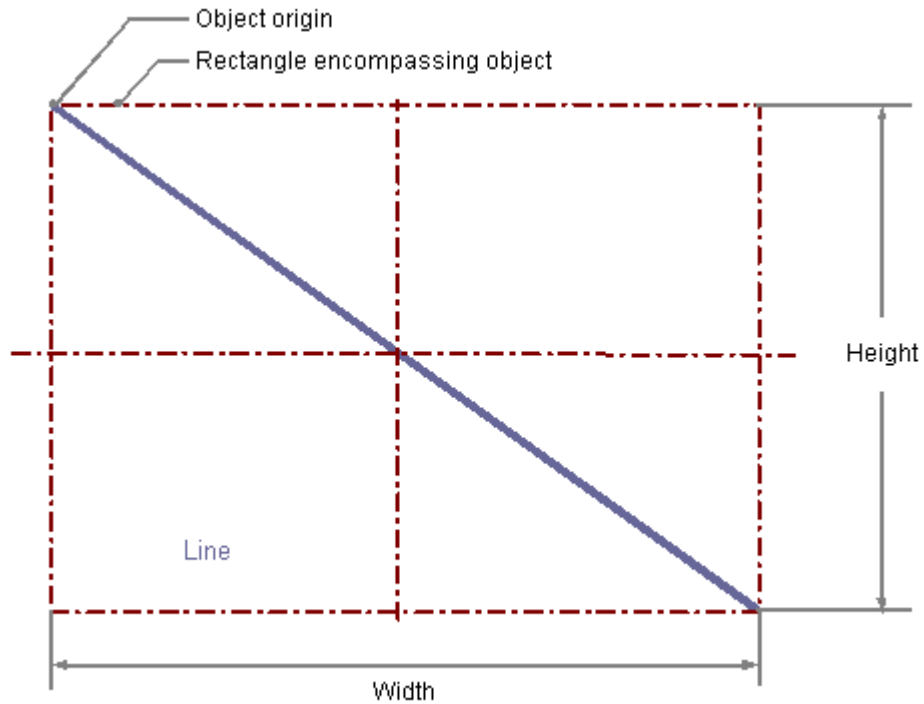

Requirement

The display of the object palette must be enabled.

Procedure

1. Open the layout in which you want to paste a line.
2. Click the "Line" standard object in the Object palette.
3. Place the mouse pointer at the position in the layout where you want to insert the line. The mouse pointer changes into a crosshair with an object symbol attached.
4. Hold down the mouse button and drag the line to the length and direction you want. When you release the mouse button, the line is finished.

Changing Lines with the Mouse

Rectangle surrounding the object

Drag the rectangle surrounding the object to a new position in order to arrange the object in the layout.

Drag the handles on the rectangle surrounding the object to a new position in order to resize the object.

Palettes and toolbars

Use elements of the Style Palette to change the display style for the object.

Changing lines with value input

The display of objects can also be changed by entering new values in the attributes. You will find more information in the section entitled "Change Attribute".

See also

[How to Change an Attribute \(Page 2181\)](#)

[The Properties of an Object \(Page 2175\)](#)

[Working with Standard Objects \(Page 2194\)](#)

[How to Paste an Object into a Layout \(Page 2167\)](#)

How to Draw a Polygon

Introduction

The polygon is a closed object that can be filled with a color or pattern. A polygon can have any number of corners. The corners are numbered in their sequence of creation and can be modified individually or deleted.

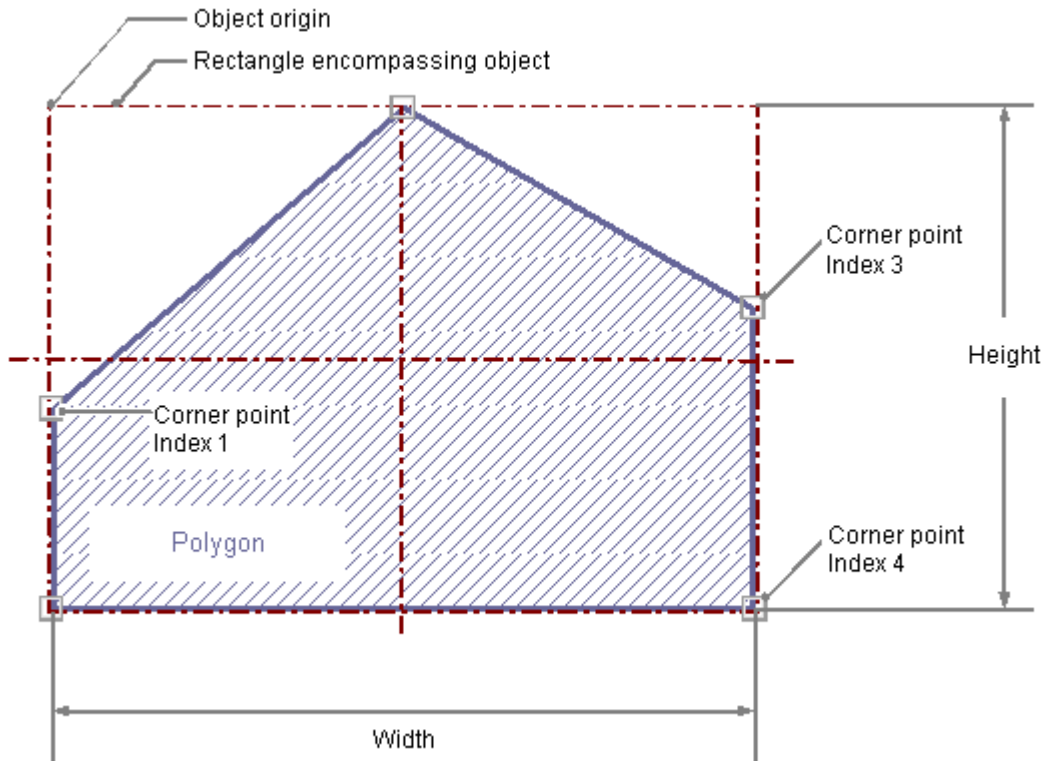

Requirement

The display of the object palette must be enabled.

Procedure

1. Open the layout in which you want to insert a polygon.
2. Click the standard object "Polygon" in the Object palette.
3. Place the mouse pointer at the position in the layout where you want to insert the polygon. The mouse pointer changes into a crosshair with an object symbol attached.
4. Click the selected starting point with the left mouse button.

5. Move the mouse pointer to the next corner point. Click with the left mouse button to set the corner point. Set as many further corner points as you like in the same way.
6. Double-click with the left mouse button to set the last corner point and finish the polygon.

Changing Polygons with the Mouse

Rectangle surrounding the object

Drag the rectangle surrounding the object to a new position in order to arrange the object in the layout.

Drag the handles on the rectangle surrounding the object to a new position in order to resize the object.

Palettes and toolbars

Use elements of the Style Palette to change the display style for the object.

Changing Polygons with Value Input

The display of objects can also be changed by entering new values in the attributes. You will find more information in the section entitled "Change Attribute".

See also

[How to Change an Attribute \(Page 2181\)](#)

[The Properties of an Object \(Page 2175\)](#)

[Working with Standard Objects \(Page 2194\)](#)

[How to Paste an Object into a Layout \(Page 2167\)](#)

How to Draw a Polyline

Introduction

The polyline is an open object. Even if the start and finish point have the same coordinates, the area cannot be filled. A polyline can have any number of corners. The corners are numbered in their sequence of creation and can be modified individually or deleted. The line ends of a polyline can for example be shown as arrows or points.

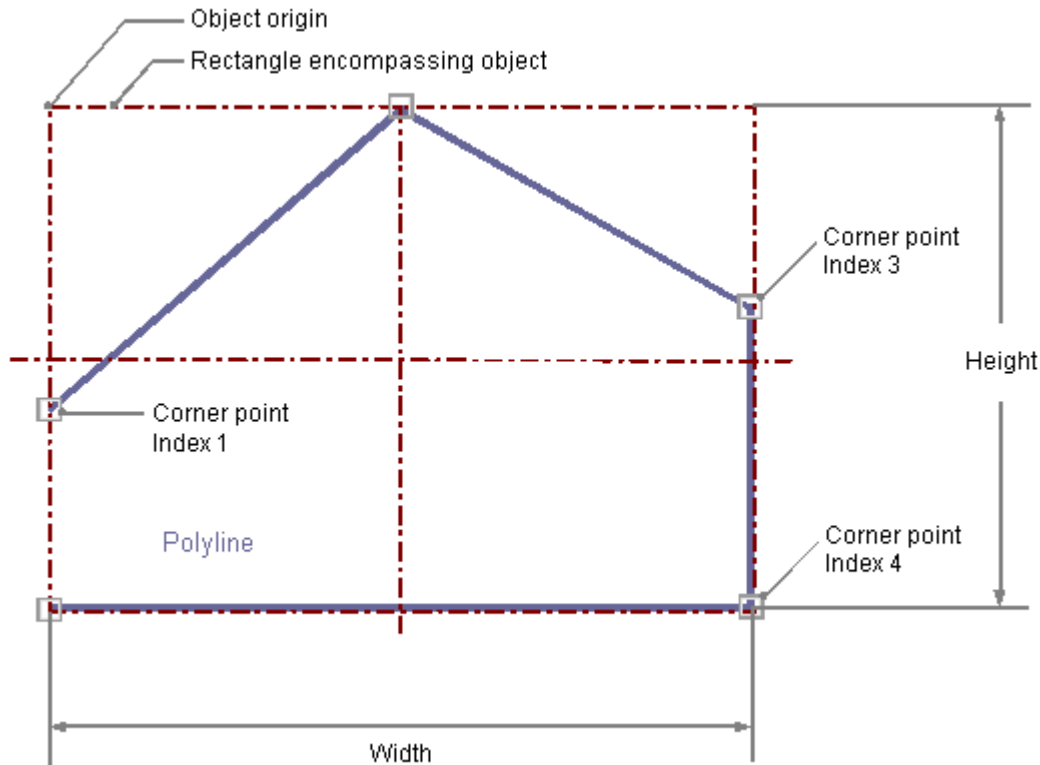

Requirement

The display of the object palette must be enabled.

Procedure

1. Open the layout in which you want to insert a polyline.
2. Click the "Polyline" standard object in the Object palette.
3. Place the mouse pointer at the position in the layout where you want to insert the polyline. The mouse pointer changes into a crosshair with an object symbol attached.
4. Click the selected starting point with the left mouse button.

5. Move the mouse pointer to the next corner point. Click with the left mouse button to set the corner point. Set as many further corner points as you like in the same way.
6. Double-click with the left mouse button to set the last corner point and finish the polyline.

Changing Polylines with the Mouse

Rectangle surrounding the object

Drag the rectangle surrounding the object to a new position in order to arrange the object in the layout.

Drag the handles on the rectangle surrounding the object to a new position in order to resize the object.

Palettes and toolbars

Use elements of the Style Palette to change the display style for the object.

Changing Polylines with Value Input

The display of objects can also be changed by entering new values in the attributes. You will find more information in the section entitled "Change Attribute".

See also

[How to Change an Attribute \(Page 2181\)](#)

[The Properties of an Object \(Page 2175\)](#)

[Working with Standard Objects \(Page 2194\)](#)

[How to Paste an Object into a Layout \(Page 2167\)](#)

How to Draw an Ellipse

Introduction

The ellipse is a closed object that can be filled with a color or pattern. The height and width of an ellipse can be modified as desired to allow it to be aligned horizontally or vertically.

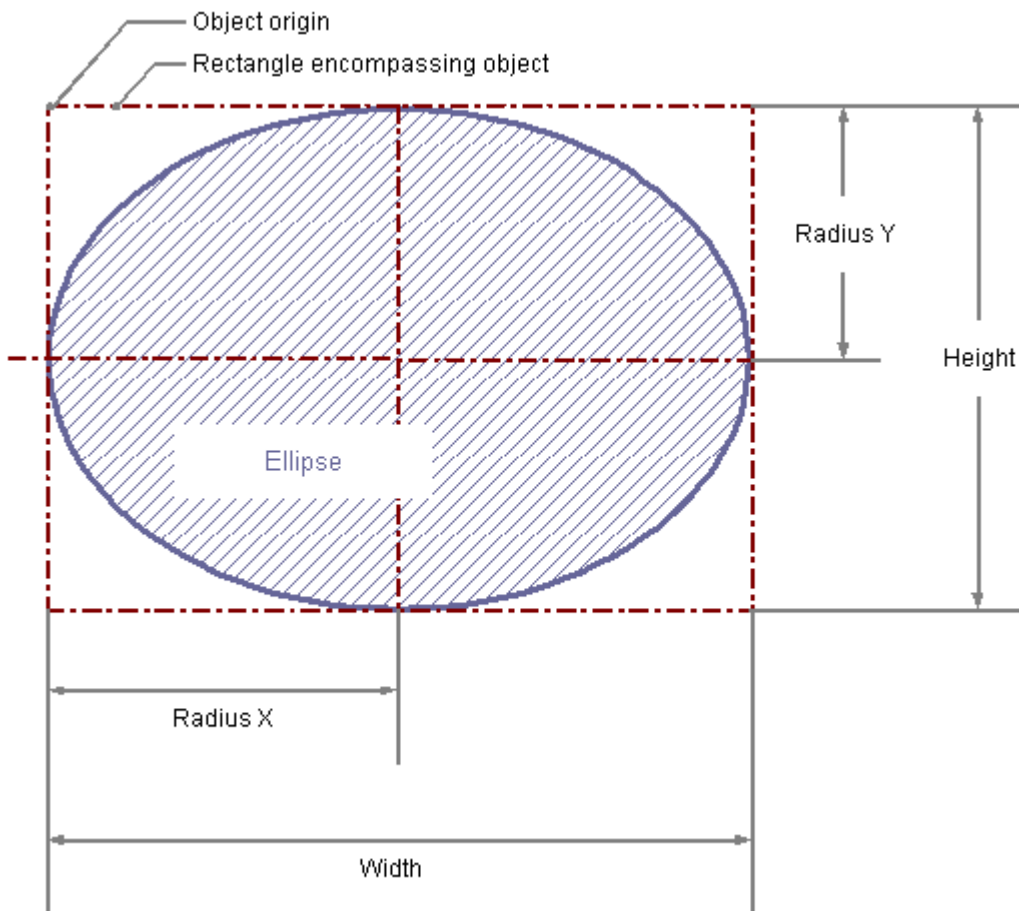

Requirement

The display of the object palette must be enabled.

Procedure

1. Open the layout in which you want to insert an ellipse.
2. Click on the "Ellipse" standard object in the Object palette.

3. Place the mouse pointer at the position in the layout where you want to insert the ellipse. The mouse pointer changes into a crosshair with an object symbol attached.
4. Hold down the mouse button and drag the ellipse to the size and direction you want. When you release the mouse button, the ellipse is finished.

Changing an Ellipse with the Mouse

Rectangle surrounding the object

Drag the rectangle surrounding the object to a new position in order to arrange the object in the layout.

Drag the handles on the rectangle surrounding the object to a new position in order to resize the object.

Palettes and toolbars

Use elements of the Style Palette to change the display style for the object.

Changing an Ellipse with Value Input

The display of objects can also be changed by entering new values in the attributes. You will find more information in the section entitled "Change Attribute".

See also

[How to Change an Attribute \(Page 2181\)](#)

[The Properties of an Object \(Page 2175\)](#)

[Working with Standard Objects \(Page 2194\)](#)

[How to Paste an Object into a Layout \(Page 2167\)](#)

How to Draw a Circle

Introduction

A circle is a closed object that can be filled with a color or pattern. A circle can be resized at will.

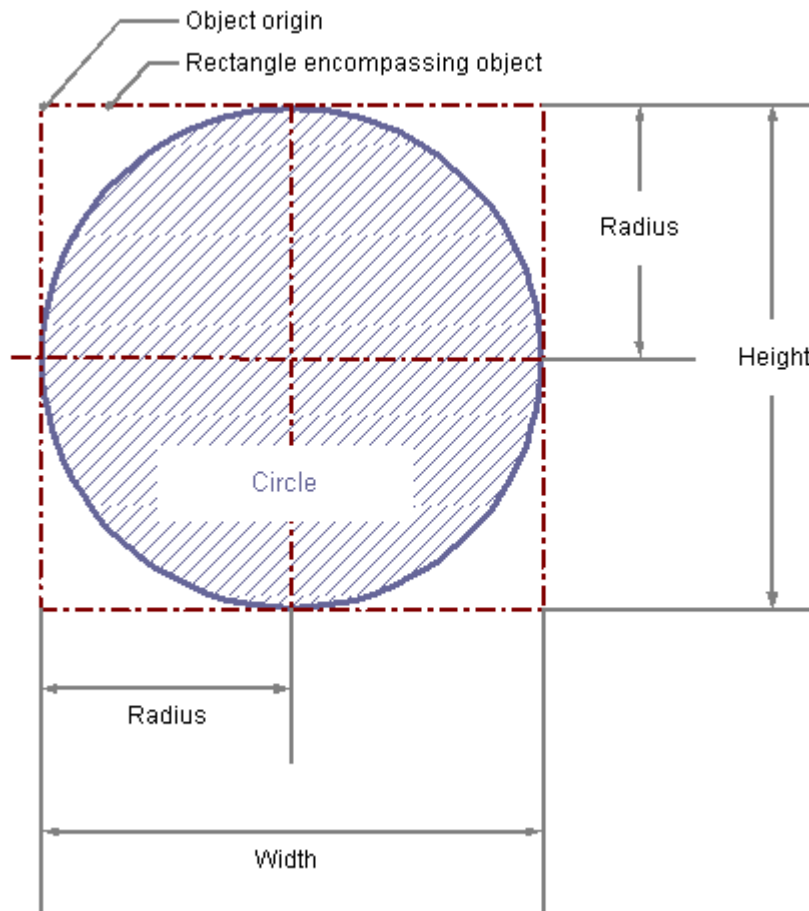

Requirement

The display of the object palette must be enabled.

Procedure

1. Open the layout in which you want to insert a circle.
2. Click the "Circle" standard object in the Object palette.

3. Place the mouse pointer at the position in the layout where you want to insert the circle. The mouse pointer changes into a crosshair with an object symbol attached.
4. Hold down the mouse button and drag the circle to the size and direction you want. When you release the mouse button, the circle is finished.

Changing Circles with the Mouse

Rectangle surrounding the object

Drag the rectangle surrounding the object to a new position in order to arrange the object in the layout.

Drag the handles on the rectangle surrounding the object to a new position in order to resize the object.

Palettes and toolbars

Use elements of the Style Palette to change the display style for the object.

Changing Circles with Value Input

The display of objects can also be changed by entering new values in the attributes. You will find more information in the section entitled "Change Attribute".

See also

[How to Change an Attribute \(Page 2181\)](#)

[The Properties of an Object \(Page 2175\)](#)

[Working with Standard Objects \(Page 2194\)](#)

[How to Paste an Object into a Layout \(Page 2167\)](#)

How to Draw an Ellipse Segment

Introduction

The ellipse segment is a closed object that can be filled with a color or pattern. The height and width of an ellipse segment can be modified as desired to allow it to be aligned horizontally or vertically.

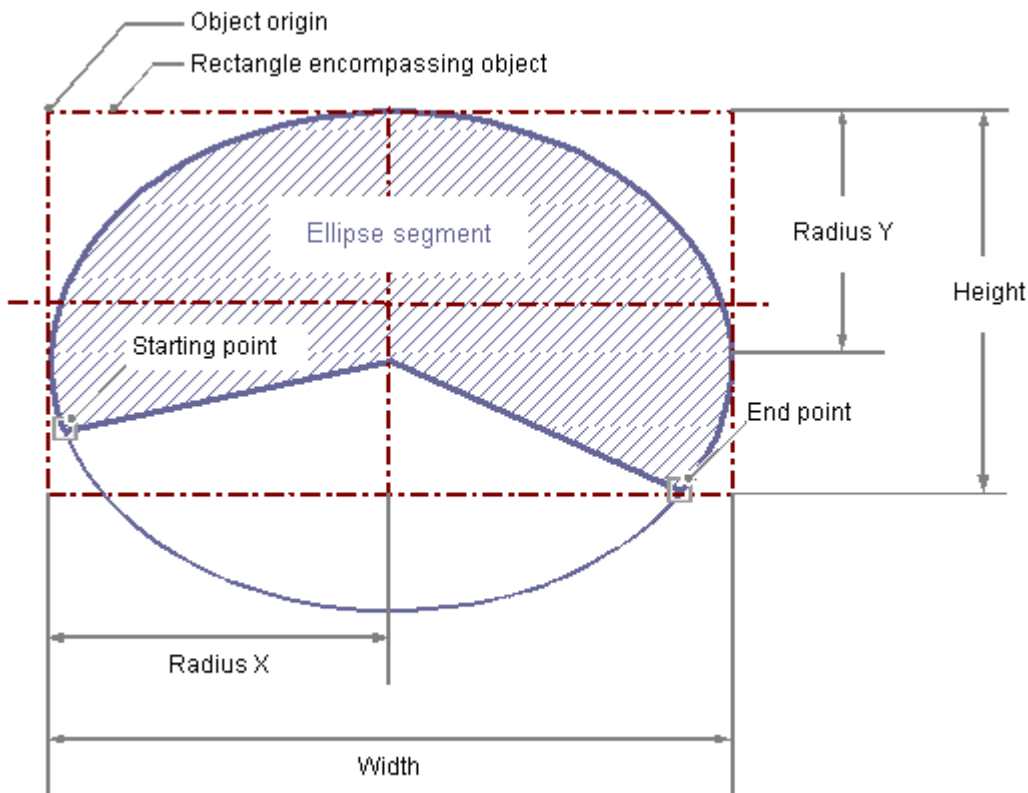

Requirement

The display of the object palette must be enabled.

Procedure

1. Open the layout in which you want to insert an ellipse segment.
2. Click the "Ellipse segment" standard object in the Object palette.
3. Place the mouse pointer at the position in the layout where you wish to position the origin of the ellipse segment.
The mouse pointer changes into a crosshair with an object symbol attached.
4. Hold down the mouse button and drag the ellipse segment to the size and direction you want.
When you release the mouse button, the ellipse segment insertion is finished.

5. The start and end points of the ellipse segment are shown by small gray squares. Place the mouse pointer on one of these squares. The mouse pointer will change to a cross.
6. Drag the start or end point to the desired position while holding down the mouse button.

Changing Ellipse Segments with the Mouse

Rectangle surrounding the object

Drag the rectangle surrounding the object to a new position in order to arrange the object in the layout.

Drag the handles on the rectangle surrounding the object to a new position in order to resize the object.

Palettes and toolbars

Use elements of the Style Palette to change the display style for the object.

Changing ellipse Segments with Value Input

The display of objects can also be changed by entering new values in the attributes. You will find more information in the section entitled "Change Attribute".

Note

Even if the values of the start and end angle are identical, an ellipse segment does not turn into a closed ellipse.

See also

[How to Change an Attribute \(Page 2181\)](#)

[The Properties of an Object \(Page 2175\)](#)

[Working with Standard Objects \(Page 2194\)](#)

[How to Paste an Object into a Layout \(Page 2167\)](#)

How to Draw a Pie Segment

Introduction

The pie segment is a closed object that can be filled with a color or pattern. A pie segment can be resized at will.

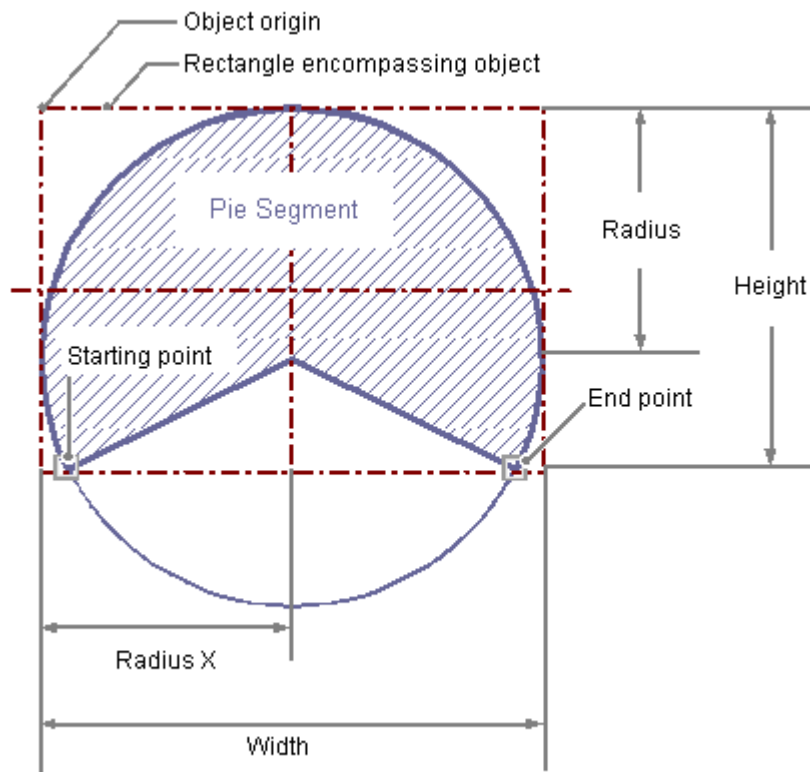

Requirement

The display of the object palette must be enabled.

Procedure

1. Open the layout in which you want to insert a pie segment.
2. Click in the "pie segment" standard object in the Object palette.
3. Place the mouse pointer at the position in the layout where you wish to position the origin of the pie segment.
The mouse pointer changes into a crosshair with an object symbol attached.
4. Hold down the mouse button and drag the pie segment to the size and direction you want.
When you release the mouse button, the pie segment insertion is finished.

5. The start and end points of the pie segment are shown by small gray squares. Place the mouse pointer on one of these squares. The mouse pointer will change to a cross.
6. Drag the start or end point to the desired position while holding down the mouse button.

Changing Pie Segments with the Mouse

Rectangle surrounding the object

Drag the rectangle surrounding the object to a new position in order to arrange the object in the layout.

Drag the handles on the rectangle surrounding the object to a new position in order to resize the object.

Palettes and toolbars

Use elements of the Style Palette to change the display style for the object.

Changing Pie Segments with Value Input

The display of objects can also be changed by entering new values in the attributes. You will find more information in the section entitled "Change Attribute".

Note

Even if the values of the start and end angle are identical, a pie segment does not turn into a closed circle.

See also

[Working with Standard Objects \(Page 2194\)](#)

[How to Change an Attribute \(Page 2181\)](#)

[The Properties of an Object \(Page 2175\)](#)

[How to Paste an Object into a Layout \(Page 2167\)](#)

How to draw an Ellipse Arc

Introduction

The ellipse arc is an open object. The height and width of an ellipse arc can be modified as desired to allow it to be aligned horizontally or vertically.

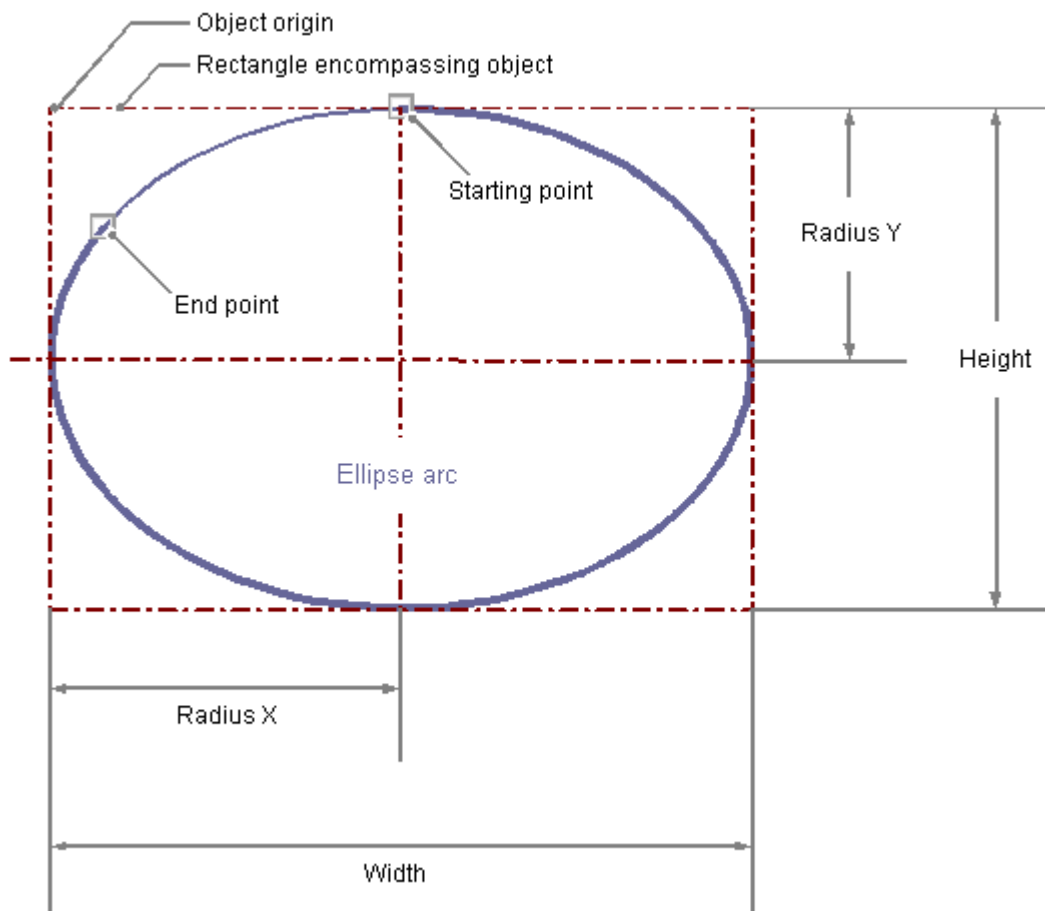

Requirement

The display of the object palette must be enabled.

Procedure

1. Open the layout in which you want to insert an ellipse arc.
2. Click the "Ellipse arc" standard object in the Object palette.
3. Place the mouse pointer at the position in the layout where you wish to position the origin of the ellipse arc.
The mouse pointer changes into a crosshair with an object symbol attached.

4. Hold down the mouse button and drag the ellipse arc to the size and direction you want. When you release the mouse button, the ellipse arc insertion is finished.
5. The start and end points of the ellipse arc are shown by small gray squares. Place the mouse pointer on one of these squares. The mouse pointer will change to a cross.
6. Drag the start or end point to the desired position while holding down the mouse button.

Changing Ellipse Arcs with the Mouse

Rectangle surrounding the object

Drag the rectangle surrounding the object to a new position in order to arrange the object in the layout.

Drag the handles on the rectangle surrounding the object to a new position in order to resize the object.

Palettes and toolbars

Use elements of the Style Palette to change the display style for the object.

Changing Ellipse Arcs with Value Input

The display of objects can also be changed by entering new values in the attributes. You will find more information in the section entitled "Change Attribute".

Note

Even if the values of the start and end angle are identical, an ellipse arc does not turn into a closed ellipse.

See also

[How to Change an Attribute \(Page 2181\)](#)

[The Properties of an Object \(Page 2175\)](#)

[Working with Standard Objects \(Page 2194\)](#)

[How to Paste an Object into a Layout \(Page 2167\)](#)

How to Draw a Circular Arc

Introduction

The circular arc is an open object. A circular arc can be resized at will.

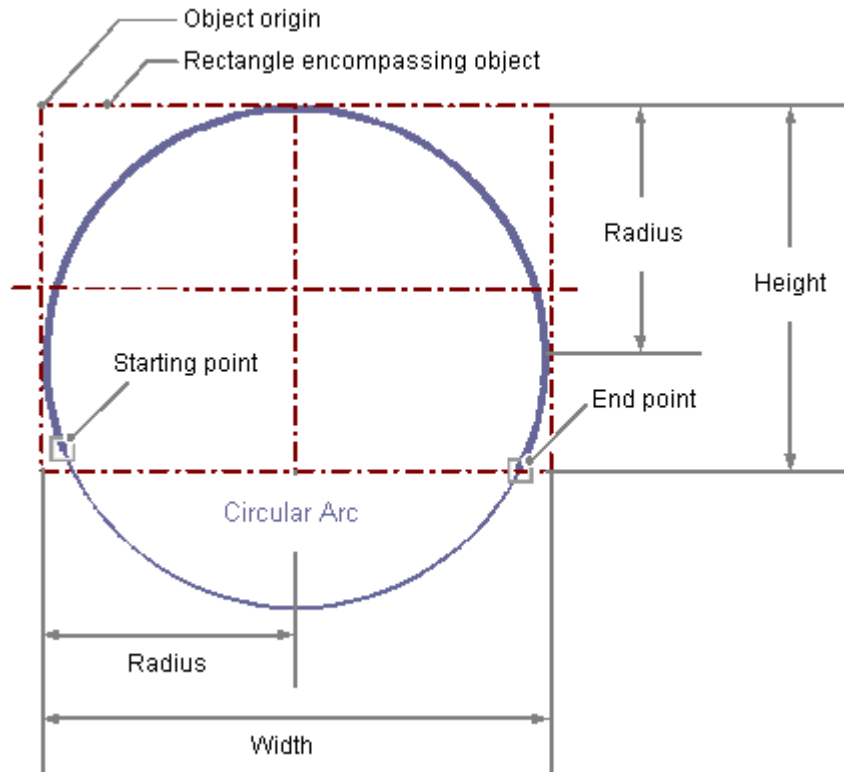

Requirement

The display of the object palette must be enabled.

Procedure

1. Open the layout in which you want to insert a circular arc.
2. Click the "Circular arc" standard object in the Object palette.
3. Place the mouse pointer at the position in the layout where you wish to position the origin of the circular arc.
The mouse pointer changes into a crosshair with an object symbol attached.
4. Hold down the mouse button and drag the circular arc to the size and direction you want.
When you release the mouse button, the circular arc insertion is finished.

5. The start and end points of the circular arc are shown by small gray squares. Place the mouse pointer on one of these squares. The mouse pointer will change to a cross.
6. Drag the start or end point to the desired position while holding down the mouse button.

Changing Circular Arcs with the Mouse

Rectangle surrounding the object

Drag the rectangle surrounding the object to a new position in order to arrange the object in the layout.

Drag the handles on the rectangle surrounding the object to a new position in order to resize the object.

Palettes and toolbars

Use elements of the Style Palette to change the display style for the object.

Changing Circular Arcs with Value Input

The display of objects can also be changed by entering new values in the attributes. You will find more information in the section entitled "Change Attribute".

Note

Even if the values of the start and end angle are identical, a circular arc does not turn into a closed circle.

See also

[How to Change an Attribute \(Page 2181\)](#)

[The Properties of an Object \(Page 2175\)](#)

[Working with Standard Objects \(Page 2194\)](#)

[How to Paste an Object into a Layout \(Page 2167\)](#)

How to Draw a Rectangle

Introduction

The rectangle is a closed object that can be filled with a color or pattern. The height and width of a rectangle can be modified as desired to allow it to be aligned horizontally or vertically.

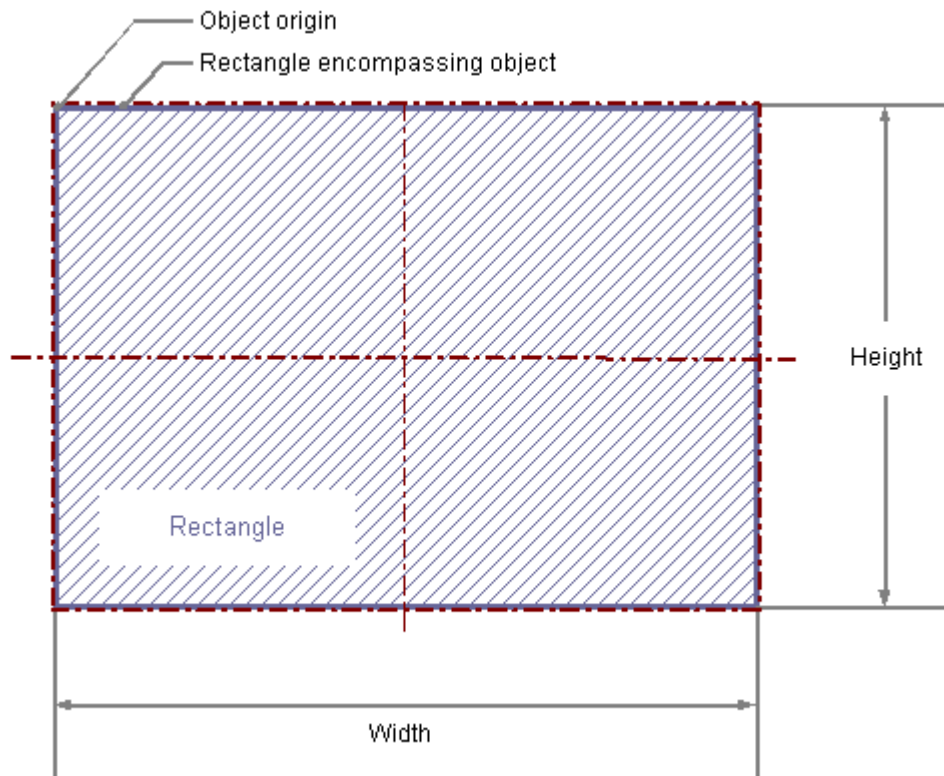

Requirements

The display of the object palette must be enabled.

Procedure

1. Open the layout in which you want to insert a rectangle.
2. Click the "Rectangle" standard object in the Object palette.
3. Place the mouse pointer at the position in the layout where you want to insert the rectangle. The mouse pointer changes into a crosshair with an object symbol attached.
4. Hold down the mouse button and drag the rectangle to the size and direction you want. When you release the mouse button, the rectangle is finished.

Changing Rectangles with the Mouse

Rectangle surrounding the object

Drag the rectangle surrounding the object to a new position in order to arrange the object in the layout.

Drag the handles on the rectangle surrounding the object to a new position in order to resize the object.

Palettes and toolbars

Use elements of the Style Palette to change the display style for the object.

Changing Rectangles with Value Input

The display of objects can also be changed by entering new values in the attributes. You will find more information in the section entitled "Change Attribute".

See also

[How to Change an Attribute \(Page 2181\)](#)

[The Properties of an Object \(Page 2175\)](#)

[Working with Standard Objects \(Page 2194\)](#)

[How to Paste an Object into a Layout \(Page 2167\)](#)

How to Draw a Rounded Rectangle

Introduction

The rounded rectangle is a closed object that can be filled with a color or pattern. The height and width of a rounded rectangle can be modified as desired to allow it to be aligned horizontally or vertically. The corners of a rounded rectangle can be rounded as much as desired.

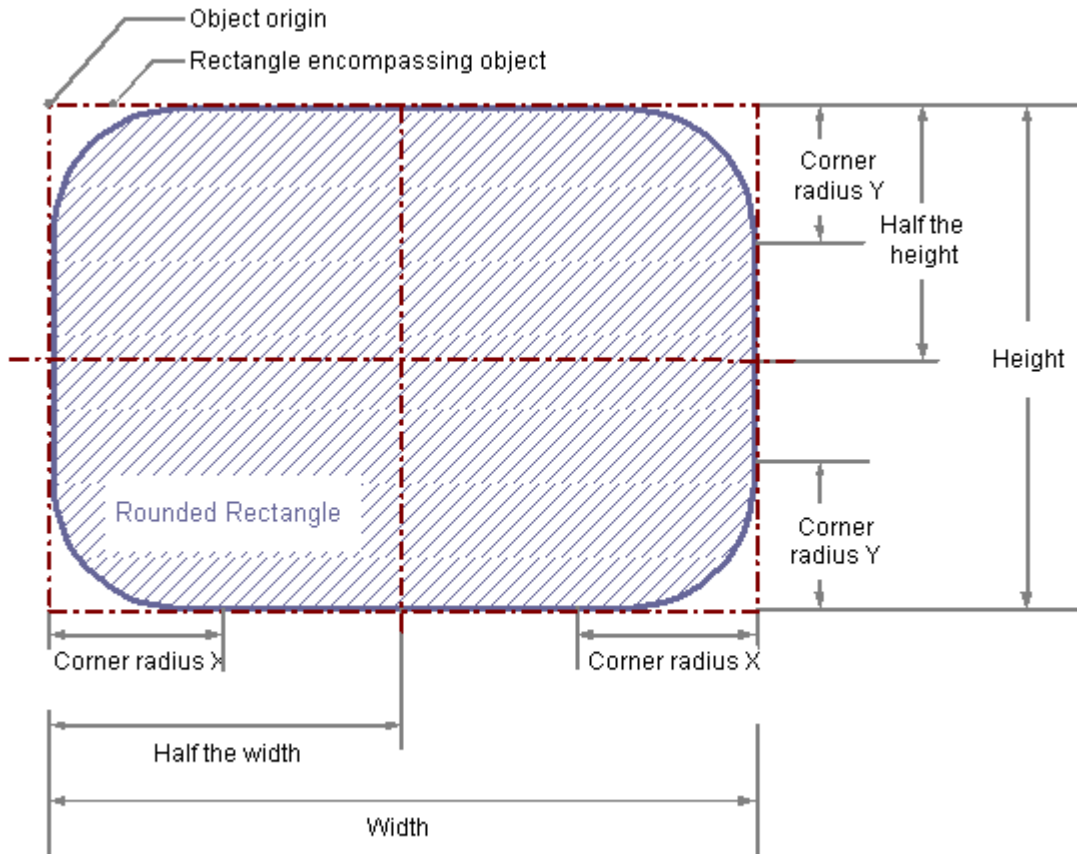

Requirements

The display of the object palette must be enabled.

Procedure

1. Open the layout in which you want to insert a rounded rectangle.
2. Click the "Rounded rectangle" standard object in the Object palette.

3. Place the mouse pointer at the position in the layout where you want to insert the rounded rectangle.
The mouse pointer changes into a crosshair with an object symbol attached.
4. Hold down the mouse button and drag the rounded rectangle to the size and direction you want.
When you release the mouse button, the rounded rectangle is finished.

Changing Rounded Rectangles with the Mouse

Rectangle surrounding the object

Drag the rectangle surrounding the object to a new position in order to arrange the object in the layout.
Drag the handles on the rectangle surrounding the object to a new position in order to resize the object.

Palettes and toolbars

Use elements of the Style Palette to change the display style for the object.

Changing Rounded Rectangles with Value Input

The display of objects can also be changed by entering new values in the attributes. You will find more information in the section entitled "Change Attribute".

Note

If the "corner radius X" and "corner radius Y" attributes are both set to the value of 100pt, 1cm or 1, depending on the units, the rounded rectangle will be displayed as an ellipse or circle. If both attributes have a value of 0, a normal rectangle without rounded corners will be displayed.

See also

[How to Change an Attribute \(Page 2181\)](#)

[The Properties of an Object \(Page 2175\)](#)

[Working with Standard Objects \(Page 2194\)](#)

[How to Paste an Object into a Layout \(Page 2167\)](#)

How to Insert Static Text

Introduction

The field for static text is a closed object that can be filled with a color or pattern. The static text is entered into a field of any desired size. The text can be entered on one or more lines.

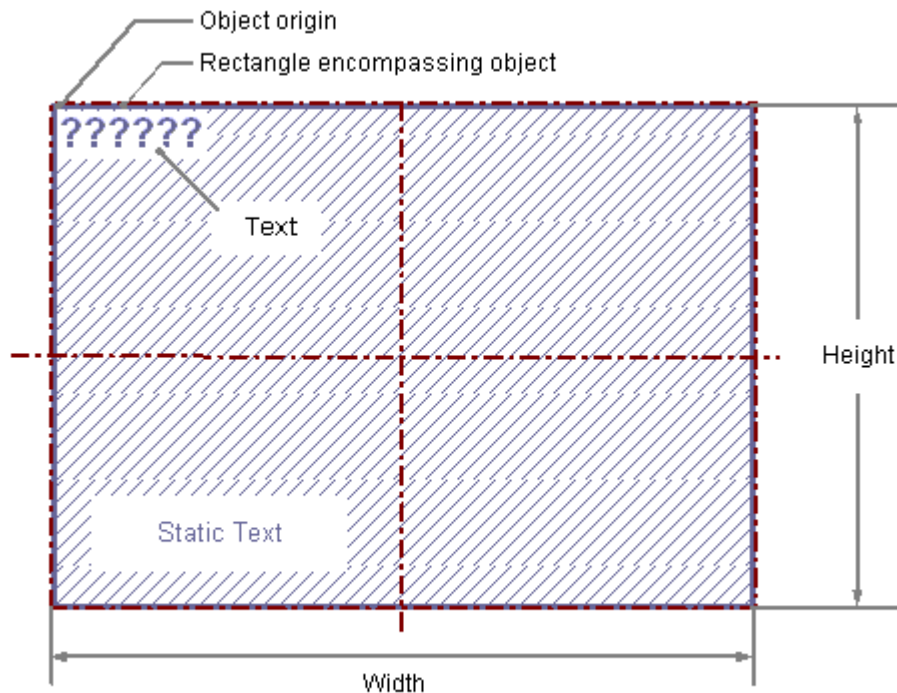

Requirements

The display of the object palette must be enabled.

Procedure

1. Open the layout in which you want to insert static text.
2. Click the "static text" standard object in the Object palette.
3. Place the mouse pointer at the position in the layout where you want to insert the static text. The mouse pointer changes into a crosshair with an object symbol attached.
4. Hold down the mouse button and drag the text field to the required size. The field for the static text is complete as soon as you release the mouse button. The word Text appears in the field.

5. Overwrite the Text with your own text.
For text on multiple lines, create a line break by pressing the ENTER key, the key combination SHIFT+ENTER or the key combination CTRL+M.
6. Clicking outside the object ends the text input.

Changing the Contents of the Static Text

Double-click the static text to open the input mode for text. The complete text is selected. Position the insertion point with another click at the position in the text at which you want to change something. For text on multiple lines, create a line break by pressing the Enter key, the key combination "Shift"+"Enter" or the key combination "Ctrl"+"M".

Changing Static Text with the Mouse

Rectangle surrounding the object

Drag the rectangle surrounding the object to a new position in order to arrange the object in the layout.

Drag the handles on the rectangle surrounding the object to a new position in order to resize the object.

Palettes and toolbars

Use elements of the Style Palette to change the display style for the object.

Changing Static Text with Value Input

The display of objects can also be changed by entering new values in the attributes. You will find more information in the section entitled "Change Attribute".

Note

In the "Font" property, "Text" attribute a line break will be displayed as a control character in the "Static" column. If the text is edited using the dialog for the "Text" attribute, no line breaks can be added.

See also

[How to Change an Attribute \(Page 2181\)](#)

[The Properties of an Object \(Page 2175\)](#)

[Working with Standard Objects \(Page 2194\)](#)

[How to Paste an Object into a Layout \(Page 2167\)](#)

How to Insert an OLE Object

Introduction

The OLE object enables you to insert files created with other programs into a layout. Therefore all OLE elements registered in the Windows operating system can be integrated. The size and properties taken on by an OLE object in runtime are defined in the page layout editor. No changes can be made to OLE elements in runtime.

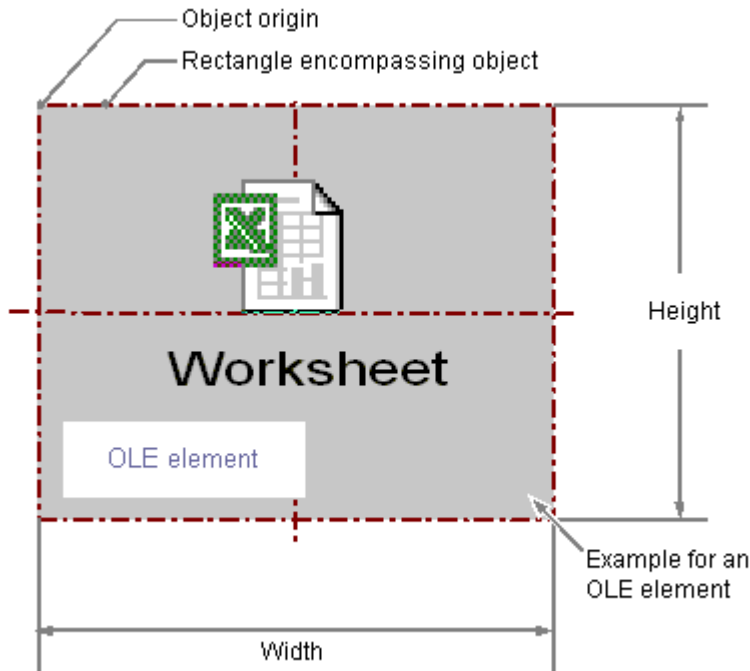

Requirements

- The display of the object palette must be enabled.
- The file type you wish to use must be registered in the Windows operating system.

Insert the OLE object, option "Create from file".

With the option "Create from file", an already existing file is chosen for display in the selected OLE object. The selected file is edited in the OLE object with the program that is registered for editing the selected file type in the Windows operating system.



1. Open the layout in which you want to paste an OLE object, and click the standard object "OLE object" in the Object palette.
2. Place the mouse pointer at the position in the layout where you want to insert the OLE object. The mouse pointer changes into a crosshair with an object symbol attached.
3. Drag the OLE object to the desired size. The "Insert Object" dialog is opened.
4. Select option Create from File. In the "Paste object" dialog, an input field, the "Browse..." button and the "Link" check box are displayed.
5. Enter the directory path and the name of the desired file into the input field. Or click on the "Browse..." button to select the file with the "Browse" dialog.
6. Mark the "Link" check box if the selected file should not be copied to the OLE object, but rather should only be used as a reference.
7. Mark the "As icon" check box if only an icon for the associated file type should be displayed and not the contents of the selected file.
8. Confirm your entry with "OK". The insertion process for the OLE object is finished.

Inserting the OLE object, "Create new" option.

The "Create new" option selects a file type for a new file that is created in the selected OLE object. During editing, the file in the OLE object is edited with the program registered in the Windows operating system for editing the selected file type.

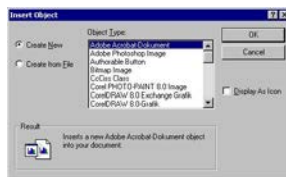

1. Open the layout where you want to paste an OLE object, and click on the "OLE object" in the Object palette.
2. Place the mouse pointer at the position in the layout where you want to insert the OLE object. The mouse pointer changes into a crosshair with an object symbol attached.
3. Drag the OLE object to the desired size. The "Insert Object" dialog is opened.
4. Select the option Create New. The Insert Object dialog, a list of all file types registered in the Windows operating system is displayed.
5. Select the object type for the file that you want to create in the selected OLE object.
6. Mark the "As icon" check box if only an icon for the associated file type should be displayed and not the contents of the selected file.
7. Confirm your entry with "OK". The insertion process for the OLE object is finished.

8. Double-click the OLE object to edit the embedded file in the OLE object.
The program registered in the Windows operating system for editing the associated file type opens in the page layout editor.
9. Finish editing the embedded file by deselecting the OLE object.
The changes are accepted.

Changing OLE Objects with the Mouse

Rectangle surrounding the object

Drag the rectangle surrounding the object to a new position in order to arrange the object in the layout.

Drag the handles on the rectangle surrounding the object to a new position in order to resize the object.

Palettes and toolbars

Use elements of the Style Palette to change the display style for the object.

Changing OLE Objects with Value Input

The display of objects can also be changed by entering new values in the attributes. You will find more information in the section entitled "Change Attribute".

See also

[How to Change an Attribute \(Page 2181\)](#)

[The Properties of an Object \(Page 2175\)](#)

[Working with Standard Objects \(Page 2194\)](#)

[How to Paste an Object into a Layout \(Page 2167\)](#)

How to Insert a Static Metafile

Introduction

The static metafile field is a closed object that can be filled with a color or pattern. A graphic file of any size is entered into the field.

Requirements

- The display of the object palette must be enabled.
- The graphic file must be in the *.emf format.

Procedure

1. Open the layout in which you want to insert a static metafile.
2. Click the "Static Metafile" standard object in the object palette.
3. Place the mouse pointer at the position in the layout where you want to insert the static metafile.
The mouse pointer changes into a crosshair with an object symbol attached.
4. Hold down the mouse button and drag the object to the size and direction you want.
When you release the mouse button, the static metafile is finished.
5. Double-click the "Metafile Name" attribute in the "Miscellaneous" property group of the "Object Properties" window in order to enter the name of the graphic file.
6. A file dialog opens in which you can select the graphic file you want in the *.emf format.
7. Confirm the selected file with the "Open" button. The selected graphic file will be inserted in the object.

Changing Static Metafiles with the Mouse

Rectangle surrounding the object

Drag the rectangle surrounding the object to a new position in order to arrange the object in the layout.

Drag the handles on the rectangle surrounding the object to a new position in order to resize the object.

Palettes and toolbars

Use elements of the Style Palette to change the display style for the object.

Changing Static Metafiles with Value Input

The display of objects can also be changed by entering new values in the attributes. You will find more information in the section entitled "Change Attribute".

See also

How to Change an Attribute (Page 2181)

The Properties of an Object (Page 2175)

Working with Standard Objects (Page 2194)

How to Paste an Object into a Layout (Page 2167)

10.5.8.3 Working with Dynamic Standard Objects

Working with Dynamic Standard Objects

Introduction

In this chapter you will learn details about the dynamic standard objects available in the page layout editor. You will learn how to work with the objects, and what are the basic conditions for each object.

Usage

With dynamic standard objects you link to tags, databases and screen contents that you wish to output in a log. You can only paste dynamic standard objects in the dynamic part of a page layout.

See also

[How to Transfer Object Properties \(Page 2182\)](#)

[How to Change an Attribute \(Page 2181\)](#)

[The Rectangle Surrounding the Object \(Page 2166\)](#)

[The Properties of an Object \(Page 2175\)](#)

[How to Paste an Object into a Layout \(Page 2167\)](#)

[Overview of the Dynamic Objects \(Page 2130\)](#)

Working with Embedded Layouts

Introduction

With the "Embedded layout" dynamic object you can embed one layout in another and output both of them together. However, the layouts cannot be nested in just any fashion. A maximum of one layer of embedded layouts can be used. An embedded layout within an embedded layout is not permitted. If dynamic objects are used in an embedded layout, these also cannot be mixed in just any fashion. The following illustrations will clarify the options for using embedded layouts.

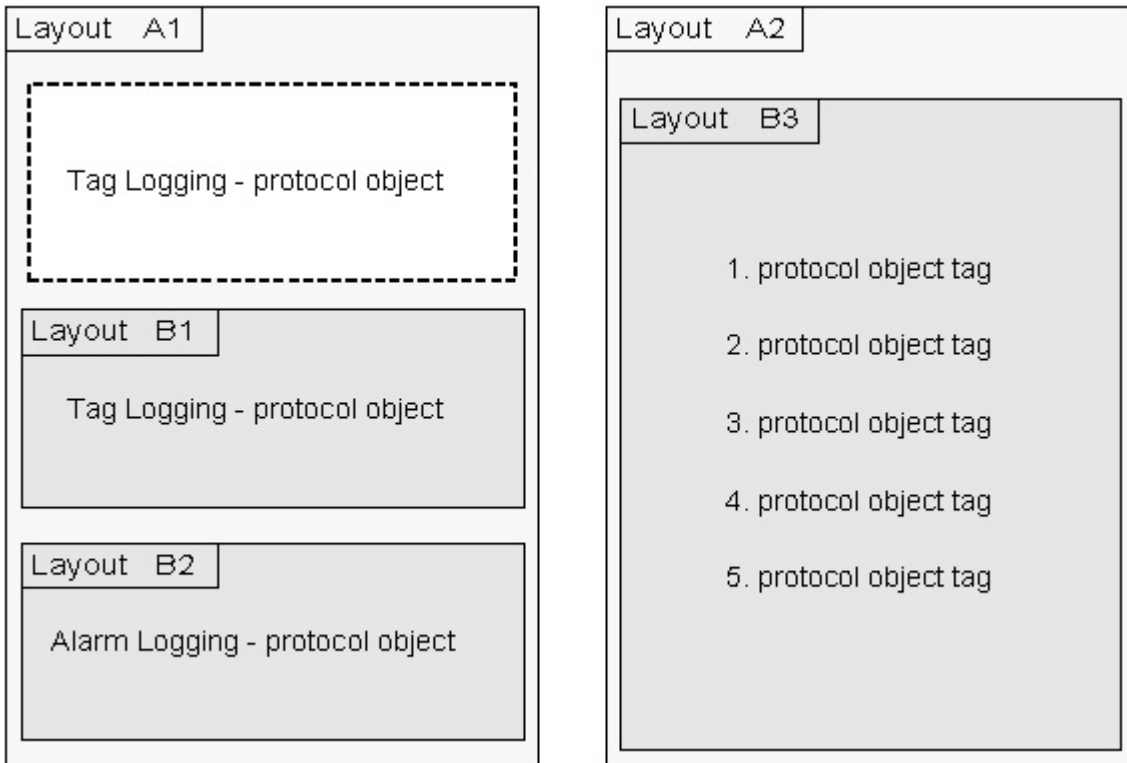

Possible combinations: Layouts B1, B2 and a log object are directly embedded in Layout A1. An embedded layout with several log objects of the same type is embedded in layout A2.

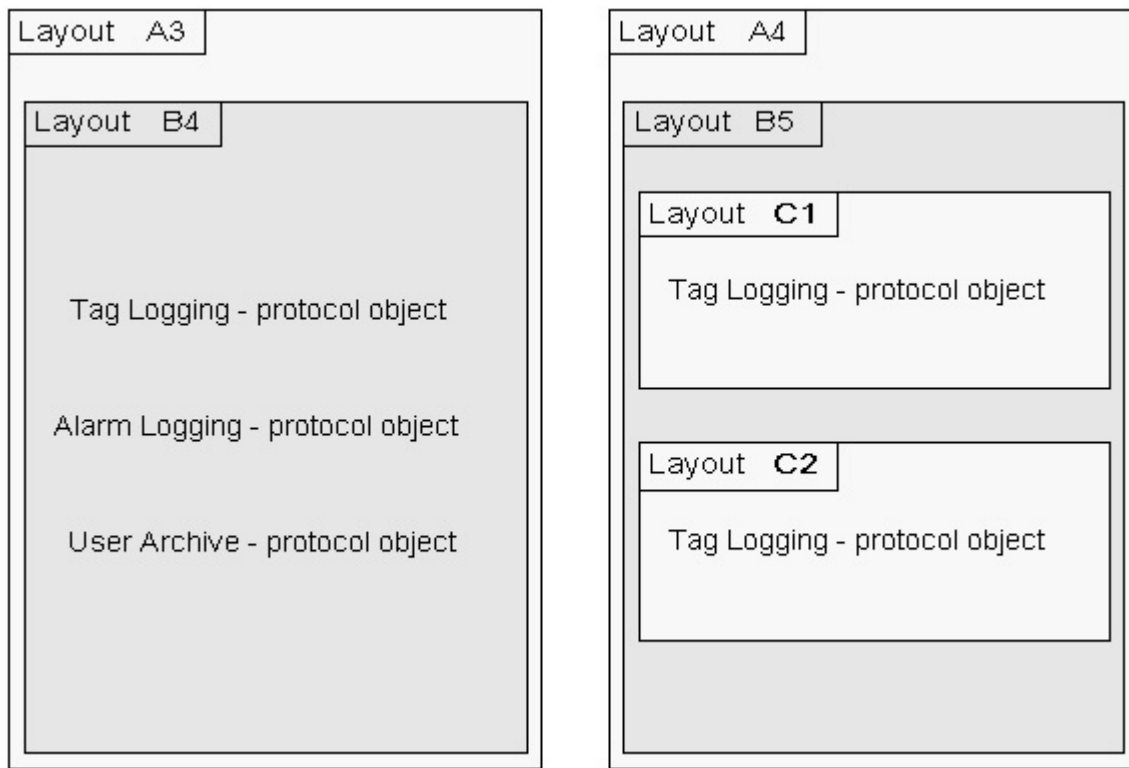

Non-permitted combinations: The embedded layout B4 contains several dynamic tables of different WinCC components. In layout A4 the nesting depth is too large.

Purpose

The functionality of the "Embedded layout" object is used, for example, with the project documentation of pictures from the Graphics Designer. The configuration data of all pictures in a WinCC project are output with the "@PdIPic" layout in this way. The data are output in blocks for every picture. The output thus occurs in this form:

Picture 1

- output of all data for picture 1

Picture 2

- output of all data for picture 2

Picture n

- output of all data for picture n

If the objects for the project documentation are pasted from the object palette one after the other into a layout, then the data of the current object will be collected and output. The output then occurs in this form:

Object 1

- output of object data for picture 1, picture 2, picture n

Object 2

- output of object data for picture 1, picture 2, picture n

Object n

- output of object data for picture 1, picture 2, picture n

For the runtime configuration, the necessary log objects can be filed in a structure. Thus for example, additional information you want can be configured in a separate layout and output as an embedded layout.

Example:

The output of a tag logging - variable curve is configured in a page layout. Several report objects of the "Tag" type, which are to be output in the log for the current measured values of the curve, are configured in a layout to be embedded. Additionally, a WinCC tag will be configured which forms a mean value via a script. The mean value will likewise be output with the "Tag" log object.

Applications

Print job	Layout used	Function
@Documentation Graphics Designer Dynamics	@PDLPicDyn	Nested layout for outputting the dynamization data of a Graphics Designer picture.
@Documentation Graphics Designer	@PDLPic	Nested layout for outputting the general display, statistics data, objects in the picture, picture attributes, actions on the picture, direct connections to the picture, object statistics, attributes of the objects, actions on the objects, and direct connections to objects. The data is output on a separate page for each picture.
@Documentation Global Script Project Function	@GSC_RPFC	Nested layout for outputting the information and source text of the project functions. Output is started in WinCC Explorer.
@Documentation Global Script Standard Function	@GSC_SFC	Layout for outputting information and the source text for a standard function open in the Global Script editor.

How to Change the Output Options for the Hardcopy Object

Introduction

With the "Hardcopy" object type, you can paste a shot of the current screen contents, a portion thereof, or a currently selected picture window in the dynamic part of a page layout.

Requirements

- The hardcopy object is already pasted into the layout
- The inserted object has been selected.
- The "Object properties" window is open
- You are familiar with the Link tab.

Procedure

1. Select "Area selection" from the "Name" column in the right area of the Link tab. Clicking on the "Edit..." button opens the "Area selection" dialog.

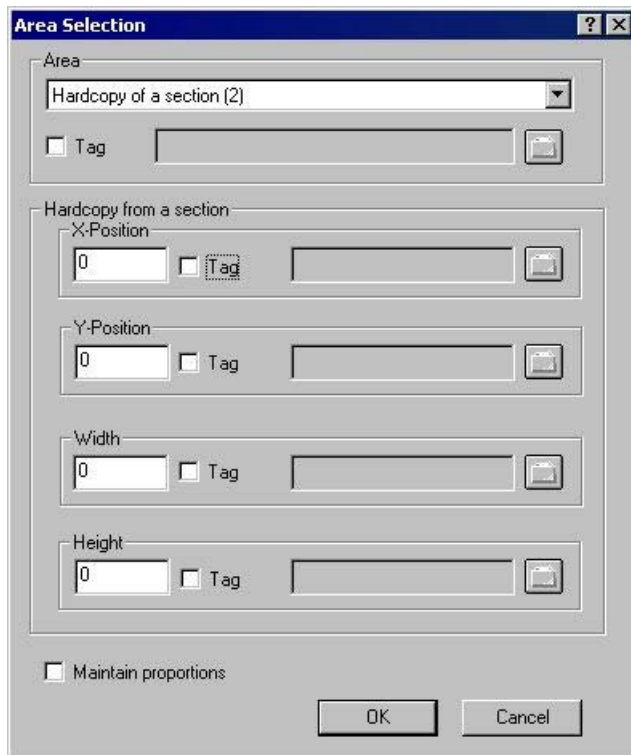

2. From the selection list, choose the area from which you want to prepare a hard copy for the report.
3. The configured area is static. You can, however, link a WinCC tag in order to change the area to dynamic in runtime. The report system reads the value from the variable at runtime. If the variable cannot be read, the configured value is used.
The WinCC tag must be of the Number type. The numbers have the following significance:
0 – Hard copy of the entire screen
1 – Hard copy of the current window
2 – Hard copy of a section
4. If you have selected "Hardcopy of a section", you must enter the X and Y positions of the upper left corner of the area in the lower part of the dialog, as well as set the width and height of the section in pixels.
5. The numeric values for setting the section can also be dynamized using WinCC tags. The WinCC tags must be of the number type. The report system reads the value from the variable at runtime. If the variable cannot be read, the configured value is used.
6. If you want to maintain the proportions of the screen contents during printing, select the appropriate check box.

Dynamizing with WinCC tags

In order to dynamize parameters for output, the necessary tags must be set in the WinCC tag management. WinCC tags can be provided with new values in runtime. You can find further information on this subject in the section "Changing output options online".

Changing Hardcopy Objects with the Mouse

Rectangle surrounding the object

Drag the rectangle surrounding the object to a new position in order to arrange the object in the layout.

Drag the handles on the rectangle surrounding the object to a new position in order to resize the object.

Palettes and toolbars

Use elements of the Style Palette to change the display style for the object.

Changing Hardcopy Objects by Value Input

The display of objects can also be changed by entering new values in the attributes. You will find more information in the section entitled "Change Attribute".

See also

[How to Transfer Object Properties \(Page 2182\)](#)

[How to Change an Attribute \(Page 2181\)](#)

[The Properties of an Object \(Page 2175\)](#)

[The Link tab in the Object Properties Window \(Page 2180\)](#)

[Working with Dynamic Standard Objects \(Page 2224\)](#)

[How to Paste an Object into a Layout \(Page 2167\)](#)

How to Change the Output Options for the ODBC Database Field

Introduction

With the "ODBC database field" object, you can paste the contents of a database field as text in the dynamic part of a page layout via the ODBC interface. If the content of the database field concerns a text object, only the first value of the first line will be returned, independent of the size of the volume of results.

Requirements

- The "ODBC database field" object is already pasted into the layout
- The inserted object has been selected.
- The "Object properties" window is open
- You are familiar with the Link tab.
- A valid ODBC data source exists and is registered
- Knowledge of ODBC and SQL

Procedure

1. Select "Database link" from the "Name" column in the right area of the Link tab. Click the "Edit..." button to open a configuration dialog.

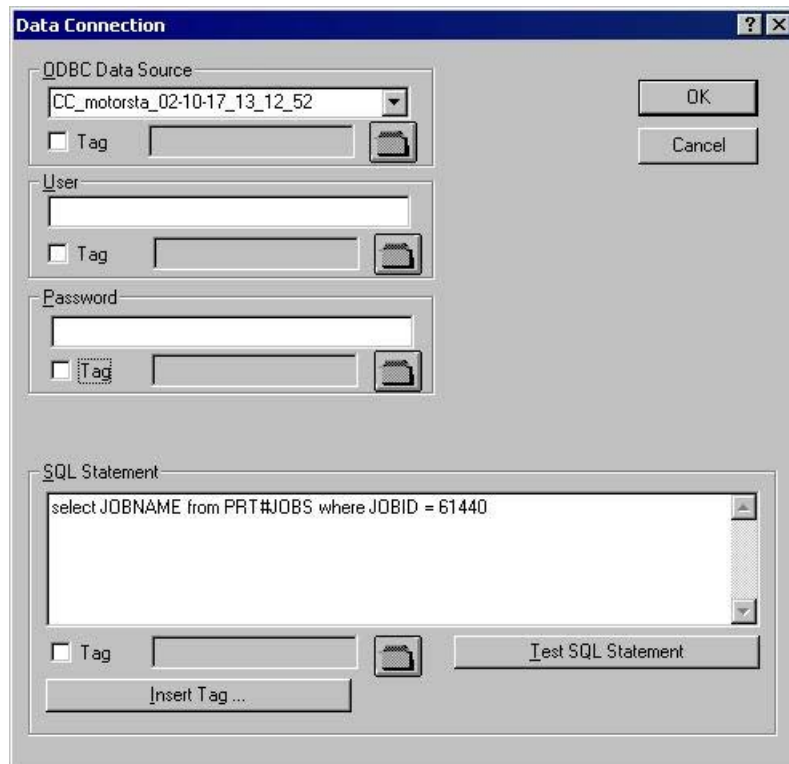

2. Use the selection list in the "ODBC data source" area to select the desired data source. All registered ODBC data sources are available for selection. The project creator is responsible for the registration and validity of the data sources.
3. If the data source has any database-specific access limitations, enter the necessary information in the fields for the user and password.
4. The selection of the data for output takes place using an SQL statement. Enter the required statement in the SQL statement area. Using the "Insert tag..." button, you can insert a tag into the SQL statement in order to complete it at runtime.
5. You can check your entries by using the "Test SQL statement" button. The project must be activated for the check when using WinCC tags.
6. Confirm your entries by clicking "OK". The dialog closes.
7. Save the layout.

Dynamizing with WinCC tags

All the tasks in this dialog can also be dynamized with WinCC tags. To do so, activate the "Tag" checkbox in the "Data connection" dialog and select a tag form the tag selection dialog using the folder button. If you know the tag name, you can enter it directly instead. The tags must all be of the "Text" type.

In order to dynamize parameters for output, the necessary tags must be set in the WinCC tag management. WinCC tags can be provided with new values in runtime. You can find further information on this subject in the section "Types of dynamization".

NOTICE

The SQL statements are not subject to any constraints. If you do the wrong thing, it is possible to destroy or delete the data source.
--

Changing the ODBC database field with the mouse

Rectangle surrounding the object

Drag the rectangle surrounding the object to a new position in order to arrange the object in the layout.

Drag the handles on the rectangle surrounding the object to a new position in order to resize the object.

Palettes and toolbars

Use elements of the Style Palette to change the display style for the object.

Changing the ODBC database field by entering values

The display of objects can also be changed by entering new values in the attributes. You will find more information in the section entitled "Change Attribute".

See also

[How to Paste an Object into a Layout \(Page 2167\)](#)

[How to Transfer Object Properties \(Page 2182\)](#)

[How to Change an Attribute \(Page 2181\)](#)

[The Properties of an Object \(Page 2175\)](#)

[The Link tab in the Object Properties Window \(Page 2180\)](#)

[Working with Dynamic Standard Objects \(Page 2224\)](#)

How to Change the Output Options for the ODBC Database Table

Introduction

With the "ODBC database table" object, you can paste the contents of a database table as text in the dynamic part of a page layout via the ODBC interface.

Requirements

- The "ODBC database table" object is already pasted into the layout
- The inserted object has been selected.
- The "Object properties" window is open
- You are familiar with the Link tab.
- A valid ODBC data source exists and is registered
- Knowledge of ODBC and SQL

Procedure

1. Select "Database link" from the "Name" column in the right area of the Link tab. Click the "Edit..." button to open a configuration dialog.

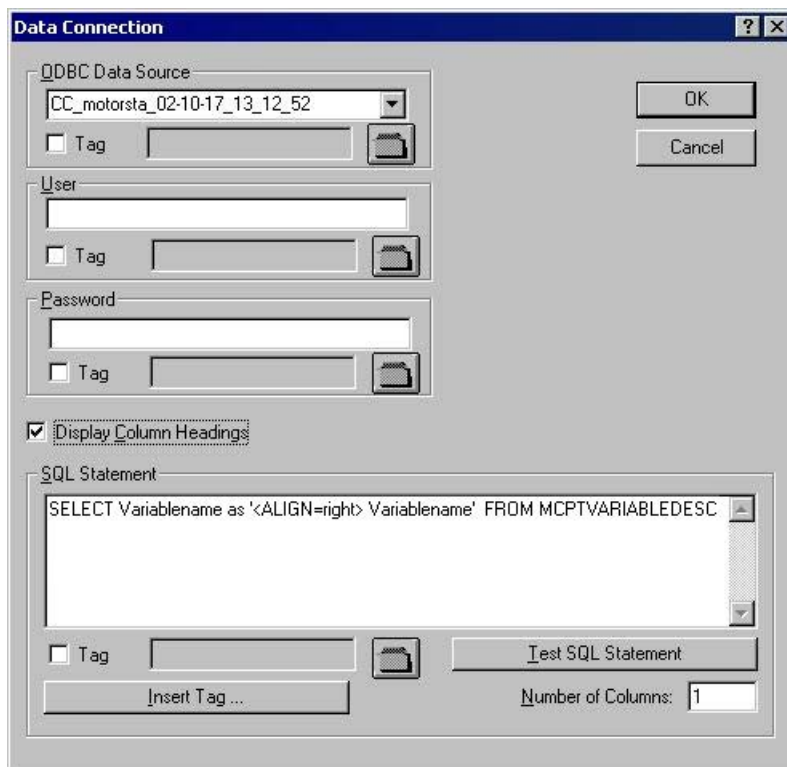

2. Use the selection list in the "ODBC data source" area to select the desired data source. All registered ODBC data sources are available for selection. The project creator is responsible for the registration and validity of the data sources.
3. If the data source has any access limitations, enter the necessary information in the fields for the user and password.
4. The selection of the data for output takes place using an SQL statement. Enter the required statement in the SQL statement area. The example refers to the MCPTVARIABLEDESC table from the WinCC database. Using the "Insert tag..." button, you can insert a tag into the SQL statement in order to complete it at runtime.

5. You can check your entries by using the "Test SQL statement" button. If the test is successful, then the number of columns found in the "Number of columns" field will be applied. The project must be activated for the check when using WinCC tags.
6. If the column headings are to be output, then confirm this by marking the accompanying check box. Confirm your entries by clicking "OK". The dialog is closed.
7. Save the layout.

Dynamizing with WinCC tags

All the tasks in this dialog can also be dynamized with WinCC tags. To do so, activate the "Tag" checkbox in the "Data connection" dialog and select a tag from the tag selection dialog using the folder button. If you know the tag name, you can enter it directly instead. The tags must all be of the "Text" type.

In order to dynamize parameters for output, the necessary tags must be set in the WinCC tag management. WinCC tags can be provided with new values in runtime. You can find further information on this subject in the section "Types of dynamization".

Formatting the table output

You can format the table output by including the formatting instructions in the SQL statement with the help of control characters. The formatting is as follows for the example of the text alignment in the table:

Format statement	Representation
SELECT tag name FROM MCPTVARIABLEDESC	aligns by default the column text to the left
SELECT tag name as '<ALIGN=right> tag name ' FROM MCPTVARIABLEDESC	aligns the column text including column title to the right
SELECT '<ALIGN=right>' + tag name as Name' FROM MCPTVARIABLEDESC	aligns the column title towards the left and the column text to the right
SELECT '<ALIGN=left>' + tag name as '<ALIGN=center> Name' FROM MCPTVARIABLEDESC	aligns the column title in the center and the column text to the left

Control Characters for Table Output

<END>	If the interpretation of control sequences is done, the rest of the text will be transferred as it is given.
<COLOR=#rrggbb>	Font color in hexadecimal notation (default = as set for the table)
<BGCOLOR=#rrggbb>	Background color in hexadecimal notation (default = as set for the table)
	Bold
<U>	Underlined
<I>	Italic
<STRIKE>	Strike-through
<ALIGN=left>	Left aligned
<ALIGN=center>	Centered
<ALIGN=right>	Right aligned

NOTICE

The SQL statements are not subject to any constraints. If you do the wrong thing, it is possible to destroy or delete the data source.

Change Column Width

The width of the columns for output can be set individually for every column.

1. Enable the properties tab in the "Object properties" window.
2. In the "Geometry" property group double-click the "Columns" attribute to open the "Table columns" dialog.

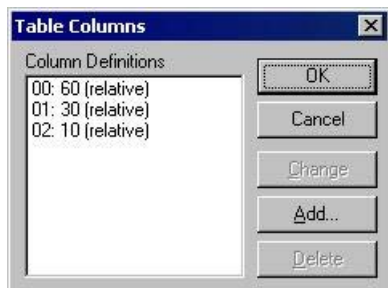

3. Use the dialog to define the column width of the individual columns. The widths of the columns can be changed relative to one another. Every column will receive its assigned share of the total width.
4. Confirm your entries with "OK".

Changing ODBC Database Tables with the Mouse

Rectangle surrounding the object

Drag the rectangle surrounding the object to a new position in order to arrange the object in the layout.

Drag the handles on the rectangle surrounding the object to a new position in order to resize the object.

Palettes and toolbars

Use elements of the Style Palette to change the display style for the object.

Changing the ODBC Database Table by Value Input

The display of objects can also be changed by entering new values in the attributes. You will find more information in the section entitled "Change Attribute".

See also

- How to Change an Attribute (Page 2181)
- How to Transfer Object Properties (Page 2182)
- The Properties of an Object (Page 2175)
- The Link tab in the Object Properties Window (Page 2180)
- Working with Dynamic Standard Objects (Page 2224)
- How to Paste an Object into a Layout (Page 2167)

Working with the Tag Object

Introduction

With the "Tag" dynamic object, you can output the tag value or the return value of a C action during reporting in runtime.

Procedure

1. Open the layout in which you want to insert a "Tag" object.
2. In the object palette, click the standard object "Tag".
3. Place the mouse pointer at the position in the layout where you want to insert a tag. The tag selection dialog is displayed.
4. Select the tag you want from the list of WinCC tags and confirm your selection with the "OK" button. The "Output Value" attribute now contains this tag.

Linking a Script

Using the "Calculation" attribute in the "Miscellaneous" object property, you can call a script for the output. Then a tag must not be selected.

1. If no script has been specified, then the "Create a New Script" option field is enabled. After confirmation of this dialog, the "Edit Action" dialog opens. In this dialog you can formulate an action in the high-level language ANSI-C.
2. Set the data type for the return value in the "Return Value" field. You can only set the data type while creating the script; it is not possible to change it later. The following data types are available for selection: "long", "double" and "char".
3. If a script has already been specified, then you can edit this script by selecting the option "Edit an Existing Script".
4. Select the option "Delete an Existing Script" to delete the specified script without a query when the dialog is confirmed.

Note

Setting the script compilation language

The C compiler does not support Unicode. Use the toolbar to set the language for compilation of the respective script.

Setting the Output Format

You can set the display of the output value with the "Output Format" attribute. The display depends on the data type.

Data type	Format	Description
Binary	1	Every "1" stands for a character of the output value. A preceding "0" indicates that a leading zero (corresponding to the number position) will be added if necessary.
String	*	The existing string is output
String	?	n characters are output, starting from the left.
Hexadecimal	f	Every "f" stands for a character of the output value. A preceding "0" indicates that a leading zero (corresponding to the number position) will be added if necessary.
Decimal	s	the sign will be output
Decimal	e	Exponent display
Decimal	9	digit between 0 and 9
Decimal	0	Leading zero will be output
Decimal	.	Decimal point

Example for the Output

The example shows the different output formats for the output of the value 1.0 of the "Decimal" data type.

Output format	Display
9.9	1.0
s9.9	+1.0
s9.99e	+1.0e+000
099.99	01.00

Changing "Tag" Objects with the Mouse

Rectangle surrounding the object

Drag the rectangle enclosing the object to a new position to arrange the object in the layout. Drag the handles on the rectangle enclosing the object to a new position to resize the object.

Palettes and toolbars

Use elements of the Style Palette to change the display style for the object.

Changing "Tag" objects by Value Input

The display of objects can also be changed by entering new values in the attributes. You will find more information in the section entitled "Change Attribute".

See also

Working with Dynamic Standard Objects (Page 2224)

How to Transfer Object Properties (Page 2182)

How to Change an Attribute (Page 2181)

The Properties of an Object (Page 2175)

How to Paste an Object into a Layout (Page 2167)

10.5.8.4 Working with System Objects

Introduction

The following system objects can be output in a report:

- date and time
- Page number
- Project name
- Layout name

You can only paste system objects into the static part of a page layout.

Requirements

The display of the object palette must be enabled.

Procedure

1. Open the layout in which you want to paste a system object.
2. Select "Static Part" from the "View" menu.
3. Click the system object you want in the "Standard Objects" tab in the object palette.
4. Place the mouse pointer at the position in the layout where
5. Hold down the mouse button and drag the object to the size and direction you want. When you release the mouse button, the system object is finished.

Format Options

You can set the display of the output value with the following format options. The representation is dependent on the data format. If no format is set, a predefined format will be used for all system objects during the report output. Please note that the specification of the parameters is case-sensitive.

System object	Format	Description
Layout name	%L or %l	the layout name
Project name	%R or %r	the project name
Page number	%N or %n	the current page number
Page number	%T or %t	the total page count
Date/Time	%a	Weekday, short form
Date/time	%A	Weekday, written out
Date/time	%b	Month, short form
Date/time	%B	Month, written out
Date/time	%c	Date and time in standard format
Date/time	%d	Day and month as decimal number (01-31)
Date/time	%H	Hours in 24 hour format (00-23)
Date/time	%I	Hours in 12 hour format (01-12)
Date/time	%j	Day of the year as a decimal number (000-366)
Date/time	%m	Month as decimal number (01-12)
Date/time	%M	Minute as decimal number (00-59)
Date/time	%p	P.M./A.M. code for 12-hour format
Date/time	%S	Seconds as decimal number(00-59)
Date/time	%U	Week of the year as decimal number (01-51)
Date/time	%x	Date in standard format
Date/time	%X	Time in standard format
Date/time	%y	Year without century as decimal number (00-99)
Date/time	%Y	Year with century as decimal number
Date/time	%z	Time zone as name
Date/time	%%	Percentage sign

Changing System Objects with the Mouse

Rectangle surrounding the object

Drag the rectangle surrounding the object to a new position in order to arrange the object in the layout.

Drag the handles on the rectangle surrounding the object to a new position in order to resize the object.

Palettes and toolbars

Use elements of the Style Palette to change the display style for the object.

Changing System Objects by Value Input

The display of objects can also be changed by entering new values in the attributes. You will find more information in the section entitled "Change Attribute".

See also

- How to Transfer Object Properties (Page 2182)
- How to Change an Attribute (Page 2181)
- The Properties of an Object (Page 2175)
- How to Paste an Object into a Layout (Page 2167)
- Overview of the System Objects (Page 2131)

10.5.8.5 Working with the Layout Object

Introduction

A layout opened in the page layout editor is treated as an object. The layout object has object properties and can be edited using the "Object Properties" dialog. However, the properties of the layout object cannot be transferred to another layout object using the eyedropper.

The layout object has the following property groups:

- Colors
- Geometry
- Miscellaneous

You can obtain further information in the descriptions of the individual property groups in chapter "Properties of an Object".

Requirements

A layout must be open in the page layout editor.

Procedure

1. Click with the mouse on any free space in the working area. Click the "Properties" button in the toolbar. The "Object Properties" dialog opens.
2. Click the Properties tab.
3. Select the property group you want from the left area. The available attributes are shown in the right area.
4. Edit the attributes you want.
5. Save your changes.

In principle, changes to the properties of a layout object effect the cover sheet, the report contents and the closing page.

The object name of the layout object is not displayed in the object selection of the "Object Properties" dialog. Therefore, the layout object cannot be selected in the "Object Properties" dialog using the object selection. If the "Object Properties" dialog is already open and fixed with the pin, then simply click any free area of the work area for selection.

See also

The Miscellaneous Property Group (Page 2191)

The Geometry Property Group (Page 2186)

The Colors Property Group (Page 2185)

10.5.9 Working with Objects for the Runtime Documentation

10.5.9.1 Working with Objects for the Runtime Documentation

Introduction

The following chapters provide details regarding the Page Layout Editor objects available for the runtime documentation.

Application

The runtime documentation objects are available for the output of runtime data in logs. The objects are linked with the pertinent WinCC applications and provide the output data in runtime. The objects for runtime documentation can only be inserted in the dynamic part of a page layout.

Configure only the basic properties of the layout for the "WinCC Control Runtime Printprovider" object. The report parameters for the output are determined by properties of the WinCC Control and cannot be assigned dynamic properties.

In addition to the basic properties, configure the static and dynamic report parameters of the layout for all other objects of the Runtime documentation. The objects provide dialogs for the selection of output data.

See also

How to Configure the Dynamic Parameters of WinCC Alarm Control (Page 2257)

How to Transfer Object Properties (Page 2182)

How to Change an Attribute (Page 2181)

The Rectangle Surrounding the Object (Page 2166)

The Properties of an Object (Page 2175)

The Link tab in the Object Properties Window (Page 2180)

How to Configure the Static Parameters of WinCC Online Table Control (Page 2241)

How to Configure the Dynamic Parameters of WinCC Online Table Control (Page 2244)
How to Configure the Static Parameters of WinCC Online Trend Control (Page 2246)
How to Configure the Dynamic Parameters of the WinCC Online Trend Control (Page 2249)
How to Configure the Static Parameters of WinCC Function Trend Control (Page 2251)
Configuring the dynamic parameters of the WinCC Function Trend Control (Page 2253)
How to Configure the Static Parameters of WinCC Alarm Control (Page 2255)
Objects for the Runtime Documentation (Page 2132)

10.5.9.2 Modify output options for WinCC Online Table Control

How to Configure the Static Parameters of WinCC Online Table Control

Introduction

The "WinCC Online Table Control/Table" report object is used to output process data from the associated Tag Logging Archives in a tabular format.

You can define static parameters for each column of the table and for some proper properties of Control.

Requirements

- The WinCC Online Table Control/Table object is pasted into the layout.
- The inserted object has been selected.
- The "Object properties" window is open
- Process value archives or compression archives are inserted
- Archive tags have been inserted

Procedure

1. In the "Link" tab of the "Object Properties" window, click the entry "Parameterization". The dialog with the Control properties is displayed.
2. Configure in the Columns tab the columns you want to output. Select an archive tag for each column.

3. Define the table properties in the General tab. Only the non-grayed options can be customized for report output.

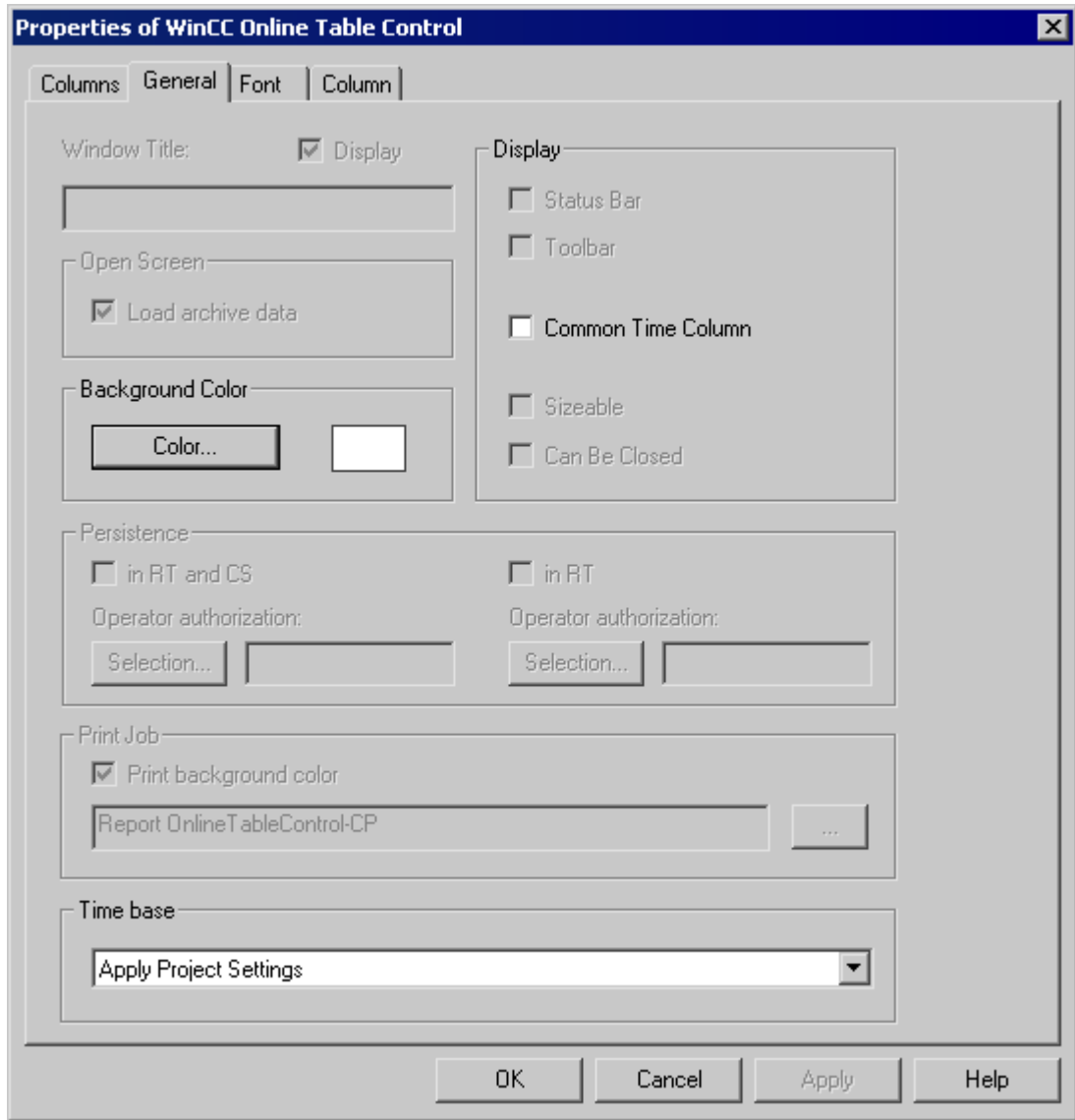

4. Configure the time range to be considered for each column in the Column tab.

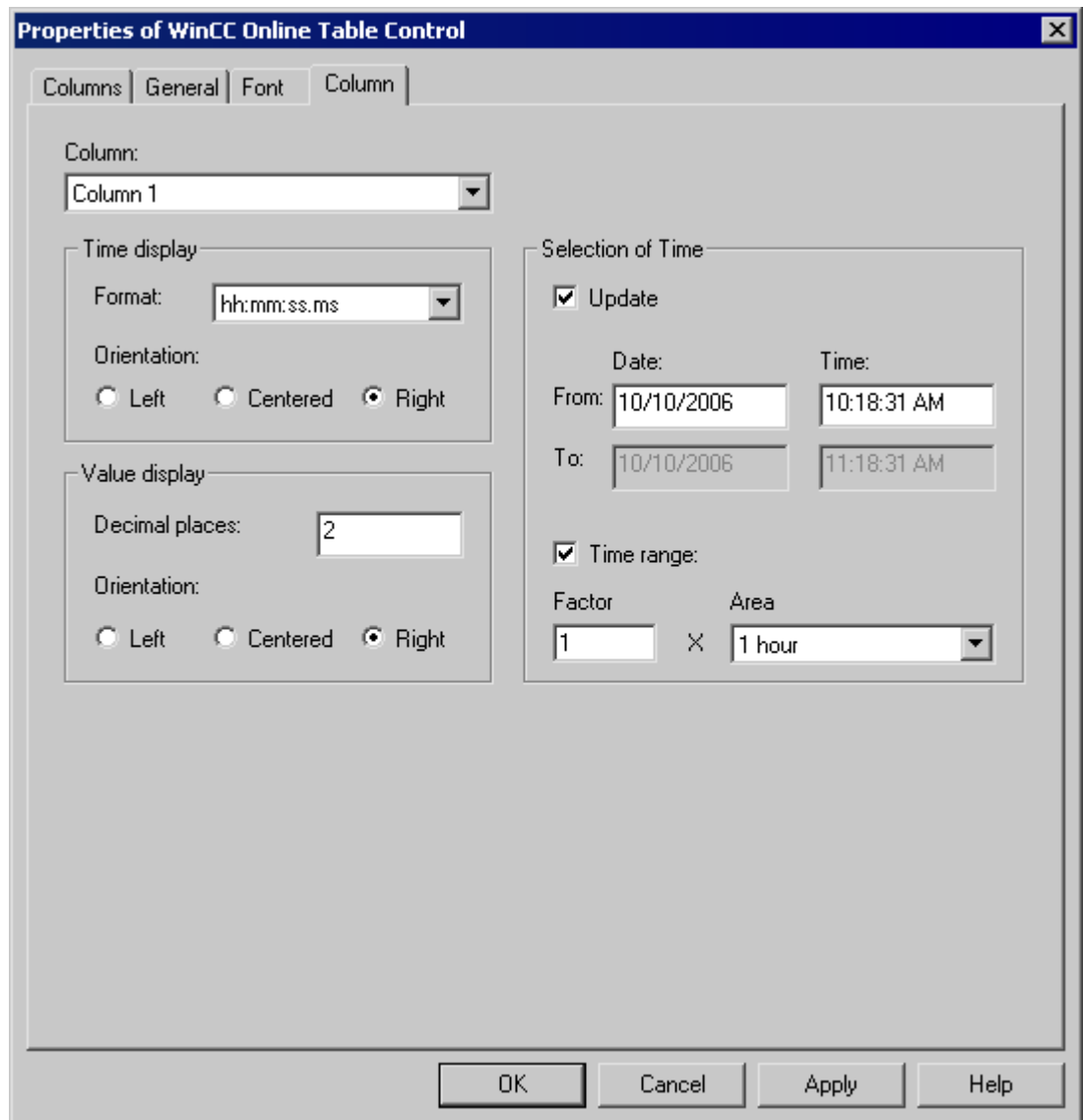

You can enter a start time and an end time or a start time with a time range. If the "Update" checkbox is activated, the start time refers to the current time. The previous values are then output in the defined time interval.

1. Configure the time and value display formats in the Column tab.

See also

How to Configure the Dynamic Parameters of WinCC Online Table Control (Page 2244)

How to Configure the Dynamic Parameters of WinCC Online Table Control

Introduction

The "WinCC Online Table Control/Table" report object is used to output process data from the associated Tag Logging Archives in a tabular format.

You can define dynamic parameters for each column of the table and for some properties of Control.

For a print order, the dynamizable parameters of WinCC Online Table Control are provided with the current values of the assigned WinCC tags during runtime.

Value are supplied to WinCC tag through scripts, process-controlled actions or via other WinCC applications. An overview of the dynamizable Runtime documentation parameters is included in chapter Dynamizable Parameters for Runtime Documentation.

Requirements

- The WinCC Online Table Control/Table object is pasted into the layout.
- The inserted object has been selected.
- The "Object properties" window is open
- Process value archives or compression archives are inserted
- Archive tags have been inserted
- You have inserted the columns for the output via the static parameters.

Procedure

1. In the "Link" tab of the "Object Properties" window, click the entry "Dynamized Parameterization". The dialog with the list of dynamizable properties opens.

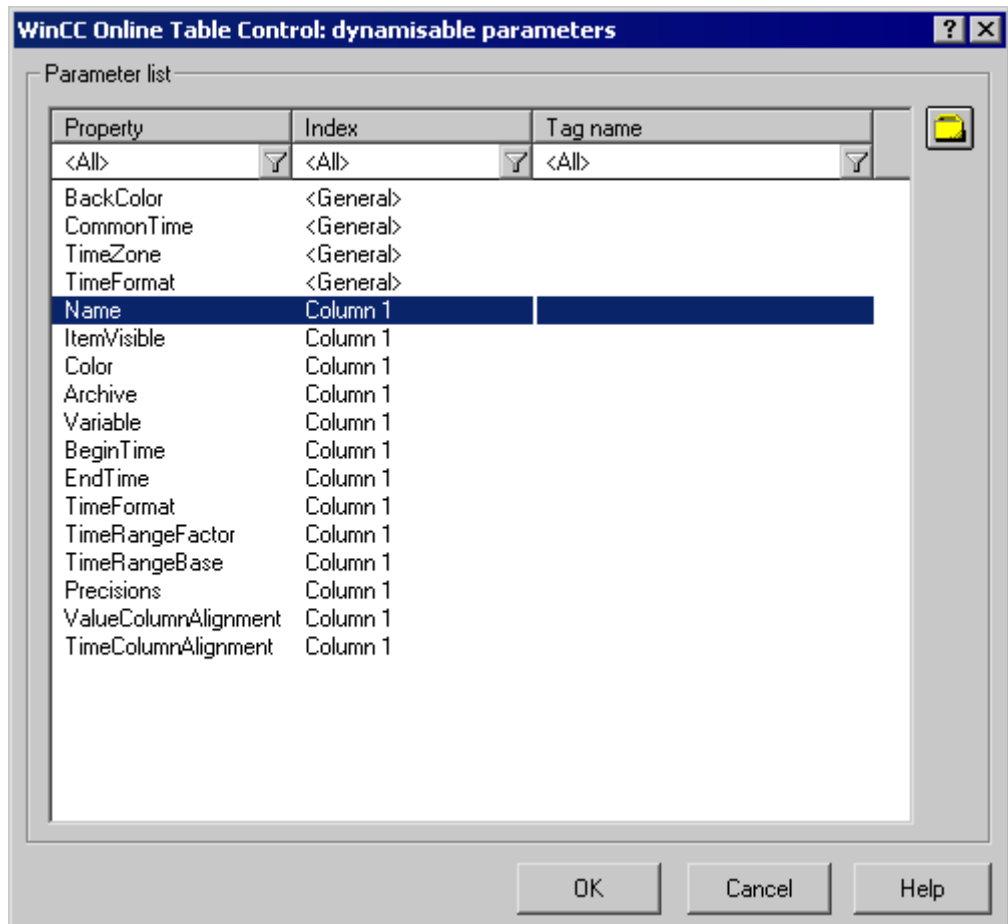

2. In the Parameter list, click the property you want to dynamize. When you click with the mouse the "?" icon, you will get the following information:
 - Description of the properties
 - Format of the properties
 - Suitable tag type
3. Click the tag selection symbol on the upper right side. The tag selection dialog is displayed.
4. Select the desired tag, or create a new tag. Edit the properties of the tag in the tag selection dialog. If necessary, specify a start value for the tag.
5. Apply the settings by clicking OK and save the layout.

See also

- How to Configure the Static Parameters of WinCC Online Table Control (Page 2241)
- Dynamizable Parameters for Runtime Documentation (Page 2077)

10.5.9.3 Modify output options for WinCC Online Trend Control

How to Configure the Static Parameters of WinCC Online Trend Control

Introduction

The "WinCC Online Trend Control/Picture" report object is used to output process data from the associated Tag Logging Archives in the form of a trend.

You can define static parameters for each trend and for some properties of Control.

Requirements

- The WinCC Online Trend Control/Picture object is pasted into the layout.
- The inserted object has been selected.
- The "Object properties" window is open
- Process value archives or compression archives are inserted
- Archive tags have been inserted

Procedure

1. In the "Link" tab of the "Object Properties" window, click the entry "Parameterization". The dialog with the Control properties is displayed.
2. Configure in the Columns tab the columns you want to output.
 - Select an archive tag for each trend
 - Define the display format for each trend
 - Define the display line weight for each trend

3. Define the Control properties in the General tab. Only the non-grayed options can be customized for report output.

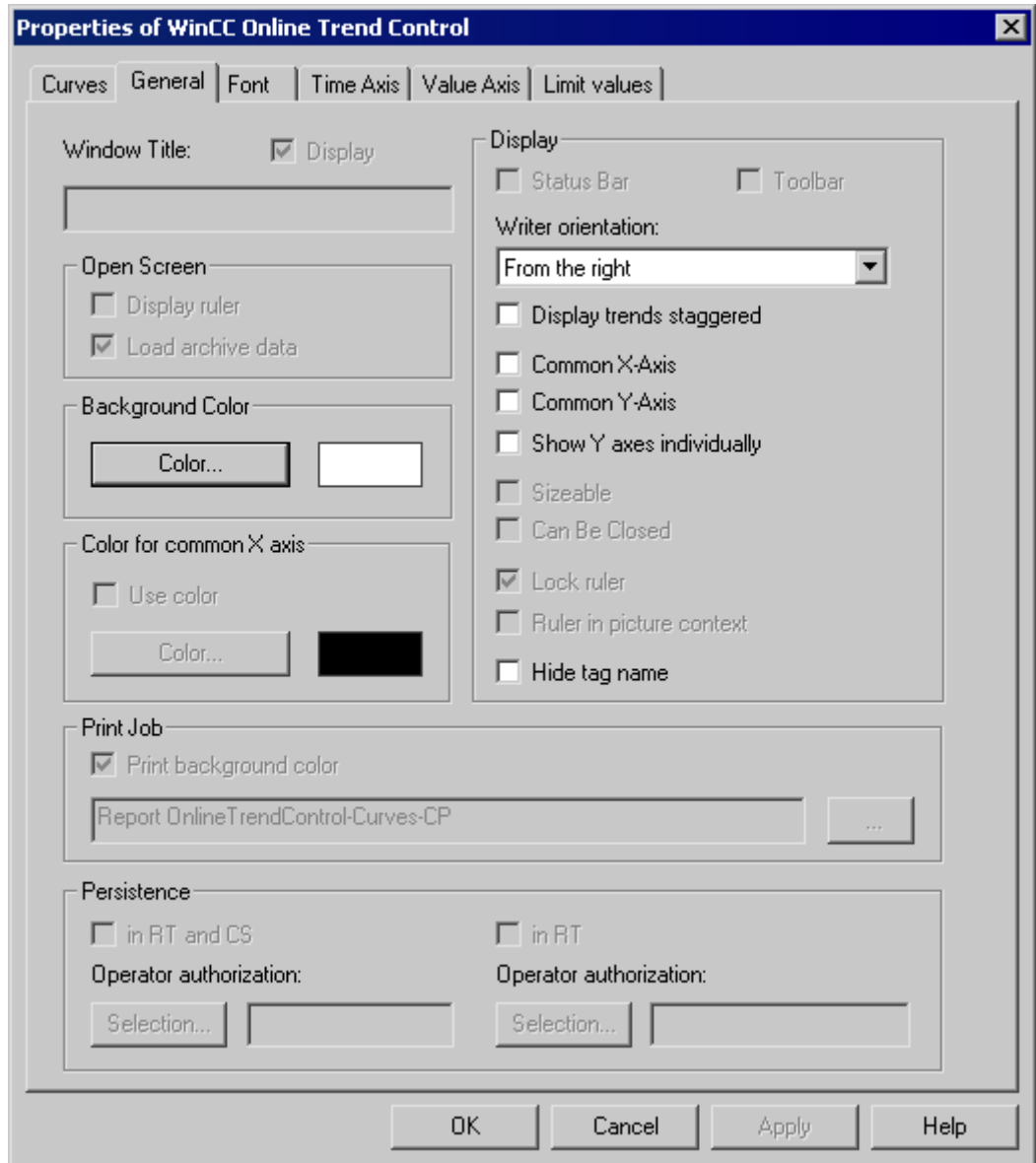

4. Configure the time range or measurement range for each trend in the "Time Axis" tab.

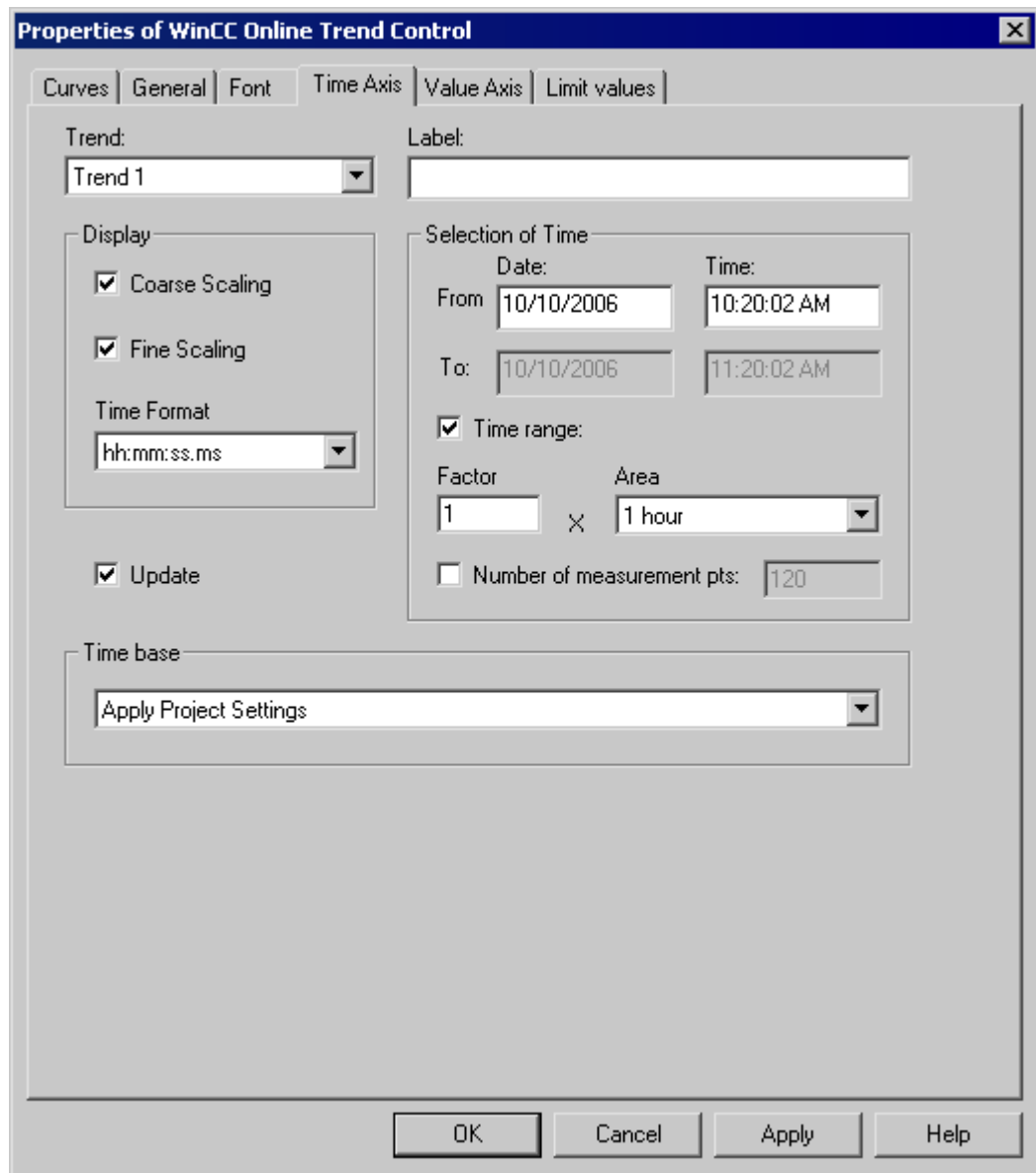

To output values for a time range, either define the start time or the end time or a start time with a time range. To output values for a measurement range define the start time and the number of measuring points.

If the "Update" checkbox is activated, the start time refers to the current time. The previous values are then output in the defined time interval or measurement range.

1. For each trend, configure the properties of the value axis in the Value Axis tab.

See also

How to Configure the Dynamic Parameters of the WinCC Online Trend Control (Page 2249)

How to Configure the Dynamic Parameters of the WinCC Online Trend Control

Introduction

The "WinCC Online Trend Control/Picture" report object is used to output process data from the associated Tag Logging Archives in the form of a trend.

You can define dynamic parameters for each trend and for some properties of Control.

For a print order, the dynamizable parameters of WinCC Online Trend Control are provided with the current values of the assigned WinCC tags during runtime.

Value are supplied to WinCC tag through scripts, process-controlled actions or via other WinCC applications. An overview of the Runtime documentation parameters that can be dynamized is included in chapter Dynamizable Parameters for Runtime Documentation.

Requirements

- The WinCC Online Trend Control/Picture object is pasted into the layout.
- The inserted object has been selected.
- The "Object properties" window is open
- Process value archives or compression archives are inserted
- Archive tags have been inserted
- You have inserted the trends for the output via the static parameters.

Procedure

1. In the "Link" tab of the "Object Properties" window, click the entry "Dynamized Parameterization". The dialog with the list of dynamizable properties opens.

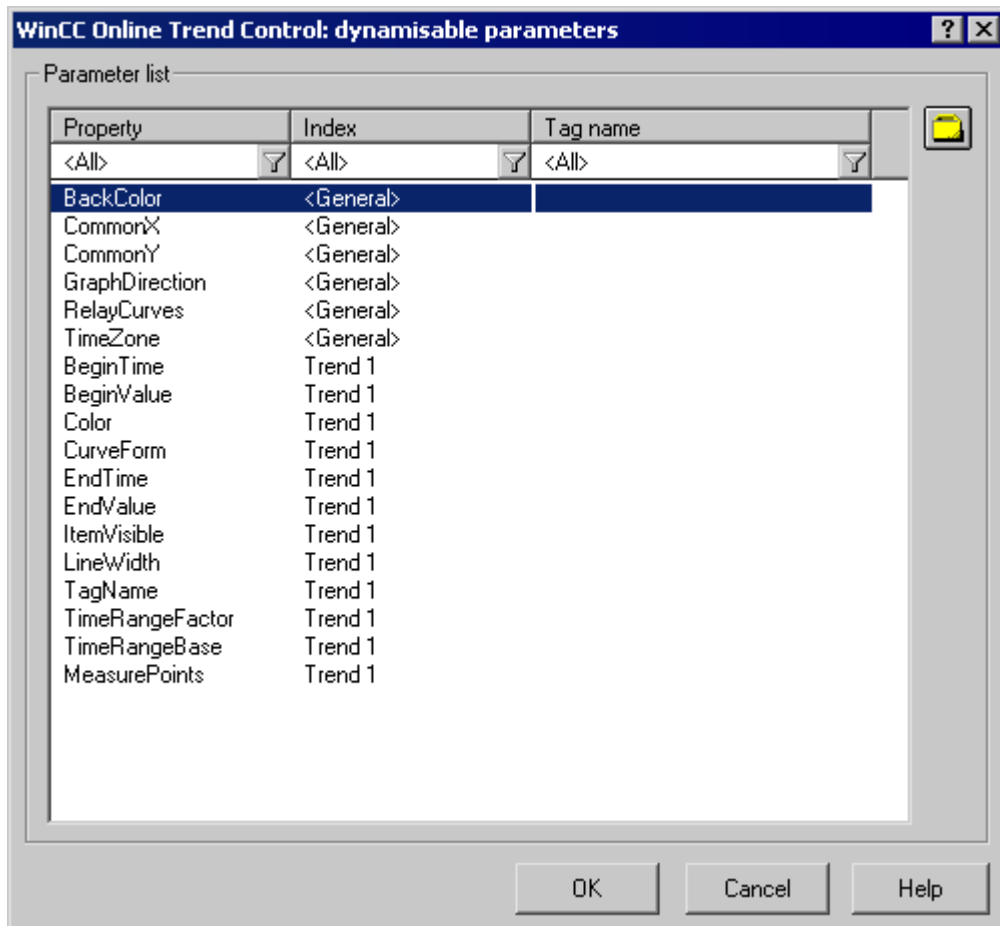

2. In the Parameter list, click the property you want to dynamize. When you click in the list the "?" icon, you will get the following information:
 - Description of the properties
 - Format of the properties
 - Suitable tag type
3. Click the tag selection symbol on the upper right side. The tag selection dialog is displayed.
4. Select the desired tag, or create a new tag. Edit the properties of the tag in the tag selection dialog. If necessary, specify a start value for the tag.
5. Apply the settings by clicking OK and save the layout.

See also

How to Configure the Static Parameters of WinCC Online Trend Control (Page 2246)

Dynamizable Parameters for Runtime Documentation (Page 2077)

10.5.9.4 Modify output options for WinCC Function Trend Control

How to Configure the Static Parameters of WinCC Function Trend Control

Introduction

The "WinCC Function Trend Control/Picture" report object is used to output process data as function of another tag from the process value, compression and user archives in the form of a trend.

You can define static parameters for each trend and for some properties of Control.

Requirements

- The WinCC Function Trend Control/Picture object is pasted into the layout.
- The inserted object has been selected.
- The "Object properties" window is open
- Process value archives, compression archives or user archives are inserted
- Archive tags have been inserted

Procedure

1. In the "Link" tab of the "Object Properties" window, click the entry "Parameterization". The dialog with the Control properties is displayed.
2. Configure in the Columns tab the columns you want to output.
 - Configure, if required, the setpoint trend for each trend
 - Define the display format for each trend
 - Define the display line weight for each trend

3. Define the Control properties in the General tab. Only the non-grayed options can be customized for report output.

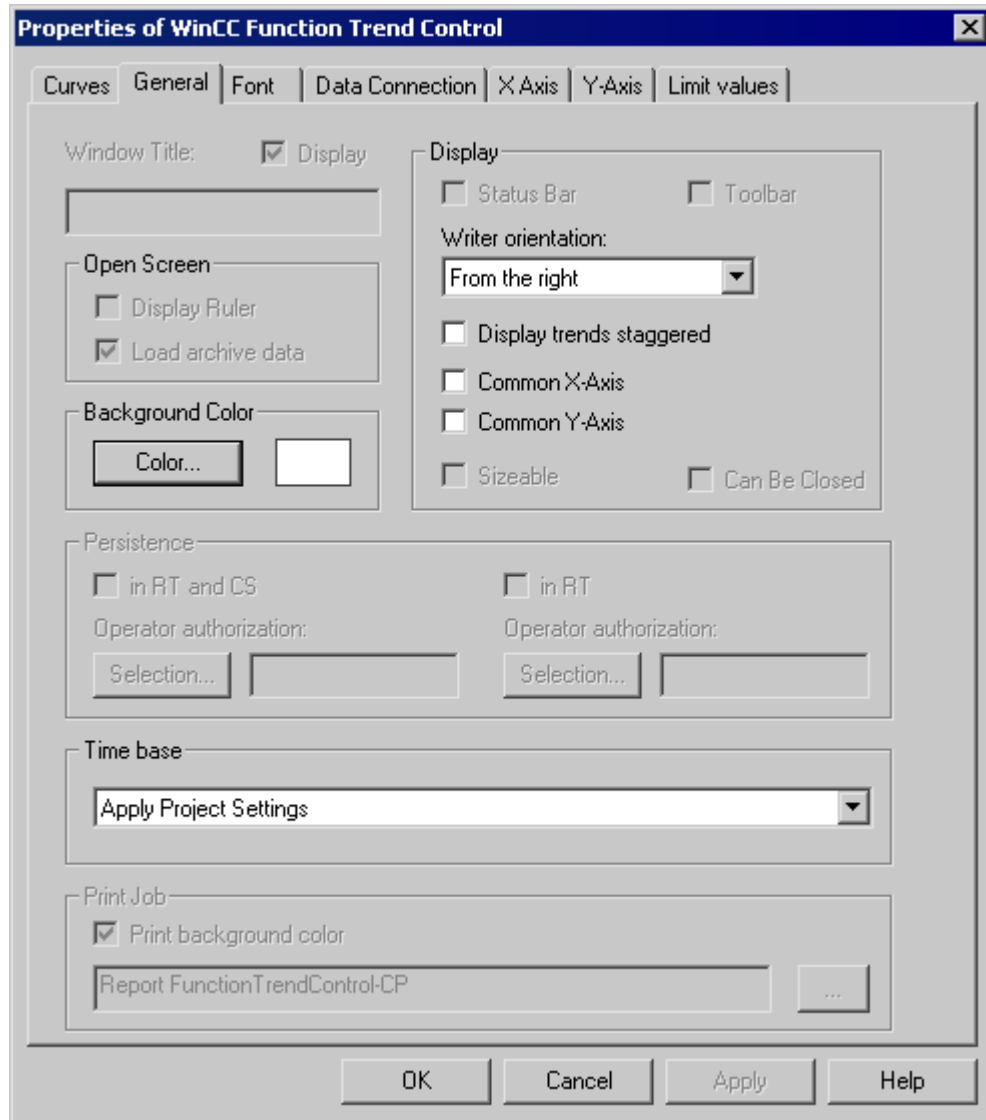

4. In the Data Link tab, configure the data supply for the trends with archive tags or from user archives.
5. In the X-Axis and Y-Axis tabs, configure the axis properties for each trend.

See also

Configuring the dynamic parameters of the WinCC Function Trend Control (Page 2253)

Configuring the dynamic parameters of the WinCC Function Trend Control

Introduction

The "WinCC Function Trend Control/Picture" report object is used to output process data as function of another tag from the process value, compression and user archives in the form of a trend.

You can define dynamic parameters for each trend and for some properties of Control.

For a print job, the dynamizable parameters of WinCC Function Trend Control are provided with the current values of the assigned WinCC tags during runtime.

Value are supplied to WinCC tag through scripts, process-controlled actions or via other WinCC applications. An overview of the Runtime documentation parameters that can be dynamized is included in chapter Dynamizable Parameters for Runtime Documentation.

Requirements

- The WinCC Function Trend Control/Picture object is pasted into the layout.
- The inserted object has been selected.
- The "Object properties" window is open
- Process value archives, compression archives or user archives are inserted
- Archive tags have been inserted
- You have inserted the trends for the output via the static parameters.

Procedure

1. In the "Link" tab of the "Object Properties" window, click the entry "Dynamized Parameterization". The dialog with the list of dynamizable properties opens.

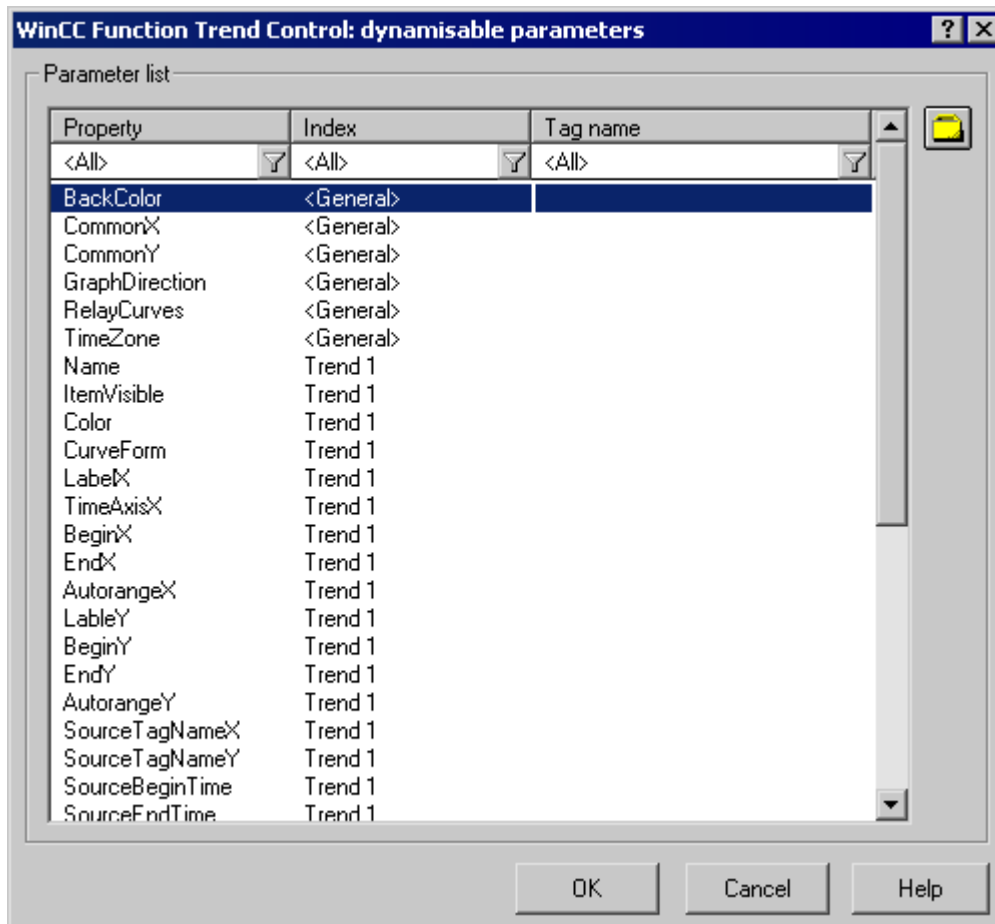

2. In the Parameter list, click the property of a trend or control you want to dynamize. When you click with the mouse the "?" icon, you will get the following information:
 - Description of the properties
 - Format of the properties
 - Suitable tag type
3. Click the tag selection symbol on the upper right side. The tag selection dialog is displayed.
4. Select the desired tag, or create a new tag. Edit the properties of the tag in the tag selection dialog. If necessary, specify a start value for the tag.
5. Apply the settings by clicking OK and save the layout.

See also

How to Configure the Static Parameters of WinCC Function Trend Control (Page 2251)
 Dynamizable Parameters for Runtime Documentation (Page 2077)

10.5.9.5 Modify output options for WinCC Alarm Control

How to Configure the Static Parameters of WinCC Alarm Control

Introduction

The "WinCC Alarm Control/Table" report object is used to output the message lists in a tabular format.

For the output, define a message list and configure the static parameters of the message list.

Requirements

- The "WinCC Alarm Control/Table" object is pasted into the layout.
- The inserted object has been selected.
- The "Object properties" window is open
- Message configuration has been carried out in Alarm Logging

Procedure

1. In the "Link" tab of the "Object Properties" window, click the entry "Parameterization". The dialog with the Control properties is displayed.
2. Define the message list you want to output in the General tab. Configure the Control properties. Only the non-grayed options can be customized for report output.

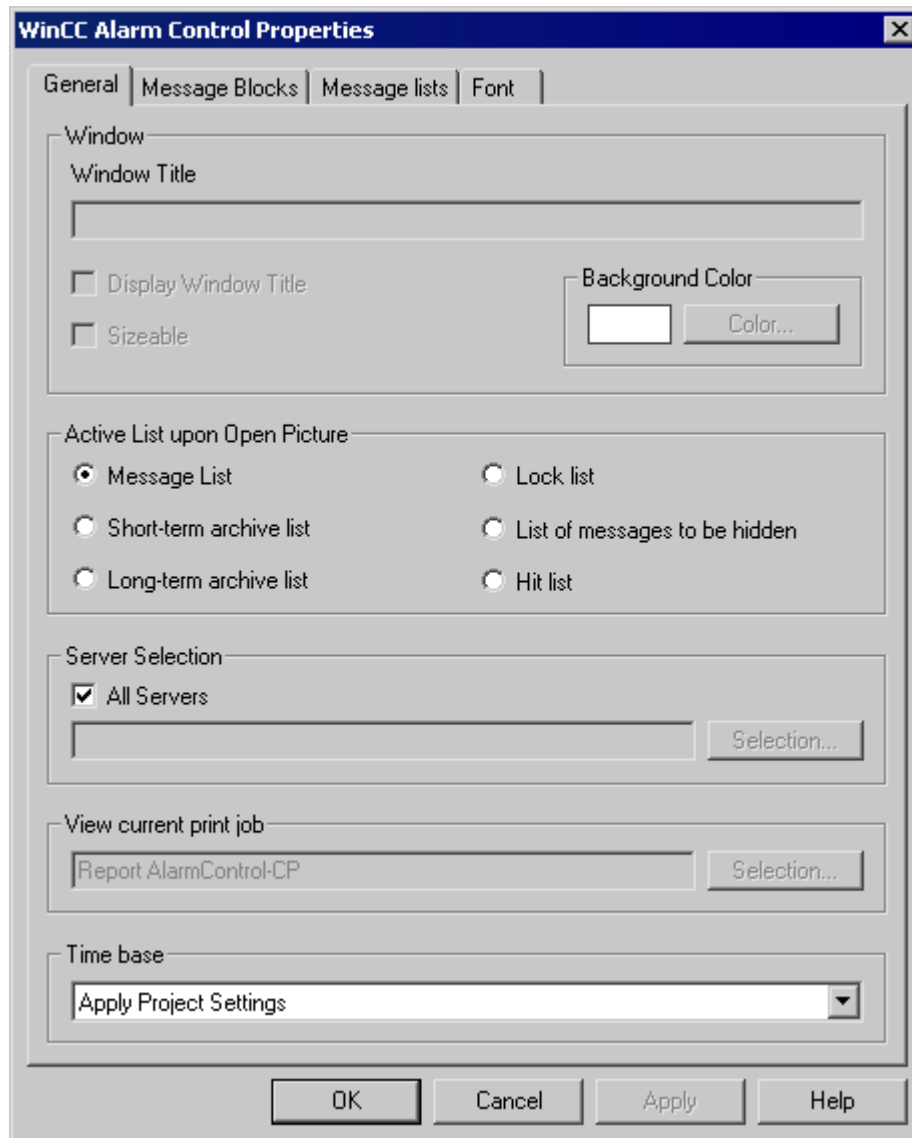

3. In the Message Blocks tab, configure the message blocks that are to be considered for the message list output.
4. Assign the message blocks to the table columns of the message list in the Message List tab. Click the "Selection..." button to open a dialog where you define the messages you want to output.

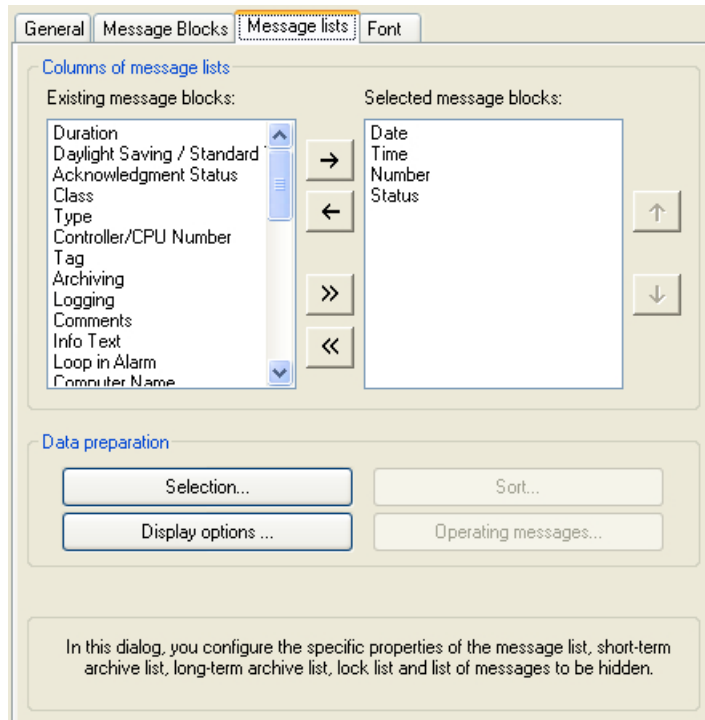

See also

[How to Configure the Dynamic Parameters of WinCC Alarm Control \(Page 2257\)](#)

How to Configure the Dynamic Parameters of WinCC Alarm Control

Introduction

The "WinCC Alarm Control/Table" report object is used to output the message lists in a tabular format.

You can define dynamic parameters for output to message lists.

In Runtime, the dynamic parameters are read from the system and written to the WinCC tags. The start values of the tags are overwritten.

Value are supplied to WinCC tag through scripts, process-controlled actions or via other WinCC applications. An overview of the Runtime documentation parameters that can be dynamized is included in chapter Dynamizable Parameters for Runtime Documentation.

Requirements

- The "WinCC Alarm Control/Table" object is pasted into the layout.
- The inserted object has been selected.
- The "Object properties" window is open
- Message configuration has been carried out in Alarm Logging
- You have configured the message list for the output via the static parameters.

Procedure

1. In the "Link" tab of the "Object Properties" window, click the entry "Dynamized Parameterization". The dialog with the list of dynamizable properties opens.

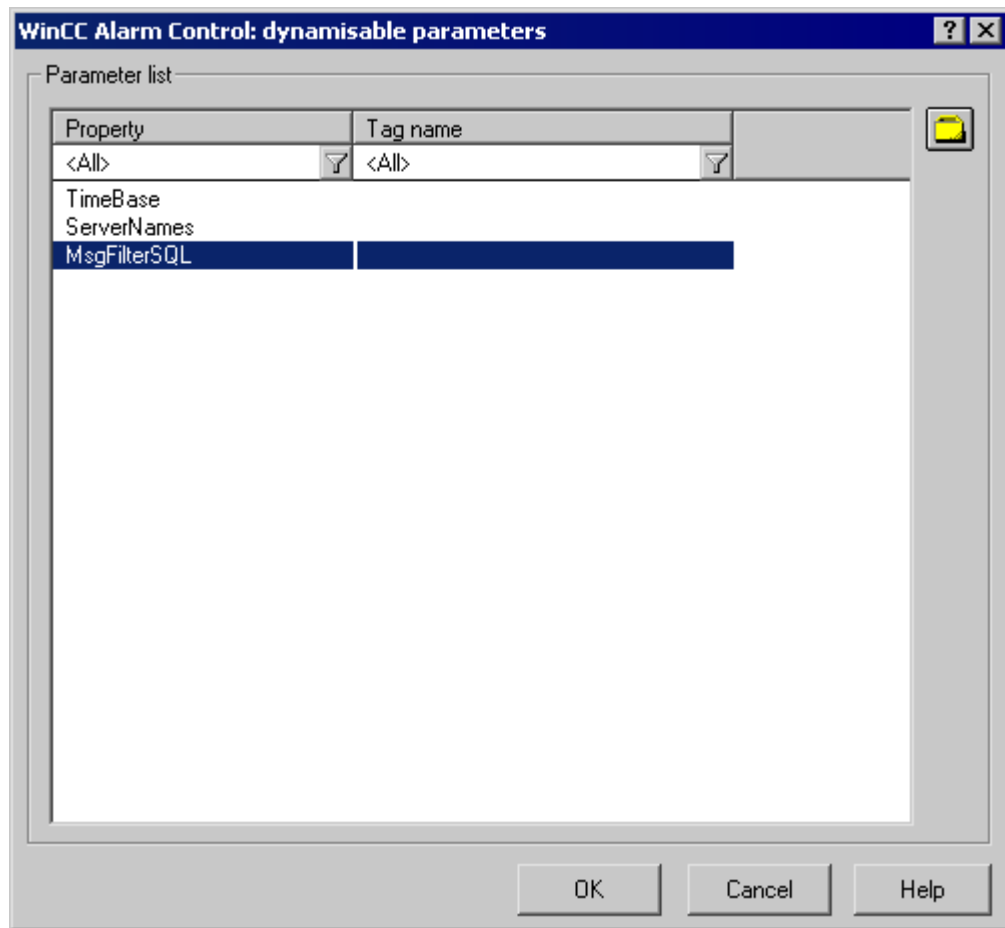

2. In the Parameter list, click the property you want to dynamize. When you click with the mouse the "?" icon, you will get the following information:
 - Description of the properties
 - Format of the properties
 - Suitable tag type
3. Click the tag selection symbol on the upper right side. The tag selection dialog is displayed.

4. Select the desired tag, or create a new tag. Edit the properties of the tag in the tag selection dialog. If necessary, specify a start value for the tag.
5. Apply the settings by clicking OK and save the layout.

See also

How to Configure the Static Parameters of WinCC Alarm Control (Page 2255)
Dynamizable Parameters for Runtime Documentation (Page 2077)

10.5.9.6 Change output options for WinCC UserArchiveControl

How to configure the properties of the WinCC UserArchiveControl

Introduction

The report object "CCAxUserArchiveControl" serves for output of data from user archives outside of the WinCC UserArchiveControl.

You specify the properties of the control in the Report Designer using the tabs of the WinCC UserArchiveControl.

Requirements

- The "CCAxUserArchiveControl" object is inserted in the layout.
- The inserted object is selected.
- The "Object properties" window is open.
- A user archive is created using the "User Archive" editor.

Procedure

1. Double-click the "Properties" entry on the "Connect" tab in the "Object properties" window. The dialog with the properties of the control opens.
2. Specify the user archive that you want to use on the "General" tab.
3. Configure the properties of the control that you need to output or adapt the user archive on the tabs, for example, which columns you want to output or the representation of the table.

See also

How to configure the dynamic parameters of the WinCC UserArchiveControl (Page 2260)

How to configure the dynamic parameters of the WinCC UserArchiveControl

Introduction

The report object "CCAxUserArchiveControl" serves for output of data from user archives outside of the WinCC UserArchiveControl.

You can dynamize the selection of the data in the user archive, the sorting of columns and the time base.

The parameters of the WinCC UserArchiveControl that can be dynamized are provided with the current values of the assigned WinCC tags in Runtime for a print job, for example, via scripts.

Requirements

- The "CCAxUserArchiveControl" object is inserted in the layout.
- The inserted object is selected.
- The "Object properties" window is open.
- A user archive is created using the "User Archive" editor.
- You have specified the columns you want to output by configuring the properties of the control.

Procedure

1. In the "Link" tab of the "Object Properties" window, click the entry "Dynamized Parameterization". The dialog with the list of properties that can be dynamized opens.
2. In the Parameter list, click the property you want to dynamize. When you click with the mouse the "?" icon, you will get the following information:
 - Description of the properties
 - Format of the properties
 - Suitable tag type
3. Click the tag selection symbol on the upper right side. The tag selection dialog appears.
4. Select the desired tag, or create a new tag. Edit the properties of the tag in the tag selection dialog. If necessary, specify a start value for the tag.
5. Apply the settings you have made by clicking "OK" and save the layout.

See also

How to configure the properties of the WinCC UserArchiveControl (Page 2259)

10.5.9.7 Changing Output Options for Message Reports from Alarm Logging

How to Change the Output Options for Message Reports from Alarm Logging Runtime

Introduction

You can control the output of messages from the message list or from the message archive in Runtime in advance via a user-specific selection of messages.

Overview

The following layouts are available for alarm logging in Runtime in the page layout editor:

- | | |
|----------------|---|
| Archive report | The layout is linked to the Alarm Logging message archive and serves to display the messages recorded there in a log. |
| Message report | The layout is linked to the Alarm Logging Runtime and serves to display the current message list in a log. The layout also provides a message sequence report in a page layout. |

The output data selection procedure is the same for both layouts. In the following, the steps are described for the message report.

In order to return a user-specific selection of messages, you can use a pre-defined layout, or create your own layout. You can also create multiple layouts, filter the messages through the selection criteria, and return them in separate logs. For the layout output, you need to configure a job. See AUTOHOTSPOT for more information.

Requirements

- The object "Message report" has already been inserted in the layout
- The inserted object has been selected
- The "Object properties" window is open
- You are familiar with the Link tab.
- Message configuration has been carried out in Alarm Logging.

Editing Options

For the objects "Archive report" and "Message report", you can select the data from the message system as well as the time base.

Procedure

1. Open the "Link" tab in the "Object Properties" window and double-click the entry "Selection" in the list of editing options. The "Alarm Logging Runtime: Log Tables - Selection" dialog opens.
2. Select the output data using the dialog. The dialog is described under "Selection of data for a message report".
3. Apply the settings by clicking "OK".

See also

[How to Modify the Time Range \(Page 2262\)](#)

[How to Transfer Object Properties \(Page 2182\)](#)

[How to Change an Attribute \(Page 2181\)](#)

[The Properties of an Object \(Page 2175\)](#)

[The Link tab in the Object Properties Window \(Page 2180\)](#)

[Working with Objects for the Runtime Documentation \(Page 2240\)](#)

[Selection of the Data for a Message Report \(Page 2263\)](#)

[Filter criteria for alarm output \(Page 2308\)](#)

How to Modify the Time Range

Introduction

By changing the base for time specifications, you can convert the indicated time in the time stamp to a different time base. These indicated times are only converted for output in the log; they are not written back to the Alarm Log or Tag Log, or user archives. If, for example, you want to output the data of a remote computer in another time zone, you can use this function to ensure that the data is output with a comparable time. If, in this case, both computers worked with the time base "Local Time", the two systems would contain logs with different time specifications. The results would not be directly comparable. You can find additional information in the section "Adjusting the Time Settings in the Project".

If you change the time base for the output, ensure that the time reference is also output in the report. For example, specify an identifier in the alias for the "Time" message block. For more details, please refer to "Selection of data for a message report".

Requirements

- The object "Message report" has already been inserted in the layout
- The inserted object has been selected.
- The "Object properties" window is open
- You are familiar with the Link tab.
- Message configuration has been carried out in Alarm Logging.

Edit Options

For the objects "Archive report" and "Message report", you can select the data from the message system as well as the time base.

Procedure

1. In the "Object Properties" window, you can also change the base for time specifications. To do that, double-click the entry "Base for time specifications" in the list of editing options. The following dialog will open.



2. Select the required time base and confirm your selection with "OK".
3. Modify the external form of the object, if necessary, by changing the attribute values in the Properties tag.
4. Close the "Object Properties" dialog and save the layout.

See also

How to Change the Output Options for User Archive Tables (Page 2267)

How to Change the Output Options for Message Reports from Alarm Logging Runtime (Page 2261)

Selection of the Data for a Message Report

Data Selection

The "Alarm Logging Runtime: Report Table Column Selection" dialog is used to select the data to output in the message report or message archive report.

It allows you to select the servers, message blocks, and filter criteria for alarm output.

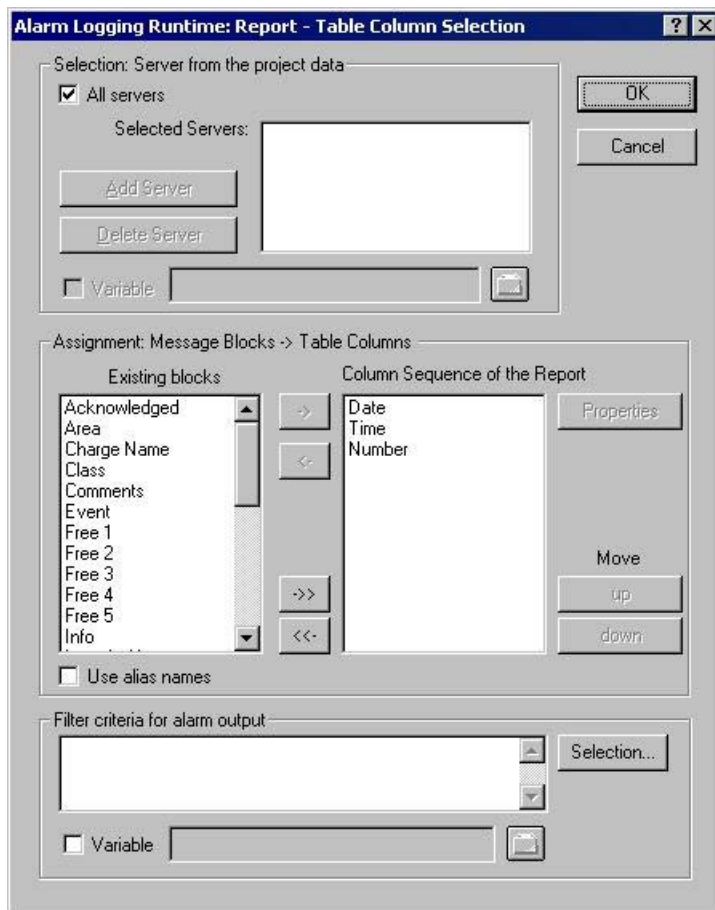

Selecting the Servers

Server selection is only necessary if you:

- generate the message reports on a WinCC client.
or
- in distributed systems, generate the message reports for one server on another server.

In the "Selection: Server from the Project Data" area, you can select the servers whose messages are to be logged.

Only those servers whose "packages" have been loaded are offered. The selected servers are displayed in the window.

In the case of a single-user and multi-user project this selection is not required.

Dynamization of Server Selection by Means of a WinCC Variable

You can dynamize server selection in order to select servers when a project is activated directly before logging is started.

The report system reads the value from the variable at runtime. If the variable cannot be read, the configured value is used.

1. Select the "Variable" check box.
The text box and the folder button are activated.
2. Use the folder button to open the variable selection dialog.
Select the desired variable there, and close the variable selection dialog.
Alternatively, enter the variable name directly in the text box.

Configure value assignment to the WinCC variable.

You will find more information in the section "Dynamizing process pictures > Types of Dynamization (Page 1163)".

Selecting Message Blocks

In the "Assignment: Message Blocks -> Table Columns" area, you can define the message blocks for output in the report.

In the "Message Blocks" area, select the desired message blocks from the list of existing message blocks.

Insert the message blocks, individually or in groups, in the current column sequence list using the controls provided in the dialog.

Editing the Properties of the Message Blocks

From the list of the current column sequence of the report you can select individual message blocks and edit their properties.

To do this, select a message block from the current column sequence of the report and click the "Properties" button.

You can now assign an alias to the block name and change the format for the date and time message blocks. The appearance of the dialog that opens depends on the type of message block selected.

The changes are only effective for the output of the report and are not written back to the Alarm Logging.

"Use alias names"

If the "Use Aliases" check box is selected, the configured aliases are output as the column headings. The aliases cannot be configured for multiple languages.

If the check box is cleared, the names of the message blocks are used as column headings. If the language is changed, the names stored for the message blocks in the text library are output. By default, the check box is cleared.

If the "Use Aliases" check box is selected and there are no aliases configured, the names of the message blocks are output.

Setting Filter Criteria for Alarm Output

In the "Filter Criteria for Alarm Output" area you can use the "Selection..." button to display the dialog for setting criteria for alarm output.

In the selection dialog, choose your selection criteria by checking the appropriate boxes.

When you apply the settings by clicking the "OK" button, the selected selection criteria are displayed in the "Filter Criteria for Alarm Output" area. The individual arguments are always ANDed.

You will find more information in the section "Filter criteria for alarm output (Page 2308)".

You can also make a selection in the print job by means of the size or time range.

You will find more information in the section "Documentation of configuration and runtime data > Print jobs in WinCC (Page 2031)".

Dynamization by Means of the Configuration Dialog

Instead of setting the dynamics through WinCC tags, you can use the configuration dialog as well.

To do this, select the option "Configuration dialog" from the "Dialog" area of the selected print job. At the start of the runtime output, the configuration dialog will then be launched.

Through this configuration dialog, you can open the dialog Alarm Logging Runtime: Report Table Selection described above, and modify the settings directly before the output.

You will find more information in the section "Documentation of configuration and runtime data > Runtime documentation > How to change output options in Runtime (Page 2074)".

See also

How to Transfer Object Properties (Page 2182)

How to Change an Attribute (Page 2181)

The Properties of an Object (Page 2175)

The Link tab in the Object Properties Window (Page 2180)

Working with Objects for the Runtime Documentation (Page 2240)

Filter criteria for alarm output (Page 2308)

Types of Dynamization (Page 1163)

How to Change Output Options in Runtime (Page 2074)

How to Change the Output Options for Message Reports from Alarm Logging Runtime (Page 2261)

Print Jobs in WinCC (Page 2031)

10.5.9.8 Changing Output Options for User Archive Tables

How to Change the Output Options for User Archive Tables

Introduction

The report object "User Archive Runtime/Table" is available for the output of runtime data from a user archive or a view. The object is linked to user archives and provides data output from the selected user archive/view.

The output data selection procedure is the same for user archives and views. In the following, the steps are described for a user archive.

To return the current view of the User Archive Table Control, you only need to activate a pre-defined button in this control. For more details, please refer to chapter "Data Output from User Archives".

In order to return a user-specific selection of data, you can use a pre-defined layout, or create your own layout. For the layout output, you need to configure a job. For more details, please refer to chapter "Creating Print Jobs for Runtime Documentation".

Requirements

- The object "User Archive Runtime Table" has already been inserted in the layout.
- The inserted object has been selected.
- The "Object Properties" window is open
- You are familiar with the Link tab.
- At least one user archive has been created

Editing Options

For the object "User Archive Runtime/Table", you can select the data from a user archive or a view, as well as the time base.

Procedure

1. Open the "Link" tab in the "Object Properties" window and double-click the entry "Table Selection" in the list of editing options. This opens the "Table Selection" dialog.
2. Use the dialog to configure the selection of data for output. The dialog is described under "Selection of Data for User Archive Tables".
3. Apply the settings by clicking "OK".

See also

How to Modify the Time Range (Page 2270)

How to Modify the Time Range (Page 2262)

How to Transfer Object Properties (Page 2182)

How to Change an Attribute (Page 2181)

The Properties of an Object (Page 2175)

The Link tab in the Object Properties Window (Page 2180)

Working with Objects for the Runtime Documentation (Page 2240)

Selection of Data for the User Archive Table (Page 2268)

Selection of Data for the User Archive Table

Data Selection

The "Table selection" dialog serves to choose a user archive/view, select the table columns, and specify the filter conditions and sorting.

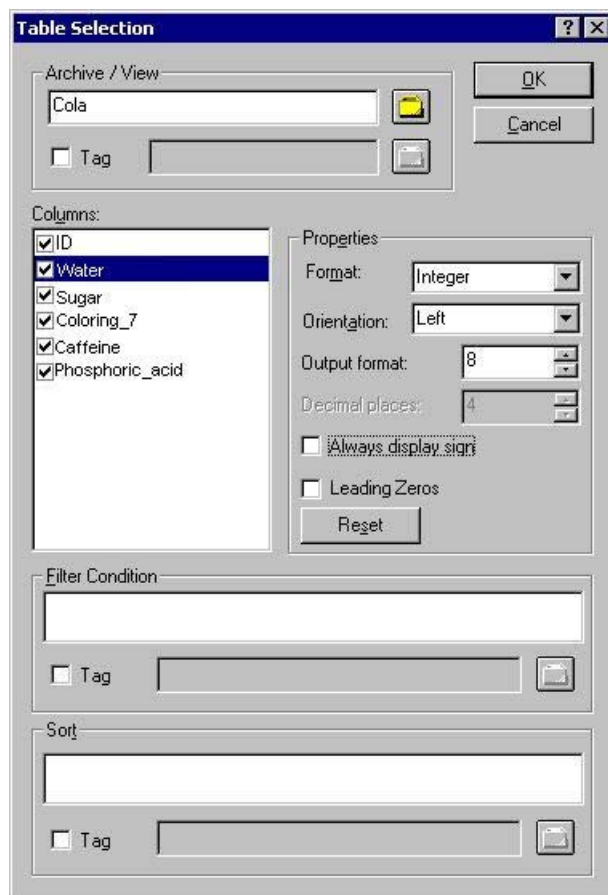

Selecting a user archive/view

In the "Archive/View" area, you can select one of the user archives/views that are available in the project. Clicking on the Folder button will open the Package Browser which lets you select a user archive/view. You can choose from all user archives/views of the servers whose packages were loaded.

Selecting the columns

Following the selection of an archive/view, you can choose the desired columns from the archive/view. When a column is selected, its properties become unlocked. Use the dialog to specify the format, orientation, number of places returned in the output, etc., for each column.

Setting filter conditions

In the "Filter condition" area, you can use SQL statements to set the filter conditions for the output values from the archive database. To write up the filter conditions, you need to be familiar with the database language SQL. For further information, please refer to the user archive help.

Setting the sorting

In the "Sorting" area, you can use SQL statements to set the sorting conditions for the output values from the archive database. To write up the sorting conditions, you need to be familiar with the database language SQL. For further information, please refer to the user archive help.

Dynamization through a WinCC variable

You can make the archive/view selection as well as the filter and sorting conditions dynamic with WinCC variables in order to carry out the selection directly before the logging is triggered with an activated project. The report system reads the value from the variable at runtime. If the variable cannot be read, the configured value is used.

1. Activate the "Tag" check box in the corresponding area of the dialog. The text box and the folder button are activated.
2. Use the folder button to open the variable selection dialog. Select the desired variable there, and close the variable selection dialog. Alternatively, enter the variable name directly in the text box.

Configure value assignment to the WinCC variable. You will find more information in the section "Types of Dynamization".

Dynamization by Means of the Configuration Dialog

Instead of setting the dynamics through WinCC tags, you can use the configuration dialog as well. To do this, select the option "Configuration dialog" from the "Dialog" area of the selected print job. At the start of the runtime output, the configuration dialog will then be launched.

Through this configuration dialog, you can open the dialog "Table selection" described above, and modify the settings directly before the output. For further details, please see the chapter "Changing output options in runtime".

See also

[How to Transfer Object Properties \(Page 2182\)](#)

[How to Change an Attribute \(Page 2181\)](#)

[The Properties of an Object \(Page 2175\)](#)

[The Link tab in the Object Properties Window \(Page 2180\)](#)

[Working with Objects for the Runtime Documentation \(Page 2240\)](#)

How to Modify the Time Range

Introduction

By changing the base for time specifications, you can convert the indicated time in the time stamp to a different time base. These indicated times are only converted for output in the log; they are not written back to the Alarm Log or Tag Log, or user archives. If, for example, you want to output the data of a remote computer in another time zone, you can use this function to ensure that the data is output with a comparable time. If, in this case, both computers worked with the time base "Local Time", the two systems would contain logs with different time specifications. The results would not be directly comparable. You can find additional information in the section "Adjusting the Time Settings in the Project".

If you change the time base for the output, ensure that the time reference is also output in the report. For example, specify an identifier in the alias for the "Time" message block. For more details, please refer to "Selection of data for a message report".

Requirements

- The object "Message report" has already been inserted in the layout
- The inserted object has been selected.
- The "Object properties" window is open
- You are familiar with the Link tab.
- Message configuration has been carried out in Alarm Logging.

Edit Options

For the objects "Archive report" and "Message report", you can select the data from the message system as well as the time base.

Procedure

1. In the "Object Properties" window, you can also change the base for time specifications. To do that, double-click the entry "Base for time specifications" in the list of editing options. The following dialog will open.



2. Select the required time base and confirm your selection with "OK".
3. Modify the external form of the object, if necessary, by changing the attribute values in the Properties tag.
4. Close the "Object Properties" dialog and save the layout.

See also

How to Change the Output Options for User Archive Tables (Page 2267)

How to Change the Output Options for Message Reports from Alarm Logging Runtime (Page 2261)

10.5.9.9 How to Change the Output Options for CSV Provider Tables

Introduction

The log object "CSV provider table" is available for the output of user-specific data from a data source in CSV format. The object can be linked to a data source in CSV format and returns the data from this source as a table in a WinCC protocol.

Requirements

- The object "CSV Provider Table" has already been inserted in the layout
- The inserted object has been selected.
- The "Object properties" window is open
- You are familiar with the Link tab.
- A CSV file is provided, or the file name is known

Edit Options

For the object "CSV provider table", you can select a CSV file for the output.

Procedure

1. Open the "Link" tab in the "Object Properties" window and double-click the entry "CSV table selection" in the list of editing options. This opens the "CSV table selection" dialog.

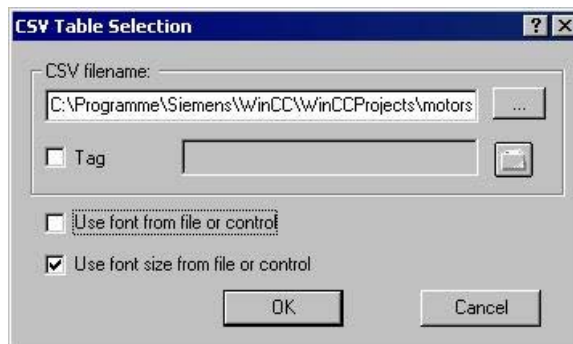

2. Use the "..." button to open the file selection dialog. Navigate to the desired CSV data source and select it, or enter the path and file name directly in the input field.
3. To take over the font and font size from the file, enable the corresponding check boxes in the dialog. If those boxes are not checked, the settings will be taken from the attributes of the object properties.

4. Confirm your entries with "OK."
5. You can modify the external form of the object, if necessary, by changing the attribute values in the Properties tab of the "Object properties" window.
6. Close the "Object Properties" window and save the layout.

Changing the Output Options

Dynamization through a WinCC variable

To render the selection of output data more flexible, you can make the file selection dynamic. This way, you can select the CSV file whose content is to be returned in runtime directly before the output. The report system reads the value from the variable at runtime. If the variable cannot be read, the configured value is used.

1. Activate the "Tag" check box in the corresponding area of the dialog. The text box and the folder button are activated.
2. Use the folder button to open the variable selection dialog. Select the desired variable there, and close the variable selection dialog. Alternatively, enter the variable name directly in the text box.

Configure value assignment to the WinCC variable. You will find more information in the section "Types of Dynamization".

Dynamization by Means of the Configuration Dialog

Instead of setting the dynamics through WinCC tags, you can use the configuration dialog as well. To do this, select the option "Configuration dialog" from the "Dialog" area of the selected print job. At the start of the runtime output, the configuration dialog will then be launched. Through this configuration dialog, you can open the dialog "CSV table selection" described above, and modify the settings directly before the output. For further details, please see the chapter "Changing output options in runtime".

Changing the format options

You can modify the external form of the object, if necessary, by changing the attribute values in the Properties tab of the "Object properties" dialog. The font and font size settings are applied only when the corresponding checkboxes in the "CSV table selection" dialog have not been activated.

If the above mentioned check boxes are activated, the formatting information will be taken from the CSV file. In the CSV data source, you can add control characters for font size, font, color and alignment, etc. For information regarding formatting with control characters, please refer to chapter Reporting Requirements for a CSV Data Source.

See also

[Requests to a CSV File for Reporting \(Page 2306\)](#)

[How to Change the Output Options for CSV Provider Trends \(Page 2273\)](#)

[How to Transfer Object Properties \(Page 2182\)](#)

[How to Change an Attribute \(Page 2181\)](#)

[The Properties of an Object \(Page 2175\)](#)

The Link tab in the Object Properties Window (Page 2180)

Working with Objects for the Runtime Documentation (Page 2240)

10.5.9.10 How to Change the Output Options for CSV Provider Trends

Introduction

The "CSV provider trend" report object is available for the output of user-specific data from a data source in CSV format. The object can be linked to a data source in CSV format and returns the data from this source as a curve in a WinCC protocol.

Requirements

- The object "CSV Provider Trend" has already been inserted in the layout
- The inserted object has been selected.
- The "Object properties" window is open
- You are familiar with the Link tab.
- A CSV file is provided, or the file name is known

Edit Options

For the object "CSV Provider Trend", you can select a CSV file for the output.

Procedure

1. Open the "Link" tab in the "Object Properties" window and double-click the entry "CSV table selection" in the list of editing options. This opens the "CSV table selection" dialog.



2. Use the "..." button to open the file selection dialog. Navigate to the desired CSV data source and select it, or enter the path and file name directly in the input field.
3. Confirm your entries with "OK."
4. You can modify the external form of the object, if necessary, by changing the attribute values in the Properties tab of the "Object properties" window.
5. Close the "Object Properties" window and save the layout.

Changing the Output Options

Dynamization through a WinCC variable

To render the selection of output data more flexible, you can make the file selection dynamic. This way, you can select the CSV file whose content is to be returned in runtime directly before the output. The report system reads the value from the variable at runtime. If the variable cannot be read, the configured value is used.

1. Activate the "Tag" check box in the corresponding area of the dialog. The text box and the folder button are activated.
2. Use the folder button to open the variable selection dialog. Select the desired variable there, and close the variable selection dialog. Alternatively, enter the variable name directly in the text box.

Configure value assignment to the WinCC variable. You will find more information in the section "Types of Dynamization".

Dynamization by Means of the Configuration Dialog

Instead of setting the dynamics through WinCC tags, you can use the configuration dialog as well. To do this, select the option "Configuration dialog" from the "Dialog" area of the selected print job. At the start of the runtime output, the configuration dialog will then be launched. Through this configuration dialog, you can open the dialog "CSV trend selection" described above, and modify the settings directly before the output. For further details, please see the chapter "Changing output options in runtime".

Changing the format options

In the CSV data source, you can add control characters for the layout of the trend output. Numerous options are available. For information regarding formatting with control characters, please refer to the chapter "Reporting requirements for a CSV data source".

See also

Requests to a CSV File for Reporting (Page 2306)

How to Change the Output Options for CSV Provider Tables (Page 2271)

How to Transfer Object Properties (Page 2182)

How to Change an Attribute (Page 2181)

The Properties of an Object (Page 2175)

The Link tab in the Object Properties Window (Page 2180)

Working with Objects for the Runtime Documentation (Page 2240)

10.5.10 Working with Objects for the Project Documentation

10.5.10.1 Working with Objects for the Project Documentation

Introduction

In this chapter, you will find details regarding the available objects of the page layout editor for the project documentation. You will learn how to work with the objects, and what are the basic conditions for each object.

The project documentation objects are provided for the report output of configured data. The objects are linked to the corresponding WinCC applications and return the configuration data of the WinCC project for output in a report. The objects for project documentation can only be inserted in the dynamic part of a page layout.

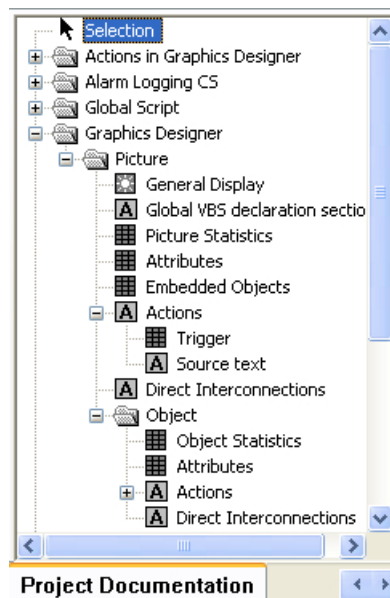

Some objects provide an option to select output data. This allows you to restrict the output to the data you currently need. For some of these objects, the selection options are identical. For each type of selection, this chapter will describe the changes that can be made to the output options. The relevant objects are listed with the descriptions.

The other objects do not offer an option to select output data. There are 3 types of these objects. The editing steps to change the output options are identical for objects of the same type and are described once for each object type.

Objects without data selection

The following object types are available:

	Dynamic text
	Dynamic metafile
	Dynamic table

The modification of output options is described for each of these object types.

- Changing output options for dynamic texts
- Changing output options for dynamic metafiles
- Changing output options for dynamic tables without data selection

See also

[How to Change an Attribute \(Page 2181\)](#)

[How to Change the Output Options for the Dynamic Tables without Data Selection \(Page 2304\)](#)

[How to Change the Output Options for the Dynamic Metafiles \(Page 2302\)](#)

[How to Change the Output Options for the Dynamic Texts \(Page 2301\)](#)

[How to Call up the Selection Dialogs \(Page 2276\)](#)

10.5.10.2 How to Call up the Selection Dialogs

Selection dialogs are called in the same way for all project documentation objects. The selection options depend on the object in question.

Requirements

- A project documentation object has been inserted in the layout, and selected.
- The Object Properties window is open, and the Link tab is active.
- You are familiar with the Link tab.

Procedure

1. Open the branching node(s) on the left of the Link tab. Choose an entry and select it. The list of editing options will then show the item "Selection...". The available selection type depends on the object which was chosen from the object tree.
2. Double-click on the entry "Selection...". This will open the corresponding selection dialog.

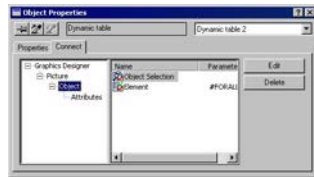

Depending on the object, you may be given several selection options in the area on the right. In this case, make your selections one after the other. When a selection has been made, its symbol on the right will be checked with a red mark. The entry "Element" is used for internal purposes only.

If the left side of the window contains several hierarchical entries, the subentries may offer various selection options, too. This depends on the object in question. It allows you to carry out a hierarchical selection.

In the picture above, for example, the entry "Object" was marked in the window on the left; the objects can now be selected in the window on the right. The entry "Attributes" is then marked on the left. The attributes can now be selected on the right.

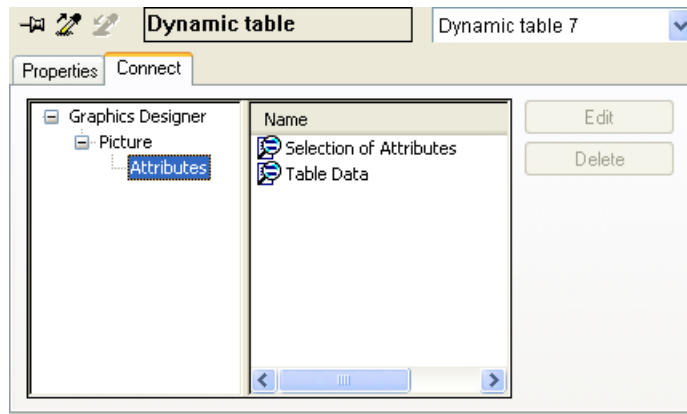

In the output, only the selected attributes for the objects chosen in the previous step will be returned.

For an overview of available objects and output options for each component of WinCC, please refer to the chapter "Project documentation".

See also

- How to Change the Output Options for the Selection of Connection List (Page 2300)
- How to Change the Output Options for the Tag Table of WinCC Explorer (Page 2297)
- How to Change the Output Options for the Language Selection from the Text Library (Page 2296)

How to Change the Output Options for the Selection of the Archive Tags from Tag Logging (Page 2293)

How to Change the Output Options for the Selection of Archives from Tag Logging (Page 2290)

How to Change the Output Options for the Selection of Action types (Page 2289)

How to Change the Output Options for the Selection of Object Statistics (Page 2287)

How to Change the Output Options for the Selection of Attributes (Page 2285)

How to Change the Output options for the Selection of the Picture Statistics (Page 2283)

How to Change the Output Options for the Selection of Views (Page 2282)

How to Change the Output Options for the Selection of User Archives (Page 2279)

How to Change Output Options for Single Message from Alarm Logging CS (Page 2278)

10.5.10.3 How to Change Output Options for Single Message from Alarm Logging CS

Introduction

The object "Single Messages" allows you to output all, or individually selected, messages from Alarm Logging in a report. The object is located in the Page Layout Editor object tree, in the "Project documentation" tab under "Alarm Logging CS".

Requirements

- Messages must be configured in Alarm Logging.
- The object "Single Messages" has been inserted in the layout, and selected.
- The Object Properties window is open, and the Link tab is active.
- You are familiar with the Link tab.

Edit Options

Of all the objects for the Alarm Logging project documentation, the object "Single Messages" is the only one that provides the option to select your output data.

For further information, please see the chapter "Project documentation in Alarm Logging".

Procedure

1. Open the branching node on the left of the Link tab. Select the entry "Single messages". The list of editing options will then show the item "Selection".
2. Double-click on the entry "Selection". The Alarm Logging CS dialog: Selecting Single Messages dialog is opened.



If the "All single messages" checkbox is checked, all configured single messages that are available at the time the report is generated will be returned. The buttons for accepting the messages will only be enabled when the checkbox "All single messages" has been deactivated.

3. Select the desired items from the list of available single messages and add them individually or in groups, using the dialog buttons, to the list of selected single messages.
4. Confirm the selection with "OK".
5. Modify the external form of the object "Single Messages", if necessary, by changing the attribute values in the Properties tab.
6. Close the "Object Properties" window and save the layout.

See also

[How to Change an Attribute \(Page 2181\)](#)

[The Properties of an Object \(Page 2175\)](#)

[The Link tab in the Object Properties Window \(Page 2180\)](#)

[Working with Objects for the Project Documentation \(Page 2275\)](#)

10.5.10.4 How to Change the Output Options for the Selection of User Archives

Introduction

The object "Archive" allows you to output the configuration data of user archives in a report. The object is located in the Page Layout Editor object tree, in the "Project documentation" tab under "User archive configuration".

Requirements

- A user archive must have been created.
- The object "Archives" has been inserted in the layout, and selected.
- The Object Properties window is open, and the Link tab is active.
- You are familiar with the Link tab.

Edit Options

The objects "Archive" and "Views" are available for the project documentation of the user archive configuration. Both objects offer options to select data for output. For further information about the "Views" object, please see the chapter "Changing output options for the selection of views".

Procedure

1. Open the branching node on the left of the Link tab. Select the entry "Archives". The list of editing options will then show the item "Archive selection".
2. Double-click on the entry "Archive selection". This will open the Archive selection dialog.



If the "All" checkbox is checked, all configured archives that are available at the time the report is generated will be returned.

3. From the list of available archives, select one or more for output.
4. Activate the check boxes for the archive attributes which you want to appear in the report.
5. To include archive field information in the output, activate the checkbox "Display fields".
6. Activate the check boxes for the field attributes which you want to appear in the report.
7. Confirm the selection with "OK".
8. Modify the external form of the object "Views", if necessary, by changing the attribute values in the Properties tag.
9. Close the "Object Properties" window and save the layout.

Note

If multiple user archives were selected, the selection of archive attributes will be applied to all selected user archives. If the checkbox "All" is activated, the configuration data of all user archives within the WinCC project will be returned. The selection of archive attributes applies to all user archives in this case as well.

The following table shows all the attributes that can be returned. The functions of the attributes are briefly described.

Attributes	Description
ID	ID of the user archive or field.
Name	Name of the user archive or field.
Alias	Alias name of the user archive or field.

Attributes	Description
Type	Shows whether a user archive belongs to the type Limited or Unlimited (maximum number of data records limited or unlimited). With fields, the type is the same as the tag type.
Size	The size of the user archive.
Changed	The date of the last change.
Com. Type	Communication type of the connection between user archive and automation level.
PLCID	Identification number for the connection between user archive and automation level.
Variable	For archives, the name of the WinCC tag for the connection to the automation level. For fields, the value in the user archive field.
ID tag	Name of the control tag "ID".
Job tag	Name of the control tag "Job".
Field tag	Name of the control tag "Field".
Value tag	Name of the control tag "Value".
Reading rights	Reading rights allocated for an archive or archive field.
Write protection	Writing rights allocated for an archive or archive field.
Flags)	Information about set flags. For archives: Flag for last access, output = LA Flag for last user, output = U For fields: Flag for Field must possess a value, output = NN Flag for Field must possess a unique value, output = U Flag for Field should be supported by an index, output = I
Length	Length of the user archive field.
Decimal places	Number of decimal places in the user archive field.
Minimum	Configured minimum value of the user archive field.
Maximum	Configured maximum value of the user archive field.
Start value	Configured start value of the user archive field.

See also

How to Change the Output Options for the Selection of Views (Page 2282)

How to Change an Attribute (Page 2181)

The Properties of an Object (Page 2175)

The Link tab in the Object Properties Window (Page 2180)

Working with Objects for the Project Documentation (Page 2275)

10.5.10.5 How to Change the Output Options for the Selection of Views

Introduction

The object "Views" allows you to return the configuration data for views of user archives in a report. The object is located in the Page Layout Editor object tree, in the "Project documentation" tab under "User archive configuration".

Requirements

- A view must have been created.
- The object "Views" has been inserted in the layout, and selected.
- The Object Properties window is open, and the Link tab is active.
- You are familiar with the Link tab.

Edit Options

The objects "Archive" and "Views" are available for the project documentation of the user archive configuration. Both objects offer options to select data for output. For further information about the object "Archives", please see the chapter "Changing output options for the selection of user archives".

Procedure

1. Open the branching node on the left of the Link tab. Select the entry "Views". The list of editing options will then show the item "View selection".
2. Double-click on the entry "View selection". This will open the View selection dialog.



If the "All" checkbox is active, all configured views that are available at the time the report is generated will be returned.

3. From the list of available views, select one or more for output.
4. Activate the check boxes for the view attributes which you want to appear in the report.
5. To include view column information in the output, activate the checkbox "Display columns".
6. Activate the check boxes for the columns which you want to appear in the report.
7. Confirm the selection with "OK".
8. Modify the external form of the object "Views", if necessary, by changing the attribute values in the Properties tag.
9. Close the "Object Properties" window and save the layout.

Note

If multiple views were selected, the selection of view attributes will be applied to all selected views. If the checkbox "All" is activated, the configuration data of all views within the WinCC project will be returned. The selection of view attributes applies to all views in this case as well.

The following table shows all the attributes that can be returned. The functions of the attributes are briefly described.

Attributes	Description
ID	ID of the view or column.
Name	Name of the view or column.
Alias	Alias name of the view or column.
Relation	Shows the relation between the user archive fields in a view.
Changed	Date and time of the last change.
Archive ID	ID of the user archive.
archive	Name of the user archive.
Field ID	ID of the user archive field.
Array	Name of the user archive field.

See also

[How to Change the Output Options for the Selection of User Archives \(Page 2279\)](#)

[How to Change an Attribute \(Page 2181\)](#)

[The Properties of an Object \(Page 2175\)](#)

[The Link tab in the Object Properties Window \(Page 2180\)](#)

[Working with Objects for the Project Documentation \(Page 2275\)](#)

10.5.10.6 How to Change the Output options for the Selection of the Picture Statistics

Introduction

The object "Picture Statistics" allows you to output the statistics data for the pictures of the Graphic Designer in a report. The object is located in the Page Layout Editor object tree, in the "Project documentation" tab under "Graphics Designer/Picture".

Requirements

- A Graphics Designer picture must have been created.
- The object "Picture statistics" has been inserted in the layout, and selected.

- The Object Properties window is open, and the Link tab is active.
- You are familiar with the Link tab.

Edit Options

For the object "Picture statistics", you can select the statistic data.

For an overview of available objects for the product documentation of the Graphics Designer and their output options, please refer to the chapter "Project documentation in the Graphics Designer".

Procedure

1. Open the branching node on the left of the Link tab. Select the entry "Picture Statistics". The list of editing options will then show the item "Statistics data for the picture".
2. Double-click on the entry "Statistics data for the picture". This will open the dialog "Selection of picture statistics".



If the checkbox "with descriptive column" is checked, a descriptive column will be returned along with the statistics data.

3. Choose the desired items from the list of selection options and add them individually or in groups, using the dialog buttons, to the list of selected data.
4. Using the "Up" and "Down" buttons, specify the output sequence of the tags.
5. Confirm the selection with "OK".
6. Modify the external form of the object "Picture Statistics", if necessary, by changing the attribute values in the Properties tag.
7. Close the "Object Properties" window and save the layout.

Output with descriptive column

Picture name	PictureDocumentation.Pdl
Creation date	23.07.2002 13:33:47
Number of objects in the picture	1
Number of objects with tag connection	0

Output without descriptive column

PictureDocumentation.Pdl

23.07.2002 13:33:47

1

0

See also

How to Change an Attribute (Page 2181)

The Properties of an Object (Page 2175)

The Link tab in the Object Properties Window (Page 2180)

Working with Objects for the Project Documentation (Page 2275)

10.5.10.7 How to Change the Output Options for the Selection of Attributes

Introduction

The object "Attributes" facilitates the output of configuration data for the attributes of Graphics Designer pictures and objects within in a report. The provided selection options allow you to limit the output to relevant information.

You have two choices:

- All with tag connection – Returns all attributes which are linked to a tag.
- All with action connection – Returns all attributes which are linked to an action.
- All not interconnected – Returns all attributes which are not dynamic.

The object is located in the Page Layout Editor object tree, in the "Project documentation" tab under "Graphics Designer/Picture," and under "Graphics Designer/Picture/Object".

Requirements

- A Graphics Designer picture must have been created.
- The object "Attributes" has been inserted in the layout, and selected.
- The Object Properties window is open, and the Link tab is active.
- You are familiar with the Link tab.

Edit Options

For the "Attributes" object of a picture, you can select the attributes as well as the table data.

For the "Attributes" object of an object within a picture, you can additionally select the objects. Only the table data of the selected objects will be returned then. For further information, please see the chapter "Calling the selection dialogs".

For an overview of available objects for the product documentation of the Graphics Designer and their output options, please refer to the chapter "Project documentation in the Graphics Designer".

Procedure

1. Open the branching node on the left of the Link tab. Select the entry "Attributes". The list of editing options will then show the entries "Selection of attributes" and "Table data".
2. Double-click on the entry "Selection of attributes". This will open the dialog "Selection of attributes".



Make your choices from the list of selection options.

3. Click on the "Default Attributes" button. This will open the dialog "List of default attributes".



Select the attributes that are to be returned always. Confirm the selection with "OK".

4. In the "Link" tab of the "Object Properties" window, double-click the entry "Table data". This will open the dialog "Selection of table data".

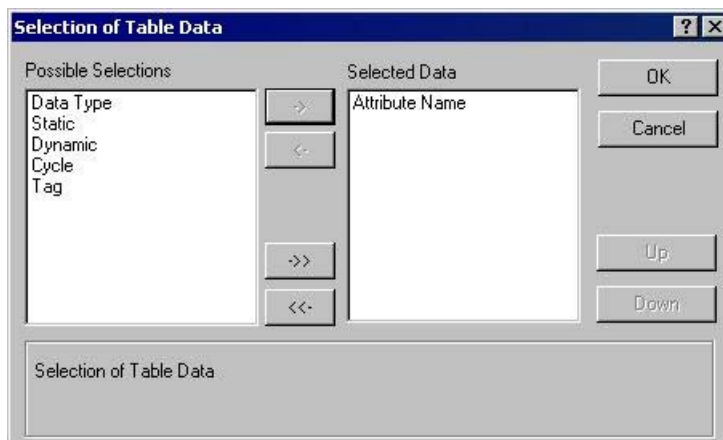

5. From the list of selection options, choose the info columns which are to appear in the attribute data table.
6. Confirm the selection with "OK".

7. Modify the external form of the object "Attributes", if necessary, by changing the attribute values in the Properties tag.
8. Close the "Object Properties" window and save the layout.

See also

How to Change an Attribute (Page 2181)

The Properties of an Object (Page 2175)

The Link tab in the Object Properties Window (Page 2180)

Working with Objects for the Project Documentation (Page 2275)

How to Call up the Selection Dialogs (Page 2276)

10.5.10.8 How to Change the Output Options for the Selection of Object Statistics

Introduction

The object "Object Statistics" allows you to output the statistics data for the objects within the pictures of the Graphic Designer in a report. The object is located in the Page Layout Editor object tree, in the "Project documentation" tab under "Graphics Designer/Picture/Object".

Requirements

- A Graphics Designer picture must have been created.
- The object "Object Statistics" has been inserted in the layout, and selected.
- The Object Properties window is open, and the Link tab is active.
- You are familiar with the Link tab.

Edit Options

For the object "Object Statistics", you can select the objects as well as the statistics data. Only the statistics data of the selected objects will be returned then. For further information, please see the chapter "Calling the selection dialogs".

For an overview of available objects for the product documentation of the Graphics Designer and their output options, please refer to the chapter "Project documentation in the Graphics Designer".

Procedure

1. Open the branching node on the left of the Link tab. Select the entry "Object". The list of editing options will then show the item "Selection of Objects".
2. Double-click on the entry "Selection of objects". This will open the dialog "Selection of objects".



Specify whether all objects should appear in the output, or only dynamic objects from Graphics Designer pictures. Confirm the selection with "OK".

3. On the left of the "Object Properties" window, select the entry "Object statistics". This will open the dialog "Statistics on the Object".

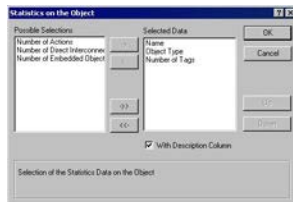

If the checkbox "with descriptive column" is checked, a descriptive column will be returned along with the statistics data.

4. Choose the desired items from the list of selection options and add them individually or in groups, using the dialog buttons, to the list of selected data.
5. Using the "Up" and "Down" buttons, specify the output sequence of the tags.
6. Confirm the selection with "OK".
7. Modify the external form of the object "Picture Statistics", if necessary, by changing the attribute values in the Properties tag.
8. Close the "Object Properties" window and save the layout.

See also

- How to Change an Attribute (Page 2181)
- The Properties of an Object (Page 2175)
- The Link tab in the Object Properties Window (Page 2180)
- Working with Objects for the Project Documentation (Page 2275)
- How to Call up the Selection Dialogs (Page 2276)

10.5.10.9 How to Change the Output Options for the Selection of Action types

Introduction

The objects "Trigger" and "Source text" facilitate the output of configuration data for the actions within Graphics Designer pictures and objects in a report.

You have two choices:

- All – Returns all elements with actions. Also returns all elements which have not yet been configured at the time of this selection.
- Assignment actions – Returns all elements with assignment actions.
- No assignment actions – Returns all elements without assignment actions.

The objects are located in the Page Layout Editor object tree, in the "Project documentation" tab under "Graphics Designer/Actions", and under "Graphics Designer/Picture/Actions".

Requirements

- A Graphics Designer picture must have been created.
- One of the objects "Trigger" or "Source text" has been inserted in the layout, and selected.
- The Object Properties window is open, and the Link tab is active.
- You are familiar with the Link tab.

Edit Options

You can select the actions for the objects "Trigger" and "Source text" of a picture.

For the objects "Trigger" and "Source text" of an object within a picture, you can additionally select the objects. Only the action data of the selected objects will then be returned. For further information, please see the chapter "Calling the selection dialogs".

For an overview of available objects for the product documentation of the Graphics Designer and their output options, please refer to the chapter "Project documentation in the Graphics Designer".

Procedure

1. Open the branching node on the left of the Link tab. Select the entry "Actions". The list of editing options will then show the item "Selection of actions".
2. Double-click on the entry "Selection of actions". This will open the dialog "Selection of action types".



Select the action types you want.

3. Confirm the selection with "OK".
4. Modify the external form of the object, if necessary, by changing the attribute values in the Properties tag.
5. Close the "Object Properties" window and save the layout.

See also

How to Change an Attribute (Page 2181)

The Properties of an Object (Page 2175)

The Link tab in the Object Properties Window (Page 2180)

Working with Objects for the Project Documentation (Page 2275)

How to Call up the Selection Dialogs (Page 2276)

10.5.10.10 How to Change the Output Options for the Selection of Archives from Tag Logging

Introduction

The objects "Process value archive" and "Compressed archive" facilitate the output of configuration data for process value and compressed archives in a report.

The objects are located in the Page Layout Editor object tree, in the "Project documentation" tab under "Tag Logging CS/Archives".

Requirements

- A process value or compressed archive must have been created.
- One of the objects "Process value archive" or "Compressed archive" has been inserted in the layout, and selected.
- The Object Properties window is open, and the Link tab is active.
- You are familiar with the Link tab.

Edit Options

For the objects "Process value archive" and "Compressed archive", you can select both the archives and the archive data.

For an overview of available objects for the Tag Logging product documentation and their output options, please refer to the chapter "Project documentation in Tag Logging".

Selection of Archives

1. Open the branching node on the left of the Link tab. Select an entry, either "Process value archive" or "Compressed archive". The list of editing options will then show the item "Archive names".
2. Double-click on the entry "Archive names". The Tag Logging CS: Archive Selection dialog is opened.



If the "All archives" checkbox is checked, the data of all archives will be returned. An existing selection will be preserved in the dialog.

3. Choose the desired items from the list of available archives and add them individually or in groups, using the dialog buttons, to the list of selected data.
4. Confirm the selection with "OK".

Selection of Process Value Archive Data

1. In the "Object Properties" window, select the entry "Process value archive". The list of editing options will then show the item "Process value archive data".
2. Double-click on the entry "Process value archive data". The Tag Logging CS: Process Archive Data Selection dialog is opened.



3. Choose the configuration data you want to appear in the output.
4. Confirm the selection with "OK".
5. Modify the external form of the object "Process value archive", if necessary, by changing the attribute values in the Properties tag.
6. Close the "Object Properties" window and save the layout.

The following table shows all the attributes that can be returned. The functions of the attributes are briefly described.

Attributes	Description
Comment	Brief description or comments about the archive.
Archive type	Type of the selected archive, here: Process value archive.
Server name	Server which is accessed by the archive.
Authorization	Authorization for read or write access.
Action During archive start/Enable	Specified action which is triggered by certain events.
Archiving at system start	Returns the starting type of the archive.
Archive type	Type of the selected archive, short-term or long-term archive.

Attributes	Description
Fill level message	Edited fill level messages for the archive.
Size in data records	Specified number of data records which can be stored in a short-term archive.
Memory location	Storage location for swap-out.
Action for relocating the short-term archive	Specified action for swap-out.
Variable	The configured archive tags.

Selection of compressed archive data

1. In the "Object Properties" window, select the entry "Compressed archive". The list of editing options will then show the item "Compressed archive data".
2. Double-click the entry "Compressed archive data". The Tag Logging CS: Compressed Archive Data Selection dialog is opened.



3. Choose the configuration data you want to appear in the output.
4. Confirm the selection with "OK".
5. Modify the external form of the object "Compressed archive", if necessary, by changing the attribute values in the Properties tag.
6. Close the "Object Properties" window and save the layout.

The following table shows all the attributes that can be returned. The functions of the attributes are briefly described.

Attributes	Description
Comment	Brief description or comments about the archive.
Archive type	Type of the selected archive, here: Compressed archive.
Server name	Server which is accessed by the archive.
Authorization	Authorization for read or write access.
Action During archive start/Enable	Specified action which is triggered by certain events.
Archive type	Type of the selected archive, short-term or long-term archive.
Compressed archive	Name of the compressed archive.
Archiving at system start	Returns the starting type of the archive.
Variable	The configured archive tags.

See also

- How to Change an Attribute (Page 2181)
- The Properties of an Object (Page 2175)
- The Link tab in the Object Properties Window (Page 2180)

Working with Objects for the Project Documentation (Page 2275)

How to Call up the Selection Dialogs (Page 2276)

10.5.10.11 How to Change the Output Options for the Selection of the Archive Tags from Tag Logging

Introduction

The objects "Process value archive tag" and "Compressed archive tag" facilitate the output of configuration data for process value and compressed archive tags in a report.

The objects are located in the Page Layout Editor object tree, in the "Project documentation" tab under "Tag Logging CS/Archives".

Requirements

- A process value or compressed archive must have been created.
- One of the objects "Process value archive tag" or "Compressed archive tag" has been inserted in the layout, and selected.
- The Object Properties window is open, and the Link tab is active.
- You are familiar with the Link tab.

Edit Options

For the objects "Process value archive tag" and "Compressed archive tag", you can select the archives, tags and tag data.

For an overview of available objects for the Tag Logging product documentation and their output options, please refer to the chapter "Project documentation in Tag Logging".

Selection of the Process Value Archive Tag

1. Open the branching node on the left of the Link tab. Select an entry, either "Process value archive tag" or "Compressed archive tag". The list of editing options will then show the item "Tag".
2. Double-click the "Tag" entry. The Tag Logging CS: Archive Tag Selection dialog is opened.

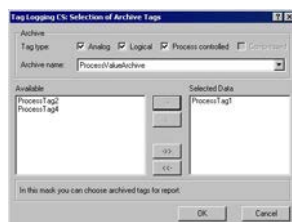

In the "Archive" area, select one or more tag types.

3. In the "Archive" area, choose a process value archive from the selection list. The process tags of the selected type which are available in the system are shown in the "Available" window.

4. Choose the desired items from the list of available tags and add them individually or in groups, using the dialog buttons, to the list of selected data.
5. Confirm the selection with "OK".

Selection of Process Value Archive Tag Data

1. In the "Object Properties" window, select the entry "Process value archive tag". The list of editing options will then show the item "Tag data".
2. Double-click the "Tag data" entry. The Tag Logging CS: Tag Data Selection dialog is opened.

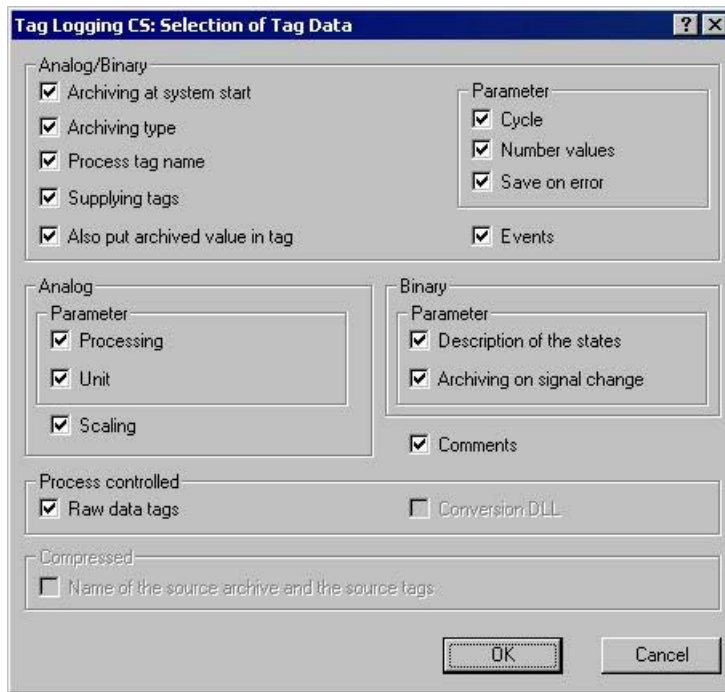

3. Choose the configuration data you want to appear in the output.
4. Confirm the selection with "OK".
5. Modify the external form of the object "Process value archive tag", if necessary, by changing the attribute values in the Properties tag.
6. Close the "Object Properties" window and save the layout.

The following table shows all the attributes that can be returned. The functions of the attributes are briefly described.

Attributes	Description
Archiving at system start	Returns the starting type of the archive tag.
Archiving type	Archiving type: acyclic, cyclic-continuous or cyclic-selective archiving.
Process tag name	Names of the corresponding WinCC tags.
Tag supply	Returns the assignment type of the tag. Specifies whether the tag is supplied with data manually, or through the system.

Attributes	Description
Also put archived value in tag	Outputs the WinCC tag in which an archived value is additionally written.
Cycle	Time cycle used for archiving and data display.
Number of values	Output of values for leader and trailer.
Save on error	Returns the saving behavior in case of errors. Specifies whether, in case of an error, the last value is saved, or rather a substitute value.
Events	Events which trigger archiving.
Editing	Returns the processing type. Specifies how data is preprocessed, e.g., by calculating an average.
Unit	Returns the unit of the specified time value.
Scaling	Returns the scaling type.
Name of statuses	Returns the names of status 0 and status 1.
Archiving on signal change	Returns the behavior which has been specified for a signal change.
Comment	Comments regarding archive tags.
Raw data tags	Name or ID of the raw data tags.

Selection of Compressed Archive Tag Data

1. In the "Object Properties" window, select the entry "Compressed archive tag". The list of editing options will then show the item "Tag data".
2. Double-click the "Tag data" entry. The Tag Logging CS: Tag Data Selection dialog is opened.



3. Choose the configuration data you want to appear in the output. For attribute descriptions, please refer to the table above.
4. Confirm the selection with "OK".
5. Modify the external form of the object "Compressed archive tag", if necessary, by changing the attribute values in the Properties tag.
6. Close the "Object Properties" window and save the layout.

See also

- How to Transfer Object Properties (Page 2182)
- How to Change an Attribute (Page 2181)
- The Properties of an Object (Page 2175)

The Link tab in the Object Properties Window (Page 2180)

Working with Objects for the Project Documentation (Page 2275)

10.5.10.12 How to Change the Output Options for the Language Selection from the Text Library

Introduction

The object type "Text Library text table" allows you to insert text from the WinCC text library in the dynamic part of a page layout. The object is located in the Page Layout Editor object tree, in the "Project documentation" tab under "Text Library". Select the languages for which text is to be returned in a table in the "Language selection" dialog.

Requirements

- User texts must be configured in the Text Library.
- The object "Text Library text table" has been inserted in the layout, and selected.
- The Object Properties window is open, and the Link tab is active.
- You are familiar with the Link tab.

Edit Options

Of all the objects for the Text Library project documentation, the object "Text Library text table" is the only one that provides the option to select your output data.

For further information, please see the chapter "Project documentation in the Text Library".

Procedure

1. Open the branching node on the left of the Link tab. Select the entry "Text Library text table". The list of editing options will then show the item "Language selection".
2. Double-click the "Language selection" entry. This will open the dialog "Text Library language selection".



If the "All" checkbox is checked, all configured languages will be returned. An existing selection in this dialog will be preserved.

3. Choose the desired items from the list of designed languages and add them individually or in groups, using the dialog buttons, to the list of selected languages.
4. Using the "Up" and "Down" buttons, specify the output sequence of the tags.

5. Use the option buttons to specify whether the different languages should appear in the output separately, or arranged horizontally or vertically.
6. Confirm the selection with "OK".
7. Modify the external form of the object "Text Library text table", if necessary, by changing the attribute values in the Properties tag.
8. Close the "Object Properties" window and save the layout.

Specify a table format

The layout of the report is specified using the table format option buttons. You can view the effect of your settings in the preview window. The following table formats are available:

- If you choose "Separate", each language will be returned in its own table in the report.
- If you choose "Horizontal", the text in the selected languages that belongs to one text ID will be returned in one row. With long text or several designed languages, this may well exceed the width of the row.
- If you choose "Vertical", the text in the selected languages that belongs to one text ID will be returned in separate rows.

See also

[How to Change an Attribute \(Page 2181\)](#)

[The Properties of an Object \(Page 2175\)](#)

[The Link tab in the Object Properties Window \(Page 2180\)](#)

[Working with Objects for the Project Documentation \(Page 2275\)](#)

10.5.10.13 How to Change the Output Options for the Tag Table of WinCC Explorer

Introduction

The object "Tags" allows you to return the tags from WinCC Tag Management in a report. The object is located in the Page Layout Editor object tree, in the "Project documentation" tab under "WinCC Explorer".

Requirements

- The Tag Management contains some tags.
- The object "Tags" has been inserted in the layout, and selected.
- The Object Properties window is open, and the Link tab is active.
- You are familiar with the Link tab.

Edit Options

For the object "Tags", you can select the tags, the tag groups and tag parameters. For the Tag data type, you can also select the output format.

For an overview of available objects for the product documentation of the WinCC Explorer and their output options, please refer to the chapter "Project documentation in the WinCC Explorer".

Selection of Tag Parameters

1. Open the branching node on the left of the Link tab. Select the entry "Tags". The list of editing options will then show the item "Selection of tag parameters".
2. Double-click on the entry "Tag parameters". The WinCC Explorer: Selecting Connections dialog is opened.



If the "Compact" checkbox is activated, all parameters of a tag will be returned in one row. Else, each parameter will be returned in its own row. If, with output in "Compact" form, the lines are too long for the rows, the rest will be cut off.

3. Activate the check boxes for the output parameters you want to use.
4. Confirm the selection with "OK".

The following table shows all the tag parameters that can be returned. The functions of the parameters are briefly described.

Parameters	Description
Data type	Returns the data type of a tag.
Group	Includes the allocation to a tag group in the output.
Parameters	Returns the address parameters of a tag.
External tag data	Returns information about the external linkage of a tag (e.g., connection, channel unit, channel).
Limit values	Returns the designed limit values of a tag.
Start value	Returns a designed start value of a tag.
Substitute value	Returns a designed substitute value of a tag.
Protocol entry	Returns information about the type of a configured log entry.

Selection of Tag Groups

1. In the "Object Properties" window, select the entry "Tags". The list of editing options will then show the item "Selection of tag groups".
2. Double-click on the entry "Selection of tag groups". The WinCC Explorer: Select Tag Groups dialog is opened.



3. Select the desired items from the list of available tag groups and add them individually or in groups to the list of selected tag groups, using the dialog buttons.
4. Confirm the selection with "OK".

Selection of Tags

1. In the "Object Properties" window, select the entry "Tags". The list of editing options will then show the item "Selection of tags".
2. Double-click the entry "Selection of tags". The WinCC Explorer: Select Tags dialog is opened.



If the "All tags" checkbox is active, all available tags will be returned. An existing selection in this dialog will be preserved.

3. To be able to select specific tags, deactivate the checkbox "All tags". This will enable the "Select" button.
4. Click on the "Select" button to open the WinCC tag selection dialog.
5. Select the desired tags individually or in groups. Confirm the selection with "OK". The selected tags will be added to the selection dialog.
6. Confirm the selection with "OK".

Formatting the Tag List

1. In the "Object Properties" window, select the entry "Tags". The list of editing options will then show the item "Format".
2. Double-click the "Format" entry. The WinCC Explorer: Format Tag List dialog is opened.



If the check box is active, the data type of the tag is returned in short form.
Long formats: Unsigned 32 bit value; floating point number 64 bit IEEE 754
Short formats: 32 bit value, without sign; 64 bit IEEE 754

3. Select the output form you want.
4. Confirm the selection with "OK".
5. Modify the external form of the object "Tags", if necessary, by changing the attribute values in the Properties tag.
6. Confirm the selection with "OK".
7. Close the "Object Properties" window and save the layout.

See also

- How to Change an Attribute (Page 2181)
- The Properties of an Object (Page 2175)
- The Link tab in the Object Properties Window (Page 2180)
- Working with Objects for the Project Documentation (Page 2275)

10.5.10.14 How to Change the Output Options for the Selection of Connection List

Introduction

The object "Connections" allows you to output the configured connections via WinCC communication drivers in a report. The object is located in the Page Layout Editor object tree, in the "Project documentation" tab under "WinCC Explorer".

Requirements

- A connection via a WinCC communication driver has been configured.
- The object "Connections" has been inserted in the layout, and selected.
- The Object Properties window is open, and the Link tab is active.
- You are familiar with the Link tab.

Edit Options

For the object "Connections", you can select the connections.

For an overview of available objects for the product documentation of the WinCC Explorer and their output options, please refer to the chapter "Project documentation in the WinCC Explorer".

Procedure

1. Open the branching node on the left of the Link tab. Select the entry "Connections". The list of editing options will then show the item "Selection of connection list".
2. Double-click on the entry "Selection of connection list". The WinCC Explorer: Select Connections dialog is opened.



If the "All connections" checkbox is active, all available connections will be returned. An existing selection in this dialog will be preserved.

3. Select the desired items from the list of available connections and add them individually or in groups, using the dialog buttons, to the list of selected connections.
4. Confirm the selection with "OK".

5. Modify the external form of the object "Connections", if necessary, by changing the attribute values in the Properties tag.
6. Close the "Object Properties" window and save the layout.

See also

How to Change an Attribute (Page 2181)

The Properties of an Object (Page 2175)

The Link tab in the Object Properties Window (Page 2180)

Working with Objects for the Project Documentation (Page 2275)

10.5.10.15 How to Change the Output Options for the Dynamic Texts

Introduction

Some of the objects in the object tree "Project documentation" are of the type "Dynamic text" and do not offer an option to select data for output. These objects are firmly linked to the WinCC applications and provide the designated configuration data as text for output in a report.

Objects of the dynamic text type are marked in the object tree with the symbol .

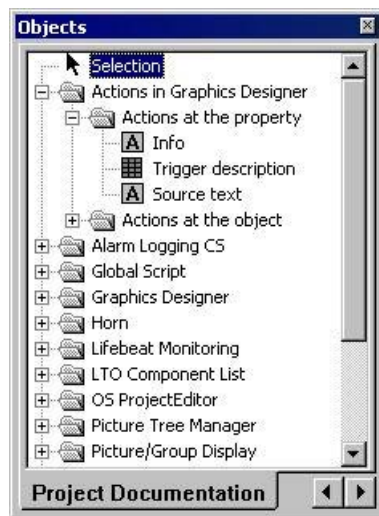

The external form of the objects can be influenced by changing their attributes. The procedure is the same for all objects of this type. You can call up direct help for each attribute by right-clicking on it in the "Attribute" column.

Requirements

- The relevant object of the type "Dynamic text" has been inserted in the layout, and selected.
- The Object Properties window is open, and the Properties tab is active.

Procedure

1. On the left of the Properties tab, select the object from the directory tree and open the branching node. The property groups of the object are shown in a directory tree.
2. Select a property group. The attribute of this group are shown in the area on the right.
3. Choose an attribute and double-click it. This will open a dialog which allows you to edit the attribute properties.
4. Specify the settings you want and confirm your entries with "OK".
5. Close the Object Properties window and save the layout.

See also

[How to Change the Output Options for the Dynamic Tables without Data Selection \(Page 2304\)](#)

[How to Change the Output Options for the Dynamic Metafiles \(Page 2302\)](#)

[How to Transfer Object Properties \(Page 2182\)](#)

[How to Change an Attribute \(Page 2181\)](#)

[The Properties of an Object \(Page 2175\)](#)

[Working with Objects for the Project Documentation \(Page 2275\)](#)

10.5.10.16 How to Change the Output Options for the Dynamic Metafiles

Introduction

Some of the objects in the object tree "Project documentation" are of the type "Dynamic metafile" and do not offer an option to select data for output. These objects are firmly linked to the WinCC applications and provide the designated configuration data as an image for output in a report.

Objects of the dynamic metafile type are marked in the object tree with the symbol .

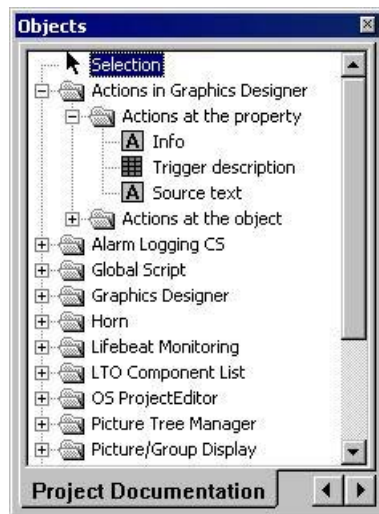

The external form of the objects can be influenced by changing their attributes. The procedure is the same for all objects of this type. You can call up direct help for each attribute by right-clicking on it in the "Attribute" column.

Requirements

- The relevant object of the type "Dynamic metafile" has been inserted in the layout, and selected.
- The Object Properties window is open, and the Properties tab is active.

Procedure

1. On the left of the Properties tab, select the object from the directory tree and open the branching node. The property groups of the object are shown in a directory tree.
2. Select a property group. The attribute of this group are shown in the area on the right.
3. Choose an attribute and double-click it. This will open a dialog which allows you to edit the attribute properties.
4. Specify the settings you want and confirm your entries with "OK".
5. Close the Object Properties window and save the layout.

See also

[How to Change the Output Options for the Dynamic Tables without Data Selection \(Page 2304\)](#)

[How to Change the Output Options for the Dynamic Texts \(Page 2301\)](#)

[How to Transfer Object Properties \(Page 2182\)](#)

[How to Change an Attribute \(Page 2181\)](#)

[The Properties of an Object \(Page 2175\)](#)

[Working with Objects for the Project Documentation \(Page 2275\)](#)

10.5.10.17 How to Change the Output Options for the Dynamic Tables without Data Selection

Introduction

Some of the objects in the object tree "Project documentation" are of the type "Dynamic table" and do not offer an option to select data for output. These objects are firmly linked to the WinCC applications and provide the designated configuration data as a table for output in a report. These dynamic tables do not offer any editing options in the "Link" tab of the "Object Properties" dialog.

Objects of the dynamic table type are marked in the object tree with the symbol .

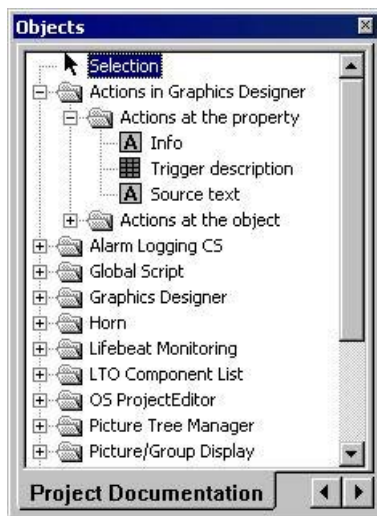

The external form of the objects can be influenced by changing their attributes. The procedure is the same for all objects of this type. You can call up direct help for each attribute by right-clicking on it in the "Attribute" column.

Requirements

- The relevant object of the type "Dynamic table" has been inserted in the layout, and selected.
- The Object Properties window is open, and the Properties tab is active.

Procedure

1. On the left of the Properties tab, select the object from the directory tree and open the branching node. The property groups of the object are shown in a directory tree.
2. Select a property group. The attribute of this group are shown in the area on the right.
3. Choose an attribute and double-click it. This will open a dialog which allows you to edit the attribute properties.
4. Specify the settings you want and confirm your entries with "OK".
5. Close the Object Properties window and save the layout.

See also

How to Change the Output Options for the Dynamic Metafiles (Page 2302)

How to Change the Output Options for the Dynamic Texts (Page 2301)

How to Transfer Object Properties (Page 2182)

How to Change an Attribute (Page 2181)

The Properties of an Object (Page 2175)

Working with Objects for the Project Documentation (Page 2275)

10.6 Appendix

10.6.1 Requests to a CSV File for Reporting

Introduction

To permit the data from a CSV file to be output in a WinCC log, the data must correspond to a set structure. The data in a CSV file are prepared by the user. You will find more information in chapters "Outputting Data from a CSV Table" and "Example of Reporting CSV Files".

Requirements for CSV File to be Output in Tabular Form

Each section must begin with the name of the corresponding file structure, followed by one or more lines containing the elements of the file structure. The following file structures are defined:

File Structure for Output in Tabular Form

The table, columns, and data must be defined as follows:

#Table; Name; Columns; Font; Font size

- Name = name of the table control or file
- Columns = number of columns
- Font = font of the table
- Font size = font size of the table

#Column; Num; Header; Width; Alignment

- Num = number of the column
- Header = header of the column
- Width = width of the column in characters
- Alignment = left aligned/centered/right aligned

#Data; Color; Col1; Col2; Col3; Col4; ...

- Color = color attribute of the line (0xbbggrr)
- Col1 = data of column 1
- Col2 = data of column 2
- etc.

Points to Note About the Data in the CSV File

The control characters for colors, alignment, etc. are always at the beginning of the output text and can be combined with each other (e.g. "<U>output text"). The entry is not case-sensitive.

The "Width" parameter indicates the relative width of the columns. The effective width of the column in the table is calculated as follows:

$$\left[\left[\text{Table width as a number of characters} \right] \times \left[\text{relative width of the column in \%} \right] / \left[\text{sum of all relative widths of the column} \right] \right]$$

The line defined for tables in the CSV file contains one more column than the data lines. If a spreadsheet program such as Excel is used to edit the data, the columns for the headings and the data will no longer match up. To prevent this from happening, you can enter a semicolon (;) as the first character in the data lines of the CSV file. The data blocks of the CSV file may not contain blanks. When you open the CSV in Excel, the data columns are shifted one column to the right. The columns for the headings and data will then match up. If the first column does not contain anything, you have to insert a blank (;blank;first data value;...).

Control Characters for Table Output

<END>	If the interpretation of control sequences is done, the rest of the text will be transferred as it is given.
<COLOR=#rrggbb>	Font color in hexadecimal notation (default = as set for the table)
<BGCOLOR=#rrggbb>	Background color in hexadecimal notation (default = as set for the table)
	Bold
<U>	Underlined
<I>	Italic
<STRIKE>	Strike-through
<ALIGN=left>	Left aligned
<ALIGN=center>	Centered
<ALIGN=right>	Right aligned

Note

The definition of the "Color" attribute conforms to the Intel byte format. The notation is 0xbbggrr (hex blue blue green green red red). The control characters for formatting the table cells conform to the HTML standard. The notation for <color=> is #rrggbb.

Each section must begin with the name of the corresponding file structure, followed by one or more lines containing the elements of the file structure. The following file structures are defined:

File Structure for Output in the Form of a Trend f(t)

#Trend_T; Name; Curves; DateFrom; DateTo; Common Y-Axis; Font; Fontsize

- Name = name of the trend control or file

- Curves = number of trends

- DateFrom = start of time range, notation: 2000-10-30 10:15:00.000

Number of digits: year(4); month(2); day(2); hours(2); minutes(2); seconds(2); milliseconds(3).

- DateTo = end of time range, notation: 2000-10-30 10:15:00.000

Number of digits: year(4); month(2); day(2); hours(2); minutes(2); seconds(2); milliseconds(3).

- Common Y-Axis = common y-axis
- Font = font
- Fontsize = font size

#Curve; Num; Name; Count; dMin; dMax; Color; Weight; CurveType; Filling

- Num = number of the trend
- Name = trend name
- Count = number of values
- dMin = lower limit of the trend (for scaling)
- dMax = upper limit of the trend (for scaling)
- Color = color attribute of the trend (0xbbggrr)
- Weight = line weight in points (e.g. 1.5)
- CurveType = trend type (LINE, DOTS, STEP)
- Filling = filling color for areas (0=no, 1=yes). The Filling parameter is currently not in use.

#Data; Num; Date; Value; Flags; Color

- Num = number of the trend
- Date = X coordinate of the trend, notation: 2000-10-30 10:15:00.000
Number of digits: year(4); month(2); day(2); hours(2); minutes(2); seconds(2); milliseconds(3).
- Value = y coordinate of the trend
- Flags = limit values/time overlap etc.
- Color (if an empty string is specified here, the color is taken from #Curve ...)

10.6.2 Filter criteria for alarm output

Introduction

The filter criteria for alarm output are transferred with the transfer of the selection criteria from the selection dialog in the "Filter criteria for alarm output" area.

The filter criteria can be edited.

Notes on configuring the filter criteria are available in the following section:

- "Creating page layouts > Working with objects for Runtime documentation > Changing output options for alarm logs from Alarm Logging > Selection of data for an alarm log (Page 2263)".

Conditions

When filtering messages, note the following:

- The structure consists of "Field", "Operand", and "Value", with the individual parameters separated by blanks.
Example: DATETIME >= '2006-12-21 00:00:00' AND MSGNR >= 100
(all messages as of 21/12/2006 with a message number greater than or equal to 100)
- Strings, date, and time must be passed in single quotation marks.
- In the DATETIME argument, the date and time of day are separated by a blank.
Regardless of the time base setting in the object properties, the output of DATETIME is based on the time base Local Time.
Exception: UTC is set as the time base: in this case, the output is based on time base UTC.

Valid operands

Arguments and operands other than those mentioned below are not permitted.

- >=
- <=
- =
- >
- <
- IN(...)
Several values as an array, separated by commas.
Example: CLASS IN(1 ,2 ,3) AND TYPE IN(1 ,2 ,19 ,20 ,37 ,38)
- LIKE
Text must contain string only.
The operand LIKE is only permissible for TEXT arguments.
Example: TEXT1 LIKE 'Error' relays message where Text1 contains the search text Error.

Valid arguments

Name	Type	data	Example:
MsgFilterSQL:	Integer	Maximum number of messages to be output	MsgFilterSQL: 10000 Up to 10000 messages are output. MsgFilterSQL: 10000MSGNR >= 1 Up to 10000 messages starting with message number 1 are output.
DATETIME	Date	'YYYY-MM-DD hh:mm:ss.msmsms'	DATETIME >= '2007-05-03 16:00:00' Output of message from 05.03.2007 16:00 hours.
MSGNR	Integer	Message number	MSGNR >= 10 AND MSGNR <= 12 Output of messages with message numbers 10 - 12.

Name	Type	data	Example:
CLASS IN AND TYPE IN	Integer	- Message class ID 1-16 and system message classes 17, 18 - Message type ID 1-256 and system message types 257, 258, 273, 274	CLASS IN (1) AND TYPE IN (2) Output of messages of message class 1 message type 2.
STATE	Integer	Value of ALARM_STATE_xx Only the operands "=" and "IN(...)" are permitted ALARM_STATE_1 ALARM_STATE_2 ALARM_STATE_3 ALARM_STATE_4 ALARM_STATE_5 ^(*) ALARM_STATE_6 ^(*) ALARM_STATE_7 ^(*) ALARM_STATE_10 ALARM_STATE_11 ALARM_STATE_16 ALARM_STATE_17	STATE IN(1,2,3) Output of all message that came in, went out and were acknowledged. Possible values: 1 = Came In messages 2 = Went Out messages 3 = acknowledged messages 4 = locked message 5 = released messages 6 = messages that came in and have been acknowledged 7 = messages that came in and went out 10 = hidden messages 11 = displayed messages 16 = messages acknowledged by the system 17 = emergency-acknowledged messages ^(*) The "ALARM_STATE_5", "ALARM_STATE_6" and "ALARM_STATE_7" states can only be output via the "Alarm Logging Runtime" layout. These states cannot be selected in the AlarmControl.
PRIORITY	Integer	Message priority 0 - 16	PRIORITY >= 1 AND PRIORITY <= 5 Outputs messages that have a priority between 1 and 5.
AGNR	Integer	PLC number	AGNR >= 2 AND AGNR <= 2 Output of messages with AG number = 2.
AGSUBNR	Integer	AG sub-number	AGSUBNR >= 5 AND AGSUBNR <= 5 Outputs messages with AG sub-number 5.
TEXTxx	Text	Search text for 'Text1'-'Text10'	TEXT2 = "Error" Outputs the messages whose Text2 corresponds with "Error". TEXT2 IN ('Error','Fault') Outputs the messages whose Text2 corresponds with the text "Error" or "Fault". TEXT2 LIKE 'Error' Outputs the messages whose Text2 includes the text "Error".
PVALUExx	Double	Search text for PVALUE1-PVALUE10	PVALUE1 >= 0 AND PVALUE1 <= 50 Output of process value 1 with start value 0 and stop value 50.

See also

How to Change the Output Options for Message Reports from Alarm Logging Runtime
(Page 2261)

Selection of the Data for a Message Report (Page 2263)

Creating Line Layouts

11.1 Creating Line Layouts

Contents

The line layout editor is an editor provided by WinCC that allows you to create and dynamize line layouts for the output of a message sequence report. As part of WinCC, it can only be used to edit line layouts belonging to the project that is open in WinCC.

This section shows you

- How to use the line layout editor
- How to create and edit line layouts
- How to design a line layout

11.2 How to Start the Line Layout Editor

Introduction

In accordance with Windows conventions, there are various ways of opening the line layout editor. The line layout editor can only be opened for the current project that is open in WinCC Explorer.

Requirement

- A project must be open in WinCC Explorer.

Opening the Line Layout Editor

The line layout editor is always called in WinCC Explorer.

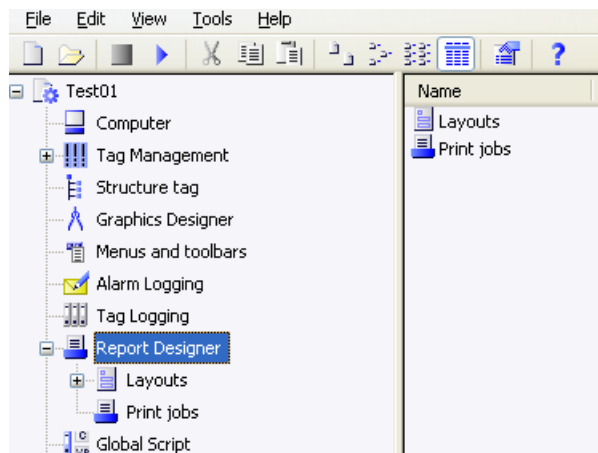

The following options are available:

Navigation window/data window of WinCC Explorer:

Select the Report Designer entry. The "Layouts" and "Print Jobs" subentries are displayed.

In the navigation or data window of WinCC Explorer, select "Layouts" and choose the "Open Line Layout Editor" command from the pop-up menu.

The line layout editor is started, and a new layout is opened.

WinCC Explorer data window:

Select the Report Designer entry. The "Layouts" and "Print Jobs" subentries are displayed.

In the navigation window, select "Layouts". The available layouts are displayed in the data window. Double-click a line layout or choose "Open Line Layout" from the pop-up menu.

The line layout editor is started, and the selected line layout is opened.

See also

The Line Layout Editor (Page 2315)

11.3 The Line Layout Editor

11.3.1 The Line Layout Editor

Introduction

The line layout editor is used only to create and edit line layouts for a message sequence report. Each line layout contains a dynamic table that is connected to the WinCC message system. Additional objects cannot be added to a line layout. Text can be entered in the header and footer. Start the line layout editor in WinCC Explorer.

Layout of the Line Layout Editor

The line layout editor has a toolbar, menu bar, status bar, and various different areas for editing a line layout. When opened, the line layout editor appears with the default settings.

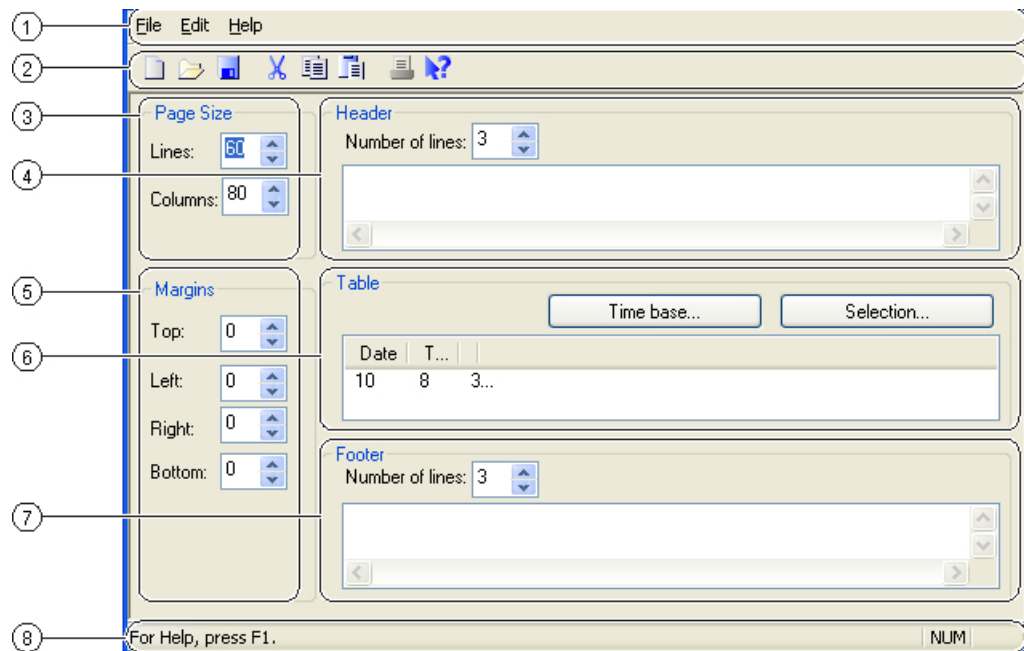

(1) The Menu Bar

The menu bar is always visible. Depending on the context, the functions in the menus are active or inactive.

(2) The Toolbar

The toolbar is always visible in the line layout editor. There are different buttons on the toolbar that allow you to activate the functions of the menu commands quickly. The buttons are either active or inactive, depending on the situation.

(3) The Header Area

The Header area allows you to enter text in order to create the header of a line layout.

(4) The Table Area

The design of the table for output is displayed in the Table area. The configured column headings and the width of the columns (number of characters per column) are displayed. The table can be configured for output using the buttons in this area.

(5) The Footer Area

The Footer Area is used to enter text in order to create the footer of a line layout.

(6) The Page Size Area

The Page Size area is used to set the number of lines and columns for a line layout.

(7) The Margins Area

The Margins area is used to set the margins for the output of a line layout.

(8) The Status Bar

You will find the status bar along the lower edge of the screen. It contains tips on the buttons on the toolbar, on menu commands, and on keyboard settings, for example.

See also

The Table Area (Page 2319)

The Header and Footer Areas (Page 2318)

The Page Size and Margins Areas (Page 2317)

The Standard Toolbar (Page 2316)

11.3.2 The Standard Toolbar





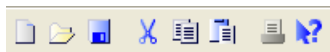



Usage

The toolbar is located under the menu bar along the top of the line layout editor. The buttons arranged on the toolbar enable you to access the functionality of the line layout editor quickly and easily.



Contents

The standard toolbar contains buttons with the following functions:

Button	Function	Key combination
	Creates a new line layout.	<CTRL+N>
	Opens an existing line layout.	<CTRL+O>
	Stores the active line layout.	<CTRL+S>
	Cuts the selected text from the header or footer and copies it to the clipboard. The function is only available when a text is selected.	<CTRL+X>
	Copies the selected text from the header or footer to the clipboard. The function is only available when a text is selected.	<CTRL+C>
	Pastes the contents of the clipboard at the location of the cursor. The function is only available if there is a text on the clipboard.	<CTRL+V>
	The "Print" function is deactivated in the line layout editor.	
	Activates the direct help (What's this?).	<SHIFT+F1>

Characteristics

The toolbar in the line layout editor is always activated. You cannot hide it.

See also

- The Page Size and Margins Areas (Page 2317)
- Working with the Line Layout Editor (Page 2321)
- The Table Area (Page 2319)
- The Header and Footer Areas (Page 2318)

11.3.3 The Page Size and Margins Areas

Introduction

Line-by-line printing is used in practice for current and synchronous documentation. WinCC allows for "line-by-line printing" on appropriate printers. The output to the printer is only possible via a local, parallel interface on the computer. You can set the page size and margins for each line layout within the permissible limits.

Page Size in the Line Layout

The page size of a line layout can be set within the following limits:

- You can set between between 20 and 400 lines.
- The number of columns can be between 20 and 400.

The value for the number of columns is defined as the number of characters per line.

Margins in the Line Layout

Because most printers cannot print right up to the edge of the page, the margins must be set accordingly in the line layout. The margins of a line layout can be set within the following limits:

- The value for the margins (left, right, top, bottom) can be between 0 and 30 characters.

Printer Settings

The number of columns set in a line layout under "Page Size" (= characters per line) must be supported by the printer used. If the number of columns is greater than the number of characters a printer can print per line, a line break is inserted. This overflow of the column text into a new line disturbs the column formatting. To remedy this, a narrower font or a smaller character width must be set for the printer.

Setting the font or character width depends on the printer used. Please check the printer manual for further information.

Note

If the suitable font is not set as the default font on the printer, it will have to be set again each time the printer is reset or switched off and on again.

See also

Working with the Line Layout Editor (Page 2321)

The Table Area (Page 2319)

The Header and Footer Areas (Page 2318)

The Standard Toolbar (Page 2316)

How to Set the Page Size (Page 2321)

11.3.4 The Header and Footer Areas

Introduction

You can define a different header and footer for each line layout. The number of headers and footers can be between 0 and 10. You can enter any text you like in them. You can output as many headers as the number of lines you have set. You do not have to output the header and footer.

Usage

The headers and footers are output with each page of the message sequence report. The width of the headers and footers is based on the number of columns (= characters per line) set under "Page Size". Text in the header or footer that is longer than the configured number of columns is truncated at output.

See also

Working with the Line Layout Editor (Page 2321)
The Table Area (Page 2319)
The Header and Footer Areas (Page 2318)
The Standard Toolbar (Page 2316)
How to Create Headers and Footers (Page 2322)

11.3.5 The Table Area

Introduction

You can define a table for the output of reports and measured values for each line layout. The number and contents of the columns are defined using the "Selection..." button. The number of columns can be between 1 and 40 and depends on the number of selected message blocks.

Usage

The configured columns with the associated headings and the set column width are displayed in the Table area. You can configure the column heading and the column width for each column separately.

Use the "Selection..." button to open the "Alarm Logging Runtime: Report - Table Column Selection" dialog. In this dialog, you can select the server(s) whose reports you want to log. You can assign the message blocks to the table columns and set the filter criteria for the alarm output. These changes are only effective for the output of the message sequence report and are not written back to the alarm logging. You can find additional information in the sections "Outputting Runtime Data with the Message Sequence Report" and "Changing Output Options for the Message Sequence Report".

See also

The Time Range (Page 2320)
Working with the Line Layout Editor (Page 2321)
The Table Area (Page 2319)
The Header and Footer Areas (Page 2318)

The Standard Toolbar (Page 2316)

How to Change the Output Options for the Message Sequence Report (Page 2325)

11.3.6 The Time Range

Introduction

By changing the base for the time settings you can convert the time specified in the time stamp of the report data to a different time base. The time settings are only converted for the output in the report and are not written back to the alarm logging. If, for example, you want to output the data of a remote computer in another time zone, you can use this function to ensure that the data is output with a comparable time. If the two computers in this case were working with the "Local Time" time base, you would receive reports on the two computers with different times. The results would not be directly comparable. You can find additional information in the section "Adjusting the Time Settings in the Project".

If you change the time base for the output, ensure that the time reference is also output in the report. For example, specify an identifier in the alias for the "Time" message block. You can find additional information "Changing the Output Options for the Message Sequence Report".

Usage

You can change the time base in the "Table" area. To do this, click the "Time Base..." button. The "Time Base Entry" dialog appears. Select the time base from the list.



See also

The Header and Footer Areas (Page 2318)

The Table Area (Page 2319)

Working with the Line Layout Editor (Page 2321)

The Standard Toolbar (Page 2316)

How to Change the Output Options for the Message Sequence Report (Page 2325)

11.4 Working with the Line Layout Editor

11.4.1 Working with the Line Layout Editor

Introduction

The line layout editor is only used to create and change line layouts for the message sequence report. It therefore has a very simple layout and is easy to use. This section describes how you can do the following:

- Set the page size of a line layout
- Create the header and footer
- Create a table in the line layout
- Change the output options for the message sequence report

See also

[How to Change the Output Options for the Message Sequence Report \(Page 2325\)](#)

[How to Create a Table in the Line Layout \(Page 2323\)](#)

[How to Create Headers and Footers \(Page 2322\)](#)

[How to Set the Page Size \(Page 2321\)](#)

11.4.2 How to Set the Page Size

Introduction

You can set the page size and margins for each line layout within the permissible limits. You can set the desired values either by using the controls or by entering them directly in the fields.

The following limits apply to the line layout:

Number of lines	Values between 20 and 400 are valid.
Number of columns	Values between 20 and 400 are permissible.
Margin width	Values between 0 and 30 are permissible.

Procedure

1. Select an existing line layout in WinCC Explorer or create a new line layout and open it in the line layout editor.
2. Set the number of lines per page in the "Page Size" area by using the corresponding controls or by entering a value.

3. Set the number of columns (= characters per line) in the "Page Size" area by using the corresponding controls or by entering a value.
4. Set the width of the margins for output in the "Margins" area by using the controls or entering values.
5. Save the changes and close the line layout editor.

See also

How to Change the Output Options for the Message Sequence Report (Page 2325)

How to Create a Table in the Line Layout (Page 2323)

How to Create Headers and Footers (Page 2322)

11.4.3 How to Create Headers and Footers

Introduction

You can create a header and footer for each line layout in the line layout editor. They are then output with each page. Headers and footers consist of text only and can have a maximum of 10 lines each. You can set the number of lines for headers and footers separately by using the corresponding controls or by entering values directly. Lines of text that are longer than the page width set in the "Page Size" area (number of columns = characters per line) are truncated at output.

Procedure

1. Open the desired line layout in the line layout editor.
2. Set the number of lines in the "Header" area by using the corresponding control or entering a value.
3. Enter the text for the header in the text box. Note the number of characters per line. Press the return key to insert a line break.
4. Edit the footer in the same way.
5. Save and close the layout.

If you enter more lines during input than are specified for "Number of Lines", a message to this effect appears. Only the number of lines set for "Number of Lines" are output. Excess lines are not output.

See also

How to Change the Output Options for the Message Sequence Report (Page 2325)

How to Create a Table in the Line Layout (Page 2323)

How to Set the Page Size (Page 2321)

11.4.4 How to Create a Table in the Line Layout

Introduction

The table object for the output of reports in the message sequence report is a fixed part of the line layout. The static object properties for this table object are predefined. Click the "Selection..." button to open the "Alarm Logging Runtime: Report - Table Column Selection" dialog. In this dialog you can specify the assignment of the message blocks to the columns for output. You also assign the column headings here and set the width of the individual columns for output.

Requirements

- The desired layout must be open in the line layout editor.
- Alarm logging must be configured.

Procedure

1. Click the "Selection..." button to open the "Alarm Logging Runtime: Report Table Column Selection" dialog.

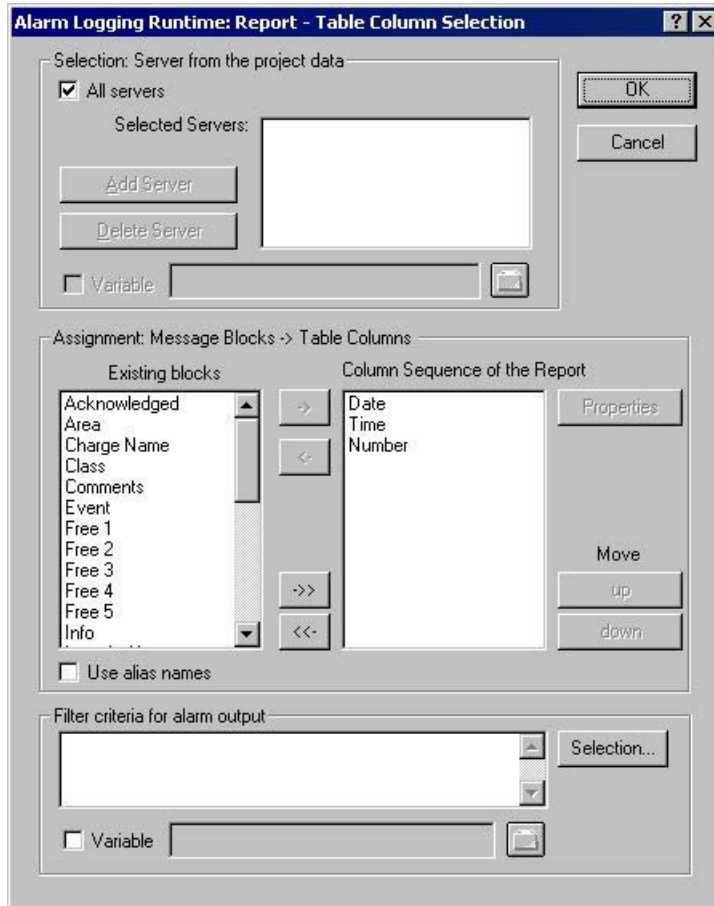

2. Use the dialog to specify the data for output. You can find additional information in the section "Changing the Output Options for the Message Sequence Report". When you close the dialog, the selected columns and their widths are displayed in characters per line in the "Table" area. If the number of characters per line is too large, a message to this effect appears.
3. Change the time base for times, if necessary. You will find more information in the section "Table Area".
4. Save the line layout, and close the editor.

See also

How to Create Headers and Footers (Page 2322)

How to Set the Page Size (Page 2321)

The Table Area (Page 2319)

How to Change the Output Options for the Message Sequence Report (Page 2325)

11.4.5 How to Change the Output Options for the Message Sequence Report

Introduction

To output a user-specific selection of messages, you can either use a predefined line layout or create your own line layout. The layout must be called in the "@Report Alarm Logging RT Message Sequence" print job.

For the output of a message sequence report in a page layout, changes to the output options must be configured in the page layout editor. You will find more information in the section "Creating a User-Defined Message Sequence Report".

Note

You cannot output a Message Sequence Report in line layout as a file.

Requirements

- The desired layout must be open in the line layout editor.
- Message configuration has been carried out in Alarm Logging.

Procedure

1. Click the "Selection" button in the "Table" area. The "Alarm Logging Runtime: Report Table Column Selection" dialog is opened.
2. Use the dialog to configure the selection of data for output. You will find a description of the dialog in the section "Data Selection" below.
3. Apply the settings by clicking "OK".
4. Save the line layout, and close the editor.

Data Selection

The "Alarm Logging Runtime: Report Table Column Selection" dialog is used to select the data to output in the message sequence report. It allows you to select the servers, message blocks, and filter criteria for alarm output.

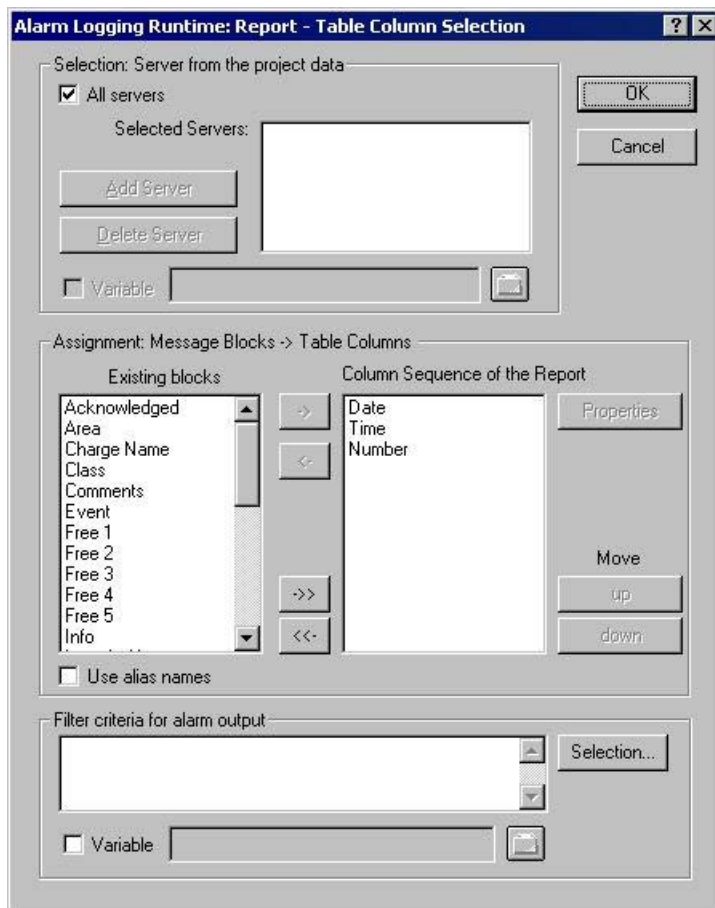

Selecting the Servers

Server selection is only necessary if you:

- want to log the messages on a WinCC client,
- or
- want to log the messages of one server on another server in a distributed system

In the "Selection: Server from the Project Data" area, you can select the servers whose messages are to be logged. Only those servers whose "packages" have been loaded are offered. The selected servers are displayed in the window. In the case of a single-user and multi-user project this selection is not required.

Dynamization of Server Selection by Means of a WinCC Variable

You can dynamize server selection in order to select servers when a project is activated directly before logging is started. The report system reads the value from the variable at runtime. If the variable cannot be read, the configured value is used.

1. Select the "Variable" check box. The text box and the folder button are activated.
2. Use the folder button to open the variable selection dialog. Select the desired variable there, and close the variable selection dialog. Alternatively, enter the variable name directly in the text box.

Configure value assignment to the WinCC variable. You will find more information in the section "Types of Dynamization".

Selecting Message Blocks

In the "Assignment: Message Blocks -> Table Columns" area, you can define the message blocks for output in the report. In the "Message Blocks" area, select the desired message blocks from the list of existing message blocks. Use the control elements in the dialog to add the message blocks to the list of the current column sequence of the report either individually or in groups.

Editing the Properties of the Message Blocks

From the list of the current column sequence of the report you can select individual message blocks and edit their properties. To do this, select a message block from the current column sequence of the report and click the "Properties" button. You can now assign an alias to the block name and change the format for the date and time message blocks. The appearance of the dialog that opens depends on the type of message block selected. The changes are only effective for the output of the report and are not written back to the Alarm Logging.

If the "Use Aliases" check box is selected, the configured aliases are output as the column headings. The aliases cannot be configured for multiple languages. If the check box is cleared, the names of the message blocks are used as column headings. If the language is changed, the names stored for the message blocks in the text library are output. By default, the check box is cleared. If the "Use Aliases" check box is selected and there are no aliases configured, the names of the message blocks are output.

Setting Filter Criteria for Alarm Output

In the "Filter Criteria for Alarm Output" area you can use the "Selection..." button to display the dialog for setting criteria for alarm output. Use the check boxes in the dialog to select the desired selection criteria. When you apply the settings by clicking the "OK" button, the selected selection criteria are displayed in the "Filter Criteria for Alarm Output" area. The individual arguments are always ANDed. You will find more information in the section "Filter Criteria for Alarm Output".

You can also make a selection in the print job by means of the size or time range. Additional information can be found in the chapter "Print Jobs in WinCC".

Note

In a message sequence report, the messages from the report system are logged as soon as they arrive. It therefore does not make sense to select the time range for the output.

See also

How to Create a Table in the Line Layout (Page 2323)

How to Create Headers and Footers (Page 2322)

How to Set the Page Size (Page 2321)

COM Provider in the Layout Editor

12.1 COM Provider in the Layout Editor

Contents

In the report system of WinCC, an user-specific report object can be integrated with the aid of a COM interface. Therefore data which does not originate in WinCC can be output in a WinCC report. The documentation provides information about:

- Application options of the COM Provider
- Integration of COM Provider into WinCC
- Outputting data with the aid of a COM object
- Details of the COM interface for reporting

12.2 Working with COM Server Objects

Introduction

To integrate user-specific data in a WinCC log, you can integrate a COM server in the report system. This COM server provides a COM object in the object selection that is selected in the page layout editor and added to a page layout. The COM object then provides the user-specific data for output in the log. The COM object can be of the type text, table, or picture.

At this point, no comment can be made about the COM object itself. Information about it is provided by the writer of the COM server.

Integration of COM Server Objects

The following steps are necessary to use a COM object in the report system:

1. Register COM object
2. If necessary, depending on the COM object, run the Registry file of the COM object.
3. Insert COM object in the object palette of the page layout editor by entering it in the registry
4. Select COM object in the object selection
5. Position COM object in the layout and parameterize it

Steps 1 to 3 must be carried out on every server and WinCC client on which you want to use such a COM object. These steps must also be carried out if the COM object should only be used in Runtime.

To create a COM server for the report system of WinCC, the Type Library "WinCCProtProvider.tlb" must be registered on the development computer. The Type Library is automatically registered on a computer with WinCC installed. To register on a computer without WinCC installed there is the following option:

Copy the "WinCCProtProvider.tlb" file from a computer with WinCC installed. The file is located in directory ".\Siemens\WinCC\Interfaces. Add the file to the target computer and register it.

A correctly integrated COM object is displayed in the object selection of the page layout editor on the "COM Server" tab. From there it can be selected and added to the layout.

For more information, refer to chapter "Details of the COM Interface for Reporting".

See also

[How to Output Data from a COM Server in a Report \(Page 2331\)](#)

[Example of an integration of a COM server \(Page 2332\)](#)

[Details of the COM Interface for Reporting \(Page 2333\)](#)

12.3 How to Output Data from a COM Server in a Report

Introduction

To integrate user-specific data in a WinCC log, you can integrate a COM server in the report system. This COM server makes a log object available in the object palette that can be selected in the page layout editor and inserted in a page layout. The COM object then provides the user-specific data for output in the log.

Available Log Objects

COM object defined by the user	Serves to output data from data sources of the user in a WinCC log.
--------------------------------	---

Requirements

- Knowledge of how to create layouts and insert log objects

Procedure

1. Create a new page layout, and open it in the page layout editor.
2. In the object palette on the COM Server tab, select a COM object integrated by the user, and drag it to the desired size in the working area.
3. The creator of the COM object makes specifications available on the connection and selection of the data.
4. Configure the COM object in accordance with the specifications made there.
5. Save the layout.
6. Create a print job, and select the configured page layout there.
7. Start output by means of the print job in WinCC Explorer or by means of a configured call in a WinCC picture, for example.

Output options

You receive information on possible output options from whoever wrote the COM object.

See also

Working with COM Server Objects (Page 2330)
Details of the COM Interface for Reporting (Page 2333)
Example of an integration of a COM server (Page 2332)

12.4 Example of an integration of a COM server

Introduction

There two examples provided on the WinCC CD-ROM, each containing a COM server. One example is written in Visual Basic, the second one is written in Visual C. The examples are in zip format under "Options\ODK\Samples" on the WinCC CD-ROM. The "CCProtTableServerExampleVB.zip" file contains the example in Visual Basic. "CCProtPicturerExampleCPP.zip" file contains the example in Visual C++.

Procedure

Unpack the compressed file into a temporary directory. Integrate the files into the system.

1. Provide the Type Library
2. Compile example
3. Register COM server
4. Integrate COM server in the report system

To integrate the COM Server in the system, you require extensive programming skills that cannot be provided in this documentation. Chapter "COM Interface Requirements for Reporting" contains instructions regarding the formal COM server requirements.

The "*.REG" files supplied with the examples are not part of the sample projects in Visual Basic or Visual C. Instead they are used to insert the COM Servers into the object palette of the page layout editor.

Note

The ClassId for Visual Basic exists only in the compiled DLL. This this file is not included, a new ClassID will be generated during compilation. This new ClassID must then be entered in the RegFile of the Report Provider.

You will find the new ClassID using the "OLEView" tool. Search the ProgID.

See also

Details of the COM Interface for Reporting (Page 2333)

How to Output Data from a COM Server in a Report (Page 2331)

12.5 Details of the COM Interface for Reporting

Introduction

This chapter provides information and the requirements of a COM Interface for reporting. Further instructions can be found in the chapters "COM Server Data Output" and "Example of the Integration of a COM Server".

Call Interface

An object can/must provide the following COM interfaces so that the WinCC report system can use this object:

```
interface IWinCCProtProvider : IDispatch
{
    HRESULT Register([in]IDispatch* pDispWinCCProtReportParams);
    HRESULT Unregister();
    HRESULT GetName([out, retval]BSTR* pName);
    HRESULT ShowPrivateDialog([in]long hwndParent, [out, retval]BOOL* pfOK);
    HRESULT SetPrivateData([in]VARIANT PrivateInfo);
    HRESULT GetNameOfPrivateData([out, retval]BSTR* pPrivateInfoName);
    HRESULT GetPrivateData([out, retval]VARIANT* pPrivateData);
};

interface IWinCCProtProviderText : IDispatch
{
    HRESULT GetText([out, retval]BSTR* pName);
};

interface IWinCCProtProviderTable : IDispatch
{
    HRESULT GetNumCols([out, retval]int* pnNumCols);
    HRESULT GetNumLines([out, retval]int* pnNumLines);
    HRESULT GetText([in]int nLine, [in]int nCol, [out, retval]BSTR* pName);
    HRESULT HasHeader([out, retval]BOOL* pfHasHeader);
    HRESULT GetHeader([in]int nCol, [out, retval]BSTR* pName);
};

interface IWinCCProtProviderPicture : IDispatch
{
    HRESULT Draw( [in]long hdc, [in]int left, [in]int top,
[in]int right, [in]int bottom);
```

};

The object must support the interface IWinCCProtProvider and one of the interfaces IWinCCProtProviderText, IWinCCProtProviderTable and IWinCCProtProviderPicture.

CR+ is used as line feed characters at the IWinCCProtProviderText interface.

LF (CR = "Carriage return" and LF = "line feed").

Interface IWinCCProtProvider

Register	Is called after starting the COM Server to pass a pointer to IWinCCProtReportParams to the server.
Unregister	Is called to instruct the COM Server to rerelease the pointer to the interface IWinCCProtReportParams.
GetName	Returns the name of the COM Server to display it on the configuration interface.
ShowPrivateDialog	Open the COM Server selection dialog box.
SetPrivateData	Passes on the SelCrit data saved in the layout to the COM Server.
GetPrivateData	Reads the SelCrit data from the COM Server to save it in the layout.
GetNameOfPrivateData	Returns the name of the selection criterion to display it on the configuration interface.

Interface IWinCCProtProviderTable

GetNumCols	Returns the number of columns to be printed in the report.
GetNumLines	Returns the number of rows which should be printed in the report.
HasHeader	Returns the information as to whether a table header should be printed in the report.
GetHeader	Returns the table header text to be printed in the report.
GetText	Returns the text to be printed in the report.

Special aspects of the data:

The control characters for colors, alignment, etc. always precede the output text and can be combined with each other (e.g. "<U>output text"). They are not case-sensitive.

<END>	Concludes the interpretation of control sequences. The rest of the text is accepted as specified.
<COLOR=#rrggbb>	Font color in hexadecimal notation (default = as set for the table)
<BGCOLOR=#rrggbb>	Background color in hexadecimal notation (default = as set for the table)
	Bold
<U>	Underlined
<I>	Italic
<STRIKE>	Strike-through
<ALIGN=left>	Left aligned

<ALIGN=center>	Centered
<ALIGN=right>	Right aligned

Interface IWinCCProtProviderText

GetText Returns the text to be printed in the report

Interface IWinCCProtProviderPicture

Draw Hands over a handle to the device connect to the COM Server and coordinated in which you can draw.

Draw the output field here in the specified device context. It is an enhanced metafile. Drawing is done in MM_HIMETRIC mode.

Interface to Read Parameters from the Report Context

The report system provides an interface to read parameters from the report context (settings from the report system and the job properties).

Interface IWinCCProtReportParams : IDispatch

```
{
HRESULT GetParameter ( [in]BSTR PropertyName, [out]VARIANT* Value );
};
```

Currently the following properties can be read:

TimeFrom	Parameter from the print job
TimeTo	Parameter from the print job
PrivateSelCrit	Is used e.g. when the "Print" button in WinCC Control is pressed. Using this PrivateSelCrit, the current selections of the WinCC Control are sent to the COM server.
ProjectName	WinCC project name
LCID_APP	Currently set language in the application which the COM server calls (PrintIt/ProtCS). The WinCC system language might be different because the Runtime language is not actively supported by WinCC.
LCID_RT	Current Runtime language of WinCC. This setting is only visible in Runtime.

Registry Entries

The entries in the Registry are made automatically depending on the COM object or must be made in the Registry by calling a Registry file. The Registry file must be supplied by the COM object. Without these Registry entries, a COM object is not available to the report system, even if the COM object is registered. The COM objects are registered by the user.

Example of Registry entries of COM server:

```
HKEY_LOCAL_MACHINE\SOFTWARE\SIEMENS\WinCC\Report Designer
\ReportClientDLLs\{4BF175C2-8BFF-11D0-840D-0080AD1374C8} (GUI-ID of the COM
object as a unique key)
"DllClientGUID"="{4BF175C2-8BFF-11D0-840D-0080AD1374C8}" (GUID of the COM object)
"DllFileName"="CCPComProvider.dll"
"NeedsRuntime"="NO"
"RunsOnServer"="YES"
"RunsOnClient"="YES"
"RunsOnMultiClient"="YES"
"UseReportDesignerObjTab"="COM-Server"
```

Behavior of the Application Objects

The calls in the COM Server are timed.

Debugging support:

So that debugging COM servers is not unnecessarily made more difficult by the timeout behavior, the timeout period can be set. If the Registry Key is not defined, the default value (10000 milliseconds) is used.

```
HKEY_CURRENT_USER\Software\SIEMENS\WINCC\ReportSystem\TimeOuts\
```

```
InvokeTimeOut (vom Typ DWORD) --> TimeOut period in milliseconds
```

If timeout period 0xffffffff (-1) is entered as value, the report system waits infinitely for the function.

See also

How to Output Data from a COM Server in a Report (Page 2331)

Example of an integration of a COM server (Page 2332)

Setting Up Multilingual Projects

13.1 Setting Up Multilingual Projects

Content

WinCC offers the following possibilities:

- Different languages can be set for the project interface.
- Create projects that run in multiple languages in Runtime.

WinCC provides the following tools for creating multilingual projects:

- Text Library editor:
 - Managing and maintaining almost all texts of your project
 - Exporting and importing texts of the project
- Text Distributor
The Text Distributor provides all editors with user-friendly export and import options for translating the configured text records.
- WinCC Configuration Studio
Direct input of the translated texts in the Alarm Logging, User Administrator and User Archive editors in the properties with translatable texts

This chapter shows you:

- How to export texts for translating and import them again with the Text Distributor.
- How to manage texts centrally with the "Text Library" editor, export texts for translating and import them again.
- How to configure multilingual pictures in the "Graphics Designer" editor.
- How to configure multilingual messages in "Alarm Logging" editor.
- How to configure reports for multilingual projects.
- How to configure multilingual date and time displays.
- How to configure changes of language in Runtime.

Note

Observing migration instructions

Observe the "Migration" instructions for old projects, process pictures and scripts.

13.2 Language support in WinCC

13.2.1 Language support in WinCC

Multilingual Configuration in WinCC

WinCC enables you to configure your projects in multiple languages. For this purpose WinCC supports the multilingual configuration of almost all objects containing text that is visible in Runtime.

In addition to direct text entry, WinCC provides you with user-friendly export and import options for translating your configuration with the Text Library and the Text Distributor. This is especially advantageous if you are configuring large projects with a high text content.

Supported Languages

In principle WinCC allows you to create projects for every language installed on your operating system. During installation WinCC also offers you a set of languages that you can use to set up your WinCC configuration interface.

- German
- English (US)
- Spanish (Traditional)
- Italian
- French
- Japanese
- Chinese (Simplified, PR China)
- Chinese (Traditional, Taiwan)
- Korean

You can set up the WinCC Configuration interface in the installed languages. In addition, once a language has been installed all standard texts are available in that language.

If a project should be used on another computer, then WinCC must be installed on the target computer in the same language as on the source computer. You should always install WinCC with all available languages.

Note

Asian languages

You need a "License Key USB Hardlock" to work with Asian languages.

Standard texts

Standard texts are all texts that already exist in the languages installed in WinCC, e.g. default names of message classes in the "Alarm Logging" editor, WinCC system messages, and the title bar captions and column titles in WinCC Control.

Configuration Scenarios

When configuring in other languages the following scenarios can occur:

- You are configuring a project for a language with which you are unfamiliar.
Example:
You are an English speaking project engineer and configuring for an Asiatic market: Display the project user interface of WinCC in your preferred language.
There are two procedures for configuration:
 - Configure the project in a language with which you are familiar, export the texts, translate the texts externally and import the translated texts back into the WinCC project.
 - You enter all text for your project directly in the language that is intended to be displayed later in Runtime. Direct text entry is recommended only in cases where you have configured just a small amount of text in your project.
- You are configuring a project for a number of languages with which you are unfamiliar.
Example:
You are a French speaking project engineer and configuring a project for a system which must be operated by Russian, English and German speaking users: Display the project user interface of WinCC in your preferred language. Configure the project in a language you are familiar with and export all the text. Distribute the export files to translators for the respective language. Following translation, import the translated texts back into your WinCC project. Configure a change of language facility for the operators as well, so that they can use it in Runtime to select the desired language for the operator interface.

13.2.2 Language expressions in WinCC

Principle of Language Expressions in WinCC

When using WinCC to create multilingual projects, you can set up languages at multiple system levels. It is therefore helpful to distinguish between these various levels by using clearly defined language expressions.

Operating System Language

The operating system language (system locale) is the language environment set in the operating system in which applications such as WinCC run. This setting defines, for example, the used "Code Page" in character sets.

Note

WinCC-GUI language and operating system language

Set the operating system language corresponding to your WinCC user interface so that the correct code page is used and all character sets are correctly displayed. Alternatively you can use an operating system in the corresponding language.

Information about the operating system language and code pages can be found in your Windows documentation.

Operating system user interface language

The operating system user interface language is the language in which the GUI of operating system is displayed. All Windows menus, dialogs and info texts are displayed in this language. During configuration, some system dialog boxes are displayed in WinCC Configuration in the operating system user interface language, for example, standard dialogs such as "Open file" and "Save as".

The operating system user interface language can only be switched with multilingual operating systems.

WinCC GUI language

The WinCC GUI language is the language of the project interface in WinCC Configuration, i.e. the language in which the WinCC menus, dialog boxes and help are displayed during configuration. You can set any language as the WinCC GUI language installed during setup. The maximum installation includes: German, English, Italian, Spanish, French, Japanese, Korea, Chinese (Simplified), and Chinese (Traditional).

You need a "License Key USB Hardlock" to work with Asian languages.

The language that you selected for the installation of WinCC is set as the WinCC GUI language when you first start WinCC. The next time you start WinCC the interface is displayed in the WinCC GUI language that you set up last.

Set dialog language for the WinCC user interface centrally in WinCC Explorer, "Extras" menu. Select a language you are familiar with as the WinCC GUI language for configuration.

Note

User interface language of WinCC and of the operating system

If the current WinCC GUI language is not the same as the operating system user interface language, the standard dialog elements of certain WinCC editors remain unchanged and continue to be displayed in the operating system user interface language. This applies to standard buttons, such as "Cancel", and standard system dialogs, such as "Save as", "Open file" or "Print".

In order to display these elements in the desired language, you need to set the operating system user interface to the same language as you are using for the WinCC GUI language.

Project language

The project language is the language to be used for the project you are creating. You can create a project containing multiple project languages in order to make several languages available in runtime.

In the WinCC Configuration Studio menu, the language is defined as "Input language".

Note

Operating system languages as configuration languages

In addition to the languages installed with WinCC you can select any other language supported by your operating system as the project language.

Of the operating system languages, WinCC < V7.2 only supports the primary languages, e.g. English (USA), but not English (GB), Spanish (Spain), but not Spanish (Argentina).

In each case set up the project language directly in the editor you are using for configuration, for example, in the "Alarm Logging" editor or the "Graphics Designer" editor.

After switching the configuration language, the user interface remains the same in WinCC Configuration. Only the language of the texts which you create for your project is switched.

The current project language is displayed in the status bar of the respective editor.

Runtime language

The Runtime language is the language in which the project is displayed in Runtime. You may set a Runtime language in WinCC in which the project will start in Runtime. The language must be set up in the text library.

When creating a project containing multiple languages, configure operating elements which will allow the operator to change the Runtime language.

Note

Runtime language

Always select one of your configuration languages or the Runtime default language as the Runtime language.

Runtime Default Language

In the computer properties in WinCC Explorer, a Runtime default language may be set which applies to graphics objects.

If, for a specific text, there is no translation available into the current Runtime language, the text is shown in the configured Runtime default language. If the text is not available in this language "???" is displayed.

Default Runtime Language for Objects

The default Runtime language is English. The default Runtime language is the language used for texts of a WinCC object, such as AlarmControl or TableControl, if no translation of the respective Runtime language is available. This mainly affects the title and column headers of the WinCC Controls if the Runtime language is not one of the languages installed with WinCC. In the languages installed with WinCC the controls are displayed correctly. This does not apply to texts and their translations stored in the Text Library.

13.2.3 Configuring Multiple Languages

Operating system requirements

When configuring projects for multiple languages, your operating system must meet the following requirements:

- The project languages must be installed.
- The correct system regional setting (operating system language) must be specified as default in the operating system of your computer.
This is particularly important if you are configuring for languages which are not Western European, e.g. Asian.
WinCC as of V7.2 supports Unicode. This means that a project may contain several languages of different regional schemes. Set the code page or code pages in the operating system of your computer that are used for programs that do not support Unicode.
- Any special fonts that you use must be available on your operating system. This applies particularly to non-Latin fonts used for example in Cyrillic or Asian languages.
- You must install input methods on your operating system to input e.g. Asian fonts.
For each running application, select the input methods independently of one another.

Note

How to make the corresponding settings or installation in your operating system is described in your Windows documentation.

Language combinations

Due to the various language setting options in WinCC and your operating system, a number of different language combinations can occur, for example:





- Configure a single-language project in the language preferred:
Operating system language, operating system user interface language, WinCC user interface language and configuration language are all the same.
- Configure a single-language project in but not in your preferred language:
Operating system user interface language and WinCC GUI language are your preferred language. The project language is the language in which you subsequently display the project in Runtime.
If you configure for Asian languages, define the operating system language so that the character set to be used is displayed in the respective code page.
If all languages are from one regional area (e.g. Western European), this setting is not necessary because it was already made implicitly.
Make sure that you use a font that contains all necessary characters for your project.
- You are configuring a multilingual project. One of the languages is your preferred language:
Operating system user interface language and WinCC GUI language are your preferred language. The project languages are the languages in which you subsequently display the project in Runtime. Configure the project in your preferred language and hand over the text for translation when the project is complete.
- Several project engineers who prefer different languages and configure on one computer:
A neutral language, e.g. English, is selected as the operating system user interface language. Each configuration engineer can set the WinCC GUI language to his preferred language. The languages that will subsequently be displayed in Runtime are set as the project languages.
If you configure for Asian languages, define the operating system language so that the character set to be used is displayed in the respective code page.
If all languages are from one regional area (e.g. Western European), this setting is not necessary because it was already made implicitly.
Make sure that you use a font that contains all necessary characters for your project.

Note





If you are using a multilingual operating system, the configuration engineer can also set the operating system user interface language to his preferred language.

Configuring for multiple languages - main editors

When configuring for multiple languages use the following editors:

- **Text Distributor:** 
The text distributor is a comfortable tool for exporting language-dependent text of the WinCC project. The exported data is translated in an external program. You then import the texts again following translation.
- **Text Library:** 
All project texts are managed centrally in the "Text Library" editor except for texts from "Graphics Designer" editor. You export centrally the texts of one or all languages for the translation. As an alternative, you can translate the text directly in the "Text Library" editor or the respective editor.
- **Graphics Designer:** 
Configure the pictures for the project in the "Graphics Designer" editor. Pictures can contain different text elements, such as Static Text, Tooltips or Labels for ActiveX Controls. The text is saved in the respective picture. You export the text with the text distributor for the translation or you enter the translated text directly.
- **Alarm Logging:** 
The "Alarm Logging" editor is used to configure messages that are issued in Runtime. The texts for the message system are managed centrally in the Text Library.
To translate the text, you have the following possibilities:
 - Export the text for translation from Alarm Logging
 - Translation in the "Text Library" editor
 - Translation in the "Alarm Logging" editor

If there is a large number of message text records, it is to your advantage to export them. Configuring with SIMATIC STEP 7: Alarm logging texts from the SIMATIC Manager are stored in the Text Library when transferred and must be translated there.

- **Report Designer:** 
The following is configured in the "Report Designer" editor:
 - Language-dependent layouts for reports to be output in Runtime
 - Language-dependent layouts for the project documentation of your project
- **User Administrator:** 
The authorizations that you configure in the User Administrator are language-dependent. These text records are managed centrally in the "Text Library" editor.
You export the text records from the User Administrator or you translate them in the "Text Library" editor.
The User Administrator supports the languages which can be defined for the user interface. In order that the texts are created in the project Text Library, you must open the User Administrator in the respective language.
- **User Archive:** 
All the texts in the user archives are managed centrally in the "Text Library" editor. You export the text records from the user archive or you translate them in the "Text Library" editor.
- **Picture Tree (option):** 
The container names are administered centrally in the Text Library. You export these text records or you translate them in the "Picture Tree" editor or "Text Library".

Note

The project language is set up separately for the "Graphics Designer" editor and the editors in WinCC Configuration Studio. By default the editors start with the set Runtime language as the project language.

WinCC elements such as archive names, tag names and script functions are unique and cannot be configured for multiple languages.

Do not use any national special characters or Asian fonts in language-dependent WinCC elements. These characters are illegible or prevent WinCC from working properly after switching languages.

Exception:

In tag names you may also use non-ASCII characters, e.g. Asian characters.

WinCC as of V. 7.2 supports Unicode. Projects may contain several languages with different code pages. Exceptions are ActiveX components, channels, and the C compiler. For this reason, C-scripts and VB scripts can only contain text in a single language.

Non-translated texts

Non-translated texts are displayed differently in Runtime. For more information, refer to "Language expressions in WinCC (Page 2339)".

13.2.4 How to Create a Multilingual Project

Introduction

The following section gives you an overview of the steps you need to take in order to configure multilingual projects. The optimal procedure is described in this chapter. Alternative procedures are described in the respective segments of this help.

Basic procedure

1. Install all required fonts and input methods on your operating system.
If you are configuring in non-Latin fonts, the relevant fonts must be available as Small Fonts.
2. Activate the languages to be configured in your operating system.
Your Windows documentation will tell you exactly how to do this.
3. Use the operating system of your computer to set the language that is used for programs and program parts that do not support Unicode.
4. Install WinCC with all languages that are available as dialog language for the WinCC user interface.
If you install languages at a later point in time, the standard text for these languages is not automatically put into the Text Library.

5. When you create a new project, the WinCC GUI language is the language you selected for the installation of WinCC. When launched again, WinCC opens in the WinCC GUI language last set.
If you use a language that is not provided with WinCC as the configuration language:
 - Make sure that the standard text records of these languages do not exist as translations in WinCC. In this case, the standard text records are entered in the current WinCC GUI language in the Text Library. You can translate these texts later or directly enter the language in the "Text Library" editor before changing to the project language.
6. Specify whether to export text files in Unicode in the "Project properties" > "Options" dialog.
7. Configure your project in a language with which you are familiar. This project language later serves as a basis for translation of the texts.
8. Export the text records with the Text Library.
If you have created picture objects with multilingual texts in the Graphics Designer, export the texts with the Text Distributor. You then have several files to translate.
9. Translate the texts in an external editor.
10. Re-import the translated texts.
11. Test your translated project in runtime.

Note

Creating the WinCC languages when copying a project

If you copy your project to another computer, all WinCC languages must be installed in the project's Text Library of the target computer. You may have to install the missing languages in the project's "Text Library" editor and may have to configure the language entries for these languages.

13.2.5 How to Switch the Language of the Operating System

Introduction

Windows makes all languages and fonts available. You install languages when you install Windows.

If you enable a language that is not actually installed, you are prompted to install it from the Windows DVD. Enable the necessary languages and fonts in your operating system.

Note

Windows display language and operating system language

For example, if you work with the "Chinese (simplified)" operating system and you want to configure with English language support in WinCC Explorer, you must select "English" language for menus and dialogs:

- "Control Panel > Time, Language, and Region > Language > Advanced Settings":
Under "Override for Windows Display Language", select English (United States).

This will correctly display the fonts in the dialogs and menus.

Activating languages in the operating system

Change the language setting in the "Control Panel > Clock, Language, and Region > Language".

Add additional keyboard layouts with "Options > Add input method".

Changing the input language

You can define a key combination for changing the input language.

Under "Language" select the "Advanced settings" link and define the settings under "Switching input methods".

Changing the locale

In the "Control Panel > Clock, Language, and Region > Region", you set the language for non-Unicode programs in the "Administrative" tab.

13.2.6 How to Change Languages in WinCC

Requirements

When setting up languages in WinCC, observe the following requirements:

- If you are configuring with non-Latin fonts, the necessary fonts and input methods must be installed in your operating system.
- All configuration languages you wish to use must be installed in your operating system.
- If you are configuring Asian languages, the proper system locale (operating system language) must be set to change the WinCC GUI language in the operating system Control Panel so that the used character sets are displayed with the matching code page. If all languages are from one regional area (e.g. Western European), this setting is not necessary because it was already made implicitly. WinCC as of V. 7.2 supports Unicode. For this reason, you only need to make these settings for programs that do not support Unicode.

Note

Operating system settings

For information on how to enter the appropriate settings and installation in your operating system, please refer to your Windows documentation.

Recommendations

In order to configure efficiently, please note the following:

- Always configure for one language at a time if possible.
- Set the Runtime language to be the language to be configured.
The editors always start with the set Runtime language as the configuration language.

Changing the WinCC GUI Language

To change the WinCC GUI language, the language must have been installed with WinCC.

Select "Tools > Language" in WinCC Explorer to change the WinCC user interface language.

In the selection window, you will be offered all installed WinCC languages with the exception of the current WinCC GUI language.

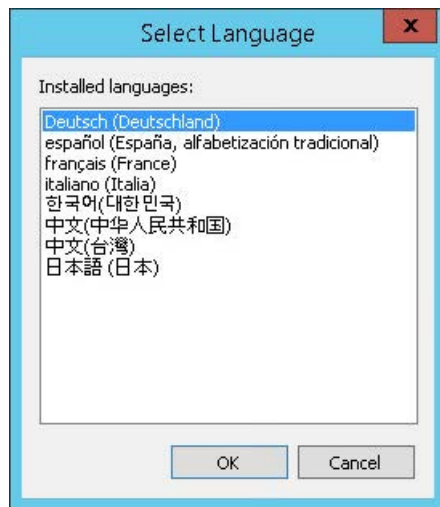

Order of the displayed languages:

- German
- English
- Spanish
- French
- Italian
- Korean

- Chinese (Simplified, PR China)
- Chinese (Traditional, Taiwan)
- Japanese

Following the change, the operating elements, menus and dialogs in WinCC Configuration are changed to the selected language.

Note

Operating system user interface language

If the current WinCC GUI language is not the same as the operating system user interface language, the standard dialog elements of certain WinCC editors remain unchanged and continue to be displayed in the operating system language.

This applies to standard buttons such as "Cancel", and standard system dialogs such as "Save as", "Open file" or "Print".

In order to display these elements in the desired language, you need to set the operating system language to the same language as you are using for the WinCC GUI language.

Note

Asian languages

If you are configuring for Asian languages and the current WinCC user interface language does not correspond to the operating system language, a large part of the Asian user interface will not be displayed correctly in WinCC < V7.2.

Changing the configuration language in the editors

You can set the configuration language separately for the "Graphics Designer" editor and the "Alarm Logging" editor.

To change the configuration language, open the editor concerned and select the menu command "View > Language" or "View > Input language". A selection window offers you all languages available on your system.

Following the change, all configured texts are displayed in the selected configuration language. If you have not configured the language yet, all texts in the "Graphics Designer" editor will be displayed as "???", and the "Alarm Logging" editor will not display any texts.

The set configuration language is displayed in the status bar of the Graphics Designer editor.

Setting Runtime language and Runtime default language

Set the Runtime language and Runtime default language in WinCC during centralized configuration in the start configuration of the Runtime computer. For more information, refer to "How to Set the Runtime Computer Starting Configuration (Page 2394)".

13.2.7 Fonts in Multilingual Projects

Introduction

In WinCC you can set a custom font for each configured language.

The fonts that you wish to use must be installed in your operating system.

You need special fonts if you use project languages containing non-Latin characters, such as Cyrillic, Greek or Asian character sets. For further information please refer to "Configuring with Non-Latin Fonts".

Note

If your configuration permits it, set the same language for operating system language, operating system user interface language, WinCC GUI language and configuration language.

Setting fonts in WinCC

WinCC supports Unicode. You can set a font that contains all characters required for all or multiple languages.

In WinCC you set the fonts in the "Graphics Designer" editor:

- You can set the font in the object properties of the respective object for all objects containing a text display:
 - "Properties" tab, "Static" column
currently displayed Runtime language
 - "Texts" tab
all Runtime languages
- For some objects you can set the font for the current Runtime language in the configuration dialog.

Non-Latin text is not correctly displayed in certain input windows, regardless of whether or not the font was properly set. The display is correct in runtime. In such an event you may enter the text in another editor (e.g. Word) and transfer it to the input field using copy & paste.

Objects containing nonadjustable font

Tooltips:

- In order to display tooltips in runtime in a non-Latin font, go to the Control Panel of your operating system and set the font for tooltips in Display Properties. Note that when you make this change, the fonts for the tooltips of all the other applications on your Windows system are also changed.

Window and column headings of ActiveX Controls:

- If the current Runtime language is not a WinCC language, text is always displayed in the Runtime default language (English).

In some text input windows of the "Graphics Designer" editor, you cannot set the font.

- In this event select an input dialog in which the font can be set.

13.2.8 Prohibited Characters in WinCC

General procedure

Depending on the language and the component, only certain characters are permitted in WinCC.

A complete overview of all characters that are not permitted can be found in the WinCC Information System under the topic "Working with WinCC > Working with projects > Appendix > AUTOHOTSPOT".

13.2.9 Configuring with Non-Latin Fonts

Non-Latin Fonts

When configuring your project in languages that use non-Latin fonts, such as Asian or Cyrillic character sets, you need the corresponding fonts on your operating system and in WinCC.

In your operating system activate the corresponding languages and keyboard layouts as described under "Switching Operating System Languages".

To display the Asian characters in Runtime, you absolutely require the Asian version of WinCC. With the Asian version, in addition to the texts configured by you, WinCC standard texts such as e.g. the Runtime dialog boxes, system messages are also available in Asian languages.

Using non-Latin fonts

For the majority of non-Latin fonts you can use the Input Method Editor (IME) in Windows. For further information on using the IME please refer to your Windows documentation.

Special Characteristics of Non-Latin Fonts in WinCC

When entering text in graphic objects there are some input windows in which non-Latin text is incorrectly displayed even though the font was correctly set. The characters are displayed correctly in Runtime. You can get round this by entering the text in another editor and then using Copy & Paste to add it to the input field.

Note

Depending on the operating system and language settings, carry out copy & paste actions may not be executed properly. To solve this problem, set the same input methods in the source and target application.

With certain objects in WinCC the font either cannot be set or can only be set in special circumstances. For further information on objects that cannot be changed see "Fonts in Multilingual Projects".

Notes regarding Configuration with Non-Latin Fonts

- Always configure a language in a uniform font.
 - For Alarm Logging editor texts, set the input language in the Alarm Logging editor.
 - In the "Graphics Designer" editor you configure the font directly in all the objects that contain text.
- The title and column headings for the following objects are only available in the languages installed with WinCC and the languages cannot be switched between:
 - A few WinCC controls
 - Trend control axes labels

If the current Runtime language is not a language installed with WinCC, labels are always displayed in the Runtime default language English.

- If you create records in non-Latin fonts:

Basically, language-specific layouts are used. Possible languages for the layouts are those installed with WinCC.

When a printout is started, the layout of the current Runtime language is used. If the current Runtime language is not a language installed with WinCC, the English layout is used.

If you want to generate a printout with a non-Latin font, define the respective font in the English layout. Select the whole layout and then set the font.

13.3 Text export and text import with the Text Distributor

13.3.1 Text export and text import in the Text Distributor

Introduction

WinCC allows the configuration of projects for many languages. The texts are displayed in runtime based on the configured language.

Overview

The project texts created by WinCC are centrally managed in the text library, except for most text from the "Graphics Designer" editor. Referenced texts in the "Text list" and "WinCC AlarmControl" objects are also managed in the text library.

The Text Distributor is a comfortable tool for exporting and importing all language-dependent text. Here you can export and import targeted languages, individual objects or groups of objects. The exported data is processed with an external program.

Starting the Text Distributor

You have the following options for starting Text Distributor:

- Double-clicking in WinCC Explorer
- Selecting the menu command "Tools > Text Import & Export..." in the "Graphics Designer" editor

Note

Special characters changed by saving in Excel

Be aware of the following when you export texts to TXT files using the "Text Distributor" editor, edit the texts in Excel, save and reimport them:

- Texts in quotation marks are enclosed in additional quotation marks (" "). You cannot change this characteristic of Microsoft Excel.
- Texts with "+" or "-" prefix are interpreted as numerical values. An error is written in the cell.
- Texts with "=" prefix are interpreted as cell references. The error or the text contained in the cell will be written to the cell.

To affect the way in which Microsoft Excel handles special characters, format the column or cells as "Text".

Use the "File Conversion Wizard" when opening a TXT file for this purpose.

13.3.2 How to export language-dependent texts

Introduction

Use the Text Distributor to export language-dependent texts to CSV files or TXT files. The Text Distributor creates several files that all begin with the same name.

Note

No import of texts with WinCC V6 format to WinCC as of version V7.2

WinCC as of V7.2 supports Unicode:

- You cannot import texts in WinCC V6 format to WinCC as of version V7.2.
 - Texts that you export from WinCC as of version V7.2 cannot be imported with an older version.
-

Text file export settings

Check the export settings for text files. For this purpose, select the project in WinCCExplorer and then select "Project properties" > "Options" from the shortcut menu. "Export Text files as Unicode" is set automatically by default.

Example

Enter the name "Mixing_station" in the "File prefix" field. Select the "*.txt" format in the "File format" field. The following files will be created among others:

- Mixing_station_Languages.txt
- Mixing_station_AlarmLogging.txt
- ...

NOTICE
Invalid file format
If you are using "*.csv" as the export format, Excel converts the Unicode file into an ANSI file. If you want to edit the exported data with Excel, select the "*.txt" file format during export.

Languages available for export and import

The Text Distributor offers all languages that are listed in the Text Library. You can export and import languages that originate from different regions.

For example, if you want to export Asian text from WinCC < V7.2, the corresponding system locale (operating system language) must be set in your operating system. Only then will the associated languages be available.

"English" is always available.

Note

WinCC V6 format

If you want to obtain an export file compatible to WinCC V6 when exporting, select the "Export" command in the "Tools > TextLibrary V6.x format".

Unknown objects

If a picture contains "unknown objects", the export or import of the picture is aborted immediately and "Unknown" appears in the information window.

Procedure

1. Open the Text Distributor by double-clicking in the WinCC Explorer or select the menu command "Tools > Text Import & Export..." in Graphics Designer.
2. Select or clear the editors from which you want to export text. If necessary, check or uncheck the individual objects of the editors.

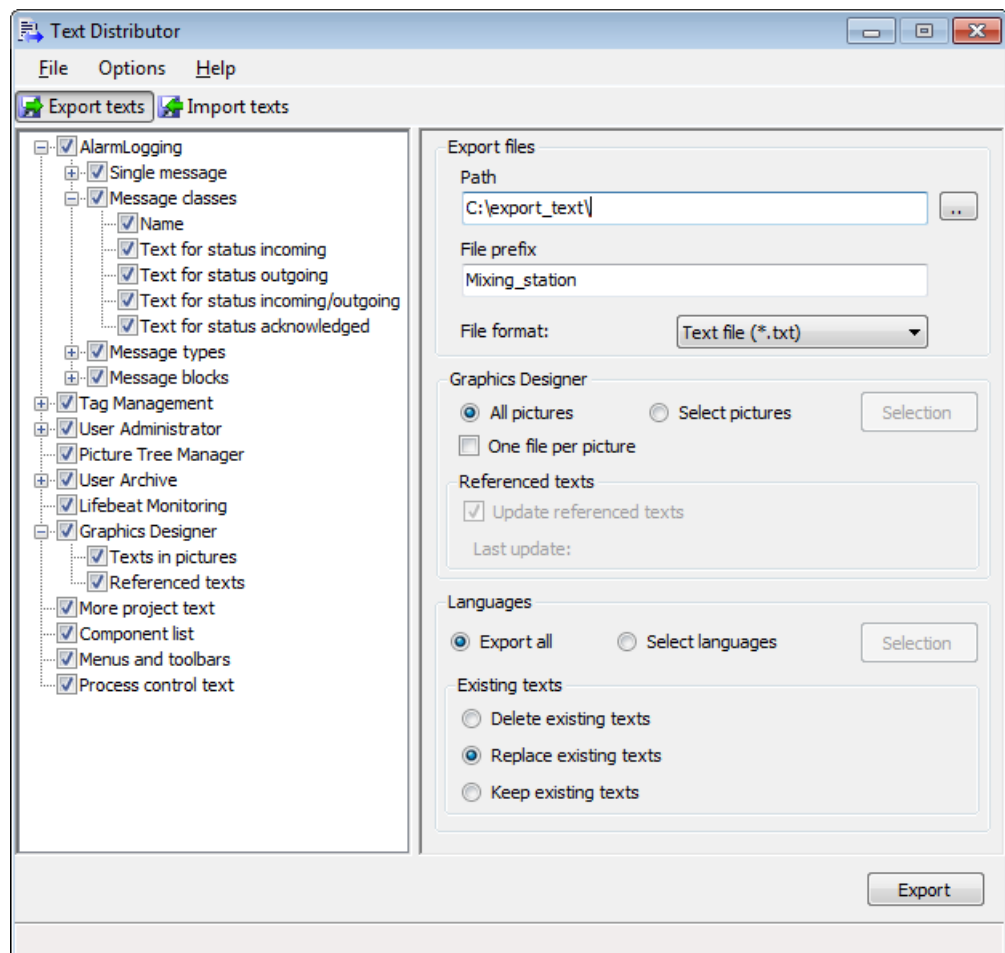

3. In the "Export files" area, select the path where the export files are to be saved.

4. Enter a meaningful name in the "File prefix" field.
All export files are created with a name that begins with this description.
5. Select the desired format, "*.txt" or "*.csv", in the "File format" field.
6. Specify the settings for the text export in the "Graphics Designer" editor.
 - Activate the "Select pictures" option if you only want to export the text from selected pictures. Select the desired pictures using the "Selection" button.
 - Activate "One file per picture" to create a separate export file for each picture.
 - Activate the "Update referenced texts" option after having edited or configured the "Text list" and "AlarmControl" in Graphics Designer. This updates the texts linked to the Text Library prior to the export.
7. If you want to export individual languages, select the languages in the "Languages" section using the "Selection" button.
8. Specify how to handle existing texts in the "Existing texts" section.
 - Activate the "Delete existing texts" option to delete existing export files.
 - Activate the "Replace existing texts" option to replace existing export files.
 - Activate the "Keep existing texts" option to prevent overwriting of existing export files.
9. Start the text export by clicking the "Export" button.

Result

The export files are created and saved in the select path.

13.3.3 Structure of the Export Files

13.3.3.1 Export File Overview

Overview

Use the Text Distributor to export language-dependent texts to CSV files or TXT files. During export, the Text Distributor creates several files that all begin with the same description.

Example:

You enter description "Mixing_station" in the "File prefix" field. In the "File format:" field select "*.txt". The following files are created:

- Mixing_station_Languages.txt
- Mixing_station_AlarmLogging.txt
- ...

Export Files

A different number of files are created depending on which objects you select during export. The following types of files exist:

- Files for text from the "Text Library" editor
- Files for text from the "Graphics Designer" editor
- File for references texts of the "Graphics Designer" editor
- File "<Description>_Languages.csv" or "<Description>_Languages.txt"
This file is always created.
This file specifies the following for the text:
 - Language-specific font type
 - Language-specific font size
 - ...

If font type, font size, etc. are configured for the language-dependent text in the "Graphics Designer", the settings in the "Graphics Designer" editor apply.

13.3.3.2 Construction of files with text from the Text Library

Overview

Use the Text Distributor to export language-dependent texts to CSV files or TXT files. During export, the text from the Text Library is saved in the following files:

- <Description>_AlarmLogging.txt or <Description>_AlarmLogging.csv
- <Description>_DataManager.txt or <Description>_DataManager.csv
- <Description>_LifeBeatMonitoring.txt or <Description>_LifeBeatMonitoring.csv
- <Description>_PictureTreeManager.txt or <Description>_PictureTreeManager.csv
- <Description>_NoSystemtext.txt or <Description>_NoSystemtext.csv
- <Name>_UserAdministrator.txt or <Name>_UserAdministrator.csv
- <Description>_GraphicsDesignerReferences.txt or
<Description>_GraphicsDesignerReferences.csv

The associated files are created depending on which editors you select during export.

Note

Information on the font type, font size, etc. of a language is entered in the "<Description>_Languages.csv" or "<Description>_Languages.txt" file. Change the entries if necessary.

You can also generate the "<Description>_NoSystemtext.txt", or "<Description>_NoSystemtext.csv" file. This file can contain the following:

- Text that was not found in the configuration.
This can happen for the following reasons:
 - The text is no longer used in the configuration.
 - The text is used e.g. in the Global Script.

Structure of the Files

A separate block is created for each object type. Each block has the following structure:

- [Header]
The object type is entered here: e.g.: <MessageClassName> and a header line consisting of [ID] and the respective languages, e.g. English, German.
- Exported texts
The text ID from the Text Library is entered in the following rows in the first column. The following columns contain the text in the respective language.

Example: File "Example_AlarmLogging.txt" with object blocks <MessageClassStateCome>, <MessageTypeName> and <MessageBlocks>

<MessageClassStateCome>			
ID	English	German	Spanish
2	+	+	+
<MessageTypeName>			
ID	English	German	Spanish
8	Alarm	Alarm	Alarma
9	Warning	Warnung	Advertencia
10	Failure	Fehler	Error
11	Process control system	Leittechnik	Sistema de control de procesos
12	System messages	Systemmeldungen	Avisos de sistema
13	Operator input messages	Bedienmeldungen	Avisos de operador
<MessageBlocks>			
ID	English	German	Spanish
14	Date	Datum	Fecha

13.3.3.3 Construction of files with text records from the "Graphics Designer" editor

Overview

When exporting, the text records of the "Graphics Designer" editor are stored in file "<Description>_GraphicsDesigner". If you have activated "One file per picture" for the export procedure, another file is created for every picture.

Per picture, the file contains a header, an object description and the objects.

Example:

- [Header]
The picture name is entered here, e.g.: <PIC_1.PDL>
- [Object]
Object description: Indicates what is contained in the respective columns.
 - Column "Object"
Object name of the object that contains language-dependent text.
 - Column "Property"
Language-dependent property of the object.
 - The language column, e. g. "English".
 - Format information and text for every existing language in the columns:
"FontName", "FontSize", "FontBold", "FontItalic", "FontUnderline"
- [Objects]
The objects are defined with the existing text records and properties in the following lines.
If the text does not exist, "???????" is entered.

Example: Export file "Example_GraphicsDesigner" with pictures PIC_1.PDL and PIC_2.PDL

The German text records are not translated yet and are entered as "???????".

PIC_1.PDL										
Object	Property	English	English Font Name	English Font-Size	English FontBold	English FontItalic	English Font Underline	German	German Font Name
Static Text1	Text	Valve	Arial	12	False	False	False	???????	Arial
Static Text2	Text	Motor	Arial	12	False	False	False	???????	Arial
Text list	Assignment	closed	Arial	12	False	False	False	???????	Arial
PIC_2.PDL										
Object	Property	English	English Font Name	English Font-Size	English FontBold	English FontItalic	English Font Underline	German	German Font Name
Static Text1	Text	Engine	Arial	12	False	False	False	???????	Arial
.....

Line breaks

If language-dependent text contains line breaks, the placeholders {CR} {LF} are entered. Do not change or delete the placeholders. The placeholders must be included in the translated text at the identical positions.

Referenced texts of the "Graphics Designer" editor

The referenced texts from the text lists and AlarmControl are stored in the text library. The texts are exported to the following files:

- "<Description>_GraphicsDesigner" or respective picture file
- "<Designation>_GraphicsDesignerReferences"

If you import the file "<Name>_GraphicsDesignerReferences" again, make sure that the texts of the text lists and AlarmControl are translated exactly as in the respective export file of the "Graphics Designer" editor.

You can find mapping for the exported, referenced texts in the pictures and objects of the Graphics Designer in the "GraphTextRefs.xml" file located in the in the "GraCS" project folder.

13.3.3.4 Structure of the "_Languages" Files

Overview

The "<Description>_Languages.csv" file is created. The file specified the default settings for font type, font size, etc. for each language.

Note

If font type, font size, etc. are configured for the language-dependent text in the "Graphics Designer", the settings in the "Graphics Designer" editor are applied.

The "*_Languages.csv" is structured as follows:

- [Header]
The header has two lines.
The file type is entered in the first line: <Languages>.
The headers are entered in the second line. This line indicates which information is entered in the following columns:
 - LanguageName: Name of the language
 - LanguageID: Language code
 - FontName: Name of the font type used
 - FontSize: Size of the font type
 - FontBold: "Bold" font type
 - FontItalic: "Italics" font type
 - FontUnderlined: Underline
- Information for each language
The following lines contain the corresponding entries for each language created.

Example:

<Languages>						
LanguageName	LanguageID	FontName	FontSize	FontBold	FontItalic	FontUnderlined

English	1033	Arial	9.75	False	False	False
German	1031	Arial	9.75	False	False	False
French	1036	Arial	9.75	True	False	False
Italian	1040	Arial	9.75	False	False	False
Spanish	1034	Arial	9.75	False	False	False

13.3.3.5 Status bar for the export and import

After the export or import, a dialog appears in which all export or import procedures are handled.

The "Info" dialog lists messages in the following categories:

- "OK" (Successful export or import)
- "Warning"
- "Error" (An error has occurred during export or import.)
- "Info" (With export: Object contains no language-dependent text records, with import: No text records have been imported for this object.)

You filter the output of the dialog by clicking on the respective buttons by the categories.

Example:

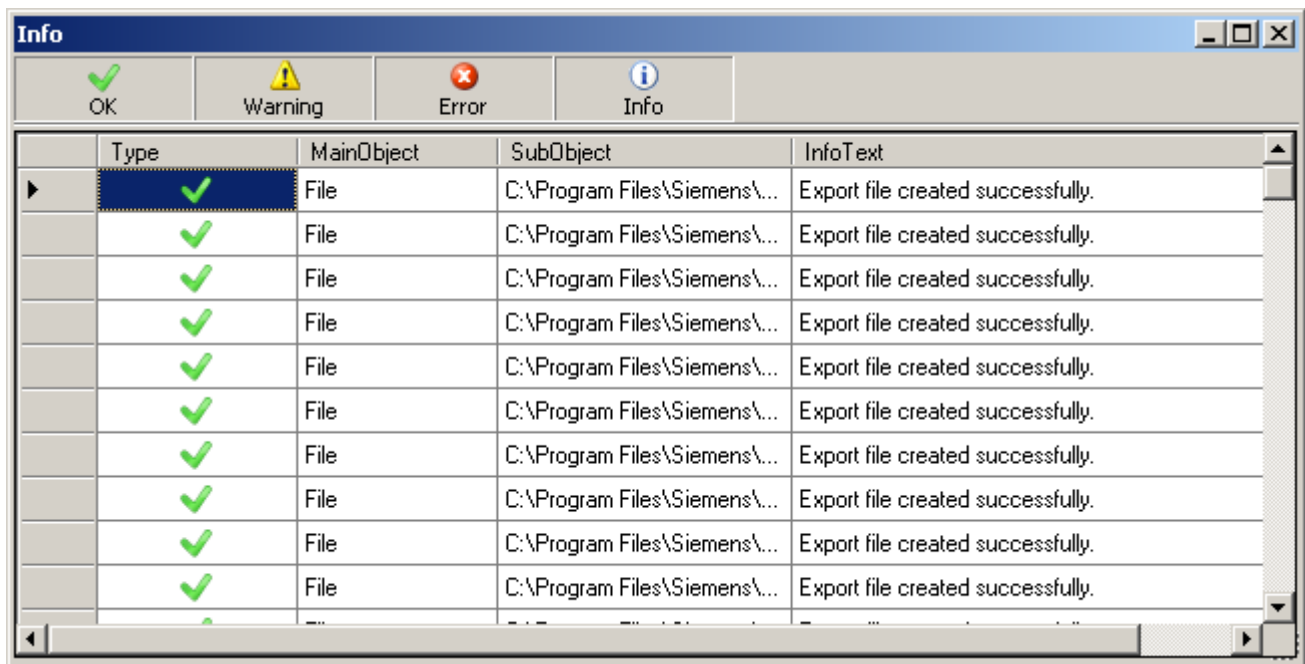

13.3.4 How to edit and translate exported text files

General procedure

The exported TXT or CSV files can be edited e.g. in Excel, Access or in a text editor like Notepad. This chapter describes the process for editing in Excel.

Start by checking the settings for text file export. For this purpose, select the project in WinCC Explorer and then select "Project properties" > "Options" from the shortcut menu. "Export Text files as Unicode" is set automatically by default.

NOTICE

Invalid file format

If you are using "*.csv" as the export format, Excel converts the Unicode file into an ANSI file. If you want to edit the exported data with Excel, select the "*.txt" file format during export.

Please note the following:

Only permitted changes can be made in the exported files and before import to WinCC.

Impermissible Changes

The following changes are not permitted:

- Structural changes to the export file.
- Swapping, deleting or duplicate use of IDs or object descriptions.
- Text changes in the header area. This text is generally identified by angled brackets: <>.
- Text changes in WinCC if text is in the translation. New text can be added in the editors. If you change exported text, it is overwritten with the original text depending on the setting during import.

Line breaks

If language-dependent text contains line breaks, the placeholders {CR} {LF} are entered. Do not change or delete the placeholders. The placeholders must be included in the translated text at the identical positions.

Note

Editing texts with non-Latin fonts

To edit texts containing non-Latin fonts, use a software package that can save Unicode. Excel is not suitable for this purpose. Use Access instead or use the programming interface from WinCC to access picture text. Alternatively, use a version of Excel in the respective language.

Note**Information on the fonts of a language**

Information on the font type, font size, etc. of a language are available in the "<Name>_Languages" file and in the export files of the "Graphics Designer" editor. Change the entries if necessary.

If a language was not created in the Text Library before export, add the language entry for this language in the "<Description>_Languages" file.

NOTICE**Text Import Not Possible**

Do not double-click in Windows Explorer to open the files. Otherwise the file will be loaded to Excel incorrectly. It is then no longer possible to import the file to WinCC. When using Excel, open the file as follows.

Procedure

1. Open Excel.
2. Select "File > Open". The "Open" dialog is displayed.
3. Select the path where the export files are saved.
4. Select type "Text files (*.txt)" from the "File type" list.
5. Select your export file and click "Open". The file is correctly opened in Excel.
6. Edit and translate the required texts. Note the aforementioned information.
7. To avoid changing the format of the file when saving with Excel, all of the required fields must be marked off:
 - Mark all necessary rows and columns.
 - Select "Format cells" from the shortcut menu. Open the "Border" tab.
 - Click "Outer" and "Inner".
8. Save the file in "*.txt" format again using the "File" > "Save As" command.

Results

The TXT file contains the translated text. You can import the TXT file into the WinCC project using the Text Distributor.

13.3.5 How to import language-dependent texts

Introduction

After you have translated the exported text, import the text to the WinCC project using the Text Distributor.

Example

During export, the text distributor creates several files that all begin with the same description. Enter the name "Mixing_station" in the "File prefix" field and "*.txt" in the "File format" field. The following files will be created among others:

- Mixing_station_Languages.txt
- Mixing_station_AlarmLogging.txt
- ...

If you specify this name again in the "File prefix" field during import, all available objects will be listed in the left window. You can select from the existing languages and objects.

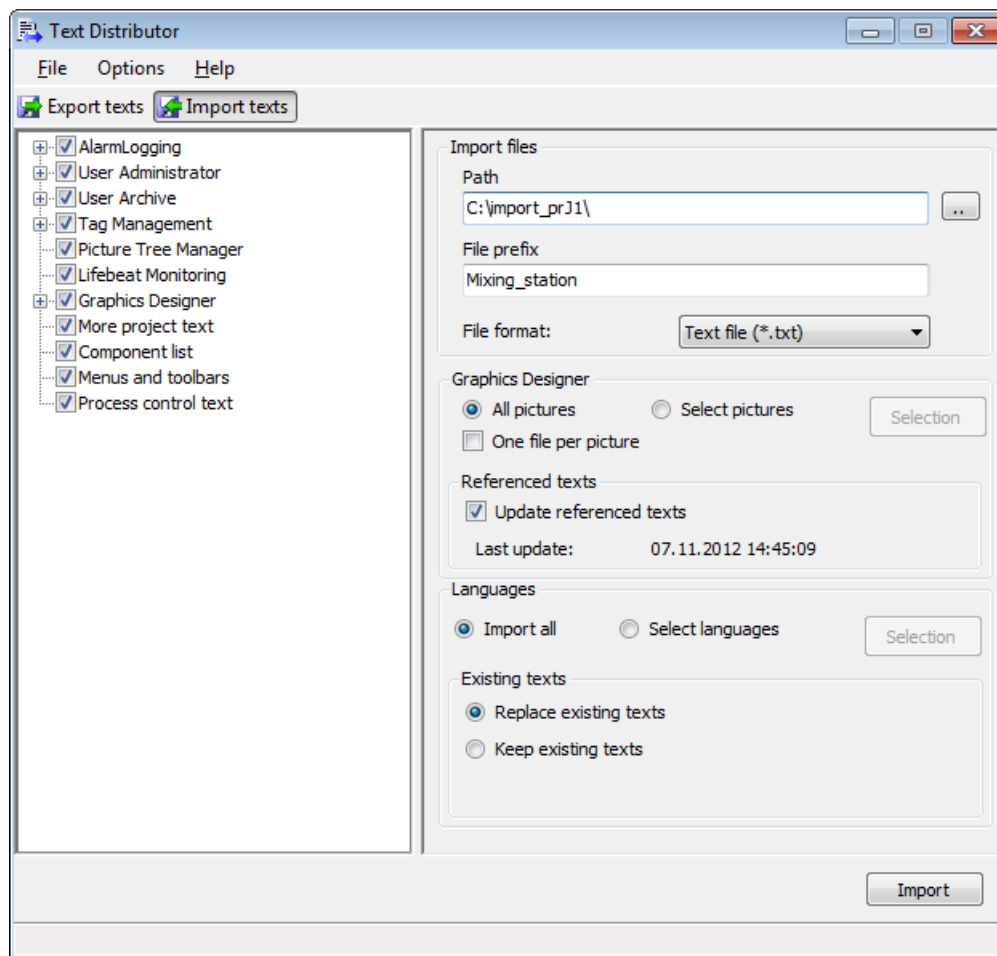

Languages available for export and import

The Text Distributor offers all languages that are listed in the Text Library. You can export and import languages that originate from different regions.

For example, if you want to export Asian text from WinCC < V7.2, the corresponding system locale (operating system language) must be set in your operating system. Only then will the associated languages be available.

"English" is always available.

Note

WinCC V6 format

If you want to import a Text Library export file created with the WinCC V6, select the "Import" command in the "Tools > TextLibrary V6.x format". As was the case with WinCC V6, however, the complete Text Library is deleted before the import.

Unknown objects

If a picture contains "unknown objects", the export or import of the picture is aborted immediately and "Unknown" appears in the information window.

Procedure

1. Open the text distributor by double-clicking in WinCC Explorer. As an alternative, you can select the "Tools > Text Import & Export..." menu command in the Graphics Designer.
2. Go to the "Import text" tab.
3. Navigate to the path where the imported files are saved using "Path" in the "Import files" area.
4. Enable or disable the desired editors from which you want to import text.
5. In the "File prefix" field, enter the name with which the text was exported.
All export files were created with a name that starts with this string.
The objects that you can import are listed.
6. In the "File format" field, select the format of the text.
7. Specify the settings for the text import in the "Graphics Designer" editor.
 - If you want to import texts from individual pictures only, select the "Select pictures" option. Select the desired pictures using the "Selection" button.
 - If you created one picture per file when exporting, select "One file per picture".
 - If you have subsequently configured the "Text list" and "AlarmControl" objects in the Graphics Designer, select the "Update referenced texts" option. The referenced texts thereby maintain a consistent data inventory in the Text Library following the import. The filter in the Text Library is up-to-date once again.
8. If you want to import individual languages, select the languages in the "Languages" section using the "Selection" button.
9. Specify how to handle existing texts in the "Existing texts" section.
 - If you want to replace existing text entries, select the "Replace existing texts" option.
 - If you do not want to overwrite existing text entries, select the "Keep existing texts" option.
10. Start the import process by pressing "Import".

Note

Avoiding overwriting of modified texts

Texts that you export and then edit before their re-import, for example in the Text Library, will be overwritten with the modified import text.

Remedy:

- Edit the text before you run the export.
 - Wait for completion of the import, and then edit and export the text again for compilation.
 - V7 exports are handled separately for each component. This may possibly cause texts with the same ID to be stored in different files. Store the modified text with the same ID in all import files. Make sure that you apply the changes in all respective languages.
-

Result

The content of the files is written to the corresponding language columns in the Text Library or to the language-dependent objects in the Graphics Designer.

13.4 Text Management with the "Text Library" Editor

13.4.1 Text management with the "Text Library" editor

Principle

All texts for your project are centrally managed in the Text Library except for most text from the Graphics Designer. Each text entry is assigned a unique ID, by which the texts in WinCC are referenced.

Links Between the WinCC Editors and the Text Library

The following WinCC editors store your texts in the Text Library:

- Alarm Logging:
 - All user-defined texts, for example, messages, points of error and standard texts.
 - Names for message classes, message status or message blocks.
 - Message text of system messages
- Graphics Designer:
 - Only the referenced texts from configured text lists and AlarmControl
- User Administrator:
 - Authorizations
- User Archive:
 - All configured alias names
- Picture Tree (option):
 - All configured text

Languages in the Text Library

You can create languages with different code pages in the Text Library.

Note

With languages not installed with WinCC, note that the standard texts are entered in the current WinCC GUI language because these other languages are not stored in WinCC. If the project language and the WinCC GUI language are different, you must also translate the standard texts.

Translating the text

You have the following possibilities for translating texts:

- External translation of exported texts via the Text Library
- External translation of exported texts via the Text Distributor
- Direct input of the translated texts in the respective language columns of the Text Library editor.
- Direct input of the translated texts in the "Alarm Logging", "User Administrator", "User Archive" and "Picture Tree" editors in the properties with translatable texts

Font Administration

You set the font in the Graphics Designer at the individual objects for specific languages. This is particularly important if you are configuring in non-Latin fonts and to create, say, a Cyrillic font. The set font is applied at the referenced locations in WinCC. WinCC V7.2 or higher lets you set a font that contains all necessary characters for all languages.

See also

How to export language-dependent texts (Page 2354)

How to import language-dependent texts (Page 2364)

13.4.2 Operator's overview of the Text Library

Operating the Text Library

You will find the editor language entries created in the project listed in clear table form in the Text Library. Each language entry is provided with an ID which is its unique reference in the WinCC database.

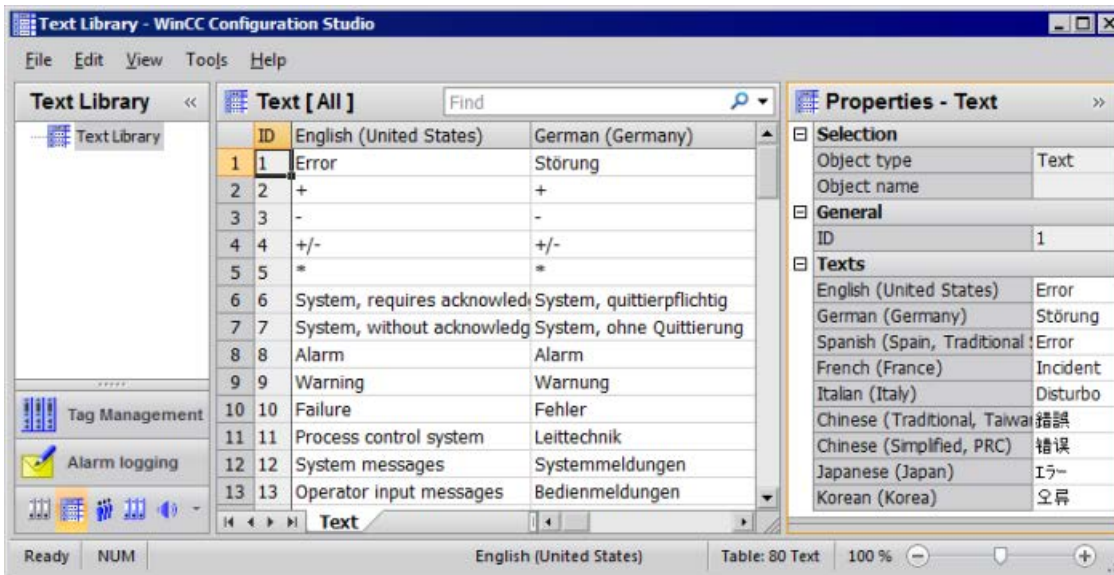

Overview of operation

The following sections give you an overview of the most important options for operating the "Text Library" editor.

Some menu commands can be executed via the shortcut menu or via shortcuts.

Note

Inputs or changes are automatically saved to the WinCC database when you exit from a field.

<p>NOTICE</p> <p>Unintentional deletion of text</p> <p>The "Delete" function deletes a selected area without prior warning in the "Text Library > 'Texts' tab". If you do not undo the deletion with the "Edit > Undo" menu command before closing the editor, these texts are irretrievably lost.</p> <p>You can use the "Cross Reference" editor to insert missing text IDs with the rows once again in the Text Library. However, you cannot restore the deleted texts.</p> <p>Unintentional overwriting of existing texts during copying</p> <p>As in MS Excel, existing texts are overwritten when pasting copied cells in a selected area. If you do not undo the deletion with the "Edit > Undo" menu command before closing the editor, these texts are irretrievably lost. Pay close attention into which cells you are copying which text.</p>
--



Translating text

Objective	Solution
Export the texts of the languages from the Text Library for translation.	"Edit > Export..."
Import translated text into the Text Library.	"Edit > Import..."

Language administration

Objective	Solution
Add a new language.	<ol style="list-style-type: none"> 1. Select "Add languages" in the shortcut menu in the navigation area. 2. Select the language you want to use from the list in the dialog window.
Delete a language.	<ol style="list-style-type: none"> 1. Select "Delete languages" in the shortcut menu in the navigation area. 2. Select the language you want to delete from the list in the dialog window.

Find and replace

Objective	Solution
Search and replace text in the selected language in the highlighted area or in the entire Text Library.	"Shortcut menu > Find and Replace > Find" or <Ctrl + F> "Shortcut menu > Find and Replace > Replace" or <Ctrl + H> "Shortcut menu > Find and Replace > Find Next"
Find specific text in entire data area or in a specific language.	 ▾ Fast search in data area
Find specific ID in the entire data area or in the "ID" column	 ▾ Fast search in data area

Advanced settings

The "Search for" and "Replace with" boxes allow you to enter special text, such as control characters or Asian characters.

Click in the box and select the desired setting in the shortcut menu:

Entry	Description
Right to left reading order	The writing direction runs from right to left.
Show Unicode control characters	Show or hide the entered control characters.
Insert Unicode control characters	List of control characters that mainly support the entry of non-Latin fonts.
Start IME / close IME	Input of characters from non-Latin fonts using the Windows Input Method Editor (IME).
Convert back	Conversion of characters back into Latin font.

Filter Text Library

Objective	Solution
Ascending sorting order	Select column and "Shortcut menu > Filter" or arrow next to a language column. Select filter conditions, for example "(empty)", to list missing texts
Descending sorting order	
Select all	
Select specific text entries	
Missing translated texts	

View of the Text Library

Objective	Solution
Set input language	"View > Input language"
Set color scheme	"View > Color scheme"

Generating reports

Objective	Solution
Print contents of the Text Library as a report.	"File > Project Documentation - Print"
Check a report prior to printing.	"File > Project Documentation - Preview"
Set parameters of a report, e.g. select the template.	"File" > "Project Documentation - Setup"

13.4.3 This is how you perform an external translation of the texts

External translation

External translation provides an easy and comfortable option for creating multilingual projects.

For precise information about translation costs and times, contact your external translation provider or translator.

External translation has 3 steps:

1. Export the text
2. Translating the text
3. Import the translated text

Perform the export and import using the Text Library.

Procedure - exporting texts

1. Open the Text Library in the WinCC Explorer.
2. Select the "Edit > Export" menu command.
The "Export" dialog opens.
3. Navigate to the path in which the export files are stored.
4. Enter a meaningful file name in the "File name" field.
An export file with this name is created.
5. Select the desired format in the "File format:" field.
6. Start the export process using the "Export" button.
When the export process is complete you will receive a message with the number of exported texts.

Translating the text

The exported texts are saved to files with <.xlsx> or <.txt> format. Observe the information about translation of the texts in section "How to edit and translate exported text files (Page 2362)".

Procedure - Importing texts

1. Open the Text Library in the WinCC Explorer.
The Text Library opens.
2. Select the "Edit > Import" menu command.
The "Import" dialog opens.
3. Navigate to the path where the files you want to import are saved.
4. In the "File name" field, enter the file name with which the text was exported.
5. In the listbox, select the format of the text.
6. Start the import process by pressing "Import".
You then receive a message about the number of imported texts. You will receive information on how the existing texts have been treated.

Checking the Translation

After the import, check the translation of the text in Runtime or in the "Alarm Logging" editor. Reset the Runtime language accordingly.

13.4.4 Multilingual messages

Language-Dependent Message Objects

Translations in the WinCC installation languages are provided for messages and other message objects provided by WinCC during installation. You can change these default texts as you wish.

The Alarm Logging editor is where you can find texts which are stored in the Text Library immediately after input:

- User texts
You configure the user texts yourself or you accept the default names:
 - Names of message classes
 - Names of message blocks ¹⁾
 - Names of message types
 - Message text
 - Point of error
 - Other user text blocks
- Standard texts
Standard text records are delivered in the languages installed with WinCC. Standard texts and WinCC system messages are entered in the appropriate language column of the Text Library. Standard text records can be changed in the "Alarm Logging" editor or in the "Text Library" editor.

- Info texts
Info texts are user texts which are not stored in the Text Library and whose language cannot be changed. Only use info texts if you are configuring just one language or enter the texts in a "neutral" language, e.g. English.
 - Texts of the message system from the SIMATIC Manager are also stored in the Text Library during transmission
- 1) The following behavior applies on a client with its own project: The texts of the message blocks are applied from the text library of the local PC or from the properties of the WinCC Alarm Control. When the setting "Apply project settings" is activated, the text from the text library of the WinCC server is applied.

Note

If you set up a language not installed with WinCC as the project language, the standard texts are not entered in the selected project language, but in the current interface language. You must therefore take special care that these texts are translated.

Compile message texts

You have the following options for translating the texts:

- External translation following an export and subsequent import of the translated texts in WinCC Configuration Studio.
External translation is recommended for a large amount of text.
- Direct input of the translated texts in the respective language columns of the Text Library editor
- Direct input of the translated texts in the Alarm Logging editor

Note

To the greatest possible extent, set the WinCC GUI and the configuration language the same in the "Alarm Logging" editor to prevent non-uniform languages in the GUI in the "Text Library" editor.

Entering the translated texts in the Alarm Logging editor

You select the input language for the editors in WinCC Configuration Studio using the menu "View" > "Input language".

In the Alarm Logging editor, the texts are displayed in the input language and in the available translations. You can edit each of these properties.

Note

If you are configuring messages for multiple languages, be aware of the different text lengths in the various languages. Set the length of your messages accordingly.

13.5 Multilingual Pictures in the "Graphics Designer" Editor

13.5.1 Multilingual pictures in the "Graphics Designer" editor

Languages in the "Graphics Designer" editor

In the "Graphics Designer" editor, you can create text for graphic objects in the languages that are configured in the "Text Library" editor.

The text that you configure in the "Graphics Designer" editor is saved with each picture.

WinCC offers the following options for translating the object texts:

- Export the text records with the Text Distributor.
You translate the exported texts outside of WinCC and import them afterwards.
- You edit the texts in the "Texts" tab of the object properties.
You also configure the desired font and formatting for each language in this table.
- If you have configured only a few texts for your pictures, translate the texts in the Graphics Designer in the object properties.

Text list / WinCC AlarmControl

The "Text list" and "WinCC AlarmControl" objects are special.

With the "Text list" object, you can select whether you want to store the configured text in the picture itself or in the text library. The text is stored in the picture as default.

With the "AlarmControl" object, the texts are stored by default in the text library.

Language switching in the "Graphics Designer" editor

When you open the Graphics Designer, the selected runtime language is set as the configuration language.

If you want to check a translation or enter text directly in another language, change the configuration language in the "Graphics Designer" editor. The required configuration language must be configured in the "Text Library" editor.

To change the project language, select the menu "View > Language...".

Note

Different linguistic regions

If the newly selected language originates from another linguistic area as the previous one, you must also change the operating system language (system locale).

Start your operating system again afterwards.

Result of the language switch

After switching, all configured texts are displayed in the Graphics Designer in the selected language. If you have not yet configured a language, its texts are displayed with characters "???" instead of the text.

You always configure the language-dependent object properties in the "Properties" tab for the selected Runtime language.

The current configuration language is displayed in the status bar of the "Graphics Designer" editor.

Displaying the text for the controls

The text display for the Controls in the "Graphics Designer" editor is based on the configuration language set in the WinCC Explorer. Example:

You configure in an Asian language in the "Graphics Designer" editor.

In order to display the text of an inserted control correctly, you must also select this Asian language in the WinCC Explorer.

13.5.2 Language-dependent properties of picture objects

Language Input Options for Picture Objects

Depending on the picture object, you have different options for entering text:

- In the object itself, such as in the case of static text
- In the Configuration dialog, for example for the label on a button
- Object Properties dialog:
In the object properties, enter the major part of the text directly or in other dialogs such as tooltips, output text, text attributes.
- In the "Texts" tab in the object properties
You also configure the desired font and formatting for each language in this table.

Additional information on configuring graphic objects can be found in the WinCC information system in section "Creating process pictures".

Language-Dependent Object Properties

The objects of the "Graphics Designer" editor have different object properties with different language properties.

With the exception of the window titles of the "Picture Window/Application Window" smart objects and certain properties of the WinCC controls, you can change the language of all object properties.

"Text" property

Objects: Static text, Text list, Button, Check box, Option group, Multiple row text, List Box, Combo Box

"Font" property

Objects: Static text, I/O field, Bar, Group display, Text list, Multiple row text, List Box, Combo Box

"Tooltip" property

Objects: All objects except Picture Window and Application Window

Special Features: Tooltips can certainly be configured in multiple languages, but without any special setting for the font. When configuring tooltips in non-Latin fonts, you must set the corresponding font in runtime in your operating system's Control Panel.

Note that when you change the operating system language, the tooltips in all the other Windows applications are also changed.

"Window Header" property

Objects: Picture Window, Application Window

ActiveX controls

Certain ActiveX Controls have text properties such as Column Name, Window Title or Axis Label for which the language cannot be changed. In WinCC these properties are stored in all languages installed with WinCC and are correctly displayed in runtime. If you are configuring in a language that was not installed with WinCC, these elements are displayed in runtime in the runtime default language (English).

When configuring language changes to languages with non-Latin fonts, use a neutral language for these ActiveX Control properties, such as English without a special font. If you have configured a non-Latin font for these object properties, this font is used for each displayed language.

13.5.3 How to export and import text from pictures

Introduction

You have the following options for translating text in the "Graphics Designer" editor:

- External translation
External translation is recommended for a large amount of text.
- Direct input of the translated text in the "Graphics Designer" editor.
You can enter the translated text directly in the object properties dialogs for the languages created in the "Text Library".
 - "Texts" tab: All languages
 - "Properties" tab: Current Runtime language

Requirement

- All languages that you wish to translate into must be created in the "Text Library" editor.
- The text to be translated in all pictures and picture objects is configured in at least one language.

Observe the following points during configuration:

- **Text length**
If you are configuring picture objects for multiple languages, be aware of the different text lengths in the various languages. A French text is about 50% longer than the equivalent German text. Dimension your graphic objects accordingly.
- **Adapt border**
For the "Static Text" object, use the Object Properties dialog box to set the attribute "Properties > Miscellaneous > Adapt Border" to "Yes". The text border is then automatically adapted to the contents.

Procedure

You can export and import the texts via the Text Distributor. You can export all target languages or create a separate file for each language. This is advantageous if you want to give the text to several translators. Make sure that no structural changes whatsoever are made in the files, e.g. to the order of columns.

1. Export the texts.
 - You can export all the pictures from a project or just individual pictures. A separate file can be generated for each picture.
 - Activate the "Update referenced texts" function if you have configured text lists or WinCC Alarm Controls since the last update.
2. Translate the texts.
3. Import the translated texts.

For more information on procedures, refer to section " Text export and text import with the Text Distributor (Page 2353) "

After import, check your translations in runtime or in the "Graphics Designer" editor. Reset the Runtime language accordingly.

Note

Texts from "Text list" and "AlarmControl" objects

Texts from text lists and AlarmControl stored in the text library are saved in the "<Name>_GraphicsDesignerReferences" file.

See also

How to edit and translate exported text files (Page 2362)

Text export and text import in the Text Distributor (Page 2353)

13.5.4 How to configure picture objects for more languages in the "Graphics Designer" editor

Introduction

Texts that you configure in your pictures are not stored in the Text Library, but with the picture itself.

This section provides a description of procedures used to directly enter the translated text in the "Graphics Designer" editor. These procedures are mainly suitable for small amounts of text.

Observe the following points during configuration:

Text length

If you are configuring picture objects for multiple languages, be aware of the different text lengths in the various languages. A French text is about 50% longer than the equivalent German text. Dimension your graphic objects accordingly.

Adapt border

For the "Static Text" object, use the Object Properties dialog box to set the attribute "Properties > Miscellaneous > Adapt Border" to "Yes". The text border is then automatically adapted to the contents.

Certain graphic objects have elements for which you cannot set the font. For these elements select a neutral language such as English for the text entries.

Note

Text list

The object known as Text List is a special case. If you are configuring a Text List for multiple languages, please refer to "Configuring a Text List in Multiple Languages".

When configuring an I/O field, please note that WinCC only supports numbers for value input in the form of Arabic numerals (1, 2, 3, ...).

Basic procedure

In order to configure picture objects for multiple languages, proceed as follows:

1. First configure all pictures and picture objects in your preferred language.
2. Enter the translation in the "Texts" tab of the "Object Properties" window.
Untranslated texts are displayed as "???".
Alternatively, enter the translated texts directly on the objects in the respective language.

Alternative Procedures

In most cases you have several options for entering labels in picture objects:

- "Font" property group > "Text" object property > "Static" box:
 - Only current Runtime language
 - Input of special characters is possible
 - Configuring the font: Font palette
- "Text input" dialog that opens with a double-click on the object property:
 - All configured Runtime languages
 - Input of special characters is possible
 - Configuring the font: Using the font palette or in the object properties
- Language table in the "Texts" tab of the object properties:
 - All configured Runtime languages
 - Configuring the font: Using the button in the language table

Some WinCC objects offer additional alternatives, e.g.

- Static text
Double-click the object in the process picture:
 - Only current Runtime language
- Button
In the configuration dialog:
 - Only current Runtime language

Additional information on configuring graphic objects can be found in the WinCC information system in section "Creating process pictures".

Display of fonts

In the case of non-Latin fonts the text in the input box is sometimes incorrectly displayed even though the font was correctly set, but the appearance in the picture is correct in runtime.

You can remedy this by entering the text in another application (such as Word) and then using Copy & Paste to transfer it to the input box.

Set the same input methods in the source and target applications to properly carry out copy & paste.

Tooltips use system font

The font for Tooltips cannot be set in WinCC.

Text in non-Latin fonts is correctly displayed in runtime if the corresponding font for tooltips is set in your operating system's Control Panel.

When you are configuring a project for Latin and non-Latin fonts, after a change of language the font for tooltips must be correspondingly set in the operating system.

See also

The "Texts" tab in the "Object Properties" window (Page 519)

The "Properties" Tab in the "Object Properties" Window (Page 514)

13.5.5 Configuring a Text List in Multiple Languages

Special characteristics of the text list

Select whether the configured text should be stored in the picture or in the text library for the text list object.

For exporting with the text distributor, the text of the text lists is entered in the following export files:

- When storing the text directly in the picture
 - Only in the export file of the Graphics Designer or in the respective picture file
- When storing the text in the text library
 - In the export file of the Graphics Designer or in the respective picture file
 - In the export file "<Description>_GraphicsDesignerReferences"

"Text list" object property

When you link the "Text list" object with a text list that you have configured the "Text and graphic list" editor, the display texts are always stored in the text library.

You can find additional information about configuration under "Create process pictures > Working with text lists and graphic lists > How to create text lists (Page 449)".

Procedure

1. Open the "Graphics Designer" editor.
2. Open the "Object Properties" dialog box of the text list from the shortcut menu.
3. On the "Properties" tab activate the "Output/Input" group.
4. Double click on "Assignments".
The "Textlist assignments" dialog box appears.
5. Enter the "Range type", "Value range" and the desired text for every value/value range.
6. Confirm your entries with "OK".

7. If you want to save text in the picture:
 - Export the text with the text distributor and translate the text externally.
For more information on the text distributor, refer to the section " How to export language-dependent texts (Page 2354) ".
 - As an alternative, change the configuration language in the "Graphics Designer" editor and enter the translated text respectively.
8. If the texts are to be stored in the text library and translated:
 - On the "Properties" tab activate the "Miscellaneous" group.
 - Then double-click "Text Reference".
The default setting "no" switches to "yes". This stores the text records in the text library.
 - Export the text with the text distributor and translate the text externally.
For more information on the text distributor, refer to the section " Text export and text import for translations".
 - As an alternative, start the "Text Library" editor and translate the text directly in the respective language columns.
You can find additional information on translating text in the text library in the section " Text management with the "Text Library" editor (Page 2367) ".

You can find additional information on planning and configuring the text list in the WinCC information system in the section "Creating process pictures > Working with objects > Working with smart objects > Text list".

See also

Text management with the "Text Library" editor (Page 2367)

How to export language-dependent texts (Page 2354)

How to create text lists (Page 449)

Text list (Page 639)

13.6 Reports for Multilingual Projects

13.6.1 Reports for Multilingual Projects

Principle

There are two types of report in WinCC:

- Project documentation
The project documentation contains reports that are output during the configuration. These reports contain overviews of the configured data. You can output the project documentation in all Runtime languages.
In the project documentation you document all multilingual texts you configured.
- Logs that are output in runtime, such as regular printouts of measurement data. These reports can be output in the respectively defined set runtime language.

13.6.2 Layout and layout file

Print Job and Layout

A print job just be stored for every report or every log in WinCC. Every print job is connected with a layout. There are language-neutral and language-dependent layouts.

Layout and layout file

A language-neutral layout contains one layout file. Stored in language-neutral layout files \<Name of computer>\Project name\PRT".

A language-dependent layout contains several language-dependent layout files.

Layout files

The designation of language-dependent layout files contains a language ID. The language-specific layout files are stored in language-specific folders in folder \\<Name of computer>\Project name\PRT". The following table shows the language IDs and language folder with languages that can be installed with WinCC.

Language	Language ID in file names	Folder
German	DEU	PRT\DEU
English	ENU	PRT\ENU
French	FRA	PRT\FRA
Italian	ITA	PRT\ITA
Spanish	ESP	PRT\ESP
Chinese (simplified)	CHS	PRT\CHS
Chinese (traditional)	CHT	PRT\CHT

Language	Language ID in file names	Folder
Korean	KOR	PRT\KOR
Japanese	JPN	PRT\JPN
Language-neutral		PRT\

When you add other Runtime languages in the "Layouts" shortcut menu, the language-specific folders are created in the PRT folder of the project folder.

System print jobs

WinCC provides various system print jobs. The respective layout files are available in all languages that can be installed with WinCC.

The system print jobs cannot be deleted. You may rename the system print jobs, if necessary.

For the page layouts installed with WinCC, the layout files for the languages installed with WinCC are installed in language-specific folders in the project folder.

Example:

The following layout files belong to the "Documentation_Alarm_logging" print job:

Language	Layout file
German	@algcs_DEU.rpl
English	@algcs_ENU.rpl
French	@algcs_FRA.rpl
Italian	@algcs_ITA.rpl
Spanish	@algcs_ESP.rpl
Chinese (simplified)	@algcs_CHS.rpl
Chinese (traditional)	@algcs_CHT.rpl
Korean	@algcs_KOR.rpl
Japanese	@algcs_JPN.rpl

Language-dependent layout files

The layout files are only available if you have completed the following:

- You have clicked on the "Report Designer" entry.

More information on creating and configuring logs and log layouts can be found in the WinCC Information System in chapter "Documentation of configuration and runtime data".

See also

Multilingual logs in runtime (Page 2390)

13.6.3 How to change or create layouts

Introduction

A layout is assigned to each print job. You edit page layouts in the page layout editor. The layout files of the layout are saved in a folder structure in the WinCC Explorer.

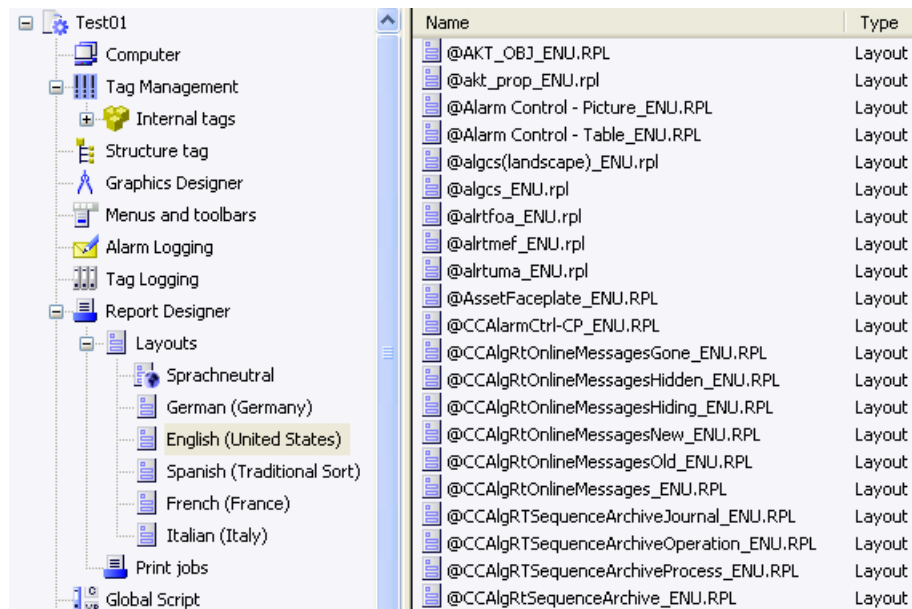

When printing print jobs with language-dependent layouts, WinCC uses the layout file with the language code of the current WinCC Runtime language.

Adding Additional Languages to System Print Jobs

If you want to print system print jobs in languages other than that installed with WinCC, you must add the layout file of the new language to the system layout.

Print Jobs with Your Own Layout

You can create print jobs with your own page layouts. The easiest thing to do is copy an existing layout and change it based on your needs.

If you want to create print jobs with a language-neutral layout, you must create a layout file and save it in the \\<Computer name>\Project name\PRT folder.

If you want to create print jobs with a language-dependent layout, you must create a layout file for each Runtime language. You must save the language-dependent layout file in the correct folder.

Procedure - Creating a language-neutral layout file

1. Click on the "Report Designer" entry.
The "Layouts" and "Print Jobs" sub-entries are displayed in the data window.
2. Click on the "Layouts" entry.
The "Language-neutral" entry and one or more language-specific folders are located under the "Layouts" entry.
3. Click on the "Language-neutral" entry and open the shortcut menu.
4. Select the "Open page layout editor" command in pop-up menu.
5. Create the language-neutral layout file and use "Save as" to save it in the "\\<Computer name>\Project name\PRT" folder.

Procedure - Adding a new Runtime language for a layout

Note

WinCC <V7.2 display dependent on system locale

You can only add the language-specific folders that use the same codepage. If you need to edit layout files in languages that need another codepage, you must set up the associated system locale (operating system language) in the system control of your operating system.

Note

Unicode as of WinCC V7.2

WinCC as of V. 7.2 supports Unicode. This dispenses with restrictions in terms of Chinese (Simplified) and Chinese (Traditional). You can open layouts that were created in older WinCC versions. However, you cannot use these without code page restrictions until you have completed a migration. For this purpose, select the "Layouts" entry in WinCC Explorer and start migration from the shortcut menu.

1. Click on the "Report Designer" entry.
The "Layouts" and "Print Jobs" sub-entries are displayed in the data window.
2. Select the "Layouts" entry and select the "Add language..." command in the pop-up menu.
3. Select the desired Runtime language.
The language must be defined in the text library to make it available in Runtime.

Result

The folder of the new Runtime language is saved in the "\\<Name of the computer>\Project name\PRT" folder. The folder of the new Runtime language is displayed in WinCC Explorer.

Procedure - Creating a language-dependent layout file

Note

As soon as there is a language-dependent layout file for a layout, the layout is language-neutral. This does not depend on whether language-dependent layout files also exist.

If necessary, delete the language-neutral layout file is in the "\\<Computer name>\Project name \PRT" folder.

Language-dependent layout files are saved in a language-specific folder in the "PRT" folder of the project folder.

1. Click on the "Report Designer" entry.
The "Layouts" and "Print Jobs" sub-entries are displayed in the data window.
2. Double-click on the "Layouts" entry.
The "Language-neutral" entry and one or more language-specific folders are located under the "Layouts" entry.
3. Open the folder of the desired language.
4. Create a new page layout or change an existing layout.
5. When saving the layout file, specify the language code, e.g. "DEU" or "ENU".
6. Save the language-dependent layout file in the corresponding language folder.
7. Also create the layout file for the rest of the Runtime languages.

13.6.4 How to change or create print jobs

Introduction

There must be a layout for every print job.

Procedure - Creating a print job

1. Click on "Print jobs" in the navigation window.
The available print jobs are listed in the data window.
2. Create a new page job or change an existing print job.

3. Select the desired layout from the "Layout:" selection field.

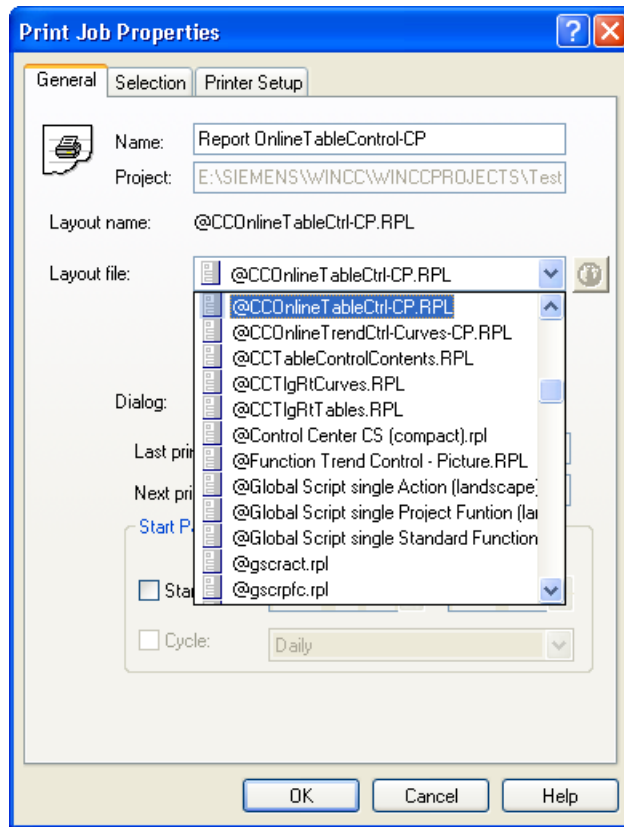

4. Save the print job with "OK".



Result

The print job has been created.

The  icon indicates whether a language-independent or language-dependent layout that is not available in all Runtime languages is used in the print job.

Identifying the Layout File

The layouts are indicated with a symbol in the "Layout:" selection field.

Icon	Meaning
	Layout is language-dependent. Layout files are available in all Runtime languages. No language-neutral layout file exists.
	Layout is language-dependent. Layout files are not available in all Runtime languages. You can use the layout. When you change a Runtime language, for which there is no layout file available, the English layout file is used.
	The layout is language-neutral. In runtime, the language-neutral layout is always active. This does not depend on whether language-specific layout files exist for the selected layout.

13.6.5 How to create the multilingual project documentation

Introduction

You use project documentation in WinCC to document your configured data. You can create project documentation with data from the following editors:

- WinCC Explorer
- Graphics Designer
- Tag Management
- Alarm Logging
- Tag Logging
- Text Library
- User Administrator
- Global Script
- Cross Reference
- Horn
- Time Synchronization
- Picture Tree
- Lifebeat Monitoring
- OS Project Editor

Rules for multilingual project documentation

The following rules apply to reports involving project documentation:

- Captions, table names and object properties are printed in the current WinCC language. The text is output in English if it is not available in the current language.
- Configured text is output in the WinCC user interface language that you have set up in WinCC Explorer under "Tools ...".
If no text is configured for this language, "???" are output.

Procedure

1. Exit Runtime.
2. Set a WinCC user interface language that you also want to use to create the project documentation.
All languages initially installed along with WinCC are available for use as WinCC user interface language.
3. Check the project documentation by selecting the menu command "Preview Project Documentation" in the respective editor.
4. Output the project documentation by selecting the menu command "Print Project Documentation".

More information on creating and configuring logs and log layouts can be found in the WinCC Information System in section "Documentation of configuration and Runtime data".

13.6.6 Multilingual logs in runtime

Introduction

In runtime you can output reports for process values, for instance regular measurement data reports, curves or message reports. If your project runs in runtime in multiple languages, logs in runtime will always be output in the current runtime language.

If a log is output in runtime, the layout file of the current runtime language is used.

Note

Layout file does not exist in current runtime language

If the layout file does not exist in the current runtime language, the English layout file is used.

Output of message sequence reports

Message sequence reports are always output in runtime in the language in which Runtime was started. This also applies if e.g. the language was changed using the Set Language function.

More information on creating and configuring logs and log layouts can be found in the WinCC Information System in chapter "Documentation of configuration and runtime data".

13.7 Displaying Regional Date and Time

Principle

Regional date and time displays are language-dependent. In some countries the European format is displayed (Day.Month.Year), and the American format (Year/Month/Day) is used in others. You must also pay attention to this display format for multilingual objects.

Date and time displays are configured in Alarm Logging and in Graphics Designer.

Note

If the central date and time format according to ISO 8601 is entered in the "Computer Properties" dialog, it will have an effect on the configurable time formats and on the display of time during Runtime. The date display is unambiguously set by the ISO 8601 format. You may find additional information on ISO 8601 format under "Working with Projects" > "Setting Time in WinCC".

Alarm Logging

You can select different formats for the "Time" and "Date" system blocks in Alarm Logging.

The configured format applies to the whole project and is not affected by changing the Runtime language.

If you insert an Alarm Control in Graphics Designer, it accepts the date and time setting that you configured in Alarm Logging.

Graphics Designer

The following objects, which you can configure in Graphics Designer, display the date and time:

- WinCC Alarm Control: The format of date and time is configured in Alarm Logging. The configured setting applies to the entire project.
- WinCC TrendControl, WinCC TableControl: The format of date and time may be configured directly under Control Properties. The settings apply to the current picture.
- D/A Clock: The WinCC ActiveX Control Digital/Analog Clock accepts the local computer-specific settings from your operating system settings. They cannot be changed in the Control.

Note

When configuring a Chinese project, you must set China (Taiwan) as the input locale and then adjust the date and time display format in the Control Panel of your operating system.

Report Designer

Report Designer lets you adapt the date and time format by parameterizing the "Format" attribute in the "Miscellaneous" group in the "Object Properties" dialog of the "Date/Time" system object. You can get an overview of the possible parameters and settings from the Direct Help on this attribute.

Display in Runtime

The date and time display in Runtime is determined by the settings in:

- Object properties of the computer > "Parameters" tab
- Graphics Designer
- Report Designer
- Alarm Logging

In runtime, the date and time displays are not changed in the event of a language change.

For more information, refer to the Graphics Designer, Alarm Logging and Report Designer online help, as well as to "Working with projects" > "How to set the timebase for the Runtime documentation".

13.8 Languages in Runtime

13.8.1 Languages in Runtime

Runtime language

Set the language for displaying your project in Runtime centrally in WinCC Explorer under computer properties.

You can select as the Runtime language any language for which a language column has been created in the Text Library.

Runtime Default Language

You can set a Runtime language that is globally valid for all graphic objects in the computer properties dialog of WinCC Explorer.

A specific text for which no translation is available is displayed in the configured Runtime default language. If the text is not available in this language "???" is displayed.

Displaying Non-Translated Texts in Runtime

Non-translated texts of graphics objects are displayed in runtime as "???" as long as no translated text exists in the runtime default language either.

If message system texts are not translated, nothing is displayed. By this means you can test your project in runtime to check whether all texts are present.

If you have configured a change to a language that has not been created in the Text Library, the previously set language continues to be displayed.

Changing languages in Runtime

When you have configured a project in multiple languages, configure an operating element which will allow the operator to change the language in runtime. WinCC offers you several preconfigured operating elements that you can use in your project. Of course, you may also assign language change functions to custom picture objects, e.g. buttons.

WinCC <V7.2:

If the new language originates from another linguistic area as the previous one, you must also change the operating system language (system locale). This is necessary so that the character set works with the proper code page. Restart your operating system after changing the language.

WinCC as of V7.2 supports Unicode. This means that you can use different system locales in a project.

13.8.2 How to Set the Runtime Computer Starting Configuration

Requirements

You can only select languages as Runtime languages that have been created in the Text Library.

Procedure

1. In WinCC Explorer, select "Computer" with the right mouse button and select "Properties" in the pop-up menu.
2. Select the required computer from the list (for multi-user projects only) and click the "Properties" button.
3. In the "Computer Properties" dialog, select the Parameters tab.
4. In the "Runtime language" field, select the language in which to start the project in Runtime.

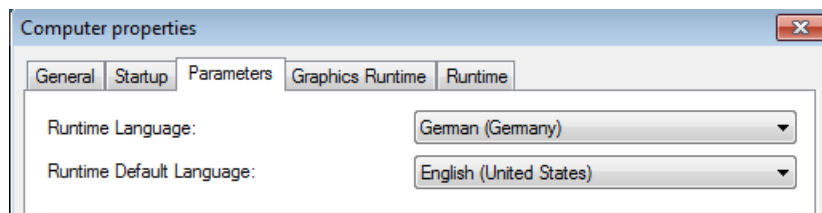

In the "Runtime Default Language" field, select the language in which to display texts from graphics objects instead.

The texts will be displayed in this Runtime default language, if translations into the language set in "Language Setting at Runtime" do not exist.

5. Confirm your settings with "OK".

Result

In runtime, the project will be started in the set language. Non-translated texts of graphics objects are displayed as "???" as long as no translated text exists in the runtime default language either.

If message system texts are not translated, nothing is displayed.

13.8.3 Configuring Language Changes

Introduction

You can configure language changes within operating elements yourself, or use preconfigured WinCC objects for changing languages.

The following preconfigured WinCC objects are available:

- Buttons for each WinCC language for operating using mouse or finger (touch screen operation).
- Hot key symbols for each WinCC language for operating with the keyboard.
- Radio box lists for changing between two or all available WinCC languages.

Drag & drop WinCC objects for changing languages into your picture from the WinCC library ("Operation" group, "Language Change" subgroup).

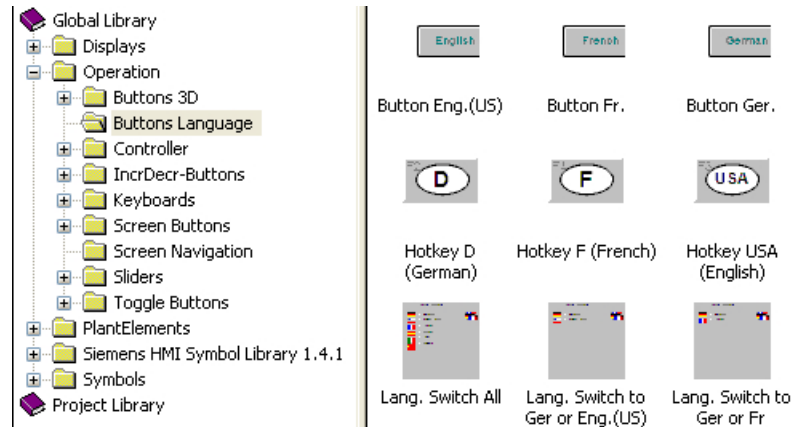

If you are configuring a language change in a picture object and decide not to use any of the preconfigured WinCC objects, the following picture objects are recommended:

- A button for changing between two languages.
If using a button, you must also configure a button that operators can use to return to the previous language. By using a toggle function, you can change to a language and back with just one button.
- An input/output field in which the operator inputs the language directly. This solution requires script programming.
- Radio buttons or check boxes for selecting a language. This solution requires script programming.

The following section contains an example to show you how you can configure a language change on a single button.

Requirement

Always configure a change to a language for which texts have already been configured. If these texts are not available during Runtime, graphics objects will display "???" after the language change as long as no translated text is available in the runtime default language either. If message system texts are not translated, nothing is displayed.

Language changes must always have a target language that has been created in the Text Library. If the target language is not present, the language change has no effect and the previously set language continues to be displayed.

Procedure

1. In the Graphics Designer open the picture in which you wish to configure a language change.
2. Configure a button.
3. Double-click the "Language Change" wizard in the Dynamic Wizard dialog.
The Dynamic Wizard for language changes opens.
4. Click "Continue" to move on from the opening screen.
5. Select a language change trigger such as mouse click in the "Select Trigger" dialog.
6. Select the target language in the "Set Options" dialog.
Source language is always the current Runtime language or the current project language if this is different to the Runtime language.
7. Click "Continue" to view your chosen options, and click "Finish" to finish configuring.

Result

When an operator clicks the button in Runtime, the language is changed from the current Runtime language to the language you have specified.

13.9 Example of Configuration

13.9.1 Example of Configuration

Overview

The following example shows you how to create a small multilingual project in a few steps:

- You configure a graphic object in multiple languages.
- You configure a language change.
- You run the project and change the language in runtime.
- You export the texts for translation and import the translated texts.

See also

Example: How to translate the text records in different linguistic regions (Page 2402)

13.9.2 Example: How to Configure a Multilingual Graphic Object

Introduction

In the following section, you configure a button for the "End Runtime" function with labels in the configurable languages.

Procedure

1. Open the Graphics Designer.
2. Create a new picture for the example, e.g. "language.pdf". In a project you position the language change as a rule on the starting page.
3. Create a button from the group of Windows objects in the Object Palette.
4. After creating this, the Configuration dialog opens. In the Configuration dialog, enter the button label in the configuration language of the Graphics Designer, e.g., "End Runtime".
5. Input a font such as Arial Black and click OK to close the dialogs.
6. Use the appropriate Dynamic Wizard to load the button with the "End Runtime" function.
7. Open the "Object Properties" dialog box of the button using the shortcut menu command "Properties".
8. In the Properties tab, double-click the "Text" field in the "Font" group. The "Text Input" dialog opens. You can now enter the text for the respective languages for all languages that are created in the "Text Library".
9. Save your picture.

Result

When you change the project language in the Graphics Designer between English, French and Italian, the text is displayed on the button in the current project language in each case.

13.9.3 Example: How to Configure Language Changes

Introduction

Below you configure a language change with which you can change between English, French and Italian in runtime.

Requirement

You must have configured the button as described under "Example": "Configuring a Multilingual Graphic Object".

Procedure

Note

In the following example you configure a Language change by means of an object from the WinCC library. These objects are already preconfigured and ready for use. If you wish to create a dedicated operating element for changing languages, select the "Language Change" Dynamic Wizard.

1. Open the picture "languages.pdl".
2. Click the  button to open the WinCC library or select the menu command "View" > "Library".
3. In the Global Library, open the folder "Operation" > "Language Change".

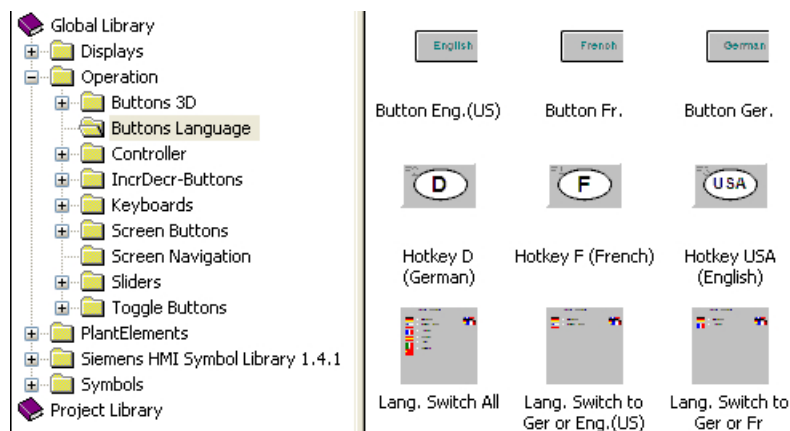

4. Select the object "Change all Languages" and drag & drop it into your picture. The WinCC Library object automatically adapts its label to the current project language; in this case French.



5. Save your picture.

13.9.4 Example: How to Change Language in Runtime

Introduction

In the following section you execute your example project in Runtime.

Requirement

You have configured the button and the language change as described under "Example: Configuring Multilingual Graphic Object" and "Example: Configuring Language Change".

Procedure

Note

Before starting Runtime, you must go to the Text Library and create the languages to be used. The texts of the pictures are not stored in the Text Library. A language must, however, be created in the Text Library so that it may be selected as Runtime language.

1. Open the WinCC Text Library.
2. Check whether the Runtime language is set. Your project starts in the Runtime language.
3. If the Runtime language is missing, enter it in the data area in the "Languages" tab. Open the drop-down list in the top free row in the "Languages" column and select the desired language.
4. Close the Text Library.

5. Select the computer in the WinCC Explorer. Click the "Properties" shortcut menu command to open the "Object properties" dialog.
6. Click the "Parameter" tab.
7. In the "Runtime language" field, select "Italian", for example, and "English" in the "Runtime Default Language" field. Close the dialog by clicking OK.
8. Open the picture "language.pdl" in the Graphics Designer.
9. Click  to start the picture in Runtime. The picture starts in the set Runtime language, which is Italian.



10. Change the language to one of the configured languages (English or French):



11. For demonstration purposes, switch to a language that is in the Text Library but for which you have not yet configured text for the button, for example, German. The text that is not configured is displayed as "???":



12. For demonstration purposes, switch the language back to English, and then to a language that is neither configured nor registered in the Text Library, for example, Spanish. As the language is not available in the Text Library, the language is not changed. The previously set language, in this case English, is kept:



Using the system dialog to change the language in Runtime

Another option for changing the language in Runtime is outlined in "Working with projects" in the following chapters:

- "How to set up system dialogs"
- "How to change the language in Runtime".

13.9.5 Example: How to translate the text records in different linguistic regions

Principle

If you are translating to a language that originates from a different linguistic region, the respective system locale must be defined in the control panel of your operating system.

When translating the text records in other linguistic regions, you must therefore consider the settings for your computer.

WinCC as of V7.2 supports Unicode. In your operating system, you therefore only set the system locale for programs that do not support Unicode. Select a font that contains all necessary characters. Depending on the character input language and medium you are using, it may be necessary to make additional settings in the Control Panel of your OS, e.g. dialog language and keyboard settings.

The following example shows how you translate from English to Chinese (Simplified, PR China).

The example assumes that the text exists in English.

Procedure

1. Export the English text records with the Text Library.
 - In the "File name" field, enter the file name "ENU_CHS_Languages".
 - Select the "Unicode Text (*.txt)" file type.
2. Export the English picture texts with the Text Distributor.
 - In the "File prefix" field, enter "ENU_CHS".
 - Select the "Text file (*.txt)" file format.
3. Set the system locale for Chinese in the operating system of your computer. The Input Method Editor (IME) is available in Windows for configuring Asian text.
4. Restart the operating system.
5. Open the file "ENU_CHS_Languages.txt".
6. Expand the file by the language Chinese. Enter 1028 in the column "Language ID". In column "FontName", enter "Ming Lui". Change the other parameters for the font if necessary.
7. Save the file "ENU_CHS_Languages.txt".
8. Open the file with the exported text records of the Text Library.
 - Create another column for Chinese in the file.
 - Write the text "Chinese" in every object block in line "ID" in the new column.
 - Enter the correct translation for every Text ID in the Chinese column.
 - Save the file once again in "Unicode Text (*.txt)" format.
 - Repeat these steps for all files with exported text records of the Text Library, if necessary.

9. Open the file <ENU_CHS_GraphicsDesigner.txt> or one of the picture files.
For every line that begins with "Object":
 - Enter the following text records in the next free cells: "Chinese", "Chinese FontName", "Chinese FontSize", "Chinese FontBold", "Chinese FontItalic", "ChineseFontUnderline".
 - Change the entries in column "Chinese FontName" to "Ming Lui" and the other properties as desired.
 - Enter the translated text in column "Chinese".
 - Save the file.
 - If you have individual picture files, repeat these steps for every file.
10. Start WinCC.
11. Open the Text Library.
12. Select the "Edit > Import" menu command.
13. Select the file "ENU_CHS_Languages.txt".
14. Start the import with a double-click on the "Import" button.
15. Start the Text Distributor.
16. Change to the "Import text" tab.
17. Select Chinese (Simplified, PR China) under "Select language".
18. Start the import with a double-click on the "Import" button.

Result

The Chinese text records are available in the WinCC project. The text records can be displayed in the configuration and in Runtime.

Structure of the User Administration

14.1 Setting up user administration

Overview

You use the User Administrator to assign and manage access rights for operation in runtime and configuration in the configuration system.

All of the operator stations are included in the user administration system, including WinCC/ WebNavigator clients and WinCC/DataMonitor clients.

The User Administrator also supports centralized user administration, integrated in Windows, via SIMATIC Logon.

You can also use and edit the user administration in Runtime using the WinCC UserAdminControl.

Principles of user administration

The User Administrator contains predefined default authorizations and system authorizations. You can if necessary add or remove authorizations.

You create user groups and users and assign them joint or individual authorizations. You can also assign authorizations in runtime.

Function	Enable
1 User Administration	<input checked="" type="checkbox"/>
2 Value input	<input checked="" type="checkbox"/>
3 Process controlling	<input checked="" type="checkbox"/>
4 Picture Editing	<input checked="" type="checkbox"/>
5 Change picture	<input checked="" type="checkbox"/>
6 Window selection	<input checked="" type="checkbox"/>
7 Hardcopy	<input checked="" type="checkbox"/>
8 Confirm alarms	<input checked="" type="checkbox"/>
9 Lock alarms	<input checked="" type="checkbox"/>
10 Free alarms	<input checked="" type="checkbox"/>
11 Message Editing	<input checked="" type="checkbox"/>
12 Start archive	<input checked="" type="checkbox"/>
13 Stop archive	<input checked="" type="checkbox"/>
14 Edit archive values	<input checked="" type="checkbox"/>

Properties - Group	
Selection	
Object type	Group
Object name	tester
General	
Group name	tester
Login	
Logon with smart card	<input type="checkbox"/>
Logout	
Type of automatic logoff	None
Period of time before automatic logoff	
Web	
WebNavigator	<input type="checkbox"/>
WebNavigator start picture	
Use horn on Web Client	<input type="checkbox"/>
WebUX	<input type="checkbox"/>
Start Picture of WebUX	
Web language	

When a user logs on, the User Administrator checks whether he is registered and what authorizations he holds. A user who is not registered does not have the rights to access or display data. If the user accesses a WinCC object with access protection, the User Administrator checks whether the user has the required operator authorization.

You open the User Administrator with the WinCC Explorer. If you have already opened another editor in the WinCC Configuration Studio, you can change to the User Administrator with the editor selection on the bottom left.

Advanced user administration functions

- You configure the web options for the users for operation via the Intranet/Internet.
- If necessary, you can configure automatic logout for user groups or individual users.
- WinCC supports logon to a computer using a tag value, e.g. using a key-operated switch.
- Logon with a chip card is possible using the "Chip card" option.
- The option "Basic Process Control" supports those authorizations and areas which correspond to the PCS 7 user hierarchies. You can activate the audible signal device for use on the Web clients.

Performance data

Object	Maximum number
Authorizations	999
Users	128
User groups	128
Ranges	256

Operating the "User Administrator" editor

You configure the user administration in the WinCC Configuration Studio using the "User Administrator" editor .

The basic functions and general operation are described under "Working with Projects > AUTOHOTSPOT".

Special types of configuration are described in the corresponding function descriptions.

See also

Logon with a chip card (Page 2432)

Configuring automatic logout (Page 2424)

Configuring logon with a tag (Page 2425)

Central user administration with SIMATIC Logon (Page 2440)

Administering authorizations (Page 2409)

Administering users (Page 2417)

14.2 Overview of the configuration steps

Basic steps in WinCC user administration

1. If necessary, create more authorizations in addition to those predefined.
2. Create the necessary user groups.
3. Assign the authorizations to the user groups.
4. Save the users in the corresponding user groups. The group properties can be imported.
5. Assign specific authorizations to individual users.
6. If necessary, configure web access for user groups or individual users.
7. If necessary, set a time for user groups or individual users after which the system automatically logs out a logged on user.
8. If necessary, configure user logon with a tag, for example so that the users log in with a key-operated switch instead of the logon dialog.
9. If necessary, authorize user groups or individual users to log on using a chip card.
10. The configured data are immediately applied. There is no "Save" function.
11. You configure the operator authorizations in the editors of the WinCC project. Examples:
 - Specifying the authorization to operate a button in a picture in the Graphics Designer.
 - Configuring an electronic signature for operating objects.

User administration in distributed systems

When you configure a client-server system, observe the notes under "User administration in distributed systems (Page 2433)":

- Use a role concept when managing multiple users.
- Use the Export/Import function of the User Administrator.

Alternative procedure using SIMATIC Logon

You can set up central user administration with SIMATIC Logon instead of WinCC user administration.

The basic package for the "SIMATIC Logon Service" must be installed on all computers involved. Select the "SIMATIC Logon" option in the User Administrator.

You can find additional information under "Central user administration with SIMATIC Logon (Page 2440)".

See also

- Adding authorizations (Page 2409)
- Creating a user group (Page 2417)
- Setting up users (Page 2417)

14.2 Overview of the configuration steps

Configuring automatic logout (Page 2424)

Administering users for web access (Page 2422)

Configuring operator authorization (Page 2427)

Configuring an electronic signature (Page 2428)

Configuring logon with a tag (Page 2425)

User administration in distributed systems (Page 2433)

Central user administration with SIMATIC Logon (Page 2440)

14.3 Administering authorizations

14.3.1 Adding authorizations

Introduction

The User Administrator provides predefined default authorizations and system authorizations. The number and type of the authorizations displayed depends on whether the option "Basic Process Control" has been installed.

You can, if necessary, add additional authorizations in the User Administrator.

Procedure

1. Open the User Administrator in the WinCC Configuration Studio.
2. Select "User Administration" in the navigation area.
3. Select the "Authorization levels" tab in the data area.
The existing authorizations are displayed.
4. Enter the ID of the new authorization.
The ID must be between "1" and "999".
5. Enter the name of the new authorization.
The name can be no longer than 70 characters.
6. Enter the translation of the name in the corresponding columns, if necessary.
You can also manage the translations by means of the "Text Library" editor.
7. Select a user or a user group in the navigation area.
8. Assign the new authorization in the data area in the "Authorization" tab.

14.3.2 Deleting authorizations

Introduction

You can delete created authorizations in the "User Administrator" editor. You cannot delete authorizations during runtime.

Deleted authorizations are lost for all registered users.

You cannot delete system authorizations numbered 1000 -1099.

Procedure

1. Select "User Administration" in the navigation area.
2. Select the "Authorization levels" tab in the data area.
The existing authorizations are displayed.

14.3 Administering authorizations

3. Select the line containing the authorization you wish to delete.
4. Select "Delete" from the shortcut menu.
The authorization is deleted.

14.3.3 Plant-specific authorizations

Introduction

In PCS 7 projects, or in WinCC projects with "Basic Process Control", you may grant authorizations for access to the entire plant, or limit these to specific areas.

Authorizations which are not plant-specific can only be granted to the user or group for the entire plant.

Authorizations which are plant-specific can be granted to a user or group either for the entire plant or for specific areas only.

Note

Making good use of authorization for individual areas

If it makes no sense to grant an authorization for individual areas, you cannot grant the authorization for individual areas.

For example, it is advisable to grant the "System change" authorization only for the entire plant.

Requirement

- The OS Project Editor has been run for the WinCC project.
- In a WinCC project, plant areas have to be created using the "Picture Tree" editor.

Procedure

1. Select "User Administration" in the navigation area.
2. Select the "Authorization levels" tab in the data area.
The existing authorizations are displayed.

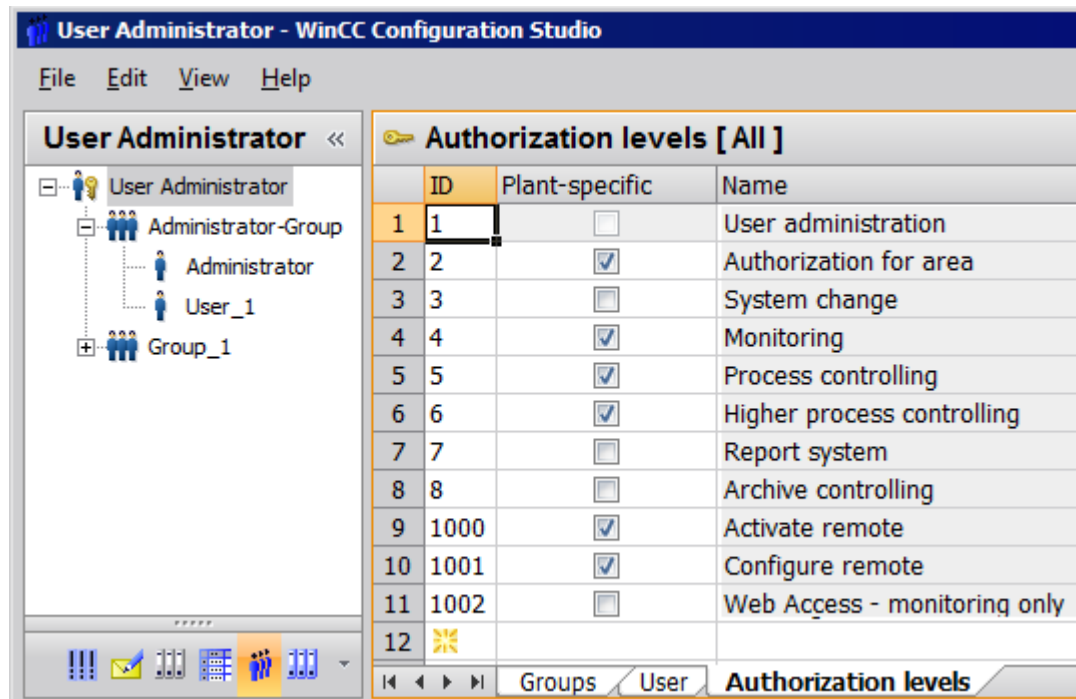

3. Select the authorizations that you want to enable for a specific plant.
4. Select each option in the "Plant-specific" column.

- Select a user or group in the navigation area.
In the data area, you can see the individual areas and authorizations in the "Authorizations" tab.

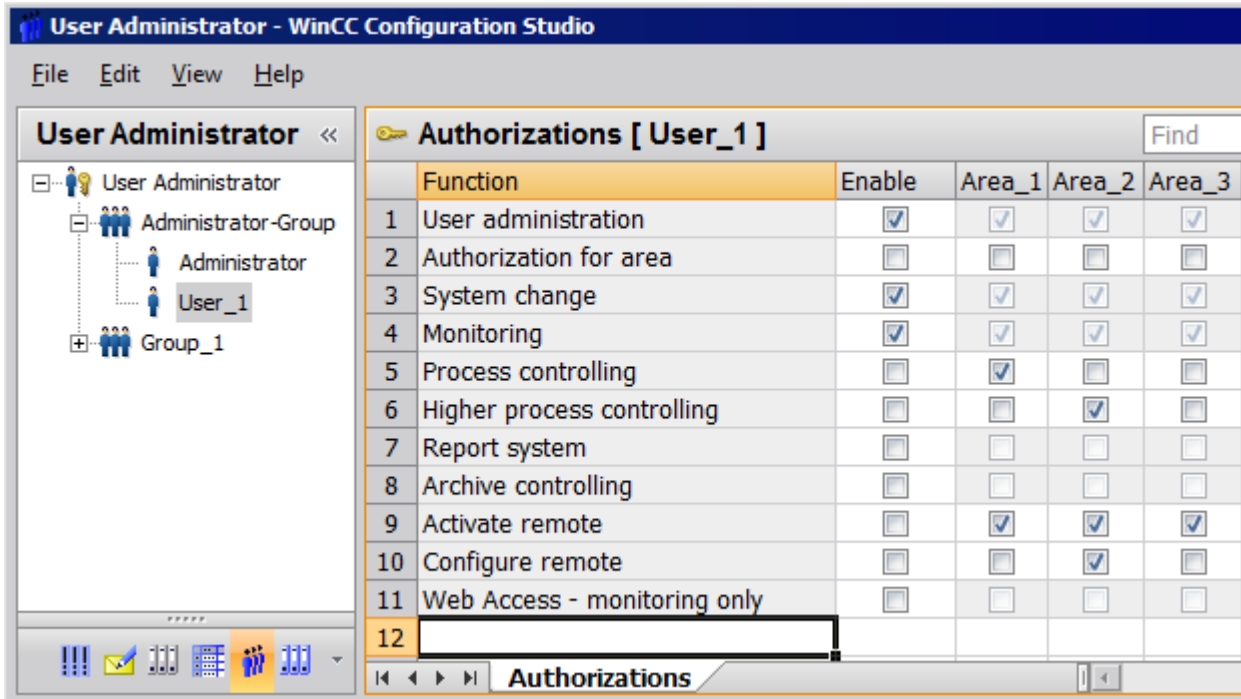

- For selected functions, activate the general enable or the enable for individual areas, for example Area_1. Authorizations that are not configured plant-specific are grayed out in the areas.

14.3.4 Overview of Authorizations

14.3.4.1 Default Authorizations

Introduction

The User Administrator contains predefined default authorizations and system authorizations. Authorizations with lower numbers are not included in authorizations with higher numbers. Each authorization functions independently. Authorizations are only effective in runtime.

The name of each authorization indicates the influence of the corresponding authorization. However, the names do not indicate how the authorizations are actually used.

Accessing the authorizations

You can delete or edit all authorizations with the exception of "User administration". A member of the "Administrator Group" always receives access to the "User Administration" authorization.

Overview of default authorizations

No. 1: User administration

Users can access user administration and make changes.

No. 2: Value input

Users can enter values manually, for example in I/O fields.

No. 3: Process controlling

Users can operate processes.

No. 4: Picture editing

Users can change pictures and picture elements.

No. 5: Picture change

Users can trigger a picture change and open another configured picture.

No. 6: Window selection

Users can switch application windows in Windows.

No. 7: Hard copy

Users can make a hardcopy of the current process picture.

No. 8: Confirming messages

Users can acknowledge messages.

No. 9: Locking messages

Users can lock messages.

No. 10: Unlocking messages

Users can unlock messages.

No. 11: Message editing

Users can edit messages in the "Alarm logging" editor, for example with ODK.

No. 12: Starting archive

Users can launch an archiving process.

No. 13: Stopping archive

Users can end archiving.

No. 14: Archive value editing

Users can configure the evaluation of archive tags.

No. 15: Archive editing

Users can control and change archiving.

No. 16: Action editing

Users can run and edit scripts, for example with ODK.

No. 17: Project manager

Users have unrestricted access to WinCC Explorer.

14.3.4.2 System authorizations

Introduction

System authorizations are generated automatically by the system. A user cannot edit, delete or create new system authorizations. System authorizations can only be assigned to users.

System authorizations take effect in the configuration system and in runtime. In the configuration system, for example, they prevent project access by a user not registered for that project.

Overview of system authorizations

No. 1000: remote activation

Users can start and terminate runtime from another computer.

No. 1001: Remote configuration

Users can configure and edit the project from another computer.

No. 1002: Web access - monitoring only

Users can open the project from another computer but cannot change or control it.

14.3.4.3 Basis Process Control Authorizations

Introduction

If the option "Basic Process Control" is installed, you can define area-specific access rights for the users in the User Administrator. Predefined authorizations and areas of the configured hierarchy from PCS 7 are available following processing by the OS project editor.

You can add, delete and change authorizations. The predefined authorizations cannot be deleted or changed. Authorizations with lower numbers are not included in the authorizations with higher numbers. Each authorization functions independently. Authorizations are only effective in runtime.

Overview of authorizations with the "Basic Process Control" option

No. 1: User administration

Users can access user administration and make changes.

No. 2: Authorization for area

User can enable the selection of pictures in the authorized system areas.

No. 3: System change

Users can trigger a change of state, for example end runtime.

No. 4: Monitoring

Users can monitor but not control the process, for example selection of batch visualization.

No. 5: Process controlling

Users can operate processes.

No. 6: Higher process controlling

Users can perform control operations with permanent effects on the process, for example modify the limit values of a controller.

No. 7: Report system

No longer used by the system.

14.3.4.4 PCS 7 system authorizations

Introduction

System authorizations are generated automatically by the system. A user cannot edit, delete or create new system authorizations. System authorizations can only be assigned to users.

No. 1100: Highest process controlling

Used with PCS 7 in combination with the Advanced Process Library only.

No. 1101: Extended operation 1

Used with PCS 7 in combination with the Advanced Process Library only.

No. 1102: Extended operation 2

Used with PCS 7 in combination with the Advanced Process Library only.

14.4 Administering users

14.4.1 Creating a user group

Introduction

Users with the same access rights or areas are grouped together.

The User Administrator permits only one single group level. You cannot create any subgroups.

Inheriting authorizations

The authorizations of a group are inherited by the group members.

When you create a user in a group, the authorizations of the group are automatically applied with your settings to the user. You can adapt the authorizations for individual users later.

Changes of the group authorizations at a later time are not inherited by the users.

Procedure

1. Select "User Administration" in the navigation area.
2. Select the "Groups" tab in the data area.
3. Enter the name of the new group in the "Group name" column.
The name must consist of at least four characters.
A group name can only be assigned once.
4. Select the new group in the navigation area.
5. Assign the required authorizations in the "Authorization" tab.

14.4.2 Setting up users

Introduction

You add a user to a group so the user can log on in Runtime with his logon.

The assigned authorizations grant the user access to functions and areas in Runtime.

All authorizations of a group are inherited by the group members when you create the user. Changes of the group authorizations at a later time are not inherited by the users. If you want to apply group authorizations, copy the lines of the relevant authorizations and paste them for the user.

After creating a user, you can assign individual authorizations to this user.

You may use Unicode characters for the user name and password. For restrictions, refer to "Working with projects > Appendix > Illegal characters".

User names

A user name can only be assigned once.

The length of the user name is limited to a maximum of 24 Unicode characters.

If you wish to display the user names in messages, limit the user names to a maximum of 16 characters. The length in the "User name" system block is limited to 16 characters in the message system.

Passwords

The password must be between 6 and 24 Unicode characters in length.

Make sure that the passwords meet the standard security guidelines, for example:

- Use of uppercase and lowercase letters
- Use of special characters
- Minimum number of characters.

Procedure

1. In the navigation area, select the group in which you want to create a new user.
2. In the "User" tab, enter the user name or the login in the "User name" column. A color coding in the "Password" column indicates that you have not yet assigned a password for the user.
3. Click the field and the "..." button displayed in it. The "Change password" dialog opens.
4. Enter the password. Enter the password again to confirm. The quality of the password is displayed during the input.

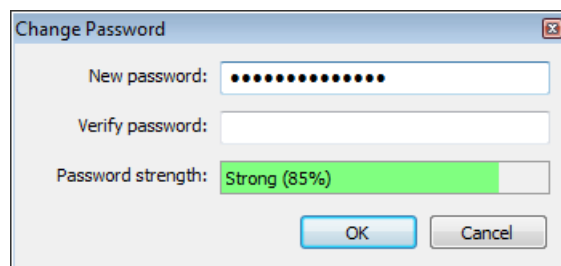

5. Close the dialog with the "OK" button. The currently set authorizations of the group are applied to the user. To change the user authorizations, select the user in the navigation area and enable the required authorizations in the data area.

14.4.3 Administrating users

Introduction

The following user-related management tasks are available in the User Administrator:

- Changing the user name.
- Changing the password of a user.
- Copying a specific user with settings.
- Moving a user to another group.
- Deleting a user.
- Defining a user for WinCC service mode

Note

A user name can only be assigned once.

Management of user data

To configure the properties of a user in the User Administrator, select one of the following procedures:

- Configure in the shortcut menu of the user in the navigation area.
- Configure in a table column of the "User" tab if "User Administrator" is selected in the navigation tree.
- Configure the properties viewlet of the user.

In the described procedures, use the shortcut menu or configure the settings in the "Properties - User" viewlet.

Activity	Shortcut menu in the navigation area	Column in the data area	"Properties - User" viewlet
Copying and pasting users	X	X	---
Deleting a user	X	X	---
Renaming a user	X	X	X
Changing a password	---	X	X
Changing a group	---	X	X
Configuring automatic logoff	---	X	X
Configuring logon with a tag	---	X	X
Configuring web access	---	X	X
Exporting user data	X	X ¹⁾	---

Activity	Shortcut menu in the navigation area	Column in the data area	"Properties - User" viewlet
Specifying WinCC Service-Mode	X	---	---
Specifying "Write to Chip Card"	X	X	X

1) Select the line of the user or multiple users and "Export" in the shortcut menu.

Requirement

The user was selected in the navigation area.

Changing a user name

1. Select the user in the navigation area.
2. Change the name in the "User names" field.
After changing the name, you must enter a new password.

Changing a password

1. Select the user in the navigation area.
2. Click the "Password" field and the "..." button displayed in it. The "Change password" dialog opens.

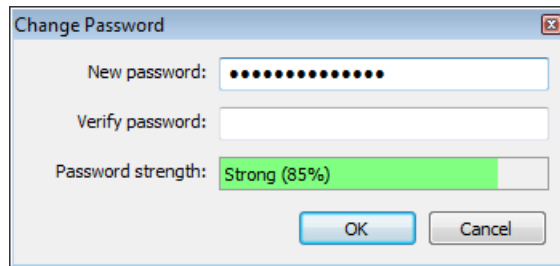

3. Enter the new password. Enter the password again to confirm.
The quality of the password is displayed during the input.
4. Close the dialog with the "OK" button.

Copying Users

1. Select the user you wish to copy in the navigation area.
2. Select the "Copy" option from the shortcut menu.
3. To create a copy of the user, select the "Paste" option in the shortcut menu of the required group.
4. Configure the password of the new user.
5. Change the properties and authorizations, if necessary.

Moving a user to another group

1. Select the group with the user in the navigation area.
2. In the "Group name" column of the data area, select the desired group from the drop-down menu.

The user is moved. The settings and authorizations are retained.

Deleting a user

1. Select the user in the navigation area.
2. Delete the user with the key or select the "Delete" option in the shortcut menu.

Defining users for WinCC service mode

WinCC Runtime can also be run on the computer in WinCC ServiceMode when no Windows user is logged on to the computer. Interactive user inputs are not possible. Authorizations are not checked.

If you still need an authorization check in WinCC ServiceMode, you can define a special user for this purpose. The authorizations of this user are checked in Runtime if no Windows user is logged on.

Requirement

The WinCC ServiceMode is configured.

Procedure

1. Select the user in the navigation area.
2. In the shortcut menu, select the "User in Service Context" option.
The user receives his own icon.

14.4.4 Administrating user groups

Introduction

The following user group-related management tasks are available in the User Administrator:

- Changing the group name.
- Deleting a group.

Note

A group name can only be assigned once.

Changing a group name

1. In the navigation area, click the group to which you want to assign a new name.
2. Click on the group name again. The name appears in a text window. Enter the new name.
3. Confirm the new name by pressing the ENTER key.

Deleting a group

1. In the navigation area, click the group you want to delete.
2. Select the "Delete" option in the shortcut menu.
If users are created in the group, a dialog opens in which you confirm the deletion. Confirm with "OK".
The group and the users included in it, if any, are deleted.

14.4.5 Administering users for web access

Introduction

You will have to configure the web options in the User Administrator if users are to access the WinCC project via the Internet/Intranet.

The following settings apply to the WinCC options WinCC/WebNavigator, WinCC/DataMonitor and WinCC/WebUX:

Setting	WinCC option	Effect
WebNavigator	DataMonitor WebNavigator	The user has access to the WebNavigator server or DataMonitor server.
WebUX	WebUX	The user has access to the WebUX server.
WebNavigator start picture	DataMonitor WebNavigator	The user sees a customized start picture in the Web browser.
Start Picture of WebUX	WebUX	
Web language	DataMonitor WebNavigator WebUX	Runtime language of the user when opening the WinCC project.
Reserve WebUX license	WebUX	The user has guaranteed access to the WebUX server with this reserved license. The number of freely available WebUX licenses is reduced by each configured reserved license.
WebUx Number of reserved licenses	WebUX	Number of WebUX licenses that are reserved. If more reserved licenses are configured than are available on the WebUX server, the licenses are used by the first users who logged on.
Authorization level 1002 "Web access - monitoring only"	DataMonitor WebNavigator WebUX	The user only has read access to a Web server. The authorization level of the license corresponds to "WinCC WebUX Monitor" for WinCC/WebUX. In WebUX, user name and password can be saved for an automatic logon.

Requirement

- The WinCC process pictures were published using Web View Publisher.
- The user or user group has been created.
- The user or user group authorizations have been specified.

Procedure

1. Select a user or a group in the navigation area.
2. Activate the "WebNavigator" or "WebUX" option in the "Properties" viewlet.
3. Click "..." to select the start picture for the user or group.
You can only select published pictures as start pictures.
If you do not select a start picture, the option "WebNavigator" or "WebUX" is disabled again when you close the editor.
4. Select the desired Runtime language for the user or group.
The languages configured in the Text Library are available for selection.
5. If required, configure a reserved license for the WebUX user.
6. If necessary, activate the authorization level "Web access - view only".

14.5 Configuring automatic logout

Introduction

You can define a period of time after which a logged in user is automatically logged out. This prevents unauthorized persons from having unlimited access to the system following control operations by the user currently logged in.

Note

If you have selected the "SIMATIC Logon" option, you will only be able to set automatic logout for the group. The setting will automatically be applied to each user in this group.

Automatic logout is deactivated if a user logs on with a chip card.

Overview

You can configure automatic logout for a user with one of the following scenarios:

- The user remains logged on until the system is shut down or another user logs on. Select the setting "None" for the logout. Automatic logout is deactivated.
- The configured time until automatic logout is counted from the time the user logs on. The time will expire irrespective of user actions during this time. Activate the "Absolute" option and enter a time in minutes.
- The configured time is counted from the last time the user operates keyboard or mouse. The user is automatically logged out after this pause. Select the "Inactive" option for automatic logout and enter a time in minutes.

Procedure

1. Select a user or a group in the navigation area.
2. Select the value "Absolute" or "Inactive" in the field "Type of automatic logoff" of the "Properties" viewlet.
3. Enter a time in minutes in the field "Period of time before automatic logoff".

14.6 Configuring logon with a tag

Introduction

A user can log on with a key-operated switch, for example, instead of via the logon dialog. Configure the "Tag logon" function to allow a user to log on or off a WinCC computer with a tag.

If a user is logged on to the system with a tag, it is not possible for a user to log on at the same computer using the logon dialog.

Note

Tag logon is not possible if you are using SIMATIC Logon.

Configuration steps

Follow the configuration steps below to log on via a tag:

1. Assign a configured tag to a computer. You have two options:
 - Assign the same tag to all computers
 - Assign a separate tag to each computer
2. Define the tag value range.
3. Assign a specific tag value to a user.

Properties of the logon tag

Tag types

The following tag types are permitted:

- Binary
- 8-bit value
- 16-bit value
- 32-bit value

Limits

Each user who logs on using a tag is assigned a separate tag value. The number of users with "Tag logon" is therefore limited by the number of tag values.

Each tag value that is not assigned to a user can be used as tag value for logging off or logout.

To specify the number of possible values, configure a low and a high limit of the tag value. The value range depends on the tag defined.

- Low limit: The maximum value range possible ranges from "0" to "32767".
- High limit: The maximum value range possible ranges from "1" to "32768".

Procedure

1. Select the "User Administration" entry in the navigation area.
2. Select a computer in the "Computer name" field of the "Properties - User Administrator" viewlet.
The list includes the computers available in the project.
3. Open tag management with the "..." button in the "Tag name" field.
4. Select the tag you want to use.
5. Enter the minimum value of the tag in the "Low limit" field.
6. Enter the maximum value of the tag in the "High limit" field.
7. Select a user in the navigation area.
8. Select a tag value in the field "Value of the tag logon".

Result

The assigned user is logged on to the system when the tag equals the configured value.

14.7 Configuring operator authorization

Introduction

An operator authorization is configured for an object property to protect the object from access. Only users with this authorization can operate the object.

Example: Operator authorization for a button

1. Create a button in the Graphics Designer.
2. Open the "Authorizations" dialog in the configuration dialog or in the "Miscellaneous" properties via "Authorization".
The created authorizations are displayed in numerical order.

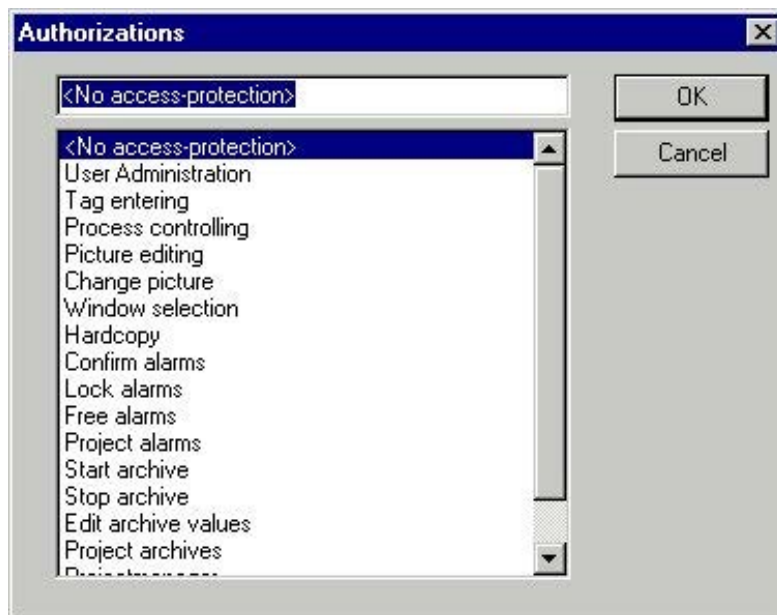

3. Select an authorization.
Operation of the button in runtime is now only possible for users with the corresponding authorization.

14.8 Configuring an electronic signature

Introduction

You can further protect the execution of critical operations with the electronic signature of a user.

A given action can only be carried out when the configured user is authenticated with a password.

If the user is not authorized or enters an incorrect password, the action is not performed.

WinCC objects and WinCC controls

The following objects allow operating confirmation by means of an electronic signature:

- Smart objects:
 - I/O field
 - Text list
 - Multiple row text
 - Combo box
 - List box
- Windows objects:
 - Button
 - Check box
 - Radio box
 - Round Button
 - Slider object
- WinCC controls:
 - WinCC AlarmControl
 - WinCC OnlineTableControl
The electronic signature is requested during the manual input of values.
 - WinCC Slider Control
 - WinCC UserArchiveControl

WinCC system message

Successful and aborted signing procedures are documented with a message:

Number	Description
1900000	Electronic signature was successfully recognized.
1900001	Electronic signature was not recognized.
1900002	Signature operation was aborted.

Number	Description
1900003	Operation of a WinCC object or WinCC control was signed once.
1900004	Operation of a WinCC object or WinCC control was signed retroactively multiple times. The function is only available when the WinCC/Audit option is installed.

Requirement

- "Alarm Logging Runtime" is activated in the startup list in the computer properties.

Procedure

1. Select the property group "Miscellaneous" in the object properties of a WinCC object. For a WinCC control, you select the property group "Control Properties".
2. Select the option "Yes" for the "Enable electronic signature" or "ElectronicSignature" property.
3. Double-click the "User for the electronic signature" or "AuthorizedGroups" property. The "Selection" dialog opens.
4. Select the desired user from the drop-down list in the "User Group" column. If you are using SIMATIC Logon, the drop-down list only contains SIMATIC Logon users. If the column is not active, click on the empty row in the "Group" column. The operator "and" is displayed in the "Link" column and the user list is activated in the "User Group" column.
5. If you are using the WinCC/Audit option, you can select user groups or multiple users. Link the users and user groups using "and" or "or". You can group the rows in the "Group" column.
6. If you are using the WinCC/Audit option, you can use the "Retroactively" option to specify that the signature is requested after the operation.
7. Click "OK" to close the dialog. The selected user names and link parameters are shown in the "Static" column.
8. If applicable, configure the display of the system messages in WinCC AlarmControl.

Result

Operation

If a user wants to operate the configured object in Runtime, the "Selection" dialog opens with the list of configured users.

When you click in the empty column for signing, the password of the user is requested in the "Identity Verification" dialog.

The user also has the option to enter a comment which is saved as comment with the triggered system message.

System messages

The system messages document all authentication attempts.

If you use the "WinCC/Audit" option, the messages for all authentication attempts are also written to audit trail databases.

See also

How to configure an electronic signature with SIMATIC Logon (Page 2445)

14.9 Logging on as user

Introduction

The logon dialog appears in runtime if there is no user logged on in runtime.

Note

Logging on can take several minutes if a large number of authorizations have been assigned per user.

Requirements

- You have created users with user name and password in the User Administrator.
- You have assigned the users authorizations in the User Administrator.
- You have defined shortcut keys for logon. Shortcut keys are configured in WinCC Explorer on the "Hotkeys" tab under project properties.

Procedure

1. Start WinCC Runtime.
2. Press the shortcut keys you have defined for logon. The logon dialog opens.
3. Enter the logon name and the password in the dialog.

Note

Passwords are case-sensitive.

Result

The system checks the rights assigned against the authorizations of the editors and configured objects. It releases the objects for use if the authorizations correspond.

14.10 Logon with a chip card

Introduction

You specify whether users or a user group require a chip card to log on in the properties in the User Administrator.

Requirements

- The "Chip card" option has been installed.
- An interface has been assigned to the chip card reader.
- The "SIMATIC Logon" option is not activated in the User Administrator.
- The "Automatic logoff" option is not selected.

Logon with chip card

To log on in WinCC, the user inserts his chip card into the card reader. The required data is read out.

The user remains logged on to the system until he removes the card from the card reader. As long as a card is inserted in the reader, logon through the Logon dialog is blocked.

The automatic logoff function is disabled when you use the chip card.

"Logon with smart card" option

If this option is selected, the user must use a smart card to log on.

If this option is not selected, a user can log on using both the smart card and the logon dialog.

You can find additional information in the WinCC information system under "Options > Options for Process Control > Chip Card Reader".

Write to smart card and check

The User Administrator provides functions for controlling a chip card read/write device. In the configuration system, you use these functions to write to chip cards.

For writing to and reading a chip card, the chip card reader must be connected to the computer before WinCC is started.

No Windows administrator rights are required to write to, check or use chip cards.

You can find additional information in the documentation of the chip card reader under "How to write to a chip card".

14.11 User administration in distributed systems

14.11.1 User administration in a distributed system

In a client/server system with one or more servers, configure the rights management and user administration on the following PCs:

- WinCC server
- WinCC clients with their own project
- Redundant WinCC server:
Changes in the User Administrator are not automatically synchronized either in the editor or in the WinCC UserAdminControl.

WinCC clients without their own project use the users and authorizations of the server project.

Configuration recommendations

To reduce the administrative workload, we recommend the following procedure:

- Configure the identical authorizations and users on multiple PCs.
Change this configuration only on the PCs for which it is actually required.
- If a user is created on multiple PCs, always give the user the same authorizations and the same password.
You reduce the rights management workload and make it easier for the user to work on different PCs.
- To obtain uniform configuration in several PCs, use the export and import function of the User Administrator.
The example "Exporting / importing the User Administrator configuration (Page 2437)" describes the basic procedure.
- If you manage a large number of users, work with a role concept.
The "Role concept (Page 2438)" example describes the basic procedure.
- Use the option "SIMATIC Logon" for a central user administration on multiple PCs.
You can find more information on SIMATIC Logon at "Central user administration with SIMATIC Logon (Page 2440)".

Information on authorizations

WinCC Clients / WinCC Server

- If the operator authorizations or user settings are changed on a WinCC server, the settings are only effective on the other PCs after a new login.
The participating PCs receive no notification of the change.

WinCC client with its own project / WinCC-Server

- Authorizations on the WinCC server may also have to be configured on the WinCC client.
Example:
In a process picture that is located on the server, an object is protected by an operator authorization. To operate the object from the client, the same authorization must be configured for the user on the client as on the server.
When authenticating only the authorization ID is checked. The authorization can have different names on server and client.
The example "Configuring operator authorization on server and client (Page 2436)" describes the basic procedure.
- In the client and server project, the authorization names are in each case translated separately from each other in the text library.
Make sure that the same authorization translation is used on all PCs. This makes orientation for the users easier on the various PCs.

WinCC client without its own project

- To open or enable the server project, the user of the client must authenticate himself on the server.
The corresponding system authorizations must be assigned on the WinCC server for this purpose.
For more information refer to the WinCC Information System under "Configuration > Distributed systems > Server configuration > How to configure operator authorizations".

Information on user

Users and user names on multiple PCs

The user name or group name must not occur multiple times within a WinCC project.

However, you can freely combine user names and the names of user groups in several PCs:

- Users and groups may be created multiple times with the same name.
Application example: An operator can log on to multiple PCs with the same user data and authentication. To make orientation easier for the operator, configure the authorizations and settings identically.
- Users or groups with different names may be created on the PCs.
This allows WinCC stations to be configured for different use cases.

Passwords

- Passwords are not centrally synchronized.
- For the same user name, you may use on the clients and servers different passwords.

See also

Example: Operator authorization on server and client configuration (Page 2436)

Example: Importing / exporting the configuration of the user administrator (Page 2437)

Example: Role concept (Page 2438)

Exporting/importing User Administrator configuration data (Page 2435)

Central user administration with SIMATIC Logon (Page 2440)

14.11.2 Exporting/importing User Administrator configuration data

Exporting configuration data

To copy the user administration and rights management from the WinCC project to another project, use the export and import function of the User Administrator.

The following configuration data are exported to a TXT file:

- Authorizations
- User groups and their settings
- Users and their settings

To transfer exported data to another WinCC project, import this TXT file to the User Administrator of the target project.

You can find an example at "Example: Importing / exporting the configuration of the user administrator (Page 2437)".

Restriction on export: Passwords

User passwords are not exported.

You must re-enter the password for each user in the target project.

Display after import.

All the exported configuration data are imported into the target project.

However, the following conditions must be met in order to display all imported data in the User Administrator:

Configuration data	Display requirements	Comment
Authorization enables	The authorization ID is created in the target project.	Only the ID of the authorization is relevant, not the name. You can also create the missing authorization after the import. In doing so the enable is used and displayed.
WebNavigator / WebUX Start picture configuration	The process picture with the same name is contained and published in the target project.	You can also create and publish the process pictures after the import. To update the start picture configuration, reimport the configuration data. Alternatively, you can configure the start pictures individually in the user properties.

Behavior during reimport

You can import exported data multiple times:

- Entered user passwords are retained during reimport.
- All other configuration changes are overwritten during reimport.

Messages during the export or import

- After the export, a message indicates which elements were exported.
- After the import, a message indicates which elements were imported.
- If errors occur during import, a log file is created that contains detailed information about the errors. The message on the completion of the import contains the link to this log file.

See also

Example: Importing / exporting the configuration of the user administrator (Page 2437)
User administration in a distributed system (Page 2433)

14.11.3 Example: Operator authorization on server and client configuration

Initial situation

- Client/server system:
 - WinCC server
 - WinCC Client with its own project
- On the WinCC server, the button with operator authorization is configured in a process picture.
The user should operate the button from the WinCC client.

Procedure

WinCC server

1. Create the user "TestUser1" on the WinCC server.
2. Create the authorization "OperationTest" with ID=20.
3. Assign "TestUser1" the "OperationTest" authorization.
4. Configure the authorization "OperationTest" in the process picture "ServerPicture.Pdl" for the object "Button".
The user "TestUser1" can operate the button in the picture "ServerPicture.Pdl" in Runtime.
5. Create the server data using "Server data".

WinCC Client with its own project

1. Load the server on the WinCC client using "Server data".
2. Create the user "ClientUser1".
Comment: User can also have the same name as on the server, i.e. "TestUser1".
3. Create the authorization "OperationTest" with ID=20.
Comment: You may also give the authorization another name, for example, "ServerAccess".
Relevant is the ID of the authorization.
4. Assign the user "ClientUser1" the authorization with ID=20.
5. Start Runtime and select the server picture "ServerPicture.Pdl".
The user "ClientUser1" can operate the button in the picture "ServerPicture.Pdl" in Runtime.

See also

User administration in a distributed system (Page 2433)

Example: Role concept (Page 2438)

14.11.4 Example: Importing / exporting the configuration of the user administrator**Initial situation**

- The rights management and the user administration are configured in the User Administrator.
- Transfer this configuration to a WinCC client.

Read the notes under "Exporting/importing User Administrator configuration data (Page 2435)".

Procedure**Transfer complete configuration**

1. Select the entry "Edit > Export" in the User Administrator menu. The actual position of the navigation tree has no effect on scope of the export.
The configuration data of the User Administrator are exported.
2. Import the exported TXT file to the WinCC client using the menu "Edit > Import".
Authorizations, user groups and users are created the same way as on the WinCC server.
3. Re-enter the user password on the WinCC client.
4. If required, configure new start pictures for the WebNavigator and WebUX options.

Transfer single users or user groups

1. Highlight in the navigation tree the user or the user group.
2. Select "Export" in the user or user group shortcut menu.
The configuration data of the user or the user group are exported.
Authorizations are not exported.

3. Import the exported TXT file to the WinCC client using the menu "Edit > Import".
The users and the user groups, if necessary, are created the same way as on the WinCC server.
4. Re-enter the user password on the WinCC client.
5. If required, configure new start pictures for the WebNavigator and WebUX options.
6. If required, configure the missing authorizations of the user or the user group.

See also

User administration in a distributed system (Page 2433)

Exporting/importing User Administrator configuration data (Page 2435)

14.11.5 Example: Role concept

The more users you are administering for your plant, the more important it is to have a well prepared role concept for the user administration and rights management.

Possible roles in a plant are, for example:

- Monitoring via web
- Operator
- Nightshift operators
- Configuration engineer
- Administrator

This example shows a possible approach to create users and user groups for different roles.

Procedure

1. Define the required roles with their authorizations.
Create, for example, a list of the users and their respective tasks. Using this list, you can identify typical roles and set the appropriate authorization.
2. In the WinCC project, create the required authorizations in the User Administrator.
3. Create a separate user group for each role, for example, "Nightshift operators".
The following steps apply to all groups that you create. This example shows the procedure for only one user group.
4. Assign the user group "Nightshift operators" the required authorizations.
5. Configure the settings of the user group, for example, automatic logout, login with smart card, web options.
Note that the group setting is only applied during the creation of users. Subsequent changes to the group authorization have to be reconfigured for each user.
6. Create a user in the "Nightshift operators" user group, for example "ShiftOperator10".
If you use WebUX, you can reserve in this step a WebUX license for all users of the group.
If only individual user requires a reserved WebUX license, configure this setting in Step 8.

7. Create all other required users of the group as a copy of "ShiftOperator10".
Once you have created multiple users, you can copy these users and hereby insert even more users.
The authorizations and settings are applied, except for the following settings:
 - Password
 - If configured: Value of the tag logon
8. Configure the settings for the copied users:
 - Password
 - If required, tag logon
 - If required, WebUX license.

Result

You have configured a user group and your users for the "Nightshift operators" role in the WinCC project.

Transfer configuration to other PCs

If you require a role in other WinCC project as well, for example in client projects, transfer the configuration data with export and import this in the User Administrator.

For additional information on the export / import, refer to:

- Exporting/importing User Administrator configuration data (Page 2435)
- Example: Importing / exporting the configuration of the user administrator (Page 2437)

See also

User administration in a distributed system (Page 2433)

Example: Importing / exporting the configuration of the user administrator (Page 2437)

Example: Operator authorization on server and client configuration (Page 2436)

Exporting/importing User Administrator configuration data (Page 2435)

14.12 Central user administration with SIMATIC Logon

14.12.1 Overview of SIMATIC Logon

Introduction

SIMATIC Logon enables central and system-wide user administration. This simplifies system validation for access protection pursuant to FDA 21 CFR Part 11.

Install the basic package "SIMATIC Logon Service" on all participating computers if you wish to implement SIMATIC Logon for WinCC.

You can find additional information on the current SIMATIC Logon version in the installation notes under "Scope of delivery".

Note

Detailed information on function and installation of the SIMATIC Logon Service may be found in the respective current manual "SIMATIC Logon and Electronic Signature".

Principle

The user groups and their authorizations are configured in the User Administrator. SIMATIC Logon is fully integrated in WinCC.

Basic procedure

- You must give the user groups the same names in WinCC as on the SIMATIC Logon server. The authorizations are then assigned to the user groups in runtime.
- You do not create users in WinCC as the users are dynamically imported from the SIMATIC Logon server during the logon process. Each logon and each password change is transferred to SIMATIC Logon from WinCC and processed.
- The users already saved in the User Administrator are ignored. Only the user groups together with their settings are used.

Note

SIMATIC Logon in migrated projects

Prior to WinCC V6.2, SIMATIC Logon had to be entered as "wincclgonconnector_x.exe" in the WinCC startup list. The entry "wincclgonconnector_x.exe" is deleted from the startup list when you open the migrated project with a WinCC version V7.3 or higher.

You are not permitted to manually re-insert the "wincclgonconnector_x.exe" entry into the startup list.

See also

How to use SIMATIC Logon with WinCC (Page 2442)

Windows settings for SIMATIC Logon (Page 2441)

14.12.2 Windows settings for SIMATIC Logon

Introduction

Access protection of "SIMATIC Logon Service" is based on mechanisms of the Windows operating system. The following section summarizes what you need to watch for in Windows settings. Windows administrator rights are required to make settings.

Windows Settings for SIMATIC Logon Service

Make the following Windows settings to ensure the smooth operation of SIMATIC Logon:

- If you have configured a "Logon Computer of the SIMATIC Logon Group" as the work environment, you must enable access to the computer via the network.
- If you have configured a "Windows Domain" as the work environment, you must assign "Read" and "Change Password" rights to authenticated domain users.
- No specific settings are necessary if a single-user computer is used.
- If you wish to display and log the user names in WinCC, enter the user name of each user under "Local Users and Groups/Complete Name".
- If logon processes are to be recorded, you must specify the following settings in the "Audit Policy" of the "Local Security Policy":
 - Audit logon events
 - Audit logon attempts
- The following settings for user accounts may be specified in the "Account Policy" of the "Local Security Policy":
 - Password policy: e.g. maximum password age, minimum password length
 - Account lock policy

Note

Users of SIMATIC Logon must be direct members of a Windows group. Users may not be members of a sub-group of a Windows group.

Failure of a SIMATIC Logon server

If you work with a logon server for the SIMATIC Logon Service, we recommend the following measures are taken in case the server fails:

- Install all users with the necessary authorizations on a second computer, e.g. the local computer.
- Select the relevant computer under "Logon to" in the "Configure SIMATIC Logon" logon dialog.

14.12.3 How to use SIMATIC Logon with WinCC

Introduction

To use the "SIMATIC Logon Service" with WinCC, follow these steps:

1. Configure settings in Windows user administration.
2. Configure settings in the User Administrator.
3. Configure visualization of logged-on user.
4. Configure logon with SIMATIC Logon.

Note

The option "Basic Process Control" must be installed if you wish to use the "PASSLoginDialog" function.

If you are using "SIMATIC Logon" in PCS 7 projects and the users want to logon by means of chip card, you must first configure the following items:

- Open the picture "@Welcome.PDL".
 - Customize the C script in the object properties under "Event/Picture-Object/Others/Select Picture" by commenting out the "PASSLoginDialog (Screen);" line.
 - Save the "@Welcome.PDL" picture.
-

Requirements

- SIMATIC Logon Service has been installed.

Configuring settings in Windows user administration

The connection between Windows user administration and WinCC user administration is based on identical user group names.

1. Create the user groups, for example, "GroupOperator".
2. Create the users and assign them to a group. Users must be direct members of a user group and may not be members of a sub-group.

Configuring settings in the User Administrator

1. Create groups with the same names, for example, "GroupOperator", in the User Administrator.
2. Select the entry "User Administrator" in the navigation area and activate the "SIMATIC Logon" option in the properties.
3. Define the authorizations for the groups.

Configuring visualization of the logged-on user in runtime

Visualization during WinCC projects

If you wish to display the logged-on user in a process picture or report in a WinCC project, use one of the following two tags:

Tag	Display in WinCC	Names in Windows User Administration
@CurrentUser	User ID	User name
@CurrentUserName	User name	Full Name

Note

If you do not use the "SIMATIC Logon" option, the user ID of the logged-in user is entered in both tags.

Visualization in LTO-/PCS 7 projects

In the OS project editor, select whether the full user name or the user ID of the logged-in user is to be shown in the system summary display.

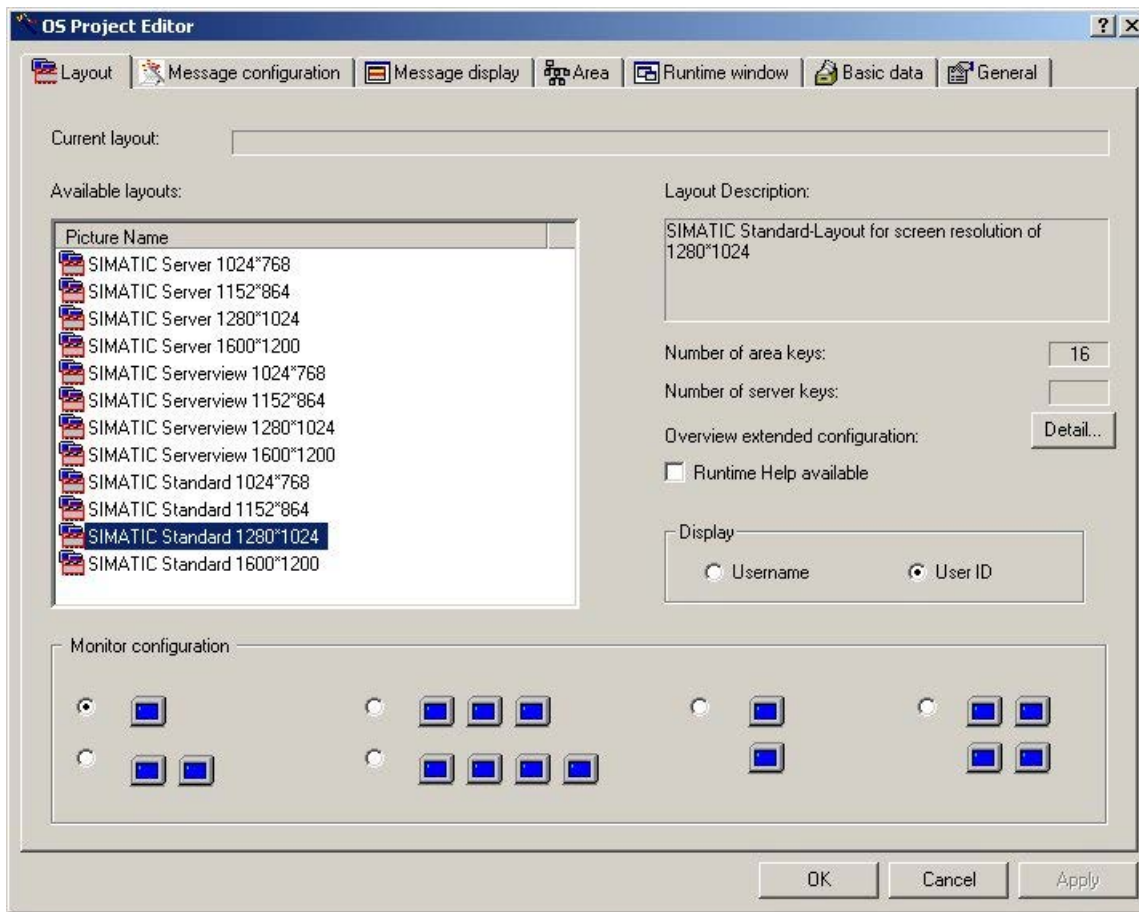

Configuring logon with SIMATIC Logon

1. Configure a button in any picture in the Graphics Designer to call the logon dialog "SIMATIC Logon Service" in runtime.
2. Link the event "Mouse Click" with a C action. If you call the function "PASSLoginDialog" within this C action, a click of the button opens the registration dialog.



Once his data has been entered, a user is assigned to the WinCC group with the same name as the Windows group. The user then receives the access rights of the WinCC group.

Note

Passwords are case-sensitive.

14.12.4 How to configure an electronic signature with SIMATIC Logon

Introduction

You can use an electronic signature to make the execution of critical operation dependent on the electronic signature of the user.

A given action can only be carried out when the configured user is authenticated with a password. If the user is not authorized or enters an incorrect password, the action is not performed.

Passwords are case-sensitive.

Note**Electronic signature on OS clients**

Note that on an OS client with its own project, a standard server for alarms must be configured in the "Server data" area.

Nothing has to be changed on an OS client without its own project.

WinCC system message

Successful and aborted signing procedures are documented with a message:

- 1900000: Electronic signature was successfully recognized.
- 1900001: Electronic signature was not recognized.
- 1900002: Signature operation was aborted.
- 1900003: Operation of a WinCC object or WinCC control was signed successfully.
- 1900004: Operation of a WinCC object or WinCC control was signed successfully by multiple users.

Requirements

- The basic package for the "SIMATIC Logon Service" is installed on all computers involved.
- The "SIMATIC Logon" option has been activated in the "User Administrator".
- The user must be a direct member of a Windows group and be included the WinCC User Administration.

Configuring an electronic signature

You can configure an electronic signature for any event of WinCC objects.

For example, a click of the mouse on a button opens the dialog for operator authentication.

1. Use the "CCESigDlg" object and call the "ShowDialog" function to set event dynamization. A VBS action and C action are then created on the pages that follow.
2. Configure the desired action by evaluating the return value.
For example, make the output command dependent on the success of authentication.
3. Configure a WinCC alarm control to have the authentication attempt messages displayed.

WinCC objects and WinCC controls

With some WinCC objects and WinCC controls, you configure the electronic signature in the object properties.

In the "Selection" dialog, you select the SIMATIC Logon user who must sign an operation.

If the WinCC/Audit option is installed, you can also select and link multiple users and user groups.

Result

Messages documenting all authentication attempts are generated in runtime following operator authentication.

Date	Time	Number	Status	Class	Comment	Source
18/09/08	14:13:11.866	1900000	+	System, need not be acknow	ESIG: S46B:Electronic signature of user winccadmin accepted.	ESIG: S46B:Electronic signature of user winccadmin accepted.
18/09/08	14:13:23.490	1900002	+	System, need not be acknow	ESIG: S46B:Electronic signature of user winccadmin canceled.	ESIG: S46B:Electronic signature of user winccadmin canceled.
18/09/08	14:13:28.974	1008001	+	System, need not be acknow	USERT: S46B:Invalid loginname/password	USERT: S46B:Invalid loginname/password
18/09/08	14:13:32.037	1008001	+	System, need not be acknow	USERT: S46B:Invalid loginname/password	USERT: S46B:Invalid loginname/password
18/09/08	14:13:33.162	1008001	+	System, need not be acknow	USERT: S46B:Invalid loginname/password	USERT: S46B:Invalid loginname/password
18/09/08	14:13:33.177	1900001	+	System, need not be acknow	ESIG: S46B:Electronic signature of user winccadmin not accepted.	ESIG: S46B:Electronic signature of user winccadmin not accepted.

If you use the "WinCC/Audit" option, the messages for all authentication attempts are also written to audit trail databases.

See also

Configuring an electronic signature (Page 2428)

14.12.5 Creating an electronic signature in a VBS action

Introduction

The VBS example shows you how to protect a process control operation from unauthorized execution with an electronic signature. Calling the "ShowDialog" function opens a dialog in runtime in which the user can be authenticated. Make the output command dependent on the success of authentication.

Syntax of the "ShowDialog" function

```
Expression.ShowDialog(User As String, DisplayedUser As String,
Domain As String, LangID As Long, Comment As String) Long
```

Expression

Required. An expression that returns an object of the "CCEsigDlg.ESIG" type.

Parameter

Parameter	Description
User	User name that is used to authenticate the user.
DisplayedUser	Name of the user that is displayed in the "User name" field of the "SIMATIC Logon – Electronic Signature" dialog box.
Domain	Name of the computer that authenticates the user: - Name of the computer that administers the users centrally (SIMATIC Logon server) - Name of the local computer The local computer is entered automatically if no other name is entered.
LangID	ID for the language variant of the dialog: 1028 – Chinese (traditional) 1031 – German 1033 – English 1034 – Spanish 1036 – French 1040 – Italian 1041 – Japanese 1042 – Korean 2052 – Chinese (simplified)
Comment	Comment entered by the user.

Return values

Return value	Identifier	Description
1	IDOK	The user has been successfully authenticated.
2	IDCANCEL	The user has closed the dialog box using the "Cancel" button.
3	IDABORT	The user has failed 3 times to authenticate himself.

Example: Output of a dialog for authenticating the user without forced comment

```
Sub OnClick(ByVal Item)
Dim mysig
Dim mycomment
Dim ret

Set mysig = CreateObject("CCEsigDlg.ESIG")

'comment optional
mysig.forcecomment = false

ret = mysig.ShowDialog("winccadmin", "winccadmin", "SIMLOGSERV", 1031, mycomment)

.
.
.

End Sub
```

Result

The following dialog for authenticating the user is displayed when the VB script is executed in runtime:

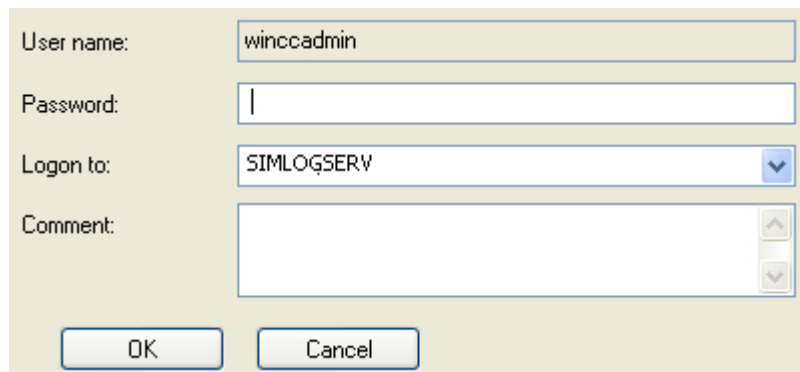

The input of a comment in the entry field is optional.

You can set various different reactions to the mouse event of the WinCC object depending on the transferred return value "ret".

A message documenting authentication or the authentication attempt is also generated.

Note

Protect the VBS action with a password from unauthorized modification and viewing of the program code.

14.12.6 Creating an electronic signature in a C action

Introduction

The C script example shows you how to protect a process control operation from unauthorized execution with an electronic signature. Calling the "ShowDialog" function opens a dialog in runtime in which the user can be authenticated. Make the output command dependent on the success of authentication.

Syntax of the "ShowDialog" function

```
INT ShowDialog(char* lpszUserName, char* lpszDisplayedUserName,  
char* lpszDomainName, int intLangID, variant* vtComment);
```

Parameter

lpszUserName

User name that is used to authenticate the user.

lpszDisplayedUserName

Name of the user that is displayed in the "User name" field of the "SIMATIC Logon – Electronic Signature" dialog box.

lpszDomainName

Name of the computer that authenticates the user:

- Name of the computer that administers the users centrally (SIMATIC Logon server)
- Name of the local computer

The local computer is entered automatically if no other name is entered.

intLangID

Identifier for the desired language variant of the dialog box:

- 1028 – Chinese (traditional)
- 1031 – German
- 1033 – English
- 1034 – Spanish
- 1036 – French
- 1040 – Italian
- 1041 – Japanese
- 1042 – Korean
- 2052 – Chinese (Simplified)

vtComment

Comment entered by the user.

Return value

Return value = 1

The user has been successfully authenticated.

Return value = 2

The user has closed the dialog box using the "Cancel" button.

Return value = 3

The user has failed 3 times to authenticate himself.

Example: Output of a dialog for authenticating the user with forced comment

```
#include "apdefap.h"
void OnClick(char* lpszPictureName, char* lpszObjectName, char* lpszPropertyName)
{
    int nRet = 0;

    VARIANT vtComment;

    __object* EsigDlg = __object_create("CCESigDlg.ESIG");

    if (!EsigDlg)
    {
        printf("Failed to create Picture Object");
        return;
    }

    nRet = EsigDlg->ShowDialog("winccadmin", "winccadmin", "SIMLOGSERV", 1033 , &vtComment);
    __object_delete(EsigDlg);

    .
    .
    .
    .
}
```

Result

The following dialog for authenticating the user is displayed when the C script is executed in runtime:

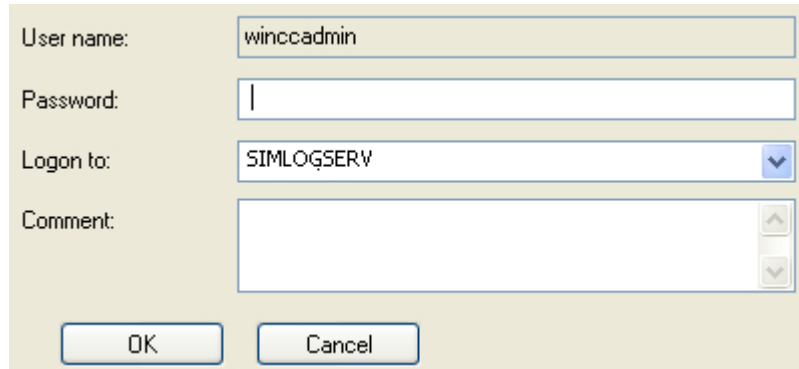

The screenshot shows a dialog box for user authentication. It has a light beige background. The fields are: 'User name:' with the text 'winccadmin', 'Password:' which is empty, 'Logon to:' with 'SIMLOGSERV' and a small blue downward arrow, and 'Comment:' which is empty. At the bottom, there are two buttons: 'OK' and 'Cancel'.

In this example, the entry of a comment is mandatory. If a comment is not mandatory, you must include the property in the function with "EsigDlg->forcecomment =FALSE".

You can set various different reactions to the mouse event of the WinCC object depending on the transferred return value "nret".

A message documenting authentication or the authentication attempt is also generated.

Note

Protect the C action with a password to prevent unauthorized modification and viewing of the program code.

14.12.7 Notes on WinCC/PCS7-OS integration

Access rights of the logged-on user

Access rights are defined by the group membership in the User Administrator:

- If the user can be authenticated, he is automatically assigned to the "Emergency_Operator" group by SIMATIC Logon.
- If the user belongs to one or more Windows groups and
 - One of the groups has the same name as a group in the User Administrator, the user is assigned the rights of this group.
 - Multiple groups have the same names as groups in the User Administrator, the user is assigned the rights of all of these groups.

Note

If a user belongs to multiple Windows groups and the groups have different values for the automatic logoff, the user is logged off after the longest configured time.

Group "DefaultGroup"

In the configuration dialog of SIMATIC Logon, you can activate the "Use following data without explicit logon" in the "General" tab. If there is no user logged into Runtime at a workstation, the selected user is automatically logged on in the "User" field. The "Default user" from the "DefaultGroup" is preset by default.

Note

The "DefaultUser" is a virtual user belonging to the "DefaultGroup". That is why you may not add this user to the Windows user administration.

If the names are identical, the "DefaultGroup" is assigned to the corresponding group in the User Administrator. You should therefore create a group in the User Administrator with the name which was entered for the "DefaultGroup" user group in the logon dialog. Assign this group authorization level "No. 2 Authorization for area".

Note

Defaults settings for message filtering in the OS project editor

Any user can acknowledge the messages on the message pages if you run the OS project editor with the default message display setting "Messages with area release".

The default setting applies even for the "Default user" logged on via SIMATIC logon, who generally has authorization level "No. 2 Authorization for area". You should therefore activate the option "Acknowledgeable messages in separate list" on the "Message display" tab before processing by the OS project editor.

Integration of WinCC in SIMATIC Manager

15.1 Integration of WinCC in SIMATIC Manager

Content

WinCC projects can be created and managed in STEP 7 within the framework of Totally Integrated Automation. This results in connections between the AS configuration and WinCC configuration. The advantages of this "integration of WinCC in STEP 7" are described in this section.

The subjects covered in this section are:

- Managing WinCC projects and objects in STEP 7
- Transferring tags and texts to WinCC
- Use of multi-user engineering and Web access
- Selection of STEP 7 symbols
- Diagnostic support in the event of faults

15.2 Advantages and Prerequisites of Integration

Introduction

The goal of an integration of automation components is the configuration and management of a shared platform. STEP 7 makes such a platform available to the SIMATIC Manager. Configuration is made a lot easier with the integration of SIMATIC WinCC and processes can be automated.

Advantages of Integration

The configuration of SIMATIC WinCC in an integrated environment provides the following advantages:

- Simple transfer of tags and texts into the WinCC project
- Direct access to STEP 7 symbols during process connection
- Uniform message configuration
- Loading the configuration data on the Runtime OS
- Extended diagnostic support

Advantages of integration for redundant systems

Integration simplifies the administration of master and standby:

- Inserting and configuring master and standby
- Configuring Master and Standby
- Overall loading of master and standby

Integration enables loading online changes in case of redundant system:

- Loading online changes is automatically enabled after overall loading.
- Automatic checking of settings and requirements with detailed error messages.
- Both partners must be in Runtime. Standby is loaded first.
- Automatic cancellation while loading on redundant system if the initial load on standby has failed

Notes on installation

If you wish to integrate WinCC in STEP 7, you must implement an installation of WinCC as well as an installation of SIMATIC STEP 7. For a new installation we recommend the following sequence of installations:

- Installation of SIMATIC STEP 7
- User Defined Installation of WinCC

In the described sequence you may install the required WinCC components at the same time. You may also install SIMATIC STEP 7 at any time thereafter. You might then have to install individual WinCC components afterwards.

Note

For the installation of SIMATIC STEP 7 and WinCC, please read the notes in the installation manual.

Required Software Components

You must install the following communication components for integration of WinCC in STEP 7:

- SIMATIC Device Drivers
- Object Manager
- AS-OS Engineering
- STEP7 Symbol Server

You must also install the WinCC option "Basic Process Control".

If you wish to use a chip card reader, you must activate the option Chip Card during the installation of SIMATIC STEP 7 and during the installation of WinCC.

Note

Prior to implementing any WinCC-specific configurations in SIMATIC Manager, you must ascertain that the language used in SIMATIC Manager is installed in WinCC as well.

Note

Project-related access protection

Starting with version V6.2, WinCC evaluates the project-related access protection that is used to protect STEP 7 or PCS7 projects.

If project-related access protection has been activated for WinCC project, then you must also enter the STEP 7 project password while opening the project.

Using an integrated WinCC project as a stand-alone WinCC project

You can also use a WinCC project which is integrated in a STEP 7/PCS7 project as a stand-alone WinCC project. For example, you only want to use the WinCC part of the project. Only WinCC must then be installed on the computer. The WinCC project is converted when opened in WinCC and saved again.

NOTICE
Once it is converted to a stand-alone WinCC project, the S7 project data is lost
When you open an integrated project with WinCC, the project data is converted and all S7 project data are removed from the WinCC project.

Procedure

1. Open the integrated WinCC project in the WinCC Explorer.
2. You are informed about the conversion of project data in a dialog. Confirm the data conversion.
3. Select the project directory where you want to copy the WinCC project.
4. Click the "Convert" button. After converting the data, the project is saved and opened in WinCC as a stand-alone WinCC project.

15.3 Managing WinCC Projects and Objects in the SIMATIC Manager

15.3.1 Managing WinCC Projects and Objects in the SIMATIC Manager

Introduction

The SIMATIC Manager can be used to organize and administrate all the components belonging to the automation solution.

Accessing these components in a common data management system makes system configuration much easier and allows a number of configuration processes to be automated.

Integration allows you to execute functions in the WinCC project directly from the SIMATIC Manager. They include:

- Opening the WinCC project
- Loading the WinCC project on the target computer
- Working with the WinCC objects "Pictures" and "Report Templates"

The "Import OS" function in the SIMATIC Manager allows to import independent WinCC projects into a STEP 7 project.

Note

Working with technological views

If you work in SIMATIC Manager with technological views, all WinCC editors must be closed.

Do not use the Project Duplicator

WinCC projects created or managed using SIMATIC Manager should not be copied using the Project Duplicator.

Restriction for multi-projects

Do not move any basis OS from a STEP 7 sub-project to another STEP 7 sub-project.

While moving, all associated OS reference stations will lose their reference to the basis OS.

WinCC projects as WinCC application or OS

You can create WinCC projects directly in the SIMATIC Manager. In this case, you have to differentiate between the following storage options:

- WinCC project as WinCC application within a PC station
- WinCC project as operator station "OS"

When creating new projects, you should use WinCC applications. They have the following advantages compared to the OS:

- The PC station can be displayed and parameterized in the network configuration.
- The interfaces and access point of the operator station are determined automatically.

Configuring a PC station

How to configure the PC station is described in the STEP 7 help.

It is recommended not to store and edit STEP 7 projects with integrated WinCC projects on an operator station.

Working with OS references

Using OS references offers the advantage of loading one WinCC project, the so called basis OS, onto several target systems. One target system is attached to each basic OS as well as for each individual reference.

The basic OS must have the following properties:

- Object type OS in the STEP 7 project
- Project type "Single-User" or "Multi User"
- No redundant partner
- The OS reference and the base OS must have been created in the same STEP 7 sub-project.

After processing, you must transfer the project to the target system of the basic OS along with all the references. Select the "Download to CPU" function for the selected basis OS or OS reference.

The objects "WinCC Appl. Ref" and "OS Ref." are used for configuration.

An OS reference supports neither clients with their own project nor clients without their own project.

Prohibited project constellations

Not all theoretically imaginable project constellations are practical or allowed in the SIMATIC Manager.

The following constellations are prohibited on the engineering station:

- A multi-user project to be operated in Runtime, although its package is loaded on another server.
- A single-user project or multi-user project to be operated in Runtime, but has been swapped out to the central archive server.

Activating Runtime on the ES

Activating Runtime with integrated WinCC projects on the ES can be influenced centrally for the project.

In WinCC Explorer, select the "Project Properties" option in the shortcut menu of the current project. In the "Options" tab, select the check box "Allow activation on ES".

The checkbox is cleared when you create a new WinCC project.

You can activate the WinCC project on the ES if the checkbox is activated.

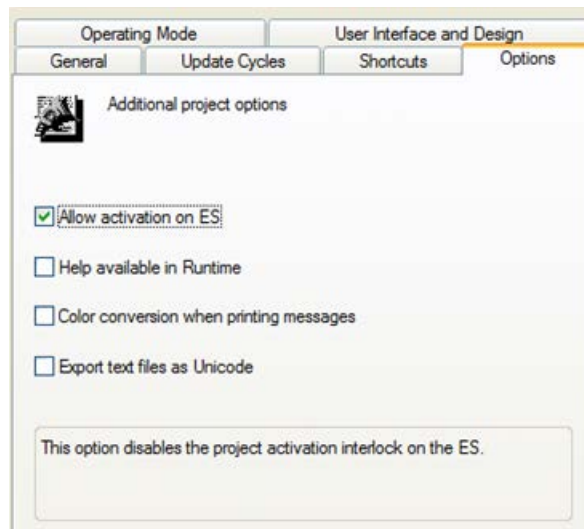

Requirements

- The WinCC project is a TIA project.
This means the WinCC project is integrated in a STEP 7 project or PCS 7 project.
- The corresponding destination path is configured.

If the WinCC project is not a TIA project or the corresponding destination path has not been configured in the ES, then the checkbox does not have any effect. In such a case, the project can be activated at any time.

Editing jobs in SIMATIC Manager at the same time

You can edit several jobs in SIMATIC Manager at the same time. You can use SIMATIC Manager to load a target system and simultaneously create a new WinCC application in the "HW Config" dialog. The parallel editing of a WinCC project with WinCC Explorer is also permitted.

If one of the jobs cannot be executed at the current time, you will be notified by an error message. You can then trigger the canceled job again at a later point in time.

See also

Working With WinCC Objects (Page 2485)

Operator Station OS (Page 2473)

WinCC Application (Page 2460)

15.3.2 WinCC Application

15.3.2.1 WinCC Application

Introduction

In a STEP 7 project, the SIMATIC PC station represents a PC which, similar to the automation station AS, contains the software and hardware components required for automation. Apart from communication processors and slot or soft PLCs, these components also include SIMATIC HMI components.

If a PC station is to be implemented as an operator station, you must add a WinCC application during configuration. You can choose between various project types, depending on the respective requirements:

- Master server in the multi-user project. The name in the PC station is "WinCC Appl.".
- Standby server as redundancy partner in the multi-user project. The name in the PC station is "WinCC Appl. (Stby.)".
- Client in the multi-user project. The name in the PC station is "WinCC Appl. Client".
- Reference to a so-called basis OS. The name in the PC station is "WinCC Appl. Ref".
- Reference to a so-called base client. The name in the PC station is "WinCC Appl. Client Ref.".
- Central archive server (master server or non-redundant archive server). The name in the PC station is "WinCC CAS Appl.".
- Central archive server (standby server). The name in the PC station is "WinCC CAS Appl. (Stby.)".
- Connectivity station, or Open_PCS7_Station. The name in the PC station is "SPOSA Appl.".

The screenshot below shows an example of how the WinCC applications appear in the SIMATIC Manager:

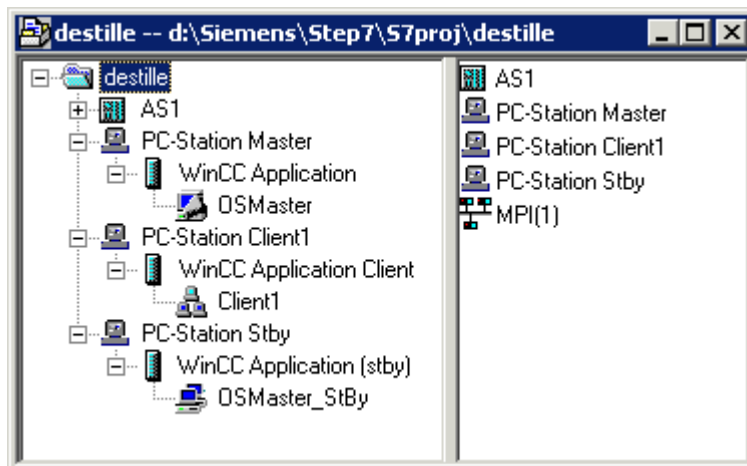

Note

If you use the PROFIBUS or Industrial Ethernet for communication between AS and OS, you should configure an appropriate connection. Only then can you utilize the advantages of the PC station, e.g. automatic setting of the unit name.

See also

How to Create an Operator Station (Page 2474)

Operator Station OS (Page 2473)

How to Create a Reference to a WinCC Application (Page 2471)

How to Load the Project on the Target Computer (Page 2470)

How to Set the Path to the Target Computer (Page 2463)

How to Create a WinCC Application (Page 2461)

15.3.2.2 How to Create a WinCC Application

Introduction

This section shows you how to create the WinCC application in a PC station.

Requirements

- A PC station must have been created in the STEP 7 project.

Procedure

1. Open the hardware configuration for the PC station. To do so, click the PC station in the navigation window. Select the Open Object option on the pop-up menu. This will open the HW Config dialog.
2. Click the object PC in the contents window. Open the hardware directory using the menu item View > Catalogue and navigate to the folder SIMATIC PC Station > HMI.

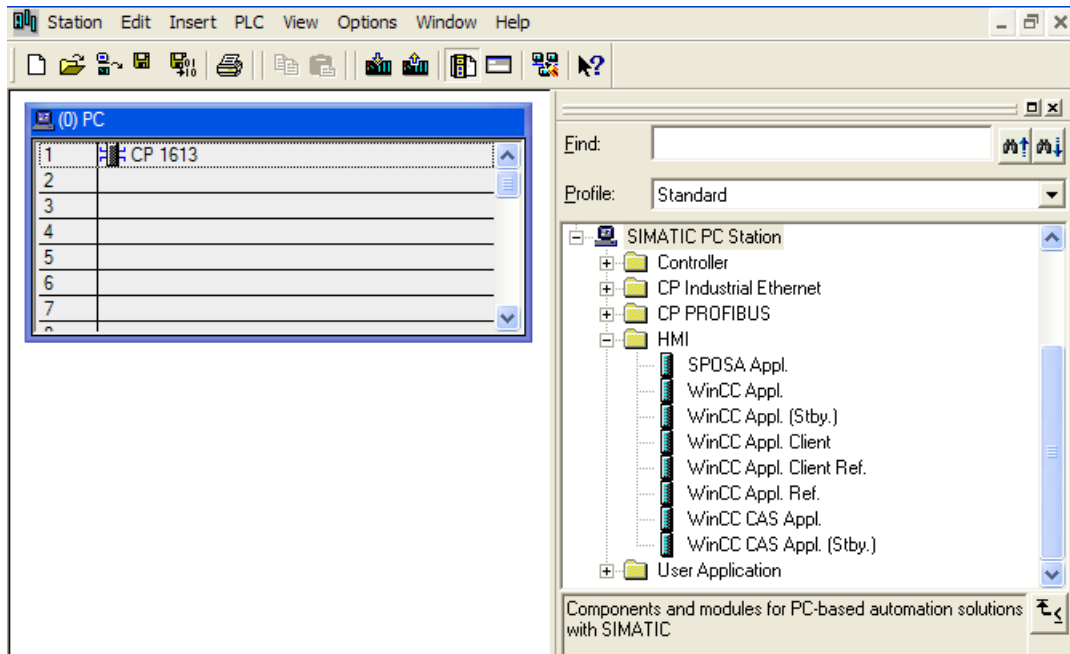

3. Select the desired type of WinCC application and drag it onto a free slot of the PC object.

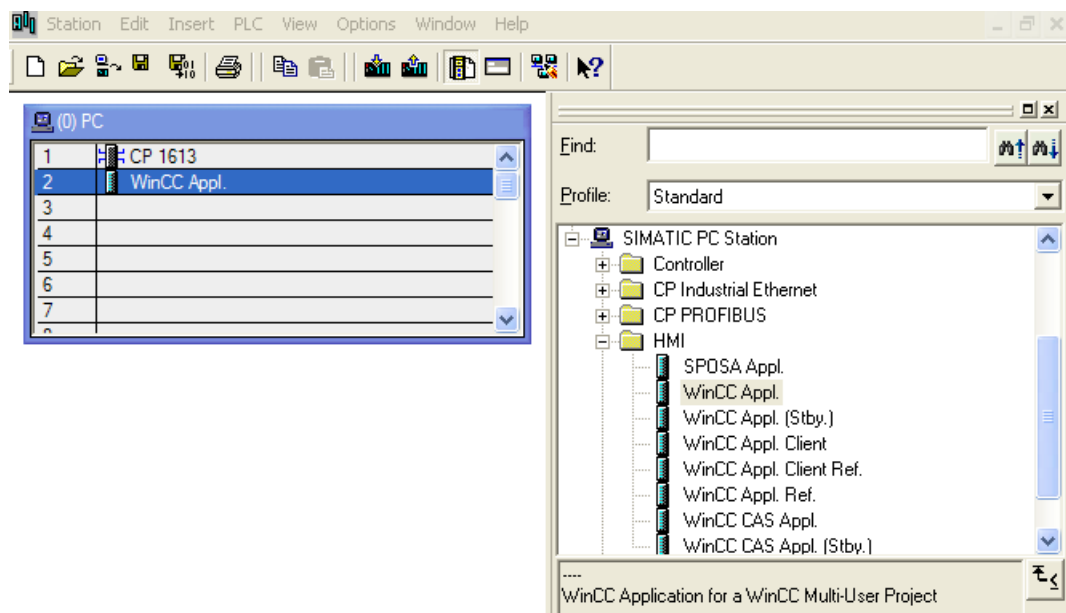

4. Save and close the hardware configuration.

Upon saving the newly created WinCC application, a subordinate OS is created.

See also

How to Create an Operator Station (Page 2474)

Operator Station OS (Page 2473)

How to Load the Project on the Target Computer (Page 2470)

How to Select the Standby Computer (Page 2467)

How to Set the Path to the Target Computer (Page 2463)

WinCC Application (Page 2460)

15.3.2.3 How to Set the Path to the Target Computer

Introduction

To be able to load the WinCC project, you must set the path to the target computer in the object properties.

The following description refers to an OS in a WinCC application. For other OS types, the dialog structure might differ.

Requirements

- The OS is created as an object of a WinCC application.

Procedure

1. Select the WinCC project and open the "Object Properties" using the pop-up menu.
2. If you wish to configure an OS of type OS, select the Target OS and Standby OS tab. If you wish to configure an OS of type OS (Client), select the Target OS tab. The following figures refer to an OS of type OS created in a WinCC application. You can enter the path to the target computer directly as shared directory in the format \<Computer name>\<Enable>. Following the direct entry, click the Apply button. The WinCC project directory and the project file will be supplemented. Alternatively, you can open a selection dialog by clicking the Browse button. If you have entered the path directly, continue with step 4.

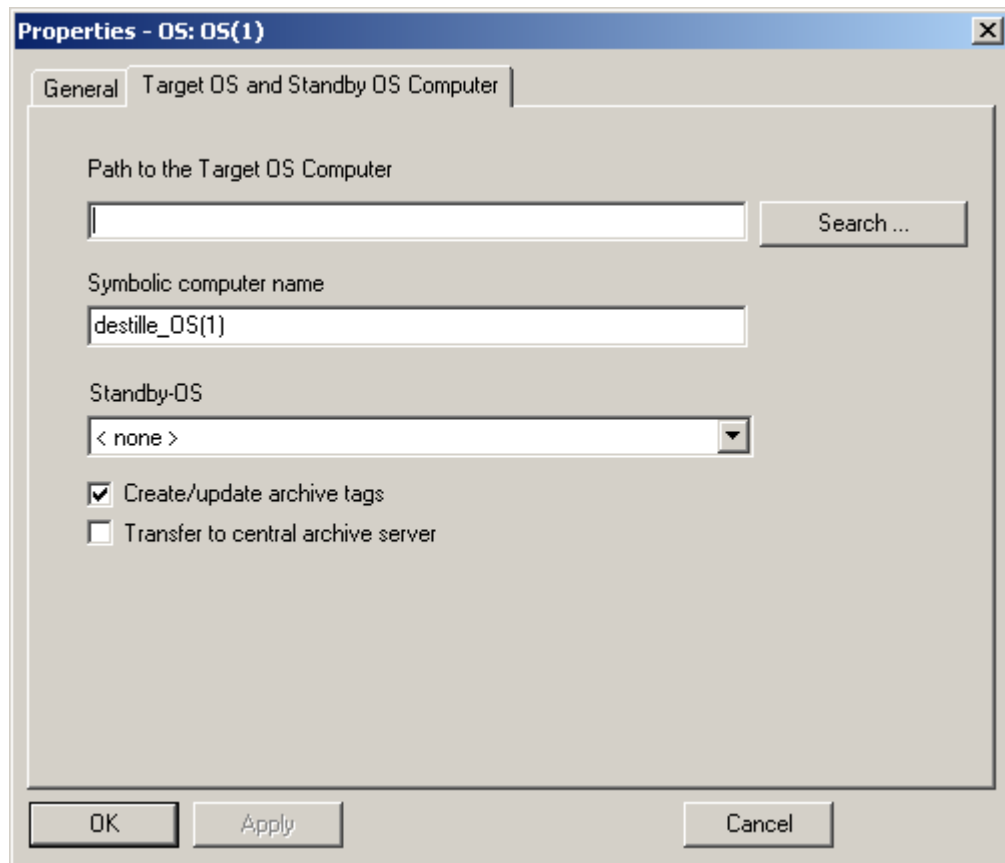

3. Click the "Browse..." button. In the Select Target OS dialog, select the network drive and the folder you require. Click "Open".

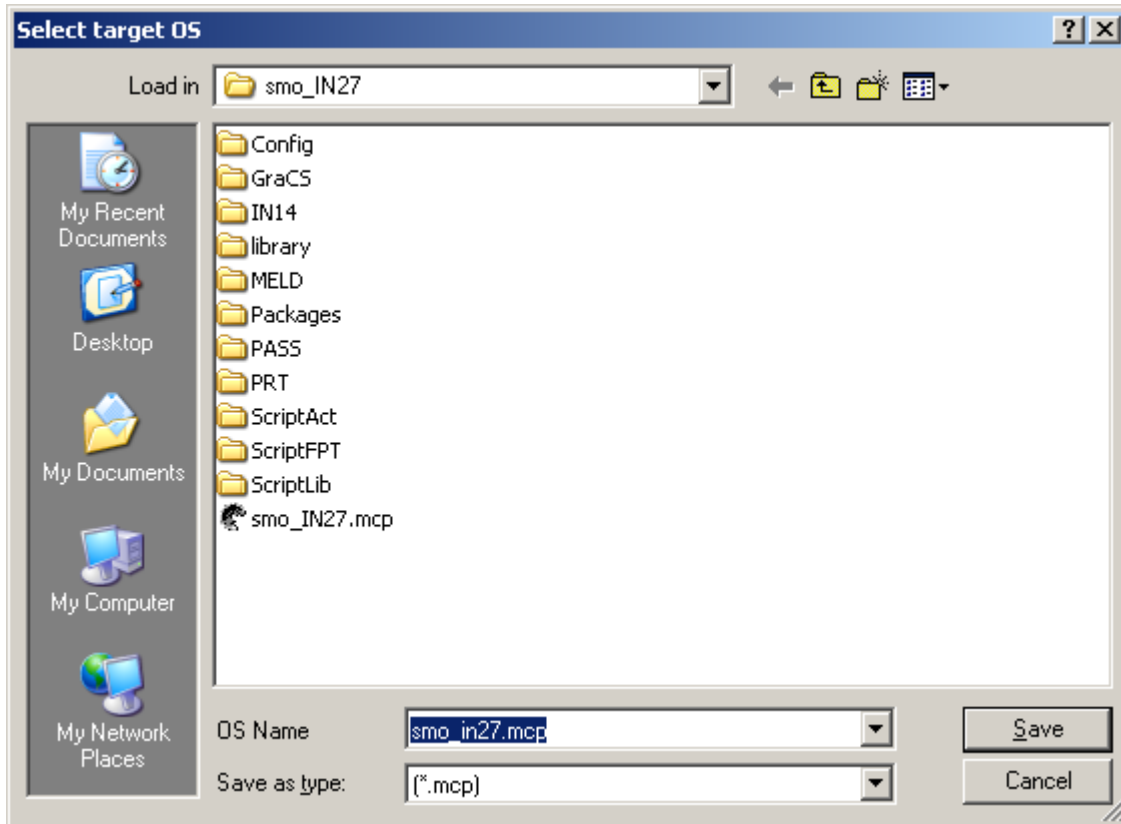

4. Check the path to the target computer and then close the Properties dialog.

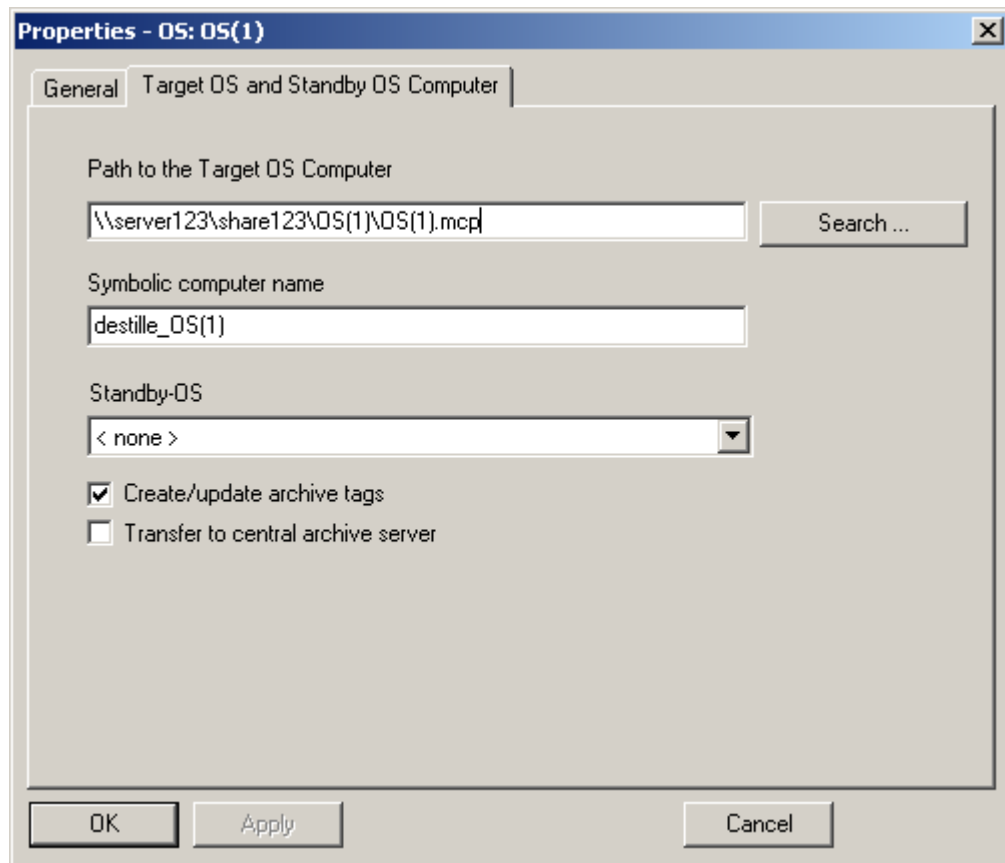

Note

The function "Generating/Updating Archive Tags" may only be used jointly with PCS7. Additional information on this function may be found in the configuration manual Process Guidance System PCS7, Operator Station in the PCS7 documentation.

See also

- How to Create an Operator Station (Page 2474)
- Operator Station OS (Page 2473)
- How to Load the Project on the Target Computer (Page 2470)
- How to Select the Standby Computer (Page 2467)
- How to Create a WinCC Application (Page 2461)

15.3.2.4 How to Select the Standby Computer

Introduction

If you configure a redundant system, the master server and the standby server must be connected to each other. You set up this connection in the object properties for the master server.

Note

The WinCC project of the standby server is a copy of the WinCC project on the master server. Both projects must be identical to ensure correct data synchronization in Runtime. For this reason, direct configuration of the standby project is not possible in the SIMATIC Manager.

Requirements

- The master server must have been created as WinCC Application.
- The standby server must have been created as WinCC Application (Stby.).

Procedure

1. Select the master project and open the "Object Properties" using the shortcut menu.
2. Select the "Target OS and Standby OS Computer" tab.

3. Select the standby OS and then close the dialog with "OK".

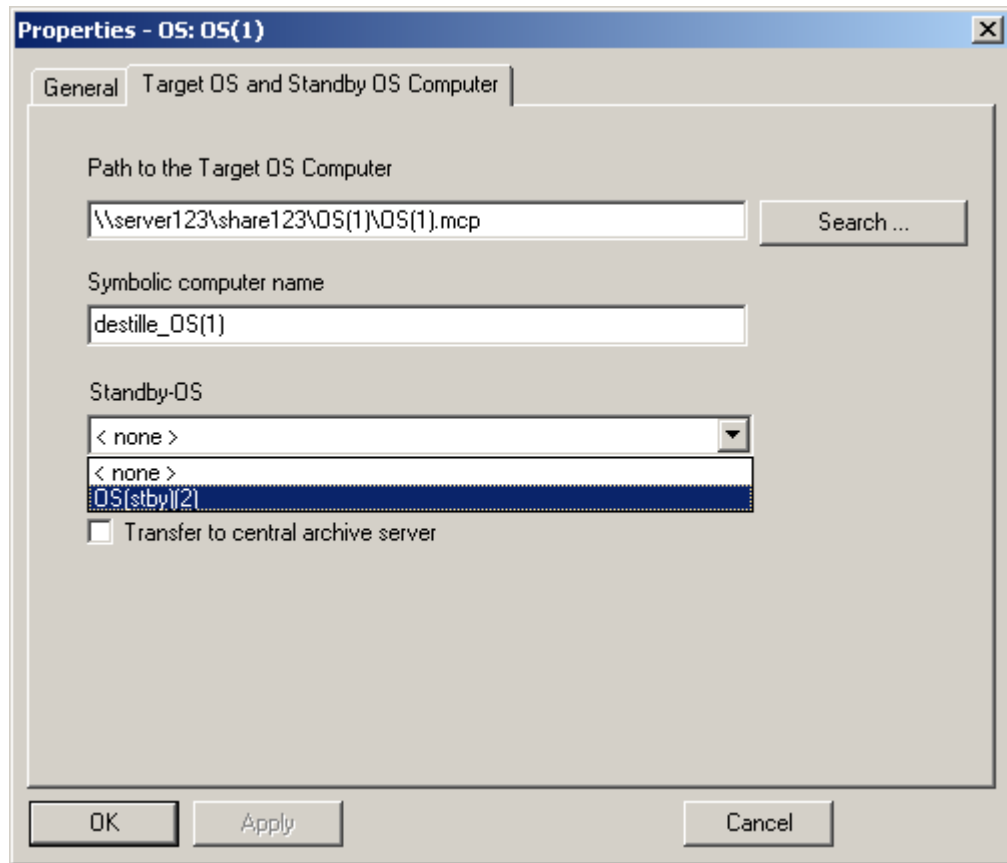

4. Check the name of the assigned standby OS in the SIMATIC Manager: It must consist of the name of the master OS with the add in "_StBy".

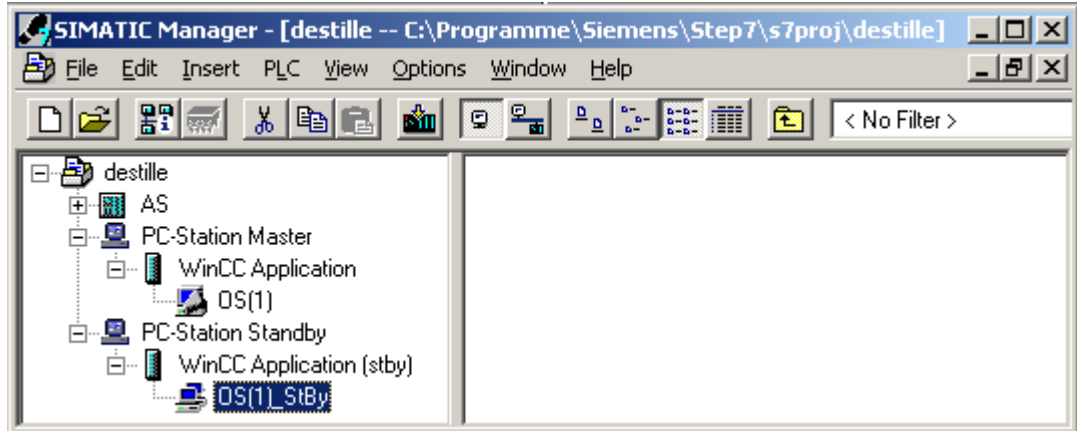

5. Please note that the path to the target computer must also be set in the properties of the standby OS. In the properties of the standby OS, check the assignment to the master OS. The field for the master OS must display the name of the master OS.

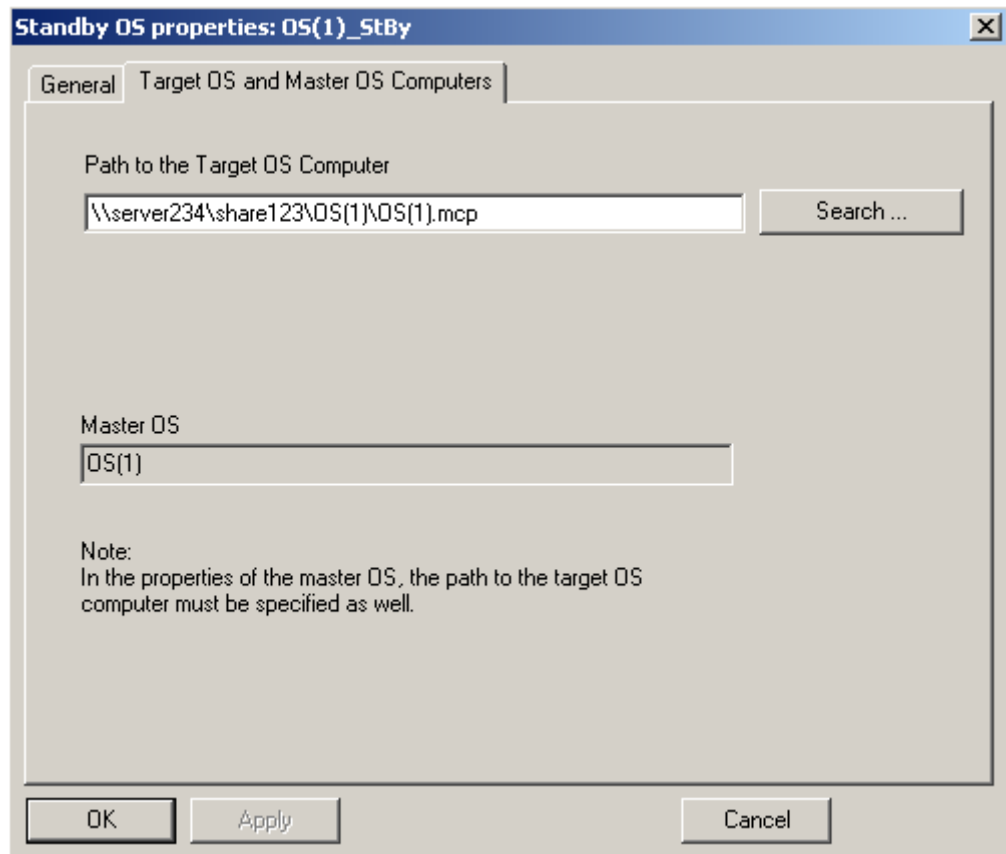

Note

In the master OS project, the redundancy is given default settings by the system. You have to perform different settings from this in the master OS project. You use the "Redundancy" editor for this purpose. It is advisable to make these settings on the creation system; no configuration is then necessary on the target computers.

See also

How to Create an Operator Station (Page 2474)

Operator Station OS (Page 2473)

How to Load the Project on the Target Computer (Page 2470)

How to Create a WinCC Application (Page 2461)

15.3.2.5 How to Load the Project on the Target Computer

Introduction

When you have completed configuration, you must load the WinCC project on the target computer. To do so, use the "Load Target System" function of SIMATIC Manager.

If you have built-up a redundant operator station, then Master server and Standby server will be loaded one after the other. The standby server is loaded together with a copy of the WinCC project of the master server. Both projects must be identical to ensure correct data synchronization in Runtime. For this reason, direct configuration of the standby project is not possible in the SIMATIC Manager.

Requirements

- The path to the target computer must have been set.
- The path must be set for Master and Standby for redundant system.

Procedure

1. Select the WinCC project in the WinCC application.
2. Start the "Target System > Load" function using the context menu.
3. In the dialog, select the scope of the load operation using the options Entire WinCC Project or Modifications.
Under the following conditions, only the Entire WinCC Project option is available:
 - When the project is loaded onto the target system for the first time.
 - As a result of configurations in the WinCC project that lead to the loss of the online modification capability.
 - When the standby server has not yet loaded the WinCC project of the master server.

Note

Do not open the project on the target computer until the load operation has been completed.

See also

How to Create a WinCC Application (Page 2461)

How to Create an Operator Station (Page 2474)

Operator Station OS (Page 2473)

How to Select the Standby Computer (Page 2467)

How to Set the Path to the Target Computer (Page 2463)

WinCC Application (Page 2460)

15.3.2.6 How to Create a Reference to a WinCC Application

Introduction

Using OS references offers the advantage of loading one WinCC project, the so called basis OS, onto several target systems. The objects "WinCC Appl. Ref" and "OS Ref." are used for configuration.

Apart from the WinCC application and its OS, each additional target system needs an application reference and an OS reference. The configuration is performed in several steps.

1. Creating the application reference.
2. Configuring the OS reference.

This section shows you how to create a reference to a WinCC application in a PC station.

Requirements

- A PC station must have been created in the STEP 7 project.
- The basis OS is of object type "OS", of project type single-user or multi-user, and does not have a redundant partner.

Procedure

1. Open the hardware configuration for the PC station. To do so, click the PC station in the navigation window. Select the "Open Object" option on the shortcut menu. This will open the "HW Config" dialog.
2. Click the object "PC" in the contents window.
Open the hardware directory using the menu command "View > Catalog" and navigate to the folder "SIMATIC PC Station > HMI".

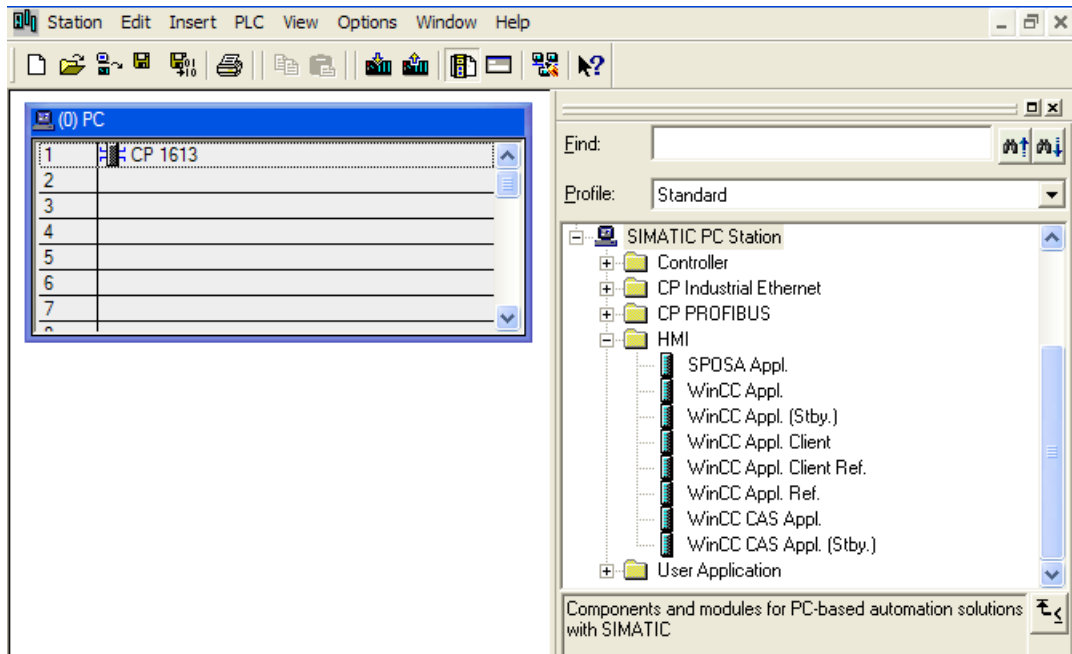

3. Select the application type "WinCC Appl. Ref" and drag the object onto a free slot of the PC in the "PC" object.

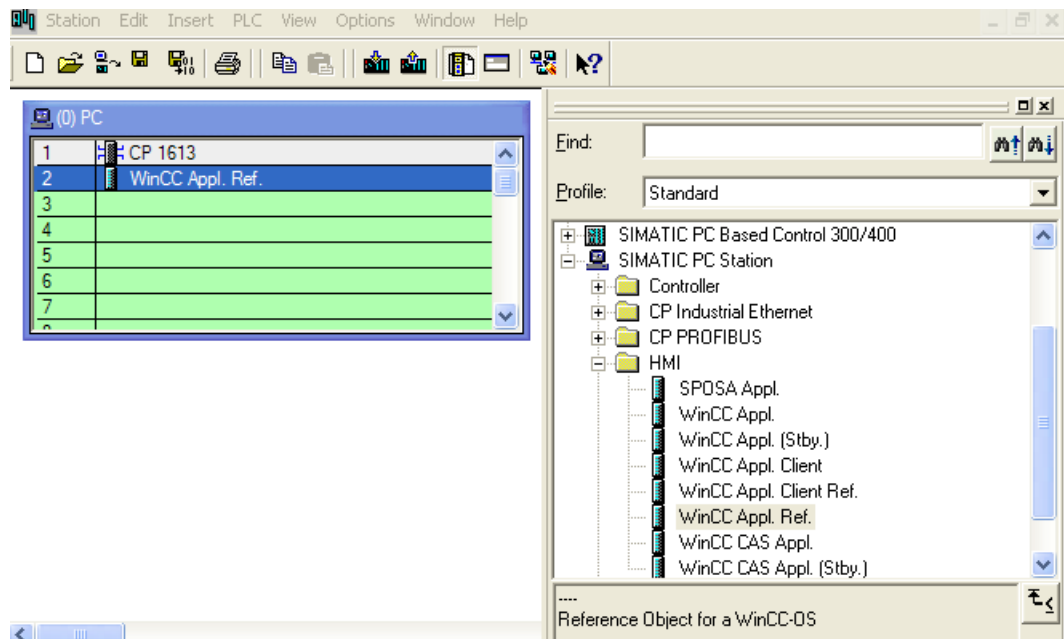

4. Save and close the hardware configuration.
5. The navigation window of SIMATIC Manager displays the just created object "WinCC Appl. Ref(n)".

In order to complete the configuration of an OS reference, the "OS Ref." object must still be configured. Additional information can be found in the section "Configuring a Reference to an OS".

Note

You can use the same method to configure the reference to a WinCC application client. The corresponding project is then of the project type "Client".

See also

How to Configure a Reference to an OS (Page 2480)

Managing WinCC Projects and Objects in the SIMATIC Manager (Page 2457)

15.3.3 Operator Station OS

15.3.3.1 Operator Station OS

Introduction

The OS represents a WinCC project in the SIMATIC Manager. Unlike the WinCC application, the OS is not integrated in the configuration of the target computer. This means that you have to carry out additional configuration steps on the target computer, e.g. setting the unit name.

You can create two different project types:

- Multi-user project
- Client project

The illustration below shows how the operator station appears in the SIMATIC Manager:

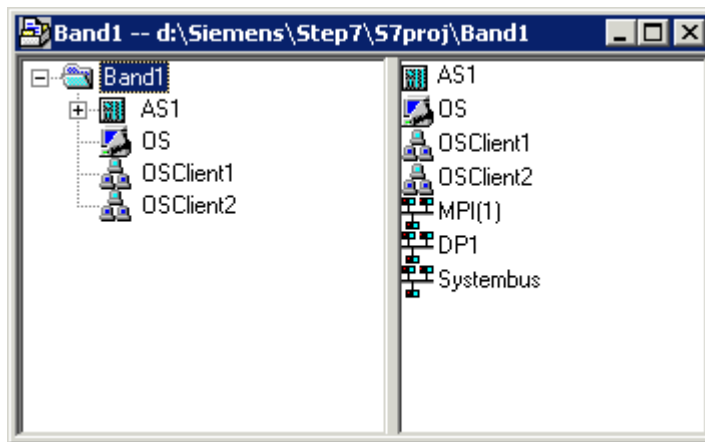

Note

Further information on the advantages of the WinCC application can be found under WinCC Application.

See also

- How to Configure a Reference to an OS (Page 2480)
- How to Create an Operator Station (Page 2474)
- How to Load the Project on the Target Computer (Page 2479)
- How to Select the Standby Computer (Page 2467)
- How to Create a WinCC Application (Page 2461)
- WinCC Application (Page 2460)
- How to Set the Path to the Target Computer (Page 2475)

15.3.3.2 How to Create an Operator Station

Introduction

This section shows you how to create an operator station in the SIMATIC Manager.

Requirement

- The STEP 7 project must have been opened using the SIMATIC Manager.

Procedure

1. Open the Navigation Window and select the project or library in which the OS should be set up.
2. Select the entry Insert New Object in the pop-up menu. You can now select either OS (for a server) or OS (client).

See also

How to Load the Project on the Target Computer (Page 2479)

How to Create a WinCC Application (Page 2461)

How to Set the Path to the Target Computer (Page 2475)

15.3.3.3 How to Set the Path to the Target Computer

Introduction

To be able to load the WinCC project, you must set the path to the target computer in the object properties.

Requirements

- The OS is inserted as object of a WinCC application or as OS (client) directly in the S7 project.

Procedure

1. Select the OS and open the "Object Properties" using the shortcut menu.
2. If you wish to configure an OS in a WinCC application, select the "Target OS" and "Standby OS" tab.

If you wish to configure an OS of type OS (Client), select the "Target OS" tab.

The following illustrations refer to an OS in a WinCC application.

You can enter the path to the target computer directly as shared directory in the format \<Computer name>\<Enable>. Following the direct entry, click the Apply button. The WinCC project directory and the project file will be supplemented.

Alternatively, you can open a selection dialog by clicking the Browse button.

If you have entered the path directly, continue with step 4.

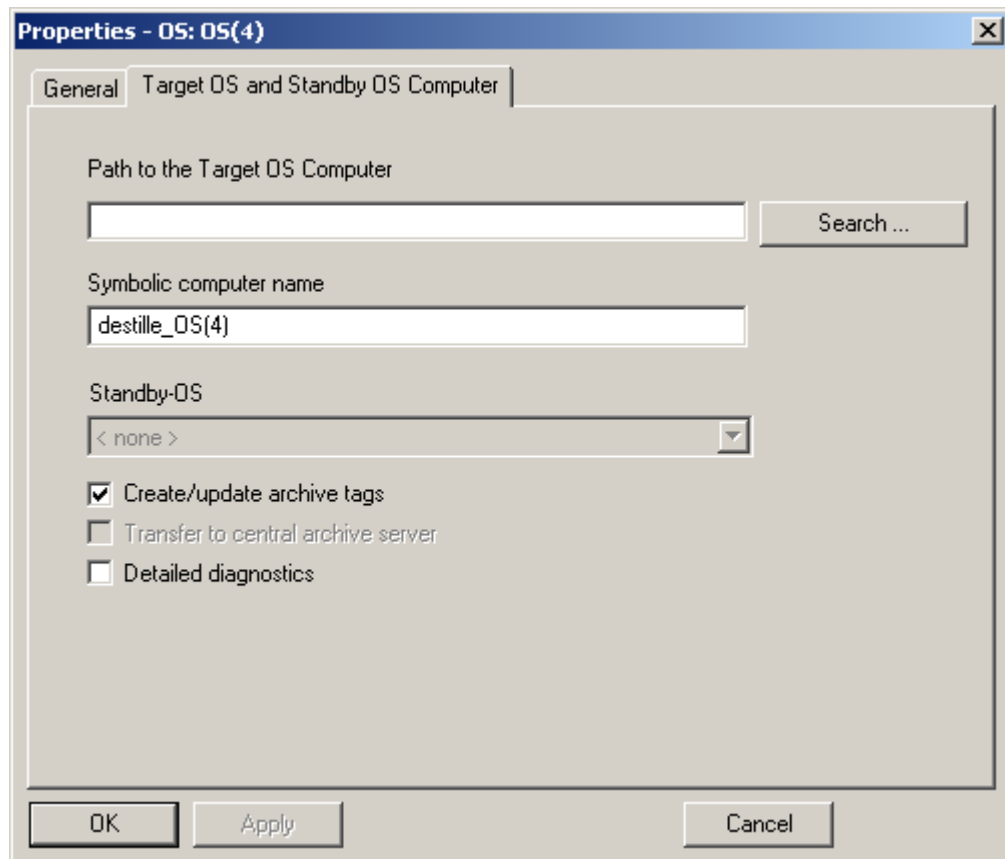

3. To select a path via a selection dialog, click the "Browse..." button. In the "Select Target OS" dialog, select the network drive and the folder you require. Click "Open".

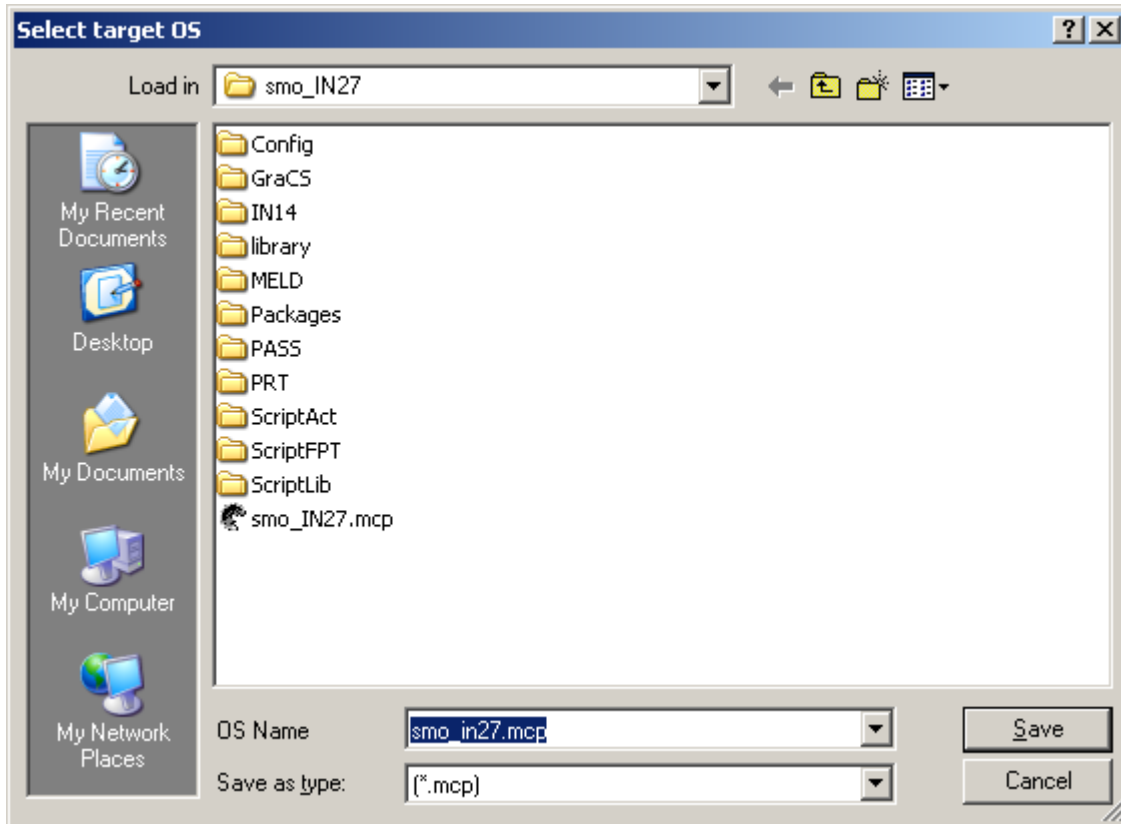

4. Check the path to the target computer and then close the Properties dialog.

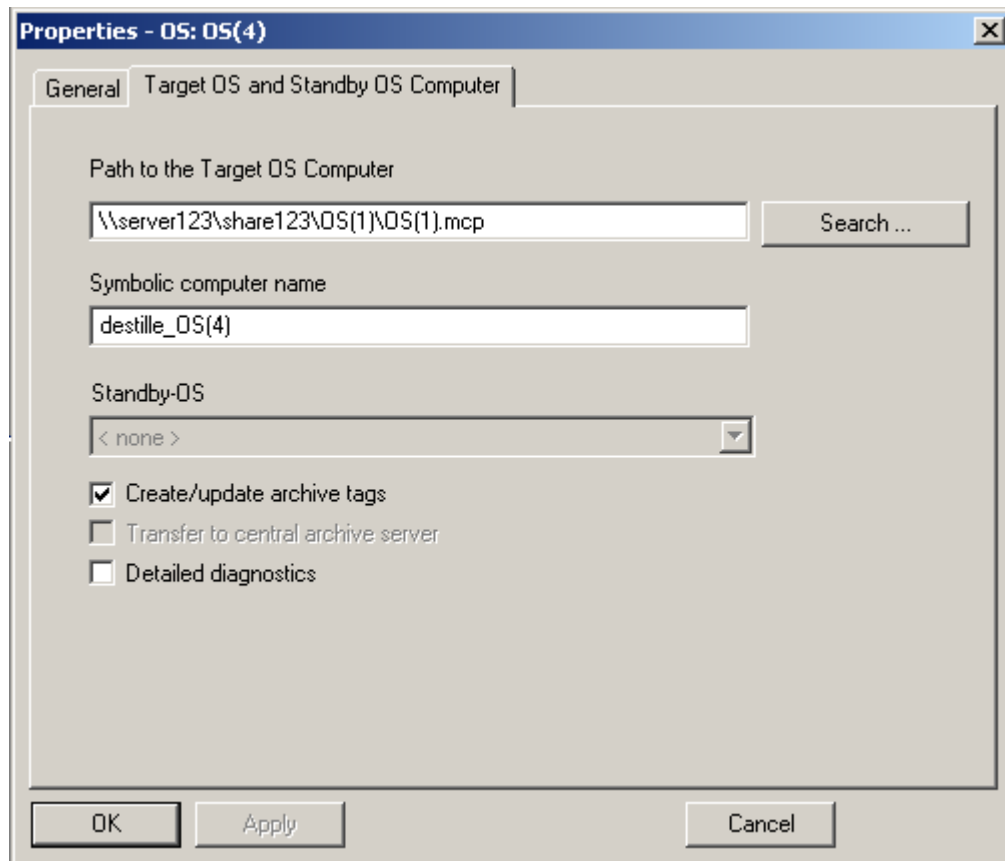

Note

Enter the computer name and the symbolic computer name and not the IP address of the computer.

Note

The function "Generating/Updating Archive Tags" may only be used jointly with PCS7. Additional information on this function may be found in the configuration manual Process Guidance System PCS7, Operator Station in the PCS7 documentation.

See also

- How to Create a WinCC Application (Page 2461)
- How to Load the Project on the Target Computer (Page 2479)
- How to Create an Operator Station (Page 2474)

15.3.3.4 How to Load the Project on the Target Computer

Introduction

When you have completed configuration, you must load the WinCC project on the target computer. To do so, use the "Load Target System" function of SIMATIC Manager.

Persistence in CS with integrated WinCC projects

Changes to the control properties in Runtime are not persistently accepted in CS with PCS 7 projects or TIA projects. During an overall loading of the ES to the OS, the changed settings on the OS are overwritten.

Configure the properties of the controls on the ES.

Note

If STEP 7 and the WinCC project are on the operator station, the WinCC project does not have to be loaded.

Requirements

- The path to the target computer must have been set.

Procedure

1. Select the OS.
2. Start the "Target System > Load" function using the shortcut menu.
3. In the dialog, select the scope of the load operation using the options Entire WinCC Project or Modifications.
Under the following conditions only the option "complete WinCC project" is available:
 - When the project is loaded to the target system for the first time.
 - In case of configurations in the WinCC project that would result in the loss of the ability to load online changes.

Result

For loading OS changes, you can call up the Deltaloader status by means of the "Details" button. The Deltaloader status indicates the following:

- Type:
The components of WinCC in which the changes were made.
- Sort:
What sort of changes were made.
- Number:
How many changes were made.
- Limit:
Shows the limit value of changes for online change loading.

If the number of changes is greater than the limit value, a complete upload is recommended. In this case a note is shown in the "Load OS" dialog.

Note

Open the project on the target computer only after the loading is complete.

See also

How to Create an Operator Station (Page 2474)

How to Select the Standby Computer (Page 2467)

How to Create a WinCC Application (Page 2461)

How to Set the Path to the Target Computer (Page 2475)

15.3.3.5 How to Configure a Reference to an OS

Introduction

Using OS references offers the advantage of loading one WinCC project, the so called basis OS, onto several target systems. The objects "WinCC Appl. Ref." und "OS Ref." are used for configuration.

Apart from the WinCC application and its OS, each additional target system needs an application reference and an OS reference. The configuration is performed in several steps.

1. Creating the application reference.
2. Configuring the OS reference. You must create the OS reference in STEP 7 sub-project of basis OS.

This section shows how to configure an OS reference.

The "WinCC Appl. Ref." application reference to this basis OS was previously created. Additional information may be found in the section Creating a Reference to a WinCC Application.

After processing, you must transfer the project to the target system of basis OS along with all the references. Select the "Download to CPU" function for the selected basis OS or OS reference.

Requirements

- A PC station must have been created in the STEP 7 project.
- The basis OS is of object type OS, of project type single-user or multi-user, and does not have a redundant partner.
- The "WinCC Appl. Ref." application reference to this basis OS was previously created.

Procedure

1. In the navigation window of SIMATIC Manager, navigate to the desired object WinCC Appl. Ref(n). Select the subordinate object OS Ref.
2. Select Object properties from the shortcut menu of the object. The Properties - OS Reference dialog opens.
3. Change over to the tab OS Ref: Options for OS Reference Objects.
4. Select the basis OS for this reference object in the basis OS field. The name of the associated basis OS is applied to the name of the OS reference object in the format <name_basic_os>_Ref(n).
Enter the associated OS path in the field Path to Target OS Computer. Alternatively, you can open a selection dialog by clicking the "..." button and select the path in this dialog.
5. Close the dialog with the "OK" button.

The project of the basis OS must now be transferred to the associated OS by using the Download to CPU function.

When you make changes in the WinCC project of the basis OS you need to transfer the same to the target system of basis OS and to each target system of references.

Note

Multi-projects have the following restriction:

Do not move any basis OS from a STEP 7 sub-project to another STEP 7 sub-project. While moving, you will lose all associated OS reference stations their reference to basis OS.

See also

How to Create a Reference to a WinCC Application (Page 2471)

How to Load the Project on the Target Computer (Page 2470)

Managing WinCC Projects and Objects in the SIMATIC Manager (Page 2457)

15.3.4 How to Import a WinCC Project with the SIMATIC Manager

Introduction

You can use the SIMATIC Manager to import a previously independent WinCC project into a STEP 7 project.

Requirements

- The WinCC project to be imported is closed.
- On the computer used for the import into the STEP 7 project, there are no open WinCC projects.

Procedure

1. In the SIMATIC Manager, open the STEP 7 project in which to import the WinCC project.
2. In the Tools menu, select Import OS The Import OS dialog opens.
3. . 3 Click the ... button to select the path of the WinCC project you want to import in the Open selection dialog. The selected path is shown in the field OS to import.

If the name of the WinCC project has more than 24 characters without file name extension or if it is not unique within the STEP 7 project, a message appears. In this case, you can specify another name.

4. Start the import by clicking the Import OS button.
When the import has been successfully completed, a message is displayed.
Exit the dialog by clicking the Exit button.

In errors occurred during the import, an error message is given and the respective errors are written into the log file import.log. The log file is stored in the WinCCOM folder under the project directory of the imported WinCC project.

During the import, a PC station with subordinate WinCC application is created for the WinCC project to be imported in the SIMATIC Manager. The imported WinCC project is created as subordinate OS object with the name specified for the import.

In the imported WinCC project, the following actions are performed:

- Existing packages are deleted.
- The computer name is set.
- An activated redundancy is deactivated.

See also

How to Create an Operator Station (Page 2474)

How to Load the Project on the Target Computer (Page 2470)

How to Select the Standby Computer (Page 2467)

How to Create a WinCC Application (Page 2461)

How to Set the Path to the Target Computer (Page 2475)

15.3.5 Handling WinCC Projects Between STEP 7 Projects and Libraries

Introduction

The following actions can be executed on WinCC projects using the SIMATIC Managers:

- Copying or moving a WinCC project within a STEP 7 project
- Copying or moving a WinCC project between STEP 7 projects
- Copying or moving a WinCC project from a STEP 7 project to a library
- Copying or moving a WinCC project from a library to a STEP 7 project
- Renaming a WinCC project
- Deleting a WinCC project

Requirements

- A WinCC project must have been created in the STEP 7 project.

Copying

1. Open the STEP 7 project into which the WinCC project is to be copied, using the "File > Open" option.
2. Select the WinCC project you want to copy and drag it onto the STEP 7 project selected as the destination.

Moving

1. Open the STEP 7 project into which the WinCC project is to be moved, using the "File > Open" option.
2. Select the WinCC project you want to move and drag it onto the STEP 7 project selected as the destination, holding down the Shift key as you do so.

Renaming

1. Select the WinCC project.
2. Select the "Rename" option on the pop-up menu and enter the new name.

Deleting

1. Select the WinCC project you want to delete.
2. Select the "Delete" option on the pop-up menu and acknowledge the warning with "Yes".

Note

In the same way, a WinCC project can be copied within a STEP 7 project or between a STEP 7 project and a library. If the WinCC project is open, Rename, Move and Delete are not executed.

15.3.6 Accepting Language Settings from SIMATIC Managers

Introduction

If a WinCC project is opened in SIMATIC Manager, WinCC Explorer will accept the current language setting from SIMATIC Manager. The language settings of SIMATIC Manager will only take effect on the language setting of the CS (Configuration System).

Behavior

There are three scenarios during opening of a WinCC project:

Scenario	Behavior
The current language of SIMATIC Manager was also installed in WinCC.	If WinCC Explorer or one of the editors (Graphics Designer, Load Online Changes or similar) is started, the language set in SIMATIC Manager is loaded. This also applies if the project is opened by using ProAgent, for example.
The current language of SIMATIC Manager was not installed in WinCC.	If WinCC Explorer or one of the editors (Graphics Designer, Load Online Changes or similar) is started, the language stored as default language is loaded. This also applies if the project is opened by using ProAgent, for example.
The WinCC project was most recently configured in a language not installed in SIMATIC Manager.	If WinCC Explorer or one of the editors (Graphics Designer, Load Online Changes or similar) is started, its language setting is retained. In this case the current language setting of SIMATIC Manager has no effect on the language setting of WinCC Explorers or the respective editor.

You can change the language setting in the open WinCC Explorer at any time. When this editor is closed and restarted, the current language setting of SIMATIC Manager is loaded again.

See also

How to Open the WinCC Project (Page 2494)

15.3.7 Working With WinCC Objects

15.3.7.1 Working With WinCC Objects

The corresponding WinCC objects are also displayed in SIMATIC Manager in addition to the WinCC project.

The objects are pictures and report templates of the project.

WinCC objects

Create WinCC objects

If you have created pictures and report templates using the Graphics Designer or Report Designer, they are not automatically visible in SIMATIC Manager. They have to be imported first.

You can also generate pictures and report templates using the SIMATIC Manager. These objects are initially "empty" and can be further edited with the Graphics Designer or the Report Designer.

Working with WinCC objects

SIMATIC Manager continues to provide functions such as copying, moving and deleting for handling these objects.

In addition, the SIMATIC Manager provides functions for managing sample solutions of WinCC objects in libraries.

The illustration below shows how the display of WinCC objects in the SIMATIC Manager.

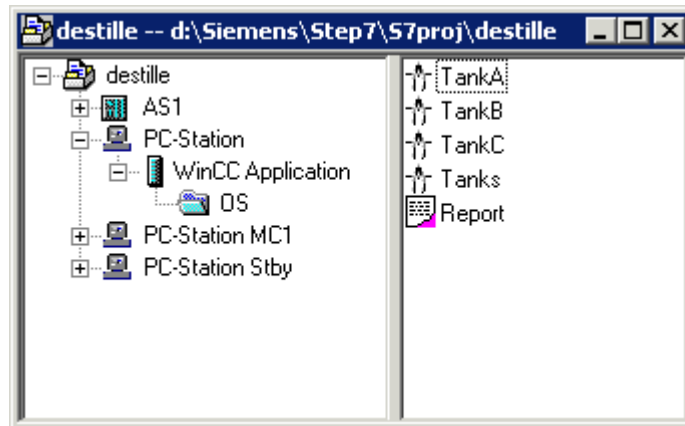

See also

[How to Import WinCC Objects \(Page 2488\)](#)

[How to Handle WinCC Objects \(Page 2486\)](#)

[How to Create WinCC Objects \(Page 2486\)](#)

15.3.7.2 How to Create WinCC Objects

Introduction

In the SIMATIC Manager, you can create the WinCC objects pictures and report templates without having to open the WinCC project. These WinCC objects have no content initially. You can, however, process them further using Graphics Designer and Report Designer.

Requirement

- A WinCC application or OS must have been created in the SIMATIC Manager.

Procedure

1. Select the WinCC project in the WinCC application or the OS.
2. Select the entry Insert New Object in the pop-up menu. You can now create either a picture or a report template.

See also

How to Import WinCC Objects (Page 2488)

How to Handle WinCC Objects (Page 2486)

Working With WinCC Objects (Page 2485)

15.3.7.3 How to Handle WinCC Objects

Introduction

You can use the SIMATIC Manager to copy, move, rename, and delete pictures and report templates.

If the object was opened by Graphics Designer or Report Designer, Rename, Move, and Delete are not possible.

Process pictures: No subfolders in WinCC projects

Do not use any folders in the Graphics Designer in integrated projects. In the SIMATIC Manager, pictures are not found in subfolders of "GraCS".

Before you import WinCC process pictures in SIMATIC Manager, move the pictures in the subfolders to the "GraCS" folder. In integrated projects, you manage pictures in the plant hierarchy of the SIMATIC Manager.

Unique names

The names of pictures and report templates must be unique within a WinCC project.

Names of pictures and graphic objects

If you rename a picture in WinCC Explorer, the new picture name must not have the same name as an existing object in the picture.

The software does not check whether the name already exists. Using a name that is already in use can lead to conflicts during access via VBA or during dynamization.

TIA objects in WinCC Explorer

If you create WinCC objects in SIMATIC Manager, you cannot rename or delete these in WinCC Explorer.

This is also true for WinCC objects that were created in WinCC and were then imported with the function "Import WinCC objects" into the SIMATIC Manager. This import transforms the WinCC object into a TIA object.

If you copy a TIA object with Graphics Designer or Report Designer, the copy is created as a WinCC object. You may rename or copy this copy as a WinCC object.

Copying / moving: General procedure

It is possible to copy and move objects between WinCC projects which have been created either in the same STEP 7 project or in different STEP 7 projects or libraries.

Copying and moving is used mainly if you want to duplicate certain system sections of a template project. You copy the pictures that contain no dynamic or a dynamic prepared with prototypes to the target project and perform the process connection there.

Dynamization

Configured dynamics are also copied when objects are copied and moved to other WinCC projects.

The process connection is lost since the used tags do not exist in the target project. You can compile a list of nonexistent tags using the CrossReference Editor. This also allows process connections to be linked.

Copy

1. Select the WinCC object.
2. Drag the object onto the WinCC project you selected as the destination.
If the object is copied between two WinCC projects in different STEP 7 projects and an object with the same name already exists, the existing object is only overwritten after confirmation.

Moving

1. Select the WinCC object.
2. Drag the object onto the WinCC project you selected as the destination, holding down the Shift key as you do so.
If the object is moved between two WinCC projects in different STEP 7 projects and an object with the same name already exists, the existing object is only overwritten after confirmation.

Rename

1. Select the WinCC object.
2. Select the "Rename" option on the shortcut menu and enter the new name.

Delete

1. Select the WinCC object.
2. Select the "Delete" option on the shortcut menu and acknowledge the warning with "Yes".

See also

How to Import WinCC Objects (Page 2488)

How to Create WinCC Objects (Page 2486)

Working With WinCC Objects (Page 2485)

15.3.7.4 How to Import WinCC Objects

Introduction

You can create pictures and report templates using the Graphics Designer and Report Designer editors. However, these WinCC objects are not displayed automatically in the SIMATIC Manager.

You can update the view in the SIMATIC Manager using the "Import WinCC objects" function.

This import transforms the WinCC object into a TIA object.

Note

Picture name: Maximum of 24 characters

It is only possible to import pictures into the SIMATIC Manager if the picture name is not longer than 24 characters.

Process pictures: No subfolders in WinCC projects

Do not use any folders in the Graphics Designer in integrated projects. In the SIMATIC Manager, pictures are not found in subfolders of "GraCS".

Before you import WinCC process pictures in SIMATIC Manager, move the pictures in the subfolders to the "GraCS" folder. In integrated projects, you manage pictures in the plant hierarchy of the SIMATIC Manager.

Requirement

- Pictures and report templates must have been created using the associated editors.

Procedure

1. Select the WinCC project in the WinCC application or the OS.
2. Select the entry "Import WinCC objects" in the pop-up menu.
The pictures and report templates are displayed in the SIMATIC Manager.

See also

How to Handle WinCC Objects (Page 2486)

How to Create WinCC Objects (Page 2486)

Working With WinCC Objects (Page 2485)

15.3.7.5 Setting Up and Monitoring of Server Assignment

Introduction

Using the SIMATIC Manager, you can assign various OS servers to a selected OS. The selected OS may be an OS client, an OS server or a central archive server.

If you have selected an OS object, the "Assignment OS server for <OS>" dialog displays a list of servers available in this project. An existing archive server is also listed.

If the selected OS project contains packages of servers unknown to the S7 project and the multi-project, respectively, the list will be expanded by entries of these servers not found. The "OS Information" column contains the entry "Unknown" in these cases.

The "Assignment OS server for <OS>" dialog

Open the "Assignment OS server for <OS>" dialog by selecting the OS in SIMATIC Manager. Select the "Assign OS server..." entry in the shortcut menu.

Alternatively, you can open the dialog in SIMATIC Manager in the "Tools" menu by using the "OS > Assign OS server..." entry.

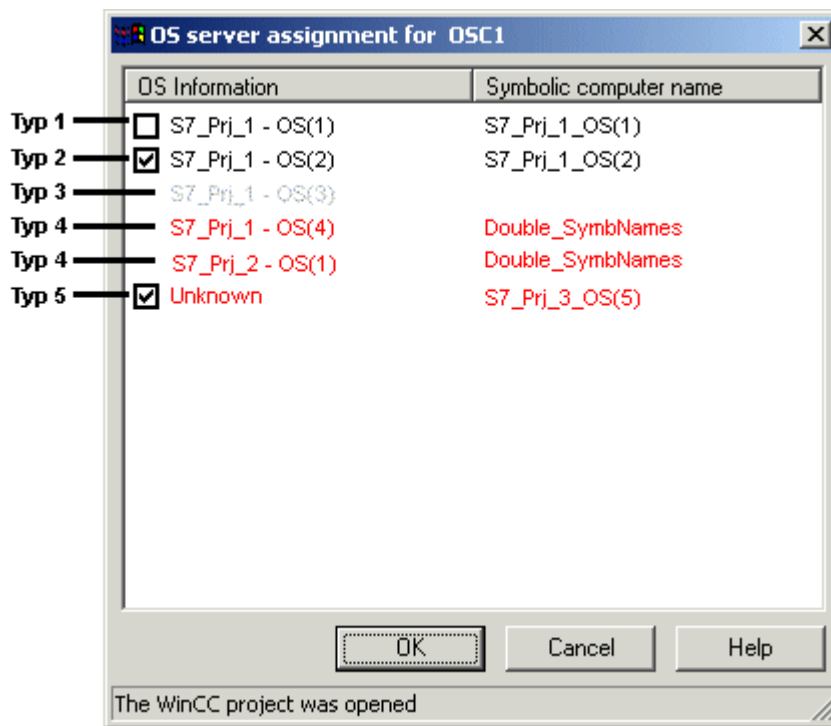

The dialog will display all OS servers that are accessible and belonging to the S7 project and the multi-project, respectively. The list may be amended by entries containing the OS information "Unknown". The following OS objects are not displayed:

- Selected OS for which the dialog was opened
- Standby OS server
- Clients
- OS of the type single-user station project
- OS References
- Client References

An entry may contain the following information:

- Checkbox to setup or delete an assignment to the selected OS object. Displays upon opening of the dialog whether or not an assignment already exists.
- OS information consisting of the name of the S7 project and the description of the OS object.
- Symbolic computer name

In order to set up an assignment, select the checkbox of the OS object and exit the dialog with OK. A package is now imported into the OS for all newly selected OS objects.

In order to delete an existing assignment, clear the checkbox of the OS object and exit the dialog with OK. The corresponding package is deleted from the OS for all newly deselected OS objects.

Significance of Colors in List Entries

Using the color of an entry, you obtain information on each OS object.

Type	Color	Supplementary info	Significance of information
1	black	Checkbox not selected	Assignment to server can be established. Server has exported package.
2	black	Checkbox selected	Assignment to server is established. OS has loaded package.
3	gray	No checkbox	Assignment to server cannot be established. Reason: Server does not have exported package.
4	red	No checkbox, OS information and symbolic computer name are entered	Assignment to server cannot be established. Reason: Exported package of server does not have unique name. There are several reasons for this: <ul style="list-style-type: none"> • The project already contains a server with an identical symbolic computer name. • The OS object contains an imported package with an identical symbolic computer name.
5	red	Checkbox selected, OS information contains the entry "Unknown" and the sym- bolic computer name has been entered	The server named in the imported package of the selected OS object cannot be found in the S7 project or multi-project. Reason: OS server no longer belongs to the multi- project or package has been deleted. In this case you should clear the checkbox for this entry and exit the "Assignment OS server for <OS>" dialog by clicking OK. Thus, you delete the imported package which cannot be assigned.

Note

If you execute one of the following actions in an S7 project, you should subsequently check the OS server assignment in the "Assignment OS server for <OS>" dialog:

- Retrieving an S7 project with "Retrieve"
- Storing an S7 project with "Save As..."
- Removing an S7 project with "Remove for editing"
- Reintegrate the S7 project with "Reintegrate after editing"
- Copying an S7 project with Windows Explorer
- Moving an S7 project with Windows Explorer

If red entries of Type 5 occur in the list during the "Assignment OS server for <OS>" dialog, proceed as follows:

1. Regenerate all packages by starting the "Compiling Multiple OS" wizard. Compilation of minimum scope suffices. Therefore, select the "Changes Only" checkbox and clear other options, such as "Tags", "Messages" and "SFC".
If the red entry is a central archive server, you must additionally trigger the generation of server data.
 2. For all OS objects, open the "Assignment OS server for <OS>" dialog and check for possible "Unknown" error entries.
 3. In these cases, make note of the symbolic computer name.
 4. Delete the "Unknown" entries by clearing the respective checkboxes and exiting the dialog with OK.
 5. Open the dialog and search for the symbolic computer name noted in Item 3. Assign these computers to the selected OS objects by selecting the respective checkbox and by exiting the dialog with OK.
 6. If you publish process pictures for Web access, run the entire configuration in WinCC Web Publishing Wizard again.
-

15.3.7.6 How to Create Model Solutions of WinCC Projects or WinCC Objects

Introduction

Using the SIMATIC Manager, complete WinCC projects can be copied or moved to a library. These WinCC projects can then be edited in the library. The model solutions thus created serve as templates for several uses in WinCC projects. The copying or moving processes to or from a library behave in the same way as between two Step 7 projects.

Individual screens and report templates can also be copied or moved from a WinCC project to an OS within a library and used as a model template.

Requirement

- Copying and moving individual screens and report templates:
An OS is set up in the library as destination.
- Copying or moving WinCC projects:
The source project is not activated.

Note

When copying or moving WinCC projects, screens and report templates to and from libraries, name conflicts may occur. This means that the library or STEP 7 project already contains a WinCC object with this name. To prevent the target object being overwritten, a new name is assigned for the inserted object. The name of the object is assigned a consecutive number meaning, for example, "Picture1" becomes "Picture1(1)".

Copying a WinCC Project or WinCC Object in a Library

1. Open the SIMATIC Manager.
2. Open the STEP 7 project to be used as the source using the menu items "File > Open".
3. Open the library in which the model solution should be copied using menu items "File > Open".
4. Select the OS, screen or report template to be copied in the STEP 7 project. Drag the object per Drag & Drop onto the target library or OS in the library.

Moving a WinCC Project or WinCC Object in a Library

1. Open the SIMATIC Manager.
2. Open the STEP 7 project to be used as the source using the menu items "File > Open".
3. Open the library in which the model solution should be copied using menu items "File > Open".
4. Select the OS, screen or report template to be copied in the STEP 7 project. Drag the object per Drag & Drop, with the Shift key pressed, onto the target library or OS in the library.

Copying a WinCC Project or WinCC Object from a Library

1. Open the SIMATIC Manager.
2. Open the library from which the model solution should be copied using menu items "File > Open".
3. Open the STEP 7 project to which the model solution should be copied using menu items "File > Open".
4. Select the OS, screen or report template to be copied in the library. Drag the object per Drag & Drop onto the S7 project selected as target or OS selected as target.

Moving a WinCC Project or WinCC Object from a Library

1. Open the SIMATIC Manager.
2. Open the library from which the model solution should be copied using menu items "File > Open".
3. Open the STEP 7 project to which the model solution should be copied using menu items "File > Open".
4. Select the OS, screen or report template to be copied in the library. Drag the object per Drag & Drop onto the S7 project selected as target or OS selected as target.

Renaming a WinCC Project or WinCC Object in a Library

1. Open the SIMATIC Manager.
2. Select the OS, screen or report template to be renamed.
3. Select the "Rename" option on the pop-up menu and enter the new name.

Deleting a WinCC Project or WinCC Object in a Library

1. Open the SIMATIC Manager.
2. Select the OS, screen or report template to be deleted.
3. Select the "Delete" option on the pop-up menu and acknowledge the warning with "Yes".

15.3.8 How to Open the WinCC Project

Introduction

You start WinCC directly from the SIMATIC Manager and open the WinCC project.

Access protection

The project-related access protection that is used to protect STEP 7 or PCS 7 projects is evaluated during opening.

If project-related access protection has been activated for the WinCC project, you must also enter the STEP 7 project password when opening the project.

Opening the WinCC project outside of the SIMATIC Manager

WinCC Projects that are integrated in a STEP 7/PCS 7 project cannot be opened using an ES where only WinCC has been installed.

For that you also need STEP 7 on the ES.

You can also create a separate WinCC project from the integrated WinCC project. You can find additional information on the page "Advantages and Prerequisites of Integration (Page 2454)".

Requirement

- The WinCC project must have been created in the SIMATIC Manager.

Procedure

1. Select the WinCC project in the WinCC application or the OS.
2. Select the "Open Object" option on the shortcut menu.

See also

How to Create a WinCC Application (Page 2461)

WinCC Application (Page 2460)

Advantages and Prerequisites of Integration (Page 2454)

15.3.9 Starting a Simulation in STEP 7

Introduction

The "Start OS simulation" function creates a temporary copy of the selected project on the local computer. This copy of the project is then started in runtime.

The temporary copy is always created locally. In this case, a new directory "OS_Simulation" is created in the existing directory structure parallel to the STEP 7 project already open.

If the selected project is on a different computer, the temporary copy is still created on the local computer. In this case, the "OS_Simulation" directory is set up in the STEP 7 installation path under "S7Proj".

This function is required in order to test the changes made in the WinCC project or STEP 7 project.

Note

With connections configured on both sides, it is important to ensure that the connections between the local computer and the AS as well as between the target computer and the AS have the same name. If this is not the case, no connection will be set up between the local computer and the AS.

During simulation, communication to other computers is restricted. The following functions, for example, are not available:

- Server-Server communication
- Client-Server communication

- Redundancy
- Communication with a central archive server

Procedure

1. Select the WinCC project in the WinCC application or the OS.
 2. Select the "Start OS Simulation" option from the context menu.
-

Note

If a WinCC project is already in runtime, the "Start OS simulation" cannot be executed. A corresponding message is issued.

15.4 Transferring Tags, Texts and Reports to WinCC

15.4.1 Transferring Tags, Texts and Reports to WinCC

Introduction

This chapter shows you the function "Compiling OS", informs you about the configuration data affected by the transfer and how this data is stored in the WinCC project. It familiarizes you with the dialogs and procedures associated with the transfer operation.

You must transfer the AS configuration data relevant for operator control and monitoring, to the data of WinCC so that it is available to you during WinCC configuration and in Runtime. Use the function "Compile OS" for this purpose.

During the transfer operation, process tags are stored in the tag management system, user texts are stored in the text library, and messages are stored in the alarm logging system of the WinCC project.

You need "PCS 7" to create archive tags by setting the property "S7_archive" in data elements of a data block and starting compilation of the OS.

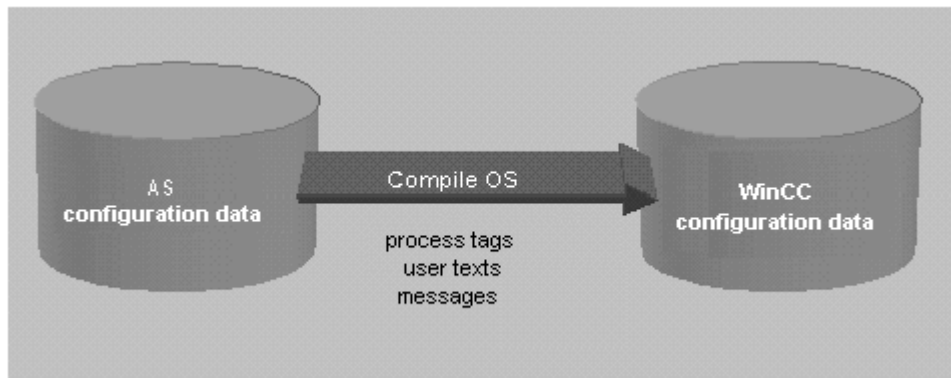

See also

Compilation log (Page 2508)

How to Compile Changes (Page 2504)

How to Compile the Entire OS (Page 2499)

Compiling OS (Page 2498)

15.4.2 Compiling OS

15.4.2.1 Compiling OS

Introduction

You use the "Compile OS" function to create the structures and data in the WinCC project that are required for operator control and monitoring.

Note

You may compile one OS or several OS. If you wish to compile one OS, use the "Compile OS" wizard. If you wish to compile multiple OS, use the "Compile multiple OSs" wizard.

Both wizards differ only by the number of OS to be compiled. The statements of the wizard "Compile OS" therefore apply equally to the wizard "Compile multiple OSs".

Scope of Compilation

The "Compile OS" function has three compile modes:

- The "Entire OS with memory reset" mode is the default mode. All AS data in the operator station is erased and the data for the S7 programs selected for compilation is transferred again.
- The "Entire OS" mode is appropriate if with several assigned S7 programs you have not selected all for compilation. This mode ensures that the already transferred data of the S7 programs not selected for compilation is retained in the operator station.
- The "Changes" mode should be used if you have only made minor changes in the S7 program. If you make changes to a structure tag where one structure element is used as message tag, then online changes cannot be loaded for messages.

Note

If you perform a "Save As" in SIMATIC Manager and have selected "with reorganization", the option "Entire OS" is the default setting. You cannot select an different compilation range.

Functions

The following functions are executed with "Compile OS":

- Creation of the communication driver SIMATIC S7 PROTOCOL SUITE
- Creation of the WinCC units, e.g. Industrial Ethernet, PROFIBUS and so on
- Creation of a logical connection for each S7 program
- Creation of raw data tags for the message system and archive system
- Creation of structure types for the component types to be transferred in WinCC and for the global data blocks

- Creation of the process tags in the tag management system
- Generation of the messages
- Transfer of the message and user texts

When Should Compilation Be Performed?

Compilation of OS should be performed:

- before WinCC Runtime is started for the first time
- after new component instances are added or component names are changed
- after operator texts and unit texts are changed
- after the operator control and monitoring attributes of an instance are changed
- after message and user texts are changed

Note

Simulation of the OS is only possible if the OS was compiled without errors.

Note

Additional information can be found in the STEP 7 help and in the "Compile OS" Wizard help.

See also

Compilation log (Page 2508)

How to Compile Changes (Page 2504)

How to Compile the Entire OS (Page 2499)

15.4.2.2 How to Compile the Entire OS

Introduction

You compile the configuration data using the Compile OS wizard. Compilation of the entire OS can be performed in two different compilation modes:

- The "Entire OS with memory reset" mode is the default mode. All AS data in the operator station is erased and the data for the S7 programs selected for compilation is transferred again.
- The "Entire OS" mode is appropriate if with several assigned S7 programs you have not selected all for compilation. This mode ensures that the already transferred data of the S7 programs not selected for compilation is retained in the operator station.

Starting the "Compile OS" Wizard

You can start the "Compile OS" wizard in SIMATIC Manager in different ways.

- If you wish to compile the configuration data of a certain operator station, first select the OS and start the assistant by using the menu item "Edit" > "Compile". Alternatively, you can also select the "Compile" option in the pop-up menu of the OS.
- If you wish to compile the configuration data of several or all operator stations, start the wizard from the menu item "Options > "Compile Multiple OSs' wizard" > "Start...".

Note

Please note that compiling the entire OS will lead to a loss of online loadability.

Further information on "Compile OS" can be found in the "STEP 7 Help" and "Compile OS" wizard Help.

Requirements

- The WinCC project must have been created.

Procedure

The compilation of a particular operator station is described in this procedure. The compilation of several operator stations is performed in the same way.

1. Select the OS, and then select "Compile" in the pop-up menu, or select the menu item "Edit" > "Compile".
2. Select the appropriate S7 program in the list of S7 programs (left) and then drag the S7 program (holding down the left-hand mouse button) onto the desired operator station in the list of operator stations (right). Click "Next".

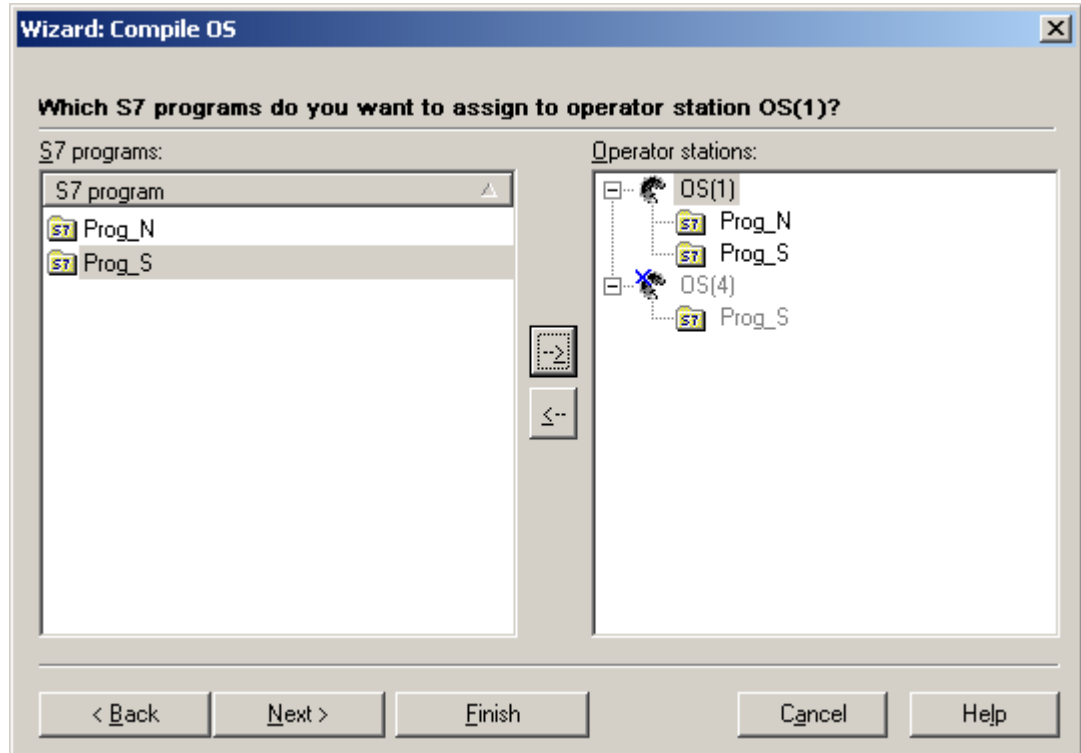

This page is only displayed if there is more than one operator station and more than one S7 program in your project. Assignment is otherwise performed automatically.

1. Using the check box, select the S7 programs that you want to transfer. Data is only transferred for the selected S7 programs.

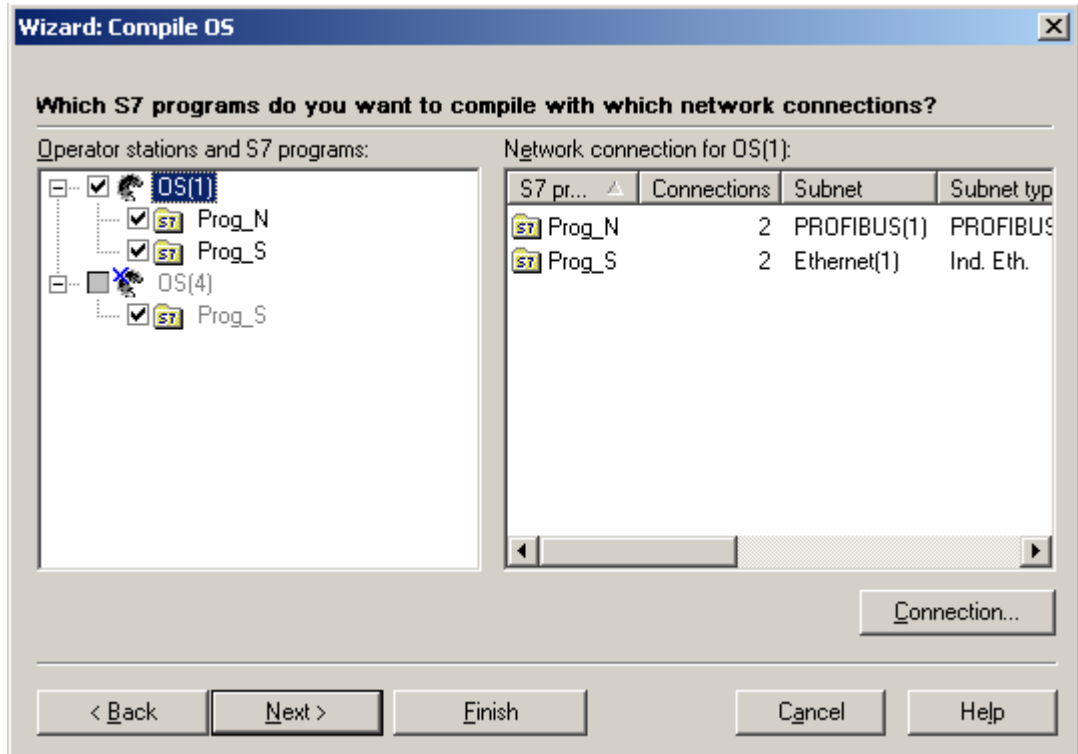

2. Select which network connections are to be used. When you select the operator station in the left-hand field, the associated S7 programs together with the configured network connections are listed in the right-hand field. To change the network connection, select the S7 program and press the "Connection..." button. Select the network connection you require. Press "OK" and then "Next".

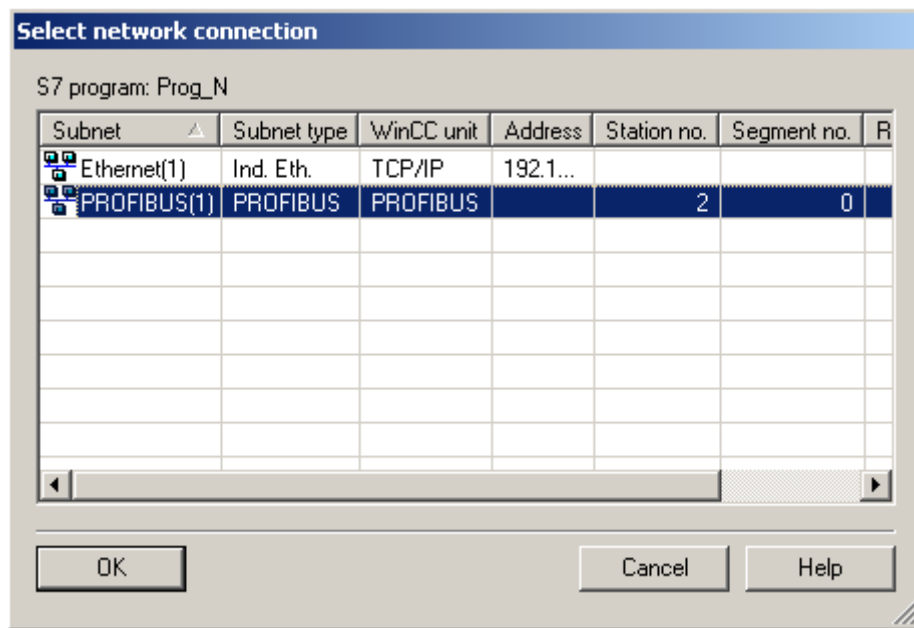

3. Select the compilation mode "Entire OS". If you want to delete all the AS data in the operator station, select "With memory reset". Click "Next".

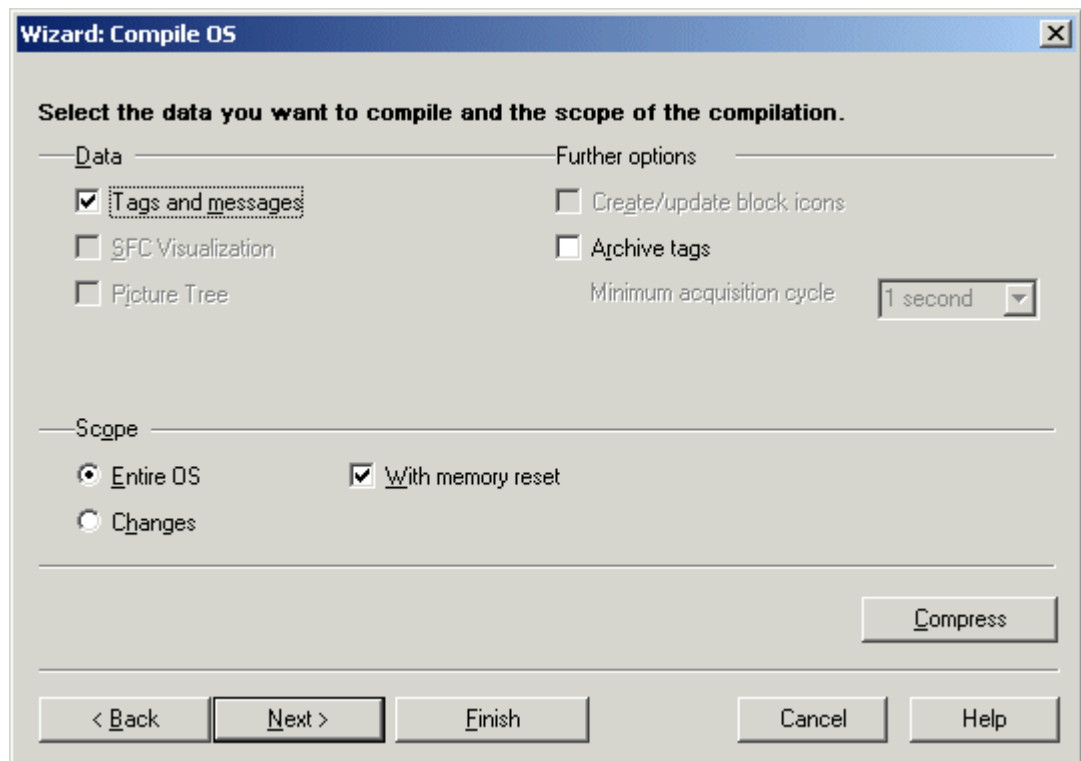

4. Check the compilation options and click Compile.
5. When the compilation procedure has been completed, a message may appear informing you of errors and warnings that have occurred. If this is the case, check the compilation report.

Note

You should not work on the project during compilation.

You may use the option Archive Tags only jointly with PCS7. Additional information on this function may be found in the configuration manual Process Guidance System PCS7, Operator Station in the PCS7 documentation.

See also

Compilation log (Page 2508)

How to Compile Changes (Page 2504)

Compiling OS (Page 2498)

15.4.2.3 How to Compile Changes

Introduction

You should compile changes if you have made only minor changes to the S7 programs. In contrast to compiling the entire OS, compiling the changes has the advantage of maintaining the online loadability.

Starting the "Compile OS" Wizard

You can start the "Compile OS" wizard in SIMATIC Manager in different ways.

- If you wish to compile the configuration data of a certain operator station, first select the OS and start the wizard by using the menu command "Edit > Compile". Alternatively, you can also select the "Compile" option in the shortcut menu of the OS.
- If you wish to compile the configuration data of several or all operator stations, start the wizard from the menu command "Options > Compile Multiple OSs' wizard > Start...".

Further information on "Compile OS" can be found in the "STEP 7 Help" and "Compile OS" wizard Help.

Requirements

- The operator station must have been configured.
- Operator control and monitoring data which has been changed must exist in the AS configuration.
- An entire compilation or an implicit compilation (with selection of connection) must have been performed for the first time.
- If you make changes to a structure tag where one structure element is used as message tag, then online changes cannot be loaded for messages.

Procedure

The compilation of a particular operator station is described in this procedure. The compilation of several operator stations is performed in the same way.

1. Select the OS, and then select "Compile" in the shortcut menu, or select the menu command "Edit > Compile".
2. If you have no changes, click Next.
If you have changes, select the appropriate S7 program in the list of S7 programs (left) and then drag the S7 program (holding down the left-hand mouse button) onto the desired operator station in the list of operator stations (right). Click "Next".

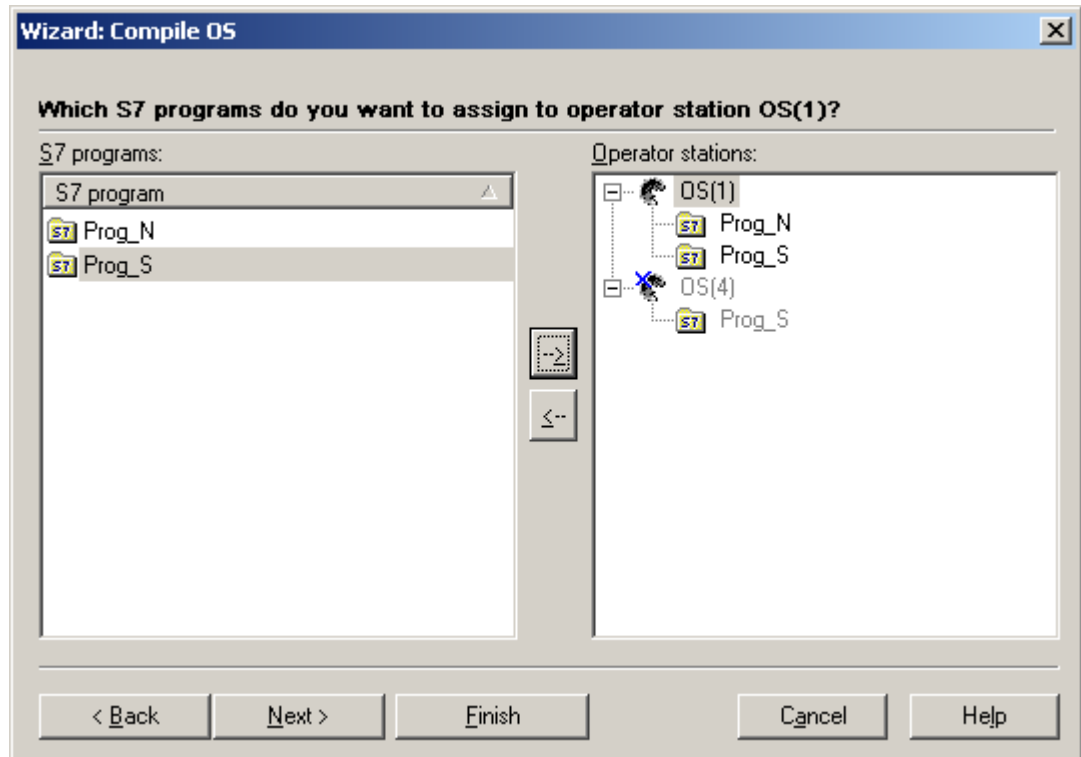

This page is only displayed if there is more than one operator station and more than one S7 program in your project. Assignment is otherwise performed automatically.

3. If you have no changes, click "Connection".

4. If you have changes, enable the check boxes to select the S7 programs that you want to transfer. Data is only transferred for the selected S7 programs. Click "Connection".

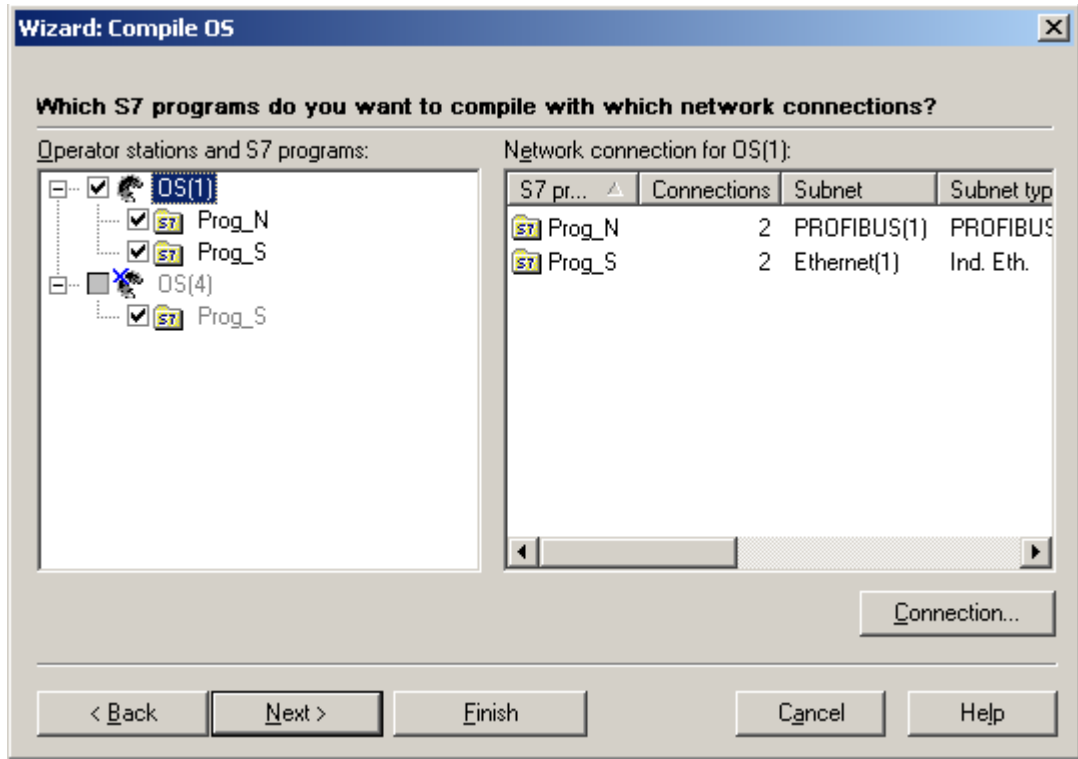

5. If you have no changes, click "Cancel".

6. If you have changes, select the network connections that you want to use. When you select the operator station in the left-hand field, the associated S7 programs together with the configured network connections are listed in the right-hand field. To change the network connection, select the S7 program and press the "Connection..." button. Select the network connection you require. Press "OK" and then "Next".

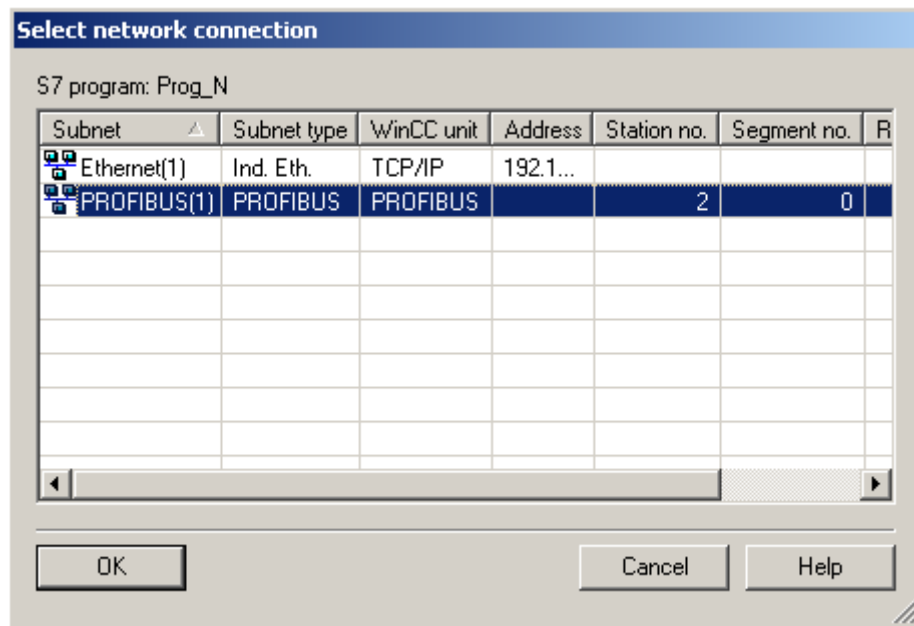

7. Select the compilation mode "Changes". Click "Next".

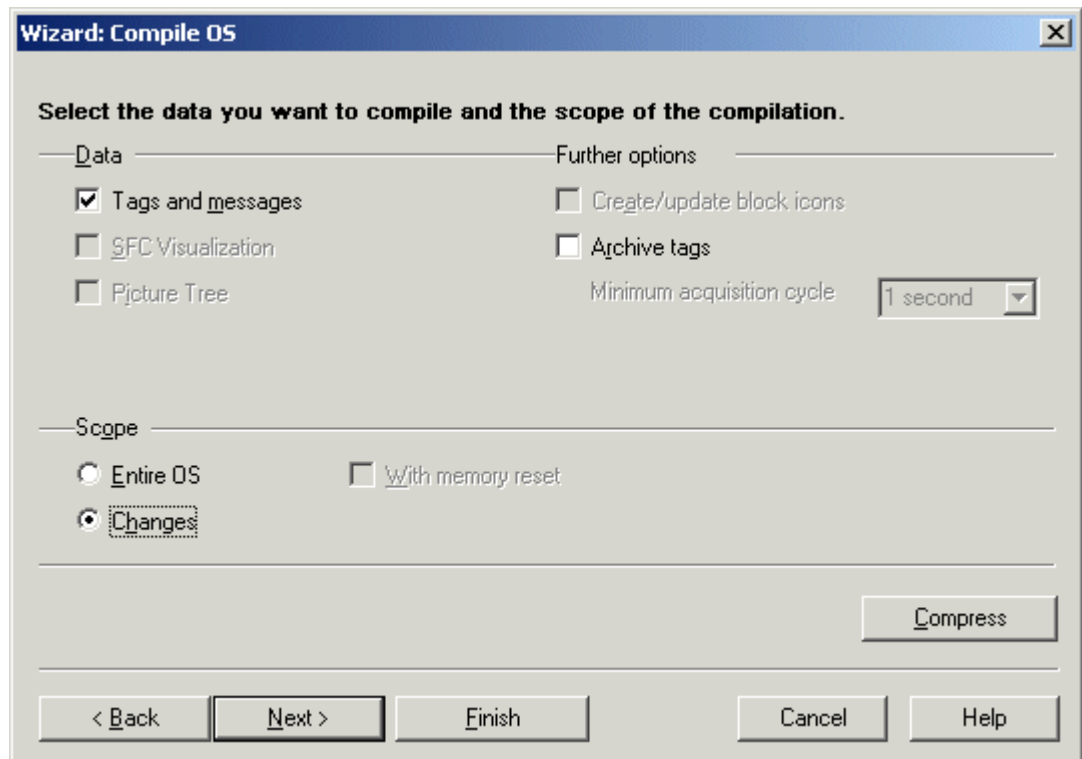

8. Check the compilation options and click Compile.
9. When the compilation procedure has been completed, a message may appear informing you of errors that have occurred. If this is the case, check the compilation report.

Note

You should not work on the project during compilation.

You may use the option Archive Tags only jointly with PCS7. Additional information on this function may be found in the configuration manual Process Guidance System PCS7, Operator Station in the PCS7 documentation.

See also

Compilation log (Page 2508)

How to Compile the Entire OS (Page 2499)

Compiling OS (Page 2498)

15.4.2.4 Compilation log

Introduction

During compilation, logs are created that provide information about:

- AS-OS connections
- Tag names
- Assignment of messages
- Errors and warnings that occurred during compilation

Compilation log

The compilation log contains entries on all objects.

Once you have compiled an OS using the Compile OS wizard, open the compilation log using the menu command "Options > OS > Display compilation log..." directly in SIMATIC Manager. Alternatively, you may also open the compilation log "transfer.log" in the WinCC project path with a text editor.

Once you have compiled multiple OS with the wizard Compile Multiple OSs, open the compilation log by clicking the menu command "Options > Compile Multiple OSs wizard > Open Log..." directly in SIMATIC Manager. Alternatively, you may also open the compilation log "transfer.log" in the STEP7 project path with a text editor.

See also

- How to Compile Changes (Page 2504)
- How to Compile the Entire OS (Page 2499)
- Compiling OS (Page 2498)

15.4.3 How to Display Transferred Tags

Introduction

The result of the "Compile OS" function can be checked in the WinCC project.

Procedure

1. Open the Tag Management and then navigate to the configured WinCC unit.
2. Open the logical connection that it contains. All compiled process tags are now displayed.

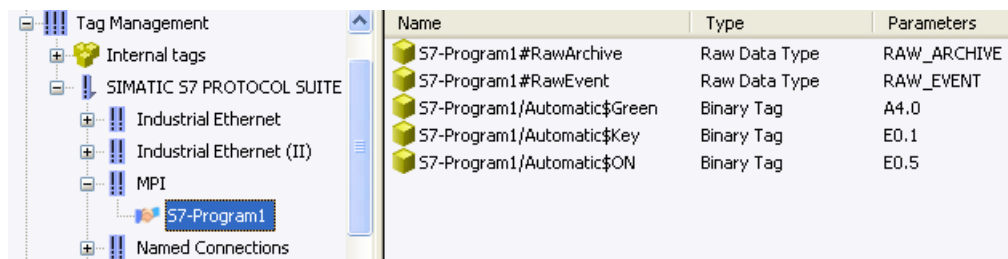

Note

In the Tag Management, the compiled tags can be recognized by the structure of their name. Their name is made up of the S7 program followed by "/".

Compiled tags are write-protected and cannot be deleted from the Tag Management. This is only possible with the Compile "OS wizard".

In the dialog box Which S7 Programs Do You Want to Transfer with Which Network Connections? you must disable the S7 programs whose tags are to be deleted in WinCC. To do this, remove the check mark in front of the program name. Choose the "Entire OS With Reset" option for the compilation mode. During the compilation operation that follows, all the tags, connections and messages not created in WinCC are deleted.

See also

- Displaying Transferred Messages and Texts (Page 2510)
- Compilation log (Page 2508)
- How to Compile Changes (Page 2504)

How to Compile the Entire OS (Page 2499)

Compiling OS (Page 2498)

15.4.4 Displaying Transferred Messages and Texts

Introduction

The result of the "Compile OS" function can be checked in WinCC.

Blocks of user and message text are stored in the text library, and messages are stored in Alarm Logging.

User and Message Texts

1. Select the "Text Library" editor in the WinCC Explorer.
2. Select the "Open" option on the shortcut menu.

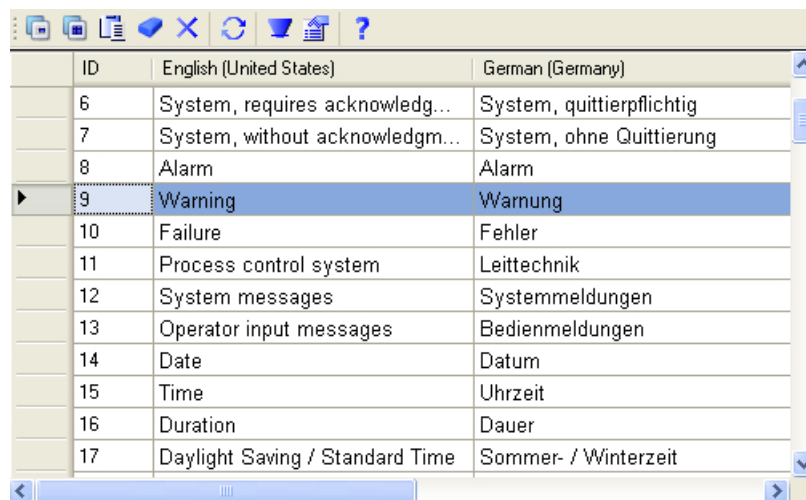

ID	English (United States)	German (Germany)
6	System, requires acknowledg...	System, quittierpflichtig
7	System, without acknowledgm...	System, ohne Quittierung
8	Alarm	Alarm
9	Warning	Warnung
10	Failure	Fehler
11	Process control system	Leittechnik
12	System messages	Systemmeldungen
13	Operator input messages	Bedienmeldungen
14	Date	Datum
15	Time	Uhrzeit
16	Duration	Dauer
17	Daylight Saving / Standard Time	Sommer- / Winterzeit

Messages

1. Open the "Alarm Logging" editor in WinCC Explorer.
The transferred messages can be recognized by the 10-digit number.

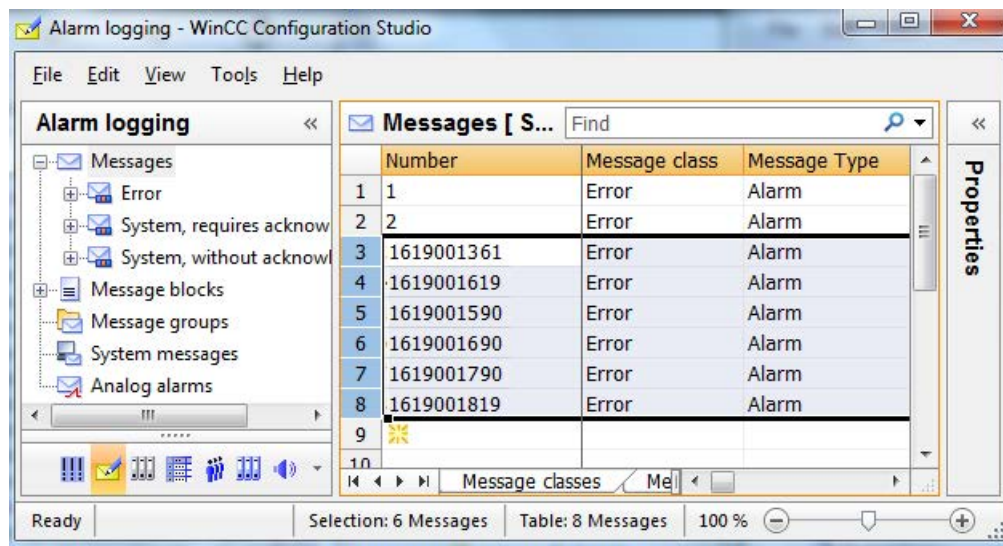

See also

- How to Display Transferred Tags (Page 2509)
- Compilation log (Page 2508)
- How to Compile Changes (Page 2504)
- How to Compile the Entire OS (Page 2499)
- Compiling OS (Page 2498)

15.4.5 How to Configure Messages in STEP7

Introduction

To ensure a consistent message configuration, two points must be observed when creating the message texts in STEP7 in order to guarantee the correct response in WinCC.

Assigning the Message Texts According to "Compile OS"

The following example a configuration of the message texts in the STEP7 message editor.

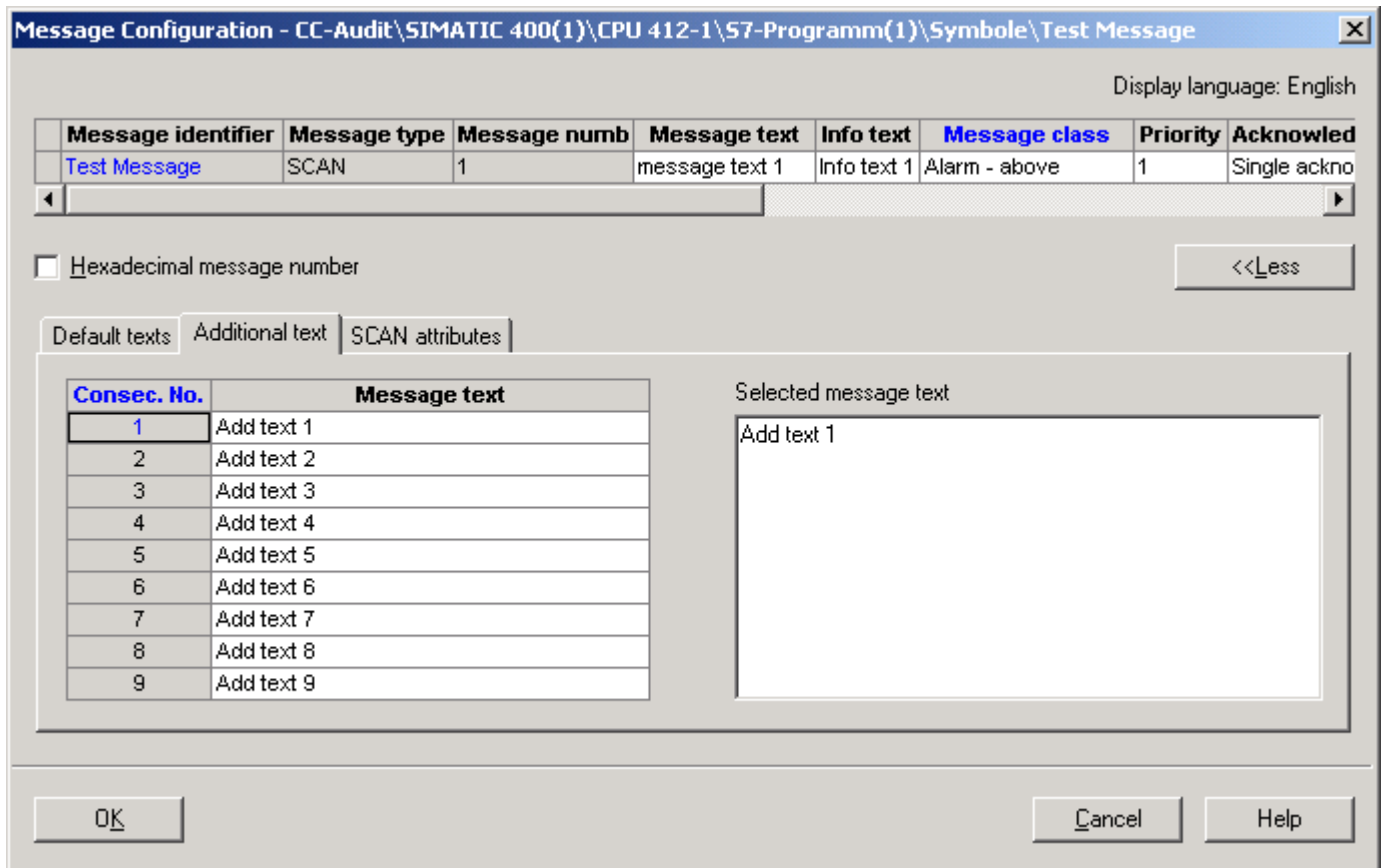

The standard texts "Message text" and "Info text" as well as the additional texts are assigned to the following user text blocks of a message after "Compile OS" in Alarm Logging from WinCC.

Single message

Parameters | **Text** | Tag/Action

Infotext: Info text 1

Source: Add text 1

Area: Add text 2

Event: message text 1

Charge Name: Add text 3

Operation: Add text 4

Free 1: Add text 5

Free 2: Add text 6

Free 3: Add text 7

Free 4: Add text 8

Free 5: Add text 9

Enter the message text

OK Cancel Help

Note

"Compile OS" enables messages to be created in Alarm Logging whose message class and message type are invalid in WinCC. Invalid messages are prevented by starting the OS project editor.

Creating a Message Group After "Compile OS"

If an additional text 2 is entered in the STEP7 message editor, a message group is created using "Compile OS" in the Alarm Logging.

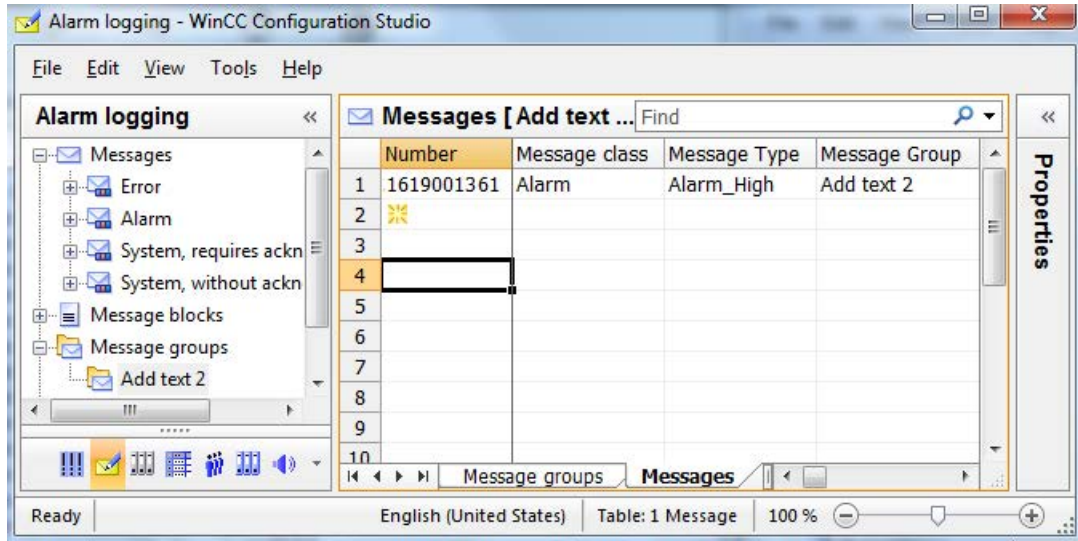

15.5 Compiling and Loading Objects

Introduction

Objects can be compiled and loaded in just one step. The SIMATIC Manager provides the Compile and Load Object dialog box for this. Further information on this topic can be found in STEP 7 Help and Compile and Load Objects Help.

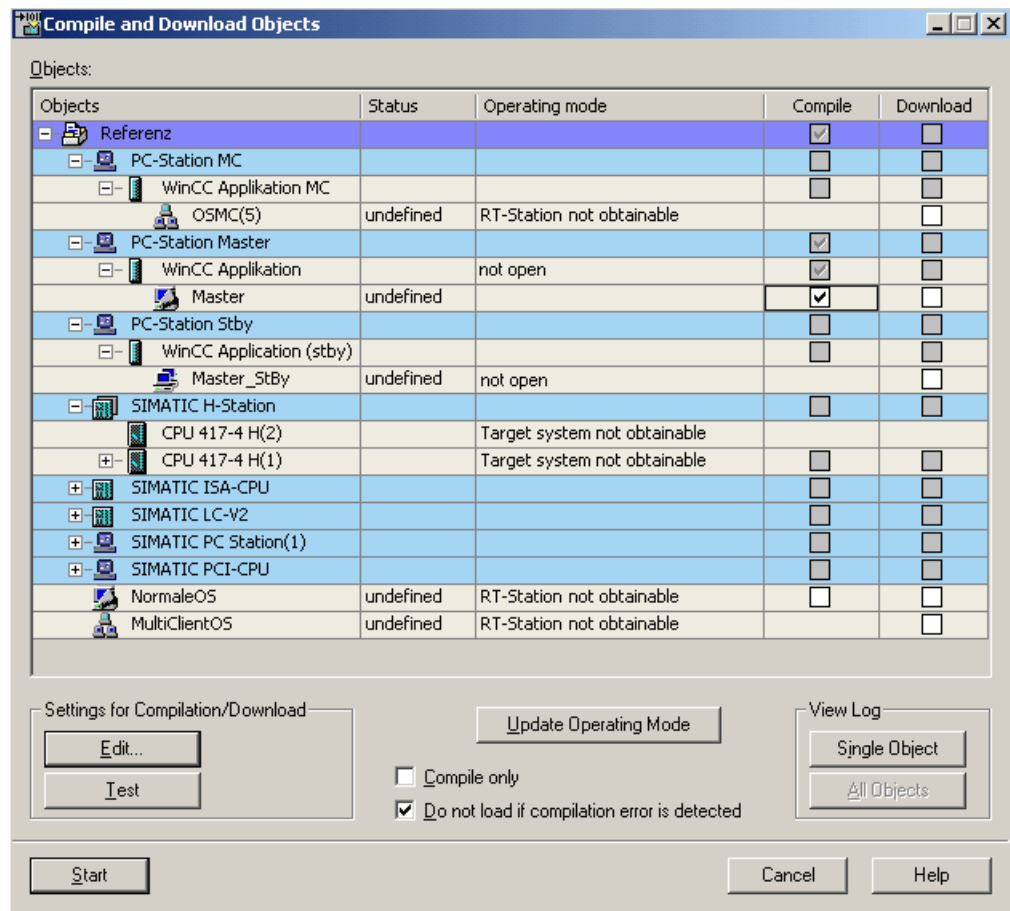

Objects table

In this area you specify which objects are to be compiled and loaded into the target system.

Objects column

Displays the objects.

Status column

Displays the status of the object.

There are the following statuses:

- undetermined: The status could not be determined.
- modified: The object has been modified. The object must be recompiled and loaded onto the system.
- compiled: The object has already been compiled but still needs to be loaded onto the system.
- loaded: The object has already been compiled and loaded onto the system already.

Operating status column

Displays the operating status of the system.

Compile/Load column

Here you define the objects that have to be compiled and loaded onto the system. Only the check boxes having a white background can be enabled or disabled.

If this check box is selected, the column Load in the Table Objects is hidden.

Settings for Compile/Load

Edit button

The Edit button opens the Settings: Compile OS dialog. You can use this dialog box to modify the settings for compiling and loading the selected object.

You will find more information about compilation at Compile OS and about loading at Loading the project onto the destination computer.

Compile Only check box

If this check box is selected, the column Load in the Table Objects is hidden. The objects are compiled only.

Do Not Load upon Compilation Error check box

If this check box has been selected, the object will not be loaded onto the system when a compilation error occurs.

Displaying Log

Single Object button

Opens the log for a specific object.

Overall button

Opens the Overall Log. The overall log contains entries about all objects.

Start button

Start the compile and load operation.

Note

You should not work on the project during compilation and loading.

See also

Compiling OS (Page 2498)

How to Load the Project on the Target Computer (Page 2479)

15.6 How to use multiuser engineering in SIMATIC Manager

Introduction

Under certain circumstances, multiple users can edit a WinCC project simultaneously from different computers and use different resources. This is also true for WinCC projects in SIMATIC Manager.

Requirement

- At least one WinCC OS project or one OS client must be present in the STEP 7 project or STEP 7 multiproject.
- The STEP 7 project or STEP 7 multiproject must not contain an OS server in which a client computer is entered.

How to enable multiuser engineering

1. Select "Central OS Settings" > "OS Multiuser Engineering" in the "Tools" menu of SIMATIC Manager. The "OS Multiuser Engineering" dialog opens.
2. Select the "activate" option. The computers connected to the project can now use various resources of the STEP 7 project or STEP 7 multiproject in parallel.

Note

If there is no longer an OS in the STEP 7 project or multiproject, multiuser engineering is deactivated automatically.

For details of the multiuser engineering process, refer to the description on page "How to use multiuser engineering" under "Working with projects > Creating and editing a project".

To find out if multiuser engineering is activated, select the "Object properties" entry from the shortcut menu of the project. The activation or deactivation of the multiuser engineering is indicated there.

Note

Depending on the number of WinCC projects within the STEP 7 project or STEP 7 multiproject, it may take some time for the "OS Multiuser Engineering" dialog to open or for changes to be saved.

Restrictions on multiuser engineering in SIMATIC Manager

The following configuring steps require that a computer has sole access to the WinCC project:

- Compile OS
- Generate server data
- Assign OS server

- Start OS simulation
- Download to target system
- Rename
- Copy
- Move

If one of these project steps is carried out, the project cannot be opened with multiuser engineering, either. In the "Multi-user resources" dialog, "Project locked" is displayed - except during OS compilation or when the "s7omwinx.lck" file was accidentally not deleted.

You cannot carry out the following configurations in the object properties if the WinCC project is open on another computer:

- On the "General" tab:
 - Change name
 - Change author
 - Change comment
- On the "Target OS and Standby OS Computer" tab:
 - Change destination path of standby OS if the assigned master OS is open
 - Assignment of a standby OS

15.7 Settings for Web access

15.7.1 Configuring Web settings

The SIMATIC Manager enables you to define central Web settings for the STEP 7 multiproject.

Web settings

The following configurations for the WinCC/WebNavigator can be configured in the SIMATIC Manager:

- Specify a "Monitoring only" cursor permanently for the project (Page 2520)
- Publish process pictures and C functions for Web access by clients (Page 2521)

See also

How to configure a custom "Monitoring only" cursor (Page 2520)

How to configure the publishing of process images (Page 2521)

15.7.2 How to configure a custom "Monitoring only" cursor

Introduction

You can specify a "Monitoring only" cursor permanently for the STEP 7 multiproject in the SIMATIC Manager.

Based on the preset cursor, users on the Web client can see that they cannot operate Runtime.

Requirements

- The user has been assigned system authorization no. 1002 - "Web access - monitoring only" in the WinCC User Administrator.

Procedure

1. In the "Tools" menu of the SIMATIC Manager, select "Central OS Settings" > "WebNavigator".
2. Enter the path and file name of the cursor.
Alternatively, navigate to the file of the desired cursor with the "..." button.
3. Click "OK".

The setting applies to all Web servers in the STEP 7 multiproject.

See also

How to configure the publishing of process images (Page 2521)

15.7.3 How to configure the publishing of process images**Introduction**

To display WinCC process pictures on a WebNavigator client or DataMonitor client, publish the required process pictures and C functions to the Web server.

You can find additional information on publishing process pictures in the documentation for WinCC/WebNavigator:

- "Configuring the WebNavigator system > Configuring a WinCC project > Publishing WinCC process pictures"

Sequence

1. In SIMATIC Manager, select the PCs with the project data you want to publish:
 - Single-user systems
 - OS clients in a multiproject
 - Assigned OS servers of the OS clients
2. In the WinCC Web Publishing Wizard, you determine what will be published:
 - Process pictures
 - Graphics used in the pictures
 - C functions
3. Use the Web View Publisher to publish the project data on the Web server.

Overview of PCs and projects

The "Publish to Web server" dialog shows the PCs on the engineering station with process pictures you can publish:

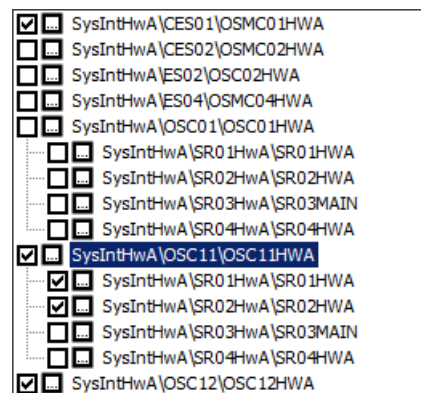

Entry	Display	Procedure
Single-user system	Single-user systems are shown as one line without a subentry.	You publish the process pictures of the local WinCC project on a single-user system.
OS client (WinCC client with its own project)	OS clients can be displayed in a single line or with subentries: <ul style="list-style-type: none"> • The entry for the OS client represents the local project data. • The subentries corresponding to the OS server packages loaded on the client. 	You can define the scope of published data as desired. <ul style="list-style-type: none"> • Project data in the local WinCC client project: Select the check box on the line of the OS client. • Project data of the assigned OS servers: Select the respective checkbox in the line of the desired OS server package. Each OS server package is configured individually.

The WinCC Web Publishing Wizard

You have the following options to start the WinCC Web Publishing Wizard in the "Publish to Web server" dialog:

Select checkbox

You also specify that the data of the selected PC or server packages are to be published.

You use this function, for example, when first configuring the publisher.

"Web View Publisher" button

Click the button: 

You only configure the project data this way. The setting for whether or not the data is to be included in the publishing is not changed.

You use this function, for example, to apply the project changes later.

Language switching

The WinCC Web Publishing wizard is always started in the WinCC user interface language of WinCC Explorer.

To retain the respective user interface language of SIMATIC Manager, follow these steps:

1. Open an OS of the PCS 7 project in SIMATIC Manager.
2. Close the OS again.
The user interface language of SIMATIC Manager is set in WinCC Explorer, and thus in WinCC Web Publishing wizard.

Procedure for configuration change

Changes in a WinCC project can result in an incorrect response in the process pictures in Runtime:

- Changing published process pictures and C functions
- Deleting published process pictures and C functions
- Retrieving the PCS 7 project with "Retrieve"
- Changing the storage path of the PCS 7 project

To avoid errors in Runtime, follow these steps:

1. Perform the configuration again in the WinCC Web Publishing Wizard.
Click the "Web View Publisher" button.
2. Publish the project data again with the "Publish" button.

Copying or moving a project

When the S7/PCS 7 project path changes, for example due to "Save as", the configuration for the WinCC Web Publishing wizard is retained. The settings continue to relate to the previous project and/or the previous project path.

To publish the process pictures and functions of the project, you have to adjust the configuration. Perform the same steps as after a configuration change.

Procedure

1. Select the "Central OS Settings > Publish in Web" command in the "Tools" menu of the SIMATIC Manager.
The PCs are displayed in the "Publish to Web server" dialog.
Select a PC or an OS server package to publish the relevant data.
2. Select the checkbox in front of the entry.
The WinCC Web Publishing Wizard opens. Follow the on-screen instructions.
3. Select the pictures and functions to be published in the dialogs that follow.
4. Click "Configuration".
The configuration is saved. Exit the wizard with "Close".
5. If necessary, repeat steps 2 to 5 for additional entries in the "Publish to Web server" dialog.
6. Click "Publish" in the "Publish to Web server" dialog.
 - The activation of the entries is saved and the dialog is closed.
 - Publishing via the Web View Publisher is started.To save the configuration without starting the publishing, select "Save". The dialog closes.

Diagnostics

If an error occurs during publishing, the operation is canceled.

The "Publish.log" file opens in a text editor. The file contains a brief error message and the path to the log file <project name>.XML. The XML file contains additional information on the configuration and the aborted operation.

The "Publish.log" file is located in the project path of the multiproject or the single project in the "Global" folder.

See also

How to configure a custom "Monitoring only" cursor (Page 2520)

15.8 Selection of STEP 7 Symbols

15.8.1 Selection of STEP 7 Symbols

Introduction

During WinCC configuration, you connect WinCC objects, e.g. I/O fields or archive tags, to tags which are used in Runtime to supply the objects with the current process values.

For process linking, you have the option to choose between two groups of tags: WinCC tags and STEP 7 symbols.

WinCC Tags

These include the internal and external tags of the Tag Management.

STEP 7 Symbols

These are all inputs, outputs, and bit memories from the symbol list as well as all global data blocks of the assigned S7 programs.

You can access STEP 7 symbols directly by means of:

- the tag selection dialog
- the tag bar of the Graphics Designer

Unlike the external WinCC tags, you can access the STEP 7 symbols without having previously performed Compile OS and without selecting with the operator control and monitoring attribute. During process connection, an implicit compilation is performed and the symbol is transferred to the Tag Management of the WinCC project.

See also

Tag Bar (Page 2534)

Tag Selection Dialog (Page 2526)

15.8.2 Tag Selection Dialog

15.8.2.1 Tag Selection Dialog

Introduction

The tag selection dialog allows you to display tags or symbols from various data sources in a selection window and to link these tags or symbols to, for example, picture objects of the Graphics Designer. You determine the displayed data in the Data Source area.

The tag selection dialog is opened automatically when a tag needs to be selected during configuration.

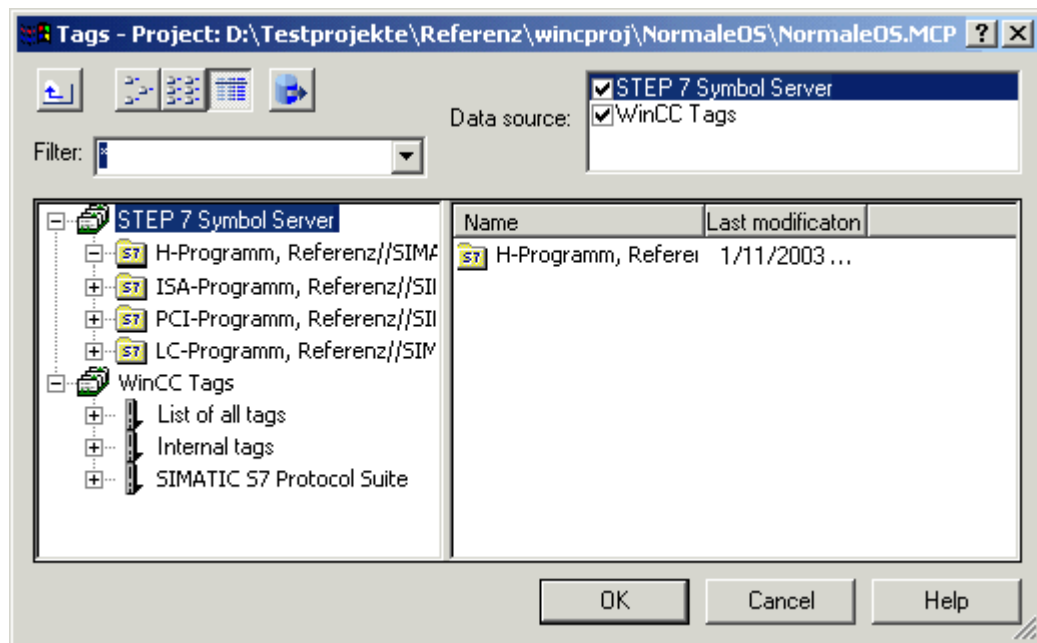

See also

- Tag Bar (Page 2534)
- How to Transfer STEP 7 Symbols (Page 2531)
- How to Select STEP 7 Symbols (Page 2529)
- How to Display STEP 7 Symbols (Page 2527)

15.8.2.2 How to Display STEP 7 Symbols

Introduction

If you activate the STEP 7 Symbol Server check box, a list of all transferable STEP 7 symbols are displayed in the data window. These symbols are all inputs, outputs, and bit memories from the STEP 7 symbol list as well as the global data blocks.

The tag selection dialog has a tag filter. In this field you can use the placeholders "*" and "?" to specify a search condition for the tag name. Only alphanumeric characters can be used for the name search. Exit the field using the Tab or Enter key. Only those tags which match your search criterion are then displayed.

Requirement

- The tag selection dialog must be open.

Procedure

1. Activate the STEP 7 Symbol Server check box.
2. Open the STEP 7 Symbol Server folder in the navigation window.

- Open and select the desired S7 program. The global data blocks and all symbols in the symbol list are now displayed.

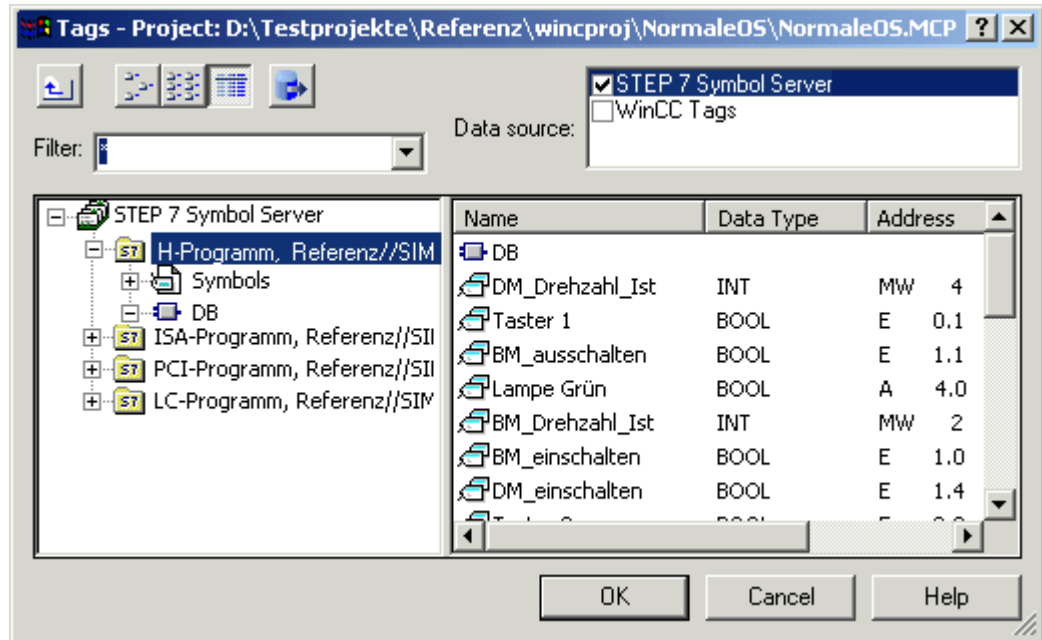

- Open and select the global data block to display its contents.

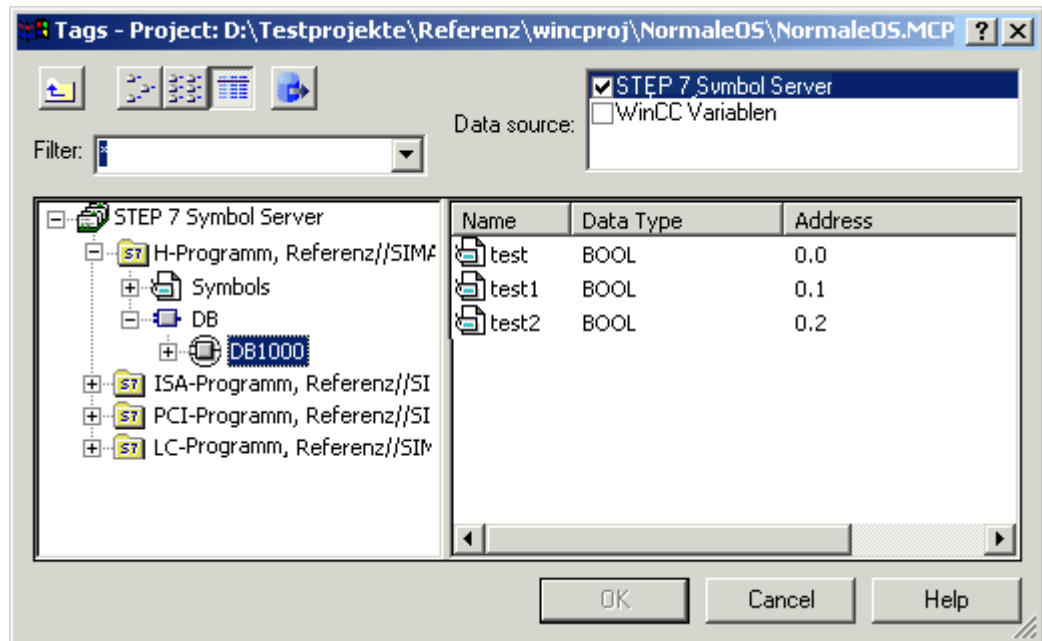

Note

Only the following data types of a global data block are displayed and can be transferred: BOOL, BYTE, WORD, DWORD, INT, DINT, REAL, CHAR and STRING.

See also

Tag Bar (Page 2534)

How to Transfer STEP 7 Symbols (Page 2531)

How to Select STEP 7 Symbols (Page 2529)

Tag Selection Dialog (Page 2526)

15.8.2.3 How to Select STEP 7 Symbols

Introduction

In the tag selection dialog you can select STEP 7 symbols directly for process connection purposes. The selected symbol is then labeled in STEP 7 as operator-controllable and monitorable and transferred to the Tag Management of WinCC by implicitly running the "Compile OS" function.

Note

If you select the symbol of a global data block, all elements provided with the operator-controllable and monitorable attributes of this block are transferred implicitly to Tag Management of WinCC.

Requirement

- STEP 7 symbols must be displayed.

Procedure

1. Select the desired symbol.
2. Select the symbol in the Select Tag dialog box and click "OK" to close the Tag Selection dialog box.

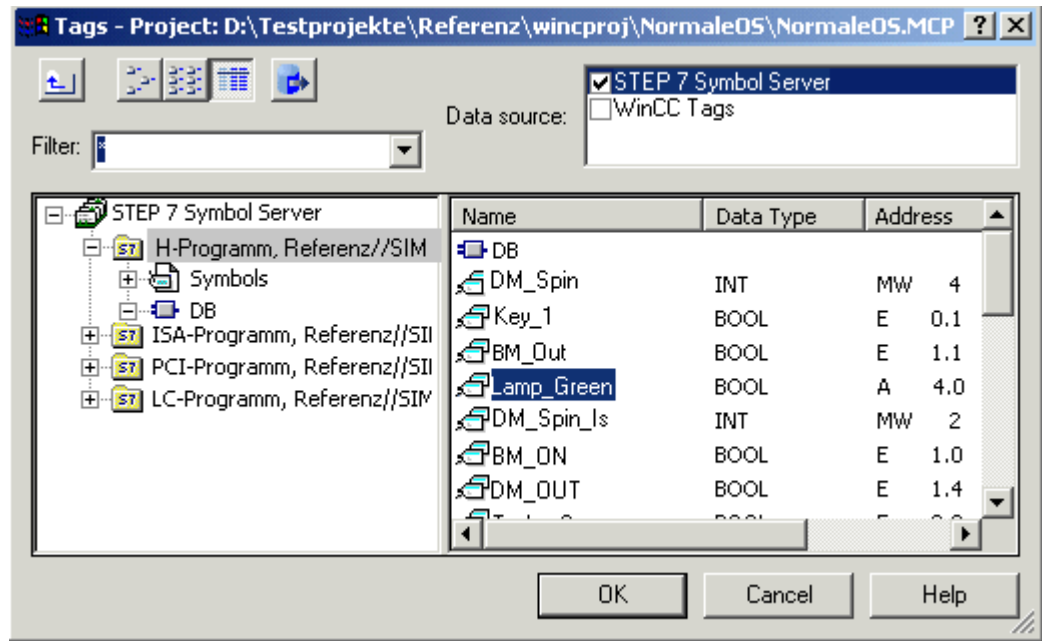

3. If the "Compile OS" function or the implicit transfer has not yet been performed, you must select the desired channel unit (once only) via which communication with the AS is to be set up. In this case, you select the desired network connection.

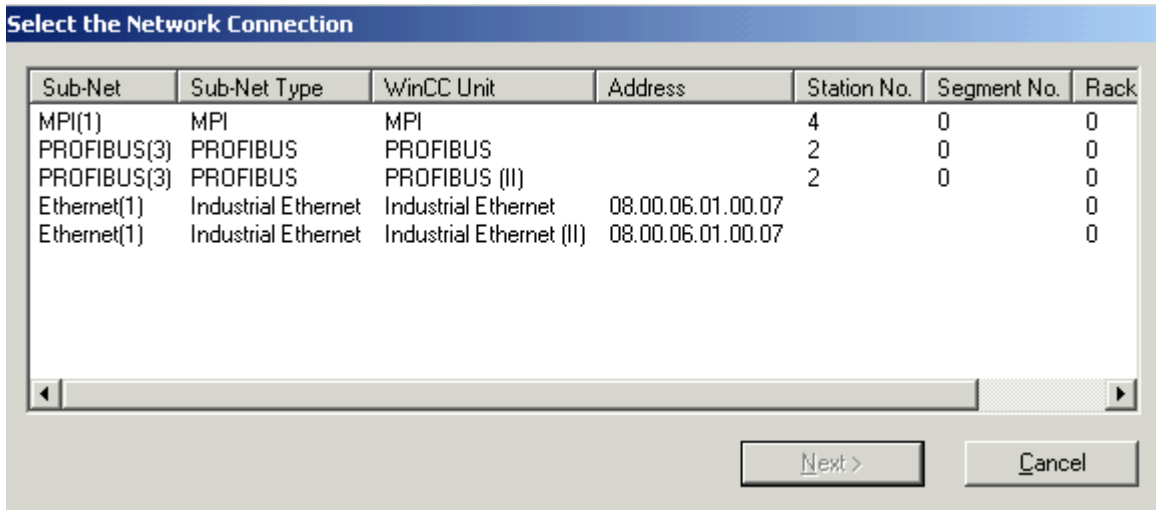

4. Check the created dynamic in the Object Properties.

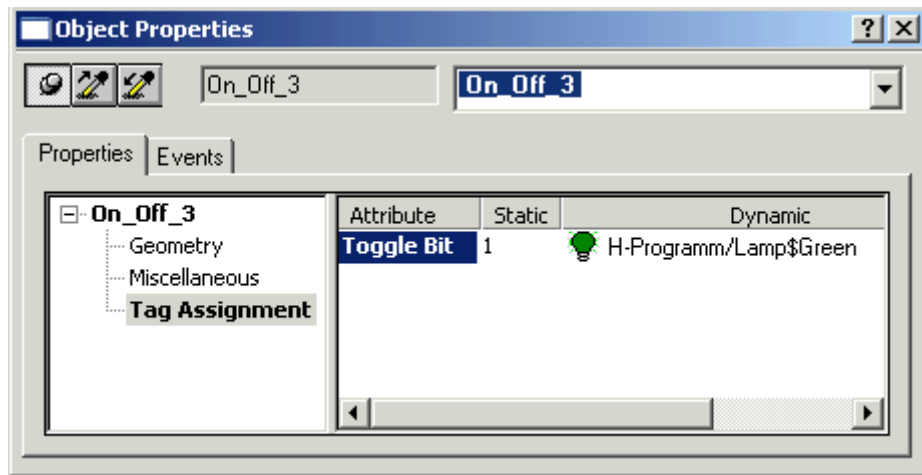

See also

- How to Transfer STEP 7 Symbols (Page 2531)
- How to Display STEP 7 Symbols (Page 2527)
- Tag Selection Dialog (Page 2526)

15.8.2.4 How to Transfer STEP 7 Symbols

Introduction

In the tag selection dialog, you can transfer STEP 7 symbols in the Tag Management without direct process connection being carried out.

Requirement

- STEP 7 symbols must be displayed.

Procedure

1. Select the desired symbols. Several symbols can be selected at the same time using the CTRL or SHIFT keys and clicking with the mouse.
2. Click the "Transfer Data" button.

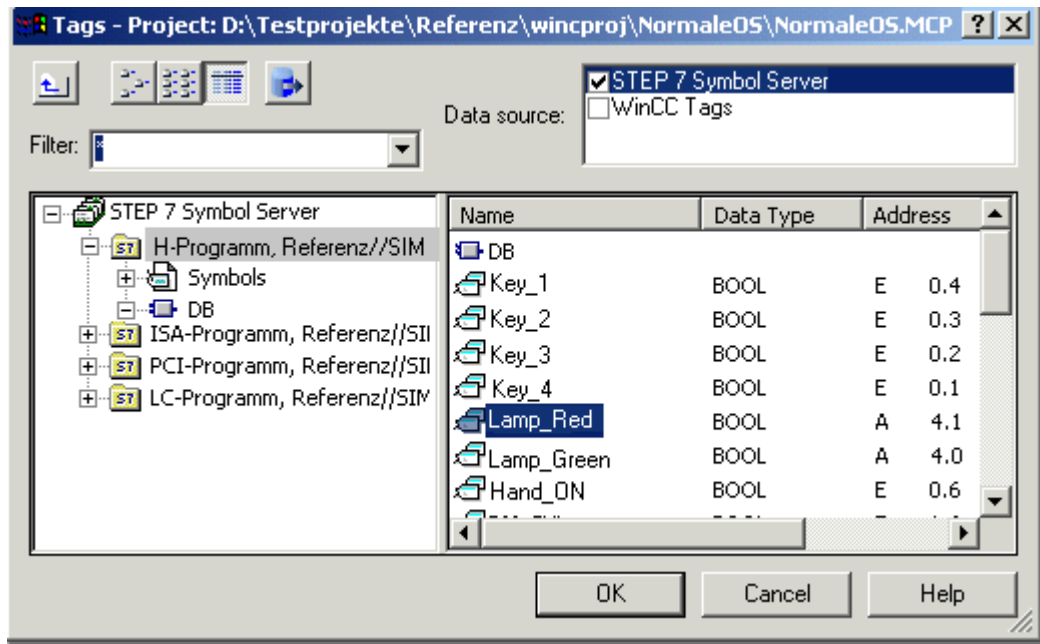

3. If the "Compile OS" function or the implicit transfer has not yet been run, you must select the desired channel unit (once only) via which communication with the AS is to be set up. In this case, you select the desired network connection.

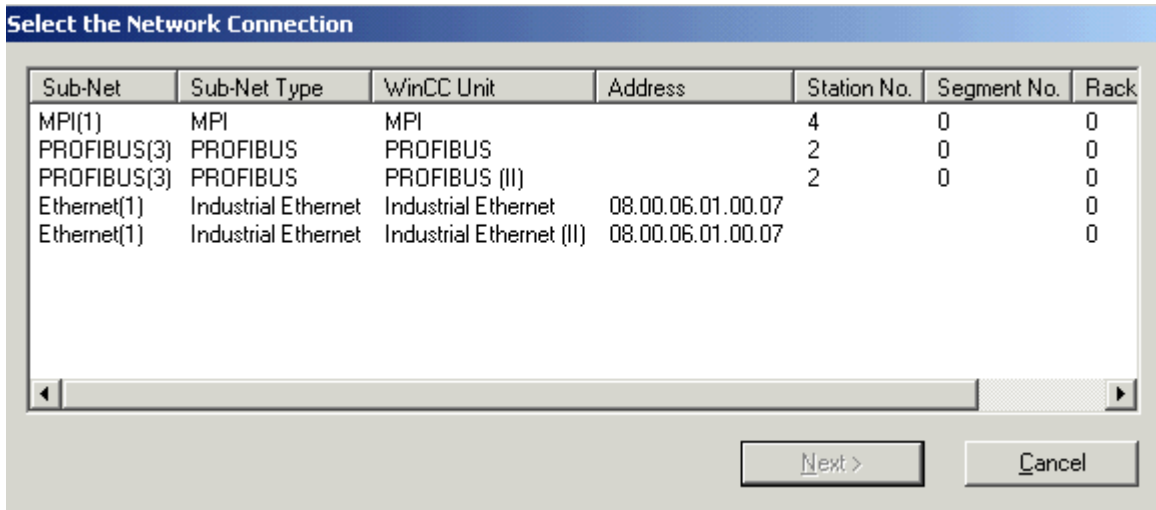

4. Check the result of the transfer in the Tag Management.

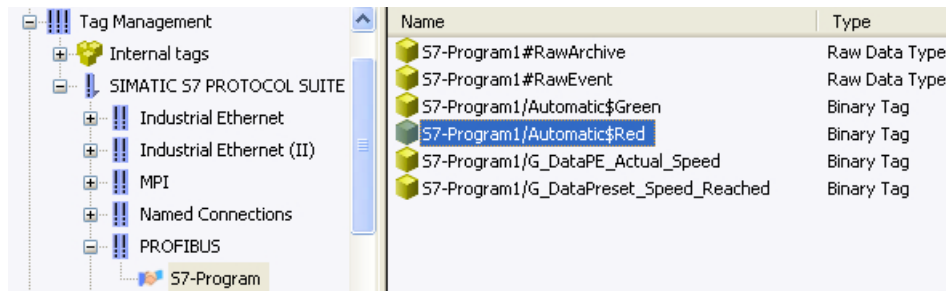

See also

- Tag Bar (Page 2534)
- How to Select STEP 7 Symbols (Page 2529)
- How to Display STEP 7 Symbols (Page 2527)
- Tag Selection Dialog (Page 2526)

15.8.3 Tag Bar

15.8.3.1 Tag Bar

Introduction

Using the tag bar, you can connect tags directly to object attributes and thus dynamize the affected attributes. The tag bar is part of the Graphics Designer and is similar in layout to the tag selection dialog.

Unlike the tag selection dialog, the tag bar remains open after an assignment operation and allows a tag to be connected to an object attribute by means of simple drag and drop.

There are two locations where you can drop the tag:

- on an object in the picture (see below for object types)
- on an attribute in the Properties tab of the Object Properties dialog

Dropping on Object in Picture

If you drop the tag on a graphic object, you do not specify the attribute to be dynamized. The following rules therefore apply:

The attribute to be dynamized is specified in the case of objects which have a simplified configuration dialog. The table shows the objects and the dynamized attribute.

Object	Attribute
I/O Field	Output value
Bar	Process driver connection
Status display	Current status
Text list	Output value
Check box	Selected fields
Option button	Selected fields
Slider object	Process driver connection

The used update cycle is the default cycle set in the Default Object Settings tab of the Settings dialog. You open the Settings dialog under the Extras ->Settings... menu.

No tags can be dropped on standard objects, e.g. circles and lines.

Dropping on Attribute:

Drop the tag on an attribute in the Properties tab of the Object Properties dialog. This attribute is then dynamized by the tag.

See also

How to Transfer STEP 7 Symbols (Page 2531)

How to Select STEP 7 Symbols (Page 2537)

How to Display STEP 7 Symbols (Page 2535)

Tag Selection Dialog (Page 2526)

15.8.3.2 How to Display STEP 7 Symbols

Introduction

The tag bar is part of the Graphics Designer. Unlike the tag selection dialog, the tag bar remains open after an assignment operation.

The tag bar has a tag filter. In this field you can use the placeholders £*£ and £?£ to specify a search condition for the tag name. Only alphanumeric characters can be used for the name search. Exit the field using the Tab or Enter key. Only those tags which match your search criterion are then displayed.

Requirement

- The Graphics Designer must be open.

Procedure

1. Open the list of toolbars by choosing View > Toolbars from the menu. Select Tags and acknowledge with OK.
2. Click on the plus sign in front of the FDLCP5412/A2 icon S7 icon. Select the DB directory. The global data blocks are then displayed.

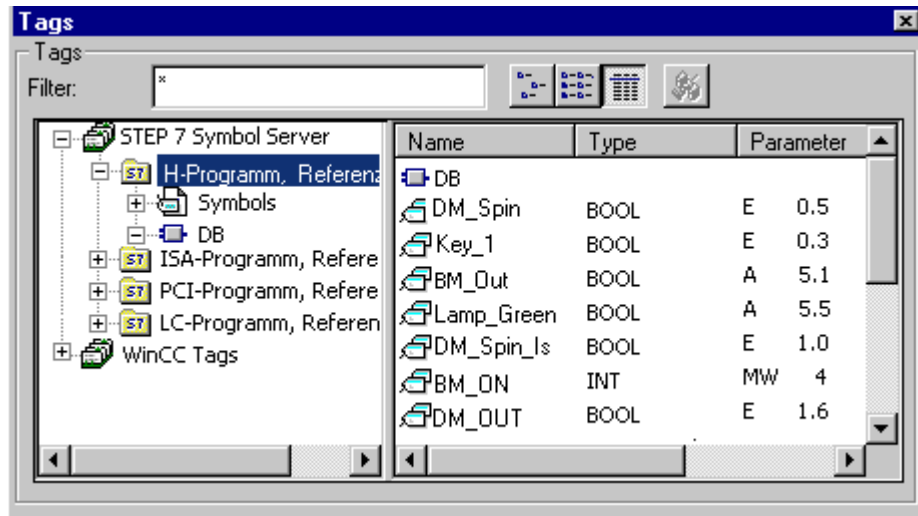

3. Open and select the global data block to display its contents.

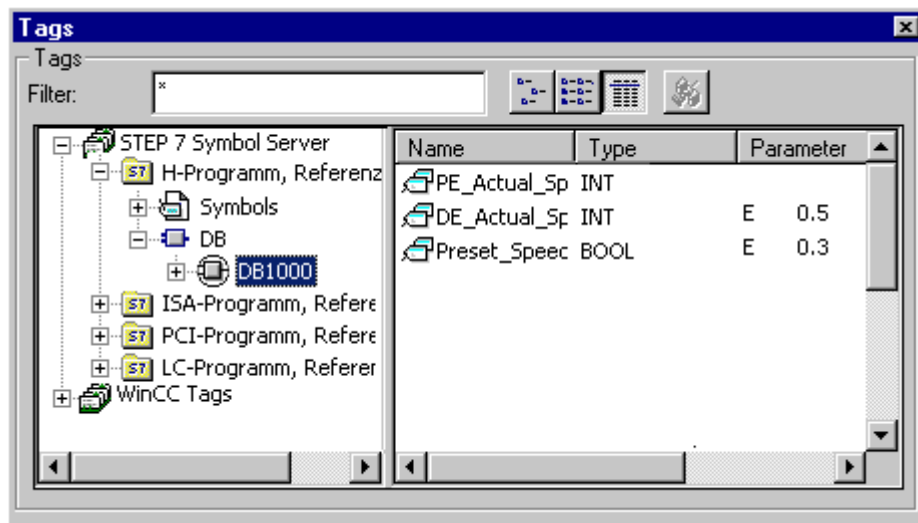

See also

- Tag Bar (Page 2534)
- How to Transfer STEP 7 Symbols (Page 2531)
- How to Select STEP 7 Symbols (Page 2537)
- Tag Selection Dialog (Page 2526)

15.8.3.3 How to Select STEP 7 Symbols

Introduction

You can perform process connection by simply dragging the STEP 7 symbol onto an object or an object attribute.

The selected symbol is then labeled in STEP 7 as operator-controllable and monitorable and transferred to the Tag Management of WinCC by implicitly running the "Compile OS" function.

Note

If you select the symbol of a global data block, all elements provided with the operator-controllable and monitorable attributes of this block are transferred implicitly to Tag Management of WinCC.

Requirements

- The tag bar must be open.
- The STEP 7 symbols must be displayed.

Procedure

1. Select the desired symbol.
2. Drag the symbol onto the desired object or the object attribute.

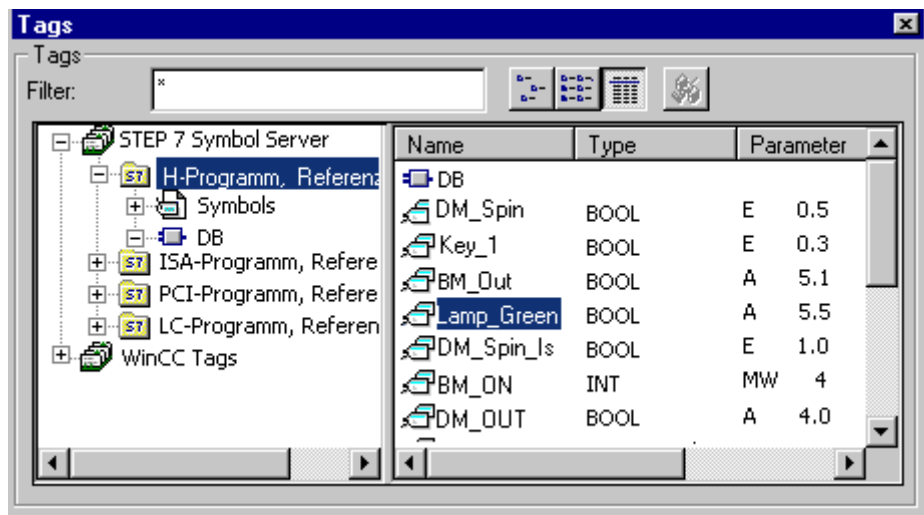

- If the "Compile OS" function or the implicit transfer has not yet been run, you must select the desired channel unit (once only) via which communication with the AS is to be set up. In this case, you select the desired network connection.

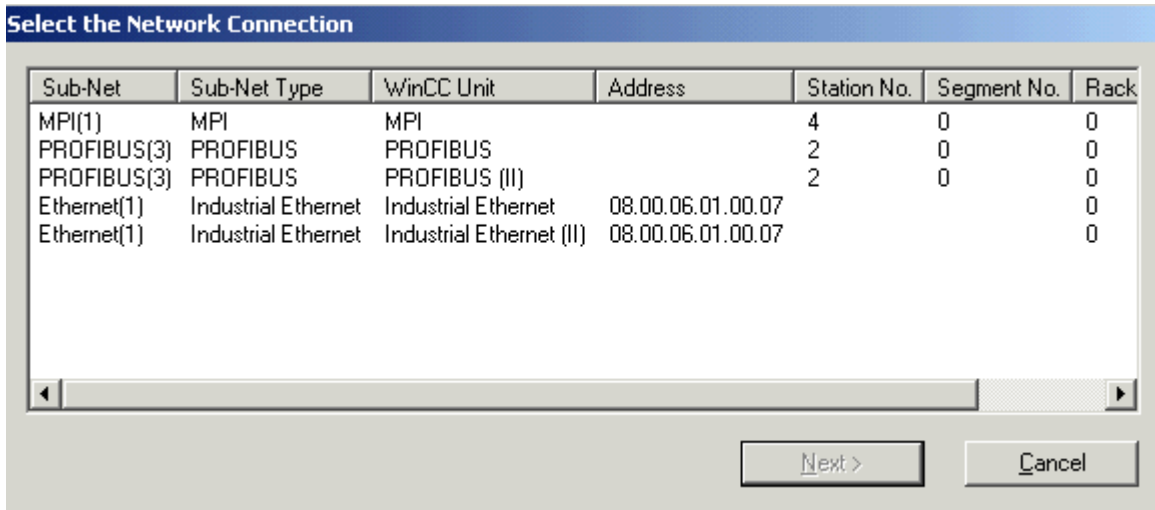

- Check the created dynamic in the Object Properties.

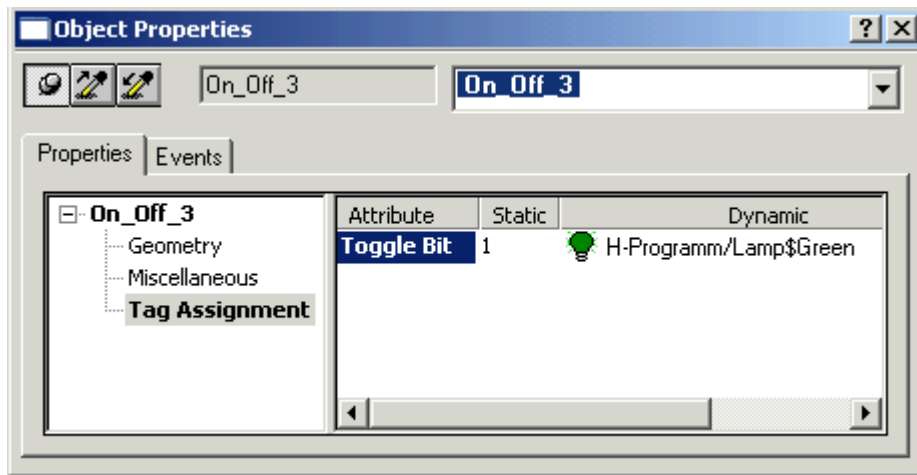

See also

- Tag Bar (Page 2534)
- How to Transfer STEP 7 Symbols (Page 2531)
- How to Display STEP 7 Symbols (Page 2535)
- Tag Selection Dialog (Page 2526)

15.9 Diagnostic Support

15.9.1 Diagnostic Support

Introduction

With the network entry jump and the entry jump into the hardware diagnostics, you can jump directly into STEP 7 from WinCC Runtime. This allows you to diagnose faults quickly and easily.

You can configure the following jumps:

- Network entry jump into the program editor LAD/FBD/STL of STEP 7. You can perform the entry jump with or without the operator authorization check.
- Network return jump from the STEP 7 program editor into the picture in which the process tag belonging to the symbol is used.
- Entry jump to the STEP 7 Hardware Diagnosis function of the respective AS. The entry jump can be completed with or without check of the access authorization.

See also

[How to Configure the Entry Jump into the Hardware Diagnostics \(Page 2546\)](#)

[Jump to Hardware Diagnosis \(Page 2546\)](#)

[How to Configure the Network Entry Jump \(Page 2540\)](#)

[Network Entry Jump \(Page 2539\)](#)

[Network Return \(Page 2543\)](#)

15.9.2 Network Entry Jump

15.9.2.1 Network Entry Jump

Introduction

With the network entry jump, you can jump directly from WinCC Runtime into the appropriate program editor LAD / FBD / STL of STEP 7 with the focus on the STEP 7 symbol belonging to the process tag. This allows you to diagnose faults quickly and easily.

You can configure the network entry jump with or without operator authorization check.

With Operator Authorization Check

For full access to the program editor of STEP 7, you must be logged on at the system and have the authorization required for the network entry jump in Runtime. If you do not have this authorization, you are only granted read access to the blocks in the program editor.

Without Operator Authorization Check

You have read and write access to all blocks in the program editor.

See also

How to Configure the Network Entry Jump (Page 2540)

How to Configure the Entry Jump into the Hardware Diagnostics (Page 2546)

Jump to Hardware Diagnosis (Page 2546)

Network Return (Page 2543)

15.9.2.2 How to Configure the Network Entry Jump

Introduction

In WinCC, you use the Dynamic Wizard to configure the network entry jump at an object created in the Graphics Designer.

Requirements

- The WinCC project must be created as a subdirectory of the STEP 7 project: "STEP 7 Project\wincproj\WinCC Project".
- The "Compile OS" function has been executed.
- A reference list has been generated in the S7 program.
- If you want to configure an operator authorization with its own user level, you must have created the level with the User Administrator beforehand.
- Because the entry jump takes place by a process tag, the process tag has to exist in the S7 connection generated during "Compile OS". STEP 7 icons can be "compiled" implicitly in the tag selection dialog.

Procedure

1. Insert a graphic object such as a "button" into the picture.
2. Select the object.
3. Start the Dynamic Wizard by choosing "View >Toolbars" from the menu.

4. Open the "Network Entry Jump" wizard on the "Standard Dynamics" tab by double-clicking.

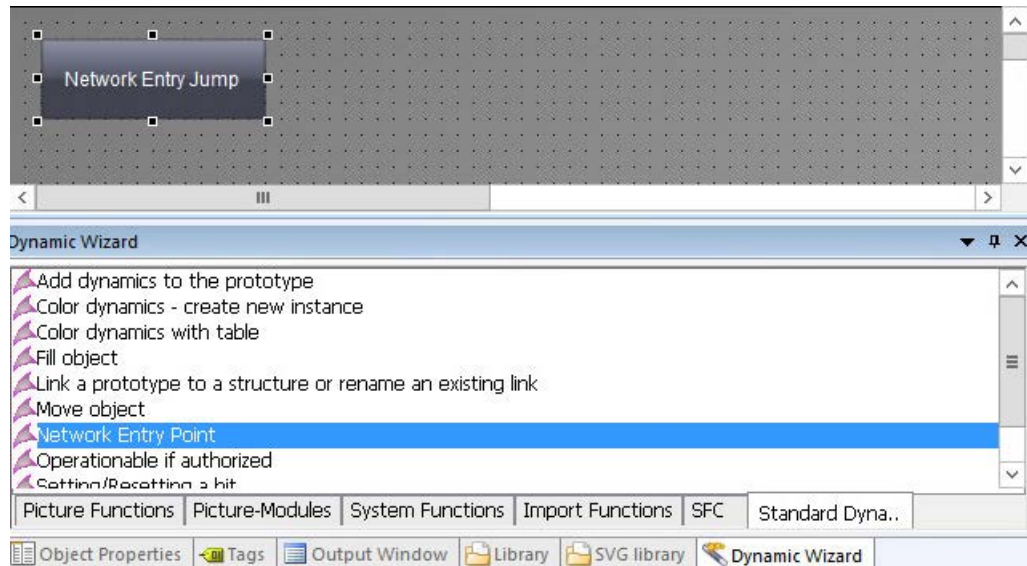

5. The wizard then guides you through the necessary configuration steps. Select the trigger with which the network entry jump is to be executed. Then click "Continue".

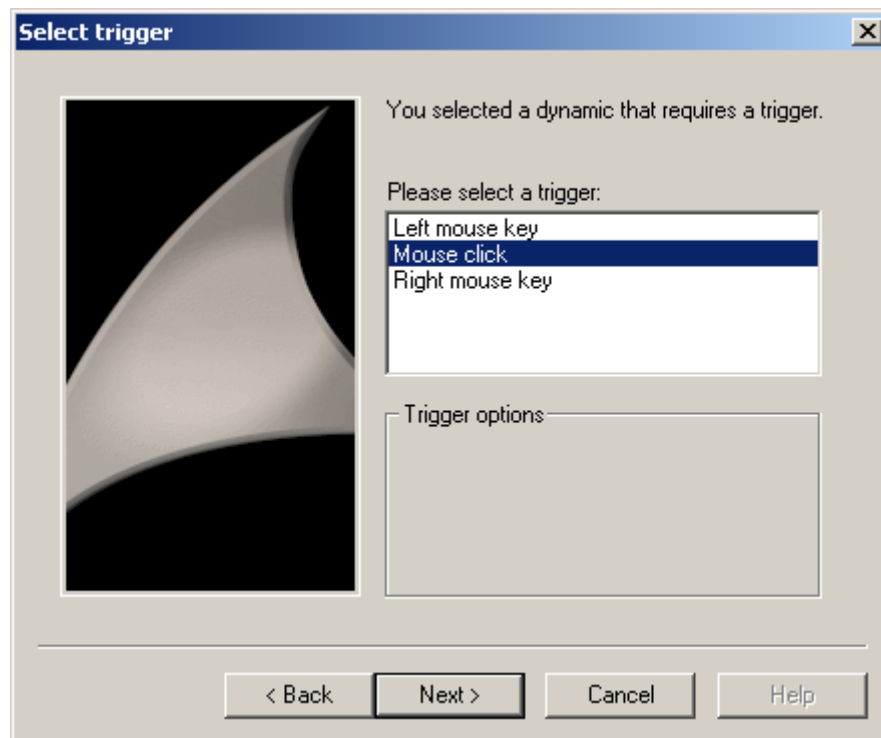

6. Select an attribute of the object such as "ToolTipText". This attribute is connected to the tag selected in the following step.

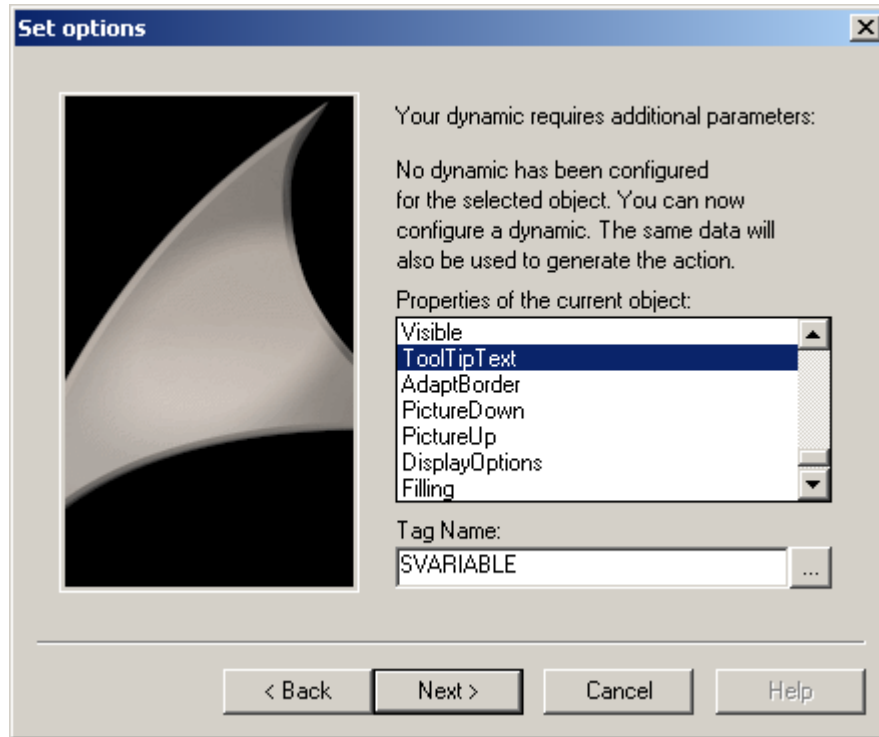

7. Now set the tag for which the network entry jump is to apply. Click the selection button to open the tag selection dialog. Select a tag and then close the dialog box by clicking "OK". Then click "Continue".

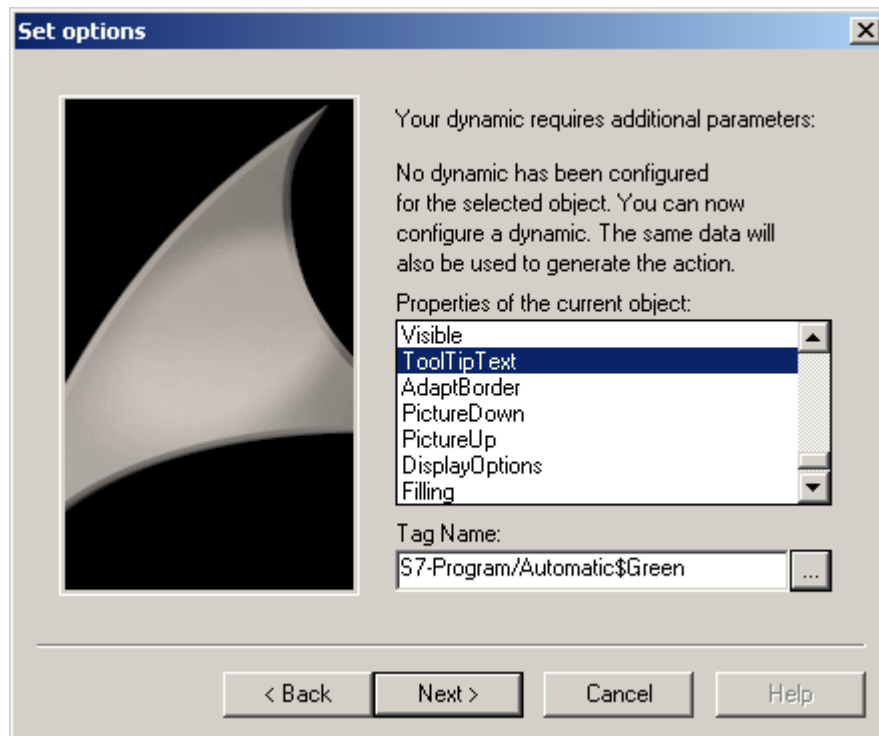

8. Set whether the STEP 7 write authorization is to be checked when the network entry jump is performed. If you want a check to be performed, you must also set the authorization level. Then click "Continue".

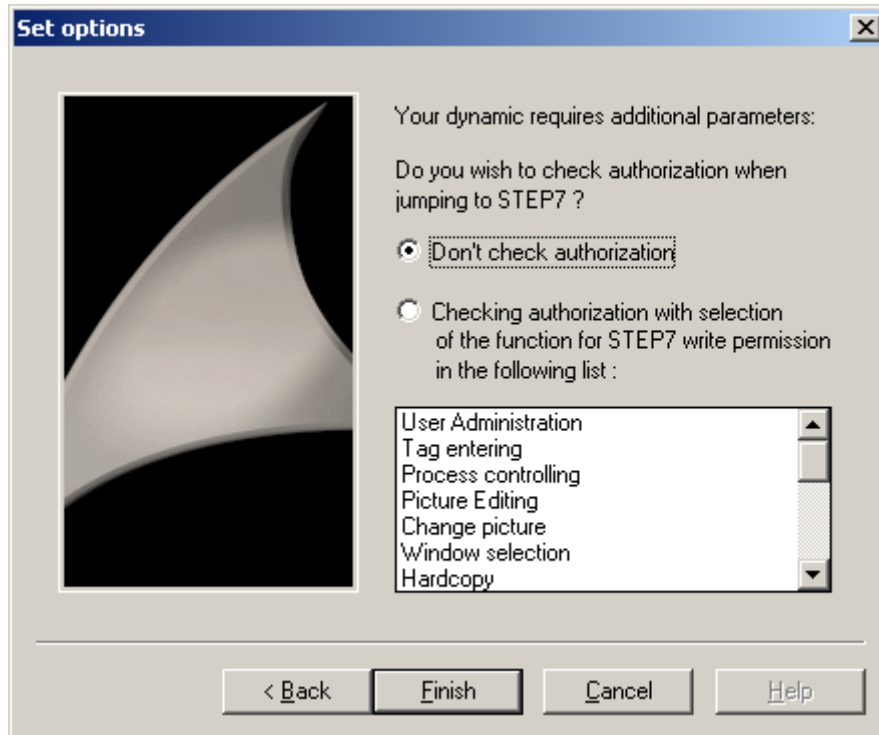

9. An overview of the options you have selected is displayed. Check the options and then click "Finish".

If in Runtime you then select the button you have just configured, the program editor LAD / FBD / STL of STEP 7 is opened and the place of use of the selected tags is displayed.

See also

How to Configure the Entry Jump into the Hardware Diagnostics (Page 2546)

Jump to Hardware Diagnosis (Page 2546)

Network Entry Jump (Page 2539)

Network Return (Page 2543)

15.9.3 Network Return

Introduction

Use the network return to jump from a STEP 7 symbol to the entry point picture.

Configuration Rule

Note the following during configuration of your WinCC pictures or picture windows in which you have also used STEP 7 tags:

- It is advisable to use only basic pictures in the entire WinCC project.
- If you want to use picture window systems, you must ensure that all calls of the network entry jump and all possible return jump destinations are configured on the same picture level. That is to say, either within basic pictures, or within picture windows in basic pictures, or within picture windows in picture windows. Possible return jump destinations are all pictures in which tags are used that are also used in STEP 7.

Requirements

- The WinCC pictures and picture windows must observe the configuration rule.
- A network entry jump out of WinCC must have been performed.

Procedure

1. Select the desired symbol in the program editor LAD / FBD / STL.

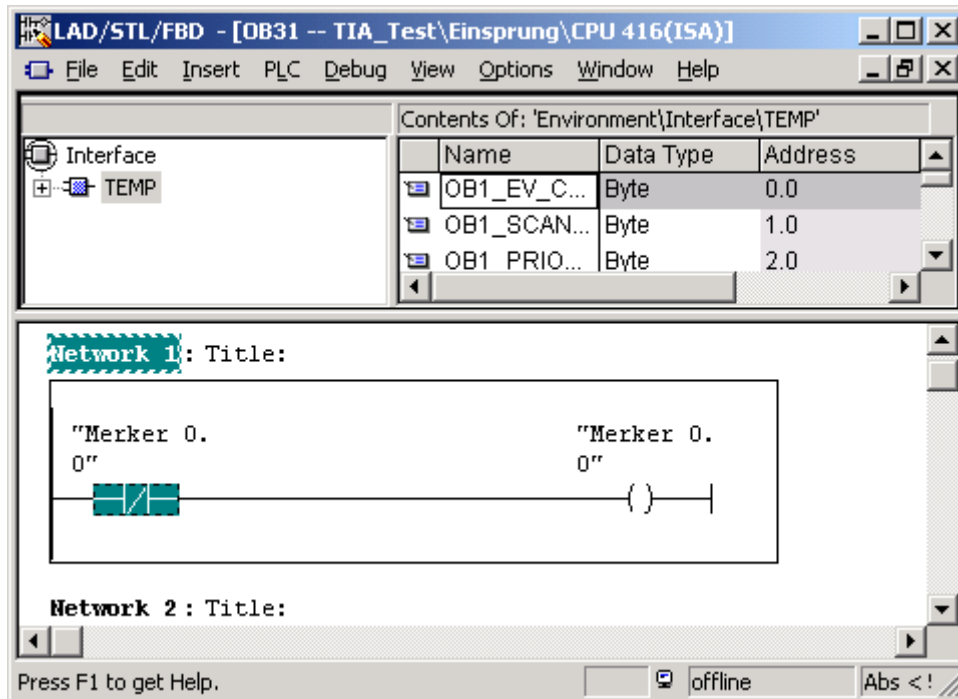

2. Select the entry "Show picture" in the shortcut menu.
3. If the symbol is used in just one picture, this picture is opened and displayed in Runtime. If the symbol is used in more than one picture, you can select the desired picture using a selection list.

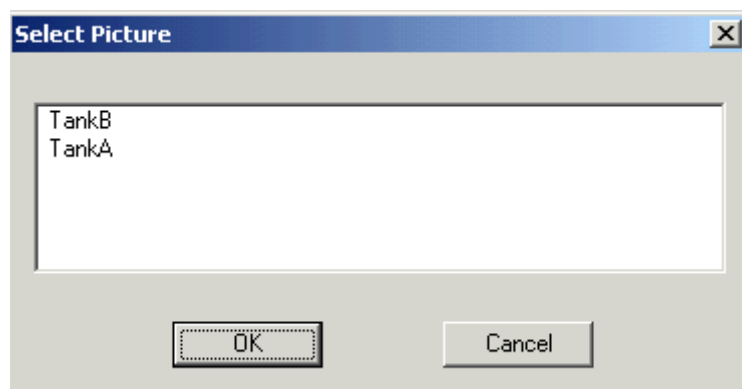

If the selected symbol is not used in any picture, you can view the current picture in Runtime.

See also

How to Configure the Network Entry Jump (Page 2540)

How to Configure the Entry Jump into the Hardware Diagnostics (Page 2546)

Jump to Hardware Diagnosis (Page 2546)

Network Entry Jump (Page 2539)

15.9.4 Jump to Hardware Diagnosis

15.9.4.1 Jump to Hardware Diagnosis

Introduction

The entry jump into the hardware diagnostics enables you to jump directly from WinCC Runtime into the STEP 7 function Hardware Diagnostics of the associated AS. It therefore allows faults to be diagnosed quickly and easily.

You can configure the entry jump into the hardware diagnostics with or without operator authorization check.

With Operator Authorization Check

For full access to the hardware diagnostics of STEP 7, you must be logged on at the system and have the authorization required for the entry jump in Runtime. If you do not have this authorization, only read access is possible.

Without Operator Authorization Check

You have full access to the hardware diagnostics.

See also

How to Configure the Entry Jump into the Hardware Diagnostics (Page 2546)

How to Configure the Network Entry Jump (Page 2540)

Network Entry Jump (Page 2539)

Network Return (Page 2543)

15.9.4.2 How to Configure the Entry Jump into the Hardware Diagnostics

Introduction

You can configure the entry jump into the hardware diagnostics at an object created in the Graphics Designer. A separate wizard for the entry jump into the hardware diagnostics is not available which means that you have to use and modify the "Network Entry Jump" wizard.

Requirements

- The "Compile OS" function has been executed.
- If you want to configure an operator authorization with its own user level, you must have created the level with the User Administrator beforehand.
- The connection parameters to the automation system are determined by means of a process tag. A process tag therefore has to exist in the S7 connection generated during "Compile OS". STEP 7 icons can be "compiled" implicitly in the tag selection dialog.

Procedure

1. Insert a graphic object such as a "button" into the picture.
2. Select the object.
3. Start the Dynamic Wizard by choosing "View > Toolbars" from the menu.
4. Open the "Network Entry Jump" wizard on the "Standard Dynamics" tab by double-clicking.
5. The wizard then guides you through the necessary configuration steps. Select the trigger with which the network entry jump is to be executed. Then click "Continue".

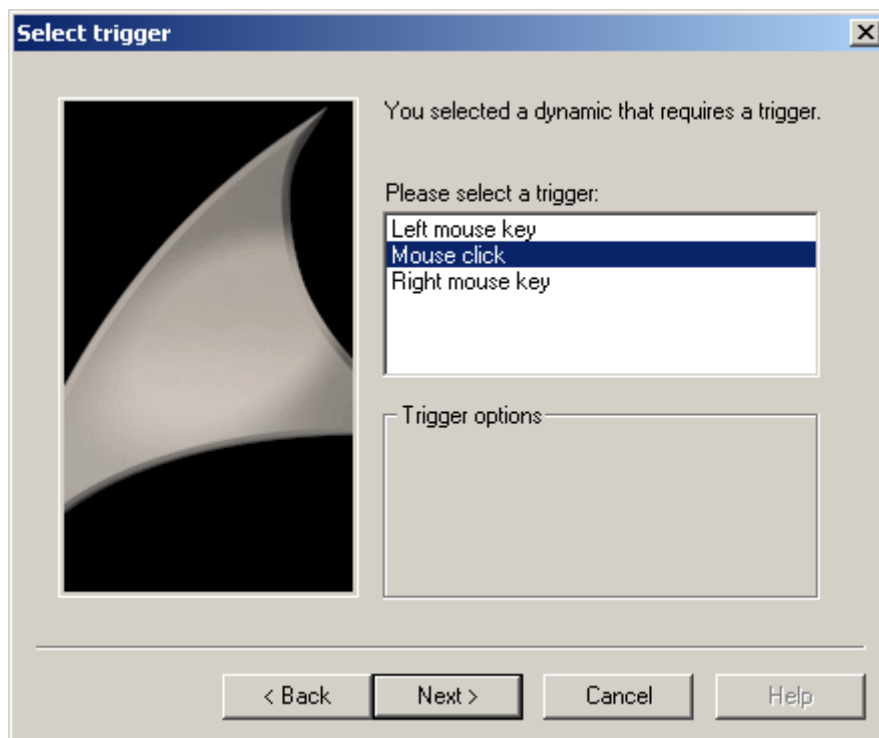

- 6. Select an attribute of the object such as "ToolTipText". This attribute is connected to the tag selected in the following step.

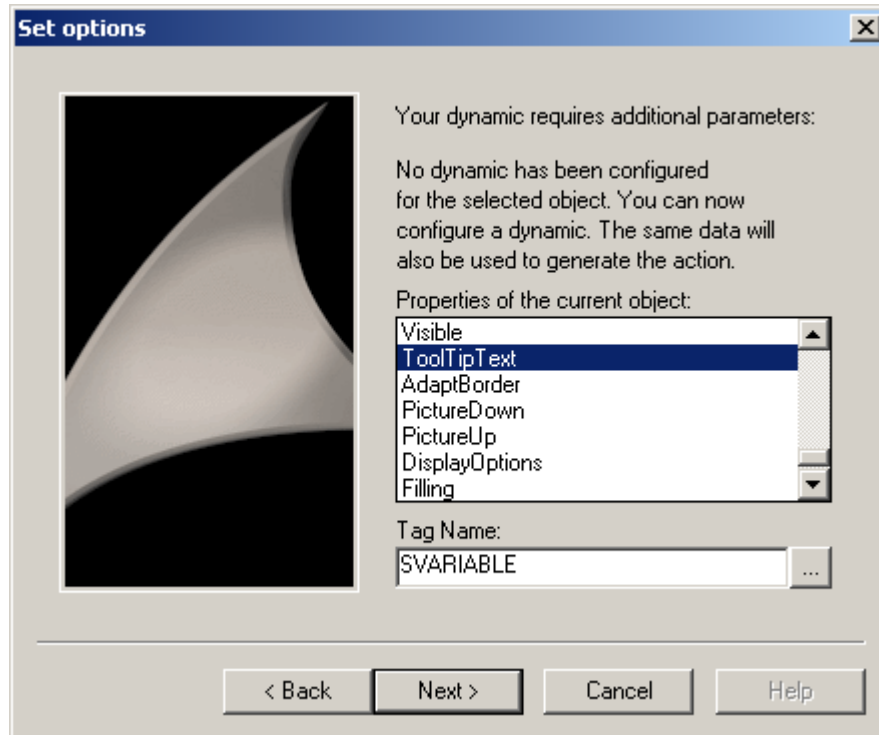

- 7. Set the tag via which the entry jump is to be performed. Click the selection button to open the tag selection dialog. Select a tag and then close the dialog box by clicking "OK". Then click "Continue".

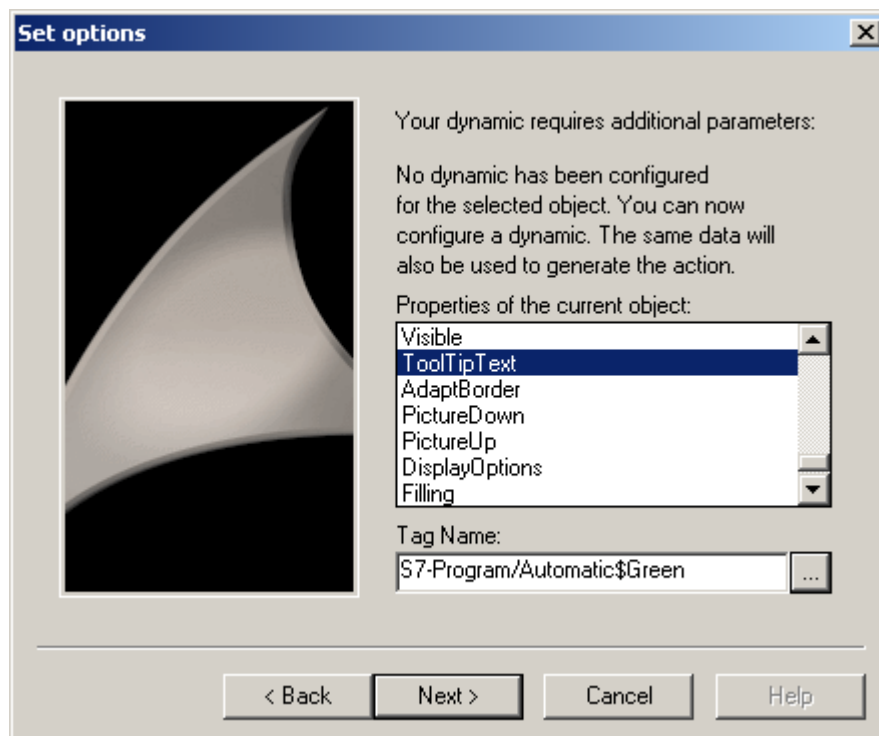

- Specify whether or not to check the STEP 7 write authorization upon network entry jump. If you want a check to be performed, you must also set the authorization level. Then click "Continue".

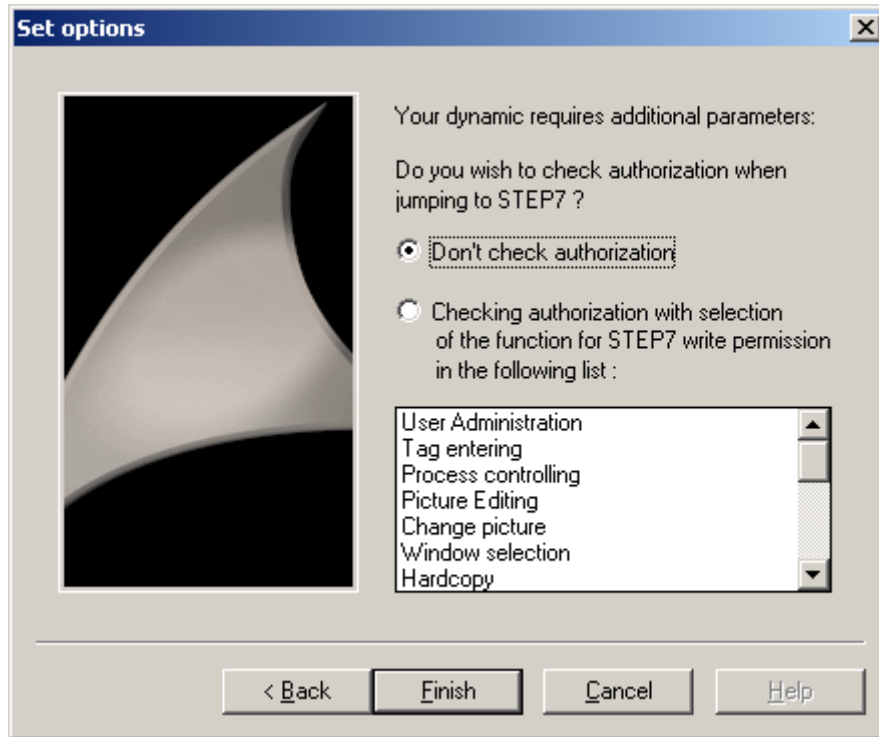

- An overview of the options you have selected is displayed. Check the options and then click "Finish".
- When the entry jump is configured, a script is created which executes the jump. You must rewrite this script for a jump into the hardware diagnostics. To do so, open the Pop-up menu of the objects which you are using, and choose the "Properties" option to open the "Object Properties" dialog box.

11. Open the "Event" tab and navigate to "Button > Mouse > Mouse Action".

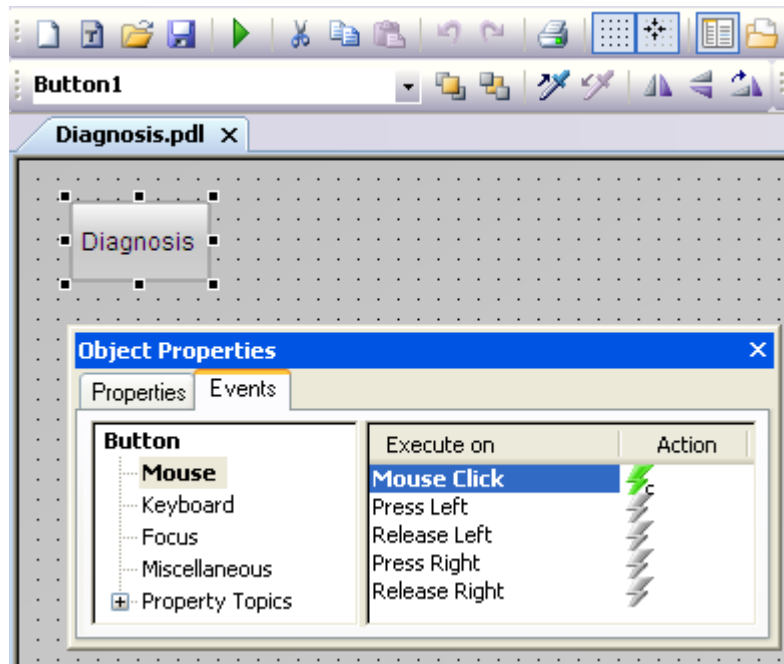

12. Double-click the symbol in the "Action" column. The editor opens and displays the script.

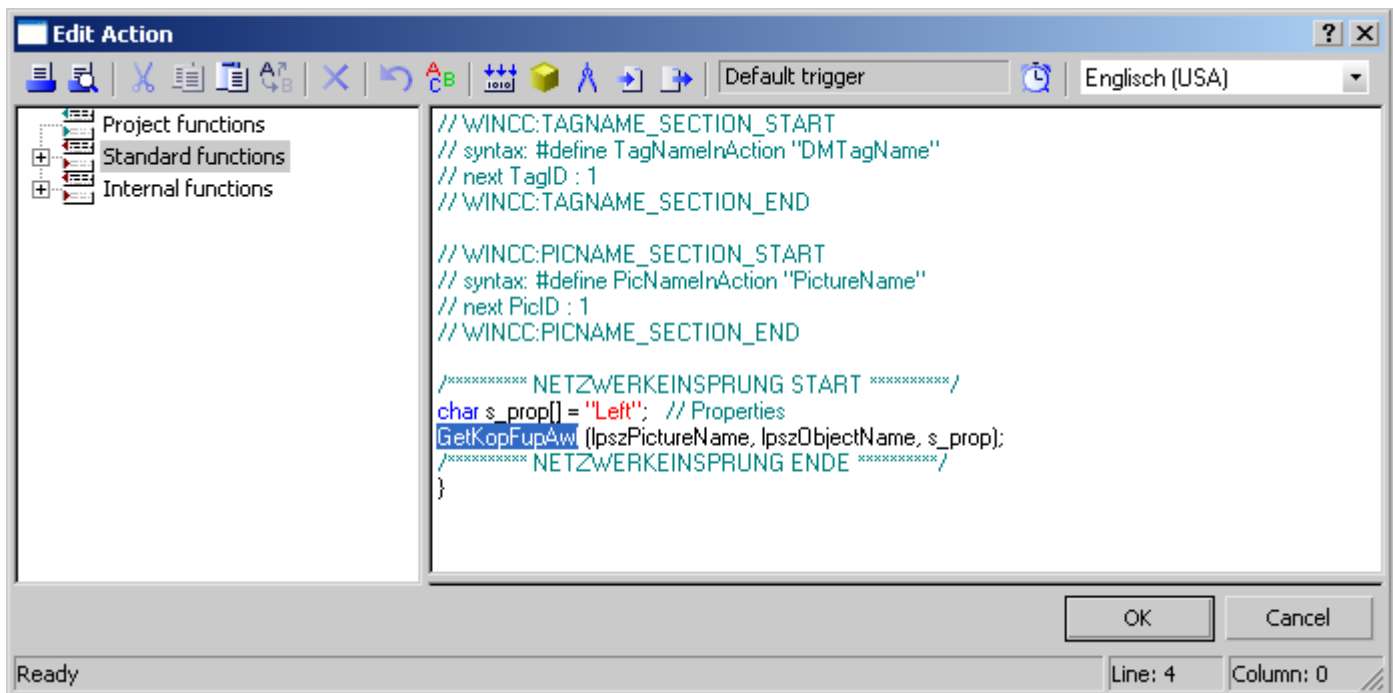

13. Replace the entry "KopFupAw1" with "HWDiag".

14. Close the dialog box and compile the changed script.

You can return to WinCC after entering hardware diagnostics by closing the hardware diagnostic program, or by pressing <ALT>+<TAB>.

See also

[Jump to Hardware Diagnosis \(Page 2546\)](#)

[How to Configure the Network Entry Jump \(Page 2540\)](#)

[Network Entry Jump \(Page 2539\)](#)

[Network Return \(Page 2543\)](#)

SmartTools

16.1 Overview

Content

SmartTools is a collection of useful programs that support working with WinCC.

It contains the following programs and files:

- WinCC Tag Simulator
- Dynamic Wizard Editor
- Documentation Viewer
- WinCC CrossReferenceAssistant

Note

SmartTools are supplementary tools.

Bear in mind that they may have an impact on how WinCC works, such as on its Runtime behavior and memory requirements.

As far as user friendliness and functionality are concerned, the same criteria as for the WinCC Basis software do not necessarily apply.

See also

[Dynamic Wizard Editor: Overview \(Page 2563\)](#)

[WinCC Tag Simulator \(Page 2554\)](#)

[WinCC Documentation Viewer \(Page 2638\)](#)

[WinCC CrossReferenceAssistant \(Page 2641\)](#)

16.2 Tag simulator

16.2.1 WinCC Tag Simulator

WinCC Tag Simulator is used to simulate projects that contain internal tags and process tags. You use it, for example, to simulate the behavior of objects and scripts in the WinCC project. The Tag Simulator is typically used to test configuration with or without connected process I/Os, however, without active process.

Brief description

The following general conditions apply for the simulator:

Update cycle	The update time for tag values is one second. Specify a multiple of a second using the "Cycle" parameter.
Quantity structure	A maximum of 300 tags can be simulated at the same time. However, you can configure and save more tags in the simulator.
Tag types	Simulation of the following tag types is not supported: <ul style="list-style-type: none"> • Raw data tag • Text reference • Date/time Only the input of numbers is supported in the text tags. Text input is not simulated.
Online configuration	Configuration changes of the simulation are immediately visible in Runtime.



WARNING

Tag Simulator writes to connected controllers

If the WinCC project is connected to a controller, the Tag Simulator writes the process values to the connected automation system.

That can trigger a reaction in any connected process I/Os.

Disconnect hardware

Before using the simulator, ensure that

- No hardware is connected, if possible.
- The connected hardware represents no danger even when values are extreme.

SIMATIC S7-PLCSIM Advanced

WinCC supports the simulation of a virtual controller with the SIMATIC S7-PLCSIM Advanced simulation software.

Additional information can be found in the PLCSIM product documentation.

See also

Using the Tag Simulator (Page 2555)
Start simulator (Page 2556)
Configuring functions for the simulation (Page 2557)
How to simulate tags (Page 2560)

16.2.2 Using the Tag Simulator**Application examples****Testing a WinCC project**

For example, the tag simulator is typically used to test a configuration without connected process I/Os or without a running process.

When process I/Os are connected, the process tags can be directly supplied with values using the simulator.

In this way, a function test of the operator control and monitoring system can be performed with the original hardware.

Presenting a WinCC project

Another possible use of the tag simulator is for implementing a project for demonstration purposes.

A process connection is usually not available for the presentation of the operator control and monitoring system.

In this case, the simulation performs the control of internal tags.

Simulation of the process tags

Without connected process I/Os, only internal tags can be simulated.

When process I/Os are connected, the process tags can be directly supplied with values using the simulator.

In this way, a function test of the operator control and monitoring system can be performed with the hardware, for example:

- Check of limit levels and message outputs.
- Test the integration of alarms, warnings, and error messages and check of status displays.
- Preset, readout, and change of digital and analog inputs and outputs.
- Alarm simulation

See also

WinCC Tag Simulator (Page 2554)

16.2.3 Start simulator

Installation

WinCC Tag Simulator is installed with the WinCC SmartTools

Supplementary installation

It is also possible to install the simulator from the WinCC DVD:

1. Double-click the "setup.exe" program in the folder "WinCC\InstData\Smarttools\Setup"
2. Select the "WinCC TAG Simulator" component
3. Follow the on-screen instructions.

Start WinCC Tag Simulator

The tag simulator is opened in a separate window of the WinCC Configuration Studio.

You have the following options for starting the simulator:

- WinCC Explorer navigation area:
 - Double-click the "Simulation tags" entry.
 - Select the "Open" command in the "Tags simulation" shortcut menu.
- WinCC Explorer data area:
 - Double-click a simulation file.
 - In the shortcut menu of a simulation file, select the "Open " command.
- In the "Siemens Automation" Windows program group, select the entry "WinCC TAG Simulator".

Simulation file

You can save a configured simulation as a file in "*.sim" format and call it up again later.

To create a new simulation file, select the entry "New simulation" in the "Tags simulation" shortcut menu.

In the data area, you can rename, open or delete the simulation via the shortcut menu.

To save your configuration in the "Tags simulation" editor, select "File > Save" or "File > Save as" in the menu.

The simulation file is saved in the WinCC project folder "Simulation".

See also

WinCC Tag Simulator (Page 2554)

Configuring functions for the simulation (Page 2557)

How to simulate tags (Page 2560)

16.2.4 Configuring functions for the simulation

Functions for the simulation

Select how the tag value is simulated for each tag.

The following functions are available:

- Sine
- Oscillation
- Random values
- Increment
- Decrement
- User input (slider)
- Script

"Binary tag" data type

The "Sine" and "Oscillation" function are not supported by binary tags.

Sine function

Periodic, non-linear function:

Parameters	Description
Amplitude	Value range
Offset	Zero point for the value range
Oscillation period	Duration of period in seconds

Oscillation

Simulation of jumps of a setpoint:

Parameters	Description
Overshoots	Maximum deviation from the rated value
Oscillation	Rated value
Oscillation period	Time interval of the oscillation in seconds. The oscillation restarts after the specified time has elapsed.
Damping	Reduction of amplitude within the oscillation period

Random values

Randomly generated values:

Parameters	Description
Random minimum value	Smallest possible value
Random maximum value	Greatest possible value

Increment

Up counter which restarts at the minimum value when it reaches the maximum value:

Parameters	Description
Initial value Increment	Minimum value The start value is applied at runtime start.
End value Increment	Maximum value
Step Increment	Value increase, e.g. in increments of 10

Decrement

Down counter; restarts the maximum value after having reached the minimum value:

Parameters	Description
Initial value Decrement	Maximum value The start value is applied at runtime start.
End value Decrement	Minimum value
Step Decrement	Value reduction, e.g. in decrements of 10

User input

Enter in the "Value set" table field or use the slider:



Parameters	Description
Slider minimum value	Lowest value that can be entered or selected with the slider
Slider initial value	Value at runtime start
Slider maximum value	Highest value that can be entered or selected with the slider.

Slider

1. To open the slider in runtime, click in the "Value set" field in the table area.
2. Click the displayed button: 
3. Move the bar with the mouse or the cursor keys.
4. Close the slider using the "x" in the top-right.

Script

VBScript function with the return value that is written to the WinCC tag:

Parameters	Description
Apply code	Deactivated: Only the "VBS function" option is active. Activated: Only the "VBS code" option is active.
VBS function	Selection of a created VBS function To select a VBS function, click on the button displayed in the field: 
VBS code	Entering a new VBS function The function is stored in the simulation file. To open the VBS editor, click on the button displayed in the field: 

Restrictions

- It is not possible to access WinCC while the script is running.
- HMIRuntime, HMITags etc. are not supported.
- If the script cannot be processed in the current cycle, it is not called up again until of next update cycle after processing has been completed.
If necessary, stop the simulation using menu command "Simulation > Stop" in order to deactivate tag simulation and correct the script.

Configuration

The VBS function must have a transfer parameter.

An object with the following properties is passed to the script during the execution:

Write / read access	Property	Description
Read and write	UserData	The script can cache a value.
Read only	Tag name	Name of the WinCC tag with the value the script calculates
	Data type	The data type of the tag as numerical value
	Counter	Counter with which the cycle is increased
	Value	Last calculated tag value

Example

```
'VBS378
Sub Tag_Simulation_01 (Byval Item)
  MyCalculatedValue = Item.Counter
  ' do your own calculation

  ' write the calculated value to be set by WinCC TAG Simulator
  Item.Value = MyCalculatedValue
End Sub
```

See also

WinCC Tag Simulator (Page 2554)

Start simulator (Page 2556)

How to simulate tags (Page 2560)

16.2.5 How to simulate tags

In the WinCC TAG Simulator, select the tags that you want to simulate.

Select the simulation type and the update cycle for each tag.

**WARNING****Tag Simulator writes to connected controllers**

If the WinCC project is connected to a controller, the Tag Simulator writes the process values to the connected automation system.

That can trigger a reaction in any connected process I/Os.

Disconnect hardware

Before using the simulator, ensure that

- No hardware is connected, if possible.
- The connected hardware represents no danger even when values are extreme.

Procedure

1. To select a tag in the "Tag name" column, click on: 
The tag selection dialog is displayed.
2. Select one or more tags and click "Apply".
The tags are inserted.
When you have inserted all required tags, close the dialog by clicking "OK".
Alternatively, drag the desired tags from the "Tag management" editor to the simulator using drag-and-drop.
3. Selection the function for the simulation
4. To change the update cycle, enter a number > 1 in the "Cycle" field.
An update cycle of 1 second is the basis. To change the simulated value, every 5 seconds for example, enter "5".

5. Select the function parameters.

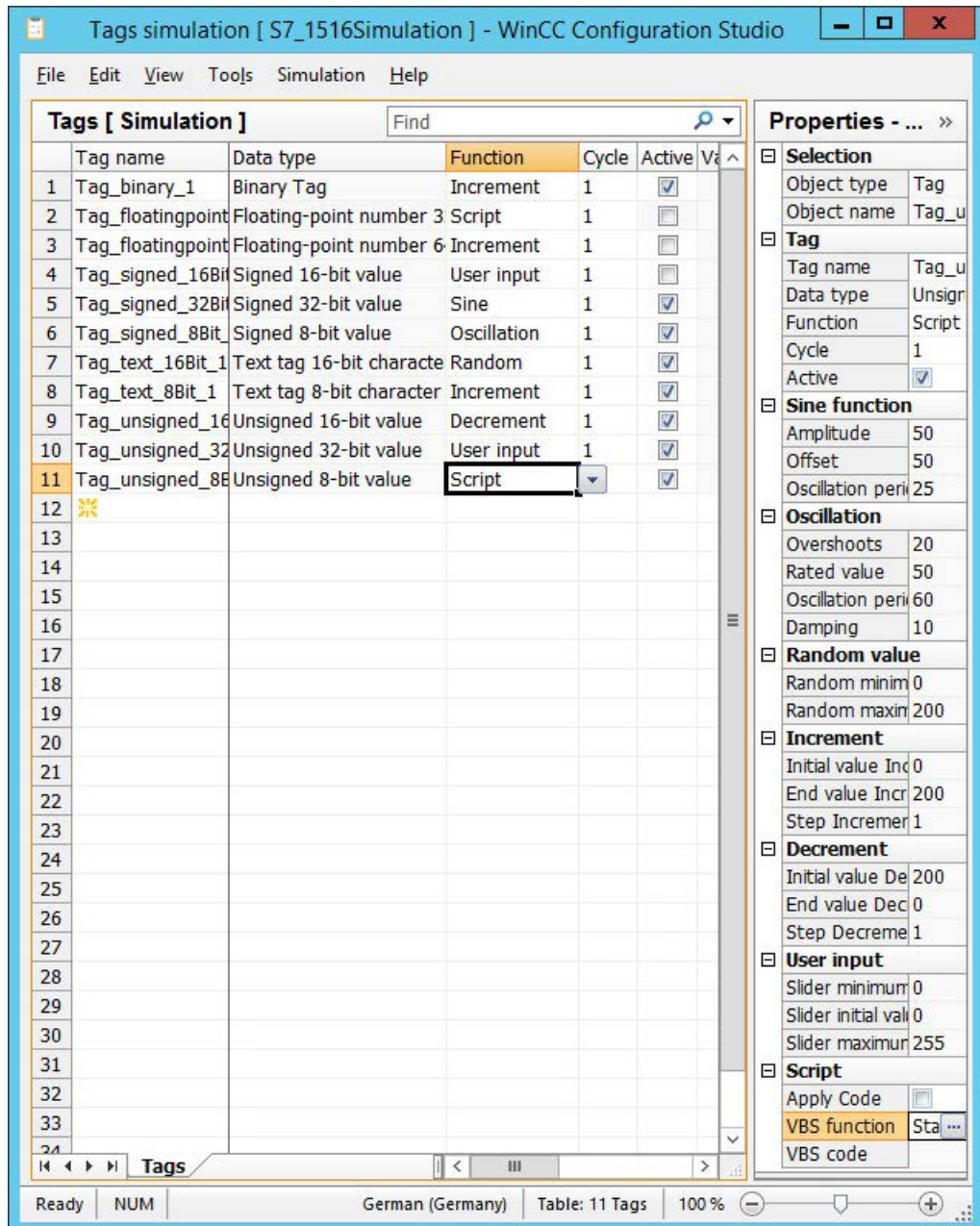

6. Activate the simulation of the required tags in the "Active" column. You can simulate a maximum of 300 tags simultaneously, even if more tags are configured in the simulator.
7. Save the simulation using the menu command "File > Save as". This allows you to reuse the projected simulation later, for example, to test a changed configuration.
8. If runtime is deactivated, activate WinCC Runtime.

- Start the simulation using the menu command "Simulation > Start".
The simulated values are displayed in the "Value set" column.
The actual values of the tags are displayed in the "Current value" column.

Tags [Simulation active]							
	Tag name ▲	Function	Cycle	Active	Value set	Current value	Time stamp
1	Tag_binary	Increment	1	<input checked="" type="checkbox"/>	0	1	7/10/2018 11 C
2	Tag_floatingpoint_3	Script	1	<input checked="" type="checkbox"/>	414	413	7/10/2018 11 C
3	Tag_floatingpoint_6	User input	1	<input checked="" type="checkbox"/>	75	75	7/10/2018 11 C
4	Tag_signed_8Bit	Sine	1	<input checked="" type="checkbox"/>	43.73333832	56	7/10/2018 11 C
5	Tag_signed_16Bit	Oscillation	1	<input checked="" type="checkbox"/>	47.42884956	49	7/10/2018 11 C
6	Tag_signed_32Bit	Random	1	<input checked="" type="checkbox"/>	69.68261718	29	7/10/2018 11 C
7	Tag_text_8Bit	Increment	1	<input checked="" type="checkbox"/>	12	11	7/10/2018 11 C
8	Tag_text_16Bit	Decrement	1	<input checked="" type="checkbox"/>	189	190	7/10/2018 11 C
9	Tag_unsigned_8Bit	User input	1	<input checked="" type="checkbox"/>	63	...	7/10/2018 11 C
10	Tag_unsigne						
11	Tag_unsigne						
12	✖						
13							
14							
15							

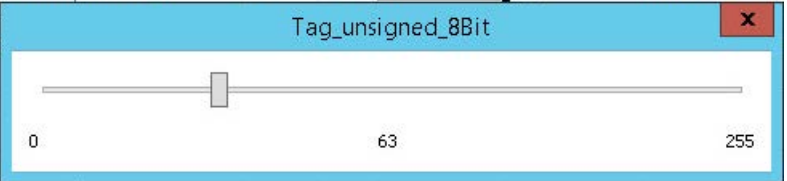

- To stop the simulation, select the menu command "Simulation > Stop".
The simulation is also closed when WinCC Runtime is deactivated.

See also

WinCC Tag Simulator (Page 2554)

Start simulator (Page 2556)

Configuring functions for the simulation (Page 2557)

16.3 Dynamic Wizard Editor

16.3.1 Dynamic Wizard Editor: Overview

Introduction

The **Dynamic Wizard Editor** is a tool for creating your own dynamic wizards. Recurring configuration sequences can be automated with dynamic wizards.

The Dynamic Wizard is available as additional functionality in the Graphics Designer. It can support the user in case of frequently recurring configuration sequences. The configuration effort is reduced and possible configuration errors are reduced.

The Dynamic Wizard consists of different Dynamic Wizard functions. A large number of Dynamic Wizard functions is already available. You can find additional information in the WinCC Information System under "Working with WinCC> Dynamizing process pictures > Dynamic Wizard".

The Dynamic Wizard functions can be replaced with self-created functions.

A separate editor is available for creating your own Dynamic Wizard functions. The program is called dynwizedit.exe.

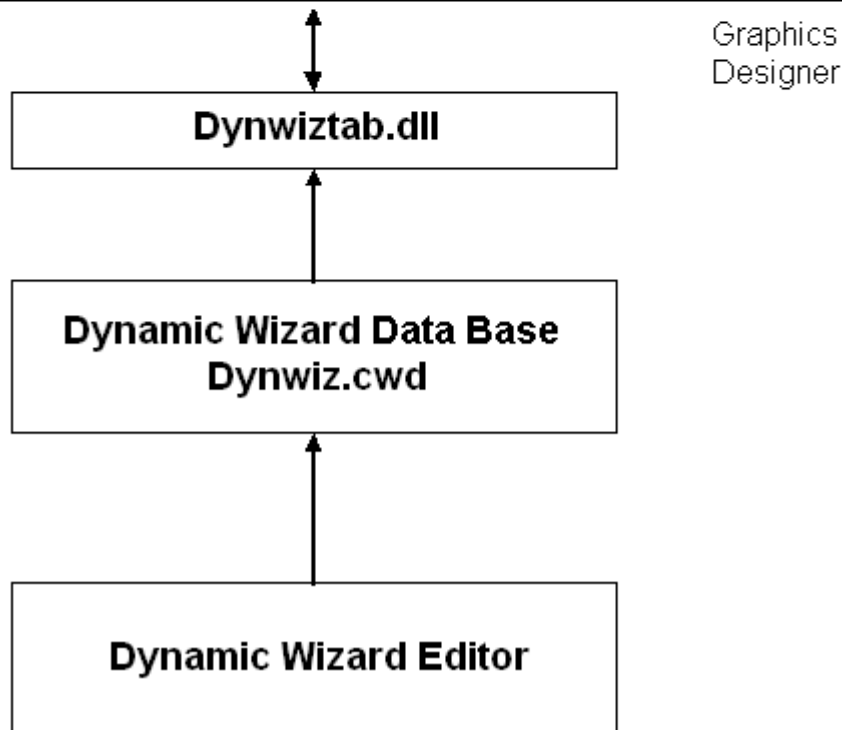
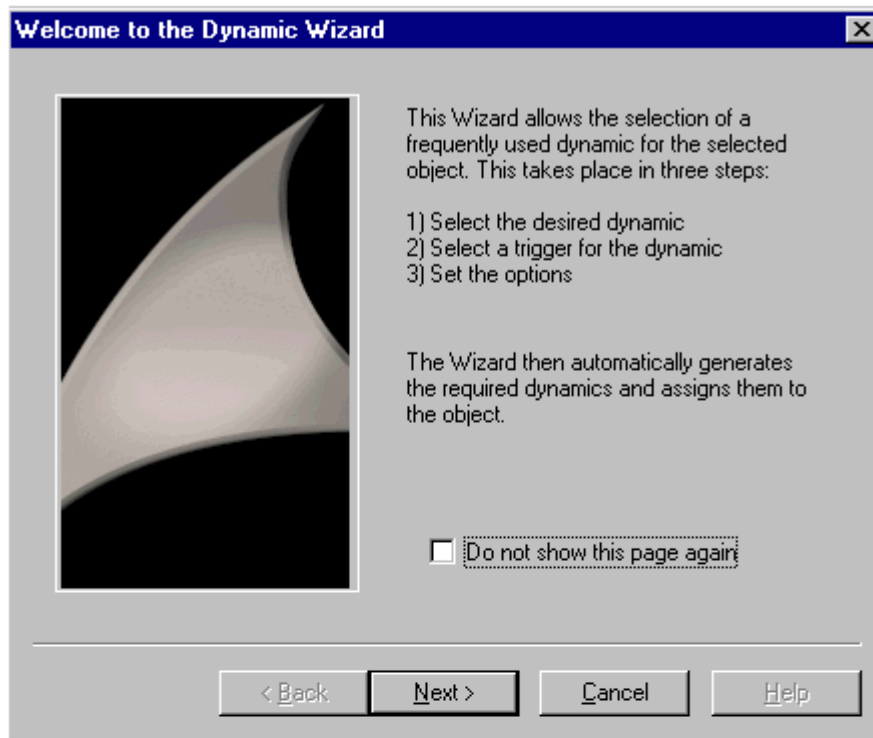

All Dynamic Wizard functions are saved on the hard disk in a database (...\\WinCC\\wscript \\Dynwiz.cwd). The Dynamic Wizard has a standardized display and user interface for selecting Dynamic Wizard functions and for specifying the parameters of the Dynamic Wizard functions. Once a Dynamic Wizard function has been selected, it is loaded into memory and executed.

Interface between Dynamic Wizard and Dynamic Wizard function

The link between the Dynamic Wizard and a Dynamic Wizard function is provided by a system interface in the Dynamic Wizard function, which has a preset structure. This interface contains information that is evaluated by the DW.

Main content of the interface:

Reference to the editing function

The process function is the intended main function of the Dynamic Wizard. It contains the "service", which a Dynamic Wizard function provides for the user, e.g. the creation of an action on a graphic object.

The option list defines the parameters required for the editing function. It also specifies how the defaults are presented in the interactive user interface.

The trigger list defines the triggers to which you want to link an object created. It also specifies how the defaults are presented in the interactive user interface.

See also

Trigger list (Page 2579)

Options list (Page 2576)

16.3.2 Installation of the Dynamic Wizard Editor

The Dynamic Wizard Editor can be installed in two different ways:

Procedure

1. During WinCC setup, select "WinCC V7 complete" from the "Programs" dialog. WinCC is installed with the SmartTools.

Start the Dynamic Wizard Editor by selecting "SIMATIC > WinCC > Tools".

Alternative procedure

You can also install the Dynamic Wizard Editor from the WinCC DVD.

1. Switch to the WinCC DVD directory "WinCC\InstData\Smarttools\Setup".
2. Double-click setup.exe.
3. Select "Dynamic Wizard Editor" in the "Components" dialog.
4. Click "Next". Follow the on-screen instructions.

16.3.3 Structure

16.3.3.1 Structure

The Dynamic Wizard Editor comprises the following elements:

Menu bar

The menu bar contains the functions of the Dynamic Wizard Editor. The menu bar is always visible.

Toolbar

The tool bar can be made visible as needed and dragged to any place on the screen with the mouse.

Editor window

The Editor window is only visible if a Dynamic Wizard function has been opened to be edited or a new one is created. Each function will be opened in its own editing window. Several editing windows can be open at the same time.

Output window

The output window can be made visible as required. It shows the result of the functions "Create CWD", "Read Wizard Script" and "Compile Script".

Status bar

The status bar can be made visible as required. It informs about the keyboard setting and the position of the cursor in the editing window.

Dynamic Wizard

With the Dynamic Wizard, you can dynamize an object using C actions. When executing wizards, preconfigured C actions and trigger events are defined and transferred to the object properties.

See also

Output window (Page 2570)

Editor window (Page 2568)

Toolbar (Page 2566)

16.3.3.2 Toolbar















Introduction

Using the buttons in the toolbar, you can activate commands.

Additional standard commands are available in the menu bar, e.g. for calling the search or for arranging the windows.

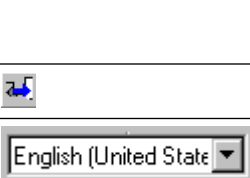

Icons

Icon	Description
	Creates a new Dynamic Wizard function.
	Opens an existing Dynamic Wizard function (*.wnf).
	Saves the Dynamic Wizard function.
	Cuts the selected text and copies it to the clipboard.
	Copies the selected text to the clipboard.
	Pastes the contents of the clipboard at the location of the cursor.
	Prints the contents of the current editing window.
	Displays additional information on the Dynamic Wizard Editor.
	Creates the Dynamic Wizard data (CWD). This function is used to read all wizard scripts available for the language that is currently set and to condition these for processing in the Dynamic Wizard. The file that is generated is stored in the WinCC installation path (installation path\wscripts\dynwiz.cwd).
	Reads in the wizard scripts and makes them available to the Dynamic Wizard.
	Sets the language for which the wizard script is configured. This includes all languages known in WinCC, independent on the installed languages. A change of the wizard language has no effect on the overall system or configuration interface.
	Changes the object. The Dynamic Wizard is also available in the editor for debugging actions and depends on the different properties of an object in Graphics Designer. You can debug a new or existing wizard script in the editor by using this function to change to an existing object in an existing picture. Based on this new object setting, the Dynamic Wizard is set up to display only the wizard scripts that are suitable for this object.
	Shows all Dynamic Wizard scripts for the selected language. Moreover, wizard scripts existing in the dialog can be deleted from the list.
	Opens the Help Editor.
	Compiles the script.

See also

Help Editor (Page 2569)

16.3.3.3 Editor window

Introduction

The editor window serves to create and edit Dynamic Wizard functions.

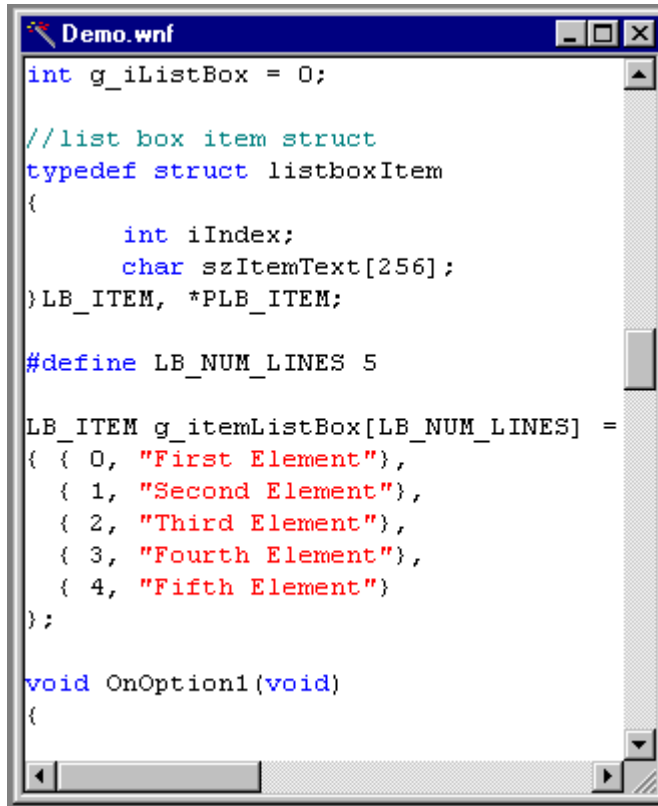

```

int g_iListBox = 0;

//list box item struct
typedef struct listBoxItem
{
    int iIndex;
    char szItemText[256];
}LB_ITEM, *PLB_ITEM;

#define LB_NUM_LINES 5

LB_ITEM g_itemListBox[LB_NUM_LINES] =
{ { 0, "First Element"},
  { 1, "Second Element"},
  { 2, "Third Element"},
  { 3, "Fourth Element"},
  { 4, "Fifth Element"}
};

void OnOption1(void)
{

```

Color coding

The C code is displayed with the following colors:

Color	Significance	Example
blue	Keywords	#define, void
green	Comments	// das ist ein Kommentar
red	Strings	"First Element"
black	other C code	OnOption1

16.3.3.4 Help Editor

Introduction

Within this dialog a help text can be entered for each page created via the wizard script. Only help texts for Dynamic Wizards already created can be entered.

The screenshot shows a dialog box titled "Help - Editor". It contains the following elements:

- Wizard - Group :** A dropdown menu with "Example" selected.
- Wizard - Name :** A dropdown menu with "Demo Wizard" selected.
- Page :** A dropdown menu with "StartPage" selected.
- Help - Text :** A large, empty text area with scrollbars.
- Buttons:** "Cancel" and "OK" buttons at the bottom right.

Elements of the Help Editor

Element	Description
Wizard group	This field is used to specify the group (=tab) containing the Dynamic Wizard.
Wizard name	This field is used to select the Dynamic Wizard for which a help text is to be created.
Page	This field is used to select the dialog page for which the help text is to be created.
Help text	In this field the help text will be entered.

16.3.3.5 Output window

Introduction

The output window shows the result of the functions "Create CWD", "Read Wizard Script" and "Compile Script".

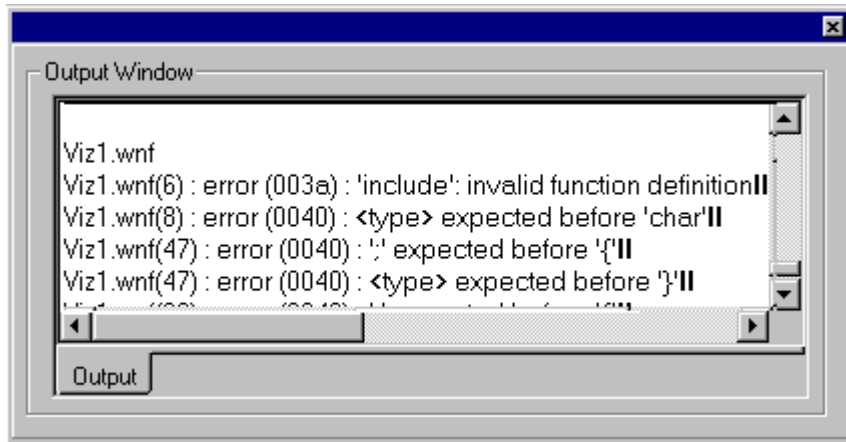

The output window helps to find errors in the scripts.

If there is an error in the script, the following message appears:

...\WinCC\wscripts\wscripts.deu\DemoWiz1.wnf(6):error(003a): 'include': invalid function definition

	Description
...\WinCC\wscripts\wscripts.deu\	Directory containing the wnf file.
DemoWiz1.wnf(6)	File name and line number where the error occurs
error(003a): 'include': invalid function definition	Error number and error description.

16.3.4 Structure of a Dynamic Wizard function

16.3.4.1 Structure of a Dynamic Wizard function

Introduction

A Dynamic Wizard function must have a certain specified structure. It corresponds to the required components.

1. Integrating header files and DLLs
2. Language-dependent definitions
3. Wizard flags
4. Property list

5. System interface
6. Global variables
7. Options list
8. Trigger list
9. Display of parameter assignment

See also

Display of parameter assignment (Page 2581)
Trigger list (Page 2579)
Options list (Page 2576)
Global variables (Page 2576)
System interface (Page 2575)
Property list (Page 2574)
Wizard flags (Page 2573)
Language-dependent definitions (Page 2572)
Integrating header files and DLLs (Page 2571)

16.3.4.2 Dynamic Wizard dialog

Introduction

Each Dynamic Wizard option has its specific functionality. However, due to the predefined function structure all functions have a similar sequence and a similar dialog interface. The Dynamic Wizard dialog consists of several dialog pages.

- "Welcome to the Dynamic Wizard" dialog
- "Select trigger" dialog
- "Set options" dialog
- "Finished !" dialog

16.3.4.3 Integrating header files and DLLs

Introduction

A header file contains declarations of constants, data types, tags and functions.

The header files are integrated into the function by means of an `#include` instruction. The most important file to be integrated is the `dynamic.h` file, in which, among others, the functions for designing the Dynamic Wizard interface are declared.

```

//*****
/**      Integration of Header-Files      **
//*****
        #include "dynamic.h"

```

DLL files (Dynamic Link Library) are executable routines which can be loaded by a program if this program requires so.

To be able to use DLL files, they are integrated into the function by means of a #pragma instruction.

```

//*****
/**      Integration of Dlls      **
//*****
        #pragma code ("pdicsapi.dll")
        #include "pdicsapi.h"
        #pragma code ()

```

In the Dynamic Wizard Editor the following paths are defined:

WinCC header files: ...\\WinCC\\aplib\\

WinCC DLLs: ...\\WinCC\\bin\\

Should the files be stored in another directory, the complete path is to be specified in the #include- and #pragma instructions.

16.3.4.4 Language-dependent definitions

Introduction

The Dynamic Wizard standard functions exist in the three languages German, English, and French. When the language is changed in the WinCC Explorer, the respective language version is also selected for the Dynamic Wizard functions.

Within the paths

..\\WinCC\\wscripts\\wscripts.deu

..\\WinCC\\wscripts\\wscripts.enu

..\\WinCC\\wscripts\\wscripts.fra

a WNF file must exist for each wizard function.

Upon creation, all language-dependent definitions should be arranged in this section. This facilitates the creation of other language versions.

```

//*****
//          Language-Dependent Definitions          //
//*****
//          German                                  //
//-----
include  "defdeu.h"

char* DynWizGroupName      = "WinCC C-Kurs";
char* DynWizDynamicName    = "Motor dynamisieren";
char* DynWizToDoOption1    = "Wählen Sie die gewünschte Strukturvariable:";
//-----
//          Englisch                                  //
//-----
#include  "defenu.h"

char* DynWizGroupName      = "WinCC C-Course";
char* DynWizDynamicName    = "Make a Motor Dynamic";
char* DynWizToDoOption1    = "Select the desired Structure Tag:";
//-----
//          French                                  //
//-----
#include  "deffra.h"

char* DynWizGroupName      = "Cours de C WinCC";
char* DynWizDynamicName    = "Dynamiser moteur";
char* DynWizToDoOption1    = "Sélectionnez la variable de structure:";

```

16.3.4.5 Wizard flags

Introduction

These Flags are used to define configuration type for which the Dynamic Wizard function applies.

```

WIZARD_FLAGS(WIZARD_FLAG_OCX | WIZARD_FLAG_ALL_PROJECT_TYPES)

BEGIN_PROPERTY_SCHEME
END_PROPERTY_SCHEME

```

Flags

FLAG	
WIZARD_FLAG_OCX	For all OCX files
WIZARD_FLAG_ALL_PROJECT_TYPES	For all projects

FLAG	
WIZARD_FLAG_SINGLEUSER_PROJECT	For single-user projects only
WIZARD_FLAG_MULTI-CLIENT_PROJECT	For client projects
WIZARD_FLAG_MULTUSER_PROJECT	For clients without project data only

16.3.4.6 Property list

Introduction

The property list defines the object types for which a Dynamic Wizard function can be used. This is done by specifying a list of object properties. If an object has at least one of the listed properties, the Dynamic Wizard function can be applied to it.

```

//*****
//** Objektauswahl mittels Objekteigenschaften **
//*****

BEGIN_PROPERTY_SCHEME
  {"BackColor", VT_I4},
END_PROPERTY_SCHEME

```

Each entry in the property list consists of two parameters:

- Property name, e.g., Backcolor in the English version.
- WinCC Data type

If an empty property list is used, the Dynamic Wizard function can be applied to all object types. In any case, there must be a property list, even if it is empty.

16.3.4.7 System interface

Introduction

The system interface is used to define the properties of the new Dynamic Wizard function.

```
BEGIN_DYNAMICS
{
  DynWizGroupName,          // 1. Parameter
  DynWizDynamicName,       // 2. Parameter
  NULL,                    // 3. Parameter
  "logo16.bmp",            // 4. Parameter
  DynWizHelpText,          // 5. Parameter
  {                        // 6. Parameter
    // "OnOption1",
    // "OnOption2",
    NULL
  },
  "OnGenerate",            // 7. Parameter
  "OnShowGenerateInfo",   // 8. Parameter
  {                        // 9. Parameter
    // PREDEFINED_MACRO,
    // {DynWizTrigger1Text, OnTrigger1},
    {NULL, NULL}
  },
},
},
END_DYNAMICS
```

Parameter description

1. The first parameter defines the tab on which the Dynamic Wizard function is to appear.
2. The second parameter defines the name under which the Dynamic Wizard function is to appear.
3. The third parameter is always NULL.
4. The fourth parameter designates the name of the icon to be used for the Dynamic Wizard function.
5. The fifth parameter is a help text with a more detailed description of the functionality of the Dynamic Wizard function.
6. The sixth parameter is a list with the names of the functions created for the individual option pages. This list is to be concluded by a NULL entry. A maximum of five option pages can be created. Additional information on this topic may be found under "Options list".
7. The seventh parameter is the name of the process function called after clicking on the "Complete" button. The process function is the intended main function of the Dynamic Wizard. It contains the "service", which a Dynamic Wizard function provides for the user, e.g. the creation of an action on a graphic object.

8. The eighth parameter is the name of the function which summarizes the setting on the option pages and displays them for the user before the latter clicks on the Complete button. Additional information on this topic may be found under "Display of parameter assignment".
9. The ninth parameter is a list of the triggers to be displayed on the trigger page. For the most common applications, macros are available to fill this trigger list. Additional information on this topic may be found under "Trigger list".

16.3.4.8 Global variables

Introduction

For each parameter to be set on the option pages a global variable must be defined. This is to make sure that the set parameters are known in all created functions and can be utilized.

Data transfer between system functions is only possible by means of global variables. This is always required when trigger and/or option parameters have to be transferred to the process function.

```
//*****  
//      Definition of Global Tags  
//*****  
  
char g_Demo_Typ = "Demo"
```

16.3.4.9 Options list

Introduction

Options are parameters needed for the functionality of the Dynamic Wizard function. Options do not require a trigger.

Options are defined in the options list of the system interface. For each option, the options list contains the name of the assigned options function, e.g. "OnOption1".

```

BEGIN_DYNAMICS
{
DynWizGroupName,
DynWizDynamicName,
NULL,
"logo16.bmp",
DynWizHelpText,
//*****
//          Optionenliste
//*****
{
"OnOption1",
"OnOption2",
NULL
},
"OnGenerate",
"OnShowGenerateInfo",
{ // Triggerliste
{ NULL, NULL }
},
},
END_DYNAMICS

```

The options list is concluded by a NULL pointer. A maximum of five options may be defined in the list.

Option functions

The Dynamic Wizard calls the option functions successively, according to their sequence in the options list. For each option function the "Set options" dialog is displayed where the function programs its specific entry.

There are wizard system functions available for programming the entry. Additional information on this topic may be found under "Wizard system functions."

The "Set options" dialog makes available a defined area for arranging static texts, input fields and other input boxes.

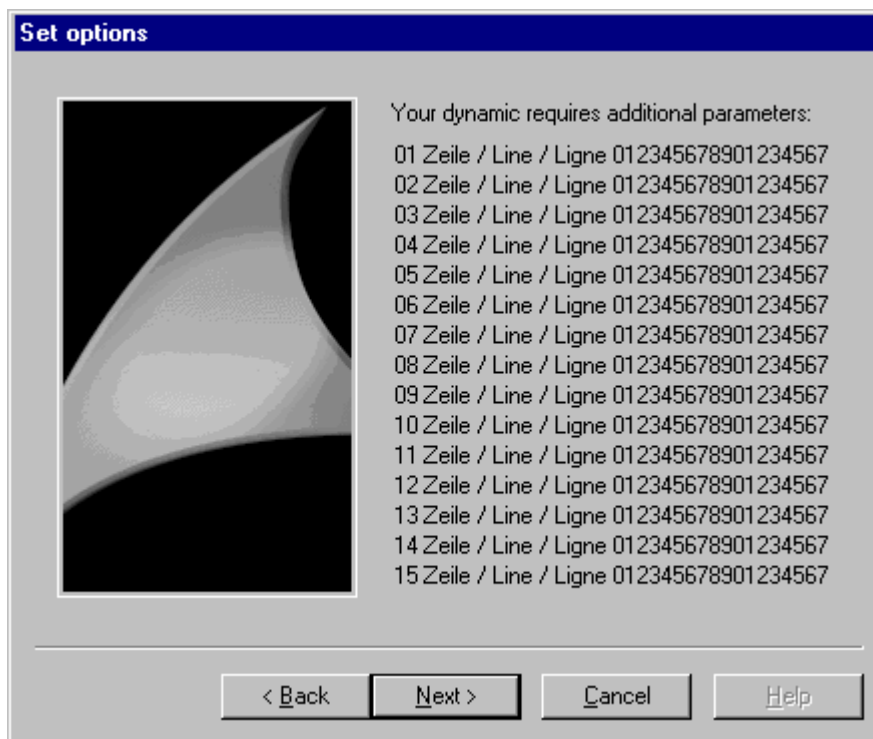

In the "Set options" dialog, the area is completely filled with lines 1 to 15.

The corresponding option function is as follows:

```
//-----
//      Option-Funktion OnOption1
//-----

void OnOption1(void)
{
  CreateStatic(0, 0, "01 Zeile / Line / Ligne 012345678901234567");
  CreateStatic(0, 15, "02 Zeile / Line / Ligne 012345678901234567");
  CeateStatic(0, 30, "03 Zeile / Line / Ligne 012345678901234567");
  CeateStatic(0, 45, "04 Zeile / Line / Ligne 012345678901234567");
  CreateStatic(0, 60, "05 Zeile / Line / Ligne 012345678901234567");
  CreateStatic(0, 75, "06 Zeile / Line / Ligne 012345678901234567");
  CreateStatic(0, 90, "07 Zeile / Line / Ligne 012345678901234567");
  CreateStatic(0, 105, "08 Zeile / Line / Ligne 012345678901234567");
  CreateStatic(0, 120, "09 Zeile / Line / Ligne 012345678901234567");
  CreateStatic(0, 135, "10 Zeile / Line / Ligne 012345678901234567");
  CreateStatic(0, 150, "11 Zeile / Line / Ligne 012345678901234567");
  CreateStatic(0, 165, "12 Zeile / Line / Ligne 012345678901234567");
  CreateStatic(0, 180, "13 Zeile / Line / Ligne 012345678901234567");
  CreateStatic(0, 195, "14 Zeile / Line / Ligne 012345678901234567");
  CreateStatic(0, 210, "15 Zeile / Line / Ligne 012345678901234567");
}
```

16.3.4.10 Trigger list

Introduction

Triggers are only required in connection with actions on a graphic object.

Triggers are defined in the trigger list of the system interface. The trigger list contains an entry for each trigger.

```

BEGIN_DYNAMICS
{
  DynWizGroupName,
  DynWizDynamicName,
  NULL,
  "logo16.bmp",
  DynWizHelpText,
  "OnOption1",
  "OnOption2",
  NULL
},
"OnGenerate",
"OnShowGenerateInfo",
{
  //*****
  //          Trigger list
  //*****
  { "Mouse click" , "OnTriggerMC" },
  { "Pressing left mouse key" , "OnTriggerLMDown" },
  { "Releasing left mouse key" , "OnTriggerLMUp" },
  { "Pressing right mouse key" , "OnTriggerRMDown" },
  { "Releasing right mouse key" , "OnTriggerRMUp" },
  { NULL, NULL }
},
},
END_DYNAMICS

```

The entry consists of two parameters. The first parameter is the designation of the trigger which is shown in the interface, such as Click left mouse button. The second parameter gives the name of the assigned trigger function.

The trigger list is concluded by a NULL pointer pair. A maximum of 50 triggers may be defined in the list.

For the triggers used most frequently, predefined macros are available.

Macro	
JCR_TRIGGERS	Trigger events DECLARE_JCR_TRIGGERS Mouse click, Left mouse button, Right mouse button
JCR_ZYCL_TRIGGERS	cyclic triggers DECLARE_JCR_ZYKL_TRIGGERS Picture cycle, Window cycle, Upon change, 250 ms, 500 ms, 1 second, 2 seconds, 5 seconds, 10 seconds, 1 minute, 5 minutes, User cycle 1, User cycle 2, User cycle 3, User cycle 4, User cycle 5
JCR_ACTION_TRIGGERS	Action triggers DECLARE_JCR_ACTION_TRIGGERS

```

...
...
BEGIN_PROPERTY_SCHEME
END_PROPERTY_SCHEME
BEGIN_DYNAMICS
    {
        "System Functions",
        "Exit WinCC Runtime",
        NULL,
        "logol6.bmp",
        "Exits WinCC Runtime and switches to \r\nthe DESIGN Mode.",
        { NULL, NULL, },
        "OnGenerate",
        "OnShowGenerateInfo",
        {
            JCR_TRIGGERS,
        },
    },
END_DYNAMICS

DECLARE_JCR_TRIGGERS
...
...

```

The "Select trigger" dialog is created from the trigger list. All trigger designations are displayed in a list box for selection.

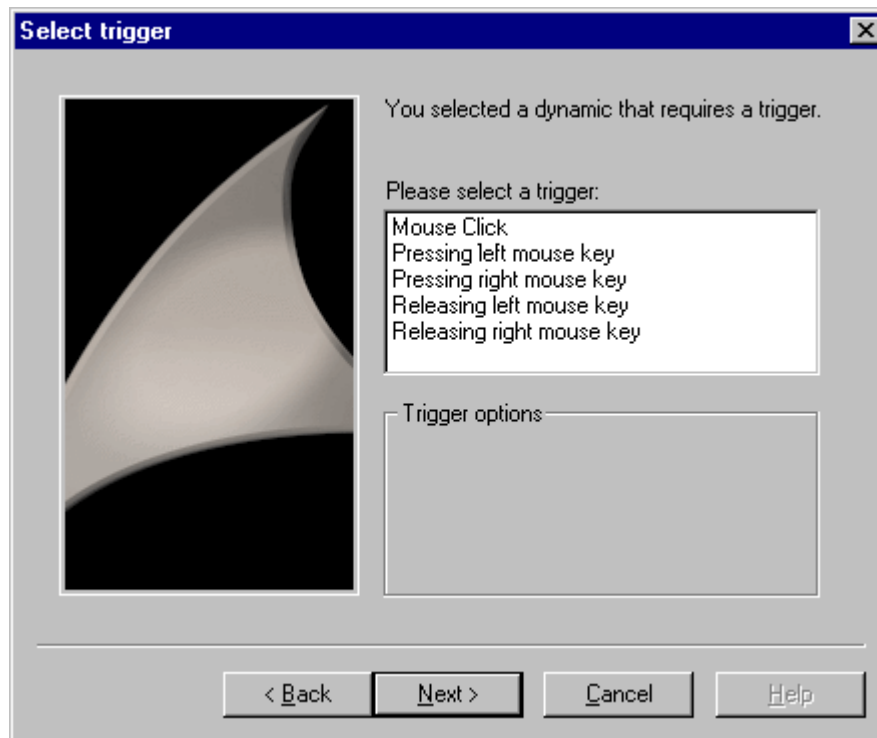

After selecting a trigger, the Dynamic Wizard calls the assigned trigger function.

16.3.4.11 Display of parameter assignment

Introduction

Trigger and option parameters can be displayed in the "Finished !" dialog. This allows the user to recheck the parameterization and change it, if required.

In the display field of the "Finished !" page, a text can be displayed using the Windows function SetWindowText The height of the display field is 12 lines.

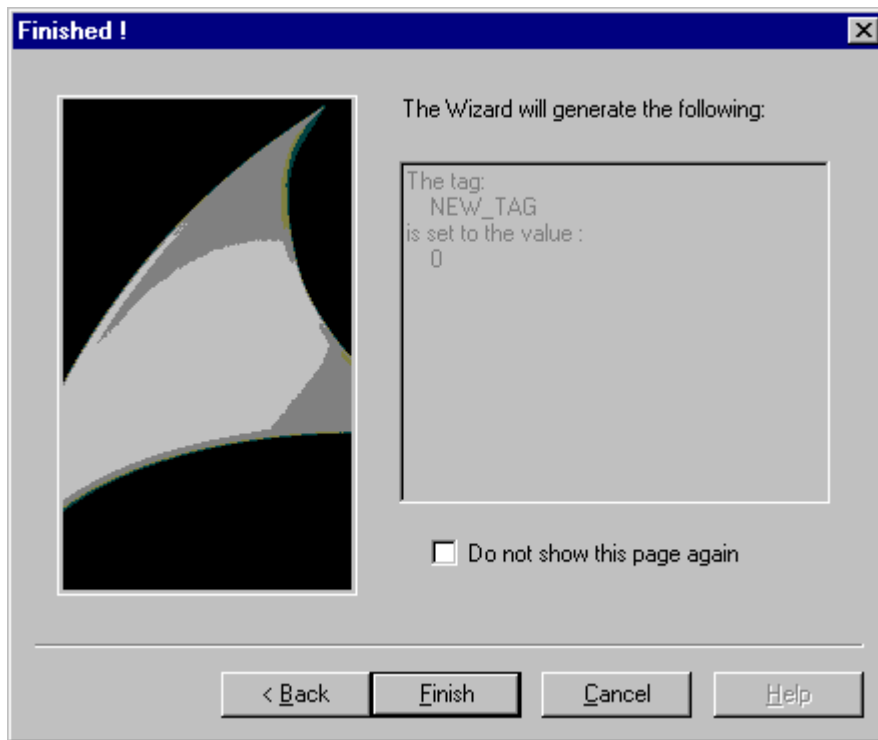

16.3.4.12 Wizard Functions for parameter input

CreateStatic

Introduction

In the "Set options" dialog a static text is displayed for the x,y coordinates.

Syntax

HWND CreateStatic (int x, int y, char* "Text")

Parameters

Parameters	Description
int x	Shows the value of the x coordinate.
int y	Shows the value of the y coordinate.
char* Text	Shows the displayed text.

Return value

	Return value
HWND	returns the object handle.

Example

The following excerpt from the file "Demo.wnf" shows the use of this function.

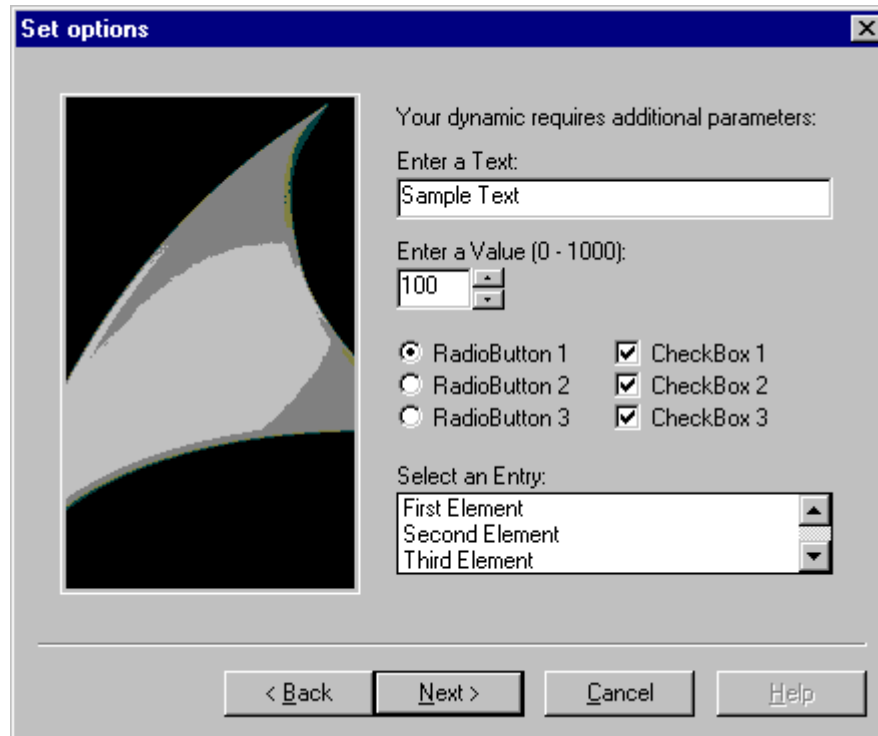

```

char* DynWizEditStatic = "Enter a text:";
...
..
void OnOption1(void)
{
static BOOL bFirst = TRUE;
HWND hWnd = NULL;
.....
if (bFirst == TRUE)
{
strcpy(g_szEdit, DynWizEdit);
bFirst = FALSE;

```

```

    }
    //Static text
    CreateStatic (0, 5, DynWizEditStatic) ;
    .....
    .....
}
    
```

CreateEdit

Introduction

In the "Set options" dialog an input field is displayed for the x,y coordinates. A text can be typed in this input field.

Syntax

HWND CreateEdit (int x, int y, char* pText)

Parameters

Parameters	Description
int x	Shows the value of the x coordinate.
int y	Shows the value of the y coordinate.
char* pText	Pointer to an input buffer. The input buffer may have a predefined value. This is displayed in the input field.

Return value

	Return value
HWND	Returns the object handle
pText	Input buffer contains the entered text.

Example

The following excerpt from the file "Demo.wnf" shows the use of this function. An input field is displayed in the "Set options" dialog of the "Demo Wizard".

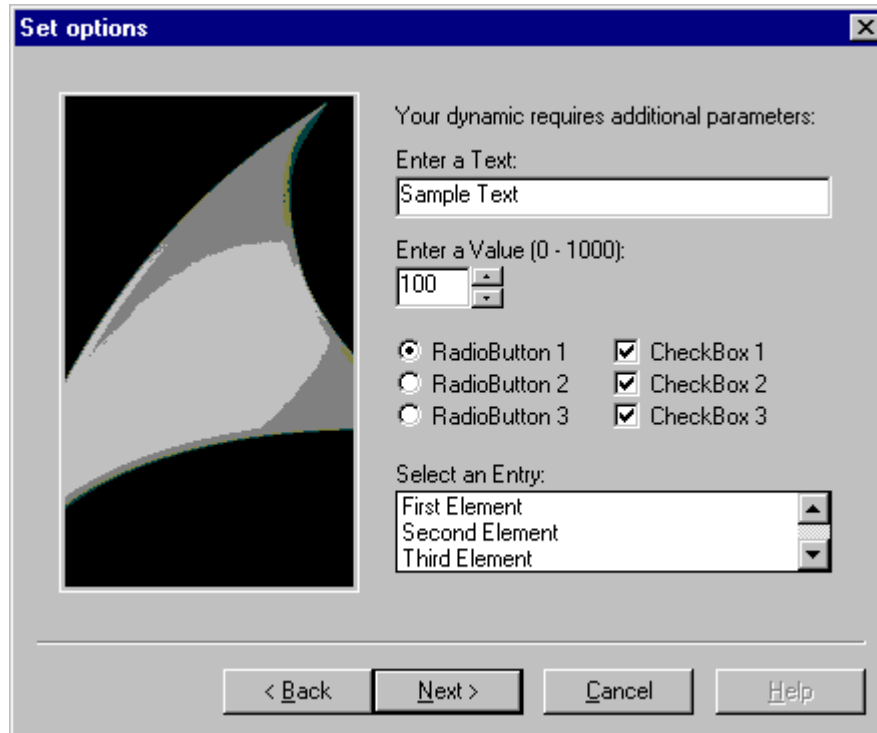

```

char* DynWizEditStatic = "Enter a text:";
char* DynWizEdit = "Sample text";
...
..
char g_szEdit[256];
void OnOption1(void)
{
static BOOL bFirst = TRUE;
HWND hWnd = NULL;
.....
if (bFirst == TRUE)
{
strcpy(g_szEdit,DynWizEdit);
bFirst = FALSE;
}
}

```

```

//Static text for the input field
CreateStatic(0,5,DynWizEditStatic);
//Input field
hWnd = CreateEdit(0,20,g_szEdit)
GetWindowRect(GetParent(hWnd), &rect);
MoveWindow(hWnd,0,20,(rect.right-rect.left),21,TRUE);
.....
.....
}

```

CreateSpinEdit

Introduction

In the "Set options" dialog an input field with controls is displayed for the x,y coordinates. This input field is used to enter an integer value into an entry variable.

Syntax

HWND CreateSpinEdit (int x, int y, int* pValue, int Min, int Max, int Base)

Parameters

Parameters	Description
int x	Shows the value of the x coordinate.
int y	Shows the value of the y coordinate.
int* pValue	Pointer to an integer entry variable. The entry variable may have a predefined default value.
int Min	Lower limit for the input value
int Max	Upper limit for the input value
int Base	Input number format: 10 = decimal input 16 = hexadecimal input

Return value

	Return value
HWND	Returns the object handle.
pValue	Entry variable contains the entered value.

Example

The following excerpt from the file "Demo.wmf" shows the use of this function. An input field with controls is displayed in the "Set options" dialog of the "Demo Wizard". You can select a value between 0 and 1000 there.

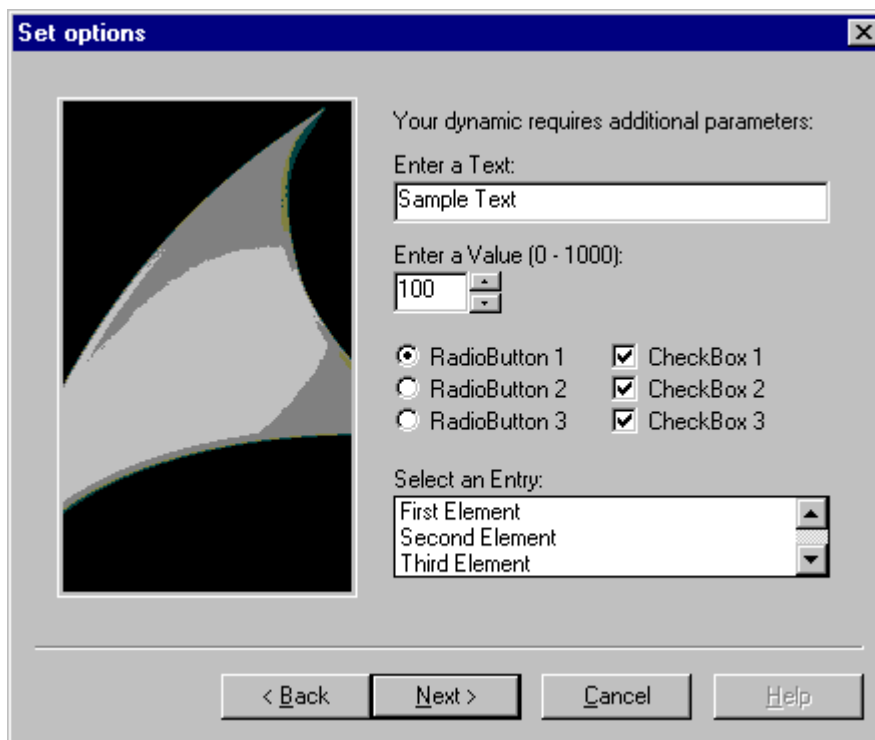

```
char* DynWizSpinStatic= "Enter a value (0 - 1000):";
char* DynWizEdit = "Sample text";
...
...
char g_szEdit[256];
void OnOption1(void)
{
static BOOL bFirst = TRUE;
HWND hWnd = NULL;
.....
if (bFirst == TRUE)
{
strcpy(g_szEdit,DynWizEdit);
bFirst = FALSE;
}
```

```

}
...
...
//Static text for the input field with controls
CreateStatic(0,50,DynWizSpinStatic);
...
//Input field with controls
hWnd = CreateSpinEdit(0,65,&g_iSpinEdit,0,1000,10);
MoveWindow(hWnd,0,65,(rect.right-rect.left)/4,21,TRUE);

...
...
}

```

CreateListBox

Introduction

In the "Set options" dialog a selection field is displayed for the x,y coordinates. The selection field allows listing several entries. By clicking the mouse, one entry can be selected.

Syntax

HWND CreateListBox (int X, int Y, char* Headline, int NumLines, int* pSelect)

Parameters

Parameters	Description
int x	Shows the value of the x coordinate.
int y	Shows the value of the y coordinate.
char* Headline	Header of the selection field
int NumLines	Number of lines in the selection field. The following must be specified: NumLines = Number of lines + 1 (1 =< NumLines = <16)
int* pSelect	Pointer to the result variable

Return value

	Return value
HWND	Returns the object handle.
pSelect	Number of the selected entry. The number is the index in the list (beginning with 0).

Example

The following excerpt from the file "Demo.wnf" shows the use of this function. In the "Set options" dialog of the "Demo Wizard" a selection field is displayed. The possible size of the selection field is three lines. As more than three entries exist, a scroll bar is displayed.

Note

With the function "CreateListBox" only the selection field itself is created. The line content must be entered using the function "SendMessage".

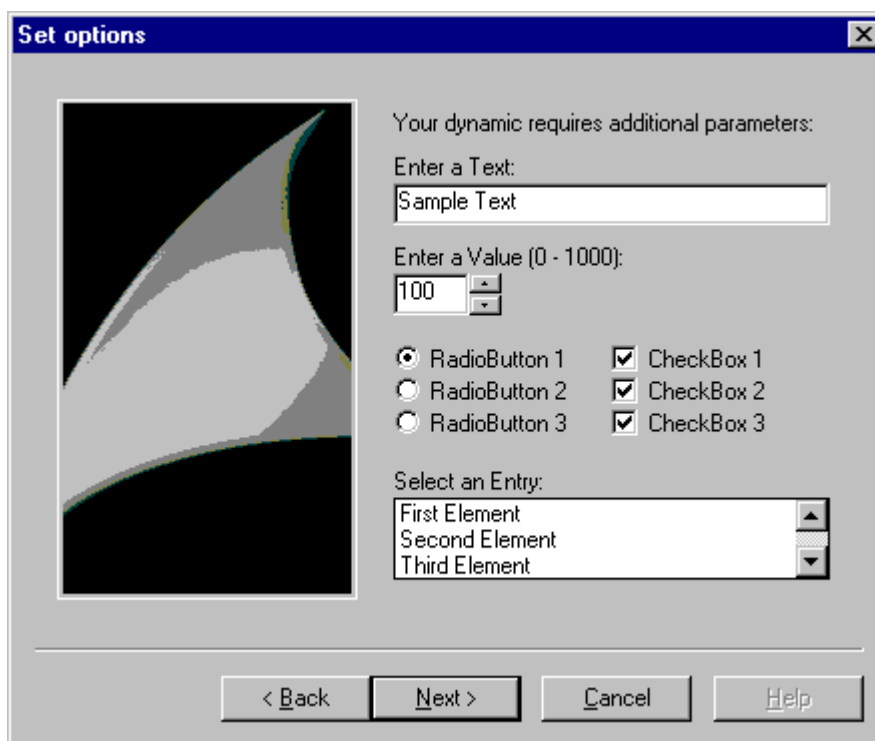

```
char* DynWizListStatic= "Select an entry:";
...
int g_iListBox = 0;
//Type definition of the elements in the selection field
typedef struct listBoxItem
{
    int iIndex;
    char szItemText[256];
}LB_ITEM, *PLB_ITEM;

#define LB_NUM_LINES 5
```

```
LB_ITEM g_itemListBox[LB_NUM_LINES] =
{
{ 0, "First Element"},
{ 1, "Second Element"},
{ 2, "Third Element"},
{ 3, "Fourth Element"},
{ 4, "Fifth Element"}
};

void OnOption1(void)
{
static BOOL bFirst = TRUE;
HWND hWnd = NULL;
.....
if (bFirst == TRUE)
{
strcpy(g_szEdit, DynWizEdit);
bFirst = FALSE;
}
...
...
//Static text for the selection field
CreateStatic(0,162,DynWizListStatic);
...
//Selection field
hWnd = CreateListbox(0,177,"Headline",LB_NUM_LINES,&g_iListBox);
MoveWindow(hWnd,0,177,(rect.right-rect.left),50,TRUE);
//With the function "CreateListbox" only the box itself is created. The line content must be
entered using //the function "SendMessage".
for (i=0; i<LB_NUM_LINES; i++)
{
SendMessage(hWnd, LB_INSERTSTRING, (WPARAM)-1,
(LPARAM)g_itemListBox[i].szItemText);
}
}
```

CreateCheckBox

Introduction

In the "Set options" dialog a check box is displayed for the x,y coordinates. This check box allows enabling an option. In a dialog, several check boxes can be used.

Syntax

HWND CreateCheckBox (int x, int y, char* Text, BOOL* pSelect)

Parameters

Parameters	Description
int x	Shows the value of the x coordinate.
int y	Shows the value of the y coordinate.
char* Text	Text displayed right of the check box.
BOOL* pSelect	Pointer to the result variable. The result variable should be preassigned a default value (True/False).

Return value

	Return value
HWND	Returns the object handle.
pSelect	Activation status FALSE = not activated TRUE = activated

Example

The following excerpt from the file "Demo.wnf" shows the use of this function. In the "Set options" dialog of the "Demo Wizard" three check boxes are displayed, each one representing an option. Each option can be independently activated.

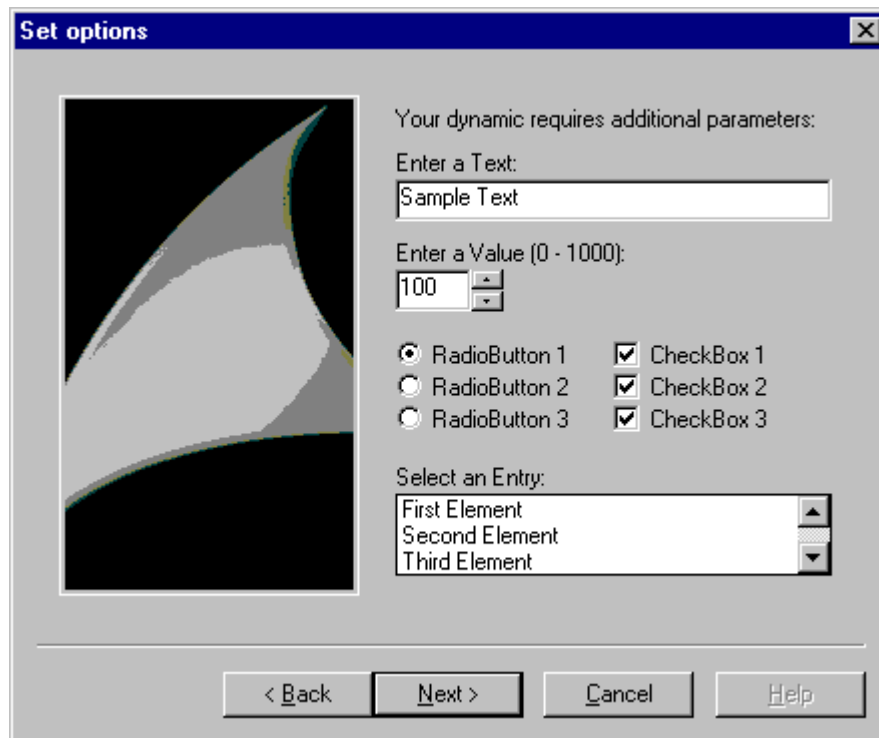

```

BOOL g_bCheck1 = TRUE;
BOOL g_bCheck2 = TRUE;
BOOL g_bCheck3 = TRUE;

void OnOption1(void)
{
    static BOOL bFirst = TRUE;
    HWND hWnd = NULL;
    .....
    if (bFirst == TRUE)
    {
        ...
    }
    ...
}

```

```

...
//Check box
iMid = (rect.right-rect.left)/2 ;

CreateCheckBox(iMid,100,"CheckBox 1",&g_bCheck1);
CreateCheckBox(iMid,116,"CheckBox 2",&g_bCheck2);
CreateCheckBox(iMid,132,"CheckBox 3",&g_bCheck3
}

```

CreateFrame

Introduction

In the "Set options" dialog a rectangular border is displayed. The left upper corner of the frame is defined by the x,y coordinates. The right lower corner of the frame is identical to the right lower corner of the option window.

Syntax

HWND CreateFrame (int x, int y, char* Title)

Parameters

Parameters	Description
int x	Shows the value of the X coordinate.
int y	Shows the value of the Y coordinate.
char* Title	Label at the top edge of the rectangle

Return value

	Return value
HWND	Returns the object handle.

Example

The following excerpt from the file "Demo.wnf" shows the use of this function. In the "Set options" dialog of the "Demo Wizard" a frame bearing the title "Frame" is displayed.

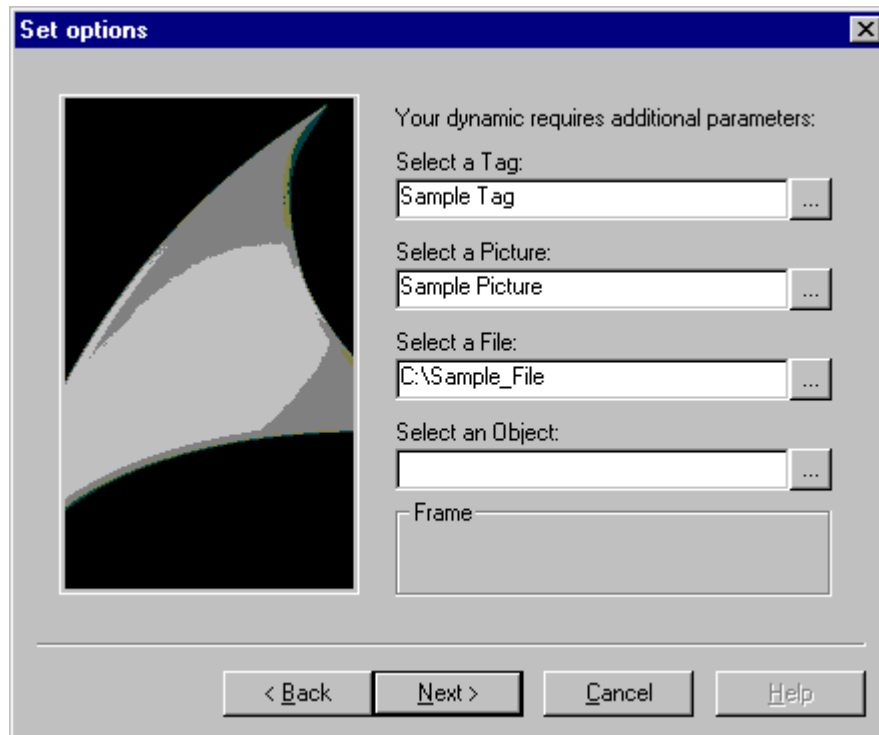

```
void OnOption2(void)
{
//Frame
  CreateFrame(0,150,"Frame");
}
...
...
```

CreateRadioButton

Introduction

In the "Set options" dialog a radio button is displayed for the x,y coordinates. This radio button allows enabling an option.

Using radio buttons is only useful if there are several of them in a dialog. There is only one radio button active at a time.

Syntax

HWND CreateRadioButton (int x, int y, char* Text, BOOL* pSelect)

Parameters

Parameters	Description
int x	Shows the value of the X coordinate.
int y	Shows the value of the Y coordinate.
char* Text	Name of the option activated with the radio button. The text is displayed to the right of the radio button.
BOOL* pSelect	Pointer to the result variable. The result variable should be preassigned a default value (True/False).

Return value

	Return value
HWND	Returns the object handle.
pSelect	Activation status: FALSE = not activated TRUE = activated

Example

The following excerpt from the file "Demo.wnf" shows the use of this function. In the "Set options" dialog of the "Demo Wizard" three radio buttons are displayed, each one representing an option. Only one option can be activated.

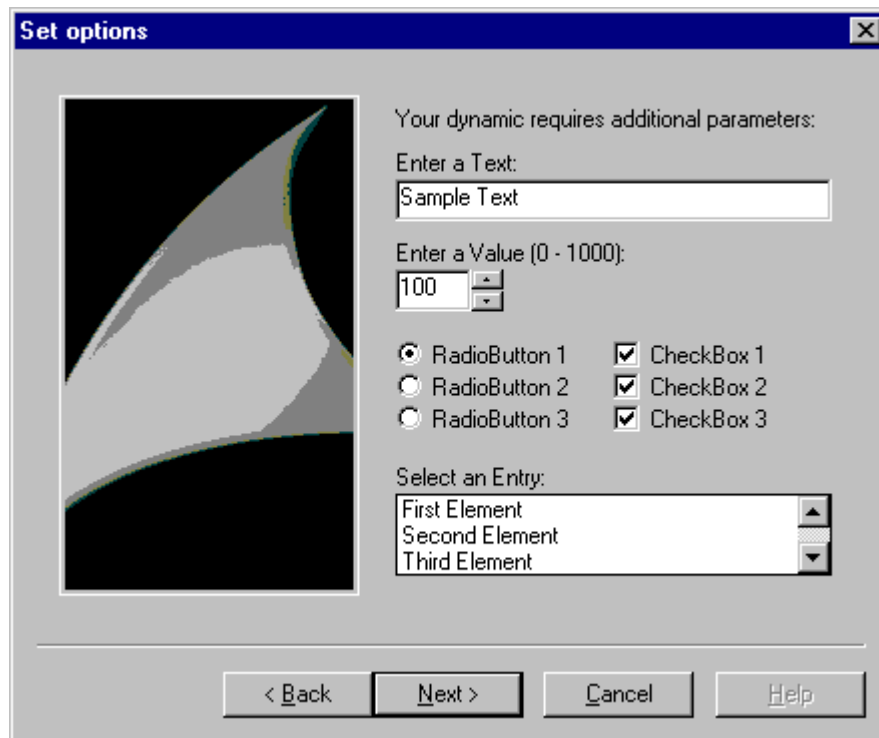

```

BOOL g_bOption1 = TRUE;
BOOL g_bOption2 = FALSE;
BOOL g_bOption3 = FALSE;

void OnOption1(void)
{
    static BOOL bFirst = TRUE;
    HWND hWnd = NULL;
    .....
    if (bFirst == TRUE)
    {
        ...
    }
    ...
}

```

```

...
//Radio buttons
CreateRadioButton(0,100,"RadioButton 1",&g_bOption1);
CreateRadioButton(0,116,"RadioButton 2",&g_bOption2);
CreateRadioButton(0,132,"RadioButton 3",&g_bOption3);
}

```

CreateFileBrowser

Introduction

In the "Set options" dialog an input field with a Browse button is displayed for the x,y coordinates. A file name can be typed in this input field.



Clicking the Browse button opens a file selection dialog.

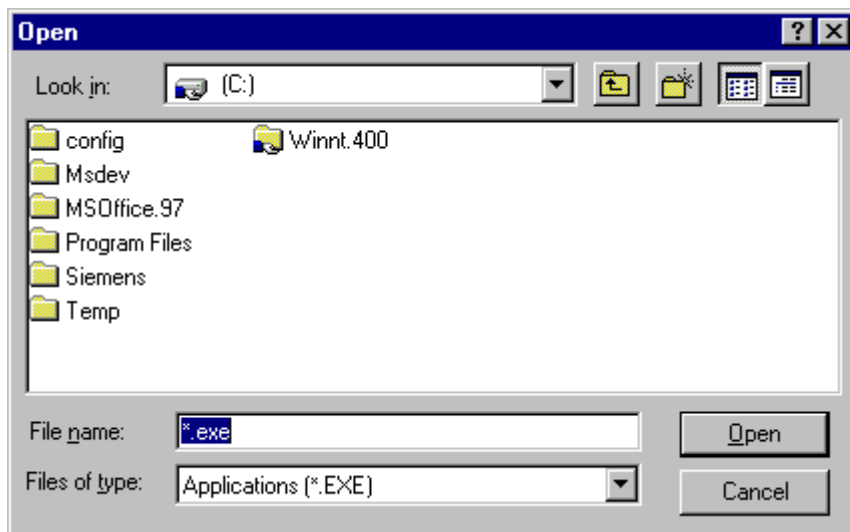

Syntax

HWND CreateFileBrowser (int x, int y, DWORD Flags, char* Filter, char* Dateiname)

Parameters

Parameters	Description
int x	Shows the value of the x coordinate.
int y	Shows the value of the y coordinate.

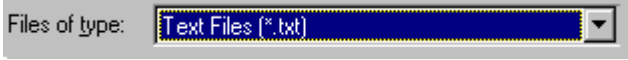
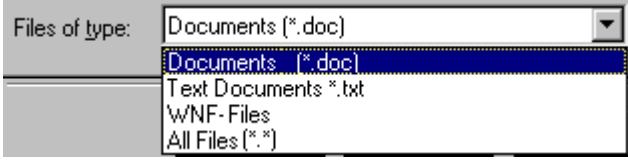
Parameters	Description
DWORD Flags	Control flag of the selection window: FB_WITHPATH = File name with path FB_SAVE_AS = Instead of the Open dialog the "Save as" dialog appears.
char* Filter	<p>Filter for the data type display in the selection field of the file selection dialog. By specifying the extension, the data types to be shown in the selection field are defined.</p> <p>A filter consists of a string pair. The first string is the filter name. The second string is the filter function in the format *.typ, 'typ' being a file extension. The selection field only shows files with this extension. 1. and second string are separated by . Several filters can be stringed by . The last filter is delimited with .</p> <p>Examples: char* Filter1 = "Graphic pictures (*.PDL) *.PDL ";</p>  <p>char* Filter2 = "Documents (*.doc) *.doc " "Text files *.txt *.txt " "WNF files *.wnf " "All files (*.*) *.* ";</p>  <p>No blanks are allowed at the end of the filter function.</p>
char* File name	Input buffer for the file name. A path name can be defined as default value. This standard value has the following effect: The path name is displayed in the input window by default. Clicking on the Browse button sets the path in the file selection dialog. If the file name has the extension '*.typ', all files of this type are shown in the selection field of the selection dialog.

Return value

	Return value
HWND	Returns the object handle.
File name	Input buffer contains the file name.

Example

The following excerpt from the file "Demo.wnf" shows the use of this function. In the "Set options" dialog of the "Demo Wizard" an input field with a Browse button is displayed. Clicking on the Browse button opens the file selection dialog.

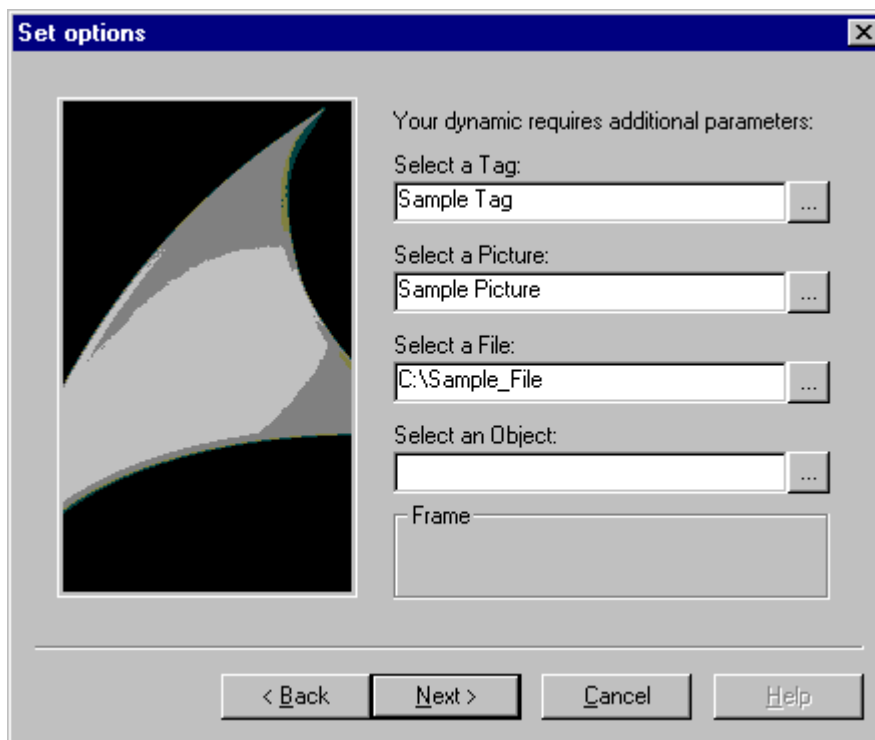

```

char* DynWizFileBrowserStatic = "Select a file:";
char* DynWizFileBrowser = "C:\\Sample file";
char* DynWizFilter = "Text files (*.txt) | *.txt|"
  "All files (*.*) | *.*||";
...
char g_szFileBrowser[256];
...
void OnOption2(void)
{
  static BOOL bFirst = TRUE;
  HWND hWnd = NULL;
  RECT rect;
  ...
  if (bFirst == TRUE)
  {

```

```

...
strcpy(g_szFileBrowser, DynWizFileBrowser);
First = FALSE;
}
...
...
// Static text for the input field with Browse button
CreateStatic(0, 95, DynWizFileBrowserStatic);
//File selection dialog
hWnd =
CreateFileBrowser(0, 110, FB_WITHPATH, DynWizFilter, g_szFileBrowser);
MoveWindow(hWnd, 0, 110, (rect.right-rect.left), 21, TRUE);
}

```

CreateVarBrowser / CreateVarBrowserEx

Introduction

In the "Set options" dialog an input field with a Browse button is displayed for the x,y coordinates. A tag name can be typed in this input field. Clicking on the Browse button opens the WinCC tag selection dialog. The function "CreateVarBrowserEx" allows the additional parameterization of a tag filter. This filter limits the tags displayed in the tag selection dialog. Filtering is possible by data type, tag group, tag name and connection.

Syntax

HWND CreateVarBrowser (int x, int y, char* VarName)

HWND CreateVarBrowserEx (int x, int y, LPDPM_VARFILTER VarFilter, char* VarName)

Parameters

Parameters	Description
int x	Shows the value of the x coordinate.
int y	Shows the value of the y coordinate.
LPDPM_VARFILTER VarFilter	Optional indication of a pointer to the tag filter. When specifying a NULL pointer no filter is active. The tag filter must be defined by means of the structure DM_VARFILTER. Additional information on this topic may be found in the WinCC ODK documentation.
char* VarName	Contains the tag name. The tag name may have a predefined default value. This entry is always displayed.

Return value

	Return value
HWND	Returns the object handle.
VarName	Input buffer contains the tag name

Example

The following excerpt from the file "Demo.wnf" shows the use of this function. In the "Set options" dialog of the "Demo Wizard" an input field with a Browse button is displayed. Clicking on the Browse button opens the WinCC tag selection dialog.

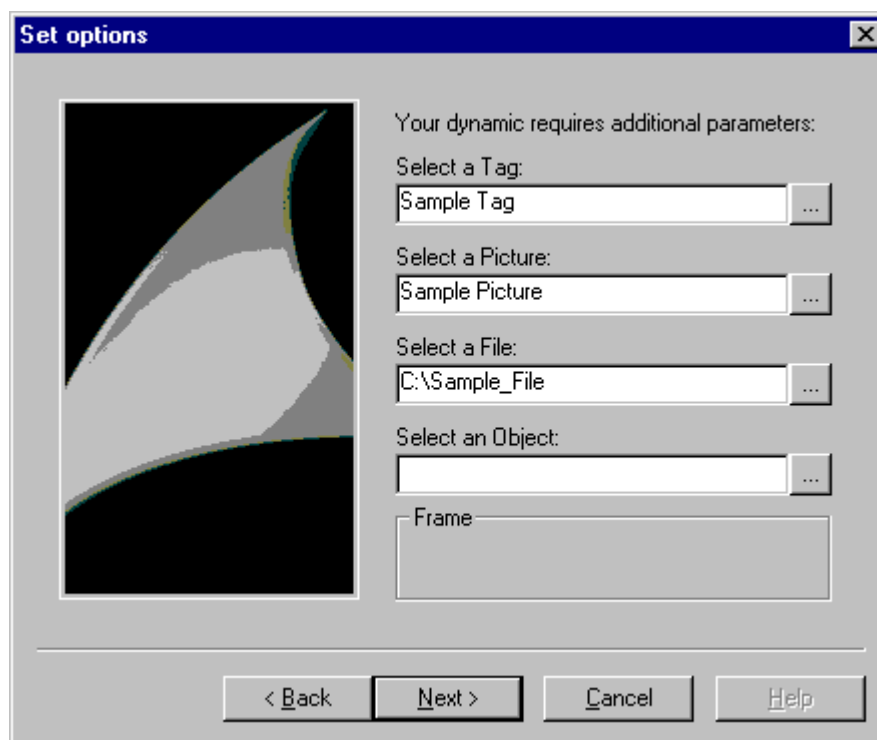

```

char* DynWizVarBrowser = "Sample tag";
char* DynWizPicBrowserStatic = "Select a picture:";
...
char g_szVarBrowser[256];
...
void OnOption2(void)
{
    static BOOL bFirst = TRUE;
    HWND hWnd = NULL;

```

```

RECT rect;
...
if (bFirst == TRUE)
{
...
strcpy(g_szVarBrowser, DynWizVarBrowser);
First = FALSE;
}
...
...
// Static text for the input field with Browse button
CreateStatic(0, 95, DynWizFileBrowserStatic);
//Tag selection dialog
hWnd =
CreateFileBrowser(0, 110, FB_WITHPATH, DynWizFilter, g_szFileBrowser);
GetWindowRect(GetParent(hWnd), &rect);
MoveWindow(hWnd, 0, 110, (rect.right-rect.left), 21, TRUE);
}

```

CreatePackageBrowser/CreatePackageBrowserEx

Introduction

In the "Set options" dialog an input field with a Browse button is displayed for the x,y coordinates. A name can be typed in this input field. The package browser is enabled by clicking on the Browse button at the right edge of the input field. The flag or the ProgID defines the type of data to be shown from the package.

With the function "CreatePackageBrowserEx" a ProgID can be transferred instead of a flag.

Syntax

HWND CreatePackageBrowser (int x, int y, DWORD flags, char* Name)

HWND CreatePackageBrowserEx (int x, int y, char* ProgID, char* Name)

Parameters

Parameters	Description
int x	Shows the value of the x coordinate.
int y	Shows the value of the y coordinate.

Parameters	Description
DWORD flags	Currently only PB_PICTURE can be used. This enables picture selection.
char* ProgID	Programmatic ID of the component used for building the selection. By transferring "WinCC.CCFileASOStub.1" the picture selection is addressed.
char* Name	Contains the name. The name may have a predefined default value. This entry is always displayed.

Return value

	Return value
HWND	Returns the object handle.
Name	Input buffer contains the name

Example

The following excerpt from the file "Demo.wnf" shows the use of this function. In the "Set options" dialog of the "Demo Wizard" an input field with a Browse button is displayed. Clicking on the Browse button opens the picture selection dialog.

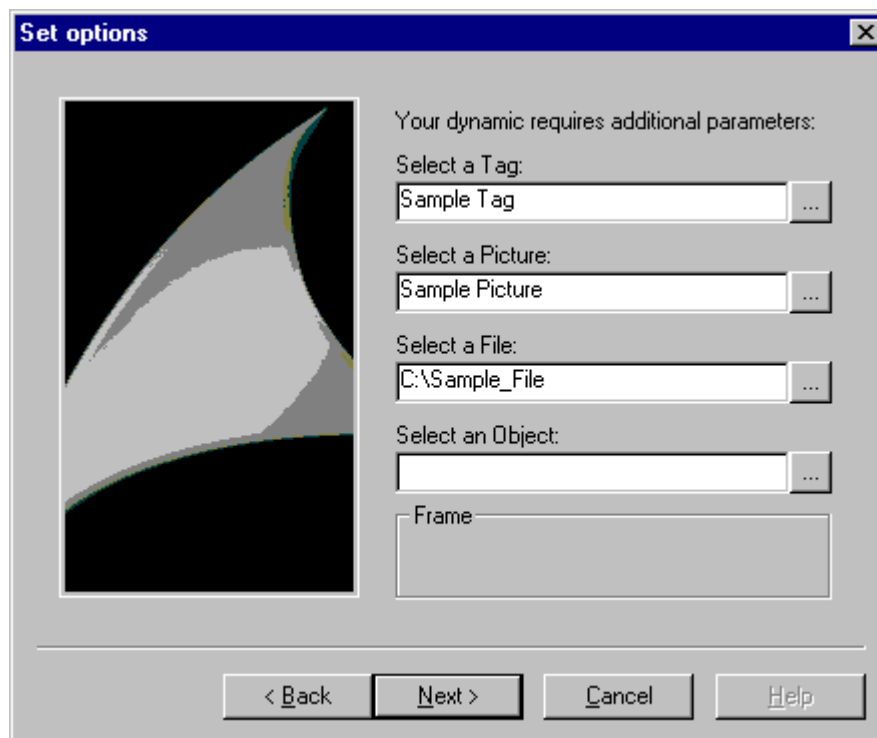

```
char* DynWizPicBrowserStatic = "Select a picture:";
char* DynWizPicBrowser = "Sample picture";
```

```
...
char g_szPicBrowser[256];
...
void OnOption2(void)
{
    static BOOL bFirst = TRUE;
    HWND hWnd = NULL;
    RECT rect;
    ...
    if (bFirst == TRUE)
    {
        ...
        &#9;strcpy(g_szPicBrowser, DynWizPicBrowser);

        First = FALSE;
    }
    ...
    ...
    // Static text for the input field with Browse button
    CreateStatic(0, 50, DynWizPicBrowserStatic);
    //Picture selection dialog
    hWnd = CreatePackageBrowser(0, 65, PB_PICTURE, g_szPicBrowser);
    MoveWindow(hWnd, 0, 65, (rect.right-rect.left), 21, TRUE);
}
```

CreateObjectBrowser

Introduction

In the "Set options" dialog an input field with a Browse button is displayed for the x,y coordinates. An object or property name can be typed in this input field. Clicking on the Browse button opens a selection dialog. In this selection dialog an object or property name can be searched and selected.

Syntax

HWND CreateObjectBrowser (int x, int y, char* Title, DWORD flags, char* ObjectName)

Parameters

Parameters	Description
int x	Shows the value of the x coordinate.
int y	Shows the value of the y coordinate.
char* title	Label of the selection dialog.
DWORD flags	Two different flags can be transferred: OB_OBJECTS Display of all objects OB_PROPERTIES Additionally the property selection is offered.
char* ObjectName	Input buffer for the object or property name. The input buffer can be set to a default value.

Return value

	Return value
HWND	Returns the object handle.
ObjectName	Input buffer contains the object or property name

Example

The following excerpt from the file "Demo.wnf" shows the use of this function. In the "Set options" dialog of the "Demo Wizard" an input field with a Browse button is displayed. Clicking on the Browse button opens the window object selection dialog.

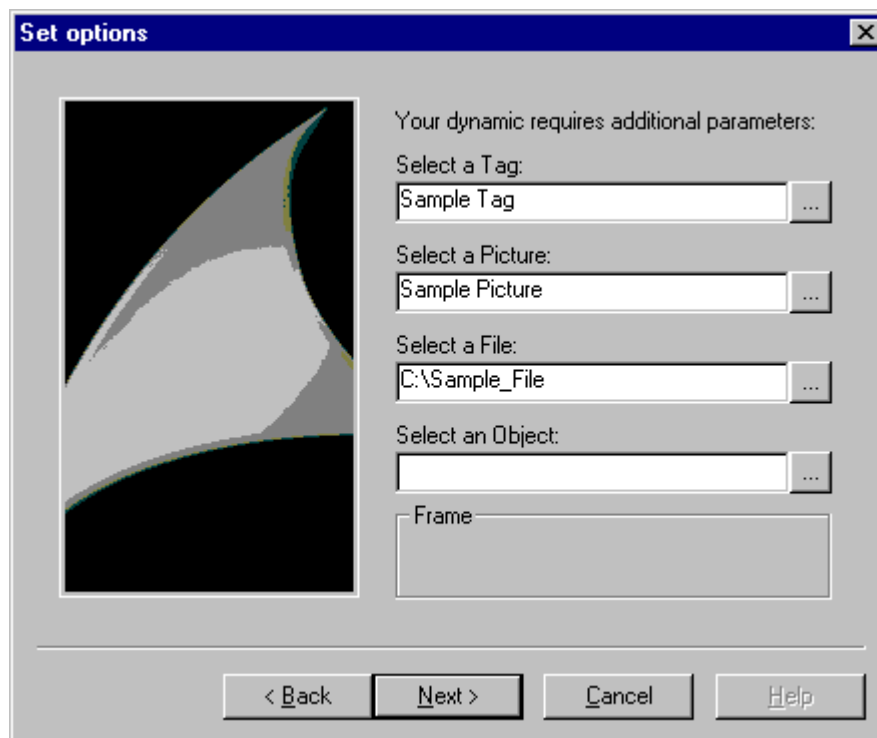

```
char* DynWizObjectBrowserStatic = "Select an object:";
char* DynWizObjectBrowser = "Object";
char* DynWizObject = "Window object selection";
;
...
char g_szObjectBrowser[256];
...
void OnOption2(void)
{
    static BOOL bFirst = TRUE;
    HWND hWnd = NULL;
    RECT rect;
    ...
    if (bFirst == TRUE)
    {
        ...
        strcpy(g_szObjectBrowser, DynWizObjectBrowser);
        First = FALSE;
    }
    ...
    ...
    // Static text for the input field with Browse button
    CreateStatic(0, 50, &#9;CreateStatic(0, 140, DynWizObjectBrowserStatic);
);
//Window selection dialog
hWnd =
CreateObjectBrowser(0, 155, DynWizObject, OB_OBJECTS, g_szObjectBrowser)
;
MoveWindow(hWnd, 0, 155, (rect.right-rect.left), 21, TRUE);
}
```

16.3.4.13 Wizard functions for generating dynamics

GenerateBLOB

Introduction

The GenerateBLOB function (BLOB = Binary Large Object) creates an action which can be appended to a graphic object property. An action comprises 3 parts.

Prologue: This is the header of the C function.

Example:

```
#include "apdefap.h"
void OnLButtonDown(char* lpszPictureName, char* lpszObjectName, char*
lpszPropertyName, UINT nFlags, int x, int y)
{
```

The prologue depends on the trigger starting the action (in the above example: clicking the left mouse button).

Epilogue: This is the end of the C function made up of the '}' symbol.

Core: This part contains the actual functionality of the C function. Example:

```
ProgramExecute("notepad.exe");
```

This function creates and compiles the C code of the action. The compilation results in a P code. This code is interpreted and processed by the WinCC runtime system. In case of an incorrect C code no P code is created.

The function creates a BLOB in which the parts of the action (C code, P code, trigger...) are stored. Before the end of the wizard function the BLOB has to be deleted again. More detailed information on deleting the BLOB function may be found under "DeleteBLOB".

Syntax

```
AP_BLOB GenerateBLOB (char* Prolog, char* Epilog, char* Format, ... )
```

Parameters

Parameters	Description
char* Prologue	Prologue of the action as ASCII string.
char* Epilogue	Epilogue of the action as ASCII string.
char* Format	Core of the action as ASCII string or format string according to the standard function "printf".

Note

The C codes are created by means of the C function `sprintf`. The parameter is processed as format string, i.e. format control characters (e.g. `\ % "`) are evaluated. If these are to be transferred into the C code (e.g. as format string for a `printf` call in an action), they must be provided with a `\`.

Example:

```
\ → \\
% → \%
" → \"
```

Return value

The function returns a structured tag of the type `AP_BLOB` with the following structural components:

Structural component	Return value
<code>DWORD dwPCodeSize</code>	Length of the created P code in bytes
<code>LPVOID lpPCode</code>	Pointer to the created P code
<code>int nErrors</code>	Number of compiler errors
<code>int nWarnings</code>	Number of compiler warnings

Example

The following excerpt from the file "Execute Programm.wnf" shows the use of this function. The wizard function creates a C script which starts another application (in this example: `notepad.exe`).

```
...
...
void OnGenerate(void)
{
    PCMN_ERROR pError;
    AP_BLOB *blob;
    char code[500];
    char sError[500];
    ..
    Slash2Db1Slash(g_Picture, strlen(g_Picture));
    ..
    sprintf(code, "%sProgramExecute(\"%s\");", ifcode, g_Picture);
    ..
    //Prologue
```

```
blob = GenerateBLOB("#include \"apdefap.h\"\r\n"
"void OnClick(char* lpszPictureName, " "char*lpszObjectName,char*
lpszPropertyName, "
"UINT nFlags,int x, int y) {",
//Epilogue
"}",
//Core
code);

BEGIN_JCR_BLOBERRORS

SetAction(NULL, blob, g_Trigger);

END_JCR_BLOBERRORS

DeleteBLOB(blob);
}
```

Created C script

```
#include "apdefap.h"
void OnLButtonDown(char* lpszPictureName,
char* lpszObjectName,
char* lpszPropertyName,
UINT nFlags, int x, int y)
{
ProgramExecute("notepad.exe");
}
```

DeleteBLOB

Introduction

The GenerateBLOB function creates a BLOB. At the end of the wizard function the BLOB has to be deleted again. The BLOB is deleted with the DeleteBLOB function.

Syntax

void DeleteBLOB (AP_BLOB* blob)

Parameters

Parameters	Description
AP_BLOB* blob	Pointer to the result variable of the "GenerateBLOB" function.

Example

DeleteBLOB(blob);

SetAction

Introduction

An action is appended to the selected graphic object at the specified trigger.

If the trigger is an event, it is used as a direct call parameter.

If the trigger is a property that has been made dynamic, it first has to be entered into the BLOB using the AddVarTrigger or AddTimeTrigger function.

Note

If the action is to be appended to a different object, i.e. not to the object selected, the PDLCSSetAction API function must be used.

Further information on the function PDLCSSet Action may be found in the WinCC ODK manual.

Syntax

Boolean SetAction (char* Property, AP_BLOB* Blob, DWORD Trigger)

Parameters

Parameters	Description
char* Property	Property name. Always use the English property name. For a trigger on an event a NULL pointer has to be transferred.
AP_BLOB* Blob	Pointer to the result variable of the "GenerateBLOB" function.
DWORD TriggerID	ID of the trigger: NOTDEFINED = trigger is entered in BLOB MOUSECLICK = Mouse click MOUSELBUTTONDOWN = Press the left mouse button MOUSELBUTTONDOWN = Release the left mouse button MOUSERBUTTONDOWN = Press right mouse button MOUSERBUTTONUP = Release right mouse button KEYBOARDDOWN = press keyboard key KEYBOARDUP = release keyboard key OBJECTCHANGE = Object change PROPERTYCHANGE = Change of the property PICTUREOPEN = Open Picture PICTURECLOSE = Close Picture

Return value

	Return value
Boolean return value	TRUE = Function executed successfully. FALSE = Function not executed successfully.

Example

See example in GenerateBLOB function.

See also

GenerateBLOB (Page 2607)

AddTimeTrigger

Introduction

The function supplements the action with a trigger of the type "cyclic trigger".

Syntax

BOOL AddTimeTrigger (AP_BLOB* Blob, char* Name, DWORD TriggerType, DWORD GraphCycleType, DWORD CycleID)

Parameters

Parameters	Description
AP_BLOB* Blob	Pointer to the result variable of the "GenerateBLOB" function.
char* Name	Name of the event. This can be any ASCII string. The name is shown as event name in the action window.
DWORD TriggerType	Type of cyclic trigger: 2 = time cycle (standard cycle) 4 = graphic object cycle
DWORD GraphCycleType	Type of graphic object cycle: 2 = window cycle 1 = picture cycle
DWORD CycleID	Trigger cycle: 0 = upon change 1 = 250 ms 2 = 500 ms 3 = 1 s 4 = 2 s 5 = 5 s 6 = 10 s 7 = 1 min 8 = 5 min 9 = 10 min 10 = 1 h 11 = user cycle 1 12 = user cycle 2 13 = user cycle 3 14 = user cycle 4 15 = user cycle 5

Return value

	Return value
BOOL	TRUE = Function completed successfully. FALSE = Function not completed successfully.

Example

The time passing between two action triggerings is 1s.

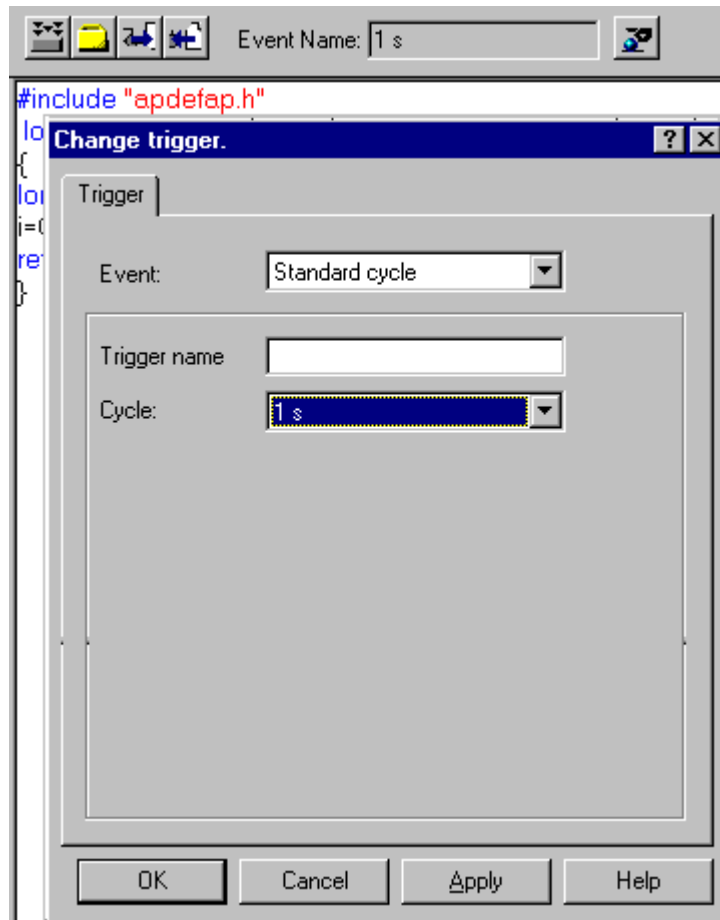

```

BOOL FctRet;
..
FctRet = AddTimeTrigger(blob, "1 sec", 2, 0, 3);

```

AddVarTrigger /AddVarTriggerEx

Introduction

The function supplements the action with a trigger of the type "tag trigger".

Syntax

```

BOOL AddVarTrigger (AP_BLOB* Blob, char* EventName, char* VarName )

```

BOOL AddVarTriggerEx (AP_BLOB* Blob, char* EventName, char* VarName, DWORD CycleID)

Parameters

Parameters	Description
AP_BLOB* Blob	Pointer to the result variable of the "GenerateBLOB" function.
char* EventName	Name of the event. This can be any ASCII string. The name is shown as event name in the action window.
char* VarName	Name of the WinCC tag initiating the triggering or participating in it.
DWORD CycleID	Trigger cycle: 0 = upon change 1 = 250 ms 2 = 500 ms 3 = 1 s 4 = 2 s 5 = 5 s 6 = 10 s 7 = 1 min 8 = 5 min 9 = 10 min 10 = 1 h 11 = user cycle 1 12 = user cycle 2 13 = user cycle 3 14 = user cycle 4 15 = user cycle 5 For the function AddVarTrigger the value CycleID = 4 ist pre-defined.

Return value

	Return value
BOOL	TRUE = Function completed successfully. FALSE = Function not completed successfully.

Example

You have entered the tag 'StartTurbine1' as trigger in the trigger type "Tag". The action is started as soon as the value of one of these tags changes.

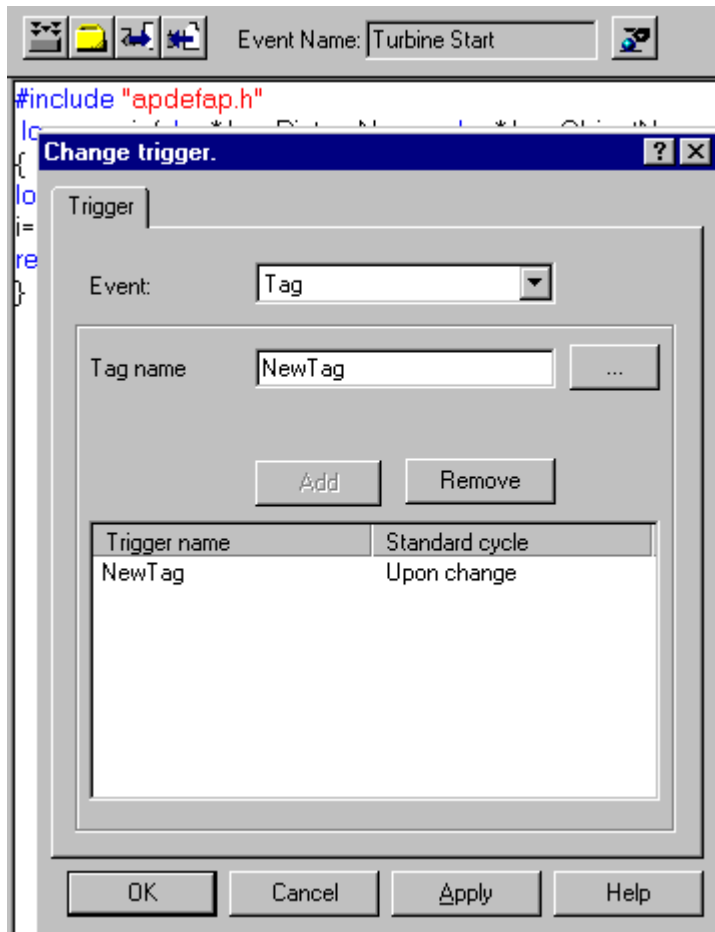

```
BOOL FctRet
```

```
FctRet = AddVarTriggerEx(blob,"Turbine Start","StartTurbine1",0);
```

SetValidateFct

Introduction

The name of a check function is communicated to the Dynamic Wizard. The check function allows checking the options and trigger parameters. In case of a negative test result a reentry can be initiated.

The check function is called when the button "Continue" is clicked in the "Select options" or "Set trigger" dialogs. In case of a positive test result the dialog is closed on the next page

appears. In case of a negative test result the dialog remains active. A continuation is only possible after entering the correct parameters.

The check function takes effect as soon as it is set in the Dynamic Wizard. It is also effective for subsequent option pages. If no or another check function is to take effect, either a dummy function (with positive test result) or another check function must be set.

Syntax

BOOL SetValidateFct (LPCSTR FctName)

Parameters

Parameters	Description
LPCSTR FctName	Name of the check function as ASCII string.

Return value

	Return value
BOOL	Result of the test TRUE = positive test result. FALSE = negative test result.

Example

The following excerpt from the file "Instanzobjekt.wnf" shows the use of this function.

The wizard function has been expanded with a check function.

```

...
...
// Validation option 1
BOOL ValidateOpt1(void)
{
// Property selected
return (strcmp(g_NewInst, ""));
}

void OnOption1(void)
{
HWND hWnd;
RECT rect;

```

```

DM_VARFILTERdmFilter = {DM_VARFILTER_TYPE, 1, NULL, NULL, NULL,
NULL };

SetValidateFct("ValidateOpt1");
sprintf(g_NewInst, "");
..
}

```

EnumProperty/EnumPropertyEx

Introduction

The EnumProperty function lists the object properties of an object. The EnumPropertyEx function allows specifying the object properties to be listed.

Syntax

BOOL EnumProperty (char* FName, LPVOID pItem, DWORD dwFlags);

BOOL EnumPropertyEx (LPCTSTR Projectname, LPCTSTR Picturename, LPCTSTR Objectname, char* FName, LPVOID pItem, DWORD dwFlags);

Parameters

Parameters	Description
LPCTSTR Projectname	Pointer to the name of the project, including directory and file extension.
LPCTSTR Picturename	Pointer to the name of the picture whose objects are to be listed. Distinction is made between upper and lower case.
LPCTSTR object name	Pointer to the name of the object
char* FName	Name of your callback function called once for each object property.
LPVOID pItem	Pointer to application-specific data passed on to the callback function. This pointer is not evaluated by the function but made available in the callback function again.
DWORD dwFlags	dwFlags specifies the property types to be listed. Presently the following specifications are possible: PropertyHasDynamic (Value: 0x0001)	Only object properties with dynamics are enumerated. PropertyHasEvents (Value: 0x0002)	Only object properties with events are enumerated. PropertyIsDynamicable (Value: 0x0003)	Only object properties that can be made dynamic are enumerated.

Return value

	Return value
BOOL	TRUE = Object properties of an object type listed FALSE = Error

Example

The following excerpt from the file "Dynamic Property.wnf" shows the use of this function.

```
...
...
// Callback function
BOOL EnumFct(char *property, VARTYPE vt, LPVOID pItem)
{
    sprintf(g_prop[SendMessage((HWND)pItem, LB_INSERTSTRING, (WPARAM)-1,
        (LPARAM)property)], property);
    return TRUE;
}

void OnOption1(void)
{
    HWND hWnd, LBHwnd;
    RECT rect;
    static BOOL bFirst = TRUE;

    if(bFirst)
    {
        ...
    }
    ...

    CreateStatic(0, 10, "Properties of the current object :");
    LBHwnd=CreateListbox(0, 30, g_Headline, 8, &g_indexProperty);
    EnumProperty("EnumFct", LBHwnd, 3);
    GetWindowRect(GetParent(LBHwnd), &rect);
    ...
}
```

16.3.4.14 Wizard WinCC functions

GetProjectName

Introduction

The path of the current WinCC project is determined.

Syntax

```
LPCSTR GetProjectName ( void )
```

Return value

	Return value
LPCSTR	Pointer to the ASCII string of the MCP file

Example

```
LPCSTR Name;
```

```
Name = GetProjectName();
```

The function provides e.g. the following result: C:\Siemens\WinCC\WinCCProjects
\Example.mcp

GetPictureName

Description

The name of the current picture (*.pdl) is determined.

Syntax

```
LPCSTR GetPictureName ( void )
```

Return value

	Return value
LPCSTR	Pointer to the ASCII string of the PDL file

Example

LPCSTR Name;

Name = GetPictureName();

The function provides e.g. the following result: TurbineControl.PDL

GetDefaultWNFPath

Description

The path of the current WNF directory is determined.

Syntax

LPCSTR GetDefaultWNFPath (void)

Return value

	Return value
LPCSTR	Pointer to the ASCII string of the path name

Example

LPCSTR Name;

Name = GetDefaultWNFPath();

The function provides e.g. the following result: C:\Siemens\WinCC\wscripts\wscripts.deu\

GetObjectName

Introduction

The name of the selected graphic object in the current picture is determined.

Syntax

LPCSTR GetObjectName (void)

Return value

	Return value
LPCSTR	Pointer to the ASCII string of the object name

Example

```
LPCSTR Name;
```

```
Name = GetObjectName();
```

The function provides e.g. the following result: Button1

InsertXRefSection

Description

The function inserts into the transferred source code a section according to the Xref notation, so that the transferred tags and picture names are entered as define.

Syntax

```
BOOL InsertXRefSection (char * SourceCode, char* TagName[], int TagCount, char*
PictName[], int PictCount)
```

Parameters

Parameters	Description
char *SourceCode	CodeBuffer in which to insert the Xref section
char *TagName[]	NULL or field of tag names inserted into the Xref section.
int TagCount	Number of tag names in the field DayName[]
char *PictName[]	NULL or field of picture names inserted into the Xref section
int PictCount	Number of picture names in the field PictName[]

Return value

	Return value
BOOL	The result value indicates whether the function has been completed successfully.
char *TagName[]	Field of the defines for the tags passed at the same position
char *PictName[]	Field of the defines for the pictures passed at the same position

Example

```
char* szPictureArray[1];
```

```
char szPictName[255];
```

```
char szSourceCode[1100];
```

```
strcpy(szPictName, "Newpdl.pdl");
szPictureArray[0] = szPictName;
strcpy(szSourceCode, "");
InsertXrefSection(szSourceCode, NULL, 0, szPictureArray, 1);
```

The function returns the following result:

```
szSourceCode:
// WINCC:TAGNAME_SECTION_START
// syntax: #define TagNameInAction "DMTagName"
// next TagID : 1
// WINCC:TAGNAME_SECTION_END
// WINCC:PICNAME_SECTION_START

// syntax: #define PicNameInAction "PictureName"
// next PicID : 1
#define PIC_0 " Newpdl.Pdl"
// WINCC:PICNAME_SECTION_END
szPictureArray[0]: "PIC_0"
```

16.3.4.15 Wizard progress functions

Wizard progress functions

Introduction

The progress functions serve to show the progress (in %) of a procedure in a "progress box".

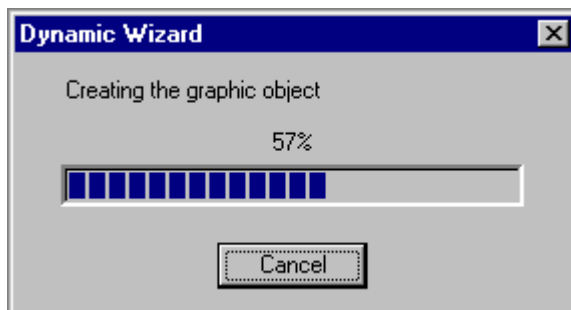

Upon creation of the progress bar (CreateProgressDlg) a start and end value and an increment are specified. The start value corresponds to 0% progress and the end value to 100% progress. The increment defines the progress change steps.

Typically, the start value is =0 and the increment =1. The end value corresponds to the number of executed actions in the process.

During the procedure the progress is incremented (Progress_StepIt) or set to a defined value (Progress_SetPos).

At the end of the procedure the progress display has to be removed again (DestroyProgressDlg)

It is possible to display a text in the progress bar (Progress_SetStatus), such as "Creating graphic objects". This can also be changed during processing to differentiate various partial procedures.

In most cases it is not possible to divide the procedure in a way that allows a chronologically linear progress display. However, this is not really necessary. Displaying the progress as such is sufficient.

See also

DestroyProgressDlg (Page 2625)

Progress_SetPos (Page 2624)

Progress_StepIt (Page 2624)

Progress_SetStatus (Page 2624)

CreateProgressDlg (Page 2623)

CreateProgressDlg

Introduction

A progress bar shows the progress of a processing procedure from 0 to 100%.

Syntax

PROGRESS_DLG CreateProgressDlg (int nLower, int nUpper, int nStepInc)

Parameters

Parameters	Description
int nLower	Progress start value (corresponds to 0 %)
int nUpper	Progress end value (corresponds to 100 %)
int nStepInc	Progress increment

Return value

	*Return value
PROGRESS_DLG	Object handle

Progress_SetStatus

Description

A text is entered as header into the progress bar.

Syntax

```
void Progress_SetStatus (PROGRESS_DLG hDlg, char* ActionName )
```

Parameters

Parameters	Description
PROGRESS_DLG hDlg	Object handle
char* ActionName	Header text

Progress_Stept

Description

The progress of a processing procedure is incremented by one step.

Syntax

```
void Progress_Stept (PROGRESS_DLG hDlg )
```

Parameters

Parameters	Description
PROGRESS_DLG hDlg	Object handle

Progress_SetPos

Description

In the progress bar the progress is set to a defined value. The value must lie between start and end value.

Syntax

```
void Progress_SetPos (PROGRESS_DLG hDlg, int nPos )
```

Parameters

Parameters	Description
PROGRESS_DLG hDlg	Object handle
int nPos	Progress value

DestroyProgressDlg

Introduction

The progress bar will be closed.

Syntax

```
void DestroyProgressDlg (PROGRESS_DLG hDlg )
```

Parameters

Parameters	Description
PROGRESS_DLG hDlg	Object handle

16.3.4.16 Wizard Windows functions

Wizard Windows functions

Introduction

The following is a short description of Windows functions which must or can be used in connection with the Wizard system functions (especially with the window functions for parameter input).

More detailed information may be found in the Programmer's Reference of Microsoft Developers Studio /Win32 SDK.

See also

MessageBox (Page 2630)

ShowWindow (Page 2629)

[GetWindow \(Page 2628\)](#)
[SendMessage \(Page 2628\)](#)
[MoveWindow \(Page 2627\)](#)
[GetWindowRect \(Page 2626\)](#)
[GetParent \(Page 2626\)](#)

GetParent

Introduction

The handle of the parent window is determined for a window, e.g. the handle of the options window.

Syntax

HWND GetParent (HWND hWnd)

Parameters

Parameters	Description
HWND hWnd	Handle of the window for which to determine the parent window

Return value

	Return value
HWND	Handle of the parent window NULL = No parent window exists.

GetWindowRect

Introduction

Size and coordinates of a window are determined, e.g. the size of the options window.

Syntax

BOOL GetWindowRect (HWND hWnd, LPRECT lpRect)

Parameters

Parameters	Description
HWND hWnd	Window handle
LPRECT lpRect	Pointer to a structured result variable

Return value

	Return value
BOOL	TRUE = Function completed successfully. FALSE = Function not completed successfully.
LPRECT lpRect	Structured result variable of the LPRECT structure with the structural components: LONG left: X coordinate of the left upper corner LONG top: Y coordinate of the left upper corner LONG right: X coordinate of the right lower corner LONG bottom: Y coordinate of the right lower corner:

See also

Adding the "Motor.wnf" script to the database (Page 2635)

CreateEdit (Page 2584)

MoveWindow

Introduction

Position and dimension of a window are changed, e.g. the position and the size of the input fields in the options window.

Syntax

BOOL MoveWindow (HWND hWnd, int x, int y, int nWidth, int nHeight, BOOL bRepaint)

Parameters

Parameters	Description
HWND hWnd	Window handle
int x	X coordinate of the left upper corner
int y,	Y coordinate of the left upper corner
int nWidth	Width
int nHeight	Height
BOOL bRepaint	TRUE = The window is redrawn.

Return value

	Return value
BOOL	TRUE = Function completed successfully. FALSE = Function not completed successfully.

See also

Creating the Dynamic Wizard function for the Motor (Page 2634)

SendMessage**Introduction**

A message is sent to a window. The function is used for filling a selection field, for example.

Syntax

LRESULT SendMessage (HWND hWnd, UINT Msg, WPARAM wParam, LPARAM lParam)

Parameters

Parameters	Description
HWND hWnd	Window handle
UINT Msg,	Message type: LB_INSERTSTRING = Insert text in a ListBox
WPARAM wParam	1. message parameter: -1 = The text is appended at the end.
LPARAM lParam	2. message parameter: Pointer to the text

Return value

	Return value
LRESULT	Object handle

GetWindow**Introduction**

The handle of a window is determined which has a certain relation to another window (original window).

Syntax

GetWindow (HWND hWnd, UINT uCmd)

Parameters

Parameters	Description
HWND hWnd	Handle of the original window
UINT uCmd	Relation GW_HWNDFIRST = upper window

Return value

	Return value
HWND	Handle of the found window or NULL

ShowWindow**Introduction**

The display type of a window is specified.

Syntax

ShowWindow (HWND hWnd, int nCmdShow)

Parameters

Parameters	Description
HWND hWnd	Window handle
int nCmdShow	Display status of the window SW_HIDE = not visible

Return value

	Return value
BOOL	TRUE = Window was visible FALSE = Window was not visible

MessageBox

Introduction

The function serves to display a message for the user if an error has occurred or a user action is required.

The message is displayed with a user specific text, title and button.

Note

"MB_SYSTEMMODAL" parameter

Execution of a message box function with parameter "MB_SYSTEMMODAL" ensures that the message box is displayed in the foreground. If this parameter is not specified, the message box is no longer visible to users (hidden in the background) and cannot be operated. Mouse clicks outside the message box are saved to a buffer and processed after the message box has been closed.

Example: `MessageBox(NULL, "Welt", "Hallo", MB_SYSTEMMODAL | MB_OK);`

Syntax

```
int MessageBox (HWND hWnd, LPCTSTR lpText, LPCTSTR lpCaption, UINT uType )
```

Parameters

Parameters	Description
HWND hWnd	Handle of the parent window NULL = Message has no parent window.
LPCTSTR lpText	Message text
LPCTSTR lpCaption	Title text
UINT uType	MB_SYSTEMMODAL = prevents the system from being blocked as long as the MessageBox is opened. Box type: MB_OK = Message with an 'OK' button MB_OKCANCEL = Message with the buttons 'OK' and 'Cancel'

Return value

	Return value
int	ID of the button operated: IDOK = 'OK' button operated IDCANCEL = 'Cancel' button operated

Example



```
int RetMsg;
```

```
RetMsg = MessageBox (NULL, "Error calling the API functions", "System error", MB_OK);
```

16.3.5 Examples

16.3.5.1 Examples

Introduction

In the context of this description two examples of Dynamic Wizard functions are given:

- Demo Wizard
- Dynamic motor

See also

[Dynamic motor \(Page 2634\)](#)

[Demo Wizard \(Page 2631\)](#)

16.3.5.2 Demo Wizard

Demo Wizard

Introduction

In the "Demo.wnf" file, a Dynamic Wizard called "Demo Wizard" is created. This Dynamic Wizard shows the basic functions available to make the entry of data convenient for the user. However, the Demo Wizard does not perform an action.

See also

[How to Add the Script "Demo.wnf" to the Database \(Page 2633\)](#)

[How to Create the Help Text \(Page 2632\)](#)

[Creating the Dynamic Wizard function for the Demo Wizard \(Page 2632\)](#)

Creating the Dynamic Wizard function for the Demo Wizard

Requirements

A WinCC project must be open.

Procedure

1. In the Windows Explorer copy the "Demo.wnf" file from the directory "Siemens\ WinCC\ documents\ german" to the directory "Siemens\ WinCC\ wscript\ wscript.deu".
2. Start the Dynamic Wizard Editor.
3. In the File menu of the Dynamic Wizard Editor select "Open". The file selection dialog box opens.
4. Mark the "Demo.wnf" file. Click "Open". The "Demo.wnf" file is shown in an editor window.
5. Click the icon  in the toolbar to compile the script. The result is displayed in the output window.

See also

How to Add the Script "Demo.wnf" to the Database (Page 2633)

How to Create the Help Text

Introduction

In this section a help for the dialog "Select trigger" is created.

Procedure

1. Click the icon  in the toolbar. The help editor opens.
2. In the "Wizard - Group" field, select "Example".
3. In the "Wizard - Name" field, select "Demo Wizard".
4. In the "Page" field, select "TriggerPage".
5. In the "Help - Text" field, enter the following text: "Select trigger
In this dialog you can specify the result for which the action is to be executed."

6. Close the help editor by clicking on the "OK" button.
7. Run the Demo Wizard. In the "Select trigger" dialog, click the "Help" button.

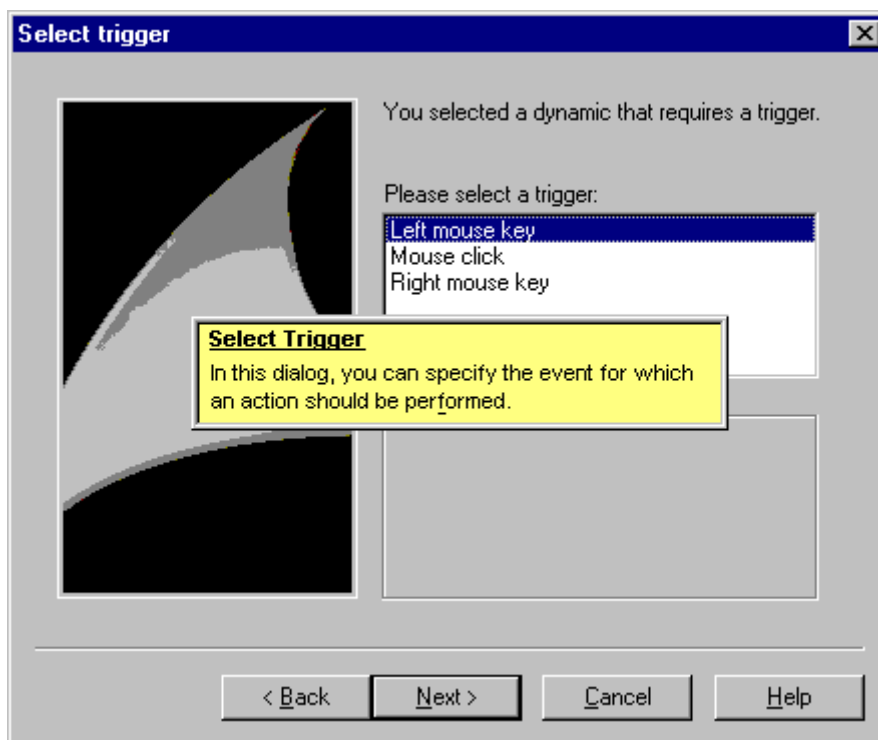

How to Add the Script "Demo.wnf" to the Database



Introduction

To be able to use the Dynamic Wizard function "Demo.wnf" in the Graphics Designer, it must be integrated into the database of the Dynamic Wizard.

To do this, the following steps are necessary,

1. Importing the Wizard scripts
2. Creating the cwd file

Procedure

1. Click the icon  in the toolbar. The file selection dialog box opens.
2. Select the "Demo.wnf" file. Click "Open".
3. Click the icon  in the toolbar to newly create the database.

4. In the "View" menu of the Dynamic Wizard Editor select "Dynamic Wizard".

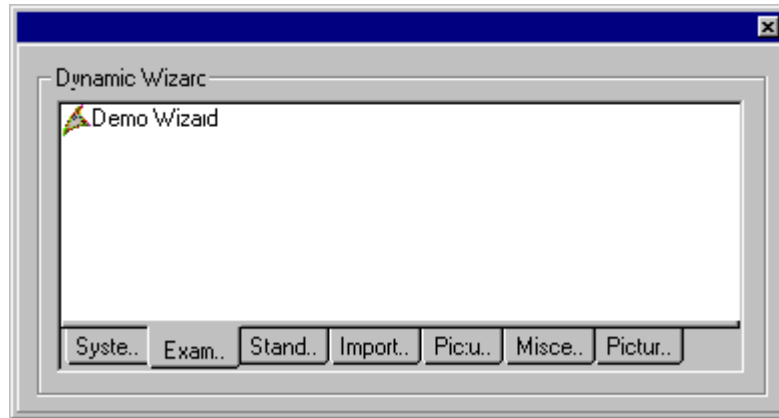

5. Click on the "Example" tab. Double-click on the entry "Demo Wizard".

16.3.5.3 Dynamic motor

Dynamic motor

Introduction

In the "Motor.wnf" script file, a Dynamic Wizard called "Make Motor Dynamic" is created.

Note

This was created especially to make a user object called Motor dynamic and cannot be applied to any other kind of object.

See also

[How to Specify the Customized Object "Dynamic Motor" \(Page 2636\)](#)

[Adding the "Motor.wnf" script to the database \(Page 2635\)](#)

[Creating the Dynamic Wizard function for the Motor \(Page 2634\)](#)

Creating the Dynamic Wizard function for the Motor

Requirements

A WinCC project must be open.

Procedure

1. In Windows Explorer open the "Motor.zip" Winzip file in the directory "Siemens\ WinCC\ documents\ german".
2. Extract the "Motor.wnf" file into the directory "..\WinCC\wscripts\wscripts.deu".
3. Extract the "Motor_dyn.pdl" file into the directory "..\WinCC\WinCCProjects\Name of the WinCCProject\GraCs".
4. Start the Dynamic Wizard Editor.
5. In the File menu of the Dynamic Wizard Editor select "Open". The file selection dialog box opens.
6. Mark the "Motor.wnf" file. Click "Open". The "Motor.wnf" file is displayed in an editor window.
7. Click the icon  in the toolbar to compile the script. The result is displayed in the output window.

See also

Adding the "Motor.wnf" script to the database (Page 2635)

Adding the "Motor.wnf" script to the database



Introduction

To be able to use the Dynamic Wizard function "Motor.wnf" in the Graphics Designer, it must be integrated into the database of the Dynamic Wizard.

To do this, the following steps are necessary,

1. Importing the Wizard scripts
2. Creating the cwd file

Procedure

1. Click the icon  in the toolbar. The file selection dialog box opens.
2. Select the "Motor.wnf" file. Click "Open".
3. Click the icon  in the toolbar to newly create the database.

See also

How to Specify the Customized Object "Dynamic Motor" (Page 2636)

How to Specify the Customized Object "Dynamic Motor"

Introduction

The Motor customized object is linked to a WinCC structure tag of the structure type "MotorStruct" via the "Dynamic Motor" dynamic wizard. In this context, various C-actions and tag connections are created on this object. This wizard cannot be used on other object types.

Requirement

- Create an internal tag "T08i_course_wiz_selected" of the data type "Text tag 8-bit character set".
- Create a structure with the name "MotorStruct" and three internal elements called "Active", "Hand" and "Error" of the data type BIT.
- Create an internal tag named "STR_Course_wiz1" of the data type "MotorStruct".

Procedure

1. Open the Graphics Designer. Select the "Open" item in the "File" menu. Select the "Motor_dyn.pdl" picture in the file selection dialog.
2. Select the Motor customized object. The "Example" tab offers the "Dynamic Motor" wizard.

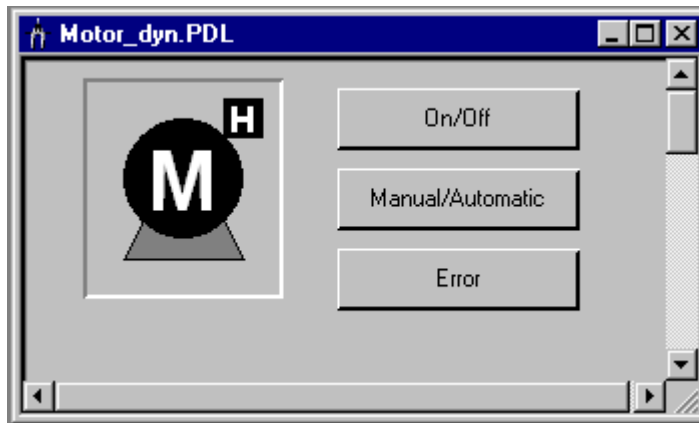

3. Start the Dynamic Wizard. Click on the "Continue" button in the "Welcome to the Dynamic Wizard" dialog. The "Set options" dialog opens up.
4. Click on the Browse button in the "Set options" dialog. The tag selection dialog opens. Select "STR_Course_wiz1" as the structure tag. Close the dialog by clicking on the "OK" button.
5. Click on the Continue button in the "Set options" dialog. The "Finished!" dialog opens. Close the dialog by clicking on the "OK" button.
6. Save the picture. Start the Graphics Designer Runtime.
7. The buttons can be used to simulate the tag values of the selected motor.

See also

Creating the structure and the structure tag (Page 2637)

Creating the structure and the structure tag

Introduction

This section illustrates how to configure the "MotorStruc" structure and the "STR_Course_wiz1" structure tag. The structure and the structure tag are used in the example "Dynamic motor".

Procedure

1. Select "New structure type" from the structure types context menu. The structure properties dialog will be displayed.
2. Rename the structure into "MotorStruc". Click "New element" and create the internal tag "Active" of the data type BIT.
3. Click "New element" and create the internal tag "Hand" of the data type BIT.
4. Click "New element" and create the internal tag "Error" of the data type BIT. Close the dialog by clicking on the "OK" button.
5. In the navigation frame, click the plus sign in front of the icon for tag management. Select "New tag" from the internal tags context menu. Create a WinCC tag "STR_Course_wiz1" of the data type "MotorStruc".

16.4 Documentation Viewer

16.4.1 WinCC Documentation Viewer

Short description

Print jobs of the WinCC report system can be redirected to a file. In case of large amounts of data one file is created for each report page.

The **WinCC Documentation Viewer** allows to display and print these files.

16.4.2 Installing WinCC Documentation Viewer

The WinCC Documentation Viewer can be installed in two different ways:

Procedure

1. During WinCC setup, select "WinCC V7 complete" from the "Programs" dialog. WinCC is installed with the SmartTools.

Start the WinCC Documentation Viewer by selecting "SIMATIC > WinCC > Tools".

Alternative procedure

You can also install the WinCC Documentation Viewer from the WinCC DVD.

1. Switch to the WinCC DVD directory "WinCC\InstData\Smarttools\Setup".
2. Double-click setup.exe.
3. Select the entry "WinCC Documentation Viewer" in the "Components" dialog.
4. Click "Next". Follow the on-screen instructions.

Note

If a WinCC project is activated, only the "emf" files of this project can be viewed and printed out. If WinCC is not active, all "emf" files can be opened and printed out with the WinCC Documentation Viewer.

16.4.3 Description

Introduction

Print jobs can be redirected to a file. In case of large amounts of data one file is created for each report page.

The WinCC Documentation Viewer allows to display and print these files.

Note

If a WinCC project is already activated when starting the WinCC Documentation Viewer, only the "emf" files of this project can be viewed and printed out.

If WinCC has been opened but not activated when starting the Viewer, all "emf" files can be opened and printed out with the Viewer.

Upon deactivating runtime, the Viewer is closed in any case.

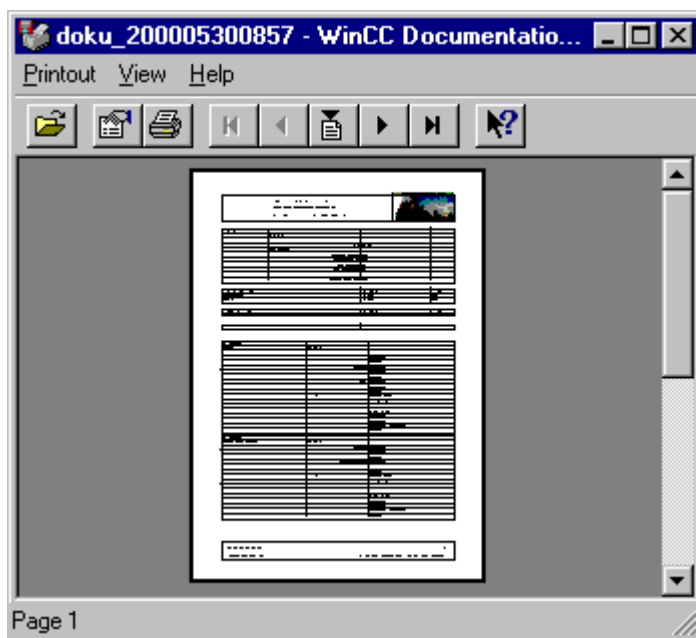

The WinCC Documentation Viewer consists of three areas.

The top border of the screen contains the menu bar. The menu items are described in the direct help.

The toolbar is directly under the menu bar. Frequently used functions, such as page up and page down, are loaded as icons on this bar. The functions of the individual icons are described in the direct help.

The window shows the current document. The display can be enlarged in two steps by clicking.

The screen is limited at the bottom by the status bar displaying information on the current operation.

16.4.4 Creating the .emf file(s)

Introduction

Print jobs can be redirected to a file. In case of large amounts of data one file is created for each report page. The print output is routed to one or several .emf files. The files are stored with the name Page <nnnnnn>.emf in the path, <nnnnn> representing a five-character consecutive number.

The path name is composed as follows: from the project path (e.g. "C:\VFSWinCC\PRT\") and <storage> + <YYYYMMDDHHMM> (YYYY = year, MM = month, DD = day, HH = hour, MM = minute).

If you enter "PDdata" in the "Storage" field, the following path structure is created for the print job within the project directory.



Procedure

1. Choose the "Project documentation setup" command from the File menu in the WinCC editors.
2. Click on the "Printer setup" tab in the "Print job properties" dialog.
3. Activate the "File (*.emf)" check box on the "Printer setup" tab. If you do not wish a simultaneous output to the printer, deactivate the "Printer" check box.
4. In the "Storage" field, enter the name of the path in which the file is to be stored. Close the dialog by clicking on the "OK" button.
5. Select the "Print project documentation" item in the "File" menu. The print output is routed to one or several .emf files. The files are stored with the name Page <nnnnnn>.emf in the path, <nnnnn> representing a five-character consecutive number.

16.5 WinCC CrossReferenceAssistant

16.5.1 WinCC CrossReferenceAssistant

Short description

WinCC CrossReferenceAssistant is a tool which searches scripts for picture names and tags and supplements the scripts so that the WinCC component **Cross Reference** finds the picture names and tags and lists them in the cross reference list.

16.5.2 Installation of the CrossReferenceAssistant

The WinCC CrossReferenceAssistant has a German, English and French user interface.

Procedure

1. During WinCC setup, select "WinCC V7 complete" from the "Programs" dialog.
WinCC is installed with the SmartTools.

Start the WinCC CrossReferenceAssistant by selecting "SIMATIC > WinCC > Tools".

Alternative procedure

It is also possible to install the WinCC CrossReferenceAssistant from the WinCC DVD.

1. Switch to the WinCC DVD directory "WinCC\InstData\Smarttools\Setup".
2. Double-click setup.exe.
3. Select the "CrossReferenceAssistant" entry in the "Components" dialog.
4. Click "Next". Follow the on-screen instructions.

16.5.3 General

WinCC is able to create CrossReference lists. To ensure the tags in the function calls are recognized properly when creating these lists, WinCC was extended by a configuration rule which provides the following:

To be able to search and replace the tag and picture names used in the C actions, the script must be written as follows:

At the start of the script, all tags and picture names must be declared in two sections. Within the sections no further instructions must be entered.

The sections are structured as follows:

```
// WINCC:TAGNAME_SECTION_START
// syntax: #define TagNameInAction DMTagName
// next TagID : 1
#define ApcVarName1 "VarName1"
// WINCC:TAGNAME_SECTION_END

// WINCC:PICNAME_SECTION_START
// syntax: #define PicNameInAction PictureName
// next PicID : 1
#define ApcPictureName1 "PictureName1"
#define ApcPictureName2 "PictureName2"
#define ApcPictureName3 "PictureName3"
// WINCC:PICNAME_SECTION_END
```

Calling the standard functions for the reading or writing of the tags must then be done through the defined tags and pictures.

```
GetTagDWord (ApcVarName1);
OpenPicture(ApcBildname1);
SetPictureName( ApcPictureName2, "PictureWindow1",ApcPictureName3);
```

If the configuration rule is not followed, no CrossReference lists can be created because the tag and picture references in the scripts cannot be resolved.

With the aid of the WinCC CrossReferenceAssistant all function calls known in the Script Management are replaced by the format described above. Only project functions, pictures and actions are converted.

The Runtime environment for the WinCC CrossReferenceAssistant is WinCC. If WinCC is not running or the project to be converted is not loaded, WinCC is started by the WinCC CrossReferenceAssistant or the project is loaded.

See also

Known functions (script management) (Page 2642)

16.5.4 Known functions (script management)

The following functions are known to the Wizard by default and are implemented during conversion:

Functions with tags as parameters:

```
GetTagBit()
GetTagByte()
GetTagChar()
GetTagDouble()
GetTagDWord()
GetTagFloat()
```

GetTagRaw()

GetTagSByte()

GetTagSDWord()

GetTagSWord()

GetTagWord()

SetTagBit()

SetTagByte()

SetTagChar()

SetTagDouble()

SetTagDWord()

SetTagFloat()

SetTagRaw()

SetTagSByte()

SetTagSDWord()

SetTagSWord()

SetTagWord()

GetTagBitWait()

GetTagByteWait()

GetTagCharWait()

GetTagDoubleWait()

GetTagDWordWait()

GetTagFloatWait()

GetTagRawWait()

GetTagSByteWait()

GetTagSDWordWait()

GetTagSWordWait()

GetTagWordWait()

SetTagBitWait()

SetTagByteWait()

SetTagCharWait()

SetTagDoubleWait()

SetTagDWordWait()

SetTagFloatWait()
SetTagRawWait()
SetTagSByteWait()
SetTagSDWordWait()
SetTagSWordWait()
SetTagWordWait()

GetTagBitState()
GetTagByteState()
GetTagCharState()
GetTagDoubleState()
GetTagDWordState()
GetTagFloatState()
GetTagRawState()
GetTagSByteState()
GetTagSDWordState()
GetTagSWordState()
GetTagWordState()

SetTagBitState()
SetTagByteState()
SetTagCharState()
SetTagDoubleState()
SetTagDWordState()
SetTagFloatState()
SetTagRawState()
SetTagSByteState()
SetTagSDWordState()
SetTagSWordState()
SetTagWordState()

GetTagBitStateWait()
GetTagByteStateWait()
GetTagCharStateWait()
GetTagDoubleStateWait()

GetTagDWordStateWait()
GetTagFloatStateWait()
GetTagRawStateWait()
GetTagSByteStateWait()
GetTagSDWordStateWait()
GetTagSWordStateWait()
GetTagWordStateWait()

SetTagBitStateWait()
SetTagByteStateWait()
SetTagCharStateWait()
SetTagDoubleStateWait()
SetTagDWordStateWait()
SetTagFloatStateWait()
SetTagRawStateWait()
SetTagSByteStateWait()
SetTagSDWordStateWait()
SetTagSWordStateWait()
SetTagWordStateWait()

Functions with picture names as parameters:

SetPictureName()
GetPictureName()
GetVisible()
SetVisible()
GetLink()
SetLink()
Set_Focus()
OpenPicture()
GetLinkedVariable()

16.5.5 Project selection

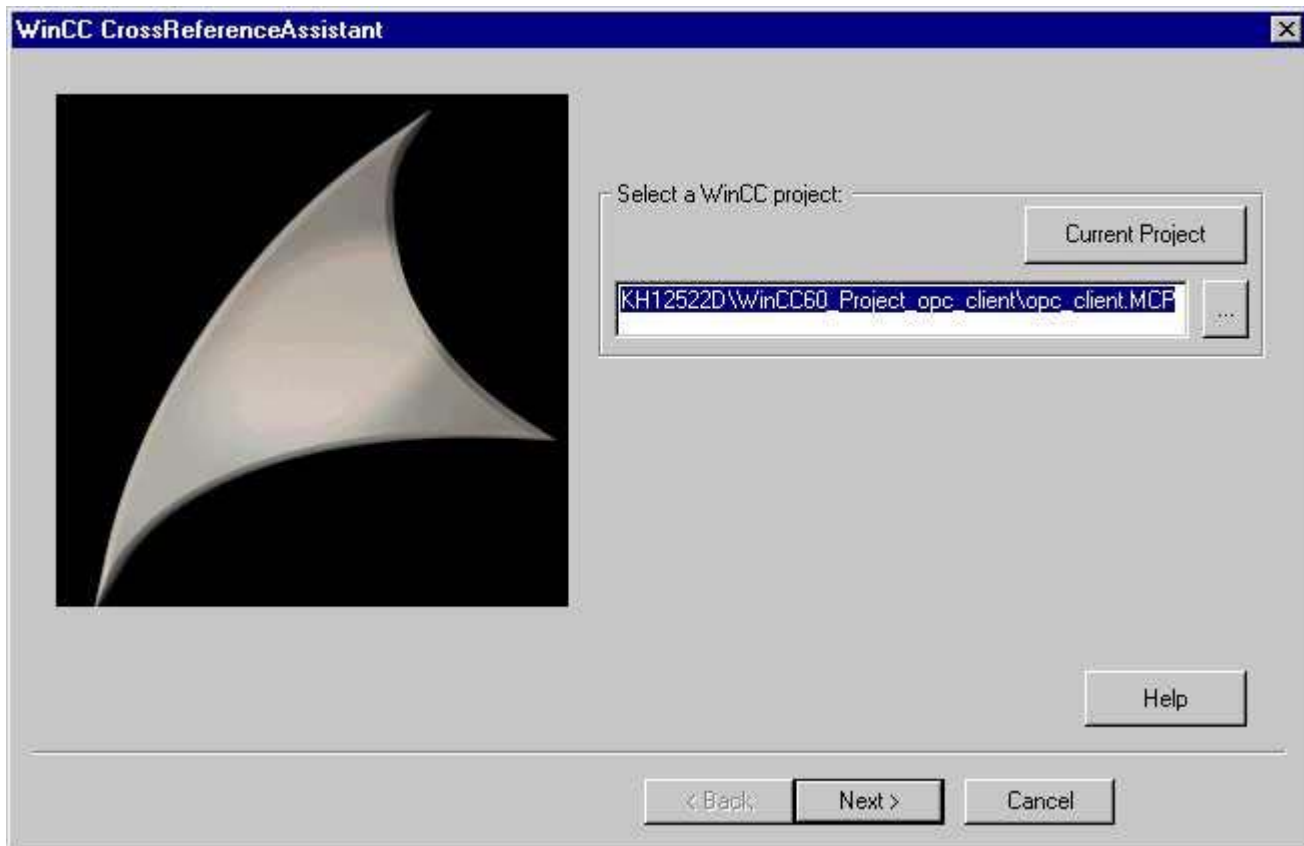

Clicking "..." opens the OpenFile dialog box which enables you to select any project. When clicking "**Current project**", the WinCC CrossReferenceAssistant tries to import and display the project currently loaded in WinCC. If WinCC is not running or no project is loaded, it is started or the required project is loaded.

If a different project has been loaded but is not activated, the project is closed and the required project is opened. This process may take some time.

As soon as text is entered in the input line at the "**Select a WinCC project**" prompt, you can click the button "**Next >**". Then the specified project is checked to see whether it is a valid WinCC project. If the project is not valid, the focus is set on the input line and a message window opens with an explanation of the corresponding error.

"Clicking **Cancel** exits the WinCC CrossReferenceAssistant.

16.5.6 File selection

All pictures, project functions and C actions belonging to the project are displayed in the right list of the dialog box. In the default setting, all files belonging to the project are converted.

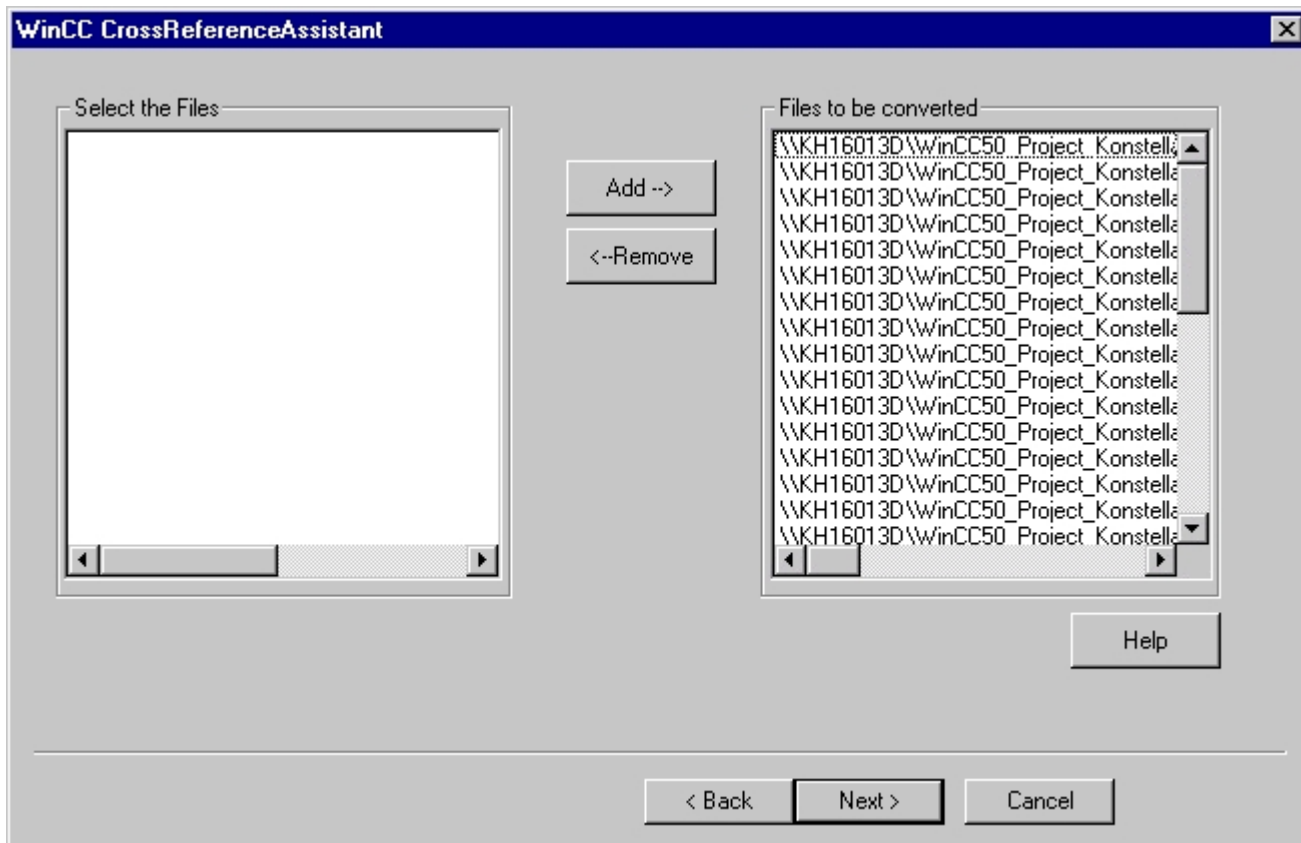

The user can decide to exclude certain files from the conversion to possibly add them later. Deleting files from the conversion list is done by (multiple) selection of the corresponding files in the **"Files to be converted"** list and clicking the **"<--Remove"** button.

Deleted files are displayed in the left list and can be added to the conversion again. To do so, these files must be selected in the **"Select files"** list. By clicking **"Add-->"** they are then added to the right list **"Files to be converted"**.

After selecting the files, click **"Next >"**. The specified files are then read and analyzed.

„Clicking **"< Previous"** takes you back to the project selection. Clicking **"Cancel"** exits the WinCC CrossReferenceAssistant.

See also

Project selection (Page 2646)

16.5.7 Conversion

Introduction

The last page of the Wizards on the one hand enables you to make "Advanced Settings" (see Advanced Settings), and on the other hand to view the progress and the file currently being processed after starting the conversion.

Description

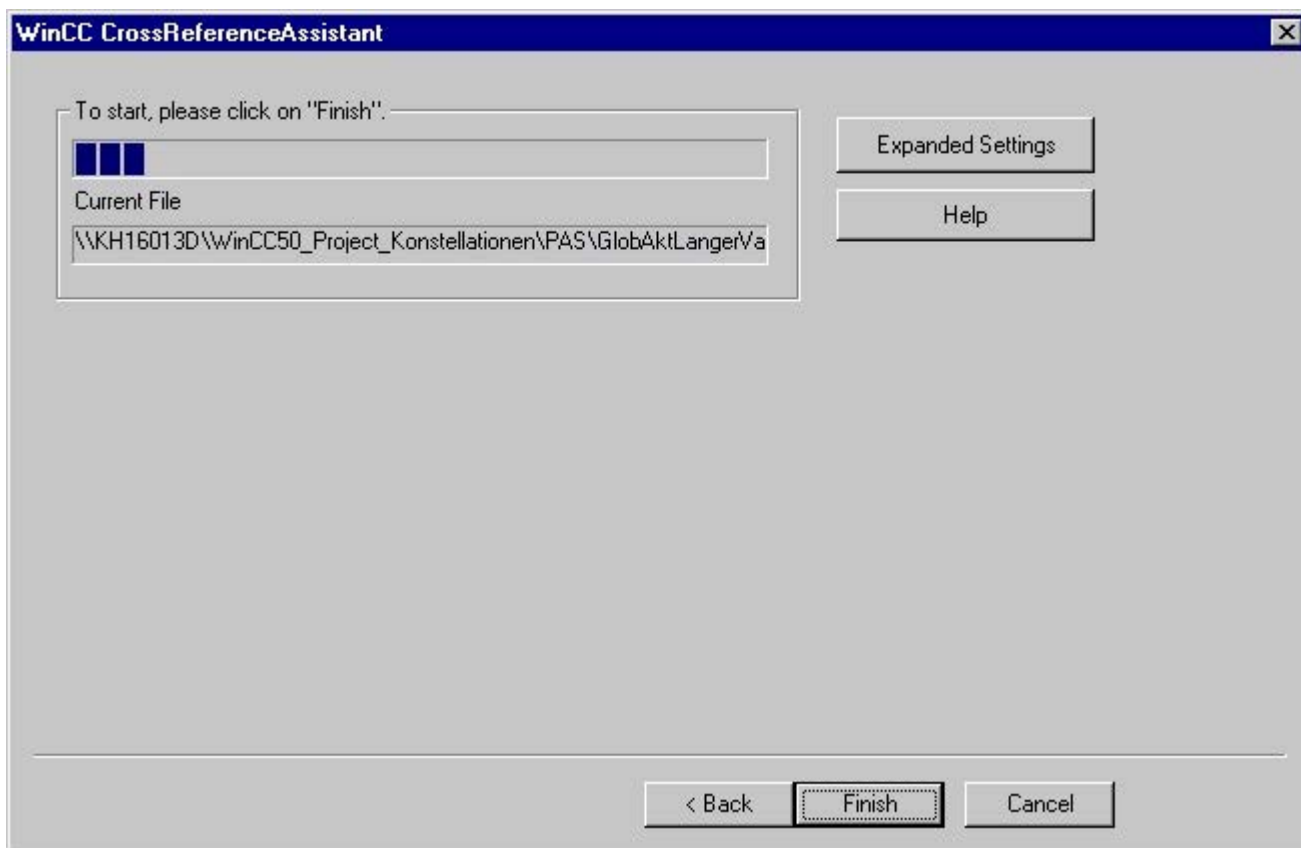

Clicking "< Back" takes you back to the File Selection. Clicking "Cancel" exits the WinCC CrossReferenceAssistant.

To start script conversion, click "Finish". After conversion begins, you cannot go back ("< Back"), or click "Advanced Settings".

During conversion, a progress bar displays what percentage of the conversion has been completed. You can also see which file is being currently converted.

The conversion is performed as follows: The scripts are examined for function calls which expect picture or tag parameters. If such a function is found in the script, the character string passed on as parameter is replaced by a define (see configuration rules).

A script management file checks which functions expect picture or tag parameters. This is why all of these functions must be entered in this file and thereby introduced to the system. The script conversion can also be used to extend the list of these functions with project functions and standard functions which also expect picture and tag parameters (advanced settings).

When the conversion is finished, a summary is displayed which provides information about how many functions, pictures and scripts in the pictures and how many tags have been converted.

If an error occurs, you can find more detailed information about the error cause by viewing the log file created during conversion. This file is located in the project directory and is called CCCrossReferenceAssistant.log.

See also

Expanded settings (Page 2649)

General (Page 2641)

File selection (Page 2647)

16.5.8 Expanded settings

If required you can activate functions you created yourself.

In the **"Select a function with tag and picture parameters:"** list, all project functions are displayed. If the **"Display standard functions"** check box is activated, the default functions in WinCC are also displayed.

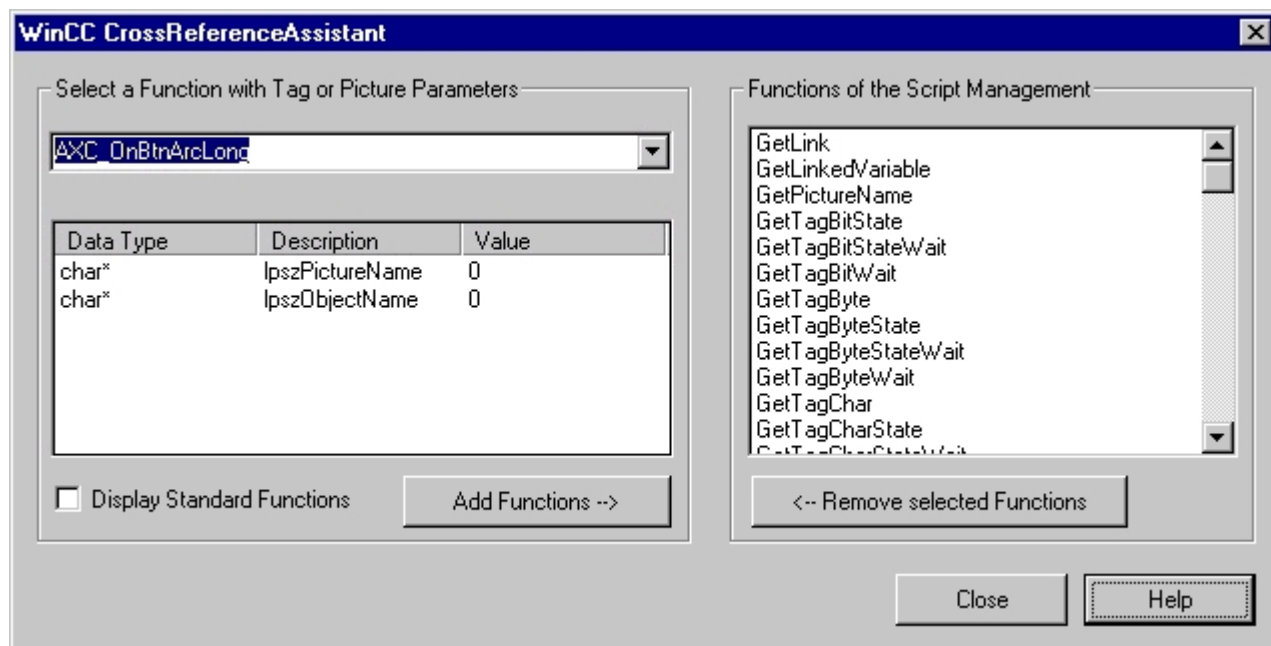

The user can select a function from the function list which expects a tag or a picture as parameter at a certain position. All functions selected here are included in a project-specific script management file.

The CrossReferenceAssistant only recognizes those functions as functions with picture and tag parameters which have been introduced to the system as such. To make sure calls of customized functions expecting tag parameters can be adapted in accordance with the configuration rules, these must be included in the script management in the course of the conversion.

The **"Functions of the script management"** dialog box displays all functions already added to the script management. When this dialog is displayed, the standard and project configuration files are read out and the common contents of both files are displayed.

To name a function expecting a tag or picture parameter, you must first select it from the **"Select a function with tag or picture parameters:"** combination field.

Using the parameter list you can then define whether the special parameter represents a tag or a picture. When clicking "..." a popup menu opens which lets the user choose whether the selected parameter is a tag or a picture.

This process must be repeated for all parameters to which one of the criteria applies.

"Add function -->" confirms the input and adds the selected function to the list on the right side of the dialog box. If you make a mistake, you can undo it by selecting the functions to be deleted in the **"Functions of the script management"** list and then removing them from the list by clicking **"<-- Remove selected functions"**.

When clicking **"Close"** the group information is written to the configuration files, the modified information is taken into account during conversion and the dialog is closed.

See also

General (Page 2641)

16.6 WinCC/Cloud Connector

16.6.1 WinCC Cloud Connector

Mode of operation of the Cloud Connector

With the WinCC 7.5 Cloud Connector it is possible to automatically transfer tags from the WinCC station to a cloud.

You can use the data stored in the cloud for further analysis or output the tag values, for example via dashboards.

The tag values are transferred via the WinCC Cloud Connector using the MQTT protocol (Message Queue Telemetry Transport).

Using the MQTT protocol, a central server, the MQTT Broker, is used for data transfer. Data exchange between sending and receiving devices takes place exclusively via the MQTT broker. For WinCC 7.5, data can only be sent to the MQTT broker, but not received.

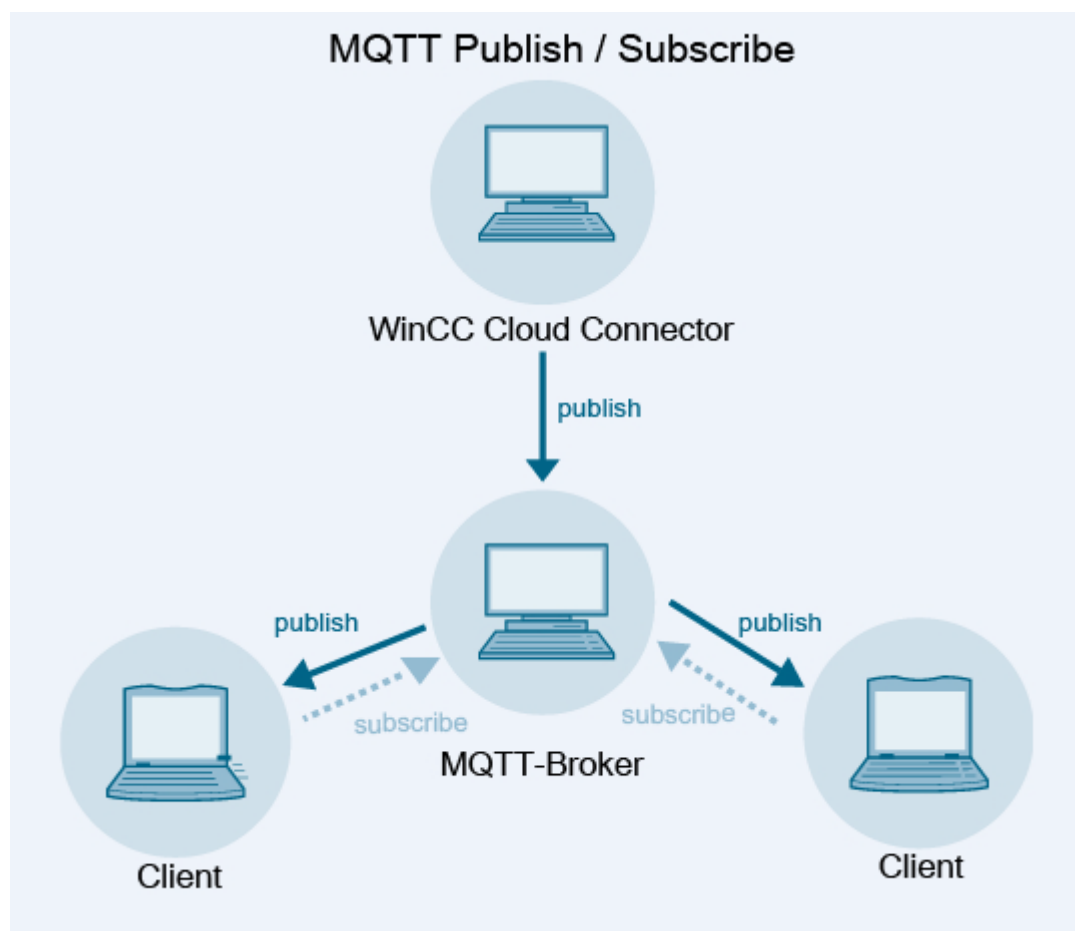

Note

MQTT protocol

For more information on the MQTT protocol, go to <https://mqtt.org/> (<https://mqtt.org/>).

Cloud provider

As MQTT broker, you can use the cloud of Amazon AWS, Microsoft Azure or generic MQTT.
To increase communication security, use an encrypted connection with certificate handshake.

16.6.2 Licensing

Licenses

You need a separate license for the Cloud Connector:

"SIMATIC WinCC Cloud Connect V7.5".

Without the license you can transfer a maximum of 5 tags for test purposes.

16.6.3 Specify settings for the cloud connection

Introduction

You define the URL and access settings of the cloud that is used in the project settings in WinCC Explorer.

Specify connection data

1. Open the WinCC Explorer.
2. Right-click the "Cloud Connector" and select "Cloud Connector Settings" in the shortcut menu.

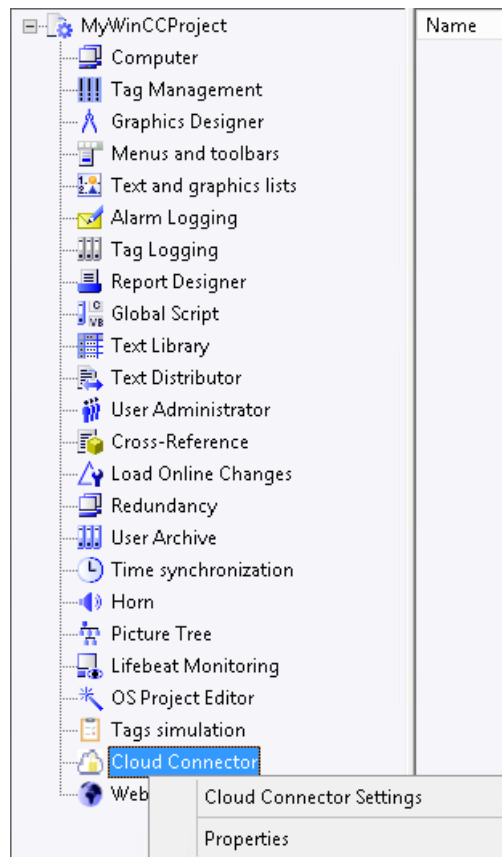

- Specify the connection data in the "WinCC Cloud Connector Settings" dialog (see description below).

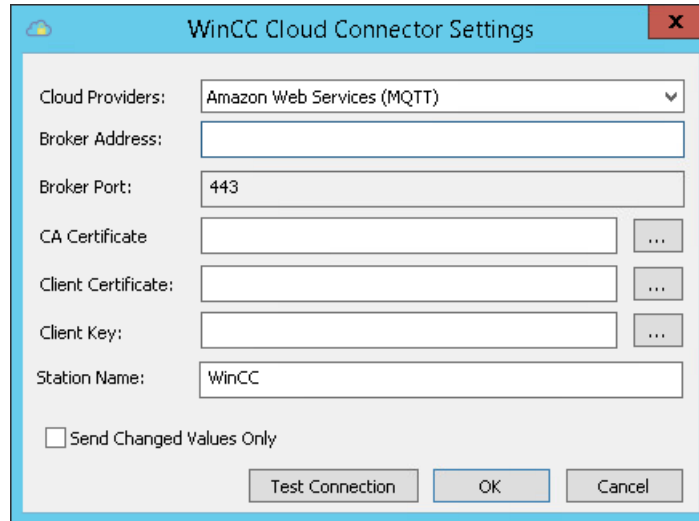

- To test the connection, click the "Test connection" button.

Cloud Connector connection data

Cloud Provider

The following providers are supported in WinCC 7.5:

- Amazon Web Services (MQTT)
- Microsoft Azure (MQTT)

Address of the MQTT broker

End point of the MQTT cloud. The data for the end point is provided by the cloud provider.

Broker port

Solely the Ports 8883 and 443 are supported.

Certificate authority's certificate

You can obtain the CA certificate from the cloud provider. Save the certificate locally on the WinCC station.

The default path for WinCC is "ProgramFilesx86\Siemens\WinCC\CloudConnector\Certificate".

Note

Amazon Web Services use certificates generated by AWS IoT or certificates with CA certification for device identification.

AWS IoT certificates are signed by the following CA certificates:

- RSA 2048 bit key: VeriSign Class 3 Public Primary G5 root CA certificate
- RSA 2048 bit key: Amazon Root CA 1
- RSA 4096 bit key: Amazon Root CA 2
- ECC 256 bit key: Amazon Root CA 3
- ECC 384 bit key: Amazon Root CA 4

To validate your devices with the AWS IoT server certificate, AWS recommends to install all five certificates on the WinCC clients.

The Microsoft Azure cloud uses temporary certificates.

Client certificates

You store the certificates that you receive from your cloud provider locally on the WinCC station. The certificates have the file type **.crt** or **.pem**.

In the input field, enter the path to the certificates.

Client key

You can obtain the client/device key from your cloud provider and store it locally on your WinCC station. The client/device keys have a file extension **.key**.

In the input field, enter the path to the client key.

Station name

Assign any name for your client. The name of the client is used as a prefix for the path of the MQTT topic (Page 2657) during tag transfer.

Send Changed Values Only

If you select this option, only the changed data is sent to the cloud.

16.6.4 Settings in the configuration studio

Enabling cloud transfer

To send the tag to the cloud, activate the "WinCC Cloud" option in the tag management and select the acquisition cycle.

The screenshot shows the WinCC configuration studio interface. On the left, the 'Tags [S7-417]' table lists various tags. The tag 'var_s5time' is selected. On the right, the 'Properties - Tag' panel is open, showing the 'WinCC Cloud' section with the 'WinCC Cloud' checkbox checked and the 'WinCC Cloud Cycle' dropdown menu open, displaying options from '1 s' to '1 h', with '1 min' selected.

Name	Data type	Length
1	DB10_Value	Floating-point number 32-bit IEEE 7 4
2	DB20_Value	Floating-point number 32-bit IEEE 7 4
3	DB30_Value	Floating-point number 32-bit IEEE 7 4
4	DB40_Value	Floating-point number 32-bit IEEE 7 4
5	MB10_Taktme	Binary Tag 1
6	var_bool	Binary Tag 1
7	var_byte	Unsigned 8-bit value 1
8	var_s5time	Unsigned 32-bit value 4
9		
10		
11		
12		
13		
14		
15		
16		
17		
18		
19		

Property	Value
Object type	Tag
Object name	var_s5time
General	
Assignment	
Linear scaling	
Limit Values	
Use Substitute Value	
Options	
Various	
Structure tag element	
WinCC Cloud	<input checked="" type="checkbox"/>
WinCC Cloud Cycle	1 min

Setting the cycle time

The cycle time can be set individually for each tag that is to be transferred to the cloud.

The configuration corresponds to the cycle time setting in WinCC tag logging.

- If you do not make any settings for the cycle time, a cycle of one minute is used as the default setting.
- The smallest cycle time is one second.
- Select either "On value change" or a fixed value for the cycle time:
1 second, 2 seconds, 5 seconds, 10 seconds, 1 minute, 5 minutes, 10 minutes, 1 hour etc.

Note

The cycle cannot be changed for structure tags or tags that were created using VBA or ODK.

Note

Note that only certain values are specified in the WinCC acquisition cycle. If you select a cycle for the cycle of the cloud tag that does not correspond to an acquisition cycle, the system automatically rounds up or down to the next acquisition cycle.

16.6.5 Transfer of data to the cloud via MQTT

Cloud provider

Data is written using the MQTT protocol via the Cloud Connector. The following cloud providers are currently supported:

- Amazon Web Services (MQTT)
- Microsoft Azure (MQTT)

Service CCCloudConnect

The Windows service CCCloudConnect is used to establish a connection between the WinCC project and the cloud system. The CCCloudConnect service is an MQTT client that connects to the MQTT broker of the cloud to receive data over the standard ports 8883 or 443.

The CCCloudConnect service captures value changes from the tag management for tags that are written in the cloud. If CCCloudConnect receives a change in value from the tag management, the service creates a message in the form of a JSON string and transmits it to the MQTT broker.

WinCC Cloud Connector and AWS-MQTT

The following graphic shows the data transfer between the WinCC Cloud Connector and the AWS platform.

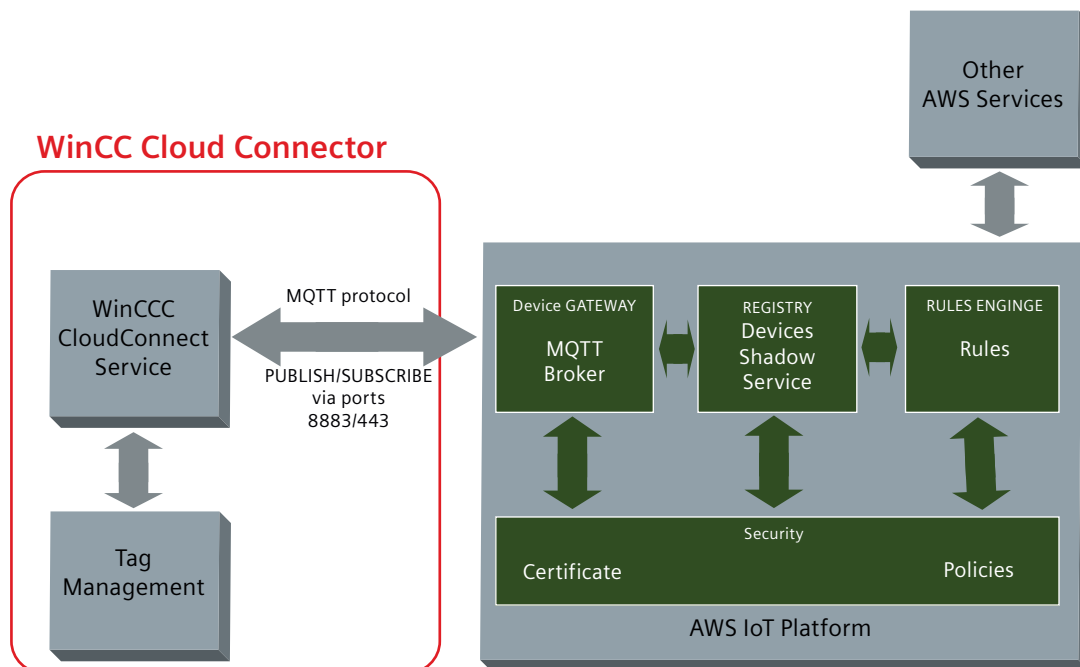

MQTT topics

Naming convention

A separate MQTT topic is created for each tag that is sent to the MQTT broker. Every client which wants to receive this topic from the broker must know the topic.

The naming convention for WinCC tags is: "WinCC/<WinCC project name>/<Tag name>"

Example

If two tags with the names "MyTag1" and "MyTag2" have been activated for the cloud in a WinCC project with the name "MyWinCCProject", CCCloudConnect sends two MQTT topics:

- WinCC/MyWinCCProject/MyTag1
- WinCC/MyWinCCProject/MyTag2

Change the prefix "WinCC" in the "WinCC Cloud Connector Settings (Page 2652)".

Other MQTT clients that want to receive these values must subscribe to the MQTT topics with the appropriate path.

Data transfer to the cloud: Queue

When data is transferred via the Cloud Connector, messages are sent according to the queue principle. This means that the message added first is also sent first. Use the registry to change the maximum number of messages in the queue. The default size of the queue is 1000.

1. Open the registry by entering "Regedit" in Windows via Start.
2. Open the folder "HKEY_LOCAL_MACHINE\Software\SIEMENS\WINCC\Cloud".
3. In "CCCloudConnect_TagQueueMax", enter the new limit for the queue.

If the specified limit of the queue is reached, a corresponding entry is created in the "CCCloudConnect.log" diagnostics file.

Data types

All data types are permissible for the transfer with the exception of structured data types (such as STRUCT or ARRAY).

The format for Date/Time tags depends on the cloud used.

Time stamp

The cloud providers use the following principles for the time stamp:

- **Amazon Web Services (MQTT)** uses Coordinated Universal Time (UTC). The time stamp has a length of 8 bytes and supports the year period from 4713 BC to 294,276 AD. The smallest time grid for the time stamp is one millisecond.
- **Microsoft Azure (MQTT)** uses the Coordinated Universal Time (UTC). The time stamp has a length of 8 bytes and supports the period from midnight January 01, 1601 00:00 to December 31, 9999.

The time stamp is generated by the WinCC station and sent to the cloud.

Disable WinCC Runtime

The Cloud Connector has no influence on ending the runtime. The last message sent to the cloud is stored in the diagnostics file "CCCloudConnect.log (Page 2660)" (only with LoggingLevel=1 or higher).

16.6.6 System tags for the current connection status of the cloud connection

Connection name

The name of the cloud connection is output in the following system tag:
"@PRF_DMRT_CLOUDCON_<Connection name>"

The connection name is the same as specified in WinCC Configuration Studio. Note that the connection name is also case-sensitive.

Resetting the connection

The connection can be reset using the "@PRF_CLDCN_RESET" system tag. If the value changes from 0 to 1, all other system tags are also set to 0.

System tags for connection monitoring

The following three tags measure the performance of the connection:

- @PRF_CLDCN_TAG_FAILED_WRITES_TOTAL
Number of transmitted tags that were not acknowledged by the cloud.
- @PRF_CLDCN_TAG_WRITES_PER_SECOND
Number of transferred tags per second.
- @PRF_CLDCN_TAG_WRITES_TOTAL
Total number of tags transferred over a connection.

16.6.7 Enabling/disabling Cloud Connector communication in runtime

Disabling/enabling Cloud Connector

1. Open the computer properties.
2. Enable or disable the Cloud Connector in the "Startup" tab.

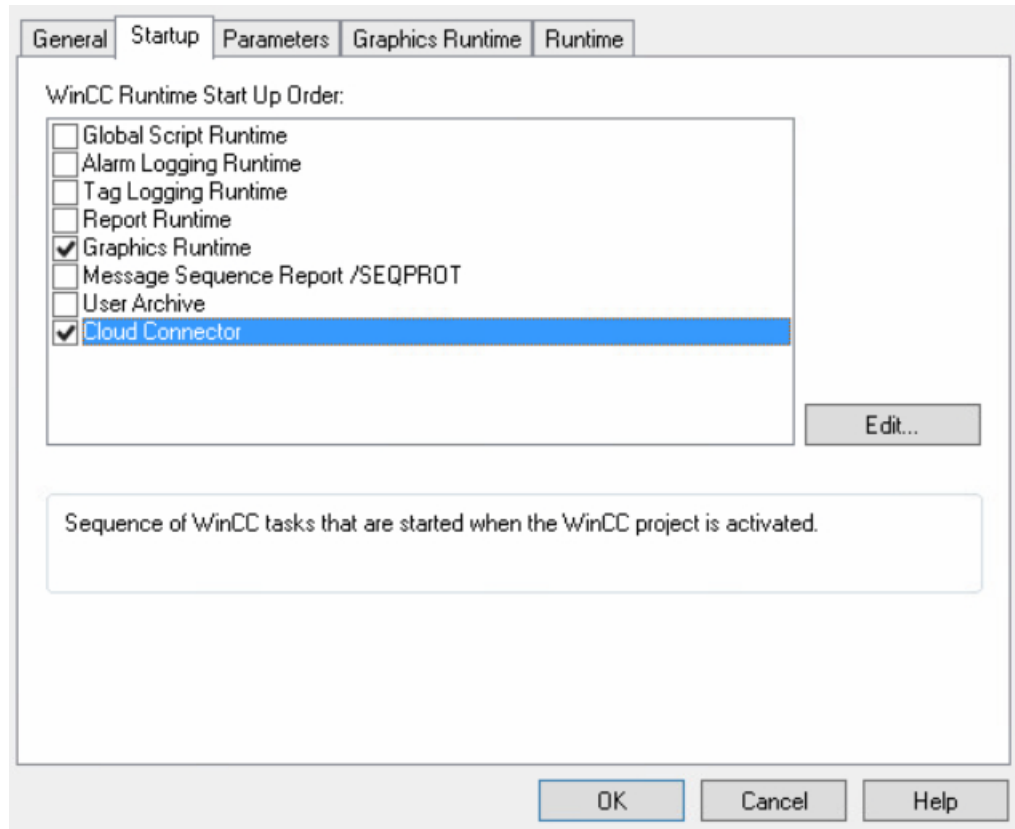

Result

If the Cloud Connector is disabled, the CCCloudConnector.exe service will not run.

16.6.8 Diagnostics file for the Cloud Connector

Content of the diagnostics file

You can use the registry to set the extent to which information is written to the diagnostics file. Critical errors (level 0) are always written to the diagnostics file. By selecting a higher level (1 to 4), you can also display more detailed error messages.

LoggingLevel:

- (0) Critical errors
Critical errors, such as access violations, are always written to the diagnostics file.
- (1) Errors
Error messages that are relevant for the correct execution of the Cloud Connector.
- (2) Warnings (default setting)
Error messages that may be relevant for the correct execution of the Cloud Connector.
- (3) Information
Information messages used to diagnose the Cloud Connector.
- (4) Detailed information
Detailed information messages

Specify the scope of the diagnostics file

1. Open the registry by entering "Regedit" in Windows via Start.
2. Open the folder
HKEY_LOCAL_MACHINE\SOFTWARE\Wow6432Node\Siemens\WinCC
\CCCloudConnector
3. Enable the writing of the diagnostics file by setting the DWORD value
"EnabelingFileLogging" to "00000001".
4. Select which errors are to be recorded by setting the DWORD value from "LoggingLevel"
to the value "00000000" to "00000004".

Creating specific diagnostics files

In addition to the diagnostics file "CCCloudConnect.log" you can also create other diagnostics files:

1. In the registry, open the folder HKEY_LOCAL_MACHINE\SOFTWARE\Wow6432Node
\Siemens\WinCC\CCCloudCommunication
2. Enable the creation of additional diagnostics files by setting the following entries to the
DWORD value "00000001":
 - "LoggingLevelWarning"
 - "LoggingLevelData"
 - "LoggingLevelCommunication"
3. Select the maximum file size and the maximum number of entries, for example:
 - "MaxLogFileSize": DWORD value 00001024
 - "MaxInfofileCount": DWORD value 00001024

Result

The files are created in the "Diagnostics" subfolder of the WinCC installation folder.

Index

"

- "Menus and toolbars" editor, 816
 - Configuring menus and toolbars, 827, 828
 - Creating menus, 822
 - Creating toolbars, 825
 - Dynamization, 818
 - Procedures, 818
 - Properties, 820
 - Specifying fonts, 829

.

- .emf, 2640
- .emf file, 2640
- .NET Control, (See Control)
- .NET Framework, 805, 806

A

- Access right, (See Authorization)
- Acknowledgment, 1290
 - Central signaling device, 1273
 - Configuring, 1273
- Acknowledgment bit, 1280, 1288, 1290, 1304, 1305, 1308
- Acknowledgment philosophy, 1244, 1273
- Acknowledgment Status
 - System block, 1261
- Acknowledgment tag, 1244, 1280, 1290, 1302, 1304, 1308
- Acquisition cycle, 1482
 - Configuring time series, 1533
 - Configuring timers, 1532
 - Continuous cyclic archives, 1508
 - Cycles, 1506
 - Cyclic selective archives, 1510
 - Events, 1506
- ActiveX Control, 598, 749, 1558
 - Configuring control selection, 306, 758
 - Inserting, 751
 - Languages, 2376
 - Registration,
 - Settings in the Graphics Designer, 358
 - Third-party ActiveX Control, 751
- ActiveX controls
 - Select, 300

Address

- Tag, 243
- Alarm Control, 1372, 1437, 1451
 - Column properties, 1451
 - Configuration of message tags, 1441
 - Configuring in the Graphics Designer, 1443
 - Configuring message blocks, 1443
 - Configuring the message line, 1443
 - Configuring the parameters, 1443
 - Configuring the toolbar, 1443
 - Emergency Acknowledgment of Messages, 1469
 - Example of configuration, 1438
 - Format, 1451
 - Hit list, 1451, 1473
 - integer, 1451
 - Locking messages, 1463
 - Message blocks, 1439
 - Operation in Runtime, 1458
 - Parameters of message window, 1443
 - Selection of messages, 1461
 - Toolbar, 1443, 1458
- Alarm log
 - Output, 2085
- Alarm Logging, 1252
 - Acknowledging messages, 1273
 - Archive backups, 1362
 - Archive reports, 2132, 2261, 2262, 2263, 2270
 - Archives, 1361
 - AS messages, 1339
 - Configuring messages, 1251
 - Configuring status texts, 1275
 - Controller alarm, 1339
 - Editing messages, 1286
 - Exporting messages, 1300
 - Filter criteria for alarm output, 2117, 2308
 - Hide messages, 1296
 - Importing messages, 1301
 - Loop In Alarm, 1295
 - Message blocks, 1260
 - Message classes, 1266
 - Message groups, 1302, 1309
 - Message reports, 2132, 2261, 2262, 2263, 2270
 - Message sequence reports, 2323, 2325
 - Message system, 1260
 - Message texts, 1291, 1293
 - Message type, 1270
 - Messages, 1278, 1280
 - Monitoring limits, 1328, 1329
 - Multilingual projects, 2342, 2373, 2391

- Project documentation, 2041, 2053, 2278
- Reloading messages after power failure, 1366
- Structure of editor, 1252
- System blocks, 1261
- System message class, 1269
- System messages, 1313, 1317
- Tag, 1287, 1288, 1290
- Alarm message, 1244
- Alarm window, 1437
 - Configuring, 1364
 - output of archive data, 1364
- AlarmControl, 749, 1364, 1372
 - Buttons, 1406
 - Configuring, 1373
 - Configuring a hit list, 1392
 - Configuring operator messages, 1394
 - Configuring table elements, 1384, 1385, 1387, 1567, 1568, 1569, 1570, 1950, 1951, 1953
 - Display of messages in Runtime, 1372
 - Dynamization, 1404
 - Example of configuration, 1423, 1424, 1427, 1428, 1434, 1435
 - Filter, 1379
 - Message blocks, 1374, 1376
 - Message lists, 2084, 2085
 - Messages, 1376, 1412, 1414, 1417, 1418, 1421
 - Online configuration, 1399, 1406, 1583, 1634, 1678, 1717, 1959
 - Operation, 1404, 1406
 - Runtime data, 1397, 1581, 1632, 1677, 1715, 1958
 - SQL statements, 1401
 - Status bar, 1388, 1410, 1571, 1624, 1673, 1707, 1954
 - Symbols, 1411
 - Toolbar, 1388, 1404, 1406, 1571, 1624, 1673, 1707, 1954
- Alias
 - Column, 1852
 - ID, 1868
 - User archive, 1848
 - User archive field, 1850
 - View, 1852
- Alignment
 - Message block, 1264
- Alpha cursor, 191, 836, 837
- analog archive tag, 1499
- Analog display
 - Extended, 672
- Application window, 598
 - Create, 559, 602
- Applying tag properties, 1772
 - PCS 7, 1772
- Archive, 1244, 1535
 - Archive databases, 1521, 1840
 - Archive system, 1482
 - Archiving methods, 1505, 1508, 1510, 1511, 1512, 1514
 - Backups, (See Archive backup)
 - create, 1858
 - Cyclic archive, 1521
 - Data buffer, 1521, 1536
 - Disconnect, 1362
 - Flags, 1525
 - Link, 1361
 - Properties, 1859
- Archive backup, 1523
 - Configuring, 1550
 - Disconnect, 1555
 - Link, 1553
 - Sign file, 1550
- Archive configuration, 1354
 - Calculating memory requirements, 1545
- Archive Contents, 1548
- Archive data, 1875
- Archive database, 1840
- Archive server, 1370
- Archive tag, 1487, 1538
 - binary, 1539
 - Compress, 1518, 1542
 - Configuring, 1539, 1540
 - Configuring cycle time, 1532
 - Configuring time series, 1533
 - Properties, 1540
 - Text, 1499
- Archive tag name, 1503
- Archive tags, 1739, 1809
 - Properties, 1499
- Archives
 - Properties, 1546
- Archiving
 - Memory requirement, 1545
 - System block, 1261
- Archiving cycle, 1482
 - Configuring time series, 1533
 - Configuring timers, 1532
 - Continuous cyclic archives, 1508
 - Cycles, 1506
 - Cyclic selective archives, 1510
 - Events, 1506
- Area
 - Navigation, 1856

- Properties, 1856
 - Table, 1856
- AS message, 1335, 1347
 - Automatic update, 1346
- AS namespace, 243
- AS number, 1283
- AS tag name, 243
- Assignment of texts
 - in the object properties, 646, 647, 649
- Associated value data
 - Extended, 1282
- Attribute, 511, 530, 2175
 - "Object Properties" window, 514, 2178
 - C actions, (See C action)
 - Changing, 525, 2181
 - Customized objects, 716, 719, 721
 - Dynamic dialog, (See Dynamic dialog)
 - Dynamic Wizard, (See Dynamic Wizard)
 - Dynamizing, 485
 - Property groups, (See Property group)
 - Tag connections, (See Tag connection)
 - VBS actions, (See VBS action)
- Authorization, 2427
 - Configure, 2409, 2410
 - Default authorizations, 2412
 - Overview, 2412, 2414, 2415, 2416
 - System authorizations, 2414, 2416
 - User archive field, 1851
 - User archives, 1865
- Authorizations and flags
 - User archive, 1848
- Automatic update, 1346
- Autostart, 36, 204, 207
- Average, 1751, 1787
- Axes, 1754, 1756, 1758
 - Display of Staggered Trends, 1798
 - Display with common axes, 1794
 - Display with Different Axes, 1794
 - Display with logarithmic axes, 1796
 - Representation of Staggered Trends, 1758
 - Representation Using Common Axes, 1756
 - Representation Using Different Axes, 1756

B

- backup, 1873
 - Archive backups, 1359, 1362
 - Archives, 1361, (See Archive backup)
 - Segment change, 1359
- Bar, 598
 - 3D bar, 598, 659
 - Changing, 623

- Configuration dialog, 703
- Configuring, 626, 627, 628
 - Inserting, 623
- BarChartControl, 1663
 - Archives, 1652, 1687
 - Bar diagrams, 1670
 - Buttons, 1680
 - Configuring, 1663, 1664, 1666, 1668, 1670
 - Diagram window, 1664
 - Display, 1671
 - Displaying a diagram, 1684
 - Online configuration, 1644, 1652, 1680, 1683, 1684, 1685, 1687, 1724
 - Status bar, 1680
 - Time axes, 1666
 - Toolbar, 1680
 - Value axes, 1668
 - Zoom functions, 1685
- Basic Process Control, 118
 - Authorizations, 2415
- Before Document_Save, 441
- binary archive tag, 1499
- Button, 679, 681
 - AlarmControl, 1406
 - BarChartControl, 1680
 - Configuration dialog, 703
 - Configuring, 683
 - Configuring a hotkey, 684
 - FunctionTrendControl, 1720
 - OnlineTableControl, 1588
 - OnlineTrendControl, 1639
 - Selecting pictures, 706
 - UserArchiveControl, 1962
- Button function, (See Button)

C

- C action, 1163, 1234, 1235
 - Configuring, 494
 - Create, 1236
 - Creation in the Dynamic Dialog, 1204
 - Dynamic Wizard, (See Dynamic Wizard)
 - Editor, 1235, 1236, 1238, 1241
 - Transferring actions, 1241
 - Triggers, 1240
- Calculating memory requirements, 1354, 1545
- Calculating statistics, 1751, 1787
- Central color palette, (See Color palette)
- Central signaling device, 1273
- Changing archive values, 1579, 1594
- Changing language
 - By means of system dialog, 2401

- Channel unit, 254
 - Connection parameters, 277
 - Create, 273
 - System parameters, 275
- Check box, 679, 686
- Chip cards, 2432
- Chronological messaging, 1244
- Class priority
 - System block, 1261
- Client
 - Runtime documentation, 2072
- Client project, (See Project)
- Clock Control, 749, 773
 - Inserting, 773
 - Settings, 774, 775, 776, 777
 - Time base,
- Cloud Connector, 2651
- Color
 - Message type, 1277
- Color conversion when printing messages, 2084
- Color palette, 331, 2139
 - Central color palette, 346, 350, 353
 - Custom colors, 2142
- Column
 - Position, 1872
- Column of a view
 - Properties, 1852
- COM server
 - COM server objects, 2134, 2330, 2331
 - Examples, 2332
 - Interface for reporting, 2333
 - Runtime documentation, 2110
- Combo box, 598, 651
- Comment, 243
 - System block, 1261
- Communication
 - User archive, 1848
- Communication driver, 254
 - Create, 273
- Communication type
 - User archive, 1848
- Comparison, 1332
- Comparison tag, 1331
- Comparison value, 1328, 1331
- Compilation
 - Display log, 2508
 - Revisions, 2504
- Component list editor
 - Project documentation, 2064
- Compressed archive, 1484, 1518, 1535
 - Backups, 1550
 - Configuring, 1537, 1542, 1548
 - Data buffer, 1521, 1536
 - Manual input, 1537
 - Project documentation, 2290, 2293
 - Properties, 1497
- Compressed tag, 1544
- Compressed tags
 - Properties, 1503
- Compression, 1514
- Compression properties, 1498
- Compression time period, 1498
- Computer
 - Start configuration, 2394
 - Status, 222
- Computer name
 - System block, 1261
- Computer properties
 - Configuring, 123
 - Cursor Control, 196
 - Hotkeys, 191
 - Parameters, 184
 - Renaming, 181
 - Runtime, 168
 - Runtime settings, 180, 200
 - Start picture, 194
 - Startup list, 172, 182
 - Time settings, 133
 - Zoom functions, 198
- Computer settings; System dialogs, 186
- Configuration dialog, 703
 - Customized objects, 716
 - Option "Use configuration dialog", 358
- Configuration file, 816, 822, 825, 827, 828
- Configuration station
 - Load online changes, 142, 144, 146
- Configuration Tool
 - Load online changes, 146
- Configuration: of User Archives Table Element, 1971
- Configure
 - Authorizations, 2410
- configuring
 - of a Form View, 1986
 - of a User Archives Control, 1971, 1972, 1974
 - of User Archives Table Element, 1972, 1974
- Configuring OS reference, 2471, 2480
- Connection
 - Creating, 274
 - Project documentation, 2300
 - Status in Runtime, 271
- Connection parameters, 277
- Connection status, 222, 271
- Control
 - .NET controls, 598, 656, 749, 752, 805

- ActiveX controls, (See ActiveX Control)
 - AlarmControl, 1372, (See AlarmControl)
 - Changing properties, 763
 - Configuring control selection, 306, 758
 - Digital/Analog Clock Control, (See Clock Control)
 - FunctionTrendControl, (See FunctionTrendControl)
 - Gauge Control, (See Gauge Control)
 - Inserting, 608, 754
 - Media Control, (See Media Control)
 - OnlineTableControl, (See OnlineTableControl)
 - OnlineTrendControl, (See OnlineTrendControl)
 - Positioning, 757
 - Push Button Control, (See Push Button Control)
 - Rectangle surrounding the object, 756, 757
 - RulerControl, (See RulerControl)
 - Scaling, 756
 - Slider Control, (See Slider Control)
 - Symbol Library, (See Symbol Library)
 - Time settings, 134
 - UserArchiveControl, (See UserArchiveControl)
 - WPF controls, 598, 658, 749, 752, 806
 - Control tag, 1861
 - Example, 1862
 - User archive, 1848
 - Controller alarm, (See: AS message)
 - Controls
 - WinCC Alarm Control, 1437
 - WinCC Online Trend Control, 1732
 - Convert, 52
 - Convert Project Data, 52
 - Coordinate system, 319, 321, 2164
 - Copy
 - Cross Reference, 2014
 - Message, 1284
 - Message class, 1267
 - Message type, 1272
 - Copy project path, 42
 - CPU number, 1280
 - Creating archive values, 1579, 1594
 - Cross Reference, 2005
 - Copy, 2014
 - Example, 2016, 2020
 - Export, 2014
 - Filter, 2009
 - Linking, 2011
 - Place of use, 2010
 - Project documentation, 2059
 - Replace, 2011
 - Tags, 2023
 - CSV file
 - Runtime documentation, 2095, 2096, 2099, 2271, 2306
 - CSV files
 - Runtime documentation, 2273
 - CSV provider, 2132
 - Cursor
 - Cursor control, 196
 - Curve parameter, 1772
 - Customized object, 709, 713
 - Attributes, 719, 721
 - Configuring, 716
 - Connect with Structure tags, 722
 - Creating, 714
 - Edit, 726
 - Events, 724, 725
 - Example, 728
 - Properties, 716, 718
 - Ungroup, 727
 - Cycle, 368, 370
 - Cycle time, 369, 1531
 - Properties, 1493
- ## D
- Data
 - Backup, 1873
 - View, 1872
 - Data compression, 1514
 - Data format
 - Differences to S5/S7, 1882
 - Data records
 - Exporting data records, 98
 - Import, 296
 - Data source, 268, 2526, 2534
 - Data type, 243, 254
 - Binary tag, 255
 - Bit, 255
 - Byte, 257
 - Char, 256
 - Date/time, 267
 - Double, 263
 - Dword, 261
 - float, 262
 - Floating-point number 32-bit, 262
 - Floating-point number 64-bit, 263
 - Format adaptations, 256, 257, 258, 259, 260, 261, 262, 263, 267
 - Internal tag, 239
 - Long, 260
 - Process tag, 241
 - Raw data tag, 265

- Short, 258
- Signed 16-bit value, 258
- Signed 32-bit value, 260
- Signed 8-bit value, 256
- Signed byte, 256
- signed Dword, 260
- Signed word, 258
- Text reference, 266
- Text tag, 265
- Unsigned 16-bit value, 259
- Unsigned 32-bit value, 261
- Unsigned 8-bit value, 257
- Unsigned byte, 257
- Unsigned Dword, 261
- Unsigned word, 259
- Word, 259
- Data window, 298, 309
 - Display Column Information, 300
 - Tag Logging, 1528
 - WinCC Explorer, 50
- Database segment, 1352
- DataSet, 598
- Date, 130, 2391
 - System block, 1261
- Date/time
 - Data type, 267
- Daylight saving time
 - System block, 1261
- Debugger, 200
- Default cycle, 490
- Default language at Runtime, 185
- Default trigger, (See Triggers)
- Delay time, 1331
- Delete
 - Limit monitoring, 1333
 - Message, 1287
 - Message class, 1269
 - Message group, 1313
 - Message type, 1278
- Delta loading, (See Load online changes)
- Diagnosis, 2539, 2546
- Diagnostic support, 2539, 2543, 2546
- Diagnostics, 2539, 2543
 - Diagnostics window, 224
 - Load online changes, 148
- Direct connection, 1163, 1198
 - Configuring, 502, 1200
 - Copying objects, 1198
 - Examples, 1198, 1201
- Discrete alarm method, 1244
- Display in front, 1748
- Display in trend form, 1754
- Display of archived values, 1750, 1754
- Display of messages, 1443
 - Colors, 1277
 - Message blocks, 1443
 - Selection of messages, 1461
- Displaying
 - Tag value, 293
- DLL parameters, 1280
- Document_Save, 441
- Drag-and-drop, 100, 102, 107, 109
 - Excel, 109
 - Graphics Designer, 461
- Drag-and-drop a design element, 345
- Duration
 - System block, 1261
- Dynamic dialog, 1163, 1204
 - Configuring, 489, 1205, 1207, 1211, 1215, 1216, 1218
 - Creating C actions, 1204
 - Example, 1220
 - Expressions, 1207
 - Quality codes, 1216
 - Tag status, 1215
 - Triggers, 1218
 - Value ranges, 1211
- Dynamic display, 1735
- Dynamic metafile
 - Project documentation, 2302
- Dynamic object, 2128, 2130, 2194, 2224
 - Embedded layout, 2130, 2225
 - Hard copy, 2130, 2227
 - ODBC database field, 2130, 2229
 - ODBC database table, 2130, 2231
 - Tag, 2130, 2235
- Dynamic table
 - Project documentation, 2304
- Dynamic text
 - Project documentation, 2301
- Dynamic Wizard, 342, 1179
 - Import functions, 1184
 - Picture components, 1183
 - Picture Functions, 1180
 - SFC, 1193
 - Standard Dynamics, 1185, 1189
 - System functions, 1192
- Dynamic Wizard Editor, 2540, 2563
 - Editor window, 2568
 - Help Editor, 2569
 - Installation, 2565
 - Output window, 2570
 - Structure, 2566
 - Toolbar, 2566

- Dynamic Wizard function, 2570
- Dynamization, 485
 - Action icons, 487
 - C actions, (See C action)
 - Configuring Events, 487
 - Creating dynamic attributes, 489, 494, 495, 497
 - Direct connections, (See Direct connection)
 - Displaying statistics, 315
 - Dynamic dialog, (See Dynamic dialog)
 - Dynamic Wizard, 342
 - Dynamization icons, 485
 - Dynamization of events, 494, 495, 502
 - Dynamization of faceplate types, 433
 - Log parameters, 2074, 2077
 - Making Attributes Dynamic, 485
 - Picture window, 605
 - Tag connections, 615, 705, (See Tag connection)
 - Triggers, (See Triggers)
 - VBS actions, (See VBS action)
- E**
- Edit
 - Archive data, 1875
 - Selecting a process value block, 1292
- Editing, 1749
- Editor, 2484
 - Changing language settings, 2484
 - Illegal characters, 226
 - Opening, 2484
 - Overview of editors, 219
- Effect, 1280
- Emergency acknowledgment, 1417, 1469
- Empty text
 - Property, 1291
- Engineering station
 - Activating runtime, 120
- Entry jump, 2539, 2546
- Event, 487
 - "Object Properties" window, 517
 - Action icons, 487
 - C actions, (See C action)
 - Customized objects, 724, 725
 - Direct connections, (See Direct connection)
 - Specifying faceplate types, 420, 432
 - Triggers, (See Triggers)
 - VBS actions, (See VBS action)
- Event nodes, 420, 432
- Example
 - COM server, 2332
 - Configuring AlarmControl, 1423, 1424, 1427, 1428, 1434, 1435
 - Configuring OnlineTrendControl, 1652, 1653, 1655, 1658, 1660
 - Creating electronic signatures, 2447, 2449
 - Customized objects, 728
 - Direct connections, 1198, 1201
 - Dynamization with the Dynamic dialog, 1220
 - Filter in Cross Reference, 2016
 - Limit monitoring, 1334
 - Linking, 2020
 - Multilingual projects, 2397, 2398, 2399, 2402
 - Place of use, 2016
 - Tag connections, 1196
 - User archive functions, 1892
 - Using control tags, 1862
- Excel
 - Drag-and-drop, 109
- existing tag, 2005
- Explorer, (See WinCC Explorer)
- Export, 384
 - Central color palette, 353
 - Cross Reference, 2005, 2014
 - Entire configuration, 294, 1300
 - Export user archive data, 1876
 - Messages, 1300
 - Runtime data, 1397, 1581, 1632, 1677, 1715, 1958
 - Tag, 294
 - User archive data, 1873
- Extended analog display, 672
- Extended associated value data, 1282
- Extended status display, 667
- F**
- Faceplate instance, 396, 598, 655
 - Update, 435, 438
 - Use, 435
- Faceplate tag
 - Defining, 410
 - Dynamization of faceplate types, 433
 - Edit, 421
- Faceplate type, 396
 - Change, 435
 - Copy, 399
 - Create, 405
 - Dynamization, 433, 442, 446
 - Events, 402, 420, 432
 - Faceplate tags, 410, 421, 431
 - Inserting objects, 399, 405
 - Name, 396, 399
 - Password protection, 406

- Properties, 402, 416, 420, 422, 424, 425
 - Settings in the Graphics Designer, 358
- Falling edge, 1280
- Favorites; pictures, 185
- Field
 - Position, 1868
- Fields
 - Creating, 1866
 - Properties, 1850
- Figure
 - Displaying user ID, 2442
- File selection, 2647
- Filter, 2005, 2009, 2016, 2527, 2535
- Filter criteria, 1983
- Filtering messages, (See Selection)
- FindFast.exe, 175
- Flashing
 - Message block, 1264
- Font
 - Multilingual projects, 2350, 2351
- Font size unit, 945
- FontSizeUnit, 945
- Form field
 - Button, 1990
 - Deleting, 1991
 - Edit, 1991
 - Editing Box, 1989
 - Text field, 1988
- Form Field:Delete, 1991
- Form Field>Edit, 1991
- Form view, 1970, 1971, 1986, 1992
 - Defining, 1977
- Form View:Define, 1977
- Format
 - Message block, 1264
- Format adaptation, 243
- Format DLL, 1283, 1488, 1503, 1514, 1540
- Format Function of the Analog Display, 676
- Format specification, 1291
- Formatting
 - Process value block, 1292
- Forms of Display, 1791
- Frame, 1244, 1489
- Frame tag, 1488, (see Raw data tag)
- Frequency, 1451
- Function
 - User archive functions, 1889, 1892, 1901, 1912, 1918
- Function block, 1882
- Function test, 2554
- Function Trend Control, 1789
 - Archive tags, 1809
 - Changing configuration, 1819
 - Common axes, 1794
 - Data from user archives, 1810
 - Determining coordinates, 1824
 - Dynamic display, 1802
 - Enlarging area, 1826
 - Forms of Display, 1791
 - Function of time, 1814
 - Ideal Trend, 1812
 - Inserting, 1808
 - Linear interpolation, 1791
 - Logarithmic scaling, 1796
 - Online tags, 1808
 - Operation in runtime, 1818
 - Properties, 1837
 - quick configuration, 1834
 - Resolution, 1789
 - Single values, 1791
 - Staggered trends, 1798
 - Starting update, 1821
 - Static display, 1802
 - Stepped trend, 1791
 - Stopping update, 1821
 - Time range, 1802
 - Trend on top, 1822
 - Values of uncertain status, 1804
 - Values outside the limit range, 1804
 - write direction, 1800
- Functions, 2642
- FunctionTrendControl, 749, 1688
 - Axes, 1696
 - Buttons, 1720
 - Configuring, 1621, 1691, 1692, 1693, 1696, 1698, 1700, 1703
 - Configuring RulerControl, 1575, 1628, 1711
 - Data connections, 1703
 - Online configuration, 1399, 1583, 1634, 1644, 1645, 1678, 1684, 1717, 1720, 1723, 1724, 1725, 1727, 1959
 - Output of process values, 2090
 - Representation formats, 1689, 1691
 - Runtime data, 1397, 1581, 1632, 1677, 1715, 1958
 - Screen resolution, 1688
 - Status bar, 1388, 1571, 1624, 1673, 1707, 1720, 1954
 - Toolbar, 1388, 1571, 1624, 1673, 1707, 1719, 1720, 1954
 - Trends, 1621, 1693, 1698, 1700
 - Zoom functions, 1727

G

Gauge Control, 749, 779
 Inserting, 779
 Settings, 780, 782, 784, 785, 786, 788

Gear ratio, 2498
 Entire OS, 2499

Global Design, 158
 Configuring,
 Design Features,
 Limit,

Global library, (See Library)

Global Script, 1224
 Project documentation, 2041, 2055

Global Scripts
 Inserting an application window, 602

Global SVG Libraries
 Apply, 743

Global SVG library
 SVG, 740

Graphic
 Linked with message, 1295

Graphic list, 452

Graphic object, 598
 Configuration dialog, 703
 Inserting, 631
 Selecting pictures, 706

Graphic OLL
 Select, 300

GraphicOLL
 Select, 304

Graphics Designer, 297, 299, 319
 Action editor, 1225
 Adapting the working environment, 370
 Alignment palette, 328
 Central color palette, (See Color palette)
 Color palette, (See Color palette)
 Configuring a message window, 1373
 Configuring AlarmControl, 1373
 Converting project data, 52
 Coordinate systems, 319, 321
 Dynamic Wizard, 342
 Font palette, 334
 Languages, 2375, 2376
 Layer palette, 330
 Multilingual projects, 2342, 2358, 2360, 2361,
 2375, 2376, 2377, 2379, 2391
 Objects, (See Object)
 Open, 298, 300
 Options, 358
 Palettes, (See Palette)

Picture types, 299

Pop-up menu, 313, 315

Project documentation, 2041, 2050, 2283, 2285,
 2287, 2289

Runtime, 204

Selecting ActiveX controls, 300

Selecting Graphic OLL, 300

Settings, 355, 356, 358, 362, 364, 366, 368

Shortcut menu, 300, 309, 373

Standard and controls, 341, 344

Start screen, 325

Status bar, 337

Style palette, 345

Tag palette, 346

Toolbars, (See Toolbar)

Zoom palette, 338

Graphics list, 637

Group, 709
 Administrating, (See User Administrator)
 Changing properties, 710
 Create, 710
 DefaultGroup, 2451
 Ungrouping Groups, 712

Group acknowledgment, 1244

Group Display, 598
 Configuring, 662
 Inserting, 662

Group value, 667, 672

H

Hard copy
 Output, 2102, 2103, 2105

Hardware diagnostics, 2539, 2546
 Configuring, 2546
 Entry jump, 2546

Help (language-neutral), 1293

Hide
 automatic, 1281
 Manual, 1296

Hide manually, 1299
 Messages, 1296

Hide mask, 1280, 1296, 1309

Hide tag, 1296, 1302, 1309, 1421

Hiding system pictures, 119

Hit list, 1244, 1372, 1437, 1451
 Configure, 1392

HitlistRelTimeFactorType, 917

Horn, 1280
 Project documentation, 2041, 2060

Hotkey, 174, 191, 196
 Event-driven triggers, 1178
 Hard copy, 2103
 Hotkeys, 684
 Hysteresis, 1331

I

I/O field, 598
 Changing, 612
 Configuration dialog, 703
 Configuring, 615, 617, 618, 620, 621, 622
 Inserting, 612
 Tag connections, 615
 Ideal Trend, 1812
 Import
 Central color palette, 353
 Import tag, 238
 Import user archive data, 1874, 1877
 Importing data records, 296
 Messages, 1301
 In trends, 1753
 Inconsistent entries, 237, 1255
 Info text, 1291
 System block, 1261
 Initial-value message, 1244
 Instance-specific event, 402
 Instance-specific property, 402
 Integration, 2454
 Notes on installation, 2454
 Required software components, 2454
 Interface
 Archive databases, 1840
 SIMATIC, 1879
 Internal tag, 239
 Interpolation, 1755, 1791
 Linear interpolation, 1791
 ISO 8601, 130
 IxDiskSpace.DiskSpace, (See Disk Space Control)

J

Jump to place of use, 2010, 2016

K

Key combination, 184
 Keyboard shortcuts, 170

L

Language, 184
 For texts, 1313
 Layout languages, 2153, 2297
 Multilingual projects, (See Multilingualism)
 Language Settings in Runtime, 184
 Last access
 User archive, 1848
 Layer, 388
 Assignment, 390
 Changing the arrangement of objects, 481
 Setting, 330, 362, 364, 391
 Layout, 2152
 Changing, 2158
 Create, 2070
 File operations, 2153
 Languages, 2152, 2153
 Layout objects, 2152, 2239
 Line layouts, (See Line layout)
 Message archive report, 1367
 Multilingual projects, 2383, 2385, 2387
 Multiple layouts, 2160
 Objects, (See Object)
 Page layout editor, (See Page layout editor)
 Page layouts, (See Page layout)
 Print jobs, 2031
 Showing properties, 2157
 LDF file, 1550
 Length of the tag, 243
 Library, 737, 2492
 Convert, 300
 Customized objects, 737
 Inserting objects, 744, 746, 747
 Library objects, 709
 Siemens HMI Symbol Library, 764
 Toolbar, 741
 License
 Communication driver, 254
 License information, 224
 Power Tags, 241
 Lifebeat Monitoring
 Project documentation, 2041
 Limit, 1331
 Limit monitoring, 1244, 1328
 Creating multiple, 1329
 Examples, 1334
 Hysteresis, 1334
 Messages, 1333
 New, 1329
 Properties, 1331

- Removing, 1333
 - Specifying a message number, 1329
- Limit value monitoring
 - Color identification, 1621, 1700
 - OnlineTrendControl, 1604
- Limits
 - Tag, 243
- Line layout, 2029, 2313
 - Create, 2086
 - Output of message sequence reports, 2086, 2089
 - Time base, 135
- Line layout editor, 2025, 2313, 2321
 - Creating headers and footers, 2318, 2322
 - Creating tables, 2319, 2323
 - opening, 2314
 - Page Setup, 2317, 2321
 - Printer Settings, 2317
 - Standard toolbar, 2316
 - Structure, 2315
 - Time Base, 2320
- Linear scaling, 243
- Linking, 2005, 2011, 2180
 - Example, 2020
- Linking fields, 1852
- List box, 598, 653
- List of Hidden Messages, 1467
- List of messages to be hidden, 1372
- ListView Control, 605
- Load online changes, 137, 142
 - Diagnostics, 148
 - Download, 153
 - enable, 151
 - Limitations, 146
 - Requirements, 144
 - Resetting, 157
- Lock
 - Operator control, 814
- Lock bit, 1304, 1307
- Lock list, 1244, 1372, 1414, 1437
- Lock tag, 1302, 1304, 1307
- Lock window, 1463
- Locking messages, 1463
 - Alarm Control, 1463
 - Persistence, 1463
- Log, 2508
 - Showing, 2508
- Logging
 - System block, 1261
- Logon, 2405
 - Connect WinCC/PCS7-OS, 2451
 - Electronic signatures, 2428, 2445, 2447, 2449

- Runtime, 2431
 - SIMATIC Logon, (See SIMATIC Logon)
 - Tag logon, 2425
- Logout, 2425
 - Automatic logout, 2424
 - Tag, 2425
- Long-term archive list, 1244, 1364, 1372, 1421, 1437
- Loop In Alarm, 1295
 - System block, 1261
- LTO
 - Load online changes, 153

M

- Manual hiding, 1467
- Maximum,
 - MDF file, 1550
- Media Control, 749, 789
 - Configuring, 790
 - Inserting, 789
- Memory requirements of messages, 1351
- Menu
 - Customized menus, (See Editor)
- Menu bar
 - WinCC Explorer, 45
- Message, 1244, 1278, 1439
 - Acknowledgment Of Messages, 1273
 - Acknowledgment tag, 1290
 - Archiving, 1354
 - AS message, 1335
 - Assigning a message group, 1311
 - Collapse, 1467
 - Colors, 1277
 - Configuration, 1251
 - Configuring, 1251
 - Configuring a hit list, 1392
 - Configuring a message, 1441
 - Configuring messages, 1260
 - Copy, 1284
 - Create, 1284
 - Creating multiple, 1284
 - Delete, 1287
 - Display in runtime, 1437
 - Editing multiple, 1286
 - Emergency acknowledgment of messages, 1417
 - Export, 1300, 1347
 - Filter, 1379
 - Hide, 1296, 1421
 - Import, 1301, 1343
 - Information text, 1291
 - Linking to picture, 1295

- Lock, 1463
- Locking in Alarm Control, 1463
- Loop In Alarm, 1295
- Message blocks, 1260
- Message classes, 1266
- Message group, 1302
- Message number, 1280
- Message system, 1260
- Message tag, 1287
- Message texts, 1291, 2373
- Monitoring limits, 1328, 1329
- Multilingual projects, 2373
- Next free number, 1257
- Parameter, 1280
- Priorities, 1280
- Process values in the message text, 1293
- Properties, 1280
- Reload after power failure, 1366
- Selecting, 1412
- Selection, 1451, 1461
- Shared, 1329
- Show, 1421
- Sorting messages, 1382, 1418
- Status tag, 1288
- Status texts, 1275
- System blocks, 1261
- System message class, 1269
- System messages, 1313, 1317
- Tag, 1287, 1288, 1290, 1309
- Visualization in Runtime, 1372
- Message archive, 1244, 1351, 1352
 - Access to the archive database, 1369
 - AlarmControl, 1364
 - Archive files, 1354
 - Archive partitions, 1352
 - Archive server, 1370
 - Backups, 1359, 1361, 1362
 - Configuring, 1352, 1354
 - Message archive report, 1367
 - Message server, 1370
 - Output in Runtime, 1363, 1364
 - Reloading messages after power failure, 1366
 - Reporting, 2084
 - Segments, 1352, 1354
 - Signature, 1359
- Message bit, 1280
- Message block, 1244, 1251, 1374, 1376, 1439
 - Configuring a hit list, 1392
 - Configuring message blocks, 1439, 1443
 - For a tag, 1330
 - For message text, 1313, 1331
 - Properties, 1264
 - Use, 1264
 - Working with message blocks, 1260
- Message class, 1244, 1266, 1439
 - Add, 1266
 - Adding message type, 1271
 - configuring, 1439
 - Create copy, 1267
 - Export, 1300
 - Removing, 1269
- Message event, 1244, 1351
- Message group, 1244, 1302
 - Assigning a message, 1311
 - Assigning a message group, 1311
 - Assigning a new message, 1312
 - Create, 1303
 - Delete, 1313
 - Hide, 1309
 - Message class, 1266
 - Properties, 1304
 - Removing a message, 1312
 - Status tag, 1305
 - Tag, 1304, 1305, 1307, 1308
- Message line, 1244, 1372, 1376, 1443
- Message list, 1244, 1372, 1437
 - Output, 2085
 - Reporting, 2084
- Message procedure, 1244
- Message sequence report, 1244, 2025, 2084
 - Create, 2089
 - Creating print jobs, 2086
 - Creating tables, 2323
 - Line layouts, (See Line layout)
 - Output options, 2325
- Message server, 1370
- Message status, 1244
 - Came In, 1275
- Message system, 1244, 1251
 - Configuring, 1260
- Message tag, 1244, 1280, 1287
- Message text, 1291
 - Inserting process values, 1293
- Message type, 1244, 1270, 1439
 - Acknowledging messages, 1273
 - Add, 1271
 - Changing properties, 1272
 - Colors, 1277
 - Configuring status texts, 1275
 - Configuring the message type, 1439
 - Create copy, 1272
 - Delete, 1278
 - Export, 1300

Message window, 1244, 1251, 1372, 1376
 Filter, 1379
 Selection, 1379
 Sorting, 1382
 Status texts, 1275
 Messages
 Editing multiple messages at the same time, 1255
 Filtering, 1255
 Finding, 1255
 Limit monitoring, 1333
 Memory requirements, 1351
 Minimum, 1751, 1787
 Modify
 selected areas, 1257
 Monitor keyboard, 200, 831
 Configuring, 832
 Operating, 834
 Monitoring event, 1244
 Mouse pointer, 200
 Mouseless operation, 836, 837, 839
 MQTT, 2651
 Multilingualism
 Configuring, 2345
 Editing texts, 2362
 Example configurations, 2397, 2398, 2402
 Exporting texts, (See Text Distributor)
 Graphics Designer, 2375, 2379
 Importing texts, (See Text Distributor)
 Language combinations, 2338
 Operating system languages, 2346
 Supported languages, 2338
 Text Distributor, (See Text Distributor)
 Translating text, 2362
 User archives, 1868
 Multiple languages
 Alarm Logging, 2342, 2373, 2391
 Configuring, 2342
 Configuring text list, 2381
 Date and time settings, 2391
 Editors, 2342, 2347
 Example configurations, 2397, 2399
 Exporting files, 2356, 2357, 2358, 2360, 2361
 Fonts, 2350, 2351
 Graphics Designer, 2342, 2376, 2377, 2391
 Language combinations, 2342
 Language terms, 2339
 Layouts, 2383, 2385
 Operating system languages, 2339
 Project documentation, 2383, 2389
 Report Designer, 2391
 Runtime documentation, 2383, 2390

 Runtime languages, 2339, 2393, 2394
 Text Library, (See Text Library)
 WinCC languages, 2339, 2347
 Multiple row text object, 598, 649
 Multiple selection, 465, 467
 Multitouch, 814, 815
 Two-hand operation, 814
 Multiuser engineering, 125, 2518
 Multi-user project, 1485, (See Project)
 Multi-user system, 111, 115
 Load online changes, 142
 Runtime, 204, 209
 Startup list, 172
 Time settings, 130

N

Navigation
 Area, 1530
 Navigation area, 234, 237, 1252, 1856
 Navigation bar, 234, 1252
 Navigation window, 298, 300
 Tag Logging, 1528
 WinCC Explorer, 42, 50
 Network entry jump, 2539, 2540
 Configuring, 2540
 Network return, 2543
 New
 Compressed archive, 1537
 Connection, 274
 Internal tag, 278
 Process value archive, 1535
 Tag group, 288
 User archive, 1858
 View, 1869
 New value message, 1244
 Non-existing tag, 2005

O

Object, 456, 2163
 Application window, 559
 Basic dynamic operations, 485, 487, 489, 494, 495, 497, 499, 502
 Basic static operations, 459, 460, 464, 467, 469, 471, 472, 474, 475, 476, 477, 478, 479, 480, 481, 483
 Central color palette, (See Color palette)
 Characteristics, (See Object property)
 Color palette, (See Color palette)
 Combined objects, 456, 709

- Configuring operator authorizations, 560
- Configuring the object selection, 304
- Coordinate systems, 321, 2164
- Copying, 393, 394, 2168
- Customized objects, (See Customized object)
- Dynamic objects, (See Dynamic object)
- Editing in the page layout editor, 2168
- Exporting, 384
- Global design, 160, 165
- In faceplate types, 399
- Layout objects, 2152, 2239
- Library objects, (See Library)
- Linking, 483, 499, 2180
- Mouseless operation, (See Mouseless operation)
- Multiple selection, 465, 467, 471
- Multiple selections, 2170, 2172, 2173, 2175
- Object name, 460, 462, 2183
- Object palette, 2127
- Object types, 457
- Origin, 319
- Pasting, 2167
- Picture window, 559
- Positioning, 469, 2168
- Project documentation, (See Project documentation)
- Properties, (See Object property)
- Rectangle surrounding the object, 323, 469, 2166
- Rotate, 558
- Runtime documentation, (See Runtime documentation)
- Selection marks, 323, 2166
- Setting transparency, 564
- Settings in the Graphics Designer, 358, 364, 366, 368
- Smart objects, (See Smart object)
- Standard objects, (See Standard object)
- Static objects, (See Static object)
- System objects, (See System object)
- Tube objects, (See Tube object)
- Use in faceplate types, 405, 416, 420
- Windows objects, (See Windows object)
- Object OLL, (See Graphic OLL)
- Object palette, 334, 2127
 - Changing the default settings of object types, 457
 - Configuring control selection, 306, 758
 - Configuring the object selection, 304
 - Object groups, 341, 344, 456
 - Smart objects, 598
 - Standard objects, 565
- Object property, 511, 2175
 - "Object Properties" window, 513, 514, 517, 525, 529, 2175, 2176, 2177, 2178, 2180
 - Attributes, 525, (See Attribute)
 - Changing attributes, 2181
 - Dynamization, (See Attribute)
 - Events, 517
 - Property groups, (See Property group)
 - Transferring, 2182
- Object property:Faceplate type, 402
- Object type
 - Changing default settings, 457
 - Configuration dialog, 703
 - Global design, 160
 - Object name, 460, 462
 - Property groups, (See Property group)
 - Settings, 358
- OCX, (See ActiveX Control)
- ODK
 - Archive databases, 1840
- Offline configuration, 1343
- OLE DB Provider
 - Archive databases, 1840
- OLE object, 598
 - Edit, 610
 - Inserting, 610
- Online configuration, 1399, 1583, 1634, 1678, 1717, 1959
 - AlarmControl, 1406
 - BarChartControl, 1680, 1683, 1685
 - FunctionTrendControl, 1644, 1645, 1684, 1720, 1723, 1724, 1725, 1727
 - OnlineTableControl, 1588, 1591, 1593, 1595, 1596, 1599
 - OnlineTrendControl, 1639, 1642, 1644, 1645, 1647, 1648, 1652, 1684, 1687, 1724, 1725
- Online Table Control, 1732
 - Changing configuration, 1743
 - configuration, 1737
 - display of archived values, 1750
 - dynamic display, 1735
 - dynamizing time range, 1735
 - Inserting, 1738
 - operation in Runtime, 1742
 - representation formats, 1732
 - starting update, 1748
 - static display, 1735
 - stopping update, 1748
 - time range, 1735
- Online tags, 1808
- Online Trend Control, 1773
 - Changing configuration, 1776
 - Common axes, 1756
 - Determine co-ordinate points, 1783, 1824
 - Display of archived values, 1786

- Inserting, 1764
- Linear Interpolation, 1755
- Online tags, 1767, 1770
- Representation formats, 1755
- Resolution, 1753
- Single values Online Trend Control:step curve, 1755
- Staggered trends, 1758
- Starting update, 1781
- Stopping update, 1781
- Trend on top, 1781
- Writer function, 1758
- Online Trend Control:configuration, 1763
- Online Trend Control:dynamic display, 1759
- Online Trend Control:dynamizing time range, 1768
- Online Trend Control:enlarging section, 1785
- Online Trend Control:static display, 1759
- Online Trend Control:time jumps, 1761
- Online Trend Control:time overlap, 1761
- Online Trend Control:time range, 1759
- OnlineTableControl, 749, 1560, 1561
 - Buttons, 1588
 - Changing archive values, 1594
 - Configuring, 1561, 1562, 1564
 - Configuring operator messages, 1579
 - Configuring RulerControl, 1575, 1628, 1711
 - Configuring table elements, 1384, 1385, 1387, 1567, 1568, 1569, 1570, 1950, 1951, 1953
 - Creating archive values, 1594
 - Online configuration, 1399, 1583, 1588, 1591, 1593, 1595, 1596, 1599, 1634, 1678, 1717, 1959
 - Output of process values, 2090
 - Runtime data, 1397, 1581, 1632, 1677, 1715, 1958
 - Status bar, 1388, 1571, 1588, 1624, 1673, 1707, 1954
 - Time columns, 1562
 - Toolbar, 1388, 1571, 1585, 1588, 1624, 1673, 1707, 1954
 - Value columns, 1564
- OnlineTrendControl, 749, 1604, 1609
 - Archives, 1652, 1687
 - Buttons, 1639
 - Configuring, 1607, 1609, 1610, 1612, 1615, 1618, 1621, 1700
 - Configuring RulerControl, 1575, 1628, 1711
 - Example, 1652, 1653, 1655, 1658, 1660
 - Online configuration, 1399, 1583, 1634, 1639, 1642, 1644, 1645, 1647, 1648, 1652, 1678, 1684, 1687, 1717, 1724, 1725, 1959
 - Output of process values, 2090
 - Representation formats, 1606, 1607
 - Runtime data, 1397, 1581, 1632, 1677, 1715, 1958
 - Screen resolution, 1604
 - Status bar, 1388, 1571, 1624, 1639, 1673, 1707, 1954
 - Time axes, 1612
 - Toolbar, 1388, 1571, 1624, 1636, 1639, 1673, 1707, 1954
 - Trend window, 1610
 - Trends, 1618, 1621, 1700
 - Value axes, 1615
 - Zoom functions, 1647
- OPC
 - Access to the archive database, 1369
 - Archive databases, 1840
- Operating system
 - Languages, 2339
 - Multilingual projects, 2339, 2342, 2346
- Operating the User Archive Control, 1993
- Operating the User Archive Table Element, 1993
- Operation
 - Multitouch, 814
 - Touch operation, 809
 - Two-hand, 814
- Operation in Runtime, 1458, 1742, 1773, 1997
- Operational message, 1244
- Operator authorization, 2539, 2540, 2546
- Operator control
 - Lock, 814
- Operator input messages, 1269
- Operator input messages upon archive value changes, 1579
- Operator message, 1244, 1348, 1394
- Operator station,
 - Creating, 2474
 - Load online changes, 142, 144, 146
- Option
 - Overview of editors, 219
- Origin, (See Coordinate system)
- OS, 2473
 - Compiling, 2498
 - Creating, 2474
 - OS properties, 2463, 2475
 - Standby OS properties, 2467
- OS project editor
 - Project documentation, 2063
- OS properties, 2463, 2475
- OS ref.WinCC application
 - ObjectWinCC Appl. Ref.WinCC application:creating reference, 2471, 2480
- OS simulation, 2495
 - Starting, 2495

Output window, 339

P

Package, 2489

Assign OS server, 2489

Page layout, 2027

Output of message sequence reports, 2086, 2089

Time base, 135

Page layout editor, 2025, 2121, 2123

Adapting the workspace, 2141, 2142, 2143, 2144

Alignment palette, 2136

Color palette, (See Color palette)

COM server objects, (See COM server)

Font palette, 2140

Linking objects, 2180

Object palette, 2127

Objects, (See Object)

Opening, 2122

Output of user-specific data, (See COM server)

Settings, 2146, 2147, 2148, 2150

Standard toolbar, 2125

Status bar, 2141

Structure, 2123

Style palette, 2135

Zoom palette, 2138

Palette, (See Toolbar)

Alignment palette, 328, 471, 2136, 2173

Arranging, 2143

Color palette, (See Color palette)

Font palette, 334, 2140

Layer palette, 330, 391

Show/hide, 2143

Standard and controls, 341, 344

Style palette, 345, 2135

Tag palette, 346

Zoom palette, 338, 2138

Parameter dialog, 2074

Parameters

Archive tag, 1540

Compressed tag, 1544

Process-controlled tag, 1542

PC station, 2460, 2461, 2471, 2480

PCS 7

Applying tag properties, 1772

Persistence, 1414

Picture, 372, 374, 2485, 2492

Assigning menus and toolbars, 827

Basic dynamic operations, 485, 487, 489, 494, 495, 497, 499, 502

Basic settings, 355

Basic static operations, 459, 460, 464, 467, 469, 471, 472, 474, 475, 476, 477, 478, 479, 480, 481, 483

Configuring operator authorizations, 560

Configuring the background picture, 386

Convert, 52

Converting libraries, 300

Coordinate systems, 319, 321

Copy, 2486

Copying to library, 2492

Create, 300, 376

Creating, 2486

Creating model solutions, 2492

Defining picture properties, 385

Delete, 309, 2486

Deleting in library, 2492

Displaying properties, 300, 309, 313

Displaying statistics, 313, 315

Edit, 378, 379, 380, 382

Editing multiple pictures, 392, 393, 394

Embedding in objects, 706

Exporting, 384

Favorite, 309

Importing, 2488

Inserting controls, 608

Mouseless operation, (See Mouseless operation)

Moving, 2486

Moving to library, 2492

Multiple selection, 465, 467

Objects, 321, 328, 366, 393, 394, 483, 499

Origin, 319

Password protection, 309, 387

Picture Cache, 200

Project documentation, 2283, 2285, 2287, 2289

Project planning guideline, 372

Rectangle surrounding the object, 323, 469, 756, 757

Rename, 309, 2486

Rename picture, 300

Renaming in library, 2492

Runtime, 807

Screen navigation, 191

Selection marks, 323, 756, 757

Setting layers, 330, 362, 364

Setting the grid, 356

Setting the transparency of objects, 564

Setting the zoom factor, 338

Start Picture, 309

Start screen, 827

Style groups, 345

Transferring picture properties, 392

Using library objects, 746, 747

- Picture Change
 - Configuring, 683, 684
- Picture cycle, 369, 490, 497, 1116
- Picture name
 - Configuration instructions, 2023
- Picture Tree
 - Multilingual projects, 2342
 - Project documentation, 2061
- Picture Tree Manager
 - Project documentation, 2041
- Picture window, 598
 - Assigning menus and toolbars, 828
 - Configuring, 128, 562
 - Create, 559, 605
 - Selecting pictures, 706
- Pictures; favorites, 185
- Place of use, 2005, 2010, 2016
- PLCID, 1848
- Point of error, 1291
- Position
 - Field, 1868
 - User archive column, 1872
- Power failure, 1366
- Power tag, 241
- Prefix, 280
- Print job, 2031
 - Attitudes, 2032
 - Create, 2072
 - Creating, 2045, 2048
 - Defining printer, 2037
 - Defining printing ranges, 2035
 - Hard disk capacity, 2037
 - Message lists, 2085
 - Message sequence reports, 2086
 - Multilingual projects, 2383, 2385, 2387
 - Properties, 2032
 - Runtime documentation, 2066, 2074
 - Settings, 2035, 2037
 - System print jobs, 2031, 2383
- Print job properties, 2640
- Print jobs, 2639
- Printing messages
 - Color conversion, 2084
- Priorities, 667, 672
- Priority
 - System block, 1261
- Process control system, 1269
- Process I/Os, 2555
- Process picture, (See Fig.)
- Process pictures; Changing languages, 187
- Process pictures; favorites, 185
- Process pictures; Navigation, 188
- Process tag, 241, 1487
 - Archiving, 1539
 - Create, 279
 - Data types, 241
 - Licensing, 241
 - Process value archives, 1508, 1510, 1511, 1512, 1514
 - Structure type, 246, 282
 - Text tag, 265
- Process value, 1487
 - Backups, (See Archive backup)
 - Displaying, 1557, 1558, 1560
 - Inserting in message text, 1293
 - Reporting, 2090
 - Reports, 1728
- Process value archive, 1481, 1482, 1484, 1521, 1535, 1738
 - Acyclic archives, 1511
 - Archive tag, (See Archive tag)
 - Archiving methods, 1505, 1548
 - Backups, 1550
 - Configuring, 1527, 1535, 1548
 - Continuous cyclic archives, 1508
 - Cycles, 1505, 1506
 - Cyclic archives, 1512
 - Cyclic selective archives, 1510
 - Data buffer, 1521, 1536
 - Events, 1506
 - Manual input, 1535
 - Multi-user projects, 1485
 - Process-controlled archives, 1514
 - Project documentation, 2290, 2293
 - Properties, 1496
 - Term definitions, 1482
- Process value block, 1244, 1394, 1579
 - Formatting, 1292
 - Maximum number of characters, 1260
 - Working with message blocks, 1260
- Process value output
 - As table, 1730
 - As trend, 1730
 - In process picture, 1730
- Process-controlled tag, 1488
 - Properties, 1502, 1542
- Processing
 - Undo, 1255, 1530
- Project, 35, 36, 204, 2484
 - Autostart, 207
 - Basic Process Control, 118
 - Changing project type, 113, 114
 - Client projects, 111
 - Computer properties, 123

- Configuring, 115, 120, 123, 128, 562
- Converting project data, 52
- Copy, 212
- Duplicate, 36, 212, 215, 217
- File structure, 230
- Global design, (See Global design)
- Hotkeys, 174
- Illegal characters, 226
- Load online changes, (See Load online changes)
- Multi-user projects, 110, 212
- Not opened with WinCC Explorer, 36
- Online configuration, 137
- Opening, 2484
- Picture window, 128, 562
- Remote projects, 204, 209
- Runtime, 204, 209
- Runtime settings, 168, 180, 181, 182, 184, 191
- Single-user projects, 110
- Startup list, 172
- Time setting, 130
- Time settings, 133
- WinCC Explorer, 36, 40
- WinCC status, 222
- Project documentation, 2025, 2041
 - Alarm Logging, 2053, 2278
 - Changing layouts, 2158
 - Component list editor, 2064
 - Compressed archives, 2290, 2293
 - Connection lists, 2300
 - Creating print jobs, 2045, 2048
 - Cross Reference, 2059
 - Displaying user ID, 2442
 - Dynamic metafiles, 2302
 - Dynamic tables, 2304
 - Dynamic text, 2301
 - Editors, 2041
 - Global Script, 2055
 - Graphics Designer, 2050
 - Horn, 2060
 - Lifebeat monitoring, 2062
 - Multilingual projects, 2383, 2385, 2387, 2389
 - Objects, 2134, 2275, 2276
 - OS project editor, 2063
 - Output, 2042
 - Output options, 2278, 2279, 2282, 2283, 2285, 2287, 2289, 2290, 2293, 2296, 2297, 2300, 2301, 2302, 2304
 - Page layouts, (See Page layout)
 - Picture Tree, 2061
 - Preview, 2044
 - Print jobs, 2112
 - Process pictures, 2283, 2285, 2287, 2289
 - Process value archives, 2290, 2293
 - Selection dialogs, 2276
 - System layouts, 2112
 - Tag Logging, 2054, 2290, 2293
 - Tags, 2297
 - Text Library, 2057, 2296
 - Time Synchronization, 2060
 - User Administrator, 2058
 - User archives, 2279, 2282
 - Views, 2282
 - WinCC Explorer, 2049
- Project Duplicator, 212, 215, 217
- Project library, (See Library)
- Project object, 2005
- Project properties
 - Global design, 158, 165
 - Hotkeys, 174
- Project selection, 2646
- Project settings; System dialogs, 186
- Project SVG library
 - Configuring, 743
 - Creating, 743
 - Export, 744
 - Import, 744
 - Inserting objects, 745
 - SVG, 740
- Properties
 - Archive, 1859
 - Archive tag, 1499, 1540
 - Area, 97, 1530, 1856
 - Column, 1871
 - Column of a view, 1852
 - Compressed archive, 1497
 - Compressed tags, 1503
 - Cycle time, 1493
 - Edit, 97, 1255
 - Editing, 287, 1530
 - Message block, 1264
 - Message class, 1268
 - Message type, 1272
 - Process value archive, 1496, 1535
 - Process-controlled tag, 1502
 - Structure tag element, 249
 - Tag, 243
 - Time series, 1494
 - User archive, 1848
 - User archive field, 1850
 - View, 1852, 1870
 - What's this?, 234
- Properties area, 97, 234, 1252
- Properties of User Archives Table Elements, 2000

- Property group, 530, 2181
 - Assignment, 555
 - Axis, 531
 - Background picture, 545
 - Colors, 538, 2185, 2186
 - Connected Objects, 554
 - Customized objects, 718
 - Display, 537
 - Filling, 541
 - Flashing, 535
 - Font, 547, 2189, 2190
 - Geometry, 542, 2186, 2188
 - Limits, 544
 - Lock, 552
 - Message types, 545
 - Miscellaneous, 548, 2191, 2192
 - Output/Input, 532
 - Picture, 534
 - Pictures, 534
 - State, 556
 - Styles, 552, 2192, 2193
 - Property nodes, 416, 420, 422, 424, 425, 431
 - Push Button Control, 749
- Q**
- Quality code, 271, 1331, 1498, 1505
 - Displaying, 243, 293
 - Quality codes, 1216
 - Compressed archive, 1520
 - Quantity limitation, 1451
 - Quantity structure, 144, 1351
- R**
- Radio box, 679, 688
 - Random numbers, 2557
 - Raw data tag, 1488, 1502, 1503, 1514, 1540
 - Data communication, 1879
 - Data communication with SIMATIC, 1879, 1883, 1884, 1885, 1886, 1887
 - Data formats, 1882
 - Frames, 1489
 - User archives, 1860
 - Reaction time, 1280
 - Read rights
 - User archive, 1849
 - User archive field, 1851
 - Reasons, 1280
 - Redundant system
 - Duplicating projects, 215, 217
 - Load online changes, 146
 - Redundant user archives, 1853
 - Runtime, 204
 - Reference, 2005
 - Reference object, 465, 467, 2170
 - Relation, 1852
 - Example, 1873
 - Relevant long term, 1502, 1503
 - Reload after power failure, 1366
 - Replace
 - Cross Reference, 2011
 - Report, 1728, 2485, (See Runtime documentation)
 - Copy, 2486
 - Creating, 2486
 - Delete, 2486
 - Importing, 2488
 - Message archive report, 1367
 - Moving, 2486
 - Rename, 2486
 - Report Designer, 2025
 - Message archive report, 1367
 - Multilingual projects, 2342
 - Page layouts, (See Page layout editor)
 - Report object, 2066
 - COM server, 2093, 2110
 - Hard copy, 2093, 2102
 - ODBC databases, 2093, 2094
 - Output of CSV data, 2093, 2095, 2096, 2099
 - Report page, 2639
 - Report system, 2330
 - Report objects, (See Report object)
 - Report template, 2492
 - Copying to library, 2492
 - Creating model solutions, 2492
 - Deleting in library, 2492
 - Moving to library, 2492
 - Renaming in library, 2492
 - Representation formats, 1732
 - Representation in trend format, 1755
 - Representation of process values, 1753
 - Representation of process values in tables, 1732
 - Reset, 1354
 - Resolution, 1789
 - Return, 2543
 - Round button, 679, 691, 706
 - Ruler window, 1575, 1599, 1628, 1648, 1711
 - RulerControl, 749, 1575, 1628, 1711
 - Configuring, 1575, 1628, 1711
 - Configuring table elements, 1384, 1385, 1387, 1567, 1568, 1569, 1570, 1950, 1951, 1953
 - Online configuration, 1399, 1583, 1634, 1678, 1717, 1959

- Runtime data, 1397, 1581, 1632, 1677, 1715, 1958
- Status bar, 1388, 1571, 1624, 1673, 1707, 1954
- Toolbar, 1388, 1571, 1624, 1673, 1707, 1954
- Runtime, 827, 1458, 1742, 1818
 - Activate, 807
 - Application window, 559
 - bringing to front, 1748
 - Buttons, 1962
 - Configuring in Runtime, (See Online configuration)
 - Connection, 271
 - Deactivate, 807
 - defining time range, 1735
 - Display in front, 1781
 - Display of archived values, 1786
 - editing fields, 1749
 - Emergency Acknowledgment of Messages, 1469
 - Exiting, 209
 - External applications, 175
 - Form view, 1992
 - Language switching, 2393, 2394
 - Languages, 2339
 - Load online changes, (See Load online changes)
 - Locking messages, 1463
 - Menus and toolbars, (See Editor)
 - Monitor keyboard, 831, 832, 834
 - Mouseless operation, (See Mouseless operation)
 - Multilingual projects, 2339, 2393, 2394
 - Multitouch, 809, 814
 - Online configuration, 137
 - Operating the User Archive Control, 1993
 - Operating the User Archive Table Element, 1993, 1997
 - Operation of Alarm Control, 1458
 - operation of Online Table Control, 1742
 - Operation of Online Trend Control, 1773
 - Operation of the Function Trend Control, 1818
 - Operation of Trend Control, 1773
 - Output of message archive, 1363, 1364
 - Parameterization dialogs, 1743, 1776
 - Performance, 489, 494, 502
 - Picture window, 559
 - Representation of process values, 1739
 - Rotation of objects, 558, 593
 - Selecting archive, 1743, 1776
 - selecting columns, 1748
 - Selecting tags, 1743, 1776
 - Selection of messages, 1461
 - Settings, 168, 180, 181, 182, 184, 191, 194, 196, 198, 200, 557
 - Sorting messages, 1470
 - Starting, 168, 204, 207
 - Startup list, 172
 - Table View, 1991
 - Tag, 292
 - Testing pictures, 807
 - Touch screen, 809
 - Trend Control, 1773
- Runtime data
 - edit, 1875
 - Exporting, 1876
 - Importing, 1877
- Runtime documentation, 2025, 2066
 - Archive reports, 2261, 2262, 2263, 2270
 - COM server objects, 2134
 - Configuring dynamic parameters, 2244, 2249, 2253, 2257, 2260
 - Configuring static parameters, 2241, 2246, 2251, 2255, 2259
 - Creating layouts, 2070
 - CSV file requirements, 2099
 - CSV files, 2271, 2273, 2306
 - Displaying user ID, 2442
 - Dynamization of log parameters, 2074, 2077
 - Line layouts, (See Line layout)
 - Message lists, (See Message list)
 - Message reports, 2261, 2262, 2263, 2270
 - Message sequence reports, (See Message sequence report)
 - Multilingual projects, 2383, 2385, 2387, 2390
 - Objects, 2132, 2240
 - Output options, 2074, 2227, 2229, 2231, 2241, 2244, 2246, 2249, 2251, 2253, 2255, 2257, 2259, 2260, 2261, 2262, 2263, 2267, 2268, 2270, 2271, 2273
 - Page layouts, (See Page layout)
 - Parameter dialog, 2074
 - Print jobs, 2072, 2115
 - Process values, 2090
 - Report objects, (See Report object)
 - System layouts, 2115
 - Time settings, 135
 - User archive tables, 2267, 2268
 - User archives, 2092
 - WinCC UserArchiveControl, 2259, 2260
- Runtime language, 184
- Runtime:defining time range, 1759
- Runtime:Form View, 1992
- Runtime:representation of process values, 1754
- Runtime:selecting trend, 1754
- Runtime:Table View, 1991
- Runtime; Changing languages, 187
- Runtime; Process picture navigation, 188
- Runtime; System dialogs, 186

S

- S7-1500 controller, 1335
 - Automatic update, 1346
 - Integrating messages, 1339
- Screen navigation, 191
- Screen savers, 175
- Script, 2641
 - Convert, 52
 - Example with user archive functions, 1892
- Script management, 2649
- Selecting statistics range, 1751, 1783
- Selection
 - Access protection, 1379
 - Importing, 1379
 - Selection dialog, 1379, 1412, 1966
- Selection borders, 465, 467, 2170
- Selection of messages, 1451, 1461
- Sequence
 - Column, 1853
 - User archive field, 1851
 - View, 1852
- Server
 - Server prefixes, 1173
- Server data, 2489
 - Assign OS server, 2489
- Service CCCloudConnect, 2657
- Shared message, 1329
- Shared time column, 1733
- Shortcut menu, 1279
- Short-term archive list, 1244, 1364, 1372, 1421, 1437
- Siemens HMI Symbol Library, (See Symbol Library)
- Signature, 1359, 2428, (See: Signature)
 - Electronic signatures, 2428, 2445, 2447, 2449
- SIMATIC Logon, 2405, 2440
 - Connect WinCC/PCS7-OS, 2451
 - Electronic signatures, 2445
 - SIMATIC Logon Service, 2441, 2442, 2445
 - WinCC startup list, 2440
- SIMATIC Manager, 2454, 2457, 2460, 2473, 2481, 2484, 2485, 2494, 2495
 - Adopting language settings, 2484
- SIMATIC S7-1200, S7-1500 channel
 - Import, 1343
- SimaticDate, 267
- SimaticDateAndLTime, 267
- SimaticDateAndTime, 267
- SimaticDTL, 267
- SimaticLTimeOfDay, 267
- SimaticTimeOfDay, 267
- Simulation, 2495, 2554
 - Application example, 2555
 - Process tag, 2555
 - SIMATIC Manager, 2495
 - Starting, 2495
 - Tags, 2557
- Simulator, 2554
- Single acknowledgment, 1244, 1280
- Single message, 1441
 - Configuring a message, 1441
 - Hiding Messages, 1467
 - Project documentation, 2278
 - Selection, 1461
- Single values, 1791
- Single-user project, (See Project)
- Single-user system, 115
- Slider, 679, 693, 695, 697, (See Slider), (See Slider Control)
- Slider Control, 749, 793
 - Inserting, 793
 - Settings, 794, 795, 797, 798, 799, 800
- Smart object, 598
 - .NET controls, 598, 656, 752
 - 3D bar, 598, 659
 - ActiveX controls, 598, 751
 - Analog display (extended), 598
 - Application window, 598, 602
 - Bar, 598, 623, 626, 627, 628
 - Combo box, 598, 651
 - Controls, 608, 754, 761
 - Descriptions, 598
 - Faceplate instance, 598, 655
 - Graphic object, 598, 631
 - Group Display, 598, 662
 - I/O field, 598, 612, 615, 617, 618, 620, 621, 622
 - List box, 598, 653
 - Multiple row text, 598, 649
 - OLE object, 598, 610
 - Picture window, 598, 605
 - Status display, 598, 633, 635, 637
 - Status display (extended), 598
 - SVG object, 677
 - Text list, 598, 639, 641, 643, 645, 647, 648
 - WPF controls, 598, 658, 752
- Smart objects
 - Drag-and-drop, 107
- Sort
 - Default sorting, 1382
 - Sort dialog, 1418
- Sort ...
 - Sort dialog, 1968
- Sort Criteria, 1983

- Sorting messages, 1451, 1470
- Source archive, 1504
- Source tag, 1504
- SQL, 1401, 1983, 1993, 1995, 1996
- SQL statement used to filter messages, 1479
- Standard and controls, 341, 344
- Standard cycle, 497
- Standard deviation, 1751, 1787
- Standard function, 1473
 - Example of use, 1475
- Standard object, 565, 2128, 2195
 - Circle, 565, 578
 - Circular arc, 565, 587
 - Connector, 565, 595
 - Dynamic objects, (See Dynamic object)
 - Ellipse, 565, 576
 - Ellipse arc, 565, 584
 - Ellipse segment, 565, 580
 - Line, 565, 567
 - Pie segment, 565, 582
 - Polygon, 565, 570
 - Polyline, 565, 573
 - Rectangle, 565, 589
 - Rounded rectangle, 565, 590
 - Static objects, (See Static object)
 - Static text, 565, 593
 - System objects, (See System object)
- Standard objects, 2194
- Standard time
 - System block, 1261
- Standard trigger, (See Triggers)
- Standby computer, 2467
 - Selecting, 2467
- Standby OS properties, 2467
- Start Picture, 194
- Start time, 1493, 1495
- Startup list, 172
 - Integrating the PrintScreen application, 2103, 2105
 - Message sequence reports, 2086
- Static display, 1735
- Static object, 2128, 2129, 2194, 2195
 - Circle, 2129, 2204
 - Circular arc, 2129, 2212
 - Ellipse, 2129, 2202
 - Ellipse arc, 2129, 2210
 - Ellipse segment, 2129, 2206
 - Line, 2129, 2196
 - OLE object, 2129
 - OLE project, 2220
 - Pie segment, 2129, 2208
 - Polygon, 2129, 2198
 - Polyline, 2129, 2200
 - Rectangle, 2129
 - Rounded rectangle, 2129, 2216
 - Square-wave, 2214
 - Static metafile, 2129, 2222
 - Static text, 2129, 2218
- Static text, 462
- Statistics area window, 1575, 1599, 1628, 1648, 1711
- Statistics of Runtime data, 1787
- Statistics range, 1787
- Statistics window, 1575, 1599, 1628, 1648, 1711
- Status
 - System block, 1261
- Status bar, 1252, 1388, 1458, 1528, 1571, 1624, 1673, 1707, 1954
 - AlarmControl, 1410
 - BarChartControl, 1680
 - FunctionTrendControl, 1720
 - Graphics Designer, 337
 - OnlineTableControl, 1588
 - OnlineTrendControl, 1639
 - Page layout editor, 2141
 - UserArchiveControl, 1962
 - WinCC Explorer, 49
- Status bit, 1280, 1288, 1304, 1305
- Status display, 222, 271, 598
 - Changing, 633
 - Configuration dialog, 703
 - Configuring, 635, 637
 - Extended, 667
 - Inserting, 633
 - Selecting pictures, 706
- Status tag, 1244, 1280, 1288, 1302, 1304, 1305
- Status text, 1275
- STEP 7, 2511
 - Message configuration, 2511
- STEP 7 symbol, 2526
- STEP 7 symbols, 2534
 - Selecting, 2529, 2537
 - Showing, 2535
 - Transferring, 2531
 - window, 2527
- STEP7 message configuration, 2511
- Stepped trend, 1791
- Structure, 2570
- Structure element, 282, (See: Structure type element)
- Structure instance, (See: Structure tag element)
- Structure tag, 246, 282
 - Creating, 285
 - Customized objects, 722
 - Editing properties, 287

- Properties, 249
- Rename, 291
- Structure tag element, 246
 - Editing properties, 287
 - Properties, 249
- Structure tag elements, 285
- Structure tag instance, (See: Structure tag element)
- Structure type, 238, 246
 - Configuring, 281
 - Creating, 282
 - Data types, 282
 - Rename, 291
- Structure type element, 246
 - Creating, 284
 - Editing properties, 287
 - Properties, 249
- Substitute value
 - Tag, 243
- Suffix, 280
- Support, 1280, 1291
- SVG Library, 740
- SVG object, 598, 677
 - Inserting, 677
- Swapping out, (See Archive backup)
- Swinging Door, 1514
- Symbol Library, 749, 764
 - Inserting, 764
 - Selecting symbols, 765
 - Settings, 766, 768, 770
- SymbolLibrary, 339
- Symbols
 - AlarmControl, 1411
- System block, 1244, 1261
 - Overview, 1261
 - Working with message blocks, 1260
- System dialog, 171
 - Changing language, 2401
- System dialogs, 186
- System dialogs; Changing languages, 187
- System logon, (See Logon)
- System menu, 171
- System message, 1244, 1269
 - Descriptions, 1317
 - refresh, 1313
 - Use, 1313
- System message class
 - Requires acknowledgment, 1269
 - without acknowledgment, 1269
- System object, 2128, 2131, 2194, 2237
 - Date/time, 2131
 - Layout name, 2131

- Page number, 2131
- Project name, 2131
- System parameters, 275
- System shutdown, 1493
- System startup, 1493
- System status, 1296
- System tag, 239

T

- Tab order, 191, 836, 839
- Tab sequence, (See Mouseless operation)
- Table, 1255, 1530
 - Configuring table elements, 1384, 1385, 1387, 1567, 1568, 1569, 1570, 1950, 1951, 1953
 - Displaying process values, 1558
 - OnlineTableControl, (See OnlineTableControl)
 - separate time columns, 1733
 - shared time column, 1733
- Table area, 234, 237, 1252, 1856
- Table display formats, 1733
- Table View, 1970, 1971, 1991
 - Defining, 1977
- Table View:Define, 1977
- table window
 - Tag Logging, 1528
- Tables, 1732
 - dynamic display, 1733, 1736
 - static display, 1735
 - time range, 1735
- Tabs, 1252, 1528
- Tag, 238, 2526, 2534
 - Acknowledgment tag, 1290, 1308
 - Assigning to groups, 289
 - Compressed tag, 1487, 1518, 1542
 - Control tag, 1861
 - Create, 278, 279
 - Create structure tags, 281
 - Current value, 243
 - Data types, 254, 255, 256, 257, 258, 259, 260, 261, 262, 263, 265, 266, 267
 - Diagnostics tag, 1492
 - Editing, 290
 - Editing properties, 280
 - Export, 294
 - External tag, (See Process tag)
 - Faceplate tags, 410, 421
 - Frame tag, 1488
 - Hide tag, 1296, 1309
 - Import, 1343
 - Internal tag, 239, 266, 278
 - Lock tag, 1307

- Message tag, 1287
- Naming conventions, 238
- Process tag, (See Process tag)
- Process-controlled tag, 1487, 1488, 1540
- Project documentation, 2297
- Properties, 243
- Raw data tag, 1488
- Rename, 291
- Runtime, 292
- Simulation, 2557
- Start value, 279
- Status tag, 1288, 1305
- Structure tag, 246
- Structure type, 246
- System tag, 239
- Tag connections, (See Tag connection)
- Tag groups, 253, 288
- Tag logon, (See logon)
- Tag prefixes, 1173
- Tag selection dialog, 268
- Transferring, 2497
- Tag assignment
 - Configuring, 1195
- Tag bar, 2534, 2535, 2537
- Tag connection, 1163, 1195
 - Configuring, 497
 - Example, 1196
 - Linking, 499
 - Selecting tags, 705
- Tag filter, 2527, 2535
- Tag group, 253
 - assigning tag, 289
 - Creating, 288
 - Editing, 290
 - Rename, 291
- Tag Logging, 1521, 1527, 1528
 - Archive backup, 1550, 1553, 1555
 - Archive backups, (See Archive backup)
 - Archive configuration, 1546, 1548
 - Archive tag, 1538, 1540
 - Compressed archives, 1484, 1537
 - Compressed tag, 1544
 - Configuring cycle time, 1532
 - Configuring time series, 1533
 - Cycle time, 1531
 - Data buffer, 1536
 - Diagnostics tag, 1492
 - Fast, 1545
 - Flags, 1525
 - Output of process values, 2090
 - Process value archives, 1482, 1484, 1535
 - Process-controlled tag, 1542
 - Project documentation, 2041, 2054, 2290, 2293
 - Slow, 1545
 - Time series, 1531
- Tag Logon, (See Logon)
- Tag Management, 233, 234
 - Communication driver, Creating a tag, 278, 279
 - Tag groups, 253
- Tag name, 1503, 1504
 - Prefix, 271, 280
 - Suffix, 271, 280
- Tag nodes, 422, 425
- Tag prefix, 246
- Tag selection dialog, 268, 2526, 2527, 2529, 2531
- Tag simulator, 2554
- Tag status
 - Displaying, 293
 - Monitoring, 1215
- Tag supply, 1504
- Tag value
 - Displaying, 293
- TagLogging
 - Function calls, 1842, 1843, 1844, 1845, 1846
 - Properties, 1546
- TagLogging Fast
 - Settings, 1548
- TagLogging Slow
 - Settings, 1548
- Tags
 - Configuration instructions, 2023
 - Deleting, 291
- Target computer, 2463, 2470, 2475, 2479
 - Load project, 2470, 2479
 - Setting path, 2463, 2475
- Target system, 2470, 2479
 - Loading, 2470, 2479
- Taskbar, 222
- Text, 2497
 - Displaying transferred text, 2510
 - Transferring, 2497
- Text and graphic lists, 449
 - Editor, 449
- Text Distributor, 2353
 - Exporting files, 2356, 2360, 2361
 - Exporting texts, 2354
 - Importing texts, 2364
 - Multilingual projects, 2338, 2342
 - Translating text, 2377
- Text library,
 - Editors, Exporting files, 2357, 2360, 2361
 - Managing texts,

- Multilingual projects, 2342
- Overview of operation,
- Project documentation,
- Reinsert text ID,
- Translating text, 2377
- Text list, 449, 598
 - Changing, 639
 - Configuration dialog, 703
 - Configuring, 641, 643, 645, 647, 648
 - Inserting, 639
 - Multilingual projects, 2375, 2381
- Text lists, 1335
- Text Tag
 - Archiving, 1499
- Texts for support, 1280, 1291
 - Action, 1280
 - Description, 1280
 - Effect, 1280
 - Reaction time, 1280
 - Reasons, 1280
- TIA Portal
 - Import, 1343
- Time, 130, 184, 2391
 - System block, 1261
- Time axis, (See BarChartControl), (See OnlineTrendControl)
- Time base, 130, 1494
 - Controls, 134
 - Projects, 133
 - Runtime documentation, 135
- Time factor, 1494
- Time range, 1735, 1802
- Time series, 1531
 - Properties, 1494
- Time series base, 1496
- Time Synchronization
 - Project documentation, 2041, 2060
- Time zone, 130
- Timer name, 1493, 1495
- Tips and Tricks
 - Option "Show Tips and Tricks", 358
- Tips from the real world, 1257
- Toolbar, 1388, 1404, 1443, 1458, 1571, 1624, 1673, 1707, 1742, 1954
 - "Edit action" dialog, 494
 - "Edit VBS action" dialog, 495
 - "Object Properties" window, 2177
 - AlarmControl, 1406
 - BarChartControl, 1680
 - Customized toolbars, (See Editor)
 - FunctionTrendControl, 1719, 1720
 - Graphics Designer, 325, 328, 330, 331, 334, 336, 337, 338, 341, 342, 344, 345, 346
 - Library, 741
 - OnlineTableControl, 1585, 1588
 - OnlineTrendControl, 1636, 1639
 - Operating the User Archive Control, 1993
 - Operating the User Archive Table Element, 1993
 - Operation of Alarm Control, 1458
 - Page layout editor, 2127, 2135, 2136, 2138, 2139, 2140, 2141, 2143, 2144
 - Standard toolbar, 336, 2125, 2144, 2316
 - Table Control, 1742
 - UserArchiveControl, 1961, 1962
 - WinCC Explorer, 48
- Tooltip, 234
- Touch and hold, 810, 813
- Touch operation, 809
- Transfer, 2531
 - STEP 7 symbols, 2531
- Translation
 - Message block, 1265
 - no, 1257, 1293
- Translation Alias
 - Column, 1853
 - User archive field, 1851
 - View, 1852
- Tray area, 222
- Tree structure
 - Alarm Logging, 1252
- Trend
 - Displaying process values, 1558
 - FunctionTrendControl, (See FunctionTrendControl)
 - OnlineTrendControl, (See OnlineTrendControl)
 - Representation formats, 1606, 1607, 1689, 1691
- Trend Control, 1753
 - Configuring in the Graphics Designer, 1764
 - Display in front, 1781
 - Operation in Runtime, 1773
 - Paramterization dialogs in Runtime, 1776
 - Runtime:Determine co-ordinates, 1783
 - Toolbar, 1773
- Trend Control:enlarged display Runtime:enlarged display, 1785
- Trend Control:example of configuration, 1768
- Trend Control:representation of archived values, 1754
- Trend display, 1802
- Trend representation, 1759
- Trends
 - Common axes, 1756
 - Linear Interpolation, 1755

- Representation formats, 1755
- Single Values, 1755
- Staggering, 1758
- Stepped trend, 1755
- Trends:staggering, 1758
- Trends:dynamic display, 1759
- Trends:resolution of curve display, 1759
- Trends:static display, 1759
- Trends:time jump, 1761
- Trends:time overlaps, 1761
- Trends:time range, 1759
- Triggers
 - C actions, 1240
 - Cyclic triggers, 1175
 - Dynamic dialog, 1218
 - Event-driven triggers, 1175, 1178
 - Settings in the Graphics Designer, 368
 - Tag Triggers, 1175
 - VBS actions, 1232
- Triggers an action, 1280
- Tube object, 698
 - Double T-piece, 698, 701
 - Polygon tube, 698, 699
 - T-piece, 698, 700
 - Tube bend, 698, 702
- Two-hand operation, 814, 815
- Type changes, 438
- Type-specific event, 402
- Type-specific property, 402

U

- uaAddArchive, 1901
- uaAddField, 1902
- uaArchiveClose, 1919
- uaArchiveDelete, 1920
- uaArchiveExport, 1920
- uaArchiveGetCount, 1921
- uaArchiveGetFieldLength, 1922
- uaArchiveGetFieldName, 1922
- uaArchiveGetFields, 1923
- uaArchiveGetFieldType, 1923
- uaArchiveGetFieldValueDate, 1924
- uaArchiveGetFieldValueDouble, 1925
- uaArchiveGetFieldValueFloat, 1925
- uaArchiveGetFieldValueLong, 1926
- uaArchiveGetFieldValueString, 1927
- uaArchiveGetFilter, 1927
- uaArchiveGetID, 1928
- uaArchiveGetName, 1928
- uaArchiveGetSort, 1929
- uaArchiveImport, 1929

- uaArchiveInsert, 1930
- uaArchiveMoveFirst, 1931
- uaArchiveMoveLast, 1931
- uaArchiveMoveNext, 1932
- uaArchiveMovePrevious, 1932
- uaArchiveOpen, 1933
- uaArchiveReadTagValues, 1933
- uaArchiveReadTagValuesByName, 1934
- uaArchiveRequery, 1935
- uaArchiveSetFieldValueDate, 1935
- uaArchiveSetFieldValueDouble, 1936
- uaArchiveSetFieldValueFloat, 1937
- uaArchiveSetFieldValueLong, 1937
- uaArchiveSetFieldValueString, 1938
- uaArchiveSetFilter, 1939
- uaArchiveSetSort, 1939
- uaArchiveUpdate, 1940
- uaArchiveWriteTagValues, 1941
- uaArchiveWriteTagValuesByName, 1941
- uaConfigArchive "Structure for Programming the Handles", 1910
- uaConnect, 1912
- uaDisconnect, 1913
- uaGetArchive, 1902
- uaGetField, 1903
- uaGetLastError, 1942
- uaGetLastHResult, 1944
- uaGetLocalEvents, 1913
- uaGetNumArchives, 1904
- uaGetNumFields, 1904
- ualsActive, 1914
- uaOpenArchives, 1914
- uaOpenViews, 1914
- uaQueryArchive, 1915
- uaQueryArchiveByName, 1916
- UaQueryConfiguration, 1905
- uaReleaseArchive, 1916
- uaReleaseConfiguration, 1905
- uaRemoveAllArchives, 1906
- uaRemoveAllFields, 1907
- uaRemoveArchive, 1907
- uaRemoveField, 1908
- uaSetArchive, 1908
- uaSetField, 1909
- uaSetLocalEvents, 1917
- uaUsers, 1917
- Undo, 1255, 1530
- Unicode, 2154, 2365, 2386
- Universal Time Coordinated, 130
- Unlocking messages, 1463
 - Alarm Control, 1463

- Update, 1773, 1818
 - Starting, 1821
 - Stopping, 1821
- Update cycle, 368, 490, 497, 515, 665
- Updating, 1742, 2005
 - Start, 1781
 - Stop, 1781
- Upon change, 370
- Use graphic list, 636, 638
- Used
 - Message block, 1264
 - System message, 1313
- used existing tag, 2005
- User administration
 - electronic signature, 2428
 - WinCC, (See User Administrator)
 - Windows, 2442
- User Administrator, 2405
 - Administrating groups, 2417, 2421, 2451
 - Administrating users, 2407, 2417, 2419, 2421, 2442, 2451
 - Authorizations, (See Authorization)
 - Automatic logout, (See Logout)
 - Connect WinCC/PCS7-OS, 2451
 - Defining users for WinCC service mode, 2419
 - Logon, (See Logon)
 - Multilingual projects, 2342
 - Options, 2432, 2440
 - Overview of authorizations, 2412, 2414, 2415, 2416
 - Project documentation, 2041, 2058
 - SIMATIC Logon, (See SIMATIC Logon)
 - Tag logon, 2425
 - User interface, 2422
 - WinCC Logon, (See Logon)
- User archive, 1810, 1847, 2132
 - Authorizations, 1865
 - Changing, 1869
 - Communication, 1860, 1879
 - Configuring, 1858, 1869
 - Control tag, 1861
 - Data communication with SIMATIC, 1879, 1883, 1884, 1885, 1886, 1887
 - Displaying data, 1810
 - Exporting, 1873, 1876
 - Functions, 1889, 1892, 1901, 1912, 1918
 - Importing, 1874, 1877
 - Multilingual projects, 2342
 - Multilingual text, 1868
 - Naming conventions, 1854
 - Output of data, 2092
 - Project documentation, 2041, 2279, 2282
 - Properties, 1848
 - Raw data tag, (See raw data tag)
 - Runtime data, 1876, 1877
 - Runtime documentation, 2267, 2268
 - SIMATIC interfaces, 1879
 - User archive functions, 1889, 1892, 1901, 1912, 1918
 - User archives, 1858
 - UserArchiveControl, 1965, 1966, 1968
 - Views, 1847, 1869
- User archive column
 - Create, 1870
 - Editing properties, 1871
- User archive field
 - Authorizations, 1851
 - Communication, 1850
 - Editing properties, 1867
 - Properties, 1850
- User Archives Control, 1970
 - configuring, 1971, 1972, 1974
 - Define Columns, 1979
 - Define Fonts, 1985
 - Defining colors, 1986
 - Defining output format, 1979
 - Deleting, 1975
 - Filter criteria, 1983
 - Form view, 1986, 1992
 - Operation in Runtime, 1993
 - Sort Criteria, 1983
 - Status bar, 1982
 - Table View, 1991
 - Toolbar, 1980
- User Archives Table Element, 1970
 - configuring, 1972, 1974
 - Define Access Types, 1977
 - Define User Archive, 1977
 - Define View, 1977
 - Form view, 1986
 - Form View:Define, 1977
 - Object properties, 1975
 - Operation in Runtime, 1993, 1997
 - Properties, 1975
 - Table View:Define, 1977
- User Archives Table Element:Configuration, 1971
- User Archives Table Element:Define Access Types, 1977
- User Archives Table Element:Define Colors, 1986
- User Archives Table Element:Define Columns, 1979
- User Archives Table Element:Define Fonts, 1985
- User Archives Table Element:Define Form View, 1977

- User Archives Table Element:Define Output Format, 1979
- User Archives Table Element:Define Table View, 1977
- User Archives Table Element:Define User Archive, 1977
- User Archives Table Element:Define View, 1977
- User Archives Table Element>Delete, 1975
- User Archives Table Element:Filter Criteria, 1983
- User Archives Table Element:Form View, 1992
- User Archives Table Element:Sort Criteria, 1983
- User Archives Table Element:Status Bar, 1982
- User Archives Table Element:Table View, 1991
- User Archives Table Element:Toolbar, 1980
- User cycle, 370
- User group
 - Create, 2417
- User name
 - System block, 1261
- User text block, 1244, 1280, 1394
 - Empty text, 1291
 - Inserting process values, 1293
 - Maximum number of characters, 1260
 - No translation, 1257
 - Working with message blocks, 1260
- User text blocks, 1291
- UserArchiveControl, 749, 1945
 - Buttons, 1962
 - Configuring, 1946, 1947
 - Configuring table elements, 1384, 1385, 1387, 1567, 1568, 1569, 1570, 1950, 1951, 1953
 - Online configuration, 1399, 1583, 1634, 1678, 1717, 1959
 - Output of data, 2092
 - Processing data, 1965, 1966, 1968
 - Runtime data, 1397, 1581, 1632, 1677, 1715, 1958
 - Status bar, 1388, 1571, 1624, 1673, 1707, 1954, 1962
 - Toolbar, 1388, 1571, 1624, 1673, 1707, 1954, 1961, 1962
- Users
 - Creating, 2417
- UTC, 130

V

- Value axis, (See BarChartControl), (See OnlineTrendControl)
- Values, 1850
- Values outside the limit range, 1804

- Variable
 - Displaying transferred tags, 2509
- VB script
 - Dynamization of faceplate types, 433, 442, 446
- VBS action, 1163, 1223, 1224
 - Action editor, 1225, 1228
 - Configuring, 495
 - Create, 1230
 - Triggers, 1232
- View, 1847
 - Column, 1870
 - Editing properties, 1870
 - Project documentation, 2282
 - Properties, 1852
 - Relation, 1852
 - User archive, 1869
- View data, 1872
- Virus scanner, 175

W

- Warning
 - Option "Display performance warnings", 358
- Web browser, 750
- WebNavigator
 - Web Options, 2422
- WinCC
 - Languages, 2339
 - Multilingual projects, 2339, 2347
 - Project status, 36
 - SIMATIC interfaces, 1879
- WinCC Alarm Control, 1437
- WinCC AlarmControl, 1372, (See AlarmControl)
- WinCC application, 2460
 - create, 2461
- WinCC BarChartControl, 749
- WinCC Client, 111
- WinCC Cloud, (See: Cloud Connector)
- WinCC Configuration Studio
 - Drag-and-drop, 100, 103
- WinCC Control, (See Control)
- WinCC Controls
 - Adapting buttons, 803, 1405, 1586, 1637
 - Adapting table elements, 803, 1405, 1586, 1637
 - Drag-and-drop, 102
- WinCC CrossReferenceAssistant, 2641
- WinCC Digital/Analog Clock Control, (See Clock Control)
- WinCC Explorer, 42
 - Basic Process Control, 118
 - Closing, 40
 - Converting project data, 52

- Copy project path, 42
 - Illegal characters, 226
 - Menu bar, 45
 - opening, 36
 - Overview of editors, 219
 - Project documentation, 2041, 2049
 - Projects, (See Project)
 - Runtime, 204, 209
 - Search, 50
 - Status bar, 49
 - Title bar, 49
 - Toolbar, 48
 - User interface, 42, 45, 48, 49
 - Window, 42
 - WinCC Function Trend Control, 1789
 - WinCC FunctionTrendControl, (See FunctionTrendControl)
 - WinCC Gauge Control, (See Gauge Control)
 - WinCC Logon, (See Logon)
 - WinCC Media Control, (See Media Control)
 - WinCC object, 2457, 2485, 2492
 - Copy, 2486
 - Copying to library, 2492
 - Creating, 2486
 - Creating model solutions, 2492
 - Delete, 2486
 - Deleting in library, 2492
 - Importing, 2488
 - Moving, 2486
 - Moving to library, 2492
 - Rename, 2486
 - Renaming in library, 2492
 - WinCC Online Trend Control, 1732, 1753
 - Applying tag properties, 1772
 - Automatic trend parameter configuration, 1772
 - Curve parameter, 1772
 - Zoom in, 1785
 - Zoom out, 1785
 - Zooming, 1785
 - WinCC OnlineTableControl, (See OnlineTableControl)
 - WinCC OnlineTrendControl, (See OnlineTrendControl)
 - WinCC project, 2457, 2460, 2473, 2484, 2492, (See Project)
 - Copying to library, 2492
 - create, 2461
 - Creating, 2474
 - Creating model solutions, 2492
 - Deleting in library, 2492
 - Importing to the SIMATIC Manager, 2481
 - Loading, 2470, 2479
 - Moving to library, 2492
 - Open, 2494
 - Opening, 2484
 - Renaming in library, 2492
 - WinCC Project Duplicator, (See Project Duplicator)
 - WinCC Push Button Control, (See Push Button Control)
 - WinCC redundancy
 - Redundant user archives, 1853
 - WinCC report system, 2639
 - WinCC RulerControl, (See RulerControl)
 - WinCC server
 - Load online changes, 146
 - WinCC Slider Control, (See Slider Control)
 - WinCC SysDiagControl, 749
 - WinCC User Archives Control, 1970
 - WinCC User Archives Table Element, 1970
 - WinCC UserAdminControl, 749
 - WinCC UserArchiveControl, 1945, (See UserArchiveControl)
 - WinCC WebBrowser Control, 750
 - Window Cycle, 370, 490, 497
 - Windows
 - Taskbar, 222
 - Tray area, 222
 - Windows object, 679
 - Button, 679, 681, 683, 684
 - Check box, 679, 686
 - Radio box, 679, 688
 - Round button, 679, 691
 - Slider, 679, 693, 695, 697, 703
 - Wizard
 - Dynamic Wizard, 342
 - WPF Control, (See Control)
 - Write direction, 1758, 1800
 - Write rights
 - User archive, 1849
 - User archive field, 1851
- X**
- X axis, (See FunctionTrendControl)
 - XFC files, 2005
- Y**
- Y axis, (See FunctionTrendControl)

Z

Zoom

- Activating, 198
- Settings in the Graphics Designer, 364
- Zoom in, 1785
- Zoom out, 1785
- Zooming, 1785