

# SIEMENS

Current transformer

Stromwandler

Transformateur de courant

Transformador de corriente

Transformatore di corrente

Transformador de corrente

Akım dönüştürücü

Трансформатор тока

Przetwornik prądu

电流互感器

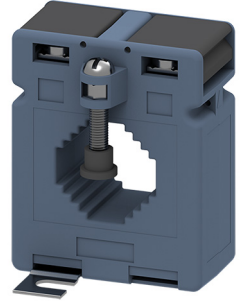

4NC51...-...21	4NC52...-...21	4NC53...-...21	4NC54...-...21	DIN EN 61869-1 DIN EN 61869-2
----------------	----------------	----------------	----------------	----------------------------------

Betriebsanleitung    Operating Instructions    Notice d'utilisation    Instructivo    Istruzioni operative  
Instruções de Serviço    İşletme kılavuzu    Руководство по эксплуатации    Instrukcja obsługi    使用说明

		<b>EN</b> <b>⚠ DANGER</b> <b>Hazardous voltage. Will cause death or serious injury.</b> Turn off and lock out all power supplying this device before working on this device. The converter may never be operated with an open secondary circuit. <b>NOTICE</b> Installation and maintenance must be carried out by qualified personnel.
<b>DE</b> <b>⚠ GEFAHR</b> <b>Gefährliche Spannung. Lebensgefahr oder schwere Verletzungsgefahr.</b> Bevor Arbeiten am Gerät durchgeführt werden, müssen alle Stromquellen ausgeschaltet und mit einer Einchsalticherung versehen werden. Gerät darf niemals mit offenem Sekundärkreis betrieben werden.	<b>FR</b> <b>⚠ DANGER</b> <b>Tension électrique dangereuse. Danger de mort ou risque de blessures graves.</b> Avant d'intervenir sur l'appareil, couper toutes les sources de tension et les consigner contre la refermeture. L'appareil ne doit jamais fonctionner à circuit secondaire ouvert.	
<b>HINWEIS</b> Installations- und Wartungsarbeiten sind von qualifiziertem Personal durchzuführen.	<b>NOTIFICATION</b> L'installation et la maintenance doivent être effectuées uniquement par des personnes qualifiées.	
<b>ES</b> <b>⚠ PELIGRO</b> <b>Tensión peligrosa. Puede causar la muerte o lesiones graves.</b> Antes de trabajar en este dispositivo, desconecte y bloquee todas las fuentes que lo alimentan eléctricamente. El dispositivo no debe operarse jamás con el circuito secundario abierto.	<b>IT</b> <b>⚠ PERICOLO</b> <b>Tensione pericolosa. Può causare la morte o lesioni gravi.</b> Prima di lavorare su questa apparecchiatura, disinserire tutte le fonti di alimentazione elettrica dell'apparecchiatura ed assicurarle contro la reinserzione. L'apparecchio non deve mai essere utilizzato con un circuito secondario aperto.	
<b>NOTA</b> La instalación y el mantenimiento deben corre a cargo de personal cualificado.	<b>NOTA</b> L'installazione e la manutenzione devono essere eseguite da personale qualificato.	
<b>PT</b> <b>⚠ PERIGO</b> <b>Tensão perigosa. Perigo de morte ou ferimentos graves.</b> Desligue e bloqueie todas as fontes de alimentação antes de executar quaisquer trabalhos no aparelho. O aparelho nunca pode ser operado com o circuito secundário aberto.	<b>TR</b> <b>⚠ TEHLİKE</b> <b>Tehlikeli gerilim. Ölüm tehlikesi veya ağır yaralanma tehlikesi mevcuttur.</b> Cihazda çalışmalar yapılmadan önce, tüm güç kaynakları kapatılmalı ve bir açma emniyetiyle donatılmalıdır. Cihaz, sekonder devre açıkken kesinlikle çalıştırılmamalıdır.	
<b>ATENÇÃO</b> A instalação e manutenção têm de ser efetuadas por pessoal qualificado.	<b>NOT</b> Montaj ve bakım işlemleri kalifiye personel tarafından yapılmalıdır.	

Technical Support:    Internet: <http://www.siemens.com/lowvoltage/technical-support>

<p><b>PY</b> <b>⚠️ ОПАСНО</b></p> <p><b>Опасное напряжение. Опасность для жизни или телесных повреждений.</b> До начала работы выключите и заблокируйте все источники питания этого устройства. Ни в коем случае не разрешается эксплуатировать устройство с разомкнутой вторичной цепью.</p> <p><b>ПРИМЕЧАНИЕ</b></p> <p>Установка и техническое обслуживание должны производиться квалифицированным персоналом.</p>	<p><b>PL</b> <b>⚠️ ZAGROŻENIE</b></p> <p><b>Niebezpieczne napięcie. Niebezpieczeństwo poważnych obrażeń lub utraty życia.</b> Wyłączyc i zablokować wszystkie źródła zasilania urządzenia przed rozpoczęciem pracy na urządzeniu. Nie należy eksploatować urządzenia, jeżeli obwód wtórny jest otwarty.</p> <p><b>UWAGA</b></p> <p>Instalacja i konserwacja muszą być wykonywane przez wykwalifikowany personel.</p>
<p><b>中</b> <b>⚠️ 危险</b></p> <p><b>危险电压。可能导致生命危险或重伤危险。</b> 操作此设备前必须确保切断其电源并采取防接通保护措施。设备严禁在开放的二次回路中运行。</p> <p><b>注意</b></p> <p>安装和维护必须由具备专业资质的人员进行。</p>	<p><b>HR</b> <b>⚠️ OPASNOST</b></p> <p><b>Opasni napon. Opasnost po život ili opasnost od teških ozljeda.</b> Prije rada na uređaju potrebno je isključiti sve izvore struje i osigurati uređaj zaštitom od uključivanja. Uređaj se nikada ne smije upotrebljavati s otvorenim sekundarnim krugom.</p> <p><b>NAPOMENA</b></p> <p>Montažu i održavanje treba obavljati kvalificirano osoblje.</p>
<p><b>FI</b> <b>⚠️ VAARA</b></p> <p><b>Vaarallinen jännite. Vakava loukkaantumisvaara tai hengenvaara.</b> Laitteen kaikki virransyöttö tulee katkaista ja sen kytketyminen päälle tulee estää lukolla ennen kuin laitteeseen kohdistetaan mitään toimenpiteitä. Laitetta ei saa koskaan käyttää avoimella toisiopiirillä.</p> <p><b>HUOMAUTUS</b></p> <p>Asennus- ja huoltotyöt on annettava pätevän ammattilaisen suoritettaviksi.</p>	<p><b>БГ</b> <b>⚠️ ОПАСНОСТ</b></p> <p><b>Опасно напряжение. Опасност за живота или опасност от тежки телесни повреди.</b> Преди да извършвате дейности по устройството, изключете и обезопасете всички захранващи източници. Устройството никога не трябва да се използва с отворена вторична верига.</p> <p><b>ПРЕДУПРЕЖДЕНИЕ</b></p> <p>Инсталирането и поддръжката трябва да се извършват от квалифициран персонал.</p>
<p><b>EE</b> <b>⚠️ OHT</b></p> <p><b>Ohtlik pinge. Oht elule või raskete vigastuste oht.</b> Enne seadme hooldustõid lülitage kõik toiteallikad välja ja võtke meetmed nende sisselülitamise takistamiseks. Seadet ei tohi kunagi avatud sekundaarringiga kasutada.</p> <p><b>MÄRKUS</b></p> <p>Paigaldus- ja hooldustööd tohib teha ainult kvalifitseeritud personal.</p>	<p><b>LV</b> <b>⚠️ BĪSTAMI</b></p> <p><b>Bīstams spriegums. Letālu seku vai smagu traumu risks.</b> Pirms veicat darbu ar šo ierīci pilnībā izslēdziet un nobloķējiet tās strāvas padevi. Iekārtu nekādā gadījumā nedrīkst darbināt, ja ir atvērtā sekundārā ķēde.</p> <p><b>BRĪDINĀJUMS</b></p> <p>Uzstādīšana un tehniskā apkope jāveic kvalificētiem darbiniekiem.</p>
<p><b>LT</b> <b>⚠️ PAVOJUS</b></p> <p><b>Pavojinga įtampa. Pavojus gyvybei arba sunkaus susižalojimo pavojus.</b> Prieš dirbdami ties šiuo prietaisu, išjunkite ir užblokuokite visus šio prietaiso maitinimo šaltinius. Prietaiso niekada negalima eksploatuoti su atvira antrine grandine.</p> <p><b>NUORODA</b></p> <p>Įrengimą ir techninę priežiūrą turi vykdyti kvalifikuoti darbuotojai.</p>	<p><b>DA</b> <b>⚠️ FARE</b></p> <p><b>Farlig spænding. Livsfare eller risiko for slemme kvæstelser.</b> Sluk for og lås strømmen, der forsyner denne enhed, før du arbejder med denne enhed. Apparatet må aldrig tages i brug med åbent sekundærkredsløb.</p> <p><b>BEMÆRK</b></p> <p>Installationen og vedligeholdelsen skal foretages af uddannet personale.</p>
<p><b>MT</b> <b>⚠️ PERIKLU</b></p> <p><b>Vultaġġ perikoluż. Riskju ta' mewt jew korrimnt serju.</b> Qabel taħdem fuq dan l-apparat, itfi kull provvista tal-elettriku tiegħu u sakkor kontra xegħil mill-gdid aċċidentali. It-tagħmir m'għandu qatt jithaddem b'ċirkwit sekondarju miftuħ.</p> <p><b>AVVIŻ</b></p> <p>L-installazzjoni u l-manutenzjoni għandhom jittwettqu minn persunal ikkwalifikat.</p>	<p><b>NL</b> <b>⚠️ GEVAAR</b></p> <p><b>Gevaarlijke spanning. Levensgevaar of gevaar voor ernstig letsel.</b> Voordat u aan dit apparaat werkt, moet u alle actieve energiebronnen voor dit apparaat uitschakelen. Het apparaat mag nooit worden gebruikt met open secundair circuit.</p> <p><b>OPMERKING</b></p> <p>Installatie en onderhoud moeten worden verricht door gekwalificeerd personeel.</p>
<p><b>EL</b> <b>⚠️ ΚΙΝΔΥΝΟΣ</b></p> <p><b>Επικίνδυνη τάση. Κίνδυνος για τη ζωή ή σοβαρού τραυματισμού.</b> Απενεργοποιήστε και ασφαλίστε όλα τα ενέργεια που τροφοδοτεί τη συσκευή, προτού εργαστείτε σε αυτή. Απαγορεύεται η λειτουργία της συσκευής με ανοιχτό δευτερεύον κύκλωμα.</p> <p><b>ΠΡΟΣΟΧΗ</b></p> <p>Η εγκατάσταση και συντήρηση πρέπει να διεξάγονται από εξειδικευμένο προσωπικό.</p>	<p><b>GA</b> <b>⚠️ CONTUIRT</b></p> <p><b>Voltais contúirteach. Baol go bhfaighfear bás nó trauamhórtú.</b> Múch gach cumhacht a sholáthraíonn an gléas seo agus glasáil amach í roimh obair a dhéanamh ar an ngléas seo. Ná oibrítear an gaireas le ciorcad tánaisteach oscailte choiche.</p> <p><b>FÓGRA</b></p> <p>Ní mór don fheistiú agus don chothabháil a bheith déanta ag pearsanra cáilithe.</p>

<b>RO</b> ⚠ <b>PERICOL</b> <b>Tensiune periculoasă. Pericol de moarte sau de accidentări grave.</b> Opriți și blocați alimentarea cu energie a acestui dispozitiv înainte de a lucra la acesta. Dispozitivul nu trebuie să fie utilizat niciodată cu circuitul secundar deschis.	<b>SV</b> ⚠ <b>FARA</b> <b>Farlig spänning. Livsfara eller risk för allvarliga personskador.</b> Innan arbete utförst på utrustningen ska strömförsörjningen till utrustningen stängas av. Enheten får aldrig drivas med öppen sekundärkrets.
 <b>ÎNȘTIINȚARE</b> Instalarea și întreținerea trebuie să se efectueze de către personalul calificat. 	 <b>OBS</b> Installation och underhåll får endast utföras av kvalificerad personal. 
<b>CZ</b> ⚠ <b>NEBEZPEČÍ</b> <b>Nebezpečné napětí. Nebezpečí smrtelného nebo těžkého úrazu.</b> Před zahájením prací na tomto zařízení odpojte a zajistěte veškeré přívody energie. Přístroj nikdy nesmí být provozován s otevřeným sekundárním obvodem.	<b>SL</b> ⚠ <b>NEVARNOST</b> <b>Nevarna napetost. Nevarnost za življenje ali nevarnost hudih poškodb.</b> Izklopite in prekinite celotno napajanje naprave, preden na njej opravljate dela. Naprave nikoli ne uporabljajte s prekinjenim sekundarnim tokokrogom.
 <b>POZNÁMKA</b> Instalaci a údržbu musí provádět kvalifikovaní pracovníci. 	 <b>OPOMBA</b> Namestitev in vzdrževanje mora opraviti usposobljeno osebje. 
<b>SK</b> ⚠ <b>NEBEZPEČENSTVO</b> <b>Nebezpečné napätie. Nebezpečenstvo ohrozenia života alebo vzniku ťažkých zranení.</b> Pred prácou na zariadení vypnite a zaistíte všetky napájacie prípojky tohto zariadenia. Prístroj nesmie byť nikdy prevádzkovaný s otvoreným sekundárnym obvodom.	<b>HU</b> ⚠ <b>VESZÉLY</b> <b>Veszélyes feszültség. Életveszély vagy súlyos sérülésveszély.</b> Mielőtt bármilyen munkavégzést kezd az eszközön, az áramellátást le kell kapcsolni, és véletlen bekapcsolás elleni védelemmel kell ellátni. A készülék nem működtethető nyitott szekunder körrel.
 <b>UPOZORNENIE</b> Inštaláciu a údržbu musí vykonávať kvalifikovaný personál. 	 <b>MEGJEGYZÉS</b> A telepítést és a karbantartást kizárólag szak-képzett személyzet végezheti. 



**Contents / Lieferumfang / Etendue de la livraison /  
Contenido / 供货范围**



4NC51...-...21

4NC59...-5LT21

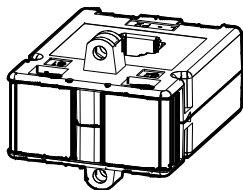

2 x

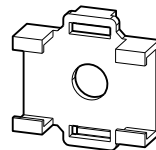
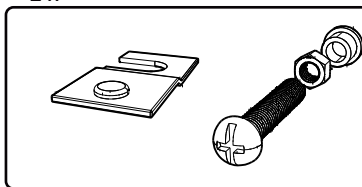

**Required tools / Notwendige Werkzeuge / Outils nécessaires /  
Herramientas requeridas / 必要工具**





## Assembly / Montage / Montaje / Montaje / 安装



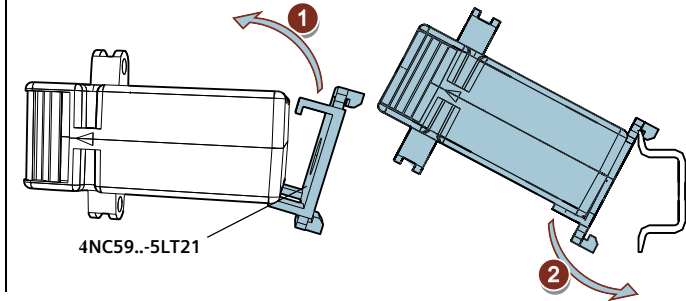
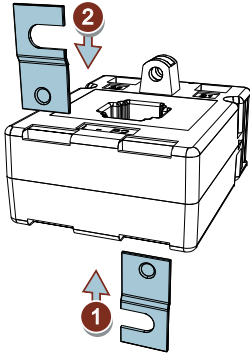

EN	Foot mounting	PT	Fixação do pé	EN	Standard rail mounting	PT	Fixação em calhas DIN
DE	Fußbefestigung	TR	Ayak montajı	DE	Hutschienenbefestigung	TR	Şapkalı ray montajı
FR	Fixation sur pattes	PY	Крепление на опоре	FR	Fixation sur rail DIN	PY	Mocowanie na szynie montażowej
ES	Fijación en pie	PL	Mocowanie nożne	ES	Fijación en perfil DIN	PL	Mocowanie na szynie montażowej
IT	Fissaggio su piedi	中	底座固定	IT	Fissaggio su guida DIN	中	DIN 导轨固定

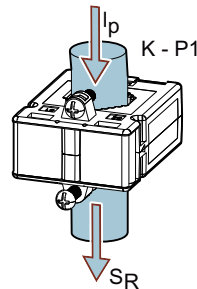
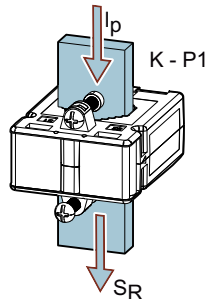
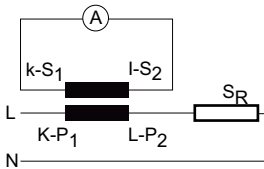
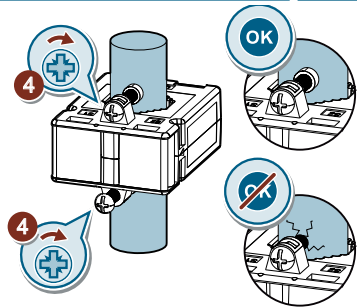
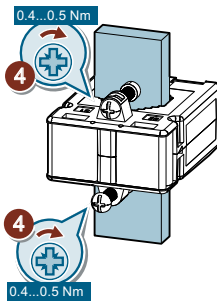
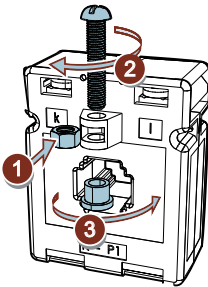

## Connection / Anschluss / Raccordement / Conexión / 连接

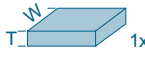
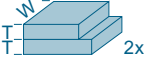





	4NC51..	4NC52..	4NC52.. (class 0,2 s)	4NC53..	4NC54..
	12 x 5 12 x 10 20 x 5	20 x 5 20 x 10 30 x 5 30 x 10	12 x 5 12 x 10 20 x 5	25 x 5 30 x 5 30 x 10 40 x 5 40 x 10 50 x 5 50 x 10	40 x 10 50 x 5 50 x 10 60 x 5 60 x 10
	—	20 x 5	—	25 x 5 30 x 5 40 x 5	40 x 5 40 x 10 50 x 5 50 x 10 60 x 5 60 x 10
	—	—	—	—	40 x 5 50 x 5 60 x 5
	max. 18.5	5...28	5...26	10...36	20...41.5

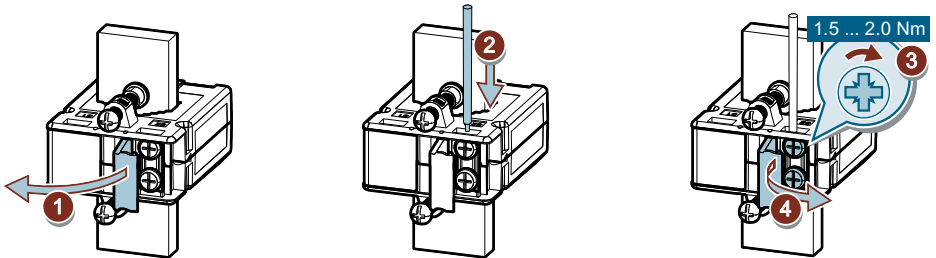

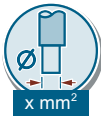
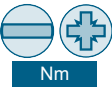
Connection / Anschluss / Raccordement / Conexión / 连接



	 x mm <sup>2</sup>	 Nm	 x mm
	1.5 ... 6	1.5 ... 2.0	10
	1.5 ... 4	1.5 ... 2.0	10



## Connection / Anschluss / Raccordement / Conexión / 连接

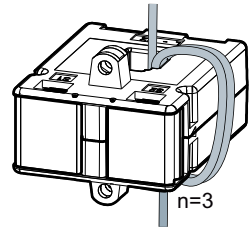
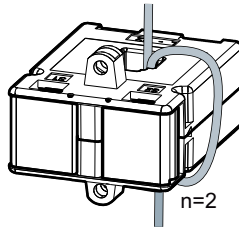
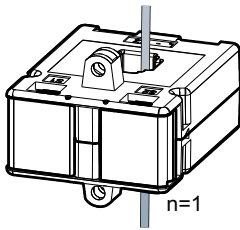

EN	The primary current value can be reduced using more cable windings on the primary side. The secondary current, the burden and the accuracy class are not affected by this. Active primary current = rated primary current: n windings e.g. n=1 --> 150/5 A; n=2 --> 75/5 A; n=3 --> 50/5 A
DE	Mit mehr Kabelwicklungen an der Primärseite kann der Wert des Primärstromes reduziert werden. Gleichzeitig bleiben Sekundärstrom, Bürde und Genauigkeitsklasse unbeeinflusst. Aktueller Primärstrom = Primär-Nennstrom: n Wicklungen z. B. n=1 --> 150/5 A; n=2 --> 75/5 A; n=3 --> 50/5 A
FR	La valeur du courant primaire peut être modifiée en ajoutant des boucles au conducteur primaire. Le courant secondaire, la charge et la classe de précision restent inchangés. Courant primaire actuel = courant primaire nominal : n boucles p. ex. : n=1 --> 150/5 A ; n=2 --> 75/5 A ; n=3 --> 50/5 A
ES	Si el cable primario se pasa más veces por el transformador se puede reducir la intensidad primaria sin afectar a la intensidad secundaria, la carga y la clase de precisión. Intensidad primaria real = intensidad primaria nominal: n pasos del cable p. ej. con n=1 --> 150/5 A; con n=2 --> 75/5 A; con n=3 --> 50/5 A
IT	Se ci sono più avvolgimenti di cavi sul lato primario, il valore della corrente primaria può ridursi. Allo stesso tempo la corrente secondaria, il carico e la classe di precisione non ne sono influenzati. Corrente primaria attuale = corrente primaria nominale: n avvolgimenti ad es. n=1 --> 150/5 A; n=2 --> 75/5 A; n=3 --> 50/5 A
PT	Com mais enrolamento de cabo no lado primário, o valor da corrente primária pode ser reduzido. Em simultâneo, a corrente secundária, a carga e a classe de exatidão permanecem inalteradas. Corrente primária atual = Corrente nominal primária: n enrolamentos p. ex. n=1 --> 150/5 A; n=2 --> 75/5 A; n=3 --> 50/5 A
TR	Primer tarafta daha fazla kablo sargısıyla primer akımın değeri azaltılabilir. Aynı anda sekonder akım, çalışma direnci ve doğruluk sınıfı bundan etkilenmez. Güncel primer akım = Nominal primer akım: n sargı örn. n=1 --> 150/5 A; n=2 --> 75/5 A; n=3 --> 50/5 A
PV	Количество кабельных обмоток на первичной стороне может сократить значение первичного тока. При этом вторичный ток, сопротивление нагрузки и класс точности остаются неизменными. Текущий первичный ток = первичный номинальный ток: n обмоток, например: n=1 --> 150/5 A; n=2 --> 75/5 A; n=3 --> 50/5 A
PL	Wartość prądu wzbudzonego może zostać zredukowana dzięki większej ilości zwojów kabli po stronie przedniej. Równocześnie nie narusza to prądu zwrotnego, ciężaru i klasy dokładności. Aktualny prąd wzbudzony = wzbudzony prąd znamionowy: n łożeń zwojów Np. n=1 --> 150/5 A; n=2 --> 75/5 A; n=3 --> 50/5 A
中	原边电缆绕组增多可使原边电流的值减小。同时副边电流、负荷以及精度等级则不受任何影响。 当前原边电流 = 额定原边电流 : n 个绕组 例如 n=1 --> 150/5 A; n=2 --> 75/5 A; n=3 --> 50/5 A

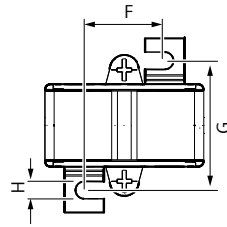
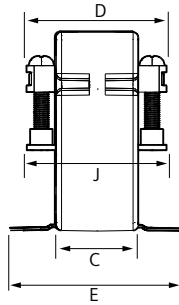
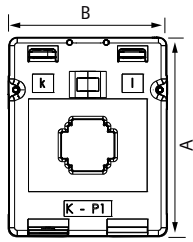

mm [+/- 1]	4NC51.. 4NC52.. (class 0,2 s)	4NC52..	4NC53	4NC54
A	75	78.5	98	127.5
B	60	60	82.5	112
C	31.5	40	50	50.5
D	55.5	65	76	76.5
E	66.5	68	84.5	86
F	30	40	44	72.5
G	51	53	69	69
H	6.5	6.5	6.5	6.5
J	59	68	78	79

4NC51..

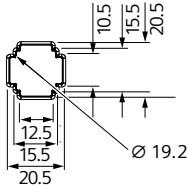

4NC52.. (class 0,2 s)

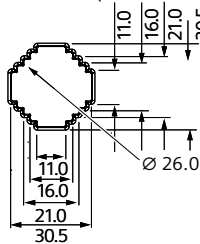

4NC52..

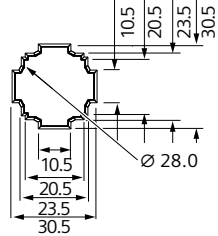

4NC53..

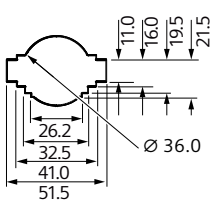



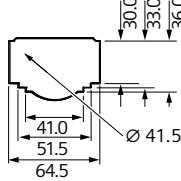

4NC54..





Information / Information / Informations / Información / 信息



 frequency	50/60 Hz	max. permanent current max. Dauerstrom Courant permanent max.max. Dauerstrom Intesidada máx. permanente Corrente permanente max. Corrente contínua máx. maks. sürekli akım макс. ток длительной нагрузки maks. prąd stały 最大恒定电流	1,2 x I <sub>pr</sub>
	5...85%	Thermal short-time current rating I <sub>th</sub> Thermische Bemessungskurzzeit-Stromstärke I <sub>th</sub> Courant assigné thermique de courte durée I <sub>th</sub> Intesidad térmica de breve duración asignada I <sub>th</sub> Corrente nominale termica di breve durata I <sub>th</sub> Intesidade de corrente momentânea nominal térmica I <sub>th</sub> Termik nominal kısa süreli amperaj I <sub>th</sub> Номинальный кратковременный ток термической стойкости I <sub>th</sub> Termiczny czas krótki pomiaru - natężenie prądu I <sub>th</sub> 额定短时耐受电流 I <sub>th</sub>	60 x I <sub>pr</sub> /1s
	20	Rated peak withstand current I <sub>dyn</sub> Bemessungsstoßstromstärke I <sub>dyn</sub> Courant dynamique assigné I <sub>dyn</sub> Intesidad asignada de pico soportable I <sub>dyn</sub> Corrente dinamica nominale I <sub>dyn</sub> Intesidade de corrente máxima assimétrica de curto-circuito I <sub>dyn</sub> Nominal darbe amperajı I <sub>dyn</sub> Номинальный динамический ток I <sub>dyn</sub> Natężenie prądu podczas obliczenia uderzenia I <sub>dyn</sub> 额定峰值耐受电流 I <sub>dyn</sub>	2,5 x I <sub>th</sub> or 150 x I <sub>pr</sub>
 ambient	1,2 x I <sub>th</sub> : -25...+40°C 1,0 x I <sub>th</sub> : -25...+55°C	max. busbar temperature max. Stromschiennentemperatur Température max. des barres de courant Temperatura máx. en las barras Temperatura max. della sbarra collettice Temperatura máx. das barras de corrente	+ 120 °C
 storage	-25...+70°C	maks. akım barası sıcaklığı макс. сила тока токопровода maks. temperatura szyny prądu 最高母线温度	
