

Take off! Enter into a New Dimension  
of Flexibility: **SIMOCODE pro**



# • sirius •

## MOTOR MANAGEMENT



**SIEMENS**



# The new generation: **SIMOCODE pro takes off.**

In many automated processes, plant downtimes have proven themselves to be extremely costly. Costs that can be relatively simply reduced. When the correct technology is applied, faults can either be prevented or when a fault does occur, it can be quickly resolved. For almost a decade, SIMOCODE-DP handled these tasks in many low-voltage switchboards worldwide with supremacy. We decided to develop a new generation of motor management systems as a result of new market requirements. These requirements included the increased use of power management systems and the demand for additional functionality. Based on SIMOCODE-DP, a system has been created that is even more flexible, simple and powerful – the name: SIMOCODE pro.

## **More powerful, simpler and more flexible: SIMOCODE pro – the motor management system**

SIMOCODE pro is the flexible and modular motor management system for low-voltage motors that can be simply and directly connected to higher-level automation systems via PROFIBUS DP. From the functionality perspective it covers all of the requirements between the motor feeder and automation system. Further, it combines in just one compact system, all of the necessary protection, monitoring and control functions for every motor feeder. This therefore increases the process control quality and at the same time reduces the costs – from planning through installation up to operation or service of a plant or system. The new generation has some extensive features onboard with a clear focus on current and future requirements:

- Multifunctional, electronic full motor protection, independent of the automation system
- Flexible software instead of hardware for the motor control
- Detailed operating, service and diagnostics data
- Open communications via PROFIBUS DP – the standard of fieldbus systems



### SIMOCODE pro – the highlights

- Overload protection for motor currents up to 820 A
- Integrated thermistor motor protection
- Integrated earth fault monitoring
- Temperature detection (e.g. Pt100/Pt1000/KTY/NTC)
- Voltage detection up to 690 V
- Power and COS phi/Power Factor
- Analog inputs and outputs
- Communications via PROFIBUS DP
- Standardized and unified, seamless integration
- Graphical parameterizing interface
- Measuring curves can be recorded/traced
- Device internal fault logging
- Just 45 mm wide
- Removable current transformer
- Typical approvals (e.g.: ATEX, UL/CSA, CCC)
- And a lot more!



## Advantages in all areas: **SIMOCODE pro connects.**

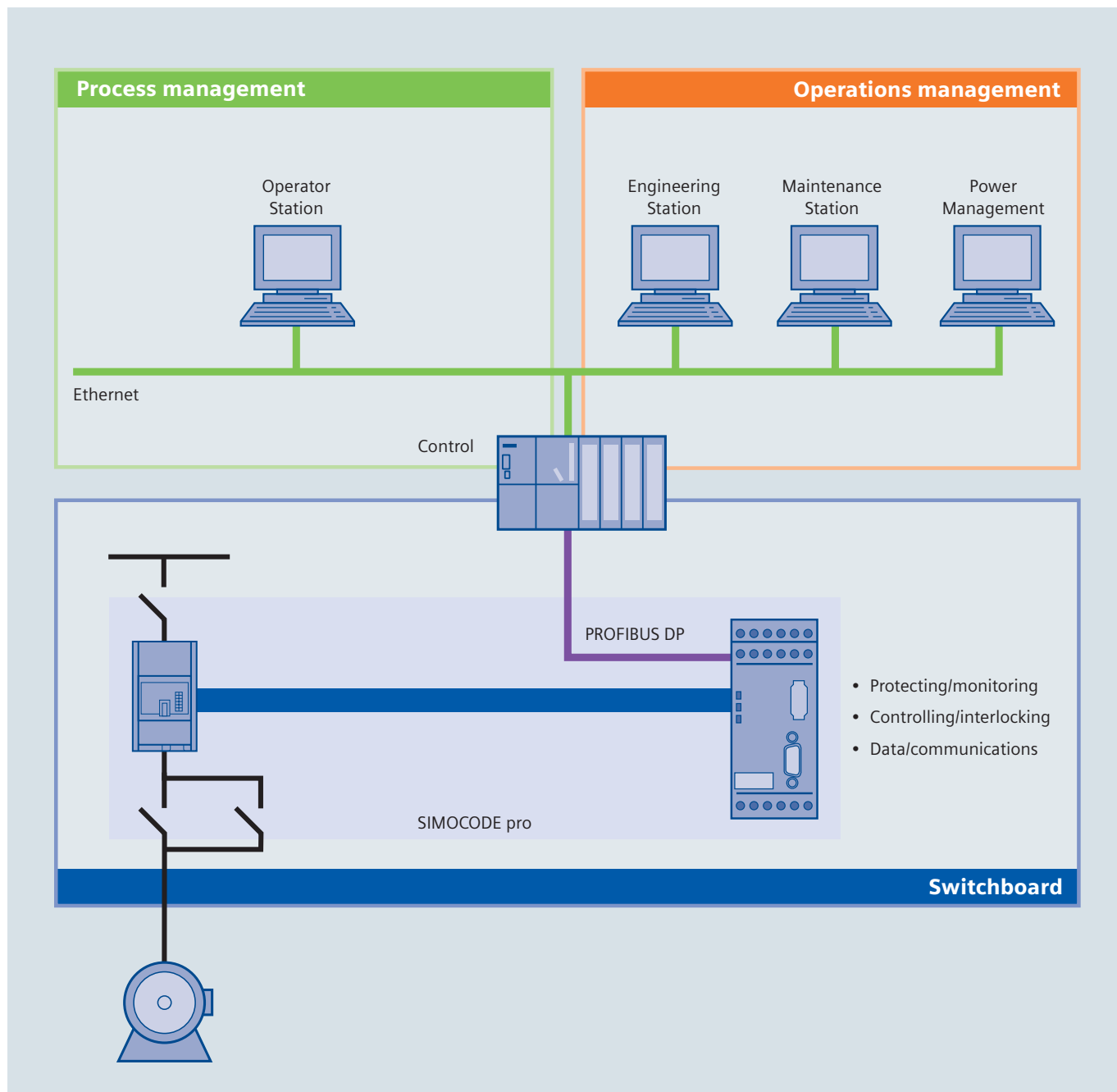

SIMOCODE pro combines all of the functions required for your motor feeder and connects this to higher-level systems via PROFIBUS DP.

# Advantages in all areas

## General:

- High plant and system availability
- Fault prevention using maintenance-relevant data
- Faster troubleshooting – faults are resolved using detailed diagnostics data
- Autonomous functions guarantee the availability of the motor feeder also when communications or supervisory control systems fail



## Process management:

- Higher process transparency and higher information density at the supervisory control level than for conventional solutions
- All of the process quantities are available
- Unified and seamless integration (Totally Integrated Automation)
- Standardized motor blocks facilitate integration and simplify handling



## Operations management:

- Reduced maintenance and service costs thanks to the integrated maintenance functions
- Service and maintenance personnel are supported by an extensive range of service and diagnostics data
- Faults can be more easily reconstructed as measuring curves are recorded and faults logged
- Power-related measured quantities are detected – allowing integration into higher-level power management systems – saving energy costs (Totally Integrated Power)

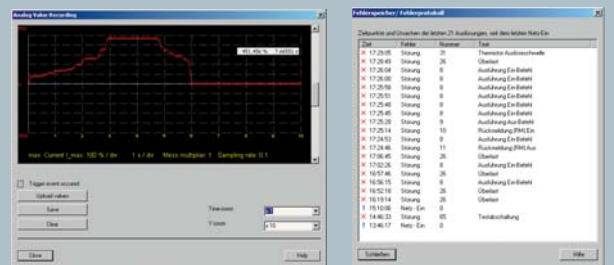

## Switchboard:

- Flexible and space-saving motor feeders thanks to the small dimensions and modular design
- Integrated PROFIBUS interface makes motor feeders communication-capable
- More functionality in a smaller space when compared to conventional solutions
- Lower wiring costs as the control circuit hardware is replaced by flexible software
- Graphic parameterization speeds up commissioning and simplifies plant documentation

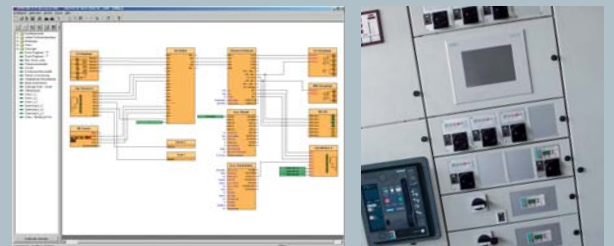

# Functionality as it is required: **SIMOCODE pro is flexible.**

We can offer you two device series that are functionally harmonized with one another so that you can enjoy the benefits of SIMOCODE pro in all areas of the process industry and power generation:



**SIMOCODE pro C**

The compact motor management system for direct and reversing starters: Presently the most cost-effective, communication-capable motor management system of its class. This makes SIMOCODE pro C the optimum solution – especially when changing over from a conventional to a communication-capable motor feeder.



**SIMOCODE pro V**

The variable motor management system: It offers an even higher functional scope. Not only this, it can be expanded by precisely those functions that you require in your motor feeder. Up to five optional expansion modules can be connected.

**Clever solution:**

**Mixed operation in one plant**

Depending on the functions required, SIMOCODE pro C and SIMOCODE pro V can be used together without any additional costs. This means that you remain flexible and can save money – quite a lot of money.

**Straightforward integration:**

**Integrated PROFIBUS DP interface**

SIMOCODE pro has an integrated PROFIBUS DP interface which means that the motor feeder can be integrated as standard into every PROFIBUS DP-capable automation system.

SIMOCODE pro supports among other things:

- Communications with up to three PROFIBUS DP masters
- Cyclic services (DPV0) and acyclic services (DPV1)
- Time synchronization via PROFIBUS\*

**Guaranteed functionality:**

**Independently executed protection and control functions**

One of the most outstanding features of SIMOCODE pro is the fact that all of the protection and control functions can be independently executed. This means that even if the bus or automation system fails, the full functionality is kept. And, it is guaranteed that the motor feeder is protected – i.e. the motor feeder remains available. A defined behavior as a response to faults can be parameterized.

\* for the basic unit to SIMOCODE pro V

**Supplementary functions as required – SIMOCODE pro V expansion modules**

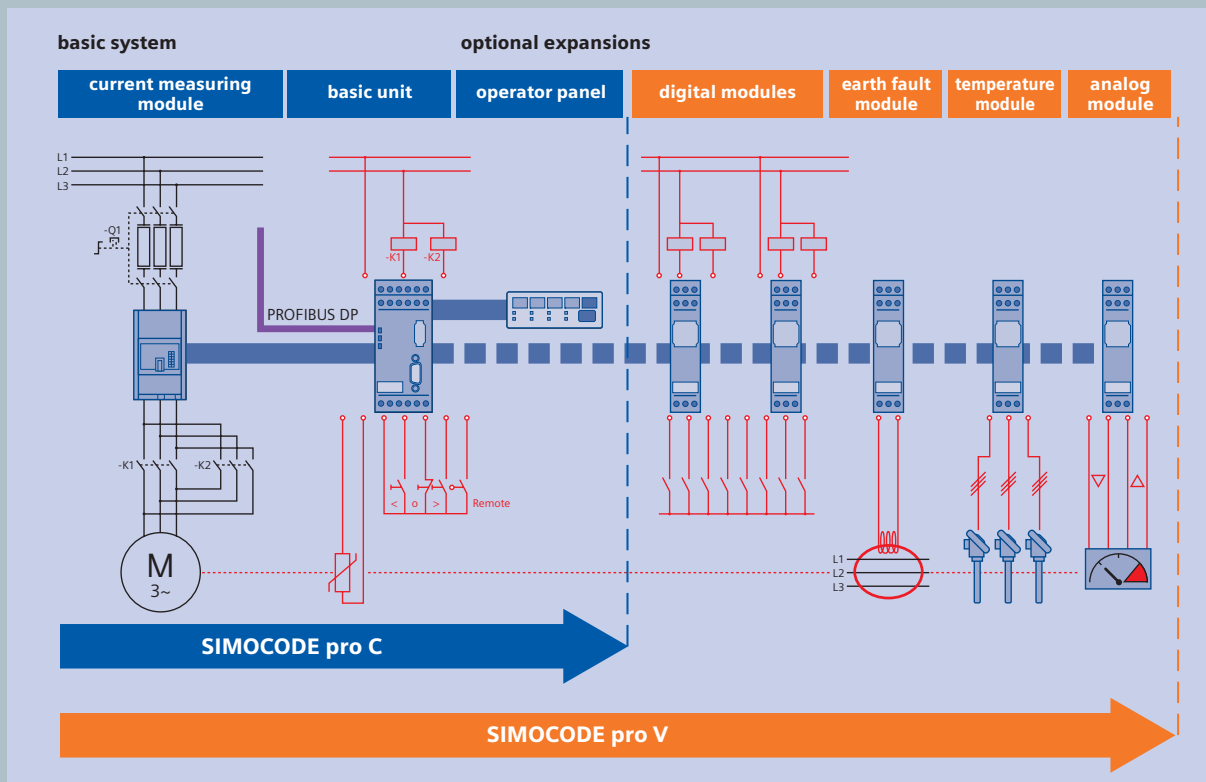

SYSTEM

# Versatility par excellence: SIMOCODE pro is extremely versatile.

There is a wide range of modules at your disposal so that SIMOCODE pro can provide you with what you require in the field coupled with the most flexible device functionality possible. Additional interesting functions will be added. Below is an overview of the wide range of versions that you can expect now and in the future.

## One system for all motor feeders:

### Measuring currents up to 820 A

SIMOCODE pro monitors motors with rated motor currents up to 820 A. Various current measuring modules are available. The modular design and the integrated, seamless system allow a significantly simpler and flexible integration of the motor feeder.

## By the way:

### Voltage, power and cos-phi/power factor

Instead of current measuring modules, for SIMOCODE pro V you can optionally use current/voltage measuring modules. This means that in addition to the motor current, you can also measure voltages up to 690 V and monitor power-related measured quantities.

MODULES

45 mm	55 mm	120 mm	145 mm
			
			
0.3–3 A; 2.4–25 A	10–100 A	20–200 A	63–630 A
straight-through transformer		busbar connection	

Current measuring modules

Current/voltage measuring modules

The matching intermediate 3UF18 current transformers for the current measuring or current/voltage measuring modules are available to measure and monitor motor currents of up to 820 A.





Operator panel with display for SIMOCODE pro V

### Easier handling: The operator panel

The operator panel is used to control the motor feeder. It is integrated in a control cabinet door and features IP54 degree of protection. Thus, SIMOCODE pro or the feeder can be directly operated from the control cabinet. The system interface integrated in the operator panel at the front serves convenient PC/PG-based parameterization and diagnostics directly on the control cabinet door. To be able to read measuring values, operational and diagnostics data directly from the control cabinet, the operator panel for SIMOCODE pro V is optionally available with a display.

### Higher range of versions: Expansion modules for SIMOCODE pro V

SIMOCODE pro V not only has even more protection, control and monitoring functions than SIMOCODE pro C, but thanks to the expansion modules can be expanded as required.



### Digital modules\*

The type and number of digital input and relay outputs of SIMOCODE pro V can be increased step-by-step using digital modules.

This means that you can:

- Input or output additional process signals and implement additional functions
- Externally supplied digital inputs can be retrofitted (24 V DC or 110–240 V AC/DC)
- Bistable relay outputs can be added – the switching status of the relay outputs is kept even after the power supply voltage fails

### Earth fault module\*

Using the earth fault module, in addition to the earth fault monitoring function integrated into the basic unit, you can configure an even more precise external earth fault monitoring using a summation current transformer.

### Temperature module\*

In parallel to the thermistor motor protection, using the temperature module, you can integrate up to 3 analog temperature sensors (e.g. Pt100, Pt1000, KTY, NTC) to your process. This means that it is simple to monitor values, e.g. gearbox oil temperature and cooling medium temperature.

### Analog module\*

Using the analog module, you can expand the SIMOCODE pro V system by analog inputs and outputs (0/4 ... 20 mA). This means that it becomes very easy to monitor processes – e.g. levels or flows.

\* for the basic unit to SIMOCODE pro V

## SIMOCODE pro software tools make it really simple for you

### SIMOCODE ES Professional

User-friendly operator control using display and evaluation of all operating, service and diagnostics data from a central location via PROFIBUS DP.

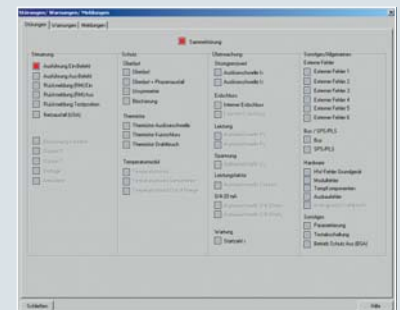

### SIMOCODE ES Smart

Time-saving parameterization, commissioning and extensive documentation directly at the device – with a user-friendly and more transparent interface.

### SIMOCODE ES Graphic

SIMOCODE ES can be optionally expanded by a graphic editor to ergonomically parameterize the system by dragging & dropping in a user-friendly fashion.

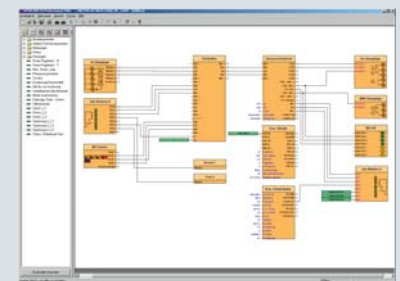

More about our software tools from page 14 onwards

# Extensive functions: SIMOCODE pro optimizes process control and plant operation.

Whether process management, operations management or switchboards – SIMOCODE pro connects all of the areas through extensive data and functions. It provides you with advantages across the board!

## Extensive protection: multi-functional, electronic full motor protection

PROTECTING & MONITORING

SIMOCODE pro offers an extensive protection of the motor feeder by combining various multistage protection and monitoring functions:

### Protection functions:

- Overload protection (Class 5–40)
- Thermistor motor protection
- Phase failure monitoring
- Unbalance protection
- Stall protection
- Earth fault monitoring
- Current limit monitoring
- Operating hours monitoring
- Motor stop time monitoring
- Number-of-starts monitoring
- And a lot more

### Expanded monitoring functions:

- Temperature monitoring Pt100/ Pt1000\*
- Voltage monitoring\*
- Power monitoring\*
- Cos-phi/power factor monitoring\*
- Phase sequence detection\*
- Input, output and monitoring of 0/4...20 mA signals\*

### Recording of measured curves\*

## Absolutely flexible: software-based motor control

CONTROLLING

SIMOCODE pro already has many pre-defined motor control functions – including all of the necessary interlocks. Your advantage: You save a whole lot of hardware and wiring and you obtain a motor feeder that is highly standardized regarding its circuit diagrams.

### Control functions:

- Direct on-line starter
- Reversing starter
- Star-delta starter\*
- Star-delta starter with reversal of rotational direction\*
- Two speeds, motors with separate windings (pole changing) also with reversal of rotational direction\*
- Two speeds, motors with separate Dahlander windings, also with reversal of rotational direction\*
- Solenoid valve actuation\*
- Positioner actuation\*
- Circuit-breaker control
- Soft starter actuation\*
- Soft starter actuation with reversal of rotational direction\*

### Simply adapt: using logic blocks and standard functions

Protection and control functions can, when required, be flexibly adapted to the requirements of your motor feeder. This is achieved using freely parameterizable logic blocks – such as truth tables, counters and edge evaluation – and using standard functions such as line supply failure monitoring\*, emergency start or external faults.

SIMOCODE pro provides you with all of the data required for process and plant operation. This data is available in the switchboard and, to the same extent, also in the supervisory control system. In addition to the many process quantities, it is especially the service and diagnostics data that support your service and maintenance personnel. SIMOCODE pro helps you to identify approaching faults and avoid them using preventive measures. However, if a fault actually occurs, then it can be quickly localized and resolved. This means that downtimes are limited to a minimum or don't even occur in the first place.

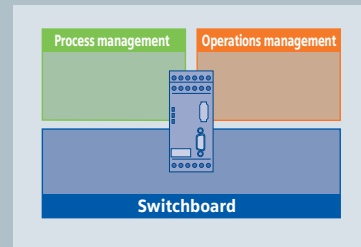

### Communications via PROFIBUS DP – extensive data available everywhere

#### Operational data:

- Motor switching state (on, off, counter-clockwise, clockwise, slow, fast)
- Current in phases 1, 2, 3 and maximum current
- Phase voltage 1, 2, 3\*
- Active power\*
- Apparent power\*
- Power factor\*
- Phase unbalance
- Phase sequence\*
- Time to trip
- Temperature rise, motor model
- Remaining cooling time of the motor
- Temperature (e.g. motor temperature)\*
- Actual value, analog signals\*
- And much more

#### Service data:

- Motor operating hours
- Motor stop times
- Number of motor starts
- Number of overload trips
- Internal comments saved in the device
- Device operating hours
- Consumed power\*
- And much more

#### Diagnostics data:

- Numerous detailed early warning and fault messages, also for further processing in the device or in the master control system
- Fault logging within the device with time stamp
- Time stamp for any selectable status, alarm and fault messages\*
- Value of the last tripping current
- Checkback faults (e.g. no current flowing in the main circuit after an On control command)
- And much more



\* for the basic unit to SIMOCODE pro V

# Totally Integrated: Software for integration.

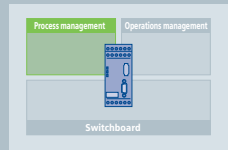

**More transparency, more data:  
optimum process control for all process control systems using SIMOCODE pro**

Increasingly, in addition to general sensor systems, motor feeder data is also being incorporated in the process control system. SIMOCODE pro is supporting this trend and provides the data to all process control systems via PROFIBUS. This means that SIMOCODE pro increases the degree of transparency of your process and ensures a significantly higher information density in the supervisory control system – but without any additional costs. Based on Totally Integrated Automation, data is integrated seamlessly and in a unified fashion. Standard motor blocks simplify the integration and make handling easier.

## User-friendly integration into the SIMATIC PCS 7 process control system

Using the PCS 7 library, SIMOCODE pro can be simply integrated into the SIMATIC PCS 7 process control system in a user-friendly fashion. The PCS 7 library SIMOCODE pro has for this purpose standard motor blocks and faceplates to operator control and visualization of the motor. All of the information that is relevant for the process is displayed in a transparent fashion, e.g.:

- Operator control elements and checkback signals
- Process quantities: motor current, temperatures, analog values, power and trends
- Process faults, process alarm and messages

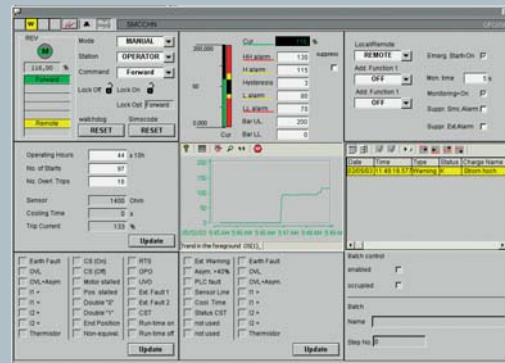

SIMATIC PCS 7

## Integration into SIMATIC PDM

It goes without saying that SIMOCODE pro is also integrated into SIMATIC PDM (PDM = Process Device Manager) for plant-wide device parameterization and diagnostics. This means that a standard, unified tool is embedded in the process control system for intelligent field devices such as SIMOCODE pro.

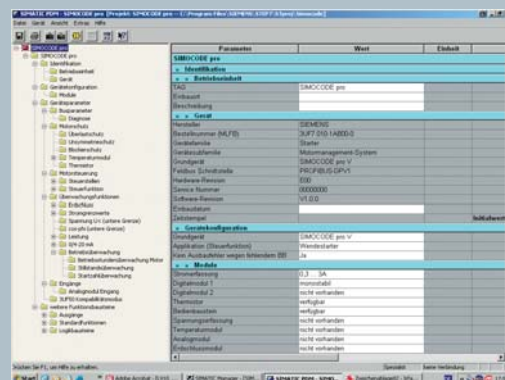

SIMATIC PDM



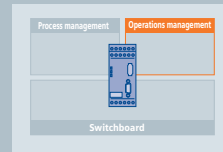

**Parameterization, diagnostics and integrated maintenance functionality: user-friendly operational control using SIMOCODE pro**

Increasingly, plant operating companies are expecting information and data for user-friendly operational management using central maintenance and power management systems that are available in addition to the process control. SIMOCODE pro supplies the systems with the necessary data. With SIMOCODE ES Professional, the SIMOCODE pro system provides, among other things, a tool with which all of the data can be displayed and evaluated.

**Parameterization, diagnostics and service with SIMOCODE ES Professional**

With SIMOCODE ES Professional, SIMOCODE pro can be parameterized and diagnosed in a user-friendly fashion from a central location via PROFIBUS. SIMOCODE ES provides important information when maintenance is required or when faults occur by displaying all of the operating, service and diagnostics data. This helps to prevent faults, more quickly localize these when a fault occurs and also resolve the problem. The system can be parameterized online – also during operation – thus avoiding unnecessary plant downtimes. Among other things, the following data is displayed in easy to understand dialog boxes:

- Alarms, faults, messages
- Operating hours, downtimes, etc.
- Fault log
- Measuring characteristics and curves

**Integration into SIMATIC S7 with the OM SIMOCODE pro object manager**

Our OM SIMOCODE pro object manager is part of SIMOCODE ES Professional and allows SIMOCODE ES to be incorporated in STEP 7. Devices can be configured, unified with S7, and parameterized simply because SIMOCODE ES can be directly executed from STEP 7. This means that SIMOCODE pro is totally integrated into SIMATIC S7.

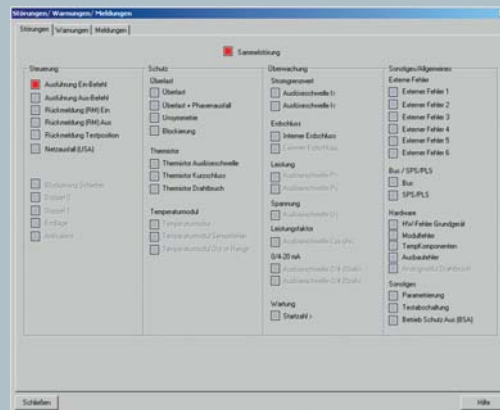

Operating and diagnostics data



Evaluating measuring curves

Motor		Timer	
Betriebsstunden Motor	429 h	Timer 1 - Istwert	0 s
Anzahl Überlastauslösungen	12	Timer 2 - Istwert	0 s
Anzahl der Starts	122	Timer 3 - Istwert	0 s
Zulässige Start- Istwert	0	Timer 4 - Istwert	0 s
Stillstandszeit	0 h		
Grundgerät		Zähler	
Betriebsstunden Gerät	17 h	Zähler 1 - Istwert	0
Ist. Anzahl Parameterlösungen	41	Zähler 2 - Istwert	0
		Zähler 3 - Istwert	0
		Zähler 4 - Istwert	0

Statistical and service data

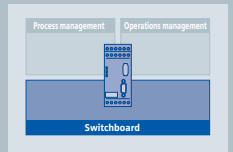

**Easy planning, high degree of engineering security, fast commissioning:  
SIMOCODE pro in the switchboard**

SIMOCODE pro is modular and is extremely compact. This makes it predestined for use in low-voltage switchboards with motor control centers. The extensive functions of SIMOCODE pro can be flexibly adapted to every customized version of a motor feeder. Optional expansion modules provide an additional degree of security when engineering the system. The pre-defined software-based control functions do away with additional hardware for interlocking. Standardized load feeders such as these decisively simplify planning and mechanical design.

Ergonomically designed tools are required so that a switchboard can be commissioned quickly. With SIMOCODE ES Smart, users have access to the same functions as with SIMOCODE ES Professional – the only difference: the parameterization is realized directly at the device.

**Parameterization and commissioning the switchboard with SIMOCODE ES**

Control and protection functions as well as the wiring of the control circuit are realized using software in SIMOCODE pro – and are parameterized with SIMOCODE ES. With SIMOCODE ES Smart, SIMOCODE pro offers a user-friendly and transparent interface to directly parameterize and commission at the unit. The integrated, flexible print function allows an extensive plant or partial documentation of all of the selected or modified parameters.

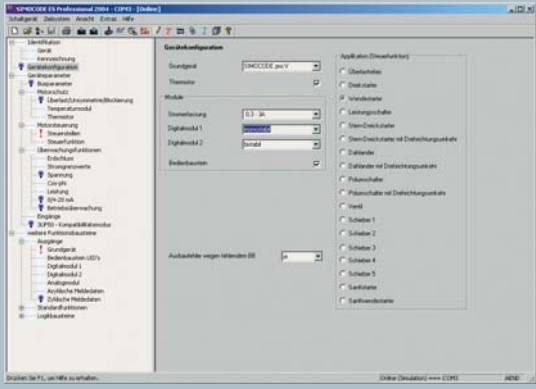

SIMOCODE ES

**Parameterization by dragging & dropping with SIMOCODE ES Graphic**

For SIMOCODE ES, there is also an optional software package. This will allow you to expand the parameterization interfaces by a graphic editor. SIMOCODE ES Graphic allows an extremely ergonomic and user-friendly parameterization by “dragging & dropping”. In so doing, the inputs and outputs of function modules can be graphically “soft-wired” and parameters can be set. The configured functions can be described in more detail by inserting comments of any type and the device parameterization can be graphically documented. This again significantly speeds up commissioning and visibly simplifies the documentation.

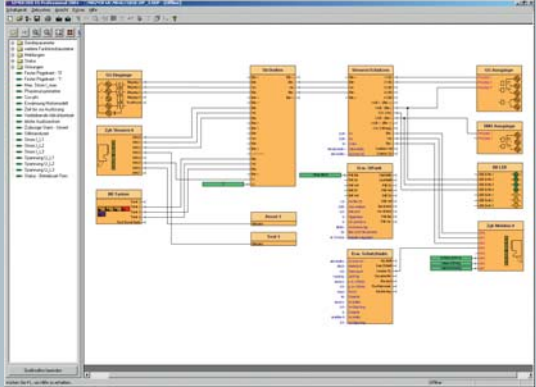

SIMOCODE ES Graphic

# For maximum plant protection: **SIMOCODE pro** with **Safety Integrated**

Also in the field of process automation, the safety-oriented employment of components is gaining in importance. Plants may at any time be subject to situations in which humans or the environment need to be protected by the safety-oriented shutdown of machines, e.g. by a safe motor shutdown. With SIMOCODE pro, you are always on the safe side.



3TK28 safety relay

Thanks to the combination of SIMOCODE pro with a 3TK28 safety relay, you profit from the advantages of a flexible, modular motor management system and the safety-oriented shutdown of the respective consumer. All applicable safety standards are complied with.

Humans and machines are extensively protected by the combination of various multi-level protective and monitoring functions in SIMOCODE pro, including the consumer's safety-oriented shutdown. Via the PROFIBUS interface integrated in SIMOCODE pro, the motor feeder can be integrated in the automation system in a standardized manner. All signal states of the 3TK28 can be signaled to the superior PLC via PROFIBUS. Additional auxiliary contacts for the safety relay and the Emergency-STOP button are done away with. As only a small number of devices is employed and the wiring expenditures are thus reduced, the required space is way smaller than with conventional solutions.

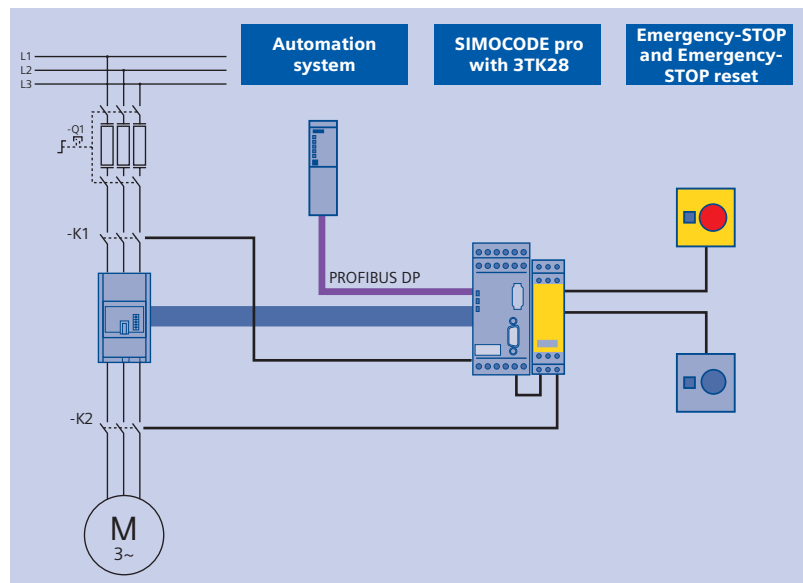

Safe consumer shutdown with SIMOCODE pro

SAFETY

# Optimum in use: **SIMOCODE pro with SIVACON**

With SIMOCODE pro, you have at your fingertips a cost-effective motor management system that is truly fit for the future. It combines many years of experience with state-of-the-art technology and has been successfully used for many years in SIVACON – Siemens low-voltage switchboards. Now, using the new SIMOCODE pro, up to 40 communication-capable motor feeders can be integrated in a control cubicle.



*SIVACON low-voltage switchboard:  
Communication-capable, cost-effective,  
extremely flexible and especially reliable.  
The switchboard with a lot more.*

With SIMOCODE pro, in addition to the communication-capable SENTRON circuit breakers or the AS-Interface modules, there is a flexible and communication-capable motor management system available for low-voltage switchboards.

SIMOCODE pro is used in SIVACON – in fixed-mounted, plug-in and withdrawable unit design – and allows load feeders to be configured. Load feeders that have a higher performance and at the same time are extremely compact and able to communicate.

SIVACON – equipped with SIMOCODE pro – allows data transfer with automation systems to be cost-effectively implemented. The standardized, non-proprietary PROFIBUS DP is used as bus system – this allows connections to be established to the widest range of automation devices.

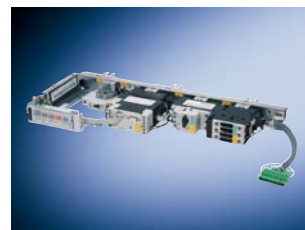

*SIVACON in-line module  
with SIMOCODE pro  
(50 mm height)*



*SIVACON withdrawable unit  
with SIMOCODE pro*



# Your project in excellent company: **SIMOCODE pro put into**

## Comprehensive diagnostics easily realized

The paper machine 4 of the paper manufacturer Lang situated in the Swabian town of Ettringen daily produces approximately 500 tons of uncoated paper. Within the scope of a plant modernization, the decision-makers at Lang searched for a possibility of integrating this machine in the new SIMATIC PCS 7 process control system in a way which ensures both efficiency and future profitability. SIMOCODE pro meets these requirements best. 130 electrical drives in the area of raw material processing are now controlled by the motor management system and connected to the control system via PROFIBUS DP. This solution brings significant advantages for the paper manufacturing process. All motor feeders are not only actuated and protected but also reliably integrated into a comprehensive diagnostic concept. The behavior of every single drive can be permanently monitored – virtually in real time – from the control center.



*"It is extremely advantageous for the entire paper manufacturing process to be able to monitor the behavior of every single drive from the control center."*

*Helmut Lieberg,  
Qualified engineer for measuring  
and control technology at Lang Papier*

### All advantages at a glance

- Easy, cost- and space-saving realization of a comprehensive diagnostic concept
- High bus quality and transfer speed
- More precise and rapid fault localization and rectification thanks to detailed diagnostics
- Enhanced flexibility for plant expansions and device replacements
- Increased productivity



PRACTICE

## A clear thing: SIMOCODE pro facilitates standardized sewage processes

The Fürth sewage treatment plant disposes of the wastewater of approx. 265,000 households. To assure safe sewage processes also for the future, the switchboard was modernized and the sludge drainage plant was retrofitted with two new machines. The objective: maximum flexibility, safety and efficiency. For the operator, the suitable solution became clear quite fast: SIMOCODE pro V. The convincing factors were the withdrawable unit technology, the high degree of standardization, the individual parameterization as well as the functional diversity way beyond current measuring. The flexible modular motor management system SIMOCODE pro V now controls and protects all drives connected to the switchboard and connects them to PROFIBUS DP. Via notebook, the staff can check the state of the drives. Faults are recorded. Any changes in the process sequence can be localized and safety routines can be activated via the devices' parameterization. The result: the sewage treatment plant benefits from a low-wear, efficient and almost autonomous operation.

### Advantages at a glance

- Space-saving device employment with maximum performance and communication capability
- Easy installation and maintenance
- Uncomplicated device replacement
- High standardization degree reduces control and maintenance inspections
- Flexible plant extensions



*"We can now work autonomously and are independent of the plant manufacturer."*

*Karl Weber, Technical operations manager  
for the Hofmockel plant manufacturer*



## Targeted motor management prevents process faults

The time between September and December is the high season for sugar. Particularly during these four months, it is vital for sugar producers to handle 24-hour shifts without interruptions. Against this background, Südzucker AG, which is situated in the Swabian town of Rain am Lech, opted for a modernization of diverse plant sections. The core of these modernization measures was the SIMOCODE pro motor management system, which allows for a precise control and monitoring of the process air. The functionality of all motors can now be monitored at any time – either from the control center or directly on site. With SIMOCODE pro even gradients can be recorded in the devices. This newly gained transparency helps to consistently prevent faults. Furthermore, service works can be carried out efficiently thanks to the easy device replacement, which takes less than 30 seconds with the memory module.

*“Like athletics, we have to consistently use the best equipment to be in top shape during the competition.”*

*Günter Leinfelder, senior electrician at Südzucker AG*



### The solution in detail

- Flexible application even under confined space conditions – thanks to compact dimensions and the separate installation of basic unit and current measuring module
- Optimized servicing as a result of reduced response times and the pluggable memory module, which reads out and records all parameters
- Maximized plant availability – thanks to the possibility of processing and monitoring performance-specific parameters in the device by means of current/voltage measuring modules up to 690 V
- Load monitoring by calculating the active power and the power factor



## A clean solution: SIMOCODE pro for reliable boiler cleaning

The Atlanta-based Clyde Bergemann Inc. is a well-known OEM supplier of state-of-the-art boiler cleaning systems. To be able to offer customers efficient and future-proof solutions for the modernization of their boiler systems, the process engineers searched for a flexible system meeting the following requirements: A modern motor management capable of reliable maintaining a high boiler performance and assuring the continuous removal of soot deposits. A solution without a permanently wired control technology. A system facilitating the basic operation of the sootblowers independently of the PLC. SIMOCODE pro perfectly satisfied these criteria. With its distributed design, the system features many useful additional functions which considerably ease the engineers' work and reduce costs. As a flexible and modular system, SIMOCODE pro can be easily connected to PROFIBUS, offers a standardized interface and provides detailed operational, service and diagnostics data. It can be easily parameterized and guarantees a reliable cleaning operation even under harsh ambient conditions.

### All advantages at a glance

- Easy installation and maintenance
- Cost savings over the entire service life of the sootblowers
- Time savings thanks to easy parameterization in standardized circuit diagram and hardware configuration
- Increased functional variety thanks to expansion modules
- Manual operation of the sootblowers in fault cases by means of local on-site control
- Active plant monitoring thanks to detailed diagnostics
- Precise, fast fault localization and rectification

*"Thanks to the numerous additional functions and diagnostic options of SIMOCODE pro, we have clearly outpaced our competitors."*

*Sandeep Shah, head of the "Technology" division*



## For a constantly high beer quality: SIMOCODE pro convinces with functional variety

The Paulaner brewery in Munich produces approximately 2.5 mio hectoliters of beer per year. 24 hours a day – seven days a week. To be able to maintain this production output and make the plant fit for the future, the decision-makers decided in favor of the modularly expandable SIMOCODE pro V system when modernizing the control technology in the filtration system. Particularly the high functional variety of SIMOCODE pro getting far beyond mere current measuring convinced the heads of the Industrial Engineering division at Paulaner. Thanks to the increased number of signal connections realized with connection of additional digital modules, all filtration and cooling process steps can now be centrally monitored and controlled. Process data are directly transferred to the control center. The high plant transparency assures a precise detection and fast rectification of faults as well as the configuration of standardized diagnostic routines.



*“From our point of view, the SIMOCODE pro motor management system is the only real diagnostic solution as it immediately detects pump and fan maloperation. It is exactly the motor management system we have been looking for.”*

*Herbert Eger, senior electrician at the Industrial Engineering division at Paulaner*



### All advantages at a glance

- Space-saving and flexible application
- Easy device replacement
- More precise and rapid fault localization and rectification thanks to detailed diagnostics
- Unified basis for the configuration of standardized diagnostic routines
- Higher plant availability as a result of the increased control system transparency

# Modules and accessories: SIMOCODE pro – a system overview

## Basic unit, SIMOCODE pro C



- Description:** Basis components of SIMOCODE pro C, PROFIBUS DP interface, 12 Mbps  
4 inputs / 3 monostable relay outputs, thermistor connection
- Range:** Rated control supply voltage:  
• 24 V DC • 110 ... 240 V AC/DC

## Basic unit, SIMOCODE pro V



- Description:** Basis components of SIMOCODE pro V, PROFIBUS DP interface, 12 Mbps  
4 inputs / 3 monostable relay outputs, thermistor connection, can be functionally expanded using expansion modules
- Range:** Rated control supply voltage:  
• 24 V DC • 110 ... 240 V AC/DC

## Current measuring modules and current/voltage measuring modules\*



- Description:** The motor current in the main circuit is measured separately from the basic unit using a measuring unit. Current/voltage measuring modules also measure voltages up to 690 V in the main circuit.
- Range:** Straight-through current transformer for rated motor currents:  
• 0.3 ... 3 A • 2.4 ... 25 A • 10 ... 100 A • 20 ... 200 A
- Current transformer with busbar connections for rated motor currents:  
• 20 ... 200 A • 63 ... 630 A
- The matching 3UF18 intermediate current transformers are available to measure and monitor motor currents up to 820 A.

## Operator panel



- Description:** For SIMOCODE pro operation at the control cabinet door with up to 10 LEDs for status display and up to 5 pushbuttons.  
The SIMOCODE pro V series is optionally available with display.

## Expansion modules\*



### Digital modules

- Description:** To expand a basic unit by additional digital I/Os; a maximum of 2 digital modules can be connected per basic unit.
- Range:** Relay outputs: Input voltage:  
• Monostable • 24 V DC  
• Bistable • 110 ... 240 V AC/DC

### Earth fault module

- Description:** To expand the basic unit by one input for the external earth fault detection with a summation current transformer, a maximum of 1 earth fault module can be connected per basic unit.

### Temperature module

- Description:** To expand the basic unit by inputs for up to 3 resistance sensors (Pt100, Pt1000, KTY, NTC), a maximum of 1 temperature module can be connected per basic unit.

### Analog module

- Description:** To expand the basic unit with two passive analog inputs and one output (0/4...20 mA), maximally one analog module can be connected per basic unit.

\* for the basic unit to SIMOCODE pro V

## Decoupling module



**Description:** For current/voltage measuring modules to measure the voltage in ungrounded networks or for application in networks with insulation measuring and monitoring.

## Memory module



**Description:** To parameterize SIMOCODE pro without PC/PG or to transfer parameters between two systems by plugging into the system interface

## Addressing plug



**Description:** To assign a PROFIBUS address without PC/PG at a basic unit by plugging into the system interface

## Door adapter



**Description:** To feed out the system interface, e.g. from a control cabinet; this makes the system interface more easily accessible when parameterizing or troubleshooting using a PC/PG

## Connection cable



**Description:** To connect the basic unit, current measuring or current/voltage measuring module, operator panel or expansion modules

**Range:** In various lengths

## PC cable



**Description:** For PC/PG communications with SIMOCODE pro via the system interface

## SIMOCODE ES

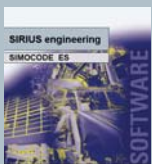

**Description:** Parameterizing and service software for SIMOCODE pro, can run under Windows XP/2000.

**Range:** Versions:

- SIMOCODE ES Smart to parameterize via the system interface
- SIMOCODE ES Professional to parameterize via PROFIBUS and the system interface, including the STEP 7 object manager
- SIMOCODE ES Graphic as optional software package for SIMOCODE ES Smart/Professional

## PCS 7 function block library



**Description:** To integrate SIMOCODE pro into the PCS 7 process control system

**Range:** Various licensing types



**SIRIUS  
Industrial Controls**

Order No. E20001-A840-P302-V1-7600



**SIMOCODE ES:  
The software that makes processes more efficient**

Order No. E20001-A700-P305-X-7600



**The PCS 7 Library SIMOCODE pro:  
Optimum Process Control**

Order No. E20001-A750-P305-X-7600



**SIRIUS Motor Management System:  
The new generation of SIMOCODE pro**

Information on compatibility with SIMOCODE DP  
Order No. E20001-A570-P305-X-7600



**SIMOCODE pro system manual**

Order No. 3UF7970-0AA00-0

**Please send me the  
selected information  
to the following address:**

\_\_\_\_\_  
Company/Department

\_\_\_\_\_  
Name

\_\_\_\_\_  
Street, Postal Code/City

\_\_\_\_\_  
Telephone/Fax

\_\_\_\_\_  
E-mail

## Any questions?

If you want to get to know more about SIMOCODE pro:

[www.siemens.com/simocode](http://www.siemens.com/simocode)

You can get answers and help from **Technical Assistance**  
from Monday to Friday 08.00 to 17.00 (GMT + 01.00) under  
Tel. +49 (9 11) 8 95-59 00

By fax around the clock  
Fax +49 (9 11) 8 95-59 07

By mail or Internet around the clock  
[technical-assistance@siemens.com](mailto:technical-assistance@siemens.com)  
[www.siemens.com/lowvoltage/technical-assistance](http://www.siemens.com/lowvoltage/technical-assistance)

## Siemens AG

Automation and Drives  
Low-Voltage Controls and Distribution  
P.O. Box 48 48, 90327 NUREMBERG,  
GERMANY

[www.siemens.com/simocode](http://www.siemens.com/simocode)  
[www.siemens.com/lowvoltage/technical-assistance](http://www.siemens.com/lowvoltage/technical-assistance)

*The information provided in this brochure contains merely general descriptions or characteristics of performance which in case of actual use do not always apply as described or which may change as a result of further development of the products. An obligation to provide the respective characteristics shall only exist if expressly agreed in the terms of contract.*

*All product designations may be trademarks or product names of Siemens AG or supplier companies whose use by third parties for their own purposes could violate the rights of the owners.*