

SIEMENS

3UF5 SIMOCODE-DP System Motor Protection and Control Device



Manual

Order No.: 3UF57 00-0AA00-1

The reproduction, transmission or use of this document or its contents is not permitted without express written authority. Offenders will be liable for damages. All rights, including rights created by patent grant or registration of a utility model or design, are reserved.

We have checked the contents of this manual for agreement with the hardware and software described. Since deviations cannot be precluded entirely, we cannot guarantee full agreement. However, the data in this manual are reviewed regularly and any necessary corrections included in subsequent editions. Suggestions for improvement are welcomed.

SIMOCODE® is a trademark of Siemens.
SIKOSTART® is a trademark of Siemens.
SIMATIC® is a trademark of Siemens.
BERO® is a trademark of Siemens.
WINDOWS® is a trademark of Microsoft.

Contents

Figures	v
Tables	ix
Introduction and Notes on the Manual	xiii
1 A Description of the System	1-1
1.1 Philosophy behind the SIMOCODE-DP 3UF5 system	1-2
1.2 Overview	1-7
1.3 Components of the SIMOCODE-DP system	1-9
1.4 System configurations	1-10
1.5 Summary of functions	1-11
1.6 Structural design of the SIMOCODE-DP system	1-12
2 The 3UF50 Basic Unit.	2-1
2.1 Description	2-2
2.2 Summary of functions	2-3
2.3 Outputs	2-4
2.4 Inputs	2-5
2.5 Protection functions	2-7
2.5.1 Current-dependent motor protection	2-7
2.5.2 Current Limit Value / Blocking Protection	2-16
2.5.3 Earth Fault Detection	2-17
2.5.4 Thermistor Motor Protection	2-19
2.6 Branch control	2-21
2.6.1 Control and motor protection block	2-21
2.6.2 Information data block	2-22
2.6.3 Description of the Control Stations	2-23
2.6.4 Description of the Control Functions	2-27
2.6.5 Description of the Function Block Inputs	2-47
2.6.6 Test / status LEDs	2-50
2.7 Logic modules	2-52
2.7.1 Signal Matching	2-52
2.7.2 Non-Resetting Elements on Power Loss	2-53
2.7.3 Truth Table 3I / 1O	2-54
2.7.4 Truth Table 5I / 2O	2-57
2.7.5 Flash /Flicker	2-59
2.7.6 Timers	2-60
2.7.7 Counters	2-61
3 The 3UF51 Expansion Module	3-1
3.1 Description	3-2
3.2 Summary of functions for Expansion Module	3-2
3.3 Inputs	3-3
3.4 Outputs	3-4

4	The 3UF52 Operator Panel	4-1
4.1	Description	4-2
4.2	Summary of functions	4-2
4.3	Control buttons, indicator LEDs	4-3
4.4	Test / status LEDs	4-4
5	Fault Diagnosis Fault Handling Warning	5-1
5.1	Behaviour in the event of a fault	5-2
5.2	Acknowledgement and fault handling	5-4
5.3	Parameter Errors	5-9
5.4	Parameterizable fault behaviour in the event of a fault	5-10
6	Communication / Data transmission	6-1
6.1	Introduction to the PROFIBUS-DP	6-2
6.1.1	Definitions	6-2
6.2	Possibilities of data transmission	6-3
6.3	Description of messages	6-5
6.4	Necessary settings for bus communication with SIMOCODE-DP	6-6
6.5	Decision chart for the PROFIBUS-DP connection	6-9
6.5.1	PROFIBUS-DP connections	6-9
6.5.2	SIMOCODE-DP to SIMATIC S5 with IM308-C	6-11
6.5.3	SIMOCODE-DP to SIMATIC S7 DP master (CPU with integrated DP interface)	6-24
6.6	PROFIBUS-DP configurations	6-36
7	Parameterization / Observation	7-1
7.1	Possible ways of parameterizing	7-2
7.1.1	Parameterizing at runtime	7-2
7.1.2	Parameterizing during starting	7-3
7.2	Basics of parameterization	7-4
7.3	Parameterizing and observing with Win-SIMOCODE-DP	7-7
7.3.1	Introduction and notes	7-7
7.3.2	After the installation	7-9
7.3.3	Program start	7-10
7.3.4	Menu bar	7-11
8	Engineering Example Direct Starter	8-1
8.1	Introduction	8-2
8.2	Block 1: Redrawing a conventional circuit diagram as a circuit diagram with SIMOCODE-DP	8-3
8.3	Block 2: Preparing a block diagram	8-11
8.4	Block 3: Parameterization with Win-SIMOCODE-DP	8-17

A	Tables	A-1
A.1	Assignment table	A-2
A.2	Active Control Stations, Contactor Controls, Lamp Controls and status messages for the Control Functions	A-4
A.3	Control, signalling and diagnostic data	A-5
A.4	Acknowledgement and Fault handling	A-10
A.5	Sketch of SIMOCODE-DP circuit diagram with basic elements	A-15
A.6	Block diagram of the assignments	A-17
A.7	Parameter table	A-19
B	Data Structure	B-1
B.1	Data formats and data records	B-2
B.2	Cyclical data	B-4
B.2.1	Basic Types	B-4
B.2.2	Assignment of cyclical messages	B-6
B.3	Diagnosis	B-8
B.3.1	Standard diagnosis	B-8
B.3.2	Device-specific diagnosis according to DP standard	B-9
B.3.3	Device-specific diagnosis according to DPV1	B-11
B.3.4	Alarms (only as S7 slave)	B-14
B.4	Reading/writing data records acyclically	B-17
B.4.1	Reading data record 130 - signals	B-17
B.4.2	Reading data record 131 - display/diagnosis	B-19
B.4.3	Writing data record 133 - statistical data	B-19
B.4.4	Writing data record 132 - control commands	B-20
B.4.5	Data record 138 - device parameters	B-20
C	Technical Data	C-1
C.1	General data	C-2
C.2	Auxiliary circuit / control circuit	C-4
C.3	Inputs	C-5
C.3.1	Number of inputs	C-5
C.3.2	Simultaneity for Basic Unit	C-5
C.3.3	Simultaneity for Expansion Module	C-5
C.3.4	Input currents / cable lengths	C-5
C.4	Communications interface	C-6
C.5	Behaviour in the event of supply-voltage failure	C-6
C.6	Short-circuit protection for motor branches for short-circuit currents up to 50 kA at 690 V	C-7
C.7	System reaction times (typical values)	C-8
C.8	New system functions as of product status E10	C-9
C.9	Description of DMD and type data files	C-9
C.10	Source of supply for DMD and type data files	C-9
D	Dimension Drawings	D-1
D.1	Basic Unit 3UF500./3UF501. /Expansion Module 3UF51	D-2
D.2	Basic Unit 3UF502	D-3
D.3	Basic Unit 3UF503	D-4
D.4	Basic Unit 3UF504	D-5
D.5	Basic Unit 3UF505	D-6
D.6	Operator Panel 3UF52	D-7

E	Typical Circuits.	E-1
E.1	Introduction	E-2
E.2	Parameter Table Default Value	E-3
E.3	Overload	E-11
E.3.1	Circuit diagram of Overload Control Function	E-11
E.3.2	Block diagram of Overload Control Function	E-12
E.3.3	Parameters of Overload Control Function	E-13
E.4	Direct Starter	E-14
E.4.1	Circuit diagram of Direct Starter Control Function	E-14
E.4.2	Block diagram of Direct Starter Control Function	E-15
E.4.3	Parameters of Direct Starter Control Function	E-16
E.5	Reversing Starter	E-17
E.5.1	Circuit diagram of Reversing Starter Control Function	E-17
E.5.2	Block diagram of Reversing Starter Control Function	E-18
E.5.3	Parameters of Reversing Starter Control Function	E-19
E.6	Star Delta Starter	E-20
E.6.1	Circuit diagram of Star Delta Starter Control Function	E-20
E.6.2	Block diagram of Star Delta Starter Control Function	E-21
E.6.3	Parameters of Star Delta Starter Control Function	E-22
E.7	Pole Changing Starter	E-23
E.7.1	Circuit diagram of Pole Changing Starter Control Function	E-23
E.7.2	Block diagram of Pole Changing Starter Control Function	E-24
E.7.3	Parameters of Pole Changing Starter Control Function	E-25
E.8	Dahlander Starter	E-26
E.8.1	Circuit diagram of Dahlander Starter Control Function	E-26
E.8.2	Block diagram of Dahlander Starter Control Function	E-27
E.8.3	Parameters of Dahlander Starter Control Function	E-28
E.9	Solenoid Valve	E-29
E.9.1	Circuit diagram of Solenoid Valve Control Function	E-29
E.9.2	Block diagram of Solenoid Valve Control Function	E-30
E.9.3	Parameters of Solenoid Valve Control Function	E-31
E.10	Positioner Control Function	E-32
E.10.1	Circuit diagram of Positioner Control Function	E-32
E.10.2	Block diagram of Positioner Control Function	E-34
E.10.3	Parameters of Positioner Control Function	E-35
E.11	Soft Starter	E-36
E.11.1	Circuit diagram of Soft Starter Control Function	E-36
E.11.2	Block diagram of Soft Starter Control Function	E-38
E.11.3	Parameters of Soft Starter Control Function	E-39
F	Order Numbers	F-1
G	Frequently asked questions	G-1
G.1	General reset	G-2
G.2	Win-SIMOCODE-DP fault situations in online operation.	G-3
H	Index	H-1
	Glossary	

Figures

	Page
1	Simplified structure of the system 1-2
2	Layout of a motor branch (Direct Starter) using conventional technology 1-3
3	Future-oriented circuit diagram with SIMOCODE-DP 1-4
4	Reducing the amount of wiring 1-5
5	Data traffic over the PROFIBUS-DP between the PLC and SIMOCODE-DP 1-6
6	SIMOCODE-DP modular system 1-9
7	Win-SIMOCODE-DP 1-9
8	System configurations 1-10
9	Summary of functions 1-11
10	Structural design of the SIMOCODE-DP system 1-13
11	Front of Basic Unit 2-2
12	Summary of functions performed by the Basic Unit 2-3
13	Diagram of Output Relays for Basic Unit 2-4
14	Diagram of the Inputs for Basic Unit 2-5
15	Diagram of input circuitry 2-6
16	Method of assembly 2-8
17	Push-through and loop-through openings on the 3UF5001 Basic Unit 2-9
18	Circuit diagram with external current transformer 2-10
19	Tripping characteristics (cold) 2-11
20	Protection of motors in potentially explosive atmospheres 2-13
21	Cooling behaviour with and without Idle Time 2-14
22	Diagram of Earth Fault Detection 2-18
23	Diagram for Thermistor Motor Protection 2-20
24	Control and motor protection block 2-21
25	Diagram of information data block 2-22
26	Diagram of Control Stations 2-23
27	Function diagram of Torque and Limit Switches in the control of Positioners 2-35
28	Torque or Limit Switch as a changeover contact 2-42
29	Interrelationship of UVO, UVO-Time, Grading Time and QE 2-49
30	Diagram of Signal Matching 2-52
31	Diagram of signal types 2-52
32	Diagram of Non-Resetting Elements on Power Loss 2-53
33	Diagram of Truth Tables 3I / 1O 2-54
34	Example of a Truth Table 2-54

35	External circuitry / parameters for the Truth Table example	2-55
36	Diagram of the Truth Table 5I / 2O	2-57
37	Diagram of Flash / Flicker components.	2-59
38	Diagram of Timers	2-60
39	Output behaviour of Timers	2-60
40	Diagram of the Counters	2-61
41	Front of Expansion Module	3-2
42	Summary of functions performed by the Expansion Module	3-2
43	Diagram of Inputs for Expansion Module	3-3
44	Diagram of Input circuitry for Expansion Module	3-3
45	Diagram of Output Relays for Expansion Module	3-4
46	Operator Panel	4-2
47	Summary of the Operator Panel's functions	4-2
48	Diagram of control buttons and indicator LEDs of the Operator Panel	4-3
49	Fast fault analysis with the "Control/Report" mask	5-2
50	Possibilities of data transmission	6-3
51	Setting parameters for DP standard	6-13
52	Enabling diagnosis according to DPV1	6-16
53	Selecting SIMOCODE-DP as a DPV1 slave with HW Config (hardware configuration)	6-25
54	Selecting SIMOCODE-DP as an S7 slave from the hardware catalog	6-25
55	Specifying operating parameters for SIMOCODE-DP	6-26
56	Parameterizing SIMOCODE-DP via a DMD file	6-27
57	Parameterizing SIMOCODE-DP with Win-SIMOCODE-DP/Professional	6-28
58	Enabling diagnosis according to DPV1 in HW Config	6-31
59	Bus segment	6-36
60	Bus termination module	6-38
61	Setting parameters	7-4
62	Connecting free elements	7-4
63	Example for establishing connections	7-5
64	Symbols used: sockets and plugs	7-5
65	Layout of a motor branch (Direct Starter) using conventional technology	8-3
66	Step 2: Drawing the elements in the SIMOCODE-DP circuit diagram	8-4
67	Step 3: Deleting elements from the SIMOCODE-DP circuit diagram	8-5
68	Step 4: Deleting elements from the SIMOCODE-DP circuit diagram	8-6
69	Step 5: Drawing the elements in the SIMOCODE-DP circuit diagram	8-7
70	Step 6: Deleting elements	8-8
71	Step 7: Deleting elements	8-9
72	Step 8: Drawing the auxiliary contact of the fuse-disconnector for test operation in the SIMOCODE-DP circuit diagram	8-10

73	Structural layout of the SIMOCODE-DP system	8-11
74	Step 1: Drawing the external elements in the block diagram	8-13
75	Opening mask of Win-SIMOCODE-DP	8-17
76	Setting the parameters in the "Order Number" dialog	8-17
77	Setting parameters in the "Overload" dialog	8-18
78	Setting parameters in the "Sensor" dialog	8-18
79	Setting the parameters in the "Motor" dialog	8-19
80	Setting parameters in the "Control Stations" dialog	8-19
81	Parameters set in the "Control Stations" dialog	8-20
82	"Operator Enabling" dialog	8-20
83	Setting CST in the "Function Block Inputs" dialog	8-21
84	Setting Out 1 - Output Relay in the "Device Outputs/LEDs" dialog	8-21
85	Setting the address in the "Bus PROFIBUS-DP" dialog	8-22
86	Diagram of Basic Types	B-4
87	Diagram of process data	B-6
88	Diagram of process data for basic types 2 and 3	B-7
89	Alarm sequence	B-14
90	Dimension drawings for the 3UF500. /3UF501. /3UF51	D-2
91	Dimension drawings for the 3UF502.	D-3
92	Dimension drawings for the 3UF503.	D-4
93	Dimension drawings for the 3UF504.	D-5
94	Dimension drawings for the 3UF505.	D-6
95	Dimension drawing for the 3UF52	D-7

Tables

	Seite
1	Summary of topics xiv
2	Detection of motor currents below 1.25 A 2-9
3	Factors for tripping times when the motor is warm 2-12
4	Description of the settings for current-dependent motor protection 2-15
5	Description of the settings for Current Limit Values / Blocking Protection 2-16
6	Description of the settings for Earth Fault Detection 2-18
7	Types of detector for Thermistor Motor Protection 2-19
8	Description of the settings for Thermistor Motor Protection 2-20
9	Operating modes of Control Stations 2-24
10	Determining Operator Enabling signals 2-26
11	Active Control Stations, Contactor Controls, Lamp Controls and status messages with Direct Starter, Reversing Starter, Star Delta Starter, Dahlander starter, Pole Changing Starter and Soft Starter 2-27
12	Active Control Stations, Contactor Controls, Lamp Controls and status messages for Positioner 2-33
13	Variants for Positioner control 2-36
14	Check-Back Signals for Positioner 1 2-37
15	Check-Back Signals for Positioner 2 2-39
16	Check-Back Signals for Positioner 3 2-40
17	Check-Back Signals for Positioner 4 2-42
18	Check-Back Signals for Positioner 5 2-43
19	Active Control Stations, Contactor Controls, Lamp Controls and status messages for a Solenoid Valve 2-44
20	Check-Back Signals for Solenoid Valve 2-45
21	Description of the settings for motor control 2-49
22	States of the status LEDs / Contactor Controls during a test 2-51
23	Status LEDs on the Basic Unit 2-51
24	NOR function 2-53
25	Description of the settings for types of signal 2-53

27	Description of the settings for Truth Tables	2-55
28	Description of the settings for Timers	2-60
29	Description of the settings for the upper limit of Counters	2-61
30	Status LEDs on the Operator Panel	4-4
31	Fault Diagnosis, Fault Handling, Warning	5-8
32	Parameter Errors	5-9
33	Description of settings for fault behaviour	5-11
34	Slave operating modes for SIMOCODE-DP on master class 1	6-4
35	Necessary settings for bus communication with SIMOCODE-DP	6-6
36	Setting the Basic Type	6-7
37	Data block (y)	6-17
38	Parameter FCT	6-18
39	Parameter FCT=DW	6-19
40	Assignment of the S5 memory area for FCT =DW	6-19
41	Parameter FCT=CW	6-20
42	Parameter FCT=DR	6-21
43	Parameter FCT=CR	6-22
44	Assignment of the S5 memory area for FCT = CR	6-22
45	Basic data for a bus segment	6-36
46	Distance between two stations	6-37
47	Length of the spur lines	6-37
48	Wiring and connecting the T-clamp	6-38
49	Parameter channels	7-3
50	Active Control Stations, Contactor Controls, Lamp Control and status messages	A-4
51	Writing control data to SIMOCODE-DP	A-5
52	Reading signalling and diagnostic data from SIMOCODE-DP	A-9
53	Assignment of control data	B-6
54	Assignment of process data	B-7
55	Assignment of device-specific diagnostic bytes	B-9
56	Device-specific diagnosis according to DPV1	B-11
57	Process alarm in the event of a fault	B-15
58	Process alarm in the event of a warning	B-16
59	Data record 130 - signals	B-17

60	Data record 131 - display / diagnosis	B-19
61	Writing data record 133 - statistical data	B-19
62	Data record 132 - control commands	B-20
63	Data record 138 - device parameters	B-20
64	General Data	C-2
65	Auxiliary circuit / control circuit	C-4
66	Number of inputs	C-5
67	Simultaneity for Expansion Module	C-5
68	Input currents / cable lengths	C-5
69	Communications interface	C-6
70	Behaviour of the contactor control circuits in the event of supply-voltage failure	C-6
71	Behaviour of the functions in the event of supply-voltage failure	C-6
72	Program cycle times	C-8
73	Description of DMD and type data files	C-9
74	Order numbers for Basic Units	F-2
75	Order numbers for expansion components	F-2

Introduction and Notes on the Manual

Purpose of the manual	This manual is intended to be used as a reference book. The information in the manual enables you to operate SIMOCODE-DP.
Topics covered	<p>The manual consists of chapters providing instructions for use and reference chapters. The topics it covers include the following:</p> <ul style="list-style-type: none">• Philosophy and overview of the SIMOCODE-DP system• Parameterization• System componenets• Description of the parameterizing and diagnosis software Win-SIMOCODE-DP• Error handling, diagnosis• Communication, data transmission• Data structure• Technical data and conductor cross sections
Configuration example	A complete configuration example is included in the manual. This example explains to you, step by step, how to configure a Direct Starter with SIMOCODE-DP.
Tables	<p>In Appendix A you will find tables and partly predrawn circuit diagrams for the purpose of configuration, diagnosis etc.. If you are already familiar with how to operate the SIMOCODE-DP, the tables are sufficient for working with the system.</p> <p>You can enter your selected parameter settings in the tables in order to facilitate subsequent parameterization. At the same time, this also gives you a record of how you have parameterized the system.</p>
Typical Circuits	In the Appendix E you will find a summary of Typical Circuits which you can use for the individual control functions.
Notes	Notes which are of special importance are enclosed by two straight lines.
Correction page	A correction page is to be found at the end of this book. Please use this page to report your suggestions for improvements, additional information or corrections and send the page back to us. In this way, you will help us improve the next edition of this manual.
Other system manuals	<p>If you are working with IM308C and COM PROFIBUS, you will additionally require the system manual</p> <ul style="list-style-type: none">• "Decentralized Peripheral System ET 200" <p>If you are working with STEP 7, you will additionally require the system manual</p> <ul style="list-style-type: none">• "System Software for S7 300/400 System and Standard Functions Reference Manual" <hr/> <p>If you want to use SIMOCODE-DP as an S7 slave, refer to the latest information on the Internet at http://www.ad.siemens.de/ans/2/support/download</p> <hr/>

Basic Contents

The following table provides a summary of the topics with their basic contents:

Section / Topic	Basic contents
1 A Description of the System	<ul style="list-style-type: none">- Performance criteria- Philosophie- System configurations
2 Basic Unit	<ul style="list-style-type: none">- Protection functions- Branch control- Signal processing
3 Expansion Module	<ul style="list-style-type: none">- Inputs- Outputs
4 Operator Panel	<ul style="list-style-type: none">- Freely assignable buttons- Freely assignable LEDs- Test / Reset
5 Fault Handling	<ul style="list-style-type: none">- Acknowledgements- Table of the individual fault messages
6 Communication / Data transmission	<ul style="list-style-type: none">- PROFIBUS-DP- Parameterizing via the bus
7 Parameterization / Observation	<ul style="list-style-type: none">- Basics- Win-SIMOCODE-DP- COM PROFIBUS
8 Configuration example Direct Starter	<ul style="list-style-type: none">- Circuit diagram- Block diagram- Parameterizing with Win-SIMOCODE-DP
Appendix A	<ul style="list-style-type: none">- Assignment table- Tables Control, Signaling, Diagnosis- Block diagram of assignments- Parameter table
Appendix B	<ul style="list-style-type: none">- Data structure
Appendix C	<ul style="list-style-type: none">- Technical data
Appendix D	<ul style="list-style-type: none">- Dimension drawings
Appendix E	<ul style="list-style-type: none">- Circuit examples
Appendix F	<ul style="list-style-type: none">- Order numbers
Appendix G	<ul style="list-style-type: none">- Frequently asked questions
Glossary Index	

Table 1: Summary of topics

A Description of the System

Secion	Topic	Page
1.1	Philosophy behind the SIMOCODE-DP 3UF5 system	1-2
1.2	Overview	1-7
1.3	Components of the SIMOCODE-DP system	1-9
1.4	System configurations	1-10
1.5	Summary of functions	1-11
1.6	Structural design of the SIMOCODE-DP system	1-12

1.1 Philosophy behind the SIMOCODE-DP 3UF5 system

Protection Control

SIMOCODE-DP 3UF5 (**S**iemens **M**otor Protection and **C**ontrol **D**evice - **D**ecentralized **P**eriphery) is a motor protection and control device with a PROFIBUS-DP interface.

The microprocessor is the central element of the system. All motor protection and control functions are implemented with the microprocessor, as well as interlocking functions, the calculation of operating, diagnosis and statistical data and high-performance communication (PROFIBUS-DP) between the automation level and the motor branch.

Current as the central reference value

The integrated current transformers serve the purpose of detecting the most important measured variable, electric current. Whether for Overload Protection, Overload Warning, the current thresholds, the On/Off Check-Back Signal, calculation of the Number of Operating Hours, etc., SIMOCODE-DP always takes the electric current as the central reference value.

Structure

The structure of the system is shown in greatly simplified form in Fig. 1:

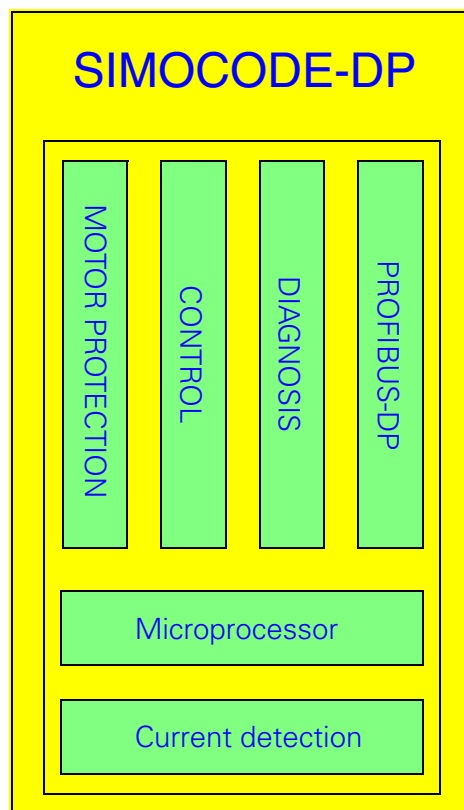

Fig. 1: Simplified structure of the system

What distinguishes the SIMOCODE-DP system from conventional motor protection and control equipment?

Great simplification

SIMOCODE-DP 3UF5 greatly simplifies the motor branch. This becomes apparent after examining Fig. 2 "Layout of a motor branch (Direct Starter) using conventional technology" and Fig. 3 "Future-oriented circuit diagram with SIMOCODE-DP".

Layout using conventional technology

The figure below shows a layout using conventional technology:

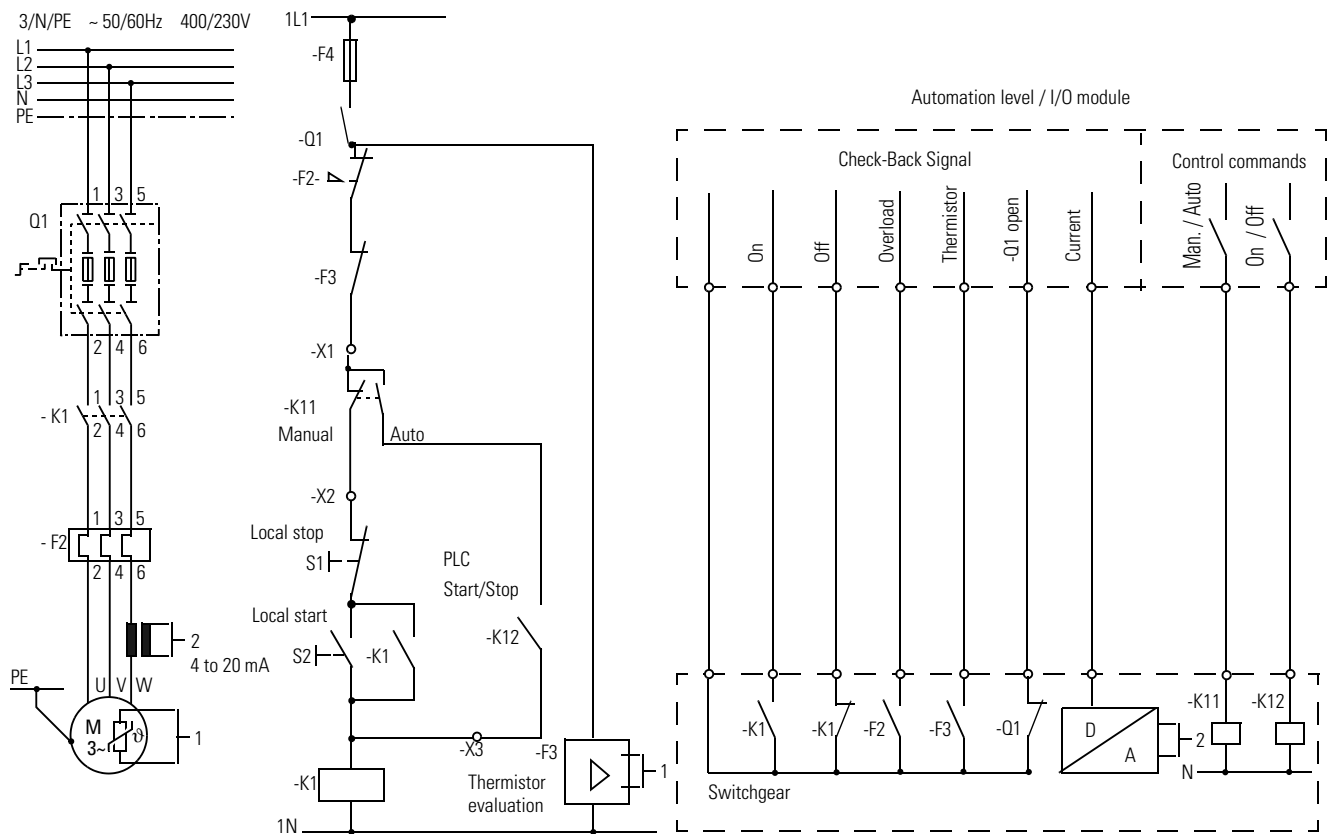

Fig. 2: Layout of a motor branch (Direct Starter) using conventional technology

Layout with SIMOCODE-DP

The SIMOCODE-DP system alone is used for all control and monitoring functions, up to and including signal preprocessing. In this way there is no need for additional overload relays, thermistor evaluation devices, current transformers, analog-to-digital converters etc.. The wiring of the control circuit is dispensed with entirely. The Start and Stop switches are wired directly to the inputs of the 3UF50 Basic Unit. The contactor coil is controlled via the output of the 3UF50 Basic Unit - an auxiliary contact for latching is unnecessary. The "Motor On/Off" Check-Back Signal, which in the past was sent via an auxiliary contact of the contactor, is implemented using the current with SIMOCODE-DP. This means that when an On command applies and current is flowing, SIMOCODE-DP returns the Check-Back Signal "Motor On", or in the event of an Off command and when current is not flowing, SIMOCODE-DP returns the Check-Back Signal "Motor Off".

Future-oriented circuit diagram

The figure below shows a layout with SIMOCODE-DP:

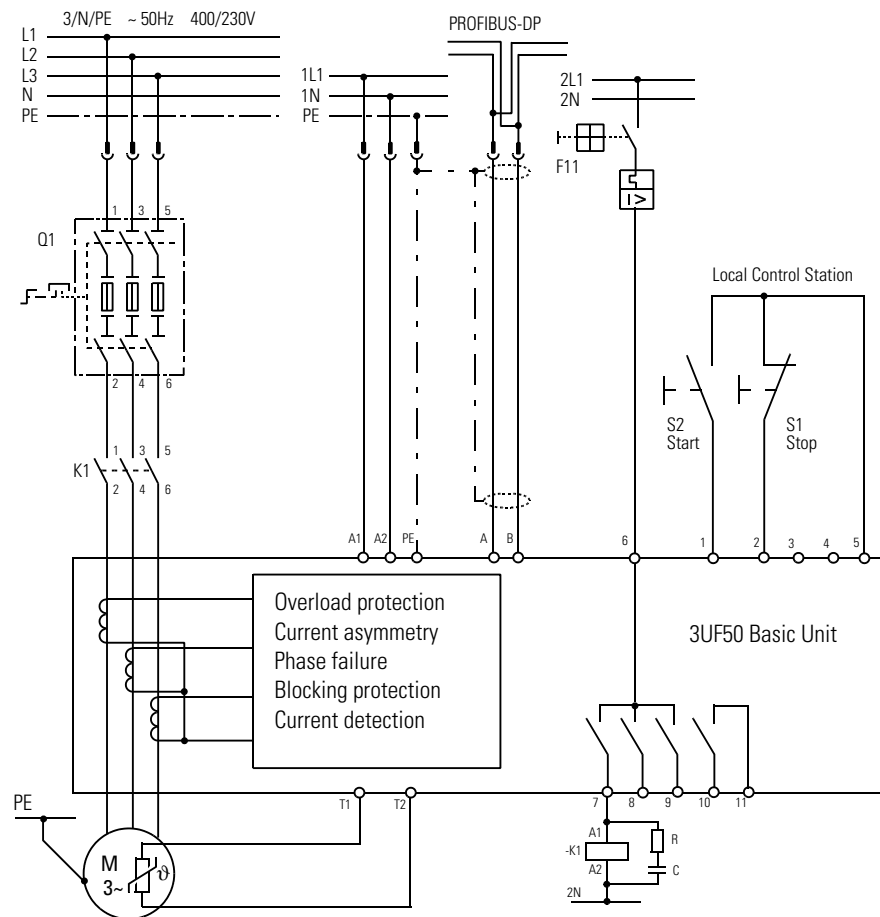

Fig. 3: Future-oriented circuit diagram with SIMOCODE-DP

Data transmission PROFIBUS-DP

The start/stop signal is transmitted from the automation system (PLC) via the PROFIBUS-DP, as are the Check-Back Signals for on, off, fault overload, fault thermistor, the current etc.

All parallel wiring between the automation system and the motor branch is omitted. In the example used here, this amounts to 23 clamping points and 10 cores. Because as many as 122 slaves (SIMOCODE-DP) can be connected to the PROFIBUS-DP when the system is fully expanded, the two-wire PROFIBUS-DP cable replaces 2806 clamping points and 1220 cores, and therefore also the I/O modules required in the automation system (PLC).

Reducing the amount of wiring

As a result of the enormous reduction in the amount of wiring and clamping points, there are also fewer potential sources of faults.

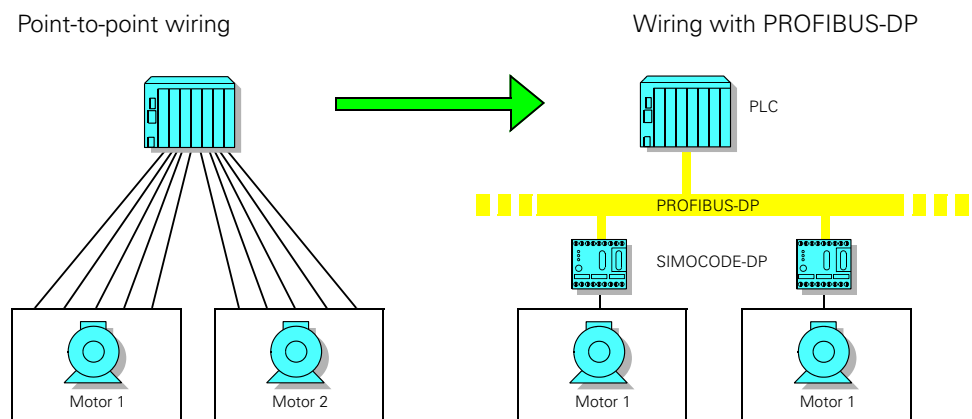

Fig. 4: Reducing the amount of wiring

Omission of supplementary components

If coupling devices and terminal boards are used in addition, these can also be omitted. Details of how to convert a conventional circuit diagram into a future-oriented circuit diagram and which parameters need to be set are explained in the chapter on "Configuration".

Logic modules

The SIMOCODE-DP system additionally makes various logic modules available, such as Truth Tables, timers, counters and Signal Matching modules. This openness enables you to translate your own installation-specific requirements into practice with SIMOCODE-DP.

Fast modification by software

Using the logic modules you can quickly change the functionality via the software during commissioning or during operation. There is no need for complex rewiring.

Autonomous operation

As all motor protection and Control Functions are processed according to a decentralized principle in the SIMOCODE-DP 3UF5 system, the motor branch can continue to be controlled even in the event of failure of the automation system (PLC) or of disturbances on the communication path. From this it also follows that SIMOCODE-DP can be operated without a connection to the PROFIBUS-DP. The PROFIBUS-DP can then be retrofitted as necessary.

PROFIBUS-DP

The non-proprietary PROFIBUS-DP (**Process Fieldbus - Decentralized Periphery**), standardized in DIN (E) 19245 Part 3 EN 50170, establishes the high-performance communication link between SIMOCODE-DP 3UF50 and the automation system (PLC).

Control commands and operating, diagnostic and statistical data are therefore transmitted via the two-wire PROFIBUS-DP cable.

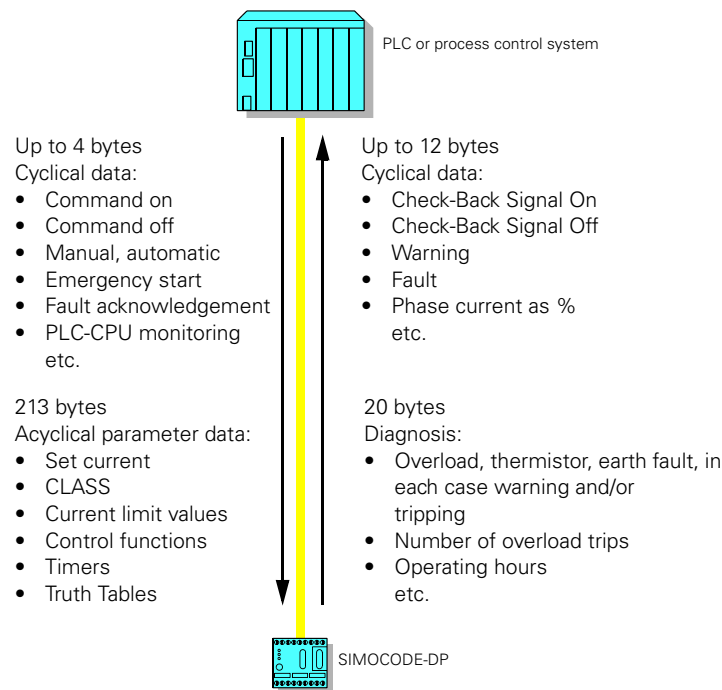

Fig. 5: Data traffic over the PROFIBUS-DP between the PLC and SIMOCODE-DP

The communication processor (CP/IM) plugged into the programmable controller takes care of management of the SIMOCODE-DP devices connected to the PROFIBUS-DP and acts as the interface to the application program. Further processing of the SIMOCODE-DP data, i.e. integration into the cross-plant control system and subsequent data preparation, is performed by the application program.

In parallel with this, all SIMOCODE-DP units can be parameterized, controlled and monitored via PROFIBUS-DP from a second "central station". For detailed information refer to the chapter entitled "Communication and Data Transmission".

On the following pages you can familiarize yourself with the scope of functions and with the available components.

1.2 Overview

Current-dependent motor protection

The Basic Unit consists of several protective mechanisms for current-dependent motor protection:

- Overload Protection
- Current Asymmetry
- Phase Failure
- Blocking Protection
- Current limit-values

Thermistor Motor Protection

Versions 3UF50.1-**A** enable Thermistor Detectors to be connected in order to monitor the motor temperature. You can choose between the following types of detector:

- PTC Binary
- PTC Analog / KTY
- NTC Analog

Earth Fault Detection

The Basic Unit has

- an internal Earth Fault Detection component. For motors with three-conductor termination, the unit can determine a possible Earth Fault current from the current balance at a particular time.
- an external Earth Fault Detection component for versions 3UF50.1-**B**. Here, the Basic Unit evaluates rated fault currents via an externally connected summation-current transformer (3UL22, NSK Catalogue, Part 4).

Control Functions

The following parameterizable Control Functions are implemented in the system:

- Direct Starter
- Reversing Starter
- Star Delta Starter
- Pole Changing Starter
- Dahlander Starter
- Positioner
- Solenoid Valve
- Softstarter SIKOSTART 3RW22

Communication

The system is equipped with the standard interfaces:

- PROFIBUS-DP
- PROFIBUS-DPV1
- RS 232 for connecting the PC

**Signal processing
in the branch**

The system incorporates several supplementary functions which can be set as required:

- Signal Matching
- Truth Table
- Timer
- Counter

**Standard Function
Blocks**

Standard function blocks are self-contained units, implementing for example time-graded restarting of the drives after a mains failure.

- Check-Back Signal Test
- Operating Protection Off
- Ready to Start
- Undervoltage Off
- Graded Restart
- External Fault
- External Warning
- Emergency Start
- External Diagnosis
- External Check-Back Signal
- Test 1 with shutdown
- Test 2 without shutdown
- Reset
- PLC-CPU Fault
- DP Fault

**Operating
statistics and
diagnostic data**

The SIMOCODE-DP supplies data such as

- Motor On / Off / Left / Slow / Close etc.
- Fault: Overload / Thermistor / etc.
- Warning: Overload / Threshold for upper current exceeded etc.
- Operating Current
- Operating Hours
- Number of switching cycles
- Number of Overload Trips
- Current for last Overload Trip

1.3 Components of the SIMOCODE-DP system

Modular system

SIMOCODE-DP is a modular system, the building blocks in the system comprising a 3UF50 Basic Unit, the 3UF51 Expansion Module, the 3UF52 Operator Panel, connecting cables and the Win-SIMOCODE-DP 3UF57 standard software for parameterization and diagnosis.

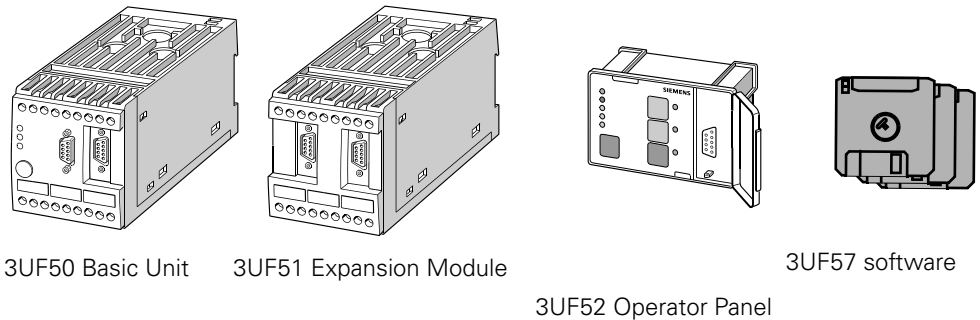

Fig. 6: SIMOCODE-DP modular system

Win-SIMOCODE-DP 3UF57

Software for the parameterization, control, diagnosis and testing of SIMOCODE-DP, online via PROFIBUS-DP or via the RS232 interface SIMOCODE-DP. Runs under Windows 95 or Windows NT, switchable between German and English.



Win-SIMOCODE-DP/Professional 3UF5710:
online via PROFIBUS-DP or RS232



Win-SIMOCODE-DP/Smart 3UF5711:
via RS232

Fig. 7: Win-SIMOCODE-DP

OM-SIMOCODE-DP

Step 7 **O**bject **M**anager for calling Win-SIMOCODE-DP/Professional in SIMATIC S7/STEP 7, Version 4.0 or higher.

Connecting cables/ connectors

Connection between the Basic Unit, Expansion Module and/or Operator Panel.

Bus connection block/ bus termination module

If the PROFIBUS-DP is connected to the 9-pole Sub-D socket of the Basic Unit, standardized 9-pole Sub-D plugs can be used. Otherwise there is a T-clamp available for connection to terminals A and B. The bus termination module with integrated power supply ensures that data traffic is carried properly even if the last slave is removed from the bus line (see page 1-13).

1.4 System configurations

System configuration 1: Minimum configuration

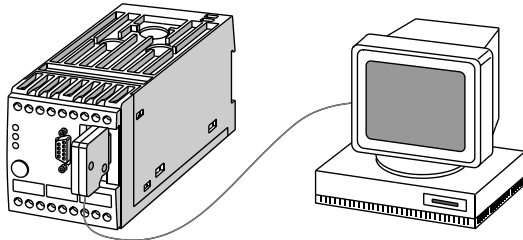

Basic Unit (BU) PC / Programming Unit (PU)

The minimum configuration is sufficient to enable you to implement all available control functions.

System configuration 2:

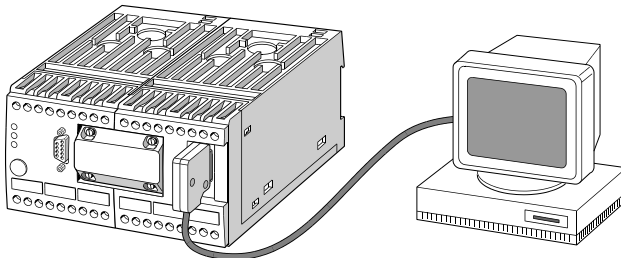

Basic Unit (BU)
Expansion Module (EM) PC / Programming Unit (PU)

System configuration 3:

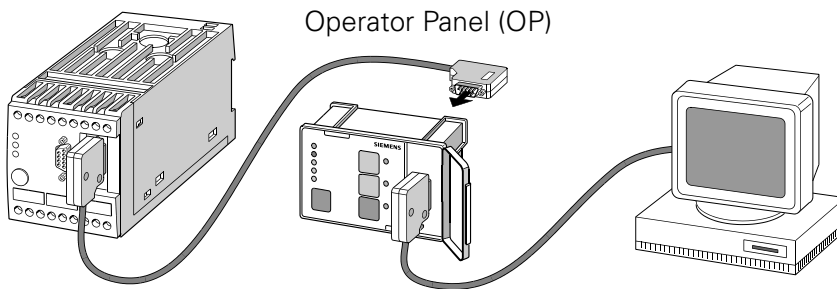

Basic Unit (BU) PC / Programming Unit (PU)

System configuration 4:

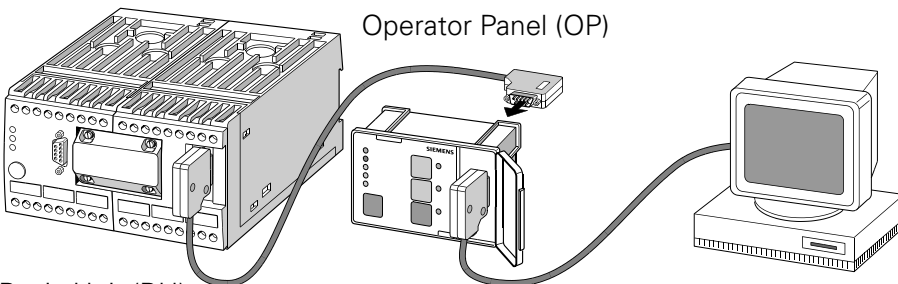

Basic Unit (BU)
Expansion Module (EM) PC / Programming Unit (PU)

Fig. 8: System configurations

1.5 Summary of functions

Diagram

Summary of functions SIMOCODE-DP system:

Basic Unit

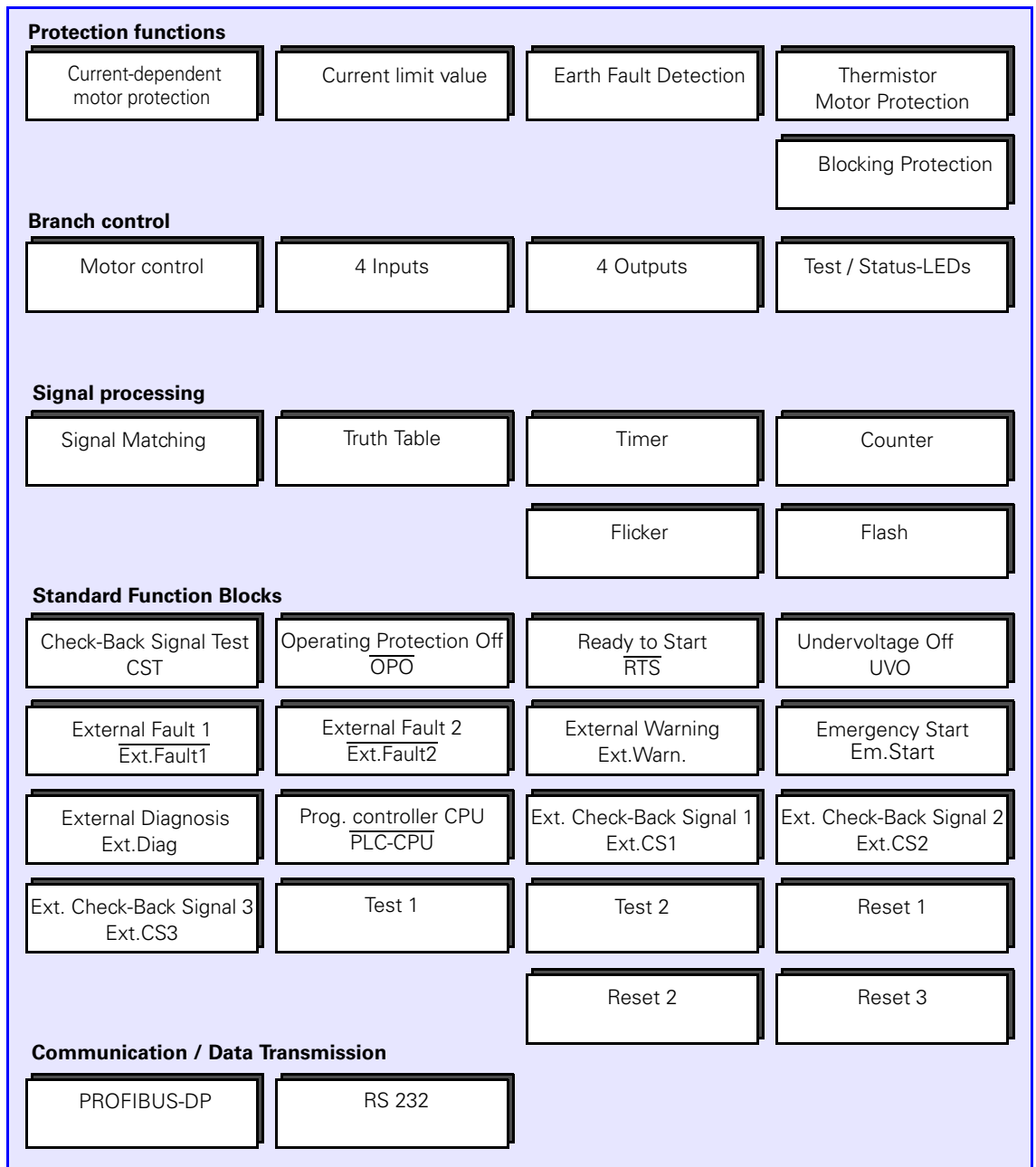

Expansion Module

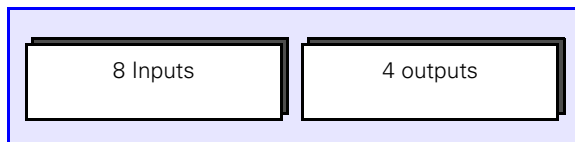

Operator Panel

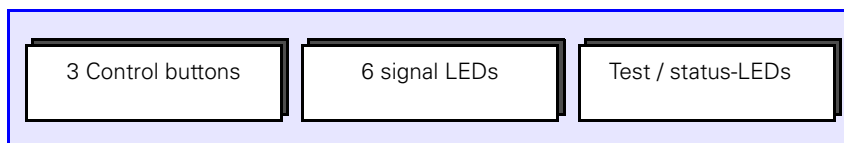





Fig. 9: Summary of functions

1.6 Structural design of the SIMOCODE-DP system

- Free elements** As the motor branches differ in terms of protection and control functions from one set of switchgear to another, all elements in the SIMOCODE-DP system are free.
- What does free mean?** Free means that the inputs and outputs can be assigned to the various elements such as
- the Control and motor protection block,
 - the Function Blocks,
 - the Logic Modules etc.
- This occurs in accordance with the requirements of the installation-specific motor branch.
- Structural design** The figure on page 1-13 shows the structural design of the system with its free elements in the form of a block diagram:
1. The four outputs of the 3UF50 Basic Unit.
 2. The process data (signal bits) that are transmitted from the SIMOCODE-DP to the PROFIBUS-DP master. There are three different base types.
 3. The logic modules for Signal Matching, Truth Tables, Timers and Counters.
 4. The Control Stations, Auxiliary Control inputs, Contactor Controls, Function Blocks.
 5. The four buttons, the three green and three yellow LEDs of the 3UF52 Operator Panel.
 6. The four inputs of the 3UF50 Basic Unit.
 7. The process data (control bits) that are transmitted from the PROFIBUS-DP master to the SIMOCODE-DP.
 8. The eight inputs and four outputs of the 3UF51 Expansion Module.
- Plugs and sockets** You will see that all of the elements have plugs  and sockets : you can connect the individual free elements to each other by parameterization. A socket  can be used as many times as required, a plug  just once.

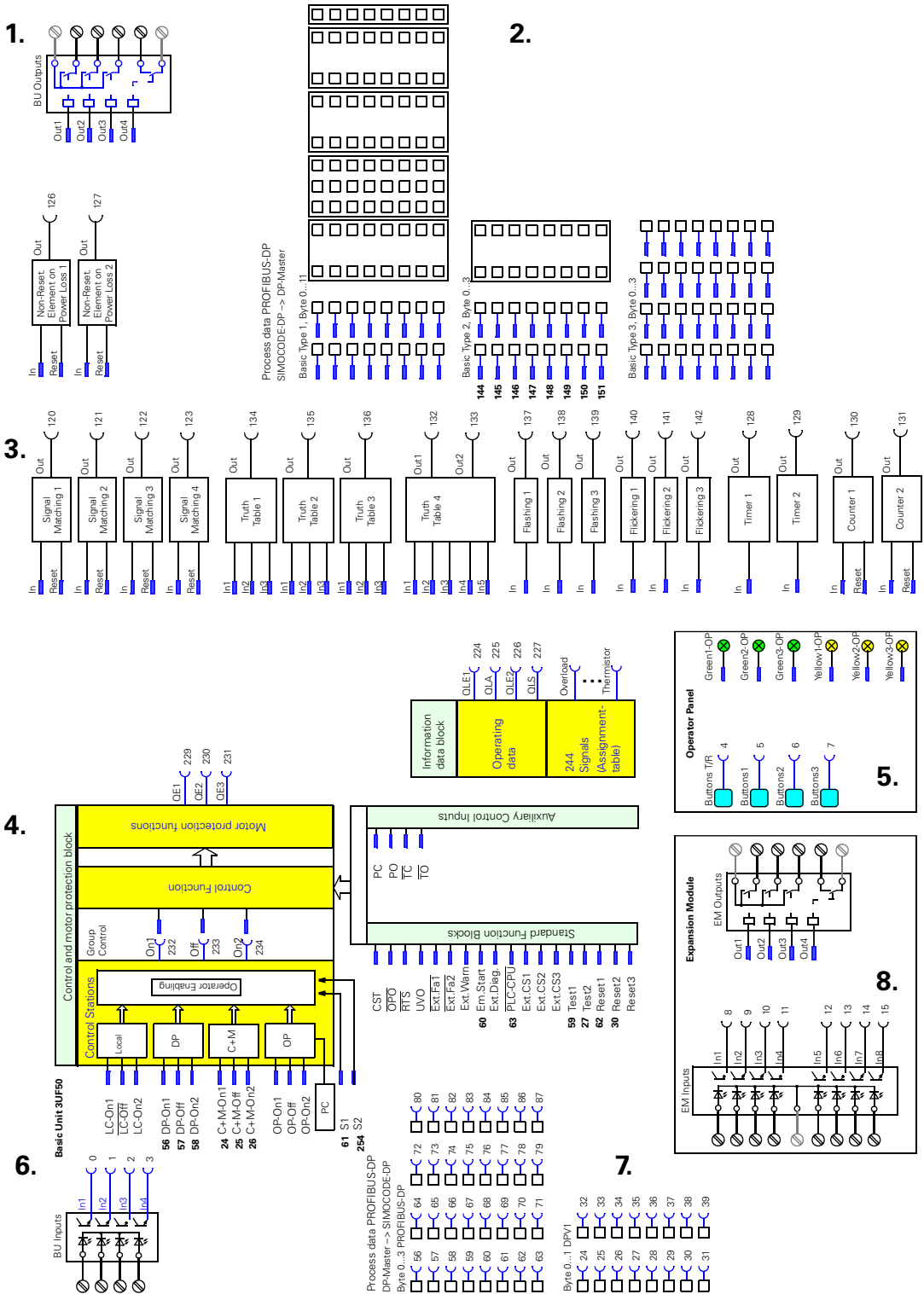

Fig. 10: Structural design of the SIMOCODE-DP system

The 3UF50 Basic Unit

Section	Topic	Page
2.1	Description	2-2
2.2	Summary of functions	2-3
2.3	Outputs	2-4
2.4	Inputs	2-5
2.5	Protection functions	2-7
2.5.1	Current-dependent motor protection	2-7
2.5.2	Current Limit Value / Blocking Protection	2-16
2.5.3	Earth Fault Detection	2-17
2.5.4	Thermistor Motor Protection	2-19
2.6	Branch control	2-21
2.6.1	Control and motor protection block	2-21
2.6.2	Information data block	2-22
2.6.3	Description of the Control Stations	2-23
2.6.4	Description of the Control Functions	2-27
2.6.5	Description of the Function Block Inputs	2-47
2.6.6	Test / status LEDs	2-50
2.7	Logic modules	2-52
2.7.1	Signal Matching	2-52
2.7.2	Non-Resetting Elements on Power Loss	2-53
2.7.3	Truth Table 3I / 1O	2-54
2.7.4	Truth Table 5I / 2O	2-57
2.7.5	Flash /Flicker	2-59
2.7.6	Timers	2-60
2.7.7	Counters	2-61

2.1 Description

Front

The following diagram shows the front of the Basic Unit, e.g. a 230 V version.

Connection of a thermistor detector for motor protection or a summation current transformer for Earth Fault Detection, depending on the version of the unit.

Connection of the supply voltage

- 24 V DC
- 115 V AC
- 230 V AC

3 LED displays

Unit test, manual reset

- Automatic reset parameterizable
- Remote reset via bus or input

4 Output Relays

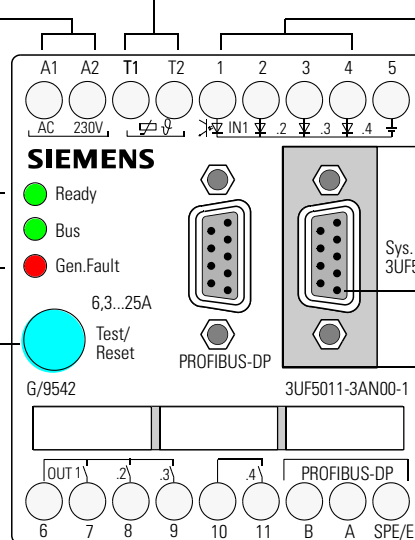

4 opto-coupler inputs

- 24 V DC, internally supplied
- External 24 V DC possible

System interface incl. RS 232

- For connection of Expansion Module, Operator Panel and PC

Bus terminal for PROFIBUS-DP

- 9-pole SUB-D socket
- Terminal, provided for plug-in units

Fig. 11: Front of Basic Unit

2.2 Summary of functions

Diagram

The following diagram contains a summary of the functions performed by the 3UF50 Basic Unit:

Basic Unit

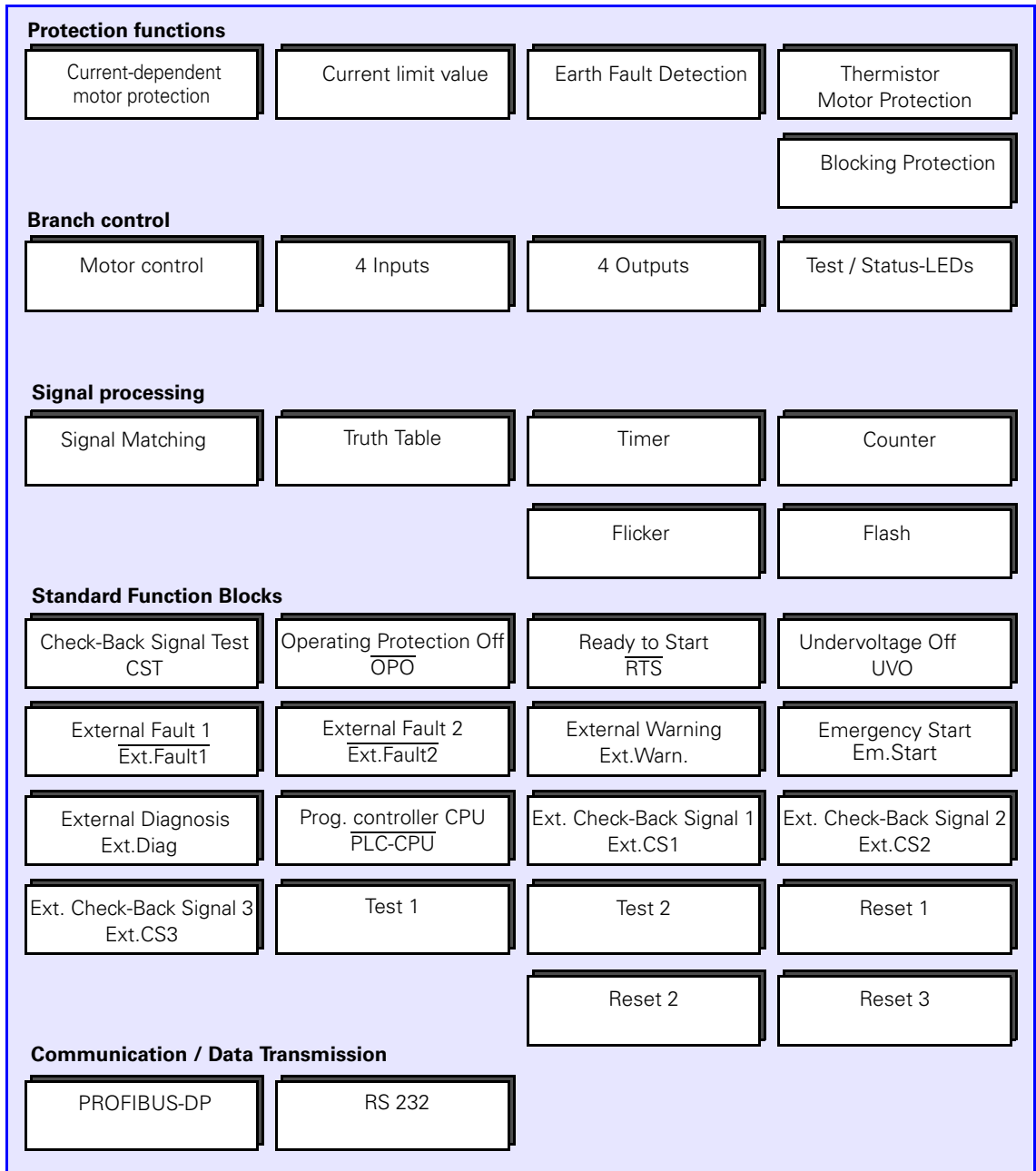

Fig. 12: Summary of functions performed by the Basic Unit

2.3 Outputs

Description of functions

The Basic Unit has 4 Output Relays with which, for example, you can operate contactors or lamps.

Bistable behaviour

If the status of the Output Relays is to be retained when the supply voltage is cut off, you have to select the 3UF.-3.10-1 version of the unit (bistable behaviour).

Then, you have to set the parameters for

- "Response - 3UF50 CPU Fault" and
- "Response - Control Voltage Fault" to "Retain Status".

Diagram

The following diagram shows the Output Relays.

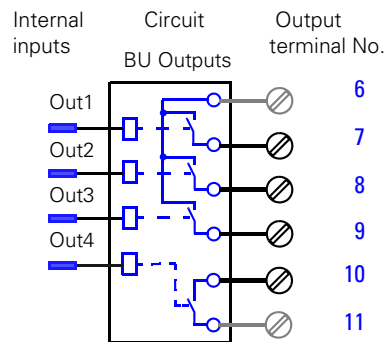

Fig. 13: Diagram of Output Relays for Basic Unit

2.4 Inputs

Description of functions

The Basic Unit has 4 inputs with which you can interrogate mechanical contacts or detectors.

Examples

If you wish, you can wire up the START and STOP keys of the Local Control to the inputs, and assign the internal control to "local".

With the signals, you can, for example, activate Function Blocks such as "Reset" or "Ready to Start (RTS)" by appropriate assignment of the inputs.

Schema

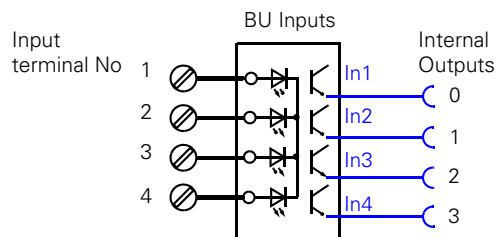

Fig. 14: Diagram of the Inputs for Basic Unit

Input delay

For reasons of interference immunity, you can set a debounce time for the inputs.

Voltage supply

- internal 24 V DC supply, if you are using *mechanical* contacts
- external 24 V DC supply, if you are using *solid-state* sensors (e.g. limit switches for level measurements). Input 1 is the reference potential, i.e. three inputs are available to you.
- external 24 V DC, if you are using *mechanical* contacts. A2 is the reference potential, i.e. there are four inputs available (only 24 V DC versions of the unit).

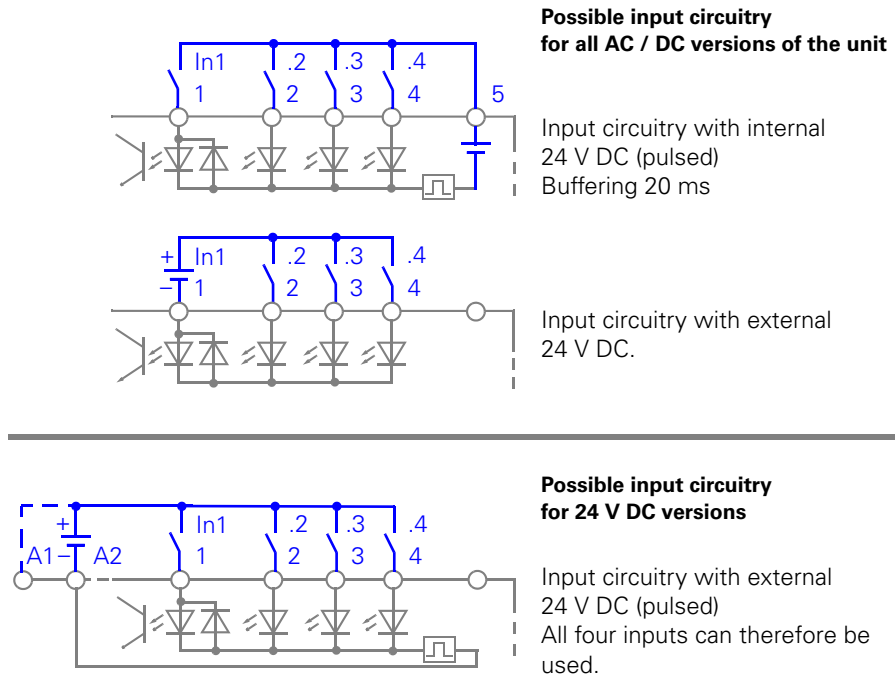

Fig. 15: Diagram of input circuitry

Note

The internal 24 V DC voltage supply must be used for the inputs of the Basic Unit only.

Cable lengths

Further information about cable lengths is given in the appendix, page C-5.

2.5 Protection functions

2.5.1 Current-dependent motor protection

Description of functions

The SIMOCODE-DP protects motors and load branches against Overload, phase failure and Current Asymmetry by means of stored current-time functions (tripping characteristic) in the range from 0.25 A to 820 A. In the event of an Overload, the SIMOCODE-DP reacts either

- by turning off the Contactor Controls or
 - with a signal,
- depending on the setting you have entered.

Current Detection

The Basic Unit detects the current of three-phases with the help of the integrated current transformer.

The Basic Unit detects Asymmetries above approximately 40 % and phase failures.

Lowest Current Detection limit

The Lowest Current Detection limit is 20% of the minimum set value.

Example: Basic Unit 3UF5001-3...0-1 setting range 1.25 A to 6.3 A

Minimum set value 1.25: Minimum detectable current: 0.25 A (20%)

Accuracy of Current Detection

The accuracy of Current Detection is 5% within the setting range.

Current Detection with SIMOCODE-DP

Assembly method

You have to select the unit with an assembly method which corresponds to the size of the Motor Current.

- Penetration method up to 100 A
- Bus connection method from 50 A to 820 A, also for direct mounting on Siemens contactors.

Penetration method

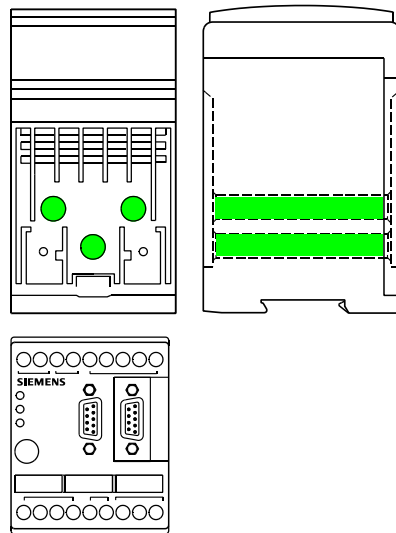

Bus connection method

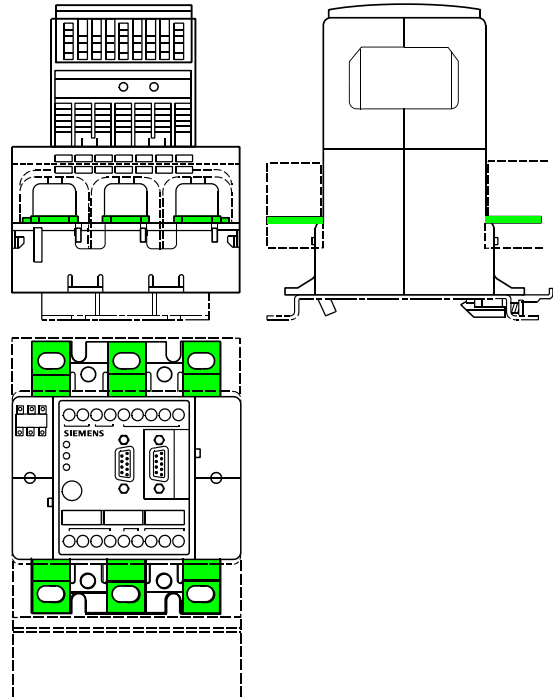

Fig. 16: Method of assembly

Current detection below 1.25 A

You can also detect motor currents of less than 1.25 A with SIMOCODE-DP. To do this you must run the motor supply leads through the push-through openings and form an appropriate number of loops. This has the effect of amplifying the primary signal.

Proceed as follows:

1. Insert the motor supply leads phase by phase through the push-through openings X
2. Guide them back through the loop-through opening Y
3. Push them through the push-through openings X again. This gives you two loops.

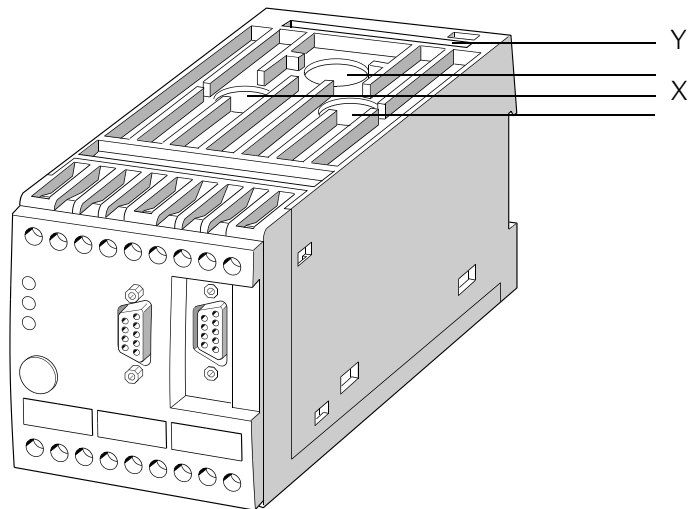

Fig. 17: Push-through and loop-through openings on the 3UF5001 Basic Unit

The table below shows the number of loops for the corresponding levels of motor rated current.

Number of loops n	5	4	3	2
Motor rated current I_N [A]	0.25 to 0.3	0.31 to 0.41	0.42 to 0.62	0.63 to 1.24
Current to be set I_s [A]	1.25 to 1.5	1.25 to 1.64	1.26 to 1.82	1.26 to 2.48

Table 2: Detection of motor currents below 1.25 A

The Set Current for the unit I_s is calculated thus: $I_s = n \times I_N$

Example

$I_N = 0.5$ A; $n = 3$;
Current to be set: $I_s = 1.5$ A

Current Detection with external current transformers

The 3UF5001 Basic Unit with bar-type transformers can be operated with external current transformers. The secondary circuits of the current transformer are looped through the three push-through openings of the Basic Unit and shorted.

Secondary current of external transformer

- 5 A: sufficient to push once through each push-through opening
- 1 A: loop lead through five times (n=5, i.e. 5 x 1 A = 5 A).

The secondary current of the external current transformer is the primary current of the SIMOCODE-DP Basic Unit. For this current of max. 5 A you require a 3UF5001 Basic Unit with a setting range from 1.25 to 6.3 A.

Example

Current transformer:

3UF1868-3GA00 (see NSK Catalog Section 1), primary current 205 A to 820 A, secondary current 1 A.

Basic Unit:

3UF5001 with lowest setting range 1.25 A to 6.3 A.

The primary signal must be amplified by looping the leads. If they are looped five times, you obtain 5 x 1 A = 5 A. The primary current in the Basic Unit is 5 A.

This means:

5 A Set Current I_s corresponds to 820 A motor current, the **upper set value** at 820 A is 5 A on the SIMOCODE-DP

The **transformation ratio** of Set Current I_s to motor current is therefore 820 A / 5 A = **164**

The **lower set value** at 205 A is then (5 A x 205 A) / 820 A = **1.25 A**.

The displayed current flowing at any one time does not need to be converted because SIMOCODE-DP outputs only the percentage value.

$$\text{Formula: Transformation ratio} = \frac{\text{Primary current (external transformer)}}{\text{Secondary current x no. of loops n (in SIMOCODE-DP)}}$$

Transformer data:

Secondary current: 1 A or 5 A

Frequency: 50 Hz / 60 Hz

Transformer output: recommended ≥ 2.5 VA; dependent on secondary current and cable length

Overcurrent factor: 5P10 or 10P10

Accuracy class: 1

Circuit diagram

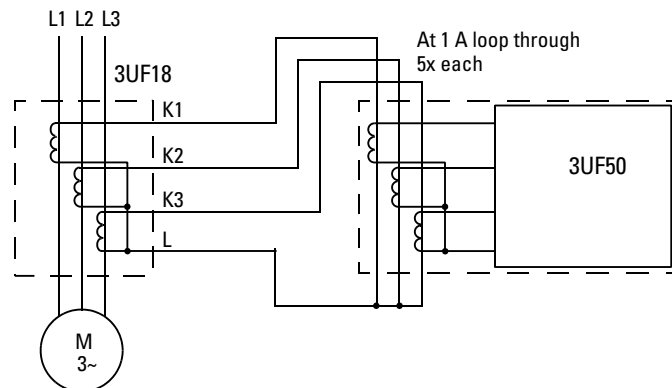

Fig. 18: Circuit diagram with external current transformer

Tripping classes, specified times, thermal memory

Class

The class (tripping class) indicates the maximum tripping time in which a protection device has to trip from cold at 7.2 times the Set Current (motor protection according to IEC 60947). The tripping characteristics show the tripping time in relation to the tripping current.

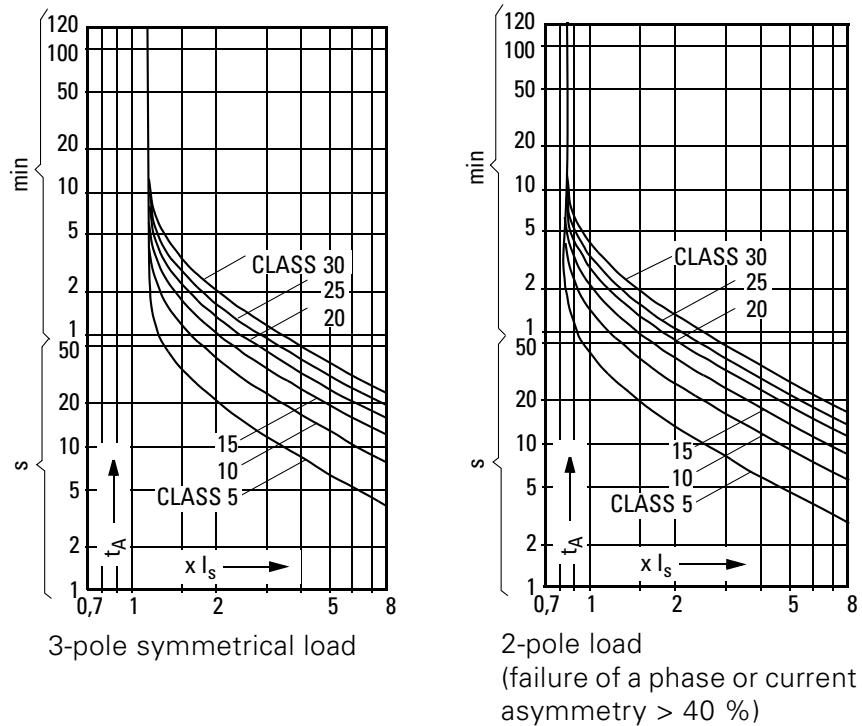

Fig. 19: Tripping characteristics (cold)

Derating

Bear in mind that, for starts > Class 10, the permissible AC3 current of the motor contactor has to be reduced (derating). The data (rated operating currents I_s [A] /AC-3) are given in Appendix D.5.

**Warm tripping
"thermal memory"**

When the motor is warm, the tripping times are reduced by the factors listed in the table. These factors apply to 3-pole symmetrical loads, Class 5 to Class 30:

$x I_s$	Pre-loading in % of the Set Current I_s					
	0	20	40	60	80	100
1.15	1	1	1	1	1	1
2	1	0.88	0.74	0.58	0.40	0.19
4	1	0.85	0.69	0.52	0.35	0.16
8	1	0.84	0.67	0.51	0.33	0.15

Table 3: Factors for tripping times when the motor is warm

Example

You have operated the motor with a Set Current of 100 % I_s and turned it off. You turn the motor on again immediately. Tripping due to overload with $2 \times I_s$, Class 10, occurs.

Tripping time when cold: approx. 40 s (tripping characteristic).

Factor for tripping time in the event of pre-loading 100 % I_s : 0.19 (table).

Reduced tripping time: $0.19 \times 40 \text{ s} = 7.6 \text{ s}$

**Failure of
supply voltage**

If the supply voltage to the 3UF50 Basic Unit fails for longer than 200 ms, the thermal memory is lost. In the event of an overload, the remaining cooling time is stored.

Type of protection EEX e

The SIMOCODE-DP 3UF5 system conforms to the regulations for the overload protection of explosion-protected motors of the "increased safety" type of protection EEx e DIN EN 50 0019 / DIN VDE 0165, DIN VDE 0170/0171 and to the PTB test regulations.

In the case of tripping units with DC operation, electrical isolation must be ensured by a battery or safety isolating transformer conforming to DIN VDE 0551.

Separate monitoring of the control supply voltage is recommended if the SIMOCODE-DP 3UF5 system is used with parameterized bistable behaviour of the output relays (Order No. 3UF50..-3..10-1) for the protection of motors with increased safety.

PTB test report no. 3.53-14605/96.

Example

Protection of motors in potentially explosive atmospheres

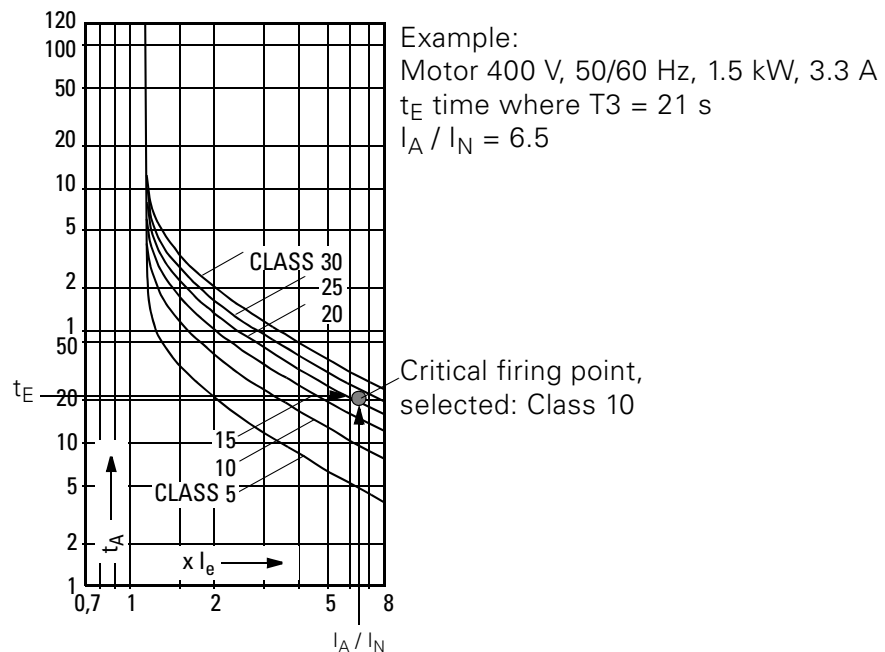

Fig. 20: Protection of motors in potentially explosive atmospheres

Original tripping characteristics

You can request the original tripping characteristics (precision ± 10 %), especially for EExe applications, from

Technical Assistance

Phone: +49 (911) 895-5900 (8⁰⁰ - 17⁰⁰ CET)

Fax: +49 (911) 895-5907

E-mail: technical-assistance@siemens.com

Internet: Service and Support (www.siemens.com/sirius/technical-assistance)

Cooling Time

The Cooling Time is the specified time after which the unit can be reset following *tripping due to overload*.

Voltage failures during this time lengthen the specified time accordingly. The Cooling Time after Overload Trip is at least 5 minutes. You can set the Cooling Time and, if necessary, extend it.

Emergency Start

A way of deleting the thermal memory and bypassing the Cooling Time, thus allowing a restart. (Reset and Switch-On commands also necessary!). The Emergency Start is only activated by edges. A new overload trip can never be prevented.

Idle Time

The Idle Time is the time specified for cooling when the motor at operating temperature is turned off by Control Functions (not due to overload!). After this time, the thermal memory is deleted and a cold start is possible. This allows frequent starting.

The following diagram shows cooling behaviour with and without Idle Time:

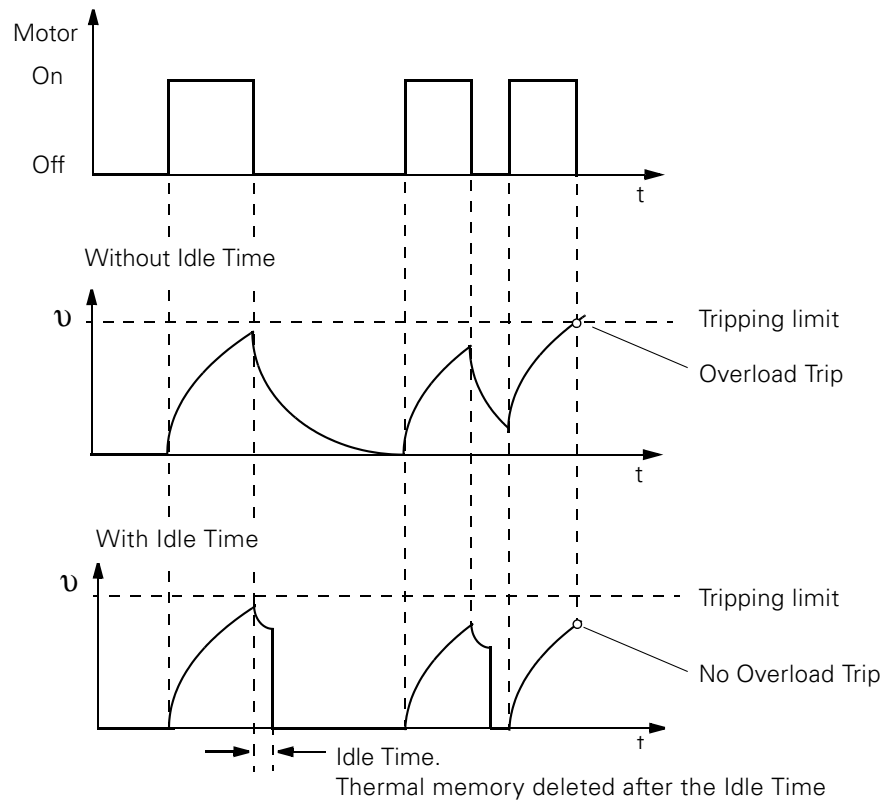

Fig. 21: Cooling behaviour with and without Idle Time

Settings

The following table contains a description of the settings.

Designation	Range	Comments
Set Current Is1	1.25 A to 820 A	Set Current 1. Range depends on version*
Set Current Is2	1.25 A to 820 A	Set Current 2. Range depends on version. Only for "Fast" operating mode when Dahlander / Pole Changing Starter is used, otherwise 0.
Tripping class / Class	5, 10, 15, 20, 25, 30	
Behaviour in the event of overload	Shutdown Warning	
Cooling Time	0.5 s to 60 min	At least 5 min., even when lower values are set. Example: Cooling Time: 6 min required; time to be set: 6 min
Idle Time	0.5 s to 60 min	
Single-phase motor	No Yes	Only one conducting path may be connected through/to the first current transformer. Internal Earth Fault Detection has to be deactivated.

Table 4: Description of the settings for current-dependent motor protection

The parameters are summarized in the parameter table (Appendix A.2).

* With Star Delta Starter: $I_{S1} = I_n \frac{1}{\sqrt{3}}$

Example: motor with $I_n = 100$ A. $I_{S1} = 57.7$ A.

2.5.2 Current Limit Value / Blocking Protection

Descriptions of functions

You can enter a lower and/or an upper Current Limit.

Example:

"Stirring mass too thick", i.e. the upper Current Limit has been exceeded.

"Idling as drive belt torn", i.e. the level has fallen below the lower limit.

The Current Limit Values and the Blocking Protection function are - for start bypassing purposes - only active after the class time has expired, z.B. Class 10 nach 10 Sekunden. If a current limit is exceeded or if the current falls below a limit, the SIMOCODE-DP reacts

- by turning off the Contactor Controls QE1 / QE2 / QE3 or
- with a warning,

depending on the setting you have entered.

The Blocking Protection function *always* turns off the Contactor Controls QE1 / QE2 / QE3 *instantaneously*.

Settings

The following table contains a description of the settings:

Designation	Range	Comments
Response threshold for lower Current Limit	20% to 1000% of the Set Current	in steps of 5%
Behaviour if the current falls below the lower Current Limit	Warning Shutdown	
Response threshold for upper Current Limit	20% to 1000% of the Set Current	in steps of 5%
Behaviour if the upper Current Limit is exceeded	Warning Shutdown	
Blocking	20% to 1000% of the Set Current	In steps of 5% Always shutdown

Table 5: Description of the settings for Current Limit Values / Blocking Protection

The parameters are summarized in the parameter table (Appendix A.2).

2.5.3 Earth Fault Detection

Description of function

Internal function

The internal Earth Fault Detection function is only suitable for motors with a 3-conductor connection and for earthed power systems! You can activate the internal Earth Fault Detection function by means of parameterization. It covers two sets of circumstances during operation:

- normal operation at up to $2 \times I_s$. The operating current has to be less than double the Set Current I_s . Fault currents amounting to $> 30\%$ of the Set Current I_s are detected.
- starting or overload at above $2 \times I_s$. The operating current is greater than double the Set Current I_s . Fault currents amounting to $> 15\%$ of the motor current are detected.

Note

If you are using internal Earth Fault Detection with a Star Delta Starter connection, spurious tripping may occur. In delta operation the net current is not equal to zero because of harmonic waves.

External function

You can operate internal Earth Fault Detection in parallel with Thermistor Motor Protection.

With the 3UL22 summation current transformer, rated fault currents of 0.3 A, 0.5 A and 1 A are evaluated. Response delay time: > 200 ms.

If the earth-fault limit is exceeded, a signal is emitted. You can specify additional tripping circumstances by means of parameterization.

Note

The external Earth Fault Detection function is an alternative to Thermistor Motor Protection (version of unit).

If the rated fault currents are exceeded, SIMOCODE-DP responds either

- with shutdown of the Contactor Controls QE1 / QE2 / QE3 or
 - with a warning
- depending on what you have set.

Diagram

The following diagram shows an example of Earth Fault Detection:

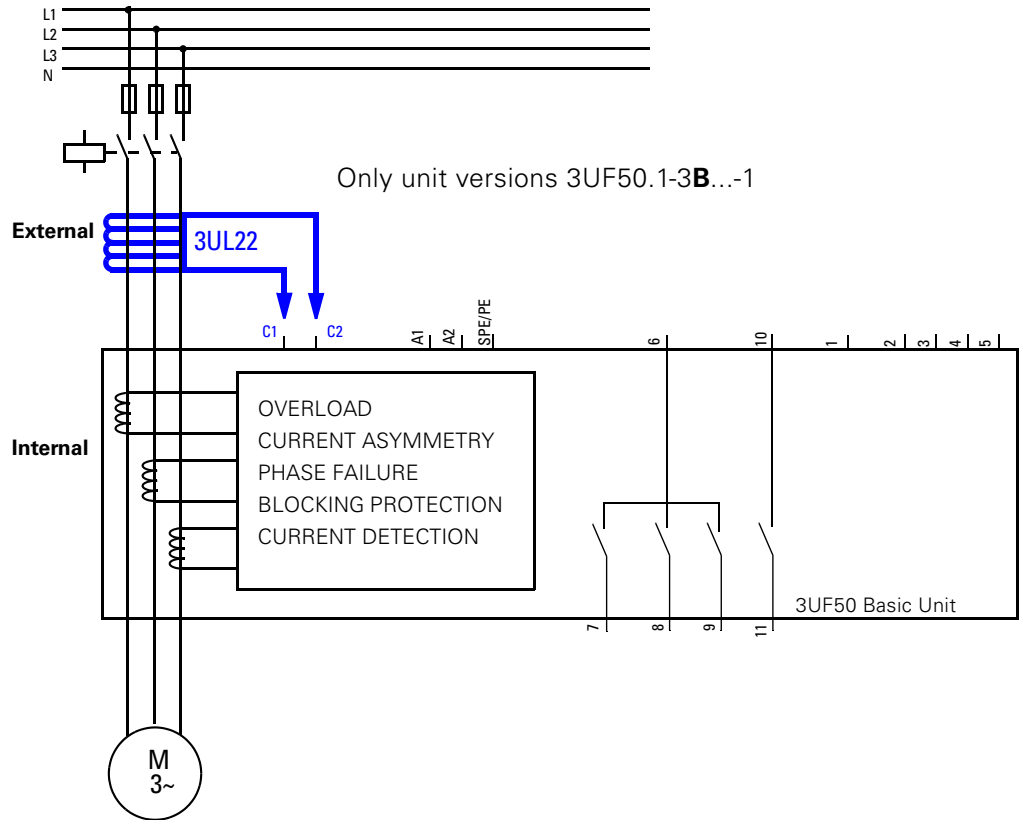

Fig. 22: Diagram of Earth Fault Detection

Settings

The following table contains a description of the settings:

Designation	Range	Comments
Internal Earth Fault Detection	Yes No	Active Not active
External Earth Fault Detection	Yes No	Active Not active
Behaviour in the event of an earth-fault	Warning Shutdown	

Table 6: Description of the settings for Earth Fault Detection

The parameters are summarized in the parameter table (Appendix A.2).

2.5.4 Thermistor Motor Protection

Description of functions

A Thermistor-detector circuit can be connected to versions 3UF50.1 to 3A... for direct temperature detection. Thermistor Motor Protection is an alternative to external Earth Fault Detection.

Operation

If the resistance values are exceeded (PTC) or fall below a certain value (NTC), the SIMOCODE-DP reacts either

- by turning off the Contactor Controls QE1 / QE2 / QE3 or
 - with a warning,
- depending on the setting you have entered.

Note

Thermistor Motor Protection is an alternative to the external Earth Fault Detection function (version of unit).

Types of detector

Three types of detector can be evaluated:

Type	Behaviour	Characteristic	Comments
1	PTC Binary		Warning <i>or</i> shutdown can be set.
2	PTC Analog KTY		Two thresholds can be evaluated. 1. Warning <i>and</i> 2. Shutdown
3	NTC Analog		Two thresholds can be evaluated. 1. Warning <i>and</i> 2. Shutdown

Table 7: Types of detector for Thermistor Motor Protection

Diagram

The following diagram shows an example of Thermistor Motor Protection:

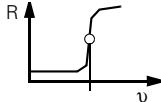
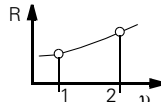
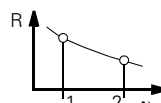
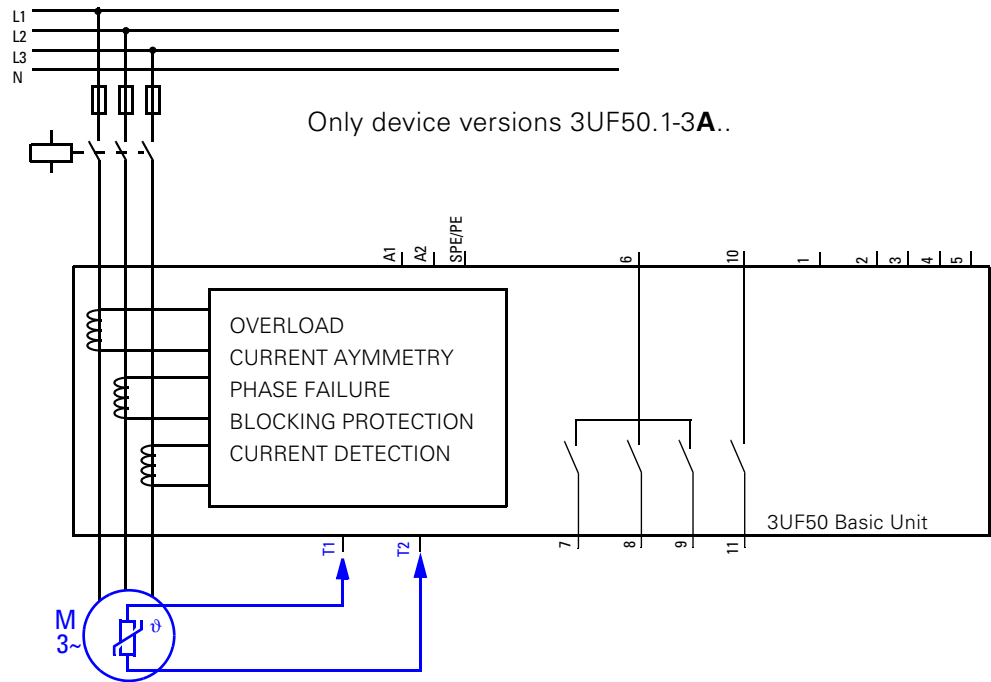

Fig. 23: Diagram for Thermistor Motor Protection

Settings

The following table contains a description of the settings.

Designation	Range	Comments
PTC Binary	Yes No	Active Not active
Behaviour PTC Binary	Warning Shutdown	
PTC Analog/KTY	Yes No	Active Not active
NTC Analog	Yes No	Active Not active
Analog tripping threshold	0..5,1 kΩ	Increment 20 Ω
Analog warning threshold	0...5,1 kΩ	Increment 20 Ω
Short-circuit in detector line	Yes / No	Only indicated

Table 8: Description of the settings for Thermistor Motor Protection

The parameters are summarized in the parameter table (Appendix A.2.).

2.6 Branch control

2.6.1 Control and motor protection block

Description of functions

In order to provide reliable protection of the motor branch, you must assign the control commands to the control and motor protection block.

Note

Otherwise Operator Enabling signals, Control Functions and protection functions have no effect.

Diagram

The principle is illustrated in the following diagram:

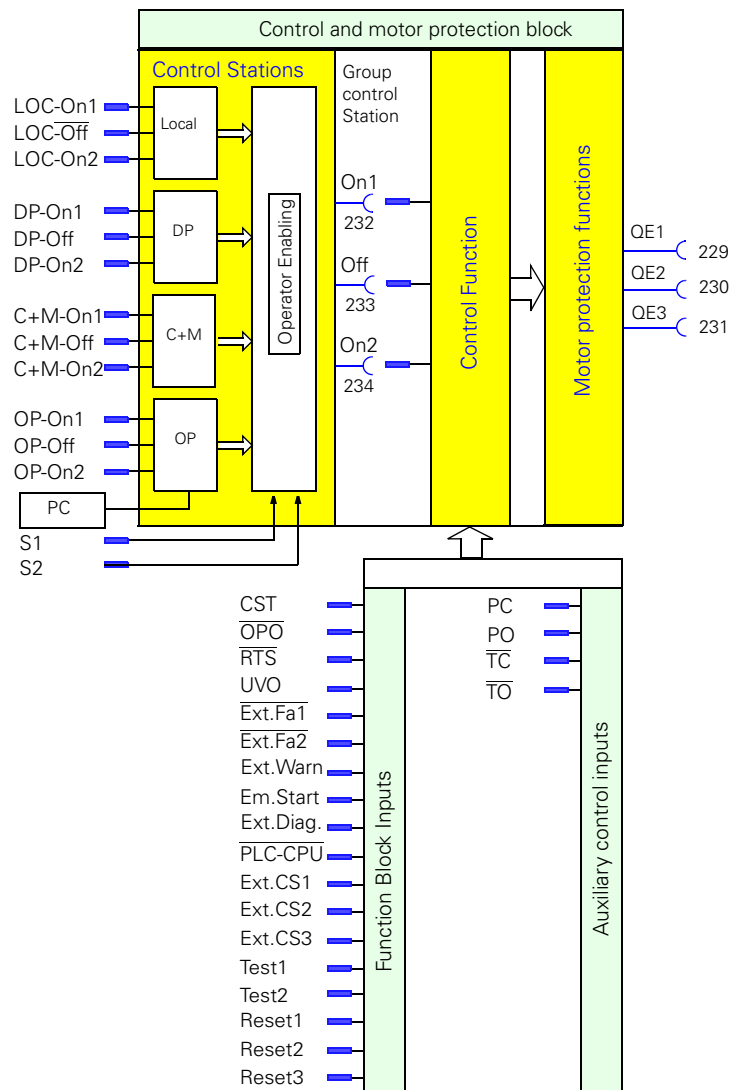

Fig. 24: Control and motor protection block

**Control Stations
Control Function**

The set Operator Enabling signals are processed in the Control Stations block, and the Control Function, for example reversing starter, in the next block. Depending on which Control Function is selected, all interlocks, logic operations and delays are implemented here. If Function Blocks are required or Auxiliary Control Inputs need to be used, for example for actuator/Positioner control, these have an effect on the Control Function.

**Motor protection
function**

The motor protection function acts as the last block in this chain. The Contactor Controls QE1/QE2/QE3 switch in accordance with the Control Function being used, see Table 11: on page 2-27. The Contactor Controls QE1/QE2/QE3 have a high signal after an "On" command and a low signal after an "Off" command or if a fault applies, in other words the motor branch is reliably switched on and off even in the event of a fault.

**Reliable on/off
switching**

The Contactor Controls QE1/QE2/QE3 reliably switch the motor branch on and off.

2.6.2 Information data block

Description of functions

The information data block makes important operating data and signals available, such as On, Off, Left, Right, Slow, Fast, Close, Open, warnings, faults etc. (see also assignment table, Appendix A.1). You can connect these signals to the outputs of the system, transmit them via PROFIBUS-DP or display them on the Operator Panel.

Diagram

The principle is shown in the following diagram:

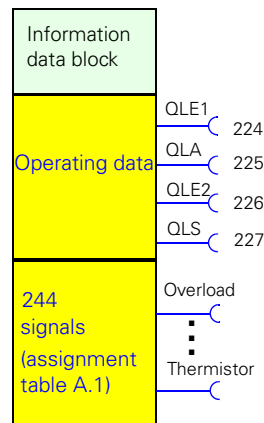

Fig. 25: Diagram of information data block

2.6.3 Description of the Control Stations

Control Stations are points from where switching commands (for example Motor On or Motor Off) are issued. Possible Control Stations include:

1. Local Control Station, which is situated in the immediate vicinity of the motor and is operated via pushbuttons, for example.
2. PROFIBUS-DP, switching commands from the automation system (PLC).
3. HMI, as an additional option for control via an operator control and monitoring station (human-machine interface) or via PROFIBUS-DPV1 with the Win-SIMOCODE-DP/Professional software.

4. 3UF52 Operator Panel, which is fitted in the switchgear cubicle door.

The SIMOCODE-DP system provides these Control Stations internally. The Control Stations each have three internal inputs: On1, On2, Off.

Note

The internal input LOC-Off is inverted and 0 is therefore active. As a result the Contactor Controls QE1/QE2/QE3 are deactivated in the event of a wire break in the supply lead to the external stop button, for example, and can only be reactivated when the fault has been rectified.

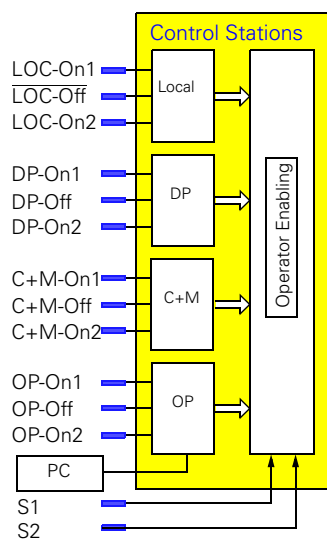

Fig. 26: Diagram of Control Stations

The options for assignment to the internal inputs of the Control Stations include, for example:

- the external Local Control Station (start and stop buttons, which are wired to the inputs of the 3UF50 Basic Unit)
- the buttons of the Operator Panel
- the PROFIBUS-DP control bits
- the PROFIBUS-DPV1 control bits

Operator Enabling

Operator Enabling signals are switching authorizations for various Control Stations. The table shows the four possible Control Stations which you can enable with operating mode Control Mode Switches S1 and S2.

Operating mode	Change-over switches		Control Station							
	S1	S2	Local Control Station [LOC]		PLC [DP]		Operator's station [HMI]		Switchgear cubicle, Operator Panel [OP]	
			On	Off	On	Off	On	Off	On	Off
1	0	0	Free	Free	Blocked	Blocked	Blocked	Blocked	Blocked	Blocked
2	0	1	Free	Free	Blocked	Blocked	Blocked	Blocked	Blocked	Blocked
3	1	0	Blocked	Blocked	Blocked	Blocked	Free	Free	Blocked	Blocked
4	1	1	Blocked	Blocked	Free	Free	Blocked	Blocked	Blocked	Blocked

Table 9: Operating modes of Control Stations

You can set all grey-shaded "Blocked" fields to either "Free" or "Blocked".

If you do not change the assignment of S1 and S2, SIMOCODE-DP automatically sets operating mode 2. You can switch between operating modes 2, 3 and 4 by activating or deactivating S1 and S2.

If you also want it to be possible to switch off from the local Control Station in operating mode 4, for example, "Free" must be set for the Off command in operating mode 4, "Local" column.

Automatic mode

A high signal must be present at Control Mode Switches S1 and S2 for automatic mode (operating mode 4). SIMOCODE-DP can then be controlled by the automation system via the PROFIBUS-DP. The particular feature of automatic mode is that, in the event of failure of the CPU of the automation system (PLC) or failure of the communication link (PROFIBUS-DP), SIMOCODE-DP can switch to the other operating mode:

- automatically, manual/automatic changeover (Control Mode Switches S1 and S2) with the automation system
- by hand, manual/automatic changeover (Control Mode Switches S1 and S2) locally, for example with a key-operated switch

Depending on which behaviour is set, SIMOCODE-DP deactivates the motor branch or maintains the status.

Example 1
Local - Automatic

In practice usually only one changeover function is used, for example in order to change over the switching authorization between the local Control Station and the automation system (PLC) with a key-operated switch or a command from the automation system.

Example 1: Local - Automatic. You want to use a PROFIBUS-DP control bit to switch between the local Control Station/operating mode 2 (local) and control via PROFIBUS-DP/operating mode 4 (automatic mode).

To do this, PROFIBUS-DP control bit 0.5 to S1 and S2 must be assigned to the "fixed level value 1".

If you want to switch over using a key-operated switch, you must connect the contact of the key-operated switch to an input terminal of the Basic Unit and assign the input terminal to Control Mode Switch S1.

Example 2
Local - Remote - Automatic

In complex installations it may be necessary to have two changeover functions, S1 and S2, for example in order to change the switching authorization from different locations with two key-operated switches.

Example 2: Local - Remote - Automatic

You want to use a PROFIBUS-DP control bit to switch between the local Control Station/operating mode 2 (local) and control via PROFIBUS-DP/operating mode 4 (automatic) and in addition you want to enable the 3UF52 Operator Panel on the switchgear cubicle/operating mode 2 (remote) with equal authorization along with the local Control Station.

To do this, PROFIBUS-DP control bit 0.5 to S1 and S2 must be assigned to the "fixed level value 1".

If you want to switch over using a key-operated switch, you must connect the contact of the key-operated switch to an input terminal of the Basic Unit and assign the input terminal to software Control Mode Switch S1.

In addition you must set "Free" for the On and Off commands in operating mode 2, "Switchgear cubicle" column.

**Setting with
COM-PROFIBUS/
Step 7**

If you set and assign the parameters via COM-PROFIBUS or Step 7, you should determine the Operator Enabling signals from the following table:

Operating mode	Control Mode Switch		Control Station							
			Local		DP		Reserve		OP	
	S1	S2	On1/ 2	Off	On1/ 2	Off	On1/ 2	Off	On1/ 2	Off
1	0	0	Free		Blocked					
2	0	1	Free		Blocked		OE4	OE1 2	OE6	OE1 4
3	1	0	OE2	OE1 0	Blocked		Free		OE7	OE1 5
4	1	1	OE1	OE9	Free		OE3	OE1 1	OE5	OE1 3

Table 10: Determining Operator Enabling signals

In order to grant Operator Enabling to the Operator Panel in operating mode 2 as in Example 2, OE6 and OE14 must be set to "1" at the corresponding point in the bit pattern.

Example:

In COM-PROFIBUS or Step 7 the following bit pattern must be set in the Motor menu group:

- Motor " OE 15 14 13 12 11 10 9
Entry "0100000", i.e. OE 14 enabled
- Motor " OE 7 6 5 4 3 2 1
Entry "0100000", i.e. OE 6 enabled

2.6.4 Description of the Control Functions

The Control Functions of the SIMOCODE-DP system implement all interlocks, logic operations and delays.

If Auxiliary Control Inputs are required, as for Actuator/Positioner control for example, or functions blocks need to be used, these have an influence (as described) on the Control Function.

Normal operation

In normal operation, without Inching Mode being activated, the switching command to the respective input of the "ON1/ON2" Control Station is stored and can only be cancelled by a switching command to the respective input of the "OFF" Control Station. This means that the auxiliary contact for locking the contactor is not necessary when using SIMOCODE-DP.

Inching Mode

The "Inching Mode" function acts on the inputs of all "ON1" and "ON2" Control Stations. If Inching Mode is activated, a switching command only has an effect provided a "high" signal is present.

Examples

In the Typical Circuits section you will find an example for each Control Function in the form of a circuit diagram, block diagram and parameter list.

General comments on the Direct Starter, Reversing Starter, Star Delta Starter, Dahlander Starter, Pole Changing Starter and Soft Starter

Closing

Depending on which Control Function is used, after an "On" command to the "ON1/ON2" Control Station the respective Contactor Controls QE1/QE2/QE3 are activated:

Control function	Control Station			Contactor Control			Lamp Control Check-Back Signal			Status message		
	ON1	ON2	OFF	QE1	QE2	QE3	QLE1 (On1)	QLE2 (On2)	QLA (Off)	On1	On2	Off
Direct Starter (DIR)	-	On	Off	On	-	-	-	On	Off	-	On	Off
Reversing starter (REV)	Left	Right	Off	Left	Right	-	Left	Right	Off	Left	Right	Off
Star Delta Starter (STAR)	-	On	Off	Mains contactor	Star contactor	Delta contactor	-	On	Off	-	On	Off
Pole Changing Starter (PREV)	Slow	Fast	Off	Slow	Fast	-	Slow	Fast	Off	Slow	Fast	Off
Dahlander (DAHL)	Slow	Fast	Off	Fast	Slow	Fast star contactor	Slow	Fast	Off	Slow	Fast	Off
Soft Starter (SOFT)	-	On	Off	On command SIKO-START	On - mains contactor (drop-out delay)	Reset - SIKO-START	-	On	Off	-	On	Off

Table 11: Active Control Stations, Contactor Controls, Lamp Controls and status messages with Direct Starter, Reversing Starter, Star Delta Starter, Dahlander starter, Pole Changing Starter and Soft Starter

Check-Back Current On	<p>The SIMOCODE-DP system determines the Check-Back Signal "Motor running" or "Contactor has picked up" by measuring the current in the main circuit:</p> <p>"Current flowing" signifies that the motor is switched on. There is no need for an auxiliary contact on the contactor for signalling purposes. The "On" state is signalled by the Lamp Controls QLE1/QLE2 or by "status message On1/On2" (Table 11: on page 2-27).</p>
Opening	<p>Depending on which Control Function is used, after an "Off" command to the "OFF" Control Station the respective Contactor Controls QE1/QE2/QE3 as shown in Table 11: on page 2-27 are deactivated.</p>
Check-Back Current Off	<p>The SIMOCODE-DP system determines the Check-Back Signal "Motor Off" or "Contactor has dropped out" by measuring the current in the main circuit: "No current flowing" signifies that the motor is switched off. There is no need for an auxiliary contact on the contactor for signalling purposes. The "Off" state is signalled by the Lamp Control QLA or by "status message Off" (Table 11: on page 2-27).</p>
Fault	<p>The Contactor Controls QE1/QE2/QE3 are deactivated. In addition, a flash signal is applied to the Lamp Control QLS, and the Gen. Fault flash signal, the "General Fault" status message and the corresponding signal bit for the fault are present.</p>
Current measurement	<p>The current in the main circuit is measured using the integrated current transformers in the 3UF50 Basic Unit.</p>
Run Time On (T-Run Time)	<p>After an "On" command, SIMOCODE-DP must measure the current in the main circuit during Run Time. If it does not, the fault message "Run Time On" is issued and SIMOCODE-DP deactivates the Contactor Controls QE1/QE2/QE3.</p>
Run Time Off (T-Run Time)	<p>After an "Off" command, SIMOCODE-DP is not permitted to measure any current in the main circuit after the Run Time. Otherwise the fault message "Run Time Off" is issued and the Contactor Controls QE1/QE2/QE3 cannot be switched back in until after the fault has been rectified.</p>

-
- We recommend not changing the factory setting.
 - The Run Time can be deactivated by setting the time to "0".
-

**Check-Back Time On
(T-CON)**

When the motor is switched off, SIMOCODE-DP constantly monitors whether there is no current flowing in the main circuit. If current does flow for longer than the set Check-Back Time without an "On" command, the fault message "Check-Back Current On" (CON)) is issued and the Contactor Controls QE1/QE2/QE3 cannot be switched back in until after the fault has been rectified.

**Check-Back Time Off
(T-COFF)**

When the motor is switched on, SIMOCODE-DP constantly monitors whether there is current flowing in the main circuit. If the current fails to flow for longer than the set Check-Back Time without an "Off" command, the fault message "Check-Back Current Off" (COFF)) is issued and the Contactor Controls QE1/QE2/QE3 are deactivated.

-
- We recommend not changing the factory setting.
 - The Run Time can be deactivated by setting the time to "0".
-

**Direct Starter
DIR**

Direct Starter. With this Control Function SIMOCODE-DP is able to switch a motor on or off.

For the active Control Stations, Contactor Controls, Lamp Controls and status messages refer to Table 11: on page 2-27.

**Reversing Starter
REV**

Reversing Starter. SIMOCODE-DP uses this Control Function to control the direction of rotation of motors. An internal logic component prevents both contactors from closing at the same time.

The time-delayed changeover from one direction of rotation to the other is implemented by the Lock-Out Time. This makes it possible to do without all contactor interlocking and pushbutton interlocking as well as the time-delay relay.

The direction of rotation can only be switched over:

- when the motor has been switched off beforehand and SIMOCODE-DP does not measure any current in the main circuit
and
- after the Lock-Out Time has expired.

For the active Control Stations, Contactor Controls, Lamp Controls and status messages refer to Table 11: on page 2-27.

**Lock-Out Time
(T-Lock)**

The Lock-Out Time prevents direct changeover of the direction of rotation. Within the Lock-Out Time the flywheel of a drive is intended to come to a standstill before the next switching command is executed.

-
- The Lock-Out Time can be deactivated by setting the time to "0".
 - This Lock-Out Time is also used for the Pole Changing Starter Control Function.
-

**Star Delta Starter
STAR**

Star Delta Starter. With this Control Function SIMOCODE-DP switches the stator winding of a motor during starting via the corresponding contactors first in a star connection and then in a delta.

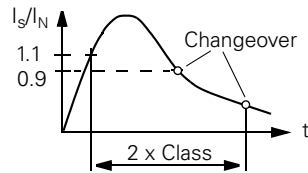

The changeover is either

- current-dependent with falling current at $0.9 \times I_s$ or
- time-dependent after $2 \times$ Class time, e.g. Class 10 after 20 seconds

Before the delta contactor is switched in, SIMOCODE-DP checks whether the star contactor has dropped out by measuring the current in the main circuit.

This makes it possible to do without all contactor interlocking and the time-delay relay for delaying the changeover from star to delta.

For the active Control Stations, Contactor Controls, Lamp Controls and status messages refer to Table 11: on page 2-27.

Note

- If you use internal Earth Fault Detection with a Star Delta connection, spurious tripping may occur. In delta operation the net current is not equal to zero, because of the harmonic waves.
- The current to be set for the Star Delta Starter Control Function must be lower by a factor of $1/\sqrt{3}$.

Example: $I_n = 100 \text{ A}$

$I_s = I_n \times 1/\sqrt{3}$

$I_s = 100 \text{ A} \times 1/\sqrt{3} = 57.7 \text{ A}$

Current to be set $I_s = 57.7 \text{ A}$

**Pole Changing Starter
PREV**

Pole Changing Starter. SIMOCODE-DP uses this Control Function to switch between two motor-speed levels. To do this, SIMOCODE-DP energizes the separate stator windings with different number of poles via the contactors. An internal logic component prevents both contactors from closing at the same time. The time-delayed changeover from one speed to the other is implemented by the Lock-Out Time. This makes it possible to do without all contactor interlocking and pushbutton interlocking as well as the time-delay relay.

The speed can only be switched over:

- when the motor has been switched off beforehand and SIMOCODE-DP does not measure any current in the main circuit and
- after the Lock-Out Time has expired.

For the active Control Stations, Contactor Controls, Lamp Controls and status messages refer to Table 11: on page 2-27.

Note

Two Set Currents must be set for Pole Changing Starter:

- Is1 for the slow speed
- Is2 for the fast speed

Depending on the current range, in many cases current detection can be carried out directly with the current transformers integrated in the 3UF50 Basic Unit. Otherwise you need a 3UF50 Basic Unit with a setting range from 1.25 A to 6.3 A and two external 3UF18 current transformers. The current transformers supply a secondary transformer rated current of 1 A. As the lowest Set Current Is is 1.25 A in the SIMOCODE-DP, it is necessary to loop the secondary circuit of the external current transformer several times through the current transformers of the 3UF50 Basic Unit.

Lock-Out Time (T-Lock)

The Lock-Out Time prevents direct changeover of the direction of rotation. Within the Lock-Out Time the flywheel of a drive is intended to come to a standstill before the next switching command is executed.

- The Lock-Out Time can be deactivated by setting the time to "0".
 - This Lock-Out Time is also used for the reversing starter Control Function.
-

Dahlander Starter DAHL

Dahlander Starter. SIMOCODE-DP can use this Control Function to switch between two motor-speed levels. To do this, SIMOCODE-DP connects the stator windings via the contactors in such a way that at a low speed there is a large number of poles and at a high speed a small number of poles. An internal logic component prevents the contactors for the "Fast" speed closing at the same time as the contactor for the "Slow" speed. This makes contactor interlocking unnecessary.

With the Dahlander Control Function, the speed can be switched over directly, without an "Off" command. However, SIMOCODE-DP must briefly measure no current in the main circuit. This is achieved with an internal short-time delay when closing the contactors.

For the active Control Stations, Contactor Controls, Lamp Controls and status messages refer to Table 11: on page 2-27.

Note

Two Set Currents must be set for Dahlander starting:

- Is1 for the slow speed
- Is2 for the fast speed

Depending on the current range, in many cases current detection can be carried out directly with the current transformers integrated in the 3UF50 Basic Unit. Otherwise you need a 3UF50 Basic Unit with a setting range from 1.25 A to 6.3 A and two external 3UF18 current transformers. The current transformers supply a secondary transformer rated current of 1 A. As the lowest Set Current Is is 1.25 A in the SIMOCODE-DP, it is necessary to loop the secondary circuit of the external current transformer several times through the current transformers of the 3UF50 Basic Unit.

**Soft Starter
SOFT**

SIMOCODE-DP can use this Control Function to control the SIKOSTART® 3RW22 Soft Starter. The SIKOSTART 3RW22 soft starter is thus linked to the PROFIBUS-DP via SIMOCODE-DP.

Contact Control QE1 supplies the On/Off command to the SIKOSTART starter via one of the Output Relays and must therefore be wired up to the On/Off terminal of the SIKOSTART.

Contact Control QE3 supplies a typical pulse of 20 ms via one of the Output Relays when a "Reset" command is issued on the SIMOCODE-DP. SIKOSTART is therefore to be reset using a PROFIBUS-DP control bit, for example, in the event of a fault.

Contact Control QE2 switches contactor K1 in the main circuit via one of the Output Relays.

Note

In the event of an Off command, Contact Control QE2 is deactivated with a 3 s delay after SIMOCODE-DP measures no current in the main circuit. The reason for this is the soft running down via SIKOSTART. In order to avoid incorrect disconnection, the Run Time in the SIMOCODE-DP must be extended by the length of the soft running down time.

The "Fault" signal from the SIKOSTART is wired to one of the inputs of the SIMOCODE-DP system and assigned to the "External Fault 1" Function Block in the SIMOCODE-DP. In the event of a SIKOSTART fault, SIMOCODE-DP deactivates the motor branch.

The "End of starting" signal from the SIKOSTART is wired to one of the inputs of the SIMOCODE-DP system.

The signal can then be assigned to a PROFIBUS-DP signal bit and processed further in the automation system.

General comments on Positioner/Actuator

The SIMOCODE-DP system can control various Positioner control circuits or actuators.

The Positioner Control Function is also described as an actuator in the technical literature. In the remainder of this description we shall use only the term Positioner or Positioner control.

Positioning command Open/Close

The "Open (ON2)" and "Close (ON1)" positioning commands act on the respective Control Stations. Contactor Control QE1 (Open) or QE2 (Close) is activated, depending on the positioning command. The Positioner is then run to its respective end position and automatically deactivated.

Control function	Control Station			Contactor Control		
	ON1	ON2	OFF	QE1	QE2	QE3
Positioner (Pos1-5)	Close	Open	Stop	Open	Close	-

Table 12: Active Control Stations, Contactor Controls, Lamp Controls and status messages for Positioner

Positioning command Open/Close

If the "Stop (OFF)" switching command is issued while the Positioner is moving, the drive remains stationary at its current position.

Direct changeover

It is possible to change the direction of motion directly without a "Stop" command. Before the direction of motion is changed, SIMOCODE-DP measures the current in the main circuit to check whether the previously active contactor has been released. Contactor interlocking is therefore unnecessary.

Check-Back Signals

Further information is provided in the descriptions of the individual Positioner controls, Positioner 1 to Positioner 5, because the Check-Back Signals are different.

Fault

Contactor Controls QE1/QE2 are deactivated. In addition a flash signal is present at the Lamp Control QLS, and the Gen. Fault flash signal, the "General Fault" status message and the corresponding signal bit for the fault are present.

Current measurement

The current is measured in the main circuit using the integrated current transformers in the 3UF50 Basic Unit.

CST

For Positioner control there is no change in the signalling state of the Lamp Control QLE1/QLE2/QLA and status messages in test mode with respect to the other Control Functions.

**Run Time On (closed)
Run Time Off (open)
(T-Run Time)**

In contrast with the other Control Functions, in the case of Positioner control the Run Time is used for monitoring the distance moved: SIMOCODE-DP starts Run Time monitoring together with the "Open" or "Close" command. The Check-Back Signal must confirm correct execution of the command within the set Run Time. If not, a fault has occurred and SIMOCODE-DP signals "Run Time On" - "End Position Closed" was not reached or "Run Time Off" - "End Position Open" was not reached.

Note

The Run Time can be deactivated by setting the time to "0" .

**Check-Back Time On
(T-CON)**

When the motor is switched off, SIMOCODE-DP constantly monitors whether there is no current flowing in the main circuit. If current does flow for longer than the set Check-Back Time without an "On" command, the fault message "Check-Back Current On" (CON)) is issued and the Contactor Controls QE1/QE2 cannot be switched back in until after the fault has been rectified.

We recommend not changing the factory setting.
The Check-Back Time can be deactivated by setting the time to "0".

**Check-Back Time Off
(T-COFF)**

When the motor is switched on, SIMOCODE-DP constantly monitors whether there is current flowing in the main circuit. If the current fails to flow for longer than the set Check-Back Time without a "Stop" command or "End position" reached, the fault message "Check-Back Current Off" (COFF) is issued and the Contactor Controls QE1/QE2/QE3 are deactivated.

Selection of Positioner control

Auxiliary Control Inputs

In relation to the control of Positioners, the SIMOCODE-DP system can additionally receive Check-Back Signals. These Check-Back Signals are Auxiliary Control Inputs and monitor the operating statuses of the Positioner control. The following signals are picked off at the Positioner via limit switches and Torque Switches as part of Positioner control:

- the Position Switch open (PO) and Position Switch Closed (PC) signals from limit switches. The limit switches close a contact when the Positioner has reached the Open position (PO=1) or the Closed position (PC=1). They open the contact when the Positioner leaves the Open position (PO=0) or the Closed position (PC=0).
- the Torque Switch Open (TO) and Torque Switch Closed (TC) signals from Torque Switches. The Torque Switches open a contact when the Positioner has reached Torque Open (TO=0) or Torque Closed (TC=0). They close a contact when the Positioner leaves Torque Open (TO=1) or Torque Closed (TC=1).

Function diagram

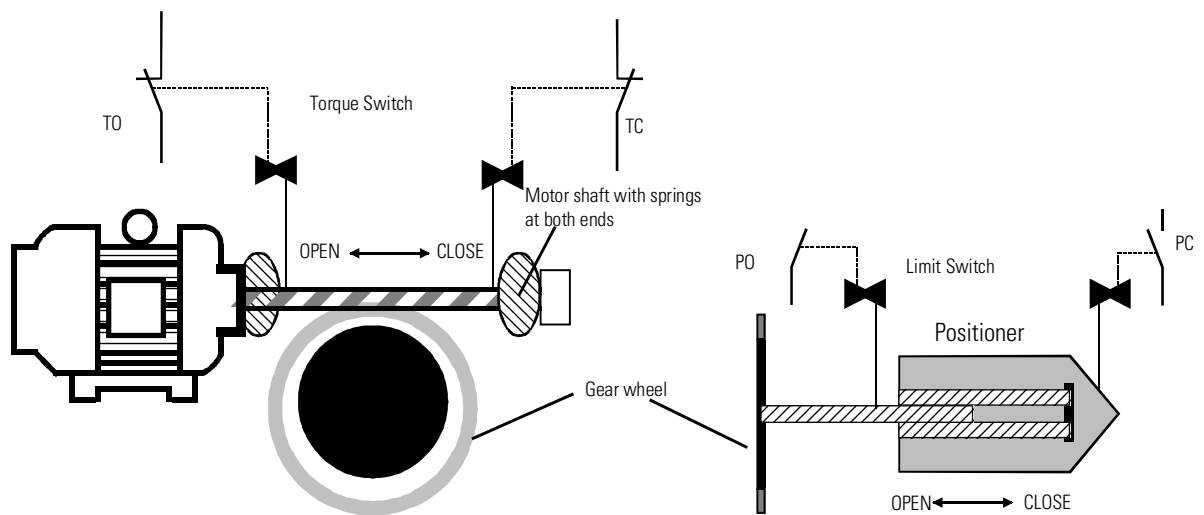

Fig. 27: Function diagram of Torque and Limit Switches in the control of Positioners

SIMOCODE-DP uses these Check-Back Signals in order to monitor the operating statuses and to shut down the drive when the end position is reached. With the five variants you can specify different combinations of Torque and limit switches for the Check-Back Signals.

Variants for Positioner control

The table below shows the five variants of Positioner control:

Variant	Cl. ←		→ Op.	
	Torque Close	Limit Close	Limit Open	Torque Open
	\overline{TC}	PC	PO	\overline{TO}
POS1		c	c	
POS2	c	b	b	c
POS3	c	b	c	
POS4		c	b	c
POS5	Non-equivalent active		Non-equivalent active	

Not active for shutdown
 b Active precondition for: **c** Active

Table 13: Variants for Positioner control

Notes

- The signals of the Torque Switches and Limit Switches must be wired to the inputs of the 3UF50 Basic Unit in order to obtain shutdown after 50 ms.
- Torque Switches must be active on zero.
- Limit Switches must be active on one.

The Check-Back Signals TC, TO, PC, PO, Travel open and Travel close are not transmitted automatically in the cyclical message or the diagnostic message. They can be assigned to the signal bits of the second byte of the cyclical message.

**Positioner
POS1**

Positioner control version 1. With this Control Function SIMOCODE-DP shuts down the drive when the Positioner reaches one of the end positions, the limit switch Check-Back Signal closed (PC) or Check-Back Signal open (PO) closes. If the signal Torque Open (TO) or Torque Closed (TC) is present before the corresponding limit switch open (PO) or closed (PC) signal, SIMOCODE-DP shuts down the drive with the fault "Positioner blocked". Compare Table 13: on page 2-36.
The Torque Switch open (TO) and Torque Switch Closed (TC) signals can be deactivated by assigning the fixed level value of 1.

Check-Back Signals

The table below shows the Check-Back Signals as a function of the initial situation and the switching command when using Positioner 1.

Switching command	Comment	Signal from Torque and Limit Switches				Lamp Control			Status message				
		TC	PC	PO	TO	QLE1 (Close)	QLE2 (Open)	QLA (Stop)	On1 (Close)	On2 (Open)	Travel close	Travel open	Off (Stop)
	Initial situation: Positioner closed	○	●	○	○	●	○	○	●	○	○	○	○
Open (ON1)	Limit Switch Closed (PC) still closed	○	●	○	○	●	⊗	○	●	○	○	●	○
-	Limit Switch Closed (PC) open 1	○	○	○	○	○	⊗	○	○	○	○	●	○
-	Positioner reaches Open end position - limit switch Open (PO) closes	○	○	●	○	○	●	○	○	●	○	○	○
	Initial situation: Positioner open	○	○	●	○	○	●	○	○	●	○	○	○
Close (ON2)	Limit Switch Open (PO) still closed	○	○	●	○	⊗	●	○	○	●	●	○	○
-	Limit Switch Open (PO) open 2	○	○	○	○	⊗	○	○	○	○	●	○	○
-	Positioner reaches Closed end position - Limit Switch Closed (PC) closes	○	●	○	○	●	○	○	●	○	○	○	○
	Initial situation: Positioner opening/closing	○	○	○	○	○/⊗	⊗/○	○	○	○	○/●	●/○	○
Stop	Limit Switches Closed (PC) and Open (PO) open	○	○	○	○	○	○	●	○	○	○	○	●
	Initial situation: Positioner stop	○	○	○	○	○	○	●	○	○	○	○	●
Open/Close (ON1)/(ON2)	Signalling state as for 1) or 2)												
-	Initial situation: Positioner opening/closing	○	○	○	○	○/⊗	⊗/○	○	○	○	○/●	●/○	○
Counter-command in opposite direction	Signalling state as for 1) or 2)												

● Continuous signal ⊗ Flickering signal ○ No signal

Table 14: Check-Back Signals for Positioner 1

For the active Control Stations and Contactor Controls refer to Table 12: on page 2-33

Notes

- With a Stop command and limit switch Closed (PC) or Open (PO) still closed there is no change to the signalling state.
- Signals from the Torque Switches are active on zero, i.e. the switch is active when the normally closed contact is open. As a result the Check-Back Signal is also present when the Torque Switch is open.

**Positioner 2
POS2**

Positioner control version 2. With this Control Function SIMOCODE-DP shuts down the drive when the Positioner reaches one of the end positions, the Limit Switch Check-Back Signal closed (PC) closes and the Torque Switch closed (TC) opens or the Limit Switch Check-Back Signal open (PO) closes and the Torque Switch Open (TO) opens. The Limit Switch (PO/PC) must respond before the Torque Switch (TO/TC). Compare Table 13: on page 2-36.

Check-Back Signals

The table below shows the Check-Back Signals as a function of the initial situation and the switching command when using Positioner control 2.

Switching command	Comment	Signal from Torque and Limit Switches				Lamp Control			Status message				
		TC	PC	PO	TO	QLE1 (Close)	QLE2 (Open)	QLA (Stop)	On1 (Close)	On2 (Open)	Travel close	Travel open	Off (Stop)
	Initial situation: Positioner closed	●	●	○	○	●	○	○	●	○	○	○	○
Open (ON1)	Torque Switch Closed (TC) is still open and Limit Switch Closed (PC) is still closed	●	●	○	○	●	⊗	○	●	○	○	●	○
-	Torque Switch Closed (TC) is closed and Limit Switch Closed (PC) is still closed	○	●	○	○	○	⊗	○	○	○	○	●	○
-	Torque Switch Closed (TC) is closed and Limit Switch Closed (PC) is open 1	○	○	○	○	○	⊗	○	○	○	○	●	○
-	Limit Switch Open (PO) closes and Torque Switch (TO) is still closed	○	○	●	○	○	⊗	○	○	○	○	●	○
-	Positioner reaches Open end position - Limit Switch Open (PO) is closed and Torque Switch Open (TO) opens	○	○	●	●	○	●	○	○	●	○	○	○
	Initial situation: Positioner open	○	○	●	●	○	●	○	○	●	○	○	○
Close (On2)	Torque Switch Open (TO) is still open and Limit Switch Open (PO) is still closed	○	○	●	●	⊗	●	○	○	●	●	○	○
-	Torque Switch Open (TO) is closed and Limit Switch Open (PO) is still closed	○	○	●	○	⊗	○	○	○	○	●	○	○
-	Torque Switch Open (TO) is closed and Limit Switch Open (PO) is open 2	○	○	○	○	⊗	○	○	○	○	●	○	○
-	Limit Switch Closed (PC) closes and Torque Switch Closed (TC) is still closed	○	●	○	○	⊗	○	○	○	○	●	○	○
-	Positioner reaches Closed end position Limit Switch (PC) is closed and Torque Switch Closed (TC) opens	●	●	○	○	●	○	○	●	○	○	○	○

Switching command	Comment	Signal from Torque and Limit Switches				Lamp Control			Status message				
		TC	PC	PO	TO	QLE1 (Close)	QLE2 (Open)	QLA (Stop)	On1 (Close)	On2 (Open)	Travel close	Travel open	Off (Stop)
	Initial situation: Positioner opening/closing	○	○	○	○	○/⊗	⊗/○	○	○	○	○/●	●/○	○
Stop	Limit Switch Closed (PC) and Open (PO) is open, Torque Switch Closed (TC) and Open (TO) is closed	○	○	○	○	○	○	●	○	○	○	○	●
	Initial situation: Positioner stop	○	○	○	○	○	○	●	○	○	○	○	●
Positioner Open/Close (ON1)/(ON2)	Signalling state as for 1) or 2)												
-	Initial situation: Positioner opening/closing	○	○	○	○	○/⊗	⊗/○	○	○	○	○/●	●/○	○
Counter-command in opposite direction	Signalling state as for 1) or 2)												

● Continuous signal ⊗ Flickering signal ○ No signal

Table 15: Check-Back Signals for Positioner 2

For the active Control Stations and Contactor Controls refer to Table 12: on page 2-33

**Positioner 3
POS3**

Positioner control version 3. With this Control Function SIMOCODE-DP shuts down the drive when the Positioner reaches one of the end positions, the Limit Switch Check-Back Signal closed (PC) closes and the Torque Switch Closed (TC) opens or the Limit Switch Check-Back Signal open (PO) closes. For this, in the closing direction the Limit Switch (PC) must respond before the Torque Switch Closed (TC) and in the opening direction only the Limit Switch open (PO). If the Torque Open (TO) signal is present before the Limit Switch open (PO), SIMOCODE-DP shuts down the drive with the fault "Positioner blocked". Compare Table 13: on page 2-36. The Torque Switch Open (TO) can be deactivated by assigning a fixed level value of 1.

Check-Back Signals

The table below shows the Check-Back Signals as a function of the initial situation and the switching command when using Positioner 3:

Switching command	Comment	Signal from Torque and Limit Switches				Lamp Control			Status message				
		TC	PC	PO	TO	QLE1 (Close)	QLE2 (Open)	QLA (Stop)	On1 (Close)	On2 (Open)	Travel close	Travel open	Off (Stop)
	Initial situation: Positioner closed	●	●	○	○	●	○	○	●	○	○	○	○
Open (ON1)	Torque Switch Closed (TC) is still open and Limit Switch Closed (PC) is still closed	●	●	○	○	●	⊗	○	●	○	○	●	○
–	Torque Switch Closed (TC) is closed and Limit Switch Closed (PC) is still closed	○	●	○	○	○	⊗	○	○	○	○	●	○
–	Torque Switch Closed (TC) is closed and Limit Switch Closed (PC) is open 1	○	○	○	○	○	⊗	○	○	○	○	●	○
	Positioner reaches Open end position - Limit Switch Open (PO) is closed	○	○	●	○	○	●	○	○	●	○	○	○
	Initial situation: Positioner open	○	○	●	○	○	●	○	○	●	○	○	○
Close (On2)	Limit Switch Open (TO) still closed	○	○	●	○	⊗	●	○	○	●	●	○	○
–	Limit Switch Open (PO) open 2	○	○	○	○	⊗	○	○	○	○	●	○	○
	Limit Switch Closed (PC) closes and Torque Switch Closed (TC) is still closed	○	●	○	○	⊗	○	○	○	○	●	○	○
–	Positioner reaches Closed end position - Limit Switch Closed (PC) is closed and Torque Switch Closed (TC) opens	●	●	○	○	●	○	○	●	○	○	○	○
	Initial situation: Positioner opening/closing	○	○	○	○	○/⊗	⊗/○	○	○	○	○/●	●/○	○
Stop	Limit Switch Closed (PC) and Open (PO) is open and Torque Switch Closed (TC) is closed	○	○	○	○	○	○	●	○	○	○	○	●
	Initial situation: Positioner stop	○	○	○	○	○	○	●	○	○	○	○	●
Positioner Open/Close (ON1)/(ON2)	Signalling state as for 1 or 2												
–	Initial situation: Positioner opening/closing	○	○	○	○	○/⊗	⊗/○	○	○	○	○/●	●/○	○
Counter-command in opposite direction	Signalling state as for 1 or 2												

● Continuous signal ⊗ Flickering signal ○ No signal

Table 16: Check-Back Signals for Positioner 3

For the active Control Stations and Contactor Controls refer to Table 12: on page 2-33.

**Positioner 4
POS4**

Positioner control version 4. With this version SIMOCODE-DP shuts down the drive when the Positioner reaches one of the end positions, the Limit Switch Check-Back Signal open (PO) closes and the Torque Switch Open (TO) opens or the Limit Switch Check-Back Signal closed (PC) closes. For this, in the opening direction the Limit Switch (PO) must respond before the Torque Switch Open (TO) and in the closing direction only the Limit Switch Closed (PC). If the Torque Closed (TC) signal is present before the Limit Switch closed (PC), SIMOCODE-DP shuts down the drive with the fault "Positioner blocked".

Compare Table 11: on page 2-27.

The Torque Switch Closed (TC) can be deactivated by assigning a fixed level value of 1.

Check-Back Signals

The table below shows the Check-Back Signals as a function of the initial situation and the switching command when using Positioner 4:

Switching command	Comment	Signal from Torque and Limit Switches				Lamp Control			Status message				
		TC	PC	PO	TO	QLE1 (Close)	QLE2 (Open)	QLA (Stop)	On1 (Close)	On2 (Open)	Travel close	Travel open	Off (Stop)
	Initial situation: Positioner closed	○	●	○	○	●	○	○	●	○	○	○	○
Open (ON1)	Limit Switch Closed (PC) is still closed	○	●	○	○	●	⊗	○	●	○	○	●	○
–	Limit Switch Closed (PC) open 1	○	○	○	○	○	⊗	○	○	○	○	●	○
	Limit Switch Open (PO) closes and Torque Switch(TO) is still closed	○	○	●	○	○	⊗	○	○	○	○	●	○
	Positioner reaches Open end position - Limit Switch Open (PO) is closed and Torque Switch Open (TO) opens	○	○	●	●	○	●	○	○	●	○	○	○
	Initial situation: Positioner open	○	○	●	●	○	●	○	○	●	○	○	○
–	Torque Switch Open (TO) is still open and Limit Switch Open (PO) is still closed	○	○	●	●	⊗	●	○	○	●	●	○	○
	Torque Switch Open (TO) is closed and Limit Switch Open (PO) is still closed	○	○	●	○	⊗	○	○	○	○	●	○	○
	Torque Switch Open (TO) is closed and Limit Switch Open (PO) is open 2	○	○	○	○	⊗	○	○	○	○	●	○	○
–	Positioner reaches Closed end position Limit Switch Closed (PC) is closed	○	●	○	○	●	○	○	●	○	○	○	○
	Initial situation: Positioner opening/closing	○	○	○	○	○/⊗	⊗/○	○	○	○	○/●	●/○	○
Stop	Limit Switch Closed (PC) and Open (PO) is open and Torque (TC) is closed	○	○	○	○	○	○	●	○	○	○	○	●

Switching command	Comment	Signal from Torque and Limit Switches				Lamp Control			Status message					
		TC	PC	PO	TO	QLE1 (Close)	QLE2 (Open)	QLA (Stop)	On1 (Close)	On2 (Open)	Travel close	Travel open	Off (Stop)	
	Initial situation: Positioner stop	○	○	○	○	○	○	●	○	○	○	○	○	●
Positioner Open/Close (ON1)/(ON2)	Signalling state as for 1) or 2)													
-	Initial situation: Positioner opening/closing	○	○	○	○	○/⊗	⊗/○	○	○	○	○/●	●/○	○	
Counter-command in opposite direction	Signalling state as for 1) or 2)													

● Continuous signal ⊗ Flickering signal ○ No signal

Table 17: Check-Back Signals for Positioner 4

For the active Control Stations and Contactor Controls refer to Table 13: on page 2-36.

**Positioner 5
POS5**

Positioner control version 5. This version is intended for drives which have either only Torque Switches or only Limit Switches which are in the form of changeover contacts.

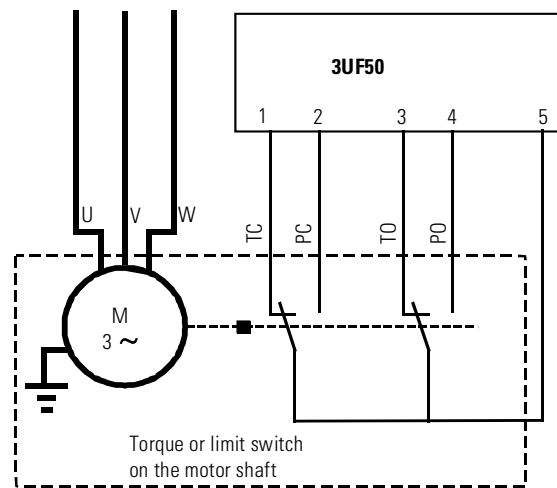

With this Control Function SIMOCODE-DP shuts down the drive when the Positioner reaches one of the end positions, and the changeover contact operates: after approximately 200 ms the changeover contact must have adopted a non-equivalent switching position, otherwise SIMOCODE-DP signals a fault. With this switching variant SIMOCODE-DP cannot determine whether the Positioner is blocked or has reached the end position.

Fig. 28: Torque or Limit Switch as a changeover contact

Check-Back Signals

The table below shows the Check-Back Signals as a function of the initial situation and the switching command when using Positioner 5:

Switching command	Comment	Signal from Torque and Limit Switches				Lamp Control			Status message				
		TC	PC	PO	TO	QLE1 (Close)	QLE2 (Open)	QLA (Stop)	On1 (Close)	On2 (Open)	Travel close	Travel open	Off (Stop)
	Initial situation: Positioner closed	●	●	○	○	●	○	○	●	○	○	○	○
Open (ON1)	Limit switch Closed (changeover contact) not yet operated	●	●	○	○	●	⊗	○	●	○	○	●	○
–	Limit switch Closed (changeover contact) operated, i.e. adopts non-equivalent position 1)	○	○	○	○	○	⊗	○	○	○	○	●	○
	Positioner reaches Open end position-Limit switch Open (changeover contact) operated, i.e. adopts non-equivalent position	○	○	●	●	○	●	○	○	●	○	○	○
	Initial situation: Positioner open	○	○	●	●	○	●	○	○	●	○	○	○
Close (ON2)	Limit switch Open (changeover contact) not yet operated	○	○	●	●	⊗	●	○	○	●	●	○	○
	Limit switch Open (changeover contact) operated, i.e. adopts non-equivalent position 1)	○	○	○	○	⊗	○	○	○	○	●	○	○
–	Positioner reaches Closed end position Limit Switch Closed (changeover contact) operated, i.e. adopts non-equivalent position	●	●	○	○	●	○	○	●	○	○	○	○
	Initial situation: Positioner opening/closing	○	○	○	○	○/⊗	⊗/○	○	○	○	○/●	●/○	○
Stop	Limit switch Open (changeover contact) and Limit Switch Closed (changeover contact) not operated	○	○	○	○	○	○	●	○	○	○	○	●
	Initial situation: Positioner stop	○	○	○	○	○	○	●	○	○	○	○	●
	Signalling state as for 1) or 2)												
–	Initial situation: Positioner opening/closing	○	○	○	○	○/⊗	⊗/○	○	○	○	○/●	●/○	○
Counter-command in opposite direction	Signalling state as for 1) or 2)												

Continuous signal
 Flickering signal
 No signal

Table 18: Check-Back Signals for Positioner 5

For the active Control Stations and Contactor Controls refer to Table 13: on page 2-36.

General comments on Solenoid Valve control

The SIMOCODE-DP system can control Solenoid Valves.

**Positioning command
Open / Close**

After an "Open(ON2)" or "Close(OFF)" positioning command is sent to the Control Station, Contactor Control QE1 is activated or deactivated.

Control function	Control Station			Contactor Control		
	ON1	ON2	OFF	QE1	QE2	QE3
Solenoid Valve (VALV)	-	Open	Close	Open	-	-

Table 19: Active Control Stations, Contactor Controls, Lamp Controls and status messages for a Solenoid Valve

Fault

Contactor Control QE1 is deactivated. In addition a flash signal is present at the Lamp Control QLS, and the Gen. Fault flash signal, the "General Fault" status message and the corresponding signal bit for the fault are present.

Current measurement

The supply leads to the solenoid coil must not be run through the current transformers of the 3UF50 Basic Unit.

Inactive functions

None of the protection functions are active, nor the Standard Function Block "Check-Back Signal Test" or the Check-Back Time Off/On.

In contrast with the other Control Functions, in the case of Solenoid Valve the Run Time is used for monitoring reaching of the end positions: SIMOCODE-DP starts Run Time monitoring together with the "Open" or "Close" command. The Check-Back Signal must confirm that the command has been executed correctly within the set Run Time.

If not, a fault has occurred and SIMOCODE-DP signals "Run Time On" - "End Position Closed" was not reached or "Run Time Off" - "End Position Open" was not reached.

Note

The Run Time can be deactivated by setting the time to "0".

**Solenoid Valve
VALV**

Solenoid Valve control. In relation to the control of Solenoid Valves, the SIMOCODE-DP system can additionally receive Check-Back Signals. These Check-Back Signals are Auxiliary Control Inputs and monitor the operating statuses of the valve. The following signals are evaluated as part of valve control:

The Position Switch Open (PO) and Position Switch Closed (PC) signals from Limit Switches. The Limit Switches close a contact when the valve has reached the Open position (PO=1) or the Closed position (PC=1). They open the contact when the valve leaves the Open position (PO=0) or the Closed position (PC=0).

After an Open command, Contactor Control QE1 remains active until the Close positioning command is issued: the solenoid remains energized until the Close positioning command is received.

Signals

The Check-Back Signals PC and PO are not automatically transmitted in the cyclical message or diagnostic message. They can be assigned to the signal bits of the second byte of the cyclical message.

Check-Back Signals

The table below shows the Check-Back Signals as a function of the initial situation and the switching command when using Solenoid Valve:

Switching command	Comment	Signal Limit Switches		Lamp Control		Status message	
		PC	PO	QLE2 (Open)	QLA (Stop)	On2 (Open)	Off (Stop)
	Initial situation: valve closed	<input checked="" type="radio"/>	<input type="radio"/>	<input type="radio"/>	<input checked="" type="radio"/>	<input type="radio"/>	<input checked="" type="radio"/>
Open (ON1)	Limit switch Closed (PC) is still closed	<input checked="" type="radio"/>	<input type="radio"/>	<input type="radio"/>	<input checked="" type="radio"/>	<input type="radio"/>	<input checked="" type="radio"/>
–	Limit switch Closed (PC) open 1	<input type="radio"/>	<input type="radio"/>	<input type="radio"/>	<input type="radio"/>	<input type="radio"/>	<input type="radio"/>
–	Valve reaches end position Open - limit switch Open (PO) closes	<input type="radio"/>	<input checked="" type="radio"/>	<input checked="" type="radio"/>	<input type="radio"/>	<input checked="" type="radio"/>	<input type="radio"/>
	Initial situation: valve open	<input type="radio"/>	<input checked="" type="radio"/>	<input checked="" type="radio"/>	<input type="radio"/>	<input checked="" type="radio"/>	<input type="radio"/>
Close (On2)	Limit switch Open (PO) is still closed	<input type="radio"/>	<input checked="" type="radio"/>	<input checked="" type="radio"/>	<input type="radio"/>	<input checked="" type="radio"/>	<input type="radio"/>
–	Limit switch Open (PO) open 2	<input type="radio"/>	<input type="radio"/>	<input type="radio"/>	<input type="radio"/>	<input type="radio"/>	<input type="radio"/>
–	Valve reaches end position Closed - limit switch Closed (PC) closes	<input checked="" type="radio"/>	<input type="radio"/>	<input type="radio"/>	<input checked="" type="radio"/>	<input type="radio"/>	<input checked="" type="radio"/>
	Initial situation: valve opening/closing	<input type="radio"/>	<input type="radio"/>	<input type="radio"/>	<input type="radio"/>	<input type="radio"/>	<input type="radio"/>
Counter-command in opposite direction	Signalling state as for 1 or 2						

Continuous signal No signal

Table 20: Check-Back Signals for Solenoid Valve

For the active Control Stations and Contactor Controls refer to Table 19: on page 2-44

CST

In contrast with the other Control Functions, the standard function block "Check-Back Signal Test" is not active with the valve Control Function.

General comments on the Overload Control Function

The SIMOCODE-DP system can also be used solely as an overload relay.

Control function	Control Station			Contactor Control		
	ON1	ON2	OFF	QE1	QE2	QE3
Overload (OVL)	-	-	-	-	-	Active

Active Control Stations, Contactor Controls, Lamp Controls and status messages for the Overload function

Inactive functions

- No switching commands
- No Run Time monitoring
- No Check-Back Signal monitoring
- No Motor On, Motor Off Check-Back Signals

Fault

Contactor Control QE3 is deactivated. In addition a flash signal is present at the Lamp Control QLS, and the Gen. Fault flash signal, the "General Fault" status message and the corresponding signal bit for the fault are present.

Overload OVL

Overload. The Overload Control Function activates Contactor Control QE3 immediately after the supply voltage is connected to the SIMOCODE-DP. This Contactor Control is deactivated only by a fault or by disconnection of the supply voltage.

Contactor Control QE3 must always act directly on the Output Relays.

CST

In contrast with the other Control Functions, the standard function block "Check-Back Signal Test" is not active with the Overload Control Function.

2.6.5 Description of the Function Block Inputs

Function Block Inputs are inside the unit and you can assign them as you require. You can, for example, interrogate protective circuit-breakers or Limit Switches with the help of the Function Block Inputs. All Function Block Inputs are mapped in the unit-specific diagnostic system of the PROFIBUS-DP and activate a diagnostic telegram if there is a change.

CST

(not in the event of OVL)

Check-Back Signal Test. This signal enables the system for the function test "Cold Run". For this purpose, you have to assign the auxiliary contact of the main switch to the CST Function Block Input. With "Cold Run", you can test all switching functions as soon as you disconnect the low-voltage branch with the main switch (main switch OFF --> CST = 1). You can alter assignments or signal states for test purposes.

After cancellation of the CST (main switch ON --> CST = 0), the old configuration is automatically reset.

A fault signal is sent if the CST signal has been activated and current is flowing in the low-voltage branch.

OPO

(not in the event of OVL)
(not during "Off")
(not when UVO = 1)

Operating Protection Off. With this signal, you can lock the low voltage-branch. When a motor cover is removed, for example, an earthing contact may respond. The SIMOCODE-DP then switches off the QE outputs and a fault signal is sent. This signal is evaluated with 0 active (0 $\hat{=}$ fault). The Positioner control is operated up to the limit position "closed".

RTS

(not in the event of OVL)
(not when CST = 1)
(not when UVO = 1)

Ready to Start. This signal shows the SIMOCODE-DP that the supply voltage for the contactors is available. You can use this signal, for example, to interrogate the auxiliary contact of an automatic control-voltage device. If RTS fails, the SIMOCODE-DP switches the QE outputs off and a fault signal is sent (0 $\hat{=}$ fault).

Ext.Fa1, Ext.Fa2

(not in the event of OVL)
(not when UVO = 1)

External Faults. These signals deactivate the QE outputs and activate "group-fault". A fault signal is also produced with the appropriate bits. (0 $\hat{=}$ fault)

External Warning	This signal results in a group warning and the corresponding diagnosis channel is activated. This signal has no influence on the Control Functions.
Emergency Start	A way of deleting the thermal memory and bypassing the Cooling Time, thus allowing a restart. (Reset and Switch-On commands also necessary!). An Emergency Start trips the thermal memory even without previous Overload Trip. The Emergency Start is only activated by edges. A new Overload Trip can never be prevented.
External Diagnosis	With this bit, you can evaluate certain process states by suitable assigning it. This bit is separately processed and evaluated by the MASTER diagnosis function.
Ext.CS1 to 3	External Check-Back Signals. These signals have no effect on the Control Functions. They are mapped in the diagnosis channel.
Test1 with shutdown	A test of the unit's functions with shutdown. QE outputs turned off after 5 s.
Test2 without shutdown	Test of the unit's functions without shutdown. Preferably for tests via the bus while the motor is running.
Reset1 to 3	Three reset inputs with the same functions in order to acknowledge existing faults.
UVO (not in the event of OVL)	<p>Undervoltage Off. This signal is produced by an external voltage watchdog. When the signal is received, the Contactor Controls are deactivated, the time monitor UVO-Time is started and then the following reactions are triggered:</p> <p>If the signal is withdrawn within a certain parameterizable time (UVO-Time), the SIMOCODE-DP reestablishes the former operating status after the Grading Time has expired (when using Star Delta operation, first in star operation).</p> <p>If the signal is not withdrawn within this time, the SIMOCODE-DP signals a fault, and the Contactor Controls QE1 / QE2 / QE3 remain deactivated. The supply voltage of the SIMOCODE-DP has to remain connected.</p>
UVO-Time	<p>Time monitor for undervoltage off. This time monitoring function acts in conjunction with the UVO Function Block Input. When a UVO signal is given, the Contactor Controls are deactivated, the time monitor is started and the following reactions are then triggered:</p> <p>If the signal is withdrawn within the UVO-Time, the SIMOCODE-DP reestablishes the old operating status after the <i>Grading Time</i>. Otherwise, a UVO fault is signalled: the QE outputs remain deactivated and a fault signal is sent. If you set it to 0, a UVO fault is signalled immediately.</p>
Grading Time	The Grading Time brings about time-graded restarting of the drive units after a mains failure. If you set it to 0, the drive units start simultaneously. The supply voltage of the SIMOCODE-DP has to remain connected.

The interrelationship of UVO, UVO-Time, Grading Time and QE

The following diagram shows the interrelationship of UVO, UVO-Time, Grading Time and of the Contactor Controls QE.

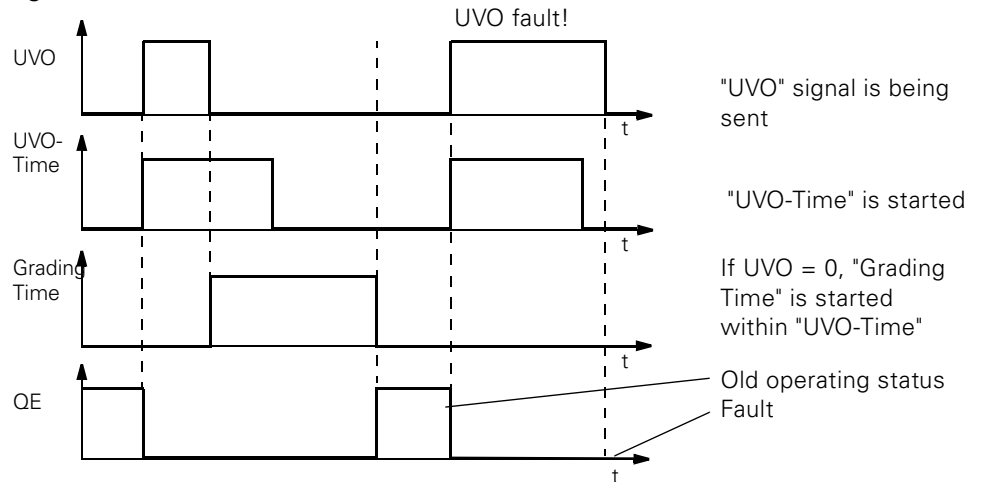

Fig. 29: Interrelationship of UVO, UVO-Time, Grading Time and QE

T-PO

Check-back Time, during which

- current may be cut off when the motor is on,
- current may be detected when the motor is off, without a fault signal being generated.

Settings

The following table contains a description of the settings.

Designation	Range	Comments
Control Functions	UVL, DIR, REV, STAR, PREV, DAHL, POS, VALV, SOFT	POS: 5 variants POS1 to POS5
Run time	0.5 s to 60 min	0: not active Increment 0.1 s
Lock-Out Time	0.5 s to 60 min	
Time monitoring Undervoltage off	0.5 s to 60 min	
Grading time	0.5 s to 60 min	
Time monitoring Check-Back Current ON	0.5 s to 60 min	
Operator Enabling-signals 7 to 1 for Control Stations	0000000 to 1111111	Enter "1" at the corresponding point in order to activate Operator Enabling-signal
Operator Enabling-signals 15 to 9 for Control Stations	0000000 to 1111111	
Inching Mode	Yes / No	

Table 21: Description of the settings for motor control

The parameters are summarized in the parameter table (Appendix A.2).

2.6.6 Test / status LEDs

Description of functions

Test

You can test various functions of the unit. You carry out a test in the following ways:

- with the "Test / Reset" button on the 3UF50 Basic Unit, 3UF52 Operator Panel, Win-SIMOCODE-DP:
manual operation: test with shutdown
automatic operation: test without shutdown (s1 =1 / s2 =1).
- with the "Test1" standard function block. The QE Contactor Controls are deactivated (relay test, manual and automatic operation).
- with the "Test2" standard function block. The QE Contactor Controls are not deactivated. You can also perform this test during operation (manual and automatic operation).

The system automatically carries out a test whenever the supply voltage is turned on.

You can carry out the test

- without the main current. The evaluation electronics for Overload, Thermistor or Earth Fault Detection are tested. In addition, the assignment paths from the Contactor Controls to the Output Relays are tested indirectly, as are the Output Relays themselves and the wiring to the contactors.
- with the main current. All the current-detection functions are tested.

The test can be reset immediately by pressing the "Reset" button.

Test phases

The following table shows the test phases when you hold down the "Test / Reset" button for the corresponding length of time.

Test phase	Status	Without main current		With main current	
		O.k.	Defective	O.k.	Defective
1: < 2s	LED Ready	●	●	●	●
	LED Gen. Fault	●	●	●	●
	Contactor Control	un- changed	un- changed	un- changed	un- changed
2: 2s to 5s	LED Ready	●	○	●	○
	LED Gen. Fault	◐	●	⊗	●
	Contactor Control	un- changed	de- activated	un- changed	de- activated
3: > 5s	LED Ready	●	○	●	○
	LED Gen. Fault	●	●	●	●
	Contactor Control	de- activated	de- activated	de- activated	de- activated

● LED lights up ◐ LED flashes ⊗ LED flickers ○ LED off

Table 22: States of the status LEDs / Contactor Controls during a test

Status LEDs

The Basic Unit has 3 LEDs for displaying specific states of the unit.

LED	Display	Meaning
Ready	Steady green light	Unit is ready for operation
Bus	Steady green light	Bus ready
Gen. Fault	Steady red light	Group fault

Table 23: Status LEDs on the Basic Unit

2.7 Logic modules

2.7.1 Signal Matching

Description of functions

The Signal Matching system has internal inputs and outputs with which, for example, you can match external signals to internal functions of the unit. You can invert signals, react to signal levels or edges and set / reset memories. For this purpose, you can use four components.

Diagram of Signal Matching

The following diagram shows the four components used for Signal Matching.

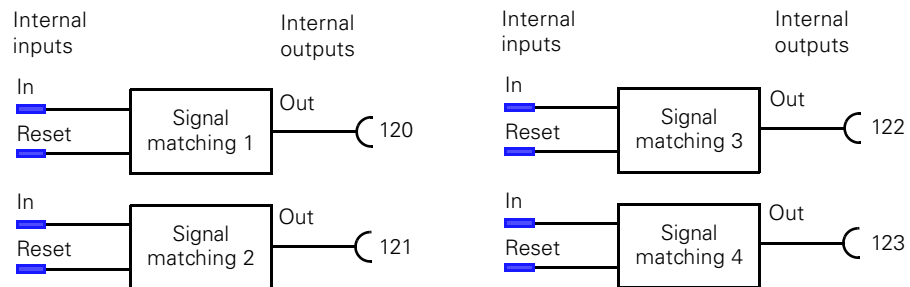

Fig. 30: Diagram of Signal Matching

Diagram of signal types

There are different ways of processing signals at internal inputs SM-In. The following diagram is an overview.

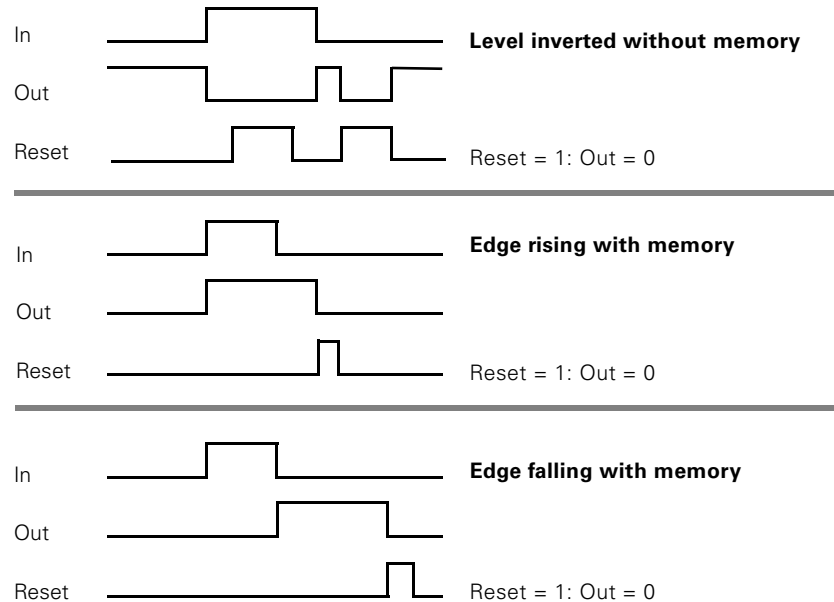

Fig. 31: Diagram of signal types

You can reset the memory with "Reset". Reset is active when a 1-signal is given.

NOR function

You can implement a NOR function with the "level inverted without memory" signal type:

Reset	In	OUT	Diagram
0	0	1	
0	1	0	
1	0	0	
1	1	0	

Table 24: NOR function

Settings

The following table contains a description of the settings.

Designation	Range	Comments
Type of signal	Level inverted without memory Edge rising with memory Edge falling with memory	

Table 25: Description of the settings for types of signal

2.7.2 Non-Resetting Elements on Power Loss

Description of functions

Non-Resetting Elements on Power Loss behave like Signal Matching elements, except that the settings are retained in the event of supply voltage failure. You have 2 blocks available.

Diagram

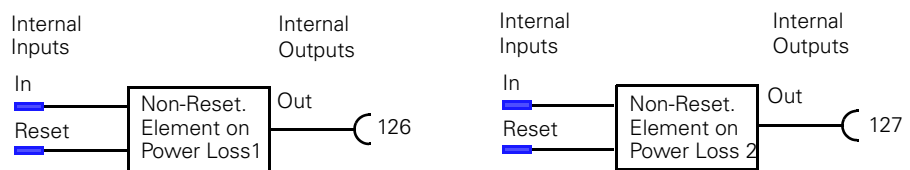

Fig. 32: Diagram of Non-Resetting Elements on Power Loss

Settings

The settings for the signal types are shown in the table above.

2.7.3 Truth Table 3I / 1O

Description of functions

A Truth Table 3I / 1O consists of

- 3 inputs inside the unit
- a logic component
- 1 internal output.

From the eight possible input conditions, you can choose those for which you wish to produce an output signal.

Altogether, three Truth Tables are available.

Diagram of the Truth Tables

The following diagram shows the three Truth Tables.

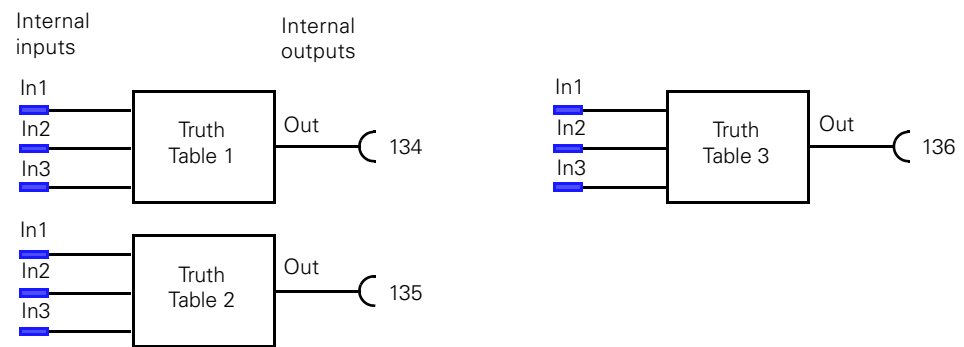
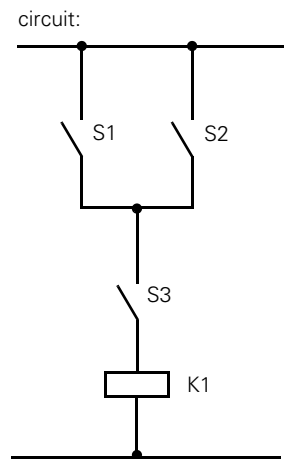

Fig. 33: Diagram of Truth Tables 3I / 1O

Example

You want to set up the following circuit arrangement:



K1 is operated when
(S1 or S2) and S3
or
S1 and S2 and S3

Truth Table, Input conditions with grey background

S1= Input 1	S2= Input 2	S3= Input 3	K1= Output
1	1	1	1
0	1	1	1
1	0	1	1
0	0	1	0
1	1	0	0
0	1	0	0
1	0	0	0
0	0	0	0

Fig. 34: Example of a Truth Table

External circuitry / parameters for the example

The external circuitry and the parameters for the 3UF50 are then as follows:

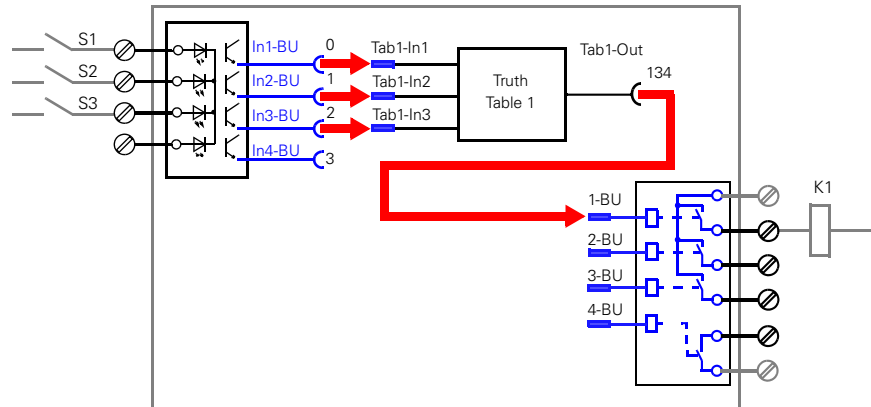

Parameters:

	Parameter designation	Main group	Subgroup	Pre-setting	Selected value
Relay outputs	:	:	:	:	
	1 Basic Unit	Out	1-BU	227	134
	:		:	:	
Truth Tables	Output bit pattern	T-tab	Tab1-type	00000000	11100000
	Table1 Input 1		Tab1-In1	255	0
	Table1 Input 2		Tab1-In2	255	1
	Table1 Input 3		Tab1-In3	255	2

Fig. 35: External circuitry / parameters for the Truth Table example

Settings

The following table contains a description of the settings.

Designation	Range	Comments
Output bit pattern of Truth Table 1	00000000 to 11111111	Enter 1 at the point where an output signal is to be produced in accordance with the selected input conditions. In the example: 11100000 is entered
Output bit pattern of Truth Table 2	00000000 to 11111111	
Output bit pattern of Truth Table 3	00000000 to 11111111	

Table 27: Description of the settings for Truth Tables

**Setting with
COM-PROFIBUS/
STEP 7**

When you are using COM-PROFIBUS / STEP 7 you have one parameter available to you in the DMD file for each Truth Table 3I / 1O in order to generate an output signal in response to the corresponding input conditions. These parameters are "T-Tab 3/1 -> Tab1-Type" to "T-Tab 3/1 -> Tab3-Type", in which you can enter a bit pattern.

Example

You want to generate an output signal given the following input conditions (shaded grey in the table):

Tab1-In1	Tab1-In2	Tab1-In3	Tab1-Out
1	1	1	1
0	1	1	1
1	0	1	1
0	0	1	0
1	1	0	0
0	1	0	0
1	0	0	0
0	0	0	0

To do this, enter the following bit pattern in COM-PROFIBUS / STEP 7:
"T-Tab 3/1 -> Tab1-Type: **11100000**"

2.7.4 Truth Table 5I / 2O

Description of functions

The Truth Table 5I / 2O consists of

- 5 inputs inside the unit
- a logic component
- 2 internal outputs

This works on the same principle as the Truth Tables 3I/1O.

From among the 32 possible input conditions you can choose those for which you want to generate up to 2 output signals.

Diagram

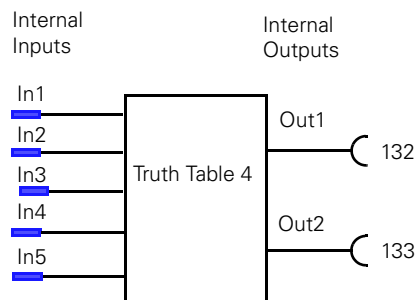

Fig. 36: Diagram of the Truth Table 5I / 2O

Table

No.	In1	In2	In3	In4	In5	Out1	Out2
1	1	1	1	1	1	Bit4.7	Bit8.7
2	0	1	1	1	1	Bit4.6	Bit8.6
3	1	0	1	1	1	Bit4.5	Bit8.5
4	0	0	1	1	1	Bit4.4	Bit8.4
5	1	1	0	1	1	Bit4.3	Bit8.3
6	0	1	0	1	1	Bit4.2	Bit8.2
7	1	0	0	1	1	Bit4.1	Bit8.1
8	0	0	0	1	1	Bit4.0	Bit8.0
9	1	1	1	0	1	Bit3.7	Bit7.7
10	0	1	1	0	1	Bit3.6	Bit7.6
11	1	0	1	0	1	Bit3.5	Bit7.5
12	0	0	1	0	1	Bit3.4	Bit7.4
13	1	1	0	0	1	Bit3.3	Bit7.3
14	0	1	0	0	1	Bit3.2	Bit7.2
15	1	0	0	0	1	Bit3.1	Bit7.1
16	0	0	0	0	1	Bit3.0	Bit7.0

No.	In1	In2	In3	In4	In5	Out1	Out2
17	1	1	1	1	0	Bit2.7	Bit6.7
18	0	1	1	1	0	Bit2.6	Bit6.6
19	1	0	1	1	0	Bit2.5	Bit6.5
20	0	0	1	1	0	Bit2.4	Bit6.4
21	1	1	0	1	0	Bit2.3	Bit6.3
22	0	1	0	1	0	Bit2.2	Bit6.2
23	1	0	0	1	0	Bit2.1	Bit6.1
24	0	0	0	1	0	Bit2.0	Bit6.0
25	1	1	1	0	0	Bit1.7	Bit5.7
26	0	1	1	0	0	Bit1.6	Bit5.6
27	1	0	1	0	0	Bit1.5	Bit5.5
28	0	0	1	0	0	Bit1.4	Bit5.4
29	1	1	0	0	0	Bit1.3	Bit5.3
30	0	1	0	0	0	Bit1.2	Bit5.2
31	1	0	0	0	0	Bit1.1	Bit5.1
32	0	0	0	0	0	Bit1.0	Bit5.0

**Setting with
COM-PROFIBUS/
STEP 7**

When you are using COM-PROFIBUS / STEP 7 you have eight parameters available to you in the DMD file in order to generate the output signals in response to the corresponding input conditions. These parameters are "T-Tab 5/2 -> Tab-Type1" to "T-Tab 5/2 -> Tab-Type8", in which you can enter a bit pattern.

The bit pattern for "T-Tab 5/2 -> Tab-Type1" contains the bits "Bit1.7" to "Bit1.0" as shown in the table above, "T-Tab 5/2 -> Tab-Type8" the bits "Bit8.7" to "Bit8.0". The other parameters are arranged according to the same principle.

Example

You want to generate up to two output signals given the following input conditions (shaded grey in the table):

No.	In1	In2	In3	In4	In5	Out1	Out2
1	1	1	1	1	1	Bit4.7	Bit8.7
2	0	1	1	1	1	Bit4.6	Bit8.6
3	1	0	1	1	1	Bit4.5	Bit8.5
4	0	0	1	1	1	Bit4.4	Bit8.4
5	1	1	0	1	1	Bit4.3	Bit8.3
6	0	1	0	1	1	Bit4.2	Bit8.2

To do this, enter the following bit pattern in COM-PROFIBUS / STEP 7:
 "T-Tab 5/2 -> Tab-Type4: 01010000" (Bit4.6 and Bit4.4)
 "T-Tab 5/2 -> Tab-Type8: 00010000" (Bit8.4)

2.7.5 Flash /Flicker

Descriptions of functions

Flash and Flicker are functions which you can assign, for example, to LEDs 1 to 3 of the Operator Panel or to the Output Relays. In this way, you can create different status displays.

The Flash frequency is approximately 2 Hz and the Flicker frequency approximately 8 Hz.

Diagram

The following diagram shows the Flash / Flicker components.

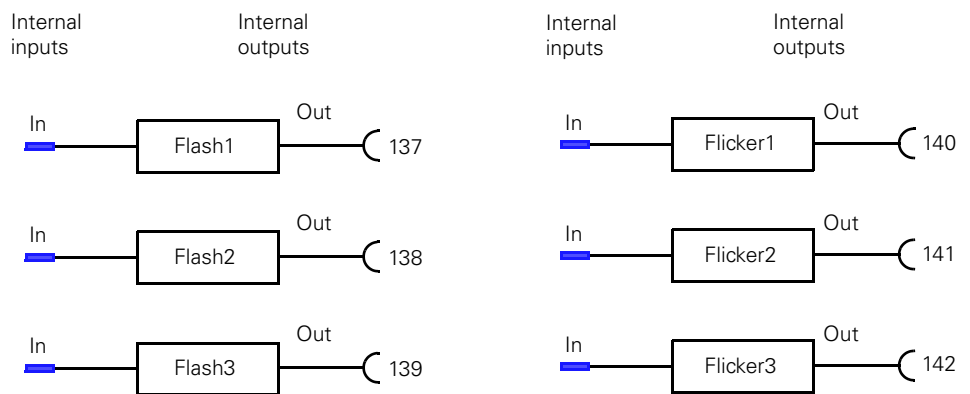

Fig. 37: Diagram of Flash / Flicker components.

2.7.6 Timers

Description of functions

There are two Timers each of which has one internal input and one internal output. You can set the output behaviour and the time.

Diagram

The following diagram shows the two Timers:

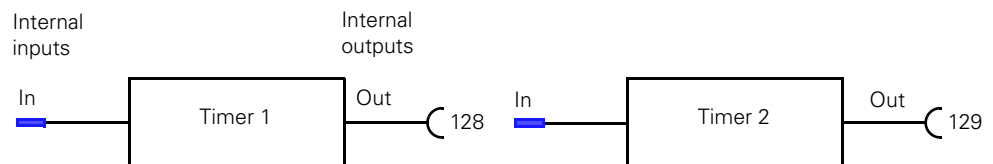

Fig. 38: Diagram of Timers

Output behaviour

There are three ways of specifying the output behaviour of the Timers as illustrated in the following diagram.

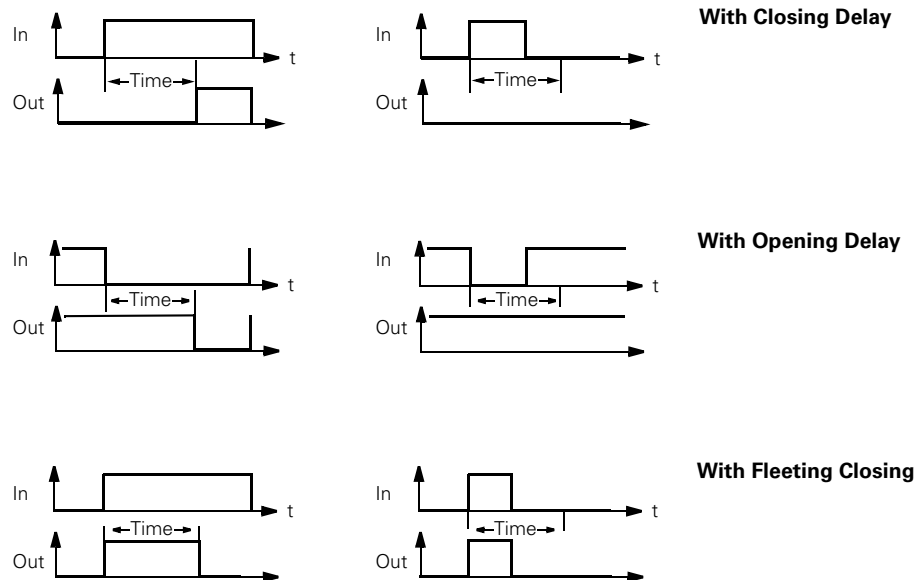

Fig. 39: Output behaviour of Timers

Settings

The following table contains a description of the settings.

Designation	Range	Comments
Time for Timer 1	0.5 s to 60 min	Step 100 ms
Output behaviour of Timer 1	With Closing delay With Opening delay With Fleeting Closing	
Time for Timer 2	0.5 s to 60 min	Step 100 ms
Output behaviour of Timer 2	With Closing delay With Opening delay With Fleeting Closing	

Table 28: Description of the settings for Timers

2.7.7 Counters

Description of functions

The SIMOCODE-DP has two Counters each of which have two internal inputs (Counter-Input and -Reset) and one internal output. You can pre-set an upper limit (maximum 65535). The Counter supplies an output signal when the limit is reached. With Reset, you can reset the Counter and the output to 0.

Diagram

The following diagram shows the two Counters:

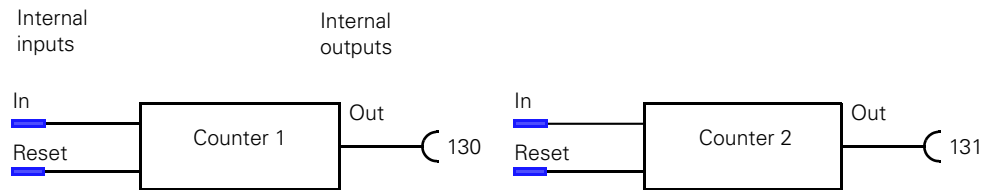

Fig. 40: Diagram of the Counters

Notes

Note the following:

- The time between the events to be counted must be at least 200 ms.
- The Counter reading remains the same during parameterization or if the supply voltage is cut off.

Settings

The following table contains a description of the settings.

Designation	Range	Comments
Upper limit for Counter 1	0 to 65535	
Upper limit for Counter 2	0 to 65535	

Table 29: Description of the settings for the upper limit of Counters

The 3UF51 Expansion Module

Section	Topic	Page
3.1	Description	3-2
3.2	Summary of functions for Expansion Module	3-2
3.3	Inputs	3-3
3.4	Outputs	3-4

3.1 Description

Front

The following diagram shows the front of the Expansion Module:

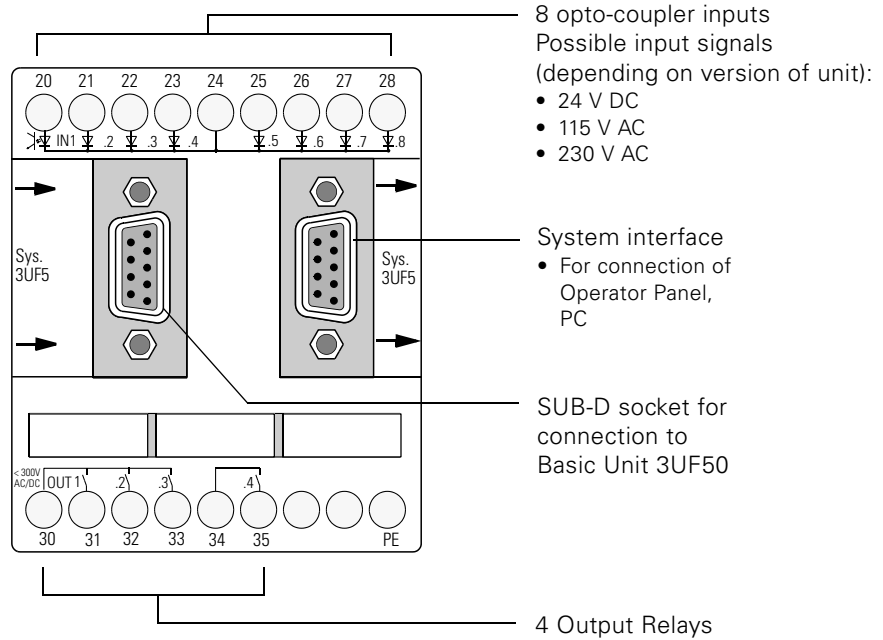

Fig. 41: Front of Expansion Module

Short description

You can use the Expansion Module in order to integrate an additional 8 inputs and 4 outputs in the system.

Termination

You connect the Expansion Module to the 3UF50 Basic Unit.

Note

Only one Expansion Module can be fitted to each Basic Unit.

Power supply

The Expansion Module is supplied with power from the Basic Unit.

3.2 Summary of functions for Expansion Module

Diagram

The following diagram contains a summary of the functions performed by the 3UF51 Expansion Module:

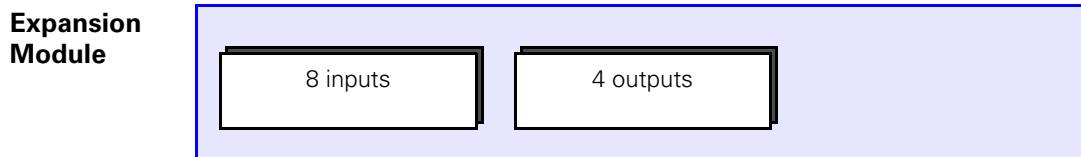

Fig. 42: Summary of functions performed by the Expansion Module

3.3 Inputs

Description of Functions

The Expansion Module has 8 inputs which you can interrogate mechanical contacts or detectors. With the signals, you can, for example, activate auxiliary control inputs such as "Reset" or "Ready To Start (RTS)" by appropriate assignment of the inputs.

Diagram

The following is a diagram of the inputs:

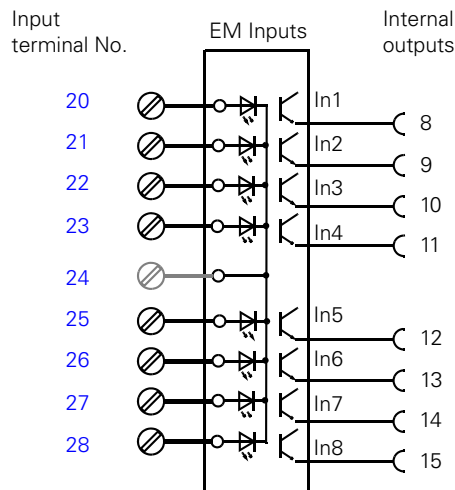

Fig. 43: Diagram of Inputs for Expansion Module

Voltage supply

You can connect up the inputs with *mechanical* contacts and / or *elektronik* sensors (e.g. the BERO® for level measurements). To do this, you need an external voltage supply of

- 24 V DC version 3UF5100-0AB00
 - 115 V AC version 3UF5100-0AJ00
 - 230 V AC version 3UF5100-0AN00
- depending on the version of the unit.

Input circuitry

The following diagram shows the input circuitry:

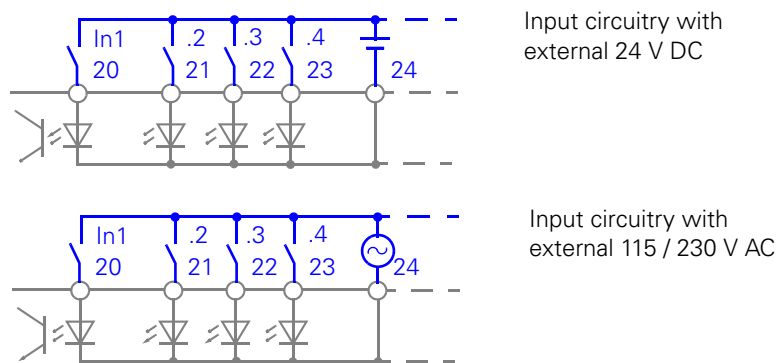

Fig. 44: Diagram of Input circuitry for Expansion Module

Note

It is not possible to connect the supply via terminal 5 of the Basic Unit.

3.4 Outputs

Description of Functions

The Expansion Module has 4 Output Relays with which, for example, you can operate contactors or lamps.

Bistable behaviour

If the status of the Output Relays is to be retained when the supply voltage is cut off, you have to select the 3UF.-3.10-1 version of the unit (bistable behaviour).

Then, you have to set the parameters for

- "Response - 3UF50 CPU Fault" and
- "Response - Control Voltage Fault" to "Retain Status".

If you are using a Basic Unit with monostable behaviour, the Expansion Module will also behave monostably.

Diagram

The following diagram shows the Output Relays

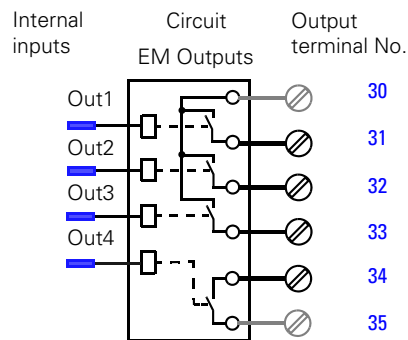



Fig. 45: Diagram of Output Relays for Expansion Module

Assignments

The internal inputs ("plugs" ) can be assigned to any internal outputs ("sockets" ) .

The assignment numbers of the sockets can be found in the assignment table (Appendix A.1).

The parameters where assignment numbers are to be entered are shown in the parameter table (Appendix A.2).

The 3UF52 Operator Panel

Section	Topic	Page
4.1	Description	4-2
4.2	Summary of functions	4-2
4.3	Control buttons, indicator LEDs	4-3
4.4	Test / status LEDs	4-4

4.1 Description

Diagram

The following diagram shows the front and the rear of the Operator Panel.

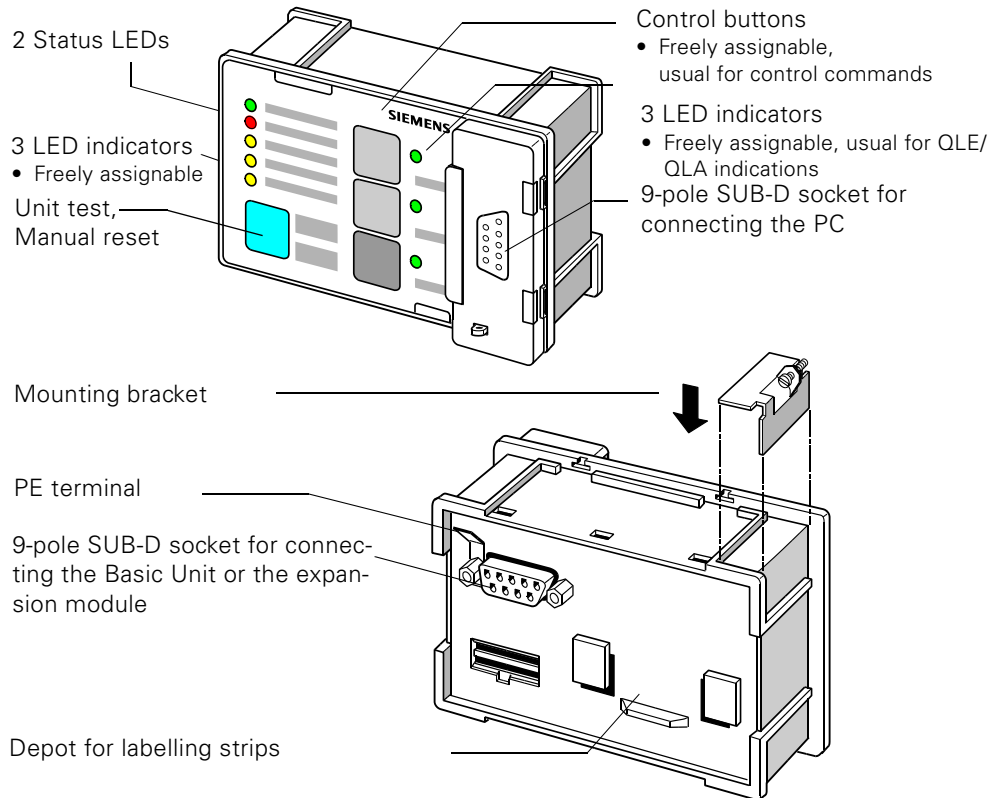

Fig. 46: Operator Panel

Short description

You can use the Operator Panel to control a motor from the control-cubicle door or from a drawer. You can use additional pushbutton functions and LED displays as alternatives.

Termination

The Operator Panel can be connected either to

- the 3UF50 Basic Unit or
- the 3UF51 expansion module.

Power supply

The Operator Panel is supplied with power from the Basic Unit.

4.2 Summary of functions

Diagram

The following diagram is a summary of the functions performed by the 3UF52 Operator Panel:

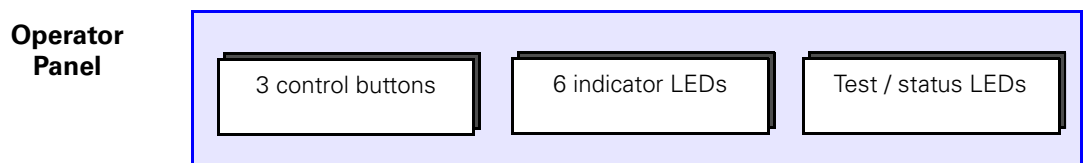

Fig. 47: Summary of the Operator Panel's functions

4.3 Control buttons, indicator LEDs

Description of functions

The unit has three control buttons which are provided to control a motor from the control cubicle, for example On1, On2, Off.

The unit also has six indicator LEDs with which you can create different status displays by assigning them accordingly. To the right of the control buttons, there are three green LEDs. They are provided for displaying the switching status of the control buttons, e.g. On1, On2, Off. You then have to assign the lamp control circuits QLE1, QLE2 and QLA to them.

Diagram

The following diagram shows the control buttons and the freely parameterizable indicator LEDs of the Operator Panel.

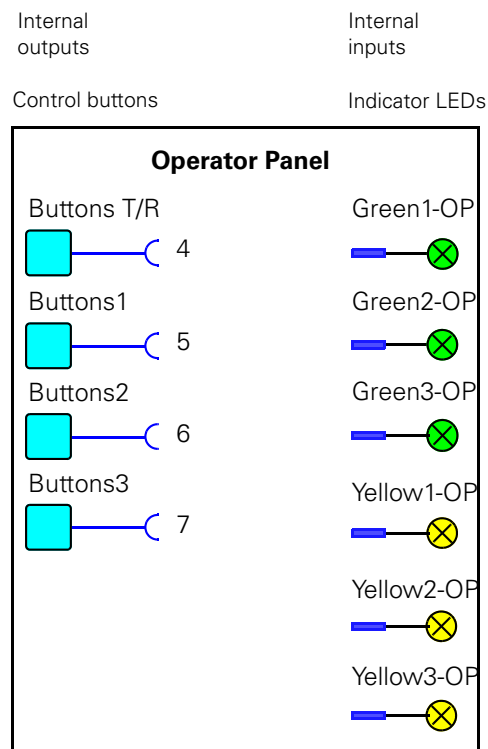

Fig. 48: Diagram of control buttons and indicator LEDs of the Operator Panel

4.4 Test / status LEDs

Description of functions

Test

The testing function is the same as that of the Basic Unit. You can test different functions of the unit by holding down the "Test / Reset" button for a specified time. The "Test / Reset" button is on the front of the module. You can also acknowledge faults with this button.

"Test / Reset" button

The "Test / Reset" button has the same function as the one on the 3UF50 Basic Unit.

Status LEDs

The Operator Panel has two status LEDs for indicating specific states of the units:

LED	Display	Meaning
Ready	Steady green light	Unit is ready for operation
Gen. Fault	Steady red light	Fault in unit

Tabelle 30: Status LEDs on the Operator Panel

Fault Diagnosis

Fault Handling

Warning

Section	Topic	Page
5.1	Behaviour in the event of a fault	5-2
5.2	Acknowledgement and fault handling	5-4
5.3	Parameter Errors	5-9
5.4	Parameterizable fault behaviour in the event of a fault	5-10

5.1 Behaviour in the event of a fault

Description of functions

Displaying fault messages

The SIMOCODE-DP indicates faults and malfunctions in the installation as follows:

- On the Basic Unit and on the Operator Panel, the "Gen. Fault" LED lights up. In the event of bus faults, the "Bus" LED also goes out.
- If you are using Win-SIMOCODE-DP, the corresponding fault message appears in plain text.
- On the PROFIBUS-DP, the corresponding bit is set in the cyclical message and/or diagnosis channel.

Additional reactions

The following reactions are also triggered:

- The QE Contactor Controls are deactivated.
- The QLS Lamp Control is activated.
- The "General Fault" bit is set.

You can assign the "General Fault" bit and/or the QLS Lamp Control to an Output Relay, for example, in order to turn on a fault indicator lamp.

Fast fault analysis with Win-SIMOCODE-DP

For carrying out fast fault analysis, in the event of a fault during commissioning or operation we recommend calling up the "Control/Signal" mask with the Win-SIMOCODE-DP software.



Fig. 49: Fast fault analysis with the "Control/Signal" mask

This mask shows you all currently applicable operational and fault messages, enabling you to carry out fault analysis quickly.

Means of acknowledgement

In order to re-activate the QE1/QE2/QE3 Contactor Controls, you must remedy the faults. There are different ways of acknowledging faults, depending on the kind of fault; for example:

- The reset is performed, and the QE1/QE2/QE3 Contactor Controls are immediately activated.
- The reset is stored, and the QE1/QE2/QE3 Contactor Controls cannot be re-activated until after the fault has been rectified. A further reset is not necessary.
- The reset is stored **in the event of Overload**, and the QE1/QE2/QE3 Contactor Controls cannot be re-activated until after expiry of the Cooling Time. A further reset is not necessary.
- The reset is stored **in the event of Thermistor tripping**, and the QE1/QE2/QE3 Contactor Controls cannot be re-activated until after the value falls below the release value. A further reset is not necessary.

Acknowledging faults

You can carry out an acknowledgement as follows:

- With the Test / Reset button on the Basic Unit or the Operator Panel.
- With the three auxiliary control inputs Reset1, Reset2 and Reset3. You can assign these to an external pushbutton, for example, and/or to a bit of the PROFIBUS-DP.
- With the parameterizable automatic reset. This only takes effect in the following cases:
 - Overload Trip
 - Overload + Asymmetry Trip
 - Thermistor Trip
- With a counter command, for example "Motor Off".

5.2 Acknowledgement and fault handling

Fault handling table



The next four pages contain a table of action to be taken on handling faults. The table applies in cases where the motor was switched on before the fault occurred.

The table contains the following information:

- What fault has occurred and what is its significance.
- What is the behaviour of the QE1/QE2/QE3 Contactor Controls and the QLS/ QLE1/QLE2/QLA Lamp Controls.
- Which status message, warning message and fault message is issued.
- Action to deal with the fault.

The table is also included in Appendix A.

Legend of symbols used and footnotes:

- LED lights up or continuous signal in the case of the QLS/QLE1/QLE2/QLA Lamp Control
- ◐ LED flashes or flashing signal in the case of the QLS/QLE1/QLE2/QLA Lamp Control
- LED off or no signal in the case of the QLS/QLE1/QLE2/QLA Lamp Control
-  Contactor Control QE1/QE2/QE3 deactivated
-  Contactor Control QE1/QE2/QE3 retains its state

- 1) Parameterized behaviour in the event of a "Shutdown" fault
- 2) Parameterized behaviour in the event of a "Warning" fault
- 3) Parameterized behaviour in the event of an "Off" fault
- 4) Parameterized behaviour in the event of a "Retain Status" fault
- 5) Applies to moving of Positioner and fault - signal states as specified
With the Positioner in the end position and a fault, no QLA signal and continuous QLE1 or QLE2 signal according to the end position
- 7) In the case of Positioner and Solenoid Valve control, continuous signal
- 8) Flashing signal only QLE1 until end Position Closed reached, then continuous signal
- 9) In the case of Positioner only reset possible
- 10) In the case of Positioner only continuous signal to QLE1 or QLE2
- 11) In the case of Positioner flashing signals to QLE1 or QLE2
- 12) In the case of Solenoid Valve QLE2 steady light and QLA no signal
- 13) When using the Overload Control Function the QLA/QLE1/QLE2 Lamp Controls are not active

Fault	Meaning	Con- tactor Control	Behaviour of LED		Behaviour of Lamp Control			Status Message	Warning	Fault	Fault handling	
			Gen.Fault		QLS		QLE1 QLE2					QLA
			before Ack- nowl. ment	after Ack- nowl. ment	before Ack- nowl. ment	after Ack- nowl. ment						
Valid for Control Function Overload ¹³⁾, Direct Starter, Reversing Starter, Star Delta Starter, Pole changing Starter, Dahlander Starter, Positioner 1-5, SIKOSTART												
Overload ^{1)positioner}	Overload detected								General Fault	—	Overload	Reset and wait until Cooling Time has expired
Overload ²⁾	Overload detected								General Warning	Overload	—	Clear fault
Overload+ Asymmetry ¹⁾	Overload and Asymmetry detected								General Fault	—	Overload+ Asymmetry	Reset and wait until Cooling Time has expired
Overload+ Asymmetry ¹²⁾	Overload and Asymmetry detected								General Warning	Overload+ Asymmetry	—	Clear fault
Thermistor ¹⁾ PTC Binary	Response value overshoot								General Fault	—	Thermistor	Reset and wait until return value has been reached
Thermistor ²⁾ PTC Binary	Response value undershoot								General Warning	Thermistor	—	Wait until return value has been reached
Thermistor PTC-/NTC Analog	Warning level overshoot/ undershoot								General Warning	Thermistor	—	Wait until return value has been reached
Thermistor PTC-/NTC-Analog	Trip level overshoot/under- shoot								General Warning General Fault	Thermistor	Thermistor	Reset and wait until return value has been reached
Earth Fault ¹⁾	Response value overshoot								General Fault	—	Earth Fault	Reset; Fault occurs again on power up -> Clear fault
Earth Fault ²⁾	Response value overshoot								General Warning	Earth Fault	—	Clear fault
Motor Stalled	Response value overshoot								General Fault	—	Motor Stalled	Reset
Overcurrent [I>], Level ¹⁾	Response value overshoot								General Fault	—	I1/I2> Fault	Reset
Overcurrent [I>], Level ²⁾	Response value overshoot								General Warning	I1/I2> Warning	—	Wait until threshold value is undershot
Undercurrent [I<], Level ¹⁾	Response value undershoot								General Fault	—	I1/I2< Fault	Reset
Undercurrent [I<], Level ²⁾	Response value undershoot								General Warning	I1/I2< Warning	—	Wait until threshold value is overshoot/undershot
Check-Back Curr. Off	Power failure in main circuit without "Open Command" longer than checkback time								General Fault	—	Check-Back Curr. (Off)	Reset or opposite command "Off"
Check-Back Curr. On	Current flow in main circuit without "Close Command" longer than checkback time						¹⁰⁾		General Fault	—	Check-Back Curr. (On)	Reset or opposite command "Off" and clear fault

Fault	Meaning	Con- tactor Control	Behaviour of LED		Behaviour of Lamp Control				Status Message	Warning	Fault	Fault handling
			Gen.Fault		QLS		QLE1 QLE2	QLA				
			before Ack- nowl. ment	after Ack- nowl. ment	before Ack- nowl. ment	after Ack- nowl. ment						
External Fault1	Signal present at function block "External Fault 1"								General Fault	—	Ext. Fault 1	Reset or opposite command "Off"/"Stop" and clear fault
External Fault2	Signal present at function block "External Fault 2"								General Fault	—	Ext.Fault 2	Reset or opposite command "Off"/"Stop" and clear fault
Check-Back Signal Test	Signal present at function block "CST" and current flowing in main circuit								General Fault	—	CST Fault	Reset or opposite command "Off"/"Stop"
Ready To Start	Signal fault at function block "Ready to Start"								General Fault	—	RTS	Clear fault
Undervoltage Off	Signal present at function block "Undervoltage OFF" after expiry of UVO time								General Fault	—	UVO	Reset or opposite command "Off"/"Stop" and clear fault
PLC-CPU-Fault ³⁾	Signal change from 1 to 0 at function block PLC-CPU monitoring								General Fault	—	PLC-CPU-Fault (Signals)	Reset
PLC-CPU-Fault ⁴⁾	Signal change from 1 to 0 at function block PLC-CPU monitoring								General Warning	PLC-CPU-Fault (Signals)	—	Clear fault
DP-Fault ³⁾	Fault on PROFIBUS-DP in Mode 4, Automatic								General Fault	--	DP-Fault (Signals)	Clear fault and reset
DP-Fault ⁴⁾	Fault on PROFIBUS-DP in Mode 4, Automatic								—	—	—	—
Parameter Errors 1-7	See description Parameter Error								Sinal only while transmitting Parameters	—	—	See Table 33 Parameter Errors
Valid for Control Function Overload, Direct Starter, Reversing Starter, Star Delta Starter, Pole Changing Starter, Dahlander Starter, SIKOSTART												
Operational Protection Off	Signal present at function block "Operational Protection Off"								General Fault	—	OPO	Opposite command "Off"; Switching On not possible until fault has been cleared
Run Time On	No current flowing in main circuit after "On Command" and expiry of run time								General Fault	—	Run Time On	Reset or opposite command "Off"
Run Time Off	Current flowing in main circuit after "Off Command" and expiry of run time								General Fault	—	Run Time Off	Reset or opposite command "Off" and clear fault

Fault	Meaning	Con- tactor Control	Behaviour of LED		Behaviour of Lamp Control			Status Message	Warning	Fault	Fault handling	
			Gen.Fault		QLS		QLE1 QLE2					QLA
			before Ack- nowl. ment	after Ack- nowl. ment	before Ack- nowl. ment	after Ack- nowl. ment						
Valid for Control Function Positioner												
Operational Protection Off	Signal present at function block "Operational Protection Off"								General Fault	—	OPO	End position closed must have been reached, then opposite command "Close"
Run Time Close (On)	positioner does not reach end position close after expiry of run time								General Fault	—	Run Time On	Reset or opposite command "Off"
Run Time Open (Off)	positioner does not reach end position open after expiry of run time								General Fault	—	Run Time Offs	Reset or opposite command "Close" and clear fault
Positioner Stalled	Torque switch responds without signal from associated limit switch								General Fault	—	Positioner Stalled	Release the torque switch "Close/Open" with opposite command "Open/Close"
Double 0	Both torque switches have responded simultaneously								General Fault	—	Double 0	Clear fault
Double 1	Both limit switches have responded simultaneously								General Fault	—	Double 1	Clear fault
Status Discrepancy	Positioner has left limit position without move command, not Positioner 5								General Fault	—	Status Discrepancy	Release the limit switch "Close/Open" with opposite command "Open/Close"
Non-Equivalence	The checkback signal (changeover contact) does not have a non-equivalent value when the Positioner reaches its end position, Positioner 5 only								General Fault	—	Non-Equivalence	Clear fault
Valid for Control Function Solenoid Valve												
External Fault 1	Signal present at function block "External Fault 1"								General Fault	—	Ext. Fault 1	Reset or opposite command "Close" and clear fault
External Fault 2	Signal present at function block "External Fault 2"								General Fault	—	Ext. Fault 2	Reset or opposite command "Close" and clear fault
Ready To Start	Signal absent at function block "Ready To Start"								General Fault	—	RTS	Clear fault
Operational Protection Off	Signal present at function block "Protection Off"								General Fault	—	OPO	Opposite command "Close"; Switching On not possible until fault has been cleared
Run Time Close (On)	Solenoid valve does not reach end position close after expiry of run time								General Fault	—	Run Time On	Reset or opposite command "Open"

Fault	Meaning	Con- tactor Control	Behaviour of LED		Behaviour of Lamp Control				Status Message	Warning	Fault	Fault handling
			Gen.Fault		QLS		QLE1 QLE2	QLA				
			before Ack- nowl. ment	after Ack- nowl. ment	before Ack- nowl. ment	after Ack- nowl. ment						
Run Time Open (Off)	Solenoid valve does not reach end position open after expiry of run time								General Fault	—	Run Time Off	Reset or opposite command "Close"
Double 1	Both limit switches have responded simultaneously								General Fault	—	Double 1	Clear fault
Status Discrepancy	Solenoid valve has moved out of end position								General Fault	—	Status Discrepancy	Opposite command "Open/Close"
PLC-CPU Fault ³⁾	Signal change from 1 to 0 at function block PLC-CPU monitoring								General Fault	—	PLC-CPU Fault (Signals)	Reset
PLC-CPU Fault ⁴⁾	Signal change from 1 to 0 at function block PLC-CPU monitoring								General Fault	PLC-CPU Fault (Signals)	--	Clear fault
DP Fault ³⁾	Fault on PROFIBUS-DP in Mode 4, Automatic								General Fault	—	DP Fault (Signals)	Clear fault and reset
DP Fault ⁴⁾	Fault on PROFIBUS-DP in Mode 4, Automatic								—	—	—	—
Parameter Errors 1-7	See description Parameter Errors								Signal only while transmitting parameters	—	—	See Table 33 Parameter Errors

Table 31: Fault Diagnosis, Fault Handling, Warning

Rules

- The table lists the statuses of the Contactor Controls, Lamp Controls, warnings and faults up until acknowledgement, NOT up until fault clearance.
- On overload and in the event of "Retain Status" or "Switch Off" arising from a fault, the general warning and overload warning always precede the status message. The same applies to overload+asymmetry.

5.3 Parameter Errors

Error message	Meaning
Para. Error 0	Discrepancy in Set Current Is1 / Is2, incorrect device version for the Set Current. Example: Basic Unit 1.25A...6.3A, 3UF5001 and set value 20A
Para. Error 1	Incorrect device version for external Earth Fault/Thermistor Motor Protection
Para. Error 2	Discrepancy in detector settings for Thermistor: value for tripping threshold and warning threshold set and no sensor or PTC Binary selected
Para. Error 3	Discrepancy between Set Current and Control Function: Is1 and Is2 set and Control Function Overload, Direct Starter, Reversing Starter, Star Delta Starter, gate/Positioner, Solenoid Valve selected or only Is1 or only Is2 and Control Function Pole Changing Starter and Dahlander Starter set
Para. Error 4	Assignments to Operator Panel parameterized although no such module is connected
Para. Error 5	Assignments to Expansion Module parameterized although no such module is connected
Para. Error 6	Bistable behaviour not available; Basic Unit 3UF50...3...00-1 used
Para. Error 7	Hardware fault, memory defective: replace unit

Table 32: Parameter Errors

5.4 Parameterizable fault behaviour in the event of a fault

Description of functions in the event of a fault

Possibilities

Should you wish, you can parameterize the Fault Response:

- 3UF50-CPU Fault
- Control Voltage Fault
- DP Fault (PROFIBUS-DP)
- PLC-CPU Fault

3UF50-CPU Fault

Failure of the processor belonging to the SIMOCODE-DP.

- "Retain Status" means that the Output Relays remain activated. Only for bistable versions of the unit, otherwise Parameter Error 6.
- "Off" means that the Output Relays are deactivated.

Control Voltage Fault

Failure of the supply voltage for the SIMOCODE-DP.

- "Retain Status" means that the Output Relays remain activated. Only for bistable versions of the unit, otherwise Parameter Error 6.
- When the supply voltage is restored, the SIMOCODE-DP always deactivates all relay outputs first. You have to turn them on again.
- "Off" means the that Output Relays are deactivated.

DP Fault

Failure of the PROFIBUS-DP.

- Only for Control Soint "DP free" (software switch S1=S2=1, operating mode 4).
- The cyclical exchange of data has to have started.
- "Retain Status" means that the QE1/QE2/QE3 Contactor Controls remain activated.
- "Off" means that the QE1/QE2/QE3 Contactor Controls are deactivated.
- When the PROFIBUS-DP recovers, you have to acknowledge.

PLC-CPU Fault

Failure of the programmable controller.

- The Function Block "PLC-CPU" has to be assigned. The SIMOCODE-DP detects a fault if the signal changes from 1 to 0.
- "Retain Status" means that the QE1/QE2/QE3 Contactor Controls remain activated.
- "Off" means that the QE1/QE2/QE3 Contactor Controls are deactivated.
- When the programmable controller recovers, you have to acknowledge.

Settings

The following table contains a description of the settings.

Designation	Range	Comments
3UF50-CPU Fault	Off / Retain Status	"Retain Status" only bistable versions of the unit, acts on the relay outputs
Control Voltage Fault	Off / Retain Status	
DP-Fault	Off / Retain Status	Acts on the QE Contactor Controls circuits and the QL Lamp Controls
PLC-CPU Fault	Off / Retain Status	

Table 33: Description of settings for fault behaviour

Communication / Data transmission

Section	Topic	Page
6.1	Introduction to the PROFIBUS-DP	6-2
6.1.1	Definitions	6-2
6.2	Possibilities of data transmission	6-3
6.3	Description of messages	6-5
6.4	Necessary settings for bus communication with SIMOCODE-DP	6-6
6.5	Decision chart for the PROFIBUS-DP connection	6-9
6.5.1	PROFIBUS-DP connections	6-9
6.5.2	SIMOCODE-DP to SIMATIC S5 with IM308-C	6-11
6.5.3	SIMOCODE-DP to SIMATIC S7 DP master (CPU with integrated DP interface)	6-24
6.6	PROFIBUS-DP configurations	6-36

6.1 Introduction to the PROFIBUS-DP

6.1.1 Definitions

PROFIBUS-DP	PROFIBUS bus system with the DP protocol. DP stands for decentralized periphery. The main task of PROFIBUS-DP is to allow the fast cyclical exchange of data between the central DP master and the peripheral devices.
PROFIBUS-DPV1	PROFIBUS-DPV1 is an extension of the DP protocol. It additionally allows the acyclical exchange of parameter data, diagnostic data, control data and test data.
DP master	A master which performs in accordance with the standard EN 50 170, Volume 2, PROFIBUS, with the DP protocol, is known as a DP master.
Master class 1	A master class 1 is an active station on the PROFIBUS-DP. A characteristic feature is cyclical data exchange with other stations. A typical master class 1 is, for example, a programmable controller with a PROFIBUS-DP connection.
Master class 2	A master class 2 is an optional station on the PROFIBUS-DP. A typical master class 2 is, for example, a PC/PU with an MPI interface and the Win-SIMOCODE-DP/Professional software.
DP slave / DP standard slave	A slave which is operated on the PROFIBUS bus with the PROFIBUS-DP protocol and which performs in accordance with the standard EN 50 170, Volume 2, PROFIBUS, is known as a DP slave.
SIMOCODE-DP S7 slave	A SIMOCODE-DP S7 slave is a particular slave with the following properties: <ul style="list-style-type: none">• It supports the S7 model (diagnosis alarms, process alarms)• It is parameterizable• Reading / writing of data records

If you want to use SIMOCODE-DP as an S7 slave, refer to the latest information on the Internet at

<http://www.ad.siemens.de/ans/2/support/download>

Type data files/DMD	Device master data (DMD) contain DP slave descriptions in a standardized format. Using DMD makes it easier to configure the master and the DP slave.
OM-SIMOCODE-DP	The OM-SIMOCODE-DP (object manager) is a piece of software with which you can enable or disable alarms, for example, under STEP 7. The OM-SIMOCODE-DP forms the interface to Win-SIMOCODE-DP/Professional (if this is installed).

6.2 Possibilities of data transmission

Possibilities of data transmission

The following picture shows the possibilities of data transmission:

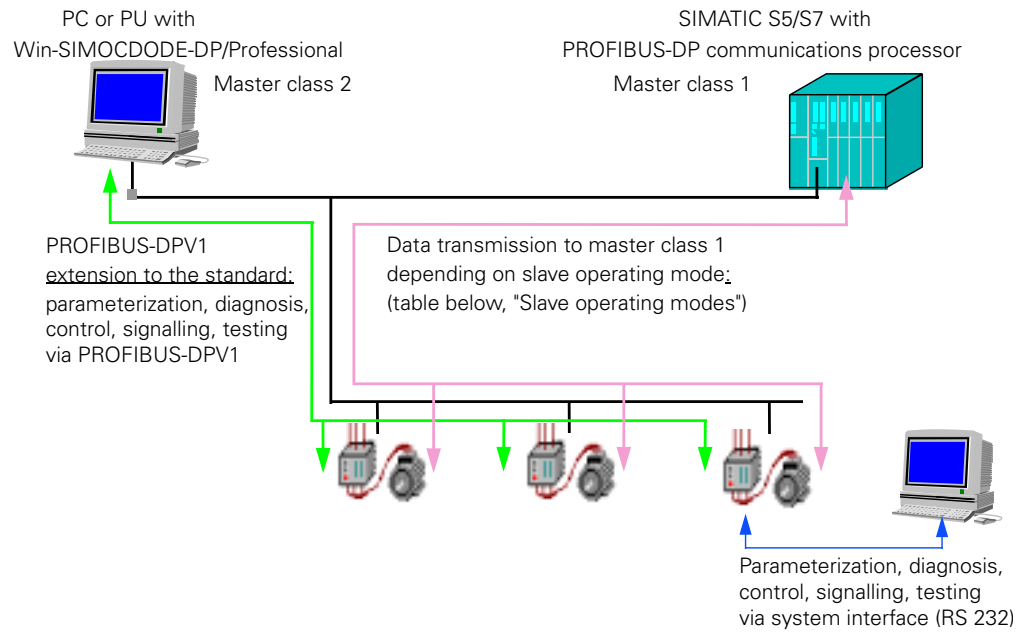

Fig. 50: Possibilities of data transmission

Writing data

Writing data means that data are transmitted **to** the SIMOCODE-DP system.

Reading data

Reading data means that data are transmitted **from** the SIMOCODE-DP system.

Slave operating modes

The table below provides an overview of the slave operating modes with which SIMOCODE-DP can be operated on the master class 1:

SIMOCODE-DP operated as:	Master class 1		
	DP standard master S5, non-proprietary	S5 master IM 308-C	S7 master
DP standard slave	<ul style="list-style-type: none"> • Cyclical data exchange • Standard diagnosis • Device-related diagnosis according to standard • Parameterization during starting 	<ul style="list-style-type: none"> • Cyclical data exchange • Standard diagnosis • Device-related diagnosis according to standard • Parameterization during starting 	<ul style="list-style-type: none"> • Cyclical data exchange • Standard diagnosis • Device-related diagnosis according to standard • Parameterization during starting
DPV1 slave		<ul style="list-style-type: none"> • Cyclical data exchange • Standard diagnosis • Device-related diagnosis according to DPV1 • Parameterization during starting • Read and write acyclical data record from application program 	<ul style="list-style-type: none"> • Cyclical data exchange • Standard diagnosis • Device-related diagnosis according to DPV1 • Parameterization during starting • Read and write acyclical data record from application program
S7 slave			<ul style="list-style-type: none"> • Cyclical data exchange • Standard diagnosis • Process and diagnosis alarm • Parameterization during starting • Read and write acyclical data record from application program

Table 34: Slave operating modes for SIMOCODE-DP on master class 1

6.3 Description of messages

Cyclical data

The cyclical data are exchanged between the PROFIBUS-DP master and slave once in each DP cycle. This involves the PROFIBUS-DP master module sending the control data to SIMOCODE-DP, with SIMOCODE-DP sending the signalling data to the master module in response.

By assigning parameters you can choose between three Basic Types with SIMOCODE-DP; these determine the content of the cyclical data:

- Basic Type 1: master → SIMOCODE-DP: 4 bytes;
SIMOCODE-DP → master: 12 bytes
- Basic Type 2: master → SIMOCODE-DP: 4 bytes;
SIMOCODE-DP → master: 4 bytes
- Basic Type 3: master → SIMOCODE-DP: 4 bytes;
SIMOCODE-DP → master: 4 bytes

A detailed description is given in the appendix.

Diagnostic data

The diagnostic data contain important information about the status of SIMOCODE-DP. This makes for simplified troubleshooting.

In contrast with the cyclical data, the diagnostic data are only transmitted to the master module in the event of a change.

According to PROFIBUS-DP, a distinction is drawn between the following:

- Standard diagnosis
- Device-related diagnosis according to the DP standard (in DP standard operating mode)
- Device-related diagnosis according to the DPV1 standard (in DPV1 operating mode) as a DPV1 slave
- Alarms (in DPV1 operating mode) as an S7 slave.

A detailed description is given in the appendix.

Parameter data during starting

On every startup of SIMOCODE-DP on the PROFIBUS-DP, parameters are sent to the device.

Depending on which master module is used, the parameters transmitted are standard parameters or standard parameters + SIMOCODE-DP parameters. If the current device parameters of SIMOCODE-DP are to be overwritten by the starting parameters, Block DP = no must be set. If Block DP = yes, the starting parameters are discarded and the current SIMOCODE-DP parameters remain active.

Setting of the starting parameters is carried out with the configuring tool if the type data file/DMD file is loaded (when connected as a standard slave/DPV1 slave) or with Win-SIMOCODE-DP/Professional (when connected as an S7 slave).

Reading and writing acyclical data records

If you are using SIMOCODE-DP in DPV1 operating mode, you can make use of the functions of the PROFIBUS-DP standard extension. One aspect of this includes the acyclical DPV1 services for reading and writing data records. This makes it possible to perform operator control, monitoring and parameterization during runtime.

If you have the SIMATIC S5-IM308-C master module you access these services via the function block FB IM308-C, whereas with SIMATIC S7 there are system function calls provided, Read_Rec and Write_Rec.

The procedure for reading and writing can be seen from the examples; a description of the data records is provided in the appendix.

6.4 Necessary settings for bus communication with SIMOCODE-DP

Table

The table below shows which bus parameters can be entered on the SIMOCODE-DP and on the master. Bus parameters in grey fields must match on the SIMOCODE-DP and the master in order to enable communication to take place.

	Master class 1			Master class 2
	DP standard	DPV1	S7 slave	Win-SIMOCODE-DP/Professional
Bus parameters, settings on the SIMOCODE-DP via the system interface (RS 232)				
Bus address	0 -126	0 -126	0 -126	0 -126
Baud rate	9.6 kB - 1.5 MB	9.6 kB - 1.5 MB	9.6 kB - 1.5 MB	9.6 kB - 1.5 MB
Basic Type	1 / 2 / 3	1 / 2 / 3	1 / 2 / 3	—
Operating mode	DP standard	DPV1	DPV1	—
Short diagnosis	yes / no IM 308-B	—	—	—
Block DP	yes / no	yes / no	yes / no	—
Bus parameters, settings on the master				
Bus address	0 -126	0 -126	0 -126	0 -126
Baud rate	9.6 kB - 1.5 MB	9.6 kB - 1.5 MB	9.6 kB - 1.5 MB	9.6 kB - 1.5 MB
Basic Type	1 / 2 / 3 and 1 / 2 / 3 compact	1 / 2 / 3	1 / 2 / 3 compact	—
Diagnosis according to DPV1	—	yes / no	—	—
Alarms	—	—	Process/ diagnosis alarm	—

Bus parameters in grey fields must match on the SIMOCODE-DP and the master, otherwise no communication can be set up

Table 35: Necessary settings for bus communication with SIMOCODE-DP

Bus address

The bus addresses for SIMOCODE-DP devices can be in the range from 0 to 126. Each bus address may be assigned no more than once within the bus system.

Baud rate

The following baud rates are permissible for SIMOCODE-DP devices: 9.6 kbit/s, 19.2 kbit/s, 45.45 kbit/s, 93.75 kbit/s, 187.5 kbit/s, 500 kbit/s, 1.5 MB

Basic Type

You can choose between different Basic Types for the cyclical exchange of data between SIMOCODE-DP and the DP master:

Basic Type	Transmitting (DP master → SIMOCODE-DP)	Receiving (SIMOCODE-DP → DP master)
1	1 to 4 bytes user-specific	12 bytes in total 1 to 2 bytes user-specific
2		4 bytes in total 1 to 2 bytes user-specific
3		4 bytes in total 1 to 4 bytes user-specific

Table 36: Setting the Basic Type

Operating mode

SIMOCODE-DP distinguishes between two operating modes for PROFIBUS-DP communication:

- DP standard: choose this operating mode if you want to use SIMOCODE-DP as a standard slave (with the identification number 0x8031). The device is then compatible with the previous product statuses.
Configuration: with the type data files/DMD files.
- DPV1: choose this operating mode if you want to use SIMOCODE-DP as a DPV1 or S7 slave (with the identification number 0x8069). In this operating mode the unit makes DPV1 services available.
Configuration: as a DPV1 slave with the DMD file SIEM8069.GSG, as an S7 slave with the object manager OM-SIMOCODE-DP in STEP7

Block DP yes/no

With the bus parameter "Block DP" you instruct SIMOCODE-DP to ignore all parameter data which are transmitted to the DP slaves during startup of the DP master. The parameter data which SIMOCODE-DP holds in a non-volatile memory are *not* overwritten by the DP master in this case. When "Block DP" is active, you can only alter the parameter data by entering the new values via the PC.

Caution! When Block DP is deactivated, the next time that PROFIBUS-DP is restarted (startup of the communication processor CP/IM) the current parameter settings of the SIMOCODE-DP will be overwritten by the data record of the memory card etc.

This may render the previous control function ineffective and lead to short circuits in the branch.

Diagnosis according to DP standard for IM308B

Special device-specific diagnosis according to the DP standard for the master module IM308-B:
If the parameter Short diagnosis = yes is selected, SIMOCODE-DP generates diagnosis with a length of 7 bytes, consisting of a header byte 007_H and the last 6 bytes of the above diagnosis.

Diagnosis according to DPV1

If the diagnosis setting is Diagnosis according to DPV1 = yes, SIMOCODE-DP generates device-specific diagnosis according to DPV1. Every time a change occurs, the diagnosis is retransmitted to the master module. If the setting is Diagnosis according to DPV1 = no, there is no diagnosis. You can obtain the SIMOCODE-DP information by reading out the relevant data records.

Details of the diagnosis structure are provided in the appendix.

Alarms

In the OM-SIMOCODE-DP you can enable and disable the following SIMOCODE-DP alarms:

- Diagnosis alarm
- Process alarm in the event of a fault
- Process alarm in the event of a warning.

If an alarm is active, a coming alarm is transmitted as soon as the alarm source = True. If the alarm source switches to False, a going alarm is transmitted. In contrast with diagnosis, alarms are acknowledged; this means that no information can be overwritten and in that way be lost.

A detailed explanation of the method of functioning is given in the appendix.

6.5 Decision chart for the PROFIBUS-DP connection

6.5.1 PROFIBUS-DP connections

Decision chart

The following diagrams show all possible PROFIBUS-DP connections from SIMOCODE-DP with the associated configuration tools:

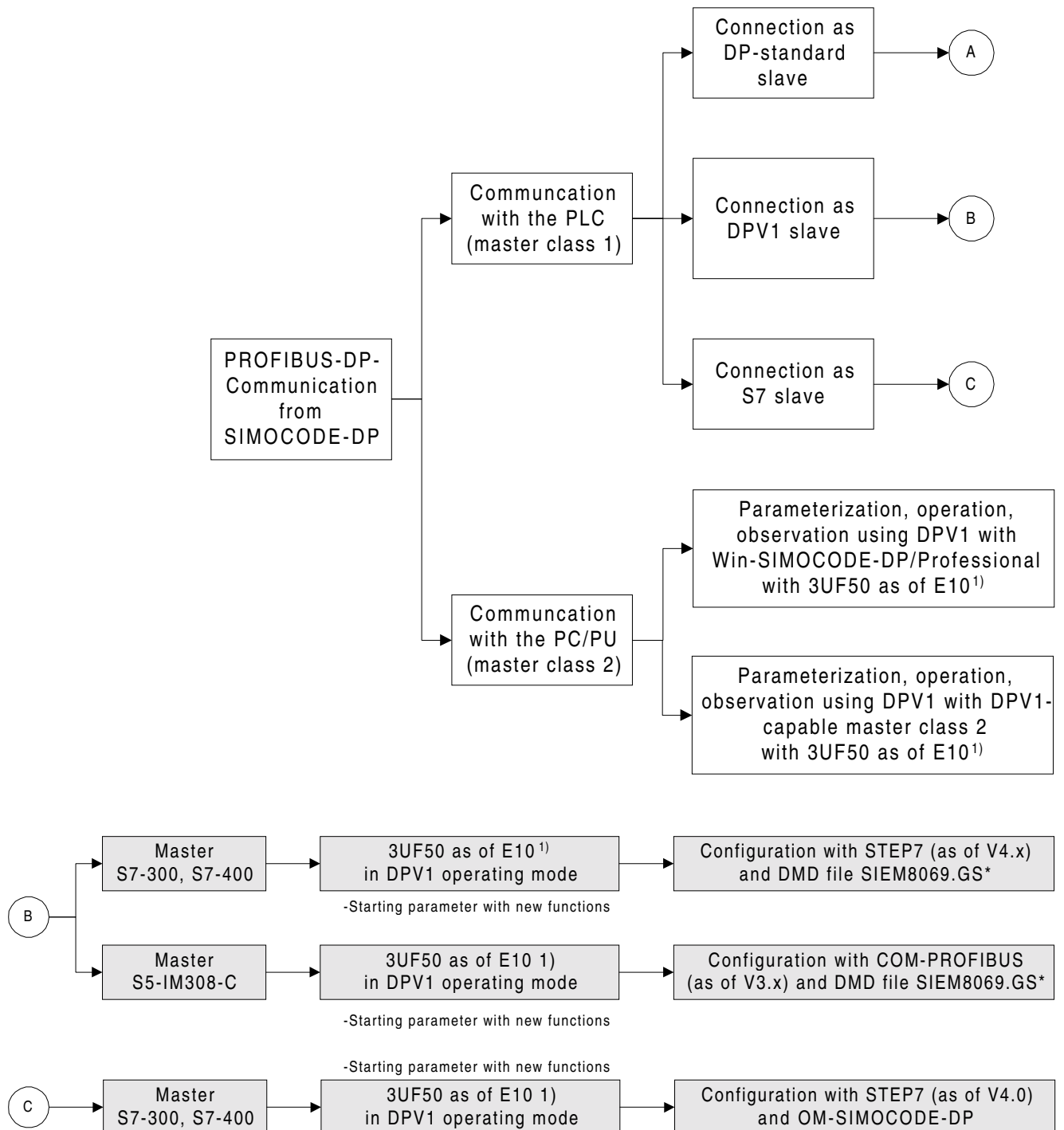

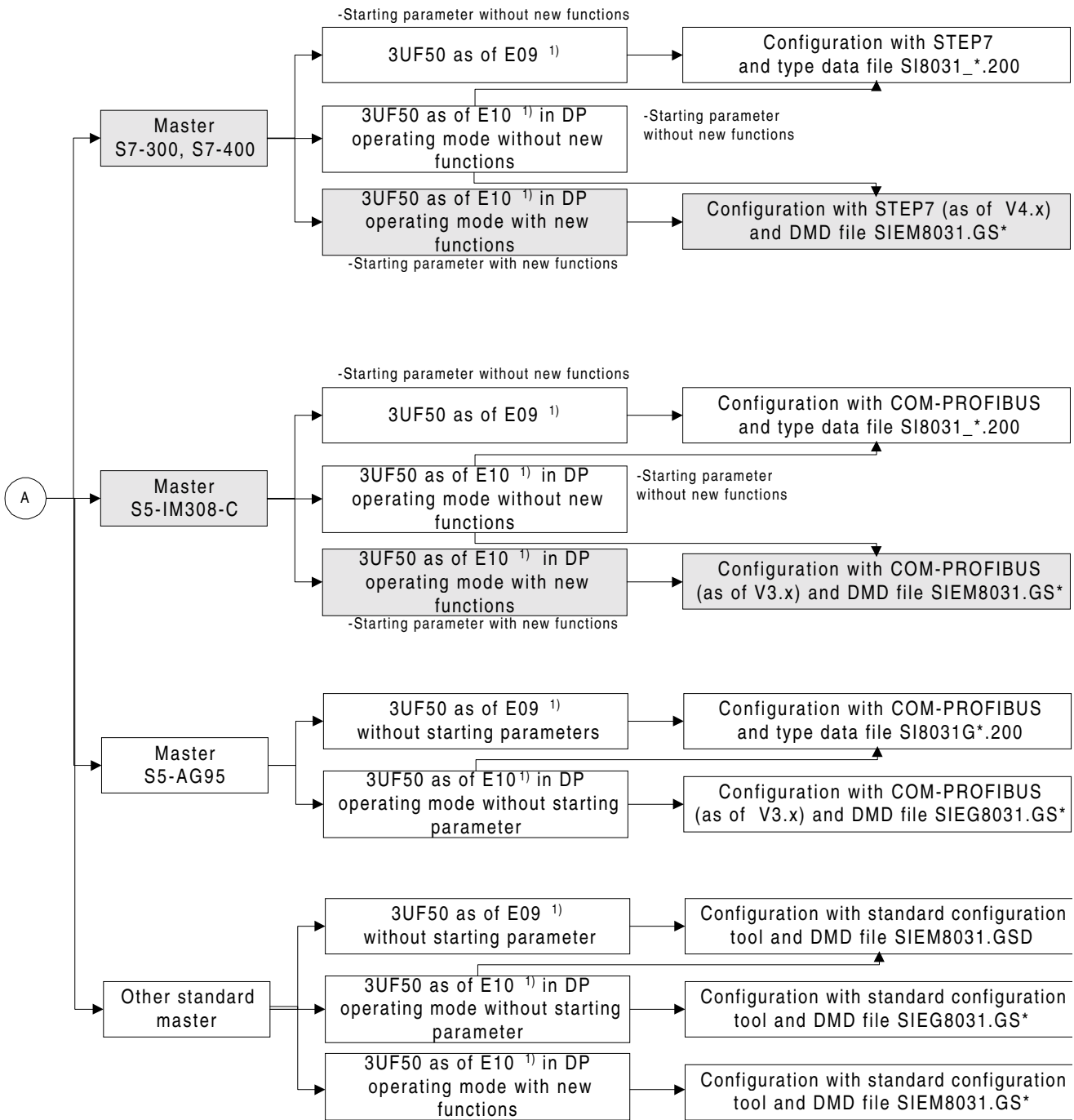

On the following pages you will find descriptions of the PROFIBUS-DP connections shown with shaded boxes.

Supplementary information

The following supplementary information is provided in Appendix D.8:

- Description of the new system functions as of E10¹⁾
- List of type data files/DMD
- Source for obtaining type data files/DMD

6.5.2 SIMOCODE-DP to SIMATIC S5 with IM308-C

Configuring the master system for IM308-C with COM PROFIBUS

COM PROFIBUS

The master system for IM308-C is configured with the COM PROFIBUS software package. The following parameters are specified with this software:

- Bus parameters
- Host parameters
- I/O ranges
- Slave parameters for SIMOCODE-DP

Installation of the DMD

In order to be able to include SIMOCODE-DP units in the master system, you need a corresponding DMD file. A description of which DMD file is needed for which functionality is provided on page C-9.

If the DMD file with the necessary release was not installed together with the COM PROFIBUS program package, you must copy this file retrospectively into the "gsd" subdirectory of the COM PROFIBUS program group. Subsequently the available DMD files are updated in COM PROFIBUS with "File—>Load DMD files". After the DMD has been installed, older versions of type data files for SIMOCODE-DP devices are no longer available.

Configuring SIMOCODE-DP

Including SIMOCODE-DP in the master system

Select SIMOCODE-DP from the switchgear catalog.

Selecting a PROFIBUS address

Select a PROFIBUS address between 3 and 123 for SIMOCODE-DP.

Selecting the station type

SIMOCODE-DP as a DP standard slave. Precondition:

- DMD SIEM8031.GSG
- Set operating mode to "DP standard" with Win-SIMOCODE-DP

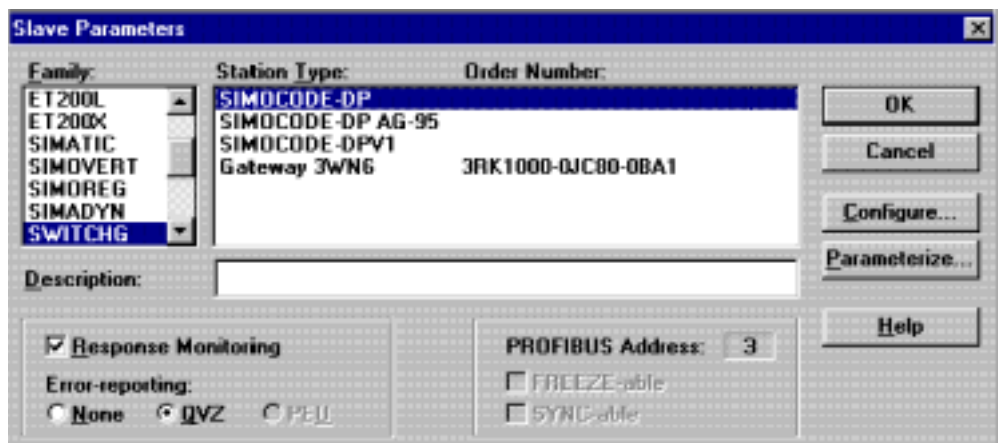

Selecting SIMOCODE-DP as a DP standard slave with COM PROFIBUS

SIMOCODE-DP as a DPV1 slave. Precondition:

- DMD SIEM8069.GSG
- Set operating mode to "DPV1" with Win-SIMOCODE-DP

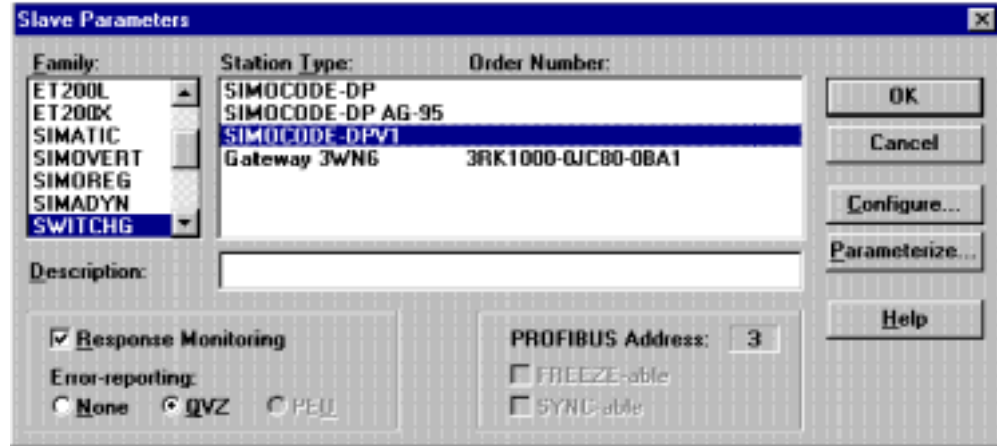

Selecting SIMOCODE-DP as a DPV1 slave

Selecting the required configuration

Select the appropriate Basic Type.

Note

The settings for the address, baud rate and Basic Type must be in agreement with the bus parameters specified with Win-SIMOCODE-DP. The operating mode of SIMOCODE-DP must be set to DP standard. As far as the agreement of the Basic Type is concerned, the "compact" suffix is of no relevance (example: the Basic Type selected with COM PROFIBUS is Basic Type 2 compact - the required SIMOCODE-DP data type is Basic Type 2).

Parameterizing SIMOCODE-DP

The parameters of SIMOCODE DP are set in the "Parameterize" dialog. Default entries are shown for all parameters; these must be changed as necessary.

DP standard:

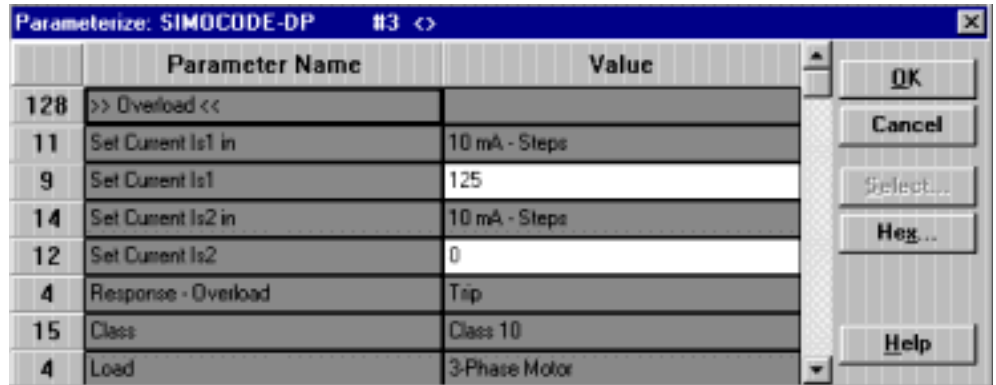

	Parameter Name	Value
128	>> Overload <<	
11	Set Current Is1 in	10 mA - Steps
9	Set Current Is1	125
14	Set Current Is2 in	10 mA - Steps
12	Set Current Is2	0
4	Response - Overload	Trip
15	Class	Class 10
4	Load	3-Phase Motor

DPV1:

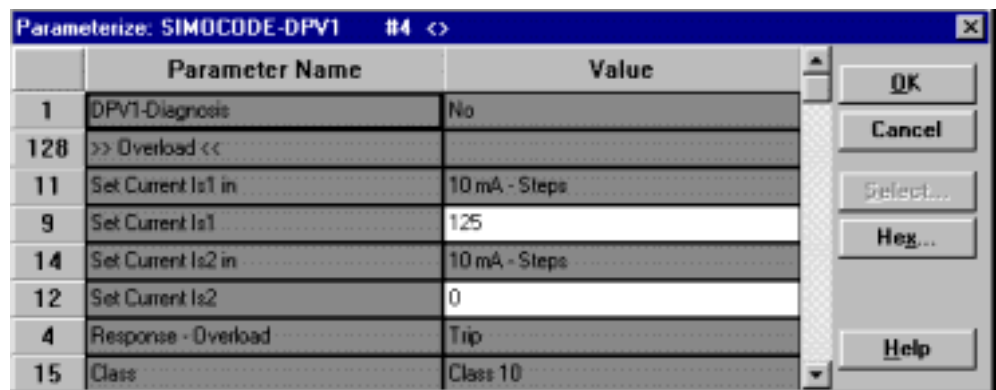

	Parameter Name	Value
1	DPV1-Diagnosis	No
128	>> Overload <<	
11	Set Current Is1 in	10 mA - Steps
9	Set Current Is1	125
14	Set Current Is2 in	10 mA - Steps
12	Set Current Is2	0
4	Response - Overload	Trip
15	Class	Class 10

Fig. 51: Setting parameters for DP standard

Diagnostic data

Requesting diagnostic data

You can evaluate the diagnostic data in the CPU. To do this you need to call the standard function block FB IM308C (FB192) in the application program of the programmable controller. This FB is supplied together with the COM PROFIBUS software package. An up-to-date version of the block is available on the Internet under

<http://www.ad.siemens.de>

At this site, choose "Support, Training and Service —> Customer support —> SIMATIC —> Downloads"

A detailed description of the FB IM308C is provided in the "Decentralized Peripheral System ET 200" manual, Section 10.

Diagnosis selection

You have two ways available to you for requesting diagnostic data:

- Master diagnosis as overview diagnosis
- Slave diagnosis as subordinate diagnosis

Master diagnosis

The SIMOCODE-DP function input "External diagnosis" is mapped within the first 16 bytes of the master diagnosis (overview diagnosis).

If the SIMOCODE-DP function input "External diagnosis" has been assigned to the SIMOCODE-DP status message "General Fault" or "General Warning", for example, the corresponding bit is set in the overview diagnosis if these status messages are active or if the slave cannot be addressed by the DP master.

In this way it is possible to request slave diagnosis selectively in the event of a "General Fault" or "General Warning" from a specific DP slave.

Note

Evaluation of the master diagnosis in conjunction with the standard function block "External Diagnosis" is not possible in DPV1 operating mode.

Slave diagnosis

Slave diagnosis incorporates all diagnostic information relating to the SIMOCODE-DP. The slave diagnostic data of the IM308C can always be requested from the CPU, irrespective of new data. If the slave diagnostic data are not evaluated in conjunction with the master diagnosis, the application program must establish whether the contents of the slave diagnostic data have changed (for example by an old-new comparison).

Further information on slave diagnosis is provided in the "Decentralized Peripheral System ET 200" manual, Section 9.4

Example:

The short example below illustrates how the slave diagnosis for SIMOCODE-DP can be read into the programmable controller with FB IM308C.

The following assumptions apply:

- SIMOCODE-DP is being run in "DP standard" operating mode
- The IM308C occupies page frames 0 to 15 as the DP master
- The station number of SIMOCODE-DP is 3
- The slave diagnosis is to be entered in DB30, from DW 0 onward
- The length of the diagnostic data of SIMOCODE-DP is 20 bytes

```
          :SPA FB 192
Name     :IM308C
DPAD    :   KH F800
IMST    :   KY 0,3
FCT     :   KC SD
GCGR    :   KM 00000000 00000000
TYP     :   KY 0,30
STAD    :   KF +0
LENG    :   KF +20
ERR     :   MW 102
```

Diagnostic data in DP standard operating mode

In "DP standard" operating mode the diagnostic information from SIMOCODE-DP is made available in the form of device-related diagnosis according to the DP standard. For this purpose, in addition to the DP standard part the SIMOCODE-DP-specific diagnostic data with a length of 14 bytes (1-byte header plus 13 diagnostic bytes) are transmitted in the diagnostic message.

Diagnostic data in DPV1 operating mode

In "DPV1" operating mode the diagnostic information from SIMOCODE-DP is made available according to DPV1.

Diagnostic data according to DPV1 are released for each SIMOCODE-DP with COM PROFIBUS in the "Set device-specific parameters" dialog under the parameter "Diagnosis according to DPV1" .

If the diagnostic data according to DPV1 are not released (default setting), SIMOCODE-DP returns only the DP standard part. As a result, evaluation of the diagnostic information as in the example above is not possible.

If the diagnostic data according to DPV1 are released, in addition to the DP standard part (6 bytes) the diagnosis with a length of 11 bytes (4-byte header plus 7 diagnosis bytes) is transmitted in the diagnostic message.

Diagram

The figure below shows how you enable diagnosis according to DPV1:

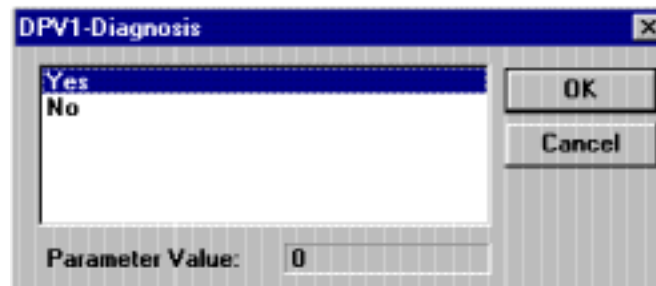

Fig. 52: Enabling diagnosis according to DPV1

Reading / writing a data record in DPV1 operating mode

In order to be able to access the SIMOCODE-DP data records from the programmable controller, you have to call the standard function block FB IM308C (FB192) in the application program on the PLC.

The extended acyclical communication functions (write data record, read data record) of SIMOCODE-DP are available under the following conditions:

- SIMOCODE-DP in "DPV1" operating mode
- Release level of FB IM308C \geq A3
- Release level of IM308C \geq 6

Select FB IM308C (reading / writing of SIMOCODE-DP data records)**Selection of the FB IM308C**

You access SIMOCODE-DP through the IM308C with the FB IM308C. For this purpose you must parameterize the FB IM308C indirectly, i.e. all required parameters are created in a data block (y).

The selection of the FB IM308C is described below. You will find the detailed description of the block parameters in the "Decentralized peripheral system ET 200" Manual, Section 10.3.

AWL				Explanation
	:A	DB	y	Opening the data block y
	:SPA	FB	192	Selecting the FB 192
Name	:IM308			
	C			
DPAD	:	KH0000		
IMST	:	KY0,0		
FCT	:	KCXX		XX: Indirect parameterization
GCGR	:	KM 00000000		
		00000000		
TYP	:	KY0,0		
STAD	:	KF+0		
LEN	:	KF+0		
ERR	:	DW	0	

Data block (y)

In indirect parameterization of the FB IM308C (FCT=XX), the DB y has the following structure starting with data word 0:

Data word	Parameter	DL	DR
DW 0	-	reserved	
DW 1	DPAD	Address range of the IM308C (e.g. F800 _H)	
DW 2	IMST	Number of the IM308C	PROFIBUS address of the DP slave
DW 3	FCT	Function of the FB IM308C	
DW 4	GCGR	reserved	
DW 5	TYP	Type of the STEP 5 memory area	
DW 6	STAD	Start of the STEP 5 memory area	
DW 7	LENG	Number of bytes to be transmitted	
DW 8	ERR	Error word of the FB IM308C	
DW 9		Slot number of the SIMOCODE-DP	Data record number
DW 10		reserved	
DW 11		Errorcode 1	Errorcode 2
DW 12		reserved	

Table 37: Data block (y)

Parameter FCT

Reading / writing SIMOCODE-DP data records can be activated only by indirect parameterization. The functions are activated through the parameter FCT (DW 3) in the data block.

FCT	Description
DW	Initiate write order and write data (Data_WRITE)
CW	Read acknowledgement of the previously initiated write order (Check_Write)
DR	Initiate read order (Data_Read)
CR	Read data and acknowledgement of the previously initiated read order (Check_Read)

Table 38: Parameter FCT

Note

To avoid faulty processing of the write and read orders, you should comply with the following rules:

- A check order (CW) is required after every write order (DW).
- A check order (CR) is required after every read order (DR).

**Parameter
FCT=DW**

You can transmit a data record to the SIMOCODE-DP (write data record) with this function. The function FCT = DW can be executed only by indirect parameterization. The used data block has the following structure:

Data word	Parameter	DL	DR
DW 0	—	not relevant	
DW 1	DPAD	Address range of the IM308C (e.g. F800 _H)	
DW 2	IMST	Number of the IM308C	PROFIBUS address of the DP slave Range 1...123 (is currently not checked)
DW 3	FCT	Function of the FB IM308C: here DW	
DW 4	GCGR	not relevant	
DW 5	TYP	Type of the STEP 5 memory area	
DW 6	STAD	Start of the STEP 5 memory area	
DW 7	LENG	Length of the data record in bytes	
DW 8	ERR	Error word of the FB IM308C	
DW 9	—	Slot number: 04 _H	Data record number
DW 10	—	not relevant	
DW 11	—	Errorcode 1	Errorcode 2
DW 12	—	not relevant	

Table 39: Parameter FCT=DW

**Assignment of the
S5 memory area**

If you have selected FCT = DW, you must assign the S5 memory area as follows:

DB/DX	M/S	Write DS x
DL (n)	Byte (n)	1st byte DS x
DR (n)	Byte (n+1)	2nd byte DS x
⋮	⋮	⋮
DL (n+l)	Byte (n+l)	Last byte DS x

l = Length of DS in bytes

Table 40: Assignment of the S5 memory area for FCT =DW

**Parameter
FCT=CW**

This function reads the acknowledgments of the previously initiated function FCT = DW (write data record). You can infer from the acknowledgments how the function FCT = DW has been concluded (DW 8: Parameter ERR of the FB IM308C; DW 11: Errorcode 1 and 2).

The function FCT = CW can be executed only by indirect parameterization. The used data block has the following structure:

Data word	Parameter	DL	DR
DW 0	—	not relevant	
DW 1	DPAD	Address range of the IM308C (z.B. F800 _H)	
DW 2	IMST	Number of the IM308C	PROFIBUS address of the DP slave Range 1...123 (is currently not checked)
DW 3	FCT	Function of the FB IM308C: here CW	
DW 4	GCGR	not relevant	
DW 5	TYP	not relevant	
DW 6	STAD	not relevant	
DW 7	LENG	not relevant	
DW 8	ERR	Acknowledgement: Error word of the FB IM308C	
DW 9	—	not relevant	
DW 10	—	not relevant	
DW 11	—	Errorcode 1	Errorcode 2
DW 12	—	not relevant	

Table 41: Parameter FCT=CW

**Parameter
FCT=DR**

With this function you can read a data record from SIMOCODE-DP (read data record). The function FCT=DR can be executed only by indirect parameterization. The used data block has the following structure:

Data word	Parameter	DL	DR
DW 0	—	not relevant	
DW 1	DPAD	Address range of the IM308C (z.B. F800 _H)	
DW 2	IMST	Number of the IM308C	PROFIBUS address of the DP slave Range 1...123 (is currently not checked)
DW 3	FCT	Function of the FB IM308C: here DR	
DW 4	GCGR	not relevant	
DW 5	TYP	not relevant	
DW 6	STAD	not relevant	
DW 7	LENG	Length of the data record	
DW 8	ERR	Error word of the FB IM308C	
DW 9	—	Slot number: 04 _H	Data record number
DW 10	—	not relevant	
DW 11	—	Errorcode 1	Errorcode 2
DW 12	—	not relevant	

Table 42: Parameter FCT=DR

**Parameter
FCT=CR**

This function shows the read data record after the previously initiated function FCT = DR (read data record). You can infer from the acknowledgments how the function FCT = DR was concluded (DW 8: Parameter ERR of the FB IM308C; DW 11: Errorcode 1 and 2).

The function FCT = CR can be executed only by indirect parameterization. The used data block has the following structure:

Data word	Parameter	DL	DR
DW 0	—	not relevant	
DW 1	DPAD	Address range of the IM308C (e.g. F800 _H)	
DW 2	IMST	Number of the IM308C	PROFIBUS address of the DP slave Range 1...123 (is currently not checked) However there is an error message at 00 _H or 123 see DW 8
DW 3	FCT	Function of the FB IM308C: here CR	
DW 4	GCGR	reserved	
DW 5	TYP	Type of the STEP 5 memory area	
DW 6	STAD	Start of the STEP 5 memory area	
DW 7	LENG	Length of the data record	
DW 8	ERR	Acknowledgement: Error word of the FB IM308C	
DW 9	—	not relevant	
DW 10	—	not relevant	
DW 11	—	Errorcode 1	Errorcode 2
DW 12	—	reserved	

Table 43: Parameter FCT=CR

**Assignment of the
S5 memory area**

The following table shows the assignment of the S5 memory area. The data contain the data record read from SIMOCODE-DP:

DB/DX	M/S	Read DS x
DL (n)	Byte (n)	1st byte DS x
DR (n)	Byte (n+1)	2nd byte DS x
⋮	⋮	⋮
DL (n+l)	Byte (n+l)	Last byte DS x

l = Length of DS in bytes

Table 44: Assignment of the S5 memory area for FCT = CR

Evaluate error messages of the FB IM308C (DS reading/writing SIMOCODE-DP)**Parameter ERR**

If an error has occurred in processing the FB IM308C, then the DW 8 contains information on the cause of the error. You will find the detailed description of the parameter ERR with the associated error numbers in the "Decentralized peripheral system ET 200" Manual, Section 10.3.3.

**Parameter
Errorcode 1**

The following error numbers are output:

- A9_H : Service is not supported
- B0_H : Access to not existing data record
- B1_H : Wrong data record length on writing
- B2_H : Access to wrong slot (<>4)
- B6_H : Access not possible
- C3_H : Access not possible at the moment (Device not in "Manual" and "Off")

6.5.3 SIMOCODE-DP to SIMATIC S7 DP master (CPU with integrated DP interface)

Configuring the master system with STEP 7 HW Config

STEP7 Version V4.0x

The prerequisite for linking SIMOCODE-DP using the methods described below is STEP7, version V4.0x.

Installing the DMD / OM

In order to be able to include SIMOCODE-DP units in the master system, you need a corresponding set of DMD or the object manager SIMOCODE-DP. A description of which DMD file is needed for which functionality is provided on page C-9.

If the DMD file with the necessary release level was not installed together with the Step 7 program package, you must copy this file retrospectively into the "s7data\gsd" subdirectory of the STEP7 program group. Subsequently you may also have to update the DMD file and/or restart STEP 7.

Future versions of STEP7 will already include the necessary DMD files for SIMOCODE-DP.

If you want to use SIMOCODE-DP as an S7 slave, you require the following software instead of the DMD:

- Object manager SIMOCODE-DP (OM SIMOCODE-DP)
- Win-SIMOCODE-DP/Professional for setting the device parameters

Configuring SIMOCODE-DP

Select SIMOCODE-DP from the switchgear catalog.

Including SIMOCODE-DP in the master system

Selecting a PROFIBUS address

Select a PROFIBUS address between 3 and 123 for SIMOCODE-DP.

Selecting the station type

SIMOCODE-DP as a DP standard slave. Precondition:

- DMD SIEM8031.GSG
- Set operating mode to "DP standard" with Win-SIMOCODE-DP



Selecting SIMOCODE-DP as a DP standard slave with HW Config (Hardware Configuration)

SIMOCODE-DP as a DPV1 slave. Precondition:

- DMD SIEM8069.GSG
- Set operating mode to "DPV1" with Win-SIMOCODE-DP

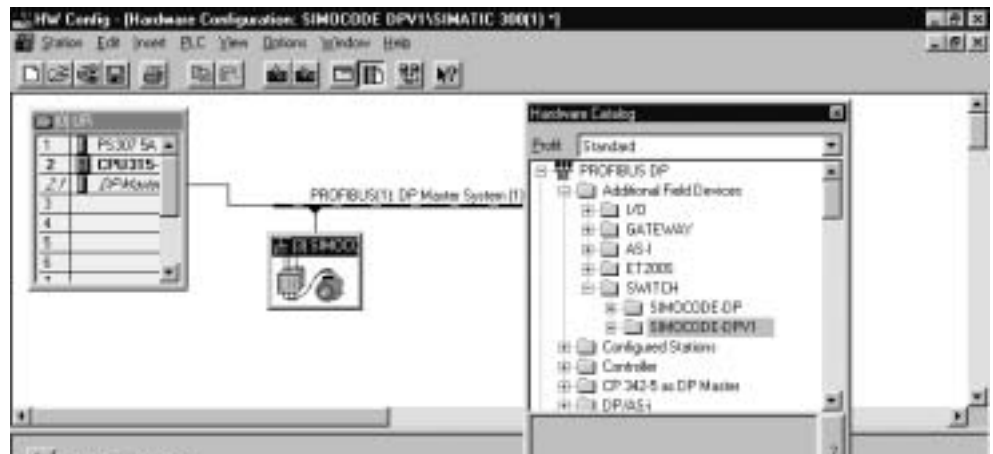

Fig. 53: Selecting SIMOCODE-DP as a DPV1 slave with HW Config (Hardware Configuration)

SIMOCODE-DP as an S7 slave. Precondition:

- OM SIMOCODE-DP. The operating mode "DPV1" set using OM SIMOCODE-DP cannot subsequently be changed.

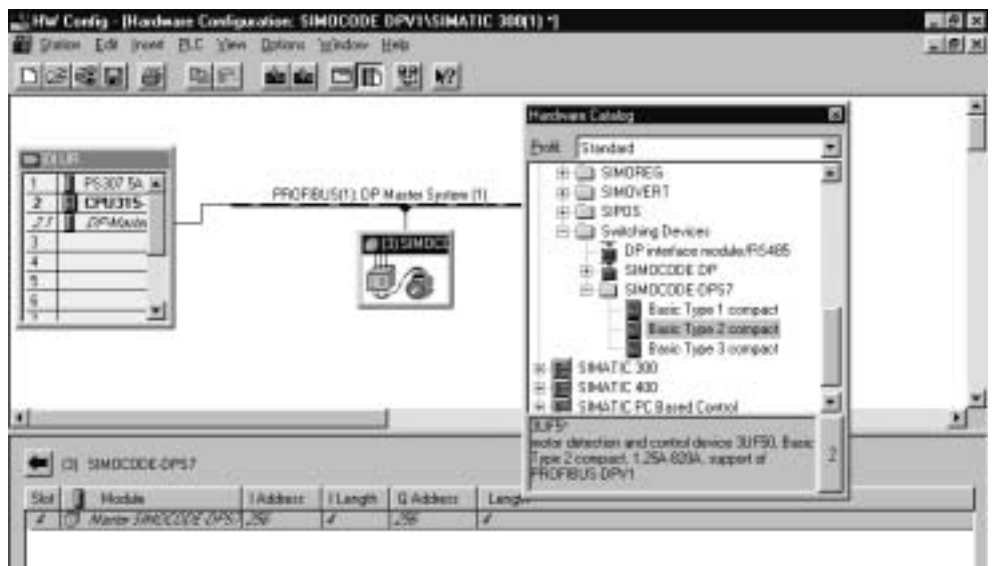

Fig. 54: Selecting SIMOCODE-DP as an S7 slave from the hardware catalog

Selecting the required configuration

Select the appropriate Basic Type.

Note

The settings for the address, baud rate and Basic Type must be in agreement with the bus parameters specified with Win-SIMOCODE-DP. The operating mode of SIMOCODE-DP must be set to DP standard. As far as the agreement of the Basic Type is concerned, the "compact" suffix is of no relevance (example: the Basic Type selected with COM PROFIBUS is Basic Type 2 compact - the required SIMOCODE-DP data type is Basic Type 2).

Specifying operating parameters (OM only)

This is where you specify the slave properties of SIMOCODE-DP. To do this, select module location 4 of SIMOCODE-DP S7.

Choose "Edit —> Object properties" to open the "DP Slave Properties" dialog. On the "Operating parameters" tab select the Basic Type and set the following enabling signals:

- Diagnosis alarm
- Process alarm in the event of a fault
- Process alarm in the event of a warning

Provided that "Win-SIMOCODE-DP/Professional" is installed, you can branch to the parameterization of SIMOCODE-DP by clicking on the "Win-SIMOCODE-DP" button.

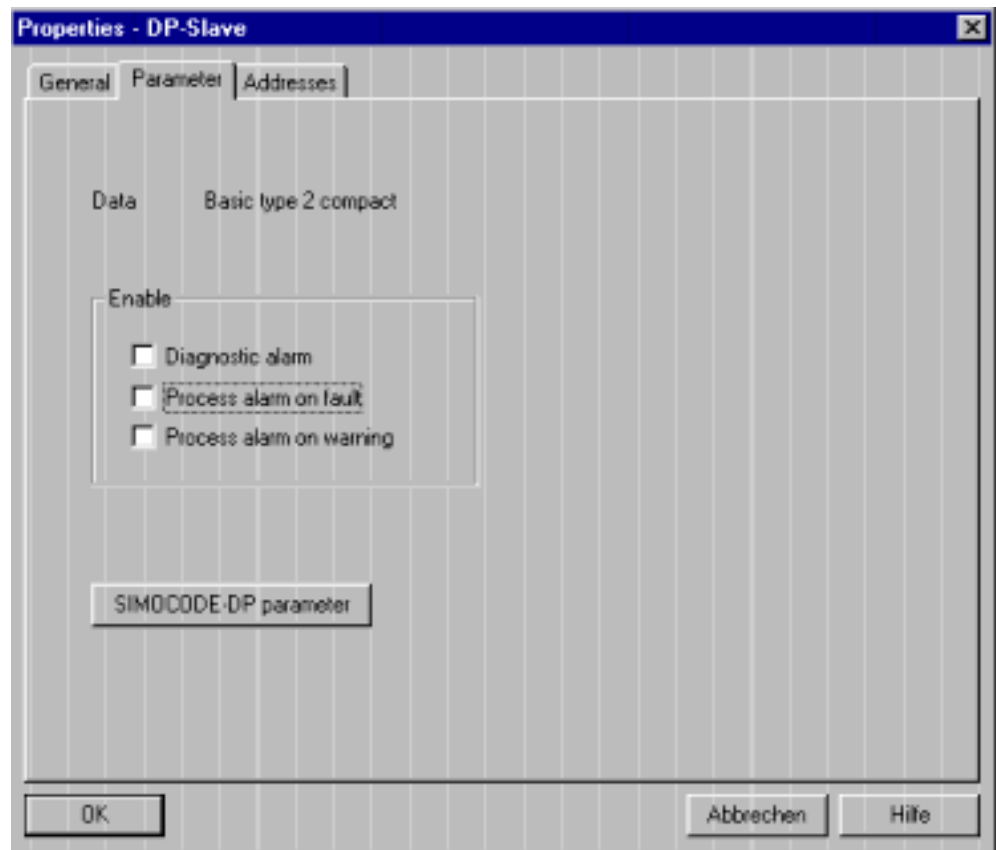

Fig. 55: Specifying operating parameters for SIMOCODE-DP

Parameterizing SIMOCODE-DP

Possibilities

When parameterizing SIMOCODE-DP, a distinction is drawn between:

- Parameterization with DMD files (SIMOCODE-DP as a DP standard slave or DPV1 slave)
- Parameterization with the OM SIMOCODE-DP and Win-SIMOCODE-DP/Professional software packages (SIMOCODE-DP as an S7 slave)

Parameterizing SIMOCODE-DP with a DMD file

You parameterize SIMOCODE DP in STEP 7 HW Config (Hardware Configuration). To do this, open the "Edit —> Object properties" dialog. The "Parameterize" tab contains the parameters. A default value is shown, which can be changed after double-clicking on the relevant parameter.

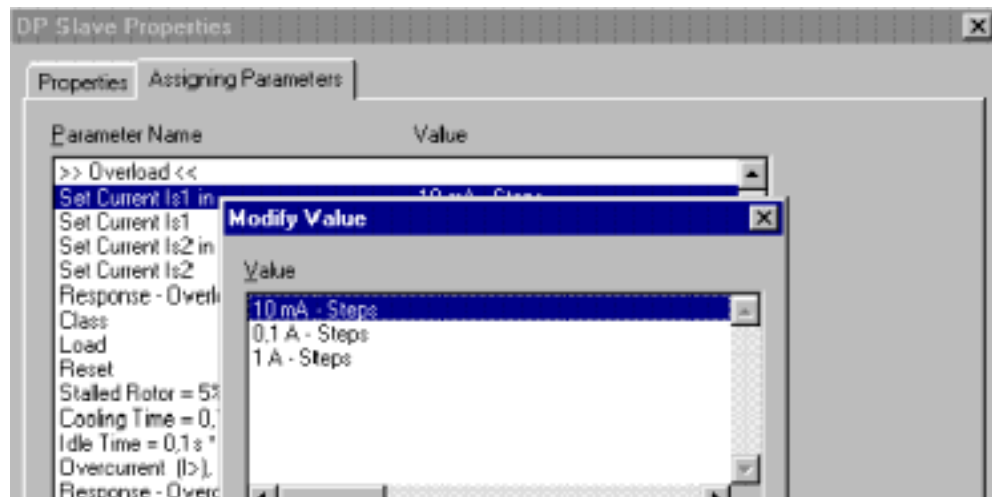

Fig. 56: Parameterizing SIMOCODE-DP via a DMD file

Parameterizing SIMOCODE-DP with OM SIMOCODE-DP and Win-SIMOCODE-DP/Professional

You parameterize SIMOCODE DP with the Win-SIMOCODE-DP/Professional software package, which you start from STEP 7 HW Config (Hardware ConfigurationHardware Configuration).

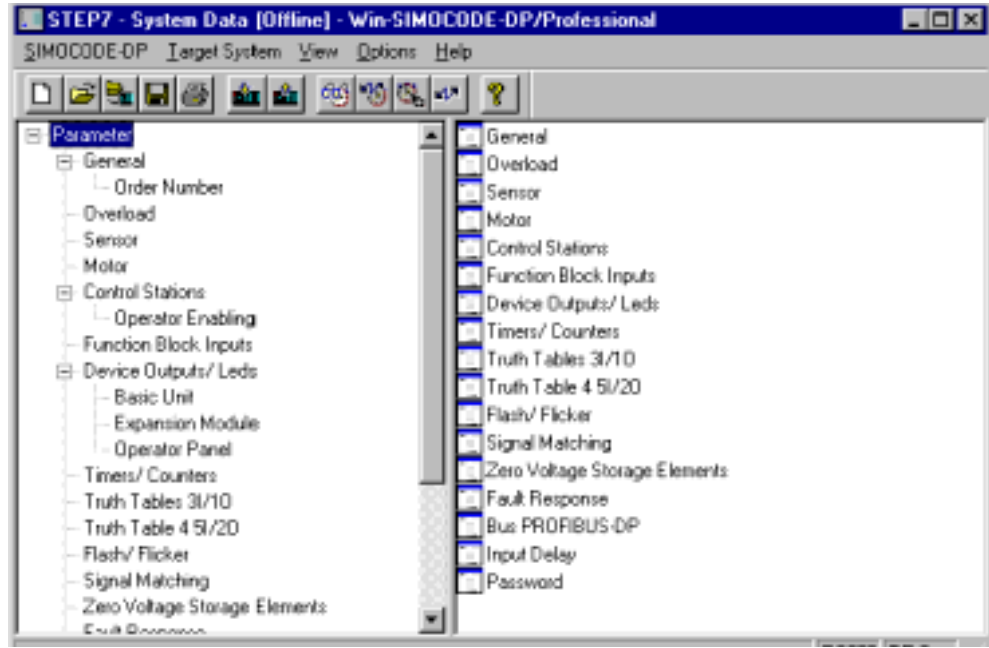

Fig. 57: Parameterizing SIMOCODE-DP with Win-SIMOCODE-DP/Professional

Automatic PROFIBUS-DP settings

After you have started Win-SIMOCODE-DP/Professional from STEP 7 HW Config, all settings for SIMOCODE-DP that are relevant to PROFIBUS-DP are automatically set to the necessary values.

After that you can set further SIMOCODE-DP device parameters.

Transferring the parameters to HW Config

When you return to STEP 7 —> HW Config after parameterization, the parameters created with Win-SIMOCODE-DP/Professional are transferred to HW Config.

- Parameters can only be transmitted when the CPU is in the "STOP" state.
- During startup of the CPU the parameters are transmitted if SIMOCODE-DP is in the "Manual / Off" or "CST" state.

Diagnostic data (SIMOCODE-DP as a DP standard slave or DPV1 slave)**Requesting diagnostic data**

If new diagnostic data is available, OB82 is automatically called in the S7 CPU. If OB82 has not been programmed, the CPU changes the operating status from RUN to STOP. By programming and evaluating the start information of OB82 you can establish which module (in this case SIMOCODE-DP slave) is signalling diagnosis.

The temporary variable OB82_MDL_ADDR contains the diagnosis address of the signalling SIMOCODE-DP.

Further information on processing OB82 is provided in the programming manual "System Software for S7-300/400, Software Design".

Reading out diagnostic data

You configure the diagnosis address for SIMOCODE-DP in HW Config in the "DP Slave Properties" dialog, on the "General" tab. By evaluating the temporary variable OB82_MDL_ADDR you can set the initiation for reading out the diagnostic data in OB82 as follows, for example:

Example

Example of OB82:

Assumption: the diagnosis address for the SIMOCODE-DP slave has been parameterized with 1022 in HW Config.

```

...
L #OB82_MDL_ADDR //Start info OB82: log. base address
L 1022 //Diagnosis address from HW Config,
//in this case 1022
==|
S M 10.0 //Initiation for SFC 13
...

```

Evaluating diagnostic data

In order to allow the diagnostic data to be evaluated in the CPU, SFC13 "DPNRM_DG" must be called in the application program (OB1). In the example below the diagnosis of SIMOCODE-DP as a DP standard slave is read out, with a total length of 20 bytes. The diagnostic data are entered in the data area covered by the RECORD parameter (in this case DB10, bytes 0 to 19). Once the diagnostic data (length: 20 bytes) have been successfully read, flag M 10.2 is set. This flag indicates that new diagnosis is available. After the diagnosis has been evaluated in the application program, flag M 10.2 is reset. Further information on processing SFC 13 is provided in the reference manual "System Software for S7-300/400, System and Standard Functions".

Example

Example of OB1:

Assumption: the diagnosis address for the SIMOCODE-DP slave has been parameterized with 1022 in HW Config.

```
...
CALL SFC 13
  REQ      :=M10.0           //
  LADDR    :=W#16#3FE       //Diagnosis address 1022
  RET_VAL  :=MW12           //
  RECORD   :=P#DB10.DBX 0.0 BYTE 20 //DB 10, bytes 0-19
  BUSY     :=M10.1         //

//Reset initiation (REQ) for SFC 13

U      M      10.0         //Initiation from OB82
UN     M      10.1         //No BUSY?
R      M      10.0         //Reset initiation
//
//Evaluate RET_VAL SFC 13: if the diagnostic data
//has been correctly read,
//RET_VAL contains the length of the diagnostic data.
//
L      MW      12         //RET_VAL SFC 13
L      20         //SIMOCODE-DP: 20 bytes diagnosis
(DP standard)
==I
S      M      10.2         //Set "New diagnosis available"
...
```

Diagnosis according to DPV1

The diagnostic data are available in accordance with DPV1 if you have configured SIMOCODE-DP as a DPV1 slave.

Precondition: diagnosis according to DPV1 has been enabled by setting the "Diagnosis acc. to DPV1" parameter to "Yes".

(For all SIMOCODE-DP devices in HW Config in the "DP Slave Properties" dialog on the "Parameterize" tab).

Requesting diagnostic data

The procedure for requesting diagnostic data is essentially the same as that for the above example for the DP standard. The difference is the length of the diagnostic information. In this case it is 17 bytes. The following adjustments are necessary:

- The RECORD parameter must be adapted with P#DB10.DBX 0.0 BYTE 17.
- The evaluation of RET_VAL with the comparison of the length must be adapted to 17.

If the diagnostic data according to DPV1 are not enabled (default setting), evaluation as described in the above example is not possible because no diagnosis events are signalled from OB82.



Fig. 58: Enabling diagnosis according to DPV1 in HW Config

Evaluating diagnosis and process alarms (SIMOCODE-DP as an S7 slave)

If SIMOCODE-DP is operated as an S7 slave, diagnostic information is made available in the form of diagnosis and process alarms. For this, they have to be enabled (figure on page 6-26).

Process alarms

If a process alarm is present, OB40 is called automatically in the S7 CPU. If OB40 has not been programmed, the CPU changes the operating status from RUN to STOP. By programming and evaluating the start information of OB40 you can establish which module (in this case SIMOCODE-DP slave) is signalling diagnosis.

The temporary variable OB40_MDL_ADDR contains the logical base address of the SIMOCODE-DP that has triggered the alarm. You configure the logical base address for SIMOCODE-DP in HW Config in the "DP Slave Properties" dialog on the "Addresses" tab.

The actual diagnostic information (alarm status of the module) for the logical base address contains the variable OB40_POINT_ADDR.

Further information on processing OB40 is provided in the programming manual "System Software for S7-300/400, Software Design".

By evaluating the temporary variable OB40_MDL_ADDR, therefore, in the OB40 for each SIMOCODE-DP the alarm status of the module can be transferred to an earmarked memory area and initiation for evaluation can be set.

Example of OB40

Example of OB40:

Assumption: the logical base address for the SIMOCODE-DP slave has been parameterized with 256 in HW Config.

```

...
L      #OB40_MDL_ADDR      //Log. base address from
                          //OB40
L      256                 //Log. base address from
                          //HW Config

<>I
SPB   next
S      M      10.2         //"New process alarm"
L      #OB40_POINT_ADDR   //Diagnostic info SIMOCODE-
DP
      T      MD      12    //Enter
next: ...
    
```

The alarm data are then evaluated in the cyclical program. After evaluation of the process alarm data in the cyclical application program, the initiation is reset.

Example of OB1:

Example of OB1:

```

...
UN     M      10.2         //New process alarm?
      SPB   next
      R      M      10.2
      L      MD      12    //Diagnostic info SIMOCODE-
DP
                          .//
                          .//Evaluation of diagnostic
info
                          .//
next: ...
    
```

Diagnosis alarms

If a diagnosis alarm is present, OB82 is called automatically in the S7 CPU. If OB82 has not been programmed, the CPU changes the operating status from RUN to STOP. By programming and evaluating the start information of OB82 you can establish which module (in this case SIMOCODE-DP slave) is signalling diagnosis.

The temporary variable OB82_MDL_ADDR contains the logical base address of the SIMOCODE-DP that has triggered the alarm. You configure the logical base address for SIMOCODE-DP in HW Config in the "DP Slave Properties" dialog on the "Addresses" tab.

The actual diagnostic information (module defect) for the logical base address contains the variable OB82_MDL_DEFECT.

By evaluating the temporary variable OB82_MDL_DEFECT, therefore, in the OB82 for each SIMOCODE-DP the status of the SIMOCODE-DP fault can be entered in an earmarked memory area and initiation for evaluation can be set.

Example of OB82

Example of OB82:

Assumption: the logical base address for the SIMOCODE-DP slave has been parameterized with 256 in HW Config.

```

...
L      #OB82_MDL_ADDR      //Log. base address from
OB82
      L      256           //Log. base address
                          //from HW Config
      <>I
      SPB   next
S      M      10.2         //"New diagnosis alarm"
      U      #OB82_MDL_DEFECT//Diagnostic info SIMO-
CODE-DP
      =      M      12.0     //Set
next: ...

```

The alarm data are then evaluated in the cyclical program. After evaluation of the diagnosis alarm data in the cyclical application program, the initiation is reset.

Example of OB1

Example of OB1:

```

...
UN     M      10.2         //New diagnosis alarm?
      SPB   next
      R      M      10.2
      U      M      12.0     //SIMOCODE-DP faulty?
                          .//
                          .//Evaluation of diagnostic
info
                          .//
next: ...

```

**Writing data records / reading data records
(SIMOCODE-DP as a DPV1 or S7 slave)**

You can access SIMOCODE-DP data records from the application program if you are running SIMOCODE-DP in DPV1 operating mode as a DPV1 or S7 slave connected to an S7 CPU with an integrated DP interface.

Write data records: by calling SFC 58 "WR_REC"

Read data records: by calling SFC 59 "RD_REC" .

Further information about the SFCs is provided in the reference manual "System Software for S7-300/400, System and Standard Functions".

Note

If SIMOCODE-DP is configured as a DPV1 slave (with DMD file siem8069.gsg), the following values must be assigned to parameters IOID and LADDR:

- IOID: always B#16#54, regardless of whether or not outputs occupy lower addresses
- LADDR: always the address of slot 0, regardless of whether or not slot 0 occupies the lowest address

(Deviation from the parameter description of SFC58/59 in the reference manual "System Software for S7-300/400, System and Standard Functions")

**Example
Write data record**

In this example statistical data are to be written to the SIMOCODE-DP-DS 133. The address 256 was configured for SIMOCODE-DP as a DPV1 slave in HW Config in the "DP Slave Properties" dialog on the "Address/Identifier" tab for slot 0. If SIMOCODE-DP is operated as an S7 slave, the address 256 was configured for the inputs and outputs in HW Config in the "DP Slave Properties" dialog on the "Addresses" tab.

The data record that is to be written is to be entered in DB20, bytes 0 to 6. The operating hours counter is to be set to 213*10, the number of motor starts to 244 and the number of trips to 4.

Example of DB 20:

```

DS_133: ARRAY[1..7] BYTE

DS_133[1]BYTE      B#16#0
DS_133[2]BYTE      B#16#D5           //213*10 operating
                                           //hours
DS_133[3]BYTE      B#16#0
DS_133[4]BYTE      B#16#0
DS_133[5]BYTE      B#16#F4           //Number of starts
DS_133[6]BYTE      B#16#0
DS_133[7]BYTE      B#16#4           //Number of
                                           //trips
    
```

Writing DS 133 is initiated once only by setting REQ.

Example of OB1:

```

CALL SFC 58 //Write data record
    REQ :=M20.0
    IOID :=B#16#54 //Identifier for "inputs"
    LADDR :=W#16#100 //Log. base address from
                    //HW Config
    RECNUM :=B#16#85 //DS 133
    RET_VAL:=MW22
    BUSY :=M20.1
    RECORD :=P#DB20.DBX 0.0 BYTE 7//DB20, bytes 0-6

    U M 20.0 //Initiation
    UN M 20.1 //No BUSY
R M 20.0 //Reset initiation

```

Example Read data record

In the following example the DS 131 - Display/Diagnosis of SIMOCODE-DP is to be read. The address 256 was configured for SIMOCODE-DP as a DPV1 slave in HW Config in the "DP Slave Properties" dialog on the "Address/Identifier" tab for slot 0. If SIMOCODE-DP is operated as an S7 slave, the address 256 was configured for the inputs and outputs in HW Config in the "DP Slave Properties" dialog on the "Addresses" tab. The data record that is read is to be entered in DB20, bytes 0 to 17. Reading DS 131 takes place in timed operation for example in the time-interrupt OB, initiated by setting REQ, whereas SFC 59 "RD_REC" is called in OB1.

Example of OB1:

```

CALL SFC 59 //Read data record
    REQ :=M20.0
    IOID :=B#16#54 //Identifier for "inputs"
    LADDR :=W#16#100 //Log. base address
                    //from HW Config
    RECNUM :=B#16#83 //DS 131
    RET_VAL:=MW22
    BUSY :=M20.1
    RECORD :=P#DB20.DBX 0.0 BYTE 18
                    //DB20, bytes 0-17

    U M 20.0 //Initiation from
                    //time interrupt OB
    UN M 20.1 //No BUSY
R M 20.0//Reset initiation

```

After it has been successfully read, DS 131 is contained in the data area covered by the RECORD parameter (in this case DB20, bytes 0 to 17)

Error messages

The error messages are transferred in RET_VAL (80 + Errorcode 1 on page 6-23).

Example: RET_VAL = 80A9_H : "Service is not supported"

6.6 PROFIBUS-DP configurations

Definition

The basic data specified in this section apply to Siemens products and cables.

What is a bus segment?

The PROFIBUS-DP consists of at least one bus segment. A bus segment has at least two stations, one of which has to be a DP master. A maximum of 32 stations can be connected to a bus segment. A terminating resistor has to be connected at the beginning and end of the bus.

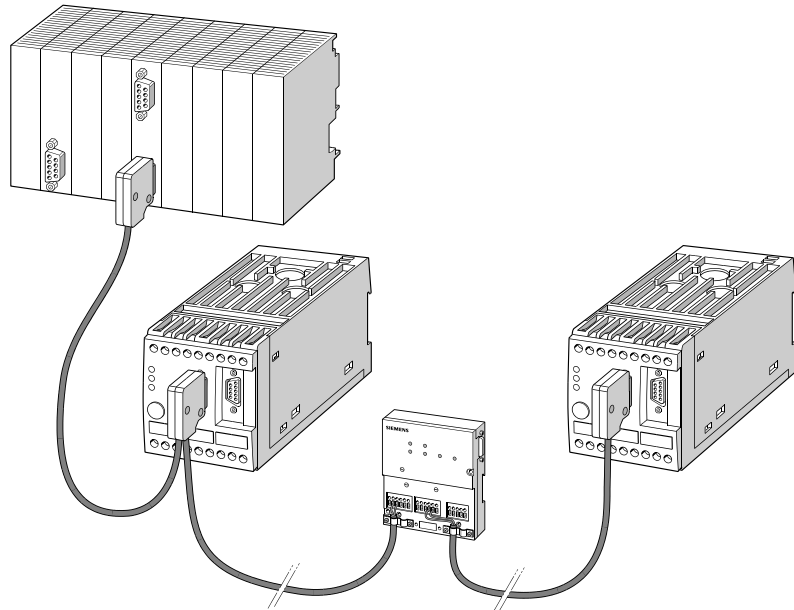

Fig. 59: Bus segment

Basic data for a bus segment

In a bus segment, you can connect a maximum of 32 stations with each other. The maximum cable length of a bus segment depends on the baud rate which has been set.

Baud rate [kbit/s]	Max. cable length of a segment [m]
9.6 to 93.75	1200
187.5	1000
500	400
1500	200

Table 45: Basic data for a bus segment

The bus cable is looped through all SIMOCODE-DP devices. It has to be terminated at both ends with a resistor. The bus connector contains a terminating resistor which can be connected if necessary.

Rules for more than 32 stations

If you want to operate more than 32 stations on a bus, you have to link the bus segments via RS 485 repeaters. A repeater counts as a physical station in both bus segments. It does not occupy an address. All bus segments **together** have to have at least one DP master and one DP slave.

Basic data for linking bus segments

In the ET 200 decentralized peripheral system, you can operate a maximum of 126 stations on a bus, of which a maximum of 124 can be DP slaves. With an IM 308-C, you can send signals to a maximum of 122 DP slaves. Each RS 485 repeater counts as a physical station (reason: it consumes power) but it does not occupy a bus address. As soon as **one** RS 485 repeater is in a segment, only a maximum of 31 additional stations can be connected. The number of RS 485 repeaters has no effect on the total number of stations on a bus.

Up to 10 bus segments can be placed in a row. The distance between the stations farthest apart must not exceed the values given in the following table.

Baud rate [kbit/s]	Max. distance between two stations [m]
9.6 to 93.75	12.000
187.5	10.000
500	4.000
1500	2.000

Table 46: Distance between two stations

Length of the spur lines

If you do not route the bus cable directly via the bus connector, e.g. if MCC with drawable units are used or if you use bus terminals, you have to keep within the maximum lengths of the spur lines. The following table contains the maximum lengths of **all** spur lines belonging to a segment.

Baud rate [kbit/s]	Max. length of the spur lines per segment [m]	Number of stations with spur line lengths of...	
		1.5 to 1.6 m	3 m
9.6 to 93.75	96	32	32
187.5	75	32	25
500	30	20	10
1500	10	6	3

Table 47: Length of the spur lines

Wiring and connecting the T-clamp

Proceed as follows if you use a T-clamp.

Step	Procedure
1	Insulate the bus cable in accordance with the following diagram: 
2	Place the two green and the two red cores as well as the cable screen in the screw terminal block in accordance with the following diagram: 
3	Tightly screw the T-clamp to screw terminals A, B and SPE/PE of the SIMOCODE-DP unit.

Table 48: Wiring and connecting the T-clamp

Using bus termination modules

The 3UF1900-1K.00 bus termination module is best suited for use in MCC motor branches. It ensures correct termination of the bus even when the MCC withdrawable units have been removed. The bus termination module can also be used if a (Sub-D) standard connector cannot be used on the last unit of a bus line.

The 3UF1900-1KA00 can be connected to 220/230 V, 380/400 V, 115/120 V or 24 V AC voltage as required. For 24 V DC voltage, you can use version 3UF1900-1KB00.

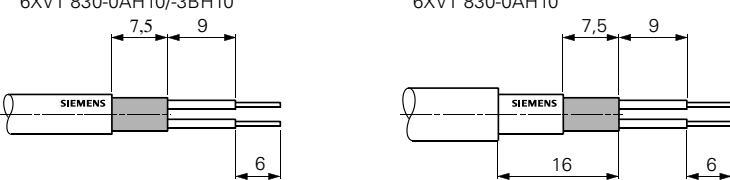
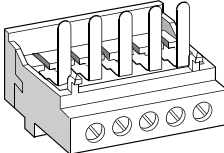
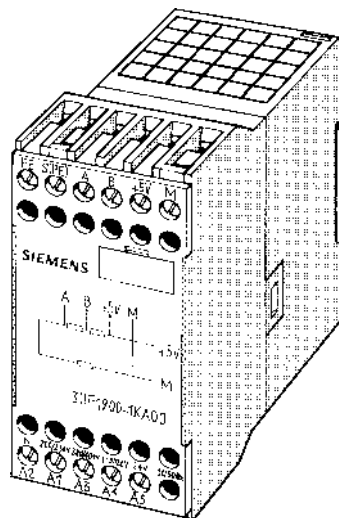

Fig. 60: Bus termination module

Parameterization / Observation

Section	Topic	Page
7.1	Possible ways of parameterizing	7-2
7.1.1	Parameterizing at runtime	7-2
7.1.2	Parameterizing during starting	7-3
7.2	Basics of parameterization	7-4
7.3	Parameterizing and observing with Win-SIMOCODE-DP	7-7
7.3.1	Introduction and notes	7-7
7.3.2	After the installation	7-9
7.3.3	Program start	7-10
7.3.4	Menu bar	7-11

7.1 Possible ways of parameterizing

7.1.1 Parameterizing at runtime

Point-to-point connection

Point to point through the SIMOCODE-DP system interface and a personal computer (PC) with Win-SIMOCODE-DP/Smart or Win-SIMOCODE-DP/Professional. For connecting PC and SIMOCODE-DP, use the corresponding connection cable with the following order number: 3RW29 20-1DA00

- Read/write parameter data without interruption of the bus communication from/to the SIMOCODE-DP
- Single device parameterization

Master class 2 Win-SIMOCODE-DP/ Professional

Through personal computer (PC) with integrated PROFIBUS-DP master interface cards, e.g. CP 5412 and Win-SIMOCODE-DP/Professional

- Read/write parameter data without interruption of the bus communication from/to the SIMOCODE-DP
- All SIMOCODE-DP devices on the bus line are parameterizable

Master class 1

From the application program

- Read/write parameter data record 138 online without interruption of the bus communication from/to the SIMOCODE-DP
- All SIMOCODE-DP devices on the bus line are parameterizable

7.1.2 Parameterizing during starting

**STEP 7 /
Type data file/DMD**

- Through STEP 7 using SIMATIC S7.
 - Parameterizing through STEP 7
 - Write parameter data from the CPU to the SIMOCODE-DP during starting
 - All SIMOCODE-DP devices on the bus line are parameterizable

**STEP 7 /
OM-SIMOCODE-DP
Win-SIMOCODE-DP/
Professional**

- Through STEP 7 using OM-SIMOCODE-DP.
 - Parameterizing through Win-SIMOCODE-DP/Professional
 - Write parameter data from the CPU to the SIMOCODE-DP during starting
 - All SIMOCODE-DP devices on the bus line are parameterizable

**S5 - COM-PROFIBUS
Type data file/DMD**

- Through COM-PROFIBUS using SIMATIC S5.
 - Parameterizing the memory card through COM PROFIBUS
 - Write parameter data from memory card to the SIMOCODE-DP on booting the communication processor
 - All SIMOCODE-DP devices on the bus line are parameterizable

**Table of
parameter channels**

The table below shows which parameters can be set via which parameter channel:

	Master class 1			Master class 2	System interface
	Type data file/ DMD	OM-SIMOCODE-DP/ Win-SIMOCODE-DP/ Professional	Read / write acyclically	Win-SIMOCODE-DP/ Professional	Win-SIMOCODE-DP/ Smart
Bus address			x ¹⁾	x ¹⁾	x ¹⁾
Baud rate			x ¹⁾	x ¹⁾	x ¹⁾
Basic Type			x ¹⁾	x ¹⁾	x ¹⁾
Operating mode			x ¹⁾	x ¹⁾	x ¹⁾²⁾
Reduced Diagnosis			x ¹⁾	x ¹⁾	x ¹⁾
Block DP		x ³⁾	x	x	x
Parameter	x	x	x	x	x

¹⁾ Interruption of PROFIBUS-DP communication is possible if this parameter is changed

²⁾ Not possible with Win-SIMOCODE-DP 3RK

³⁾ Not possible to reset the block DP by this means

Table 49: Parameter channels

7.2 Basics of parameterization

Parameterization

To parameterize the required functionality, parameters such as the motor current for the correct protection of the motor must be *set*. (Comparable with setting the motor current in a thermal overload relay)

Setting

The following figure shows how you set the motor current (set current) with Win-SIMOCODE-DP:

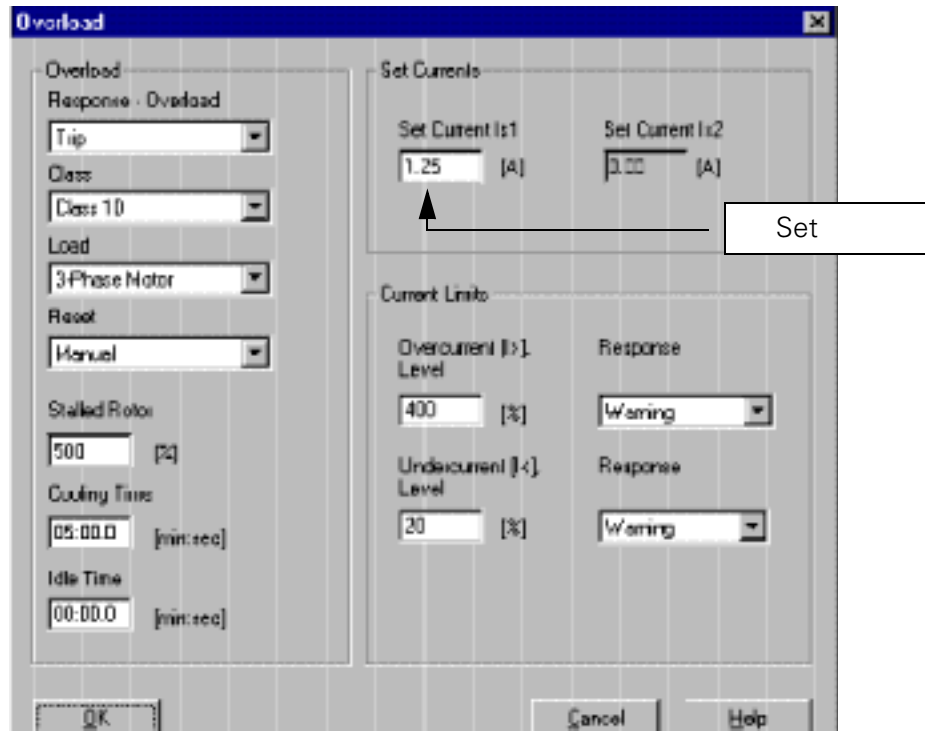

Fig. 61: Setting parameters

Connecting free elements

If you require a certain function, e.g. switching the Relay Output OUT 2 with input IN 4 of the Basic Unit, then you must *connect* the free elements with one another.

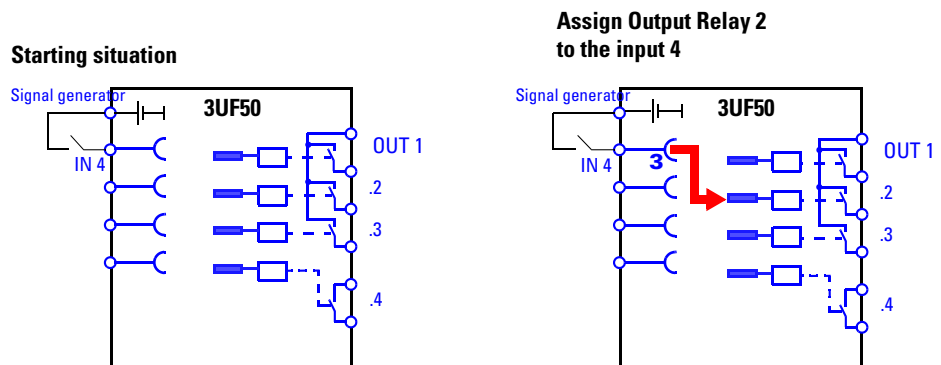

Fig. 62: Connecting free elements

Internal logical connections arise by the connection. The block circuit diagram of the assignments on page A-17 shows an overview of the free elements.

Example

The figure below shows you establish this connection with Win-SIMOCODE-DP:

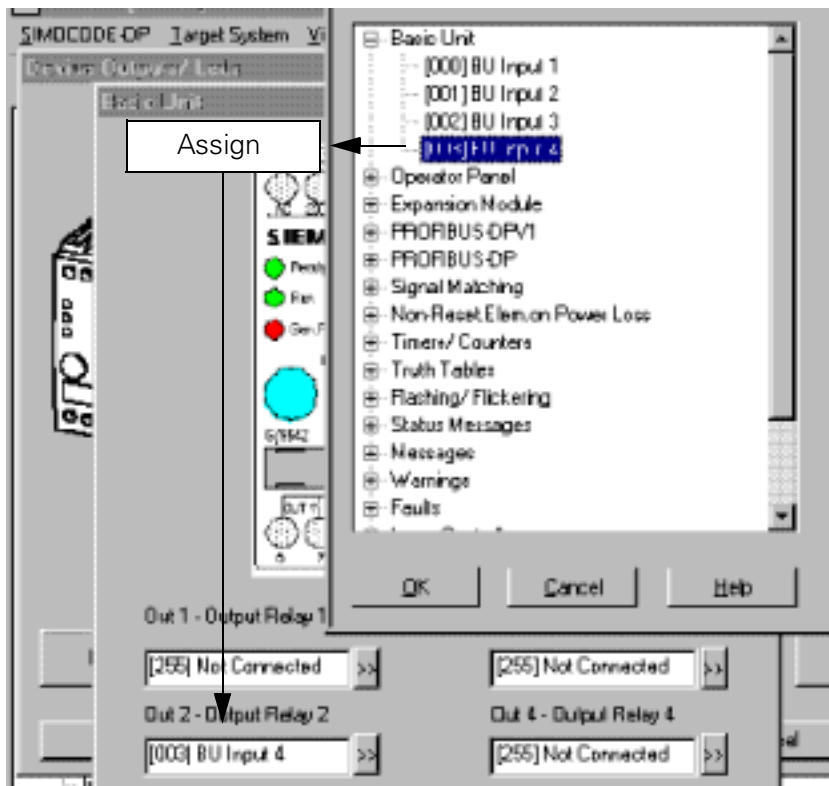

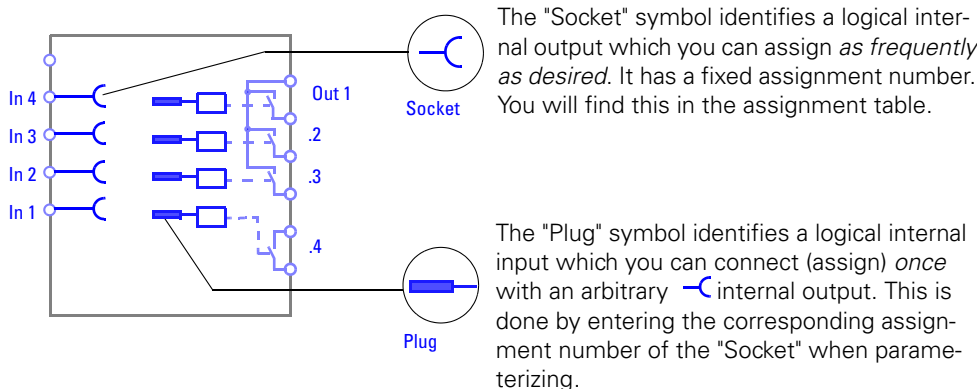

Fig. 63: Example for establishing connections

Symbols used

A socket  can be used as frequently as desired. It has a fixed assignment number. You will find this in the assignment table on page A-2. A plug  can be used only once.



Example of a timer:

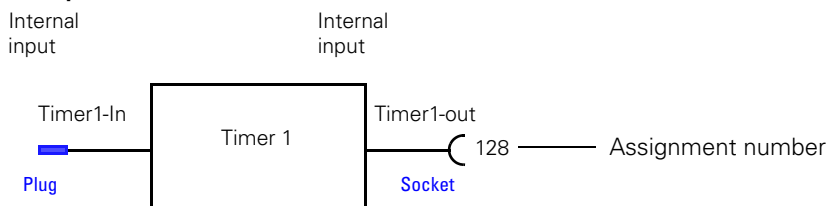

Fig. 64: Symbols used: sockets and plugs

Parameterizing assistance

You will find the inputs inside the device in the parameter table starting from page A-19 arranged according to main groups and subgroups. Default "255" means "not assigned" (open).

The relevant function is activated automatically by parameterizing another assignment number.

You will find the assignment numbers of the outputs inside the device in the assignment table page A-2.

You can copy the parameter table in order to enter the assignment numbers and settings when you configure. The free "Selected value" columns are provided for this.

Thus you have documented all parameters simultaneously.

Transmitting parameters

SIMOCODE-DP can be parameterized only if it is

- in the "Manual" and "Off" state.
- in the "Check-back Signal Test" state (CST), product status E10 or higher

Should it not be possible to parameterize SIMOCODE-DP, it is possible to perform a general reset. You see on page G-2 how you perform a general reset.

Nonvolatile

All parameter data remain stored in the SIMOCODE-DP on failure of the supply voltage.

7.3 Parameterizing and observing with Win-SIMOCODE-DP

7.3.1 Introduction and notes

What is Win-SIMOCODE-DP?

Win-SIMOCODE-DP is parameterizing, operating and observing software which is installed on a PC or PU. There are 2 versions of Win-SIMOCODE-DP:

- Win-SIMOCODE-DP/Smart
- Win-SIMOCODE-DP/Professional

The table below shows which version of Win-SIMOCODE-DP can be used for the parameterization, observation and testing of SIMOCODE-DP, using which channel, as a function of the product status (E):

Functions of Win-SIMOCODE-DP	SIMOCODE-DP			
	To product status E09	From product status E10		
	Only DP standard slave	DP standard slave	DPV1 slave	S7 slave
Win-SIMOCODE-DP/Smart Parameterization, operation, observation, testing via RS232	x	x	x	x
Win-SIMOCODE-DP/Professional Parameterization, operation, observation, testing via RS232	x	x	x	x
Parameterization, operation, observation, testing via PROFIBUS-DPV1 (master class 2)	—	x	x	x
Parameter record transferable from Win-SIMOCODE-DP to S7 CPU for start parameterization	—	—	—	x
Win-SIMOCODE-DP callable in Step 7	—	—	—	x

Required knowledge

You require the following knowledge for working with Win-SIMOCODE-DP:

- Windows 95 or Windows NT.
- SIMOCODE-DP system, parameterizing

Online help

Win-SIMOCODE-DP is largely self-explanatory and also possesses an extensive online help which quickly offers you information on all topics.

Minimum computer configuration

To be able to operate Win-SIMOCODE-DP, you require at least:

Win-SIMOCODE-DP/Smart	Win-SIMOCODE-DP/Professional
<ul style="list-style-type: none"> • PC/PU prerequisite Windows 95 or Windows NT 4.0 • Free hard disk memory at least 10 MB 	
<ul style="list-style-type: none"> • Free COM interface • RS232 connection cable (Order No. 3RW2920-1DA00) 	<ul style="list-style-type: none"> • Master card e.g. MPI interface, CP5411, CP5412, CP551, CP5611 • MPI cable (5m) for connection to SIMATIC S7/M7/C7I (Order No. 6ES7901-0BF00-0AA0)

Form of delivery

Win-SIMOCODE-DP/Smart:
 3.5 inch diskettes (Order number 3UF5711-0AA00-0)
 Win-SIMOCODE-DP/Professional:
 3.5 inch diskettes (Order number 3UF5710-0AA00-0)

Installation

Proceed as follows to install Win-SIMOCODE-DP:

1. Insert diskette 1 in the diskette drive.
2. Select "Settings —>Control Panel" in the Windows start menu.
3. Select "System Control —> Add/Remove Programs".
4. In the "Add/Remove Programs Properties" window, select the "Install/Uninstall" tab and click on the "Install" button. You can set the drive as well as the path to the setup program in the following window.

The setup program guides you through the entire installation.

Note

Uninstall the older Win-SIMOCODE-DP versions before you install Win-SIMOCODE-DP.

Password

The first time you select Win-SIMOCODE-DP you must enter the supplied password. You will find the password on the package note.

Example files

After the installation of Win-SIMOCODE, example files for the individual control functions are available to you. The example files already have many common defaults. The example files have the file extension *.smc. You can use and correspondingly modify them for your application.

7.3.2 After the installation

Win-SIMOCODE-DP/ Professional

Once you have successfully installed Win-SIMOCODE-DP/**Professional** and have restarted your computer, you must firstly set the PC-PU interface - if not already set - for the **PROFIBUS-DP**.

Setting the PC-PU interface

1. Select from the Windows start menu:
Programs —> Win-SIMOCODE-DP_Pro —> Set PC-PU interface
2. Select the corresponding interface in the "Access path" tab
3. Open the "Properties" window and adapt the station and network parameters of the PROFIBUS-DP. Click on "OK" in the "Properties" window.

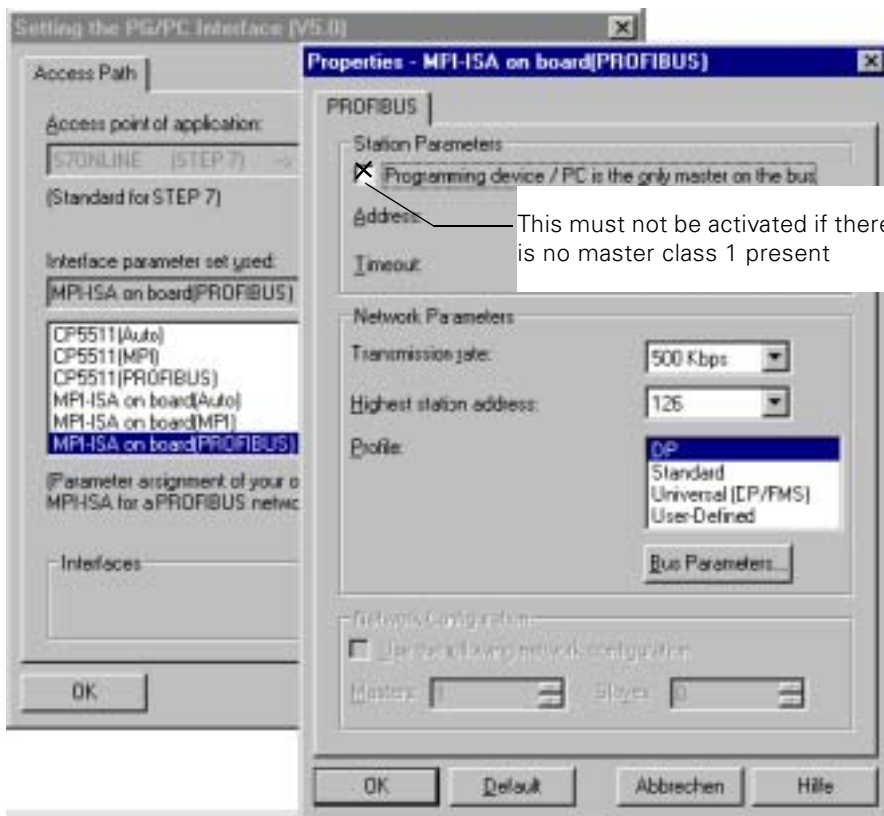

4. Click on "Install" in the "Access path" tab.
The PC-PU interface is thus set.

Step 7 - Version

If you want to use Step 7, then you need a version 4.0 or higher

7.3.3 Program start

Run-up

Start the program. Select from the Windows start menu: Programs —> Win-SIMOCODE-DP_Pro —> Win-SIMOCODE-DP_Pro. After Win-SIMOCODE-DP has run up, the following window appears:

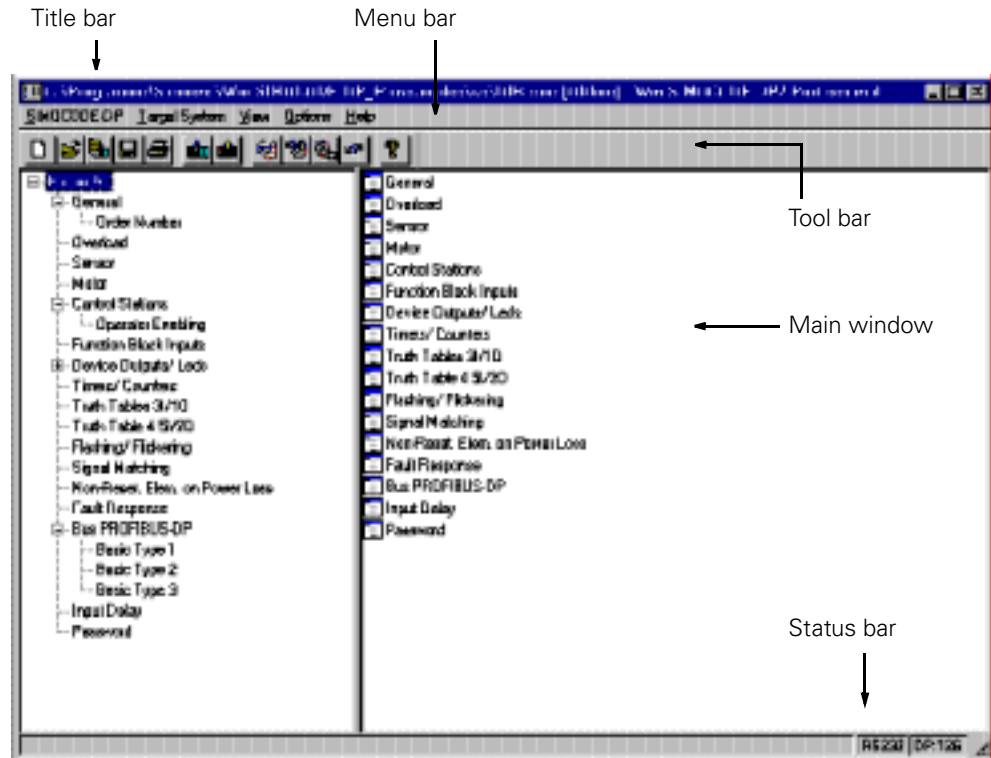

Title bar

The title bar contains

- the path of the smc file
- the device status, online or offline
- the PROFIBUS-DP address of online device status
- the Win-SIMOCODE version, Professional or Smart

Menu bar

The menu bar contains the menus

- SIMOCODE-DP
- Target system
- View
- Options
- Help

The menus are described in detail below

Tool bar The tool bar contains icons with which you can access some options from the menus by mouse click. If you remain with the mouse pointer for around 1 second on the icon, you are displayed its function in plain language.

Main window The main window contains all parameters which you can set and assign. The parameters have already been introduced in the preceding sections in the manual. Therefore the explanations are not provided at this place. Use the online help if you require further information.

Status bar The status bar contains

- the set interface. You can open the "Interfaces" window directly by double-clicking here and select the interface
- the PROFIBUS-DP address.

7.3.4 Menu bar

SIMOCODE-DP

System If you click on SIMOCODE-DP in the menu bar, then the following options appear:

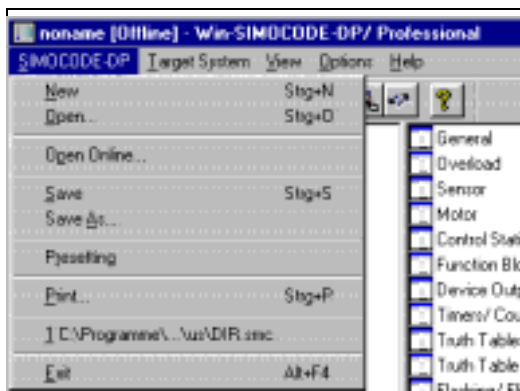

Here you can

- Create new files
- Open files
- Open Online, i.e. open directly from SIMOCODE-DP
- Save
- Print
- Exit Win-SIMOCODE-DP

All SIMOCODE-DP files have the file extension *.smc.

Target System

Diagram

If you click on Target System in the menu bar, then the following online functions appear:

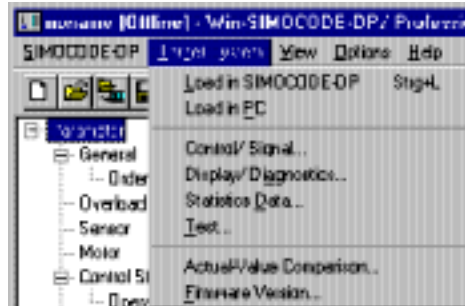

- Here you can
- Load files from the PC/PU into SIMOCODE-DP
 - Load files from SIMOCODE-DP into the PC/PU
- The following functions are described below:
- Control / Signal
 - Display/Diagnosis
 - Statistics Sata
 - Test
 - Actual-Value Comparison
 - Firmware Version

All online functions work with the set interface. You see on page 7-17 how you set the interface.

Control / Signal

If you click on Control / Signal in the Target System menu, the following window appears:

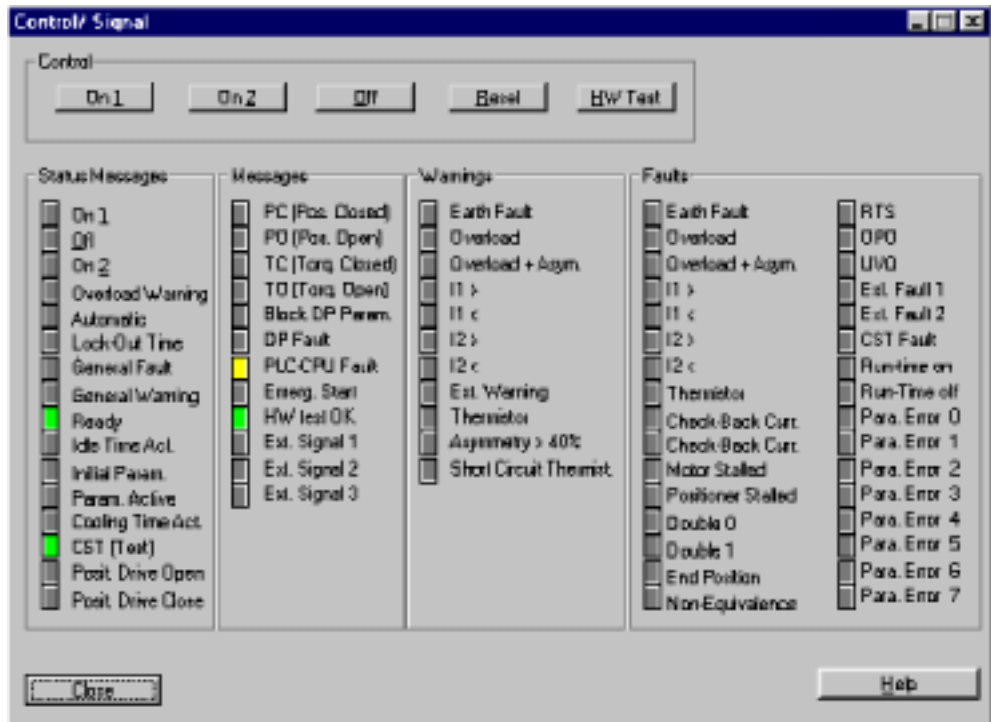

- Here you can control the branch, reset the device and initiate a hardware test with the upper buttons.
- You receive an overview of the momentary device status with the LED displays.

Display/Diagnosis

If you click on Display/Diagnosis in the Target System menu, the following window appears:

Display/ Diagnosis			
Motor Current [A]	Motor Current [%]	Last Trip Current [%]	
0.00	0	0	
Set Current Is [A]	6.30	Cooling Time [min:sec]	
		00:00.0	
Number of Starts	500	Counter Reading 1	0
Operating Hours	24000	Counter Reading 2	0
Number of Overload Trips	0	Analog Sensor Value [Ohms]	0
Close		Help	

Here you see the current operating current in the branch as well as the following displays:

- Set current
- Current in the branch at the last overload trip (in % of the set current)
- Remaining Cooling Time
- Number of Starts
- Operating Hours
- Number of Overload Trips
- Counter Reading 1 and 2
- Analog Sensor Value of the thermistor

Statistical data

If you click on Statistical data in the Target system menu, the following window appears:

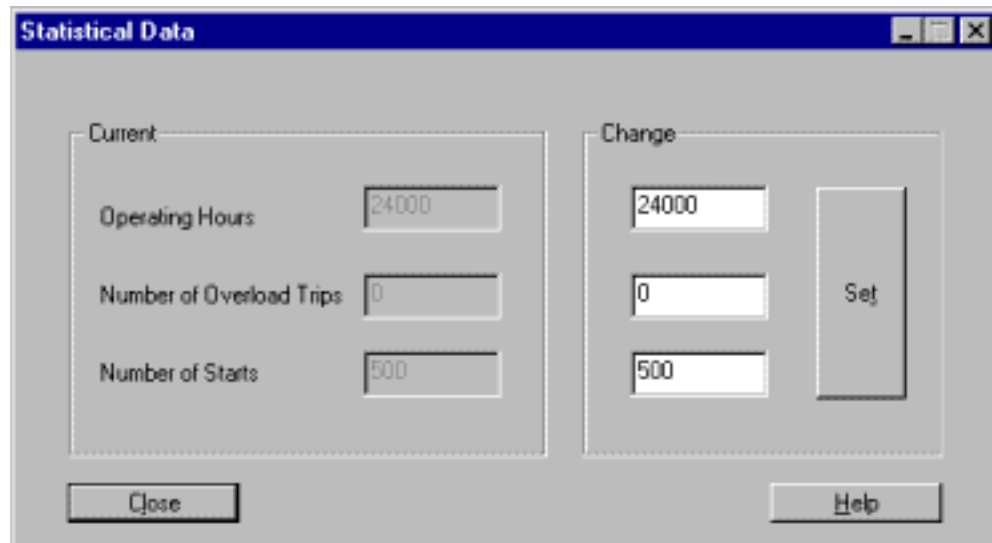

The following data are displayed here:

- Operating Hours [h] Range: 0 ... 65 5350
- Number of Overload Trips Range: 0 ... 65 535
- Number of Starts Range: 0 ... 16 777 215

You can change the data if you have replaced devices, for instance. Enter a new value in the right text box and then confirm with the "Set" button. The value is accepted by the device.

The operating hours can be entered only in steps of ten.

Test

If you click on Test in the target system menu, the following window appears:

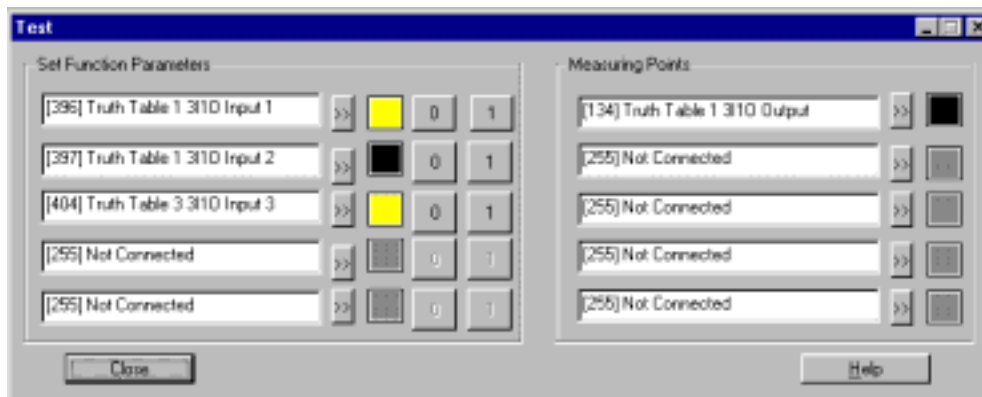

Here you can have the logical states of the inputs inside the device (plugs) displayed. You must set function parameters or assign test points for this purpose.

The lamp icons indicate the logical state:

- yellow signals logical "1"
- black signals logical "0"
- gray signals an indefinite state, e.g. with not assigned outputs

You can set all function parameters to logical "0" or to logical "1" by clicking on one of the assigned buttons.

You can enquire the status of arbitrary inputs or outputs with "Measuring Points"

You can for instance test the functioning of Truth Tables with this method.

Note

You can perform function tests only if the Function Block "CST" has been set to logical "1".

Actual Value Comparison

If you click on Actual Value Comparison in the Target System menu, then Win-SIMOCODE-DP compares the data record from the connected device with the current data record in the main memory.

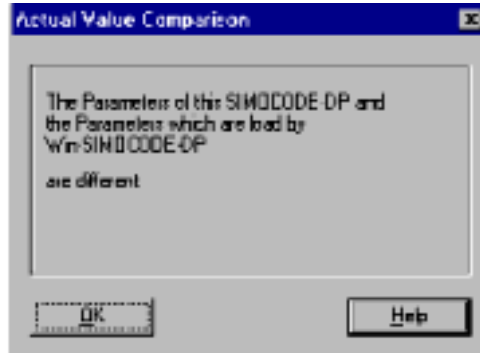

A message as to whether the parameters agree or do not agree appears.

Firmware Version

If you click on Firmware Version in the Target System menu, then Win-SIMOCODE-DP outputs the Firmware Version of the connected device. State this number if you have queries regarding your SIMOCODE-DP device.



View

If you click on View in the menu bar, then you can display or remove the status bar and the tool bar there.



Options

If you click on Options in the menu bar, then you can change the directory, the interface and the language there.

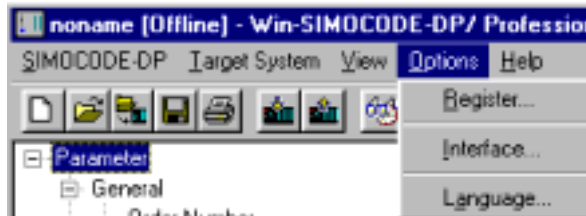

You can also open the "Interface" window in the status bar by double-clicking on the button with the set interface.

Help

If you click on Help in the menu bar, then you receive there an overview of the help topics as well as short information about Win-SIMOCODE-DP.



Engineering Example

Direct Starter

Section	Topic	Page
8.1	Introduction	8-2
8.2	Block 1: Redrawing a conventional circuit diagram as a circuit diagram	8-3
8.3	Block 2: Preparing a block diagram	8-11
8.4	Block 3: Parameterization with Win-SIMOCODE-DP	8-17

8.1 Introduction

Configuration step by step

In this chapter you learn step by step how to configure a Direct Starter with SIMOCODE-DP.

Three key parts

The procedure for configuration can be broken down into three key parts:

Part	Contents
1	Redraw a conventional circuit diagram as a circuit diagram with SIMOCODE-DP
2	Prepare a block diagram
3	Assign parameters with Win-SIMOCODE-DP

Aids

We suggest that you copy the following documents to help you in your work:

- SIMOCODE-DP circuit diagram in the appendix page A-15
- Block diagram in the appendix page A-17

Prior knowledge required

The following knowledge is required for working through this example:

- Properties of the parameters
The parameters have already been described in previous chapters of the manual, and therefore no explanations are provided here.
- Win-SIMOCODE-DP.
Information on installing and working with Win-SIMOCODE-DP is provided in Chapter 7.

8.2 Block 1: Redrawing a conventional circuit diagram as a circuit diagram with SIMOCODE-DP

In this section

In this section you find out how to convert a conventional circuit diagram of a Direct Starter step by step into a circuit diagram with SIMOCODE-DP.

Layout using conventional technology

The diagram below shows a layout using conventional technology:

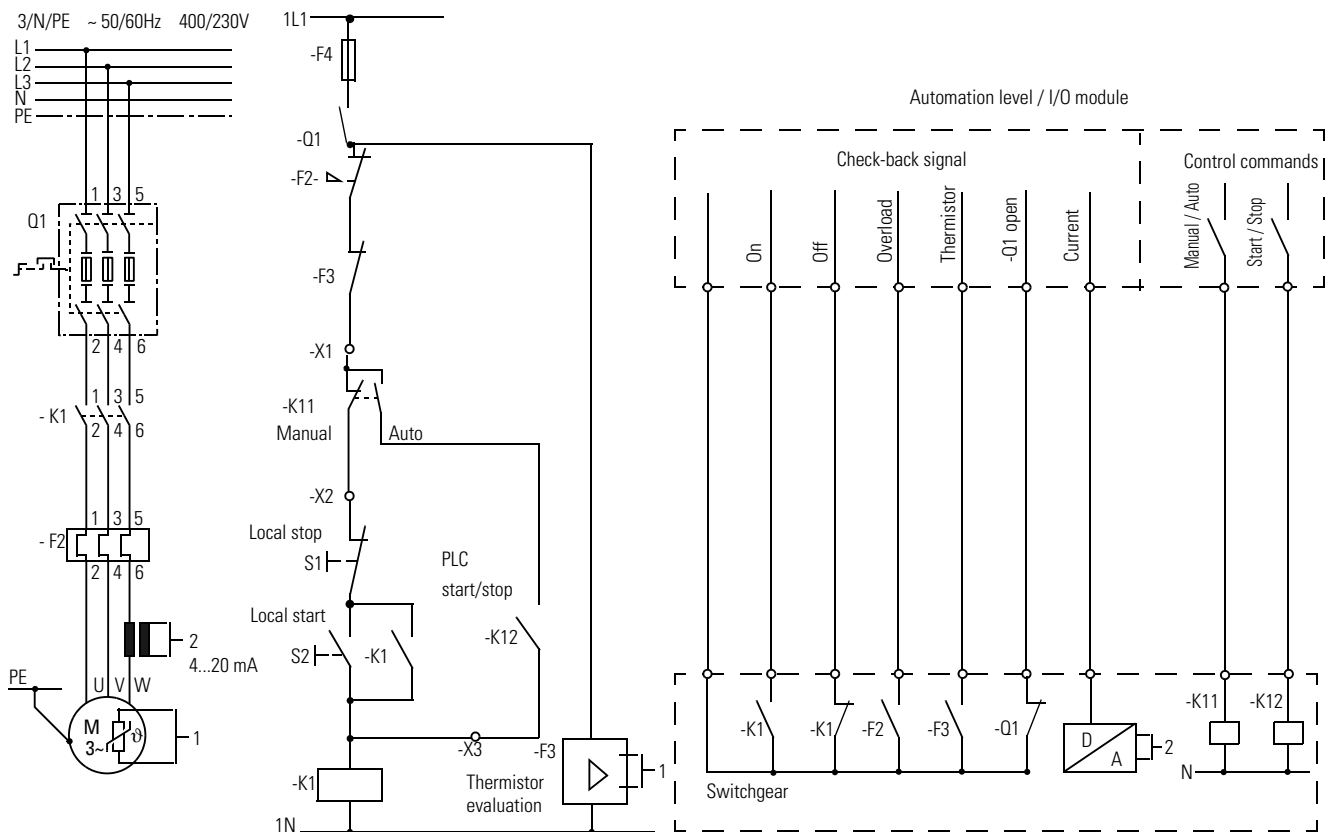

Fig. 65: Layout of a motor branch (Direct Starter) using conventional technology

Step 1

Take your copy of the SIMOCODE-DP circuit diagram. The following elements are already drawn on this diagram:

- Main circuit
- Voltage supply at terminals A1, A2
- Protective conductor at terminal PE
- Bus line at terminals A, B
- Voltage supply for the relay contacts at terminal 6

Step 2

In this step you draw the local Control Station in the SIMOCODE-DP circuit diagram:

- Pushbutton S1 for Stop
- Pushbutton S2 for Start

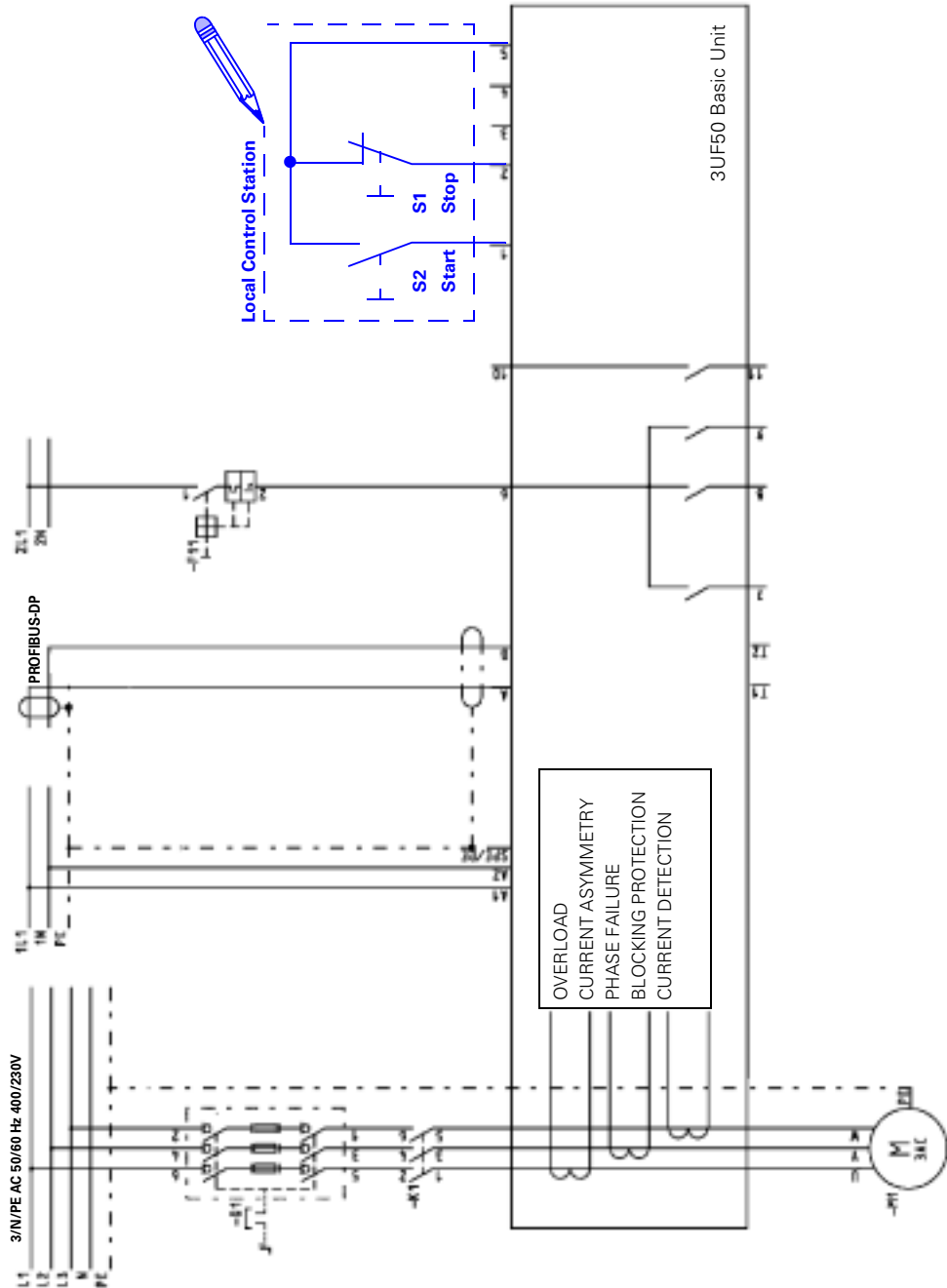

Fig. 66: Step 2: Drawing the elements in the SIMOCODE-DP circuit diagram

Step 3

Delete the following elements from the conventional circuit diagram:

- Pushbutton S1 for local stop
- Pushbutton S2 for local start and latching for contactor K1. These are taken over by SIMOCODE-DP with the Direct Starter Control Function.

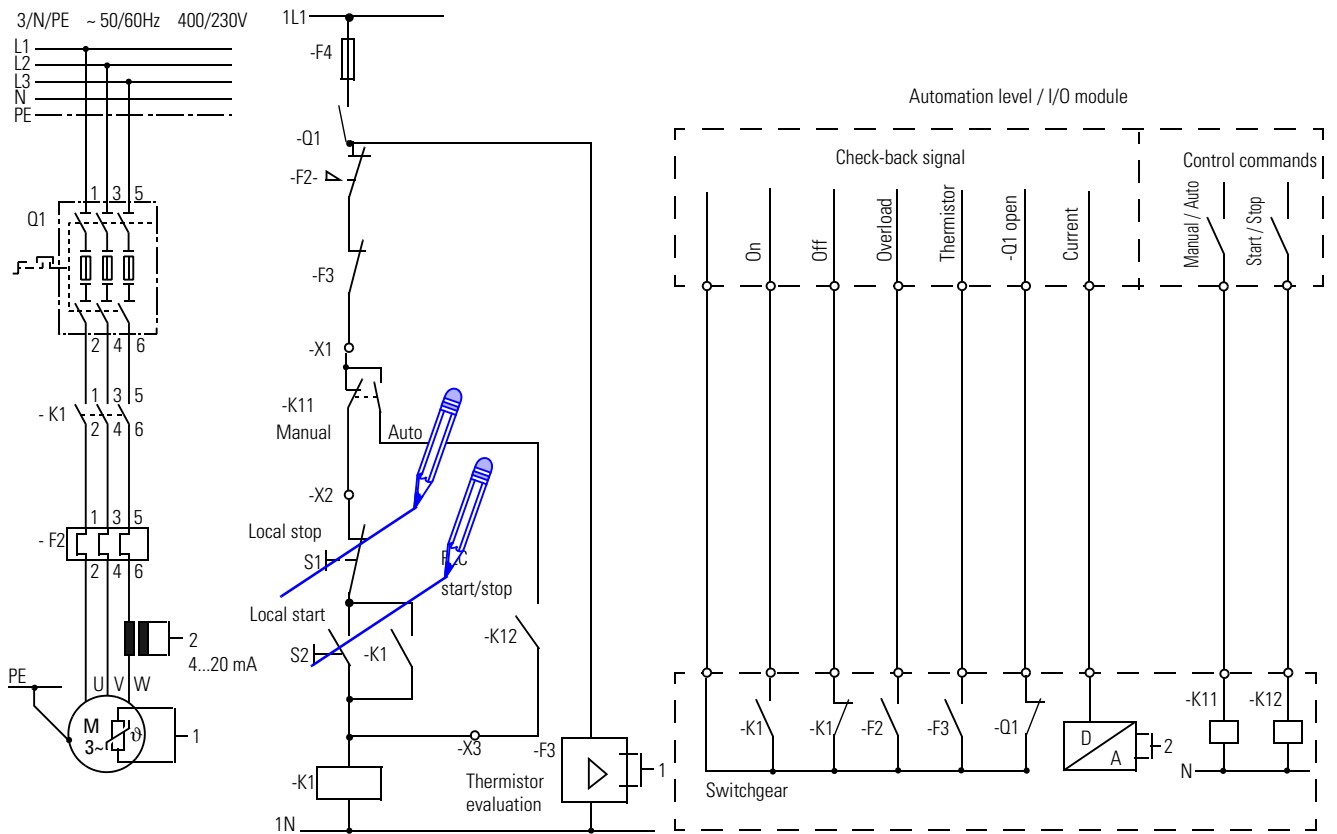

Fig. 67: Step 3: Deleting elements from the SIMOCODE-DP circuit diagram

Step 4

Nothing needs to be drawn in the SIMOCODE-DP circuit diagram because these control commands are transmitted to SIMOCODE-DP via PROFIBUS-DP.

Delete the following elements from the conventional circuit diagram:

- PLC Manual / Auto
(manual/automatic changeover from the automation system)
- PLC start / stop
(start/stop signal from the automation system)

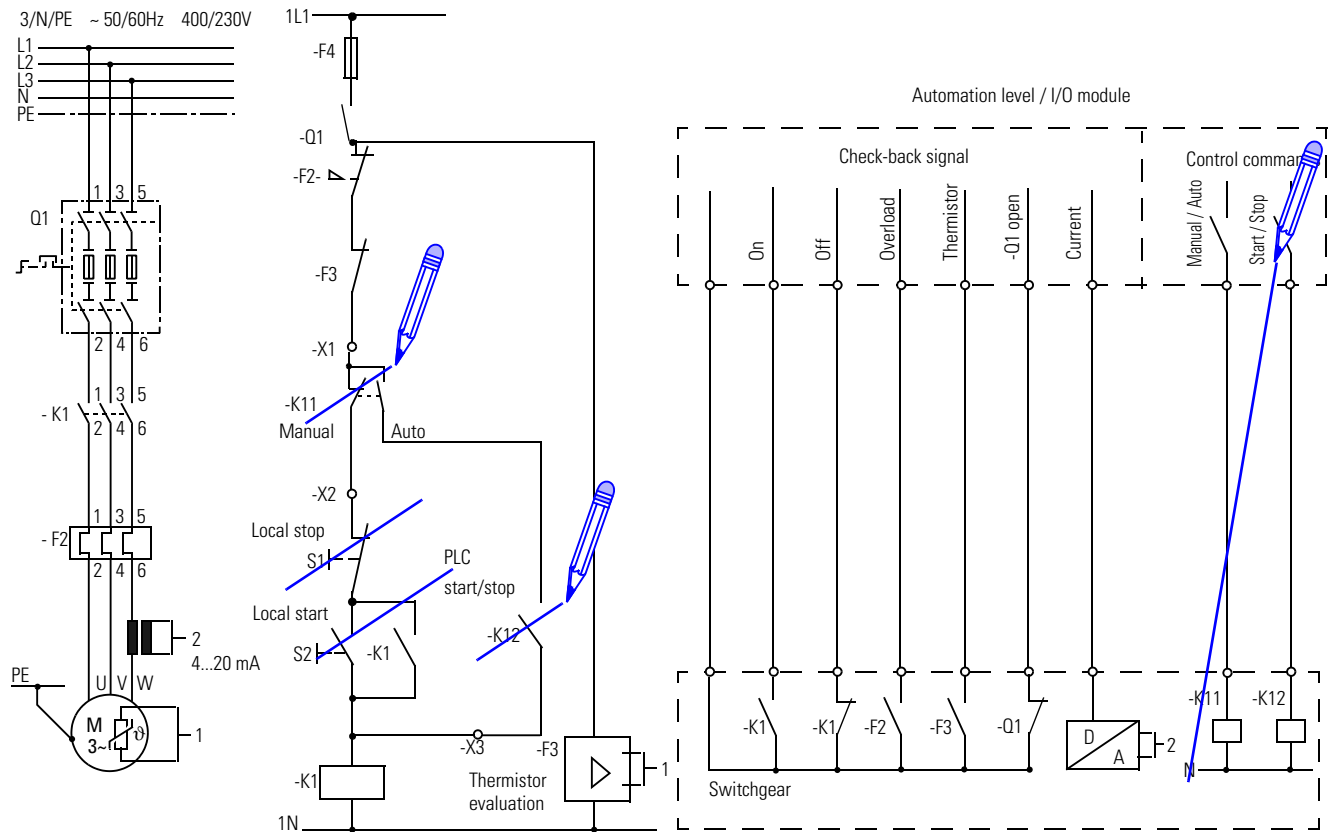

Fig. 68: Step 4: Deleting elements from the SIMOCODE-DP circuit diagram

Step 5

In this step you draw the following elements in the SIMOCODE-DP circuit diagram:

- Contactor K1 at one of the Relay Outputs, in this case: output 1 at terminal 7.
- RC combination parallel to the contactor coil to increase the service life of the Relay Outputs
- Thermistor at terminals T1 and T2

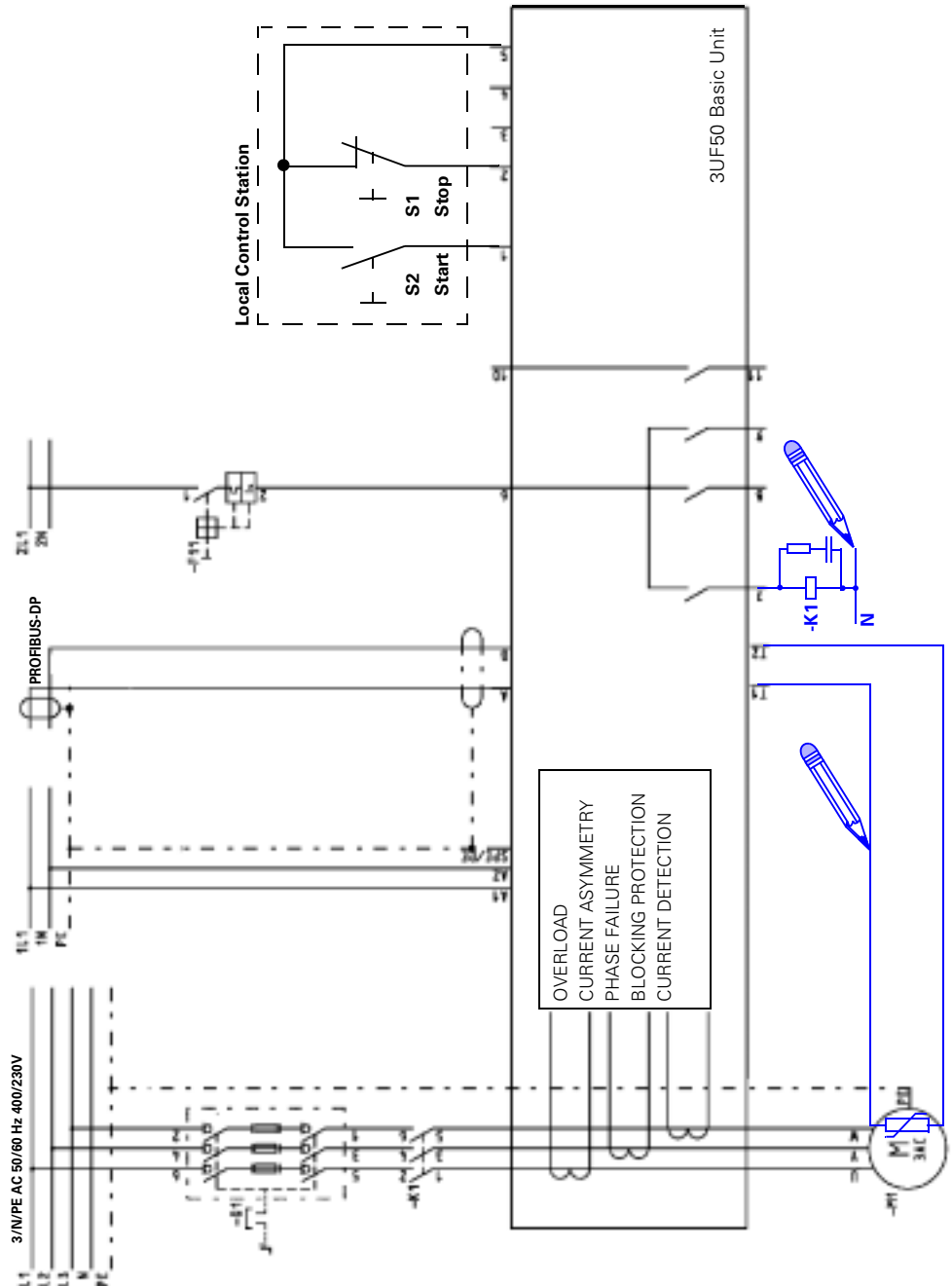

Fig. 69: Step 5: Drawing the elements in the SIMOCODE-DP circuit diagram

Step 6

Delete the following elements from the conventional circuit diagram:

- Contactor K1
- Thermal overload relay with auxiliary contact F2. SIMOCODE-DP monitors the current flowing at any one time in all three phases with the integrated current transformers, and in the event of a fault de-energizes the contactor coil.
- Thermistor evaluation with auxiliary contact F3. SIMOCODE-DP de-energizes the contactor coil if the tripping threshold is exceeded.

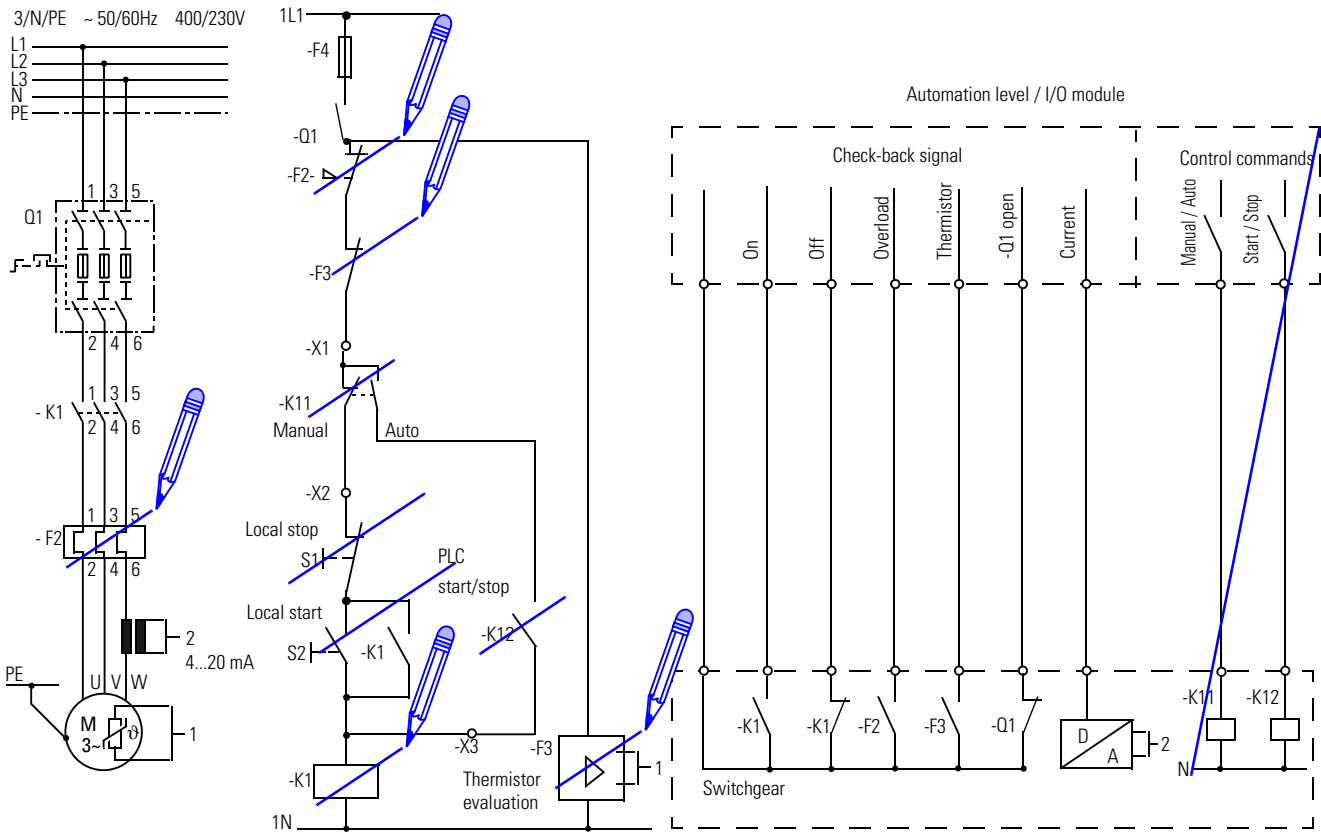

Fig. 70: Step 6: Deleting elements

Step 8

In this step the auxiliary contact of the fuse-disconnector is wired to an input of SIMOCODE-DP.

Advantages:

- If the circuit-breaker opens or is tripped, SIMOCODE-DP deactivates the motor branch, indicating a fault.
- During commissioning you can test the functionality of the branch with the fuse-disconnector open or without the motor. In that case no fault message appears.

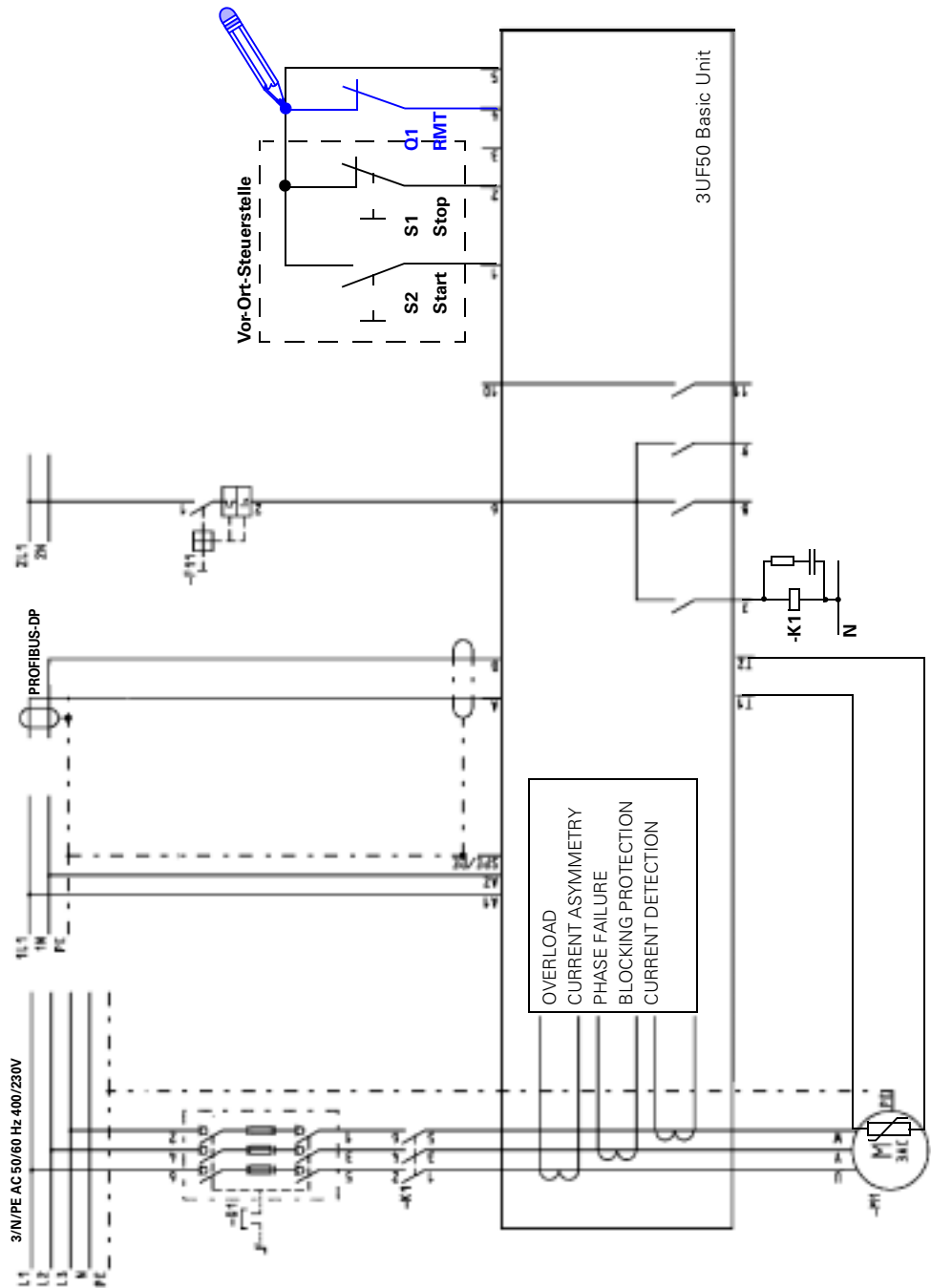

Fig. 72: Step 8: Drawing the auxiliary contact of the fuse-disconnector for test operation in the SIMOCODE-DP circuit diagram

8.3 Block 2: Preparing a block diagram

In this section

In this section you discover how to find the assignments and therefore the parameters for this example, the Direct Starter. To do this it is important to understand the block diagram.

How is the block diagram used?

The SIMOCODE-DP circuit diagram on page 8-10 shows the *external* circuitry for the Direct Starter example. In order to protect the motor branch reliably with SIMOCODE-DP, *internal* connections are necessary, which you draw in the block diagram step by step. We refer to the internal connections as assignments.

Structural layout



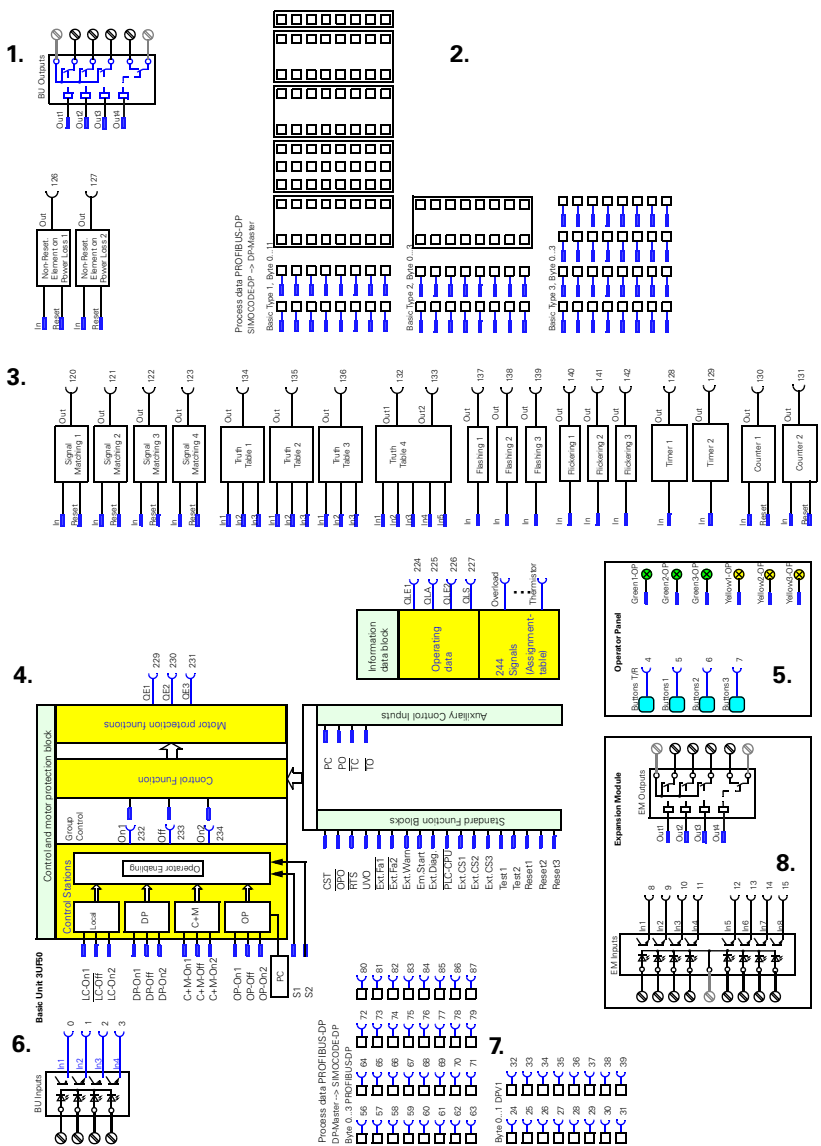

The block diagram shows the entire functional scope of the SIMOCODE-DP system:



1. The four outputs of the 3UF50 Basic Unit.
2. The process data (signal bits) that are transmitted from the SIMOCODE-DP to the PROFIBUS-DP master. There are three different Basic Types.
3. The logic modules for Signal Matching, Truth Tables, Timers and Counters.
4. The Control Stations, Auxiliary Control Inputs, Contactor Controls, Function Blocks.
5. The four buttons, the three green and three yellow LEDs of the 3UF52 Operator Panel.
6. The four inputs of the 3UF50 Basic Unit.
7. The process data (control bits) that are transmitted from the PROFIBUS-DP master to the SIMOCODE-DP.
8. The eight inputs and four outputs of the 3UF51 Expansion Module.

Fig. 73: Structural layout of the SIMOCODE-DP system

Plugs and sockets

You will notice that the elements all have plugs  and sockets . You can connect the various free elements to each other by assigning parameters, to suit your requirements. A socket  can be used as many times as necessary, whereas a plug  can be used only once.

Before you start

Initial considerations

First you should consider the circumstances in which it is permissible to switch the motor branch: in which situation and from which Control Station. In this example we specify this as follows:

- Activation and deactivation via PROFIBUS-DP in automatic mode
- Start and stop with S2 and S1 via local Control Station in manual mode

Brief review of the control and motor protection block

In order to protect the motor branch reliably, you must assign control commands to the control and motor protection block.

Note

Otherwise Operator Enabling signals, Control Functions and protection functions have no effect.

**Control Stations
Control Function**

The set Operator Enabling signals are processed in the Control Stations block, and the Control Function is processed in the next block. All interlocks, logic operations and delays are implemented here, depending on which control function is selected. If Function Blocks are required or Auxiliary Control Inputs need to be used, for example for Actuator/Positioner control, these have an influence on the Control Function.

**Motor protection
function**

The last block in this chain is the motor protection function. The Contactor Controls QE1/QE2/QE3 are switched in accordance with the Control Function being used; see Table 11: on page 2-27. Contactor Controls QE1/QE2/QE3 have a high signal after an "On" command and a low signal after an "Off" command or in the event of a fault, i.e. the motor branch is reliably switched on and off even when a fault has occurred.

**Reliable activation/
deactivation**

Contactor Controls QE1/QE2/QE3 reliably activate and deactivate the motor branch.

Step 1

Draw external elements

Take your copy of the block diagram. In this step, draw the following external elements in the block diagram:

- Pushbutton for start and stop at inputs 1,2
- Auxiliary contact Q1 at input 3
- Contactor K1 with RC combination at relay Output Relay1

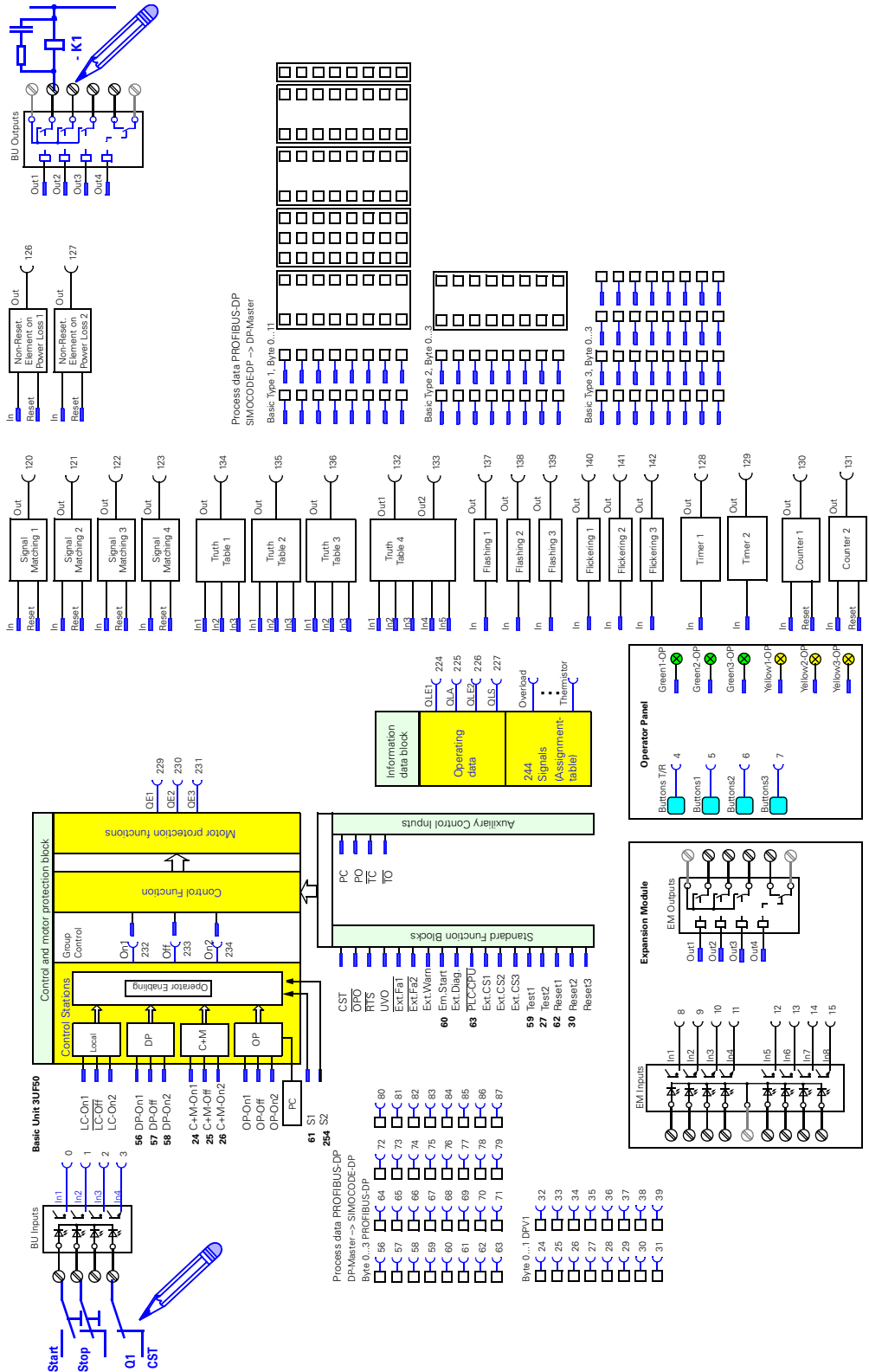

Fig. 74: Step 1: Drawing the external elements in the block diagram

Step 2

Draw
"Off/On"
control commands

Explanation

The automation system sends the following control commands via PROFIBUS-DP:

- Control bit 0.1 = "Off"
- Control bit 0.2 = "On"

Control commands via local Control Station:

- Stop pushbutton = "Off"
- Start pushbutton = "On"

Implementation with SIMOCODE-DP

In this step, draw the control commands in the block diagram:

- Control bit 0.1 = "Off" is assigned to "DP-Off"
- Control bit 0.2 = "On" is assigned to "DP-On2"
- Stop pushbutton at input 2 (In2-BU) is assigned to $\overline{\text{LC-Off}}$
- Start pushbutton at input 1 (In1-BU) is assigned to LC-On2

The assignments of the control bits are shown in Table 54: on page B-7.

Step 3

Draw
"Manual/automatic
mode" changeover

Explanation

From the conventional circuit diagram on page 8-3 you can see that the automation system (PLC) takes over the changeover from manual to automatic mode:

- In automatic mode the motor branch is switched via the automation system (PLC start/stop). For SIMOCODE-DP this means:
 - S1 receives a "1" signal from the automation system
 - S2 has a fixed level of "1"
- In manual mode the motor branch is always switched via the local Control Station (start/stop pushbutton). For SIMOCODE-DP this means:
 - S1 receives a "0" signal from the automation system
 - S2 has a fixed level of "1"

As S2 always has a fixed level of "1", S1 is solely responsible for the changeover between automatic and manual mode. Only two operating modes are possible, 2 and 4. Further information on the operating modes is given in Table 9: on page 2-24

Implementation with SIMOCODE-DP

In this step, draw the following connections in the block diagram:

- Control bit 0.5 = "operating mode" is assigned to software Control Mode Switch S1
(S1 = 1: automatic mode, S1 = 0 and S2 = 1: manual mode).
The assignments of the control bits are shown in Table 53: on page B-6.
- A fixed level of "1" is assigned to the software Control Mode Switch S2.

Step 4

Draw
Contactor Control

Explanation

From the table on page 2-27 you can see that Contactor Control QE1 is active for the Direct Starter.

Implementation with SIMOCODE-DP

In this step, draw the following connection in the block diagram:

- Contactor Control QE1 is assigned to relay output "1-BU"

Step 5

Draw
Standard Function Block
"CST"

Explanation

In order to test SIMOCODE-DP with no current flowing in the main circuit, use the standard function block "CST".

Implementation with SIMOCODE-DP

In this step, draw the following connection in the block diagram:

- Auxiliary contact Q1 at input 4 (In4-BU) is assigned to the standard function block "CST"

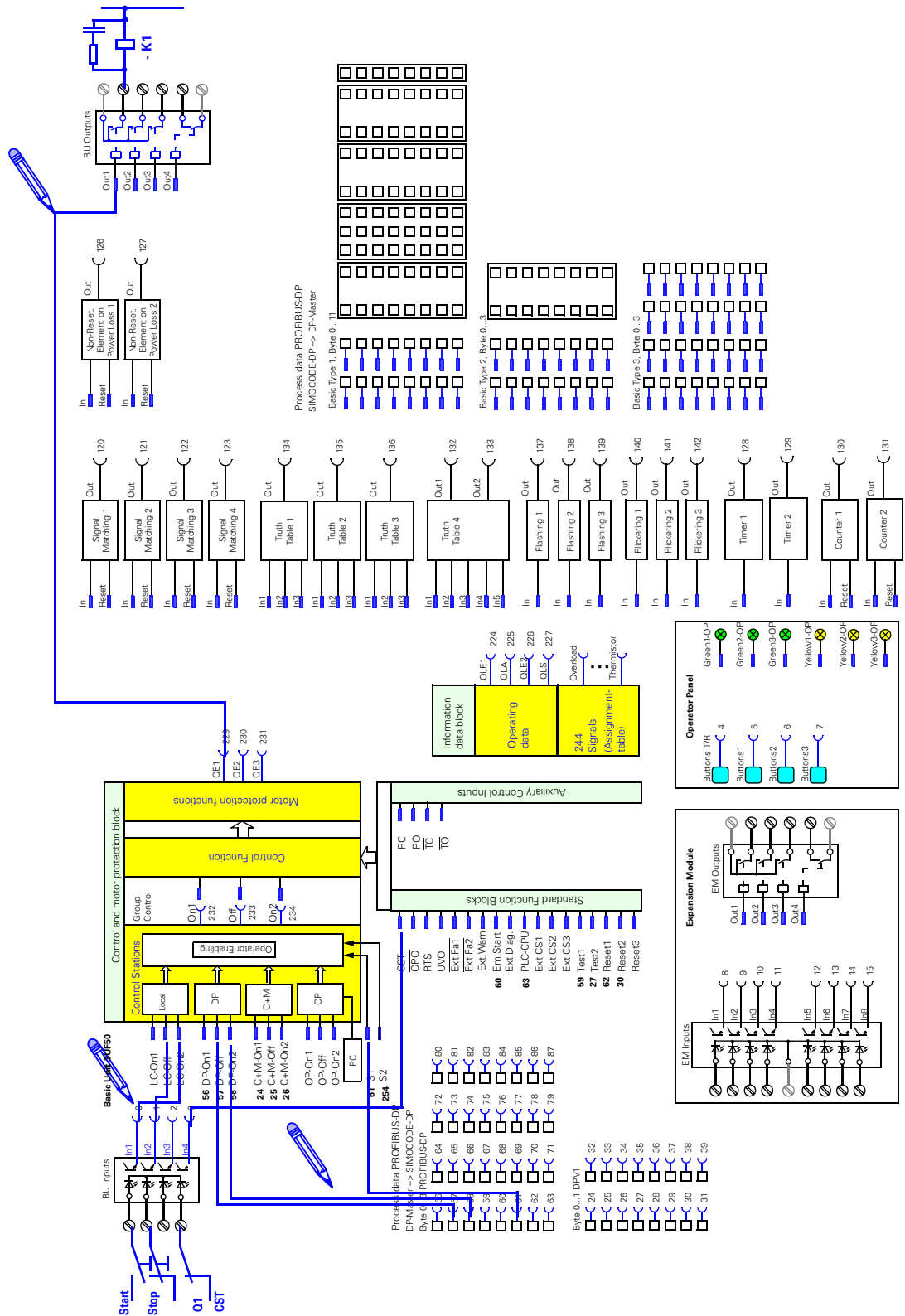

Step 2: Drawing the internal connections in the block diagram

8.4 Block 3: Parameterization with Win-SIMOCODE-DP

In this section

In this section you find out step by step how to assign the parameters for the "Direct Starter" example with Win-SIMOCODE-DP.

Step 1

Call up Win-SIMOCODE-DP/Professional or Win-SIMOCODE-DP/Smart.

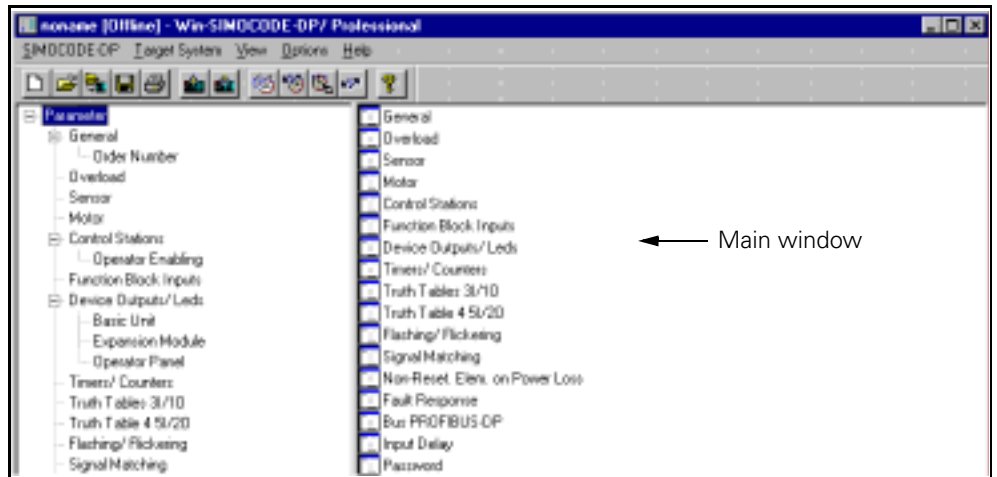

Fig. 75: Opening mask of Win-SIMOCODE-DP

Step 2

Open the "Order Number" dialog and set the device-specific parameters there. In the example, we accept the default settings.

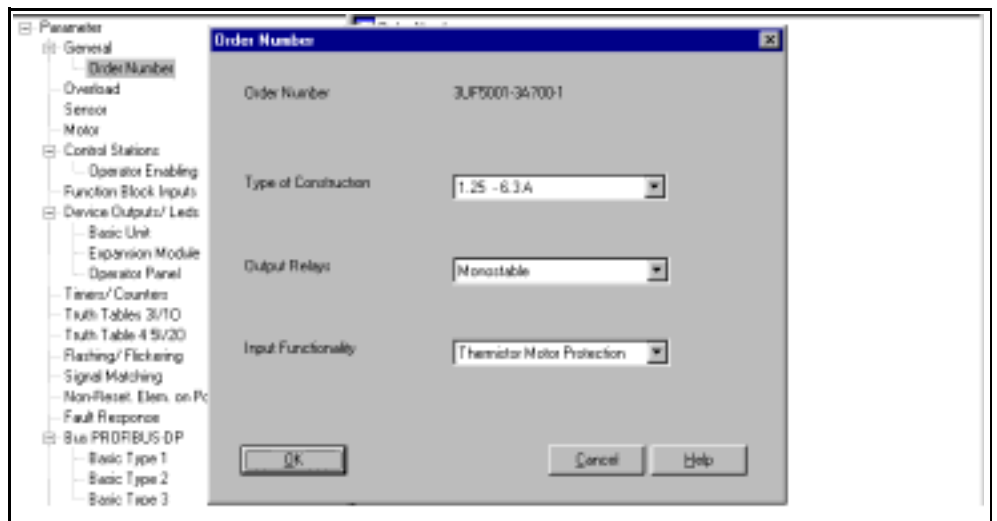

Fig. 76: Setting the parameters in the "Order Number" dialog

Step 3

Open the "Overload" dialog. Set the "Set Current" Is1 to the motor current. Set Current Is2 is only necessary when using a Dahlander starter or Pole Changing Starter. The other parameters remain unchanged in this example.

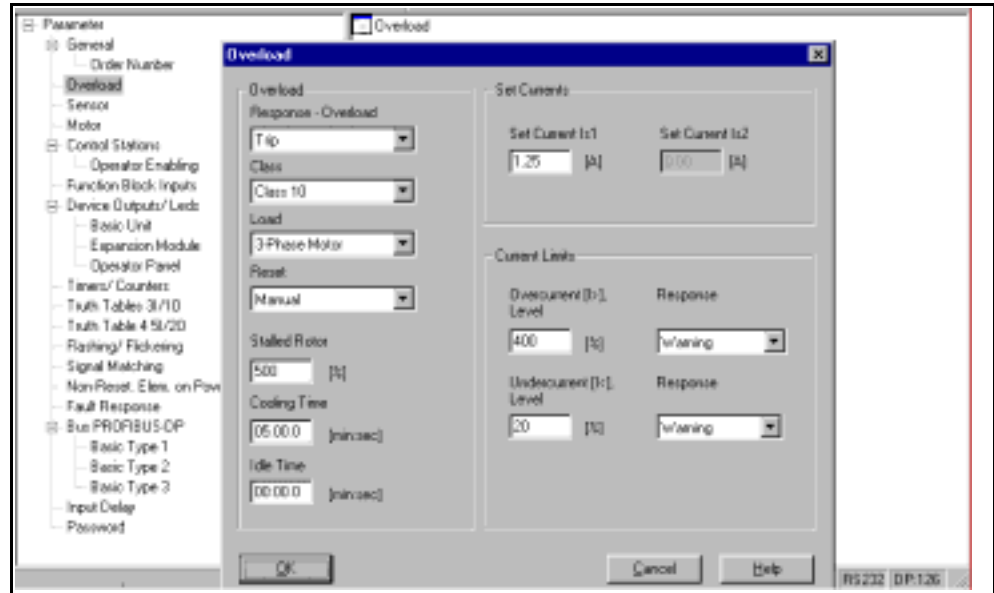

Fig. 77: Setting parameters in the "Overload" dialog

Step 4

Open the "Sensor" dialog. Set the type of detector to "PTC Binary" .

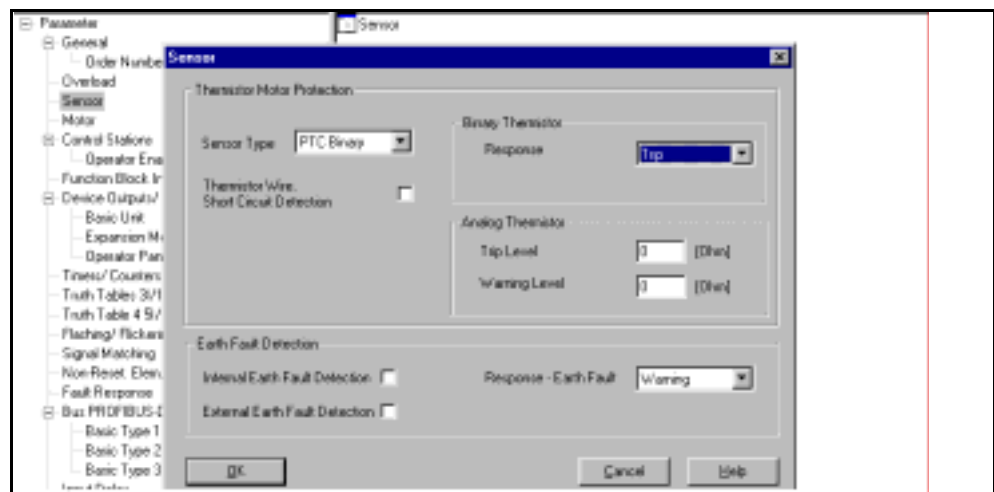

Fig. 78: Setting parameters in the "Sensor" dialog

Step 5

Open the "Motor" dialog. Set the Control Function to "Direct Starter".

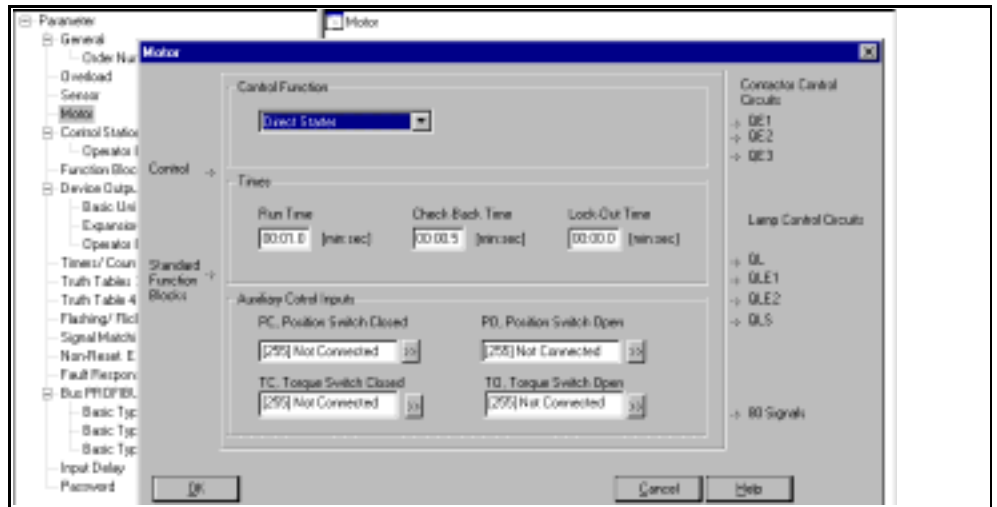



Fig. 79: Setting the parameters in the "Motor" dialog

Step 6

Open the "Control Stations" dialog. This is where you assign the start/stop pushbuttons on the Local Control Station (block diagram page 8-13) to the internal Local Control Station [LC]. Proceed as follows:

1. Click on the  button on the left next to "Off". In the next dialog "Basic Unit BU" select input 2 for the stop command (shown below).
2. Click on the  button on the left next to "On". In the next dialog "Basic Unit BU" select input 1 for the start command.

Use the default settings for the PLC/PLS [DP] Control Station and software Control Mode Switches S1 and S2.



Fig. 80: Setting parameters in the "Control Stations" dialog

The assignments of the internal Local Control [LC] then look like this:

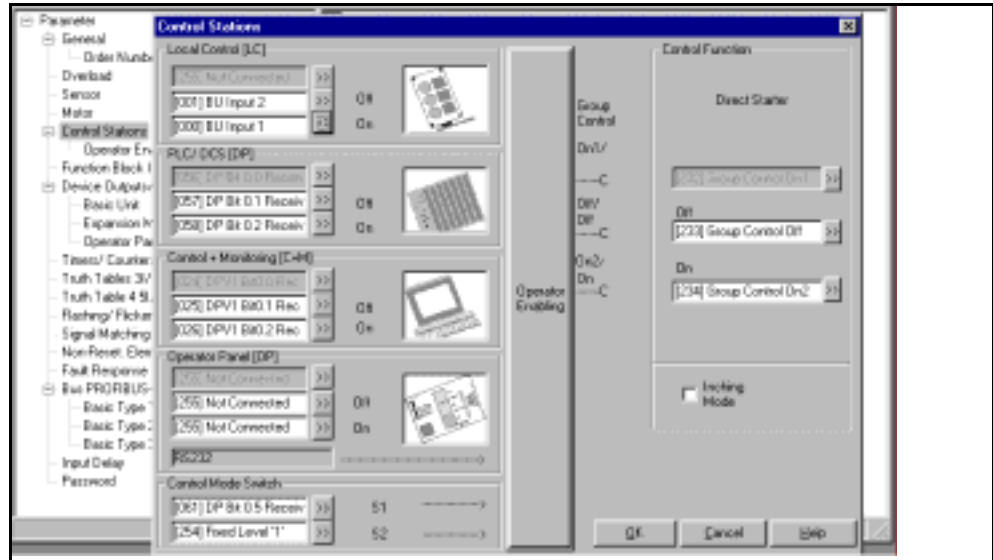

Fig. 81: Parameters set in the "Control Stations" dialog

Step 7

From the "Control Stations" dialog, open the next dialog "Operator Enabling" by clicking on the large "Operator Enabling" button. In the example, operating mode 2 or 4 is active.

- Operating mode 2 means:
Local Control Station [LC] free and PLC/PLS [DP] blocked
- Operating mode 4 means:
Local Control Station [LC] blocked and PLC/PLS [DP] free

The "Control + Monitoring Station [C+M]" and "Operator Panel [OP]" must be blocked.

Here, too, you can accept the default settings.

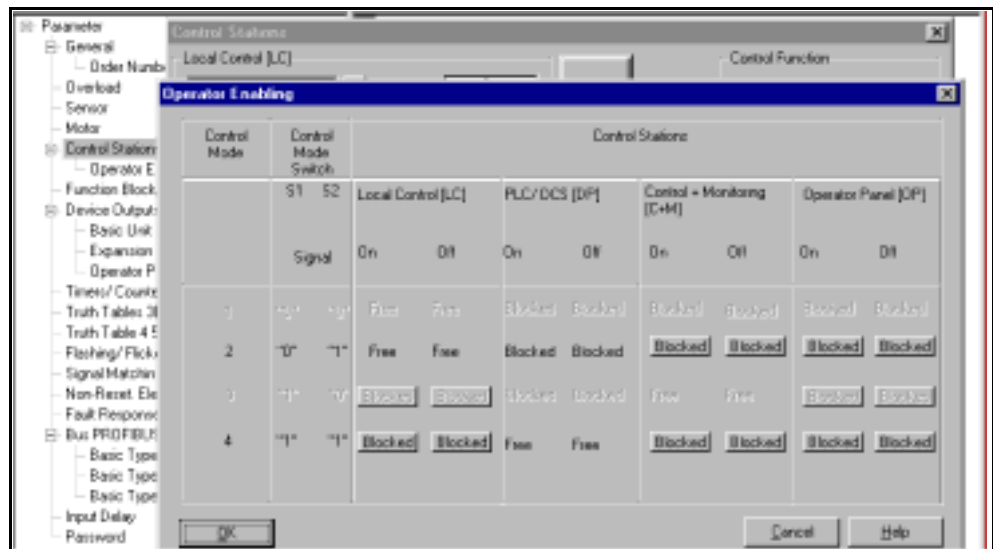



Fig. 82: "Operator Enabling" dialog

Step 8

From the "Function Block Inputs" dialog, call CST. Assign input 4 (block diagram page 8-13) to the "Check-Back Signal Test" Standard Function Block. Click on the  button next to CST). In the next dialog "Basic Unit BU" select input 4 for CST.

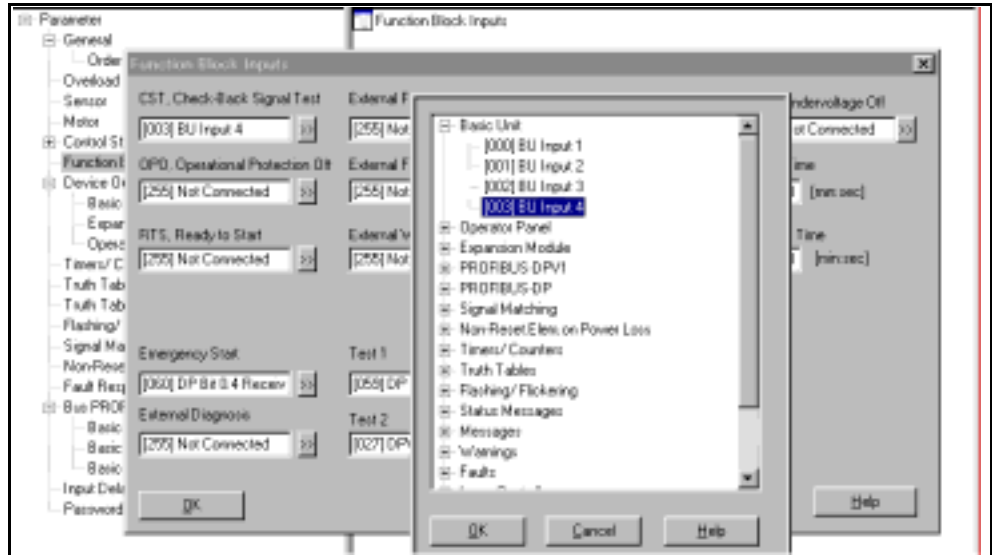



Fig. 83: Setting CST in the "Function Block Inputs" dialog

Step 9

In the "Device Outputs/LEDs" dialog, select the Basic Unit. Assign Contactor Control QE1 (block diagram page 8-13) to the "Out 1- Output Relay ". Click on the  button alongside Out 1. In the next dialog "Contactor Control" select Contactor Control 1 QE1 for Out 1.

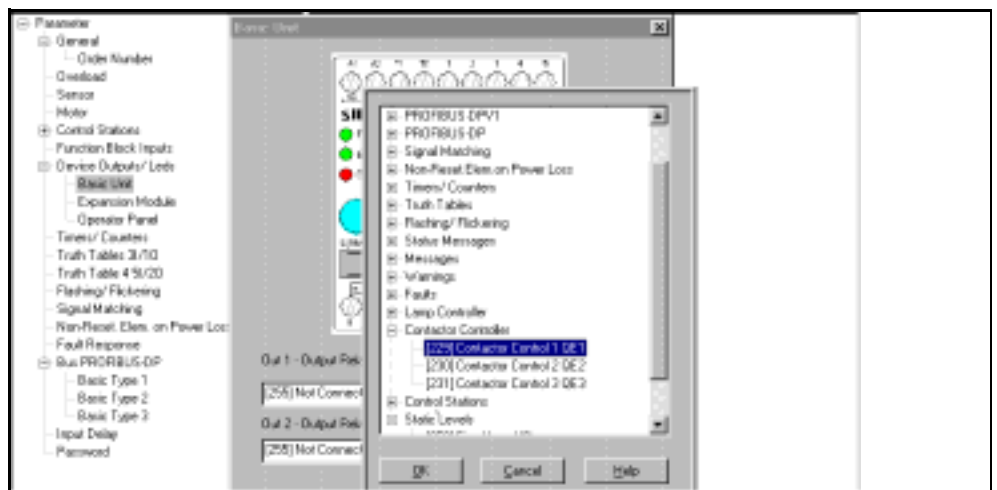

Fig. 84: Setting Out 1 - Output Relay in the "Device Outputs/LEDs" dialog

Step 10

Open the "Bus PROFIBUS-DP" dialog. Set the address to 3.

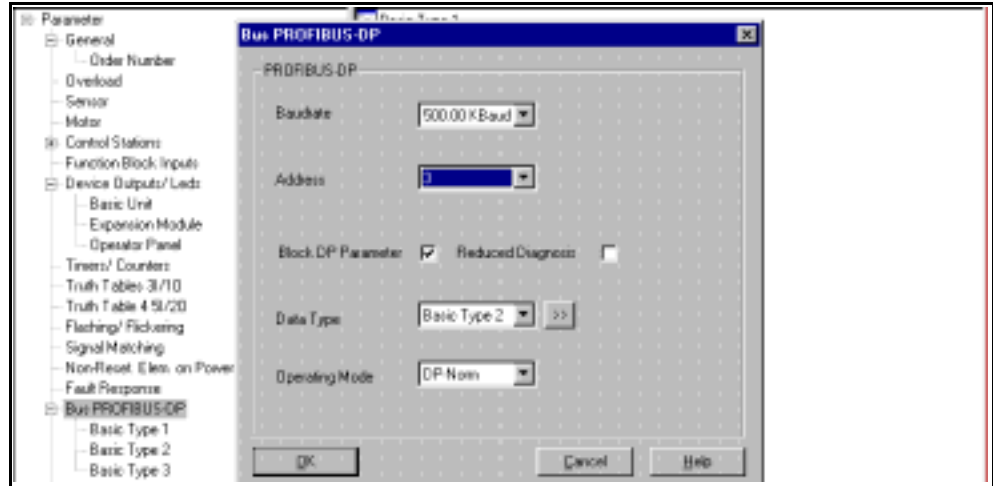

Fig. 85: Setting the address in the "Bus PROFIBUS-DP" dialog

You have now entered all parameters for this example, the Direct Starter. Save the parameter record on hard disk or floppy disk and transfer it to SIMOCODE-DP.

Parameter record

This parameter record is also available in the Win-SIMOCODE-DP/Professional and Win-SIMOCODE-DP/Smart software in the Examples folder under the name "ENGEXA.smc". The list below shows only those parameters which differ from the default values.

The full parameter table containing the default values is shown on page E-3.

Parameter name

Set value

General:

Designation Projektierungsbeispiel Direktstarter (PROBEI.smc)
 Engineering Example Direct Starter (ENGEXA.smc)

Sensor:

Sensor Type PTC Binary

Control Stations:

LC-Off Basic Unit, Input 2
 LC-On2 Basic Unit, Input 1

Function Block Inputs:

CST – Check-Back Signal Test Basic Unit, Input 4

Basic Unit:

Relais Output 1 Contactor Control QE1

Tables

Section	Topic	Page
A.1	Assignment table	A-2
A.2	Active Control Stations, Contactor Controls, Lamp Controls and status messages for the Control Functions	A-4
A.3	Control, signalling and diagnostic data	A-5
A.4	Acknowledgement and Fault handling	A-10
A.5	Sketch of SIMOCODE-DP circuit diagram with basic elements	A-15
A.6	Block diagram of the assignments	A-17
A.7	Parameter table	A-19

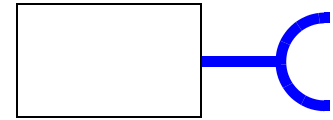

A.1 Assignment table

This table contains all the assignment numbers (No.) of the logical, internal outputs ("Sockets" ) . You can assign different logical, internal inputs ("plugs") to sockets as often as you want by entering the assignment numbers there.

Designation ("Socket")	Nr.	Designation ("Socket")	Nr.	Designation ("Socket")	Nr.	Designation ("Socket")	Nr.
Input terminals BU		PROFIBUS-DP Bit 0.5	61	Truth Table3-Out	136	Warnings	
BU Input 1	0	PROFIBUS-DP Bit 0.6	62	Truth Table4-Out1	132	Warning Ext.Warning	176
BU Input 2	1	PROFIBUS-DP Bit 0.7	63	Truth Table4-Out2	133	Warning Asymmetrie	177
BU Input 3	2	PROFIBUS-DP Bit 1.0	64			Warning Short-circuit	179
BU Input 4	3	PROFIBUS-DP Bit 1.1	65			Warning Earth Fault	184
Control Buttons OP		PROFIBUS-DP Bit 1.2	66	Flash / Flicker		Warning OVL	185
Buttons T/R	4	PROFIBUS-DP Bit 1.3	67	Flashing1-Out	137	Warning OVL+Asym.	186
Buttons 1	5	PROFIBUS-DP Bit 1.4	68	Flashing2-Out	138	Warning I1>	187
Buttons 2	6	PROFIBUS-DP Bit 1.5	69	Flashing3-Out	139	Warning I1<	188
Buttons 3	7	PROFIBUS-DP Bit 1.6	70	Flickering1-Out	140	Warning I2>	189
Input terminals EM		PROFIBUS-DP Bit 1.7	71	Flickering2-Out	141	Warning I2<	190
EM Input 1	8	PROFIBUS-DP Bit 2.0	72	Flickering3-Out	142	Warning Thermistor	191
EM Input 2	9	PROFIBUS-DP Bit 2.1	73	Status messages		Faults	
EM Input 3	10	PROFIBUS-DP Bit 2.2	74	Status On1	144	Fault DP Fault	168
EM Input 4	11	PROFIBUS-DP Bit 2.3	75	Status Off	145	Fault Earth Fault	192
EM Input 5	12	PROFIBUS-DP Bit 2.4	76	Status On2	146	Fault Overload	193
EM Input 6	13	PROFIBUS-DP Bit 2.5	77	Status OVL warning	147	Fault Overload+Asym.	194
EM Input 7	14	PROFIBUS-DP Bit 2.6	78	Status Lock-Out Time	148	Fault I1>	195
EM Input 8	15	PROFIBUS-DP Bit 2.7	79	Status Man./ Auto	149	Fault I1<	196
DPV1 (Data record 132)		PROFIBUS-DP Bit 3.0	80	Status General Fault	150	Fault I2>	197
DPV1 Bit 0.0	24	PROFIBUS-DP Bit 3.1	81	Status General Warning	151	Fault I2<	198
DPV1 Bit 0.1	25	PROFIBUS-DP Bit 3.2	82	Status Ready	152	Fault Thermistor	199
DPV1 Bit 0.2	26	PROFIBUS-DP Bit 3.3	83	Status Idle Time	153	Fault CS On	200
DPV1 Bit 0.3	27	PROFIBUS-DP Bit 3.4	84	Status Initial Param.	154	Fault CS Off	201
DPV1 Bit 0.4	28	PROFIBUS-DP Bit 3.5	85	Status Param. Active	155	Fault Motor Stalled	202
DPV1 Bit 0.5	29	PROFIBUS-DP Bit 3.6	86	Status Cooling Time	156	Fault Positioner Stalled	203
DPV1 Bit 0.6	30	PROFIBUS-DP Bit 3.7	87	Status CST	157	Fault Double 0	204
DPV1 Bit 0.7	31	Signal matching		Status Travel Open	158	Fault Double 1	205
DPV1 Bit 1.0	32	Signal Matching1-Out	120	Status Travel Closed	159	Fault Status Discrepancy	206
DPV1 Bit 1.1	33	Signal Matching2-Out	121	Signals		Fault Non-Equivalence	207
DPV1 Bit 1.2	34	Signal Matching3-Out	122	Signal PC	160	Fault RTS	208
DPV1 Bit 1.3	35	Signal Matching-Out	123	Signal PO	161	Fault OPO	209
DPV1 Bit 1.4	36	Non-Reset.Elem.1-Out	126	Signal TC	162	Fault UVO	210
DPV1 Bit 1.5	37	Non-Reset.Elem.-Out	127	Signal TO	163	Fault Ext. Fault 1	211
DPV1 Bit 1.6	38	Timer / Counter		Signal Block DP par.	169	Fault Ext. Fault 2	212
DPV1 Bit 1.7	39	Timer1-Out	128	Signal Emergency Start	170	Fault CST Fault	213
PROFIBUS-DP		Timer2-Out	129	Signal HW-test OK	171	Fault Run Time On	214
PROFIBUS-DP Bit 0.0	56	Counter1-Out	130	Signal Ext.Signal 1	173	Fault Run Time Off	215
PROFIBUS-DP Bit 0.1	57	Counter2-Out	131	Signal Ext.Signal 2	174	Fault Para.Error 0	216
PROFIBUS-DP Bit 0.2	58	Truth Table		Signal Ext.Signal 3	175	Fault Para.Error 1	217
PROFIBUS-DP Bit 0.3	59	Truth Table1-Out	134	Signal PLC-CPU Fault	178	Fault Para.Error 2	218
PROFIBUS-DP Bit 0.4	60	Truth Table2-Out	135	Motor current is flowing	235	Fault Para.Error 3	219

Designation ("Socket")	Nr.
Fault Para.Error 4	220
Fault Para.Error 5	212
Fault Para.Error 6	222
Fault Para.Error 7	223
Lamp Controls	
Ind. QLE1 (On1)	224
Ind. QLA (Off)	225
Ind. QLE2 (On2)	226
Ind. QLS (Fault)	227
Ind. Bus Active	228

Designation ("Socket")	Nr.
Contactor Controls	
Contactor Control QE1	229
Contactor Control QE2	230
Contactor Control QE3	231
Group Controls	
Group Control On1	232
Group Control Off	233
Group Control On2	234

Designation ("Socket")	Nr.
Static level	
Fixed level 0	253
Fixed level 1	254
Not connected	255

Designation ("Socket")	Nr.

A.2 Active Control Stations, Contactor Controls, Lamp Controls and status messages for the Control Functions

Control function	Control Station			Contactor Control			Lamp Control Check-back signal			Status message		
	ON1	ON2	OFF	QE1	QE2	QE3	QLE1 (On1)	QLE2 (On2)	QLA (Off)	On1	On2	Off
Overload (OVL)	–	–	–	–	–	Active	–	–	–	–	–	–
Direct Starter (DIR)	–	On	Off	On	-	-	-	On	Off	–	On	Off
Reversing Starter (REV)	Left	Right	Off	Left	Right	-	Left	Right	Off	Left	Right	Off
Star Delta Starter (STAR)	–	On	Off	Mains contactor	Star contactor	Delta contactor	-	On	Off	–	On	Off
Pole Changing Starter (PREV)	Slow	Fast	Off	Slow	Fast	-	Slow	Fast	Off	Slow	Fast	Off
Dahlander Starter (DAHL)	Slow	Fast	Off	Fast	Slow	Fast star contactor	Slow	Fast	Off	Slow	Fast	Off
Valve Control (VALV)	–	Open	Close	Open	–	–	see also table page 2-45					
Positioner (POS 1-5)	Close	Open	Stop	Open	Close	–	see also tables starting on page 2-37					
Soft Starter (SOFT)	–	On	Off	On command SIKO-START	On - mains contactor (drop-out delay)	Reset SIKO-START	-	On	Off	–	On	Off

Table 50: Active Control Stations, Contactor Controls, Lamp Control and status messages

A.3 Control, signalling and diagnostic data

These tables contains the control, signalling and diagnostic data that are transmitted, listed according to the path to or from SIMOCODE-DP. Further information on data transmission is given in Chapter 7.

	PROFIBUS-DP: cyclical writing of control data to SIMOCODE-DP	PROFIBUS-DP standard extension: acyclical writing of control data to SIMOCODE-DP	RS232 system interface SIMOCODE-DP: acyclical writing of control data to SIMOCODE-DP
Control data			
On 1	x	x	x
Off	x	x	x
On 2	x	x	x
Overload test	x	x	x
Emergency Start	x	x 5)	
Manual/Automatic changeover	x	x 5)	
Reset	x	x	x
CPU monitoring	x	x 5)	

Table 51: Writing control data to SIMOCODE-DP

	PROFIBUS-DP: cyclical reading of signals from SIMOCODE-DP	PROFIBUS-DP: reading diagnostic data in the event of a change from SIMOCODE-DP	PROFIBUS-DP standard extension: acyclical reading of signals and diagnosis from SIMOCODE-DP	RS232 system interface SIMOCODE-DP: acyclical reading of signals and diagnosis from SIMOCODE-DP
Signals				
On 1	x		x	x
Off	x		x	x
On 2	x		x	x
Overload warning	x		x	x
Lock time	x		x	x
Manual/automatic	x		x	x
Collection fault	x		x	x
Collection warning	x		x	x

	PROFIBUS-DP: cyclical reading of signals from SIMOCODE-DP	PROFIBUS-DP: reading diagnostic data in the event of a change from SIMOCODE-DP	PROFIBUS-DP standard extension: acyclical reading of signals and diagnosis from SIMOCODE-DP	RS232 system interface SIMOCODE-DP: acyclical reading of signals and diagnosis from SIMOCODE-DP
--	---	--	--	--

Diagnostic data

Ready			x	x
Idle Time			x	x
Initial Parameterization			x	x
Parameterization Active			x	x
Cooling Time running		x	x	x
Check-Back Signal Test (CST)		x	x	x
Position Drive Open			x	x
Position Drive Close			x	x
Position Close (PC)			x	x
Position Open (PO)			x	x
Torque Closed (TC)			x	x
Torque Open (TO)			x	x
DP Fault			x	x
PLC-CPU Fault		x	x	x
Block DP parameter		x	x	x
Emergency Start		x	x	x
Hardware test OK		x	x	x
External Signal 1		x	x	x
External Signal 2		x	x	x
External Signal 3		x	x	x
External Warning		x	x	x
Warning: Asymmetry		x	x	x
Warning: Sensor short-circuit		x	x	x
Warning: Earth Fault		x	x	x
Warning: Overload		x	x	x

	PROFIBUS-DP: cyclical reading of signals from SIMOCODE-DP	PROFIBUS-DP: reading diagnostic data in the event of a change from SIMOCODE-DP	PROFIBUS-DP standard extension: acyclical reading of signals and diagnosis from SIMOCODE-DP	RS232 system interface SIMOCODE-DP: acyclical reading of signals and diagnosis from SIMOCODE-DP
Warning: Overload + Asymmetry		x	x	x
Warning: I1>		x	x	x
Warning: I1<		x	x	x
Warning: I2>		x	x	x
Warning: I2<		x	x	x
Warning: Thermistor		x	x	x
Fault: Earth Fault		x	x	x
Fault: Overload		x	x	x
Fault: Overload + Asymmetry		x	x	x
Fault: I1>		x	x	x
Fault: I1<		x	x	x
Fault: I2>		x	x	x
Fault: I2<		x	x	x
Fault: Thermistor		x	x	x
Fault: Check-Back Current On		x	x	x
Fault: Check-Back Current Off		x	x	x
Fault: Motor Stalled		x	x	x
Fault: Positioner Stalled		x	x	x
Fault: Double 0		x	x	x









































































































	PROFIBUS-DP: cyclical reading of signals from SIMOCODE-DP	PROFIBUS-DP: reading diagnostic data in the event of a change from SIMOCODE-DP	PROFIBUS-DP standard extension: acyclical reading of signals and diagnosis from SIMOCODE-DP	RS232 system interface SIMOCODE-DP: acyclical reading of signals and diagnosis from SIMOCODE-DP
Fault: Double 1		x	x	x
Fault: Status Discrepancy		x	x	x
Fault: Non-Equivalence		x	x	x
Fault: Ready to Start (RTS)		x	x	x
Fault: Operating Protection Off (OPO)		x	x	x
Fault: Undervoltage Off (UVO)		x	x	x
Fault: External Fault 1		x	x	x
Fault: External Fault 2		x	x	x
Fault: Check-Back Signal Test (CST)		x	x	x
Fault: Run Time On		x	x	x
Fault: Run Time Off		x	x	x
Parameter Error 0		x	x	x
Parameter Error 1		x	x	x
Parameter Error 2		x	x	x
Parameter Error 3		x	x	x
Parameter Error 4		x	x	x
Parameter Error 5		x	x	x
Parameter Error 6		x	x	x
Parameter Error 7		x	x	x
Motor Current [%]	x4)		x	x
Number of Starts	x2)		x	x
Number of Overload Trips		x1)	x	x
Last Trip Current [%]		x1)	x	x
Number of Operating Hours		x1)	x	x

	PROFIBUS-DP: cyclical reading of signals from SIMOCODE-DP	PROFIBUS-DP: reading diagnostic data in the event of a change from SIMOCODE-DP	PROFIBUS-DP standard extension: acyclical reading of signals and diagnosis from SIMOCODE-DP	RS232 system interface SIMOCODE-DP: acyclical reading of signals and diagnosis from SIMOCODE-DP
Analog Sensor Value [Ohms]	x2)		x	x
Value of Counter 1	x2)		x	x
Value of Counter 2	x2)		x	x
Cooling Time			x	x

Table 52: Reading signalling and diagnostic data from SIMOCODE-DP

- 1) Not with diagnosis according to DPV1
- 2) Basic Type 1 only
- 3) Basic Type 2 only
- 4) Basic Type 1 and Basic Type 2
- 5) Not with Win-SIMOCODE-DP/Professional

A.4 Acknowledgement and Fault handling

Fault	Meaning	Con- tactor Control	Behaviour of LED		Behaviour of Lamp Control				Status Message	Warning	Fault
			Gen.Fault		QLS		QLE1 QLE2	QLA			
			before Ack- nowl. ment	after Ack- nowl. ment	before Ack- nowl. ment	after Ack- nowl. ment					
Valid for Control Function Overload ¹³⁾, Direct Starter, Reversing Starter, Star Delta Starter, Pole Changing Starter, Dahlander Starter, Positioner											
Overload ¹⁾	Overload detected								General Fault	—	Overloa
Overload ²⁾	Overload detected								General Warning	Overload	—
Overload+ Asymmetry ¹⁾	Overload and Asymmetry detected								General Fault	—	Overloa Asymm
Overload+ Asymmetry ¹²⁾	Overload and Asymmetry detected								General Warning	Overload+ Asymmetry	—
Thermistor ¹⁾ PTC Binary	Response value overshoot								General Fault	—	Thermi:
Thermistor ²⁾ PTC Binary	Response value undershoot								General Warning	Thermistor	—
Thermistor PTC-/NTC Analog	Warning level overshoot/ undershoot								General Warning	Thermistor	—
Thermistor PTC-/NTC-Analog	Trip level overshoot/under- shoot								General Warning General Fault	Thermistor	Thermi:
Earth Fault ¹⁾	Response value overshoot								General Fault	—	Earth F
Earth Fault ²⁾	Response value overshoot								General Warning	Earth Fault	—
Motor Stalled	Response value overshoot								General Fault	—	Motor Stalled
Overcurrent [I>], Level ¹⁾	Response value overshoot								General Fault	—	I1/I2> Fault
Overcurrent [I>], Level ²⁾	Response value overshoot								General Warning	I1/I2> Warning	—
Undercurrent [I<], Level ¹⁾	Response value undershoot								General Fault	—	I1/I2< Fault
Undercurrent [I<], Level ²⁾	Response value undershoot								General Warning	I1/I2< Warning	—

Fault	Meaning	Con- tactor Control	Behaviour of LED		Behaviour of Lamp Control			Status Message	Warning	Fault	Fault handling	
			Gen.Fault		QLS		QLE1 QLE2					QLA
			before Ack- nowl. ment	after Ack- nowl. ment	before Ack- nowl. ment	after Ack- nowl. ment						
Check-Back Curr. Off	Power failure in main circuit without "Open Command" longer than checkback time		●	○	●	○	○	●	General Fault	—	Check-Back Curr. (Off)	Reset or opposite command "Off"
Check-Back Curr. On	Current flow in main circuit without "Close Command" longer than checkback time		●	●	●	●	○ ¹⁰⁾	○	General Fault	—	Check-Back Curr. (On)	Reset or opposite command "Off" and clear fault
External Fault1	Signal present at function block "External Fault 1"		●	●	●	●	○ ⁵⁾	● ⁵⁾	General Fault	—	Ext. Fault 1	Reset or opposite command "Off"/"Stop" and clear fault
External Fault2	Signal present at function block "External Fault 2"		●	●	●	●	○ ⁵⁾	● ⁵⁾	General Fault	—	Ext.Fault 2	Reset or opposite command "Off"/"Stop" and clear fault
Check-Back Signal Test	Signal present at function block "CST" and current flowing in main circuit		●	●	●	●	○	● ⁶⁾	General Fault	—	CST Fault	Reset or opposite command "Off"/"Stop"
Ready To Start	Signal fault at function block "Ready to Start"		●	●	●	●	○ ⁵⁾	● ⁵⁾	General Fault	—	RTS	Clear fault
Undervoltage Off	Signal present at function block "Undervoltage OFF" after expiry of UVO time		●	●	●	●	○ ⁵⁾	● ⁵⁾	General Fault	—	UVO	Reset or opposite command "Off"/"Stop" and clear fault
PLC-CPU-Fault ³⁾	Signal change from 1 to 0 at function block PLC-CPU monitoring		●	○	●	○	○	●	General Fault	—	PLC-CPU- Fault (Sig- nals)	Reset
PLC-CPU-Fault ⁴⁾	Signal change from 1 to 0 at function block PLC- CPU monitoring	=	○	○	○	○	● ¹¹⁾	○	General Warning	PLC-CPU- Fault (Sig- nals)	—	Clear fault
DP-Fault ³⁾	Fault on PROFIBUS-DP in Mode 4, Automatic		●	●	●	●	○	●	General Fault	--	DP-Fault (Signals)	Clear fault and reset
DP-Fault ⁴⁾	Fault on PROFIBUS-DP in Mode 4, Automatic	=	○	○	○	○	● ¹¹⁾	○	—	—	—	—
Parameter Errors 1-7	See description Parameter Error		○	○	○	○	○	○	Sinal only while transmitting Parameters	—	—	See Table 33 Parameter Errors



Valid for Control Function Overload, Direct Starter, Reversing Starter, Star Delta Starter, Pole Changing Starter, Dahlander Starter, SIKOSTART

Fault	Meaning	Con- tactor Control	Behaviour of LED		Behaviour of Lamp Control				Status Message	Warning	Fault	Fault handling
			Gen.Fault		QLS		QLE1 QLE2	QLA				
			before Ack- nowl. ment	after Ack- nowl. ment	before Ack- nowl. ment	after Ack- nowl. ment						
Operational Protection Off	Signal present at function block "Operational Protection Off"								General Fault	—	OPO	Opposite command "Off"; Switching On not possible until fault has been cleared
Run Time On	No current flowing in main circuit after "On Command" and expiry of run time								General Fault	—	Run Time On	Reset or opposite command "Off"
Run Time Off	Current flowing in main circuit after "Off Command" and expiry of run time								General Fault	—	Run Time Off	Reset or opposite command "Off" and clear fault
Valid for Control Function Positioner												
Operational Protection Off	Signal present at function block "Operational Protection Off"								General Fault	—	OPO	End position closed must have been reached, then opposite command "Close"
Run Time Close (On)	positioner does not reach end position close after expiry of run time								General Fault	—	Run Time On	Reset or opposite command "Off"
Run Time Open (Off)	positioner does not reach end position open after expiry of run time								General Fault	—	Run Time Offs	Reset or opposite command "Close" and clear fault
Positioner Stalled	Torque switch responds without signal from associated limit switch								General Fault	—	Positioner Stalled	Release the torque switch "Close/Open" with opposite command "Open/Close"
Double 0	Both torque switches have responded simultaneously								General Fault	—	Double 0	Clear fault
Double 1	Both limit switches have responded simultaneously								General Fault	—	Double 1	Clear fault
Status Discrepancy	Positioner has left limit position without move command, not Positioner 5								General Fault	—	Status Discrepancy	Release the limit switch "Close/Open" with opposite command "Open/Close"
Non-Equivalence	The checkback signal (changeover contact) does not have a non-equivalent value when the Positioner reaches its end position, Positioner 5 only								General Fault	—	Non-Equivalence	Clear fault

Fault	Meaning	Con- tactor Control	Behaviour of LED		Behaviour of Lamp Control			Status Message	Warning	Fault	Fault handling	
			Gen.Fault		QLS		QLE1 QLE2					QLA
			before Ack- nowl. ment	after Ack- nowl. ment	before Ack- nowl. ment	after Ack- nowl. ment						
Valid for Control Function Solenoid Valve												
External Fault 1	Signal present at function block "External Fault 1"								General Fault	—	Ext. Fault 1	Reset or opposite command "Close" and clear fault
External Fault 2	Signal present at function block "External Fault 2"								General Fault	—	Ext. Fault 2	Reset or opposite command "Close" and clear fault
Ready To Start	Signal absent at function block "Ready To Start"								General Fault	—	RTS	Clear fault
Operational Protection Off	Signal present at function block "Protection Off"								General Fault	—	OPO	Opposite command "Close"; Switching On not possible until fault has been cleared
Run Time Close (On)	Solenoid valve does not reach end position close after expiry of run time								General Fault	—	Run Time On	Reset or opposite command "Open"
Run Time Open (Off)	Solenoid valve does not reach end position open after expiry of run time								General Fault	—	Run Time Off	Reset or opposite command "Close"
Double 1	Both limit switches have responded simultaneously								General Fault	—	Double 1	Clear fault
Status Discrepancy	Solenoid valve has moved out of end position								General Fault	—	Status Discrepancy	Opposite command "Open/Close"
PLC-CPU Fault ³⁾	Signal change from 1 to 0 at function block PLC-CPU monitoring								General Fault	—	PLC-CPU Fault (Signals)	Reset
PLC-CPU Fault ⁴⁾	Signal change from 1 to 0 at function block PLC-CPU monitoring								General Fault	PLC-CPU Fault (Signals)	--	Clear fault
DP Fault ³⁾	Fault on PROFIBUS-DP in Mode 4, Automatic								General Fault	—	DP Fault (Signals)	Clear fault and reset
DP Fault ⁴⁾	Fault on PROFIBUS-DP in Mode 4, Automatic								—	—	—	—
Parameter Errors 1-7	See description Parameter Errors								Signal only while transmitting parameters	—	—	See Table 33 Parameter Errors

Symbols and footnotes

Legend of symbols used and footnotes:

- LED lights up or continuous signal in the case of the QLS/QLE1/QLE2/QLA Lamp Control
- ◐ LED flashes or flashing signal in the case of the QLS/QLE1/QLE2/QLA Lamp Control
- LED off or no signal in the case of the QLS/QLE1/QLE2/QLA Lamp Control
-  Contactor Control QE1/QE2/QE3 deactivated
-  Contactor Control QE1/QE2/QE3 retains its state

- 1) Parameterized behaviour in the event of a "Shutdown" fault
- 2) Parameterized behaviour in the event of a "Warning" fault
- 3) Parameterized behaviour in the event of an "Off" fault
- 4) Parameterized behaviour in the event of a "Retain Status" fault
- 5) Applies to moving of Positioner and fault - signal states as specified
With the Positioner in the end position and a fault, no QLA signal and continuous QLE1 or QLE2 signal according to the end position
- 7) In the case of Positioner and Solenoid Valve control, continuous signal
- 8) Flashing signal only QLE1 until end Position Closed reached, then continuous signal
- 9) In the case of Positioner only reset possible
- 10) In the case of Positioner only continuous signal to QLE1 or QLE2
- 11) In the case of Positioner flashing signals to QLE1 or QLE2
- 12) In the case of Solenoid Valve QLE2 steady light and QLA no signal
- 13) When using the Overload Control Function the QLA/QLE1/QLE2 Lamp Controls are not active

Rules

- The table applies in cases where the motor was switched on before the fault occurred.
- The table lists the statuses of the Contactor Controls, Lamp Controls, warnings and faults up until acknowledgement, NOT up until fault clearance.
- On Overload and in the event of "Retain Status" or "Switch Off" arising from a fault, the General Warning and Overload Warning always precede the status message. The same applies to Overload+Asymmetry.

A.5 Sketch of SIMOCODE-DP circuit diagram with basic elements

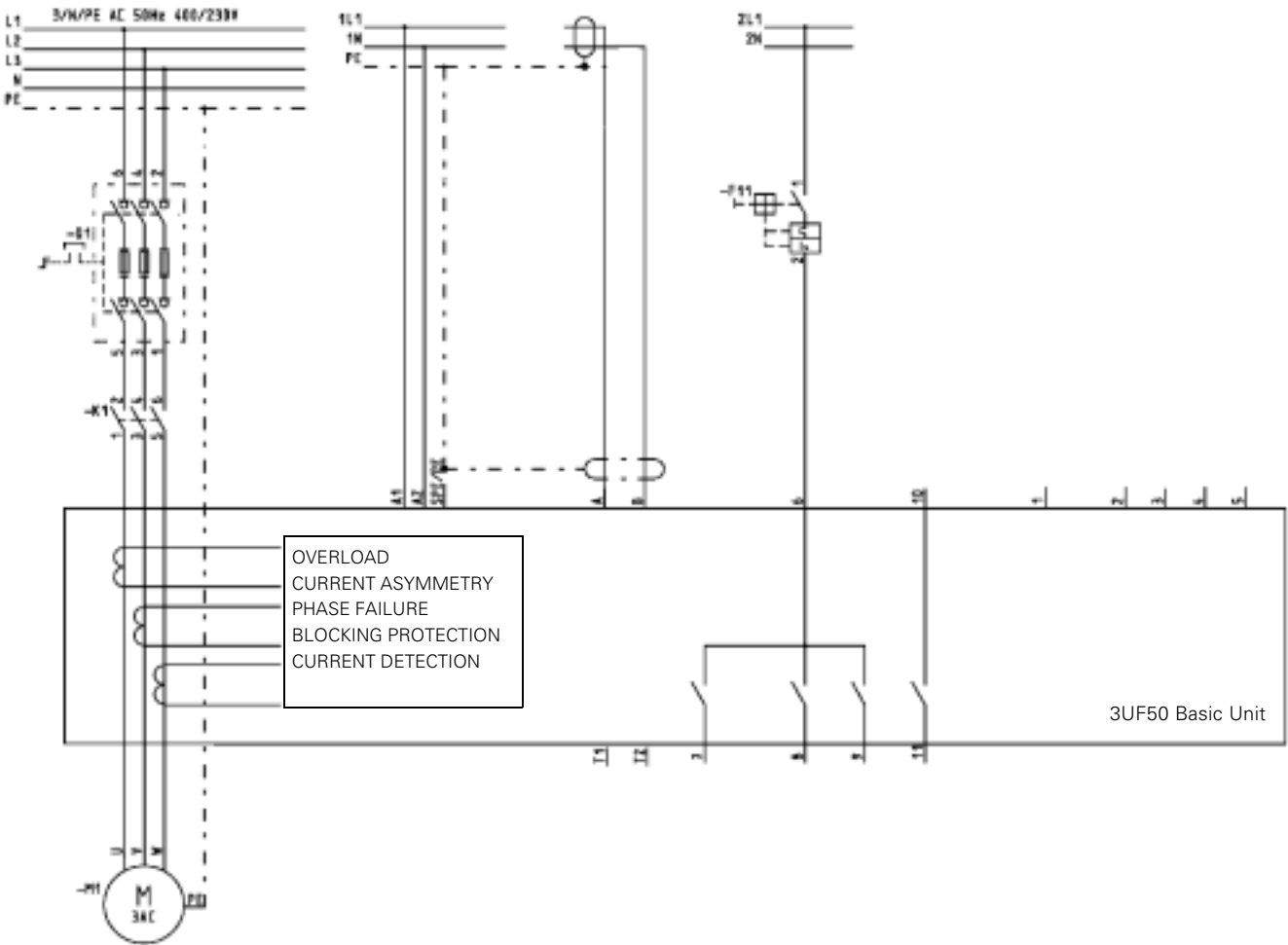

A.6 Block diagram of the assignments

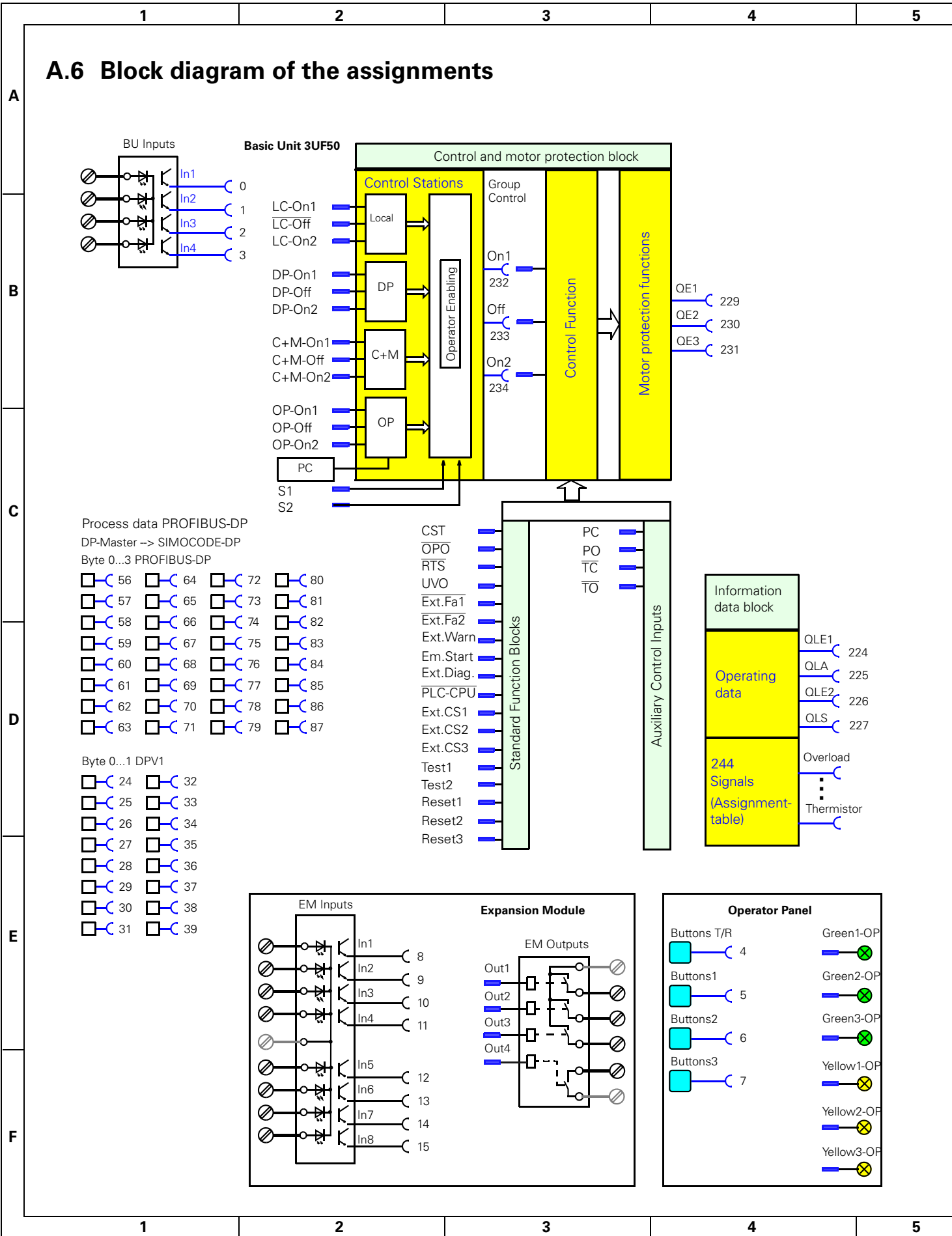

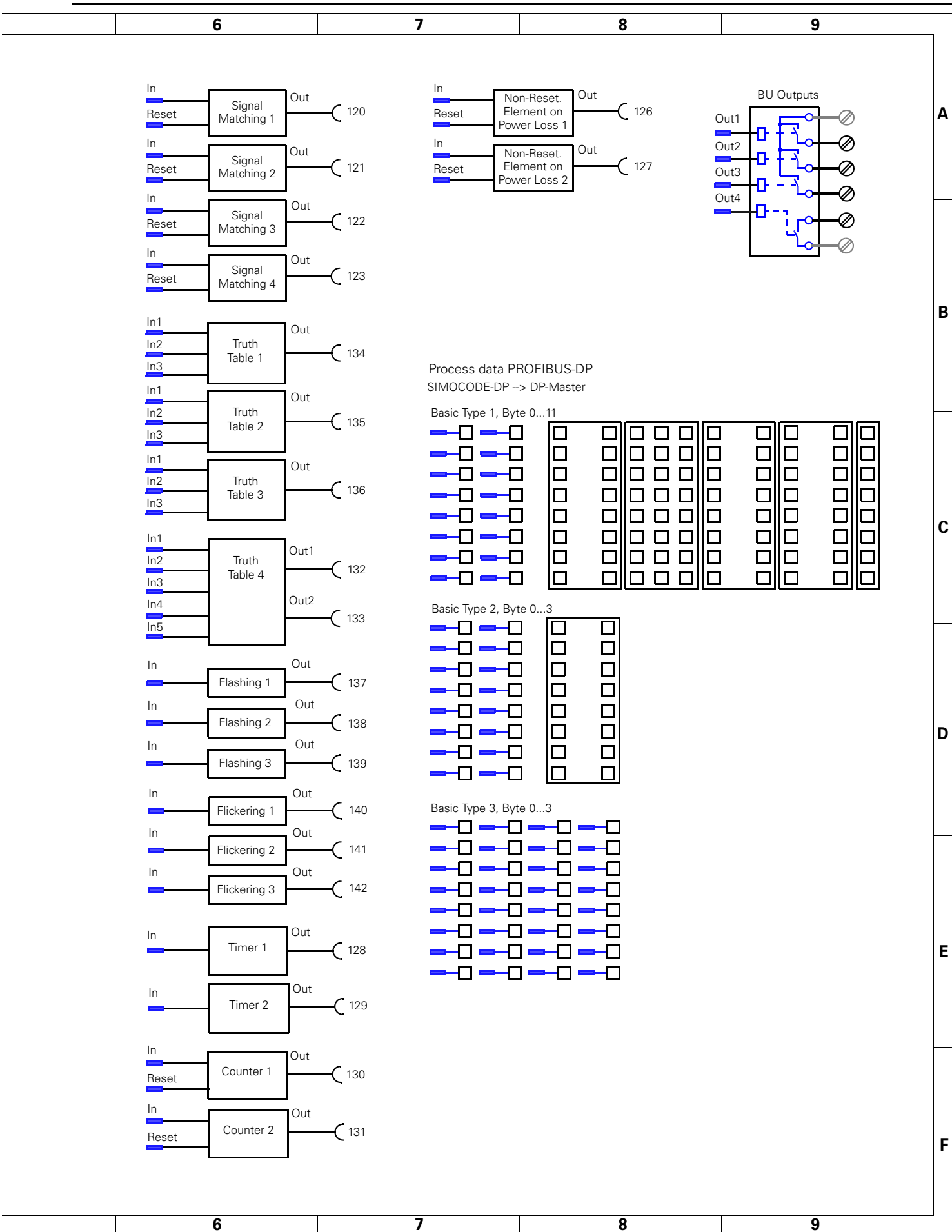

A.7 Parameter table

This table contains all the settings and assignments which you can parameterize for the SIMOCODE-DP.

■ Grey boxes "Subgroup": contain settings

□ White boxes "Subgroup": contain assignments ("plugs" ■).

You can enter your parameters in the column "Selected value".

A parameter name consists of the main group and the sub group.

Example **COM PROFIBUS**: Uela -> Is1 Current in. **Win-SIMOCODE-DP**: Parameter—>Overload—>le1.

	Parameter designation	Main group	Subgroup	Range / Plug No. ¹⁾	Increment	Pre-setting	Selected value		
Basic settings	Adresse ²⁾	Base	Adress	0...126	1	126			
	Baud rate ²⁾		Baud rate	19,2k..1500k		500k			
	Basic Type ²⁾		Basic Type	1...3	1	2			
	Block DP ²⁾		Block DP	yes / no		no			
Motor Protection against Overload	Set Current 1 ³⁾	OVL	Is1 current in	10 mA / 0,1 A / 1 A		10 mA			
	Set Current 1		Is1	0...65530		125			
	Set Current 2 ³⁾		Is2 current in	10 mA / 0,1 A / 1 A		10 mA			
	Set Current 2		Is2	0...65530		0			
	Tripping class		Class	5...30	5	10			
	Behaviour with Overload		Beh. OVL	Warning / Shutdown		Shutdown			
	Cooling Time		T-Cool.	0...3600 s	0,1 s	0			
	Idle Time		T-rest	0...3600 s	0,1 s	0			
	3-phase Motor		3-Motor	yes / no		no			
	Motor current too low		I<Threshold	0...1000 %	5 %	20 %			
	Response Undercurr. I<		Resp. I<	Warning / Shutdown		Warning			
	Motor current too high		I>Threshold	20...1000%	5 %	400 %			
	Response Overcurr. I>		Resp. I>	Warning / Shutdown		Warning			
	Block		Block	20...1000%	5 %	500 %			
	Acknowledge		Reset	Manual / Auto		Manual			
	Earth Fault		Int. Earth Fault Detection	Detect	Int. Earth	yes / no		no	
			Ext. Earth Fault Detection.		Ext. Earth	yes / no		no	
Response - Earth Fault		Resp. Earth	Warning / Shutdown			Warning			
Thermistor	PTC Binary	Thermistor	Bin. PTC	yes / no		no			
	Response - Binary PTC		Resp. PTC	Warning / Shutdown		Shutdown			
	PTC Analog		PTC Ana.	yes / no		no			
	NTC Analog		NTC Ana.	yes / no		no			
	Anal. Trip Level		Ana. Trip	0...5100 Ω	20 Ω	0			
	Anal. Warning Level		Ana. Warn	0...5100 W	20 Ω	0			
Motor Control	Th. Wire, Short Circ. Det.	Motor	Short-Circ.	yes / no		no			
	Control Function		Cont.Fctn.	OVL to POS		OVL			
	Run Time		T-Run	0...3600 s	0,1 s	1 s			
	Lock-Out Time		T-Lock	0...3600 s	0,1 s	0 / off			
	UVO-Time		T-UVO	0...3600 s	0,1 s	0 / off			
	Grading Time		T-Grad	0...3600 s	0,1 s	0 / off			
	Check-Back Time		T-ChBK	0...3600 s	0,1 s	0,5 s			
	Operator Enabling 7-1		OE7-1	0000000...1111111		0000000			
	Operator Enabling 15-9		OE15-9	0000000...1111111		0000000			

¹⁾ Plug number: Internal number for "plug" ■ .

²⁾ Input only with PC

³⁾ Input only with Type data file/DMD

	Parameter designation	Main group	Subgroup	Range / Plug No. ¹⁾	Increment	Pre-setting	Selected value		
Control Mode switch	Switch 1	Fct1	S1	189		61			
	Switch 2		S2	190		254			
Function Block Inputs	Check-Back Signal Test		CST	196		255			
	Operating Protection Off		OPO	197		255			
	Ready to Start		RTS	198		255			
	Undervoltage Off		UVO	199		255			
	External Fault 1		Ext.Fa1	200		255			
	External Fault 2		Ext.Fa2	201		255			
	External Warning		Ext.Warn.	207		255			
	Emergency Start		Em.Start	195		60			
	External Diagnosis		Ext.Diag.	211		255			
	PLC-CPU		PLC-CPU	212		63			
Auxiliary Control Inputs	Ext. Check-Back Signal 1		Fct2	Ext.CS1	208		255		
	Ext. Check-Back Signal 2			Ext.CS2	209		255		
	Ext. Check-Back Signal 3	Ext.CS3		210		255			
	Test 1	Test1		202		59			
	Test 2	Test2		203		27			
	Reset 1	Reset1		204		62			
	Reset 2	Reset2		205		30			
	Reset 3	Reset3		206		255			
	Position Switch Closed	PC		191		255			
	Position Switch Open	PO		192		255			
	Torque Closed	TC		193		255			
	Torque Open	TO		194		255			
	Output Relays	1st Basic Unit		Out	BU Output 1	63		255	
		2nd Basic Unit			BU Output 2	64		255	
3rd Basic Unit		BU Output 3	65			255			
4th Basic Unit		BU Output 4	66			255			
1st Expansion Module		EM Output 1	67			255			
2nd Expansion Module		EM Output 2	68			255			
3rd Expansion Module		EM Output 3	69			255			
4th Expansion Module		EM Output 4	70			255			
Fault Response	3UF50-CPU Fault	Fault Resp.	3UF50-CPU	Off / Retain Status		Off			
	Control Voltage Fault		Control Volt.	Off / Retain Status		Off			
	DP Fault		DP	Off / Retain Status		Off			
	PLC-CPU Fault		PLC-CPU	Off / Retain Status		Off			

	Parameter designation	Main group	Subgroup	Range / Plug No. ¹⁾	Increment	Pre-setting	Selected value
Signal Matching	Signal Matching 1 - Type	Signal	SM1-Type	Level Inv./Edge Ris./Edge fal.		Edge ris.	
	Signal Matching 1 - Input		SM1-Input	155		255	
	Signal Matching 1 - Reset		SM1-Reset	156		255	
	Signal Matching 2 - Type		SM2-Type	Level inv./Edge ris./Edge fal.		Edge ris.	
	Signal Matching 2 - Input		SM2-Input	157		255	
	Signal Matching 2 - Reset		SM2-Reset	158		255	
	Signal Matching 3 - Type		SM3-Type	Level inv./Edge ris./Edge fal.		Edge ris.	
	Signal Matching 3 - Input		SM3-Input	159		255	
	Signal Matching 3 - Reset		SM3-Reset	160		255	
	Signal Matching 4 - Type		SM4-Type	Level inv./Edge ris./Edge fal.		Edge ris.	
	Signal Matching 4 - Input		SM4-Input	161		255	
	Signal Matching 4 - Reset		SM4-Reset	162		255	
Non-Resetting Elements on Power Loss	Element 1 - Type		NE1-Type	Level inv./Edge ris./Edge fal.		Edge ris.	
	Element 1 - Input		NE1-Input	167		255	
	Element 1 - Reset		NE1-Reset	168		255	
	Element 2 - Type		NE2-Type	Level inv./Edge ris./Edge fal.		Edge ris.	
	Element 2 - Input		NE2-Input	169		255	
	Element 2 - Reset		NE2-Reset	170		255	
LED	OP LED 4 Green	LED	Green1-OP	79		255	
	OP LED 5 Green		Green2-OP	80		255	
	OP LED 6 Green		Green3-OP	81		255	
	OP LED 1 Yellow		Yellow1-OP	82		255	
	OP LED 2 Yellow		Yellow2-OP	83		255	
	OP LED 3 Yellow		Yellow3-OP	84		255	
Flashing	Flashing 1 Input		Flash1 Input	171		255	
	Flashing 2 Input		Flash2 Input	172		255	
	Flashing 3 Input		Flash3 Input	173		255	
Flickering	Flickering 1 Input		Flick1 Input	174		255	
	Flickering 2 Input		Flick2 Input	175		255	
	Flickering 3 Input		Flick3 Input	176		255	
Control Stations	Inching Mode	Control	Inch	On / Off (yes / no)		Off / no	
	Local Control [LC] On 1		LC-On1	177		255	
	Local Control [LC] Off		LC-Off	178		255	
	Local Control [LC] On2		LC-On2	179		255	
	PLC / DCS [DP] On1		DP-On1	180		56	
	PLC / DCS [DP] Off		DP-Off	181		57	
	PLC / DCS [DP] On2		DP-On2	182		58	
	Contr.+Monit. [C+M] On 1		C+M-On1	183		24	
	Contr.+Monit. [C+M] Off		C+M-Off	184		25	
	Contr.+Monit. [C+M] On2		C+M-On2	185		26	
	Operator Panel [OP] On 1		OP-On1	186		255	
	Operator Panel [OP] Off		OP-Off	187		255	
	Operator Panel [OP] On2		OP-On2	188		255	
	Input Control Function		Control Function [CF] On 1	CF-On1	132		232
Control Function [CF] Off		CF-Off	133		233		
Control Function [CF] On2		CF-On2	134		234		

	Parameter designation	Main group	Subgroup	Range / Plug No. ¹⁾	Increment	Pre-setting	Selected value		
Timers	Timer 1 - Value	T/C	Timer1-value	0...3600 s	0,1 s	0 / off			
	Timer 1 - Type		Timer1-Type	clos.del./open.del/fleet.close		clos.del.			
	Timer 1 - Input		Timer1-Input	149		255			
	Timer 2 - Value		Timer2-value	0...3600 s	0,1 s	0 / off			
	Timer 2 - Type		Timer2-Type	clos.del./open.del/fleet.close		clos.del.			
	Timer 2 - Input		Timer2-Input	150		255			
Counter	Counter 1 - Value	T-Tab	Count1-Value	0...65535	1	0 / off			
	Counter 1 - Input 1		Count1-Input	151		255			
	Counter 1 - Reset 1		Count1-Reset	152		255			
	Counter 2 - Value		Count2-Value	0...65535	1	0 / off			
	Counter 2 - Input 1		Count2-Input	153		255			
	Counter 2 - Reset 1		Count2-Reset	154		255			
Truth Tables 3I/1O	Output Bit Pattern 1	T-Tab	Tab1-Type	00000000...11111111		00000000			
	Truth Table 1 - Input 1		Tab1-Input1	140		255			
	Truth Table 1 - Input 2		Tab1-Input2	141		255			
	Truth Table 1 - Input 3		Tab1-Input3	142		255			
	Output Bit Pattern 2		Tab2-Type	00000000...11111111		00000000			
	Truth Table 2 - Input 1		Tab2-Input1	143		255			
	Truth Table 2 - Input 2		Tab2-Input2	144		255			
	Truth Table 2 - Input 3		Tab2-Input3	145		255			
	Output Bit Pattern 3		Tab3-Type	00000000...11111111		00000000			
	Truth Table 3 - Input 1		Tab3-Input1	146		255			
	Truth Table 3 - Input 2		Tab3-Input2	147		255			
	Truth Table 3 - Input 3		Tab3-Input3	148		255			
Truth Table 5I/2O	Output Bit Pattern 4.1	T-Tab	Tab4-Type1	00000000...11111111		00000000			
	Output Bit Pattern 4.2		Tab4-Type2	00000000...11111111		00000000			
	Output Bit Pattern 4.3		Tab4-Type3	00000000...11111111		00000000			
	Output Bit Pattern 4.4		Tab4-Type4	00000000...11111111		00000000			
	Output Bit Pattern 4.5		Tab4-Type5	00000000...11111111		00000000			
	Output Bit Pattern 4.6		Tab4-Type6	00000000...11111111		00000000			
	Output Bit Pattern 4.7		Tab4-Type7	00000000...11111111		00000000			
	Output bit pattern 4.8		Tab4-Type8	00000000...11111111		00000000			
	Table 4 Input 1		Tab4-Input1	135		255			
	Table 4 Input 2		Tab4-Input2	136		255			
	Table 4 Input 3		Tab4-Input3	137		255			
	Table 4 Input 4		Tab4-Input4	138		255			
	Table 4 Input 5		Tab4-Input5	139		255			
	PROFIBUS-DP		Bit 0.0	Data1	DP0.0	95		144	
			Bit 0.1		DP0.1	96		145	
			Bit 0.2		DP0.2	97		146	
Bit 0.3		DP0.3	98			147			
Bit 0.4		DP0.4	99			148			
Bit 0.5		DP0.5	100			149			
Bit 0.6		DP0.6	101			150			
Bit 0.7		DP0.7	102			151			
Bit 1.0		DP1.0	103			255			
Bit 1.1		DP1.1	104			255			
Bit 1.2		DP1.2	105			255			
Bit 1.3		DP1.3	106			255			

Parameter designation	Main group	Subgroup	Range / Plug No. ¹⁾	Increment	Pre-setting	Selected value
Bit 1.4		DP1.4	107		255	
Bit 1.5		DP1.5	108		255	
Bit 1.6		DP1.6	109		255	
Bit 1.7		DP1.7	110		255	
Bit 2.0	Data2	DP2.0	111		255	
Bit 2.1		DP2.1	112		255	
Bit 2.2		DP2.2	113		255	
Bit 2.3		DP2.3	114		255	
Bit 2.4		DP2.4	115		255	
Bit 2.5		DP2.5	116		255	
Bit 2.6		DP2.6	117		255	
Bit 2.7		DP2.7	118		255	
Bit 3.0		DP3.0	119		255	
Bit 3.1		DP3.1	120		255	
Bit 3.2		DP3.2	121		255	
Bit 3.3		DP3.3	122		255	
Bit 3.4		DP3.4	123		255	
Bit 3.5		DP3.5	124		255	
Bit 3.6	DP3.6	125		255		
Bit 3.7	DP3.7	126		255		
Input Delay	Basic Unit Inputs	BU Inputs	18...84 ms		18 ms	
	Expansion Module Inp. ³⁾	EM Inputs	36...84 ms		36 ms	

¹⁾ Plug number: Internal number for "plug"  .

²⁾ Input only with PC

³⁾ Input only with Type data file/DMD

For your installation documentation

Project: _____

Name: _____

Date: _____

Data Structure

Section	Topic	Page
B.1	Data formats and data records	B-2
B.2	Cyclical data	B-4
B.2.1	Basic Types	B-4
B.2.2	Assignment of cyclical messages	B-6
B.3	Diagnosis	B-8
B.3.1	Standard diagnosis	B-8
B.3.2	Device-specific diagnosis according to DP standard	B-9
B.3.3	Device-specific diagnosis according to DPV1	B-11
B.3.4	Alarms (only as S7 slave)	B-14
B.4	Reading/writing data records acyclically	B-17
B.4.1	Reading data record 130 - signals	B-17
B.4.2	Reading data record 131 - display/diagnosis	B-19
B.4.3	Writing data record 133 - statistical data	B-19
B.4.4	Writing data record 132 - control commands	B-20
B.4.5	Data record 138 - device parameters	B-20

B.1 Data formats and data records

Properties

SIMOCODE-DP determines a large number of Operating, Diagnosis and Statistical Data.

These data have the following properties and formats:

- **Control Data**
Data which are written to the SIMOCODE-DP, e.g. Motor On switching command, Reset.
Data format: Bit
- **Messages**
Data which are transmitted by the SIMOCODE-DP and indicate the current operating status, e.g. Motor On etc.
Data format: Bit
- **Diagnosis**
Data which are transmitted by the SIMOCODE-DP and indicate the current operating status, e.g. Fault, Overload etc.
Data format: Bit
- **Current Motor Current in %**
SIMOCODE-DP measures the current in all three phases and displays the current of the largest loaded phase as a percentage of the Set Current I_s . Here 100% is equal to the Set Current I_s .
Data format: 2 bytes
Updating time: 200 ms
 - Example: Set Current $I_s = 60\text{ A}$
Displayed Motor Current 110%
then corresponds to $60\text{ A} \times 1.1 = 66\text{ A}$
- **Current of the last Overload Trip in %**
SIMOCODE-DP measures the current in all three phases and displays the current of the largest loaded phase which flows at the time of the Overload Trip, in percent of the Set Current I_s .
Data format: 2 bytes
 - Example: Set Current $I_s = 60\text{ A}$
Displayed Motor Current 455%
then corresponds to $60\text{ A} \times 4.55 = 273\text{ A}$
- **Current Sensor Value in ohms**
SIMOCODE-DP determines the current Sensor Value of the Thermistor from 0 to 5100 ohms in 20 ohm steps.
In the evaluation of the transmitted Sensor Value through the cyclic channel of the PROFIBUS-DP, the value must be taken times 20.
Data format: 1 byte
- **Counter 1 and Counter 2 Value**
SIMOCODE-DP shows the current status of the counters in the range from 0 to 65535. The values remain stored in the SIMOCODE-DP even on failure of the supply voltage.

Statistical Data

- **Operating Hours**
SIMOCODE-DP counts the number of Operating Hours in the range from 0 to 645,350 hours in 10 hour steps. I.e. SIMOCODE-DP increments the value of the Operating Hours for the time of the current flow in the main circuit. The value remains stored in the SIMOCODE-DP even on failure of the supply voltage. You can set the number of Operating Hours by parameterization, e.g. reset it on replacement of the motor. In the evaluation of the transmitted Operating Hours through the diagnosis channel of the PROFIBUS-DP, the value times 10 must be taken.
Data format: 2 bytes
- **Number of Overload Trips**
SIMOCODE-DP counts the number of Overload Trips in the range from 0 to 64,535. The value remains stored in the SIMOCODE-DP even on failure of the supply voltage. You can set the number of Overload Trips by parameterization, e.g. reset it on replacement of the motor.
Data format: 2 bytes
- **Number of Starts**
SIMOCODE-DP counts the Number of Starts in the range from 0 to 16,777,215. I.e. if after the "On" switching command the current flows in the main circuit, SIMOCODE-DP increments the value by one. The value remains stored in the SIMOCODE-DP even on failure of the supply voltage. You can set the Number of Starts by parameterization, e.g. reset it on replacement of the motor.
Data format: 3 bytes

B.2 Cyclical data

B.2.1 Basic Types

Control data

Basic Type 1	Basic Type 1 compact
1 byte: control data	4 bytes: control data
1 byte: control data	
1 byte: control data	
1 byte: control data	

Basic Type 2	Basic Type 2 compact
1 byte: control data	4 bytes: control data
1 byte: control data	
1 byte: control data	
1 byte: control data	

Basic Type 3	Basic Type 3 compact
1 byte: control data	4 bytes: control data
1 byte: control data	
1 byte: control data	
1 byte: control data	

Default values are assigned to the control data according to profile. The assignments can be changed.

Signalling data

Basic Type 1	Basic Type 1 compact
1 byte: signalling data	12 bytes: signalling data
1 byte: signalling data	
2 bytes: motor current	+ motor current
3 bytes: number of starts	+ number of starts
2 bytes: counter 1 value	+ counter 1 value
2 bytes: counter 2 value	+ counter 2 value
1 byte: sensor value	+ sensor value

Basic Type 2	Basic Type 2 compact
1 byte: signalling data	4 bytes: signalling data
1 byte: signalling data	
2 bytes: motor current	

Basic Type 3	Basic Type 3 compact
1 byte: signalling data	4 bytes: signalling data
1 byte: signalling data	
1 byte: signalling data	
1 byte: signalling data	

Default values are assigned to the signalling data according to profile. The assignments can be changed.

motor current: [% of Is]
Sensor value: [20 ohms]

Fig. 86: Diagram of Basic Types

Possible Basic Types

When connected as

- DP standard slave
Choice between Basic Type 1/2/3 and Basic Type 1/2/3 compact
- DPV1 slave
Choice between Basic Type 1/ 2/ 3
- S7 slave
Choice between Basic Type 1/ 2/ 3 compact.

The same data are transmitted in the case of both Basic Type 1/ 2/ 3 and Basic Type 1/ 2/ 3 compact.

**Advantages of
Basic Type 1/ 2/ 3:**

You can assign a separate I/O address for each block in your automation system. This allows great flexibility in the partitioning of the SIMOCODE-DP data in the I/O area. If you are using COM PROFIBUS, it is possible to place only individual blocks in the I/O area, enabling you to save I/O memory space.

**Advantages of
Basic Type 1/ 2/ 3
compact:**

Only one I/O address must be assigned at a time. Entry is simpler. With SIMATIC S7-400 you can make full use of the I/O area (as address assignment is only possible with modulo four).

B.2.2 Assignment of cyclical messages

Control data from the DP master → SIMOCODE-DP

Bytes 0 to 3

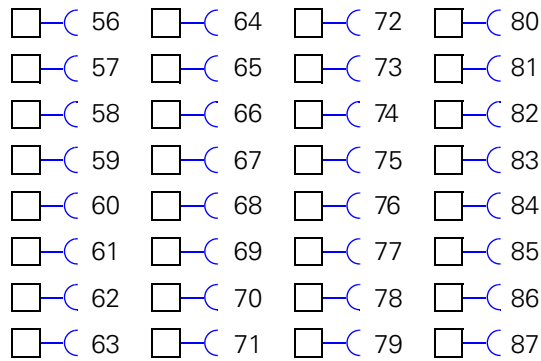

Byte-by-byte transmission into the I/O area of the DP master is possible.

Fig. 87: Diagram of process data

Assignment

The control data are transmitted cyclically from the DP master to the SIMOCODE-DP. The default assignment of byte 0 can be altered

Byte.Bit	Meaning
0.0	On 1
0.1	Off
0.2	On 2
0.3	Overload Test: Overload Test started via the bus
0.4	Emergency Start: Motor is started in spite of Overload
0.5	Operation Type Bit = 0: Manual Operation Bit = 1: Automatic Operation
0.6	Reset: Fault messages are reset when the cause of the Fault has been removed.
0.7	CPU-monitoring: Bit = 0: The CPU of the programmable-controller master has failed Bit = 1: The CPU of the programmable-controller master is intact
1.0 to 3.7	User-specific assignment carried out during parameterization

Table 53: Assignment of control data

Setting with Win-SIMOCODE-DP

You can change the default setting of the cyclical messages with Win-SIMOCODE-DP in the "Bus PROFIBUS-DP" dialog.

Signalling data
SIMOCODE-DP →
DP master

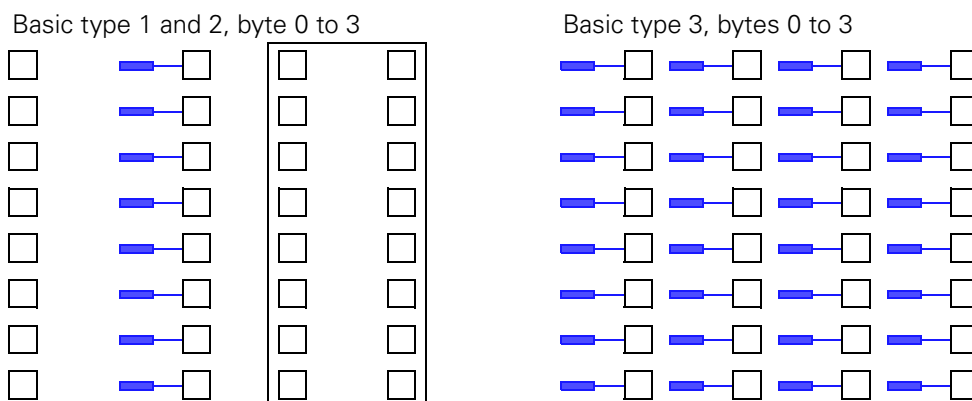

Fig. 88: Diagram of process data for basic types 2 and 3

Assignment

The process data are transmitted cyclically from the SIMOCODE-DP to the DP master. The assignment of bytes 0 and 1 can be altered, in addition to bytes 2 and 3 for basic type 3.

Byte.Bit	Meaning
0.0	On 1
0.1	Off
0.2	On 2
0.3	Warning: Overload has occurred
0.4	Message: Lock-Out Time has started, switching command blocked
0.5	Manual / Auto Bit = 0: Manual Operation has been set Bit = 1: Automatic Operation has been set
0.6	General Fault
0.7	General Warning
1.0 to 1.7	User-specific assignment carried out during parameterization
2.0 to 3.7	Current Motor Current [%]

Table 54: Assignment of process data

B.3 Diagnosis

Structure of the diagnostic message

The diagram below shows the structure of the diagnostic message:

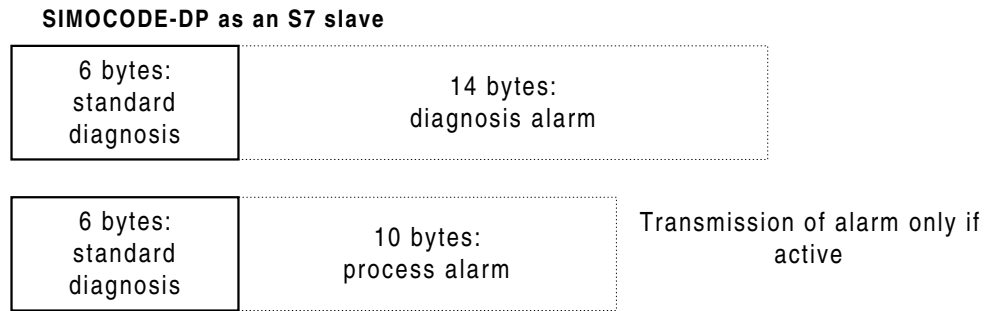
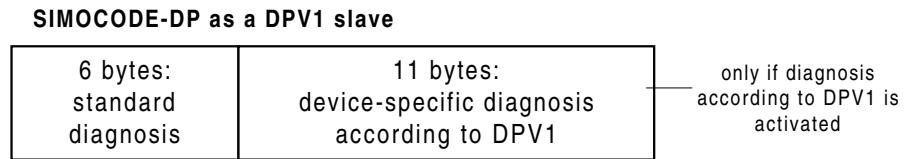
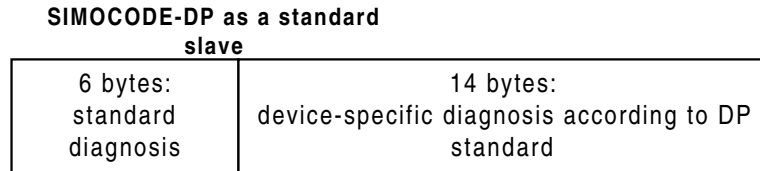

B.3.1 Standard diagnosis

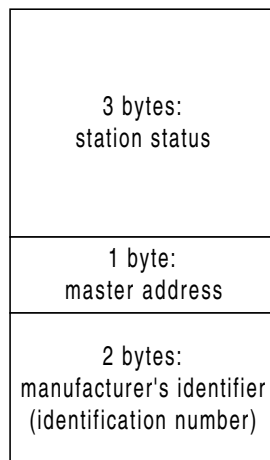

B.3.2 Device-specific diagnosis according to DP standard

If you are running SIMOCODE-DP in DP standard operating mode, the device-specific diagnosis according to the DP standard is appended to the standard diagnosis. It is transmitted to the master module every time there is a change.

Structure of device-specific diagnosis according to DP standard:

Byte.Bit	Meaning
6.0	Header with code and length of device-specific diagnosis (0E _H)
7.0	Unused
7.1	Signal: Block DP
7.2	Signal: Emergency Start
7.3	Signal: Hardware test OK
7.4	Unused
7.5	Signal: External Signal 1
7.6	Signal: External Signal 2
7.7	Signal: External Signal 3
8.0	Warning: External Warning
8.1	Warning: Asymmetry > 40%
8.2	Signal: PLC-CPU Fault
8.3	Warning: Short Circuit in sensor line
8.4	Signal: Cooling Time running
8.5	Status: CST (Check-Back Signal Test)
8.6	Unused
8.7	Unused
9.0	Warning: Earth Fault
9.1	Warning: Overload
9.2	Warning: Overload and Asymmetry
9.3	Warning: I1 >
9.4	Warning: I1 <
9.5	Warning: I2 >
9.6	Warning: I2 <
9.7	Warning: Thermistor
10.0	Fault: Earth Fault
10.1	Fault: Overload
10.2	Fault: Overload and Asymmetry Trip

Table 55: Assignment of device-specific diagnostic bytes

Byte.Bit	Meaning
10.3	Fault: I1 >
10.4	Fault: I1 <
10.5	Fault: I2 >
10.6	Fault: I2 <
10.7	Fault: Thermistor
11.0	Fault: Check-Back Current On
11.1	Fault: Check-Back Current Off
11.2	Fault: Motor Stalled
11.3	Fault: Positioner Stalled
11.4	Fault: Double "0" Error, Positioner
11.5	Fault: Double "1" Error, Positioner
11.6	Fault: End position reached
11.7	Fault: Non-equivalence fault, Positioner
12.0	Fault: Ready to Start (RTS)
12.1	Fault: Operating Protection Off (OPO)
12.2	Fault: Undervoltage Off (UVO)
12.3	Fault: External Fault 1
12.4	Fault: External Fault 2
12.5	Fault: CST Fault
12.6	Fault: Run Time On
12.7	Fault: Run Time Off
13.0	Parameter Error 0: Discrepancy in Set Current Is1 / Is2
13.1	Parameter Error 1: Incorrect device version for external Earth Fault/Thermistor Motor Protection
13.2	Parameter Error 2: Discrepancy in detector settings for Thermistor
13.3	Parameter Error 3: Discrepancy between Set Current and Control Function
13.4	Parameter Error 4: Assignments to Operator Panel parameterized although no such module is connected
13.5	Parameter Error 5: Assignments to Expansion Module parameterized although no such module is connected
13.6	Parameter Error 6: Bistable behaviour not available;
13.7	Parameter Error 7: Hardware fault, memory defective: replace unit
14.0 to 15.7	Number of overload trips (0 to 65535)* 2 Byte
16.0 to 17.7	Current of last Overload Trip [% of Is] 2 bytes

Table 55: Assignment of device-specific diagnostic bytes (cont.)

Byte.Bit	Meaning
18.0 to 19.7	Number of Operating Hours [0 to 655350 h] * (in increments of 10 h) 2 bytes
	*Also stored even after failure and restoration of supply voltage

Table 55: Assignment of device-specific diagnostic bytes (cont.)

B.3.3 Device-specific diagnosis according to DPV1

If you are running SIMOCODE-DP in DPV1 operating mode as a DPV1 slave, you can activate device-specific diagnosis according to DPV1. This is then transmitted to the master module every time there is a change. Structure of device-specific diagnosis according to DPV1:

Byte.Bit	Meaning
6.0 to 6.7	Header with code and length of device-specific diagnosis (0B _H)
7.0 to 7.7	Fixed default value (081 _H)
8.0 to 8.7	Fixed default value (004 _H)
9.0 to 9.7	Fixed default value (000 _H)
10.0	Unused
10.1	Signal: Block DP
10.2	Signal: Emergency Start
10.3	Signal: Hardware test OK
10.4	Unused
10.5	Signal: External Signal 1
10.6	Signal: External Signal 2
10.7	Signal: External Signal 3
11.0	Warning: External Warning
11.1	Warning: Asymmetry > 40%
11.2	Signal: PLC-CPU Fault
11.3	Warning: Short Circuit in sensor line
11.4	Signal: Cooling Time running
11.5	Status: CST (Check-Back Signal Test)
11.6	Unused
11.7	Unused

Table 56: Device-specific diagnosis according to DPV1

Byte.Bit	Meaning
12.0	Warning: Earth Fault
12.1	Warning: Overload
12.2	Warning: Overload+Asymmetry
12.3	Warning: I1 >
12.4	Warning: I1 <
12.5	Warning: I2 >
12.6	Warning: I2 <
12.7	Warning: Thermistor
13.0	Trip: Earth Fault
13.1	Trip: Overload
13.2	Trip: Overload+Asymmetry trip
13.3	Trip: I1 >
13.4	Trip: I1 <
13.5	Trip: I2 >
13.6	Trip: I2 <
13.7	Trip: Thermistor
14.0	Trip: Check-Back Current On
14.1	Trip: Check-Back Current On OFF
14.2	Trip: Motor Stalled
14.3	Trip: Positioner Stalled
14.4	Trip: Double "0" Error, Positioner
14.5	Trip: Double "1" Error, Positioner
14.6	Trip: End position reached
14.7	Trip: Non-Equivalence Fault, Positioner
15.0	Trip: Ready to Start (RTS)
15.1	Trip: Operating Protection Off (OPO)
15.2	Trip: Undervoltage Off (UVO)
15.3	Trip: External Fault 1
15.4	Trip: External Fault 2
15.5	Trip: CST Fault
15.6	Trip: Run Time On

Table 56: Device-specific diagnosis according to DPV1 (cont.)

Byte.Bit	Meaning
15.7	Trip: Run Time Off
16.0	Trip: Parameter Error 0: Discrepancy in Set Current Is1 / Is2
16.1	Trip: Parameter Error 1: Incorrect device version for external Earth Fault/Thermistor Motor Protection
16.2	Trip: Parameter Error 2: Discrepancy in detector settings for Thermistor
16.3	Trip: Parameter Error 3: Discrepancy between Set Current and Control Function
16.4	Trip: Parameter Error 4: Assignments to Operator Panel parameterized although no such module is connected
16.5	Trip: Parameter Error 5: Assignments to Expansion Module parameterized although no such module is connected
16.6	Trip: Parameter Error 6: Bistable behaviour not available;
16.7	Trip: Parameter Error 7: Hardware fault, memory defective: replace unit

Table 56: Device-specific diagnosis according to DPV1 (cont.)

B.3.4 Alarms (only as S7 slave)

Alarm sequence

If you are running SIMOCODE-DP in DPV1 operating mode as an S7 slave, you can activate diagnosis and process alarms. When an alarm event occurs, the alarm information is appended to the standard diagnosis. It remains there until it is acknowledged by the master module. A breakdown of an alarm sequence applicable to all SIMOCODE-DP alarms is shown in the figure below:

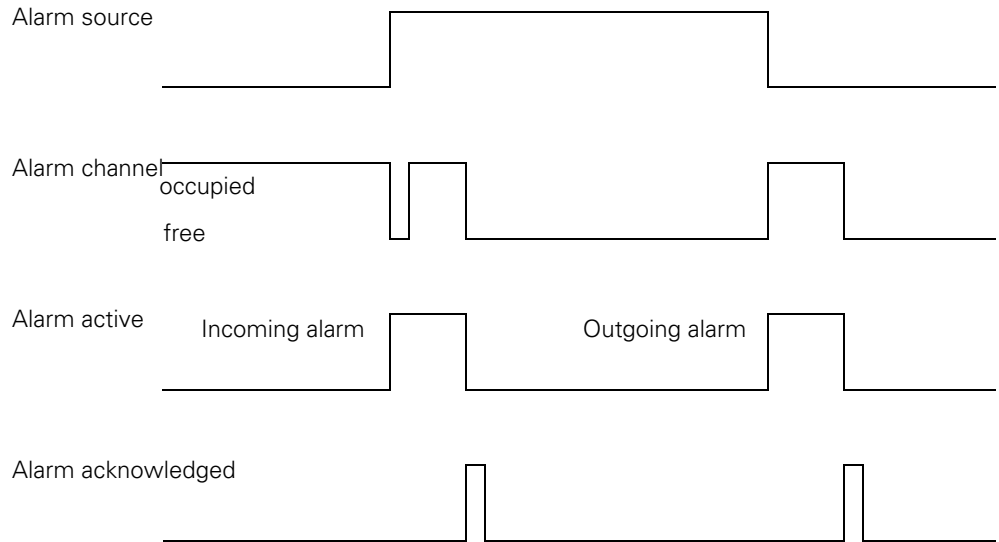

Fig. 89: Alarm sequence

After an alarm event has occurred (alarm source 0->1 or 1->0), the alarm information is buffered. As soon as the alarm channel is free, the alarm is transmitted. The alarm is not removed until after it has been acknowledged. This sequential approach is necessary because only one alarm can be transmitted at any one time.

SIMOCODE-DP generates both an incoming alarm and an outgoing alarm. As soon as SIMOCODE-DP generates an alarm, the corresponding alarm OB is started in the SIMATIC-S7. You obtain the detailed alarm information in the transfer variables. Alarms are acknowledged automatically by the SIMATIC-S7.

Diagnosis alarm

- Diagnosis alarm:
The alarm source in the case of a diagnosis alarm is *Hardware test not ok* or *Parameter error*.
As soon as SIMOCODE-DP sets a diagnosis alarm, the diagnosis alarm OB 82 is started in the SIMATIC-S7. You can read the status of SIMOCODE-DP from the variable OB82_MDL_DEFECT. You can obtain detailed information from the signalling data record, for example.

Process alarm in the event of a fault

- Process alarm in the event of a fault:
The alarm source of this process alarm is the General Fault of SIMOCODE-DP (without a Parameter Error). The incoming alarm is initiated with the rising edge of the General Fault, the outgoing alarm with the falling edge. As soon as SIMOCODE-DP sets a process alarm, one of the process alarm OBs 40 to 47 is started in the SIMATIC-S7. You can recognize the status of SIMOCODE-DP at the time of the edge change on the basis of the variable OB40_POINT_ADDR:

Byte.Bit	Meaning
0.0 to 0.3	Incoming alarm in event of fault 0101 Outgoing alarm in event of fault0110
0.4	Unused
0.5	Unused
0.6	Unused
0.7	Trip: PLC-CPU Fault
1.0	Trip: Earth Fault
1.1	Trip: Overload
1.2	Trip: Overload+Asymmetry Trip
1.3	Trip: I1 >
1.4	Trip: I1 <
1.5	Trip: I2 >
1.6	Trip: I2 <
1.7	Trip: Thermistor
2.0	Trip: Check-Back Current On
2.1	Trip: Check-Back Current On OFF
2.2	Trip: Motor Stalled
2.3	Trip: Positioner Stalled
2.4	Trip: Double "0" Error, Positioner
2.5	Trip: Double "1" Error, Positioner
2.6	Trip: End position reached
2.7	Trip: Non-Equivalence Fault, Positioner

Table 57: Process alarm in the event of a fault

Byte.Bit	Meaning
3.0	Trip: Ready to Start (RTS)
3.1	Trip: Operating Protection Off (OPO)
3.2	Trip: Undervoltage Off (UVO)
3.3	Trip: External Fault 1
3.4	Trip: External Fault 2
3.5	Trip: CST Fault
3.6	Trip: Run Time On
3.7	Trip: Run Time Off

Table 57: Process alarm in the event of a fault

Process alarm in the event of a warning

- Process alarm in the event of a warning:
The alarm source of this process alarm is the General Warning of SIMOCODE-DP. The incoming alarm is initiated with the rising edge of the General Warning, the outgoing alarm with the falling edge. As soon as SIMOCODE-DP sets a process alarm, one of the process alarm OBs 40 to 47 is started in the SIMATIC-S7. You can recognize the status of SIMOCODE at the time of the edge change on the basis of the variable OB40_POINT_ADDR:

Byte.Bit	Meaning
0.0 to 0.3	Incoming alarm in event of warning 0001 Outgoing alarm in event of warning 0010
0.4	Warning: External Warning
0.5	Warning: Asymmetry > 40%
0.6	Overload Warning
0.7	Warning: Sensor Short Circuit
1.0	Warning: Earth Fault
1.1	Warning: Overload
1.2	Warning: Overload and Asymmetry
1.3	Warning: I1 >
1.4	Warning: I1 <
1.5	Warning: I2 >
1.6	Warning: I2 <
1.7	Warning: Thermistor
2.0 to 3.7	Unused

Table 58: Process alarm in the event of a warning

B.4 Reading/writing data records acyclically

B.4.1 Reading data record 130 - signals

Byte.Bit	Parameter identifier	Data type	Value range
0.0	On 1	Bit[1]	{0 - 1}
0.1	Off	Bit[1]	{0 - 1}
0.2	On 2	Bit[1]	{0 - 1}
0.3	OVL warn.	Bit[1]	{0 - 1}
0.4	Lock-Out Time	Bit[1]	{0 - 1}
0.5	Auto	Bit[1]	{0 - 1}
0.6	General Fault	Bit[1]	{0 - 1}
0.7	General Warning	Bit[1]	{0 - 1}
1.0	Ready	Bit[1]	{0 - 1}
1.1	Idle Time	Bit[1]	{0 - 1}
1.2	Initial para.	Bit[1]	{0 - 1}
1.3	Param. Active	Bit[1]	{0 - 1}
1.4	Cooling Time	Bit[1]	{0 - 1}
1.5	CST	Bit[1]	{0 - 1}
1.6	Travel open	Bit[1]	{0 - 1}
1.7	Travel close	Bit[1]	{0 - 1}
2.0	PC	Bit[1]	{0 - 1}
2.1	PO	Bit[1]	{0 - 1}
2.2	TC	Bit[1]	{0 - 1}
2.3	TO	Bit[1]	{0 - 1}
2.4	Unused	Bit[4]	{0000 - 1111}
3.0	Failure DP	Bit[1]	{0 - 1}
3.1	Block DP	Bit[1]	{0 - 1}
3.2	Emergency Start	Bit[1]	{0 - 1}
3.3	HW Test OK	Bit[1]	{0 - 1}
3.4	Unused	Bit[1]	{0 - 1}
3.5	External Signal 1	Bit[1]	{0 - 1}
3.6	External Signal 2	Bit[1]	{0 - 1}
3.7	External Signal 3	Bit[1]	{0 - 1}
4.0	External Warning	Bit[1]	{0 - 1}

Table 59: Data record 130 - signals

Byte.Bit	Parameter identifier	Data type	Value range
4.1	Asymmetry>40%	Bit[1]	{0 - 1}
4.2	PLC-CPU Fault	Bit[1]	{0 - 1}
4.3	Sensor Short Circuit	Bit[1]	{0 - 1}
4.4	Unused	Bit[4]	{0000 - 1111}
5.0	Warning Earth Fault	Bit[1]	{0 - 1}
5.1	Warning Overload	Bit[1]	{0 - 1}
5.2	Warning Overload+Asym.	Bit[1]	{0 - 1}
5.3	Warning I1 >	Bit[1]	{0 - 1}
5.4	Warning I1 <	Bit[1]	{0 - 1}
5.5	Warning I2 >	Bit[1]	{0 - 1}
5.6	Warning I2 <	Bit[1]	{0 - 1}
5.7	Thermistor	Bit[1]	{0 - 1}
6.0	Fault Earth Fault	Bit[1]	{0 - 1}
6.1	Fault Overload	Bit[1]	{0 - 1}
6.2	Fault Overload+Asym.	Bit[1]	{0 - 1}
6.3	Fault I1 >	Bit[1]	{0 - 1}
6.4	Fault I1 <	Bit[1]	{0 - 1}
6.5	Fault I2 >	Bit[1]	{0 - 1}
6.6	Fault I2 <	Bit[1]	{0 - 1}
6.7	Thermist	Bit[1]	{0 - 1}
7.0	Check-Back Current On	Bit[1]	{0 - 1}
7.1	Check-Back Current Off	Bit[1]	{0 - 1}
7.2	Motor Stalled	Bit[1]	{0 - 1}
7.3	Positioner Stalled	Bit[1]	{0 - 1}
7.4	Double "0"	Bit[1]	{0 - 1}
7.5	Double "1"	Bit[1]	{0 - 1}
7.6	End Position	Bit[1]	{0 - 1}
7.7	Non-Equivalence	Bit[1]	{0 - 1}
8.0	Ready to Start	Bit[1]	{0 - 1}
8.1	OPO	Bit[1]	{0 - 1}
8.2	UVO	Bit[1]	{0 - 1}
8.3	Ext. Fault 1	Bit[1]	{0 - 1}
8.4	Ext. Fault 2	Bit[1]	{0 - 1}

Table 59: Data record 130 - signals (cont.)

Byte.Bit	Parameter identifier	Data type	Value range
8.5	Fault CST	Bit[1]	{0 - 1}
8.6	Run Time On	Bit[1]	{0 - 1}
8.7	Run Time Off	Bit[1]	{0 - 1}
9.0	Parameter Error 0	Bit[1]	{0 - 1}
9.1	Parameter Error 1	Bit[1]	{0 - 1}
9.2	Parameter Error 2	Bit[1]	{0 - 1}
9.3	Parameter Error 3	Bit[1]	{0 - 1}
9.4	Parameter Error 4	Bit[1]	{0 - 1}
9.5	Parameter Error 5	Bit[1]	{0 - 1}
9.6	Parameter Error 6	Bit[1]	{0 - 1}
9.7	Parameter Error 7	Bit[1]	{0 - 1}

Table 59: Data record 130 - signals (cont.)

B.4.2 Reading data record 131 - display/diagnosis

Byte.Bit	Parameter identifier	Data type	Value range
0.0	Operating Hours	Byte[2]	[0-65535] 10h
2.0	Number of Starts	Byte[3]	[0-16777216]
5.0	Counter Value 1	Byte[2]	[0-65535]
7.0	Counter Value 2	Byte[2]	[0-65535]
9.0	Cooling Time	Byte[2]	[0-35999] 100ms
11.0	Number of Overload Trips	Byte[2]	[0-65535]
13.0	I-max	Byte[2]	[0-65535] %
15.0	Last Trip Current	Byte[2]	[0-65535] %
17.0	Analog Sensor Value	Byte	[0-255] 20 ohms

Table 60: Data record 131 - display / diagnosis

B.4.3 Writing data record 133 - statistical data

Byte.Bit	Parameter identifier	Data type	Value range
0.0	Operating Hours	Byte[2]	[0-65535]
2.0	Number of Starts	Byte[3]	[0-16777216]
5.0	Number of Overload Trips	Byte[2]	[0-65535]

Table 61: Writing data record 133 - statistical data

B.4.4 Writing data record 132 - control commands



SIMOCODE-DP uses this data record for controlling. The pre-assigned value can be changed.

Byte.Bit	Parameter identifier	Data type	Value range
0.0	DPV1-ON1	Bit[1]	{0 - 1}
0.1	DPV1-OFF	Bit[1]	{0 - 1}
0.2	DPV1-ON2	Bit[1]	{0 - 1}
0.3	Hardware test	Bit[1]	{0 - 1}
0.4	Unused	Bit[2]	{00 - 11}
0.6	Reset	Bit[1]	{0 - 1}
0.7	Unused	Bit[1]	{0 - 1}
1.0	Unused	Byte	{0 - 255}

Table 62: Data record 132 - control commands

B.4.5 Data record 138 - device parameters

Note

This data record contains the same parameters as the parameter table starting on page A-19. Bytes 0 to 62 contain settings such as times, behaviour in the event of overload, etc. Bytes 63 to 212 contain free elements (plugs ) to which you can assign sockets . The assignment numbers for the sockets are shown in the assignment table for the sockets on pages A-2 to A-3.

Byte.Bit	Parameter identifier	Data type	Value range	Default value
0.0	Address	Byte	{0 - 126}	126
1.0	Baud rate	Bit[4]	{0 - 6} 0: 9.6 kilobaud 1: 19.2 kilobaud 2: 93.75 kilobaud 3: 187.5 kilobaud 4: 500 kilobaud 5: 1.5 megabaud 6: 45.45 kilobaud	4
1.4	Data type	Bit[2]	{0 - 2} 0: Basic Type 1 1: Basic Type 2 2: Basic Type 3	1
1.6	Operating Mode	Bit[1]	{0, 1} 0: DP 1: DPV1	0

Table 63: Data record 138 - device parameters

Byte.Bit	Parameter identifier	Data type	Value range	Default value
1.7	Reduced Diagnosis	Bit[1]	{0, 1}	0
2.0	Unused	Bit[1]	---	0
2.1	Inching Mode	Bit[1]	{0, 1}	0
2.2	Reset	Bit[1]	{0, 1} 0: Manual 1: Auto	0
2.3	Unused	Bit[5]	---	11000
3.0	Response - Undercurrent [I<], Level	Bit[1]	{0, 1} 0: Warning 1: shut down	0
3.1	Response - Overcurrent [I>], Level	Bit[1]	{0, 1} 0: Warning 1: shut down	0
3.2	Unused	Bit[1]	---	0
3.3	Response - Overload	Bit[1]	{0, 1} 0: shut down 1: do not shut down	0
3.4	Unused	Bit[1]	---	0
3.5	Load	Bit[1]	{0, 1} 0: 3-Phase Motor 1: single-phase motor	0
3.6	Response - Control Voltage Fault	Bit[1]	{0, 1} 0: Off 1: Retain Status	0
3.7	Response - 3UF50-CPU Fault	Bit[1]	{0, 1} 0: Off 1: Retain Status	0
4.0	Internal Earth Fault	Bit[1]	{0, 1}	0
4.1	External Earth Fault	Bit[1]	{0, 1}	0
4.2	Unused	Bit[1]	---	0
4.3	Thermistor Type	Bit[3]	{000, 001, 010, 100} 000: No Thermistor 001: PTC Binary 010: PTC Analog 100: NTC Analog	000
4.6	Unused	Bit[2]	---	00
5.0	Response - Earth Fault	Bit[1]	{0, 1} 0: Warning 1: shut down	0
5.1	Unused	Bit[2]	---	00

Table 63: Data record 138 - device parameters (cont.)

Byte.Bit	Parameter identifier	Data type	Value range	Default value
5.3	Response - Binary Thermistor	Bit[1]	{0, 1} 0: Warning 1: shut down	1
5.4	Unused	Bit[2]	--	00
5.6	Sensor Short Circuit	Bit[1]	{0, 1}	0
5.7	Unused	Bit[1]	--	0
6.0	Unused	Byte	---	0
7.0	Unused	Bit[3]	--	000
7.3	Response - DP Fault	Bit[1]	{0, 1} 0: Off 1: Retain Status	0
7.4	Response - PLC-CPU Fault	Bit[1]	{0, 1} 0: Off 1: Retain Status	0
7.5	Unused	Bit[1]	--	0
7.6	Block DP	Bit[1]	{0, 1}	0
7.7	Unused	Bit[1]	--	0
8.0	Set Current Is1	Byte[3]	[0-82000] 10mA	125
11.0	Set Current Is2	Byte[3]	[0-82000] 10mA	0
14.0	Class	Byte	{0, 5, 10, 15, 20, 25, 30} 5: Class 5 10: Class 10 15: Class 15 20: Class 20 25: Class 25 30: Class 30	10
15.0	Analog Thermistor Warning Level	Byte	[0-255] 20W	0
16.0	Analog Thermistor Trip Level	Byte	[0-255] 20W	0

Table 63: Data record 138 - device parameters (cont.)

Byte.Bit	Parameter identifier	Data type	Value range	Default value
17.0	Control Function	Byte	{00H,10H,20H,30H,40H,50H,60H,70H,71H,72H,73H,74H,80H } 00H: Overload 10H: Direct Starter 20H: Reversing Starter 30H: Star Delta Starter 40H: Dahlander Starter 50H: Pole Chang. Starter 60H: Solenoid Valve 70H: Positioner 1 71H: Positioner 2 72H: Positioner 3 73H: Positioner 4 74H: Positioner 5 80H: Soft Starter	10H
18.0	Run Time	Byte[2]	[0-35999] 100ms	10
20.0	Lock-Out Time	Byte[2]	[0-35999] 100ms	0
22.0	UVO-Time	Byte[2]	[0-35999] 100ms	0
24.0	Grading Time	Byte[2]	[0-35999] 100ms	0
26.0	Check-Back Time	Byte[2]	[0-35999] 100ms	5
28.0	Idle Time	Byte[2]	[0-35999] 100ms	0
30.0	Cooling Time	Byte[2]	[0-35999] 100ms	0
32.0	OE 7 6 5 4 3 2 1	Bit[7]	[0000000-1111111] 0: Disabled 1: Enabled	0000000
32.7	Unused	Bit[1]	---	0
33.0	OE 15 14 13 12 11 10 9	Bit[7]	[0000000-1111111] 0: Disabled 1: Enabled	0000000
33.7	Unused	Bit[1]	---	0
34.0	Undercurrent [I<], Level	Byte	[4-200] 5%	4
35.0	Undercurrent [I>], Level	Byte	[4-200] 5%	80
36.0	Blocked	Byte	[4-200] 5%	100
37.0	Truth Table 4-Type	Bit [64]	{000...0000-111...1111}	000...0000
45.0	Truth Table 1-Type	Bit[8]	{0000000-11111111}	00000000
46.0	Truth Table 2-Type	Bit[8]	{0000000-11111111}	00000000
47.0	Truth Table 3-Type	Bit[8]	{0000000-11111111}	00000000

Table 63: Data record 138 - device parameters (cont.)

Byte.Bit	Parameter identifier	Data type	Value range	Default value
48.0	Signal Matching 1 - Type	Bit[4]	{1, 3, 6} 1: Edge Rising with Memory 3: Edge Falling with Memory 6: Level Inverted without Memory	1
48.4	Signal Matching 2- Type	Bit[4]	{1, 3, 6} 1: Edge Rising with Memory 3: Edge Falling with Memory 6: Level Inverted without Memory	1
49.0	Signal Matching 3- Type	Bit[4]	{1, 3, 6} 1: Edge Rising with Memory 3: Edge Falling with Memory 6: Level Inverted without Memory	1
49.4	Signal Matching 4- Type	Bit[4]	{1, 3, 6} 1: Edge Rising with Memory 3: Edge Falling with Memory 6: Level Inverted without Memory	1
50.0	Unused	Byte[1]	--	0
51.0	Non-Resetting Element on Power Loss Element 1 -Type	Bit[4]	{1, 3, 6} 1: Edge Rising with Memory 3: Edge Falling with Memory 6: Level Inverted without Memory	1
51.4	Non-Resetting Element on Power Loss Element 2 -Type	Bit[4]	{1, 3, 6} 1: Edge Rising with Memory 3: Edge Falling with Memory 6: Level Inverted without Memory	1
52.0	Timer 1 - Value	Byte[2]	[0-35999] 100ms	0
54.0	Timer 2 - Value	Byte[2]	[0-35999] 100ms	0

Table 63: Data record 138 - device parameters (cont.)

Byte.Bit	Parameter identifier	Data type	Value range	Default value
56.0	Timer 1 - Type	Bit[4]	{1, 2, 4} 1: With Closing Delay 2: With Opening Delay 4: With Fleeting Closing	1
56.4	Timer 2 - Type	Bit[4]	{1, 2, 4} 1: With Closing Delay 2: With Opening Delay 4: With Fleeting Closing	1
57.0	Counter 1 - Value	Byte[2]	[0-65535]	0
59.0	Counter 2 - Value	Byte[2]	[0-65535]	0
61.0	Inp. Delay BU-Inputs	Bit[4]	[3-14] 6ms	3
61.4	Inp. Delay EM-Inputs	Bit[4]	[6-14] 6ms	6
62.0	Unused	Byte[1]	---	0
63.0	BU Output 1	Byte	[0-255]	255
64.0	BU Output 2	Byte	[0-255]	255
65.0	BU Output 3	Byte	[0-255]	255
66.0	BU Output 4	Byte	[0-255]	255
67.0	EM Output 1	Byte	[0-255]	255
68.0	EM Output 2	Byte	[0-255]	255
69.0	EM Output 3	Byte	[0-255]	255
70.0	EM Output 4	Byte	[0-255]	255
71.0	Unused	Byte[8]	---	8*255
79.0	OP LED 4 Green	Byte	[0-255]	255
80.0	OP LED 5 Green	Byte	[0-255]	255
81.0	OP LED 6 Green	Byte	[0-255]	255
82.0	OP LED 1 Yellow	Byte	[0-255]	255
83.0	OP LED 2 Yellow	Byte	[0-255]	255
84.0	OP LED 3 Yellow	Byte	[0-255]	255
85.0	Unused	Byte[10]	---	10*255
95.0	Byte 0 . Bit 0	Byte	[0-255]	144
96.0	Byte 0 . Bit 1	Byte	[0-255]	145
97.0	Byte 0 . Bit 2	Byte	[0-255]	146
98.0	Byte 0 . Bit 3	Byte	[0-255]	147
99.0	Byte 0 . Bit 4	Byte	[0-255]	148
100.0	Byte 0 . Bit 5	Byte	[0-255]	149
101.0	Byte 0 . Bit 6	Byte	[0-255]	150
102.0	Byte 0 . Bit 7	Byte	[0-255]	151
103.0	Byte 1 . Bit 0	Byte	[0-255]	255

Table 63: Data record 138 - device parameters (cont.)

Byte.Bit	Parameter identifier	Data type	Value range	Default value
104.0	Byte 1 . Bit 1	Byte	[0-255]	255
105.0	Byte 1 . Bit 2	Byte	[0-255]	255
106.0	Byte 1 . Bit 3	Byte	[0-255]	255
107.0	Byte 1 . Bit 4	Byte	[0-255]	255
108.0	Byte 1 . Bit 5	Byte	[0-255]	255
109.0	Byte 1 . Bit 6	Byte	[0-255]	255
110.0	Byte 1 . Bit 7	Byte	[0-255]	255
111.0	Byte 2 . Bit 0	Byte	[0-255]	255
112.0	Byte 2 . Bit 1	Byte	[0-255]	255
113.0	Byte 2 . Bit 2	Byte	[0-255]	255
114.0	Byte 2 . Bit 3	Byte	[0-255]	255
115.0	Byte 2 . Bit 4	Byte	[0-255]	255
116.0	Byte 2 . Bit 5	Byte	[0-255]	255
117.0	Byte 2 . Bit 6	Byte	[0-255]	255
118.0	Byte 2 . Bit 7	Byte	[0-255]	255
119.0	Byte 3 . Bit 0	Byte	[0-255]	255
120.0	Byte 3 . Bit 1	Byte	[0-255]	255
121.0	Byte 3 . Bit 2	Byte	[0-255]	255
122.0	Byte 3 . Bit 3	Byte	[0-255]	255
123.0	Byte 3 . Bit 4	Byte	[0-255]	255
124.0	Byte 3 . Bit 5	Byte	[0-255]	255
125.0	Byte 3 . Bit 6	Byte	[0-255]	255
126.0	Byte 3 . Bit 7	Byte	[0-255]	255
127.0	Unused	Byte[5]	---	5*255
132.0	Contr.Func.[FC]-ON1	Byte	[0-255]	232
133.0	Contr.Func.[FC]-OFF	Byte	[0-255]	233
134.0	Contr.Func.[FC]-ON2	Byte	[0-255]	234
135.0	Truth Table 4 - Input1	Byte	[0-255]	255
136.0	Truth Table 4 - Input2	Byte	[0-255]	255
137.0	Truth Table 4 - Input3	Byte	[0-255]	255
138.0	Truth Table 4 - Input4	Byte	[0-255]	255
139.0	Truth Table 4 - Input 5	Byte	[0-255]	255
140.0	Truth Table 4 - Input 1	Byte	[0-255]	255
141.0	Truth Table 4 - Input 2	Byte	[0-255]	255
142.0	Truth Table 4 - Input 3	Byte	[0-255]	255
143.0	Truth Table 2 - Input 1	Byte	[0-255]	255

Table 63: Data record 138 - device parameters (cont.)

Byte.Bit	Parameter identifier	Data type	Value range	Default value
144.0	Truth Table 2 - Input 2	Byte	[0-255]	255
145.0	Truth Table 2 - Input 3	Byte	[0-255]	255
146.0	Truth Table 3 - Input 1	Byte	[0-255]	255
147.0	Truth Table 3 - Input 2	Byte	[0-255]	255
148.0	Truth Table 3 - Input 3	Byte	[0-255]	255
149.0	Timer 1 - Input	Byte	[0-255]	255
150.0	Timer 2 - Input	Byte	[0-255]	255
151.0	Counter 1 - Input	Byte	[0-255]	255
152.0	Counter 1 - Reset	Byte	[0-255]	255
153.0	Counter 2 - Input	Byte	[0-255]	255
154.0	Counter 2 - Reset	Byte	[0-255]	255
155.0	SM 1 - Input	Byte	[0-255]	255
156.0	SM 1 - Reset	Byte	[0-255]	255
157.0	SM 2 - Input	Byte	[0-255]	255
158.0	SM 2 - Reset	Byte	[0-255]	255
159.0	SM 3 - Input	Byte	[0-255]	255
160.0	SM 3 - Reset	Byte	[0-255]	255
161.0	SM 4 - Input	Byte	[0-255]	255
162.0	SM 4 - Reset	Byte	[0-255]	255
163.0	Unused	Byte[4]	---	4*255
167.0	NE1 - Input	Byte	[0-255]	255
168.0	NE1 - Reset	Byte	[0-255]	255
169.0	NE2 - Input	Byte	[0-255]	255
170.0	NE2 - Reset	Byte	[0-255]	255
171.0	Flashing 1 Input	Byte	[0-255]	255
172.0	Flashing 2 Input	Byte	[0-255]	255
173.0	Flashing 3 Input	Byte	[0-255]	255
174.0	Flickering 1 Input	Byte	[0-255]	255
175.0	Flickering 2 Input	Byte	[0-255]	255
176.0	Flickering 3 Input	Byte	[0-255]	255
177.0	LC-On1	Byte	[0-255]	255
178.0	LC-Off	Byte	[0-255]	255
179.0	LC-On2	Byte	[0-255]	255
180.0	DP-On1	Byte	[0-255]	56
181.0	DP-Off	Byte	[0-255]	57
182.0	DP-On2	Byte	[0-255]	58

Table 63: Data record 138 - device parameters (cont.)

Byte.Bit	Parameter identifier	Data type	Value range	Default value
183.0	C+M-On1	Byte	[0-255]	24
184.0	C+M-Off	Byte	[0-255]	25
185.0	C+M-On2	Byte	[0-255]	26
186.0	OP-On1	Byte	[0-255]	255
187.0	OP-Off	Byte	[0-255]	255
188.0	OP-On2	Byte	[0-255]	255
189.0	S1	Byte	[0-255]	61
190.0	S2	Byte	[0-255]	254
191.0	PC	Byte	[0-255]	255
192.0	PO	Byte	[0-255]	255
193.0	TC	Byte	[0-255]	255
194.0	TO	Byte	[0-255]	255
195.0	Emergency Start	Byte	[0-255]	60
196.0	CST	Byte	[0-255]	255
197.0	OPO	Byte	[0-255]	255
198.0	RTS	Byte	[0-255]	255
199.0	UVO	Byte	[0-255]	255
200.0	Ext. Fault 1	Byte	[0-255]	255
201.0	Ext. Fault 2	Byte	[0-255]	255
202.0	Test 1	Byte	[0-255]	59
203.0	Test 2	Byte	[0-255]	27
204.0	Reset 1	Byte	[0-255]	62
205.0	Reset 2	Byte	[0-255]	30
206.0	Reset 3	Byte	[0-255]	255
207.0	Ext. Warning	Byte	[0-255]	255
208.0	Ext.CS1	Byte	[0-255]	255
209.0	Ext.CS2	Byte	[0-255]	255
210.0	Ext.CS3	Byte	[0-255]	255
211.0	Ext. Diagnosis	Byte	[0-255]	255
212.0	PLC-CPU Fault	Byte	[0-255]	63

Table 63: Data record 138 - device parameters (cont.)

Technical Data

Section	Topic	Page
C.1	General data	C-2
C.2	Auxiliary circuit / control circuit	C-4
C.3	Inputs	C-5
C.3.1	Number of inputs	C-5
C.3.2	Simultaneity for Basic Unit	C-5
C.3.3	Simultaneity for Expansion Module	C-5
C.3.4	Input currents / cable lengths	C-5
C.4	Communications interface	C-6
C.5	Behaviour in the event of supply-voltage failure	C-6
C.6	Short-circuit protection for motor branches for short-circuit currents up to 50 kA at 690 V	C-7
C.7	System reaction times (typical values)	C-8
C.8	New system functions as of product status E10	C-9
C.9	Description of DMD and type data files	C-9
C.10	Source of supply for DMD and type data files	C-9

C.1 General data

	B U	E M	O P	BU = Basic Unit OP = Operator Panel ■ = applies to corresponding components	EM = Expansion Module
Tripping				In the event of overload, phase-failure, current asymmetry and blocking protection as well as when the thermistor motor protection system responds and earth-fault (parameterizable)	
Tripping class				Can be altered: CLASSES 5, 10, 15, 20, 25, 30	
Reset				With combined TEST/RESET button on the unit; automatic RESET can be parameterized; remote RESET possible via bus	
Recovery time				5 min (fixed) after a trip due to overload (emergency start possible via bus); after tripping by thermistor until the temperature in the motor winding has fallen 5 K below its response temperature; none after tripping due to earth fault.	
Test function				By pressing the TEST/RESET button for up to a maximum of 5 s, the functions current detection, thermistor and earth-fault monitoring are tested. In addition, a lamp test of the indicator LEDs is initiated. By pressing the TEST/RESET button for longer than 5 s, a test of the tripping function of the auxiliary contacts is activated.	
Setting via the user interface				Set current I _s ; tripping class CLASSES 5 to 30; control functions, links between the inputs and outputs with times, counters, logic tables; assignment of the useful data to the input/output area of the bus system.	
Control functions				Overload relay, direct, reverser, star/delta starter, pole-reversal, Dahlander, encoder and valve control	
Operating, diagnostic and statistical data				For example, motor current in %, motor current of the last overload trip in %, current limit values exceeded or fallen below, cause of the last trip, number of starts, operating hours	
LED-Displays Green LED "Ready"				Steady light: "Ready" Off: "No control supply voltage" or "Function test was negative; unit is blocked"	
Green LED "Bus"				Steady light: "Bus ready"	
Red LED "General Fault"				Steady light: "Branch fault"; e.g. overload tripping	
3 green and 3 yellow LEDs				Branch specific indicators freely assignable	
Permissible ambient/storage temperature				-25 °C to +60 °C / -40 °C to +80 °C	
Site altitude				Up to 2000 m above sea level	
Degree of protection (to IEC 529)				IP 20 (≤ 100 A max. Set Current I _s); IP 00 (> 100 A max. Set Current I _s) IP 20 IP 54 IP 50	
Write cycles EEPROM				typ. 10000	

Table 64: General Data

	B U	E M	O P	BU = Basic Unit OP = Operator panel ■ = applies to corresponding components	EM = Expansion Module
Shock resistance (half-sinewave)				10 g / 5 ms	
Design				Compact, i.e. the transformers are already integrated in the housing of all unit sizes	
Dimensions (current range) (W x H x D) (mm x mm x mm)				1.25 A to 100 A:	70 x 85 x 132.5
				50 A to 250 A:	145 x 160 x 175
				125 A to 500 A:	120 x 145 x 155
				200 A to 820 A:	230 x 175 x 190
					70 x 85 x 132.5
					96 x 60 x 40.2
					100 x 180 x 44
Mounting position				any	
Mounting method				Width 70 mm: snap-on mounting on 35 mm mounting rails or screw mounting with push-in lugs	
				Width > 70 mm: screw mounting	
				Built into switch cubicle door	
EMC-immunity This is a product in Class A. In a household environment this device may be a source of radio interference. If necessary, the user must therefore take suitable counter-measures				Conducted interference. Burst in accord. with IEC 61000-4-4: 2 kV Overvoltage cut-out (RC filter) for inductive loads is necessary 1 kV on the PROFIBUS-DP cable Conducted interference, surge in accordance with IEC 61000-4-5: 2 kV Electrostatic discharge in accordance with IEC 61000-4-2: 8 kV Field interference in accordance with IEC IEC 61000-4-3: 3 V/m	
EMC emitted interference				Limit class A in acc. with EN 55011: 1991	

Main circuit

Insulation rating V_i				690 V (with pollution severity 3) Device width 70 mm 1000 V Device width > 70 mm		
Rated operating voltage V_e				690 V		
Impulse strength V_{imp}				6 kV Device width 70 mm 8 kV Device width > 70 mm		
Rated frequency and type of current				50 Hz / 60 Hz; three-phase current		
Short-circuit protection				refer to table, Appendix C.6		
Diameter of the penetration holes (≤ 100 A max. I_S)				10 mm (units ≤ 25 A max. set current I_S) 15 mm (units with 100 A max. set current I_S) (for units > 100 A max. Set Current I_S : installed with connecting bar)		
Bus connection (current range)				50 A at 205 A	at 125 A to 500 A	at 200 A to 820 A
Tightening torque (Nm)				M8: at 10 to 14	M10: at 14 to 24	M10: at 14 to 24; M12: at 20 to 35
Flexible conductor with cable lug (mm ²)				at 35 to 95	at 50 to 240	at 50 to 240
Stranded with cable lug (mm ²)				at 50 to 120	at 70 to 240	at 70 to 240

Table 64: General Data

C.2 Auxiliary circuit / control circuit

	B U	E M	O P	BU = Basic Unit EM = Expansion Module OP = Operator Panel ■ = applies to corresponding components
Rated control supply voltage	■	■		AC 50/60 Hz: 115 V and 230 V; DC: 24 V
Operating range	■	■		AC 50/60 Hz: 0.85 to 1.1 x V _S ; DC 24 V: 0.85 to 1.2 x V _S (DIN 19 240)
Power consumption	■	■		AC 50/60 Hz: 5 VA DC 24 V: 5 W
Stored energy time in the event of power-system failure	■	■		200 ms
Insulation rating V_i	■	■		300 V (for pollution severity 3)
Rated impulse strength V_{imp}	■	■		4 kV
Outputs	■	■		4 bistable relays each with a contact, NO, NC functions, can be parameterized
Auxiliary contacts of the 4 outputs	■	■		One floating contact with 3 grouped outputs and 1 separate; freely assignable to the control functions (e.g. for activating power-system, star and delta contactors and signalling the operating status)
Recommended short-circuit protection for auxiliary contacts (outputs)	■	■		Fuse-links of class gL/gA 6 A, quick-response 10 A; 1.6 A circuit-breaker, C-characteristic
Simultaneity factor of the auxiliary contacts (outputs)	■	■		100 %
Rated continuous current	■	■		5 A
Rated operational current (switching capacity)	■	■		AC-15: 6 A/24 V 6 A/120 V 3 A/230 V DC-13: 2 A/24 V 0.55 A/60 V 0.25 A/125 V
Inputs	■	■		4 internally supplied by the electronics (DC 24 V), grouped inputs for injecting process signals such as from local control points or limit switches 8 inputs connected to common potential, externally supplied with 24 V DC, 115 V AC, 230 V AC depending on version
Simultaneity factor of the inputs	■	■		100 %
Thermistor protection (PTC thermistor detector)	■	■		Summation cold resistance: 1.5 kOhm Response value: 2.7 kOhm to 3.1 kOhm Release value: 1.5 kOhm to 1.65 kOhm
Conductor sizes Tightening torque (Nm) single-core and stranded (mm ²) flexible with/without wire end ferrules (mm ²)	■	■		0.8 to 1.2 1 x (0.5 to 4.0); 2 x (0.5 to 2.5) 1 x (0.5 to 2.5); 2 x (0.5 to 1.5)

Table 65: Auxiliary circuit / control circuit

C.3 Inputs

C.3.1 Number of inputs

Input voltage	Basic Unit Rated control supply voltage			Expansion Module
	24 V DC	115 V AC	230 V AC	
24 V DC internal	4	4	4	-
24 V DC external	4	3	3	8
115 V AC	-	-	-	8*
230 V AC	-	-	-	8*

* See Table D.3.3

Table 66: Number of inputs

C.3.2 Simultaneity for Basic Unit

The simultaneity factor for internal and external 24 V DC is 100%.

C.3.3 Simultaneity for Expansion Module

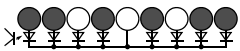
Input voltage	Ambient temperature	Max. input voltage	Number of inputs		
			Any arrangement	Fixed arrangement 	Short time <30s/10min*
230 V AC	60 °C	253 V AC	4	6	8
	50 °C	253 / 240 V AC	6 / 8	6 / 8	8
	40 °C	253 V AC	8	8	8
115 V AC	60 °C	127 V AC	6	6	8
	50 °C	127 V AC	8	8	8
24 V DC	60 °C	30 V DC	8	8	8

* e.g. for "local" switching command

Table 67: Simultaneity for Expansion Module

C.3.4 Input currents / cable lengths

Device	Input voltage	Cable lengths (single)	To DIN 19240 and EN 61131-2/Type 1
Basic unit	24 V DC	300 m	OK
Expansion module	230 V AC	200 m	Setpoint: $I_{\max} = 15 \text{ mA}$; Ist: $I_{\max} = 23 \text{ mA}$
	115 V AC	200 m	OK
	24 V DC	300 m	OK

Length of connecting cables:page F-3

Table 68: Input currents / cable lengths

C.4 Communications interface

Interface physics	RS485
Transmission medium	Twisted, screened two-core cable or glass or plastic fibre-optic cable
Max. distance	9.6 km with two-core cable; 23.8 km with glass fibre-optic cable; 425 m with plastic fibre-optic cable
Termination method	Clamp (conductor size as for the auxiliary contacts) or 9-pole SUB-D socket
Transmission system	PROFIBUS-DP (DIN (E) 19 245 Part 3/EN 50 170)
Max. transmission speed	1.5 MBaud
Range of data	Control commands, operating, diagnostic, service, statistical and parameterization data
Addressing	By user interface

Table 69: Communications interface

C.5 Behaviour in the event of supply-voltage failure

Behaviour of the contactor control circuits	up to 200 ms	after 200 ms	Return of the supply voltage
Monostable	unaltered	de-activate	de-activated
Bistable	unaltered	unaltered	de-activate

Table 70: Behaviour of the contactor control circuits in the event of supply-voltage failure

Behaviour of the functions	up to 20 ms	20 ms to 200 ms	Return of the supply voltage within 200 ms
Functionality	unaltered	Bus functions, control functions, re-reading-out of the inputs are no longer supported	Bus is re-initialized, terminated functions are continued

Table 71: Behaviour of the functions in the event of supply-voltage failure

C.6 Short-circuit protection for motor branches for short-circuit currents up to 50

Overload relay Setting type (type)	Contactor	CLASS					Fuse inserts 3)		British		Fuse inserts 3)		British	
		5 u.10	15	20	25	30	NH	Typ 3NA	NH	Standards	NH	Typ 3NA	NH	Standards
		Rated operating current I _s /AC-3 in A at					Utilization category		BS88		Utilization category		BS88	
		400V / 500V / 690V					gL(gG)		Type T		gL(gG)		Type T	
		400V / 500V / 690V					Assignment type 4)				Assignment type 4)			
							1 2		2 2		1 2		2 2	
1,25 -6,3A	3RT1015	6,3 / 5,0 / 4,0	6,3 / 5,0 / 4,0	6,3 / 5,0 / 4,0	6,3 / 5,0 / 4,0	6,3 / 5,0 / 4,0	35	20		20	35	25	20	
3RB1246-1P	3RT1016	6,3 / 6,3 / 5,2	6,3 / 6,3 / 5,2	6,3 / 6,3 / 5,2	6,3 / 6,3 / 5,2	6,3 / 6,3 / 5,2	35	20		20				
3UF50 0	3RT1017	6,3 / 6,3 / 6,3	6,3 / 6,3 / 6,3	6,3 / 6,3 / 6,3	6,3 / 6,3 / 6,3	6,3 / 6,3 / 6,3	35	20		20				
6,3 - 25A	3RT1015	7,0 / 5,0 / 4,0	7,0 / 5,0 / 4,0	7,0 / 5,0 / 4,0	7,0 / 5,0 / 4,0	7,0 / 5,0 / 4,0	35	20		20	160	125	100	
3RB1246-1Q	3RT1016	9,0 / 6,5 / 5,2	9,0 / 6,5 / 5,2	9,0 / 6,5 / 5,2	9,0 / 6,5 / 5,2	9,0 / 6,5 / 5,2	35	20		20				
3UF50 1	3RT1017	12,0 / 9,0 / 6,3	11,0 / 9,0 / 6,3	10,0 / 9,0 / 6,3	9,5 / 9,0 / 6,3	9,0 / 9,0 / 6,3	35	20		20				
	3RT1024	12,0 / 12,0 / 12,0	12,0 / 12,0 / 12,0	12,0 / 12,0 / 12,0	12,0 / 12,0 / 12,0	12,0 / 12,0 / 12,0	63	25	20	25				
	3RT1025	17,0 / 17,0 / 13,0	17,0 / 17,0 / 13,0	16,0 / 16,0 / 13,0	15,0 / 15,0 / 13,0	14,0 / 14,0 / 13,0	63	25	20	25				
	3RT1026	25,0 / 18,0 / 13,0	18,0 / 18,0 / 13,0	16,0 / 16,0 / 13,0	15,0 / 15,0 / 13,0	14,0 / 14,0 / 13,0	100	35	20	35				
	3RT1034	25,0 / 25,0 / 25,0	25,0 / 25,0 / 25,0	22,3 / 22,3 / 22,3	20,3 / 20,3 / 20,3	19,1 / 19,1 / 19,1	125	63	50	63				
	3RT1035			25,0 / 25,0 / 25,0	25,0 / 25,0 / 25,0	25,0 / 25,0 / 25,0	125	63	50	63				
25-100A	3RT1034	32,0 / 32,0 / 31,0	25,5 / 25,5 / 25,5	/	/	/	125	63	50	63	400	250	200	
3RB1246-1E	3RT1035	40,0 / 40,0 / 40,0	33,0 / 33,0 / 33,0	29,4 / 29,4 / 29,4	28,0 / 28,0 / 28,0	26,5 / 26,5 / 26,5	125	63	50	63				
3UF50 2	3RT1036	50,0 / 50,0 / 40,0	38,5 / 38,5 / 38,5	32,7 / 32,7 / 32,7	29,4 / 29,4 / 29,4	26,5 / 26,5 / 26,5	160	80	50	80				
	3RT1044	65,0 / 65,0 / 57,0	56,0 / 56,0 / 56,0	49,0 / 49,0 / 49,0	45,0 / 45,0 / 45,0	41,7 / 41,7 / 41,7	250	125	63	125				
	3RT1045	80 / 80 / 80	61 / 61 / 61	53 / 53 / 53	47 / 47 / 47	45 / 45 / 45	250	160	80	160				
	3RT1046	95 / 95 / 95	69 / 69 / 69	59 / 59 / 59	53 / 53 / 53	50 / 50 / 50	250	160	100	160				
	3TF50	100 / 100 / 100	87 / 87 / 87	76 / 76 / 76	71 / 71 / 71	65 / 65 / 65	400	224	125	160				
	3TF51	/	100 / 100 / 100	97 / 97 / 97	90 / 90 / 90	83 / 83 / 83	400	250	160	200				
	3TF52		100 / 100 / 100	100 / 100 / 100	100 / 100 / 100	100 / 100 / 100	400	250	200	200				
50-205A	3TF50 1)	110 / 110 / 110	87 / 87 / 87	76 / 76 / 76	76 / 76 / 71	64 / 64 / 64	400	224	125	160	400	250	250	
3RB1253-0F	3TF51 2)	140 / 140 / 127	111 / 111 / 111	97 / 97 / 97	97 / 97 / 90	83 / 83 / 83	400	250	160	200				
3UF50 3	3TF52 2)	170 / 170 / 170	135 / 135 / 135	118 / 118 / 118	118 / 118 / 109	101 / 101 / 101	400	250	200	250				
	3TF53	205 / 205 / 205	162 / 162 / 162	143 / 143 / 143	143 / 143 / 132	122 / 122 / 122	400	250	250	250				
	3TF54		198 / 198 / 198	174 / 174 / 174	174 / 174 / 161	149 / 149 / 149	400	250	250	250				
	3TF55		205 / 205 / 205	205 / 205 / 205	205 / 205 / 194	178 / 178 / 178	400	250	250	250				
	3TF56				/ 205	205 / 205 / 205	400	250	250	250				
125-500A	3TF52	170 / 170 / 170	135 / 135 / 135	/	/	/	400	250	200	250	800	500	500	
3RB1257-0K	3TF53 2)	205 / 205 / 170	162 / 162 / 162	143 / 143 / 143	143 / 143 / 132	/	400	250	250	315				
3UF50 4	3TF54 2)	250 / 250 / 250	198 / 198 / 198	174 / 174 / 174	174 / 174 / 161	149 / 149 / 149	500	400	250	355				
	3TF55 2)	300 / 300 / 250	238 / 238 / 238	208 / 208 / 208	208 / 208 / 194	178 / 178 / 178	500	400	315	400				
	3TF56 2)	400 / 400 / 400	318 / 318 / 318	278 / 278 / 278	278 / 278 / 259	238 / 238 / 238	800	500	400	450				
	3TF57 2)	475 / 475 / 400	378 / 378 / 378	332 / 332 / 332	332 / 332 / 307	284 / 284 / 284	800	500	630	500				
	3TF68	500 / 500 / 500	500 / 500 / 500	440 / 440 / 440	440 / 440 / 408	376 / 376 / 376	800	500	630	500				
	3TF69		500 / 500 / 500	500 / 500 / 500	500 / 500 / 500	500 / 500 / 500	800	500	630	500				
200-820A	3TF68 2)	630 / 630 / 630	502 / 502 / 502	440 / 440 / 440	440 / 440 / 408	376 / 376 / 376	1000	500	630	500	1250	630	630	
3RB1262-0L	3TF69 2)	820 / 820 / 820	662 / 662 / 662	572 / 572 / 572	572 / 572 / 531	500 / 500 / 500	1250		630	630				
3UF50 5														

without contactor

1) Contactor can be built on (after removal of frame terminal block)
 2) Contactor can be built on
 3) Comply with operating voltage

4) Assignment and short-circuit equipment in accordance with IEC60947-4-1/DIN VDE 660 Pt 4
Assignment type "1" : Contactor or starter must not endanger people or the installation in the event of a short-circuit.
 They do not have to be suitable for continued operation without repair and replacement of parts.
Assignment type "2" : Contactor or starter must not endanger people or the installation in the event of a short-circuit
 and have to be suitable for the use to which they are put. There is danger of contact welding

C.7 System reaction times (typical values)

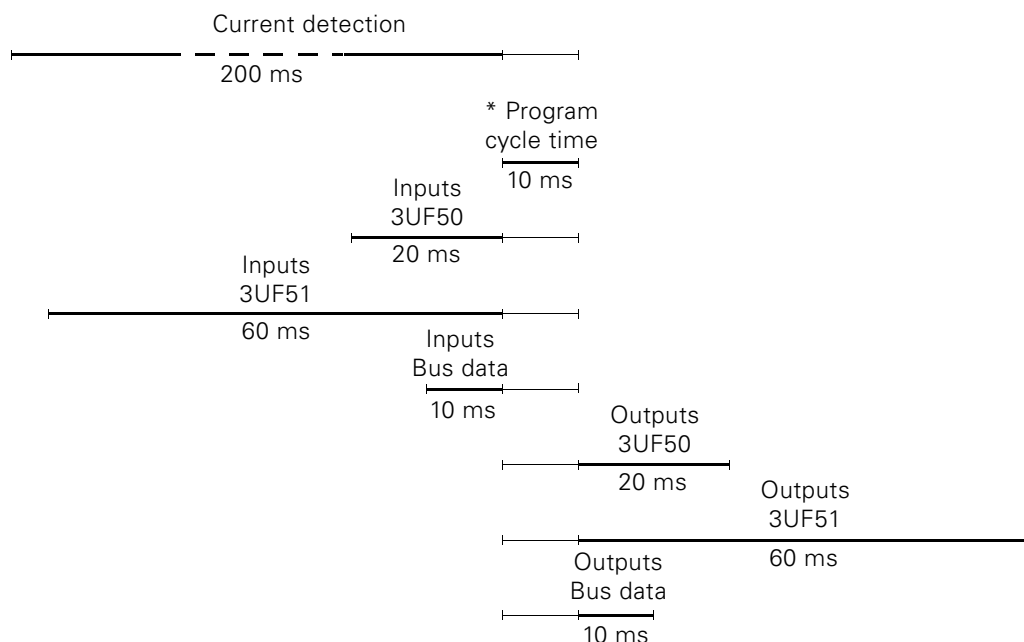

* The program cycle time contains internal processing of all read-in process states, control functions, additional functions. Following table shows the typical program cycle times:

Operating mode	typ. program cycle time
SIMOCODE-DP without communication	11 ms
SIMOCODE-DP with communication to PLC, baud rate 500 kBaud, 15 Slaves connected to bus	13 ms
SIMOCODE-DP with communication to PLC, baud rate 1,5 MBaud, 15 Slaves connected to bus	15 ms

Table 72: Program cycle times

Example: you want to operate a relay output of the Basic Unit when the bit "Automatic" has been set.

System reaction time:

$$\begin{array}{ccccccc}
 \text{Inputs} & & \text{Program} & & \text{Outputs} & & \\
 \text{Bus data} & & \text{cycle time} & & \text{3UF50} & & \\
 \hline
 10 \text{ ms} & + & 15 \text{ ms} & + & 20 \text{ ms} & = & \underline{45 \text{ ms}}
 \end{array}$$

For data to and from the programmable controller, you must add times for the bus transfer times, the IM/CP cycles and the programmable controller-CPU cycle. The relevant information can be found in the descriptions of the devices.

C.8 New system functions as of product status E10

Product status on rating plate

The product status of your SIMOCODE-DP Basic Unit is shown on the rating plate at the bottom left.

New system functions

As of product status E10 the following new system functions are available to you:

- A Truth Table 5I / 2O
- Two Non-Resetting Elements on Power Loss
- Input delay, i.e. variable debouncing times for the inputs of the 3UF50 Basic Unit and the 3UF51 Expansion Module
- A Group Control Station divided into free elements
- Exchange of acyclical data records via PROFIBUS-DPV1

C.9 Description of DMD and type data files

Type data / DMD file	Selection text in switchgear catalog	Created for 3UF5	Operation with 3UF5	Starting parameters settable	Diagnosis texts
SI8031_*.200	SIMOCODE-DP	up to E09	all	yes (up to E09)	yes (up to E09)
SI8031G*.200	SIMOCODE-DP AG95	up to E09	all	no	yes (up to E09)
SI8031T*.200	SIMOCODE-DP	up to E09	all	no	no
SIEM8031.GSD	SIMOCODE-DP	up to E09	all	no	no
SIEM8031.GS*	SIMOCODE-DP	from E10	from E10	yes (from E10)	yes (from E10)
SIEG8031.GS*	SIMOCODE-DP AG95	from E10	from E10	no	yes (from E10)
SIEM8069.GS*	SIMOCODE-DPV1	from E10	from E10	yes (from E10)	yes (from E10)

Table 73: Description of DMD and type data files

* Language dependency of the type data files:

d	e	i	f	s
German	English	Italian	French	Spanish

* Language dependency of the DMD files:

g (German)	e	i	f	s	d (default)
German	English	Italian	French	Spanish	no language

C.10 Source of supply for DMD and type data files

The latest DMD and type data files are available on the Internet under

<http://www.ad.siemens.de/ans/2/support/download>

D

Dimension Drawings

Section	Topic	Page
D.1	Basic Unit 3UF500./3UF501. / Expansion Module 3UF51	D-2
D.2	Basic Unit 3UF502.	D-3
D.3	Basic Unit 3UF503.	D-4
D.4	Basic Unit 3UF504.	D-5
D.5	Basic Unit 3UF505.	D-6
D.6	Operator Panel 3UF52	D-7

D.1 Basic Unit 3UF500./3UF501. /Expansion Module 3UF51

3UF500./
3UF501./
3UF51

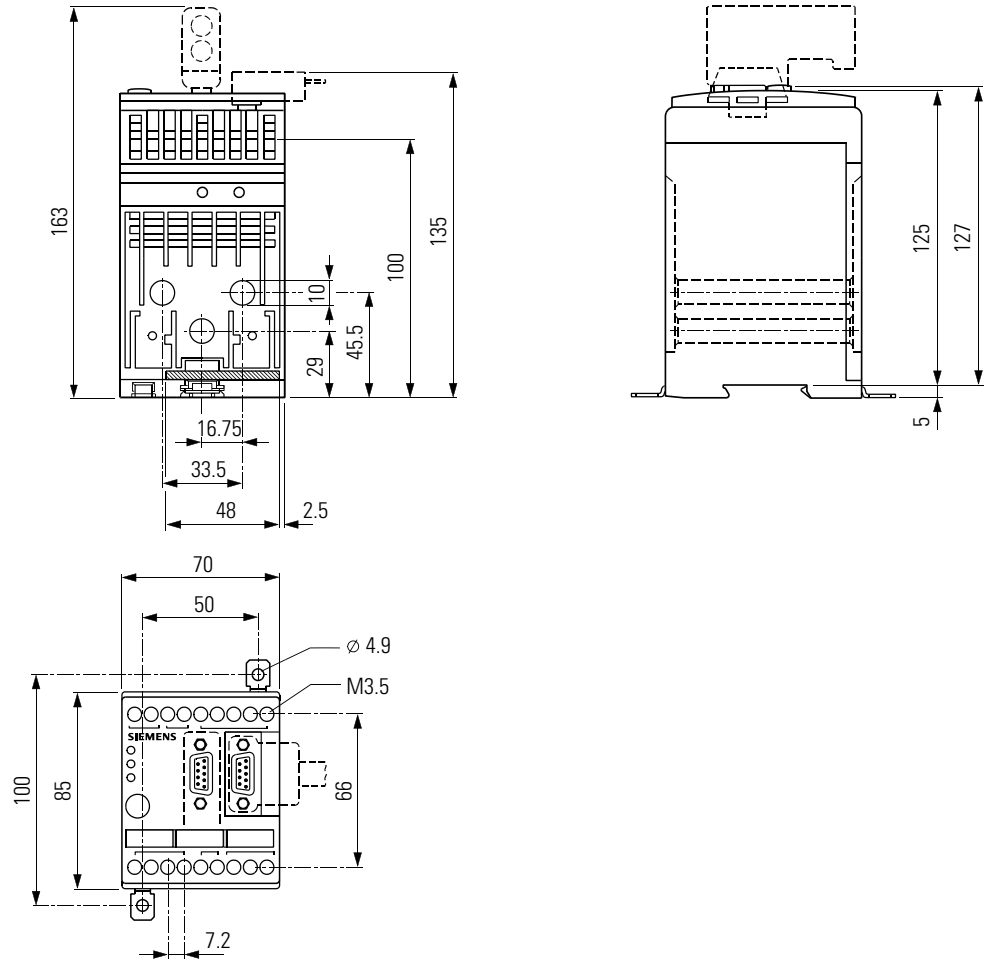

Fig. 90: Dimension drawings for the 3UF500. /3UF501. /3UF51

D.2 Basic Unit 3UF502.

3UF502.

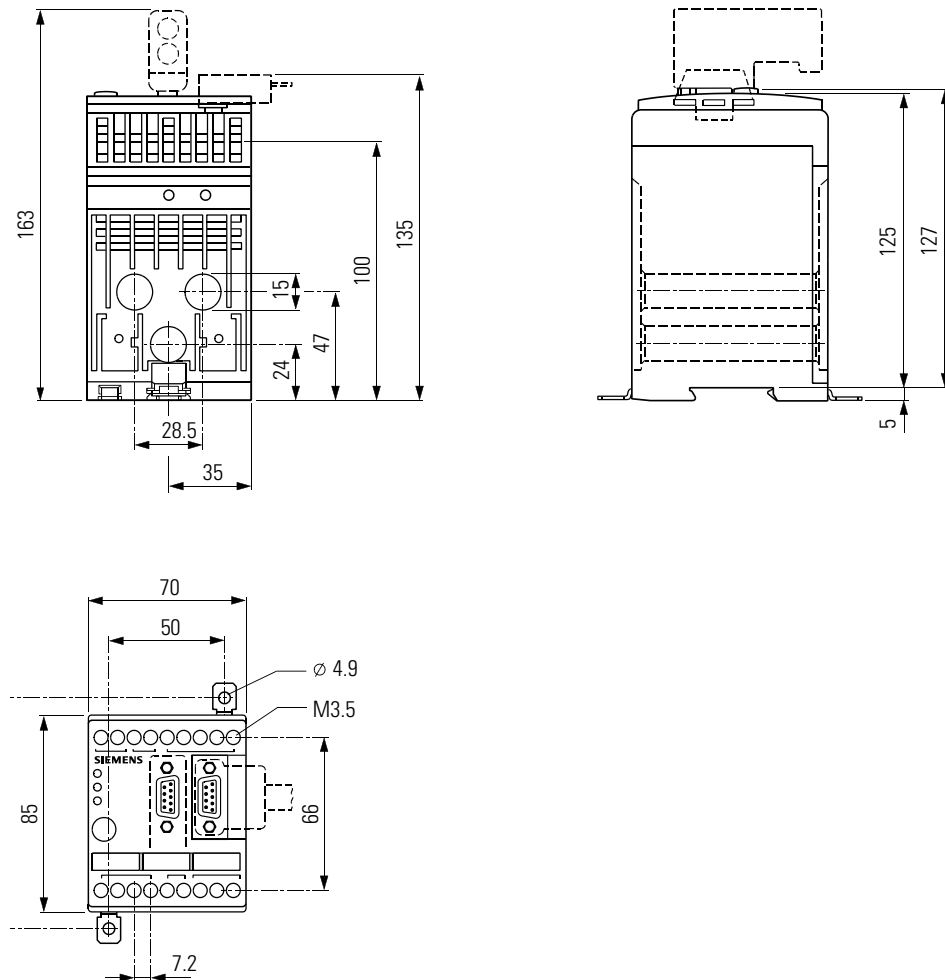

Fig. 91: Dimension drawings for the 3UF502.

D.3 Basic Unit 3UF503.

3UF503.

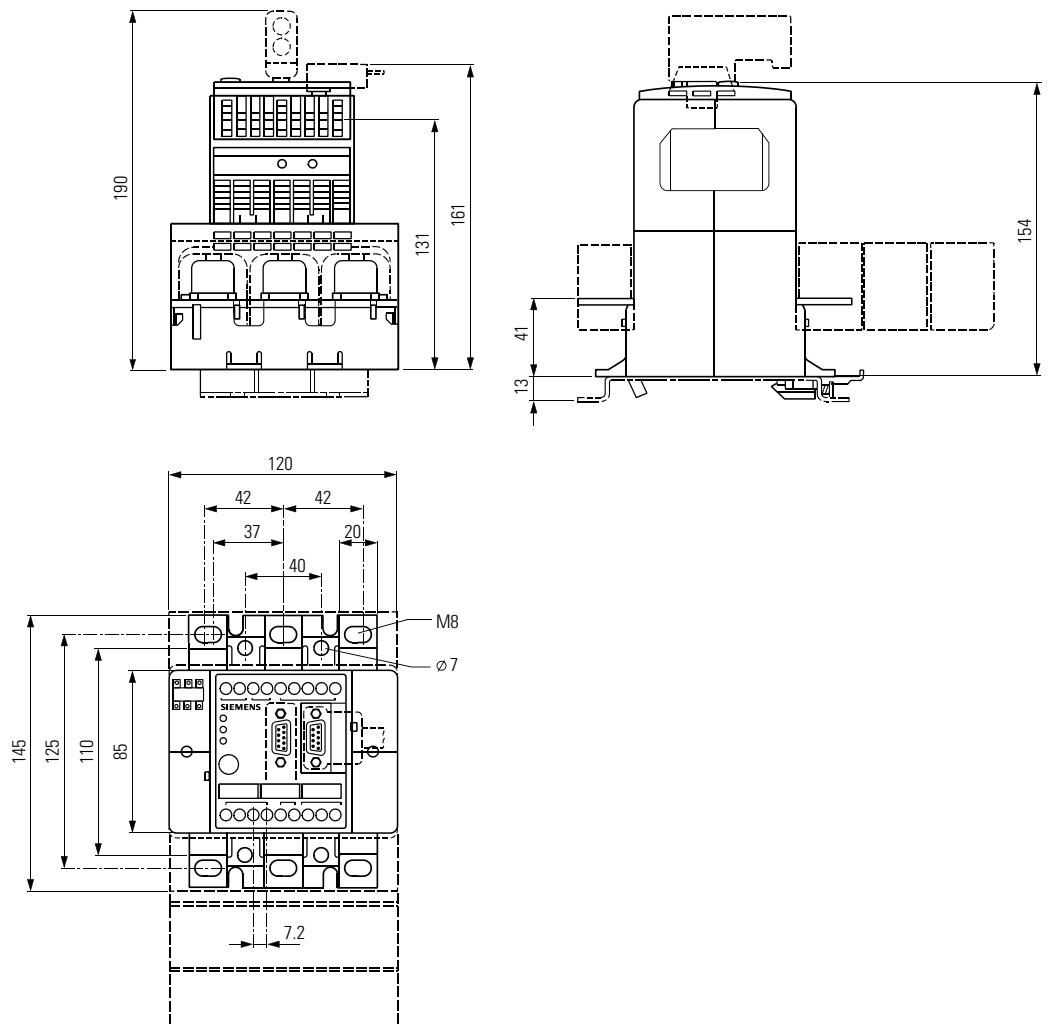

Fig. 92: Dimension drawings for the 3UF503.

D.4 Basic Unit 3UF504.

3UF504.

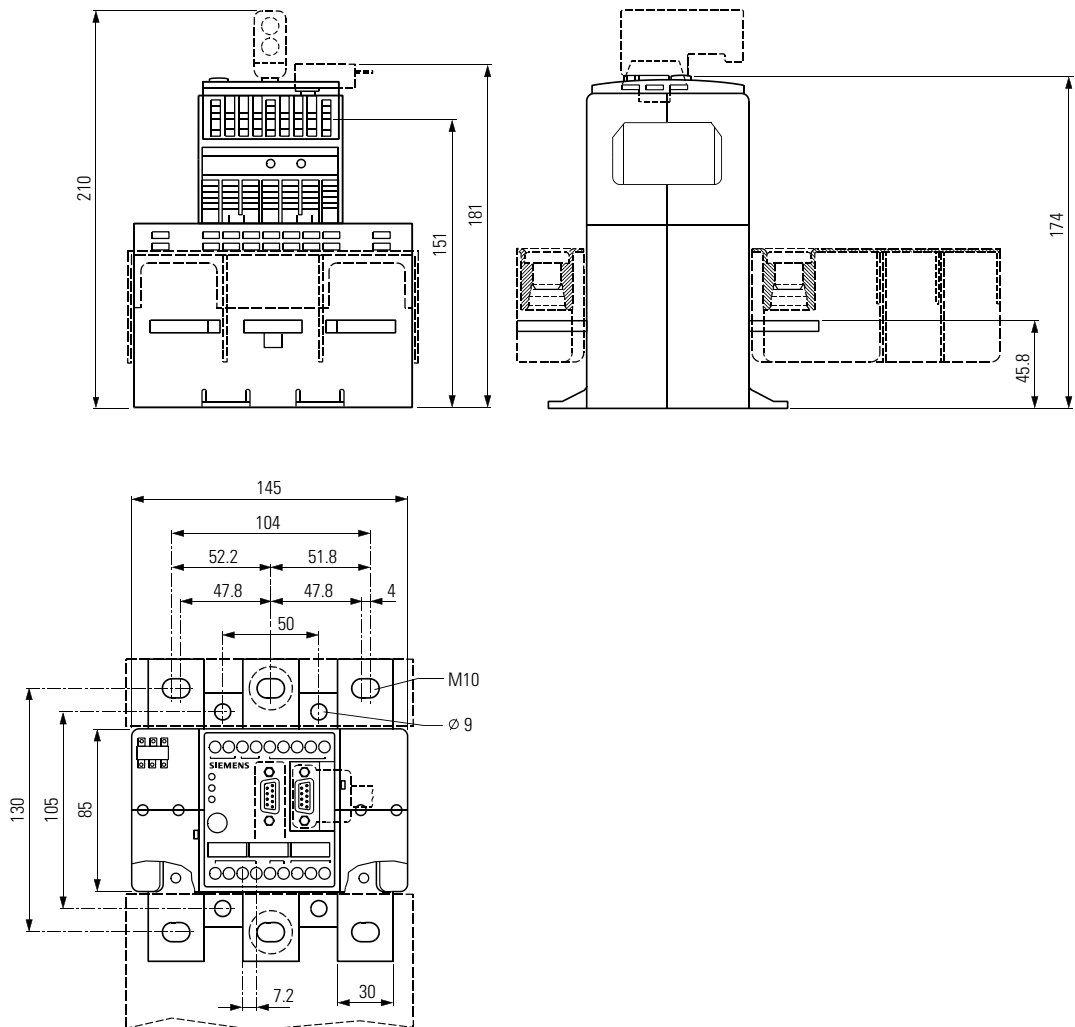

Fig. 93: Dimension drawings for the 3UF504.

D.5 Basic Unit 3UF505.

3UF505.

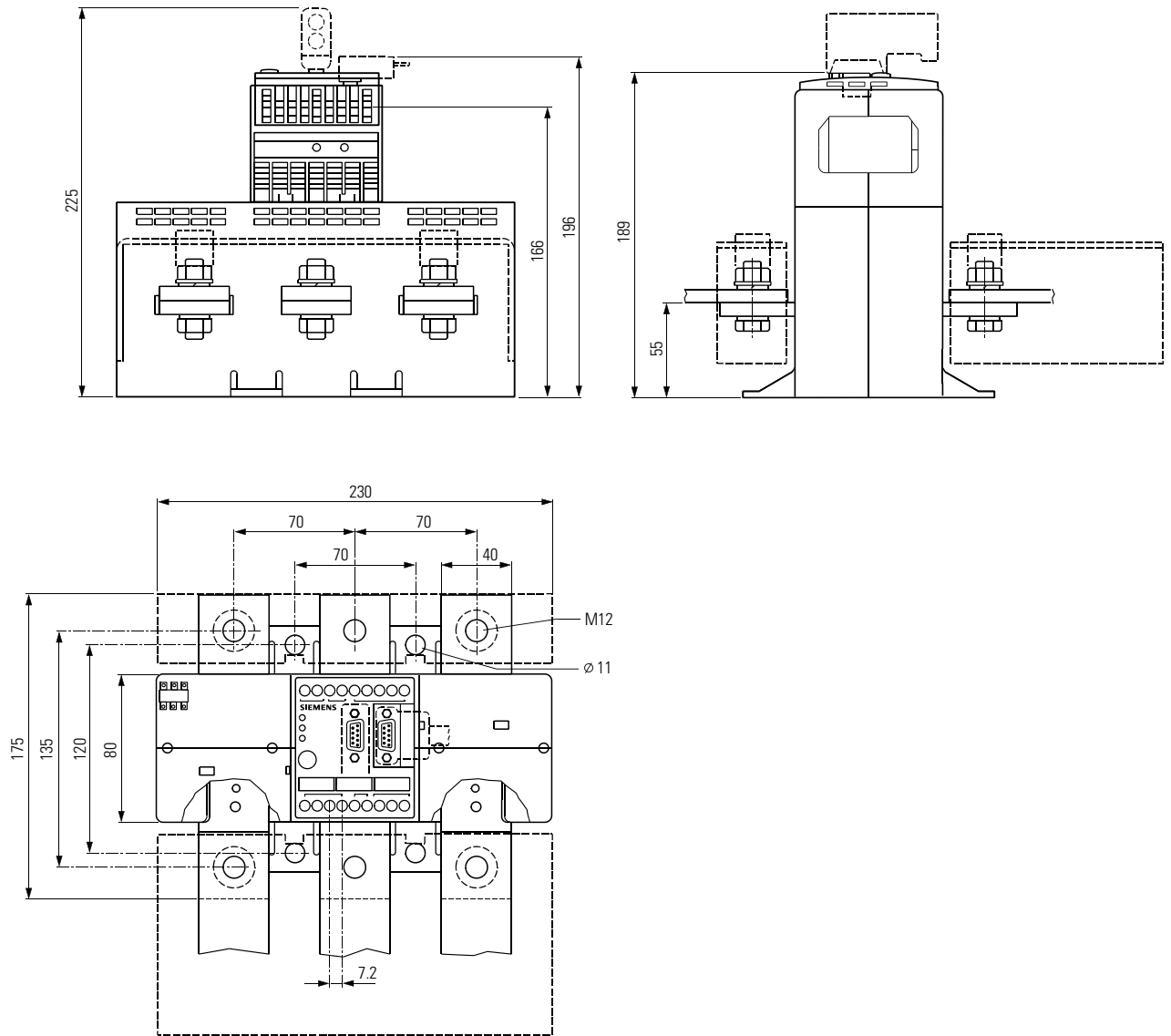

Fig. 94: Dimension drawings for the 3UF505.

D.6 Operator Panel 3UF52

3UF52

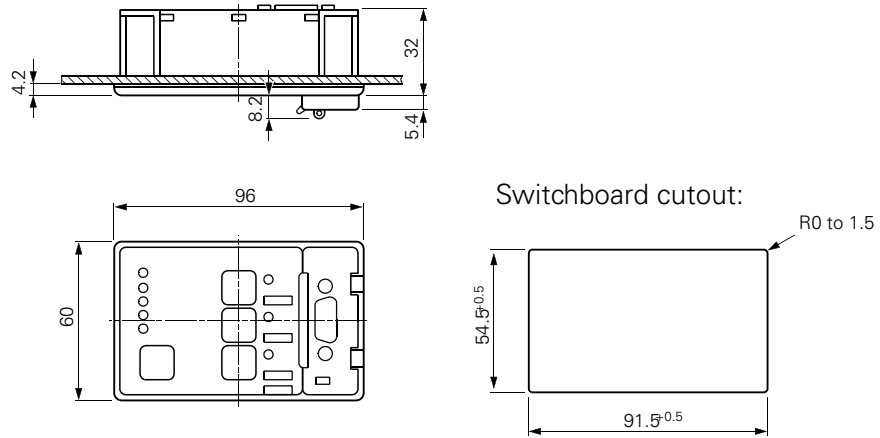

Fig. 95: Dimension drawing for the 3UF52

Typical Circuits

Section	Topic	Page
E.1	Introduction	E-2
E.2	Parameter Table Default Value	E-3
E.3	Overload	E-11
E.3.1	Circuit diagram of Overload Control Function	E-11
E.3.2	Block diagram of Overload Control Function	E-12
E.3.3	Parameters of Overload Control Function	E-13
E.4	Direct Starter	E-14
E.4.1	Circuit diagram of Direct Starter Control Function	E-14
E.4.2	Block diagram of Direct Starter Control Function	E-15
E.4.3	Parameters of Direct Starter Control Function	E-16
E.5	Reversing Starter	E-17
E.5.1	Circuit diagram of Reversing Starter Control Function	E-17
E.5.2	Block diagram of Reversing Starter Control Function	E-18
E.5.3	Parameters of Reversing Starter Control Function	E-19
E.6	Star Delta Starter	E-20
E.6.1	Circuit diagram of Star Delta Starter Control Function	E-20
E.6.2	Block diagram of Star Delta Starter Control Function	E-21
E.6.3	Parameters of Star Delta Starter Control Function	E-22
E.7	Pole Changing Starter	E-23
E.7.1	Circuit diagram of Pole Changing Starter Control Function	E-23
E.7.2	Block diagram of Pole Changing Starter Control Function	E-24
E.7.3	Parameters of Pole Changing Starter Control Function	E-25
E.8	Dahlander Starter	E-26
E.8.1	Circuit diagram of Dahlander Starter Control Function	E-26
E.8.2	Block diagram of Dahlander Starter Control Function	E-27
E.8.3	Parameters of Dahlander Starter Control Function	E-28
E.9	Solenoid Valve	E-29
E.9.1	Circuit diagram of Solenoid Valve Control Function	E-29
E.9.2	Block diagram of Solenoid Valve Control Function	E-30
E.9.3	Parameters of Solenoid Valve Control Function	E-31
E.10	Positioner Control Function	E-32
E.10.1	Circuit diagram of Positioner Control Function	E-32
E.10.2	Block diagram of Positioner Control Function	E-34
E.10.3	Parameters of Positioner Control Function	E-35
E.11	Soft Starter	E-36
E.11.1	Circuit diagram of Soft Starter Control Function	E-36
E.11.2	Block diagram of Soft Starter Control Function	E-38
E.11.3	Parameters of Soft Starter Control Function	E-39

E.1 Introduction

In this section

This section contains examples of circuits illustrating the individual control functions.

The circuit examples comprise

- the circuit diagram for a standard withdrawable unit
- the block diagram of the assignments. For the sake of clarity, in some places only the assignment numbers are specified instead of entering the entire connection. For the meaning of the assignment numbers, refer to the assignment table in Appendix A.1.
- the parameter table. This table contains only those values which differ from the default values. The parameter table with the default values starts on the next page. File name: Default.smc.

Special features of Positioner control

As far as parameterization is concerned, Positioner control circuits 1-5 differ only in terms of the Control Function itself (Positioner 1-5). The block diagrams and circuit diagrams are identical. In the case of Positioner 5, the contacts of a changeover contact are connected instead of the individual contacts of the Torque and Limit switches.

E.2 Parameter Table Default Value

<u>Parameter</u>	<u>Setting</u>
General:	
Order Number	3UF5001-3A?00-1
Type of Construction	1.25 - 6.3 A
Output Relay	monostable
Outputs/Inputs	Thermistor
Family	Switching Devices
DP slave type	SIMOCODE-DP
PROFIBUS Address	126
Baud Rate	500 Kbaud
Designation	''
Comment	''
Overload:	
Response in Event of Overload	Shutdown
Class	CLASS10
Load type	Three-phase
Reset	Manuel
Block	500 %
Cooling Time	00:00.0
Idle time	00:00.0
Set Current Is1	1.2500 A
Set Current Is2	0.00 A
Upper Current Limit:	
Value	400 %
Response	Warning
Lower Current Limit:	
Value	20 %
Response	Warning
Sensor:	
Sensor Type	No sensor
Short-Circuit Sensor Load	No
Response of Binary Sensor	Shutdown
Analog Trip Threshold	0 Ohm
Analog Warning Threshold	0 Ohm
Internal Earth Fault Detection	No
External Earth Fault Detection	No
Response in Event of Earth Fault	Warning

<u>Parameter</u>	<u>Setting</u>
Motor:	
Control Function	Direct Starter
Run-Time	00:01.0
CS-Time	00:0.5
Locking Time	00:00.0
PC - Position Switch Closed	Not connected
PO - Position Switch Open	Not connected
TC – Torque Closed	Not connected
TO – Torque Open	Not connected
Control Stations:	
Inching Mode	Off
LC ON 1	Not connected
LC OFF	Not connected
LC ON2	Not connected
DP-ON 1	DP bit 0.0
DP-OFF	DP bit 0.1
DP-ON 2	DP bit 0.2
C+M-ON1	DPV1 Bit 0.0
C+M-OFF	DPV1 Bit 0.1
C+M-ON2	DPV1 Bit 0.2
OP-ON 1	Not connected
OP-OFF	Not connected
OP-ON 2	Not connected
Control Function-ON 1	Group Control On 1
Control Function-OFF	Group Control Off
Control Function-ON 2	Group Control On 2
Control Mode Switch S1	DP Bit 0.5
Control Mode Switch S2	Fixed Level 1
Operator Enabling:	
Control Mode Switch S1	DP Bit 0.5
Control Mode Switch S2	Fixed Level 1
Mode 1: S1 = 0, S2 = 0:	
LC-On	Free
LC-Off	Free
DP-On	Blocked
DP-Off	Blocked
C+M-On	Blocked
C+M-Off	Blocked
OP-On	Blocked
OP-Off	Blocked

<u>Parameter</u>	<u>Setting</u>
Mode 2: S1 = 0, S2 = 1:	
LC-On	Free
LC-Off	Free
DP-On	Blocked
DP-Off	Blocked
C+M-On	Blocked
C+M-Off	Blocked
OP-On	Blocked
OP-Off	Blocked
Mode 3: S1 = 1, S2 = 0:	
LC-On	Blocked
LC-Off	Blocked
DP-On	Blocked
DP-Off	Blocked
C+M-On	Free
C+M-Off	Free
OP-On	Blocked
OP-Off	Blocked
Mode 4: S1 = 1, S2 = 1:	
LC-On	Blocked
LC-Off	Blocked
DP-On	Free
DP-Off	Free
C+M-On	Blocked
C+M-Off	Blocked
OP-On	Blocked
OP-Off	Blocked
Function Block Inputs:	
CST – Check-Back Signal Test	Not connected
OPO – Operating Protection Off	Not connected
RTS - Ready to Start	Not connected
External Fault 1	Not connected
External Fault 2	Not connected
External Warning	Not connected
Emergency Start	DP bit 0.4
External Diagnosis	Not connected
External Check-Back Signal CS1	Not connected
External Check-Back Signal CS2	Not connected
External Check-Back Signal CS3	Not connected
Test 1	DP Bit 0.3
Test 2	DPV1 Bit 0.3

<u>Parameter</u>	<u>Setting</u>
Reset 1	DP Bit 0.6
Reset 2	DPV1 Bit 0.6
Reset 3	Not connected
UVO – Undervoltage off	Not connected
Grading time	00:00.0
T-UVO – Undervoltage OFF Time	00:00.0
Basic Unit:	
Relay Output 1	Not connected
Relay Output 2	Not connected
Relay Output 3	Not connected
Relay Output 4	Not connected
Expansion Module:	
Relay Output 1	Not connected
Relay Output 2	Not connected
Relay Output 3	Not connected
Relay Output 4	Not connected
Operator Panel:	
LED1 Yellow	Not connected
LED2 Yellow	Not connected
LED3 Yellow	Not connected
LED4 Green	Not connected
LED5 Green	Not connected
LED6 Green	Not connected
Timer 1:	
Value	00:00.0
Type	With Closing Delay
Input	Not connected
Timer 2:	
Value	00:00.0
Type	With Closing Delay
Input	Not connected
Counter 1:	
Value	0:00.0
Input	Not connected
Reset	Not connected
Counter 2:	
Value	0:00.0
Input	Not connected
Reset	Not connected

Parameter

Setting

Truth Table 1 3I1O:

I1 I2 I3 = 111	0
I1 I2 I3 = 011	0
I1 I2 I3 = 101	0
I1 I2 I3 = 001	0
I1 I2 I3 = 110	0
I1 I2 I3 = 010	0
I1 I2 I3 = 100	0
I1 I2 I3 = 000	0
Input I1	Not connected
Input I2	Not connected
Input I3	Not connected

Truth Table 2 3I1O:

I1 I2 I3 = 111	0
I1 I2 I3 = 011	0
I1 I2 I3 = 101	0
I1 I2 I3 = 001	0
I1 I2 I3 = 110	0
I1 I2 I3 = 010	0
I1 I2 I3 = 100	0
I1 I2 I3 = 000	0
Input I1	Not connected
Input I2	Not connected
Input I3	Not connected

Truth Table 3 3I1O:

I1 I2 I3 = 111	0
I1 I2 I3 = 011	0
I1 I2 I3 = 101	0
I1 I2 I3 = 001	0
I1 I2 I3 = 110	0
I1 I2 I3 = 010	0
I1 I2 I3 = 100	0
I1 I2 I3 = 000	0
Input I1	Not connected
Input I2	Not connected
Input I3	Not connected

Truth Table 4 5I2O:

I1 I2 I3 I4 I5 =11111	0, 0
I1 I2 I3 I4 I5 =01111	0, 0
I1 I2 I3 I4 I5 =10111	0, 0
I1 I2 I3 I4 I5 =00111	0, 0

Parameter	Setting
I1 I2 I3 I4 I5 =11011	0, 0
I1 I2 I3 I4 I5 =01011	0, 0
I1 I2 I3 I4 I5 =10011	0, 0
I1 I2 I3 I4 I5 =00011	0, 0
I1 I2 I3 I4 I5 =11101	0, 0
I1 I2 I3 I4 I5 =01101	0, 0
I1 I2 I3 I4 I5 =10101	0, 0
I1 I2 I3 I4 I5 =00101	0, 0
I1 I2 I3 I4 I5 =11001	0, 0
I1 I2 I3 I4 I5 =01001	0, 0
I1 I2 I3 I4 I5 =10001	0, 0
I1 I2 I3 I4 I5 =00001	0, 0
I1 I2 I3 I4 I5 =11110	0, 0
I1 I2 I3 I4 I5 =01110	0, 0
I1 I2 I3 I4 I5 =10110	0, 0
I1 I2 I3 I4 I5 =00110	0, 0
I1 I2 I3 I4 I5 =11010	0, 0
I1 I2 I3 I4 I5 =01010	0, 0
I1 I2 I3 I4 I5 =10010	0, 0
I1 I2 I3 I4 I5 =00010	0, 0
I1 I2 I3 I4 I5 =11100	0, 0
I1 I2 I3 I4 I5 =01100	0, 0
I1 I2 I3 I4 I5 =10100	0, 0
I1 I2 I3 I4 I5 =00100	0, 0
I1 I2 I3 I4 I5 =11000	0, 0
I1 I2 I3 I4 I5 =01000	0, 0
I1 I2 I3 I4 I5 =10000	0, 0
I1 I2 I3 I4 I5 =00000	0, 0
Input I1	Not connected
Input I2	Not connected
Input I3	Not connected
Input I4	Not connected
Input I5	Not connected
Flashing 1:	
Input	Not connected
Flashing 2:	
Input	Not connected
Flashing 3:	
Input	Not connected
Flickering 1:	
Input	Not connected

<u>Parameter</u>	<u>Setting</u>
Flickering 2:	
Input	Not connected
Flickering 3:	
Input	Not connected
Signal Matching 1:	
Type	Edge Rising with Memory
Input	Not connected
Reset	Not connected
Signal Matching 2:	
Type	Edge Rising with Memory
Input	Not connected
Reset	Not connected
Signal Matching 3:	
Type	Edge Rising with Memory
Input	Not connected
Reset	Not connected
Signal Matching 4:	
Type	Edge Rising with Memory
Input	Not connected
Reset	Not connected
Non-Resetting Elements on Power Loss:	
Element 1 Type	Edge Rising with Memory
Element 1 Input	Not connected
Element 1 Reset	Not connected
Element 2 Type	Edge Rising with Memory
Element 2 Input	Not connected
Element 2 Reset	Not connected
Fault Response:	
PLC Signal	DP Bit 0.7
Response in Event of 3UF50-CPU-Failure	Off
Response in Event of Control Voltage Failure	Off
Response in Event of Bus Failure	Off
Response in Event of PLC-CPU-Failure	Off
Bus PROFIBUS-DP:	
Reduced Diagnosis Message	No
Block DP Parameter	Yes
Operating Mode	DP-Norm
DP process data:	
Format	Basic Type 2
Byte 0:	
Bit 0	Status On 1

<u>Parameter</u>	<u>Setting</u>
Bit 1	Status Off
Bit 2	Status On 2
Bit 3	Status Overload Warning
Bit 4	Status Locking Time
Bit 5	Status Auto
Bit 6	Status Group Fault
Bit 7	Status Group Warning

Byte 1:

Bit 0	Not connected
Bit 1	Not connected
Bit 2	Not connected
Bit 3	Not connected
Bit 4	Not connected

Parameter	Setting
Bit 5	Not connected
Bit 6	Not connected
Bit 7	Not connected

Hard-wired:

Byte 2/3	Current
----------	---------

Input Delay:

Input Basic Unit	18 ms
Input Expansion Unit	36 ms

E.3 Overload

E.3.1 Circuit diagram of Overload Control Function

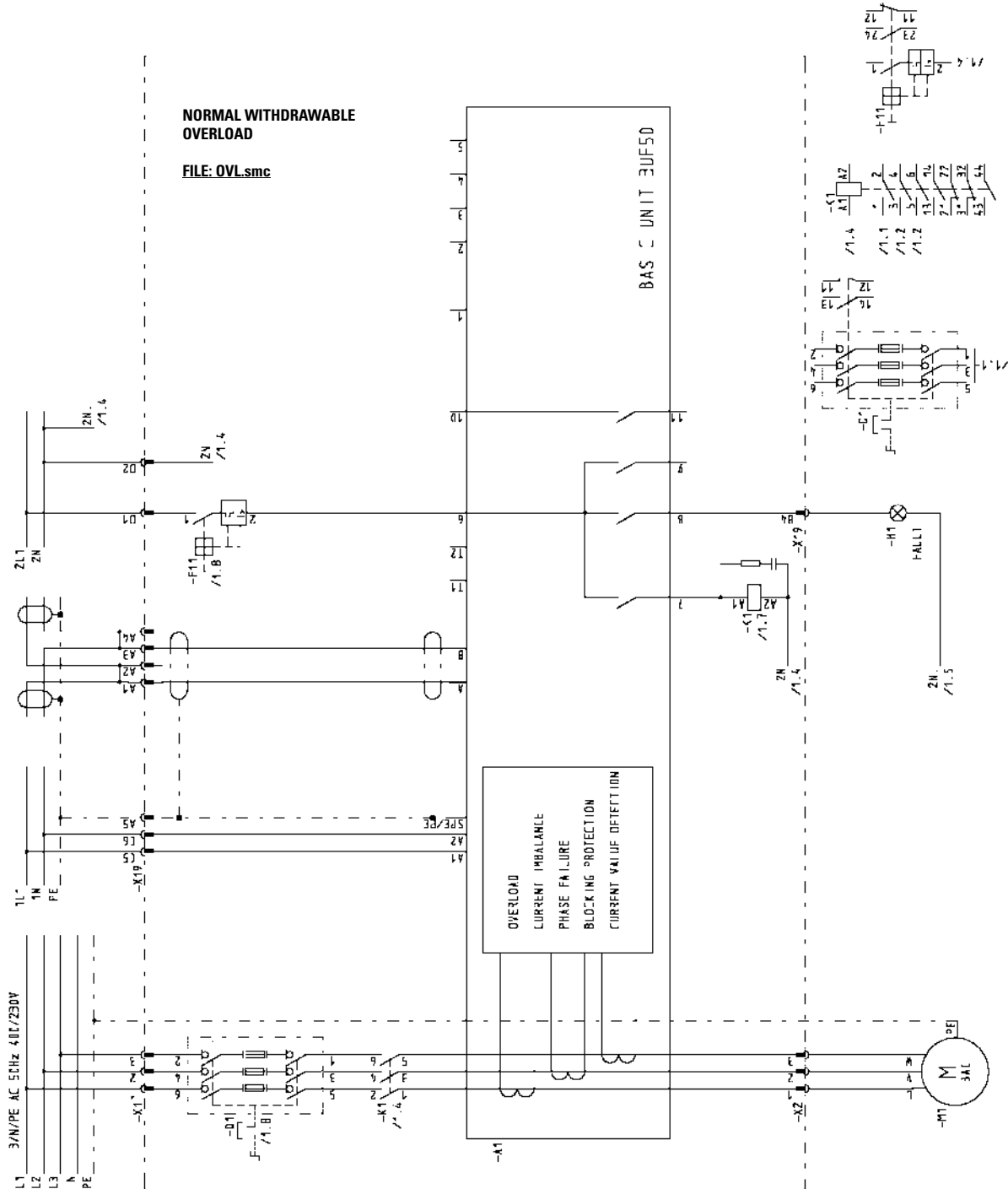

E.3.2 Block diagram of Overload Control Function

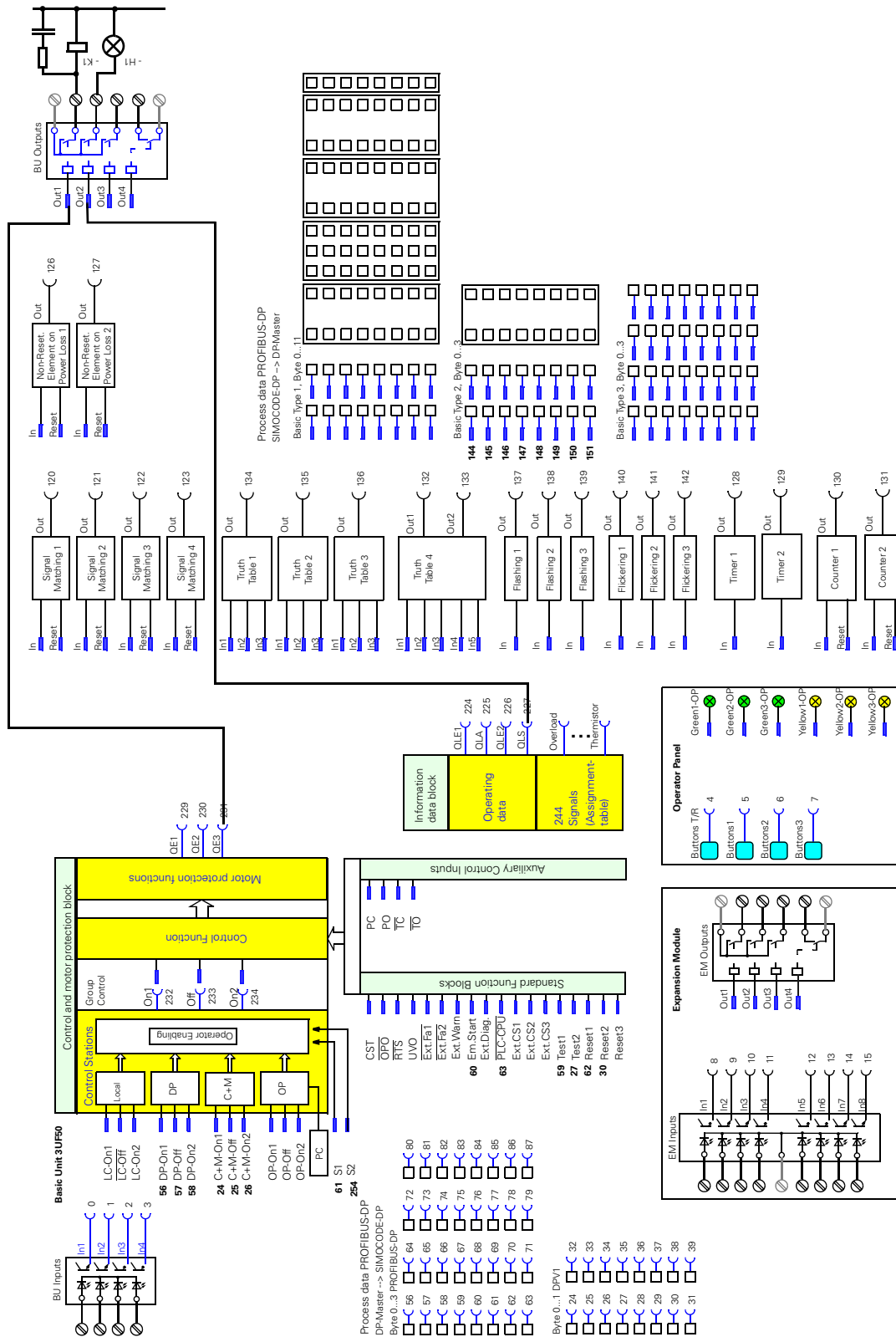

E.3.3 Parameters of Overload Control Function

<u>Parameter</u>	<u>Setting</u>
General:	
Designation	‘Überlast (UELA.smc)/Overload (OVL.smc)’
Motor:	
Control Function	Overload
Basic Unit:	
Relay Output 1	Contactors Control QE3
Relay Output 4	Lamp Control QLS

E.4 Direct Starter

E.4.1 Circuit diagram of Direct Starter Control Function

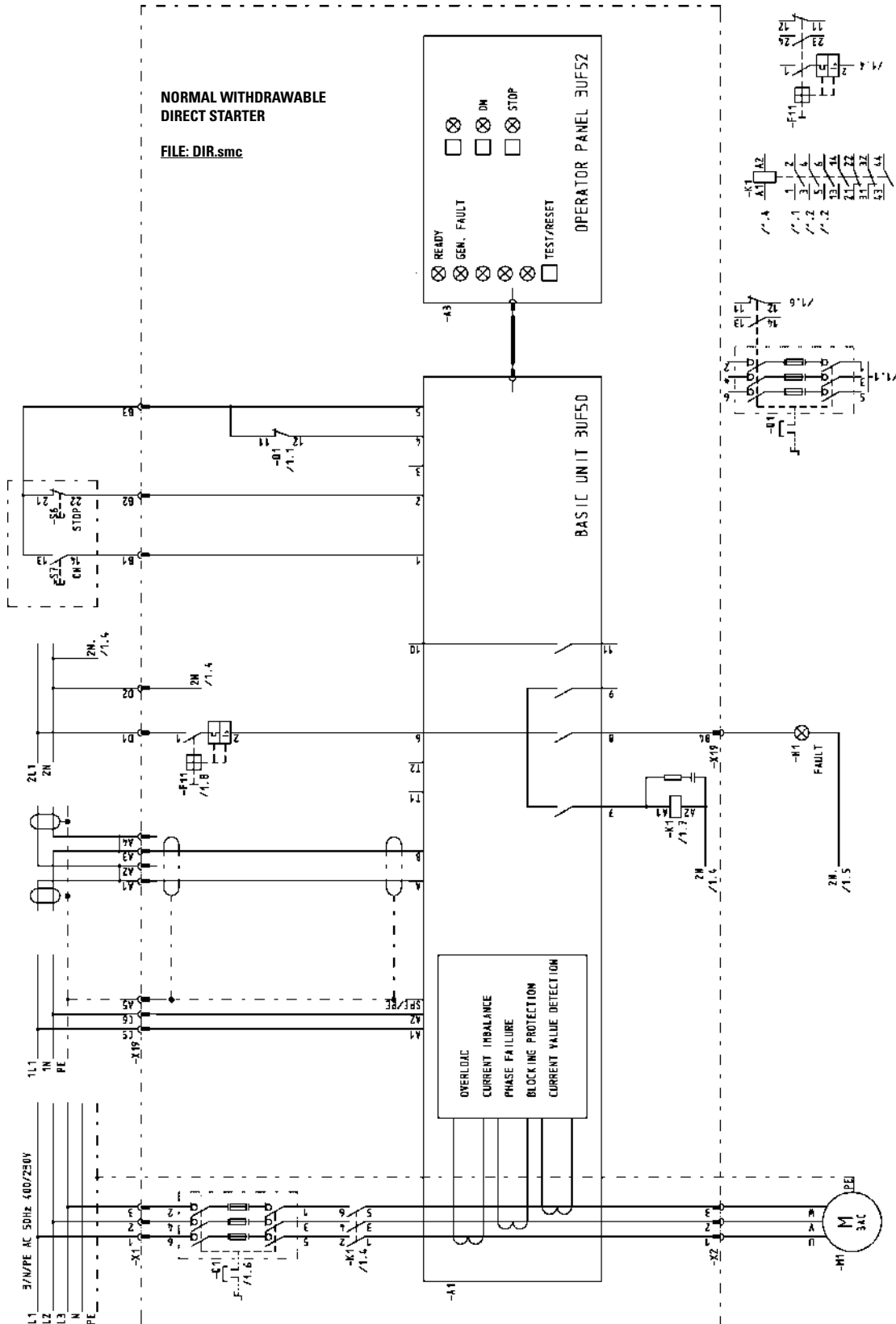

E.4.2 Block diagram of Direct Starter Control Function

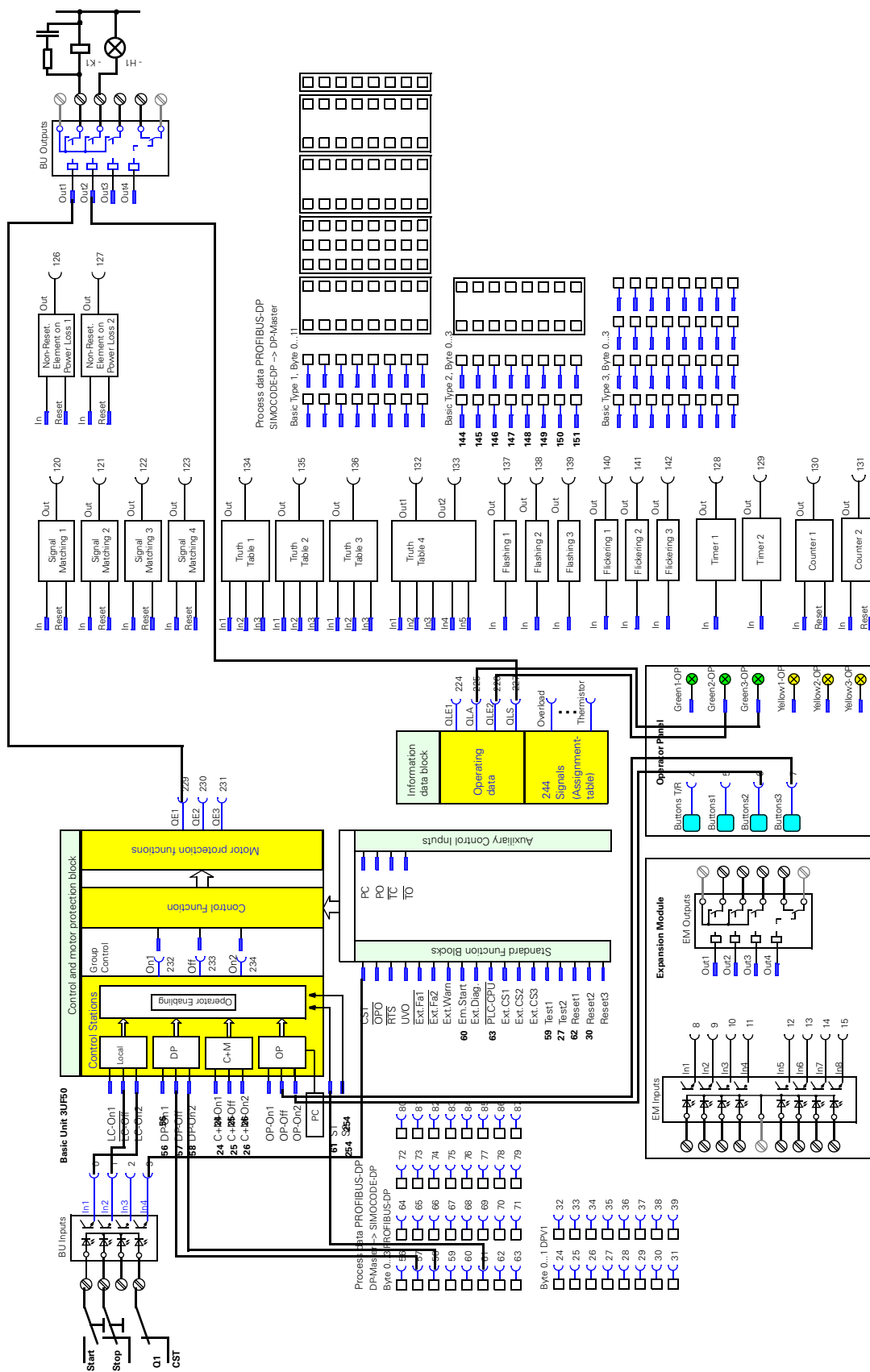

E.4.3 Parameters of Direct Starter Control Function

<u>Parameter</u>	<u>Settingt</u>
General:	
Designation	'Direktstarter (DIRE.smc)/Direct Starter (DIR.smc)'
Control Stations:	
LC OFF	Basic Unit, Input 2
LC ON2	Basic Unit, Input 1
OP-OFF	Operator Panel, Button 3
OP-ON2	Operator Panel, Button 2
S1 = 0, S2 = 1:	
OP-ON	free
OP-OFF	free
Function Block Inputs:	
CST - Checkback Signal Test	Basic Unit, Input 4
Basic Unit:	
Relay Output 1	Contactora Control QE1
Relay Output 2	Lamp Control QLS
Operator Panel:	
LED5 Green	Lamp Control QLE2 On2
LED6 Green	Lamp Control QLA Off

E.5 Reversing Starter

E.5.1 Circuit diagram of Reversing Starter Control Function

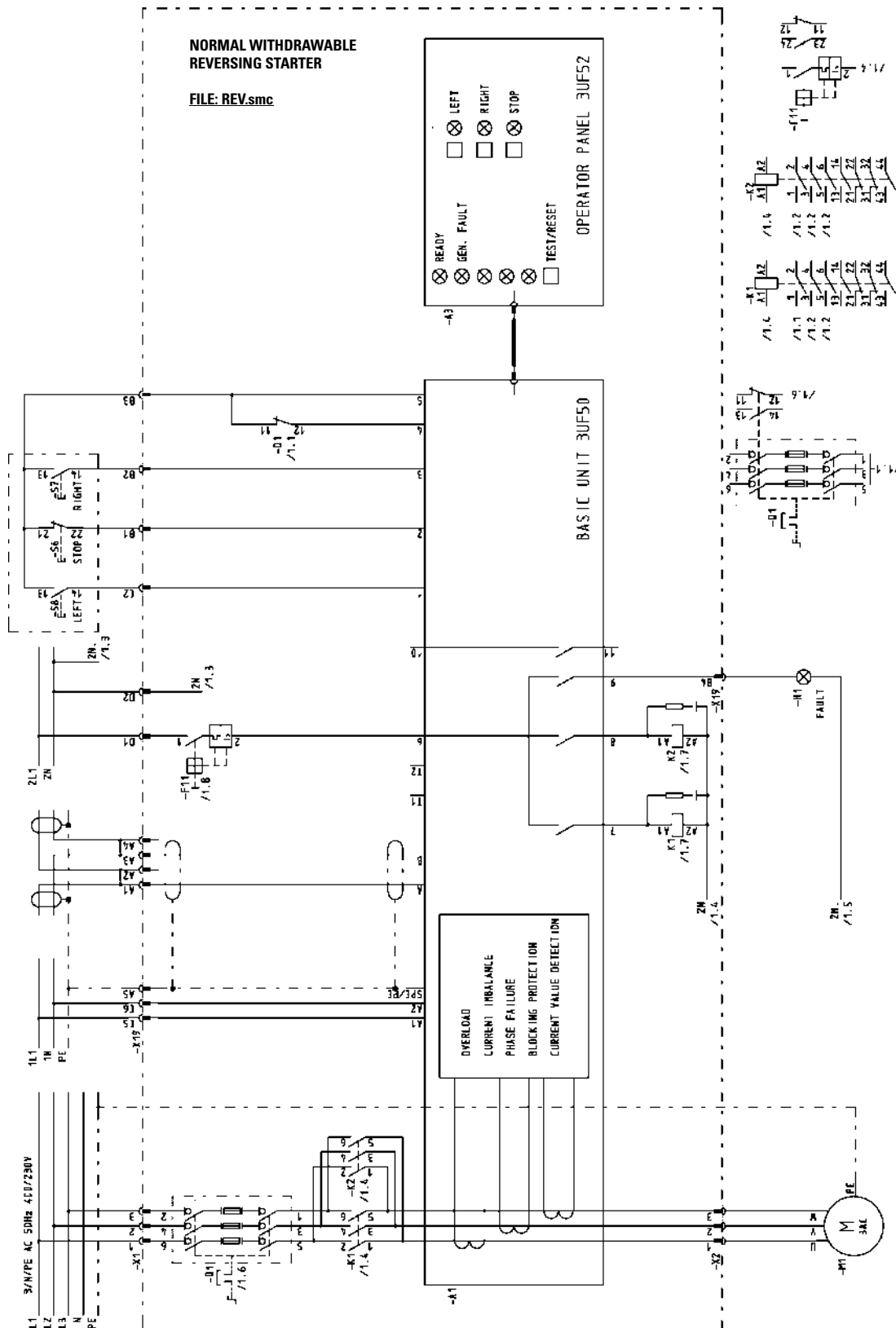

E.5.2 Block diagram of Reversing Starter Control Function

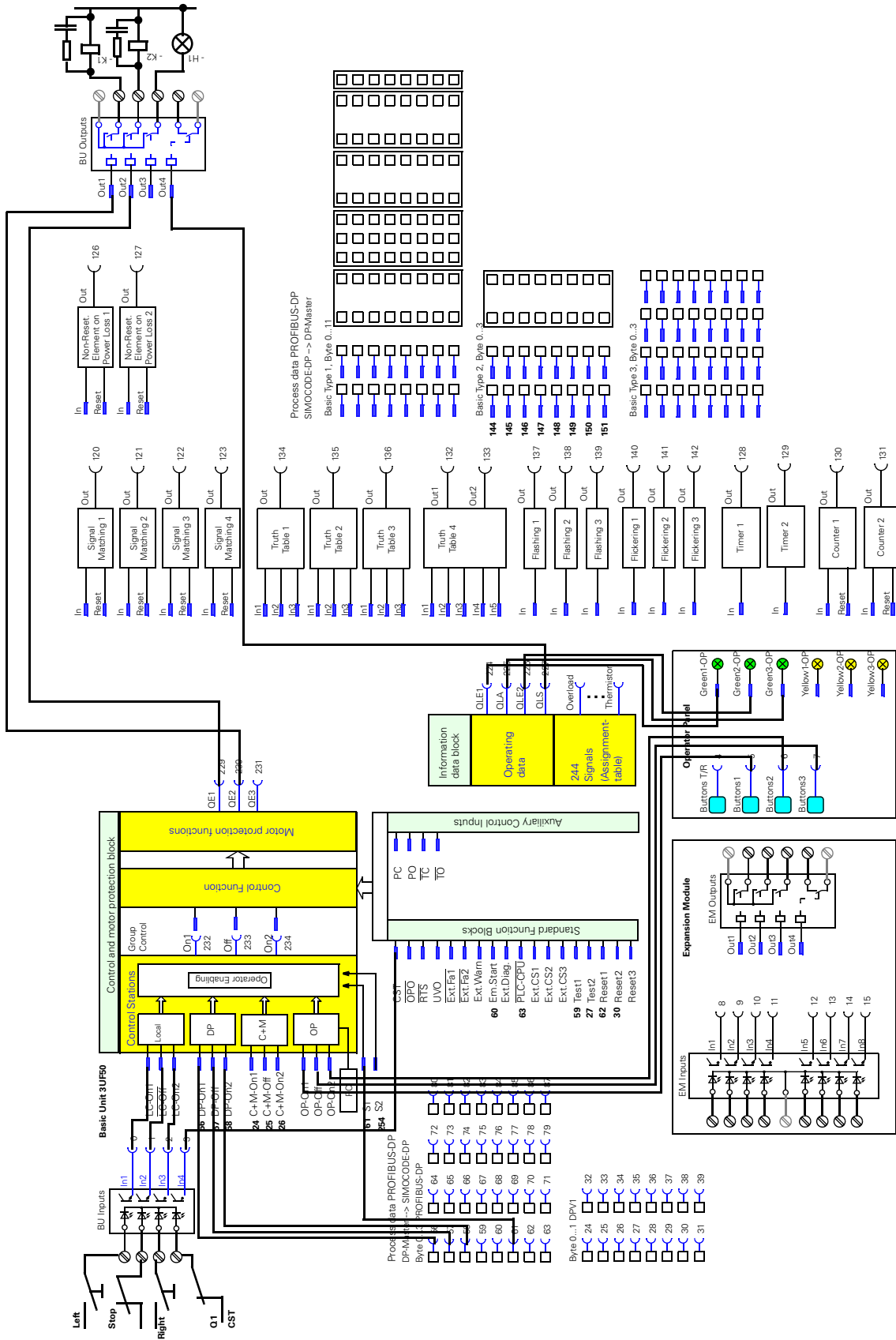

E.5.3 Parameters of Reversing Starter Control Function

<u>Parameter</u>	<u>Setting</u>
General:	
Designation	Wendestarter (WEND.smc)/Reversing starter (REV.smc)
Motor:	
Control Function	Reversing starter
Locking Time	00:05.0
Control Stations:	
LC-ON1	C, Input 1
LC-OFF	Basic Unit, Input 2
LC-ON2	Basic Unit, Input 3
OP-ON1	Operator Panel, Button 1
OP-OFF	Operator Panel, Button 3
OP-ON2	Operator Panel, Button 2
S1 = 0, S2 = 1:	
OP-ON	free
OP-OFF	free
Function Block Inputs:	
CST - Checkback Signal Test	Basic Unit, Input 4
Basic Unit:	
Relay Output 1	Contact Control QE1
Relay Output 2	Contact Control QE2
Relay Output 3	Lamp Control QLS
Operator Panel:	
LED4 Green	Lamp Control QLE1 ON1
LED5 Green	Lamp Control QLE2 ON2
LED6 Green	Lamp Control QLA OFF

E.6 Star Delta Starter

E.6.1 Circuit diagram of Star Delta Starter Control Function

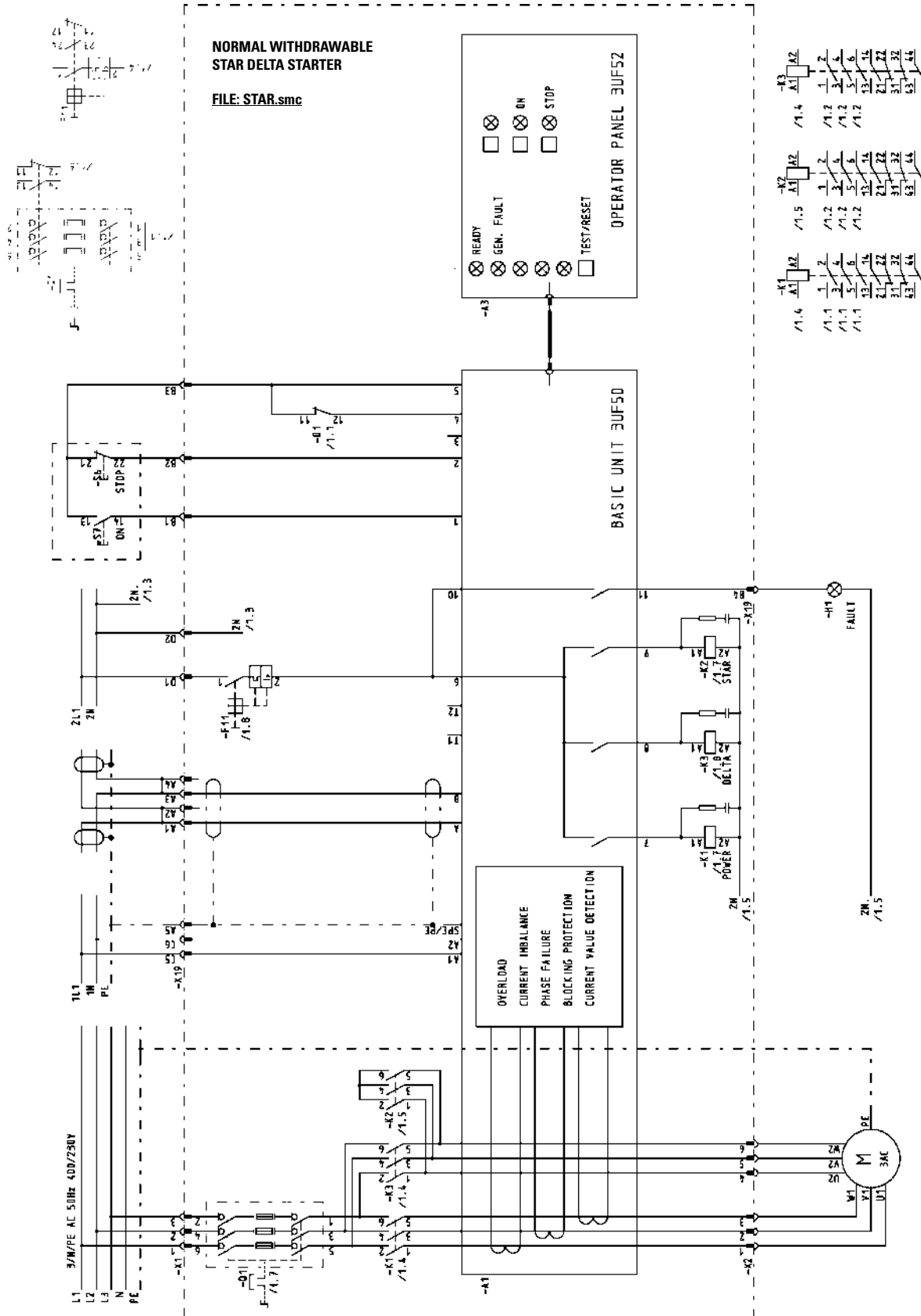

E.6.2 Block diagram of Star Delta Starter Control Function

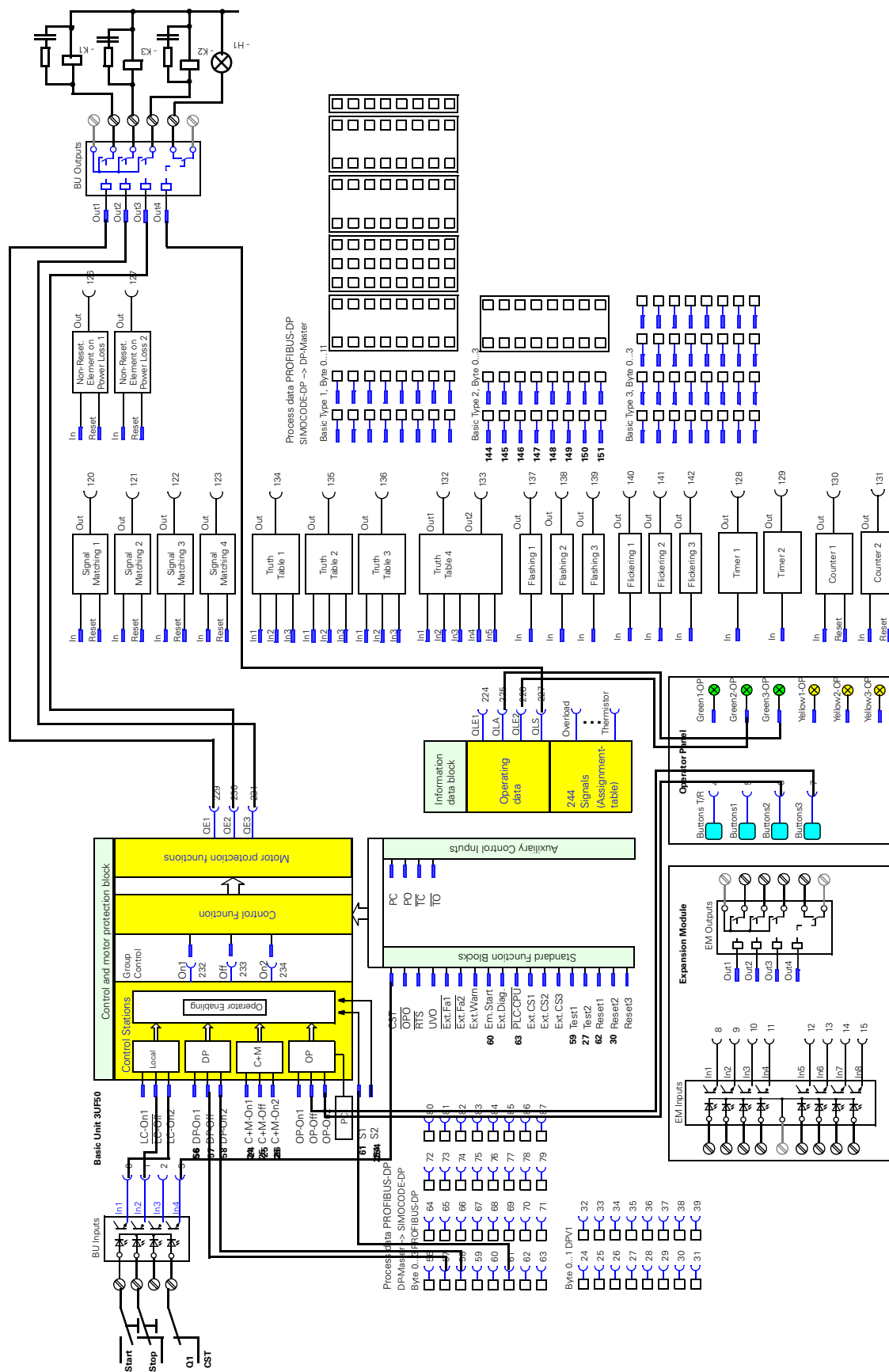

E.6.3 Parameters of Star Delta Starter Control Function

<u>Parameter</u>	<u>Setting</u>
General:	
Designation	'Stern-Dreieck-Starter/Star-Delta-Starter'
Motor:	
Control Function	Star-Delta Starter
Control Stations:	
LC-OFF	Basic Unit, Input 2
LC-ON2	Basic Unit, Input 1
DP-ON1	Not connected
OP-OFF	Operator Panel, Button 3
OP-ON2	Operator Panel, Button 2
S1 = 0, S2 = 1:	
OP-ON	free
OP-OFF	free
Function Block Units:	
CST - Checkback Signal Test	Basic Unit, Input 4
Basic Unit:	
Relay Output 1	Contactorm Control QE1
Relay Output 2	Contactorm Control QE3
Relay Output 3	Contactorm Control QE2
Relay Output 4	Lamp Control QLS
Operator Panel:	
LED5 Green	Lamp Control QLE2 On2

E.7 Pole Changing Starter

E.7.1 Circuit diagram of Pole Changing Starter Control Function

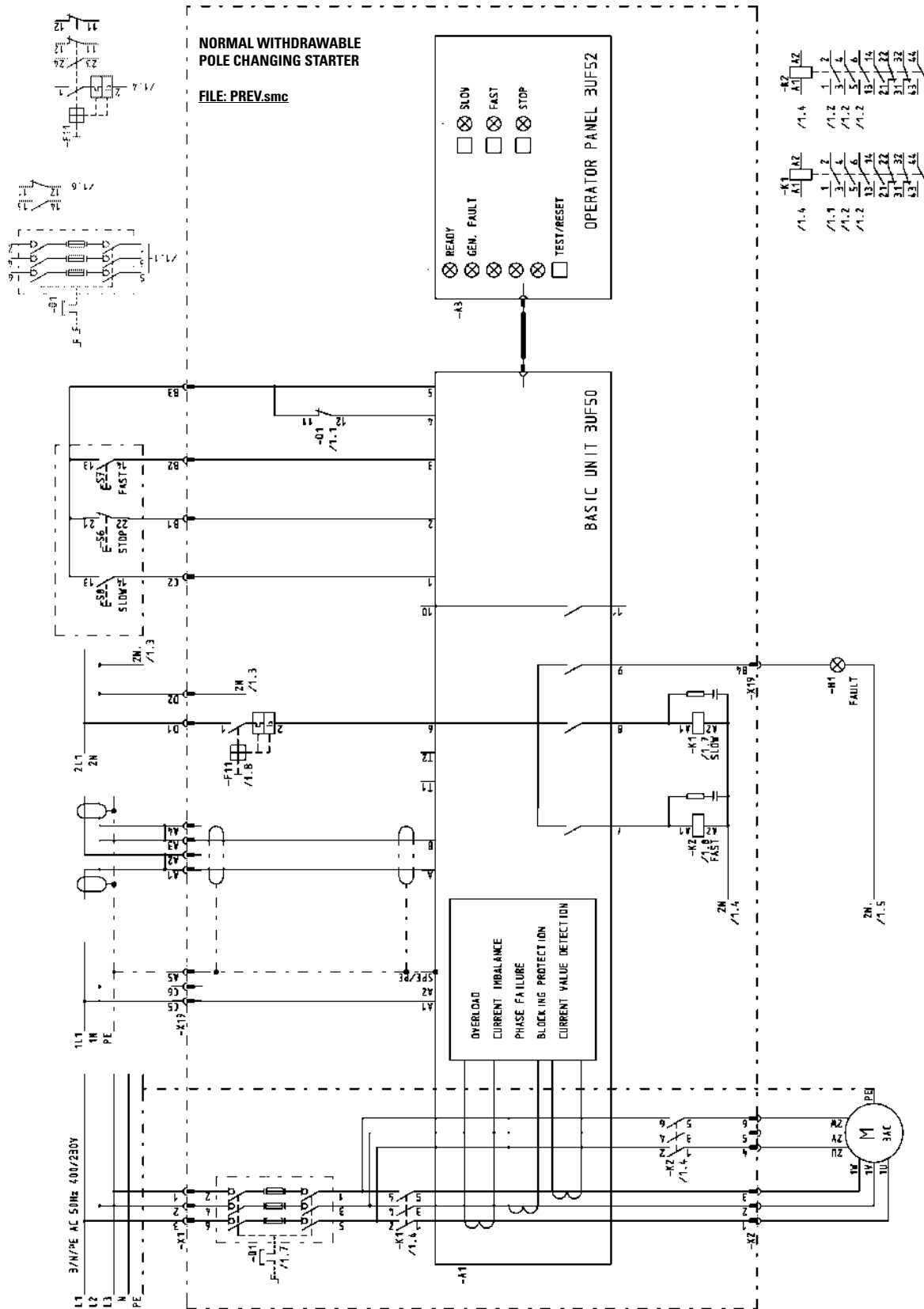

E.7.2 Block diagram of Pole Changing Starter Control Function

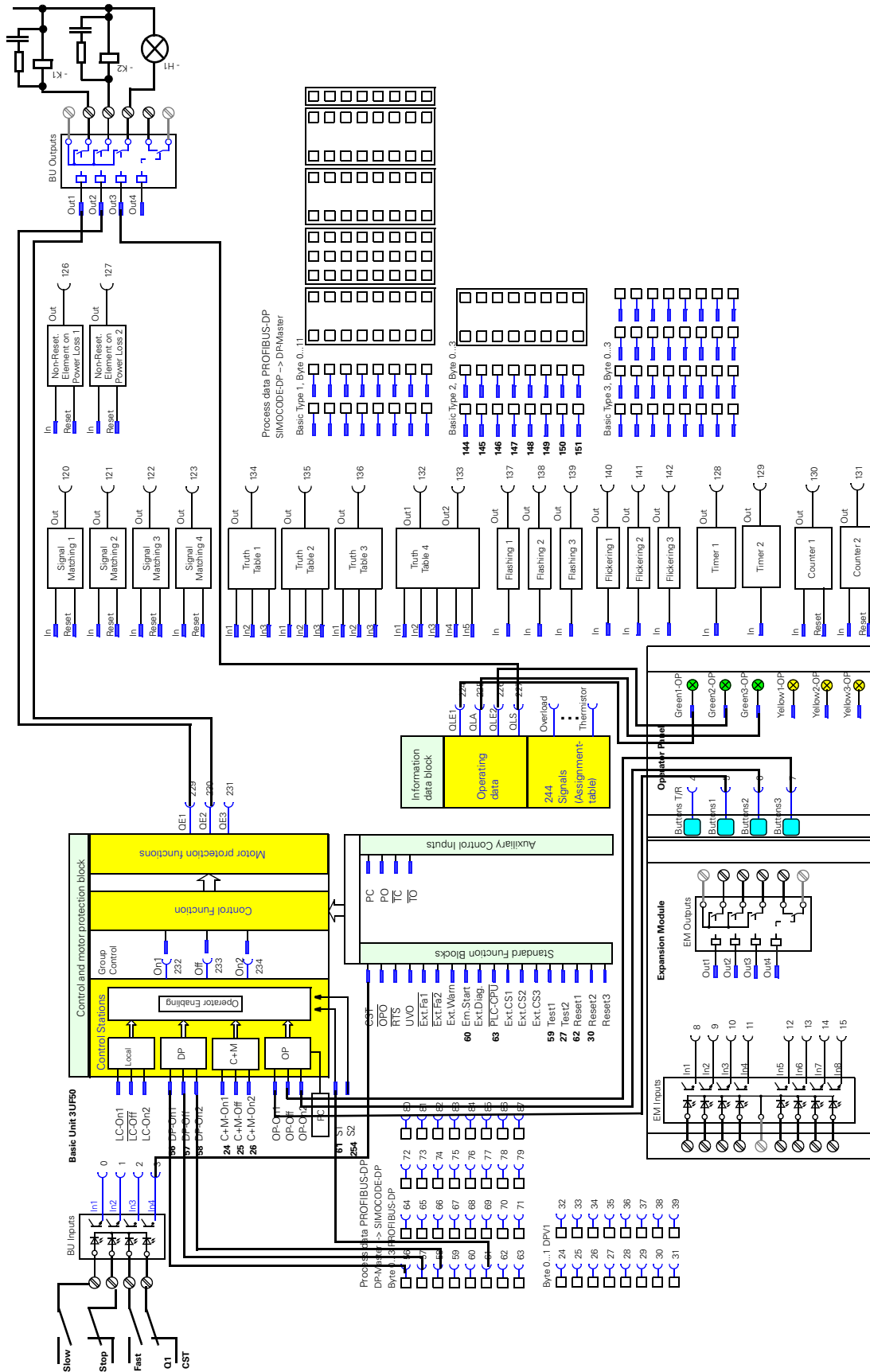

E.7.3 Parameters of Pole Changing Starter Control Function

<u>Parameter</u>	<u>Setting</u>
General:	
Designation	Polumschaltung (POLU.smc)/Pole-reversal (PREV.smc)
Overload:	
Nominal Current 2	1.25 A
Motor:	
Control Function	Pole Changing Starter
Locking Time	00:05.0
Control Stations:	
LC ON1	Basic Unit, Input 1
LC OFF	Basic Unit, Input 2
LC ON2	Basic Unit, Input 3
OP-ON1	Operator Panel, Button 1
OP-OFF	Operator Panel, Button 3
OP-ON2	Operator Panel, Button 2
S1 = 0, S2 = 1:	
OP-ON	free
OP-OFF	free
Function Block Inputs:	
CST - Checkback Signal Test	Basic Unit, Input 4
Basic Unit:	
Relay Output 1	Contact Control QE2
Relay Output 2	Contact Control QE1
Relay Output 3	Lamp Control QLS
Operator Panel:	
LED4 Green	Lamp Control QLE1 On1
LED5 Green	Lamp Control QLE2 On2
LED6 Green	Lamp Control QLA Off
General:	

E.8 Dahlander Starter

E.8.1 Circuit diagram of Dahlander Starter Control Function

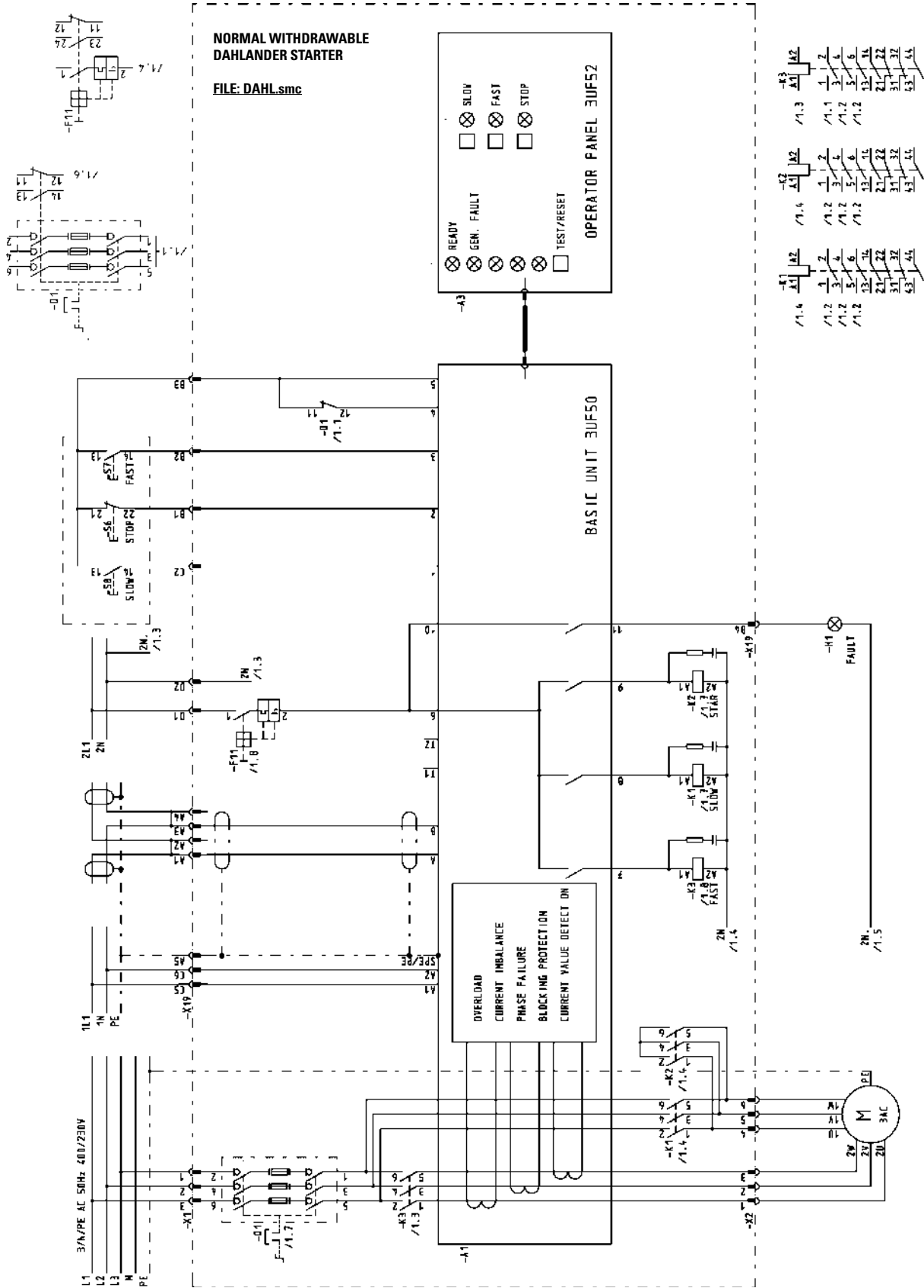

E.8.2 Block diagram of Dahlander Starter Control Function

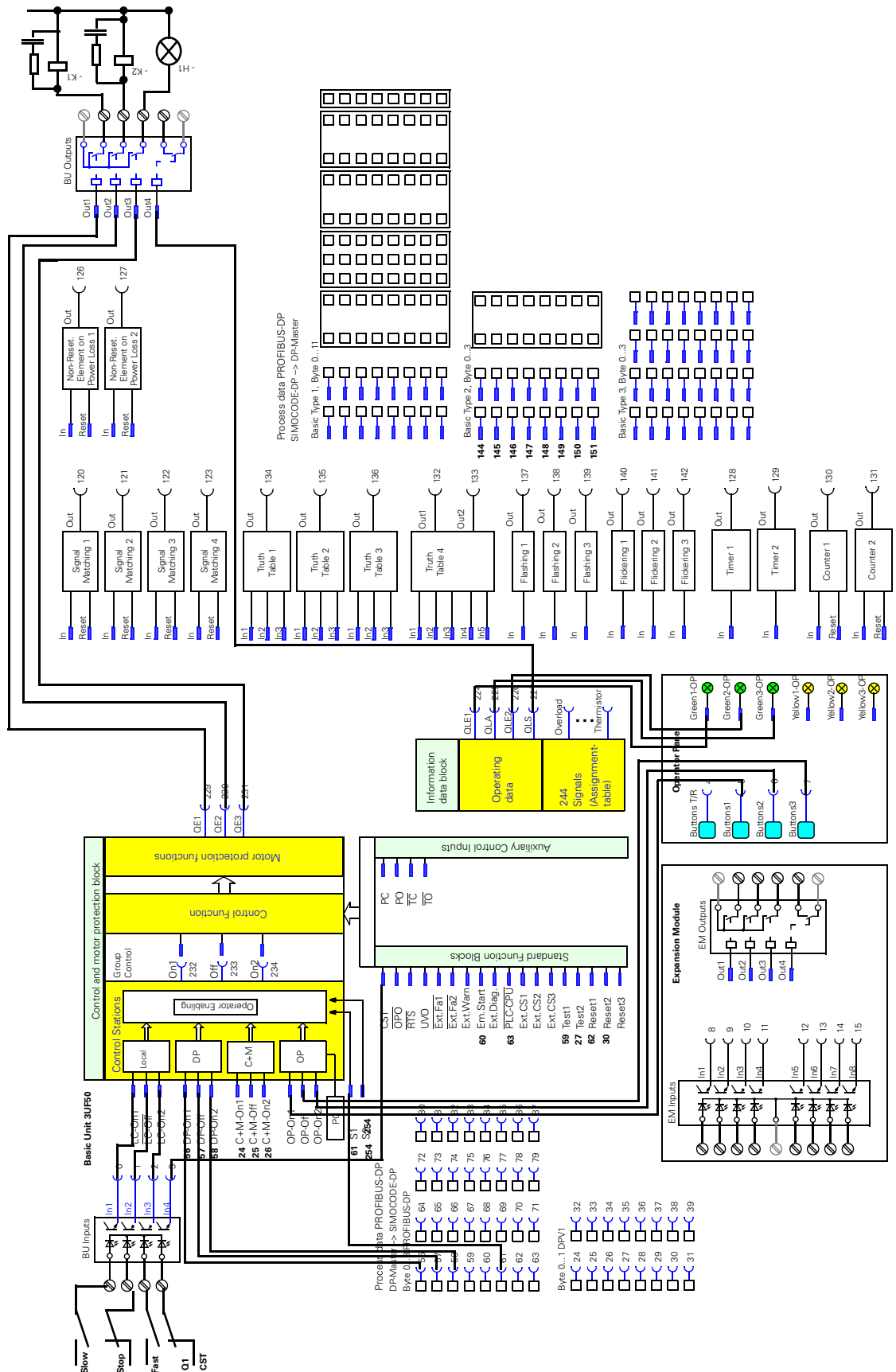

E.8.3 Parameters of Dahlander Starter Control Function

<u>Parameter</u>	<u>Setting</u>
General:	
Designation	'Dahlanderschaltung starter (DAHL.smc)' (DAHL.smc)/Dahlander
Overload:	
Set Current IS2	3.00 A
Motor:	
Control Function	Dahlander
Control Stations:	
LC ON1	Basic Unit, Input 1
LC OFF	Basic Unit, Input 2
LC ON2	Basic Unit, Input 3
OP-ON1	Operator Panel, Button 1
OP-OFF	Operator Panel, Button 3
OP-ON2	Operator Panel, Button 2
S1 = 0, S2 = 1:	
OP-ON	free
OP-OFF	free
Function Block Inputs:	
CST - Checkback Signal Test	Basic Unit, Input 4
Basic Unit:	
Relay Output 1	Contactors Control QE1
Relay Output 2	Contactors Control QE2
Relay Output 3	Contactors Control QE3
Relay Output 4	Lamp Control QLS
Operator Panel:	
LED4 Green	Lamp Control QLE1 On1
LED5 Green	Lamp Control QLE2 On2
LED6 Green	Lamp Control QLA Aus

E.9 Solenoid Valve

E.9.1 Circuit diagram of Solenoid Valve Control Function

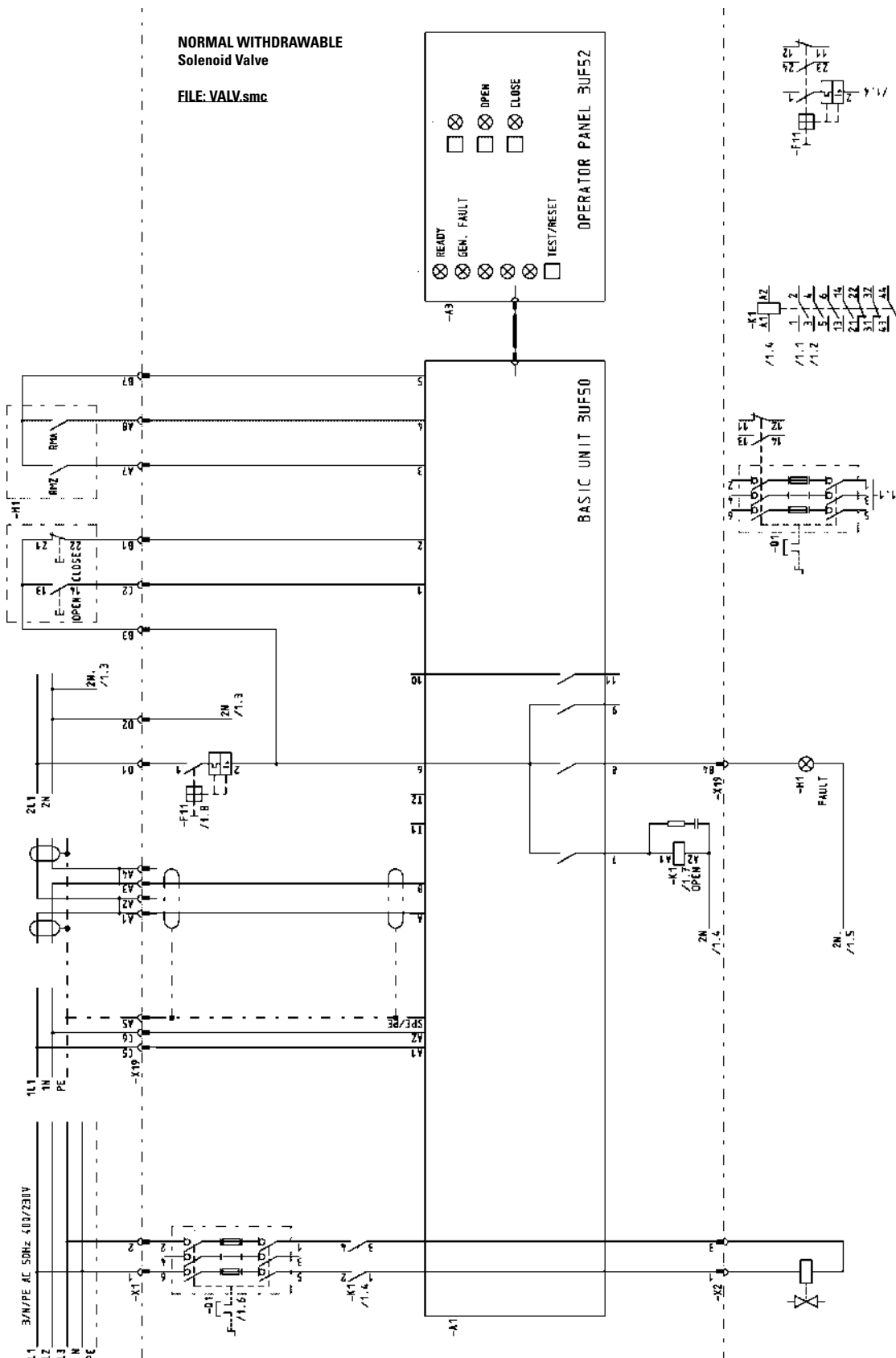

E.9.2 Block diagram of Solenoid Valve Control Function

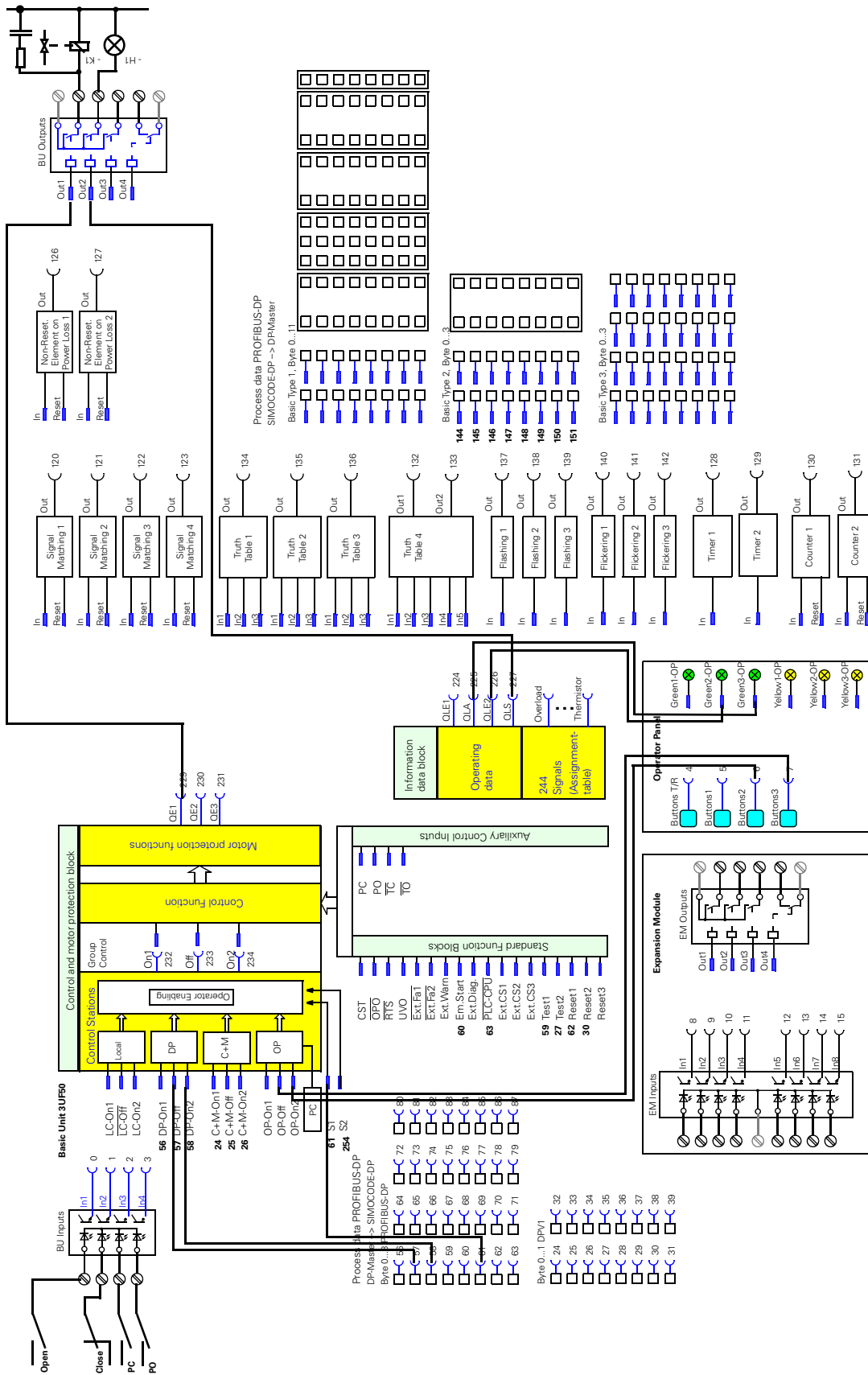

E.9.3 Parameters of Solenoid Valve Control Function

<u>Parameter</u>	<u>Setting</u>
General:	
Designation	'Magnetventilsteuerung (VENT.smc)/Valve Control (VALVE.smc)'
Overload:	
Nominal Current 1	0.00 A
Motor:	
Control Function	Positioner Control
Run-Time	00:10.0
PC, Position Switch Closed	Basic Unit, Input 3
PO, Position Switch Open	Basic Unit, Input 4
Control Stations:	
LC OFF	Basic Unit, Input 2
LC ON2	Basic Unit, Input 1
OP-OFF	Operator Panel, Button 3
OP-ON2	Operator Panel, Button 2
S1 = 0, S2 = 1:	
OP-ON	free
OP-OFF	free
Basic Unit:	
Relay Output 1	Contacteur Control QE1
Relay Output 4	Lamp Control QLS
Operator control block:	
LED5 Green	Lamp Control QLE2 On2
LED6 Green	Lamp Control QLA Off
DP process data:	
Byte 1:	
Bit 0	Mess. PC
Bit 1	Mess. PO
General:	
Designation	'Magnetventilsteuerung (VENT.smc)/Valve Control (VALVE.smc)'
Overload:	
Nominal Current 1	0.00 A
Motor:	
Control Function	Positioner Control
Run-Time	00:10.0
PC, Position Switch Closed	Basic Unit, Input 3
PO, Position Switch Open	Basic Unit, Input 4

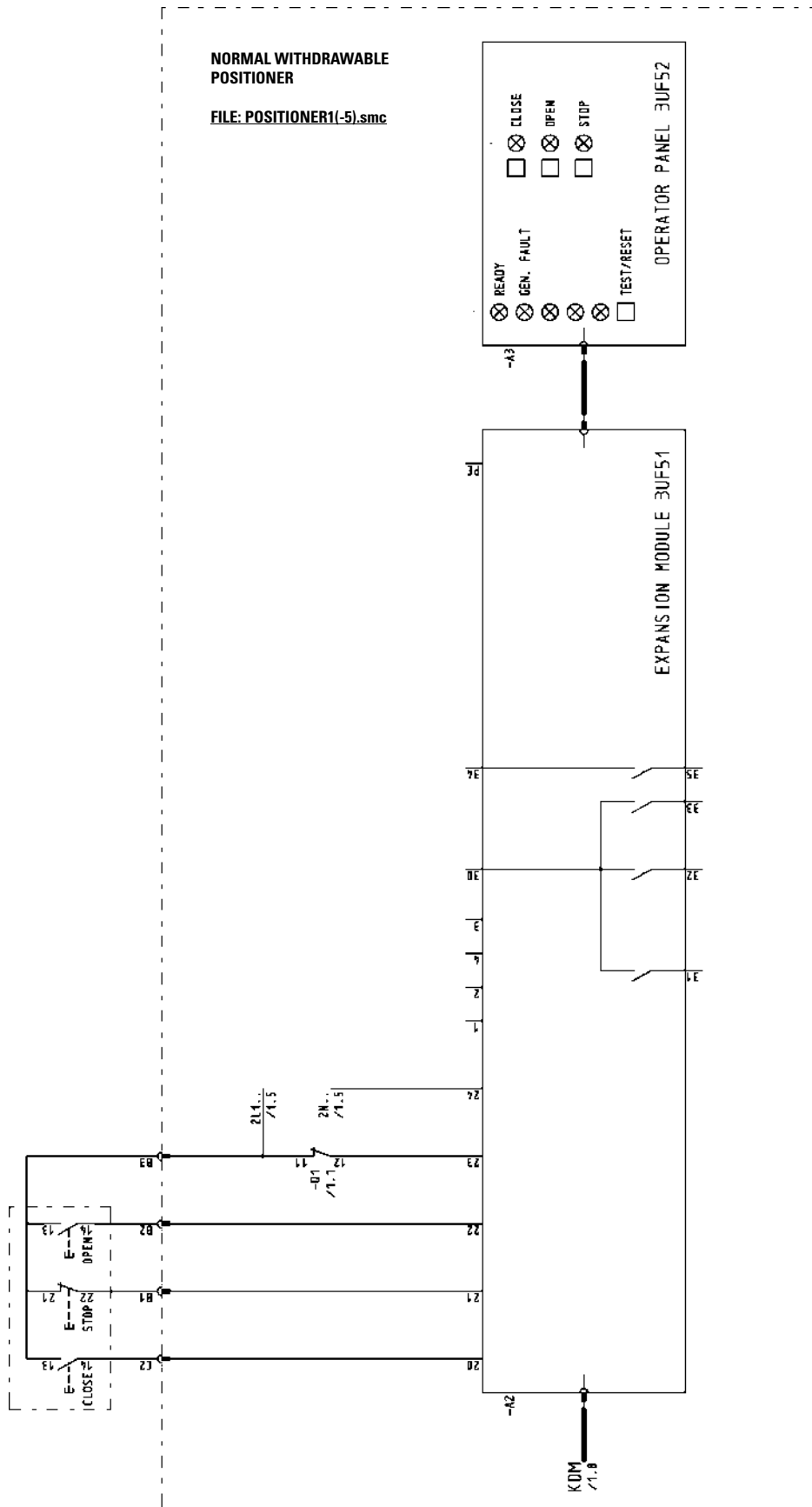

E.10.2 Block diagram of Positioner Control Function

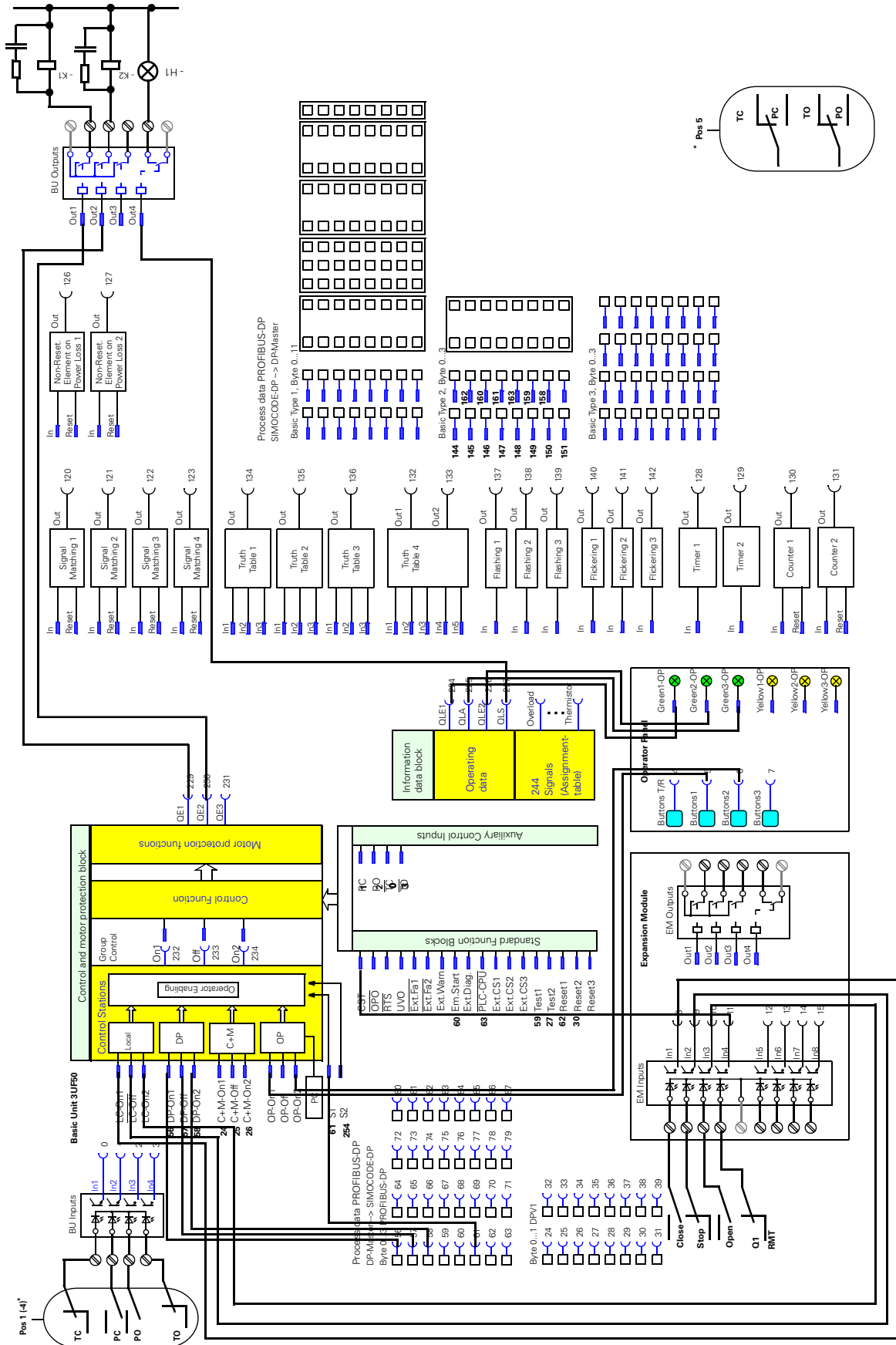

E.10.3 Parameters of Positioner Control Function

<u>Parameter</u>	<u>Setting</u>
Designation	‘Schiebersteuerung 1(-5) (Schie1(-5).smc)/Positioner starter 1(-5) (Pos1(-5).smc)’
Motor:	
Control Function	Positioner 1(-5)
Run-Time	00:10.0
PC – Position Switch Closed	Basic Unit, Input 2
PO – Position Switch Open	Basic Unit, Input 3
TC - Torque Closed	Basic Unit, Input 1
TO - Torque Open	Basic Unit, Input 4
Control Stations:	
LC ON1	Expansion Module, Input 1
LC OFF	Expansion Module, Input 2
LC ON2	Expansion Module, Input 3
OP-ON1	Operator Panel, Button 1
OP-OFF	Operator Panel, Button 3
OP-ON2	Operator Panel, Button 2
S1 = 0, S2 = 1:	
OP-ON	free
OP-OFF	free
Function Block Inputs:	
CST – Check-Back Signal Test	Expansion Module, Input 4
Basic Unit:	
Relay Output 1	Contact Control QE2
Relay Output 2	Contact Control QE1
Relay Output 3	Lamp Control QLS
Operator Panel:	
LED4 Green	Lamp Control QLE1 On1
LED5 Green	Lamp Control QLE2 On2
LED6 Green	Lamp Control QLA Off
DP process data:	
Byte 1:	
Bit 0	Mess. TC
Bit 1	Mess. PC
Bit 2	Mess. PO
Bit 3	Mess. TO
Bit 4	Status Positioner Drive Closed
Bit 5	Status Positioner Drive Open

E.11.2 Block diagram of Soft Starter Control Function

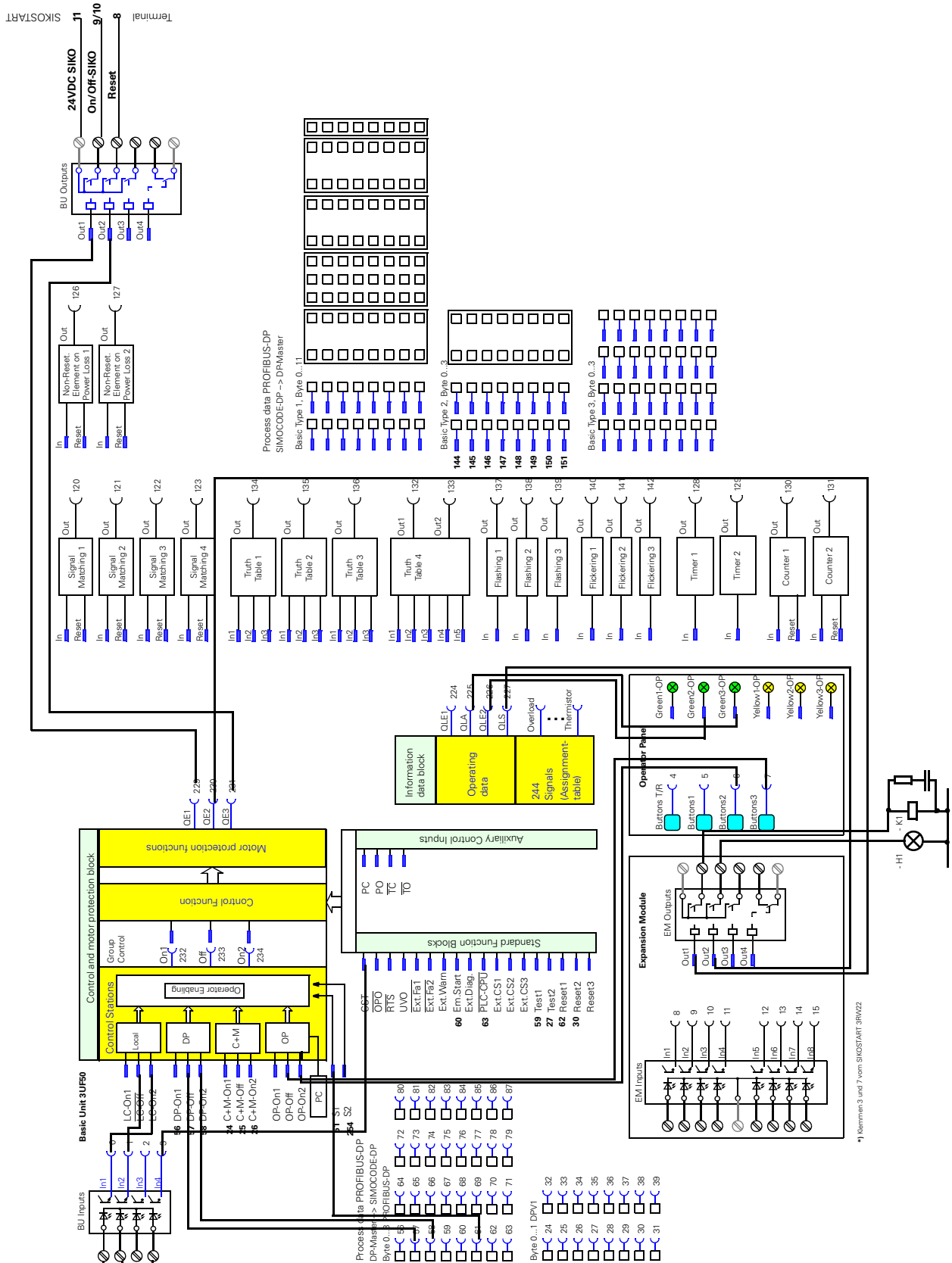

*1 Memmen 3 and 7 von SIKOSTART 3RW22

E.11.3 Parameters of Soft Starter Control Function

<u>Parameter</u>	<u>Setting</u>
General:	
Designation	'Sanftstarter (SIKO.smc)/Soft Starter (SOFT.smc)'
Motor:	
Control Function	Soft Starter
Control Stations:	
LC OFF	Basic Unit, Input 2
LC ON2	Basic Unit, Input 1
DP-ON1	Not connected
OP-OFF	Operator Panel, Button 3
OP-ON2	Operator Panel, Button 2
S1 = 0, S2 = 1:	
OP-ON	free
OP-OFF	free
Function Block Inputs:	
CST - Checkback Signal Test	Basic Unit, Input 4
External Fault 1	Expansion Module, Input 2
External Checkback Signal CS1	Expansion Module, Input 1
Basic Unit:	
Relay Output 1	Contact Control QE1
Relay Output 2	Contact Control QE3
Expansion Module:	
Relay Output 1	Contact Control QE2
Relay Output 2	Lamp Control QLS
Operator Panel:	
LED5 Green	Lamp Control QLE On 2
LED6 Green	Lamp Control QLA Off 2

Order Numbers

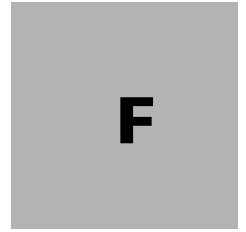

The following tables contain selection data and order numbers for the Basic Unit and other components:

**The 3UF50
Basic Unit**

Rated control supply voltage	Mount. width mm	Setting range	Order No.
AC 230 V	70	1,25 - 6,3	3UF50 01-3.N.0-1
	70	6,3 - 25	3UF50 11-3.N.0-1
	70	25 - 100	3UF50 21-3.N.0-1
	120	50 - 205	3UF50 31-3.N.0-1
	145	125 - 500	3UF50 41-3.N.0-1
	230	200 - 820	3UF50 51-3.N.0-1
AC 115 V	70	1,25 - 6,3	3UF50 01-3.J.0-1
	70	6,3 - 25	3UF50 11-3.J.0-1
	70	25 - 100	3UF50 21-3.J.0-1
	120	50 - 205	3UF50 31-3.J.0-1
	145	125 - 500	3UF50 41-3.J.0-1
	230	200 - 820	3UF50 51-3.J.0-1
DC 24 V	70	1,25 - 6,3	3UF50 01-3.B.0-1
	70	6,3 - 25	3UF50 11-3.B.0-1
	70	25 - 100	3UF50 21-3.B.0-1
	120	50 - 205	3UF50 31-3.B.0-1
	145	125 - 500	3UF50 41-3.B.0-1
	230	200 - 820	3UF50 51-3.B.0-1
Input Thermistor Motorprotection			3UF50...-3 A .□ 0-1
Input External Earth Fault Detection			3UF50...-3 B .□ 0-1
Behaviour of the outputs in the event of failure of the control supply voltage: monostable bistable			↑ 0 1

Table 74: Order numbers for Basic Units

**UF51
Expansion Module**

**3UF52
Operator Panel**

**Software
Win-SIMOCODE-DP/
Smart**

Selection data	Order No.
8 inputs and 4 outputs for snap-on mounting on 35 mm mounting rails Input voltage: AC 230 V AC 115 V DC 24 V	3UF51 00-0AN00 3UF51 00-0AJ00 3UF51 00-0AB00
For mounting in the door of the control cubicle: can be plugged into the 3UF50 Basic Unit or the 3UF51 Expansion Module	3UF52 02-1AA00-1
For parameterizing, operator control and monitoring; with PC / PG via RS232.	3UF5711-0AA00-0

Table 75: Order numbers for expansion components

	Selection data	Order No.
Software Win-SIMOCODE-DP/ Professional	For parameterizing, operator control and monitoring; with PC / PG via PROFIBUS-DP or RS232.	3UF5710-0AA00-0
MPI cable (5m)	For connection to SIMATIC S7/M7/C7	6ES7901-0BF00-0AA0
3UF59/19 plug-in connector/ connecting cable with connectors 3UF59/19	For connecting the Basic Unit / Expansion Module to the manual operating device for mounting in the front panel 9-pole, 0.50 m, flat plug and socket, screened 9-pole, 1.0 m, flat plug and socket, screened	3UF59 00-0AA00 3UF59 00-0BA00
	For connecting the Basic Unit to the Expansion Mod- ule 9-pole, 0.03 m, with flat plug, screened	3UF59 00-1AA00
	For connecting the Basic Unit to the Expansion Module or to the Operator Panel 9-pole, 0.5 m, screened, angled at 45 ° 9-pole, 2.0 m, screened, angled at 45 ° 9-pole, 2.5 m, screened, angled at 45 ° 9-pole, 0.5 m, with flat connector, screened 9-pole, 1.0 m, with flat connector, screened	3UF19 00-1AA00 3UF19 00-1BA00 3UF19 00-1CA00 3UF19 00-1DA00 3UF19 00-1EA00
	T-terminal for bus connection	3UF59 00-1GA00
	3UF1900 bus termination	Module with its own supply voltage for bus termina- tion behind the last unit on the bus line Supply voltage: AC 115/120/230 V DC 24 V
Baseplate	For snap-on mounting on 75 mm mounting rail, only for 3UF50 with 120 mm mounting width	3UF19 00-0JA00
Push-in lugs	For screw mounting on mounting plate; 2 lugs needed for each 3UF50 and 3UF51 (1 set = 10 lugs)	3RB19 00-0B

Table 75: Order numbers for expansion components

Additional components

Selection data	Order No.
<p>The link up to the SIMOCODE-DP into a PROFIBUS-DP network on SIMATIC S5 base is made by means of the parameterization and service program COM-PROFIBUS. For selection and ordering data see Catalog ST 50, "SIMATIC S5/PC/T1 505 Automation Systems", Order No. E86060-K4650-A111-A6.</p> <p>The link up to the SIMOCODE-DP into a PROFIBUS-DP network on SIMATIC S7 base is made by means of the programming language Step 7. For selection and ordering data see Catalog ST70 "SIMATIC S7/M7/C7 Automation Systems", Order No. E86060-K4670-A101-A2.</p> <p>Communication processors for SIMATIC S5 see Catalog "SIMATIC S5/PC/TI 505 Automation Systems" Order No. E86060-K4650-A111-A6 Communication processors for SIMATIC S7 see Catalog "SIMATIC S7/M7/C7" ST70 Automation Systems" Order No. E86060-K4670-A101-A2</p> <p>Bus cables, 9-pole bus plug connectors with termination resistance, components for optical fibre connection, etc. see Catalog IK 10 "Industrial Communication networks", Order No. E86060-K6710-A101-A5</p>	

Table 75: Order numbers for expansion components

Frequently asked questions

Abschnitt	Thema	Seite
G.1	General reset	G-2
G.2	Win-SIMOCODE-DP fault situations in online operation	G-3

G.1 General reset

Definition

Performing a general reset means re-establishing the factory settings of the 3UF50 Basic Unit.

Procedure

Proceed as follows:

1. Switch off the supply voltage.
2. Connect pin 5 and pin 8 on the 9-pole system plug with a wire jumper.
3. Switch on the supply voltage.
4. Switch off the supply voltage again after approximately three seconds.
5. Remove the wire jumper.

The Basic Unit has now been fully reset.

G.2 Win-SIMOCODE-DP fault situations in online operation

Fault situations in online operation

The following fault situations may occur in online operation with Win-SIMOCODE-DP:

Fault situation	Possible causes with RS232	Possible causes with DPV1
ERC:0010: time barrier exceeded [connection setup to unit]	<ul style="list-style-type: none"> • Incorrect COM interface • Interface already assigned • No SIMOCODE-DP present 	<ul style="list-style-type: none"> • Different baud rate in CP and unit • Different address in Win-SIMOCODE-DP and unit • CP not present • CP incorrectly configured (e.g. set "Not only master active" in the "Properties" window for the PC-PU interface) • Selected device is not SIMOCODE-DPV1 or DPV1 connection already in use
DPV1 in online opening not selectable		<ul style="list-style-type: none"> • Different baud rate in CP and unit • CP not present • CP incorrectly configured e.g. set "Not only master active" in the "Properties" window for the PC-PU interface)

Index

A - R

S - Z



H

A

Acknowledgement 5-3
Actuator 2-33
Assembly method 2-8
Automatic mode 2-24
Automatic reset 5-3

B

Basic Types 6-7
Basics of parameterization 7-4
Baud rate 6-36
Behaviour in the event of a fault 5-2
Block DP 6-7
Blocking Protection 2-16
Bus segment 6-36
Bus termination module 6-38

C

Check-Back Current On 2-28
Check-back Time Off 2-29
Check-back Time On 2-29
Class 2-11
Cold run 2-47
Components 1-9
Configuration 8-2
Control and motor protection block 2-21
Control buttons 4-3
Control Functions 2-27
Control Stations 2-23
Cooling behaviour 2-14
Cooling Time 2-14
Counter 2-61
Current Detection with SIMOCODE-DP 2-8
Current Detection 2-7
Current Detection with external current transformers 2-10
Current Limit Value 2-16
Current-dependent motor protection 2-7

D

Dahlander Starter 2-31
Data exchange 6-7
Derating 2-11
Description of messages 6-5
Direct Starter 2-29

E

Earth Fault Detection 2-17
ET 200 6-37

F

Fault handling 5-4
Faults 5-2
Flash 2-59
Flicker 2-59

Front of Basic Unit 2-2
Front of Expansion Module 3-2
Function Block Inputs 2-47

G

Grading Time 2-48

I

Idle Time 2-14
Inching Mode 2-27
Indicator LEDs 4-3
Inputs 2-5
Introduction to PROFIBUS-DP 6-2

L

Lock time 2-29
Lock-Out Time 2-31
Logic modules 2-52

M

Malfunctions 5-2

N

Non-Resetting Elements on Power Loss 2-53
Normal operation 2-27

O

Operating mode 6-7
Operator Enabling 2-24
original tripping characteristics 2-13
Output Relays 2-4, 3-4
Outputs 2-4, 3-4
Overload 2-46
Overload Trip 2-14

P

Parameter Errors 5-9
Parameterizable fault behaviour 5-10
Parameterizing at runtime 7-2
Parameterizing during starting 7-3
Pole Changing Starter 2-30
Positioner 2-33
Possibilities of data transmission 6-3

R

Repeater 6-37
Resistance values 2-19
Reversing Starter 2-29
Run Time Off 2-28
Run Time On 2-28

S

- Settings for bus communication 6-6
- Signal Matching 2-52
- Signal types 2-52
- SIKOSTART 2-32
- Slave operating modes 6-4
- Soft Starter 2-32
- Solenoid Valve 2-44
- Spur lines 6-37
- Star Delta Starter 2-30
- Stations 6-36
- Status LEDs 2-50, 4-4
- Structural design 1-12
- Summary of functions
 - performed by the Basic Unit 2-3
- Summary of functions
 - performed by the Expansion Module 3-2
- Summary of functions
 - SIMOCODE-DP system 1-11
- Summary of the
 - Operator Panel's functions 4-2
- Summation current transformer 2-17
- System configurations 1-10

T

- T-clamp 6-38
- Terminating resistor 6-36
- Test 2-50, 4-4
- Thermistor Motor Protection 2-19
- Timer 2-60
- Tripping characteristics 2-11, 2-13
- Truth Table 3I / 1O 2-54
- Truth Table 5I / 2O 2-57
- Type of protection EEX e 2-13
- Types of detector 2-19

V

- Voltage supply 2-6

W

- Win-SIMOCODE-DP 7-7

Glossary

AC 3 current for contactors	The AC 3 current for contactors is the rated operating current for disconnection when squirrel-cage motors are running.
Baud Rate	The Baud Rate is the rate of data transmission and indicates the number of bits transmitted per second (Baud Rate = bit rate). Baud Rates of 9.6 kilobaud to 12 megabaud are possible with PROFIBUS-DP.
Bus	Common transmission path via which all stations are connected; the Bus has two defined ends. In PROFIBUS the Bus is a two-wire line (copper wire) or an optical-fibre cable.
Bus connector	The bus connector is the physical connection between the station and the bus line.
Bus segment	—> segment
Bus system	All stations that are physically connected via a bus cable together form a bus system.
DMD	Device master data (DMD) contain DP slave descriptions in a standardized format. The use of DMD makes configuration of the master and the DP slave easier.
DP master	A master which behaves in conformance with the standard EN 50 170, Volume 2, PROFIBUS, using the DP protocol, is referred to as a DP master.
DP standard	The DP standard is the bus protocol of the ET 200 Decentralized Peripheral System in conformance with the standard EN 50 170, Volume 2, PROFIBUS.
DP slave	A slave which is operated on the PROFIBUS bus with the PROFIBUS-DP protocol and behaves in conformance with the standard EN 50 170, Volume 2, PROFIBUS, is known as a DP slave.

EEx e motors	EEx e motors are adapted to the DIN requirements regarding explosion protection. This means that the motor must be enclosed in a flameproof enclosure. In terms of mechanical design and dimensions, EEx e motors are identical to normal totally enclosed fan-cooled three-phase squirrel cage motors, but usually their rated output is lower.
Emergency Start	Possibility of deleting the thermal memory, bypassing the recovery time, and in that way allowing a restart to take place. (A reset and closing command are additionally required.) The Emergency Start is activated once only by a signal change from 0 to 1 (edge sensitive). It is never possible to prevent another tripping due to overload.
Host	A host is a system or unit which contains at least one DP master. For example, the programmable controller with the CPU is the host, and the IM 308-C is the DP master.
IM 308-C	The IM 308-C is a DP master for the ET 200 Decentralized Peripheral System. The IM 308-C can be used in conjunction with COM PROFIBUS and can be plugged into the S5-115U, S5-135U and S5-155U programmable controllers.
Master	When they have the token, masters can send data to other stations and request data from other stations (= active station).
Master interface module	Module for decentralized setup. The decentralized periphery is "connected" to the programmable controller via master interface module C.
Master-slave method	Bus access method in which only one station at a time is the master and all other stations are slaves.
Master system	All slaves which are assigned to a master with a reading and writing function form a master system together with the master.
Terminating resistor	Each bus line connecting the individual SIMOCODE-DP units to each other must be terminated with a resistor at the start and end. This prevents line reflections.
Tripping characteristic	The tripping characteristics show the tripping time as a function of tripping current. The tripping current is shown as a multiple of the set current I_s . With SIMOCODE-DP, tripping characteristics are specified for the symmetrical and asymmetrical loading of the motor from the cold and warm states.
Tripping classes	The tripping class (CLASS) specifies the maximum tripping time within which a protection device must trip from the cold state with 7.2 times the set current. If CLASS 10 is set for SIMOCODE-DP, for example, this ensures that the (cold) motor is shut down after 10 seconds given 7.2 times the set current.

PROFIBUS	<p>PROcess Field BUS, European process and fieldbus standard which is defined in the PROFIBUS standard (EN 50 170, Volume 2, PROFIBUS). It specifies functional, electrical and mechanical properties for a one-bit serial fieldbus system.</p> <p>PROFIBUS is a bus system which networks PROFIBUS-compatible automation systems and field devices at the cell and field levels.</p> <p>PROFIBUS is available with the following protocols: DP (= Decentralized Periphery), FMS (= Fieldbus Message Specification), PA (Process Automation) or TF (= Technological Functions).</p>
PROFIBUS address	<p>Each station must be assigned a PROFIBUS address for the purpose of unique identification.</p> <p>The PC/PU or the ET 200 hand-held unit have the PROFIBUS address "0".</p> <p>The master and slaves have a PROFIBUS address from within the range 1 to 125.</p>
PROFIBUS-DP	<p>PROFIBUS bus system with the DP protocol.</p> <p>DP stands for decentralized periphery.</p> <p>The primary task of PROFIBUS-DP is fast cyclical exchange of data between the central DP master and the peripheral devices.</p>
Segment	<p>The bus line between two terminating resistors forms a segment.</p> <p>A segment contains 0 to 32 stations. Segments can be coupled via RS 485 repeaters.</p>
Slave	<p>A slave may only exchange data with a master after being requested to do so by the master.</p> <p>Slaves include, for example, all DP slaves such as SIMOCODE- DP, frequency converters, etc.</p>
Station	<p>A station is a device which can transmit, receive or amplify data, for example a master, slave, RS 485 repeater, or active star coupler.</p>
Station number	—> PROFIBUS address

