

Edition

11/2023

OPERATING INSTRUCTIONS

SIMOTICS XP

Low-voltage motors

1MB..1/2/3/4

Shaft heights 63 ... 355

SIEMENS

SIMOTICS XP

Low-voltage motors 1MB..1/2/3/4 - shaft heights 63 ... 355

Operating Instructions

<u>Introduction</u>	1
<u>Safety information</u>	2
<u>Description</u>	3
<u>Preparing for use</u>	4
<u>Assembly</u>	5
<u>Electrical connection</u>	6
<u>Commissioning</u>	7
<u>Operation</u>	8
<u>Maintenance</u>	9
<u>Spare parts</u>	10
<u>Disposal</u>	11
<u>Technical data</u>	A
<u>Quality documents</u>	B

For applications in Zone 1 and Zone 2
(IEC/EN/GOST 60079-10-1, GB 3836.14)
For applications in Zone 21 and Zone 22
(IEC/EN/GOST 60079-10-2, GB/T 3836.35)

Translation of the original instructions

11/2023

A5E52779900A

Legal information

Warning notice system

This manual contains notices you have to observe in order to ensure your personal safety, as well as to prevent damage to property. The notices referring to your personal safety are highlighted in the manual by a safety alert symbol, notices referring only to property damage have no safety alert symbol. These notices shown below are graded according to the degree of danger.

 DANGER

indicates that death or severe personal injury will result if proper precautions are not taken.
--

 WARNING
--

indicates that death or severe personal injury may result if proper precautions are not taken.

 CAUTION
--

indicates that minor personal injury can result if proper precautions are not taken.
--

NOTICE

indicates that property damage can result if proper precautions are not taken.
--

If more than one degree of danger is present, the warning notice representing the highest degree of danger will be used. A notice warning of injury to persons with a safety alert symbol may also include a warning relating to property damage.

Qualified Personnel

The product/system described in this documentation may be operated only by **personnel qualified** for the specific task in accordance with the relevant documentation, in particular its warning notices and safety instructions. Qualified personnel are those who, based on their training and experience, are capable of identifying risks and avoiding potential hazards when working with these products/systems.

Proper use of Innomotics products

Note the following:

 WARNING
--

Innomotics products may only be used for the applications described in the catalog and in the relevant technical documentation. If products and components from other manufacturers are used, these must be recommended or approved by Innomotics. Proper transport, storage, installation, assembly, commissioning, operation and maintenance are required to ensure that the products operate safely and without any problems. The permissible ambient conditions must be complied with. The information in the relevant documentation must be observed.
--

Trademarks

All names identified by ® are registered trademarks of Innomotics GmbH. The remaining trademarks in this publication may be trademarks whose use by third parties for their own purposes could violate the rights of the owner.

Disclaimer of Liability

We have reviewed the contents of this publication to ensure consistency with the hardware and software described. Since variance cannot be precluded entirely, we cannot guarantee full consistency. However, the information in this publication is reviewed regularly and any necessary corrections are included in subsequent editions.

Table of contents

1	Introduction	9
1.1	About SIMOTICS	9
1.2	About this manual	9
1.2.1	Content	9
1.2.2	Target group	10
1.2.3	Avoiding dangers	11
1.2.4	Standard scope	11
1.2.5	Websites of third-party companies	11
1.3	SIMOTICS documentation	11
1.4	Service and support	12
1.4.1	Siemens Industry Online Support on the Web	12
1.4.2	Spare parts services	13
1.5	Important product information	14
2	Safety information	15
2.1	General safety instructions	15
2.1.1	Information for those responsible for the plant/system	15
2.1.2	The 5 safety rules	16
2.1.3	Qualified personnel	16
2.1.4	Safe handling	16
2.1.5	Use in hazardous areas	18
2.1.6	Electrostatic sensitive devices	20
2.1.7	Electromagnetic compatibility	21
2.1.8	Interference immunity	21
2.1.9	Influence on the line power supply through a strongly irregular torque	21
2.1.10	Interference voltages when operating the converter	22
2.1.11	Special designs and construction versions	22
2.1.12	Certificate with special conditions	22
3	Description	25
3.1	Area of application	25
3.2	Rating plates	26
3.3	Installation	28
3.3.1	Regulations	28
3.3.2	Cooling and ventilation	30
3.3.2.1	Machines with a fan	30
3.3.2.2	Machines without a fan (optional)	30
3.3.3	Bearings	31
3.3.4	Axial and radial forces	31
3.3.5	Balancing	31
3.3.6	Types of construction/method of installation	32
3.3.7	Degree of protection	34
3.3.7.1	Degree of protection for explosion-proof machines	34

3.3.8	Environmental conditions	34
3.3.9	Optional built-on and built-in accessories	35
3.3.10	Marking.....	36
3.3.11	Terminal box.....	38
3.3.12	Paint finish.....	38
4	Preparing for use	41
4.1	Safety-related aspects to consider when configuring the plant	41
4.2	Observing the operating mode.....	41
4.3	Machines without final paint coating	41
4.4	Delivery	42
4.5	Transport and storage	42
4.5.1	Safety instructions for transport	42
4.5.2	Storage.....	45
4.5.3	Temperature limits during storage.....	46
4.5.4	Securing the rotor	47
4.5.5	Commissioning after storage.....	49
4.5.5.1	Insulation resistance and polarization index	49
4.5.5.2	Lubricating the rolling bearings	49
4.5.5.3	Regreasing rolling bearings after storage periods of up to two years	49
4.5.5.4	Releasing the rotor shipping brace before commissioning	49
4.6	Ensure adequate cooling.....	50
4.7	Thermal protection	51
4.8	Interlock circuit for anti-condensation heating.....	53
4.9	Noise emission.....	53
4.10	Voltage and frequency fluctuations during line operation	53
4.11	Rotational speed limit values.....	54
4.12	System-inherent frequencies.....	54
4.13	Electromagnetic compatibility	54
4.14	Converter operation.....	55
4.14.1	Parameterizing the converter	55
4.14.2	Converter input voltage	56
4.14.3	Reducing bearing currents	56
4.14.4	Insulated bearings for converter operation	57
4.14.5	Tandem operation.....	59
4.14.6	Speed limits for converter operation	59
5	Assembly.....	61
5.1	Safety instructions for installation	61
5.2	Preparing for installation	62
5.2.1	Requirements for installation	62
5.2.2	Insulation resistance	63
5.2.2.1	Insulation resistance and polarization index	63
5.2.2.2	Checking the insulation resistance and polarization index of the winding.....	64
5.3	Mounting and installed the machine	67

5.3.1	Preparing the assembly area.....	67
5.3.2	Lift the machine to where it will be mounted and position it.....	67
5.3.3	Machines with type of construction IM B15, IM B9, IM V8 and IM V9.....	68
5.3.4	Foot mounting.....	68
5.4	Alignment and fastening.....	69
5.4.1	Repainting/touching up the paint finish of explosion-protected machines.....	69
5.4.2	Measures for alignment and mounting.....	69
5.4.3	Flatness of the supporting surfaces for conventional motors.....	70
5.4.4	Machine frame mounting feet (special design).....	70
5.5	Installing the machine.....	71
5.5.1	Preconditions for smooth, vibration-free operation.....	71
5.5.2	Aligning the machine to the driven machine and mounting.....	71
5.5.2.1	Type of construction without flange.....	71
5.5.2.2	Horizontal types of construction with mounting feet.....	71
5.5.2.3	Horizontal types of construction with flange.....	72
5.5.2.4	Vertical types of construction with flange.....	72
5.5.3	Removing the rotor shipping brace.....	73
5.5.4	Recommended alignment accuracy.....	73
5.5.5	Mounting the drive output elements.....	74
6	Electrical connection.....	77
6.1	Connecting the machine.....	78
6.1.1	Safe connection.....	78
6.1.2	Selecting cables.....	79
6.1.3	Thermal protection.....	79
6.1.4	Terminal box.....	80
6.1.4.1	Circuit diagram inside the terminal box cover.....	80
6.1.4.2	Direction of rotation.....	80
6.1.4.3	Terminal marking.....	81
6.1.4.4	Additional bores in the terminal box.....	81
6.1.4.5	Cable entry.....	81
6.1.4.6	Protruding connection cables.....	82
6.1.4.7	Connecting protruding cables.....	83
6.1.4.8	Thread sizes in the terminal box.....	83
6.1.4.9	Internal equipotential bonding.....	83
6.1.5	Cable glands.....	84
6.1.5.1	Mounting position of sheet metal nuts in screw-type connections.....	84
6.2	Tightening torques.....	85
6.3	Connecting the grounding conductor.....	85
6.3.1	Minimum surface area of grounding conductor.....	85
6.3.2	Grounding connection type.....	86
6.4	Temperature sensor/anti-condensation heating connection.....	87
6.4.1	Connecting optional integrated devices and equipment.....	87
6.5	Conductor connection.....	88
6.5.1	Connection with/without cable lugs.....	90
6.5.2	Cable ends with wire end sleeves.....	91
6.5.3	Connecting aluminum conductors.....	91
6.5.4	Minimum air clearances.....	92
6.6	Connecting the converter.....	92

6.7	Final checks	94
7	Commissioning	95
7.1	Measures before commissioning	95
7.1.1	Insulation resistance and polarization index	97
7.1.2	Checking the machine cooling	97
7.1.3	Commissioning the separately driven fan	97
7.1.4	Further documents	98
7.2	Setpoint values for monitoring the bearing temperature	99
7.3	Switching on	99
7.3.1	Test run	100
8	Operation.....	103
8.1	Safety instructions for operation	103
8.1.1	Safety instructions relating to ventilation and cooling	107
8.1.1.1	Forced ventilation (optional): Cooling method IC 416 in accordance with EN / IEC 60034-6... ..	107
8.1.2	Switching on with the anti-condensation heating active	108
8.2	Switching on the machine.....	109
8.3	Switch off the separately driven fan.....	109
8.4	Switching on again after an EMERGENCY OFF.....	109
8.5	Stoppages.....	109
8.5.1	Avoidance of damage to rolling bearings during stoppages.....	111
8.5.2	Decommissioning the machine	111
8.5.3	Re-commissioning the machine.....	111
8.6	faults.....	112
8.6.1	Inspections in the event of faults.....	112
8.6.2	Electrical faults	112
8.6.3	Mechanical faults.....	113
8.6.4	Rolling bearing faults	113
8.6.5	Faults at the external fan.....	114
8.7	Deactivating	114
9	Maintenance.....	115
9.1	General	115
9.2	Inspection and maintenance	116
9.2.1	Safety instructions for inspection and maintenance	116
9.2.2	Inspections in the event of faults.....	118
9.2.3	First inspection after installation or repair.....	119
9.2.4	General inspection	119
9.2.5	Assessing the rolling bearings	120
9.2.6	Mechanical explosion protection for rolling bearings	121
9.2.7	Maintenance intervals.....	121
9.2.8	Re-greasing.....	122
9.2.9	Cleaning	123
9.2.10	Risk of explosion due to damaged seals	124
9.2.11	Drain condensate.....	124
9.2.12	Insulation resistance and polarization index	124

9.2.13	Maintaining the external fan (forced ventilation)	125
9.2.14	Repainting	126
9.2.14.1	Repainting	126
9.3	Corrective maintenance	127
9.3.1	Machines with a certificate extended with an "X"	127
9.3.2	Anti-condensation heating	128
9.3.3	Fundamentals	129
9.3.4	Rolling bearings	129
9.3.4.1	Replacing bearings in explosion-proof machines	131
9.3.4.2	Fitting bearings	131
9.3.4.3	Explosion hazard due to overheating of the rolling bearings	133
9.3.5	Shaft sealing, mounting dimensions and alignment	133
9.3.6	Fan	134
9.3.6.1	Mounting fans	134
9.3.7	Cable entries, sealing plugs and thread adapters	135
9.3.8	Tightening torques	135
9.3.9	Screw lock washers	135
9.3.10	Links	135
9.3.11	Reassembly: Miscellaneous information	135
9.3.12	Optional add-on units	136
9.3.13	O-ring seal	136
10	Spare parts	137
10.1	Parts order	137
10.2	Purchasing commercially available spare parts	138
10.3	Determining the spare parts via the Internet	138
10.4	Replacing rolling bearings	138
10.5	Rolling bearings	138
10.6	Anti-condensation heating	139
10.7	Groups of parts	139
10.8	Ordering example	140
10.9	Machine parts	141
10.9.1	Part lists	141
10.10	Standardized parts	143
10.11	Exploded drawings	144
10.11.1	1MB1 shaft heights 63 ... 71 aluminum	144
10.11.2	1MB1 shaft heights 71 ... 90 cast iron	146
10.11.3	1MB1 shaft heights 80 ... 160 aluminum	147
10.11.4	1MB1 shaft heights 100 ... 200 cast iron	148
10.11.5	1MB1 shaft heights 180 ... 200 aluminum	149
10.11.6	1MB1 shaft heights 225 ... 315 cast iron	150
10.11.7	1MB5 shaft height. 315 cast iron	151
10.11.8	1MB5 shaft height. 355 cast iron	152
10.11.9	Terminal box 1MB1 shaft heights 63 ... 71 aluminum	153
10.11.10	Terminal box 1MB1 shaft heights 71 ... 200 cast iron	154
10.11.11	Terminal box 1MB1 shaft heights 80 ... 160 aluminum	155
10.11.12	Terminal box 1MB1 shaft heights 200 ... 225 cast iron	156

10.11.13	Terminal box 1MB1 shaft heights 250 ... 280 cast iron	158
10.11.14	Terminal box 1MB1 shaft height 315 cast iron	160
10.11.15	Terminal box 1MB5 shaft height 315 cast iron	162
10.11.16	1MB5 terminal box shaft height 355 cast iron	163
10.11.17	Separately driven fan optional shaft height 225 ... 355	164
11	Disposal	165
11.1	Introduction.....	165
11.2	RoHS - restricting the use of certain hazardous substances	165
11.3	Note regarding Article 33 of the REACH regulation.....	165
11.4	Preparing for disassembly.....	166
11.5	Dismantling the machine	166
11.6	Disposal of components	166
A	Technical data	169
A.1	Tightening torques.....	169
A.1.1	Tightening torques for screw and bolt connections	169
A.1.2	Stud-type bushings	170
A.1.3	Terminal boxes, end shields, grounding conductors, sheet metal fan covers	170
A.1.3.1	Terminal board and grounding	170
A.1.4	Tightening torques of additional connecting terminals	170
B	Quality documents	171
B.1	Quality documents SIMOTICS in SIOS	171

Introduction

Note

The following pages contain the Siemens logo and the Siemens legal information.

Please note that since July 1st, 2023 the Siemens Businesses **Large Drives Applications** and **Low Voltage Motors** are part of **Innomotics GmbH**, Germany.

All rights to and product information on the following pages have been transferred from Siemens to Innomotics.

The re-branding of the document will take place in due course.

1.1 About SIMOTICS

Description

SIMOTICS is the Siemens family of electric motors addressing the complete motor spectrum in Digital Industry.

1.2 About this manual

1.2.1 Content

To illustrate possible application areas for our products, typical use cases are listed in this product documentation and in the online help. These are purely exemplary and do not constitute a statement on the suitability of the respective product for applications in specific individual cases. Unless explicitly contractually agreed, Siemens assumes no liability for such suitability. Suitability for a particular application in specific individual cases must be assessed by the user, taking into account all technical, legal, and other requirements on a case-by-case basis. Always observe the descriptions of the technical properties and the relevant constraints of the respective product contained in the product documentation.

Description

These Operating Instructions inform you about the motor and its components. You will learn how to handle the motor properly and safely from delivery to disposal:

- Transporting and storing
- Assembly and mounting

1.2 About this manual

- Connecting
- Commissioning
- Checking
- Operation
- Troubleshooting
- Disassembling
- Disposal

This documentation should be kept in a location where it can be easily accessed and made available to the personnel responsible.

Information regarding third-party products

Note

Recommendation relating to third-party products

This document contains recommendations relating to third-party products. Siemens accepts the fundamental suitability of these third-party products.

You can use equivalent products from other manufacturers.

Siemens does not accept any warranty for the properties of third-party products.

1.2.2 Target group

Description

These operating instructions are intended for:

- Fitters
- Commissioning engineers
- Machine operators
- Service and maintenance personnel
- Warehouse personnel
- Personnel decommissioning the motor
- Personnel disposing of the motor

1.2.3 Avoiding dangers

Description

Avoid dangers. Ensure safe, problem-free operation and a maximum service life:

- Before you start using the motor, you must read these Operating Instructions.
- Always follow the safety instructions and notices in these operating instructions.

The warning notice system is explained at the beginning of this document.

1.2.4 Standard scope

Description

This documentation describes the functionality of the standard scope. This scope may differ from the scope of the functionality of the system that is actually supplied. Please refer to the ordering documentation only for the functionality of the supplied drive system.

Further functions may be executable in the system, which are not explained in this documentation. However, there is no entitlement to these functions in the case of a new delivery or service.

This documentation does not contain all detailed information on all types of the product. Furthermore, this documentation cannot take into consideration every conceivable type of installation, operation and service/maintenance.

The machine manufacturer must document any additions or modifications they make to the product themselves.

1.2.5 Websites of third-party companies

Description

This document may contain hyperlinks to third-party websites. Siemens is not responsible for and shall not be liable for these websites and their content. Siemens has no control over the information which appears on these websites and is not responsible for the content and information provided there. The user bears the risk for their use.

1.3 SIMOTICS documentation

Description

Comprehensive documentation on SIMOTICS, SIMOGEAR and on the SINAMICS converter family are provided in Internet (<https://support.industry.siemens.com/cs/ww/en/ps/13204/man>).

You can display documents or download them in PDF and HTML5 format.

The documentation is divided into the following categories:

Table 1-1 SIMOTICS / SIMOGEAR / SINAMICS documentation

Information	Documentation class ¹⁾	Content	Target group
General information	Configuration Manual	Rules, guidelines, and tools for configuring products, systems, and plants. Also contains information on the operating and ambient conditions for hardware and software, the use of functions, as well as on circuit diagrams and terminal diagrams and the installation of software insofar as this is necessary for commissioning.	Planners, configuration engineers
Device information	Installation Instructions	All relevant information on setting up, installing and cabling, as well as the required dimensional drawings and circuit diagrams	Installation personnel, commissioning engineers, service and maintenance personnel
Basic information	Operating instructions	Comprehensive collection of all information necessary for the safe operation of products, plant/system parts and complete plants (IEC 82079)	Machine operators, plant operators
	Compact instructions	Essential contents of the operating instructions in a reduced and condensed form	Machine operators, plant operators
	Product Information	Information that only becomes known shortly before or even after start of delivery and is therefore not included in the associated user documentation	Planners, configuration engineers, technologists, installation personnel, constructors; commissioning engineers, machine operators, programmers, service and maintenance personnel
	Online help	Instructions for configuring, programming, and commissioning	Configuration engineers, programmers, commissioning engineers

¹⁾ Not all documentation classes are available for every SIMOTICS / SIMOGEAR / SINAMICS product.

1.4 Service and support

1.4.1 Siemens Industry Online Support on the Web

Important product information is available through Siemens Industry Online Support using the following options:

- Website: SIOS (<https://support.industry.siemens.com/cs/ww/en/>)
- App Industry Online Support (for Apple iOS and Android)

Content of Siemens Online Support

- Product support
- Global forum for information and best practice sharing between users and specialists
- Local contact persons via the contact person database (→ Contact)
- Product information
- FAQs (frequently asked questions)
- Application examples
- Manuals
- Downloads
- Compatibility tool
- Newsletter with product selection
- Catalogs/brochures
- Certificates

For products with QR code, the manual and certificate can be directly called.



1.4.2 Spare parts services

Description

The online spare part service "Spares on Web" offers certain spare parts for the product:

- Website: SOW address (<https://www.sow.siemens.com>).

1.5 Important product information

Intended use of the machines

These machines are intended for industrial installations. They comply with the harmonized standards of the series EN / IEC 60034 (VDE 0530). It is prohibited to use these motors in hazardous zones if the marking on the motor rating plate does not explicitly permit line or converter operation. If other/more wide-ranging demands (e.g. protection so that they cannot be touched by children) are made in special cases – i.e. use in non-industrial installations – these conditions must be ensured by the customer.

Note

EU Machinery Directive

Low-voltage motors are components designed for installation in machines in accordance with the EU Machinery Directive. Commissioning is prohibited until it has been absolutely identified that the end product is in conformance with this Directive. Comply with standard EN / IEC 60204-1.

Safety information

2.1 General safety instructions

2.1.1 Information for those responsible for the plant/system

This motor is a partly completed machine in the sense of directive 2006/42/EC ("machinery directive"), and has been designed and built in compliance with the applicable's health and safety protection requirements of this directive, including the protection goals of directive 2014/35/EU ("Low-Voltage Directive") regarding electrical hazards. It is intended for use in industrial plants and systems. Please observe the country-specific regulations when using the motor outside the European Union. Comply with local and industry-specific safety and installation regulations.

The persons responsible for the plant must ensure the following:

- Planning and configuration work and all work carried out on and with the machine is only to be done by qualified personnel.
- The operating instructions are always available when performing any work.
- The technical data as well as the specifications relating to the permissible installation, connection, ambient and operating conditions as well as the other safety-related data and notes in these operating instructions are taken into account at all times.
- The specific setup and safety regulations as well as regulations on the use of personal protective equipment are strictly complied with.

Note

Engage the services and support provided by the local service center (Page 12) for planning, installation, commissioning and service work.

Further, this machine has been designed, built and tested in accordance with Directive 2014/34/EU ("Explosion Protection Directive") and is intended for use in industrial plants with a potentially explosive atmosphere (corresponding to the data on the rating plate).

Commissioning in hazardous areas

Only commission the machine if it has been absolutely confirmed that the plant or system is in full conformance with the valid directive.

When using the machine, carefully comply with country-specific regulations relating to protection against explosion.

2.1 General safety instructions

2.1.2 The 5 safety rules

To ensure your own personal safety as well as to avoid material damage, always comply with the safety-relevant instructions when carrying out any work. Also carefully comply with the 5 safety rules according to EN 50110-1 "Working in a no-voltage state" in the specified sequence.

5 safety rules

1. Disconnect the system.
Also disconnect the auxiliary circuits, for example, anti-condensation heating.
2. Secure against reconnection.
3. Verify absence of operating voltage.
4. Ground and short-circuit.
5. Provide protection against adjacent live parts.

To energize the system, apply the measures in reverse order.

2.1.3 Qualified personnel

All work at the machine must be carried out by qualified personnel only. For the purpose of this documentation, qualified personnel is taken to mean people who fulfill the following requirements:

- Through appropriate training and experience, they are able to recognize and avoid risks and potential dangers in their particular field of activity.
- They have been instructed to carry out work on the machine by the appropriate person responsible.

2.1.4 Safe handling

Workplace safety depends on the attentiveness, care, and common sense of the personnel who install, operate, and maintain the machine. In addition to the safety measures cited, as a matter of principle, the use of caution is necessary when you are near the machine. Always pay attention to your safety.

Also observe the following to prevent accidents:

- General safety regulations applicable in the country where the machine is deployed.
- Manufacturer-specific and application-specific regulations
- Special agreements made with the operator
- Separate safety instructions supplied with the machine
- Safety symbols and instructions on the machine and its packaging

Danger as a result of stationary parts under voltage (live parts)

Live parts represent a hazard. Touch protection against active (live) parts is no longer guaranteed if covers are removed. The minimum clearance and creepage distances may be violated when coming close to live parts. Touching or coming close to them can result in death, serious injury or material damage.

- Ensure that all live parts are suitably covered.
- Switch off and disconnect the machine first if you want to remove covers. Observe the "5 safety rules".

Risk of injury due to rotating parts

Rotating parts are dangerous. Touch protection against rotating parts is no longer guaranteed if covers are removed. Touching rotating parts can result in death, serious injury or material damage.

- Ensure that all rotating parts are reliably covered.
- Switch off and disconnect the machine first if you want to remove covers. Observe the "5 safety rules".
- Only remove covers when the rotating parts have come to a complete standstill.

Risk of burns due to hot surfaces

Individual machine parts can become hot in operation. Burns can result when coming into contact with these parts.

- Never touch machine parts during operation.
- Allow the machine to cool before starting work on the machine.
- Check the temperature of parts before touching them. If required, wear suitable protective equipment.

Health hazard due to chemical substances

Chemical substances required for the setup, operation and maintenance of machines can present a health risk.

- Observe the product information provided by the manufacturer.

Flammable substances hazard

Chemical substances required for the setup, operation and maintenance of machines may be flammable. These substances can ignite if handled incorrectly. They can cause burns and property damage.

- Observe the product information provided by the manufacturer.

See also

Inspection and maintenance (Page 116)

2.1 General safety instructions

Noise emissions

During operation, the machine's noise emission levels can exceed those permitted at the workplace, which can cause hearing damage.

- Ensure that nobody is in the area of increased noise emissions during machine operation.
- Take steps to reduce noise so that the machine can be operated safely within your system. The following measures may help to reduce noise.
 - Covers
 - Noise insulation
 - Hearing protection measures

Prevention of hearing damage

If the permissible sound pressure level is exceeded, hearing damage can occur when operating three-phase motors at their rated power.

The permissible sound pressure level is 70 dB (A).

Electromagnetic fields when operating electrical power equipment

Electrical power equipment generate electromagnetic fields during operation. Potentially lethal malfunctions can occur in medical implants, e.g. pacemakers, in the vicinity of electrical power equipment. Data may be lost on magnetic or electronic data carriers.

- Protect the personnel working in the plant by taking appropriate measures, such as erecting identifying markings, safety barriers and warning signs and giving safety talks.
- Comply with all of the national health and safety regulations.
- It is forbidden for people with pacemakers to be close to the machine.
- Do not carry any magnetic or electronic data media.

2.1.5 Use in hazardous areas

Electrical installations in hazardous zones must be mounted, installed and operated by the applicable responsible persons in accordance with the applicable rules and regulations.

Note

The basic requirements relating to electrical installations and their operation in hazardous areas are described, for instance, in directive 1999/92/EC as well as in standard IEC / EN 60079-14 or when using the electrical machine outside the European Community, in the country-specific regulations.

Ignition hazards

The assessment of operating risks and local operating conditions and the necessary monitoring methods must be clarified and made binding by the system operator in consultation with the responsible supervisory authority. The required measures must be complied with. Regarding this topic, the machine manufacturer cannot provide any generally applicable recommendations. Comply with the information provided in these operating instructions.

Note

The basic requirements relating to the assessment of ignition hazards arising from electrical equipment and their operation in hazardous zones are specified in the 2014/34/EU and 1999/92/EC directives as well as in the IEC/EN 60079 series of standards; or when using the electrical machine outside the European Community, provided in the country-specific regulations.

If a third-party certification is available for the machine, then carefully comply with the technical data defined in it and any special conditions.

The certificate must be available before commissioning.

Explosion hazard from hybrid mixtures

Hybrid mixtures are mixtures of flammable dusts with explosive gas/air atmospheres which can together create a dangerous explosive atmosphere if they occur at the same time. Changes can arise in the safety performance characteristics here, such as a change in the zonal classification, increase in the explosion pressure, reduction in the minimum ignition energy and a reduction in the maximum temperatures to be complied with.

An explosion can occur. This can result in death, serious injury or material damage.

- For this reason, the relative characteristics must be considered both for gas (zones 0, 1 and 2) and for dust (zones 20, 21 and 22) where hybrid mixtures arise. It is necessary for a competent assessor to determine in the individual case whether the parameters determining ignition are unfavorably affected in a particular hybrid mixture.
- Motors with dual plates for G ("Gas") and D ("Dust") may only be used where these two occur after prior examination of the properties of the hybrid mixtures by the user.
- These explosion-protected machines are not suitable for hybrid explosive environments. Use in atmospheres where there is a risk of explosion caused by both gas and dust simultaneously is absolutely prohibited.

2.1.6 Electrostatic sensitive devices

Material damage due to electrostatic discharge

Electronic modules contain components that can be destroyed by electrostatic discharge. These components can be damaged or destroyed if they are not handled correctly. To protect equipment against damage, follow the instructions given below.

- Only touch electronic modules if you absolutely have to work on them.
- The body of the person concerned must have been electrostatically discharged and grounded immediately before any electronic modules are touched.
- Electronic modules should not be brought into contact with electrically insulating materials, such as:
 - Plastic film
 - Plastic parts
 - Insulating table supports
 - Clothing made of synthetic fibers
- Always place the modules on conductive and grounded surfaces.
- Always pack, store and transport electronic modules or components in conductive packaging, such as:
 - Metallized plastic or metal containers
 - Conductive foam material
 - Domestic aluminum foil

The ESD protective measures required for components that can be destroyed due to electrostatic discharge are shown in the following drawings:

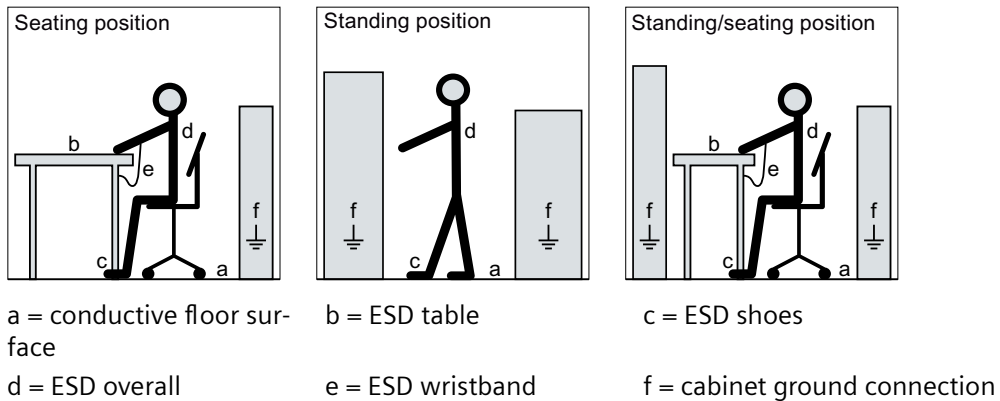

Risk of explosion due to electrostatic discharge

Electrostatic discharge poses a potential ignition source. Dangerous electrostatic charging can occur, for example as a result of mechanical friction, flowing air that contains particles, processes that generate significant levels of charge – or persons that are not appropriately grounded, e.g. when carrying out maintenance or cleaning work.

In an explosive atmosphere, there is a risk of an explosion. This can result in death, serious injury or material damage.

- When cleaning, ensure that there is absolutely no explosive atmosphere present.
- Comply with ESD protective measures.
- Avoid carrying out work specified above on non-metallic parts, e.g. foam rubber for noise dampeners/attenuators.
- Use the tested, original paint when recoating or touching up.
- Carefully check repaired or subsequently applied coating systems to ensure that they strictly comply with the electrostatic requirements according to IEC/EN 60079-0.
- Do not subsequently attach any additional plates or labels to the machine that do not comply with the electrostatic requirements relating to protection against explosion.
- Clean the plastic parts and components so that absolutely no static charging occurs.
- Do not use compressed air for cleaning.
- Minimize the risk of electrostatic charging by applying effective measures according to IEC 60079-32-1.

2.1.7 Electromagnetic compatibility

Electromagnetic compatibility

This machine is designed in accordance with IEC/EN 60034, and when used as specified it satisfies the requirements of European Directive 2014/30/EU on Electromagnetic Compatibility.

2.1.8 Interference immunity

By selecting suitable signal cables and evaluation units, ensure that the interference immunity of the machine is not diminished.

2.1.9 Influence on the line power supply through a strongly irregular torque

A strongly irregular torque, for example with the drive of a reciprocating motor, forces a non-sinusoidal motor current. The emerging harmonics can have an impermissible influence on the line power supply via the connection lines.

2.1.10 Interference voltages when operating the converter

Interference voltages when operating the converter

When a converter is in operation, the emitted interference varies in strength depending on the converter (manufacturer, type, interference suppression measures undertaken). On machines with integrated sensors (e.g. PTC thermistors), interference voltages caused by the converter may occur on the sensor lead. This can cause faults which can result in eventual or immediate death, serious injury or material damage.

- Comply with the EMC information provided by the manufacturer of the converter. This is how you prevent limit values according to IEC/EN 61000-6-2 IEC/EN 61000-6-4 for the drive system (consisting of the machine and converter) from being exceeded.
- You must put appropriate EMC measures in place.

2.1.11 Special designs and construction versions

Before carry out any work on the machine, determine the machine version.

If there are any deviations or uncertainty, contact the manufacturer, specifying the type designation and serial number (see the rating plate), or contact the Service Center (Page 12).

2.1.12 Certificate with special conditions

The certificate with special conditions is provided under the Quality documents press (Page 171). To do this, under field "Enter search term", enter the certificate number and select the appropriate document from the documents that are listed.

The machine has an "X" marking (for EACEx in the Ex marking, for ATEX, IECEx and UKCA, in the certificate number). To ensure safe operation in potentially explosive zones, the special conditions of the certificate specified on the nameplate must be strictly complied with:

EPS 18 ATEX 1 202 X, EPS 18 ATEX 1 203 X, IECEx EPS 18.0104X, RU C-DE.AA81.B.00156-19, EPS 21 UKEX 1 250 X, EPS 21 UKEX 1 255 X:

- It is not permissible to operate groups of motors connected to a converter. The rated converter current may correspond as a maximum to twice the rated motor current. It is only permissible to operate the motor with a SINAMICS converter or a converter that is comparable. When commissioning the system, with reference to the rated voltage (UN) of the winding insulation, carefully ensure that no converter-related overvoltages with a peak value exceeding $(1.1 * \sqrt{2} * UN)$ occur at the terminals of the electric motor.
- If anti-condensation heating is used, then an interlock circuit must ensure that the anti-condensation heating can only be operated when the motor is shut down. Once the motor has been shut down, the anti-condensation heating may only be switched on after a specified wait time has elapsed.
- The information provided in the Operating Instructions must be strictly complied with.

- If the three-phase motor is cooled using a separately driven fan, then it must be strictly ensured that the three-phase motor can only be operated when the separately driven fan is switched on.
- It is only permissible to use these motors if they are in full compliance with local regulations (e.g. energy efficiency, product safety) in the country in which they are being used.

DMT 01 ATEX E 014X, RU C-DE.AЖ58.B.02301-22, EPS 21 UKEX 1 310 X:

- It is not permissible that the motors are operated if they have an excessively thick layer of dust on them.
- When installing motors with the free shaft stub facing upwards, the mounting method must prevent foreign bodies from falling into vent holes.
- For motors with a fixed connecting cable: The free end of the cable must be connected according to valid regulations for electrical installations.
- If the three-phase motor is cooled using a separately driven fan, then it must be strictly ensured that the motor can only be operated when the cooling is switched on.
- Before commissioning, it must be carefully ensured that when fed from a converter, no inadmissibly high overvoltages occur at the motor terminals.
- The clearances and creepage distances in the terminal box do not permit overvoltages as a result of converter operation with a periodic peak value of more than 1500 V for rated voltages ≤ 500 V. The motor insulation system may mean that it is necessary to further limit periodically occurring overvoltages.

BVS 14 ATEX E 081 X, BVS 14 ATEX E 082 X, IECEx BVS 14.0052X, 2020312301002068, RU C-DE.AA81.B.00156-19, EPS 21 UKEX 1 301 X, EPS 21 UKEX 1 303 X:

- It is only permissible that the motor is fed from a voltage-source DC link converter with pulse width modulation when the performance characteristics listed in Section 15.3 (ATEX) / "parameters" (IECEx) are strictly maintained.
- Before commissioning, it must be carefully ensured that when fed from a converter, no inadmissibly high overvoltages occur at the motor terminals.
- The clearances and creepage distances in the terminal box do not permit overvoltages as a result of converter operation with a periodic peak value of more than 1500 V for rated voltages ≤ 1000 V. The motor insulation system may mean that it is necessary to further limit periodically occurring overvoltages. If the motor is operated with a plastic fan, a circumferential velocity of less than 50 m/s must be strictly maintained.

2.1 General safety instructions

Description

3.1 Area of application

The rotating electrical motors of this series are used as industrial drives. They are designed for a wide range of drive applications both for line operation as well as in conjunction with frequency converters.

They are characterized by their high power density, extreme robustness, long service life and outstanding reliability.

CE - European Low-Voltage Directive



Machines without CE marking are intended for operation outside the European Economic Area (EEA). Within the EEA, only use machines with CE marking.

UKCA - United Kingdom Conformity Assessed



In England, Wales and Scotland, only use machines with UKCA marking.

EAC = Eurasian Conformity



EAC machines are appropriately marked on the rating plate, and are intended for operation within the Eurasian customs union.

Within the Eurasian Customs Union, only use machines with EAC marking.

CCC - China Compulsory Certification



Explosion-proof machines with CCC marking (China Compulsory Certification) are intended for the Chinese market.

In China, only use explosion-proof machines with CCC marking.

Use in hazardous areas

Explosion-proof electrical machines correspond to standards of the IEC/EN 60034 and IEC/EN 60079 series. Only operate the machine in hazardous areas, strictly complying with the specifications of the responsible supervisory authority. The relevant supervisory authority is responsible for determining the hazard level of each area and classifying the zones. The type of protection as well as special regulations are stamped on the rating plate or in the test certificate. If the certification number is supplemented by an X, to safely operate the machine, observe the special notes in the operating instructions - or if available, in the EC type examination certificate or in the IECEx Certificate of Conformity. Converter operation must be certified. It is crucial that you carefully observe the specific manufacturer's information and instructions.

Type of protection Ex nA or ex ec

This machine has type of protection "non-sparking" Ex nA according to IEC / EN 60079-0 and IEC / EN 60079-15 - or type of protection "Increased safety" Ex ec according to IEC / EN 60079-0 and IEC / EN 60079-7. Only operate the machine in hazardous **Zone 2** according to IEC / EN 60079-10-1.

Type of protection Ex e or Ex eb

This machine has type of protection "Increased safety" Ex e or ex eb according to IEC / EN 60079-0 and IEC / EN 60079-7. Only operate the machine in hazardous **Zones 1 and 2** according to IEC / EN 60079-10-1.

Type of protection Ex tb, Ex tc

This machine has optionally (or exclusively) "Protection through enclosure" (Ex t) type of protection according to IEC / EN 60079-0 and IEC / EN 60079-31. Only operate the machine in hazardous **Zones 21 and 22** in type of protection Ex tb - and only in **Zone 22** in type of protection Ex tc according to IEC / EN 60079-10-2.

3.2 Rating plates

The rating plate shows the identification data and the most important technical data. The data on the rating plate and the contractual agreements define the limits of proper and intended use.

Data on the rating plate

Item	Description	Item	Description
General data		Electrical data	
1	Type of machine	31	Electrical data
2	Machine type	33	Rated voltage V
3	Serial number (incl. date of manufacture YY.MM)	34	Winding connections
4	Standards	35	Frequency Hz
5	Additional details (optional)	36	Rated power kW
6	Customer data (optional)	37	Rated current A
7	Country of origin	38	Power factor cosφ
8	Manufacturer specifications	39	Rated speed rpm

Item	Description	Item	Description
9	Identification number of testing agency (optional)	40	Efficiency class
10	Regulations (optional)	41	Efficiency
49	Company logo	42	Torque Nm (optional)
52	Marine regulation	45	Starting current ratio (optional)
53	Motor type	46	Operating mode (optional)
54	Data for explosion-protected machines	48	Anti-condensation heating (optional)
Mechanical data		51	Converter data
11	Frame size	57	Temperature class
12	Type of construction		
13	Degree of protection		
14	Machine weight kg		
15	Temperature class		
16	Ambient temperature range (optional)		
17	Installation altitude (only if higher than 1000 m)		
18	Vibration severity grade		
19	Bearing sizes		
20	Relubrication data/specifications (optional)		
24	Feather key arrangement		

Line operation (DOL) rating plate

(49)	(10)	(24) 									
(8)	(7)	(9)									
(1)	(53)	(2)	(3)	(54)							
(4)	(11)	(12)	(13)	(54)							
(14)	(15)	(16)	(17)	(54)							
(52)	(19)	(20)	(54)	(54)							
(18)	(54)	(33)(34)	(35)	(37)	(36)	(38)	(41)	(39)	(40)	(45)	(57)
(31)	(54)	(57)	(57)	(57)	(57)	(57)	(57)	(57)	(57)	(57)	(57)
(5)	(6)	(48)									

3.3 Installation

Converter operation (VSD) rating plate

(49)							
(8)		(7)					
(1)	(53)	(2)					(3)
(4)							
(51)							
(46)							
(33)(34)	(35)	(37)	(36)	(38)	(42)	(39)	
(31)							
(5)							

3.3 Installation

Machine design

The regulations and standards used as the basis to design and test this machine are stamped on the rating plate.

The machine design basically complies with the subsequent standards. Please refer to the EU Declaration of Conformity for the versions of the harmonized standards referenced.

3.3.1 Regulations

Table 3-1 Applicable general regulations

Feature	Standard	EAC	GB	BS
Dimensioning and operating behavior	EN/IEC 60034-1	GOST IEC 60034-1	GB 755	IEC 60034-1
Procedure for determining the losses and the efficiency of rotating electrical machines and inspections	EN/IEC 60034-2-1 EN/IEC 60034-2-2 EN/IEC 60034-2-3	GOST IEC 60034-2-1 GOST IEC 60034-2-2 GOST IEC 60034-2-3	GB/T 1032	BS EN 60034-2-1 BS EN 60034-2-2 BS EN IEC 60034-2-3
Degree of protection	EN/IEC 60034-5	GOST IEC 60034-5	GB/T 4942.1	BS EN IEC 60034-5
Cooling	EN/IEC 60034-6	GOST R IEC 60034-6	GB/T 1993	BS EN 60034-6
Type of construction	EN/IEC 60034-7	GOST R IEC 60034-7	GB/T 997	BS EN 60034-7
Terminal designations and direction of rotation	EN/IEC 60034-8	GOST 26772	GB/T 1971	BS EN 60034-8
Noise emission	EN/IEC 60034-9	GOST IEC 60034-9	GB 10069.3	BS EN 60034-9
Integrated thermal protection	EN/IEC 60034-11	GOST 27888	GB/T 13002	BS EN 60034-11
Starting characteristics of rotating electrical machines	EN/IEC 60034-12	GOST IEC 60034-12	GB/T 21210	BS EN 60034-12

Feature	Standard	EAC	GB	BS
Vibration severity grades	EN/IEC 60034-14	GOST IEC 60034-14	GB 10068	BS EN IEC 60034-14
Efficiency classification of three-phase squirrel-cage induction motors	EN/IEC 60034-30-1	GOST IEC 60034-30-1	GB 18613	BS EN 60034-30-1
IEC standard voltages	IEC 60038	GOST R IEC 61800-1	GB/T 156	BS EN 60038
Vibration limits	ISO 10816-3	GOST ISO 10816-1	GB/T 6075.3	BS ISO 10816-3

Table 3-2 Regulations applied for explosion-protected machines

Feature	Standard	EAC	GB	BS
Electrical equipment for hazardous zones - Part 0: General requirements	EN/IEC 60079-0	GOST 31610.0	GB/T 3836.1	BS EN IEC 60079-0
Electrical equipment for hazardous gas atmospheres – Part 1: Device protection provided by flameproof enclosure "d"	EN / IEC 60079-1	GOST IEC 60079-1	GB/T 3836.2	BS EN 60079-1
Electrical equipment for hazardous gas atmospheres, Part 7: Equipment protection provided by increased safety "e"	EN / IEC 60079-7	GOST 31610.7	GB/T 3836.3	BS EN IEC 60079-7
Electrical equipment for hazardous zones - Part 11: Device protection provided by intrinsic safety "i"	EN / IEC 60079-11	GOST 31610.11	GB/T 3836.4	BS EN 60079-11
Electrical equipment for hazardous zones - Part 14: Configuring, selection and installation of electrical systems	EN / IEC 60079-14	GOST IEC 60079-14	GB/T 3836.15	BS EN 60079-14
Electrical equipment for hazardous gas atmospheres, Part 15: Equipment protection provided by increased safety "n"	EN / IEC 60079-15	GOST 31610.15	GB/T 3836.8	BS EN 60079-15
Electrical equipment for hazardous zones - Part 17: Checking and maintaining electrical installations	EN / IEC 60079-17	GOST 31610.17	GB/T 3836.16	BS EN 60079-17
Electrical equipment for hazardous zones - Part 19: Repairs and overhauls	EN / IEC 60079-19	GOST 60079-19	GB/T 3836.13	BS EN IEC 60079-19
Potentially explosive atmosphere - Part 31: Device dust explosion protection by enclosure "t"	EN / IEC 60079-31	GOST R IEC 60079-31	GB 12476.1, GB/T 3836.31	BS EN 60079-31
Electrical equipment for hazardous zones - Part 32-1: Electrostatic risks, guidelines	IEC / TS 60079-32-1	GOST 31610.32-1	GB/T 3836.26	IEC/TS 60079-32-1
Electrical equipment for hazardous zones - Part 32-2: Electrostatic risks - Test techniques	EN / IEC 60079-32-2	GOST 31610.32-2	GB/T 3836.27	BS EN 60079-32-2
Directive regarding the harmonization of legislation of the Member States for devices and protection systems for correct use in hazardous zones	Directive 2014/34/EU	TR CU 012/2011	CNCA-C23-01:2019	UK S.I. 2016 No. 1107

3.3.2 Cooling and ventilation

The machines of this series are three-phase induction machines with a closed primary (internal) cooling circuit and an open secondary cooling circuit (surface cooling). The surface cooling varies depending on the version.

3.3.2.1 Machines with a fan

Self-ventilation (standard): Cooling method IC 411 according to EN / IEC 60034-6

Located at the ND end of the stator housing is an air intake cowl that guides the external air on its way to the motor. The external air is drawn in through openings in the air intake cowl and flows axially across the outer cooling ribs of the motor frame. The fan wheel for the external flow of cooling air is attached to the machine shaft.

The fan wheels are bidirectional.

Check the cooling effect below rated speed in the case of frequent switching or braking – or if the speed is controlled continually below the rated speed.

IC411 IC4A1A1

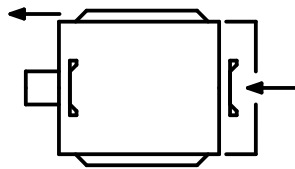

Forced ventilation (optional): Type of cooling IC 416 in accordance with EN / IEC 60034-6

Cooling that does not depend on the speed is achieved by means of a unit that is independent of the motor operating state (forced ventilation). This unit is closed to the outside by a fan cover. It has its own main drive with fan impeller which creates the cooling air flow required for cooling the motor.

IC416 IC4A1A6

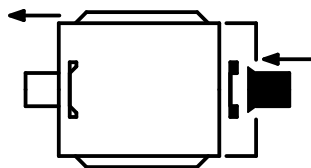

3.3.2.2 Machines without a fan (optional)

Cooling method IC 410

Surface cooling by free convection: Cooling method IC 410 according to EN / IEC 60034-6

Cooling method IC 418

Surface cooling by relative movement of cooling air: Cooling method IC 418 according to EN / IEC 60034-6

3.3.3 Bearings

To support the machine shaft and maintain its position in the non-moving part of the machine, DE and NDE rolling bearings are used. One end performs the function of a locating bearing that transfers axial and radial forces from the rotating machine shaft to the non-moving part of the machine. The opposite end is implemented as a floating and support bearing to allow thermal expansion inside the machine and transfer radial forces.

The nominal (theoretical) service life of the bearings according to ISO 281 is at least 20,000 hours when the permissible radial/axial forces are complied with, and the machine is operated on 50 Hz line supplies. However, the achievable useful life of the bearings can be significantly longer in the case of lower forces (e.g. operation with self-aligning couplings).

Rolling bearings with permanent lubrication are maintenance-free.

3.3.4 Axial and radial forces

Permissible values for axial and radial forces are listed in the catalog or stamped on the rating plate depending on the type of construction / mounting type. The data stamped on the rating plate have priority.

 WARNING
Damage to bearings or the shaft
Large output masses and their centers of gravity outside the shaft extensions can lead to resonance in operation. This can result in damage to the bearings and shaft. In an explosive atmosphere, there is a risk of explosion. Death, serious injury, or material damage can result.
<ul style="list-style-type: none">• Ensure that the permissible loads for the forces on the shaft extension are adhered to in accordance with the catalog data or configuration data.• Under all circumstances, maintain the minimum radial load of cylindrical rolling bearings of 50 % of the permissible radial force.

The machine is equipped with grease-lubricated rolling bearings.

- In the standard version, the bearings of machines up to shaft height 250 are permanently lubricated.
- The bearings of machines from shaft height 280 and above are equipped with a relubrication system.

3.3.5 Balancing









As standard, the machine is designed with vibration severity level A. The rotor is dynamically balanced with a half feather key (code "H").

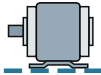

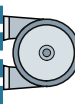
Vibration severity level B can be ordered as option, and stamped on the rating plate.

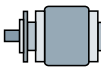
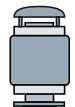
3.3.6 Types of construction/method of installation

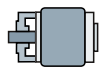
The type of construction of the machine is stated on the rating plate.

Table 3-3 Type of construction

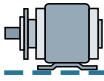
Basic type of construction code	Diagram	Other methods of installation	Diagram
IM B3 (IM 1001)		IM V5 (IM 1011)	
		IM V6 (IM 1031)	
		IM B6 (IM 1051)	
		IM B7 (IM 1061)	
		IM B8 (IM 1071)	
Basic type of construction code	Diagram	Other methods of installation	Diagram
IM B5 (IM 3001)		IM V1 (IM 3011)	
		IM V3 (IM 3031)	
Basic type of construction code	Diagram	Other methods of installation	Diagram
IM B14 (IM 3601)		IM V18 (IM 3611)	
		IM V19 (IM 3631)	

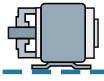
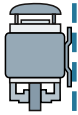
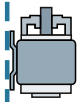
Basic type of construction code	Diagram		
IM B35 (IM 2001)		IM V15 (IM 2011)	
		IM V35 (IM 2031)	
IM B34 (IM 2101)		IM V17 (IM 2111)	
		IM V37 (IM 2131)	

Types of construction/Installation conditions for explosion-proof machines



The type of construction of the machine is stated on the rating plate.

In the case of explosion-proof machines where the shaft extensions point downwards (types of construction IM V5, IM V1 or IM V18) a protective top cover is mandatory. Explosion-proof machines with IM V5, IM V1 and IM V18 types of construction are fitted with a canopy at the factory.

Table 3-4 Construction type with canopy

Conditions of installation	Diagram
IM V5 (IM 1011)	
IM V1 (IM 3011)	
IM V15 (IM 2011)	

3.3 Installation

Conditions of installation	Diagram
IM V17 (IM 2111)	
IM V18 (IM 3611)	

Note

Motors up to shaft height 200 may be operated in a vertical or horizontally inclined position. Vertical types of construction may be inclined through $\pm 45^\circ$ from the vertical axis, and horizontal types of construction $\pm 45^\circ$ from the horizontal axis. When doing this, forces listed in the catalog for vertical types of construction or the configured forces should be taken into consideration.

A canopy may be necessary for explosion-proof motors.

If condensation drain holes are provided, ensure that condensate can be freely discharged or that sealed condensate holes are also opened.

3.3.7 Degree of protection

The machine has a type of protection as stamped on the rating plate, and can be installed in dusty or humid environments.

3.3.7.1 Degree of protection for explosion-proof machines

Machines intended for use in Zone 1 (increased safety "e" or "eb") or in Zone 2 (type of protection "nA" or "ec") are designed with an IP55 degree of protection.

Machines intended for use in Zone 21 (dust explosion protection "tb") and Group IIIC have IP 65 degree of protection. Machines intended for use in Zone 22 (dust explosion protection "tc") and Group IIIB have IP 55 degree of protection and can be used in dusty environments such as in mills, silos, animal feed plants, and malhouses, as well as in certain areas of the chemical industry.

3.3.8 Environmental conditions

Limit values for the standard version

Relative humidity for ambient temperature T_{amb} 40 °C	Max. 55 %
Ambient temperature	-20 °C to +40 °C

Installation altitude	≤ 1000 m
Air with normal oxygen content, usually	21 % (V/V)

The standard machines are not suitable for use in corrosive atmospheres, atmospheres with a high salt content, or outdoor applications.

Limit values for the special versions

If the environmental conditions are different from the details listed here, then the values on the rating plate or in the catalog will apply.

3.3.9 Optional built-on and built-in accessories

Machines can be equipped with the following integrated components/devices:

- Temperature sensors integrated in the stator winding in order to monitor the temperature and protect the stator winding from overheating.
- Anti-condensation heating for machines whose windings are subject to a risk of condensation due to the climatic conditions.

Machines can be equipped with the following mounted components/devices:

- Brake
- Rotary pulse encoder
- External fan (forced ventilation)
- Measuring nipple for SPM shock pulse measurement for bearing monitoring
- Backstop
- Bearing temperature sensors

Note

Further documents

Observe all of the other documents provided with this machine.

Supplementary devices

Depending on the order, various supplementary devices can be installed or mounted. These include temperature sensors for monitoring bearing temperatures or winding temperatures, for example.

 DANGER
Risk of explosion during operation due to too high surface temperature
This can result in death, serious injury, or material damage.
<ul style="list-style-type: none"> • Prevent the maximum surface temperature from being exceeded by maintaining the specified operating conditions. • Monitor the coil temperature. Use the temperature sensor that is built into the stator winding for this as specified on the rating plate or extra rating plate.

3.3.10 Marking

Table 3-5 For applications in Zone 1 - IEC/EN/BS/GOST 60079-10-1, GB3836.14

















	1026		II 2G Ex eb IIB T. Gb	FTZU 18 ATEX 0016 ... 0019, PTB 20 ATEX 3006
	1026		II 2G Ex eb IIC T. Gb	FTZU 18 ATEX 0016 ... 0019, PTB 18 ATEX 3005 ... 3013, PTB 20 ATEX 3006
Ex eb IIB T. Gb			IECEX FTZU 18.0024 ... 0027	
Ex eb IIC T. Gb			IECEX FTZU 18.0024 ... 0027, IECEX PTB 19.0001 ... 0009	
	8507		II 2G Ex eb IIB T. Gb	EPS 21 UKEX 1 254, EPS 22 UKEX 1 047 ... 050
	8507		II 2G Ex eb IIC T. Gb	EPS 21 UKEX 1 254, EPS 21 UKEX 1 273 ... 281, EPS 22 UKEX 1 047 ... 050
	1Ex e IIB T. Gb X		EAЭC RU C-DE.AA87.B.00156/19, EAЭC RU C-DE.AЖ58.B.02301/22	
	1Ex e IIC T. Gb X			

Table 3-6 For applications in Zone 2 - IEC/EN/BS/GOST 60079-10-1, GB3636.14

		II 3G Ex ec IIA T. Gc	BVS 14 ATEX E 081 X, EPS 18 ATEX 1 202 X, PTB 12 ATEX 3014
		II 3G Ex ec IIB T. Gc	BVS 14 ATEX E 081 X, EPS 18 ATEX 1 202 X, FTZU 13 ATEX 0040, FTZU 13 ATEX 0055, FTZU 15 ATEX 0084, PTB 12 ATEX 3014, PTB 12 ATEX 3016
		II 3G Ex ec IIC T. Gc	
Ex ec IIA T. Gc			IECEX EPS 18.0104X, IECEX PTB 17.0009
Ex ec IIB T. Gc			IECEX EPS 18.0104X, IECEX FTZU 13.0029, IECEX FTZU 13.0031, IECEX FTZU 15.0034, IECEX PTB 17.0009



























Ex ec IIC T. Gc			IECEX BVS 14.0052X, IECEX FTZU 13.0029, IECEX FTZU 13.0031, IECEX FTZU 15.0034, IECEX EPS 18.0104X, IECEX PTB 17.0009
		II 3G Ex ec IIA T. Gc	EPS 21 UKEX 1 255 X, ...303 X, ...304, ...305
		II 3G Ex ec IIB T. Gc	EPS 21 UKEX 1 255 X, ...256, ...257, ...258, ...303 X, ... 304, ...305
		II 3G Ex ec IIC T. Gc	
	2Ex nA IIB T. Gc X		EAЭC RU C-DE.AA87.B.00156/19
	2Ex nA IIC T. Gc X		
	Ex ec IIB T. Gc		2020312301002066 ... 068, 2020312301002073 ... 076, 2020312301002087 ... 089
	Ex ec IIC T. Gc		

















Table 3-7 For applications in Zone 21 - IEC/EN/BS/GOST 60079-10-2, GB/T3836.35

	1026		II 2D Ex tb IIIA T... °C Db	BVS 14 ATEX E 082 X, PTB 12 ATEX 3018, EPS 18 ATEX 1 203 X
	1026		II 2D Ex tb IIIB T... °C Db	
	1026		II 2D Ex tb IIIC T... °C Db	BVS 14 ATEX E 082 X, DMT 01 ATEX E 014 X, EPS 18 ATEX 1 203 X, FTZU 13 ATEX 0039, FTZU 13 ATEX 0054, FTZU 15 ATEX 0083, FTZU 18 ATEX 0016 ... 0019, PTB 12 ATEX 3018, PTB 18 ATEX 3005 ... 3013
Ex tb IIIA T... °C Db			IECEX EPS 18.0104X, IECEX PTB 17.0010	
Ex tb IIIB T... °C Db				
Ex tb IIIC T... °C Db			IECEX BVS 14.0052X, IECEX EPS 18.0104X, IECEX FTZU 13.0027, IECEX FTZU 13.0030, IECEX FTZU 15.0033, IECEX FTZU 18.0024 ... 027, IECEX PTB 17.0010, IECEX PTB 19.0001 ... 0009	
	8507		II 2D Ex tb IIIA T... °C Db	EPS 21 UKEX 1 250 X, ...301 X, ...302
	8507		II 2D Ex tb IIIB T... °C Db	
	8507		II 2D Ex tb IIIC T... °C Db	EPS 21 UKEX 1 250 X, ...251, ...252, ...253, ...273 ... 281, ...301 X, ...302, ...310 X, EPS 22 UKEX 1 047 ... 050
	Ex tb IIIC T... °C Db X		EAЭC RU C-DE.AA87.B.00156/19, EAЭC RU C-DE.AЖ58.B.02301/22	
	Ex tb IIIA T... °C Db		2020312301002066 ... 068, 2020312301002077 ... 078, 2020312301002082 ... 086	
	Ex tb IIIB T... °C Db			
	Ex tb IIIC T... °C Db			

Description

3.3 Installation

Table 3-8 For applications in Zone 22 - IEC/EN/BS/GOST 60079-10-2, GB/T3836.35

		II 3D Ex tc IIIA T... °C Dc	BVS 14 ATEX E 081 X, EPS 18 ATEX 1 202 X, PTB 12 ATEX 3016
		II 3D Ex tc IIIC T... °C Dc	
		II 3D Ex tc IIIB T... °C Dc	BVS 14 ATEX E 081 X, EPS 18 ATEX 1 202 X, FTZU 13 ATEX 0040, FTZU 13 ATEX 0055, FTZU 15 ATEX 0084, PTB 12 ATEX 3016
Ex tc IIIA T... °C Dc			IECEX EPS 18.0104X, IECEX PTB 17.0009
Ex tc IIIC T... °C Dc			
Ex tc IIIB T... °C Dc			IECEX BVS 14.0052X, IECEX EPS 18.0104X, IECEX FTZU 13.0029, ...0031, IECEX FTZU 15.0034, IECEX PTB 17.0009
		II 3D Ex tc IIIA T... °C Dc	EPS 21 UKEX 1 255 X, ...303 X, ...304
		II 3D Ex tc IIIB T... °C Dc	
		II 3D Ex tc IIIC T... °C Dc	EPS 21 UKEX 1 255 X, ...256, ...257, ...258, ...303 X, ...304
	Ex tc IIIB T... °C Dc X		EAЭC RU C-DE.AA87.B.00156/19, EAЭC RU C-DE.AЖ58.B.02301/22
	Ex tc IIIA T... °C Dc		2020312301002066 ... 068, 2020312301002073 ... 076, 2020312301002087 ... 089
	Ex tc IIIB T... °C Dc		
	Ex tc IIIC T... °C Dc		

Note

If the certificate number ends with an "X", then strictly comply with the information in Chapter Certificate with special conditions (Page 22).

3.3.11 Terminal box

As an option, additional connecting terminals are available in the terminal box for monitoring equipment. For larger machines, an additional terminal box can be optionally mounted. You can see the number of available terminals in the circuit diagrams.

It is possible to turn the top side of a machine terminal box 4 x 90 degrees (if screwed on).

3.3.12 Paint finish

Paint finish

The machine is painted according to the instructions in your order.

Suitability test of the paint system for hazardous areas

For the paint systems ordered as standard on explosion-protected machines, verification of the electrostatic suitability is available.

Such verification is not available for paint systems that are non-standard or specifically requested by customers. Take into consideration that the provided verification is not valid for repainting/recoating.

- Use the tested, original paint when recoating or touching up.
- The operating company is responsible for carrying out an electrostatic test of the complete system.

3.3 Installation

Preparing for use

Good planning and preparation of machine applications are essential in terms of keeping installation simple and avoiding errors, ensuring safe operation, and allowing access to the machine for servicing and corrective maintenance.

This chapter explains how you should proceed when engineering a plant or system in relation to this machine and the preparations you need to make before the machine is delivered.

4.1 Safety-related aspects to consider when configuring the plant

A number of residual risks are associated with the machine. These are described in the chapter titled "Safety information" (Page 15) and in related sections.

Take appropriate safety precautions (covers, barriers, markings, etc.) to ensure the machine is operated safely within your plant.

4.2 Observing the operating mode

Observe the machine's operating mode. Use a suitable control system to prevent overspeeds, thus protecting the machine from damage.

4.3 Machines without final paint coating

Machines without final paint coating

For machines, which are only delivered with primer, you must paint them to comply with the applicable guidelines for the specific application. The primer alone does not provide adequate corrosion protection.

The paint applied must conform to the requirements to avoid electrostatic charging, see EN 60079-0.

Please contact the Service Center (Page 12) for recommendations relating to painting.

4.4 Delivery

Checking the delivery for completeness

The drive systems are put together on an individual basis. When receiving the delivery, immediately check whether the scope of delivery matches the accompanying documents. No claims relating to defects/items missing from the delivery will be accepted if these are submitted at a later date.

- Report any apparent transport damage to the delivery agent immediately.
- Immediately report any apparent defects/incomplete delivery to your local sales partner.
- Put the operating instructions included in the scope of supply in a secure place.

The rating plate optionally enclosed as a loose item with the delivery is provided to enable the motor data to be attached on or near the machine or installation.

4.5 Transport and storage

Comply with the following when carrying out any work on the machine:

- Comply with the general safety instructions (Page 15).
- Comply with the applicable national and sector-specific regulations.
- When using the motor within the European Union, comply with the specifications laid down in EN 50110-1 regarding safe operation of electrical equipment.

4.5.1 Safety instructions for transport

The information required to correctly attach, lift and transport the machine - such as weight, center of gravity and attachment points - is provided here:

- Machine dimension drawing and the associated explanations or the technical specifications
- Transport data
- Rating plate and lifting plate, if available
- Shipping parts list
- Packaging

Danger when incorrectly lifting and transporting

Danger of death, serious injury, or substantial material damage caused by tipping or falling transported goods. Comply with the following safety instructions:

- All work must be performed with due caution and care.
- Comply with any notes in the shipping papers.

- Carefully comply with all of the handling information and markings on the packages whenever transporting and putting the equipment into storage according to ISO 780.
- Only use suitable and correctly dimensioned lifting equipment, conveying equipment and transport vehicles.

Danger due to incorrect attachment and lifting

- Ensure that suitable lifting equipment is available.
- Only hoist the goods using the designated hoisting points and/or at marked positions. The attachment points are not dimensioned for additional loads.
- Use suitable strap guiding or spreading devices.
- If not specified otherwise in the transport data, always transport the machine in the position associated with its specific type of construction.

Danger due to damaged attachment points

- Carefully check the attachment points provided on the motor unit, e.g. attachment eyes, lifting lugs or ring bolts for possible damage. Replace damaged attachment points.
- Before using, carefully ensure that the attachment points are correctly attached.

Danger when incorrectly transporting the motor suspended from cables or ropes

If you transport the motor suspended from cables or ropes, the cables or ropes can break, e.g. as a result of damage. Further, if not adequately attached, the motor can swing. This can result in death, serious injury, or material damage.

- Use additional, suitable lifting equipment for transport and during installation.
- Two cables alone must be able to carry the complete load.
- Prevent the lifting equipment from sliding by appropriately securing it.
- When using 2-cable lifting equipment, ensure that the maximum angle of inclination is $\leq 45^\circ$ according to ISO 3266 (DIN 580).
- Align the eyebolts so that the cables used for lifting are aligned with the planes of the eyebolts.

Danger when incorrectly lifting and transporting

The motor can slide or topple over if it is not correctly lifted or transported. This can result in death, serious injury or material damage.

- Use all the lifting eyes on the machine.
- When using the lifting eyes on the machine, do not attach any additional loads or weight. The lifting eyes are only designed for the weight of the machine itself.
- Any eyes that are screwed in must be tightly fastened.
- Eyebolts must be screwed in right up to their supporting surface.

- Comply with the permissible eyebolt loads.
- When necessary, use suitably dimensioned lifting equipment, for example hoisting slings (EN1492-1) and webbing load restraints (EN12195-2).
- Never remain under or in the immediate vicinity of the machine when it is lifted.

 WARNING
Danger to life as a result of a machine falling
If the lifting gear or load handling attachments were to fail, the machine could fall. This can result in death, serious injury or material damage.
<ul style="list-style-type: none">• In order to gain easy and safe access to the underside of the machine, place it in a secure and raised position.

Note







When lifting the machines for transport, only lift them in a position that corresponds to their basic construction type.

The type of construction of the machine is stated on the rating plate.

If any transport locks are in place, remove them before commissioning. Store the transport locks or disable them. Use the transport locks when transporting the motors again or reactivate the transport locks.

The machines are packed in different ways depending on how they are transported and their size. If not otherwise contractually agreed, the packaging corresponds to the packing guidelines according to ISPM (International Standards for Phytosanitary Measures).

Comply with the graphic symbols provided on the packaging. Their meaning is as follows:

						
This way up	Fragile goods	Protect against moisture	Protect against heat	Center of gravity	Hand hooks forbidden	Attach here

4.5.2 Storage

Storing outdoors

NOTICE
Damage to the motor
Damage can occur if incorrectly stored.
Take all precautions to protect the motor under extreme climatic conditions, e.g. salt-laden and/or dusty, moist/humid atmospheres.

Choose a dry storage location which is safe from flooding and free from vibration. Repair any damage to the packaging before putting the equipment into storage if this is necessary to ensure proper storage conditions. In order to ensure protection against ground moisture, locate machines, equipment and crates on pallets, wooden beams or foundations. Prevent equipment from sinking into the ground. Do not impede air circulation under the stored items.

Covers or tarpaulins used to protect the equipment against the weather must not come into contact with the surfaces of the equipment. Use wooden spacer elements to ensure that air can circulate freely around the equipment.

Storing indoors

The storage rooms must provide protection against extreme weather conditions. They must be dry, free from dust, frost and vibration and well ventilated.

Bare metal surfaces

For transport, the bare surfaces (shaft ends, flange surfaces, centering edges) should be coated with an anti-corrosion agent which will last for a limited amount of time (<6 months). Apply suitable anti-corrosion measures for longer storage times.

Condensation drain hole

Open any condensation drain holes to drain the condensation depending on the environmental conditions, every six months at the latest.

4.5.3 Temperature limits during storage

The materials used are specially designed for the temperature range required by the customer. The relevant temperature limits are specified on the rating plate.

 **WARNING**

Risk of explosion due to damaged sealing materials

Storing machines at temperatures that do not fall within the specified limits can damage the material of the seals and cause them to no longer seal correctly. The certified type of protection of the machine can no longer be complied with.

As a result, a potentially explosive gaseous atmosphere can enter the machine and be ignited during commissioning. Explosions can occur. This can result in death, serious injury or material damage.

- Do not store the machine in conditions that lie outside the specified temperature limits.

Storage temperature

Permissible temperature range: -20 °C to +50 °C

Maximum permissible air humidity: 60%

For machines that have a special design regarding the ambient temperature in the operating state or the installation altitude, other conditions could apply regarding the storage temperature. In this case, refer to the machine rating plate for data on the ambient temperature and installation altitude.

Storage time

Turn the shaft once every year to avoid bearing brinelling. Prolonged storage periods reduce the useful life of the bearing grease (aging).

Open bearings

- For open bearings, e.g. 1Z, check the status of the grease when stored for longer than 12 months.
- Replace the grease if it is identified that the grease has lost its lubricating properties or is polluted. The consistency of the grease will change if condensation is allowed to enter.

Closed bearings

- For closed bearings, replace the DE and NDE bearings after a storage time of 48 months.

NOTICE**Storage**

The motor can be damaged if you use it or store it unprotected outdoors.

- Protect the motor against intensive solar radiation, rain, snow, ice and dust. Use a superstructure or additional cover, for example.
- If required, contact the Service Center (Page 12) and/or technically coordinate outdoor use.

4.5.4 Securing the rotor

Depending on the version, the machine is fitted with a rotor shipping brace. This protects the bearings against damage due to shock and vibration during transport or storage.

NOTICE**Motor damage due to vibrations**

Not using the rotor shipping brace can cause damage to the machine if it is jolted during transport or storage. Material damage can result.

- If the machine is fitted with a rotor shipping brace, this should always be used when transporting the machine. The rotor shipping brace must be attached during the transport.
- Protect the motor against strong radial shocks and vibration when storing, as the rotor shipping brace cannot completely absorb these forces.
- Do not remove the rotor shipping brace until you are ready to push on the output element.
- If the customer already has mounted parts, such as a coupling or belt pulley, the bearings can be damaged during transport. In this case, make sure that the customer uses a rotor shipping brace.
- For machines with a vertical type of construction:
 - Do not remove the rotor shipping brace until the machine is in a vertical position.
 - If a machine has to be transported in a horizontal position, the rotor must be fixed in position before the machine is turned onto its side. Vertical machines can be supplied in the horizontal position from the manufacturing plant.

Alternative rotor bracing

- If you transport the machine after the output element has been pulled on, then you must axially fix the rotor in another way.

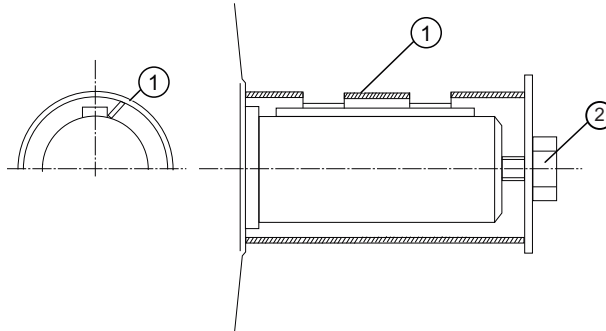

Thread in the shaft extension	Tightening torque
M16	40 Nm
M20	80 Nm
M24	150 Nm
M30	230 Nm

Tightening torques for other rotor shipping brace types

- The thread in the shaft extension indicates the rotor weight. This indirectly specifies the required preload force when axially fastening the rotor.

Thread in the shaft extension	Preload
M16	13 kN
M20	20 kN
M24	30 kN
M30	40 kN

Axial preload force for other rotor shipping brace types

Storing the rotor locking device

Store the rotor locking device in a safe place. It must be remounted if the machine is removed and shipped on further.

4.5.5 Commissioning after storage

4.5.5.1 Insulation resistance and polarization index

Measuring the insulation resistance and polarization index (PI) provides information on the condition of the machine. It is therefore important to check the insulation resistance and the polarization index at the following times:

- Before starting up a machine for the first time
- After an extended period in storage or downtime
- Within the scope of maintenance work

The following information is provided regarding the state of the winding insulation:

- Is the winding head insulation conductively contaminated?
- Has the winding insulation absorbed moisture?

From this, you can determine whether the machine needs commissioning or any necessary measures such as cleaning and/or drying the winding:

- Can the machine be put into operation?
- Must the windings be cleaned or dried?

Detailed information on testing and the limit values can be found here:

"Testing the insulation resistance and polarization index" (Page 64)

4.5.5.2 Lubricating the rolling bearings

If you correctly store the machine for a longer period of time, it can be assumed that within a period of 2 years, the grease in the bearings will not deteriorate.

- For motors with thermal class 155, for normal ambient temperatures, use a lithium-soap rolling bearing grease with a dropping point of at least 180 °C.
- For machines with thermal class 180, and for certain special machines, use the special grease specified on the machine lubricant plate.

4.5.5.3 Regreasing rolling bearings after storage periods of up to two years

- For machines with regreasing systems, briefly lubricate both bearings after commissioning with the machine running as a precautionary measure.
- Grease type, grease quantity and relubrication intervals for the regreasing system are stamped on the rating plate attached to the machine.

4.5.5.4 Releasing the rotor shipping brace before commissioning

If one is being used, release the rotor shipping brace before commissioning.

4.6 Ensure adequate cooling

⚠ WARNING

Overheating and failure of the motor

Death, severe injury or material damage can occur if you do not strictly comply with the following points, for explosion-proof machines, an explosion can occur.

- Do not obstruct the ventilation.
- Prevent the air expelled by neighboring equipment from being immediately sucked in again.
- For vertical types of machine construction with the air intake from above, protect the air intakes from the ingress of foreign bodies and water.
- If the shaft extension is facing upwards, liquid must be prevented from entering by moving along the shaft.

⚠ WARNING

Damage to the ventilation system

Material damage and injury can occur if the fan is destroyed and therefore the machine overheats.

- Prevent foreign bodies from falling into the fan cover. For vertical machine installation with the shaft end facing downwards, attach a protective canopy.
- Take suitable measures to prevent water from entering the ventilation system. The optional canopy is not suitable as protection against water ingress.
- Ensure that the cooling air flow is not reduced as a result of covers and that the minimum air clearances are maintained.

Table 4-1 Air guidance

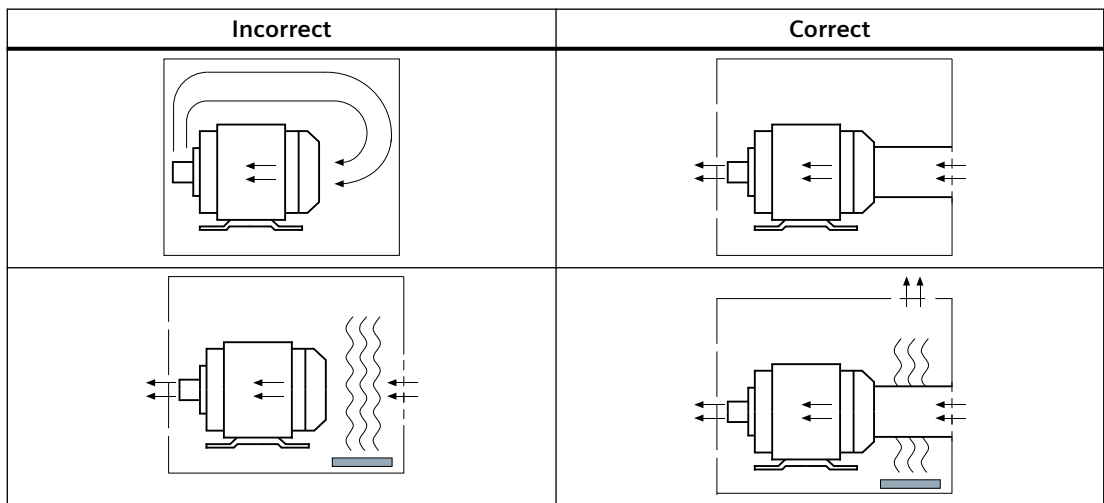

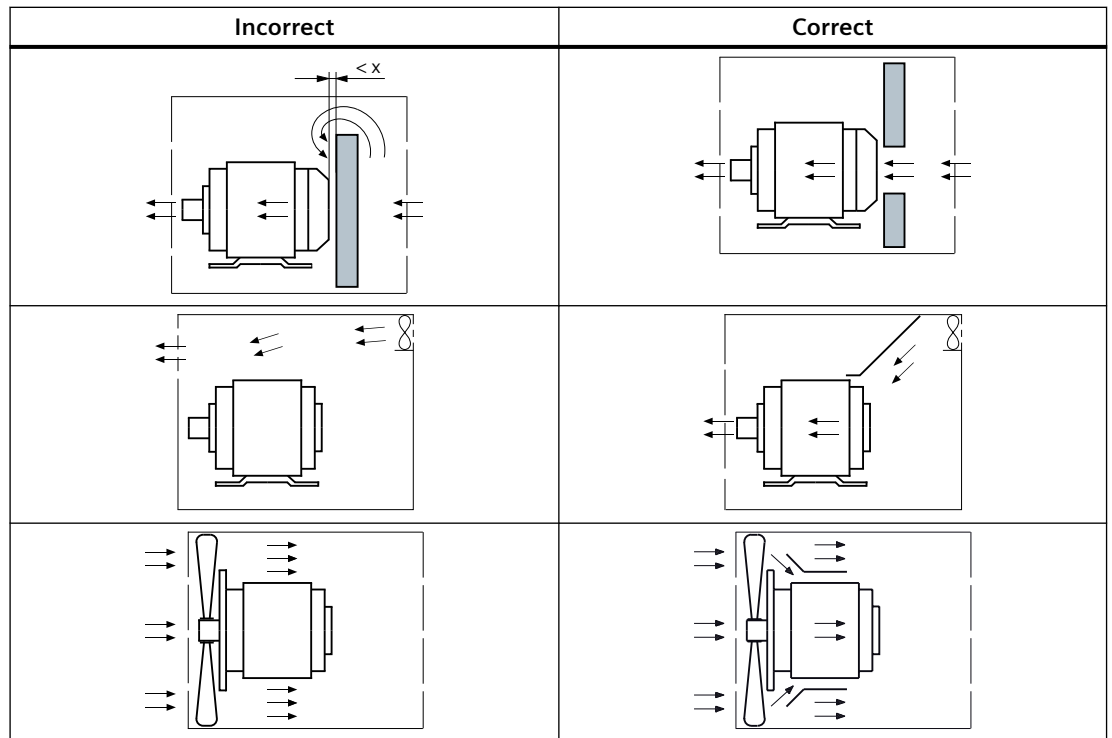

Minimum dimension "x" for the distance between neighboring modules and the air intake of the machine

Table 4-2 Minimum dimension "x" for the distance between adjacent modules and the air intake of the machine

Shaft height	x mm
63 ... 71	15
80 ... 100	20
112	25
132	30
160	40
180 ... 200	90
225 ... 250	100
280 ... 315	110
355	140

4.7 Thermal protection

Protect explosion-protected machines against overload according to IEC / EN 60079-14, Section "Rotating electrical machines".

Use a motor circuit breaker, directly monitor the winding temperature or use equipment to provide the same functionality corresponding to the explosion type of protection.

For pole-changing motors, in addition to the circuit breaker, use temperature sensors in the windings.

Ex d and Ex t

Line supply

- Set the protective device (e.g. circuit breaker) to the rated current (see the rating plate).
- Or protect the machine using the certified temperature monitoring specified on the supplementary plate .

Converter

- Always operate explosion-protected machines fed from converters with temperature sensors that directly monitor the temperature.

Ex e and Ex eb

Line supply

- Set the protective device (e.g. circuit breaker) to the rated current (see the rating plate), I_A/I_N and the locked rotor time (t_E).
- Or protect the machine using the certified temperature monitoring specified on the supplementary plate.

Converter

- Always operate explosion-protected machines fed from converters with temperature sensors that directly monitor the temperature.
- Converter operation for these machines must be expressly certified. It is crucial that you carefully observe the specific manufacturer's information and instructions. Converter, machine and protective devices must be marked as belonging together and the permitted operating data must be defined in the common EC-type examination certificate.

Ex n and Ex ec

Line supply

- Set the protective device (e.g. circuit breaker) to the rated current (see the rating plate).
- Or protect the machine using the certified temperature monitoring specified on the supplementary plate .

Converter

- Always operate explosion-protected machines fed from converters with temperature sensors that directly monitor the temperature.
- Converter operation for these machines must be expressly certified. Observe the specific manufacturer's information and instructions

4.8 Interlock circuit for anti-condensation heating

If the anti-condensation heating is operated while the machine is running, this can increase the temperatures inside the machine.

- Install an interlock circuit that switches off the anti-condensation heating once the main machine is switched on.
- Only switch on the anti-condensation heating after the motor has been switched off. Comply with the data stamped on the plate of the anti-condensation heating, if available.

4.9 Noise emission

Prevention of hearing damage

If the permissible sound pressure level is exceeded, hearing damage can occur when operating three-phase motors at their rated power.

The permissible sound pressure level is 70 dB (A).

4.10 Voltage and frequency fluctuations during line operation

Unless otherwise stated on the rating plate, the permissible voltage/frequency fluctuation corresponds to Zone B in IEC / EN 60034-1.

Material damage due to excessively high winding temperature rise

Do not exceed the winding temperature tolerances. Inadmissibly high winding temperatures can damage the machine over the long term.

Keep within the permissible tolerance for voltage and frequency.

Every machine must be protected against an inadmissible temperature rise. Observe the following notes:

- Protect every machine according to IEC/EN 60079–14 using a current-dependent, delayed circuit breaker with phase failure protection according to IEC/EN 60947 or a similar device in all phases.
- Set the protective device to the rated current (value is stamped on the rating plate).
- Protect the windings in a delta connection in such a way that the tripping unit or relay is connected in series with the winding phases. When selecting and setting the tripping unit, define the rated value of the phase current. The phase current is 0.58 times the rated machine current. Any thermal machine protection via direct temperature monitoring to be used in addition to the machine circuit breaker is specified on the rating plate if required.

See also

Thermal protection (Page 51)

4.11 Rotational speed limit values

Danger as a result of resonance within certain speed ranges

At over-critical speeds, machines encounter resonance within certain speed ranges. Such vibrations can reach impermissibly high levels. This can result in death, serious injury or material damage.

- The controller must ensure that those speed ranges are blocked when the converter is in operation. Please comply with the data on the blocked speed ranges specified in the electrical data.
- The blocked speed ranges must be run through rapidly.

Machine damage due to excessively high speeds

Excessive rotational speed can lead to serious damage to the machine. This can result in death, serious injury or material damage.

- Avoid operation above the permissible speed by using the appropriate control function.
- Comply with the speeds stamped on the rating plate and in the electrical data.

4.12 System-inherent frequencies

Excessively high vibration levels and system resonances can damage the machine set.

- Configure and match the system consisting of the foundation and machine set in such a way that no system resonances can arise and result in the permissible vibration levels being exceeded.
- Do not exceed the vibration values according to DIN ISO 10816-3.

4.13 Electromagnetic compatibility

Note

If the torque levels are very unequal (e.g. when a reciprocating compressor is being driven), a non-sinusoidal machine current will be induced whose harmonics can have an impermissible effect on the supply system and cause impermissible interference emissions as a result.

Note**Converter**

- If operated with a frequency converter, the emitted interference varies in strength, depending on the design of the converter (type, interference suppression measures, manufacturer).
 - Avoid that the specified limit values stipulated for the drive system (consisting of the motor and converter) are exceeded.
 - You must observe the EMC information from the manufacturer of the converter.
 - The most effective method of shielding is to conductively connect a shielded machine supply cable to the metal terminal box of the machine (with a metal screw connection) over a large surface area.
 - On machines with integrated sensors (e.g. PTC thermistors), disturbance voltages caused by the converter may occur on the sensor cable.
-

When used in accordance with their proper and intended purpose and operated on an electrical supply system with characteristics according to EN 50160, the enclosed machines comply with the requirements of the EC Directive regarding electromagnetic compatibility.

Immunity to interference

The machines fulfill the requirements of interference immunity in conformity with EN / IEC 61000-6-2. For machines with integrated sensors, e.g. PTC thermistors, the operating company must ensure sufficient interference immunity by selecting a suitable sensor signal cable (possibly with shielding, connected in the same way as the machine feeder cable) and a suitable evaluation unit.

When operating the machines from a converter at speeds higher than the rated speed, carefully comply with the mechanical speed limits (safe operating speed EN / IEC 60034-1).

4.14 Converter operation

4.14.1 Parameterizing the converter

- If the design of the motor requires connection to a particular converter type, the rating plate will contain corresponding additional information.
- Correctly parameterize the converter. Parameterizing data can be taken from the machine rating plates.
You can find parameter data here:
 - In the converter operating instructions
 - In the TIA selection tool
 - In the SINAMICS Configuration Manual if available
 - For explosion-proof machines, also in the declaration of compliance with the order 2.1.

- Do not exceed or fall below limit speed n_{\min} or n_{\max} . If no other value is specified, the minimum speed limit is n_{\min} 5 Hz. The speed limits are either stamped on the rating plate or the supplementary plate for converter operation as the highest or lowest specified speed.
- Carefully check that it is guaranteed that the machine is cooled when it is being commissioned.

4.14.2 Converter input voltage

The insulation system of SIMOTICS LV machines always complies with the requirements of stress category C (IVIC C = high stress). If voltage peaks higher than those specified according to IVIC C can occur, contact the Service Center (Page 12).

- For a line supply voltage (converter input voltage) up to max. 480 V, and when controlled from a SINAMICS converter with uncontrolled/controlled infeed: Comply with the guidelines for configuring motor and converter.
- For line voltages (converter input voltages) higher than 480 V, motors have an appropriate insulation system when ordered for converter operation.
- Operation with a converter from another manufacturer: Comply with the permissible voltage peaks according to IEC 60034-18-41 in accordance with stress category C, dependent on the particular line voltage (converter input voltage) and the motor insulation system.

NOTICE

Material damage caused by an excessively high supply voltage

The insulation system will be damaged if the supply voltage is too high for the insulation system. This can completely destroy the machine.

- Comply with the peak voltages as laid down in the guidelines above.

4.14.3 Reducing bearing currents

To prevent damage due to bearing currents, you must carefully assess the complete system, i.e. the motor, converter and driven machine.

- In addition to grounding the motors via the solid grounding conductor, use low impedance grounding in the high frequency range using braided flat copper straps or RF stranded wire conductors. Connect these conductors through a large contact surface. Solid copper cables are not suitable for RF grounding because of the skin effect.
- Use symmetrically structured, shielded connecting cables to connect the motor to a converter. The protective braided shield, comprising many strands, must have a high electrical conductivity. Braided shields made of copper or aluminum are well suited. Connect the shielding at both ends on the motor and on the converter. Keep unshielded cable ends short.

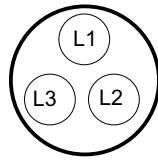

Concentric copper or aluminum shield

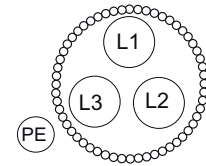
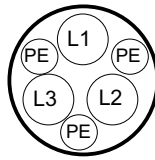

Steel armor

- To ensure that high-frequency currents are appropriately discharged, establish a contact through the largest possible surface area at both ends. Establish a 360° contact of the cable shielding on the motor enclosure and on the protective grounding bar of the converter, for example, as follows:
 - Motor side: EMC glands at the cable entries
 - Converter side: EMC shield clips
- In the overall system, set up a properly meshed grounding system with low impedance for high-frequency currents.
- No potential difference between the motor, converter, and working machine.
 - Use equipotential bonding cables between the terminal box and the high-frequency grounding point on the motor enclosure.
 - Use a separate high-frequency equipotential bonding cable between the motor enclosure and the protective grounding bar of the converter.
 - Use a separate high-frequency equipotential bonding cable between the motor enclosure and the driven machine.
- Use the common-mode filter (damping cores) at the converter output. The SIEMENS sales partner is responsible for selecting and dimensioning.
- Limit the rise in voltage by using output filters. Output filters dampen the harmonic content in the output voltage.
- Use the motor reactors.
- Preferably use an IT line supply with an insulated neutral point.

The operating instructions for the converter are not part of this documentation. Carefully comply with the instructions in the converter configuring information.

4.14.4 Insulated bearings for converter operation

If you control the machine from a low-voltage converter, depending on the machine type, use an insulated bearing at the NDE.

Shaft height	Insulated bearings NDE
100 ... 280	Optional
315 ... 450	Standard

An insulated speed encoder can be optionally mounted.

Comply with the information provided on the machine plates relating to bearing insulation and possible jumpers.

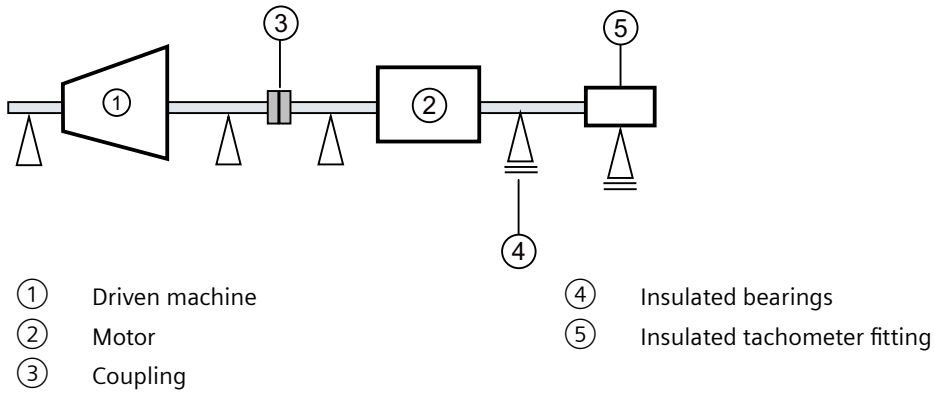

Figure 4-1 Schematic representation of a single drive

NOTICE

Bearing damage

The bearing insulation must not be bridged. Bearing currents can damage bearings.

- Do not bridge the bearing insulation for subsequent installation work, such as the installation of an automatic lubrication system or a non-insulated vibration sensor.
- If you have any questions, please contact the Service Center (Page 12).

If you connect 2 motors in series in "tandem operation", install an insulated coupling between the motors.

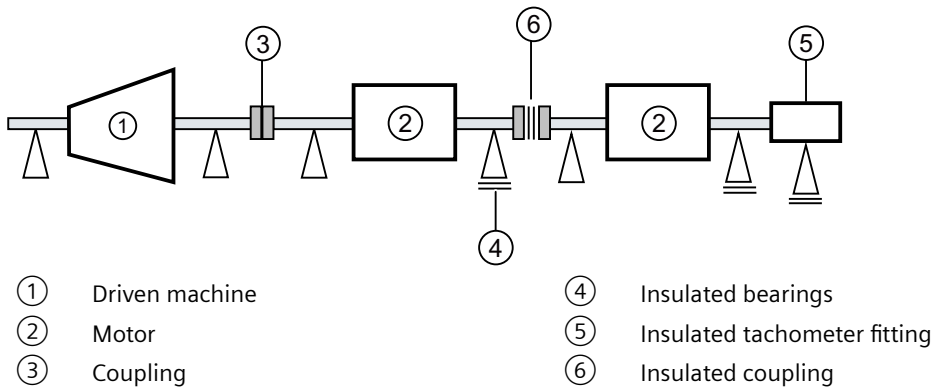

Figure 4-2 Schematic representation of a tandem drive

NOTICE

Bearing damage

Bearing currents can flow if the coupling between the motors of the tandem drive is not insulated. This can damage the DE bearings of both motors.

- Use an insulated coupling to couple the motors.

4.14.5 Tandem operation

If you connect two motors in series in "tandem operation", locate a coupling between the motors; this coupling should satisfy the Directive 2014/34/EU or the regulations that apply in the country where the equipment is installed.

4.14.6 Speed limits for converter operation

Observe the information on the rating plate regarding the speed limits for converter operation.

Assembly

Comply with the following when carrying out any work on the machine:

- Comply with the general safety instructions (Page 15).
- Comply with the applicable national and sector-specific regulations.
- When using the motor within the European Union, comply with the specifications laid down in EN 50110-1 regarding safe operation of electrical equipment.

5.1 Safety instructions for installation

Injury and material damage caused by inappropriate fastening material

If screws of an incorrect property class have been selected or if they have been fastened to an incorrect tightening torque, they may break or become loose. This will cause the machine to move, which could damage the bearings. The rotor could smash into the machine enclosure and machine parts could be flung out of place. This can result in death, serious injury or material damage.

- Comply with the required property classes for screwed connections.
- Tighten the screwed connections to the specified tightening torques.

Injury and material damage caused by incorrect machine alignment

If the machine has not been properly aligned, this will mean the fastening parts are subjected to stress/distortion. Screws may become loose or break, the machine will move, machine parts could be flung out of place. This can result in death, serious injury or material damage.

- Carefully align the machine to the driven machine.

Material damage caused by improper handling

Mounting parts such as temperature sensors or speed sensors are attached to the machine and could be ripped off or destroyed as a result of improper handling. This could lead to machine malfunctions, extending even to total loss of the machine.

- Use suitable steps when carrying out installation work on the machine.
- Do not stand on cables or attachments during installation. Do not use attachments as steps.

Loss of conformity with respect to the applied directives

In the delivery state, the machine corresponds to the requirements according to the directives stamped on the type plate or in the documentation provided. Unauthorized changes or modifications to the machine lead to the loss of conformity with the applicable directives and the loss of the associated warranty.

Explosion hazard when making modifications to the machine

Modifications to the machine, such as drilling holes or additional mechanical work, are not permitted or may only be performed by the manufacturer. Otherwise an explosion can occur in an explosive atmosphere. This can result in death, serious injury or material damage.

- Where necessary, contact the Service Center (Page 12).

5.2 Preparing for installation

5.2.1 Requirements for installation

The following requirements must be satisfied prior to starting installation work:

- Staff have access to the operating and installation instructions.
- The machine is unpacked and ready for mounting at the installation location.
- Measure the insulation resistance of the winding before starting any installation work. If the insulation resistance lies below the specified value, take appropriate remedial measures. These remedial measures may necessitate the machine being removed again and transported.

Note

Note also the technical data on the rating plates on the motor enclosure.

NOTICE
Damage to the motor
To avoid material damage, before commissioning, check whether the correct direction of rotation of the machine has been set on the customer side, e.g. by decoupling from the driven load.

Damage to mounted parts and components as a result of high temperatures

The motor components get very hot during operation. High temperatures can damage parts mounted by customers, such as cables manufactured out of materials that are not heat resistant.

- Temperature-sensitive parts must not come into contact with or be attached to components mounted on the machine.
- Only use heat-resistant mounting parts. The connecting cables and cable entries must be suitable for the particular application.

5.2.2 Insulation resistance

5.2.2.1 Insulation resistance and polarization index

Measuring the insulation resistance and polarization index (PI) provides information on the condition of the machine. It is therefore important to check the insulation resistance and the polarization index at the following times:

- Before starting up a machine for the first time
- After an extended period in storage or downtime
- Within the scope of maintenance work

The following information is provided regarding the state of the winding insulation:

- Is the winding head insulation conductively contaminated?
- Has the winding insulation absorbed moisture?

From this, you can determine whether the machine needs commissioning or any necessary measures such as cleaning and/or drying the winding:

- Can the machine be put into operation?
- Must the windings be cleaned or dried?

Detailed information on testing and the limit values can be found here:

"Testing the insulation resistance and polarization index" (Page 64)

5.2.2.2 Checking the insulation resistance and polarization index of the winding

Measure the insulation resistance

1. Follow the instructions in the Operating Manual of the insulation measuring instrument used.
2. Ground other windings, integrated winding temperature sensors and, if applicable, other mounted and installed components.



⚠ WARNING

Hazardous voltage at the terminals

Hazardous voltages are sometimes present at the terminals during and immediately after measurement of the insulation resistance or polarization index of the winding. Contact with these can result in death, serious injury or material damage.

- If power cables are connected, ensure that a line voltage cannot be applied. If no power cables are connected, this reduces the effect of the I/O devices on the measurement.
- Discharge the winding after measurement until the risk is eliminated, e.g. using the following measures:
 - Connect the terminals with the ground potential until the recharge voltage drops to a non-hazardous level
 - Attach the connecting cable.

3. Measure the winding temperature and the insulation resistance of the winding in relation to the machine enclosure. The winding temperature should not exceed 40 °C during the measurement.
4. Convert the measured insulation resistances in accordance with the formula to the reference temperature of 40 °C. This thereby ensures that the minimum values specified can be compared.
5. Read out the insulation resistance one minute after applying the measuring voltage.
6. Discharge the winding after performing the measurement.

Limit values for the winding insulation resistance

The following table lists the measuring voltage and limit values for the insulation resistance R_i . These values correspond to recommendations provided in IEC 60034-27-4.

Table 5-1 Insulation resistance of the winding at 40 °C

U_{rated}/V	U_{meas}/V	$R_{iC}/M\Omega$
$U \leq 1000$	500	≥ 5
$1000 \leq U \leq 2500$	500, max. 1000	100
$2500 < U \leq 5000$	1000, max. 2500	
$5000 < U \leq 12000$	2500, max. 5000	
$U > 12000$	5000, max. 10000	

U_{rated} = rated voltage, see the rating plate

U_{meas} = DC measuring voltage

R_{iC} = minimum insulation resistance up to 40 °C winding temperature

Converting to the reference temperature according to IEC 60034-27-4

Convert values measured at winding temperatures of 40 to 60 °C to the reference temperature of 40 °C:

$R_{iC} = R_{iT} \times K_T$	$R_{iC} = R_i$ converted to the reference temperature of 40 °C
	$R_{iT} = R_i$ at the given winding temperature T in °C
	K_T = temperature correction factor
$K_T = 0,5^{\frac{40-T}{X}}$	$X = 1$ in the range 10 ... 40 °C
	$X = 17$ in the range 40 ... 60 °C
	40 = reference temperature in °C
	T = measurement/winding temperature in °C

The values apply for the complete winding to ground. Twice the minimum values apply to the measurement of individual assemblies.

- Dry, new windings have an insulation resistance of between 100 ... 2000 MΩ, or possibly even higher values. An insulation resistance value close to the minimum value could be due to moisture and/or dirt accumulation. The size of the winding, the rated voltage and other characteristics influence the insulation resistance, and may need to be taken into account when determining measures.
- Over its operating lifetime, the motor winding insulation resistance can drop due to ambient and operational influences.
 - Calculate the critical insulation resistance value depending on the rated voltage by multiplying the rated voltage (kV) by the specific critical resistance value.
 - Convert the value for the current winding temperature at the time of measurement, see above table.

Note

Comment to IEEE 43

According to IEEE 43, also for winding temperatures < 40 °C, R_i must be converted over to the reference temperature of 40 °C.

As the minimum values for R_i apply at 40 °C, the required R_i values are somewhat higher for winding temperatures below 40 °C.

Measuring the polarization index

1. To determine the polarization index, measure the insulation resistances after 1 and 10 minutes.
2. Express the measured values as a ratio:
 Polarization index = $R_{i\ 10\ min} / R_{i\ 1\ min}$
 Many measuring devices display these values automatically following the measurement.

Measuring the polarization index is not helpful for insulation resistances > 5000 MΩ, and is therefore not included in the assessment.

$R_{i\ 10\ min} / R_{i\ 1\ min}$	Assessment
≥ 2	Insulation in good condition
< 2	Dependent on the complete diagnosis of the insulation

NOTICE

Damage to insulation

If the critical insulation resistance is reached or undershot, this can damage the insulation and cause voltage flashovers.

- Contact the service center (Page 12).
- If the measured value is close to the critical value, you must subsequently check the insulation resistance at shorter intervals.

See also

Insulation resistance and polarization index (Page 63)

Limit values of the anti-condensation heating insulation resistance

The insulation resistance of the anti-condensation heating with respect to the machine housing must not be lower than 1 MΩ when measured at 500 V DC.

5.3 Mounting and installed the machine

5.3.1 Preparing the assembly area

1. Prepare a suitable assembly area (e.g. assembly stands). Make sure that the assembly area has sufficient clearance from the floor for the DE shaft end. The necessary data is provided in the machine dimension drawing.
2. Refer to the shipping documents to check that all motor components are available for assembly.

5.3.2 Lift the machine to where it will be mounted and position it

- For vertical installation, use all the eyebolts provided and when necessary, hoisting straps according to EN 1492-1 and/or lashing straps according to EN 12195-2 to stabilize the position.
- Prevent foreign bodies from falling into the fan cover. For vertical machine installation with the shaft end facing downwards, attach a protective canopy.
- If the shaft extension is facing upwards, the user must prevent liquid from moving along the shaft and entering the motor.
- Clean bare metal surfaces with anti-corrosion agent using mineral spirits to ensure proper installation and/or machine mounting.
- Do not obstruct the ventilation. Do not draw in the hot discharged air directly – also from adjacent equipment.
- Avoid exposing them to direct, intense solar radiation, rain, snow, ice, or also dust for extended periods. Attach a covering structure or an additional cover when using or storing outdoors.
- Do not exceed the permissible axial and radial forces.
- When clouds or layers of dust are present, strictly maintain the temperature limits according to EN/IEC 60079-14. The maximum surface temperature is stamped on the rating plate for dust explosion-proof motors.
- Only use explosion-proof machines in the appropriate areas in accordance with directive 1999/92/EC or in accordance with the appropriate country regulations. If the certification is supplemented by an X, comply with the special conditions in the EC type examination certificate or the IECEx Certificate of Conformity. Certificate with special conditions (Page 22)
- When installing electrical systems in hazardous zones, comply with EN/IEC 60079-14 and the corresponding country regulations.
- Take into account thermal transfer between the driven load and the machine. Carefully ensure that permissible temperatures are maintained.

5.3 Mounting and installed the machine

- The machine temperature class specified on the rating plate must be equal to or greater than the temperature class of any combustible gases that may develop.
- Select optional mounted equipment according to the requirements of Directive 2014/34/EU, IECEx scheme or in accordance with the appropriate country regulations.

5.3.3 Machines with type of construction IM B15, IM B9, IM V8 and IM V9

Types of construction without bearings on the drive side

These machines do not have their own bearing system for the machine shaft at the drive end (DE). The machine shaft is accepted by the (hollow) shaft or coupling of the system or driven machine.

- Using the centering edge, the machine is aligned with respect to enclosures, flanges or driven machines.
- Note that the temperature of the motor and motor shaft increases during operation. The thermal expansion of the machine shaft must be compensated by the customer by applying suitable measures.
Use the spring washers provided to locate the NDE bearing without any play.

NOTICE
Damage to the motor
Material damage can occur if the following notes are not carefully observed:
<ul style="list-style-type: none">• The IM B3 bearing shield with integrated distance ring mounted at the drive end (DE) is only used transport lock. A warning label is attached to this bearing shield.• The spacer ring is not a roller bearing.• Remove the bearing shield and the spacer ring.• Remove the transport lock before commissioning.

5.3.4 Foot mounting

Note

Only authorized retrofit partners must be employed to relocate the bolted-on mounting feet at the machine enclosure.

After attaching the mounting feet, you must note the following in order to avoid stressing and deforming the machine.

- Ensure that the foot mounting surfaces are aligned in one plane and are parallel to the machine shaft.
- Post-machine the foot mounting surfaces or use thin shims, for example.

- Professionally touch up damaged painted surfaces.
- Observe the information provided in Chapter Aligning and mounting (Page 69)

5.4 Alignment and fastening

Observe the following when aligning and mounting:

- Ensure a flat and uniform contact surface for foot and flange mounting.
- When mounting on the wall, support the machine from below, e.g. using a bracket, or bolt it.
- Precisely align the machine when couplings are used.
- Ensure that the mounting surfaces are clean and free of any dirt.
- Remove any anti-corrosion protection using white spirit.
- Avoid installation-related resonances with the rotating frequency and twice the line frequency.
- Note any unusual noise when the rotor is manually turned.
- Check the direction of rotation with the motor uncoupled.
- Avoid rigid couplings.
- Repair any damage to the paint, this must be done immediately and correctly.

5.4.1 Repainting/touching up the paint finish of explosion-protected machines

Note**Repainting/touching up the paint finish of explosion-protected machines**

For explosion-protected machines, observe the information in Chapter Repainting/touching up (Page 126).

5.4.2 Measures for alignment and mounting

The following measures are required in order to compensate any radial offset at the coupling and to horizontally adjust the electrical machine with respect to the driven load:

- **Vertical positioning**
For vertical mounting positions, avoid deforming the machines by placing shims under the mounting feet. Keep the number of shims low; only use a few stacked shims.
- **Horizontal positioning**
To position the machine horizontally, shift it sideways on the foundation and ensure that the axial position is maintained (angularity error).

- When positioning the motor, ensure that a uniform axial gap is maintained around the coupling.

- **Smooth running**

Preconditions for smooth, vibration-free operation:

- Stable foundation design free of any shock or vibration.
- A precisely aligned coupling.
- A well-balanced drive output element (coupling, belt pulleys, fans, ...)

Maintain the maximum permissible vibration values in operation according to ISO 10816-3. Avoid inadmissible vibration caused by imbalance, for example (drive output element), external vibration or any resonance over the complete speed range.

It may be necessary to completely balance the machine with the drive output element or the system resonance frequency must be shifted.

- **Foot mounting/flange mounting**

- Use the specified thread size laid down in EN 50347 when flanging the machine to a foundation or a machine flange.
- Mount the machine at all the foot or flanged holes provided. The choice of fixing elements depends on the foundation and is the plant operator's responsibility. Comply with the required property classes for screwed connections and materials for fixing elements.
- Select the correct screw length for IM B14 flanges.
- Ensure that the screw heads are in full contact with the flange surface. Use additional flat washers (ISO 7093), especially for elongated foot mounting holes.

5.4.3 Flatness of the supporting surfaces for conventional motors

Shaft height	Flatness [mm]
≤ 132	0.10
160	0.15
≥ 180	0.20

5.4.4 Machine frame mounting feet (special design)

Please note that when the terminal box is mounted at the NDE (option H08), dimension C can deviate from EN 50347.

To comply with dimension C according to EN 50347, for machines with double or triple holes at the NDE, use the appropriate screw bore.

5.5 Installing the machine

5.5.1 Preconditions for smooth, vibration-free operation

Preconditions for smooth, vibration-free operation:

- Stable foundation design
- Precise alignment of the machine
- Correct balancing of parts to be fitted to the shaft end.
- Vibration values in compliance with ISO 10816-3

5.5.2 Aligning the machine to the driven machine and mounting

5.5.2.1 Type of construction without flange

If the motor is not fitted with a flange, align the motor to suit the driven machine.

For types of construction without flange (e.g. IM B3), use suitable covers to ensure that no small parts can fall down between the transmission element and the bearing shield on the drive side.

5.5.2.2 Horizontal types of construction with mounting feet

1. Refer to any instructions for aligning the driven machine and those of the coupling manufacturer.
2. Align the machines with coupling output to the driven machine in such a manner that the center lines of the shafts are parallel with no offset. This ensures that no additional forces affect their bearings during operation.
3. For the vertical positioning ($x \rightarrow 0$) place thin shims under the machine feet. The number of shims should be kept as low as possible, i.e. stack as few as possible. This also prevents the machine being subjected to any stress/distortion. If available, use the existing tapped holes for the forcing-off bolts to somewhat raise the machine.
4. When positioning the machine, ensure that a uniform axial gap ($y \rightarrow 0$) is maintained around the coupling.
5. Fix the machine to the foundation. The choice of fixing elements depends on the foundation and is the plant operator's responsibility.

Note

Machine expansion

When aligning, make allowance for the thermal expansion of the machine when the temperature increases.

See also

Tightening torques for screw and bolt connections (Page 169)

5.5.2.3 Horizontal types of construction with flange

The standard flange is provided with a centering. The choice of fit for the mating flange on the driven machine is the system manufacturer's or the plant operator's responsibility.

If the machine is not fitted with a standard flange, align the machine to suit the driven machine.

Procedure

The machine axis must be horizontal when it is lifted and the flange must be parallel to the mating flange, so as to avoid seizing and stressing. Otherwise damage to the centering will result.

1. Grease the centering flange with assembly paste to make the process easier.
2. Screw three studs into tapped holes spaced about 120° apart around the driven machine flange. The studs act as positioning aids.
3. Position the machine so that its axis is aligned with that of the driven machine, but not yet quite touching. Advance the machine slowly towards the driven machine; advancing too quickly risks damaging the centering.
4. If necessary, rotate the machine into the right position so that the clearance holes in the flange are central to the tapped holes.
5. Move the machine fully up against the mating flange so that it is fully in contact.
6. Fix the machine using the flange fixing bolts, finishing by replacing the studs.

See also

Tightening torques for screw and bolt connections (Page 169)

5.5.2.4 Vertical types of construction with flange

The standard flange is provided with a centering. The choice of fit for the mating flange on the driven machine is the system manufacturer's or the plant operator's responsibility.

If the machine is not fitted with a standard flange, align the machine to suit the driven machine.

Procedure

The machine axis must be vertical when it is lifted and the flange must be parallel to the mating flange, so as to avoid seizing and stressing. Otherwise damage to the centering will result.

1. Grease the centering flange with assembly paste to make the process easier.
2. Screw in two studs into tapped holes on opposite sides of the driven machine flange. The studs act as positioning aids.

3. Lower the machine slowly toward the driven machine and into the centering, so that the flanges do not quite touch. Lowering too quickly risks damaging the centering.
4. If necessary, rotate the machine into the right position so that the clearance holes in the flange are central to the tapped holes.
5. Lower the machine completely onto the mating flange so that it is fully in contact; then remove the studs.
6. Fix the machine using the flange fixing bolts.

5.5.3 Removing the rotor shipping brace

If a rotor shipping brace is attached to the machine, remove it at the last possible moment, for example, when you are ready to push on the output or drive element.

Storing the rotor locking device

Store the rotor locking device in a safe place. It must be remounted if the machine is removed and shipped on further.

5.5.4 Recommended alignment accuracy

The alignment accuracy required depends essentially on the configuration of the overall machine train. Observe the required alignment accuracy of the coupling manufacturer in all cases when aligning the machine.

Table 5-2 Recommended alignment accuracy

Speed rpm	Parallel offset mm	Angular misalignment mm per 100 mm coupling diameter
0 ... 900	0.09	0.09
900 ... 1800	0.06	0.05
1800 ... 3600	0.03	0.025

5.5.5 Mounting the drive output elements

The rotor is dynamically balanced. For shaft extensions with feather keys, the type of balancing is specified using the following coding on the face of the drive end of the shaft extension and on the rating plate:

- "H" means balancing with a half feather key (standard)
- "F" means balancing with a whole feather key
- "N" means balancing without a featherkey.

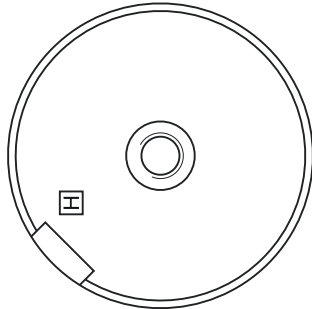

Figure 5-1 DE balancing type

⚠ WARNING

Risk of injury due to Incorrect installation or removal

The feather key may be flung out if the motor is operated without drive output elements, such as coupling, etc. Carefully comply with the required measures. This can result in death, serious injury or material damage.

- The general touch protection measures for drive output elements must be observed.
- Only operate the machine with the drive output element mounted.
- Drive output elements may only be pulled on or pulled off with the correct equipment.
- The feather keys are only locked against falling out during shipping. For test operation or when commissioning **without drive output element**, carefully secure the feather key using a suitable locking element. When doing this, take into account the type of machine balancing.

Pulling on drive output elements

- Requirements:
 - The coupling and/or the drive output element must be appropriately dimensioned for the operating case at hand.
 - Observe the coupling manufacturer's instructions.
 - Make sure that the balancing type of the drive output element correctly matches the type of balance of the rotor.
 - Use only ready drilled and balanced drive output elements. Check the hole diameters and the balancing status before pulling them on. Thoroughly clean the shaft extension.
- Pulling on:
 - Heat up the drive output elements to expand them before pulling them on. Select the temperature difference for the heating process to suit the coupling diameter, fit and material. Observe the coupling manufacturer's instructions.
 - Drive output elements may only be pulled on or pulled off with the correct equipment. The drive output element must be pulled on in one continuous operation via the front thread holes in the shaft or pushed on by hand.
 - Do not use a hammer, as this will damage the bearings.

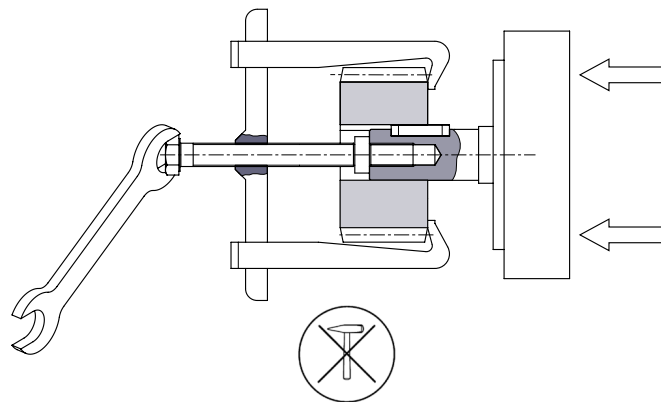

Withdrawing drive output elements

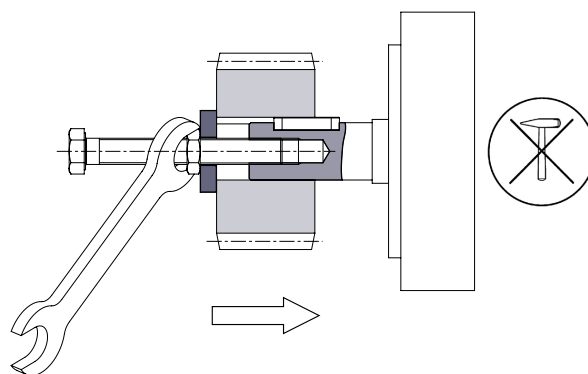

Mounting drive output elements

Only transfer radial or axial forces specified in the catalog to the machine bearings via the shaft extension.

You can obtain the permissible values for axial and radial forces by contacting the Service Center (Page 12) or by referring to the machine catalog.

See also

Axial and radial forces (Page 31)

Shaft extensions with feather key

The feather key data for the shaft and drive output element must match and indicate the correct type of balancing. The drive output element must be correctly mounted.

The balance quality corresponds to vibration severity grade "A" for the complete machine; vibration severity grade "B" is possible as an option. To ensure the required balance quality, it must be ensured that the feather key data on the hub and machine shaft match in the case of a shorter or longer drive output element.

- If the drive output element is shorter than the feather key with balancing type "H", then you must machine off the section of feather key protruding from the shaft contour and drive output element in order to maintain the balance quality.
- If the drive output element is longer than the feather key, when balancing the coupling, take into account that the feather key does not take up all of the coupling slot.

The following applies to all four-pole machines with a frequency ≥ 60 Hz:

- The feather key must be shortened if the coupling hub is shorter than the feather key.
- The center of gravity of the coupling half should be within the length of the shaft end.
- The coupling used must be prepared for system balancing.

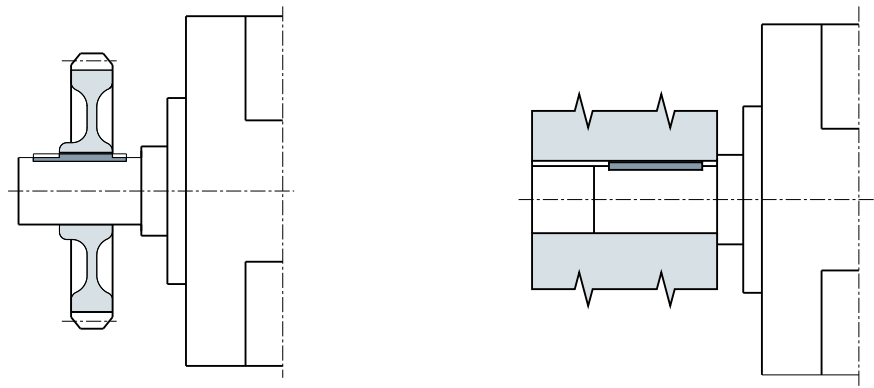

Align the offset at the coupling between electrical machines and the driven machines so that the maximum permissible vibration values according to ISO 10816-3 are not exceeded.

Electrical connection

Comply with the following when carrying out any work on the machine:

- Comply with the general safety instructions (Page 15).
- Comply with the applicable national and sector-specific regulations.
- When using the motor within the European Union, comply with the specifications laid down in EN 50110-1 regarding safe operation of electrical equipment.

Hazardous voltages on electrical connections

Dangerous voltages can arise on electric motors. Death, injury or material damage can occur. Observe the following safety information before connecting up the motor:

- Only qualified personnel should carry out work.
- Carefully follow the 5 safety rules.
- Disconnect the machine from the power supply and take measures to prevent it being reconnected. This also applies to auxiliary circuits.
- Check that the machine really is in a no-voltage condition.
- Ensure that there is a safe and reliable protective conductor connection before starting any work.
- If the incoming power supply system displays any deviations from the rated values in terms of voltage, frequency, curve form or symmetry, such deviations will increase the temperature and influence electromagnetic compatibility.
- Operating the machine on a line supply system with a non-grounded neutral point is only permitted over short time intervals that occur rarely, e.g. the time leading to a fault being eliminated (ground fault of a cable, IEC/EN 60034-1).

Note

Service Center

If you require support when electrically connecting up the machine, contact the Service Center (Page 12).

Risk of explosion by fixing elements becoming loose

If you use fixing elements made from the wrong material or apply the wrong tightening torque, this could impair current transfer or cause connecting parts to become loose. Fastening elements can work loosely, so that the minimum air clearances are no longer maintained. Sparking formation may occur, in an explosive atmosphere it can lead to an explosion. This could result in death, serious injury or material damage to the machine or even in failure, which could in turn lead to indirect material damage of the plant or system.

- Tighten the screwed connections to the specified tightening torques.
- Only use the fixing accessories provided or only the original spare parts from Siemens.
- Always carefully check the fastenings when carrying out service work.

See also

Tightening torques (Page 169)

6.1 Connecting the machine

6.1.1 Safe connection

- Carefully comply with the information provided in EN / IEC 60034-1 (VDE 0530-1) regarding operation at the limits of A and B zones, especially in respect of temperature increase and deviation of the operating data from the rated data stamped on the rating plate. Do not exceed these limits. Do not use machines in zone B that are marked for zone A.
- Connect up so that a permanently safe electrical connection is guaranteed (no protruding wire ends); use the assigned cable-end fittings (e.g. cable lugs, end sleeves). Connect up the line supply voltage and arranged the disconnecting link in accordance with the circuit diagram provided in the terminal box.
- Select the connecting cables in accordance with DIN VDE 0100 taking into account the rated current and the installation-specific conditions – e.g. ambient temperature, routing method etc. - according to DIN VDE 0298 and/or EN / IEC 60204-1.

The technical specifications stipulate the following that have to be taken into account with respect to the motor connection:

- Direction of rotation
- The number and arrangement of the terminal boxes.
- The circuit and connection of the motor winding

6.1.2 Selecting cables

Take the following criteria into account when selecting the connecting cables:

- Rated current
- Rated voltage
- If required, service factor
- System-dependent conditions, such as ambient temperature, routing type, cable cross-section as defined by required length of cable, etc.
- Configuration notes
- Requirements according to IEC/EN 60204-1
- Dimensioning for bundled cable routing, e.g. according to DIN VDE 0298 Part 4 or IEC 60364-5-52

6.1.3 Thermal protection

- Protect every explosion-protected machine according to EN / IEC 60079-14 Chapter "Rotating electrical machines".
- For machines with type of protection increased safety "eb", select the overcurrent device with current-dependent delayed trip so that the tripping time, which should be taken from the characteristic of the switch for the ratio I_A / I_N of the machine to be protected, is not longer than the safe locked rotor time (t_E). Take the ratio I_A / I_N as well as the safe locked rotor time (t_E) from the rating plate. Set the protective device to the rated current. Use a trip unit certified according to directive 2014/34/EU or the corresponding national regulations.
- For machines with increased safety "eb" type of protection, in the event of a locked rotor the protective device must disconnect within the safe locked rotor time (t_E) specified for the relevant temperature class. Protect electrical machines for heavy duty starting (acceleration time $> 1.7 \times t_E$ time) according to the specifications of the EU-type examination certificate using a function to monitor starting.
Direct monitoring of the winding temperature is permissible as a means of thermal machine protection, provided that this is certified and specified on the rating plate.
- With pole-changing machines, separate, interlocked protective devices are required for each speed step. Devices with an EU-type examination certificate are recommended.

See also

Thermal protection (Page 51)

6.1.4 Terminal box



⚠ DANGER
Hazardous voltage Electric motors have high voltages. When incorrectly handled, this can result in death or severe injury. Switch off the machine so that it is in a no-voltage condition before you open the terminal box.

NOTICE
Damage to the terminal box If you incorrectly carry out work on or in the terminal box, this can result in material damage. You must observe the following to avoid damaging the terminal box: <ul style="list-style-type: none">• Ensure that the components inside the terminal box are not damaged.• It must be ensured that there are no foreign bodies, dirt or moisture in the terminal box.• Close the terminal box using the original seal so that it is dust tight and water tight.• Use O-rings or suitable flat gaskets to seal entries in the terminal box (DIN 42925) and other open entries.• Please observe the tightening torques for cable entries and other screws.• Do not apply manual force to the terminal board. The terminal board mountings are designed for the cable sizes specified in the documentation.

See also

Tightening torques for screw and bolt connections (Page 169)

6.1.4.1 Circuit diagram inside the terminal box cover

Data on the connection and connecting the machine winding can be found in the circuit diagram in the cover of the terminal box.

6.1.4.2 Direction of rotation

The standard motors are suitable for clockwise and counter-clockwise rotation.

For defined directions of rotation (direction of rotation arrow), appropriately connect the line power cables.

- If you connect the line cables with phase sequence L1, L2, L3 at U, V, W or according to NEMA at T1 T2 T3 , then the machine rotates in the clockwise direction.
- If you interchange 2 connections, e.g. L1, L2, L3 at V, U, W or according to NEMA at T2 T1 T3, then the machine rotates counterclockwise.

	Direction of rotation	According to IEC	According to NEMA
Line feeder cables	-	L1 L2 L3	L1 L2 L3
Terminal connection	Clockwise rotation	U V W	T1 T2 T3
Terminal connection	Counter-clockwise rotation	V U W	T2 T1 T3

Direction of rotation of the motor when viewing the DE

6.1.4.3 Terminal marking

According to IEC / EN 60034-8, the following basic definitions apply to the terminal markings for 3-phase machines:

Table 6-1 Terminal markings using the 1U1-1 as an example

1	U	1	-	1	Marking
x					Code for split winding, where applicable. Special case for pole assignment for pole-changing machines. A lower index signifies a lower speed.
	x				Phase designation U, V, W
		x			Index for winding start (1) or end (2) or if there is more than one connection per winding
				x	Additional indices for cases in which it is obligatory to connect parallel power feed cables to several terminals with otherwise identical markings

6.1.4.4 Additional bores in the terminal box

Additional bores in the terminal box must be drilled by the manufacturer or by a specialist workshop for electrical machinery that has been authorized by the manufacturer.

6.1.4.5 Cable entry

Certified cable entries, thread adapters and sealing plugs

Only use sealing plugs, cable glands and conductor glands or thread adapters that are suitable, certified and marked for use in the respective explosion protection type and degree of protection (IEC / EN 60079-14) or the appropriate country regulations.

Terminal box

The number and size of the cable entry tapped holes is provided in the machine dimension drawing.

Inserting cables into the terminal box

1. Only use cable entries that are suitable for the cables.
2. Only use cable entries and cables suitable for the prevailing ambient temperature.
3. Ensure that the power cables are strain relieved when inserting them in the terminal box.
4. Carefully connect the cables and ensure a reliable protective conductor connection.
5. Tighten the glands and the elements for the strain relief with the torque specified by the manufacturer.
6. Check the cable entries and cables to ensure that they are correctly sealed and firmly seated.
7. Correctly close and seal threads or holes that are not being used ensuring that the IP degree of protection is maintained. The IP degree of protection is specified on the rating plate.

Cable entries, sealing plugs and thread adapters

All cable entries and sealing plugs must be approved for use in the respective hazardous zone.

- Any openings that are not being used must be sealed using the appropriate certified sealing plugs.
- Please observe the manufacturer's specifications when fitting cable entries.

Note the following when mounting:

- Avoid damaging the cable jacket.
- Adapt the tightening torques to the cable jacket materials.

Observe the documentation for tightening torques of the cable entries and sealing plugs for direct mounting at the machine as well as additional glands (e.g. adapters).

6.1.4.6 Protruding connection cables



⚠ WARNING

Risk of short-circuit and voltage hazard

A short circuit can occur if connecting cables are clamped and crushed between parts of the enclosure and the cover plate.

This can result in death, severe injury and material damage.

- During disassembly and particularly when installing the cover plate, make sure that the connecting cables are not clamped between enclosure parts and the cover plate.

⚠ CAUTION

Damage to connecting cables that are freely led out

You must observe the following note to avoid damaging connecting cables that are freely led out:

- It must be ensured that there are no foreign bodies, dirt, or moisture in the terminal base of the machine enclosure.
- Use O-rings or suitable flat gaskets to seal entries in cover plates (DIN 42925) and other open entries.
- Seal the terminal base of the machine enclosure using the original seal of the cover plate to prevent dust and water from entering.
- Please observe the tightening torques for cable entries and other screws.

6.1.4.7 Connecting protruding cables

In the case of connection cables brought out of the machine, no terminal board is installed on the terminal base of the machine housing. The connection cables are directly connected to stator winding terminals at the factory.

The connection cables are color-coded or labeled. The customer directly connects individual cables in the control cabinet for their system in accordance with the labeling.

6.1.4.8 Thread sizes in the terminal box

Shaft height	Threaded entry	
	Size	Quantity
63 ... 90	M16 x 1.5 M25 x 1.5	1
100 ... 132	M32 x 1.5	2
160 ... 180	M40 x 1.5	2
200 ... 225	M50 x 1.5	2
250 ... 315	M63 x 1.5	2
355	M80 x 2	2

Thread size for additional glands, e.g. PTC thermistor or anti-condensation heating M16x1.5 or M20x1.5

Deviating thread sizes are specified at the motor.

6.1.4.9 Internal equipotential bonding

The internal equipotential bonding between the grounding terminal in the terminal box, the terminal box components and the machine enclosure is ensured via metallic contact, a copper braided strip or a stranded wire.

6.1.5 Cable glands

Cable glands with (sheet metal) nuts (EN 50262)

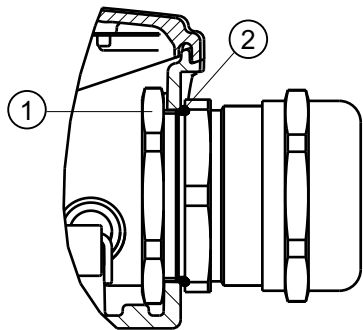

- ① Nut
- ② O ring

Cable glands with reductions and (sheet metal) nuts (EN 50262)

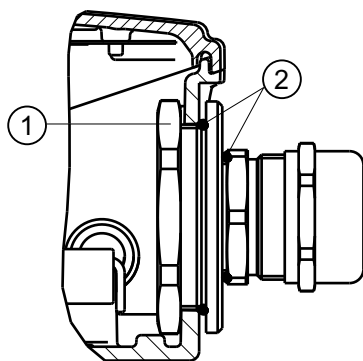

- ① Nut
- ② O ring

6.1.5.1 Mounting position of sheet metal nuts in screw-type connections

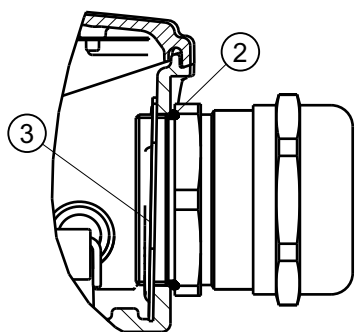

- ② O ring
- ③ Mounting position of metal-sheet nuts

Cable glands with connecting thread in the terminal box (EN 50262)

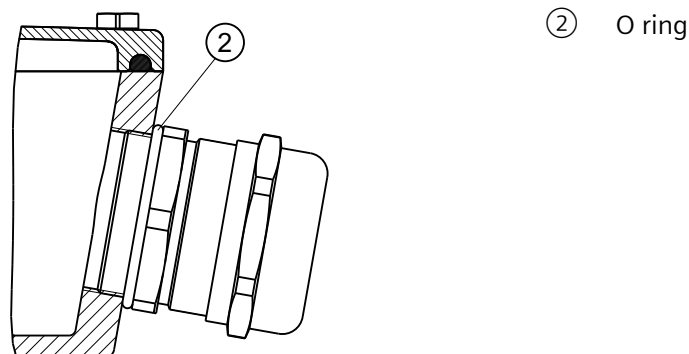

6.2 Tightening torques

Note the information in Chapter Tightening torques (Page 169).

6.3 Connecting the grounding conductor

The machine's grounding conductor cross-section must comply with EN / IEC 60034-1.

Please also observe installation regulations such as those specified in EN / IEC 60204-1.

Basically, there are two ways of connecting a grounding conductor to the machine.

- Internal grounding with a connection in terminal box at the location intended for this purpose and marked accordingly.
- External grounding with connection at the stator housing at the locations intended for this purpose and marked accordingly.

6.3.1 Minimum surface area of grounding conductor

Table 6-2 Minimum cross-sectional area of grounding conductor

Minimum cross-section of the phase conductor for installation S mm^2	Minimum cross-section of the associated grounding connection mm^2
$S \leq 25$	S
$25 < S \leq 50$	25
$S > 50$	$0.5 S$

6.3.2 Grounding connection type

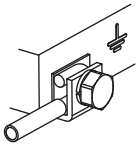
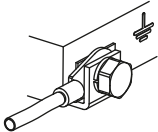
Type of enclosure grounding		Conductor cross-section mm ²
Connection of an individual conductor under the external grounding bracket.		... 10
Connection is made using a DIN cable lug under the external grounding bracket. DIN 46 234		... 25

Internal ground terminal

Comply with the following instructions when connecting up:

- Ensure that the connecting surface is bare and is protected against corrosion using a suitable substance, e.g. acid-free Vaseline.
- Arrange the spring lock washer under the screw head.
- Locate the cable lug under the clamping bracket.
- Use the terminals designated for the grounding conductor in the terminal box.
- Observe the tightening torque (Page 170) for the locking screw.

External ground terminal

Comply with the following instructions when connecting up:

- Ensure that the connecting surface is bare and is protected against corrosion using a suitable substance, e.g. acid-free Vaseline.
- Locate the cable lug between the contact bracket and the grounding bracket; do not remove the contact bracket pressed into the enclosure.
- Arrange the flat washer and spring washer under the bolt head.
- Use the marked connection location for the grounding conductor on the stator housing.
- Observe the tightening torque (Page 170) for the locking screw.

Shaft height	Thread size for the grounding conductor
63 ... 160	1 x M5
180	1 x M6
200	2 x M6

Shaft height	Thread size for the grounding conductor
225 ... 280	2 x M8
315 ... 355	2 x M12

The additional grounding point (generally on the opposite side) is optionally available.

6.4 Temperature sensor/anti-condensation heating connection



⚠ WARNING

Hazard due to electric shock

The installation of the temperature sensors for the winding monitoring with respect to the winding is implemented according to the requirements for basic insulation. The temperature sensor connections are located in terminal boxes that are safe to touch and have no protective separation. This is the reason that in the case of a fault, a hazardous voltage can be present at the measuring sensor cable. When touched, this can result in death, severe bodily injury and material damage.

- When connecting the temperature sensor to external temperature monitoring devices, when required, apply additional measures to fully comply with the requirements set out in IEC 60664-1 or IEC 61800-5-1 "Hazard due to electric shock".

6.4.1 Connecting optional integrated devices and equipment

In addition to the current-dependent overload protective device located in the connecting cables, use the optionally available integrated devices and equipment, for example, temperature sensors, anti-condensation heating.

Depending on the terminal box version, connect the auxiliary circuits to the terminal block or to the terminal board.

Terminal block connection

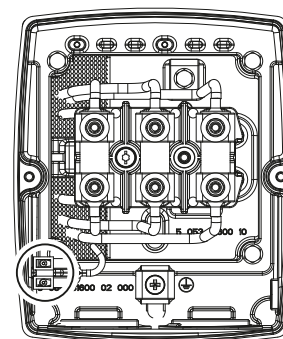
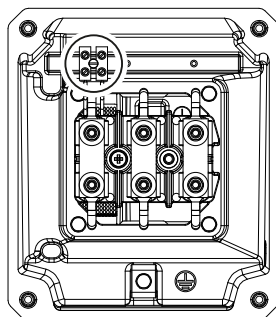

6.5 Conductor connection



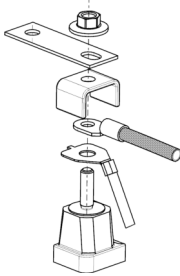
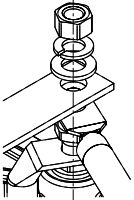
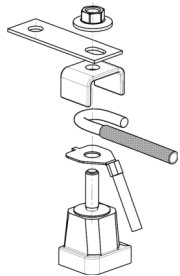

Cross-sections that can be connected depending on the size of the terminal (possibly reduced due to size of cable entries)

Table 6-3 Maximum conductor connection for explosion-protected machines

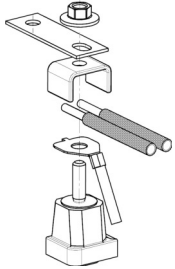
Shaft height	Max. connectable conductor cross-section mm ²
63 ... 112	4.0
132	6.0
160	16.0
180	10.0
200 ... 225	50.0
250 ... 280	120.0
315	240.0

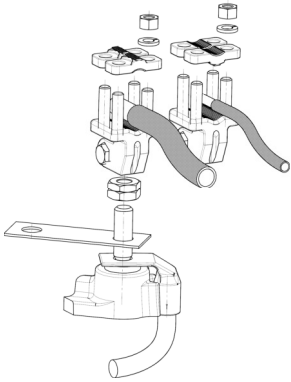
Type of connection	Terminal studs	Cable cross-section mm ²
Connection with cable lug DIN 46234 	M4	1 ... 4 1 ... 6 (shaft height 132)
	M5	1 ... 16
	M6	4 ... 35
Connection with cable lug DIN 46234 Degree of protection "tb / tc" 	M8	6 ... 35
	M10	6 ... 120
	M12	10 ... 240
	M16	25 ... 240
Connection of a single conductor 	M4	1 ... 4 1 ... 6 (shaft height 132)
	M5	1 ... 16
	M6	4 ... 35

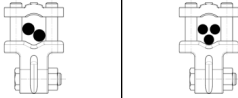
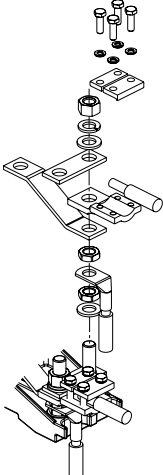
Type of connection	Terminal studs	Cable cross-section mm ²
Connecting 2 conductors with the same thickness using a terminal clamp 	M4	Not permitted
	M5	Not permitted
	M6	4 ... 35

Type of connection	Terminal studs	Cable position with terminal	Cable cross-section mm ²
	M8		2.5 ... 25
	M10		10 ... 95
	M12		25 ... 185
	M16		50 ... 300
	M10		50 ... 120
	M12		95 ... 240
	M16		120 ... 300
	M10		16 ... 35
	M12		16 ... 70
M16	16 ... 120		
	M16		25 ... 300

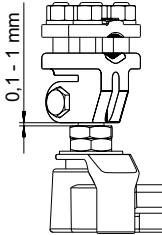
Assembly of clamping device	
	<p>M8, M10, M12, M16</p> <p>Mount the clamping devices on the terminal board at a distance of 0.1 mm ... 1 mm with respect to the lock nuts.</p>

6.5.1 Connection with/without cable lugs

In the case of terminals with terminal clamps, distribute the conductors in such a way that the clamping heights on both sides of the fillet are about the same. This method of connection requires that you must bend a single conductor in a U shape or use a cable lug. The same applies to the inner and outer terminals of the ground conductor.

When connecting up using cable lugs, select their size corresponding to the required cable cross-section and the stud size. An inclined arrangement is only permitted provided the required air clearances and creepage distances are carefully maintained.

Remove insulation from the ends of the conductors so that the remaining insulation almost reaches the cable lug.

Note

The direct contact between the cable lug surfaces and the contact nuts or contact screws ensure that the connection can conduct current.



WARNING

Short-circuit hazard

Live conductors released from the terminal board can cause short circuits. Death or serious injury can result.

- You must bend single-core line conductors into a U shape in order to prevent the contact force being transferred at just one side.
- In order to prevent the cable lug from rotating, for a line connection using a cable lug, angle single- or multi-core cables downwards through an angle of approx. 40°.

6.5.2 Cable ends with wire end sleeves

1. Preferably use end sleeves instead of soldering cable ends.
2. Before connecting, attach the end sleeves so as to form a technically correct, current-carrying crimped joint at the end of the conductor.

 **WARNING**

Risk of explosion due to excessive temperature rise

If the end of the conductor is not correctly enclosed by the end sleeve, but is trapped by it, this can lead to overheating. The temperature class of the machine can be exceeded. This can trigger ignition of an explosive mixture. This can result in death, serious injury or material damage.

- Insert only one conductor end into each end sleeve. Attach the end sleeve correctly.

6.5.3 Connecting aluminum conductors

If you are using aluminum conductors, then comply with the following:

- Use only cable lugs that are suitable for connecting aluminum conductors.
- Immediately before inserting the aluminum conductor, remove the oxide layer from the contact areas on the conductor and/or the mating piece. Do this using a brush or file.
- Then grease the contact areas immediately using neutral Vaseline. This prevents a new oxide layer from forming.

NOTICE

Aluminum flow due to contact pressure

Aluminum flows following installation due to the contact pressure. The connection using clamping nuts can loosen as a result. The contact resistance increases, obstructing the current from being conducted. This can result in fire and material damage to the machine – or even in total failure, as well as material damage to the plant or system due to machine failure.

- Retighten the clamping nuts after approximately 24 hours and then again after approximately 4 weeks. Make sure that the terminals are de-energized before you tighten the nuts.

6.5.4 Minimum air clearances

After proper installation, verify that the minimum air clearances between non-insulated parts are maintained. Be aware of any protruding wire ends.

Table 6-4 Minimum air clearance dependent on rms value of the alternating voltage U_{rms}

Rms value of the alternating voltage U_{rms}	Minimum air clearance mm		
	Ex tc Ex tb	Ex nA Ex ec	Ex e Ex eb
≤ 250 V	3.0	2.5	5.0
≤ 500 V	3.0	5.0	8.0
≤ 630 V	5.5	5.5	10.0
≤ 1000 V	8.0	8.0	14.0

Values apply at an installation altitude of up to 2000 m.

When determining the required minimum air clearance, the voltage value in the table may be increased by a factor of 1.1, so that the rated input voltage range is taken into account during general use.

6.6 Connecting the converter

NOTICE

Material damage caused by an excessively high supply voltage

Material damage can occur if the supply voltage is too high for the insulation system.

- Observe the values in the following tables.

SIMOTICS machines can be operated with SINAMICS converters (uncontrolled and controlled infeed) when maintaining the permissible voltage peaks.

The insulation system of SIMOTICS machines corresponds to the specifications laid down in IEC 60034-18-41 according to voltage stress category C (IVIC C = high stress).

Table 6-5 Maximum voltage peaks at the motor terminals for line (DOL) motors, converter operation possible

Rated motor voltage V	Maximum peak voltage at the motor terminals		
	$\hat{U}_{\text{phase-to-phase}}$ V_{pk}	$\hat{U}_{\text{phase-to-ground}}$ V_{pk}	DC link U_{DC} V
≤ 500 V	1500	1100	750

Table 6-6 Maximum voltage peaks at the motor terminals for motors specifically designed for converter operation

Rated motor voltage V	Maximum peak voltage at the motor terminals		
	$\hat{U}_{\text{phase-to-phase}}$ V_{pk}	$\hat{U}_{\text{phase-to-ground}}$ V_{pk}	DC link U_{DC} V

≤ 500 V	1600	1400	750
> 500 V to 690 V	2200	1500	1080

Depending on the step height, the voltage rise times for the individual voltage steps in the line-to-ground voltage at the motor end of the cable must not fall below the following values.

Table 6-7 Rise times as a function of voltage level

Step height V	Minimum rise time t_r ns
900	100
1050	200
1260	400

 **WARNING**

Machine overheating

Operating explosion-protected machines at the converter without using the appropriate protective equipment can result in death or severe injury.

Always use PTC thermistor monitoring when operating explosion-protected machines at the converter. Trip units according to Directive 2014/34/EU ("Explosion Protection Directive") or according to country regulations are always necessary when using PTC thermistor monitoring.

Machines with non-sparking "ec" "nA" type of protection

Operating explosion-proof machines with a converter is permitted, when the specifications for the speed control range and torque characteristic are observed, and if winding temperature monitoring is ensured via the integrated temperature sensors in conjunction with a certified trip unit.

Machines with increased safety "e" or "eb" type of protection

Converter operation for these machines must be expressly certified. Observe the specific manufacturer's information and instructions. Converter and protective devices must be marked as belonging together and the permitted operating data must be defined in the common certificate, e.g. EU-type examination certificate, IECEx certificate of conformity or country-specific certificate.

Machines with type of protection, dust explosion protection "tb" or dust explosion protection "tc"

These machines are generally equipped with 3 PTC thermistors in accordance with DIN VDE V 0898-1-401, with a rated response temperature that depends on the maximum possible surface temperature. Select the PTC thermistors in accordance with this standard. If the temperature of the cable glands is not stamped on the rating plate, then it is max. 70 °C. Use suitable cables for this temperature. Do not exceed the maximum frequency dependent on the number of poles, which is stamped on the rating plate.

System, converter - cable - electrical machine

Carefully comply with the information and data provided in EN/IEC 60034-17 and EN/IEC 60034-25 regarding winding stress. For line supplies with operating voltages up to 690 V, the maximum value of the voltage peaks at the end of the cable must not exceed twice the value of the converter's DC-link voltage.

See also

Thermal protection (Page 51)

6.7 Final checks

Before closing the terminal box/terminal base of the machine enclosure, check the following:

- Establish the electrical connections in the terminal box in accordance with the information in this documentation.
- Maintain the air clearances between non-insulated parts as described in Chapter Minimum air clearances. (Page 92)
- Avoid protruding wire ends.
- In order not to damage the cable insulation, freely arrange the connecting cables.
- Connect the machine corresponding to the specified direction of rotation.
- Keep the inside of the terminal box clean and free from trimmed-off ends of wire.
- Ensure that all seals and sealing surfaces are undamaged and clean.
- Correctly and professionally close unused openings in the terminal boxes. Observe the information in this documentation.
- Observe the information on torques in this documentation.

See also

Tightening torques for screw and bolt connections (Page 169)

Commissioning

Comply with the following when carrying out any work on the machine:

- Comply with the general safety instructions (Page 15).
- Comply with the applicable national and sector-specific regulations.
- When using the motor within the European Union, comply with the specifications laid down in EN 50110-1 regarding safe operation of electrical equipment.
- Before commissioning, carefully observe the requirements laid down in Standard IEC / EN 60079-14 or IEC / EN 60079-17 or according to the corresponding country regulations.

Note**Service Center**

Please contact the Service Center (Page 12) if you require commissioning support.

7.1 Measures before commissioning

The following list of checks to be performed prior to commissioning does not claim to be complete. It may be necessary to perform additional checks and tests according to the specific plant or system.

Once the system has been correctly installed, check the following prior to commissioning:

- The machine is undamaged.
- The machine has been properly installed and aligned.
- The output transmission elements are set correctly for their type, e.g. alignment and balancing of couplings, belt forces in the case of a belt drive, tooth forces and tooth-flank backlash in the case of geared output, radial and axial clearance in the case of coupled shafts.
- All fixing screws, connection elements, and electrical connections have been tightened to the specified tightening torques.
- The operating conditions match the data provided in accordance with the technical documentation, such as degree of protection, ambient temperature, etc.
- Moving parts, for example the coupling, move freely.
- All touch protection measures for both moving and live parts have been implemented.
- Screwed-in lifting eyes are removed after installation or secured to prevent them from becoming loose.

See also

Tightening torques for screw and bolt connections (Page 169)

Second shaft end

If the second shaft end is not used:

- Carefully secure the feather key to prevent it from being thrown out, and for balancing type "H" (standard type), ensure its weight is reduced to approximately 60 % of the original value.
- Using covers, carefully secure the unused shaft end so that it cannot be touched.

Risk of losing the IP degree of protection as a result of damaged shaft sealing rings

This can result in death, serious injury, or material damage.

- Replace damaged components immediately.
- Rotate the rotor to ensure that it does not touch the stator.
- Ensure that the bearing insulation is not bridged/jumpered.
- Using the appropriately designed and adjusted control and speed monitoring functions, ensure that the permissible speeds specified on the rating plate cannot be exceeded.
- Ensure that any supplementary equipment used to monitor the motor is correctly connected and is functioning.

Electrical connection

- Carefully check the grounding and potential bonding connections.
- Connect the machine corresponding to the specified direction of rotation.
- Using the appropriate open-loop control and speed monitoring functions, carefully ensure that no higher speeds can be achieved than are permitted and specified in the technical data. For this purpose, compare the data on the rating plate or, if necessary, the system-specific documentation.
- Comply with the minimum insulation resistances.
- Comply with the minimum air clearances.
- Correctly connect possibly available machine monitoring devices and equipment - and carefully ensure that they are functioning correctly.
- Check the correct functioning of the brakes or backstops.
- Set the values for "Alarm" and "Shutdown" at the monitoring devices.
- Carefully ensure that temperature-sensitive parts and components, e.g. cables are not in contact with the machine enclosure.

Converter operation

- If the motor design requires connection to a specific converter type, carefully check the supplementary data on the rating plate/supplementary plate.
- Ensure that the converter is correctly parameterized. Depending on the design, you will find some parameterization data on the rating plate of the machine. Further information is provided in the converter documentation. Contact the Service Center (Page 12) if required.

- Check that the supplementary equipment and devices to monitor the machine are correctly connected and are functioning correctly.
- In continuous operation, carefully ensure that the motor cannot exceed the specified upper speed limit n_{\max} or fall below the lower speed limit n_{\min} .
The permissible acceleration time to the limit speed n_{\min} depends on the parameter assignment.

7.1.1 Insulation resistance and polarization index

Measuring the insulation resistance and polarization index (PI) provides information on the condition of the machine. It is therefore important to check the insulation resistance and the polarization index at the following times:

- Before starting up a machine for the first time
- After an extended period in storage or downtime
- Within the scope of maintenance work

The following information is provided regarding the state of the winding insulation:

- Is the winding head insulation conductively contaminated?
- Has the winding insulation absorbed moisture?

From this, you can determine whether the machine needs commissioning or any necessary measures such as cleaning and/or drying the winding:

- Can the machine be put into operation?
- Must the windings be cleaned or dried?

Detailed information on testing and the limit values can be found here:

"Testing the insulation resistance and polarization index" (Page 64)

7.1.2 Checking the machine cooling

Cooling

- Carefully check that it is guaranteed that the machine is cooled when it is being commissioned.

See also

Preparing for use (Page 41)

7.1.3 Commissioning the separately driven fan

The separately driven fan ensures that the main machine is cooled irrespective of the main machine speed or direction of rotation. The separately driven fan is only suitable for one direction of rotation.

Checks before the first test run

Before the first test run, carry out the following checks:

- The separately driven fan is correctly fitted and aligned.
- The rotor runs freely.
- All of the retaining elements and electrical connections are securely tightened.
- The grounding and equipotential bonding connections to the mains have been correctly made.
- The air flow is not impeded or shut off by flaps, covers or similar.
- If the cooling air is in open circulation, it has only weak, chemically abrasive properties and a low dust content.
- All protection measures have been taken to prevent accidental contact with moving or live parts.

Performing the test run

1. Switch the separately driven fan motor on and off briefly.
2. Compare the direction of rotation of the separately driven fan with the specified direction of rotation. The direction of rotation of the separately driven fan is indicated with an arrow on the fan cover specifying the direction of rotation or with a terminal designation on the rating plate of the separately driven fan unit.
Depending on the version, the fan impeller is visible through the air inlet opening in the fan cover on the separately driven fan motor.
3. If the direction of rotation is incorrect, then interchange 2 phase conductors in the separately driven fan motor terminal box.

Note

Use these operating instructions for motors with external fans.

7.1.4 Further documents

Note

Further documents

Observe all of the other documents provided with this machine.

7.2 Setpoint values for monitoring the bearing temperature

Prior to commissioning

If the machine is equipped with bearing thermometers, set the temperature value for disconnection on the monitoring equipment before the first machine run.

Table 7-1 Set values for monitoring the bearing temperatures before commissioning

Set value	Temperature
Alarm	115 °C
Shutting down	120 °C

Normal operation

Determine the maximum operating temperature of the bearings $T_{\text{operation}}$ taking into account the temperature, bearing load and influences of the plant on the motor in °C. Set the values for shutdown and warning corresponding to the operating temperature T_{op} .

Table 7-2 Set values for monitoring the bearing temperatures

Set value	Temperature
Alarm	$T_{\text{operation}} + 5 \text{ K} \leq 115 \text{ °C}$
Shutting down	$T_{\text{operation}} + 10 \text{ K} \leq 120 \text{ °C}$

7.3 Switching on

Measures for start-up

After installation or inspections, the following measures are recommended for normal start-up of the machines:

- Start the machine without a load. To do this, close the circuit breaker and do not switch off prematurely. Switching the machine off again while it is starting and still running at slow speed should only be done to the extent necessary, for example for checking the direction of rotation or for checking in general. Allow the machine to run down before switching it on again.
- Check mechanical operation for noise or vibration at the bearings or end shields.
- If the machine is not running smoothly or is emitting abnormal noises, switch it off, and determine the cause of the fault as it runs down.
- If mechanical operation improves immediately after the machine is switched off, then the cause is magnetic or electrical, e.g. voltage imbalance, magnetic imbalance. If mechanical operation does not improve immediately after switching the machine off, then the cause is mechanical, e.g. an imbalance in the electrical machines or in the driven machine, inadequate alignment of the machine set, operation of the machine with the system resonating (system = machine + base frame + foundations etc.).

- If the machine runs perfectly in terms of its mechanical operation, switch on any cooling devices present and continue to monitor the machine for a while as it idles.
- If it runs perfectly, connect a load. Check that it runs smoothly.
Read off and document the values for voltage, current, and power.
Where possible, read off corresponding values for the driven machine and document them as well.
- Monitor the bearing temperature, winding temperature, etc. until the system reaches a steady state.
Document these, provided this is possible with existing measuring instruments.

NOTICE

Destruction of the machine

The machine can be destroyed if the vibration values are not strictly complied with.

- In operation, maintain vibration values in accordance with DIN ISO 10816-3.
-
- Start the machine without a load; to do this, close the motor starter protector and do not switch the machine off prematurely.
 - You should limit how often you switch the machine off while it is starting up and still running at a slow speed, for checking the direction of rotation or the required dimensions, for example.
 - Allow machines to reach a standstill before switching them back on.

7.3.1 Test run

After installation or inspection, carry out a test run:

1. Start the machine without a load. To do this, close the circuit breaker and do not switch off prematurely. Check whether it is running smoothly.
Switching the machine off again while it is starting and still running at slow speed should only be done to the extent necessary, for example for checking the direction of rotation or for checking in general.
Allow the machine to run down before switching it on again.
2. If the machine is running smoothly and evenly, switch on the cooling equipment. Continue to observe the machine for a while in no-load operation.

3. If it runs perfectly, connect a load.

NOTICE

Thermal overload of motors connected directly to the line supply

In addition to the load torque, the ramp-up (accelerating) time is essentially influenced by the moment of inertia to be accelerated. While ramping up when connected to the line supply, the inrush (starting) current is a multiple of the rated current. This can result in thermal overload. This can damage the motor.

As a consequence, when ramping up, observe the following:

- Monitor the ramp-up time and number of consecutive starts.
- Comply with the limit values and/or ramp-up conditions specified in the catalog or the order documentation.

4. During the test run, check and document the following:
 - Check whether it is running smoothly.
 - Document the voltage, current and power values. As far as possible, document the corresponding values of the driven machine.
 - If this is possible using the available measuring equipment, check the bearing and stator winding temperatures until they have reached steady-state values.
 - Check mechanical operation for noise or vibration at the bearings or end shields.
5. In case of uneven running or abnormal noise, switch off the machine. As the machine runs down, identify the cause.
 - If the mechanical operation improves immediately after the machine is switched off, then the cause is magnetic or electrical.
 - If the mechanical running does not improve immediately after switching the machine off, then the cause is mechanical.
 - Imbalance of the electrical machine or the driven machine
 - The machine set has not been adequately aligned
 - The machine is being operated at the system resonance point. System = motor, base frame, foundation, ...

NOTICE

Destruction of the machine

If the vibration values in operation are not maintained in accordance with ISO 10816-3, then the machine can be mechanically destroyed.

- In operation, maintain vibration values in accordance with ISO 10816-3.

Operation

Comply with the following when carrying out any work on the machine:

- Comply with the general safety instructions (Page 15).
- Comply with the applicable national and sector-specific regulations.
- When using the motor within the European Union, comply with the specifications laid down in EN 50110-1 regarding safe operation of electrical equipment.

8.1 Safety instructions for operation

Hazardous voltages at the machine

Electrical machines have hazardous voltage levels. Contact with these can result in death, serious injury or material damage.

Operating the machine on a line supply system with a non-grounded neutral point is only permissible for short periods of time that occur rarely, e.g. the time leading to a fault being eliminated. Cable ground fault EN / IEC 60034-1.

Risk of injury due to rotating parts

Rotating parts are dangerous. Touch protection against rotating parts is no longer guaranteed if covers are removed. Touching rotating parts can cause sparking with subsequent ignition of an explosive atmosphere resulting in death, serious injury or material damage.

- Carefully ensure that all of the covers are closed while operational.
- First switch off and disconnect the machine if you must remove covers. Carefully comply with the "5 safety rules (Page 16)".
- Only remove the covers when the rotating parts have come to a complete standstill.

Danger as a result of stationary parts under voltage (live parts)

Live parts represent a hazard. Touch protection against active (live) parts is no longer guaranteed if covers are removed. The minimum air and creepage distances may be fallen below (violated) when coming close to active parts. Touching or coming close can result in death, serious injury or material damage.

- Carefully ensure that all of the covers are closed while operational.
- First switch off and disconnect the machine if you must remove covers. Carefully comply with the "5 safety rules" (Page 16).
- In operation, the terminal box must always be kept closed. It is only permissible to open the terminal box when the motor is stationary and in a no voltage condition.

Faults in operation

Any changes with respect to the normal condition can indicate that the machine is not functioning correctly.

- Higher power consumption, temperatures or vibration levels.
- Unusual noise or smells.
- Monitoring devices respond.

These changes can cause faults which can result in eventual or immediate death, serious injury or material damage.

- Immediately inform the service personnel.
- If you are in doubt, immediately switch off the machine, carefully observing the system-specific safety conditions.

Corrosion damage as a result of condensation

Humidity can condense inside the machine if the machine and/or ambient temperatures fluctuate, for intermittent operation or load fluctuations.

Condensation can accumulate. Moisture can have a negative impact on the winding insulation or result in damage, such as corrosion.

- Ensure that any condensation can freely flow away.
- If available, remove the screw plugs to drain the water depending on the ambient and operating conditions.
- If available, reinsert the screw plugs.

If the motor is equipped with drain plugs, then the water can drain away by itself.

Risk of burn injuries as a result of hot surfaces

Individual machine parts can become hot in operation. Burns can result when coming into contact with these parts.

- Never touch machine parts during operation.
- Allow the machine to cool down before starting work.
- Check the temperature of parts before touching them. If required, wear suitable protective equipment.

Hazardous substances

Chemical substances required for the setup, operation and maintenance of machines can present a health risk. Poisoning, skin damage, cauterization of the respiratory tract, and other health damage may result.

- Carefully comply with the information in these operating instructions and the product information supplied by the manufacturer.
- Observe the relevant safety regulations and wear the personal protective equipment specified.

Substances that can be easily ignited and are flammable

Chemical substances required for the setup, operation and maintenance of machines may be flammable. Burns and other damage to health and material may result.

- Carefully comply with the information in these operating instructions and the product information supplied by the manufacturer.
- Observe the relevant safety regulations and wear the personal protective equipment specified.

Risk of explosion if the permissible axial and radial forces are exceeded

- Carefully comply with the permissible values for axial and radial forces (Page 31).
- For cylindrical rolling bearings, carefully comply with the minimum radial load levels.
- In operation, comply with the permissible vibration values in accordance with ISO 10816-3.

Risk of explosion as a result of premature bearing failure

- Use insulated bearings if bearing currents occur. Carefully comply with the information in Chapter Converter operation (Page 55)
- Carefully comply with the specified grease change intervals, relubrication intervals and oil change intervals.

Explosion hazard if the bridging is removed from the insulated bearing

Removing the factory-fitted bridging of the insulated bearing leads to potential differences between the rotor and the grounded motor. This can cause the generation of sparks, which especially in an explosive atmosphere can ignite surrounding dust or combustible gases. Explosions can occur. There is also a risk of an electric shock. Death, serious injury, or material damage will result.

- Do not open the bridging of the bearing insulation during operation.

Overheating as a result of the anti-condensation heating

If the anti-condensation heating is operated while the machine is operational, this can increase the temperatures inside the machine and cause material damage.

- Install an interlock circuit that switches off the anti-condensation heating once the main machine is switched on.
- Only switch on the anti-condensation heating after the motor has been switched off. Comply with the data stamped on the plate of the anti-condensation heating, if available.

Explosion hazard from hybrid mixtures

Hybrid mixtures are mixtures of flammable dusts with explosive gas/air atmospheres which can together create a dangerous explosive atmosphere if they occur at the same time. Changes can arise in the safety performance characteristics here, such as a change in the zonal classification, increase in the explosion pressure, reduction in the minimum ignition energy and a reduction in the maximum temperatures to be complied with.

An explosion can occur. This can result in death, serious injury or material damage.

- For this reason, the relative characteristics must be considered both for gas (zones 0, 1 and 2) and for dust (zones 20, 21 and 22) where hybrid mixtures arise. It is necessary for a competent assessor to determine in the individual case whether the parameters determining ignition are unfavorably affected in a particular hybrid mixture.
- Motors with dual plates for G ("Gas") and D ("Dust") may only be used where these two occur after prior examination of the properties of the hybrid mixtures by the user.
- These explosion-protected machines are not suitable for hybrid explosive environments. Use in atmospheres where there is a risk of explosion caused by both gas and dust simultaneously is absolutely prohibited.

Risk of explosion when used in the incorrect zone

Only install machines with type of protection increased safety "e" or "eb" and machines "nA" or "ec" in hazardous zones, carefully complying with the regulations laid down by the responsible regulatory body. The responsible regulatory body is responsible for determining the level of explosion hazard (classifying zones).

Risk of explosion when the operating mode is not complied with

If there are no other specifications in the EU-type examination certificate or on the rating plate regarding operating mode and tolerance, electrical machines are designed for continuous duty and normal starting procedures that are performed infrequently and do not result in an excessive temperature rise. Only use these machines for the operating mode specified on the rating plate.

See also

Thermal protection (Page 51)

Explosion hazard due to overheating of the machine caused by a layer of dust

Deposits of dust have a thermal insulation effect, which can lead to the machine overheating. The maximum surface temperature of the machine cannot be adhered to. The dust can ignite, resulting in an explosion. This can result in death, serious injury or material damage.

- Dust the machine regularly.
- Do not allow dust layers thicker than 5 mm to build up on the machine surface.
- Do not switch the machine on until the dust has been removed.

Risk of explosion due to excessive bearing temperature

The surface temperature cannot be maintained within maximum permissible limits if the bearing becomes too hot. The dust can ignite, resulting in an explosion. This can result in death, serious injury or material damage.

- Monitor the bearing temperature (Page 99).
- In addition to the current-dependent overload protection system located in the three phases of the connecting cable, we recommend that you also monitor the temperature rise in the machine using temperature sensors integrated in the stator winding.

Risk of explosion due to static charging

If you clean the motor, plastic components may become statically charged and ignite a potentially explosive atmosphere. An explosion can occur. This can result in death, serious injury or material damage.

- When cleaning, ensure that there is **absolutely no** explosive atmosphere present.
- Clean the plastic parts and components so that **absolutely no** static charging occurs
- Do **not** use compressed air for cleaning.

8.1.1 Safety instructions relating to ventilation and cooling

8.1.1.1 Forced ventilation (optional): Cooling method IC 416 in accordance with EN / IEC 60034-6

Explosion hazard if the temperature class is exceeded

If a force-ventilated machine is operated without a separately driven fan, the temperature class or the maximum surface temperature of the machine can be exceeded.

In an explosive atmosphere, there is a risk of an explosion. This can result in death, serious injury or material damage.

- Install an interlock circuit that prevents the machine from being switched on if the separately driven fan is not switched on/is not operational.
- Do not commission the machine without a separately driven fan.
- Always use PTC thermistor monitoring when operating force-ventilated machines with a converter. Trip units according to Directive 2014/34/EU ("Explosion Protection Directive") or according to country regulations are always necessary when using PTC thermistor monitoring.

 **CAUTION**

Risk of injury when touching the fan

There is a risk of injury at machines equipped with a fan cover (e.g. on machines in the textile industry), as the fan is not completely touch protected.

- Do not touch the rotating fan.
- Do not put your fingers into the larger air discharge openings.
- Prevent manual intervention by using suitable measures, e.g. appropriate housings or a protective grating.

8.1.2 Switching on with the anti-condensation heating active

Excessively high machine temperature when the anti-condensation heating is switched on

If the anti-condensation heating is operated while the machine is running, this can increase the temperatures inside the machine. Material damage can result.

- Switch off the anti-condensation heating before switching on the machine.
- Only operate anti-condensation heating when the machine is switched off.

 **WARNING**

Explosion hazard

If the anti-condensation heating is switched on during operation, the temperature class or the maximum surface temperature of the machine can be exceeded.

In an explosive atmosphere, there is a risk of an explosion. This can result in death, serious injury or material damage.

- Only switch on the anti-condensation heating after the motor has been switched-off.
Comply with the data stamped on the plate of the anti-condensation heating, if available.

8.2 Switching on the machine

1. Operate the machine without a load and check that it is running smoothly.
2. If it runs perfectly, connect a load.

NOTICE

Thermal overload of motors connected directly to the line supply

In addition to the load torque, the ramp-up (accelerating) time is essentially influenced by the moment of inertia to be accelerated. While ramping up when connected to the line supply, the inrush (starting) current is a multiple of the rated current. This can result in thermal overload. This can damage the motor.

As a consequence, when ramping up, observe the following:

- Monitor the ramp-up time and number of consecutive starts.
- Comply with the limit values and/or ramp-up conditions specified in the catalog or the order documentation.

3. Check the bearing temperature and the stator winding temperature if this is possible using the available measuring equipment.

8.3 Switch off the separately driven fan

Do not immediately switch off the separately-driven fan after switching off the machine. First wait for the machine to cool down. This will prevent the accumulation of residual heat.

8.4 Switching on again after an EMERGENCY OFF

- After an EMERGENCY OFF, check the machine before recommissioning the driven machine.
- Eliminate all the causes that led to the EMERGENCY OFF

8.5 Stoppages

The stoppage is a shutdown for a period of time, during which the machine is stopped but remains at the location of use.

Under normal ambient conditions, e.g. the stationary machine is not exposed to any external vibration, no increased level of corrosion, ... then the following measures are required.

Longer non-operational periods

- For longer non-operational periods (> 1 month), either operate the machine or at least turn the rotor regularly, approximately once per month.
- If attached, remove the rotor shipping brace before you turn the rotor.
- Carefully comply with the information in Section "Switching on" before switching on to recommission the motor.

NOTICE
Restricted motor function
If not used for longer periods of time, material damage or complete motor failure can occur. If the motor is out of service for a period of more than 12 months, then environmental effects can damage the motor.
<ul style="list-style-type: none">• Apply suitable corrosion protection, preservation, packaging and drying measures.

Switching on the anti-condensation heating, if available

Only switch on the anti-condensation heating after the motor has been switched off. Comply with the data stamped on the plate of the anti-condensation heating, if available.

Taking the machine out of service

Detailed information on how to take the machine out of service is provided in Chapter Preparing for use (Page 41).

Lubricating before recommissioning

NOTICE
Dry running bearings
Bearings can be damaged if they do not have sufficient grease.
<ul style="list-style-type: none">• Re-grease the bearings if they have been out of service for more than one year. The shaft must rotate so that the grease can be distributed in the bearings. Follow the instructions on the lubricant plate.• More information can be found in Chapter Installing rolling bearings (Page 131).

 WARNING
Explosion hazard
If the anti-condensation heating is switched on directly after the machine is switched off, the temperature class or the maximum surface temperature of the machine can be exceeded.
In an explosive atmosphere, there is a risk of an explosion. This can result in death, serious injury or material damage.
<ul style="list-style-type: none">• Only switch on the anti-condensation heating after the motor has been switched off. Comply with the data stamped on the plate of the anti-condensation heating, if available.

8.5.1 Avoidance of damage to rolling bearings during stoppages

Extended stoppages at the identical or almost identical resting position of the rotor in the rolling bearings can result in damage, such as brinelling or corrosion.

- During stoppages, regularly start up the machine for a brief period once a month. As a minimum, turn the rotor several times.
If you have uncoupled the machine from the driven machine and secured the rotor with a rotor shipping brace, then remove this before turning the rotor over or starting up the machine.
Make sure that the resting position of the rotor after the rotor has been turned over is different from its previous position. Use the fitted key or the coupling halves as reference markers.
- When recommissioning, carefully comply with the information in Chapter "Commissioning (Page 95)".

8.5.2 Decommissioning the machine

- Record the decommissioning steps. This log will be useful upon recommissioning.
- If the machine is going to be out of service for longer than six months, then take the necessary measures for preservation and storage. Otherwise, the machine could be damaged as a result of not being operated.

8.5.3 Re-commissioning the machine

When you re-commission the machine, proceed as follows:

- Study the record made when the machine was decommissioned, and reverse the measures that were taken for conservation and storage.
- Perform the measures listed in Chapter "Commissioning (Page 95)".

8.6 faults

8.6.1 Inspections in the event of faults

Natural disasters or unusual operating conditions, such as overloading or short circuit, are faults that overload the machine electrically or mechanically.

Immediately perform an inspection after such faults.

Correct the cause of the fault as described in the respective remedial measures section. Repair any damage to the machine.

8.6.2 Electrical faults

Note

If you are operating the motor with a converter, the operating instructions of the converter must also be observed if electrical faults occur.

Table 8-1 Electrical faults

↓ Motor fails to start							
↓ Motor accelerates sluggishly							
↓ Rumbling noise during startup							
↓ Rumbling noise during operation							
↓ High temperature rise during no-load operation							
↓ High temperature rise with load							
↓ High temperature rise of individual winding sections							
						Possible causes of faults	Remedial measures
X	X		X		X	Overload	Reduce the load.
X						Interrupted phase in the supply cable	Check the switches and cables.
	X	X	X		X	Interrupted phase in the feeder cable after switching on	Check the switches and cables.
	X					Mains voltage too low, frequency too high	Check the power supply conditions.
				X		Mains voltage too high, frequency too low	Check the power supply conditions.
X	X	X	X		X	Stator winding incorrectly connected	Check the winding connection in the terminal box.
	X	X	X		X	Winding short circuit or phase short circuit in stator winding	Determine the winding resistances and insulation resistances. Carry out repair work after consultation with the manufacturer.
					X	Incorrect direction of rotation	Check the connection.

8.6.3 Mechanical faults

Table 8-2 Mechanical faults

↓ Grinding noise				
↓ Radial vibrations				
↓ Axial vibrations				
		Possible causes of faults	Remedial measures	
X		Rotating parts grind	Establish the cause and realign the parts.	
	X	Rotor or coupling not balanced.	Disconnect the rotor or coupling and rebalance. If the machine has two shaft ends, and a transmission element is only fitted to one end, secure the fitted key at the other end to prevent it from being thrown out. If the rotor has balance type "H" (standard type), the fitted key must be cut back to roughly half of its length.	
	X	Rotor out of round, shaft bent	Consult the manufacturing plant.	
	X	X	Poor alignment	Align the machine set; check the coupling. ⁽¹⁾
	X		Coupled machine not balanced	Rebalance the coupled machine.
		X	Shocks from coupled machine	Investigate the coupled machine.
	X	X	Uneven running of gear unit	Fix the gearing.
	X	X	Resonance of the overall system comprising motor and foundation	Stabilize the foundation following consultation.
	X	X	Changes in foundation	Establish the cause of the changes and eliminate them if necessary; realign the machine.

⁽¹⁾ Take any changes into account when warming up the machine.

8.6.4 Rolling bearing faults

Damage to rolling bearings can be difficult to detect in some cases. If in doubt, replace the rolling bearing. Use other bearing designs only **after consulting the manufacturer**.

Table 8-3 Rolling bearing faults

↓ Bearing overheats				
↓ Bearing "whistles"				
↓ Bearing "knocks"				
		Possible causes of faults	Remedial measures	
X		High coupling pressure	Align the machine more accurately.	
X		Belt tension too high	Reduce the drive belt tension.	
X		Bearing contaminated	Clean or replace the bearing. Check the seals.	
X		High ambient temperature	Use a suitable high-temperature grease.	
X	X	Insufficient lubrication	Grease the bearings as instructed.	
X	X	Bearing canted	Contact the service center.	
X	X	Insufficient bearing play	Contact the service center.	
		X	Excessive bearing play	Contact the service center.
X	X	Bearing corroded	Replace the bearing. Check the seals.	

8.7 Deactivating

X		Too much grease in bearing	Remove surplus grease.
X		Wrong grease in the bearing	Use the correct grease.
	X	Friction marks on raceway	Replace the bearing.
	X	Brinelling or scoring	Replace the bearing. Avoid any vibration at standstill

8.6.5 Faults at the external fan

The following table shows the possible causes of and remedial measures for faults on forced-ventilated machines.

Table 8-4 Cooling system faults

↓ High temperature rise with load		
	Possible causes of faults	Remedial measures
X	Wrong direction of rotation of the separately driven fan	Check the electrical connections to the separately driven fan.
X	Separately driven fan is not running	Check the separately driven fan and its connections.
X	Reduced air flow	Check the air ducts; clean the machine.

8.7 Deactivating

Commission any devices provided for protection against condensation after switching off the machine.

Maintenance

9.1 General

Through careful and regular maintenance, inspections and overhauls, you can detect faults at an early stage and resolve them. This means that you can avoid consequential damage.

Operating situations and characteristics can vary widely. For this reason, only general maintenance intervals can be specified here. Maintenance intervals should therefore be scheduled to suit the local conditions (dirt, starting frequency, load, etc.).

Comply with the following when carrying out any work on the machine:

- Comply with the general safety instructions (Page 12).
- Comply with the applicable national and sector-specific regulations.
- When using the motor within the European Union, comply with the specifications laid down in EN 50110-1 regarding safe operation of electrical equipment.

Carefully comply with the IEC / EN 6007917 standard or according to the appropriate country regulations when carrying out all service and maintenance work on the machine.

When making changes or repairs to listed machines, maintain the corresponding design standards! These machines are labeled on the rating plate with the following markings.



UKCA marking
Great Britain (England, Wales and Scotland)



Customs union Eurasia
Eurasian customs union



Explosion-protected



China Compulsory Certification

Note

Please contact the service center (Page 12), if you require support with service, maintenance or repair.

9.2 Inspection and maintenance

9.2.1 Safety instructions for inspection and maintenance

Explosion hazard due to overheating of the machine caused by a layer of dust

Deposits of dust have a thermal insulation effect, which can lead to the machine overheating. The maximum surface temperature of the machine cannot be adhered to. The dust can ignite, resulting in an explosion. This can result in death, serious injury or material damage.

- Dust the machine regularly.
- Do not allow dust layers thicker than 5 mm to build up on the machine surface.
- Do not switch the machine on until the dust has been removed.

Risk of explosion due to excessive bearing temperature

The surface temperature cannot be maintained within maximum permissible limits if the bearing becomes too hot. The dust can ignite, resulting in an explosion. This can result in death, serious injury or material damage.

- Monitor the bearing temperature (Page 99).
- In addition to the current-dependent overload protection system located in the three phases of the connecting cable, we recommend that you also monitor the temperature rise in the machine using temperature sensors integrated in the stator winding.

Risk of explosion if the permissible axial and radial forces are exceeded

- Carefully comply with the permissible values for axial and radial forces (Page 31).
- For cylindrical rolling bearings, carefully comply with the minimum radial load levels.
- In operation, comply with the permissible vibration values in accordance with ISO 10816-3.

Risk of explosion as a result of premature bearing failure

- Use insulated bearings if bearing currents occur. Carefully comply with the information in Chapter Converter operation
- Carefully comply with the specified grease change intervals, relubrication intervals and oil change intervals.

Risk of explosion due to static charging

If you clean the motor, plastic components may become statically charged and ignite a potentially explosive atmosphere. An explosion can occur. This can result in death, serious injury or material damage.

- When cleaning, ensure that there is **absolutely no** explosive atmosphere present.
- Clean the plastic parts and components so that **absolutely no** static charging occurs
- Do **not** use compressed air for cleaning.

Explosion hazard due to increased surface temperature

Components within the motor may be hotter than the maximum permissible surface temperature for the enclosure. For machines in type of protection Ex d or Ex t, an atmosphere can be ignited and can cause an explosion. This can result in death, serious injury or material damage.

- Do not open the motor in an explosive and dusty atmosphere when it is still at normal operating temperature.
- Allow the machine to cool down before opening it.

Danger as a result of stationary parts under voltage (live parts)

Live parts represent a hazard. Touch protection against active (live) parts is no longer guaranteed if covers are removed. The minimum air and creepage distances may be fallen below (violated) when coming close to active parts. Touching or coming close can result in death, serious injury or material damage.

- Carefully ensure that all of the covers are closed while operational.
- First switch off and disconnect the machine if you must remove covers. Carefully comply with the "5 safety rules" (Page 16).
- In operation, the terminal box must always be kept closed. It is only permissible to open the terminal box when the motor is stationary and in a no voltage condition.

Risk of injury due to rotating parts

Rotating parts are dangerous. Touch protection against rotating parts is no longer guaranteed if covers are removed. Touching rotating parts can cause sparking with subsequent ignition of an explosive atmosphere resulting in death, serious injury or material damage.

- Carefully ensure that all of the covers are closed while operational.
- First switch off and disconnect the machine if you must remove covers. Carefully comply with the "5 safety rules (Page 16)".
- Only remove the covers when the rotating parts have come to a complete standstill.

Risk of burn injuries as a result of hot surfaces

Individual machine parts can become hot in operation. Burns can result when coming into contact with these parts.

- Never touch machine parts during operation.
- Allow the machine to cool down before starting work.
- Check the temperature of parts before touching them. If required, wear suitable protective equipment.

Damage if the machine is not maintained

The machine can be damaged if it is not appropriately maintained. This can cause faults which can result in eventual or immediate death, serious injury or material damage.

- Maintain the machine at the specified maintenance intervals.

Damage from foreign bodies in the machine

Foreign bodies such as dirt, tools or loose components can be left by accident inside the machine after maintenance is performed. These can cause short circuits, reduce the performance of the cooling system or increase noise in operation. They can also damage the machine.

- Ensure that no foreign bodies are left in or on the machine.
- Securely attach all loose parts once you have completed the work.
- Carefully remove any dirt.

9.2.2 Inspections in the event of faults

Natural disasters or unusual operating conditions, such as overloading or short circuit, are faults that overload the machine electrically or mechanically.

Immediately perform an inspection after such faults.

Note

Inspection specifications

- Carefully comply with the relubrication intervals for rolling bearings that deviate from the inspection intervals.
 - When servicing a three-phase machine, it is generally not necessary to dismantle it. The machine only has to be dismantled if the bearings are to be replaced.
-

9.2.3 First inspection after installation or repair

Perform the following checks after approximately 500 operating hours or at the latest six months after commissioning:

Table 9-1 Checks after assembly or repair

Checking	When the motor is running	At standstill
The electrical parameters are maintained.	X	
The permissible bearing and winding temperatures are not exceeded.	X	
The smooth running characteristics and machine running noise have not deteriorated.	X	
The foundation has no cracks or indentations. (*)	X	X

(*) You can perform these checks while the motor is running or at a standstill.

Additional tests may also be required according to the system-specific conditions.

NOTICE
<p>Machine damage</p> <p>When carrying out the inspection, if you detect any impermissible deviations from the normal state, you must rectify them immediately. They may otherwise cause damage to the machine.</p>

9.2.4 General inspection

Check that the installation conditions are observed. We recommend doing this after approx. 16 000 operating hours. Check the following at the latest after 2 years:

Table 9-2 Checks that have to be performed during the general inspection

Checking	When the motor is running	At standstill
The electrical parameters are maintained.	X	
The permissible bearing temperatures are not exceeded.	X	
The smooth running characteristics and machine running noise have not deteriorated.	X	
The foundation has no cracks or indentations. (*)	X	X
The machine is aligned within the permissible tolerance ranges		X
All the fixing bolts/screws for the mechanical and electrical connections have been securely tightened		X
All the potential connections, grounding connections and shield supports are correctly seated and properly bonded		X
The winding insulation resistances are sufficiently high		X

Checking	When the motor is running	At standstill
Any bearing insulation is fitted as shown on the plates and labels		X
The CABLES and insulating parts and components are in good condition and there is no evidence of discoloring		X

(*) You can perform these checks while the motor is at standstill or, if required, while running.

NOTICE
Machine damage
When carrying out the inspection, if you detect any impermissible deviations from the normal state, you must rectify them immediately. They may otherwise cause damage to the machine.

9.2.5 Assessing the rolling bearings

To assess the rolling bearings, it is generally not necessary to dismantle the machines. The motor only has to be dismantled if the bearings are to be replaced.

The state of a rolling bearing can be assessed by analyzing the bearing vibration. The measured values provide an indication and can be assessed by specialists. In this case, contact the Service Center (Page 12).

9.2.6 Mechanical explosion protection for rolling bearings

All machines marked in accordance with Directive 2014/34/EU ("Explosion Protection Directive") must be regularly inspected for mechanical damage which could constitute a risk of ignition in accordance with IEC/EN 60079-17 .

- Comply with the following intervals:
 - Bearing replacement intervals
 - Relubrication intervals
 - Grease replacement intervals
 - Oil change intervals
- Rolling bearing service life
 - Replace the rolling bearings once the nominal service life has been reached. Alternatively, you can verify they are free of mechanical damage as part of an inspection.
 - In the case of rolling bearings without a regreasing system, it is ensured that the nominal service life will only be achieved clearly after achievement of the service life of the grease in the bearings.
 - For machines that are subject to radial or axial forces, the rolling bearing service life at the full, specified load is at least 20 000 when operated on 50 Hz line supplies.
 - The nominal rolling bearing service life of machines that are not subject to any forces is at least 40 000 hours when operated on 50 Hz line supplies.
- For rolling bearings with external oil supply, monitor that lubrication is maintained.

9.2.7 Maintenance intervals

Please note the following in order to identify faults at an early stage, rectify them and avoid follow-on damage:

- Maintain the machine regularly and carefully.
- Inspect the machine.
- Motors must be allocated a revision/inspection number after inspection.

NOTICE
<p>Motor failure</p> <p>Material damage can occur if the machine develops faults or is overloaded.</p> <ul style="list-style-type: none"> • Immediately inspect the machine if faults occur. • An immediate inspection is especially necessary, if the three-phase motor is excessively stressed, either electrically or mechanically (e.g. overload or short-circuit).

9.2 Inspection and maintenance

The machines are equipped with permanently lubricated rolling bearings. The machine may be equipped with a regreasing device.

 CAUTION
<p>Skin irritations and eye inflammations</p> <p>Many greases can cause skin irritations and eye inflammations.</p> <ul style="list-style-type: none"> • Follow all safety instructions of the manufacturer.

Measures, intervals and deadlines

Measures after operating period intervals or deadlines have elapsed:

Operating situations and characteristics can vary widely. For this reason, only general maintenance intervals are specified here. Maintenance intervals should therefore be scheduled to suit the local conditions (dirt, starting frequency, load, etc.).

Table 9-3 Operating period intervals

Measures	Operating period intervals	Intervals
Initial inspection	After 500 operating hours	After 1/2 year at the latest
Relubrication (optional)	Refer to the lubrication plate or the rating plate	
Clean	Depending on the degree of pollution	
Main inspection	Approximately every 16000 operating hours	After two years at the latest
Drain condensate	Depending on the climatic conditions	

9.2.8 Re-greasing

For machines with regreasing system, relubrication intervals, grease quantity and grease grade are provided on the lubricant plate. Additional data can be taken from the main machine rating plate.

Grade of grease for standard motors (IP55) UNIREX N3 - ESSO.

Note

It is not permissible to mix different types of grease.

Prolonged storage periods reduce the useful lifetime of the bearing grease. Check the condition of the grease if the equipment has been in storage for more than 12 months. If the grease is found to have lost oil content or to be contaminated, the machine must be immediately relubricated before commissioning. For information on permanently-greased bearings, please refer to the section titled Rolling bearings (Page 129).

Procedure

To relubricate the rolling bearings, proceed as follows:

1. Clean the grease nipples at the drive end and non-drive end.
2. Press-in the specified grease and amount of grease according to the data stamped on the lubrication plate.
 - Please observe the information on the rating and lubricant plates.
 - Regreasing should be carried out when the motor is running (max. 3600 rpm).

The bearing temperature can rise significantly at first, and then drops to the normal value again when the excess grease is displaced out of the bearing.

 WARNING
Rotor can fall out
If the machine is in a vertical position, the rotor can fall out while work is being performed on the locating bearing. This can result in death, serious injury or material damage.
Support or relieve the rotor when carrying out work with the machine in a vertical position.

9.2.9 Cleaning

Cleaning the grease ducts and spent grease chambers

The spent grease collects outside each bearing in the spent grease chamber of the outer bearing cap. When replacing bearings, remove the spent grease.

Dismantle the bearing cartridges to replace the grease in the lubrication duct.

Cleaning the cooling air ducts

Regularly clean the cooling air ducts through which the ambient air flows.

The frequency of the cleaning intervals depends on the local degree of fouling.

Damage to the machine when cleaning with compressed air or water jets

- Do not direct compressed air or water jets in the direction of the shaft outlet or machine openings.
- Avoid direct impact of compressed air and water jets on sealing elements of the machine.

Note

Please note the safety instructions for cleaning.

9.2.10 Risk of explosion due to damaged seals

 WARNING
<p>Risk of explosion due to damaged seals</p> <p>The seals can be damaged if you clean motors with type of protection Ex t using compressed air. The type of protection is no longer complied with. An explosion can occur. This may result in death, personal injury and material damage.</p> <ul style="list-style-type: none"> • Avoid pointing compressed air directly onto shaft sealing rings or labyrinth seals of the machine.

9.2.11 Drain condensate

If there are condensation drain holes present, open these at regular intervals, depending on climatic conditions.



 WARNING
<p>Hazardous voltage</p> <p>The winding can be damaged if objects are introduced into the condensation holes (optional). This can lead to death, serious injury or material damage.</p> <p>Note the following to maintain the degree of protection:</p> <ul style="list-style-type: none"> • Switch off the machine so that it is in a no-voltage condition before you open the condensation drain holes. • Close the condensation drain holes, e.g. using T-plugs, before commissioning the machine.

NOTICE
<p>Reduction of the degree of protection</p> <p>If condensation drain holes are not closed, then this can result in material damage to the motor. In order to maintain the degree of protection, after the condensation has been drained, you must close all of the drain holes.</p>

9.2.12 Insulation resistance and polarization index

Measuring the insulation resistance and polarization index (PI) provides information on the condition of the machine. It is therefore important to check the insulation resistance and the polarization index at the following times:

- Before starting up a machine for the first time
- After an extended period in storage or downtime
- Within the scope of maintenance work

The following information is provided regarding the state of the winding insulation:

- Is the winding head insulation conductively contaminated?
- Has the winding insulation absorbed moisture?

From this, you can determine whether the machine needs commissioning or any necessary measures such as cleaning and/or drying the winding:

- Can the machine be put into operation?
- Must the windings be cleaned or dried?

Detailed information on testing and the limit values can be found here:

"Testing the insulation resistance and polarization index" (Page 64)

9.2.13 Maintaining the external fan (forced ventilation)



WARNING

Rotating or live parts

Live electrical parts are dangerous. Contact with them can cause death, serious injury or material damage.

Before performing any maintenance work on the separately driven fan, disconnect it from the mains, particularly before opening the terminal box. Make sure that the device cannot be switched back on.

Servicing the separately driven fan

The separately driven fan is essentially maintenance-free. However, dirt and dust deposits on the impeller and the motor, particularly in the gap between the impeller and the inlet nozzle can impair its function.

- Remove the dirt and dust deposits regularly; the intervals depend on how dirty the surrounding area is.
- Make sure that the impeller is evenly cleaned if the impeller draws-in a free flow of air, as irregular deposits can lead to an imbalance.
Full fan performance (flow rate) is only achieved if the impeller can draw-in a free flow of air.

Servicing the separately driven fan motor

Carefully comply with all specifications and intervals in the operating instructions for the separately driven fan motor. If a **SIMOTICS XP 1MB..** low-voltage motor is used as an separately driven fan motor, these operating instructions also apply for the separately driven fan motor.

To avoid unnecessary downtimes, always carry out all inspection and maintenance work on the main and separately driven fan motor simultaneously.

- Occasionally inspect the separately driven fan motor, and check it electrically and mechanically every time the rolling bearings are replaced.
- Replace permanently lubricated rolling bearings in the separately driven fan motor as specified in the operating instructions for the separately driven fan motor.

9.2.14 Repainting

If the paint is damaged, it must be repaired in order to protect the unit against corrosion.

Note

Paint system

Contact the Service Center (Page 12) before you repair any damage to paint. They will provide you with more information about the correct paint system and methods of repairing paint damage.

9.2.14.1 Repainting

Repainting

When you recoat painted surfaces, you must strictly comply with one of the following requirements relating to the complete system, original paint plus paint used for recoating:

- Limit the total paint film thickness according to the explosion protection group:
 - IIA, IIB: Total paint coating thickness ≤ 2 mm
 - IIC: Overall coating thickness ≤ 0.2 mm for motors of group II (gas)
- Strictly limit the surface resistance of the paint system used:
 - ≤ 1 G Ω , measured at 50 ± 5 % relative humidity
 - ≤ 100 G Ω , measured at 30 ± 5 % relative humidity for motors, Groups II and III (gas and dust)
- Charge transfer limit
 - 60 nC for Group I or Group IIA devices
 - 25 nC for Group IIB devices
 - 10 nC for Group IIC devices
 - 200 nC for Group III devices (values not valid for strong charge generating processes)
- Breakdown voltage ≤ 4 kV for explosion groups II and III (gas and dust)

 WARNING
Explosion hazard caused by incorrect painting
The paint coat can become electrostatically charged if an excessively thick paint coat is applied. Electrostatic discharge can then occur. There is a risk of explosion if potentially explosive mixtures are also present at this moment.
This can result in death, serious injury or material damage.

 WARNING
Risk of explosion as a result of processes with high levels of electrostatic charging
For paint finishes in explosion group III, the paint can be electrostatically charged as a result of intensive dust turbulence or processes with high levels of electrostatic charging. Electrostatic discharges can occur. Minimize the risk of electrostatic charging by applying effective measures according to IEC 60079-32-1. This can result in death, serious injury or material damage.

Suitability test of the paint system for hazardous areas

Suitability certificates for the electrostatic suitability on explosion-protected machines are available for paint systems ordered as standard. Non-standard or customer-specific paint systems that have been used as well as subsequent painting require that customers perform a suitability check regarding electrostatic charge according to EN/IEC 60079-0.

9.3 Corrective maintenance

Comply with the following when carrying out any work on the machine:

- Comply with the general safety instructions (Page 15).
- Comply with the applicable national and sector-specific regulations.
- When using the motor within the European Union, comply with the specifications laid down in EN 50110-1 regarding safe operation of electrical equipment.

If the motor has to be transported, please observe the information and instructions in the "Transport (Page 42)" chapter.

9.3.1 Machines with a certificate extended with an "X"

The machine marking based on IEC / EN 60079–0 was supplemented by the "X" symbol.

- Perform maintenance, repair and modification work on explosion-protected machines in strict compliance with the corresponding national health and safety legislation, the safety instructions and descriptions in the general maintenance instructions.

9.3 Corrective maintenance

Have work influencing explosion protection performed by the manufacturer or by a specialist workshop for electrical machinery authorized by the manufacturer. This includes the following operations, for example:

- Repairs to the stator or rotor windings and to the terminals
- Repairs to the ventilation system
- Repairs to the bearings
- Dismantling machines with flameproof enclosures
- Connection work performed in the terminal box

Identify the work performed by an additional repair plate bearing the following information:

- Date
- Company carrying out repair
- Type of repair
- Reference number of the repair technician regarding repair work

Test in accordance with the relevant EU directives after repair.

Risk of explosion as a result of inadmissible repair work

Repairs are only permissible within the scope of the work described in these operating instructions. Otherwise an explosion can occur in an explosive atmosphere. This can result in death, serious injury or material damage.

- For repairs that go beyond this scope, contact the Service Center (Page 12).

9.3.2 Anti-condensation heating

Explosion hazard due to improper maintenance of the anti-condensation heating

If the anti-condensation heating is not correctly repaired, e.g. if unauthorized or untested spare parts are used, this can result in explosions during operation in a potentially explosive atmosphere. This can result in death, serious injury or material damage.

- Only appropriately trained specialists in the service center (Page 12) are authorized to repair anti-condensation heating systems. The anti-condensation heating must then be subject to a routine test, which requires extensive specialist knowledge.
- Only use authorized and tested spare parts.

9.3.3 Fundamentals

Note

Before commencing removal, you should mark how each of the fastening elements has been assigned, as well as how internal connections are arranged. This simplifies subsequent reassembly.

If possible, assemble the machine on an alignment plate. This ensures that the mounting feet surfaces are all on the same plane.

Avoid damaging the windings protruding out of the stator enclosure when assembling the end shield.

Sealing measures

1. For 1MB10, shaft heights 100...160, apply the appropriate liquid sealant, e.g. Fluid-D or Hylomar to the centering edge.
2. Check the terminal box seals, and if required, replace these.
3. Repair any damage to the paint, also to screws/bolts.
4. Take the necessary measures to ensure compliance with the applicable degree of protection.
5. Do not forget the foam rubber cover in the cable entry. Completely seal the holes, and ensure that cables do not come into contact with sharp edges.

9.3.4 Rolling bearings

Refer to the rating plate or the catalog for the designations of the bearings being used.

Bearing lifetime

Prolonged storage periods reduce the useful lifetime of the bearing grease. For permanently lubricated bearings, this reduces the bearing service life.

We recommend that the grease is replaced after a storage time of 12 months. Replace greased bearings also in the case of closed bearings (suffix 2Z or 2 RS). After 4 years in storage, generally replace all rolling bearings and grease.

Replacing bearings

Recommended interval after which bearings are to be replaced under normal operating conditions:

Table 9-4 Bearing replacement intervals

Ambient temperature	Principle of operation	Bearing replacement intervals
40 °C	Vertical coupled operation	20 000 h
40 °C	Horizontal coupled operation	40 000 h
40 °C	With axial and radial forces	20 000 h

- Do not reuse bearings that have been removed.
- Remove the dirty spent grease from the bearing shield.
- Replace the existing grease with new grease.
- Replace the shaft seals when the bearings are replaced.
- Slightly grease the contact surfaces of the sealing lips.

Note

Special operating conditions

The operating hours are reduced, e.g.

- When machines are vertically mounted.
 - High vibration and surge loads
 - Frequent reversing operation
 - Higher ambient temperatures.
 - High speeds etc.
-

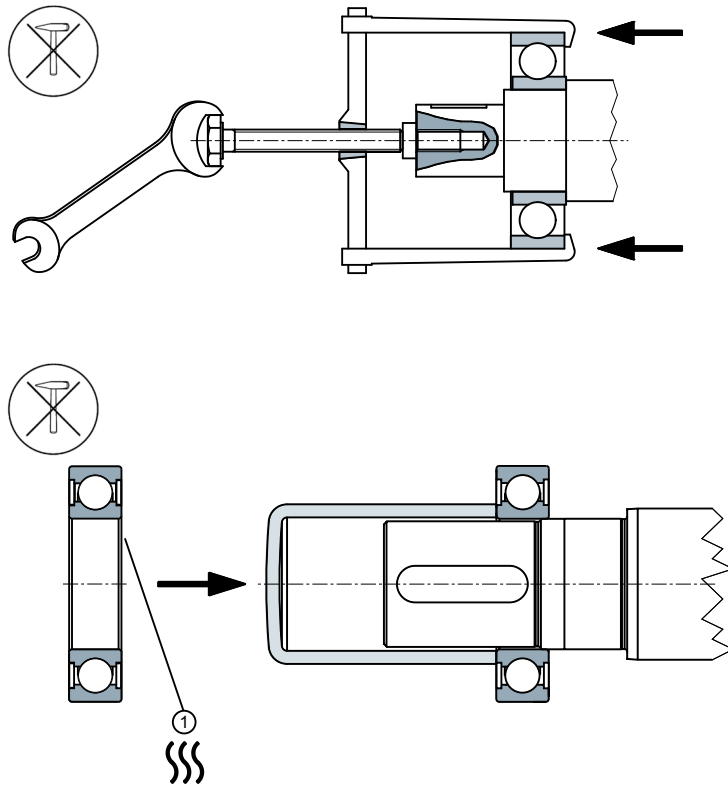

① Heat up 80 ... 100 °C

9.3.4.1 Replacing bearings in explosion-proof machines

- When changing the bearings, renew the sealing rings and only use original Siemens spare parts.
- For radial sealing rings with dust protection lip (DIN 3760-AS), completely fill the spaces (100%) in the sealing ring as well as in the bearing shield hub with a suitable grease.

9.3.4.2 Fitting bearings

Note**Bearing seals for explosion-protected machines**

For explosion-protected machines, only use the original replacement and repair parts.

Sealing the bearings

Note the following details:

- Shaft sealing rings are used to seal machines at the rotor shaft.
 - For V rings, comply with the assembly dimension.
- Use the specified bearings.
- Ensure that the bearing sealing disks are in the correct position.
- Insert the elements for bearing preloading at the correct end.
- Fixed bearings can have a locking ring or bearing cover.
- Seal the bearing cap screws with the appropriate gaskets or with grease.
- Do not interchange the position of the bearing covers (DE and NDE or inner and outer).

Danger as a result of rotor falling out

If the motor is in a vertical position, the rotor can fall out while work is being performed on the locating bearing. This can result in death, serious injury or damage.

- Support or unload the rotor when carrying out work with the machine in a vertical position.

Installing rolling bearings

- Extreme caution and attention to cleanliness are vital when installing rolling bearings. Observe the correct assembly sequence of the components.
- Attach all components with the specified tightening torques (Page 169).

- For individually mounted angular contact ball bearings, carefully comply with the installation position corresponding to the permissible direction of force.

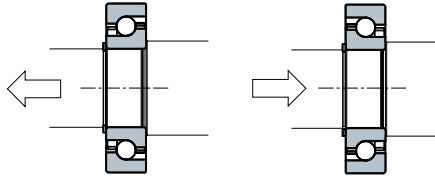

- Angular contact ball bearings arranged in pairs must always be installed in strict compliance with the manufacturer's specifications.
- Always use angular contact ball bearings of the same type.

Note

For further information about mounting the rolling bearing, please refer to the catalog or the information provided by the rolling bearing manufacturer.

Procedure

1. Replace the damaged components.
2. Remove any dirt from the components. Remove any grease and the remains of sealant or liquid threadlocker.
3. Prepare the bearing seats:
 - Lightly oil the inner ring seat.
 - Grease the outer ring seat with a solid lubricant such as Altemp Q NB 50.
 - Press the inner bearing cover onto the shaft.
4. Warm up the rolling bearing.
5. Push the inner ring of the warmed up rolling bearing onto the shaft. Avoid any blows that might damage the bearing.
6. Ensure that the rolling bearing is resting against the shaft shoulder or the 2nd bearing.
7. Fill the bearing to the top with the specified lubricating grease as stamped on the lubricant plate.
8. Warm up the grease slinger (if one is available), and push it onto the shaft.
9. Depending on the particular version, fix the bearing with a locking ring or shaft nut.
10. Support the rotor when installing the bearing housing or bearing end shield.
11. Use a suitable sealant when assembling.
12. Assemble the bearing shield or bearing housing together with the bearing shield.
13. Install the outer bearing cover (if one is available).
14. Install the sealing elements:

9.3.4.3 Explosion hazard due to overheating of the rolling bearings

 WARNING
<p>Explosion hazard due to overheating of the rolling bearings</p> <p>If the rolling bearings are not regularly regreased, local overheating may be possible, and, as a consequence, an explosion in an explosive atmosphere. This can result in death, serious injury or material damage.</p> <ul style="list-style-type: none"> • Regrease the rolling bearings regularly according to the lubrication plate. • Implement bearing temperature monitoring if not yet in existence.

9.3.5 Shaft sealing, mounting dimensions and alignment

Mounting dimension "x" of V rings

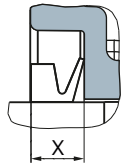
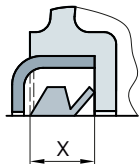
Shaft height	x mm	
63 ... 71	4.5 ± 0.6	<p>Standard design</p>  <p>Special design</p> 
80 ... 112	6 ± 0.8	
132 ... 160	7 ± 1	
180 ... 225	11 ± 1	
250 ... 315	13.5 ± 1.2	

- Extreme caution and attention to the correct positioning are vital during installation and assembly.
- Make sure the sealing surface is free of dirt and damage.
- Lightly grease the sealing lips.

9.3.6 Fan

NOTICE
Destruction of the fan
Material damage can occur by forcefully removing the fan from the shaft. Take care not to damage the snapping mechanisms on fans that are equipped with these.

Plastic fan

- Correctly expose the breakout openings provided in the fan plate.
- Heat up the fans to a temperature of approximately 50° C around the area of the hub.
- Use a suitable tool to pull off the fan (puller).
- Locate the arms of the pulling tool in the breakout openings and slightly tension the pressure screw of the tool.
- For fans with snapping mechanisms, simultaneously release the two snap-in lugs of the fan from the annular shaft groove.
Keep the snap-in lugs in this position.
- Uniformly withdraw the fan from the shaft by turning the pressure screw of the pulling tool.
- Do not apply any hammer blows to avoid damaging the rotor shaft, the fan and the bearings.
- Order the appropriate new parts if damaged.

Metal fan

- Shaft height 63: Release the two M4 clamping screw so that the fan can rotate freely on the shaft.
- Shaft heights 71...90: Release the M5 set screw so that the fan can rotate freely on the shaft.
- Shaft height 100...355: Remove the locking ring.
- Use a suitable tool to pull off the fan (puller).
- Locate the arms of the pulling tool in the openings in the fan in the vicinity of the hub.
- Alternatively, place the pulling tool at the outer edge of the fan plate.
- Uniformly withdraw the fan from the shaft by turning the pressure screw of the pulling tool.
- Do not apply any hammer blows to avoid damaging the rotor shaft, the fan and the bearings.
- Order the appropriate new parts if damaged.

9.3.6.1 Mounting fans

- Take care not to damage the snapping mechanisms on fans that are equipped with these.
- To ensure this, the fans should be heated to a temperature of approximately 50 °C around the area of the hub.
- If any damage is caused, request new parts.

9.3.7 Cable entries, sealing plugs and thread adapters

All cable entries and sealing plugs must be approved for use in the respective hazardous zone.

- Any openings that are not being used must be sealed using the appropriate certified sealing plugs.
- Please observe the manufacturer's specifications when fitting cable entries.

Note the following when mounting:

- Avoid damaging the cable jacket.
- Adapt the tightening torques to the cable jacket materials.

Observe the documentation for tightening torques of the cable entries and sealing plugs for direct mounting at the machine as well as additional glands (e.g. adapters).

9.3.8 Tightening torques

Note the information in Chapter Tightening torques (Page 169).

9.3.9 Screw lock washers

Nuts or bolts that are mounted together with locking, resilient and/or force-distributing elements (e.g., safety plates, spring-lock washers, etc.) must be refitted together with identical, fully functional elements.

Locking and sealing elements must always be replaced!

9.3.10 Links

- Replace any corroded screws.
- Take care not to damage the insulation of live parts.
- Document the position of any rating and supplementary plates that have been removed.
- Avoid damaging the centering edges.

9.3.11 Reassembly: Miscellaneous information

- Position all rating and supplementary plates as in the original state.
- Where relevant, fix electric cables.
- Check the tightening torques of all screws, as well as those of screws that have not been released.

9.3.12 Optional add-on units

You can find additional operating instructions here: AUTOHOTSPOT

9.3.13 O-ring seal

If O-ring seals are present, you should check that they are in perfect condition and that the O-ring seals are properly seated in the grooves between the components. Replace damaged O-ring seals.

O-ring seals can be present on the following components, for instance:

- Adapters, tapers
- Entries, glands
- Bearing seals
- End shield seals
- Terminal box sealing
- etc.

Spare parts

10.1 Parts order

In addition to the exact part designation, please specify the machine type and the serial number of the machine in all orders for spare parts and repair parts. Ensure that the part designation is the same as that in the parts list, and make sure you also use the associated part number.

When spare and repair parts are ordered, the following details must be provided:

- Designation and part number
- Order number and serial number of the machine

The machine type and serial number can be found on the rating plate.

See also

Spares On Web (<https://www.sow.siemens.com/>)

Note

The graphical representations in this chapter show schematic diagrams of the basic versions. They are used for spare parts definitions. The supplied version may differ in details from these representations.

Data matrix code

A data matrix code may be provided on machines manufactured in Europe. You can retrieve the following information from the data matrix code:

- Machine type
- Serial number
- Customer material number, if ordered as option Y84
- Using the Data Matrix code and the App "SIMOTICS Digital Data", you can access the technical data, spare parts and operating instructions for your motor.

10.2 Purchasing commercially available spare parts

 **WARNING**

Explosion hazard due to unsuitable spare parts

If you use parts other than the original spare parts, the type of protection can no longer be guaranteed. This can result in an explosion during operation in a potentially explosive atmosphere. This can result in death, serious injury or material damage.

- Use only original spare parts for explosion-proof machines, including components, such as seals, terminals, cables, and cable entries. If you have any questions, please contact the service center (Page 12).
- You can purchase commercially available equivalent standard parts such as screws.

10.3 Determining the spare parts via the Internet



You can use "Spares on Web" to determine the order numbers for motor spare parts quickly and easily.

Spares on Web (<https://www.sow.siemens.com/?lang=en>)

10.4 Replacing rolling bearings

Rolling bearings

When ordering rolling bearings, in addition to the bearing identification code, the supplementary specifying code is also necessary for the bearing version. Both of these codes are stamped on the lubricant plate and specified in the motor documentation, or can also be taken from the installed bearings.

Always replace the rolling bearings with the identical bearings.

10.5 Rolling bearings

If insulated rolling bearings are fitted, use insulated rolling bearings of the same type as spare parts. This will prevent any bearing damage being caused by bearing currents.

10.6 Anti-condensation heating

 **WARNING**

Explosion hazard due to improper maintenance

If repairs to the anti-condensation heating are not carried out correctly, e.g. if unauthorized or untested spare parts are used, this can result in explosions during operation in a potentially explosive gaseous atmosphere. This can result in death, serious injury or material damage.

- Repairing and mounting the anti-condensation heating and the subsequent routine testing must always be undertaken by experts from the service center (Page 12), because this work requires extensive specialist knowledge.
- Only authorized and tested spare parts may be used.

10.7 Groups of parts

A distinction is made between the following groups of parts:

Spare parts

Spare parts are machine parts that can be ordered during the production time - and for a further 5 years after discontinuation of production. These parts should be replaced only by authorized service or modification partners.

Repair parts

Repair parts are machine parts that can only be supplied during the active production of the machine (until the product discontinuation). Repair parts are parts used for the repair or modification of the current products. These parts should be replaced only by authorized service or modification partners.

Standardized parts

Standardized parts are machine parts that can be commercially obtained with the necessary dimensions, materials and surface finish. A detailed list can be found in Chapter "Standardized parts".

Other parts

Other parts are small parts required to complete the exploded drawing. These parts cannot be supplied as individual spare or repair parts. Delivery as assembled units, for example as complete terminal box, is possible on request.

Delivery obligations for replacement machines and repair parts

The following delivery obligations apply to replacement machines and repair parts after production has been phased out.

- For up to 3 years after the delivery of the original machine, in the event of total machine failure, Siemens will supply a comparable replacement machine with regard to the mounting dimensions and functions; it is possible that this will involve a new series.
- If a replacement machine is supplied within the 3 year period, this does not mean that the warranty restarts.
- Replacement machines delivered after the active production of the machine series are also identified as spare motors on the rating plate.
- Spare parts are available only on request for these spare motors. Repair or replacement is not possible.
- After a period of 3 years (after the delivery of the original machine), it is only possible to repair these machines, depending on the availability of the spare parts required.
- After the delivery of the original motor, spare parts will be available for up to 5 years. For an additional period of 5 years, Siemens provides information about spare parts, and when required, provides documentation.

10.8 Ordering example

Table 10-1 Ordering example

End shield, drive end	1.40 End shield
Machine type *	1MB1543-2BB03-4AA4
Ident: No. *	UC 1706/218923701

* corresponding to the rating plate

Take the type and serial number from the rating plate and the machine documentation.

When replacing rolling-contact bearings, in addition to the bearing identification code, the replacement code for the bearing version is required. Both of these codes are specified on the rating plate and in the machine documentation. They are also shown on the installed bearings.

The graphical representations in this chapter show schematic diagrams of the basic versions. They are used for spare part definitions. The supplied version may differ in details from these representations.

10.9 Machine parts

10.9.1 Part lists

Part	Description	Part	Description
1.00	DE bearings		Terminal box, complete
1.30	Screw	5.47	Screw
1.40	Bearing shield	5.48	Spring lock washer
1.43	Shaft sealing ring	5.49	Screw
1.44	Bearing cover DE, inner	5.51	Flanged nut
1.45	Screw (bearing cover)	5.52	Cable entry
1.46	Cover ring	5.55	Nut
1.49	Screw	5.64	Spring lock washer
1.50	Flanged nut	5.65	Screw
1.56	Spacer washer	5.70	Terminal clamp
1.58	Spring washer	5.76	Terminal plate / contact bracket
1.60	Rolling bearings	5.78	Spring lock washer
1.61	Spring band for end shield hub	5.79	Screw
1.63	Condensation drain plug	5.81	Screw
1.65	Grease nipple	5.83	Seal
3.00	Rotor, complete	5.84	Terminal box cover
3.38	Fitted key	5.85	Terminal box cover including seal (optional screw)
4.00	Stator, complete	5.89	Screw
4.04	Eyebolt	5.93	Seal
4.05	Washer	5.96	Screw plugs
4.07	Housing foot	5.97	Locknut
4.08	Housing foot, left	5.98	Metal-sheet nut
4.09	Housing foot, right	5.99	Adapter plate
4.10	Spring lock washer	6.00	Bearings, NDE
4.11	Screw	6.02	Locking ring
4.12	Nut	6.03	Bearing cover NDE, inner
4.18	Rating plate	6.10	Rolling bearings
4.19	Self tapping screw or slotted pin	6.11	Spring band for end shield hub
4.20	Cover	6.20	Bearing shield
4.30	Contact bracket	6.23	Shaft sealing ring
4.31	Grounding bracket	6.25	Lubrication sleeve
4.35	Washer	6.26	Cover
4.37	Terminal board	6.29	Screw
4.38	Spring lock washer	6.31	Nut
4.39	Grounding stud	6.65	Grease nipple
5.00	Terminal box, complete	6.74	Sleeve
5.03	Seal (upper terminal box section)	6.75	Screw

Spare parts









10.9 Machine parts

Part	Description	Part	Description
5.04	Seal (adapter plate)	7.00	Complete ventilation
5.06	Mounting rail	7.04	Fan
5.10	Complete terminal board	7.12	Locking ring
5.11	Terminal block	7.40	Fan cover
5.13	Link rail	7.48	Washer
5.17	Screw	7.49	Screw
5.18	Spring lock washer	7.80	Separately driven fan, complete
5.19	Screw	7.81	Fan motor, complete
5.21	Screw (drilled)	7.83	Sheet metal fan cover, welded
5.27	Terminal clamp	7.84	Sealing plugs
5.29	Lower saddle terminal	7.85	Washer
5.35	Cable entry	7.86	Screw
5.36	Spring lock washer	7.87	Washer
	Terminal box, complete	7.88	Screw
5.37	Spring lock washer	7.89	Shaft coupling
5.42	Terminal box housing, including seal	7.90	Washer
5.43	Cable entry plate	7.91	Screw
5.44	Terminal box upper section	7.92	Fan, complete
5.45	Housing	7.94	Screw
5.46	Screw		

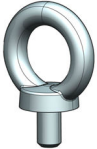
Tools for mounting and withdrawing rolling bearings; fans and drive output elements cannot be supplied.

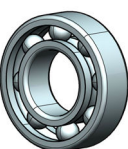
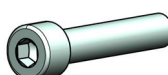
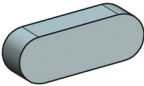
10.10 Standardized parts

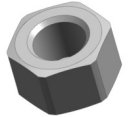
Table 10-2 Purchase standard parts according to dimensions, material and surface properties through normal commercial channels.

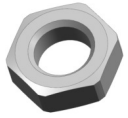
No	Standard	Picture	No	Standard	Picture
3.02 6.02 7.12	DIN 471		5.17	EN ISO 4014	
6.12	DIN 472				
4.04	DIN 580		1.49 4.11 4.39 5.65 5.89 7.49 7.86	EN ISO 4017	
	DIN 582		6.75	EN ISO 4026	
1.60 6.10	DIN 625		1.30 1.45 4.11 5.19 5.46 5.47 5.49 6.29 7.88 7.91 7.94	EN ISO 4762	
7.85 7.87	DIN 6796				
3.38	DIN 6885		4.19	EN ISO 7045	
4.12 5.55	EN ISO 4032		4.05 7.48	EN ISO 7089	
5.51	EN ISO 4035				

10.11 Exploded drawings

10.11.1 1MB1 shaft heights 63 ... 71 aluminum

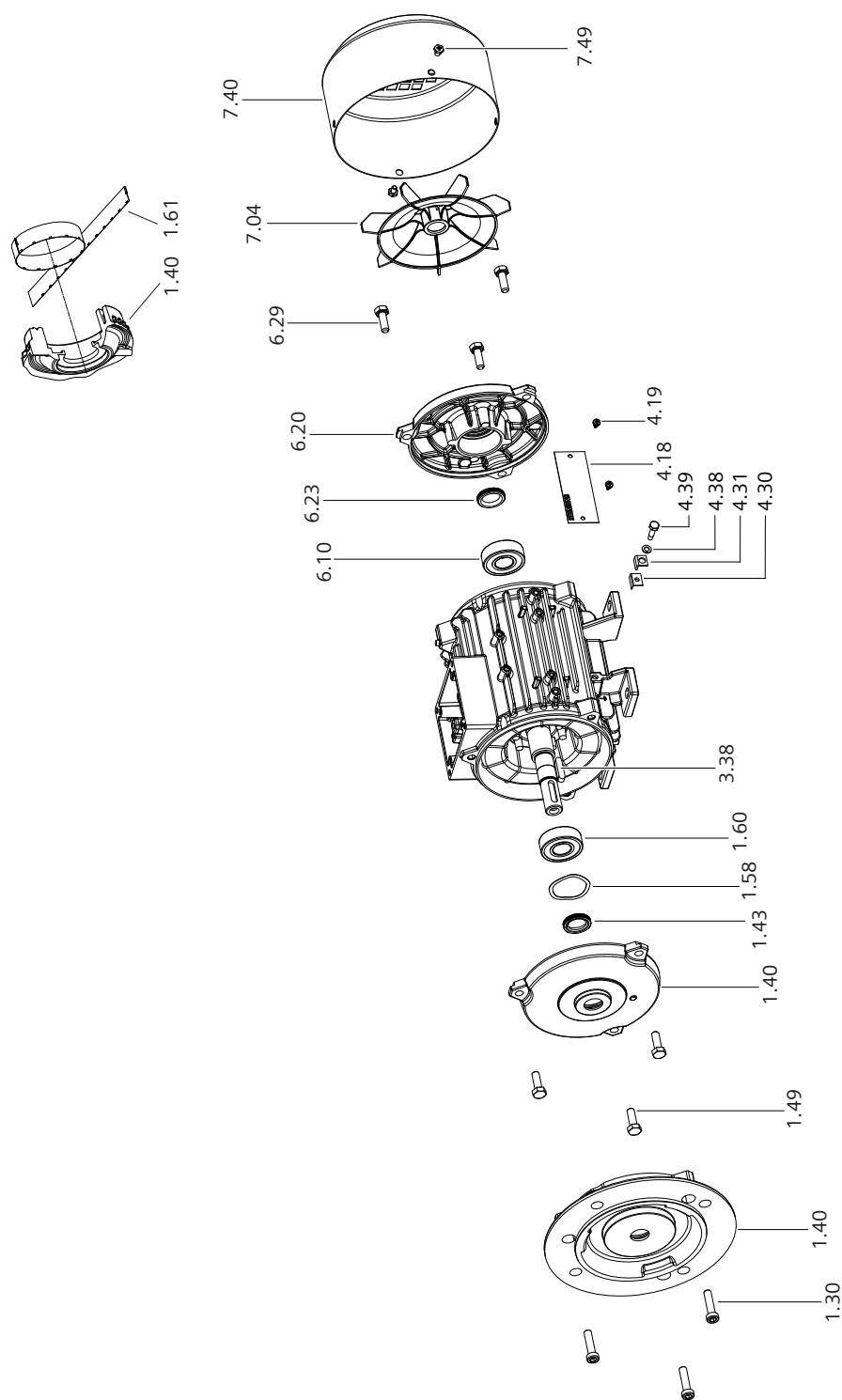

10.11.2 1MB1 shaft heights 71 ... 90 cast iron

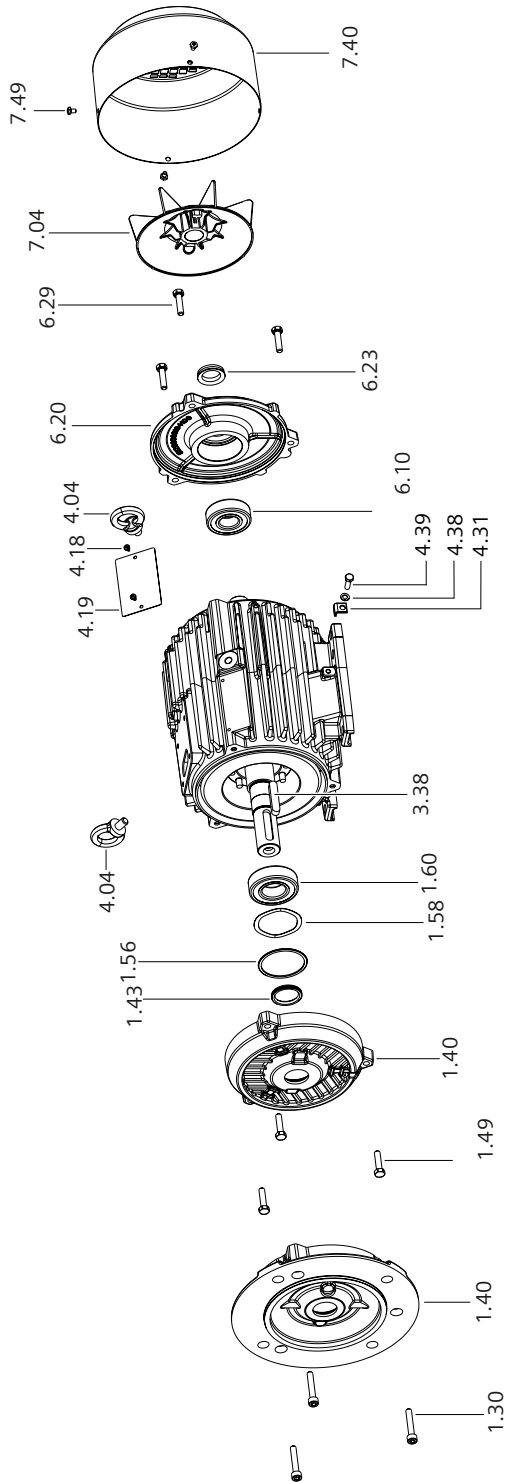

10.11.3 1MB1 shaft heights 80 ... 160 aluminum

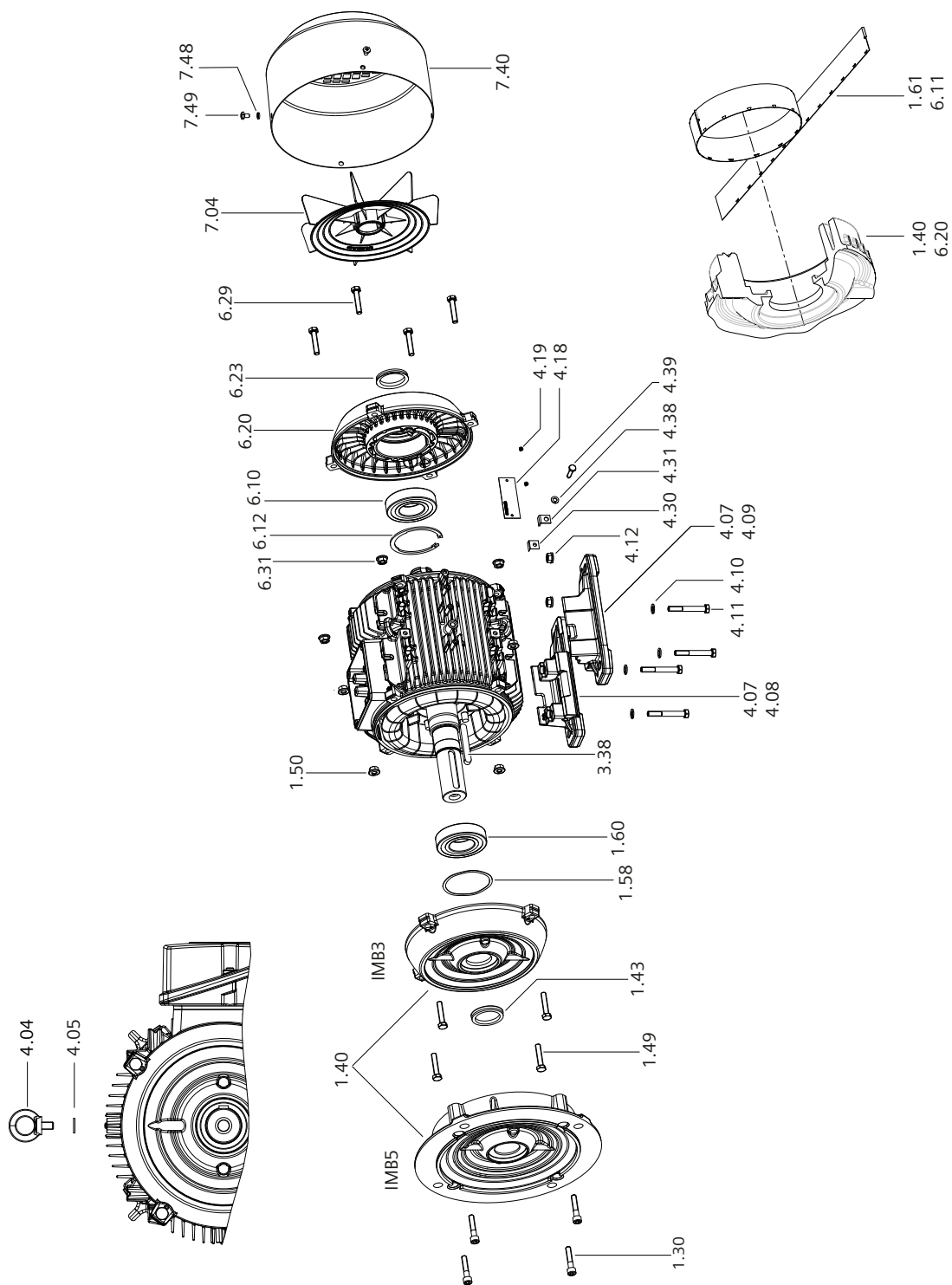

10.11.4 1MB1 shaft heights 100 ... 200 cast iron

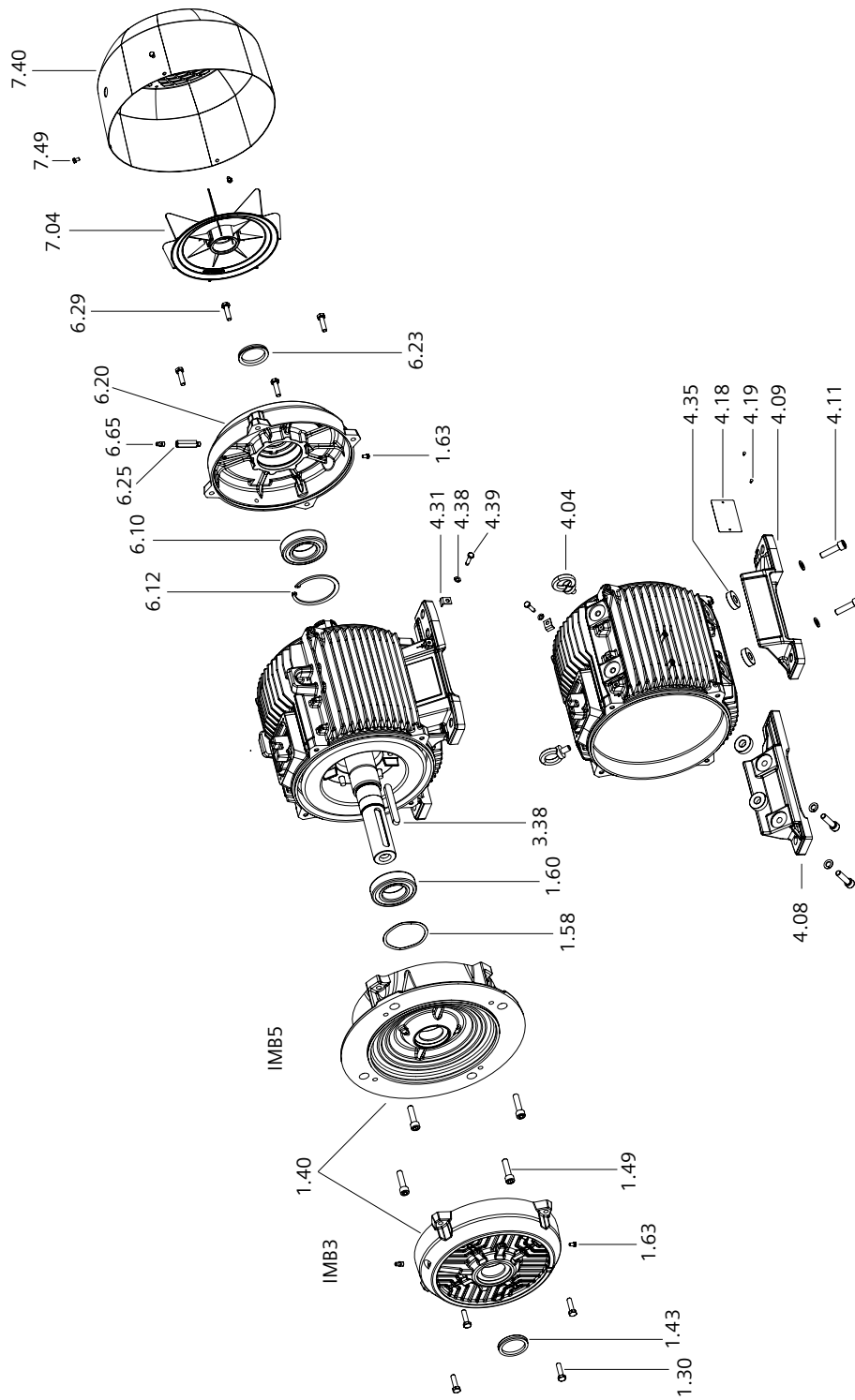

10.11.5 1MB1 shaft heights 180 ... 200 aluminum

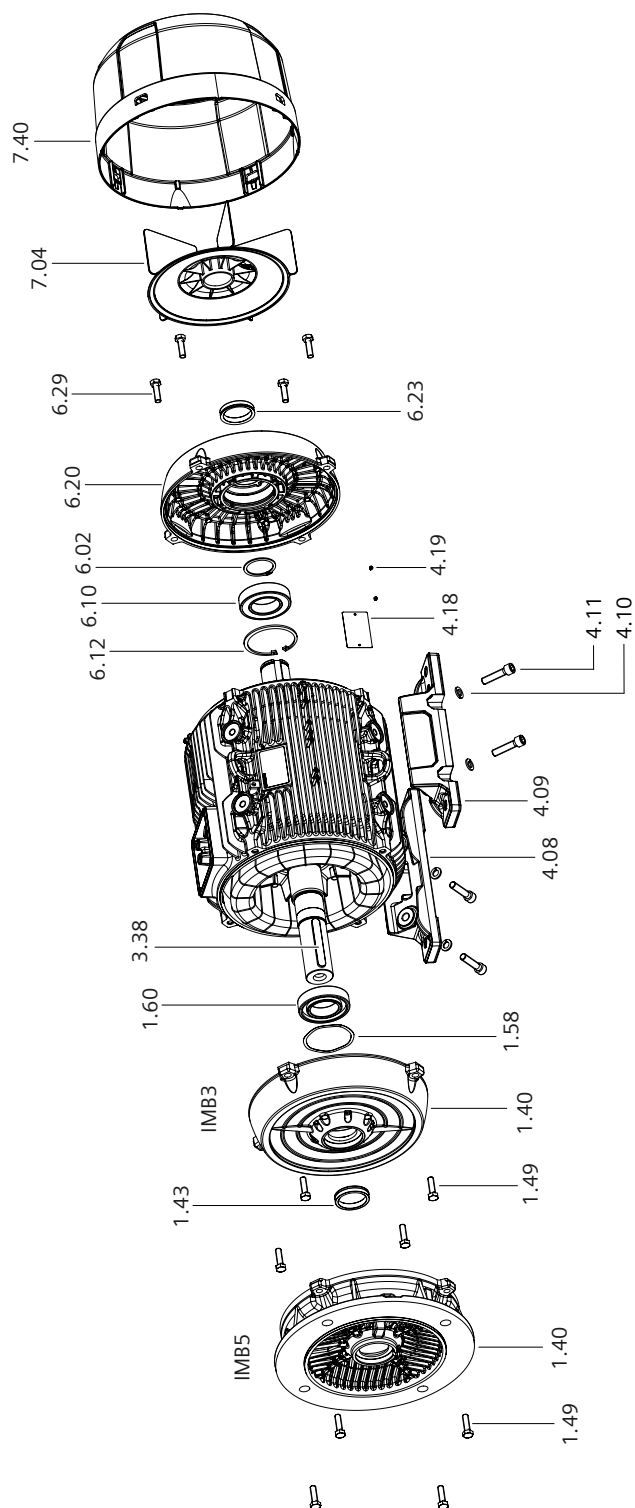

10.11.6 1MB1 shaft heights 225 ... 315 cast iron

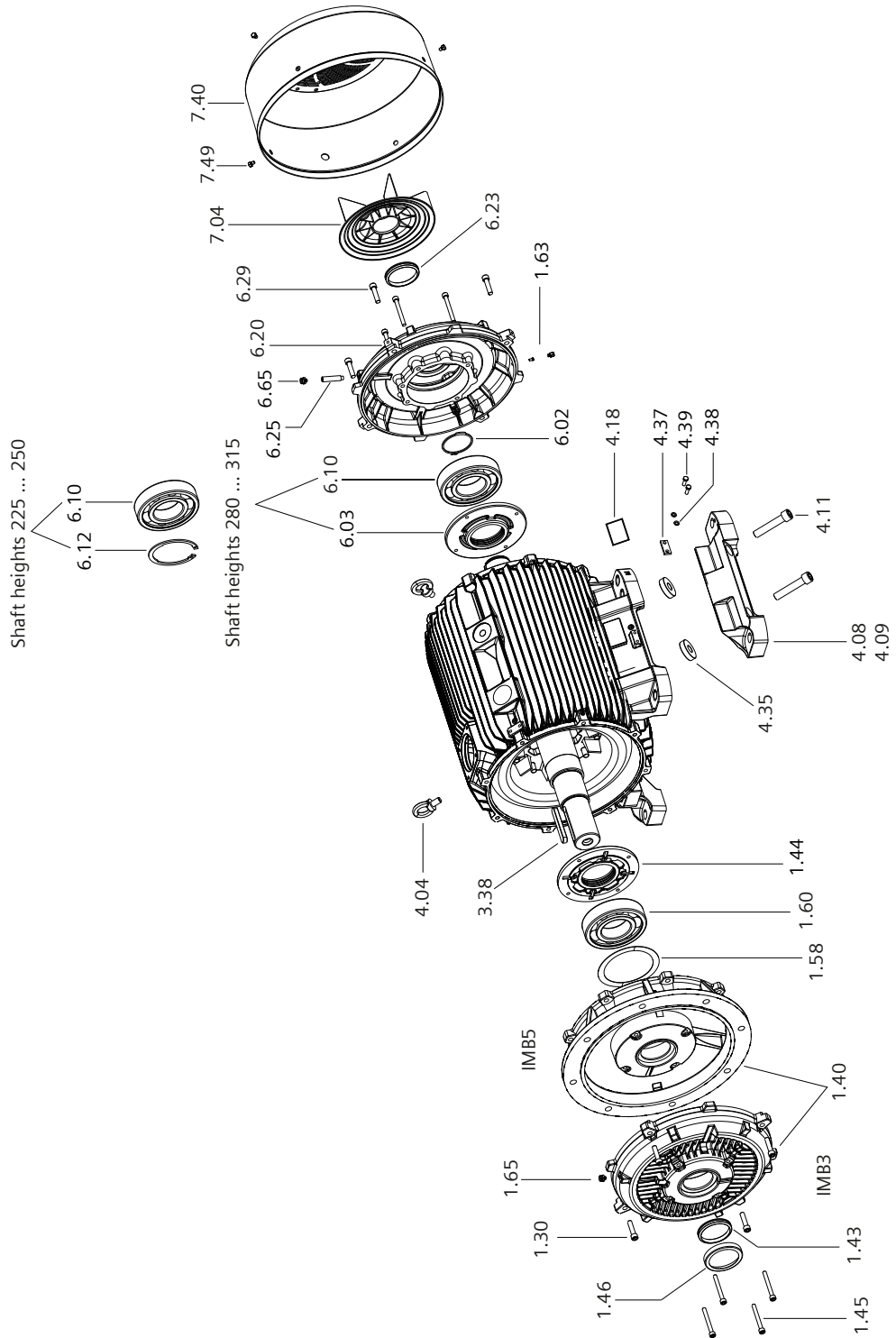

10.11.7 1MB5 shaft height. 315 cast iron

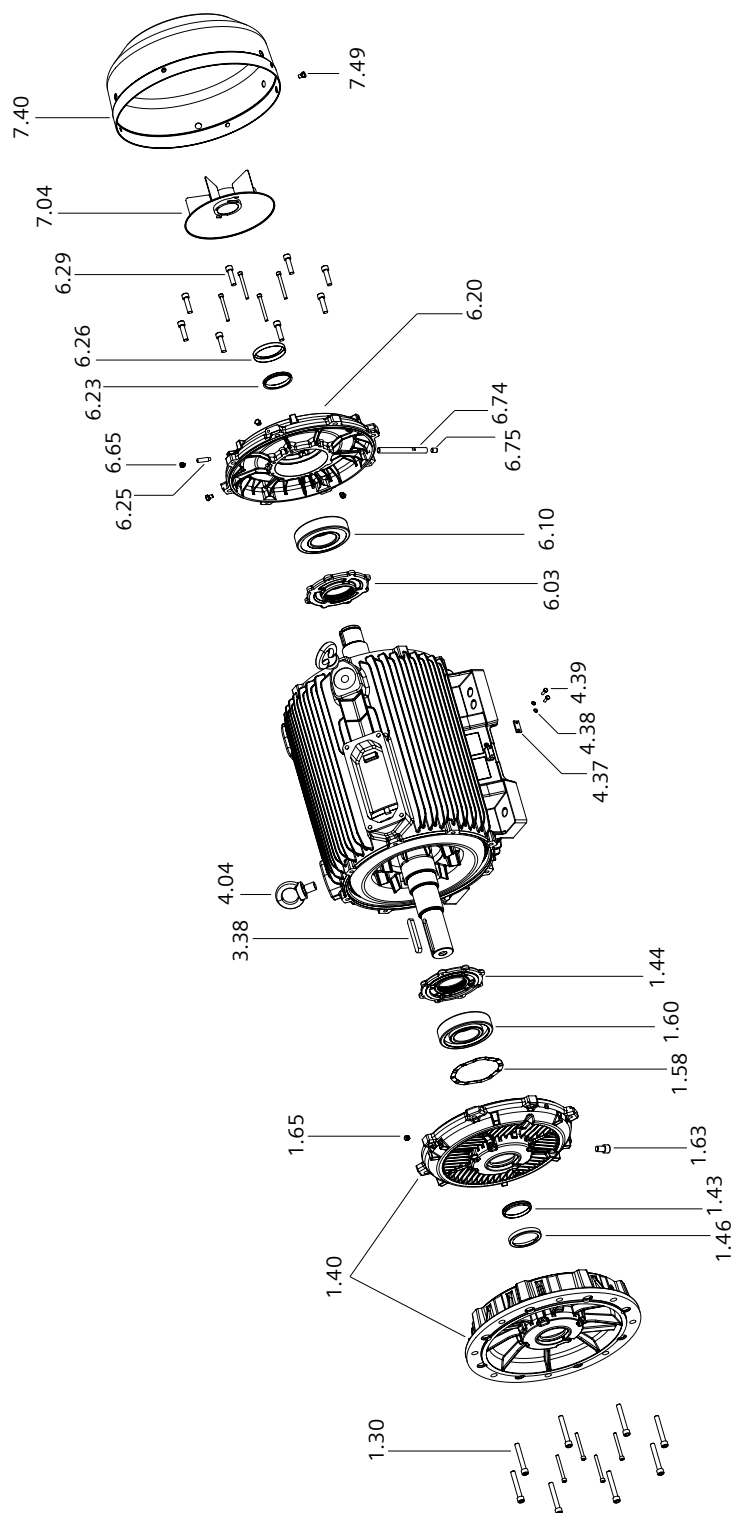

10.11.8 1MB5 shaft height. 355 cast iron

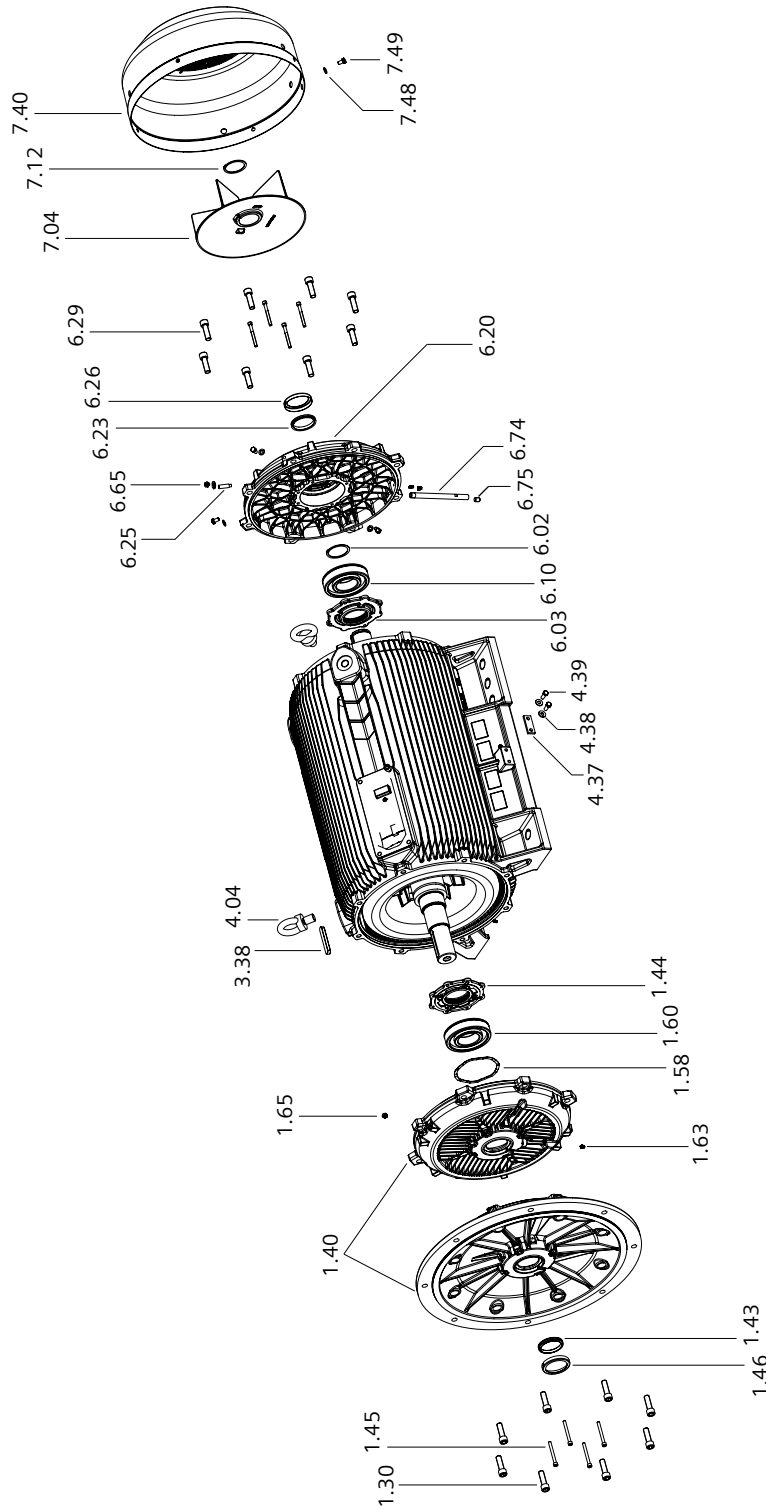

10.11.9 Terminal box 1MB1 shaft heights 63 ... 71 aluminum

TB1B20

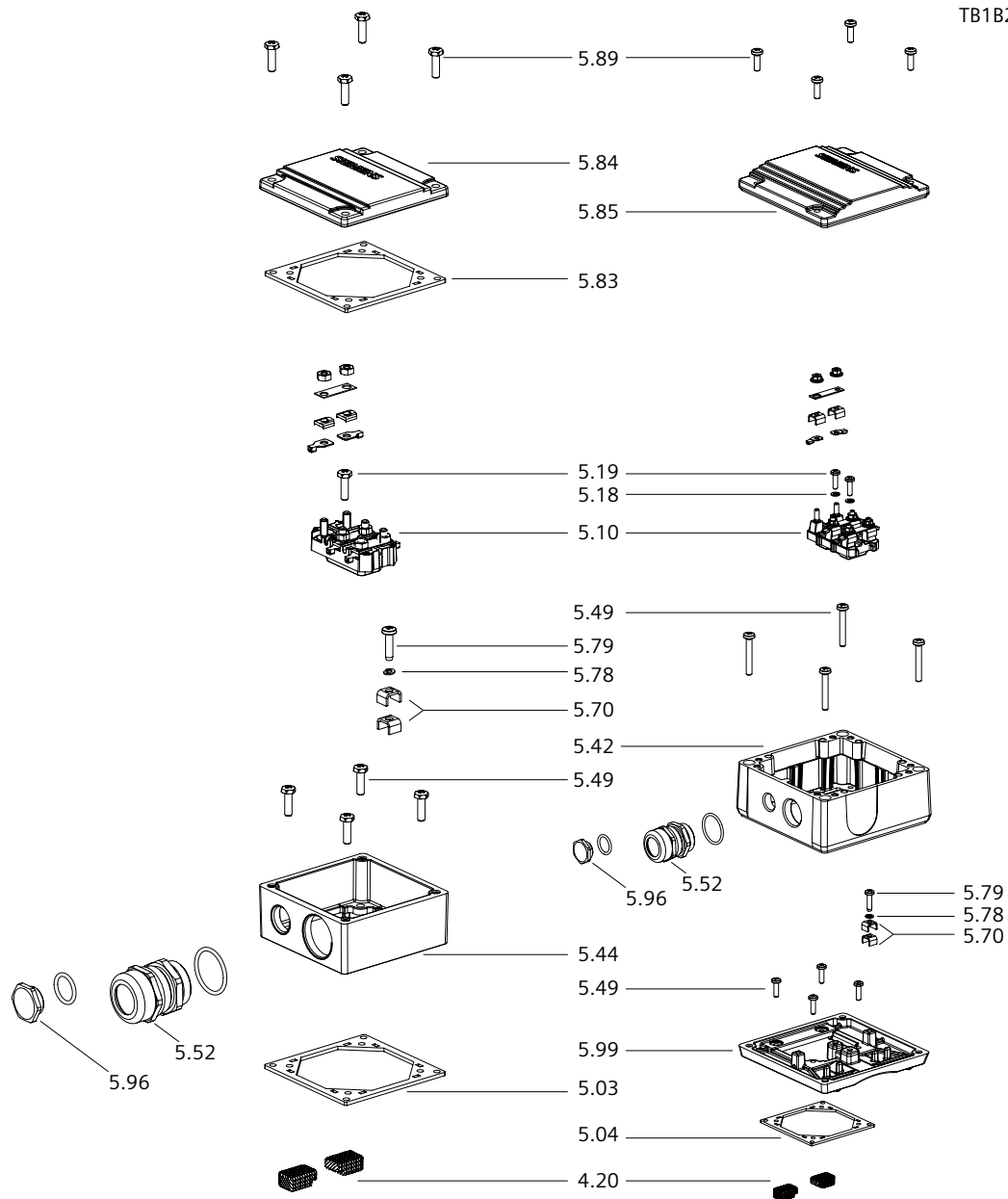

10.11.10 Terminal box 1MB1 shaft heights 71 ... 200 cast iron

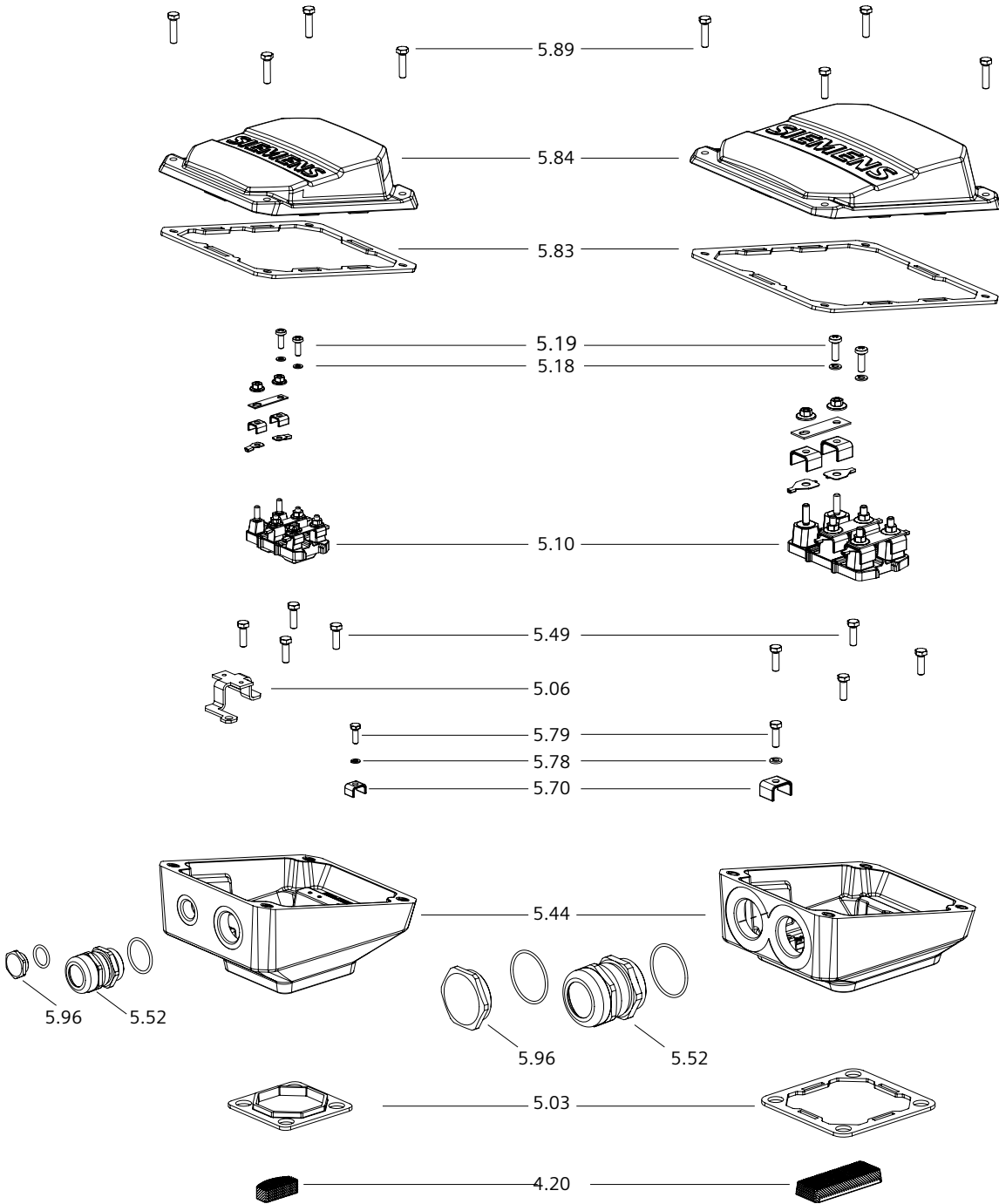

10.11.11 Terminal box 1MB1 shaft heights 80 ... 160 aluminum

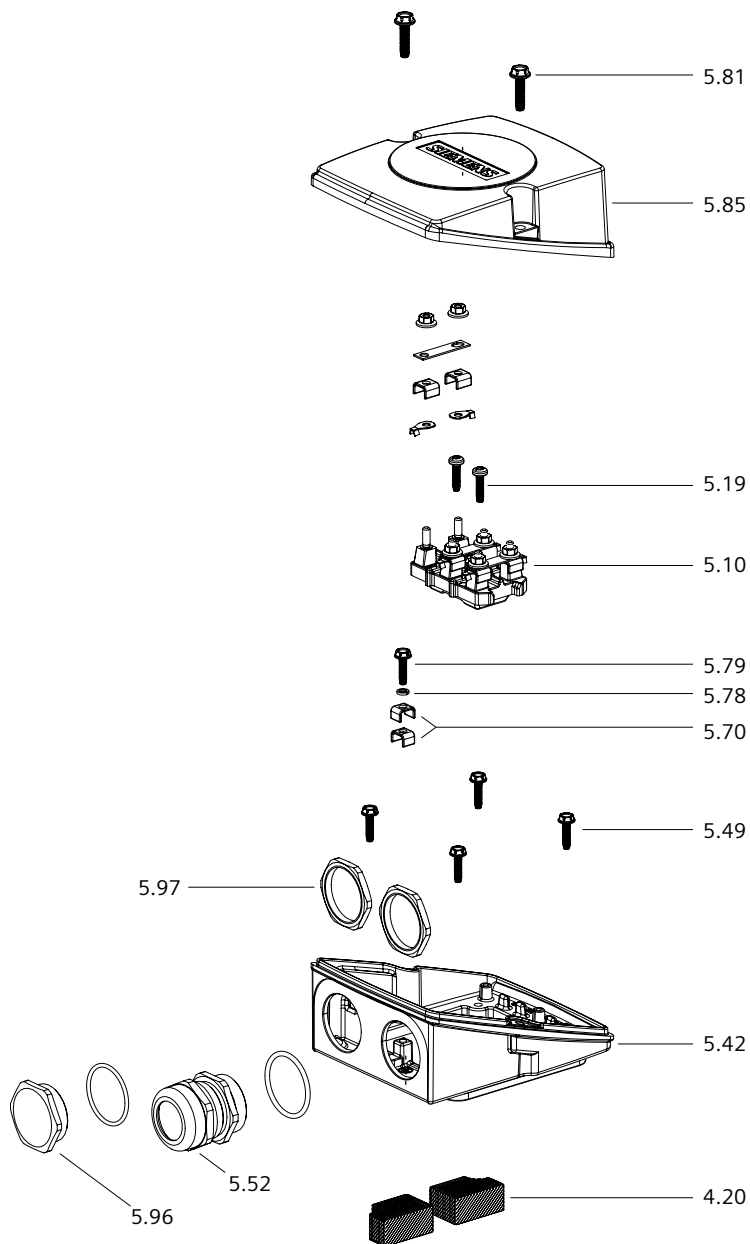

10.11.12 Terminal box 1MB1 shaft heights 200 ... 225 cast iron

TB1L61

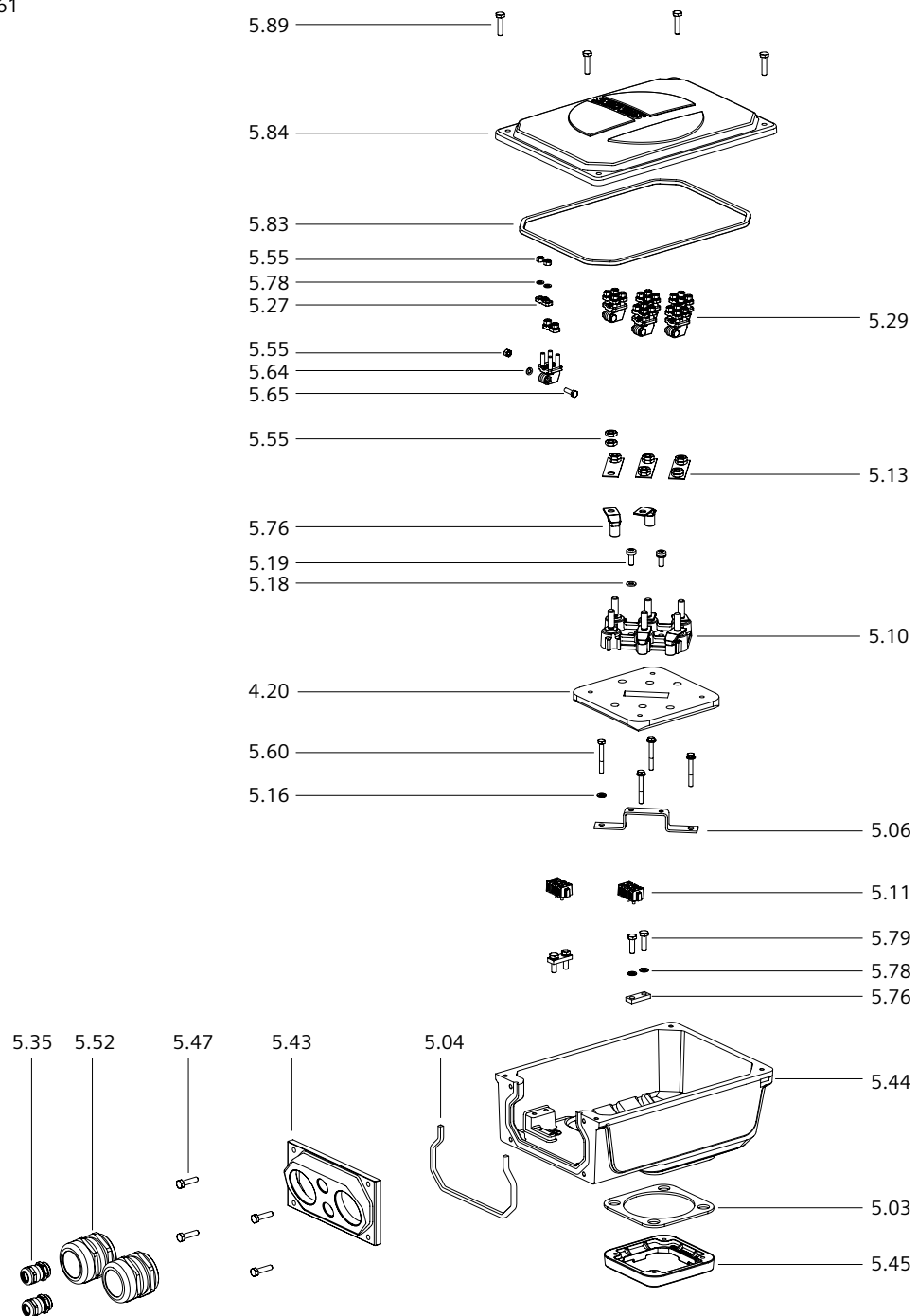

TB1L21

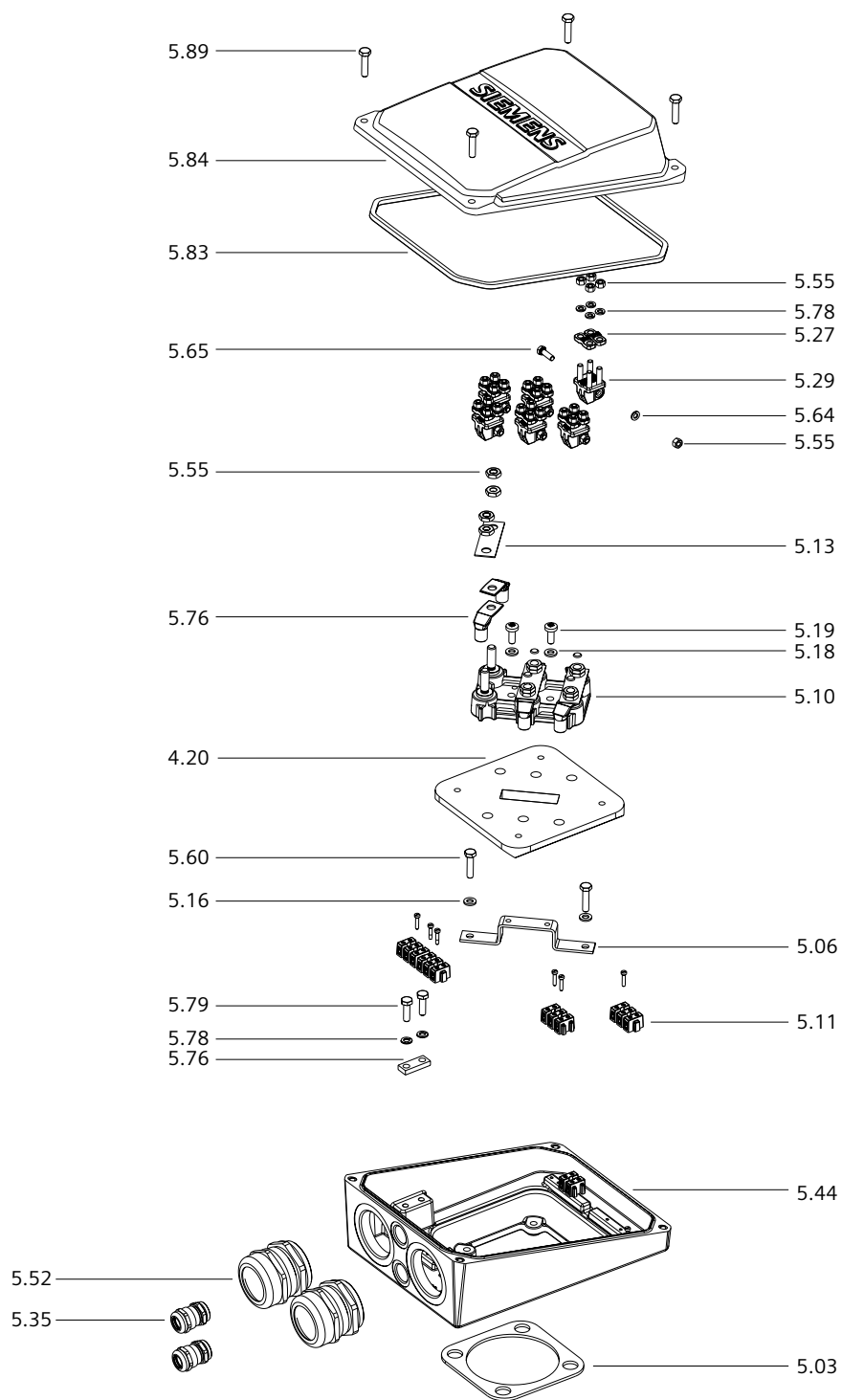

10.11.13 Terminal box 1MB1 shaft heights 250 ... 280 cast iron

TB1N21

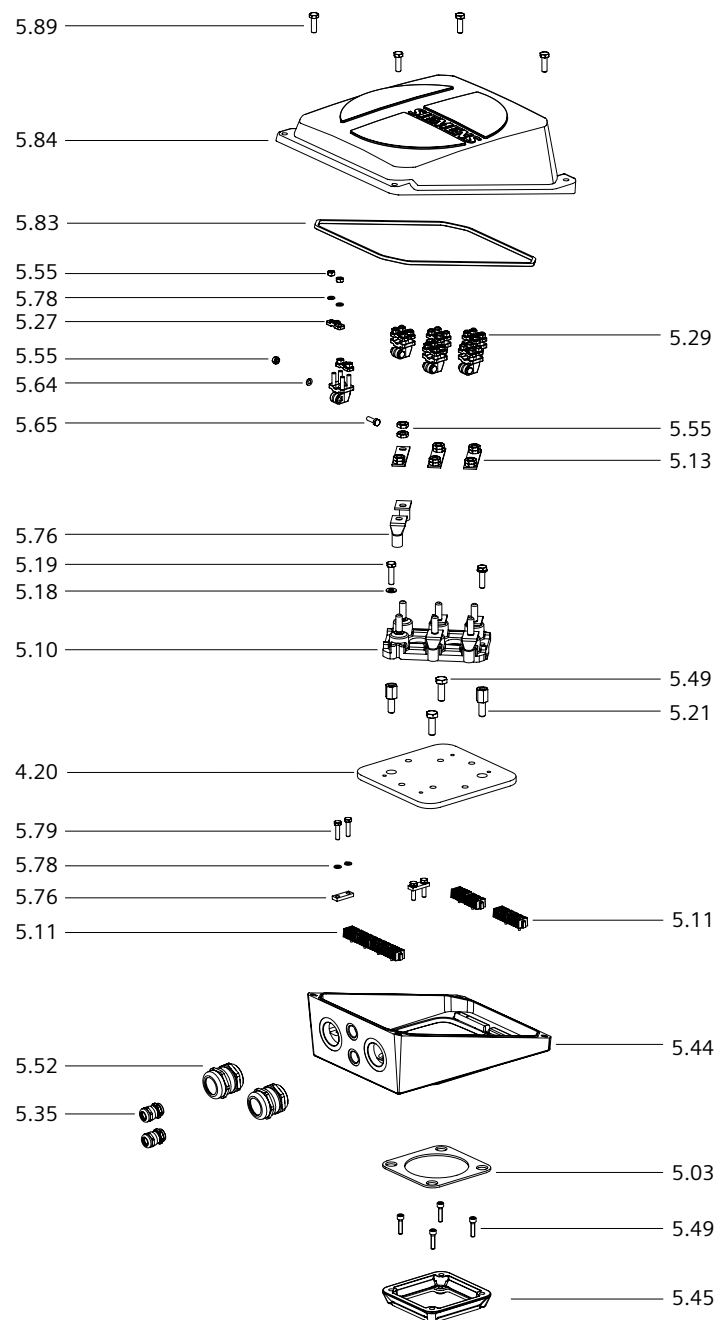

TB1N61

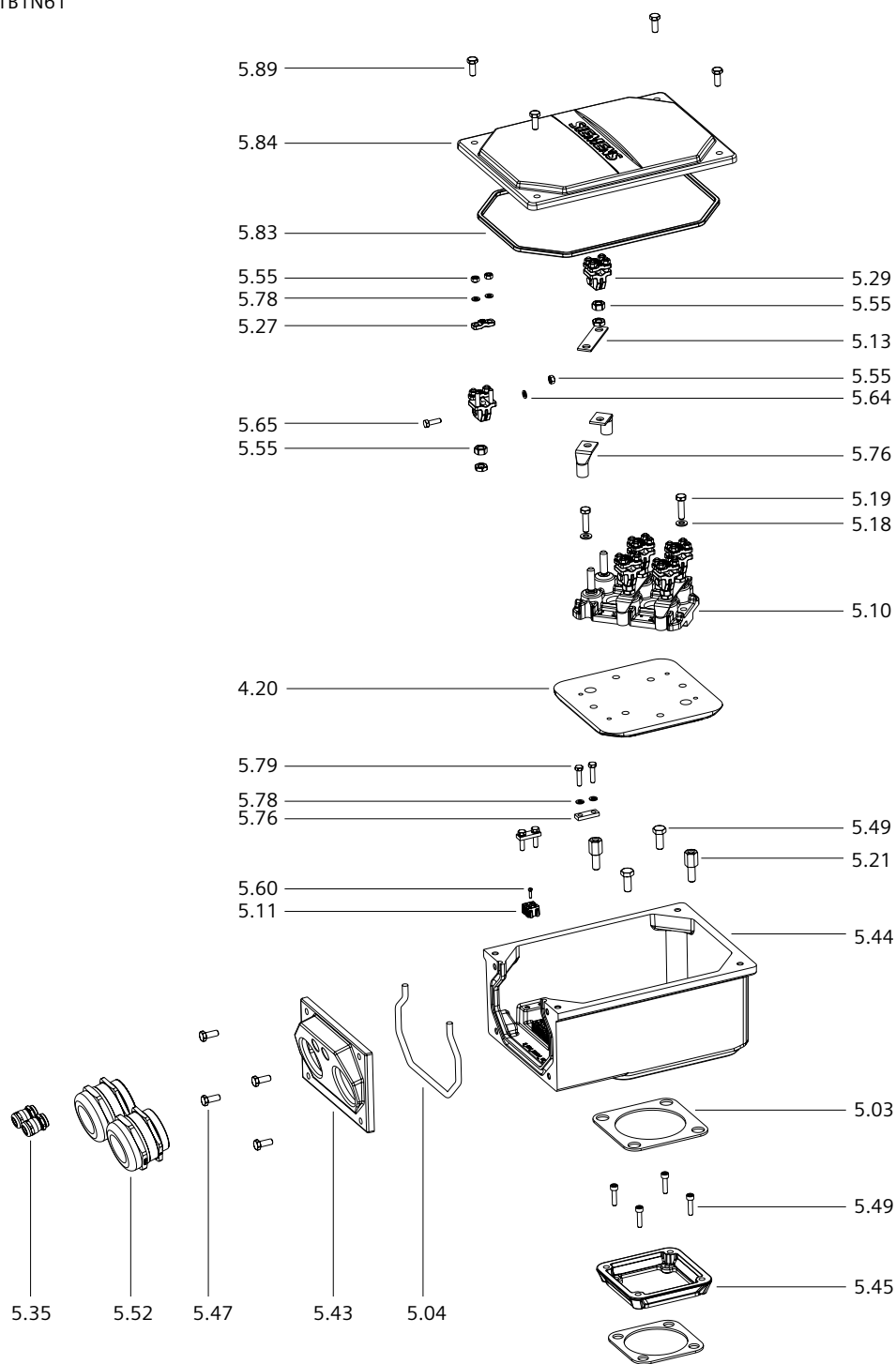

10.11.14 Terminal box 1MB1 shaft height 315 cast iron

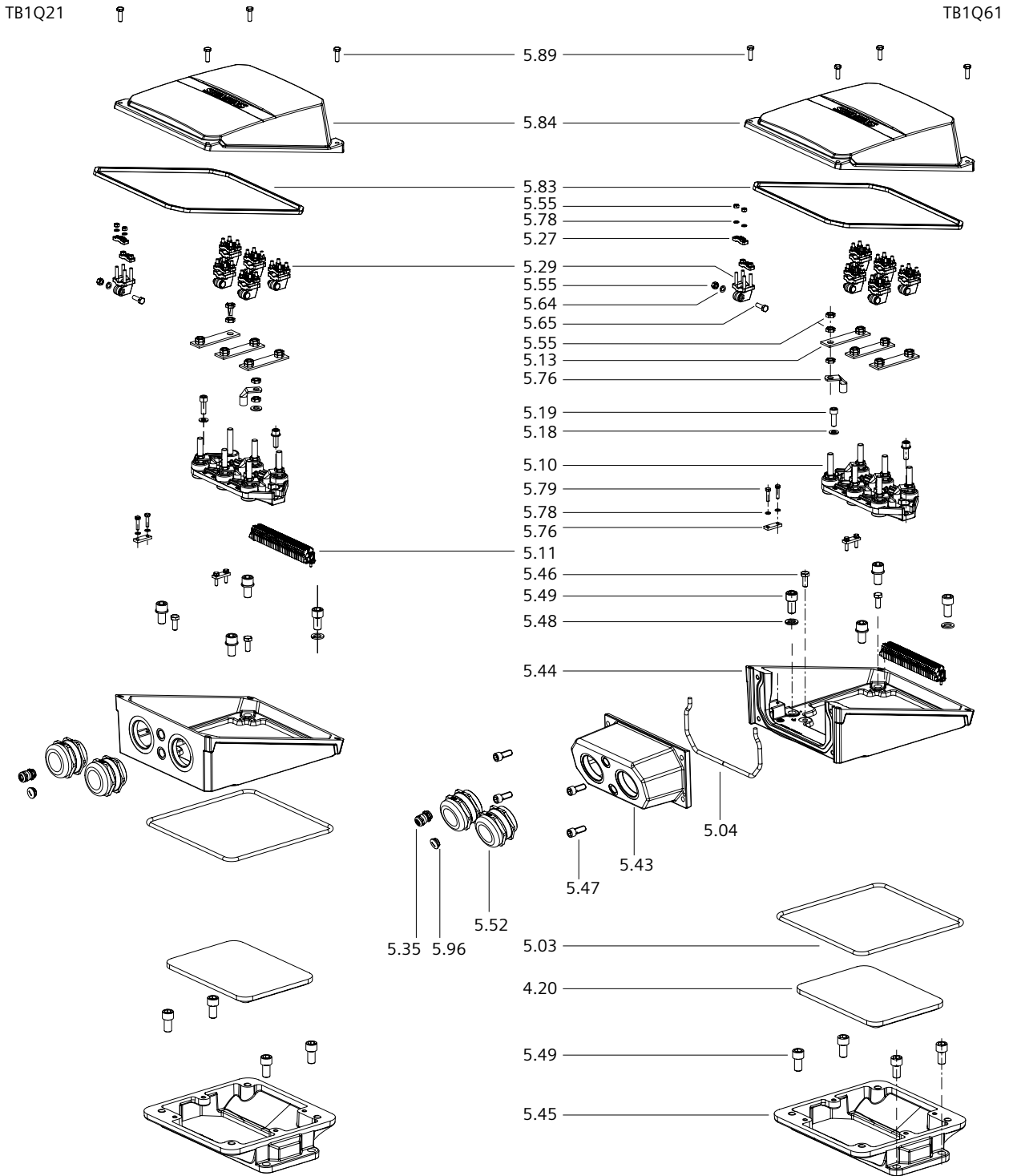

TB1R01

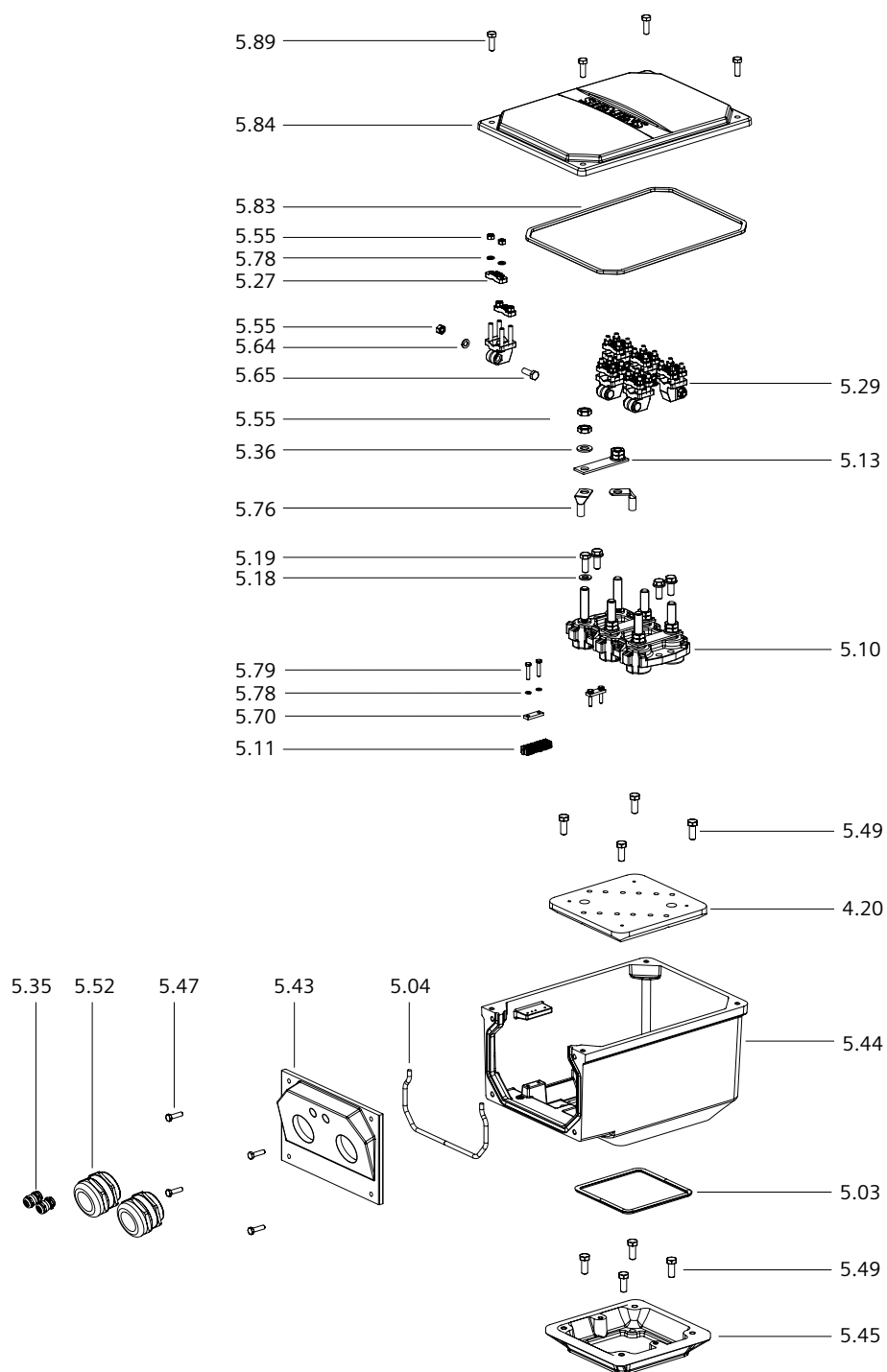

10.11.15 Terminal box 1MB5 shaft height 315 cast iron

TB3Q21

TB3Q61

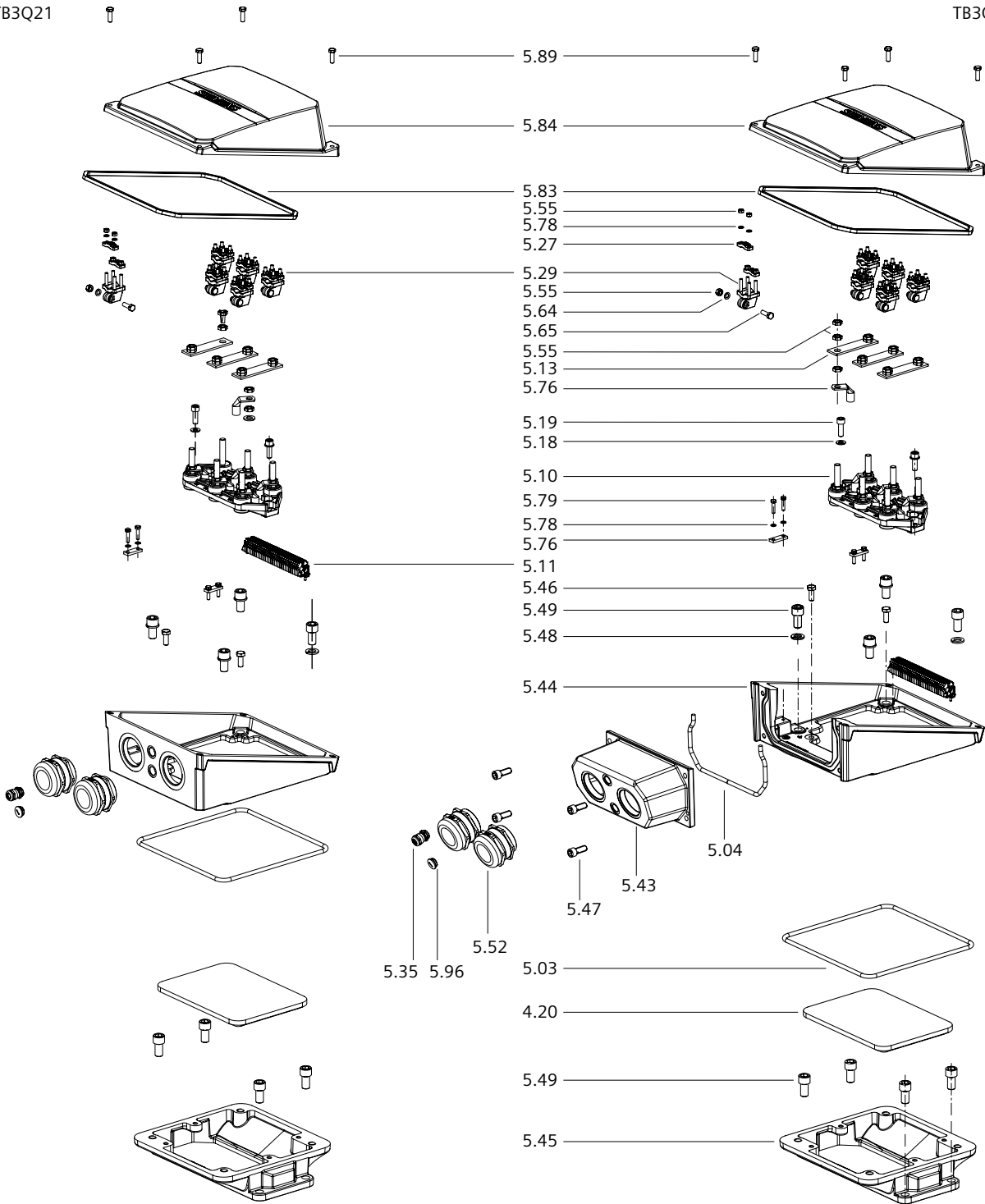

10.11.16 1MB5 terminal box shaft height 355 cast iron

TB3R21

TB3R61

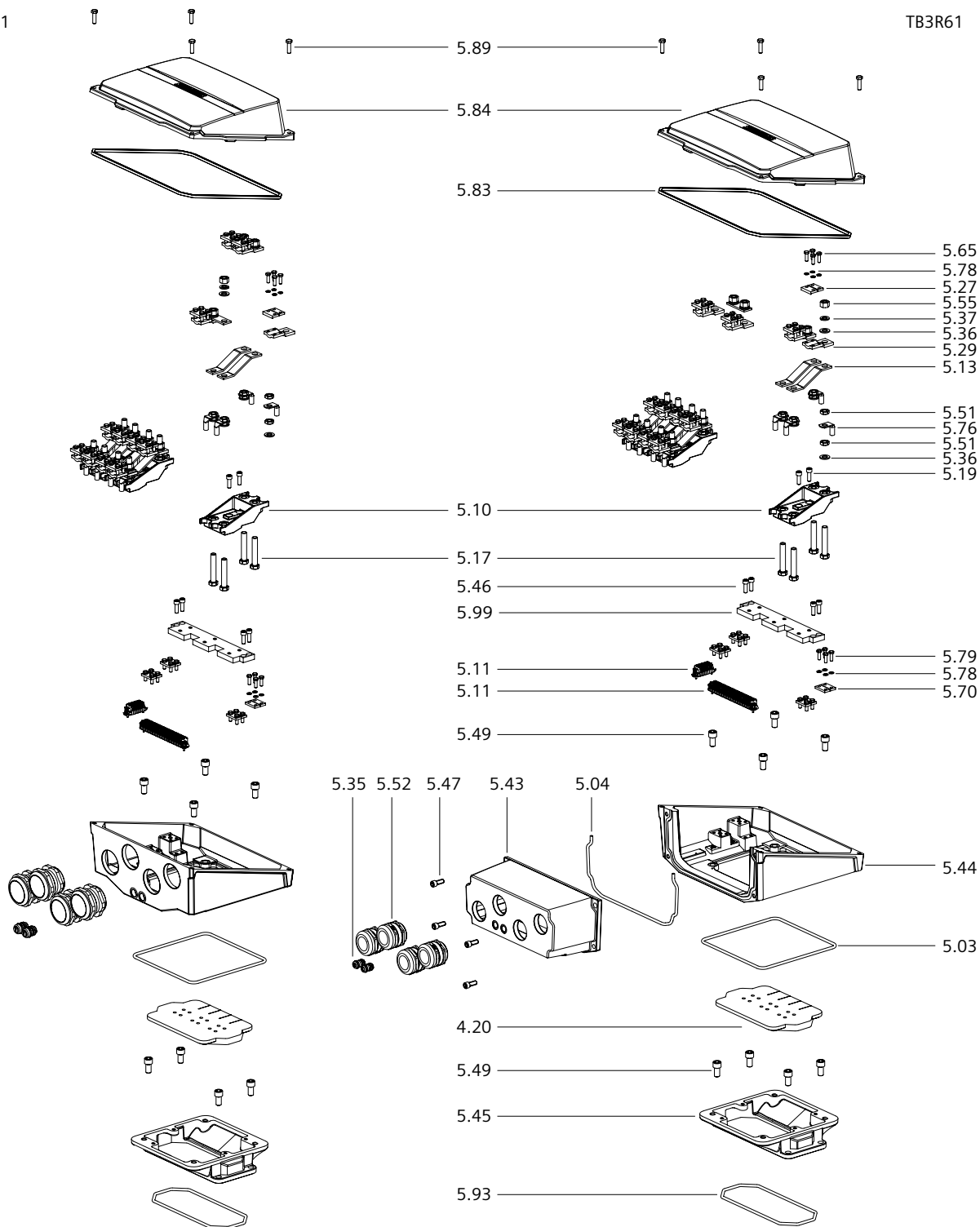

10.11.17 Separately driven fan optional shaft height 225 ... 355

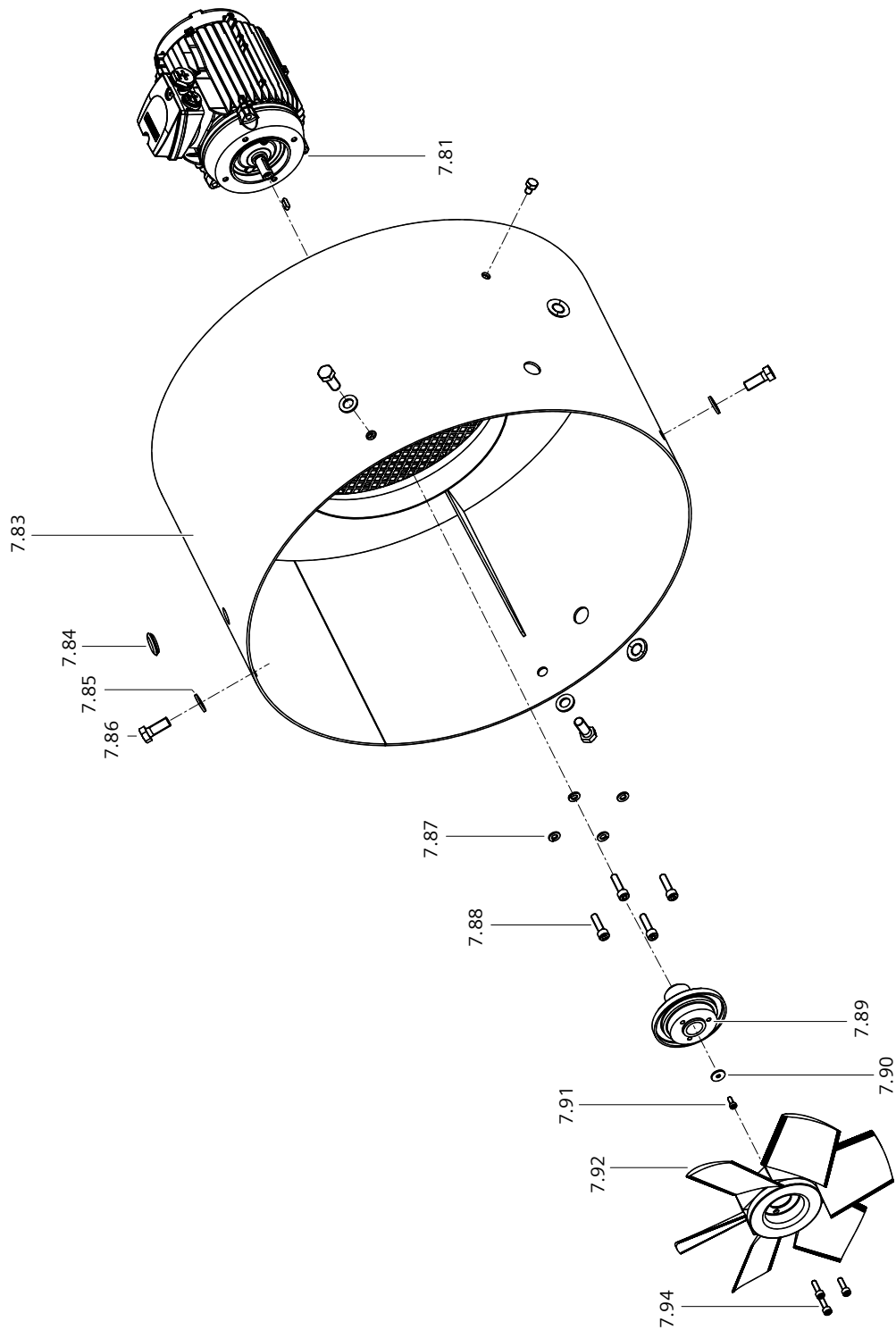

Disposal

11.1 Introduction

Protecting the environment and preserving its resources are corporate goals of the highest priority for us. Our worldwide environmental management system to ISO 14001 ensures compliance with legislation and sets high standards in this regard. Environmentally friendly design, technical safety and health protection are always firm goals even at the product development stage.

Recommendations for the environmentally friendly disposal of the machine and its components are given in the following section. Be sure to comply with local disposal regulations.

Country-specific legislation



The machine uses materials that can be recovered or recycled. Correctly separating materials helps to simply recycle important materials.

- When disposing of the machine or of waste that is created during the individual phases of its life cycle, please observe the statutory requirements applicable in the country of use.
- Please contact your local authorities for more information about disposal.

11.2 RoHS - restricting the use of certain hazardous substances

In compliance with RoHS ("Restriction of certain Hazardous Substances") we replace substances that are damaging to the environment by those that are not based on state-of-the-art technology. In doing so, safety in operation and handling will take priority at all times.

11.3 Note regarding Article 33 of the REACH regulation

Note regarding an obligation to provide information according to Article 33 of the REACH regulation:

Refer to the delivery note for substances and notes relating to safe handling.

11.4 Preparing for disassembly

Disassembly of the machine must be carried out and/or supervised by qualified personnel with appropriate expert knowledge.

1. Contact a certified waste disposal organization in your vicinity. Clarify what is expected in terms of the quality of dismantling the machine and provision of the components.
2. Carefully follow the 5 safety rules (Page 16).
3. Disconnect all electrical connections and remove all cables.
4. Remove all liquids e.g. oil and cooling liquids. Collect the liquids separately and dispose of them in a professional manner.
5. Detach the machine fixings.
6. Transport the machine to a suitable location for disassembly.

11.5 Dismantling the machine

Dismantle the machine using the general procedures commonly used in mechanical engineering.



WARNING

Machine parts can fall

The machine is made up of heavy parts. These parts are liable to fall during dismantling. This can result in death, serious injury or material damage.

- Before you release any machine parts, secure them so that they cannot fall.

11.6 Disposal of components

Components

The machines consist mainly of steel and various proportions of copper and aluminum. Metals are generally considered to be unlimitedly recyclable.

Sort the components for recycling according to whether they are:

- Iron and steel
- Aluminum
- Non-ferrous metal, e.g. windings
The winding insulation is incinerated during copper recycling.
- Insulating materials
- Cables and wires
- Electronic waste

Process materials and chemicals

Sort the process materials and chemicals for recycling according to whether they are for example:

- Oil
- Grease
- Cleaning substances and solvents
- Paint residues
- Anti-corrosion agent
- Coolant additives such as inhibitors, antifreeze or biocides

Dispose of the separated components according to local regulations or via a specialist disposal company. The same applies for cloths and cleaning agents that have been used while working on the machine.

Packaging material

- If necessary, contact a suitable specialist disposal company.
- Wooden packaging for sea transport consists of impregnated wood. Comply with the local regulations.
- The foil used for water-proof packaging is an aluminum composite foil. It can be recycled thermally. Dirty foil must be disposed of through incineration.

Technical data

Siemens Product Configurator

The Siemens Product Configurator supports you in configuring the optimum drive technology products for a number of applications – starting with gearboxes, motors, converters as well as the associated options and components and ending with controllers, software licenses and connection systems.

The Siemens Product Configurator can be used on the internet without any installation. The Siemens Product Configurator is available through the Siemens Industry Mall at the following address: Siemens Product Configurator (www.siemens.com/spc)

A.1 Tightening torques

A.1.1 Tightening torques for screw and bolt connections

Bolt locking devices

- When assembling, refit nuts or bolts that are mounted together with locking, resilient, and/or force-distributing elements with identical, fully-functional elements. Always renew keyed elements.
- When screwing together threads secured with a liquid adhesive, use a suitable medium such as Loctite 243.
- Always use suitable securing devices or removable adhesives (e.g., Loctite 243) when installing fixing bolts with a clamping length of less than 25 mm. The clamping length is taken as the distance between the head of the bolt and the point at which the bolt is screwed in.

Tightening torques

The bolted connections with metal contact surfaces, such as end shields, bearing cartridge parts, terminal box parts bolted onto the stator frame, should be tightened to the following torques, depending on the thread size:

Table A-1 Tightening torques for bolted connections with a tolerance of $\pm 10\%$.

Thread \varnothing	M5	M6	M8	M10	M12	M16	M20	M24
Nm	5	8	20	40	70	170	340	600

The tightening torques stated above apply to screws with property class 8.8, A4-70 or A4-80 according to ISO 898-1, however only to bolts screwed into components made from materials with the same or higher property class, e.g. cast iron, steel or cast steel.

A.1 Tightening torques

Non-standard tightening torques

Different tightening torques for electrical connections and bolted connections for parts with flat seals or insulating parts are specified in the relevant sections and drawings.

A.1.2 Stud-type bushings

Table A-2 Tightening torques for stud-type bushings

Thread Ø		M4	M5	M6	M8	M10	M12	M16	M20
Nm	Min.	1	1.6	2.5	5	8	13	25	42
	Max.	1.2	2	3	6	10	15.5	30	52

A.1.3 Terminal boxes, end shields, grounding conductors, sheet metal fan covers

If no other tightening torques are specified, then the values in the following table apply.

Table A-3 Tightening torques for screws on the terminal box, end shields, screw-type grounding conductor connections

Thread Ø		M3.5	M4	M5	M6	M8	M10	M12	M16	M20
Nm	min.	0.8	2	3.5	6	16	28	46	110	225
	max.	1.2	3	5	9	24	42	70	165	340

Tightening torque for the condensation drain plug

Tighten the condensation drain plug M6x0.75 with a torque between 1.5 and 2.0 Nm.

A.1.3.1 Terminal board and grounding

Table A-4 Tightening torques for electrical connections on the terminal board and grounding

Thread Ø		M3.5	M4	M5	M6	M8	M10	M12	M16
Nm	min.	0.8	0.8	1.8	2.7	5.5	9	14	27
	max.	1.2	1.2	2.5	4	8	13	20	40

A.1.4 Tightening torques of additional connecting terminals

Table A-5 Tightening torques for electrical connections of monitoring equipment and anti-condensation heating

Main terminal box EN 60999-1: 2000 table 4 III	0.4 Nm	
Auxiliary terminal box	min 0.6 Nm	max 0.8 Nm

Quality documents

B.1 Quality documents SIMOTICS in SIOS



You can find the quality documents here:

<https://support.industry.siemens.com/cs/ww/de/ps/13310/cert> (<https://support.industry.siemens.com/cs/ww/en/ps/13310/cert>)

More information

Siemens:
www.siemens.com/simotics

Industry Online Support (Service and Support):
www.siemens.com/online-support

IndustryMall:
www.siemens.com/industrymall

Innomotics GmbH
Vogelweiherstrass 1-15
90441 NUERNBERG
Germany

A5E44455710A

