



Edition

07/2023

OPERATING INSTRUCTIONS

SINAMICS/SIMOTICS

SINAMICS S200 PROFINET servo drive system

SINAMICS S200 converter product line
SIMOTICS S-1FL2 servo motor

SIEMENS

SINAMICS/SIMOTICS

SINAMICS S200 PROFINET servo drive system with SIMOTICS S-1FL2

Operating Instructions

PROFINET version, Firmware V6.2

Introduction	1
Fundamental safety instructions	2
Description	3
Application planning	4
Mounting	5
Connecting	6
Commissioning (web server)	7
Commissioning (Startdrive)	8
Series commissioning	9
Functions	10
Tuning	11
System messages	12
Corrective maintenance	13
Technical data	14
Examples/applications	15
Appendix	A

Legal information

Warning notice system

This manual contains notices you have to observe in order to ensure your personal safety, as well as to prevent damage to property. The notices referring to your personal safety are highlighted in the manual by a safety alert symbol, notices referring only to property damage have no safety alert symbol. These notices shown below are graded according to the degree of danger.

 DANGER
indicates that death or severe personal injury will result if proper precautions are not taken.

 WARNING
indicates that death or severe personal injury may result if proper precautions are not taken.

 CAUTION
indicates that minor personal injury can result if proper precautions are not taken.

NOTICE
indicates that property damage can result if proper precautions are not taken.

If more than one degree of danger is present, the warning notice representing the highest degree of danger will be used. A notice warning of injury to persons with a safety alert symbol may also include a warning relating to property damage.

Qualified Personnel

The product/system described in this documentation may be operated only by **personnel qualified** for the specific task in accordance with the relevant documentation, in particular its warning notices and safety instructions. Qualified personnel are those who, based on their training and experience, are capable of identifying risks and avoiding potential hazards when working with these products/systems.

Proper use of Siemens products

Note the following:

 WARNING
Siemens products may only be used for the applications described in the catalog and in the relevant technical documentation. If products and components from other manufacturers are used, these must be recommended or approved by Siemens. Proper transport, storage, installation, assembly, commissioning, operation and maintenance are required to ensure that the products operate safely and without any problems. The permissible ambient conditions must be complied with. The information in the relevant documentation must be observed.

Trademarks

All names identified by ® are registered trademarks of Siemens AG. The remaining trademarks in this publication may be trademarks whose use by third parties for their own purposes could violate the rights of the owner.

Disclaimer of Liability

We have reviewed the contents of this publication to ensure consistency with the hardware and software described. Since variance cannot be precluded entirely, we cannot guarantee full consistency. However, the information in this publication is reviewed regularly and any necessary corrections are included in subsequent editions.

Table of contents

1	Introduction	15
1.1	About SINAMICS	15
1.2	About this manual	16
1.2.1	Content	16
1.2.2	Target group	16
1.2.3	Standard scope	17
1.2.4	Use of third-party products in this documentation	17
1.2.5	Websites of third-party companies.....	17
1.3	SINAMICS documentation	18
1.4	Service and Support.....	19
1.4.1	Siemens Industry Online Support on the Web.....	19
1.4.2	Siemens Industry Online Support on the road.....	19
1.4.3	Getting information about the product.....	20
1.4.4	Feedback on the technical documentation	21
1.4.5	mySupport documentation	21
1.4.6	Technical support.....	22
1.4.7	Training	23
1.4.8	Spare parts services	23
1.5	Important product information	24
1.5.1	Intended use.....	24
1.5.2	Firmware updates and constraints.....	25
1.5.3	Open-source software (OSS)	25
1.5.4	Compliance with the General Data Protection Regulation.....	26
2	Fundamental safety instructions.....	27
2.1	General safety instructions.....	27
2.2	Equipment damage due to electric fields or electrostatic discharge	35
2.3	Warranty and liability for application examples	36
2.4	Security information	37
2.5	Residual risks of power drive systems	38
3	Description.....	41
3.1	System overview.....	41
3.1.1	Converter	45
3.1.2	Motor	45
3.1.3	MOTION-CONNECT 350 and 380 cables.....	46
3.2	Scope of delivery	47
3.2.1	Converter	47
3.2.1.1	Rating plate	48
3.2.1.2	Article number explanation.....	49
3.2.1.3	Serial number explanation	50

3.2.2	Motor	50
3.2.2.1	Rating plate	52
3.2.2.2	Article number explanation	54
3.2.2.3	Serial number explanation	55
3.2.3	MOTION-CONNECT 350 and 380 cables	56
3.2.3.1	Overview	56
3.2.3.2	Article number explanation	56
3.3	Device combinations	58
3.3.1	S200 PN 200 V servo drive system	58
3.3.2	S200 PN 400 V servo drive system	59
3.4	Accessories	61
3.4.1	Connector kits	61
3.4.2	Cables and connectors	62
3.4.2.1	MOTION-CONNECT cables and connectors	62
3.4.2.2	I/O cable and connector	64
3.4.3	Line filter	65
3.4.3.1	Recommended line filters	66
3.4.3.2	Technical data	66
3.4.3.3	Dimension drawing	67
3.4.3.4	Mounting instructions for the line filter	71
3.4.4	External 24 V DC power supply	71
3.4.5	Replacement fans	72
3.4.6	Shield plate kit	73
3.4.7	SD card	73
3.5	Directives and standards	75
3.5.1	Directives, standards and certificates for the converter	75
3.5.2	Directives, standards and certificates for the motor	76
3.5.3	Directives, standards and certificates for the MOTION-CONNECT cable	78
4	Application planning	81
4.1	Protection of persons from electromagnetic fields	81
4.2	Fault protection for the motor circuit	83
4.3	Permissible mains supply network configurations for motors	84
4.4	Line connection conditions for the S200 product line with the motor 1FL2	85
4.5	Minimum cross-section of the protective conductors	86
4.6	Electromagnetic compatibility (EMC)	88
4.6.1	Interference caused by electromagnetic fields (EMF)	88
4.6.2	Electromagnetic compatibility (EMC)	88
4.6.3	EMC environments in residential and industrial areas	89
4.6.4	EMC category	89
4.6.5	SINAMICS S200 converter product line in the 2nd environment (industrial areas)	90
4.6.5.1	Complying with Category C2 interference emission	90
4.6.5.2	Complying with Category C3 interference emission	91
4.6.5.3	Harmonic current emissions	92
4.6.6	EMC limit values in South Korea	93
4.7	EMC-compliant control cabinet installation	94
4.7.1	Potential equalization between control cabinets	94
4.7.2	EMC zones in the control cabinet	94

4.7.3	Shielded cables for the converter	95
4.7.4	EMC-compliant cable routing	95
4.7.5	Shielding and potential equalization inside the control cabinet	97
5	Mounting	99
5.1	Converter	99
5.1.1	Mounting instructions for the converter	99
5.1.2	Mounting position	99
5.1.3	Dimension drawings and drilling dimensions	100
5.1.3.1	Dimension drawing and drilling dimensions for the 200 V converter	100
5.1.3.2	Dimension drawing and drilling dimensions for the 400 V converter	101
5.1.4	Minimum clearances	102
5.2	Motor	103
5.2.1	Transporting and lifting	103
5.2.2	Checklist prior to mounting	106
5.2.3	Safety labels on the motor	107
5.2.4	Mounting instructions for the motor	108
5.2.5	Mounting position	110
5.2.6	Dimension drawings for motors	111
5.2.6.1	Dimension drawing for the 1FL2 motor, shaft height 20	111
5.2.6.2	Dimension drawing for the 1FL2 motor, shaft height 30	112
5.2.6.3	Dimension drawing for the 1FL2 motor, shaft height 40	113
5.2.6.4	Dimension drawing for the 1FL2 motor, shaft height 45	114
5.2.6.5	Dimension drawing for the 1FL2 motor, shaft height 48	115
5.2.6.6	Dimension drawing for the 1FL2 motor, shaft height 52	116
5.2.6.7	Dimension drawing for the 1FL2 motor, shaft height 65	117
5.2.6.8	Dimension drawing for the 1FL2 motor, shaft height 90	118
5.2.7	Mounting the feather key	119
5.2.8	Attaching output elements	120
5.2.9	Laying cables in cable carriers (for MOTION-CONNECT 380 only)	123
6	Connecting	127
6.1	System connection	128
6.2	Overview of the converter interfaces	129
6.3	Cables and connectors	130
6.3.1	Maximum permissible cable lengths	130
6.3.2	Conductor cross-sections and cable lugs	130
6.4	Connecting the mains supply	132
6.4.1	Interface description - X1	132
6.4.2	Wiring	132
6.4.3	Using several single-phase converters in machines and plants	133
6.5	Connecting the motor	135
6.5.1	Routing cables in damp environments	135
6.5.2	Connecting the motor power	135
6.5.2.1	Interface description - X2 (converter side)	135
6.5.2.2	Interface description - power connector (motor side)	136
6.5.2.3	Wiring	138
6.5.3	Connecting the motor holding brake	139
6.5.3.1	Interface description (converter side)	139
6.5.3.2	Interface description (motor side)	139

6.5.3.3	Wiring	140
6.5.4	Connecting the encoder	143
6.5.4.1	Interface description - X120 (converter side)	143
6.5.4.2	Interface description (motor side)	144
6.5.4.3	Wiring	145
6.5.5	Rotating the connectors at the motor	145
6.6	Connecting the braking resistor.....	148
6.6.1	Interface description - X1	148
6.6.2	Wiring	148
6.7	Connecting the 24 V DC power supply.....	151
6.7.1	Interface description - X124	151
6.7.2	Wiring	151
6.8	Connecting the inputs and outputs	153
6.8.1	Interface description - X130	153
6.8.2	Wiring	154
6.8.2.1	Wiring of digital inputs.....	154
6.8.2.2	Wiring of digital outputs	155
6.8.2.3	Wiring of pulse train outputs.....	155
6.9	Connecting STO (for the S200 converter only).....	157
6.9.1	Interface description - X131	157
6.9.2	Wiring	157
6.10	Connecting to the fieldbus	159
6.10.1	Interface description - X150	159
6.10.2	Wiring	160
6.11	Connecting the service interface (Ethernet).....	161
6.11.1	Interface description - X127	161
7	Commissioning (web server).....	163
7.1	Introduction.....	163
7.2	Fundamentals.....	164
7.2.1	Supported operating units	164
7.2.2	Requirements for commissioning	164
7.2.3	Supported browsers.....	164
7.2.4	Communication interfaces	165
7.2.5	Making the operating instructions available for the web server information system.....	166
7.2.6	Using the web server information system	168
7.2.7	Reloading pages	170
7.3	Getting started	171
7.3.1	Calling the web server.....	171
7.3.2	Settings for brand new converters.....	172
7.3.3	Basic settings	172
7.3.4	Security settings	173
7.4	Functions and menus.....	175
7.4.1	Home page.....	175
7.4.2	Commissioning.....	176
7.4.2.1	Complete commissioning workflow.....	176
7.4.2.2	Quick setup	177
7.4.2.3	Testing the converter configuration	180

7.4.2.4	Optimization.....	180
7.4.3	Monitoring and operation	183
7.4.3.1	Drive status	183
7.4.3.2	Inputs/outputs	185
7.4.4	Diagnostics	186
7.4.4.1	Messages.....	186
7.4.4.2	Diagnostic buffer	188
7.4.4.3	Safety Integrated (for the S200 converter only)	189
7.4.4.4	Connection overview	190
7.4.4.5	Communication	190
7.4.4.6	Status word and control word	193
7.4.5	Parameters	194
7.4.5.1	Parameter lists	194
7.4.5.2	User-defined parameter list	197
7.4.6	Backup and restore	197
7.4.6.1	Overview	197
7.4.6.2	Save drive data to backup file	199
7.4.6.3	Status after backing up	199
7.4.6.4	Restore drive data from backup file	200
7.4.6.5	Restore factory settings.....	201
7.4.7	System	201
7.4.7.1	Settings	201
7.4.7.2	User administration	203
7.4.7.3	Protection & Security.....	204
7.4.7.4	Licenses.....	206
7.4.7.5	Firmware update.....	207
7.4.7.6	About web server.....	207
7.4.8	Support	208
7.4.9	Control panel.....	209
8	Commissioning (Startdrive).....	211
8.1	Introduction.....	211
8.2	Requirements for commissioning	212
8.3	Basics	213
8.3.1	Communication interfaces	213
8.3.2	Protected communication	214
8.3.3	User administration and security	214
8.3.4	Loading data from the drive into the project.....	216
8.3.5	Loading project data into the drive	218
8.3.6	Saving changes in the project.....	218
8.3.7	Retentively saving changes to the SD card	219
8.3.8	Using parameter lists and user-defined lists	220
8.4	Procedures for device configuration and commissioning	222
8.4.1	Requirements	222
8.4.2	Simple basic parameterization (offline)	223
8.4.3	Simple basic parameterization (online).....	224
8.4.4	Basic parameterization together with a SIMATIC controller	225
8.5	Combining and configuring devices in the project.....	226
8.5.1	Converter	226
8.5.1.1	Inserting a converter into the project.....	226

8.5.1.2	Optional: Replacing a converter.....	228
8.5.1.3	Making detailed converter settings.....	232
8.5.1.4	Specifying a motor.....	233
8.5.2	Control and technology object.....	235
8.5.2.1	Inserting a SIMATIC S7 controller into the project.....	235
8.5.2.2	Networking a controller and a converter.....	237
8.5.2.3	Inserting a technology object into the SIMATIC S7 controller.....	239
8.5.2.4	Interconnecting the technology object and a converter.....	243
8.6	Carrying out guided quick startup.....	245
8.6.1	Overview.....	245
8.6.2	Editing mode (online only).....	248
8.6.3	Connection to PLC.....	250
8.6.4	Application.....	251
8.6.5	Limits.....	252
8.6.5.1	Configuring limits when "Speed control" is active.....	252
8.6.5.2	Configuring limits when "Positioning" is active.....	253
8.6.6	Application settings.....	257
8.6.6.1	Configuring active homing.....	257
8.6.6.2	Configuring absolute encoder adjustment.....	259
8.6.7	I/O configuration.....	261
8.6.8	Telegrams (offline only).....	262
8.6.9	Rotate & optimize.....	264
8.6.10	"Overview" function view.....	265
8.6.10.1	Offline mode.....	265
8.6.10.2	Online mode.....	266
8.7	Configuring the converter.....	267
8.7.1	Basic parameterization.....	267
8.7.2	Configuring digital inputs and outputs via technology objects.....	269
8.7.2.1	Configuring a measuring probe using the technology objects.....	270
8.7.3	Technology functions.....	271
8.7.3.1	Basic positioner.....	271
8.7.3.2	Configuring Pulse Train Output (PTO) (for the S200 converter only).....	274
8.7.4	Configuring telegrams.....	276
8.7.4.1	Calling the telegram configuration.....	276
8.7.4.2	Telegram settings.....	277
8.7.4.3	Adding telegrams.....	277
8.8	Optimizing commissioning.....	279
8.8.1	Establishing an online connection to the converter.....	279
8.8.2	Traversing the converter from the control panel with speed setpoint.....	280
8.8.3	Performing One Button Tuning.....	282
8.8.4	Terminating the online connection from the converter.....	284
8.9	Using online diagnostic functions.....	285
8.9.1	Diagnostic icons.....	285
8.9.2	Display messages.....	285
8.9.3	Calling diagnostic functions.....	287
8.9.4	Security.....	289
8.9.5	Communication.....	290
8.9.5.1	Receive direction.....	290
8.9.5.2	Send direction.....	291
8.9.6	Functions.....	292

8.9.6.1	Overview	292
8.9.6.2	Setting the time-of-day	293
8.9.6.3	Setting the time with synchronization (NTP server).....	294
8.9.6.4	Setting the time with synchronization (PLC as NTP server)	295
8.9.6.5	Setting the time without synchronization	295
8.9.7	Backup and restore	296
8.9.7.1	Restarting the drive.....	296
8.9.7.2	Retentively saving the drive data	297
8.9.7.3	Restore factory settings.....	297
8.9.8	Overview of licenses	298
8.9.9	Updating the firmware in the Startdrive project.....	300
8.10	Checking using the trace function	302
9	Series commissioning	307
9.1	Series commissioning with SD card	308
9.2	Series commissioning using the web server.....	309
10	Functions	311
10.1	Overview of the functions.....	311
10.2	Inputs/outputs	313
10.2.1	Digital inputs	313
10.2.2	Digital outputs.....	314
10.3	Fieldbus communication	317
10.3.1	Communication via PROFINET IO.....	317
10.3.2	Configuring PROFINET IO operation	317
10.3.2.1	Connecting the PROFINET cable to the converter	317
10.3.2.2	Configuring communication using SIMATIC S7 control	318
10.3.2.3	Setting communication via PROFINET	318
10.3.3	PROFINET protocols.....	319
10.3.3.1	PROFINET protocols.....	319
10.3.3.2	Media redundancy	320
10.3.3.3	Connection-oriented communication protocols	321
10.3.4	Telegram	322
10.3.4.1	Telegram structure.....	322
10.3.4.2	Supported telegrams.....	324
10.3.4.3	Telegrams used for speed control	325
10.3.4.4	Telegrams used for position control	328
10.3.4.5	Supplementary telegram.....	330
10.3.5	Control word definition	331
10.3.5.1	Control word 1	331
10.3.5.2	Control word 2.....	335
10.3.5.3	Encoder 1 control word	338
10.3.5.4	Position block selection control word	339
10.3.5.5	Position MDI mode control word	340
10.3.5.6	Position control word 1	341
10.3.5.7	Position control word 2	342
10.3.6	Status word definition	344
10.3.6.1	Status word 1	344
10.3.6.2	Status word 2	347
10.3.6.3	Encoder 1 status word	350

10.3.6.4	Message word status word	351
10.3.6.5	Position status word 1	352
10.3.6.6	Position status word 2	354
10.3.7	Identification & Maintenance (I&M) data	356
10.4	General functions	357
10.4.1	Stopping method at servo-off	357
10.4.2	Speed limit	358
10.4.3	Torque limit	360
10.4.4	Vertical axis	361
10.4.5	PTO function (for the S200 converter only).....	362
10.4.6	Setting motor overload protection in accordance with UL 61800-5-1 Ed.2.....	364
10.5	Basic positioner (EPOS)	365
10.5.1	Mechanical system	366
10.5.1.1	Axis type.....	366
10.5.1.2	Units of measurement.....	367
10.5.1.3	Setting the backlash.....	368
10.5.2	Limits	370
10.5.2.1	Limiting the traversing range	370
10.5.2.2	Limiting the traversing profiles	370
10.5.3	Position monitoring	371
10.5.3.1	Positioning and standstill monitoring	371
10.5.3.2	Following error monitoring	372
10.5.4	Homing	373
10.5.4.1	Terms for homing	374
10.5.4.2	Active homing	375
10.5.4.3	Passive homing.....	379
10.5.4.4	Absolute encoder adjustment.....	379
10.5.5	Traversing blocks	380
10.5.5.1	Traversing blocks	380
10.5.5.2	Travel to fixed stop	386
10.5.6	Direct setpoint input (MDI).....	387
10.5.7	Jog	391
10.5.8	Measuring probe evaluation and homing mark search	393
10.6	Safety Integrated (for the S200 converter only)	395
10.6.1	Safety Integrated Functions.....	395
10.6.2	Certification	396
10.6.3	PFH values	397
10.6.4	Usage time	397
10.6.5	Safety Integrated Basic Functions	398
10.6.5.1	Safe Torque Off (STO).....	398
10.6.5.2	Functional features of STO	400
10.6.5.3	Discrepancy time	400
10.6.5.4	Input filter.....	401
10.6.5.5	Self-test of the fail-safe digital input (F-DI).....	402
10.6.6	Safety Integrated function status/diagnostics.....	402
10.6.7	Responses to safety messages	403
10.6.7.1	Stop responses.....	403
10.6.7.2	Fail-safe acknowledgement of safety messages	404
10.6.8	Response time	404
10.6.9	Functional safety	404
10.6.10	Machinery Directive	405

11	Tuning	407
11.1	Tuning workflow	407
11.2	Autotuning	408
11.2.1	One Button Tuning	408
11.2.2	Real Time Tuning (Online Tuning).....	409
11.3	Manual tuning	411
11.3.1	Control loops	411
11.3.2	Servo gain adjustment	412
11.4	Resonance suppression	414
12	System messages	417
12.1	SDI Status	417
12.1.1	SDI Status overview	417
12.1.2	Status display via LEDs	418
12.1.3	SDI Status display.....	420
12.1.4	Function buttons	421
12.2	System runtime	423
12.3	Faults and alarms.....	424
12.3.1	Overview of faults and alarms	424
12.3.2	Faults	425
12.3.3	Alarms.....	426
12.3.4	Explanation of the list of faults and alarms	426
12.3.5	List of fault codes and alarm codes.....	432
13	Corrective maintenance	641
13.1	Service and maintenance for the converter.....	641
13.1.1	Restoring the converter to factory settings	641
13.1.1.1	Restoring factory settings via a commissioning tool	641
13.1.1.2	Manual reset to factory settings with SD card	641
13.1.2	Converter firmware update.....	643
13.1.2.1	Overview of firmware update	643
13.1.2.2	Firmware update via SD card	643
13.1.3	Replacing the converter	644
13.1.3.1	Replacing a converter using an SD card with firmware	646
13.1.3.2	Replacing a converter using an SD card without firmware	647
13.1.3.3	Replacing a converter using a backup file (no SD card)	649
13.1.3.4	Replacing a converter without data backup (no SD card, no backup file).....	651
13.1.4	Forming the DC link capacitors	651
13.2	Service and maintenance for the motor.....	653
13.2.1	Replacing the motor bearings.....	655
13.2.2	Replacing the motor.....	656
13.3	Service and maintenance for spare parts	658
13.3.1	Spare parts and spare parts compatibility	658
13.3.2	Replacing the fan unit, FSC 400 V and FSD 400 V only	658
13.4	Device disposal	661

14	Technical data	663
14.1	Technical data of the converter	663
14.1.1	Permissible environmental conditions for the converter	663
14.1.2	General technical data	664
14.1.3	Specific data of the 200 V converters	666
14.1.4	Specific data of the 400 V converters	668
14.1.5	Overload capacity	670
14.1.6	Power derating as a function of the installation altitude and ambient temperature.....	671
14.1.7	Braking resistor	672
14.1.7.1	Internal braking resistor	672
14.1.7.2	External braking resistor.....	672
14.2	Technical data of the motor.....	677
14.2.1	General technical data	677
14.2.2	Permissible environmental conditions for the motor	678
14.2.3	Protection against electromagnetic fields (motor)	680
14.2.4	Cooling.....	680
14.2.5	Derating factors	681
14.2.6	Degree of protection	683
14.2.7	Balancing	685
14.2.8	Vibrational behavior	685
14.2.9	Shaft extension.....	686
14.2.10	Radial eccentricity, concentricity, and axial eccentricity.....	687
14.2.11	Axial and radial forces	689
14.2.11.1	Permissible axial forces	689
14.2.11.2	Permissible radial forces	690
14.2.12	Available encoders.....	695
14.2.13	Brake data	696
14.2.13.1	Overview of the 1FL2 holding brake.....	696
14.2.13.2	Technical data of the 1FL2 holding brake.....	697
14.2.14	Technical data and characteristics of the 1FL2	699
14.2.14.1	1FL2102-2AG connected to 1 AC 200 V/3 AC 220 V	699
14.2.14.2	1FL2102-4AG connected to 1 AC 200 V/3 AC 220 V	700
14.2.14.3	1FL2103-2AG connected to 1 AC 200 V/3 AC 220 V	701
14.2.14.4	1FL2103-4AG connected to 1 AC 200 V/3 AC 220 V	702
14.2.14.5	1FL2104-2AG connected to 1 AC 200 V/3 AC 220 V	703
14.2.14.6	1FL2104-4AG connected to 1 AC 200 V/3 AC 220 V	704
14.2.14.7	1FL2102-2AF connected to 3 AC 380 V/3 AC 400 V.....	705
14.2.14.8	1FL2102-4AF connected to 3 AC 380 V/3 AC 400 V.....	706
14.2.14.9	1FL2103-2AF connected to 3 AC 380 V/3 AC 400 V.....	707
14.2.14.10	1FL2103-4AF connected to 3 AC 380 V/3 AC 400 V.....	708
14.2.14.11	1FL2104-2AF connected to 3 AC 380 V/3 AC 400 V.....	709
14.2.14.12	1FL2104-4AF connected to 3 AC 380 V/3 AC 400 V.....	710
14.2.14.13	1FL2105-2AF connected to 3 AC 380 V/3 AC 400 V.....	711
14.2.14.14	1FL2105-4AF connected to 3 AC 380 V/3 AC 400 V.....	712
14.2.14.15	1FL2203-2AG connected to 1 AC 200 V/3 AC 220 V	713
14.2.14.16	1FL2203-4AG connected to 1 AC 200 V/3 AC 220 V	714
14.2.14.17	1FL2204-2AG connected to 1 AC 200 V/3 AC 220 V	715
14.2.14.18	1FL2204-4AG connected to 1 AC 200 V/3 AC 220 V	716
14.2.14.19	1FL2203-2AF connected to 3 AC 380 V/3 AC 400 V.....	717
14.2.14.20	1FL2203-4AF connected to 3 AC 380 V/3 AC 400 V.....	718
14.2.14.21	1FL2204-2AF connected to 3 AC 380 V/3 AC 400 V.....	719

14.2.14.22	1FL2204-4AF connected to 3 AC 380 V/3 AC 400 V.....	720
14.2.14.23	1FL2205-2AF connected to 3 AC 380 V/3 AC 400 V.....	721
14.2.14.24	1FL2205-4AF connected to 3 AC 380 V/3 AC 400 V.....	722
14.2.14.25	1FL2304-2AF connected to 3 AC 380 V/3 AC 400 V.....	723
14.2.14.26	1FL2304-4AF connected to 3 AC 380 V/3 AC 400 V.....	724
14.2.14.27	1FL2306-1AC connected to 3 AC 380 V/3 AC 400 V.....	725
14.2.14.28	1FL2306-2AC connected to 3 AC 380 V/3 AC 400 V.....	726
14.2.14.29	1FL2306-4AC connected to 3 AC 380 V/3 AC 400 V.....	727
14.2.14.30	1FL2306-6AC connected to 3 AC 380 V/3 AC 400 V.....	728
14.2.14.31	1FL2306-7AC connected to 3 AC 380 V/3 AC 400 V.....	729
14.2.14.32	1FL2310-0AC connected to 3 AC 380 V/3 AC 400 V.....	730
14.2.14.33	1FL2310-2AC connected to 3 AC 380 V/3 AC 400 V.....	731
14.2.14.34	1FL2310-4AC connected to 3 AC 380 V/3 AC 400 V.....	732
14.2.14.35	1FL2310-6AC connected to 3 AC 380 V/3 AC 400 V.....	733
14.3	Technical data of MOTION-CONNECT cables.....	734
14.3.1	Technical data of MOTION-CONNECT 350.....	734
14.3.1.1	General technical data.....	734
14.3.1.2	Specific technical data.....	735
14.3.2	Technical data of MOTION-CONNECT 380.....	736
14.3.2.1	General technical data.....	736
14.3.2.2	Specific technical data.....	736
15	Examples/applications.....	739
A	Appendix.....	741
A.1	UL Markings.....	741
A.2	EMERGENCY OFF and EMERGENCY STOP.....	743
A.3	Parameters.....	745
A.3.1	Explanation of the list of parameters.....	745
A.3.2	Parameter list.....	749
A.4	Assembling cables.....	932
A.4.1	General notes.....	932
A.4.2	Assembling connectors on the converter side.....	933
A.4.2.1	Assembling the cable lugs.....	933
A.4.2.2	Assembling the encoder connector.....	934
A.4.2.3	Assembling the I/O connector.....	937
A.4.3	Assembling connectors on the motor side.....	938
A.4.3.1	Assembling the hybrid plug for 1FL2 motors, shaft heights 20, 30, and 40.....	938
A.4.3.2	Assembling connectors for 1FL2 motors, shaft heights 48 and 52.....	944
A.4.3.3	Assembling connectors for 1FL2 motors, shaft heights 45, 65 and 90.....	946
A.5	Motor selection.....	951
A.5.1	Selection procedure.....	951
A.5.2	Selection examples.....	952

Introduction

1.1 About SINAMICS

Description

With the SINAMICS converter series you can solve drive tasks in the low, medium and DC voltage range. All Siemens drive components, such as converters, motors, and controls, are matched to each other and can be integrated into your existing automation systems.

You can find more information via the SINAMICS YouTube playlist (<https://www.youtube.com/playlist?list=PLw7lLwXw4H53rtHeTeifKtVMr2aXTYt0X>).

1.2 About this manual

1.2.1 Content

Description

This manual provides a summary of all of the information required to safely and reliably operate the converter-motor combination.

The manual enables the target groups being addressed to mount, connect, and commission the converter and motor safely and correctly.

To illustrate possible application areas for our products, typical use cases are listed in this product documentation and in the online help. These are purely exemplary and do not constitute a statement on the suitability of the respective product for applications in specific individual cases. Unless explicitly contractually agreed, Siemens assumes no liability for such suitability. Suitability for a particular application in specific individual cases must be assessed by the user, taking into account all technical, legal, and other requirements on a case-by-case basis. Always observe the descriptions of the technical properties and the relevant constraints of the respective product contained in the product documentation.

1.2.2 Target group

Description

This manual is intended for persons who perform different tasks in the drive environment. The intended target groups include, but are not limited to the following:

- Planning engineers
- Project engineers
- Machine manufacturers
- Commissioning engineers
- Electricians
- Installation personnel
- Service and maintenance personnel

1.2.3 Standard scope

Description

This documentation describes the functionality of the standard scope. This scope may differ from the scope of the functionality of the system that is actually supplied. Please refer to the ordering documentation only for the functionality of the supplied drive system.

Further functions may be executable in the system, which are not explained in this documentation. However, there is no entitlement to these functions in the case of a new delivery or service.

This documentation does not contain all detailed information on all types of the product. Furthermore, this documentation cannot take into consideration every conceivable type of installation, operation and service/maintenance.

The machine manufacturer must document any additions or modifications they make to the product themselves.

1.2.4 Use of third-party products in this documentation

Description

This documentation contains recommendations relating to third-party products. Siemens accepts the fundamental suitability of these third-party products. You can use equivalent products from other manufacturers.

Siemens does not accept any warranty for the use of third-party products.

1.2.5 Websites of third-party companies

Description

This document may contain hyperlinks to third-party websites. Siemens is not responsible for and shall not be liable for these websites and their content. Siemens has no control over the information which appears on these websites and is not responsible for the content and information provided there. The user bears the risk for their use.

1.3 SINAMICS documentation

Description

The documentation on the SINAMICS product series is available under Siemens Industry Online Support (<https://support.industry.siemens.com/cs/ww/en/view/109807358>).

You can display documents or download them in PDF and HTML5 formats.

The SINAMICS product documentation essentially includes the following manuals:

Table 1-1 SINAMICS product documentation

Information	Documentation class	Content
Basic information	Operating Instructions	Compilation of all of the information required to operate the SINAMICS product
	Compact Operating Instructions	Essential contents of the Operating Instructions in reduced and compressed form
	Product Information	Information that only becomes known shortly before or even after start of delivery and is therefore not included in the associated user documentation
General information	Industrial Security Configuration Manual	Information on the security functions and safe SINAMICS product operation

1.4 Service and Support

1.4.1 Siemens Industry Online Support on the Web

Description

The following is available via Siemens Industry Online Support (<https://support.industry.siemens.com/cs/ww/en/>), among others:

- Product support
- Global forum for information and best practice sharing between users and specialists
- Local contact persons via the contact person database (→ Contact)
- Search for product info
- Important topics at a glance
- FAQs (frequently asked questions)
- Application examples
- Manuals
- Downloads
- Compatibility tool
- Newsletters with information about your products
- Catalogs/brochures

1.4.2 Siemens Industry Online Support on the road

Description



Figure 1-1 "Siemens Industry Online Support" app



The "Industry Online Support" app supports you in the following areas, for example:

- Resolving problems when executing a project
- Troubleshooting when faults develop
- Expanding a system or planning a new system

Furthermore, you have access to the Technical Forum and other articles that our experts have drawn up:

- FAQs
- Application examples
- Manuals
- Certificates
- Product announcements and much more

There is a data matrix code or QR code on the nameplate of your product. Scan the code using the "Industry Online Support" app (<https://support.industry.siemens.com/cs/ww/en/sc/2067>) to obtain technical information about the device.

The app is available for Apple iOS and Android.

1.4.3 Getting information about the product

Overview

You can use the ID link to get information about your product.

The ID link is a globally unique identifier according to IEC 61406-1.

Requirement

There is a QR code on the product and on the product packaging.



Figure 1-2 QR code with ID link included

You can recognize the ID link by the frame with a black frame corner at the bottom right.

Procedure

Scan the QR code using either a standard code scanner or the "Industry Online Support" app.

When using a standard code scanner, you open the scanned ID link in an Internet browser that is provided on your device.

Result

You can use the ID link to get product data, manuals, declarations of conformity, certificates and other information about your product.

1.4.4 Feedback on the technical documentation

Description

We welcome your questions, suggestions, and corrections for this technical documentation. Please use the "Provide feedback" link at the end of the entries in Siemens Industry Online Support.

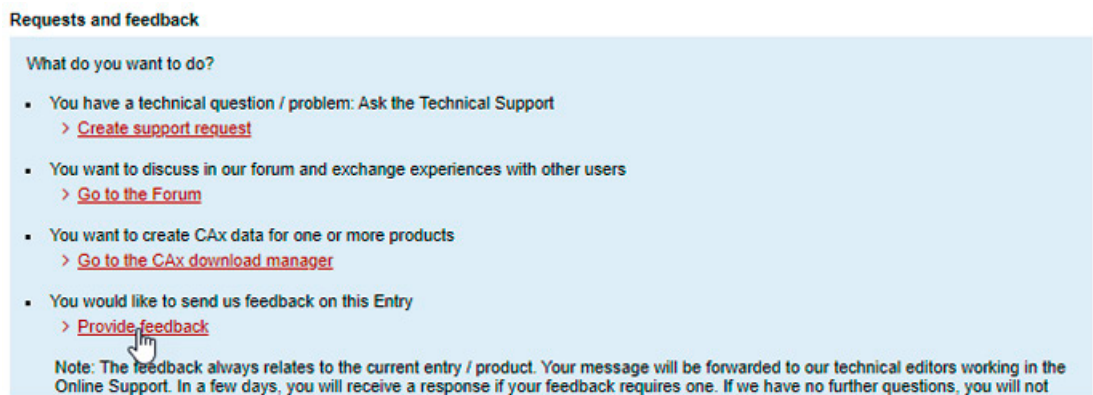

Figure 1-3 Requests and feedback

1.4.5 mySupport documentation

Description

With the "mySupport documentation" web-based system, you can compile your own individual documentation based on Siemens content and adapt this for your own machine documentation.

To start the application, click the "My Documentation" tile on the mySupport homepage (<https://support.industry.siemens.com/cs/ww/en/my>):

mySupport Links and Tools

Figure 1-4 mySupport

The configured manual can be exported in the PDF or XML format.

Siemens content that supports the mySupport documentation can be identified by the "Configure" link.

1.4.6 Technical support

Description

Your routes to technical support (<https://support.industry.siemens.com/cs/ww/en/sc/4868>):

- Support Request (<https://www.siemens.com/SupportRequest>)
- Contact person database (https://www.automation.siemens.com/aspa_app)
- "Industry Online Support" mobile app

The Support Request is the most important input channel for questions relating to products from Siemens Industry. This will assign your request a unique ticket number for tracking purposes. The Support Request offers you:

- Direct access to technical experts
- Recommended solutions for various questions (e.g. FAQs)
- Status tracking of your requests

Technical support also assists you in some cases via remote support (<https://support.industry.siemens.com/cs/de/en/view/106665159>) to resolve your requests. A Support representative will assist you in diagnosing or resolving the problem through screen transfer.

More information on the Support service packages is available on the Internet via the following address (<https://support.industry.siemens.com/cs/ww/en/sc/4869>).

1.4.7 Training

Description

SITRAIN – Digital Industry Academy offers a comprehensive range of training courses on Siemens industrial products – directly from the manufacturer, for all industries and use cases, for all knowledge levels from beginner to expert.

More information can be found on the Internet via the following address (<https://www.siemens.com/sitrain>).

1.4.8 Spare parts services

Description

By using the online spare parts service "Spares on Web", you ensure the smooth operation of your product. The spare parts service is aimed at the following:

- Improved spare parts inventories by balancing stock and spare parts on call
- Minimized downtimes during a plant standstill
- Reduced costs

More information can be found on the Internet via the following address (<https://www.sow.siemens.com>).

1.5 Important product information

1.5.1 Intended use

Requirement

 WARNING
Death or serious injury if not used as intended Not using as intended can result in hazardous states. <ul style="list-style-type: none">Carefully observe the description of proper and intended use.

 WARNING
Incorrect use of the motor Incorrect use of the motor may cause death, serious injury (crushing) and/or property damage. <ul style="list-style-type: none">Carefully observe the description of proper and intended useDo not use the motors in hazardous areas (where there is a risk of explosion), if the motors have not been expressly released and authorized for these types of applications. Carefully observe any special supplementary notes that may be attached.Make sure that the conditions at the location of use comply with all the rating plate data.Make sure that the conditions at the location of use comply with the conditions specified in this documentation. When necessary, take into account deviations regarding approvals or country-specific regulations.

Note

It cannot be guaranteed that EMC emission limits are complied with if the products are connected to an isolated line supply grounded through a high ohmic connection or a line supply with grounded line conductor.

- Draw-up an EMC plan to comply with the EMC requirements of the intended application.

Description

The products described in this manual, together with software, accessories and options, form an electrical power drive system intended to feed low-voltage AC motors.

The products are professional equipment for stationary indoor use in industrial, light-industrial, and commercial applications and are intended for supply from non-public (industrial) low-voltage line supplies. The products are not intended for use in residential areas and are not intended for supply from public low-voltage networks.

The products must be properly transported and stored and must be installed, commissioned and maintained by professionals who have adequate knowledge to implement the safety, security and EMC measures in accordance with the specifications described in this manual and with recognized state-of-the-art engineering practice.

You may only use the products when the following requirements are complied with:

- All regulations and directives that are applicable at the place of final use, especially with regard to electrical safety, functional safety and electromagnetic compatibility (EMC).
- All instructions, notes, technical data, safety information and security information contained in this document and other supporting documentation.

The products are part of a machine or system. When designing the system, apply suitable measures to ensure that the products can provide intended safety to persons and material assets and achieve intended electromagnetic compatibility.

Perform a risk assessment of the complete application, including third-party products and implement adequate safety and security measures before using the product.

Products without protective enclosure (IP00 or IP20) are intended for installation in control panels or control cabinets that provide the required level of protection.

Any other use that is not expressly permitted can result in malfunctions and unpredictable hazards.

The motors are intended for converter control and may not be connected directly to the line supply. The motors are not approved for use in explosive atmospheres.

1.5.2 Firmware updates and constraints

Description

Firmware updates and constraints for the converters with the current firmware are available in SIOS:

Updates and constraints for SINAMICS S200 (<https://support.industry.siemens.com/cs/ww/en/view/109812409>)

1.5.3 Open-source software (OSS)

Description

The license conditions and copyright information of the open-source software components used by the device are saved on the device itself. You can download license and copyright information onto your PC via the support page of the integrated web server.

1.5.4 Compliance with the General Data Protection Regulation

Description

Siemens complies with the principles of the **General Data Protection Regulation (EU)**, in particular the principle of data minimization (privacy by design). For this SINAMICS product, this means:

- **User management and access control (UMAC)**

The product processes or stores the following personal data:

- Login data for user management and access control:
User name, group, password, role, rights.

The data for user management and access control is stored in the converter and optionally on a memory card.

- **Support data (optional)**

For optimal support in service cases, the end user or machine manufacturer (OEM) can optionally store contact data (header, email address, telephone number, homepage) in the converter.

If this data is created, the author must give thought to data protection consent for this optional data. Siemens takes no responsibility for this data.

This support contact data can be read and is freely accessible in, for example, the user interface as well as in the diagnostics report. This data is not encrypted!

This data is used for user management and access control (UMAC) and for the support function. The storage of this data is appropriate and limited to what is necessary, as it is essential to identify the authorized operators and service contact.

The personal data is also available as part of the backup system to ensure fast recovery of use cases.

The above-mentioned personal data cannot be stored anonymously or pseudonymized, as it serves the purpose of identifying the operating personnel. The anonymization or pseudonymization, e.g. of the login data, must be performed using suitable login names and contact data by the plant/machine operator.

Our product does not provide any functions for automatically deleting personal data. Individual UMAC data can be deleted manually by authorized personnel as soon as this is deemed recommended/required.

Fundamental safety instructions

2.1 General safety instructions



WARNING

Electric shock and danger to life due to other energy sources

Touching live components can result in death or severe injury.

- Only work on electrical devices when you are qualified for this job.
- Always observe the country-specific safety rules.

Generally, the following steps apply when establishing safety:

1. Prepare for disconnection. Notify all those who will be affected by the procedure.
2. Isolate the drive system from the power supply and take measures to prevent it being switched back on again.
3. Wait until the discharge time specified on the warning labels has elapsed.
4. Check that there is no voltage between any of the power connections, and between any of the power connections and the protective conductor connection.
5. Check whether the existing auxiliary supply circuits are de-energized.
6. Ensure that the motors cannot move.
7. Identify all other dangerous energy sources, e.g. compressed air, hydraulic systems, or water. Switch the energy sources to a safe state.
8. Check that the correct drive system is completely locked.

After you have completed the work, restore the operational readiness in the inverse sequence.



WARNING

Risk of electric shock and fire from supply networks with an excessively high impedance

Excessively low short-circuit currents can lead to the protective devices not tripping or tripping too late, and thus causing electric shock or a fire.

- In the case of a conductor-conductor or conductor-ground short-circuit, ensure that the short-circuit current at the point where the converter is connected to the line supply at least meets the minimum requirements for the response of the protective device used.
- You must use an additional residual-current device (RCD) if a conductor-ground short circuit does not reach the short-circuit current required for the protective device to respond. The required short-circuit current can be too low, especially for TT supply systems.



⚠ WARNING

Risk of electric shock and fire from supply networks with an excessively low impedance

Excessively high short-circuit currents can lead to the protective devices not being able to interrupt these short-circuit currents and being destroyed, and thus causing electric shock or a fire.

- Ensure that the prospective short-circuit current at the line terminal of the converter does not exceed the breaking capacity (SCCR or Icc) of the protective device used.



⚠ WARNING

Electric shock if there is no ground connection

For missing or incorrectly implemented protective conductor connection for devices with protection class I, high voltages can be present at open, exposed parts, which when touched, can result in death or severe injury.

- Ground the device in compliance with the applicable regulations.



⚠ WARNING

Electric shock due to connection to an unsuitable power supply

When equipment is connected to an unsuitable power supply, exposed components may carry a hazardous voltage. Contact with hazardous voltage can result in severe injury or death.

- Only use power supplies that provide SELV (Safety Extra Low Voltage) or PELV- (Protective Extra Low Voltage) output voltages for all connections and terminals of the electronics modules.



⚠ WARNING

Electric shock due to damaged motors or devices

Improper handling of motors or devices can damage them.

Hazardous voltages can be present at the enclosure or at exposed components on damaged motors or devices.

- Ensure compliance with the limit values specified in the technical data during transport, storage and operation.
- Do not use any damaged motors or devices.



⚠ WARNING

Electric shock due to unconnected cable shields

Hazardous touch voltages can occur through capacitive cross-coupling due to unconnected cable shields.

- As a minimum, connect cable shields and the cores of cables that are not used at one end at the grounded housing potential.



⚠ WARNING

Arcing when a plug connection is opened during operation

Opening a plug connection when a system is in operation can result in arcing that may cause serious injury or death.

- Only open plug connections when the equipment is in a voltage-free state, unless it has been explicitly stated that they can be opened in operation.



⚠ WARNING

Electric shock due to residual charges in power components

Because of the capacitors, a hazardous voltage is present for up to 5 minutes after the power supply has been switched off. Contact with live parts can result in death or serious injury.

- Wait for 5 minutes before you check that the unit really is in a no-voltage condition and start work.

NOTICE

Damage to equipment due to unsuitable tightening tools.

Unsuitable tightening tools or fastening methods can damage the screws of the equipment.

- Only use screw inserts that exactly match the screw head.
- Tighten the screws with the torque specified in the technical documentation.
- Use a torque wrench or a mechanical precision nut runner with a dynamic torque sensor and speed limitation system.
- Adjust the tools used regularly.

⚠ WARNING

Electromagnetic interference due to inadequate shield support

A lack of adequate shield support for the power cables can cause malfunctions and impermissibly high levels of interference.

- Use the shield connection plates supplied or recommended.
- Use the shield connection clips recommended.

 **WARNING**

Spread of fire from built-in devices

Built-in devices can cause a fire and a pressure wave in the event of a fault. Fire and smoke can escape from the control cabinet and cause serious personal injury and property damage.

- Install built-in appliances in a robust metal control cabinet that is suitable for protecting people from fire and smoke.
- Only operate built-in devices with the control cabinet doors closed.
- Ensure that smoke can only escape via controlled and monitored paths.

 **WARNING**

Active implant malfunctions due to electromagnetic fields

Converters generate electromagnetic fields (EMF) in operation. Electromagnetic fields may interfere with active implants, e.g. pacemakers. People with active implants in the immediate vicinity of an converter are at risk.

- As the operator of an EMF-emitting installation, assess the individual risks of persons with active implants.
- Observe the data on EMF emission provided in the product documentation.



 **WARNING**

Active implant malfunctions due to permanent-magnet fields

Even when switched off, electric motors with permanent magnets represent a potential risk for persons with heart pacemakers or implants if they are close to converters/motors.

- If you have a heart pacemaker or implant, maintain the minimum distance specified in the Chapter "Technical data".
- When transporting or storing permanent-magnet motors always use the original packing materials with the warning labels attached.
- Clearly mark the storage locations with the appropriate warning labels.
- IATA regulations must be observed when transported by air.

 **CAUTION****Symptomatic respiratory and skin reaction to chemicals**

A newly purchased product might contain traces of substances that are identified as sensitizers.

Sensitizers are substances which can cause sensitization in the lungs and skin after exposure to them.

Once sensitized, individuals can have severe reactions to further exposure, even in small amounts. In the most extreme cases, individuals might develop asthma or dermatitis respectively.

- If the product has a strong smell, keep it in a well-ventilated area for 14 days.

 **WARNING****Unexpected machine movement caused by radio devices or mobile phones**

Using radio devices, cellphones, or mobile WLAN devices in the immediate vicinity of the components can result in equipment malfunction. Malfunctions may impair the functional safety of machines and can therefore put people in danger or lead to property damage.

- Therefore, if you move closer than 20 cm to the components, be sure to switch off radio devices, cellphones or WLAN devices.
- Use the "SIEMENS Industry Online Support App" or a QR code scanner only on equipment that has already been switched off.

NOTICE**Damage to motor insulation due to excessive voltages**

When operated on systems with grounded line conductors or in the event of a ground fault in the IT system, the motor insulation can be damaged by the higher voltage against ground. If you use motors that have insulation that is not designed for operation with grounded line conductors, you must perform the following measures:

- IT system: Use a ground fault monitor and eliminate the fault as quickly as possible.
- TN or TT systems with grounded line conductor: Use an isolating transformer on the line side.

 **WARNING****Fire due to inadequate ventilation clearances**

Inadequate ventilation clearances can cause overheating of components with subsequent fire and smoke. This can cause severe injury or even death. This can also result in increased downtime and reduced service lives for devices/systems.

- Ensure compliance with the specified minimum clearance as ventilation clearance for the respective component.

NOTICE

Overheating due to inadmissible mounting position

The device may overheat and therefore be damaged if mounted in an inadmissible position.

- Only operate the device in admissible mounting positions.



WARNING

Unrecognized dangers due to missing or illegible warning labels

Dangers might not be recognized if warning labels are missing or illegible. Unrecognized dangers may cause accidents resulting in serious injury or death.

- Check that the warning labels are complete based on the documentation.
- Attach any missing warning labels to the components, where necessary in the national language.
- Replace illegible warning labels.

NOTICE

Device damage caused by incorrect voltage/insulation tests

Incorrect voltage/insulation tests can damage the device.

- Before carrying out a voltage/insulation check of the system/machine, disconnect the devices as all converters and motors have been subject to a high voltage test by the manufacturer, and therefore it is not necessary to perform an additional test within the system/machine.



WARNING

Unexpected movement of machines caused by inactive safety functions

Inactive or non-adapted safety functions can trigger unexpected machine movements that may result in serious injury or death.

- Observe the information in the appropriate product documentation before commissioning.
- Carry out a safety inspection for functions relevant to safety on the entire system, including all safety-related components.
- Ensure that the safety functions used in your drives and automation tasks are adjusted and activated through appropriate parameterizing.
- Perform a function test.
- Only put your plant into live operation once you have guaranteed that the functions relevant to safety are running correctly.

Note**Important Safety instructions for Safety Integrated**

If you want to use Safety Integrated functions, you must observe the Safety instructions in the Safety Integrated documentation.

 **WARNING****Malfunctions of the machine as a result of incorrect or changed parameter settings**

As a result of incorrect or changed parameterization, machines can malfunction, which in turn can lead to injuries or death.

- Protect the parameterization against unauthorized access.
- Handle possible malfunctions by taking suitable measures, e.g. emergency stop or emergency off.

 **WARNING****Injury caused by moving or ejected parts**

Contact with moving motor parts or drive output elements and the ejection of loose motor parts (e.g. feather keys) out of the motor enclosure can result in severe injury or death.

- Remove any loose parts or secure them so that they cannot be flung out.
- Do not touch any moving parts.
- Safeguard all moving parts using the appropriate safety guards.

 **WARNING****Fire due to incorrect operation of the motor**

When incorrectly operated and in the case of a fault, the motor can overheat resulting in fire and smoke. This can result in severe injury or death. Further, excessively high temperatures destroy motor components and result in increased failures as well as shorter service lives of motors.

- Operate the motor according to the relevant specifications.
- Only operate the motors in conjunction with effective temperature monitoring.
- Immediately switch off the motor if excessively high temperatures occur.



 **CAUTION**

Burns and thermal damage caused by hot surfaces

Temperatures above 100 °C may occur on the surfaces of motors, converters, and other drive components.

Touching hot surfaces may result in burns. Hot surfaces may damage or destroy temperature sensitive parts.

- Ensure that temperature-sensitive parts do not come into contact with hot surfaces.
- Mount drive components so that they are not accessible during operation.

Measures when maintenance is required:

- Allow drive components to cool off before starting any work.
- Use appropriate personnel protection equipment, e.g. gloves.

2.2 Equipment damage due to electric fields or electrostatic discharge

Electrostatic sensitive devices (ESD) are individual components, integrated circuits, modules or devices that may be damaged by either electric fields or electrostatic discharge.



NOTICE

Equipment damage due to electric fields or electrostatic discharge

Electric fields or electrostatic discharge can cause malfunctions through damaged individual components, integrated circuits, modules or devices.

- Only pack, store, transport and send electronic components, modules or devices in their original packaging or in other suitable materials, e.g. conductive foam rubber or aluminum foil.
- Only touch components, modules and devices when you are grounded by one of the following methods:
 - Wearing an ESD wrist strap
 - Wearing ESD shoes or ESD grounding straps in ESD areas with conductive flooring
- Only place electronic components, modules or devices on conductive surfaces (table with ESD surface, conductive ESD foam, ESD packaging, ESD transport container).

2.3 Warranty and liability for application examples

Application examples are not binding and do not claim to be complete regarding configuration, equipment or any eventuality which may arise. Application examples do not represent specific customer solutions, but are only intended to provide support for typical tasks.

As the user you yourself are responsible for ensuring that the products described are operated correctly. Application examples do not relieve you of your responsibility for safe handling when using, installing, operating and maintaining the equipment.

2.4 Security information

Siemens provides products and solutions with industrial security functions that support the secure operation of plants, systems, machines and networks.

In order to protect plants, systems, machines and networks against cyber threats, it is necessary to implement – and continuously maintain – a holistic, state-of-the-art industrial security concept. Siemens' products and solutions constitute one element of such a concept.

Customers are responsible for preventing unauthorized access to their plants, systems, machines and networks. Such systems, machines and components should only be connected to an enterprise network or the internet if and to the extent such a connection is necessary and only when appropriate security measures (e.g. firewalls and/or network segmentation) are in place.

For additional information on industrial security measures that may be implemented, please visit

<https://www.siemens.com/industrialsecurity>.

Siemens' products and solutions undergo continuous development to make them more secure. Siemens strongly recommends that product updates are applied as soon as they are available and that the latest product versions are used. Use of product versions that are no longer supported, and failure to apply the latest updates may increase customer's exposure to cyber threats.

To stay informed about product updates, subscribe to the Siemens Industrial Security RSS Feed under

<https://www.siemens.com/cert>.

Further information is provided on the Internet:

Industrial Security Configuration Manual (<https://support.industry.siemens.com/cs/ww/en/view/109810578>)

WARNING

Unsafe operating states resulting from software manipulation

Software manipulations, e.g. viruses, Trojans, or worms, can cause unsafe operating states in your system that may lead to death, serious injury, and property damage.

- Keep the software up to date.
- Incorporate the automation and drive components into a holistic, state-of-the-art industrial security concept for the installation or machine.
- Make sure that you include all installed products into the holistic industrial security concept.
- Protect files stored on exchangeable storage media from malicious software by with suitable protection measures, e.g. virus scanners.
- On completion of commissioning, check all security-related settings.

2.5 Residual risks of power drive systems

When assessing the machine or system-related risk in accordance with the respective local regulations (e.g. EC Machinery Directive), the machine manufacturer or system integrator must take into account the following residual risks emanating from the control and drive components of a drive system:

1. Unintentional movements of driven machine or system components during commissioning, operation, maintenance, and repairs caused by, for example,
 - Hardware faults and/or software errors in the sensors, control system, actuators, and connections
 - Response times of the control system and of the drive
 - Operation and/or environmental conditions outside the specification
 - Condensation/conductive contamination
 - Parameterization, programming, cabling, and installation errors
 - Use of wireless devices/mobile phones in the immediate vicinity of electronic components
 - External influences/damage
 - X-ray, ionizing radiation and cosmic radiation
2. Unusually high temperatures inside and outside the components, including open flames, as well as emissions of light, noise, particles, gases, etc. due to fault conditions, e.g.:
 - Component failure
 - Software errors
 - Operation and/or environmental conditions outside the specification
 - External influences/damage
 - Short circuits or ground faults in the intermediate DC circuit of the converter
3. Hazardous shock voltages caused by, for example:
 - Component failure
 - Influence during electrostatic charging
 - Induction of voltages in moving motors
 - Operation and/or environmental conditions outside the specification
 - Condensation/conductive contamination
 - External influences/damage
4. Electrical, magnetic and electromagnetic fields generated in operation that can pose a risk to people with a pacemaker, implants or metal replacement joints, etc., if they are too close
5. Release of environmental pollutants or emissions as a result of improper operation of the system and/or failure to dispose of components safely and correctly

6. Influence of network-connected and wireless communications systems, e.g. ripple-control transmitters or data communication via the network or mobile radio, WLAN or Bluetooth.
7. Motors for use in potentially explosive areas:
When moving components such as bearings become worn, this can cause enclosure components to exhibit unexpectedly high temperatures during operation, creating a hazard in areas with a potentially explosive atmosphere.

For more information about the residual risks of the drive system components, see the relevant sections in the technical user documentation.

Description

3.1 System overview

Description

The SINAMICS S200 servo drive system is a single-axis servo drive system. It includes the following components tailored to one another:

- SINAMICS S200 converter product line, which is available in the following two variants:
 - SINAMICS S200 Basic converter (referred to as "S200 Basic")
 - SINAMICS S200 converter (referred to as "S200")
- SIMOTICS S-1FL2 motor (referred to as "1FL2")
- MOTION-CONNECT 350 standard cable or MOTION-CONNECT 380 flexible cable

The converter and the motor are intended for use with a higher-level controller (PLC). Prefabricated MOTION-CONNECT 350 and MOTION-CONNECT 380 cables are available in various lengths for simple and reliable connection of the motor to the converter.

3.1 System overview

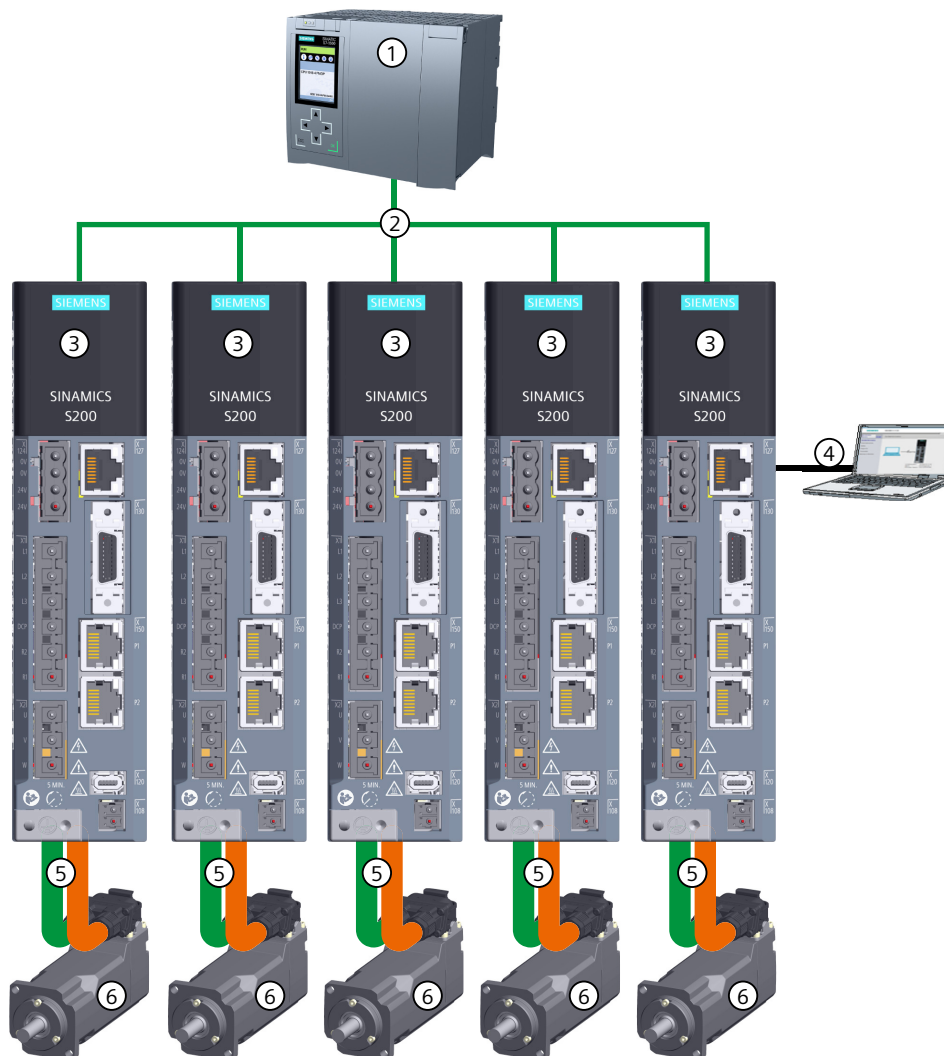

- ① Controller (for example, SIMATIC S7-1500)
- ② Communication between the converter and the controller via PROFINET
- ③ SINAMICS S200 converter product line
- ④ Engineering via LAN with the web server in the converter
- ⑤ MOTION-CONNECT 350 or MOTION-CONNECT 380 cables for the motor power, the motor holding brake, and the encoder connections
- ⑥ SIMOTICS S-1FL2 motor

Figure 3-1 System overview

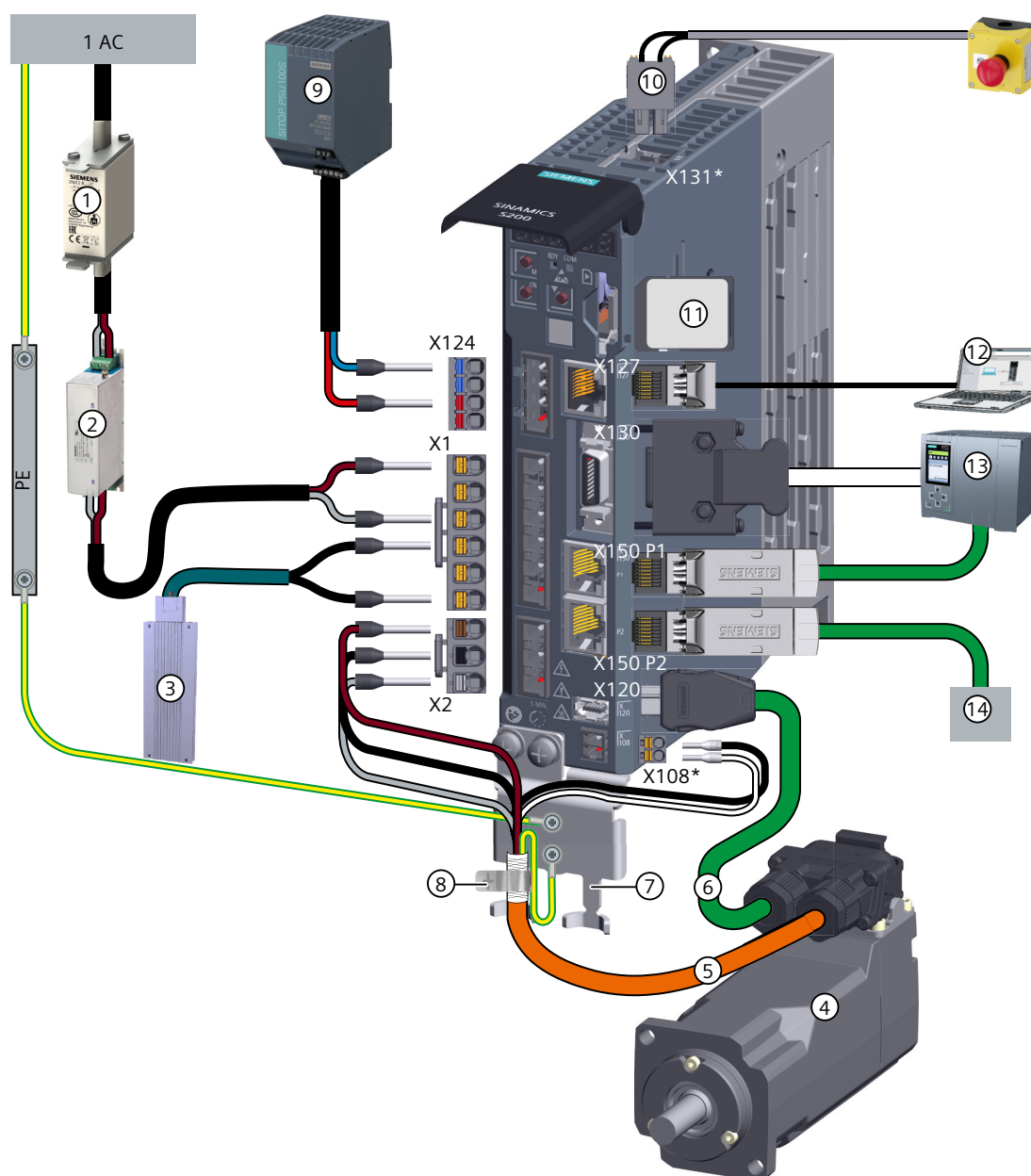

* The interfaces X131 and X108 are available on the SINAMICS S200 converter only. For more information about the motor holding brake connection on the SINAMICS S200 Basic converter, see Section "Connecting the motor holding brake (Page 139)".

- | | |
|--|---|
| ① Fuse or motor starter protector | ⑧ Shield clamp |
| ② Line filter (optional) ¹⁾ | ⑨ 24 V DC power supply |
| ③ External braking resistor (optional) ¹⁾ | ⑩ STO plug |
| ④ SIMOTICS S-1FL2 motor | ⑪ SD card (optional) |
| ⑤ Motor power cable (with brake conductors) | ⑫ Commissioning device |
| ⑥ Encoder cable | ⑬ Controller (for example, SIMATIC S7-1500) |
| ⑦ Shield plate | ⑭ PROFINET to the next participant |

¹⁾ When using the components, make sure that they are connected to the ground correctly.

Figure 3-2 System components and accessories for converters with 1 AC line connection

Description

3.1 System overview

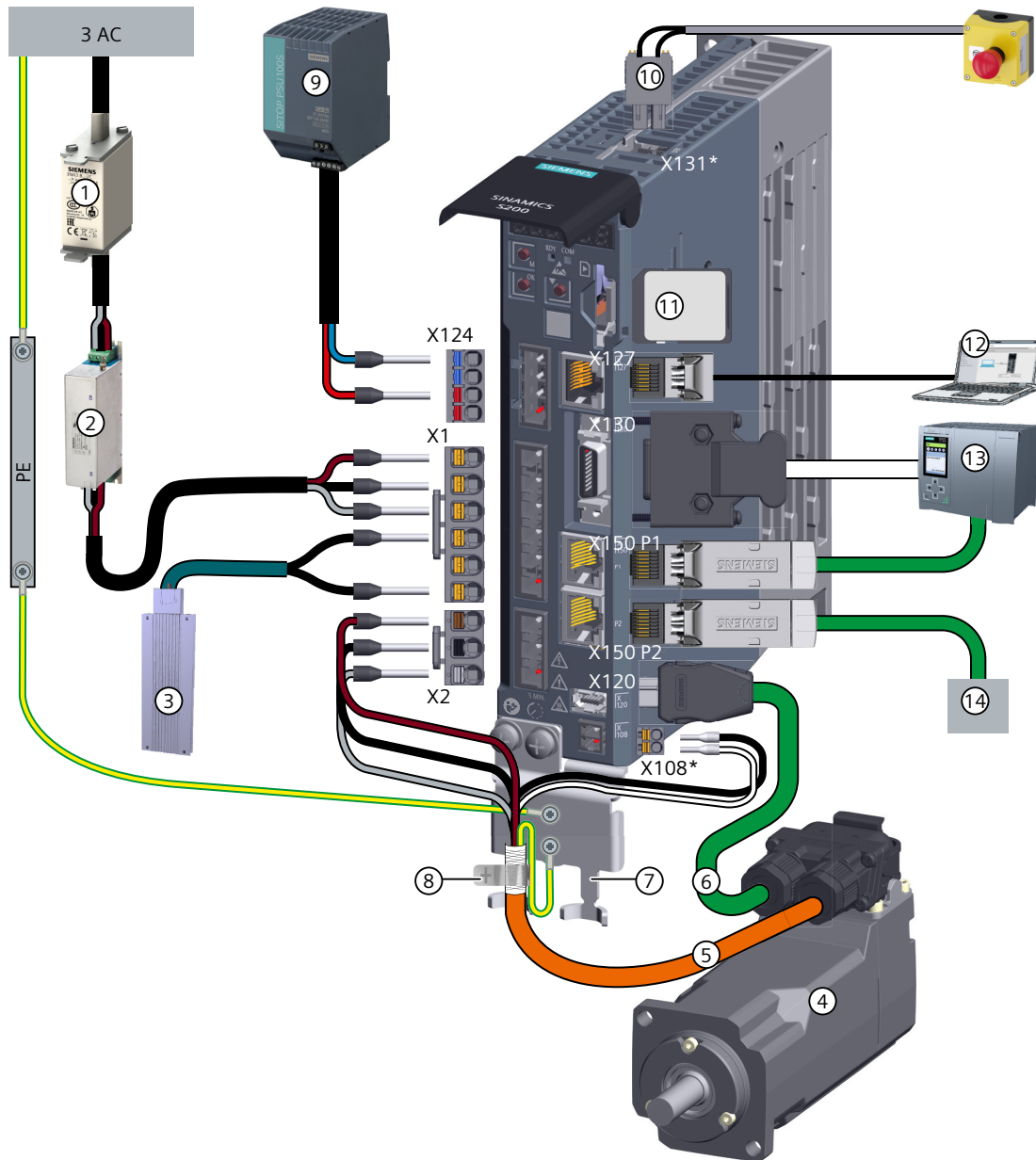

* The interfaces X131 and X108 are available on the SINAMICS S200 converter only. For more information about the motor holding brake connection on the SINAMICS S200 Basic converter, see Section "Connecting the motor holding brake (Page 139)".

- | | |
|--|---|
| ① Fuse or motor starter protector | ⑧ Shield clamp |
| ② Line filter (optional) ¹⁾ | ⑨ 24 V DC power supply |
| ③ External braking resistor (optional) ¹⁾ | ⑩ STO plug |
| ④ SIMOTICS S-1FL2 motor | ⑪ SD card (optional) |
| ⑤ Motor power cable (with brake conductors) | ⑫ Commissioning device |
| ⑥ Encoder cable | ⑬ Controller (for example, SIMATIC S7-1500) |
| ⑦ Shield plate | ⑭ PROFINET to the next participant |

¹⁾ When using the components, make sure that they are connected to the ground correctly.

Figure 3-3 System components and accessories for converters with 3 AC line connection

More information

For more information about the device combination, see Section "Device combinations (Page 58)".

For more information about the interface connection, see Section "Connecting (Page 127)".

3.1.1 Converter

Description

The S200 converter product line includes two converter variants: S200 Basic (200 V only) and S200 (200 V and 400 V).

Both S200 Basic and S200 are used on the 1 AC 200 V or 3 AC 200 V mains supply network to control the 1FL2 motor with low or medium moments of inertia.

The S200 can additionally be used on the 3 AC 400 V mains supply network to control the 1FL2 motor with all the moments of inertia.

Table 3-1 Converter variants

Converter	Frame size	Rated power (kW)	Mains supply network
S200 Basic/S200	FSA	0.1, 0.2	1 AC/3 AC 200 V ... 240 V
	FSB	0.4	
	FSC	0.75, 1.0	
S200	FSA	0.2, 0.4	3 AC 380 V ... 480 V
	FSB	0.75, 1.0	
	FSC	1.75, 2.5	
	FSD	3.5, 5.0, 7.0	

3.1.2 Motor

Description

The 1FL2 motor is intended for use with the S200 converter product line. The motor is available in the 200 V variant (low or medium inertia) and the 400 V variant (low, medium, or high inertia), and with different shaft heights.

Table 3-2 Motor variants

Shaft height	Moments of inertia	Rated power (kW)	Mains supply network
SH20	Low inertia	0.05, 0.1	200 V/400 V
SH30	Low inertia, medium inertia	0.2, 0.4	
SH40		0.75, 1.0	

Description

3.1 System overview

Shaft height	Moments of inertia	Rated power (kW)	Mains supply network
SH48	Medium inertia	1.0, 1.5	400 V
SH52	Low inertia	1.45, 2.1	
SH45	High inertia	0.4, 0.75	
SH65		0.75, 1.0, 1.5, 1.75, 2.0	
SH90		2.5, 3.5, 5.0, 7.0	

3.1.3 MOTION-CONNECT 350 and 380 cables

Description

Prefabricated MOTION-CONNECT cables are used to connect the 1FL2 motor to the S200 converter product line. The cables are available in two variants:

- MOTION-CONNECT 350 standard cable, which provides a connection solution for fixed installation applications
- MOTION-CONNECT 380 flexible cable, which provides a connection solution for drag chain installation applications that require high cable flexibility

3.2 Scope of delivery

Description

You must order the converter, motor, and cable components individually.

3.2.1 Converter

Description

The S200 and S200 Basic are single-axis converters. The delivery includes at least the following components:

- A ready-to-run converter with loaded firmware
- A connector kit:
 - X124 plug: connector for external 24 V DC power supply
 - X1 plug: connector for power supply (jumper for internal braking resistor and blanking plug for R1 terminal are included)
 - X2 plug: connector for motor power connection
 - X108 plug: connector for motor holding brake (only available in the delivery scope of S200)
 - X131 (STO) plug: connector for connecting the external safety devices (only available in the delivery scope of S200)
 - X131 (STO) disable plug: connector for disabling Safety Integrated Functions (only available in the delivery scope of S200)
 - A shield plate kit
- A "Safety instructions" sheet
- The converter contains open-source software (OSS). The OSS license terms are stored in the converter and can be displayed via webserver.

3.2 Scope of delivery

3.2.1.1 Rating plate

Description

The rating plate contains the article number and the technical data of the converter.

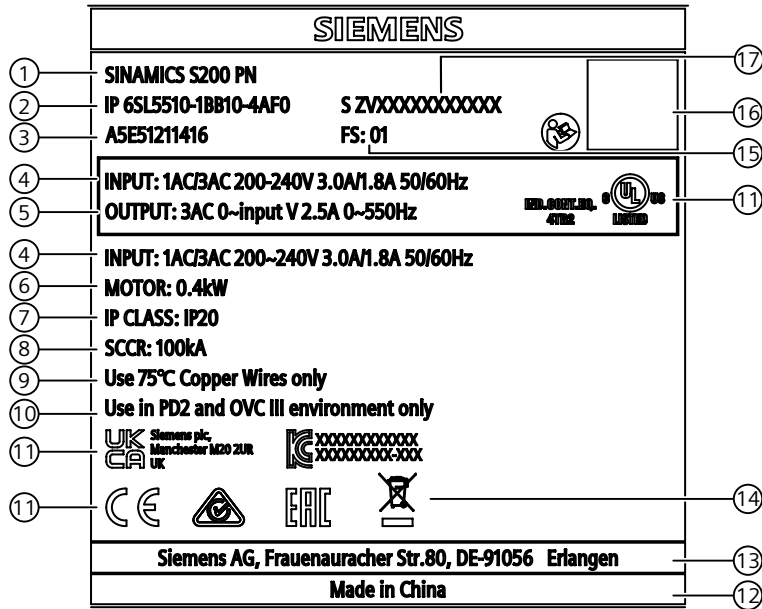

1	Converter type	10	Pollution degree and overvoltage category
2	Article number	11	Certifications
3	Material number	12	Country of origin
4	Mains input	13	Manufacturer's address
5	Output data	14	Note on disposal
6	Supported motor rated power	15	Function release/version
7	Degree of protection	16	QR code
8	Rated short-circuit current	17	Serial number
9	Copper wire		

Figure 3-4 Rating plate example

3.2.1.2 Article number explanation

Description

The following figure shows an explanation of the article number for the converter.

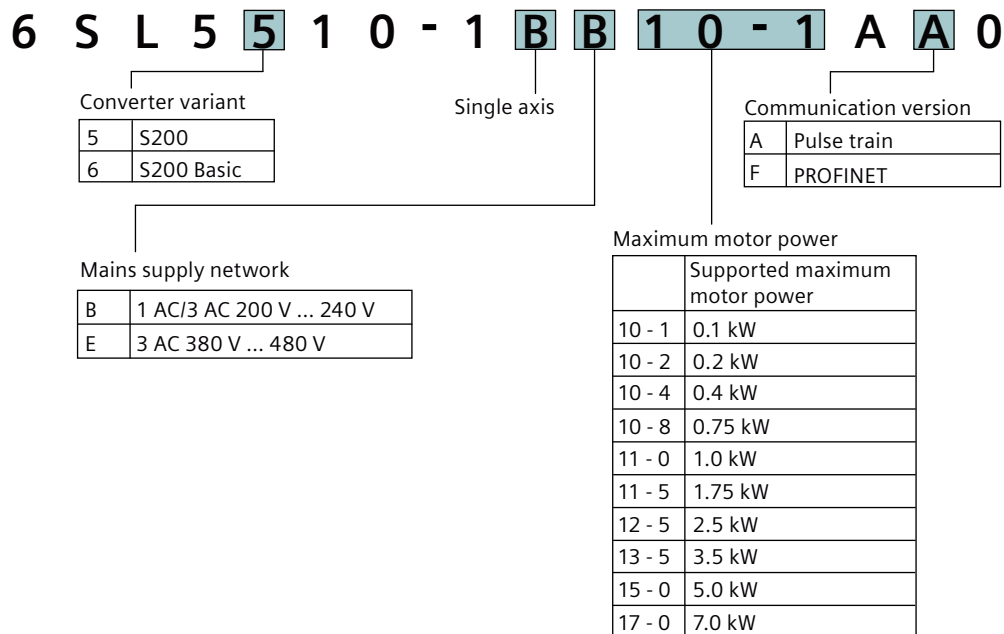
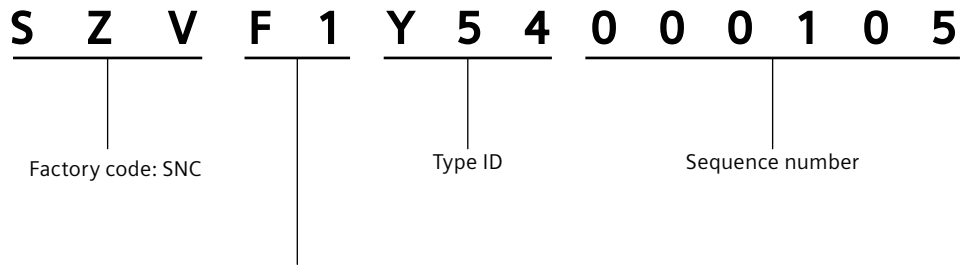

Figure 3-5 Article number for the S200 converter product line

3.2 Scope of delivery

3.2.1.3 Serial number explanation

Description



Production date (year/month)

Code	Calendar year	Code	Month
A	2010, 2030	1	January
B	2011, 2031	2	February
C	2012, 2032	3	March
D	2013, 2033	4	April
E	2014, 2034	5	May
F	2015, 2035	6	June
H	2016, 2036	7	July
J	2017, 2037	8	August
K	2018, 2038	9	September
L	2019, 2039	O	October
M	2020, 2040	N	November
N	2021, 2041	D	December
P	2022, 2042		
R	2023, 2043		
S	2024, 2044		
T	2025, 2045		
U	2026, 2046		
V	2027, 2047		
W	2028, 2048		
X	2029, 2049		

Figure 3-6 Serial number for S200 converter product line

3.2.2 Motor

Description

The 1FL2 motor is a servo motor with an integrated encoder and a high degree of protection.

The motor delivery includes the following components:

- A ready-to-run motor
- A "Safety instructions" sheet
- Three "Hot surface" warning labels

3.2 Scope of delivery

3.2.2.1 Rating plate

Description

The rating plate contains the article number and the technical data of the motor.

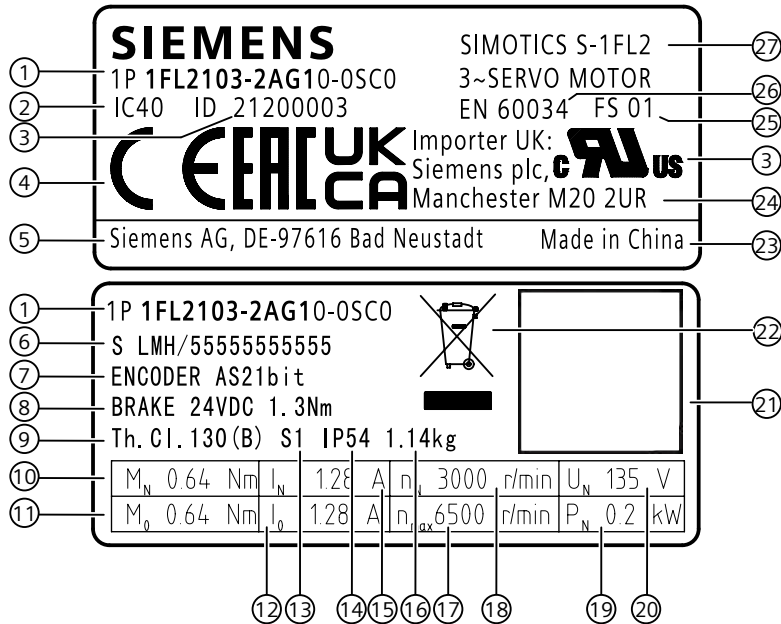

1	Article number	15	Rated current I_N
2	Cooling method according to EN 60034-6	16	Weight
3	Motor ID	17	Maximum speed n_{max}
4	Certifications	18	Rated speed n_N
5	Manufacturer's address	19	Rated power P_N
6	Serial number	20	Rated voltage U_N
7	Encoder type and resolution	21	QR code
8	Holding brake	22	Note on disposal
9	Thermal class	23	Country of origin
10	Rated torque M_N	24	UK importer address
11	Static torque M_0	25	Function release/version
12	Stall current I_0	26	Standard for all rotating electrical machines
13	Motor operating mode	27	Motor type
14	Degree of protection		

Figure 3-7 Rating plate example for 1FL2 SH20 and SH30

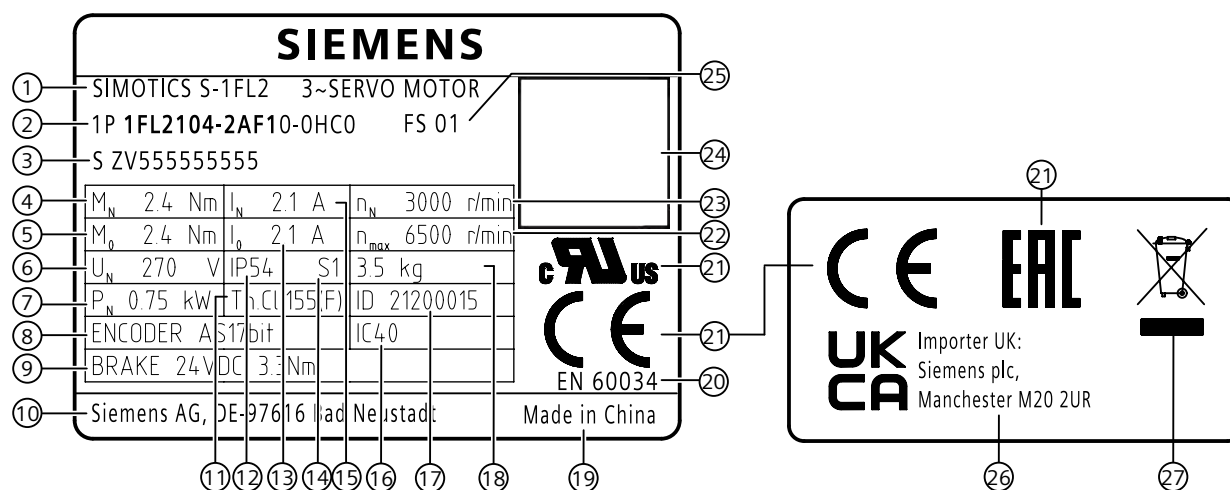

1	Motor type	15	Rated current I_N
2	Article number	16	Cooling method according to EN 60034-6
3	Serial number	17	Motor ID
4	Rated torque M_N	18	Weight
5	Static torque M_0	19	Country of origin
6	Rated voltage U_N	20	Standard for all rotating electrical machines
7	Rated power P_N	21	Certifications
8	Encoder type and resolution	22	Maximum speed n_{max}
9	Holding brake	23	Rated speed n_N
10	Manufacturer's address	24	QR code
11	Thermal class	25	Function release/version
12	Degree of protection	26	UK importer address
13	Stall current I_0	27	Note on disposal
14	Motor operating mode		

Figure 3-8 Rating plate example for 1FL2 SH40 and above

3.2 Scope of delivery

3.2.2.2 Article number explanation

Description

The following figure shows an explanation of the article number for the motor.

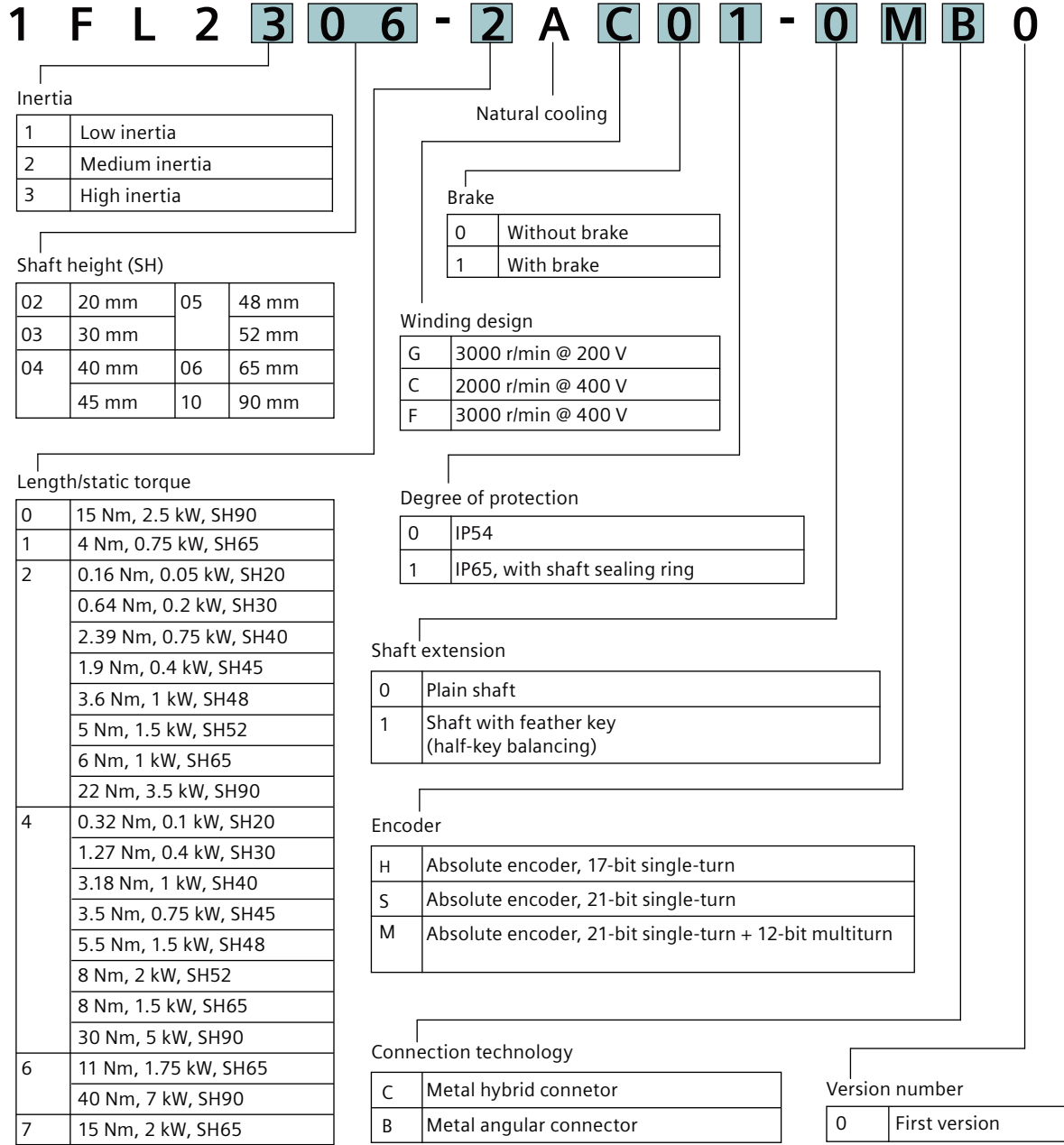

Figure 3-9 Article number for 1FL2 servo motors

3.2.2.3 Serial number explanation

Description

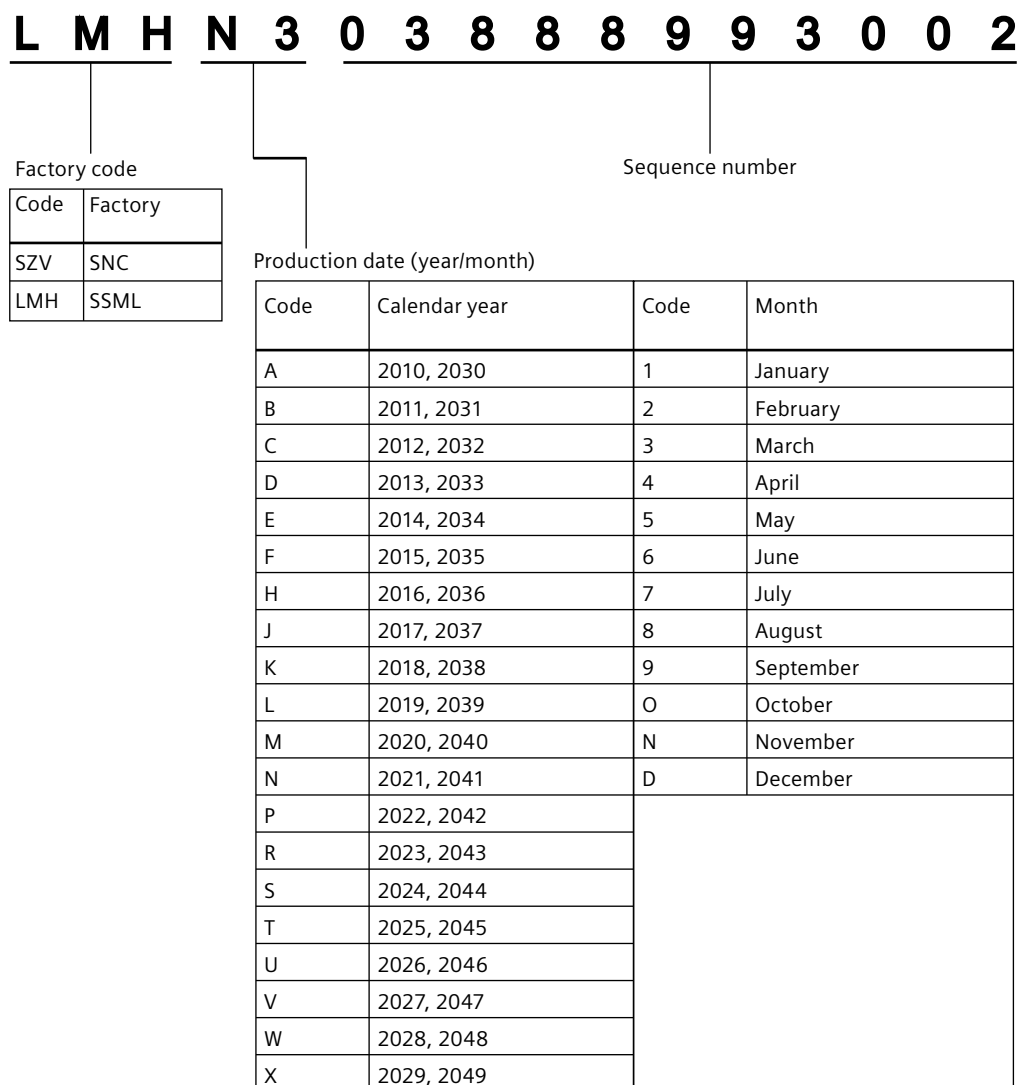

Figure 3-10 Serial number for 1FL2 servo motors

3.2.3 MOTION-CONNECT 350 and 380 cables

3.2.3.1 Overview

Description

The MOTION-CONNECT 350/380 cable delivery includes the following components:

- The MOTION-CONNECT cable with assembled connectors for connecting the motor to the converter
- A shield clamp for connection of the power cable to the shield plate of the converter
- A "Safety instructions" sheet

3.2.3.2 Article number explanation

Description

Table 3-3 Article numbers for MOTION-CONNECT 350 and 380 cables

Description		Position of the article number																	
		1	2	3	4	5	6	7	-	8	9	10	11	12	-	13	14	15	16
MOTION-CONNECT cables		6	F	X	3		0	2											
Cable variant	MOTION-CONNECT 350 standard cable	5																	
	MOTION-CONNECT 380 flexible cable	8																	
Connector type	Hybrid connector									7									
	Power connector or brake connector									5									
	Encoder connector									2									
Cable type	Power cable with brake conductors												D						
	Power cable without brake conductors												C						
	Dual cable with hybrid connector, drive end outlet												D						
	Dual cable with hybrid connector, non-drive end outlet												N						
	Power cable with M17 circular connector												K						
	Power cable with M23 circular connector									5	C	L							
	Brake cable									5	B	L							
	Encoder cable									2	X	B							
Cable cross-section	Dual cable with hybrid connector (0.75 mm ²)									0		1							
	Power cable with M23 circular connector (0.75 mm ²)																		
	Power cable with M23 circular connector (1.5 mm ²)									0		2							
	Power cable with M23 circular connector (2.5 mm ²)									1		2							
	Power cable with M17 circular connector (0.75 mm ²)									3		2							
	Brake cable (0.75 mm ²)									5	B	L	0	3					
	Encoder cable (0.25 and 0.38 mm ²)									2	X	B	1	1					
									2	X	B	1	2						

Description		Position of the article number																	
		1	2	3	4	5	6	7	-	8	9	10	11	12	-	13	14	15	16
Cable length	3 m															1	A	D	0
	5 m															1	A	F	0
	7 m															1	A	H	0
	10 m															1	B	A	0
	15 m															1	B	F	0
	20 m															1	C	A	0
	30 m															1	D	A	0

More information

For more information about the cable and connector combination, see Section "MOTION-CONNECT cables and connectors (Page 62)".

3.3 Device combinations

3.3.1 S200 PN 200 V servo drive system

Description

Table 3-4 200 V servo drive system

1FL2 servo motors						200 V converters (S200/S200 Basic)		MOTION-CONNECT prefabricated cables		
Rated torque (Nm)	Rated power (kW)	Rated speed (r/min)	Shaft height (mm)	Inertia	Article number 1FL2	Article number 6SL5□10-1BB	Frame size	Article number 6FX3□02-7□□01- ¹⁾		
0.16	0.05	3000	20	Low	102-2AG□□-□□C0	10-1AF0	FSA	□□□□		
0.32	0.1	3000			102-4AG□□-□□C0					
0.64	0.2	3000	30	Low	103-2AG□□-□□C0	10-2AF0				
				Medium	203-2AG□□-□□C0					
1.27	0.4	3000		Low	103-4AG□□-□□C0	10-4AF0	FSB			
				Medium	203-4AG□□-□□C0					
2.4	0.75	3000	40	Low	104-2AG□□-□□C0	10-8AF0	FSC			
				Medium	204-2AG□□-□□C0					
3.2	1.0	3000		Low	104-4AG□□-□□C0	11-0AF0				
				Medium	204-4AG□□-□□C0					
Cable length										
3 m								1AD0		
5 m								1AF0		
7 m								1AH0		
10 m								1BA0		
15 m								1BF0		
20 m								1CA0		
30 m								1DA0		

¹⁾ The last four digits (□□□□) in the cable article number define the cable length corresponding to the length code.

3.3.2 S200 PN 400 V servo drive system

Description

Table 3-5 400 V servo drive system

1FL2 servo motors						400 V converters (S200 only)		MOTION-CONNECT prefabricated cables
Rated torque (Nm)	Rated power (kW)	Rated speed (r/min)	Shaft height (mm)	Inertia	Article number 1FL2	Article number 6SL5510-1BE	Frame size	Article number 6FX3□02- ¹⁾
0.16	0.05	3000	20	Low	102-2AF□□-□□C0	10-2AF0	FSA	Dual cable with hybrid connector: 7□□01-□□□□ Dual cable variants: • Power cable (with brake conductors) + encoder cable • Power cable (without brake conductors) + encoder cable
0.32	0.1	3000			102-4AF□□-□□C0			
0.64	0.2	3000	30	Low	103-2AF□□-□□C0			
				Medium	203-2AF□□-□□C0			
1.27	0.4	3000		Low	103-4AF□□-□□C0			
				Medium	203-4AF□□-□□C0			
2.4	0.75	3000	40	Low	104-2AF□□-□□C0	10-8AF0	FSB	
				Medium	204-2AF□□-□□C0			
3.2	1.0	3000		Low	104-4AF□□-□□C0	11-0AF0		
				Medium	204-4AF□□-□□C0			
3.0	1.0	3000	48	Medium	205-2AF□□-□□B0	11-5AF0	FSC	
4.6	1.45	3000			205-4AF□□-□□B0			
4.6	1.45	3000	52	Low	105-2AF□□-□□B0	12-5AF0		
6.6	2.1	3000			105-4AF□□-□□B0			

Description

3.3 Device combinations

1FL2 servo motors						400 V converters (S200 only)		MOTION-CONNECT prefabricated cables
Rated torque (Nm)	Rated power (kW)	Rated speed (r/min)	Shaft height (mm)	Inertia	Article number 1FL2	Article number 6SL5510-1BE	Frame size	Article number 6FX3□□02- ¹⁾
1.27	0.4	3000	45	High	304-2AF□□-□□B0	10-4AF0	FSA	Power cable: 5CL□□-□□□□ Brake cable: 5BL03-□□□□ Encoder cable: 2XB12-□□□□
2.39	0.75	3000			304-4AF□□-□□B0	10-8AF0	FSB	
3.58	0.75	2000	65		306-1AC□□-□□B0	11-0AF0		
4.78	1.0				2000		306-2AC□□-□□B0	
7.16	1.5	2000	306-4AC□□-□□B0		11-5AF0	FSC		
8.4	1.75	2000	306-6AC□□-□□B0					
9.6	2.0	2000	306-7AC□□-□□B0		12-5AF0			
11.9	2.5	2000	90		310-0AC□□-□□B0	13-5AF0	FSD	
16.7	3.5				2000			
23.9	5.0				2000	310-4AC□□-□□B0	15-0AF0	
33.4	7.0				2000	310-6AC□□-□□B0	17-0AF0	
Cable length								
3 m								1AD0
5 m								1AF0
7 m								1AH0
10 m								1BA0
15 m								1BF0
20 m								1CA0
30 m								1DA0

¹⁾ The last four digits (□□□□) in the cable article number define the cable length corresponding to the length code.

3.4 Accessories

3.4.1 Connector kits

Description

If you need new connectors used on the converter front panel, you can order connector kits from Siemens using the following article numbers.

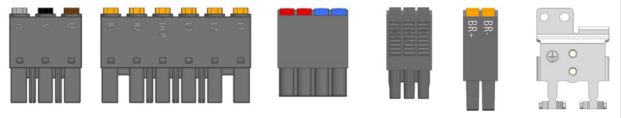
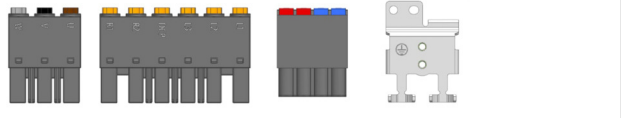
Converter	Article number	Illustration
S200	6SL5568-0XX00-0AA0	
S200 Basic	6SL5668-0XX00-0AA0	

3.4.2 Cables and connectors





3.4.2.1 MOTION-CONNECT cables and connectors

Description

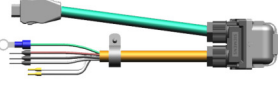
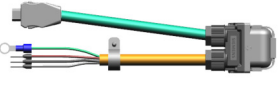
Siemens recommends that you use MOTION-CONNECT prefabricated cable assemblies and connectors for connecting the motor to the converter. All Siemens cable assemblies and connectors are tested and compliant with CE standards and EMC requirements.

Table 3-6 Overview of MOTION-CONNECT 350 and 380 cables

MOTION-CONNECT 350 and 380 cables				Connectors	
Type	Article number 6FX3□□02- ¹⁾	Applicable 1FL2 motor	Cross-section for conductors (mm ²)	Drive side 6FX2003 -	Motor side 6FX2003- -
Dual cable with hybrid connector: Power cable (with brake conductors) ²⁾ + encoder cable 	7DD01- □□□□	SH20 SH30	<ul style="list-style-type: none"> Power cable (with brake conductors): <ul style="list-style-type: none"> – 4 × 0.75 + 2 × 0.38 Encoder cable: <ul style="list-style-type: none"> – Cable length ≤ 15 m: 3 × 2 × 0.25 – Cable length 20 m or 30 m: 2 × 2 × 0.25 + 2 × 0.38 	ODE61	3HD00
	7DN01- □□□□	SH40			3HN00
Dual cable with hybrid connector: Power cable (without brake conductors) + encoder cable 	7CD01- □□□□		<ul style="list-style-type: none"> Power cable (without brake conductors): <ul style="list-style-type: none"> – 4 × 0.75 Encoder cable: <ul style="list-style-type: none"> – Cable length ≤ 15 m: 3 × 2 × 0.25 – Cable length 20 m or 30 m: 2 × 2 × 0.25 + 2 × 0.38 		3HD00
	7CN01- □□□□				3HN00

MOTION-CONNECT 350 and 380 cables				Connectors		
Type	Article number 6FX3□□02- ¹⁾	Applicable 1FL2 motor	Cross-section for conductors (mm ²)	Drive side 6FX2003 -	Motor side 6FX2003- -	
Power cable (with brake conductors) 	5DK32- □□□□	SH48 SH52	4 × 0.75 + 2 × 0.38	-	0LL63	
Power cable (without brake conductors) 	5CK32- □□□□		4 × 0.75			
	5CL01- □□□□	SH45 SH65 SH90	4 × 0.75			0LL13
	5CL02- □□□□		4 × 1.5			
	5CL12- □□□□		4 × 2.5			
Encoder cable 	2XB11- □□□□	SH48 SH52	<ul style="list-style-type: none"> Cable length ≤ 15 m: 3 × 2 × 0.25 Cable length 20 m or 30 m: 2 × 2 × 0.25 + 2 × 0.38 	0DE61	0DB63	
	2XB12- □□□□	SH45 SH65 SH90			0DB13	
Brake cable 	5BL03- □□□□		2 × 0.75	-	0LL53	

- ¹⁾ The last four digits (□□□□) in the cable article number define the cable length corresponding to the length code: 1AD0 = 3 m, 1AF0 = 5 m, 1AH0 = 7 m, 1BA0 = 10 m, 1BF0 = 15 m, 1CA0 = 20 m, 1DA0 = 30 m.
- ²⁾ The conductors for the motor holding brake are integrated in the MOTION-CONNECT power cable.











If you prefer to use non-Siemens cables, Siemens provides the following connectors for you to assemble your own cables.

Note that Siemens does not provide any guarantee or warranty regarding the functionality, reliability or quality of non-Siemens cables used with the S200 servo drive system, and is not responsible for device (e.g. motor and converter) damages due to the use of non-Siemens cables.

Description

3.4 Accessories

Table 3-7 Overview of connectors and crimp contacts

Cable connectors					
	Article number 6FX2003-	Description	Connection type	Quantity per package	Illustration
Connector (connected to motor)	3HD00	Hybrid plug (drive end)	Crimping	5 pieces/pack	
	3HN00	Hybrid plug (non-drive end)	Crimping	5 pieces/pack	
	0LL63	M17 circular connector	Crimping	5 pieces/pack	
	0DB63	M17 circular connector	Crimping	5 pieces/pack	
	0LL13	M23 circular connector	Crimping	5 pieces/pack	
	0DB13	M17 circular connector	Crimping	5 pieces/pack	
	0LL53	M23 circular connector	Crimping	5 pieces/pack	
Connector (connected to converter)	0DE61	IX-C connector	Crimping	5 pieces/pack	
Crimp contact	7HP00	Hybrid power contacts	Crimping	2000 pieces/reel	
	7HS00	Hybrid signal contacts	Crimping	2000 pieces/reel	

More information

For more information about the MOTION-CONNECT cable article number explanation, see Section "Article number explanation (Page 56)".

For more information about assembling cables, see Section "Assembling cables (Page 932)".

3.4.2.2 I/O cable and connector

Description

The cable is used to connect the converter to a controller for signal transmission on the interface X130.

Table 3-8 I/O cable and connector

Name	Article number	Length (m)
I/O cable (20 pins)	6SL5562-1XX00-0AC0	1
I/O connector (20 pins)	6SL3260-2MA00-0VA0	-

More information

For more information about the I/O cable and connector, see Section "Connecting the inputs and outputs (Page 153)".

For more information about how to assemble the I/O connector, see Section "Assembling the I/O connector (Page 937)".

3.4.3 Line filter

Description

Line filters limit the conducted interference emissions from the SINAMICS S200 converter product line to the permissible limit values according to IEC 61800-3 Category C2.

Line filters are passive components used to expand the EMC properties of the S200 servo drive system.

Siemens recommends that you use a line filter to protect the system from high frequency noise.

Note

For applications in European Union, UK, and Korea, the use of the recommended line filters is mandatory to fulfill the local EMC directives.

Note

The maximum length of the cable used to connect the line filter to the converter is 3 m.

3.4.3.1 Recommended line filters

Table 3-9 Recommended line filters

Converter frame size	Rated current (A)	Article number	Degree of protection
1 AC, 200 V ... 240 V			
FSA/FSB/FSC	18	6SL5550-0XB21-8CA0	IP20
3 AC, 200 V ... 240 V			
FSA/FSB/FSC	5	6SL3203-0BE15-0VA0	IP20
3 AC, 380 V ... 480 V			
FSA/FSB	5	6SL5550-0XE20-5CA0	IP20
FSC	12	6SL5550-0XE21-2CA0	
FSD	20	6SL5550-0XE22-0CA0	

3.4.3.2 Technical data

Technical data

Table 3-10 Technical data of line filters

Article number	6SL5550-0XB21-8CA0	6SL3203-0BE15-0VA0	6SL5550-0XE20-5CA0	6SL5550-0XE21-2CA0	6SL5550-0XE22-0CA0
Line voltage (V)	200 ... 240 V, 1 AC	275 ... 480 V, 3 AC	275 ... 480 V, 3 AC	275 ... 480 V, 3 AC	275 ... 480 V, 3 AC
Rated current (A)	18	5	5	12	20
Power loss (W)	4.7	2	2.7	3.9	10.1
Type of connection	Screw terminals	Screw terminals	Screw terminals	Screw terminals	Screw terminals
Conductor cross-section (mm²)					
For single-conductor connection	0.25 ... 6 (AWG 24 ... 10)	0.25 ... 6 (AWG 24 ... 10)	0.25 ... 6 (AWG 24 ... 10)	0.25 ... 6 (AWG 24 ... 10)	0.25 ... 6 (AWG 24 ... 10)
For flexible cable connection	0.25 ... 4 (AWG 24 ... 10)	0.25 ... 4 (AWG 24 ... 10)	0.25 ... 4 (AWG 24 ... 10)	0.25 ... 4 (AWG 24 ... 10)	0.25 ... 4 (AWG 24 ... 10)
Insulation stripping length (mm)	8 ... 9	8 ... 9	8 ... 9	8 ... 9	8 ... 9
Protective conductor connection	M5	M6	M6	M6	M6
Degree of protection	IP20	IP20	IP20	IP20	IP20
Dimensions (W × H × D, mm)	58 × 155 × 53	55 × 170 × 130	55 × 170 × 130	75 × 195 × 140	60 × 250 × 130
Weight (kg)	0.75	0.67	0.72	1.34	1.5
Leakage current (mA)	11.84	4.31	4.37	7.05	8.88

3.4.3.3 Dimension drawing

6SL5550-0XB21-8CA0

All dimensions are specified in millimeters.

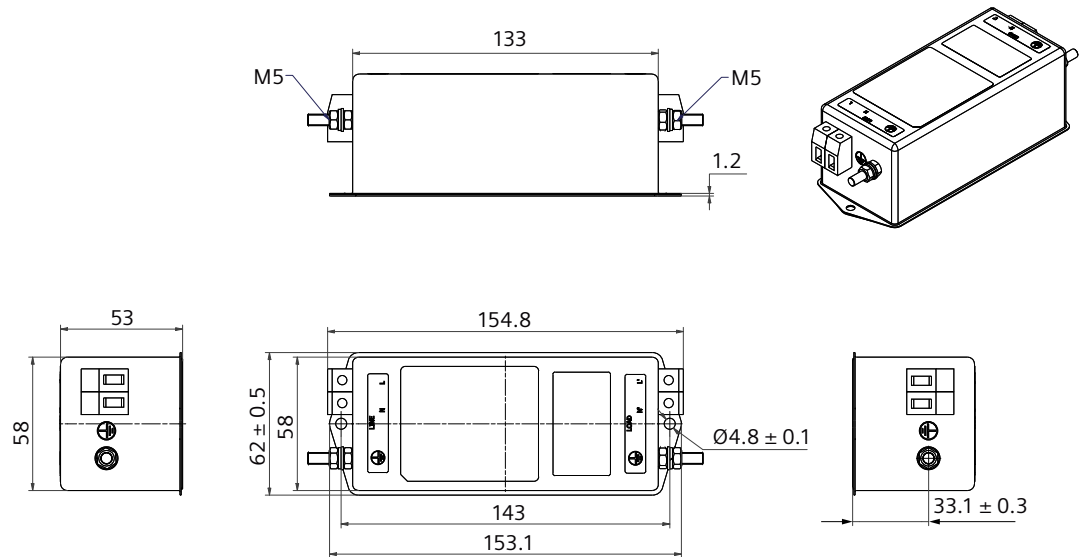

Tightening torque for the mounting screws: 2.5 Nm

Tightening torque for the protective conductor fastening bolt: 2.0 Nm ... 2.2 Nm

Tightening torque for the line-side and load-side screw connection: 0.7 Nm ... 0.8 Nm

6SL3203-0BE15-0VA0 and 6SL5550-0XE20-5CA0

All dimensions are specified in millimeters.

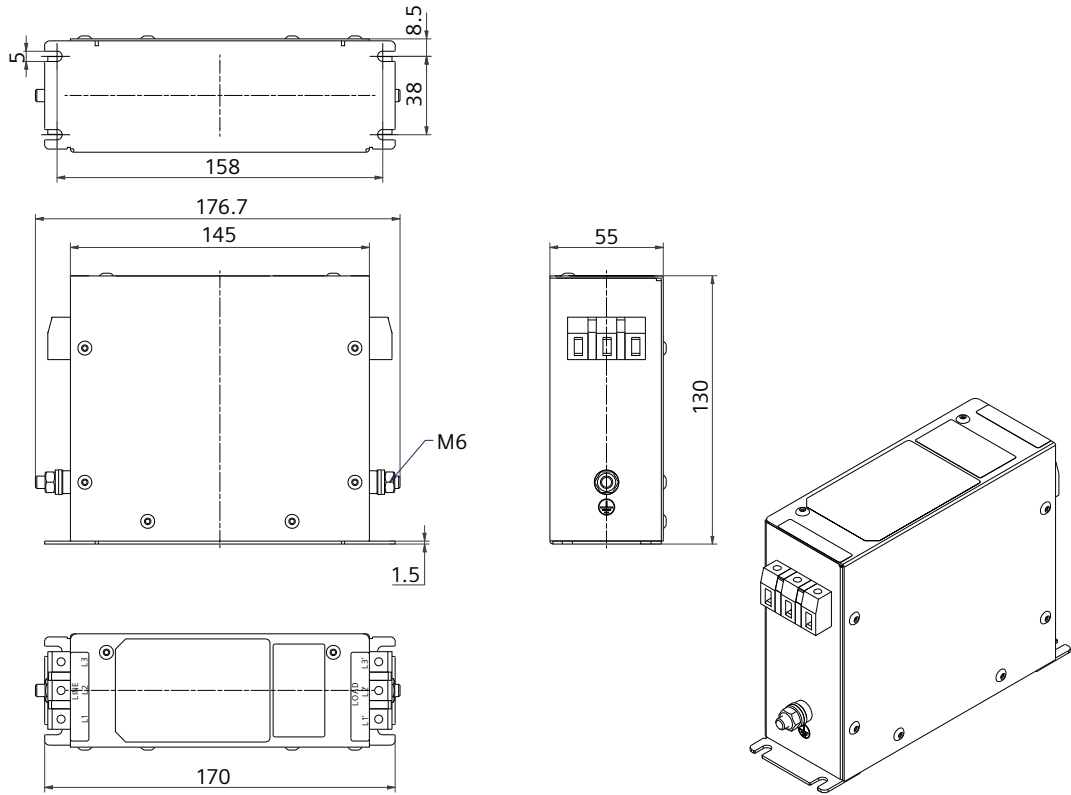

Tightening torque for the mounting screws: 2.5 Nm

Tightening torque for the protective conductor fastening bolt: 3.5 Nm ... 4.0 Nm

Tightening torque for the line-side and load-side screw connection: 0.7 Nm ... 0.8 Nm

6SL5550-0XE21-2CA0

All dimensions are specified in millimeters.

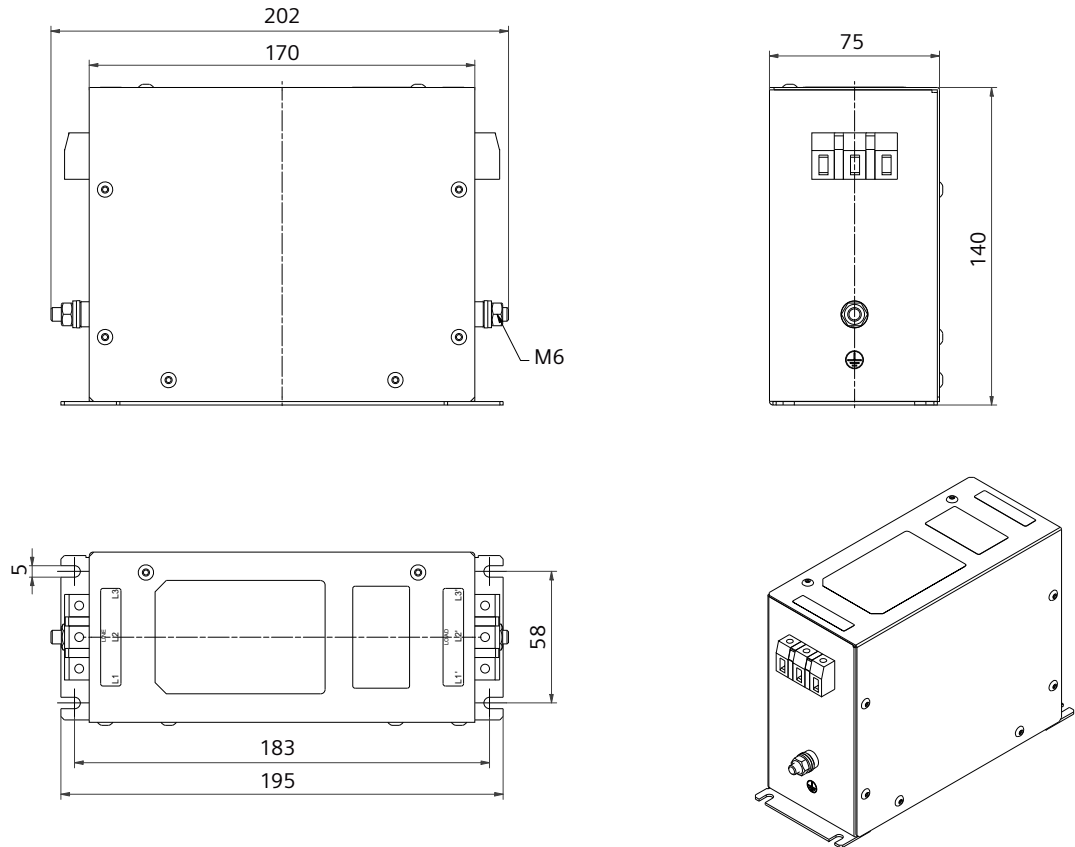

Tightening torque for the mounting screws: 2.5 Nm

Tightening torque for the protective conductor fastening bolt: 3.5 Nm ... 4.0 Nm

Tightening torque for the line-side and load-side screw connection: 0.7 Nm ... 0.8 Nm

6SL5550-0XE22-0CA0

All dimensions are specified in millimeters.

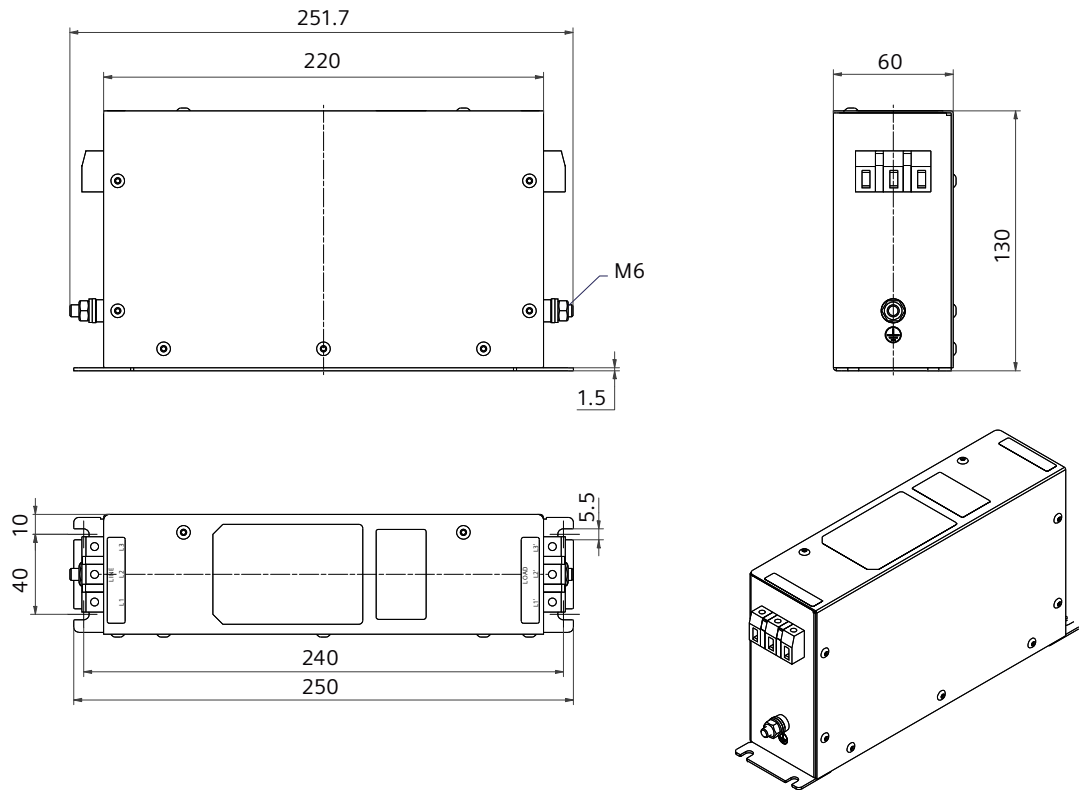

Tightening torque for the mounting screws: 2.5 Nm

Tightening torque for the protective conductor fastening bolt: 3.5 Nm ... 4.0 Nm

Tightening torque for the line-side and load-side screw connection: 0.7 Nm ... 0.8 Nm

3.4.3.4 Mounting instructions for the line filter

Description

- Observe the requirements for "EMC-compliant control cabinet installation (Page 94)" when mounting the line filter.
- To achieve a low-impedance connection, mount the line filter on the same metallic mounting plate as the converter. Mount these two components as close as possible.

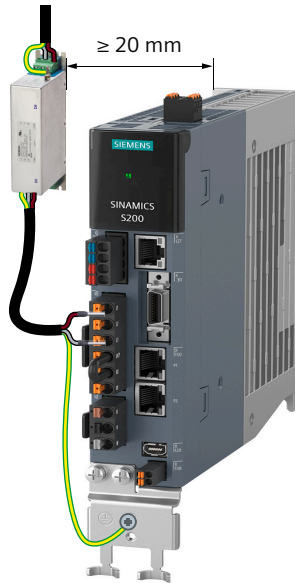

Figure 3-11 Connecting the line filter (example)

3.4.4 External 24 V DC power supply

Description

A 24 V DC power supply is needed to supply the SINAMICS S200 converter product line. The following table provides the technical specifications of the required external 24 V DC power supply:

Table 3-11 Specifications of the required external 24 V DC power supply

Parameter	Description
Rated voltage (V)	24 (-15% to +20%) ¹⁾
Permissible voltage fluctuation (V)	When using a motor without brake: 20.4 ... 28.8 When using a motor with brake: 22.8 ... 28.8

Description

3.4 Accessories

Parameter	Description
Maximum current (A)	<ul style="list-style-type: none">For 200 V variants When using a motor without brake: 1.2 When using a motor with brake: 2.2For 400 V variants When using a motor without brake: 1.2 When using a motor with brake: 3.2
Safety insulation class	SELV/PELV

¹⁾ When using a motor with brake, the minimum voltage of 24 V DC -5% must be available at the connector on the motor side to guarantee that the brake reliably opens. If the maximum voltage of 24 V DC +20% is exceeded, then the brake could re-close. The voltage drop along the brake feeder cable must be taken into consideration. The voltage drop ΔU for copper cables can be approximately calculated as follows:

$$\Delta U [V] = 0.01742 \Omega \cdot \text{mm}^2/\text{m} \cdot (2 \cdot l/q) \cdot I_{\text{Brake}}$$

Where: l = cable length [m], q = brake cable cross section [mm^2], I_{Brake} = DC current of brake [A]

Note

Siemens recommends that you use different 24 V DC power supplies for the converter and for the inductive loads such as relays or solenoid valves.

If you use the 24 V DC power supply to supply both the inductive loads and the converter at the same time, make sure that you connect surge protection devices to the load side.

3.4.5 Replacement fans

Description

The FSC 400 V and FSD 400 V converters are integrated with a fan unit. The service life of the fan can reach 20,000 hours at the average 40 °C operation temperature and average 100% operation load.

Replace the defective fan in time to ensure the proper operation of the converter.

To replace the fan, you can order fan units from Siemens using the following article numbers.

Table 3-12 Replacement fans

SINAMICS S200	Article number
3 AC, 380 V ... 480 V	
FSC	6SL5560-0CE00-0AA0
FSD	6SL5560-0DE00-0AA0

3.4.6 Shield plate kit

Description

The shield plate kit (article number: 6SL5566-0AB00-0AA0) includes a shield plate and four fixing screws (M4 × 12). The shield plate can establish ground connections to both shielded cables and protective conductors.

You can use the supplied two M4 screws to fix the shield plate with a tightening torque of 2.2 Nm.

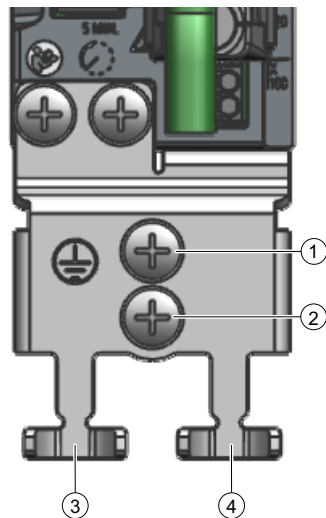

- ① Converter grounding
- ② Motor cable grounding
- ③ Fixing motor power cable
- ④ Reserved (recommended to fix brake cable and encoder cable)

Figure 3-12 Shield plate

For the connection of ① or ②, you can connect the protective conductor with a cable lug and an M4 screw to the shield plate.

3.4.7 SD card

Description

The converter can be operated with or without an SD card.

The converter supports FAT32-format SD cards with a capacity of up to 32 GB.

A permanently inserted SD card from Siemens is required to use functions that require a license. The license key can only be assigned to the Siemens SD card.

An SD card from Siemens or a third-party manufacturer (for example, Kingston or SanDisk) is suitable for the following situations:

- Data backup and restore
- Transfer of the converter settings from one converter to another
- Firmware update

Table 3-13 SD card ordering data

Siemens SD card	Article number
SD card without firmware	6SL5970-0AA00-0AA0
SD card with firmware V6.2	6SL5570-0GC00-0AA0

3.5 Directives and standards

3.5.1 Directives, standards and certificates for the converter

The following directives and standards are relevant for the SINAMICS S200 converter product line:



European Low Voltage Directive

The S200 converter product line fulfills the requirements stipulated in the Low-Voltage Directive 2014/35/EU, if they are covered by the application area of this directive.

European Machinery Directive

The S200 converter product line fulfills the requirements stipulated in the Machinery Directive 2006/42/EC, if they are covered by the application area of this directive.

However, the use of the S200 converter product line in a typical machine application has been fully assessed for compliance with the main regulations in this directive concerning health and safety.

European RoHS Directive

The S200 converter product line complies with Directive 2011/65/EU regarding limiting the use of certain hazardous substances.

European EMC Directive

The compliance of the S200 converter product line with the regulations of the Directive 2014/30/EU has been verified through full compliance with the IEC 61800-3.

European Directive on Waste Electrical and Electronic Equipment (WEEE)

The S200 converter product line complies with the 2012/19/EU directive on taking back and recycling waste electrical and electronic equipment.

Safety Integrated

The S200 converters comply with the requirements relating to functional safety/safety of machinery.



Underwriters Laboratories (North American market)

The S200 converter product line provided with the test symbol displayed fulfills the requirements stipulated for the North American market, and are appropriately listed.



UKCA certification

The S200 converter product line complies with the requirements for the market in Great Britain (England, Wales and Scotland).



Australia and New Zealand (RCM formerly C-Tick)

The S200 converter product line with the symbol displayed on the rating plate fulfills the EMC requirements for Australia and New Zealand.



Eurasian Conformity

The S200 converter product line complies with the requirements of the Russia/Belarus/Kazakhstan customs union (EAC).



EMC requirements for South Korea

The S200 converter product line with the KC marking on the rating plate satisfies the EMC requirements for South Korea.

China RoHS

The S200 converter product line complies with the requirements of China RoHS. You can find additional information on the Internet:

 China RoHS (<https://support.industry.siemens.com/cs/ww/en/ps/29596/cert>)

Immunity to voltage drop of semiconductor process equipment

The S200 converter product line fulfills the requirements of the standard SEMI F47-0706.

Quality systems

Siemens AG employs a quality management system that meets the requirements of ISO 9001 and ISO 14001.

Certificates for download

You can find all relevant certificates for download on the Internet:

 Certificates (<https://support.industry.siemens.com/cs/ww/en/ps/29596/cert>)

3.5.2 Directives, standards and certificates for the motor

The following directives and standards are relevant for the 1FL2 servo motors:



European Low Voltage Directive

The motors fulfill the requirements stipulated in the Low-Voltage Directive 2014/35/EU, if they are covered by the application area of this directive.

European Machinery Directive

The motors fulfill the requirements stipulated in the Machinery Directive 2006/42/EC, if they are covered by the application area of this directive.

However, the use of the motors in a typical machine application has been fully assessed for compliance with the main regulations in this directive concerning health and safety.

European Directive on rotating electrical machines

The motors comply with the requirements of EN 60034 directive on rotating electrical machines.

European RoHS Directive

The motors comply with Directive 2011/65/EU regarding limiting the use of certain hazardous substances.

European EMC Directive

The compliance of the motors with the regulations of the Directive 2014/30/EU has been verified through full compliance with the IEC/EN 61800-3.

European Directive on Waste Electrical and Electronic Equipment (WEEE)

The motors comply with the 2012/19/EU directive on taking back and recycling waste electrical and electronic equipment.

Underwriters Laboratories (North American market)

The motors provided with the test symbol displayed fulfill the requirements stipulated for the North American market, and are appropriately listed.

UKCA certification

The motors comply with the requirements for the market in Great Britain (England, Wales and Scotland).

Eurasian Conformity

The motors comply with the requirements of the Russia/Belarus/Kazakhstan customs union (EAC).

Registration, Evaluation and Authorization of Chemicals

The motors comply with the requirements of Registration, Evaluation and Authorization of Chemicals (REACH).

China RoHS

The motors comply with the requirements of China RoHS. You can find additional information on the Internet:

 China RoHS (<https://support.industry.siemens.com/cs/ww/en/ps/29685/cert>)

Quality systems

Siemens AG employs a quality management system that meets the requirements of ISO 9001 and ISO 14001.

China Energy Label

The motors fulfill the China Energy Label Grade 2 according to GB 30253-2013.

Table 3-14 Specifications of China Energy Label

Name of the standard	Minimum allowable values for energy efficiency and energy efficiency class of permanent-magnet synchronous motors (GB30253-2013)
Date of entry into force	July 1, 2020
Affected motors	Permanent-magnet synchronous motors (without incorporated brake) with a rated power of 0.55 kW to 90 kW and a rated speed of 500 r/min to 3000 r/min driven by variable-frequency equipment on a power supply below 1000 V.

3.5 Directives and standards

Motor requirements	As of the implementation date of the standard, all affected motors must be provided with the "China Energy Label".
Affected Siemens products	Affected Siemens motors are subject to the requirements of standard GB30253-2013: SIMOTICS S-1FL2 servo motors.



Figure 3-13 Example of the China Energy Label

The article number ① stated on the China Energy Label corresponds to the first 11 digits of the article number of the SIMOTICS S-1FL2 motor.

Certificates for download

You can find all relevant certificates for download on the Internet:

 Certificates (<https://support.industry.siemens.com/cs/ww/en/ps/29685/cert>)

3.5.3 Directives, standards and certificates for the MOTION-CONNECT cable

The following directives and standards are relevant for the MOTION-CONNECT 350 and 380 cables:



European Low Voltage Directive

The MOTION-CONNECT cables fulfill the requirements stipulated in the Low-Voltage Directive 2014/35/EU, if they are covered by the application area of this directive.

European Machinery Directive

The MOTION-CONNECT cables fulfill the requirements stipulated in the Machinery Directive 2006/42/EC, if they are covered by the application area of this directive.

However, the use of the converters and motors in a typical machine application has been fully assessed for compliance with the main regulations in this directive concerning health and safety.

European RoHS Directive

The MOTION-CONNECT cables comply with Directive 2011/65/EU regarding limiting the use of certain hazardous substances.

European EMC Directive

The compliance of the MOTION-CONNECT cables with the regulations of the Directive 2014/30/EU has been verified through full compliance with the IEC/EN 61800-3.

European Directive on Waste Electrical and Electronic Equipment (WEEE)

The MOTION-CONNECT cables comply with the 2012/19/EU directive on taking back and recycling waste electrical and electronic equipment.

Underwriters Laboratories (North American market)

The MOTION-CONNECT cables provided with the test symbol displayed fulfill the requirements stipulated for the North American market, and are appropriately listed.

UKCA certification

The MOTION-CONNECT cables comply with the requirements for the market in Great Britain (England, Wales and Scotland).

Eurasian Conformity

The MOTION-CONNECT cables comply with the requirements of the Russia/Belarus/Kazakhstan customs union (EAC).

China RoHS

The MOTION-CONNECT cables comply with the requirements of China RoHS. You can find additional information on the Internet:

 China RoHS (<https://support.industry.siemens.com/cs/ww/en/ps/14662/cert>)

Quality systems

Siemens AG employs a quality management system that meets the requirements of ISO 9001 and ISO 14001.

Certificates for download

You can find all relevant certificates for download on the Internet:

 Certificates (<https://support.industry.siemens.com/cs/ww/en/ps/14662/cert>)

Application planning

4.1 Protection of persons from electromagnetic fields

Overview

Protection of workers from electromagnetic fields is specified in the European EMF Directive 2013/35/EU. This directive is implemented in national law in the European Economic Area (EEA). Employers are obligated to design workplaces in such a way that workers are protected from impermissibly strong electromagnetic fields.

To this end, assessments and/or measurements must be performed for workplaces.

Requirement

The following general conditions apply for the evaluations and measurements:

1. The laws for protection from electromagnetic fields in force in individual EU member states can go beyond the minimum requirements of the EMF Directive 2013/35/EU and always take precedence.
2. The ICNIRP 2010 limits for the workplace are the basis for the assessment.
3. The 26th BImSchV (German Federal Emission Protection Regulation) defines 100 μT (RMS) for the assessment of active implants.
According to Directive 2013/35/EU, 500 μT (RMS) at 50 Hz is applicable here.
4. The routing of power cables has a significant impact on the electromagnetic fields that occur. Install and operate the components inside metallic cabinets in compliance with the documentation and use shielded motor cables (see "EMC-compliant control cabinet installation (Page 94)").

Description

The converters are normally used in machines. The assessment and testing is based on DIN EN 12198-1 and IEC 62311.

Compliance with the limit values was assessed for the following frequencies:

- Line frequency 47 ... 63 Hz
- 8 kHz pulse frequency

4.1 Protection of persons from electromagnetic fields

The indicated minimum distances apply to the head and complete torso of the human body. Shorter distances are possible for extremities.

Table 4-1 Minimum distances to the converter

Individuals without active implants		Individuals with active implants	
Control cabinet closed	Control cabinet open	Control cabinet closed	Control cabinet open
0 cm	Forearm length (approximately 35 cm)	Must be separately assessed depending on the active implant.	

4.2 Fault protection for the motor circuit

Description

The converter provides short-circuit protection at the motor output terminals.

The manufacturer's declaration describes the conditions regarding protection against electric shock in the event of an insulation failure in the motor circuit.

More information

You can find more information on the Internet: Manufacturer's declaration (<https://support.industry.siemens.com/cs/ww/en/view/109476638>)

4.3 Permissible mains supply network configurations for motors

Description

In combination with the drive system, the motors are generally certified for operation on TN and TT line systems with grounded neutral point and on IT line systems.

The following special features should be noted:

- For operation on IT line systems, the occurrence of the first fault between an active part and ground must be signaled by a monitoring device. According to IEC 60364-4-41, it is recommended that the first fault is removed as quickly as practically possible. Motor operation in such a fault situation can reduce the service life due to a damage insulation system as a result of partial discharge.
- For 3 AC 380 V ... 480 V mains supply networks with a grounded line conductor, an isolating transformer with grounded neutral point (secondary side) must be connected between the mains supply and the drive system to protect the motor insulation from excessive stress.

4.4 Line connection conditions for the S200 product line with the motor 1FL2

Description

The drive system is designed for connection to grounded TN/TT and non-grounded IT mains supply networks.

Depending on the motor/converter combination and the planned installation altitude, the following constraints must be taken into account regarding the line connection.

Table 4-2 Line connection conditions for the S200 product line with the motor 1FL2

Motor	Converter input voltage	Permissible line system configurations for installation altitude no higher than 2000 m	Permissible line system configurations for installation between 2000 m and 4000 m
200 V	1 AC 200 V ... 240 V (-15% ... +10%)	<ul style="list-style-type: none"> TN and TT line systems with grounding at any potential IT line systems 	Install an isolating transformer and ground the secondary side at any potential.
200 V	3 AC 200 V ... 240 V (-15% ... +10%)	<ul style="list-style-type: none"> TN and TT line systems with grounding at any potential IT line systems 	<ul style="list-style-type: none"> TN and TT line systems with grounded neutral point IT line systems with an isolating transformer with grounded neutral point (secondary side)
400 V	3 AC 380 V ... 480 V (-15% ... +10%)	<ul style="list-style-type: none"> TN and TT line systems with grounded neutral point IT line systems 	Install an isolating transformer and ground the secondary side at the neutral point.

NOTICE

Damage to motor insulation due to excessive voltages

In the event of a ground fault in the IT supply system, the motor insulation can be damaged by the higher voltage to ground.

- Use a ground fault monitor.
- Eliminate the ground fault as quickly as possible.

4.5 Minimum cross-section of the protective conductors

Overview

A high leakage current flows through the protective conductor in converter operation. For reliable touch protection during operation, the protective conductor of the converter must not be interrupted. This primarily results in requirements for the minimum conductor cross-section of the protective conductor.

No restriction applies to the length of the protective conductor for touch protection; however, short protective conductors are advantageous for EMC-compliant installation.

Description



WARNING

Electric shock due to interrupted protective conductor

The drive components conduct a high leakage current via the protective conductor. Touching conductive parts when the protective conductor is interrupted can result in death or serious injury.

- Comply with the requirements for the protective conductor.

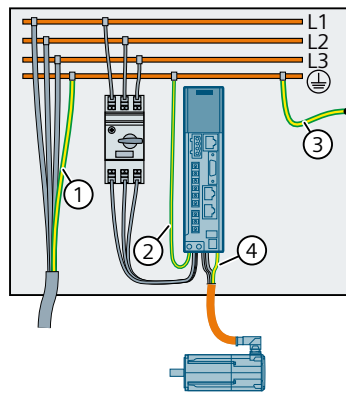

- ① **Protective conductor for the mains supply cable**
 The protective conductor must be dimensioned in compliance with local installation rules for equipment with increased discharge currents. As a minimum, one of the following conditions must be satisfied:
- The protective conductor is routed so that along its complete length it is protected against mechanical damage.
 - The protective conductor has a cross-section $\geq 10 \text{ mm}^2 \text{ Cu}$.
 - A second protective conductor with the same cross-section is provided.
 - The protective conductor of a multi-conductor cable has a cross-section $\geq 2.5 \text{ mm}^2 \text{ Cu}$.
- ② **Protective conductor of the converter line supply cable**
 The protective conductor must be dimensioned in compliance with local installation rules.
- If each converter is individually protected, the protective conductor with the same cross-section must be routed in the same way as the line connection cable to the converter.
- ③ **Protective conductor between PE and control cabinet**
 The cable cross-section must be dimensioned in compliance with local installation rules.
- ④ **Protective conductor of the motor power cable**
 The protective conductor has the same cross-section as the line conductor of the motor power cable.

4.6 Electromagnetic compatibility (EMC)

4.6.1 Interference caused by electromagnetic fields (EMF)

Description

Fluctuating currents and voltages generate electromagnetic fields (EMF). Electromagnetic fields can interfere with the operation of electrical devices.

Equipment that generates electromagnetic fields is called a source of interference. Sources of interference may be converters that have not been correctly installed, for example. On the other hand, interference sinks are devices that are disturbed by electromagnetic fields, e.g. mobile telephones.

The type of transmission is another distinguishing feature of interference. A source of interference transmits the interference to the sink either through conduction or through radiation.

4.6.2 Electromagnetic compatibility (EMC)

Description

Interference suppression measures increase the electromagnetic compatibility (EMC).

EMC interference suppression measures allow the device to function correctly. As a consequence, the device is neither a source of interference for other devices nor an interference sink that can be disturbed by other devices.

More information

Fundamental information for EMC-compliant planning and EMC-compliant installation is provided in the Internet:

EMC Design Guidelines Configuration Manual (<https://support.industry.siemens.com/cs/ww/en/view/60612658>).

4.6.3 EMC environments in residential and industrial areas

Description

IEC 61800-3 defines EMC requirements for using variable-speed drives in the following 2 environments:

- 1st environment: Residential environment
The residential environment includes residential buildings or locations where the drive is directly connected to the public low-voltage grid without using an intermediate transformer. Equipment and systems that are operated on the public low-voltage grid must comply with defined limit values for interference immunity and interference emission. The limit values are specified in the applicable standards. Especially for interference emissions, increased requirements apply regarding the 2nd environment.
- 2nd environment: Industrial Environment
An industrial environment includes all other installations that are not directly connected to the low-voltage supply for residential buildings. The 2nd environment essentially encompasses industrial areas that are supplied from the medium voltage grid via their own transformers.

4.6.4 EMC category

Description

Together with the associated motors and encoders, including the connecting cables, the converter forms a variable-speed drive. Product standard IEC 61800-3 defines the EMC requirements for a variable-speed drive. Product standard IEC 61800-3 calls a variable-speed drive a "Power Drive System" (PDS).

IEC 61800-3 defines categories for electromagnetic compatibility in the 1st environment and the 2nd environment.

Table 4-3 Environments and categories according to IEC 61800-3

Environment	1st environment		2nd environment	
Category	C1	C2	C3	C4 ¹⁾
Voltage, current	< 1 000 V			≥ 1 000 V or ≥ 400 A
Line system configuration	TN, TT			TN, TT, IT
Installation, commissioning	No requirement	By professional personnel		

¹⁾ Precondition: Plant manufacturers and operating companies agree on plant-specific measures in an appropriate EMC plan. If specified in the product documentation, the drive can also be operated on ungrounded line supplies (IT line systems) in accordance with product standard IEC 61800-3.

More information

To comply with product standards of plants and/or machines, when integrating the converter in plants or machines, additional measures may be required. The additional measures are the responsibility of the plant builder or machine OEM.

Disturbance-free operation of the converter is only guaranteed when specialist personnel carry out the installation work in strict compliance with EMC regulations.

4.6.5 SINAMICS S200 converter product line in the 2nd environment (industrial areas)

Description

The converter is intended for industrial, light-industrial, and commercial use in the 2nd environment.

The SINAMICS S200 servo drive system has been tested in accordance with the emission requirements of IEC 61800-3 Category C2.

- For a radiated emission test, an external line filter (between the mains supply network and the converter) is required to meet the EMC requirements. The converter needs to be installed inside a shielded metallic cabinet, while other parts of the motion control system (including the PLC, DC power supply, spindle drive, and motor) need to be put outside the shielded cabinet.
- For a conductive emission test, an external line filter (between the mains supply network and the converter) is required to meet the EMC requirements.
- For the radiated emission and conductive emission tests, the length of the line supply cable between the line filter and the converter must be shorter than 1 m.

4.6.5.1 Complying with Category C2 interference emission

Description

The converter meets the limit values of IEC 61800-3 Category C2 with regard to conducted and radiated interference emissions under the following conditions:

- Operation on a TN or TT line system with a grounded neutral point
- Use of shielded motor cables with low capacitance
- Use of shielded motor power cables of up to 30 m

- Operation with the default pulse frequency or with reduced pulse frequency
- Use of line filters C2
If a converter is used without an integrated filter or with a filter other than that specified for the converter, then the machine OEM or plant design engineer must certify that the emitted interference does not exceed the limit values of Category C2.
Separate line filters for each converter can be used, or a common line filter for several converters.
The maximum length of the cable used to connect the line filter to the converter is 3 m.

Note**To be observed for devices used in Category C2**

In a residential environment this product may cause radio-frequency interference, which may make interference suppression measures necessary.

- Have qualified personnel carry out the installation and commissioning with suitable interference suppression measures.

Note

When using a cable of more than 3 m to connect the converter to the PROFINET or Ethernet interface, electromagnetic interferences may occur. Use appropriate ferrite clamps, cabinet feedthrough, or fiber optic transceivers to minimize the interference emission.

4.6.5.2 Complying with Category C3 interference emission

Description

The converter complies with the limit values of IEC 61800-3 Category C3 with regard to conducted and radiated interference emissions under the following conditions:

- Operation on a TN or TT line system with a grounded neutral point
- Use of shielded motor cables with low capacitance
- Use of shielded motor power cables of up to 30 m
- Operation with the default pulse frequency or with reduced pulse frequency
- Use of line filters C2 or C3:
For a converter without integrated filter or with a filter other than that specified for the converter, the machine OEM or plant design engineer must certify that the emitted interference does not exceed the limit values of Category C3.
Separate line filters for each converter can be used, or a common line filter for several converters.
The maximum length of the cable used to connect the line filter to the converter is 3 m.

Note

The conducted and radiated emissions of the PROFINET ports are in compliance with the standards of IEC 61800-6-8, Class A (CISPR 32), and IEC 61800-3 Category C3.

Note**To be observed for devices used in Category C3**

In a residential environment this product may cause radio-frequency interference.

- Do not use this device in the first environment (residential area).

4.6.5.3 Harmonic current emissions**Description**

IEC 61800-3 does not define any current harmonic limits when converters are operated on industrial line supplies. A system evaluation according to IEC 61800-3 Annex B.4 is recommended.

Table 4-4 Typical harmonic currents of the S200 product line, 1 AC 200 V

200 V converter	Typical harmonic current (A) at U_k 4%								
	5th	7th	11th	13th	17th	19th	23rd	25th	THC
FSA	0.57	0.42	0.16	0.07	0.10	0.10	0.07	0.04	1.05
FSB	0.55	0.44	0.22	0.11	0.05	0.06	0.05	0.02	1.04
FSC	0.19	0.18	0.15	0.10	0.04	0.03	0.01	0.02	0.43

THC = Total Harmonic Current: sum of all harmonic currents

Table 4-5 Typical harmonic currents of the S200 product line, 3 AC 200 V

200 V converter	Typical harmonic current (A) at U_k 4%								
	5th	7th	11th	13th	17th	19th	23rd	25th	THC
FSA	0.18	0.13	0.08	0.05	0.04	0.02	0.02	0.02	0.26
FSB	0.94	0.66	0.19	0.08	0.15	0.13	0.07	0.07	1.2
FSC	2.37	1.64	0.40	0.22	0.34	0.25	0.10	0.13	2.97

THC = Total Harmonic Current: sum of all harmonic currents

Table 4-6 Typical harmonic currents of the S200 product line, 3 AC 400 V

400 V converter	Typical harmonic current (A) at U_k 4%								
	5th	7th	11th	13th	17th	19th	23rd	25th	THC
FSA	0.38	0.31	0.24	0.29	0.34	0.29	0.30	0.29	1.03
FSB	1.11	0.79	0.74	0.87	0.80	0.72	0.75	0.74	2.56
FSC	3.05	2.08	2.11	2.40	2.10	1.80	1.66	1.47	6.17
FSD	5.69	3.29	4.42	4.58	2.81	2.47	1.86	1.26	10.27

THC = Total Harmonic Current: sum of all harmonic currents

4.6.6 EMC limit values in South Korea

Description

이 기기는 업무용(A 급) 전자파적합기기로서 판매자 또는 사용자는 이 점을 주의하시기 바라며, 가정외의 지역에서 사용하는 것을 목적으로 합니다.
For sellers or users, please keep in mind that this device is an A-grade electromagnetic wave device.
This device is intended to be used in areas other than home.

The EMC limit values to be observed for Korea correspond to the limit values of the EMC product standard for variable-speed electric drives EN 61800-3 of category C2 or the limit value class A, Group 1 to KN11.

By implementing appropriate additional measures, the limit values according to category C2 or limit value class A, Group 1, are observed.

Additional measures, such as the use of an additional RFI suppression filter (EMC filter), may be necessary.

In addition, measures for EMC-compliant configuration of the plant or system are described in detail in this manual.

The final statement on compliance with the applicable standard is given by the respective label attached to the individual device.

4.7 EMC-compliant control cabinet installation

4.7.1 Potential equalization between control cabinets

Description

EMC-compliant potential equalization between control cabinets is structured as follows:

- The PE rail runs through all control cabinets without any interruption.
- The frames of the control cabinets are connected at multiple locations using serrated washers through a large surface area to establish a good electrical connection.
- In systems where the control cabinets are lined up next to one another, and which are installed in two groups back to back, the PE rails of the two cabinet line-ups are connected with one another at multiple locations.

4.7.2 EMC zones in the control cabinet

Description

Spatially separating disturbance sources and disturbance sinks avoids mutual disturbances. To achieve this, the control cabinet and the plant or machine are split up into EMC zones. Disturbance sources and disturbance sinks are installed in their own specific EMC zones.

An EMC-compliant control cabinet is structured as follows:

- All devices in the control cabinet are assigned to the appropriate EMC zones.
- Using one of the following measures, the zones are electromagnetically decoupled from one another:
 - Lateral clearance
 - Separate metal enclosure
 - Partition panels with large surface areas
- The cables associated with various EMC zones are routed in separate cable harnesses or cable ducts.
- Filters or isolating amplifiers are used at the interfaces of the EMC zones.

4.7.3 Shielded cables for the converter

Description

The following cables must be shielded to comply with EMC regulations:

- Inside the control cabinet:
 - Cable between the converter and line filter
 - Signal and data cables
- Outside the control cabinet:
 - Motor connection cables
 - Signal and data cables

To achieve EMC-compliant installation of the converter, connect the shields of the power cable to the shield plate via the shield clamps. The shield plate is shipped with the converter.

For better EMC effects, Siemens recommends that you strip the brake cable and the encoder cable and connect the cable shields to earth. Make sure that the shield plate, the converter and the motor are properly grounded.

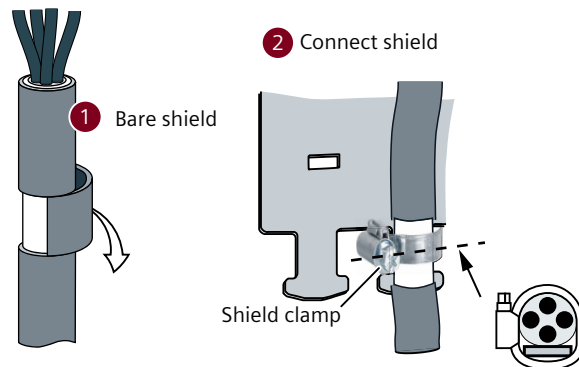

Figure 4-1 Correct EMC-compliant shield connection

4.7.4 EMC-compliant cable routing

Overview

Power cables with a high interference level significantly influence the electromagnetic fields in a system or a machine.

Routing cables to be compliant with EMC is a requirement for disturbance-free operation of a system or machine.

Description

The converter connection cables have different interference levels:

- Cables with a high level of interference:
 - Cable between the line filter and converter
 - Motor connection cables
 - Cable at the converter DC link connection
- Cables with a low level of interference:
 - Cable between the line and line filter
 - Signal and data cables

EMC-compliant cable routing complies with the following requirements:

- All cables are as short as possible.
- All cables are routed close to the mounting plates or control cabinet frames.
- Power cables with a high level of interference are routed so that there is a minimum clearance of 20 cm to cables with a low level of interference.
If the minimum clearance of 20 cm is not possible, insert separating metal panels between the cables with a high level of interference and those with a low level of interference. The separating metal panels are connected to the mounting plate to establish a good electrical connection.
- Cables with a high level of interference and cables with a low level of interference only cross over at right angles.
- All signal and data cables enter the control cabinet from only one side, from below, for example.
- Signal and data cables, as well as the associated equipotential bonding cables, are routed in parallel and close to one another.
- Any unused conductors of signal and data cables are grounded at both ends.
- Incoming and outgoing individual conductors that are not shielded are twisted with one another.
Alternatively, incoming and outgoing conductors are routed in parallel, but close to one another.

4.7.5 Shielding and potential equalization inside the control cabinet

Description

A control cabinet with EMC-compliant shielding is structured as follows:

- The size of the openings and breakouts at the control cabinet depend on whether it is to be used in the 1st or 2nd environment.
- Connect the door, side panels, top and base panels of the control cabinet with the control cabinet frame using one of the following methods:
 - Electrical contact surface of several cm² for each contact location
 - Several screwed connections
 - Short, finely stranded, braided copper wires with cross-sections $\geq 95 \text{ mm}^2 / 000 (3/0) (-2) \text{ AWG}$
- A shield support is provided for shielded cables that are routed out of the control cabinet.
- The PE rail and shield support should be connected to the control cabinet frame through a large surface area to establish a good electrical connection.
- Devices and components are mounted on a bare, metal mounting plate.
- The mounting plate is connected to the control cabinet frame, PE rail and shield support through a large surface area to establish a good electrical connection.
- For screwed connections on painted or anodized surfaces, establish a good electrical connection by using one of the following methods:
 - Serrated contact washers that cut through the painted or anodized surface
 - The insulating coating (e.g. paint) at the contact locations has been removed.

Mounting

5.1 Converter

5.1.1 Mounting instructions for the converter

Description

Observe the conditions listed below in order to guarantee reliable, continuous and trouble-free operation:

- The converter is designed for installation in a control cabinet.
- The converter is certified for use in environments with degree of pollution 2 without condensation; i.e. in environments where no conductive pollution/dirt occurs. Condensation is not permissible.
- The converter fulfills degree of protection IP20 according to IEC 60529.
- Ensure that all converters and cabinets are grounded according to Section "EMC-compliant control cabinet installation (Page 94)".
- Use a conductive steel sheet no thinner than 2 mm as the mounting plate.

Note

Keep the cover of the integrated operator panel closed to protect the control buttons and the SD card.

5.1.2 Mounting position

Description

NOTICE
Overheating due to impermissible mounting position
The converter can overheat and therefore be damaged if mounted in an impermissible position.
<ul style="list-style-type: none"> • Only mount the converter in a permissible position.

The converter supports vertical mounting only. Mount the converter vertically with the integrated operator panel facing upwards.



Figure 5-1 Converter mounting orientation

5.1.3 Dimension drawings and drilling dimensions

5.1.3.1 Dimension drawing and drilling dimensions for the 200 V converter

Dimension drawing

All dimensions are specified in millimeters.

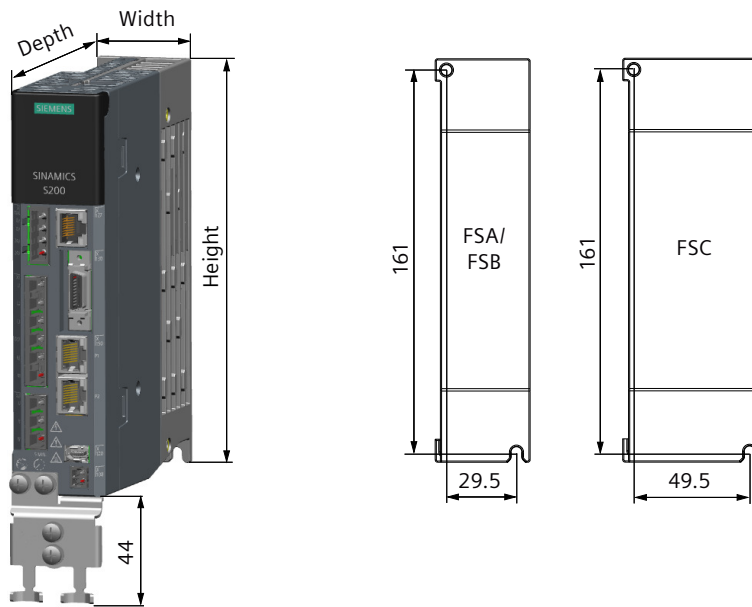

Table 5-1 Dimensions and mounting, 1 AC/3 AC 200 V, FSA ... FSC, IP20

Frame size	Width	Height	Depth	Fixing
FSA	40 mm	170 mm	135 mm	2 x M4 / 2.5 Nm
FSB	40 mm	170 mm	170 mm	
FSC	60 mm	170 mm	195 mm	

5.1.3.2 Dimension drawing and drilling dimensions for the 400 V converter

Dimension drawing

All dimensions are specified in millimeters.

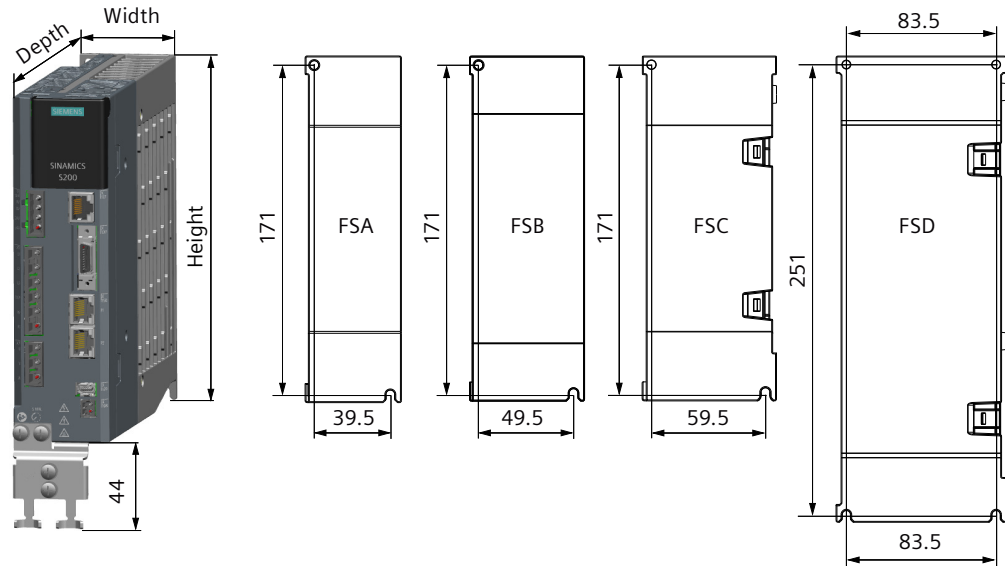

Table 5-2 Dimensions and mounting, 3 AC 400 V, FSA ... FSD, IP20

Frame size	Width	Height	Depth	Fixing
FSA	50 mm	180 mm	200 mm	2 x M4 / 2.5 Nm
FSB	60 mm	180 mm	200 mm	
FSC	70 mm	180 mm	200 mm	
FSD	95 mm	260 mm	230 mm	4 x M4 / 2.5 Nm

5.1.4 Minimum clearances

Description

Observe the following minimum mounting clearances. For converters without built-in fans, install cooling fans above the converters for sufficient heat dissipation.

Note

When the surrounding temperature in the cabinet is between 45 °C and 55 °C, the airflow velocity above the converters must be greater than 0.5 m/s for variants without built-in fans.

All dimensions are specified in millimeters.

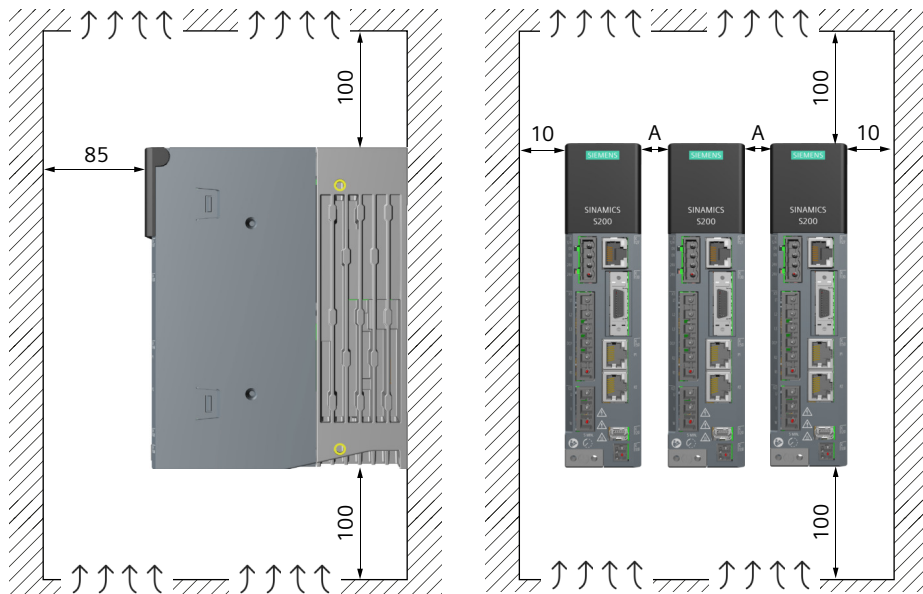

Table 5-3 Minimum clearances to other devices or components

	Single-converter installation	Side-by-side installation
Minimum clearance at top and bottom	100 mm	100 mm
Minimum clearance at front	85 mm	85 mm
Minimum lateral clearance (A) between multiple converters	-	200 V converter: 1 mm 400 V converter: 10 mm A mixture of 200 V and 400 V converters: 10 mm
Minimum lateral clearance to other devices	10 mm	10 mm

5.2 Motor

5.2.1 Transporting and lifting

Note

Comply with the local national regulations for the transportation of motors.

Requirement

- Use suitable load suspension devices when transporting and installing the motor.
- Do not lift the motor by the connector.
- Transport the motor carefully.

Procedure**Lifting and transporting the motor using slings**

You can lift and transport the motor using lifting slings.

**! WARNING****Incorrectly dimensioned or incorrectly used lifting slings**

If lifting slings are incorrectly dimensioned or incorrectly used, the motor can fall and cause death, severe injury and/or damage to property.

- Only use lifting slings that are suitable for the weight of the motor.
- Attach the lifting slings as shown in the figure "Lifting and transporting with lifting slings".



Figure 5-2 Lifting and transporting with lifting slings (example diagram)

Lifting and transporting the motor using eyebolts

The 1FL2310 motor (SH90) has two M8 threaded holes for screwing in two eyebolts. You can use eyebolts and a crossbar for lifting and transporting the motor.



! WARNING

Incorrect or unused lifting points

Due to incorrect or unused lifting points, the motor can fall and cause death, severe injury and/or damage to property.

- Only lift and transport larger motors using the eyebolts.
- Completely screw in the eyebolts and tighten by hand (approx. 10 Nm, or according to your specific requirement).
- Do not use bent or damaged eyebolts.
- Only use eyebolts with laminated fiber washers.
- Loads applied transversely to the plane of the eyebolts are not permitted.

1. Screw in the eyebolts.

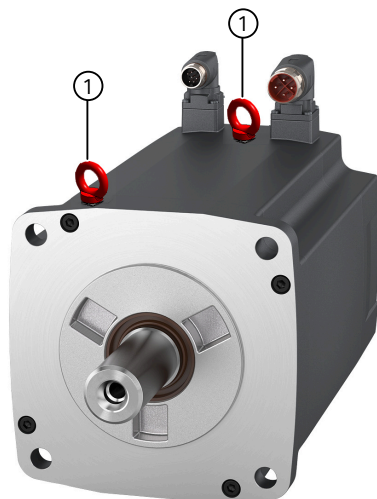

① Position of the eyebolts

2. Hook the crossbar into the eyebolts.

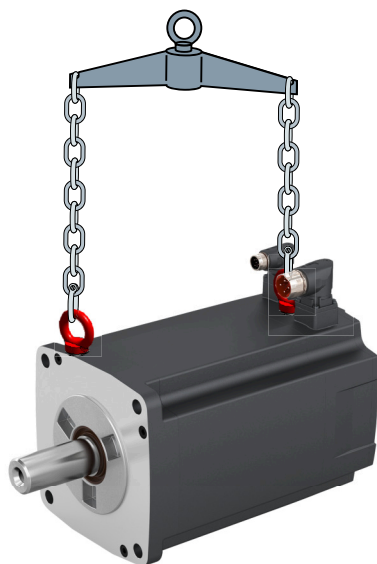

Figure 5-3 Lifting and transporting with a crossbar (example diagram)

3. Set the motor down on a hard, level surface.



⚠ WARNING

Danger of severe injury due to unintentional movements of the motor

If the motor is not secured after being set down, unintentional movements of the motor can cause serious injury.

- After the motor has been set down, secure it in position.
- Do not release the lifting devices until the motor has been secured in position.

4. Secure the motor against unintentional movements.

5.2.2 Checklist prior to mounting

Description

The checklist below is a minimum benchmark and must be performed in any case. Further checks before, during, and after the installation of the motor depend on the system-specific conditions and are the responsibility of the plant or system manufacturer.

Table 5-4 Checklist before installing



Check	OK
General checks	
Are the environmental conditions in the permissible range?	
Checks regarding the mechanical system	
Is the motor free of visible damage?	
Have the mounting surfaces such as the flange and shaft on the customer machine and on the motor been cleaned?	
Are the mounting surfaces free of corrosion?	
Do the mounting dimensions such as the shaft diameter, shaft length, and radial eccentricity on the customer machine meet the specifications?	

5.2.3 Safety labels on the motor

Description

NOTICE
Damage to the encoder due to shocks Shocks at the motor shaft extension can cause an encoder damage. <ul style="list-style-type: none"> • Do not exert any shock at the shaft extension.

In the delivery state, the following two warning labels are attached to the motor. In addition, there are three "hot surface" warning labels included in the scope of delivery. Before mounting the motor, attach them to the motor surfaces and make sure that they are clearly visible on all the four longitudinal sides of the motor.

	"Hot surface" warning label
	"No shocks at the shaft extension" warning label

5.2.4 Mounting instructions for the motor

Description

NOTICE**Damage to shaft sealing rings caused by solvent**

If shaft sealing rings come into contact with solvents when preservation coating is removed, the shaft sealing rings can be damaged.

- Avoid contact between solvents and shaft sealing rings.

NOTICE**Damage to the motor due to radial eccentricity at the shaft extension**

Radial eccentricity and axial forces at the shaft extension can damage the motor.

- Mount the motor in such a way that no radial eccentricity and axial forces at the shaft extension occur.

- Adhere to the specifications on the rating plate (Page 52).
- Observe the warning and information plates on the motor.
- Check the installation site and permissible environmental conditions such as temperature and installation altitude. See Section "Permissible environmental conditions for the motor (Page 678)".
- Thoroughly remove any anti-corrosion agents from the shaft extension with commercially available solvents.
- Ensure that power losses are adequately dissipated. See Section "Cooling (Page 680)".
- If the motor is installed vertically with the shaft extension facing up, ensure that no liquid can enter the upper bearing.
- Ensure that the flange is in even contact with the mounting surface.
- Use hexagon socket head cap screws with a property class of at least 8.8.

- Avoid any uneven stressing when tightening the fastening screws.
- Observe the tightening torques for the fastening screws.
The general tolerance for the tightening torque is 10%. The tightening torque is based on a friction coefficient of $\mu = 0.14$.

Motor	Screw DIN 7984	Washer ISO 7092 (mm)	Tightening torque for screws (not for electrical connections)
1FL2102	M4	4 ($d_{2 \max} = 8$)	2.4 Nm
1FL2□03	M5	5 ($d_{2 \max} = 9$)	4.7 Nm
1FL2104 1FL2204 1FL2205	M6	6 ($d_{2 \max} = 11$)	8 Nm
1FL2105 1FL2304 1FL2306	M8	8 ($d_{2 \max} = 15$)	20 Nm
1FL2310	M12	12 ($d_{2 \max} = 20$)	85 Nm

Tightening torques for the fastening screws

5.2.5 Mounting position

Description

The 1FL2 motor supports flange mounting only. It can be installed in three orientations as shown in the following table.

Table 5-5 Type of construction according to IEC 60034-7

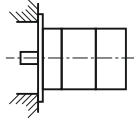
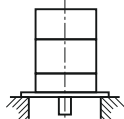
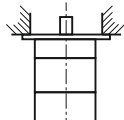
Designation	Representation	Description
IM B5		Standard
IM V1		The motor can be used in types of construction IM V1 and IM V3 without restriction.
IM V3		

Note

IM V3 type of construction

When configuring the IM V3 type of construction, pay attention to the permissible axial forces and especially to the necessary degree of protection.

5.2.6 Dimension drawings for motors

5.2.6.1 Dimension drawing for the 1FL2 motor, shaft height 20

Dimension drawing

All dimensions are specified in millimeters.

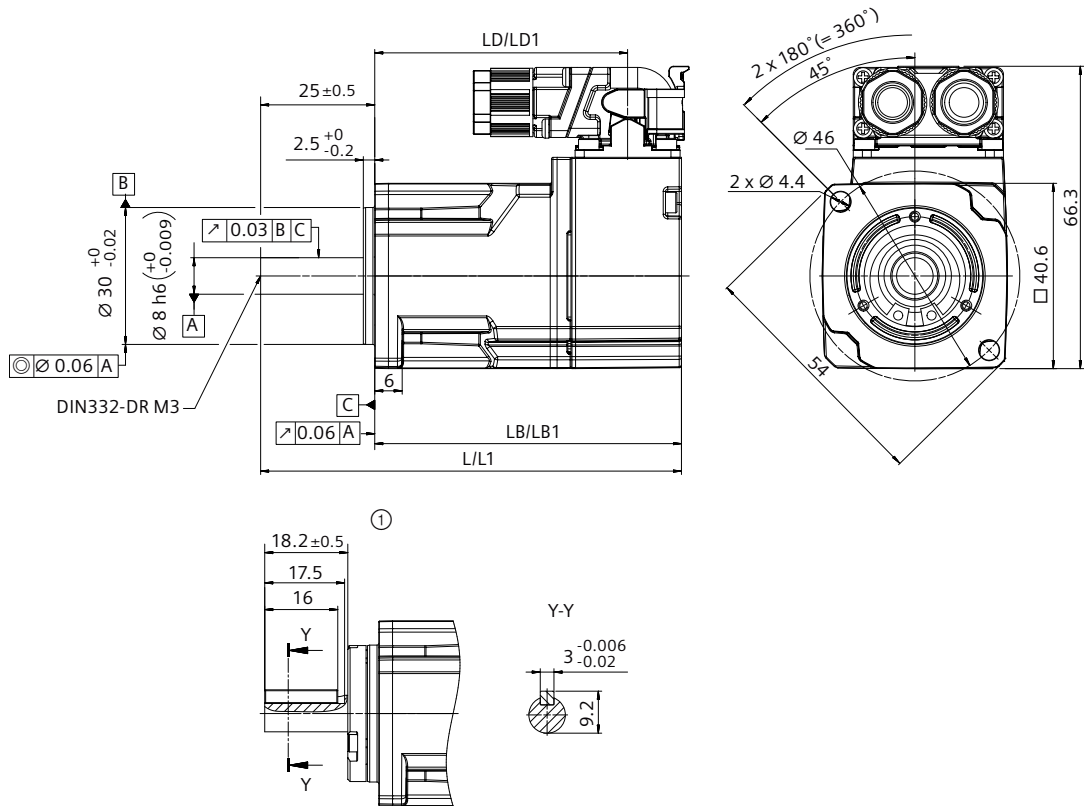

① With shaft sealing ring (IP65) and feather key

Table 5-6 Dimensions, 1FL2102

SIMOTICS S-1FL2 Shaft height 20	Motor length					
	Without brake			With brake		
	L	LB	LD	L1	LB1	LD1
1FL2102-2	92.2	67.2	55.7	121.9	96.9	85.4
1FL2102-4	105.2	80.2	68.7	134.9	109.9	98.4

5.2.6.2 Dimension drawing for the 1FL2 motor, shaft height 30

Dimension drawing

All dimensions are specified in millimeters.

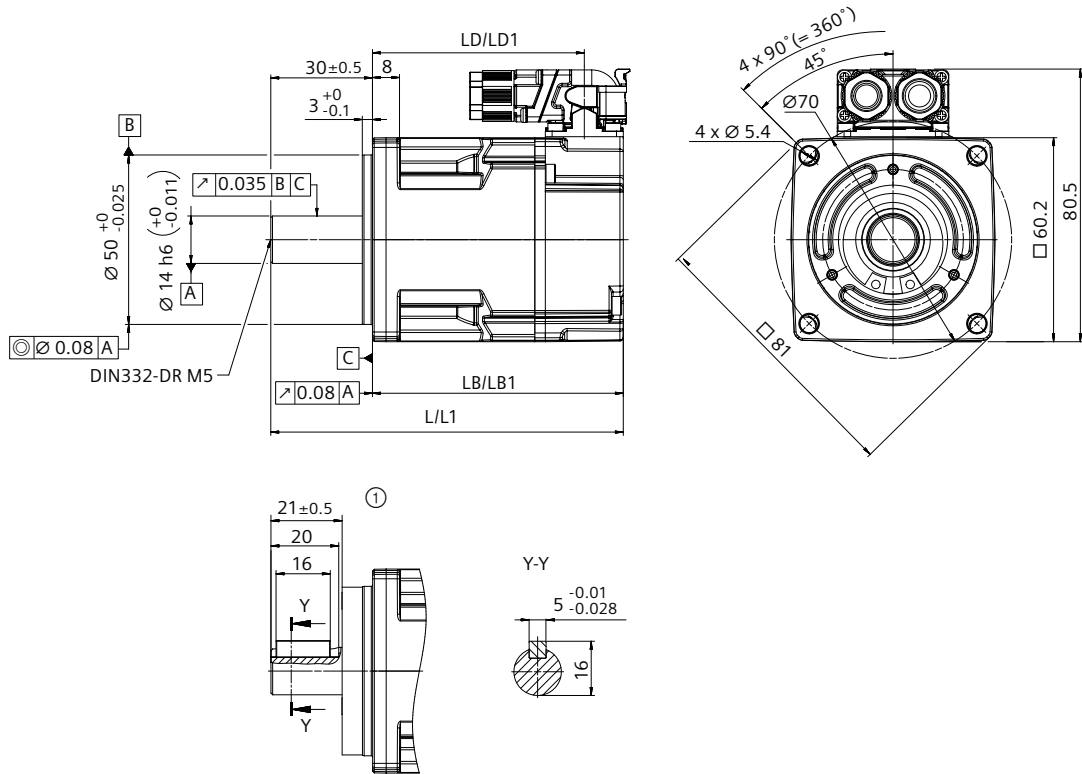

① With shaft sealing ring (IP65) and feather key

Table 5-7 Dimensions, 1FL2□03

SIMOTICS S-1FL2 Shaft height 30	Motor length					
	Without brake			With brake		
	L	LB	LD	L1	LB1	LD1
1FL2103-2	105.5	75.5	63.8	135.5	105.5	93.8
1FL2103-4	124.5	94.5	82.8	154.5	124.5	112.8
1FL2203-2	104	74	62.3	134	104	92.3
1FL2203-4	121.5	91.5	79.8	151.5	121.5	109.8

5.2.6.3 Dimension drawing for the 1FL2 motor, shaft height 40

Dimension drawing

All dimensions are specified in millimeters.

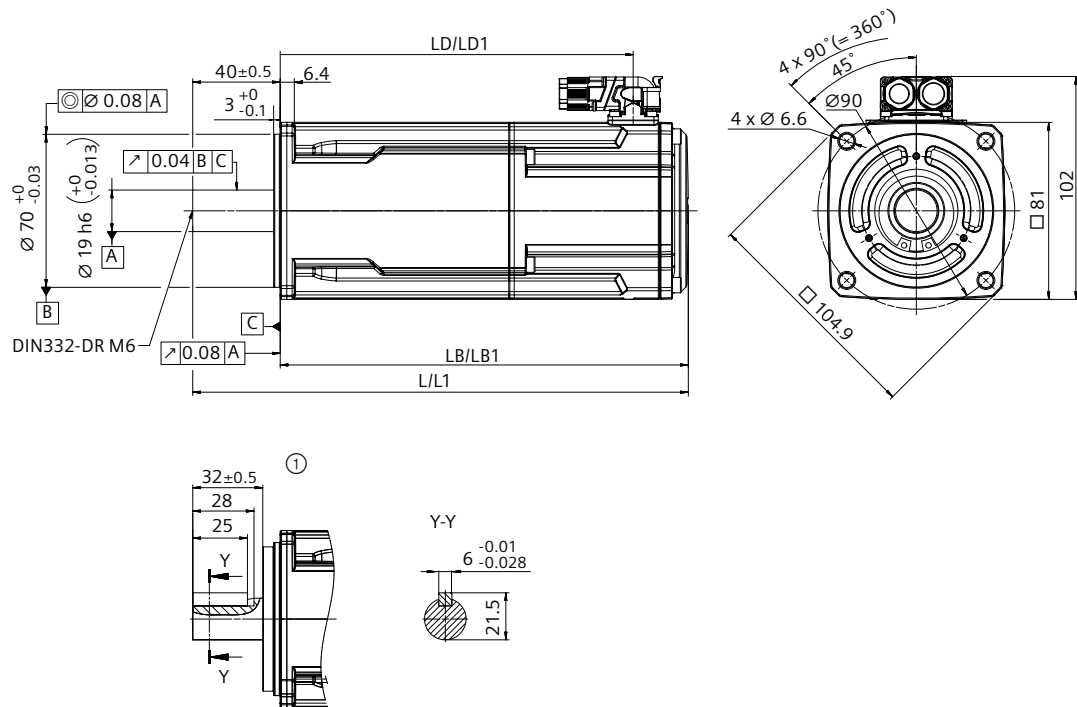

① With shaft sealing ring (IP65) and feather key

Table 5-8 Dimensions, 1FL2104, 1FL2204

SIMOTICS S-1FL2 Shaft height 40	Motor length					
	Without brake			With brake		
	L	LB	LD	L1	LB1	LD1
1FL2104-2	164.6	124.6	99.4	208.6	168.6	143.4
1FL2204-2						
1FL2104-4	182.6	142.6	117.4	226.6	186.6	161.4
1FL2204-4						

5.2.6.4 Dimension drawing for the 1FL2 motor, shaft height 45

Dimension drawing

All dimensions are specified in millimeters.

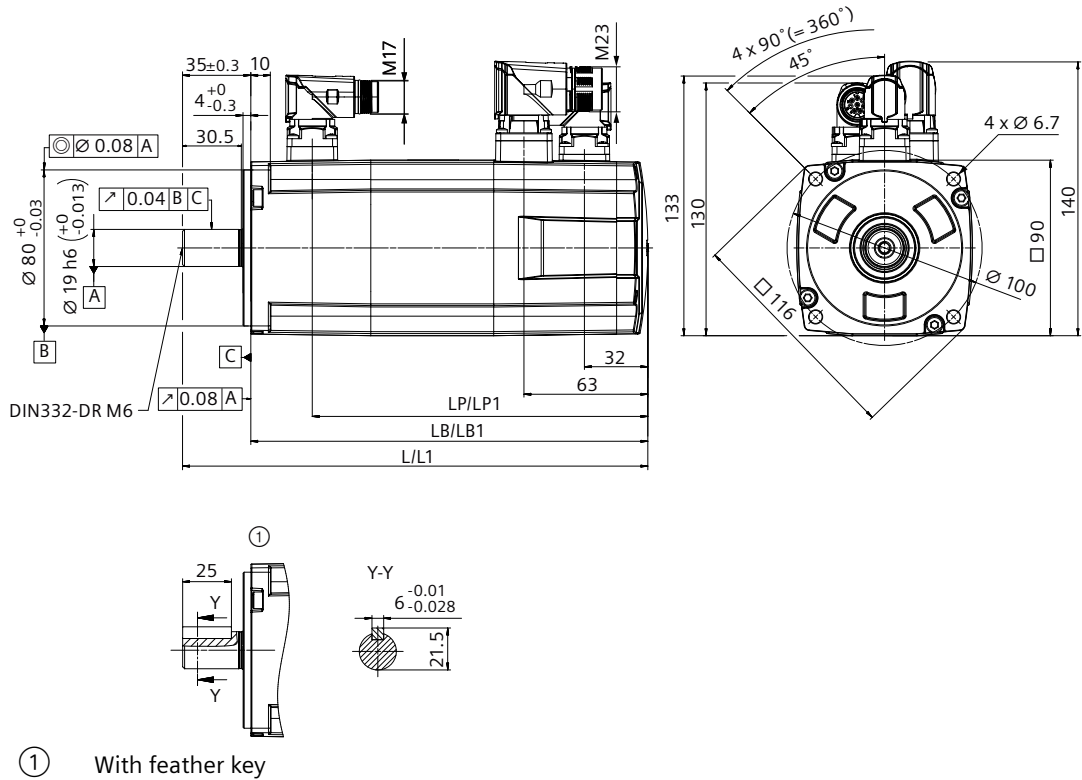

① With feather key

Table 5-9 Dimensions, 1FL2304

SIMOTICS S-1FL2 Shaft height 45	Motor length					
	Without brake			With brake		
	L	LB	LP	L1	LB1	LP1
1FL2304-2	192	157	/	238.5	203.5	172
1FL2304-4	239	204	/	285.5	250.5	219

5.2.6.5 Dimension drawing for the 1FL2 motor, shaft height 48

Dimension drawing

All dimensions are specified in millimeters.

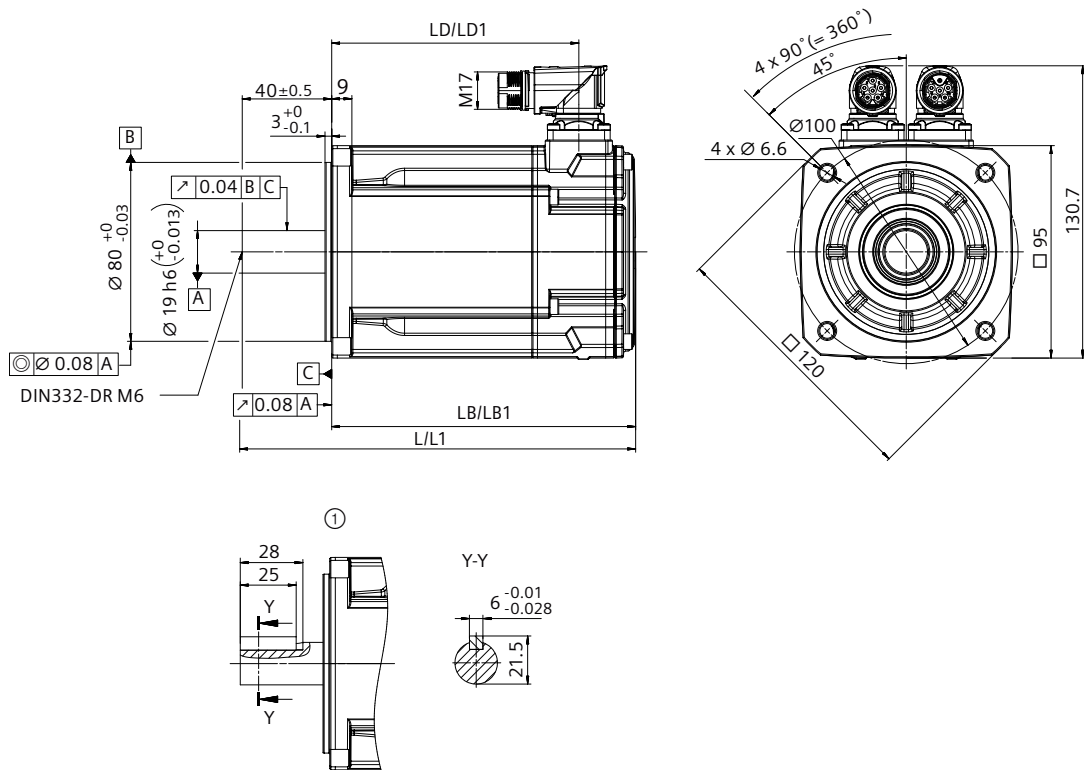

① With feather key

Table 5-10 Dimensions, 1FL2205

SIMOTICS S-1FL2 Shaft height 48	Motor length					
	Without brake			With brake		
	L	LB	LD	L1	LB1	LD1
1FL2205-2	175.9	135.9	110.5	218.9	178.9	153.5
1FL2205-4	207.9	167.9	142.5	250.9	210.9	185.5

5.2.6.6 Dimension drawing for the 1FL2 motor, shaft height 52

Dimension drawing

All dimensions are specified in millimeters.

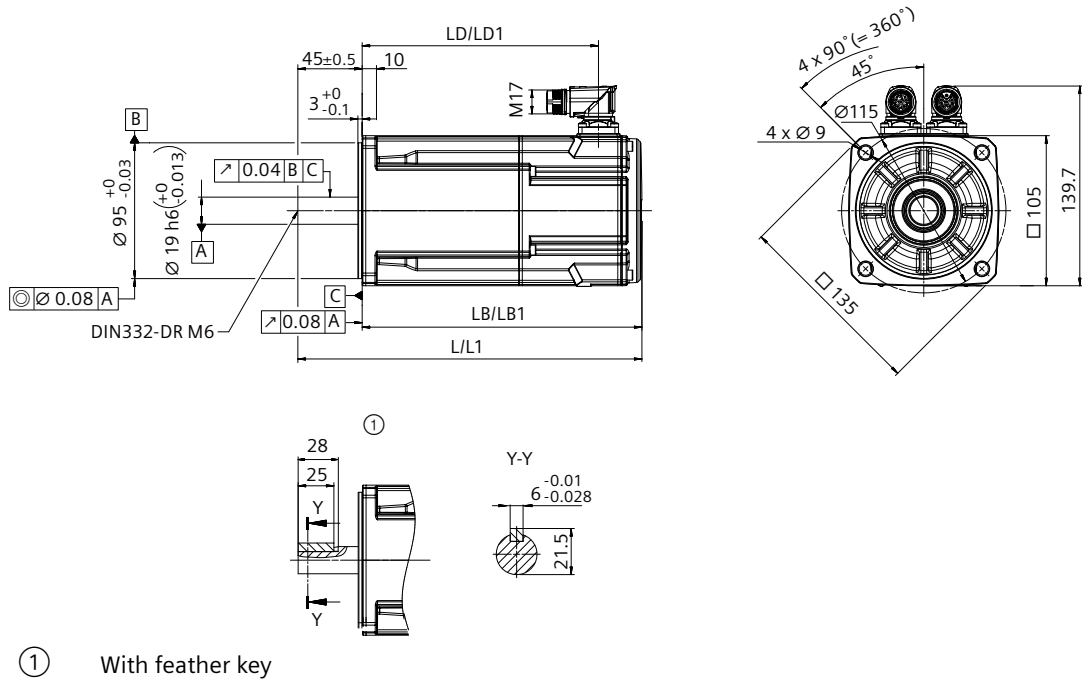

Table 5-11 Dimensions, 1FL2105

SIMOTICS S-1FL2 Shaft height 52	Motor length					
	Without brake			With brake		
	L	LB	LD	L1	LB1	LD1
1FL2105-2	213.9	168.9	138.5	240.7	195.7	165.3
1FL2105-4	255.9	210.9	180.5	282.7	237.7	207.3

5.2.6.7 Dimension drawing for the 1FL2 motor, shaft height 65

Dimension drawing

All dimensions are specified in millimeters.

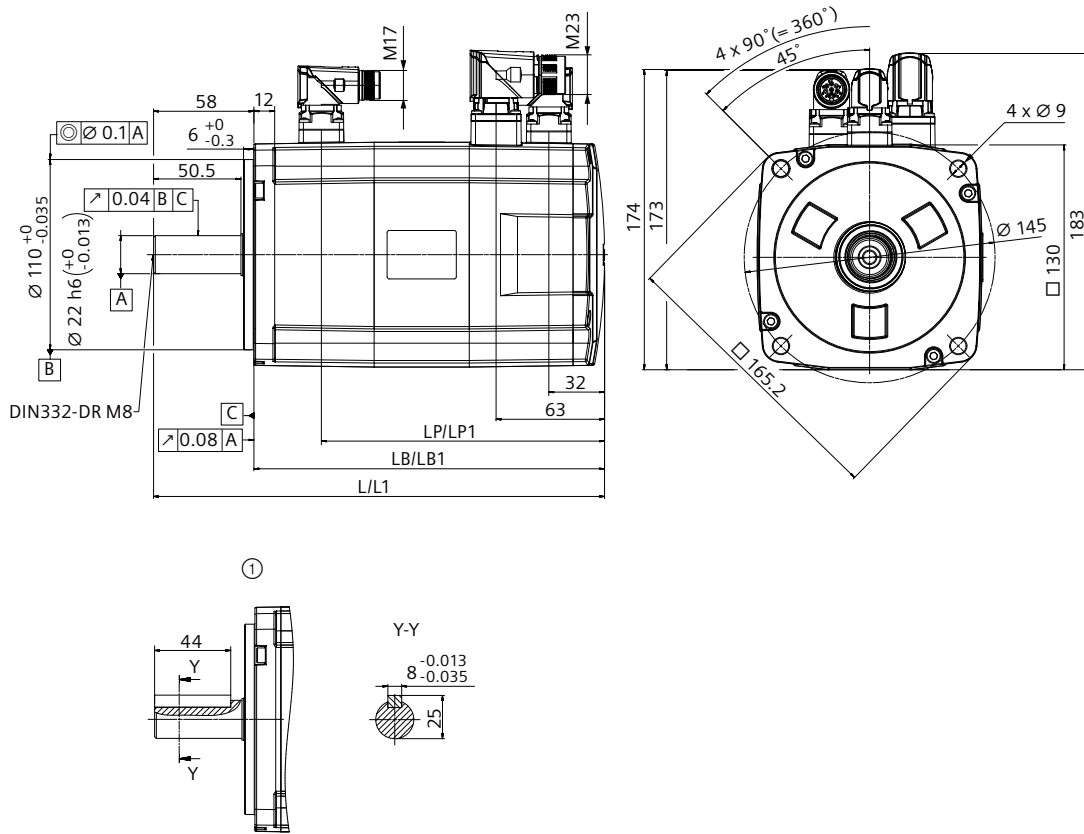

① With feather key

Table 5-12 Dimensions, 1FL2306

SIMOTICS S-1FL2 Shaft height 65	Motor length					
	Without brake			With brake		
	L	LB	LP	L1	LB1	LP1
1FL2306-1	206.2	148.2	/	260.7	202.7	163.7
1FL2306-2	222.7	164.7	/	277.2	219.2	180.2
1FL2306-4	239.2	181.2	/	293.7	235.7	196.7
1FL2306-6	272.2	214.2	/	326.7	268.7	229.7
1FL2306-7	305.2	247.2	/	359.7	301.7	262.7

5.2.6.8 Dimension drawing for the 1FL2 motor, shaft height 90

All dimensions are specified in millimeters.

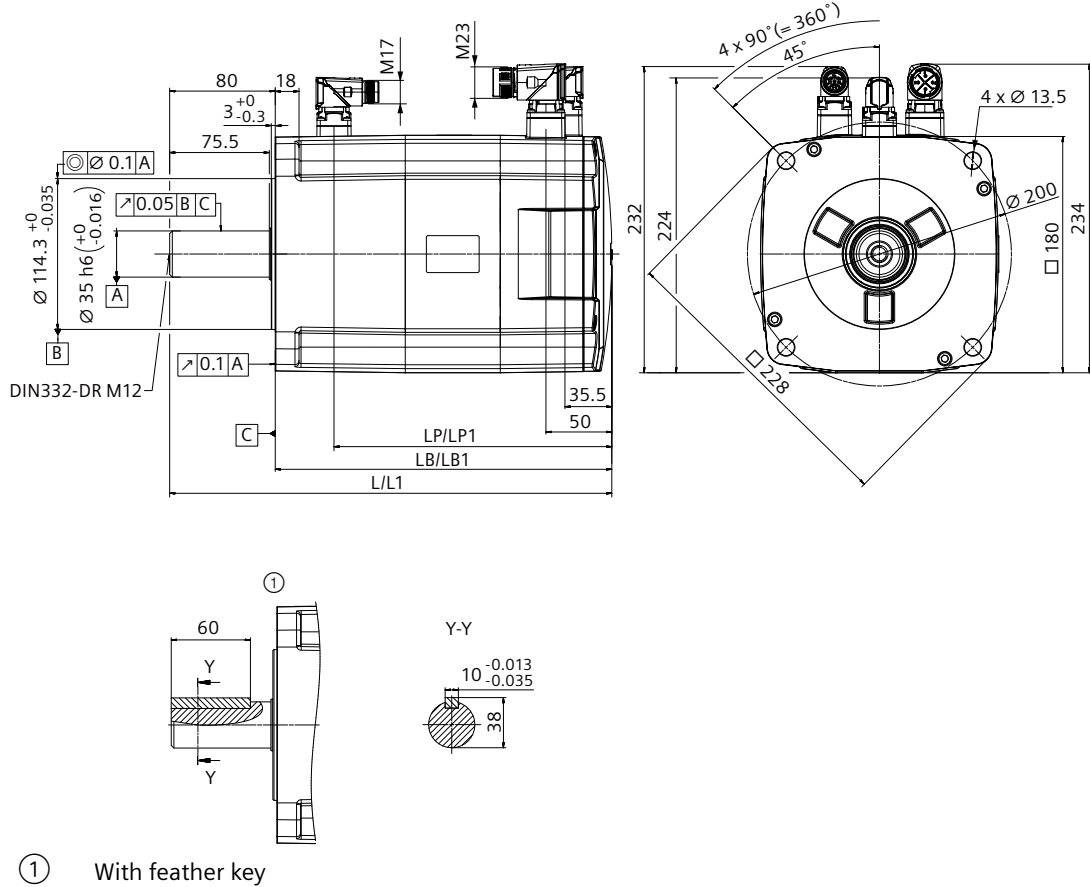

Table 5-13 Dimensions, 1FL2310

SIMOTICS S-1FL2 Shaft height 90	Motor length					
	Without brake			With brake		
	L	LB	LP	L1	LB1	LP1
1FL2310-0	269.5	189.5	/	335	255	210.5
1FL2310-2	295.5	215.5	/	361	281	236.5
1FL2310-4	321.5	241.5	/	387	307	262.5
1FL2310-6	373.5	293.5	/	439	359	314.5

5.2.7 Mounting the feather key

Requirement



WARNING

Injuries due to feather key flung out

When a motor using a key is running, the feather key on the shaft can be thrown out by centrifugal force. This can result in personal injury or material damage.

- Before operating the motor, the feather key on the shaft must be firmly secured to prevent from being thrown out by the centrifugal force.

NOTICE

Damage to motor bearing due to improper operation

Never mount the feather key by hammering into the key slot; otherwise, there is a risk of bearing damage.

- Pay attention to the installation direction of the feather key.
- Mount the key without striking the key slot or the shaft extension.

Procedure

Proceed as follows to mount the feather key into the key slot:

1. Install the feather key ("①") to the key slot ("②") and make sure that the feather key and the key slot are fitted closely. Siemens recommends that you place the V-type block ("③") under the shaft extension for supporting.
2. Knock the feather key into the key slot by using a copper bar.

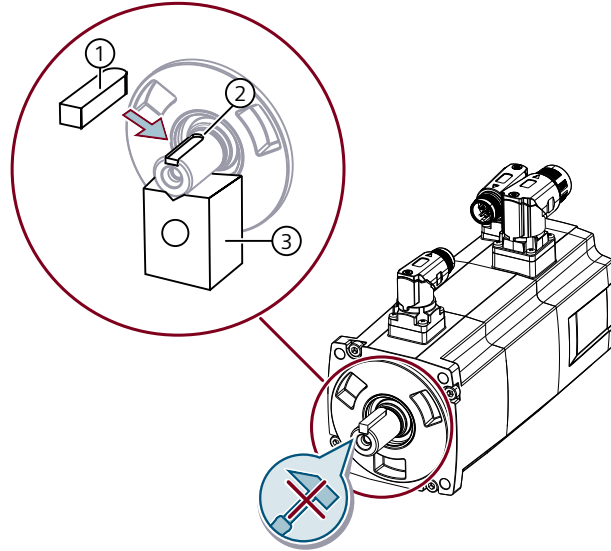

- ① Well-lubricated feather key
- ② Key slot
- ③ V-type block

Figure 5-4 Mounting the feather key

5.2.8 Attaching output elements

Overview

Appropriate arrangement of the output elements reduces the bending torque load applied to the shaft and the bearing.

Requirement

Mount the output elements as close as possible to the motor bearing.

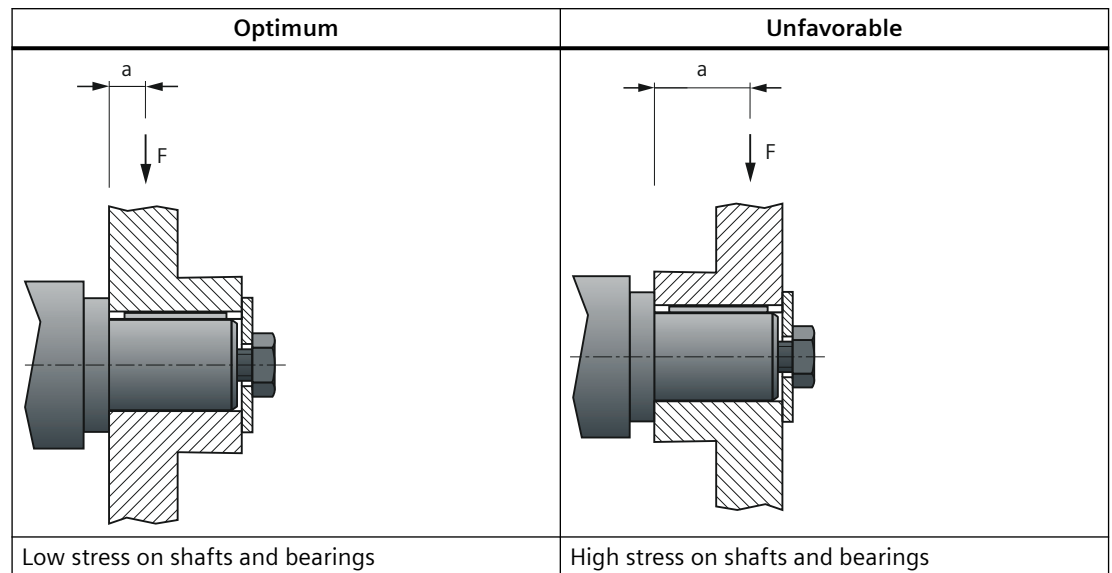

Mount or remove the output elements (for example, couplings, gear wheels, and belt pulleys) by using suitable devices only.

- Use the threaded hole in the shaft extension.
- If required, heat up the output elements before mounting or removing.
- When removing the output elements, use an intermediate disk to protect the centering in the shaft extension.

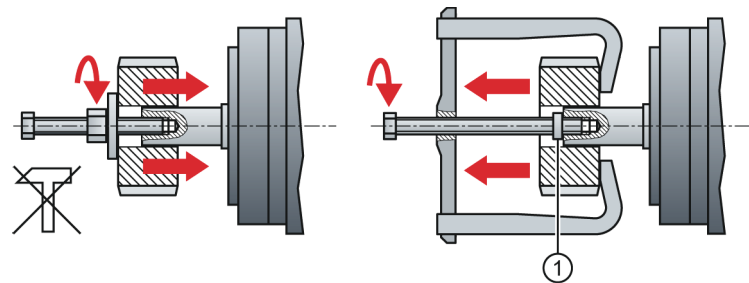

① Intermediate washer/disk

Figure 5-5 Mounting and removing output elements

- If necessary, completely balance the motor together with the output elements according to ISO 1940.

Note

Motors with feather key are half-key balanced. The motors have been balanced with half a feather key.

Procedure

Proceed as follows to attach an output element (for example, a coupling) to the motor:

1. Select a coupling.
Use a flexible coupling with high torsional rigidity specifically designed for servo motors, which can transfer the motor torque to the mechanics and compensate radial, axial, and angular misalignments.
2. Install the coupling.
Do not strike the shaft when installing a coupling. Ensure that the radial and axial forces are smaller than the allowable maximum values specified in Section "Axial and radial forces (Page 689)".
3. Align the coupling.
When a motor is used with a flange coupling, the radial deviation must be smaller than 0.03 mm; otherwise, the bearing will be damaged. The required alignment accuracy varies with the motor speed and the coupling type. Determine the accuracy according to actual applications.

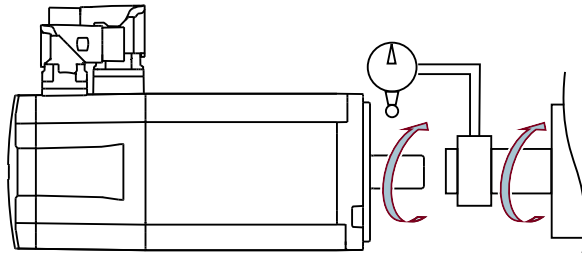

- Rotate the motor shaft and the machine shaft to align the coupling.
 - An alignment accuracy test is preferred. If unachievable, judge the accuracy by observing whether the coupling can slide smoothly on both shafts.
4. Realign the coupling.
If the coupling gives out abnormal sounds, refer to Step 3 "Align a coupling" to realign the coupling until the sounds disappear.
 5. Measure tension.
The belt tension must be smaller than the allowable radial forces of the motor.

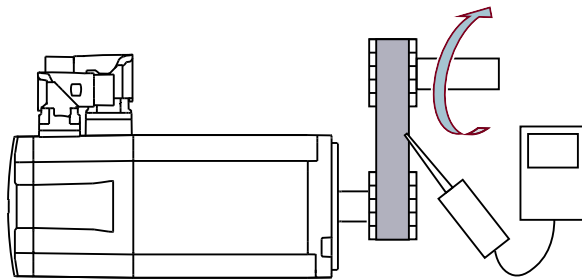

- Measure the belt tension at multiple points using a tension meter while turning the motor shaft by 45°.
- Reduce the axial misalignment of the belt-pulleys to keep the axial forces to the motor shaft to a minimum.

5.2.9 Laying cables in cable carriers (for MOTION-CONNECT 380 only)

Requirement

None

Procedure

Proceed as follows to arrange cables in cable carriers:

1. Lay the cables.

- Use spacers to separate cables with different outer diameters or cables made of different materials.
- Fill the spacers evenly to ensure that the position of cables does not change during operation.
- Distribute cables symmetrically according to their weights and dimensions.
- Keep cables untwisted in the cable carrier.
- When inserting prefabricated cables in the cable carrier, do not pull the connector, as this may damage the strain relief or cable clamping.

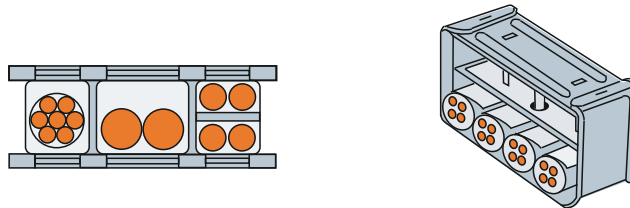

2. Move the cables.

- Lay the cables loosely in the carrier, so that the cables are free to move in particular in the bending radii of the carrier.
- Observe the specified minimum bending radii.

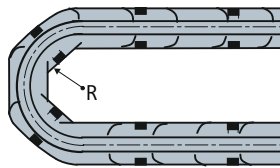

R Bending radius on the cable carrier

3. Fix the cables.

- Make sure that cables in the carrier are unattached and movable.
- Place cable fixings in a "dead" zone at each end, suitably far away from each end point of the moving parts.

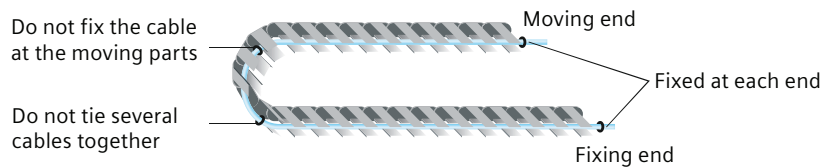

Note**Additional fixing of the cable**

If between the cable strain relief on the cable carrier and the terminal at the motor, part of the cable is hanging loose or is not routed, Siemens recommends that the cable is additionally fixed for vibration load and with horizontal or vertical cable entries.

- Additionally fix the cable where the motor is fixed so that machine vibrations are not transferred to the connector.
-

Connecting

Note**Note for connecting the drive system**

Fix all the connecting cables to the converter shield plate by using shield clamps or suitable cable ties.

6.1 System connection

Overview diagram

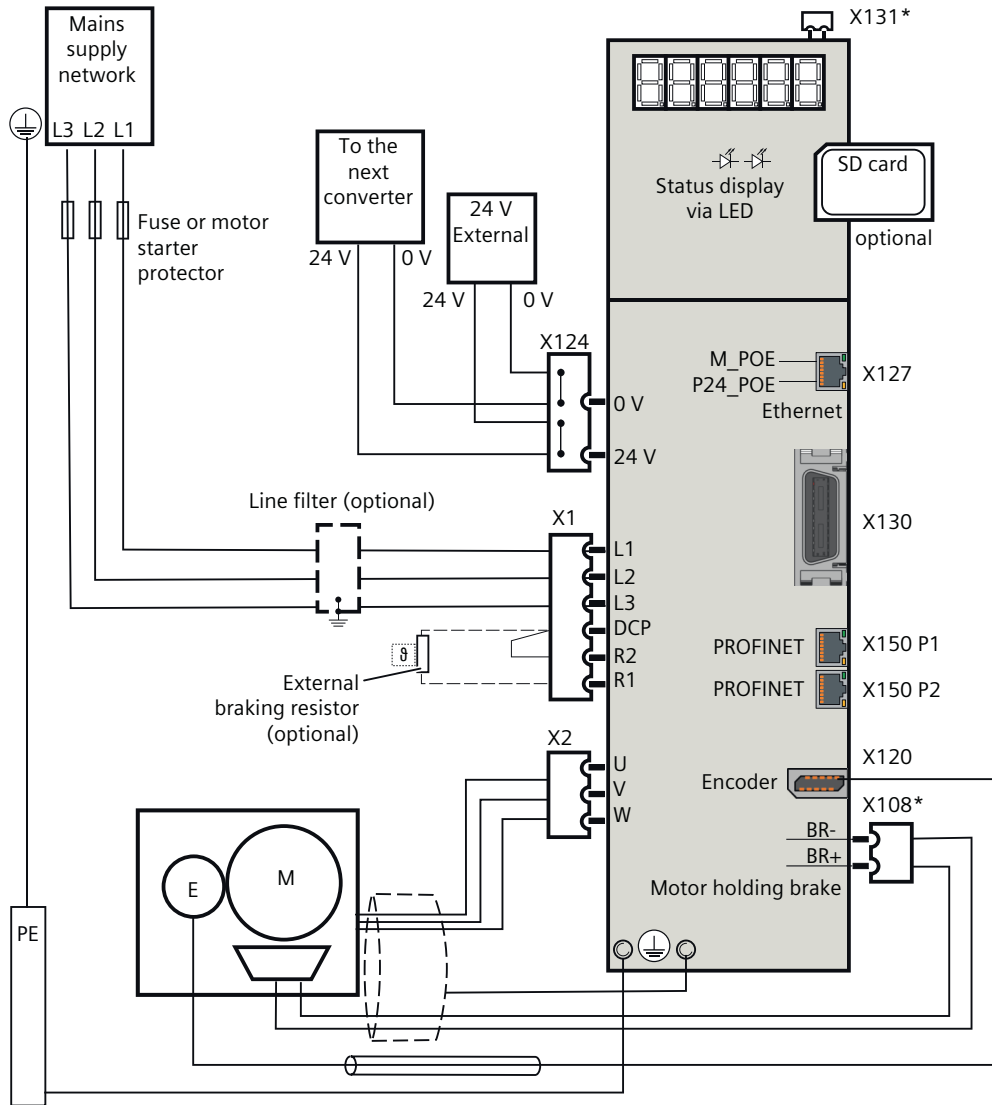

* The interfaces X131 and X108 are available on the SINAMICS S200 converter only.

Figure 6-1 Connection example for converters with 3 AC line connection

6.2 Overview of the converter interfaces

Overview diagram

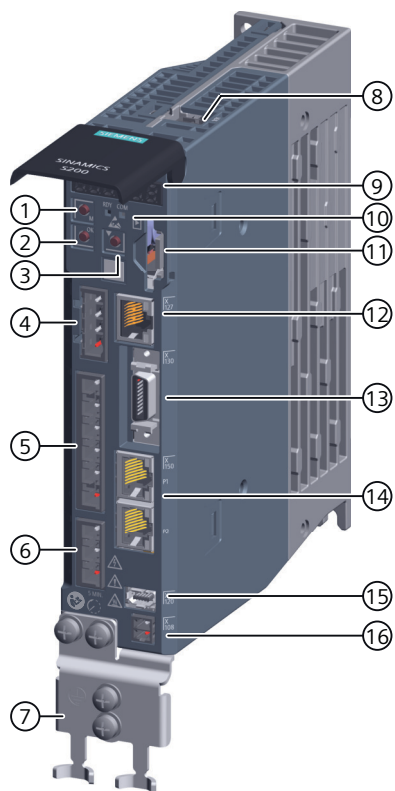

- | | |
|---|--|
| ① M button | ⑨ 6-digit display |
| ② OK button | ⑩ LED status indicators |
| ③ DOWN button | ⑪ SD card slot |
| ④ 24 V DC power supply - X124 | ⑫ Service interface (Ethernet) - X127 |
| ⑤ Mains and braking resistor interface - X1 | ⑬ Control/status inputs and outputs - X130 |
| ⑥ Motor power interface - X2 | ⑭ PROFINET interface - X150 |
| ⑦ Shield plate | ⑮ Encoder interface - X120 |
| ⑧ STO interface - X131 ¹⁾ | ⑯ Motor holding brake interface - X108 ¹⁾ |

¹⁾ The interfaces X131 and X108 are available on the SINAMICS S200 converter only.

Figure 6-2 Converter interfaces

6.3 Cables and connectors

6.3.1 Maximum permissible cable lengths

Technical data

Table 6-1 Maximum permissible cable length

Connection type	Interface on the converter	Maximum permissible cable length (m)
Mains supply	X1 (L1, L2, and L3)	No restriction
External braking resistor	X1 (DCP and R1)	3
24 V DC power supply	X124	30
Motor power connection	X2	30
Encoder connection	X120	30
Motor holding brake	X108	30
Control/status inputs and outputs	X130	3
PROFINET connection	X150	100
Ethernet connection	X127	10
STO connection	X131	30

6.3.2 Conductor cross-sections and cable lugs

Description

Table 6-2 Conductor cross-sections and cable lugs

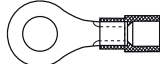
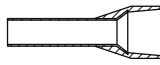
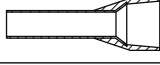
Connection type	Terminal type	Conductor cross-section	Stripping length	Cable lug
Mains supply (L1, L2, L3)	Spring-loaded	0.75 mm ² ... 2.5 mm ² (AWG: 18 ... 12)	9 mm ... 10 mm	Pin-type 
Mains supply (PE)	Screw-type	0.75 mm ² ... 2.5 mm ² (AWG: 18 ... 12)	10 mm	Ring type 
24 V DC power supply	Spring-loaded	0.2 mm ² ... 2.5 mm ² (AWG: 24 ... 12)	10 mm ... 11 mm ¹⁾	Pin-type 
External braking resistor	Spring-loaded	0.2 mm ² ... 2.5 mm ² (AWG: 24 ... 12)	9 mm ... 10 mm	Pin-type 

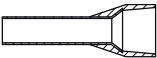
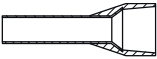
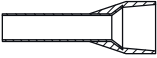
Connection type	Terminal type	Conductor cross-section	Stripping length	Cable lug
STO connection ²⁾	Spring-loaded	0.2 mm ² ... 1.5 mm ² (AWG: 24 ... 16)	10 mm	Pin-type 
Motor power connection	Spring-loaded	0.75 mm ² ... 2.5 mm ² (AWG: 18 ... 12)	9 mm ... 10 mm	Pin-type 
Motor holding brake ²⁾	Spring-loaded	0.38 mm ² ... 0.75 mm ² (AWG: 22 ... 18)	9 mm ... 10 mm	Pin-type 

¹⁾ If you use cable lugs with insulated end sleeves, make sure that the length of the cable lugs is 12 mm.

²⁾ For the SINAMICS S200 converter only

More information

For more information about assembling cable terminals, see Section "Assembling cables (Page 932)".

6.4 Connecting the mains supply

6.4.1 Interface description - X1

Overview

The converter connects to the mains supply via terminals L1, L2, and L3 on the interface X1.

Description

Table 6-3 Interface X1

X1	Terminal	Designation	Technical data
	L1	Line phase L1/line phase L ¹⁾	Maximum current limit: 20 A
	L2	Line phase L2	
	L3	Line phase L3/neutral N ¹⁾	
	DCP		
	R2		
	R1		

¹⁾ For applications on the single-phase mains supply network

6.4.2 Wiring

Requirement

You have assembled the converter line supply cable.

Procedure

1. Assemble the X1 plug to the converter.
2. Attach the cable terminals to the plug as shown below:

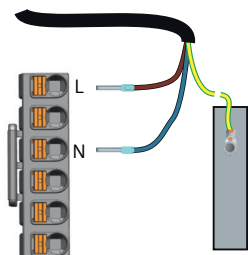

Figure 6-3 Connecting to the single-phase mains supply network

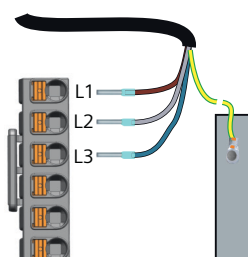

Figure 6-4 Connecting to the three-phase mains supply network

More information

For more information about cable requirements, see Section "Cables and connectors (Page 130)".

For more information about assembling cable terminals, see Section "Assembling the cable lugs (Page 933)".

6.4.3 Using several single-phase converters in machines and plants

Overview

Evaluate the input currents of single-phase converters in your machine or plant in terms of harmonics and unbalance.

Description

In unfavorable cases, the harmonic currents of several converters in the neutral conductor (N) add up to a value greater than the currents of the line conductors (L1, L2, L3). The current-carrying capacity of the neutral conductor must be sufficient for this.

IEC 60364-5-52:2019 Section 524 makes recommendations for sizing the neutral conductor. If no more precise information is available, the standard recommends dimensioning the neutral conductor for 1.45 times the current-carrying capacity of the line conductors.

 **WARNING**

Fire caused by neutral conductor (N) overload

The neutral conductor can heat up due to the load from harmonic currents and cause a fire.

- Consider the harmonic currents when dimensioning the neutral conductor.



 **WARNING**

Electric shock caused by PEN conductor overload

In TN-C supply networks, the protective function of the PEN conductor can be adversely affected by exposure to harmonic currents.

- Consider the harmonic currents when dimensioning the PEN conductor.

6.5 Connecting the motor

6.5.1 Routing cables in damp environments

Description

To operate the motor in a damp environment, follow the installation instructions below:

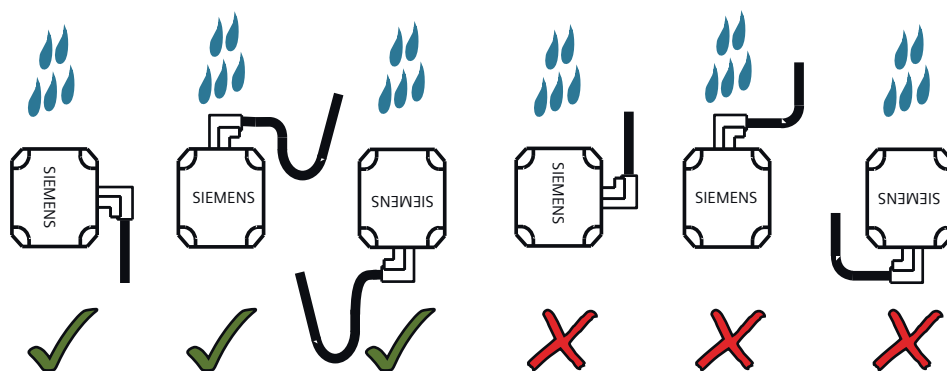

Figure 6-5 Routing cables in damp environments

6.5.2 Connecting the motor power

6.5.2.1 Interface description - X2 (converter side)

Overview

The converter connects to the motor on the interface X2.

Description

Table 6-4 Interface X2

X2	Terminal	Designation	Technical data
 U V W	U	Motor phase U	Maximum current limit: 20 A
	V	Motor phase V	
	W	Motor phase W	

6.5.2.2 Interface description - power connector (motor side)

Overview

The 1FL2 motor power interface on the motor side has different variants:

- SH20, 30, and 40: hybrid connector that integrates power, encoder, and holding brake interfaces
- SH48 and 52: M17 angular connector that integrates power and holding brake interfaces
- SH45, 65, and 90: M23 angular connector

Description

- 1FL2 shaft heights 20, 30, and 40

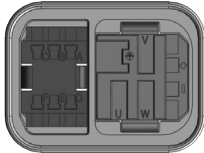
Motor power interface	Pin	Designation
 Hybrid connector	U	Phase U
	V	Phase V
	W	Phase W
	PE	Protective grounding
	+	Holding brake, positive
	-	Holding brake, negative
	A	Encoder power supply, 5 V
	B	Encoder power supply, reference ground
	C	Absolute encoder clock signal, positive
	D	Absolute encoder clock signal, negative
E	Absolute encoder data signal, positive	
F	Absolute encoder data signal, negative	

- 1FL2 shaft heights 48 and 52

Motor power interface	Pin	Designation
 M17 angular connector	U	Phase U
	V	Phase V
	W	Phase W
	PE	Protective grounding
	A	Holding brake, positive
	B	Holding brake, negative

- 1FL2 shaft heights 45, 65, and 90

Motor power interface	Pin	Designation
 M23 angular connector	1	Phase U
	2	Phase V
	3	Phase W
	PE	Protective grounding

6.5.2.3 Wiring

Connection example

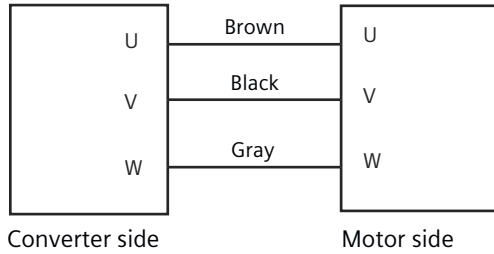
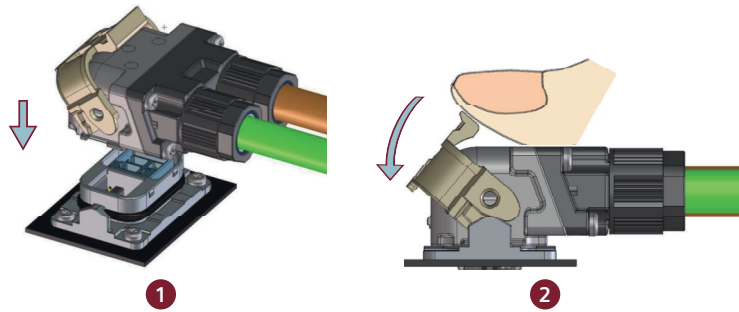

Figure 6-6 Motor power connection

Connection example of the hybrid connector

- Connecting the hybrid plug to the socket
Insert the hybrid plug into the socket and push down the lever to secure the connection.



- Disconnecting the hybrid plug from the socket
Insert a slotted screwdriver into the gap between the lever and the housing and slightly rotate the screwdriver to release the lever.

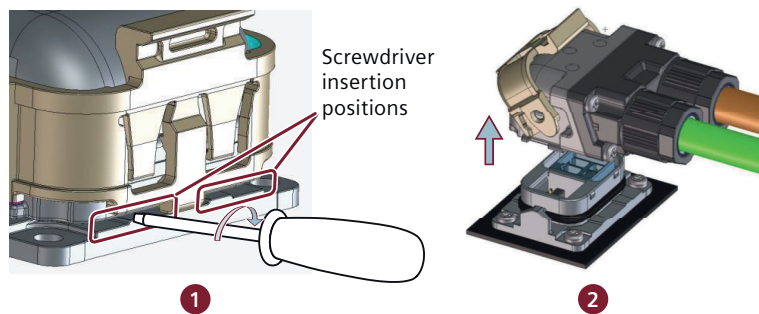

More information

For more information about cable requirements, see Section "Cables and connectors (Page 130)".

For more information about assembling cable terminals, see Section "Assembling cables (Page 932)".

6.5.3 Connecting the motor holding brake

6.5.3.1 Interface description (converter side)

Overview

The motor holding brake prevents the moving load from unexpected motions (for example, falling under the influence of gravity) when the servo drive system is deactivated.

The holding brake is activated once the motor power is cut off. Use the holding brake only when the motor is at a standstill. Do not use the holding brake to stop the load in motion.

Description

The SINAMICS S200 converter connects to the motor holding brake via the interface X108.

Table 6-5 Interface X108

X108	Terminal	Designation	Technical specifications
	1	BRN	Motor holding brake, negative
	2	BRP	Motor holding brake, positive

The SINAMICS S200 Basic converter does not have a designated interface for connecting to the holding brake. To use the holding brake, connect a third-party device via a digital output at the interface X130 and configure the holding brake function as follows:

- Set p1215 to 3.
- Interconnect the digital output signal to r0899.12.

6.5.3.2 Interface description (motor side)

Overview

The motor holding brake interface on the motor is used to connect the built-in holding brake to the converter.

Description

- 1FL2 shaft heights 20, 30, and 40
The holding brake interface is integrated into the hybrid connector. For more information, see Section "Interface description - power connector (motor side) (Page 136)".
- 1FL2 shaft heights 48 and 52
The holding brake interface is integrated into the M17 power connector. For more information, see Section "Interface description - power connector (motor side) (Page 136)".
- 1FL2 shaft heights 45, 65, and 90

Holding brake interface	Pin	Designation
 M17 angular connector	1	Holding brake, positive
	2	Holding brake, negative

6.5.3.3 Wiring

Connection example

Connecting the S200 converter to the motor holding brake

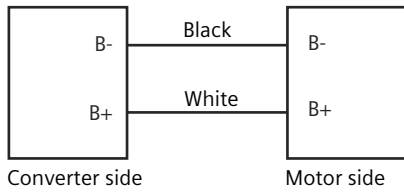

Figure 6-7 Motor holding brake connection via X108

Connecting the S200 Basic converter to the motor holding brake

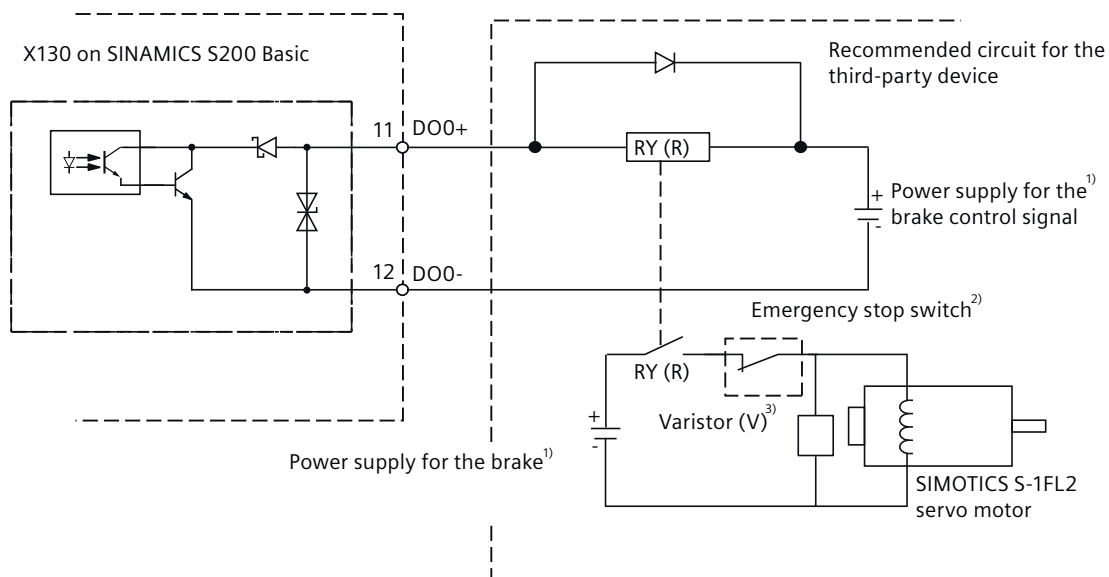

Figure 6-8 Motor holding brake connection via a digital output (example 1)

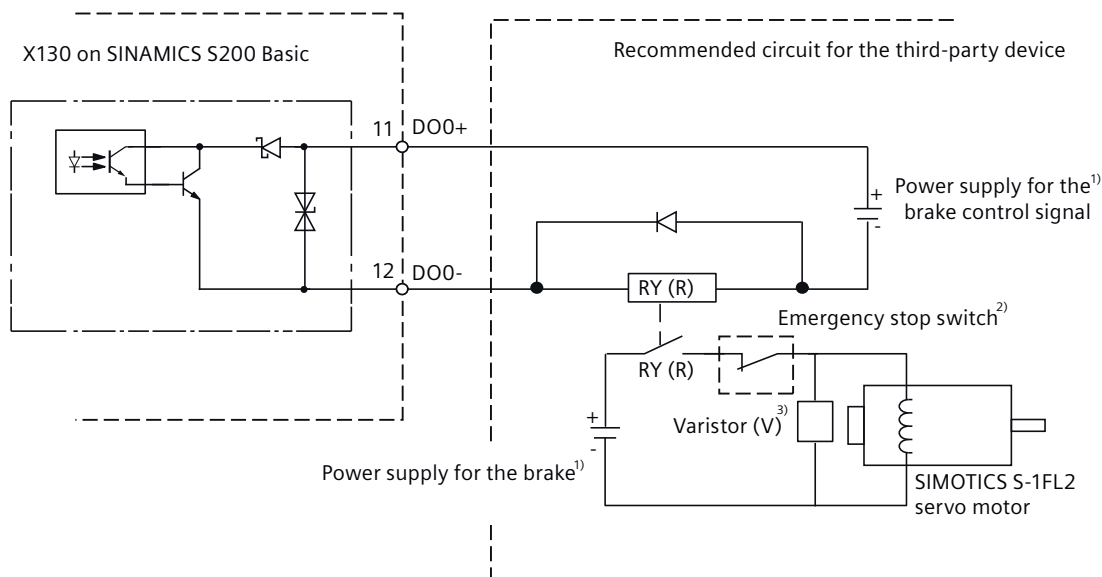

Figure 6-9 Motor holding brake connection via a digital output (example 2)

Note

¹⁾ To avoid electro-magnetic interference to electronic components, make sure that you use different power supplies for the brake and the brake control signal.

²⁾ The motor holding brake can be controlled by the brake control signal from the digital output and an external emergency stop.

³⁾ Install a varistor to suppress the surge voltage or surge current generated by the relay (RY) during its ON/OFF operation.

Varistor (V) used for the power supply of the brake

Note

All the following data on a varistor is provided based on the low inertia motors with a rated power of 2 kW; however, the data is also applicable to the low inertia motors of other power ranges.

Consider the following current-time and voltage-time characteristics when using a varistor to suppress the surge voltage or surge current:

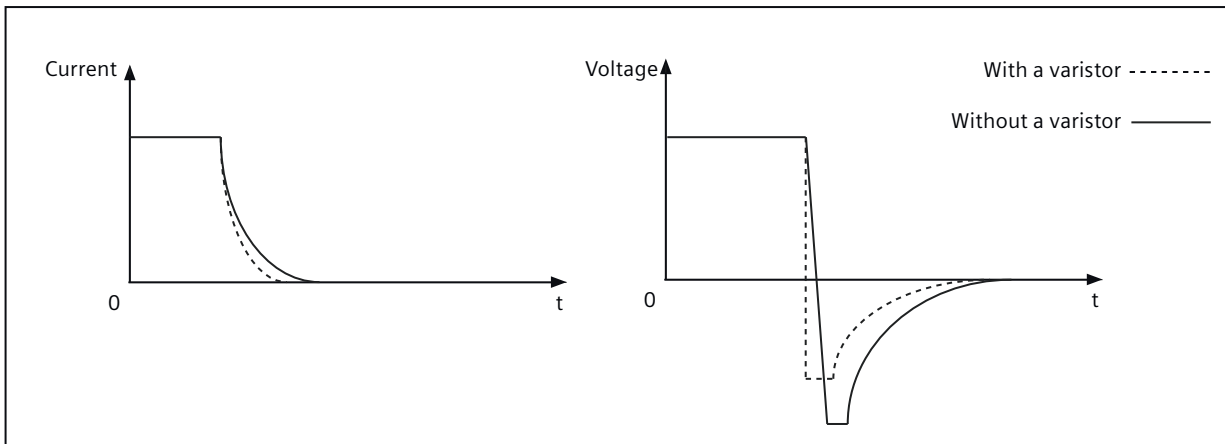

You may select an appropriate varistor with reference to the table below:

Power supply voltage of the brake		24 V DC
Order information	Manufacturer	EPCOS
	Model	S20K20
Specification requirements	Operating temperature	-20 °C to 60 °C
	Delay switching frequency	< 10 times/min
	Maximum operating DC voltage	26 V
	Average power dissipation	0.2 W
	Voltage at 1 mA	33 V ± 10%
	Clamping voltage at 20 A (8/20 μs)	65 V
Energy absorption (2 ms) at a time		18 J

Relay (R) used for the power supply of the brake

Siemens recommends that you choose a Siemens relay (article number: 3RQ2000-1AW00 or 3RQ2000-2AW00).

You can also select other appropriate relays with reference to the table below:

Insulation voltage for overvoltage category III according to IEC 60664 for pollution degree 3	300 V
Max. permissible voltage for protective separation between control circuit and auxiliary circuit according to IEC 60947-1	300 V
Control supply voltage	24 ... 240 AC/DC; 50/60 Hz

Operating range factor of control supply voltage	0.7 ... 1.1
Current-carrying capacity of the output relay	2 A
<ul style="list-style-type: none"> At DC-13 at 24 V 	

More information

For more information about cable requirements, see Section "Cables and connectors (Page 130)".

For more information about assembling cable terminals, see Section "Assembling cables (Page 932)".

6.5.4 Connecting the encoder

6.5.4.1 Interface description - X120 (converter side)

Overview

The servo drive system supports three types of encoders:

- Absolute encoder, 17-bit single-turn
- Absolute encoder, 21-bit single-turn
- Absolute encoder, 21-bit single-turn +12-bit multturn

The converter connects to the encoder of the motor on the interface X120.

Description

Table 6-6 Interface X120

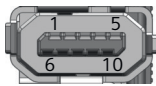
X120	Pin	Designation	Technical specifications
 IX-C socket	1	DP1	Absolute encoder data signal, positive
	2	DN1	Absolute encoder data signal, negative
	3	Reserved	Reserved
	4	CLKP1	Absolute encoder clock signal, positive
	5	CLKN1	Absolute encoder clock signal, negative
	6	M	Reference ground
	7	Power_ENC1	Encoder power supply, 5 V DC
	8	M_ENC1	Encoder power supply, reference ground
	9	Reserved	Reserved
	10	Reserved	Reserved

6.5.4.2 Interface description (motor side)

Overview

The encoder interface on the motor is used to transfer position data to the converter for real time control.

Description

- 1FL2 shaft heights 20, 30, and 40
The encoder interface is integrated into the hybrid connector. For more information, see Section "Interface description - power connector (motor side) (Page 136)".
- 1FL2 shaft heights 48 and 52

Encoder interface	Pin	Designation
 M17 angular connector	1	Encoder power supply, 5 V
	2	Encoder power supply, reference ground
	3	Absolute encoder clock signal, positive
	4	Absolute encoder clock signal, negative
	5	Absolute encoder data signal, positive
	6	Absolute encoder data signal, negative

- 1FL2 shaft heights 45, 65, and 90

Encoder interface	Pin	Designation
 M17 angular connector	1	Encoder power supply, 5 V
	2	Encoder power supply, reference ground
	3	Reserved
	4	Absolute encoder clock signal, negative
	5	Absolute encoder data signal, positive
	6	Absolute encoder clock signal, positive
	7	Reserved
	8	Absolute encoder data signal, negative

6.5.4.3 Wiring

Connection example

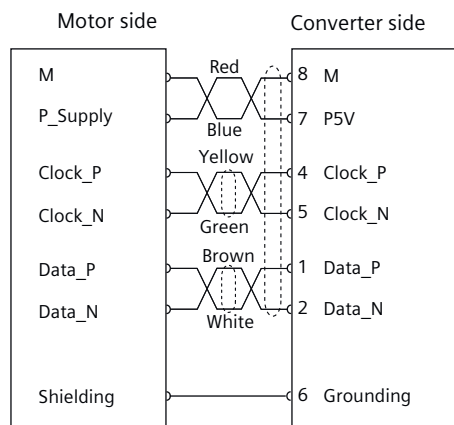

Figure 6-10 Encoder connection

More information

For more information about cable requirements, see Section "Cables and connectors (Page 130)".

For more information about assembling cable terminals, see Section "Assembling cables (Page 932)".

6.5.5 Rotating the connectors at the motor

Overview

The connectors at the 1FL2 motor with shaft heights 45, 48, 52, 65, and 90 can be rotated to a different angle to a limited extent.

Use a suitable socket connector as a lever to rotate the connector.

Note

Rotating the connectors

- Do not exceed the permissible range of rotation.
- To ensure the degree of protection, do not rotate more than 10 times.

WARNING

Adjusting cable directions

Before adjusting the cables, switch off the power supply. Otherwise, the motor contains a hazardous voltage and a risk of electric shock.

Description

Table 6-7 Rotation range of the power connector ① and encoder connector ②

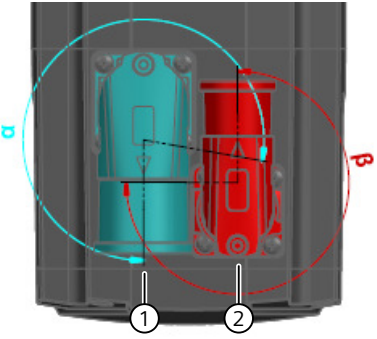
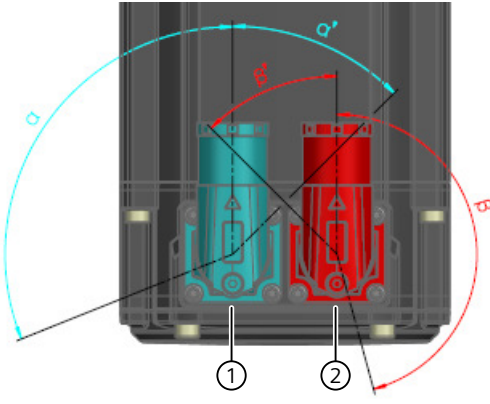
Motor	Power connector ①, size M17 and M23			Encoder connector ②, size M17		Drawing
	Connector size	Angle α	Angle α'	Angle β	Angle β'	
SH45	M23	280°	-	270°	-	
SH48 SH52	M17	135°	45°	175°	45°	

Motor	Power connector ①, size M17 and M23			Encoder connector ②, size M17		Drawing
	Connector size	Angle α	Angle α'	Angle β	Angle β'	
SH65	M23	280°	30°	270°	40°	
SH90	M23	210°	100°	270°	40°	

Table 6-8 Rotation range of the holding brake connector ③

Motor	Holding brake connector ③, size M17		Drawing
	Angle θ	Angle θ'	
SH45 SH65 SH90	220°	90°	

6.6 Connecting the braking resistor

6.6.1 Interface description - X1

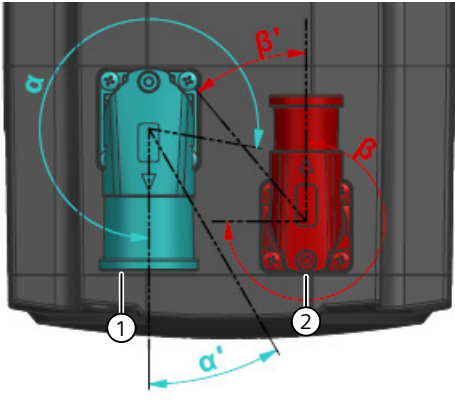
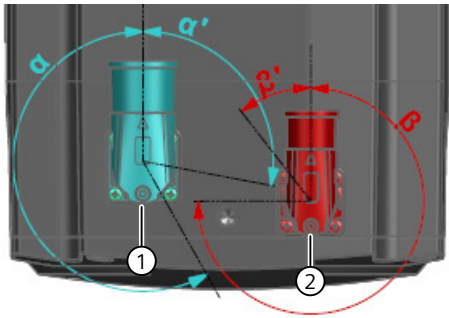
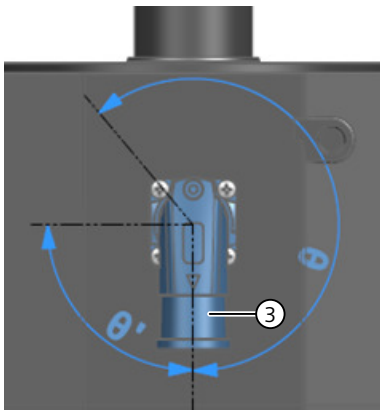
Overview

The converter connects to the braking resistor via terminals DCP, R1, and R2 on the interface X1.

Description

Table 6-9 Interface X1

X1	Terminal	Designation
	DCP	DC link positive (for connection to the braking resistor)
	R2	Connection to the internal braking resistor ¹⁾
	R1	Connection to the external braking resistor

¹⁾ The S200 Basic (FSA and FSB) and S200 FSA (0.1 kW) do not have an internal braking resistor.

6.6.2 Wiring

Overview

The S200 Basic FSC and S200 (excluding FSA 0.1 kW) converters have an integrated braking resistor for absorbing regenerative energy from the motor. To use the internal braking resistor, connect DCP and R2 with the jumper included in the scope of delivery.

To use an external braking resistor, connect the converter to an external braking resistor via terminals DCP and R1.

When the terminal R1 or R2 is not in use, cover it with the blanking plug provided in the connector kit (installed on R1 upon delivery).

Requirement

WARNING

Electric shock as a result of a residual charge in power components

After the power supply has been switched off, it takes up to five minutes until the capacitors in the converter have discharged so that the residual charge is at a non-hazardous level. Touching the converter immediately after powering off can result in electric shock due to residual charge in the power components.

- Check the voltage at the converter connections before you connect the external braking resistor.

WARNING

Fire caused by an unsuitable or improperly installed braking resistor

Using an unsuitable or improperly installed braking resistor can result in fire and formation of smoke. Fire and smoke can cause severe personal injury or property damage.

- Only use braking resistors that are approved for the converter.
- Install the braking resistor in accordance with regulations.

Procedure

Connecting the internal braking resistor

1. Switch off all power supplies to the converter, including the mains supply and the 24 V DC power supply.
2. Cover the terminal R1 with the blanking plug.
3. Connect DCP and R2 with the jumper included in the scope of delivery as shown below:

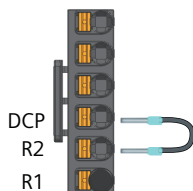

Connecting an external braking resistor

1. Switch off all power supplies to the converter, including the mains supply and the 24 V DC power supply.
2. Wait for five minutes to allow the converter to discharge and check that no voltage is present at the converter connections.
3. Remove the connection between DCP and R2.

6.6 Connecting the braking resistor

4. Remove the blanking plug from R1 and insert it into R2.
5. Connect the external braking resistor cable to terminals DCP and R1 as shown below:

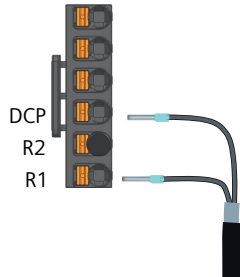

More information

For more information about cable requirements, see Section "Cables and connectors (Page 130)".

For more information about assembling cable terminals, see Section "Assembling cables (Page 932)".

6.7 Connecting the 24 V DC power supply

6.7.1 Interface description - X124

Overview

The servo drive system supports the daisy-chain connection of multiple converters to an external 24 V power supply via interface X124. The maximum permissible number of daisy-chained converters depends on the maximum current limit of the X124 plug.

Description

Table 6-10 Interface X124

X124	Terminal	Designation	Technical data
 0 V 0 V 24 V 24 V	0 V	Power supply, 0 V	Maximum current limit: 10 A
	0 V	Power supply, 0 V	
	24 V	Power supply, 24 V DC	
	24 V	Power supply, 24 V DC	

6.7.2 Wiring

Requirement

 WARNING
<p>Electric shock due to unsuitable power supply</p> <p>When the converter is connected to an unsuitable power supply, exposed components may carry a hazardous voltage that might result in serious injury or death.</p> <ul style="list-style-type: none"> Only use 24 V power supplies that provide SELV (Safety Extra Low Voltage) or PELV (Protective Extra Low Voltage) output voltages (maximum 60 V DC briefly).

Procedure

1. Assemble the X124 plug to the converter.
2. Attach the cable to the plug as shown below:

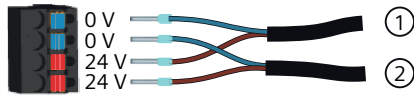

- ① Connecting to the 24 V DC power supply
- ② Connecting to the daisy-chained converter

More information

For more information about cable requirements, see Section "Cables and connectors (Page 130)".

For more information about assembling cable terminals, see Section "Assembling the cable lugs (Page 933)".

6.8 Connecting the inputs and outputs

6.8.1 Interface description - X130

Overview

The converter connects to the controller for signal transmission on the interface X130.

Description

Table 6-11 Interface X130

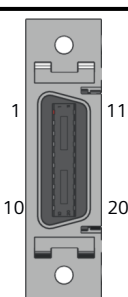
X130	Pin	Designation		Technical specifications	Conductor color
		S200	S200 Basic		
 <p>20-pin MDR socket</p>	1	DI0	DI0	Digital input 0 (high-speed digital input)	White-Gray
	2	DI1	DI1	Digital input 1 (high-speed digital input)	Gray-Brown
	3	DI2	DI2	Digital input 2	White-Pink
	4	DI3	DI3	Digital input 3	Pink-Brown
	5	M	M	Reference ground	White
	6	DI_COM	DI_COM	Common terminal for digital inputs	Brown
	7	DI_COM	DI_COM	Common terminal for digital inputs	Green
	8	M	M	Reference ground	Yellow
	9	-	-	-	-
	10	FE	FE	Functional grounding	Pink
	11	DO0+	DO0+	Digital output 0, positive	Blue
	12	DO0-	DO0-	Digital output 0, negative	Red
	13	DO1+	-	Digital output 1, positive	Black
	14	DO1-	-	Digital output 1, negative	Violet
	15	PTOA+	-	Pulse train output A, positive	Gray-Pink
	16	PTOA-	-	Pulse train output A, negative	Red-Blue
	17	PTOB+	-	Pulse train output B, positive	White-Green
	18	PTOB-	-	Pulse train output B, negative	Brown-Green
	19	PTOZ+	-	Pulse train output Z, positive	White-Yellow
	20	PTOZ-	-	Pulse train output Z, negative	Yellow-Brown

More information

For more information about cable requirements, see Section "Cables and connectors (Page 130)".

For more information about assembling cable terminals, see Section "Assembling the I/O connector (Page 937)".

6.8.2 Wiring

6.8.2.1 Wiring of digital inputs

Overview

The converter offers four digital inputs. DI0 and DI1 only support PNP wiring, and DI2 and DI3 support both NPN and PNP types of wiring.

Connection example

Connecting DI0 and DI1

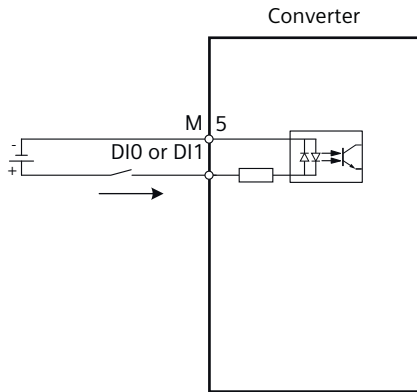
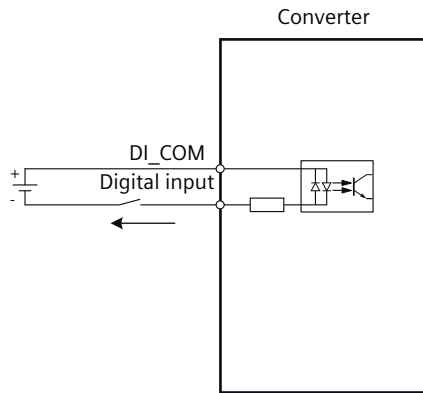
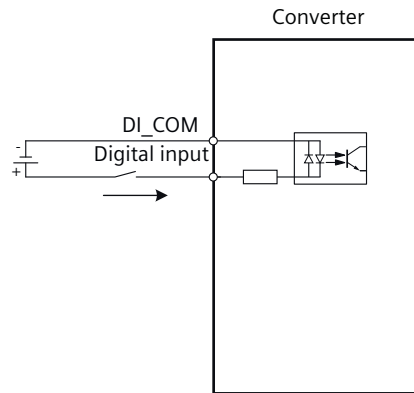

Figure 6-11 PNP wiring

Connecting DI2 and DI3



NPN wiring



PNP wiring

More information

For more information about the technical data of digital inputs, see Section "General technical data (Page 664)".

6.8.2.2 Wiring of digital outputs

Overview

The S200 converter offers two digital outputs, DO0 and DO1, and the S200 Basic converter offers only DO0. The digital outputs support both NPN and PNP types of wiring.

Requirement

 CAUTION
Damage to property due to overload of digital outputs
<p>If digital outputs are overloaded, this can result in damage due to fire, device defects, or malfunctions.</p> <ul style="list-style-type: none"> • Ensure that the digital outputs are not loaded in excess of 100 mA. • Install a 100 mA fuse for connection to the digital output.

Connection example

You can connect the digital outputs as shown below:

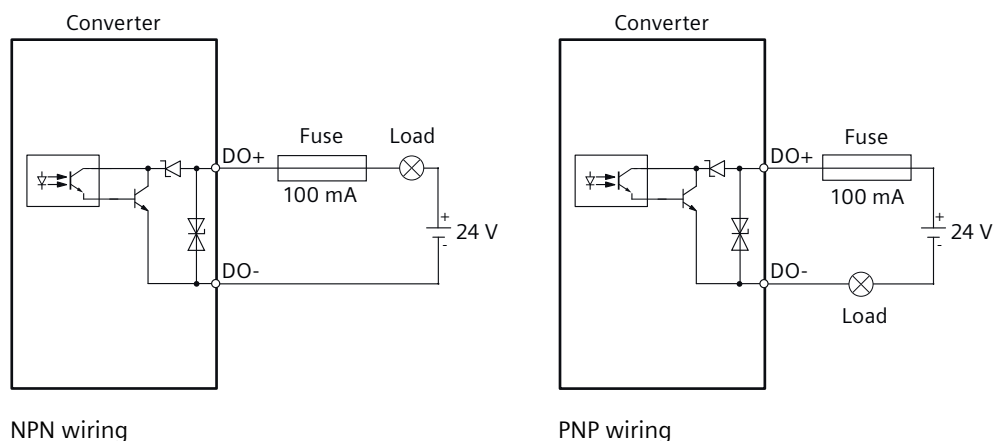

More information

For more information about the technical data of digital outputs, see Section "General technical data (Page 664)".

6.8.2.3 Wiring of pulse train outputs

Overview

The S200 converter supports high-speed 5 V differential signals (A+/A-, B+/B-, Z+/Z-).

Connection example

You can connect the pulse train outputs as shown below:

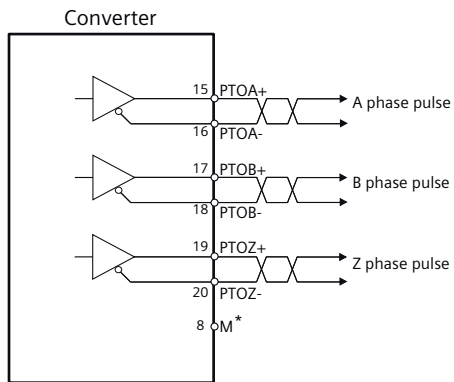

* Connected to the reference ground of the PLC

More information

For more information about the technical data of pulse train outputs, see Section "General technical data (Page 664)".

6.9 Connecting STO (for the S200 converter only)

6.9.1 Interface description - X131

Overview

The SINAMICS S200 converter offers the Safe Torque Off (STO) function. The function is enabled by default and cannot be configured.

To disable the Safety Integrated Functions, cover the interface X131 with the STO disable plug included in the connector kit.

Requirement

 WARNING
Material damages and personal injuries by the drop of a vertical axis
Unexpected drop of the vertical axis can cause material damages and personal injuries.
<ul style="list-style-type: none"> Do not use the STO function with a vertical axis.

Description

Table 6-12 Interface X131

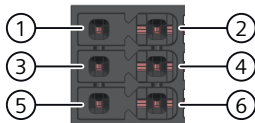
X131	Terminal	Designation	Technical specifications
	1	STO1+	STO channel 1, positive
	2	STO1-	STO channel 1, negative
	3	STO-VS	STO power supply
	4	STO-M	STO power supply, reference ground
	5	STO2+	STO channel 2, positive
	6	STO2-	STO channel 2, negative

6.9.2 Wiring

Overview

The SINAMICS S200 converter offers two STO channels for connection to external safety devices.

To connection to external safety devices, first assemble the X131 plug to the converter. You can use the internal or an external 24 V power supply for the connection.

To ensure EMC performance, Siemens recommends that you use twisted pair cables for STO connection.

Connection example

The following illustrations take EMERGENCY STOP buttons as an example.

Interconnection for an EMERGENCY STOP button with 24 V DC internal

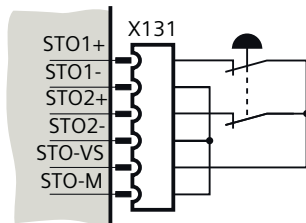

Figure 6-12 STO connection example with 24 V internal

Interconnection for an EMERGENCY STOP button with 24 V DC external

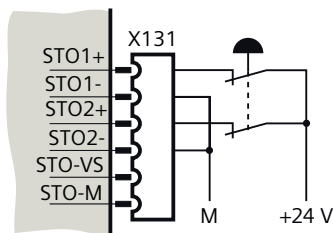

Figure 6-13 STO connection example with 24 V external

More information

For more information about cable requirements, see Section "Cables and connectors (Page 130)".

For more information about assembling cable terminals, see Section "Assembling the cable lugs (Page 933)".

For more information about the STO function, see Section "Safety Integrated (for the S200 converter only) (Page 395)".

6.10 Connecting to the fieldbus

6.10.1 Interface description - X150

Overview

The converter connects to the PROFINET network via ports 1 and 2 of interface X150. The transmission rate on the interface is 10 Mbit/s or 100 Mbit/s.

Every PROFINET device on the network is uniquely identified by its PROFINET interface. For this purpose, a PROFINET interface has the following attributes:

- A MAC address (factory default)
- An IP address
- A device name (name of the station)

Description

Table 6-13 Interface X150

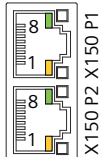
X150	Pin	Designation	Technical specifications
	1	TXP	Transmit data +
	2	TXN	Transmit data -
	3	RXP	Receive data +
	4	Reserved	Reserved
	5	Reserved	Reserved
	6	RXN	Receive data -
	7	Reserved	Reserved
	8	Reserved	Reserved

LED states

For diagnostic purposes, the PROFINET interface X150 is equipped with a green LED and a yellow LED.

Table 6-14 LED states of the service interface X150

LED	Color	Status	Description
Link port	-	Off	Missing or faulty link
	Green	Continuous light	10 or 100 Mbit link is available
Activity port	-	Off	No activity
	Yellow	Flashing light	Sending or receiving data

6.10.2 Wiring

Overview

The maximum length of cables between stations (L1 to Ln) is 100 m. Siemens recommends that you fix the cable on the cabinet to prevent connector damage caused by dragging. If a cable with a length of more than 3 m is connected to the PROFINET port, electromagnetic interference may occur. Minimization of the interference emission is possible by the use of ferrite cores, cabinet feedthrough or fiber optic transceiver.

Note

When connecting the ports P1 and P2, make sure that the physical input and output connections are the same with the connections in the topology.

Connection example

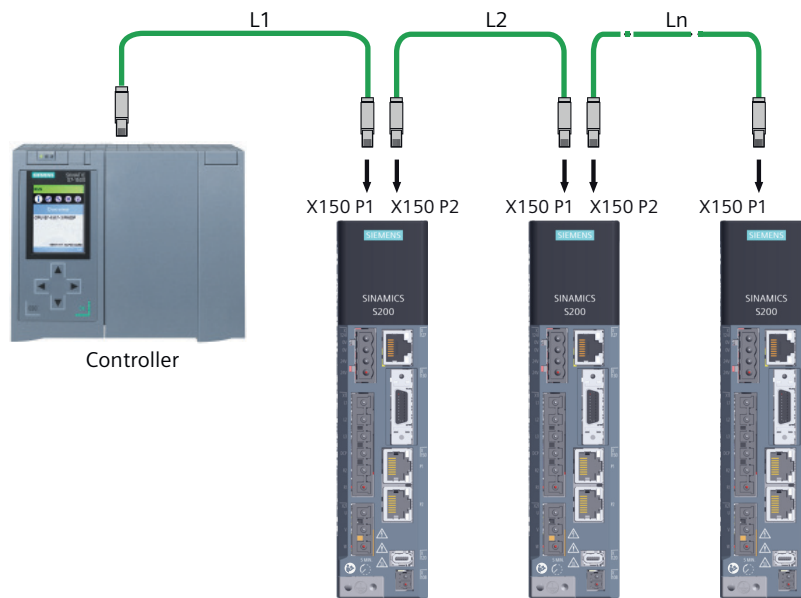

Figure 6-14 Connecting to the fieldbus

More information

For more information about cable requirements, see Section "Cables and connectors (Page 130)".

6.11 Connecting the service interface (Ethernet)

6.11.1 Interface description - X127

Overview

The converter connects to a commissioning device via the Ethernet interface X127. The interface offers 24 V DC power supply to the connected device. The transmission rate on the interface is 10 Mbit/s or 100 Mbit/s.

Requirement

Note

The service interface X127 is used for commissioning and diagnostics. Do not use it for long-term monitoring.

Description

Table 6-15 Interface X127

X127	Pin	Designation	Technical specifications
 RJ45 socket	1	TXP	Transmit data +
	2	TXN	Transmit data -
	3	RXP	Receive data +
	4	P24_POE	Power supply over Ethernet, 24 V DC
	5	P24_POE	Power supply over Ethernet, 24 V DC
	6	RXN	Receive data -
	7	M_POE	Power supply over Ethernet, reference ground
	8	M_POE	Power supply over Ethernet, reference ground

LED states

For diagnostic purposes, the service interface X127 is equipped with a green LED and a yellow LED.

Table 6-16 LED states of the service interface X127

LED	Color	Status	Description
Link port	-	Off	Missing or faulty link
	Green	Continuous light	10 or 100 Mbit link is available
Activity port	-	Off	No activity
	Yellow	Flashing light	Sending or receiving data

More information

For more information about cable requirements, see Section "Cables and connectors (Page 130)".

Commissioning (web server)

7.1 Introduction

Description

The web server commissioning tool is integrated in the converter.

The web server supports you throughout the service life of the application:

- Online commissioning
- Diagnostics
- Operator control and monitoring
- Service and maintenance
- Support

The settings made are applied after commissioning has been completed and transferred to the converter.

The web server has multi-level security functionality.

More information

For more information about security settings in the web server, see Configuration Manual SINAMICS Industrial Security (<https://support.industry.siemens.com/cs/ww/en/view/109810578>).

7.2 Fundamentals

7.2.1 Supported operating units

Description

The following operating units are supported for the connection with the web server:

- PC
- Smartphone or tablet PC
Mobile devices can be connected to the converter via third-party Ethernet OTG adapters or external WLAN access points.

As a result of the responsive design, content is adapted to the screen size of the operating unit.

7.2.2 Requirements for commissioning

Description

- You have correctly installed the converter and the motor.
- You have attached the motor including encoder to the mechanical system.
- You have connected the motor to the converter.
- You have connected the converter and the operating unit via service interface X127 or PROFINET interface X150.
- You have switched on the converter supply voltage.
- The converter has ramped up.

7.2.3 Supported browsers

Description

Table 7-1 Browsers supported by the web server

Browser ¹⁾	Version
Apple Safari	≥ Version 15.0
Google Chrome	≥ Version 83
Microsoft Edge	≥ Version 88
Mozilla Firefox	≥ Version 91

¹⁾ Siemens recommends that you use the latest version of the browsers.

7.2.4 Communication interfaces

Description

The following interfaces are available for accessing the converter:

Interface	Information
Service interface X127	The default access to the web server is via the service interface X127.
	Ethernet interface X127 is intended for commissioning and diagnostics, which means that it must always be accessible.
	Defaults: <ul style="list-style-type: none"> • IP address: 169.254.11.22 • Subnet mask: 255.255.0.0 • Connection type: HTTPS
	Restrictions: <ul style="list-style-type: none"> • Only local access is allowed. • No networking or only local networking in a closed and locked electrical cabinet is permissible. • For remote access to the electrical cabinet, you must apply additional security measures to prevent misuse through sabotage, data manipulation by unqualified persons and interception of confidential data.
	Access using mobile end devices: <ul style="list-style-type: none"> • If you carry out commissioning or diagnostics using a mobile end device such as a smartphone or tablet, you may temporarily connect the service interface X127 to an external WLAN access point.
PROFINET interface X150	The IP addresses of the service interface X127 and the PROFINET interface X150 must not be in the same subnet.

7.2.5 Making the operating instructions available for the web server information system

Overview

For selected topics, you can use the information system of the web server to access the product documentation directly. To do this, you must make the product documentation available on a prepared SD card.

Requirement

- You have an empty SD card with a maximum storage capacity of 32 GB (e.g. 6SL5570-0GC00-0AA0) onto which you can load the product documentation.
- You have connected a suitable SD card reader to your PC.

Procedure

To make the product documentation available for the web server information system, proceed as follows:

1. Download the product documentation to your PC.
The product documentation for the web server information system can be found at this address (<https://support.industry.siemens.com/cs/ww/en/ps/29596>).
The file "product_manual_edition_Webserver.zip" is located under "Appendix to this entry".
Explanation of the file name:
 - Product: Abbreviated form of product names
 - Manual: Abbreviated form of the manual title, for example "op_instr" for operating instructions
 - Edition: Month and year of publication of the manual in the format MMY
2. Unzip the file that you downloaded "product_manual_edition_Webserver.zip".
The file contains all available language versions as separately zipped files.

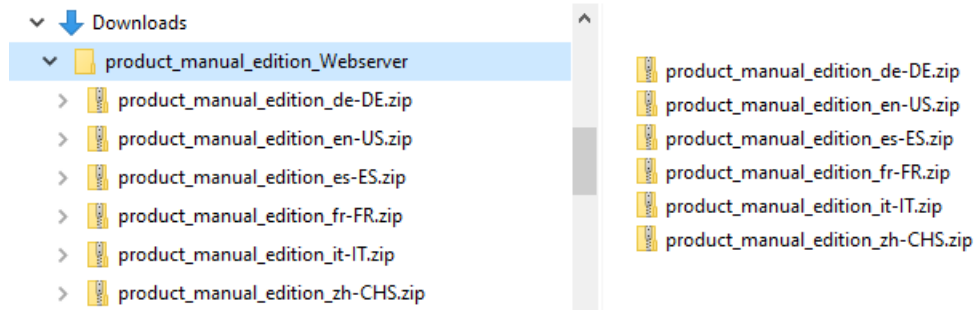

3. Unzip the required language version to a folder with the name of the ZIP file (e.g. for the English version "product_manual_edition_en-US").
4. Insert the SD card into your PC's SD card reader.
5. In the root directory of the SD card, create a folder called "DOC".

- Copy the unzipped folder (for example "product_manual_edition_en-US") to the "DOC" directory on the SD card.

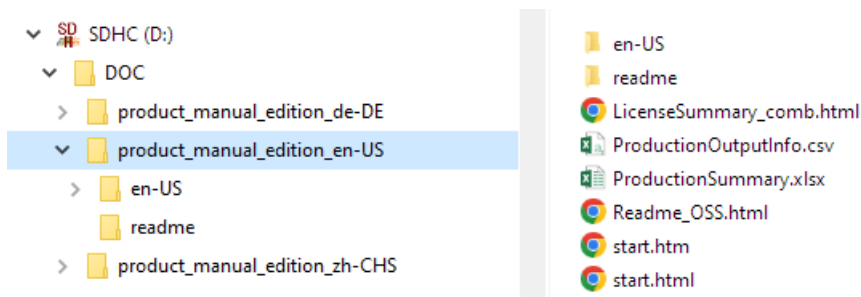

Depending on the available space on the SD card, you can copy all available language versions to the SD card. To do this, repeat the unzip/copy process for each language version.

- Eject the SD card from the PC.
- Remove the SD card from the reader.
- Insert the SD card into the converter.

Result

You have made the product documentation available for the web server information system.

For selected topics, you can now access the instructions via the context-sensitive information system.

7.2.6 Using the web server information system

Overview

In the web server, you have the support of an integrated, multi-level information system. You decide in a context-sensitive interface how much and what kind of information is displayed.

Description of function

The screenshot shows the 'Rated speed' dialog box in the Siemens SINAMICS web server. The dialog box is titled 'Rated speed' and has a close button (X) in the top right corner. It is divided into three sections: Overview, Parameter, and Manual. The Overview section (1) contains technical data for a SIMOTICS 3 ~ Mot. motor, including torque (M₀, M_N), current (I₀, I_N), speed (n₀, n_N), voltage (U_{IN}), mass (m), and IP rating. The Parameter section (2) provides a description of the setting. The Manual section (3) contains links to technical data. A hand cursor is pointing to the 'Technical data and characteristics' link in the Manual section (4).

SIEMENS		
SIMOTICS 3 ~ Mot.		
Z:		
M ₀ 1,27 Nm	I ₀ 2,4 A	n ₀ 7400 /min
M _N 1,27 Nm	I _N 2,4 A	n _N 3000 /min
U _{IN} 108 V		Th.CL155 (F)
m: 3 kg	IP 64	IC410
Encoder Brake 24 VDC		
RN 000		
Siemens AG, DE-97616 Bad Neustadt Made in Germany		

① Overview

Display general information about the meaning or function of the setting.

- Click or tap on "Overview" or on the associated expand icon to show general information about the meaning or function of the setting.
- ✓ Click or tap again on "Overview" or on the associated collapse icon to hide the general information about the meaning or function of the setting.

② Parameter

Display detailed information about the parameter defined by the setting.

- Click or tap on "Parameter" or on the associated expand icon to show detailed information about the parameter.
- ✓ Click or tap again on "Parameter" or on the associated collapse icon to hide the detailed information about the parameter.

7.2 Fundamentals

③ Manual

For selected settings, you can use the links under "Manual" to access the operating instructions directly.

The requirements in order to do this are set out in Chapter "Making the operating instructions available for the web server information system (Page 166)".



Click or tap on "Manual" or on the associated expand icon to show links to the operating instructions.



Click or tap again on "Manual" or on the associated collapse icon to hide the links to the operating instructions.

④ Click or tap on a link to open the web browser and display the linked information in the operating instructions.

Figure 7-1 Information in a context-sensitive help window (example)

7.2.7 Reloading pages

Procedure

If the web server does not respond, or if buttons are inactive or are not labeled, although the converter is not fully utilized with internal calculations, reload the web server pages as follows:

- At the PG/PC via <F5>
- At the tablet PC or smartphone via 

7.3 Getting started

7.3.1 Calling the web server

Overview

Converter commissioning takes place with the user interface of the web server.

Requirement

- You have connected the converter and the operating unit via the service interface X127.

Procedure

To access the web server via the service interface X127, enter the IP address of the converter, e.g. `https://169.254.11.22`, in the browser.

More information

- Basic settings
 - When you call the web server for the first time, you are prompted to define the basic settings.
 - If you have already made the basic settings, then the web server starts and opens the home page. You can commission the converter, troubleshoot it, operate it, monitor it or call up support through the support pages.
- Alternative access via PROFINET interface X150

You can also access the web server via PROFINET interface X150.
To access the integrated web server, you must assign PROFINET interface X150 a valid IP address (other than X127) using Startdrive.

7.3.2 Settings for brand new converters

Overview

The basis settings are required before performing first commissioning for a brand-new converter.

Requirement

- The operating unit is connected to the converter via the service interface X127 or the PROFINET interface X150.
- The web server is accessed with the IP address:
 - For service interface X127: 169.254.11.22 (default)
 - For PROFINET interface X150: 0.0.0.0 (default)
Before you establish an online connection via PROFINET, you must configure a suitable IP address for the PROFINET interface. With firmware V6.2, the configuration is possible in Startdrive only.

Description of function

If the web server was called, then you are automatically transferred to define the settings.

The function view contains the following settings:

- Basic settings (Page 172)
- Security settings (Page 173)

7.3.3 Basic settings

Overview

Initial basic settings are defined in the function view.

Requirement

The web server is being called for the first time.

Description of function

The basic settings are as follows:

- Preferred language of the user interface
- Converter date and time; either manually or via NTP

After these entries have been made, using the "Next" button, you can continue to the Security Wizard.

7.3.4 Security settings

Overview

The settings for user management and access control (UMAC) are defined using the Security Wizard.

Requirement

NOTICE**Converter damage due to data manipulation**

Inadequate protection of drive data makes it easier to gain unauthorized access to the converter. Unauthorized data manipulation can change the converter settings. Changed settings can stop the converter working properly or damage the converter.

- Only deploy low protection in exceptional cases and only when no outsider can access the converter, e.g. if the converter is not yet connected to a network.
- Protect the interfaces of the converter against unauthorized access, e.g. with a locking control cabinet.
- Create a higher level of security as soon as possible.

Description of function

One of the following options can be selected:

- "Configure security settings"
Siemens recommends this setting for comprehensive protection.
- "Continue with low security settings"
With this setting, UMAC is deactivated.
You can configure the security settings at a later time, see Section "Protection & Security (Page 204)".

Select "Configure security settings"

Define the settings for UMAC:

- "Activate User Management & Access Control":
Activation is preset.
If UMAC is activated, it can only be deactivated by a full reset of the converter to factory settings. This causes all security settings to be lost.
You can find more information about the full reset to factory settings in Section "Restore factory settings (Page 201)".
- "Administrator setup":
Specify the user name and password of the drive administrator.
The drive administrator is permanently assigned the runtime role "Drive Administrator". This assignment cannot be changed.
- "Guest access configuration":
Specify whether the user has read rights without logging in and whether the user is allowed to acknowledge results without logging in.
The option is deactivated in the factory setting. If guest access is not permitted, then the login page is displayed when the web server is called.

Define the settings to access the web server:

- "Web server activation":
Factory setting to access the web server:
 - Via service interface X127 with the HTTPS protocol
 - Via PROFINET interface X150 with the HTTPS protocol
If the factory settings are deactivated, then it is not possible to access the web server.

Check the selected security settings:

- "Summary":
The summary provides an overview of the selected settings.

Finish and continue

The security settings are checked by clicking on "Finish". If there is no error, the settings are applied.

After finishing, you can continue with one of the following options:

- Continue with quick setup
- Continue with the web server home page

7.4 Functions and menus

7.4.1 Home page

Description

The web server interface depends on the converter. The web server view of your converter may vary from that shown here depending on your product and firmware version.

The following figure shows the basic structure of the web server pages.

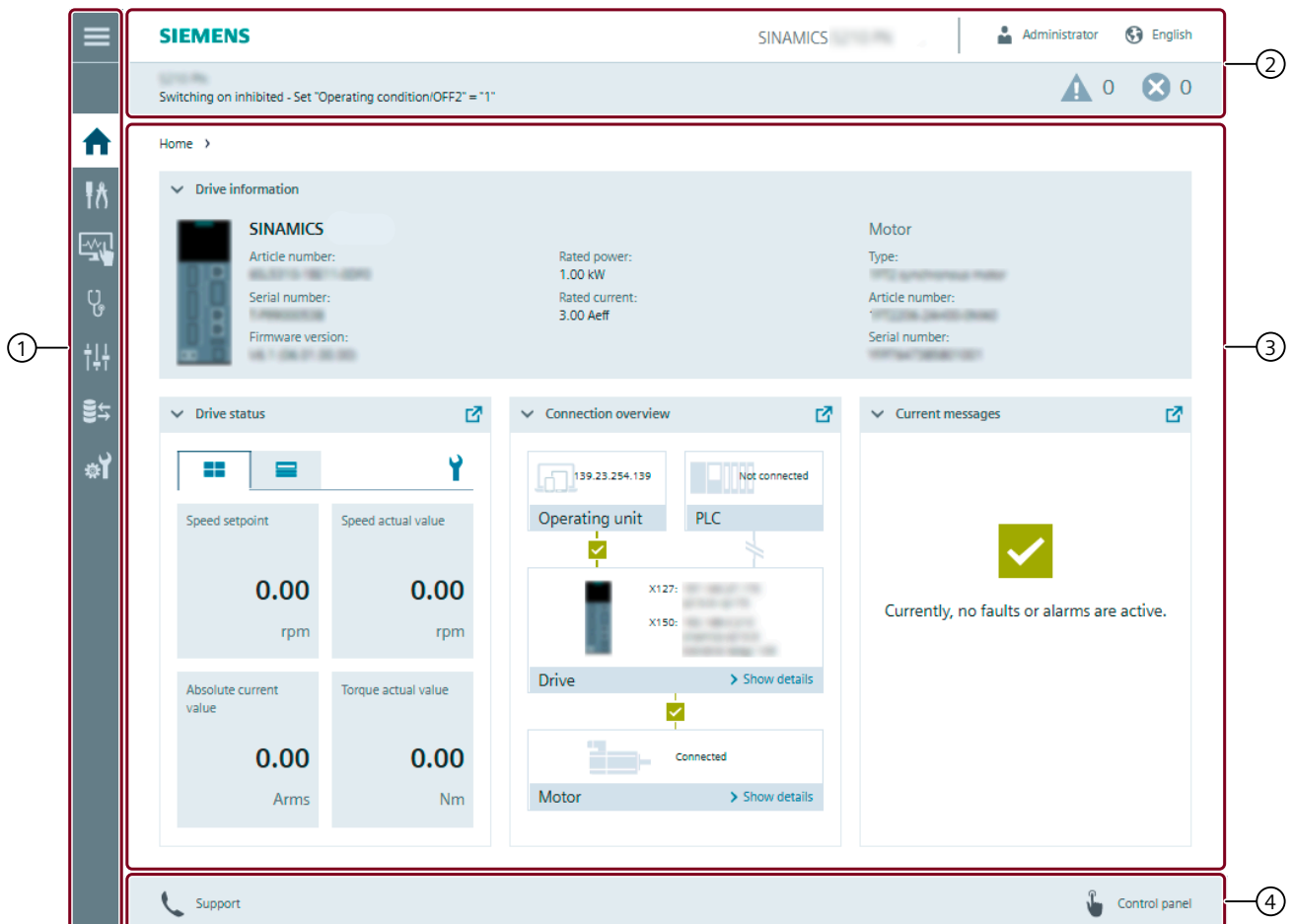

① Navigation bar

② Status bar

③ Main window

Access to the function views depends on the access rights of the logged-in user.

④ Action bar

Note: The action bar may also contain a Save button if manual saving is activated in the menu "System" > "Settings". However, if automatic saving is activated there is no Save button .

Figure 7-2 Structure of the web server (example)

7.4.2 Commissioning

7.4.2.1 Complete commissioning workflow

Overview

The web server guides users step-by-step through the converter commissioning.

Description of function

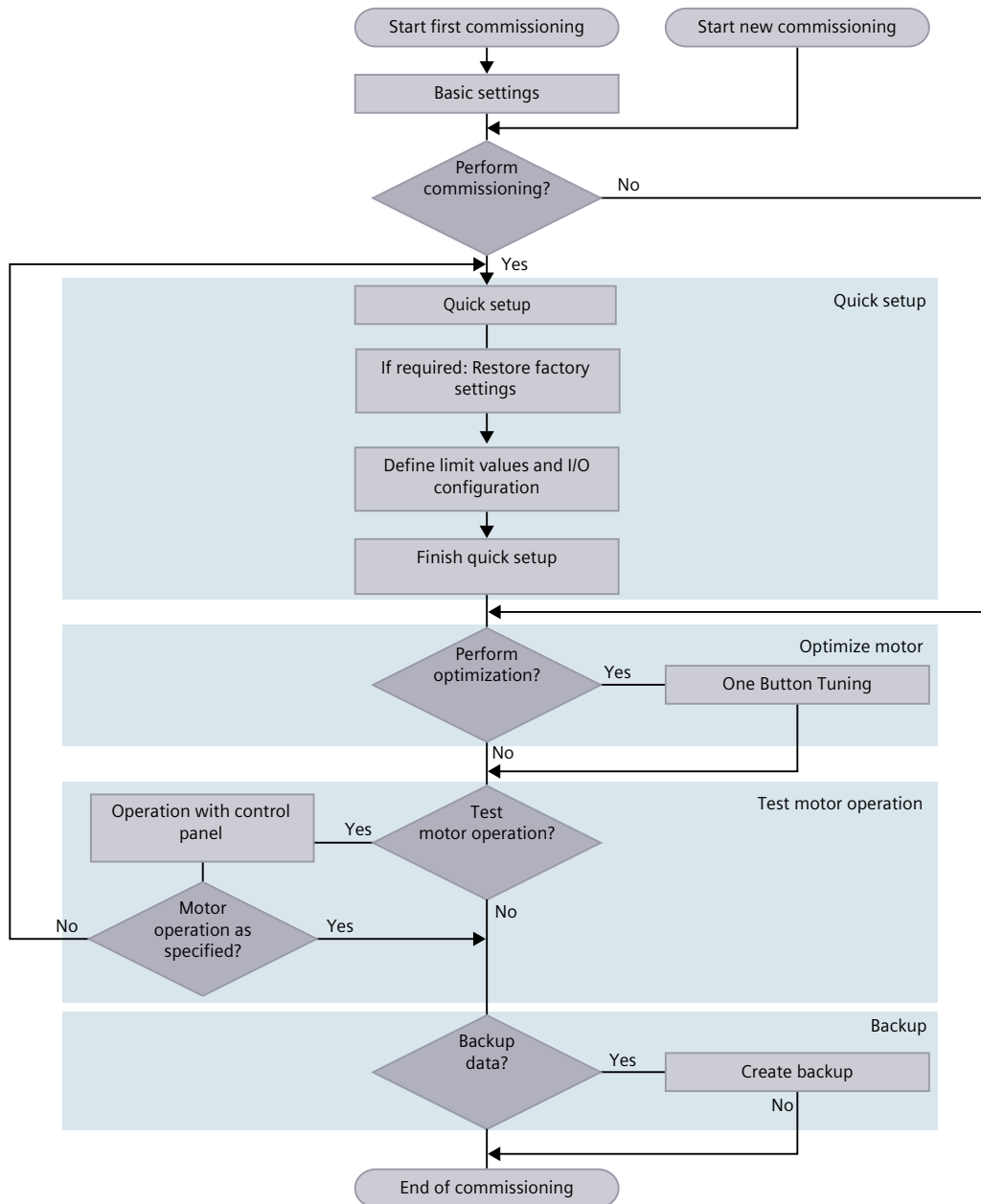

Commissioning involves the following steps:

- **Basic settings:**
If the converter has already been commissioned, then the web server jumps to the basic settings.
The following settings are required for a brand-new converter:
 - Language, date, time
 - Configuring security settings
The Security Wizard can be called again at any time from the menu "System".
- **Quick setup:**
Menu "Commissioning" > "Quick setup"
The converter identifies the motor and encoder data after the supply voltage has been switched on.
Optionally, you can define the limit values to be respected and the I/O configuration.
- **Optimize motor:**
Menu "Commissioning" > "Optimization"
With the One Button Tuning (OBT) function, the mechanical drive train is measured using short test signals.
In this way, the controller parameters are optimally adapted to the existing mechanical system.
- **Test motor operation:**
Action bar > "Control panel"
The closed-loop speed control of the motor can be tested by moving the motor from the web server control panel in jog or continuous motion.
- **Backup:**
Menu "Backup and restore"
Siemens recommends a backup of the converter settings.

More information

For more information about user management and security settings, see the Configuration Manual SINAMICS Industrial Security (<https://support.industry.siemens.com/cs/ww/en/view/109810578>).

7.4.2.2 Quick setup

Overview

The converter can generally be operated without making additional settings using quick setup.

Siemens recommends that quick setup is performed to set the limit values and the I/O configuration to optimally address the target application.

Requirement

- The drive system has been configured. The components are wired.
- Web server access is active.

Description of function

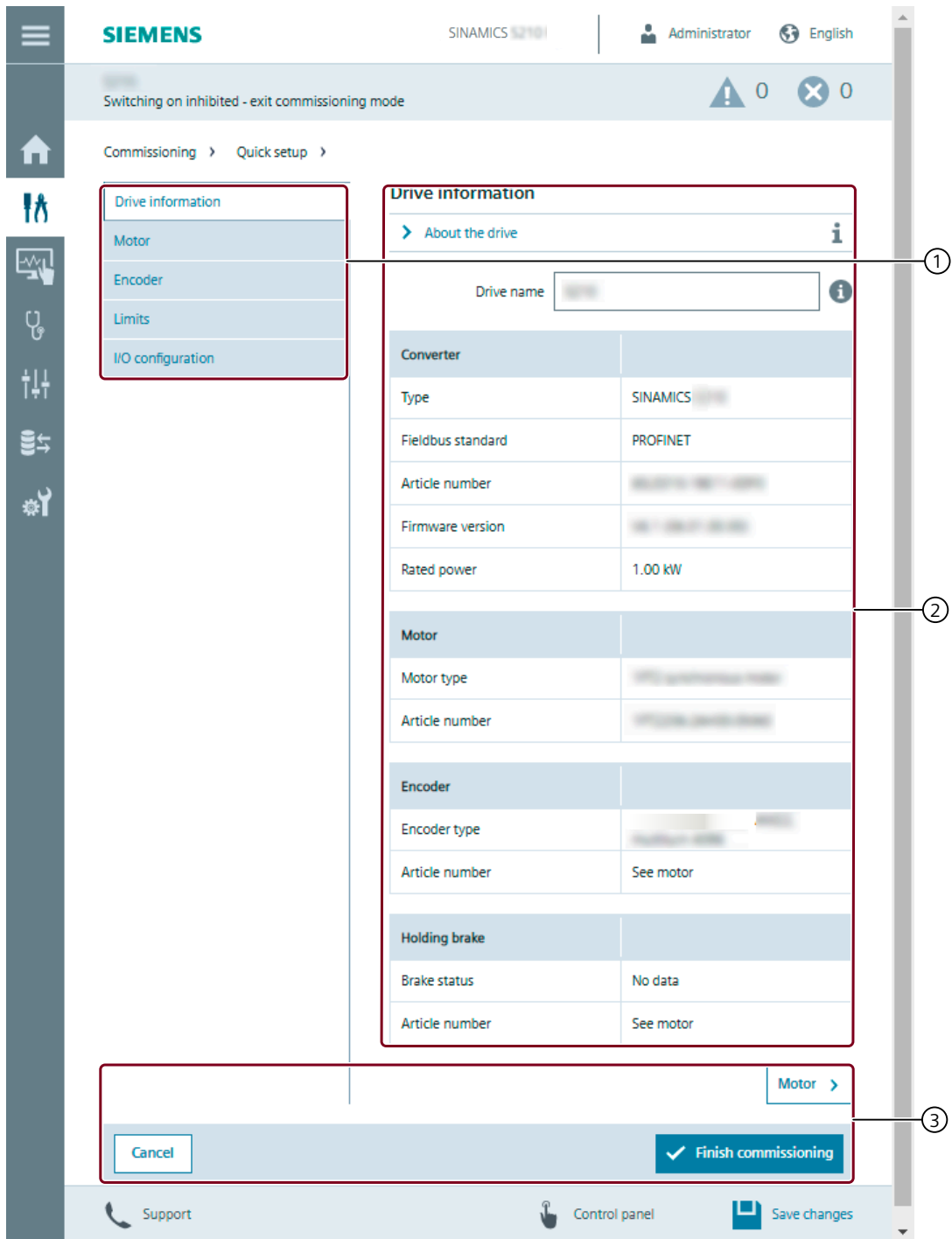

- ① Menu and navigation for quick setup
- ② Display of the individual quick setup steps
- ③ Navigation

Figure 7-3 Quick setup using the web server

Only the most important properties of the converter are configured in the quick setup.

Motor and encoder are directly detected during ramp-up. The data is accepted and shown in steps "Motor" and "Encoder". The data is for information only and cannot be changed during quick setup.

The converter creates a restore point when quick setup is started. The converter saves the changes after every commissioning step. The converter is reset to the restore point if quick setup is canceled.

For fast navigation through the quick setup, for example to check the set configuration data, the web server has a read-only mode.

The Commissioning Wizard of the web server guides users through the following quick setup steps.

Drive information

The step provides information about the converter, motor, encoder and motor holding brake being used.

The following data can be changed:

- Drive name
A specific drive name can be assigned.

Motor

The data of the motor being used are displayed. It is not possible to configure another motor.

The direction of rotation of the motor can be selected:

- Clockwise
- Counterclockwise

Encoder

The data of the encoder being used are displayed. Configuration is not possible.

Limits

The converter limit values are shown graphically and in a tabular form.

The following data can be configured:

- Limit values by making an entry in the table
The table and diagram are linked with one another.
- Device supply voltage (only available for 400 V variants)

I/O configuration

The configuration of the converter inputs and outputs is shown in a tabular form.

Configuration options:

- In the table, a function can be assigned to an input or output of the terminal. Specified functions can be selected. Do not assign a function to more than one input or output.

7.4.2.3 Testing the converter configuration

Overview

After the quick setup, the web server allows you to test the converter configuration in jog mode or continuous motion via the control panel.

Description of function

To test the configuration, the control panel must be open and the speed setpoint entered.

There are 2 ways of opening the control panel:

- Button "Finish quick setup" > Dialog query with selection option "Open control panel"
- Action bar > "Control panel"

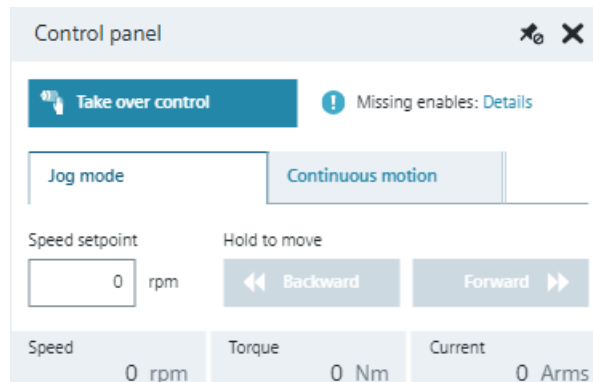

Figure 7-4 Testing the converter configuration via the control panel

More information

For more information, see Section "Control panel (Page 209)"

7.4.2.4 Optimization

Overview

Once quick setup has been completed the converter settings are optimized using function One Button Tuning (OBT).

With One Button Tuning, the mechanical drive train is measured using short test signals. In this way, the controller parameters are optimally adapted to the existing mechanical system.

Requirement

To reduce the stress on the mechanical system, before OBT, the torque limit can be reduced, and after OBT has been completed, the previous value can be set again.

NOTICE**Material damage caused by an impermissible direction of motion of the motor**

One Button Tuning runs the motor in both directions. Impermissible directions of motion can damage the machine or installation.

- If a particular direction of motion of the motor is impermissible, do not carry out One Button Tuning.

Description of function

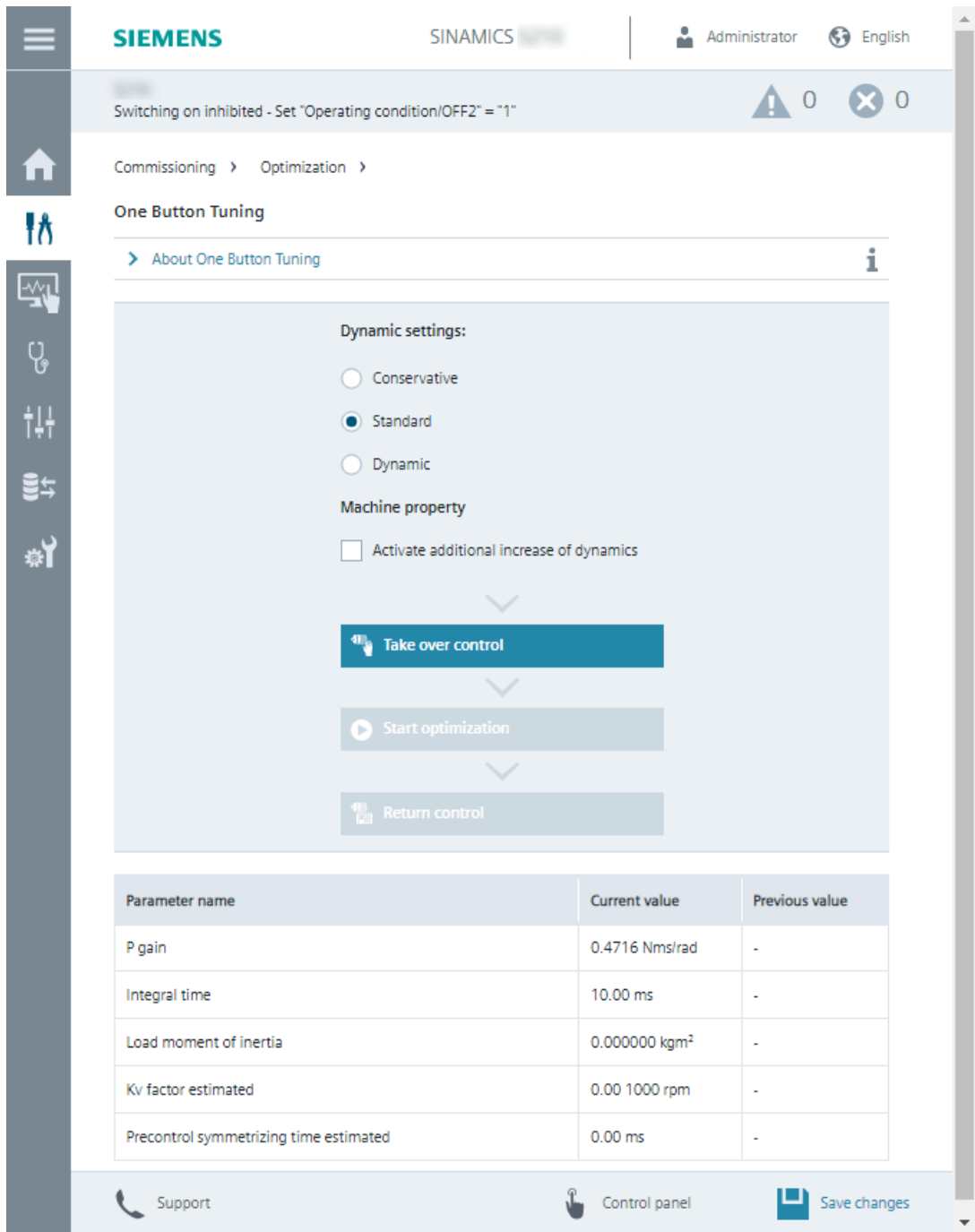

Figure 7-5 One Button Tuning

The optimum controller settings are determined using the following settings:

- "Dynamic settings"
 - Conservative
60% dynamic response; speed control without torque precontrol
 - Standard
80% dynamic response; speed control with torque precontrol
 - Dynamic
100% dynamic response; speed control with fast torque precontrol
- "Machine property"
The "Activate additional increase of dynamics" option increases the proportional gain of the optimized speed control. The dynamic response is increased. The speed controller becomes faster.
If the dynamic factor is increased too much, the speed controller may become unstable.
- "Take over control" and "Return control"
Take over master control before starting to optimize the controller.
Return master control back to the converter once the controller has been optimized.
- "Start optimization"
 - Enter the angle of rotation (rotation limit) through which the motor and the connected machine are permitted to turn for the required measurements (e.g. 360°) without the mechanical system being damaged. Sensible controller parameters are obtained from an angle > 90°.
When a negative angle is entered, then the motor moves in the opposite direction.
 - The table shows how the settings have been changed by OBT.

If OBT was not successful, then optimization must be repeated with other settings.

7.4.3 Monitoring and operation

7.4.3.1 Drive status

Overview

Function view "Drive status" shows the current status of the converter.

Description of function

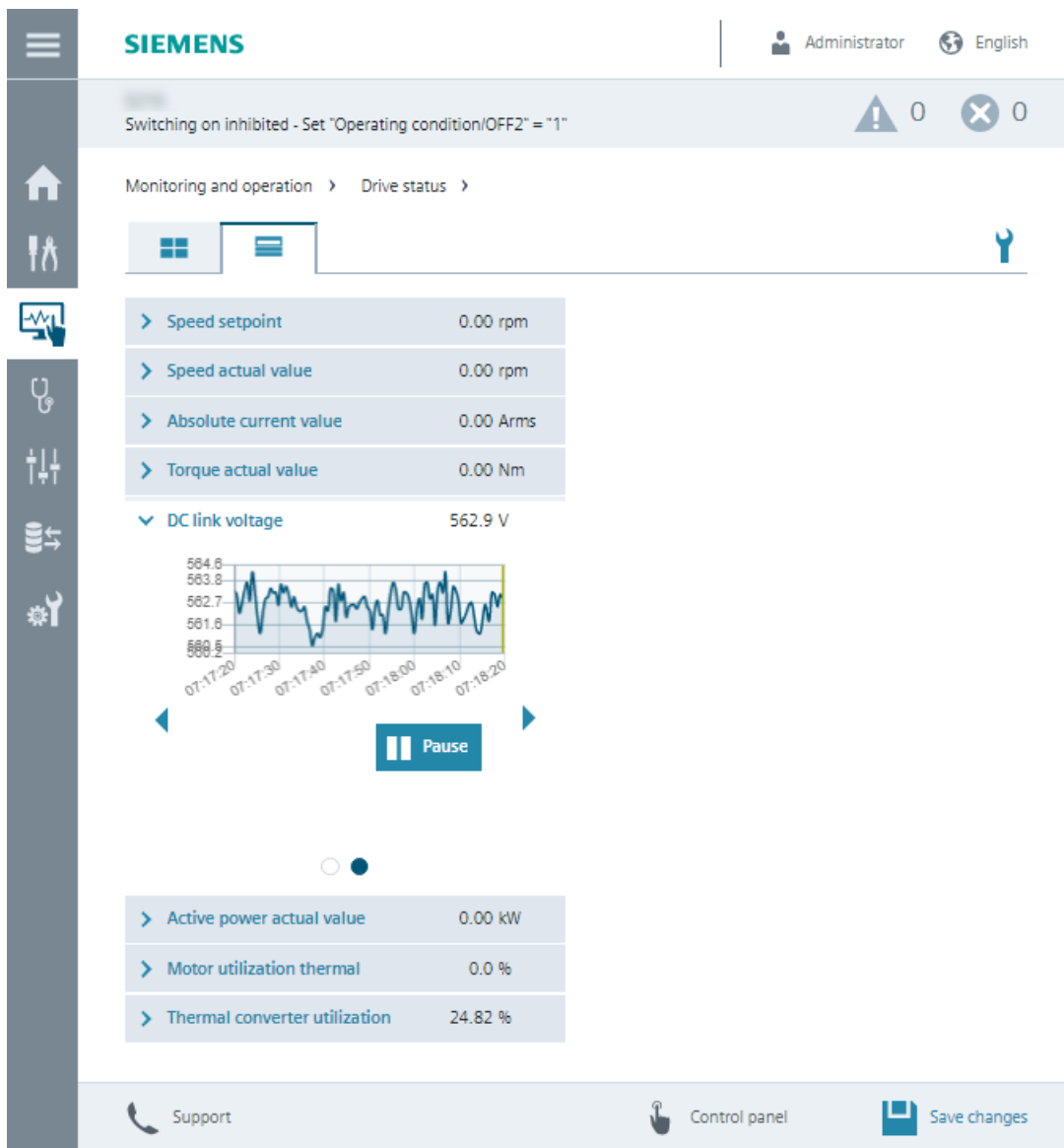

The drive information displayed is preset in the factory setting, and when required, can be adapted using symbol . If user management is active, the "Edit web server configuration" right is required in order to make changes.

Values are indicated as follows:

- Factory setting: 8 values are displayed
- It is possible to display all values completely

The drive status is displayed as follows:

- : Individual values are continuously displayed
- : Individual values and trend diagrams are continuously displayed

7.4.3.2 Inputs/outputs

Overview

The function view "Inputs/outputs" shows the status of the digital inputs offered by the converter.

Description of function

The screenshot shows the 'Inputs/outputs' monitoring page for a SINAMICS S200 PN drive. The page is titled 'S200 PN: Switching on inhibited - Carry out first commissioning' and shows a warning icon with the number '1'. The navigation path is 'Monitoring and operation > Inputs/outputs >'. The main content area contains two tables: 'Digital inputs' and 'Digital outputs'. Both tables show functions and their current values, all of which are 'Low'.

Digital inputs	
Function	Value
DI 0 (X130.1) Measuring input 1	<input type="checkbox"/> Low
DI 1 (X130.2) Measuring input 2	<input type="checkbox"/> Low
DI 2 (X130.3) -	<input type="checkbox"/> Low
DI 3 (X130.4) -	<input type="checkbox"/> Low

Digital outputs	
Function	Value
DO 0 (DO+: X130.11 / DO-: X130.12) Operation enabled	<input type="checkbox"/> Low
DO 1 (DO+: X130.13 / DO-: X130.14) Fault present	<input type="checkbox"/> Low

Figure 7-6 Inputs/outputs

7.4.4 Diagnostics

7.4.4.1 Messages

Overview

The function view "Messages" shows active and historical messages.

Description of function

With search and filter options, the number of alarms and faults can be restricted. The available filter options can be combined with one another and can be reset at any time.

The message history can be optionally displayed.

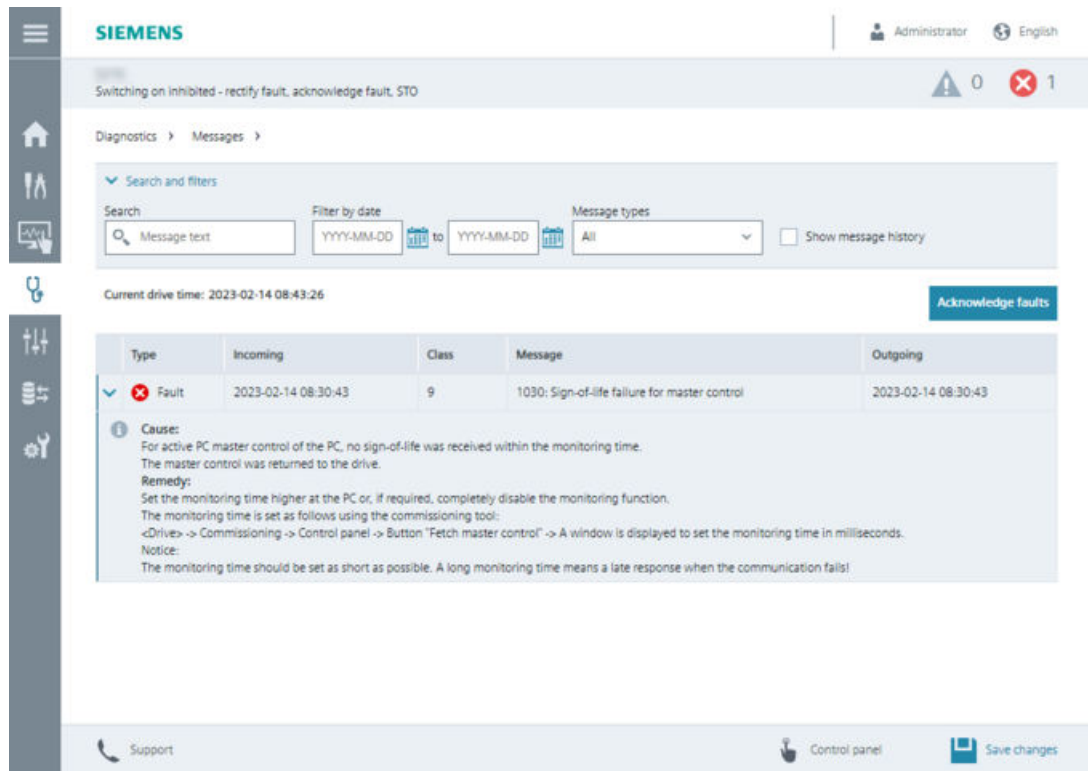

Figure 7-7 Messages

Selecting messages

- | | |
|----------------|---|
| Search | Enter a keyword |
| Filter by date | Select a date or time interval |
| Message types | Select the message type that should be displayed: <ul style="list-style-type: none"> • All • Faults • Alarms |

Displaying messages

Type	Displaying the message type: <ul style="list-style-type: none">• Alarm• Fault
Incoming	Time when the message was received
Class	Assign the message to a message class according to PROFIdrive <ul style="list-style-type: none">• The message number is output on all operating units, e.g. PC.
Message	Specification of the message number with message text
Outgoing	Time when the message went <ul style="list-style-type: none">• Faults are given the status "Outgoing" if the following are true:<ul style="list-style-type: none">– The causes have been eliminated.– The message has been acknowledged.
>	Selection for more information: <ul style="list-style-type: none">• Description of the message with cause and remedy

7.4.4.2 Diagnostic buffer

Overview

Function view "Diagnostics buffer" provides information about all system-relevant operations, e.g. commissioning, new ramp-up, generation of a certificate.

Description of function

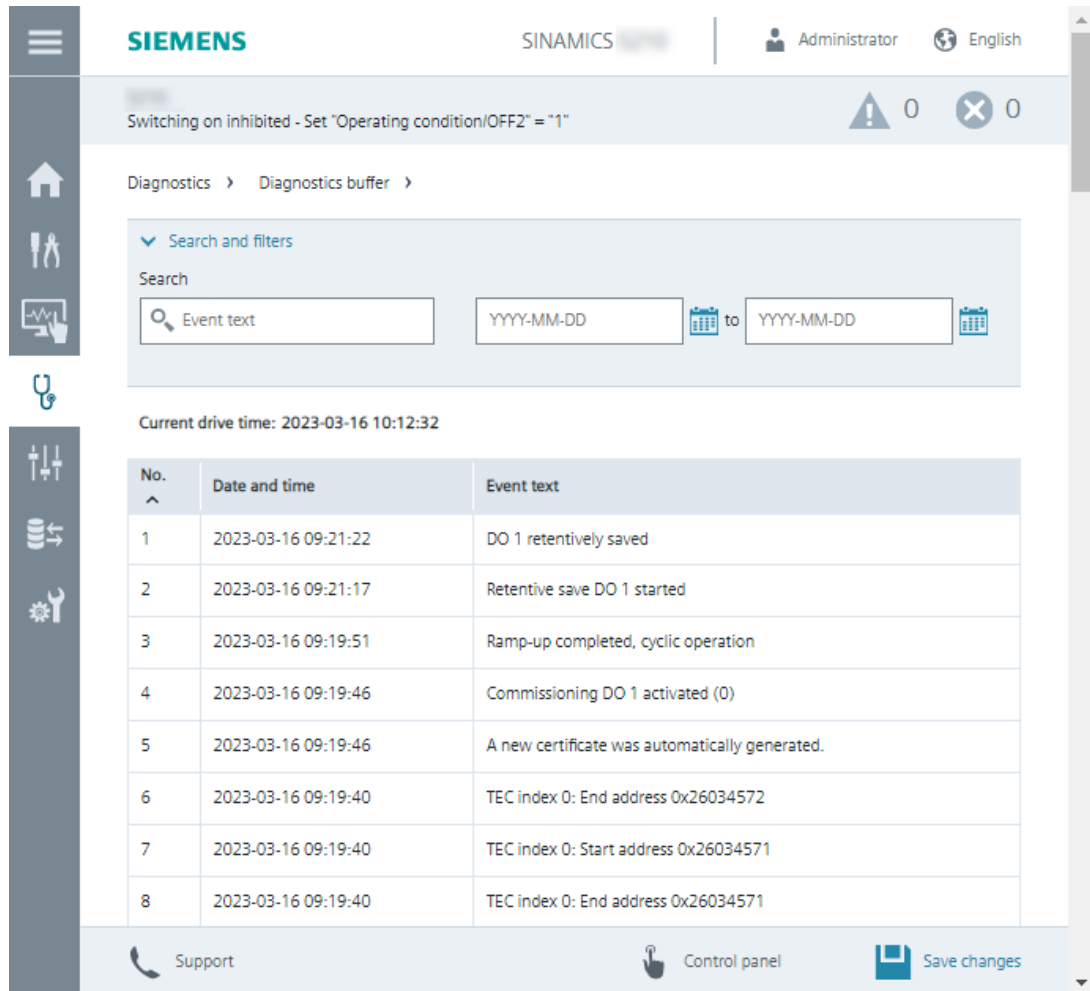

Figure 7-8 Diagnostic buffer

Reading out the diagnostic buffer facilitates converter diagnostics and supports fault analysis. The search can be limited by searching for keywords and using the filter function according to date.

The diagnostic buffer is kept when restoring factory settings via menu "Backup and restore".

7.4.4.3 Safety Integrated (for the S200 converter only)

Overview

Function view "Safety Integrated" provides information about the Safety Integrated Functions that have been enabled.

Description of function

The screenshot shows the Siemens SINAMICS web server interface. The top navigation bar includes the Siemens logo, the SINAMICS brand name, and user/language settings. A status bar at the top right shows a warning icon with the number 1 and a close icon with the number 0. The main content area is titled "Diagnostics > Safety Integrated >".

The "Status of Safety Integrated Functions" section contains a graph showing the STO status over time (t). The graph shows a pulse labeled "STO" with a yellow arrow pointing right, and the text "Not active" is displayed next to it.

The "Status" section shows a green checkmark and the text "No internal event".

The "Versions" section, marked with an information icon (i), lists the following components and their versions:

- SINAMICS Safety Integrated firmware version
- I/O processor firmware version
- Encoder firmware version

The bottom of the interface features a "Support" link and a "Control panel" icon.

Figure 7-9 Monitoring Safety Integrated Functions

The following content is displayed:

- "Status of Safety Integrated Functions"
Displays the status of STO
- "Status"
Displays "Active" if STO is active
- "Versions"
Displays the safety-relevant software versions of the corresponding components

7.4.4.4 Connection overview

Overview

Function view "Connection overview" provides information about the connections in the drive system.

Description of function

The individual components with IP address and additional details are graphically displayed in the connection overview.

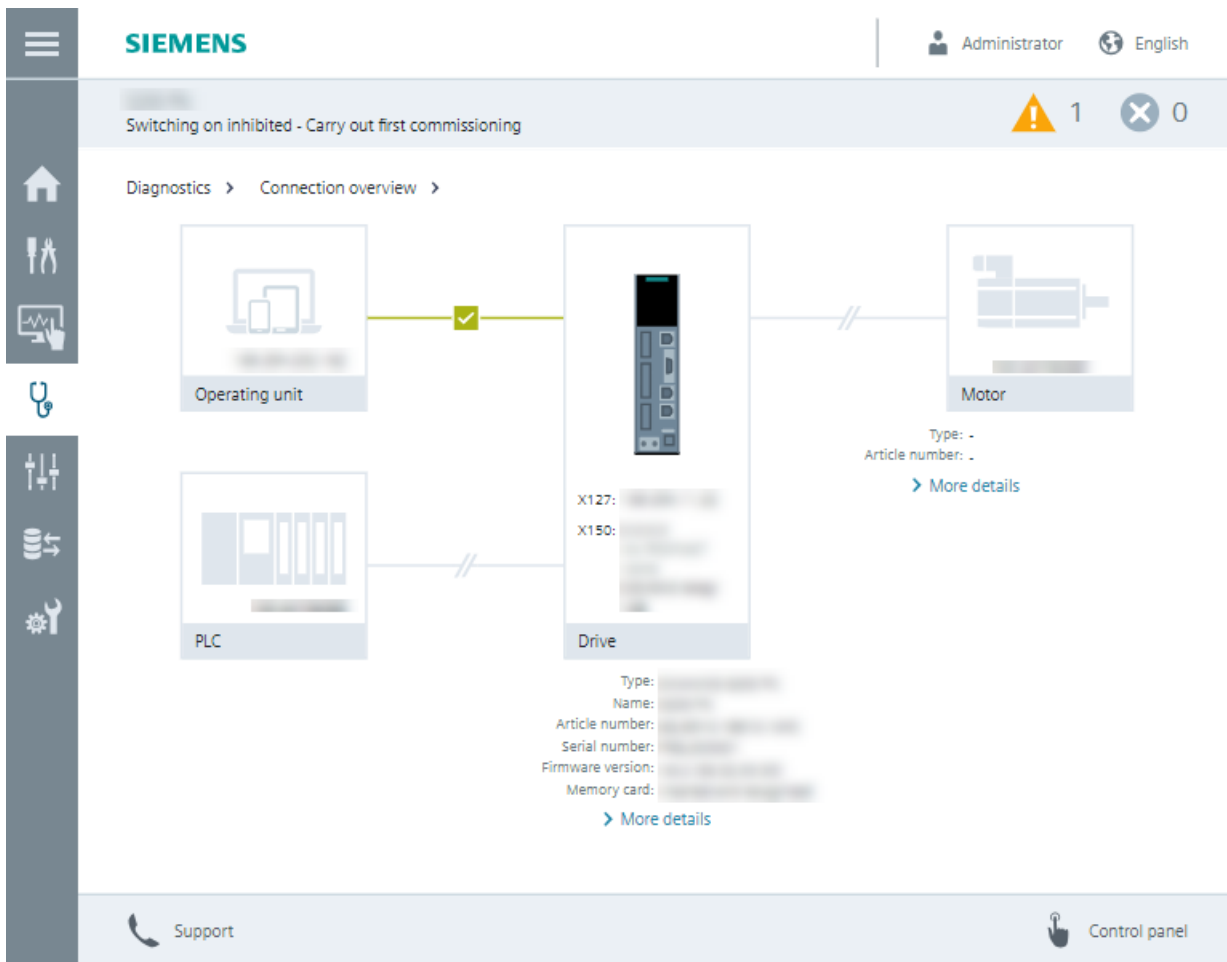

Figure 7-10 Connection overview

7.4.4.5 Communication

Overview

Function view "Communication" provides information about the activated fieldbus interface.

Description of function

Switching on inhibited - Carry out first commissioning ! 1 X 0

Diagnostics > Communication >

PROFINET IP of Station: 0.0.0.0
 PROFINET Name of Station: -
 PN cyclic connection diagnostics: Not connected

PROFIdrive PZD telegram selection: SIEMENS telegram 105, PZD-10/10

Receive direction: control > converter

PZD	Designation	Explanation	Value	
1	STW1	Control word 1	0000	hex
2_3	NSOLL_B	Speed setpoint B (32-bit)	0000 0000	hex
4	STW2	Control word 2	0000	hex
5	MOMRED	Torque reduction	0000	hex
6	G1_STW	Encoder 1 control word	0000	hex
7_8	XERR	Position deviation	0000 0000	hex
9_10	KPC	Position controller gain factor	0000 0000	hex

Send direction: converter > control

PZD	Designation	Explanation	Value	
1	ZSW1	Status word 1	0000	hex
2_3	NIST_B	Speed actual value B (32-bit)	0000 0000	hex
4	ZSW2	Status word 2	0000	hex
5	MELDW	Message word	0000	hex
6	G1_ZSW	Encoder 1 status word	0000	hex
7_8	G1_XIST1	Encoder 1 position actual value 1	0000 0000	hex
9_10	G1_XIST2	Encoder 1 position actual value 2	0000 0000	hex

Support Control panel

Figure 7-11 Communication

The following content is displayed:

- Connection status
- Process data of the set telegram in the send and receive directions.
The values are shown in the hexadecimal format. The display of individual values is switched between the binary and hex format by clicking on the button to the right of the value.

7.4.4.6 Status word and control word

Overview

The function view "Control/status word" provides information about the current status of the sequence control system.

Description of function

Switching on inhibited - exit commissioning mode

Diagnostics > Control/ status word >

Parameter	Value	Parameter	Value
Control word sequence control	1000 H	Status word sequence control	2240 H
00: ON/OFF1	No	00: Ready for switching on	No
01: Operating condition / OFF2	No	01: Ready	No
02: Operating condition / OFF3	No	02: Operation enabled	No
03: Enable operation	No	03: Jog active	No
04: Enable ramp-function generator	No	04: No coasting active	OFF2 active
05: Continue ramp-function generator	No	05: No Quick Stop active	OFF3 inactive
06: Enable speed setpoint	No	06: Switching on inhibited active	No
07: Command open brake	No	07: Drive ready	No
08: Jog 1	No	08: Controller enable	Yes
09: Jog 2	No	09: Control request	No
10: Master control by PLC	No	11: Pulses enabled	No
12: Speed controller enable	No	12: Open holding brake	No
14: Command close brake	Yes	13: Command close holding brake	Yes

Support Control panel

Figure 7-12 Control and status word

The control and status word is indicated by all sequence control states. This also includes states that are not available, which prevent the motor from being switched on and switched off. Diagnostics supports fault analysis.

7.4.5 Parameters

7.4.5.1 Parameter lists

Overview

The parameter list shows all the parameters of the converter. The parameter list allows specific parameters to be changed.

Description of function

	No.	Parameter	Value	Unit
<input type="checkbox"/>	r2	Operating display	Switching on inhibited - exit commissioning mode (46)	
<input type="checkbox"/>	r20	Speed setpoint smoothed	0.0	rpm
<input type="checkbox"/>	r21	Speed actual value smoothed	0.0	rpm
<input type="checkbox"/>	r26	DC link voltage smoothed	551.4	V
<input type="checkbox"/>	r27	Absolute actual current smoothed	0.00	Arms
<input type="checkbox"/>	r31	Actual torque smoothed	-0.00	Nm
<input type="checkbox"/>	r32	Active power actual value smoothed	0.00	kW
<input type="checkbox"/>	r34	Motor utilization thermal	0	%
<input checked="" type="checkbox"/>	r37[0]	Drive temperatures	36	°C
<input checked="" type="checkbox"/>	r39[0]	Energy display	0.00	kWh
<input type="checkbox"/>	r44	Thermal converter utilization	0.00	%
<input checked="" type="checkbox"/>	r46[0]	Missing enable signal	100 0000 0000 0010 0001 1100 0000 1111 B	



Figure 7-13 Parameter list

The parameter list offers the following options:

- Toggling between two list views
 - Show as "Simple view" and "Advanced view" with parameter numbers
- Searching parameters
 - Search by parameter number or text search within parameter names

7.4 Functions and menus

- Filtering the parameter list
 - Parameter groups: Only show the parameters that are assigned to a particular function.
 - Parameter types: display and/or setting parameters
- Changing parameter values directly in a parameter list
 - Exception: blocked parameters

p	Setting parameters	Are read/write.
		The setting parameter can only be parameterized in the active commissioning mode. Depending on the parameter, changes are possible in the quick setup.
		The setting parameter can only be parameterized when the user has the appropriate function rights.
r	Display parameters	Can only be read and cannot be edited.
c	Display parameters	Can only be read and cannot be edited.

7.4.5.2 User-defined parameter list

Overview

A user-defined parameter list is a combination of specific parameters from the standard parameter list of the converter. These can be used to configure frequently used user functions, for example.

Description of function

With the user-defined parameter lists, the web server provides the following functions:

- Creating up to 20 user-defined parameter lists
 - Configuring list properties
 - Name
 - Position or sequence of the tabs
 - Comment
 - Delete list
 - Exporting and importing user-defined parameter lists
 - Export:
 - Export one or several user-defined parameter lists.
 - The web server exports the lists exclusively as a json file.
 - Export files generated by the web server can be imported into a Startdrive project.
 - Import:
 - The list import function in the web server exclusively imports json files.
 - User-defined parameter lists exported via the web server or Startdrive as a json file can be imported into another drive of the same type via the web server.
Requirement: same drive type and same firmware version
- If values are changed, the data must be saved retentively.

7.4.6 Backup and restore

7.4.6.1 Overview

Overview

With "Backup and restore" you can back up parameters and other settings and restore the settings again if necessary.

Description of function

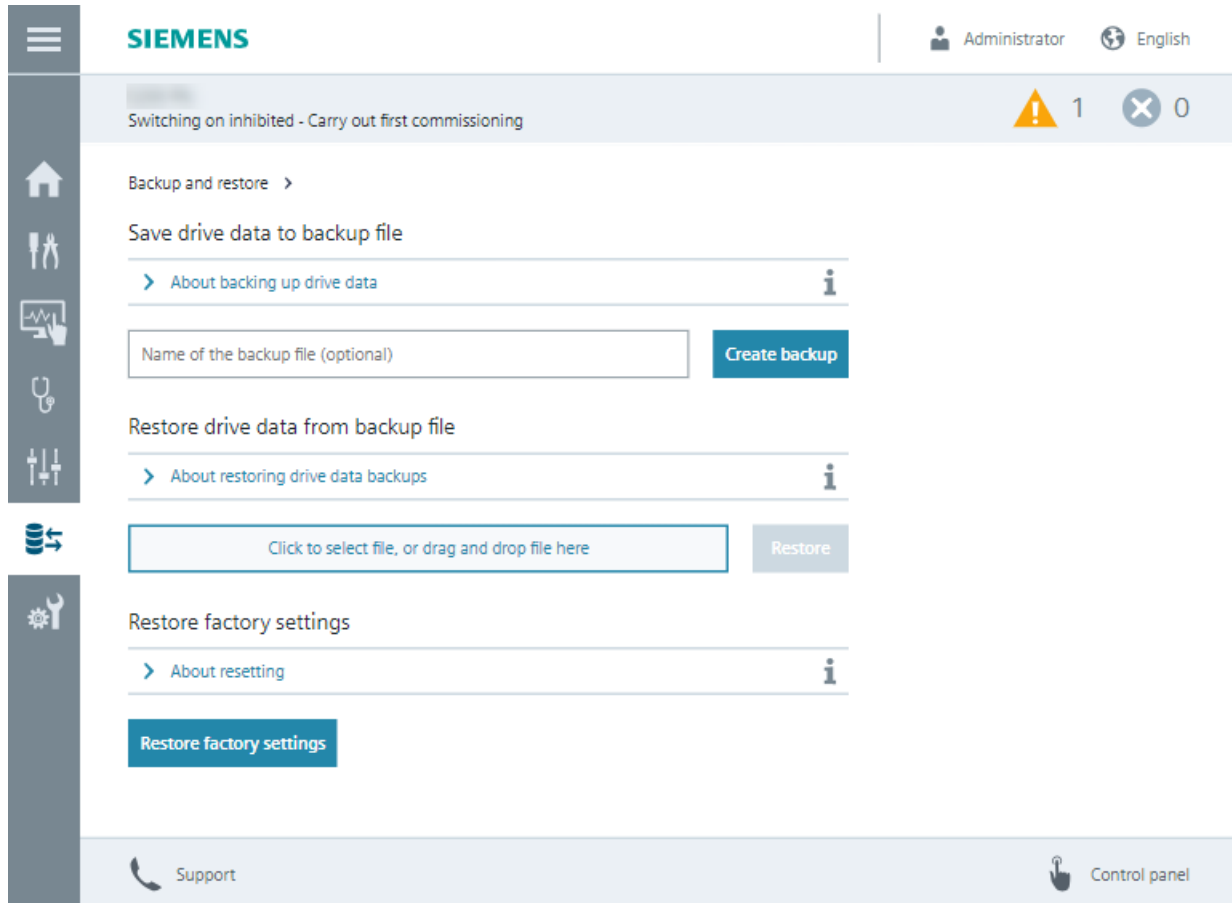

Figure 7-14 Backup and restore

The following functions are available to back up and restore data and settings:

- Save drive data to backup file
Back up the parameter settings to a file after commissioning.
- Restore drive data from backup file
When replacing a device or for series commissioning, load the backed-up parameter settings to the converter.
- Restore factory settings
Reset all converter settings to the factory values.

More information

If you want to restore the converter to factory settings with the SD card, see the information in Chapter "Manual reset to factory settings with SD card (Page 641)".

7.4.6.2 Save drive data to backup file

Overview

With "Save drive data to backup file" you can back up all converter settings to one file. Perform function "Save drive data to backup file" in the following cases:

- After commissioning
- Before "Restore factory settings"
- Before a firmware update/downgrade

Requirement

None

Procedure

1. Call the "Backup and restore" menu.
2. Click the "Create backup" button.
A name can be optionally assigned to the backup file. Parameters are backed up. The backup file is saved in the download folder of your operating unit.
3. Optional: If you only wish to use the backup file at a later point in time, then place the backup file in a protected location in the operating unit.

More information

You can load backed-up data and settings of a converter to other converters. The target converter must satisfy the following prerequisites:

- The rated power of the target converter is the same as the backed-up rated power.
- Firmware version of the target converter is \geq firmware version of the converter from which the backed-up data and settings originate.

7.4.6.3 Status after backing up

Overview

The "Back up parameters" function backs up all converter settings to one file.

Description

The converter backs up the following data and settings:

- Communication interface settings
- Parameters (including safety parameters)
- Security settings

7.4 Functions and menus

- UMAC data
- Web server settings:
 - Modified settings in window "Drive status" on the home page
 - User-defined parameter lists
 - Support settings
 - Save changes manually/automatically
- Displayed parameters (display standard parameters/all parameters):
 - Standard parameters
 - View all parameters
 - Display brightness

The converter firmware files are not backed up.

7.4.6.4 Restore drive data from backup file

Overview

When replacing a device or for series commissioning, you load the backed-up parameter settings to the converter.

Requirement

- You have a backup file on your operating unit.
- The rated power of the target converter is the same as that of the backed-up converter.
- Firmware version of the target converter is \geq firmware version of the converter from which the backed up data and settings originate.
- Function rights required for active user management (UMAC):
 - Edit device configuration or drive applications

Procedure

1. Call the "Backup and restore" menu.
2. Select the backup file from the file system of the operating unit.
3. Click the "Restore" button.

The backup file is loaded to the converter.

7.4.6.5 Restore factory settings

Overview

The reset to factory settings with the web server deletes the user-specific parameterization of the converter, for example the motor data.

The following data are retained when the factory settings are restored:

- Communication interface settings
- Security settings
- Language setting
- Date and time

In the following cases it may be necessary to restore the converter to factory settings:

- If the motor is changed
- If there is uncertainty regarding the previous parameterization and/or the previous use of the converter

Requirement

If User Management & Access Control is activated, you will need the following function rights:

- Edit device configuration or drive applications

Procedure

1. Call the "Backup and restore" menu.
2. Click the "Restore factory settings" button.
3. Acknowledge the confirmation prompt.

The converter is reset and then restarted.

More information

For a full reset of the converter, proceed as described in Chapter "Manual reset to factory settings with SD card (Page 641)".

7.4.7 System

7.4.7.1 Settings

Overview

The function view "Settings" offers basic settings for the web server and the converter.

Requirement

- To edit the web server settings you will need the "Edit web server configuration" right.
- To edit the drive settings you will need the "Edit device configuration or drive applications" right.

Description of function

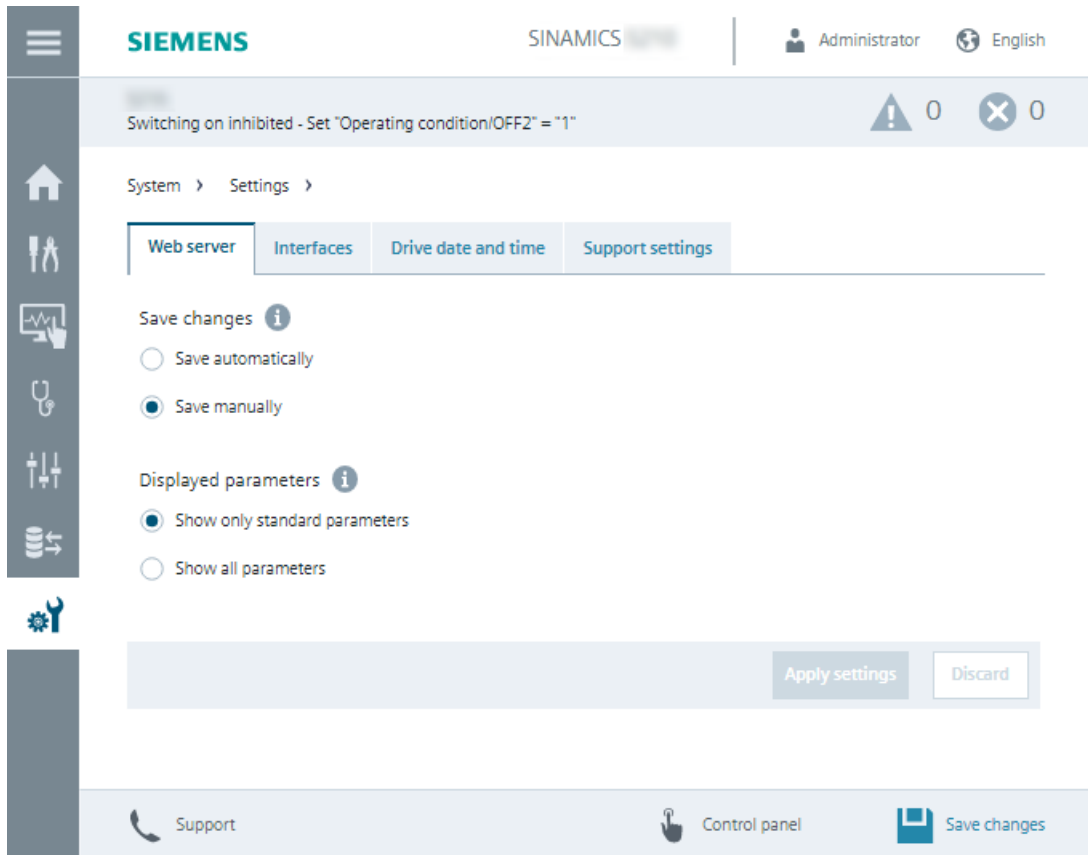

Figure 7-15 Web server system setting

Web server

Under "Web server", the web server offers options for saving changes and displaying parameters.

Interfaces

Under "Interfaces", the web server provides information about the status and the settings of the interfaces of the converter.

Drive date and time

Under "Drive date and time", the web server provides options for setting the date format and for obtaining the date, time and time zone of the converter.

Support settings

Under "Support settings", the web server provides the option to store additional support and hotline data. The web server displays these data in the function view "Support".

7.4.7.2 User administration

Overview

In "User administration" you manage users and configure their roles and rights for accessing the converter.

Requirement

- You activated user management (UMAC) in "Configure security settings" during first commissioning.
- You are logged into the web server and have the necessary rights to manage users.

Description of function

System > User administration >

Users Roles Password policy

+ Add user

	User name	Roles	Session timeout	
>	Anonymous	Drive Ext. Role Fieldbus, Drive Guest	Never	
✓	Administrator	Drive Administrator	30 minutes	

Assigned roles: Drive Administrator

Right	All operating units
Manage users and roles	<input checked="" type="checkbox"/>
Edit web server configuration	<input checked="" type="checkbox"/>
Edit Safety Integrated application	<input checked="" type="checkbox"/>
Edit device configuration or drive applications	<input checked="" type="checkbox"/>

Support Control panel Save changes

Figure 7-16 User administration

7.4 Functions and menus

Users

Under "Users", the web server provides a summary of the created users and offers the following functions:

- Create new user accounts
- Change existing user accounts
- Activate or deactivate user accounts

Roles are assigned to give users read or write access to certain functions.

Roles

Under "Roles", the web server provides a summary of the existing roles and the assigned rights.

Password policy

Under "Password policy", you specify the requirements a password must meet. You define the password complexity and the time to password expiry (if any).

More information

More detailed information on user management and security settings is provided in the Configuration Manual SINAMICS Industrial Security (<https://support.industry.siemens.com/cs/ww/en/view/109810578>).

7.4.7.3 Protection & Security

Overview

In "Protection & Security", you configure basic security settings using the Security Wizard and the tables it contains.

Requirement

- You activated the security settings during first commissioning.
- You are logged into the web server and have the necessary rights to edit drive data.

Description of function

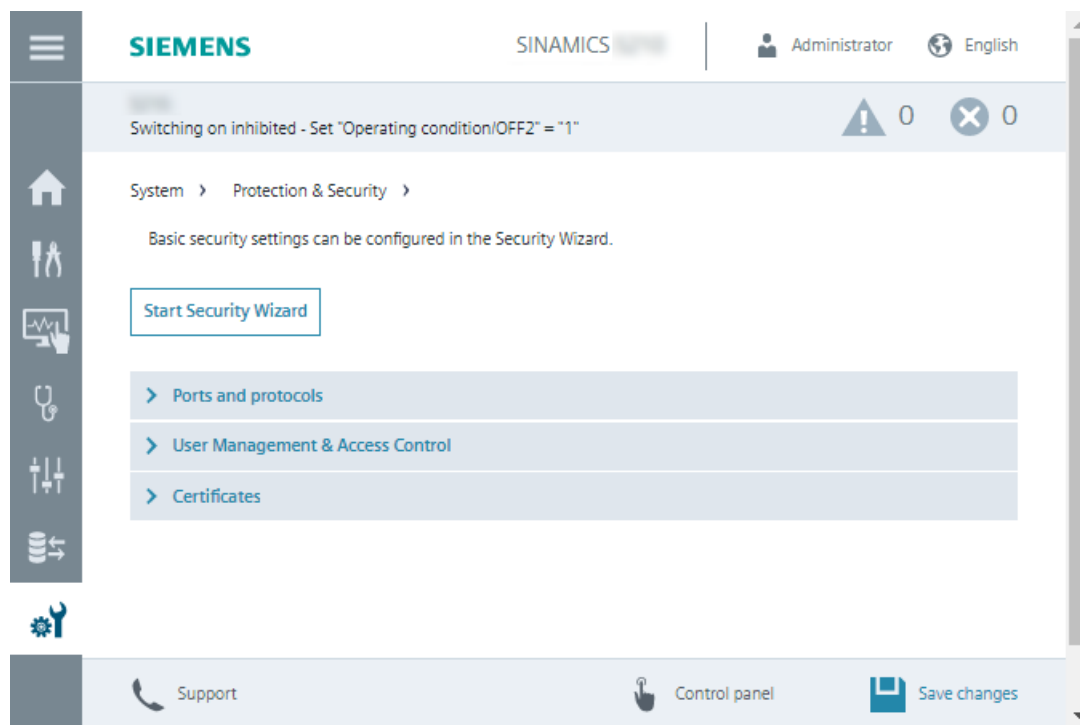

Start Security Wizard

In the Security Wizard, you configure the most important security settings for the converter. They include User Management & Access Control and web server activation.

Ports and protocols

The web server provides an overview of the available ports and protocols and their status. This is where you activate or deactivate the communication interfaces.

User Management & Access Control

The web server provides an overview of the settings in user management.

Certificates

The web server provides an overview of the issued certificates. Digital certificates identify the converter as a "trusted device". The web server cannot be accessed from an operating unit without a digital certificate. When activating user management, a certificate is automatically created and assigned to the converter.

Use "Download certificate to operating panel" to download a certificate to the operating panel.

More information

More detailed information on configuring secure communication is provided in the Configuration Manual SINAMICS Industrial Security (<https://support.industry.siemens.com/cs/ww/en/view/109810578>).

7.4.7.4 Licenses

Overview

You must purchase licenses for supplementary functions and options.

Use the function view "Licenses" to manage the licenses for drive functions and options.

Requirement

- You are logged into the web server and have the necessary rights to edit drive data.
- The operating panel is connected online with the drive.

Description of function

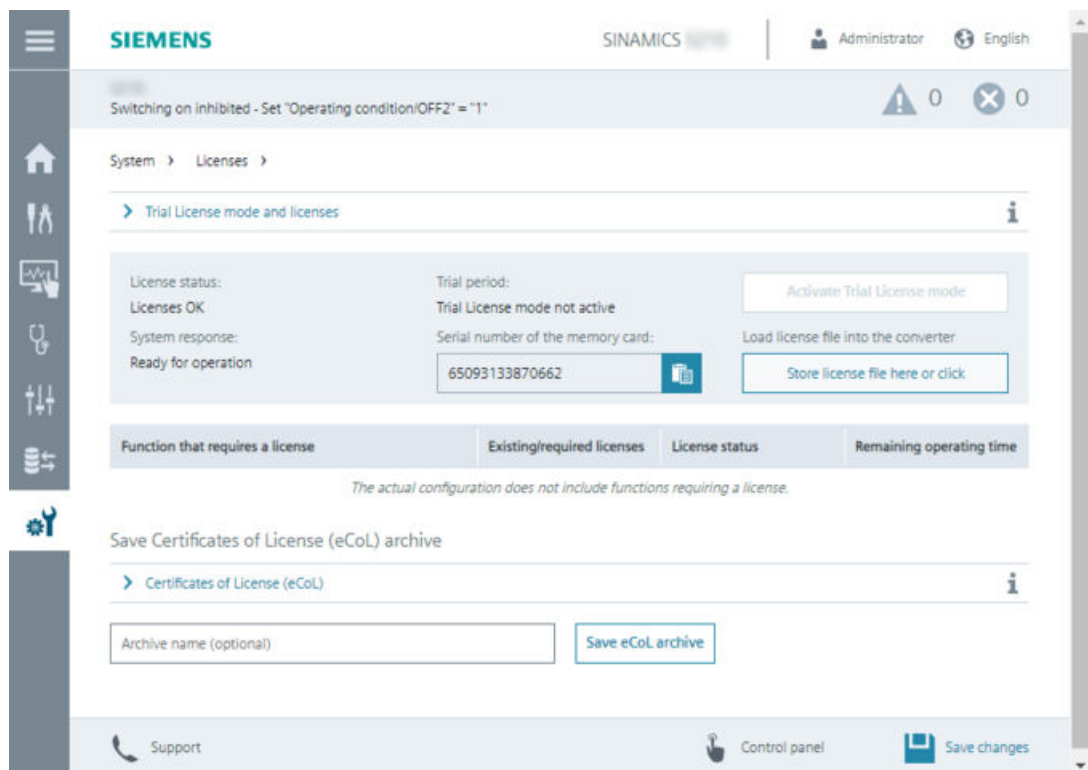

Figure 7-17 Licenses

The function view "Licenses" offers the following functions:

- Display the installed functions requiring licenses
- Read and copy the serial number of the SD card inserted into the converter
- Load and activate purchased licenses

Load and activate licenses

Under "Trial License mode and licenses", you upload license files created with the Web License Manager.

In Trial License mode, you can try out functions for a specified period.

Using functions/options requiring a license

The web server provides an overview of the options that require licensing and their license status.

Certificates of License (eCoL)

Under "Certificates of License (eCoL)", you load purchased licenses directly from an SD card into the file system of the operating unit.

7.4.7.5 Firmware update**Overview**

You can perform a firmware update in the web server:

- For an upgrade, the converter settings are retained.
- For a downgrade, the converter is restored to factory settings.

Requirement

You have saved the ZIP file with the firmware to a drive, which you can access using the operating panel.

Note

An empty SD card must be inserted into the converter during update for storing the downloaded ZIP file temporarily.

Description of function

This function view "Firmware update" displays the current version of the firmware and of the web server.

To copy a different firmware version to the converter, load the ZIP file containing the firmware from the file system of the operating panel.

7.4.7.6 About web server**Overview**

"About web server" contains information about the web server and links to additional information.

Description of function

Under "Versions" you can see the revision levels of the web server and the loaded firmware.

Under "Third-party software" there is a link to information about any third-party software used. The license conditions are loaded to the operating panel in the file "READ_OSS.ZIP". You can display the HTML file included in the ZIP file using your browser.

There are more links to information about:

- Cookie policies
- Industrial Cybersecurity
- Privacy policy

7.4.8 Support

Overview

The footer of the web server contains a support dialog.

Description of function

The support dialog contains links to additional information for the converter.

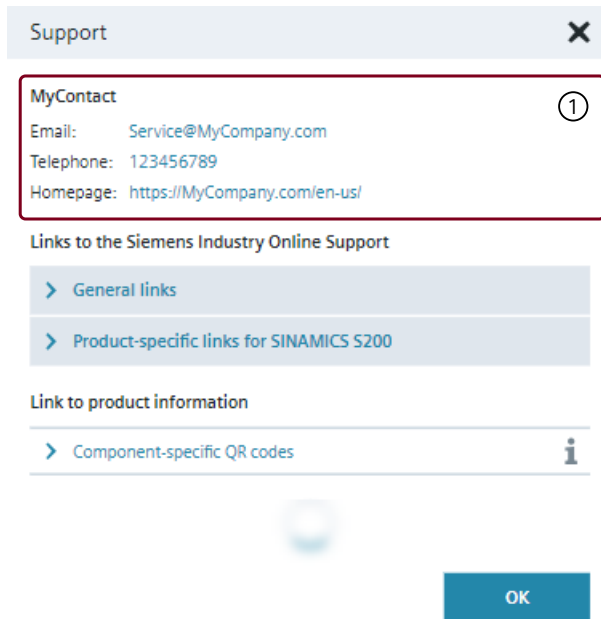

- ① Display of additional support and hotline data
For more information about configuration, see Chapter "Settings (Page 201)".

Figure 7-18 Support information

7.4.9 Control panel

Overview

The control panel moves the motor using the operating unit, bypassing the higher-level controller, for example to test the converter settings after commissioning.

Requirement

 WARNING
<p>Unexpected motor movement through incorrect operation</p> <p>If the control panel is active, the safety shutdowns of the higher-level controller have no effect. The "Stop with space bar" function is not guaranteed in all operating states. Incorrect operation by untrained personnel may result in unexpected motor movement which can cause death or serious injuries.</p> <ul style="list-style-type: none"> • Only use the control panel for commissioning, diagnostics and service purposes. • Only use the control panel if you are trained and authorized accordingly. • Install an EMERGENCY STOP for the drive which is independent of the higher-level controller.

Description of function

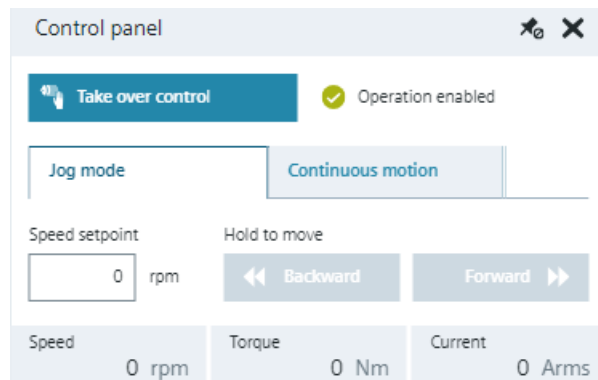

Figure 7-19 Control panel

The "Take over control" dialog deactivates the signals of the higher-level controller and switches the source for enables and the setpoint value to the control panel.

Note

Drive responds immediately

Although all enable signals are removed before returning the master control, the setpoints and commands still come from the original parameterized sources after the master control is returned.

The control panel offers the following operating modes to move the motor:

- Jog mode moves the motor while the direction buttons are pressed.
- Continuous motion starts the motor when a direction button is pressed.

Commissioning (Startdrive)

8.1 Introduction

Overview

You configure devices and commission your converter in the Startdrive commissioning tool. Further information about the Startdrive commissioning tool can be found in the information system of the TIA Portal.

8.2 Requirements for commissioning

Requirements

- TIA Portal version V18 or higher is installed on your operating unit.
- Startdrive version V18 SP2 or higher is installed on your operating unit.
You will find the download page at the following link (<https://support.industry.siemens.com/cs/ww/en/ps/13438/dl>).
- Firmware version V6.2 or higher is installed in the converter.
- You have all of the required licenses to use the TIA Portal without any restrictions.

8.3 Basics

8.3.1 Communication interfaces

Overview

The following interfaces are available for accessing the converter:

Interface	Information
Service interface X127	The default access to Startdrive is via the service interface X127.
	Ethernet interface X127 is intended for commissioning and diagnostics, which means that it must always be accessible.
	Defaults: <ul style="list-style-type: none"> • IP address: 169.254.11.22 • Subnet mask: 255.255.0.0 • Connection type: HTTPS
	Restrictions: <ul style="list-style-type: none"> • Only local access is allowed. • No networking or only local networking in a closed and locked electrical cabinet is permissible. • For remote access to the electrical cabinet, you must apply additional security measures to prevent misuse through sabotage, data manipulation by unqualified persons and interception of confidential data.
	Access using mobile end devices: <ul style="list-style-type: none"> • If you carry out commissioning or diagnostics using a mobile end device such as a smartphone or tablet, you may temporarily connect the service interface X127 to an external WLAN access point.
PROFINET interface X150	Defaults (offline): <ul style="list-style-type: none"> • IP address: 0.0.0.0 • Subnet mask: 0.0.0.0
	Requirements: <ul style="list-style-type: none"> • The converter and your operating unit must be located in the same subnet to ensure an effective online connection. • Before you can go online on a converter via PROFINET, you must assign the PROFINET interface of the converter a suitable IP address. • The IP addresses of the service interface X127 and the PROFINET interface X150 must not be in the same subnet.

8.3.2 Protected communication

Description

If the Startdrive project and the converter are unprotected, access is possible via both interfaces. This enables unrestricted access from the project or a higher-level controller to the converter data.

Non-authorized users can manipulate the converter data. To avoid the risk of data manipulation, Siemens recommends that you protect access to the project and the converter.

Detailed information about security settings is provided in the Configuration Manual SINAMICS Industrial Security (<https://support.industry.siemens.com/cs/ww/en/view/109810578>).

8.3.3 User administration and security

Overview

Startdrive provides the possibility to use user management and access control (UMAC) for projects. This allows you to create and manage user accounts and roles in your project. The roles bundle different access rights for the project. Different users can be granted different access rights to functions. Once the project protection has been activated, the project can only be opened and edited by authorized users.

Requirement

- A project has been created or an existing project is open.

Description of function

You can define the following settings through the "Security settings" entry in the project tree.

- **Project protection**
With the help of the user administration you can activate project protection for Startdrive projects.
As soon as you specify a project administrator, your project will be protected. Users can then only access the project in Startdrive by logging in. The drive itself is also protected. In this case, you must always log in to access the drive online.
Activated project protection cannot be canceled. Activated drive protection (runtime) can only be deactivated by completely restoring the factory settings (using an SD Card).
- **Users and roles**
You can create local and global user accounts in the user administration and specify the general roles and rights for these users.
The following rules apply when you create user accounts:

Setting	Number
Maximum number of roles	In addition to the system-defined roles, you can create 20 user-defined roles.
Maximum number of user accounts	25 (excluding "Anonymous" user)
Maximum assignable roles to a user account	10
Role names (maximum number of characters)	32
User account name (maximum number of characters)	100
Maximum password length (maximum number of characters)	120

Each user requires function rights to access protected drive data. These function rights are summarized in roles and define which data and functions the respective user can access. Each user can be assigned multiple system-defined roles. In addition, user-specific roles can also be created and assigned. This is done by a user who has the function right "Manage users and roles".

In regard to function rights, a distinction must be made between two groups:

- **Engineering rights**
These always refer to a protected Startdrive project (UMAC for the project is enabled). However, these rights are also checked when accessing a protected drive.
- **Runtime rights**
These always refer to a protected device accessed in online mode (UMAC for the drive is enabled).
SINAMICS Startdrive and web server use the same runtime rights.

More information

For more information about UMAC, see the information system of the TIA Portal.

8.3.4 Loading data from the drive into the project

Overview

If you change the configuration of a converter in the online mode, then the configuration deviates from the data in the Startdrive project. To update project data, load the drive data from the converter into the project.

Requirement

- A project with a matching drive is created and is open in Startdrive.
- The converter and SIMATIC S7 controller are in offline mode.
- For activated user management (UMAC):
The function rights for editing drive data are activated for your user account.
Details on this topic are provided in Chapter "Security settings in Startdrive" of the Configuration Manual SINAMICS Industrial Security.

Procedure

Proceed as follows to load data from the drive into your project:

1. Click the  icon in the toolbar.
The following dialog box opens. Establish an online connection to the required drive in the dialog box.

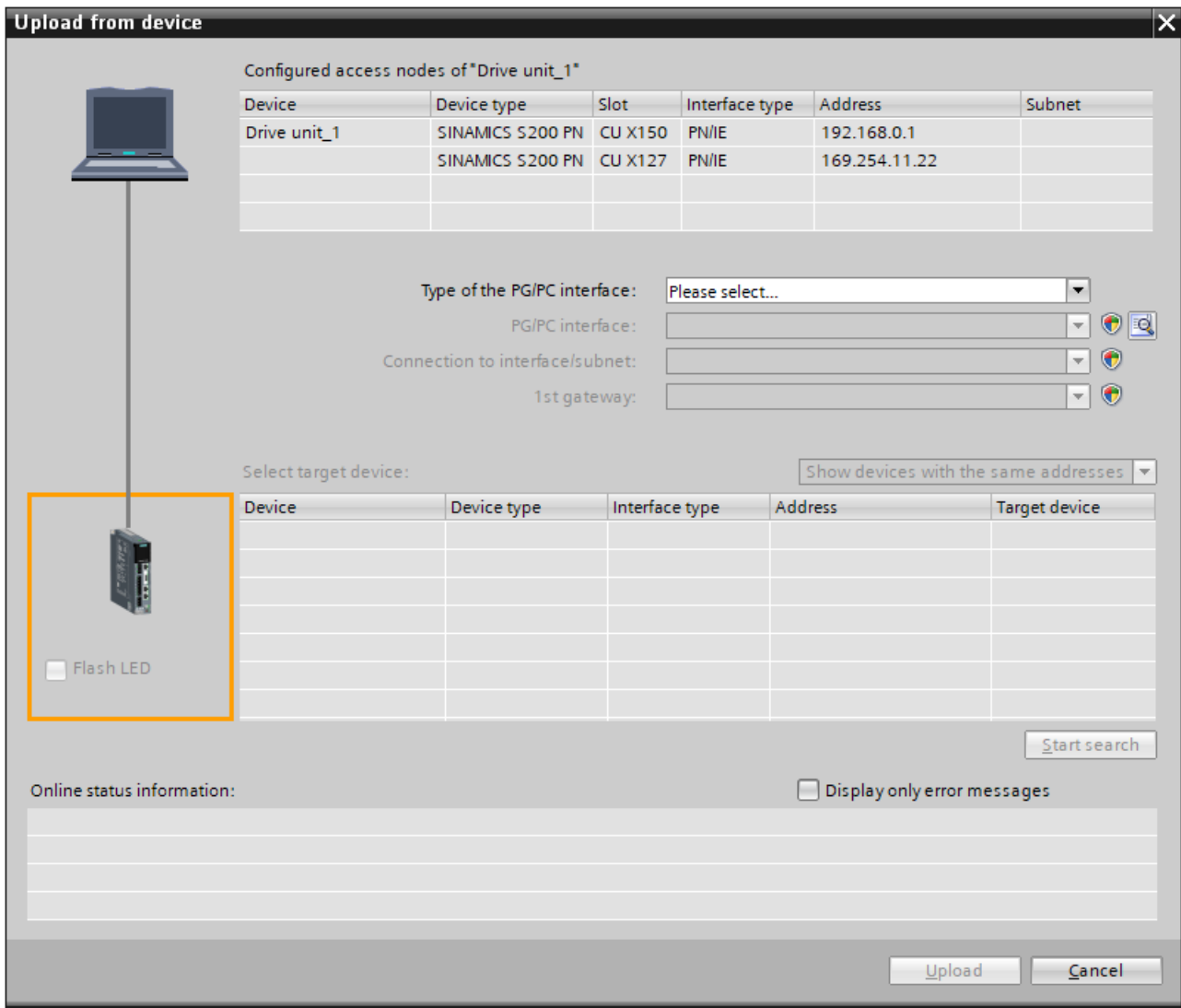

Figure 8-1 Uploading data from the device

2. Check the messages in the "Online status information" area.
As soon as uploading becomes possible, the "Upload" button is enabled.
3. Click the "Upload" button.
The data are loaded from the drive into the project. The drive data are saved with the project.

8.3.5 Loading project data into the drive

Overview

Load the data from your Startdrive project into a drive.

Requirement

- A project has been created.
- A drive has been created and completely configured in the project.
- Optional: There is an active online connection between the converter and operating unit.
- For activated user management (UMAC):
The function rights for editing and loading drive data are activated for the user account. Details on this topic are provided in Chapter "Security settings in Startdrive" of the Configuration Manual SINAMICS Industrial Security.

Procedure

Proceed as follows to load the project data into your converter:

1. Select a drive in the project tree.
2. Click the  icon in the toolbar.
 - If you have already established an online connection, then the "Load preview" dialog opens.
This dialog displays alarms and proposes actions necessary for loading.
 - If you have not established an online connection, then the "Extended loading" dialog opens.
Using this dialog, establish an online connection to the required drive.
3. Check the messages in the "Load preview" dialog.
The "Save parameterization retentively" action is enabled by default.
4. Click "Load".
The project data are downloaded into the drive.

8.3.6 Saving changes in the project

Overview

Project data that are not saved are lost when closing the project. The entire project must be saved in order for the settings to take effect permanently.

Requirement

- For activated user management (UMAC):
The function rights for editing drive data are activated for your user account. Details on this topic are provided in Chapter "Security settings in Startdrive" of the Configuration Manual SINAMICS Industrial Security.

Procedure

Proceed in either of the following ways to save changes in the project:

- In the toolbar, click the  icon.
- Select the "Project > Save" or "Project > Save as" menu.

8.3.7 Retentively saving changes to the SD card

Overview

Parameter assignments of your converter are always volatile and are lost when the converter is switched off. Information is subsequently provided as to how you can retentively save online data or offline data.

Requirement

- A project has been created.
- A drive has been created and completely configured in the project.
- For activated user management (UMAC):
The function rights for editing drive data are activated for your user account. Details on this topic are provided in Chapter "Security settings in Startdrive" of the Configuration Manual SINAMICS Industrial Security.

Procedure

Retentively saving online data

Proceed in either of the following ways to save online data retentively:

- In the function view of the active Startdrive project, click the  icon.
- In the project tree of your drive device, double-click "Online & Diagnostics".
 - In the secondary navigation select the "Functions > Backup/Restore" menu.
 - In the "Retentively save RAM data" area, click "Save".

The system checks whether an SD card is available. If an appropriate SD card is detected, then the parameter values are retentively saved to the SD card.

Retentively saving offline data

When retentively saving data, it is important that the settings made are not only saved on your operating unit in the Startdrive project, but also permanently saved on the SD card (also known as "save retentively" or "RAM to ROM"). An online connection must be established to the drive for this purpose.

Proceed as follows to save offline data retentively:

1. Establish an online connection to your drive.
2. Load the project data into your drive.
3. Click the  icon in the function view of the active Startdrive project.
The current project settings are stored retentively on the SD card of the drive.

8.3.8 Using parameter lists and user-defined lists

Overview

Users configure a drive in Startdrive as standard using specific configuration views. For the configuration, experienced users preferably take the parameter lists or user-defined lists.

Requirement

- For activated user management (UMAC):
The function rights for editing drive data are activated for your user account.
Details on this topic are provided in Chapter "Security settings in Startdrive" of the Configuration Manual SINAMICS Industrial Security.

Description of function

Parameter list

The following functions are available:

- Monitoring parameter values
- Editing parameter values directly from the parameter view
Only parameters with a light grey background can be directly edited in the parameter list. Other parameters are locked in the parameter list and cannot be edited in the current operating mode.
- Exporting parameters as CSV
- Comparing parameter settings:
 - Offline - Factory setting
 - Online - Offline
 - Online - Factory setting

User-defined list

You compile the selected parameters in a user-defined list. This involves an excerpt with specific parameters, from an underlying parameter list.

User-defined lists are only created and edited in the project tree.

You use user-defined lists for the following purposes:

- Compiling the most important parameters
- Assigning parameters to parameter groups with comments for users
- Carrying out series commissioning based on saved parameter values
- Documentation of the drive with listed parameters and setting values

Opening and reading parameter lists in the web server engineering tool

Parameter lists are exported in the json format. You can open lists and view parameter values if you access the converter using the web server.

Example

In the following application, you create a user-defined list with the objective of accepting parameter values for an additional drive.

1. You create a user-defined list with parameter values for a configured drive.
2. You open the list in another drive with the same hardware configuration.
3. You compare the parameter values of the drive with the saved values.
4. You apply the required parameter values for the drive.

More information

For more information about parameter lists and use-defined lists, see the related TIA Portal information system.

8.4 Procedures for device configuration and commissioning

8.4.1 Requirements

Description

Note**Only in the offline mode**

The drive components can only be combined and specified in the offline mode. In the online mode, all corresponding setting ranges are disabled in the device view and in the inspector window.

Note**User management and security**

SINAMICS converters of the latest generation generally have extended protection. This usually has the effect that, as a user, you have to log in to view or edit the converter data offline as well as online.

The most important protective measures in brief:

- Project protection can be activated for Startdrive projects in the TIA Portal (offline). If project protection is activated, corresponding rights are required for access. Once project protection has been activated, it cannot be deactivated.
- A "Security Wizard" usually appears when creating new converters in the project. With the help of this wizard, you can already make the most important security settings for this converter within the project when creating the converter. After loading the project data into the converter, the protection settings become effective there.
- To access a protected converter online, you ALWAYS need the corresponding access rights. This also applies if no project protection is activated for the Startdrive project.

Detailed information on this topic is provided in the Configuration Manual SINAMICS Industrial Security in Chapter "Security settings in Startdrive".

Note**Editing mode required for online commissioning**

If you want to make important settings online, activation of the editing mode is mandatory. Restore points that are required as a return point following a cancellation of the current online parameterization are automatically created by the editing mode in the "guided quick startup" (and in the "Parameterization" area) during configuration.

No separate editing mode is necessary in the "Rotate & optimize" area.

Note**Telegram configuration offline**

In the guided quick startup, telegram settings can in principle only be made offline.

8.4.2 Simple basic parameterization (offline)

Overview

The following workflow represents the simplest form of commissioning.

Requirement

None

Procedure

Proceed as follows to perform basic parameterization in offline mode:

1. Create or open a project with Startdrive.
2. Create device configuration in Startdrive offline.
 - Insert and specify the SINAMICS drive in the project.
 - Create and specify SINAMICS components.
 - Make detailed settings for the drive and components.
 - Optional: Configure user management and make protection settings for the drive.
3. Make basic settings offline via the guided quick startup.
4. Load project data to the target device.
5. Establish an online connection between Startdrive and the target device.
6. Optimize commissioning.

Result

The motor rotates.

8.4.3 Simple basic parameterization (online)

Overview

The basic parameterization can be carried out in online mode as an alternative to offline mode.

Requirement

None

Procedure

Proceed as follows to perform basic parameterization in online mode:

1. Create or open a project with Startdrive.
2. Create device configuration in Startdrive offline.
 - Insert the specify the SINAMICS drive in the project.
 - Create and specify SINAMICS components.
 - Make detailed settings for the drive and components.
 - Optional: Configure user management and make protection settings for the drive.
3. Load project data to the target device.
4. Establish an online connection between Startdrive and the target device.
5. Make basic parameterization settings online via the guided quick startup in the editing mode.
 - Make basic settings in the quick startup steps.
 - Optimize commissioning.

Result

The motor rotates.

8.4.4 Basic parameterization together with a SIMATIC controller

Overview

SINAMICS drives are frequently operated with SIMATIC or SINUMERIK controls. To speed up commissioning the individual components, the drive and control can be commissioned together in a Startdrive project.

Requirement

None

Procedure

Proceed as follows to perform the basic parameterization for the drive together with a SIMATIC controller:

1. Create or open a project with Startdrive.
2. Create device configuration in Startdrive offline.
 - Insert and specify the SINAMICS drive in the project.
 - Insert and specify the SIMATIC controller in the project.
 - Network the SIMATIC controller and the SINAMICS drive.
 - Optional: Configure user management and protection settings for the drive and control system.
 - Insert a technology object into the SIMATIC controller.
 - Interconnect the technology object with the drive.
3. Load project data to the target devices.
4. Establish an online connection between Startdrive and the target device.
5. Make basic settings online via the guided quick startup in the editing mode.
 - Make basic parameterization settings in the quick startup steps.
 - Optimize commissioning.

Result

The motor rotates.

8.5 Combining and configuring devices in the project

8.5.1 Converter

8.5.1.1 Inserting a converter into the project

Overview

You either add a new converter to the project view or to the portal view. For the latest generation of SINAMICS converters, you can define the security settings for access to the drive data at the time of setup.

Requirement

Note

Firmware versions

The description in these operating instructions refers exclusively to S200 drives with firmware version V6.2 or higher, which are configured with a Startdrive version V18 SP2 or higher.

- A new project has been created or an existing project is open.
- For activated user management (UMAC):
The function rights for editing drive data are activated for your user account.
Details on this topic are provided in Chapter "Security settings in Startdrive" of the Configuration Manual SINAMICS Industrial Security.

Procedure

Proceed as follows to insert a converter into the project:

1. Double-click "Add new device" in the project tree.
The corresponding dialog box opens.

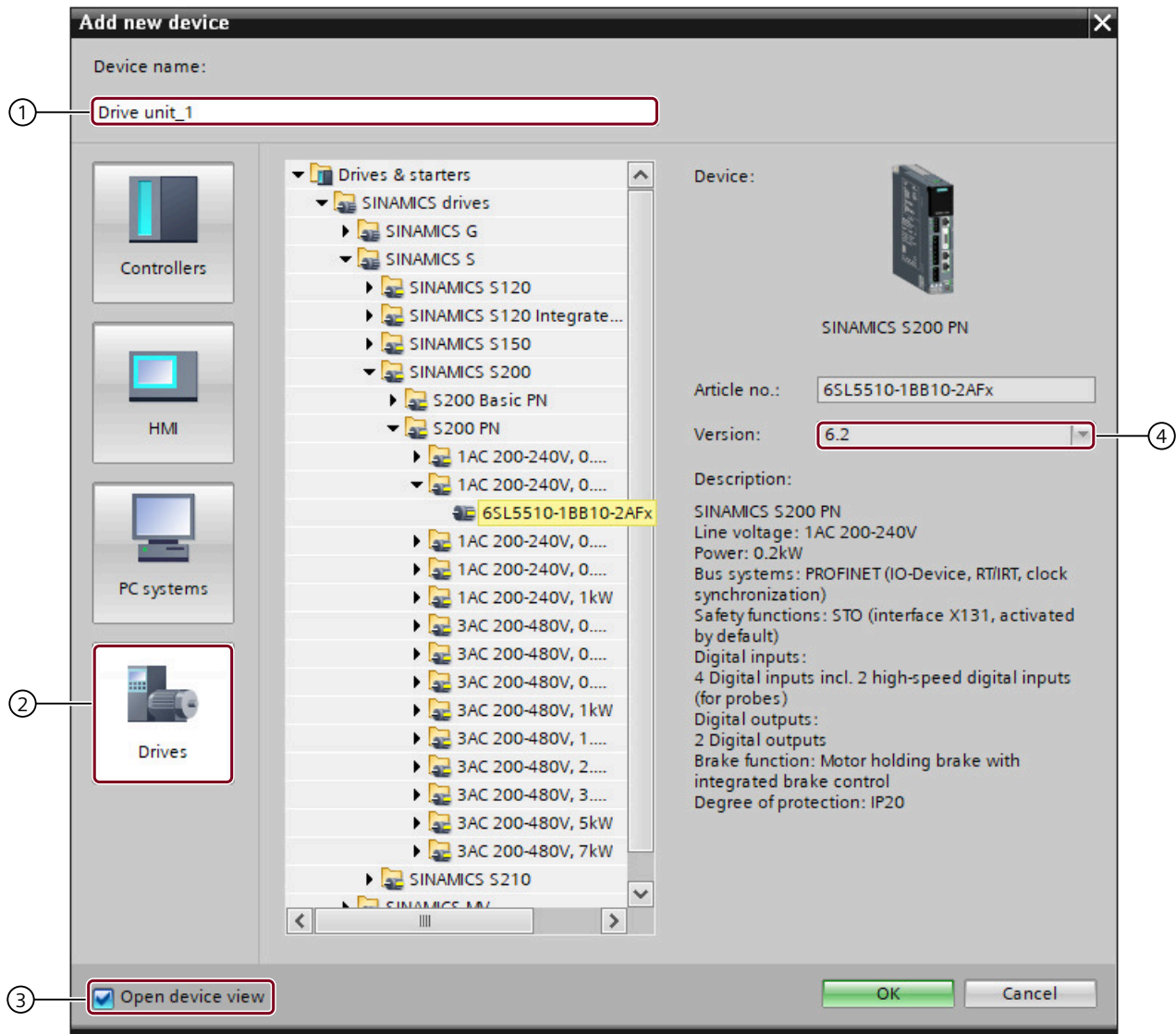

- ① "Device name" input field ("Drive unit_xx" by default)
- ② "Drives" button
- ③ Enable/disable the "Open device view" option
- ④ Firmware version drop-down list

Figure 8-2 Inserting a converter into the project

2. Click "②" to display the available SINAMICS converters.
3. Expand the "SINAMICS S200" entry in the displayed list.
A list of all available SINAMICS S200 Basic and S200 PROFINET converters is displayed.

8.5 Combining and configuring devices in the project

4. Expand the entry (e.g. 1AC 200-240 V, 0.2 kW) for the relevant converter.
The selected converter is displayed with the corresponding article number.
5. Click on the desired converter.
When a converter is created, the latest firmware version is always suggested in "④".
6. If the firmware version on the converter SD card deviates from the displayed firmware version, then change the firmware version via "④". You can also install the corresponding firmware version on your converter.
It will not be possible to go online later if the firmware versions do not match.
7. Assign a different device name in "①" if required.
8. Click "OK".
If "③" is enabled, the converter is automatically created in the project and displayed in the device view.

Result

The inserted converter is displayed in the device view and can be configured.

8.5.1.2 Optional: Replacing a converter

Overview

In the device configuration and the project tree of a drive, at any time, you can replace the current device by a device with another power rating. When replacing the drive, previous configurations of the motor and/or the encoder are kept if both devices are compatible with one another.

Requirement

- A project has been created.
- A converter has been inserted in the device configuration.
- For activated user management (UMAC):
The function rights for editing drive data are activated for your user account.
Details on this topic are provided in Chapter "Security settings in Startdrive" of the Configuration Manual SINAMICS Industrial Security.

Procedure

Replacing a device via the project tree

Proceed as follows to replace the current device via the project tree:

1. In the project tree, select the converter to be replaced. Open context menu "Change device". The corresponding dialog box opens.

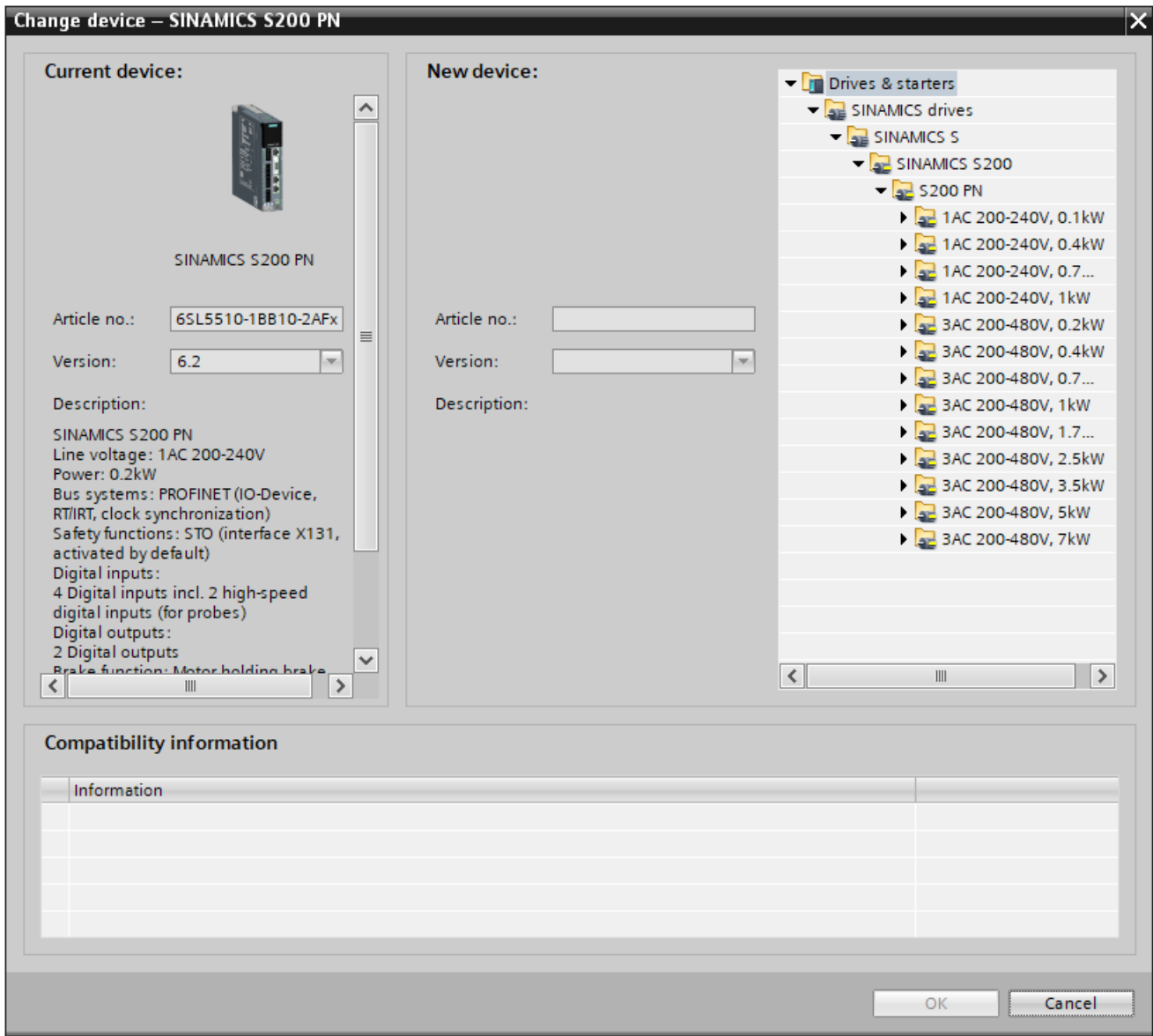

Figure 8-3 Changing the device via the project tree

The data of the current converter are displayed on the top left. At the top right, the replacement devices that are applicable are displayed in a hardware catalog.

2. Select the replacement device required in the hardware catalog of the dialog box.

8.5 Combining and configuring devices in the project

Only the most important data of the new converter are displayed at the center of the dialog box in the "New device" field. You can compare these data with the data of the current converter (left-hand side).

If both converters are not fully compatible, then the corresponding information is displayed in the "Compatibility information" field. This means that you may have to assign another motor if you still go ahead and accept the required replacement device.

3. Click "OK" to accept the new converter.

Replacing a device using the hardware catalog

Proceed as follows to replace the current device using the hardware catalog:

1. Select the new converter in the "Hardware catalog" task card. Drag the drive to the placeholder for the current drive in the "Device view" tab.
The corresponding dialog box opens.

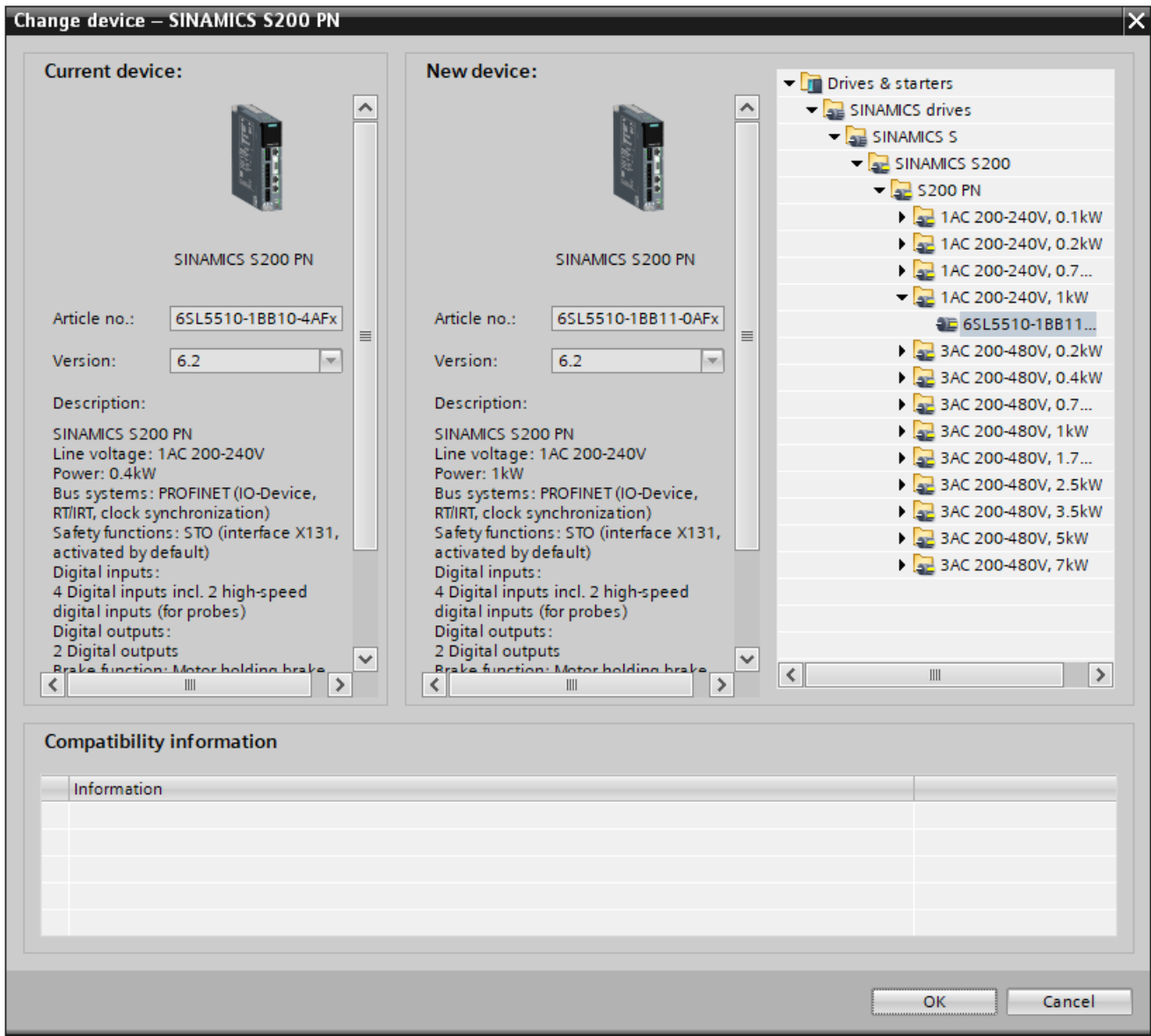

Figure 8-4 Changing the device using the hardware catalog

In the dialog box, the most important data of the existing converter and the new converter are compared.

If both converters are not fully compatible, then the corresponding information is displayed in the "Compatibility information" field. This means that you may have to assign another motor if you still go ahead and accept the required replacement device.

2. Click "OK" to accept the new drive.

Result

The current device is replaced by the required replacement device.

If the two devices are not completely compatible with one another, then in the "Device view" tab, the placeholder for the motor is displayed unspecified. You must reassign an appropriate motor power.

8.5.1.3 Making detailed converter settings

Overview

You can configure the following details for the converter:

Table 8-1 Detailed converter settings in the inspector window

Group	Settings
General	<ul style="list-style-type: none"> • Product information Name data • Catalog information Brief description, description of the components included, firmware version used • Identification & Maintenance Information and data to identify and localize a drive within a plant or system.
PROFINET interface [X150]	<ul style="list-style-type: none"> • General • Ethernet addresses Subnet, IP address, subnet mask, PROFINET names • Telegram configuration <ul style="list-style-type: none"> – Telegrams of the closed-loop drive control: Send, receive Details are contained in Chapter "Configuring telegrams (Page 276)" • Advanced options <ul style="list-style-type: none"> – Interface options – Media redundancy – Clock cycle synchronization for local modules (isochronous mode) – Real time settings – Port [X150 P1] and port [X150 P2]
Module parameters	<ul style="list-style-type: none"> • Activation of channel diagnostics
Protection & Security	<ul style="list-style-type: none"> • Wizard for security settings • User Management & Access Control (UMAC) • Ports and protocols • Encryption of drive data <p>Note: Information about these protection settings is provided in the Configuration Manual SINAMICS Industrial Security or in the information system of the TIA Portal.</p>
Ethernet commissioning interface [X127]	<ul style="list-style-type: none"> • General • Ethernet addresses: <ul style="list-style-type: none"> – Subnet, IP address, subnet mask

Group	Settings
Time synchronization/Time	<ul style="list-style-type: none"> Option "Synchronize with NTP server" If the drive is connected to a controller in the device configuration, the option "Use PLC as NTP server" is activated automatically. If the drive is connected to a PLC, the IP address of the PLC is displayed. In this case, the IP address and the time zone of the NTP server can be changed. Option "No synchronization" In this case, NTP synchronization is not managed in the project. You can configure this synchronization separately for the drive in online mode with the Online & Diagnostics function "Set time".
Hardware settings	<ul style="list-style-type: none"> Supply voltage
Web server	<ul style="list-style-type: none"> Enabling access to the PROFINET interface [X150] and the service interface [X127] via HTTP or HTTPS.

Requirement

- A new project has been created or an existing project is open.
- An S200 drive has been created in the project.
- For activated user management (UMAC):
The function rights for editing drive data are activated for your user account.
Details on this topic are provided in Chapter "Security settings in Startdrive" of the Configuration Manual SINAMICS Industrial Security.

Procedure

1. Select the converter in the device view and open the inspector window.
2. In the secondary navigation of the inspector window, select the desired detail menu (see the table above).
3. Make the required detail settings in the white fields. Default settings are usually available in most detail menus.
The gray fields are corrected automatically in accordance with their setting. Fields with a gray background cannot be edited directly.

Result

You have made the detailed settings for the converter in your device configuration.

8.5.1.4 Specifying a motor

Overview

The drive that has just been inserted in the project has a placeholder for the required motor (standard motor type: "1FL2"). You must specify this placeholder in the configuration.

Requirement

- A project has been created.
- An S200 drive is inserted in the device configuration.
- For activated user management (UMAC):
The function rights for editing drive data and configuring in the inspector window are activated for your user account.
Details on this topic are provided in Chapter "Security settings in Startdrive" of the Configuration Manual SINAMICS Industrial Security.

Procedure

1. Double-click on the white motor placeholder (MOT) in the drive. The inspector window is displayed.
2. Select the "Motor - selection - 1FL2" entry in the secondary navigation in the inspector window.
3. In the list, select the motor power rating and an associated encoder based on the article number.

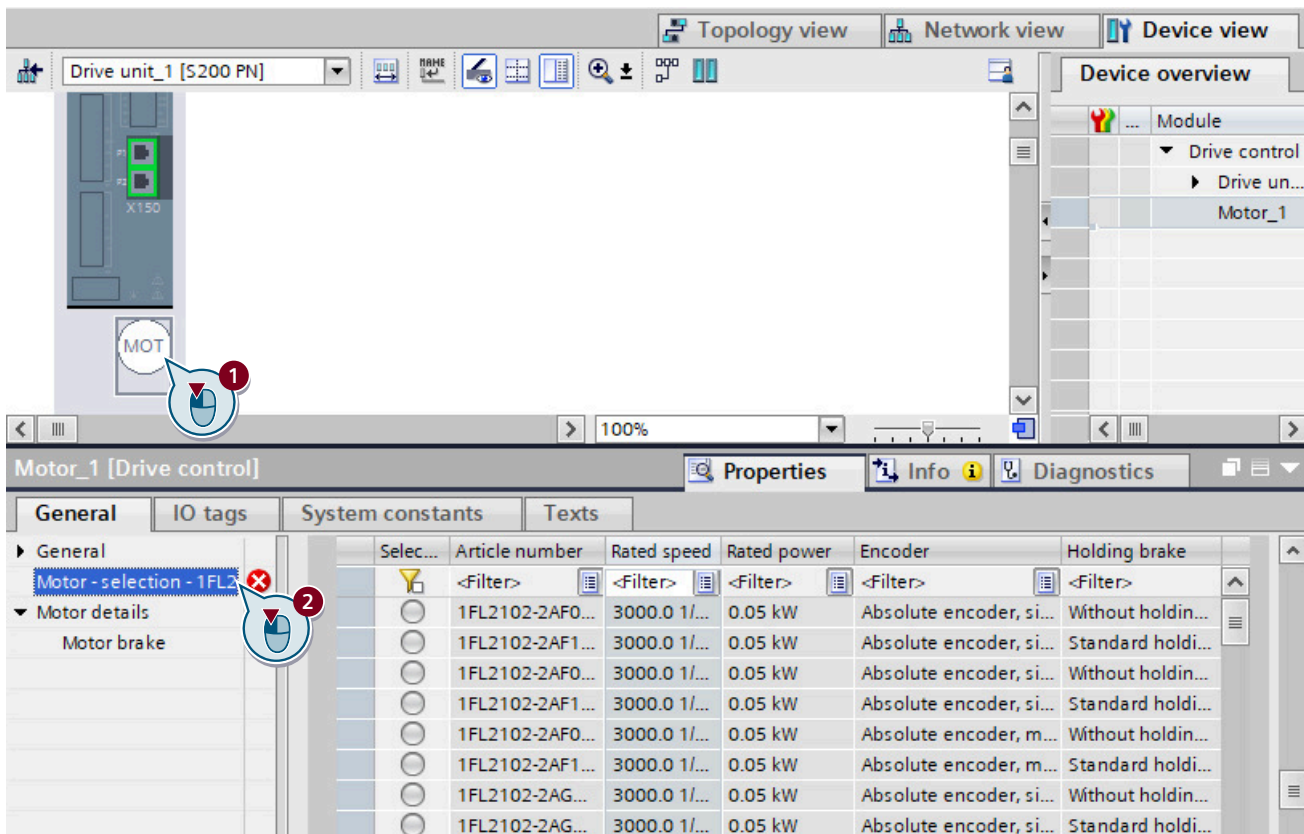

Figure 8-5 Selecting a motor in the inspector window

Result

The motor placeholder is assigned the data of the selected motor. The white area turns gray.

The motor has been added. The assigned encoder and the encoder evaluation are automatically also added and specified.

You can then carry out the basic parameterization (Page 267), or alternatively, you can carry out the guided quick startup (Page 245).

8.5.2 Control and technology object

8.5.2.1 Inserting a SIMATIC S7 controller into the project

Overview

If, in addition to the SINAMICS drive, you also wish to use a SIMATIC S7 controller in the device configuration, then create an appropriate PLC in your project.

Note**Other control systems**

As an alternative to a SIMATIC S7 controller, a SINUMERIK ONE or a SINUMERIK MC can be used. The procedure remains the same.

Requirement

- A new project has been created or an existing project is open.
- For activated user management (UMAC):
The function rights for editing drive and control system data are activated for your user account.
Details on this topic are provided in Chapter "Security settings in Startdrive" of the Configuration Manual SINAMICS Industrial Security.

Procedure

Proceed as follows to insert a SIMATIC S7 controller into the project:

1. Double-click "Add new device" in the project tree.
The corresponding dialog opens.

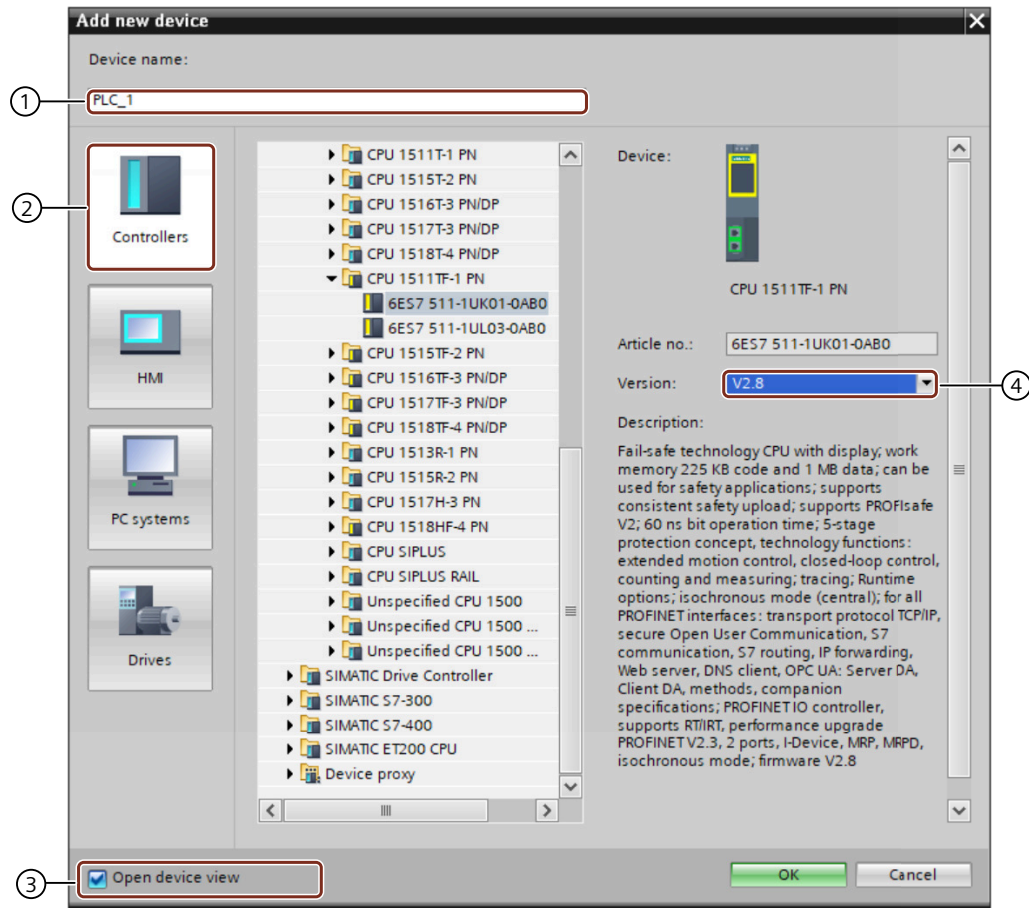

- ① "Device name" input field ("PLC_xx" by default)
- ② "Controller" button
- ③ Enable/disable the "Open device view" option
- ④ Firmware version drop-down list

2. Click "②" to show the available controllers.
3. Expand the desired controller type (e.g. SIMATIC S7-1500) and select the desired CPU (e.g. CPU 1511TF-1 PN) in the list.
When the CPU is expanded, the component is displayed with its article number.
The current firmware version is always suggested in "④" when you create a SIMATIC S7 controller.
4. If the firmware version on the SD card of your SIMATIC S7 controller deviates from the displayed firmware version, then change the firmware version via "④".
It will not be possible to go online later if the firmware versions do not match.

5. Assign a different device name in "①" if required.
6. Click "OK".
If "③" is activated, the SIMATIC S7 controller is automatically created in the project and then displayed in the device view.

Result

The inserted SIMATIC S7 controller is displayed in the device view and can be configured.

8.5.2.2 Networking a controller and a converter

Overview

After inserting a SIMATIC S7 controller and a converter into the project, network the components in the network and topology view.

Requirement

- A project is open.
- The project includes at least one drive and one control system.
- For activated user management (UMAC):
The function rights for editing drive and control system data are activated for your user account.
Details on this topic are provided in Chapter "Security settings in Startdrive" of the Configuration Manual SINAMICS Industrial Security.

Procedure

Proceed as follows to establish the connection between the controller and the drive.

1. Double-click "Devices & networks" in the project tree to open the network view.
2. Draw a connection between the PROFINET interface of the controller and the PROFINET interface X150 of the converter.
The PROFINET connection is established, and the converter is assigned to the controller.

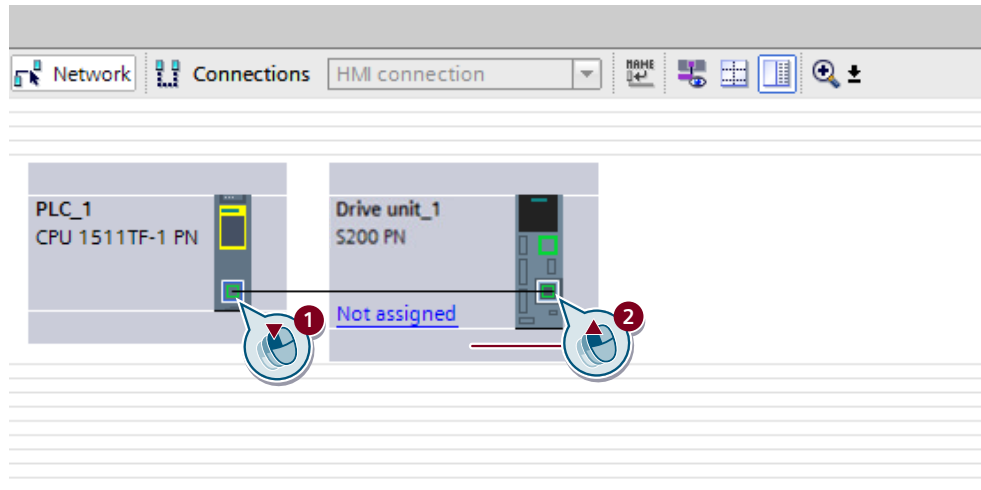

3. Click the PROFINET interface_1 [X1].

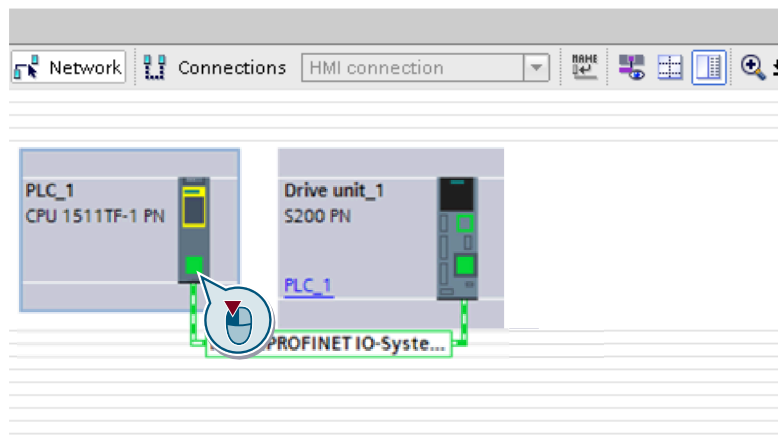

4. Open the "Advanced options" menu.
The menu item is in the secondary navigation, in the "General" tab.
5. Open the "Realtime settings" menu.

- Open the "Synchronization" menu with a double-click.

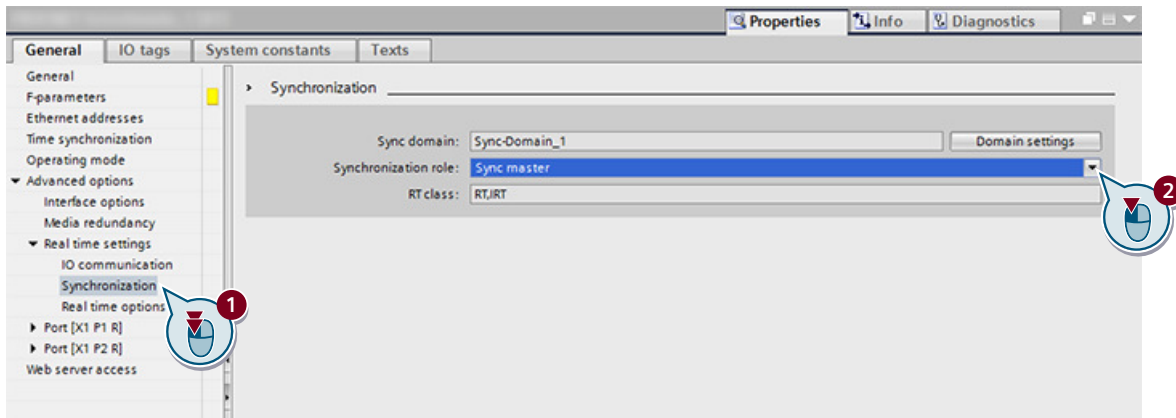

- Select the "Sync master" setting from the "Synchronization role" drop-down list.
- Switch to the topology view.
- Draw a connection between Port_1 [X1.P1] of the controller and Port_1 [X150.P1] of the converter.

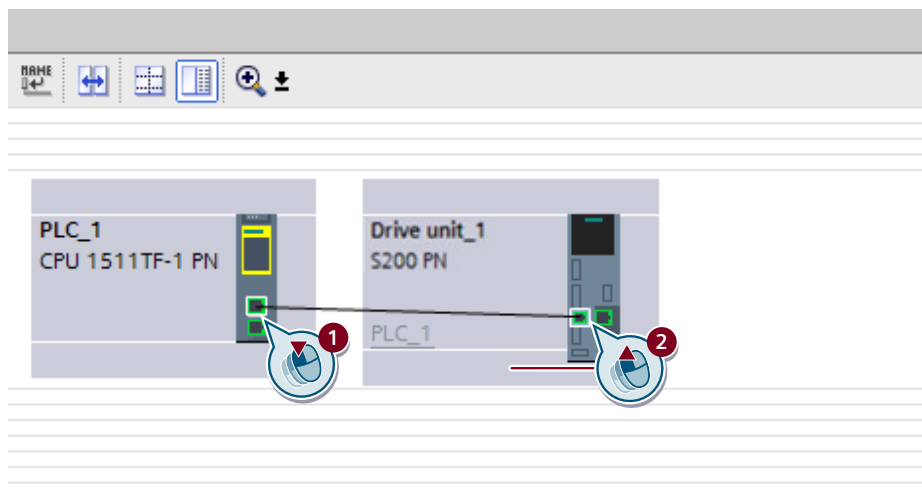

Result

The SIMATIC S7 controller and the converter are networked with one another in the network and topology view.

8.5.2.3 Inserting a technology object into the SIMATIC S7 controller

Overview

Through the technology object, Motion Control functions such as positioning and synchronous axes are available to you. For this reason, insert a new technology object (TO) in the SIMATIC S7 controller. In the "Configuration" function view, you can directly assign the inserted SINAMICS drive and go to the drive configuration.

8.5 Combining and configuring devices in the project

Positioning is the most frequent application for SINAMICS drives. To be able to perform positioning tasks in the SIMATIC S7 controller, you need to insert the Motion Control function "TO_PositioningAxis". Inserting a TO is described below based on the example of the Motion Control function "TO_PositioningAxis".

Requirement

- A SINAMICS drive is created and specified.
- A control system (e.g. SIMATIC S7-1500) is created and networked with the drive.
- For activated user management (UMAC):
The function rights for editing drive and control system data are activated for your user account.
Details on this topic are provided in Chapter "Security settings in Startdrive" of the Configuration Manual SINAMICS Industrial Security.

Procedure

Proceed as follows to insert a technology object into the controller:

1. In the project tree, expand the "Technology objects" entry under the menu for the SIMATIC S7 controller.

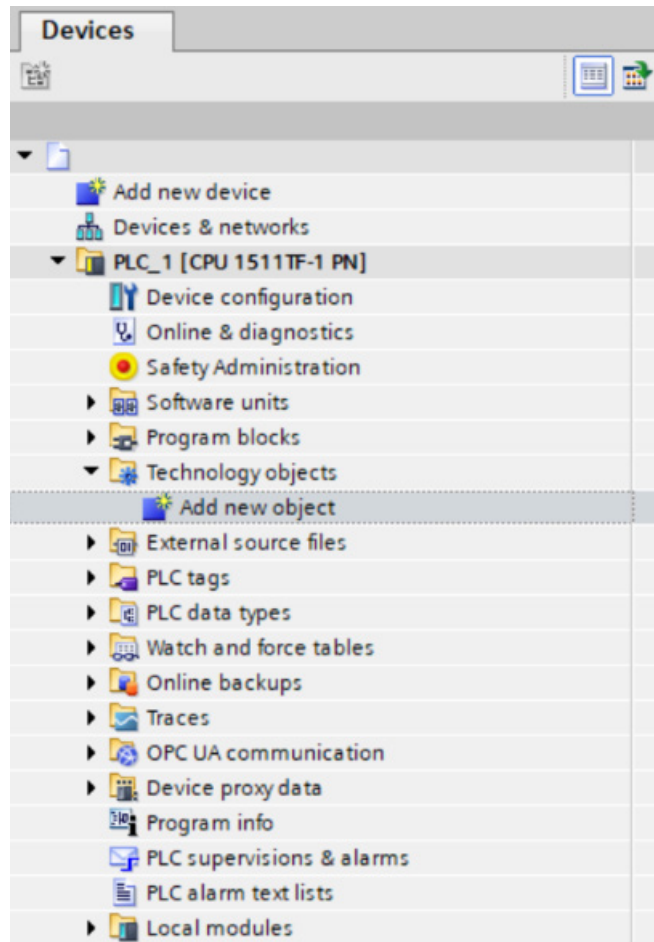

2. Double-click the "Add new object" entry.
The corresponding dialog opens.

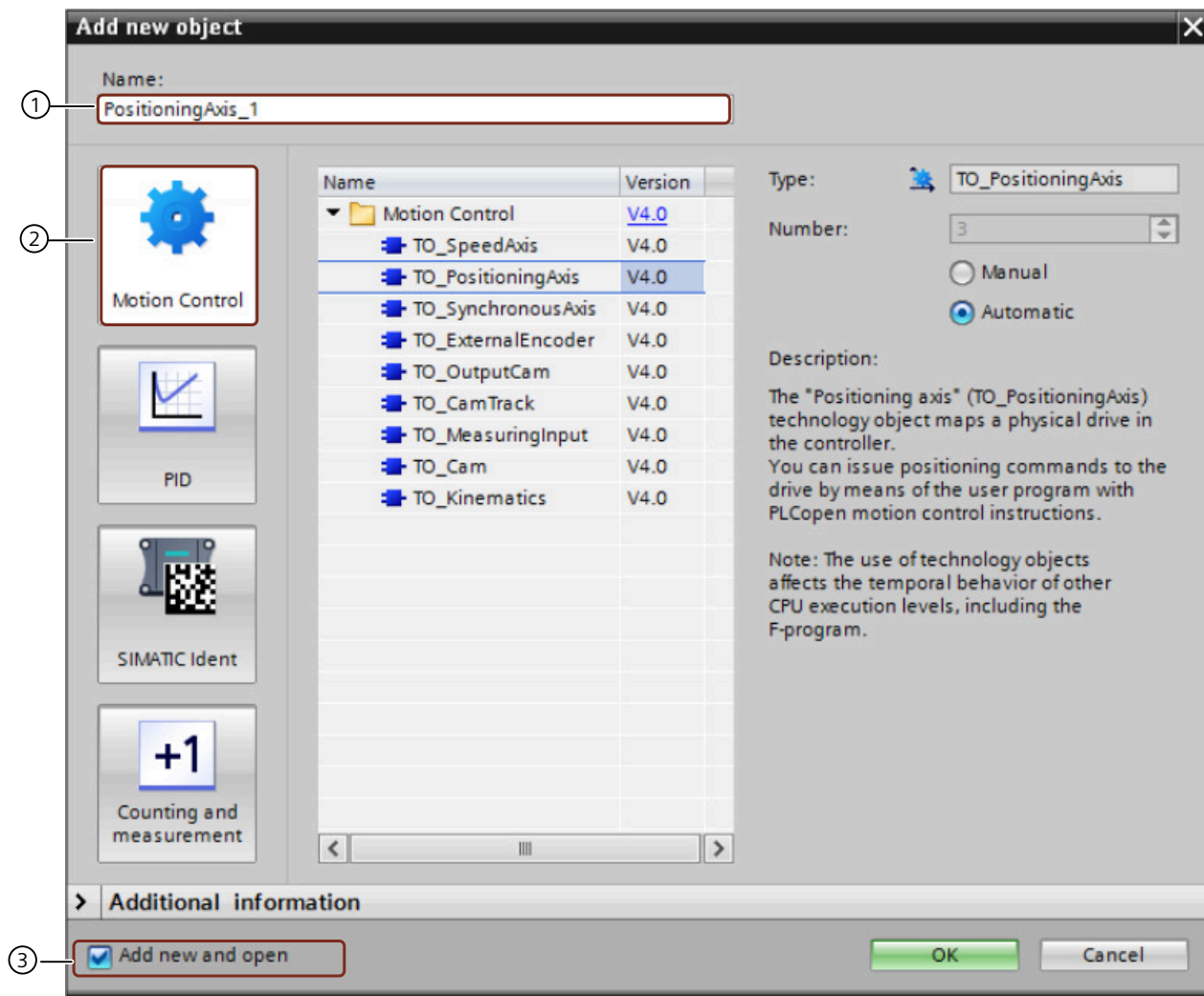

① "Object name" input field

② "Motion Control" button

③ Enable/disable "Add new and open" option

3. Click "②" to present the available technology objects.
4. Select the object "TO_PositioningAxis".
5. If required, assign a different name for the object in "①".
6. Click "OK".

Result

The "TO_PositioningAxis" technology object has been inserted and can be configured.

8.5.2.4 Interconnecting the technology object and a converter

Overview

The inserted technology object "TO_PositioningAxis" must be interconnected with the converter.

Requirement

- A SINAMICS drive is created and specified.
- A control system (e.g. SIMATIC S7-1500) is created and networked with the drive.
- For activated user management (UMAC):
The function rights for editing drive and control system data are activated for your user account.
Details on this topic are provided in Chapter "Security settings in Startdrive" of the Configuration Manual SINAMICS Industrial Security.

Procedure

Proceed as follows to manually interconnect the drive with the inserted TO:

1. In the project tree, double-click the "Configuration" entry under the created technology object.
2. Select the "Hardware interface" menu ① in the secondary navigation. The corresponding function view opens.

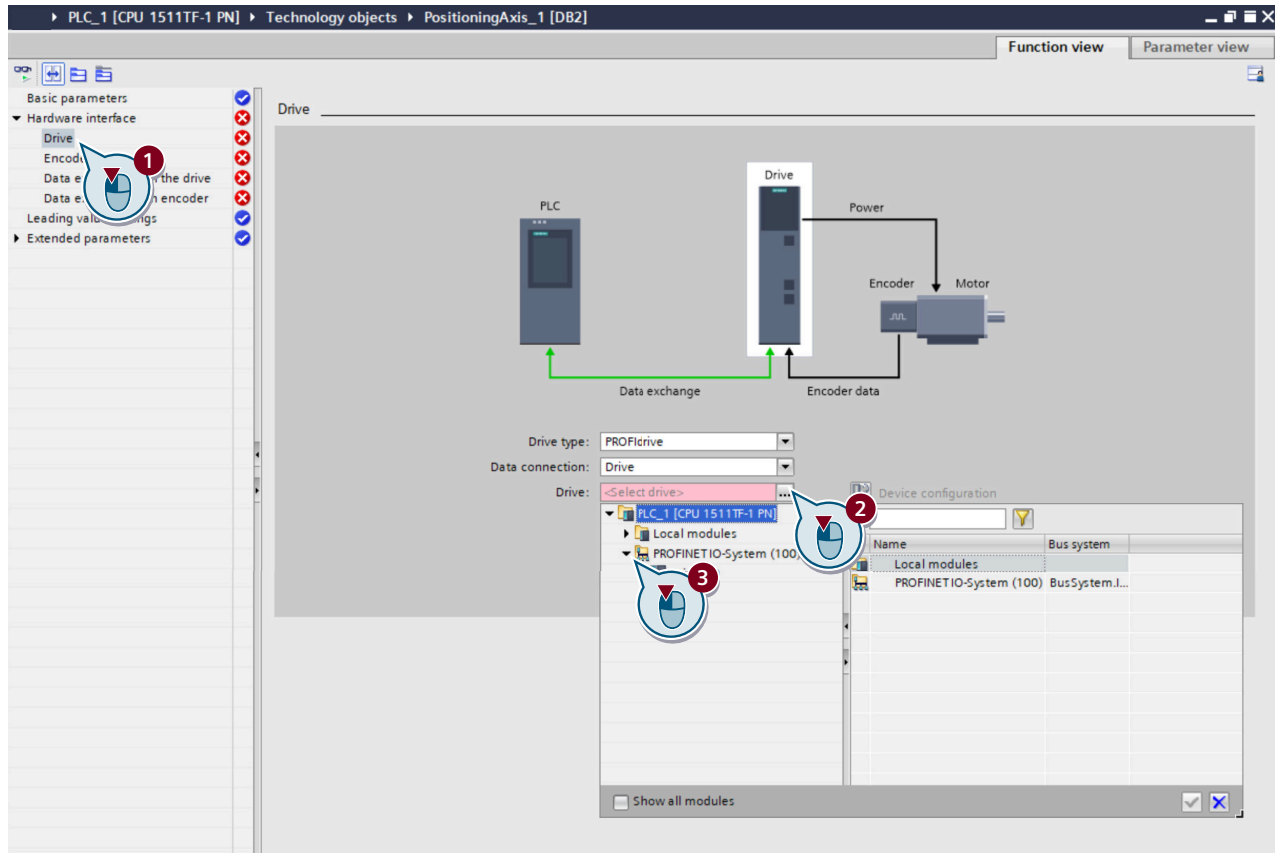

3. Open the selection list in the "Drive" selection box ②.
4. Expand the "PROFINET IO system (100)" entry ③.
5. Click on the displayed converter (in this case: "Drive unit_1"). Telegram 105 is automatically preset.
6. Click on the checkmark icon to confirm the selection. The "Device configuration" setting option is enabled. In addition, the "Drive configuration" setting option is displayed and enabled.
7. Click  to get to the basic parameter assignment of the converter.

8.6 Carrying out guided quick startup

8.6.1 Overview

Overview

Using the "guided quick startup", you perform the basic settings for the drive in Startdrive that are used to avoid the following detailed settings as far as possible. All drive settings are pre-assigned according to the required application use via these basic settings.

Requirement

- The drive has been completely created and specified in the device configuration. Without a complete specification, the guided quick startup cannot be used and a message appears.
- If a control is also used, it must be connected to the drive in the topology view and in the network view. The connection between the devices must also be configured.
- Optional: The operating unit is connected to the drive via LAN (physically online).
- For activated user management (UMAC):
The function rights for editing drive data are activated for your user account. Details on this topic are provided in Chapter "Security settings in Startdrive" of the Configuration Manual SINAMICS Industrial Security.

Description of function

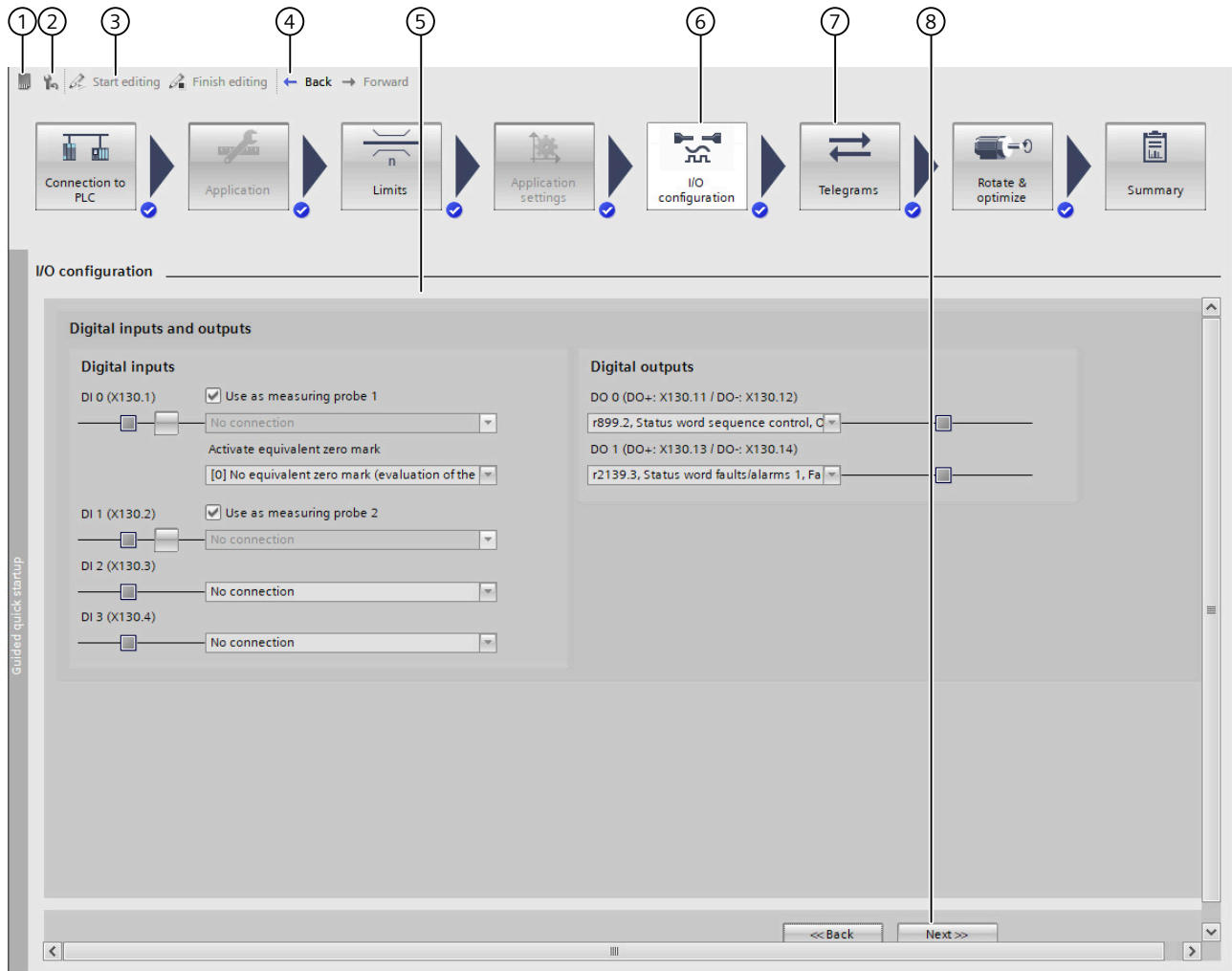

- ① Icon: save data retentively (in the online mode)
- ② Icon: restore the factory settings (in online mode)
- ③ Buttons: start or exit the editing mode (in the online mode)
- ④ Buttons: jump to the next or previous step
- ⑤ Detailed setting of active quick startup step
- ⑥ Active quick startup step: button is brightened
- ⑦ Inactive quick startup step: one of several possible steps
- ⑧ Quick startup buttons:
 - Back/Next: are always displayed.
 - Cancel/finish: only displayed in online mode.

Figure 8-6 Example: guided quick startup in offline mode

You can define the following basic settings in the quick startup steps with the same name:

- **Connection to PLC**
This step shows that the converter in the project can only be operated with a controller only. You specify whether motion control is carried out by the drive or the controller.
- **Application**
You define the converter control mode in this step. With the "Positioning" control mode activated, make detailed settings, for example the motion type, the measuring unit, encoder settings for the position control or the values for a modulo correction.
- **Limits**
The settings in this step depend on the control mode selected in step "Application".
 - "Speed control" control mode
In this case, you define the minimum and maximum values of the motor used: torque, speed, and operating times.
 - "Positioning" control mode
In this case, you make the settings for the traversing profile, for alternative ramp-down times, for jerk limitation and for traversing range limitation.
- **Application settings**
This step is only active when the "Positioning" control mode is activated. You make the detailed settings for active homing and absolute encoder adjustment in this step.
- **I/O configuration**
You specify the function of individual inputs and outputs of the converter.
- **Telegrams**
The preferred telegrams are suggested based on the selected control mode. You can define different telegrams and make detailed settings. Telegram settings can be made in offline mode only.
- **Rotate & Optimize**
You optimize the motor in the online mode. The control panel or One Button Tuning is available for this purpose.
- **Summary**
You find a compilation of all settings made after completing the configuration in the guided quick startup.
 - Offline mode: When required, you can load these settings directly to the drive.
 - Online mode: When required, you can load these settings directly to the Startdrive project.

Note

The significance of Note symbols

Settings of individual steps may affect the previous settings of other steps. In this case, an appropriate note with the  symbol appears at the active quick startup step. Check and, if necessary, correct the corresponding settings.

Further identifications:



The  symbol designates information or a context-sensitive note for users.

The  symbol identifies an area of the step where an entry is urgently required.

Status display after changes

Changes to individual settings can also affect settings in the guided quick startup. Status symbols indicate the change state of the particular step

Table 8-2 Status symbols

Icon	Meaning
	The system defaults in this step are valid.
	The settings made in this step are valid. The settings were made directly in this step, or are the consequences of settings in another step.
	The program changed the settings in this step. Possible causes are: <ul style="list-style-type: none"> • Subsequent changes were made in other steps, which are not automatically valid. • The device configuration was subsequently changed. The changes influence the original settings. Check the settings of this step.

More information

For more information about guided quick startup, see the information system of the TIA Portal.

8.6.2 Editing mode (online only)**Overview**

If you want to work with the guided quick startup in online mode, you need restore points in case commissioning is aborted. Restore points are stored retentively on the SD card of the converter.

Restore points are automatically created when activating or exiting the editing mode and also when switching from one step into the next step of the quick startup.

Note**Behavior when the online connection is terminated**

If the connection to the drive is re-established after the online connection has been terminated, the program reverts to the stored data of the last restore point.

Requirement



- The drive has been completely created and specified in the device configuration.
- If a control is also used, it must be connected to the drive in the topology view and in the network view. The connection between the devices must also be configured.
- There is an active online connection between the drive and the operating unit.
- No other access from another operating unit to the selected converter is active.

Procedure

Activating/exiting editing mode

Settings in the guided quick startup can be made online only in an "editing mode".

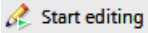
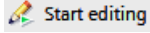
Table 8-3 Activating and exiting editing mode

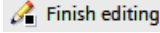
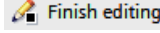
Display	Status	Description
	The editing mode is not yet activated.	<p>Proceed in either of the following ways to activate editing mode:</p> <ul style="list-style-type: none"> In the toolbar of the step, click on the button  Click in the step below the button  <p>You can configure the settings.</p>
	The editing mode is active.	<p>Proceed in either of the following ways to exit editing mode:</p> <ul style="list-style-type: none"> In the toolbar of the step, click on the button  Click in the step below the button  <p>Editing has been finished. A new restore point is assigned automatically. The current configuration is saved retentively.</p>

Note

Message in case of multiple access

The editing mode can only be activated if the drive is not simultaneously accessed by another PC via Startdrive or the web server.

If another access is active, activation of the editing mode will be denied. An appropriate message is displayed.

Note

Message when editing factory settings in the online mode

A message is displayed if a drive still has the factory settings, and the editing mode of the guided quick startup is started. This states that the motor data are based on the rated power of a standard motor.

Therefore, check the motor data online in the "Show motor data" dialog box. When required, correct the motor data and close the dialog.

Completing online commissioning

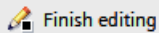
- To complete online commissioning in the guided quick startup, click on button . All settings made in the quick startup are then saved retentively. You are provided with an overview of all of the settings made in the last "Overview" step.

Canceling online commissioning

- If you want to cancel online commissioning via the guided quick startup, click on the "Cancel" button, and a confirmation prompt appears.
- If you really want to cancel, click "OK". All settings made in the quick startup are then discarded. Then the previous settings are restored via the last restore point.

8.6.3 Connection to PLC

Overview

The quick startup step "Connection to PLC" indicates that this drive can only be commissioned in conjunction with a controller.

In this step, you specify whether Motion Control is carried out by the drive or the controller.

Requirement

- The drive has been completely created and specified in the device configuration. Optionally, a controller (PLC) also can be created in the device configuration and networked with the drive.
- For activated user management (UMAC):
The function rights for configuring in the quick startup are activated for your user role. Details on this topic are provided in Chapter "Security settings in Startdrive" of the Configuration Manual SINAMICS Industrial Security.

Procedure

The setting "Define the connection to PLC" is automatically preassigned with "Yes". SINAMICS S200 drives can only be operated in conjunction with a PLC. For this reason, this setting cannot be changed.

Proceed as follows to define whether Motion Control is executed by the drive or by the controller:

1. Specify whether the Motion Control is executed by the drive or by a connected controller. The activated area of the switch is marked blue (). Click the white part of the switch if you wish to change the active setting.
2. Save the setting in the project.
3. Click "Next" to display the next quick startup step.

Result

Startdrive defines the default settings of the setup based on your specifications.

Note

EPOS settings deactivated

If you defined that the ramp-function generator function (Motion Control) is performed by a connected control system, then quick startup steps "Application" and "Application settings" are deactivated. EPOS settings are then not possible.

8.6.4 Application

Overview

In quick startup step "Application" you define in detail in which application area the drive is to be used. You define the following settings:

- The control mode of the application
- The motion type of the drive
- The encoder (type) for the position control
- The modulo correction

Requirements

- The drive has been completely created and specified in the device configuration.
- In quick startup step "Connection to the PLC", it is defined that the ramp-function generator in the drive should be used.
- For activated user management (UMAC):
The function rights for configuring in the quick startup are activated for your user role. Details on this topic are provided in Chapter "Security settings in Startdrive" of the Configuration Manual SINAMICS Industrial Security.

Procedure

1. Select how you wish to control your drive in your application. Define the required control mode. Click the appropriate button:
 - Speed control
The speed is controlled as precisely as possible to track a specified setpoint.
 - Positioning
A "Basic positioner (EPOS)" calculates the traversing profile to traverse an axis as quickly as possible to a target position.

It is impossible to select several control modes simultaneously. For control mode "Speed control" no other settings are possible.
For control mode "Positioning", the following detailed settings are required:
2. Select the motion type that you wish to use for the drive when positioning.
For more information about the motion type, see Section "Axis type (Page 366)".
3. Select the measurement units for position and velocity.
The units that can be set depend on the motion type. All values are reset to the default values when changing the measurement unit and the axis type.
4. Use the settings for the motor encoder used for the position control:
 - Acquire the number of motor revolutions, load revolutions, and leadscrew pitch.
5. Optionally, activate option "Modulo correction activation" and define the modulo range.
6. Click "Next" to display the next quick startup step.

Result

Startdrive defines the default settings of the setup based on what you have specified. The telegrams that match the selected application area are also preset.

When control mode "Positioning" is activated, then the additional quick startup step "Application settings" is activated. In this step, you define the settings for active homing or for an absolute encoder adjustment.

You can also configure additional EPOS functions via the function view "Parameterization > Technology functions > Basic positioner".

8.6.5 Limits

8.6.5.1 Configuring limits when "Speed control" is active

Overview

When speed control is active, you define the basic properties of the closed-loop drive control in the "Limits" quick startup step. When positioning is active, all other settings are visible (see Section "Configuring limits when "Positioning" is active (Page 253)").

Designation	Number	Description
Positive speed limit	p1083	Maximum speed for the positive direction. The set value must be less than or equal to the maximum speed (p1082).
Negative speed limit	p1086	Maximum speed for the negative direction. The set value must be less than or equal to the maximum speed (p1082).
Torque limit upper	p1520	Defines the upper torque limit or torque limit when motoring.
Torque limit lower	p1521	Defines the lower torque limit or the torque limit when generating.
Quick stop Ramp-down time (OFF3)	p1135	The OFF3 ramp-down time is effective from the maximum speed down to the motor standstill.

Note

Displaying the actual motor data

The actual motor data of the drive are shown in dialog "Show motor data". The dialog can be opened using button "Show motor data". The following values can be configured:

- Supply voltage
- Motor ambient temperature
- Direction of rotation

Requirement

- The motor used in the device configuration of the drive has been completely specified and configured.
- Control mode "Speed control" is activated in the quick startup step "Application". When "Positioning" is active other settings are displayed.
- For activated user management (UMAC):
The function rights for configuring in the quick startup are activated for your user role. Details on this topic are provided in Chapter "Security settings in Startdrive" of the Configuration Manual SINAMICS Industrial Security.

Procedure

1. When required, adapt the specified default values (see the table above).
2. Click "Next" to display the next quick startup step.

Result

Startdrive defines the default settings of the setup based on what you have specified.

8.6.5.2 Configuring limits when "Positioning" is active**Overview**

The following settings are displayed in quick startup step "Limits" if a basic positioner is used in the drive for positioning. You define the following limits for EPOS in the lower part of the step:

- Traversing profile
Defines the maximum traversing profile limitation referred to the velocity.
- Ramp-down times
Defines the maximum delay time referred to the maximum speed.
- Jerk
Jerk limitation delays the acceleration.
- Traversing range limitation
The traversing range is dynamically limited by the software limit switch, or alternatively, via the hardware limit switch.

Note**Displaying the actual motor data**

The actual motor data of the drive are shown in dialog "Show motor data". The dialog can be opened using button "Show motor data". The following values can be configured:

- Supply voltage
 - Motor ambient temperature
 - Direction of rotation
-

Requirement

- The motor used in the device configuration of the drive has been completely specified and configured.
- Control mode "Positioning" is activated in the quick startup step "Application".
When "Speed control" is active other settings are displayed.
- For activated user management (UMAC):
The function rights for configuring in the quick startup are activated for your user role.
Details on this topic are provided in Chapter "Security settings in Startdrive" of the Configuration Manual SINAMICS Industrial Security.

Procedure

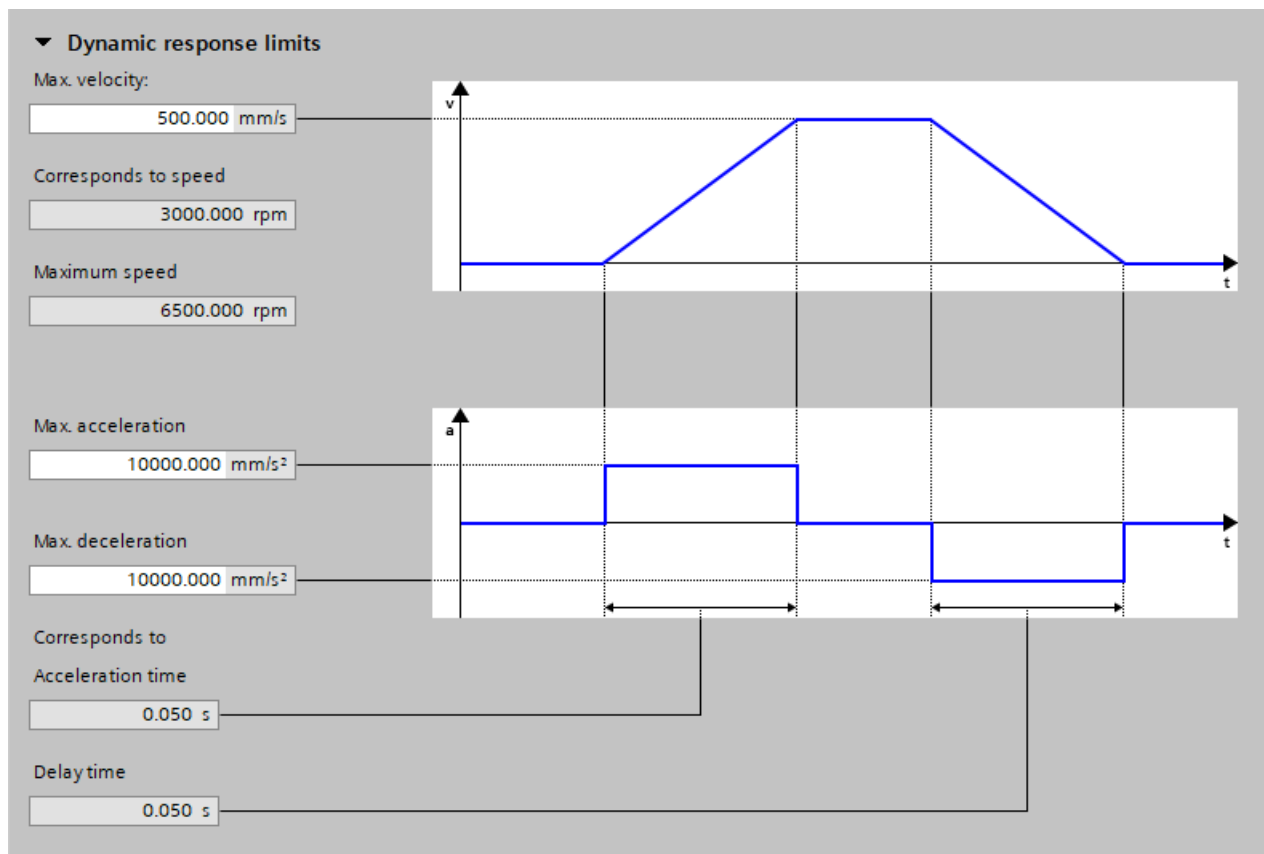

Figure 8-7 Specifying the maximum traversing profile limitation

Step 1: Specifying the maximum traversing profile limitation

Proceed as follows to specify the maximum traversing profile limitation

1. Correct the specified value for the maximum velocity in the "Max. velocity" field.
The maximum velocity defines the maximum travel velocity. A change immediately limits the velocity of an active traversing block.
The "Corresponds to speed" field displays the converted speed, the "Maximum speed" field displays the maximum speed.
The limitation acts when positioning (jogging, processing the traversing blocks, direct setpoint input, home position approach).
2. Correct the specified value for the acceleration at "Max. acceleration".
The "Corresponds to Acceleration time" field displays the converted acceleration time.
3. Correct the specified value for the deceleration at "Max. deceleration".
The "Delay time" field displays the converted deceleration time.
The maximum acceleration and maximum deceleration specify the maximum acceleration for increasing the velocity and the maximum deceleration for reducing the velocity. Both values act when positioning (jogging, processing the traversing blocks, direct setpoint input, home position approach).
4. Save the settings.

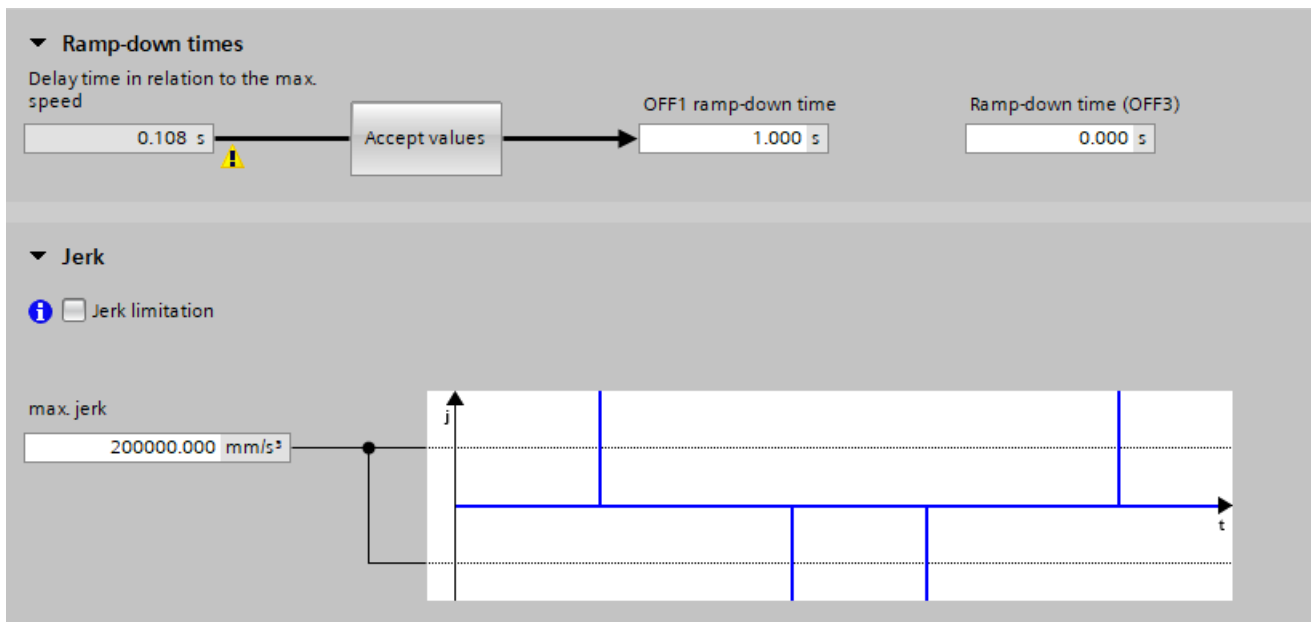

Figure 8-8 Specifying the ramp-down time and jerk limitation

Step 2: Specifying the ramp-down time referred to the maximum speed

The velocity, acceleration and deceleration limitation values do not apply for faults or for a safe stop. Instead, the ramp-down times for OFF1 and OFF3 are used. The proposed ramp-down time is displayed in the "Delay time in relation to the max. speed" field.

1. If you want to apply this delay time to OFF1, click the "Accept values" button.
The delay time is now applied to the "OFF1 ramp-down time" (p1121) field.
2. Enter the required value in field "Ramp-down time (OFF3)" (p1135).
3. Save the settings.

Step 3: Specifying the maximum jerk limitation

A jerk limitation delays the acceleration. Proceed as follows to specify the maximum jerk limitation:

1. Activate option "Jerk limitation". (p2575)
2. Enter a value for the maximum jerk limitation under "max. jerk" (p2574).
The converted values for the minimum acceleration time and minimum deceleration time are displayed in the fields below the graphic.
3. Save the settings.

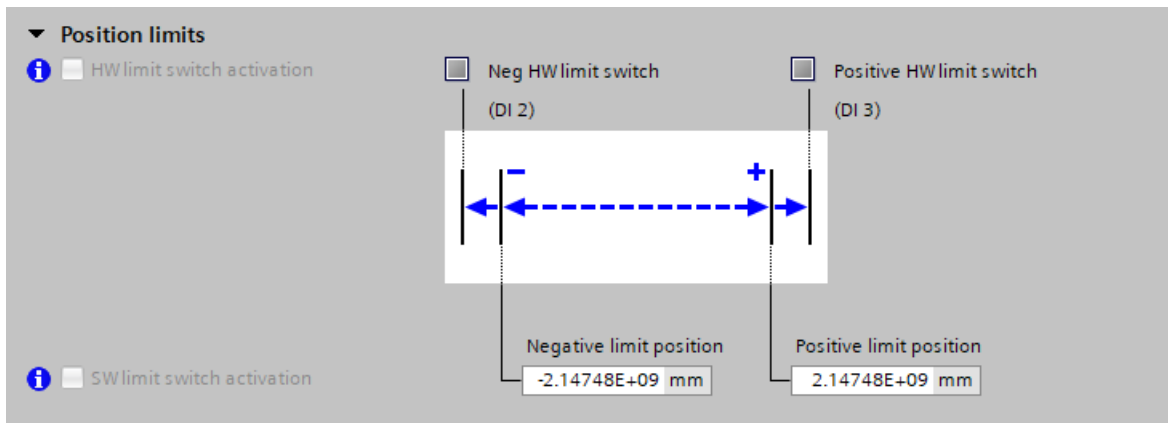

Figure 8-9 Defining traversing range limitation

Step 4: Defining traversing range limitation

1. Activate option "SW limit switch activation" if you wish to limit the traversing range using the software.
2. Then enter the values for the negative end position and the positive end position.
Both values are preassigned with the factory settings.
3. Activate option "HW limit switch activation" if you wish to limit the traversing range optionally or additionally on the hardware side.
4. Save the settings.

Result

Startdrive defines the default settings of the setup based on what you have specified. These default settings have an impact on the following EPOS settings in the guided quick startup or under "Parameterization > Technology functions > Basic positioner".

8.6.6 Application settings

Overview

Make the positioning settings for EPOS in quick startup step "Application settings". The positioning settings listed depend on the defined application area.

Description of function

You can make the following EPOS settings:

- Active homing
- Absolute encoder adjustment

You can make the following additional EPOS settings via function view "Parameterization":

- Passive homing
- Limitations
- Position monitoring functions
- Direct setpoint specification (MDI)
- Traversing blocks
- Jogging

In addition, in the same function view you can also see the status of all EPOS functions.

8.6.6.1 Configuring active homing

Overview

With an incremental measuring system, the drive can be homed without requiring a higher-level control. Active homing can be used to traverse to a home position.

The drive itself controls and monitors the homing cycle. There are 3 homing modes for active homing.

Requirements

- The drive has been completely created and specified in the device configuration.
- In quick startup step "Connection to the PLC", it is defined that the drive executes the Motion Control.

8.6 Carrying out guided quick startup

- "Positioning" as method of control is defined in quick startup step "Application".
- For activated user management (UMAC):
The function rights for configuring in the quick startup are activated for your user role. Details on this topic are provided in Chapter "Security settings in Startdrive" of the Configuration Manual SINAMICS Industrial Security.

Procedure

1. In quick startup step "Application settings" open the detailed settings for homing mode "Active homing".
The detailed settings are displayed.
2. Activate the required homing mode in field "Homing mode selection".

①	Use the encoder zero mark and reference cam
②	Use the encoder zero mark
③	Use the external zero mark via digital input

3. Activate the required approach direction (positive or negative).
4. Optional (for ① and ③):
For home position approach, enter the approach velocity to the reference cam in field "to the reference cam".

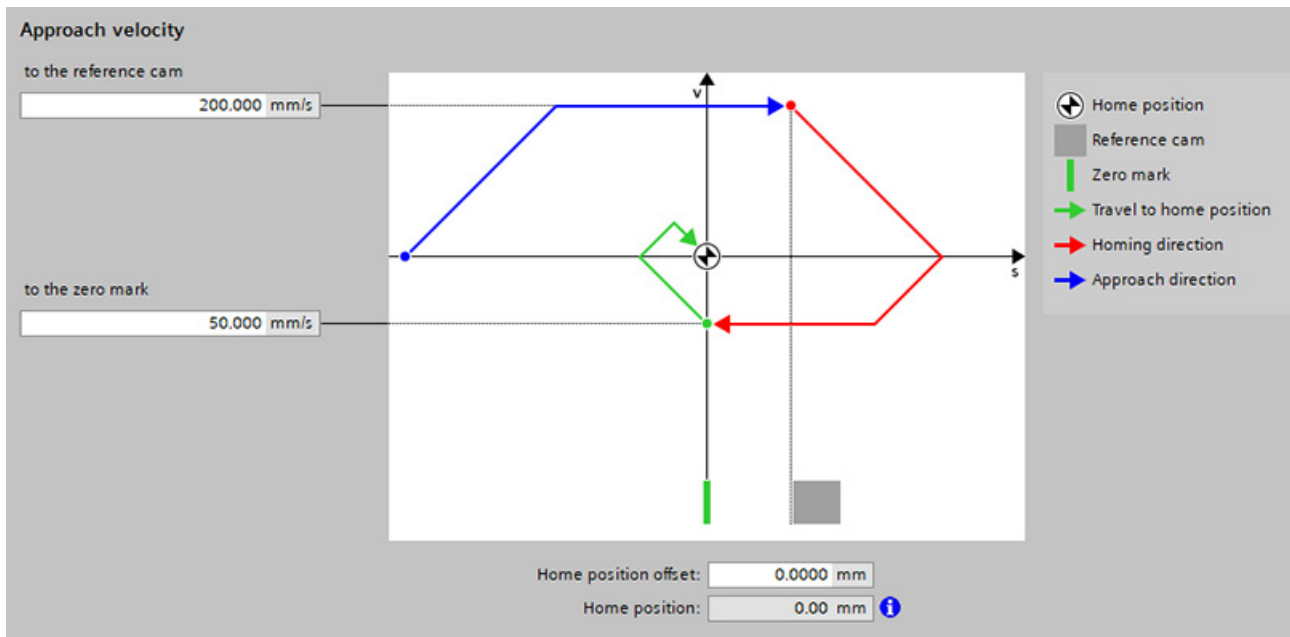

Figure 8-10 Example: configuring approach velocity in mode ①

5. Enter an approach velocity in field "to the zero mark".
For home position approach, this approach velocity is applicable after detecting the reference cam to search for the zero mark.

6. Optional (for ③):
From drop-down list "Digital input of the external zero mark" (p0494) select the input terminal to connect a zero mark replacement.
This parameter supplies incorrect measured values during an active measurement. In this particular case, it is not permissible to write to the parameter.
7. Enter the required home position offset for the home position approach in field "Home position offset".
8. Enter the position value of the home position coordinate in field "Home position".
9. Click on "Next" if you do not wish to make any additional EPOS settings.
The quick setup step "I/O configuration" is displayed.

Result

Drive configuration continues based on the selected positioning settings.

8.6.6.2 Configuring absolute encoder adjustment

Overview

Absolute encoders must be adjusted during commissioning. When the machine is switched off, the position information of the encoder is retained. The absolute encoder is therefore first adjusted to the home position, e.g. by jogging.

Requirements

- The drive has been completely created and specified in the device configuration.
- In quick startup step "Connection to the PLC", it is defined that the ramp-function generator in the S200 drive should be used.
- Control mode "Positioning" is activated in the quick startup step "Application".
- An online connection to the drive has been established.
- For activated user management (UMAC):
The function rights for configuring in the quick startup are activated for your user role. Details on this topic are provided in Chapter "Security settings in Startdrive" of the Configuration Manual SINAMICS Industrial Security.

Procedure

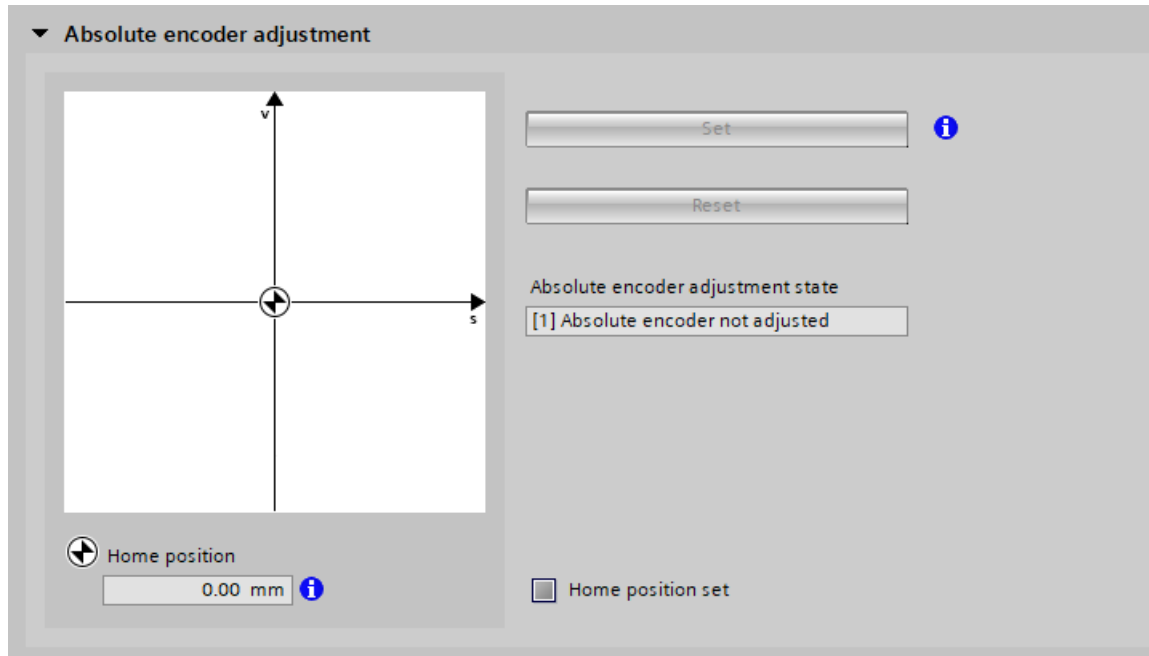

Figure 8-11 Absolute encoder adjustment

Setting the home position coordinate

1. In quick startup step "Application settings", open the detailed settings for homing mode "Absolute encoder adjustment".
The absolute encoder adjustment settings are displayed.
2. Optional: Establish an online connection to the drive if an online connection does not already exist.
3. Correct the home position value in the field "Home position".
4. Click "Set".
Status display "Home position set" is then updated. When the adjustment is correct, entry "Absolute encoder adjusted" is displayed in field "Absolute encoder adjustment state".

Resetting the home position coordinate

1. In quick startup step "Application settings", open the detailed settings for homing mode "Absolute encoder adjustment".
The absolute encoder adjustment settings are displayed.
2. Click "Reset".
Status display "Home position set" is then updated. After the reset, entry "Absolute encoder not adjusted" is displayed in field "Absolute encoder adjustment state".
3. Optional: Then set a new home position coordinate.

Result

Drive configuration continues based on the selected positioning settings. Click on "Next" if you do not wish to make any additional EPOS settings.

The quick setup step "I/O configuration" is displayed.

8.6.7 I/O configuration

Overview

In quick startup step "I/O configuration", make the basic settings for the digital inputs of the converter:

- Digital input (DI 0 to DI 3)
You can assign control signals (high/low) or functions to all digital inputs using drop-down lists. The program prevents the same signals or functions being assigned to different digital inputs.
You can alternatively use digital inputs DI 0 and DI 1 as measuring probe and therefore evaluate in the control.
- Digital output (DO 0 to DO 1)
You can assign status signals (high/low) or functions to the two digital outputs using drop-down lists. Different signals or functions should be assigned to the two digital outputs. The program prevents a multiple assignment.

Note**S200 Basic**

SINAMICS S200 Basic drives only have one DO.

Requirement

- The motor used in the device configuration of the drive has been completely specified and configured.
- You do not want to manage the digital inputs via a technology object of the control system.
- For activated user management (UMAC):
The function rights for configuring in the quick startup are activated for your user role. Details on this topic are provided in Chapter "Security settings in Startdrive" of the Configuration Manual SINAMICS Industrial Security.

Procedure

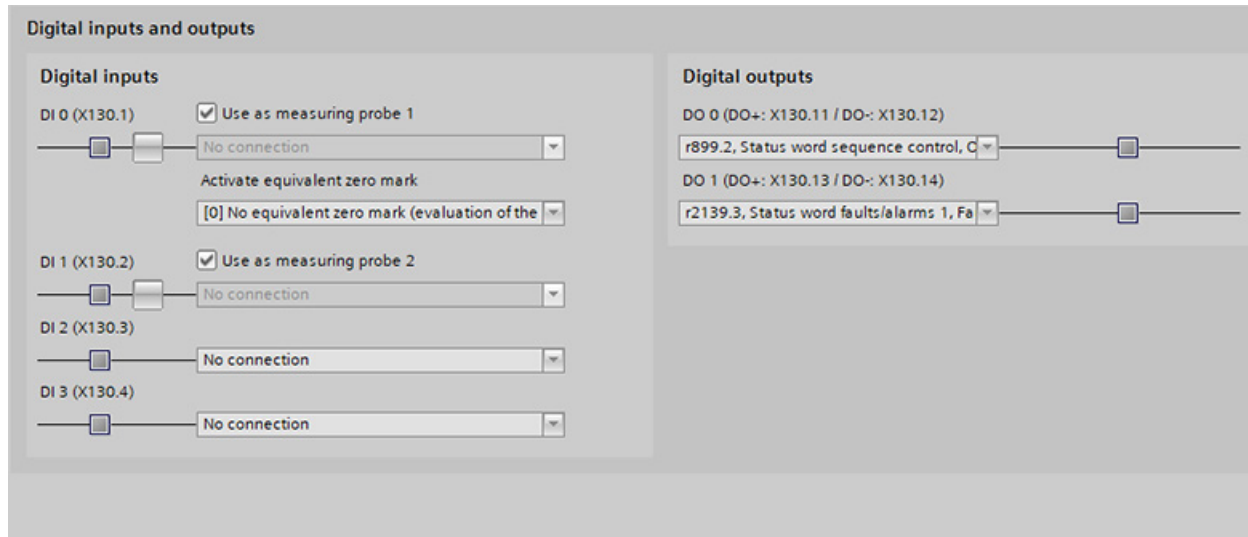



Figure 8-12 Presettings of digital inputs and outputs

1. If you wish to use the digital inputs as measuring probe, for DI 0 or DI 1 activate option "Use as measuring probe".
Both digital inputs can be activated as measuring probe. The corresponding drop-down list is then deactivated.
When activating a DI as measuring probe, option "Activate equivalent zero mark" is displayed.
2. Optional: Click the  icon to invert the signal.
When the signal is inverted, the icon changes to .
3. In the drop-down list "Activate equivalent zero mark", select whether you wish to use an equivalent zero mark or whether this equivalent zero mark should apply for DI 2 or DI 3.
4. If you want to additionally execute status signals of functions via digital inputs, in the digital input, select the appropriate signal or the required function.
You can use all 4 digital inputs for this purpose. However, it is not permissible that the required digital input is activated as measuring probe (drop-down list deactivated).
The program prevents the same signal being selected a multiple number of times or the same function for several digital inputs.
5. In the drop-down list under "Digital outputs", select the required status signals or functions for digital outputs DO 0 to DO 1.
6. Click "Next" to display the next quick startup step.

8.6.8 Telegrams (offline only)

Overview

The telegrams of the drive were preconfigured by the specifications previously defined in the guided quick startup.

In quick startup step "Telegrams", you can optimize these default settings if this is necessary for your drive.

Requirement

- The motor used in the device configuration of the drive has been completely specified and configured.
- Optionally, a controller (PLC) can also be created in the device configuration and networked with the drive.
- There is no active online connection between the drive and operating unit. Telegrams can only be configured offline.
- For activated user management (UMAC):
The function rights for configuring in the quick startup are activated for your user role. Details on this topic are provided in Chapter "Security settings in Startdrive" of the Configuration Manual SINAMICS Industrial Security.

Procedure

Proceed as follows to configure the telegrams:

1. Select the desired standard telegram from the "Telegram" drop-down list.
2. Correct the preset reference speed in the field with the same name.
3. Click  if you wish to optimize the settings of the telegrams used in the telegram configuration.
The properties of the PROFINET interface are displayed in the inspector window. Make the required settings under "Telegram settings (Page 277)".
4. Switch back to the quick startup step "Telegrams".
5. Click "Next" to display the next quick startup step.

Result

The telegrams for communication are configured.

8.6.9 Rotate & optimize

Overview

Optimize the converter online in quick startup step "Rotate & Optimize". To do this, use either the control panel or One Button Tuning (OBT). No settings can be made in offline mode.

Note

Alternatively: Operate the converter from the control panel

If you wish to traverse the converter, click on the "Use control panel" button. Instead of One Button Tuning, the control panel is now displayed in the quick startup step. Proceed as described in the following chapter: "Traversing the converter from the control panel with speed setpoint (Page 280)".

Requirement

- The motor used in the device configuration of the drive has been completely specified and configured.
- There is an active online connection between the drive and the operating unit.
- The editing mode is activated.
- For activated user management (UMAC):
The function rights for configuring in the quick startup and using the control panel are activated for your user account.
Details on this topic are provided in Chapter "Security settings in Startdrive" of the Configuration Manual SINAMICS Industrial Security.

Procedure

Proceed as follows to carry out the optimization settings:

1. Choose the dynamic response setting for the OBT based on the mechanical system of your machine.
The OBT optimizes the converter based on the selected dynamic response setting.
 - Conservative
Slow closed-loop speed control – low mechanical load
 - Standard
Best compromise between fast closed-loop speed control and low mechanical load
 - Dynamic
Fast speed control – high mechanical load
2. In the "Distance limit" field, enter the angle through which the motor and the connected machine are permitted to turn for the required measurements (e.g. 360°) without the mechanical system being damaged.
The angle should be at least 60° in order to determine useful controller parameters. Longer traversing distances result in better optimization results.

3. If you want to perform extended settings, click the "Extended settings" button.
The "Machine property" dialog opens. You obtain information about the conditions under which you can increase the speed control dynamic performance. If you wish to increase the dynamic response, activate option "Set the current setpoint filter with loop compensation".
4. Establish an online connection to the converter if up until now you had worked in the offline mode.
 - Activate master control.
 - Start the OBT.
 - Check the optimization results.
 - Deactivate the master control.
5. Click on "Next" to display the next quick startup step.

Result

The result of the optimization is displayed in the "Status" area. The "Optimization result" list compares the settings changed by the optimization with the earlier settings prior to optimization.

If optimization was not successful, repeat the optimization, possibly with modified data.

More information

For more information about One Button Tuning, see Section "Performing One Button Tuning (Page 282)".

8.6.10 "Overview" function view

8.6.10.1 Offline mode

Overview

After completing the commissioning steps in the guided quick startup, here, you will find a compilation of all settings that were made offline.

If necessary, you can load the settings made offline from the "Overview" function view into the device.

Requirement

- The drive has been completely created and specified in the device configuration.
- For activated user management (UMAC):
The function rights for configuring in the quick startup are activated for your user account. Details on this topic are provided in Chapter "Security settings in Startdrive" of the Configuration Manual SINAMICS Industrial Security.

8.6 Carrying out guided quick startup

Procedure

Proceed as follows to download the project data to the device:

1. In the "Overview" function view, click "Download".
To transfer the protected project data, you must log into the device with your user data.
2. Proceed as described in Chapter "Loading project data into the drive (Page 218)".

8.6.10.2 Online mode

Overview



After completing the commissioning steps in the guided quick startup, here, you will find a compilation of all settings that were made online. You can sort and export the corresponding information or also compare it with the factory settings.

Requirement

- The drive has been completely created and specified in the device configuration.
- There is an active online connection between the converter and the operating unit.
- The online configuration was completed.
- For activated user management (UMAC):
The function rights for configuring in the quick startup are activated for your user account. Details on this topic are provided in Chapter "Security settings in Startdrive" of the Configuration Manual SINAMICS Industrial Security.

Procedure

Proceed as follows to upload project data from the device:

1. After the online commissioning has been completed, if you want to transfer the current project data into the TIA project of your operating unit, click "Finish".
 is subsequently displayed in function view "Overview".
2. Click  and proceed as described in the following chapter: "Loading data from the drive into the project (Page 216)".

8.7 Configuring the converter

Overview

After carrying out the basic configuration of devices in the project, make the extended settings for commissioning.

Description of function

The following areas are provided in display area "Parameterization":

- **Basic parameterization**
Here you can view the preassigned basic parameters of the converter, and if necessary you can change individual values. If the motor brake is available, then you can also set that this brake is forced open.
- **Inputs/outputs**
Here you can configure the digital inputs and outputs of the converter.
- **Technology functions**
Here you configure the basic positioner (EPOS) and pulse train output (PTO).

Note

Guided quick startup

You can also easily configure the settings of the basic parameterization and the digital inputs using the guided quick startup (Page 245).

Note

Telegram configuration

You configure the telegrams used in the converter configuration in the inspector window in the telegram configuration. The most important settings are listed in Chapter "Configuring telegrams (Page 276)".

8.7.1 Basic parameterization

Overview

You can parameterize the following operating parameters in the basic setting:

- Device supply voltage
- Direction of rotation
- Speed limit
- Torque limit

8.7 Configuring the converter

- Ramp-down times
After an OFF1 command, and for a quick stop OFF3.
- Forced opening of the brake
Only if the motor being used is equipped with a holding brake.

Requirement

- The drive has been completely created and completely specified in the device configuration.
- For activated user management (UMAC):
The function rights required to read the drive data are activated for your user account.
Details on this topic are provided in Chapter "Security settings in Startdrive" of the Configuration Manual SINAMICS Industrial Security.

Procedure

Proceed as follows to carry out the basic parameterization:

1. Change the default settings of this function view.
2. Optionally, if the motor being used is equipped with a "Standard holding brake", and you wish to permanently open this brake:
Click "Force open brake".
3. Save the project to apply the settings.

8.7.2 Configuring digital inputs and outputs via technology objects

Overview

The function of the digital inputs DI 0 (≙ activate measuring probe 1) and DI 1 (≙ activate measuring probe 2) is already pre-configured and activated.

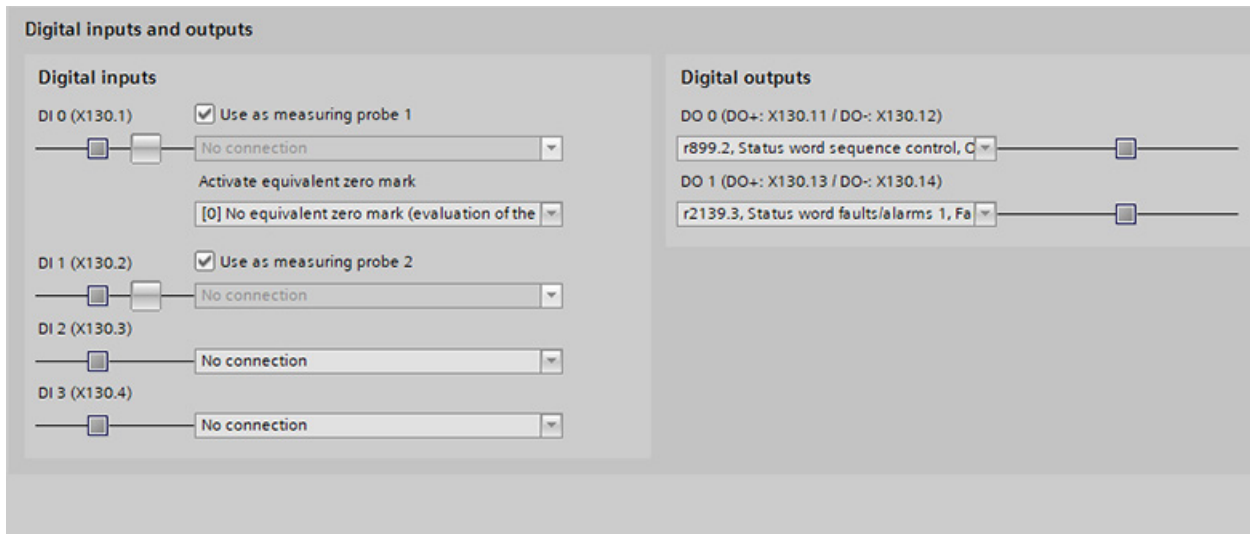

Figure 8-13 Configuring digital inputs and outputs

Requirement

- The drive has been completely created and completely specified in the device configuration.
- For activated user management (UMAC):
The function rights required to edit the drive data are activated for your user role. Details on this topic are provided in Chapter "Security settings in Startdrive" of the Configuration Manual SINAMICS Industrial Security.

Procedure

Proceed as follows to configure digital inputs and outputs:

1. If you are not using any measuring probes, you can deactivate them manually using the check box.
Measuring probes are generally available. The default setting is correct in these cases.
2. In the drop-down list "Activate equivalent zero mark", select whether you wish to use an external zero mark and whether this external zero mark should apply for DI 0 or DI 1.
3. If required, you can assign a function for each digital input/output using the drop-down list.
4. Save the project to apply the settings.



8.7.2.1 Configuring a measuring probe using the technology objects

Requirement

- The project includes a control system, and is connected to the converter.
- A technology object "PositioningAxis_1" is created for the control system and is active.

Procedure

Proceed as follows to use a measuring input:

1. In the project navigation, expand the follow entries in the order specified below:
 -  Technology objects
 -  PositioningAxis_1
 -  Measuring inputs

The "Add new measuring input" entry is displayed.

2. Double-click the "Add new measuring input" entry ①.
A new measuring input is created and additional functions are displayed.

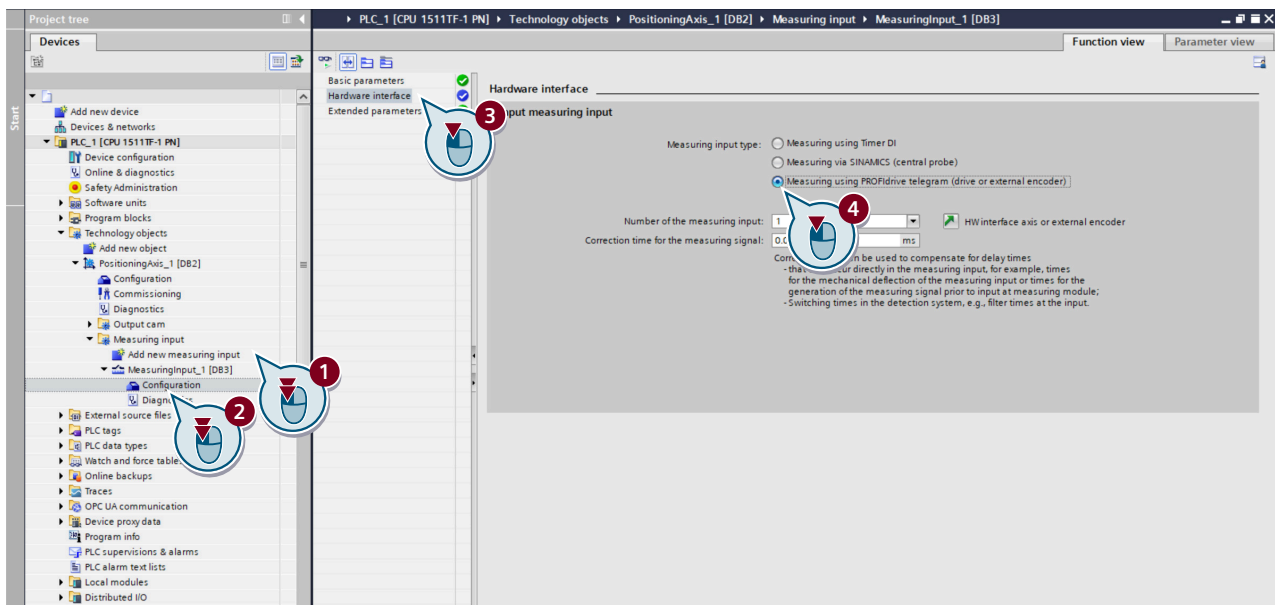

3. Double-click the "Configuration" entry ②.
The corresponding screen form opens in the device view.
4. Click the "Hardware interface" option ③ in the secondary navigation.
The corresponding screen form opens.

5. Select the measuring input type "Measuring using PROFIdrive telegram (drive or external encoder)" ④.
A measuring input of the type "Measuring using PROFIdrive telegram (drive or external encoder)" is created.
With measurement using a PROFIdrive telegram, only one measuring input can be active at the same time on an actual value or encoder in the PROFIdrive telegram. A maximum of two measuring inputs can be configured using PROFIdrive on an actual value or encoder in the PROFIdrive telegram.
6. To correct the measuring time point, set a correction time.

Result

A measuring input of the type "Measuring using PROFIdrive telegram (converter or external encoder)" is created and can be used.

8.7.3 Technology functions

8.7.3.1 Basic positioner

Overview

The basic positioner (EPOS) calculates the traversing profile for the time-optimized traversing of the axis to the target position.

Requirement

- The device configuration is completely executed (an encoder has been assigned).
- The configuration in the guided quick startup has been completely executed.
- Control mode "Positioning" is activated in the quick startup step "Application".
- For activated user management (UMAC):
The function rights for editing drive data are activated for your user account.
Details on this topic are provided in Chapter "Security settings in Startdrive" of the Configuration Manual SINAMICS Industrial Security.

Description of function

You can define the following settings in the function view with the same name:

- Limitation
 - Position limits
You can activate and configure the software and hardware limit switches to limit the traversing range.
 - Dynamic response limits
You can define the limitations of the traversing profile by specifying the maximum velocity, acceleration, deceleration, and jerk.
- Homing
Homing establishes the reference of the position measurement in the converter to the machine. You can select between two homing types:
 - Active homing
You can select from three active homing modes to traverse the axis to a home position. The drive itself then controls and monitors the homing cycle. You can also decide whether absolute encoder adjustment should be automatically performed after home position approach.
 - Passive homing
You select the input terminal for direct measuring probe 1 in the function view. When the measuring probe is detected, the difference between the home position and the determined measured value is corrected on-the-fly.
 - Absolute encoder adjustment
Absolute encoders must be adjusted during commissioning. When the machine is switched off, the position information of the encoder is retained. The absolute encoder is therefore first adjusted to the home position, e.g. by jogging.
- Position monitoring functions
 - Position/standstill monitoring
You specify the positioning window, positioning monitoring time, standstill window, and standstill monitoring time. The drive sets the "Setpoint stationary" signal to 1 as soon as the setpoint for the position within a positioning operation no longer changes. With this signal, the drive starts to monitor the actual position value.
 - Following error monitoring
You specify the maximum following error for the actual position value. If this following error is violated, the position control cancels the current positioning operation and generates a fault message.
- Direct setpoint specification (MDI)
The setpoints listed in the function view are entered via PLC communications. You check these setpoints in the function view for diagnostic purposes.
- Traversing blocks
You can define a maximum of 32 traversing blocks in a configuration table in the function view. For each traversing block, you define the required settings (Page 380) and make fixed stop configuration. An external control can subsequently select a traversing block that has been selected.

- Jog
You set the following parameters for incremental jogging:
 - Velocity setpoint (either for jog 1 or 2)
 - Traversing distances (either for jog 1 or 2)
- Function status
You view the active EPOS operating mode, existing enables, and the detailed status of individual EPOS functions.

More information

For more information about the basic positioner, see Section "Basic positioner (EPOS) (Page 365)".

For more information about configuring the basic positioner in Startdrive, see the information system of the TIA Portal.

8.7.3.2 Configuring Pulse Train Output (PTO) (for the S200 converter only)

Overview

Pulse Train Output (PTO) is referred to as pulse/direction interface. The pulse/direction interface comprises two signals. The frequency of the pulse output represents the speed and the number of output pulses for the section to be traversed. The direction output defines the traversing direction. As a consequence, the position is specified in precise increments.

Requirements

- The drive has been completely created and specified in the device configuration.
- A control (PLC) is created in the device configuration and networked with the drive. The required technology objects for the control have been completely created in the device configuration (e.g. "TO_PositioningAxis").
- For activated user management (UMAC):
The function rights for editing drive data are activated for your user account. Details on this topic are provided in Chapter "Security settings in Startdrive" of the Configuration Manual SINAMICS Industrial Security.

Procedure

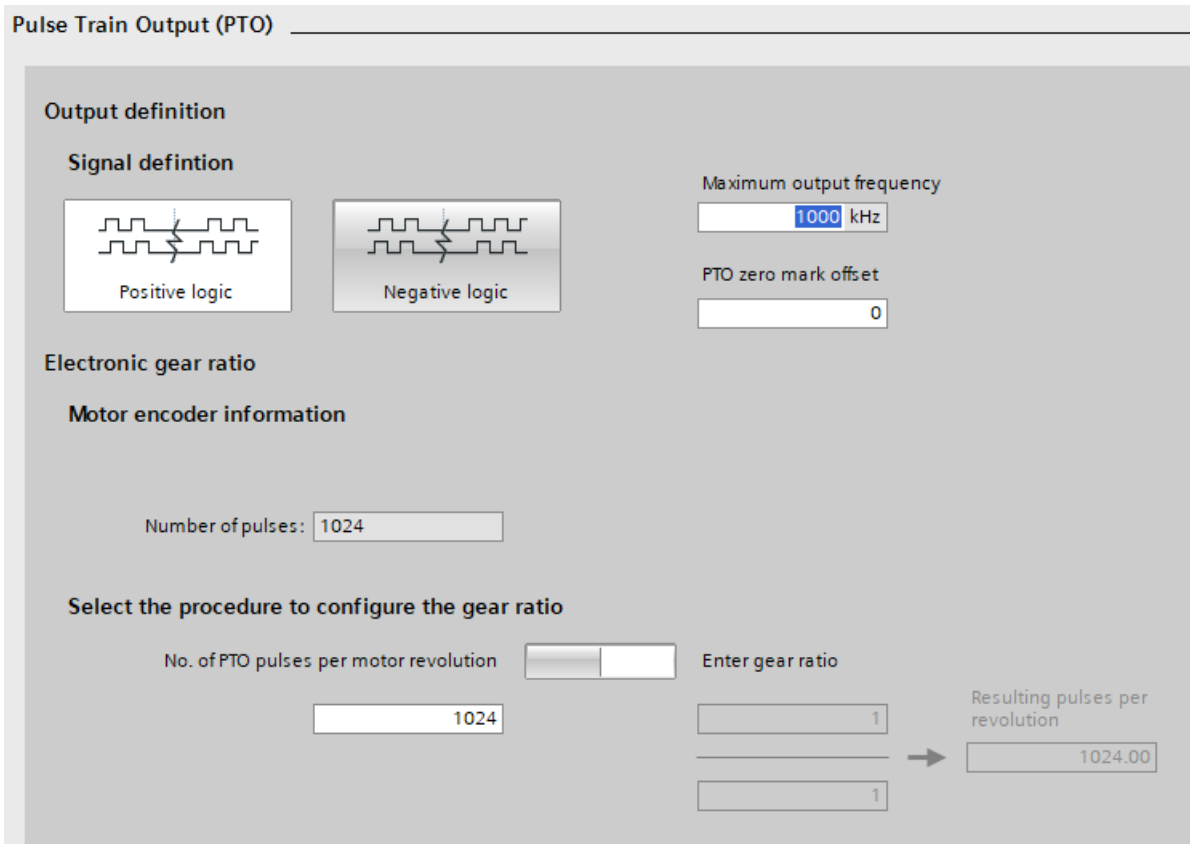

Figure 8-14 Configuring PTO

Proceed as follows to configure PTO in the function view:

1. Define whether the PTO position actual value should be inverted. Click on the appropriate button:
 - Positive logic (= not inverted, default setting)
 - Negative logic (= inverted)
2. Correct the value for the maximum output frequency.
This value represents the velocity and the number of output pulses for the section to be traversed.
3. Using a switch, define which values you wish to use to define the gearbox ratio.
 - Number of PTO pulses per motor revolution
 - Gearbox ratio is entered using numerator/denominator = p4410/p4409

4. Proceed as follows according to your selection:
 - If you select "No. of PTO pulses per motor revolution", enter the number of pulses per motor revolution.
 - If you select "Enter gear ratio", enter the gearbox ratio directly in the two input fields above and below the fraction bar.
The resulting pulses per revolution are calculated from this entry.
5. Save the settings in the project.

8.7.4 Configuring telegrams

8.7.4.1 Calling the telegram configuration

Overview

The "Telegram configuration" function is part of the device configuration, and is displayed in the inspector window.

You can either call this function via the project tree or for Startdrive S drives, also via direct links from the communication screen forms.

Information about the telegrams used in the converter is provided in "Telegram (Page 322)".

Requirement

- The converter has been completely created and specified in the device configuration.
- For activated user management (UMAC):
The function rights required to configure telegrams in the inspector window are activated for your user role.
Details on this topic are provided in Chapter "Security settings in Startdrive" of the Configuration Manual SINAMICS Industrial Security.

Procedure

1. Double-click the entry "Device configuration" in the project tree.
2. Click on the converter in the device configuration.
3. Click the entry "Telegram configuration" under "PROFINET interface [X150]" in the "Properties" tab of the inspector window.
The settings for the telegram configuration are displayed below the respective fieldbus interface.

8.7.4.2 Telegram settings

Overview

The dialog box for the telegram configuration is structured as follows:

Name	Item	Link	Telegram	Length	Extension	Direction	Type	Partner	Partner data area
▼ Drive control-Telegrams	1								
Send (Actual value)		↗	SIEMENS telegram 1..	12 w...	—	→	CD	unspecified	
Receive (Setpoint)		↖	SIEMENS telegram 1..	17 w...	—	←	CD	unspecified	
<Add telegram>									

- ① Drive object display
- ② Link to the communication screen forms of the particular drive object
- ③ Drop-down list with the available telegrams
- ④ Length of the telegram
- ⑤ Telegram extension
- ⑥ Communication direction (send direction →/receive direction ←)
- ⑦ Type of communication
CD = Controller - Device for PROFINET IO
- ⑧ Name of the partner (controller)
- ⑨ Partner data area
- ⑩ Area for drive objects (setpoints and actual values)
- ⑪ Area for the interfaces
- ⑫ Area for the communication partners of the drive (e.g. controller or another converter)

8.7.4.3 Adding telegrams

Overview

You can add the following telegrams once, as long as they are still not available in the telegram list of the drive object:

- Torque telegram 750

Requirement

- A drive and a partner are created in the project, and connected via a fieldbus. The drive is selected and the parameter editor is open.
- For activated user management (UMAC):
The function rights required to configure telegrams in the inspector window are activated for your user role.
Details on this topic are provided in Chapter "Security settings in Startdrive" of the Configuration Manual SINAMICS Industrial Security.

Procedure

Proceed as follows to add a telegram:

1. Open the following menu path from the secondary navigation of the inspector window:
"Properties > PROFINET interface > Telegram configuration".
2. Click the "Add telegram" entry (at the required drive object).
A drop-down list opens. All telegram types that have not been assigned yet can be used.
3. Select the required telegram type.
The entries for the telegram are created.
4. If required, now change the telegram type, e.g. from telegram 30 to telegram 901.
5. Save the project.

8.8 Optimizing commissioning

8.8.1 Establishing an online connection to the converter

Overview

Before you traverse your drive with the control panel or perform optimization of the axis, you need to connect to your drive online.

Requirement

- The configuration is loaded into the SIMATIC S7 controller.
The converter can therefore be accessed in the PROFINET network via the SIMATIC S7 controller and your operating unit is connected to the corresponding PROFINET interface of the controller (e.g. X1).
- For activated user management (UMAC):
The function rights required to edit the drive data are activated for your user account. Details on this topic are provided in Chapter "Security settings in Startdrive" of the Configuration Manual SINAMICS Industrial Security.

Procedure

Proceed as follows to establish an online connection to your converter:

1. Double-click "Online & diagnostics" in the project navigation under the S200 drive.
The "Online access" function view is displayed.
2. Select the PROFINET network in the "Connection to interface/subnet" drop-down list.
3. Click "Go online".

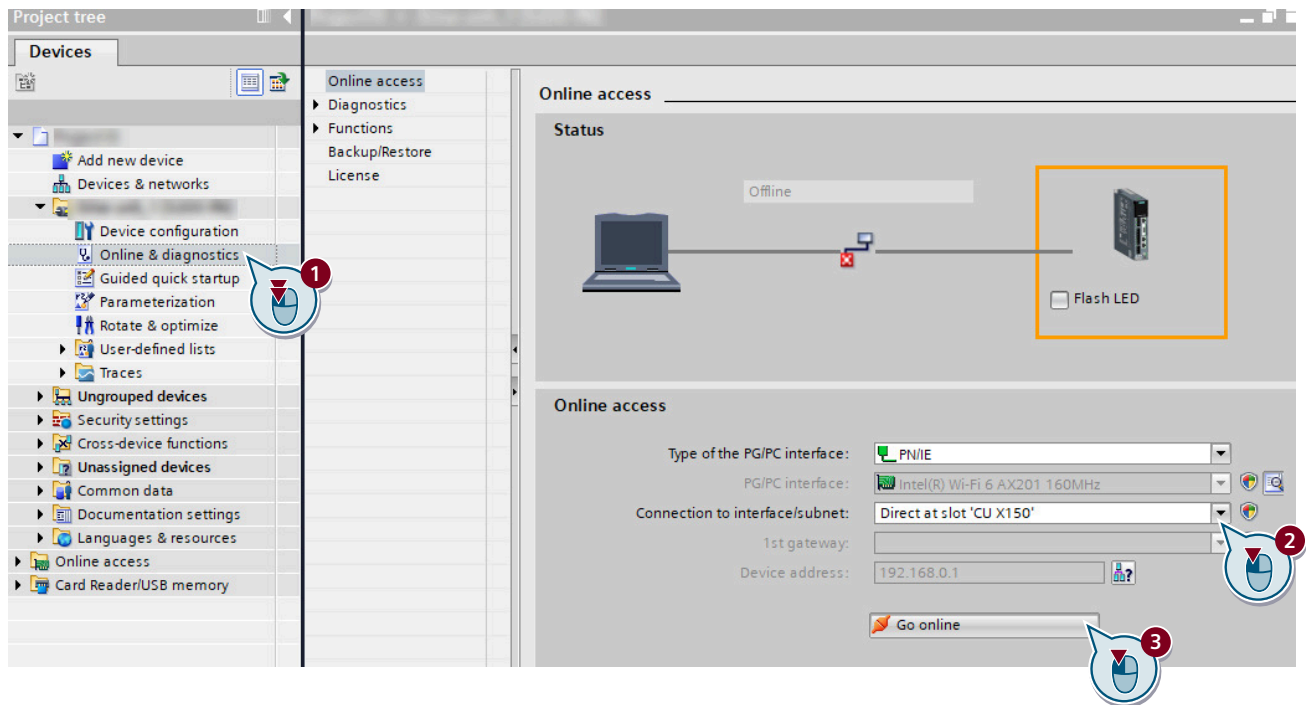

Result

The online connection to the drive is established.

8.8.2 Traversing the converter from the control panel with speed setpoint

Overview

Traverse the drive from the control panel and test the settings made. The control panel can only be activated for one drive.

By activating the control panel, you assume master control of the drive. Although all enable signals are removed before returning the master control, the setpoints and commands still come from the original parameterized sources after the master control is returned.

 **WARNING**

Risk of death if the safety instructions for the control panel are not carefully complied with

The safety shutdowns from the higher-level controller have no effect with this function. The **Stop with space bar** function is not guaranteed in all operating states. Incorrect operation by untrained personnel – without taking into account the appropriate safety instructions – can therefore result in death or severe injury.

- Make sure that this function is only used for commissioning, diagnostic and service purposes.
- Make sure that this function is only used by trained and authorized skilled personnel.
- Ensure that EMERGENCY OFF circuit is always implemented as hardware circuit.

Note

Drive responds immediately

Although all enable signals are removed before returning the master control, the setpoints and commands still come from the original parameterized sources after the master control is returned.

Requirement

- The drive has been completely created and specified in the device configuration.
- There is an active online connection between the converter and the operating unit.
- Display area "Rotate & Optimize" was opened via the project tree.
- For activated user management (UMAC):
The function rights required to edit the drive data and to use the control panel are activated for your user account.
Details on this topic are provided in Chapter "Security settings in Startdrive" of the Configuration Manual SINAMICS Industrial Security.

Procedure

You can traverse the drive using both the control panel of the technology object and the control panel of the drive itself.

Proceed as follows to traverse the converter from the control panel of the drive:

1. Select the "Control panel" function in the secondary navigation.
The corresponding function view is displayed.
2. Click the "Activate" button to enable master control for the drive.
The "Activate master control" message window is displayed.

3. Read the alarms carefully and check the value for the monitoring time.
The monitoring time specifies the time during which the connection from your operating unit to the drive is cyclically monitored. The monitoring time is preset to 2000 ms and should only be changed if required.
4. Confirm the monitoring time with "OK".
The message window closes and the control panel is enabled. The drive enables are set automatically.
5. In the "Speed" input field, enter a value \leq the maximum speed.
6. Traverse the drive in the desired direction using the controller buttons.
7. Click the "Deactivate" button to disable master control.
The "Deactivate master control" dialog window is displayed.
8. Confirm deactivation of master control with "Yes".

Result

The current values of various parameters are displayed under "Actual values". Enables and faults are displayed under "Drive status". In addition to "Active fault", the currently pending fault is displayed.

8.8.3 Performing One Button Tuning



Overview

For One Button Tuning (OBT), the mechanical drive train is measured using short test signals. This means that you optimally adapt the controller parameters to the mechanical system being used. Using this optimization routine, you can determine the optimum controller settings with just a few entries.

Requirement

- The drive has been completely created and specified in the device configuration.
- There is an active online connection between the drive and the operating unit.
- Display area "Rotate & Optimize"  was opened via the project tree.
- For activated user management (UMAC):
The function rights required to edit the drive data and to use the control panel are activated for your user account.
Details on this topic are provided in Chapter "Security settings in Startdrive" of the Configuration Manual SINAMICS Industrial Security.

Procedure



1. Select the "One Button Tuning" function in the secondary navigation.
The corresponding function view is displayed.
2. Select the desired setting (e.g. "Conservative") in the "Dynamic settings" area.
The "Standard" setting is selected by default.
3. Enter a value (e.g. 360) in the input field "Path limit from 0° to".
Sensible controller parameters are obtained from an angle > 90°.
4. Confirm the entry with "Enter".
The error icon  is then hidden.
5. Click the "Activate" button to enable master control for the drive.
The "Activate master control" message window is displayed.
6. Read the alarms carefully and check the value for the monitoring time.
The monitoring time specifies the time during which the connection from your operating unit to the drive is cyclically monitored. The monitoring time is preset to 2000 ms and should only be changed if required.
7. Confirm the monitoring time with "OK".
The message window is closed and One Button Tuning is activated.
8. Click the "Start" button to start the optimization.
Optimization of the drive is performed. After optimization is completed successfully, the green status icon  appears in the "Drive status" area and the changed values are shown in the "Actual values" area.

NOTICE

Unpredictable drive response when making manual changes after One Button Tuning

Manual changes of the calculated values can lead to unpredictable behavior of the drive. This can damage the drive.

- After the One Button Tuning, carefully check that the optimized values are not subsequently changed manually.
- Always first restore the factory settings if you do not want to use the values optimized using One Button Tuning.

9. Click the "Deactivate" button to disable master control.
The "Deactivate master control" dialog window is displayed.
10. Confirm deactivation of master control with "Yes".
11. Click  to store the result of the optimization permanently in your drive.
12. To load the data from your drive into the project, first select the drive unit in the project tree and then click  in the toolbar.
13. Click  to store the result of the optimization permanently in your project.

Result

You have performed the optimization routine and saved the result of the optimization permanently in your drive and project.

8.8.4 Terminating the online connection from the converter

Overview

After you traverse your converter from the control panel or optimize the axis, you need to disconnect the online connection to the converter.

Requirement

- For activated user management (UMAC):
The function rights required to edit the converter data are activated for your user account. Details on this topic are provided in Chapter "Security settings in Startdrive" of the Configuration Manual SINAMICS Industrial Security.

Procedure

Proceed as follows to

1. Click the drive in the project tree.
2. Click  in the menu bar.

Result

The online connection to the converter is disconnected.

8.9 Using online diagnostic functions

8.9.1 Diagnostic icons

Overview

Faults, alarms and any maintenance that is required are indicated using diagnostic icons.













Description of function

The diagnostics icons are displayed in the following areas of the TIA Portal:

- Project tree
- Device view
- Device overview

The icons are displayed in both the network as well as topology views.

Table 8-4 Overview of the possible diagnostic icons

Icon	Meaning
	No fault or maintenance required
	Maintenance required
	Maintenance requirement for a subordinate component
	Maintenance request
	Maintenance request for a subordinate component
	Fault/error
	Fault/error on a subordinate component
	Connection error to the device
	Establish a connection
	The diagnostic status is determined.
	The configured device and the actual device have incompatible types.
	The device is only available in the offline configured device configuration and has been deactivated.

8.9.2 Display messages

Overview

The diagnostic icons, which are displayed in the network and topology views, are assigned to specific messages.

Requirement

- For activated user management (UMAC):
The function rights required to read the drive data are activated for your user account. Details on this topic are provided in Chapter "Security settings in Startdrive" of the Configuration Manual SINAMICS Industrial Security.

Procedure

Proceed as follows to display messages:

1. Double-click a diagnostics icon, for example .
The inspector window opens.
2. Click the "Message display" tab.
All current messages are displayed.

8.9.3 Calling diagnostic functions

Overview

In the diagnostics view, you can see important information about the drive or make important basic settings.

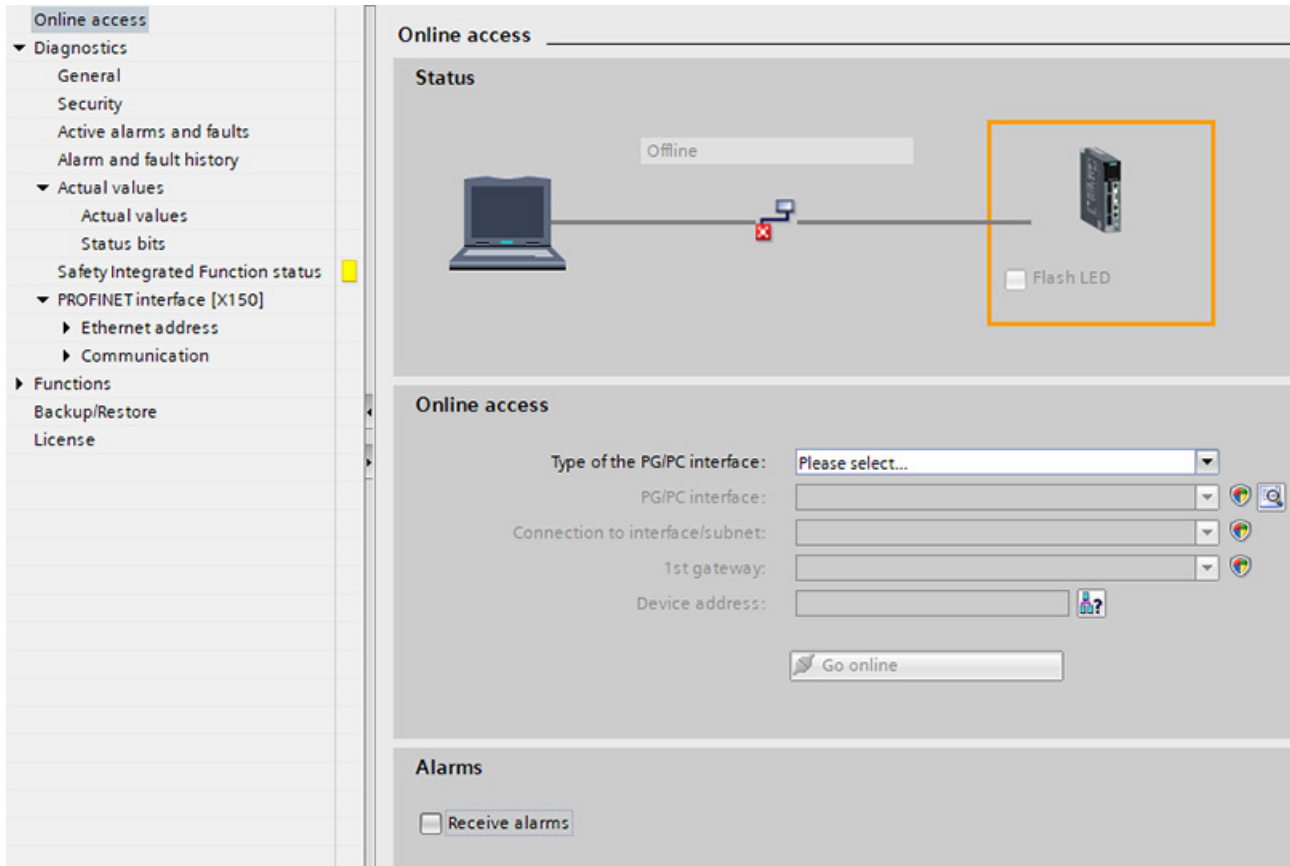

Figure 8-15 Overview: diagnostic functions

Requirement

- For activated user management (UMAC):
The function rights required to read the drive data are activated for your user account. Details on this topic are provided in Chapter "Security settings in Startdrive" of the Configuration Manual SINAMICS Industrial Security.

Procedure

Proceed as follows to call the diagnostic functions:

1. In the project tree, double-click on menu "Online & 'Diagnostics".
Diagnostics and diagnostic functions are displayed in the secondary navigation and can be called from here.
2. Select the "Online access" entry in the secondary navigation.
3. Select the network interface of your operating unit.
4. Click "Go online".
The online connection to the converter is established.
5. Click "Go offline" in the menu bar.
The online connection to the converter is disconnected.

Overview

In the "Diagnostics" area, you can receive the following information via the secondary navigation:

- General
- Active alarms and message history
- Actual values
- Safety Integrated functional status
- PROFINET interface (X150)

A description of how you can use these functions on your converter is provided below.

Requirement

- There is an online connection between the converter and the operating unit.
Diagnostic information can only be read out in the online mode.
- For activated user management (UMAC):
The function rights required to read the drive data are activated for your user account.
Details on this topic are provided in Chapter "Security settings in Startdrive" of the Configuration Manual SINAMICS Industrial Security.

Description of function

You call the individual diagnostic information in the secondary navigation of the diagnostics view.

The following information on the connected converter is provided in the diagnostics view:

- **General**
Information about component, module and manufacturer
 - You can identify the converter, and the most important converter data are displayed.
- **Security**
Information about security settings of the connected converter
You can find more information in Chapter "Security (Page 289)".
- **Active messages**
Information about active alarms and faults
 - For a fault, the status signal ZSW1.3 is sent. Faults must be acknowledged once the cause has been resolved. To do this, use the function icon at the top of the function view (📧/📧).
 - For an alarm, status signal ZSW1.7 is set. The alarm is also entered into the alarm buffer. Alarms are self-acknowledging.
- **Message history**
 - The message history records all alarms and faults.
 - Using the function icons in the function view, you can either delete the fault buffer (🗑️) or export to a CSV file (📄➡️).
- **Actual values**
Information about the most important parameter actual values and status bits
- **Safety Integrated functional status**
Information on the current status of STO
- **PROFINET interface (X150)**
 - Ethernet address
Information about IP parameters (IP address and subnet mask) and network connection (MAC address)
 - Communication
Information about send and receive directions (PZDs of telegrams e.g. 105)
More detailed information on PZDs and telegrams is provided in Section "Communication (Page 290)".

8.9.4 Security

Overview

The "Security" function, which are displayed in view "Diagnostics" to set security settings of the converter.

Requirement

- There is an online connection between the converter and the operating unit. Diagnostic information can only be read out in the online mode.
- The user administration (UMAC) is activated for the project and converter. The following applies:
The function rights required to read the converter data are activated for your user account. Details on this topic are provided in Chapter "Security settings in Startdrive" of the Configuration Manual SINAMICS Industrial Security.

Description of function

A summary of the active security settings of the connected converter is displayed in diagnostics view "Security".

- Logged-in user:
 - The user that is logged into the converter.
OR
 - No logged-in user, as UMAC is not active.
In this case, Siemens recommends that you activate UMAC.
- Ports & protocols:
Displays the activation state for the interfaces of the following areas:
 - Web server access
 - Fieldbus and associated protocols
 - S7 commissioning reports
 - DHCP configuration
- UMAC:
Shows certain UMAC settings which are activated for the converter. Shows, for example, whether UMAC is active and what rights the user account "Anonymous" has.

You can only change the displayed security settings offline in the inspector window of the converter in the project.

8.9.5 Communication

8.9.5.1 Receive direction

Overview

As standard, the components and interconnections of PROFIdrive telegrams in the receive direction for the converter are displayed in this function view (e.g. 105 or 750).

You can add additional telegrams via the telegram configuration (). The content of the selected telegram is then displayed in the "Supplementary data" area.

Requirement

- For activated user management (UMAC):
The function rights required to read the drive data are activated for your user account. Details on this topic are provided in Chapter "Security settings in Startdrive" of the Configuration Manual SINAMICS Industrial Security.

Description of function

The process data in the receive direction are created automatically.

Only those telegrams available for the converter are offered. The following information of the displayed telegrams is displayed:

Table 8-5 Telegram structure

Telegram type	PZD	Display of the value	Format switchover	Control words
	The numbering and arrangement of the process data.	Value of the process data (PZD)	The value of the process data is switched to a different representation (hex, bin, dec).	List of the control words that are transmitted in the telegram.
PROFIdrive 3, 5, 102, 105	X	X	X	X
Torque supplementary telegram 750	X	X	X	X

8.9.5.2 Send direction

Overview

As standard, the components and interconnections of PROFIdrive telegrams in the send direction for the converter are displayed in this function view (e.g. 105 or 750).

You can add additional telegrams via the telegram configuration (). The content of the selected telegram is then displayed in the "Supplementary data" area.

Requirement

- For activated user management (UMAC):
The function rights required to read the converter data are activated for your user account. Details on this topic are provided in Chapter "Security settings in Startdrive" of the Configuration Manual SINAMICS Industrial Security.

Description of function

The interconnections for the process data in the send direction are created automatically for the standard and manufacturer-specific telegrams.

The following information of the displayed telegrams is displayed:

Table 8-6 Telegram structure

Telegram type	Status words	Value	Format switchover	PZD
	List of the status words that are transferred in the telegram.	Value of the process data (PZD)	The value of the process data is switched to a different representation (hex, bin, dec).	Numbering and arrangement of the process data.
PROFIdrive 3, 5, 102, 105	X	X	X	X
Torque supplementary telegram 750	X	X	X	X

8.9.6 Functions

8.9.6.1 Overview

Overview

In the "Functions" area, you can call the following functions via the secondary navigation of the diagnostic view and make settings within them:

- Assign IP address
- Firmware update
- Assign PROFINET device name
- Reset PROFINET interface parameters
- Set time

Overview

To restore the converter to the delivery state, you need to reset the PROFINET interfaces of the converter in addition to restoring the factory settings.

If the converter is connected to a controller while the PROFINET interfaces are being reset, the controller assigns new interface parameters to the converter immediately after the reset. To prevent this, switch the controller to "Stop" mode before the reset or terminate the connection between controller and converter.

Requirement

- The connection between the converter and control system is disconnected.
- For activated user management (UMAC):
The function rights required to edit drive data are activated for your user account. Details on this topic are provided in Chapter "Security settings in Startdrive" of the Configuration Manual SINAMICS Industrial Security.

Procedure

Proceed as follows to reset the parameter assignment of the PROFINET interfaces to the factory settings:

1. Expand the "Functions" entry in the secondary navigation.
2. Click the "Reset of PROFINET interface parameters" entry.
The corresponding screen form opens.
3. Select one of the following options:
 - Retain I&M data
If the option "Retain I&M data" is active, the I&M1 to I&M3 data are retained.
 - Delete I&M data
If the option "Delete I&M data" is active, the I&M1 to I&M3 data are deleted.
4. Click the "Reset" button.

Result

The parameters of the PROFINET interfaces are reset. The reset data are displayed in the "Online access" function view.

More information

More information on restoring the factory settings is provided in Chapter "Restore factory settings (Page 297)".

8.9.6.2 Setting the time-of-day

Overview

The option "Synchronize with an NTP server" is activated when the "Set time" diagnostics view is called up for the first time.

Description of function

For the operation of a drive, the definition of a drive time is important. The following options are available:

- Synchronize with NTP server
If the drive is connected to other devices and a central NTP server is to provide the time for the connected devices. Alternatively, a controller can also act as NTP server.
- No synchronization, set time manually
if the drive is initially operated without control.

You set the drive time in the diagnostics view as a direct function. If a time has already been set, it is displayed in the "Current drive time" area. If it is a synchronized time, the NTP server used is also displayed in the "Time source" field.

Alternatively, you can set the time settings offline in the inspector window of the drive. However, these settings are only transferred to the drive when the drive data are loaded.

If you differentiate the time settings between the drive and the project, this is indicated by the . In this case, reload the drive data into the drive.

8.9.6.3 Setting the time with synchronization (NTP server)

Requirement

- The drive is operated with a controller.
- There is an online connection between the drive and the operating unit.
The direct functions can only be performed in online mode.

Procedure

Proceed as follows to set the time with synchronization (NTP server):

1. If the "Synchronize with NTP server" option is not enabled, enable this option.
By default, the "Use PLC as NTP server" option is now enabled. If the drive is connected to a PLC, the IP address of the PLC is displayed.
2. Disable the option "Use PLC as NTP server".
The input field for the IP address is cleared.
3. Enter the IP address of the desired NTP server in the "IP address" field.
4. Select the time zone of your country in the "Time zone" area.
Example: For Central Europe, use the time zone "GMT+01:00".
5. Then click "Apply".

Result

The set time is directly transferred to the drive. The current time settings are displayed in the "Current drive time" area.

8.9.6.4 Setting the time with synchronization (PLC as NTP server)

Requirement

- The drive is operated with a controller.
- There is an online connection between the drive and the operating unit.
The direct functions can only be performed in online mode.

Procedure

Proceed as follows to set the time with synchronization (NTP server):

1. If the "Synchronize with NTP server" option is not enabled, enable this option.
By default, the "Use PLC as NTP server" option is now enabled. If the drive is connected to a PLC, the IP address of the PLC is displayed.
2. Select the time zone of your country in the "Time zone" area.
Example: For Central Europe, use the time zone "GMT+01:00".
3. Then click on "Apply".

Result

The set time is directly transferred to the drive. The current time settings are displayed in the "Current drive time" area.

8.9.6.5 Setting the time without synchronization

Overview

A time of the drive without synchronization is used if the drive is operated for test purposes without a control unit connected.

Requirement

- There is an online connection between the drive and the operating unit.
The direct functions can only be performed in online mode.

Procedure

1. Activate the option "No synchronization, set time manually".
You can then choose whether to copy the time from your operating unit or enter the time manually.
2. If you want to use the time from your operating unit, activate the option "Use time from PG/PC".
Or
If you want to set the time manually, proceed as follows:
 - In the "Drive time" area, set the current calendar day, the current year, and the desired time.
 - Select the time zone of your country in the "Time zone" area.
Example: For Central Europe, use the time zone "GMT+01:00".
3. Then click "Apply".

Result

The set time is directly transferred to the drive. The current time settings are displayed in the "Current drive time" area.

8.9.7 Backup and restore

Overview

Perform the following actions in function view "Backup/Restore":

- Restart the drive now
- Retentively save the data in the converter
- Restore the drive data to factory settings
Security and interface settings are excluded.

8.9.7.1 Restarting the drive

Requirement

- There is an online connection between the project and the drive (see Chapter "Establishing an online connection to the converter (Page 279)").
- The drive is switched on and has voltage.
- For activated user management (UMAC):
The function rights required to edit the converter data are activated for your user account. Details on this topic are provided in Chapter "Security settings in Startdrive" of the Configuration Manual SINAMICS Industrial Security.

Procedure

Proceed as follows to restart the converter:

1. In the secondary navigation, click menu "Backup/Restore".
The corresponding function view opens.
2. In the "Restart the drive" field, click on "Restart".

8.9.7.2 Retentively saving the drive data

Requirement

- There is an online connection between the project and the drive (see Chapter "Establishing an online connection to the converter (Page 279)").
- Optional SD card is inserted (for a parameter backup).
- For activated user management (UMAC):
The function rights required to edit and save the drive data are activated for your user account.
Details on this topic are provided in Chapter "Security settings in Startdrive" of the Configuration Manual SINAMICS Industrial Security.

Procedure

Proceed as follows to save the drive data retentively:

1. In the secondary navigation, click on menu "Backup/Restore".
The corresponding function view opens.
2. Click the "Save" button in the "Save RAM data retentively" field.

Result

Drive data are retentively saved in the drive.

If you have inserted a SD card in the converter, the drive data are stored on the SD card in addition.

8.9.7.3 Restore factory settings

Overview

With this function, you restore the user-specific parameterization of the converter to factory settings.

The following data are retained when the factory settings are restored:

- Communication interface settings
- Security settings

- Language setting
- Date and time

In the following cases it may be necessary to restore the converter to factory settings:

- Incomplete commissioning
- If the motor is changed
- If there is uncertainty regarding the previous parameterization and/or the previous use of the converter

Requirement

- There is an online connection between the project and the drive (see Chapter "Establishing an online connection to the converter (Page 279)").
- For activated user management (UMAC):
The function rights required for "Restore factory settings" are activated for your user account. Details on this topic are provided in Chapter "Security settings in Startdrive" of the Configuration Manual SINAMICS Industrial Security.

Procedure

Proceed as follows to restore factory settings:

1. In the secondary navigation, click on menu "Backup/Restore".
The corresponding function view opens.
2. Click the "Start" button in the "Restore factory setting" field.

Result

The converter is reset and then restarted. If the "RDY" and "COM" LEDs on the converter light up green, resetting is complete.

More information

For a full reset of the converter, see Section "Manual reset to factory settings with SD card (Page 641)"

8.9.8 Overview of licenses

Overview

In the online mode, in function view "License", you can view information about options/ functions that require licensing and also perform the following actions:



- View status of individual licenses.
- Load license file.

- Display and copy serial number of the SD card being used.
- Activate Trial License mode.

Requirement

- For activated user management (UMAC):
The function rights required to edit the drive data are activated for your user account. Details on this topic are provided in Chapter "Security settings in Startdrive" of the Configuration Manual SINAMICS Industrial Security.

Description of function

Element	Description
General license status	Indicates the current license status (e.g. you do not have all of the licenses you need).
System response	Displays the system response to the current license status, e.g. "Blocks the drive from being switched on again."
Trial period	Displays of the Trial License status; e.g. "Trial License mode not active".
Serial number of the SD card	Serial number of the SD card and button to copy the serial number
Activate Trial License mode	Button for activating Trial License mode
Activate the license key file	Button for loading a license file
Save eCoL archive	Button for saving the license certificates to the file system of the operating unit
Table columns	
Status	The following icons indicate the status:  License is complete.  Trial License mode is active.  License is not available or the SD card with license is not inserted (under licensed).
Function that requires licensing	List of all used system options/functions subject to licensing
Existing/required licenses	The required number of licenses compared with the number of licenses included with the license key. For operation, the number of available licenses \geq the number of licenses required.
License status	Displays the current status of the function subject to licensing.
Remaining operating time	Displays the remaining operating time of a trial period.

8.9.9 Updating the firmware in the Startdrive project

Overview

You upgrade the converter firmware directly in the Startdrive project.

Note

Firmware version in Startdrive project and converter

Online connections between the Startdrive project and converter are only possible if the firmware versions in the project and the converter are the same.

- Create a new project if your current project works with a firmware version that is older than the firmware version of the converter. Set the firmware version of the project to the currently upgraded version of the converter. Apply all of the other settings from the old project.
 - If you are using an old Startdrive version, it may be necessary to install a new Startdrive version that supports the firmware version.
-

Requirement

- A backup is made before updating the firmware.
 - The ZIP file with the desired firmware is saved in the file directory of your operating unit.
-

Note

An empty SD card must be inserted into the converter during update for storing the downloaded ZIP file temporarily.

- A physical connection between the Ethernet interface of your operating unit and the Ethernet or PROFINET interface of your converter.
- For activated user management (UMAC):
The function rights required for the firmware update are activated for your user account. Details on this topic are provided in Chapter "Security settings in Startdrive" of the Configuration Manual SINAMICS Industrial Security.

Procedure

Proceed as follows to perform a firmware update directly from your project:

1. Open the  Online access entry in the project tree.
2. Select the network interface of your operating unit.
3. Double-click "Update accessible devices".
The accessible device is displayed with the IP address.
4. Call the "Online & diagnostics" function for the displayed device.
An online connection to the selected participant is established and the "Online access" function view opens.
5. Expand the "Functions" entry in the secondary navigation.

6. Click the "Firmware update" entry.
The corresponding function view opens.
In the "Online data" area, the article number of the converter and the firmware version currently in use are displayed.
7. Click the "Browse" button in the "Firmware loader" area.
A selection dialog opens.
8. Select the firmware file with the required version in the file system of your operating unit.
The firmware file is displayed in the line with the same name in the "Firmware loader" area.
9. Check in the "Firmware version" field whether you have selected the required firmware version.
10. In the "Status" field, check that the firmware can be read.
11. Optional: Activate the option "Restart drive automatically".
If this option is activated, there is no need to restart the converter manually after the firmware update. Step 13 is omitted in this case.
12. To load the firmware to the converter, click on "OK".
The status of the firmware update is displayed in the "Status" field.
The new firmware is installed. The installation may take up to 15 minutes or longer.

Note**Check that the firmware has been updated**

Startdrive displays an appropriate message when completing the update. After the message has been displayed, using the LEDs, check whether the converter update has been completed.

13. Optional: If you have not activated the option "Restart drive automatically...", switch the converter off and on again.
14. Optional: Call the catalog information using the secondary navigation in the inspector window. Check whether the new firmware version is installed.

8.10 Checking using the trace function

Overview

In a trace configuration, depending on the SINAMICS S drive being used, define the following:

- Signals to be recorded
- Recording duration
- Trigger conditions

Requirement

- For activated user management (UMAC):
The function rights required for trace configuration are activated for your user account. Details on this topic are provided in Chapter "Security settings in Startdrive" of the Configuration Manual SINAMICS Industrial Security.

Description of function

The trace configuration for S200 drives is characterized by the following special features and device-specific default settings:

- Preset trace signals:
 - For the first trace that you create for an S200 drive, the first four signals are preassigned with the following parameters, which are typical for Motion Control applications:
 - r0062 (Speed setpoint after filter)
 - r0061[0] (Actual speed unsmoothed: Encoder 1)
 - r0080 (Torque actual value)
 - r0479[0] (Diagnostics encoder position actual value Gn_XIST1: Encoder 1)

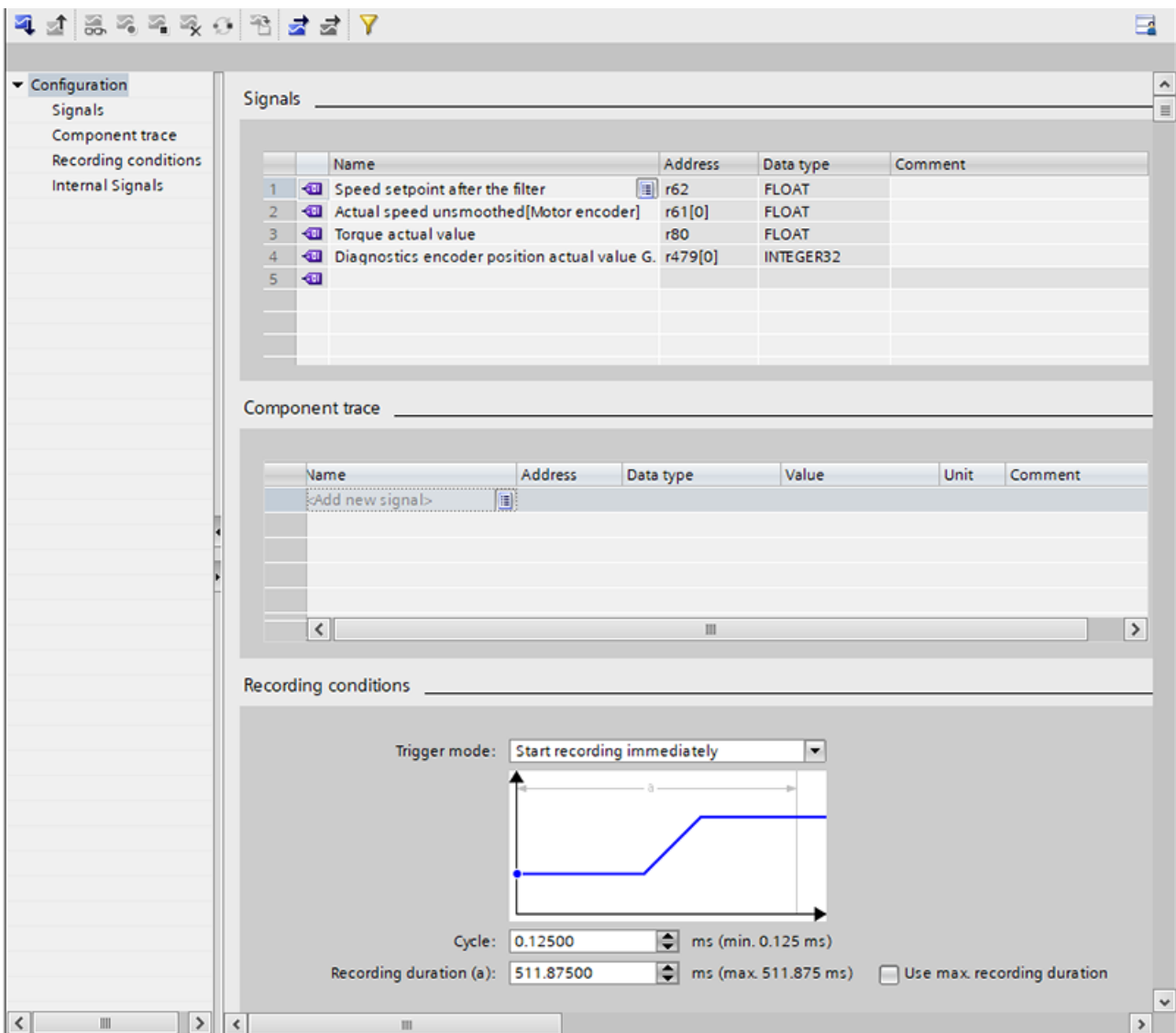

Figure 8-16 S200 trace called

8.10 Checking using the trace function

No signals are preset for other traces you create for an S200 drive. Up to eight signals can be selected.



- Possible cycle times:
In the "Cycle" input field of the trace configuration, you can enter the cycle time with which the trace should be recorded. The minimum cycle time for an S200 drive is 0.125 ms.
- Selecting signal bits based on plain text descriptions:
By selecting a trigger variable, you can display individual signal bits based on plain text descriptions (e.g. "Drive control.control word sequence control.ON / OFF1") in the trace configuration and select them directly. A description of how you can select an individual signal bit and set a trigger event is provided below using the "Drive control.control word sequence control" trigger variable as an example.

More information

More information about the trace function and configuration in the TIA Portal, see TIA Portal information system.

Example

In the following application, you want to make the basic settings for evaluating a trace.

1. Define a trigger mode (e.g. "Trigger on tag") via the "Trigger mode" drop-down list.
2. To open the signal selection table, click the  in the "Trigger tag" input field. The signal selection table is displayed.
3. In the signal selection table, scroll to the desired signal (e.g. "control word sequence control").
4. Click  in the row with the desired signal to open the bit selection table. The bit selection table shows the bits of the selected signal in plain text (e.g. "control word sequence control.ON / OFF1").

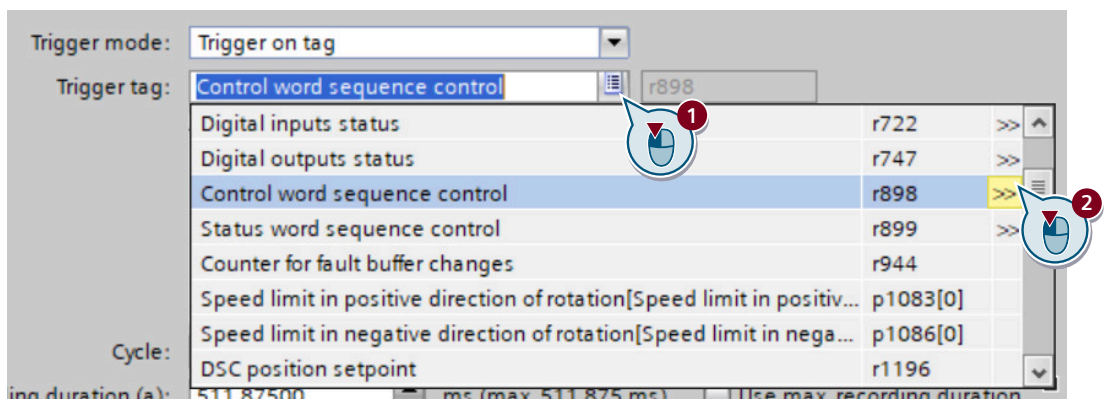

5. Select the required bit.
The selected bit is displayed in "①".

- To show the "Event" input field ("②"), press <Enter>. The input field is displayed with a preset trigger event.

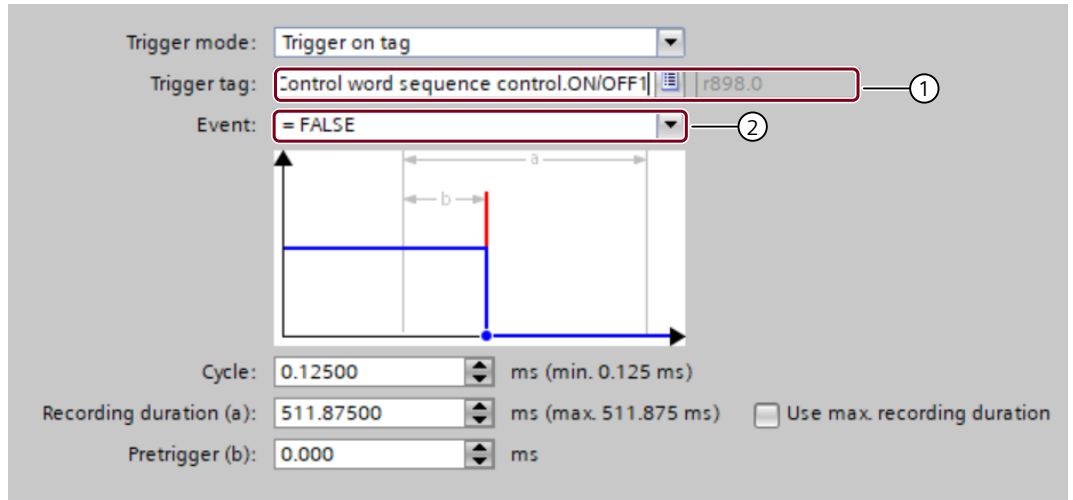

- Select the desired trigger event, if necessary, using the drop-down list in "②". The selected trigger event is displayed in "②".

Series commissioning

Overview

In series commissioning, the backed-up data and settings of a converter are loaded to other converters.

Requirement

The target converter must satisfy the following prerequisites:

- The rated power of the target converter is the same as the rated power of the converter from which the backed-up data and settings originate.
- The firmware version of the target converter is higher than or equal to the firmware version of the converter from which the backed-up data and settings originate.
- The machines that are commissioned via series commissioning are identical in terms of the application, converter and motor.
- The target converters are all configured to factory settings.

Description of function

Note

PROFINET-IP address and PROFINET device name are transferred for series commissioning. You must configure the PROFINET IP address and the PROFINET device names for the new devices later.

There are two options when carrying out series commissioning of the converter:

- **Series commissioning with SD card**
All settings on the SD card (including user management and access control) are transferred to the converter.
- **Series commissioning using the web server**
All settings from the parameter backup (including user management and access control) are transferred to the converter.
When performing series commissioning, also observe the fundamental principles for working with the web server (see section "Fundamentals (Page 164)").

9.1 Series commissioning with SD card

Requirement

- The machines that are commissioned via series commissioning are identical in terms of the application, converter and motor.

Procedure

Proceed as follows to perform series commissioning using an SD card:

1. Insert an empty SD card with a maximum capacity of 32 GB (e.g.: 6SL5570-0GC00-0AA0) into the card slot of the converter while it is switched off.
2. Switch on the converter and perform commissioning.
3. Save the settings at the end of commissioning.
This saves the settings in a non-volatile manner not only on the converter but also to the SD card.
4. Switch off the converter and remove the SD card from the converter.
5. Insert the SD card into the next, and switched off converter.
6. Switch on the converter and wait until it has ramped up - the RDY LED lights green.
During ramp-up, the converter takes the settings from the SD card - including user management and access control.
7. Switch off the converter and remove the SD card from the converter.

Repeat steps 5 to 7 for all converters to which you want to transfer these settings.

9.2 Series commissioning using the web server

Requirement

- The machines that are commissioned via series commissioning are identical in terms of the application, converter and motor.

Procedure

Proceed as follows to perform series commissioning using the web server:

1. Switch on the converter supply voltage and use your operating unit, e.g. a PC, to perform commissioning.
You can find more information in Chapter "Commissioning (web server) (Page 163)".
2. Save the settings at the end of commissioning.
3. Select "Backup and Restore" in the navigation - and back up the parameter settings in a file using "Back up parameters".
4. Connect your operating unit to the next converter.
5. Switch on the supply voltage to the converter.
6. Enter the IP address of the converter, e.g. `https://169.254.11.22`, in the browser.
7. Select the option "Exit the Security Wizard and continue with low security settings".
User management and access control (UMAC) is not activated.
You can configure the security settings at a later time, see Chapter "Protection & Security (Page 204)".
8. In the navigation, select "Backup and Restore" - and load the parameter settings using "Restore parameters via file" to the converter.
The converter accepts the parameters (including from user management and access control) from the file and restarts.

Repeat steps 4 to 7 for all converters to which you want to transfer these settings.

Functions

10.1 Overview of the functions

Overview

The SINAMICS S200 converter product line receives its commands from the higher-level controller via the PROFINET fieldbus interface. It uses different telegrams to realize different control functions.

Description of function

Supported telegrams

- Telegram 1
- Telegram 2
- Telegram 3
- Telegram 5
- Telegram 7
- Telegram 9
- Telegram 102
- Telegram 105
- Telegram 111
- Telegram 112
- Supplementary telegram

Control functions

- Stopping method at servo-off
- Vertical axis
- Speed limit
- Torque limit

10.1 Overview of the functions

- PTO function (for the S200 converter only)
- Basic positioner (EPOS)
 - Mechanical system
 - Limits
 - Position monitoring
 - Homing
 - Traversing blocks
 - Direct setpoint input (MDI)
 - Jogging

Safety functions (for the S200 converter only)

- Safe Torque Off (STO) safety function
Safe Torque Off (STO) is a safety function that immediately ensures that torque or force-generating energy is not fed to the motor.

10.2 Inputs/outputs

10.2.1 Digital inputs

Overview

A digital input detects a signal coming from outside. The function of a digital input is adjustable.

Description of function

The converter has four digital inputs, DI0 ... DI3. A parameter r0722.x is assigned to each digital input. You can adjust the function of digital inputs by interconnecting the signals to r0722.x in commissioning tools.

The following signals are assignable to the digital inputs.

Table 10-1 Assignable signals

Parameter	Signal	Type	Description	Available control mode	
				EPOS	S
c2104	Acknowledge all faults (RESET)	Edge 0→1	0→1: reset alarms	✓	✓
c2569	EPOS negative hardware limit switch	Edge 1→0	<ul style="list-style-type: none"> 1: condition for operation 1→0: quick stop (OFF3) 	✓	-
c2570	EPOS positive hardware limit switch	Edge 1→0	<ul style="list-style-type: none"> 1: condition for operation 1→0: quick stop (OFF3) 	✓	-
c0849	No quick stop OFF3 (EMGS)	Level	<ul style="list-style-type: none"> 0: OFF3 1: no OFF3 	✓	✓
c29048	Torque limit selection bit 0 (TLIM0)	Level	TLIM1 : TLIM0 <ul style="list-style-type: none"> 0 : 0: internal torque limit 0 0 : 1: internal torque limit 1 1 : 0: internal torque limit 2 1 : 1: internal torque limit 3 	✓	✓
c29049	Torque limit selection bit 1 (TLIM1)	Level			
c29063	Speed limit selection bit 0 (SLIM0)	Level	SLIM1 : SLIM0 <ul style="list-style-type: none"> 0 : 0: internal speed limit 0 0 : 1: internal speed limit 1 1 : 0: internal speed limit 2 1 : 1: internal speed limit 3 	✓	✓
c29064	Speed limit selection bit 1 (SLIM1)	Level			
c2596	EPOS set home position (SREF)	Level	<ul style="list-style-type: none"> 0: do not set home position 1: set home position 	✓	-
c2612	EPOS active homing reference cam (REF)	Level	1: reference cam active	✓	-

The following signals are assigned to the digital inputs by default.

Table 10-2 Default configuration of digital inputs

Digital input	Parameter	Default signal	
		S200	S200 Basic
DI0	r0722.0	Measuring probe 1	Measuring probe 1
DI1	r0722.1	Measuring probe 2	Measuring probe 2
DI2	r0722.2	EPOS negative hardware limit switch	-
DI3	r0722.3	EPOS positive hardware limit switch	-

More information

For more information about wiring digital inputs, see Section "Wiring of digital inputs (Page 154)".

Parameters

The following list includes the parameters of the "digital inputs" function.

Number	Name	Unit
r0722.0...3	Digital inputs status	
c0849[0]	No Quick Stop / Quick Stop (OFF3)	
c2104[0]	2nd acknowledge faults	
c2569	EPOS negative hardware limit switch	
c2570	EPOS positive hardware limit switch	
c2596	EPOS set home position	
c2612[0...1]	EPOS active homing reference cam	
c29048	Torque limit selection bit 0	
c29049	Torque limit selection bit 1	
c29063	Speed limit selection bit 0	
c29064	Speed limit selection bit 1	

10.2.2 Digital outputs

Overview

A digital output reports signal states of the converter to the outside. The function of a digital output is adjustable.

Description of function

The S200 converter has two digital outputs, DO0 and DO1. The S200 Basic converter offers DO0 only.

You can adjust the function of digital inputs by interconnecting the signal parameters to c730 and c731 in commissioning tools.

The following signals are assignable to the digital outputs.

Table 10-3 Assignable signals

Parameter	Signal	Available control mode	
		EPOS	S
r899.2	Operation enabled (RDY) <ul style="list-style-type: none"> 1: the converter is ready. 0: the converter is not ready (a fault occurs or the enable signal is missing). 	✓	✓
r29404.0	Ready for servo-on (RDY_ON) <ul style="list-style-type: none"> 1: the converter is ready for servo-on. 0: the converter is not ready for servo-on. 	✓	✓
r2139.3	Fault present (FAULT) <ul style="list-style-type: none"> 1: in the fault state. 0: no fault. 	✓	✓
r2684.10	Target position reached <ul style="list-style-type: none"> 1: the converter has reached target position. 0: the converter has not reached target position. 	✓	-
r2199.0	n_act < p2161: zero speed detection (ZSP) <ul style="list-style-type: none"> 1: motor speed ≤ zero speed (can be set with p2161). 0: motor speed > zero speed + hysteresis (10 r/min). 	✓	✓
r1407.7	Torque limit reached (TLR) <ul style="list-style-type: none"> 1: the generated torque has nearly (internal hysteresis) reached the value of the positive torque limit or negative torque limit. 0: the generated torque has not reached any torque limit. 	✓	✓
r899.12	Motor holding brake control <ul style="list-style-type: none"> 1: release the motor holding brake. The motor can rotate. 0: engage the motor holding brake. The motor cannot rotate. 	✓	✓
r899.13	Motor holding brake status <ul style="list-style-type: none"> 1: the motor holding brake is active. The motor cannot rotate. 0: the motor holding brake is released. The motor can rotate. 	✓	✓
r29404.2	Overload level reached (OLL) <ul style="list-style-type: none"> 1: the motor has reached the parameterizable output overload level (p29080 in % of the rated torque). 0: the motor has not reached the overload level. 	✓	✓
r2684.11	Home position set (REFOK) <ul style="list-style-type: none"> 1: homing is completed. 0: homing is not completed. 	✓	-

Parameter	Signal	Available control mode	
		EPOS	S
r46.8	STO status (STO_EP) <ul style="list-style-type: none"> 1: the enable signal is missing, indicating that STO is active. 0: the enable signal is available, indicating that STO is inactive. Note: STO_EP is only a status signal for STO input terminals but not a safe DO for the Safety Integrated function.	✓	✓
r2683.10	Direct output 1 via traversing block	✓	-
r2683.11	Direct output 2 via traversing block	✓	-

The following signals are assigned to the digital outputs by default.

Table 10-4 Default configuration of digital outputs

Digital output	Parameter	Default signal	
		S200	S200 Basic
DO0	c0730	RDY	RDY
DO1	c0731	FAULT	-

More information

For more information about wiring digital outputs, see Section "Wiring of digital outputs (Page 155)".

Parameters

The following list includes the parameters of the "digital outputs" function.

Number	Name	Unit
r0046.0...30	Missing enable signal	
c0730	Signal for terminal DO 1	
c0731	CU signal source for terminal DO 2	
r0899.0...13	Status word sequence control	
r1407.0...28	Status word speed controller	
r2139.0...15	Status word faults/alarms 1	
r2199.0...11	Status word monitoring 3	
r2683.0...14	EPOS status word 1	
r2684.0...15	EPOS status word 2	
r29404.0...5	DO status word	

10.3 Fieldbus communication

10.3.1 Communication via PROFINET IO

Overview

You can integrate the converter into a PROFINET network.

Description of function

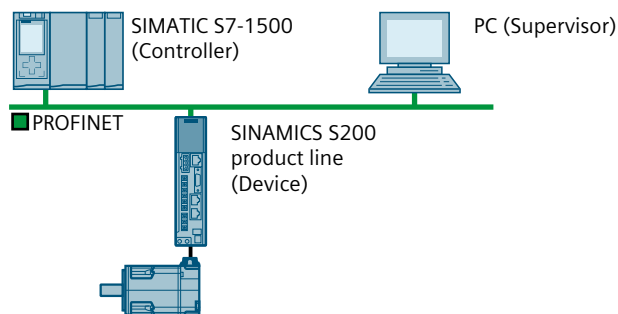

Figure 10-1 The converter in PROFINET IO operation (examples)

The converter supports the following functions:

- RT (Real-Time)
- IRT (Isochronous Real-Time)
- MRP (Media Redundancy Protocol): Media redundancy, with transition bump.
- MRPD (Media Redundancy Planned Duplication): Media redundancy, bumpless.
- Diagnostic alarms in accordance with the error classes specified in the PROFIdrive profile.
- Device replacement without removable data storage medium: The replacement converter is assigned the device name from the IO controller, not from its SD card or from the programming device.

10.3.2 Configuring PROFINET IO operation

10.3.2.1 Connecting the PROFINET cable to the converter

Requirement

You have set up a PROFINET network for connecting the converter.

Procedure

1. Connect the PROFINET cables to the two PROFINET sockets X150-P1 and X150-P2 on the controller.
The maximum permitted cable length from the previous station and to the next station is 100 m.
2. Connect the external 24 V power supply to the terminals X124: 1, 3 and X124: 2, 4. The external 24 V power supply is only required if communications with the controller is also intended to run when the line voltage is disconnected.

Result

You have connected the PROFINET cable to the converter.

10.3.2.2 Configuring communication using SIMATIC S7 control

Procedure

Proceed as follows to configure communication with a SIMATIC S7 controller in PROFINET:

- Install the current Startdrive version.
OR
- Install the GSDML of the converter using "Option/Manage general station description (GSD)" in the components catalog.

10.3.2.3 Setting communication via PROFINET

Overview

For PROFINET communication between the IO controller and the converter, you must set a device, an IP address, and a telegram.

Requirement

None

Procedure

1. Assign a device name that is unique in the PROFINET network.
PROFINET uses a device name in addition to the MAC address and the IP address to identify the PROFINET devices.
2. Specify an IP address.
You have the following options to specify the IP address of the converter:
 - The IP address is specified using the engineering software.
 - The IO controller assigns an IP address to the converter.

3. Set the same telegram in the IO controller as in the converter.
If you have not set a telegram in the converter, the converter assumes the telegram setting of the IO controller.
4. Interconnect the telegram in the control program of the IO controller with the signals of your choosing.

Result

You have set communication via PROFINET.

10.3.3 PROFINET protocols

10.3.3.1 PROFINET protocols

Overview

The converter supports the PROFINET protocols listed in the table.

The information contained is required to set Industrial Cybersecurity measures such as the firewall to protect the system.

Description of function

The address parameters, the relevant communication layer, and the communication role and communication direction are specified for each protocol.

Table 10-5 PROFINET protocols

Protocol	Port number	Layer (2) Link layer (4) Transport layer	Description
DCP: Discovery and Configuration Protocol	not relevant	(2) Ethernet II and IEEE 802.1Q and Ethertype 0x8892 (PROFINET)	Accessible stations, PROFINET Discovery and Configuration DCP detects PROFINET devices and enable basic settings. DCP uses the special multicast MAC address: xx-xx-xx-01-0E-CF, xx-xx-xx = Organizationally Unique Identifier
LLDP: Link Layer Discovery Protocol	not relevant	(2) Ethernet II and IEEE 802.1Q and Ethertype 0x88CC (PROFINET)	PROFINET Link Layer Discovery Protocol LLDP determines and manages neighbor relationships between PROFINET devices. LLDP uses the special multicast MAC address: 01-80-C2-00-00-0E

10.3 Fieldbus communication

Protocol	Port number	Layer (2) Link layer (4) Transport layer	Description
MRP: Media Redundancy Protocol	not relevant	(2) Ethernet II and IEEE 802.1Q and Ethertype 0x88E3 (PROFINET)	PROFINET Medium Redundancy MRP enables the control of redundant routes through a ring topology. MRP uses the special multicast MAC address: xx-xx-xx-01-15-4E, xx-xx-xx = Organizationally Unique Identifier
PTCP: Precision Transparent Clock Protocol	not relevant	(2) Ethernet II and IEEE 802.1Q and Ethertype 0x8892 (PROFINET)	PROFINET send clock and time synchronization, based on IEEE 1588 PTCP enables the send clock synchronization and time synchronization between RJ45 ports required for IRT operation. PTCP uses the special multicast MAC address: xx-xx-xx-01-0E-CF, xx-xx-xx = Organizationally Unique Identifier
PROFINET IO data	not relevant	(2) Ethernet II and IEEE 802.1Q and Ethertype 0x8892 (PROFINET)	PROFINET cyclic IO data transfer The PROFINET IO telegrams transfer process data cyclically between the PROFINET IO controller and IO devices via Ethernet.
PROFINET Context Manager	34964	(4) UDP	PROFINET connection less RPC The PROFINET Context Manager provides an endpoint mapper in order to establish an application relationship (PROFINET AR).

10.3.3.2 Media redundancy

Overview

The converter supports media redundancy based on MRP (Media Redundancy Protocol). Media redundancy is a function to increase system availability through redundant communication paths.

MRP can be expanded to MRPD (Media Redundancy with Planned Duplication of frames).

Requirement

The following preconditions apply regarding media redundancy:

- PROFINET as ring topology with redundancy manager
- Each device in the ring topology supports MRP or MRPD
- Maximum of 50 devices for each ring topology
- MRPD requires a suitable controller. In addition, a topology must be configured.

Description of function

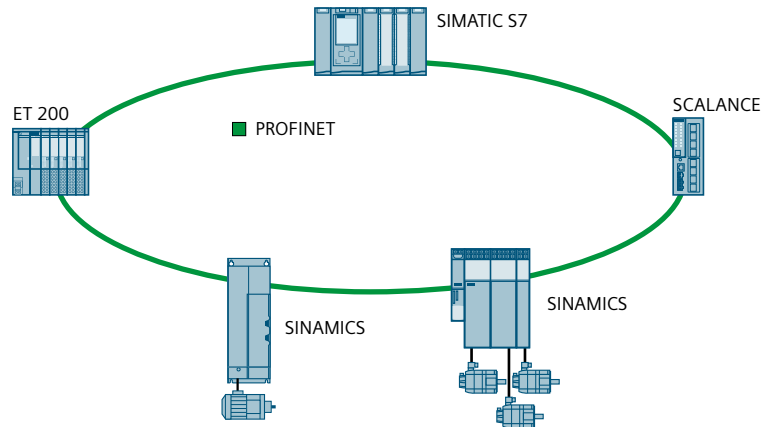

SIMATIC S7	PROFINET controller
ET 200	Distributed I/O
SINAMICS	Converter
SCALANCE	Redundancy manager

Figure 10-2 Example of a ring topology

Ethernet as basis for PROFINET only permits a single, unique data path from the controller to a device via a line-type topology or a star-type topology. MRP allows a line-type topology to be closed using a redundancy manager to create a ring-type topology. This means that every device can be accessed via 2 data paths.

When a device fails or if a cable is interrupted, the redundancy manager informs the device that the ring-type topology has now been switched over to a linear-type topology. The devices can be accessed again once a switchover has been made to a linear-type topology.

When the cable is interrupted, a short-time interruption (0 ... 200 ms) of the data transfer may occur until the redundant data path is switched.

If a short-time interruption is not allowed, there are two alternative ways:

- Set the watchdog time in the hardware configuration above 200 ms.
- Set the data transfer to IRT High Performance.

10.3.3.3 Connection-oriented communication protocols

Overview

The converter supports connection-oriented communication protocols.

Connection-oriented communication ensures that data arrives in the correct order.

Description of function

Table 10-6 Connection-oriented communication protocols

Protocol	Port number	Layer (2) Link layer (4) Transport layer	Description
DHCP Dynamic Host Configuration Protocol	68	(4) UDP	Is used to query an IP address. Is closed when delivered, and is opened when selecting the DHCP mode.
ISO on TCP (according to RFC 1006)	102	(4) TCP	ISO on TCP (according to RFC 1006) is used for the message-oriented data exchange to a remote CPU, WinAC or devices of other suppliers. Communication with engineering system, human machine interface, etc. Is activated in the factory setting.
SNMP Simple network management protocol	161	(4) UDP	SNMP enables network management data to be read out and set (SNMP managed objects) by the SNMP manager.
https Secure Hypertext Transfer Protocol	443	(4) TCP	https is used for communication with the CU-internal web server via Transport Layer Security (TLS). Is open in the as-supplied state and can be deactivated.
Reserved	49152 ... 65535	(4) TCP (4) UDP	Dynamic port area that is used for the active connection endpoint if the application does not specify the local port number.

10.3.4 Telegram

10.3.4.1 Telegram structure

Overview

Converter and higher-level control system exchange data via a fieldbus using telegrams.

Description of function

The converter receives data from the higher-level control cyclically and returns data to the control cyclically.

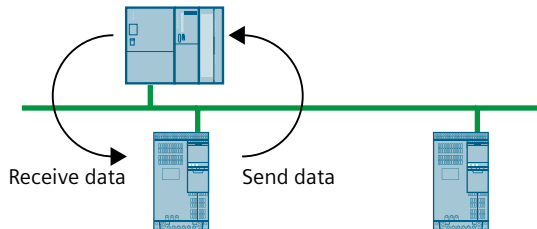

Figure 10-3 Cyclic data exchange

Converter and higher-level control system package their data in telegrams.

Specific telegrams are defined for typical applications in the PROFIdrive profile and are provided with a fixed PROFIdrive telegram number. Behind every PROFIdrive telegram number is thus a fixed composition of signals. This means that a telegram number provides an unambiguous description of the cyclic data exchange.

10.3.4.2 Supported telegrams

Overview

SINAMICS S200 converter product line supports standard telegrams and Siemens telegrams for speed control and position control.

Description of function

From the perspective of the converter, the received process data represents the receive words and the process data to be sent represents the send words.

Table 10-7 Overview of supported telegrams

Telegram	Maximum number of PZD ¹⁾	
	Received word	Send word
Standard telegram 1	2	2
Standard telegram 2	4	4
Standard telegram 3	5	9
Standard telegram 5	9	9
Standard telegram 7	2	2
Standard telegram 9	10	5
Siemens telegram 102	6	10
Siemens telegram 105	10	10
Siemens telegram 111	12	12
Siemens telegram 112	17	12
Siemens telegram 750 (supplementary telegram)	3	1

¹⁾ One PZD = one word

10.3.4.3 Telegrams used for speed control

Overview

Telegrams 1, 2, 3, 5, 102, and 105 are used for speed control.

Description of function

Table 10-8 Telegram 1

Process data	Telegram 1			
	Control → Converter		Converter → Control	
	Signal	Explanation	Signal	Explanation
PZD01	STW1	Control word 1	ZSW1	Status word 1
PZD02	NSOLL_A	16-bit speed setpoint	NIST_A	16-bit speed actual value

Table 10-9 Telegram 2

Process data	Telegram 2			
	Control → Converter		Converter → Control	
	Signal	Explanation	Signal	Explanation
PZD01	STW1	Control word 1	ZSW1	Status word 1
PZD02	NSOLL_B	32-bit speed setpoint	NIST_B	32-bit speed actual value
PZD03				
PZD04	STW2	Control word 2	ZSW2	Status word 2

Table 10-10 Telegram 3

Process data	Telegram 3			
	Control → Converter		Converter → Control	
	Signal	Explanation	Signal	Explanation
PZD01	STW1	Control word 1	ZSW1	Status word 1
PZD02	NSOLL_B	32-bit speed setpoint	NIST_B	32-bit speed actual value
PZD03				
PZD04	STW2	Control word 2	ZSW2	Status word 2
PZD05	G1_STW	Control word for encoder 1	G1_ZSW	Status word from encoder 1
PZD06	---	Not used	G1_XIST1	Position actual value 1 from encoder 1
PZD07	---			
PZD08	---		G1_XIST2	Position actual value 2 from encoder 1
PZD09	---			

Table 10-11 Telegram 5

Process data	Telegram 5			
	Control → Converter		Converter → Control	
	Signal	Explanation	Signal	Explanation
PZD01	STW1	Control word 1	ZSW1	Status word 1
PZD02	NSOLL_B	32-bit speed setpoint	NIST_B	32-bit speed actual value
PZD03				
PZD04	STW2	Control word 2	ZSW2	Status word 2
PZD05	G1_STW	Control word for encoder 1	G1_ZSW	Status word from encoder 1
PZD06	XERR	Position deviation	G1_XIST1	Position actual value 1 from encoder 1
PZD07				
PZD08	KPC	Position controller gain factor	G1_XIST2	Position actual value 2 from encoder 1
PZD09				

Table 10-12 Telegram 102

Process data	Telegram 102			
	Control → Converter		Converter → Control	
	Signal	Explanation	Signal	Explanation
PZD01	STW1	Control word 1	ZSW1	Status word 1
PZD02	NSOLL_B	32-bit speed setpoint	NIST_B	32-bit speed actual value
PZD03				
PZD04	STW2	Control word 2	ZSW2	Status word 2
PZD05	MOMRED	Torque reduction	MELDW	Message word
PZD06	G1_STW	Control word for encoder 1	G1_ZSW	Status word from encoder 1
PZD07	---	Not used	G1_XIST1	Position actual value 1 from encoder 1
PZD08	---			
PZD09	---		G1_XIST2	Position actual value 2 from encoder 1
PZD10	---			

Table 10-13 Telegram 105

Process data	Telegram 105			
	Control → Converter		Converter → Control	
	Signal	Explanation	Signal	Explanation
PZD01	STW1	Control word 1	ZSW1	Status word 1
PZD02	NSOLL_B	32-bit speed setpoint	NIST_B	32-bit speed actual value
PZD03				
PZD04	STW2	Control word 2	ZSW2	Status word 2
PZD05	MOMRED	Torque reduction	MELDW	Message word

Process data	Telegram 105			
	Control → Converter		Converter → Control	
	Signal	Explanation	Signal	Explanation
PZD06	G1_STW	Control word for encoder 1	G1_ZSW	Status word from encoder 1
PZD07	XERR	Position deviation	G1_XIST1	Position actual value 1 from encoder 1
PZD08				
PZD09	KPC	Position controller gain factor	G1_XIST2	Position actual value 2 from encoder 1
PZD10				

10.3.4.4 Telegrams used for position control

Overview

Telegrams 7, 9, 111, and 112 are used for position control.

Description of function

Table 10-14 Telegram 7

Process data	Telegram 7			
	Control → Converter		Converter → Control	
	Signal	Explanation	Signal	Explanation
PZD01	STW1	Control word 1	ZSW1	Status word 1
PZD02	SATZANW	Position block selection	AKTSATZ	Selected position block

Table 10-15 Telegram 9

Process data	Telegram 9			
	Control → Converter		Converter → Control	
	Signal	Explanation	Signal	Explanation
PZD01	STW1	Control word 1	ZSW1	Status word 1
PZD02	SATZANW	Position block selection	AKTSATZ	Selected position block
PZD03	STW2	Control word 2	ZSW2	Status word 2
PZD04	MDI_TARPOS	MDI position	XIST_A	Position actual value A
PZD05				
PZD06	MDI_VELOCITY	MDI velocity	---	---
PZD07			---	---
PZD08	MDI_ACC	MDI acceleration override	---	---
PZD09	MDI_DEC	MDI deceleration override	---	---
PZD10	MDI_MOD	Position MDI mode	---	---

Table 10-16 Telegram 111

Process data	Telegram 111			
	Control → Converter		Converter → Control	
	Signal	Explanation	Signal	Explanation
PZD01	STW1	Control word 1	ZSW1	Status word 1
PZD02	POS_STW1	Position control word	POS_ZSW1	Position status word
PZD03	POS_STW2	Position control word	POS_ZSW2	Position status word
PZD04	STW2	Control word 2	ZSW2	Status word 2
PZD05	VERRIDE	Position velocity override	MELDW	Message word

Process data	Telegram 111			
	Control → Converter		Converter → Control	
	Signal	Explanation	Signal	Explanation
PZD06	MDI_TARPOS	MDI position	XIST_A	Position actual value A
PZD07				
PZD08	MDI_VELOCITY	MDI velocity	NIST_B	32-bit speed actual value
PZD09				
PZD10	MDI_ACC	MDI acceleration override	FAULT_CODE	Fault code
PZD11	MDI_DEC	MDI deceleration override	WARN_CODE	Alarm code
PZD12	---	---	---	---

Table 10-17 Telegram 112

Process data	Telegram 112			
	Control → Converter		Converter → Control	
	Signal	Explanation	Signal	Explanation
PZD01	STW1	Control word 1	ZSW1	Status word 1
PZD02	POS_STW1	Position control word	POS_ZSW1	Position status word
PZD03	POS_STW2	Position control word	POS_ZSW2	Position status word
PZD04	STW2	Control word 2	ZSW2	Status word 2
PZD05	OVERRIDE	Position velocity override	Reserved	---
PZD06	MDI_TARPOS	MDI position	XIST	Position actual value
PZD07				
PZD08	MDI_VELOCITY	MDI velocity	VIST	Velocity actual value
PZD09				
PZD10	MDI_ACC	MDI acceleration override	MELDW	Message word
PZD11			FAULT_CODE	Fault code
PZD12	MDI_DEC	MDI deceleration override	WARN_CODE	Alarm code
PZD13			---	---
PZD14	Reserved	---	---	---
PZD15			---	---
PZD16	REF_COORDINATE	EPOS home position signal	---	---
PZD17			---	---

Note

When you use the telegrams 111 and 112 in EPOS functions JOG, MDI, traversing block, and homing, the value of the PZD5 OVERRIDE affects the speed.

10.3.4.5 Supplementary telegram

Overview

Converter and higher-level control system exchange data via a fieldbus using telegrams.

Description of function

Table 10-18 Telegram 750

Process data	Telegram 750			
	Control → Converter		Converter → Control	
	Signal	Explanation	Signal	Explanation
PZD01	M_ADD1	Additional torque	M_ACT	Actual torque
PZD02	M_LIMIT_POS	Upper torque limit	---	---
PZD03	M_LIMIT_NEG	Lower torque limit	---	---

Note

Before setting the supplementary telegram, you must select a main telegram firstly. If you change the main telegram, the supplementary telegram will be disabled automatically. So after changing the main telegram, you must set the supplementary telegram again.

However, if you change the control mode of the converter, the supplementary telegram keeps the same state as that in the former control mode. The available supplementary telegram will not be disabled automatically. For example, if you enabled the supplementary telegram 750 before you change the control mode, the supplementary telegram 750 keeps enabled after the control mode change.

Note

After you enabled the supplementary telegram, the PZDs of the supplementary telegram follow after the PZDs of the main telegram.

Note

When you use the telegram 750 in application of rewinding and unwinding, the built-in braking resistor of the converter is not sufficient to absorb the excess regenerative energy.

Note

When you use the telegram 750, if either of the following settings is done, the motor will accelerate in an uncontrollable manner:

- Setting a negative value of the upper torque limit via the PZD M_LIMIT_POS
- Setting a positive value of the lower torque limit via the PZD M_LIMIT_NEG

10.3.5 Control word definition

10.3.5.1 Control word 1

Overview

The control word 1 (STW1) is available for all telegrams, except for supplementary telegram.

Description of function

The definition of STW1 varies for different telegrams in different control modes.

In speed control

- For telegrams 1, 2, 3, 5

Note

When telegram 5 is used, STW1.4, STW1.5, and STW1.6 are disabled.

Note

STW1.10 must be set to 1 to allow the PLC to control the converter.

Bit	Signal	Description
0	0 = OFF1	The motor brakes with the ramp-down time p1121 of the ramp-function generator. The converter switches off the motor at standstill.
	0 → 1 = ON	The converter is ready to switch on the motor.
1	0 = OFF2	The converter switches off the motor immediately. The motor coasts down to a standstill.
	1 = No OFF2	The motor can be switched on with the ON command.
2	0 = Quick stop (OFF3)	The motor brakes with the OFF3 ramp-down time p1135. The converter switches off the motor at standstill.
	1 = No quick stop (OFF3)	The motor can be switched on with the ON command.
3	0 = Inhibit operation	The converter switches off the motor immediately with pulses suppressed.
	1 = Enable operation	The converter switches on the motor.
4	0 = Inhibit ramp-function generator	Set the ramp-function generator output to zero.
	1 = Operating condition	Enable the ramp-function generator.
5	0 = Freeze ramp-function generator	Freeze the ramp-function generator output.
	1 = Continue ramp-function generator	Continue the ramp-function generator output.
6	0 = Inhibit setpoint	Set the ramp-function generator input to zero.
	1 = Enable setpoint	Enable the ramp-function generator input.
7	0 → 1 = Acknowledge faults	
8	Reserved	
9	Reserved	
10	1 = Control via PLC	The converter accepts the process data from the PLC.
11	1 = Setpoint inversion	Invert the setpoint in the converter.
12	Reserved	
13	Reserved	
14	Reserved	
15	Reserved	

- For telegrams 102 and 105

Note

When telegram 105 is used, STW1.4, STW1.5, and STW1.6 are disabled.

Note

STW1.10 must be set to 1 to allow the PLC to control the converter.

Bit	Signal	Description
0	0 = OFF1	The motor brakes with the ramp-down time p1121 of the ramp-function generator. The converter switches off the motor at standstill.
	0 → 1 = ON	The converter is ready to switch on the motor.
1	0 = OFF2	The converter switches off the motor immediately. The motor coasts down to a standstill.
	1 = No OFF2	The motor can be switched on with the ON command.
2	0 = Quick stop (OFF3)	The motor brakes with the OFF3 ramp-down time p1135. The converter switches off the motor at standstill.
	1 = No quick stop (OFF3)	The motor can be switched on with the ON command.
3	0 = Inhibit operation	The converter switches off the motor immediately with pulses suppressed.
	1 = Enable operation	The converter switches on the motor.
4	0 = Inhibit ramp-function generator	Set the ramp-function generator output to zero.
	1 = Operating condition	Enable the ramp-function generator.
5	0 = Freeze ramp-function generator	Freeze the ramp-function generator output.
	1 = Continue ramp-function generator	Continue the ramp-function generator output.
6	0 = Inhibit setpoint	Set the ramp-function generator input to zero.
	1 = Enable setpoint	Enable the ramp-function generator input.
7	0 → 1 = Acknowledge faults	
8	Reserved	
9	Reserved	
10	1 = Control via PLC	The converter accepts the process data from the PLC.
11	1 = Ramp-function generator active	
12	1 = Open the holding brake with no condition	
13	Reserved	
14	0 = Closed-loop speed control active	
	1 = Closed-loop torque control active	
15	Reserved	

In position control

- For telegrams 7, 9, 111, 112

Note

STW1.10 must be set to 1 to allow the PLC to control the converter.

Bit	Signal	Description
0	0 = OFF1	The motor brakes with the ramp-down time p1121 of the ramp-function generator. The converter switches off the motor at standstill.
	0 → 1 = ON	The converter is ready to switch on the motor.
1	0 = OFF2	The converter switches off the motor immediately. The motor coasts down to a standstill.
	1 = No OFF2	The motor can be switched on with the ON command.
2	0 = Quick stop (OFF3)	The motor brakes with the OFF3 ramp-down time p1135. The converter switches off the motor at standstill.
	1 = No quick stop (OFF3)	The motor can be switched on with the ON command.
3	0 = Inhibit operation	The converter switches off the motor immediately with pulses suppressed.
	1 = Enable operation	The converter switches on the motor.
4	0 = Reject a traversing task	The converter rejects a traversing task. The motor brakes with the maximum deceleration rate.
	1 = Do not reject a traversing task	The converter accepts a traversing task.
5	0 = Intermediate stop	The converter stops performing the traversing task.
	1 = No intermediate stop	The converter continues to perform the traversing task.
6	0 → 1 = Activate traversing task	The traversing task is activated.
7	0 → 1 = Acknowledge faults	
8	1 = Jog 1 signal source	Jog 1 is activated.
9	1 = Jog 2 signal source	Jog 2 is activated.
10	1 = Control via PLC	The converter accepts the process data from the PLC.
11	1 = Start homing	The converter starts homing.
	0 = Stop homing	The converter stops homing.
12	Reserved	
13	0 → 1 = External block change	The external block is changed.
14	Reserved	
15	Reserved	

10.3.5.2 Control word 2

Overview

The control word 2 (STW2) is available for some specific telegrams.

Description of function

The definition of STW2 varies for different telegrams in different control modes.

In speed control

- For telegrams 2, 3, 5

Bit	Signal
0	Reserved
1	Reserved
2	Reserved
3	Reserved
4	Reserved
5	Reserved
6	Reserved
7	Reserved
8	1 = Travel to fixed stop
9	Reserved
10	Reserved
11	Reserved
12	Master sign-of-life, bit 0
13	Master sign-of-life, bit 1
14	Master sign-of-life, bit 2
15	Master sign-of-life, bit 3

- For telegrams 102 and 105

Bit	Signal
0	Reserved
1	Reserved
2	Reserved
3	Reserved
4	1 = Bypass ramp-function generator
5	Reserved
6	1 = Integrator inhibit, speed controller
7	Reserved
8	1 = Travel to fixed stop
9	Reserved
10	Reserved
11	Reserved
12	Master sign-of-life, bit 0
13	Master sign-of-life, bit 1
14	Master sign-of-life, bit 2
15	Master sign-of-life, bit 3

In position control

- For telegrams 9, 111, 112

Bit	Signal
0	Reserved
1	Reserved
2	Reserved
3	Reserved
4	Reserved
5	Reserved
6	Reserved
7	Reserved
8	1 = Travel to fixed stop
9	Reserved
10	Reserved
11	Reserved
12	Master sign-of-life, bit 0
13	Master sign-of-life, bit 1
14	Master sign-of-life, bit 2
15	Master sign-of-life, bit 3

10.3.5.3 Encoder 1 control word

Overview

The encoder 1 control word (G1_STW) is available for telegrams 3 and 5.

Description of function

The definition of G1_STW is as follows.

Table 10-19 Encoder 1 control word

Bit	Signal															
0	Selects the function to be activated (with bit value = 1)															
1	<table border="1"> <thead> <tr> <th>Function No.</th> <th>Function for bit 7 = 0 (search for homing mark)</th> <th>Function for bit 7 = 1 (flying measurement)</th> </tr> </thead> <tbody> <tr> <td>1</td> <td>Homing mark 1</td> <td>⤴ Measuring probe 1</td> </tr> <tr> <td>2</td> <td>Homing mark 2</td> <td>⤵ Measuring probe 1</td> </tr> <tr> <td>3</td> <td>Homing mark 3</td> <td>⤴ Measuring probe 2</td> </tr> <tr> <td>4</td> <td>Homing mark 4</td> <td>⤵ Measuring probe 2</td> </tr> </tbody> </table>	Function No.	Function for bit 7 = 0 (search for homing mark)	Function for bit 7 = 1 (flying measurement)	1	Homing mark 1	⤴ Measuring probe 1	2	Homing mark 2	⤵ Measuring probe 1	3	Homing mark 3	⤴ Measuring probe 2	4	Homing mark 4	⤵ Measuring probe 2
Function No.		Function for bit 7 = 0 (search for homing mark)	Function for bit 7 = 1 (flying measurement)													
1		Homing mark 1	⤴ Measuring probe 1													
2		Homing mark 2	⤵ Measuring probe 1													
3		Homing mark 3	⤴ Measuring probe 2													
4	Homing mark 4	⤵ Measuring probe 2														
2																
3																
4																
5																
6	<table border="1"> <tbody> <tr> <td>0</td> <td>1</td> <td>0</td> <td>1</td> </tr> <tr> <td>0</td> <td>0</td> <td>1</td> <td>1</td> </tr> <tr> <td>0</td> <td>0</td> <td>0</td> <td>0</td> </tr> </tbody> </table> <p> Interrupt function Read generated value Activate selected function No function </p>	0	1	0	1	0	0	1	1	0	0	0	0			
0	1	0	1													
0	0	1	1													
0	0	0	0													
7	Mode of the function to be activated 1 = Flying measurement 0 = Search for homing mark															
8	Reserved															
9	Reserved															
10	Reserved															
11	Reserved															
12	Reserved															
13	1 = Request value cyclic transfer of the absolute position value in Gn_XIST2															
14	1 = Request parking encoder															
15	0 → 1 = Acknowledge encoder fault															

10.3.5.4 Position block selection control word

Overview

The position block selection control word (SATZANW) is available for telegrams 7 and 9.

Description of function

The definition of SATZANW is as follows.

Table 10-20 Position block selection control word

Bit	Signal
0	1 = Traversing block selection, bit 0
1	1 = Traversing block selection, bit 1
2	1 = Traversing block selection, bit 2
3	1 = Traversing block selection, bit 3
4	1 = Traversing block selection, bit 4
5	1 = Traversing block selection, bit 5
6	Reserved
7	Reserved
8	Reserved
9	Reserved
10	Reserved
11	Reserved
12	Reserved
13	Reserved
14	Reserved
15	1 = Activate MDI 0 = Deactivate MDI

10.3.5.5 Position MDI mode control word

Overview

The position MDI mode control word (MDI_MOD) is available for telegram 9.

Description of function

The definition of MDI_MOD is as follows.

Table 10-21 Position MDI mode control word

Bit	Signal
0	1 = Absolute positioning is selected 0 = Relative positioning is selected
1	0 = Absolute positioning through the shortest distance
2	1 = Absolute positioning in the positive direction 2 = Absolute positioning in the negative direction 3 = Absolute positioning through the shortest distance
3	Reserved
4	Reserved
5	Reserved
6	Reserved
7	Reserved
8	Reserved
9	Reserved
10	Reserved
11	Reserved
12	Reserved
13	Reserved
14	Reserved
15	Reserved

10.3.5.6 Position control word 1

Overview

The position control word 1 (POS_STW1) is available for telegrams 111 and 112.

Description of function

The definition of POS_STW1 is as follows.

Table 10-22 Position control word 1

Bit	Signal
0	1 = Traversing block selection, bit 0
1	1 = Traversing block selection, bit 1
2	1 = Traversing block selection, bit 2
3	1 = Traversing block selection, bit 3
4	1 = Traversing block selection, bit 4
5	1 = Traversing block selection, bit 5
6	Reserved
7	Reserved
8	1 = Absolute positioning is selected 0 = Relative positioning is selected
9	0 = Absolute positioning through the shortest distance
10	1 = Absolute positioning/MDI direction selection, positive 2 = Absolute positioning/MDI direction selection, negative 3 = Absolute positioning through the shortest distance
11	Reserved
12	1 = Continuous transfer 0 = Activate MDI block change with of a traversing task (STW1.6)
13	Reserved
14	1 = Signal setting-up selected 0 = Signal positioning selected
15	1 = MDI selection

10.3.5.7 Position control word 2

Overview

The position control word 2 (POS_STW2) is available for telegrams 111 and 112.

Description of function

- The definition of POS_STW2 for **telegram 111** is as follows.

Bit	Signal
0	1 = Tracking mode active
1	1 = Set reference point
2	1 = Reference cam active
3	Reserved
4	Reserved
5	1 = Jogging, incremental active 0 = Jogging, velocity active
6	Reserved
7	Reserved
8	Reserved
9	1 = Start the search for homing in the negative direction 0 = Start the search for homing in the positive direction
10	Reserved
11	Reserved
12	Reserved
13	Reserved
14	1 = Software limit switch activation
15	1 = STOP cam active

Note

If the tracking mode is activated, the position setpoint follows the actual position value (position setpoint = actual position value).

- The definition of POS_STW2 for **telegram 112** is as follows.

Bit	Signal
0	1 = Tracking mode active
1	1 = Set home position
2	1 = Reference cam active
3	Initiate absolute encoder adjustment
4	Reserved
5	1 = Jogging, incremental active 0 = Jogging, velocity active
6	Reserved
7	Reserved
8	Select passive homing
9	1 = Start the search for homing in the negative direction 0 = Start the search for homing in the positive direction
10	Measuring probe 2 is activated
11	Select measuring probe edge
12	Reserved

Bit	Signal
13	Reserved
14	1 = Software limit switch activation
15	1 = STOP cam active

10.3.6 Status word definition

10.3.6.1 Status word 1

Overview

The status word 1 (ZSW1) is available for all telegrams, except for supplementary telegram.

Description of function

The definition of ZSW1 varies for different telegrams in different control modes.

In speed control

- For telegrams 1, 2, 3, 5

Bit	Signal
0	1 = Ready for servo-on
1	1 = Ready for operation
2	1 = Operation enabled
3	1 = Fault present
4	1 = No coast down active (OFF2 inactive)
5	1 = No emergency stop active (OFF3 inactive)
6	1 = Switching on inhibited active
7	1 = Alarm present
8	1 = Speed setpoint - actual value deviation within tolerance t_{off}
9	1 = Control requested
10	1 = f or n comparison value reached/exceeded (default comparison value = 5 r/min)
11	0 = I, M, or P limit reached
12	1 = Open the holding brake
13	1 = No motor overtemperature alarm
14	1 = Motor rotates forwards ($n_{act} \geq 0$) 0 = Motor rotates backwards ($n_{act} < 0$)
15	1 = No alarm, thermal overload, power unit

- For telegrams 102 and 105

Bit	Signal
0	1 = Ready for servo-on
1	1 = Ready for operation
2	1 = Operation enabled
3	1 = Fault present
4	1 = No coast down active (OFF2 inactive)
5	1 = No emergency stop active (OFF3 inactive)
6	1 = Switching on inhibited active
7	1 = Alarm present
8	1 = Speed setpoint - actual value deviation within tolerance t_{off}
9	1 = Control requested
10	1 = f or n comparison value reached/exceeded (default comparison value = 5 r/min)
11	1 = Alarm class bit 0
12	1 = Alarm class bit 1
13	Reserved
14	1 = Closed-loop torque control active
15	Reserved

In position control

- For telegrams 7, 9, 111, 112

Bit	Signal
0	1 = Ready for servo-on
1	1 = Ready for operation (DC link loaded, pulses blocked)
2	1 = Operation enabled (converter follows n_set)
3	1 = Fault present
4	1 = No coast down active (OFF2 inactive)
5	1 = No emergency stop active (OFF3 inactive)
6	1 = Switching on inhibited active
7	1 = Alarm present
8	1 = Following error within tolerance
9	1 = Control requested
10	1 = Target position reached
11	1 = Home position set
12	0 → 1 = Acknowledgement traversing block activated
13	1 = Setpoint fixed
14	1 = Axis accelerated
15	1 = Axis decelerated

10.3.6.2 Status word 2

Overview

The status word 2 (ZSW2) is available for some specific telegrams.

Description of function

The definition of ZSW2 varies for different telegrams in different control modes.

In speed control

- For telegrams 2, 3, 5

Bit	Signal
0	Reserved
1	Reserved
2	Reserved
3	Reserved
4	Reserved
5	1 = Alarm class bit 0
6	1 = Alarm class bit 1
7	Reserved
8	1 = Travel to fixed stop
9	Reserved
10	1 = Pulses enabled
11	Reserved
12	Device sign-of-life, bit 0
13	Device sign-of-life, bit 1
14	Device sign-of-life, bit 2
15	Device sign-of-life, bit 3

- For telegrams 102 and 105

Bit	Signal
0	Reserved
1	Reserved
2	Reserved
3	Reserved
4	1 = Ramp-function generator inactive
5	1 = Open the holding brake
6	1 = Integrator inhibit, speed controller
7	Reserved
8	1 = Travel to fixed stop
9	Reserved
10	Reserved
11	Reserved
12	Device sign-of-life, bit 0
13	Device sign-of-life, bit 1
14	Device sign-of-life, bit 2
15	Device sign-of-life, bit 3

In position control

- For telegrams 9, 111, 112

Bit	Signal
0	Reserved
1	Reserved
2	Reserved
3	Reserved
4	Reserved
5	1 = Alarm class bit 0
6	1 = Alarm class bit 1
7	Reserved
8	1 = Travel to fixed stop
9	Reserved
10	1 = Pulses enabled
11	Reserved
12	Device sign-of-life, bit 0
13	Device sign-of-life, bit 1
14	Device sign-of-life, bit 2
15	Device sign-of-life, bit 3

10.3.6.3 Encoder 1 status word

Overview

The encoder 1 status word (G1_ZSW) is available for telegrams 3, 5, 102, and 105.

Description of function

The definition of G1_ZSW is as follows.

Table 10-23 Encoder 1 status word

Bit	Signal	
0	Feedback signal of the active function (1 = function active)	
1	Function No. For homing number and flying measurement	
2		
3	1	▲ Homing mark 1 or measuring probe 1
	2	▼ Homing mark 1 or measuring probe 2
4	1 = Position actual value from function 1	Generated value in Gn_XIST2 (and can be read)
5	1 = Position actual value from function 2	
6	1 = Position actual value from function 3	
7	1 = Position actual value from function 4	
8	Reserved	
9	Reserved	
10	Reserved	
11	1 = Acknowledge encoder fault active	
12	Reserved (for homing position offset)	
13	Absolute value is cyclically transferred	
14	Parking encoder active	
15	Encoder fault, the fault is in Gn_XIST2	

10.3.6.4 Message word status word

Overview

The message word status word (MELDW) is available for telegrams 102, 105, 111, and 112.

Description of function

The definition of MELDW is as follows.

Table 10-24 Message word status word

Bit	Signal
0	1 = Ramp-up/ramp-down complete 0 = Ramp-function generator active
1	1 = Torque utilization [%] < torque threshold value 2
2	1 = $ n_{act} < \text{speed threshold value 3 (p2161)}$
3	1 = $ n_{act} \leq \text{speed threshold value 2}$
4	1 = Vdc_min controller active
5	Reserved
6	1 = No motor overtemperature alarm
7	1 = No alarm, thermal overload, power unit
8	1 = Speed setpoint - actual value deviation within tolerance t_on
9	Reserved
10	Reserved
11	1 = Controller enabled
12	1 = Converter ready
13	1 = Pulses enabled
14	Reserved
15	Reserved

10.3.6.5 Position status word 1

Overview

The position status word 1 (POS_ZSW1) is available for telegrams 111 and 112.

Description of function

- The definition of POS_ZSW1 for **telegram 111** is as follows.

Bit	Signal
0	Active traversing block bit 0
1	Active traversing block bit 1
2	Active traversing block bit 2
3	Active traversing block bit 3
4	Active traversing block bit 4
5	Active traversing block bit 5
6	Reserved
7	Reserved
8	1 = STOP cam minus active
9	1 = STOP cam plus active
10	1 = Jogging active
11	1 = Home position approach active
12	Reserved
13	1 = Traversing block active
14	1 = Set-up active
15	1 = MDI active 0 = MDI inactive

- The definition of POS_ZSW1 for **telegram 112** is as follows.

Bit	Signal
0	Active traversing block bit 0
1	Active traversing block bit 1
2	Active traversing block bit 2
3	Active traversing block bit 3
4	Active traversing block bit 4
5	Active traversing block bit 5
6	Reserved
7	Reserved
8	1 = STOP cam minus active
9	1 = STOP cam plus active
10	1 = Jogging active
11	1 = Home position approach active
12	1 = Passive homing active
13	1 = Traversing block active
14	1 = Set-up active
15	1 = MDI active 0 = MDI inactive

10.3.6.6 Position status word 2

Overview

The position status word 2 (POS_ZSW2) is available for telegrams 111 and 112.

Description of function

- The definition of POS_ZSW2 for **telegram 111** is as follows.

Bit	Signal
0	1 = Tracking mode active
1	1 = Velocity limiting active
2	1 = Setpoint available
3	Reserved
4	1 = Axis moves forward
5	1 = Axis moves backwards
6	1 = Software limit switch minus reached
7	1 = Software limit switch plus reached
8	1 = Position actual value \leq cam switching position 1
9	1 = Position actual value \leq cam switching position 2
10	1 = Direct output 1 via traversing block
11	1 = Direct output 2 via traversing block
12	1 = Fixed stop reached
13	1 = Fixed stop clamping torque reached
14	1 = Travel to fixed stop active
15	1 = Traversing command active

- The definition of POS_ZSW2 for **telegram 112** is as follows.

Bit	Signal
0	1 = Tracking mode active
1	1 = Velocity limiting active
2	1 = Target position reached
3	Printing mark outside outer window
4	1 = Axis moves forward
5	1 = Axis moves backwards
6	1 = Software limit switch minus reached
7	1 = Software limit switch plus reached
8	1 = Position actual value \leq cam switching position 1
9	1 = Position actual value \leq cam switching position 2
10	1 = Direct output 1 via traversing block
11	1 = Direct output 2 via traversing block
12	1 = Fixed stop reached
13	1 = Fixed stop clamping torque reached
14	1 = Travel to fixed stop active
15	1 = Traversing command active

10.3.7 Identification & Maintenance (I&M) data

Overview

I&M data are identification and maintenance data that are stored in a device. The higher-level controller has access to the I&M data of all devices on the fieldbus.

Using the I&M data, the plant operator can identify and label devices and define maintenance measures.

The converter supports the identification and maintenance (I&M) data listed in the table.

Description of function

Table 10-25 I&M data

I&M data	Format	Explanation	Example for the content
I&M0	u8[54] PROFINET	Converter-specific data, read only	See below
I&M1	Visible String [32]	Plant/system identifier	"ak12-ne.bo2=fu1"
	Visible String [22]	Location code	"sc2+or45"
I&M2	Visible String [16]	Date	"2013-01-21 16:15"
I&M3	Visible String [54]	Any comment or remark	-
I&M4	Octet String[54]	Check signature to track changes for Safety Integrated.	Values of r9781[0] and r9782[0]

When requested, the converter transfers its I&M data to a higher-level control or to a PC/PG with installed TIA Portal.

Table 10-26 I&MO

Designation	Format	Example for the content
MANUFACTURER_ID	u16	42d hex (=Siemens)
ORDER_ID	Visible String [20]	"6SL3246-0BA22-1FA0"
SERIAL_NUMBER	Visible String [16]	"T-R32015957"
HARDWARE_REVISION	u16	0001 hex
SOFTWARE_REVISION	char, u8[3]	"V" 04.70.19
REVISION_COUNTER	u16	0000 hex
PROFILE_ID	u16	3A00 hex
PROFILE_SPECIFIC_TYPE	u16	0000 hex
IM_VERSION	u8[2]	01.02
IM_SUPPORTED	bit[16]	001E hex

10.4 General functions

10.4.1 Stopping method at servo-off

Overview

You can select a stopping method when the converter is in "servo-off" state. The following stopping methods are available:

- Ramp-down (OFF1)
- Coast-down (OFF2)
- Quick stop (OFF3)

Description of function

Ramp-down (OFF1) and coast-down (OFF2)

The ramp-down and coast-down can be configured with the PROFINET control words STW1.0 and STW1.1:

- **Ramp-down (OFF1)**

Control word	Setting	Description
STW1.0	Rising edge (0 → 1)	Power circuit is powered on and the servo motor is ready to run.
	0	Motor ramps down.

Note

The control word STW1.0 can be used to control the start and stop of the motor.

- **Coast-down (OFF2)**

Control word	Setting	Description
STW1.1	1	The servo motor is ready to run.
	0	Motor coasts down.

Quick stop (OFF3)

The quick stop can be configured with the PROFINET control word STW1.2 or the digital input signal EMGS:

- **Configuring with STW1.2**

Control word	Setting	Description
STW1.2	1	The servo motor is ready to run.
	0	Quick stop.

- **Configuring with EMGS**

DI signal	Setting	Description
EMGS	1	The servo motor is ready to run.
	0	Quick stop.

More information

For more information about the PROFINET control word and the digital input signal EMGS, see Sections "Control word definition (Page 331)" and "Inputs/outputs (Page 313)".

10.4.2 Speed limit

Overview

The following four sources are available for the speed limit selection. You can select one of them via a combination of digital input signals SLIM0 and SLIM1 and switch among them when the converter is running.

Table 10-27 Combinations of SLIM0 and SLIM1 signals

Digital input		Speed limit
SLIM1	SLIM0	
0	0	Internal speed limit 0
0	1	Internal speed limit 1
1	0	Internal speed limit 2
1	1	Internal speed limit 3

In addition to the above four sources, the overall speed limit is also valid.

Note

Fault F07901 occurs when the actual speed exceeds the positive speed limit + hysteresis speed (p2162) or the negative speed limit - hysteresis speed (p2162).

Description of function

Internal speed limit

Select an internal speed limit by setting the following parameters. The default parameter value depends on the maximum motor speed.

Table 10-28 Parameter - internal speed limit

Parameter	Value range	Default	Unit	Description	Digital input	
					SLIM1	SLIM0
p29070[0]	0 ... 210000	210000	r/min	Internal speed limit 0 (positive)	0	0
p29070[1]	0 ... 210000	210000	r/min	Internal speed limit 1 (positive)	0	1
p29070[2]	0 ... 210000	210000	r/min	Internal speed limit 2 (positive)	1	0
p29070[3]	0 ... 210000	210000	r/min	Internal speed limit 3 (positive)	1	1
p29071[0]	-210000 ... 0	-210000	r/min	Internal speed limit 0 (negative)	0	0
p29071[1]	-210000 ... 0	-210000	r/min	Internal speed limit 1 (negative)	0	1
p29071[2]	-210000 ... 0	-210000	r/min	Internal speed limit 2 (negative)	1	0
p29071[3]	-210000 ... 0	-210000	r/min	Internal speed limit 3 (negative)	1	1

Overall speed limit

The overall speed limit can be configured by setting the following parameters.

Table 10-29 Parameter - overall speed limit

Parameter	Value range	Default	Unit	Description
p1083	0 ... 210000	210000	r/min	Overall speed limit for positive direction
p1086	-210000 ... 0	-210000	r/min	Overall speed limit for negative direction

Note

After the motor is commissioned, the internal speed limit is set to the default value and the overall speed limit is set to the maximum speed of the motor automatically.

Parameters

The following list includes the parameters of the "Speed limit" function.

Number	Name	Unit
p1083[0]	Speed limit in positive direction of rotation	[rpm]
p1086[0]	Speed limit in negative direction of rotation	[rpm]
p2162[0]	Hysteresis speed $n_{act} > n_{max}$	[rpm]
p29070[0...3]	Speed limit in positive direction of rotation	[rpm]
p29071[0...3]	Speed limit in negative direction of rotation	[rpm]

10.4.3 Torque limit

Overview

The following four sources are available for the torque limit in all control modes. You can select one of them via a combination of digital input signals TLIM0 and TLIM1 and switch among them when the converter is running.

Table 10-30 Combinations of TLIM0 and TLIM1 signals

Digital input		Torque limit
TLIM1	TLIM0	
0	0	Internal torque limit 0
0	1	Internal torque limit 1
1	0	Internal torque limit 2
1	1	Internal torque limit 3

In addition to the above four sources, the overall torque limit is also valid.

Note

When the motor torque exceeds the torque limit of the selected group determined by TLM0 and TLM1, fault F52911 or F52912 occurs.

Description of function

Internal torque limit

Select an internal torque limit by setting the following parameters.

Table 10-31 Parameter - internal torque limit

Parameter	Value range	Default	Unit	Description	Digital input	
					TLIM1	TLIM0
p29050[0]	-150 ... 350	350	%	Internal torque limit 0 (upper)	0	0
p29050[1]	-150 ... 350	350	%	Internal torque limit 1 (upper)	0	1
p29050[2]	-150 ... 350	350	%	Internal torque limit 2 (upper)	1	0
p29050[3]	-150 ... 350	350	%	Internal torque limit 3 (upper)	1	1
p29051[0]	-350 ... 150	-350	%	Internal torque limit 0 (lower)	0	0
p29051[1]	-350 ... 150	-350	%	Internal torque limit 1 (lower)	0	1
p29051[2]	-350 ... 150	-350	%	Internal torque limit 2 (lower)	1	0
p29051[3]	-350 ... 150	-350	%	Internal torque limit 3 (lower)	1	1

The following diagram shows how the internal torque limit functions. When the torque setpoint reaches the torque limit, the actual torque output is limited to the value selected by TLIM0/TLIM1.

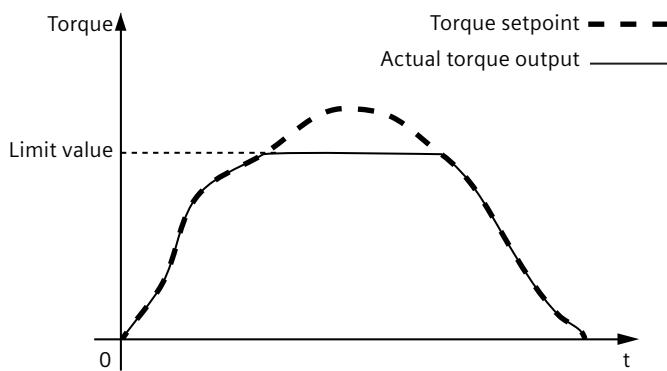

Overall torque limit

The overall torque limit takes effect when a quick stop (OFF3) happens. In this case, the servo drive brakes with a maximum torque.

Table 10-32 Parameter - overall torque limit

Parameter	Value range	Default	Unit	Description
p1520	-1000000.00 ... 20000000.00	0	Nm	Overall torque limit (upper)
p1521	-20000000.00 ... 1000000.00	0	Nm	Overall torque limit (lower)

Torque limit reached (TLR)

When the generated torque has nearly (internal hysteresis) reached the value of the upper torque limit, lower torque limit or analog torque limit, the signal TLR is output.

Parameters

The following list includes the parameters of the "Torque limit" function.

Number	Name	Unit
p1520[0]	Torque limit upper	[Nm]
p1521[0]	Torque limit lower	[Nm]
p29050[0...3]	Upper torque limit	[%]
p29051[0...3]	Lower torque limit	[%]

10.4.4 Vertical axis

Description of function

With a vertical axis without mechanical weight compensation, electronic weight compensation can be set by offsetting the torque limits (p1532). The torque limits specified in p1520 and p1521 are shifted by this offset value. The offset value can be read in r0031 and transferred in p1532.

To reduce compensation after a brake has been released, the torque offset can be interconnected as a supplementary torque setpoint. As a result, the holding torque is immediately specified after the brake is released.

Automatically configuring weight compensation

Siemens recommends that this function is used for vertical axes with an almost constant force due to weight. Start the automatic determination of the force due to weight using $p1558 = 1$. As soon as the technique has been started, the torque, which is required to hold the axis, is measured and entered into $p1532$. Further, interconnection between supplementary torque setpoint and $p1532$ is established for the precontrol, and the scaling of the precontrol channel is set to 100%.

The measurement can be started when the pulses are inhibited or the pulses are enabled ($p1558 = 1$). If the measurement was started with the pulses inhibited, it is only executed after the pulses have been enabled. In both cases, after starting, alarm A07991 (Drive: motor data identification activated) is output. The alarm is automatically withdrawn after the motor data identification routine has been successfully completed.

10.4.5 PTO function (for the S200 converter only)

Overview

Pulse Train Output is a simple and universal interface between a SIMATIC control and a SINAMICS drive. PTO is supported worldwide by many stepper drives and servo drives and is used in many positioning applications, for example, for adjusting or feed axes.

A pulse train encoder output which provides pulse signals can transmit the signals to the controller to realize a closed-loop control system inside the controller, or transmit them to another drive as pulse train setpoint for a synchronous axis or as control interface of another device (for example, a line scan camera).

Description of function

PTO is also referred to as pulse/direction interface. The pulse/direction interface comprises two signals.

- **PTO direction output**
The direction output defines the traversing direction. You can define whether the PTO position actual value should be inverted via $p4422$:
 - Positive logic (= not inverted, default setting)
 - Negative logic (= inverted)
- **Maximum output frequency**
The maximum output frequency represents the velocity and the number of output pulses for the section to be traversed. You can set the maximal output frequency of the pulse train output via $p4405$.

Electronic gear ratio

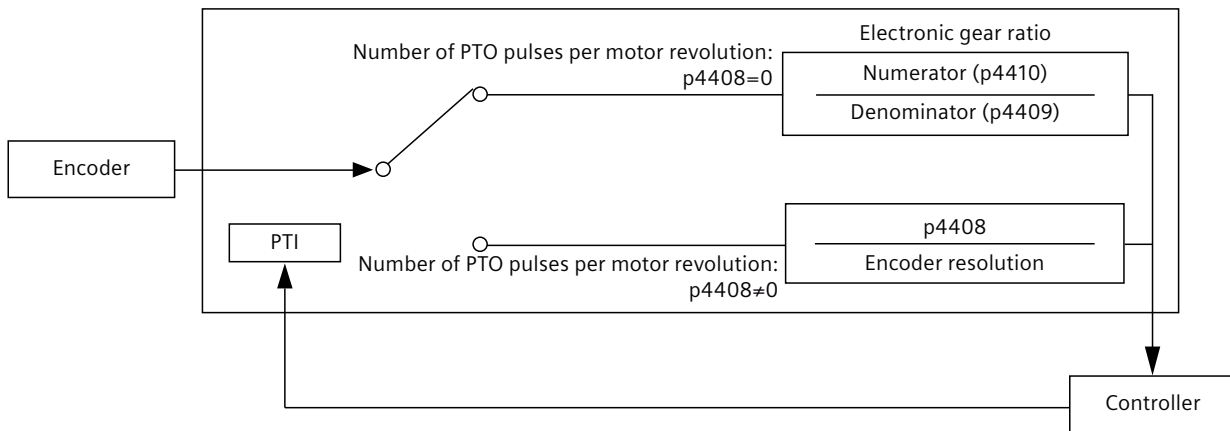

The electronic gear ratio is a multiplier factor to the pulse train output to a controller.

You can select one of the following two values to define the electronic gear ratio:

- Number of PTO pulses per motor revolution (p4408).
- Gear ratio by using a numerator (p4410) and a denominator (p4409).

Note

When you use the numerator and the denominator to define the electronic gear ratio, the number of PTO pulses per motor revolution (p4408) must be set to 0. Otherwise, no electronic gear ratio is active.

Note

The range of electronic gear ratio is from 0.02 to 8000.

The electronic gear ratio can be set at servo-off state only.

Note

When you use the PTO electronic gear function, if the product of the PTO setpoint pulses per motor revolution multiplied by the electronic gear ratio is not an integer, there is no zero mark generated.

Parameters

The following list includes the parameters of the "PTO" function.

Number	Name	Unit
p4405	PTO maximum output frequency	[kHz]
p4408	PTO pulse number	
p4409	Gearbox encoder (motor)/PTO denominator (Control Unit)	
p4410	Gearbox encoder (motor)/PTO numerator (Control Unit)	
r4419	PTO diagnostics position setpoint	

10.4 General functions

c4420	PTO position setpoint
p4422.0	PTO configuration
p4426	PTO zero mark offset

10.4.6 Setting motor overload protection in accordance with UL 61800-5-1 Ed.2

Overview

The motor overload protection function works without temperature sensors in the 1FL2 motors. To comply with UL 61800-5-1 Ed.2, you must make some additional settings when operating the converter with a 1FL2 motor.

Requirement

- You have completed quick commissioning with the correct motor data.

Procedure

Proceed as follows to activate the motor overload protection according to UL 61800-5-1 Ed.2:

1. Set p5375.0 = 1
2. Set p5375.1 = 1

10.5 Basic positioner (EPOS)

Overview

Position control means controlling the position of an axis. An "axis" is a machine or system component that comprises the converter with active position control and the driven mechanical system.

The basic positioner (EPOS) calculates the traversing profile for the time-optimized traversing of the axis to the target position.

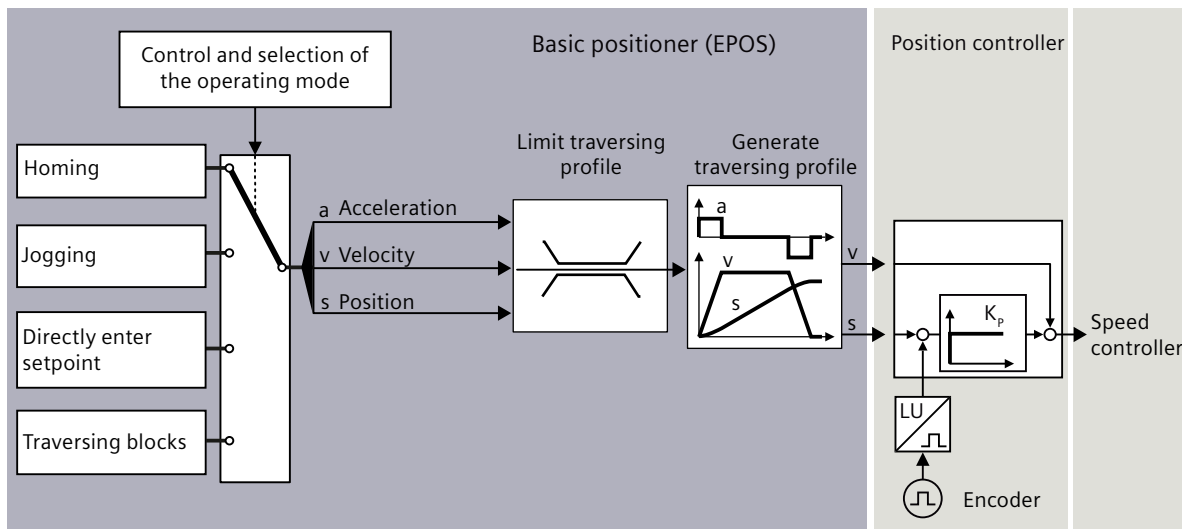

Figure 10-4 Basic positioner and position control

Description of function

The following functions can be carried out by using the basic positioner:

- **Limits**
 - Limiting the traversing range: specification of the possible traversing range through the configuration of various end positions
 - Limiting the traversing profiles: restriction of the dynamic travel response through limitation of the maximum velocity, acceleration, deceleration, and jerk
- **Monitoring**
 - Position/standstill monitoring: monitoring of the axis positioning motion and monitoring of the axis position after a traversing motion
 - Following error monitoring: monitoring of the maximum deviation between the actual value and the setpoint

- **Homing**
Homing establishes the home position measurement in the converter to the machine. Possible homing types are:
 - Active homing
 - Passive homing
 - Absolute encoder adjustment
- **Traversing blocks**
Position setpoints are saved in different traversing blocks in the converter. The external control selects a traversing block.
- **Direct setpoint input (MDI)**
The external control specifies the position setpoint for the axis.
- **Jogging**
This function is used to incrementally traverse the axis (for example, for setting up).

More information

For more information about configuring the basic positioner (EPOS) in Startdrive, see the information system of the TIA Portal.

10.5.1 Mechanical system

10.5.1.1 Axis type

Overview

Axes in your actual application can be configured with different motion control applications:

- For speed control applications: flexible control of the speed and direction of rotation of rotary axes
- For positioning control applications: relative/absolute positioning of rotary or linear axes (depending on mechanics)

Description of function

Linear axis

A linear axis is an axis whose traversing range is limited in both motor directions of rotation by the mechanical system of the machine, for example:

- Stacker crane
- Elevating platform
- Tilting station
- Gate/door drive

- Conveyor belt
- Roller conveyor

For linear axes, the position of the axis is specified as a linear measure, for example, millimeters (mm).

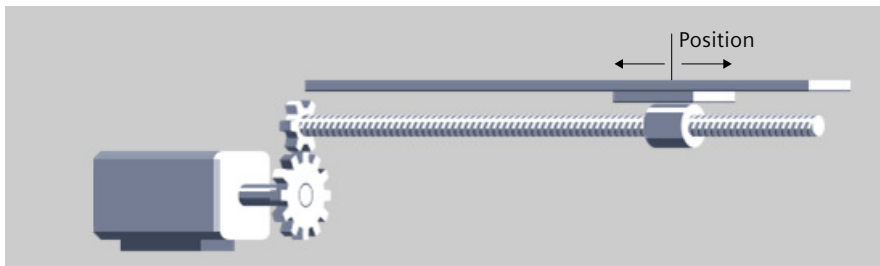

Rotary axis

A rotary axis is an axis with an infinite traversing range, for example:

- Rotary table

For rotary axes, the position of the axis is specified as an angular measure, for example, degrees ($^{\circ}$).

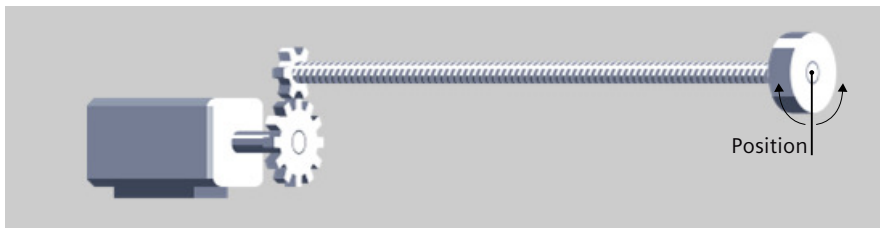

10.5.1.2 Units of measurement

Overview

The converter supports not only the physical units but also the length unit (LU) for positioning.

Description of function

- **Physical units (default setting)**

The converter provides the physical units for position, speed, acceleration/deceleration, and jerk. You can selected the desired physical units according to the actual axis type via relevant parameters during commissioning.

Axis type	Available physical units	
	Position	Velocity
Linear axis	km, m, mm , μm, nm, in, ft, mi	km/h, km/min, m/h, m/min, m/s, mm/h, mm/min, mm/s , in/min, in/s, ft/min, ft/s, mi/h
Rotary axis	degree (°)	degree (°)/s

Note:

Units in bold are the default units.

The acceleration is set accordingly as the position/s² measurement unit.

The jerk is set accordingly as the position/s³ measurement unit.

- **Length unit**

The converter calculates the position actual value of the axis using the neutral position unit LU (Length Unit). The length unit LU is independent of whether the converter controls the position of an elevating platform or the angle of rotary table.

Note

If you change the axis type from linear axis to rotary axis or vice versa, the units will be set to default units automatically.

10.5.1.3 Setting the backlash

Overview

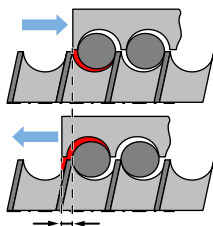

Backlash: p2583

Backlash (also called play, dead travel on reversing) is the distance or the angle that a motor must travel through when the direction of rotation reverses until the axis actually moves in the other direction.

Description of function

Backlash measurement

Proceed as follows to measure the backlash:

1. Move the axis to position A in the machine. Mark this position in the machine and note down the actual position value in the converter.
2. Move the axis a little bit more in the same direction.
3. Move the axis in the opposite direction until the actual position value in the converter shows the same value as at position A. Due to the backlash when reversing, the axis is now at position B.
4. Measure the position difference $\Delta = A - B$ in the machine.

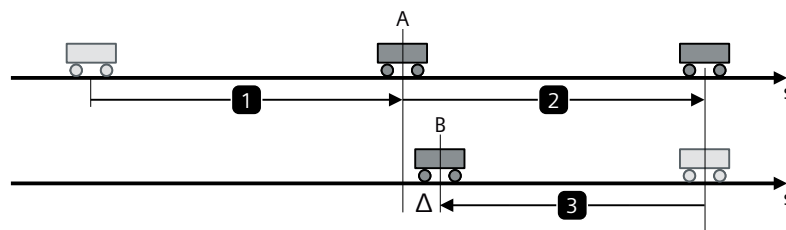

Figure 10-5 Measuring backlash

Backlash compensation

When mechanical force is transferred between a machine part and its drive, generally backlash occurs. If the mechanical system was to be adjusted/ designed so that there was absolutely no backlash, this would result in high wear. Thus, backlash can occur between the machine component and the encoder. For axes with indirect position sensing, when the axis is operated in a process that the traversing direction is reversed, the mechanical backlash results in an error of the traversing distance, as the axis travels either too far or not far enough.

Note

Precondition for backlash compensation

The backlash compensation is active with the precondition that the axis has been adjusted for absolute measuring systems.

In order to compensate the backlash, the determined backlash must be specified in p2583 with the correct polarity. At each direction of rotation reversal, the actual axis value is corrected dependent on the actual traversing direction and displayed in r2667. This value is taken into account in the actual position value using p2516 (position offset).

If a stationary axis is homed by setting the home position or an adjusted axis is powered-up with an absolute encoder, then the parameter c2604 (home position approach, starting direction) is relevant for switching-in the compensation value.

10.5.2 Limits

10.5.2.1 Limiting the traversing range

Overview

The traversing range of a linear axis can be limited using either the software limit switch or the hardware limit switch.

Description of function

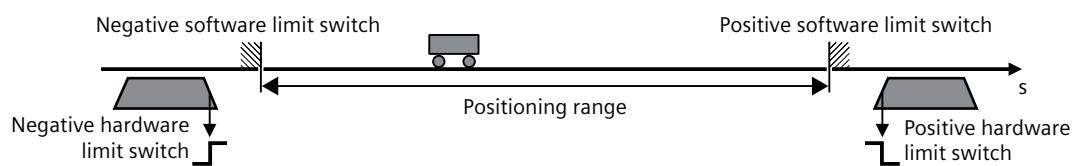

Figure 10-6 Software and hardware limit switches

The converter only accepts position setpoints that lie within the software limit switches. Activated software limit switches limit the position set value by specifying the p2580 (negative software limit switch) and p2581 (positive software limit switch).

Activated hardware limit switches are evaluated on the converter using c2569 (negative hardware limit switch) and c2570 (positive hardware limit switch). When passing the hardware limit switch, the converter brakes the axis with the OFF3 ramp-down time, switches the motor off and outputs fault F07491 or F07492. In order to bring the axis back into the valid traversing range, you must move the axis away from the hardware limit switch, for example, by using the jogging function.

10.5.2.2 Limiting the traversing profiles

Overview

The traversing profile is the acceleration, velocity and position characteristics of an axis when being positioned. You can influence the traversing profile by limiting the velocity, the acceleration, or the jerk (= change of the acceleration over time).

Description of function

If the axis must traverse more slowly or must accelerate at a lower rate or "softly", then you must set the relevant limits to lower values. The lower that one of the limits is, the longer the converter needs to position the axis.

- Without jerk limitation

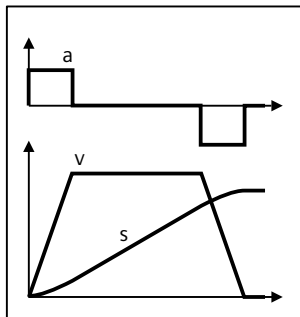

- With jerk limitation

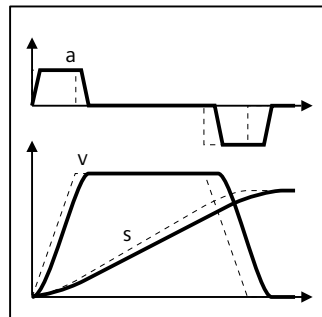

Note

Jerk limitation is not active when messages are generated with stop responses OFF1/OFF2/OFF3.

10.5.3 Position monitoring

The converter supports the following position monitoring functions:

- Standstill and positioning monitoring
- Following error monitoring

10.5.3.1 Positioning and standstill monitoring

Overview

Positioning and standstill monitoring is used to monitor the axis positioning motion and the axis position after a traversing motion.

Description of function

As soon as the setpoint for the position within a positioning operation no longer changes, then the converter sets the "Setpoint stationary" signal to 1. With this signal, the converter starts to monitor the position actual value:

- As soon as the axis has reached the positioning window, the converter signals that the target has been reached, and maintains the axis in closed-loop control.
- If the axis does not come to a standstill within the standstill monitoring time, the converter reports fault F07450.
- If the axis does not enter the positioning window within the positioning monitoring time, the converter reports fault F07451.

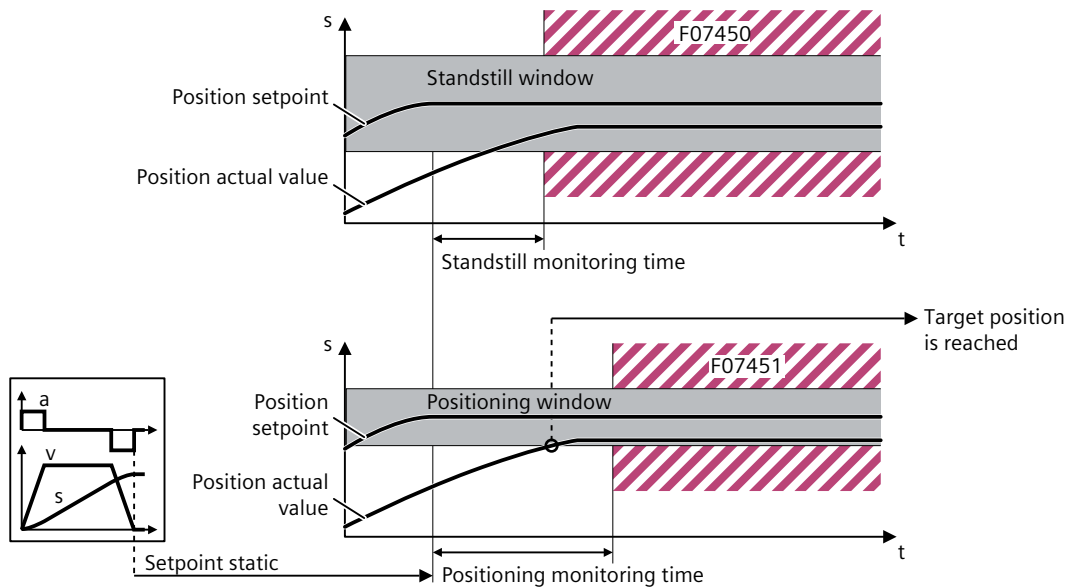

Figure 10-7 Standstill monitoring and positioning monitoring

10.5.3.2 Following error monitoring

Overview

Following error monitoring is used to monitor the maximum deviation between the actual value and the position setpoint.

Description of function

The following error is the deviation between the position setpoint and the position actual value while the converter is positioning the axis. The converter reports fault F07452 if the following error is too high. If you set the tolerance to 0, monitoring is deactivated.

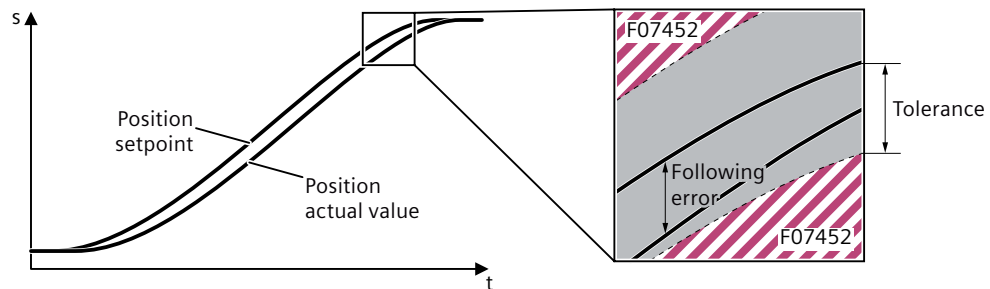

Figure 10-8 Following error monitoring

10.5.4 Homing

Overview

Homing re-establishes the reference between the zero point of the position calculated in the converter and the machine zero point. Homing is a requirement for display of the correct position for the technology object and for absolute positioning.

Absolute encoders retain their position information, even after the supply has been switched off.

The converter offers various ways of homing the axis:

- Active homing
- Passive homing
- Set home position
- Absolute encoder adjustment

Description of function

Homing can occur by means of an independent homing motion (active homing), the detection of a homing mark during a motion initiated (passive homing) or a direct position assignment.

- **Active homing**
The converter automatically traverses the axis to a defined home position.
- **Passive homing**
The converter corrects its position actual value while traversing and reduces errors, e.g. caused by wheel slip or a gear ratio that has not been precisely set.
- **Set the home position and absolute encoder adjustment**
The converter takes the reference point coordinate as the new axis position.

10.5.4.1 Terms for homing

Overview

The following terms are relevant to the homing.

Description

Homing mark

A homing mark is an input signal, on whose occurrence a known mechanical position can be assigned to the actual values.

A homing mark can be:

- **A zero mark**
The zero mark of an incremental encoder or an external zero mark is used as a homing mark. The zero mark is detected at the drive module or encoder module and transmitted in the PROFIdrive telegram. Perform the setting and evaluation as an encoder zero mark or external zero mark at the drive module and encoder module.
- **An edge at the digital input**
The negative or positive edge at a digital input is used as a homing mark.

Reference cam

If there are several zero marks in the traversing range, the reference cam is used to select a specific zero mark before or after the reference cam.

Homing mark position

This is the position assigned to the homing mark.

With active homing, the homing mark position corresponds to the home position minus home position offset.

With passive homing, the homing mark position corresponds to the home position.

Home position

At the end of the active homing motion, the axis arrives at the home position.

Home position offset

The difference between the home position and the homing mark position is the home position offset.

Direction reversal at the hardware limit switch (reversing cam)

Hardware limit switches can be used as reversing cams in active homing. If the homing mark was not detected or was approached from the wrong side, the motion continues in the opposite direction after the reversing cam.

Approach velocity

With active homing, the technology object approaches the reference cam/digital input at the approach velocity.

A home position offset is also retracted at the approach velocity.

Homing velocity

With active homing, the technology object approaches the homing mark at homing velocity.

10.5.4.2 Active homing

Overview

Three homing modes are available for active homing:

- Use encoder zero mark and reference cam
- Use encoder zero mark
- Use external zero mark via digital input

Description of function

Active homing by using encoder zero mark and reference cam

The following figure shows an example of the homing motion with the following settings:

- Active homing with reference cam and encoder zero mark
- Approach in the positive direction

- Homing in the positive direction
- Positive home position offset

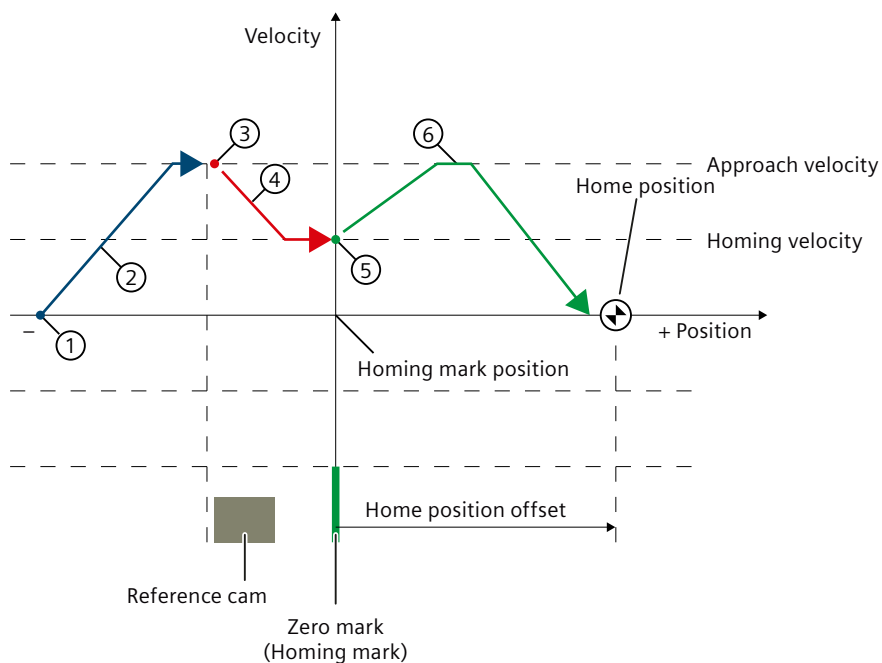

Motion sequence

- ① Start of active homing
- ② Approach to the reference cam in approach direction with approach velocity
- ③ Enable detection of the reference cam and homing mark detection
- ④ Approach to the homing mark with homing velocity
- ⑤ Detection of the homing mark
- ⑥ Approach to the home position with approach velocity

Figure 10-9 Example: active homing in positive direction by using encoder zero mark and reference cam

Note

If the velocity cannot be reduced to the homing velocity between detection of the reference cam and the zero mark, homing is performed at the velocity present when the zero mark is crossed.

Active homing by using encoder zero mark

The following figure shows an example of the homing motion with the following settings:

- Active homing with encoder zero mark
- Homing in the positive direction
- Positive home position offset

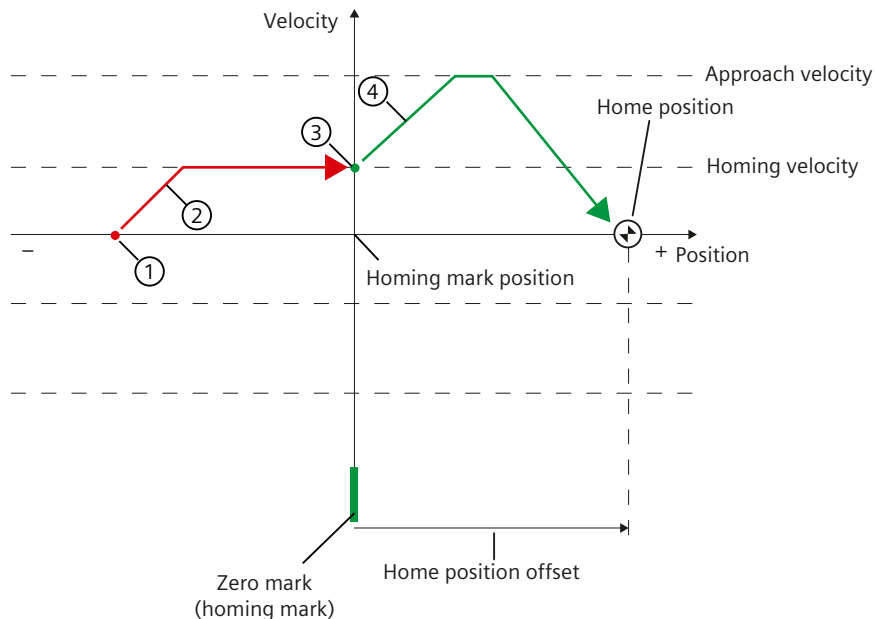

Motion sequence

- ① Start of active homing
- ② Approach to the homing mark in the homing direction with homing velocity
- ③ Detection of the homing mark
- ④ Approach to the home position with approach velocity

Figure 10-10 Example: active homing in positive direction by using encoder zero mark

Active homing by using external zero mark via digital input

The following figure shows an example of the homing motion with the following settings:

- Active homing with digital input
- Approach in the positive direction

- Homing mark on the positive side of the digital input
- Positive home position offset

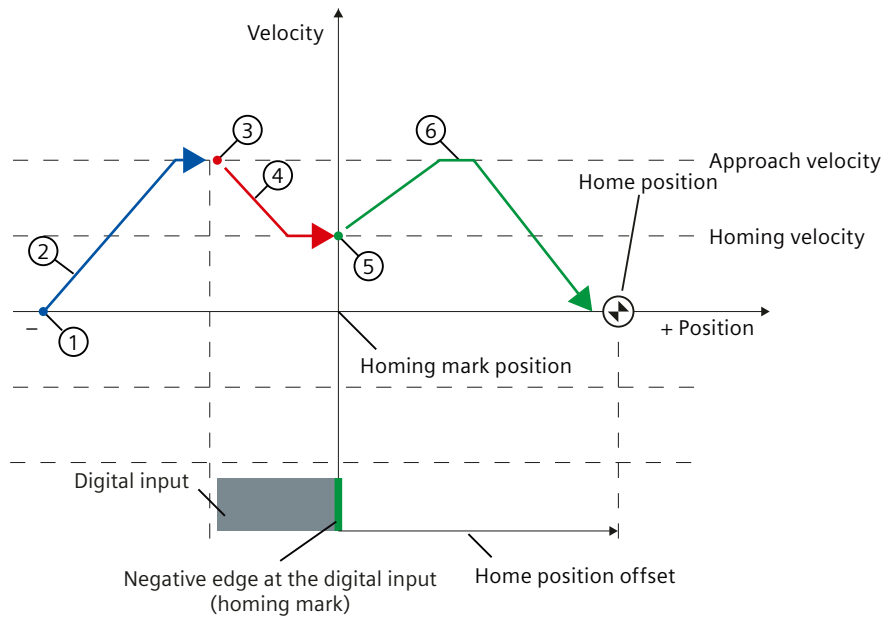

Motion sequence

- ① Start of active homing
- ② Move on the positive edge at the digital input in the approach direction with approach velocity
- ③ Detection of the positive edge at the digital input
- ④ Approach to the homing mark in the homing direction with the homing velocity
- ⑤ Detection of the homing mark
- ⑥ Approach to the home position with approach velocity

Figure 10-11 Example: active homing in positive direction by using external zero mark via digital input

Note

If the velocity cannot be reduced to the homing velocity between detection of the reference cam and the zero mark, homing is performed at the velocity present when the zero mark is crossed.

10.5.4.3 Passive homing

Overview

Passive homing is used to dynamically modify the current position value to zero when the axis is working in any positioning state. With the "Passive homing" function, the loadside position accuracy is increased because inaccuracies in actual value acquisition are compensated for. The function can be used in every mode (jog, traversing block, direct setpoint specification for positioning / setup) and is superimposed over the active operating mode.

Description of function

The function is selected by a "1" signal of c2597 (Homing type selection) and is activated by a 0/1 edge of c2595 (Homing start). The signal of c2595 must be set during the entire homing process; otherwise, the process is aborted.

Status bit r2684.1 (passive homing active) is linked with activate measuring probe evaluation. It activates measuring probe evaluation. c2510 (measuring probe evaluation selection) and c2511 (measuring probe evaluation edge) can be used to check which measuring probe (1 or 2) and which measuring edge (0/1 or 1/0) is used.

The probe pulse is used to supply the measured value determined by the function "homing mark search" and "measuring probe evaluation" via parameter r2523. The validity of the measurement is reported via r2526.2.

Note

The "Passive homing" function is superimposed on an active operating mode, it is therefore not an active mode. In contrast to the home position approach, the function can be carried out superimposed by the machine process.

As standard, for passive homing, measuring probe evaluation is used; when enabled, the measuring probe is selected and the measuring probe edge evaluation is active. (In the default settings, measuring probe 1 is always the measuring probe and the measuring probe evaluation is always the 0/1 edge.)

10.5.4.4 Absolute encoder adjustment

Overview

The function is only available when using a servo motor with the absolute encoder. When commissioning the absolute encoder for the first time, a mechanical axis position is aligned with the encoder absolute position and then the system is synchronized.

After the drive has been switched off the encoder position information is retained. This means that the axis does not have to be readjusted when the drive powers up.

Note

It is crucial that absolute encoders are adjusted the first time that they are commissioned.

Description of function

For the absolute encoder adjustment, the machine axis must be moved to the desired position first, this can be done in jog mode or manually. A position marking, a fixed stop, or measuring the distance between the axis and the fixed home position can be used as a reference. Once the desired position of the axis is reached, the home position coordinate can be set accordingly. You must save the parameters after setting the position coordinate.

Note

After being commissioned for the first time, carefully ensure that the drive train and its configuration cannot be mechanically changed or modified. When mechanical changes are made, the synchronization between the encoder actual value and the machine zero is lost. In this particular case, it is crucial that the axis is readjusted.

Setting the home position

Note

The function is only available when the converter is online in Startdrive.

You can set the home position ($p2507 = 2$) and the status "Home position set" ($r2684.11$) is updated. When the adjustment is correct, "Absolute encoder adjusted" is displayed.

Resetting the home position

You can also reset the home position ($p2507 = 1$) and the status display for the absolute encoder adjustment is then updated. The adjustment is deactivated. After the reset, "Absolute encoder not adjusted" is displayed.

10.5.5 Traversing blocks

10.5.5.1 Traversing blocks

Overview

A traversing block describes a positioning instruction for the drive. Up to 32 different traversing tasks can be saved in the converter. All parameters which describe a traversing task are effective during a block change.

Description of function

Activating the traversing block function

When telegrams 111 and 112 is used, the traversing block function can be configured with the PROFINET control word POS_STW1.15:

Control word	Signal	Description
POS_STW1.15	1	MDI selection.
	0	Traversing block selection.

When telegrams 7 and 9 are used, the traversing block function can be configured with the PROFINET control word SATZANW.15:

Control word	Signal	Description
SATZANW.15	1	MDI selection.
	0	Traversing block selection.

Traversing blocks are parameterized using parameter sets that have a fixed structure:

- **Traversing block number (p2616[0...31])**
Each traversing block must have a traversing block number assigned to it. The traversing blocks are executed in the sequence of the traversing block numbers. Numbers containing the value "-1" are ignored so that the space can be reserved for subsequent traversing blocks, for example.
- **Task (p2621[0...31])**
 - 1: POSITIONING
 - 2: FIXED ENDSTOP
 - 3: ENDLESS_POS
 - 4: ENDLESS_NEG
 - 5: WAIT
 - 6: GOTO
 - 7: SET_O
 - 8: RESET_O
 - 9: JERK
- **Motion parameters**
 - Target position or traversing distance (p2617[0...31])
 - Velocity (p2618[0...31])
 - Acceleration override (p2619[0...31])
 - Deceleration override (p2620[0...31])

- **Task mode (p2623[0...31])**
 Processing a traversing task can be affected by the parameter p2623 (task mode).
 Value = 0000 cccc bbbb aaaa
 - aaaa: Identifiers
 000x → hide/show block (x = 0: show, x = 1: hide)
 - bbbb: Continuation condition
 0000, END: 0/1 edge at STW1.6
 0001, CONTINUE_WITH_STOP:
 The exact position parameterized in the block is approached (brake to standstill and positioning window monitoring) before block processing can continue.
 0010, CONTINUE_ON-THE-FLY:
 The system switches to the next traversing block "on the fly" when the braking point for the current block is reached (if the direction needs to be changed, this does not occur until the drive stops within the positioning window).
 0011, CONTINUE_EXTERNAL:
 Same as "CONTINUE_ON-THE-FLY", except that an instant block change can be triggered up to the braking point by a 0/1 edge. If an external block change is not triggered, a block change is triggered at the braking point.
 0100, CONTINUE_EXTERNAL_WAIT:
 Control signal "External block change" can be used to trigger a flying changeover to the next task at any time during the traveling phase. If "External block change" is not triggered, the axis remains in the parameterized target position until the signal is issued. The difference here is that with CONTINUE_EXTERNAL, a flying changeover is carried out at the braking point if "External block change" has not been triggered, while here the drive waits for the signal in the target position.
 0101, CONTINUE_EXTERNAL_ALARM:
 This is the same as CONTINUE_EXTERNAL_WAIT, except that alarm A07463 "External traversing block change in traversing block x not requested" is output when "External block change" is not triggered by the time the drive comes to a standstill. The alarm can be converted to a fault with a stop response so that block processing can be canceled if the control signal is not issued.
 - cccc: positioning mode
 The POSITIONING task (p2621 = 1) defines how the position specified in the traversing task is to be approached.
 0000, ABSOLUTE:
 The position specified in p2617 is approached.
 0001, RELATIVE:
 The axis is traveled along the value specified in p2617
 0010, ABS_POS:
 For rotary axes with modulo offset only. The position specified in p2617 is approached in a positive direction.
 0011, ABS_NEG:
 For rotary axes with modulo offset only. The position specified in p2617 is approached in a negative direction.
- **Task parameter (command-dependent significance) (p2622[0...31])**

Traversing block tasks**• POSITIONING**

The POSITIONING task initiates motion. The following parameters are evaluated:

- p2616[x] Block number
- p2617[x] Position
- p2618[x] Velocity
- p2619[x] Acceleration override
- p2620[x] Deceleration override
- p2623[x] Task mode

The task is executed until the target position is reached. If, when the task is activated, the converter is already located at the target position, then for the block change enable (CONTINUE_ON-THE-FLY or CONTINUE_EXTERNAL), the next task is selected in the same interpolation cycle. For CONTINUE_WITH_STOP, the next block is activated in the next interpolation cycle. CONTINUE_EXTERNAL_ALARM causes a message to be output immediately.

• FIXED STOP

The FIXED STOP task triggers a traversing movement with reduced torque to fixed stop. The following parameters are relevant:

- p2616[x] Block number
- p2617[x] Position
- p2618[x] Velocity
- p2619[x] Acceleration override
- p2620[x] Deceleration override
- p2623[x] Task mode
- p2622[x] Task parameter clamping torque [0.01 Nm] with rotary motors.

Possible continuation conditions include END, CONTINUE_WITH_STOP, CONTINUE_EXTERNAL, CONTINUE_EXTERNAL_WAIT.

- **ENDLESS POS, ENDLESS NEG**

Using these tasks, the axis is accelerated to the specified velocity and is moved until:

- A software limit switch is reached.
- A STOP cam signal has been issued.
- The traversing range limit is reached.
- Motion is interrupted by the control signal "no intermediate stop / intermediate stop" (STW1.5).
- Motion is interrupted by the control signal "do not reject traversing task / reject traversing task" (STW1.4).
- An external block change is triggered (with the appropriate continuation condition).

The following parameters are relevant:

- p2618[x] Velocity
- p2619[x] Acceleration override
- p2623[x] Task mode

All continuation conditions are possible.

- **JERK**

Jerk limitation can be activated (command parameter = 1) or deactivated (task parameter = 0) by means of the JERK task. p2575 "Active jerk limitation" must be set to zero. The value parameterized in "jerk limit" p2574 is the jerk limit.

A precise stop is always carried out here regardless of the parameterized continuation condition of the task preceding the JERK task.

The following parameters are relevant:

- p2622[x] Task parameter = 0 or 1

All continuation conditions are possible.

- **WAIT**

The WAIT task can be used to set a waiting period which should expire before the following task is processed.

The following parameters are relevant:

- p2622[x] Task parameter = delay time in milliseconds ≥ 0 ms, but is rounded-off to a multiple of numeral 8
- p2623[x] Task mode

Regardless of the parameterized continuation condition which is parameterized for the task that precedes the WAIT task, an exact stop is always executed before the waiting time expires. The WAIT task can be executed by an external block change.

Possible continuation conditions include END, CONTINUE_WITH_STOP, CONTINUE_EXTERNAL, CONTINUE_EXTERNAL_WAIT, and CONTINUE_EXTERNAL_ALARM.

The fault message is triggered when "External block change" has still not been issued after the waiting time has elapsed.

• **GOTO**

Using the GOTO task, jumps can be executed within a sequence of traversing tasks. The block number which is to be jumped to must be specified as task parameter. A continuation condition is not permissible. If there is no block with this number, then alarm A07468 (jump destination does not exist in traversing block x) is output and the block is designated as being inconsistent.

The following parameters are relevant:

- p2622[x] Task parameter = Next traversing block number

Any two of the SET_O, RESET_O and GOTO tasks can be processed in an interpolation cycle and a subsequent POSITION and WAIT task can be started.

• **SET_O, RESET_O**

The tasks SET_O and RESET_O allow up to two binary signals (output 1 or 2) to be simultaneously set or reset. The number of the output (1 or 2) is specified bit-coded in the task parameter.

The following parameters are relevant:

- p2616[x] Block number
- p2622[x] Task parameter = bit-coded output:
 - 0x1: Output 1
 - 0x2: Output 2
 - 0x3: Output 1 and output 2

Possible continuation conditions are END, CONTINUE_ON-THE-FLY and CONTINUE_WITH_STOP, and CONTINUE_EXTERNAL_WAIT.

Any two of the SET_O, RESET_O and GOTO tasks can be processed in an interpolation cycle and a subsequent POSITIONING and WAIT task can be started.

Intermediate stop and reject a traversing task

When telegrams 7, 9, 111, and 112 are used, perform an intermediate stop with the PROFINET control word STW1.5:

Control word	Signal	Description
STW1.5	1	No intermediate stop.
	0	Intermediate stop.

When telegrams 7, 9, 111, and 112 are used, reject a traversing task with the PROFINET control word STW1.4:

Control word	Signal	Description
STW1.4	1	Do not reject a traversing task.
	0	Reject a traversing task (ramp-down with the maximum deceleration).

Parameters

The following list includes the parameters of the "Traversing block" function. The parameters displayed twice indicate that they may have different properties and descriptions depending on the selected axis type. For more information, see Section "Parameter list (Page 749)".

Number	Name	Unit
--------	------	------

10.5 Basic positioner (EPOS)

p2615	EPOS maximum number of traversing blocks	
p2616[0...n]	EPOS traversing block block number	
p2617[0...n]	EPOS traversing block position	[LU]
p2617[0...n]	EPOS traversing block position	[LU]
p2618[0...n]	EPOS traversing block velocity	[1000 LU/min]
p2618[0...n]	EPOS traversing block velocity	[1000 LU/min]
p2619[0...n]	EPOS traversing block acceleration override	[%]
p2620[0...n]	EPOS traversing deceleration override	[%]
p2621[0...n]	EPOS traversing block task	
p2622[0...n]	EPOS traversing block task parameter	
p2623[0...n]	EPOS traversing block task mode	

10.5.5.2 Travel to fixed stop

Overview

The "Travel to fixed stop" function can be used, for example, to traverse sleeves to a fixed stop against the workpiece with a predefined torque. In this way, the workpiece can be securely clamped. The clamping torque can be parameterized in the traversing task (p2622). An adjustable monitoring window for travel to fixed stop prevents the drive from traveling beyond the window if the fixed stop should break away.

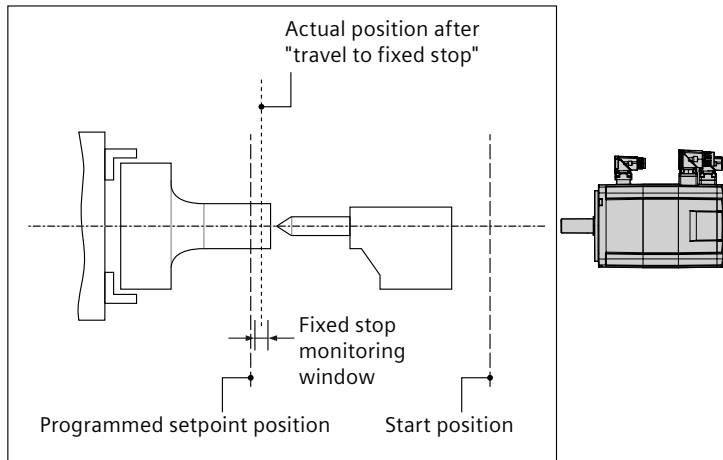

Description of function

In positioning mode, travel to fixed stop is started when a traversing block is processed with the FIXED STOP command. In this traversing block, in addition to the specification of the dynamic parameterized position, speed, acceleration override and delay override, the required clamping torque can be specified as task parameter p2622. From the start position onwards, the target position is approached with the parameterized speed. The fixed stop (the workpiece) must be between the start position and the braking point of the axis; that is, the target position is placed inside the workpiece.

The preset torque limit is effective from the start, i.e. travel to fixed stop also occurs with a reduced torque. The preset acceleration and delay overrides and the current speed override

are also effective. Dynamic following error monitoring (p2546) in the position controller is not effective when traveling to the fixed stop. As long as the drive travels to the fixed stop or is in fixed stop, the "Travel to fixed stop active" status bit r2683.14 is set.

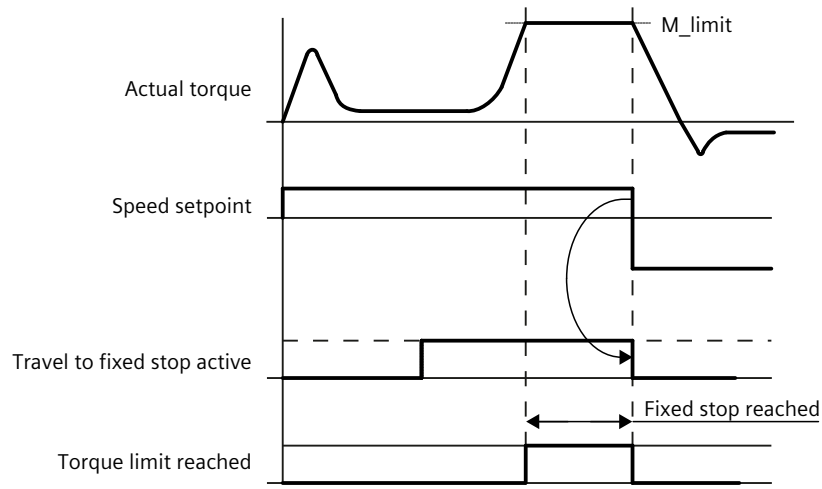

10.5.6 Direct setpoint input (MDI)

Overview

The "direct setpoint input (MDI, Manual Data Input)" function allows for positioning (absolute, relative) and setting-up (endless position-controlled) by means of direct setpoint inputs (e.g. via the PLC using process data). A higher-level control provides the converter with the position setpoint and traversing profile.

Description of function

During traversing, the motion parameters can also be influenced (on-the-fly setpoint acceptance) and an on-the-fly change can be undertaken between the "setting-up" and "positioning" modes. The "direct setpoint specification" mode (MDI) can also be used if the axis is not homed in the "setting-up" or "relative positioning" modes.

"Setting-up" mode

The higher-level control selects the mode "Set-up":

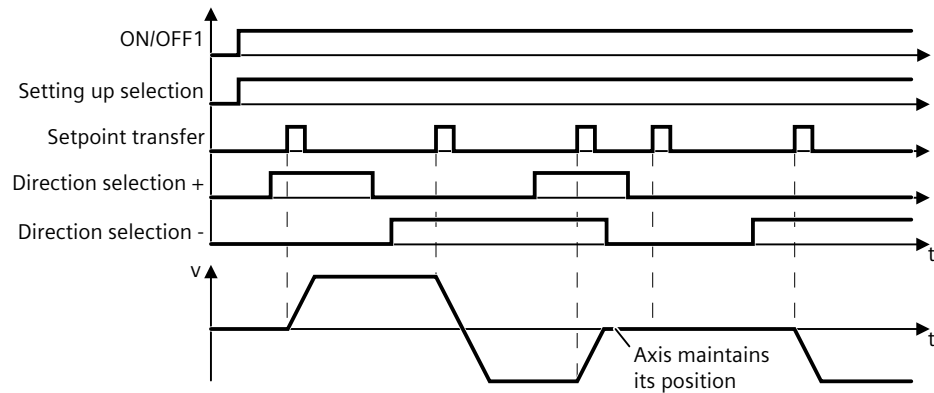

Figure 10-12 Set up axis with direct setpoint input (MDI)

"Positioning" mode

The higher-level control specifies the value of the setpoint either as a relative or an absolute position setpoint:

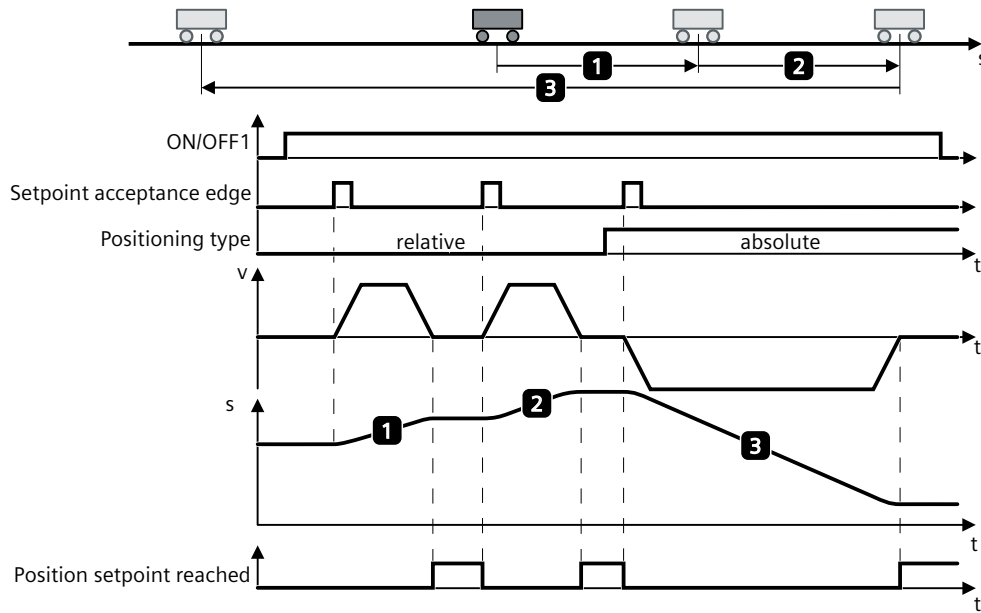

Figure 10-13 Position axis with direct setpoint input (MDI)

Activating the direct setpoint input function

When telegrams 111 and 112 are used, the direct setpoint input function can be configured with the PROFINET control word POS_STW1.15:

Control word	Signal	Description
POS_STW1.15	1	MDI selection.
	0	Traversing block selection.

When telegrams 7 and 9 are used, the direct setpoint input function can be configured with the PROFINET control word SATZANW.15:

Control word	Signal	Description
SATZANW.15	1	MDI selection.
	0	Traversing block selection.

Selecting a working mode

In "Positioning" mode, the parameters (position, velocity, acceleration and deceleration) can be used to carry out absolute or relative positioning.

In "Setting-up" mode, using parameters (velocity, acceleration and deceleration) endless closed-loop position control behavior can be carried out.

When telegrams 111 and 112 are used, select a working mode with the PROFINET control word POS_STW1.14:

Control word	Signal	Description
POS_STW1.14	1	Signal setting-up selected.
	0	Signal positioning selected. ¹⁾

¹⁾ Telegrams 7 and 9 can only work in signal positioning mode.

Selecting a positioning type in signal positioning mode

When telegrams 111 and 112 are used, select a positioning type with the PROFINET control word POS_STW1.8:

Control word	Signal	Description
POS_STW1.8	1	Absolute positioning is selected.
	0	Relative positioning is selected.

When telegram 9 is used, select a positioning type with the PROFINET control word MDI_MOD.0:

Control word	Signal	Description
MDI_MOD.0	1	Absolute positioning is selected.
	0	Relative positioning is selected.

Selecting an absolute positioning direction in signal positioning mode

When telegrams 111 and 112 are used, select an absolute positioning direction with the PROFINET control words POS_STW1.9 and POS_STW1.10:

Control word	Signal	Description
POS_STW1.9	0	Absolute positioning through the shortest distance.
POS_STW1.10	1	Absolute positioning/MDI direction selection, positive.
	2	Absolute positioning/MDI direction selection, negative.
	3	Absolute positioning through the shortest distance.

When telegram 9 is used, select an absolute positioning direction with the PROFINET control words MDI_MOD.1 and MDI_MOD.2:

Control word	Signal	Description
MDI_MOD.1	0	Absolute positioning through the shortest distance.
MDI_MOD.2	1	Absolute positioning/MDI direction selection, positive.
	2	Absolute positioning/MDI direction selection, negative.
	3	Absolute positioning through the shortest distance.

Selecting a direction in signal setting-up mode

When telegrams 111 and 112 are used, select a direction with the PROFINET control words POS_STW1.9 and POS_STW1.10

Control word	Signal	Description
POS_STW1.9	1	MDI direction selection, positive.
POS_STW1.10	2	MDI direction selection, negative.

Selecting an MDI transfer type

When telegrams 111 and 112 are used, select an MDI transfer type with the PROFINET control word POS_STW1.12:

Control word	Signal	Description
POS_STW1.12	1	Continuous transfer.
	0	Activate MDI block change with of a traversing task (STW1.6).

Setting MDI setpoints

When telegrams 9, 111, and 112 are used, set MDI setpoints with the following PROFINET control words:

- Position setpoint (MDI_TARPOS): 1 hex = 1 LU
- Velocity setpoint (MDI_VELOCITY): 1 hex = 1000 LU/min
- Acceleration override (MDI_ACC): 4000 hex = 100%
- Deceleration override (MDI_DEC): 4000 hex = 100%

Intermediate stop and reject an MDI task

When telegrams 7, 9, 111, and 112 are used, perform an intermediate stop with the PROFINET control word STW1.5:

Control word	Signal	Description
STW1.5	1	No intermediate stop.
	0	Intermediate stop with parameterized deceleration MDI_DEC (telegrams 9, 111, and 112).

When telegrams 7, 9, 111, and 112 are used, reject an MDI task with the PROFINET control word STW1.4:

Control word	Signal	Description
STW1.4	1	Do not reject a traversing task.
	0	Reject a traversing task (ramp-down with the maximum deceleration).

10.5.7 Jog

Overview

It is possible to change over between jog incremental and jog velocity. The traversing distances p2587 and p2588 and velocities p2585 and p2586 are entered according to the jog signals c2589 and c2590. The traversing distances are only effective for a "1" signal at p2591 (jog incremental). For p2591 = "0", the axis moves to the start of the traversing range or to the end of the traversing range with the specified velocity.

Description of function

Jog incremental

In the case of incremental jogging, input a relative traversing distance and a velocity setpoint into the converter. With the signals "Jogging 1" or "Jogging 2" the converter positions the axis by the respective travel path.

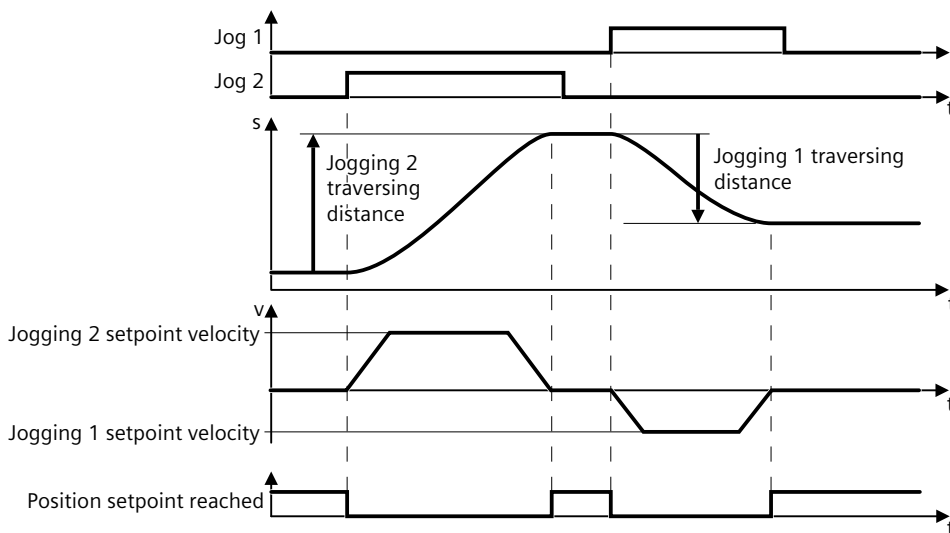

Figure 10-14 Jog incremental

Jog velocity

Only input a setpoint velocity for the converter for velocity jog. With the signal "Jogging 1" or "Jogging 2", the converter accelerates the axis to the relevant setpoint velocity. The converter stops the axis when the respective "Jog" signal returns to zero.

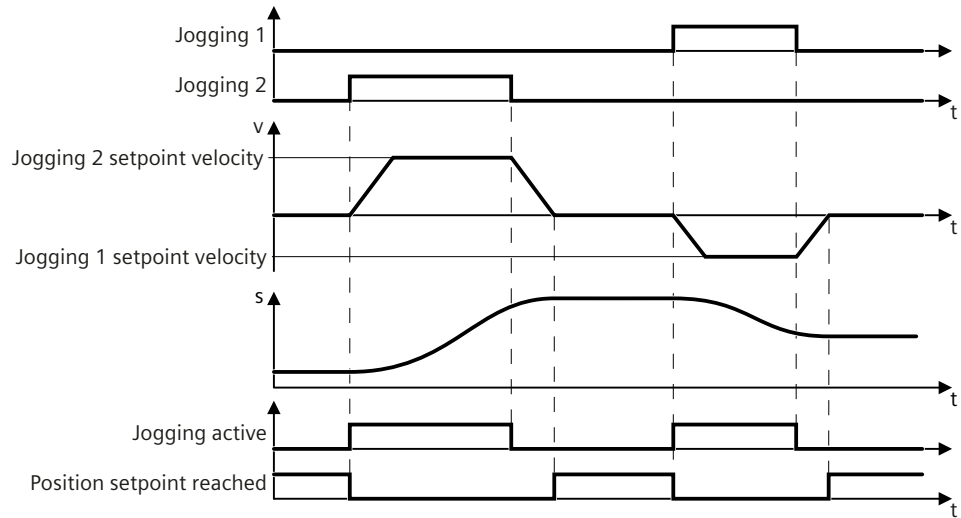

Figure 10-15 Jog velocity

Selecting a jogging mode

When telegrams 7, 9, 111 and 112 are used, select a jogging channel with the PROFINET control words STW1.8 and STW1.9:

Control word	Signal	Description
STW1.8	0	No jogging channel activated.
STW1.9	1	Jog 1 signal source rising edge activated.
	2	Jog 2 signal source rising edge activated.
	3	Reserved.

When telegrams 111 and 112 are used, select a jogging mode with the PROFINET control word POS_STW2.5:

Control word	Signal	Description
POS_STW2.5	1	Jogging, incremental active.
	0	Jogging, velocity active.

Note

When telegrams 7 and 9 are used, endless jogging is fixed.

Setting jogging setpoints

When telegrams 7 and 9 are used, set the following jogging setpoint with the appropriate parameters:

- Velocity (p2585, p2586)

When telegrams 111 and 112 are used, set the following jogging setpoints with the appropriate parameters:

- Velocity (p2585, p2586)
- Incremental (p2587, p2588)

Parameters

The following list includes the parameters of the "Jog" function. The parameters displayed twice indicate that they may have different properties and descriptions depending on the selected axis type. For more information, see Section "Parameter list (Page 749)".

Number	Name	Unit
p2585	EPOS jog 1 setpoint velocity	[1000 LU/min]
p2585	EPOS jog 1 setpoint velocity	[1000 LU/min]
p2586	EPOS jog 2 setpoint velocity	[1000 LU/min]
p2586	EPOS jog 2 setpoint velocity	[1000 LU/min]
p2587	EPOS jog 1 traversing distance	[LU]
p2587	EPOS jog 1 traversing distance	[LU]
p2588	EPOS jog 2 traversing distance	[LU]
p2588	EPOS jog 2 traversing distance	[LU]
c2589	EPOS jog 1	
c2590	EPOS jog 2	
c2591	EPOS jogging incremental	

10.5.8 Measuring probe evaluation and homing mark search

Overview

SINAMICS S200 product line supports the "homing mark search" and the "measuring probe evaluation" in position control.

Description of function

The "homing mark search" and the "measuring probe evaluation" functions mode can be defined via c2510 (measuring probe evaluation selection) and c2511 (measuring probe evaluation edge). In the default settings, measuring probe 1 is always the measuring probe and the measuring probe evaluation is always the 0/1 edge.

The probe signals are recorded via the encoder status and control word. To speed up signal processing, direct measuring probe evaluation can be activated by selecting the input terminals for probes 1 or 2.

The system outputs a message if the same probe input is already being used (see also p0488, p0489).

The appropriate function is started using a 0/1 edge via the encoder control word. Status bit r2526.1 (homing active) signals that the function is active (feedback from the encoder

10.5 Basic positioner (EPOS)

status word). Status bit r2526.2 (measured value valid) shows the presence of the required measurement r2523.

Once the function is completed (position determined for homing mark or measuring probe), r2526.1 (homing active) and r2526.2 (measured value valid) remain active and the measurement is provided by r2523 until the corresponding encoder control word is reset (0 signal).

If the function (homing mark search or measuring probe evaluation) has not been completed yet, while the encoder control word is reset, then the function is interrupted and the status bit r2526.1 (homing active) is reset via the encoder status word.

If the homing mark search and the measuring probe evaluation functions are simultaneously set, this causes the active function to be interrupted or no function is enabled. Alarm A07495 "homing function interrupted" occurs and remains until the signals at the inputs are reset. The alarm is also generated if a fault is signaled using the encoder status word during an activated function (homing mark search or measuring probe evaluation).

If the "position control" function module is selected, these parameters (c2510 to c2511) are preassigned with "0". If the "basic positioner" function module is selected, the "homing mark search" (for the homing position searching) and "measuring probe evaluation" (for the passive homing function) functions are initiated by the "basic positioner" function module and feedback (r2526, r2523) returned to this.

Parameters

The following list includes the parameters of the "Homing mark search" and "Measuring probe evaluation" functions.

Number	Name	Unit
p0488[0...2]	Measuring probe 1 input terminal	
p0489[0...2]	Measuring probe 2 input terminal	
c2510[0...3]	LR selecting measuring probe evaluation	
c2511[0...3]	LR measuring probe evaluation edge	
r2523[0...3]	LR measured value	[LU]
r2523[0...3]	LR measured value	[LU]
r2526.0...12	LR status word	

10.6 Safety Integrated (for the S200 converter only)

WARNING

Unexpected motor movements due to manipulated connecting cables

The manipulation of the connecting cables can cause unexpected motor movements in a machine or plant. Particularly in machines or plants in which Safety Integrated Functions are used to minimize risks, manipulation can result in serious personal injury or death.

- Prevent unauthorized access to the converter, for example by using a lockable control cabinet.
- Protect the cables inside and outside the control cabinet against manipulation by taking one of the following measures:
 - Sheathe the cables to the motors, encoders and sensors.
 - Lay the cables in empty conduits.

WARNING

Unexpected machine movement caused by inactive Safety Integrated Functions

Inactive Safety Integrated Functions or Safety Integrated Functions that have not been adapted can trigger unexpected machine movements that may result in serious injury or death.

- Prevent unauthorized persons accessing the drive.
- Protect configurations with active Safety Integrated Functions against changes by assigning roles using user management (UMAC).

Note

Safety Integrated Functions should be protected with UMAC (User Management and Access Control).

The "Drive Safety Engineer" role must be assigned to a named user and must not be assigned to Anonymous.

If the role is not assigned, alarm A01637 is displayed.

Note

Fault of Safety Integrated Functions in the case of non-EMC-compliant installation

A non-EMC-compliant installation of your machine/system can result in sporadic Safety Integrated function faults.

- Install the drive so that it is EMC-compliant.

10.6.1 Safety Integrated Functions

Overview

Safety Integrated Functions are used to reduce risk in safety-related applications.

Description of function

In comparison to standard converter functions, Safety Integrated Functions have especially high fail-safety. The Performance Level (PL) and Safety Integrity Level (SIL) of the corresponding standards are a measure of fail-safety.

Safety Integrated Functions are accordingly suitable for reducing risk in safety-related applications. If the risk analysis of the machine or the system indicates a special hazard potential in the application, an application is safety-related.

Safety Integrated means that the functions are integrated into the converter and can be executed without need of external components.

The converter performs a self-test of the shutdown paths (Safe Torque Off), functions as well as interfaces (fail-safe digital inputs and outputs) cyclically and in compliance with the standards. A test stop (forced checking procedure) by the operator is not required.

Note

Protection against manipulation by unauthorized third parties

Safety Integrated Functions protect against hardware faults and software errors, but not against manipulation by unauthorized third parties.

Protective measures against unauthorized manipulation are described in the Startdrive Operating Instructions and online help. The measures address the following issues:

- Parameter configuration of the safety functions
 - Connection
 - Hardware components
-

10.6.2 Certification

Description

The Safety Integrated Functions comply with:

- Safety Integrity Level (SIL) 3 according to IEC 61800-5-2
- Performance Level (PL) e according to ISO 13849-1
- Category 3 according to ISO 13849-1

The Safety Integrated Functions correspond to functions according to IEC 61800-5-2.

10.6.3 PFH values

Description

The probability of failure for Safety Integrated Functions must be specified in the form of a PFH value (Probability of Failure per Hour) according to IEC 61800-5-2, IEC 62061, and ISO 13849-1. The PFH value of a Safety Integrated Function depends on the safety concept of the converter and its hardware configuration, as well as on the PFH values of other components used for this Safety Integrated Function.

Corresponding PFH values are provided for the SINAMICS S200 servo drive system and the PFH value of the complete SINAMICS S200 converter is 10×10^{-9} per hour.

More information

The PFH values can be found under: PFH values (<https://support.industry.siemens.com/cs/ww/en/view/76254308>)

You can map the PFH values of all Safety Integrated components from Siemens using the "Safety evaluation" function in the TIA selection tool: Safety evaluation (<http://www.siemens.com/safety-evaluation-tool>)

10.6.4 Usage time

Description

You may not operate converters with Safety Integrated Functions for longer than 20 years. The 20 years starts when the device is delivered. The mission time cannot be extended. This is the case even if a service department checks the converter – or in the meantime, the converter was decommissioned.

10.6.5 Safety Integrated Basic Functions

10.6.5.1 Safe Torque Off (STO)

Overview

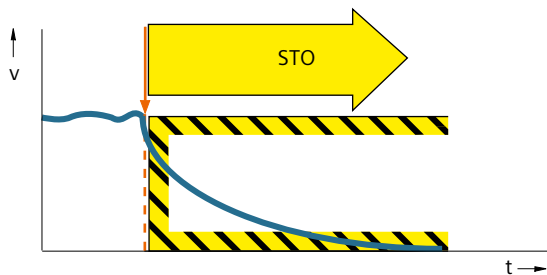

Figure 10-16 Overview STO

The Safe Torque Off (STO) function prevents the torque-generating supply of energy to the motor and prevents the motor from unexpectedly starting.

Requirement

⚠ WARNING

Unexpected motor movement through active Safe Torque Off

There may be unexpected motor movements if the Safe Torque Off (STO) function is active. For instance, the motor can coast down to a standstill or a hanging load may accelerate the motor.

Unexpected movements can lead to damage to property, risk to persons, severe injury and death.

- Take account of the way the Safe Torque Off (STO) function works when you perform risk assessments of the machine or system.
- Prevent movements of the motor, for example by using a holding brake.

The STO function is enabled.

Description of function

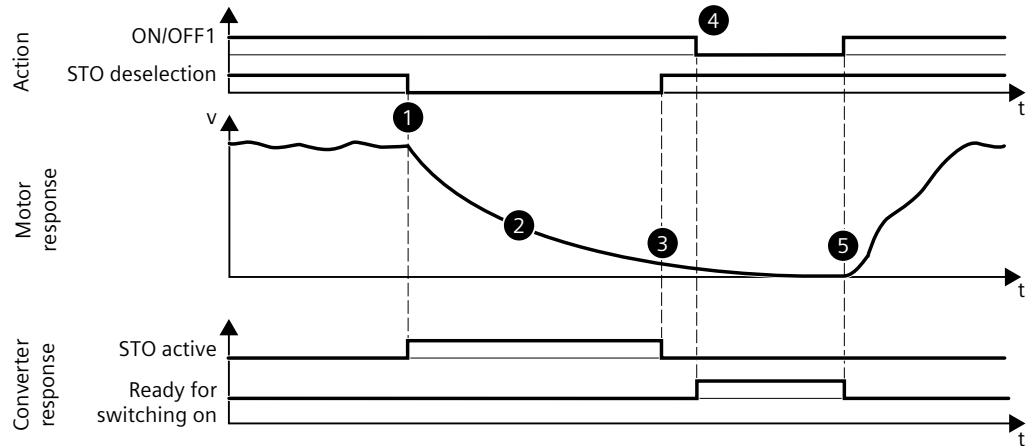

Figure 10-17 Flow diagram STO

Action		Motor/converter response
①	Selection of STO	<ul style="list-style-type: none"> The converter detects selection of STO and signals the status "STO active" (r9722.0). The converter interrupts the torque-generating energy feed to the motor. If you use a line contactor, the converter opens the line contactor. The "switching on inhibited" status prevents the motor from restarting automatically.
②		<ul style="list-style-type: none"> The motor coasts down to a standstill.
③	Deselection of STO	<ul style="list-style-type: none"> The converter detects deselection of STO.
④	Signal change at ON/OFF1 from 1 to 0	<ul style="list-style-type: none"> The converter is ready to start again.
⑤	Signal change at ON/OFF1 from 0 to 1	<ul style="list-style-type: none"> The motor starts again.

Example

Applications include all machines and systems with moving axes (for example, conveyor technology, handling).

With STO, maintenance work on the machine with an open protective door is possible, for example. An EMERGENCY STOP with electromechanical disconnection is not required. The drive remains connected to the line power supply and can be fully diagnosed.

Parameters

The following list includes the parameters of the "Safe Torque Off (STO)" function.

Number	Name	Unit
r9722.0...7	SI status signals	

10.6.5.2 Functional features of STO

Overview

The STO function of S200 converter is enabled by default and it is active with specified default settings. No additional settings are required.

Description of function

A stop function for Emergency Stop via X131 terminal is defined and is permanently assigned.

You can use the provided STO plug to connect the external safety device, for example, an EMERGENCY STOP button .

If you do not want to use the STO function, insert the provided STO disable plug into the X131 socket to disable the STO function.

More information

For more information about the terminal description and terminal wiring, see Section "Connecting STO (for the S200 converter only) (Page 157)".

10.6.5.3 Discrepancy time

Overview

During the discrepancy time, the converter tolerates inconsistent input signals.

Description of function

The converter monitors at the two input terminals of the F-DI whether the input signals attain the same logical signal state within the discrepancy time. For electromechanical sensors, for example, EMERGENCY STOP buttons or position switches, the two sensor contacts never switch at precisely the same time. The input signals of the F-DI are inconsistent (discrepancy).

During the discrepancy time, the converter tolerates inconsistent input signals. The discrepancy time does not extend the converter response time.

A permanent discrepancy signifies an error in the F-DI interconnection. In this case, the converter responds with a safety message.

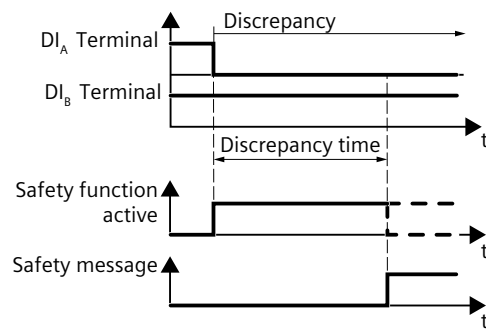

Figure 10-18 Permanent discrepancy

The discrepancy time must be set so that it is always less than the smallest expected switching interval of the signal at this F-DI, see the illustration below.

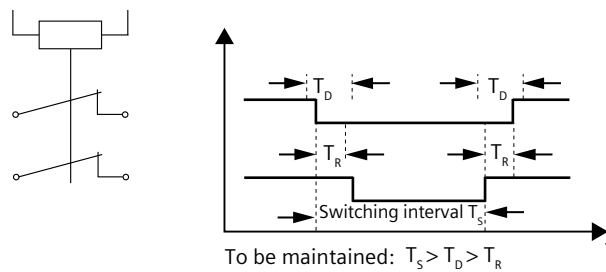

Figure 10-19 Discrepancy time

Note

For the SINAMICS S200 converter, the discrepancy time is fixed to 500 ms.

10.6.5.4 Input filter

Overview

The input filter suppresses unwanted brief signal changes at a fail-safe digital input (F-DI).

Requirement

	<p>WARNING</p>
<p>Unexpected movements due to long connecting cables</p> <p>If a cable at a fail-safe digital input is too long, the fail-safe digital input might not reliably detect a short-circuit of the connecting cable to 24 V or to ground. An undetected short-circuit may mean that the connected sensor is no longer working. This may impair the functional safety of the machine or the system and therefore endanger people or lead to material damage.</p> <ul style="list-style-type: none"> • Only connect cables with a length of ≤ 30 m to a fail-safe digital input. 	

Description of function

If a fail-safe digital input (F-DI) is connected to an electromechanical sensor, for example, then contact bounce leads to brief signal changes. In this case, an immediate response of the converter to signal changes is not desirable. Too many signal changes within a specific time result in a converter fault.

During the filter time (p10017) of the input filter, the converter ignores signal changes. The input filter time is fixed to 4 ms.

The set input filter impacts the response time of the safety function connected to the F-DI.

10.6.5.5 Self-test of the fail-safe digital input (F-DI)

Overview

To detect faults at an early stage, the converter tests its shutdown paths, functions and interfaces using the online self-test.

Self-test with internal test signals is available to test a fail-safe digital input (F-DI).

Description of function

The self-test checks with test signals at the input terminals of the F-DI whether the F-DI can be switched to the fail-safe state (to "low"). If the converter does not detect a feedback signal, then it triggers a fault response.

The converter internally generates test signals for the input circuit of the F-DI (p10041 = 0).

The test signal length and the test cycle cannot be changed.

The self-test with internal test signals complies with:

- Safety Integrity Level (SIL) 3 according to IEC 61800-5-2
- Performance Level (PL) e according to EN ISO 13849-1
- Category 3 according to EN ISO 138491

10.6.6 Safety Integrated function status/diagnostics

Overview

Function status/diagnostics shows information about the Safety Integrated settings and states of the converter.

Description of function

Function status/diagnostics shows the status of STO. If STO is active, then the status indicates "active" (r9722). When STO is active, then Emergency Stop is initiated.

In addition to the function status, the following data can be viewed:

- Status of the converter
Provides information as to whether internal events (e.g. software errors in the converter or a discrepancy in the monitoring channels) have been signaled and whether the communication functions.
- Version
The version shows the software versions of the corresponding components relevant for Safety Integrated. This data is predominantly provided as information for service and update.
 - SINAMICS Safety firmware version
 - I/O processor firmware version

10.6.7 Responses to safety messages

10.6.7.1 Stop responses

Description of function

The converter triggers a fault reaction in response to certain events:

- Stop response SCF
The converter detects a discrepancy in the Safety Integrated monitoring channels, for example, an error in the result and data comparison.

It is not possible to select a stop response externally. All stop responses bring the motor to a standstill.

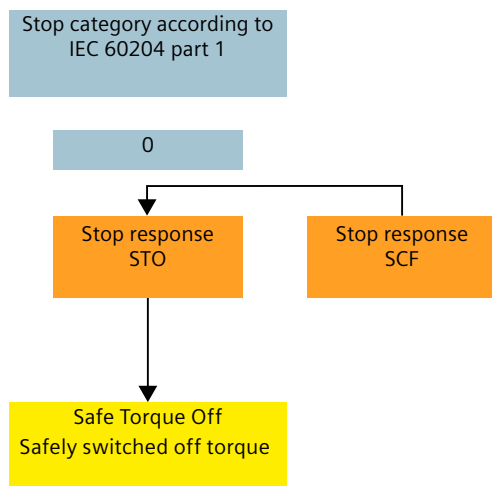

STO Safe Torque Off
SCF Safety Channel Failure

Figure 10-20 Stop responses

10.6.7.2 Fail-safe acknowledgement of safety messages

Overview

In the event of safety messages, the converter detects an internal event.
A safety message requires a fail-safe acknowledgement.

Requirement

You have checked and eliminated the cause of the internal event.

Procedure

You must acknowledge safety messages with a fail-safe signal. You have the following options for fail-safe acknowledgement:

Via selection and deselection of STO

By selecting and then deselecting STO, the safety messages are automatically withdrawn.

By switching the supply voltage off and on

Temporarily switch the power supply of the converter off and on again.

10.6.8 Response time

Technical data

The following response time is applicable to the stop function control via the STO terminal. The response time of the stop function is the time between the selection of the stop function and the initiation of a stop response. The monitoring cycle (p9500) is 4 ms.

The specified response time is applicable to a fault-free drive system as well as when a fault is active in the system.

Table 10-33 Technical data - response time

Function	Unit	Worst case delay time
STO	[ms]	15.5 ms

10.6.9 Functional safety

Overview

A system or machine is considered functionally safe if the safety-relevant parts of the protection and control equipment function correctly.

Description of function

Safety, from the perspective of the object to be protected, cannot be split-up. The causes of danger and therefore also the technical measures to prevent them can vary widely. This is the reason that a distinction is made between various safety types (e.g. by specifying the cause of potential hazards). "Functional safety" is involved if safety depends on the correct function.

To ensure the functional safety of a system or machine, the safety-related parts of the protection and control devices must function correctly. In the case of a fault, systems must respond in such a way that either the plant remains in a safe state or it is brought into a safe state. In this case, it is necessary to use specially qualified technology that fulfills the requirements described in the associated Standards. The requirements to implement functional safety are based on the following basic objectives:

- Avoiding systematic faults
- Controlling random faults or failures

Benchmarks for establishing whether or not a sufficient level of functional safety has been achieved include the probability of hazardous failures, the fault tolerance and the quality that is to be guaranteed by avoiding systematic faults. This is expressed in the standards using specific classification. In EN 61508, IEC 62061 "Safety Integrity Level" (SIL) and EN ISO 13849-1 "Category" and "Performance Level" (PL).

10.6.10 Machinery Directive

Overview

The basic safety and health requirements specified in Annex I of the Directive must be fulfilled for the safety of machines.

Description of function

The protective goals must be implemented responsibly to ensure compliance with the Directive.

Manufacturers of a machine must verify that their machine complies with the basic requirements. This verification is facilitated by means of harmonized standards.

IEC 61800-5-2 Adjustable-speed electrical power drive systems Part 5-2 is relevant for the Machinery Directive: Safety requirements - Functional safety

Within the context of IEC 61508, IEC 61800-5-2 considers adjustable speed electric power drive systems (PDS), which are suitable for use in safety-related applications (PDS(SR)).

IEC 61800-5-2 places requirements on PDS(SR) as subsystems of a safety-related system. This therefore permits the implementation of the electrical/electronic/programmable electronic elements of a PDS(SR) taking into account the safety-relevant performance of the safety function(s) of a PDS.

Manufacturers and suppliers of PDS(SR) can prove to users (e.g. integrators of control systems, developers of machines and plants etc.) the safety-relevant performance of their equipment by implementing the specifications stipulated in standard IEC 61800-5-2.

10.6 Safety Integrated (for the S200 converter only)

Tuning

11.1 Tuning workflow

Overview

Tuning is a process of adjusting servo gains in the control loops of the converter to achieve desired performance.

Description of function

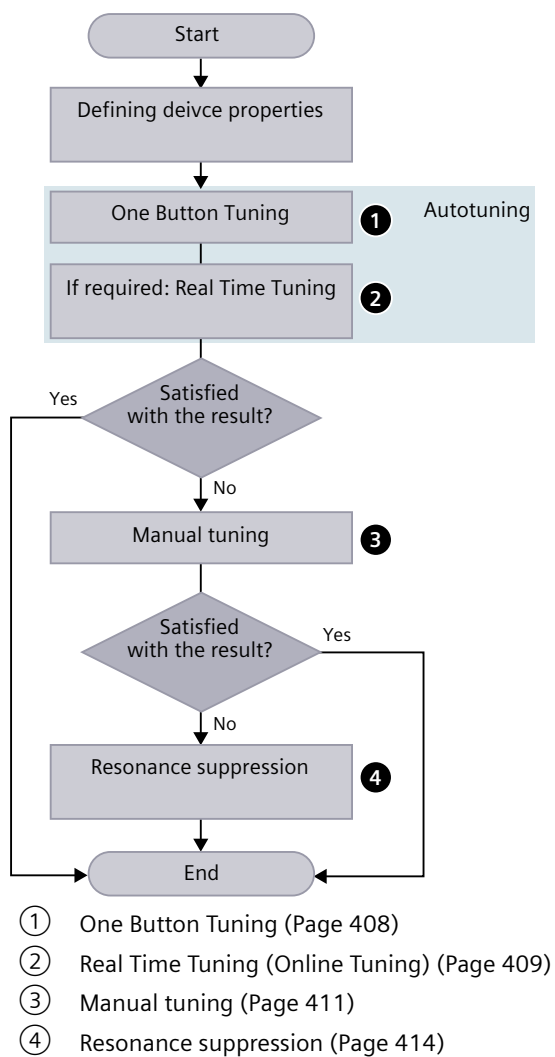

11.2 Autotuning

Overview

The term "Autotuning" comprises all converter-internal functions that adapt controller parameters during operation based on internal measured variables. The settings are written to the parameters, but are not saved permanently.

Description of function

Applications

The autotuning function is applicable to the following scenarios:

- Support of the commissioning
- Adaptation of the controller to major changes in the mechanical system

Available modes

The autotuning function is activated/deactivated with parameter p5300. The following autotuning modes are available for the converter:

- **One Button Tuning**
With this procedure, the speed controller and position controller can be automatically tuned (optimized). In this regard, the servo drive system is measured once and the controller is then set.
- **Real Time Tuning**
With this procedure, controller parameters are determined from the constantly estimated or parameterized moments of inertia.
Deactivate Real Time Tuning as soon as the controller data has been calculated and the established values for controller optimization, as well as the filter settings have been saved in a non-volatile memory.

11.2.1 One Button Tuning

Requirement

NOTICE
Changing the controller parameters manually
Manually changing controller parameters that were set automatically by One Button Tuning can result in an unstable controller and therefore material damage.
<ul style="list-style-type: none">• Do not change the following parameters during One Button Tuning: p0430, p1160, p1400, p1413 to p1426, p1428, p1429, p1433 to p1435, p1441, p1460 to p1465, p1498, p1513, p1656 to p1676, p2533 to p2539, p2567, p2572, p2573, p5280

Procedure

Proceed as follows to perform One Button Tuning with your operating unit:

1. Configure the dynamic response setting (p5292).
The higher the dynamic factor, the faster and more unstable the control. You should find a desired dynamic factor within a resonance-free range.
2. Set the traversing distance for the motor (p5308).
Generally, longer traversing distances result in better tuning results.
3. Configure the One Button Tuning function (p5301).
4. Activate the One Button Tuning function (p5300 = 1).

More information

For the detailed One Button Tuning procedures in the web server, see Section "Optimization (Page 180)".

Parameters

The following list includes the parameters of the "One Button Tuning" function.

Number	Name	Unit
p5271[0].0...7	Online / One Button Tuning configuration	
p5292	FFT tuning dynamic factor	[%]
p5300[0]	Autotuning selection	
p5301[0].0...8	One Button Tuning configuration 2	
p5308[0]	One Button Tuning distance limiting	[°]

11.2.2 Real Time Tuning (Online Tuning)

Requirement

NOTICE

Changing the controller parameters manually

Manually changing controller parameters that were set automatically by Real Time Tuning can result in an unstable controller and therefore material damage.

- Do not change the following parameters during Real Time Tuning:
p0430, p1160, p1400, p1413 to p1426, p1428, p1429, p1433 to p1435, p1441, p1460 to p1465, p1498, p1513, p1656 to p1676, p2533 to p2539, p2567, p2572, p2573, p5280

Procedure

Proceed as follows to perform Real Time Tuning with your operating unit:

1. Configure the Real Time Tuning function (p5302).
2. Set the controllers via p5271.
3. Activate Real Time Tuning (p5300 = 2).
4. To save the determined values for speed and position controllers, save the parameters in a non-volatile memory (RAM to ROM or p0977 = 1).
In this way, the start values for Real Time Tuning are retained, for example, after POWER ON. Through deactivation and reactivation of Real Time Tuning, the estimated load moment of inertia and the load torques are reset.

Parameters

The following list includes the parameters of the "Real Time Tuning" function.

Number	Name	Unit
p5271[0].0...7	Online / One Button Tuning configuration	
p5300[0]	Autotuning selection	
p5302[0].2...8	Online tuning configuration	

11.3 Manual tuning

Overview

When the autotuning function cannot achieve your expected tuning results, you can manually perform tuning.

Description of function

To perform tuning manually, you can disable the autotuning function by setting the parameter p5300:

- p5300 = -1: The autotuning function is disabled and the default values for the speed and position controller are restored.
- p5300 = 0: The autotuning function is disabled and the existing controller parameters are not changed.

To store the determined values for the speed and position controller retentively, set p0977 = 1 or execute the "Copy RAM to ROM" command.

11.3.1 Control loops

Description

The converter consists of three control loops:

- Current control loop
- Speed control loop
- Position control loop

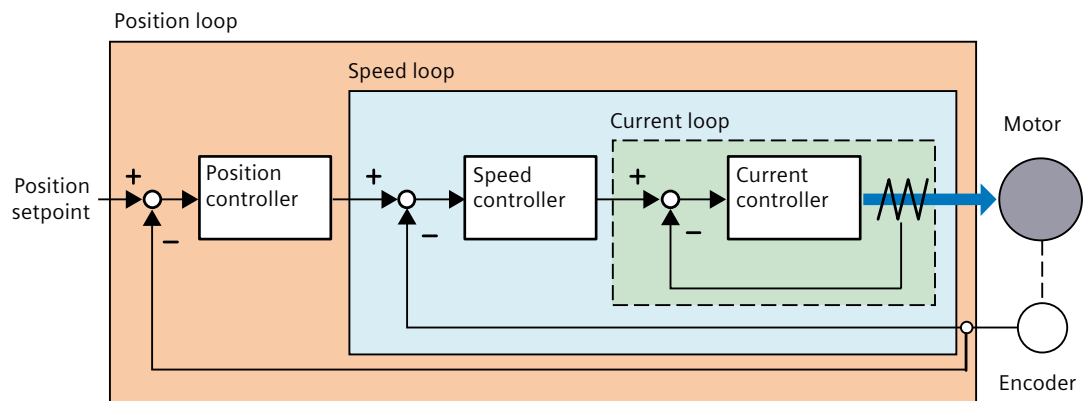

The control loops monitor the feedback of the controlled machines and correct the commands given to the converter.

In theory, frequency width of the inside control loop must be wider than that of the outer control loop; otherwise, the whole control system might vibrate or show low responsiveness. The relationship between the frequency widths of these three control loops is as follows:

Current loop > speed loop > position loop

11.3.2 Servo gain adjustment

Overview

You can set the loop servo gains in the control loops to optimize the responsiveness of a machine.

The servo gains are set through a combination of parameters. These parameters influence each other so you must consider the balance between the set values when tuning.

Description of function

Generally, the responsiveness of a machine with high rigidity can be improved by increasing the servo gains; however, if the servo gains of a machine with low rigidity are increased, the machine may vibrate and the responsiveness cannot be improved.

Since the current loop gain is automatically set by the system according to the detected motor data, you can adjust the following control parameters for servo gain adjustment:

- **Position loop gain**
The position loop gain directly influences the responsiveness of the position loop. If the mechanical system does not vibrate or produce noises, you can increase the position loop gain to increase the responsiveness of the position loop and shorten the positioning time.
- **Position loop feed forward gain**
You can slowly increase the position loop feed forward gain to increase the responsiveness and reduce the position deviation.
An inappropriately high position loop feed forward gain may lead to overshoots in the motor speed and a repeated ON/OFF switch of the digital output signal INP.
- **Speed loop gain**
The speed loop gain directly influences the responsiveness of the speed loop. If the mechanical system does not vibrate or produce noises, you can increase the speed loop gain to increase the responsiveness of the speed loop.
- **Speed loop integral time**
With the integral component added to the speed loop, the converter can eliminate the steady-state error of speed and respond to small speed changes.
If the mechanical system does not vibrate or produce noises, you can decrease speed loop integral time to increase the system rigidity.
For mechanical systems with a resonance factor or a high load inertia ratio, you can increase the speed loop integral time to suppress resonance.

Parameters

The following list includes the parameters of the "servo gain adjustment" function.

Number	Name	Unit
p1460[0]	Speed controller P gain	[Nms/rad]
p1462[0]	Speed controller integral time	[ms]
p2534[0]	LR speed precontrol factor	[%]
p2538[0]	LR proportional gain	[1000 rpm]

11.4 Resonance suppression

Overview

The resonance suppression functions suppresses mechanical resonance at a frequency higher than 100 Hz.

The function is achieved by setting the current setpoint filters as bandstop filters. Four current setpoint filters are available for the converter.

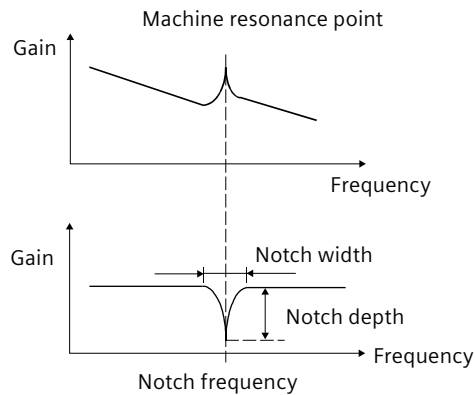

Figure 11-1 Working principle of a bandstop filter

Description of function

Resonance suppression with autotuning

During the autotuning process, resonance suppression is activated by default.

- Resonance suppression with One Button Tuning (p5300 = 1, p5291.1 = 1)
The current setpoint filters are automatically determined and set once with the aid of a noise signal. Four current setpoint filters can be activated at most after One Button Tuning is completed.
- Resonance suppression with Real Time Tuning (p5300 = 2, p5302.6 = 1)
Filter 4 is automatically parameterized as a bandstop filter and activated as an adaptive resonance filter. To use the other three current setpoint filters in this case, you must manually configure their settings.
When there is no resonance in the machine, Siemens recommends that the resonance suppression function is deactivated (p5302.6 = 0) in Real Time Tuning to get a high dynamic performance.

Resonance suppression with manual tuning

When resonance suppression with autotuning cannot reach the suppression effect, you can proceed as follows to suppress the resonance manually:

1. Activate the current setpoint filters that you want to use (p1656[0].0...3).
2. For the activated current setpoint filters, parameterize the following values:
 - Type: general 2nd order filter
 - Denominator natural frequency
 - Denominator damping
 - Numerator natural frequency
 - Numerator damping

Note

Assume the notch frequency is f_{sp} , notch width is f_{BB} , and notch depth is K , then the filter parameters can be calculated as follows:

- Denominator natural frequency = Numerator natural frequency = f_{sp}
 - Denominator damping = $f_{BB}/(2 \times f_{sp})$
 - Numerator damping = $(f_{BB} \times 10^{(k/20)})/(2 \times f_{sp})$
-

Parameters

The following list includes the parameters of the "resonance suppression" function.

Number	Name	Unit
p1656[0].0...3	Activates current setpoint filter	
p1657[0]	Current setpoint filter 1 type	
p1658[0]	Current setpoint filter 1 denominator natural frequency	[Hz]
p1659[0]	Current setpoint filter 1 denominator damping	
p1660[0]	Current setpoint filter 1 numerator natural frequency	[Hz]
p1661[0]	Current setpoint filter 1 numerator damping	
p1662[0]	Current setpoint filter 2 type	
p1663[0]	Current setpoint filter 2 denominator natural frequency	[Hz]
p1664[0]	Current setpoint filter 2 denominator damping	
p1665[0]	Current setpoint filter 2 numerator natural frequency	[Hz]
p1666[0]	Current setpoint filter 2 numerator damping	
p1667[0]	Current setpoint filter 3 type	
p1668[0]	Current setpoint filter 3 denominator natural frequency	[Hz]
p1669[0]	Current setpoint filter 3 denominator damping	
p1670[0]	Current setpoint filter 3 numerator natural frequency	[Hz]
p1671[0]	Current setpoint filter 3 numerator damping	
p1672[0]	Current setpoint filter 4 type	
p1673[0]	Current setpoint filter 4 denominator natural frequency	[Hz]
p1674[0]	Current setpoint filter 4 denominator damping	
p1675[0]	Current setpoint filter 4 numerator natural frequency	[Hz]
p1676[0]	Current setpoint filter 4 numerator damping	

11.4 Resonance suppression

p5291.0...16	FFT tuning configuration
p5302[0].2...8	Online tuning configuration

System messages

12.1 SDI Status

12.1.1 SDI Status overview

Description

The SINAMICS S200 converter product line is designed with a SINAMICS SDI (Smart Drive Interface) Status panel on the front of the converter.



- ① Cover*
- ② 6-digit 7-segment display
- ③ LED display
- ④ Function buttons

* Open the cover gently from the lower right corner.

Figure 12-1 SDI Status layout

12.1 SDI Status

You can use the SDI Status panel for the following operations:





- **Monitoring**
The SINAMICS SDI Status enters the monitoring mode when the servo state changes from OFF to ON. In this mode, it displays the actual speed, actual torque, actual position, actual DC link voltage, and position following error. You can press the DOWN button to navigate to the next item.
- **Diagnosis**
The SINAMICS SDI Status enters the diagnosis mode when a new fault, alarm, or safety message appears. You can press the OK button to acknowledge the faults after eliminating the causes.
You can press the M button to switch between the monitoring mode and the diagnosis mode.
- **Converter restart**
You can press the key combination of the M button and the OK button for four seconds to restart the converter.

12.1.2 Status display via LEDs

Description

The following tables explain the LED icons and states:

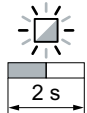
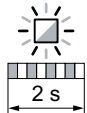
Table 12-1 Explanation of LED icons

LED	Explanation
	LED is ON.
	LED is OFF.
	LED flashes slowly.
	LED flashes quickly.
	LED flashes with variable frequency.
	LED flashes in alternating order 3 times quickly - 2 s pause - ...











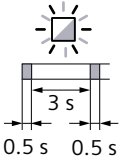











LED	Explanation
	LED is ON for 3 s then flashes 3 times quickly
	LED flashes briefly every 3 s

Table 12-2 Signal states of RDY and COM LEDs during converter ramp-up and operation

RDY	COM	Description	Remedy
		<ul style="list-style-type: none"> Temporary state after the supply voltage is switched on Restart 	
		<ul style="list-style-type: none"> Temporary state after the supply voltage is switched on: firmware being loaded and initialized. Cyclic communication in progress 	
		No fieldbus link: <ul style="list-style-type: none"> No data exchange or configuration error Data exchange lost Data exchange in progress, but there are no setpoints (controller in stop state) 	<ul style="list-style-type: none"> Check message display and rectify cause of fault. Check operating mode of controller (PLC).
		<ul style="list-style-type: none"> Converter signals a fault. Firmware error 	Check message display, rectify cause of fault.
	-	Converter is ready for operation and error-free.	
		File error: <ul style="list-style-type: none"> SD card is not available or is faulty. File corrupt • CRC error	<ul style="list-style-type: none"> Switch the converter supply voltage off and on. Check SD card if available. Reload firmware. Contact Hotline/Support.
		BIOS error: <ul style="list-style-type: none"> General error Loading error 	<ul style="list-style-type: none"> Switch the converter supply voltage off and on. Check SD card if available. Reload firmware. Contact Hotline/Support.
	-	Converter detection via DCP flashing	
	-	<ul style="list-style-type: none"> Commissioning via web server Restore factory settings via commissioning tool 	

12.1 SDI Status

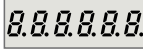
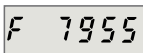



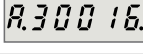

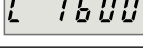

Table 12-3 Signal states of RDY and COM LEDs during firmware update

RDY	COM	Description	Remedy
		Firmware update in progress	
		Firmware update signals an error.	<ul style="list-style-type: none"> Switch the converter supply voltage off and on, and repeat the firmware update. Firmware update via memory card: Replace memory card and repeat firmware update. Contact Support/Hotline.
		Firmware update is completed. The converter is waiting.	Switch the converter supply voltage off and on.

Please contact Technical Support for LED states that are not described above.

12.1.3 SDI Status display

Description

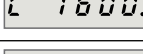
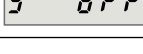
Display	Example	Description	Remarks
8.8.8.8.8.8.		Converter is in startup state	
Fxxxxx		Fault code	In the case of a single fault
F.xxxxx.		Fault code of the first fault	In the case of multiple faults
Fxxxxx.		Fault code	In the case of multiple faults
Axxxxx		Alarm code	In the case of a single alarm
A.xxxxx.		Alarm code of the first alarm	In the case of multiple alarms
Axxxxx.		Alarm code	In the case of multiple alarms
Cxxxxx		Safety message code	In the case of a single safety message
C.xxxxx.		Safety message code of the first safety message	In the case of multiple safety messages
Cxxxxx.		Safety message code	In the case of multiple safety messages
S Off		Operating display: servo-off	



Display	Example	Description	Remarks
r xxx		Actual speed (positive direction)	
r -xxx		Actual speed (negative direction)	
T x.x		Actual torque (positive direction)	
T -x.x		Actual torque (negative direction)	
P.xxxxx		Actual position (positive direction)	The digits are not fully displayed. Press the DOWN button to scroll to the next page.
Px.xxxx		Actual position (positive direction)	The remaining digits have been fully displayed.
P.-xxxx		Actual position (negative direction)	The digits are not fully displayed. Press the DOWN button to scroll to the next page.
Px.xxxx		Actual position (negative direction)	The remaining digits have been fully displayed.
DCxxx.x		Actual DC link voltage	
E.xxxxx		Position following error (positive direction)	The digits are not fully displayed. Press the DOWN button to scroll to the next page.
Ex.xxxx		Position following error (positive direction)	The remaining digits have been fully displayed.
E.-xxxx		Position following error (negative direction)	The digits are not fully displayed. Press the DOWN button to scroll to the next page.
Ex.xxxx		Position following error (negative direction)	The remaining digits have been fully displayed.
Restart		Restart the converter	
P-----		The parameter does not exist.	The symbol "P" could be other parameter symbols, like "T", "E", etc.

12.1.4 Function buttons

Description

Button	Description	Functions
	M button	Switch between the diagnosis mode and the monitoring mode
	OK button	Acknowledge faults in the diagnosis mode

12.1 SDI Status

Button	Description	Functions
	DOWN button	Navigate to the next item
 + 	Press the key combination for four seconds to restart the converter ¹⁾	

¹⁾ The converter cannot be restarted with this key combination when it is in the “servo-on” state.

12.2 System runtime

Overview

By evaluating the system runtime of the converter, you can decide when you should replace components (such as fans and motors) subject to wear in time before they fail.

Description of function

The system runtime starts once the power supply of the converter is switched on. The system runtime stops when the power supply is switched off.

The system runtime includes r2114[0] (milliseconds) and r2114[1] (days). It is calculated as follows:

System runtime = r2114[1] × days + r2114[0] × milliseconds

If r2114[0] has reached a value of 86,400,000 ms (24 hours), r2114[0] is set to the value 0 and the value of r2114[1] is increased by 1.

You cannot reset the system runtime.

Parameters

The following list includes the parameters of the "system runtime" function.

Number	Name	Unit
r2114[0...1]	System runtime total	

12.3 Faults and alarms

12.3.1 Overview of faults and alarms

Description

Definitions

A message includes a letter and a relevant number.

The letters have the following meaning:

- A means "Alarm"
- F means "Fault"
- N means "No message" or "Internal message"
- C means "Safety message"

In the delivery state (p3117 = 0), safety messages correspond to message type "C" and the safety message buffer is active. With p3117 = 1, safety messages correspond to the message types "A" or "F" and are stored in the fault buffer or the alarm buffer.

Differences between faults and alarms

An alarm reports an operating state which is non-critical at present. A fault means that it is normally no longer possible to run the motor. The converter therefore responds to alarms and faults differently.

Table 12-4 Differences between faults and alarms

Type	Description
Faults	<p>How does a converter respond when a fault occurs?</p> <ul style="list-style-type: none"> • Initiate the appropriate fault reaction. • Set the status signal ZSW1.3. • Enter the fault into the fault buffer. <p>How are faults eliminated?</p> <ul style="list-style-type: none"> • Remove the cause of the fault. • Acknowledge the fault.
Alarms	<p>How does a converter respond when an alarm occurs?</p> <ul style="list-style-type: none"> • Set the status signal ZSW1.7. • Enter the alarm into the alarm buffer. <p>How are alarms eliminated?</p> <ul style="list-style-type: none"> • Alarms are self-acknowledging. <p>If the cause of the alarm is no longer present, the converter resets the alarm.</p>

Note:

Messages from encoders whose signal is not used for control purposes are output by the converter as a warning.

12.3.2 Faults

Overview

A fault indicates that the reliable operation of the motor by the converter is at risk.

Description of function

Properties of faults

Faults have the following properties:

- The fault may cause the motor to be switched off.
- Faults must be acknowledged.
- Faults are displayed as follows:
 - On the converter via the LEDs
 - On the SINAMICS SDI Status panel via the 6-digit 7-segment display
 - In the web server
You can find more information on the display of faults in Section "Messages"
 - In Startdrive
You can find more information on the display of faults in Section "Display messages (Page 285)"

Acknowledge faults

You need to resolve the cause of the fault before you can acknowledge a fault.

To acknowledge a fault, you have the following options:

- Acknowledging via the OK button on the SINAMICS SDI Status panel
- Switching off the converter power supply and switch on again
- Acknowledging via the web server or Startdrive
- The Safety Integrated fault is acknowledged by selecting and then deselecting the STO function.

You can only acknowledge faults detected by the internal converter monitoring of hardware and firmware by switching the supply voltage off and on again. In the list of faults, you will find the information on limitations when acknowledging at the corresponding fault codes.

More information

You can find more information on faults in Section "Overview of faults and alarms (Page 424)".

12.3.3 Alarms

Overview

An alarm indicates that the reliable operation of the motor by the converter is at risk.

Description of function

Properties of alarms

Alarms have the following properties:

- Alarms have no direct influence on the drive system.
- When the cause is eliminated, the alarm is no longer displayed.
- Alarms do not have to be acknowledged.
- Alarms are displayed as follows:
 - On the converter via the LEDs
 - On the SINAMICS SDI Status panel via the 6-digit 7-segment display
 - In the web server
You can find more information on the display of alarms in Section "Messages".
 - In Startdrive
You can find more information on the display of alarms in Section "Display messages (Page 285)".

Alarm code or alarm value describe the cause of the alarm.

More information

You can find more information on alarms in Section "Overview of faults and alarms (Page 424)".

12.3.4 Explanation of the list of faults and alarms

Overview

The representation of a message includes as a maximum the information listed below. Depending on the message, some information can be omitted.

The messages are displayed according to the following pattern:

Fxxxxx	Fault location (optional): Name	
Message class:	Text of the message class (number according to PROFIdrive)	
Message value:	Component number: %1, fault cause: %2	
Variant:	Product variant	
Component:	Hardware component	
Response:	NONE	
Acknowledgment:	POWER ON	
Explanation of the message value:	For %2	
	Value Cause	Remedy
	11 Fault cause for value = 11	Remedy for value = 11
	15 Fault cause for value = 15	Remedy for value = 15
Cause:	Description of possible causes. Fault value (r0949, interpret <format>): or alarm value (r2124, interpret <format>): (optional) Information about fault and alarm values (optional).	
Remedy:	Description of possible remedies.	

Description of function

Fault location (optional): Name

The fault location (optional), the name of the fault or alarm and the message number are all used to identify the message (e.g. with the commissioning software).

Message class

Every message is assigned a message class using the following structure:

Text of the message class (number according to PROFIdrive)

The message classes are transferred at different interfaces to higher-level control systems and their associated display and operating units.

The message classes that are available are listed in the following table. In addition to the text of the message class and its number according to PROFIdrive – as well as a brief help text regarding the cause and remedy – they also include information about the various diagnostic interfaces:

- PN (hex)
Specifies the "Channel error type" of the PROFINET channel diagnostics.
When activating the channel diagnostics, using the GSDML file, the texts listed in the table can be displayed.
- DS1 (dec)
Specifies the bit number in data set DS1 of the diagnostic alarm for SIMATIC S7.
When the diagnostic alarms are activated, the texts listed in the table can be displayed.

Table 12-5 Message classes and coding of various diagnostic interfaces

Text of the message class	Number according to PROFIdrive	Diagnostics interface	
		PN (hex)	DS1 (dec)
Cause and remedy			
Hardware/software fault A hardware or software malfunction was detected. <ul style="list-style-type: none"> • Carry out a POWER ON for the relevant component. • If it occurs again, contact the hotline. • Replace device. 	(1)	9000	0
Line fault A line supply fault has occurred (phase failure, voltage level...). <ul style="list-style-type: none"> • Check the line supply/fuses. • Check the supply voltage. • Check the wiring. 	(2)	9001	1
Supply voltage fault An electronics supply voltage fault (48 V, 24 V, 5 V...) was detected. <ul style="list-style-type: none"> • Check the wiring. • Check the voltage level. 	(3)	9002	2
DC link overvoltage The DC link voltage has assumed an inadmissibly high value. <ul style="list-style-type: none"> • Check the dimensioning of the system (line supply, reactor, voltages). • Check the infeed settings. 	(4)	9003	3
Power electronics fault An inadmissible operating state of the power electronics has been identified (overcurrent, overtemperature, IGBT failure...). <ul style="list-style-type: none"> • Check that the permissible duty cycles are complied with. • Check the ambient temperatures (fan). 	(5)	9004	4
Electronic component overload The temperature in the component has exceeded the highest permissible limit. <ul style="list-style-type: none"> • Check the ambient temperature /control cabinet cooling. 	(6)	9005	5
Ground fault/inter-phase short-circuit detected A ground fault/interphase short-circuit was detected in the power cables or in the motor windings. <ul style="list-style-type: none"> • Check the power cables (connection). • Check the motor. 	(7)	9006	6
Motor overload The motor was operated outside the permissible limits (temperature, current, torque...). <ul style="list-style-type: none"> • Check the duty cycles and set limits. • Check the ambient temperature/motor cooling. 	(8)	9007	7

Text of the message class	Number according to PROFIdrive	Diagnostics interface	
		PN (hex)	DS1 (dec)
Cause and remedy			
Communication error to the higher-level controller The communication to the higher-level controller (internal coupling, PROFIBUS, PROFINET...) is faulted or interrupted. <ul style="list-style-type: none"> • Check the state of the higher-level control system. • Check the communication connection/wiring. • Check the bus configuration/clock cycles. 	(9)	9008	8
Safety monitoring channel has identified an error A safe operation monitoring function (Safety) has detected an error.	(10)	9009	9
Actual position value/actual speed value incorrect or not available An illegal signal state was detected while evaluating the encoder signals (track signals, zero marks, absolute values...). <ul style="list-style-type: none"> • Check the encoder/status of the encoder signals. • Observe the maximum permissible frequencies. 	(11)	900A	10
Internal (DRIVE-CLiQ) communication error The internal communication between the SINAMICS components is faulted or interrupted. <ul style="list-style-type: none"> • Check the DRIVE-CLiQ wiring. • Ensure an EMC-compliant design. • Observe the maximum quantity structure/cycles. 	(12)	900B	11
Infeed fault The infeed is faulted or has failed. <ul style="list-style-type: none"> • Check the infeed and its environment (line supply, filters, reactors, fuses...). • Check the infeed control. 	(13)	900C	12
Braking controller/Braking Module faulted The internal or external Braking Module is faulted or overloaded (temperature). <ul style="list-style-type: none"> • Check the connection/state of the Braking Module. • Comply with the permissible number of braking operations and their duration. 	(14)	900D	13
Line filter faulted The line filter monitoring has identified an excessively high temperature or other inadmissible state. <ul style="list-style-type: none"> • Check the temperature/temperature monitoring. • Check the configuration to ensure that it is permissible (filter type, infeed, thresholds). 	(15)	900E	14

Text of the message class	Number according to PROFIdrive	Diagnostics interface	
Cause and remedy		PN (hex)	DS1 (dec)
<p>External measured value/signal state outside of the permissible range</p> <p>A measured value/signal state read in via the input area (digital/analog/temperature) has assumed an inadmissible value/state.</p> <ul style="list-style-type: none"> • Determine and check the relevant signal. • Check the set thresholds. 	(16)	900F	15
<p>Application/technology function faulted</p> <p>The application/technological function has exceeded a (set) limit (position, speed, torque...).</p> <ul style="list-style-type: none"> • Determine and check the relevant limit. • Check the setpoint specified by the higher-level controller. 	(17)	9010	16
<p>Error in the parameterization/configuration/commissioning sequence</p> <p>An error has been identified in the parameterization or in a commissioning procedure, or the parameterization does not match the actual device configuration.</p> <ul style="list-style-type: none"> • Determine the precise cause of the fault using the commissioning tool. • Adapt the parameterization or device configuration. 	(18)	9011	17
<p>General drive fault</p> <p>Group fault.</p> <ul style="list-style-type: none"> • Determine the precise cause of the fault using the commissioning tool. 	(19)	9012	18
<p>Auxiliary unit faulted</p> <p>The monitoring of an auxiliary unit (incoming transformer, cooling unit...) has identified an inadmissible state.</p> <ul style="list-style-type: none"> • Determine the exact cause of the fault and check the device involved. 	(20)	9013	19

Message value

Provides information about the composition of the fault/alarm value.

Example:

Message value: Component number: %1, fault cause: %2

In this example, the message value contains information about the component number and cause of the fault. Entries %1 and %2 are placeholders. If the commissioning software is connected to the converter, then these placeholders are populated with the appropriate values.

Variant

Specifies the product variant in which the message exists. This information is not applicable if an alarm is the same for all product variants.

Component

Type of hardware component that has triggered the fault or alarm. For "None", it is not possible to assign the message to a hardware component.

Explanation of the message value

Explains the possible values of the placeholders (%n) in the message value. In this case, detailed information can be specified regarding the cause and remedy for specific values.

Response

Specifies the response in the event of a fault.

The following table lists all fault responses and their meanings used for the entire SINAMICS drive family.

Table 12-6 Fault responses

List	PROFIdrive	Response	Description
NONE	–	None	No response when a fault occurs.
OFF1	ON/OFF	Brake along the ramp-function generator deceleration ramp followed by pulse inhibit	<p>Closed-loop speed control</p> <ul style="list-style-type: none"> The motor is braked by immediately specifying $n_set = 0$ at the ramp-function generator deceleration ramp (p1121). The pulses are suppressed when standstill has been identified. "Switching on inhibited" is activated. <p>Torque control</p> <ul style="list-style-type: none"> The following applies for torque control: Response as for OFF2. When switching into torque control, the following applies: There is no dedicated braking response. The pulses are suppressed when standstill has been identified. "Switching on inhibited" is activated.
OFF2	COASTSTOP	Internal/external pulse inhibit	<p>Closed-loop speed and torque control</p> <ul style="list-style-type: none"> Immediate pulse cancellation, the motor "coasts down" to a standstill. "Switching on inhibited" is activated.
OFF3	QUICKSTOP	Braking along the OFF3 deceleration ramp followed by pulse inhibit	<p>Closed-loop speed control</p> <ul style="list-style-type: none"> The motor is braked along the OFF3 deceleration ramp (p1135) by immediately entering $n_set = 0$. The pulses are suppressed when standstill has been identified. "Switching on inhibited" is activated. <p>Torque control</p> <ul style="list-style-type: none"> Switchover to closed-loop speed control and other responses as described for closed-loop speed control.
STOP2	–	STOP2	<ul style="list-style-type: none"> The motor is braked along the OFF3 deceleration ramp (p1135) by immediately entering $n_set = 0$. The drive remains in closed-loop speed control.
ENCODER	–	Internal/external pulse inhibit	The ENCODER fault response occurs because of a sensor error and results in OFF2.

Acknowledgment

A fault can only be acknowledged if the cause has been resolved.

The acknowledgment specifies when the fault can be acknowledged.

An alarm is self-acknowledging.

Table 12-7 Acknowledging faults

Acknowledgment	Description
IMMEDIATELY	Acknowledgment can be immediately realized after the cause has been resolved.
PULSE INHIBIT	Once the cause has been resolved, the fault can only be acknowledged when the pulses are inhibited (r0899.11 = 0).
POWER ON	The fault can only be acknowledged using POWER ON (the converter is switched-off/switched-on).
NONE	For alarms (type "A"), an acknowledgment is not required.

Cause

Describes the possible causes of the fault or alarm. Optionally, a message value, fault value or alarm value can be additionally specified.

Remedy

Generally explains possible procedures to resolve the cause of this active fault or alarm.

12.3.5 List of fault codes and alarm codes

Product: SINAMICS S200, Version: 602024000, Language: eng
 Objects: S200 Basic PN, S200 PN

F01000 Internal software error

Message class: Hardware/software error (1)

Message value: Module: %1, line: %2

Component: Control Unit (CU)

Response: OFF2

Acknowledgment: POWER ON

Cause: An internal software error has occurred.
 Fault value (r0949, interpret hexadecimal):
 Only for internal Siemens troubleshooting.

- Remedy:**
- Evaluate fault buffer (r0945).
 - Carry out a POWER ON (switch-off/switch-on) for all components.
 - If required, check the data on the non-volatile memory (e.g. memory card).
 - Upgrade firmware to later version.
 - Contact Technical Support.
 - Replace the converter.

F01001 FloatingPoint exception

Message class: Hardware/software error (1)

Message value: %1

Component: Control Unit (CU)
Response: OFF2
Acknowledgment: POWER ON
Cause: An exception occurred for an operation with the FloatingPoint data type.
The error can be caused by the basic system or a technology function.
Fault value (r0949, interpret hexadecimal):
Only for internal Siemens troubleshooting.
Remedy:

- Carry out a POWER ON (switch-off/switch-on) for all components.
- Check configuration and signals of the blocks in FBLOCKS.
- Check configuration and signals of DCC charts.
- Check configuration and signals of TEC charts.
- Upgrade firmware to later version.
- Contact Technical Support.

F01002 Internal software error

Message class: Hardware/software error (1)
Message value: %1
Component: Control Unit (CU)
Response: OFF2
Acknowledgment: IMMEDIATELY
Cause: An internal software error has occurred.
Fault value (r0949, interpret hexadecimal):
Only for internal Siemens troubleshooting.
Remedy:

- Carry out a POWER ON (switch-off/switch-on) for all components.
- Upgrade firmware to later version.
- Contact Technical Support.

F01003 Acknowledgment delay when accessing the memory

Message class: Hardware/software error (1)
Message value: %1
Component: Control Unit (CU)
Response: OFF2
Acknowledgment: IMMEDIATELY
Cause: A memory area was accessed that does not return a "READY".
Fault value (r0949, interpret hexadecimal):
Only for internal Siemens troubleshooting.
Remedy:

- Carry out a POWER ON (switch-off/switch-on) for all components.
- Contact Technical Support.

N01004 Internal software error

Message class: Hardware/software error (1)
Message value: %1
Component: Control Unit (CU)
Response: NONE
Acknowledgment: NONE
Cause: An internal software error has occurred.
Fault value (r0949, hexadecimal):
Only for internal Siemens troubleshooting.
Remedy:

- Contact Technical Support.

F01005 Firmware download for DRIVE-CLiQ component unsuccessful

Message class: Hardware/software error (1)
Message value: Component number: %1, fault cause: %2
Component: None
Response: NONE
Acknowledgment: IMMEDIATELY
Explanation of the message value: For %2

Value	Cause	Remedy
11	DRIVE-CLiQ component has detected a checksum error.	After POWER ON has been carried out again for the DRIVE-CLiQ component, download firmware again.
15	The selected DRIVE-CLiQ component did not accept the contents of the firmware file.	Use a suitable firmware version
18	Firmware version is too old and is not accepted by the component.	Use a suitable firmware version
19	Firmware version is not suitable for the hardware release of the component.	Use a suitable firmware version
101	After several communication attempts, no response from the DRIVE-CLiQ component.	Check the DRIVE-CLiQ wiring.
139	Initially, only one new boot loader was loaded.	After POWER ON has been carried out again for the DRIVE-CLiQ component, download firmware again.
140	Firmware file for the DRIVE-CLiQ component not available on the memory card.	Use a suitable firmware version
141	An inconsistent length of the firmware file was signaled.	Use a suitable firmware version
142	Component has not changed to the mode for firmware download.	After POWER ON has been carried out again for the DRIVE-CLiQ component, download firmware again.
156	Component with the specified component number is not available (p7828).	Check the selected component number.

Cause: It was not possible to download the firmware to a DRIVE-CLiQ component.
 Fault value (r0949, interpret hexadecimal):
 yyxxxx hex: yy = component number, xxxx = fault cause
 Example: xxxx = 000B hex = 11 dec:

xxxx = 008D hex = 141 dec:
 An inconsistent length of the firmware file was signaled.
 The firmware download may have been caused by a loss of connection to the firmware file.
 This can occur during a project download/reset, for example.

xxxx = 008F hex = 143 dec:
 Component has not changed to the mode for firmware download. It was not possible to delete the existing firmware.

xxxx = 0090 hex = 144 dec:
 When checking the firmware that was downloaded (checksum), the component detected a fault. It is possible that the file on the memory card is defective.

xxxx = 0091 hex = 145 dec:
 Checking the loaded firmware (checksum) was not completed by the component in the appropriate time.

Remedy:

- Check the selected component number.
- Check the DRIVE-CLiQ wiring.
- Use a component with a suitable hardware version.
- After warm restart has been carried out again for the DRIVE-CLiQ component, download the firmware again.

A01006 Firmware update for DRIVE-CLiQ component required

Message class: General drive fault (19)

Message value: Component number: %1

Component: None

Response: NONE

Acknowledgment: NONE

Explanation of the message value: For %1

Component in target topology

Cause: The firmware of a DRIVE-CLiQ component must be updated as there is no suitable firmware or firmware version in the component for operation with the converter.

Alarm value (r2124, interpret decimal):

Component number of the DRIVE-CLiQ component.

Remedy: Repeat the firmware update by switching off the device and switching on again.

A01007 POWER ON for DRIVE-CLiQ component required

Message class: General drive fault (19)

Message value: Component number: %1

Component: None

Response: NONE

Acknowledgment: NONE

Explanation of the message value: For %1

Component in target topology

Cause: A DRIVE-CLiQ component must be switched on again (POWER ON) (e.g. due to a firmware update).

Alarm value (r2124, interpret decimal):

Component number of the DRIVE-CLiQ component.

Note:

For a component number = 1, a POWER ON of the Control Unit is required.

Remedy: - Switch off the power supply of the specified DRIVE-CLiQ component and switch it on again.

- For SINUMERIK, auto commissioning is prevented. In this case, a POWER ON is required for all components and the auto commissioning must be restarted.

A01009 Control Unit overtemperature

Message class: Overtemperature of the electronic components (6)

Message value: -

Component: Control Unit (CU)

Response: NONE

Acknowledgment: NONE

Cause: The temperature (r0037[0]) of the converter has exceeded the specified limit value.

Remedy: - Check the converter air intake.

- Check the converter fan.

Note:

The alarm is automatically withdrawn once the limit value has been fallen below.

F01011 Download interrupted

Message class: Error in the parameterization / configuration / commissioning procedure (18)

Message value: %1

Component: None

Response: NONE

12.3 Faults and alarms

Acknowledgment: IMMEDIATELY

Cause: The project download was interrupted.
Fault value (r0949, interpret decimal):
1: The user prematurely interrupted the project download.
2: The communication cable was interrupted (e.g. cable breakage, cable withdrawn).
3: The project download was prematurely exited by the commissioning tool.
100: Different versions between the firmware version and project files which were loaded by loading into the file system "Download from memory card".
Note:
The response to an interrupted download is the state "first commissioning".

Remedy:

- Check the communication cable.
- Download the project again.
- Boot from previously saved files (switch-off/switch-on or p0976).
- When loading into the file system (download from memory card), use the matching version.

F01014 Topology: DRIVE-CLiQ component property changed

Message class: Hardware/software error (1)
Message value: Component number: %1
Component: None
Response: NONE
Acknowledgment: IMMEDIATELY
Cause: The properties of the DRIVE-CLiQ component have fundamentally changed.
Fault value (r0949, interpret hexadecimal):
Component number.
Remedy:

- Check the DRIVE-CLiQ component, and if required replace.
- Carry out a restart, reload parameters.

F01015 Internal software error

Message class: Hardware/software error (1)
Message value: %1
Component: Control Unit (CU)
Response: OFF2
Acknowledgment: POWER ON
Cause: An internal software error has occurred.
Fault value (r0949, interpret decimal):
Only for internal Siemens troubleshooting.
Remedy:

- Carry out a POWER ON (switch-off/switch-on) for all components.
- Upgrade firmware to later version.
- Contact Technical Support.

A01016 Firmware changed

Message class: Hardware/software error (1)
Message value: %1
Component: Control Unit (CU)
Response: NONE
Acknowledgment: NONE

Cause: At least one firmware file in the directory was illegally changed on the non-volatile memory (memory card/device memory) with respect to the version when shipped from the factory.
Alarm value (r2124, interpret decimal):
0: Checksum of one file is incorrect.
1: File missing.
2: File too many.
3: Incorrect firmware version.
4: Incorrect checksum of the backup file.

Remedy: For the non-volatile memory for the firmware (memory card/device memory), restore the delivery condition.

A01017 Component lists changed

Message class: Hardware/software error (1)
Message value: %1
Component: Control Unit (CU)
Response: NONE
Acknowledgment: NONE

Cause: The memory card has a defective file.
Alarm value (r2124, interpret decimal):
xyz dec: x = problem, y = file name
x = 1: file checksum is incorrect.
x = 2: error when parsing the file.
y = 1: file MOTARM.ACX
y = 2: file MOTARMLD.ACX
y = 3: file MOTSRM.ACX
y = 4: file MOTSLM.ACX
y = 5: file MOTRESM.ACX
y = 6: file BEARING.ACX
y = 7: file CFG_BEAR.ACX
y = 8: file BEARINGTYPE.ACX
y = 9: file BRAKE.ACX
y = 10: file CFG_BRAKE.ACX
y = 11: file ENCODER.ACX
y = 12: file CFG_ENCODER.ACX
y = 13: file ENCODERGEAR.ACX
y = 14: file CFG_ENC_GEAR.ACX
y = 15: file LOADGEAR.ACX
y = 16: file THERMMOTMOD3.ACX
y = 17: file CFG_THERMMOTMOD3.ACX
y = 30: file WHITELIST.ACX

Remedy: Correct the file involved.

F01018 Runup has been interrupted several times

Message class: Hardware/software error (1)
Message value: -
Component: None
Response: NONE
Acknowledgment: POWER ON

12.3 Faults and alarms

Cause: Module booting was interrupted several times. As a consequence, the module boots with the factory setting.
Possible reasons for booting being interrupted:
- Power supply interrupted.
- CPU crashed.
- Parameterization invalid.

Remedy: - Carry out a POWER ON (switch-off/switch-on). After switching on, the module reboots from the valid parameterization (if available).
- Restore the valid parameterization.
Examples:
a) Carry out a first commissioning, save, carry out a POWER ON (switch-off/switch-on).
b) Load another valid parameter backup (e.g. from the memory card), save, carry out a POWER ON (switch-off/switch-on).
Note:
If the fault situation is repeated, then this fault is again output after several interrupted boots.

A01019 Writing to the removable data medium unsuccessful

Message class: Hardware/software error (1)
Message value: -
Component: Control Unit (CU)
Response: NONE
Acknowledgment: NONE
Cause: The write access to the removable data medium was unsuccessful.
Remedy: - Check the removable data medium and if required replace.
- Repeat the data backup.

A01020 Writing to RAM disk unsuccessful

Message class: Hardware/software error (1)
Message value: -
Component: Control Unit (CU)
Response: NONE
Acknowledgment: NONE
Cause: A write access to the internal RAM disk was unsuccessful.
Remedy: Adapt the file size for the system logbook to the internal RAM disk (p9930).

F01023 Software timeout (internal)

Message class: Hardware/software error (1)
Message value: %1
Component: Control Unit (CU)
Response: NONE
Acknowledgment: IMMEDIATELY
Cause: An internal software timeout has occurred.
Fault value (r0949, interpret decimal):
Only for internal Siemens troubleshooting.
Remedy: - Carry out a POWER ON (switch-off/switch-on) for all components.
- Upgrade firmware to later version.
- Contact Technical Support.

F01030 Sign-of-life failure for master control

Message class: Communication error to the higher-level control system (9)
Message value: -

Component: None
Response: OFF3
Acknowledgment: IMMEDIATELY
Cause: For active PC master control of the PC, no sign-of-life was received within the monitoring time.
The master control was returned to the drive.
Remedy: Set the monitoring time higher at the PC or, if required, completely disable the monitoring function.
The monitoring time is set as follows using the commissioning tool:
<Drive> -> Commissioning -> Control panel -> Button "Fetch master control" -> A window is displayed to set the monitoring time in milliseconds.
Notice:
The monitoring time should be set as short as possible. A long monitoring time means a late response when the communication fails!

A01032 All parameters must be saved

Message class: Hardware/software error (1)
Message value: %1
Component: Control Unit (CU)
Response: NONE
Acknowledgment: NONE
Cause: Data backup is incomplete
The partially saved parameters are not loaded the next time the system runs up.
For the system to successfully power up, all of the parameters must have been completely backed up.
Alarm value (r2124, interpret decimal):
Only for internal Siemens troubleshooting.
Remedy: Save all parameters.
See also: p0977 (Save all parameters)

F01033 Units changeover: Reference parameter value invalid

Message class: Error in the parameterization / configuration / commissioning procedure (18)
Message value: Parameter: %1
Component: None
Response: NONE
Acknowledgment: IMMEDIATELY
Cause: When changing over the units to the referred representation type, it is not permissible for any of the required reference parameters to be equal to 0.0
Fault value (r0949, parameter):
Reference parameter whose value is 0.0.
Remedy: Set the value of the reference parameter to a number different than 0.0.
See also: p0304, p0305, p2000, p2002, p2003

F01034 Units changeover: Calculation parameter values after reference value change unsuccessful

Message class: Error in the parameterization / configuration / commissioning procedure (18)
Message value: Parameter: %1
Component: None
Response: NONE
Acknowledgment: IMMEDIATELY

Cause: The change of a reference parameter meant that for an involved parameter the selected value was not able to be re-calculated in the per unit representation. The change was rejected and the original parameter value restored.
Fault value (r0949, parameter):
Parameter whose value was not able to be re-calculated.
See also: p0304, p0305, p2000, p2002, p2003

Remedy: - Select the value of the reference parameter such that the parameter involved can be calculated in the per unit representation.

A01035 ACX: Parameter backup file corrupted

Message class: Hardware/software error (1)

Message value: %1

Component: Control Unit (CU)

Response: NONE

Acknowledgment: NONE

Cause: When the converter runs up, no complete data set was found from the parameter backup files. The last time that the parameterization was saved, it was not completely carried out.
It is possible that the backup was interrupted by switching off or withdrawing the memory card.
Alarm value (r2124, interpret hexadecimal):
ddccbbaa hex:
aa = 01 hex:
Power up was realized without data backup. The drive is in the factory setting.
aa = 02 hex:
The last available backup data record was loaded. The parameterization must be checked. It is recommended that the parameterization is downloaded again.
dd, cc, bb:
Only for internal Siemens troubleshooting.
See also: p0977 (Save all parameters)

Remedy: - Download the project again using the commissioning tool.
- Retentively save parameters (save all parameters p0977 = 1)
See also: p0977 (Save all parameters)

F01036 Parameter backup file missing

Message class: Hardware/software error (1)

Message value: %1

Component: Control Unit (CU)

Response: NONE

Acknowledgment: IMMEDIATELY

Cause: When loading the device parameterization, a parameter backup file cannot be found.

Remedy: If you have saved your project data using the commissioning tool, carry-out a new download for your project.
Retentively save parameters (save all parameters p0977 = 1)
This means that the parameter files are again completely written into the non-volatile memory.
Note:
If the project data have not been backed up, then a new first commissioning is required.

F01038 Loading the parameter backup file unsuccessful

Message class: Hardware/software error (1)

Message value: %1

Component: Control Unit (CU)

Response: NONE

Acknowledgment: IMMEDIATELY

Cause: An error has occurred when loading parameter backup files from the non-volatile memory.

Remedy:

- If you have saved the project data using the commissioning tool, download the project again. Retentively save the data or set p0977 = 1. This means that the parameter files are again completely written to the non-volatile memory.
- Replace the memory card or the converter.

F01039 Writing to the parameter back-up file unsuccessful

Message class: Hardware/software error (1)

Message value: %1

Component: Control Unit (CU)

Response: NONE

Acknowledgment: IMMEDIATELY

Cause: Writing to at least one parameter backup file in the non-volatile memory was unsuccessful.

- A parameter backup file has the "read only" file attribute and cannot be overwritten.
- There is not sufficient free memory space available.
- The non-volatile memory is defective and cannot be written to.

Remedy:

- Check the free memory space in the non-volatile memory.
- Replace the memory card or the converter.

F01040 Save parameter settings and carry out a POWER ON

Message class: Error in the parameterization / configuration / commissioning procedure (18)

Message value: -

Component: None

Response: OFF2

Acknowledgment: POWER ON

Cause: A parameter was changed, which means that it is necessary to save the parameters and reboot.

Remedy:

- Back up parameters.
- Carry out a POWER ON (switch-off/switch-on) for all components.

Then:

- Upload the drive unit (commissioning tool).

F01041 Parameter save necessary

Message class: Error in the parameterization / configuration / commissioning procedure (18)

Message value: %1

Component: None

Response: NONE

Acknowledgment: IMMEDIATELY

Cause: Defective or missing files were detected on the memory card when booting.

Fault value (r0949, interpret decimal):

- 1: Source file cannot be opened.
- 2: Source file cannot be read.
- 3: Target directory cannot be set up.
- 4: Target file cannot be set up/opened.
- 5: Target file cannot be written to.

Additional values:

Only for internal Siemens troubleshooting.

Remedy:

- Save the parameters.
- Download the project again to the drive unit.
- Update the firmware
- If required, replace the converter and/or memory card.

F01042 Parameter error during project download

Message class: Error in the parameterization / configuration / commissioning procedure (18)

Message value: Parameter: %1, index: %2, fault cause: %3

Component: None

Response: OFF2

Acknowledgment: IMMEDIATELY

Cause: An error was detected when downloading a project using the commissioning software (e.g. incorrect parameter value). It is possible that the parameter limits are dependent on other parameters.
The detailed cause of the fault can be determined using the fault value.
Fault value (r0949, interpret hexadecimal):
ccbbaaaa hex
aaaa = Parameter
bb = Index
cc = fault cause
0: Parameter number illegal.
1: Parameter value cannot be changed.
2: Lower or upper value limit exceeded.
3: Sub-index incorrect.
4: No array, no sub-index.
5: Data type incorrect.
6: Setting not permitted (only resetting).
7: Descriptive element cannot be changed.
9: Descriptive data not available.
11: No master control.
15: No text array available.
17: Task cannot be executed due to operating state.
20: Illegal value.
21: Response too long.
22: Parameter address illegal.
23: Format illegal.
24: Number of values not consistent.
25: Drive object does not exist.
101: Presently deactivated.
104: Illegal value.
107: Write access not permitted when controller enabled.
108: Unit unknown.
109: Write access only in the commissioning status, encoder.
110: Write access only in the commissioning status, motor.
111: Write access only in the commissioning status, power unit.
112: Write access only in the quick commissioning mode.
113: Write access only in the ready mode.
114: Write access only in the commissioning status, parameter reset.
115: Write access only in the Safety Integrated commissioning status.
116: Write access only in the commissioning status, technological application/units.
117: Write access only in the commissioning status.
118: Write access only in the commissioning status, download.
119: Parameter may not be written in download.
120: Write access only in the commissioning status, drive basis configuration.
121: Write access only in the commissioning status, define drive type.
122: Write access only in the commissioning status, data set basis configuration.
123: Write access only in the commissioning status, device configuration.
124: Write access only in the commissioning status, device download.
125: Write access only in the commissioning status, device parameter reset.
126: Write access only in the commissioning status, device ready.
127: Write access only in the commissioning status, device.
129: Parameter may not be written in download.
131: Requested signal interconnection not possible as the signal source does not supply float value.
132: Free signal interconnection via PROFIdrive telegram setting inhibited.

- 133: Access method not defined.
- 200: Below the valid values.
- 201: Above the valid values.
- 202: Cannot be accessed from the Basic Operator Panel (BOP).
- 203: Cannot be read from the Basic Operator Panel (BOP).
- 204: Write access not permitted.

- Remedy:**
- Correct the parameterization in the commissioning tool and download the project again.
 - Enter the correct value in the specified parameter.
 - Identify the parameter that restricts the limits of the specified parameter.

F01043 Fatal error at project download

Message class: Error in the parameterization / configuration / commissioning procedure (18)

Message value: Fault cause: %1

Component: None

Response: NONE

Acknowledgment: IMMEDIATELY

Cause: A fatal error was detected when downloading a project using the commissioning tool.

Fault value (r0949, interpret decimal):

- 1: Device status cannot be changed to device download (drive object ON?).
 - 2: Drive object number incorrect.
 - 3: A drive object that has already been deleted is deleted again.
 - 4: A drive object that has already been registered for generation is deleted.
 - 5: A drive object that does not exist is deleted.
 - 6: An undeleted drive object that already existed is generated.
 - 7: A drive object already registered for generation is generated again.
 - 8: Maximum number of drive objects that can be generated is exceeded.
 - 9: Error when generating the device drive object.
 - 10: Error when generating the target topology parameter.
 - 11: Error when generating a drive object (global component).
 - 12: Error when generating a drive object (drive component).
 - 13: Drive object type unknown.
 - 14: Drive status cannot be changed to "ready for operation" (r0947 and r0949).
 - 15: Drive status cannot be changed to drive download.
 - 16: Device status cannot be changed to "ready for operation".
 - 17: It is not possible to download the topology. The component wiring should be checked, taking into account the various messages/signals.
 - 18: A new download is only possible if the factory settings are restored for the drive unit.
 - 19: The slot for the option module has been configured several times (e.g. CAN and COMM BOARD).
 - 20: The configuration is inconsistent.
 - 21: Error when accepting the download parameters.
 - 22: Software-internal download error.
 - 24: Download not possible during a partial power up after inserting a component.
- Additional values:

Only for internal Siemens troubleshooting.

- Remedy:**
- Use the current version of the commissioning tool.
 - Modify the offline project and carry out a new download (e.g. compare the number of drive objects, motors, encoders, power units in the offline project and at the drive).
 - Change the drive state (is a drive rotating or is there a message/signal?).
 - Observe additional active messages/signals and remove their cause (e.g. correct any incorrectly set parameters).
 - Automatically calculate the control parameters.
 - Boot from previously saved files (switch-off/switch-on or p0976).
 - Before a new download, restore the factory setting.

F01044 Descriptive data error

Message class: Hardware/software error (1)
Message value: %1
Component: Control Unit (CU)
Response: OFF2
Acknowledgment: POWER ON
Cause: An error was detected when loading the descriptive data saved in the non-volatile memory.
Remedy: Replace the memory card or the converter.

A01045 CU: Configuring data invalid

Message class: Hardware/software error (1)
Message value: %1
Component: Control Unit (CU)
Response: NONE
Acknowledgment: NONE
Cause: An error was detected when evaluating the parameter files PSxxxxxyy.ACX, PTxxxxyy.ACX, CAxxxxyy.ACX, or CCxxxxyy.ACX saved in the non-volatile memory. Under certain circumstances, several of the saved parameter values were not able to be accepted.
Alarm value (r2124, interpret hexadecimal):
Only for internal Siemens troubleshooting.
Remedy: - Restore the factory setting (p0976 = 1) and reload the project into the converter.
Then retentively save the parameterization or set p0977 = 1. This overwrites the incorrect parameter files in the non-volatile memory – and this alarm is withdrawn.

A01049 CU: It is not possible to write to file

Message class: Hardware/software error (1)
Message value: %1
Component: Control Unit (CU)
Response: NONE
Acknowledgment: NONE
Cause: It is not possible to write to a write-protected parameter backup file. The write request was interrupted.
Alarm value (r2124, interpret decimal):
Number drive object
Remedy: Check whether the "write protected" attribute has been set for the files in the non-volatile memory.
When required, remove write protection and repeat the save operation (e.g. set p0977 = 1).

F01050 Memory card and device incompatible

Message class: Error in the parameterization / configuration / commissioning procedure (18)
Message value: -
Component: Control Unit (CU)
Response: OFF2
Acknowledgment: IMMEDIATELY
Cause: The memory card and the device type do not match (e.g. a memory card for SINAMICS S is inserted in SINAMICS G).
Remedy: - Insert the matching memory card.
- Use the matching converter or power unit.

F01054 CU: System limit exceeded

Message class: Error in the parameterization / configuration / commissioning procedure (18)
Message value: %1

12.3 Faults and alarms

Component: Control Unit (CU)
Response: OFF2
Acknowledgment: IMMEDIATELY
Cause: At least one system overload has been identified.
Fault value (r0949, interpret decimal):
1: Computing time load too high.
5: Peak load too high.
Note:
As long as this fault is present, it is not possible to save the parameters (p0977).
Remedy:
- Reduce the computing time load of the drive unit to below 100 %.
- Deactivate functions.
- Deactivate drive objects.
- Remove drive objects from the target topology.
- Note the DRIVE-CLiQ topology rules and if required, change the DRIVE-CLiQ topology.

F01068 CU: Data memory memory overflow

Message class: Error in the parameterization / configuration / commissioning procedure (18)
Message value: %1
Component: Control Unit (CU)
Response: OFF2
Acknowledgment: IMMEDIATELY
Cause: The utilization for a data memory area is too large.
Fault value (r0949, interpret binary):
Bit 0 = 1: High-speed data memory 1 overloaded
Bit 1 = 1: High-speed data memory 2 overloaded
Bit 2 = 1: High-speed data memory 3 overloaded
Bit 3 = 1: High-speed data memory 4 overloaded
Remedy:
- Deactivate function.
- Deactivate drive object.
- Remove drive object from the target topology.

A01069 Parameter backup and device incompatible

Message class: Error in the parameterization / configuration / commissioning procedure (18)
Message value: -
Component: Control Unit (CU)
Response: NONE
Acknowledgment: NONE
Cause: The parameter backup on the memory card and the drive unit do not match.
The module boots with the factory settings.
Example:
Devices A and B. are not compatible and a memory card with the parameter backup for device A is inserted in device B.
Remedy:
- Insert a memory card with compatible parameter backup and carry out a POWER ON.
- Insert a memory card without parameter backup and carry out a POWER ON.
- Save the parameters (p0977 = 1).

F01070 Project/firmware is being downloaded to the memory card

Message class: Error in the parameterization / configuration / commissioning procedure (18)
Message value: %1
Component: Control Unit (CU)
Response: OFF2

Acknowledgment: IMMEDIATELY

Cause: An upgrade (project/firmware download) was initiated on the memory card.
While this fault is active, the corresponding update takes place with plausibility and consistency checks. After this, depending on the command option, a new boot (reset) for the converter is initiated.
Caution:
While upgrading and while this fault is active, it is not permissible to switch off the converter.
If the operation is interrupted, this can destroy the file system on the memory card. The memory card will then no longer work properly and must be repaired.

Remedy: Not necessary.
The fault is automatically withdrawn after the upgrade has been completed.

F01072 Memory card restored from the backup copy

Message class: General drive fault (19)
Message value: -
Component: Control Unit (CU)
Response: NONE
Acknowledgment: IMMEDIATELY
Cause: The converter was switched-off while writing to the memory card. This is why the visible partition became defective. After switching on, the data from the non-visible partition (backup copy) were written to the visible partition.
Remedy: Check that the firmware and parameterization is up-to-date.

A01073 POWER ON required for backup copy on memory card

Message class: General drive fault (19)
Message value: -
Component: Control Unit (CU)
Response: NONE
Acknowledgment: NONE
Cause: The parameter assignment on the visible partition of the memory card has changed.
In order that the backup copy on the memory card is updated on the non-visible partition, it is necessary to carry out a POWER ON or hardware reset (p0972) of the Control Unit.
Note:
It is possible that a new POWER ON is requested via this alarm (e.g. after saving with p0971 = 1).
Remedy: - Carry out a POWER ON (switch-off/switch-on) for the Control Unit.
- Carry out a hardware reset (RESET button, p0972).

F01082 Parameter error when running up from data backup

Message class: Error in the parameterization / configuration / commissioning procedure (18)
Message value: Parameter: %1, index: %2, fault cause: %3
Component: None
Response: OFF2
Acknowledgment: IMMEDIATELY

12.3 Faults and alarms

- Cause:** Parameterizing errors have been detected (e.g. incorrect parameter value). It is possible that the parameter limits are dependent on other parameters.
- The detailed cause of the fault can be determined using the fault value.
- Fault value (r0949, interpret hexadecimal):
- ccbbaaaa hex
- aaaa = Parameter
- bb = Index
- cc = fault cause
- 0: Parameter number illegal.
 - 1: Parameter value cannot be changed.
 - 2: Lower or upper value limit exceeded.
 - 3: Sub-index incorrect.
 - 4: No array, no sub-index.
 - 5: Data type incorrect.
 - 6: Setting not permitted (only resetting).
 - 7: Descriptive element cannot be changed.
 - 9: Descriptive data not available.
 - 11: No master control.
 - 15: No text array available.
 - 17: Task cannot be executed due to operating state.
 - 20: Illegal value.
 - 21: Response too long.
 - 22: Parameter address illegal.
 - 23: Format illegal.
 - 24: Number of values not consistent.
 - 25: Drive object does not exist.
 - 101: Presently deactivated.
 - 104: Illegal value.
 - 107: Write access not permitted when controller enabled.
 - 108: Unit unknown.
 - 109: Write access only in the commissioning status, encoder.
 - 110: Write access only in the commissioning status, motor.
 - 111: Write access only in the commissioning status, power unit.
 - 112: Write access only in the quick commissioning mode.
 - 113: Write access only in the ready mode.
 - 114: Write access only in the commissioning status, parameter reset.
 - 115: Write access only in the Safety Integrated commissioning status.
 - 116: Write access only in the commissioning status, technological application/units.
 - 117: Write access only in the commissioning status.
 - 118: Write access only in the commissioning status, download.
 - 119: Parameter may not be written in download.
 - 120: Write access only in the commissioning status, drive basis configuration.
 - 121: Write access only in the commissioning status, define drive type.
 - 122: Write access only in the commissioning status, data set basis configuration.
 - 123: Write access only in the commissioning status, device configuration.
 - 124: Write access only in the commissioning status, device download.
 - 125: Write access only in the commissioning status, device parameter reset.
 - 126: Write access only in the commissioning status, device ready.
 - 127: Write access only in the commissioning status, device.
 - 129: Parameter may not be written in download.
 - 131: Requested signal interconnection not possible as the signal source supplies non-float value.
 - 132: Free signal interconnection via PROFIdrive telegram setting inhibited.

133: Access method not defined.
200: Below the valid values.
201: Above the valid values.
202: Cannot be accessed from the Basic Operator Panel (BOP).
203: Cannot be read from the Basic Operator Panel (BOP).
204: Write access not permitted.

Remedy:

- Correct the parameterization in the commissioning tool and download the project again.
- Enter the correct value in the specified parameter.
- Identify the parameter that restricts the limits of the specified parameter.

A01100 CU: Memory card withdrawn

Message class: General drive fault (19)

Message value: -

Component: Control Unit (CU)

Response: NONE

Acknowledgment: NONE

Cause: The memory card (non-volatile memory) was withdrawn during operation.

Notice:

It is not permissible for the memory card to be withdrawn or inserted under voltage.

Remedy:

- Switch off the drive system.
- Re-insert the memory card that was withdrawn - This card must match the drive system.
- Switch on the drive system again.

F01105 CU: Insufficient memory

Message class: Error in the parameterization / configuration / commissioning procedure (18)

Message value: %1

Component: Control Unit (CU)

Response: OFF1

Acknowledgment: POWER ON

Cause: The functionality on this Control Unit is too extensive (e.g. too many drives, functions, data sets, Technology Extensions, blocks, etc).

Fault value (r0949, interpret decimal):

Only for internal Siemens troubleshooting.

Remedy:

- Change the configuration on this Control Unit, e.g.
 - Use fewer axes
 - Reduce the number of configurable functions
 - Use fewer data sets
 - Reduce Technology Extensions and blocks
- Use an additional Control Unit.

F01107 CU: Save to memory card unsuccessful

Message class: Hardware/software error (1)

Message value: %1

Component: Control Unit (CU)

Response: NONE

Acknowledgment: IMMEDIATELY

12.3 Faults and alarms

Cause: A data save in the non-volatile memory was not able to be successfully carried out.
- Non-volatile memory is defective.
- Insufficient space in the non-volatile memory.
Fault value (r0949, interpret decimal):
Only for internal Siemens troubleshooting.

Remedy: - Try to save again.
- Replace the memory card or Control Unit.

F01110 CU: More than one SINAMICS G on one Control Unit

Message class: Error in the parameterization / configuration / commissioning procedure (18)
Message value: %1
Component: None
Response: NONE
Acknowledgment: IMMEDIATELY

Cause: More than one SINAMICS G type power unit is being operated from the Control Unit.
Fault value (r0949, interpret decimal):
Number of the second drive with a SINAMICS G type power unit.

Remedy: Only one SINAMICS G drive type is permitted.

F01111 CU: Mixed operation of drive units illegal

Message class: Error in the parameterization / configuration / commissioning procedure (18)
Message value: %1
Component: None
Response: NONE
Acknowledgment: IMMEDIATELY

Cause: Illegal operation of various drive units on one Control Unit:
- SINAMICS S together with SINAMICS G
- SINAMICS S together with SINAMICS S Value or Combi
Fault value (r0949, interpret decimal):
Number of the first drive object with a different power unit type.

Remedy: Only power units of one particular drive type may be operated with one Control Unit.

F01112 CU: Power unit not permissible

Message class: Error in the parameterization / configuration / commissioning procedure (18)
Message value: %1
Component: None
Response: NONE
Acknowledgment: IMMEDIATELY

Cause: The connected power unit cannot be used together with this Control Unit.
Fault value (r0949, interpret decimal):
1: Power unit is not supported (e.g. PM240).
2: DC/AC power unit connected to CU310 not permissible.
3: Power unit (S120M) not permitted for vector control.

Remedy: Replace the power unit that is not permissible by a component that is permissible.

F01122 Frequency at the measuring probe input too high

Message class: Application/technological function faulted (17)
Message value: %1
Component: None

Response: OFF1
Acknowledgment: IMMEDIATELY
Cause: The frequency of the pulses at the measuring probe input is too high.
Fault value (r0949, interpret decimal):
1: DI/DO 9 (X122.8)
2: DI/DO 10 (X122.10)
4: DI/DO 11 (X122.11)
8: DI/DO 13 (X132.8)
16: DI/DO 14 (X132.10)
32: DI/DO 15 (X132.11)
64: DI/DO 8 (X122.7)
128: DI/DO 12 (X132.7)
Remedy: Reduce the frequency of the pulses at the measuring probe input.

F01123 Power unit does not support digital inputs/outputs
Message class: Error in the parameterization / configuration / commissioning procedure (18)
Message value: -
Component: Power Unit
Response: OFF1
Acknowledgment: IMMEDIATELY
Cause: The power unit does not support the activated "Digital inputs/outputs" function.
Remedy: Deactivate function.

F01150 CU: Number of instances of a drive object type exceeded
Message class: Error in the parameterization / configuration / commissioning procedure (18)
Message value: Drive object type: %1, number permitted: %2, actual number: %3
Component: None
Response: NONE
Acknowledgment: IMMEDIATELY
Cause: The maximum permissible number of instances of a drive object type was exceeded.
Note regarding the message value:
The individual information is coded as follows in the message value (r0949/r2124):
ddccbbaa hex:
aa = drive object type:
- Drive object type (p0107), for which the maximum permissible number of instances was exceeded.
bb = number permitted:
- Maximum permissible number of instances for this drive object type.
cc = actual number:
- Actual number of instances for this drive object type.
dd = no significance
Remedy: - Switch off the unit.
- Suitably restrict the number of instances of a drive object type by reducing the number of inserted components.
- Re-commission the unit.

F01151 CU: Number of drive objects of a category exceeded
Message class: Error in the parameterization / configuration / commissioning procedure (18)
Message value: Drive object category: %1, number permitted: %2, actual number: %3
Component: None
Response: NONE
Acknowledgment: IMMEDIATELY

12.3 Faults and alarms

Cause: The maximum permissible number of drive objects of a category was exceeded.
Note regarding the message value:
The individual information is coded as follows in the message value (r0949/r2124):
ddccbbaa hex:
aa = drive object category:
- Drive object category, for which the maximum permissible number of drive objects was exceeded.
bb = number permitted:
- Maximum permissible number for this drive object category.
cc = actual number:
- Actual number for this drive object category.
dd = no significance

Remedy: - Switch off the unit.
- Suitably restrict the number of drive objects of the specified category by reducing the number of inserted components.
- Re-commission the unit.

F01152 CU: Invalid constellation of drive object types

Message class: Error in the parameterization / configuration / commissioning procedure (18)
Message value: -
Component: None
Response: NONE
Acknowledgment: POWER ON
Cause: It is not possible to simultaneously operate drive object types SERVO, VECTOR and HLA.
A maximum of 2 of these drive object types can be operated on a Control Unit.
Remedy: - Switch off the unit.
- Restrict the use of drive object types SERVO, VECTOR, HLA to a maximum of 2.
- Re-commission the unit.

F01200 CU: Time slice management internal software error

Message class: Hardware/software error (1)
Message value: %1
Component: Control Unit (CU)
Response: OFF2
Acknowledgment: IMMEDIATELY
Cause: A time slice management error has occurred.
It is possible that the sampling times have been inadmissibly set.
Fault value (r0949, interpret hexadecimal):
998:
Too many time slices occupied by technology functions (e.g. DCC).
999:
Too many time slices occupied by the basic system. Too many different sampling times may have been set.
Additional values:
Only for internal Siemens troubleshooting.
Remedy: - Contact Technical Support.

F01205 CU: Time slice overflow

Message class: Hardware/software error (1)
Message value: %1
Component: Control Unit (CU)
Response: OFF2
Acknowledgment: POWER ON

Cause: Insufficient processing time is available for the existing topology.
Fault value (r0949, interpret hexadecimal):
Only for internal Siemens troubleshooting.

Remedy: - Reduce the number of drives.

F01250 EEPROM incorrect read-only data

Message class: Hardware/software error (1)
Message value: %1
Component: Control Unit (CU)
Response: NONE
Acknowledgment: POWER ON

Cause: Error when reading the read-only data of the EEPROM in the converter.
Fault value (r0949, interpret decimal):
Only for internal Siemens troubleshooting.

Remedy: - Carry out a POWER ON (switch-off/switch-on).
- Replace the converter.

A01251 CU: CU-EEPROM incorrect read-write data

Message class: Hardware/software error (1)
Message value: %1
Component: Control Unit (CU)
Response: NONE
Acknowledgment: NONE

Cause: Error when reading the read-write data of the EEPROM in the converter.
Alarm value (r2124, interpret decimal):
Only for internal Siemens troubleshooting.

Remedy: For alarm value $r2124 < 256$, the following applies:
- Carry out a POWER ON (switch-off/switch-on).
- Replace the converter.

For alarm value $r2124 \geq 256$, the following applies:
- For the converter with this alarm, clear the fault memory ($p0952 = 0$).
- Replace the converter.

F01255 CU: Option Board EEPROM read-only data error

Message class: Hardware/software error (1)
Message value: %1
Component: None
Response: NONE
Acknowledgment: POWER ON

Cause: Error when reading the read-only data of the EEPROM in the Option Board.
Fault value (r0949, interpret decimal):
Only for internal Siemens troubleshooting.

Remedy: - Carry out a POWER ON (switch-off/switch-on).
- Replace the Control Unit.

A01256 CU: Option Board EEPROM read-write data error

Message class: Hardware/software error (1)
Message value: %1
Component: None

12.3 Faults and alarms

Response: NONE
Acknowledgment: NONE
Cause: Error when reading the read-write data of the EEPROM in the Option Board.
Alarm value (r2124, interpret decimal):
Only for internal Siemens troubleshooting.
Remedy: - Carry out a POWER ON (switch-off/switch-on).
- Replace the Control Unit.

A01304 Firmware version of DRIVE-CLiQ component is not up-to-date

Message class: General drive fault (19)
Message value: %1
Component: None
Response: NONE
Acknowledgment: NONE
Cause: The non-volatile memory has a more recent firmware version than the one in the connected DRIVE-CLiQ component.
Alarm value (r2124, interpret decimal):
Component number of the DRIVE-CLiQ component involved.
Remedy: Repeat the firmware update by switching off the device and switching on again.

A01306 Firmware of the DRIVE-CLiQ component being updated

Message class: General drive fault (19)
Message value: %1
Component: None
Response: NONE
Acknowledgment: NONE
Cause: Firmware update is active for at least one DRIVE-CLiQ component.
Alarm value (r2124, interpret decimal):
Component number of the DRIVE-CLiQ component.
Remedy: Not necessary.
This alarm is automatically withdrawn after the firmware update has been completed.

A01314 Topology: Component must not be present

Message class: Error in the parameterization / configuration / commissioning procedure (18)
Message value: %1, to %2, %3, connection: %4
Component: None
Response: NONE

Acknowledgment: NONE

Explanation of the message value: For %1, %2

Value	Cause	Remedy
0	Component unknown	
1	Control Unit	
2	Motor Module	
3	Line Module	
4	Sensor Module	
5	Voltage Sensing Module	
6	Terminal Module	
7	DRIVE-CLiQ Hub Module	
8	Controller Extension	
9	Filter module	
10	Hydraulic Module	
49	DRIVE-CLiQ component	
50	Option slot	
60	Encoder	
70	DRIVE-CLiQ motor	
71	Hydraulic cylinder	
72	Hydraulic valve	
80	Motor	

Explanation of the message value: For %3

Component in target topology

Explanation of the message value: For %4

Value	Cause	Remedy
0	Port 0	
1	Port 1	
2	Port 2	
3	Port 3	
4	Port 4	
5	Port 5	
6	Port 6	
7	Port 7	
8	Port 8	
9	Port 9	
10	X100	
11	X101	
12	X102	
13	X103	
14	X104	
15	X105	
20	X200	
21	X201	
22	X202	
23	X203	
24	X204	

12.3 Faults and alarms

25	X205
40	X400
41	X401
42	X402
50	X500
51	X501
52	X502
53	X503
54	X504
55	X505
56	X506
57	X507

Cause: For a component, "deactivate and not present" is set but this component is still in the topology.

Alarm value (r2124, interpret hexadecimal):

ddccbbaa hex:

aa = component number

bb = component class of the component

cc = connection number

Note:

Component class and connection number are described in F01375.

Remedy: - Remove the corresponding component.

- Change the setting "deactivate and not present".

Note:

Under "Topology --> Topology view", the commissioning tool where relevant offers improved diagnostics capability (e.g. setpoint/actual value comparison).

A01317 Deactivated component again present

Message class: Error in the parameterization / configuration / commissioning procedure (18)

Message value: -

Component: None

Response: NONE

Acknowledgment: NONE

Cause: If a component of the target topology for an active drive object is inserted and the associated parameter of the component is set to "deactivate" (p0125, p0145, p0155, p0165).

Note:

This is the only message that is displayed for a deactivated component.

Remedy: The alarm is automatically withdrawn for the following actions:

- Activate the components involved (p0125 = 1, p0145 = 1, p0155 = 1, p0165 = 1).

- Again withdraw the component involved.

A01318 Deactivated signal interconnections available

Message class: Error in the parameterization / configuration / commissioning procedure (18)

Message value: %1

Component: None

Response: NONE

Acknowledgment: NONE

Cause: This alarm is used in the following cases:

- If an inactive/non-operational drive object is active again/ready for operation

- The list of parameters that can be interconnected as signal sink is not empty.

- The signal interconnections saved in the list of parameters were actually changed.

Remedy: - Deactivate the drive object again.

A01319 **Inserted component not initialized**

Message class: Error in the parameterization / configuration / commissioning procedure (18)

Message value: -

Component: None

Response: NONE

Acknowledgment: NONE

Cause: Initialization is required for at least one inserted component.
This is only possible if the pulse inhibit is active on all drive objects.

Remedy: Activate pulse inhibit for all drive objects.

F01325 **Topology: Component number not included in target topology**

Message class: Error in the parameterization / configuration / commissioning procedure (18)

Message value: Component number: %1

Component: None

Response: NONE

Acknowledgment: IMMEDIATELY

Cause: The component referenced in a data set (e.g. PDS, MDS or EDS) is not contained in the target topology.
Fault value (r0949, interpret decimal)

Remedy: Establish consistency between the topology and data set configuration.

A01330 **Topology: Quick commissioning not possible**

Message class: Error in the parameterization / configuration / commissioning procedure (18)

Message value: Fault cause: %1, supplementary information: %2, preliminary component number: %3

Component: None

Response: NONE

Acknowledgment: NONE

- Cause:** Unable to carry out a quick commissioning. The existing actual topology does not fulfill the requirements.
Alarm value (r2124, interpret hexadecimal):
ccccbbaa hex: cccc = preliminary component number, bb = supplementary information, aa = fault cause
aa = 01 hex = 1 dec:
On one component illegal connections were detected.
- bb = 01 hex = 1 dec: For a Motor Module, more than one motor with DRIVE-CLiQ was detected.
- bb = 02 hex = 2 dec: For a motor with DRIVE-CLiQ, the DRIVE-CLiQ cable is not connected to a Motor Module.
aa = 02 hex = 2 dec:
The topology contains too many components of a particular type.
- bb = 01 hex = 1 dec: There is more than one master Control Unit.
- bb = 02 hex = 2 dec: There is more than 1 infeed (8 for a parallel circuit configuration).
- bb = 03 hex = 3 dec: There are more than 10 Motor Modules (8 for a parallel circuit configuration).
- bb = 04 hex = 4 dec: There are more than 9 encoders.
- bb = 05 hex = 5 dec: There are more than 8 Terminal Modules.
- bb = 07 hex = 7 dec: Unknown component type.
- bb = 08 hex = 8 dec: There are more than 6 DRIVE-CLiQ components.
- bb = 09 hex = 9 dec: Not permitted to connect a DRIVE-CLiQ component.
- bb = 0a hex = 10 dec: There is no drive master.
- bb = 0b hex = 11 dec: There is more than one motor with DRIVE-CLiQ for a parallel circuit.
- bb = 0c hex = 12 dec: Different power units are being used in a parallel connection.
- bb = 0d hex = 13 dec: There are more than 2 encoders.
- cccc: Not used.
aa = 03 hex = 3 dec:
More than 16 components are connected at a DRIVE-CLiQ socket of the Control Unit.
- bb = 0, 1, 2, 3 means e.g. detected at the DRIVE-CLiQ socket X100, X101, X102, X103.
- cccc: Not used.
aa = 04 hex = 4 dec:
The number of components connected one after the other is greater than 125.
- bb: Not used.
- cccc = preliminary component number of the first component and component that resulted in the fault.
aa = 05 hex = 5 dec:
The component is not permissible for SERVO.
- bb = 01 hex = 1 dec: SINAMICS G available.
- bb = 02 hex = 2 dec: Chassis available.
- cccc = preliminary component number of the first component and component that resulted in the fault.
aa = 06 hex = 6 dec:
On one component illegal EEPROM data was detected. These must be corrected before the system continues to boot.
- bb = 01 hex = 1 dec: The Article No. [MLFB] of the power unit that was replaced includes a space retainer. The space retainer (*) must be replaced by a correct character.
- cccc = preliminary component number of the component with illegal EEPROM data.
aa = 07 hex = 7 dec:
The actual topology contains an illegal combination of components.
- bb = 01 hex = 1 dec: Active Line Module (ALM) and Basic Line Module (BLM).
- bb = 02 hex = 2 dec: Active Line Module (ALM) and Smart Line Module (SLM).
- bb = 03 hex = 3 dec: SIMOTION control (e.g. SIMOTION D445) and SINUMERIK component (e.g. NX15).
- bb = 04 hex = 4 dec: SINUMERIK control (e.g. SINUMERIK 730.net) and SIMOTION component (e.g. CX32).
- cccc: Not used.
aa = 08 hex = 8 dec:
The motor is not completely connected.
- bb: Not used.
- cccc: Not used.
aa = 09 hex = 9 dec:

It is not permissible that any component is connected at encoder interface X101.

Note:

Connection type and connection number are described in F01375.

Remedy:

- Adapt the output topology to the permissible requirements.
- Commission the device using the commissioning tool.
- For motors with DRIVE-CLiQ, connect the power and DRIVE-CLiQ cable to the same Motor Module (Single Motor Module: DRIVE-CLiQ at X202, Double Motor Module: DRIVE-CLiQ from motor 1 (X1) to X202, from motor 2 (X2) to X203).

For aa = 06 hex = 6 dec and bb = 01 hex = 1 dec:
Correct the Article No. when commissioning using the commissioning tool.

For aa = 09 hex = 9 dec:
Using encoder interface X100

F01341 Topology: Maximum number of DRIVE-CLiQ components exceeded

Message class: Error in the parameterization / configuration / commissioning procedure (18)

Message value: -

Component: None

Response: NONE

Acknowledgment: IMMEDIATELY

Cause: Too many DRIVE-CLiQ components were defined in the actual topology.

Note:

Pulse enable is withdrawn and prevented.

Remedy:

- Check the DRIVE-CLiQ wiring.
- Reduce the number components on the DRIVE-CLiQ line involved in order to maintain the maximum quantity structure.

F01354 Topology: Actual topology indicates an illegal component

Message class: Error in the parameterization / configuration / commissioning procedure (18)

Message value: Fault cause: %1, component number: %2

Component: None

Response: OFF2

Acknowledgment: IMMEDIATELY

Cause: The actual topology indicates at least one illegal component.

Fault value (r0949, interpret hexadecimal):

yyxx hex: yy = component number, xx = cause.

xx = 1: Component at this Control Unit not permissible.

xx = 2: Component in combination with another component not permissible.

Note:

Pulse enable is prevented.

Remedy: Remove the illegal components and restart the system.

F01356 Topology: There is a defective DRIVE-CLiQ component

Message class: Hardware/software error (1)

Message value: Fault cause: %1, Component number: %2, Connection number: %3

Component: None

Response: NONE

Acknowledgment: IMMEDIATELY

12.3 Faults and alarms

Cause: The actual topology indicates at least one defective DRIVE-CLiQ component.
Fault value (r0949, interpret hexadecimal):
zzyyxx hex:
zz = connection number of the component at which the defective component is connected
yy = component number of the component at which the defective component is connected
xx = fault cause
xx = 1: Component at this Control Unit not permissible.
xx = 2: component with communication defect.
Note:
Pulse enable is withdrawn and prevented.

Remedy: Replace the defective component and restart the system.

F01357 Topology: Two converters identified on the DRIVE-CLiQ line

Message class: Error in the parameterization / configuration / commissioning procedure (18)
Message value: component number: %1, connection number: %2
Component: None
Response: NONE
Acknowledgment: IMMEDIATELY

Cause: In the actual topology, 2 converters are connected with one another through DRIVE-CLiQ.
As standard, this is not permitted.
Fault value (r0949, interpret hexadecimal):
yyxx hex:
yy = connection number of the converter to which the second converter is connected
xx = component number of the converter to which the second converter is connected
Note:
Pulse enable is withdrawn and prevented.

Remedy: - Remove the connection to the second converter and restart.

A01358 Topology: Line termination not available

Message class: Error in the parameterization / configuration / commissioning procedure (18)
Message value: CU connection number: %1, component number: %2, connection number: %3
Component: None
Response: NONE
Acknowledgment: NONE

Cause: At least one line with distributed drives is not terminated. The last participant on the line must be terminated with a line termination connector.
This therefore ensures the degree of protection of the distributed drives.
Alarm value (r2124, interpret hexadecimal):
zzyyxx hex:
zz = connection number of the distributed drive where there is no terminating connector
yy = component number
xx = CU connection number

Remedy: Install the line terminating connector for the last distributed drive.

F01359 Topology: DRIVE-CLiQ performance not sufficient

Message class: Error in the parameterization / configuration / commissioning procedure (18)
Message value: %1
Component: None
Response: NONE
Acknowledgment: IMMEDIATELY

Cause: The DRIVE-CLiQ performance is not sufficient at one line in order to identify an inserted component.
Fault value (r0949, interpret hexadecimal):
Only for internal Siemens troubleshooting.

Remedy: - Carry out a POWER ON (switch-off/switch-on).
- Distribute components across several DRIVE-CLiQ lines.

Note:
For this topology, do not withdraw and insert components in operation.

F01360 Topology: Actual topology not permissible

Message class: Error in the parameterization / configuration / commissioning procedure (18)

Message value: Fault cause: %1, preliminary component number: %2

Component: None

Response: NONE

Acknowledgment: IMMEDIATELY

Cause: The detected actual topology is not permissible.
Fault value (r0949, interpret hexadecimal):
ccccbbaa hex:
cccc = preliminary component number, bb = no significance, aa = fault cause
aa = 01 hex = 1 dec:
Too many components were detected at the Control Unit. A maximum of 199 components is permissible.
aa = 02 hex = 2 dec:
The component type of a component is not known.
aa = 03 hex = 3 dec:
It is illegal to combine ALM and BLM.
aa = 04 hex = 4 dec:
It is illegal to combine ALM and SLM.
aa = 05 hex = 5 dec:
It is illegal to combine BLM and SLM.
aa = 06 hex = 6 dec:
A CX32 was not directly connected to a permitted Control Unit.
aa = 07 hex = 7 dec:
An NX10 or NX15 was not directly connected to a permitted Control Unit.
aa = 08 hex = 8 dec:
A component was connected to a Control Unit that is not permitted for this purpose.
aa = 09 hex = 9 dec:
A component was connected to a Control Unit with out-of-date firmware.
aa = 0A hex = 10 dec:
Too many components of a particular type detected.
aa = 0B hex = 11 dec:
Too many components of a particular type detected on a single line.

Note:
The drive system is no longer booted. In this state, the drive control (closed-loop) cannot be enabled.

12.3 Faults and alarms

Remedy:

For fault cause = 1:
Change the configuration. Connect less than 199 components to the Control Unit.

For fault cause = 2:
Remove the component with unknown component type.

For fault cause = 3, 4, 5:
Establish a valid combination.

For fault cause = 6, 7:
Connect the expansion module directly to a permitted Control Unit.

For fault cause = 8:
Remove component or use a permissible component.

For fault cause = 9:
Upgrade the firmware of the Control Unit to a later version.

For fault cause = 10, 11:
Reduce the number of components.

A01361 Topology: Actual topology contains SINUMERIK and SIMOTION components

Message class: Error in the parameterization / configuration / commissioning procedure (18)

Message value: %1

Component: None

Response: NONE

Acknowledgment: NONE

Cause:

The detected actual topology contains SINUMERIK and SIMOTION components.
The drive system is no longer booted. In this state, the drive control (closed-loop) cannot be enabled.
Alarm value (r2124, interpret hexadecimal):
ddccbaa hex: cc = fault cause, bb = component class of the actual topology, aa = component number of the component
cc = 01 hex = 1 dec:
An NX10 or NX15 was connected to a SIMOTION control.
cc = 02 hex = 2 dec:
A CX32 was connected to a SINUMERIK control.

Remedy:

For alarm value = 1:
Replace all NX10 or NX15 by a CX32.

For alarm value = 2:
Replace all CX32 by an NX10 or NX15.

A01362 Topology: Topology rule(s) broken

Message class: Error in the parameterization / configuration / commissioning procedure (18)

Message value: %1

Component: None

Response: NONE

Acknowledgment: NONE

Cause:	<p>At least one topology rule for the SINAMICS S120 Combi has been broken.</p> <p>In the event of a fault, the ramping up of the drive system is aborted and closed-loop drive control is not enabled.</p> <p>Alarm value (r2124, interpret decimal):</p> <p>The alarm value indicates which rule has been violated.</p> <p>1: The S120 Combi may only be wired via DRIVE-CLiQ socket X200 to X100 on the NCU.</p> <p>2: In DRIVE-CLiQ socket X101 on the NCU, only one Single Motor Module (SMM) may be connected via X200, one Double Motor Module (DMM) via X200, one Terminal Module 54F (TM54F) via X500 or one DRIVE-CLiQ Hub Module (DMC20, DME20) via X500.</p> <p>3: In DRIVE-CLiQ socket X102 on the NCU, only one Terminal Module 54F (TM54F) may be connected via X500, one DRIVE-CLiQ Hub Module (Hub) via X500 or one NX15 via X100.</p> <p>4: Only Sensor Modules may be connected to DRIVE-CLiQ sockets X201 up to X203 (3-axis) or X204 (4-axis) on the S120 Combi.</p> <p>5: In DRIVE-CLiQ socket X205 (X204 is not available for 3 axes), only SMC / SME Sensor Modules and DRIVE-CLiQ encoders may be connected.</p> <p>6: In the case of a Single Motor Module as first expansion axis, only one additional Single Motor Module may be connected in the DRIVE-CLiQ socket X201 via X200, one Terminal Module 54F (TM54F) via X500 or one DRIVE-CLiQ Hub Module (DMC20, DME20) via X500.</p> <p>7: Only Sensor Modules or DRIVE-CLiQ encoders may be connected in the DRIVE-CLiQ socket X202 on possibly available Single Motor Modules.</p> <p>8: For a second Single Motor Module or for a Double Motor Module, at X201 a 54F Terminal Module (TM54F) or a DRIVE-CLiQ Hub Module (DMC20, DME20) may be connected via X500.</p> <p>9: If a Double Motor Module is used as an expansion axis, only Sensor Modules may be connected to X202 and X203.</p> <p>10: If a Terminal Module 54F (TM54F) is configured, only one DRIVE-CLiQ Hub Module (DMC20, DME20) may be connected to X501 of the TM54F module via DRIVE-CLiQ socket X500. In this case, it is not permissible that an existing Hub Module is connected elsewhere.</p> <p>11: For DRIVE-CLiQ Hub Modules, only Sensor Modules (SMC, SME) and DRIVE-CLiQ encoders may be connected to X501 to X505.</p> <p>12: Only certain Motor Modules may be used for expansion axes.</p> <p>13: For an S120 Combi with 3 axes, nothing must be connected at the DRIVE-CLiQ Hub Module at X503.</p> <p>14: A maximum of one Terminal Module 54F (TM54F) is permitted.</p> <p>15: A maximum of one DRIVE-CLiQ Hub Module (DMC20, DME20) is permitted.</p> <p>16: DRIVE-CLiQ socket X100 of NX15 must be connected with the NCU via X102.</p> <p>17: The S120 Combi may only be connected to X101 of the NX15 via the DRIVE-CLiQ socket X200.</p> <p>18: In DRIVE-CLiQ socket X102 on the NX15, only one Single Motor Module (SMM) may be connected via X200, one Double Motor Module (DMM) via X200, one Terminal Module 54F (TM54F) via X500 or one DRIVE-CLiQ Hub Module (DMC20, DME20) via X500.</p> <p>19: It is not permissible that anything is connected at DRIVE-CLiQ socket X103 on the NX15.</p>
Remedy:	Evaluate the alarm value and ensure compliance with the corresponding topology rule(s).

F01375 Topology: Connection duplicated between two components

Message class:	Error in the parameterization / configuration / commissioning procedure (18)
Message value:	Component: %1, %2, connection: %3
Component:	None
Response:	NONE

12.3 Faults and alarms

Acknowledgment: IMMEDIATELY

Explanation of the message value: For %2

Value	Cause	Remedy
0	Component unknown	
1	Control Unit	
2	Motor Module	
3	Line Module	
4	Sensor Module	
5	Voltage Sensing Module	
6	Terminal Module	
7	DRIVE-CLiQ Hub Module	
8	Controller Extension	
9	Filter module	
10	Hydraulic Module	
49	DRIVE-CLiQ component	
50	Option slot	
60	Encoder	
70	DRIVE-CLiQ motor	
71	Hydraulic cylinder	
72	Hydraulic valve	
80	Motor	

Explanation of the message value: For %3

Value	Cause	Remedy
0	Port 0	
1	Port 1	
2	Port 2	
3	Port 3	
4	Port 4	
5	Port 5	
6	Port 6	
7	Port 7	
8	Port 8	
9	Port 9	
10	X100	
11	X101	
12	X102	
13	X103	
14	X104	
15	X105	
20	X200	
21	X201	
22	X202	
23	X203	
24	X204	
25	X205	
40	X400	
41	X401	

42 X402
50 X500
51 X501
52 X502
53 X503
54 X504
55 X505
56 X506
57 X507

Cause: When checking the actual topology, a ring-type connection was detected.
The fault value describes a component contained in the ring.
Fault value (r0949, interpret hexadecimal):
ccbbaaaa hex:
cc = connection number (%3)
bb = component class (% 2)
aaaa = preliminary component number (%1)

Remedy: Output the fault value and remove the specified connection.
Note:
Under "Topology --> Topology view" the commissioning tool where relevant offers improved diagnostics capability (e.g. setpoint/actual value comparison).

F01380 Topology: Actual topology EEPROM defective

Message class: Hardware/software error (1)

Message value: Preliminary component number: %1

Component: None

Response: NONE

Acknowledgment: POWER ON

Cause: When detecting the actual topology, a component with a defective EEPROM was detected.
Fault value (r0949, interpret hexadecimal):
bbbbaaaa hex:
bbbb = reserved
aaaa = preliminary component number of the defective components

Remedy: Output the fault value and remove the defected component.

A01382 Topology: Sensor Module incorrectly inserted

Message class: Error in the parameterization / configuration / commissioning procedure (18)

Message value: Component: %1, to %2, %3, connection: %4

Component: None

Response: NONE

12.3 Faults and alarms

Acknowledgment: NONE

Explanation of the message value: For %1

Component in target topology

Explanation of the message value: For %2

Value	Cause	Remedy
0	Component unknown	
1	Control Unit	
2	Motor Module	
3	Line Module	
4	Sensor Module	
5	Voltage Sensing Module	
6	Terminal Module	
7	DRIVE-CLiQ Hub Module	
8	Controller Extension	
9	Filter module	
10	Hydraulic Module	
49	DRIVE-CLiQ component	
50	Option slot	
60	Encoder	
70	DRIVE-CLiQ motor	
71	Hydraulic cylinder	
72	Hydraulic valve	
80	Motor	

Explanation of the message value: For %3

Component in actual topology

Explanation of the message value: For %4

Value	Cause	Remedy
0	Port 0	
1	Port 1	
2	Port 2	
3	Port 3	
4	Port 4	
5	Port 5	
6	Port 6	
7	Port 7	
8	Port 8	
9	Port 9	
10	X100	
11	X101	
12	X102	
13	X103	
14	X104	
15	X105	
20	X200	
21	X201	

22 X202
23 X203
24 X204
25 X205
40 X400
41 X401
42 X402
50 X500
51 X501
52 X502
53 X503
54 X504
55 X505
56 X506
57 X507

Cause: The topology comparison has detected a Sensor Module in the actual topology that has been incorrectly inserted with respect to the target topology.

Alarm value (r2124, interpret hexadecimal):

ddccbbaa hex:

dd = connection number (%4)

cc = component number (%3)

bb = component class (% 2)

aa = component number of the incorrectly inserted component (% 1)

Note:

The component is described in dd, cc and bb, where the component involved is incorrectly inserted.

Component class and connection number are described in F01375.

The drive system is no longer booted. In this state, the drive control (closed-loop) cannot be enabled.

Remedy: Adapting topologies:

- Insert the components involved at the right connection (correct the actual topology).

- Adapt the project/parameterizing in the commissioning tool (correct the target topology).

- Automatically resolve the topology error.

Note:

Under "Topology --> Topology view" the commissioning tool where relevant offers improved diagnostics capability (e.g. setpoint/actual value comparison).

A01383 Topology: Terminal Module incorrectly inserted

Message class: Error in the parameterization / configuration / commissioning procedure (18)

Message value: Component: %1, to %2, %3, connection: %4

Component: None

Response: NONE

12.3 Faults and alarms

Acknowledgment: NONE

Explanation of the message value: For %1

Component in target topology

Explanation of the message value: For %2

Value	Cause	Remedy
0	Component unknown	
1	Control Unit	
2	Motor Module	
3	Line Module	
4	Sensor Module	
5	Voltage Sensing Module	
6	Terminal Module	
7	DRIVE-CLiQ Hub Module	
8	Controller Extension	
9	Filter module	
10	Hydraulic Module	
49	DRIVE-CLiQ component	
50	Option slot	
60	Encoder	
70	DRIVE-CLiQ motor	
71	Hydraulic cylinder	
72	Hydraulic valve	
80	Motor	

Explanation of the message value: For %3

Component in actual topology

Explanation of the message value: For %4

Value	Cause	Remedy
0	Port 0	
1	Port 1	
2	Port 2	
3	Port 3	
4	Port 4	
5	Port 5	
6	Port 6	
7	Port 7	
8	Port 8	
9	Port 9	
10	X100	
11	X101	
12	X102	
13	X103	
14	X104	
15	X105	
20	X200	
21	X201	

22 X202
23 X203
24 X204
25 X205
40 X400
41 X401
42 X402
50 X500
51 X501
52 X502
53 X503
54 X504
55 X505
56 X506
57 X507

Cause: The topology comparison has detected a Terminal Module in the actual topology that has been incorrectly inserted with respect to the target topology.

Alarm value (r2124, interpret hexadecimal):

ddccbbaa hex:

dd = connection number (%4)

cc = component number (%3)

bb = component class (% 2)

aa = component number of the incorrectly inserted component (% 1)

Note:

The component is described in dd, cc and bb, where the component involved is incorrectly inserted.

Component class and connection number are described in F01375.

The drive system is no longer booted. In this state, the drive control (closed-loop) cannot be enabled.

Remedy: Adapting topologies:

- Insert the components involved at the right connection (correct the actual topology).

- Adapt the project/parameterizing in the commissioning tool (correct the target topology).

- Automatically resolve the topology error.

Note:

Under "Topology --> Topology view" the commissioning tool where relevant offers improved diagnostics capability (e.g. setpoint/actual value comparison).

A01384 Topology: DRIVE-CLiQ Hub Module incorrectly inserted

Message class: Error in the parameterization / configuration / commissioning procedure (18)

Message value: Component: %1, to %2, %3, connection: %4

Component: None

Response: NONE

12.3 Faults and alarms

Acknowledgment: NONE

Explanation of the message value: For %1

Component in target topology

Explanation of the message value: For %2

Value	Cause	Remedy
0	Component unknown	
1	Control Unit	
2	Motor Module	
3	Line Module	
4	Sensor Module	
5	Voltage Sensing Module	
6	Terminal Module	
7	DRIVE-CLiQ Hub Module	
8	Controller Extension	
9	Filter module	
10	Hydraulic Module	
49	DRIVE-CLiQ component	
50	Option slot	
60	Encoder	
70	DRIVE-CLiQ motor	
71	Hydraulic cylinder	
72	Hydraulic valve	
80	Motor	

Explanation of the message value: For %3

Component in actual topology

Explanation of the message value: For %4

Value	Cause	Remedy
0	Port 0	
1	Port 1	
2	Port 2	
3	Port 3	
4	Port 4	
5	Port 5	
6	Port 6	
7	Port 7	
8	Port 8	
9	Port 9	
10	X100	
11	X101	
12	X102	
13	X103	
14	X104	
15	X105	
20	X200	
21	X201	

22 X202
23 X203
24 X204
25 X205
40 X400
41 X401
42 X402
50 X500
51 X501
52 X502
53 X503
54 X504
55 X505
56 X506
57 X507

Cause: The topology comparison has detected a DRIVE-CLiQ Hub Module in the actual topology that has been incorrectly inserted with respect to the target topology.
Alarm value (r2124, interpret hexadecimal):
ddccbbaa hex:
dd = connection number (%4)
cc = component number (%3)
bb = component class (% 2)
aa = component number of the incorrectly inserted component (% 1)
Note:
The component is described in dd, cc and bb, where the component involved is incorrectly inserted.
Component class and connection number are described in F01375.
The drive system is no longer booted. In this state, the drive control (closed-loop) cannot be enabled.

Remedy: Adapting topologies:
- Insert the components involved at the right connection (correct the actual topology).
- Adapt the project/parameterizing in the commissioning tool (correct the target topology).
- Automatically resolve the topology error.
Note:
Under "Topology --> Topology view" the commissioning tool where relevant offers improved diagnostics capability (e.g. setpoint/actual value comparison).

A01385 **Topology: Controller Extension incorrectly inserted**
Message class: Error in the parameterization / configuration / commissioning procedure (18)
Message value: Component: %1, to %2, %3, connection: %4
Component: None
Response: NONE

12.3 Faults and alarms

Acknowledgment: NONE

Explanation of the message value: For %1

Component in target topology

Explanation of the message value: For %2

Value	Cause	Remedy
0	Component unknown	
1	Control Unit	
2	Motor Module	
3	Line Module	
4	Sensor Module	
5	Voltage Sensing Module	
6	Terminal Module	
7	DRIVE-CLiQ Hub Module	
8	Controller Extension	
9	Filter module	
10	Hydraulic Module	
49	DRIVE-CLiQ component	
50	Option slot	
60	Encoder	
70	DRIVE-CLiQ motor	
71	Hydraulic cylinder	
72	Hydraulic valve	
80	Motor	

Explanation of the message value: For %3

Component in actual topology

Explanation of the message value: For %4

Value	Cause	Remedy
0	Port 0	
1	Port 1	
2	Port 2	
3	Port 3	
4	Port 4	
5	Port 5	
6	Port 6	
7	Port 7	
8	Port 8	
9	Port 9	
10	X100	
11	X101	
12	X102	
13	X103	
14	X104	
15	X105	
20	X200	
21	X201	

22 X202
23 X203
24 X204
25 X205
40 X400
41 X401
42 X402
50 X500
51 X501
52 X502
53 X503
54 X504
55 X505
56 X506
57 X507

Cause: The topology comparison has detected a controller extension 32 (CX32) in the actual topology that has been incorrectly inserted with respect to the target topology.
Alarm value (r2124, interpret hexadecimal):
ddccbbaa hex:
dd = connection number (%4)
cc = component number (%3)
bb = component class (% 2)
aa = component number of the incorrectly inserted component (% 1)
Note:
The component is described in dd, cc and bb, where the component involved is incorrectly inserted.
Component class and connection number are described in F01375.
The drive system is no longer booted. In this state, the drive control (closed-loop) cannot be enabled.

Remedy: Adapting topologies:
- Insert the components involved at the right connection (correct the actual topology).
- Adapt the project/parameterizing in the commissioning tool (correct the target topology).
- Automatically resolve the topology error.
Note:
Under "Topology --> Topology view" the commissioning tool where relevant offers improved diagnostics capability (e.g. setpoint/actual value comparison).

A01386 **Topology: DRIVE-CLiQ component incorrectly inserted**
Message class: Error in the parameterization / configuration / commissioning procedure (18)
Message value: Component: %1, to %2, %3, connection: %4
Component: None
Response: NONE

12.3 Faults and alarms

Acknowledgment: NONE

Explanation of the message value: For %1

Component in target topology

Explanation of the message value: For %2

Value	Cause	Remedy
0	Component unknown	
1	Control Unit	
2	Motor Module	
3	Line Module	
4	Sensor Module	
5	Voltage Sensing Module	
6	Terminal Module	
7	DRIVE-CLiQ Hub Module	
8	Controller Extension	
9	Filter module	
10	Hydraulic Module	
49	DRIVE-CLiQ component	
50	Option slot	
60	Encoder	
70	DRIVE-CLiQ motor	
71	Hydraulic cylinder	
72	Hydraulic valve	
80	Motor	

Explanation of the message value: For %3

Component in actual topology

Explanation of the message value: For %4

Value	Cause	Remedy
0	Port 0	
1	Port 1	
2	Port 2	
3	Port 3	
4	Port 4	
5	Port 5	
6	Port 6	
7	Port 7	
8	Port 8	
9	Port 9	
10	X100	
11	X101	
12	X102	
13	X103	
14	X104	
15	X105	
20	X200	
21	X201	

22 X202
23 X203
24 X204
25 X205
40 X400
41 X401
42 X402
50 X500
51 X501
52 X502
53 X503
54 X504
55 X505
56 X506
57 X507

Cause: The topology comparison has detected a DRIVE-CLiQ component in the actual topology that has been incorrectly inserted with respect to the target topology.

Alarm value (r2124, interpret hexadecimal):

ddccbbaa hex:

dd = connection number (%4)

cc = component number (%3)

bb = component class (% 2)

aa = component number of the incorrectly inserted component (% 1)

Note:

The component is described in dd, cc and bb, where the component involved is incorrectly inserted.

Component class and connection number are described in F01375.

The drive system is no longer booted. In this state, the drive control (closed-loop) cannot be enabled.

Remedy: Adapting topologies:

- Insert the components involved at the right connection (correct the actual topology).

- Adapt the project/parameterizing in the commissioning tool (correct the target topology).

- Automatically resolve the topology error.

Note:

Under "Topology --> Topology view" the commissioning tool where relevant offers improved diagnostics capability (e.g. setpoint/actual value comparison).

A01389 Topology: Motor with DRIVE-CLiQ incorrectly inserted

Message class: Error in the parameterization / configuration / commissioning procedure (18)

Message value: Component: %1, to %2, %3, connection: %4

Component: None

Response: NONE

12.3 Faults and alarms

Acknowledgment: NONE

Explanation of the message value: For %1

Component in target topology

Explanation of the message value: For %2

Value	Cause	Remedy
0	Component unknown	
1	Control Unit	
2	Motor Module	
3	Line Module	
4	Sensor Module	
5	Voltage Sensing Module	
6	Terminal Module	
7	DRIVE-CLiQ Hub Module	
8	Controller Extension	
9	Filter module	
10	Hydraulic Module	
49	DRIVE-CLiQ component	
50	Option slot	
60	Encoder	
70	DRIVE-CLiQ motor	
71	Hydraulic cylinder	
72	Hydraulic valve	
80	Motor	

Explanation of the message value: For %3

Component in actual topology

Explanation of the message value: For %4

Value	Cause	Remedy
0	Port 0	
1	Port 1	
2	Port 2	
3	Port 3	
4	Port 4	
5	Port 5	
6	Port 6	
7	Port 7	
8	Port 8	
9	Port 9	
10	X100	
11	X101	
12	X102	
13	X103	
14	X104	
15	X105	
20	X200	
21	X201	

22 X202
23 X203
24 X204
25 X205
40 X400
41 X401
42 X402
50 X500
51 X501
52 X502
53 X503
54 X504
55 X505
56 X506
57 X507

Cause: The topology comparison has detected a motor with DRIVE-CLiQ in the actual topology that has been incorrectly inserted with respect to the target topology.
Alarm value (r2124, interpret hexadecimal):
ddccbbaa hex:
dd = connection number (%4)
cc = component number (%3)
bb = component class (% 2)
aa = component number of the incorrectly inserted component (% 1)
Note:
The component is described in dd, cc and bb, where the component involved is incorrectly inserted.
Component class and connection number are described in F01375.
The drive system is no longer booted. In this state, the drive control (closed-loop) cannot be enabled.

Remedy: Adapting topologies:
- Insert the components involved at the right connection (correct the actual topology).
- Adapt the project/parameterizing in the commissioning tool (correct the target topology).
- Automatically resolve the topology error.
Note:
Under "Topology --> Topology view" the commissioning tool where relevant offers improved diagnostics capability (e.g. setpoint/actual value comparison).

A01416 Topology: Component additionally inserted

Message class: Error in the parameterization / configuration / commissioning procedure (18)
Message value: %1, to %2, %3, connection: %4
Component: None
Response: NONE

12.3 Faults and alarms

Acknowledgment: NONE

Explanation of the message value: For %1, %2

Value	Cause	Remedy
0	Component unknown	
1	Control Unit	
2	Motor Module	
3	Line Module	
4	Sensor Module	
5	Voltage Sensing Module	
6	Terminal Module	
7	DRIVE-CLiQ Hub Module	
8	Controller Extension	
9	Filter module	
10	Hydraulic Module	
49	DRIVE-CLiQ component	
50	Option slot	
60	Encoder	
70	DRIVE-CLiQ motor	
71	Hydraulic cylinder	
72	Hydraulic valve	
80	Motor	

Explanation of the message value: For %3

Component in target topology

Explanation of the message value: For %4

Value	Cause	Remedy
0	Port 0	
1	Port 1	
2	Port 2	
3	Port 3	
4	Port 4	
5	Port 5	
6	Port 6	
7	Port 7	
8	Port 8	
9	Port 9	
10	X100	
11	X101	
12	X102	
13	X103	
14	X104	
15	X105	
20	X200	
21	X201	
22	X202	
23	X203	
24	X204	

25 X205
40 X400
41 X401
42 X402
50 X500
51 X501
52 X502
53 X503
54 X504
55 X505
56 X506
57 X507

Cause: The topology comparison has found a component in the actual topology which is not specified in the target topology.
Alarm value (r2124, interpret hexadecimal):
ddccbbaa hex:
dd = component class (% 2)
cc = connection number (%4)
bb = component class of the additional component (%1)
aa = component number (%3)
Note:
The component class of the additional component is contained in bb.
The component is described in dd, cc and aa, where the additional component is inserted.
Component class and connection number are described in F01375.

Remedy: Adapting topologies:
- Remove the additional component (correct the actual topology).
- Adapt the project/parameterizing in the commissioning tool (correct the target topology).
Note:
Under "Topology --> Topology view" the commissioning tool where relevant offers improved diagnostics capability (e.g. setpoint/actual value comparison).

A01420 Topology: Component different

Message class: Error in the parameterization / configuration / commissioning procedure (18)
Message value: Component: %1, target: %2, actual: %3, difference: %4
Component: None
Response: NONE

12.3 Faults and alarms

Acknowledgment: NONE

Explanation of the message value: For %1

Component in target topology

Explanation of the message value: For %2, %3

Value	Cause	Remedy
0	Component unknown	
1	Control Unit	
2	Motor Module	
3	Line Module	
4	Sensor Module	
5	Voltage Sensing Module	
6	Terminal Module	
7	DRIVE-CLiQ Hub Module	
8	Controller Extension	
9	Filter module	
10	Hydraulic Module	
49	DRIVE-CLiQ component	
50	Option slot	
60	Encoder	
70	DRIVE-CLiQ motor	
71	Hydraulic cylinder	
72	Hydraulic valve	
80	Motor	

Explanation of the message value: For %4

Value	Cause	Remedy
1	Different component type	
2	Different article number	
3	Different manufacturer	
4	Incorrect subcomponent connected	
5	NX10 or NX15 used instead of CX32.	
6	CX32 used instead of NX10 or NX15.	
7	Different number of connections	

Cause: The topology comparison has detected differences in the actual topology and target topologies in the electronic rating plate.

Alarm value (r2124, interpret hexadecimal):

ddccbbaa hex:

aa = component number (%1),

bb = component class of the target topology (%2),

cc = component class of the actual topology (%3),

dd = difference (%4)

Note:

dd = 04 hex = 4 dec:

For a multi-component module, the incorrect subcomponent (index) is connected (e.g. Double Motor Module X201 instead of X200) - or only a part of a multi-component module is set to "deactivate and not available".

Note:

The component class is described in F01375.

The drive system is no longer booted. In this state, the drive control (closed-loop) cannot be enabled.

Remedy: Adapting topologies:
 - Connect the expected component (correct the actual topology).
 - Adapt the project/parameterizing in the commissioning tool (correct the target topology).

Note:
 Under "Topology --> Topology view" the commissioning tool where relevant offers improved diagnostics capability (e.g. setpoint/actual value comparison).

A01425 Topology: Serial number different

Message class: Error in the parameterization / configuration / commissioning procedure (18)

Message value: Component: %1, %2, differences: %3

Component: None

Response: NONE

Acknowledgment: NONE

Explanation of the message value: For %1

Component in target topology

Explanation of the message value: For %2

Value	Cause	Remedy
0	Component unknown	
1	Control Unit	
2	Motor Module	
3	Line Module	
4	Sensor Module	
5	Voltage Sensing Module	
6	Terminal Module	
7	DRIVE-CLiQ Hub Module	
8	Controller Extension	
9	Filter module	
10	Hydraulic Module	
49	DRIVE-CLiQ component	
50	Option slot	
60	Encoder	
70	DRIVE-CLiQ motor	
71	Hydraulic cylinder	
72	Hydraulic valve	
80	Motor	

Cause: The topology comparison has detected differences in the actual and target topologies in relation to one component. The serial number is different.

Alarm value (r2124, interpret hexadecimal):

ddccbbaa hex:

dd = reserved

cc = number of differences (%3)

bb = component class (% 2)

aa = component number (%1)

Note:

The component class is described in F01375.

The drive system is no longer booted. In this state, the drive control (closed-loop) cannot be enabled.

12.3 Faults and alarms

Remedy: Adapting topologies:
- Change over the actual topology to match the target topology.
- Load the target topology that matches the actual topology (commissioning tool).
Note:
Under "Topology --> Topology view" the commissioning tool where relevant offers improved diagnostics capability (e.g. setpoint/actual value comparison).

A01428 **Topology: Incorrect connection used**
Message class: Error in the parameterization / configuration / commissioning procedure (18)
Message value: Component: %1, %2, connection (actual): %3, connection (target): %4
Component: None
Response: NONE

Acknowledgment: NONE

Explanation of the message value: For %1

Component in target topology

Explanation of the message value: For %2

Value	Cause	Remedy
0	Component unknown	
1	Control Unit	
2	Motor Module	
3	Line Module	
4	Sensor Module	
5	Voltage Sensing Module	
6	Terminal Module	
7	DRIVE-CLiQ Hub Module	
8	Controller Extension	
9	Filter module	
10	Hydraulic Module	
49	DRIVE-CLiQ component	
50	Option slot	
60	Encoder	
70	DRIVE-CLiQ motor	
71	Hydraulic cylinder	
72	Hydraulic valve	
80	Motor	

Explanation of the message value: For %3, %4

Value	Cause	Remedy
0	Port 0	
1	Port 1	
2	Port 2	
3	Port 3	
4	Port 4	
5	Port 5	
6	Port 6	
7	Port 7	
8	Port 8	
9	Port 9	
10	X100	
11	X101	
12	X102	
13	X103	
14	X104	
15	X105	
20	X200	
21	X201	
22	X202	
23	X203	
24	X204	

12.3 Faults and alarms

- 25 X205
- 40 X400
- 41 X401
- 42 X402
- 50 X500
- 51 X501
- 52 X502
- 53 X503
- 54 X504
- 55 X505
- 56 X506
- 57 X507

Cause: The topology comparison has detected differences in the actual and target topologies in relation to one component. For a component, another connection was used.

The different connections of a component are described in the alarm value.

Alarm value (r2124, interpret hexadecimal):

ddccbbaa hex:

dd = connection number of the target topology (%4)

cc = connection number of the actual topology (%3)

bb = component class (% 2)

aa = component number (%1)

Note:

Component class and connection number are described in F01375.

The drive system is no longer booted. In this state, the drive control (closed-loop) cannot be enabled.

Remedy: Adapting topologies:

- Reinsert the DRIVE-CLiQ cable to the component (correct the actual topology).

- Adapt the project/parameterizing in the commissioning tool (correct the target topology).

- Automatically resolve the topology error.

Note:

Under "Topology --> Topology view" the commissioning tool where relevant offers improved diagnostics capability (e.g. setpoint/actual value comparison).

F01451 Topology: Target topology is invalid

Message class: Error in the parameterization / configuration / commissioning procedure (18)

Message value: %1

Component: None

Response: NONE

Acknowledgment: IMMEDIATELY

Cause: An error was detected in the target topology.

The target topology is invalid.

Fault value (r0949, interpret hexadecimal):

ccccbbaa hex: cccc = index error, bb = component number, aa = fault cause

aa = 1B hex = 27 dec: Error not specified.

aa = 1C hex = 28 dec: Value illegal.

aa = 1D hex = 29 dec: Incorrect ID.

aa = 1E hex = 30 dec: Incorrect ID length.

aa = 1F hex = 31 dec: Too few indices left.

aa = 20 hex = 32 dec: component not connected to Control Unit.

Remedy: Download the target topology again using the commissioning tool.

A01481 **Topology: Motor Module not connected**
Message class: Error in the parameterization / configuration / commissioning procedure (18)
Message value: Component: %1, to %2, %3, connection: %4
Component: None
Response: NONE

12.3 Faults and alarms

Acknowledgment: NONE

Explanation of the message value: For %1, %3

Component in target topology

Explanation of the message value: For %2

Value	Cause	Remedy
0	Component unknown	
1	Control Unit	
2	Motor Module	
3	Line Module	
4	Sensor Module	
5	Voltage Sensing Module	
6	Terminal Module	
7	DRIVE-CLiQ Hub Module	
8	Controller Extension	
9	Filter module	
10	Hydraulic Module	
49	DRIVE-CLiQ component	
50	Option slot	
60	Encoder	
70	DRIVE-CLiQ motor	
71	Hydraulic cylinder	
72	Hydraulic valve	
80	Motor	

Explanation of the message value: For %4

Value	Cause	Remedy
0	Port 0	
1	Port 1	
2	Port 2	
3	Port 3	
4	Port 4	
5	Port 5	
6	Port 6	
7	Port 7	
8	Port 8	
9	Port 9	
10	X100	
11	X101	
12	X102	
13	X103	
14	X104	
15	X105	
20	X200	
21	X201	
22	X202	
23	X203	
24	X204	

25 X205
40 X400
41 X401
42 X402
50 X500
51 X501
52 X502
53 X503
54 X504
55 X505
56 X506
57 X507

Cause: The topology comparison has detected a Motor Module that is missing in the actual topology with respect to the target topology.

Alarm value (r2124, interpret hexadecimal):

ddccbbaa hex:

dd = connection number (%4)

cc = component number (%3)

bb = component class (% 2)

aa = component number of the component that has not been inserted (% 1)

Note:

The component is described in dd, cc and bb, where the component has not been inserted.

Component class and connection number are described in F01375.

Remedy:

Adapting topologies:

- Insert the components involved at the right connection (correct the actual topology).

- Adapt the project/parameterizing in the commissioning tool (correct the target topology).

Check the hardware:

- Check the 24 V supply voltage.

- Check DRIVE-CLiQ cables for interruption and contact problems.

- Check that the component is working properly.

Note:

Under "Topology --> Topology view" the commissioning tool where relevant offers improved diagnostics capability (e.g. setpoint/actual value comparison).

A01482 Topology: Sensor Module not connected

Message class: Error in the parameterization / configuration / commissioning procedure (18)

Message value: Component: %1, to %2, %3, connection: %4

Component: None

Response: NONE

12.3 Faults and alarms

Acknowledgment: NONE

Explanation of the message value: For %1, %3

Component in target topology

Explanation of the message value: For %2

Value	Cause	Remedy
0	Component unknown	
1	Control Unit	
2	Motor Module	
3	Line Module	
4	Sensor Module	
5	Voltage Sensing Module	
6	Terminal Module	
7	DRIVE-CLiQ Hub Module	
8	Controller Extension	
9	Filter module	
10	Hydraulic Module	
49	DRIVE-CLiQ component	
50	Option slot	
60	Encoder	
70	DRIVE-CLiQ motor	
71	Hydraulic cylinder	
72	Hydraulic valve	
80	Motor	

Explanation of the message value: For %4

Value	Cause	Remedy
0	Port 0	
1	Port 1	
2	Port 2	
3	Port 3	
4	Port 4	
5	Port 5	
6	Port 6	
7	Port 7	
8	Port 8	
9	Port 9	
10	X100	
11	X101	
12	X102	
13	X103	
14	X104	
15	X105	
20	X200	
21	X201	
22	X202	
23	X203	
24	X204	

25 X205
40 X400
41 X401
42 X402
50 X500
51 X501
52 X502
53 X503
54 X504
55 X505
56 X506
57 X507

Cause: The topology comparison has detected a Sensor Module that is missing in the actual topology with respect to the target topology.

Alarm value (r2124, interpret hexadecimal):

ddccbbaa hex:

dd = connection number (%4)

cc = component number (%3)

bb = component class (% 2)

aa = component number of the component that has not been inserted (% 1)

Note:

The component is described in dd, cc and bb, where the component has not been inserted.

Component class and connection number are described in F01375.

Remedy: Adapting topologies:

- Insert the components involved at the right connection (correct the actual topology).

- Adapt the project/parameterizing in the commissioning tool (correct the target topology).

Check the hardware:

- Check the 24 V supply voltage.

- Check DRIVE-CLiQ cables for interruption and contact problems.

- Check that the component is working properly.

A01483 Topology: Terminal Module not connected

Message class: Error in the parameterization / configuration / commissioning procedure (18)

Message value: Component: %1, to %2, %3, connection: %4

Component: None

Response: NONE

12.3 Faults and alarms

Acknowledgment: NONE

Explanation of the message value: For %1, %3

Component in target topology

Explanation of the message value: For %2

Value	Cause	Remedy
0	Component unknown	
1	Control Unit	
2	Motor Module	
3	Line Module	
4	Sensor Module	
5	Voltage Sensing Module	
6	Terminal Module	
7	DRIVE-CLiQ Hub Module	
8	Controller Extension	
9	Filter module	
10	Hydraulic Module	
49	DRIVE-CLiQ component	
50	Option slot	
60	Encoder	
70	DRIVE-CLiQ motor	
71	Hydraulic cylinder	
72	Hydraulic valve	
80	Motor	

Explanation of the message value: For %4

Value	Cause	Remedy
0	Port 0	
1	Port 1	
2	Port 2	
3	Port 3	
4	Port 4	
5	Port 5	
6	Port 6	
7	Port 7	
8	Port 8	
9	Port 9	
10	X100	
11	X101	
12	X102	
13	X103	
14	X104	
15	X105	
20	X200	
21	X201	
22	X202	
23	X203	
24	X204	

25 X205
40 X400
41 X401
42 X402
50 X500
51 X501
52 X502
53 X503
54 X504
55 X505
56 X506
57 X507

Cause: The topology comparison has detected a Terminal Module that is missing in the actual topology with respect to the target topology.

Alarm value (r2124, interpret hexadecimal):

ddccbbaa hex:

dd = connection number (%4)

cc = component number (%3)

bb = component class (% 2)

aa = component number of the component that has not been inserted (% 1)

Note:

The component is described in dd, cc and bb, where the component has not been inserted.

Component class and connection number are described in F01375.

Remedy: Adapting topologies:

- Insert the components involved at the right connection (correct the actual topology).

- Adapt the project/parameterizing in the commissioning tool (correct the target topology).

Check the hardware:

- Check the 24 V supply voltage.

- Check DRIVE-CLiQ cables for interruption and contact problems.

- Check that the component is working properly.

Note:

Under "Topology --> Topology view" the commissioning tool where relevant offers improved diagnostics capability (e.g. setpoint/actual value comparison).

A01484 Topology: DRIVE-CLiQ Hub Module not connected

Message class: Error in the parameterization / configuration / commissioning procedure (18)

Message value: Component: %1, to %2, %3, connection: %4

Component: None

Response: NONE

12.3 Faults and alarms

Acknowledgment: NONE

Explanation of the message value: For %1, %3

Component in target topology

Explanation of the message value: For %2

Value	Cause	Remedy
0	Component unknown	
1	Control Unit	
2	Motor Module	
3	Line Module	
4	Sensor Module	
5	Voltage Sensing Module	
6	Terminal Module	
7	DRIVE-CLiQ Hub Module	
8	Controller Extension	
9	Filter module	
10	Hydraulic Module	
49	DRIVE-CLiQ component	
50	Option slot	
60	Encoder	
70	DRIVE-CLiQ motor	
71	Hydraulic cylinder	
72	Hydraulic valve	
80	Motor	

Explanation of the message value: For %4

Value	Cause	Remedy
0	Port 0	
1	Port 1	
2	Port 2	
3	Port 3	
4	Port 4	
5	Port 5	
6	Port 6	
7	Port 7	
8	Port 8	
9	Port 9	
10	X100	
11	X101	
12	X102	
13	X103	
14	X104	
15	X105	
20	X200	
21	X201	
22	X202	
23	X203	
24	X204	

25 X205
40 X400
41 X401
42 X402
50 X500
51 X501
52 X502
53 X503
54 X504
55 X505
56 X506
57 X507

Cause: The topology comparison has detected a DRIVE-CLiQ Hub Module missing in the actual topology with respect to the target topology.

Alarm value (r2124, interpret hexadecimal):

ddccbbaa hex:

dd = connection number (%4)

cc = component number (%3)

bb = component class (% 2)

aa = component number of the component that has not been inserted (% 1)

Note:

The component is described in dd, cc and bb, where the component has not been inserted.

Component class and connection number are described in F01375.

Remedy:

Adapting topologies:

- Insert the components involved at the right connection (correct the actual topology).

- Adapt the project/parameterizing in the commissioning tool (correct the target topology).

Check the hardware:

- Check the 24 V supply voltage.

- Check DRIVE-CLiQ cables for interruption and contact problems.

- Check that the component is working properly.

A01485 Topology: Controller Extension not connected

Message class: Error in the parameterization / configuration / commissioning procedure (18)

Message value: Component: %1, to %2, %3, connection: %4

Component: None

Response: NONE

12.3 Faults and alarms

Acknowledgment: NONE

Explanation of the message value: For %1, %3

Component in target topology

Explanation of the message value: For %2

Value	Cause	Remedy
0	Component unknown	
1	Control Unit	
2	Motor Module	
3	Line Module	
4	Sensor Module	
5	Voltage Sensing Module	
6	Terminal Module	
7	DRIVE-CLiQ Hub Module	
8	Controller Extension	
9	Filter module	
10	Hydraulic Module	
49	DRIVE-CLiQ component	
50	Option slot	
60	Encoder	
70	DRIVE-CLiQ motor	
71	Hydraulic cylinder	
72	Hydraulic valve	
80	Motor	

Explanation of the message value: For %4

Value	Cause	Remedy
0	Port 0	
1	Port 1	
2	Port 2	
3	Port 3	
4	Port 4	
5	Port 5	
6	Port 6	
7	Port 7	
8	Port 8	
9	Port 9	
10	X100	
11	X101	
12	X102	
13	X103	
14	X104	
15	X105	
20	X200	
21	X201	
22	X202	
23	X203	
24	X204	

25 X205
40 X400
41 X401
42 X402
50 X500
51 X501
52 X502
53 X503
54 X504
55 X505
56 X506
57 X507

Cause: The topology comparison has detected a Control Extension (CX32) missing in the actual topology with respect to the target topology.

Alarm value (r2124, interpret hexadecimal):

ddccbbaa hex:

dd = connection number (%4)

cc = component number (%3)

bb = component class (% 2)

aa = component number of the component that has not been inserted (% 1)

Note:

The component is described in dd, cc and bb, where the component has not been inserted.

Component class and connection number are described in F01375.

Remedy:

Adapting topologies:

- Insert the components involved at the right connection (correct the actual topology).

- Adapt the project/parameterizing in the commissioning tool (correct the target topology).

Check the hardware:

- Check the 24 V supply voltage.

- Check DRIVE-CLiQ cables for interruption and contact problems.

- Check that the component is working properly.

Note:

Under "Topology --> Topology view" the commissioning tool where relevant offers improved diagnostics capability (e.g. setpoint/actual value comparison).

A01486 Topology: DRIVE-CLiQ component not connected

Message class: Error in the parameterization / configuration / commissioning procedure (18)

Message value: Component: %1, to %2, %3, connection: %4

Component: None

Response: NONE

12.3 Faults and alarms

Acknowledgment: NONE

Explanation of the message value: For %1, %3

Component in target topology

Explanation of the message value: For %2

Value	Cause	Remedy
0	Component unknown	
1	Control Unit	
2	Motor Module	
3	Line Module	
4	Sensor Module	
5	Voltage Sensing Module	
6	Terminal Module	
7	DRIVE-CLiQ Hub Module	
8	Controller Extension	
9	Filter module	
10	Hydraulic Module	
49	DRIVE-CLiQ component	
50	Option slot	
60	Encoder	
70	DRIVE-CLiQ motor	
71	Hydraulic cylinder	
72	Hydraulic valve	
80	Motor	

Explanation of the message value: For %4

Value	Cause	Remedy
0	Port 0	
1	Port 1	
2	Port 2	
3	Port 3	
4	Port 4	
5	Port 5	
6	Port 6	
7	Port 7	
8	Port 8	
9	Port 9	
10	X100	
11	X101	
12	X102	
13	X103	
14	X104	
15	X105	
20	X200	
21	X201	
22	X202	
23	X203	
24	X204	

25 X205
40 X400
41 X401
42 X402
50 X500
51 X501
52 X502
53 X503
54 X504
55 X505
56 X506
57 X507

Cause: The topology comparison has detected a DRIVE-CLiQ component missing in the actual topology with respect to the target topology.

Alarm value (r2124, interpret hexadecimal):

ddccbbaa hex:

dd = connection number (%4)

cc = component number (%3)

bb = component class (% 2)

aa = component number of the component that has not been inserted (% 1)

Note:

The component is described in dd, cc and bb, where the component has not been inserted.

Component class and connection number are described in F01375.

Remedy:

Adapting topologies:

- Insert the components involved at the right connection (correct the actual topology).

- Adapt the project/parameterizing in the commissioning tool (correct the target topology).

Check the hardware:

- Check the 24 V supply voltage.

- Check DRIVE-CLiQ cables for interruption and contact problems.

- Check that the component is working properly.

Note:

Under "Topology --> Topology view" the commissioning tool where relevant offers improved diagnostics capability (e.g. setpoint/actual value comparison).

A01487 Topology: Option slot component not inserted

Message class: Error in the parameterization / configuration / commissioning procedure (18)

Message value: Component: %1, to %2, %3, connection: %4

Component: None

Response: NONE

12.3 Faults and alarms

Acknowledgment: NONE

Explanation of the message value: For %1, %3

Component in target topology

Explanation of the message value: For %2

Value	Cause	Remedy
0	Component unknown	
1	Control Unit	
2	Motor Module	
3	Line Module	
4	Sensor Module	
5	Voltage Sensing Module	
6	Terminal Module	
7	DRIVE-CLiQ Hub Module	
8	Controller Extension	
9	Filter module	
10	Hydraulic Module	
49	DRIVE-CLiQ component	
50	Option slot	
60	Encoder	
70	DRIVE-CLiQ motor	
71	Hydraulic cylinder	
72	Hydraulic valve	
80	Motor	

Explanation of the message value: For %4

Value	Cause	Remedy
0	Port 0	
1	Port 1	
2	Port 2	
3	Port 3	
4	Port 4	
5	Port 5	
6	Port 6	
7	Port 7	
8	Port 8	
9	Port 9	
10	X100	
11	X101	
12	X102	
13	X103	
14	X104	
15	X105	
20	X200	
21	X201	
22	X202	
23	X203	
24	X204	

25 X205
40 X400
41 X401
42 X402
50 X500
51 X501
52 X502
53 X503
54 X504
55 X505
56 X506
57 X507

Cause: The topology comparison has detected an option slot component missing in the actual topology with respect to the target topology.

Alarm value (r2124, interpret hexadecimal):

ddccbbaa hex:

dd = connection number (%4)

cc = component number (%3)

bb = component class (% 2)

aa = component number of the component that has not been inserted (% 1)

Note:

The component is described in dd, cc and bb, where the component has not been inserted.

Component class and connection number are described in F01375.

Remedy: Adapting topologies:

- Insert the components involved at the right connection (correct the actual topology).

- Adapt the project/parameterizing in the commissioning tool (correct the target topology).

Check the hardware:

- Check the 24 V supply voltage.

- Check DRIVE-CLiQ cables for interruption and contact problems.

- Check that the component is working properly.

Note:

Under "Topology --> Topology view" the commissioning tool where relevant offers improved diagnostics capability (e.g. setpoint/actual value comparison).

A01489 Topology: motor with DRIVE-CLiQ not connected

Message class: Error in the parameterization / configuration / commissioning procedure (18)

Message value: Component: %1, to %2, %3, connection: %4

Component: None

Response: NONE

12.3 Faults and alarms

Acknowledgment: NONE

Explanation of the message value: For %1, %3

Component in target topology

Explanation of the message value: For %2

Value	Cause	Remedy
0	Component unknown	
1	Control Unit	
2	Motor Module	
3	Line Module	
4	Sensor Module	
5	Voltage Sensing Module	
6	Terminal Module	
7	DRIVE-CLiQ Hub Module	
8	Controller Extension	
9	Filter module	
10	Hydraulic Module	
49	DRIVE-CLiQ component	
50	Option slot	
60	Encoder	
70	DRIVE-CLiQ motor	
71	Hydraulic cylinder	
72	Hydraulic valve	
80	Motor	

Explanation of the message value: For %4

Value	Cause	Remedy
0	Port 0	
1	Port 1	
2	Port 2	
3	Port 3	
4	Port 4	
5	Port 5	
6	Port 6	
7	Port 7	
8	Port 8	
9	Port 9	
10	X100	
11	X101	
12	X102	
13	X103	
14	X104	
15	X105	
20	X200	
21	X201	
22	X202	
23	X203	
24	X204	

25 X205
40 X400
41 X401
42 X402
50 X500
51 X501
52 X502
53 X503
54 X504
55 X505
56 X506
57 X507

Cause: The topology comparison has detected a motor with DRIVE-CLiQ missing in the actual topology with respect to the target topology.

Alarm value (r2124, interpret hexadecimal):

ddccbbaa hex:

dd = connection number (%4)

cc = component number (%3)

bb = component class (% 2)

aa = component number of the component that has not been inserted (% 1)

Note:

The component is described in dd, cc and bb, where the component has not been inserted.

Component class and connection number are described in F01375.

Remedy: Adapting topologies:

- Insert the components involved at the right connection (correct the actual topology).

- Adapt the project/parameterizing in the commissioning tool (correct the target topology).

Check the hardware:

- Check the 24 V supply voltage.

- Check DRIVE-CLiQ cables for interruption and contact problems.

- Check that the component is working properly.

Note:

Under "Topology --> Topology view" the commissioning tool where relevant offers improved diagnostics capability (e.g. setpoint/actual value comparison).

F01512 No scaling available

Message class: Error in the parameterization / configuration / commissioning procedure (18)

Message value: %1

Component: None

Response: OFF2

Acknowledgment: POWER ON

Cause: An attempt was made to determine a conversion factor for a scaling that does not exist.

Fault value (r0949, interpret decimal):

Unit (e.g. corresponding to SPEED) for which an attempt was made to determine a factor.

Remedy: Apply scaling or check the transfer value.

A01514 Error when writing during a reconnect

Message class: Error in the parameterization / configuration / commissioning procedure (18)

Message value: Parameter: %1

Component: None

Response: NONE

12.3 Faults and alarms

Acknowledgment: NONE

Cause: During a reconnect operation (e.g. while booting or downloading - but can also occur in normal operation) a parameter was not able to be written to.
The parameter is then reset to the factory setting.

Alarm value (r2124, interpret decimal):
Parameter number

Remedy: Not necessary.

A01550 Security: Drive data encryption invalid

Message class: Hardware/software error (1)

Message value: -

Component: Control Unit (CU)

Response: NONE

Acknowledgment: NONE

Cause: The password for drive data encryption (DDE) does not match the password configured in the converter or no password was configured.

The DDE password protects sensitive data on the SD card.
It is not possible to transfer the data backup from the SD card.

Remedy: To be able to restore the data backup on the SD card, the DDE password must correspond to the password that was originally configured for the data backup in the original converter:

- With the SD card inserted, enter the correct DDE password in the Security Wizard of the web server and restart the converter.

- In Startdrive, with the SD card inserted, under Online & Diagnostics, enter the correct DDE password in screen form "Specify password for encryption of the drive data" and restart the converter.

If the data backup on the SD card is not be used:

- Remove the SD card from the converter and restart the converter.

Notice: Not observing this and continuing to work at the converter can lead to the data backup on the SD card being lost.

A01590 Drive: Motor maintenance interval expired

Message class: General drive fault (19)

Message value: Fault cause: %1 bin

Component: Motor

Response: NONE

Acknowledgment: NONE

Cause: The selected service/maintenance interval for this motor was reached.

Alarm value (r2124, interpret decimal):

Motor data set number.

Remedy: carry out service/maintenance and reset the service/maintenance interval (p0651).

C01600 SI: STO self test failed

Message class: Safety monitoring channel has identified an error (10)

Message value: %1

Variant: S200 PN

Component: None

Response: OFF2

Acknowledgment: IMMEDIATELY

Cause: The "Safety Integrated" function integrated in the drive has identified a fault in the self test of the switch-off signal path, and has initiated an STO (Safe Torque Off).
Fault value (r60049, interpret decimal):
1005: STO active, although STO not selected and there is no internal STO active.
1010: STO inactive, although STO is selected or an internal STO is active.
1015: The self test was unsuccessful in operation.
1016: Error in the communication path for brake/F-DI/F-DO/STO

Remedy:

- Select STO and then deselect again.
- Carry out a POWER ON (switch-off/switch-on) for all components.
- Upgrade software to a later version.
- Contact Technical Support.

C01603 SI: Module temperature - limit value exceeded

Message class: Safety monitoring channel has identified an error (10)

Message value: -

Variant: S200 PN

Component: None

Response: OFF2

Acknowledgment: IMMEDIATELY

Cause: A safe monitoring function has detected that the module temperature has exceeded a limit value. STO (Safe Torque Off) was initiated to maintain the safe state.

Remedy:

- Check the ambient temperature.
- Check the module fan.
- Operate the module in the permissible range.

F01604 SI: Safety EEPROM data error

Message class: Safety monitoring channel has identified an error (10)

Message value: %1

Variant: S200 PN

Component: Control Unit (CU)

Response: OFF2

Acknowledgment: POWER ON

Cause: Safety relevant EEPROM data are not correct.
This message results in an STO (Safe Torque Off).

Message value (r0949, interpret decimal): Only for internal Siemens fault diagnostics.

Remedy: Replace the module.

A01605 SI: Checksum error has occurred

Message class: Safety monitoring channel has identified an error (10)

Message value: %1

Variant: S200 PN

Component: Control Unit (CU)

Response: NONE

Acknowledgment: NONE

Cause: A checksum error (CRC error) has occurred in the converter program memory.
Alarm value (r2124, interpret decimal):
Only for internal Siemens troubleshooting.

Remedy:

- Carry out a POWER ON (switch-off/switch-on).
- Upgrade firmware to later version.
- Contact Technical Support.

A01637 SI: Safety configuration not protected

Message class: Error in the parameterization / configuration / commissioning procedure (18)

Message value: -

Variant: S200 PN

Component: None

Response: NONE

Acknowledgment: NONE

Cause: Safety configuration is not protected using UMAC (User Management and Access Control).

Remedy: Activate UMAC and assign the rights for changing the "Edit Safety Integrated application" safety configuration to a specific user that is saved with user name and password.

F01646 SI: Change logbook

Message class: Safety monitoring channel has identified an error (10)

Message value: %1

Variant: S200 PN

Component: Control Unit (CU)

Response: OFF2

Acknowledgment: IMMEDIATELY

Cause: The saved functional safety checksum (r9780[0]) or hardware-related safety checksum (r9780[1]) differs from the safety checksum calculated when running up or a previously calculated safety checksum was not found.
An acceptance test is required as changes have been made to a safety parameter or the safety hardware.
Fault value (r0949, interpret decimal):

- 1: The safety logbook has identified that a functional safety checksum has changed. An acceptance test is required.
- 2: The safety logbook has identified that a hardware-related safety checksum has changed. An acceptance test is required.

Remedy: For fault value = 1:
- Carry out an acceptance test and generate an acceptance report.
For fault value = 2:
- Carry out the function checks for the modified hardware and generate an acceptance report.
Note:
The procedure when carrying out an acceptance test as well as an example of the acceptance report are provided in the following literature:
SINAMICS Function Manual Safety Integrated

C01649 SI: Internal software error

Message class: Hardware/software error (1)

Message value: Module: %1, line: %2

Variant: S200 PN

Component: Control Unit (CU)

Response: OFF2

Acknowledgment: IMMEDIATELY

Cause: An internal error has occurred in the Safety Integrated software.

Note:
This message results in an STO (Safe Torque Off) that cannot be acknowledged.
Message value (r60049, interpret hexadecimal): Only for internal Siemens fault diagnostics.

- Remedy:**
- Carry out a POWER ON (switch-off/switch-on) for all components.
 - Re-commission the "Safety Integrated" function and carry out a POWER ON.
 - Upgrade firmware to later version.
 - Contact Technical Support.
 - Replace hardware component.

F01650 SI: Acceptance test required

Message class: Safety monitoring channel has identified an error (10)

Message value: %1

Variant: S200 PN

Component: Control Unit (CU)

Response: OFF2

Acknowledgment: IMMEDIATELY

Cause: The drive-integrated "Safety Integrated" function requires an acceptance test.
Message value (r0949, interpret decimal):
2003: Acceptance test is required as a safety parameter has been changed.

Remedy: For message value = 2003:
- Carry out an acceptance test and generate an acceptance report.
The procedure when carrying out an acceptance test as well as an example of the acceptance report are provided in the product operating instructions.

F01661 SI: Simulation of the safety inputs active

Message class: General drive fault (19)

Message value: Fault cause: %1 bin

Variant: S200 PN

Component: Control Unit (CU)

Response: OFF2

Acknowledgment: IMMEDIATELY

Cause: The simulation of the digital inputs is active (p0795).
It is not permissible that safety inputs are simulated.
Fault value (r0949, interpret binary):
The displayed bits indicate which digital inputs must not be simulated.

Remedy:
- Deactivate the simulation of the digital inputs for the safety inputs (p0795).
- Acknowledge fault.

C01668 SI: Checksum error safety monitoring functions

Message class: Safety monitoring channel has identified an error (10)

Message value: %1

Variant: S200 PN

Component: Control Unit (CU)

Response: OFF2

Acknowledgment: IMMEDIATELY

Cause: The actual checksum calculated by the drive and entered in r10098 via the safety-relevant parameters does not match the reference checksum saved in p10099 at the last machine acceptance.
Safety-relevant parameters have been changed or a fault is present.
Note:
This message results in an STO (Safe Torque Off).
Message value (r60049, only for internal Siemens diagnostics)

Remedy:
- Carry out safety commissioning.
- Carry out an acceptance test.

C01677 **SI: Incorrect onboard F-I/O parameter value**

Message class: Error in the parameterization / configuration / commissioning procedure (18)

Message value: Parameter: %1, supplementary information: %2

Variant: S200 PN

Component: None

Response: NONE

Acknowledgment: IMMEDIATELY

Cause: The parameter cannot be parameterized with this value.

Note:

This message does not result in a safety stop response.

Message value (r60049, interpret decimal): yyyyxxxx dec:

yyyy = supplementary information

xxxx = parameter

yyyy = 0:

No additional information available.

xxxx = 10000 and

yyyy = F-DI number:

A non-existent F-DI was enabled.

xxxx = 10002:

The F-DI discrepancy time (p10002) is less than or equal to the SI monitoring clock cycle.

xxxx = 10017 and

yyyy = F-DI number:

The input filter (p10017) is less than or equal to (p10018 + 2ms) when simultaneously selecting "Self test using specified dark pulses" (p10041[y] = 1).

xxxx = 10018 and

yyyy = F-DI number:

Setting "F-DI self test length dark pulses" (p10018) is zero when simultaneously selecting "Self test using specified dark pulses" (p10041[y] = 1).

xxxx = 10041 and

yyyy = F-DI number:

An invalid value was set in "F-DI self test mode selection" (p10041[y]).

xxxx = 10071 and

yyyy = F-DI number:

An F-DI status r10071[y], which was not enabled in p10000, was set.

Remedy: Correct the parameter value.
For xxxx = 10000 and yyyy = F-DI number:
- Correct "SI F-DI enable" (p10000).
For xxxx = 10002:
- Set "SI F-DI switchover discrepancy time" (p10002) greater than the "SI monitoring clock cycle".
For xxxx = 10017 and yyyy = F-DI number:
- Set "SI digital inputs input filter" (p10017) greater than (p10018 + 2 ms)
- Change "SI F-DI self test mode selection" (p10041[y])
For xxxx = 10018 and yyyy = F-DI number:
- Set "SI F-DI self test length dark pulses" (p10018) greater than zero.
- Change p10041[y] "SI F-DI self test mode selection".
For xxxx = 10041 and yyyy = F-DI number:
- Change "SI F-DI self test mode selection" (p10041[y])
For xxxx = 10071 and yyyy = F-DI number:
- Correct "SI F-DI enable" (p10000).

C01680 SI: Checksum error safety monitoring functions

Message class: Safety monitoring channel has identified an error (10)
Message value: %1
Variant: S200 PN
Component: Control Unit (CU)
Response: OFF2
Acknowledgment: IMMEDIATELY
Cause: The actual checksum over the safety-relevant parameters, calculated by the drive, does not match the reference checksum last saved for the last machine acceptance test.
Safety-relevant parameters have been changed or a fault is present.
Note:
This message results in an STO (Safe Torque Off).
Message value (r60049, only for internal Siemens diagnostics)
Remedy: - Check the safety-relevant parameters and if required, correct.
- Retentively save parameters.
- Perform a POWER ON if safety parameters requiring a POWER ON have been modified.
- Carry out an acceptance test.

C01681 SI: Incorrect parameter value

Message class: Error in the parameterization / configuration / commissioning procedure (18)
Message value: Parameter: %1, supplementary information: %2
Variant: S200 PN
Component: None
Response: OFF2
Acknowledgment: IMMEDIATELY
Cause: The parameter cannot be parameterized with this value.
Note:
This fault results in STO.
Fault value (r60049, interpret decimal):
yyyyxxx dec: yyyy = supplementary information, xxxx = parameter
yyyy = 0:
No additional information available.
xxxx = 10006 or 10022:
An inadmissible signal source for the control via F-DI was set.

Remedy: Correct parameters:
For xxxx = 10006 or 10022:
- Set a valid signal source in pxxxx.

C01682 SI: Monitoring function not supported

Message class: Error in the parameterization / configuration / commissioning procedure (18)

Message value: %1

Variant: S200 PN

Component: None

Response: OFF2

Acknowledgment: IMMEDIATELY

Cause: At least one of the monitoring functions enabled in p9604 is not supported with this firmware version on this device.
Note:

The message value (r60049, interpret binary) indicates the bits of the monitoring functions, which form this firmware version on this device, are not supported. If several, non-supported monitoring functions are simultaneously enabled, then these are all displayed in the message value.

This message results in an STO (Safe Torque Off).

See also: p9604 (SI enable)

Remedy: Correct parameter p9604 so that monitoring functions only permitted for this firmware version and for this device are enabled.

See also: p9604 (SI enable)

C01690 SI: Data backup problem for the NVRAM

Message class: Hardware/software error (1)

Message value: %1

Variant: S200 PN

Component: Control Unit (CU)

Response: OFF2

Acknowledgment: POWER ON

Cause: When saving parameters r9780, r9781 and r9782 (Safety logbook) says, an error has occurred in conjunction with the NVRAM.

Note:

This fault does not result in a safety stop response.

Fault value (r60049, interpret decimal):

1: There is no physical NVRAM in the drive.

2: There is no longer any free memory space in the NVRAM.

Remedy: For fault value = 1:

- Replace the hardware.

For fault value = 2:

- De-select functions that are not required and that take up memory space in the NVRAM.

- Contact Technical Support.

Note:

NVRAM: Non-Volatile Random Access Memory (non-volatile read and write memory)

C01700 SI: STO (Safe Torque Off) initiated

Message class: Safety monitoring channel has identified an error (10)

Message value: -

Variant: S200 PN

Component: None

Response: OFF2

Acknowledgment: IMMEDIATELY
Cause: The drive is stopped using STO (Safe Torque Off).
 Possible causes:
 Subsequent response, following messages: C01706, C01714, C01715, C01716.
Remedy: Carry out diagnostics for the active messages (C01706, C01714, C01715, C01716).

C01711 **SI: SCF (Safety Channel Failure) initiated**
Message class: Safety monitoring channel has identified an error (10)
Message value: -
Variant: S200 PN
Component: None
Response: NONE
Acknowledgment: IMMEDIATELY
Cause: The drive has detected an error in a safe monitoring function and has initiated SCF (Safety Channel Failure).
 Monitoring functions are no longer reliable. Safe operation not possible.
 Possible causes:
 Subsequent response, following messages: C01648, C01750, C01751, C01753, C01754, C01769.

Note:
 This fault results in an SS1 (Safe Stop 1) and as a consequence STO (Safe Torque Off) is initiated.
Remedy: Carry out diagnostics for the active messages (C01648, C01750, C01751, C01753, C01754, C01769).

C01770 **SI: Fault of the failsafe inputs**
Message class: Safety monitoring channel has identified an error (10)
Message value: Fault cause: %1, F-DI number: %2
Variant: S200 PN
Component: Control Unit (CU)
Response: NONE
Acknowledgment: IMMEDIATELY
Explanation of the message value: For %1

	Value Cause	Remedy
	1 Discrepancy error (state between two monitoring channels different for too long)	Check the F-DI wiring
	2 Too many switching operations	Reduce the switching frequency
	3 Test pulse error	Check the F-DI wiring
	4 Internal software error	

Cause: The failsafe digital inputs (F-DI) have a fault condition.
 Message value (r60049, interpret hexadecimal):
 yyyyxxxx hex
 xxxx: number of the failsafe digital input (F-DI).
 yyyy: fault cause

Note:
 If several faults occur consecutively, then this message is only signaled for the first fault that occurs.

12.3 Faults and alarms

Remedy:

- Check the wiring of the F-DI (contact problems).
- If the wiring is correct, and for example there is no wire breakage, then a check must be made as to whether the switching frequency at F-DI is too high and must therefore be reduced (switching pulses must have a longer time between them). The time interval between each signal edge at an F-DI must be at least equal to the discrepancy time before the input is switched again.

Note:

This message can be acknowledged via F-DI or PROFIsafe (safe acknowledgment).

Discrepancy errors of an F-DI can only be acknowledged if safe acknowledgment was carried out after the cause of the error was resolved (acknowledgment via PROFIsafe, extended message acknowledgment, self acknowledgment). As long as safety acknowledgment was not carried out, the corresponding F-DI stays in the safe state internally.

A self acknowledgment for an F-DI can be realized using a positive edge at the corresponding F-DI.

Sets the discrepancy time for fast switching operations at the F-DIs:

For fast switching operations at the failsafe digital inputs (F-DI), it may be necessary to adapt the discrepancy time to the switching frequency:

- The period of a cyclic switching pulse must be less than half of the discrepancy time (if necessary, round down).
- The time between two fast switching pulses should be longer than the discrepancy time (if necessary, round up).
- The discrepancy time must be greater or equal to the SI monitoring clock cycle (it must always be rounded up or down to be an integer multiple of the SI monitoring clock cycle).

If an input filter has been parameterized ($p10017 > 0$), then the shortest possible discrepancy time is directly specified by the input filter.

- The period of a cyclic switching pulse must be less than half of the discrepancy time $p10017$ (if necessary, round down).
- The time between two fast switching pulses should be longer than the discrepancy time + $p10017$ (if necessary, round up).
- The discrepancy time must be greater or equal to the SI monitoring clock cycle. The input filter must always be set less than the discrepancy time.

Self test with specified dark pulses ($p10041 > 0$) for long cable lengths:

- Increase the dark pulse length ($p10018$ or $p10019$).
- Increase the input filter ($p10017$).

Note:

F-DI: Failsafe Digital Input

C01793 SI: Internal safety message buffer is full

Message class: Safety monitoring channel has identified an error (10)
Message value: %1
Variant: S200 PN
Component: None
Response: NONE
Acknowledgment: IMMEDIATELY
Cause: Too many safety messages have occurred within a short time so that some have not been able to be displayed.
Remedy: No remedy required

F01800 DRIVE-CLiQ: Hardware/configuration error

Message class: Internal (DRIVE-CLiQ) communication error (12)
Message value: %1
Component: None
Response: NONE
Acknowledgment: IMMEDIATELY

Cause:	<p>A DRIVE-CLiQ connection fault has occurred.</p> <p>Fault value (r0949, interpret decimal): 100 ... 107: Communication via DRIVE-CLiQ socket X100 ... X107 has not been switched to cyclic operation. The cause may be an incorrect structure or a configuration that results in an impossible bus timing.</p> <p>10: Loss of the DRIVE-CLiQ connection. The cause may be, for example, that the DRIVE-CLiQ cable was withdrawn from the Control Unit or as a result of a short-circuit for motors with DRIVE-CLiQ. This fault can only be acknowledged in cyclic communication.</p> <p>11: Repeated faults when detecting the connection. This fault can only be acknowledged in cyclic communication.</p> <p>12: A connection was detected but the node ID exchange mechanism does not function. The reason is probably that the component is defective. This fault can only be acknowledged in cyclic communication.</p>
Remedy:	<p>For fault value = 100 ... 107:</p> <ul style="list-style-type: none">- Ensure that the DRIVE-CLiQ components have the same firmware versions.- Avoid longer topologies for short current controller sampling times. <p>For fault value = 10:</p> <ul style="list-style-type: none">- Check the DRIVE-CLiQ cables at the Control Unit.- Remove any short-circuit for motors with DRIVE-CLiQ.- Carry out a POWER ON. <p>For fault value = 11:</p> <ul style="list-style-type: none">- Check the electrical cabinet design and cable routing for EMC compliance. <p>For fault value = 12:</p> <ul style="list-style-type: none">- Replace the component involved.

A01839 DRIVE-CLiQ diagnostics: cable fault to the component

Message class:	General drive fault (19)
Message value:	Component number: %1
Component:	Control Unit (CU)
Response:	NONE
Acknowledgment:	NONE
Cause:	<p>The fault counter to monitor the DRIVE-CLiQ connections/cables has been incremented.</p> <p>Alarm value (r2124, interpret decimal): Component number.</p> <p>Note: The component number specifies the component whose feeder cable from the direction of the converter is faulted. The alarm is automatically withdrawn after 5 seconds, assuming that no other data transfer error has occurred.</p>
Remedy:	<ul style="list-style-type: none">- Check the corresponding DRIVE-CLiQ cables.- Check the electrical cabinet design and cable routing for EMC compliance.

A01840 SMI: Component found without motor data

Message class:	Hardware/software error (1)
Message value:	Component number: %1
Component:	None
Response:	NONE
Acknowledgment:	NONE
Explanation of the message value:	For %1 Component in target topology

12.3 Faults and alarms

Cause: An SMI/DQI without motor data has been found (e.g. SMI installed as replacement part).
Alarm value (r2124, interpret decimal):
Component number from target topology.

Remedy: 1. Download the SMI/DQI data (motor/encoder data) from the data backup again (p4690, p4691).
2. Carry out a POWER ON (switch-off/switch-on) for this component.

Note:
DQI: DRIVE-CLiQ Sensor Integrated
SMI: SINAMICS Sensor Module Integrated

A01900 PN: Configuration telegram error

Message class: Error in the parameterization / configuration / commissioning procedure (18)

Message value: %1

Component: None

Response: NONE

Acknowledgment: NONE

Cause: A controller attempts to establish a connection using an incorrect configuring telegram.
Alarm value (r2124, interpret decimal):
2:
Too many PZD data words for output or input. The number of possible PZD is specified by the number of indices in r2050/
r2053.
3:
Uneven number of bytes for input or output.
4:
Setting data for synchronization not accepted. For more information, see A01902.
211:
Unknown parameterizing block.
Additional values:
Only for internal Siemens troubleshooting.

Remedy: Check the bus configuration on the controller and device sides.

A01902 PN: Isochronous operation parameterization not permissible

Message class: Error in the parameterization / configuration / commissioning procedure (18)

Message value: %1

Component: None

Response: NONE

Acknowledgment: NONE

Cause: Parameterization for isochronous operation is not permissible.
Alarm value (r2124, interpret decimal):
0: Bus cycle time Tdp < 0.5 ms.
1: Bus cycle time Tdp > 32 ms.
2: Bus cycle time Tdp is not an integer multiple of the current controller sampling time.
3: Instant of the actual value sensing Ti > Bus cycle time Tdp or Ti = 0.
4: Instant of the actual value sensing Ti is not an integer multiple of the current controller sampling time.
5: Instant of the setpoint acceptance To >= Bus cycle time Tdp or To = 0.
6: Instant of the setpoint acceptance To is not an integer multiple of the current controller sampling time.
7: Controller application cycle time Tmapc is not an integer multiple of the speed controller sampling time.
8: Bus reserve bus cycle time Tdp - Data exchange time Tdx less than two current controller sampling times.
10: Instant of the setpoint acceptance To <= data exchange time Tdx + current controller sampling time
11: Controller application cycle time Tmapc > 14 x Tdp or Tmapc = 0.
12: PLL tolerance window Tpll_w > Tpll_w_max.
13: Bus cycle time Tdp is not a multiple of the speed controller clock cycle.

Remedy:

- Adapt the bus parameterization Tdp, Ti, To.
- Adapt the sampling time for the current controller or speed controller.

For alarm value = 10:

- Reduce Tdx by using fewer bus participants or shorter telegrams.

Note:

PB: PROFIBUS
PN: PROFINET

A01904 PN: Controller setting of the PZD telegram rejected

Message class: Communication error to the higher-level control system (9)
Message value: %1
Component: None
Response: NONE
Acknowledgment: NONE
Cause: A controller attempts to set a PZD telegram. The setting is not applied.
Alarm value (r2124, interpret decimal):
3: Controllers have no function rights for making changes.
4: Telegram cannot be set as a result of the drive configuration.
See also: r0922 (PROFIdrive PZD telegram selection)
Remedy: Check and align the telegram settings in the drive project and in the controller.

A01905 PN: Controller setting to activate the channel diagnostics rejected

Message class: Communication error to the higher-level control system (9)
Message value: %1
Component: Control Unit (CU)
Response: NONE
Acknowledgment: NONE
Cause: A controller attempted to change the activation of the channel diagnostics. The setting is not applied as the controller does not have the function rights to make a change.
Alarm value (r2124, interpret decimal):
1: Channel diagnostics are activated. Controller attempts to deactivate them.
2: Channel diagnostics are not activated. Controller attempts to activate them.
Remedy: Activate channel diagnostics in the bus configuration and check and align function rights in the drive.

F01910 Fieldbus: setpoint timeout

Message class: Communication error to the higher-level control system (9)
Message value: -
Component: None
Response: OFF3
Acknowledgment: IMMEDIATELY
Cause: The reception of setpoints from the fieldbus interface (PROFINET) is interrupted.
- Bus connection interrupted.
- Controller switched off.
- Controller set into the STOP state.
Remedy: Restore the bus connection and set the controller to RUN.

F01911 PN: Isochronous operation, clock cycle failure

Message class: Communication error to the higher-level control system (9)
Message value: -
Component: None

Response: OFF1
Acknowledgment: IMMEDIATELY
Cause: The telegram to synchronize the clock cycles has failed for several bus clock cycles or in several bus clock cycles has consecutively violated the specified time grid (see bus cycle time, Tdp and Tpllw).
Remedy:
- Check the physical bus configuration (cable, connector, terminating resistor, shielding, etc.).
- Check whether communication was briefly or permanently interrupted.
- Check the utilization level of the bus and controller (e.g. bus cycle time Tdp was set too short).
Note:
PN: PROFINET

F01912 PN: Isochronous operation sign-of-life missing
Message class: Communication error to the higher-level control system (9)
Message value: -
Component: None
Response: OFF1
Acknowledgment: IMMEDIATELY
Cause: The maximum permissible number of errors in the controller sign-of-life (isochronous operation) has been exceeded in cyclic operation.
Remedy:
- Check the physical bus configuration (cables, connectors, etc.).
- Check whether the controller correctly sends the sign-of-life (e.g. create a trace with STW2.12 ... STW2.15 and trigger signal ZSW1.3).
- Check the permissible telegram failure rate (p0925).
- Check the utilization level of the bus and controller (e.g. bus cycle time Tdp was set too short).
Note:
PN: PROFINET

A01932 PN: Clock cycle synchronization missing for DSC
Message class: Error in the parameterization / configuration / commissioning procedure (18)
Message value: -
Component: None
Response: NONE
Acknowledgment: NONE
Cause: There is no clock synchronization or clock synchronous sign of life and DSC is selected.
Note:
DSC: Dynamic Servo Control
See also: r0922 (PROFIdrive PZD telegram selection)
Remedy: Set clock synchronization across the bus configuration and transfer clock synchronous sign-of-life.

A01940 PB/PN: clock cycle synchronism not reached
Message class: Communication error to the higher-level control system (9)
Message value: -
Component: None
Response: NONE
Acknowledgment: NONE
Cause: The bus is in the data exchange state and clock synchronous operation has been selected using the parameterizing telegram. Synchronization with the clock cycle specified by the controller was still not able to be performed.
- The controller does not send an isochronous telegram, although isochronous operation was selected when configuring the bus.
- The controller uses another isochronous bus clock cycle than was transferred to the device in the parameterizing telegram.

Remedy:

- Check the controller application and bus configuration.
- Check the consistency between the clock cycle input when configuring the device and clock cycle setting at the controller.

Note:
PB: PROFIBUS
PN: PROFINET

A01941 PN: Clock cycle signal missing when the bus is being established

Message class: Communication error to the higher-level control system (9)
Message value: -
Component: None
Response: NONE
Acknowledgment: NONE
Cause: The bus is in the data exchange state and clock synchronous operation has been selected using the parameterizing telegram. The synchronization telegram is not received.
Remedy: Check the controller application and bus configuration.
Note:
PN: PROFINET

A01943 PN: Clock cycle signal error when the bus is being established

Message class: Communication error to the higher-level control system (9)
Message value: -
Component: None
Response: NONE
Acknowledgment: NONE
Cause: The bus is in the data exchange state and clock synchronous operation has been selected using the parameterizing telegram.
The synchronization telegram is irregularly received.

- The controller sends an irregular synchronization telegram.
- The controller uses another isochronous bus clock cycle than was transferred to the device in the parameterizing telegram.

Remedy:

- Check the controller application and bus configuration.
- Check the consistency between the clock cycle input when configuring the device and clock cycle setting at the controller.

Note:
PN: PROFINET

A01944 PN: Sign-of-life synchronism not reached

Message class: Communication error to the higher-level control system (9)
Message value: -
Component: None
Response: NONE
Acknowledgment: NONE
Cause: The bus is in the data exchange state and clock synchronous operation has been selected using the parameterizing telegram.
Synchronization with the controller sign-of-life (STW2.12 ... STW2.15) could not be completed because the sign-of-life changes differently to how it was configured in the Tmapc time grid.
Remedy: - Ensure that the controller correctly increments the sign-of-life in the controller application clock cycle Tmapc.
Note:
PN: PROFINET

F01950 PN: Isochronous operation, synchronization unsuccessful

Message class: Communication error to the higher-level control system (9)

12.3 Faults and alarms

Message value: -
Component: None
Response: OFF1
Acknowledgment: IMMEDIATELY
Cause: Synchronization of the internal clock cycle to the controller clock cycle has failed. The internal clock cycle exhibits an unexpected shift.
Remedy: Only for internal Siemens troubleshooting.
 Note:
 PN: PROFINET

A01980 PN: cyclic connection interrupted

Message class: Communication error to the higher-level control system (9)
Message value: %1
Component: None
Response: NONE
Acknowledgment: NONE
Cause: The cyclic connection to the PROFINET controller is interrupted.
 See also: r8936 (PN cyclic connection state)
Remedy: Establish the PROFINET connection and activate the PROFINET controller in the cyclic mode.
 Check parameters "Name of Station" and "IP of Station".

A01981 PN: Maximum number of controllers exceeded

Message class: Error in the parameterization / configuration / commissioning procedure (18)
Message value: Info 1: %1, Info 2: %2
Component: None
Response: NONE
Acknowledgment: NONE
Cause: A controller attempts to establish a connection to the drive, and as a consequence exceeds the permitted number of PROFINET connections.
 The alarm is automatically withdrawn after approx. 30 seconds.
 Alarm value (r2124, interpret hexadecimal):
 yyyyxxxx hex: yyyy = info. 1, xxxx = info. 2
 Info 1 = 0: number of RT connections exceeded
 Info 1 > 0: number of IRT connections exceeded
 Info 2: permitted number of connections
Remedy: Check the configuration of the PROFINET controllers.

A01989 PN: internal cyclic data transfer error

Message class: Communication error to the higher-level control system (9)
Message value: %1
Component: None
Response: NONE
Acknowledgment: NONE
Cause: The cyclic actual values and/or setpoints were not transferred within the specified times.
 Alarm value (r2124, interpret hexadecimal):
 Only for internal Siemens troubleshooting.
Remedy: Correctly set T_io_input or T_io_output.

A02000 Function generator: Start not possible

Message class: Error in the parameterization / configuration / commissioning procedure (18)

Message value: -
Component: None
Response: NONE
Acknowledgment: NONE
Cause: The function generator has already been started.
Remedy: Stop the function generator and restart again if necessary.
Note:
The alarm is reset as follows:
- Remove the cause of this alarm.
- Restart the function generator.

A02006 Function generator: No drive specified for connection

Message class: Error in the parameterization / configuration / commissioning procedure (18)
Message value: -
Component: None
Response: NONE
Acknowledgment: NONE
Cause: No drive specified for connection was specified.
Remedy: At least one drive to be connected must be specified.
Note:
The alarm is reset as follows:
- Remove the cause of this alarm.
- Restart the function generator.

A02010 Function generator: Speed setpoint from the drive is not zero

Message class: Error in the parameterization / configuration / commissioning procedure (18)
Message value: -
Component: None
Response: NONE
Acknowledgment: NONE
Cause: The speed setpoint of a drive selected for connection is greater than the value for the standstill detection set using p1226.
Remedy: For all of the drives specified for connection, set the speed setpoints to zero.
Note:
The alarm is reset as follows:
- Remove the cause of this alarm.
- Restart the function generator.

A02020 Function generator: Parameter cannot be changed

Message class: Error in the parameterization / configuration / commissioning procedure (18)
Message value: -
Component: None
Response: NONE
Acknowledgment: NONE
Cause: This parameter setting cannot be changed when the function generator is active.
Remedy: - Stop the function generator before parameterizing.
- Possibly start the function generator.
Note:
The alarm is reset as follows:
- Remove the cause of this alarm.
- Restart the function generator.

A02026 Function generator: Pulse width too high

Message class: Error in the parameterization / configuration / commissioning procedure (18)

Message value: -

Component: None

Response: NONE

Acknowledgment: NONE

Cause: The selected pulse width is too high.
The pulse width must be less than the period duration.

Remedy: Reduce pulse width.
Note:
The alarm is reset as follows:
- Remove the cause of this alarm.
- Restart the function generator.

A02030 Function generator: Physical address equals zero

Message class: Error in the parameterization / configuration / commissioning procedure (18)

Message value: -

Component: None

Response: NONE

Acknowledgment: NONE

Cause: The specified physical address is zero.

Remedy: Set a physical address with a value other than zero.
Note:
The alarm is reset as follows:
- Remove the cause of this alarm.
- Restart the function generator.

A02040 Function generator: Illegal value for offset

Message class: Error in the parameterization / configuration / commissioning procedure (18)

Message value: -

Component: None

Response: NONE

Acknowledgment: NONE

Cause: The value for the offset is higher than the value for the upper limit or lower than the value for the lower limit.

Remedy: Adjust the offset value accordingly.
Note:
The alarm is reset as follows:
- Remove the cause of this alarm.
- Restart the function generator.

A02041 Function generator: Illegal value for bandwidth

Message class: Error in the parameterization / configuration / commissioning procedure (18)

Message value: -

Component: None

Response: NONE

Acknowledgment: NONE

Cause: The bandwidth referred to the time slice clock cycle of the function generator has either been set too low or too high. Depending on the time slice clock cycle, the bandwidth is defined as follows:
 $\text{Bandwidth_max} = 1 / (2 \times \text{time slice clock cycle})$
 $\text{Bandwidth_min} = \text{Bandwidth_max} / 100000$
 Example:
 Assumption: Time slice clock cycle = 125 μs
 --> $\text{Bandwidth_max} = 1 / (2 \times 125 \mu\text{s}) = 4000 \text{ Hz}$
 --> $\text{Bandwidth_min} = 4000 \text{ Hz} / 100000 = 0.04 \text{ Hz}$

Remedy: Check the value for the bandwidth and adapt accordingly.
 Note:
 The alarm is reset as follows:
 - Remove the cause of this alarm.
 - Restart the function generator.

A02047 Function generator: Time slice clock cycle invalid
Message class: Error in the parameterization / configuration / commissioning procedure (18)
Message value: -
Component: None
Response: NONE
Acknowledgment: NONE
Cause: The time slice clock cycle selected does not match any of the existing time slices.
Remedy: Enter an existing time slice clock cycle. The fastest cycle time can be read out using the commissioning tool.
 Note:
 The alarm is reset as follows:
 - Remove the cause of this alarm.
 - Restart the function generator.

A02050 Trace: Start not possible
Message class: Error in the parameterization / configuration / commissioning procedure (18)
Message value: -
Component: None
Response: NONE
Acknowledgment: NONE
Cause: The trace has already been started.
Remedy: Stop the trace and, if necessary, start again.

A02051 Trace: recording not possible as a result of know-how protection
Message class: Error in the parameterization / configuration / commissioning procedure (18)
Message value: initiating recorder: %1, parameter %2
Component: None
Response: NONE
Acknowledgment: NONE
Explanation of the message value: For %1

Value	Cause	Remedy
1	Recorder 0	
2	Recorder 1	
3	Recorders 0 and 1	

12.3 Faults and alarms

Cause: TRACE recording is not possible as at least one signal or trigger signal being used is under know-how protection.
Alarm value (r2124, interpret hexadecimal):
bbbbaaaa hex:
aaaa = 1: recorder 0
aaaa = 2: recorder 1
aaaa = 3: recorders 0 and 1
bbbb = parameter number (hexadecimal), that was not able to be written to.

Remedy:

- Temporarily activate or deactivate know-how protection (p7766).
- Include the signal in the OEM exception list (p7763, p7764).
- Where relevant do not record the signal.

A02055 Trace: Recording time too short

Message class: Error in the parameterization / configuration / commissioning procedure (18)
Message value: -
Component: None
Response: NONE
Acknowledgment: NONE

Cause: The trace duration is too short.
The minimum is twice the value of the trace clock cycle.

Remedy: Check the selected recording time and, if necessary, adjust.

A02056 Trace: Recording cycle too short

Message class: Error in the parameterization / configuration / commissioning procedure (18)
Message value: -
Component: None
Response: NONE
Acknowledgment: NONE

Cause: The selected recording clock cycle is shorter than the selected basic clock cycle 0.

Remedy: Increase the value for the trace cycle. The fastest cycle time can be read out using the commissioning tool.

A02057 Trace: Time slice clock cycle invalid

Message class: Error in the parameterization / configuration / commissioning procedure (18)
Message value: -
Component: None
Response: NONE
Acknowledgment: NONE

Cause: The time slice clock cycle selected does not match any of the existing time slices.

Remedy: Enter an existing time slice clock cycle. The fastest cycle time can be read out using the commissioning tool.

A02059 Trace: Time slice clock cycle for 2 x 8 recording channels not valid

Message class: Error in the parameterization / configuration / commissioning procedure (18)
Message value: -
Component: None
Response: NONE
Acknowledgment: NONE

Cause: The selected time slice clock cycle cannot be used for more than 4 recording channels.

Remedy: Enter the clock cycle of an existing time slice with a cycle time ≥ 4 ms or reduce the number of recording channels to 4 per trace.
The fastest cycle time can be read out using the commissioning tool.

A02060 Trace: Signal to be traced missing

Message class: Error in the parameterization / configuration / commissioning procedure (18)
Message value: -
Component: None
Response: NONE
Acknowledgment: NONE
Cause: - A signal to be traced was not specified.
- The specified signals are not valid.
Remedy: - Specify the signal to be traced.
- Check whether the relevant signal can be traced.

A02062 Trace: Invalid trigger signal

Message class: Error in the parameterization / configuration / commissioning procedure (18)
Message value: -
Component: None
Response: NONE
Acknowledgment: NONE
Cause: - A trigger signal was not specified.
- The specified signal does not exist.
- The specified signal is not a fixed-point signal.
- The specified signal cannot be used as a trigger signal for the trace.
Remedy: Specify a valid trigger signal.

A02063 Trace: Invalid data type

Message class: Error in the parameterization / configuration / commissioning procedure (18)
Message value: %1
Component: None
Response: NONE
Acknowledgment: NONE
Cause: The specified data type to select a signal using a physical address is invalid.
Remedy: Use a valid data type.

A02070 Trace: Parameter cannot be changed

Message class: Error in the parameterization / configuration / commissioning procedure (18)
Message value: -
Component: None
Response: NONE
Acknowledgment: NONE
Cause: The trace parameter settings cannot be changed when the trace is active.
Remedy: - Stop the trace before parameterization.
- If required, start the trace.

A02075 Trace: Pretrigger time too long

Message class: Error in the parameterization / configuration / commissioning procedure (18)
Message value: -
Component: None
Response: NONE
Acknowledgment: NONE

Cause: The selected pretrigger time must be shorter than the trace time.

Remedy: Check the pretrigger time setting and change if necessary.

F02080 Trace: Parameterization deleted due to unit changeover

Message class: Error in the parameterization / configuration / commissioning procedure (18)

Message value: -

Component: None

Response: NONE

Acknowledgment: IMMEDIATELY

Cause: The trace parameterization in the drive unit was deleted due to a unit changeover or a change in the reference parameters.

Remedy: Restart trace.

A02085 Message function: Parameterization error

Message class: Error in the parameterization / configuration / commissioning procedure (18)

Message value: Parameter: %1, index:%2

Component: Power Unit

Response: NONE

Acknowledgment: NONE

Cause: A parameterization error was identified when starting the variable message function.

Alarm value (r2124, interpret decimal):

yyxxxx dec: yy = index, xxxx = parameter

Remedy: Correct the parameter and restart.

Note:

The alarm is automatically withdrawn when stopping, or when successfully starting the variable message function.

A02096 MTrace 0: cannot be saved

Message class: Error in the parameterization / configuration / commissioning procedure (18)

Message value: %1

Component: None

Response: NONE

Acknowledgment: NONE

Cause: It is not possible to save the measurement results of a multiple trace on the memory card (trace recorder 0).

A multiple trace is not started or is canceled.

Alarm value (r2124, interpret decimal):

1: Memory card cannot be accessed.

- Card is not inserted or is blocked by a mounted USB drive.

3: Data save operation too slow.

- A second trace has been completed before the measurement results of the first trace were able to be saved.

- Writing the measurement result files to the card is blocked by the parameter save.

4: Data save operation canceled.

- For instance, the file required for the data save operation was not able to be found.

Remedy: - Insert or remove the memory card.

- Use a larger memory card.

- Configure a longer trace time or use an endless trace.

- Avoid saving parameters while a multiple trace is running.

- Check whether other functions are presently accessing measurement result files.

A02098 MTrace 1: cannot be saved

Message class: Error in the parameterization / configuration / commissioning procedure (18)

Message value: %1
Component: None
Response: NONE
Acknowledgment: NONE
Cause: It is not possible to save the measurement results of a multiple trace on the memory card (trace recorder 1).
A multiple trace is not started or is canceled.
Alarm value (r2124, interpret decimal):
1: Memory card cannot be accessed.
- Card is not inserted or is blocked by a mounted USB drive.
3: Data save operation too slow.
- A second trace has been completed before the measurement results of the first trace were able to be saved.
- Writing the measurement result files to the card is blocked by the parameter save.
4: Data save operation canceled.
- For instance, the file required for the data save operation was not able to be found.
Remedy:
- Insert or remove the memory card.
- Use a larger memory card.
- Configure a longer trace time or use an endless trace.
- Avoid saving parameters while a multiple trace is running.
- Check whether other functions are presently accessing measurement result files.

A02099 Trace: Insufficient Control Unit memory

Message class: Error in the parameterization / configuration / commissioning procedure (18)
Message value: -
Component: None
Response: NONE
Acknowledgment: NONE
Cause: The memory space still available on the Control Unit is no longer sufficient for the trace function.
Remedy: Reduce the memory required, e.g. as follows:
- Reduce the trace time.
- Increase the trace clock cycle.
- Reduce the number of signals to be traced.

A02150 TEC: Technology Extension cannot be loaded

Message class: Hardware/software error (1)
Message value: %1
Component: None
Response: NONE
Acknowledgment: NONE
Cause: The system was not able to load a Technology Extension.
Alarm value (r2124, interpret hexadecimal):
10 hex (16 dec):
The interface version in the DCB user library is not compatible to the DCC standard library that has been loaded.
12 hex (18 dec):
A technology package was not able to be downloaded to a Control Unit because the warm restart necessary was not able to be performed.
Only for internal Siemens troubleshooting.

12.3 Faults and alarms

Remedy:

- Carry out a POWER ON (switch-off/switch-on) for all components.
- Upgrade firmware to later version.
- Contact Technical Support.

For alarm value = 10 hex (16 dec):
Load a compatible DCB user library (compatible to the interface of the DCC standard library).
For alarm value = 12 hex (18 dec):
Carry out a POWER ON (switch-off/switch-on) for all components.

Note:
DCB: Drive Control Block
DCC: Drive Control Chart
TEC: Technology Extension

F02151 TEC: internal software error

Message class: Hardware/software error (1)

Message value: %1

Component: None

Response: OFF2

Acknowledgment: IMMEDIATELY

Cause: An internal software error has occurred within a Technology Extension.
Fault value (r0949, interpret hexadecimal):
Only for internal Siemens troubleshooting.

Remedy:

- Carry out a POWER ON (switch-off/switch-on) for all components.
- Upgrade firmware to later version.
- Contact Technical Support.
- Replace the Control Unit.

Note:
TEC: Technology Extension

F02152 TEC: insufficient memory

Message class: Hardware/software error (1)

Message value: %1

Component: None

Response: OFF1

Acknowledgment: IMMEDIATELY

Cause: The functionality on this Control Unit is too extensive (e.g. too many drives, functions, data sets, Technology Extensions, blocks, etc).
Fault value (r0949, interpret decimal):
Only for internal Siemens troubleshooting.

Remedy:

- Change the configuration on this Control Unit, e.g.
 - Use fewer axes
 - Reduce the number of configurable functions
 - Use fewer data sets
 - Reduce Technology Extensions and blocks
- Use an additional Control Unit.

F02153 TEC: technology function does not exist

Message class: Hardware/software error (1)

Message value: -

Component: None

Response: OFF2

Acknowledgment: IMMEDIATELY

Cause: A technology function (e.g. Technology Extension, DCB library) does not exist on the drive device.
When configuring, a technology function is activated, which does not exist on the drive device. This can occur when downloading a project or when powering up.

Remedy: - Load the required technology function to the drive device.
- If required, deactivate the technology function not required in the configuration.

Note:

DCB: Drive Control Block

TEC: Technology Extension

F03001 NVRAM checksum incorrect

Message class: Hardware/software error (1)

Message value: %1

Component: Control Unit (CU)

Response: NONE

Acknowledgment: IMMEDIATELY

Cause: A checksum error occurred when evaluating the non-volatile data (NVRAM) on the converter.
The NVRAM data affected was deleted.

Remedy: Carry out a POWER ON (switch-off/switch-on) for all components.

A03506 24 V power supply missing

Message class: Supply voltage fault (undervoltage) (3)

Message value: %1

Component: None

Response: NONE

Acknowledgment: NONE

Cause: The 24 V power supply for the digital outputs (X124) is missing.

Remedy: Check the terminals for the power supply voltage (X124, L1+, M).

F03590 TM: Module not ready

Message class: Error in the parameterization / configuration / commissioning procedure (18)

Message value: %1

Component: Terminal Module (TM)

Response: NONE

Acknowledgment: IMMEDIATELY

Cause: The Terminal Module involved does not send a ready signal and no valid cyclic data.
Fault value (r0949, interpret decimal):
Drive object number of the Terminal Module involved.

Remedy: - Check the 24 V power supply.
- Check the DRIVE-CLiQ wiring.

F05055 Parallel connection: Power units with illegal code numbers

Message class: Error in the parameterization / configuration / commissioning procedure (18)

Message value: Parameter: %1

Component: Power Unit

Response: OFF2

Acknowledgment: IMMEDIATELY

12.3 Faults and alarms

Cause: The code numbers of the power units do not match.
Fault value (r0949, interpret decimal):
Parameter in which the first different power unit code number was detected.

Remedy: Use power units with the same code number.
For parallel circuit configurations, only power units with identical power unit data may be used.

F05056 Parallel circuit: Power unit EEPROM versions differ

Message class: Error in the parameterization / configuration / commissioning procedure (18)

Message value: Parameter: %1

Component: Power Unit

Response: OFF2

Acknowledgment: IMMEDIATELY

Cause: The EEPROM versions of the power units do not match.
Fault value (r0949, interpret decimal):
Parameter in which the first different version number was detected.

Remedy: Use power units with the same EEPROM version.
Note:
For parallel circuit configurations, only power units with identical EEPROM versions may be used.

F05057 Parallel circuit: Power unit firmware versions differ

Message class: Error in the parameterization / configuration / commissioning procedure (18)

Message value: Parameter: %1

Component: Power Unit

Response: OFF2

Acknowledgment: IMMEDIATELY

Cause: The firmware versions of the power units connected in parallel do not match.
Fault value (r0949, interpret decimal):
Parameter in which the first different version number was detected.

Remedy: Use power units with the same firmware version.
For parallel circuit configurations, only power units with identical firmware versions may be used.

F05058 Parallel circuit: VSM EEPROM versions differ

Message class: General drive fault (19)

Message value: Parameter: %1

Component: Power Unit

Response: NONE

Acknowledgment: IMMEDIATELY

Cause: The EEPROM versions of the Voltage Sensing Modules (VSM) do not match.
Fault value (r0949, interpret decimal):
Parameter in which the first different version number was detected.

Remedy: For parallel circuit configurations, only Voltage Sensing Modules (VSM) with identical EEPROM versions may be used.

F05059 Parallel circuit: VSM firmware versions differ

Message class: General drive fault (19)

Message value: Parameter: %1

Component: Power Unit

Response: NONE

Acknowledgment: IMMEDIATELY

Cause: The firmware versions of the Voltage Sensing Module (VSM) do not match.
Fault value (r0949, interpret decimal):
Parameter in which the first different version number was detected.

Remedy: For parallel circuit configurations, only Voltage Sensing Modules (VSM) with identical firmware versions may be used.

F05060 Parallel circuit: Power unit firmware version does not match

Message class: Error in the parameterization / configuration / commissioning procedure (18)
Message value: Parameter: %1
Component: Power Unit
Response: OFF2
Acknowledgment: IMMEDIATELY

Cause: Firmware from version V02.30.01.00 is required when connecting the power units in parallel.

Remedy: Update the firmware of the power units (at least V02.30.01.00).

F06310 Supply voltage (p0210) incorrectly parameterized

Message class: Network fault (2)
Message value: -
Component: None
Response: NONE
Acknowledgment: IMMEDIATELY

Cause: For AC/AC drive units, the measured DC link voltage lies outside the tolerance range after precharging has been completed.
The following applies for the tolerance range: $1.16 * p0210 < r0070 < 1.6 * p0210$
Note:
The fault can only be acknowledged when the drive is switched off.
See also: p0210 (Device supply voltage)

Remedy: - Check the parameterized supply voltage and if required change (p0210).
- Check the line supply voltage.
See also: p0210 (Device supply voltage)

F07011 Drive: Motor overtemperature

Message class: Motor overload (8)
Message value: %1
Component: Motor
Response: OFF2
Acknowledgment: IMMEDIATELY

12.3 Faults and alarms

Cause: The calculated motor temperature is too high.
Possible causes:
- Motor overloaded.
- Motor ambient temperature too high.
- Sensor wire breakage.
Fault value (r0949, interpret decimal):
200:
Motor temperature model 1 (I2t): temperature too high.
300:
Motor temperature model 3: after the monitoring time has expired, the temperature is still higher than the alarm threshold.
301:
Motor temperature model 3: temperature is too high, or the model has not been parameterized.
302:
Motor temperature model 3: Encoder temperature is not within the valid range.
400:
Additional motor overload protection: the load is too high.

Remedy:

- Reduce the motor load.
- Check the ambient temperature and the motor ventilation.
- Check the wiring and temperature sensor connection.
- Check monitoring limits.
- Check activation of the additional motor overload protection (5375).

A07012 Drive: Motor temperature model overtemperature

Message class: Motor overload (8)
Message value: %1
Component: Motor
Response: NONE
Acknowledgment: NONE

Cause: Motor temperature model 1/3 or the additional motor overload protection identified that the alarm threshold was exceeded.
Hysteresis:2K
Alarm value (r2124, interpret decimal):
200:
Motor temperature model 1 (I2t): temperature too high.
300:
Motor temperature model 3: temperature too high.
400:
Additional motor overload protection: the load is too high. If the load remains at this level, the drive is shut down with fault F07011.
See also: r0034, p0613

Remedy:

- Check the motor load and if required, reduce.
- Check the motor ambient temperature.
- Check activation of the additional motor overload protection (p5375).

See also: r0034 (Motor utilization thermal)

F07082 Macro: Execution not possible

Message class: Error in the parameterization / configuration / commissioning procedure (18)
Message value: Fault cause: %1, supplementary information: %2, preliminary parameter number: %3
Component: None
Response: NONE
Acknowledgment: IMMEDIATELY

Cause: The macro cannot be executed.
Fault value (r0949, interpret hexadecimal):
ccccbbaa hex:
cccc = preliminary parameter number, bb = supplementary information, aa = fault cause
Fault causes for the trigger parameter itself:
19: Called file is not valid for the trigger parameter.
20: Called file is not valid for parameter 15.
21: Called file is not valid for parameter 700.
22: Called file is not valid for parameter 1000.
23: Called file is not valid for parameter 1500.
24: Data type of a TAG is incorrect (e.g. Index, number or bit is not U16).
Fault causes for the parameters to be set:
25: Error level has an undefined value.
26: Mode has an undefined value.
27: A value was entered as string in the tag value that is not "DEFAULT".
31: Entered drive object type unknown.
32: A device was not able to be found for the determined drive object number.
34: A trigger parameter was recursively called.
35: It is not permissible to write to the parameter via macro.
36: Check, writing to a parameter unsuccessful, parameter can only be read, not available, incorrect data type, value range or assignment incorrect.
37: Source parameter for a signal interconnection was not able to be determined.
38: An index was set for a non-indexed (or CDS-dependent) parameter.
39: No index was set for an indexed parameter.
41: A bit operation is only permissible for parameters with the parameter format DISPLAY_BIN.
42: A value not equal to 0 or 1 was set for a bit operation.
43: Reading the parameter to be changed by the bit operation was unsuccessful.
51: Factory setting for DEVICE may only be executed on the DEVICE.
61: The setting of a value was unsuccessful.

Remedy: - Check the parameter involved.
- Check the macro file and signal interconnection.

F07083 Template: ACX file not found

Message class: Error in the parameterization / configuration / commissioning procedure (18)
Message value: Parameter: %1
Component: None
Response: NONE
Acknowledgment: IMMEDIATELY
Cause: The template to be executed was not able to be found.
Fault value (r0949, interpret decimal):
Parameter number with which the execution was started.
Remedy: - Check whether the corresponding template number is available.

F07084 Macro: Condition for WaitUntil not fulfilled

Message class: Error in the parameterization / configuration / commissioning procedure (18)
Message value: Parameter: %1
Component: None
Response: NONE
Acknowledgment: IMMEDIATELY

12.3 Faults and alarms

Cause: The WaitUntil condition set in the macro was not fulfilled in a certain number of attempts.
Fault value (r0949, interpret decimal):
Parameter number for which the condition was set.

Remedy: Check and correct the conditions for the WaitUntil loop.

F07085 Drive: Open-loop/closed-loop control parameters changed

Message class: Error in the parameterization / configuration / commissioning procedure (18)
Message value: Parameter: %1
Component: None
Response: NONE
Acknowledgment: IMMEDIATELY

Cause: Open-loop/closed-loop control parameters have had to be changed.
Possible causes:
1. As a result of other parameters, they have exceeded the dynamic limits.
2. They cannot be used due to the fact that the hardware detected not having certain features.
3. The value is estimated as the thermal time constant is missing.
4. Motor temperature model 1 is activated as thermal motor protection is missing.
See also: p1082 (Maximum speed)

Remedy: Not necessary.
It is not necessary to change the parameters as they have already been correctly limited.

F07086 Units changeover: Parameter limit violation due to reference value change

Message class: Error in the parameterization / configuration / commissioning procedure (18)
Message value: Parameter: %1
Component: None
Response: NONE
Acknowledgment: IMMEDIATELY

Cause: A reference parameter was changed in the system. This resulted in the fact that for the parameters involved, the selected value was not able to be written in the per unit notation.
The values of the parameters were set to the corresponding violated minimum limit/maximum limit or to the factory setting.
Possible causes:
- The steady-state minimum limit/maximum limit or that defined in the application was violated.
Fault value (r0949, parameter):
Diagnostics parameter to display the parameters that were not able to be re-calculated.
See also: p0304, p0305, p2000, p2002, p2003

Remedy: Check the adapted parameter value and if required correct.

F07088 Units changeover: Parameter limit violation due to units changeover

Message class: Error in the parameterization / configuration / commissioning procedure (18)
Message value: Parameter: %1
Component: None
Response: NONE
Acknowledgment: IMMEDIATELY

Cause: A changeover of units was initiated. This resulted in a violation of a parameter limit
Possible causes for the violation of a parameter limit:
- When rounding off a parameter corresponding to its decimal places, the steady-state minimum limit or maximum limit was violated.
- Inaccuracies for the data type "FloatingPoint".
In these cases, when the minimum limit is violated then the parameter value is rounded up and when the maximum limited is violated the parameter value is rounded down.
Fault value (r0949, interpret decimal).

Remedy: Check the adapted parameter values and if required correct.

A07089 Unit switchover: Function activation is blocked because the units have been switched over

Message class: Error in the parameterization / configuration / commissioning procedure (18)
Message value: -
Component: None
Response: NONE
Acknowledgment: NONE
Cause: An attempt was made to activate a function. This is not permissible if the units have already been changed over.
Remedy: Restore units that have been changed over to the factory setting.

F07090 Drive: Upper torque limit less than the lower torque limit

Message class: Error in the parameterization / configuration / commissioning procedure (18)
Message value: -
Component: None
Response: OFF2
Acknowledgment: IMMEDIATELY
Cause: The upper torque limit is lower than the lower torque limit.
Remedy: When setting the torque limits via telegram 750, the positive torque limit must be \geq the negative torque.

A07091 Drive: determined current controller dynamic response invalid

Message class: Error in the parameterization / configuration / commissioning procedure (18)
Message value: %1
Component: Control Unit (CU)
Response: NONE
Acknowledgment: NONE
Cause: When One Button Tuning is activated (p5300 = 1), the current controller is measured after the pulses have been enabled. Evaluation has indicated that the current control loop was not appropriately set.
Possible causes:
- Incorrectly set current controller.
- PRBS amplitude set too high (p5296).
Alarm value (r2124, interpret hexadecimal):
1: Dynamic response too low.
2: Current controller unstable.
Note:
PRBS: Pseudo Random Binary Signal (binary noise)
Remedy: - The measurement can be repeated with a smaller excitation amplitude (p5296).

A07092 Drive: moment of inertia estimator still not ready

Message class: Error in the parameterization / configuration / commissioning procedure (18)
Message value: %1
Component: Control Unit (CU)

12.3 Faults and alarms

Response: NONE
Acknowledgment: NONE
Cause: The moment of inertia estimator has still not determined any valid values.
The acceleration cannot be calculated.
The moment of inertia estimator has stabilized, if the frictional values as well as the moment of inertia were determined and the corresponding status signal is set.
Remedy: Traverse the axis until the moment of inertia estimator has stabilized.
This alarm is automatically withdrawn after the moment of inertia estimator has stabilized.

F07093 Drive: Test signal error

Message class: Error in the parameterization / configuration / commissioning procedure (18)

Message value: %1

Component: Control Unit (CU)

Response: OFF3

Acknowledgment: IMMEDIATELY

Cause: An error was identified when executing the "Test signal" function.
The function was not executed or was canceled.
Fault value (r0949, interpret decimal):
1: No distance limit has been defined (p5308 = 0).
2: The moment of inertia estimator has not stabilized in the parameterized time (p5309).
3: The parameterized distance (p5308) was exceeded.
4: No motor encoder parameterized (closed-loop speed control without encoder).
6: Pulse enable was withdrawn while traversing.
7: speed setpoint not equal to zero.
See also: p5308, p5309

Remedy: For fault value = 1:
- Define distance limiting (p5308).
For fault value = 2:
- Increase the duration, distance limit or speed limit (p5309, p5308, p1082, p1083, p1086).
For fault value = 3:
- Check distance limiting (p5308).
For fault value = 4:
- Configure speed control with encoder.
For fault value = 6:
- Keep the drive switched on until the "Test signal" function has been completely exited.
For fault value = 7:
- Set the speed setpoint to zero. It is possible that the setpoint was entered from the control panel.

A07094 General parameter limit violation

Message class: Hardware/software error (1)

Message value: Parameter: %1

Component: None

Response: NONE

Acknowledgment: NONE

Cause: As a result of the violation of a parameter limit, the parameter value was automatically corrected.
Minimum limit violated --> parameter is set to the minimum value.
Maximum limit violated --> parameter is set to the maximum value.
Alarm value (r2124, interpret decimal):
Parameter number, whose value had to be adapted.

Remedy: Check the adapted parameter values and if required correct.

A07095 Drive: One Button Tuning activated

Message class: Error in the parameterization / configuration / commissioning procedure (18)
Message value: -
Component: None
Response: NONE
Acknowledgment: NONE
Cause: The One Button Tuning function is active.
One Button Tuning is performed at the next switch-on command.
See also: p5300 (Autotuning selection)
Remedy: Not necessary.
The alarm is automatically withdrawn after One Button Tuning has been exited (p5300 = 0).

F07097 Drive: Test signal error distance limiting

Message class: Error in the parameterization / configuration / commissioning procedure (18)
Message value: Fault cause: %1, traversing distance: %2
Component: Control Unit (CU)
Response: OFF3
Acknowledgment: IMMEDIATELY
Cause: An error was identified when executing function "Test signal" or One Button Tuning selection (p5300 = 1).
The function was not executed or was canceled.
Fault value (r0949, interpret decimal):
yyyyxxx hex: yyyy = fault cause, xxxx = traversing distance.
See also: p5308, p5309
Remedy: - Enter the traversing path in parameter p5308 - or deselect the function involved in p5301.
- For fault cause = 1, 2, shorter traversing paths may be possible.
For fault cause = 1:
- Deselect bit 0 and bit 1 in parameter p5301.
For fault cause = 2:
- Deselect bit 2 in parameter p5301.
For fault cause = 3:
- Deselect bit 4 and bit 5 in parameter p5301.

A07200 Drive: Master control ON command present

Message class: Error in the parameterization / configuration / commissioning procedure (18)
Message value: -
Component: None
Response: NONE
Acknowledgment: NONE
Cause: The ON/OFF1 command is present (no 0 signal).
The command is either influenced via binary signal sink c0840 (actual CDS) or control word bit 0 via the master control.
Remedy: Switch the signal to 0 via binary signal sink c0840 (actual CDS) or control word bit 0 via the master control.

F07220 Drive: Master control by PLC missing

Message class: Communication error to the higher-level control system (9)
Message value: -
Component: None
Response: OFF1
Acknowledgment: IMMEDIATELY

12.3 Faults and alarms

Cause: The "master control by PLC" signal was missing in operation.
- The higher-level control has withdrawn the "master control by PLC" signal.
- Data transfer via the fieldbus (controller/drive) was interrupted.

Remedy: - Check the "master control by PLC" signal and, if required, switch in.
- Check data transfer via the fieldbus (controller/drive).

Note:
If the drive should continue to operate after withdrawing "master control by PLC", then the fault response must be parameterized to NONE or the message type should be parameterized as alarm.

F07300 Drive: Line contactor feedback signal missing

Message class: Auxiliary unit faulted (20)

Message value: -

Component: None

Response: OFF2

Acknowledgment: IMMEDIATELY

Cause: - The line contactor was not able to be closed within the time in p0861.
- The line contactor was not able to be opened within the time in p0861.
- The line contactor dropped out during operation
- The line contactor has closed although the drive converter is switched off.

Remedy: - Check the setting of p0860.
- Check the feedback circuit from the line contactor.
- Increase the monitoring time in p0861.

A07350 Drive: Measuring probe parameterized to a digital output

Message class: Error in the parameterization / configuration / commissioning procedure (18)

Message value: %1

Component: None

Response: NONE

Acknowledgment: NONE

Cause: The measuring probe is connected to a bidirectional digital input/output and the terminal is set as output.
Alarm value (r2124, interpret decimal):
8: DI/DO 8 (X122.9/X132.1)
9: DI/DO 9 (X122.10/X132.2)
10: DI/DO 10 (X122.12/X132.3)
11: DI/DO 11 (X122.13/X132.4)
12: DI/DO 12 (X132.9)
13: DI/DO 13 (X132.10)
14: DI/DO 14 (X132.12)
15: DI/DO 15 (X132.13)

Regarding the terminal designation:
The first designation is valid for CU320, the second for CU305.
Remedy: - Deselect measuring probe (p0488, p0489).

F07410 Drive: Current controller output limited

Message class: Application/technological function faulted (17)

Message value: -

Component: None

Response: OFF2

Acknowledgment: IMMEDIATELY

- Cause:** The condition " $I_{act} = 0$ and $U_{q_set_1}$ longer than 16 ms at its limit" is present and can be caused by the following:
- Motor not connected or motor contactor open.
 - No DC link voltage present.
 - Power unit defective.
- Remedy:**
- Connect the motor or check the motor contactor.
 - Check the DC link voltage (r0070).
 - Check the power unit.

F07412 Drive: Commutation angle incorrect (motor model)

Message class: Position/speed actual value incorrect or not available (11)

Message value: %1

Component: None

Response: ENCODER

Acknowledgment: IMMEDIATELY

Cause: An incorrect commutation angle was detected, which can result in a positive coupling in the speed controller.

Possible causes:

- The phase sequence of the output phases for the motor is incorrect (e.g. the phases are interchanged).
- The motor encoder is incorrectly adjusted with respect to the magnet position.
- The motor encoder is damaged.
- The motor encoder speed signal is faulted.
- The control loop is instable due to incorrect parameterization.

Remedy:

- Check the phase sequence for the motor, and if required, correct.
- If the encoder mounting was changed, re-adjust the encoder.
- Replace the defective motor and/or motor encoder.

F07419 Drive: Current setpoint filter adaptation error

Message class: Error in the parameterization / configuration / commissioning procedure (18)

Message value: %1

Component: None

Response: OFF1

Acknowledgment: IMMEDIATELY

Cause: An error has occurred when configuring or when using the "Current setpoint filter adaptation" function.

Fault value (r0949, interpret binary):

Bit 2: the assigned filter is a type or has a characteristic, which is unsuitable for adaptation.

Bit 3: the assigned filter has not been activated (p1656).

Bits 0, 1, 4 ... 31: internal fault occurred.

Remedy: The remedy should be applied depending on the fault value.

For bit 2:

Set the filter type "General filter 2nd order" and set the characteristic of a bandstop filter.

For bit 3:

Activate filter (p1656).

For bits 0, 1, 4 ... 15:

- Carry out a POWER ON (switch-off/switch-on) for all components.
- Upgrade firmware to later version.

F07420 Drive: Current setpoint filter natural frequency > Shannon frequency

Message class: Error in the parameterization / configuration / commissioning procedure (18)

Message value: %1

Component: None

Response: NONE

12.3 Faults and alarms

Acknowledgment: IMMEDIATELY

Cause: One of the filter natural frequencies is greater than the Shannon frequency.
The Shannon frequency is calculated according to the following formula: $0.5 / \text{current controller sampling time}$
Fault value (r0949, interpret binary):
Bit 0: Filter 1 (p1658, p1660)
Bit 1: Filter 2 (p1663, p1665)
Bit 2: Filter 3 (p1668, p1670)
Bit 3: Filter 4 (p1673, p1675)

Remedy: - Reduce the numerator or denominator natural frequency of the current setpoint filter involved.
- Deactivate the filter involved (p1656).

F07421 Drive: Speed filter natural frequency > Shannon frequency

Message class: Error in the parameterization / configuration / commissioning procedure (18)
Message value: %1
Component: None
Response: NONE
Acknowledgment: IMMEDIATELY

Cause: One of the filter natural frequencies is greater than the Shannon frequency.
The Shannon frequency is calculated according to the following formula: $0.5 / \text{speed controller sampling time}$.
Fault value (r0949, interpret binary):
Bit 0: Filter 1 (p1417, p1419)
Bit 1: Filter 2 (p1423, p1425)

Remedy: - Reduce the numerator or denominator natural frequency of the speed setpoint filter involved.
- Deactivate the filter involved (p1414).

F07422 Drive: Reference model natural frequency > Shannon frequency

Message class: Error in the parameterization / configuration / commissioning procedure (18)
Message value: -
Component: None
Response: NONE
Acknowledgment: IMMEDIATELY

Cause: The natural filter frequency of the PT2 element for the reference model (p1433) is greater than the Shannon frequency.
The Shannon frequency is calculated according to the following formula: $0.5 / \text{speed controller sampling time}$.

Remedy: - Reduce the natural frequency of PT2 element for reference model (p1433).

F07432 Drive: Motor without overvoltage protection

Message class: Error in the parameterization / configuration / commissioning procedure (18)
Message value: %1
Component: None
Response: OFF2
Acknowledgment: IMMEDIATELY

Cause: In the case of a fault at maximum speed, the motor can generate an overvoltage that can destroy the converter.

Remedy: Limit the maximum speed (p1082) without any additional protection.
Note:
The maximum speed is calculated as follows:
 $p1082 \leq 11.695 * \text{DC link voltage overvoltage threshold} / r0316$
DC link voltage overvoltage threshold:
- Line connection 1 AC: 410 V
- Line connection 3 AC: 820 V
See also: r0316, p1082

F07434 Drive: It is not possible to change the direction of rotation with the pulses enabled

Message class: Application/technological function faulted (17)
Message value: -
Component: None
Response: OFF2
Acknowledgment: IMMEDIATELY
Cause: With the pulses enabled, a drive data set that has a different parameterized direction of rotation was selected (p1821). It is only possible to change the motor direction of rotation using p1821 when the pulses are inhibited.
Remedy: - Change over the drive data set with the pulses inhibited.
- Ensure that the changeover to a drive data set does not result in the motor direction of rotation being changed (i.e. for these drive data sets, the same value must be in p1821).
See also: p1821 (Direction of rotation)

A07440 EPOS: Jerk time is limited

Message class: Error in the parameterization / configuration / commissioning procedure (18)
Message value: -
Component: None
Response: NONE
Acknowledgment: NONE
Cause: The calculation of the jerk time $T_r = \max(p2572, p2573) / p2574$ resulted in an excessively high value so that the jerk time is internally limited to 1000 ms.
Note:
The alarm is also output if jerk limiting is not active.
Remedy: - Increase the jerk limiting (p2574).
- Reduce maximum acceleration or maximum deceleration (p2572, p2573).
See also: p2572 (EPOS maximum acceleration), p2573 (EPOS maximum deceleration), p2574 (EPOS jerk limiting)

A07441 LR: Save the position offset of the absolute encoder adjustment

Message class: Error in the parameterization / configuration / commissioning procedure (18)
Message value: -
Component: None
Response: NONE
Acknowledgment: NONE
Cause: The status of the absolute encoder adjustment has changed.
To permanently accept the determined position offset, it must be retentively saved (p0977).
Possible causes:
- Motor or encoder were replaced (applies to EQN and DQI).
- Position-relevant parameters were changed.
- A non-adjusted encoder was adjusted (retentively save the project).
Note:
This message is not output when switching-on the axis after having first moved it in the switched-off state, as long as the parameterizable monitoring window was not exited.
Remedy: Readjust the encoder.
See also: p2507 (LR absolute encoder adjustment status)

F07442 LR: Multiturn does not match the modulo range

Message class: Error in the parameterization / configuration / commissioning procedure (18)
Message value: -
Component: None
Response: OFF1

12.3 Faults and alarms

Acknowledgment: IMMEDIATELY

Cause: The ratio between the multivolt resolution and the modulo range (p2576) is not an integer number.
This results in the adjustment being set back, as the position actual value cannot be reproduced after switch-off/switch-on.

Remedy: Make the ratio between the multivolt resolution and the modulo range an integer number.

The ratio v is calculated as follows:

$$v = (p0421 * p2506 * p2505) / (p2504 * p2576)$$

See also: p2504 (LR motor/load motor revolutions), p2505 (LR motor/load load revolutions), p2506, p2576 (EPOS modulo correction modulo range)

F07443 LR: Home position not in the permissible range

Message class: Error in the parameterization / configuration / commissioning procedure (18)

Message value: %1

Component: None

Response: OFF1

Acknowledgment: IMMEDIATELY

Cause: The home position received when adjusting the encoder via numerical signal sink r2599 lies outside the half of the encoder range and cannot be set as actual axis position.

Fault value (r0949, interpret decimal):

Maximum permissible value for the home position

Remedy: Set the home position to a lower value than specified in the fault value.

See also: c2598 (EPOS home position signal), p2599 (EPOS home position value)

F07446 Load gearbox: Position tracking cannot be reset

Message class: Application/technological function faulted (17)

Message value: %1

Component: None

Response: OFF1

Acknowledgment: IMMEDIATELY

Cause: The position tracking cannot be reset.

Remedy: Reset the position tracking as follows:

- Select encoder commissioning.
- Reset position tracking, position (p2720.2 = 1).
- Deselect encoder commissioning.

Then acknowledge the fault and, if necessary, re-adjust the absolute encoder (p2507).

F07450 LR: Standstill monitoring has responded

Message class: Application/technological function faulted (17)

Message value: -

Component: None

Response: OFF1

Acknowledgment: IMMEDIATELY

Cause: After the standstill monitoring time (p2543) expired, the drive left the standstill window (p2542).

- Standstill window set too small (p2542).
- Standstill monitoring time set too low (p2543).
- Position loop gain too low (p2538).
- Position loop gain too high (instability/oscillation, p2538).
- Mechanical overload.
- Connecting cable, motor/drive converter incorrect (phase missing, interchanged).

Remedy: Check the causes and resolve.

F07451 LR: Position monitoring has responded
Message class: Application/technological function faulted (17)
Message value: -
Component: None
Response: OFF1
Acknowledgment: IMMEDIATELY
Cause: When the position monitoring time (p2545) expired, the drive had still not reached the positioning window (p2544).
- Positioning window parameterized too small (p2544).
- Position monitoring time parameterized too short (p2545).
- Position loop gain too low (p2538).
- Position loop gain too high (instability/oscillation, p2538).
- Drive mechanically locked.
Remedy: Check the causes and resolve.

F07452 LR: Following error too high
Message class: Application/technological function faulted (17)
Message value: -
Component: None
Response: OFF1
Acknowledgment: IMMEDIATELY
Cause: The difference between the position setpoint position actual value (following error dynamic model, r2563) is higher than the tolerance (p2546).
- The drive torque or accelerating capacity exceeded.
- Position measuring system fault.
- Encoder cable interrupted.
- Position control sense incorrect.
- Mechanical system locked.
- Excessively high traversing velocity or excessively high position reference value (setpoint) differences.
Remedy: Check the causes and resolve.

F07453 LR: Position actual value preprocessing error
Message class: Application/technological function faulted (17)
Message value: -
Component: None
Response: OFF1
Acknowledgment: IMMEDIATELY
Cause: A position measuring system fault has occurred (F31110, F31111).
An error has occurred during the position actual value preprocessing.
Remedy: Resolve the cause of the position measuring position fault.
Check the encoder for the position actual value preprocessing.
See also: p2502 (LR encoder assignment)

A07454 LR: Position actual value preprocessing does not have a valid encoder
Message class: Error in the parameterization / configuration / commissioning procedure (18)
Message value: -
Component: None
Response: NONE
Acknowledgment: NONE

12.3 Faults and alarms

Cause: One of the following problems has occurred with the position actual value preprocessing:

- An encoder is not assigned for the position actual value preprocessing (p2502 = 0).
- An encoder is assigned, but no encoder data set (p0187 = 99 or p0188 = 99 or p0189 = 99).
- An encoder and an encoder data set have been assigned, however, the encoder data set does not contain any encoder data (p0400 = 0) or invalid data (e.g. p0408 = 0).

Remedy: Check the drive data sets, encoder data sets and encoder assignment.
See also: p0400 (Encoder type selection), p2502 (LR encoder assignment)

A07455 EPOS: Maximum velocity limited

Message class: Error in the parameterization / configuration / commissioning procedure (18)

Message value: -

Component: None

Response: NONE

Acknowledgment: NONE

Cause: The maximum velocity (p2571) is too high to correctly calculate the modulo correction.
Within the sampling time for positioning, at the maximum velocity, a maximum of the half modulo length must be moved through. p2571 was limited to this value.

Remedy: - Reduce the maximum velocity (p2571).

A07456 EPOS: Setpoint velocity limited

Message class: Application/technological function faulted (17)

Message value: -

Component: None

Response: NONE

Acknowledgment: NONE

Cause: The actual setpoint velocity is greater than the parameterized maximum velocity (p2571) and is therefore limited.

Remedy: - Check the entered setpoint velocity.
- Reduce the velocity override (c2646).
- Increase the maximum velocity (p2571).

A07457 EPOS: Combination of input signals illegal

Message class: Application/technological function faulted (17)

Message value: %1

Component: None

Response: NONE

Acknowledgment: NONE

Cause: An illegal combination of input signals that are simultaneously set was identified.
Alarm value (r2124, interpret decimal):

- 0: Jog 1 and jog 2 (c2589, c2590).
- 1: Jog 1 or jog 2 and direct setpoint input/MDI (c2589, c2590, c2647).
- 2: Jog 1 or jog 2 and start homing (c2589, c2590, c2595).
- 3: Jog 1 or jog 2 and activate traversing task (c2589, c2590, c2631).
- 4: Direct setpoint input/MDI and starting homing (c2647, c2595).
- 5: Direct setpoint input/MDI and activate traversing task (c2647, c2631).
- 6: Start homing and activate traversing task (c2595, c2631).

Remedy: Check the appropriate input signals and correct.

F07458 EPOS: Reference cam not found

Message class: Application/technological function faulted (17)

Message value: -

Component: None
Response: OFF1
Acknowledgment: IMMEDIATELY
Cause: After the active homing starts, the axis moved through the maximum permissible distance to search for the reference cam without actually finding the reference cam.
Remedy: - Check signal "Reference cam" (c2612).
- Check the maximum permissible distance to the reference cam (p2606).
- If axis does not have any reference cam, then set p2607 to 0.
See also: p2606 (EPOS active homing reference cam maximum distance), p2607 (EPOS active homing reference cam available), c2612 (EPOS active homing reference cam)

F07459 EPOS: No zero mark

Message class: Application/technological function faulted (17)
Message value: -
Component: None
Response: OFF1
Acknowledgment: IMMEDIATELY
Cause: After leaving the reference cam, the axis has traversed the maximum permissible distance between the reference cam and zero mark without finding the zero mark.
Remedy: - Check the encoder regarding the zero mark.
- Check the maximum permissible distance between the reference cam and zero mark (p2609).
- use an external encoder zero mark (equivalent zero mark) (p0494).
See also: p2609 (EPOS active homing max distance reference cam and zero mark)

F07460 EPOS: End of reference cam not found

Message class: Application/technological function faulted (17)
Message value: -
Component: None
Response: OFF1
Acknowledgment: IMMEDIATELY
Cause: In the "active homing" mode, when approaching the zero mark, the axis reached the end of the traversing range without detecting an edge at binary signal "Reference cam" (c2612).
Maximum traversing range: -2147483648 [LU] ... -2147483647 [LU]
Remedy: - Check signal "reference cam" (c2612).
- Repeat active homing.
See also: c2612 (EPOS active homing reference cam)

A07461 EPOS: Home position not set

Message class: Application/technological function faulted (17)
Message value: -
Component: None
Response: NONE
Acknowledgment: NONE
Cause: When starting a traversing block/direct setpoint input, a home position is not set (r2684.11 = 0).
Remedy: Carry out homing (active homing, passive homing, set home position).

A07462 EPOS: Selected traversing block number does not exist

Message class: Error in the parameterization / configuration / commissioning procedure (18)
Message value: %1
Component: None

12.3 Faults and alarms

Response: NONE
Acknowledgment: NONE
Cause: A traversing block selected via binector input c2625 ... c2629 was started via binary signal c2631 = 0/1 edge "Activate traversing task".
- The number of the started traversing block is not contained in p2616[0...n].
- The started traversing block is suppressed.
Alarm value (r2124, interpret decimal):
Number of the selected traversing block that is also not available.
Remedy: - Correct the traversing program.
- Select an available traversing block number.

A07463 EPOS: External block change not requested in the traversing block

Message class: Application/technological function faulted (17)
Message value: %1
Component: None
Response: NONE
Acknowledgment: NONE
Cause: For a traversing block with the block change enable CONTINUE_EXTERNAL_ALARM, the external block change was not requested.
Alarm value (r2124, interpret decimal):
Number of the traversing block.
Remedy: Resolve the reason why the signal edge at the measuring probe is missing.

F07464 EPOS: Traversing block is inconsistent

Message class: Error in the parameterization / configuration / commissioning procedure (18)
Message value: %1
Component: None
Response: OFF1
Acknowledgment: IMMEDIATELY
Cause: The traversing block does not contain valid information.
Alarm value (r2124, interpret decimal):
Number of the traversing block with invalid information.
Remedy: Check the traversing block and where relevant, take into consideration alarms that are present.

A07465 EPOS: Traversing block does not have a subsequent block

Message class: Error in the parameterization / configuration / commissioning procedure (18)
Message value: %1
Component: None
Response: NONE
Acknowledgment: NONE
Cause: There is no subsequent block in the traversing block.
Alarm value (r2124, interpret decimal):
Number of the traversing block with the missing subsequent block.
Remedy: - Parameterize this traversing block with the block change enable END.
- Parameterize additional traversing blocks with a higher block number and for the last block, using the block change enable END.

A07466 EPOS: Traversing block number assigned a multiple number of times

Message class: Error in the parameterization / configuration / commissioning procedure (18)
Message value: %1

Component: None
Response: NONE
Acknowledgment: NONE
Cause: The same traversing block number was assigned a multiple number of times.
Alarm value (r2124, interpret decimal):
Number of the traversing block that was assigned a multiple number of times.
Remedy: Correct the traversing blocks.

A07467 EPOS: Traversing block has illegal task parameters

Message class: Error in the parameterization / configuration / commissioning procedure (18)
Message value: %1
Component: None
Response: NONE
Acknowledgment: NONE
Cause: The task parameter in the traversing block contains an illegal value.
Alarm value (r2124, interpret decimal):
Number of the traversing block with an illegal task parameter.
Remedy: Correct the task parameter in the traversing block.

A07468 EPOS: Traversing block jump destination does not exist

Message class: Error in the parameterization / configuration / commissioning procedure (18)
Message value: %1
Component: None
Response: NONE
Acknowledgment: NONE
Cause: In a traversing block, a jump was programmed to a non-existent block.
Alarm value (r2124, interpret decimal):
Number of the traversing block with a jump destination that does not exist.
Remedy: - Correct the traversing block.
- Add the missing traversing block.

A07469 EPOS: Traversing block target position < negative software limit switch

Message class: Error in the parameterization / configuration / commissioning procedure (18)
Message value: %1
Component: None
Response: NONE
Acknowledgment: NONE
Cause: In the traversing block the specified absolute target position lies outside the range limited by the negative software limit switch.
Alarm value (r2124, interpret decimal):
Number of the traversing block with illegal target position.
Remedy: - Correct the traversing block.
- Change the negative software limit switch (c2578, p2580).

A07470 EPOS: Traversing block target position > positive software limit switch

Message class: Error in the parameterization / configuration / commissioning procedure (18)
Message value: %1
Component: None
Response: NONE

12.3 Faults and alarms

Acknowledgment: NONE

Cause: In the traversing block the specified absolute target position lies outside the range limited by the positive software limit switch.

Alarm value (r2124, interpret decimal):

Number of the traversing block with illegal target position.

Remedy: - Correct the traversing block.
- Change the positive software limit switch (c2579, p2581).

A07471 EPOS: Traversing block target position outside the modulo range

Message class: Application/technological function faulted (17)

Message value: %1

Component: None

Response: NONE

Acknowledgment: NONE

Cause: In the traversing block the target position lies outside the modulo range.

Alarm value (r2124, interpret decimal):

Number of the traversing block with illegal target position.

Remedy: - In the traversing block, correct the target position.
- Change the modulo range (p2576).

A07472 EPOS: Traversing block ABS_POS/ABS_NEG not possible

Message class: Application/technological function faulted (17)

Message value: %1

Component: None

Response: NONE

Acknowledgment: NONE

Cause: In the traversing block the positioning mode ABS_POS or ABS_NEG were parameterized with the modulo correction not activated.

Alarm value (r2124, interpret decimal):

Number of the traversing block with the illegal positioning mode.

Remedy: Correct the traversing block.

A07473 EPOS: Beginning of traversing range reached

Message class: Application/technological function faulted (17)

Message value: -

Component: None

Response: NONE

Acknowledgment: NONE

Cause: When traversing, the axis has moved to the traversing range limit.

Remedy: Move away in the positive direction.

A07474 EPOS: End of traversing range reached

Message class: Application/technological function faulted (17)

Message value: -

Component: None

Response: NONE

Acknowledgment: NONE

Cause: When traversing, the axis has moved to the traversing range limit.

Remedy: Move away in the negative direction.

F07475 EPOS: Target position < start of traversing range

Message class: Error in the parameterization / configuration / commissioning procedure (18)
Message value: -
Component: None
Response: OFF1
Acknowledgment: IMMEDIATELY
Cause: The target position for relative traversing lies outside the traversing range.
Remedy: Correct the target position.

F07476 EPOS: Target position > end of the traversing range

Message class: Error in the parameterization / configuration / commissioning procedure (18)
Message value: -
Component: None
Response: OFF1
Acknowledgment: IMMEDIATELY
Cause: The target position for relative traversing lies outside the traversing range.
Remedy: Correct the target position.

A07477 EPOS: Target position < negative software limit switch

Message class: Error in the parameterization / configuration / commissioning procedure (18)
Message value: -
Component: None
Response: NONE
Acknowledgment: NONE
Cause: In the actual traversing operation, the target position is less than the negative software limit switch.
Remedy: - Correct the target position.
- Change the negative software limit switch (c2578, p2580).
See also: c2578 (EPOS negative software limit switch), p2580 (EPOS negative software limit switch), c2582 (EPOS software limit switch activation)

A07478 EPOS: Target position > positive software limit switch

Message class: Error in the parameterization / configuration / commissioning procedure (18)
Message value: -
Component: None
Response: NONE
Acknowledgment: NONE
Cause: In the actual traversing operation, the target position is greater than the positive software limit switch.
Remedy: - Correct the target position.
- Change the positive software limit switch (c2579, p2581).
See also: c2579 (EPOS positive software limit switch), p2581 (EPOS positive software limit switch), c2582 (EPOS software limit switch activation)

A07479 EPOS: Negative software limit switch reached

Message class: Application/technological function faulted (17)
Message value: -
Component: None
Response: NONE
Acknowledgment: NONE
Cause: The axis is at the position of the negative software limit switch. An active traversing block was interrupted.

12.3 Faults and alarms

Remedy:

- Correct the target position.
- Change the negative software limit switch (c2578, p2580).

See also: c2578 (EPOS negative software limit switch), p2580 (EPOS negative software limit switch), c2582 (EPOS software limit switch activation)

A07480 EPOS: Positive software limit switch reached

Message class: Application/technological function faulted (17)

Message value: -

Component: None

Response: NONE

Acknowledgment: NONE

Cause: The axis is at the position of the positive software limit switch. An active traversing block was interrupted.

Remedy:

- Correct the target position.
- Change the positive software limit switch (c2579, p2581).

See also: c2579 (EPOS positive software limit switch), p2581 (EPOS positive software limit switch), c2582 (EPOS software limit switch activation)

F07481 EPOS: Axis position < negative software limit switch

Message class: Application/technological function faulted (17)

Message value: -

Component: None

Response: OFF1

Acknowledgment: IMMEDIATELY

Cause: The actual position of the axis is less than the position of the negative software limit switch.

Remedy:

- Correct the target position.
- Change the negative software limit switch (c2578, p2580).

See also: c2578 (EPOS negative software limit switch), p2580 (EPOS negative software limit switch), c2582 (EPOS software limit switch activation)

F07482 EPOS: Axis position > positive software limit switch

Message class: Application/technological function faulted (17)

Message value: -

Component: None

Response: OFF1

Acknowledgment: IMMEDIATELY

Cause: The actual position of the axis is greater than the position of the positive software limit switch.

Remedy:

- Correct the target position.
- Change the positive software limit switch (c2579, p2581).

See also: c2579 (EPOS positive software limit switch), p2581 (EPOS positive software limit switch), c2582 (EPOS software limit switch activation)

A07483 EPOS: Travel to fixed stop clamping torque not reached

Message class: Application/technological function faulted (17)

Message value: -

Component: None

Response: NONE

Acknowledgment: NONE

Cause: The fixed stop in the traversing block was reached without the clamping torque/clamping force having been achieved.

Remedy:

- Check the torque limits (p1520, p1521).

F07484 EPOS: Fixed stop outside the monitoring window

Message class: Application/technological function faulted (17)
Message value: -
Component: None
Response: OFF3
Acknowledgment: IMMEDIATELY
Cause: In the "fixed stop reached" state, the axis has moved outside the defined monitoring window (p2635).
Remedy: - Check the monitoring window (p2635).
- Check the mechanical system.

F07485 EPOS: Fixed stop not reached

Message class: Application/technological function faulted (17)
Message value: -
Component: None
Response: OFF1
Acknowledgment: IMMEDIATELY
Cause: In a traversing block with the task FIXED STOP, the end position was reached without detecting a fixed stop.
Remedy: - Check the traversing block and locate the target position further into the workpiece.
- If required, reduce the maximum following error window to detect the fixed stop (p2634).

A07486 EPOS: Intermediate stop missing

Message class: Application/technological function faulted (17)
Message value: -
Component: None
Response: NONE
Acknowledgment: NONE
Cause: In operating mode "traversing blocks" or "direct setpoint input/MDI", at the start of motion, c2640 is set to an intermediate stop, i.e. to a 0 signal.
Remedy: Set c2640 to "No intermediate stop" (1 signal) and restart motion.
See also: c2640 (EPOS intermediate stop (0 signal))

A07487 EPOS: Reject traversing task missing

Message class: Application/technological function faulted (17)
Message value: -
Component: None
Response: NONE
Acknowledgment: NONE
Cause: In the modes "Traversing blocks" or "Direct setpoint input/MDI" at the start of motion, the binary signal sink "Do not reject traversing task/reject traversing task" (c2641) does not have a 1 signal.
Remedy: Connect a 1 signal to the binary signal sink "Do not reject traversing task/reject traversing task" (c2641) and restart motion.
See also: c2641 (EPOS reject traversing task (0 signal))

F07488 EPOS: Relative positioning not possible

Message class: Application/technological function faulted (17)
Message value: -
Component: None
Response: OFF1
Acknowledgment: IMMEDIATELY

12.3 Faults and alarms

Cause: In the mode "direct setpoint input/MDI", for continuous transfer (c2649 = 1) relative positioning was selected (c2648 = 0 signal).
Remedy: Check the control.

F07490 EPOS: Enable signal withdrawn while traversing

Message class: Application/technological function faulted (17)

Message value: -

Component: None

Response: OFF1

Acknowledgment: IMMEDIATELY

Cause: - For a standard assignment, another fault may have occurred as a result of withdrawing the enable signals.
- The drive is in the "switching on inhibited" state (for a standard assignment).

Remedy: - Set the enable signals or check the cause of the fault that first occurred and then result (for a standard assignment).
- Check the assignment to enable the basic positioning function.

F07491 EPOS: Negative hardware limit switch reached

Message class: Application/technological function faulted (17)

Message value: -

Component: None

Response: OFF3

Acknowledgment: IMMEDIATELY

Cause: A 0 signal was detected at c2569, i.e. the negative hardware limit switch was reached.
For a positive traversing direction, the negative hardware limit switch was reached - i.e. the hardware limit switch wiring is incorrect.
See also: c2569 (EPOS negative hardware limit switch)

Remedy: - Leave the negative hardware limit switch in the positive traversing direction and return the axis to the valid traversing range.
- Check the wiring of the hardware limit switch.

F07492 EPOS: Positive hardware limit switch reached

Message class: Application/technological function faulted (17)

Message value: -

Component: None

Response: OFF3

Acknowledgment: IMMEDIATELY

Cause: A 0 signal was detected at c2570, i.e. the positive hardware limit switch was reached.
For a negative traversing direction, the positive hardware limit switch was reached - i.e. the hardware limit switch wiring is incorrect.
See also: c2570 (EPOS positive hardware limit switch)

Remedy: - Leave the positive hardware limit switch in the negative traversing direction and return the axis to the valid traversing range.
- Check the wiring of the hardware limit switch.

F07493 LR: Overflow of the value range for position actual value

Message class: Application/technological function faulted (17)

Message value: %1

Component: None

Response: OFF1

Acknowledgment: IMMEDIATELY

Cause: The value range (-2147483648 ... 2147483647) for the position actual value representation was exceeded.
When the overflow occurs, the "homed" or "adjustment absolute measuring system" status is reset.
Fault value (r0949, interpret decimal):
1: The position actual value (r2521) has exceeded the value range.
2: The encoder position actual value Gn_XIST2 has exceeded the value range.
3: The maximum encoder value times the factor to convert the absolute position Gn_XIST2 from increments to length units (LU) has exceeded the value range for displaying the position actual value.

Remedy: If required, reduce the traversing range or position resolution (p2506).
Note for fault value = 3:
If the value for the maximum possible absolute position (LU) is greater than 4294967296, then it is not possible to make an adjustment due to an overflow.
For rotary encoders, the maximum possible absolute position (LU) is calculated as follows:
 $p2506 * p2505 / p2504$
 $p2506 * p2505 * p0421 / p2504$ for multturn encoders

F07494 LR: Drive Data Set changeover in operation

Message class: Application/technological function faulted (17)
Message value: -
Component: None
Response: OFF1
Acknowledgment: IMMEDIATELY
Cause: A Drive Data Set changeover (DDS) with a change of the mechanical relationships (p2503 ... 2506), direction of rotation (p1821) or the encoder assignment (p2502) was requested in operation.
Note:
DDS: Drive Data Set

Remedy: To changeover the drive data set, initially, exit the "operation" mode.

A07495 LR: Homing function interrupted

Message class: Application/technological function faulted (17)
Message value: -
Component: None
Response: NONE
Acknowledgment: NONE
Cause: An activated homing function (homing mark search or measuring probe evaluation) was canceled.
Possible causes:
- An encoder fault has occurred (Gn_ZSW.15 = 1).
- Position actual value was set during an activated homing function.
- Homing mark search and measuring probe evaluation simultaneously activated.
- Activated homing function (homing mark search or measuring probe evaluation) was de-activated.

Remedy: - Check the causes and resolve.
- Reset the control and activate the required function.

A07496 EPOS: Enable not possible

Message class: Application/technological function faulted (17)
Message value: %1
Component: None
Response: NONE
Acknowledgment: NONE

12.3 Faults and alarms

Cause: It is not possible to enable the basic positioner because at least one condition is missing.
Alarm value (r2124, interpret decimal):
1: EPOS enable missing.
2: Position actual value, valid feedback signal missing.

Remedy: Check the corresponding missing condition.

F07498 LR: Measuring probe evaluation not possible

Message class: Application/technological function faulted (17)

Message value: %1

Component: None

Response: NONE

Acknowledgment: NONE

Cause: When evaluating the measuring probe, an error occurred.
Alarm value (r2124, interpret decimal):
6:
The input terminal for the measuring probe is not set.
4098:
Error when initializing the measuring probe.
4100:
The measuring pulse frequency is too high.
> 50000:
The measuring clock cycle is not a multiple integer of the position controller clock cycle.

Remedy: Deactivate measuring probe evaluation (c2509 = 0 signal).
For alarm value = 6:
Set the input terminal for the measuring probe (p0488, p0489 or p2517, p2518).
For alarm value = 4098:
Check the Control Unit hardware.
For alarm value = 4100:
Reduce the frequency of the measuring pulses at the measuring probe.
For alarm value > 50000:
Set the clock cycle ratio of the measuring clock cycle to the position controller clock cycle to an integer multiple.
To do this, the currently effective measuring clock cycle can be determined from the alarm value as follows:
 $T_{\text{meas}} [125 \mu\text{s}] = \text{alarm value} - 50000$
With PROFIBUS, the measuring clock cycle corresponds to the bus clock cycle (r2064[1]).
Without PROFIBUS, the measuring clock cycle is an internal cycle time that cannot be influenced.

F07499 EPOS: Reversing cam approached with the incorrect traversing direction

Message class: Application/technological function faulted (17)

Message value: -

Component: None

Response: OFF3

Acknowledgment: IMMEDIATELY

Cause: The negative reversing cam was approached in the positive traversing direction, or the positive reversing cam was approached in the negative traversing direction.
See also: c2613 (EPOS active homing negative reversing cam), c2614 (EPOS active homing positive reversing cam)

Remedy: - Check the wiring of the reversing cam (c2613, c2614).
- Check the traversing direction to approach the reversing cam.

F07503 EPOS: Hardware limit switch approached with the incorrect traversing direction

Message class: Application/technological function faulted (17)

Message value: %1
Component: None
Response: NONE
Acknowledgment: IMMEDIATELY
Cause: The negative hardware limit switch was approached in the positive traversing direction, or the positive hardware limit switch was approached in the negative traversing direction.
Remedy:
- Check the wiring of the hardware limit switch (c2569, c2570).
- Check the traversing direction when approaching the hardware limit switch.

A07507 EPOS: Home position cannot be set

Message class: Application/technological function faulted (17)
Message value: -
Component: Motor
Response: NONE
Acknowledgment: NONE
Cause: After the home position correction, the position setpoint lies outside the traversing range limits.
Remedy:
- Optimize the position controller.
- Due to a possible position controller deviation, home position p2599 should not be directly placed at the traversing range limits.

A07520 Drive: Motor cannot be changed over

Message class: Application/technological function faulted (17)
Message value: %1
Component: None
Response: NONE
Acknowledgment: NONE
Cause: A motor data set switchover was requested via PROFINET that the converter does not support.
Remedy: - Check the PROFINET telegram

A07530 Drive: Drive Data Set DDS not present

Message class: Error in the parameterization / configuration / commissioning procedure (18)
Message value: -
Component: None
Response: NONE
Acknowledgment: NONE
Cause: A data set switchover was requested via PROFINET that the converter does not support.
Remedy: - Check the PROFINET telegram

A07531 Drive: Command Data Set CDS not present

Message class: Error in the parameterization / configuration / commissioning procedure (18)
Message value: -
Component: None
Response: NONE
Acknowledgment: NONE
Cause: The selected command data set is not available (r0836 > p0170). The command data set was not changed over.
Remedy:
- Select the existing command data set.
- Set up additional command data sets.

A07550 Drive: Not possible to reset encoder parameters**Message class:** Hardware/software error (1)**Message value:** %1**Component:** None**Response:** NONE**Acknowledgment:** NONE**Cause:** When restoring a factory setting, it was not possible to reset the encoder parameters. The encoder parameters are directly read out of the encoder.

Alarm value (r2124, interpret decimal):

Component number of the encoder involved.

Remedy:
- Repeat the operation.
- Check the encoder connection.**F07555 Drive encoder: Configuration position tracking****Message class:** Error in the parameterization / configuration / commissioning procedure (18)**Message value:** Component number: %1, encoder data set: %2, drive data set: %3, fault cause: %4**Component:** Encoder 1**Response:** OFF2**Acknowledgment:** IMMEDIATELY**Cause:** For position tracking, the configuration is not supported.

Position tracking can only be activated for absolute encoders.

For linear axes, it is not possible to simultaneously activate the position tracking for load and measuring gears.

Fault value (r0949, interpret hexadecimal):

ddccbbaa hex

aa = encoder data set

bb = component number

cc = drive data set

dd = fault cause

dd = 00 hex = 0 dec

An absolute encoder is not being used.

dd = 01 hex = 1 dec

Position tracking cannot be activated because the memory of the internal NVRAM is not sufficient or a Control Unit does not have an NVRAM.

dd = 02 hex = 2 dec

For a linear axis, the position tracking was activated for the load and measuring gearbox.

dd = 03 hex = 3 dec

Position tracking cannot be activated because position tracking with another gear ratio, axis type or tolerance window has already been detected for this encoder data set.

dd = 04 hex = 4 dec

A linear encoder is being used.

See also: p0404 (Encoder configuration effective)

Remedy: For fault value 0:

- Use an absolute encoder.

For fault value 1:

- Use a Control Unit with sufficient NVRAM.

For fault value = 2, 4:

- If necessary, deselect the position tracking (p0411 for the measuring gearbox, p2720 for the load gearbox).

For fault value 3:

- Only activate position tracking of the load gearbox in the same encoder data set if the gear ratio (p2504, p2505), axis type (p2720.1) and tolerance window (p2722) are also the same. These parameters must be the same in all drive data sets, which use the same motor encoder.

F07556 Measuring gearbox: Position tracking, maximum actual value exceeded

Message class: Position/speed actual value incorrect or not available (11)

Message value: Component number: %1, encoder data set: %2

Component: None

Response: NONE

Acknowledgment: IMMEDIATELY

Cause: When the position tracking of the measuring gearbox is configured, the drive/encoder identifies a maximum possible absolute position actual value (r0483) that cannot be represented within 32 bits.

Maximum value: $p0408 * p0412 * 2^{p0419}$

Fault value (r0949, interpret decimal):

aaaayyx hex: yy = component number, xx = encoder data set

See also: p0408 (Rotary encoder pulse number)

Remedy:

- Reduce the fine resolution (p0419).
- Reduce the multiturn resolution (p0412).

A07557 Motor encoder: Home position not in the permissible range

Message class: Application/technological function faulted (17)

Message value: %1

Component: None

Response: NONE

Acknowledgment: NONE

Cause: The home position received via p2599 when adjusting the encoder lies outside half of the encoder range and cannot be set as actual axis position.

The maximum permissible value is displayed in the supplementary information.

Remedy: Set the home position less than the value from the supplementary information.
See also: c2598 (EPOS home position signal)

F07562 Drive, encoder: Position tracking, incremental encoder not possible

Message class: Error in the parameterization / configuration / commissioning procedure (18)

Message value: Fault cause: %1, component number: %2, encoder data set: %3

Component: None

Response: OFF2

Acknowledgment: IMMEDIATELY

Cause: The requested position tracking for incremental encoders is not supported.

Fault value (r0949, interpret hexadecimal):

ccccbbaa hex

aa = encoder data set

bb = component number

cccc = fault cause

cccc = 00 hex = 0 dec

The encoder type does not support the "Position tracking incremental encoder" function.

cccc = 01 hex = 1 dec

Position tracking cannot be activated because the memory of the internal NVRAM is not sufficient or a Control Unit does not have an NVRAM.

cccc = 04 hex = 4 dec

A linear encoder is used that does not support the "position tracking" function.

See also: p0404 (Encoder configuration effective)

Remedy:

- Check the encoder parameterization (p0400, p0404).
- Use a Control Unit with sufficient NVRAM.
- If required, deselect position tracking for the incremental encoder (p0411.3 = 0).

A07565 Drive: Encoder error in PROFIdrive encoder interface 1**Message class:** Position/speed actual value incorrect or not available (11)**Message value:** %1**Component:** Sensor Module Encoder 1**Response:** NONE**Acknowledgment:** NONE**Cause:** An encoder error was signaled for encoder 1 via the PROFIdrive encoder interface (G1_ZSW.15).
Alarm value (r2124, interpret decimal):
Error code from G1_XIST2.**Remedy:** Acknowledge the encoder error using the encoder control word (G1_STW.15 = 1).

A07569 Enc identification active**Message class:** Error in the parameterization / configuration / commissioning procedure (18)**Message value:** -**Component:** None**Response:** NONE**Acknowledgment:** NONE**Cause:** During encoder identification (waiting) with p0400 = 10100, the encoder could still not be identified.
There is possibly an incorrect encoder or no encoder available, an incorrect encoder cable inserted or no encoder cable inserted.**Remedy:** - Check the encoder cable and if necessary connect it.
- Enter the corresponding encoder type in p0400.

F07575 Drive: Motor encoder not ready**Message class:** Position/speed actual value incorrect or not available (11)**Message value:** -**Component:** Sensor Module Encoder 1**Response:** OFF2**Acknowledgment:** IMMEDIATELY**Cause:** The motor encoder signals that it is not ready.
- Initialization of encoder 1 (motor encoder) was unsuccessful.
- The function "parking encoder" is active (encoder control word G1_STW.14 = 1).
- The Sensor Module is defective.**Remedy:** Evaluate other active faults via the motor encoder.

A07577 Motor encoder: Measuring probe evaluation not possible**Message class:** Application/technological function faulted (17)**Message value:** %1**Component:** None**Response:** NONE**Acknowledgment:** NONE**Cause:** When evaluating the measuring probe, an error occurred.
Alarm value (r2124, interpret decimal):
6: The input terminal for the measuring probe is not set.
4098: Error when initializing the probe.
4100: The measuring pulse frequency is too high.
4200: The bus cycle time is not a multiple integer of the position controller clock cycle.

Remedy: Deactivate measuring probe evaluation (c2509 = 0 signal).
For alarm value = 6:
Set the input terminal for the measuring probe (p0488, p0489 or p2517, p2518).
For alarm value = 4098:
Check the Control Unit hardware.
For alarm value = 4100:
Reduce the frequency of the measuring pulses at the measuring probe.
For alarm value = 4200:
Set the clock cycle ratio between the bus cycle time and the position controller clock cycle to an integer multiple.

A07580 Drive: No Sensor Module with matching component number

Message class: Error in the parameterization / configuration / commissioning procedure (18)
Message value: Encoder data set: %1
Component: None
Response: NONE
Acknowledgment: NONE
Cause: A Sensor Module with the specified component number was not found.
Alarm value (r2124, interpret decimal):
Encoder data set involved.
Remedy: Correct the component number of the Sensor Module.

A07581 Motor encoder: Position actual value preprocessing error

Message class: Position/speed actual value incorrect or not available (11)
Message value: -
Component: Encoder 1
Response: NONE
Acknowledgment: NONE
Cause: An error has occurred during the position actual value preprocessing.
Remedy: Check the encoder for the position actual value preprocessing.
See also: p2502 (LR encoder assignment)

A07587 Motor encoder: Position actual value preprocessing has no valid encoder

Message class: Error in the parameterization / configuration / commissioning procedure (18)
Message value: -
Component: Encoder 1
Response: NONE
Acknowledgment: NONE
Cause: The following problem has occurred during the position actual value preprocessing:
- An encoder data set has been assigned, however, the encoder data set does not contain any encoder data (p0400 = 0) or invalid data (e.g. p0408 = 0).
Remedy: Check the drive data sets, encoder data sets.
See also: p0400 (Encoder type selection), p2502 (LR encoder assignment)

A07593 Motor encoder: Value range for position actual value exceeded

Message class: Application/technological function faulted (17)
Message value: %1
Component: None
Response: NONE
Acknowledgment: NONE

12.3 Faults and alarms

Cause: The value range (-2147483648 ... 2147483647) for the position actual value representation was exceeded.
When the overflow occurs, the "homed" or "absolute encoder adjusted" status is reset.
Alarm value (r2124, interpret decimal):
1: The position actual value (r2521) has exceeded the value range.
2: The encoder position actual value Gn_XIST2 has exceeded the value range.
3: The maximum encoder value multiplied by the factor to convert the absolute position Gn_XIST2 from increments to length units (LU) has exceeded the value range for displaying the position actual value.

Remedy: If required, reduce the traversing range or position resolution.
For alarm value = 3:
Reducing the position resolution and conversion factor:
- Reduce the length unit (LU) per load revolution for rotary encoders (p2506).

A07596 Motor encoder: Homing function interrupted

Message class: Application/technological function faulted (17)

Message value: -

Component: None

Response: NONE

Acknowledgment: NONE

Cause: An activated homing function (homing mark search or measuring probe evaluation) was canceled.
- An encoder fault has occurred (Gn_ZSW.15 = 1).
- Position actual value was set during an activated homing function.
- Homing mark search and measuring probe evaluation simultaneously activated.
- Activated homing function (homing mark search or measuring probe evaluation) was de-activated.

Remedy: - Check the causes and resolve.
- Reset the control and activate the required function.

F07800 Drive: No power unit present

Message class: Error in the parameterization / configuration / commissioning procedure (18)

Message value: -

Component: Power Unit

Response: NONE

Acknowledgment: IMMEDIATELY

Cause: The power unit parameters cannot be read or no parameters are stored in the power unit.
It is possible that the DRIVE-CLiQ cable between the Control Unit and power unit is interrupted or defective.
Note:
This fault also occurs if an incorrect topology was selected in the commissioning tool and this parameterization is then downloaded to the Control Unit.

Remedy: - Carry out a POWER ON (switch-off/switch-on) for all components.
- Check the DRIVE-CLiQ cable between the Control Unit and power unit.
- Check the power unit and replace if necessary.
- Check the Control Unit, and if required replace it.
- After correcting the topology, the parameters must be again downloaded using the commissioning tool.

F07801 Drive: Motor overcurrent

Message class: Motor overload (8)

Message value: -

Component: Motor

Response: OFF2

Acknowledgment: IMMEDIATELY

- Cause:** The permissible motor limit current was exceeded.
- Active current limit too low.
 - Current controller not correctly set.
 - Load is too high.
 - Short-circuit in the motor cable or ground fault.
 - Motor current does not match the drive current.
- Remedy:**
- Reduce the load.
 - Check the motor and motor cables for short-circuit and ground fault.
 - Check the drive and motor combination.

F07802 Drive: Infeed not ready

- Message class:** Infeed faulted (13)
- Message value:** -
- Component:** None
- Response:** OFF2
- Acknowledgment:** IMMEDIATELY
- Cause:** The drive does not signal a ready state after an internal switch-on command.
- DC link voltage is not present.
 - Defective drive.
 - Supply voltage incorrectly set.
- Remedy:**
- Check the enable signals for the drive.
 - Replace the drive.
 - Check the line supply voltage setting (p0210).

F07808 HF Damping Module: damping not ready

- Message class:** Power electronics faulted (5)
- Message value:** %1
- Component:** None
- Response:** OFF2
- Acknowledgment:** IMMEDIATELY
- Cause:** When switching on or in the switched-on state, the HF Damping Module does not return a ready signal.
- Fault value (r0949, interpret hexadecimal):
- 1: Fault at switch-on identified.
 - 2: Fault during operation identified.
- Remedy:**
- Check the DRIVE-CLiQ wiring to the HF Damping Module.
 - Check the 24 V supply voltage.
 - If required, replace the HF Damping Module.
- Note:
- HF Damping Module

F07810 Drive: Power unit EEPROM without rated data

- Message class:** Hardware/software error (1)
- Message value:** -
- Component:** Power Unit
- Response:** NONE
- Acknowledgment:** IMMEDIATELY
- Cause:** No rated data are stored in the power unit EEPROM.
- Remedy:** Replace the power unit or inform Siemens Customer Service.

F07815 Drive: Power unit has been changed

Message class: Error in the parameterization / configuration / commissioning procedure (18)

Message value: Parameter: %1

Component: Power Unit

Response: NONE

Acknowledgment: IMMEDIATELY

Cause: The code number of the actual power unit does not match the saved number. This occurs if a saved configuration (SD card, backup file) of a converter with another power rating is used.

Fault value only for internal Siemens diagnostics.

See also: p0201 (Power unit code number)

Remedy:

- Reset to the factory settings, which corresponds to recommissioning the converter.
- Use an SD card or backup file with the configuration correct for the drive being used and switch-off/switch-on the drive.
- In case of doubt, before using an SD card, delete the existing configuration of the USER folder.
- For a series commissioning, only use the same converter types (order number, power class).

F07860 External fault 1

Message class: External measured value / signal state outside the permissible range (16)

Message value: -

Component: None

Response: OFF2

Acknowledgment: IMMEDIATELY

Cause: The condition for "External fault 1" is active.

Note:

"External fault 1" is initiated by a 1/0 edge via c2106.

See also: c2106 (External fault 1)

Remedy:

- Eliminate the causes of this fault.
- Acknowledge fault.

F07900 Drive: Motor blocked/speed controller at its limit

Message class: Application/technological function faulted (17)

Message value: -

Component: Motor

Response: OFF2

Acknowledgment: IMMEDIATELY

Cause: The motor operates longer than 0.2 seconds at the torque limit and below the speed threshold in p2175.

This signal can also be initiated if the speed actual value is oscillating and the speed controller output repeatedly goes to its limit.

See also: p2175, p2177

Remedy:

- Check that the motor can freely move.
- Check the effective torque limit (r1538, r1539).
- Check the parameter of the "Motor blocked" signal and possibly correct (p2175).

F07901 Drive: Motor overspeed

Message class: Application/technological function faulted (17)

Message value: -

Component: Motor

Response: OFF2

Acknowledgment: IMMEDIATELY

Cause: The maximum permissible speed was either positively or negatively exceeded (p1082).

Remedy:

- Check the speed controller (p1460, p1462).
- Check the moment of inertia (p1498).
- Check the maximum speed (p1082).

A07920 Drive: Torque/speed too low

Message class: Application/technological function faulted (17)
Message value: -
Component: Motor
Response: NONE
Acknowledgment: NONE
Cause: The torque deviates from the torque/speed envelope characteristic (too low).
Remedy:

- Check the connection between the motor and load.
- Adapt the parameterization corresponding to the load.

A07921 Drive: Torque/speed too high

Message class: Application/technological function faulted (17)
Message value: -
Component: Motor
Response: NONE
Acknowledgment: NONE
Cause: The torque deviates from the torque/speed envelope characteristic (too high).
Remedy:

- Check the connection between the motor and load.
- Adapt the parameterization corresponding to the load.

A07922 Drive: Torque/speed out of tolerance

Message class: Application/technological function faulted (17)
Message value: -
Component: Motor
Response: NONE
Acknowledgment: NONE
Cause: The torque deviates from the torque/speed envelope characteristic.
Remedy:

- Check the connection between the motor and load.
- Adapt the parameterization corresponding to the load.

F07923 Drive: Torque/speed too low

Message class: Application/technological function faulted (17)
Message value: -
Component: Motor
Response: OFF1
Acknowledgment: IMMEDIATELY
Cause: The torque deviates from the torque/speed envelope characteristic (too low).
Remedy:

- Check the connection between the motor and load.
- Adapt the parameterization corresponding to the load.

F07924 Drive: Torque/speed too high

Message class: Application/technological function faulted (17)
Message value: -
Component: Motor
Response: OFF1

Acknowledgment: IMMEDIATELY

Cause: The torque deviates from the torque/speed envelope characteristic (too high).

Remedy: - Check the connection between the motor and load.
- Adapt the parameterization corresponding to the load.

F07925 Drive: Torque/speed out of tolerance

Message class: Application/technological function faulted (17)

Message value: -

Component: Motor

Response: OFF1

Acknowledgment: IMMEDIATELY

Cause: The torque deviates from the torque/speed envelope characteristic.

Remedy: - Check the connection between the motor and load.
- Adapt the parameterization corresponding to the load.

F07934 Drive: S120 Combi motor holding brake configuration

Message class: Error in the parameterization / configuration / commissioning procedure (18)

Message value: %1

Component: None

Response: NONE

Acknowledgment: IMMEDIATELY

Cause: A connected motor holding brake has been detected with an S120 Combi. However, this brake has not been assigned to just one Combi feed drive and, therefore, brake control is not configured (correctly).

Fault value (r0949, interpret decimal):

0: No motor holding brake is assigned (p1215 = 0 or 3 on all S120 Combi feed drives).

1: More than one motor holding brake has been assigned (p1215 = 1 or 2 on more than one S120 Combi feed drive) - or there is more than one DRIVE-CLiQ motor with motor holding brake.

2: Brake was accidentally assigned to the spindle (p1215 = 1); this is not permitted for this software release.

3: An attempt was made to enable the function "Safe Brake Control" (SBC, p9602 = p9802 = 1) for the spindle. This is not permitted for this software release.

Remedy: Check whether the motor holding brake has been assigned to one S120 Combi feed drive exclusively (p1215 = 1 or 2).
The fault will only be withdrawn once the motor holding brake has been assigned to just one of the S120 Combi feed drives (p1215 = 1 or 2 for this one drive). From this point, the motor holding brake will be controlled by this drive.
See also: p1215 (Motor holding brake configuration)

F07955 Drive: Motor has been changed

Message class: Error in the parameterization / configuration / commissioning procedure (18)

Message value: -

Component: Motor

Response: NONE

Acknowledgment: IMMEDIATELY

Cause: The code number of the actual motor with DRIVE-CLiQ does not match the saved number.
If available:

The code numbers of the bearings, gearbox and brake do not match the saved numbers.

Remedy: Connect the original motor and switch on the converter again (POWER ON) - or restore the factory settings.
Note:
The data for bearings, gearbox and brake are reloaded.

F07956 Drive: Motor code does not match the list (catalog) motor

Message class: Error in the parameterization / configuration / commissioning procedure (18)

Message value: %1
Component: Motor
Response: NONE
Acknowledgment: IMMEDIATELY
Cause: The motor code of the connected motor with DRIVE-CLiQ does not match the possible list motor types (see selection in p0300).
The connected motor with DRIVE-CLiQ might not be supported by this firmware version.
Fault value (r0949, interpret decimal):
Motor code of the connected motor with DRIVE-CLiQ.
Note:
The first three digits of the motor code generally correspond to the list motor type.
Remedy: Use a motor with DRIVE-CLiQ and the matching motor code.

F08000 TB: +/-15 V power supply faulted

Message class: Supply voltage fault (undervoltage) (3)
Message value: %1
Component: Controller Extension (CX)
Response: NONE
Acknowledgment: IMMEDIATELY
Cause: Terminal Board 30 detects an incorrect internal power supply voltage.
Fault value (r0949, interpret decimal):
0: Error when testing the monitoring circuit.
1: Fault in normal operation.
Remedy: - Replace Terminal Board 30.
- Replace Control Unit.

F08010 TB: Analog-digital converter

Message class: Hardware/software error (1)
Message value: -
Component: Controller Extension (CX)
Response: NONE
Acknowledgment: IMMEDIATELY
Cause: The analog/digital converter on Terminal Board 30 has not supplied any converted data.
Remedy: - Check the power supply.
- Replace Terminal Board 30.

A08560 IE: Syntax error in configuration file

Message class: Error in the parameterization / configuration / commissioning procedure (18)
Message value: -
Component: None
Response: NONE
Acknowledgment: NONE
Cause: A syntax error has been detected in the configuration file for the Industrial Ethernet interface (X127). The saved configuration file has not been loaded.
Note:
IE: Industrial Ethernet
Remedy: Reinitialize the station using the "Edit Ethernet node" screen form (e.g. with Startdrive commissioning tool).

A08561 IE: Consistency error affecting adjustable parameters

Message class: Error in the parameterization / configuration / commissioning procedure (18)

12.3 Faults and alarms

Message value: %1
Component: None
Response: NONE
Acknowledgment: NONE
Cause: A consistency error was detected when activating the configuration for the Industrial Ethernet interface (X127).
Alarm value (r2124, interpret decimal):
0: General consistency error
1: Error in the IP configuration (IP address, subnet mask or standard gateway).
2: Error in the station names.
5: Standard gateway is also set at the PROFINET interface.
6: The station name is also set at the PROFINET interface.
7: The IP address is located in the same subnet as the IP address of the PROFINET interface.
Note:
For alarm value = 0, 1, 2, 5, 7 the following applies: the configuration was not changed.
For alarm value = 6 the following applies: The new configuration was however activated.
IE: Industrial Ethernet
Remedy: Reinitialize the station using the "Edit Ethernet node" screen form (e.g. with Startdrive commissioning tool).

A08562 PROFINET: Syntax error in configuration file

Message class: Error in the parameterization / configuration / commissioning procedure (18)
Message value: -
Component: None
Response: NONE
Acknowledgment: NONE
Cause: A syntax error has been detected in the configuration file for the PROFINET interface (X150). The saved configuration file has not been loaded.
Remedy: Reinitialize the station using the "Edit Ethernet node" screen form (e.g. with Startdrive commissioning tool).

A08563 PROFINET: Consistency error affecting adjustable parameters

Message class: Error in the parameterization / configuration / commissioning procedure (18)
Message value: %1
Component: None
Response: NONE
Acknowledgment: NONE
Cause: A consistency error was detected when activating the configuration for the PROFINET interface (X150).
Alarm value (r2124, interpret decimal):
0: General consistency error
1: Error in the IP configuration (IP address, subnet mask or standard gateway).
2: Error in the station names.
3: DHCP was not able to be activated, as a cyclic PROFINET connection already exists.
5: Standard gateway is also set at the Industrial Ethernet interface (X127).
6: Standard station name is also set at the Industrial Ethernet interface (X127).
7: IP address is located in the same subnet as the IP address of the Industrial Ethernet interface (X127).
Note:
For alarm value = 0, 1, 2, 3, 4, 5, 7, the following applies: the configuration was not changed.
For alarm value = 6 the following applies: The new configuration was however activated.
DHCP: Dynamic Host Configuration Protocol
Remedy: Reinitialize the station using the "Edit Ethernet node" screen form (e.g. with Startdrive commissioning tool).

A08566 IIOt: Syntax error in configuration file

Message class: Error in the parameterization / configuration / commissioning procedure (18)

Message value: -

Component: None

Response: NONE

Acknowledgment: NONE

Cause: A syntax error has been detected in the configuration file for the IIOt interface (X128). The saved configuration file has not been loaded.

Note:

IIOt: Industrial Internet of Things

Remedy: Reinitialize the station using the "Edit Ethernet node" screen form (e.g. with Startdrive commissioning tool).

A08567 IIOt: Consistency error for adjustable parameters

Message class: Error in the parameterization / configuration / commissioning procedure (18)

Message value: %1

Component: None

Response: NONE

Acknowledgment: NONE

Cause: A consistency error was detected when activating the configuration for the IIOt interface (X128).

Alarm value (r2124, interpret decimal):

0: General consistency error

1: Error in the IP configuration (IP address, subnet mask or standard gateway).

2: Error in the station names.

5: Standard gateway is also set at the PROFINET interface.

6: The station name is also set at the PROFINET interface.

7: The IP address is located in the same subnet as the IP address of the PROFINET interface.

Note:

For alarm value = 0, 1, 2, 5, 7 the following applies: the configuration was not changed.

For alarm value = 6 the following applies: The new configuration was however activated.

IE: Industrial Ethernet

Remedy: Reinitialize the station using the "Edit Ethernet node" screen form (e.g. with Startdrive commissioning tool).

A08800 PROFlenergy energy-saving mode active

Message class: Communication error to the higher-level control system (9)

Message value: %1

Component: None

Response: NONE

Acknowledgment: NONE

Cause: The PROFlenergy energy-saving mode is active

Alarm value (r2124, interpret decimal):

Mode ID of the active PROFlenergy energy-saving mode.

Remedy: The alarm is automatically withdrawn when the energy-saving mode is exited.

Note:

The energy-saving mode is exited after the following events:

- The PROFlenergy command end_pause is received from the higher-level control.
 - The higher-level control has changed into the STOP operating state.
 - The PROFINET connection to the higher-level control has been disconnected.
-

F13000 License not adequate

Message class: Error in the parameterization / configuration / commissioning procedure (18)

12.3 Faults and alarms

Message value: %1
Component: Control Unit (CU)
Response: OFF2
Acknowledgment: IMMEDIATELY
Cause:
- The converter uses options that require a license and the licenses are not sufficient.
- An error has occurred when checking the licensing.
Fault value (r0949, interpret decimal):
0: Adequate licensing was not able to be determined as there is no licensing data available on the memory card.
1: Adequate licensing was not able to be determined as the memory card with the required licensing data was withdrawn in operation or the memory card is defective.
2: Adequate licensing was not able to be determined as there is no licensing data available on the memory card.
3: Adequate licensing was not able to be determined as the licensing data does not match the serial number of the memory card being used.
4, 5, 6, 7: Adequate licensing was not able to be determined as the licensing data were manipulated and are therefore invalid.
8, 9: An internal error occurred when checking the license.
Remedy:
For fault value = 0:
Transfer a license file with the required licenses to the converter.
For fault value = 1:
Reinsert the memory card into the converter. If you have to replace a defective memory card, contact Technical Support.
For fault value = 2:
Transfer a license file with the required licenses to the converter.
For fault value = 3:
Compare the license file name (after "LK_" to ".ZIP") with the serial number of the memory card.
Transfer the appropriate license file to the converter.
For fault value = 4, 5, 6, 7, 8, 9:
- Carry out a POWER ON.
- Upgrade firmware to later version.
- Contact Technical Support.
Note:
An overview of the converter functions requiring a license can be displayed using a commissioning tool in the online mode. Depending on the commissioning tool, you can also obtain the necessary licensing (serial number, license file, Trial License Mode).

A13002 Licensing not sufficient in operation

Message class: Error in the parameterization / configuration / commissioning procedure (18)
Message value: -
Component: Control Unit (CU)
Response: NONE
Acknowledgment: NONE
Cause:
- For the converter, the options that require a license are being used but the licenses are not sufficient.
- An error occurred when checking the existing licenses.
Alarm value (r2124, interpret decimal):
0: The existing license is not sufficient.
1: An adequate license was not able to be determined as the memory card with the required licensing data was withdrawn in operation or the memory card has developed a defect.
2: An adequate license was not able to be determined as there is no licensing data available on the memory card.
3: An adequate license was not able to be determined as there is no licensing data available on the memory card.
4, 5, 6, 7: An adequate license was not able to be determined as the licensing data were manipulated and are therefore invalid.
8,9: An internal error occurred when checking the license.

Remedy:

- For alarm value = 0:
Additional licenses are required and must be activated.
- For alarm value = 1:
Reinsert or replace the memory card that matches the system.
- For alarm value = 2:
Transfer the license file to the converter.
- For alarm value = 3:
Compare the license file name (after "LK_" to ".ZIP") with the serial number of the memory card.
Transfer the appropriate license file to the converter.
- For alarm value = 4, 5, 6, 7, 8, 9:
 - Carry out a POWER ON.
 - Upgrade firmware to later version.
 - Contact Technical Support.

Note:
An overview of the converter functions requiring a license can be displayed using a commissioning tool in the online mode. Depending on the commissioning tool, you can also obtain the necessary licensing (serial number, license file, Trial License Mode).

A13030 Trial License activated

Message class: Error in the parameterization / configuration / commissioning procedure (18)
Message value: -
Component: Control Unit (CU)
Response: NONE
Acknowledgment: NONE
Cause: The "Trial License" function was activated. One of the available periods is expiring.
Remedy: Not necessary.
The alarm is automatically withdrawn after the periods have expired.

A13031 Trial License period expired

Message class: Error in the parameterization / configuration / commissioning procedure (18)
Message value: -
Component: Control Unit (CU)
Response: NONE
Acknowledgment: NONE
Cause: One of the available periods of the "Trial License" function has expired.
Remedy:

- If required, start an additional period.
- Deactivate functions requiring a license.
- Appropriately license the drive unit.

Note:
A license that is not adequate will only become evident after the next time the system runs up.

A13032 Trial License last period activated

Message class: Error in the parameterization / configuration / commissioning procedure (18)
Message value: -
Component: Control Unit (CU)
Response: NONE
Acknowledgment: NONE
Cause: The "Trial License" function was activated. The last of the available periods is expiring.
Remedy: Not necessary.
The alarm is automatically withdrawn after the last period has expired.

A13033 **Trial License last period expired**

Message class: Error in the parameterization / configuration / commissioning procedure (18)

Message value: -

Component: Control Unit (CU)

Response: NONE

Acknowledgment: NONE

Cause: The last period of the "Trial License" function has expired. No additional periods available.

Remedy: - Deactivate functions requiring a license.

- Appropriately license the drive unit.

Note:

A license that is not adequate will only become evident after the next time the system runs up.

F30001 **Drive: overcurrent**

Message class: Power electronics faulted (5)

Message value: Fault cause: %1 bin

Component: Power Unit

Response: OFF2

Acknowledgment: IMMEDIATELY

Cause: The drive has detected an overcurrent condition.

- Closed-loop control is incorrectly parameterized.

- Motor has a short-circuit or fault to ground (frame).

- The rated motor current is significantly higher than that of the drive.

- Infeed: High discharge and post-charging currents for line voltage dip.

- Infeed: High post-charging currents for overload when motoring and DC link voltage dip.

- Infeed: Short-circuit currents at switch-on as there is no line reactor.

- Power cables are not correctly connected.

- The power cables exceed the maximum permissible length.

- Defective drive.

- Line phase interrupted.

Fault value (r0949, interpret bit-serial):

Bit 0: Phase U.

Bit 1: Phase V.

Bit 2: Phase W.

Remedy: - Check the motor data - If required, carry out commissioning.

- Check the assignment of the rated currents of the motor and converter.

- Infeed: Check the line supply quality.

- Infeed: Reduce the motor load.

- Infeed: Check that the line filter and line reactor are correctly connected.

- Check the power cable connections.

- Check the power cables for short-circuit or ground fault.

- Check the length of the power cables.

- Replace drive.

- Check the line supply phases.

F30002 **Drive: DC link overvoltage**

Message class: DC link overvoltage (4)

Message value: %1

Component: Power Unit

Response: OFF2

Acknowledgment: IMMEDIATELY

- Cause:** The drive has detected an overvoltage condition in the DC link.
- Motor regenerates too much energy.
 - Device supply voltage too high.
 - Line phase interrupted.
- Fault value only for internal Siemens diagnostics.
- Remedy:**
- Increase the ramp-down time.
 - Use a braking resistor.
 - Use a drive with a higher power rating.
 - Check the device supply voltage (p0210).
 - Check the line supply phases.
- See also: p0210 (Device supply voltage)

F30003 Power unit: DC link voltage undervoltage

- Message class:** Infeed faulted (13)
- Message value:** -
- Component:** Power Unit
- Response:** OFF2
- Acknowledgment:** IMMEDIATELY
- Cause:** The power unit has detected an undervoltage condition in the DC link.
- Line supply failure.
 - Line supply voltage below the permissible value.
 - Line supply infeed failed or interrupted.
 - Line phase interrupted.
- Note:**
The monitoring threshold for undervoltage in the DC link is indicated in r0296.
- Remedy:**
- Check the line supply voltage.
 - Check the line supply infeed and observe the fault messages relating to it (if there are any).
 - Check the line supply phases.
 - Check the line supply voltage setting (p0210).
- See also: p0210 (Device supply voltage)

F30004 Power unit: Overtemperature heat sink inverter

- Message class:** Power electronics faulted (5)
- Message value:** %1
- Component:** Power Unit
- Response:** OFF2
- Acknowledgment:** IMMEDIATELY
- Cause:** The temperature of the power unit heat sink has exceeded the permissible limit value.
- Insufficient cooling, fan failure.
 - Overload.
 - Ambient temperature too high.
 - Pulse frequency too high.
- Fault value (r0949, interpret decimal):
Temperature [0.01 °C].
- Remedy:**
- Check whether the fan is running.
 - Check the fan elements.
 - Check whether the ambient temperature is in the permissible range.
 - Check the motor load.
 - Reduce the pulse frequency if this is higher than the rated pulse frequency.
- Notice:**
This fault can only be acknowledged after the alarm threshold for alarm A30250 has been fallen below.

F30005 Power unit: Overload I2t (AC)**Message class:** Power electronics faulted (5)**Message value:** %1**Component:** Power Unit**Response:** OFF2**Acknowledgment:** IMMEDIATELY**Cause:** The fault threshold for the I2t overload on the AC side of the power unit has been exceeded. The permissible load duty cycle or the continuous load was not maintained.

Fault value (r0949, interpret decimal):

I2t (AC) [100 % = 16384]

See also: r0036 (Power unit overload)

Remedy:

- Reduce the continuous load.
- Adapt the load duty cycle.
- Check the rated currents of the motor and power unit.

See also: p0307 (Rated motor power)

F30011 Power unit: Line phase failure in main circuit**Message class:** Network fault (2)**Message value:** %1**Component:** Power Unit**Response:** OFF2**Acknowledgment:** IMMEDIATELY**Cause:** At the power unit, the DC link voltage ripple has exceeded the permissible limit value.

Possible causes:

- A line phase has failed.

- The 3 line phases are inadmissibly asymmetrical.

- The capacitance of the DC link capacitor forms a resonance frequency with the line inductance and the reactor integrated in the power unit.

- The fuse of a phase of a main circuit has ruptured.

- A motor phase has failed.

- For power units operated on a single phase, the permissible active power was exceeded.

Only for internal Siemens troubleshooting.

Remedy:

- Check the main circuit fuses.
- Check whether a single-phase load is distorting the line voltages.
- Detune the resonant frequency with the line inductance by using an upstream line reactor.
- Dampen the resonant frequency with the line inductance by switching over the DC link voltage compensation in the software or increase the smoothing. However, this can have a negative impact on the torque ripple at the motor output.
- Check the motor feeder cables.

F30012 Power unit: Temperature sensor wire breakage**Message class:** Power electronics faulted (5)**Message value:** %1**Component:** Power Unit**Response:** OFF1**Acknowledgment:** IMMEDIATELY

Cause: The connection to a temperature sensor in the power unit is interrupted.
Fault value (r0949, interpret binary):
Bit 1: Air intake
Bit 2: Inverter 1
Bit 3: Inverter 2
Bit 4: Inverter 3
Bit 5: Inverter 4
Bit 6: Inverter 5
Bit 7: Inverter 6
Bit 8: Rectifier
Bit 10: Moisture ext. moisture sensor
Bit 11: Temperature ext. moisture sensor
Bit 14: Capacitor air discharge
Bit 15: Liquid intake

Remedy: Contact Technical Support.

F30013 Power unit: Temperature sensor short-circuit

Message class: Power electronics faulted (5)
Message value: %1
Component: Power Unit
Response: OFF1
Acknowledgment: IMMEDIATELY

Cause: A temperature sensor in the power unit is short-circuited.
Fault value (r0949, interpret binary):
Bit 1: Air intake
Bit 2: Inverter 1
Bit 3: Inverter 2
Bit 4: Inverter 3
Bit 5: Inverter 4
Bit 6: Inverter 5
Bit 7: Inverter 6
Bit 8: Rectifier
Bit 10: Moisture ext. moisture sensor
Bit 11: Temperature ext. moisture sensor
Bit 14: Capacitor air discharge
Bit 15: Liquid intake

Remedy: Contact Technical Support.

F30015 Power unit: Phase failure motor cable

Message class: Application/technological function faulted (17)
Message value: -
Component: Motor
Response: OFF2
Acknowledgment: IMMEDIATELY

Cause: A phase failure in the motor feeder cable was detected.
The signal can also be output in the following case:
- The motor is correctly connected, however the closed-speed control is instable and therefore an oscillating torque is generated.
Note:
Chassis power units do not feature phase failure monitoring.

- Remedy:**
- Check the motor feeder cables.
 - Check the speed controller settings.

A30016 Power unit: Load supply switched off

Message class: Network fault (2)

Message value: %1

Component: Power Unit

Response: NONE

Acknowledgment: NONE

Cause: The DC link voltage is too low.
Alarm value (r2124, interpret decimal):
DC link voltage at the time of the trip [V].

- Remedy:**
- Switch on load supply.
 - Check the line supply if necessary.

F30017 Power unit: Hardware current limit has responded too often

Message class: Power electronics faulted (5)

Message value: Fault cause: %1 bin

Component: Power Unit

Response: OFF2

Acknowledgment: IMMEDIATELY

Cause: The hardware current limitation in the relevant phase (see A30031, A30032, A30033) has responded too often. The number of times the limit has been exceeded depends on the design and type of power unit.

- Closed-loop control is incorrectly parameterized.
- Fault in the motor or in the power cables.
- The power cables exceed the maximum permissible length.
- Motor load too high
- Power unit defective.

Fault value (r0949, interpret binary):

Bit 0: Phase U

Bit 1: Phase V

Bit 2: Phase W

Additional bits:

Only for internal Siemens troubleshooting.

Note:

Fault value = 0 means that the phase with current limiting is not recognized (e.g. for blocksize device).

- Remedy:**
- Check the motor data.
 - Check the motor circuit configuration (star-delta).
 - Check the motor load.
 - Check the power cable connections.
 - Check the power cables for short-circuit or ground fault.
 - Check the length of the power cables.
 - Replace power unit.

F30020 Power unit: Configuration not supported

Message class: Error in the parameterization / configuration / commissioning procedure (18)

Message value: Fault cause: %1, additional information: %2

Component: Power Unit

Response: OFF2

Acknowledgment: IMMEDIATELY

Cause: A configuration is requested that is not supported by the power unit.
Fault value (r0949, interpret hexadecimal):
yyyyxxxx hex: xxxx = fault cause, yyyy = additional information (internal Siemens)
xxxx = 1: The requested DRIVE-CLiQ timing is not permissible.
xxxx = 3: Initialization was not able to be successfully completed. It is possible that the converter was switched-off before or while running up.
xxxx = 4: The combination of power unit and converters is not supported.
xxxx = 8: The version of the ASIC installed in the power unit is no longer supported.

Remedy: For fault cause = 1:
Update the converter firmware or change the DRIVE-CLiQ topology.
For fault cause = 3, 4:
Use a converter with the appropriate power unit and carry out a POWER ON for the converter.
For fault cause = 8:
Replace the power unit by one which has a newer ASIC version.

F30021 Drive: Ground fault

Message class: Ground fault / inter-phase short-circuit detected (7)

Message value: %1

Component: Power Unit

Response: OFF2

Acknowledgment: IMMEDIATELY

Cause: The drive has detected a ground fault.

Possible causes:

- Ground fault in the power cables.
- Ground fault at the motor.
- When the brake closes, this causes the hardware DC current monitoring to respond.
- Short-circuit at the braking resistor.

Fault value (r0949, interpret decimal):

0:

- The hardware DC current monitoring has responded.
- Short-circuit at the braking resistor.

> 0:

Absolute value summation current amplitude.

Remedy: - Check the power cable connections.
- Check the motor.
- Check the cables and contacts of the brake connection (a wire is possibly broken).
- Check the braking resistor.

F30022 Power unit: Monitoring U_{ce}

Message class: Ground fault / inter-phase short-circuit detected (7)

Message value: Fault cause: %1 bin

Component: Power Unit

Response: OFF2

Acknowledgment: POWER ON

12.3 Faults and alarms

Cause: In the power unit, the monitoring of the collector-emitter voltage (U_{ce}) of the semiconductor has responded.
Possible causes:

- Fiber-optic cable interrupted.
- The power supply for power semiconductor gating missing.
- Short-circuit at the power unit output.
- Defective semiconductor in the power unit.

Fault value (r0949, interpret binary):
Bit 0: Short-circuit in phase U
Bit 1: Short-circuit in phase V
Bit 2: Short-circuit in phase W
Bit 3: Short-circuit in phase N
See also: r0949 (Fault value)

Remedy:

- Check the fiber-optic cable and if required, replace.
- Check the power supply for the power semiconductor gating (24 V).
- Check the power cable connections.
- Select the defective semiconductor and replace.

F30024 Power unit: Overtemperature thermal model

Message class: Power electronics faulted (5)

Message value: Power semiconductor: %1, temperature: [0.01 degrees C] %2

Component: Power Unit

Response: OFF2

Acknowledgment: IMMEDIATELY

Cause: The temperature difference between the power semiconductor involved and the heat sink has exceeded the permissible fault threshold.

- The permissible load duty cycle was not maintained.
- Insufficient cooling, fan failure.
- Overload.
- Ambient temperature too high.
- Pulse frequency too high.

Fault value (r0949, interpret hexadecimal):
yyyyxxx hex: yyyy= Power semiconductor, xxx = Temperature in 0.01°C
See also: r0037 (Power unit temperatures)

Remedy:

- Adapt the load duty cycle.
- Check whether the fan is running.
- Check the fan elements.
- Check whether the ambient temperature is in the permissible range.
- Check the motor load.
- Reduce the pulse frequency if this is higher than the rated pulse frequency.

F30025 Power unit: Chip overtemperature

Message class: Power electronics faulted (5)

Message value: Power semiconductor: %1, temperature: [0.01 degrees C] %2

Component: Power Unit

Response: OFF2

Acknowledgment: IMMEDIATELY

Cause: The chip temperature of the power semiconductor involved has exceeded the permissible fault threshold.

- The permissible load duty cycle was not maintained.
- Insufficient cooling, fan failure.
- Overload.
- Ambient temperature too high.
- Pulse frequency too high.

Fault value (r0949, interpret hexadecimal):

yyyyxxxx hex: yyyy= Power semiconductor, xxxx = Temperature in 0.01°C

Remedy:

- Adapt the load duty cycle.
- Check whether the fan is running.
- Check the fan elements.
- Check whether the ambient temperature is in the permissible range.
- Check the motor load.
- Reduce the pulse frequency if this is higher than the rated pulse frequency.

Note:

This fault can only be acknowledged after the alarm threshold for alarm A030252 has been fallen below.

See also: r0037 (Power unit temperatures)

F30027 Power unit: Precharging DC link time monitoring

Message class: Infeed faulted (13)

Message value: Enable signals: %1, Status: %2

Component: Power Unit

Response: OFF2

Acknowledgment: IMMEDIATELY

12.3 Faults and alarms

- Cause:** The power unit DC link was not able to be precharged within the expected time.
- 1) There is no line supply voltage connected.
 - 2) The line contactor/line side switch has not been closed.
 - 3) The line supply voltage is too low.
 - 4) Line supply voltage incorrectly set (p0210).
 - 5) The precharging resistors are overheated as there were too many precharging operations per time unit.
 - 6) The precharging resistors are overheated as the DC link capacitance is too high.
 - 7) The precharging resistors are overheated because when there is no "ready for operation" (r0863.0) of the infeed unit, power is taken from the DC link.
 - 8) The precharging resistors are overheated as the line contactor was closed during the DC link fast discharge through the Braking Module.
 - 9) The DC link has either a ground fault or a short-circuit.
 - 10) The precharging circuit is possibly defective (only for chassis units).
 - 11) Infeed defective and/or fuse ruptured

Fault value (r0949, interpret binary):

yyyyxxxx hex:

yyyy = power unit state

0: Fault status (wait for OFF and fault acknowledgment).

1: Restart inhibit (wait for OFF).

2: Overvoltage condition detected -> change into the fault state.

3: Undervoltage condition detected -> change into the fault state.

4: Wait for bridging contactor to open -> change into the fault state.

5: Wait for bridging contactor to open -> change into restart inhibit.

6: Wait for bypass contactor to open

7: Commissioning.

8: Ready for precharging.

9: Precharging started, DC link voltage lower than the minimum switch-on voltage.

10: Precharging, DC link voltage end of precharging still not detected.

11: Wait for the end of the de-bounce time of the main contactor after precharging has been completed.

12: Precharging completed, ready for pulse enable.

13: It was detected that the STO terminal was energized at the power unit.

xxxx = Missing internal enable signals, power unit (inverted bit-coded, FFFF hex -> all internal enable signals available)

Bit 0: Power supply for the power semiconductor gating shut down.

Bit 1: Ground fault detected.

Bit 2: Peak current intervention.

Bit 3: I2t exceeded.

Bit 4: Thermal model overtemperature calculated.

Bit 5: (heat sink, gating module, power unit) overtemperature measured.

Bit 6: Reserved.

Bit 7: Overvoltage detected.

Bit 8: Power unit has completed precharging, ready for pulse enable.

Bit 9: STO terminal missing.

Bit 10: Overcurrent detected.

Bit 11: Armature short-circuit active.

Bit 12: DRIVE-CLiQ fault active.

Bit 13: Vce fault detected, transistor de-saturated due to overcurrent/short-circuit.

Bit 14: Undervoltage detected.

See also: p0210 (Device supply voltage)

Remedy:

In general:

- Check the line supply voltage at the input terminals.
- Check the line supply voltage setting (p0210).

For booksize drive units, the following applies:

- Wait (approx. 8 minutes) until the precharging resistors have cooled down. For this purpose, preferably disconnect the infeed unit from the line supply.

For 5):

- Carefully observe the permissible precharging frequency (refer to the product documentation).

For 6):

- Check the total capacitance of the DC link and reduce in accordance with the maximum permissible DC link capacitance if necessary (refer to the product documentation).

For 7):

- Interconnect the ready-for-operation signal from the infeed unit (r0863.0) in the enable logic of the drives connected to this DC link.

For 8):

- Check the connections of the external line contactor. The line contactor must be open during DC link fast discharge.

For 9):

- Check the DC link for ground faults or short-circuits.

For 11):

- Check the DC link voltage of the infeed (r0070) and Motor Modules (r0070).

If the DC link voltage generated by the infeed (or external) is not displayed for the Motor Modules (r0070), then a fuse has ruptured in the Motor Module.

See also: p0210 (Device supply voltage)

A30030 Power unit: Internal overtemperature alarm

Message class: Power electronics faulted (5)

Message value: %1

Component: Power Unit

Response: NONE

Acknowledgment: NONE

Cause: The temperature inside the drive converter has exceeded the permissible temperature limit.

- Insufficient cooling, fan failure.
- Overload.
- Ambient temperature too high.

Alarm value (r2124, interpret decimal):

Only for internal Siemens troubleshooting.

Remedy:

- Possibly use an additional fan.
- Check whether the ambient temperature is in the permissible range.

Notice:

This alarm is automatically withdrawn once the permissible temperature limit value has been fallen below minus 5 K.

A30031 Power unit: Hardware current limiting in phase U

Message class: Power electronics faulted (5)

Message value: -

Component: Power Unit

Response: NONE

Acknowledgment: NONE

12.3 Faults and alarms

- Cause:** Hardware current limit for phase U responded. The pulsing in this phase is inhibited for one pulse period.
- Closed-loop control is incorrectly parameterized.
 - Fault in the motor or in the power cables.
 - The power cables exceed the maximum permissible length.
 - Motor load too high
 - Power unit defective.
- Remedy:**
- Check the motor data.
 - Check the motor circuit configuration (star/delta).
 - Check the motor load.
 - Check the power cable connections.
 - Check the power cables for short-circuit or ground fault.
 - Check the length of the power cables.

A30032 Power unit: Hardware current limiting in phase V

Message class: Power electronics faulted (5)

Message value: -

Component: Power Unit

Response: NONE

Acknowledgment: NONE

Cause: Hardware current limit for phase V responded. The pulsing in this phase is inhibited for one pulse period.

- Closed-loop control is incorrectly parameterized.
- Fault in the motor or in the power cables.
- The power cables exceed the maximum permissible length.
- Motor load too high
- Power unit defective.

- Remedy:**
- Check the motor data.
 - Check the motor circuit configuration (star/delta).
 - Check the motor load.
 - Check the power cable connections.
 - Check the power cables for short-circuit or ground fault.
 - Check the length of the power cables.

A30033 Power unit: Hardware current limiting in phase W

Message class: Power electronics faulted (5)

Message value: -

Component: Power Unit

Response: NONE

Acknowledgment: NONE

Cause: Hardware current limit for phase W responded. The pulsing in this phase is inhibited for one pulse period.

- Closed-loop control is incorrectly parameterized.
- Fault in the motor or in the power cables.
- The power cables exceed the maximum permissible length.
- Motor load too high
- Power unit defective.

- Remedy:**
- Check the motor data.
 - Check the motor circuit configuration (star/delta).
 - Check the motor load.
 - Check the power cable connections.
 - Check the power cables for short-circuit or ground fault.
 - Check the length of the power cables.

A30034 Power unit: Internal overtemperature

Message class: Power electronics faulted (5)

Message value: %1

Component: Power Unit

Response: NONE

Acknowledgment: NONE

Cause: The alarm threshold for internal overtemperature has been reached.
If the temperature inside the power unit increases up to the fault threshold, then fault F30036 is triggered.

- Ambient temperature might be too high.
- Insufficient cooling, fan failure.

Alarm value (r2124, interpret binary):

- Bit 0 = 1: Overtemperature in the control electronics area.
- Bit 1 = 1: Overtemperature in the power electronics area.
- Bit 2 = 1: Overtemperature in the processor area.
- Bit 3 = 1: Overtemperature in the processor area.
- Bit 4 = 1: Overtemperature when the internal fan is defective.
- Bit 5 = 1: Intake air overtemperature.

Remedy:

- Check the ambient temperature.
- Check the fan for the inside of the unit.

F30036 Power unit: Internal overtemperature

Message class: Power electronics faulted (5)

Message value: %1

Component: Power Unit

Response: OFF2

Acknowledgment: IMMEDIATELY

Cause: The temperature inside the converter has exceeded the permissible limit value.

- Insufficient cooling, fan failure.
- Overload.
- Ambient temperature too high.

Fault value (r0949, interpret binary):

- Bit 0 = 1: Overtemperature in the control electronics area.
- Bit 1 = 1: Overtemperature in the power electronics area.
- Bit 2 = 1: Overtemperature in the processor area.
- Bit 3 = 1: Overtemperature in the processor area.
- Bit 4 = 1: Overtemperature when the internal fan is defective.
- Bit 5 = 1: Intake air overtemperature.

Remedy:

- Check the internal fan.
- Check the fan elements.
- Check whether the ambient temperature is in the permissible range.

Notice:
This fault can only be acknowledged once the permissible temperature limit minus 5 K has been fallen below.

F30037 Power unit: Rectifier overtemperature

Message class: Power electronics faulted (5)

Message value: %1

Component: Power Unit

Response: OFF2

Acknowledgment: IMMEDIATELY

12.3 Faults and alarms

Cause: The temperature in the rectifier of the power unit has exceeded the permissible temperature limit.

- Insufficient cooling, fan failure.
- Overload.
- Ambient temperature too high.
- Line supply phase failure.

Fault value (r0949, interpret decimal):
Temperature [0.01 °C].

Remedy:

- Check whether the fan is running.
- Check the fan elements.
- Check whether the ambient temperature is in the permissible range.
- Check the motor load.
- Check the line supply phases.

Notice:
This fault can only be acknowledged after the alarm threshold for alarm A05004 has been undershot.

F30040 Power unit: 24/48 V undervoltage

Message class: Supply voltage fault (undervoltage) (3)
Message value: Channel: %1, voltage: %2 [0.1 V]
Component: Power Unit
Response: OFF2
Acknowledgment: IMMEDIATELY

Cause: The undervoltage threshold of the 24 V power supply for the power unit was fallen below for longer than 3 ms.

Note:

- For booksize power units, the undervoltage threshold is 15 V.
- For CU310-2, CUA31 and CUA32 the undervoltage threshold is 16 V.
- for all other power units (e.g. S120M), the undervoltage threshold depends on the power unit, and is not displayed.

Fault value (r0949, interpret hexadecimal):
yyxxxx hex: yy = channel, xxxx = voltage [0.1 V]
yy = 0: 24 V power supply
yy = 1: 48 V power supply

Remedy:

- Check the power supply of the power unit.
- Carry out a POWER ON (switch-off/switch-on) for the component.

A30041 Power unit: Undervolt 24/48 V alarm

Message class: Supply voltage fault (undervoltage) (3)
Message value: Channel: %1, voltage: %2 [0.1 V]
Component: Power Unit
Response: NONE
Acknowledgment: NONE

Cause: For the power unit power supply, the lower threshold has been violated.

Alarm value (r2124, interpret hexadecimal):
yyxxxx hex: yy = channel, xxxx = voltage [0.1 V]
yy = 0: 24 V power supply
yy = 1: 48 V power supply

Remedy:

- Check the power supply of the power unit.
- Carry out a POWER ON (switch-off/switch-on) for the component.

A30042 Power unit: Fan has reached the maximum operating hours

Message class: Power electronics faulted (5)
Message value: %1

Component: Power Unit
Response: NONE
Acknowledgment: NONE
Cause: The maximum operating time of at least one fan will soon be reached, or has already been exceeded.
Alarm value (r2124, interpret binary):
Bit 0 = 1:
The wear counter of the heat sink fan has reached 99 %. The remaining service life is 1 %. After this 1 % has elapsed, bit 0 is cleared and bit 2 is set in the alarm value.
Bit 2 = 1:
The wear counter of the heat sink fan has exceeded 100 %.
Bit 8 = 1:
The wear counter of the 1st internal fan has reached 99 %. The remaining service life is 1 %. After this 1 % has elapsed, bit 8 is cleared and bit 10 is set in the alarm value.
Bit 10 = 1:
The wear counter of the 1st internal fan has exceeded 100 %.
Bit 16 = 1:
The wear counter of the 2nd internal fan has reached 99 %. The remaining service life is 1 %. After this 1 % has elapsed, bit 16 is cleared and bit 18 is set in the alarm value.
Bit 18 = 1:
The wear counter of the 2nd internal fan has exceeded 100 %.
Remedy: For the fan involved, carry out the following:
1. Replace the fan.
2. Reset the wear counter using the appropriate button in Startdrive or the web server.
See also: r0277 (Power unit heat sink fan wear counter)

F30043 **Power unit: Overvolt 24/48 V**
Message class: Supply voltage fault (overvoltage) (3)
Message value: Channel: %1, voltage: %2 [0.1 V]
Component: Power Unit
Response: OFF2
Acknowledgment: POWER ON
Cause: For the power unit power supply, the upper threshold has been violated.
Fault value (r0949, interpret hexadecimal):
yyxxxx hex: yy = channel, xxxx = voltage [0.1 V]
yy = 0: 24 V power supply
yy = 1: 48 V power supply
Remedy: Check the power supply of the power unit.

A30044 **Power unit: Overvolt 24/48 V alarm**
Message class: Supply voltage fault (overvoltage) (3)
Message value: Channel: %1, voltage: %2 [0.1 V]
Component: Power Unit
Response: NONE
Acknowledgment: NONE
Cause: For the power unit power supply, the upper threshold has been violated.
Alarm value (r2124, interpret hexadecimal):
yyxxxx hex: yy = channel, xxxx = voltage [0.1 V]
yy = 0: 24 V power supply
yy = 1: 48 V power supply
Remedy: Check the power supply of the power unit.

F30045 Power unit: Supply undervoltage

Message class: Supply voltage fault (undervoltage) (3)

Message value: %1

Component: Power Unit

Response: OFF2

Acknowledgment: IMMEDIATELY

Cause: Power supply fault in the power unit.

- The voltage monitor signals an undervoltage fault on the module.

The following applies for CU31x:

- The voltage monitoring on the DAC board signals an undervoltage fault on the module.

For S120M, the following applies:

- This message is displayed for undervoltage or overvoltage.

Remedy: - Check the power supply of the power unit.

- Carry out a POWER ON (switch-off/switch-on) for the component.

- Replace the module if necessary.

A30046 Power unit: Undervoltage alarm

Message class: Power electronics faulted (5)

Message value: %1

Component: Power Unit

Response: NONE

Acknowledgment: NONE

Cause: Before the last restart, a problem occurred at the power unit power supply.

The voltage monitor in the internal FPGA of the PSA signals an undervoltage fault on the module.

Alarm value (r2124, interpret decimal):

Register value of the voltage fault register.

Remedy: - Check the 24 V DC voltage supply to power unit.

- Carry out a POWER ON (switch-off/switch-on) for the component.

- Replace the module if necessary.

A30048 Power unit: fan defective

Message class: External measured value / signal state outside the permissible range (16)

Message value: Fault cause: %1 bin

Component: Power Unit

Response: NONE

Acknowledgment: NONE

Cause: The feedback signal of a fan signals a fault, or there is a communication error with one or several fans.

- Fan defective.

- Fan blocked.

- Feedback signal error.

Alarm value (r2124, interpret binary):

Bit 0 = 1: heat sink fan

Bit 1 = 1: fan 1 inside the device

Bit 2 = 1: fan 2 inside the device

Bit 4 = 1: Internal communication error to one or several fans

Remedy:

- Check the fan involved.
- If required, replace the fan.
- For communication errors, update the software or replace the power unit.

Note:

If the alarm has been withdrawn, this does not necessarily mean that the cause of the fault has been resolved. It is also possible that the software switched off the fan, and therefore can no longer evaluate the feedback signal.

F30050 Power unit: 24 V supply overvoltage

Message class: Supply voltage fault (overvoltage) (3)

Message value: -

Component: Power Unit

Response: OFF2

Acknowledgment: POWER ON

Cause: The voltage monitor signals an overvoltage fault on the module.

Remedy:

- Check the 24 V power supply.
- Replace the module if necessary.

F30051 Power unit: Motor holding brake short-circuit detected

Message class: External measured value / signal state outside the permissible range (16)

Message value: %1

Component: Power Unit

Response: OFF2

Acknowledgment: IMMEDIATELY

Cause: A short-circuit at the motor holding brake terminals has been detected.
Fault value (r0949, interpret decimal):
Only for internal Siemens troubleshooting.

Remedy:

- Check the motor holding brake for a short-circuit.
- Check the connection and cable for the motor holding brake.

F30052 EEPROM data error

Message class: Hardware/software error (1)

Message value: %1

Component: Power Unit

Response: OFF2

Acknowledgment: POWER ON

Cause: The EEPROM data of the power unit module are incorrect.
Fault value (r0949, interpret hexadecimal):
Only for internal Siemens troubleshooting.

Remedy: Replace the power unit module or update the EEPROM data.

F30053 FPGA data faulty

Message class: Hardware/software error (1)

Message value: %1

Component: Power Unit

Response: NONE

Acknowledgment: POWER ON

Cause: The FPGA data of the power unit are faulty. This can be caused, for example, if a firmware update is interrupted.

12.3 Faults and alarms

Remedy: Replace the power unit or update of the FPGA data by updating the firmware.
Note:
If this fault occurs after a firmware update, then update the firmware again.

F30055 Power unit: Braking chopper overcurrent

Message class: Braking Module faulted (14)

Message value: -

Component: None

Response: OFF2

Acknowledgment: IMMEDIATELY

Cause: An overcurrent condition has occurred in the braking chopper.

Remedy: - Check whether the braking resistor has a short-circuit.
- For an external braking resistor, check whether the resistor may have been dimensioned too small.
Note:
The braking chopper is only enabled again at pulse enable after the fault has been acknowledged.

A30057 Power unit: Line asymmetry

Message class: Network fault (2)

Message value: %1

Component: Power Unit

Response: NONE

Acknowledgment: NONE

Cause: Frequencies have been detected on the DC link voltage that would suggest line asymmetry or failure of a line phase. It is also possible that a motor phase has failed.
If these frequencies occur with the same or even higher amplitudes, then after a device-specific time elapses, fault F30011 is output
Alarm value, only for internal Siemens troubleshooting.

Remedy: - Check the line phase connection.
- Check the motor feeder cable connections.
If there is no phase failure of the line or motor, then line asymmetry is involved.
- Reduce the power in order to avoid fault F30011.

F30058 Power unit: heat sink fan defective

Message class: External measured value / signal state outside the permissible range (16)

Message value: %1

Component: Power Unit

Response: OFF2

Acknowledgment: IMMEDIATELY

Cause: The feedback signal of the heat sink fan signals a fault, or there is a communication error with the fan.
- Fan defective.
- Fan blocked.
- Feedback signal error.

Fault value (r0949, interpret decimal):
0: Feedback signal of the fan signals a fault
1: Internal communication error to the fan

Remedy: - Check the heat sink fan and replace if necessary.
- For communication errors, update the software or replace the power unit.
Note:
- If the fault can be acknowledged, this does not necessarily mean that the cause of the fault has been resolved. It is also possible that the software switched off the fan, and therefore can no longer evaluate the feedback signal.

F30059 Power unit: Internal fan 1 defective

Message class: Auxiliary unit faulted (20)

Message value: %1

Component: Power Unit

Response: OFF2

Acknowledgment: IMMEDIATELY

Cause: The feedback signal of internal fan 1 signals a fault, or there is a communication error with the fan.

Fault value (r0949, interpret decimal):

0: Feedback signal of the fan signals a fault

1: Internal communication error to the fan

Remedy: - Check internal fan 1 and replace if necessary.

- For communication errors, update the software or replace the power unit.

Note:

If the fault can be acknowledged, this does not necessarily mean that the cause of the fault has been resolved. It is also possible that the software switched off the fan, and therefore can no longer evaluate the feedback signal.

F30062 Bypass contactor opened under current

Message class: Infeed faulted (13)

Message value: -

Component: Power Unit

Response: OFF2

Acknowledgment: IMMEDIATELY

Cause: The bypass contactor of the precharging unit has been opened under current.

Possible causes:

- A defect at the bypass contactor

Remedy: It is urgently recommended that the components involved are replaced to prevent serious damage to the entire converter line-up.

F30068 Power unit: undertemperature inverter heat sink

Message class: Power electronics faulted (5)

Message value: %1

Component: Power Unit

Response: OFF2

Acknowledgment: IMMEDIATELY

Cause: The actual inverter heat sink temperature is below the permissible minimum value.

Possible causes:

- The power unit is being operated at an ambient temperature that lies below the permissible range.

- The temperature sensor evaluation is defective.

Fault value (r0949, interpret decimal):

Inverter heat sink temperature [0.1 °C].

Remedy: - Ensure that higher ambient temperatures prevail.

- Replace the power unit.

A30076 Power unit: Thermal overload braking resistor alarm

Message class: Braking Module faulted (14)

Message value: %1

Component: Power Unit

Response: NONE

Acknowledgment: NONE

12.3 Faults and alarms

Cause: The energy absorbed by the braking resistor has exceeded the alarm threshold of 80 %. If the power unit is still operated in the generator mode, then this can reach the shutdown threshold. To avoid overheating of the braking resistor, use of the braking resistor is inhibited and alarm A30077 is output.
Alarm value (r2124, interpret decimal):
Energy absorbed by the braking resistor [Ws].

Remedy: Reduce the power when generating.
Note:
For a DC link coupling, the generating power of all of the coupled power units must be taken into consideration.

A30077 Power unit: Thermal overload braking resistor

Message class: Braking Module faulted (14)

Message value: %1

Component: Power Unit

Response: NONE

Acknowledgment: NONE

Cause: The braking resistor is thermally overloaded. This is the reason that its use was inhibited.
Alarm value (r2124, interpret decimal):
Energy absorbed by the braking resistor [Ws].

Remedy: Reduce the power when generating.
Note:
- Once the braking resistor has thermally recovered, it is enabled for further use.
- For a DC link coupling, the generating power of all the coupled power units must be taken into consideration.

F30078 Power unit: Line reactor overheated

Message class: Overtemperature of the electronic components (6)

Message value: -

Component: Power Unit

Response: OFF2

Acknowledgment: IMMEDIATELY

Cause: The temperature monitoring of the line reactor has responded. In addition to the OFF2 response, the use of the braking resistor was inhibited.
Note:

- An overtemperature condition of the line reactor can occur when a DC link coupling is used – and if the power when motoring, which is fed into the DC link - is not evenly distributed across the rectifiers of the power units.

Remedy: - Check the converter fan and replace if necessary.
- Reduce the motoring power.

A30082 Power unit: cooling medium flow rate too low alarm threshold

Message class: Power electronics faulted (5)

Message value: -

Component: Power Unit

Response: NONE

Acknowledgment: NONE

Cause: The flow rate is too low, and has fallen below the specified alarm threshold. If the flow rate is still too low after the specified time has expired, then fault F30083 is output.

Remedy: - Check the coolant flow rate.
- Check the thermal conductivity of the coolant.
- Check the coolant concentration.

F30083 Power unit: cooling medium flow rate too low fault threshold

Message class: Power electronics faulted (5)
Message value: -
Component: Power Unit
Response: OFF2
Acknowledgment: IMMEDIATELY
Cause: The flow rate is too low, and has fallen below the specified fault threshold.
Remedy: - Check the coolant flow rate.
- Check the thermal conductivity of the coolant.
- Check the coolant concentration.

A30086 Power unit: coolant temperature has exceeded the alarm threshold

Message class: Power electronics faulted (5)
Message value: %1
Component: Power Unit
Response: NONE
Acknowledgment: NONE
Cause: The coolant temperature has exceeded the specified alarm threshold.
If the coolant temperature increases up to the specified fault threshold, then fault F30087 is output.
Alarm value (r2124, interpret decimal):
Coolant temperature.
Remedy: Check the cooling system and the ambient conditions.

F30087 Power unit: coolant temperature has exceeded the fault threshold

Message class: Power electronics faulted (5)
Message value: %1
Component: Power Unit
Response: OFF2
Acknowledgment: IMMEDIATELY
Cause: The coolant temperature has exceeded the specified fault threshold.
Fault value (r0949, interpret decimal):
Coolant temperature.
Remedy: Check the cooling system and the ambient conditions.

F30105 PU: Actual value sensing fault

Message class: Power electronics faulted (5)
Message value: -
Component: Power Unit
Response: OFF2
Acknowledgment: IMMEDIATELY
Cause: At least one incorrect actual value channel was detected on the Power Stack Adapter (PSA).
The incorrect actual value channels are displayed in the following diagnostic parameters.
Remedy: Evaluate the diagnostic parameters.
If the actual value channel is incorrect, check the components and if required, replace.

A30250 Power unit: Overtemperature heat sink inverter

Message class: Power electronics faulted (5)
Message value: -
Component: Power Unit

Response: NONE
Acknowledgment: NONE
Cause: The alarm threshold for overtemperature at the inverter heat sink has been reached.
Fault F30004 is initiated if the temperature of the heat sink increases by 5 K.
Remedy: Check the following:
- Is the ambient temperature within the defined limit values?
- Have the load conditions and the load duty cycle been appropriately dimensioned?
- Has the cooling failed?

A30251 Power unit: Rectifier overtemperature

Message class: Power electronics faulted (5)
Message value: -
Component: Power Unit
Response: NONE
Acknowledgment: NONE
Cause: The alarm threshold for the overtemperature of the rectifier has been reached. The response is set using p0290.
If the temperature of the rectifier increases by an additional 5 K, then fault F30037 is triggered.
Remedy: Check the following:
- Is the ambient temperature within the defined limit values?
- Have the load conditions and the load duty cycle been appropriately dimensioned?
- Has the fan failed? Check the direction of rotation.
- Has a phase of the line supply failed?
- Is an arm of the supply (incoming) rectifier defective?

A30252 Power unit: Chip overtemperature alarm

Message class: Power electronics faulted (5)
Message value: Power semiconductor: %1, temperature: [0.01 degrees C] %2
Component: Power Unit
Response: NONE
Acknowledgment: NONE
Cause: The chip temperature of the power semiconductor involved has exceeded the permissible alarm threshold.
Note:
- If the chip temperature of the power semiconductor involved increases by 5K, then fault F30025 is initiated.

Alarm value (r2124, interpret hexadecimal):
yyyyxxx hex: yyyy= Power semiconductor, xxx = Temperature in 0.01°C
Remedy: Check the following:
- Is the ambient temperature within the defined limit values?
- Have the load conditions and the load duty cycle been appropriately dimensioned?
- Has the cooling failed?
- Pulse frequency too high?

A30253 Power unit: Overtemperature thermal model alarm

Message class: Power electronics faulted (5)
Message value: Power semiconductor: %1, temperature: [0.01 degrees C] %2
Component: Power Unit
Response: NONE
Acknowledgment: NONE

Cause: The temperature difference between the power semiconductor involved and the heat sink has exceeded the permissible alarm threshold.
The maximum output current is reduced as overload response.

Alarm value (r2124, interpret hexadecimal):
yyyyxxx hex: yyyy= Power semiconductor, xxxx = Temperature in 0.01°C

Remedy: Not necessary.
The alarm is automatically withdrawn once the alarm threshold has been fallen below.
Note:
If the temperature continues to increase, this can result in fault F30024.

A30256 Power unit: Overload I2t (AC)

Message class: Power electronics faulted (5)

Message value: -

Component: Power Unit

Response: NONE

Acknowledgment: NONE

Cause: The alarm threshold for the I2t overload on the AC side of the power unit has been exceeded. Depending on the selected overload response, the output current and therefore the output frequency can be reduced. If the current reduction is not sufficient to thermally relieve the power unit, then when the fault threshold for overload is reached the drive switches off the power unit and outputs fault F30005.

See also: r0036 (Power unit overload)

Remedy: - Reduce the continuous load.
- Adapt the load duty cycle.
- Check the rated currents of the motor and power unit.
See also: p0290 (Power unit overload response)

A30257 Power unit: Overload I2t (DC)

Message class: Power electronics faulted (5)

Message value: -

Component: Power Unit

Response: NONE

Acknowledgment: NONE

Cause: The alarm threshold for the I2t overload on the DC side of the power unit has been exceeded.
Depending on the selected overload response, the output current and therefore the output frequency can be reduced. If the current reduction is not sufficient to thermally relieve the power unit, then when the fault threshold for overload is reached the drive switches off the power unit and outputs fault F30258.

See also: r0036 (Power unit overload)

Remedy: - Reduce the continuous load.
- Adapt the load duty cycle.
See also: p0290 (Power unit overload response)

F30258 Power unit: Overload I2t (DC)

Message class: Power electronics faulted (5)

Message value: %1

Component: Power Unit

Response: OFF2

Acknowledgment: IMMEDIATELY

12.3 Faults and alarms

Cause: The fault threshold for the I2t overload on the DC side of the power unit has been exceeded.
The permissible load duty cycle or the continuous load was not maintained.
Fault value (r0949, interpret decimal):
I2t (DC) [100 % = 16384]
See also: r0036 (Power unit overload)

Remedy: - Reduce the continuous load.
- Adapt the load duty cycle.
See also: p0307 (Rated motor power)

F30260 Power unit: Fault in the driver supply for the power semiconductor

Message class: Hardware/software error (1)
Message value: -
Component: Power Unit
Response: OFF2
Acknowledgment: IMMEDIATELY
Cause: A fault has occurred in the driver supply of the power semiconductor.
Remedy: There is a hardware defect. The device must be replaced.

F30262 Power unit: Braking chopper defective

Message class: Power electronics faulted (5)
Message value: -
Component: Power Unit
Response: OFF2
Acknowledgment: IMMEDIATELY
Cause: The braking chopper is defective.
Remedy: Replace the converter.

F30263 Power unit: Braking chopper upper defective

Message class: Power electronics faulted (5)
Message value: -
Component: Power Unit
Response: OFF2
Acknowledgment: IMMEDIATELY
Cause: The upper braking chopper is defective.
Remedy: Replace the converter.

F30264 Power unit: Braking chopper inhibited due to implausible DC link voltage

Message class: Braking Module faulted (14)
Message value: %1
Component: Power Unit
Response: OFF2
Acknowledgment: IMMEDIATELY
Cause: The braking chopper was inhibited because the unloaded DC link voltage continuously reaches or exceeds the chopper activation threshold. This prevents the braking chopper from being permanently active and possibly damaged.

Possible causes:
The value of parameter p0210 does not match the line voltage.

Fault value (r0949, interpret decimal): DC link voltage [V]

Remedy: Replace the converter.

F30265 Power unit: Line voltage failure detected

Message class: Power electronics faulted (5)

Message value: -

Component: Power Unit

Response: OFF3

Acknowledgment: IMMEDIATELY

Cause: Line voltage failure was detected

Remedy: - Switch on the line voltage.
- To increase the degree of ruggedness, the delay time in p3234 can be increased.
- If necessary, line voltage failure detection can be deactivated using p2149.16.
See also: p2149, p3234

A30266 Power unit: Required modulator setting cannot be implemented

Message class: Hardware/software error (1)

Message value: %1

Component: Power Unit

Response: NONE

Acknowledgment: NONE

Cause: The required modulator setting was not able to be implemented. This can involve some undesirable effects; for example, unexpectedly high switching losses can occur or the current controller bandwidth can be reduced.

Alarm value (r2124, interpret hexadecimal):

Only for internal Siemens troubleshooting.

Remedy: - Carry out a POWER ON (switch-off/switch-on).

A30267 Power unit: Active power overload

Message class: Power electronics faulted (5)

Message value: -

Component: Power Unit

Response: NONE

Acknowledgment: NONE

Cause: The alarm threshold for the active power overload of the power unit has been exceeded. Depending on the selected overload response, the output current and therefore the output frequency can be reduced. If the current reduction is not sufficient to thermally relieve the power unit, then when the fault threshold for overload is reached the drive switches off the power unit and outputs fault F30268.

See also: r0036 (Power unit overload)

Remedy: - Reduce the continuous load.
- Adapt the load duty cycle.
See also: p0290 (Power unit overload response)

F30268 Power unit: Active power overload

Message class: Power electronics faulted (5)

Message value: %1

Component: Power Unit

Response: OFF2

Acknowledgment: IMMEDIATELY

12.3 Faults and alarms

Cause: The fault threshold for the active power overload of the power unit has been exceeded.
The permissible load duty cycle or the continuous load was not maintained.
Fault value (r0949, interpret decimal):
Active power [100 % = 16384]
See also: r0036 (Power unit overload)

Remedy: - Reduce the continuous load.
- Adapt the load duty cycle.
See also: p0307 (Rated motor power)

F30314 Power unit: 24 V power supply overloaded by PM

Message class: Supply voltage fault (undervoltage) (3)
Message value: -
Component: Power Unit
Response: OFF2
Acknowledgment: IMMEDIATELY

Cause: The 24 V power supply through the Power Module (PM) is overloaded.
An external 24 V power supply via X124 on the Control Unit is not connected.

Remedy: Connect an external 24 V power supply via X124 at the Control Unit.

A30315 Power unit: 24 V power supply overloaded by PM

Message class: Supply voltage fault (undervoltage) (3)
Message value: -
Component: Power Unit
Response: NONE
Acknowledgment: NONE

Cause: The 24 V power supply through the Power Module (PM) is overloaded.
An external 24 V power supply via X124 on the Control Unit is not connected.

Remedy: Connect an external 24 V power supply via X124 at the Control Unit.

A30502 Power unit: DC link overvoltage

Message class: DC link overvoltage (4)
Message value: %1
Component: Power Unit
Response: NONE
Acknowledgment: NONE

Cause: The power unit has detected overvoltage in the DC link on a pulse inhibit.
- Device supply voltage too high.
- Line reactor incorrectly dimensioned.
Alarm value (r2124, interpret decimal):
DC link voltage [1 bit = 100 mV].
See also: r0070 (Actual DC link voltage)

Remedy: - Check the device supply voltage (p0210).
- Check the dimensioning of the line reactor.
See also: p0210 (Device supply voltage)

C30603 SI: Module temperature - limit value exceeded

Message class: Safety monitoring channel has identified an error (10)
Message value: -
Variant: S200 PN

Component: None
Response: OFF2
Acknowledgment: IMMEDIATELY
Cause: A safe monitoring function has detected that the module temperature has exceeded a limit value. STO (Safe Torque Off) was initiated to maintain the safe state.
Remedy: - Check the ambient temperature.
- Check the module fan.
- Operate the module in the permissible range.

F30604 SI: Safety EEPROM data error

Message class: Safety monitoring channel has identified an error (10)
Message value: %1
Variant: S200 PN
Component: Power Unit
Response: OFF2
Acknowledgment: POWER ON
Cause: Safety relevant EEPROM data are not correct.
This message results in an STO (Safe Torque Off).

Message value (r0949, interpret decimal): Only for internal Siemens fault diagnostics.
Remedy: Replace the module

A30605 SI: Checksum error has occurred

Message class: Safety monitoring channel has identified an error (10)
Message value: %1
Variant: S200 PN
Component: None
Response: NONE
Acknowledgment: NONE
Cause: A checksum error (CRC error) has occurred in the converter program memory.
Remedy: - Carry out a POWER ON (switch-off/switch-on).
- Upgrade firmware to later version.
- Contact Technical Support.

C30649 SI: Internal software error

Message class: Hardware/software error (1)
Message value: Module: %1, line: %2
Variant: S200 PN
Component: Power Unit
Response: OFF2
Acknowledgment: IMMEDIATELY
Cause: An internal error has occurred in the Safety Integrated software.
Note:
This message results in an STO (Safe Torque Off) that cannot be acknowledged.
Message value (r60049, interpret hexadecimal):
Only for internal Siemens troubleshooting.

12.3 Faults and alarms

Remedy:

- Carry out a POWER ON (switch-off/switch-on) for all components.
- Re-commission the "Safety Integrated" function and carry out a POWER ON.
- Upgrade the converter firmware to a later version.
- Contact Technical Support.
- Replace the converter.

Note:
SI: Safety Integrated

N30800 Power unit: Group signal

Message class: Power electronics faulted (5)
Message value: -
Component: Power Unit
Response: OFF2
Acknowledgment: NONE
Cause: The power unit has detected at least one fault.
Remedy: Evaluate the other messages that are presently available.

F30801 Power unit DRIVE-CLiQ: Sign-of-life missing

Message class: Internal (DRIVE-CLiQ) communication error (12)
Message value: Component number: %1, fault cause: %2
Component: Control Unit (CU)
Response: OFF2
Acknowledgment: IMMEDIATELY
Cause: A DRIVE-CLiQ communication error has occurred from the Control Unit to the power unit concerned.
The computing time load might be too high.
Message value (r0949/r2124):
0000yyxx hex: yy = component number, xx = error cause
xx = 0A hex (10 dec):
The sign-of-life bit in the receive telegram is not set.
Remedy:

- Deselect functions that are not required.
- Replace the component involved (power unit, Control Unit).

F30802 Power unit: Time slice overflow

Message class: Hardware/software error (1)
Message value: %1
Component: Power Unit
Response: OFF2
Acknowledgment: IMMEDIATELY
Cause: A time slice overflow has occurred.
Fault value (r0949, interpret decimal):
xx: time slice number
Remedy:

- Carry out a POWER ON (switch-off/switch-on) for all components.
- Upgrade firmware to later version.
- Contact Technical Support.

F30804 Power unit: Checksum error occurred

Message class: Hardware/software error (1)
Message value: %1
Component: Power Unit

Response: OFF2
Acknowledgment: IMMEDIATELY
Cause: A checksum error (CRC error) has occurred for the power unit.
Remedy:
- Carry out a POWER ON (switch-off/switch-on) for all components.
- Upgrade firmware to later version.
- Contact Technical Support.

F30805 Power unit: EEPROM checksum error

Message class: Hardware/software error (1)
Message value: %1
Component: Power Unit
Response: OFF2
Acknowledgment: IMMEDIATELY
Cause: Internal parameter data is corrupted.
Fault value (r0949, interpret hexadecimal):
01: EEPROM access error.
02: Too many blocks in the EEPROM.
Remedy: Replace the module.

F30809 Power unit: Switching information not valid

Message class: Hardware/software error (1)
Message value: -
Component: Power Unit
Response: OFF2
Acknowledgment: IMMEDIATELY
Cause: For 3P gating unit, the following applies:
The last switching status word in the setpoint telegram is identified by the end ID. Such an end ID was not found.
Remedy:
- Carry out a POWER ON (switch-off/switch-on) for all components.
- Upgrade firmware to later version.
- Contact Technical Support.

F30810 Power unit: Watchdog timer expired

Message class: Hardware/software error (1)
Message value: -
Component: Power Unit
Response: OFF2
Acknowledgment: IMMEDIATELY
Cause: The watchdog timer has expired. This can only be caused by a fatal software error.
Remedy:
- Carry out a POWER ON (switch-off/switch-on) for all components.
- Upgrade firmware to later version.
- Contact Technical Support.

F30815 Power unit: Processor clock signal error

Message class: Hardware/software error (1)
Message value: -
Component: Power Unit
Response: OFF2
Acknowledgment: POWER ON
Cause: The processor clock signal monitoring has signaled an error. This can involve the signal itself or its PLL.

12.3 Faults and alarms

Remedy: - Replace the hardware.
- Contact Technical Support.

F30820 Power unit DRIVE-CLiQ: Telegram error

Message class: Internal (DRIVE-CLiQ) communication error (12)

Message value: Component number: %1, fault cause: %2

Component: Power Unit

Response: OFF2

Acknowledgment: IMMEDIATELY

Cause: A DRIVE-CLiQ communication error has occurred from the Control Unit to the power unit concerned.

Error cause:

1 (= 01 hex):

Checksum error (CRC error).

2 (= 02 hex):

Telegram is shorter than specified in the length byte or in the receive list.

3 (= 03 hex):

Telegram is longer than specified in the length byte or in the receive list.

4 (= 04 hex):

The length of the receive telegram does not match the receive list.

5 (= 05 hex):

The type of the receive telegram does not match the receive list.

6 (= 06 hex):

The address of the component in the telegram and in the receive list do not match.

7 (= 07 hex):

A SYNC telegram is expected - but the received telegram is not a SYNC telegram.

8 (= 08 hex):

No SYNC telegram is expected - but the received telegram is one.

9 (= 09 hex):

The error bit in the receive telegram is set.

16 (= 10 hex):

The receive telegram is too early.

Note regarding the message value:

The individual information is coded as follows in the message value (r0949/r2124):

0000yyxx hex: yy = component number, xx = error cause

Remedy: - Carry out a POWER ON (switch-off/switch-on).
- Check the electrical cabinet design and cable routing for EMC compliance.
- Check the DRIVE-CLiQ wiring (interrupted cable, contacts, ...).

F30835 Power unit DRIVE-CLiQ: Cyclic data transfer error

Message class: Internal (DRIVE-CLiQ) communication error (12)

Message value: Component number: %1, fault cause: %2

Component: Power Unit

Response: OFF2

Acknowledgment: IMMEDIATELY

Cause: A DRIVE-CLiQ communication error has occurred from the Control Unit to the power unit concerned. The nodes do not send and receive in synchronism.
Error cause:
33 (= 21 hex):
The cyclic telegram has not been received.
34 (= 22 hex):
Timeout in the telegram receive list.
64 (= 40 hex):
Timeout in the telegram send list.
Note regarding the message value:
The individual information is coded as follows in the message value (r0949/r2124):
0000yyxx hex: yy = component number, xx = error cause

Remedy:

- Carry out a POWER ON.
- Replace the component involved (power unit, Control Unit).

F30836 Power unit DRIVE-CLiQ: Send error for DRIVE-CLiQ data

Message class: Internal (DRIVE-CLiQ) communication error (12)
Message value: Component number: %1, fault cause: %2
Component: Power Unit
Response: OFF2
Acknowledgment: IMMEDIATELY

Cause: A DRIVE-CLiQ communication error has occurred from the Control Unit to the power unit concerned. Data were not able to be sent.
Error cause:
65 (= 41 hex):
Telegram type does not match send list.
Note regarding the message value:
The individual information is coded as follows in the message value (r0949/r2124):
0000yyxx hex: yy = component number, xx = error cause

Remedy: Carry out a POWER ON.

F30845 Power unit DRIVE-CLiQ: Cyclic data transfer error

Message class: Internal (DRIVE-CLiQ) communication error (12)
Message value: Component number: %1, fault cause: %2
Component: Power Unit
Response: OFF2
Acknowledgment: IMMEDIATELY

Cause: A DRIVE-CLiQ communication error has occurred from the Control Unit to the power unit concerned.
Error cause:
11 (= 0B hex):
Synchronization error during alternating cyclic data transfer.
Note regarding the message value:
The individual information is coded as follows in the message value (r0949/r2124):
0000yyxx hex: yy = component number, xx = error cause

Remedy: Carry out a POWER ON (switch-off/switch-on).

F30850 Power unit: Internal software error

Message class: Hardware/software error (1)
Message value: %1
Component: Power Unit

Response: OFF1
Acknowledgment: POWER ON
Cause: An internal software error has occurred in the power unit.
Fault value (r0949, interpret decimal):
Only for internal Siemens troubleshooting.
Remedy: - Replace power unit.
- If required, upgrade the firmware in the power unit.
- Contact Technical Support.

F30851 Power unit DRIVE-CLiQ (CU): Sign-of-life missing

Message class: Internal (DRIVE-CLiQ) communication error (12)
Message value: Component number: %1, fault cause: %2
Component: Power Unit
Response: OFF2
Acknowledgment: IMMEDIATELY
Cause: A DRIVE-CLiQ communication error has occurred from the power unit to the Control Unit involved.
The DRIVE-CLiQ component did not set the sign-of-life to the Control Unit.
Message value (r0949/r2124):
0000yyxx hex: yy = component number, xx = error cause
xx = 0A hex (10 dec):
The sign-of-life bit in the receive telegram is not set.
Remedy: - Deselect functions that are not required.
- Replace the component involved (power unit, Control Unit).

A30853 Power unit: Sign-of-life error cyclic data

Message class: General drive fault (19)
Message value: -
Component: Control Unit (CU)
Response: NONE
Acknowledgment: NONE
Cause: The cyclic setpoint telegrams of the power unit were not refreshed on time.
Remedy: - Check the power unit and if required replace.

F30860 Power unit DRIVE-CLiQ (CU): Telegram error

Message class: Internal (DRIVE-CLiQ) communication error (12)
Message value: Component number: %1, fault cause: %2
Component: Power Unit
Response: OFF2
Acknowledgment: IMMEDIATELY

Cause:	<p>A DRIVE-CLiQ communication error has occurred from the power unit to the Control Unit involved.</p> <p>Error cause:</p> <p>1 (= 01 hex): Checksum error (CRC error).</p> <p>2 (= 02 hex): Telegram is shorter than specified in the length byte or in the receive list.</p> <p>3 (= 03 hex): Telegram is longer than specified in the length byte or in the receive list.</p> <p>4 (= 04 hex): The length of the receive telegram does not match the receive list.</p> <p>5 (= 05 hex): The type of the receive telegram does not match the receive list.</p> <p>6 (= 06 hex): The address of the power unit in the telegram and in the receive list do not match.</p> <p>9 (= 09 hex): The DRIVE-CLiQ communication from the DRIVE-CLiQ component involved to the Control Unit signals that the supply voltage has failed.</p> <p>16 (= 10 hex): The receive telegram is too early.</p> <p>17 (= 11 hex): CRC error and the receive telegram is too early.</p> <p>18 (= 12 hex): The telegram is shorter than that specified in the length byte or in the receive list and the receive telegram is too early.</p> <p>19 (= 13 hex): The telegram is longer than that specified in the length byte or in the receive list and the receive telegram is too early.</p> <p>20 (= 14 hex): The length of the receive telegram does not match the receive list and the receive telegram is too early.</p> <p>21 (= 15 hex): The type of the receive telegram does not match the receive list and the receive telegram is too early.</p> <p>22 (= 16 hex): The address of the power unit in the telegram and in the receive list does not match and the receive telegram is too early.</p> <p>25 (= 19 hex): The error bit in the receive telegram is set and the receive telegram is too early.</p> <p>Note regarding the message value: The individual information is coded as follows in the message value (r0949/r2124): 0000yyxx hex: yy = component number, xx = error cause</p>
Remedy:	<ul style="list-style-type: none">- Carry out a POWER ON (switch-off/switch-on).- Check the electrical cabinet design and cable routing for EMC compliance.- Check the DRIVE-CLiQ wiring (interrupted cable, contacts, ...).

F30875 Power unit: power supply voltage failed

Message class:	Supply voltage fault (undervoltage) (3)
Message value:	Component number: %1, fault cause: %2
Component:	Power Unit
Response:	OFF2
Acknowledgment:	IMMEDIATELY

12.3 Faults and alarms

Cause: The component involved has signaled that the 24 V supply has failed.
Error cause:
9 (= 09 hex):
The power supply voltage for the components has failed.
Note regarding the message value:
The individual information is coded as follows in the message value (r0949/r2124):
0000yyxx hex: yy = component number, xx = error cause

Remedy:

- Check the supply voltage wiring (interrupted cable, contacts, ...).
- Check the dimensioning of the 24 V supply, check cable lengths.

F30885 CU DRIVE-CLiQ (CU): Cyclic data transfer error

Message class: Internal (DRIVE-CLiQ) communication error (12)

Message value: Component number: %1, fault cause: %2

Component: Power Unit

Response: OFF2

Acknowledgment: IMMEDIATELY

Cause: A DRIVE-CLiQ communication error has occurred from the power unit to the Control Unit involved.

The nodes do not send and receive in synchronism.

Error cause:

26 (= 1A hex):

Sign-of-life bit in the receive telegram not set and the receive telegram is too early.

33 (= 21 hex):

The cyclic telegram has not been received.

34 (= 22 hex):

Timeout in the telegram receive list.

64 (= 40 hex):

Timeout in the telegram send list.

98 (= 62 hex):

Error at the transition to cyclic operation.

Note regarding the message value:

The individual information is coded as follows in the message value (r0949/r2124):

0000yyxx hex: yy = component number, xx = error cause

Remedy:

- Check the power supply voltage of the component involved.
- Carry out a POWER ON.
- Replace the component involved.

F30886 PU DRIVE-CLiQ (CU): Error when sending DRIVE-CLiQ data

Message class: Internal (DRIVE-CLiQ) communication error (12)

Message value: Component number: %1, fault cause: %2

Component: Power Unit

Response: OFF2

Acknowledgment: IMMEDIATELY

Cause: A DRIVE-CLiQ communication error has occurred from the power unit to the Control Unit involved.

Data were not able to be sent.

Error cause:

65 (= 41 hex):

Telegram type does not match send list.

Note regarding the message value:

The individual information is coded as follows in the message value (r0949/r2124):

0000yyxx hex: yy = component number, xx = error cause

Remedy: Carry out a POWER ON.

F30895 PU DRIVE-CLiQ (CU): Alternating cyclic data transfer error

Message class: Internal (DRIVE-CLiQ) communication error (12)
Message value: Component number: %1, fault cause: %2
Component: Power Unit
Response: OFF2
Acknowledgment: IMMEDIATELY
Cause: A DRIVE-CLiQ communication error has occurred from the power unit to the Control Unit involved.
Error cause:
11 (= 0B hex):
Synchronization error during alternating cyclic data transfer.
Note regarding the message value:
The individual information is coded as follows in the message value (r0949/r2124):
0000yyxx hex: yy = component number, xx = error cause
Remedy: Carry out a POWER ON (switch-off/switch-on).

F30896 Power unit DRIVE-CLiQ (CU): Inconsistent component properties

Message class: Internal (DRIVE-CLiQ) communication error (12)
Message value: Component number: %1
Component: Power Unit
Response: OFF2
Acknowledgment: IMMEDIATELY
Explanation of the message value: For %1
Component in target topology
Cause: The properties of the DRIVE-CLiQ component (power unit), specified by the fault value, have changed in an incompatible fashion with respect to the properties when booted. One cause can be, e.g. that a DRIVE-CLiQ cable or DRIVE-CLiQ component has been replaced.
Fault value (r0949, interpret decimal):
Component number.
Remedy:
- Carry out a POWER ON.
- When a component is replaced, the same component type and if possible the same firmware version should be used.
- When a cable is replaced, only cables whose length is the same as or as close as possible to the length of the original cables should be used (ensure compliance with the maximum cable length).

F30899 Power unit: Unknown fault

Message class: Power electronics faulted (5)
Message value: New message: %1
Component: Power Unit
Response: NONE
Acknowledgment: IMMEDIATELY
Cause: A fault occurred on the power unit, which cannot be interpreted by the converter firmware.
This can occur if the firmware on this component is more recent than the converter firmware.
Fault value (r0949, interpret decimal):
Fault number.
Note:
If required, the significance of this new fault can be read about in a more recent description of the converter.
Remedy:
- Replace the firmware on the power unit by an older firmware version.
- Upgrade the converter firmware.

F30903 Power unit: I2C bus error occurred

Message class: Hardware/software error (1)
Message value: %1
Component: Power Unit
Response: NONE
Acknowledgment: IMMEDIATELY
Cause: Communications error with an EEPROM or an analog/digital converter.
Fault value (r0949, interpret hexadecimal):
80000000 hex:
- Internal software error.
00000001 hex ... 0000FFFF hex:
- Module fault.
Remedy: For fault value = 80000000 hex:
- Upgrade firmware to later version.
For fault value = 00000001 hex ... 0000FFFF hex:
- Replace the module.

F30907 Power unit: FPGA configuration unsuccessful

Message class: Hardware/software error (1)
Message value: -
Component: Power Unit
Response: OFF2
Acknowledgment: IMMEDIATELY
Cause: During initialization within the power unit, an internal software error has occurred.
Remedy: - If required, upgrade the firmware in the power unit.
- Replace power unit.
- Contact Technical Support.

A30919 Power unit: Temperature monitoring failed

Message class: Overtemperature of the electronic components (6)
Message value: %1
Component: Power Unit
Response: NONE
Acknowledgment: NONE
Cause: The temperature monitoring in the power unit has failed.
Fault-free operation of the drive system is no longer guaranteed.
Alarm value (r2124, interpret binary):
Bit 0: Sensor 1 for the internal temperature can no longer be evaluated.
Bit 1: Sensor 2 for the internal temperature can no longer be evaluated.
Remedy: Replace the power unit immediately.

F30950 Power unit: Internal software error

Message class: Hardware/software error (1)
Message value: %1
Component: Power Unit
Response: OFF2
Acknowledgment: POWER ON

Cause: An internal software error has occurred.
Fault value (r0949, interpret decimal):
Information about the fault source.
Only for internal Siemens troubleshooting.

Remedy: - If necessary, upgrade the firmware in the power unit to a later version.
- Contact Technical Support.

A30999 Power unit: Unknown alarm

Message class: Power electronics faulted (5)
Message value: New message: %1
Component: Power Unit
Response: NONE
Acknowledgment: NONE

Cause: An alarm occurred on the power unit, which cannot be interpreted by the converter firmware.
This can occur if the firmware on this component is more recent than the firmware on the converter.
Alarm value (r2124, interpret decimal):
Alarm number.
Note:
If required, the significance of this new alarm can be read about in a more recent description of the converter.

Remedy: - Replace the firmware on the power unit by an older firmware version.
- Upgrade the converter firmware.

F31110 Motor encoder: Serial communication faulted

Message class: Position/speed actual value incorrect or not available (11)
Message value: Fault cause: %1 bin
Component: Encoder 1
Response: ENCODER
Acknowledgment: PULSE INHIBIT

Cause: There is an error in the transfer of the serial communication protocol between the encoder and internal or external evaluation module.
Fault value (r0949, interpret binary):
Bit 0: Alarm bit in the position protocol.
Bit 2: Encoder does not respond (does not supply a start bit within 50 ms).
Bit 3: CRC error: The checksum in the protocol from the encoder does not match the data.
Bit 6: Timeout when cyclically reading.
Bit 7: Timeout for the register communication.
Bit 14: Register communication error.

Remedy: For fault value, bit 0 = 1:
- Encoder defect F31111 may provide further details.
For fault value, bit 2 = 1:
- Incorrect encoder type / replace the encoder or encoder cable.
For fault value, bit 3 = 1:
- EMC / connect the cable shield, replace the encoder or encoder cable.
For fault value, bit 6 = 1:
- Update the firmware
For fault value, bit 7 = 1:
- Incorrect encoder type / replace the encoder or encoder cable.
For fault value, bit 14 = 1:
- Incorrect encoder type / replace the encoder or encoder cable.

F31111 Motor encoder: Encoder signals an internal error (detailed information)

Message class: Position/speed actual value incorrect or not available (11)
Message value: Fault cause: %1 bin, additional information: %2
Component: Encoder 1
Response: ENCODER
Acknowledgment: PULSE INHIBIT
Cause: The encoder error word provides detailed information (error bit).
 Fault value (r0949, interpret binary):
 yyyyxxxx hex: yyyy = supplementary information, xxxx = fault cause
 Bit 0: Error in the multiturn block.
 Bit 1: EEPROM error.
 Bit 2: Singleturn position incorrect.
 Bit 3: Multiturn position incorrect.
 Bit 4: MLS generation error.
 Bit 5: Reserved.
 Bit 6: Overtemperature.
 Bit 7: Internal fault.
Remedy: Encoder is defective. Replace the encoder or motor.

F31112 Motor encoder: Encoder signals an internal error

Message class: Position/speed actual value incorrect or not available (11)
Message value: %1
Component: Encoder 1
Response: ENCODER
Acknowledgment: PULSE INHIBIT
Cause: The encoder signals an internal error via serial protocol.
 Fault value (r0949, interpret binary):
 Bit 0: Fault bit in the position protocol.
Remedy: For fault value, bit 0 = 1:
 In the case of an EnDat encoder, F31111 may provide further details.

F31150 Motor encoder: Initialization error

Message class: Error in the parameterization / configuration / commissioning procedure (18)
Message value: %1
Component: Sensor Module Encoder 1
Response: ENCODER
Acknowledgment: PULSE INHIBIT
Cause: Encoder functionality selected in p0404 cannot be executed.
 Fault value (r0949, interpret hexadecimal):
 Encoder malfunction.
 The bit assignment corresponds to that of p0404 (e.g. bit 5 set: Error track C/D).
 See also: p0404 (Encoder configuration effective)
Remedy: - Check that p0404 is correctly set.
 - Check the encoder type used (incremental/absolute) and for SMCxx, the encoder cable.
 - If relevant, note additional fault messages that describe the fault in detail.

A31407 Motor encoder: Function limit reached

Message class: Position/speed actual value incorrect or not available (11)
Message value: %1

Component: Encoder 1
Response: NONE
Acknowledgment: NONE
Cause: The encoder has reached one of its function limits. A service is recommended.
Alarm value (r2124, interpret decimal):
1: Incremental signals
3: Absolute track
4: Code connection
Remedy: Perform service. Replace the encoder if necessary.

A31410 Motor encoder: Communication error (encoder and Sensor Module)

Message class: Position/speed actual value incorrect or not available (11)
Message value: Fault cause: %1 bin
Component: Encoder 1
Response: NONE
Acknowledgment: NONE
Cause: There is an error in the transfer of the serial communication protocol between the encoder and internal or external evaluation module.
Fault value (r0949, interpret binary):
Bit 0: Alarm bit in the position protocol.
Bit 2: Encoder does not respond (does not supply a start bit within 50 ms).
Bit 3: CRC error: The checksum in the protocol from the encoder does not match the data.
Bit 6: Timeout when cyclically reading.
Bit 7: Timeout for the register communication.
Bit 14: Register communication error.
Remedy:
- Check that the encoder cables are routed in compliance with EMC.
- Check the plug connections.
- Replace encoder.

A31411 Motor encoder: Encoder signals an internal alarm (detailed information)

Message class: Position/speed actual value incorrect or not available (11)
Message value: Fault cause: %1 bin, additional information: %2
Component: Encoder 1
Response: NONE
Acknowledgment: NONE
Cause: The encoder error word provides detailed information (alarm bit).
Alarm value (r2124, interpret binary):
yyyyxxx hex: yyyy = supplementary information, xxxx = fault cause
Bit 0: LED current incorrect.
Bit 1: Signal amplitude outside the control range.
Bit 2: Overtemperature.
Remedy: Replace encoder.

A31412 Motor encoder: Encoder signals an internal alarm

Message class: Position/speed actual value incorrect or not available (11)
Message value: %1
Component: Encoder 1
Response: NONE
Acknowledgment: NONE

12.3 Faults and alarms

Cause: The encoder signals an internal alarm via serial protocol.
Alarm value (r2124, interpret binary):
Bit 0: Fault bit in the position protocol.
Bit 1: Alarm bit in the position protocol.

Remedy:

- Carry out a POWER ON (switch-off/switch-on) for all components.
- Check that the encoder cables are routed in compliance with EMC.
- Check the plug connections.
- Replace encoder.

F31502 Motor encoder: Encoder with measuring gearbox without valid signals

Message class: Position/speed actual value incorrect or not available (11)
Message value: -
Component: Sensor Module Encoder 1
Response: OFF1
Acknowledgment: IMMEDIATELY

Cause: The encoder with measuring gearbox no longer provides any valid signals.

Remedy: It must be ensured that all of the encoders, with mounted measuring gearbox, provide valid actual values in operation.

F31503 Motor encoder: Position tracking cannot be reset

Message class: Position/speed actual value incorrect or not available (11)
Message value: -
Component: None
Response: OFF1
Acknowledgment: IMMEDIATELY

Cause: The position tracking for the measuring gearbox cannot be reset.

Remedy: The fault should be resolved as follows:

- Select commissioning.
- Reset the position tracking as follows (p0411.2 = 1).
- Deselect commissioning.

The fault should then be acknowledged and the absolute encoder adjusted.

A31700 Motor encoder: Functional safety monitoring initiated

Message class: Safety monitoring channel has identified an error (10)
Message value: Fault cause: %1 bin
Component: Sensor Module Encoder 1
Response: NONE
Acknowledgment: NONE

Cause: Functional safety was activated. Self test of the DRIVE-CLiQ encoder has detected a fault.
Alarm value (r2124, interpret binary):
Bit x = 1: Effectivity test x unsuccessful.

Remedy: Replace encoder.

N31800 Motor encoder: Group signal

Message class: Position/speed actual value incorrect or not available (11)
Message value: -
Component: None
Response: ENCODER
Acknowledgment: NONE

Cause: The motor encoder has detected at least one fault.

Remedy: Evaluate the other messages that are presently available.

F31801 Motor encoder DRIVE-CLiQ: Sign-of-life missing

Message class: Internal (DRIVE-CLiQ) communication error (12)

Message value: Component number: %1, fault cause: %2

Component: Control Unit (CU)

Response: ENCODER

Acknowledgment: IMMEDIATELY

Cause: There is a DRIVE-CLiQ communication error between the converter and the encoder involved.

Fault value (r0949, interpret hexadecimal):

0000yyxx hex:

yy = component number,

xx = fault cause

Error cause:

10 (= 0A hex):

The sign-of-life bit in the receive telegram is not set.

Remedy:

- Check the electrical cabinet design and cable routing for EMC compliance.
- Replace the component involved.

F31802 Motor encoder: Time slice overflow

Message class: Hardware/software error (1)

Message value: %1

Component: Sensor Module Encoder 1

Response: ENCODER

Acknowledgment: IMMEDIATELY

Cause: A time slice overflow for the motor encoder has occurred.

Fault value (r0949, interpret hexadecimal):

yx hex: y = function involved (Siemens-internal fault diagnostics), x = time slice involved

x = 9:

Time slice overflow of the fast (current controller clock cycle) time slice.

x = A:

Time slice overflow of the average time slice.

x = C:

Time slice overflow of the slow time slice.

yx = 3E7:

Timeout when waiting for SYNO (e.g. unexpected return to non-cyclic operation).

Remedy: Increase the current controller sampling time

Note:

For a current controller sampling time = 31.25 µs, use an SMx20 with Article No. 6SL3055-0AA00-5xA3.

F31804 Motor encoder: Sensor Module checksum error

Message class: Hardware/software error (1)

Message value: %1

Component: Sensor Module Encoder 1

Response: ENCODER

Acknowledgment: POWER ON

12.3 Faults and alarms

Cause: A checksum error has occurred when reading-out the program memory on the Sensor Module.
Fault value (r0949, interpret hexadecimal):
yyyyxxxx hex
yyyy: Memory area involved.
xxxx: Difference between the checksum at POWER ON and the actual checksum.

Remedy:

- Carry out a POWER ON (switch-off/switch-on).
- Upgrade firmware to later version.
- Check whether the permissible ambient temperature for the component is maintained.

F31805 Motor encoder: EEPROM checksum error

Message class: Hardware/software error (1)
Message value: %1
Component: Sensor Module Encoder 1
Response: ENCODER
Acknowledgment: IMMEDIATELY

Cause: Data in the EEPROM corrupted .
Fault value (r0949, interpret hexadecimal):
01: EEPROM access error.
02: Too many blocks in the EEPROM.

Remedy: Replace the module.

F31813 Motor encoder: Hardware logic unit failed

Message class: Hardware/software error (1)
Message value: Fault cause: %1 bin
Component: Sensor Module Encoder 1
Response: ENCODER
Acknowledgment: PULSE INHIBIT

Cause: The logic unit of the DRIVE-CLiQ encoder has failed.
Fault value (r0949, interpret binary):
Bit 0: ALU watchdog has responded.
Bit 1: ALU has detected a sign-of-life error.

Remedy: When the error reoccurs, replace the encoder.

F31820 Motor encoder DRIVE-CLiQ: Telegram error

Message class: Internal (DRIVE-CLiQ) communication error (12)
Message value: Component number: %1, fault cause: %2
Component: Sensor Module Encoder 1
Response: ENCODER
Acknowledgment: IMMEDIATELY

Cause: There is a DRIVE-CLiQ communication error between the converter and the encoder involved.

Fault value (r0949, interpret hexadecimal):

0000yyxx hex:

yy = component number,

xx = fault cause

Error cause:

1 (= 01 hex):

Checksum error (CRC error).

2 (= 02 hex):

Telegram is shorter than specified in the length byte or in the receive list.

3 (= 03 hex):

Telegram is longer than specified in the length byte or in the receive list.

4 (= 04 hex):

The length of the receive telegram does not match the receive list.

5 (= 05 hex):

The type of the receive telegram does not match the receive list.

6 (= 06 hex):

The address of the component in the telegram and in the receive list do not match.

7 (= 07 hex):

A SYNC telegram is expected - but the received telegram is not a SYNC telegram.

8 (= 08 hex):

No SYNC telegram is expected - but the received telegram is one.

9 (= 09 hex):

The error bit in the receive telegram is set.

16 (= 10 hex):

The receive telegram is too early.

Remedy:

- Carry out a POWER ON (switch-off/switch-on).
- Check the electrical cabinet design and cable routing for EMC compliance.
- Check the DRIVE-CLiQ wiring (interrupted cable, contacts, ...).

F31835 Motor encoder DRIVE-CLiQ: Cyclic data transfer error

Message class: Internal (DRIVE-CLiQ) communication error (12)

Message value: Component number: %1, fault cause: %2

Component: Sensor Module Encoder 1

Response: ENCODER

Acknowledgment: IMMEDIATELY

12.3 Faults and alarms

Cause: There is a DRIVE-CLiQ communication error between the converter and the encoder involved. The nodes do not send and receive in synchronism.

Fault value (r0949, interpret hexadecimal):

0000yyxx hex:

yy = component number,

xx = fault cause

Error cause:

33 (= 21 hex):

The cyclic telegram has not been received.

34 (= 22 hex):

Timeout in the telegram receive list.

64 (= 40 hex):

Timeout in the telegram send list.

Remedy: - Carry out a POWER ON.
- Replace the component involved.

F31836 Motor encoder DRIVE-CLiQ: Send error for DRIVE-CLiQ data

Message class: Internal (DRIVE-CLiQ) communication error (12)

Message value: Component number: %1, fault cause: %2

Component: Sensor Module Encoder 1

Response: ENCODER

Acknowledgment: IMMEDIATELY

Cause: There is a DRIVE-CLiQ communication error between the converter and the encoder involved. Data were not able to be sent.

Fault value (r0949, interpret hexadecimal):

0000yyxx hex:

yy = component number,

xx = fault cause

Error cause:

65 (= 41 hex):

Telegram type does not match send list.

Remedy: Carry out a POWER ON.

F31837 Motor encoder DRIVE-CLiQ: Component fault

Message class: Internal (DRIVE-CLiQ) communication error (12)

Message value: Component number: %1, fault cause: %2

Component: Sensor Module Encoder 1

Response: ENCODER

Acknowledgment: IMMEDIATELY

Cause: Fault detected on the DRIVE-CLiQ component involved. Faulty hardware cannot be excluded.

Fault value (r0949, interpret hexadecimal):

0000yyxx hex:

yy = component number,

xx = fault cause

Error cause:

32 (= 20 hex):

Error in the telegram header.

35 (= 23 hex):

Receive error: The telegram buffer memory contains an error.

66 (= 42 hex):

Send error: The telegram buffer memory contains an error.

67 (= 43 hex):

Send error: The telegram buffer memory contains an error.

Remedy:

- Check the DRIVE-CLiQ wiring (interrupted cable, contacts, ...).
- Check the electrical cabinet design and cable routing for EMC compliance.
- Replace the component involved.

F31845 Motor encoder DRIVE-CLiQ: Cyclic data transfer error

Message class: Internal (DRIVE-CLiQ) communication error (12)

Message value: Component number: %1, fault cause: %2

Component: Sensor Module Encoder 1

Response: ENCODER

Acknowledgment: IMMEDIATELY

Cause: There is a DRIVE-CLiQ communication error between the converter and the encoder involved.

Fault value (r0949, interpret hexadecimal):

0000yyxx hex:

yy = component number,

xx = fault cause

Error cause:

11 (= 0B hex):

Synchronization error during alternating cyclic data transfer.

Remedy: Carry out a POWER ON (switch-off/switch-on).

F31850 Motor encoder: Encoder evaluation internal software error

Message class: Hardware/software error (1)

Message value: %1

Component: Sensor Module Encoder 1

Response: ENCODER

Acknowledgment: POWER ON

Cause: An internal software error has occurred in the Sensor Module of the motor encoder.
Fault value (r0949, interpret decimal):
1: Background time slice is blocked.
2: Checksum over the code memory is not correct.
10000: OEM memory of the EnDat encoder contains data that cannot be interpreted.
11000 ... 11499: Descriptive data from EEPROM incorrect.
11500 ... 11899: Calibration data from EEPROM incorrect.
11900 ... 11999: Configuration data from EEPROM incorrect.
12000 ... 12008: communication with analog/digital converter faulted.
16000: DRIVE-CLiQ encoder initialization application error.
16001: DRIVE-CLiQ encoder initialization ALU error.
16002: DRIVE-CLiQ encoder HISI / SISI initialization error.
16003: DRIVE-CLiQ encoder safety initialization error.
16004: DRIVE-CLiQ encoder internal system error.

Remedy:

- Replace the Sensor Module.
- If required, upgrade the firmware.
- Contact Technical Support.

F31851 Encoder 1 DRIVE-CLiQ: Sign-of-life missing

Message class: Internal (DRIVE-CLiQ) communication error (12)
Message value: Component number: %1, fault cause: %2
Component: Sensor Module Encoder 1
Response: ENCODER
Acknowledgment: IMMEDIATELY

Cause: There is a DRIVE-CLiQ communication error from the Sensor Module involved (encoder 1) to the converter. The DRIVE-CLiQ component did not set the sign-of-life to the converter.

Fault value (r0949, interpret hexadecimal):
0000yyxx hex:
yy = component number,
xx = fault cause

Error cause:
10 (= 0A hex):
The sign-of-life bit in the receive telegram is not set.

Remedy:

- Upgrade the firmware of the component involved.
- Carry out a POWER ON (switch-off/switch-on) for the component involved.

F31860 Encoder 1 DRIVE-CLiQ: Telegram error

Message class: Internal (DRIVE-CLiQ) communication error (12)
Message value: Component number: %1, fault cause: %2
Component: Sensor Module Encoder 1
Response: ENCODER
Acknowledgment: IMMEDIATELY

Cause:	<p>There is a DRIVE-CLiQ communication error from the Sensor Module involved (encoder 1) to the converter.</p> <p>Fault value (r0949, interpret hexadecimal): 0000yyxx hex: yy = component number, xx = fault cause</p> <p>Error cause:</p> <p>1 (= 01 hex): Checksum error (CRC error).</p> <p>2 (= 02 hex): Telegram is shorter than specified in the length byte or in the receive list.</p> <p>3 (= 03 hex): Telegram is longer than specified in the length byte or in the receive list.</p> <p>4 (= 04 hex): The length of the receive telegram does not match the receive list.</p> <p>5 (= 05 hex): The type of the receive telegram does not match the receive list.</p> <p>6 (= 06 hex): The address of the power unit in the telegram and in the receive list do not match.</p> <p>9 (= 09 hex): The DRIVE-CLiQ communication from the DRIVE-CLiQ component involved to the converter signals that the supply voltage has failed.</p> <p>16 (= 10 hex): The receive telegram is too early.</p> <p>17 (= 11 hex): CRC error and the receive telegram is too early.</p> <p>18 (= 12 hex): The telegram is shorter than that specified in the length byte or in the receive list and the receive telegram is too early.</p> <p>19 (= 13 hex): The telegram is longer than that specified in the length byte or in the receive list and the receive telegram is too early.</p> <p>20 (= 14 hex): The length of the receive telegram does not match the receive list and the receive telegram is too early.</p> <p>21 (= 15 hex): The type of the receive telegram does not match the receive list and the receive telegram is too early.</p> <p>22 (= 16 hex): The address of the power unit in the telegram and in the receive list does not match and the receive telegram is too early.</p> <p>25 (= 19 hex): The error bit in the receive telegram is set and the receive telegram is too early.</p>
Remedy:	<ul style="list-style-type: none">- Carry out a POWER ON (switch-off/switch-on).- Check the electrical cabinet design and cable routing for EMC compliance.- Check the DRIVE-CLiQ wiring (interrupted cable, contacts, ...).

F31875 Motor encoder: Supply voltage failed

Message class:	Supply voltage fault (undervoltage) (3)
Message value:	Component number: %1, fault cause: %2
Component:	Sensor Module Encoder 1
Response:	ENCODER
Acknowledgment:	IMMEDIATELY

12.3 Faults and alarms

Cause: The component involved has signaled that the 24 V supply has failed.
Error cause:
9 (= 09 hex):
The power supply voltage for the components has failed.
Note regarding the message value:
The individual information is coded as follows in the message value (r0949/r2124):
0000yyxx hex: yy = component number, xx = error cause

Remedy:

- Check the supply voltage wiring (interrupted cable, contacts, ...).
- Check the dimensioning of the 24 V supply, check cable lengths.

F31885 Motor encoder DRIVE-CLiQ (CU): Cyclic data transfer error

Message class: Internal (DRIVE-CLiQ) communication error (12)

Message value: Component number: %1, fault cause: %2

Component: Sensor Module Encoder 1

Response: ENCODER

Acknowledgment: IMMEDIATELY

Cause: There is a DRIVE-CLiQ communication error between the Sensor Module (motor encoder) involved and the Control Unit.
The nodes do not send and receive in synchronism.

Error cause:

26 (= 1A hex):

Sign-of-life bit in the receive telegram not set and the receive telegram is too early.

33 (= 21 hex):

The cyclic telegram has not been received.

34 (= 22 hex):

Timeout in the telegram receive list.

64 (= 40 hex):

Timeout in the telegram send list.

98 (= 62 hex):

Error at the transition to cyclic operation.

Note regarding the message value:

The individual information is coded as follows in the message value (r0949/r2124):

0000yyxx hex: yy = component number, xx = error cause

Remedy:

- Check the power supply voltage of the component involved.
- Carry out a POWER ON (switch-off/switch-on).
- Replace the component involved.

F31886 Motor encoder DRIVE-CLiQ (CU): Error when sending DRIVE-CLiQ data

Message class: Internal (DRIVE-CLiQ) communication error (12)

Message value: Component number: %1, fault cause: %2

Component: Sensor Module Encoder 1

Response: ENCODER

Acknowledgment: IMMEDIATELY

Cause: There is a DRIVE-CLiQ communication error from the Sensor Module involved (encoder 1) to the converter.
Data were not able to be sent.

Fault value (r0949, interpret hexadecimal):

0000yyxx hex:

yy = component number,

xx = fault cause

Error cause:

65 (= 41 hex):

Telegram type does not match send list.

Remedy: - Carry out a POWER ON.

F31887 Motor encoder DRIVE-CLiQ (CU): Component fault

Message class: Internal (DRIVE-CLiQ) communication error (12)

Message value: Component number: %1, fault cause: %2

Component: Sensor Module Encoder 1

Response: ENCODER

Acknowledgment: IMMEDIATELY

Cause: A fault has been detected on the DRIVE-CLiQ component involved (Sensor Module for the motor encoder). Faulty hardware cannot be excluded.

Fault value (r0949, interpret hexadecimal):

0000yyxx hex:

yy = component number,

xx = fault cause

Error cause:

32 (= 20 hex):

Error in the telegram header.

35 (= 23 hex):

Receive error: The telegram buffer memory contains an error.

66 (= 42 hex):

Send error: The telegram buffer memory contains an error.

67 (= 43 hex):

Send error: The telegram buffer memory contains an error.

96 (= 60 hex):

Response received too late during runtime measurement.

97 (= 61 hex):

Time taken to exchange characteristic data too long.

Remedy:

- Check the DRIVE-CLiQ wiring (interrupted cable, contacts, ...).
- Check the electrical cabinet design and cable routing for EMC compliance.
- Replace the component involved.

F31895 Encoder 1 DRIVE-CLiQ: Alternating cyclic data transfer error

Message class: Internal (DRIVE-CLiQ) communication error (12)

Message value: Component number: %1, fault cause: %2

Component: Sensor Module Encoder 1

Response: ENCODER

Acknowledgment: IMMEDIATELY

12.3 Faults and alarms

Cause: There is a DRIVE-CLiQ communication error from the Sensor Module involved (encoder 1) to the converter.
Error cause:
11 (= 0B hex):
Synchronization error during alternating cyclic data transfer.
Note regarding the message value:
The individual information is coded as follows in the message value (r0949/r2124):
0000yyxx hex:
yy = component number,
xx = fault cause

Remedy: Carry out a POWER ON.

F31896 Motor encoder DRIVE-CLiQ (CU): Inconsistent component properties

Message class: Internal (DRIVE-CLiQ) communication error (12)

Message value: Component number: %1

Component: Sensor Module Encoder 1

Response: OFF2

Acknowledgment: IMMEDIATELY

Explanation of the message value: For %1

Component in target topology

Cause: The properties of the DRIVE-CLiQ component (Sensor Module for the motor encoder), specified by the fault value, have changed in an incompatible fashion with respect to the properties when running up. One cause can be, e.g. that a DRIVE-CLiQ cable or DRIVE-CLiQ component has been replaced.

Fault value (r0949, interpret decimal):

Component number.

Remedy:

- Carry out a POWER ON.
- When a component is replaced, the same component type and if possible the same firmware version should be used.
- When a cable is replaced, only cables whose length is the same as or as close as possible to the length of the original cables should be used (ensure compliance with the maximum cable length).

F31899 Motor encoder: Unknown fault

Message class: Position/speed actual value incorrect or not available (11)

Message value: New message: %1

Component: Sensor Module Encoder 1

Response: ENCODER

Acknowledgment: IMMEDIATELY

Cause: A fault has occurred on the Sensor Module for the motor encoder, which cannot be interpreted by the Control Unit firmware. This can occur if the firmware on this component is more recent than the firmware on the Control Unit.

Fault value (r0949, interpret decimal):

Fault number.

Note:

If required, the significance of this new fault can be read about in a more recent description of the Control Unit.

Remedy:

- Replace the firmware on the Sensor Module by an older firmware version (r0148).
- Upgrade the firmware on the Control Unit (r0018).

A31902 Motor encoder: SPI-BUS error occurred

Message class: Hardware/software error (1)

Message value: %1

Component: Sensor Module Encoder 1

Response: NONE

Acknowledgment: NONE

Cause: Error when operating the internal SPI bus.
Alarm value (r2124, interpret hexadecimal):
Only for internal Siemens troubleshooting.

Remedy: - Replace the Sensor Module.
- If required, upgrade the firmware in the Sensor Module.
- Contact Technical Support.

A31903 Motor encoder: I2C-BUS error occurred

Message class: Hardware/software error (1)

Message value: %1

Component: Sensor Module Encoder 1

Response: NONE

Acknowledgment: NONE

Cause: Error when operating the internal I2C bus.
Alarm value (r2124, interpret hexadecimal):
Only for internal Siemens troubleshooting.

Remedy: - Replace the Sensor Module.
- If required, upgrade the firmware in the Sensor Module.
- Contact Technical Support.

F31905 Motor encoder: Encoder parameterization error

Message class: Error in the parameterization / configuration / commissioning procedure (18)

Message value: Parameter: %1, supplementary information: %2

Component: Sensor Module Encoder 1

Response: ENCODER

Acknowledgment: IMMEDIATELY

Cause: An error was identified in the encoder parameterization.
It is possible that the parameterized encoder type does not match the connected encoder.
Determine the parameter number using the fault value (r0949).

Fault value (r0949, interpret decimal):
yyyyxxxx dec: yyyy = supplementary information, xxxx = parameter
yyyy = 0:
No additional information available.
yyyy = 10:
The connected encoder is not supported.

Remedy: - Check whether the connected encoder type matches the encoder that has been parameterized.
- Correct the parameter specified by the fault value (r0949).

F31950 Motor encoder: Internal software error

Message class: Hardware/software error (1)

Message value: %1

Component: Sensor Module Encoder 1

Response: ENCODER

Acknowledgment: POWER ON

Cause: An internal software error has occurred.
Fault value (r0949, interpret decimal):
The fault value contains information regarding the fault source.
Only for internal Siemens troubleshooting.

Remedy:

- If necessary, upgrade the firmware in the Sensor Module to a later version.
- Contact Technical Support.

A31999 Motor encoder: Unknown alarm

Message class: Position/speed actual value incorrect or not available (11)

Message value: New message: %1

Component: Sensor Module Encoder 1

Response: NONE

Acknowledgment: NONE

Cause: An alarm occurred on the Sensor Module for encoder 1, which cannot be interpreted by the converter firmware. This can occur if the firmware on this component is more recent than the converter firmware.

Alarm value (r2124, interpret decimal):

Alarm number.

Note:

If required, the significance of this new alarm can be read about in a more recent description of the converter.

Remedy:

- Replace the firmware on the Sensor Module by an older firmware version.
- Upgrade the converter firmware.

A32700 Encoder 2: Effectivity test does not supply the expected value

Message class: Safety monitoring channel has identified an error (10)

Message value: Fault cause: %1 bin

Component: Sensor Module Encoder 2

Response: NONE

Acknowledgment: NONE

Cause: The DRIVE-CLiQ encoder fault word supplies fault bits that have been set.

Alarm value (r2124, interpret binary):

Bit x = 1: Effectivity test x unsuccessful.

Remedy: Replace encoder.

N32800 Encoder 2: Group signal

Message class: Position/speed actual value incorrect or not available (11)

Message value: -

Component: None

Response: OFF1

Acknowledgment: NONE

Cause: The motor encoder has detected at least one fault.

Remedy: Evaluation of other active messages.

F32801 Encoder 2 DRIVE-CLiQ: Sign-of-life missing

Message class: Internal (DRIVE-CLiQ) communication error (12)

Message value: Component number: %1, fault cause: %2

Component: Control Unit (CU)

Response: OFF1

Acknowledgment: IMMEDIATELY

Cause: A DRIVE-CLiQ communication error has occurred from the Control Unit to the encoder involved.
Error cause:
10 (= 0A hex):
The sign-of-life bit in the receive telegram is not set.
Note regarding the message value:
The individual information is coded as follows in the message value (r0949/r2124):
0000yyxx hex: yy = component number, xx = error cause

Remedy: - Check the electrical cabinet design and cable routing for EMC compliance.
- Replace the component involved.

F32802 Encoder 2: Time slice overflow

Message class: Hardware/software error (1)
Message value: %1
Component: Sensor Module Encoder 2
Response: OFF1
Acknowledgment: IMMEDIATELY

Cause: A time slice overflow has occurred in encoder 2.
Fault value (r0949, interpret hexadecimal):
yx hex: y = function involved (Siemens-internal fault diagnostics), x = time slice involved
x = 9:
Time slice overflow of the fast (current controller clock cycle) time slice.
x = A:
Time slice overflow of the average time slice.
x = C:
Time slice overflow of the slow time slice.
yx = 3E7:
Timeout when waiting for SYNO (e.g. unexpected return to non-cyclic operation).

Remedy: Increase the current controller sampling time
Note:
For a current controller sampling time = 31.25 µs, use an SMx20 with Article No. 6SL3055-0AA00-5xA3.

F32805 Encoder 2: EEPROM checksum error

Message class: Hardware/software error (1)
Message value: %1
Component: Sensor Module Encoder 2
Response: OFF1
Acknowledgment: IMMEDIATELY

Cause: Data in the EEPROM corrupted .
Fault value (r0949, interpret hexadecimal):
01: EEPROM access error.
02: Too many blocks in the EEPROM.

Remedy: Replace the module.

F32813 Encoder 2: Hardware logic unit failed

Message class: Hardware/software error (1)
Message value: Fault cause: %1 bin
Component: Sensor Module Encoder 2
Response: OFF1
Acknowledgment: PULSE INHIBIT

12.3 Faults and alarms

Cause: The logic unit of the DRIVE-CLiQ encoder has failed.
Fault value (r0949, interpret binary):
Bit 0: ALU watchdog has responded.
Bit 1: ALU has detected a sign-of-life error.

Remedy: When the error reoccurs, replace the encoder.

F32820 Encoder 2 DRIVE-CLiQ: Telegram error

Message class: Internal (DRIVE-CLiQ) communication error (12)

Message value: Component number: %1, fault cause: %2

Component: Sensor Module Encoder 2

Response: OFF1

Acknowledgment: IMMEDIATELY

Cause: A DRIVE-CLiQ communication error has occurred from the Control Unit to the encoder concerned.

Error cause:

1 (= 01 hex):

Checksum error (CRC error).

2 (= 02 hex):

Telegram is shorter than specified in the length byte or in the receive list.

3 (= 03 hex):

Telegram is longer than specified in the length byte or in the receive list.

4 (= 04 hex):

The length of the receive telegram does not match the receive list.

5 (= 05 hex):

The type of the receive telegram does not match the receive list.

6 (= 06 hex):

The address of the component in the telegram and in the receive list do not match.

7 (= 07 hex):

A SYNC telegram is expected - but the received telegram is not a SYNC telegram.

8 (= 08 hex):

No SYNC telegram is expected - but the received telegram is one.

9 (= 09 hex):

The error bit in the receive telegram is set.

16 (= 10 hex):

The receive telegram is too early.

Note regarding the message value:

The individual information is coded as follows in the message value (r0949/r2124):

0000yyxx hex: yy = component number, xx = error cause

Remedy:

- Carry out a POWER ON (switch-off/switch-on).
- Check the electrical cabinet design and cable routing for EMC compliance.
- Check the DRIVE-CLiQ wiring (interrupted cable, contacts, ...).

F32835 Encoder 2 DRIVE-CLiQ: Cyclic data transfer error

Message class: Internal (DRIVE-CLiQ) communication error (12)

Message value: Component number: %1, fault cause: %2

Component: Sensor Module Encoder 2

Response: OFF1

Acknowledgment: IMMEDIATELY

Cause: A DRIVE-CLiQ communication error has occurred from the Control Unit to the encoder concerned. The nodes do not send and receive in synchronism.
Error cause:
33 (= 21 hex):
The cyclic telegram has not been received.
34 (= 22 hex):
Timeout in the telegram receive list.
64 (= 40 hex):
Timeout in the telegram send list.
Note regarding the message value:
The individual information is coded as follows in the message value (r0949/r2124):
0000yyxx hex: yy = component number, xx = error cause

Remedy:

- Carry out a POWER ON.
- Replace the component involved.

F32836 Encoder 2 DRIVE-CLiQ: Send error for DRIVE-CLiQ data

Message class: Internal (DRIVE-CLiQ) communication error (12)
Message value: Component number: %1, fault cause: %2
Component: Sensor Module Encoder 2
Response: OFF1
Acknowledgment: IMMEDIATELY

Cause: A DRIVE-CLiQ communication error has occurred from the Control Unit to the encoder involved. Data were not able to be sent.
Error cause:
65 (= 41 hex):
Telegram type does not match send list.
Note regarding the message value:
The individual information is coded as follows in the message value (r0949/r2124):
0000yyxx hex: yy = component number, xx = error cause

Remedy: Carry out a POWER ON.

F32845 Encoder 2 DRIVE-CLiQ: Cyclic data transfer error

Message class: Internal (DRIVE-CLiQ) communication error (12)
Message value: Component number: %1, fault cause: %2
Component: Sensor Module Encoder 2
Response: OFF1
Acknowledgment: IMMEDIATELY

Cause: A DRIVE-CLiQ communication error has occurred from the Control Unit to the encoder involved.
Error cause:
11 (= 0B hex):
Synchronization error during alternating cyclic data transfer.
Note regarding the message value:
The individual information is coded as follows in the message value (r0949/r2124):
0000yyxx hex: yy = component number, xx = error cause

Remedy: Carry out a POWER ON (switch-off/switch-on).

F32851 Encoder 2 DRIVE-CLiQ (CU): Sign-of-life missing

Message class: Internal (DRIVE-CLiQ) communication error (12)
Message value: Component number: %1, fault cause: %2
Component: Sensor Module Encoder 2

12.3 Faults and alarms

Response: OFF1
Acknowledgment: IMMEDIATELY
Cause: A DRIVE-CLiQ communication error has occurred from the Sensor Module (encoder 2) involved to the Control Unit.
The DRIVE-CLiQ component did not set the sign-of-life to the Control Unit.
Error cause:
10 (= 0A hex):
The sign-of-life bit in the receive telegram is not set.
Note regarding the message value:
The individual information is coded as follows in the message value (r0949/r2124):
0000yyxx hex: yy = component number, xx = error cause
Remedy:
- Upgrade the firmware of the component involved.
- Carry out a POWER ON (switch-off/switch-on) for the component involved.

F32860 Encoder 2 DRIVE-CLiQ (CU): Telegram error

Message class: Internal (DRIVE-CLiQ) communication error (12)
Message value: Component number: %1, fault cause: %2
Component: Sensor Module Encoder 2
Response: OFF1
Acknowledgment: IMMEDIATELY

Cause:	<p>A DRIVE-CLiQ communication error has occurred from the Sensor Module (encoder 2) involved to the Control Unit.</p> <p>Error cause:</p> <p>1 (= 01 hex): Checksum error (CRC error).</p> <p>2 (= 02 hex): Telegram is shorter than specified in the length byte or in the receive list.</p> <p>3 (= 03 hex): Telegram is longer than specified in the length byte or in the receive list.</p> <p>4 (= 04 hex): The length of the receive telegram does not match the receive list.</p> <p>5 (= 05 hex): The type of the receive telegram does not match the receive list.</p> <p>6 (= 06 hex): The address of the power unit in the telegram and in the receive list do not match.</p> <p>9 (= 09 hex): The DRIVE-CLiQ communication from the DRIVE-CLiQ component involved to the Control Unit signals that the supply voltage has failed.</p> <p>16 (= 10 hex): The receive telegram is too early.</p> <p>17 (= 11 hex): CRC error and the receive telegram is too early.</p> <p>18 (= 12 hex): The telegram is shorter than that specified in the length byte or in the receive list and the receive telegram is too early.</p> <p>19 (= 13 hex): The telegram is longer than that specified in the length byte or in the receive list and the receive telegram is too early.</p> <p>20 (= 14 hex): The length of the receive telegram does not match the receive list and the receive telegram is too early.</p> <p>21 (= 15 hex): The type of the receive telegram does not match the receive list and the receive telegram is too early.</p> <p>22 (= 16 hex): The address of the power unit in the telegram and in the receive list does not match and the receive telegram is too early.</p> <p>25 (= 19 hex): The error bit in the receive telegram is set and the receive telegram is too early.</p> <p>Note regarding the message value: The individual information is coded as follows in the message value (r0949/r2124): 0000yyxx hex: yy = component number, xx = error cause</p>
Remedy:	<ul style="list-style-type: none">- Carry out a POWER ON (switch-off/switch-on).- Check the electrical cabinet design and cable routing for EMC compliance.- Check the DRIVE-CLiQ wiring (interrupted cable, contacts, ...).

F32875 Encoder 2: power supply voltage failed

Message class:	Supply voltage fault (undervoltage) (3)
Message value:	Component number: %1, fault cause: %2
Component:	Sensor Module Encoder 2
Response:	OFF1
Acknowledgment:	IMMEDIATELY

12.3 Faults and alarms

Cause: The component involved has signaled that the 24 V supply has failed.
Error cause:
9 (= 09 hex):
The power supply voltage for the components has failed.
Note regarding the message value:
The individual information is coded as follows in the message value (r0949/r2124):
0000yyxx hex: yy = component number, xx = error cause

Remedy:

- Check the supply voltage wiring (interrupted cable, contacts, ...).
- Check the dimensioning of the 24 V supply, check cable lengths.

F32885 Encoder 2 DRIVE-CLiQ (CU): Cyclic data transfer error

Message class: Internal (DRIVE-CLiQ) communication error (12)

Message value: Component number: %1, fault cause: %2

Component: Sensor Module Encoder 2

Response: OFF1

Acknowledgment: IMMEDIATELY

Cause: A DRIVE-CLiQ communication error has occurred from the Sensor Module (encoder 2) involved to the Control Unit.
The nodes do not send and receive in synchronism.

Error cause:

26 (= 1A hex):

Sign-of-life bit in the receive telegram not set and the receive telegram is too early.

33 (= 21 hex):

The cyclic telegram has not been received.

34 (= 22 hex):

Timeout in the telegram receive list.

64 (= 40 hex):

Timeout in the telegram send list.

98 (= 62 hex):

Error at the transition to cyclic operation.

Note regarding the message value:

The individual information is coded as follows in the message value (r0949/r2124):

0000yyxx hex: yy = component number, xx = error cause

Remedy:

- Check the power supply voltage of the component involved.
- Carry out a POWER ON (switch-off/switch-on).
- Replace the component involved.

F32886 Encoder 2 DRIVE-CLiQ (CU): Error when sending DRIVE-CLiQ data

Message class: Internal (DRIVE-CLiQ) communication error (12)

Message value: Component number: %1, fault cause: %2

Component: Sensor Module Encoder 2

Response: OFF1

Acknowledgment: IMMEDIATELY

Cause: A DRIVE-CLiQ communication error has occurred from the Sensor Module (encoder 2) involved to the Control Unit.
Data were not able to be sent.

Error cause:

65 (= 41 hex):

Telegram type does not match send list.

Note regarding the message value:

The individual information is coded as follows in the message value (r0949/r2124):

0000yyxx hex: yy = component number, xx = error cause

Remedy: Carry out a POWER ON.

F32895 Encoder 2 DRIVE-CLiQ (CU): Alternating cyclic data transfer error

Message class: Internal (DRIVE-CLiQ) communication error (12)
Message value: Component number: %1, fault cause: %2
Component: Sensor Module Encoder 2
Response: OFF1
Acknowledgment: IMMEDIATELY
Cause: A DRIVE-CLiQ communication error has occurred from the Sensor Module (encoder 2) involved to the Control Unit.
Error cause:
11 (= 0B hex):
Synchronization error during alternating cyclic data transfer.
Note regarding the message value:
The individual information is coded as follows in the message value (r0949/r2124):
0000yyxx hex: yy = component number, xx = error cause
Remedy: Carry out a POWER ON.

F32896 Encoder 2 DRIVE-CLiQ (CU): Inconsistent component properties

Message class: Internal (DRIVE-CLiQ) communication error (12)
Message value: Component number: %1
Component: Sensor Module Encoder 2
Response: OFF2
Acknowledgment: IMMEDIATELY
Explanation of the message value: For %1
Component in target topology
Cause: The properties of the DRIVE-CLiQ component (Sensor Module for encoder 2), specified by the fault value, have changed in an incompatible fashion with respect to the properties when booted. One cause can be, e.g. that a DRIVE-CLiQ cable or DRIVE-CLiQ component has been replaced.
Fault value (r0949, interpret decimal):
Component number.
Remedy:
- Carry out a POWER ON.
- When a component is replaced, the same component type and if possible the same firmware version should be used.
- When a cable is replaced, only cables whose length is the same as or as close as possible to the length of the original cables should be used (ensure compliance with the maximum cable length).

F32899 Encoder 2: Unknown fault

Message class: Position/speed actual value incorrect or not available (11)
Message value: New message: %1
Component: Sensor Module Encoder 2
Response: OFF1
Acknowledgment: IMMEDIATELY
Cause: A fault occurred on the Sensor Module for encoder 2, which cannot be interpreted by the converter firmware.
This can occur if the firmware on this component is more recent than the converter firmware.
Fault value (r0949, interpret decimal):
Fault number.
Note:
If required, the significance of this new fault can be read about in a more recent description of the converter.
Remedy:
- Replace the firmware on the Sensor Module by an older firmware version.
- Upgrade the converter firmware.

A32902 Encoder 2: SPI-BUS error occurred

Message class: Hardware/software error (1)
Message value: %1
Component: Sensor Module Encoder 2
Response: NONE
Acknowledgment: NONE
Cause: Error when operating the internal SPI bus.
Alarm value (r2124, interpret hexadecimal):
Only for internal Siemens troubleshooting.
Remedy: - Replace the Sensor Module.
- If required, upgrade the firmware in the Sensor Module.
- Contact Technical Support.

A32903 Encoder 2: I2C-BUS error occurred

Message class: Hardware/software error (1)
Message value: %1
Component: Sensor Module Encoder 2
Response: NONE
Acknowledgment: NONE
Cause: Error when operating the internal I2C bus.
Alarm value (r2124, interpret hexadecimal):
Only for internal Siemens troubleshooting.
Remedy: - Replace the Sensor Module.
- If required, upgrade the firmware in the Sensor Module.
- Contact Technical Support.

F32950 Encoder 2: Internal software error

Message class: Hardware/software error (1)
Message value: %1
Component: Sensor Module Encoder 2
Response: OFF1
Acknowledgment: POWER ON
Cause: An internal software error has occurred.
Fault value (r0949, interpret decimal):
Information about the fault source.
Only for internal Siemens troubleshooting.
Remedy: - If necessary, upgrade the firmware in the Sensor Module to a later version.
- Contact Technical Support.

A32999 Encoder 2: Unknown alarm

Message class: Position/speed actual value incorrect or not available (11)
Message value: New message: %1
Component: Sensor Module Encoder 2
Response: NONE
Acknowledgment: NONE

Cause: An alarm occurred on the Sensor Module for encoder 2, which cannot be interpreted by the converter firmware. This can occur if the firmware on this component is more recent than the converter firmware.
Alarm value (r2124, interpret decimal):
Alarm number.
Note:
If required, the significance of this new alarm can be read about in a more recent description of the converter.

Remedy:

- Replace the firmware on the Sensor Module by an older firmware version.
- Upgrade the converter firmware.

F33899 Encoder 3: Unknown fault

Message class: Position/speed actual value incorrect or not available (11)
Message value: New message: %1
Component: Sensor Module Encoder 3
Response: OFF1
Acknowledgment: IMMEDIATELY

Cause: A fault occurred on the Sensor Module for encoder 3, which cannot be interpreted by the converter firmware. This can occur if the firmware on this component is more recent than the converter firmware.
Fault value (r0949, interpret decimal):
Fault number.
Note:
If required, the significance of this new fault can be read about in a more recent description of the converter.

Remedy:

- Replace the firmware on the Sensor Module by an older firmware version.
- Upgrade the converter firmware.

A33999 Encoder 3: Unknown alarm

Message class: Position/speed actual value incorrect or not available (11)
Message value: New message: %1
Component: Sensor Module Encoder 3
Response: NONE
Acknowledgment: NONE

Cause: A alarm occurred on the Sensor Module for encoder 3, which cannot be interpreted by the converter firmware. This can occur if the firmware on this component is more recent than the converter firmware.
Alarm value (r2124, interpret decimal):
Alarm number.
Note:
If required, the significance of this new alarm can be read about in a more recent description of the converter.

Remedy:

- Replace the firmware on the Sensor Module by an older firmware version.
- Upgrade the converter firmware.

F34851 VSM DRIVE-CLiQ (CU): Sign-of-life missing

Message class: Internal (DRIVE-CLiQ) communication error (12)
Message value: Component number: %1, fault cause: %2
Component: Voltage Sensing Module (VSM)
Response: NONE
Acknowledgment: IMMEDIATELY

12.3 Faults and alarms

Cause: A DRIVE-CLiQ communications error has occurred from the Voltage Sensing Module involved (VSM) to the Control Unit.
The DRIVE-CLiQ component did not set the sign-of-life to the Control Unit.
Error cause:
10 (= 0A hex):
The sign-of-life bit in the receive telegram is not set.
Note regarding the message value:
The individual information is coded as follows in the message value (r0949/r2124):
0000yyxx hex: yy = component number, xx = error cause

Remedy: Upgrade the firmware of the component involved.

F34860 VSM DRIVE-CLiQ (CU): Telegram error

Message class: Internal (DRIVE-CLiQ) communication error (12)

Message value: Component number: %1, fault cause: %2

Component: Voltage Sensing Module (VSM)

Response: NONE

Acknowledgment: IMMEDIATELY

Cause: A DRIVE-CLiQ communications error has occurred from the Voltage Sensing Module involved (VSM) to the Control Unit.
Error cause:
1 (= 01 hex):
Checksum error (CRC error).
2 (= 02 hex):
Telegram is shorter than specified in the length byte or in the receive list.
3 (= 03 hex):
Telegram is longer than specified in the length byte or in the receive list.
4 (= 04 hex):
The length of the receive telegram does not match the receive list.
5 (= 05 hex):
The type of the receive telegram does not match the receive list.
6 (= 06 hex):
The address of the power unit in the telegram and in the receive list do not match.
9 (= 09 hex):
The DRIVE-CLiQ communication from the DRIVE-CLiQ component involved to the Control Unit signals that the supply voltage has failed.
16 (= 10 hex):
The receive telegram is too early.
17 (= 11 hex):
CRC error and the receive telegram is too early.
18 (= 12 hex):
The telegram is shorter than that specified in the length byte or in the receive list and the receive telegram is too early.
19 (= 13 hex):
The telegram is longer than that specified in the length byte or in the receive list and the receive telegram is too early.
20 (= 14 hex):
The length of the receive telegram does not match the receive list and the receive telegram is too early.
21 (= 15 hex):
The type of the receive telegram does not match the receive list and the receive telegram is too early.
22 (= 16 hex):
The address of the power unit in the telegram and in the receive list does not match and the receive telegram is too early.
25 (= 19 hex):
The error bit in the receive telegram is set and the receive telegram is too early.
Note regarding the message value:
The individual information is coded as follows in the message value (r0949/r2124):
0000yyxx hex: yy = component number, xx = error cause

- Remedy:**
- Carry out a POWER ON (switch-off/switch-on).
 - Check the electrical cabinet design and cable routing for EMC compliance.
 - Check the DRIVE-CLiQ wiring (interrupted cable, contacts, ...).

F34875 VSM: power supply voltage failed

- Message class:** Supply voltage fault (undervoltage) (3)
Message value: Component number: %1, fault cause: %2
Component: Voltage Sensing Module (VSM)
Response: OFF2
Acknowledgment: IMMEDIATELY
Cause: The component involved has signaled that the 24 V supply has failed.
Error cause:
9 (= 09 hex):
The power supply voltage for the components has failed.
Note regarding the message value:
The individual information is coded as follows in the message value (r0949/r2124):
0000yyxx hex: yy = component number, xx = error cause
Remedy:
- Check the supply voltage wiring (interrupted cable, contacts, ...).
 - Check the dimensioning of the 24 V supply, check cable lengths.

F34885 VSM DRIVE-CLiQ (CU): Cyclic data transfer error

- Message class:** Internal (DRIVE-CLiQ) communication error (12)
Message value: Component number: %1, fault cause: %2
Component: Voltage Sensing Module (VSM)
Response: NONE
Acknowledgment: IMMEDIATELY
Cause: A DRIVE-CLiQ communications error has occurred from the Voltage Sensing Module involved (VSM) to the Control Unit.
The nodes do not send and receive in synchronism.
Error cause:
26 (= 1A hex):
Sign-of-life bit in the receive telegram not set and the receive telegram is too early.
33 (= 21 hex):
The cyclic telegram has not been received.
34 (= 22 hex):
Timeout in the telegram receive list.
64 (= 40 hex):
Timeout in the telegram send list.
98 (= 62 hex):
Error at the transition to cyclic operation.
Note regarding the message value:
The individual information is coded as follows in the message value (r0949/r2124):
0000yyxx hex: yy = component number, xx = error cause
Remedy:
- Check the power supply voltage of the component involved.
 - Carry out a POWER ON.
 - Replace the component involved.

F34886 VSM DRIVE-CLiQ (CU): Error when sending DRIVE-CLiQ data

- Message class:** Internal (DRIVE-CLiQ) communication error (12)
Message value: Component number: %1, fault cause: %2
Component: Voltage Sensing Module (VSM)

12.3 Faults and alarms

Response: NONE
Acknowledgment: IMMEDIATELY
Cause: A DRIVE-CLiQ communications error has occurred from the Voltage Sensing Module involved (VSM) to the Control Unit.
 Data were not able to be sent.
 Error cause:
 65 (= 41 hex):
 Telegram type does not match send list.
 Note regarding the message value:
 The individual information is coded as follows in the message value (r0949/r2124):
 0000yyxx hex: yy = component number, xx = error cause
Remedy: Carry out a POWER ON.

F34895 VSM DRIVE-CLiQ (CU): Alternating cyclic data transfer error

Message class: Internal (DRIVE-CLiQ) communication error (12)
Message value: Component number: %1, fault cause: %2
Component: Voltage Sensing Module (VSM)
Response: NONE
Acknowledgment: IMMEDIATELY
Cause: A DRIVE-CLiQ communications error has occurred from the Voltage Sensing Module involved (VSM) to the Control Unit.
 Error cause:
 11 (= 0B hex):
 Synchronization error during alternating cyclic data transfer.
 Note regarding the message value:
 The individual information is coded as follows in the message value (r0949/r2124):
 0000yyxx hex: yy = component number, xx = error cause
Remedy: Carry out a POWER ON.

F34896 VSM DRIVE-CLiQ (CU): Inconsistent component properties

Message class: Internal (DRIVE-CLiQ) communication error (12)
Message value: Component number: %1
Component: Voltage Sensing Module (VSM)
Response: OFF2
Acknowledgment: IMMEDIATELY
Explanation of the message value: For %1
 Component in target topology
Cause: The properties of the DRIVE-CLiQ component (Voltage Sensing Module), specified by the fault value, have changed in an incompatible fashion with respect to the properties when booted. One cause can be, e.g. that a DRIVE-CLiQ cable or DRIVE-CLiQ component has been replaced.
 Fault value (r0949, interpret decimal):
 Component number.
Remedy:
 - Carry out a POWER ON.
 - When a component is replaced, the same component type and if possible the same firmware version should be used.
 - When a cable is replaced, only cables whose length is the same as or as close as possible to the length of the original cables should be used (ensure compliance with the maximum cable length).

F34950 VSM: Internal software error

Message class: Hardware/software error (1)
Message value: %1
Component: Voltage Sensing Module (VSM)

Response: OFF2
Acknowledgment: POWER ON
Cause: An internal software error in the Voltage Sensing Module (VSM) has occurred.
Fault value (r0949, interpret decimal):
Information about the fault source.
Only for internal Siemens troubleshooting.
Remedy: - If necessary, upgrade the firmware in the Voltage Sensing Module to a later version.
- Contact Technical Support.

F35220 TM: Frequency limit reached for signal output

Message class: Application/technological function faulted (17)
Message value: -
Component: Terminal Module (TM)
Response: OFF1
Acknowledgment: IMMEDIATELY
Cause: The signals output from the Terminal Module 41 (TM41) for tracks A/B have reached the limit frequency. The output signals are no longer in synchronism with the specified setpoint.
SIMOTION (p4400 = 0) operating mode:
- If the TM41 has been configured as the technology project, this fault is also output in response to short-circuited A/B signals in X520.
SINAMICS (p4400 = 1) operating mode:
- The fine resolution of TM41 in p0418 does not match that of the encoder that was interconnected at connector input p4420.
- The encoder position actual value r0479 interconnected at connector input p4420 has an excessively high actual speed.
- The output signals correspond to a speed, which is greater than the maximum speed (r1082 of TM41).
Remedy: SIMOTION (p4400 = 0) operating mode:
- Enter a lower speed setpoint (p1155).
- Reduce the encoder pulse number (p0408).
- Check track A/B for short-circuits.
SINAMICS (p4400 = 1) operating mode:
- Enter a lower speed setpoint (p1155).
- Reduce the encoder pulse number (p0408).
Notice:
The output signal is no longer monitored after changing the message type to "Alarm" (A).

F35851 TM DRIVE-CLiQ (CU): Sign-of-life missing

Message class: Internal (DRIVE-CLiQ) communication error (12)
Message value: Component number: %1, fault cause: %2
Component: Terminal Module (TM)
Response: OFF1
Acknowledgment: IMMEDIATELY
Cause: A DRIVE-CLiQ communication error has occurred from the Terminal Module involved (TM) to the Control Unit.
The DRIVE-CLiQ component did not set the sign-of-life to the Control Unit.
Error cause:
10 (= 0A hex):
The sign-of-life bit in the receive telegram is not set.
Note regarding the message value:
The individual information is coded as follows in the message value (r0949/r2124):
0000yyxx hex: yy = component number, xx = error cause
Remedy: Upgrade the firmware of the component involved.

F35860 TM DRIVE-CLiQ (CU): Telegram error

Message class: Internal (DRIVE-CLiQ) communication error (12)

Message value: Component number: %1, fault cause: %2

Component: Terminal Module (TM)

Response: OFF1

Acknowledgment: IMMEDIATELY

Cause: A DRIVE-CLiQ communication error has occurred from the Terminal Module involved (TM) to the Control Unit.

Error cause:

1 (= 01 hex):

Checksum error (CRC error).

2 (= 02 hex):

Telegram is shorter than specified in the length byte or in the receive list.

3 (= 03 hex):

Telegram is longer than specified in the length byte or in the receive list.

4 (= 04 hex):

The length of the receive telegram does not match the receive list.

5 (= 05 hex):

The type of the receive telegram does not match the receive list.

6 (= 06 hex):

The address of the power unit in the telegram and in the receive list do not match.

9 (= 09 hex):

The DRIVE-CLiQ communication from the DRIVE-CLiQ component involved to the Control Unit signals that the supply voltage has failed.

16 (= 10 hex):

The receive telegram is too early.

17 (= 11 hex):

CRC error and the receive telegram is too early.

18 (= 12 hex):

The telegram is shorter than that specified in the length byte or in the receive list and the receive telegram is too early.

19 (= 13 hex):

The telegram is longer than that specified in the length byte or in the receive list and the receive telegram is too early.

20 (= 14 hex):

The length of the receive telegram does not match the receive list and the receive telegram is too early.

21 (= 15 hex):

The type of the receive telegram does not match the receive list and the receive telegram is too early.

22 (= 16 hex):

The address of the power unit in the telegram and in the receive list does not match and the receive telegram is too early.

25 (= 19 hex):

The error bit in the receive telegram is set and the receive telegram is too early.

Note regarding the message value:

The individual information is coded as follows in the message value (r0949/r2124):

0000yyxx hex: yy = component number, xx = error cause

Remedy:

- Carry out a POWER ON (switch-off/switch-on).

- Check the electrical cabinet design and cable routing for EMC compliance.

- Check the DRIVE-CLiQ wiring (interrupted cable, contacts, ...).

F35875 TM: power supply voltage failed

Message class: Supply voltage fault (undervoltage) (3)

Message value: Component number: %1, fault cause: %2

Component: Terminal Module (TM)

Response: OFF1

Acknowledgment: IMMEDIATELY

Cause: The component involved has signaled that the 24 V supply has failed.
Error cause:
9 (= 09 hex):
The power supply voltage for the components has failed.
Note regarding the message value:
The individual information is coded as follows in the message value (r0949/r2124):
0000yyxx hex: yy = component number, xx = error cause

Remedy:

- Check the supply voltage wiring (interrupted cable, contacts, ...).
- Check the dimensioning of the 24 V supply, check cable lengths.

F35885 TM DRIVE-CLiQ (CU): Cyclic data transfer error

Message class: Internal (DRIVE-CLiQ) communication error (12)
Message value: Component number: %1, fault cause: %2
Component: Terminal Module (TM)
Response: OFF1
Acknowledgment: IMMEDIATELY

Cause: A DRIVE-CLiQ communication error has occurred from the Terminal Module involved (TM) to the Control Unit.
The nodes do not send and receive in synchronism.
Error cause:
26 (= 1A hex):
Sign-of-life bit in the receive telegram not set and the receive telegram is too early.
33 (= 21 hex):
The cyclic telegram has not been received.
34 (= 22 hex):
Timeout in the telegram receive list.
64 (= 40 hex):
Timeout in the telegram send list.
98 (= 62 hex):
Error at the transition to cyclic operation.
Note regarding the message value:
The individual information is coded as follows in the message value (r0949/r2124):
0000yyxx hex: yy = component number, xx = error cause

Remedy:

- Check the power supply voltage of the component involved.
- Carry out a POWER ON.
- Replace the component involved.

F35886 TM DRIVE-CLiQ (CU): Error when sending DRIVE-CLiQ data

Message class: Internal (DRIVE-CLiQ) communication error (12)
Message value: Component number: %1, fault cause: %2
Component: Terminal Module (TM)
Response: OFF1
Acknowledgment: IMMEDIATELY

Cause: A DRIVE-CLiQ communication error has occurred from the Terminal Module involved (TM) to the Control Unit.
Data were not able to be sent.
Error cause:
65 (= 41 hex):
Telegram type does not match send list.
Note regarding the message value:
The individual information is coded as follows in the message value (r0949/r2124):
0000yyxx hex: yy = component number, xx = error cause

Remedy: Carry out a POWER ON.

F35895 TM DRIVE-CLiQ (CU): Alternating cyclic data transfer error

Message class: Internal (DRIVE-CLiQ) communication error (12)

Message value: Component number: %1, fault cause: %2

Component: Terminal Module (TM)

Response: OFF1

Acknowledgment: IMMEDIATELY

Cause: A DRIVE-CLiQ communication error has occurred from the Terminal Module involved (TM) to the Control Unit.

Error cause:

11 (= 0B hex):

Synchronization error during alternating cyclic data transfer.

Note regarding the message value:

The individual information is coded as follows in the message value (r0949/r2124):

0000yyxx hex: yy = component number, xx = error cause

Remedy: Carry out a POWER ON.

F35896 TM DRIVE-CLiQ (CU): Inconsistent component properties

Message class: Internal (DRIVE-CLiQ) communication error (12)

Message value: Component number: %1

Component: Terminal Module (TM)

Response: OFF2

Acknowledgment: IMMEDIATELY

Explanation of the message value: For %1

Component in target topology

Cause: The properties of the DRIVE-CLiQ component (Terminal Module), specified by the fault value, have changed in an incompatible fashion with respect to the properties when booted. One cause can be, e.g. that a DRIVE-CLiQ cable or DRIVE-CLiQ component has been replaced.

Fault value (r0949, interpret decimal):

Component number.

Remedy: - Carry out a POWER ON.

- When a component is replaced, the same component type and if possible the same firmware version should be used.

- When a cable is replaced, only cables whose length is the same as or as close as possible to the length of the original cables should be used (ensure compliance with the maximum cable length).

F35950 TM: Internal software error

Message class: Hardware/software error (1)

Message value: %1

Component: Terminal Module (TM)

Response: OFF2

Acknowledgment: POWER ON

Cause: An internal software error has occurred.

Fault value (r0949, interpret decimal):

Information about the fault source.

Only for internal Siemens troubleshooting.

Remedy: - If necessary, upgrade the firmware in the Terminal Module to a later version.

- Contact Technical Support.

F36207 Hub: Overtemperature component

Message class: Overtemperature of the electronic components (6)
Message value: %1
Component: Terminal Board (TB)
Response: NONE
Acknowledgment: IMMEDIATELY
Cause: The temperature on the DRIVE-CLiQ Hub Module has exceeded the fault threshold.
Fault value (r0949, interpret decimal):
Actual temperature in 0.1 °C resolution.
Remedy: - Check ambient temperature at component installation location.
- Replace the component involved.

A36211 Hub: Overtemperature alarm component

Message class: Overtemperature of the electronic components (6)
Message value: %1
Component: Terminal Board (TB)
Response: NONE
Acknowledgment: NONE
Cause: The temperature on the DRIVE-CLiQ Hub Module has exceeded the alarm threshold.
Alarm value (r2124, interpret decimal):
Actual temperature in 0.1 °C resolution.
Remedy: - Check ambient temperature at component installation location.
- Replace the component involved.

F36214 Hub: overvoltage fault 24 V supply

Message class: Supply voltage fault (overvoltage) (3)
Message value: %1
Component: Terminal Board (TB)
Response: NONE
Acknowledgment: IMMEDIATELY
Cause: The 24 V power supply on the DRIVE-CLiQ Hub Module has exceeded the fault threshold.
Fault value (r0949, interpret decimal):
Actual operating voltage in 0.1 °C resolution
Remedy: - Check the power supply of the component.
- Replace the component involved.

F36216 Hub: undervoltage fault 24 V supply

Message class: Supply voltage fault (undervoltage) (3)
Message value: %1
Component: Terminal Board (TB)
Response: NONE
Acknowledgment: IMMEDIATELY
Cause: The 24 V power supply on the DRIVE-CLiQ Hub Module has undershot the fault threshold.
Fault value (r0949, interpret decimal):
Actual operating voltage in 0.1 °C resolution
Remedy: - Check the power supply of the component.
- Replace the component involved.

A36217 Hub: undervoltage alarm 24 V supply

Message class: Supply voltage fault (undervoltage) (3)
Message value: %1
Component: Terminal Board (TB)
Response: NONE
Acknowledgment: NONE
Cause: The 24 V power supply on the DRIVE-CLiQ Hub Module has undershot the alarm threshold.
Alarm value (r2124, interpret decimal):
Actual operating voltage in 0.1 °C resolution
Remedy: - Check the power supply of the component.
- Replace the component involved.

N36800 Hub: Group signal

Message class: General drive fault (19)
Message value: -
Component: None
Response: NONE
Acknowledgment: NONE
Cause: The DRIVE-CLiQ Hub Module has detected at least one fault.
Remedy: Evaluation of other active messages.

A36802 Hub: Time slice overflow

Message class: Hardware/software error (1)
Message value: %1
Component: Terminal Board (TB)
Response: NONE
Acknowledgment: NONE
Cause: A time slice overflow has occurred on the DRIVE-CLiQ Hub Module.
Fault value (r0949, interpret decimal):
xx: Time slice number xx
Remedy: - Reduce the current controller frequency.
- Carry out a POWER ON (switch-off/switch-on) for all components.
- Upgrade firmware to later version.
- Contact Technical Support.

F36804 Hub: Checksum error has occurred

Message class: Hardware/software error (1)
Message value: %1
Component: Terminal Board (TB)
Response: NONE
Acknowledgment: IMMEDIATELY
Cause: A checksum error occurred when reading out the program memory on the DRIVE-CLiQ Hub Module.
Fault value (r0949, interpret hexadecimal):
Difference between the checksum at POWER ON and the actual checksum.
Remedy: - Check whether the permissible ambient temperature for the component is maintained.
- Replace the DRIVE-CLiQ Hub Module.

F36805 Hub: EEPROM checksum incorrect

Message class: Hardware/software error (1)

Message value: %1
Component: Terminal Board (TB)
Response: NONE
Acknowledgment: IMMEDIATELY
Cause: The internal parameter data on the DRIVE-CLiQ Hub Module is incorrect.
Alarm value (r2124, interpret hexadecimal):
01: EEPROM access error.
02: Too many blocks in the EEPROM.
Remedy:
- Check whether the permissible ambient temperature for the component is maintained.
- Replace the DRIVE-CLiQ Hub Module.

F36837 Hub DRIVE-CLiQ: Component fault

Message class: Internal (DRIVE-CLiQ) communication error (12)
Message value: Component number: %1, fault cause: %2
Component: Terminal Board (TB)
Response: NONE
Acknowledgment: IMMEDIATELY
Cause: Fault detected on the DRIVE-CLiQ component involved. Faulty hardware cannot be excluded.
Error cause:
32 (= 20 hex):
Error in the telegram header.
35 (= 23 hex):
Receive error: The telegram buffer memory contains an error.
66 (= 42 hex):
Send error: The telegram buffer memory contains an error.
67 (= 43 hex):
Send error: The telegram buffer memory contains an error.
Note regarding the message value:
The individual information is coded as follows in the message value (r0949/r2124):
0000yyxx hex: yy = component number, xx = error cause
Remedy:
- Check the DRIVE-CLiQ wiring (interrupted cable, contacts, ...).
- Check the electrical cabinet design and cable routing for EMC compliance.
- If required, use another DRIVE-CLiQ socket.
- Replace the component involved.

F36851 Hub DRIVE-CLiQ (CU): Sign-of-life missing

Message class: Internal (DRIVE-CLiQ) communication error (12)
Message value: Component number: %1, fault cause: %2
Component: Terminal Board (TB)
Response: NONE
Acknowledgment: IMMEDIATELY
Cause: DRIVE-CLiQ communication error from DRIVE-CLiQ Hub Module in question to Control Unit.
The DRIVE-CLiQ component did not set the sign-of-life to the Control Unit.
Error cause:
10 (= 0A hex):
The sign-of-life bit in the receive telegram is not set.
Note regarding the message value:
The individual information is coded as follows in the message value (r0949/r2124):
0000yyxx hex: yy = component number, xx = error cause
Remedy: Upgrade the firmware of the component involved.

F36860 Hub DRIVE-CLiQ (CU): Telegram error

Message class: Internal (DRIVE-CLiQ) communication error (12)

Message value: Component number: %1, fault cause: %2

Component: Terminal Board (TB)

Response: NONE

Acknowledgment: IMMEDIATELY

Cause: DRIVE-CLiQ communication error from DRIVE-CLiQ Hub Module in question to Control Unit.

Error cause:

1 (= 01 hex):

Checksum error (CRC error).

2 (= 02 hex):

Telegram is shorter than specified in the length byte or in the receive list.

3 (= 03 hex):

Telegram is longer than specified in the length byte or in the receive list.

4 (= 04 hex):

The length of the receive telegram does not match the receive list.

5 (= 05 hex):

The type of the receive telegram does not match the receive list.

6 (= 06 hex):

The address of the power unit in the telegram and in the receive list do not match.

9 (= 09 hex):

The DRIVE-CLiQ communication from the DRIVE-CLiQ component involved to the Control Unit signals that the supply voltage has failed.

16 (= 10 hex):

The receive telegram is too early.

17 (= 11 hex):

CRC error and the receive telegram is too early.

18 (= 12 hex):

The telegram is shorter than that specified in the length byte or in the receive list and the receive telegram is too early.

19 (= 13 hex):

The telegram is longer than that specified in the length byte or in the receive list and the receive telegram is too early.

20 (= 14 hex):

The length of the receive telegram does not match the receive list and the receive telegram is too early.

21 (= 15 hex):

The type of the receive telegram does not match the receive list and the receive telegram is too early.

22 (= 16 hex):

The address of the power unit in the telegram and in the receive list does not match and the receive telegram is too early.

25 (= 19 hex):

The error bit in the receive telegram is set and the receive telegram is too early.

Note regarding the message value:

The individual information is coded as follows in the message value (r0949/r2124):

0000yyxx hex: yy = component number, xx = error cause

Remedy:

- Carry out a POWER ON (switch-off/switch-on).

- Check the electrical cabinet design and cable routing for EMC compliance.

- Check the DRIVE-CLiQ wiring (interrupted cable, contacts, ...).

F36875 HUB: power supply voltage failed

Message class: Supply voltage fault (undervoltage) (3)

Message value: Component number: %1, fault cause: %2

Component: Terminal Board (TB)

Response: OFF1

Acknowledgment: IMMEDIATELY

Cause: The component involved has signaled that the 24 V supply has failed.
Error cause:
9 (= 09 hex):
The power supply voltage for the components has failed.
Note regarding the message value:
The individual information is coded as follows in the message value (r0949/r2124):
0000yyxx hex: yy = component number, xx = error cause

Remedy:

- Check the supply voltage wiring (interrupted cable, contacts, ...).
- Check the dimensioning of the 24 V supply, check cable lengths.

F36885 Hub DRIVE-CLiQ (CU): Cyclic data transfer error

Message class: Internal (DRIVE-CLiQ) communication error (12)
Message value: Component number: %1, fault cause: %2
Component: Terminal Board (TB)
Response: NONE
Acknowledgment: IMMEDIATELY

Cause: DRIVE-CLiQ communication error from DRIVE-CLiQ Hub Module in question to Control Unit.
The nodes do not send and receive in synchronism.
Error cause:
26 (= 1A hex):
Sign-of-life bit in the receive telegram not set and the receive telegram is too early.
33 (= 21 hex):
The cyclic telegram has not been received.
34 (= 22 hex):
Timeout in the telegram receive list.
64 (= 40 hex):
Timeout in the telegram send list.
98 (= 62 hex):
Error at the transition to cyclic operation.
Note regarding the message value:
The individual information is coded as follows in the message value (r0949/r2124):
0000yyxx hex: yy = component number, xx = error cause

Remedy:

- Check the power supply of the component involved.
- Carry out a POWER ON.
- Replace the component involved.

F36886 Hub DRIVE-CLiQ (CU): Error when sending DRIVE-CLiQ data

Message class: Internal (DRIVE-CLiQ) communication error (12)
Message value: Component number: %1, fault cause: %2
Component: Terminal Board (TB)
Response: NONE
Acknowledgment: IMMEDIATELY

Cause: DRIVE-CLiQ communication error from DRIVE-CLiQ Hub Module in question to Control Unit.
Data were not able to be sent.
Error cause:
65 (= 41 hex):
Telegram type does not match send list.
Note regarding the message value:
The individual information is coded as follows in the message value (r0949/r2124):
0000yyxx hex: yy = component number, xx = error cause

Remedy: Carry out a POWER ON.

F36895 Hub DRIVE-CLiQ (CU): Alternating cyclic data transfer error

Message class: Internal (DRIVE-CLiQ) communication error (12)

Message value: Component number: %1, fault cause: %2

Component: Terminal Board (TB)

Response: NONE

Acknowledgment: IMMEDIATELY

Cause: DRIVE-CLiQ communication error from DRIVE-CLiQ Hub Module in question to Control Unit.

Error cause:

11 (= 0B hex):

Synchronization error during alternating cyclic data transfer.

Note regarding the message value:

The individual information is coded as follows in the message value (r0949/r2124):

0000yyxx hex: yy = component number, xx = error cause

Remedy: Carry out a POWER ON.

F36896 Hub DRIVE-CLiQ (CU): Inconsistent component properties

Message class: Internal (DRIVE-CLiQ) communication error (12)

Message value: Component number: %1

Component: Terminal Board (TB)

Response: NONE

Acknowledgment: IMMEDIATELY

Explanation of the message value: For %1

Component in target topology

Cause: The properties of the DRIVE-CLiQ component (DRIVE-CLiQ Hub Module), specified by the fault value, have changed in an incompatible fashion with respect to the properties when booted. One cause can be, e.g. that a DRIVE-CLiQ cable or DRIVE-CLiQ component has been replaced.

Fault value (r0949, interpret decimal):

Component number.

Remedy: - Carry out a POWER ON.

- When a component is replaced, the same component type and if possible the same firmware version should be used.

- When a cable is replaced, only cables whose length is the same as or as close as possible to the length of the original cables should be used (ensure compliance with the maximum cable length).

F36899 Hub: Unknown fault

Message class: General drive fault (19)

Message value: New message: %1

Component: Terminal Board (TB)

Response: NONE

Acknowledgment: IMMEDIATELY

Cause: A fault occurred on the DRIVE-CLiQ Hub Module, which cannot be interpreted by the firmware.

This can occur if the firmware on this component is more recent than the firmware on the converter.

Fault value (r0949, interpret decimal):

Fault number.

Note:

If required, the significance of this new fault can be read about in a more recent description of the converter.

Remedy: - Replace the firmware on the DRIVE-CLiQ Hub Module with older firmware.

- Upgrade the converter firmware.

F36950 Hub: Internal software error

Message class: Hardware/software error (1)

Message value: %1

Component: Terminal Board (TB)

Response: OFF2

Acknowledgment: POWER ON

Cause: An internal software error has occurred.
Fault value (r0949, interpret decimal):
Information about the fault source.
Only for internal Siemens troubleshooting.

Remedy: - If required, upgrade the firmware in the DRIVE-CLiQ Hub Module to a more recent version.
- Contact Technical Support.

A36999 Hub: Unknown alarm

Message class: General drive fault (19)

Message value: New message: %1

Component: Terminal Board (TB)

Response: NONE

Acknowledgment: NONE

Cause: An alarm has occurred on the DRIVE-CLiQ Hub Module, which cannot be interpreted by the converter firmware.
This can occur if the firmware on this component is more recent than the firmware on the converter.
Alarm value (r2124, interpret decimal):
Alarm number.
Note:

If required, the significance of this new alarm can be read about in a more recent description of the converter.

Remedy: - Replace the firmware on the DRIVE-CLiQ Hub Module with older firmware.
- Upgrade the converter firmware.

Corrective maintenance

13.1 Service and maintenance for the converter

13.1.1 Restoring the converter to factory settings

13.1.1.1 Restoring factory settings via a commissioning tool

Description

The reset to factory settings with a commissioning tool (web server, Startdrive) only deletes the user-specific parameterization of the converter, for example motor data.

The following settings are retained with the reset:

- Activation and settings of User Management & Access Control
- The "IP configuration" and "Device name" communication settings of the service interface (X127) and PROFINET interface (X150)
- Installed firmware on the converter

The reset to factory settings with the commissioning tool is described in the following sections:

- Web server: Restore factory settings (Page 201)
- Startdrive: Restore factory settings (Page 297)

13.1.1.2 Manual reset to factory settings with SD card

Overview

In the following cases it may be necessary to restore the converter to factory settings:

- The available credentials do not allow the necessary configuration of the converter (no password for example).
- Before recommissioning of the converter, for example if the application use of the converter changes.
- Before the converter is sold or disposed of, in order to erase all user-defined settings.

13.1 Service and maintenance for the converter

The manual reset to factory settings with SD card deletes the following user-defined settings on the converter:

- Parameterization of the converter
- Activation and settings of User Management & Access Control
- User-defined parameter lists in the web server

The reset to factory settings with SD card retains the installed SINAMICS firmware on the converter.



Requirement

- You can access the converter manually.
- Disconnect all of the electrical connections to the motor (encoder, power, and brake cables).
- Disconnect the PROFINET connection to the control system and other devices.
- You have an empty writable SD card with a maximum of 32 GB.

Procedure

Proceed as follows to manually reset the converter to factory settings with an SD card:

1. Create an empty file called RESET.TXT in the root directory of the SD card.
2. Switch off the converter.
3. Wait until all LEDs of the converter are off.
4. Insert the SD card into the card slot of the converter.
5. Switch on the converter again.
6. The converter deletes the user-defined settings.
While the settings are being reset to factory settings, both the RDY and COM LEDs flash at 2 Hz.
7. User-defined converter settings are deleted.
The RDY LED flashes at 2 Hz.

RDY	COM	Description
		Resetting to factory settings in progress
	-	Resetting to factory settings is completed.

8. Remove the SD card.

Result

User-defined converter settings are deleted.

After the manual reset to factory settings, access to the web server is possible via the service interface (X127) and via the PROFINET interface (X150). For access via the service interface (X127), use the secure transmission protocol HTTPS.

13.1.2 Converter firmware update

13.1.2.1 Overview of firmware update

Requirement

NOTICE
Damage to equipment during firmware update due to voltage supply interruption
When the firmware is being updated, interrupting the power supply or disconnecting the motor can result in defects or cause the devices to malfunction.
<ul style="list-style-type: none"> Do not switch off the converter's supply voltage during firmware update.

Description of function

Firmware updates change the settings in the converter according to the relative firmware version:

- If the converter is upgraded to a more recent firmware version, the converter settings are retained.
- Downgrading to an older firmware version resets the converter to factory settings.

The following options are available for a firmware update:

- Firmware update via SD card (Page 643)
- Firmware update via web server (Page 207)
- Firmware update via Startdrive (Page 300)

13.1.2.2 Firmware update via SD card

Overview

If you have physical access to your converter, you can update the firmware directly on the converter by using an SD card.

Requirement

You have an SD card with the appropriate firmware, or you have an empty SD card with a maximum capacity of 32 GB onto which you can load the firmware.



13.1 Service and maintenance for the converter

You can download the available firmware versions at the following link (<https://support.industry.siemens.com/cs/ww/en/ps/29596/dl>).

Procedure

Proceed as follows to update the firmware using an SD card:

1. Switch off the converter.
2. Insert the SD card into the converter and switch on the converter.
The new firmware is installed. This process takes approximately two minutes.

RDY	COM	Explanation of LED displays
		Firmware update is active: <ul style="list-style-type: none"> • Do not switch off the power supply. • Do not disconnect the motor from the converter.
	-	Firmware update is completed

3. Switch the converter off and remove the SD card.
4. Switch on the converter again. Check whether the new version is installed. The firmware version of the converter is displayed on the home page of the web server.

More information

You can find more information about the SD card in Section "SD card (Page 73)".

13.1.3 Replacing the converter

Overview

The new converter must have the same converter type and power as the converter being replaced.



 WARNING
Fire or electric shock after tripping of overcurrent protection devices
If an overcurrent protection device is tripped, the converter may be defective. A defective converter can cause a fire or electric shock.
<ul style="list-style-type: none"> • Have the converter and the overcurrent protection device checked by a specialist.



⚠ WARNING

Electric shock as a result of a residual charge in power components

After the power supply has been switched off, it takes up to five minutes for the capacitors in the converter to discharge enough that the residual charge is safe.

- Check the voltage at the converter connections before removing the connecting cables.

⚠ WARNING

Unexpected machine movement caused by incorrect converter type

If a replacement is made with a converter of a different type, this can result in incomplete or unsuitable converter settings. This can result in unexpected machine movements, e.g. speed oscillation, overspeed or incorrect direction of rotation. Unexpected machine movements can result in death, injury or property damage.

- In all cases not permitted according to the above requirements, you must recommission the drive after replacing the converter.

⚠ WARNING

Unexpected machine movement caused by unsuitable converter settings

Missing or unsuitable converter settings can lead to unexpected operating states or machine movements, e.g. a non-functioning EMERGENCY STOP or an incorrect direction of rotation. This can result in damage to machine components or system sections or in death or bodily injury.

- Back up the settings of the converter to be replaced by uploading them to an external storage medium, e.g. an SD card.
- Transfer the settings of the converter to be replaced by downloading them to the new converter.
- If you do not have a backup of the converter settings, recommission the new converter.
- Check the new converter for proper functioning.

NOTICE

Damage caused by interchanging the motor cables

The direction in which the motor rotates switches if the two phases of the motor cable are interchanged. An incorrect direction of rotation can lead to damage in the machine or system.

- Connect the three phases of the motor cables in the correct sequence.

Description

Operation with SD card

If the converter being replaced was operated with an SD card, you have the following options in a spare part scenario:

- If the SD card contains the configuration data and the firmware of the converter, proceed as described in Section "Replacing a converter using an SD card with firmware (Page 646)".
- If the SD card only contains the configuration data, proceed as described in Section "Replacing a converter using an SD card without firmware (Page 647)".

Operation without SD card

If the converter being replaced was operated without an SD card, you have the following options in a spare part scenario:

- If you have a backup file, proceed as described in Section "Replacing a converter using a backup file (no SD card) (Page 649)".
- If there is no backup file, proceed as described in Section "Replacing a converter without data backup (no SD card, no backup file) (Page 651)".

13.1.3.1 Replacing a converter using an SD card with firmware

Overview

If you retentively saved the configuration of the converter being replaced after commissioning, all configuration data are stored in the "USER" folder on the SD card.

Requirement

- The converter being replaced was operated with an SD card.
- The SD card contains the firmware files and the configuration data of the converter being replaced.
- The rated power of the replacement device is the same as the rated power of the converter being replaced.
- The replacement device is unused or has been reset to factory settings.

Procedure

1. Switch off the supply voltage to the converter.
2. Remove the SD card from the converter.
3. Check that all parts of the device are in a no-voltage condition.
4. Release all of the connections at the converter, replace the converter and re-establish the connections.

5. Insert the SD card into the converter.
6. Switch on the supply voltage to the converter.
If the firmware version in the replacement device differs from the firmware version in the converter being replaced, the converter performs a firmware update. Switch off the supply voltage to the converter and switch it on again after the update.

More information

You can find more information about converter mounting and connecting in the following sections:

- "Mounting the converter (Page 99)"
- "Connecting the converter (Page 127)"

13.1.3.2 Replacing a converter using an SD card without firmware

Overview

If you retentively saved the configuration of the converter being replaced after commissioning, all configuration data are stored in the "USER" folder on the SD card.

The procedure is described below using the web server as an example.

Requirement

- The converter being replaced was operated with an SD card.
- The SD card contains the configuration data of the converter being replaced.
- The rated power of the replacement device is the same as the rated power of the converter being replaced.
- The replacement device is unused or has been reset to factory settings.

Procedure

1. Switch off the supply voltage to the converter.
2. Remove the SD card from the converter.
3. Check that all parts of the device are in a no-voltage condition.
4. Release all of the connections at the converter, replace the converter and re-establish the connections.
5. Switch on the supply voltage to the converter.
6. Connect your operating unit to the converter via the service interface X127.
7. Enter the IP address of the converter, e.g. <https://169.254.11.22>, in the browser.
When the web server is called for the first time, the function view appears with the basic settings.

13.1 Service and maintenance for the converter

8. Make the following basic settings:
 - Preferred language of the user interface
 - Converter date and time; either manually or via NTP
 9. Click on the "Next" button.
You are taken to the Security Wizard.
 10. Select the option "Exit the Security Wizard and continue with low security settings".
User management and access control (UMAC) is not activated.
You can configure the security settings at a later time, see Section "Protection & Security (Page 204)".
 11. Check the installed firmware version on the home page of the web server.
 - If the firmware in the replacement device is older than the firmware in the replaced converter, proceed as described in step 12.
-
- Note**
Loss of configuration data
- If you skip step 12, the converter will be reset to factory settings at the next ramp-up. The configuration data will be lost.
-
- If the firmware in the replacement device is the same as or higher than the firmware in the replaced converter, skip step 12 and proceed with step 13.
 12. Perform a firmware update to a firmware same or higher than the firmware in the replaced converter.
You can find more information on updating the firmware using the web server in Section "Firmware update (Page 207)".
 13. Switch off the supply voltage to the converter.
 14. Insert the SD card into the converter.
 15. Switch on the supply voltage to the converter.
 - The converter imports the settings from the SD card during ramp-up.
 - Following ramp-up, commissioning is completed.
 16. Log in to the web server via the IP address of the converter, e.g. <https://169.254.11.22>.
 17. Save the settings retentively using the "Save" button .

More information

- You can find more information about converter mounting and connecting in the following sections:
 - "Mounting the converter (Page 99)"
 - "Connecting the converter (Page 127)"
- You can find information about all options of firmware update in Section "Converter firmware update (Page 643)".
- You can find available firmware versions on this website (<https://support.industry.siemens.com/cs/ww/en/ps/29596/dl>).

13.1.3.3 Replacing a converter using a backup file (no SD card)

Overview

If you retentively saved the configuration of the converter being replaced after commissioning, and created a backup file, all configuration data are stored in the backup file.

The procedure is described below using the web server as an example.

Requirement

- The backup file was created in the web server with the function "Save drive data to backup file".
- The backup file is in the file directory of your operating unit.
- The rated power of the replacement device is the same as the rated power of the converter being replaced.
- The replacement device is unused or has been reset to factory settings.

Procedure

1. Switch off the supply voltage to the converter.
2. Check that all parts of the device are in a no-voltage condition.
3. Release all of the connections at the converter, replace the converter and re-establish the connections.
4. Switch on the supply voltage to the converter.
5. Connect your operating unit to the converter via the service interface X127.
6. Enter the IP address of the converter, e.g. <https://169.254.11.22>, in the browser.
When the web server is called for the first time, the function view appears with the basic settings.
7. Make the following basic settings:
 - Preferred language of the user interface
 - Converter date and time; either manually or via NTP
8. Click on the "Next" button.
You are taken to the Security Wizard.
9. Select the option "Exit the Security Wizard and continue with low security settings".
User management and access control (UMAC) is not activated.
You can configure the security settings at a later time, see Section "Protection & Security (Page 204)".

13.1 Service and maintenance for the converter

10. Check the installed firmware version on the home page of the web server.
 - If the firmware in the replacement device is older than the firmware in the replaced converter, proceed as described in step 11.

Note

Loss of configuration data

If you skip step 11, the converter will be reset to factory settings at the next ramp-up. The configuration data will be lost.

- If the firmware in the replacement device is the same as or higher than the firmware in the replaced converter, skip step 11 and proceed with step 12.
11. Perform a firmware update to a firmware same or higher than the firmware in the replaced converter.
You can find more information on updating the firmware using the web server in Section "Firmware update (Page 207)".
 12. Call the function view "Backup and restore".
 13. In the area "Restore drive data from backup file", click on the "Click to select file, or drag and drop file here" button.
A dialog window opens.
 14. In your file directory, select the backup file.
 15. Click "Restore".
 - The backup file is checked and loading begins.
 - To load the settings to the converter, a ramp-up (reset) is initiated.
When the process has been completed successfully, a corresponding message is displayed.
 - The current settings are displayed after the ramp-up (reset).
 16. If the UMAC settings are changed through loading of the backup file, you may be logged out of the web server. Now log back in to the web server.
 17. Save the settings retentively using the "Save" button .

More information

- You can find more information about converter mounting and connecting in the following sections:
 - "Mounting the converter (Page 99)"
 - "Connecting the converter (Page 127)"
- You can find information about all options of firmware update in Section "Converter firmware update (Page 643)".
- You can find available firmware versions on this website (<https://support.industry.siemens.com/cs/ww/en/ps/29596/dl>).

13.1.3.4 Replacing a converter without data backup (no SD card, no backup file)

Requirement

The replacement device is unused or has been reset to factory settings.

Procedure

1. Switch off the supply voltage to the converter.
2. Check that all parts of the device are in a no-voltage condition.
3. Release all of the connections at the converter, replace the converter and re-establish the connections.
4. Switch on the supply voltage to the converter.
5. Carry out a complete commissioning procedure with a commissioning tool.

More information

- Information about converter mounting and connecting can be found in the following sections:
 - "Mounting the converter (Page 99)"
 - "Connecting the converter (Page 127)"
- Information about performing commissioning can be found in the following sections:
 - "Commissioning (web server) (Page 163)"
 - "Commissioning (Startdrive) (Page 211)"

13.1.4 Forming the DC link capacitors

Overview

If the converter has been out of operation for too long, you must form the DC link capacitors before connecting the full line voltage to the converter. Non-formed DC link capacitors can damage the converter in operation.

Forming can be omitted if the line voltage is applied to the converter once a year for one hour.

Requirement

Form the DC link capacitors in the following cases:

- The converter has been out of operation for more than one year.
- It has been more than one year since converter production when the converter is commissioned for the first time.
 The production date of the converter is coded in the 3rd and 4th digits of the serial number on the rating plate: S .. ③④...
 Example: Serial number S ZVF1Y54000105 → Production date January 2015

Table 13-1 Production year and production month

Digit ③	Production year	Digit ④	Production month
A	2010, 2030	1 ... 9	January ... September
B	2011, 2031	O	October
C	2012, 2032	N	November
...	...	D	December

Procedure

Form the DC link capacitors by connecting power to the converters as shown below:

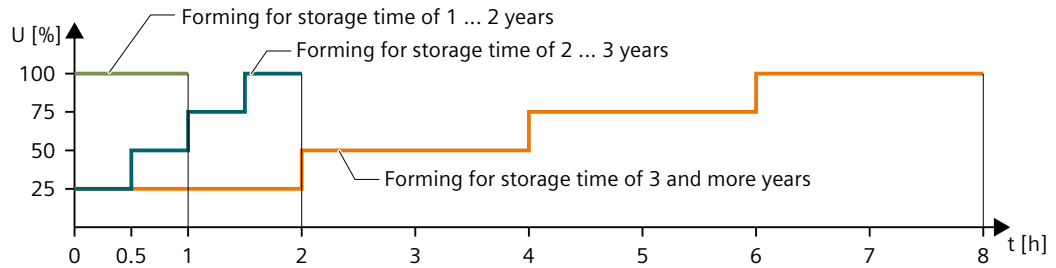



Figure 13-1 Forming the DC link capacitors

13.2 Service and maintenance for the motor

Requirement

 WARNING
Risk of injury if protective devices are removed. Operation without functioning protective devices can cause death or severe injury. <ul style="list-style-type: none">• Operate the motor, even in test operation, only with functioning protective devices.

Procedure

If there are deviations from normal operation or if faults occur, proceed as follows.

1. Identify the fault using the following table.
You should also take account of the messages of the converter.

Fault	Fault cause															
	A	B														
Motor does not start	A	B														
Motor starts slowly	A		C		F											
Humming sound when starting			C		F											
Humming sound in operation	A		C		F											
High temperature rise under no-load operation				D		I										
High temperature rise under load	A		C			I										
High temperature rise of individual winding sections					F											
Uneven running							J	K								
Grinding sound, running noise									L							
Radial vibrations										M	N	O	P			R
Axial vibrations												O		Q		R

2. Rectify the fault using the following table.

No.	Fault cause	Remedial measures
A	Overload	Reduce load
B	Interrupted phase in the converter line supply cable or motor winding	Check the converter and converter line supply cable, measure the winding resistance and insulation resistance, repair after consultation with manufacturer
C	Interrupted phase in the converter line supply cable after switching on	Check the converter, converter line supply cable, and the winding resistance
D	Converter output voltage too high, frequency too low	Check the settings on the converter, perform automatic motor identification
F	Winding short-circuit or phase short-circuit in stator winding	Measure the winding resistances and insulation resistances, repair after consultation with the manufacturer, replace the motor if required
I	Heat dissipation impeded by deposits	Clean the surface of the servo drive system and ensure that the cooling air can flow in and out unimpeded
	Cooling air inlet or outlet is blocked by foreign bodies	Remove the things that block the inlet or outlet and ensure that the cooling air can flow in and out unimpeded
J	Insufficient shielding for motor and/or encoder cable	Check the shielding and grounding
K	Excessive drive controller gain	Adjust the controller
L	Rotating parts are grinding	Determine cause and adjust parts
	Foreign bodies inside the motor	Replace the motor
	Bearing damage	For low or medium inertia motors, replace the motor; for high inertia motors, replace the bearings
M	Rotor not balanced	Replace the motor

No.	Fault cause	Remedial measures
N	Rotor out of true, shaft bent	Consult the manufacturer
O	Poor alignment	Align motor set, check coupling
P	Coupled machine not balanced	Re-balance coupled machine
Q	Shocks from coupled machine	Check coupled machine
R	Fault originating from the gearbox	Adjust or repair the gearbox

If the fault still cannot be resolved after taking the measures stated above, contact the manufacturer or the Siemens Service Center.

13.2.1 Replacing the motor bearings

Description

Motor bearings are wearing parts. They must be replaced after a defined number of operating hours. At medium loads, the motor bearings last approximately 20000 hours.

Especially favorable ambient conditions, such as low average speed, low radial force (transverse force) and vibration load, can prolong the interval until motor replacement.

Note

Premature bearing and motor replacement

Harsh operating conditions (for example, continuous operation at n_{max} , high vibration or shock loads, frequent reversing duty) reduce the bearing or motor replacement interval by up to 50%.

The procedure for replacing the motor bearing depends on the size of the motor. Replacement of the motor bearings is only intended for high inertia motors. For low or medium inertia motors, it is not possible to replace the motor bearings. Replace the motors in their entirety.

The maintenance and repair of the motor can be performed in authorized Siemens Service Centers all over the world. Contact your personal Siemens representative if you need this service.

13.2.2 Replacing the motor

Requirement

The new motor has the same article number as the motor to be replaced. If you want to replace the motor with another motor with a different article number, you must commission the converter again after replacing the motor.



! WARNING

Danger to life due to unintentional starting of the drive unit

Unintentional starting of the drive unit can cause death or severe injury.

- Make sure that the drive unit cannot be started accidentally.
- Post a warning notice at the point where the switch is located.



! CAUTION

Burns as a result of touching hot surfaces

In operation, the motor enclosure can reach a high temperature, which can cause burns if touched.

- Do not touch any hot surfaces.
- Allow the motor to cool down before starting any work.
- Use the appropriate personnel protection equipment, for example, gloves.

Procedure

Replacing the motor with a motor with the same article number

1. Switch off the converter power supply.
2. Replace the motor.
 - Disconnect the motor from the converter. You can find detailed information in Section "Connecting the motor (Page 135)".
 - Release the motor mounting screws.
 - Remove the motor.
 - Mount and install the new motor. You can find detailed information in Section "Mounting the motor (Page 103)".
3. Switch the converter on.

Replacing the motor with a motor with another article number

If you are using a different motor type, after performing the three steps above, you must also carry out the following steps:

1. Reset the converter to factory settings.
You can find more information in Section "Restoring the converter to factory settings (Page 641)".
2. Commission the converter. You can find more information in the following sections:
"Commissioning (web server) (Page 163)"
"Commissioning (Startdrive) (Page 211)"
"Series commissioning (Page 307)"

Result

You have now replaced the motor.

13.3 Service and maintenance for spare parts

13.3.1 Spare parts and spare parts compatibility

Overview

Spare parts can be ordered on the Internet via the spare parts service Spares on Web (<https://www.sow.siemens.com/>).

Spares on Web also gives you the option of determining the article numbers of spare parts.

Description

Converter components are being continuously developed within the scope of product maintenance.

Product maintenance includes, for example, measures to increase the ruggedness or hardware changes that become necessary as components are discontinued.

These further developments are "spare parts-compatible" and do not change the article number.

In the scope of such spare parts-compatible ongoing development, connectors or connection positions are sometimes slightly modified. This does not cause any problems when the component is used as intended. Take this fact into consideration in special installation situations (for example, allow sufficient reserve regarding the cable length).

13.3.2 Replacing the fan unit, FSC 400 V and FSD 400 V only

Overview

The FSC 400 V and FSD 400 V converters are integrated with a fan unit.

The average service life of the fan is 20000 hours; however, the service life may be shorter, especially in a dusty environment.

Parameter r0277 is used to display the fan wear as a percentage of the operating hours.

Alarm A30042 appears if the maximum operating hours will soon be reached or has already been exceeded.

The alarm value is contained in r2124 (interpret as a binary value):

- Bit 0 = 1: The wear counter has reached 99%, and after the remaining 1% has elapsed, bit 0 is cleared and bit 2 is set.
- Bit 2 = 1: The wear counter has exceeded 100%.

Replace the defective fan in time to ensure the proper operation of the converter.

You can find the article number of the replacement fan in Section "Replacement fans (Page 72)"

Requirement

You have switched off the converter power supply before replacing the fan unit.

 **CAUTION**
Injury caused by a rotating fan

Touching a fan while it is rotating can result in injury.

- Switch off the supply voltage to the converter.
- Wait until the fan is stationary before working on it.

 **WARNING**
Electric shock as a result of a residual charge in power components

After the power supply has been switched off, it takes up to five minutes until the capacitors in the converter have discharged so that the residual charge is at a non-hazardous level.

Therefore, touching the converter immediately after powering off can result in electric shock due to residual charge in the power components.

- Check the voltage at the converter connections before releasing the connections at the converter.

 **WARNING**
Electric shock when live parts are touched

After the fan unit is removed, the live components of the converter are no longer protected from being touched. Contact with live parts can result in death or serious injury.

- Before replacing the fan, switch off the power supply at terminals X1: L1, L2, L3.
- Check that the fan unit is de-energized before removing it.
- Wait until the discharge time specified on the warning labels has elapsed.

Procedure

The fan unit is installed at the top of the converter.

1. Switch off the converter power supply.
2. Press the release clips to remove the fan unit from the converter as shown below. Use a screwdriver if necessary.

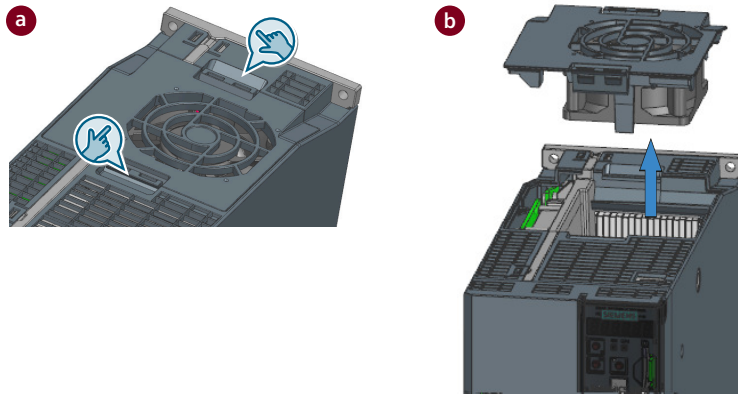

3. Install the new fan unit in the inverse sequence as shown below.

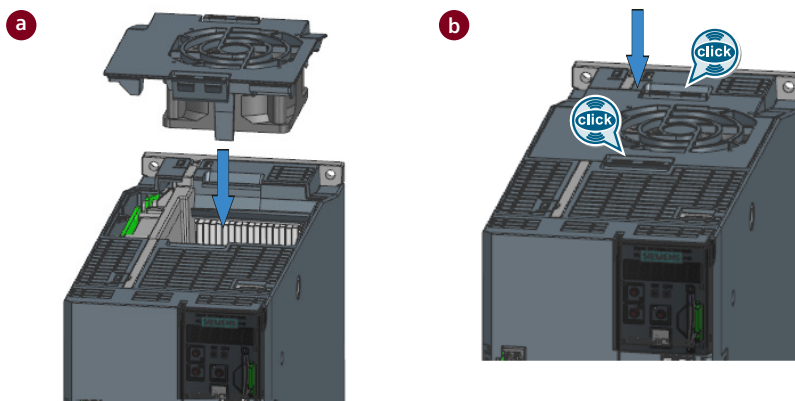

Result

You have now replaced the fan unit.

13.4 Device disposal

Description



For environmentally-friendly recycling and disposal of your old device, contact a company certified for the disposal of waste electrical and electronic equipment, and dispose of the old device as prescribed in the respective country of use.

Technical data

14.1 Technical data of the converter

14.1.1 Permissible environmental conditions for the converter

Technical data

Table 14-1 Environmental conditions

Property	Description
Environmental conditions for transport in the transport packaging	
Climatic environmental conditions	<ul style="list-style-type: none"> Surrounding air temperature: -40 °C ... +70 °C Suitable according to Class 2K4 to IEC 60721-3-2 Humidity: Max. 95% at 45 °C according to IEC 60721-3-2
Mechanical environmental conditions	Vibration: <ul style="list-style-type: none"> 2 Hz ... 9 Hz: 7.5 mm deflection 9 Hz ... 200 Hz: 2 g vibration Vibrations permissible according to Class 2M3 to IEC 60721-3-2
Protection against chemical substances	Protected according to Class 2C2 to IEC 60721-3-2
Biological environmental conditions	Suitable according to Class 2B2 to IEC 60721-3-2
Environmental conditions for long-term storage in the product packaging	
Climatic environmental conditions	<ul style="list-style-type: none"> Surrounding air temperature: -40 °C ... +70 °C Relative humidity: Max. 95%, condensation not permissible
Mechanical environmental conditions	Vibrations permissible according to Class 1M2 to IEC 60721-3-1
Protection against chemical substances	Protected according to Class 1C2 to IEC 60721-3-1
Biological environmental conditions	Suitable according to Class 1B2 to IEC 60721-3-1
Environmental conditions in operation	
Installation altitude	<ul style="list-style-type: none"> Up to 2000 m above sea level without power derating Up to 4000 m with power derating
Climatic environmental conditions	<ul style="list-style-type: none"> Surrounding air temperature: 0 °C ... 55 °C, > 45 °C with power derating Relative humidity: Max. 95%, condensation not permissible

14.1 Technical data of the converter

Property	Description
Mechanical environmental conditions	<ul style="list-style-type: none"> • Shock: <ul style="list-style-type: none"> – Peak acceleration: 5 g – Duration of shock: 30 ms • Vibration: <ul style="list-style-type: none"> – 10 Hz ... 58 Hz: 0.075 mm deflection – 58 Hz ... 200 Hz: 1 g vibration Shocks and vibrations permissible according to Class 3M1 to IEC 60721-3-3
Protection against chemical substances	Protected according to Class 3C2 to IEC 60721-3-3
Biological environmental conditions	Suitable according to Class 3B1 to IEC 60721-3-3
Pollution	Suitable for environments with degree of pollution 2 according to IEC 61800-5-1

14.1.2 General technical data

Technical data

Table 14-2 General technical data of the converter

Parameter	Description
Overload capability	350% overload: for 200 V and 400 V variants with a power rating of 0.1 kW to 0.75 kW 300% overload: for 200 V and 400 V variants with a power rating of 1 kW to 7 kW
Output frequency (Hz)	0 ... 550
IGBT pulse frequency without derating (kHz)	8
Control system	Servo control
Dynamic brake	Integrated
Protective functions	Grounding fault protection, output short-circuit protection ¹⁾ , overvoltage/undervoltage protection ²⁾ , converter I ² t protection, motor overtemperature protection ³⁾ , IGBT overtemperature protection
Surge voltage	Fulfill the requirement of the standard IEC 61800-3
Overvoltage category	Category III according to IEC 61800-5-1
Minimum prospective short-circuit current	20 to 25 times of the rated current of the protective device is required
Maximum permissible short-circuit current (SCCR, kA rms)	<ul style="list-style-type: none"> • For 200 V variants: 100⁴⁾ • For 400 V variants: 65
Cooling type	<ul style="list-style-type: none"> • For 200 V variants: Natural cooling • For 400 V variants: <ul style="list-style-type: none"> – FSA and FSB: Natural cooling – FSC and FSD: Fan cooling
Mains supply	

Parameter	Description
Permissible mains supply network	TN, TT, IT
Line voltage	1 AC/3 AC 200 V ... 240 V 3 AC 380 V ... 480 V
Line frequency (Hz)	50/60
Permissible line voltage fluctuation	-15% ... +10%
Permissible line frequency fluctuation	-10% ... +10%
24 V DC power supply	
Voltage (V)	24 (-15% ... +20%) ⁵⁾
Permissible voltage fluctuation (V)	When using a motor without brake: 20.4 ... 28.8 When using a motor with brake: 22.8 ... 28.8
Maximum current (A)	<ul style="list-style-type: none"> • For 200 V variants: <ul style="list-style-type: none"> – When using a motor without a brake: 1.2 – When using a motor with a brake: 2.2 • For 400 V variants: <ul style="list-style-type: none"> – When using a motor without a brake: 1.2 – When using a motor with a brake: 3.2
Safety insulation class	SELV
Inputs and outputs	
Digital inputs	<ul style="list-style-type: none"> • Maximum input current: 4 mA (for "1" signal: > 1.5 mA) • General delay time: <ul style="list-style-type: none"> – DI 0 → 1: < 10 μs – DI 1 → 0: < 150 μs • Fast digital input delay time: <ul style="list-style-type: none"> – F-DI 0 → 1: < 5 μs – F-DI 1 → 0: < 5 μs
Digital outputs	<ul style="list-style-type: none"> • Maximum output current: 100 mA • Delay time: < 2 ms
Pulse train output (for the S200 converter only)	Output voltage: line driver (5 V differential) Output frequency: ≤ 4 MHz
Safety Integrated (for the S200 converter only)	
Safety function	STO, SIL 3 / PL e / Category 3

14.1 Technical data of the converter

Parameter	Description
	<p>STO fulfills the requirements of the following standards:</p> <ul style="list-style-type: none"> • SIL 3 according to IEC 61800-5-2 • PL e according to ISO 13849-1 • Category 3 according to ISO 13849-1
	<p>Response time:</p> <p>The response time of the Safe Torque Off function is the time between selecting the function and the function becoming active.</p>
	<p>Probability of failures:</p> <ul style="list-style-type: none"> • Probability of dangerous failure per hour: PFH < 10×10^{-9} PFH according to IEC 61800-5-2 • Probability of dangerous failure on demand: PFD < 50×10^{-5} PFD according to IEC 61508
	<p>Mission time: 20 years</p> <p>You may not operate converters with integrated safety functions for longer than the mission time. The mission time starts when the device is delivered. The mission time cannot be extended. This is the case even if a service department checks the converter – or in the meantime, the converter was decommissioned.</p>

- ¹⁾ Integral solid state short circuit protection does not provide branch circuit protection. Branch circuit protection must be provided in accordance with the National Electrical Code and any additional local codes.
- ²⁾ The 200 V converter has an overvoltage threshold of 410 V DC and an undervoltage threshold of 155 V DC; the 400 V converter has an overvoltage threshold of 820 V DC and undervoltage threshold of 320 V DC.
- ³⁾ Motor temperature is calculated by motor thermal model and protected by the output current from the converter.
- ⁴⁾ The maximum permissible short-circuit current for 200 V variants with Type E Combination Motor Controllers is 65 kA.
- ⁵⁾ When the converter works with a motor with a brake, the voltage tolerance of 24 V DC power supply must be -5% to +20% to meet the voltage requirement of the brake.

14.1.3 Specific data of the 200 V converters

Technical data

Table 14-3 Specific technical data of the 200 V converters frame size A

Article No. 6SL5□10-1BB	10-1AF0	10-2AF0
Frame size	FSA	FSA
Rated input current (A) 1 AC	1.2	2.0
3 AC	0.6	1.1
Rated output current (A)	0.81	1.33
Maximum output current (A)	3.3	5.1
Maximum supported motor power (kW)	0.1	0.2
Power loss (W)	12	15
Inrush current (A)	10.5	10.5

14.1 Technical data of the converter

Article No. 6SL5□10-1BB	10-1AF0	10-2AF0
Fuse according to IEC	3NA3804 (4 A) 3NW6304-1 (4 A)	3NA3804 (4 A) 3NW6304-1 (4 A)
Fuse according to UL, Class J	3 A	3 A
Leakage current (mA)	1 AC 3 AC	19 24
Outline dimensions (W x H x D, mm)	40 x 170 x 135	40 x 170 x 135
Weight (g)	S200 S200 Basic	763 763

Table 14-4 Specific technical data of the 200 V converters frame size B

Article No. 6SL5□10-1BB	10-4AF0
Frame size	FSB
Rated input current (A)	1 AC 3 AC
Rated output current (A)	2.4
Maximum output current (A)	9.2
Maximum supported motor power (kW)	0.4
Power loss (W)	24
Inrush current (A)	8.5
Fuse according to IEC	3NA3801 (6 A) 3NW6301-1 (6 A)
Fuse according to UL, Class J	6 A
Leakage current (mA)	1 AC 3 AC
Outline dimensions (W x H x D, mm)	40 x 170 x 170
Weight (g)	S200 S200 Basic

Table 14-5 Specific technical data of the 200 V converters frame size C

Article No. 6SL5□10-1BB	10-8AF0	11-0AF0
Frame size	FSC	FSC
Rated input current (A)	1 AC 3 AC	8.0 4.0
Rated output current (A)	4.4	4.4
Maximum output current (A)	16.8	16.8
Maximum supported motor power (kW)	0.75	1.0
Power loss (W)	45	46
Inrush current (A)	7.6	7.6

Technical data

14.1 Technical data of the converter

Article No. 6SL5□10-1BB	10-8AF0	11-0AF0
Fuse according to IEC	3NA3805 (16 A) 3NW6006-1 (12 A)	3NA3805 (16 A) 3NW6006-1 (12 A)
Fuse according to UL, Class J	15 A	15 A
Leakage current (mA)		
1 AC	20	20
3 AC	23	23
Outline dimensions (W x H x D, mm)	60 x 170 x 195	60 x 170 x 195
Weight (g)		
S200	1741.4	1741.4
S200 Basic	1741.4	1741.4

14.1.4 Specific data of the 400 V converters

Technical data

Table 14-6 Specific technical data of the 400 V converters frame size A

Article No. 6SL5510-1BE	10-2AF0	10-4AF0
Frame size	FSA	FSA
Rated input current (A)	1.3	1.3
Rated output current (A)	1.3	1.3
Maximum output current (A)	5.1	6.0
Maximum supported motor power (kW)	0.2	0.4
Power loss (W)	31	32
Inrush current (A)	7.5	7.5
Fuse according to IEC	3NA3804 (4 A) 3NW6304-1 (4 A)	3NA3804 (4 A) 3NW6304-1 (4 A)
Fuse according to UL, Class J	3 A	3 A
Leakage current (mA)	36	36
Outline dimensions (W x H x D, mm)	50 x 180 x 200	50 x 180 x 200
Weight (g)	1517.5	1517.5

Table 14-7 Specific technical data of the 400 V converters frame size B

Article No. 6SL5510-1BE	10-8AF0	11-0AF0
Frame size	FSB	FSB
Rated input current (A)	2.5	3.0
Rated output current (A)	2.5	3.0
Maximum output current (A)	9.3	11.5
Maximum supported motor power (kW)	0.75	1.0
Power loss (W)	46	54
Inrush current (A)	7.5	7.5

14.1 Technical data of the converter

Article No. 6SL5510-1BE	10-8AF0	11-0AF0
Fuse according to IEC	3NA3803 (10 A) 3NW6303-1 (10 A)	3NA3803 (10 A) 3NW6303-1 (10 A)
Fuse according to UL, Class J	10 A	10 A
Leakage current (mA)	39	39
Outline dimensions (W x H x D, mm)	60 x 180 x 200	60 x 180 x 200
Weight (g)	1912.4	1912.4

Table 14-8 Specific technical data of the 400 V converters frame size C

Article No. 6SL5510-1BE	11-5AF0	12-5AF0
Frame size	FSC	FSC
Rated input current (A)	5.5	8.0
Rated output current (A)	5.3	7.8
Maximum output current (A)	20	26.5
Maximum supported motor power (kW)	1.75	2.5
Power loss (W)	84	123
Inrush current (A)	15	15
Fuse according to IEC	3NA3805 (16 A) 3NW6006-1 (12 A)	3NA3805 (16 A) 3NW6305-1 (16 A)
Fuse according to UL, Class J	15 A	20 A
Leakage current (mA)	46	46
Outline dimensions (W x H x D, mm)	70 x 180 x 200	70 x 180 x 200
Weight (g)	2008.4	2008.4

Table 14-9 Specific technical data of the 400 V converters frame size D

Article No. 6SL5510-1BE	13-5AF0	15-0AF0	17-0AF0
Frame size	FSD	FSD	FSD
Rated input current (A)	11.0	13.0	14.2
Rated output current (A)	11	12.6	13.2
Maximum output current (A)	38.1	38.8	37.4
Maximum supported motor power (kW)	3.5	5.0	7.0
Power loss (W)	171	194	205
Inrush current (A)	3	3	3
Fuse according to IEC	3NA3807 (20 A) 3NW6307-1 (20 A)	3NA3807 (20 A) 3NW6007-1 (20 A)	3NA3810 (25 A) 3NW6010-1 (25 A)
Fuse according to UL, Class J	25 A	25 A	25 A
Leakage current (mA)	60	60	60
Outline dimensions (W x H x D, mm)	95 x 260 x 230	95 x 260 x 230	95 x 260 x 230
Weight (g)	4517.5	4517.5	4517.5

14.1.5 Overload capacity

Description

SINAMICS S200 converter product line can work with a certain overload capacity for a specific time period.

- 350% overload capacity: for 200 V and 400 V variants with a power rating of 0.1 kW to 0.75 kW
- 300% overload capacity: for 200 V and 400 V variants with a power rating of 1 kW to 7 kW

The typical load cycle can be repeated without limitation.

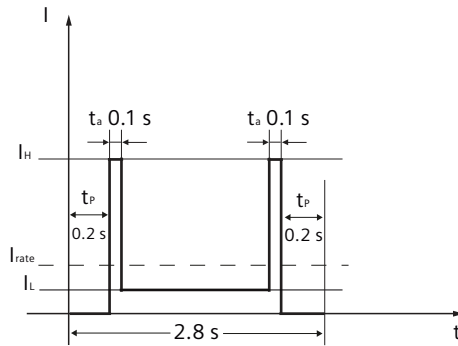

I_H	Maximum current	t_a	Acceleration time
I_{rate}	Rated current	t_p	Preset time
I_L	Minimum current	T	Total cycle period
I_0	Stall current		

Figure 14-1 Typical load cycle

The other duty cycle can be calculated by the following formula:

$$I_{rate}^2 \times T = I_0^2 \times t_p \times 2 + I_H^2 \times t_a \times 2 + I_L^2 \times (T - t_p \times 2 - t_a \times 2)$$

$$I_H = n \times I_{rate} \quad (3 < n < 4.2)$$

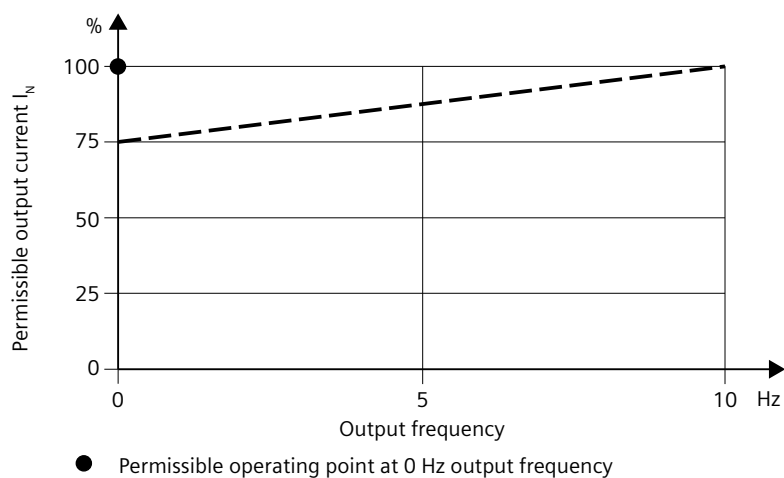
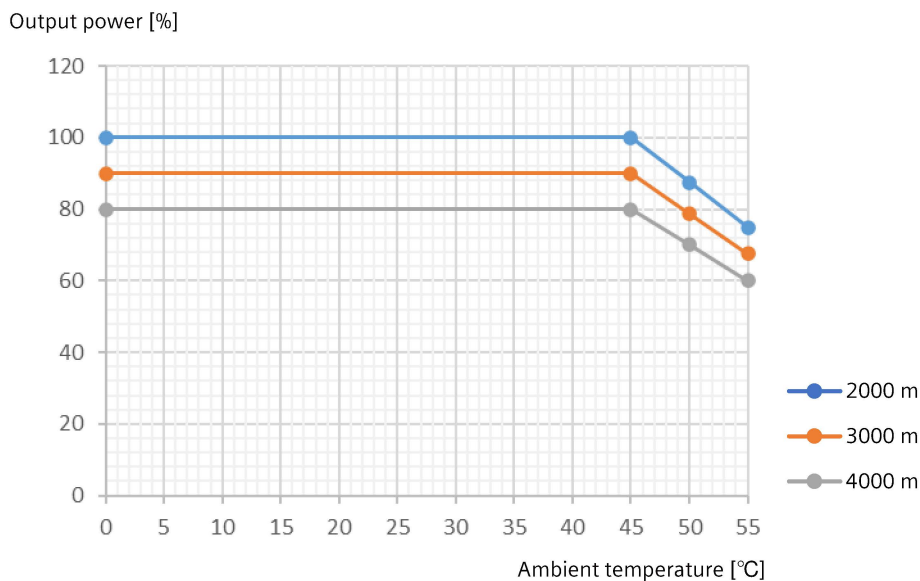

Figure 14-2 Permitted output current at low frequency

14.1.6 Power derating as a function of the installation altitude and ambient temperature

Description

Power derating as a function of the installation altitude and ambient temperature



Note

A maximum of 2000 m is permissible for CSA compliance.

14.1.7 Braking resistor

14.1.7.1 Internal braking resistor

Description

An internal braking resistor is designed in the converter (excluding S200 Basic FSA and FSB and S200 FSA (0.1 kW)) to absorb regenerative energy from the motor. The table below shows the information of the internal braking resistor:

Table 14-10 Internal braking resistor of the SINAMICS S200 converter product line

Frame size	Resistance (Ω)	Maximum continuous power ($P_{\text{cont_int}}$) (W)	Maximum peak power ($P_{\text{max_int}}$) (W)	Maximum braking energy ($E_{\text{max_int}}$) (J)
1 AC/3 AC, 200 V ... 240 V				
FSA (0.2 kW)	200	8	373	63
FSB (0.4 kW)	100	16	742	123
FSC (0.75 kW, 1 kW)	50	30	1884	292
3 AC, 380 V ... 480 V				
FSA (0.2 kW, 0.4 kW)	500	14	754	210
FSB (0.75 kW ... 1.0 kW)	160	15	2312	637
FSC (1.75 kW ... 2.5 kW)	70	30	5086	1137
FSD (3.5 kW ... 7.0 kW)	27	65	9896	1948

More information

For more information about connecting the braking resistor, see Section "Connecting the braking resistor (Page 148)".

14.1.7.2 External braking resistor

Description

If the motor feeds back more energy than can be dissipated by the internal braking resistor, or when you use a converter without the internal braking resistor, you will require an external braking resistor. You can select a suitable external braking resistor according to your calculation result for the specific application.

When selecting a braking resistor, you must take into account the factors such as load inertia, deceleration time, speed variation, and braking period according to your specific application and technology.

For more information about selecting a motor, see Section "Motor selection (Page 951)".

 WARNING**Risk of fire caused by continuous overload**

An explosion or a fire could occur if the external braking resistor is continuously overloaded (for example as the result of a defective Braking Module). This can result in severe injury or death and/or the enclosure could melt.

- Use only braking resistors that are intrinsically safe.

NOTICE**Damage to the converter due to its maximum load being exceeded**

If the maximum permissible continuous power, peak power or braking energy is exceeded, the converter may be damaged.

- Only ever operate the converter within its maximum permissible working range.

Load cycles for braking resistors

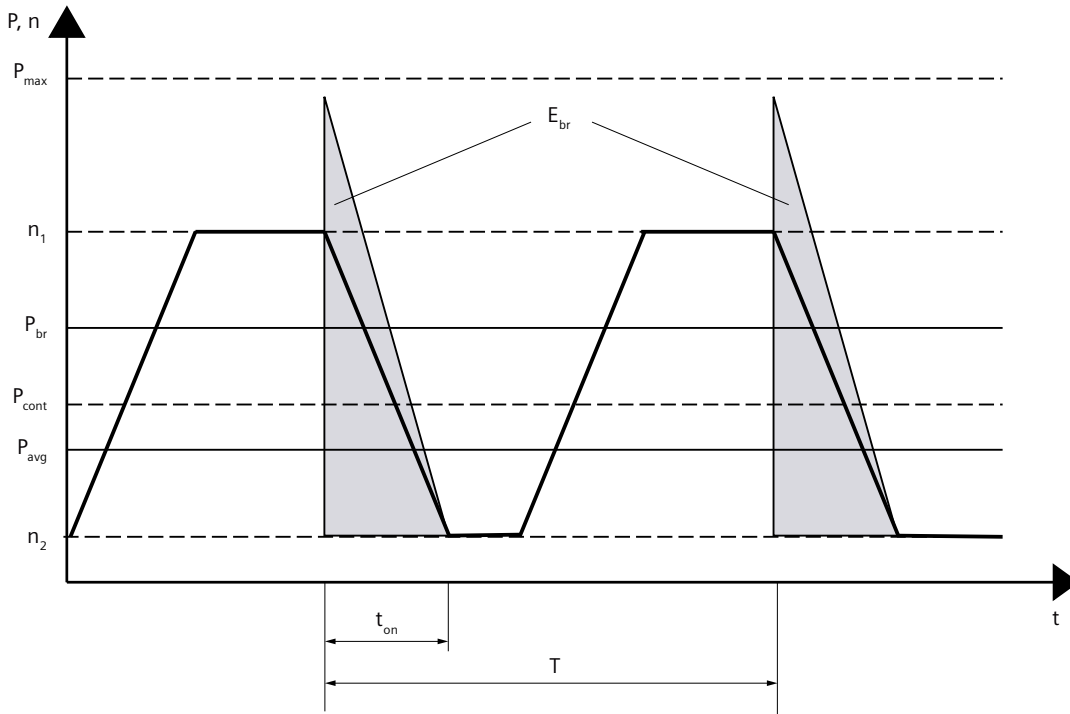

- P_{max} [W]: Maximum peak power
- P_{cont} [W]: Maximum continuous power
- P_{br} [W]: Application-specific braking power
- P_{avg} [W]: Application-specific average braking power
- E_{max} [J]: Maximum braking energy
- E_{br} [J]: Application-specific braking energy
- t_{on} [s]: Braking duration
- T [s]: Cycle duration
- n_1 [r/min]: Initial speed
- n_2 [r/min]: Speed after braking
- P_{max_int} [W]: Maximum peak power of internal braking resistor
- P_{max_ext} [W]: Maximum peak power of external braking resistor
- P_{cont_int} [W]: Maximum continuous power of internal braking resistor
- P_{cont_ext} [W]: Maximum continuous power of external braking resistor
- E_{max_int} [J]: Maximum braking energy of internal braking resistor
- E_{max_ext} [J]: Maximum braking energy of external braking resistor

Figure 14-3 Peak power, continuous power and duty cycle of the braking resistor

The following conditions must be met simultaneously when selecting the braking resistor:

- The calculated braking energy required in the application E_{br} must not exceed the maximum braking energy E_{max} . If $E_{br} < E_{max_intr}$, you don't require an external braking resistor. If $E_{br} > E_{max_intr}$, you must use the external braking resistor. Select the external braking resistor with $E_{max_ext} > E_{br}$.
- The braking power required in the application P_{br} must not exceed the maximum peak power P_{max} . When using the internal braking resistor, if $P_{br} > P_{max_intr}$, you can adjust the braking duration t_{on} . If the requirement ($P_{br} < P_{max_intr}$) of the specific application still can not be satisfied, you must use the external braking resistor. Select the external braking resistor with $P_{max_ext} > P_{br}$.
- The average braking power required in the application P_{avg} (arithmetic mean of the braking cycle) must not exceed the maximum continuous power P_{cont} . When using the internal braking resistor, if $P_{avg} > P_{cont_intr}$, you can adjust the braking cycle duration T . If the requirement ($P_{avg} < P_{cont_intr}$) of the specific application still can not be satisfied, you must use the external braking resistor. Select the external braking resistor with $P_{cont_ext} > P_{avg}$.

You can find the resistance data of the internal braking resistor for each frame size in the table "Internal braking resistor of the SINAMICS S200 converter product line" in Section "Internal braking resistor (Page 672)".

Calculating the braking energy, the braking power, and the average braking power

- Calculate the braking energy according to the following formula:

$$E_{br} = \frac{1}{2} (J_{mot} + J) \frac{4\pi^2}{3600} (n_1^2 - n_2^2)$$

Note

As the friction is not taken into account in the above formula, less energy is fed back to the servo drive system in practice than that calculated in the formula.

- Calculate the braking power according to the following formula:
 $P_{br} = E_{br} / t_{on}$
- Calculate the average braking power according to the following formula:
 $P_{avg} = E_{br} / T$

E_{br} / J	Application-specific braking energy
J_{mot} / kgm^2	Moment of inertia of the servo motor
J / kgm^2	Moment of inertia of the driven mechanical system in relation to the shaft of the servomotor
$n_1 / \text{r/min}$	Initial speed
$n_2 / \text{r/min}$	Speed after braking
P_{br} / W	Application-specific braking power
P_{avg} / W	Application-specific average braking power

14.1 Technical data of the converter

t_{on} / s Braking duration
 T / s Cycle duration

Example for internal braking resistor application

A 1FL2104-4AG... servomotor with low moment of inertia (with integrated holding brake) with a mechanical system is fed from a SINAMICS S200 6SL5510-1BB11-0A□0. It is to be braked from 3000 r/min to 600 r/min with a braking duty cycle as $t_{on} = 0.05$ s, $T = 2$ s.

Moment of inertia of the servomotor 1FL2104-4AG... $J_{mot} = 0.71 \times 10^{-4}$ kgm²
 Moment of inertia of the driven mechanical system $J = 4 \times 10^{-4}$ kgm²
 $n_1 = 3000$ r/min $n_2 = 600$ r/min
 $\Rightarrow E_{br} = 22.31$ J < $E_{max_int} = 292$ J (1 J = 1 Ws)
 $\Rightarrow P_{br} = 446.26$ W < $P_{max_int} = 1884$ W
 $\Rightarrow P_{avg} = 11.16$ W < $P_{cont_int} = 30$ W

In this case, therefore, no external braking resistor is required.

Example for external braking resistor application

A 1FL2104-4AG... servomotor with low moment of inertia (with integrated holding brake) with a mechanical system is fed from a SINAMICS S200 6SL5510-1BB11-0A□0. It is to be braked from 6000 r/min to 600 r/min with a braking duty cycle as $t_{on} = 0.05$ s, $T = 2$ s.

Moment of inertia of the servomotor 1FL2104-4AG... $J_{mot} = 0.71 \times 10^{-4}$ kgm²
 Moment of inertia of the driven mechanical system $J = 8 \times 10^{-4}$ kgm²
 $n_1 = 6000$ r/min $n_2 = 600$ r/min
 $\Rightarrow E_{br} = 170.21$ J < $E_{max_int} = 292$ J (1 J = 1 Ws)
 $\Rightarrow P_{br} = 3404.18$ W > $P_{max_int} = 1884$ W
 $\Rightarrow P_{avg} = 85.10$ W > $P_{cont_int} = 30$ W

In this case, therefore, an external braking resistor is required. Select the external braking resistor according to the following table.

Frame size	Resistance (Ω)	Continuous power (W)	Peak power (W)	Braking energy (J)
FSC (1 kW)	≥ 50	> 85.10	> 3404.18	> 170.21

More information

For more information about connecting the braking resistor, see Section "Connecting the braking resistor (Page 148)".

14.2 Technical data of the motor

14.2.1 General technical data

Technical data

Table 14-11 General technical data of the motor

Property	Description
Type of motor	Servo motor
Rotor inertia	<ul style="list-style-type: none"> 1FL21: motor with low rotor inertia 1FL22: motor with medium rotor inertia 1FL23: motor with high rotor inertia
Cooling	Natural cooling
Thermal class	<ul style="list-style-type: none"> 1FL2102, 1FL2□03, 1FL23□□: B 1FL2104, 1FL2204, 1FL2□05: F
Impulse voltage insulation class (IVIC) according to IEC/EN 60034-18-41	C
Operating temperature	-15 °C ... +40 °C, power derating at higher temperatures
Relative humidity	< 90% at 30 °C, condensation not permissible
Installation altitude according to EN 60034-6	≤ 1000 m above sea level; otherwise power derating
Type of construction according to IEC/EN 60034-7	IM B5 (IM V1, IM V3)
Degree of protection according to IEC/EN 60034-5	<ul style="list-style-type: none"> 1FL2102, 1FL2□03, 1FL2104, 1FL2204: IP54 for the shaft extension (without shaft sealing) and IP65 for the motor body, optionally IP65 for the whole motor (with shaft sealing) 1FL2□05, 1FL23□□: IP65
Temperature monitoring	Thermal motor model
Paint finish	Anthracite (614 Anthrazit)
Shaft extension according to DIN 748-3 and IEC 60072-1	Plain shaft, optionally shaft with feather key (half-key balancing)
Radial eccentricity, concentricity, and axial eccentricity according to DIN 42955 and IEC 60072-1	Tolerance N (normal)
Vibration severity grade according to IEC/EN 60034-14	Grade A
Sound pressure level L_{pA} (1 m) according to DIN EN ISO 1680, max. tolerance +3 dB(A)	<ul style="list-style-type: none"> 1FL2102, 1FL2□03, 1FL2104, 1FL2204: 60 dB(A) 1FL2□05, 1FL2304: 65 dB(A) 1FL2306, 1FL2310: 70 dB(A)
Encoder	<ul style="list-style-type: none"> Absolute encoder single-turn, 17-bit (identification letter: H) Absolute encoder single-turn, 21-bit (identification letter: S) Absolute encoder, 21-bit single-turn + 12-bit multiturn (identification letter: M)

14.2 Technical data of the motor

Property	Description
Holding brake	Optional integrated holding brake
Connection	<ul style="list-style-type: none"> 1FL2102, 1FL2□03, 1FL2104, 1FL2204: dual-cable connections with a hybrid connector 1FL2□05: two-cable connections with two angular connectors 1FL23□□: three-cable connections with three angular connectors

14.2.2 Permissible environmental conditions for the motor

Technical data

Table 14-12 Environmental conditions for transport

Environmental conditions for transport in the transport packaging according to Class 2K3 to DIN EN IEC 60721-3-2, except for environmental variables "air temperature" and "condensation"	
Climatic environmental conditions	<ul style="list-style-type: none"> Temperature: -15 °C ... +70 °C Highest relative humidity: < 90% at 30 °C, condensation not permissible
Mechanical environmental conditions	Single shocks (6 ms), max. 300 m/s ²
Protection against chemical substances	Protected according to Class 2C2
Biological environmental conditions	Suitable according to Class 2B2

Table 14-13 Environmental conditions for long-term storage

Environmental conditions for long-term storage in the product packaging according to Class 1K3 to DIN EN IEC 60721-3-1, except for environmental variables "air temperature", "highest relative humidity" and "condensation"	
Climatic environmental conditions	<ul style="list-style-type: none"> Temperature: -20 °C ... +65 °C Highest relative humidity: < 90% at 30 °C, condensation not permissible
Mechanical environmental conditions	Vibration-free storage space, $v_{rms} < 0.2$ mm/s
Protection against chemical substances	Protected according to Class 1C2
Biological environmental conditions	Suitable according to Class 1B2
Duration	<ul style="list-style-type: none"> Six months for the above-mentioned conditions. Special preservation measures are required for storage periods of six months up to a maximum of two years. <p>For more information, please contact your local sales partner.</p>

Table 14-14 Environmental conditions during operation

Environmental conditions during operation according to 3K4 to DIN EN IEC 60721-3-3, except for environmental variables "low air temperature", "condensation" and "low air pressure"	
Installation altitude	Up to 1000 m above sea level without limitations You can get additional information in Section "Derating factors (Page 681)".
Climatic environmental conditions ¹⁾	<ul style="list-style-type: none"> • Temperature: -15 °C ... +40 °C, power derating at higher temperatures • Relative humidity: < 90% at 30 °C, condensation not permissible • Absolute air humidity: 1 g/m³ ... 29 g/m³ • Rate of temperature change²⁾: 0.5°/min • Atmospheric pressure: 89 kPa^{1) 3)} ... 106 kPa⁴⁾ • Solar radiation: 700 W/m² ²⁾ • Movement of the air: 1.0 m/s • Water (other than rain): see Section "Degree of protection (Page 683)"
Mechanical environmental conditions	<ul style="list-style-type: none"> • Vibration severity grade: A (according to IEC 60034-14:2003) • Shock resistance (m/s²): <ul style="list-style-type: none"> – 1FL2102, 1FL2□03, 1FL2104, 1FL2204, 1FL2□05: 50 (continuous in axial direction), 50 (continuous in radial direction), 300 (in a short time of 11 ms) – 1FL23□□: 25 (continuous in axial direction), 50 (continuous in radial direction), 300 (in a short time of 11 ms)
Protection against chemical substances	Protected according to 3C2 to DIN EN IEC 60721-3-3
Biological environmental conditions	Suitable according to 3B2 to DIN EN IEC 60721-3-3
Pollution	Suitable for environments with degree of pollution 2 according to IEC 61800-5-1
Cooling air	Clean and dry air
The motors are not suitable for operation under the following circumstances:	
<ul style="list-style-type: none"> • In a vacuum⁵⁾ • In salt-laden or aggressive atmospheres • Outdoors 	

1) Increased ruggedness with regard to low air temperature and low atmospheric pressure better than 3K3 according to DIN EN IEC 60721-3-3

2) Averaged over a period of 5 min

3) The limit value of 89 kPa covers applications at altitudes up to 1000 m.

4) Conditions in mines are not considered.

5) Operation in a vacuum is not permissible because of the low dielectric strength and poor heat dissipation.

14.2.3 Protection against electromagnetic fields (motor)

Description

 WARNING
<p>Malfunction of active implants due to magnetic and electrical fields</p> <p>Electric motors pose a danger to people with active medical implants, e.g. heart pacemakers, who come close to these motors.</p> <ul style="list-style-type: none"> • If you are affected, stay a minimum distance of 30 cm away from the motors (tripping threshold for static magnetic fields of 0.5 mT according to Directive 2013/35/EU).

<p>NOTICE</p>
<p>Damage to the absolute encoder due to the magnetic interference from the magnetic field</p> <p>The magnetic interference from the magnetic field can cause a damage to the absolute encoder.</p> <ul style="list-style-type: none"> • To avoid magnetic interference to the absolute encoder, keep the motor at least 15 mm away from devices that produce a magnetic field stronger than 10 mT.

14.2.4 Cooling

Description

The 1FL2 motor is a non-ventilated motor.

To ensure sufficient heat dissipation when installed, the motor requires a minimum clearance of 100 mm from adjacent components on three sides.

Maintain the clearance irrespective of the following mounting variants.

Non-thermally insulated mounting

Some of the motor power loss is dissipated through the flange when the motor is connected to the mounting surface.

Table 14-15 Mounting conditions for non-thermally insulated mounting

Motor	Steel plate: width x height x thickness (mm)
1FL2102	200 x 200 x 6
1FL2□03	250 x 250 x 6
1FL2104	
1FL2204	
1FL2□05	300 x 300 x 12
1FL2304	270 x 270 x 10

Motor	Steel plate: width x height x thickness (mm)
1FL2306	390 x 390 x 15
1FL2310	420 x 420 x 20

The data in the table refers to an ambient temperature of +40 °C and an installation altitude up to 1000 m above sea level. If the environmental conditions are different, derating may be required. You can find information on this in Section "Derating factors (Page 681)".

Larger mounting surfaces improve heat dissipation.

Thermally insulated mounting without additional mounted components

For naturally cooled motors, you must reduce the S1-characteristic curve as follows:

- Reduce the motor static torque by a range of 20% to 30%.
- Reduce the torque at 3000 r/min by a range of 40% to 50%.

Thermal motor protection

The converter monitors the motor temperature based on a thermal motor model and issues the alarm "Motor overtemperature" before the maximum temperature is reached. If the motor exceeds the maximum temperature, the converter switches off the motor with the fault message "Motor overtemperature".

If the ambient temperature exceeds 40 °C, you need to set the ambient temperature at the converter so that the motor is reliably protected.

- To do this, select parameter p0613 at the converter.
- Set the maximum ambient temperature that occurs.

Parameter r0034 indicates the thermal load of the motor as a percentage. The reading is influenced by the ambient temperature selected in parameter p0613.

You can find additional information in Section "Parameter list (Page 749)".

14.2.5 Derating factors

Overview

Due to the decreasing air pressure in higher installation altitudes, the cooling of the motor deteriorates. Therefore, reduce the power of the motor as the installation altitude increases.

Multiply the permissible torques or powers by the factors from the following table.

Reduce the torques and powers according to the values determined.

Description

Factors for power derating depending on the installation altitude and the ambient temperature

Table 14-16 Power derating factors

Installation altitude above sea level in m	Ambient temperature in °C			
	30	40	45	50
1000	1.08	1.00	0.96	0.91
2000	1.02	0.93	0.89	0.84
3000	0.95	0.86	0.81	0.75
4000	0.88	0.77	0.72	0.66
5000	0.80	0.68	0.62	0.55

Calculating the reduced characteristic curve

$$M_{S1\ red}(n) = x_d \cdot M_{S1}(n / x_d)$$

$M_{S1\ red}$ Reduced motor torque for S1 operation at the required installation altitude and ambient temperature

M_{S1} Motor torque for S1 operation at ambient temperature of 40 °C and 1000 m above sea level

n Motor speed

x_d Derating factor from the table above

Graphic display of the derating factors

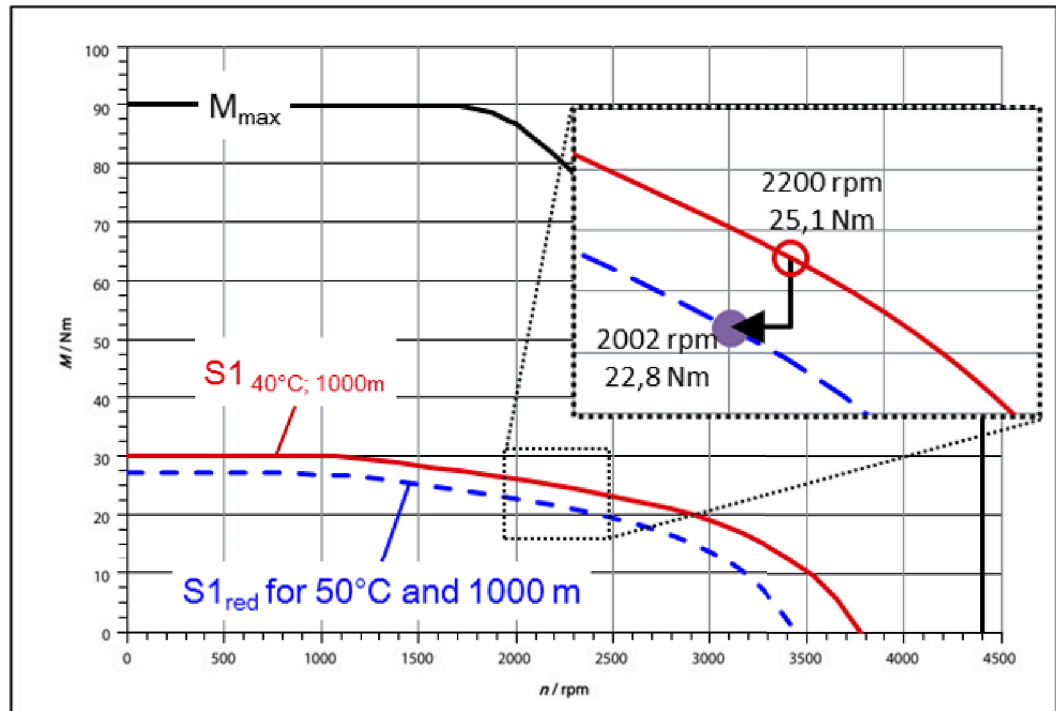

Factors for reducing the DC link voltage depending on the installation altitude

The voltage strength of the motor insulation is reduced for installation altitudes exceeding 2000 m above sea level. Check whether it is necessary to limit the DC link voltage.

Reduce the permissible DC link voltage with increasing installation altitude due to the decreasing air pressure.

Table 14-17 Limit values for the DC link voltage for 1FL2 motors at installation altitudes below 2000 m mean sea level

Motors with the following rated speed in the article number 1FL2□□□-□□X□□..., X =	Max. permissible converter DC link voltage in V
G	375
C, F	720

Table 14-18 Typical DC link voltage of the SINAMICS converters

Network	Infeed	DC link voltage in V
1 AC 200 V	Non-regulated	230
1 AC 240 V	Non-regulated	276
3 AC 200 V	Non-regulated	270
3 AC 240 V	Non-regulated	324
3 AC 380 V	Non-regulated	513
3 AC 480 V	Non-regulated	648

As the DC link voltage is reduced, the converter output voltage also decreases. This reduces the operating range in the M-n diagram.

The M-n diagrams are provided in Section Technical data and characteristics of the 1FL2 (Page 699).

14.2.6 Degree of protection

Overview

The degree of protection of a motor is marked, for example, using "IP65".

The motor degree of protection is classified according to EN 60034-5 (IEC 60034-5).

IP = International Protection

1st digit = protection against the ingress of foreign bodies

2nd digit = protection against water

DIN 60034-5 is valid for water as potentially occurring medium, not for oil or other creeping fluids.

Configure the motor in the required degree of protection.

Description

Table 14-19 Degree of protection of 1FL2

Article number	Degree of protection ¹⁾
1FL2102 1FL2□03 1FL2104 1FL2204	IP54 for the shaft extension (without shaft sealing) and IP65 for the motor body, optionally IP65 for the whole motor (with shaft sealing)
1FL2□05 1FL23□□	IP65

¹⁾ The degree of protection is specified on the rating plate.

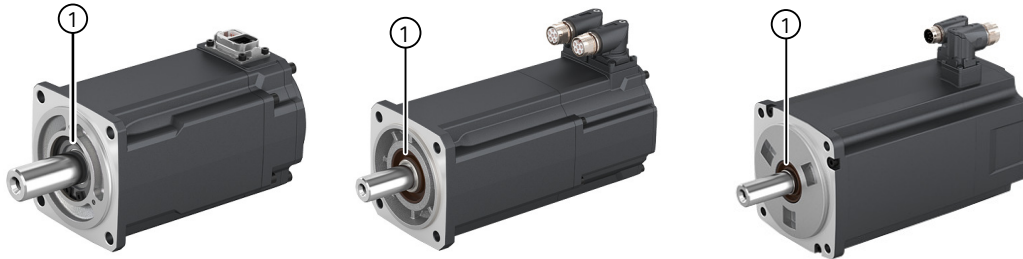

1FL2102
1FL2□03
1FL2104
1FL2204

1FL2□05

1FL23□□

① Radial shaft sealing ring

The radial shaft sealing ring shortens the length of shaft extension that can be used.

Note

The radial shaft sealing ring should be used with sufficient lubricant oil splashed on it. Do not use a motor with a radial shaft sealing ring submerged in oil.

It is permissible that the radial shaft sealing ring runs dry for a short time.

With degrees of protection IP65, it is not permissible for liquid to collect on the flange.

The service life of the radial shaft sealing ring is approximately 5000 operating hours.

More information

For more information, see Section "Shaft extension (Page 686)".

14.2.7 Balancing

Description

The motors are balanced according to EN 60034-14.

Motors with feather key in the shaft are half-key balanced.

A mass equalization for the protruding half key must be taken into account for the output elements.

14.2.8 Vibrational behavior

Description

Vibration severity grade

The vibration response of the system at the location of use is influenced by output elements, any built-on parts, the alignment, the installation, and external vibrations. This can change the vibration values of the motor.

The motors conform to vibration severity grade A according to IEC/EN 60034-14: 2003.

The specified values refer only to the motor. The conditions at the installation location can influence the system vibration response and increase the vibration values on the motor.

The vibration severity grade is maintained up to the rated speed (n_N).

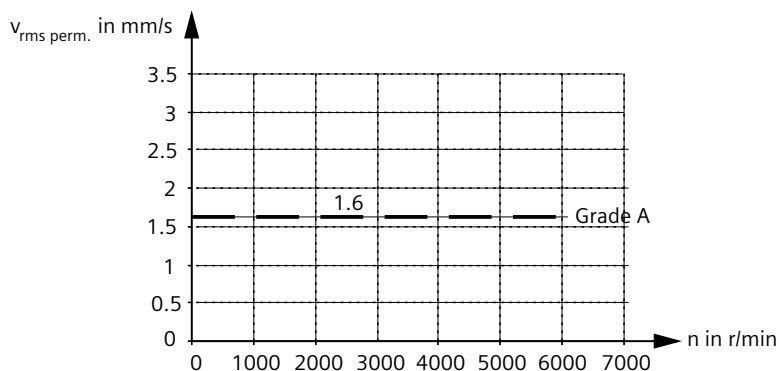

Vibration response

Comply with the vibration values in the following tables to ensure perfect functioning of the motor and a long service life.

Table 14-20 Vibration values for motors with low or medium inertia

Vibration velocity V_{rms} to ISO 10816	Vibration acceleration a_{peak} axial	Vibration acceleration a_{peak} radial
Max. 4.5 mm/s	50 m/s ²	50 m/s ²

14.2 Technical data of the motor

Table 14-21 Vibration values for motors with high inertia

Vibration velocity V_{rms} to ISO 10816	Vibration acceleration α_{peak} axial	Vibration acceleration α_{peak} radial
Max. 4.5 mm/s	25 m/s ²	50 m/s ²

To evaluate the vibration velocity, the measuring equipment must meet the requirements of ISO 2954.

Select the measuring locations according to ISO 10816-1, Section 3.2. See the illustration below for more information on the measuring points.

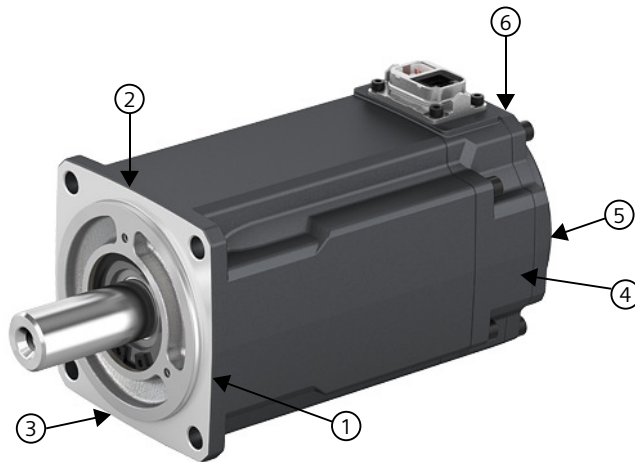

- ① End shield DE radial
- ② End shield DE radial
- ③ End shield DE axial
- ④ End shield NDE radial
- ⑤ End shield NDE axial
- ⑥ End shield NDE radial

The vibration acceleration is evaluated in the frequency range from 10 Hz to 2000 Hz. The maximum peak in the measurement time range is considered.

The vibration values must not exceed the specified limits at any measuring location.

14.2.9 Shaft extension

Technical data

The motors are supplied with cylindrical shaft extensions. The shaft extension usually has a centering thread according to DIN 332, form DR.

Optionally, a shaft extension with key slot and feather key is available.

With motors 1FL2102, 1FL2□03, 1FL2104, and 1FL2204, the usable shaft extension is reduced by the radial shaft sealing ring with the IP65 degree of protection.

Table 14-22 Dimension values

Motor	Shaft dimensions with IP54 Diameter x length in mm	Shaft dimensions with IP65 Diameter x length in mm	Feather key Width x height x length in mm	Centering thread
1FL2102	8 (h6) × 22.5	8 (h6) × 18.2	3 × 3 × 16	M3
1FL2□03	14 (h6) × 27	14 (h6) × 21	5 × 5 × 16	M5
1FL2104	19 (h6) × 37	19 (h6) × 32	6 × 6 × 25	M6
1FL2204				
1FL2105	-	19 (h6) × 42	6 × 6 × 25	M6
1FL2205	-	19 (h6) × 37	6 × 6 × 25	M6
1FL2304	-	19 (h6) × 30	6 × 6 × 25	M6
1FL2306	-	22 (h6) × 50.5	8 × 7 × 44	M8
1FL2310	-	35 (h6) × 75	10 × 8 × 60	M12

14.2.10 Radial eccentricity, concentricity, and axial eccentricity

Technical data

The shaft and flange accuracies for the 1FL2 motors are implemented according to DIN 42955 and IEC 60072-1 as standard (Normal class).

Table 14-23 Radial eccentricity tolerance of the shaft to the frame axis (referring to cylindrical shaft extensions)

Motor	Standard (Normal class)
1FL2102	0.03 mm
1FL2□03	0.035 mm
1FL2□04	0.04 mm
1FL2□05	
1FL2306	
1FL2310	0.05 mm

14.2 Technical data of the motor

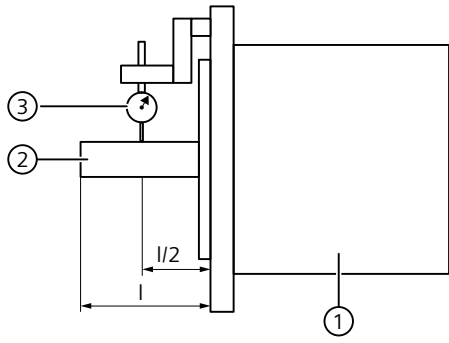

- ① Motor
- ② Motor shaft
- ③ Dial gauge

Figure 14-4 Checking the radial eccentricity

Table 14-24 Concentricity and axial eccentricity tolerance of the flange surface to the shaft axis (referring to the centering diameter of the mounting flange)

Motor	Standard (Normal class)
1FL2102	0.06 mm
1FL2□03	0.08 mm
1FL2□04	
1FL2□05	
1FL2306	0.1 mm
1FL2310	

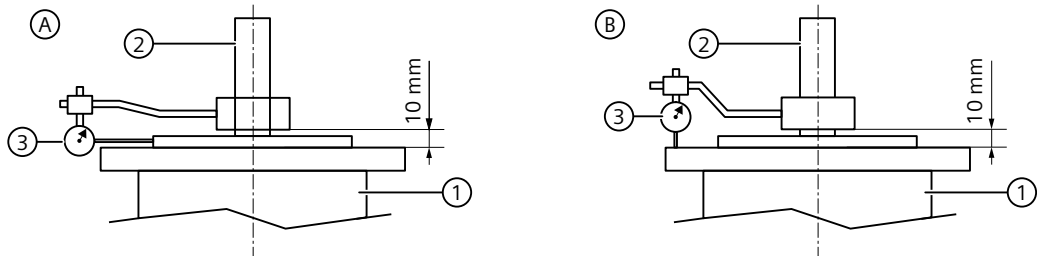

- A Check for concentricity
- B Check for axial eccentricity
- ① Motor
- ② Motor shaft
- ③ Dial gauge

Figure 14-5 Checking the concentricity and axial eccentricity

14.2.11 Axial and radial forces

14.2.11.1 Permissible axial forces

Technical data

Table 14-25 Permissible axial forces

Type	Axial force, static ¹⁾ $F_{A\text{ stat}} / \text{N}$
1FL2102	50
1FL2□03	98
1FL2104 1FL2204	100
1FL2□05	120
1FL2304	140
1FL2306	245
1FL2310	590

¹⁾ The specified axial forces are determined by the spring loading and therefore also apply to motors with holding brake.

Note

Applications with an angular toothed pinion directly on the motor shaft are not permitted if the permissible axial forces are exceeded.

14.2.11.2 Permissible radial forces

Description

As a result of the bearing arrangement, the 1FL2 is designed for aligned forces. Forces such as these occur for belt drives, for example.

All radial forces always refer to aligned forces.

NOTICE

Motor damage caused by circulating forces

Circulating forces can cause bearing motion, and therefore damage the motor.

- Avoid rotating forces.

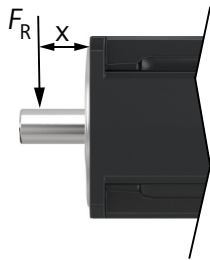

- F_R Point of application of the radial force
- x Distance between where the radial force is applied and the shaft shoulder in mm

Figure 14-6 Point of application of radial forces F_R at the shaft extension

The following diagrams indicate the maximum permissible radial force for the corresponding motor frame size. It depends on the force application point and the average speed for a nominal bearing service life (L10h) of 20000 h.

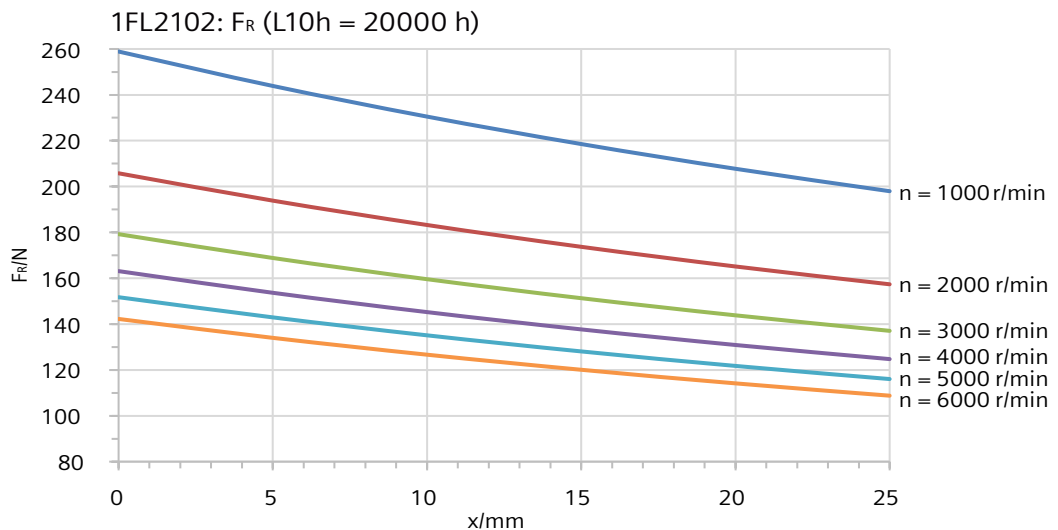

Figure 14-7 Radial force diagram 1FL2102

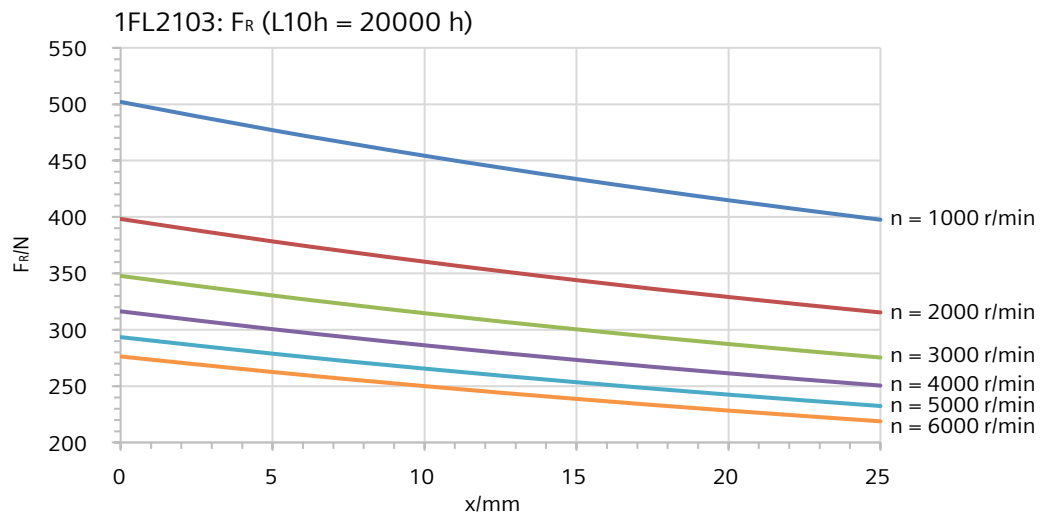

Figure 14-8 Radial force diagram 1FL2103

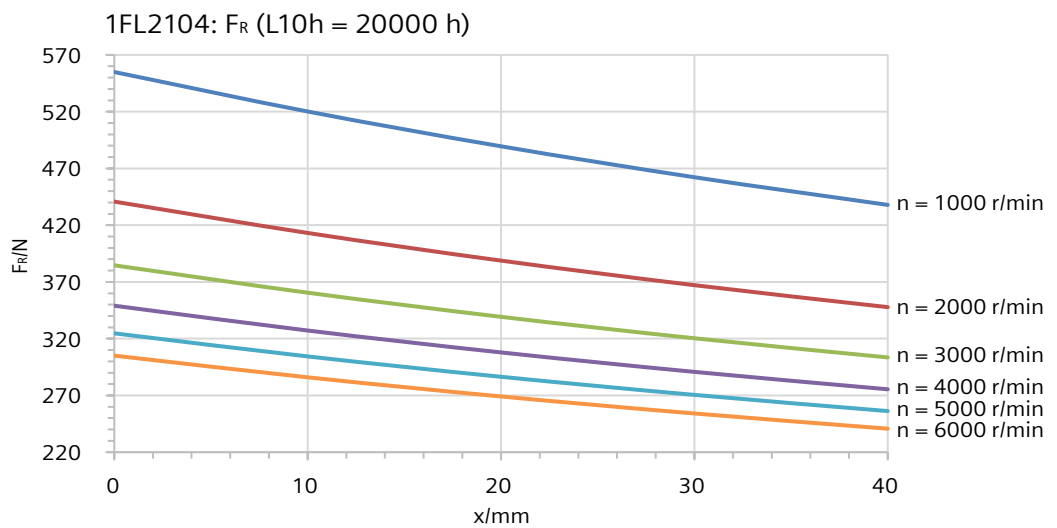

Figure 14-9 Radial force diagram 1FL2104

14.2 Technical data of the motor

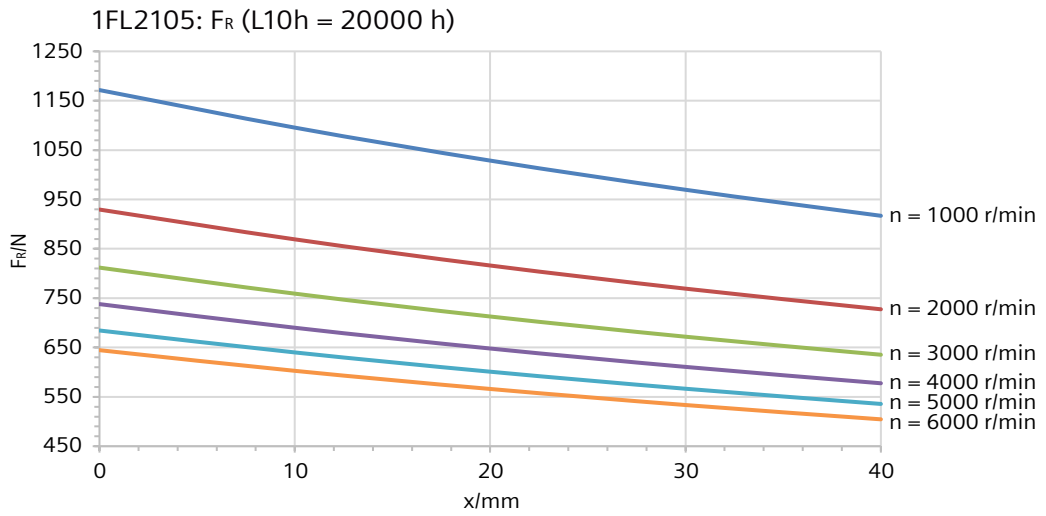

Figure 14-10 Radial force diagram 1FL2105

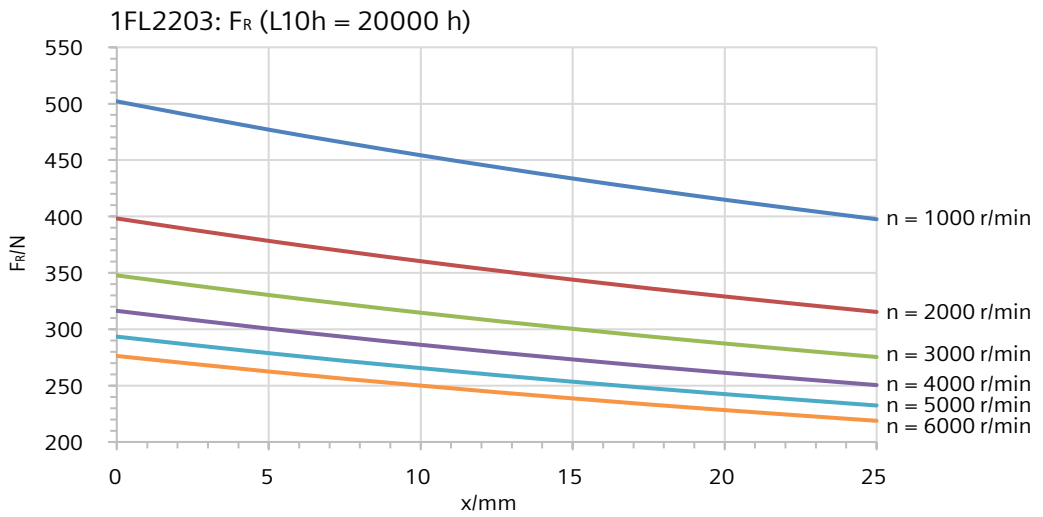

Figure 14-11 Radial force diagram 1FL2203

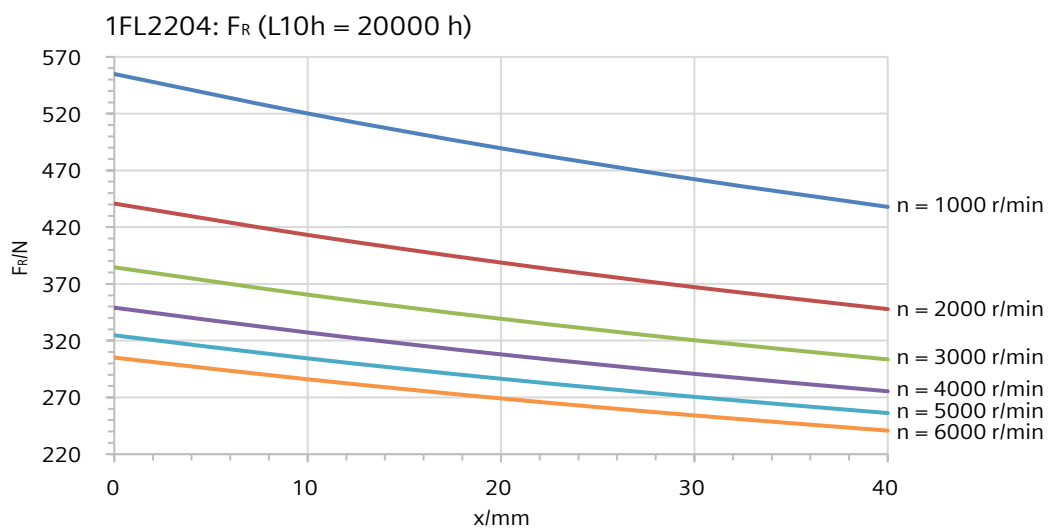

Figure 14-12 Radial force diagram 1FL2204

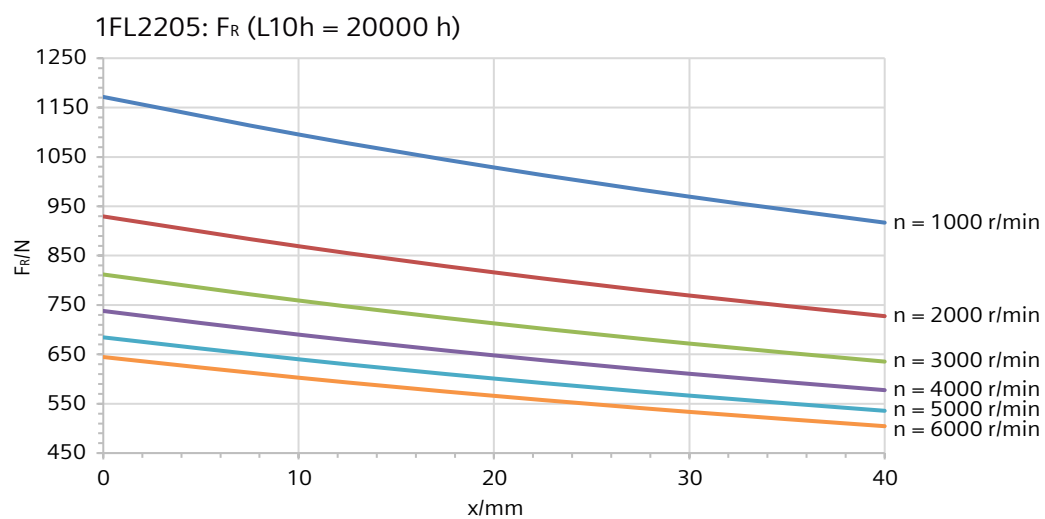

Figure 14-13 Radial force diagram 1FL2205

14.2 Technical data of the motor

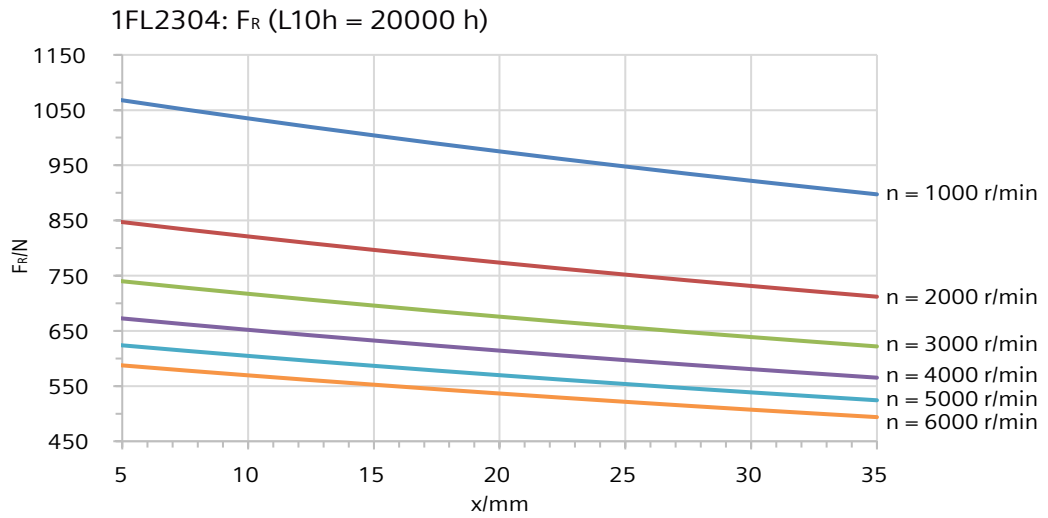

Figure 14-14 Radial force diagram 1FL2304

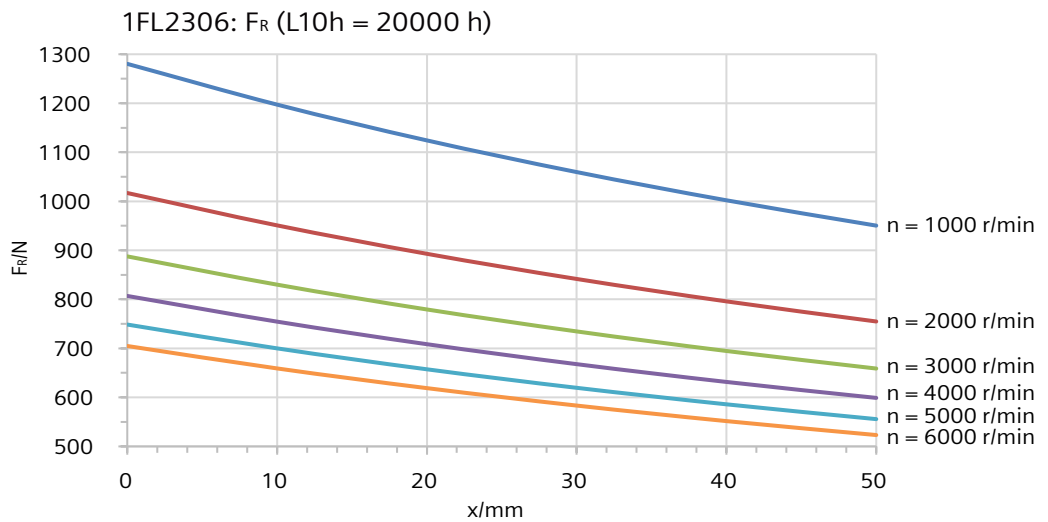

Figure 14-15 Radial force diagram 1FL2306

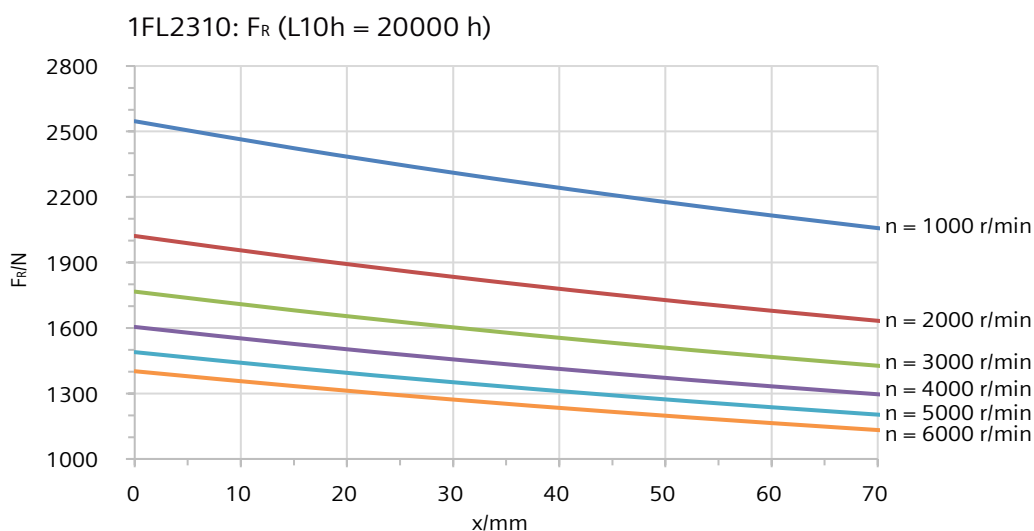

Figure 14-16 Radial force diagram 1FL2310

14.2.12 Available encoders

Technical data

Table 14-26 Encoders that can be ordered for the 1FL2

	Absolute encoder single-turn, 17-bit	Absolute encoder single-turn, 21-bit	Absolute encoder, 21-bit single-turn + 12-bit multiturn
Identification in the article number	H	S	M
Resolution	131072 = 17-bit	2097152 = 21-bit	2097152 = 21-bit
Absolute position	One revolution	One revolution	4096 revolutions (12-bit)
Angle error	$\pm 120''$	$\pm 120''$	$\pm 120''$

14.2.13 Brake data

14.2.13.1 Overview of the 1FL2 holding brake

Description

The holding brake is used to clamp the motor shaft when the motor is at a standstill. The holding brake is not a working brake for braking the rotating motor. When the motor is at a standstill, the holding brake is designed for at least five million switching cycles.

Limited EMERGENCY STOP operation is permissible. Take into account the maximum permissible single operating energy as well as service life, total operating energy of the brake.



WARNING

Unintentional movements through inadequate braking effect

If you use the holding brake incorrectly, for example, as an operating brake or you ignore the permissible operating energy of the brake, then the brake will be subject to excessive and impermissible wear. As a consequence, there may be no brake effect. Unintentional movements of the machine or system can result in death or serious injury.

- Observe the permissible number of operating cycles and EMERGENCY STOP properties.
- Operate the motor only in conjunction with an intact brake.
- Avoid repeated brief acceleration of the motor against a holding brake that is still closed.

The holding brakes of the 1FL2 have a torsional backlash of less than 1°.

14.2.13.2 Technical data of the 1FL2 holding brake

Technical data

Table 14-27 Technical data of the holding brake

Motor type	Holding torque	Dynamic braking torque	Opening time	Closing time	Maximum permissible single operating energy ¹⁾	Total operating energy (service life)	Holding current
	M_4 / Nm	M_{1m} / Nm	t_{open_f} / ms	t_{close_f} / ms	W_{max} / J	W_{tot} / kJ	I_h / A
Permanent-magnet brake							
1FL2□05	8	5	90	25	142	284	< 1 A
Spring-loaded brake							
1FL2102	0.32	-	35	10	1	2	< 1 A
1FL2□03	1.3	-	60	10	10	20	< 1 A
1FL2104	3.3	-	110	30	43	86	< 1 A
1FL2204							
1FL2304	3.5	-	60	45	140	280	< 2 A
1FL2306	12		180	60	600	1200	< 2 A
1FL2310	30	-	220	115	1100	2200	< 2 A

¹⁾ Maximum of three consecutive EMERGENCY STOP procedures. Maximum 25% of all EMERGENCY STOP procedures as high-energy stops with W_{max} .

Holding torque M_4 : The holding torque M_4 is the highest permissible torque for the closed brake in steady-state operation without slip (holding function when motor is at standstill). The data applies to the state at operating temperature (120 °C).

Dynamic braking torque M_{1m} : The dynamic braking torque M_{1m} is the smallest mean dynamic braking torque that can occur for an EMERGENCY STOP.

Opening time t_o and closing time t_{cl} : The delay times that occur when switching the brake t_o and t_{cl} are saved in the motor and are automatically taken into consideration. After activation of the holding brake (opening), the speed/velocity setpoint remains at "Zero" during the opening time t_o . The speed/velocity setpoint is only enabled after the opening time t_o has elapsed. After OFF1 or OFF3 and activation of the holding brake (closing), the motor still remains in closed-loop control with speed/velocity setpoint "Zero" during closing time t_{cl} . The pulses are only deleted after this.

Maximum permissible single operating energy W_{max} : The maximum permissible single operating energy of an individual EMERGENCY STOP operation. After an EMERGENCY STOP with the maximum single operating energy, allow a cooling time of at least three minutes before you operate the motor again.

Total operating energy (service life) W_{total} : The total operating energy is the sum of the single operating energy (operating energy for each EMERGENCY STOP procedure). If you exceed the total operating energy, problem-free functioning of the brake can no longer be guaranteed.

Holding current I_h : The holding current I_h keeps the holding brake open. The holding current I_h continues to load the 24 V power supply of the converter after overexcitation until the brake is released.

Formula to calculate the operating energy per braking operation

$$W_{br} = (J_{mot\ br} + J_{load}) \cdot n_{mot}^2 / 182.4$$

W_{br} / J	Operating energy per braking operation
$n_{mot} / r/min$	Speed at which the brake is engaged
$J_{mot\ br} / kgm^2$	Rotor moment of inertia of the motor with brake (see Technical data and characteristics of the 1FL2 (Page 699))
J_{load} / kgm^2	Load moment of inertia of the mounting part on the motor with brake
182.4	Constant for calculating the circular frequency and SI units

14.2.14 Technical data and characteristics of the 1FL2

14.2.14.1 1FL2102-2AG connected to 1 AC 200 V/3 AC 220 V

Technical data

Table 14-28 Technical data of 1FL2102-2AG

Feature	Symbol	Unit	Value
Static torque	M_0	Nm	0.16
Stall current	I_0	A	0.81
Maximum permissible speed	n_{max}	r/min	6500
Maximum torque	M_{max}	Nm	0.56
Maximum current	I_{max}	A	3.1
Thermal time constant	T_{th}	min	6.2
Moment of inertia	J_{mot}	kgcm ²	0.017
Moment of inertia (with brake)	$J_{mot br}$	kgcm ²	0.022
Recommended load to motor inertia ratio	-	-	Maximum 40x
Weight	m_{mot}	kg	0.29
Weight (with brake)	$m_{mot br}$	kg	0.46
Rated speed	n_{rated}	r/min	3000
Rated torque	M_{rated}	Nm	0.16
Rated current	I_{rated}	A	0.81
Rated power	P_{rated}	kW	0.05

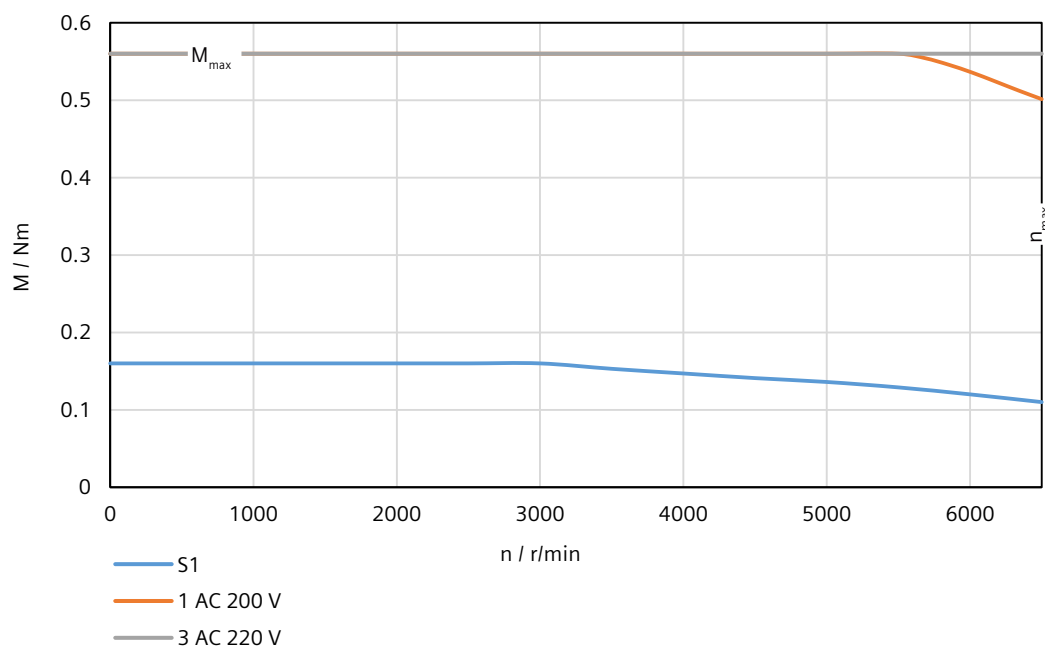

14.2.14.2 1FL2102-4AG connected to 1 AC 200 V/3 AC 220 V

Technical data

Table 14-29 Technical data of 1FL2102-4AG

Feature	Symbol	Unit	Value
Static torque	M_0	Nm	0.32
Stall current	I_0	A	0.76
Maximum permissible speed	n_{max}	r/min	6500
Maximum torque	M_{max}	Nm	1.12
Maximum current	I_{max}	A	2.95
Thermal time constant	T_{th}	min	6.2
Moment of inertia	J_{mot}	kgcm ²	0.029
Moment of inertia (with brake)	$J_{mot br}$	kgcm ²	0.034
Recommended load to motor inertia ratio	-	-	Maximum 30x
Weight	m_{mot}	kg	0.39
Weight (with brake)	$m_{mot br}$	kg	0.56
Rated speed	n_{rated}	r/min	3000
Rated torque	M_{rated}	Nm	0.32
Rated current	I_{rated}	A	0.76
Rated power	P_{rated}	kW	0.1

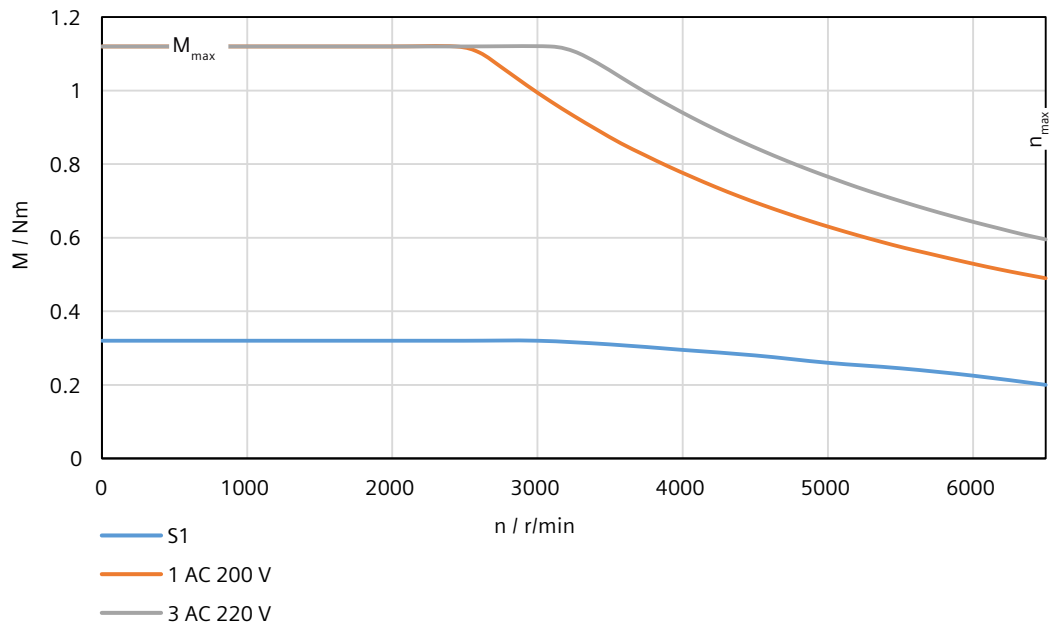

14.2.14.3 1FL2103-2AG connected to 1 AC 200 V/3 AC 220 V

Technical data

Table 14-30 Technical data of 1FL2103-2AG

Feature	Symbol	Unit	Value
Static torque	M_0	Nm	0.64
Stall current	I_0	A	1.28
Maximum permissible speed	n_{max}	r/min	6500
Maximum torque	M_{max}	Nm	2.24
Maximum current	I_{max}	A	4.8
Thermal time constant	T_{th}	min	10.2
Moment of inertia	J_{mot}	kgcm ²	0.080
Moment of inertia (with brake)	$J_{mot br}$	kgcm ²	0.110
Recommended load to motor inertia ratio	-	-	Maximum 30x
Weight	m_{mot}	kg	0.79
Weight (with brake)	$m_{mot br}$	kg	1.14
Rated speed	n_{rated}	r/min	3000
Rated torque	M_{rated}	Nm	0.64
Rated current	I_{rated}	A	1.28
Rated power	P_{rated}	kW	0.2

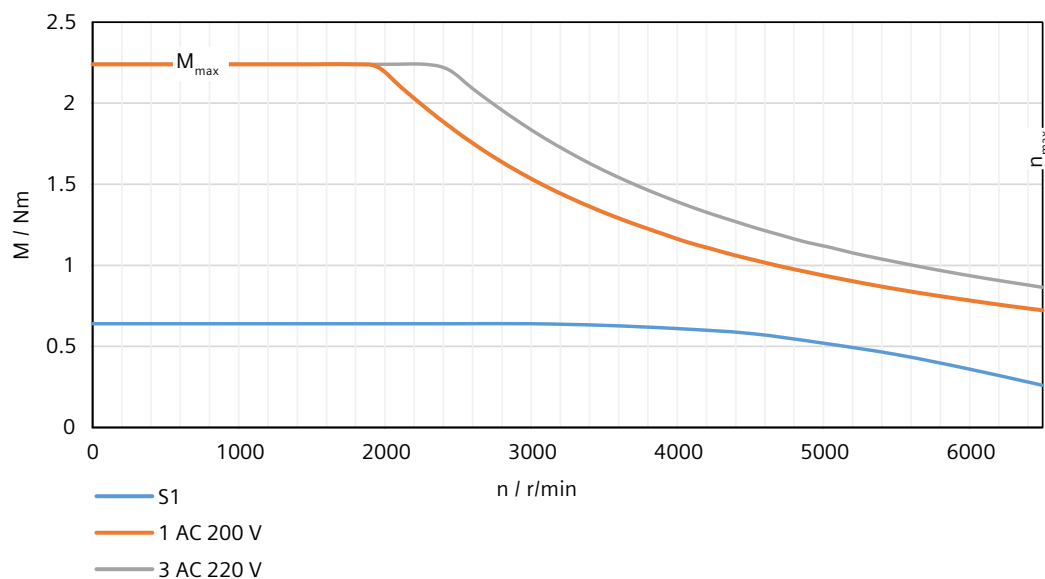

14.2.14.4 1FL2103-4AG connected to 1 AC 200 V/3 AC 220 V

Technical data

Table 14-31 Technical data of 1FL2103-4AG

Feature	Symbol	Unit	Value
Static torque	M_0	Nm	1.27
Stall current	I_0	A	2.4
Maximum permissible speed	n_{max}	r/min	6500
Maximum torque	M_{max}	Nm	4.45
Maximum current	I_{max}	A	8.7
Thermal time constant	T_{th}	min	13
Moment of inertia	J_{mot}	kgcm ²	0.155
Moment of inertia (with brake)	$J_{mot br}$	kgcm ²	0.185
Recommended load to motor inertia ratio	-	-	Maximum 30x
Weight	m_{mot}	kg	1.16
Weight (with brake)	$m_{mot br}$	kg	1.5
Rated speed	n_{rated}	r/min	3000
Rated torque	M_{rated}	Nm	1.27
Rated current	I_{rated}	A	2.4
Rated power	P_{rated}	kW	0.4

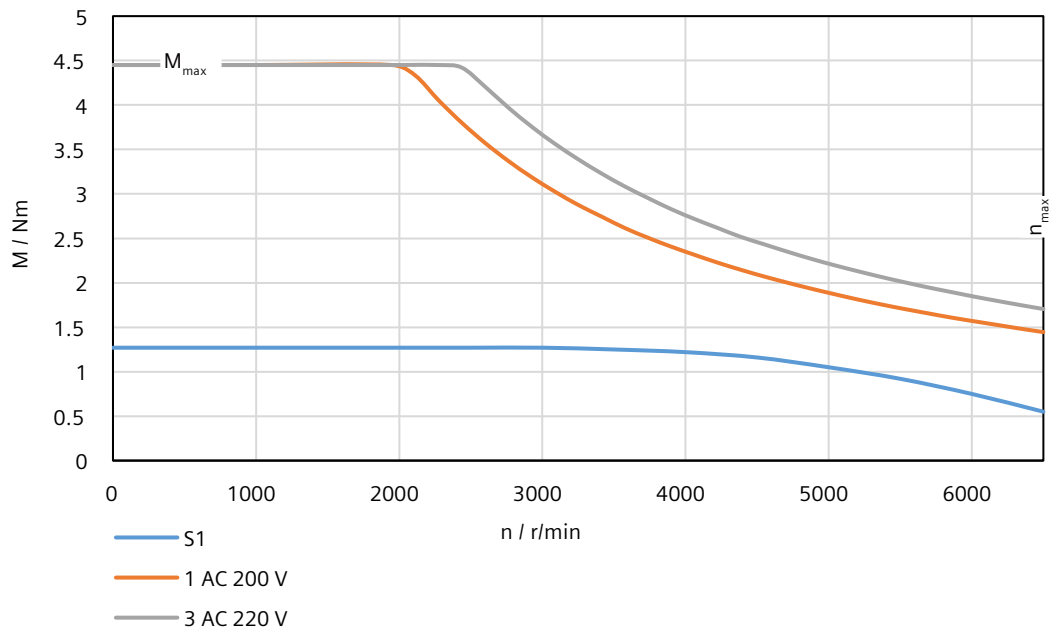

14.2.14.5 1FL2104-2AG connected to 1 AC 200 V/3 AC 220 V

Technical data

Table 14-32 Technical data of 1FL2104-2AG

Feature	Symbol	Unit	Value
Static torque	M_0	Nm	2.4
Stall current	I_0	A	4.4
Maximum permissible speed	n_{max}	r/min	6500
Maximum torque	M_{max}	Nm	8
Maximum current	I_{max}	A	16
Thermal time constant	T_{th}	min	23.4
Moment of inertia	J_{mot}	kgcm ²	0.50
Moment of inertia (with brake)	$J_{mot br}$	kgcm ²	0.58
Recommended load to motor inertia ratio	-	-	Maximum 20x
Weight	m_{mot}	kg	2.7
Weight (with brake)	$m_{mot br}$	kg	3.5
Rated speed	n_{rated}	r/min	3000
Rated torque	M_{rated}	Nm	2.4
Rated current	I_{rated}	A	4.4
Rated power	P_{rated}	kW	0.75

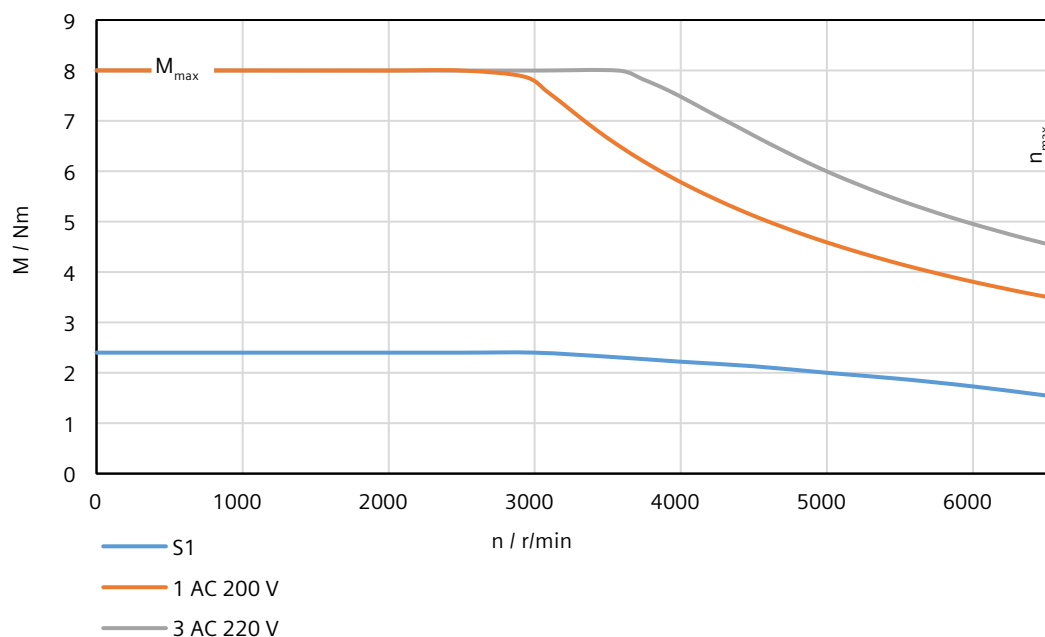

14.2.14.6 1FL2104-4AG connected to 1 AC 200 V/3 AC 220 V

Technical data

Table 14-33 Technical data of 1FL2104-4AG

Feature	Symbol	Unit	Value
Static torque	M_0	Nm	3.2
Stall current	I_0	A	4.4
Maximum permissible speed	n_{max}	r/min	6500
Maximum torque	M_{max}	Nm	10.8
Maximum current	I_{max}	A	16
Thermal time constant	T_{th}	min	29.6
Moment of inertia	J_{mot}	kgcm ²	0.63
Moment of inertia (with brake)	$J_{mot br}$	kgcm ²	0.71
Recommended load to motor inertia ratio	-	-	Maximum 20x
Weight	m_{mot}	kg	3.3
Weight (with brake)	$m_{mot br}$	kg	4.1
Rated speed	n_{rated}	r/min	3000
Rated torque	M_{rated}	Nm	3.2
Rated current	I_{rated}	A	4.4
Rated power	P_{rated}	kW	1

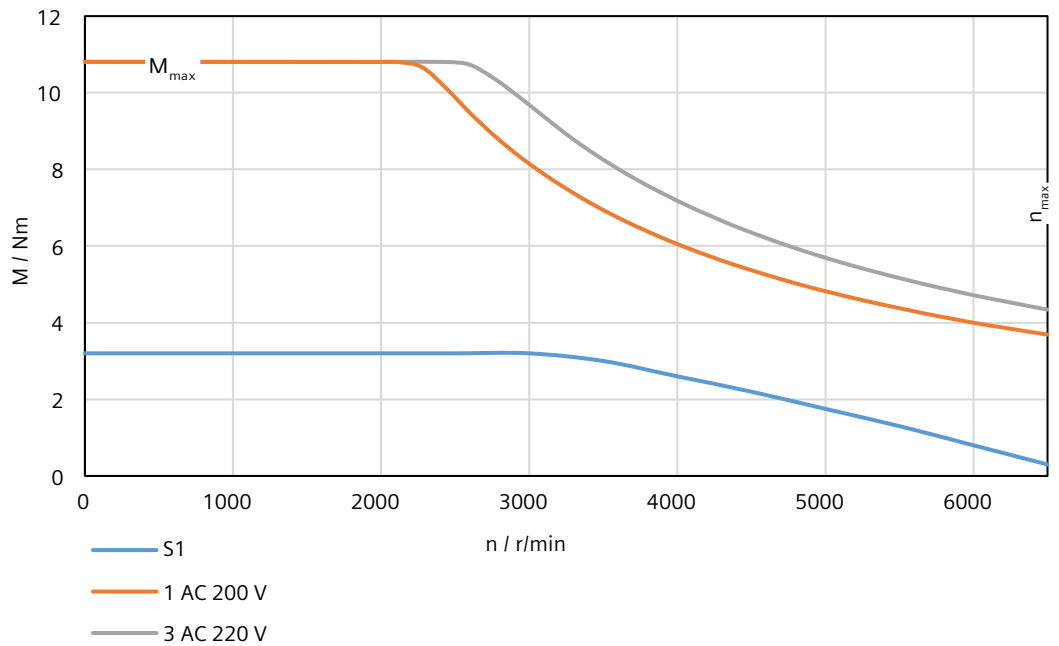

14.2.14.7 1FL2102-2AF connected to 3 AC 380 V/3 AC 400 V

Technical data

Table 14-34 Technical data of 1FL2102-2AF

Feature	Symbol	Unit	Value
Static torque	M_0	Nm	0.16
Stall current	I_0	A	0.84
Maximum permissible speed	n_{max}	r/min	6500
Maximum torque	M_{max}	Nm	0.56
Maximum current	I_{max}	A	3.4
Thermal time constant	T_{th}	min	4.8
Moment of inertia	J_{mot}	kgcm ²	0.017
Moment of inertia (with brake)	$J_{mot br}$	kgcm ²	0.022
Recommended load to motor inertia ratio	-	-	Maximum 40x
Weight	m_{mot}	kg	0.29
Weight (with brake)	$m_{mot br}$	kg	0.45
Rated speed	n_{rated}	r/min	3000
Rated torque	M_{rated}	Nm	0.16
Rated current	I_{rated}	A	0.84
Rated power	P_{rated}	kW	0.05

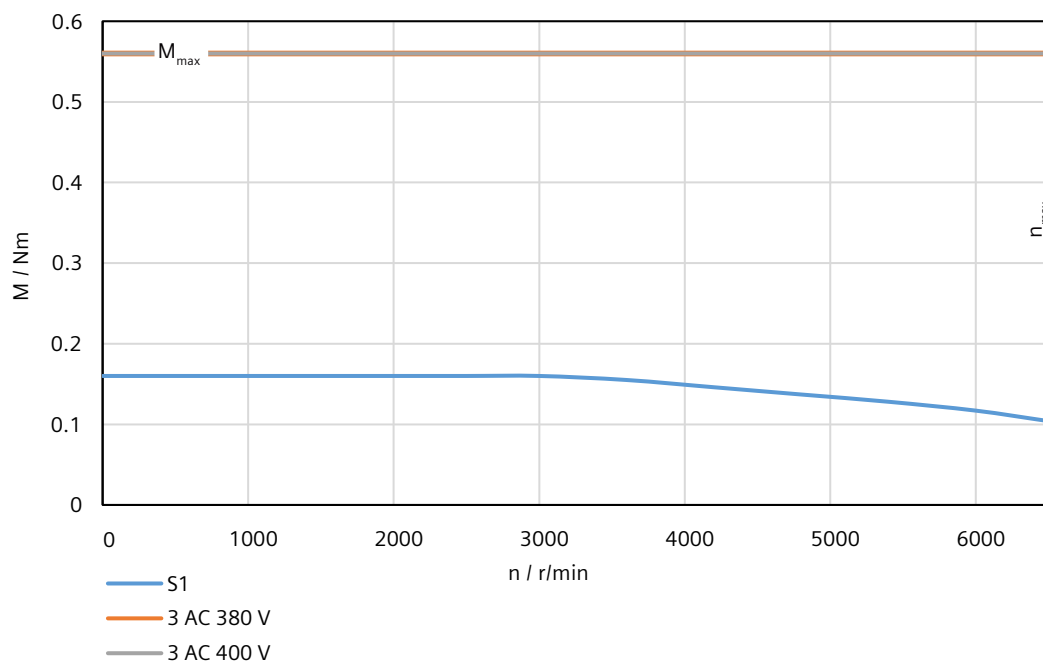

14.2.14.8 1FL2102-4AF connected to 3 AC 380 V/3 AC 400 V

Technical data

Table 14-35 Technical data of 1FL2102-4AF

Feature	Symbol	Unit	Value
Static torque	M_0	Nm	0.32
Stall current	I_0	A	0.81
Maximum permissible speed	n_{max}	r/min	6500
Maximum torque	M_{max}	Nm	1.12
Maximum current	I_{max}	A	2.9
Thermal time constant	T_{th}	min	4.6
Moment of inertia	J_{mot}	kgcm ²	0.029
Moment of inertia (with brake)	$J_{mot br}$	kgcm ²	0.034
Recommended load to motor inertia ratio	-	-	Maximum 30x
Weight	m_{mot}	kg	0.38
Weight (with brake)	$m_{mot br}$	kg	0.55
Rated speed	n_{rated}	r/min	3000
Rated torque	M_{rated}	Nm	0.32
Rated current	I_{rated}	A	0.81
Rated power	P_{rated}	kW	0.1

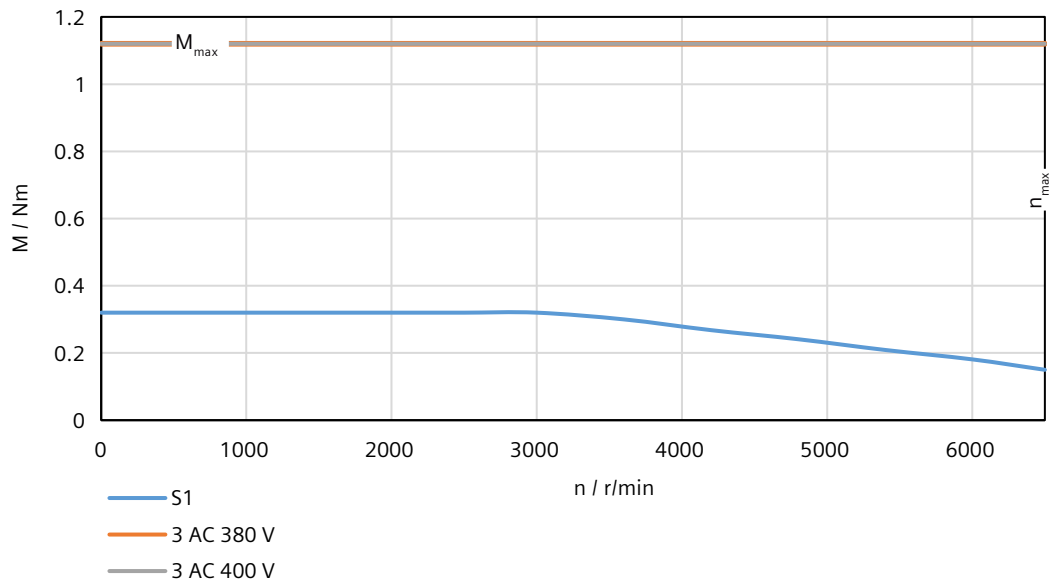

14.2.14.9 1FL2103-2AF connected to 3 AC 380 V/3 AC 400 V

Technical data

Table 14-36 Technical data of 1FL2103-2AF

Feature	Symbol	Unit	Value
Static torque	M_0	Nm	0.64
Stall current	I_0	A	1.3
Maximum permissible speed	n_{max}	r/min	6500
Maximum torque	M_{max}	Nm	2.24
Maximum current	I_{max}	A	4.8
Thermal time constant	T_{th}	min	8.1
Moment of inertia	J_{mot}	kgcm ²	0.080
Moment of inertia (with brake)	$J_{mot br}$	kgcm ²	0.110
Recommended load to motor inertia ratio	-	-	Maximum 30x
Weight	m_{mot}	kg	0.78
Weight (with brake)	$m_{mot br}$	kg	1.12
Rated speed	n_{rated}	r/min	3000
Rated torque	M_{rated}	Nm	0.64
Rated current	I_{rated}	A	1.3
Rated power	P_{rated}	kW	0.2

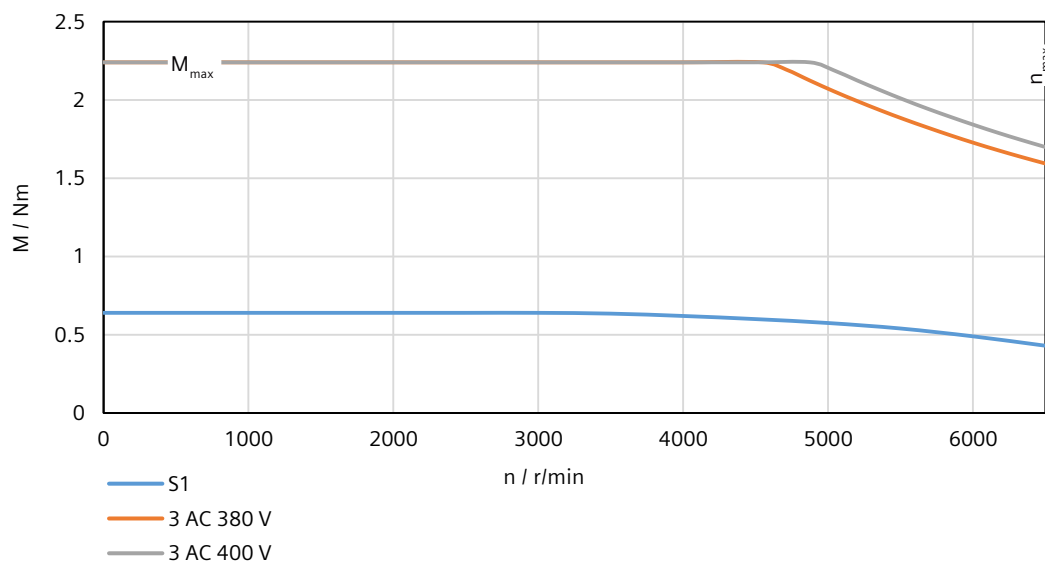

14.2.14.10 1FL2103-4AF connected to 3 AC 380 V/3 AC 400 V

Technical data

Table 14-37 Technical data of 1FL2103-4AF

Feature	Symbol	Unit	Value
Static torque	M_0	Nm	1.27
Stall current	I_0	A	1.3
Maximum permissible speed	n_{max}	r/min	6500
Maximum torque	M_{max}	Nm	4.45
Maximum current	I_{max}	A	4.8
Thermal time constant	T_{th}	min	9.3
Moment of inertia	J_{mot}	kgcm ²	0.155
Moment of inertia (with brake)	$J_{mot br}$	kgcm ²	0.185
Recommended load to motor inertia ratio	-	-	Maximum 30x
Weight	m_{mot}	kg	1.14
Weight (with brake)	$m_{mot br}$	kg	1.49
Rated speed	n_{rated}	r/min	3000
Rated torque	M_{rated}	Nm	1.27
Rated current	I_{rated}	A	1.3
Rated power	P_{rated}	kW	0.4

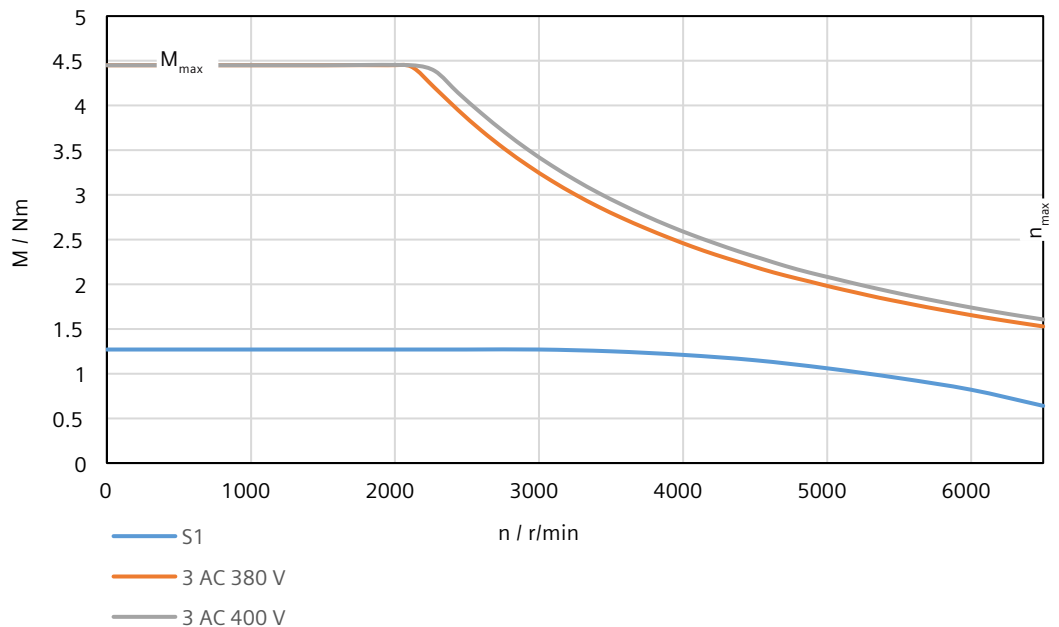

14.2.14.11 1FL2104-2AF connected to 3 AC 380 V/3 AC 400 V

Technical data

Table 14-38 Technical data of 1FL2104-2AF

Feature	Symbol	Unit	Value
Static torque	M_0	Nm	2.4
Stall current	I_0	A	2.1
Maximum permissible speed	n_{max}	r/min	6500
Maximum torque	M_{max}	Nm	8
Maximum current	I_{max}	A	7.6
Thermal time constant	T_{th}	min	23.3
Moment of inertia	J_{mot}	kgcm ²	0.50
Moment of inertia (with brake)	$J_{mot\ br}$	kgcm ²	0.58
Recommended load to motor inertia ratio	-	-	Maximum 20x
Weight	m_{mot}	kg	2.7
Weight (with brake)	$m_{mot\ br}$	kg	3.5
Rated speed	n_{rated}	r/min	3000
Rated torque	M_{rated}	Nm	2.4
Rated current	I_{rated}	A	2.1
Rated power	P_{rated}	kW	0.75

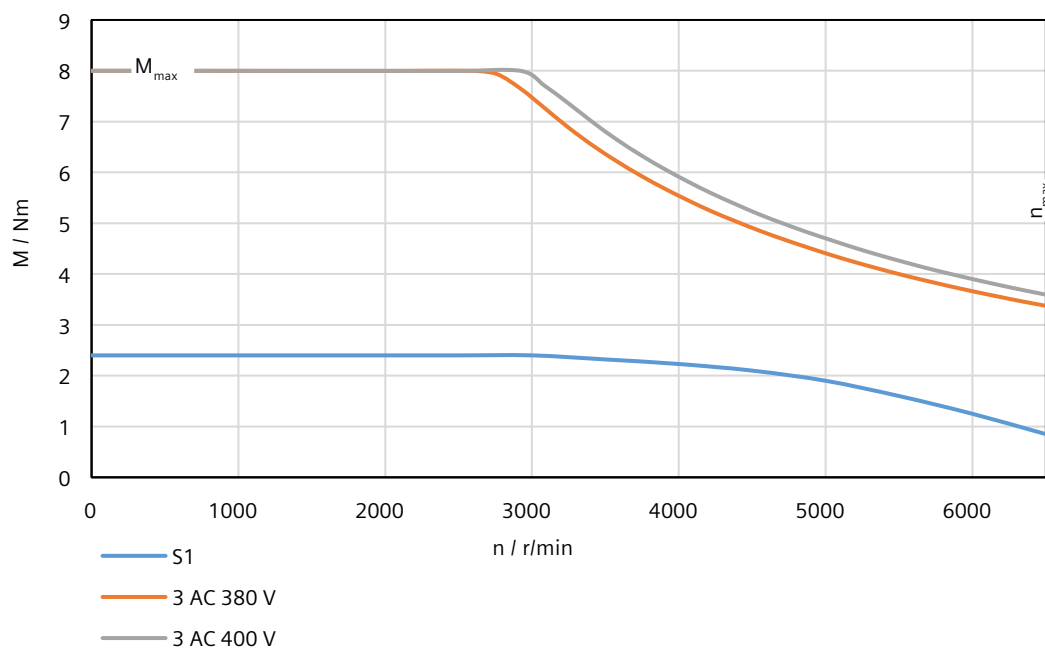

14.2.14.12 1FL2104-4AF connected to 3 AC 380 V/3 AC 400 V

Technical data

Table 14-39 Technical data of 1FL2104-4AF

Feature	Symbol	Unit	Value
Static torque	M_0	Nm	3.2
Stall current	I_0	A	3
Maximum permissible speed	n_{max}	r/min	6500
Maximum torque	M_{max}	Nm	10.8
Maximum current	I_{max}	A	10.9
Thermal time constant	T_{th}	min	25.4
Moment of inertia	J_{mot}	kgcm ²	0.63
Moment of inertia (with brake)	$J_{mot br}$	kgcm ²	0.71
Recommended load to motor inertia ratio	-	-	Maximum 20x
Weight	m_{mot}	kg	3.3
Weight (with brake)	$m_{mot br}$	kg	4.1
Rated speed	n_{rated}	r/min	3000
Rated torque	M_{rated}	Nm	3.2
Rated current	I_{rated}	A	3
Rated power	P_{rated}	kW	1

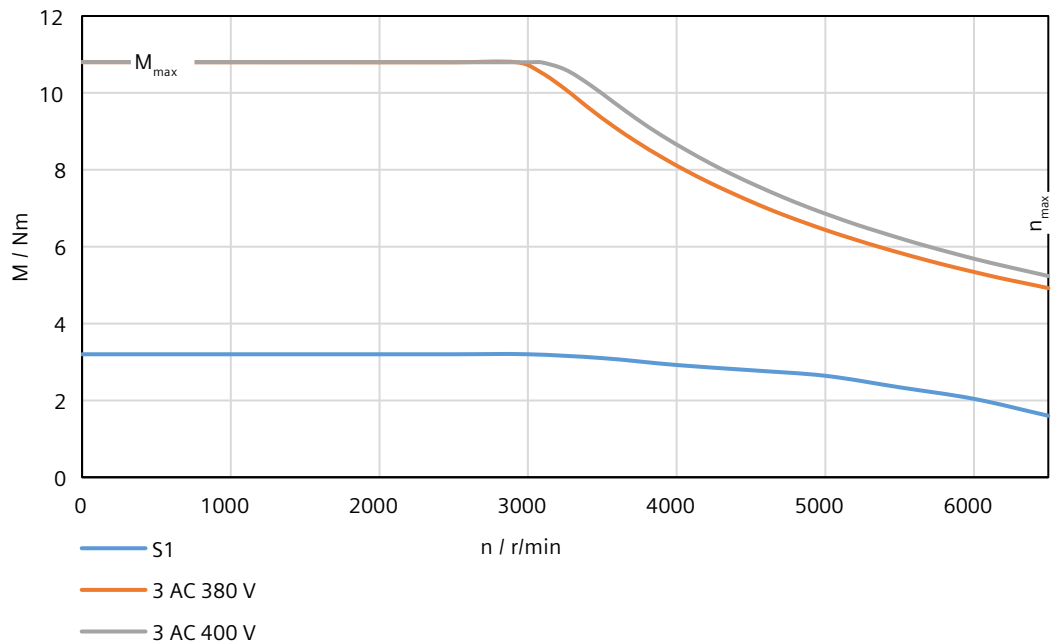

14.2.14.13 1FL2105-2AF connected to 3 AC 380 V/3 AC 400 V

Technical data

Table 14-40 Technical data of 1FL2105-2AF

Feature	Symbol	Unit	Value
Static torque	M_0	Nm	5
Stall current	I_0	A	4.65
Maximum permissible speed	n_{max}	r/min	6000
Maximum torque	M_{max}	Nm	15.9
Maximum current	I_{max}	A	18
Thermal time constant	T_{th}	min	37
Moment of inertia	J_{mot}	kgcm ²	1.71
Moment of inertia (with brake)	$J_{mot br}$	kgcm ²	2.54
Recommended load to motor inertia ratio	-	-	Maximum 20x
Weight	m_{mot}	kg	5.5
Weight (with brake)	$m_{mot br}$	kg	6.4
Rated speed	n_{rated}	r/min	3000
Rated torque	M_{rated}	Nm	4.6
Rated current	I_{rated}	A	4.35
Rated power	P_{rated}	kW	1.45

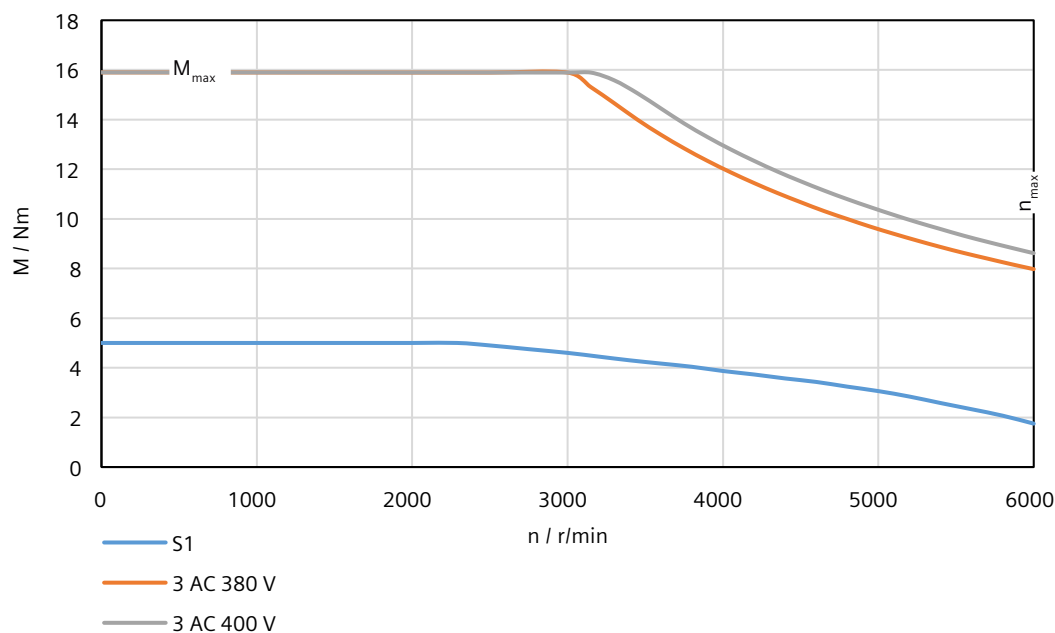

14.2.14.14 1FL2105-4AF connected to 3 AC 380 V/3 AC 400 V

Technical data

Table 14-41 Technical data of 1FL2105-4AF

Feature	Symbol	Unit	Value
Static torque	M_0	Nm	8
Stall current	I_0	A	6.7
Maximum permissible speed	n_{max}	r/min	6000
Maximum torque	M_{max}	Nm	25.3
Maximum current	I_{max}	A	24
Thermal time constant	T_{th}	min	42.9
Moment of inertia	J_{mot}	kgcm ²	2.65
Moment of inertia (with brake)	$J_{mot br}$	kgcm ²	3.48
Recommended load to motor inertia ratio	-	-	Maximum 15x
Weight	m_{mot}	kg	7.8
Weight (with brake)	$m_{mot br}$	kg	8.7
Rated speed	n_{rated}	r/min	3000
Rated torque	M_{rated}	Nm	6.6
Rated current	I_{rated}	A	5.6
Rated power	P_{rated}	kW	2.1

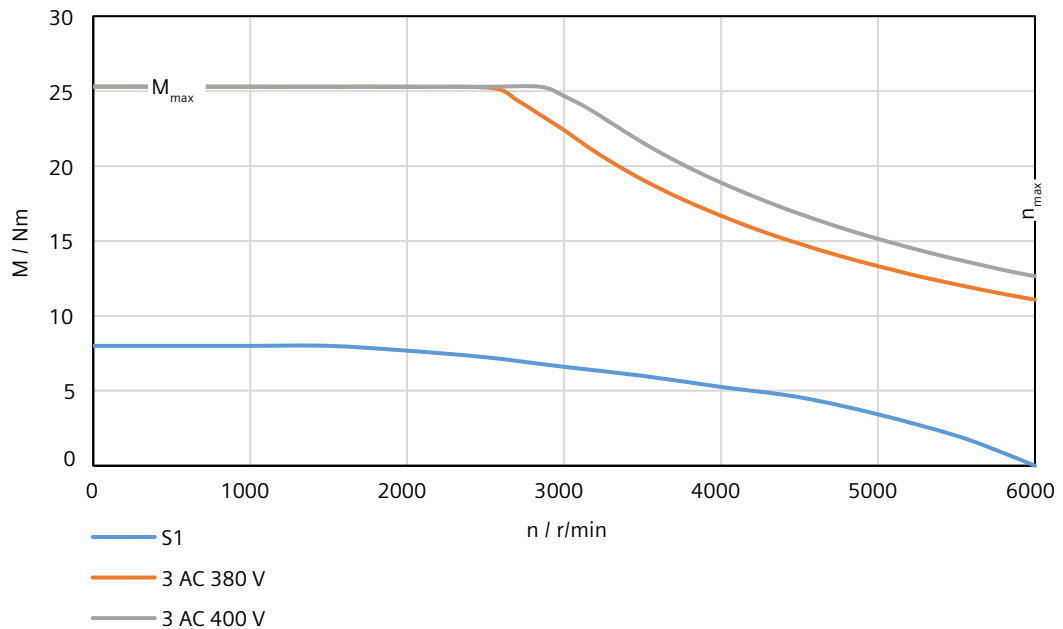

14.2.14.15 1FL2203-2AG connected to 1 AC 200 V/3 AC 220 V

Technical data

Table 14-42 Technical data of 1FL2203-2AG

Feature	Symbol	Unit	Value
Static torque	M_0	Nm	0.64
Stall current	I_0	A	1.33
Maximum permissible speed	n_{max}	r/min	6500
Maximum torque	M_{max}	Nm	2.24
Maximum current	I_{max}	A	4.8
Thermal time constant	T_{th}	min	11.5
Moment of inertia	J_{mot}	kgcm ²	0.180
Moment of inertia (with brake)	$J_{mot br}$	kgcm ²	0.210
Recommended load to motor inertia ratio	-	-	Maximum 30x
Weight	m_{mot}	kg	0.76
Weight (with brake)	$m_{mot br}$	kg	1.11
Rated speed	n_{rated}	r/min	3000
Rated torque	M_{rated}	Nm	0.64
Rated current	I_{rated}	A	1.33
Rated power	P_{rated}	kW	0.2

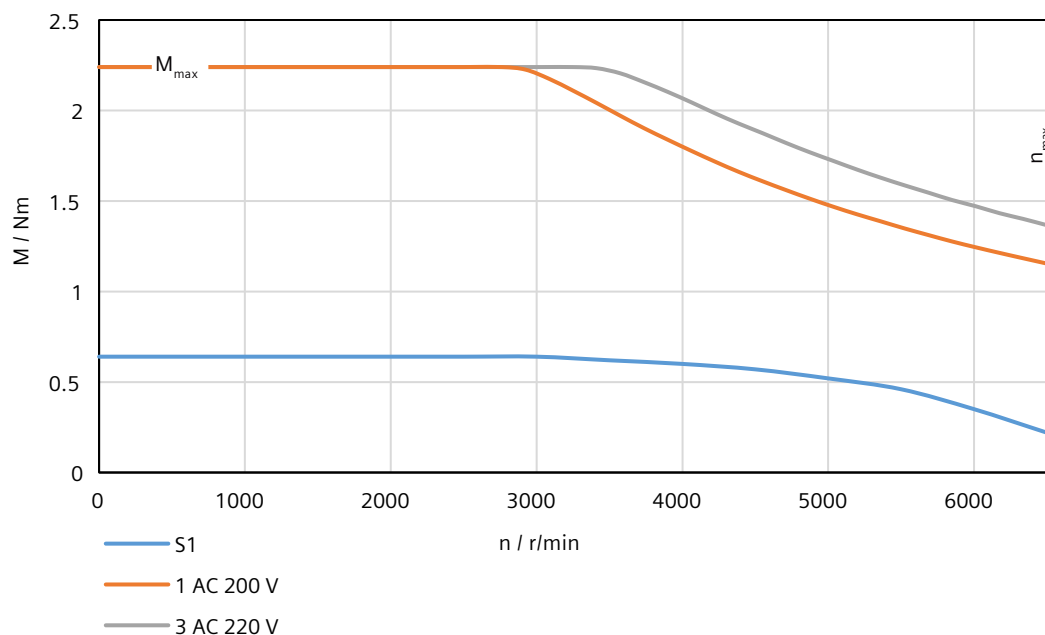

14.2.14.16 1FL2203-4AG connected to 1 AC 200 V/3 AC 220 V

Technical data

Table 14-43 Technical data of 1FL2203-4AG

Feature	Symbol	Unit	Value
Static torque	M_0	Nm	1.27
Stall current	I_0	A	2.4
Maximum permissible speed	n_{max}	r/min	6500
Maximum torque	M_{max}	Nm	4.45
Maximum current	I_{max}	A	8.7
Thermal time constant	T_{th}	min	12.8
Moment of inertia	J_{mot}	kgcm ²	0.350
Moment of inertia (with brake)	$J_{mot br}$	kgcm ²	0.380
Recommended load to motor inertia ratio	-	-	Maximum 30x
Weight	m_{mot}	kg	1.11
Weight (with brake)	$m_{mot br}$	kg	1.46
Rated speed	n_{rated}	r/min	3000
Rated torque	M_{rated}	Nm	1.27
Rated current	I_{rated}	A	2.4
Rated power	P_{rated}	kW	0.4

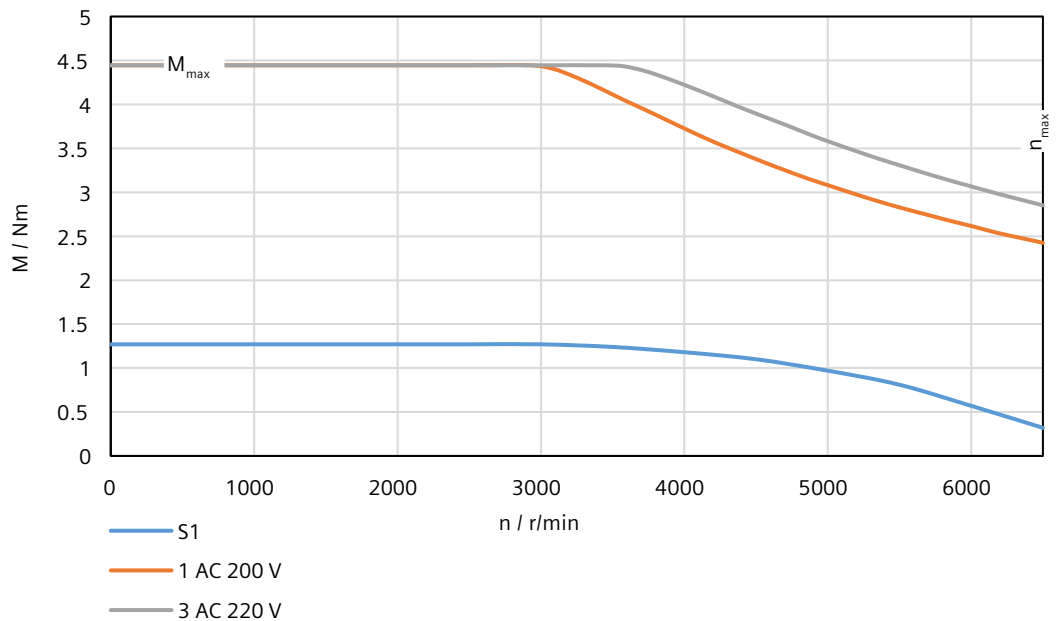

14.2.14.17 1FL2204-2AG connected to 1 AC 200 V/3 AC 220 V

Technical data

Table 14-44 Technical data of 1FL2204-2AG

Feature	Symbol	Unit	Value
Static torque	M_0	Nm	2.4
Stall current	I_0	A	4.4
Maximum permissible speed	n_{max}	r/min	6500
Maximum torque	M_{max}	Nm	7.5
Maximum current	I_{max}	A	14.2
Thermal time constant	T_{th}	min	25.1
Moment of inertia	J_{mot}	kgcm ²	1.23
Moment of inertia (with brake)	$J_{mot\ br}$	kgcm ²	1.31
Recommended load to motor inertia ratio	-	-	Maximum 15x
Weight	m_{mot}	kg	2.6
Weight (with brake)	$m_{mot\ br}$	kg	3.4
Rated speed	n_{rated}	r/min	3000
Rated torque	M_{rated}	Nm	2.4
Rated current	I_{rated}	A	4.4
Rated power	P_{rated}	kW	0.75

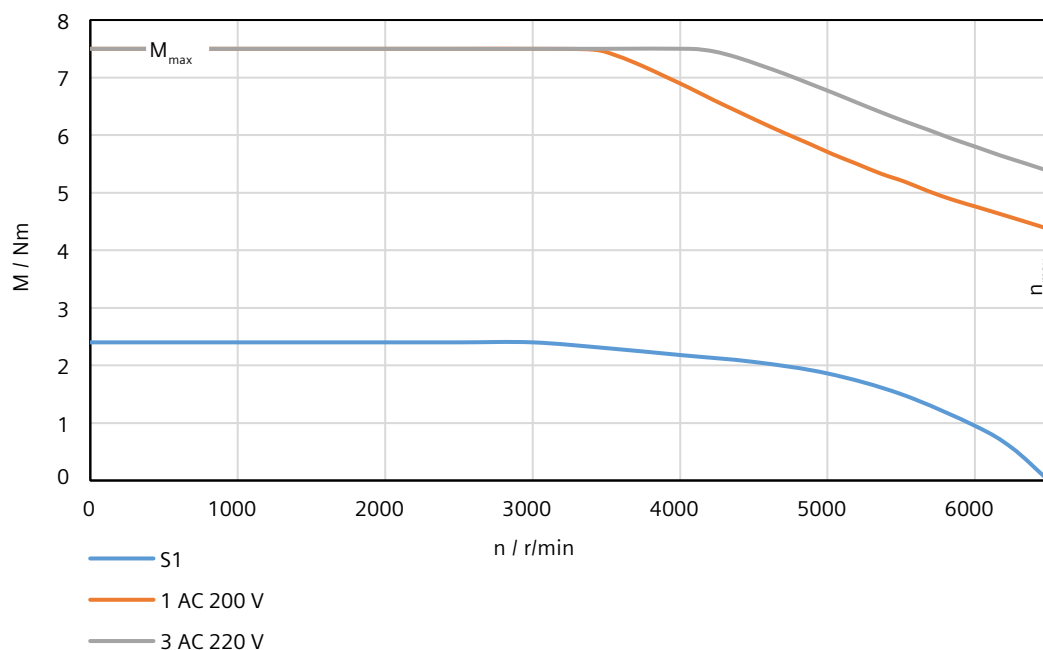

14.2.14.18 1FL2204-4AG connected to 1 AC 200 V/3 AC 220 V

Technical data

Table 14-45 Technical data of 1FL2204-4AG

Feature	Symbol	Unit	Value
Static torque	M_0	Nm	3.2
Stall current	I_0	A	4.4
Maximum permissible speed	n_{max}	r/min	6500
Maximum torque	M_{max}	Nm	11.3
Maximum current	I_{max}	A	16
Thermal time constant	T_{th}	min	24.1
Moment of inertia	J_{mot}	kgcm ²	1.61
Moment of inertia (with brake)	$J_{mot br}$	kgcm ²	1.69
Recommended load to motor inertia ratio	-	-	Maximum 15x
Weight	m_{mot}	kg	3.1
Weight (with brake)	$m_{mot br}$	kg	3.9
Rated speed	n_{rated}	r/min	3000
Rated torque	M_{rated}	Nm	3.2
Rated current	I_{rated}	A	4.4
Rated power	P_{rated}	kW	1

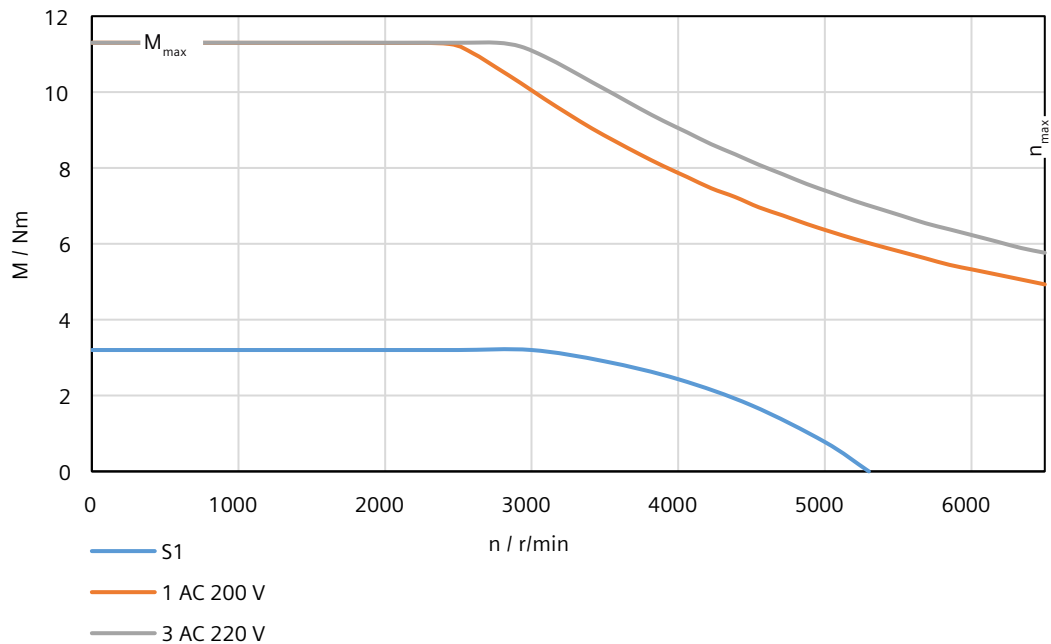

14.2.14.19 1FL2203-2AF connected to 3 AC 380 V/3 AC 400 V

Technical data

Table 14-46 Technical data of 1FL2203-2AF

Feature	Symbol	Unit	Value
Static torque	M_0	Nm	0.64
Stall current	I_0	A	1.3
Maximum permissible speed	n_{max}	r/min	6500
Maximum torque	M_{max}	Nm	2.24
Maximum current	I_{max}	A	4.8
Thermal time constant	T_{th}	min	8.3
Moment of inertia	J_{mot}	kgcm ²	0.180
Moment of inertia (with brake)	$J_{mot\ br}$	kgcm ²	0.210
Recommended load to motor inertia ratio	-	-	Maximum 30x
Weight	m_{mot}	kg	0.77
Weight (with brake)	$m_{mot\ br}$	kg	1.12
Rated speed	n_{rated}	r/min	3000
Rated torque	M_{rated}	Nm	0.64
Rated current	I_{rated}	A	1.3
Rated power	P_{rated}	kW	0.2

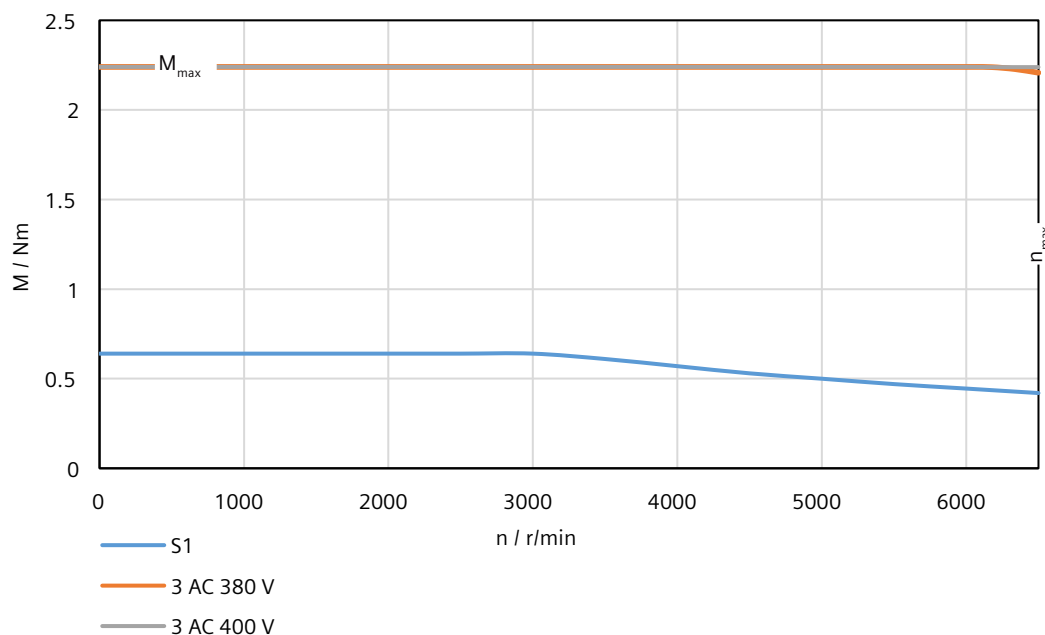

14.2.14.20 1FL2203-4AF connected to 3 AC 380 V/3 AC 400 V

Technical data

Table 14-47 Technical data of 1FL2203-4AF

Feature	Symbol	Unit	Value
Static torque	M_0	Nm	1.27
Stall current	I_0	A	1.3
Maximum permissible speed	n_{max}	r/min	6500
Maximum torque	M_{max}	Nm	4.45
Maximum current	I_{max}	A	4.8
Thermal time constant	T_{th}	min	9.4
Moment of inertia	J_{mot}	kgcm ²	0.350
Moment of inertia (with brake)	$J_{mot br}$	kgcm ²	0.380
Recommended load to motor inertia ratio	-	-	Maximum 30x
Weight	m_{mot}	kg	1.09
Weight (with brake)	$m_{mot br}$	kg	1.44
Rated speed	n_{rated}	r/min	3000
Rated torque	M_{rated}	Nm	1.27
Rated current	I_{rated}	A	1.3
Rated power	P_{rated}	kW	0.4

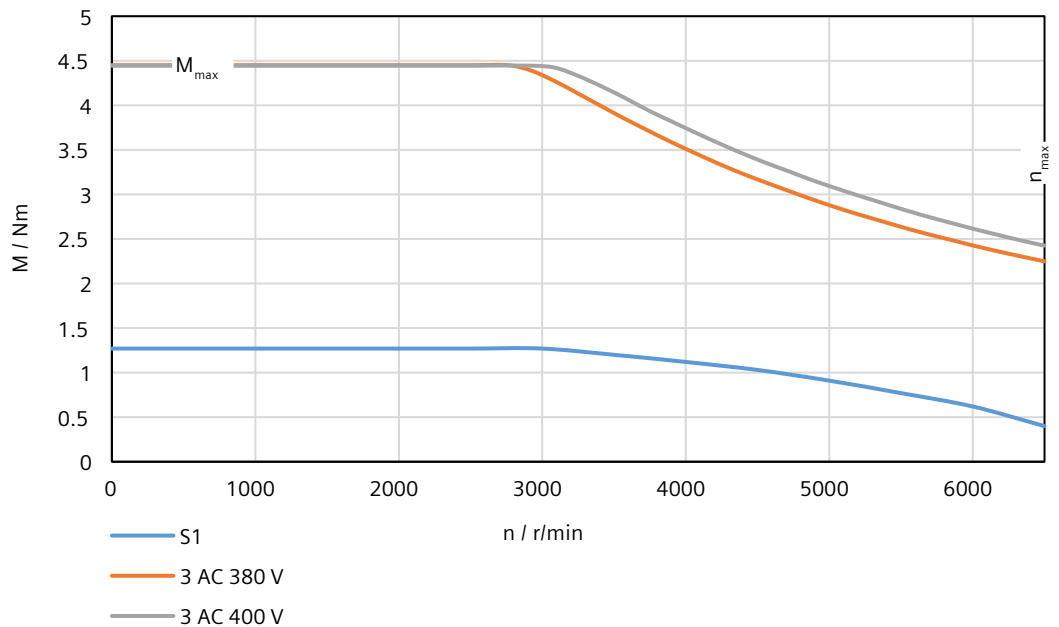

14.2.14.21 1FL2204-2AF connected to 3 AC 380 V/3 AC 400 V

Technical data

Table 14-48 Technical data of 1FL2204-2AF

Feature	Symbol	Unit	Value
Static torque	M_0	Nm	2.4
Stall current	I_0	A	2.25
Maximum permissible speed	n_{max}	r/min	6500
Maximum torque	M_{max}	Nm	7.5
Maximum current	I_{max}	A	7.1
Thermal time constant	T_{th}	min	22.5
Moment of inertia	J_{mot}	kgcm ²	1.23
Moment of inertia (with brake)	$J_{mot br}$	kgcm ²	1.31
Recommended load to motor inertia ratio	-	-	Maximum 15x
Weight	m_{mot}	kg	2.6
Weight (with brake)	$m_{mot br}$	kg	3.4
Rated speed	n_{rated}	r/min	3000
Rated torque	M_{rated}	Nm	2.4
Rated current	I_{rated}	A	2.25
Rated power	P_{rated}	kW	0.75

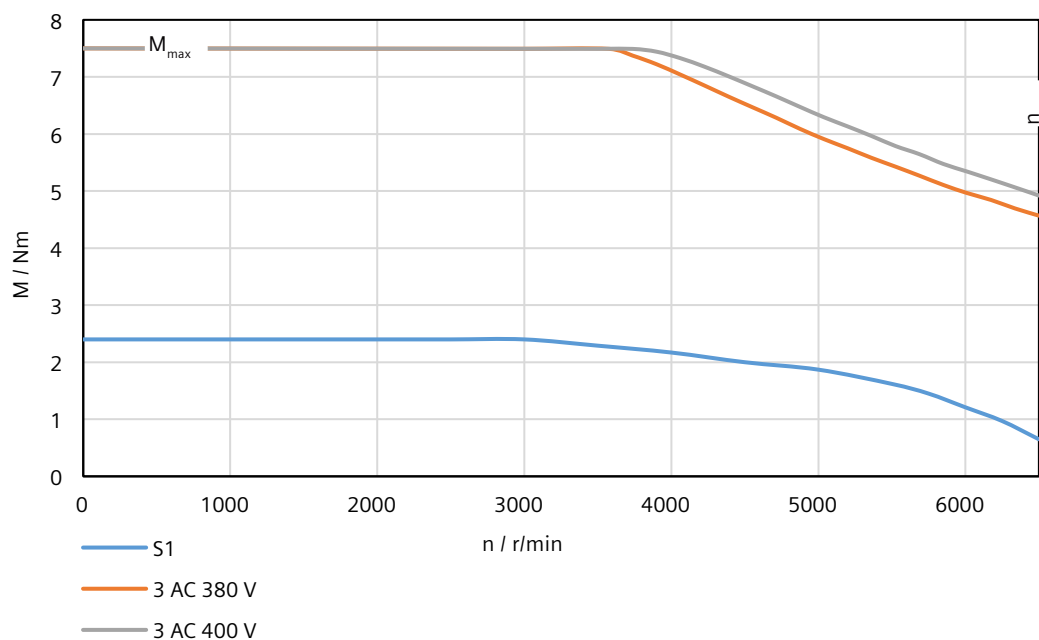

14.2.14.22 1FL2204-4AF connected to 3 AC 380 V/3 AC 400 V

Technical data

Table 14-49 Technical data of 1FL2204-4AF

Feature	Symbol	Unit	Value
Static torque	M_0	Nm	3.2
Stall current	I_0	A	3
Maximum permissible speed	n_{max}	r/min	6500
Maximum torque	M_{max}	Nm	10
Maximum current	I_{max}	A	9.9
Thermal time constant	T_{th}	min	28.4
Moment of inertia	J_{mot}	kgcm ²	1.61
Moment of inertia (with brake)	$J_{mot br}$	kgcm ²	1.69
Recommended load to motor inertia ratio	-	-	Maximum 15x
Weight	m_{mot}	kg	3.1
Weight (with brake)	$m_{mot br}$	kg	3.9
Rated speed	n_{rated}	r/min	3000
Rated torque	M_{rated}	Nm	3.2
Rated current	I_{rated}	A	3
Rated power	P_{rated}	kW	1

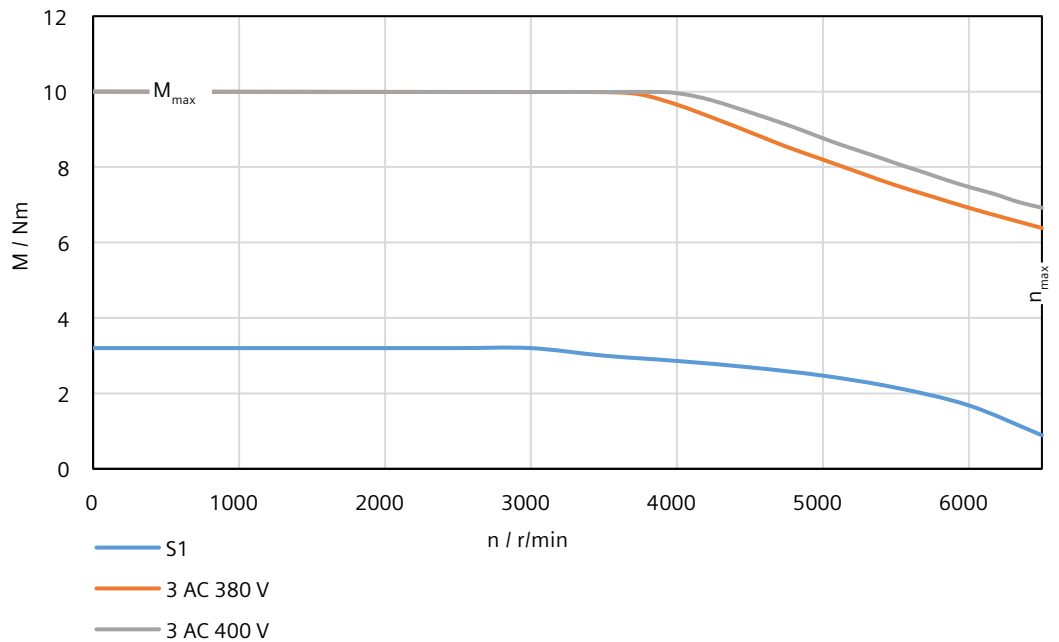

14.2.14.23 1FL2205-2AF connected to 3 AC 380 V/3 AC 400 V

Technical data

Table 14-50 Technical data of 1FL2205-2AF

Feature	Symbol	Unit	Value
Static torque	M_0	Nm	3.6
Stall current	I_0	A	2.9
Maximum permissible speed	n_{max}	r/min	6000
Maximum torque	M_{max}	Nm	11.5
Maximum current	I_{max}	A	9.5
Thermal time constant	T_{th}	min	24.4
Moment of inertia	J_{mot}	kgcm ²	3.15
Moment of inertia (with brake)	$J_{mot br}$	kgcm ²	4.03
Recommended load to motor inertia ratio	-	-	Maximum 15x
Weight	m_{mot}	kg	3.6
Weight (with brake)	$m_{mot br}$	kg	4.7
Rated speed	n_{rated}	r/min	3000
Rated torque	M_{rated}	Nm	3
Rated current	I_{rated}	A	2.5
Rated power	P_{rated}	kW	0.94

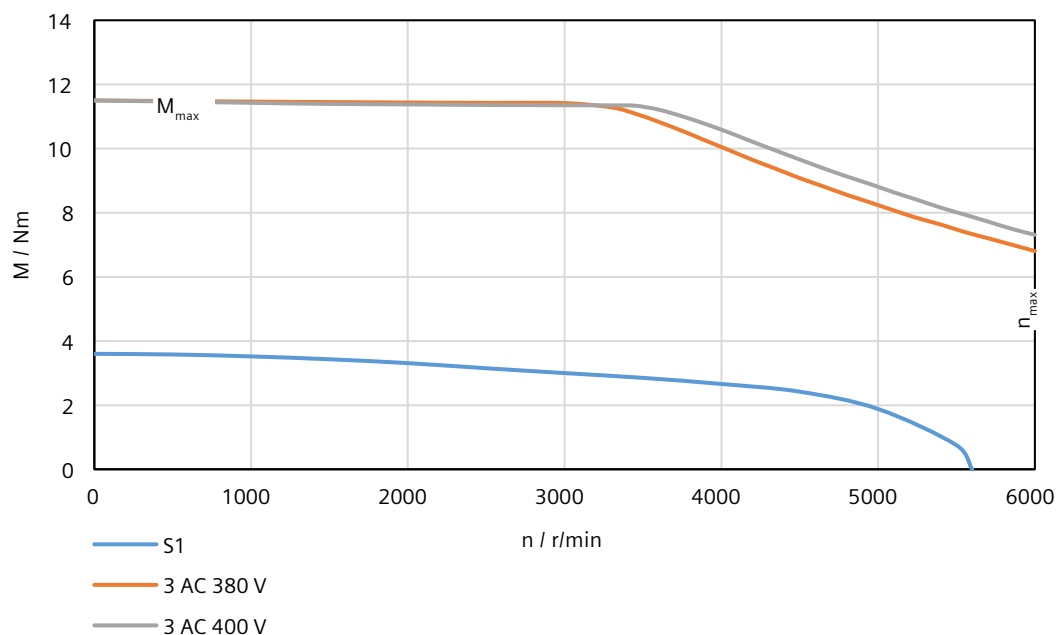

14.2.14.24 1FL2205-4AF connected to 3 AC 380 V/3 AC 400 V

Technical data

Table 14-51 Technical data of 1FL2205-4AF

Feature	Symbol	Unit	Value
Static torque	M_0	Nm	6
Stall current	I_0	A	4.7
Maximum permissible speed	n_{max}	r/min	6000
Maximum torque	M_{max}	Nm	19.3
Maximum current	I_{max}	A	15.1
Thermal time constant	T_{th}	min	31
Moment of inertia	J_{mot}	kgcm ²	5.10
Moment of inertia (with brake)	$J_{mot br}$	kgcm ²	5.98
Recommended load to motor inertia ratio	-	-	Maximum 15x
Weight	m_{mot}	kg	5
Weight (with brake)	$m_{mot br}$	kg	6.1
Rated speed	n_{rated}	r/min	3000
Rated torque	M_{rated}	Nm	4.6
Rated current	I_{rated}	A	3.75
Rated power	P_{rated}	kW	1.45

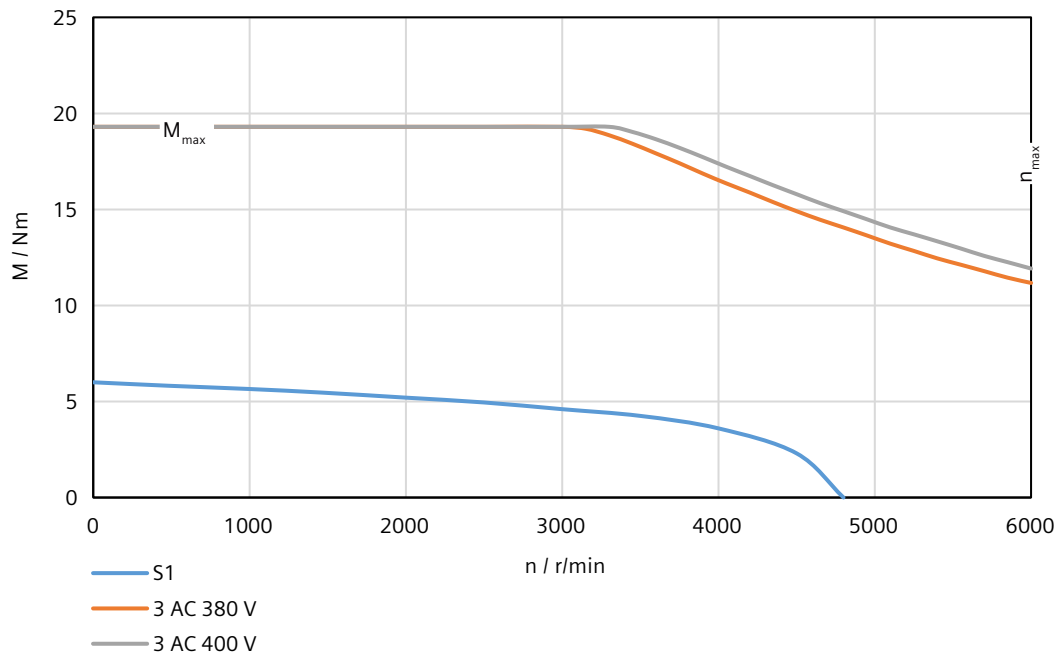

14.2.14.25 1FL2304-2AF connected to 3 AC 380 V/3 AC 400 V

Technical data

Table 14-52 Technical data of 1FL2304-2AF

Feature	Symbol	Unit	Value
Static torque	M_0	Nm	1.45
Stall current	I_0	A	1.3
Maximum permissible speed	n_{max}	r/min	4000
Maximum torque	M_{max}	Nm	4.445
Maximum current	I_{max}	A	4.2
Thermal time constant	T_{th}	min	18
Moment of inertia	J_{mot}	kgcm ²	2.69
Moment of inertia (with brake)	$J_{mot\ br}$	kgcm ²	3.05
Recommended load to motor inertia ratio	-	-	Maximum 10x
Weight	m_{mot}	kg	3.5
Weight (with brake)	$m_{mot\ br}$	kg	4.9
Rated speed	n_{rated}	r/min	3000
Rated torque	M_{rated}	Nm	1.27
Rated current	I_{rated}	A	1.2
Rated power	P_{rated}	kW	0.4

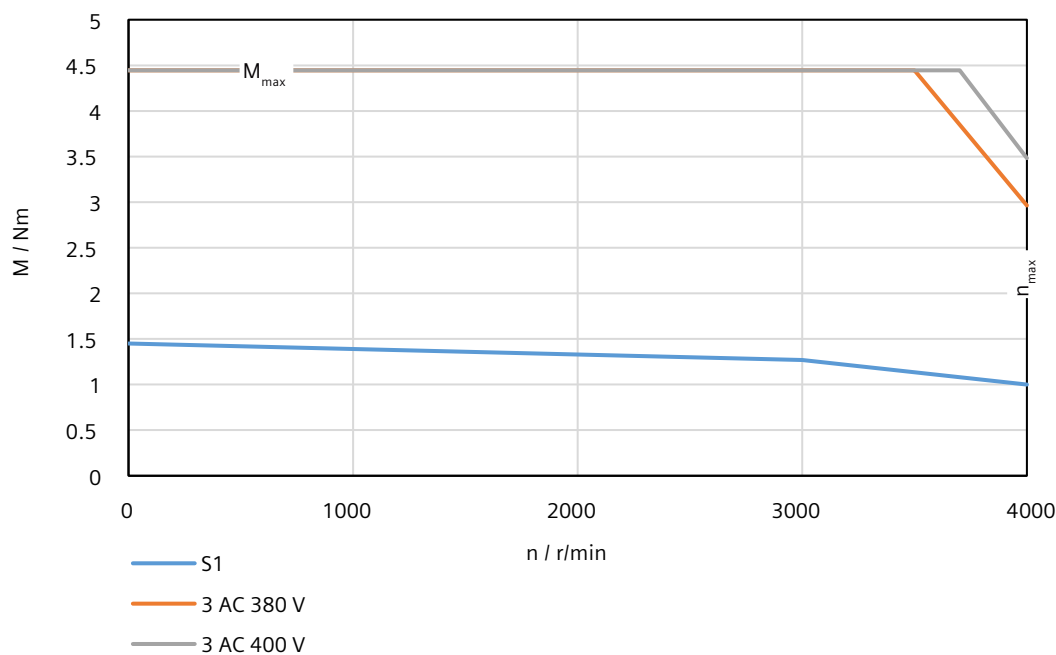

14.2.14.26 1FL2304-4AF connected to 3 AC 380 V/3 AC 400 V

Technical data

Table 14-53 Technical data of 1FL2304-4AF

Feature	Symbol	Unit	Value
Static torque	M_0	Nm	3.02
Stall current	I_0	A	2.5
Maximum permissible speed	n_{max}	r/min	4000
Maximum torque	M_{max}	Nm	8.365
Maximum current	I_{max}	A	7.3
Thermal time constant	T_{th}	min	22
Moment of inertia	J_{mot}	kgcm ²	5.18
Moment of inertia (with brake)	$J_{mot br}$	kgcm ²	5.54
Recommended load to motor inertia ratio	-	-	Maximum 10x
Weight	m_{mot}	kg	5.4
Weight (with brake)	$m_{mot br}$	kg	6.8
Rated speed	n_{rated}	r/min	3000
Rated torque	M_{rated}	Nm	2.39
Rated current	I_{rated}	A	2.1
Rated power	P_{rated}	kW	0.75

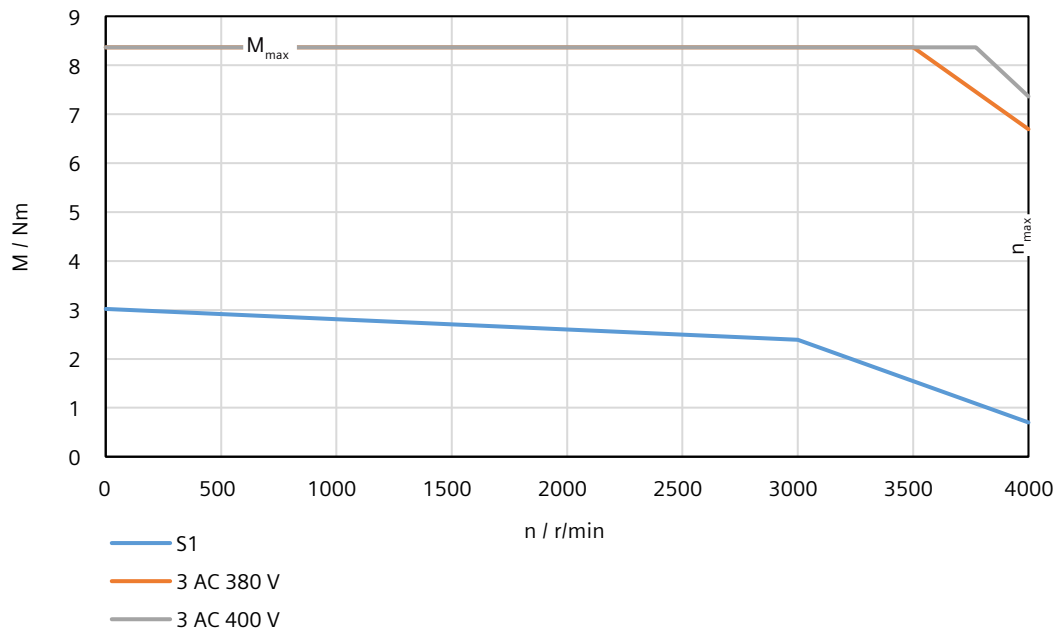

14.2.14.27 1FL2306-1AC connected to 3 AC 380 V/3 AC 400 V

Technical data

Table 14-54 Technical data of 1FL2306-1AC

Feature	Symbol	Unit	Value
Static torque	M_0	Nm	3.7
Stall current	I_0	A	2.5
Maximum permissible speed	n_{max}	r/min	3000
Maximum torque	M_{max}	Nm	12
Maximum current	I_{max}	A	8.4
Thermal time constant	T_{th}	min	22
Moment of inertia	J_{mot}	kgcm ²	7.96
Moment of inertia (with brake)	$J_{mot br}$	kgcm ²	9.57
Recommended load to motor inertia ratio	-	-	Maximum 10x
Weight	m_{mot}	kg	5.9
Weight (with brake)	$m_{mot br}$	kg	8.9
Rated speed	n_{rated}	r/min	2000
Rated torque	M_{rated}	Nm	3.58
Rated current	I_{rated}	A	2.5
Rated power	P_{rated}	kW	0.75

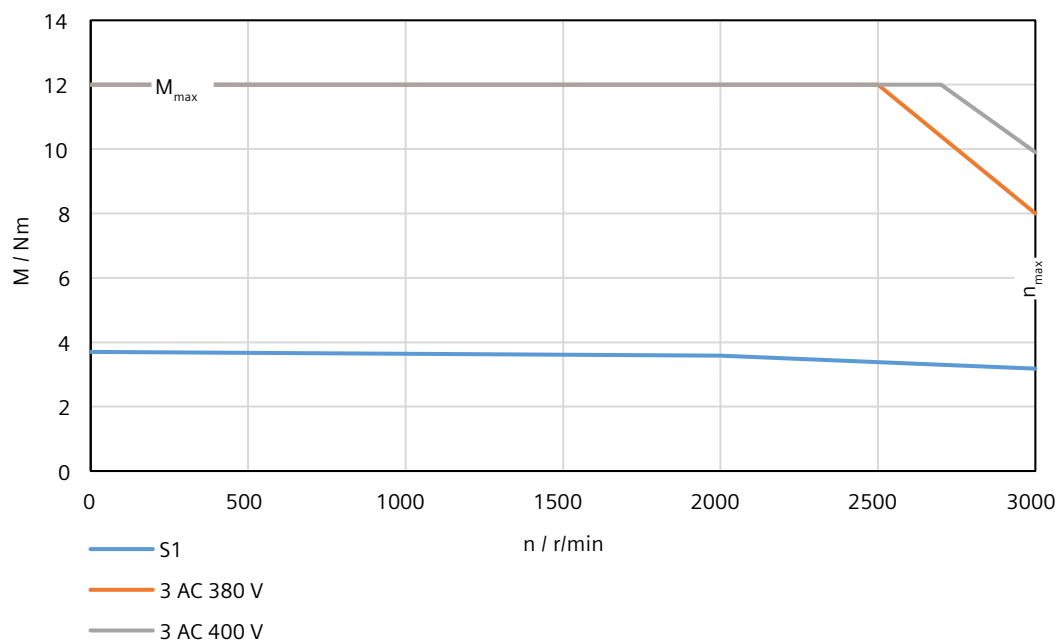

14.2.14.28 1FL2306-2AC connected to 3 AC 380 V/3 AC 400 V

Technical data

Table 14-55 Technical data of 1FL2306-2AC

Feature	Symbol	Unit	Value
Static torque	M_0	Nm	5
Stall current	I_0	A	3
Maximum permissible speed	n_{max}	r/min	3000
Maximum torque	M_{max}	Nm	17
Maximum current	I_{max}	A	10.7
Thermal time constant	T_{th}	min	22
Moment of inertia	J_{mot}	kgcm ²	11.65
Moment of inertia (with brake)	$J_{mot br}$	kgcm ²	13.26
Recommended load to motor inertia ratio	-	-	Maximum 5x
Weight	m_{mot}	kg	7.3
Weight (with brake)	$m_{mot br}$	kg	10.3
Rated speed	n_{rated}	r/min	2000
Rated torque	M_{rated}	Nm	4.78
Rated current	I_{rated}	A	3
Rated power	P_{rated}	kW	1

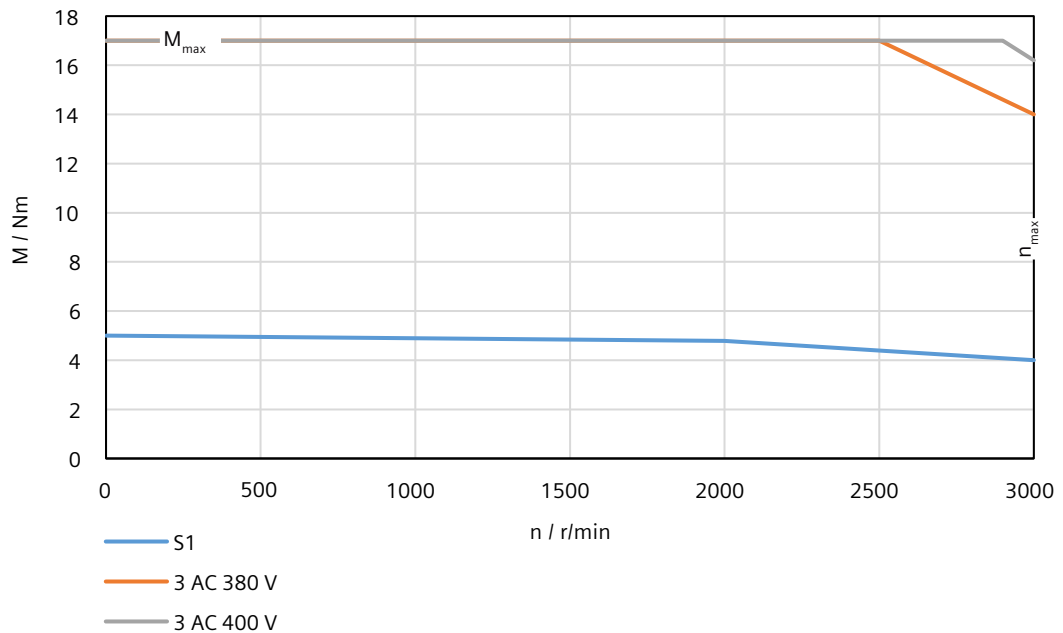

14.2.14.29 1FL2306-4AC connected to 3 AC 380 V/3 AC 400 V

Technical data

Table 14-56 Technical data of 1FL2306-4AC

Feature	Symbol	Unit	Value
Static torque	M_0	Nm	8
Stall current	I_0	A	4.9
Maximum permissible speed	n_{max}	r/min	3000
Maximum torque	M_{max}	Nm	22
Maximum current	I_{max}	A	14.1
Thermal time constant	T_{th}	min	30
Moment of inertia	J_{mot}	kgcm ²	15.29
Moment of inertia (with brake)	$J_{mot\ br}$	kgcm ²	16.90
Recommended load to motor inertia ratio	-	-	Maximum 5x
Weight	m_{mot}	kg	8.6
Weight (with brake)	$m_{mot\ br}$	kg	11.6
Rated speed	n_{rated}	r/min	2000
Rated torque	M_{rated}	Nm	7.16
Rated current	I_{rated}	A	4.6
Rated power	P_{rated}	kW	1.5

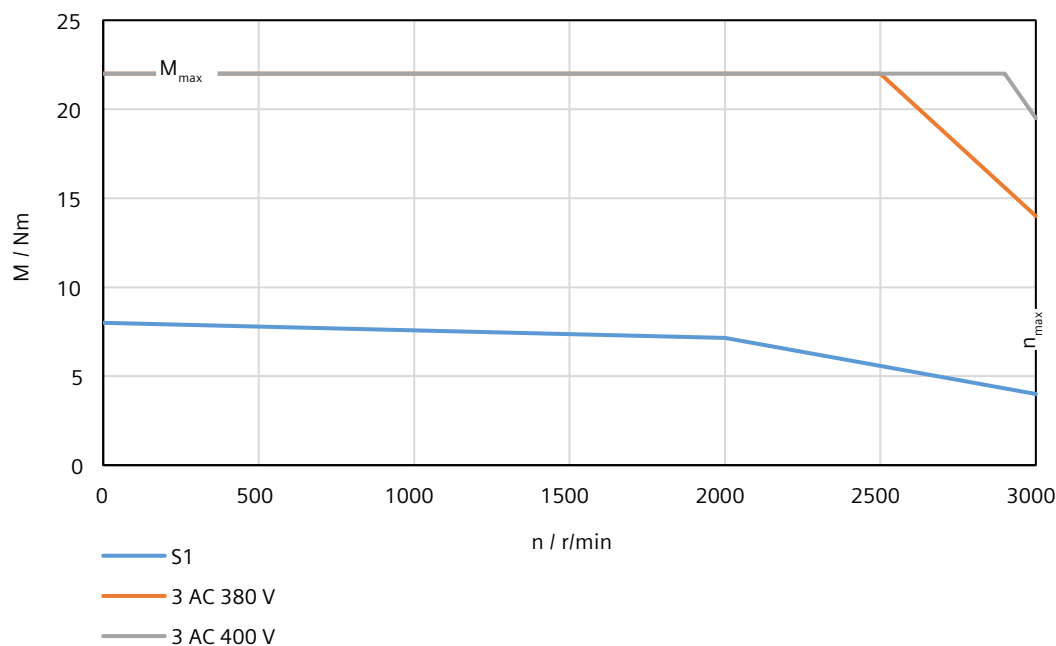

14.2.14.30 1FL2306-6AC connected to 3 AC 380 V/3 AC 400 V

Technical data

Table 14-57 Technical data of 1FL2306-6AC

Feature	Symbol	Unit	Value
Static torque	M_0	Nm	8.8
Stall current	I_0	A	5.3
Maximum permissible speed	n_{max}	r/min	3000
Maximum torque	M_{max}	Nm	30
Maximum current	I_{max}	A	19
Thermal time constant	T_{th}	min	30
Moment of inertia	J_{mot}	kgcm ²	22.61
Moment of inertia (with brake)	$J_{mot br}$	kgcm ²	24.22
Recommended load to motor inertia ratio	-	-	Maximum 5x
Weight	m_{mot}	kg	11.1
Weight (with brake)	$m_{mot br}$	kg	14.1
Rated speed	n_{rated}	r/min	2000
Rated torque	M_{rated}	Nm	8.4
Rated current	I_{rated}	A	5.3
Rated power	P_{rated}	kW	1.75

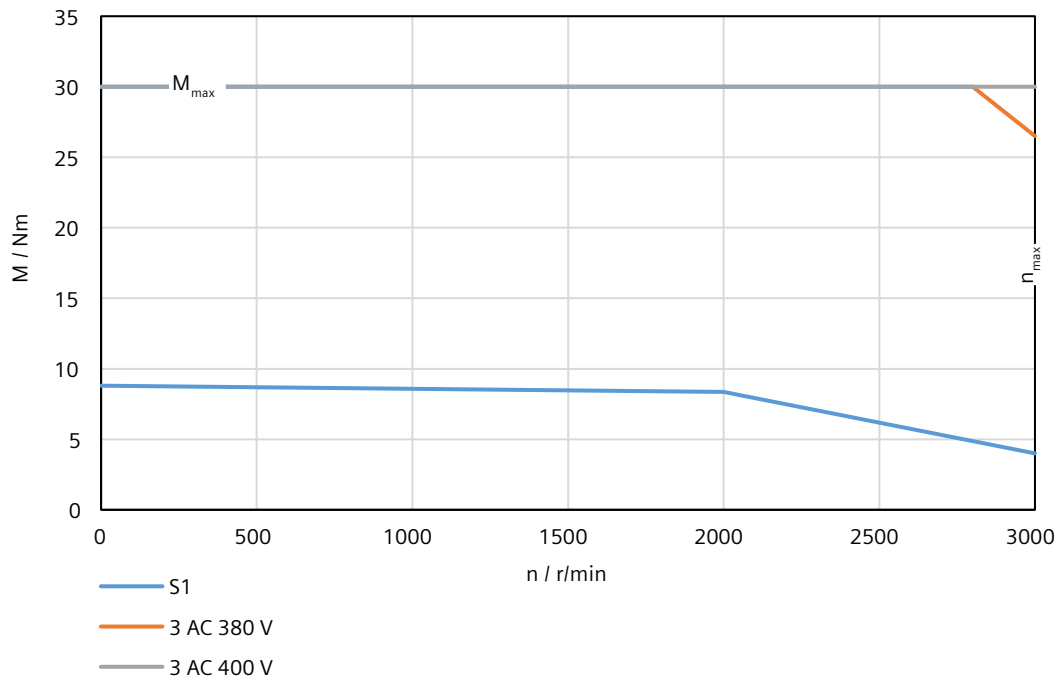

14.2.14.31 1FL2306-7AC connected to 3 AC 380 V/3 AC 400 V

Technical data

Table 14-58 Technical data of 1FL2306-7AC

Feature	Symbol	Unit	Value
Static torque	M_0	Nm	13.3
Stall current	I_0	A	7.8
Maximum permissible speed	n_{max}	r/min	3000
Maximum torque	M_{max}	Nm	33.425
Maximum current	I_{max}	A	20.7
Thermal time constant	T_{th}	min	32
Moment of inertia	J_{mot}	kgcm ²	29.94
Moment of inertia (with brake)	$J_{mot\ br}$	kgcm ²	31.55
Recommended load to motor inertia ratio	-	-	Maximum 5x
Weight	m_{mot}	kg	13.7
Weight (with brake)	$m_{mot\ br}$	kg	16.7
Rated speed	n_{rated}	r/min	2000
Rated torque	M_{rated}	Nm	9.6
Rated current	I_{rated}	A	5.9
Rated power	P_{rated}	kW	2

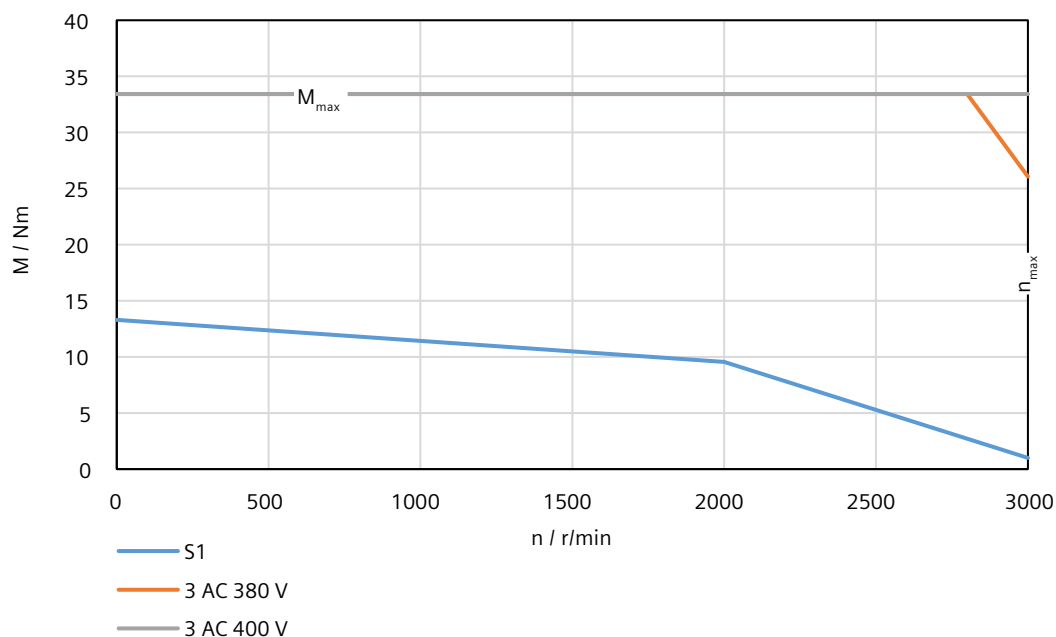

14.2.14.32 1FL2310-0AC connected to 3 AC 380 V/3 AC 400 V

Technical data

Table 14-59 Technical data of 1FL2310-0AC

Feature	Symbol	Unit	Value
Static torque	M_0	Nm	12.6
Stall current	I_0	A	7.8
Maximum permissible speed	n_{max}	r/min	3000
Maximum torque	M_{max}	Nm	37.5
Maximum current	I_{max}	A	25.2
Thermal time constant	T_{th}	min	35
Moment of inertia	J_{mot}	kgcm ²	47.41
Moment of inertia (with brake)	$J_{mot br}$	kgcm ²	56.78
Recommended load to motor inertia ratio	-	-	Maximum 5x
Weight	m_{mot}	kg	15.4
Weight (with brake)	$m_{mot br}$	kg	21.4
Rated speed	n_{rated}	r/min	2000
Rated torque	M_{rated}	Nm	11.9
Rated current	I_{rated}	A	7.8
Rated power	P_{rated}	kW	2.5

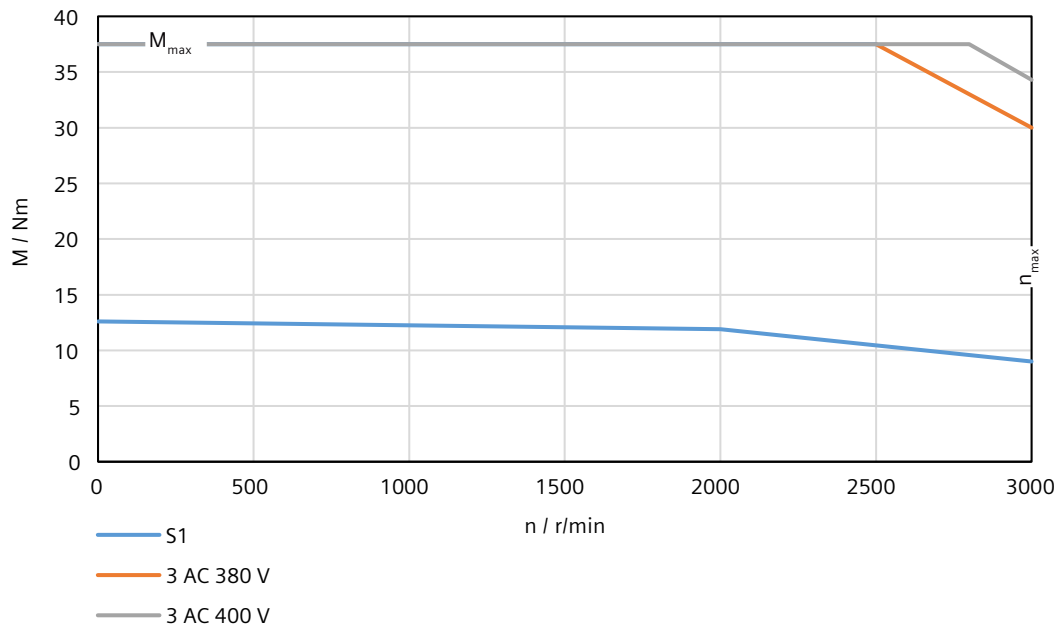

14.2.14.33 1FL2310-2AC connected to 3 AC 380 V/3 AC 400 V

Technical data

Table 14-60 Technical data of 1FL2310-2AC

Feature	Symbol	Unit	Value
Static torque	M_0	Nm	18.1
Stall current	I_0	A	11
Maximum permissible speed	n_{max}	r/min	3000
Maximum torque	M_{max}	Nm	55
Maximum current	I_{max}	A	36.2
Thermal time constant	T_{th}	min	38
Moment of inertia	J_{mot}	kgcm ²	69.10
Moment of inertia (with brake)	$J_{mot\ br}$	kgcm ²	78.47
Recommended load to motor inertia ratio	-	-	Maximum 5x
Weight	m_{mot}	kg	19.4
Weight (with brake)	$m_{mot\ br}$	kg	25.4
Rated speed	n_{rated}	r/min	2000
Rated torque	M_{rated}	Nm	16.7
Rated current	I_{rated}	A	11
Rated power	P_{rated}	kW	3.5

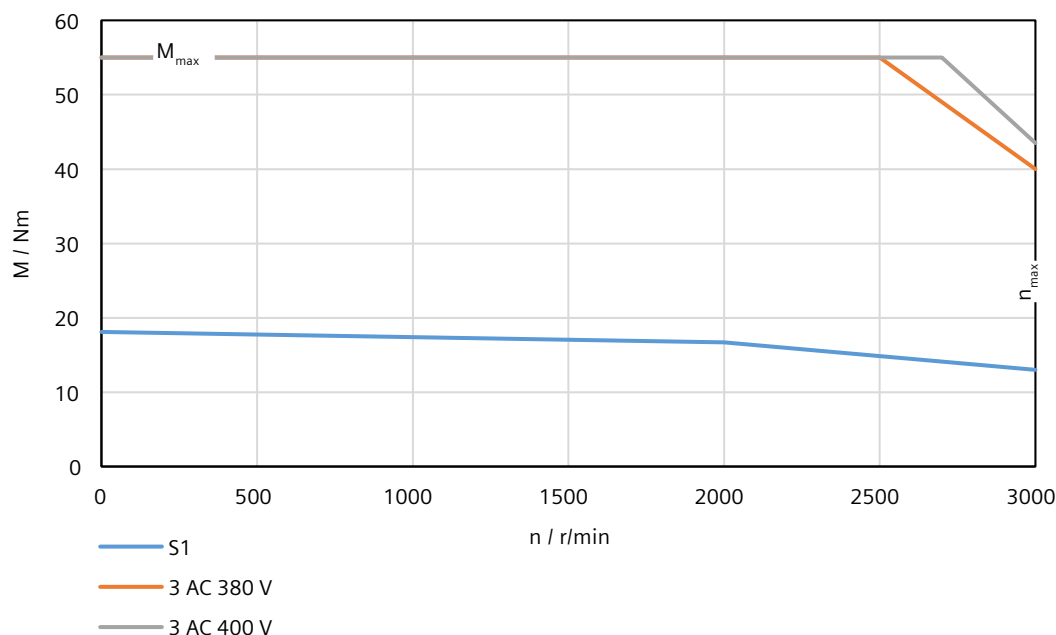

14.2.14.34 1FL2310-4AC connected to 3 AC 380 V/3 AC 400 V

Technical data

Table 14-61 Technical data of 1FL2310-4AC

Feature	Symbol	Unit	Value
Static torque	M_0	Nm	25.2
Stall current	I_0	A	12.6
Maximum permissible speed	n_{max}	r/min	2500
Maximum torque	M_{max}	Nm	70
Maximum current	I_{max}	A	36.9
Thermal time constant	T_{th}	min	45
Moment of inertia	J_{mot}	kgcm ²	90.83
Moment of inertia (with brake)	$J_{mot br}$	kgcm ²	100.20
Recommended load to motor inertia ratio	-	-	Maximum 5x
Weight	m_{mot}	kg	23.7
Weight (with brake)	$m_{mot br}$	kg	29.7
Rated speed	n_{rated}	r/min	2000
Rated torque	M_{rated}	Nm	23.9
Rated current	I_{rated}	A	12.6
Rated power	P_{rated}	kW	5

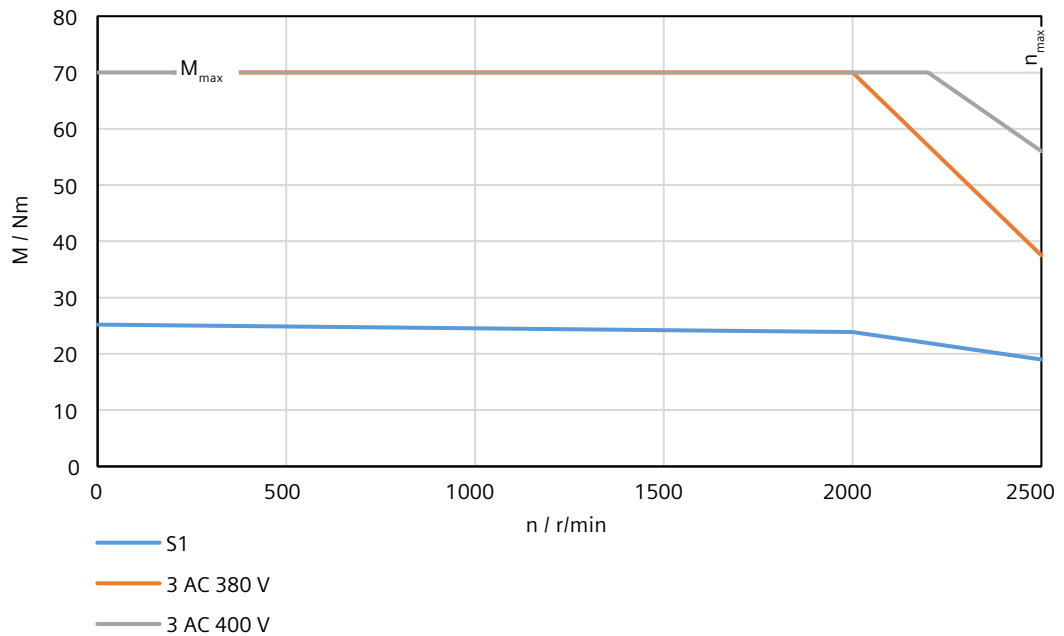

14.2.14.35 1FL2310-6AC connected to 3 AC 380 V/3 AC 400 V

Technical data

Table 14-62 Technical data of 1FL2310-6AC

Feature	Symbol	Unit	Value
Static torque	M_0	Nm	35.2
Stall current	I_0	A	13.2
Maximum permissible speed	n_{max}	r/min	2000
Maximum torque	M_{max}	Nm	90
Maximum current	I_{max}	A	35.6
Thermal time constant	T_{th}	min	55
Moment of inertia	J_{mot}	kgcm ²	134.29
Moment of inertia (with brake)	$J_{mot\ br}$	kgcm ²	143.66
Recommended load to motor inertia ratio	-	-	Maximum 5x
Weight	m_{mot}	kg	31.9
Weight (with brake)	$m_{mot\ br}$	kg	37.9
Rated speed	n_{rated}	r/min	2000
Rated torque	M_{rated}	Nm	33.4
Rated current	I_{rated}	A	13.2
Rated power	P_{rated}	kW	7

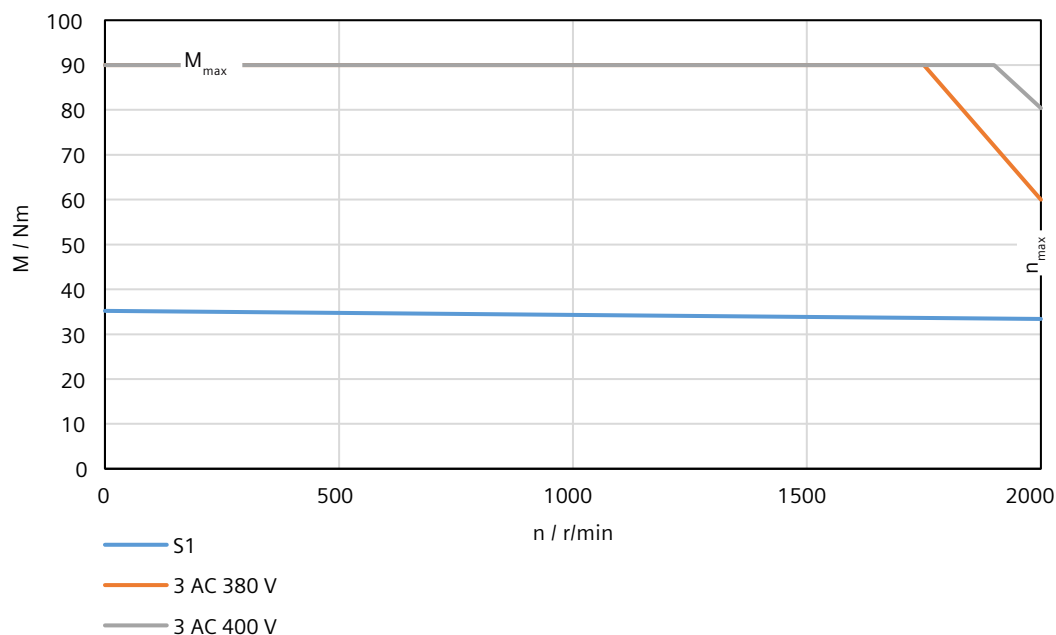

14.3 Technical data of MOTION-CONNECT cables

14.3.1 Technical data of MOTION-CONNECT 350

14.3.1.1 General technical data

Technical data

Table 14-63 General technical data of MOTION-CONNECT 350

Property	MOTION-CONNECT 350 power cable	MOTION-CONNECT 350 encoder cable	MOTION-CONNECT 350 brake cable
Jacket material	PVC	PVC	PVC
Number of conductors	<ul style="list-style-type: none"> With brake conductors: 6 Without brake conductors: 4 	6	2
Operating temperature (°C)	-20 ... +80	-20 ... +80	-20 ... +80
Shielding	Braided shield; coverage ≥ 85%	Braided shield; coverage ≥ 85%	Braided shield; coverage ≥ 85%
Oil resistance	EN 60811-2-1	EN 60811-2-1	EN 60811-2-1
Flame retardancy	EN 60332-1-1 to 1-3	EN 60332-1-1 to 1-3	EN 60332-1-1 to 1-3
Coolant resistance	EN 60811-2-1	EN 60811-2-1	EN 60811-2-1
Degree of protection (motor-side only)	IP65	IP65	IP65
Bending cycles	1 million	1 million	1 million
Rated voltage U_0/U (V)	<ul style="list-style-type: none"> 200 V converters: 300/1000 400 V converters: 600/1000 	30/300	30/300

14.3.1.2 Specific technical data

Technical data

Table 14-64 Cable used for 1FL2 low or medium inertia motors

Property	MOTION-CONNECT 350 power cable	MOTION-CONNECT 350 encoder cable	MOTION-CONNECT 350 brake cable
Cross-section of conductors (mm ²)	<ul style="list-style-type: none"> With brake conductors: 4 x 0.75 + 2 x 0.38 Without brake conductors: 4 x 0.75 	<ul style="list-style-type: none"> Cable length up to 15 m: 3 x 2 x 0.25 Cable length 20 m or 30 m: 2 x 2 x 0.25 + 2 x 0.38 	-
Outer diameter (mm)	∅ (7.5 ± 0.2)	∅ (7 ± 0.2)	-
Minimum bending radius, static (mm)	4 x outer diameter	4 x outer diameter	-
Minimum bending radius, dynamic (mm)	7.5 x outer diameter	7.5 x outer diameter	-
Maximum acceleration (m/s ²)	3	3	-
Maximum traversing velocity (m/min)	40	40	-

Table 14-65 Cable used for 1FL2 high inertia motors

Property	MOTION-CONNECT 350 power cable	MOTION-CONNECT 350 encoder cable	MOTION-CONNECT 350 brake cable
Cross-section of conductors (mm ²)	<ul style="list-style-type: none"> 1FL2 0.4 kW ... 2 kW: 4 x 0.75 1FL2 2.5 kW: 4 x 1.5 1FL2 3.5 kW ... 7 kW: 4 x 2.5 	<ul style="list-style-type: none"> Cable length up to 15 m: 3 x 2 x 0.25 Cable length 20 m or 30 m: 2 x 2 x 0.25 + 2 x 0.38 	2 x 0.75
Outer diameter (mm)	<ul style="list-style-type: none"> 1FL2 0.4 kW ... 2 kW: ∅ (7.5 ± 0.2) 1FL2 2.5 kW: ∅ (7.8 ± 0.3) 1FL2 3.5 kW ... 7 kW: ∅ (9 ± 0.3) 	∅ (7 ± 0.2)	∅ (6 ± 0.2)
Minimum bending radius, static (mm)	4 x outer diameter	4 x outer diameter	4 x outer diameter
Minimum bending radius, dynamic (mm)	7.5 x outer diameter	7.5 x outer diameter	7.5 x outer diameter
Maximum acceleration (m/s ²)	3	3	3
Maximum traversing velocity (m/min)	<ul style="list-style-type: none"> 1FL2 0.4 kW ... 2 kW: 40 1FL2 2.5 kW: 50 1FL2 3.5 kW ... 7 kW: 50 	40	50

14.3.2 Technical data of MOTION-CONNECT 380

14.3.2.1 General technical data

Technical data

Table 14-66 General technical data of MOTION-CONNECT 380

Property	MOTION-CONNECT 380 power cable	MOTION-CONNECT 380 encoder cable	MOTION-CONNECT 380 brake cable
Jacket material	PUR	PUR	PUR
Number of conductors	<ul style="list-style-type: none"> With brake conductors: 6 Without brake conductors: 4 	6	2
Operating temperature (°C)	-20 ... +80	-20 ... +80	-20 ... +80
Shielding	Braided shield; coverage ≥ 85%	Braided shield; coverage ≥ 85%	Braided shield; coverage ≥ 85%
Oil resistance	EN 60811-2-1	EN 60811-2-1	EN 60811-2-1
Flame retardancy	EN 60332-1-1 to 1-3	EN 60332-1-1 to 1-3	EN 60332-1-1 to 1-3
Coolant resistance	EN 60811-2-1	EN 60811-2-1	EN 60811-2-1
Degree of protection (motor-side only)	IP65	IP65	IP65
Bending cycles	5 million	5 million	5 million
Rated voltage U_0/U (V)	<ul style="list-style-type: none"> 200 V converters: 300/1000 400 V converters: 600/1000 	30/300	30/300

14.3.2.2 Specific technical data

Technical data

Table 14-67 Cable used for 1FL2 low or medium inertia motors

Property	MOTION-CONNECT 380 power cable	MOTION-CONNECT 380 encoder cable	MOTION-CONNECT 380 brake cable
Cross-section of conductors (mm ²)	<ul style="list-style-type: none"> With brake conductors: 4 x 0.75 + 2 x 0.38 Without brake conductors: 4 x 0.75 	<ul style="list-style-type: none"> Cable length up to 15 m: 3 x 2 x 0.25 Cable length 20 m or 30 m: 2 x 2 x 0.25 + 2 x 0.38 	-
Outer diameter (mm)	∅ (7.5 ± 0.2)	∅ (7 ± 0.2)	-

14.3 Technical data of MOTION-CONNECT cables

Property	MOTION-CONNECT 380 power cable	MOTION-CONNECT 380 encoder cable	MOTION-CONNECT 380 brake cable
Minimum bending radius, static (mm)	4 x outer diameter	4 x outer diameter	-
Minimum bending radius, dynamic (mm)	7.5 x outer diameter	7.5 x outer diameter	-
Maximum acceleration (m/s ²)	5	5	-
Maximum traversing velocity (m/min)	180	180	-

Table 14-68 Cable used for 1FL2 high inertia motors

Property	MOTION-CONNECT 380 power cable	MOTION-CONNECT 380 encoder cable	MOTION-CONNECT 380 brake cable
Cross-section of conductors (mm ²)	<ul style="list-style-type: none"> • 1FL2 0.4 kW ... 2 kW: 4 x 0.75 • 1FL2 2.5 kW: 4 x 1.5 • 1FL2 3.5 kW ... 7 kW: 4 x 2.5 	<ul style="list-style-type: none"> • Cable length up to 15 m: 3 x 2 x 0.25 • Cable length 20 m or 30 m: 2 x 2 x 0.25 + 2 x 0.38 	2 x 0.75
Outer diameter (mm)	<ul style="list-style-type: none"> • 1FL2 0.4 kW ... 2 kW: $\varnothing (7.5 \pm 0.2)$ • 1FL2 2.5 kW: $\varnothing (9 \pm 0.3)$ • 1FL2 3.5 kW ... 7 kW: $\varnothing (10.5 \pm 0.3)$ 	$\varnothing (7 \pm 0.2)$	$\varnothing (6 \pm 0.3)$
Minimum bending radius, static (mm)	4 x outer diameter	4 x outer diameter	4 x outer diameter
Minimum bending radius, dynamic (mm)	7.5 x outer diameter	7.5 x outer diameter	7.5 x outer diameter
Maximum acceleration (m/s ²)	5	5	5
Maximum traversing velocity (m/min)	180	180	180

Examples/applications

Description

You can find SINAMICS application examples in the Application examples (<https://support.industry.siemens.com/cs/ww/en/view/60733299>).

Appendix

A.1 UL Markings

Description

Converter variant of 1 AC/3 AC 200 V ... 240 V

For US/Canadian installations (UL/cUL): The products are cULus-listed under File E355661.

- Suitable for use in a circuit that cannot provide more than 100 kA rms (symmetrical), max. 240 V.

Note: The maximum permissible short-circuit current for 200 V variants with Type E Combination Motor Controllers is 65 kA.

- Protection of the branch circuit for individual drives must be guaranteed using Class J fuses in accordance with the technical data.

For other protection equipment and SCCRs (Short Circuit Current Rating) for individual drives, see:

Protective Devices for SINAMICS S200 Product Line (<https://support.industry.siemens.com/cs/ww/en/ps/29596/man>)

- This device must be installed in an enclosure that provides an environment with degree of pollution 2 (controlled).
- Maximum rated temperature 45 °C.
- The device provides overtemperature and overload protection.
- Use copper wires with a permissible temperature of 75 °C for all power cables. You can also use cables with a higher rated temperature value. It is not permissible to reduce the conductor cross-section.

Converter variant of 3 AC 380 V ... 480 V

For US/Canadian installations (UL/cUL): The products are cULus-listed under File E355661.

- Suitable for use in a circuit that cannot provide more than 65 kA rms (symmetrical), max. 480 V.

- Protection of the branch circuit for individual drives must be guaranteed using Class J fuses in accordance with the technical data.

- For other protection equipment and SCCRs (Short Circuit Current Rating) for individual drives, see:

Protective Devices for SINAMICS S200 Product Line (<https://support.industry.siemens.com/cs/ww/en/ps/29596/man>)

- This device must be installed in an enclosure that provides an environment with degree of pollution 2 (controlled).
- Maximum rated temperature 45 °C. Maximum height 4000 m.

- The device provides overtemperature and overload protection.
- Use copper wires with a permissible temperature of 75 °C for all power cables. You can also use cables with a higher rated temperature value. It is not permissible to reduce the conductor cross-section.

Additional requirements relating to CSA compliance:

Maximum height for CSA: 2000 m.

Motor overload protection according to UL 61800-5-1 Ed.2

For the settings required to activate the motor overload protection according to UL 61800-5-1 Ed.2, see Section "Setting motor overload protection in accordance with UL 61800-5-1 Ed.2 (Page 364)".

MOTION-CONNECT connection system

The recommended assignment of motors and cables can be found in Section "Device combinations (Page 58)".

Other assignments are not possible.

The technical parameters of the cables are tailored to the requirements of the motors and verified by system tests. For detailed information, see Section "Technical data of MOTION-CONNECT cables (Page 734)".

A.2 EMERGENCY OFF and EMERGENCY STOP

Overview

In plants, systems and machines a distinction must be made between "EMERGENCY OFF" and "EMERGENCY STOP".

The Safe Torque Off (STO) Safety Integrated function is suitable for implementing an "EMERGENCY STOP" but is not suitable for implementing an "EMERGENCY OFF".

Description of function

IEC 60204-1 defines "EMERGENCY OFF" and "EMERGENCY STOP":

- "EMERGENCY OFF" and "EMERGENCY STOP" are actions taken in an emergency.
- "EMERGENCY OFF" and "EMERGENCY STOP" reduce different risks in the machine or system:
 - "EMERGENCY OFF" reduces the risk from electric shock.
 - "EMERGENCY STOP" reduces the risk from unexpected movement.

Table A-1 The distinction between "EMERGENCY OFF" and "EMERGENCY STOP"

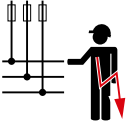
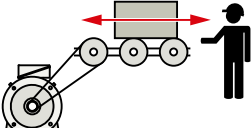
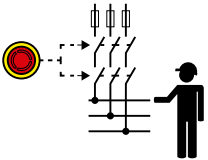
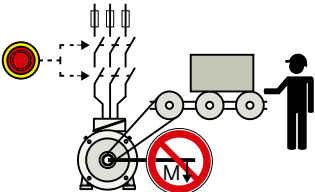
Action:	EMERGENCY OFF	EMERGENCY STOP Stop category 0 according to IEC 60204-1
Risk:	 <p>Electric shock</p>	 <p>Unexpected motion</p>
Measure to minimize risk:	<p>Switch off voltage Switch off hazardous voltages completely or in part</p>	<p>Prevent movement Prevent any hazardous movement</p>
Classic solution:	<p>Switch off the voltage:</p> 	<p>Switch off the power supply of the drive:</p> 

A.2 EMERGENCY OFF and EMERGENCY STOP

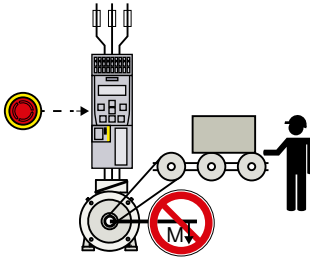
Action:	EMERGENCY OFF	EMERGENCY STOP Stop category 0 according to IEC 60204-1
<p>Solution with the STO Safety Integrated function integrated into the drive:</p>	<p>STO is not suitable for switching off an electrical voltage.</p>	<p>Select STO:</p>  <p>It is permissible that you also switch off the converter supply voltage. However, switching off the voltage is not required as a risk reduction measure.</p>

A.3 Parameters

A.3.1 Explanation of the list of parameters

Overview

The representation of a parameter includes as a maximum the information listed below. Depending on the specific parameter, some of the listed information is not applicable.

The parameters are displayed according to the following example:

rxxxx	Parameter name		
Variant	Data type: Integer16	Visible in: Standard display	
	Read permission:	Read drive data or acknowledge messages	
	Write permission:	Edit device configuration or drive applications	
	Can be changed in the operating state:	Ready for operation	
	Parameter group:	Name of the group(s)	
	Unit: -		
	Min: -	Max: -	Factory setting: -
Description:	Text		
Value:	0: Name of value 0 10: Name of value 10		
Recommendation:	Text		
Index:	[0] = Name and meaning of index 0 [1] = Name and meaning of index 1		
Bit array:	Bit	Signal name	1 signal 0 signal
	00	Name of bit 0	Yes No
	01	Name of bit 1	Yes No
Dependency:	Text		
	See also: pxxx, rxxx		
	See also: Fxxxxx, Axxxxx, Cxxxxx		
Danger/ Caution/ Warning/ Notice:	Safety-related note corresponding to the warning note concept		
Note:	Text		

Note

Some parameters may have different properties and descriptions depending on the selected axis type. And those parameters are displayed twice in the parameter list with additional labels. You need to refer to the specific parameters according to your actual axis type.

Description of function

Parameter number

The parameter number is made up of a "p", "r" or "c", followed by several numbers and optionally an index and bit array.

The parameter number has the following syntax: pxxxx[0...n], rxxxx[0...n], cxxxx[0...n], pxxxx.0...15 or rxxxx.0...15, cxxxx.0...15, pxxxx[0...n].0...15 or rxxxx[0...n].0...15, cxxxx[0...n].0...15.

Examples of representation in the parameter list:

- p... Adjustable parameters (read and write)
- r... Display parameters (read-only)
- c... Display parameters (read-only)
- p0972 Adjustable parameter 972
- p0489[0...2] Adjustable parameter 489, index 0 to 2
- r0945 Display parameter 945
- r0196[0...255].0...15 Display parameter with index 0 to 255 and bit array from bit 0 to bit 15
- r5613.0...1 Display parameter 5613 with bit array from bit 0 to bit 1
- c8997[0...2] Display parameter 8997, index 0 to 2

Other examples of the notation in the documentation:

- p9563[1] Adjustable parameter 9563, index 1
- r0196[1].5 Display parameter 196, index 1, bit 5
- r0964[2] Display parameter 964, index 2
- p5611.1 Adjustable parameter 5611, bit 1

Parameter name

Shows the parameter name in the long form.

Variant

Specifies the product variant for which the parameter is valid. This information is not applicable if a parameter is the same for all product variants used in the parameter list.

- For parameters that displayed only once
 - S200 PN: The parameter applies to the S200 PN converter only.
 - S200 Basic PN: The parameter applies to the S200 Basic PN converter only.
- For parameters that displayed twice
 - S200 Basic PN (EPOS load side, rotating), S200 PN (EPOS load side, rotating): The parameter is used in the "rotary" axis type application only and applies to both the S200 PN converter and the S200 Basic PN converter.
 - blank: The parameter is used in the "linear" axis type application only and applies to both the S200 PN converter and the S200 Basic PN converter.

Data type

Each parameter is assigned one of the following data types:

- Integer8 I8 8-bit integer
- Integer16 I16 16-bit integer
- Integer32 I32 32-bit integer
- Unsigned8 U8 8-bit without sign

- Unsigned16 U16 16-bit without sign
- Unsigned32 U32 32-bit without sign
- FloatingPoint32 Float 32-bit floating-point number

Visible in

You change the number of parameters displayed in the commissioning tool via:

- Standard display
Only the basic parameters are displayed.
- Extended display
The full scope of parameters is displayed.

Permission

The user and rights management (UMAC) controls access to the parameters.

You require runtime function rights to read and set parameters.

The following read permissions are available:

- Read drive data or acknowledge messages

The following write permissions are available:

- Control drive in manual mode
- Perform drive diagnostics
- Perform firmware update
- Create backup or load drive data to the commissioning tool
- Edit device configuration or drive applications
- Edit web server configuration
- Manage users and roles

Runtime function rights depend on user roles, which are assigned in the commissioning tool being used. As a consequence, setting parameters can be write-protected.

The commissioning tool provides additional support.

Can be changed in the operating state

A parameter can only be changed in this operating state. The change only becomes active after exiting the state.

The following states exist:

- Operation
The pulses have been enabled.
- Ready for operation
The pulses are not enabled and state "Commissioning" is not active.
- Commissioning
Commissioning takes place.
The pulses cannot be enabled.

Parameter group

A parameter group contains parameters that are functionally associated with one another.

Unit

Shows the default unit of the parameter. For adjustable parameters, the unit is additionally specified according to the values (Min, Max, Factory setting) in square brackets.

Min, Max, Factory setting

The parameter value "when shipped" is specified under "Factory setting" with the relevant unit in square parentheses.

The value can be adjusted within the range defined by "Min" and "Max".

This information is not applicable for display parameters.

Min	Minimum value of the parameter [unit]
Max	Maximum value of the parameter [unit]
Factory setting	Value when delivered [unit]

Description

Explanation of the function of a parameter.

Value

List of the possible values of a parameter.

Recommendation

Information about recommended settings.

Index

Indexed parameters represent the name and its significance for each individual index.

The following applies to the values (Min, Max, Factory setting) of indexed adjustable parameters:

- Min, Max:
The adjustment range and the unit apply to all indices.
- Factory setting:
When all indices have the same factory setting, index 0 is specified with the unit to represent all indices.
When the indices have different factory settings, they are all listed individually with the unit.

Bit array

For parameters with bit fields, the following information is provided about each bit:

- Bit number and signal name
- Meaning for signal states 0 and 1
- Function diagram (optional)
The signal is shown in the function diagram.

Dependency

Specification of interactions that this parameter can potentially have:

- Effect on other parameters
- Dependent on other parameter settings (dependent on the selected functions)
- List of other parameters to be considered
- List of faults and alarms to be considered

Danger/Caution/Warning/Notice

The safety-relevant notes correspond to the warning note concept and contain the following information:

- Important information that must be observed to avoid the risk of physical injury or material damage.
- Information that must be observed to avoid any problems.
- Information that the user may find useful.

Note

Additional explanations about parameters

A.3.2 Parameter list

Product: SINAMICS S200, Version: 602024000, Language: eng
Objects: S200 Basic PN, S200 PN

r0002	Drive operating display																												
	<table style="width: 100%; border: none;"> <tr> <td style="width: 40%;">Data type: Integer16</td> <td>Visible in: Standard display</td> </tr> <tr> <td>Read permission:</td> <td>Read drive data or acknowledge messages</td> </tr> <tr> <td>Write permission:</td> <td>Edit device configuration or drive applications</td> </tr> <tr> <td>Parameter group:</td> <td>Status parameters, Diagnostics general, Drive enable signals</td> </tr> <tr> <td>Unit: -</td> <td></td> </tr> </table>	Data type: Integer16	Visible in: Standard display	Read permission:	Read drive data or acknowledge messages	Write permission:	Edit device configuration or drive applications	Parameter group:	Status parameters, Diagnostics general, Drive enable signals	Unit: -																			
Data type: Integer16	Visible in: Standard display																												
Read permission:	Read drive data or acknowledge messages																												
Write permission:	Edit device configuration or drive applications																												
Parameter group:	Status parameters, Diagnostics general, Drive enable signals																												
Unit: -																													
Description:	Operating display for the drive.																												
Value:	<table style="width: 100%; border: none;"> <tr><td>0:</td><td>Operation - Everything enabled</td></tr> <tr><td>10:</td><td>Operation - Set "Enable setpoint" = "1"</td></tr> <tr><td>11:</td><td>Operation - Set "Enable speed controller" = "1"</td></tr> <tr><td>12:</td><td>Operation - RFG frozen, set "RFG start" = "1"</td></tr> <tr><td>13:</td><td>Operation - Set "Enable ramp-function generator" = "1"</td></tr> <tr><td>14:</td><td>Operation - MotID, excitation running or brake opens, SS2</td></tr> <tr><td>15:</td><td>Operation - Open brake (p1215)</td></tr> <tr><td>16:</td><td>Operation - Withdraw braking with OFF1 using "ON/OFF1" = "1"</td></tr> <tr><td>17:</td><td>Operation - Braking with OFF3 can only be interrupted with OFF2</td></tr> <tr><td>18:</td><td>Operation - Brake on fault, remove fault, acknowledge</td></tr> <tr><td>21:</td><td>Ready for operation - Set "Enable operation" = "1"</td></tr> <tr><td>22:</td><td>Ready for operation - De-magnetizing running</td></tr> <tr><td>23:</td><td>Ready for operation - Set "Infeed operation" = "1"</td></tr> <tr><td>31:</td><td>Ready for switching on - Set "ON/OFF1" = "0/1"</td></tr> </table>	0:	Operation - Everything enabled	10:	Operation - Set "Enable setpoint" = "1"	11:	Operation - Set "Enable speed controller" = "1"	12:	Operation - RFG frozen, set "RFG start" = "1"	13:	Operation - Set "Enable ramp-function generator" = "1"	14:	Operation - MotID, excitation running or brake opens, SS2	15:	Operation - Open brake (p1215)	16:	Operation - Withdraw braking with OFF1 using "ON/OFF1" = "1"	17:	Operation - Braking with OFF3 can only be interrupted with OFF2	18:	Operation - Brake on fault, remove fault, acknowledge	21:	Ready for operation - Set "Enable operation" = "1"	22:	Ready for operation - De-magnetizing running	23:	Ready for operation - Set "Infeed operation" = "1"	31:	Ready for switching on - Set "ON/OFF1" = "0/1"
0:	Operation - Everything enabled																												
10:	Operation - Set "Enable setpoint" = "1"																												
11:	Operation - Set "Enable speed controller" = "1"																												
12:	Operation - RFG frozen, set "RFG start" = "1"																												
13:	Operation - Set "Enable ramp-function generator" = "1"																												
14:	Operation - MotID, excitation running or brake opens, SS2																												
15:	Operation - Open brake (p1215)																												
16:	Operation - Withdraw braking with OFF1 using "ON/OFF1" = "1"																												
17:	Operation - Braking with OFF3 can only be interrupted with OFF2																												
18:	Operation - Brake on fault, remove fault, acknowledge																												
21:	Ready for operation - Set "Enable operation" = "1"																												
22:	Ready for operation - De-magnetizing running																												
23:	Ready for operation - Set "Infeed operation" = "1"																												
31:	Ready for switching on - Set "ON/OFF1" = "0/1"																												

35:	Switching on inhibited - Carry out first commissioning
41:	Switching on inhibited - Set "ON/OFF1" = "0"
42:	Switching on inhibited - Set "Operating condition/OFF2" = "1"
43:	Switching on inhibited - Set "Operating condition/OFF3" = "1"
44:	Switching on inhibited - Supply STO terminal w/ 24 V (hardware)
45:	Switching on inhibited - Rectify fault, acknowledge fault, STO
46:	Switching on inhibited - Exit commissioning mode
60:	Drive deactivated/not operational
70:	Initialization
200:	Wait for booting/partial booting
250:	Device signals a topology error

Dependency: See also: r0046

NOTICE

For several missing enable signals, the corresponding value with the highest number is displayed.

Note

OC: Operating condition
 EP: Enable Pulses (pulse enable)
 RFG: Ramp-function generator
 COM: Commissioning
 MotID: Motor data identification

r0020**Speed setpoint smoothed**

Data type: FloatingPoint32 **Visible in:** Standard display
Read permission: Read drive data or acknowledge messages
Write permission: Edit device configuration or drive applications
Parameter group: Mode signals / displays
Unit: rpm

Description: Displays the currently smoothed speed setpoint at the input of the speed controller or U/f characteristic (after the interpolator).

Dependency: See also: r1438

Note

Smoothing time constant = 100 ms
 The signal is not suitable as a process quantity and may only be used as a display quantity.
 The speed setpoint is available smoothed (r0020) and unsmoothed (r1438).

r0021**Speed actual value smoothed**

Data type: FloatingPoint32 **Visible in:** Standard display
Read permission: Read drive data or acknowledge messages
Write permission: Edit device configuration or drive applications
Parameter group: Diagnostics, Mode signals / displays
Unit: rpm

Description: Display for the smoothed actual value of the motor speed.

Dependency: See also: r0063

Note

Smoothing time constant = 100 ms
 The speed actual value is available smoothed (r0021) and unsmoothed (r0063).

r0026

DC link voltage smoothed

Data type: FloatingPoint32 **Visible in:** Standard display
Read permission: Read drive data or acknowledge messages
Write permission: Edit device configuration or drive applications
Parameter group: Brake control, Mode signals / displays
Unit: V

Description: Displays the smoothed actual value of the DC link voltage.

Dependency: See also: r0070

NOTICE
This smoothed signal is not suitable for diagnostics or evaluation of dynamic operations. In this case, the unsmoothed value should be used.

Note
Smoothing time constant = 100 ms
The signal is not suitable as a process quantity and may only be used as a display quantity.
The DC link voltage is available smoothed (r0026) and unsmoothed (r0070).

r0027

Absolute actual current smoothed

Data type: FloatingPoint32 **Visible in:** Standard display
Read permission: Read drive data or acknowledge messages
Write permission: Edit device configuration or drive applications
Parameter group: Mode signals / displays, Power unit
Unit: Arms

Description: Displays the smoothed absolute current actual value.

Dependency: See also: r0068

NOTICE
This smoothed signal is not suitable for diagnostics or evaluation of dynamic operations. In this case, the unsmoothed value should be used.

Note
A_INF, S_INF, VECTOR: Smoothing time constant = 300 ms
SERVO: Smoothing time constant = 100 ms
The signal is not suitable as a process quantity and may only be used as a display quantity.
The absolute current actual value is available smoothed (r0027) and unsmoothed (r0068).

r0031

Actual torque smoothed

Data type: FloatingPoint32 **Visible in:** Standard display
Read permission: Read drive data or acknowledge messages
Write permission: Edit device configuration or drive applications
Parameter group: Brake control, Mode signals / displays
Unit: Nm

Description: Displays the smoothed torque actual value.

Dependency: See also: r0080

Note
Smoothing time constant = 100 ms
The signal is not suitable as a process quantity and may only be used as a display quantity.
The torque actual value is available smoothed (r0031) and unsmoothed (r0080).

r0032	Active power actual value smoothed
Data type: FloatingPoint32	Visible in: Standard display
Read permission:	Read drive data or acknowledge messages
Write permission:	Edit device configuration or drive applications
Parameter group:	Mode signals / displays
Unit: kW	
Description:	Display for the smoothed actual value of the active power.
Dependency:	See also: r0082
<hr/>	
Note	
The active power is available smoothed (r0032 with 100 ms, r0082[1] with 1 ms) and unsmoothed (r0082[0]).	

r0034	Motor utilization thermal
Data type: FloatingPoint32	Visible in: Standard display
Read permission:	Read drive data or acknowledge messages
Write permission:	Edit device configuration or drive applications
Parameter group:	Motor temperature, Mode signals / displays
Unit: %	
Description:	Displays the thermal motor utilization taking into account the ambient temperature set in p0613.
Dependency:	See also: p0613 See also: F07011, A07012
<hr/>	
NOTICE	
After the drive is switched on, the system starts to determine the motor temperature with an assumed model value. This means that the value for the motor utilization is only valid after a stabilization time.	

r0036[0...2]	Power unit overload
Data type: FloatingPoint32	Visible in: Extended display
Read permission:	Read drive data or acknowledge messages
Write permission:	Edit device configuration or drive applications
Parameter group:	Mode signals / displays, Power unit
Unit: %	
Description:	Display when the power unit is overloaded. A reference value is defined for the monitoring functions. An overload (0 %) is not displayed if the reference value is not exceeded. The display value increases if the reference value is exceeded. An alarm is output if an overload is active over a certain time period; a fault is output when 100% is reached.
Index:	[0] = I2t (AC) [1] = Reserved [2] = Reserved
Dependency:	See also: p0290 See also: F30005, A30256, A30257, F30258, A30267, F30268

Note

For index [0]:

This index shows the actual state of the I2t monitoring on the AC side.

The reference value represents the AC current that the power unit can permanently provide, without the influence of switching losses (e.g. the continuously permissible current of capacitors, inductances, busbars, etc.).

For index [1]:

This index shows the actual state of the active power monitoring.

The reference value represents the active power that the power unit can continuously provide.

For index [2]:

This index shows the actual state of the I2t monitoring on the DC side.

The reference value represents the DC current that can continuously flow in the DC link.

r0037[0...10]

Power unit temperatures

Data type: FloatingPoint32

Visible in: Extended display

Read permission:

Read drive data or acknowledge messages

Write permission:

Edit device configuration or drive applications

Parameter group:

Mode signals / displays, Power unit

Unit: °C

Description:

Display for the temperatures in the power unit.

Index:

[0] = Inverter maximum value

[1] = Depletion layer maximum value

[2] = Rectifier maximum value

[3] = Air intake

[4] = Interior of power unit

[5] = Cooling unit liquid intake

[6] = Capacitor air discharge

[7] = Depletion layer maximum value 1

[8] = Depletion layer maximum value 2

[9] = Depletion layer maximum value 3

[10] = Depletion layer maximum value 4

Note

The value of -200 indicates that there is no measuring signal.

r0037[0]: Maximum value of the inverter temperatures.

r0037[1]: Maximum value of the depletion layer temperatures.

In the case of a fault, the particular shutdown threshold depends on the power unit, and cannot be read out.

r0039[0...2]

Energy display

Data type: FloatingPoint32

Visible in: Standard display

Read permission:

Read drive data or acknowledge messages

Write permission:

Edit device configuration or drive applications

Parameter group:

Mode signals / displays, Power loss optimization

Unit: kWh

Description:

Display for the energy values at the drive output terminals.

Index:

[0] = Energy balance (sum)

[1] = Energy drawn

[2] = Energy fed back

Note

For index [0]:

Difference between the energy drawn and energy that is fed back.

r0044	Thermal converter utilization
Data type:	FloatingPoint32
Visible in:	Standard display
Read permission:	Read drive data or acknowledge messages
Write permission:	Edit device configuration or drive applications
Parameter group:	Mode signals / displays, Power unit
Unit:	%
Description:	Displays the thermal converter utilization as a percentage. With this value, various thermal monitoring functions are taken into account.
Dependency:	See also: r0034
<hr/>	
Note	
The thermal motor utilization is displayed in parameter r0034.	

r0046.0...30	Missing enable signal																																																																
Data type:	Unsigned32																																																																
Visible in:	Standard display																																																																
Read permission:	Read drive data or acknowledge messages																																																																
Write permission:	Edit device configuration or drive applications																																																																
Parameter group:	Control/status words, Drive enable signals																																																																
Unit:	-																																																																
Description:	Displays the missing enable signals. All enable signals are required to operate the drive. The enable signals are set by the control.																																																																
Bit array:	<table> <thead> <tr> <th>Bit</th> <th>Signal name</th> <th>1 signal</th> <th>0 signal</th> </tr> </thead> <tbody> <tr> <td>00</td> <td>OFF1 enable missing</td> <td>Yes</td> <td>No</td> </tr> <tr> <td>01</td> <td>OFF2 enable missing</td> <td>Yes</td> <td>No</td> </tr> <tr> <td>02</td> <td>OFF3 enable missing</td> <td>Yes</td> <td>No</td> </tr> <tr> <td>03</td> <td>Operation enable missing</td> <td>Yes</td> <td>No</td> </tr> <tr> <td>08</td> <td>Safety enable missing</td> <td>Yes</td> <td>No</td> </tr> <tr> <td>10</td> <td>Ramp-function generator enable missing</td> <td>Yes</td> <td>No</td> </tr> <tr> <td>12</td> <td>Speed setpoint enable missing</td> <td>Yes</td> <td>No</td> </tr> <tr> <td>16</td> <td>OFF1 enable internal missing</td> <td>Yes</td> <td>No</td> </tr> <tr> <td>17</td> <td>OFF2 enable internal missing</td> <td>Yes</td> <td>No</td> </tr> <tr> <td>18</td> <td>OFF3 enable internal missing</td> <td>Yes</td> <td>No</td> </tr> <tr> <td>19</td> <td>Pulse enable internal missing</td> <td>Yes</td> <td>No</td> </tr> <tr> <td>21</td> <td>STOP2 enable internal missing</td> <td>Yes</td> <td>No</td> </tr> <tr> <td>26</td> <td>Drive inactive or not operational</td> <td>Yes</td> <td>No</td> </tr> <tr> <td>28</td> <td>Brake open missing</td> <td>Yes</td> <td>No</td> </tr> <tr> <td>30</td> <td>Speed controller enable missing</td> <td>Yes</td> <td>No</td> </tr> </tbody> </table>	Bit	Signal name	1 signal	0 signal	00	OFF1 enable missing	Yes	No	01	OFF2 enable missing	Yes	No	02	OFF3 enable missing	Yes	No	03	Operation enable missing	Yes	No	08	Safety enable missing	Yes	No	10	Ramp-function generator enable missing	Yes	No	12	Speed setpoint enable missing	Yes	No	16	OFF1 enable internal missing	Yes	No	17	OFF2 enable internal missing	Yes	No	18	OFF3 enable internal missing	Yes	No	19	Pulse enable internal missing	Yes	No	21	STOP2 enable internal missing	Yes	No	26	Drive inactive or not operational	Yes	No	28	Brake open missing	Yes	No	30	Speed controller enable missing	Yes	No
Bit	Signal name	1 signal	0 signal																																																														
00	OFF1 enable missing	Yes	No																																																														
01	OFF2 enable missing	Yes	No																																																														
02	OFF3 enable missing	Yes	No																																																														
03	Operation enable missing	Yes	No																																																														
08	Safety enable missing	Yes	No																																																														
10	Ramp-function generator enable missing	Yes	No																																																														
12	Speed setpoint enable missing	Yes	No																																																														
16	OFF1 enable internal missing	Yes	No																																																														
17	OFF2 enable internal missing	Yes	No																																																														
18	OFF3 enable internal missing	Yes	No																																																														
19	Pulse enable internal missing	Yes	No																																																														
21	STOP2 enable internal missing	Yes	No																																																														
26	Drive inactive or not operational	Yes	No																																																														
28	Brake open missing	Yes	No																																																														
30	Speed controller enable missing	Yes	No																																																														
Dependency:	See also: r0002																																																																

Note

The value r0046 = 0 indicates that all enable signals for this drive are present.

Bit 00 = 1 (enable signal missing), if:

- OFF1 from the PROFINET interface missing.
- Switching on inhibited is active.

Bit 01 = 1 (enable signal missing), if:

- OFF2 from the PROFINET interface missing.

Bit 02 = 1 (enable signal missing), if:

- OFF3 from the PROFINET interface missing.

Bit 03 = 1 (enable signal missing), if:

- "Enable operation" from the PROFINET interface missing.

Bit 08 = 1 (enable signal missing), if:

- Safety functions have been enabled and STO is active.
- A safety-relevant message with STO as response is active.

STO enabled via terminals:

- Pulse enable via the STO terminals has a 0 signal.
- Additional details relating to the reason that STO was selected, see parameter r10352.

Bit 10 = 1 (enable signal missing), if:

- "Enable ramp-function generator" from the PROFINET interface missing.

Bit 12 = 1 (enable signal missing), if:

- "Enable setpoint" from the PROFINET interface missing.

Bit 16 = 1 (enable signal missing), if:

- There is an OFF1 fault response. The system is only enabled if the fault is removed and was acknowledged and the "switching on inhibited" withdrawn with OFF1 = 0.

Bit 17 = 1 (enable signal missing), if:

- The commissioning mode is selected.
- There is an OFF2 fault response.
- The drive is inactive or not capable of operation.

Bit 18 = 1 (enable signal missing), if:

- OFF3 has still not been completed or an OFF3 fault response is present.

Bit 19 = 1 (internal pulse enable missing), if:

- Synchronization still not completed.

Bit 21 = 1 (enable signal missing), if:

The pulses have been enabled and the speed setpoint has still not been enabled, because:

- The holding brake opening time has still not elapsed.
- The encoder has not been calibrated (synchronous motor).

Bit 26 = 1 (enable signal missing), if:

- The drive is inactive or not capable of operation.
- The drive device is in the "PROFenergy energy-saving mode".

Bit 28 = 1 (enable signal missing), if:

- The holding brake is closed or has still not been opened.

Bit 30 = 1 (speed controller inhibited), if one of the following applies:

- Pulse enable missing

- The function generator with current input is active.
- The measuring function "current controller reference frequency characteristic" is active.
- The pole position identification is active.
- Motor data identification is active (only certain steps).

r0060	Speed setpoint before the setpoint filter
	Data type: FloatingPoint32 Visible in: Extended display
	Read permission: Read drive data or acknowledge messages
	Write permission: Edit device configuration or drive applications
	Parameter group: Mode signals / displays, Speed setpoint filter
	Unit: rpm
Description:	Displays the currently unsmoothed speed setpoint at the input of the speed controller or U/f characteristic (after the interpolator).

r0061[0...1]	Actual speed unsmoothed
	Data type: FloatingPoint32 Visible in: Extended display
	Read permission: Read drive data or acknowledge messages
	Write permission: Edit device configuration or drive applications
	Parameter group: Motor encoder, Mode signals / displays
	Unit: rpm
Description:	Displays the unsmoothed speed actual values sensed by the encoders.
Index:	[0] = Motor encoder [1] = Encoder 2

r0062	Speed setpoint after the filter
	Data type: FloatingPoint32 Visible in: Extended display
	Read permission: Read drive data or acknowledge messages
	Write permission: Edit device configuration or drive applications
	Parameter group: U/f control, Speed controller, Mode signals / displays, Speed setpoint filter
	Unit: rpm
Description:	Display and numerical signal source for the speed setpoint after the setpoint filters.

r0063	Speed actual value smoothed
	Data type: FloatingPoint32 Visible in: Extended display
	Read permission: Read drive data or acknowledge messages
	Write permission: Edit device configuration or drive applications
	Parameter group: U/f control, Speed controller, Speed actual value filter, Mode signals / displays
	Unit: rpm
Description:	Display for the smoothed speed actual value.
Dependency:	See also: r0021, r0061, p1441

Note

The smoothing time is set in p1441.

The speed actual value is available strongly smoothed (r0021) and unsmoothed (r0061).

r0068	Absolute current actual value		
	Data type: FloatingPoint32 Visible in: Extended display Read permission: Read drive data or acknowledge messages Write permission: Edit device configuration or drive applications Parameter group: Mode signals / displays Unit: Arms		
Description:	Displays actual absolute current.		
Dependency:	See also: r0027		
	<table border="1"> <tr> <td>NOTICE</td> </tr> <tr> <td>For A_INF, S_INF the following applies: The value is updated with the current controller sampling time. The following applies for SERVO: The value is updated with a sampling time of 1 ms.</td> </tr> </table>	NOTICE	For A_INF, S_INF the following applies: The value is updated with the current controller sampling time. The following applies for SERVO: The value is updated with a sampling time of 1 ms.
NOTICE			
For A_INF, S_INF the following applies: The value is updated with the current controller sampling time. The following applies for SERVO: The value is updated with a sampling time of 1 ms.			
	Note Absolute current value = $\sqrt{I_q^2 + I_d^2}$ The absolute current actual value is available smoothed (r0027) and unsmoothed (r0068).		
r0070	Actual DC link voltage		
	Data type: FloatingPoint32 Visible in: Extended display Read permission: Read drive data or acknowledge messages Write permission: Edit device configuration or drive applications Parameter group: Vdc-min/max controller, Mode signals / displays, Power unit, Vdc controller Unit: V		
Description:	Display and numerical signal source for the measured actual value of the DC link voltage.		
Dependency:	See also: r0026		
	Note The DC link voltage is available smoothed (r0026) and unsmoothed (r0070).		
r0072	Output voltage		
	Data type: FloatingPoint32 Visible in: Extended display Read permission: Read drive data or acknowledge messages Write permission: Edit device configuration or drive applications Parameter group: U/f control, Current controller, Mode signals / displays, Power unit Unit: Vrms		
Description:	Display for the actual output voltage of the power unit.		
r0076	Current actual value field-generating		
	Data type: FloatingPoint32 Visible in: Extended display Read permission: Read drive data or acknowledge messages Write permission: Edit device configuration or drive applications Parameter group: U/f control, Current controller, Mode signals / displays Unit: Arms		
Description:	Display for the field-generating current actual value.		

r0077	Current setpoint torque-generating
Data type: FloatingPoint32	Visible in: Extended display
Read permission:	Read drive data or acknowledge messages
Write permission:	Edit device configuration or drive applications
Parameter group:	Current controller, Mode signals / displays
Unit: Arms	
Description:	Display and numerical signal source for the torque/force-generating current setpoint.
	Note
	This value is irrelevant for the U/f control mode.

r0078[0...1]	Current actual value torque-generating
Data type: FloatingPoint32	Visible in: Extended display
Read permission:	Read drive data or acknowledge messages
Write permission:	Edit device configuration or drive applications
Parameter group:	Mode signals / displays
Unit: Arms	
Description:	Display for the actual value of the torque-generating current Iq.
Index:	[0] = Unsmoothed [1] = Smoothed with 1 ms

r0079[0...1]	Torque setpoint total
Data type: FloatingPoint32	Visible in: Extended display
Read permission:	Read drive data or acknowledge messages
Write permission:	Edit device configuration or drive applications
Parameter group:	Torque limiting, Mode signals / displays
Unit: Nm	
Description:	Display for the torque setpoint at the output of the speed controller.
Index:	[0] = Unsmoothed [1] = Smoothed with 1 ms

r0080	Torque actual value
Data type: FloatingPoint32	Visible in: Extended display
Read permission:	Read drive data or acknowledge messages
Write permission:	Edit device configuration or drive applications
Parameter group:	Motor model, Mode signals / displays
Unit: Nm	
Description:	Display and numerical signal source for the torque actual value.
Dependency:	See also: r0031
	Note
	The value is available smoothed (r0031) and unsmoothed (r0080).

r0081	Torque utilization
Data type: FloatingPoint32	Visible in: Extended display
Read permission:	Read drive data or acknowledge messages
Write permission:	Edit device configuration or drive applications
Parameter group:	Torque limiting, Mode signals / displays
Unit: %	

Description: Displays the torque utilization as a percentage.
The torque utilization is obtained from the required smoothed torque referred to the torque limit.

Note

The torque utilization is obtained from the required torque referred to the torque limit as follows:
- Positive torque: $r0081 = ((r0079 + p1532) / (r1538 - p1532)) * 100 \%$
- Negative torque: $r0081 = ((-r0079 + p1532) / (-r1539 + p1532)) * 100 \%$
The calculation of the torque utilization depends on the selected smoothing time constant (1 ms).

r0082[0...3] Active power actual value

Data type: FloatingPoint32 **Visible in:** Extended display
Read permission: Read drive data or acknowledge messages
Write permission: Edit device configuration or drive applications
Parameter group: Mode signals / displays
Unit: kW

Description: Displays the actual active power.

Index: [0] = Unsmoothed
[1] = Smoothed with 1 ms
[2] = Power drawn
[3] = Power drawn smoothed

Dependency: See also: r0032

Note

The mechanical active power is available smoothed (r0032 with 100 ms, r0082[1] with 1 ms) and unsmoothed (r0082[0]).

For index [3]:
Smoothing time constant = 0.25 ms

r0196[0...255].0...15 Topology component status

Data type: Unsigned32 **Visible in:** Extended display
Read permission: Read drive data or acknowledge messages
Write permission: Edit device configuration or drive applications
Parameter group: Diagnostics general
Unit: -

Description: Displays the status of the components.
r0196[0]: Group status of all components
r0196[1]: Status of component with component number 1
...
r0196[255]: Status of component with component number 255

Bit array:	Bit	Signal name	1 signal	0 signal
	00	Component status bit 0	High	Low
	01	Component status bit 1	High	Low
	02	Component status bit 2	High	Low
	03	Component status bit 3	High	Low
	04	Component state	Active	Inactive/parking
	06	Topology problem active	Yes	No
	07	Part of the target topology	Yes	No only act topo
	08	Alarm present	Yes	No
	09	Safety message present	Yes	No
	10	Fault present	Yes	No
	11	Alarm class bit 0	High	Low
	12	Alarm class bit 1	High	Low

A.3 Parameters

13	Maintenance required	Yes	No
14	Maintenance urgently required	Yes	No
15	Fault gone/can be acknowledged	Yes	No

Note

For bit 03 ... 00:

Bit 3, 2, 1, 0 = 0, 0, 0, 0 --> component not available.

Bit 3, 2, 1, 0 = 0, 0, 0, 1 --> power up, non-cyclic DRIVE-CLiQ communication (LED = orange).

Bit 3, 2, 1, 0 = 0, 0, 1, 0 --> operating mode, cyclic DRIVE-CLiQ communication (LED = green).

Bit 3, 2, 1, 0 = 0, 0, 1, 1 --> alarm (LED = green).

Bit 3, 2, 1, 0 = 0, 1, 0, 0 --> fault (LED = red).

Bit 3, 2, 1, 0 = 0, 1, 0, 1 --> detection via LED and operating mode (LED = green/orange).

Bit 3, 2, 1, 0 = 0, 1, 1, 0 --> detection via LED and alarm (LED = green/orange).

Bit 3, 2, 1, 0 = 0, 1, 1, 1 --> detection via LED and fault (LED = red/orange).

Bit 3, 2, 1, 0 = 1, 0, 0, 0 --> firmware being downloaded (LED = green/red with 0.5 Hz).

Bit 3, 2, 1, 0 = 1, 0, 0, 1 --> firmware download completed, wait for POWER ON (LED = green/red with 2.0 Hz).

For bits 12 ... 11:

These status bits are used for the classification of internal alarm classes and are intended for diagnostic purposes only on certain automation systems with integrated SINAMICS functionality.

p0201[0]

Power unit code number

Data type: Unsigned16	Visible in: Extended display	
Read permission:	Read drive data or acknowledge messages	
Write permission:	Edit device configuration or drive applications	
Can be changed in the operating state:	Commissioning	
Parameter group:	Power unit	
Unit: -		
Min:	Max:	Factory setting:
0	65535	0

Description: Sets the actual code number of the power unit being used.

p0210

Device supply voltage

Data type: Unsigned16	Visible in: Standard display	
Read permission:	Read drive data or acknowledge messages	
Write permission:	Edit device configuration or drive applications	
Can be changed in the operating state:	Ready for operation	
Parameter group:	Power unit, Quick commissioning	
Unit: V		
Min:	Max:	Factory setting:
1 [V]	63000 [V]	400 [V]

Description: Sets the device supply voltage.
 The voltage between two phases should be entered as the device supply voltage.
 This setting is important for operating with voltages that are less than the voltage range for which the drive is designed.

Note

Setting ranges for p0210 as a function of the rated power unit voltage:

U_{rated} = 230 V:

- p0210 = 200 ... 240 V

U_{rated} = 400 V:

- p0210 = 380 ... 480 V (wide voltage range, in addition to 200 ... 240 V)

r0277[0]	<p>Power unit heat sink fan wear counter</p> <p>Data type: FloatingPoint32 Visible in: Extended display</p> <p>Read permission: Read drive data or acknowledge messages</p> <p>Write permission: Edit device configuration or drive applications</p> <p>Parameter group: Power unit</p> <p>Unit: %</p> <p>Description: Displays the wear counter of the heat sink fan in the power unit. After a fan has been replaced, using an appropriate button, the value can be reset in the commissioning tool to 0.</p> <p>Dependency: See also: A30042</p>
-----------------	--

p0290	<p>Power unit overload response</p> <p>Data type: Integer16 Visible in: Extended display</p> <p>Read permission: Read drive data or acknowledge messages</p> <p>Write permission: Edit device configuration or drive applications</p> <p>Can be changed in the operating state: Ready for operation</p> <p>Parameter group: Power unit</p> <p>Unit: -</p> <table border="0" style="width: 100%;"> <tr> <td style="width: 33%;">Min:</td> <td style="width: 33%;">Max:</td> <td style="width: 33%;">Factory setting:</td> </tr> <tr> <td>0</td> <td>1</td> <td>0</td> </tr> </table>	Min:	Max:	Factory setting:	0	1	0
Min:	Max:	Factory setting:					
0	1	0					

Description:	<p>Sets the response to a thermal overload condition of the power unit.</p> <p>The following quantities can result in a response to thermal overload:</p> <ul style="list-style-type: none"> - Heat sink temperature (r0037[0]). - Chip temperature (r0037[1]). - Power unit overload I2t (r0036). <p>Possible measures to avoid thermal overload:</p> <ul style="list-style-type: none"> - Reduce the output current limit r0289 and r0067 (for closed-loop speed/velocity or torque/force control) or the output frequency (for U/f control indirectly via the output current limit and the intervention of the current limiting controller). - Reduce the pulse frequency. <p>A reduction, if parameterized, is always realized after an appropriate alarm is output.</p> <p>For p0290 = 0:</p> <p>When a temperature alarm threshold is exceeded, the output current is reduced, and in turn, the output frequency. If the current reduction is not sufficient to thermally relieve the power unit, when the drive reaches the temperature fault threshold it switches off.</p> <p>This setting is not suitable for drives requiring a constant torque.</p> <p>Application: pumps, fans</p> <p>For p0290 = 1:</p> <p>The power unit operates at the required operating point. When the fault threshold is reached, the drive switches off and an appropriate fault is output.</p> <p>Application: Drive applications where, as a result of the underlying process, no setpoint deviations of individual drives in the group are permitted - or where the pulse frequency must be strictly maintained.</p> <p>For p0290 = 2:</p> <p>The pulse frequency is reduced to a permissible minimum when a temperature alarm threshold is exceeded. If the pulse frequency reduction is not sufficient to thermally relieve the power unit, then the output current is also reduced.</p> <p>Application: Drives with a low dynamic performance and occasional overload where speed deviations are permissible.</p> <p>For p0290 = 3:</p> <p>Only the pulse frequency is reduced to a permissible minimum when a temperature alarm threshold is exceeded.</p> <p>Application: Drives with a low dynamic performance and occasional overload where a speed deviation is not permissible.</p> <p>For p0290 = 10:</p> <p>For Booksize devices, in addition to the heat sink and chip temperatures, the difference between the two temperatures is monitored as an additional variable. When a temperature threshold is exceeded, the output current is reduced - and in turn, the output frequency.</p> <p>This overload response is activated as default setting for Booksize devices with a pulse frequency higher than or equal to 16 kHz.</p> <p>For p0290 = 12:</p> <p>In this particular case, the chip temperature is evaluated based on the actual load. If the temperature exceeds this alarm threshold, then the pulse frequency is reduced to a permissible minimum. The output current is only reduced if the actual chip temperature increases above a certain temperature threshold.</p> <p>Application: Drives that are frequently started and accelerated - and which manifest a significantly fluctuating torque profile (e.g. centrifuges, flywheel presses, cranes).</p> <p>For p0290 = 13:</p> <p>In this particular case, the chip temperature is evaluated based on the actual load. If the temperature exceeds this alarm threshold, then the pulse frequency is reduced to a permissible minimum.</p> <p>Application: Drives that are frequently started and accelerated - and which manifest a significantly fluctuating torque profile, and where the output current is not to be reduced (e.g. centrifuges, flywheel presses, cranes).</p>
Value:	<p>0: Reduce output current</p> <p>1: No reduction shutdown when overload threshold is reached</p>

Dependency: For a thermal power unit overload, an appropriate alarm or fault is output and r2135.15 or r2135.13 set. Settings, where the pulse frequency is reduced, are not possible if the "Extended torque control" function module (r0108.1) is activated.

For p0290 = 2, 3:
These responses are only applicable for blocksize power units.

For p0290 = 10:
This response is only applicable for booksize power units.

See also: r0036, r0037

NOTICE

If the thermal overload of the power unit is not sufficiently reduced by the actions taken, the drive is always shut down. This means that the power unit is always protected irrespective of the setting of this parameter.

Note

Under overload conditions, the current and torque limit are reduced, and therefore the motor is braked and forbidden speed ranges (e.g. minimum speed p1080 and suppression [skip] speeds p1091 ... p1094) can be passed through. When the motor data identification routine is selected, parameter p0290 cannot be changed.

For p0290 = 0, 2, 12:

This is setting is only practical if the load decreases with decreasing speed (e.g. for applications with variable torque such as for pumps and fans).

For p0290 = 2, 3, 12, 13:

The I2t overload detection of the power unit does not influence the response "Reduce pulse frequency".

For p0290 = 10, 12, 13:

The possible load duty cycles, calculated based on the previous model (p0290 = 0, 1, 2, 3) for booksize power units cannot be transferred in every case. This is the reason that we recommend that you contact our application support department if you are uncertain about dimensioning the device.

r0296**DC link voltage undervoltage threshold**

Data type: Unsigned16

Visible in: Extended display

Read permission:

Read drive data or acknowledge messages

Write permission:

Edit device configuration or drive applications

Parameter group:

Power unit

Unit: V

Description:

Threshold to detect a DC link undervoltage.

If the DC link voltage falls below this threshold, the drive unit is tripped due to a DC link undervoltage condition.

Dependency:

See also: F30003

Note

The actual threshold value depends on the device type and the selected device supply voltage (p0210).

r0297**DC link voltage overvoltage threshold**

Data type: Unsigned16

Visible in: Extended display

Read permission:

Read drive data or acknowledge messages

Write permission:

Edit device configuration or drive applications

Parameter group:

Power unit

Unit: V

Description:

Threshold to detect a DC link overvoltage.

If the DC link voltage exceeds the threshold specified here, the drive device is tripped due to DC link overvoltage.

Dependency:

See also: F30002

p0300[0]	Motor type selection		
	Data type: Integer16	Visible in: Standard display	
	Read permission:	Read drive data or acknowledge messages	
	Write permission:	Edit device configuration or drive applications	
	Can be changed in the operating state:	Commissioning	
	Parameter group:	Motor data, Quick commissioning	
	Unit: -		
	Min:	Max:	Factory setting:
	0	10000	0
Description:	Selects the motor type or start to read in the motor parameters for a motor with DRIVE-CLiQ (p0300 = 10000). The following applies for p0300 < 10000: The first digit of the parameter value always defines the general motor type and corresponds to the third-party motor belonging to a motor list: 2 = rotating synchronous motor		
Value:	0: No motor 2: Synchronous motor 2120: 1FL2 synchronous motor 10000: Motor with DRIVE-CLiQ		
Dependency:	See also: p0301		

p0301[0]	Motor code number selection		
	Data type: Unsigned32	Visible in: Standard display	
	Read permission:	Read drive data or acknowledge messages	
	Write permission:	Edit device configuration or drive applications	
	Can be changed in the operating state:	Commissioning	
	Parameter group:	Motor data, Quick commissioning	
	Unit: -		
	Min:	Max:	Factory setting:
	0	99999999	0
Description:	Code number of the connected motor, whose data was accepted when commissioning.		
Dependency:	Code numbers can only be selected for motor types that correspond to the motor type selected in p0300. See also: p0300		

r0302[0]	Motor code (identified)		
	Data type: Unsigned32	Visible in: Standard display	
	Read permission:	Read drive data or acknowledge messages	
	Write permission:	Edit device configuration or drive applications	
	Parameter group:	Motor data, Quick commissioning	
	Unit: -		
Description:	Displays the identified motor code number. When the drive powers up, the motor code is read out the motor. For r0302 = 0, the motor data were not identified.		

p0304[0]	Rated motor voltage		
	Data type: FloatingPoint32	Visible in: Standard display	
	Read permission:	Read drive data or acknowledge messages	
	Write permission:	Edit device configuration or drive applications	
	Can be changed in the operating state:	Commissioning	
	Parameter group:	Motor data, Quick commissioning	
	Unit: Vrms		
	Min: 0 [Vrms]	Max: 20000 [Vrms]	Factory setting: 0 [Vrms]
Description:	Displays the rated motor voltage.		
p0305[0]	Rated motor current		
	Data type: FloatingPoint32	Visible in: Standard display	
	Read permission:	Read drive data or acknowledge messages	
	Write permission:	Edit device configuration or drive applications	
	Can be changed in the operating state:	Commissioning	
	Parameter group:	Motor data, Quick commissioning	
	Unit: Arms		
	Min: 0.00 [Arms]	Max: 10000.00 [Arms]	Factory setting: 0.00 [Arms]
Description:	Displays the rated motor current.		
p0307[0]	Rated motor power		
	Data type: FloatingPoint32	Visible in: Standard display	
	Read permission:	Read drive data or acknowledge messages	
	Write permission:	Edit device configuration or drive applications	
	Can be changed in the operating state:	Commissioning	
	Parameter group:	Motor data, Quick commissioning	
	Unit: kW		
	Min: 0.00 [kW]	Max: 100000.00 [kW]	Factory setting: 0.00 [kW]
Description:	Displays the rated motor power.		
p0311[0]	Rated motor speed		
	Data type: FloatingPoint32	Visible in: Standard display	
	Read permission:	Read drive data or acknowledge messages	
	Write permission:	Edit device configuration or drive applications	
	Can be changed in the operating state:	Commissioning	
	Parameter group:	Motor data, Quick commissioning	
	Unit: rpm		
	Min: 0.0 [rpm]	Max: 210000.0 [rpm]	Factory setting: 0.0 [rpm]
Description:	Displays the rated motor speed.		

p0312[0]	Rated motor torque		
	Data type: FloatingPoint32	Visible in: Standard display	
	Read permission:	Read drive data or acknowledge messages	
	Write permission:	Edit device configuration or drive applications	
	Can be changed in the operating state:	Commissioning	
	Parameter group:	Motor data	
	Unit: Nm		
	Min:	Max:	Factory setting:
	0.00 [Nm]	1000000.00 [Nm]	0.00 [Nm]
Description:	Displays the rated motor torque.		

r0316[0]	Motor torque constant		
	Data type: FloatingPoint32	Visible in: Extended display	
	Read permission:	Read drive data or acknowledge messages	
	Write permission:	Edit device configuration or drive applications	
	Parameter group:	Motor data, Quick commissioning	
	Unit: Nm/A		
Description:	Sets the torque constant of the synchronous motor. r0316 = 0: The torque constant is calculated from the motor data. r0316 > 0: The selected value is used as torque constant.		

p0318[0]	Motor stall current		
	Data type: FloatingPoint32	Visible in: Extended display	
	Read permission:	Read drive data or acknowledge messages	
	Write permission:	Edit device configuration or drive applications	
	Can be changed in the operating state:	Commissioning	
	Parameter group:	Motor data	
	Unit: Arms		
	Min:	Max:	Factory setting:
	0.00 [Arms]	10000.00 [Arms]	0.00 [Arms]
Description:	Displays the rated motor stall current.		

p0319[0]	Motor static torque		
	Data type: FloatingPoint32	Visible in: Standard display	
	Read permission:	Read drive data or acknowledge messages	
	Write permission:	Edit device configuration or drive applications	
	Can be changed in the operating state:	Commissioning	
	Parameter group:	Motor data	
	Unit: Nm		
	Min:	Max:	Factory setting:
	0.00 [Nm]	100000.00 [Nm]	0.00 [Nm]
Description:	Displays the motor standstill/static torque.		

p0322[0]	Maximum motor speed		
	Data type: FloatingPoint32	Visible in: Extended display	
	Read permission:	Read drive data or acknowledge messages	
	Write permission:	Edit device configuration or drive applications	
	Can be changed in the operating state:	Commissioning	
	Parameter group:	Motor data, Quick commissioning	
	Unit: rpm		
	Min: 0.0 [rpm]	Max: 210000.0 [rpm]	Factory setting: 0.0 [rpm]
Description:	Displays the maximum motor speed.		
Dependency:	See also: p1082		

p0323[0]	Maximum motor current		
	Data type: FloatingPoint32	Visible in: Extended display	
	Read permission:	Read drive data or acknowledge messages	
	Write permission:	Edit device configuration or drive applications	
	Can be changed in the operating state:	Commissioning	
	Parameter group:	Motor data, Quick commissioning	
	Unit: Arms		
	Min: 0.00 [Arms]	Max: 20000.00 [Arms]	Factory setting: 0.00 [Arms]
Description:	Displays the maximum permissible motor current.		

r0341[0]	Motor moment of inertia		
	Data type: FloatingPoint32	Visible in: Extended display	
	Read permission:	Read drive data or acknowledge messages	
	Write permission:	Edit device configuration or drive applications	
	Parameter group:	Motor data, Speed controller	
	Unit: kgm ²		
Description:	Displays the motor moment of inertia (without load).		

p0400[0]	Encoder type selection		
	Data type: Integer16	Visible in: Standard display	
	Read permission:	Read drive data or acknowledge messages	
	Write permission:	Edit device configuration or drive applications	
	Can be changed in the operating state:	Commissioning	
	Parameter group:	Motor encoder, Quick commissioning	
	Unit: -		
	Min: 0	Max: 10100	Factory setting: 0
Description:	Selects the encoder from the list of encoder types supported.		
Value:	0:	No encoder	
	801:	Digital encoder interface AS17, singleturn	
	802:	Digital encoder interface AS21, singleturn	
	803:	Digital encoder interface AM21, multiturn 4096	
	9999:	User defined	

10100: Identify encoder (waiting)

NOTICE
An encoder type with p0400 < 9999 defines an encoder for which there is an encoder parameter list. When selecting a catalog encoder (p0400 < 9999) the parameters from the encoder parameter list cannot be changed (write protection).

Note

The connected encoder can be identified using p0400 = 10100. This means that the encoder must support this.

For p0400 = 10100 the following applies:

The connected encoder is identified. If identification is not possible, then p0400 remains set = 10100, and the system waits until identification is possible.

p0404[0].0...23 Encoder configuration effective

Data type: Unsigned32	Visible in: Standard display
Read permission:	Read drive data or acknowledge messages
Write permission:	Edit device configuration or drive applications
Can be changed in the operating state:	Commissioning
Parameter group:	Motor encoder
Unit: -	
Min: -	Max: -
	Factory setting: 0000 0000 0000 0000 0000 0000 0000 0000 0000 bin

Description:

Settings for the basic encoder properties.

Bit array:

Bit	Signal name	1 signal	0 signal
00	Linear encoder	Yes	No
01	Absolute encoder	Yes	No
02	Multiturn encoder	Yes	No
03	Track A/B square-wave	Yes	No
04	Track A/B sine	Yes	No
05	Track C/D	Yes	No
06	Hall sensor	Yes	No
08	EnDat encoder	Yes	No
09	SSI encoder	Yes	No
10	DRIVE-CLiQ encoder	Yes	No
11	Digital encoder	Yes	No
12	Equidistant zero mark	Yes	No
13	Irregular zero mark	Yes	No
14	Distance-coded zero mark	Yes	No
16	Acceleration	Yes	No
17	Track A/B analog	Yes	No
20	Voltage level 5 V	Yes	No
21	Voltage level 24 V	Yes	No
22	Remote sense (only SMC30)	Yes	No
23	Resolver excitation	Yes	No

NOTICE
This parameter is automatically pre-assigned for encoders from the encoder list and for identify encoder (p0400). When selecting a catalog encoder, this parameter cannot be changed (write protection). Information in p0400 should be carefully observed when removing write protection.

Note

For bit 01, 02 (absolute encoder, multiturn encoder):
These bits can only be selected for a DRIVE-CLiQ encoder.

For bit 10 (DRIVE-CLiQ encoder):

This bit is only used for the large-scale integrated DRIVE-CLiQ encoders that provide their encoder data directly in DRIVE-CLiQ format without converting this data. Therefore, this bit is not set for first generation DRIVE-CLiQ encoders.

p0408[0]

Rotary encoder pulse number

Data type: Unsigned32 **Visible in:** Standard display
Read permission: Read drive data or acknowledge messages
Write permission: Edit device configuration or drive applications
Can be changed in the operating state: Commissioning
Parameter group: Motor encoder
Unit: -

Min:	Max:	Factory setting:
0	16777215	1024

Description:

Sets the number of pulses for a rotary encoder.
In conjunction with the fine resolution, the pulse number defines the transfer format for position actual values Gn_XIST1 (r0479).

NOTICE
This parameter is automatically pre-assigned for encoders from the encoder list and for identify encoder (p0400).
When selecting a catalog encoder, this parameter cannot be changed (write protection).

Note

The smallest permissible value is 1 pulse.
This value does not always correspond to the pulse number of the measuring device. For a DEI encoder, a value is entered here that facilitates optimum transfer of the resolution (p0423).

p0421[0]

Absolute encoder rotary multiturn resolution

Data type: Unsigned32 **Visible in:** Standard display
Read permission: Read drive data or acknowledge messages
Write permission: Edit device configuration or drive applications
Can be changed in the operating state: Commissioning
Parameter group: Motor encoder
Unit: -

Min:	Max:	Factory setting:
0	4294967295	4096

Description:

Sets the number of revolutions that can be resolved for a rotary absolute encoder.

NOTICE
This parameter is automatically pre-assigned for encoders from the encoder list and for identify encoder (p0400).
When selecting a catalog encoder, this parameter cannot be changed (write protection). Information in p0400 should be carefully observed when removing write protection.

p0423[0] Absolute encoder rotary singleturn resolution

Data type: Unsigned32	Visible in: Standard display	
Read permission:	Read drive data or acknowledge messages	
Write permission:	Edit device configuration or drive applications	
Can be changed in the operating state:	Commissioning	
Parameter group:	Motor encoder	
Unit: -		
Min:	Max:	Factory setting:
0	1073741823	8192

Description: Sets the number of measuring steps per revolution for a rotary absolute encoder. The resolution refers to the absolute position.

NOTICE

This parameter is automatically pre-assigned for encoders from the encoder list and for identify encoder (p0400). When selecting a catalog encoder, this parameter cannot be changed (write protection). Information in p0400 should be carefully observed when removing write protection.

r0479[0...2] Diagnostics encoder position actual value Gn_XIST1

Data type: Integer32	Visible in: Standard display
Read permission:	Read drive data or acknowledge messages
Write permission:	Edit device configuration or drive applications
Parameter group:	Motor encoder
Unit: -	

Description: Display for the encoder position actual value Gn_XIST1 according to PROFIdrive for diagnostics. The value is displayed with sign.

Index: [0] = Motor encoder
[1] = Reserved
[2] = Reserved

p0488[0...2] Measuring probe 1 input terminal

Data type: Integer16	Visible in: Standard display	
Read permission:	Read drive data or acknowledge messages	
Write permission:	Edit device configuration or drive applications	
Can be changed in the operating state:	Operation	
Parameter group:	Measuring probe, Traversing blocks	
Unit: -		
Min:	Max:	Factory setting:
0	210	[0] 210 [1] 0 [2] 0

Description: Sets the input terminal to connect probe 1.

Value: 0: No measuring probe
210: DI 0 (X130.1)

Index: [0] = Motor encoder
[1] = Reserved
[2] = Reserved

Dependency: See also: p0489, p0490

 CAUTION
In order to prevent incorrect measurement values, these parameters may not be written during an active measurement.

Note

DI: Digital Input

Refer to the encoder interface for PROFIdrive.

If parameterization is rejected, check whether the terminal is already being used in p2517 or p2518.

p0489[0...2]**Measuring probe 2 input terminal****Data type:** Integer16**Visible in:** Standard display**Read permission:**

Read drive data or acknowledge messages

Write permission:

Edit device configuration or drive applications

Can be changed in the operating state: Operation**Parameter group:**

Measuring probe, Traversing blocks

Unit: -**Min:**

0

Max:

211

Factory setting:

[0] 211

[1] 0

[2] 0

Description: Sets the input terminal to connect probe 2.**Value:** 0: No measuring probe

211: DI 1 (X130.2)

Index:

[0] = Motor encoder

[1] = Reserved

[2] = Reserved

Dependency:

See also: p0488, p0490

 CAUTION
In order to prevent incorrect measurement values, these parameters may not be written during an active measurement.

Note

DI: Digital Input

Refer to the encoder interface for PROFIdrive.

If parameterization is rejected, check whether the terminal is already being used in p2517 or p2518.

p0490.0...1**Invert measuring probe or equivalent zero mark****Data type:** Unsigned32**Visible in:** Standard display**Read permission:**

Read drive data or acknowledge messages

Write permission:

Edit device configuration or drive applications

Can be changed in the operating state: Operation**Parameter group:**

Measuring probe

Unit: -**Min:**

-

Max:

-

Factory setting:

0000 bin

Description: Setting to invert the digital input signals to connect a measuring probe or an equivalent zero mark.**Bit array:****Bit** **Signal name**

00 DI 0 (X130.1)

01 DI 1 (X130.2)

1 signal

Inverted

Inverted

0 signal

Not inverted

Not inverted

Dependency:

See also: p0488, p0489, p0494

Note

The terminal must be set as input.

When the measuring probe or the equivalent zero mark is inverted, this has no effect on the status displays of the digital inputs (r0721, r0722).

DI: Digital Input

p0494[0]**Equivalent zero mark input terminal**

Data type: Integer16

Visible in: Standard display

Read permission:

Read drive data or acknowledge messages

Write permission:

Edit device configuration or drive applications

Can be changed in the operating state: Operation

Parameter group:

Motor encoder, Homing

Unit: -

Min:

0

Max:

211

Factory setting:

0

Description:

Selects the input terminal for connecting an equivalent zero mark (external encoder zero mark).

Value:

0: No equivalent zero mark (evaluation of the encoder zero mark)

210: DI 0 (X130.1)

211: DI 1 (X130.2)

Dependency:

See also: p0490

**CAUTION**

In order to prevent incorrect measurement values, these parameters may not be written during an active measurement.

Note

Refer to the encoder interface for PROFIdrive.

p0550[0]**Brake version**

Data type: Integer16

Visible in: Extended display

Read permission:

Read drive data or acknowledge messages

Write permission:

Edit device configuration or drive applications

Can be changed in the operating state: Commissioning

Parameter group:

Motor holding brake, Quick commissioning

Unit: -

Min:

0

Max:

2

Factory setting:

0

Description:

Sets the brake version.

Value:

0: No data

1: Holding brake

2: High performance holding brake

NOTICE

After entering a corresponding code number (p0551), this parameter is automatically pre-assigned and write protected. The information in p0551 should be observed when removing write protection.

Note

For p0550 = 1:

The default value for opening time/closing time applies.

For p0550 = 2:

A shorter opening time/closing time is realized if the power unit supports the function.

p0551[0]	Brake code number		
	Data type: Unsigned32	Visible in: Extended display	
	Read permission:	Read drive data or acknowledge messages	
	Write permission:	Edit device configuration or drive applications	
	Can be changed in the operating state:	Commissioning	
	Parameter group:	Motor holding brake, Quick commissioning	
	Unit: -		
	Min:	Max:	Factory setting:
	0	4294967295	1

Description: Display and setting the code number for the brake.
0 = No data
1 = Manual entry
> 1 = valid code number
For value = 0:
- Parameters listed under Dependent are set to a value of zero and are write protected.
- Parameters p1216, p1217 are set to a value of zero.
For value = 1:
- Write protection for the parameters listed under Dependent is withdrawn.
For value > 1:
- Parameters listed under Dependent are automatically pre-assigned and are write protected.
- Parameters p1216, p1217 are automatically appropriately pre-assigned.

Dependency: See also: p0550

Note
Only code numbers can be set that are permitted for the selected motor code (p0301).

p0613[0]	Mot_temp_mod 1/3 ambient temperature		
	Data type: FloatingPoint32	Visible in: Extended display	
	Read permission:	Read drive data or acknowledge messages	
	Write permission:	Edit device configuration or drive applications	
	Can be changed in the operating state:	Operation	
	Parameter group:	Motor temperature	
	Unit: °C		
	Min:	Max:	Factory setting:
	-40 [°C]	100 [°C]	20 [°C]

Description: If the thermal motor model is activated for permanent-magnet synchronous motors, then the parameter is incorporated in the model calculation if a temperature sensor is not being used.

Dependency: See also: F07011, A07012

Note
If the thermal motor model is activated for permanent-magnet synchronous motors, then the parameter is incorporated in the model calculation if a temperature sensor is not being used.

r0721.0...3	CU digital inputs terminal actual value		
	Data type: Unsigned32	Visible in: Standard display	
	Read permission:	Read drive data or acknowledge messages	
	Write permission:	Edit device configuration or drive applications	
	Parameter group:	Digital inputs	
	Unit: -		

Description: Displays the actual value at the digital inputs.
This means that the actual input signal can be checked at terminal DI x prior to switching from the simulation mode (p0795.x = 1) to the terminal mode (p0795.x = 0).

Bit array:	Bit	Signal name	1 signal	0 signal
	00	DI 0 (X130.1)	High	Low
	01	DI 1 (X130.2)	High	Low
	02	DI 2 (X130.3)	High	Low
	03	DI 3 (X130.4)	High	Low

Note

DI: Digital Input

r0722.0...3**Digital inputs status**

Data type: Unsigned32 **Visible in:** Standard display
Read permission: Read drive data or acknowledge messages
Write permission: Edit device configuration or drive applications
Parameter group: Digital inputs
Unit: -

Description: Display and signal source for the status of the digital inputs.

Bit array:	Bit	Signal name	1 signal	0 signal
	00	DI 0 (X130.1)	High	Low
	01	DI 1 (X130.2)	High	Low
	02	DI 2 (X130.3)	High	Low
	03	DI 3 (X130.4)	High	Low

Dependency: See also: p0488, p0489

NoteDI: Digital Input
For bits 00, 01: DI 0 and DI 1 are fast digital inputs and can be used as measuring probe (p0488, p0489).**c0730****Signal for terminal DO 1**

Data type: Unsigned8 **Visible in:** Standard display
Read permission: Read drive data or acknowledge messages
Write permission: Edit device configuration or drive applications
Parameter group: Relay outputs, Digital outputs
Unit: -

Description: Signal for terminal DO 0 (X130.11/12).

Note

DO: Digital Output

c0731**CU signal source for terminal DO 2**

S200 PN **Data type:** Unsigned8 **Visible in:** Standard display
Read permission: Read drive data or acknowledge messages
Write permission: Edit device configuration or drive applications
Parameter group: Relay outputs, Digital outputs
Unit: -

Description: Signal for terminal DO 1 (X130.13/14).

Note

DO: Digital Output

r0747.0	Digital outputs status		
S200 Basic PN	Data type: Unsigned32	Visible in: Standard display	
	Read permission:	Read drive data or acknowledge messages	
	Write permission:	Edit device configuration or drive applications	
	Parameter group:	Relay outputs, Digital outputs	
	Unit: -		
Description:	Displays the status of digital outputs.		
Bit array:	Bit	Signal name	1 signal
	00	DO 0 (DO+: X130.11 / DO-: X130.12)	High
			0 signal
			Low
	Note		
	DO: Digital Output		

r0747.0...1	Digital outputs status		
S200 PN	Data type: Unsigned32	Visible in: Standard display	
	Read permission:	Read drive data or acknowledge messages	
	Write permission:	Edit device configuration or drive applications	
	Parameter group:	Relay outputs, Digital outputs	
	Unit: -		
Description:	Displays the status of digital outputs.		
Bit array:	Bit	Signal name	1 signal
	00	DO 0 (DO+: X130.11 / DO-: X130.12)	High
	01	DO 1 (DO+: X130.13 / DO-: X130.14)	High
			0 signal
			Low
	Note		
	DO: Digital Output		

p0795.0...3	Digital inputs simulation mode		
	Data type: Unsigned32	Visible in: Standard display	
	Read permission:	Read drive data or acknowledge messages	
	Write permission:	Edit device configuration or drive applications	
	Can be changed in the operating state:	Operation	
	Parameter group:	Digital inputs	
	Unit: -		
	Min:	Max:	Factory setting:
	-	-	0000 bin
Description:	Sets the simulation mode for digital inputs.		
Bit array:	Bit	Signal name	1 signal
	00	DI 0 (X130.1)	Simulation
	01	DI 1 (X130.2)	Simulation
	02	DI 2 (X130.3)	Simulation
	03	DI 3 (X130.4)	Simulation
			0 signal
			Terminal eval
Dependency:	The setpoint for the input signals is specified using p0796. See also: p0796		
	Note		
	This parameter is not saved when backing up data (p0977). DI: Digital Input		

p0796.0...3	Digital inputs simulation mode setpoint		
	Data type: Unsigned32	Visible in: Standard display	
	Read permission:	Read drive data or acknowledge messages	
	Write permission:	Edit device configuration or drive applications	
	Can be changed in the operating state:	Operation	
	Parameter group:	Digital inputs	
	Unit: -		
	Min:	Max:	Factory setting:
	-	-	0000 bin
Description:	Sets the setpoint for the input signals in the digital input simulation mode.		
Bit array:	Bit	Signal name	1 signal 0 signal
	00	DI 0 (X130.1)	High Low
	01	DI 1 (X130.2)	High Low
	02	DI 2 (X130.3)	High Low
	03	DI 3 (X130.4)	High Low
Dependency:	The simulation of a digital input is selected using p0795. See also: p0795		
	Note This parameter is not saved when backing up data (p0977). DI: Digital Input		

c0849[0]	No Quick Stop / Quick Stop (OFF3)		
	Data type: Unsigned8	Visible in: Extended display	
	Read permission:	Read drive data or acknowledge messages	
	Write permission:	Edit device configuration or drive applications	
	Parameter group:	Shutdown functions, Drive enable signals	
	Unit: -		
Description:	Second signal for command "No Quick Stop / Quick Stop (OFF3)" The following signals are AND'ed: - c0848 "No Quick Stop / Quick Stop (OFF3) signal 1" - c0849 "No Quick Stop / Quick Stop (OFF3) signal 2" For the PROFIdrive profile, the result of the AND logic operation corresponds to control word 1 bit 2 (STW1.2). c0848 = 0 signal or c0849 = 0 signal - OFF3 (braking along the OFF3 ramp (p1135), then pulse cancellation and switching on inhibited) c0848 = 1 signal or c0849 = 1 signal - No OFF3 (enable is possible)		
	⚠ CAUTION When "master control from PC" is activated, then this binary signal sink is effective.		
	Note For drives with closed-loop torque control (activated using c1501), the following applies: 0 signal: - No dedicated braking response, but pulse cancellation when standstill is detected (p1226, p1227).		

r0898.0...14

Control word sequence control

Data type: Unsigned16 **Visible in:** Standard display
Read permission: Read drive data or acknowledge messages
Write permission: Edit device configuration or drive applications
Parameter group: Control/status words
Unit: -

Description: Display and numerical signal source for the control word of the sequence control.

Bit array:	Bit	Signal name	1 signal	0 signal
	00	ON/OFF1	Yes	No
	01	Operating condition / OFF2	Yes	No
	02	Operating condition / OFF3	Yes	No
	03	Enable operation	Yes	No
	04	Enable ramp-function generator	Yes	No
	05	Continue ramp-function generator	Yes	No
	06	Enable speed setpoint	Yes	No
	07	Command open brake	Yes	No
	10	Master control by PLC	Yes	No
	12	Enable speed controller	Yes	No
	14	Command close brake	Yes	No

Note
 OC: Operating condition

r0899.0...13

Status word sequence control

Data type: Unsigned16 **Visible in:** Standard display
Read permission: Read drive data or acknowledge messages
Write permission: Edit device configuration or drive applications
Parameter group: Control/status words
Unit: -

Description: Display for the status word of the sequence control.
 The status word is cyclically sent from the drive to the higher-level control.

Bit array:	Bit	Signal name	1 signal	0 signal
	00	Ready for switching on	Yes	No
	01	Ready	Yes	No
	02	Operation enabled	Yes	No
	03	Jog active	Yes	No
	04	No coasting active	OFF2 inactive	OFF2 active
	05	No Quick Stop active	OFF3 inactive	OFF3 active
	06	Switching on inhibited active	Yes	No
	07	Drive ready	Yes	No
	08	Controller enable	Yes	No
	09	Control requested	Yes	No
	11	Pulses enabled	Yes	No
	12	Motor holding brake control	Yes	No
	13	Motor holding brake status	Yes	No

Note
 For bits 00, 01, 02, 04, 05, 06, 09:
 For PROFIdrive, these signals are used for status word 1.
 For bit 13:
 When function "SBC (Safe Brake Control)" is activated and selected, the brake is no longer controlled using this signal.

r0922	PROFIdrive PZD telegram selection	
	Data type: Unsigned16	Visible in: Standard display
	Read permission:	Read drive data or acknowledge messages
	Write permission:	Edit device configuration or drive applications
	Parameter group:	Quick commissioning, Configuration
	Unit: -	
Description:	Displays the PROFIdrive telegram.	
Value:	1: Standard telegram 1, PZD-2/2	
	2: Standard telegram 2, PZD-4/4	
	3: Standard telegram 3, PZD-5/9	
	5: Standard telegram 5, PZD-9/9	
	102: SIEMENS telegram 102, PZD-6/10	
	105: SIEMENS telegram 105, PZD-10/10	
	Note	
	The telegram is set in the commissioning tool or by the control.	
r0922	PROFIdrive PZD telegram selection	
S200 Basic PN (Interpolator for EPOS), S200 PN (Interpolator for EPOS)	Data type: Unsigned16	Visible in: Standard display
	Read permission:	Read drive data or acknowledge messages
	Write permission:	Edit device configuration or drive applications
	Parameter group:	Quick commissioning, Configuration
	Unit: -	
Description:	Displays the PROFIdrive telegram.	
Value:	7: Standard telegram 7, PZD-2/2	
	9: Standard telegram 9, PZD-10/5	
	111: SIEMENS telegram 111, PZD-12/12	
	112: SIEMENS telegram 112, PZD-17/12	
	Note	
	The telegram is set in the commissioning tool or by the control.	
r0924[0...1]	ZSW bit pulses enabled	
	Data type: Unsigned16	Visible in: Extended display
	Read permission:	Read drive data or acknowledge messages
	Write permission:	Edit device configuration or drive applications
	Parameter group:	Configuration
	Unit: -	
Description:	Displays the position of the "Pulses enabled" status signal in the PROFIdrive telegram.	
Index:	[0] = Signal number	
	[1] = Bit position	
p0925	PROFIdrive clock synchronous sign-of-life tolerance	
	Data type: Unsigned16	Visible in: Extended display
	Read permission:	Read drive data or acknowledge messages
	Write permission:	Edit device configuration or drive applications
	Can be changed in the operating state:	Operation
	Parameter group:	Configuration
	Unit: -	

	Min: 0	Max: 65535	Factory setting: 1
Description:	Sets the number of tolerated consecutive sign-of-life errors of the isochronous controller. The sign-of-life signal is normally received in PZD4 (control word 2) from the controller.		
Dependency:	See also: F01912		
	Note The sign-of-life monitoring is disabled for p0925 = 65535.		

r0930	PROFIdrive operating mode		
	Data type: Unsigned16	Visible in: Extended display	
	Read permission:	Read drive data or acknowledge messages	
	Write permission:	Edit device configuration or drive applications	
	Parameter group:	Configuration	
	Unit: -		
Description:	Displays the operating mode. 1: Closed-loop speed controlled operation with ramp-function generator 2: Closed-loop position controlled operation 3: Closed-loop speed controlled operation without ramp-function generator		

r0944	Counter for fault buffer changes		
	Data type: Unsigned16	Visible in: Extended display	
	Read permission:	Read drive data or acknowledge messages	
	Write permission:	Edit device configuration or drive applications	
	Parameter group:	Faults / alarms	
	Unit: -		
Description:	Display and numerical signal source for the counter for changes of the fault buffer. This counter is incremented every time the fault buffer changes.		
Recommendation:	Used to check whether the fault buffer has been read out consistently.		
Dependency:	See also: r0945, r0947, r0948, r0949, r2109		

r0945[0...63]	Fault code		
	Data type: Unsigned16	Visible in: Extended display	
	Read permission:	Read drive data or acknowledge messages	
	Write permission:	Edit device configuration or drive applications	
	Parameter group:	Faults / alarms	
	Unit: -		
Description:	Displays the codes of faults that have occurred.		
Dependency:	See also: r0947, r0948, r0949, r2109, r2130, r2133, r2136, r3122		

NOTICE
The properties of the fault buffer should be taken from the corresponding product documentation.

Note

The buffer parameters are cyclically updated (states are indicated in r2139).

Fault buffer structure (general principle):

r0945[0], r0949[0] or r2133[0], r2130[0], r0948[0], r2136[0], r2109[0] --> fault 1 (oldest active fault) of the active incident

...

r0945[7], r0949[7] or r2133[7], r2130[7], r0948[7], r2136[7], r2109[7] --> fault 8 (latest active fault) of the active incident

For more than 8 active faults, only the entries are overwritten at the eighth position (index 7).

History of acknowledged faults:

If a fault incident is acknowledged, then all alarms of the 1st fault incident are transferred into the 2nd fault incident, this becomes the 1st acknowledged fault incident.

The 2nd incident is transferred into the 3rd, the 3rd into the 4th etc. The last incident is rejected.

r0945[8], r0949[8] or r2133[8], r2130[0], r0948[8], r2136[8], r2109[8] --> fault 1 of the 1st acknowledged incident

...

r0945[16], r0949[16] or r2133[16], r2130[16], r0948[16], r2136[16], r2109[16] --> fault 1 of the 2nd acknowledged incident

...

r0945[56], r0949[56] or r2133[56], r2130[56], r0948[56], r2136[56], r2109[56] --> fault 1 of the 7th acknowledged incident

...

r0945[63], r0949[63] or r2133[63], r2130[63], r0948[63], r2136[63], r2109[63] --> fault 8 (oldest fault that has gone) of the 7th acknowledged incident

r0947[0...63]

Fault number

Data type: Unsigned16

Visible in: Extended display

Read permission:

Read drive data or acknowledge messages

Write permission:

Edit device configuration or drive applications

Parameter group:

Faults / alarms

Unit: -

Description:

Displays the numbers of faults that have occurred.

Dependency:

See also: r0945

NOTICE
The properties of the fault buffer should be taken from the corresponding product documentation.

Note

The buffer parameters are cyclically updated (states are indicated in r2139).

Fault buffer structure (general principle):

r0945[0], r0949[0] or r2133[0], r2130[0], r0948[0], r2136[0], r2109[0] --> fault 1 (oldest active fault) of the active incident

...

r0945[7], r0949[7] or r2133[7], r2130[7], r0948[7], r2136[7], r2109[7] --> fault 8 (latest active fault) of the active incident

For more than 8 active faults, only the entries are overwritten at the eighth position (index 7).

History of acknowledged faults:

If a fault incident is acknowledged, then all alarms of the 1st fault incident are transferred into the 2nd fault incident, this becomes the 1st acknowledged fault incident.

The 2nd incident is transferred into the 3rd, the 3rd into the 4th etc. The last incident is rejected.

r0945[8], r0949[8] or r2133[8], r2130[0], r0948[8], r2136[8], r2109[8] --> fault 1 of the 1st acknowledged incident

...

r0945[16], r0949[16] or r2133[16], r2130[16], r0948[16], r2136[16], r2109[16] --> fault 1 of the 2nd acknowledged incident

...

r0945[56], r0949[56] or r2133[56], r2130[56], r0948[56], r2136[56], r2109[56] --> fault 1 of the 7th acknowledged incident

...

r0945[63], r0949[63] or r2133[63], r2130[63], r0948[63], r2136[63], r2109[63] --> fault 8 (oldest fault that has gone) of the 7th acknowledged incident

r0948[0...63]**Fault time received in milliseconds**

Data type: Unsigned32

Visible in: Extended display

Read permission:

Read drive data or acknowledge messages

Write permission:

Edit device configuration or drive applications

Parameter group:

Faults / alarms

Unit: ms

Description:

Displays the system runtime in milliseconds when the fault occurred.

Dependency:

See also: r0945, r0947, r0949, r2109, r2114, r2130, r2133, r2136, r3122

NOTICE

The time comprises r2130 (days) and r0948 (milliseconds).

Note

The buffer parameters are cyclically updated in the background (refer to status signal in r2139).

The structure of the fault buffer and the assignment of the indices is shown in r0945.

When the parameter is read via PROFIdrive, the TimeDifference data type applies.

r0949[0...63]**Fault value**

Data type: Integer32

Visible in: Extended display

Read permission:

Read drive data or acknowledge messages

Write permission:

Edit device configuration or drive applications

Parameter group:

Faults / alarms

Unit: -

Description:

Displays additional information about the fault that occurred (as integer number).

Dependency:

See also: r0945, r0947, r0948, r2109, r2130, r2133, r2136, r3122

Note

The buffer parameters are cyclically updated in the background (refer to status signal in r2139).

The structure of the fault buffer and the assignment of the indices is shown in r0945.

p0952	Fault cases counter		
	Data type: Unsigned16	Visible in: Extended display	
	Read permission:	Read drive data or acknowledge messages	
	Write permission:	Edit device configuration or drive applications	
	Can be changed in the operating state:	Operation	
	Parameter group:	Faults / alarms	
	Unit: -		
	Min:	Max:	Factory setting:
	0	65535	0
Description:	Number of fault situations that have occurred since the last reset.		
Dependency:	The fault buffer is deleted (cleared) by setting p0952 to 0. In order that faults with "POWER ON" acknowledgment can also be cleared from the fault buffer, POWER ON must first be carried out. See also: r0945, r0947, r0948, r0949, r2109, r2130, r2133, r2136		

r0964[0...6]	Device identification		
	Data type: Unsigned16	Visible in: Standard display	
	Read permission:	Read drive data or acknowledge messages	
	Write permission:	Edit device configuration or drive applications	
	Parameter group:	System identification	
	Unit: -		
Description:	Displays the device identification.		
Index:	[0] = Company (Siemens = 42) [1] = Device type [2] = Firmware version [3] = Firmware date (year) [4] = Firmware date (day/month) [5] = Reserved [6] = Firmware patch/hot fix		

Note

Example:

r0964[0] = 42 --> SIEMENS

r0964[1] = device type, see below

r0964[2] = 602 --> first part firmware version V06.02 (second part, refer to index 6)

r0964[3] = 2023 --> year 2023

r0964[4] = 1706 --> June 17

r0964[5] = 1 --> 1 (fixed value)

r0964[6] = 0 --> second part firmware version (complete version: V06.02.00.00)

Device type:

r0964[1] = 11200 --> SINAMICS S200 PN

r0964[1] = 11202 --> SINAMICS S200 PTI

r0964[1] = 11210 --> SINAMICS S200 Basic PN

r0964[1] = 11212 --> SINAMICS S200 Basic PTI

r0965	PROFIdrive profile number profile version		
	Data type: Unsigned16	Visible in: Standard display	
	Read permission:	Read drive data or acknowledge messages	
	Write permission:	Edit device configuration or drive applications	
	Parameter group:	Configuration	
	Unit: -		

Description: Displays the PROFIdrive profile number and profile version.
Constant value = 032A hex.
Byte 1: Profile number = 03 hex = PROFIdrive profile
Byte 2: profile version = 2A hex = 42 dec = version 4.2

Note

When the parameter is read via PROFIdrive, the Octet String 2 data type applies.

p0972

Drive unit reset

Data type: Unsigned16	Visible in: Extended display	
Read permission:	Read drive data or acknowledge messages	
Write permission:	Edit device configuration or drive applications	
Can be changed in the operating state:	Ready for operation	
Parameter group:	Save & reset	
Unit: -		
Min:	Max:	Factory setting:
0	3	0

Description: Sets the required procedure to execute a hardware reset for the drive unit.

Value:

0:	Inactive
1:	Hardware-Reset immediate
2:	Hardware reset preparation
3:	Hardware reset after cyclic communication has failed

DANGER It must be absolutely ensured that the system is in a safe condition. The memory card/device memory of the converter must not be accessed.
--

Note

For value = 1:
Reset is immediately executed and communications interrupted.
After communications have been established, check the reset operation (refer below).
This value cannot be set in operation.

For value = 2:
Help to check the reset operation.
Firstly, set p0972 = 2 and then read back. Secondly, set p0972 = 1 (it is possible that this request is possibly no longer acknowledged). The communication is then interrupted.
After communications have been established, check the reset operation (refer below).

For value = 3:
The reset is executed after interrupting cyclic communication. This setting is used to implement a synchronized reset by a control for several drive units.
If cyclic communication is not active, then the reset is immediately executed.
After communications have been established, check the reset operation (refer below).
To check the reset operation:
After the drive unit has been restarted and communications have been established, read p0972 and check the following:
p0972 = 0 --> the reset was successfully executed.
p0972 > 0 --> the reset was not executed.

r0975[0...10]

Converter identification

Data type: Unsigned16	Visible in: Extended display
Read permission:	Read drive data or acknowledge messages
Write permission:	Edit device configuration or drive applications
Parameter group:	System identification
Unit: -	

Description:	Displays the identification of the converter. The drive internally comprises components, device and converter. Both components require their own identification parameters according to PROFIdrive.
Index:	[0] = Company (Siemens = 42) [1] = Converter type [2] = Firmware version [3] = Firmware date (year) [4] = Firmware date (day/month) [5] = PROFIdrive converter type class [6] = PROFIdrive converter subtype class [7] = Reserved [8] = Reserved [9] = Reserved [10] = Firmware patch/hot fix
Dependency:	See also: r0964

Note

Example:

r0975[0] = 42 --> SIEMENS

r0975[1] = 311 --> SERVO converter type

r0975[2] = 602 --> first part firmware version V06.02 (second part refer to index 10)

r0975[3] = 2023 --> year 2023

r0975[4] = 1706 --> 17th of June

r0975[5] = 1 --> PROFIdrive type class = 1 (axis)

r0975[6] = 8 --> PROFIdrive subtype class = 4 (application class)

r0975[7] = 1 --> 1 (fixed value)

r0975[8] = 0 (reserved)

r0975[9] = 0 (reserved)

r0975[10] = 0 --> second part firmware version (complete version: V06.02.00.00)

p0976**Reset all parameters****Data type:** Unsigned16**Visible in:** Extended display**Read permission:**

Read drive data or acknowledge messages

Write permission:

Edit device configuration or drive applications

Can be changed in the operating state: Ready for operation**Parameter group:** Save & reset**Unit:** -**Min:**

0

Max:

1

Factory setting:

0

Description: Resets all parameters of the drive system.**Value:** 0: Inactive

1: Start to reset all parameters

NOTICE

Writing to parameters is inhibited during the reset operation.

p0977

Save all parameters

Data type: Unsigned16 **Visible in:** Extended display
Read permission: Read drive data or acknowledge messages
Write permission: Edit device configuration or drive applications
Can be changed in the operating state: Operation
Parameter group: Save & reset
Unit: -
Min: **Max:** **Factory setting:**
0 1 0

Description: Retentively saves all parameters of the drive system to the non-volatile memory.
When saving, only the adjustable parameters intended to be saved are taken into account.

Value: 0: Inactive
1: Save in non-volatile memory - Loaded at POWER ON

Dependency: See also: p0976

NOTICE
The converter power supply may only be switched off after saving has been completed (i.e. after saving has started, wait until the parameter again has a value of 0).
Writing to parameters is inhibited while saving.

r0979[0...30]

PROFIdrive encoder format

Data type: Unsigned32 **Visible in:** Standard display
Read permission: Read drive data or acknowledge messages
Write permission: Edit device configuration or drive applications
Parameter group: System identification, Configuration
Unit: -

Description: Displays the actual position encoder used according to PROFIdrive.

Index: [0] = Header
[1] = Motor encoder type
[2] = Motor encoder resolution
[3] = Shift factor G1_XIST1
[4] = Shift factor G1_XIST2
[5] = Distinguishable revolutions motor encoder
[6...10] = Reserved
[11] = Type encoder 2
[12] = Resolution encoder 2
[13] = Shift factor G2_XIST1
[14] = Shift factor G2_XIST2
[15] = Distinguishable revolutions encoder 2
[16...20] = Reserved
[21] = Type encoder 3
[22] = Resolution encoder 3
[23] = Shift factor G3_XIST1
[24] = Shift factor G3_XIST2
[25] = Distinguishable revolutions encoder 3
[26...30] = Reserved

Note
Information about the individual indices can be taken from the following literature:
PROFIdrive Profile Drive Technology

r0980[0...299] List of existing parameters 1

Data type: Unsigned16	Visible in: Extended display
Read permission:	Read drive data or acknowledge messages
Write permission:	Edit device configuration or drive applications
Parameter group:	System identification
Unit: -	

Description: Displays the parameters that exist for this drive.

Dependency: See also: r0981, r0989

Note

Modified parameters are displayed in indices 0 to 298. If an index contains the value 0, then the list ends here. In a long list, index 299 contains the parameter number at which position the list continues.

This list consists solely of the following parameters:

r0980[0...299], r0981[0...299] ... r0989[0...299]

The parameters in this list are not displayed in the parameter lists of the commissioning tool. However, they can be read from a higher-level control system (e.g. PROFIBUS master).

r0981[0...299] List of existing parameters 2

Data type: Unsigned16	Visible in: Extended display
Read permission:	Read drive data or acknowledge messages
Write permission:	Edit device configuration or drive applications
Parameter group:	System identification
Unit: -	

Description: Displays the parameters that exist for this drive.

Dependency: See also: r0980, r0989

Note

Modified parameters are displayed in indices 0 to 298. If an index contains the value 0, then the list ends here. In a long list, index 299 contains the parameter number at which position the list continues.

This list consists solely of the following parameters:

r0980[0...299], r0981[0...299] ... r0989[0...299]

The parameters in this list are not displayed in the expert list of the commissioning tool. However, they can be read from a higher-level control system.

r0989[0...299] List of existing parameters 10

Data type: Unsigned16	Visible in: Extended display
Read permission:	Read drive data or acknowledge messages
Write permission:	Edit device configuration or drive applications
Parameter group:	System identification
Unit: -	

Description: Displays the parameters that exist for this drive.

Dependency: See also: r0980, r0981

Note

Modified parameters are displayed in indices 0 to 298. If an index contains the value 0, then the list ends here.

This list consists solely of the following parameters:

r0980[0...299], r0981[0...299] ... r0989[0...299]

The parameters in this list are not displayed in the parameter lists of the commissioning tool. However, they can be read from a higher-level control system.

p1082[0]	Maximum speed		
	Data type: FloatingPoint32	Visible in: Standard display	
	Read permission:	Read drive data or acknowledge messages	
	Write permission:	Edit device configuration or drive applications	
	Can be changed in the operating state:	Ready for operation	
	Parameter group:	Motorized potentiometer, Speed limiting, U/f control, Speed controller, Quick commissioning	
	Unit: rpm		
	Min: 0.000 [rpm]	Max: 210000.000 [rpm]	Factory setting: 1500.000 [rpm]
Description:	Sets the maximum motor speed to a value less than or equal to the maximum motor speed (p0322). The set value is valid for both directions of rotation.		
Dependency:	See also: p0322		

p1083[0]	Speed limit in positive direction of rotation		
	Data type: FloatingPoint32	Visible in: Standard display	
	Read permission:	Read drive data or acknowledge messages	
	Write permission:	Edit device configuration or drive applications	
	Can be changed in the operating state:	Operation	
	Parameter group:	Speed limiting, U/f control, Speed controller	
	Unit: rpm		
	Min: 0.000 [rpm]	Max: 210000.000 [rpm]	Factory setting: 210000.000 [rpm]
Description:	Sets the maximum speed for the positive direction.		

p1086[0]	Speed limit in negative direction of rotation		
	Data type: FloatingPoint32	Visible in: Standard display	
	Read permission:	Read drive data or acknowledge messages	
	Write permission:	Edit device configuration or drive applications	
	Can be changed in the operating state:	Operation	
	Parameter group:	Speed limiting, U/f control, Speed controller	
	Unit: rpm		
	Min: -210000.000 [rpm]	Max: 0.000 [rpm]	Factory setting: -210000.000 [rpm]
Description:	Sets the speed limit for the negative direction.		

p1115	Ramp-function generator selection		
	Data type: Integer16	Visible in: Extended display	
	Read permission:	Read drive data or acknowledge messages	
	Write permission:	Edit device configuration or drive applications	
	Can be changed in the operating state:	Ready for operation	
	Parameter group:	Ramp-function generator	
	Unit: -		
	Min: 0	Max: 1	Factory setting: 0
Description:	Sets the ramp-function generator type.		

Value:	0:	Basic ramp-function generator
	1:	Extended ramp-function generator

Note

Another ramp-function generator type can only be selected when the motor is at a standstill.

p1120[0] Ramp-function generator ramp-up time

Data type:	FloatingPoint32	Visible in:	Standard display
Read permission:			Read drive data or acknowledge messages
Write permission:			Edit device configuration or drive applications
Can be changed in the operating state:			Operation
Parameter group:			Ramp-function generator, Quick commissioning
Unit:	s		
Min:	0.000 [s]	Max:	999999.000 [s]
		Factory setting:	10.000 [s]

Description: The ramp-function generator ramps-up the speed setpoint from standstill (setpoint = 0) up to the maximum speed (p1082) in this time.

Dependency: See also: p1082

p1121[0] OFF1 ramp-down time

Data type:	FloatingPoint32	Visible in:	Standard display
Read permission:			Read drive data or acknowledge messages
Write permission:			Edit device configuration or drive applications
Can be changed in the operating state:			Operation
Parameter group:			Quick commissioning
Unit:	s		
Min:	0.000 [s]	Max:	999999.000 [s]
		Factory setting:	1.000 [s]

Description: Sets the ramp-down time after an OFF1 command.

The value is referred to the maximum speed (p1082).

After an OFF1 command, within this time, the speed setpoint is ramped down from the maximum speed (p1082) to standstill.

Dependency: See also: p1082

p1130[0] Ramp-function generator initial rounding-off time

Data type:	FloatingPoint32	Visible in:	Extended display
Read permission:			Read drive data or acknowledge messages
Write permission:			Edit device configuration or drive applications
Can be changed in the operating state:			Operation
Parameter group:			Ramp-function generator
Unit:	s		
Min:	0.000 [s]	Max:	30.000 [s]
		Factory setting:	0.000 [s]

Description: Sets the initial rounding-off time for the extended ramp-function generator.

The value applies to ramp-up and ramp-down.

Note

Rounding-off times avoid an abrupt response and prevent damage to the mechanical system.

p1131[0]	Ramp-function generator final rounding-off time		
	Data type: FloatingPoint32	Visible in: Extended display	
	Read permission:	Read drive data or acknowledge messages	
	Write permission:	Edit device configuration or drive applications	
	Can be changed in the operating state:	Operation	
	Parameter group:	Ramp-function generator	
	Unit: s		
	Min: 0.000 [s]	Max: 30.000 [s]	Factory setting: 0.000 [s]
Description:	Sets the final rounding-off time for the extended ramp generator. The value applies to ramp-up and ramp-down.		
	Note Rounding-off times avoid an abrupt response and prevent damage to the mechanical system.		

p1135[0]	OFF3 ramp-down time		
	Data type: FloatingPoint32	Visible in: Standard display	
	Read permission:	Read drive data or acknowledge messages	
	Write permission:	Edit device configuration or drive applications	
	Can be changed in the operating state:	Operation	
	Parameter group:	Ramp-function generator, Shutdown functions, Setpoint addition, Quick commissioning	
	Unit: s		
	Min: 0.000 [s]	Max: 600.000 [s]	Factory setting: 0.000 [s]
Description:	Sets the ramp-down time from the maximum speed down to zero speed for the OFF3 command.		
	Note This time can be exceeded if the DC link voltage reaches its maximum value.		

r1196	DSC position setpoint		
	Data type: Integer32	Visible in: Standard display	
	Read permission:	Read drive data or acknowledge messages	
	Write permission:	Edit device configuration or drive applications	
	Parameter group:	Speed precontrol	
	Unit: -		
Description:	Display and numerical signal source of the position setpoint of DSC in fine pulses.		
	Note DSC: Dynamic Servo Control		

p1215[0]	Motor holding brake configuration		
S200 Basic PN	Data type: Integer16	Visible in: Standard display	
	Read permission:	Read drive data or acknowledge messages	
	Write permission:	Edit device configuration or drive applications	
	Can be changed in the operating state:	Ready for operation	
	Parameter group:	Motor holding brake	
	Unit: -		

	Min:	Max:	Factory setting:
	0	3	0
Description:	Sets the configuration for the motor holding brake.		
Value:	0: No motor holding brake available 3: Motor holding brake like seq control, conn via interconnection		
Dependency:	See also: p1216, p1217, p1226, p1227, p1228		
CAUTION			
For the setting p1215 = 0, if a brake is used, it remains closed. If the motor moves, this will destroy the brake.			
NOTICE			
If p1215 was set to 3, then when the pulses are canceled, the brake is closed even if the motor is still rotating. Pulses can be canceled as a result of an OFF2 or "Enable operation" via fieldbus or a fault with OFF2 response.			
Note			
If an external motor holding brake is being used, then p1215 should be set to 3 and r0899.12 should be used as brake control signal.			
The parameter can only be set to zero when the pulses are inhibited.			

p1215[0]	Motor holding brake configuration		
S200 PN	Data type: Integer16	Visible in: Standard display	
	Read permission:	Read drive data or acknowledge messages	
	Write permission:	Edit device configuration or drive applications	
	Can be changed in the operating state:	Ready for operation	
	Parameter group:	Motor holding brake	
	Unit: -		
	Min:	Max:	Factory setting:
	0	2	0
Description:	Sets the configuration for the motor holding brake. For value 2: This setting allows the motor shaft to be rotated for installation purposes.		
Value:	0: No motor holding brake available 1: Motor holding brake acc. to sequence control 2: Motor holding brake always open		
Dependency:	See also: p1216, p1217, p1226, p1227, p1228		
CAUTION			
For the setting p1215 = 0, if a brake is used, it remains closed. If the motor moves, this will destroy the brake. Setting p1215 = 2 is not permissible if the brake is used to hold loads.			

p1216[0]	Motor holding brake opening time		
	Data type: FloatingPoint32	Visible in: Extended display	
	Read permission:	Read drive data or acknowledge messages	
	Write permission:	Edit device configuration or drive applications	
	Can be changed in the operating state:	Operation	
	Parameter group:	Motor holding brake	
	Unit: ms		
	Min:	Max:	Factory setting:
	0 [ms]	10000 [ms]	100 [ms]
Description:	Displays the opening time for the motor holding brake. The speed setpoint is kept at 0 for this time. The speed setpoint is then enabled.		

Dependency: See also: p1215, p1217

p1217[0]

Motor holding brake closing time

Data type: FloatingPoint32	Visible in: Extended display	
Read permission:	Read drive data or acknowledge messages	
Write permission:	Edit device configuration or drive applications	
Can be changed in the operating state:	Operation	
Parameter group:	Motor holding brake	
Unit: ms		
Min: 0 [ms]	Max: 10000 [ms]	Factory setting: 100 [ms]

Description: Sets the time to apply the motor holding brake.
After OFF1 or OFF3 and the holding brake is controlled (the brake closes), then the drive remains closed-loop controlled for this time stationary with a speed setpoint/velocity setpoint of zero. The pulses are canceled when the time expires.

Recommendation: This time should be set longer than the actual closing time of the brake. This ensures that the pulses are only canceled after the brake has closed.

Dependency: See also: p1215, p1216

NOTICE
If the selected closing time is too short with respect to the actual closing time of the brake, then the load can sag. If the closing time is selected to be too long with respect to the actual closing time of the brake, the control works against the brake and therefore reduces its lifetime.

Note
For a motor with DRIVE-CLiQ and integrated brake, for p0300 = 10000, this time is pre-assigned the value saved in the motor.
For p1217 = 0 ms, the monitoring and the message A07932 "Brake does not close" are deactivated.

p1226[0]

Threshold for zero speed detection

Data type: FloatingPoint32	Visible in: Extended display	
Read permission:	Read drive data or acknowledge messages	
Write permission:	Edit device configuration or drive applications	
Can be changed in the operating state:	Operation	
Parameter group:	Motor holding brake, Shutdown functions	
Unit: rpm		
Min: 0.00 [rpm]	Max: 210000.00 [rpm]	Factory setting: 20.00 [rpm]

Description: Sets the speed threshold for the standstill identification.
Acts on the actual value and setpoint monitoring.
When braking with OFF1 or OFF3, when the threshold is undershot, standstill is identified.
The following applies when the brake control is activated:
When the threshold is undershot, the brake control is started and the system waits for the brake closing time in p1217. The pulses are then canceled.
if the brake control is not activated, the following applies:
When the threshold is undershot, the pulses are canceled and the drive coasts down.

Dependency: See also: p1215, p1216, p1217, p1227

NOTICE
For reasons relating to the compatibility to earlier firmware versions, a parameter value of zero in indices 1 to 31 is overwritten with the parameter value in index 0 when the Control Unit boots.

Note

Standstill is identified in the following cases:

- The speed actual value falls below the speed threshold in p1226 and the time started after this in p1228 has expired.
- The speed setpoint falls below the speed threshold in p1226 and the time started after this in p1227 has expired.

The actual value sensing is subject to measuring noise. For this reason, standstill cannot be detected if the speed threshold is too low.

p1227[0]**Zero speed detection monitoring time**

Data type: FloatingPoint32

Visible in: Extended display

Read permission:

Read drive data or acknowledge messages

Write permission:

Edit device configuration or drive applications

Can be changed in the operating state: Operation

Parameter group: Motor holding brake, Shutdown functions

Unit: s

Min:

Max:

Factory setting:

0.000 [s]

300.000 [s]

4.000 [s]

Description:

Sets the monitoring time for the standstill identification.

When braking with OFF1 or OFF3, standstill is identified after the time set here has expired, after the setpoint speed has fallen below p1226.

After this, the brake control is started, the system waits for the closing time in p1217 and then the pulses are canceled.

Dependency:

See also: p1215, p1216, p1217, p1226

Note

Standstill is detected if at least one of the following conditions is satisfied:

- The speed actual value falls below the speed threshold in p1226 and the time started after this in p1228 has expired.
- The speed setpoint falls below the speed threshold in p1226 and the time started after this in p1227 has expired.

For p1227 = 300.000 s the following applies:

Monitoring is deactivated.

For p1227 = 0.000 s, the following applies:

With OFF1 or OFF3 and a ramp-down time = 0, the pulses are immediately canceled and the motor "coasts" down.

p1228[0]**Pulse cancellation delay time**

Data type: FloatingPoint32

Visible in: Extended display

Read permission:

Read drive data or acknowledge messages

Write permission:

Edit device configuration or drive applications

Can be changed in the operating state: Operation

Parameter group: Motor holding brake, Shutdown functions

Unit: s

Min:

Max:

Factory setting:

0.000 [s]

299.000 [s]

0.000 [s]

Description:

Sets the delay time for pulse cancellation.

After OFF1 or OFF3, the pulses are canceled, if at least one of the following conditions is fulfilled:

- The speed actual value falls below the threshold in p1226 and the time started after this in p1228 has expired.
- The speed setpoint falls below the threshold in p1226 and the time started after this in p1227 has expired.

Dependency:

See also: p1226, p1227

NOTICE

When the motor holding brake is activated, pulse cancellation is additionally delayed by the brake closing time (p1217).

r1407.0...28**Status word speed controller****Data type:** Unsigned32**Visible in:** Extended display**Read permission:**

Read drive data or acknowledge messages

Write permission:

Edit device configuration or drive applications

Parameter group:

Torque setpoints, U/f control, Torque limiting, Speed actual value filter, Control/status words, Acceleration model, Setpoint addition, Speed precontrol, Speed setpoint filter

Unit: -**Description:**

Display and signal source for the status word of the speed controller.

Bit array:

Bit	Signal name	1 signal	0 signal
00	Reserved	Yes	No
01	Reserved	Yes	No
02	Torque control active	Yes	No
04	Speed setpoint from DSC	Yes	No
05	Speed controller I component frozen	Yes	No
06	Speed controller I component set	Yes	No
07	Torque limit reached	Yes	No
08	Upper torque limit active	Yes	No
09	Lower torque limit active	Yes	No
11	Speed setpoint limited	Yes	No
13	Encoderless operation due to a fault	Yes	No
19	Reserved	Yes	No
20	Reserved	Yes	No
21	Reserved	Yes	No
22	Reserved	Yes	No
23	Torque-speed precontrol with encoder on	Yes	No
24	Moment of inertia estimator active	Yes	No
25	Load estimate active	Yes	No
26	Moment of inertia estimator stabilized	Yes	No
28	Speed precontrol	For symmetrizing	For setp_filter 2

Note

For bit 01, 13:

If, after a fault, the encoder still provides a valid commutation position ($p1992.10 = 1$), then a switch is not immediately made into encoderless operation. Both bits remain at 0 for this time.

For bit 04:

The following conditions must be fulfilled to set to 1:

- Connector input p1190 and p1191 must be interconnected with a signal source that is not equal to zero.
- OFF1, OFF3 or STOP2 must not be active.
- It is not permissible that the motor data identification is active.
- Master control must not be active.

The following conditions can mean that the DSC function is not active in spite of the fact that the bit is set:

- Isochronous operation is not selected ($r2054$ not equal to 4).
- The PROFIBUS is not isochronous ($r2064[0]$ not equal to 1).
- DSC is not activated on the control side, therefore $KPC = 0$ is transferred as value to connector input p1191.

p1414[0].0...1	Speed setpoint filter activation			
	Data type: Unsigned16	Visible in: Extended display		
	Read permission:	Read drive data or acknowledge messages		
	Write permission:	Edit device configuration or drive applications		
	Can be changed in the operating state:	Operation		
	Parameter group:	Speed setpoint filter		
	Unit: -			
	Min:	Max:	Factory setting:	
	-	-	0000 bin	
Description:	Setting for activating/deactivating the speed setpoint filter.			
Recommendation:	If only one filter is required, filter 1 should be activated and filter 2 deactivated, to avoid excessive processing time.			
Bit array:	Bit	Signal name	1 signal	0 signal
	00	Activate filter 1	Yes	No
	01	Activate filter 2	Yes	No
Dependency:	The individual speed setpoint filters are parameterized from p1415.			

p1415[0]	Speed setpoint filter 1 type			
	Data type: Integer16	Visible in: Extended display		
	Read permission:	Read drive data or acknowledge messages		
	Write permission:	Edit device configuration or drive applications		
	Can be changed in the operating state:	Operation		
	Parameter group:	Speed setpoint filter		
	Unit: -			
	Min:	Max:	Factory setting:	
	0	2	0	
Description:	Sets the type for speed setpoint filter 1.			
Value:	0:	Low pass: PT1		
	1:	Low pass: PT2		
	2:	General 2nd order filter		
Dependency:	PT1 low pass: p1416 PT2 low pass: p1417, p1418 General filter: p1417 ... p1420			

p1416[0]	Speed setpoint filter 1 time constant			
	Data type: FloatingPoint32	Visible in: Extended display		
	Read permission:	Read drive data or acknowledge messages		
	Write permission:	Edit device configuration or drive applications		
	Can be changed in the operating state:	Operation		
	Parameter group:	Speed setpoint filter		
	Unit: ms			
	Min:	Max:	Factory setting:	
	0.00 [ms]	5000.00 [ms]	0.00 [ms]	
Description:	Sets the time constant for the speed setpoint filter 1 (PT1).			
Dependency:	See also: p1414, p1415			

Note

This parameter is only effective if the filter is set as a PT1 low pass.

p1417[0]	Speed setpoint filter 1 denominator natural frequency		
	Data type: FloatingPoint32	Visible in: Extended display	
	Read permission:	Read drive data or acknowledge messages	
	Write permission:	Edit device configuration or drive applications	
	Can be changed in the operating state:	Operation	
	Parameter group:	Speed setpoint filter	
	Unit: Hz		
	Min: 0.5 [Hz]	Max: 16000.0 [Hz]	Factory setting: 2000.0 [Hz]
Description:	Sets the denominator natural frequency for speed setpoint filter 1 (PT2, general filter).		
Dependency:	See also: p1414, p1415		
	Note		
	This parameter is only effective if the speed filter is parameterized as a PT2 low pass or as general filter. The filter is only effective if the natural frequency is less than half of the sampling frequency.		

p1418[0]	Speed setpoint filter 1 denominator damping		
	Data type: FloatingPoint32	Visible in: Extended display	
	Read permission:	Read drive data or acknowledge messages	
	Write permission:	Edit device configuration or drive applications	
	Can be changed in the operating state:	Operation	
	Parameter group:	Speed setpoint filter	
	Unit: -		
	Min: 0.001	Max: 10.000	Factory setting: 0.700
Description:	Sets the denominator damping for speed setpoint filter 1 (PT2, general filter).		
Dependency:	See also: p1414, p1415		
	Note		
	This parameter is only effective if the speed filter is parameterized as a PT2 low pass or as general filter.		

p1419[0]	Speed setpoint filter 1 numerator natural frequency		
	Data type: FloatingPoint32	Visible in: Extended display	
	Read permission:	Read drive data or acknowledge messages	
	Write permission:	Edit device configuration or drive applications	
	Can be changed in the operating state:	Operation	
	Parameter group:	Speed setpoint filter	
	Unit: Hz		
	Min: 0.5 [Hz]	Max: 16000.0 [Hz]	Factory setting: 2000.0 [Hz]
Description:	Sets the numerator natural frequency for speed setpoint filter 1 (general filter).		
Dependency:	See also: p1414, p1415		
	Note		
	This parameter is only effective if the speed filter is set as a general filter. The filter is only effective if the natural frequency is less than half of the sampling frequency.		

p1420[0]	Speed setpoint filter 1 numerator damping		
	Data type: FloatingPoint32	Visible in: Extended display	
	Read permission:	Read drive data or acknowledge messages	
	Write permission:	Edit device configuration or drive applications	
	Can be changed in the operating state:	Operation	
	Parameter group:	Speed setpoint filter	
	Unit: -		
	Min: 0.000	Max: 10.000	Factory setting: 0.700
Description:	Sets the numerator damping for speed setpoint filter 1 (general filter).		
Dependency:	See also: p1414, p1415		
	Note This parameter is only effective if the speed filter is set as a general filter.		

p1421[0]	Speed setpoint filter 2 type		
	Data type: Integer16	Visible in: Extended display	
	Read permission:	Read drive data or acknowledge messages	
	Write permission:	Edit device configuration or drive applications	
	Can be changed in the operating state:	Operation	
	Parameter group:	Speed setpoint filter	
	Unit: -		
	Min: 0	Max: 2	Factory setting: 0
Description:	Sets the type for speed setpoint filter 2.		
Value:	0: Low pass: PT1 1: Low pass: PT2 2: General 2nd order filter		
Dependency:	PT1 low pass: p1422 PT2 low pass: p1423, p1424 General filter: p1423 ... p1426		

p1422[0]	Speed setpoint filter 2 time constant		
	Data type: FloatingPoint32	Visible in: Extended display	
	Read permission:	Read drive data or acknowledge messages	
	Write permission:	Edit device configuration or drive applications	
	Can be changed in the operating state:	Operation	
	Parameter group:	Speed setpoint filter	
	Unit: ms		
	Min: 0.00 [ms]	Max: 5000.00 [ms]	Factory setting: 0.00 [ms]
Description:	Sets the time constant for the speed setpoint filter 2 (PT1).		
Dependency:	See also: p1414, p1421		
	Note This parameter is only effective if the speed filter is set as a PT1 low pass.		

p1423[0]	Speed setpoint filter 2 denominator natural frequency		
	Data type: FloatingPoint32	Visible in: Extended display	
	Read permission:	Read drive data or acknowledge messages	
	Write permission:	Edit device configuration or drive applications	
	Can be changed in the operating state:	Operation	
	Parameter group:	Speed setpoint filter	
	Unit: Hz		
	Min: 0.5 [Hz]	Max: 16000.0 [Hz]	Factory setting: 2000.0 [Hz]
Description:	Sets the denominator natural frequency for speed setpoint filter 2 (PT2, general filter).		
Dependency:	See also: p1414, p1421		
	Note		
	This parameter is only effective if the speed filter is parameterized as a PT2 low pass or as general filter. The filter is only effective if the natural frequency is less than half of the sampling frequency.		

p1424[0]	Speed setpoint filter 2 denominator damping		
	Data type: FloatingPoint32	Visible in: Extended display	
	Read permission:	Read drive data or acknowledge messages	
	Write permission:	Edit device configuration or drive applications	
	Can be changed in the operating state:	Operation	
	Parameter group:	Speed setpoint filter	
	Unit: -		
	Min: 0.001	Max: 10.000	Factory setting: 0.700
Description:	Sets the denominator damping for speed setpoint filter 2 (PT2, general filter).		
Dependency:	See also: p1414, p1421		
	Note		
	This parameter is only effective if the speed filter is parameterized as a PT2 low pass or as general filter.		

p1425[0]	Speed setpoint filter 2 numerator natural frequency		
	Data type: FloatingPoint32	Visible in: Extended display	
	Read permission:	Read drive data or acknowledge messages	
	Write permission:	Edit device configuration or drive applications	
	Can be changed in the operating state:	Operation	
	Parameter group:	Speed setpoint filter	
	Unit: Hz		
	Min: 0.5 [Hz]	Max: 16000.0 [Hz]	Factory setting: 2000.0 [Hz]
Description:	Sets the numerator natural frequency for speed setpoint filter 2 (general filter).		
Dependency:	See also: p1414, p1421		
	Note		
	This parameter is only effective if the speed filter is set as a general filter. The filter is only effective if the natural frequency is less than half of the sampling frequency.		

p1426[0]	Speed setpoint filter 2 numerator damping		
	Data type: FloatingPoint32	Visible in: Extended display	
	Read permission:	Read drive data or acknowledge messages	
	Write permission:	Edit device configuration or drive applications	
	Can be changed in the operating state:	Operation	
	Parameter group:	Speed setpoint filter	
	Unit: -		
	Min: 0.000	Max: 10.000	Factory setting: 0.700
Description:	Sets the numerator damping for speed setpoint filter 2 (general filter).		
Dependency:	See also: p1414, p1421		
	Note This parameter is only effective if the speed filter is set as a general filter.		

p1433[0]	Speed controller reference model natural frequency		
	Data type: FloatingPoint32	Visible in: Extended display	
	Read permission:	Read drive data or acknowledge messages	
	Write permission:	Edit device configuration or drive applications	
	Can be changed in the operating state:	Operation	
	Parameter group:	Speed controller	
	Unit: Hz		
	Min: 0.00 [Hz]	Max: 8000.00 [Hz]	Factory setting: 0.00 [Hz]
Description:	Sets the natural frequency of a PT2 element for the reference model of the speed controller.		
Recommendation:	The reference model is finely set using p1433.		

r1438	Speed controller speed setpoint		
	Data type: FloatingPoint32	Visible in: Standard display	
	Read permission:	Read drive data or acknowledge messages	
	Write permission:	Edit device configuration or drive applications	
	Parameter group:	U/f control, Speed controller	
	Unit: rpm		
Description:	Displays the speed setpoint after setpoint limiting for the P component of the speed controller.		

p1441[0]	Actual speed smoothing time		
	Data type: FloatingPoint32	Visible in: Extended display	
	Read permission:	Read drive data or acknowledge messages	
	Write permission:	Edit device configuration or drive applications	
	Can be changed in the operating state:	Operation	
	Parameter group:	Speed controller, Speed actual value filter	
	Unit: ms		
	Min: 0.00 [ms]	Max: 50.00 [ms]	Factory setting: 0.00 [ms]
Description:	Sets the smoothing time constant (PT1) for the speed actual value.		
Dependency:	See also: r0063		

Note

The speed actual value should be smoothed for encoders with a low pulse number or for resolvers.
After this parameter has been changed, we recommend that the speed controller is adapted and/or the speed controller settings checked Kp (p1460) and Tn (p1462).

p1460[0]

Speed controller P gain

Data type: FloatingPoint32	Visible in: Standard display	
Read permission:	Read drive data or acknowledge messages	
Write permission:	Edit device configuration or drive applications	
Can be changed in the operating state:	Operation	
Parameter group:	Speed controller	
Unit: Nms/rad		
Min: 0.0000 [Nms/rad]	Max: 500000000.0000 [Nms/rad]	Factory setting: 0.3000 [Nms/rad]

Description: Sets the P gain of the speed controller.
The drive determines the P gain for One Button Tuning and writes the value to p1460.
The value can be changed.

Dependency: See also: p1462

Note

The higher the set P gain, the faster and more unstable the control.

p1462[0]

Speed controller integral time

Data type: FloatingPoint32	Visible in: Standard display	
Read permission:	Read drive data or acknowledge messages	
Write permission:	Edit device configuration or drive applications	
Can be changed in the operating state:	Operation	
Parameter group:	Speed controller	
Unit: ms		
Min: 0.00 [ms]	Max: 100000.00 [ms]	Factory setting: 10.00 [ms]

Description: Sets the integral time for the speed controller
The drive determines the integral time for One Button Tuning - and writes the value to p1462.

Dependency: See also: p1460

Note

The shorter the integral time, the faster and more unstable the control.

p1498[0]

Load moment of inertia

Data type: FloatingPoint32	Visible in: Extended display	
Read permission:	Read drive data or acknowledge messages	
Write permission:	Edit device configuration or drive applications	
Can be changed in the operating state:	Operation	
Parameter group:	Speed controller	
Unit: kgm ²		
Min: - [kgm ²]	Max: - [kgm ²]	Factory setting: - [kgm ²]

Description: Sets the load moment of inertia.
The setting is made during commissioning while the One Button Tuning is being performed.

p1520[0]**Torque limit upper**

Data type: FloatingPoint32	Visible in: Standard display	
Read permission:	Read drive data or acknowledge messages	
Write permission:	Edit device configuration or drive applications	
Can be changed in the operating state:	Operation	
Parameter group:	Torque limiting	
Unit: Nm		
Min: -1000000.00 [Nm]	Max: 20000000.00 [Nm]	Factory setting: 0.00 [Nm]

Description: Setting the upper torque limit.
This setting is made as part of the basic commissioning.

Dependency: See also: p1521, p1532, r1538, r1539

p1521[0]**Torque limit lower**

Data type: FloatingPoint32	Visible in: Standard display	
Read permission:	Read drive data or acknowledge messages	
Write permission:	Edit device configuration or drive applications	
Can be changed in the operating state:	Operation	
Parameter group:	Torque limiting	
Unit: Nm		
Min: -20000000.00 [Nm]	Max: 1000000.00 [Nm]	Factory setting: 0.00 [Nm]

Description: Sets the lower torque limit
This setting is made as part of the basic commissioning.

Dependency: See also: p1520, p1532, r1538, r1539

p1532[0]**Torque limit offset**

Data type: FloatingPoint32	Visible in: Extended display	
Read permission:	Read drive data or acknowledge messages	
Write permission:	Edit device configuration or drive applications	
Can be changed in the operating state:	Operation	
Parameter group:	Torque limiting	
Unit: Nm		
Min: -100000.00 [Nm]	Max: 100000.00 [Nm]	Factory setting: 0.00 [Nm]

Description: Sets the torque offset for the torque limit.
The setting allows electronic weight equalization to be used for vertical axes.

Recommendation: The torque offset can also be used for torque precontrol or as integrator setting value for the speed controller.

Dependency: See also: p1520, p1521

 DANGER

If the offset is set higher/lower than the lower/upper torque limit, then the unloaded drive can accelerate up to the maximum speed.
--

r1538	<p>Upper effective torque limit</p> <p>Data type: FloatingPoint32 Visible in: Standard display</p> <p>Read permission: Read drive data or acknowledge messages</p> <p>Write permission: Edit device configuration or drive applications</p> <p>Parameter group: Torque limiting</p> <p>Unit: Nm</p>
Description:	Displays the currently effective upper torque limit.
	<p>Note</p> <p>The value in r1538 may not exceed the value in p1520.</p>

r1539	<p>Lower effective torque limit</p> <p>Data type: FloatingPoint32 Visible in: Standard display</p> <p>Read permission: Read drive data or acknowledge messages</p> <p>Write permission: Edit device configuration or drive applications</p> <p>Parameter group: Torque limiting</p> <p>Unit: Nm</p>
Description:	Displays the currently effective lower torque limit.
	<p>Note</p> <p>The value in r1539 may not exceed the value in p1521.</p>

p1558	<p>Measure/precontrol hanging/suspended axis force due to weight</p> <p>Data type: Integer16 Visible in: Standard display</p> <p>Read permission: Read drive data or acknowledge messages</p> <p>Write permission: Edit device configuration or drive applications</p> <p>Can be changed in the operating state: Operation</p> <p>Parameter group: Motor data identification routine</p> <p>Unit: -</p> <table border="0" style="width: 100%;"> <tr> <td style="width: 33%;">Min:</td> <td style="width: 33%;">Max:</td> <td style="width: 33%;">Factory setting:</td> </tr> <tr> <td>-1</td> <td>1</td> <td>0</td> </tr> </table>	Min:	Max:	Factory setting:	-1	1	0
Min:	Max:	Factory setting:					
-1	1	0					
Description:	<p>Setting to start/reset the measurement of the force due to weight for a hanging/suspended axis. The measurement can be started when the pulses are inhibited or the pulses are enabled (p1558 = 1). If it was started when the pulses were inhibited, then it is only executed after the pulses have been enabled. For the measurement, the torque to hold the axis is determined and entered into p1532. Further, this value is used internally for the precontrol.</p>						
Value:	<p>-1: Reset values</p> <p>0: Inactive</p> <p>1: Start measurement and activate precontrol</p>						
Dependency:	<p>The pulse enable is withdrawn at the end of the measurement.</p> <p>See also: p1532</p>						
	<p>Note</p> <p>For master control with speed setpoint input from the commissioning tool, the torque precontrol channels are deactivated, so that the weight equalization entered here is not active.</p>						

r1651	Torque setpoint function generator
Data type: FloatingPoint32	Visible in: Extended display
Read permission:	Read drive data or acknowledge messages
Write permission:	Edit device configuration or drive applications
Parameter group:	Current setpoint filter
Unit: Nm	
Description:	Displays the torque setpoint of the function generator.

p1656[0].0...3	Activates current setpoint filter																				
Data type: Unsigned16	Visible in: Extended display																				
Read permission:	Read drive data or acknowledge messages																				
Write permission:	Edit device configuration or drive applications																				
Can be changed in the operating state:	Operation																				
Parameter group:	Current setpoint filter																				
Unit: -																					
Min: -	Max: -	Factory setting: 0001 bin																			
Description:	Setting for activating/de-activating the current setpoint filter.																				
Bit array:	<table> <thead> <tr> <th>Bit</th> <th>Signal name</th> <th>1 signal</th> <th>0 signal</th> </tr> </thead> <tbody> <tr> <td>00</td> <td>Filter 1</td> <td>Active</td> <td>Inactive</td> </tr> <tr> <td>01</td> <td>Filter 2</td> <td>Active</td> <td>Inactive</td> </tr> <tr> <td>02</td> <td>Filter 3</td> <td>Active</td> <td>Inactive</td> </tr> <tr> <td>03</td> <td>Filter 4</td> <td>Active</td> <td>Inactive</td> </tr> </tbody> </table>	Bit	Signal name	1 signal	0 signal	00	Filter 1	Active	Inactive	01	Filter 2	Active	Inactive	02	Filter 3	Active	Inactive	03	Filter 4	Active	Inactive
Bit	Signal name	1 signal	0 signal																		
00	Filter 1	Active	Inactive																		
01	Filter 2	Active	Inactive																		
02	Filter 3	Active	Inactive																		
03	Filter 4	Active	Inactive																		
Dependency:	The individual current setpoint filters are parameterized as of p1657.																				
	Note																				
	If not all of the filters are required, then the filters should be used consecutively starting from filter 1.																				

p1657[0]	Current setpoint filter 1 type	
Data type: Integer16	Visible in: Extended display	
Read permission:	Read drive data or acknowledge messages	
Write permission:	Edit device configuration or drive applications	
Can be changed in the operating state:	Operation	
Parameter group:	Current setpoint filter	
Unit: -		
Min: 1	Max: 2	Factory setting: 1
Description:	Sets the current setpoint filter 1 as low pass (PT2) or general 2nd-order filter.	
Value:	1: PT2 low pass 2: General 2nd order filter	
Dependency:	The current setpoint filter 1 is activated via p1656.0 and parameterized via p1657 ... p1661.	
	Note	
	For a general 2nd order filter, by inserting the same natural frequency in both the numerator and in the denominator, i.e. bandstop frequency, a bandstop filter is implemented. If the numerator damping of zero is selected, the bandstop frequency is completely suppressed.	
	The denominator damping can be determined from the equation for the 3 dB bandwidth: $f_{3dB} \text{ bandwidth} = 2 * D_{denominator} * f_{bandstop} \text{ frequency}$	

p1658[0]	Current setpoint filter 1 denominator natural frequency		
	Data type: FloatingPoint32	Visible in: Extended display	
	Read permission:	Read drive data or acknowledge messages	
	Write permission:	Edit device configuration or drive applications	
	Can be changed in the operating state:	Operation	
	Parameter group:	Current setpoint filter	
	Unit: Hz		
	Min: 0.5 [Hz]	Max: 16000.0 [Hz]	Factory setting: 1999.0 [Hz]
Description:	Sets the denominator natural frequency for current setpoint filter 1 (PT2, general filter).		
Dependency:	The current setpoint filter 1 is activated via p1656.0 and parameterized via p1657 ... p1661.		

p1659[0]	Current setpoint filter 1 denominator damping		
	Data type: FloatingPoint32	Visible in: Extended display	
	Read permission:	Read drive data or acknowledge messages	
	Write permission:	Edit device configuration or drive applications	
	Can be changed in the operating state:	Operation	
	Parameter group:	Current setpoint filter	
	Unit: -		
	Min: 0.001	Max: 10.000	Factory setting: 0.700
Description:	Sets the denominator damping for current setpoint filter 1.		
Dependency:	The current setpoint filter 1 is activated via p1656.0 and parameterized via p1657 ... p1661.		

p1660[0]	Current setpoint filter 1 numerator natural frequency		
	Data type: FloatingPoint32	Visible in: Extended display	
	Read permission:	Read drive data or acknowledge messages	
	Write permission:	Edit device configuration or drive applications	
	Can be changed in the operating state:	Operation	
	Parameter group:	Current setpoint filter	
	Unit: Hz		
	Min: 0.5 [Hz]	Max: 16000.0 [Hz]	Factory setting: 1999.0 [Hz]
Description:	Sets the numerator natural frequency for current setpoint filter 1 (general filter).		
Dependency:	The current setpoint filter 1 is activated via p1656.0 and parameterized via p1657 ... p1661.		

p1661[0]	Current setpoint filter 1 numerator damping		
	Data type: FloatingPoint32	Visible in: Extended display	
	Read permission:	Read drive data or acknowledge messages	
	Write permission:	Edit device configuration or drive applications	
	Can be changed in the operating state:	Operation	
	Parameter group:	Current setpoint filter	
	Unit: -		
	Min: 0.000	Max: 10.000	Factory setting: 0.700

Description: Sets the numerator damping for current setpoint filter 1.
Dependency: The current setpoint filter 1 is activated via p1656.0 and parameterized via p1657 ... p1661.

p1662[0]**Current setpoint filter 2 type**

Data type: Integer16 **Visible in:** Extended display
Read permission: Read drive data or acknowledge messages
Write permission: Edit device configuration or drive applications
Can be changed in the operating state: Operation
Parameter group: Current setpoint filter
Unit: -
Min: 1 **Max:** 2 **Factory setting:** 1

Description: Sets current setpoint filter 2 as lowpass filter (PT2) or general 2nd order filter.

Value:
 1: PT2 low pass
 2: General 2nd order filter

Dependency: Current setpoint filter 2 is activated via p1656.1 and parameterized via p1662 ... p1666.

Note

For a general 2nd order filter, by inserting the same natural frequency in both the numerator and in the denominator, i.e. bandstop frequency, a bandstop filter is implemented. If the numerator damping of zero is selected, the bandstop frequency is completely suppressed.

The denominator damping can be determined from the equation for the 3 dB bandwidth:

$$f_{3dB} \text{ bandwidth} = 2 * D_{denominator} * f_{bandstop} \text{ frequency}$$

p1663[0]**Current setpoint filter 2 denominator natural frequency**

Data type: FloatingPoint32 **Visible in:** Extended display
Read permission: Read drive data or acknowledge messages
Write permission: Edit device configuration or drive applications
Can be changed in the operating state: Operation
Parameter group: Current setpoint filter
Unit: Hz
Min: 0.5 [Hz] **Max:** 16000.0 [Hz] **Factory setting:** 1999.0 [Hz]

Description: Sets the denominator natural frequency for current setpoint filter 2 (PT2, general filter).

Dependency: Current setpoint filter 2 is activated via p1656.1 and parameterized via p1662 ... p1666.

p1664[0]**Current setpoint filter 2 denominator damping**

Data type: FloatingPoint32 **Visible in:** Extended display
Read permission: Read drive data or acknowledge messages
Write permission: Edit device configuration or drive applications
Can be changed in the operating state: Operation
Parameter group: Current setpoint filter
Unit: -
Min: 0.001 **Max:** 10.000 **Factory setting:** 0.700

Description: Sets the denominator damping for current setpoint filter 2.

Dependency: Current setpoint filter 2 is activated via p1656.1 and parameterized via p1662 ... p1666.

p1665[0] Current setpoint filter 2 numerator natural frequency

Data type: FloatingPoint32 **Visible in:** Extended display

Read permission: Read drive data or acknowledge messages

Write permission: Edit device configuration or drive applications

Can be changed in the operating state: Operation

Parameter group: Current setpoint filter

Unit: Hz

Min: 0.5 [Hz]	Max: 16000.0 [Hz]	Factory setting: 1999.0 [Hz]
-------------------------	-----------------------------	--

Description: Sets the numerator natural frequency for current setpoint filter 2 (general filter).

Dependency: Current setpoint filter 2 is activated via p1656.1 and parameterized via p1662 ... p1666.

p1666[0] Current setpoint filter 2 numerator damping

Data type: FloatingPoint32 **Visible in:** Extended display

Read permission: Read drive data or acknowledge messages

Write permission: Edit device configuration or drive applications

Can be changed in the operating state: Operation

Parameter group: Current setpoint filter

Unit: -

Min: 0.000	Max: 10.000	Factory setting: 0.700
----------------------	-----------------------	----------------------------------

Description: Sets the numerator damping for current setpoint filter 2.

Dependency: Current setpoint filter 2 is activated via p1656.1 and parameterized via p1662 ... p1666.

p1667[0] Current setpoint filter 3 type

Data type: Integer16 **Visible in:** Extended display

Read permission: Read drive data or acknowledge messages

Write permission: Edit device configuration or drive applications

Can be changed in the operating state: Operation

Parameter group: Current setpoint filter

Unit: -

Min: 1	Max: 2	Factory setting: 1
------------------	------------------	------------------------------

Description: Sets current setpoint filter 3 as lowpass filter (PT2) or general 2nd order filter.

Value:

1:	PT2 low pass
2:	General 2nd order filter

Dependency: Current setpoint filter 3 is activated via p1656.2 and parameterized via p1667 ... p1671.

p1668[0] Current setpoint filter 3 denominator natural frequency

Data type: FloatingPoint32 **Visible in:** Extended display

Read permission: Read drive data or acknowledge messages

Write permission: Edit device configuration or drive applications

Can be changed in the operating state: Operation

Parameter group: Current setpoint filter

Unit: Hz

	Min: 0.5 [Hz]	Max: 16000.0 [Hz]	Factory setting: 1999.0 [Hz]
Description:	Sets the denominator natural frequency for current setpoint filter 3 (PT2, general filter).		
Dependency:	Current setpoint filter 3 is activated via p1656.2 and parameterized via p1667 ... p1671.		

p1669[0]	Current setpoint filter 3 denominator damping		
	Data type: FloatingPoint32	Visible in: Extended display	
	Read permission:	Read drive data or acknowledge messages	
	Write permission:	Edit device configuration or drive applications	
	Can be changed in the operating state:	Operation	
	Parameter group:	Current setpoint filter	
	Unit: -		
	Min: 0.001	Max: 10.000	Factory setting: 0.700
Description:	Sets the denominator damping for current setpoint filter 3.		
Dependency:	Current setpoint filter 3 is activated via p1656.2 and parameterized via p1667 ... p1671.		

p1670[0]	Current setpoint filter 3 numerator natural frequency		
	Data type: FloatingPoint32	Visible in: Extended display	
	Read permission:	Read drive data or acknowledge messages	
	Write permission:	Edit device configuration or drive applications	
	Can be changed in the operating state:	Operation	
	Parameter group:	Current setpoint filter	
	Unit: Hz		
	Min: 0.5 [Hz]	Max: 16000.0 [Hz]	Factory setting: 1999.0 [Hz]
Description:	Sets the numerator natural frequency for current setpoint filter 3 (general filter).		
Dependency:	Current setpoint filter 3 is activated via p1656.2 and parameterized via p1667 ... p1671.		

p1671[0]	Current setpoint filter 3 numerator damping		
	Data type: FloatingPoint32	Visible in: Extended display	
	Read permission:	Read drive data or acknowledge messages	
	Write permission:	Edit device configuration or drive applications	
	Can be changed in the operating state:	Operation	
	Parameter group:	Current setpoint filter	
	Unit: -		
	Min: 0.000	Max: 10.000	Factory setting: 0.700
Description:	Sets the numerator damping for current setpoint filter 3.		
Dependency:	Current setpoint filter 3 is activated via p1656.2 and parameterized via p1667 ... p1671.		

p1672[0]	Current setpoint filter 4 type		
	Data type: Integer16	Visible in: Extended display	
	Read permission:	Read drive data or acknowledge messages	
	Write permission:	Edit device configuration or drive applications	
	Can be changed in the operating state:	Operation	
	Parameter group:	Current setpoint filter	
	Unit: -		
	Min:	Max:	Factory setting:
	1	2	1
Description:	Sets current setpoint filter 4 as lowpass filter (PT2) or general 2nd order filter.		
Value:	1: PT2 low pass		
	2: General 2nd order filter		
Dependency:	Current setpoint filter 4 is activated via p1656.3 and parameterized via p1672 ... p1676.		

p1673[0]	Current setpoint filter 4 denominator natural frequency		
	Data type: FloatingPoint32	Visible in: Extended display	
	Read permission:	Read drive data or acknowledge messages	
	Write permission:	Edit device configuration or drive applications	
	Can be changed in the operating state:	Operation	
	Parameter group:	Current setpoint filter	
	Unit: Hz		
	Min:	Max:	Factory setting:
	0.5 [Hz]	16000.0 [Hz]	1999.0 [Hz]
Description:	Sets the denominator natural frequency for current setpoint filter 4 (PT2, general filter).		
Dependency:	Current setpoint filter 4 is activated via p1656.3 and parameterized via p1672 ... p1676.		

p1674[0]	Current setpoint filter 4 denominator damping		
	Data type: FloatingPoint32	Visible in: Extended display	
	Read permission:	Read drive data or acknowledge messages	
	Write permission:	Edit device configuration or drive applications	
	Can be changed in the operating state:	Operation	
	Parameter group:	Current setpoint filter	
	Unit: -		
	Min:	Max:	Factory setting:
	0.001	10.000	0.700
Description:	Sets the denominator damping for current setpoint filter 4.		
Dependency:	Current setpoint filter 4 is activated via p1656.3 and parameterized via p1672 ... p1676.		

p1675[0]	Current setpoint filter 4 numerator natural frequency		
	Data type: FloatingPoint32	Visible in: Extended display	
	Read permission:	Read drive data or acknowledge messages	
	Write permission:	Edit device configuration or drive applications	
	Can be changed in the operating state:	Operation	
	Parameter group:	Current setpoint filter	
	Unit: Hz		

	Min: 0.5 [Hz]	Max: 16000.0 [Hz]	Factory setting: 1999.0 [Hz]
Description:	Sets the numerator natural frequency for current setpoint filter 4 (general filter).		
Dependency:	Current setpoint filter 4 is activated via p1656.3 and parameterized via p1672 ... p1676.		

p1676[0]	Current setpoint filter 4 numerator damping		
	Data type: FloatingPoint32	Visible in: Extended display	
	Read permission:	Read drive data or acknowledge messages	
	Write permission:	Edit device configuration or drive applications	
	Can be changed in the operating state:	Operation	
	Parameter group:	Current setpoint filter	
	Unit: -		
	Min: 0.000	Max: 10.000	Factory setting: 0.700
Description:	Sets the numerator damping for current setpoint filter 4.		
Dependency:	Current setpoint filter 4 is activated via p1656.3 and parameterized via p1672 ... p1676.		

p1703[0]	Isq current controller precontrol scaling		
	Data type: FloatingPoint32	Visible in: Extended display	
	Read permission:	Read drive data or acknowledge messages	
	Write permission:	Edit device configuration or drive applications	
	Can be changed in the operating state:	Operation	
	Parameter group:	Current controller	
	Unit: %		
	Min: 0.0 [%]	Max: 200.0 [%]	Factory setting: 0.0 [%]
Description:	Sets the scaling of the dynamic current controller precontrol for the torque/force-generating current component Isq.		

p1821[0]	Direction of rotation		
	Data type: Integer16	Visible in: Standard display	
	Read permission:	Read drive data or acknowledge messages	
	Write permission:	Edit device configuration or drive applications	
	Can be changed in the operating state:	Commissioning	
	Parameter group:	Motor data	
	Unit: -		
	Min: 0	Max: 1	Factory setting: 0
Description:	Setting to change the direction of rotation. If the parameter is changed, it reverses the direction of rotation of the motor and the encoder actual value without changing the setpoint.		
Value:	0: Clockwise 1: Counterclockwise		
Dependency:	See also: F07434		

NOTICE

After changing parameter p1821, the direction of rotation is not automatically adapted in the safety area.

p2000	Reference speed		
	Data type: FloatingPoint32	Visible in: Standard display	
	Read permission:	Read drive data or acknowledge messages	
	Write permission:	Edit device configuration or drive applications	
	Can be changed in the operating state:	Ready for operation	
	Parameter group:	Reference variables	
	Unit: rpm		
	Min: 6.00 [rpm]	Max: 210000.00 [rpm]	Factory setting: 3000.00 [rpm]
Description:	Sets the reference quantity for the speed values. All speeds specified as relative values refer to this reference quantity. The reference quantity corresponds to 100% or 4000 hex (word) or 4000 0000 hex (double word).		
Dependency:	See also: p2003		

p2002	Reference current		
	Data type: FloatingPoint32	Visible in: Extended display	
	Read permission:	Read drive data or acknowledge messages	
	Write permission:	Edit device configuration or drive applications	
	Can be changed in the operating state:	Ready for operation	
	Parameter group:	Reference variables	
	Unit: Arms		
	Min: 0.10 [Arms]	Max: 100000.00 [Arms]	Factory setting: 100.00 [Arms]
Description:	Sets the reference quantity for currents. All currents specified as relative value are referred to this reference quantity. The reference quantity corresponds to 100% or 4000 hex (word) or 4000 0000 hex (double word).		
	Note Default value is 2 * p0305 or the motor current limit.		

p2003	Reference torque		
	Data type: FloatingPoint32	Visible in: Standard display	
	Read permission:	Read drive data or acknowledge messages	
	Write permission:	Edit device configuration or drive applications	
	Can be changed in the operating state:	Ready for operation	
	Parameter group:	Reference variables	
	Unit: Nm		
	Min: 0.01 [Nm]	Max: 20000000.00 [Nm]	Factory setting: 1.00 [Nm]
Description:	Sets the reference quantity for the torque values. All torques specified as relative value are referred to this reference quantity. The reference quantity corresponds to 100% or 4000 hex (word) or 4000 0000 hex (double word).		

r2043.0...2	PROFIdrive PZD state		
	Data type: Unsigned8	Visible in: Extended display	
	Read permission:	Read drive data or acknowledge messages	
	Write permission:	Edit device configuration or drive applications	
	Parameter group:	Configuration	
	Unit: -		
Description:	Displays the PROFIdrive PZD state.		
Bit array:	Bit	Signal name	1 signal
	00	Setpoint failure	Yes
	01	Isochronous operation active	Yes
	02	Fieldbus running	Yes
			0 signal
			No
			No
			No
	Note		
	When using the "setpoint failure" signal, the bus can be monitored and an application-specific response triggered when the setpoint fails.		

r2050[0...21]	PROFIdrive PZD receive word		
	Data type: Unsigned16	Visible in: Standard display	
	Read permission:	Read drive data or acknowledge messages	
	Write permission:	Edit device configuration or drive applications	
	Parameter group:	Receive direction	
	Unit: -		
Description:	Displays the PZD (setpoints) in the word format received from the fieldbus controller.		
Index:	[0] = PZD 1		
	[1] = PZD 2		
	[2] = PZD 3		
	[3] = PZD 4		
	[4] = PZD 5		
	[5] = PZD 6		
	[6] = PZD 7		
	[7] = PZD 8		
	[8] = PZD 9		
	[9] = PZD 10		
	[10] = PZD 11		
	[11] = PZD 12		
	[12] = PZD 13		
	[13] = PZD 14		
	[14] = PZD 15		
	[15] = PZD 16		
	[16] = PZD 17		
	[17] = PZD 18		
	[18] = PZD 19		
	[19] = PZD 20		
	[20] = PZD 21		
	[21] = PZD 22		
Dependency:	See also: r2060		

r2053[0...27]	PROFIdrive PZD send word	
	Data type: Unsigned16	Visible in: Standard display
	Read permission:	Read drive data or acknowledge messages
	Write permission:	Edit device configuration or drive applications
	Parameter group:	Send direction
	Unit: -	
Description:	Displays the PZD (actual values) in the word format that are sent to the fieldbus controller.	
Index:	[0] = PZD 1 [1] = PZD 2 [2] = PZD 3 [3] = PZD 4 [4] = PZD 5 [5] = PZD 6 [6] = PZD 7 [7] = PZD 8 [8] = PZD 9 [9] = PZD 10 [10] = PZD 11 [11] = PZD 12 [12] = PZD 13 [13] = PZD 14 [14] = PZD 15 [15] = PZD 16 [16] = PZD 17 [17] = PZD 18 [18] = PZD 19 [19] = PZD 20 [20] = PZD 21 [21] = PZD 22 [22] = PZD 23 [23] = PZD 24 [24] = PZD 25 [25] = PZD 26 [26] = PZD 27 [27] = PZD 28	

r2060[0...20]	PROFIdrive PZD receive double word	
	Data type: Integer32	Visible in: Standard display
	Read permission:	Read drive data or acknowledge messages
	Write permission:	Edit device configuration or drive applications
	Parameter group:	Receive direction
	Unit: -	
Description:	Displays the PZD (setpoints) in the double word format received from the fieldbus controller.	

Index:	[0] = PZD 1 + 2
	[1] = PZD 2 + 3
	[2] = PZD 3 + 4
	[3] = PZD 4 + 5
	[4] = PZD 5 + 6
	[5] = PZD 6 + 7
	[6] = PZD 7 + 8
	[7] = PZD 8 + 9
	[8] = PZD 9 + 10
	[9] = PZD 10 + 11
	[10] = PZD 11 + 12
	[11] = PZD 12 + 13
	[12] = PZD 13 + 14
	[13] = PZD 14 + 15
	[14] = PZD 15 + 16
	[15] = PZD 16 + 17
	[16] = PZD 17 + 18
	[17] = PZD 18 + 19
	[18] = PZD 19 + 20
	[19] = PZD 20 + 21
	[20] = PZD 21 + 22

Dependency: See also: r2050

r2063[0...26]**PROFIdrive PZD send double word**

Data type: Unsigned32

Visible in: Standard display

Read permission:

Read drive data or acknowledge messages

Write permission:

Edit device configuration or drive applications

Parameter group:

Send direction

Unit: -

Description:

Displays the PZD (actual values) in the double word format that are sent to the fieldbus controller.

Index:	[0] = PZD 1 + 2
	[1] = PZD 2 + 3
	[2] = PZD 3 + 4
	[3] = PZD 4 + 5
	[4] = PZD 5 + 6
	[5] = PZD 6 + 7
	[6] = PZD 7 + 8
	[7] = PZD 8 + 9
	[8] = PZD 9 + 10
	[9] = PZD 10 + 11
	[10] = PZD 11 + 12
	[11] = PZD 12 + 13
	[12] = PZD 13 + 14
	[13] = PZD 14 + 15
	[14] = PZD 15 + 16
	[15] = PZD 16 + 17
	[16] = PZD 17 + 18
	[17] = PZD 18 + 19
	[18] = PZD 19 + 20
	[19] = PZD 20 + 21
	[20] = PZD 21 + 22
	[21] = PZD 22 + 23
	[22] = PZD 23 + 24
	[23] = PZD 24 + 25
	[24] = PZD 25 + 26
	[25] = PZD 26 + 27
	[26] = PZD 27 + 28

NOTICE
A maximum of 4 indices of the "trace" function can be used.

c2104[0]	2nd acknowledge faults
	Data type: Unsigned8 Visible in: Extended display
	Read permission: Read drive data or acknowledge messages
	Write permission: Edit device configuration or drive applications
	Parameter group: Faults / alarms
	Unit: -

Description: Signal 2 to acknowledge faults.

Note
A fault acknowledgment is triggered with a 0/1 signal.

c2106[0]	External fault 1
	Data type: Unsigned8 Visible in: Extended display
	Read permission: Read drive data or acknowledge messages
	Write permission: Edit device configuration or drive applications
	Parameter group: Faults / alarms
	Unit: -

Description: Signal for external fault 1.

Dependency: See also: F07860

Note

An external fault is initiated with a 1->0 edge.

If this fault is initiated at the Control Unit, then it is transferred to all of the drive objects available.

r2109[0...63]**Fault time removed in milliseconds**

Data type: Unsigned32

Visible in: Extended display

Read permission:

Read drive data or acknowledge messages

Write permission:

Edit device configuration or drive applications

Parameter group:

Faults / alarms

Unit: ms

Description:

Displays the system runtime in milliseconds when the fault was removed.

Dependency:

See also: r0945, r0947, r0948, r0949, r2114, r2130, r2133, r2136, r3122

NOTICE

The time comprises r2136 (days) and r2109 (milliseconds).

Note

The buffer parameters are cyclically updated in the background (refer to status signal in r2139).

The structure of the fault buffer and the assignment of the indices is shown in r0945.

r2111**Alarm counter**

Data type: Unsigned16

Visible in: Extended display

Read permission:

Read drive data or acknowledge messages

Write permission:

Edit device configuration or drive applications

Parameter group:

Faults / alarms

Unit: -

Description:

Number of alarms that have occurred.

Dependency:

See also: r2122, r2123, r2124, r2125

Note

The parameter is reset to 0 at POWER ON.

r2114[0...1]**System runtime total**

Data type: Unsigned32

Visible in: Standard display

Read permission:

Read drive data or acknowledge messages

Write permission:

Edit device configuration or drive applications

Parameter group:

Diagnostics general

Unit: -

Description:

Displays the total system runtime of the converter.

The time comprises r2114[0] (milliseconds) and r2114[1] (days).

After r2114[0] has reached a value of 86.400.000 ms (24 hours) this value is reset and r2114[1] is incremented.

Index:

[0] = Milliseconds

[1] = Days

Note

The counter values are saved when the power supply is switched off.

After the converter is switched on, the counter continues to run with the last value that was saved.

r2121 **Counter alarm buffer changes**

Data type: Unsigned16 **Visible in:** Extended display

Read permission: Read drive data or acknowledge messages

Write permission: Edit device configuration or drive applications

Parameter group: Faults / alarms

Unit: -

Description: This counter is incremented every time the alarm buffer changes.

Dependency: See also: r2122, r2123, r2124, r2125

r2122[0...63] **Alarm number**

Data type: Unsigned16 **Visible in:** Extended display

Read permission: Read drive data or acknowledge messages

Write permission: Edit device configuration or drive applications

Parameter group: Faults / alarms

Unit: -

Description: Displays the numbers of the last 64 alarms.

Dependency: See also: r2123, r2124, r2125, r2134, r2145, r2146, r3123

NOTICE
The properties of the alarm buffer should be taken from the corresponding product documentation.

Note

The buffer parameters are cyclically updated in the background.

Alarm buffer structure (general principle):

Currently active alarms (not gone):

r2122[0], r2124[0], r2123[0], r2125[0] --> alarm 1 (the oldest)

...

r2122[7], r2124[7], r2123[7], r2125[7] --> Alarm 8 (the latest)

History of alarms that have gone:

r2122[8], r2124[8], r2123[8], r2125[8] --> Alarm 1 (the latest)

...

r2122[63], r2124[63], r2123[63], r2125[63] --> alarm 56 (the oldest)

r2123[0...63] **Alarm time received in milliseconds**

Data type: Unsigned32 **Visible in:** Extended display

Read permission: Read drive data or acknowledge messages

Write permission: Edit device configuration or drive applications

Parameter group: Faults / alarms

Unit: ms

Description: Displays the system runtime in milliseconds when the alarm occurred.

Dependency: See also: r2114, r2122, r2124, r2125, r2134, r2145, r2146, r3123

NOTICE
The time comprises r2145 (days) and r2123 (milliseconds).

Note

The buffer parameters are cyclically updated in the background (refer to status signal in r2139).

The structure of the alarm buffer and the assignment of the indices is shown in r2122.

r2124[0...63]**Alarm value****Data type:** Integer32**Visible in:** Extended display**Read permission:**

Read drive data or acknowledge messages

Write permission:

Edit device configuration or drive applications

Parameter group:

Faults / alarms

Unit: -**Description:**

Displays additional information about the active alarm (as integer number).

Dependency:

See also: r2122, r2123, r2125, r2134, r2145, r2146, r3123

Note

The buffer parameters are cyclically updated in the background (refer to status signal in r2139).

The structure of the alarm buffer and the assignment of the indices is shown in r2122.

r2125[0...63]**Alarm time removed in milliseconds****Data type:** Unsigned32**Visible in:** Extended display**Read permission:**

Read drive data or acknowledge messages

Write permission:

Edit device configuration or drive applications

Parameter group:

Faults / alarms

Unit: ms**Description:**

Displays the system runtime in milliseconds when the alarm was removed.

Dependency:

See also: r2114, r2122, r2123, r2124, r2134, r2145, r2146, r3123

NOTICE

The time comprises r2146 (days) and r2125 (milliseconds).

Note

The buffer parameters are cyclically updated in the background (refer to status signal in r2139).

The structure of the alarm buffer and the assignment of the indices is shown in r2122.

r2130[0...63]**Fault time received in days****Data type:** Unsigned16**Visible in:** Extended display**Read permission:**

Read drive data or acknowledge messages

Write permission:

Edit device configuration or drive applications

Parameter group:

Faults / alarms

Unit: -**Description:**

Displays the system runtime in days when the fault occurred.

Dependency:

See also: r0945, r0947, r0948, r0949, r2109, r2114, r2133, r2136, r3122

NOTICE

The time comprises r2130 (days) and r0948 (milliseconds).

Note

The buffer parameters are cyclically updated in the background (refer to status signal in r2139).

r2131**Actual fault code****Data type:** Unsigned16**Visible in:** Standard display**Read permission:**

Read drive data or acknowledge messages

Write permission:

Edit device configuration or drive applications

Parameter group:

Faults / alarms

Unit: -**Description:**

Displays the code of the oldest active fault.

Note

0: No fault present.

r2132

Actual alarm code

Data type: Unsigned16 **Visible in:** Standard display
Read permission: Read drive data or acknowledge messages
Write permission: Edit device configuration or drive applications
Parameter group: Faults / alarms
Unit: -

Description: Displays the code of the last alarm that occurred.

Note

0: No alarm present.

r2133[0...63]

Fault value for float values

Data type: FloatingPoint32 **Visible in:** Extended display
Read permission: Read drive data or acknowledge messages
Write permission: Edit device configuration or drive applications
Parameter group: Faults / alarms
Unit: -

Description: Displays additional information about the fault that occurred for float values.

Dependency: See also: r0945, r0947, r0948, r0949, r2109, r2130, r2136

Note

The buffer parameters are cyclically updated in the background (refer to status signal in r2139).

r2134[0...63]

Alarm value for float values

Data type: FloatingPoint32 **Visible in:** Extended display
Read permission: Read drive data or acknowledge messages
Write permission: Edit device configuration or drive applications
Parameter group: Faults / alarms
Unit: -

Description: Displays additional information about the active alarm for float values.

Dependency: See also: r2122, r2123, r2124, r2125, r2145, r2146, r3123

Note

The buffer parameters are cyclically updated in the background (refer to status signal in r2139).

r2136[0...63]

Fault time removed in days

Data type: Unsigned16 **Visible in:** Extended display
Read permission: Read drive data or acknowledge messages
Write permission: Edit device configuration or drive applications
Parameter group: Faults / alarms
Unit: -

Description: Displays the system runtime in days when the fault was removed.

Dependency: See also: r0945, r0947, r0948, r0949, r2109, r2114, r2130, r2133, r3122

NOTICE

The time comprises r2136 (days) and r2109 (milliseconds).

Note

The buffer parameters are cyclically updated in the background (refer to status signal in r2139).

r2139.0...15**Status word faults/alarms 1**

Data type: Unsigned16 **Visible in:** Extended display
Read permission: Read drive data or acknowledge messages
Write permission: Edit device configuration or drive applications
Parameter group: Faults / alarms

Unit: -

Description: Display and signal source for status word 1 of faults and alarms.

Bit array:

Bit	Signal name	1 signal	0 signal
00	Being acknowledged	Yes	No
01	Acknowledgment required	Yes	No
03	Fault present	Yes	No
05	Safety message present	Yes	No
07	Alarm present	Yes	No
11	Alarm class bit 0	High	Low
12	Alarm class bit 1	High	Low
13	Maintenance required	Yes	No
14	Maintenance urgently required	Yes	No
15	Fault gone/can be acknowledged	Yes	No

Note

For bit 03, 05, 07:

These bits are set if at least one fault/alarm or safety message occurs. The entry in the fault/alarm buffer or safety message buffer is delayed. This is the reason that the fault/alarm buffer or safety message buffer should only be read if, after "Fault active", "Alarm active" or "Safety message active" occurs, a change is also identified in the buffer (r0944, r2121, r60044).

For bits 11, 12:

These status bits are used for the classification of internal alarm classes and are intended for diagnostic purposes only on certain automation systems with integrated SINAMICS functionality.

r2145[0...63]**Alarm time received in days**

Data type: Unsigned16 **Visible in:** Extended display
Read permission: Read drive data or acknowledge messages
Write permission: Edit device configuration or drive applications
Parameter group: Faults / alarms

Unit: -

Description: Displays the system runtime in days when the alarm occurred.

Dependency: See also: r2114, r2122, r2123, r2124, r2125, r2134, r2146, r3123

NOTICE

The time comprises r2145 (days) and r2123 (milliseconds).

Note

The buffer parameters are cyclically updated in the background (refer to status signal in r2139).

r2146[0...63]**Alarm time removed in days**

Data type: Unsigned16 **Visible in:** Extended display
Read permission: Read drive data or acknowledge messages
Write permission: Edit device configuration or drive applications
Parameter group: Faults / alarms

Unit: -

Description: Displays the system runtime in days when the alarm was removed.

Dependency: See also: r2114, r2122, r2123, r2124, r2125, r2134, r2145, r3123

NOTICE
The time comprises r2146 (days) and r2125 (milliseconds).

Note

The buffer parameters are cyclically updated in the background (refer to status signal in r2139).

p2149[0].16

Monitoring configuration

Data type: Unsigned32 **Visible in:** Extended display
Read permission: Read drive data or acknowledge messages
Write permission: Edit device configuration or drive applications
Can be changed in the operating state: Operation
Parameter group: Speed messages, Load torque monitoring
Unit: -
Min: **Max:** **Factory setting:**
- - 0000 0000 0000 0001 0000 0000 0000
0000 bin

Description: Sets the configuration for messages and monitoring functions.

Bit	Signal name	1 signal	0 signal
16	Line voltage failure detection	Yes	No

Note

For bit 16:
When the bit is set, the line voltage failure detection function is activated

p2153[0]

Speed actual value filter time constant

Data type: FloatingPoint32 **Visible in:** Extended display
Read permission: Read drive data or acknowledge messages
Write permission: Edit device configuration or drive applications
Can be changed in the operating state: Operation
Parameter group: Speed messages
Unit: ms
Min: **Max:** **Factory setting:**
0 [ms] 1000000 [ms] 0 [ms]

Description: Sets the time constant of the PT1 element to smooth the speed / velocity actual value.
The smoothed actual speed/velocity is compared with the threshold values and is only used for messages and signals.

p2161[0]

Speed threshold 3

Data type: FloatingPoint32 **Visible in:** Extended display
Read permission: Read drive data or acknowledge messages
Write permission: Edit device configuration or drive applications
Can be changed in the operating state: Operation
Parameter group: Speed messages
Unit: rpm
Min: **Max:** **Factory setting:**
0.00 [rpm] 210000.00 [rpm] 5.00 [rpm]

Description: Sets the speed threshold value for signal "|n_act| < speed threshold 3".

Dependency: See also: r2199

p2162[0]**Hysteresis speed $n_{act} > n_{max}$**

Data type: FloatingPoint32	Visible in: Extended display	
Read permission:	Read drive data or acknowledge messages	
Write permission:	Edit device configuration or drive applications	
Can be changed in the operating state:	Operation	
Parameter group:	Speed messages	
Unit: rpm		
Min: 0.00 [rpm]	Max: 60000.00 [rpm]	Factory setting: 0.00 [rpm]

Description:

Sets the hysteresis speed (bandwidth) for signal " $n_{act} > n_{max}$ ".

NOTICE

For $p0322 = 0$, the following applies: $p2162 \leq 0.1 * p0311$
 For $p0322 > 0$, the following applies: $p2162 \leq 1.02 * p0322 - p1082$
 If one of the conditions is violated, p2162 is appropriately and automatically reduced when exiting the commissioning mode.

Note

For a negative speed limit, the hysteresis is effective below the limit value and for a positive speed limit, above the limit value.

If significant overshoot occurs in the maximum speed range (e.g. due to load shedding), you are advised to increase the dynamic response of the speed controller (if possible). If this is insufficient, the hysteresis p2162 can only be increased by more than 10% of the rated speed when the maximum speed (p0322) of the motor is sufficiently greater than the speed limit p1082.

p2175[0]**Motor blocked speed threshold**

Data type: FloatingPoint32	Visible in: Extended display	
Read permission:	Read drive data or acknowledge messages	
Write permission:	Edit device configuration or drive applications	
Can be changed in the operating state:	Operation	
Parameter group:	Speed messages	
Unit: rpm		
Min: 0.00 [rpm]	Max: 210000.00 [rpm]	Factory setting: 120.00 [rpm]

Description:

Sets the speed threshold for message "Motor blocked".
 Monitoring is deactivated with $p2175 = 0$.

Dependency:

See also: p2177
 See also: F07900

Note

If the motor speed is less than the threshold value set in p2175 - and the motor is operated for longer than 200 ms at the torque limit - then the motor is shut down and a fault is output.

p2177[0]**Motor blocked delay time**

Data type: FloatingPoint32	Visible in: Extended display
Read permission:	Read drive data or acknowledge messages
Write permission:	Edit device configuration or drive applications
Can be changed in the operating state:	Operation
Parameter group:	Speed messages
Unit: s	

	Min: 0.000 [s]	Max: 65.000 [s]	Factory setting: 1.000 [s]
Description:	Sets the delay time for the message "Motor blocked".		
Dependency:	See also: p2175 See also: F07900		

r2199.0...11 **Status word monitoring 3**

Data type: Unsigned16	Visible in: Extended display
Read permission:	Read drive data or acknowledge messages
Write permission:	Edit device configuration or drive applications
Parameter group:	Speed messages, Control/status words
Unit: -	

Description: Display and signal source for the third status word of the monitoring functions.

Bit array:	Bit	Signal name	1 signal	0 signal
	00	n_act < p2161	Yes	No
	01	f or n comparison value reached or exceeded	Yes	No
	04	Speed setpoint - actual value deviation in tolerance t_on	Yes	No
	05	Ramp-up/ramp-down completed	Yes	No
	11	Torque utilization < torque threshold value 2	Yes	No

Note

For bit 00:
The speed threshold 3 is set in p2161.

For bit 01:
The comparison value is set in p2141. We recommend setting the hysteresis (p2142) for canceling the bit to a value lower than that in p2141. Otherwise, the bit is not reset.

For bit 11:
The torque threshold value 2 is set in p2194.

p2496 **LR dimension system physical length units**

Data type: Integer16	Visible in: Standard display
Read permission:	Read drive data or acknowledge messages
Write permission:	Edit device configuration or drive applications
Can be changed in the operating state:	Commissioning
Parameter group:	Position control
Unit: -	

Min: 0	Max: 8	Factory setting: 3
------------------	------------------	------------------------------

Description: Sets the physical length units.

Value:	0: LU (no dimension)
	1: km
	2: m
	3: mm
	4: μm
	5: nm
	6: in
	7: ft
	8: mi

Note

This parameter is only of significance for visualization (e.g. using the commissioning tool). Internally in the drive, the neutral length unit (LU) without dimensions is used for calculations.

p2496

S200 Basic PN (EPOS load side, rotating), S200 PN (EPOS load side, rotating)

LR dimension system physical length units**Data type:** Integer16**Visible in:** Standard display**Read permission:**

Read drive data or acknowledge messages

Write permission:

Edit device configuration or drive applications

Can be changed in the operating state: Commissioning**Parameter group:**

Position control

Unit: -**Min:**

0

Max:

10

Factory setting:

10

Description:

Sets the physical length units.

Value:

0: LU (no dimension)

10: °

Note

This parameter is only of significance for visualization (e.g. using the commissioning tool). Internally in the drive, the neutral length unit (LU) without dimensions is used for calculations.

p2497**LR dimension system physical velocity****Data type:** Integer16**Visible in:** Standard display**Read permission:**

Read drive data or acknowledge messages

Write permission:

Edit device configuration or drive applications

Can be changed in the operating state: Commissioning**Parameter group:**

Position control, Mechanics

Unit: -**Min:**

0

Max:

15

Factory setting:

8

Description:

Sets the physical unit for the velocities.

Value:

0: 1000LU/min (no dimension)

1: km/h

2: km/min

3: m/h

4: m/min

5: m/s

6: mm/h

7: mm/min

8: mm/s

11: in/min

12: in/s

13: ft/min

14: ft/s

15: mi/h

p2497	LR dimension system physical velocity		
S200 Basic PN (EPOS load side, rotating), S200 PN (EPOS load side, rotating)	Data type: Integer16	Visible in: Standard display	
	Read permission:	Read drive data or acknowledge messages	
	Write permission:	Edit device configuration or drive applications	
	Can be changed in the operating state:	Commissioning	
	Parameter group:	Position control, Mechanics	
	Unit: -		
	Min:	Max:	Factory setting:
	0	18	18
Description:	Sets the physical unit for the velocities.		
Value:	0: 1000LU/min (no dimension)		
	18: °/s		

p2498	LR dimension system physical acceleration		
	Data type: Integer16	Visible in: Standard display	
	Read permission:	Read drive data or acknowledge messages	
	Write permission:	Edit device configuration or drive applications	
	Can be changed in the operating state:	Commissioning	
	Parameter group:	Position control, Mechanics	
	Unit: -		
	Min:	Max:	Factory setting:
	0	11	7
Description:	Sets the physical unit for the accelerations.		
Value:	0: 1000LU/s ² (no dimension)		
	6: m/s ²		
	7: mm/s ²		
	10: in/s ²		
	11: ft/s ²		

p2498	LR dimension system physical acceleration		
S200 Basic PN (EPOS load side, rotating), S200 PN (EPOS load side, rotating)	Data type: Integer16	Visible in: Standard display	
	Read permission:	Read drive data or acknowledge messages	
	Write permission:	Edit device configuration or drive applications	
	Can be changed in the operating state:	Commissioning	
	Parameter group:	Position control, Mechanics	
	Unit: -		
	Min:	Max:	Factory setting:
	0	18	18
Description:	Sets the physical unit for the accelerations.		
Value:	0: 1000LU/s ² (no dimension)		
	18: °/s ²		

p2499	LR dimension system physical jerk		
	Data type: Integer16	Visible in: Standard display	
	Read permission:	Read drive data or acknowledge messages	
	Write permission:	Edit device configuration or drive applications	
	Can be changed in the operating state:	Commissioning	
	Parameter group:	Position control, Mechanics	
	Unit: -		
	Min:	Max:	Factory setting:
	0	11	7
Description:	Sets the physical unit für jerk.		
Value:	0: 1000LU/s ³ (no dimension)		
	7: mm/s ³		
	10: in/s ³		
	11: ft/s ³		

p2499	LR dimension system physical jerk		
S200 Basic PN (EPOS load side, rotating), S200 PN (EPOS load side, rotating)	Data type: Integer16	Visible in: Standard display	
	Read permission:	Read drive data or acknowledge messages	
	Write permission:	Edit device configuration or drive applications	
	Can be changed in the operating state:	Commissioning	
	Parameter group:	Position control, Mechanics	
	Unit: -		
	Min:	Max:	Factory setting:
	0	18	18
Description:	Sets the physical unit für jerk.		
Value:	0: 1000LU/s ³ (no dimension)		
	18: °/s ³		

p2502[0]	LR encoder assignment		
	Data type: Integer16	Visible in: Standard display	
	Read permission:	Read drive data or acknowledge messages	
	Write permission:	Edit device configuration or drive applications	
	Can be changed in the operating state:	Commissioning	
	Parameter group:	Mechanics, Actual position value preprocessing	
	Unit: -		
	Min:	Max:	Factory setting:
	0	1	1
Description:	Setting to assign the encoder.		
	The actual value preprocessing and the closed-loop position control are carried out using the assigned encoder.		
Value:	0: No encoder		
	1: Motor encoder		

NOTICE

For the setting p2502 = 0 (no encoder), closed-loop position control is not possible. This setting is only practical as supportive measure to implement encoderless closed-loop speed control (e.g. if the motor encoder is defective).

Note

An encoder data set must be assigned to the assigned encoder (p2502 = 1, 2, 3).

p2503[0]	LR length unit MU per 10 mm		
	Data type: FloatingPoint32	Visible in: Extended display	
	Read permission:	Read drive data or acknowledge messages	
	Write permission:	Edit device configuration or drive applications	
	Can be changed in the operating state:	Commissioning	
	Parameter group:	Position control	
	Unit: LU		
	Min:	Max:	Factory setting:
	0.000001 [LU]	2147483650.000000 [LU]	10.000000 [LU]
Description:	Sets the length unit MU per 10 mm set by the user. For a linear scale, this establishes a reference between the physical arrangement and the neutral length units LU used in the drive. Example: Linear scale, 10 mm should be broken down to units of μm (i.e. 1 LU = 1 μm). --> p2503 = 10000		
	Note When selecting a physical length unit, the drive automatically preassigns the parameter and it cannot be changed. The assignment to the grid spacing can be achieved using this for a rotary axis with linear encoder. MU: measurement unit		

p2503[0]	LR length unit MU per 10 mm		
S200 Basic PN (EPOS load side, rotating), S200 PN (EPOS load side, rotating)	Data type: FloatingPoint32	Visible in: Extended display	
	Read permission:	Read drive data or acknowledge messages	
	Write permission:	Edit device configuration or drive applications	
	Can be changed in the operating state:	Commissioning	
	Parameter group:	Position control	
	Unit: LU		
	Min:	Max:	Factory setting:
	0.000001 [LU]	2147483650.000000 [LU]	10.000000 [LU]
Description:	Sets the length unit MU per 10 mm set by the user. For a linear scale, this establishes a reference between the physical arrangement and the neutral length units LU used in the drive. Example: Linear scale, 10 mm should be broken down to units of μm (i.e. 1 LU = 1 μm). --> p2503 = 10000		
	Note When selecting a physical length unit, the drive automatically preassigns the parameter and it cannot be changed. The assignment to the grid spacing can be achieved using this for a rotary axis with linear encoder. MU: measurement unit		

p2504[0]	LR motor/load motor revolutions		
	Data type: Unsigned32	Visible in: Standard display	
	Read permission:	Read drive data or acknowledge messages	
	Write permission:	Edit device configuration or drive applications	
	Can be changed in the operating state:	Commissioning	
	Parameter group:	Position control, Mechanics	
	Unit: -		

	Min:	Max:	Factory setting:
	1	1048576	1
Description:	Sets the motor revolutions for the gearbox factor between the motor shaft and load shaft. Gearbox factor = motor revolutions (p2504) / load revolutions (p2505)		
Dependency:	See also: p2505		

p2505[0]	LR motor/load load revolutions		
	Data type: Integer32	Visible in: Standard display	
	Read permission:	Read drive data or acknowledge messages	
	Write permission:	Edit device configuration or drive applications	
	Can be changed in the operating state:	Commissioning	
	Parameter group:	Position control, Mechanics	
	Unit: -		
	Min:	Max:	Factory setting:
	-1048576	1048576	1
Description:	Sets the load revolutions for the gearbox factor between the motor shaft and load shaft. Gearbox factor = motor revolutions (p2504) / load revolutions (p2505)		
Dependency:	See also: p2504		

p2506[0]	LR length unit MU per load distance		
	Data type: FloatingPoint32	Visible in: Extended display	
	Read permission:	Read drive data or acknowledge messages	
	Write permission:	Edit device configuration or drive applications	
	Can be changed in the operating state:	Commissioning	
	Parameter group:	Position control, Mechanics	
	Unit: LU		
	Min:	Max:	Factory setting:
	0.000001 [LU]	2147483650.000000 [LU]	10.000000 [LU]
Description:	Sets the length unit MU per load distance set by the user. For a rotary encoder, this establishes a reference between the actual physical situation and the user-specific length unit MU. Example: Rotary encoder, ballscrew with 10 mm/revolution, 10 mm should be broken down to units of μm . Length unit LU (p2496 = 0) --> One load distance corresponds to 10000 LU (i.e. 1 LU = 1 μm) --> p2506 = 10000 Physical unit μm (2496) = 4 --> One load distance corresponds to 10000 μm --> p2506 = 10000		
Dependency:	See also: p2496		

p2506[0]	LR length unit MU per load revolution		
S200 Basic PN (EPOS load side, rotating), S200 PN (EPOS load side, rotating)	Data type: FloatingPoint32	Visible in: Extended display	
	Read permission:	Read drive data or acknowledge messages	
	Write permission:	Edit device configuration or drive applications	
	Can be changed in the operating state:	Commissioning	
	Parameter group:	Position control, Mechanics	
	Unit: LU		
	Min:	Max:	Factory setting:
	0.000001 [LU]	2147483650.000000 [LU]	360.000000 [LU]
Description:	Sets the rotary unit MU per load revolution set by the user. For a rotary encoder, this establishes a reference between the physical arrangement and the user-specific rotating unit MU. Example: Rotating unit LU (p2496 = 0) Rotary encoder, 1 revolution should be broken down into mdegrees, (i.e. 1 LU = 1 mdegrees). --> One load revolution corresponds to 360000 LU --> p2506 = 360000		
Dependency:	See also: p2496		
	Note When selecting a physical length unit, the drive automatically preassigns the parameter and it cannot be changed.		

p2507[0]	LR absolute encoder adjustment status		
	Data type: Integer16	Visible in: Standard display	
	Read permission:	Read drive data or acknowledge messages	
	Write permission:	Edit device configuration or drive applications	
	Can be changed in the operating state:	Operation	
	Parameter group:	Position control	
	Unit: -		
	Min:	Max:	Factory setting:
	0	3	1
Description:	Activates the adjustment and display of the status of the adjustment for absolute encoders. For p2507 = 2: This initiates encoder adjustment. The status is displayed using the other values.		
Value:	0: Error occurred while adjusting 1: Absolute encoder not adjusted 2: Absolute encoder not adjusted and encoder adjustment initiated 3: Absolute encoder adjusted		
Dependency:	See also: c2598, p2599, c11500		

⚠ CAUTION

For rotating absolute encoders, when adjusting, a range is set up symmetrically around zero with half of the encoder range, within which the position must be re-established after switch-off/switch-on. In this range, it is only permissible that the encoder overflows.

After the adjustment has been completed, it must be guaranteed that the range is not exited. The reason for this is that outside the range, there is no clear reference any longer between the encoder actual value and mechanical system. If the home position (c2598) lies in this range, then the position actual value is set when adjusting to the home position. Otherwise, adjustment is canceled with F07443.

There is no overflow for linear absolute encoders. This means that after the adjustment, the position can be re-established in the complete traversing range after switch-off/switch-on. When adjusting, the position actual value is set to the home position.

Note

To permanently accept the determined position offset, it must be retentively saved (p0977).
This adjustment can only be initiated for an absolute encoder.

c2510[0...3]**LR selecting measuring probe evaluation**

Data type: Unsigned8 **Visible in:** Standard display
Read permission: Read drive data or acknowledge messages
Write permission: Edit device configuration or drive applications
Parameter group: Homing, Traversing blocks, Position control
Unit: -

Description: Signal to select the measuring probe.
0 signal, measuring probe 1 is used.
1 signal, measuring probe 2 is used.

Index: [0] = Position control
[1] = Motor encoder
[2] = Encoder 2
[3] = Encoder 3

Dependency: See also: p2502, c2511

Note

When function "Basic positioner" is activated, the measuring probe is selected at the 0/1 edge at r2684.1 (passive homing active).

c2511[0...3]**LR measuring probe evaluation edge**

Data type: Unsigned8 **Visible in:** Standard display
Read permission: Read drive data or acknowledge messages
Write permission: Edit device configuration or drive applications
Parameter group: Homing, Traversing blocks, Position control
Unit: -

Description: Signal to evaluate the measuring probe edge.
1 signal:
The falling edge of the measuring probe (c2510) is used.
0 signal:
The rising edge of the measuring probe (c2510) is used.

Index: [0] = Position control
[1] = Motor encoder
[2] = Encoder 2
[3] = Encoder 3

Dependency: See also: p2502, c2510

r2521[0...3]**LR position actual value**

Data type: FloatingPoint32 **Visible in:** Standard display
Read permission: Read drive data or acknowledge messages
Write permission: Edit device configuration or drive applications
Parameter group: Jog, Homing, Traversing blocks, Direct setpoint input (MDI), Actual position value preprocessing
Unit: LU

Description: Display for the actual position actual value determined by the position actual value preprocessing.

Index: [0] = Position control
[1] = Motor encoder
[2] = Reserved
[3] = Reserved

Dependency: See also: p2502, r2526

Note
r2526.0 = 1 --> The position actual value in r2521[0] for the position control is valid.

r2521[0...3] LR position actual value

S200 Basic PN (EPOS load side, rotating), S200 PN (EPOS load side, rotating)

Data type: FloatingPoint32 **Visible in:** Standard display

Read permission: Read drive data or acknowledge messages

Write permission: Edit device configuration or drive applications

Parameter group: Jog, Homing, Traversing blocks, Direct setpoint input (MDI), Actual position value preprocessing

Unit: LU

Description: Display for the actual position actual value determined by the position actual value preprocessing.

Index: [0] = Position control
[1] = Motor encoder
[2] = Reserved
[3] = Reserved

Dependency: See also: p2502, r2526

Note
r2526.0 = 1 --> The position actual value in r2521[0] for the position control is valid.

r2522[0...3] LR velocity actual value

Data type: FloatingPoint32 **Visible in:** Standard display

Read permission: Read drive data or acknowledge messages

Write permission: Edit device configuration or drive applications

Parameter group: Jog, Homing, Traversing blocks, Direct setpoint input (MDI), Actual position value preprocessing

Unit: 1000 LU/min

Description: Display for the actual velocity value determined by the position actual value preprocessing.

Index: [0] = Position control
[1] = Motor encoder
[2] = Reserved
[3] = Reserved

Dependency: See also: p2502, r2526

Note
r2526.0 = 1 --> The velocity actual value in r2522[0] for the position control is valid.

r2522[0...3] LR velocity actual value

S200 Basic PN (EPOS load side, rotating), S200 PN (EPOS load side, rotating)

Data type: FloatingPoint32 **Visible in:** Standard display

Read permission: Read drive data or acknowledge messages

Write permission: Edit device configuration or drive applications

Parameter group: Jog, Homing, Traversing blocks, Direct setpoint input (MDI), Actual position value preprocessing

Unit: 1000 LU/min

Description: Display for the actual velocity value determined by the position actual value preprocessing.

A.3 Parameters

Index: [0] = Position control
 [1] = Motor encoder
 [2] = Reserved
 [3] = Reserved

Dependency: See also: p2502, r2526

Note
 r2526.0 = 1 --> The velocity actual value in r2522[0] for the position control is valid.

r2523[0...3] LR measured value

Data type: FloatingPoint32 **Visible in:** Extended display
Read permission: Read drive data or acknowledge messages
Write permission: Edit device configuration or drive applications
Parameter group: Position control
Unit: LU

Description: Display for the value determined by the function "homing mark search" and "measuring probe evaluation".

Index: [0] = Position control
 [1] = Motor encoder
 [2] = Reserved
 [3] = Reserved

Dependency: See also: p2502, r2526

Note
 r2526.2 = 1 --> The measured value in r2523[0] for the position control is valid.

r2523[0...3] LR measured value

S200 Basic PN (EPOS load side, rotating), S200 PN (EPOS load side, rotating)

Data type: FloatingPoint32 **Visible in:** Extended display
Read permission: Read drive data or acknowledge messages
Write permission: Edit device configuration or drive applications
Parameter group: Position control
Unit: LU

Description: Display for the value determined by the function "homing mark search" and "measuring probe evaluation".

Index: [0] = Position control
 [1] = Motor encoder
 [2] = Reserved
 [3] = Reserved

Dependency: See also: p2502, r2526

Note
 r2526.2 = 1 --> The measured value in r2523[0] for the position control is valid.

r2526.0...12 LR status word

Data type: Unsigned16 **Visible in:** Standard display
Read permission: Read drive data or acknowledge messages
Write permission: Edit device configuration or drive applications
Parameter group: Actual position value preprocessing
Unit: -

Description: Display and signal source for the status word of the position controller.

Bit array:	Bit	Signal name	1 signal	0 signal
	00	Position actual value valid	Yes	No
	01	Homing active	Yes	No

02	Measured value valid	Yes	No
03	Position control active	Yes	No
04	Fixed stop reached	Yes	No
05	Fixed stop outside window	Yes	No
06	Position controller output limited	Yes	No
07	Request tracking mode	Yes	No
08	Clamping active when traveling to fixed stop	Yes	No
09	Setting value for adjustment valid	Yes	No
10	Absolute encoder adjusted	Yes	No
11	Absolute encoder adjustment unsuccessful	Yes	No
12	Absolute encoder being adjusted	Yes	No

Dependency: See also: r2521, r2522, r2523

Note

For bit 04:
The signal is influenced via p2634.
For bit 05:
The signal is influenced via p2635.

c2530

LR position setpoint

Data type: FloatingPoint32 **Visible in:** Standard display
Read permission: Read drive data or acknowledge messages
Write permission: Edit device configuration or drive applications
Parameter group: Position controller
Unit: LU

Description: Signal for the position setpoint of the position controller.

Dependency: See also: r2665

c2530

LR position setpoint

S200 Basic PN (EPOS load side, rotating), S200 PN (EPOS load side, rotating)

Data type: FloatingPoint32 **Visible in:** Standard display
Read permission: Read drive data or acknowledge messages
Write permission: Edit device configuration or drive applications
Parameter group: Position controller
Unit: LU

Description: Signal for the position setpoint of the position controller.

Dependency: See also: r2665

c2531

LR velocity setpoint

Data type: FloatingPoint32 **Visible in:** Standard display
Read permission: Read drive data or acknowledge messages
Write permission: Edit device configuration or drive applications
Parameter group: Position controller
Unit: 1000 LU/min

Description: Signal for the velocity setpoint of the position controller.

Dependency: See also: r2666

c2531

S200 Basic PN (EPOS load side, rotating), S200 PN (EPOS load side, rotating)

LR velocity setpoint**Data type:** FloatingPoint32**Visible in:** Standard display**Read permission:**

Read drive data or acknowledge messages

Write permission:

Edit device configuration or drive applications

Parameter group:

Position controller

Unit: 1000 LU/min**Description:**

Signal for the velocity setpoint of the position controller.

Dependency:

See also: r2666

p2533[0]**LR position setpoint filter time constant****Data type:** FloatingPoint32**Visible in:** Extended display**Read permission:**

Read drive data or acknowledge messages

Write permission:

Edit device configuration or drive applications

Can be changed in the operating state: Operation**Parameter group:**

Position controller

Unit: ms**Min:**

0.00 [ms]

Max:

1000.00 [ms]

Factory setting:

0.00 [ms]

Description:

Sets the time constant for the position setpoint filter (PT1).

Note

The effective Kv factor (position loop gain) is reduced with the filter. This allows a softer control behavior with improved tolerance with respect to noise/disturbances.

Applications:

- reduces the precontrol dynamic response.
- jerk limiting.

p2534[0]**LR speed precontrol factor****Data type:** FloatingPoint32**Visible in:** Standard display**Read permission:**

Read drive data or acknowledge messages

Write permission:

Edit device configuration or drive applications

Can be changed in the operating state: Operation**Parameter group:**

Position controller

Unit: %**Min:**

0.00 [%]

Max:

200.00 [%]

Factory setting:

0.00 [%]

Description:

Setting for activation and weighting of the speed precontrol value.

Value = 0 % --> The precontrol is deactivated.

Dependency:

See also: p2535, p2536, r2563

Note

When the axis control loop is optimally set as well as a precisely determined equivalent time constant of the speed control loop, the precontrol factor is 100%.

p2535[0]	<p>LR speed precontrol symmetrizing filter dead time</p> <p>Data type: FloatingPoint32 Visible in: Extended display</p> <p>Read permission: Read drive data or acknowledge messages</p> <p>Write permission: Edit device configuration or drive applications</p> <p>Can be changed in the operating state: Operation</p> <p>Parameter group: Position controller</p> <p>Unit: -</p> <table border="0"> <tr> <td>Min:</td> <td>Max:</td> <td>Factory setting:</td> </tr> <tr> <td>0.00</td> <td>2.00</td> <td>0.00</td> </tr> </table>	Min:	Max:	Factory setting:	0.00	2.00	0.00
Min:	Max:	Factory setting:					
0.00	2.00	0.00					
Description:	Sets the "fractional" dead time to emulate the timing behavior of the speed control loop. The selected multiplier refers to the position controller sampling time (dead time= p2535 * position controller clock cycle).						
Dependency:	See also: p2536						
<p>NOTICE</p> <p>When speed precontrol is active (p2534 > 0 %), the following applies: In addition to the set dead time (p2535), internally two position controller sampling times are effective.</p> <p>When speed precontrol is inactive (p2534 = 0 %), the following applies: No dead time is effective (p2535 and internal).</p>							
<p>Note</p> <p>Together with p2536, the time response of the closed speed control loop can be emulated.</p>							

p2536[0]	<p>LR speed precontrol symmetrizing filter PT1</p> <p>Data type: FloatingPoint32 Visible in: Extended display</p> <p>Read permission: Read drive data or acknowledge messages</p> <p>Write permission: Edit device configuration or drive applications</p> <p>Can be changed in the operating state: Operation</p> <p>Parameter group: Position controller</p> <p>Unit: ms</p> <table border="0"> <tr> <td>Min:</td> <td>Max:</td> <td>Factory setting:</td> </tr> <tr> <td>0.00 [ms]</td> <td>100.00 [ms]</td> <td>0.00 [ms]</td> </tr> </table>	Min:	Max:	Factory setting:	0.00 [ms]	100.00 [ms]	0.00 [ms]
Min:	Max:	Factory setting:					
0.00 [ms]	100.00 [ms]	0.00 [ms]					
Description:	Sets a PT1 filter to emulate the time response of the closed speed control loop.						
Dependency:	See also: p2535						
<p>NOTICE</p> <p>When speed precontrol is inactive (p2534 = 0 %), the following applies: If a PT1 filter has been set, it is not effective.</p>							
<p>Note</p> <p>Together with p2535, the time response of the closed speed control loop can be emulated.</p>							

p2538[0]	<p>LR proportional gain</p> <p>Data type: FloatingPoint32 Visible in: Standard display</p> <p>Read permission: Read drive data or acknowledge messages</p> <p>Write permission: Edit device configuration or drive applications</p> <p>Can be changed in the operating state: Operation</p> <p>Parameter group: Position controller</p> <p>Unit: 1000 rpm</p>
-----------------	--

	Min: 0.000 [1000 rpm]	Max: 300.000 [1000 rpm]	Factory setting: 1.000 [1000 rpm]
Description:	Sets the proportional gain (P gain, position loop gain, Kv factor) of the position controller.		
Dependency:	See also: p2539, r2557, r2558		
Note			
The proportional gain is used to define at which traversing velocity which following error is obtained (without precontrol)			
Low proportional gain:			
Slow response to a setpoint - actual value difference, the following error becomes large.			
High proportional gain:			
Fast response to the setpoint - actual value difference, the following error becomes small.			

p2539[0]	LR integral time		
	Data type: FloatingPoint32	Visible in: Extended display	
	Read permission:	Read drive data or acknowledge messages	
	Write permission:	Edit device configuration or drive applications	
	Can be changed in the operating state:	Operation	
	Parameter group:	Position controller	
	Unit: ms		
	Min: 0.00 [ms]	Max: 100000.00 [ms]	Factory setting: 0.00 [ms]
Description:	Setting to activate the integral time of the position controller. Value = 0 ms --> The I component of the position controller is deactivated.		
Dependency:	See also: p2538, r2559		

p2540	LR position controller output speed limit		
	Data type: FloatingPoint32	Visible in: Extended display	
	Read permission:	Read drive data or acknowledge messages	
	Write permission:	Edit device configuration or drive applications	
	Can be changed in the operating state:	Operation	
	Parameter group:	Position controller	
	Unit: rpm		
	Min: 0.000 [rpm]	Max: 210000.000 [rpm]	Factory setting: 210000.000 [rpm]
Description:	Setting and numerical signal source for the speed limit of the position controller output.		
Dependency:	See also: c2541		

c2541	LR position controller output speed limit signal		
	Data type: FloatingPoint32	Visible in: Extended display	
	Read permission:	Read drive data or acknowledge messages	
	Write permission:	Edit device configuration or drive applications	
	Parameter group:	Position controller	
	Unit: rpm		
Description:	Signal for limiting the position controller output.		
Dependency:	See also: p2540		

p2542	LR standstill window		
	Data type: FloatingPoint32	Visible in: Standard display	
	Read permission:	Read drive data or acknowledge messages	
	Write permission:	Edit device configuration or drive applications	
	Can be changed in the operating state:	Operation	
	Parameter group:	Position controller monitoring	
	Unit: LU		
	Min: 0.0000 [LU]	Max: 2147483647.0000 [LU]	Factory setting: 0.2500 [LU]
Description:	Sets the standstill window for the standstill monitoring function. After the standstill monitoring time expires, it is cyclically checked whether the difference between the setpoint and actual position is located within the standstill window and, if required, an appropriate fault is output. Value = 0 --> The standstill monitoring is deactivated.		
Dependency:	See also: p2543, p2544		
	Note The following applies for the setting of the standstill window and positioning window: Standstill window (p2542) >= positioning window (p2544)		

p2542	LR standstill window		
S200 Basic PN (EPOS load side, rotating), S200 PN (EPOS load side, rotating)	Data type: FloatingPoint32	Visible in: Standard display	
	Read permission:	Read drive data or acknowledge messages	
	Write permission:	Edit device configuration or drive applications	
	Can be changed in the operating state:	Operation	
	Parameter group:	Position controller monitoring	
	Unit: LU		
	Min: 0.0000 [LU]	Max: 2147483647.0000 [LU]	Factory setting: 10.0000 [LU]
Description:	Sets the standstill window for the standstill monitoring function. After the standstill monitoring time expires, it is cyclically checked whether the difference between the setpoint and actual position is located within the standstill window and, if required, an appropriate fault is output. Value = 0 --> The standstill monitoring is deactivated.		
Dependency:	See also: p2543, p2544		
	Note The following applies for the setting of the standstill window and positioning window: Standstill window (p2542) >= positioning window (p2544)		

p2543	LR standstill monitoring time		
	Data type: FloatingPoint32	Visible in: Standard display	
	Read permission:	Read drive data or acknowledge messages	
	Write permission:	Edit device configuration or drive applications	
	Can be changed in the operating state:	Operation	
	Parameter group:	Position controller monitoring	
	Unit: ms		
	Min: 0.00 [ms]	Max: 100000.00 [ms]	Factory setting: 200.00 [ms]

Description:	Sets the standstill monitoring time for the standstill monitoring function. After the standstill monitoring time expires, it is cyclically checked whether the difference between the setpoint and actual position is located within the standstill window and, if required, an appropriate fault is output.
Dependency:	See also: p2542, p2545
Note	
The following applies for the setting of the standstill and positioning monitoring time: Standstill monitoring time (p2543) <= positioning monitoring time (p2545)	

p2544	LR positioning window
	Data type: FloatingPoint32 Visible in: Standard display
	Read permission: Read drive data or acknowledge messages
	Write permission: Edit device configuration or drive applications
	Can be changed in the operating state: Operation
	Parameter group: Position controller monitoring
	Unit: LU
	Min: Max: Factory setting:
	0.0000 [LU] 2147483647.0000 [LU] 0.0500 [LU]
Description:	Sets the positioning window for the positioning monitoring function. After the positioning monitoring time expires, it is checked once as to whether the difference between the setpoint and actual position lies within the positioning window and if required an appropriate fault is output. Value = 0 --> The positioning monitoring function is deactivated.
Dependency:	See also: p2542, p2545, r2684
Note	
The following applies for the setting of the standstill and positioning window: Standstill window (p2542) >= positioning window (p2544)	

p2544	LR positioning window
S200 Basic PN (EPOS load side, rotating), S200 PN (EPOS load side, rotating)	Data type: FloatingPoint32 Visible in: Standard display
	Read permission: Read drive data or acknowledge messages
	Write permission: Edit device configuration or drive applications
	Can be changed in the operating state: Operation
	Parameter group: Position controller monitoring
	Unit: LU
	Min: Max: Factory setting:
	0.0000 [LU] 2147483647.0000 [LU] 2.0000 [LU]
Description:	Sets the positioning window for the positioning monitoring function. After the positioning monitoring time expires, it is checked once as to whether the difference between the setpoint and actual position lies within the positioning window and if required an appropriate fault is output. Value = 0 --> The positioning monitoring function is deactivated.
Dependency:	See also: p2542, p2545, r2684
Note	
The following applies for the setting of the standstill and positioning window: Standstill window (p2542) >= positioning window (p2544)	

p2545	LR positioning monitoring time		
	Data type: FloatingPoint32	Visible in: Standard display	
	Read permission:	Read drive data or acknowledge messages	
	Write permission:	Edit device configuration or drive applications	
	Can be changed in the operating state:	Operation	
	Parameter group:	Position controller monitoring	
	Unit: ms		
	Min:	Max:	Factory setting:
	0.00 [ms]	100000.00 [ms]	1000.00 [ms]
Description:	Sets the positioning monitoring time for the positioning monitoring. After the positioning monitoring time expires, it is checked once as to whether the difference between the setpoint and actual position lies within the positioning window and if required an appropriate fault is output.		
Dependency:	See also: p2543, p2544, r2684		

Note

The following applies for the setting of the standstill and positioning monitoring time:
Standstill monitoring time (p2543) <= positioning monitoring time (p2545)

p2546[0]	LR dynamic following error monitoring tolerance		
	Data type: FloatingPoint32	Visible in: Standard display	
	Read permission:	Read drive data or acknowledge messages	
	Write permission:	Edit device configuration or drive applications	
	Can be changed in the operating state:	Operation	
	Parameter group:	Position controller monitoring	
	Unit: LU		
	Min:	Max:	Factory setting:
	0.0000 [LU]	2147483647.0000 [LU]	1.0000 [LU]
Description:	Sets the tolerance for the dynamic following error monitoring. If the dynamic following error (r2563) exceeds the selected tolerance, then an appropriate fault is output. Value = 0 --> The dynamic following error monitoring is deactivated.		
Dependency:	See also: r2563, r2684		

Note

The tolerance bandwidth is intended to prevent the dynamic following error monitoring incorrectly responding due to operational control sequences (e.g. during load surges).

p2546[0]	LR dynamic following error monitoring tolerance		
S200 Basic PN (EPOS load side, rotating), S200 PN (EPOS load side, rotating)	Data type: FloatingPoint32	Visible in: Standard display	
	Read permission:	Read drive data or acknowledge messages	
	Write permission:	Edit device configuration or drive applications	
	Can be changed in the operating state:	Operation	
	Parameter group:	Position controller monitoring	
	Unit: LU		
	Min:	Max:	Factory setting:
	0.0000 [LU]	2147483647.0000 [LU]	36.0000 [LU]
Description:	Sets the tolerance for the dynamic following error monitoring. If the dynamic following error (r2563) exceeds the selected tolerance, then an appropriate fault is output. Value = 0 --> The dynamic following error monitoring is deactivated.		
Dependency:	See also: r2563, r2684		

Note

The tolerance bandwidth is intended to prevent the dynamic following error monitoring incorrectly responding due to operational control sequences (e.g. during load surges).

r2556	LR position setpoint after setpoint smoothing	Data type: FloatingPoint32	Visible in: Standard display
		Read permission:	Read drive data or acknowledge messages
		Write permission:	Edit device configuration or drive applications
		Parameter group:	Position controller
		Unit: LU	
Description:	Display and signal source for the position setpoint after setpoint smoothing.		
r2556	LR position setpoint after setpoint smoothing	Data type: FloatingPoint32	Visible in: Standard display
S200 Basic PN (EPOS load side, rotating), S200 PN (EPOS load side, rotating)		Read permission:	Read drive data or acknowledge messages
		Write permission:	Edit device configuration or drive applications
		Parameter group:	Position controller
		Unit: LU	
Description:	Display and signal source for the position setpoint after setpoint smoothing.		
r2557	LR position controller input system deviation	Data type: FloatingPoint32	Visible in: Standard display
		Read permission:	Read drive data or acknowledge messages
		Write permission:	Edit device configuration or drive applications
		Parameter group:	Position controller
		Unit: LU	
Description:	Display and signal source for the difference between the position setpoint and the position actual value at the position controller input.		
r2557	LR position controller input system deviation	Data type: FloatingPoint32	Visible in: Standard display
S200 Basic PN (EPOS load side, rotating), S200 PN (EPOS load side, rotating)		Read permission:	Read drive data or acknowledge messages
		Write permission:	Edit device configuration or drive applications
		Parameter group:	Position controller
		Unit: LU	
Description:	Display and signal source for the difference between the position setpoint and the position actual value at the position controller input.		
r2558	LR position controller output P component	Data type: FloatingPoint32	Visible in: Extended display
		Read permission:	Read drive data or acknowledge messages
		Write permission:	Edit device configuration or drive applications
		Parameter group:	Position controller
		Unit: rpm	
Description:	Display and signal source for the P component at the output of the position controller (speed setpoint).		

r2559	<p>LR position controller output I component</p> <p>Data type: FloatingPoint32 Visible in: Extended display</p> <p>Read permission: Read drive data or acknowledge messages</p> <p>Write permission: Edit device configuration or drive applications</p> <p>Parameter group: Position controller</p> <p>Unit: rpm</p>
Description:	Display and signal sources for the I component at the output of the position controller (speed setpoint).

r2560	<p>LR speed setpoint</p> <p>Data type: FloatingPoint32 Visible in: Standard display</p> <p>Read permission: Read drive data or acknowledge messages</p> <p>Write permission: Edit device configuration or drive applications</p> <p>Parameter group: Position controller</p> <p>Unit: rpm</p>
Description:	Display and signal source for the speed setpoint after limiting (c2541).

r2561	<p>LR speed precontrol value</p> <p>Data type: FloatingPoint32 Visible in: Standard display</p> <p>Read permission: Read drive data or acknowledge messages</p> <p>Write permission: Edit device configuration or drive applications</p> <p>Parameter group: Position controller</p> <p>Unit: rpm</p>
Description:	Display and signal source for the speed setpoint as a result of precontrol.

r2562	<p>LR total speed setpoint</p> <p>Data type: FloatingPoint32 Visible in: Standard display</p> <p>Read permission: Read drive data or acknowledge messages</p> <p>Write permission: Edit device configuration or drive applications</p> <p>Parameter group: Position controller</p> <p>Unit: rpm</p>
Description:	Display and signal source for the total speed setpoint. This value is obtained from the sum of the speed precontrol and position controller output.
Dependency:	See also: r2560, r2561

r2563	<p>LR following error dynamic model</p> <p>Data type: FloatingPoint32 Visible in: Standard display</p> <p>Read permission: Read drive data or acknowledge messages</p> <p>Write permission: Edit device configuration or drive applications</p> <p>Parameter group: Jog, Homing, Traversing blocks, Direct setpoint input (MDI), Position controller monitoring</p> <p>Unit: LU</p>
Description:	Display and signal source for the dynamic following error. This value is the deviation, corrected by the velocity-dependent component, between the position setpoint and the position actual value.

Note

For p2534 \geq 100 % (precontrol activated) the following applies:

The dynamic following error (r2563) corresponds to the system deviation (r2557) at the position controller input.

For 0 % < p2534 < 100 % (precontrol activated) or p2534 = 0 % (precontrol deactivated) the following applies:

The dynamic following error (r2563) is the deviation between the measured position actual value and a value that is calculated from the position setpoint via a PT1 model. This compensates the system-related velocity-dependent system deviation for a P controller.

r2563

S200 Basic PN (EPOS load side, rotating), S200 PN (EPOS load side, rotating)

LR following error dynamic model

Data type: FloatingPoint32

Visible in: Standard display

Read permission:

Read drive data or acknowledge messages

Write permission:

Edit device configuration or drive applications

Parameter group:

Jog, Homing, Traversing blocks, Direct setpoint input (MDI), Position controller monitoring

Unit: LU

Description:

Display and signal source for the dynamic following error.

This value is the deviation, corrected by the velocity-dependent component, between the position setpoint and the position actual value.

Note

For p2534 \geq 100 % (precontrol activated) the following applies:

The dynamic following error (r2563) corresponds to the system deviation (r2557) at the position controller input.

For 0 % < p2534 < 100 % (precontrol activated) or p2534 = 0 % (precontrol deactivated) the following applies:

The dynamic following error (r2563) is the deviation between the measured position actual value and a value that is calculated from the position setpoint via a PT1 model. This compensates the system-related velocity-dependent system deviation for a P controller.

r2564**LR torque precontrol value**

Data type: FloatingPoint32

Visible in: Standard display

Read permission:

Read drive data or acknowledge messages

Write permission:

Edit device configuration or drive applications

Parameter group:

Position controller

Unit: Nm

Description:

Display and signal source for the torque precontrol value.

Note

The torque precontrol value is the derivation over time of the speed precontrol value and is referred to a moment of inertia of 1 kgm²/2 PI. When using the precontrol, then this should be evaluated corresponding to the actual moment of inertia.

r2565**LR following error actual**

Data type: FloatingPoint32

Visible in: Standard display

Read permission:

Read drive data or acknowledge messages

Write permission:

Edit device configuration or drive applications

Parameter group:

Position controller

Unit: LU

Description:

Display and signal source for the actual following error.

This value is the deviation between the position setpoint - after fine interpolation - and the position actual value.

NOTICE

When speed precontrol is active (p2534 > 0 %), the following applies:

To calculate this value, the position setpoint is delayed by two position controller sampling times.

When speed precontrol is inactive (p2534 = 0 %), the following applies:

To calculate this value, the position setpoint is delayed by two position controller clock cycles.

r2565	LR following error actual	
S200 Basic PN (EPOS load side, rotating), S200 PN (EPOS load side, rotating)	Data type: FloatingPoint32	Visible in: Standard display
	Read permission:	Read drive data or acknowledge messages
	Write permission:	Edit device configuration or drive applications
	Parameter group:	Position controller
	Unit: LU	
Description:	Display and signal source for the actual following error. This value is the deviation between the position setpoint - after fine interpolation - and the position actual value.	
	NOTICE When speed precontrol is active (p2534 > 0 %), the following applies: To calculate this value, the position setpoint is delayed by two position controller sampling times. When speed precontrol is inactive (p2534 = 0 %), the following applies: To calculate this value, the position setpoint is delayed by two position controller clock cycles.	

p2567[0]	LR torque precontrol moment of inertia		
S200 Basic PN (EPOS load side, rotating), S200 PN (EPOS load side, rotating)	Data type: FloatingPoint32	Visible in: Standard display	
	Read permission:	Read drive data or acknowledge messages	
	Write permission:	Edit device configuration or drive applications	
	Can be changed in the operating state:	Operation	
	Parameter group:	Position controller	
	Unit: kgm ²		
		Min: 0.000000 [kgm ²]	Max: 100000.000000 [kgm ²]
Description:	Sets the moment of inertia for the torque precontrol.		
Dependency:	See also: p2534, r2564		
	Note When calculating the torque precontrol value (c2654), the time derivation of the speed precontrol value is multiplied by 2 PI * p2567. For reasons associated with the compatibility to earlier firmware versions, the factory setting for p2567 = 1 kgm ² /2 PI. This means that r2564 remains as standard the derivation over time of the speed precontrol value and is referred, as before, to a moment of inertia of 1 kgm ² /2 PI. For torque precontrol, the moment of inertia can now be directly entered into p2567 (instead of subsequently evaluating the precontrol value).		

c2568	EPOS hardware limit switch activation		
S200 Basic PN (EPOS load side, rotating), S200 PN (EPOS load side, rotating)	Data type: Unsigned8	Visible in: Standard display	
	Read permission:	Read drive data or acknowledge messages	
	Write permission:	Edit device configuration or drive applications	
	Parameter group:	Limit	
	Unit: -		
Description:	Signal to activate the hardware limit switch. c2568 = 1 signal --> The evaluation of the negative hardware limit switch (c2569) and the positive hardware limit switch (c2570) is active.		
Dependency:	See also: c2569, c2570		
	Note The traversing range can also be limited using software limit switches.		

c2569**EPOS negative hardware limit switch**

Data type: Unsigned8 **Visible in:** Standard display
Read permission: Read drive data or acknowledge messages
Write permission: Edit device configuration or drive applications
Parameter group: Limit
Unit: -

Description: Signal for the hardware limit switch in the negative direction of travel.

Recommendation: Set the OFF3 ramp-down time (p1135) so that after the axis reaches the hardware limit switch at maximum velocity, the braking distance traveled by the axis is not greater than the distance that is available.

Sets message 07491 as alarm (A07491):

Set the maximum deceleration (p2573) so that after the axis reaches the hardware limit switch at maximum velocity, the braking distance traveled by the axis is not greater than the distance that is available.

Dependency: See also: p1135, c2568, c2570, p2573, r2684

⚠ CAUTION

The hardware limit switches are low active.

Sets message 07491 as fault (F07491):

For a 0 signal, the drive stops with the OFF3 ramp-down time (p1135), status signal r2684.13 = 1 is set, saved and the corresponding fault is output. After the fault has been acknowledged, only motion moving away from the hardware limit switch is permitted.

For a 0/1 signal and valid travel direction, when the hardware limit switch is exited, this is detected and status signal r2684.13 is set to 0.

Sets message 07491 as alarm (A07491):

For a 0 signal, the axis is stopped with the maximum deceleration (p2573), status signal r2684.13 is set to 1, saved and the appropriate alarm is output. Only motion away from the hardware limit switch is permitted.

For a 0/1 signal and valid travel direction, when the hardware limit switch is exited, this is detected and status signal r2684.13 is set to 0 and the alarm is cleared.

c2570**EPOS positive hardware limit switch**

Data type: Unsigned8 **Visible in:** Standard display
Read permission: Read drive data or acknowledge messages
Write permission: Edit device configuration or drive applications
Parameter group: Limit
Unit: -

Description: Signal for the hardware limit switch in the positive direction of travel.

Recommendation: Set the OFF3 ramp-down time (p1135) so that after the axis reaches the hardware limit switch at maximum velocity, the braking distance traveled by the axis is not greater than the distance that is available.

Sets message 07492 as alarm (A07492):

Set the maximum deceleration (p2573) so that after the axis reaches the hardware limit switch at maximum velocity, the braking distance traveled by the axis is not greater than the distance that is available.

Dependency: See also: p1135, c2568, c2569, p2573, r2684

⚠ CAUTION

The hardware limit switches are low active.

Sets message 07492 as fault (F07492):

For a 0 signal, the drive stops with the OFF3 ramp-down time (p1135), status signal r2684.14 = 1 is set, saved and the corresponding fault is output. After the fault has been acknowledged, only motion moving away from the hardware limit switch is permitted.

For a 0/1 signal and valid travel direction, when the hardware limit switch is exited, this is detected and status signal r2684.14 is set to 0.

Sets message 07492 as alarm (A07492):

For a 0 signal, the axis is stopped with the maximum deceleration (p2573), status signal r2684.14 is set to 1, saved and the appropriate alarm is output. Only motion away from the hardware limit switch is permitted.

For a 0/1 signal and valid travel direction, when the hardware limit switch is exited, this is detected and status signal r2684.14 is set to 0 and the alarm is cleared.

p2571	EPOS maximum velocity		
	Data type: FloatingPoint32	Visible in: Standard display	
	Read permission:	Read drive data or acknowledge messages	
	Write permission:	Edit device configuration or drive applications	
	Can be changed in the operating state:	Operation	
	Parameter group:	Limit	
	Unit: 1000 LU/min		
	Min: 0.010 [1000 LU/min]	Max: 40000000.000 [1000 LU/min]	Factory setting: 500.000 [1000 LU/min]
Description:	Sets the maximum velocity for the "basic positioner" function (EPOS).		
Dependency:	See also: p2503, p2504, p2505, p2506		
	Note		
	The maximum velocity is active in all of the operating modes of the basic positioner.		
	The maximum velocity for the basic positioner should be aligned with the maximum speed/velocity of the speed/velocity controller:		
	Rotary encoders:		
	$p2571[1000 \text{ LU/min}] = \min(p1082, p1083, p1086)[\text{rpm}] \times p2505/p2504 \times p2506/1000$		
	Linear encoders:		
	$p2571[1000 \text{ LU/min}] = \min(p1082, p1083, p1086)[\text{m/min}] \times p2503/10[\text{m}]$		

p2571	EPOS maximum velocity		
S200 Basic PN (EPOS load side, rotating), S200 PN (EPOS load side, rotating)	Data type: FloatingPoint32	Visible in: Standard display	
	Read permission:	Read drive data or acknowledge messages	
	Write permission:	Edit device configuration or drive applications	
	Can be changed in the operating state:	Operation	
	Parameter group:	Limit	
	Unit: 1000 LU/min		
	Min: 0.010 [1000 LU/min]	Max: 40000000.000 [1000 LU/min]	Factory setting: 18000.000 [1000 LU/min]
Description:	Sets the maximum velocity for the "basic positioner" function (EPOS).		
Dependency:	See also: p2503, p2504, p2505, p2506		
	Note		
	The maximum velocity is active in all of the operating modes of the basic positioner.		
	The maximum velocity for the basic positioner should be aligned with the maximum speed/velocity of the speed/velocity controller:		
	Rotary encoders:		
	$p2571[1000 \text{ LU/min}] = \min(p1082, p1083, p1086)[\text{rpm}] \times p2505/p2504 \times p2506/1000$		
	Linear encoders:		
	$p2571[1000 \text{ LU/min}] = \min(p1082, p1083, p1086)[\text{m/min}] \times p2503/10[\text{m}]$		

p2572	EPOS maximum acceleration		
	Data type: FloatingPoint32	Visible in: Standard display	
	Read permission:	Read drive data or acknowledge messages	
	Write permission:	Edit device configuration or drive applications	
	Can be changed in the operating state:	Ready for operation	
	Parameter group:	Limit, Jog	
	Unit: 1000 LU/s ²		

	Min: 0.001 [1000 LU/s ²]	Max: 2000000.000 [1000 LU/s ²]	Factory setting: 10000.000 [1000 LU/s ²]
Description:	Sets the maximum acceleration for the "basic positioner" function (EPOS).		
Dependency:	See also: p2619, c2644		

Note

The maximum acceleration appears to exhibit jumps (without jerk).

"Traversing blocks" operating mode:

The programmed acceleration override (p2619) acts on the maximum acceleration.

"Direct setpoint input/MDI" operating mode:

The acceleration override is effective (c2644, 4000 hex = 100 %).

"Jog" and "Active homing" operating modes:

No acceleration override is active. The axis starts with the maximum acceleration.

p2572

S200 Basic PN (EPOS load side, rotating), S200 PN (EPOS load side, rotating)

EPOS maximum acceleration

Data type: FloatingPoint32

Visible in: Standard display

Read permission:

Read drive data or acknowledge messages

Write permission:

Edit device configuration or drive applications

Can be changed in the operating state: Ready for operation

Parameter group:

Limit, Jog

Unit: 1000 LU/s²

Min:

0.001 [1000 LU/s²]

Max:

2000000.000 [1000 LU/s²]

Factory setting:

360000.000 [1000 LU/s²]

Description:

Sets the maximum acceleration for the "basic positioner" function (EPOS).

Dependency:

See also: p2619, c2644

Note

The maximum acceleration appears to exhibit jumps (without jerk).

"Traversing blocks" operating mode:

The programmed acceleration override (p2619) acts on the maximum acceleration.

"Direct setpoint input/MDI" operating mode:

The acceleration override is effective (c2644, 4000 hex = 100 %).

"Jog" and "Active homing" operating modes:

No acceleration override is active. The axis starts with the maximum acceleration.

p2573**EPOS maximum deceleration**

Data type: FloatingPoint32

Visible in: Standard display

Read permission:

Read drive data or acknowledge messages

Write permission:

Edit device configuration or drive applications

Can be changed in the operating state: Ready for operation

Parameter group:

Limit, Jog

Unit: 1000 LU/s²

Min:

0.001 [1000 LU/s²]

Max:

2000000.000 [1000 LU/s²]

Factory setting:

10000.000 [1000 LU/s²]

Description:

Sets the maximum deceleration for the "basic positioner" function (EPOS).

Dependency:

See also: p2620, c2645

Note

The maximum deceleration appears to exhibit jumps (without jerk).
 "Traversing blocks" operating mode:
 The programmed deceleration override (p2620) acts on the maximum deceleration.
 "Direct setpoint input/MDI" operating mode:
 The deceleration override is effective (c2645, 4000 hex = 100 %).
 "Jog" and "Active homing" operating modes:
 No deceleration override is effective. The axis breaks with the maximum deceleration.

p2573

EPOS maximum deceleration

S200 Basic PN (EPOS load side, rotating), S200 PN (EPOS load side, rotating)

Data type: FloatingPoint32	Visible in: Standard display	
Read permission:	Read drive data or acknowledge messages	
Write permission:	Edit device configuration or drive applications	
Can be changed in the operating state:	Ready for operation	
Parameter group:	Limit, Jog	
Unit: 1000 LU/s ²		
Min: 0.001 [1000 LU/s ²]	Max: 2000000.000 [1000 LU/s ²]	Factory setting: 360000.000 [1000 LU/s ²]

Description: Sets the maximum deceleration for the "basic positioner" function (EPOS).

Dependency: See also: p2620, c2645

Note

The maximum deceleration appears to exhibit jumps (without jerk).
 "Traversing blocks" operating mode:
 The programmed deceleration override (p2620) acts on the maximum deceleration.
 "Direct setpoint input/MDI" operating mode:
 The deceleration override is effective (c2645, 4000 hex = 100 %).
 "Jog" and "Active homing" operating modes:
 No deceleration override is effective. The axis breaks with the maximum deceleration.

p2574

EPOS jerk limiting

Data type: FloatingPoint32	Visible in: Standard display	
Read permission:	Read drive data or acknowledge messages	
Write permission:	Edit device configuration or drive applications	
Can be changed in the operating state:	Operation	
Parameter group:	Limit	
Unit: 1000 LU/s ³		
Min: 0.001 [1000 LU/s ³]	Max: 100000000.000 [1000 LU/s ³]	Factory setting: 200000.000 [1000 LU/s ³]

Description: Sets the jerk limiting

Dependency: See also: p2572, p2573, c2575

Note

The jerk limiting is internally converted into a jerk time as follows:

$$\text{Jerk time } Tr = \max(p2572, p2573) / p2574$$

The jerk time is internally limited to 1000 ms and is rounded-off to an integer multiple of the sampling time of the basic positioner clock cycle.

The jerk time is valid for the acceleration and deceleration phases also for unequal maximum acceleration (p2572) and maximum deceleration (p2573).

For unequal maximum acceleration and maximum deceleration, the motion is not optimal from a time perspective as the jerk limit cannot be used for the lower of the two values.

If, in the traversing profile, the acceleration time without jerk limiting is shorter than jerk time Tr , then motion with jerk limiting is not time-optimized.

For traversing motion with a direct transition between acceleration and deceleration (i.e. jerk time is greater than the constant velocity phase), jerk can increase up to twice the parameterized jerk.

CONTINUE_FLYING with direction reversal acts internally just like a CONTINUE_WITH_STOP without the "position reached" being set. Without jerk limiting, this behavior can hardly be noticed as, when reversing, the position setpoint is only kept at zero for one interpolator clock cycle.

For block change enable CONTINUE_WITH_STOP, jerk limiting results in a longer delay time.

p2574

S200 Basic PN (EPOS load side, rotating), S200 PN (EPOS load side, rotating)

EPOS jerk limiting

Data type: FloatingPoint32

Visible in: Standard display

Read permission:

Read drive data or acknowledge messages

Write permission:

Edit device configuration or drive applications

Can be changed in the operating state: Operation

Parameter group: Limit

Unit: 1000 LU/s³

Min:

0.001 [1000 LU/s³]

Max:

100000000.000 [1000 LU/s³]

Factory setting:

7200000.000 [1000 LU/s³]

Description:

Sets the jerk limiting

Dependency:

See also: p2572, p2573, c2575

Note

The jerk limiting is internally converted into a jerk time as follows:

$$\text{Jerk time } Tr = \max(p2572, p2573) / p2574$$

The jerk time is internally limited to 1000 ms and is rounded-off to an integer multiple of the sampling time of the basic positioner clock cycle.

The jerk time is valid for the acceleration and deceleration phases also for unequal maximum acceleration (p2572) and maximum deceleration (p2573).

For unequal maximum acceleration and maximum deceleration, the motion is not optimal from a time perspective as the jerk limit cannot be used for the lower of the two values.

If, in the traversing profile, the acceleration time without jerk limiting is shorter than jerk time Tr , then motion with jerk limiting is not time-optimized.

For traversing motion with a direct transition between acceleration and deceleration (i.e. jerk time is greater than the constant velocity phase), jerk can increase up to twice the parameterized jerk.

CONTINUE_FLYING with direction reversal acts internally just like a CONTINUE_WITH_STOP without the "position reached" being set. Without jerk limiting, this behavior can hardly be noticed as, when reversing, the position setpoint is only kept at zero for one interpolator clock cycle.

For block change enable CONTINUE_WITH_STOP, jerk limiting results in a longer delay time.

c2575**EPOS jerk limiting activation**

Data type: Unsigned8

Visible in: Standard display

Read permission:

Read drive data or acknowledge messages

Write permission:

Edit device configuration or drive applications

Parameter group:

Limit, Jog, Homing, Traversing blocks, Direct setpoint input (MDI)

Unit: -

Description: Signal to activate jerk limiting.
 Activating/deactivating:
 - Using c2575 = 1 signal or 0 signal.
 - Using the JERK command in the traversing block (only for c2575 = 0 signal).

Dependency: See also: p2574

Note

A change to the signal state is only accepted at zero speed.

p2576**EPOS modulo correction modulo range**

Data type: FloatingPoint32 **Visible in:** Standard display
Read permission: Read drive data or acknowledge messages
Write permission: Edit device configuration or drive applications
Can be changed in the operating state: Ready for operation
Parameter group: Basic positioner, Mechanics, Actual position value preprocessing
Unit: LU
Min: 1.0000 [LU] **Max:** 2147482647.0000 [LU] **Factory setting:** 360.0000 [LU]

Description: Sets the modulo range for axes with modulo correction.

Dependency: See also: c2577

p2576**EPOS modulo correction modulo range**

S200 Basic PN (EPOS load side, rotating), S200 PN (EPOS load side, rotating)

Data type: FloatingPoint32 **Visible in:** Standard display
Read permission: Read drive data or acknowledge messages
Write permission: Edit device configuration or drive applications
Can be changed in the operating state: Ready for operation
Parameter group: Basic positioner, Mechanics, Actual position value preprocessing
Unit: LU
Min: 1.0000 [LU] **Max:** 2147482647.0000 [LU] **Factory setting:** 360.0000 [LU]

Description: Sets the modulo range for axes with modulo correction.

Dependency: See also: c2577

c2577**EPOS modulo correction activation**

Data type: Unsigned8 **Visible in:** Standard display
Read permission: Read drive data or acknowledge messages
Write permission: Edit device configuration or drive applications
Parameter group: Basic positioner, Mechanics, Actual position value preprocessing
Unit: -

Description: Signal to activate modulo correction.

Dependency: See also: p2576

Note

When the signal state changes, this only becomes effective in the "ready for switching on" state.

Selecting modulo correction:

The actual position setpoint in the modulo range is corrected. The position actual value differs from the position setpoint by the following error and can also leave the modulo range.

Deselecting modulo correction:

It is based on the actual position actual value.

c2578	EPOS negative software limit switch
Data type: FloatingPoint32	Visible in: Standard display
Read permission:	Read drive data or acknowledge messages
Write permission:	Edit device configuration or drive applications
Parameter group:	Limit
Unit: LU	
Description:	Signal for the negative software limit switch.
Dependency:	See also: c2579, p2580, p2581, c2582

NOTICE

A change to the software limit switch immediately becomes effective.
If the software limit switch is changed, then this results in the positions in the traversing blocks being checked.

Note

The following applies for the setting of the software limit switch:
Negative software limit switch < positive software limit switch

c2578	EPOS negative software limit switch
S200 Basic PN (EPOS load side, rotating), S200 PN (EPOS load side, rotating)	Data type: FloatingPoint32
	Visible in: Standard display
	Read permission:
	Read drive data or acknowledge messages
	Write permission:
	Edit device configuration or drive applications
	Parameter group:
	Limit
	Unit: LU
Description:	Signal for the negative software limit switch.
Dependency:	See also: c2579, p2580, p2581, c2582

NOTICE

A change to the software limit switch immediately becomes effective.
If the software limit switch is changed, then this results in the positions in the traversing blocks being checked.

Note

The following applies for the setting of the software limit switch:
Negative software limit switch < positive software limit switch

c2579	EPOS positive software limit switch
	Data type: FloatingPoint32
	Visible in: Standard display
	Read permission:
	Read drive data or acknowledge messages
	Write permission:
	Edit device configuration or drive applications
	Parameter group:
	Limit
	Unit: LU
Description:	Signal for the positive setpoint limit switch.
Dependency:	See also: c2578, p2580, p2581, c2582

NOTICE

A change to the software limit switch immediately becomes effective.
If the software limit switch is changed, then this results in the positions in the traversing blocks being checked.

Note

The following applies for the setting of the software limit switch:
Negative software limit switch < positive software limit switch

c2579 **EPOS positive software limit switch**
 S200 Basic PN (EPOS load side, rotating), S200 PN (EPOS load side, rotating)
Data type: FloatingPoint32 **Visible in:** Standard display
Read permission: Read drive data or acknowledge messages
Write permission: Edit device configuration or drive applications
Parameter group: Limit
Unit: LU
Description: Signal for the positive setpoint limit switch.
Dependency: See also: c2578, p2580, p2581, c2582

NOTICE
 A change to the software limit switch immediately becomes effective.
 If the software limit switch is changed, then this results in the positions in the traversing blocks being checked.

Note
 The following applies for the setting of the software limit switch:
 Negative software limit switch < positive software limit switch

p2580 **EPOS negative software limit switch**
Data type: FloatingPoint32 **Visible in:** Standard display
Read permission: Read drive data or acknowledge messages
Write permission: Edit device configuration or drive applications
Can be changed in the operating state: Operation
Parameter group: Limit
Unit: LU
Min: **Max:** **Factory setting:**
 -2147482648.0000 [LU] 2147482647.0000 [LU] -2147482648.0000 [LU]
Description: Sets the software limit switch, in the negative direction of travel.
Dependency: See also: c2578, c2579, p2581, c2582

p2580 **EPOS negative software limit switch**
 S200 Basic PN (EPOS load side, rotating), S200 PN (EPOS load side, rotating)
Data type: FloatingPoint32 **Visible in:** Standard display
Read permission: Read drive data or acknowledge messages
Write permission: Edit device configuration or drive applications
Can be changed in the operating state: Operation
Parameter group: Limit
Unit: LU
Min: **Max:** **Factory setting:**
 -2147482648.0000 [LU] 2147482647.0000 [LU] -2147482648.0000 [LU]
Description: Sets the software limit switch, in the negative direction of travel.
Dependency: See also: c2578, c2579, p2581, c2582

p2581 **EPOS positive software limit switch**
Data type: FloatingPoint32 **Visible in:** Standard display
Read permission: Read drive data or acknowledge messages
Write permission: Edit device configuration or drive applications
Can be changed in the operating state: Operation
Parameter group: Limit
Unit: LU

	Min: -2147482648.0000 [LU]	Max: 2147482647.0000 [LU]	Factory setting: 2147482647.0000 [LU]
Description:	Sets the software limit switch, in the positive direction of travel.		
Dependency:	See also: c2578, c2579, p2580, c2582		

p2581

S200 Basic PN (EPOS load side, rotating),
S200 PN (EPOS load side, rotating)

EPOS positive software limit switch

Data type: FloatingPoint32	Visible in: Standard display
Read permission:	Read drive data or acknowledge messages
Write permission:	Edit device configuration or drive applications
Can be changed in the operating state:	Operation
Parameter group:	Limit
Unit: LU	

Min: -2147482648.0000 [LU]	Max: 2147482647.0000 [LU]	Factory setting: 2147482647.0000 [LU]
--------------------------------------	-------------------------------------	---

Description:	Sets the software limit switch, in the positive direction of travel.
Dependency:	See also: c2578, c2579, p2580, c2582

c2582**EPOS software limit switch activation**

Data type: Unsigned8	Visible in: Standard display
Read permission:	Read drive data or acknowledge messages
Write permission:	Edit device configuration or drive applications
Parameter group:	Limit
Unit: -	

Description:	Signal to activate the software limit switch.
Dependency:	See also: c2578, c2579, p2580, p2581

⚠ CAUTION

Software limit switch effective:
- Axis is homed (r2684.11 = 1) and c2582 = 1 signal.
Software limit switch ineffective:
- Modulo correction active (c2577 = 1 signal).
- Active homing is being performed.

NOTICE

Target position for relative positioning outside software limit switch:
The traversing block is started and the axis comes to a standstill at the software limit switch. An appropriate alarm is output and the traversing block is interrupted. Traversing blocks with valid position can be activated.
Target position for absolute positioning outside software limit switch:
In the "traversing blocks" mode, the traversing block is not started and an appropriate fault is output.
Axis outside the valid traversing range:
If the axis is already outside the valid traversing range, then an appropriate fault is output. The fault can be acknowledged at standstill. Traversing blocks with valid position can be activated.

Note

The traversing range can also be limited using hardware limit switches.

p2583	EPOS backlash compensation		
	Data type: FloatingPoint32	Visible in: Extended display	
	Read permission:	Read drive data or acknowledge messages	
	Write permission:	Edit device configuration or drive applications	
	Can be changed in the operating state:	Operation	
	Parameter group:	Basic positioner	
	Unit: LU		
	Min:	Max:	Factory setting:
	-200000.0000 [LU]	200000.0000 [LU]	0.0000 [LU]
Description:	Sets the amount of play (backlash) for positive or negative play. 0: backlash compensation is deactivated. > 0: Positive backlash (normal case) When the direction is reversed, the encoder actual value leads the actual value. < 0: Negative backlash When the direction is reversed, the actual value leads the encoder actual value.		
Dependency:	If a stationary axis is referenced by "setting the home position", or an adjusted with absolute encoder is switched on, then the setting of c2604 is relevant for entering the compensation value. c2604 = 1: Traveling in the positive direction -> A compensation value is immediately entered. Traveling in the negative direction -> A compensation value is not entered c2604 = 0: Traveling in the positive direction -> A compensation value is not entered Traveling in the negative direction -> A compensation value is immediately entered. When again setting the home position (a homed axis) or for "passive homing", c2604 is not relevant but instead the history of the axis. See also: c2604		

p2583	EPOS backlash compensation		
S200 Basic PN (EPOS load side, rotating), S200 PN (EPOS load side, rotating)	Data type: FloatingPoint32	Visible in: Extended display	
	Read permission:	Read drive data or acknowledge messages	
	Write permission:	Edit device configuration or drive applications	
	Can be changed in the operating state:	Operation	
	Parameter group:	Basic positioner	
	Unit: LU		
	Min:	Max:	Factory setting:
	-200000.0000 [LU]	200000.0000 [LU]	0.0000 [LU]
Description:	Sets the amount of play (backlash) for positive or negative play. 0: backlash compensation is deactivated. > 0: Positive backlash (normal case) When the direction is reversed, the encoder actual value leads the actual value. < 0: Negative backlash When the direction is reversed, the actual value leads the encoder actual value.		

Dependency: If a stationary axis is referenced by "setting the home position", or an adjusted with absolute encoder is switched on, then the setting of c2604 is relevant for entering the compensation value.

c2604 = 1:
 Traveling in the positive direction -> A compensation value is immediately entered.
 Traveling in the negative direction -> A compensation value is not entered

c2604 = 0:
 Traveling in the positive direction -> A compensation value is not entered
 Traveling in the negative direction -> A compensation value is immediately entered.

When again setting the home position (a homed axis) or for "passive homing", c2604 is not relevant but instead the history of the axis.
 See also: c2604

p2584.0...3**EPOS functions configuration**

Data type: Unsigned32 **Visible in:** Extended display
Read permission: Read drive data or acknowledge messages
Write permission: Edit device configuration or drive applications
Can be changed in the operating state: Ready for operation
Parameter group: Basic positioner
Unit: -
Min: **Max:** **Factory setting:**
 - - 0100 bin

Description:

Sets the configuration for additional functions for the basic positioner (EPOS).

Bit array:

Bit	Signal name	1 signal	0 signal
00	Activate position feedback signal	Yes	No
01	Hardware limit switch evaluation	Level evaluation	Edge evaluation
02	Travel to fixed stop - torque calculation based on the offset	Yes	No
03	Active homing with absolute encoder adjustment	Yes	No

Note

For bit 00:
 When the bit is set, for traversing blocks with absolute target positions (p2617[x]) when the tolerance window (p2688) is reached, the traversing block number (p2616[x]) is output bit-coded (r2689).

For bit 01:
 When the bit is set, the hardware limit switch is evaluated, level-triggered.
 This setting is recommended for a poor position actual value resolution, as in this case the direction does not have to be evaluated.

For bit 02:
 When the bit is set, for "Travel to fixed stop", the torque setpoints are calculated based on the offset for the torque limit (p1532).

For bit 03:
 After successful active homing, an absolute encoder is adjusted (p2507).

p2585**EPOS jog 1 setpoint velocity**

Data type: FloatingPoint32 **Visible in:** Standard display
Read permission: Read drive data or acknowledge messages
Write permission: Edit device configuration or drive applications
Can be changed in the operating state: Operation
Parameter group: Jog
Unit: 1000 LU/min
Min: **Max:** **Factory setting:**
 -4000000.000 [1000 LU/min] 4000000.000 [1000 LU/min] -100.000 [1000 LU/min]

Description: Sets the setpoint velocity for jog 1.
Dependency: See also: p2587, c2589, c2591

p2585	EPOS jog 1 setpoint velocity		
S200 Basic PN (EPOS load side, rotating), S200 PN (EPOS load side, rotating)	Data type: FloatingPoint32	Visible in: Standard display	
	Read permission:	Read drive data or acknowledge messages	
	Write permission:	Edit device configuration or drive applications	
	Can be changed in the operating state:	Operation	
	Parameter group:	Jog	
	Unit: 1000 LU/min		
	Min:	Max:	Factory setting:
	-40000000.000 [1000 LU/min]	40000000.000 [1000 LU/min]	-3600.000 [1000 LU/min]
Description:	Sets the setpoint velocity for jog 1.		
Dependency:	See also: p2587, c2589, c2591		

p2586	EPOS jog 2 setpoint velocity		
	Data type: FloatingPoint32	Visible in: Standard display	
	Read permission:	Read drive data or acknowledge messages	
	Write permission:	Edit device configuration or drive applications	
	Can be changed in the operating state:	Operation	
	Parameter group:	Jog	
	Unit: 1000 LU/min		
	Min:	Max:	Factory setting:
	-40000000.000 [1000 LU/min]	40000000.000 [1000 LU/min]	100.000 [1000 LU/min]
Description:	Sets the setpoint velocity for jog 2.		
Dependency:	See also: p2588, c2590, c2591		

p2586	EPOS jog 2 setpoint velocity		
S200 Basic PN (EPOS load side, rotating), S200 PN (EPOS load side, rotating)	Data type: FloatingPoint32	Visible in: Standard display	
	Read permission:	Read drive data or acknowledge messages	
	Write permission:	Edit device configuration or drive applications	
	Can be changed in the operating state:	Operation	
	Parameter group:	Jog	
	Unit: 1000 LU/min		
	Min:	Max:	Factory setting:
	-40000000.000 [1000 LU/min]	40000000.000 [1000 LU/min]	3600.000 [1000 LU/min]
Description:	Sets the setpoint velocity for jog 2.		
Dependency:	See also: p2588, c2590, c2591		

p2587	EPOS jog 1 traversing distance		
	Data type: FloatingPoint32	Visible in: Standard display	
	Read permission:	Read drive data or acknowledge messages	
	Write permission:	Edit device configuration or drive applications	
	Can be changed in the operating state:	Operation	
	Parameter group:	Jog	
	Unit: LU		
	Min: 0.0000 [LU]	Max: 2147482647.0000 [LU]	Factory setting: 1.0000 [LU]
Description:	Sets the traversing distance for incremental jog 1.		
Dependency:	See also: p2585, c2589, c2591		
	Note Incremental jog 1 is started with c2591 = 1 signal and c2589 = 0/1 signal. With c2589 = 0 signal, incremental jogging is interrupted.		
p2587	EPOS jog 1 traversing distance		
S200 Basic PN (EPOS load side, rotating), S200 PN (EPOS load side, rotating)	Data type: FloatingPoint32	Visible in: Standard display	
	Read permission:	Read drive data or acknowledge messages	
	Write permission:	Edit device configuration or drive applications	
	Can be changed in the operating state:	Operation	
	Parameter group:	Jog	
	Unit: LU		
	Min: 0.0000 [LU]	Max: 2147482647.0000 [LU]	Factory setting: 36.0000 [LU]
Description:	Sets the traversing distance for incremental jog 1.		
Dependency:	See also: p2585, c2589, c2591		
	Note Incremental jog 1 is started with c2591 = 1 signal and c2589 = 0/1 signal. With c2589 = 0 signal, incremental jogging is interrupted.		
p2588	EPOS jog 2 traversing distance		
	Data type: FloatingPoint32	Visible in: Standard display	
	Read permission:	Read drive data or acknowledge messages	
	Write permission:	Edit device configuration or drive applications	
	Can be changed in the operating state:	Operation	
	Parameter group:	Jog	
	Unit: LU		
	Min: 0.0000 [LU]	Max: 2147482647.0000 [LU]	Factory setting: 1.0000 [LU]
Description:	Sets the traversing distance for incremental jog 2.		
Dependency:	See also: p2586, c2590, c2591		
	Note Incremental jog 2 is started with c2591 = 1 signal and c2590 = 0/1 signal. Incremental jogging is interrupted with c2590 = 0 signal.		

p2588	EPOS jog 2 traversing distance		
S200 Basic PN (EPOS load side, rotating), S200 PN (EPOS load side, rotating)	Data type: FloatingPoint32	Visible in: Standard display	
	Read permission:	Read drive data or acknowledge messages	
	Write permission:	Edit device configuration or drive applications	
	Can be changed in the operating state:	Operation	
	Parameter group:	Jog	
	Unit: LU		
	Min: 0.0000 [LU]	Max: 2147482647.0000 [LU]	Factory setting: 36.0000 [LU]
Description:	Sets the traversing distance for incremental jog 2.		
Dependency:	See also: p2586, c2590, c2591		
	Note Incremental jog 2 is started with c2591 = 1 signal and c2590 = 0/1 signal. Incremental jogging is interrupted with c2590 = 0 signal.		

c2589	EPOS jog 1		
	Data type: Unsigned8	Visible in: Standard display	
	Read permission:	Read drive data or acknowledge messages	
	Write permission:	Edit device configuration or drive applications	
	Parameter group:	Jog	
	Unit: -		
Description:	Signal for jog 1.		
Dependency:	When jogging, the axis is accelerated or braked with the maximum acceleration/deceleration (p2572/p2573). c2591 = 0 signal The axis endlessly moves with the setpoint velocity, jog 1 (p2585). c2591 = 1 signal The axis traverses through a parameterized distance (p2585) with the setpoint velocity, jog 1 (p2587). See also: p2572, p2573, p2585, p2587, c2591		
	NOTICE The parameter may be protected as a result of r0922 and cannot be changed.		

c2590	EPOS jog 2		
	Data type: Unsigned8	Visible in: Standard display	
	Read permission:	Read drive data or acknowledge messages	
	Write permission:	Edit device configuration or drive applications	
	Parameter group:	Jog	
	Unit: -		
Description:	Signal for jog 2.		
Dependency:	When jogging, the axis is accelerated or braked with the maximum acceleration/deceleration (p2572/p2573). c2591 = 0 signal The axis endlessly moves with the setpoint velocity, jog 2 (p2586). c2591 = 1 signal The axis traverses through a parameterized distance (p2586) with the setpoint velocity, jog 2 (p2588). See also: p2572, p2573, p2586, p2588, c2591		
	NOTICE The parameter may be protected as a result of r0922 and cannot be changed.		

c2591	EPOS jogging incremental
	Data type: Unsigned8 Visible in: Standard display
	Read permission: Read drive data or acknowledge messages
	Write permission: Edit device configuration or drive applications
	Parameter group: Jog
	Unit: -
Description:	Signal for incremental jogging.
Dependency:	See also: p2585, p2586, p2587, p2588, c2589, c2590

c2595	EPOS homing start
	Data type: Unsigned8 Visible in: Standard display
	Read permission: Read drive data or acknowledge messages
	Write permission: Edit device configuration or drive applications
	Parameter group: Homing
	Unit: -
Description:	Signal to start "Active homing" or "Passive homing". 0/1 signal edge: Homing is started. 1/0 signal edge: Homing is interrupted.
Dependency:	See also: c2597, c2598, p2599, r2684

NOTICE

The parameter may be protected as a result of r0922 and cannot be changed.

Note

Active homing (c2597 = 0 signal):

Active homing can only be activated (0/1 edge) after traversing motion that is being processed has been completed.

With the start, where relevant, the state signal "home position set" (r2684.11) is reset.

Passive homing (c2597 = 1 signal):

With the start, the state signal "home position set" (r2684.11) is not reset.

c2596	EPOS set home position
	Data type: Unsigned8 Visible in: Standard display
	Read permission: Read drive data or acknowledge messages
	Write permission: Edit device configuration or drive applications
	Parameter group: Homing
	Unit: -
Description:	Signal for "Set home position".
Dependency:	See also: c2598, p2599, r2684

NOTICE

The parameter may be protected as a result of r0922 and cannot be changed.

Note

Home position setting is effective in the following operating states:

- In the basic state.
- For FIXED STOP with progress condition END (corresponds to the initial state).
- For traversing block interrupted via c2640 = 0 signal (intermediate stop).
- For EPOS not enabled and position actual value valid

c2597	EPOS homing type selection	
	Data type: Unsigned8	Visible in: Standard display
	Read permission:	Read drive data or acknowledge messages
	Write permission:	Edit device configuration or drive applications
	Parameter group:	Homing
	Unit: -	
Description:	Signal to select homing type. 1 signal: Passive homing 0 signal: Active homing	
Dependency:	See also: c2595	
<hr/>		
	Note	
	Homing is activated as follows: - Select homing type (c2597) - Start homing (c2595 = 0/1 signal edge)	

c2598[0...3]	EPOS home position signal	
	Data type: FloatingPoint32	Visible in: Standard display
	Read permission:	Read drive data or acknowledge messages
	Write permission:	Edit device configuration or drive applications
	Parameter group:	Homing
	Unit: LU	
Description:	Signal for the home position. This value is used as reference for the following homing operations: - Active homing - Set home position - Passive homing - Absolute value adjustment	
Index:	[0] = Position control [1] = Motor encoder [2] = Encoder 2 [3] = Encoder 3	
Dependency:	See also: p2502, p2507, c2595, c2596, c2597, p2599	
<hr/>		
	Note	
	When function "Basic positioner" is activated, the following applies: Incremental measuring system: After the home position is reached, the drive accepts the actual axis position from the position value received via c2598[0]. Absolute encoder: When adjusting the encoder, the position received is set as the actual axis position.	

c2598[0...3]	EPOS home position signal	
S200 Basic PN (EPOS load side, rotating), S200 PN (EPOS load side, rotating)	Data type: FloatingPoint32	Visible in: Standard display
	Read permission:	Read drive data or acknowledge messages
	Write permission:	Edit device configuration or drive applications
	Parameter group:	Homing
	Unit: LU	

A.3 Parameters

Description:	Signal for the home position. This value is used as reference for the following homing operations: - Active homing - Set home position - Passive homing - Absolute value adjustment
Index:	[0] = Position control [1] = Motor encoder [2] = Encoder 2 [3] = Encoder 3
Dependency:	See also: p2502, p2507, c2595, c2596, c2597, p2599
<hr/>	
	Note When function "Basic positioner" is activated, the following applies: Incremental measuring system: After the home position is reached, the drive accepts the actual axis position from the position value received via c2598[0]. Absolute encoder: When adjusting the encoder, the position received is set as the actual axis position.
<hr/>	

p2599	EPOS home position value		
	Data type: FloatingPoint32	Visible in: Standard display	
	Read permission:	Read drive data or acknowledge messages	
	Write permission:	Edit device configuration or drive applications	
	Can be changed in the operating state:	Operation	
	Parameter group:	Homing	
	Unit: LU		
	Min: -2147482648.0000 [LU]	Max: 2147482647.0000 [LU]	Factory setting: 0.0000 [LU]
Description:	Sets the position value for the home position. This value is set as the actual axis position after homing or adjustment.		
Dependency:	See also: p2507, c2595, c2596, c2597, c2598		

p2599	EPOS home position value		
S200 Basic PN (EPOS load side, rotating), S200 PN (EPOS load side, rotating)	Data type: FloatingPoint32	Visible in: Standard display	
	Read permission:	Read drive data or acknowledge messages	
	Write permission:	Edit device configuration or drive applications	
	Can be changed in the operating state:	Operation	
	Parameter group:	Homing	
	Unit: LU		
	Min: -2147482648.0000 [LU]	Max: 2147482647.0000 [LU]	Factory setting: 0.0000 [LU]
Description:	Sets the position value for the home position. This value is set as the actual axis position after homing or adjustment.		
Dependency:	See also: p2507, c2595, c2596, c2597, c2598		

p2600	EPOS active homing home position offset		
	Data type: FloatingPoint32	Visible in: Standard display	
	Read permission:	Read drive data or acknowledge messages	
	Write permission:	Edit device configuration or drive applications	
	Can be changed in the operating state:	Operation	
	Parameter group:	Homing	
	Unit: LU		
	Min:	Max:	Factory setting:
	-2147482648.0000 [LU]	2147482647.0000 [LU]	0.0000 [LU]
Description:	Sets the home position shift for active homing.		
Dependency:	See also: c2598		

p2600	EPOS active homing home position offset		
S200 Basic PN (EPOS load side, rotating), S200 PN (EPOS load side, rotating)	Data type: FloatingPoint32	Visible in: Standard display	
	Read permission:	Read drive data or acknowledge messages	
	Write permission:	Edit device configuration or drive applications	
	Can be changed in the operating state:	Operation	
	Parameter group:	Homing	
	Unit: LU		
	Min:	Max:	Factory setting:
	-2147482648.0000 [LU]	2147482647.0000 [LU]	0.0000 [LU]
Description:	Sets the home position shift for active homing.		
Dependency:	See also: c2598		

c2604	EPOS active homing start direction		
	Data type: Unsigned8	Visible in: Standard display	
	Read permission:	Read drive data or acknowledge messages	
	Write permission:	Edit device configuration or drive applications	
	Parameter group:	Homing	
	Unit: -		
Description:	Signal for the start direction for active homing. 1 signal: Start in the negative direction. 0 signal: Start in the positive direction.		
Dependency:	See also: p2583, c2595, c2597		

p2605	EPOS active homing approach velocity reference cam		
	Data type: FloatingPoint32	Visible in: Standard display	
	Read permission:	Read drive data or acknowledge messages	
	Write permission:	Edit device configuration or drive applications	
	Can be changed in the operating state:	Operation	
	Parameter group:	Homing	
	Unit: 1000 LU/min		
	Min:	Max:	Factory setting:
	1.000 [1000 LU/min]	40000000.000 [1000 LU/min]	200.000 [1000 LU/min]
Description:	Sets the approach velocity to the reference cam for active homing.		

Dependency: Active homing only starts with the approach velocity to the reference cam when there is a reference cam (p2607 = 1).
See also: c2595, c2597, c2604, p2606, p2607

Note

When traversing to the reference cam, the velocity override is effective.

If, at the start of active homing, the axis is already at the reference cam, then the axis immediately starts to traverse to the zero mark.

p2605

S200 Basic PN (EPOS load side, rotating),
S200 PN (EPOS load side, rotating)

EPOS active homing approach velocity reference cam**Data type:** FloatingPoint32**Visible in:** Standard display**Read permission:**

Read drive data or acknowledge messages

Write permission:

Edit device configuration or drive applications

Can be changed in the operating state: Operation**Parameter group:**

Homing

Unit: 1000 LU/min**Min:**

1.000 [1000 LU/min]

Max:

40000000.000 [1000 LU/min]

Factory setting:

7200.000 [1000 LU/min]

Description:

Sets the approach velocity to the reference cam for active homing.

Dependency:Active homing only starts with the approach velocity to the reference cam when there is a reference cam (p2607 = 1).
See also: c2595, c2597, c2604, p2606, p2607**Note**

When traversing to the reference cam, the velocity override is effective.

If, at the start of active homing, the axis is already at the reference cam, then the axis immediately starts to traverse to the zero mark.

p2606**EPOS active homing reference cam maximum distance****Data type:** FloatingPoint32**Visible in:** Extended display**Read permission:**

Read drive data or acknowledge messages

Write permission:

Edit device configuration or drive applications

Can be changed in the operating state: Operation**Parameter group:**

Homing

Unit: LU**Min:**

-340.28235E36 [LU]

Max:

2147482647.0000 [LU]

Factory setting:

2147482647.0000 [LU]

Description:

Sets the maximum distance after starting active homing when traversing to the reference cam.

Dependency:

See also: c2595, c2597, c2604, p2605, p2607

Note

When using a reversing cam, the maximum distance must be set appropriately long.

p2606

S200 Basic PN (EPOS load side, rotating),
S200 PN (EPOS load side, rotating)

EPOS active homing reference cam maximum distance**Data type:** FloatingPoint32**Visible in:** Extended display**Read permission:**

Read drive data or acknowledge messages

Write permission:

Edit device configuration or drive applications

Can be changed in the operating state: Operation**Parameter group:**

Homing

Unit: LU**Min:**

-340.28235E36 [LU]

Max:

2147482647.0000 [LU]

Factory setting:

2147482647.0000 [LU]

Description: Sets the maximum distance after starting active homing when traversing to the reference cam.
Dependency: See also: c2595, c2597, c2604, p2605, p2607

Note
 When using a reversing cam, the maximum distance must be set appropriately long.

p2607

EPOS active homing reference cam available

Data type: Unsigned8	Visible in: Standard display	
Read permission:	Read drive data or acknowledge messages	
Write permission:	Edit device configuration or drive applications	
Can be changed in the operating state:	Operation	
Parameter group:	Homing	
Unit: -		
Min:	Max:	Factory setting:
0	1	1

Description: Sets whether or not a reference cam is available for active homing.
 Value = 1: Reference cam present.
 Value = 0: No reference cam present.

Dependency: See also: c2595, c2597, c2604, p2605, p2606

p2608

EPOS active homing approach velocity zero mark

Data type: FloatingPoint32	Visible in: Standard display	
Read permission:	Read drive data or acknowledge messages	
Write permission:	Edit device configuration or drive applications	
Can be changed in the operating state:	Operation	
Parameter group:	Homing	
Unit: 1000 LU/min		
Min:	Max:	Factory setting:
1.000 [1000 LU/min]	40000000.000 [1000 LU/min]	50.000 [1000 LU/min]

Description: Sets the approach velocity after detecting the reference cam to search for the zero mark for active homing.

Dependency: If there is no reference cam (p2607 = 0), active homing starts immediately with the axis traversing to the zero mark.
 See also: c2595, c2597, c2604, p2607, p2609

⚠ CAUTION
 If the reference cam is not adjusted so that for each active homing the same zero mark for synchronization is detected, then an "incorrect" axis reference point is obtained.
 After the reference cam has been left, the search for the zero mark is activated with a time delay due to internal factors. This is the reason that the reference cam should be adjusted in this center between two zero marks and the approach velocity should be adapted to the distance between two zero marks.

Note
 The velocity override is not effective when traversing to the zero mark.

p2608	EPOS active homing approach velocity zero mark		
S200 Basic PN (EPOS load side, rotating), S200 PN (EPOS load side, rotating)	Data type: FloatingPoint32	Visible in: Standard display	
	Read permission:	Read drive data or acknowledge messages	
	Write permission:	Edit device configuration or drive applications	
	Can be changed in the operating state:	Operation	
	Parameter group:	Homing	
	Unit: 1000 LU/min		
	Min:	Max:	Factory setting:
	1.000 [1000 LU/min]	40000000.000 [1000 LU/min]	1800.000 [1000 LU/min]
Description:	Sets the approach velocity after detecting the reference cam to search for the zero mark for active homing.		
Dependency:	If there is no reference cam (p2607 = 0), active homing starts immediately with the axis traversing to the zero mark. See also: c2595, c2597, c2604, p2607, p2609		
<p>⚠ CAUTION</p> <p>If the reference cam is not adjusted so that for each active homing the same zero mark for synchronization is detected, then an "incorrect" axis reference point is obtained. After the reference cam has been left, the search for the zero mark is activated with a time delay due to internal factors. This is the reason that the reference cam should be adjusted in this center between two zero marks and the approach velocity should be adapted to the distance between two zero marks.</p>			
Note			
The velocity override is not effective when traversing to the zero mark.			

p2609	EPOS active homing max distance reference cam and zero mark		
	Data type: FloatingPoint32	Visible in: Standard display	
	Read permission:	Read drive data or acknowledge messages	
	Write permission:	Edit device configuration or drive applications	
	Can be changed in the operating state:	Operation	
	Parameter group:	Homing	
	Unit: LU		
	Min:	Max:	Factory setting:
	0.0000 [LU]	2147482647.0000 [LU]	20.0000 [LU]
Description:	Sets the maximum distance after leaving the reference cam when traversing to the zero mark.		
Dependency:	See also: c2595, c2597, c2604, p2607, p2608		

p2609	EPOS active homing max distance reference cam and zero mark		
S200 Basic PN (EPOS load side, rotating), S200 PN (EPOS load side, rotating)	Data type: FloatingPoint32	Visible in: Standard display	
	Read permission:	Read drive data or acknowledge messages	
	Write permission:	Edit device configuration or drive applications	
	Can be changed in the operating state:	Operation	
	Parameter group:	Homing	
	Unit: LU		
	Min:	Max:	Factory setting:
	0.0000 [LU]	2147482647.0000 [LU]	720.0000 [LU]
Description:	Sets the maximum distance after leaving the reference cam when traversing to the zero mark.		
Dependency:	See also: c2595, c2597, c2604, p2607, p2608		

p2611	EPOS active homing approach velocity home position		
	Data type: FloatingPoint32	Visible in: Standard display	
	Read permission:	Read drive data or acknowledge messages	
	Write permission:	Edit device configuration or drive applications	
	Can be changed in the operating state:	Operation	
	Parameter group:	Homing	
	Unit: 1000 LU/min		
	Min: 1.000 [1000 LU/min]	Max: 40000000.000 [1000 LU/min]	Factory setting: 50.000 [1000 LU/min]
Description:	Sets the approach velocity after detecting the zero mark to approach the home position.		
Dependency:	See also: c2595, c2597, c2604, p2607, p2609		
	Note When traversing to the home position, the velocity override is not effective.		

p2611	EPOS active homing approach velocity home position		
S200 Basic PN (EPOS load side, rotating), S200 PN (EPOS load side, rotating)	Data type: FloatingPoint32	Visible in: Standard display	
	Read permission:	Read drive data or acknowledge messages	
	Write permission:	Edit device configuration or drive applications	
	Can be changed in the operating state:	Operation	
	Parameter group:	Homing	
	Unit: 1000 LU/min		
	Min: 1.000 [1000 LU/min]	Max: 40000000.000 [1000 LU/min]	Factory setting: 1800.000 [1000 LU/min]
Description:	Sets the approach velocity after detecting the zero mark to approach the home position.		
Dependency:	See also: c2595, c2597, c2604, p2607, p2609		
	Note When traversing to the home position, the velocity override is not effective.		

c2612[0...1]	EPOS active homing reference cam		
	Data type: Unsigned8	Visible in: Standard display	
	Read permission:	Read drive data or acknowledge messages	
	Write permission:	Edit device configuration or drive applications	
	Parameter group:	Homing	
	Unit: -		
Description:	Signal for the reference cam.		
Index:	[0] = Reference cam selection 1 [1] = Reference cam selection 2		
Dependency:	See also: r0922, p2607		
	NOTICE Parameter c2612[0] may be protected as a result of r0922 and cannot be changed.		
	Note The selection of reference cam 1 or 2 can be configured using p11550.		

c2613	EPOS active homing negative reversing cam
	Data type: Unsigned8 Visible in: Standard display
	Read permission: Read drive data or acknowledge messages
	Write permission: Edit device configuration or drive applications
	Parameter group: Homing
	Unit: -
Description:	Signal for the reversing cam in the negative direction of travel. 1 signal: Reversing cam not reached. 0 signal: Reversing cam reached.
Dependency:	See also: c2614
	Note If, during active homing of the positive and negative reversing cam, a 0 signal is detected, then the axis remains at a standstill.

c2614	EPOS active homing positive reversing cam
	Data type: Unsigned8 Visible in: Standard display
	Read permission: Read drive data or acknowledge messages
	Write permission: Edit device configuration or drive applications
	Parameter group: Homing
	Unit: -
Description:	Signal for the reversing cam in the positive direction of travel. 1 signal: Reversing cam not reached. 0 signal: Reversing cam reached.
Dependency:	See also: c2613
	Note If, during active homing of the positive and negative reversing cam, a 0 signal is detected, then the axis remains at a standstill.

p2615	EPOS maximum number of traversing blocks
	Data type: Unsigned8 Visible in: Extended display
	Read permission: Read drive data or acknowledge messages
	Write permission: Edit device configuration or drive applications
	Can be changed in the operating state: Commissioning
	Parameter group: Traversing blocks
	Unit: -
	Min: Max: Factory setting:
	1 32 32
Description:	Sets the maximum number of traversing blocks that are available.
Dependency:	See also: p2616, p2617, p2618, p2619, p2620, p2621, p2622, p2623

p2616[0...n]	EPOS traversing block block number
	Data type: Integer16 Visible in: Standard display
	Read permission: Read drive data or acknowledge messages
	Write permission: Edit device configuration or drive applications
	Can be changed in the operating state: Operation
	Parameter group: Traversing blocks
	Unit: -

	Min:	Max:	Factory setting:
	-1	31	-1
Description:	Sets a block number.		
	-1: Invalid block number. These blocks are not taken into account.		
	0 ... 31: Valid block number.		
Dependency:	The number of indices depends on p2615.		
	See also: p2615, p2617, p2618, p2619, p2620, p2621, p2622, p2623		

p2617[0...n]	EPOS traversing block position		
	Data type: FloatingPoint32	Visible in: Standard display	
	Read permission:	Read drive data or acknowledge messages	
	Write permission:	Edit device configuration or drive applications	
	Can be changed in the operating state:	Operation	
	Parameter group:	Traversing blocks	
	Unit: LU		
	Min:	Max:	Factory setting:
	-2147482648.0000 [LU]	2147482647.0000 [LU]	0.0000 [LU]
Description:	Sets the target position for the traversing block.		
Dependency:	The number of indices depends on p2615.		
	See also: p2615, p2616, p2618, p2619, p2620, p2621, p2622, p2623		

Note

The target position is approached in either relative or absolute terms depending on p2623.

p2617[0...n]	EPOS traversing block position		
S200 Basic PN (EPOS load side, rotating), S200 PN (EPOS load side, rotating)	Data type: FloatingPoint32	Visible in: Standard display	
	Read permission:	Read drive data or acknowledge messages	
	Write permission:	Edit device configuration or drive applications	
	Can be changed in the operating state:	Operation	
	Parameter group:	Traversing blocks	
	Unit: LU		
	Min:	Max:	Factory setting:
	-2147482648.0000 [LU]	2147482647.0000 [LU]	0.0000 [LU]
Description:	Sets the target position for the traversing block.		
Dependency:	The number of indices depends on p2615.		
	See also: p2615, p2616, p2618, p2619, p2620, p2621, p2622, p2623		

Note

The target position is approached in either relative or absolute terms depending on p2623.

p2618[0...n]	EPOS traversing block velocity		
	Data type: FloatingPoint32	Visible in: Standard display	
	Read permission:	Read drive data or acknowledge messages	
	Write permission:	Edit device configuration or drive applications	
	Can be changed in the operating state:	Operation	
	Parameter group:	Traversing blocks	
	Unit: 1000 LU/min		

	Min: 1.000 [1000 LU/min]	Max: 40000000.000 [1000 LU/min]	Factory setting: 100.000 [1000 LU/min]
Description:	Sets the velocity for the traversing block.		
Dependency:	The number of indices depends on p2615. See also: p2615, p2616, p2617, p2619, p2620, p2621, p2622, p2623, c2646		
Note			
The velocity can be influenced using the velocity override (c2646).			

p2618[0...n]	EPOS traversing block velocity		
S200 Basic PN (EPOS load side, rotating), S200 PN (EPOS load side, rotating)	Data type: FloatingPoint32	Visible in: Standard display	
	Read permission:	Read drive data or acknowledge messages	
	Write permission:	Edit device configuration or drive applications	
	Can be changed in the operating state: Operation		
	Parameter group:	Traversing blocks	
	Unit: 1000 LU/min		
	Min: 1.000 [1000 LU/min]	Max: 40000000.000 [1000 LU/min]	Factory setting: 3600.000 [1000 LU/min]
Description:	Sets the velocity for the traversing block.		
Dependency:	The number of indices depends on p2615. See also: p2615, p2616, p2617, p2619, p2620, p2621, p2622, p2623, c2646		
Note			
The velocity can be influenced using the velocity override (c2646).			

p2619[0...n]	EPOS traversing block acceleration override		
	Data type: FloatingPoint32	Visible in: Standard display	
	Read permission:	Read drive data or acknowledge messages	
	Write permission:	Edit device configuration or drive applications	
	Can be changed in the operating state: Operation		
	Parameter group:	Traversing blocks	
	Unit: %		
	Min: 1.0 [%]	Max: 100.0 [%]	Factory setting: 100.0 [%]
Description:	Sets the acceleration override for the traversing block. The override refers to the maximum acceleration (p2572).		
Dependency:	The number of indices depends on p2615. See also: p2572, p2615, p2616, p2617, p2618, p2620, p2621, p2622, p2623		

p2620[0...n]	EPOS traversing deceleration override		
	Data type: FloatingPoint32	Visible in: Standard display	
	Read permission:	Read drive data or acknowledge messages	
	Write permission:	Edit device configuration or drive applications	
	Can be changed in the operating state: Operation		
	Parameter group:	Traversing blocks	
	Unit: %		
	Min: 1.0 [%]	Max: 100.0 [%]	Factory setting: 100.0 [%]

Description: Sets the deceleration override for the traversing block.
The override refers to the maximum deceleration (p2573).

Dependency: The number of indices depends on p2615.
See also: p2573, p2615, p2616, p2617, p2618, p2619, p2621, p2622, p2623

NOTICE

If, when calculating the traversing profile, it is identified that the target position of the next block with the programmed deceleration override will not be reached without direction reversal (flying block change), then the old (actual) deceleration override remains effective.

p2621[0...n] EPOS traversing block task

Data type: Integer16 **Visible in:** Standard display

Read permission: Read drive data or acknowledge messages

Write permission: Edit device configuration or drive applications

Can be changed in the operating state: Operation

Parameter group: Traversing blocks

Unit: -

Min:	Max:	Factory setting:
1	9	1

Description: Sets the required task for the traversing block.

Value:

1:	POSITIONING
2:	FIXED STOP
3:	ENDLESS_POS
4:	ENDLESS_NEG
5:	WAITING
6:	GOTO
7:	SET_O
8:	RESET_O
9:	JERK

Dependency: The number of indices depends on p2615.
See also: p2615, p2616, p2617, p2618, p2619, p2620, p2622, p2623

p2622[0...n] EPOS traversing block task parameter

Data type: Integer32 **Visible in:** Standard display

Read permission: Read drive data or acknowledge messages

Write permission: Edit device configuration or drive applications

Can be changed in the operating state: Operation

Parameter group: Traversing blocks

Unit: -

Min:	Max:	Factory setting:
-2147483648	2147483647	0

Description: Sets additional information/data of the appropriate task for the traversing block.

Dependency: The number of indices depends on p2615.
See also: p2615, p2616, p2617, p2618, p2619, p2620, p2621, p2623

Note

The following should be set depending on the task:

FIXED STOP: Clamping torque and clamping force (rotary 0...65536 [0.01 Nm], linear 0...65536 [N])

WAIT: Wait time [ms]

GOTO: Block number

SET_O: 1, 2 or 3 - set direct output 1, 2 or 3 (both)

RESET_O: 1, 2 or 3 - reset direct output 1, 2 or 3 (both)

JERK: 0 - deactivate, 1 - activate

p2623[0...n]**EPOS traversing block task mode**

Data type: Unsigned16

Visible in: Standard display

Read permission:

Read drive data or acknowledge messages

Write permission:

Edit device configuration or drive applications

Can be changed in the operating state: Operation

Parameter group: Traversing blocks

Unit: -

Min:

Max:

Factory setting:

0

65535

0

Description:

Sets the influence of the task for the traversing block.

Value = 0000 cccc bbbb aaaa

cccc: Positioning mode

cccc = 0000 --> ABSOLUTE

cccc = 0001 --> RELATIVE

cccc = 0010 --> ABS_POS (only for a rotary axis with modulo correction)

cccc = 0011 --> ABS_NEG (only for a rotary axis with modulo correction)

bbbb: Progression condition

bbbb = 0000 --> END

bbbb = 0001 --> CONTINUE WITH STOP

bbbb = 0010 --> CONTINUE FLYING

bbbb = 0011 --> CONTINUE EXTERNAL

bbbb = 0100 --> CONTINUE EXTERNAL WAIT

bbbb = 0101 --> CONTINUE EXTERNAL ALARM

aaaa: IDs

aaaa = 000x --> show/hide block (x = 0: show, x = 1: hide)

Dependency:

The number of indices depends on p2615.

See also: p2615, p2616, p2617, p2618, p2619, p2620, p2621, p2622

c2625**EPOS traversing block selection bit 0**

Data type: Unsigned8

Visible in: Standard display

Read permission:

Read drive data or acknowledge messages

Write permission:

Edit device configuration or drive applications

Parameter group:

Traversing blocks

Unit: -

Description:

Signal to select the traversing block, bit 0.

Dependency:

Parameters c2625, c2626, c2627, c2628 and c2629 are used to select one of the maximum 64 traversing blocks.

See also: c2626, c2627, c2628, c2629

c2626	<p>EPOS traversing block selection bit 1</p> <p>Data type: Unsigned8 Visible in: Standard display</p> <p>Read permission: Read drive data or acknowledge messages</p> <p>Write permission: Edit device configuration or drive applications</p> <p>Parameter group: Traversing blocks</p> <p>Unit: -</p>
Description:	Signal to select the traversing block, bit 1.
Dependency:	Parameters c2625, c2626, c2627, c2628 and c2629 are used to select one of the maximum 64 traversing blocks. See also: c2625, c2627, c2628, c2629

c2627	<p>EPOS traversing block selection bit 2</p> <p>Data type: Unsigned8 Visible in: Standard display</p> <p>Read permission: Read drive data or acknowledge messages</p> <p>Write permission: Edit device configuration or drive applications</p> <p>Parameter group: Traversing blocks</p> <p>Unit: -</p>
Description:	Signal to select the traversing block, bit 2.
Dependency:	Parameters c2625, c2626, c2627, c2628 and c2629 are used to select one of the maximum 64 traversing blocks. See also: c2625, c2626, c2628, c2629

c2628	<p>EPOS traversing block selection bit 3</p> <p>Data type: Unsigned8 Visible in: Standard display</p> <p>Read permission: Read drive data or acknowledge messages</p> <p>Write permission: Edit device configuration or drive applications</p> <p>Parameter group: Traversing blocks</p> <p>Unit: -</p>
Description:	Signal to select the traversing block, bit 3.
Dependency:	Parameters c2625, c2626, c2627, c2628 and c2629 are used to select one of the maximum 64 traversing blocks. See also: c2625, c2626, c2627, c2629

c2629	<p>EPOS traversing block selection bit 4</p> <p>Data type: Unsigned8 Visible in: Standard display</p> <p>Read permission: Read drive data or acknowledge messages</p> <p>Write permission: Edit device configuration or drive applications</p> <p>Parameter group: Traversing blocks</p> <p>Unit: -</p>
Description:	Signal to select the traversing block, bit 4.
Dependency:	Parameters c2625, c2626, c2627, c2628 and c2629 are used to select one of the maximum 64 traversing blocks. See also: c2625, c2626, c2627, c2628

c2631	<p>EPOS activate traversing task (0 -> 1)</p> <p>Data type: Unsigned8 Visible in: Standard display</p> <p>Read permission: Read drive data or acknowledge messages</p> <p>Write permission: Edit device configuration or drive applications</p> <p>Parameter group: Traversing blocks</p> <p>Unit: -</p>
--------------	--

A.3 Parameters

Description: Signal for "Activate traversing task".
c2631 = 0/1 signal
The traversing task, selected using c2625 ... c2629, is started.

Dependency: See also: c2625, c2626, c2627, c2628, c2629, c2640, c2641

NOTICE
The parameter may be protected as a result of r0922 and cannot be changed.

Note
To start a traversing block, the axis must be referenced (r2684.11 = 1).
The status signal r2684.12 = 0/1 signal is used for acknowledgment.
A traversing task can be influenced using the following signals:
- Intermediate stop via c2640.
- Reject traversing task via c2641.

p2632

EPOS external block change evaluation

Data type: Integer16 **Visible in:** Extended display
Read permission: Read drive data or acknowledge messages
Write permission: Edit device configuration or drive applications
Can be changed in the operating state: Ready for operation
Parameter group: Traversing blocks
Unit: -
Min: **Max:** **Factory setting:**
0 1 0

Description: Sets the mode to evaluate "external block change".

Value:
0: External block change via a measuring probe
1: External block change via c2633

Dependency: See also: p2623, c2633, r2677, r2678

Note
In the mode "external block change via measuring probe" (p2632 = 0), the following applies:
When starting a traversing block with the block change enable CONTINUE_EXTERNAL, CONTINUE_EXTERNAL_WAIT and CONTINUE_EXTERNAL_ALARM, an activated "passive homing" is interrupted.
After ending the block, "Passive homing" must be reactivated using a 0/1 edge in c2595.

c2633

EPOS external block change (0 -> 1)

Data type: Unsigned8 **Visible in:** Extended display
Read permission: Read drive data or acknowledge messages
Write permission: Edit device configuration or drive applications
Parameter group: Traversing blocks
Unit: -

Description: Signal for the "External block change".
c2633 = 0/1 signal

Dependency: The evaluation of the signal is only active p2632 = 1.
See also: p2623, p2632, c2640, c2641, r2677, r2678

NOTICE
The parameter may be protected as a result of r0922 and cannot be changed.

Note

A 0/1 edge initiates a flying block change in the subsequent traversing block.
 When the external block change is identified, the actual position is saved in r2678.
 A traversing task can be influenced using the following signals:
 - Intermediate stop via c2640.
 - Reject traversing task via c2641.

p2634[0]

EPOS fixed stop maximum following error

Data type: FloatingPoint32 **Visible in:** Standard display
Read permission: Read drive data or acknowledge messages
Write permission: Edit device configuration or drive applications
Can be changed in the operating state: Operation
Parameter group: Traversing blocks
Unit: LU
Min: **Max:** **Factory setting:**
 0.0000 [LU] 2147482647.0000 [LU] 1.0000 [LU]

Description: Sets the following error to detect the "fixed stop reached" state (r2526.4).
Dependency: See also: r2526, p2621, r2675

Note

The state "fixed stop reached" is detected if the following error exceeds the theoretically calculated following error value by p2634.

p2634[0]

S200 Basic PN (EPOS load side, rotating),
 S200 PN (EPOS load side, rotating)

EPOS fixed stop maximum following error

Data type: FloatingPoint32 **Visible in:** Standard display
Read permission: Read drive data or acknowledge messages
Write permission: Edit device configuration or drive applications
Can be changed in the operating state: Operation
Parameter group: Traversing blocks
Unit: LU
Min: **Max:** **Factory setting:**
 0.0000 [LU] 2147482647.0000 [LU] 36.0000 [LU]

Description: Sets the following error to detect the "fixed stop reached" state (r2526.4).
Dependency: See also: r2526, p2621, r2675

Note

The state "fixed stop reached" is detected if the following error exceeds the theoretically calculated following error value by p2634.

p2635

EPOS fixed stop monitoring window

Data type: FloatingPoint32 **Visible in:** Standard display
Read permission: Read drive data or acknowledge messages
Write permission: Edit device configuration or drive applications
Can be changed in the operating state: Operation
Parameter group: Traversing blocks
Unit: LU
Min: **Max:** **Factory setting:**
 0.0000 [LU] 2147482647.0000 [LU] 0.1000 [LU]

Description: Sets the monitoring window of the actual position after the fixed stop is reached.

Dependency: See also: r2526, r2683

Note

If, after the fixed stop is reached, the end stop shifts in either the positive or negative direction by more than the value set here, then r2526.5 is set to 1 and an appropriate message is output.

p2635

S200 Basic PN (EPOS load side, rotating),
S200 PN (EPOS load side, rotating)

EPOS fixed stop monitoring window

Data type: FloatingPoint32

Visible in: Standard display

Read permission:

Read drive data or acknowledge messages

Write permission:

Edit device configuration or drive applications

Can be changed in the operating state: Operation

Parameter group:

Traversing blocks

Unit: LU

Min:

0.0000 [LU]

Max:

2147482647.0000 [LU]

Factory setting:

3.6000 [LU]

Description:

Sets the monitoring window of the actual position after the fixed stop is reached.

Dependency:

See also: r2526, r2683

Note

If, after the fixed stop is reached, the end stop shifts in either the positive or negative direction by more than the value set here, then r2526.5 is set to 1 and an appropriate message is output.

c2640**EPOS intermediate stop (0 signal)**

Data type: Unsigned8

Visible in: Standard display

Read permission:

Read drive data or acknowledge messages

Write permission:

Edit device configuration or drive applications

Parameter group:

Traversing blocks, Direct setpoint input (MDI)

Unit: -

Description:

Signal for "No intermediate stop/intermediate stop".

1 signal: No intermediate stop

0 signal: Intermediate stop.

Dependency:

See also: c2631, c2641, c2647, c2649

CAUTION

For c2649 = 1 signal, the following applies:
Motion starts without any explicit control signal.

NOTICE

The parameter may be protected as a result of r0922 and cannot be changed.

Note

This signal is only effective in the modes "traversing blocks" and "direct setpoint input/MDI".

When the intermediate stop is activated, then the axis brakes with the parameterized deceleration (p2620 or c2645).

c2641**EPOS reject traversing task (0 signal)**

Data type: Unsigned8

Visible in: Standard display

Read permission:

Read drive data or acknowledge messages

Write permission:

Edit device configuration or drive applications

Parameter group:

Traversing blocks, Direct setpoint input (MDI)

Unit: -

Description: Signal for "Do not reject traversing task/reject traversing task".
1 signal: Do not reject traversing task.
0 signal: Reject traversing task

Dependency: See also: c2631, c2640, c2647, c2649

CAUTION
For c2649 = 1 signal, the following applies:
Motion starts without any explicit control signal.

NOTICE
The parameter may be protected as a result of r0922 and cannot be changed.

Note
This signal is only effective in the modes "traversing blocks" and "direct setpoint input/MDI".
When activating reject traversing tasks, then the axis brakes with the maximum deceleration (p2573).

c2642 EPOS direct setpoint input/MDI position setpoint

Data type: FloatingPoint32 **Visible in:** Standard display
Read permission: Read drive data or acknowledge messages
Write permission: Edit device configuration or drive applications
Parameter group: Direct setpoint input (MDI)
Unit: LU

Description: Signal for the position setpoint in the mode "direct setpoint input/MDI".

Dependency: See also: c2648, c2649, c2650

NOTICE
The parameter may be protected as a result of r0922 and cannot be changed.

Note
Depending on c2649, the position setpoint is either transferred continuously or edge-triggered.
The position setpoint input is interpreted as length unit [LU].

c2642 EPOS direct setpoint input/MDI position setpoint

S200 Basic PN (EPOS load side, rotating), S200 PN (EPOS load side, rotating)
Data type: FloatingPoint32 **Visible in:** Standard display
Read permission: Read drive data or acknowledge messages
Write permission: Edit device configuration or drive applications
Parameter group: Direct setpoint input (MDI)
Unit: LU

Description: Signal for the position setpoint in the mode "direct setpoint input/MDI".

Dependency: See also: c2648, c2649, c2650

NOTICE
The parameter may be protected as a result of r0922 and cannot be changed.

Note
Depending on c2649, the position setpoint is either transferred continuously or edge-triggered.
The position setpoint input is interpreted as length unit [LU].

c2643 EPOS direct setpoint input/MDI velocity setpoint

Data type: FloatingPoint32 **Visible in:** Standard display
Read permission: Read drive data or acknowledge messages
Write permission: Edit device configuration or drive applications
Parameter group: Direct setpoint input (MDI)
Unit: 1000 LU/min

Description: Signal for the velocity setpoint in the mode "Direct setpoint input/MDI".

Dependency: See also: c2649, c2650

NOTICE

The parameter may be protected as a result of r0922 and cannot be changed.
--

Note

Depending on c2649, the velocity setpoint is either transferred continuously or edge-triggered.
The velocity setpoint input is interpreted as [1000 LU/min].

c2643

S200 Basic PN (EPOS load side, rotating), S200 PN (EPOS load side, rotating)

EPOS direct setpoint input/MDI velocity setpoint

Data type: FloatingPoint32

Visible in: Standard display

Read permission:

Read drive data or acknowledge messages

Write permission:

Edit device configuration or drive applications

Parameter group:

Direct setpoint input (MDI)

Unit: 1000 LU/min

Description: Signal for the velocity setpoint in the mode "Direct setpoint input/MDI".

Dependency: See also: c2649, c2650

NOTICE

The parameter may be protected as a result of r0922 and cannot be changed.
--

Note

Depending on c2649, the velocity setpoint is either transferred continuously or edge-triggered.
The velocity setpoint input is interpreted as [1000 LU/min].

c2644**EPOS direct setpoint input/MDI acceleration override**

Data type: FloatingPoint32

Visible in: Standard display

Read permission:

Read drive data or acknowledge messages

Write permission:

Edit device configuration or drive applications

Parameter group:

Direct setpoint input (MDI)

Unit: %

Description: Signal for acceleration override in the operating mode "direct setpoint input/MDI".

Dependency: See also: c2649, c2650, c11560

NOTICE

The parameter may be protected as a result of r0922 and cannot be changed.
--

Note

Depending on c2649, the acceleration override is either transferred continuously or edge-triggered.
The signal value 4000 hex (16384 dec) corresponds to 100 %.

c2645**EPOS direct setpoint input/MDI deceleration override**

Data type: FloatingPoint32

Visible in: Standard display

Read permission:

Read drive data or acknowledge messages

Write permission:

Edit device configuration or drive applications

Parameter group:

Traversing blocks

Unit: %

Description: Signal for the deceleration override in the operating mode "Direct setpoint input/MDI".

Dependency: See also: c2649, c2650, c11561

NOTICE
If, when calculating the traversing profile, it is identified that the target position with the programmed deceleration override cannot be reached without reversing the direction, then when accepting the dynamic values, the larger deceleration override is accepted and becomes effective. The parameter may be protected as a result of r0922 and cannot be changed.

Note

Depending on c2649, the deceleration override is either transferred continuously or edge-triggered.
The signal value 4000 hex (16384 dec) corresponds to 100 %.

c2646**EPOS velocity override**

Data type: FloatingPoint32 **Visible in:** Standard display
Read permission: Read drive data or acknowledge messages
Write permission: Edit device configuration or drive applications
Parameter group: Jog, Homing, Traversing blocks, Direct setpoint input (MDI)
Unit: %

Description:

Signal for the velocity override.

This velocity override is effective in the following operating modes "Direct setpoint input/MDI", "Traversing blocks", "Jogging" and "Active homing" (when approaching the reference cam).

Dependency:

See also: p2571, p2585, p2586, p2605, p2618, c2643, r2681

NOTICE
The parameter may be protected as a result of r0922 and cannot be changed.

Note

The effective override (r2681) can differ from the specified override due to limits (e.g. maximum velocity).

c2647**EPOS direct setpoint input/MDI selection**

Data type: Unsigned8 **Visible in:** Standard display
Read permission: Read drive data or acknowledge messages
Write permission: Edit device configuration or drive applications
Parameter group: Direct setpoint input (MDI)
Unit: -

Description:

Signal to select operating mode "Direct setpoint input/MDI".

Dependency:

See also: c2640, c2641, c2642, c2643, c2644, c2645, c2646, c2648, c2649, c2650, c2651, c2652, c2653

Note

In this mode, using c2653, a flying changeover can be made between setting-up and positioning.
In this mode, even if the axis is not referenced (r2684.11 = 0) relative positioning is possible.

c2648**EPOS direct setpoint input/MDI positioning type**

Data type: Unsigned8 **Visible in:** Standard display
Read permission: Read drive data or acknowledge messages
Write permission: Edit device configuration or drive applications
Parameter group: Direct setpoint input (MDI)
Unit: -

Description:

Signal for the positioning type in mode "Direct setpoint input/MDI".

1 signal: Absolute positioning is selected.

0 signal: Relative positioning is selected.

Dependency:

See also: c2649, c2650, c2654

NOTICE
Absolute positioning: To traverse, the home position must be set (r2684.11 = 1). Relative positioning: To traverse, it is not necessary that the home position is set.

Note

Depending on c2649, the positioning type is either transferred continuously or edge-triggered.
Parameter c2648 is only evaluated for p2654 = 0.
Parameter c2648 is possibly not evaluated as a result of the selected telegram.

c2649**EPOS direct setpoint input/MDI transfer type selection**

Data type: Unsigned8 **Visible in:** Standard display
Read permission: Read drive data or acknowledge messages
Write permission: Edit device configuration or drive applications
Parameter group: Direct setpoint input (MDI)
Unit: -

Description: Signal to define how values are transferred in operating mode "Direct setpoint input/MDI".
1 signal: Values are continually transferred (refer to parameter under dependency).
0 signal: The values are transferred for c2650 = 0/1 signal.

Dependency: See also: c2642, c2643, c2644, c2645, c2648, c2650, c2651, c2652

 CAUTION
For a 1 signal, the following applies: Motion starts without any explicit control signal.

Note

Parameter c2649 can only be changed when r0922 = 999.

c2650**EPOS direct setpoint input/MDI setpoint acceptance edge**

Data type: Unsigned8 **Visible in:** Standard display
Read permission: Read drive data or acknowledge messages
Write permission: Edit device configuration or drive applications
Parameter group: Direct setpoint input (MDI)
Unit: -

Description: Signal to accept the values for edge-triggered selection (c2649 = 0 signal) in the operating mode "Direct setpoint input/MDI".
c2650 = 0/1 signal and c2649 = 0 signal

Values are accepted, edge-triggered (refer to parameter under dependency).

Dependency: See also: c2640, c2641, c2642, c2643, c2644, c2645, c2648, c2649, c2651, c2652, r2684

NOTICE
The parameter may be protected as a result of r0922 and cannot be changed.

Note

The status signal r2684.12 = 0/1 signal is used for acknowledgment.
The operating mode "direct setpoint input/MDI" can be influenced via the following signals:
- Intermediate stop via c2640.
- Reject traversing task via c2641.

c2651	<p>EPOS direct setpoint input/MDI direction selection, positive</p> <p>Data type: Unsigned8 Visible in: Standard display</p> <p>Read permission: Read drive data or acknowledge messages</p> <p>Write permission: Edit device configuration or drive applications</p> <p>Parameter group: Direct setpoint input (MDI)</p> <p>Unit: -</p>
Description:	Signal for the positive direction selection in operating mode "Direct setpoint input/MDI".
Dependency:	See also: p2576, c2648, c2649, c2650, c2652, c2653, c2654
	<p>Note</p> <p>The following applies for "setting-up":</p> <ul style="list-style-type: none"> - The traversing direction can be specified using this parameter. - If both directions (c2651, c2652) are selected, then the axis remains stationary (zero speed). - If both directions (c2651, c2652) are deselected, then the axis remains stationary (zero speed). <p>The following applies for "positioning":</p> <p>Using parameters c2651 and c2652, when the modulo correction (c2577 = 1 signal) is activated and absolute positioning (c2648 = 1 signal), the travel direction is specified as follows:</p> <p>c2651 / c2652</p> <p>0 signal / 0 signal: Absolute positioning through the shortest distance.</p> <p>1 signal / 0 signal: Absolute positioning in the positive direction.</p> <p>0 signal / 1 signal: Absolute positioning in the negative direction.</p> <p>1 signal / 1 signal: Absolute positioning through the shortest distance.</p>

c2652	<p>EPOS direct setpoint input/MDI direction selection negative</p> <p>Data type: Unsigned8 Visible in: Standard display</p> <p>Read permission: Read drive data or acknowledge messages</p> <p>Write permission: Edit device configuration or drive applications</p> <p>Parameter group: Direct setpoint input (MDI)</p> <p>Unit: -</p>
Description:	The signal for the negative direction selection in the operating mode "Direct setpoint input/MDI".
Dependency:	See also: p2576, c2648, c2649, c2650, c2651, c2653, c2654
	<p>Note</p> <p>The following applies for "setting-up":</p> <ul style="list-style-type: none"> - The travel direction is specified using this signal. - If both directions (c2651, c2652) are selected, then the axis remains stationary (zero speed). - If both directions (c2651, c2652) are deselected, then the axis remains stationary (zero speed). <p>The following applies for "positioning":</p> <p>Using c2651 and c2652, when the modulo correction (c2577 = 1 signal) is activated and absolute positioning (c2648 = 1 signal), the travel direction can be specified as follows:</p> <p>c2651 / c2652</p> <p>0 signal / 0 signal: Absolute positioning through the shortest distance.</p> <p>1 signal / 0 signal: Absolute positioning in the positive direction.</p> <p>0 signal / 1 signal: Absolute positioning in the negative direction.</p> <p>1 signal / 1 signal: Absolute positioning through the shortest distance.</p>

c2653	<p>EPOS direct setpoint input/MDI setting-up selection</p> <p>Data type: Unsigned8 Visible in: Standard display</p> <p>Read permission: Read drive data or acknowledge messages</p> <p>Write permission: Edit device configuration or drive applications</p> <p>Parameter group: Direct setpoint input (MDI)</p> <p>Unit: -</p>
--------------	--

Description: Signal for setting-up in operating mode "Direct setpoint input/MDI".
1 signal: Setting-up selected.
0 signal: Positioning selected.

Dependency: See also: c2651, c2652

Note

In the operating mode "direct setpoint input/MDI", it is possible to make a flying changeover between setting-up and positioning.

For "setting up" (c2653 = 1 signal), the following applies:

A traversing direction must be selected using parameters c2651 and c2652.

c2654 EPOS direct setpoint input/MDI mode adaptation

Data type: Unsigned16

Visible in: Standard display

Read permission:

Read drive data or acknowledge messages

Write permission:

Edit device configuration or drive applications

Parameter group:

Direct setpoint input (MDI)

Unit: -

Description: Signal of the MDI mode via PROFIBUS telegram 110 in operating mode "direct setpoint input/MDI".

c2654 = 0: Signals are evaluated.

c2654 > 0: Signals are not evaluated.

The evaluation involves the following signals:

- c2648 (positioning type)

- c2651 (positive direction selection)

- c2652 (negative direction selection)

In this case, the following definitions apply:

Signal via c2654 = xx0x hex -> absolute

Signal via c2654 = xx1x hex -> relative

Signal via c2654 = xx2x hex -> abs_pos (only for modulo correction)

Signal via c2654 = xx3x hex -> abs_neg (only for modulo correction)

Dependency: See also: c2648, c2651, c2652

c2655[0...1] EPOS select tracking mode

Data type: Unsigned8

Visible in: Extended display

Read permission:

Read drive data or acknowledge messages

Write permission:

Edit device configuration or drive applications

Parameter group:

Basic positioner

Unit: -

Description: Signal to select tracking operation.

c2655[0] or c2655[1] = 1 signal

Tracking mode after withdrawing the enable signal from EPOS (c2656 = 0 signal).

c2655[0] and c2655[1] = 0 signal

No tracking mode after withdrawing the enable signal from EPOS (c2656 = 0 signal).

NOTICE

The parameter may be protected as a result of r0922 and cannot be changed.

Note

For the following events, independent of the signal that is present, tracking mode is selected:

- After booting.

- After a 0/1 signal at c2658 (EPOS position actual value, valid feedback signal).

- While a fault is present.

r2665	EPOS position setpoint	
	Data type: FloatingPoint32	Visible in: Standard display
	Read permission:	Read drive data or acknowledge messages
	Write permission:	Edit device configuration or drive applications
	Parameter group:	Jog, Homing, Traversing blocks, Direct setpoint input (MDI)
	Unit: LU	
Description:	Displays the actual absolute position setpoint.	
Dependency:	See also: c2530	
<hr/>		
Note		
As default, c2530 is interconnected with r2665.		

r2665	EPOS position setpoint	
S200 Basic PN (EPOS load side, rotating), S200 PN (EPOS load side, rotating)	Data type: FloatingPoint32	Visible in: Standard display
	Read permission:	Read drive data or acknowledge messages
	Write permission:	Edit device configuration or drive applications
	Parameter group:	Jog, Homing, Traversing blocks, Direct setpoint input (MDI)
	Unit: LU	
Description:	Displays the actual absolute position setpoint.	
Dependency:	See also: c2530	
<hr/>		
Note		
As default, c2530 is interconnected with r2665.		

r2666	EPOS velocity setpoint	
	Data type: FloatingPoint32	Visible in: Standard display
	Read permission:	Read drive data or acknowledge messages
	Write permission:	Edit device configuration or drive applications
	Parameter group:	Jog, Homing, Traversing blocks, Direct setpoint input (MDI)
	Unit: 1000 LU/min	
Description:	Displays the actual velocity setpoint.	
Dependency:	See also: c2531	
<hr/>		
Note		
As default, c2531 is interconnected with r2666.		

r2666	EPOS velocity setpoint	
S200 Basic PN (EPOS load side, rotating), S200 PN (EPOS load side, rotating)	Data type: FloatingPoint32	Visible in: Standard display
	Read permission:	Read drive data or acknowledge messages
	Write permission:	Edit device configuration or drive applications
	Parameter group:	Jog, Homing, Traversing blocks, Direct setpoint input (MDI)
	Unit: 1000 LU/min	
Description:	Displays the actual velocity setpoint.	
Dependency:	See also: c2531	
<hr/>		
Note		
As default, c2531 is interconnected with r2666.		

r2669.0...5**EPOS actual operating mode****Data type:** Unsigned32**Visible in:** Standard display**Read permission:**

Read drive data or acknowledge messages

Write permission:

Edit device configuration or drive applications

Parameter group:

Jog, Homing, Traversing blocks, Direct setpoint input (MDI)

Unit: -**Description:**

Displays the actual active operating mode.

Bit array:

Bit	Signal name	1 signal	0 signal
00	Jog operating mode	Active	Not active
01	Operating mode active homing	Active	Not active
02	Operating mode traversing blocks	Active	Not active
03	Operating mode positioning for direct setpoint input / MDI	Active	Not active
04	Operating mode setting up for direct setpoint input / MDI	Active	Not active
05	Option passive homing	Active	Not active

Dependency:

See also: c2589, c2590, c2595, c2631, c2647, c2653

r2670.0...15**EPOS status word active traversing block****Data type:** Unsigned32**Visible in:** Standard display**Read permission:**

Read drive data or acknowledge messages

Write permission:

Edit device configuration or drive applications

Parameter group:

Traversing blocks

Unit: -**Description:**

Displays the status word for the active traversing block.

r2670.0: Active traversing block, bit 0

...

r2670.5: Active traversing block, bit 5

r2670.15: MDI active

Bit array:

Bit	Signal name	1 signal	0 signal
00	Active traversing block bit 0	Active	Not active
01	Active traversing block bit 1	Active	Not active
02	Active traversing block bit 2	Active	Not active
03	Active traversing block bit 3	Active	Not active
04	Active traversing block bit 4	Active	Not active
05	Active traversing block bit 5	Active	Not active
15	MDI active	Active	Not active

Dependency:

See also: c2631, c2647

Note

For bit 00 ... 05:

Displays the active traversing block in the traversing blocks operating mode.

For bit 15:

For a 1 signal, the operating mode - direct setpoint input/MDI - is active

r2671**EPOS actual position setpoint****Data type:** FloatingPoint32**Visible in:** Standard display**Read permission:**

Read drive data or acknowledge messages

Write permission:

Edit device configuration or drive applications

Parameter group:

Jog, Traversing blocks, Direct setpoint input (MDI)

Unit: LU**Description:**

Displays the position setpoint presently being processed.

Note

A position of 0 is displayed for non position-related tasks (e.g. ENDLESS_POS, ENDLESS_NEG).

r2671

EPOS actual position setpoint

S200 Basic PN (EPOS load side, rotating), S200 PN (EPOS load side, rotating)

Data type: FloatingPoint32 **Visible in:** Standard display
Read permission: Read drive data or acknowledge messages
Write permission: Edit device configuration or drive applications
Parameter group: Jog, Traversing blocks, Direct setpoint input (MDI)
Unit: LU

Description: Displays the position setpoint presently being processed.

Note

A position of 0 is displayed for non position-related tasks (e.g. ENDLESS_POS, ENDLESS_NEG).

r2672

EPOS actual velocity setpoint

Data type: FloatingPoint32 **Visible in:** Standard display
Read permission: Read drive data or acknowledge messages
Write permission: Edit device configuration or drive applications
Parameter group: Jog, Homing, Traversing blocks, Direct setpoint input (MDI)
Unit: 1000 LU/min

Description: Displays the velocity setpoint presently being processed.

r2672

EPOS actual velocity setpoint

S200 Basic PN (EPOS load side, rotating), S200 PN (EPOS load side, rotating)

Data type: FloatingPoint32 **Visible in:** Standard display
Read permission: Read drive data or acknowledge messages
Write permission: Edit device configuration or drive applications
Parameter group: Jog, Homing, Traversing blocks, Direct setpoint input (MDI)
Unit: 1000 LU/min

Description: Displays the velocity setpoint presently being processed.

r2673

EPOS actual acceleration override

Data type: FloatingPoint32 **Visible in:** Standard display
Read permission: Read drive data or acknowledge messages
Write permission: Edit device configuration or drive applications
Parameter group: Jog, Traversing blocks, Direct setpoint input (MDI)
Unit: %

Description: Displays the acceleration override presently being processed.

Note

An override of 100% is effective in the "Jogging" and "Active homing" operating modes.

r2674

EPOS actual deceleration override

Data type: FloatingPoint32 **Visible in:** Standard display
Read permission: Read drive data or acknowledge messages
Write permission: Edit device configuration or drive applications
Parameter group: Jog, Traversing blocks, Direct setpoint input (MDI)
Unit: %

Description: Displays the deceleration override presently being processed.

Note

An override of 100% is effective in the "Jogging" and "Active homing" operating modes.

r2675**EPOS actual task****Data type:** Integer16**Visible in:** Standard display**Read permission:**

Read drive data or acknowledge messages

Write permission:

Edit device configuration or drive applications

Parameter group:

Traversing blocks

Unit: -**Description:**

Display and signal source for the task currently being processed.

Value:

0: Inactive

1: POSITIONING

2: FIXED STOP

3: ENDLESS_POS

4: ENDLESS_NEG

5: WAITING

6: GOTO

7: SET_O

8: RESET_O

9: JERK

Dependency:

See also: p2621

r2676**EPOS actual task parameter****Data type:** Integer32**Visible in:** Standard display**Read permission:**

Read drive data or acknowledge messages

Write permission:

Edit device configuration or drive applications

Parameter group:

Traversing blocks

Unit: -**Description:**

Displays the task parameter presently being processed in the "traversing blocks" operating mode.

Dependency:

See also: p2622

Note

The following is displayed depending on the task:

FIXED STOP: Clamping torque (0 ... 65536 [0.01 Nm]) or clamping force (0 ... 65536 [N])

WAIT: Wait time [ms]

GOTO: Block number

SET_O: 1, 2, 3 --> direct output 1, 2 or 3 (both) is set

RESET_O: 1, 2, 3 --> direct output 1, 2 or 3 (both) is reset

JERK: 0 --> deactivate, 1 --> activate

r2677**EPOS actual task mode****Data type:** Unsigned16**Visible in:** Standard display**Read permission:**

Read drive data or acknowledge messages

Write permission:

Edit device configuration or drive applications

Parameter group:

Traversing blocks

Unit: -**Description:**

Displays the task mode presently being processed.

Dependency:

See also: p2623

r2678	EPOS external block change actual position	
	Data type: FloatingPoint32	Visible in: Standard display
	Read permission:	Read drive data or acknowledge messages
	Write permission:	Edit device configuration or drive applications
	Parameter group:	Traversing blocks, Direct setpoint input (MDI)
	Unit: LU	
Description:	Displays the actual position for the following events: - External block change via measuring probe (p2632 = 0, c2661 = 0/1 signal). - External block change via c2633 (p2632 = 1, c2633 = 0/1 signal). - Activate traversing task (c2631 = 0/1 signal).	
Dependency:	See also: c2631, p2632, c2633	
<hr/>		
r2678	EPOS external block change actual position	
S200 Basic PN (EPOS load side, rotating), S200 PN (EPOS load side, rotating)	Data type: FloatingPoint32	Visible in: Standard display
	Read permission:	Read drive data or acknowledge messages
	Write permission:	Edit device configuration or drive applications
	Parameter group:	Traversing blocks, Direct setpoint input (MDI)
	Unit: LU	
Description:	Displays the actual position for the following events: - External block change via measuring probe (p2632 = 0, c2661 = 0/1 signal). - External block change via c2633 (p2632 = 1, c2633 = 0/1 signal). - Activate traversing task (c2631 = 0/1 signal).	
Dependency:	See also: c2631, p2632, c2633	
<hr/>		
r2680	EPOS clearance reference cam and zero mark	
	Data type: FloatingPoint32	Visible in: Standard display
	Read permission:	Read drive data or acknowledge messages
	Write permission:	Edit device configuration or drive applications
	Parameter group:	Homing
	Unit: LU	
Description:	Display and signal source for the distance (clearance) between the reference cam and zero mark. The value is determined for active homing.	
<hr/>		
r2680	EPOS clearance reference cam and zero mark	
S200 Basic PN (EPOS load side, rotating), S200 PN (EPOS load side, rotating)	Data type: FloatingPoint32	Visible in: Standard display
	Read permission:	Read drive data or acknowledge messages
	Write permission:	Edit device configuration or drive applications
	Parameter group:	Homing
	Unit: LU	
Description:	Display and signal source for the distance (clearance) between the reference cam and zero mark. The value is determined for active homing.	
<hr/>		
r2681	EPOS velocity override effective	
	Data type: FloatingPoint32	Visible in: Standard display
	Read permission:	Read drive data or acknowledge messages
	Write permission:	Edit device configuration or drive applications
	Parameter group:	Jog, Homing, Traversing blocks, Direct setpoint input (MDI)
	Unit: %	
Description:	Displays the actual effective velocity override.	

Dependency: See also: p2571, c2646

Note

The effective override can differ from the specified override due to limits (e.g. p2571, maximum velocity).

r2682

EPOS residual distance to go

Data type: FloatingPoint32 **Visible in:** Standard display
Read permission: Read drive data or acknowledge messages
Write permission: Edit device configuration or drive applications
Parameter group: Jog, Traversing blocks, Direct setpoint input (MDI)
Unit: LU

Description: Displays the current residual distance.
 The remaining distance is the distance to still to be moved through up to the end of the actual positioning task.

Dependency: See also: r2665, r2671, r2678

r2682

EPOS residual distance to go

S200 Basic PN (EPOS load side, rotating), S200 PN (EPOS load side, rotating)

Data type: FloatingPoint32 **Visible in:** Standard display
Read permission: Read drive data or acknowledge messages
Write permission: Edit device configuration or drive applications
Parameter group: Jog, Traversing blocks, Direct setpoint input (MDI)
Unit: LU

Description: Displays the current residual distance.
 The remaining distance is the distance to still to be moved through up to the end of the actual positioning task.

Dependency: See also: r2665, r2671, r2678

r2683.0...14

EPOS status word 1

Data type: Unsigned16 **Visible in:** Standard display
Read permission: Read drive data or acknowledge messages
Write permission: Edit device configuration or drive applications
Parameter group: Control/status words, Jog, Homing, Traversing blocks, Direct setpoint input (MDI), Position controller monitoring
Unit: -

Description: Display and signal source for status word 1 of the basic positioner (EPOS).

Bit array:	Bit	Signal name	1 signal	0 signal
	00	Tracking mode active	Yes	No
	01	Speed limiting active	Yes	No
	02	Setpoint fixed	Yes	No
	03	Set position reached	Yes	No
	04	Axis moves forward	Yes	No
	05	Axis moves backward	Yes	No
	06	Negative software limit switch reached	Yes	No
	07	Positive software limit switch reached	Yes	No
	10	Direct output 1 via traversing block	Yes	No
	11	Direct output 2 via traversing block	Yes	No
	12	Fixed stop reached	Yes	No
	13	Fixed stop clamping torque reached	Yes	No
	14	Travel to fixed stop active	Yes	No

Dependency: See also: r2684

Note

For bit 02, 04, 05, 06, 07:
This signals designate the state after jerk limiting.
For bits 08, 09:
These signals are generated in the "closed-loop position control" function module.

r2684.0...15

EPOS status word 2

Data type: Unsigned16 **Visible in:** Standard display
Read permission: Read drive data or acknowledge messages
Write permission: Edit device configuration or drive applications
Parameter group: Control/status words, Limit, Jog, Homing, Traversing blocks, Direct setpoint input (MDI), Mechanics, Position controller monitoring

Unit: -

Description: Display and signal source for status word 2 of the basic positioner (EPOS).

Bit	Signal name	1 signal	0 signal
00	Active homing active	Active	Not active
01	Passive homing active	Active	Not active
02	Homing active	Active	Not active
03	Printing mark outside outer window	Yes	No
04	Axis accelerating	Yes	No
05	Axis decelerating	Yes	No
06	Jerk limiting active	Yes	No
07	Activate correction	Yes	No
08	Following error in tolerance	Yes	No
09	Modulo correction active	Yes	No
10	Target position reached	Yes	No
11	Home position set	Yes	No
12	Acknowledgment traversing block activated	Yes	No
13	Positive hardware limit switch reached	Yes	No
14	Negative hardware limit switch reached	Yes	No
15	Traversing command active	Yes	No

Note

For bit 02:
The "homing active" signal is an OR logic operation of "active homing active" and "passive homing active"
For bit 00 ... 07 and 11 ... 14:
For bit 08:
The signal is generated in function "Closed-loop position control".

r2685

EPOS corrective value

Data type: FloatingPoint32 **Visible in:** Standard display
Read permission: Read drive data or acknowledge messages
Write permission: Edit device configuration or drive applications
Parameter group: Basic positioner

Unit: LU

Description: Display and signal source for the correction value of the position actual value.

Dependency: See also: r2684

Note

Using this value, for example, modulo corrections are carried out.

r2685	EPOS corrective value	
S200 Basic PN (EPOS load side, rotating), S200 PN (EPOS load side, rotating)	Data type: FloatingPoint32	Visible in: Standard display
	Read permission:	Read drive data or acknowledge messages
	Write permission:	Edit device configuration or drive applications
	Parameter group:	Basic positioner
	Unit: LU	
Description:	Display and signal source for the correction value of the position actual value.	
Dependency:	See also: r2684	
	Note	
	Using this value, for example, modulo corrections are carried out.	
r2686[0...1]	EPOS torque limiting effective	
	Data type: FloatingPoint32	Visible in: Standard display
	Read permission:	Read drive data or acknowledge messages
	Write permission:	Edit device configuration or drive applications
	Parameter group:	Basic positioner
	Unit: %	
Description:	Displays the effective torque limiting.	
	r2686[0]: Displays the active upper torque limiting when traversing to fixed stop.	
	r2686[1]: Displays the active lower torque limiting when traversing to fixed stop.	
Index:	[0] = Upper [1] = Lower	
Dependency:	See also: p1520, p1521, r2676	
r2687	EPOS torque setpoint	
	Data type: FloatingPoint32	Visible in: Standard display
	Read permission:	Read drive data or acknowledge messages
	Write permission:	Edit device configuration or drive applications
	Parameter group:	Traversing blocks
	Unit: Nm	
Description:	Displays the active torque setpoint when reaching the fixed stop.	
Dependency:	See also: p1520, p1521, r2676	
p2688	EPOS position feedback signal tolerance window	
	Data type: FloatingPoint32	Visible in: Extended display
	Read permission:	Read drive data or acknowledge messages
	Write permission:	Edit device configuration or drive applications
	Can be changed in the operating state:	Operation
	Parameter group:	Basic positioner
	Unit: LU	
	Min:	Max:
	-340.28235E36 [LU]	2147482647.0000 [LU]
		Factory setting:
		0.0400 [LU]
Description:	Sets the tolerance window for the position feedback signal. If, for a positioning operation, the actual value (r2521) lies within this tolerance window of the target position, then the traversing block number is displayed at connector output r2689.	

Dependency: This parameter is only active when the "Position feedback signal" function is activated (p2584.0 = 1).
See also: p2584, r2689

p2688**EPOS position feedback signal tolerance window**

S200 Basic PN (EPOS load side, rotating),
S200 PN (EPOS load side, rotating)

Data type: FloatingPoint32 **Visible in:** Extended display
Read permission: Read drive data or acknowledge messages
Write permission: Edit device configuration or drive applications
Can be changed in the operating state: Operation
Parameter group: Basic positioner
Unit: LU

Min: -340.28235E36 [LU] **Max:** 2147482647.0000 [LU] **Factory setting:** 1.5000 [LU]

Description: Sets the tolerance window for the position feedback signal.
If, for a positioning operation, the actual value (r2521) lies within this tolerance window of the target position, then the traversing block number is displayed at connector output r2689.

Dependency: This parameter is only active when the "Position feedback signal" function is activated (p2584.0 = 1).
See also: p2584, r2689

r2689[0...1]**EPOS position feedback signal display**

Data type: Unsigned32 **Visible in:** Extended display
Read permission: Read drive data or acknowledge messages
Write permission: Edit device configuration or drive applications
Parameter group: Basic positioner
Unit: -

Description: Display and signal source for the traversing block number for position feedback signal.
Here, the block number of the traversing blocks is displayed bit-coded, whose absolute target positions lie within the tolerance window around the actual position.

Index: [0] = Position feedback signal low
[1] = Position feedback signal high

Dependency: This parameter is only active when the "Position feedback signal" function is activated (p2584.0 = 1).
See also: p2584, p2688

Note

r2689[0]:
Bit-coded display of traversing block numbers 0 to 31
r2689[1]:
Bit-coded display of traversing block numbers 32 to 63

r2741**LR acceleration precontrol value**

Data type: FloatingPoint32 **Visible in:** Standard display
Read permission: Read drive data or acknowledge messages
Write permission: Edit device configuration or drive applications
Parameter group: Position controller
Unit: rev/s²

Description: Display and numerical signal source for the acceleration precontrol value.

Note

The acceleration precontrol value is a derivation of the speed precontrol value with respect to time.

p3117 Change safety message type

S200 PN

Data type: Unsigned32**Visible in:** Extended display**Read permission:**

Read drive data or acknowledge messages

Write permission:

Edit device configuration or drive applications

Can be changed in the operating state: Commissioning (Safety Integrated)**Parameter group:**

Safety Integrated, Faults / alarms

Unit: -**Min:****Max:****Factory setting:**

0

1

0

Description:

Sets the re-parameterization of all safety messages for faults and alarms. The relevant message type during changeover is selected by the firmware.

0: Safety messages are not reparameterized (safety message buffer)
1: Safety messages are reparameterized (no safety message buffer)

Note

When online safety commissioning has been completed, a change results in an automatic restart.

r3122[0...63].0...20 Diagnostic attribute fault**Data type:** Unsigned32**Visible in:** Extended display**Read permission:**

Read drive data or acknowledge messages

Write permission:

Edit device configuration or drive applications

Parameter group:

Faults / alarms

Unit: -**Description:**

Displays the diagnostic attribute of the fault which has occurred.

Bit array:

Bit	Signal name	1 signal	0 signal
00	Hardware replacement recommended	Yes	No
15	Message has gone	Yes	No
16	PROFIdrive fault class bit 0	High	Low
17	PROFIdrive fault class bit 1	High	Low
18	PROFIdrive fault class bit 2	High	Low
19	PROFIdrive fault class bit 3	High	Low
20	PROFIdrive fault class bit 4	High	Low

Dependency:

See also: r0945, r0947, r0948, r0949, r2109, r2130, r2133, r2136

Note

The buffer parameters are cyclically updated in the background (refer to status signal in r2139).
The structure of the fault buffer and the assignment of the indices is shown in r0945.

For bits 20 ... 16:

- Bits 20, 19, 18, 17, 16 = 0, 0, 0, 0, 0 --> PROFIdrive message class 0: not assigned
- Bits 20, 19, 18, 17, 16 = 0, 0, 0, 0, 1 --> PROFIdrive message class 1: hardware fault/software error
- Bits 20, 19, 18, 17, 16 = 0, 0, 0, 1, 0 --> PROFIdrive message class 2: line fault
- Bits 20, 19, 18, 17, 16 = 0, 0, 0, 1, 1 --> PROFIdrive message class 3: supply voltage fault
- Bits 20, 19, 18, 17, 16 = 0, 0, 1, 0, 0 --> PROFIdrive message class 4: DC link fault
- Bits 20, 19, 18, 17, 16 = 0, 0, 1, 0, 1 --> PROFIdrive message class 5: power electronics faulted
- Bits 20, 19, 18, 17, 16 = 0, 0, 1, 1, 0 --> PROFIdrive message class 6: overtemperature electronic components
- Bits 20, 19, 18, 17, 16 = 0, 0, 1, 1, 1 --> PROFIdrive message class 7: ground fault/phase fault detected
- Bits 20, 19, 18, 17, 16 = 0, 1, 0, 0, 0 --> PROFIdrive message class 8: motor overload
- Bits 20, 19, 18, 17, 16 = 0, 1, 0, 0, 1 --> PROFIdrive message class 9: communication error to the higher-level control
- Bits 20, 19, 18, 17, 16 = 0, 1, 0, 1, 0 --> PROFIdrive message class 10: safe monitoring channel has identified an error
- Bits 20, 19, 18, 17, 16 = 0, 1, 0, 1, 1 --> PROFIdrive message class 11: incorrect position actual value/speed actual value or not available
- Bits 20, 19, 18, 17, 16 = 0, 1, 1, 0, 0 --> PROFIdrive message class 12: internal (DRIVE-CLiQ) communication error
- Bits 20, 19, 18, 17, 16 = 0, 1, 1, 0, 1 --> PROFIdrive message class 13: infeed unit faulted
- Bits 20, 19, 18, 17, 16 = 0, 1, 1, 1, 0 --> PROFIdrive message class 14: braking controller/Braking Module faulted
- Bits 20, 19, 18, 17, 16 = 0, 1, 1, 1, 1 --> PROFIdrive message class 15: line filter faulted
- Bits 20, 19, 18, 17, 16 = 1, 0, 0, 0, 0 --> PROFIdrive message class 16: external measured value/signal state outside the permissible range
- Bits 20, 19, 18, 17, 16 = 1, 0, 0, 0, 1 --> PROFIdrive message class 17: application/technology function faulted
- Bits 20, 19, 18, 17, 16 = 1, 0, 0, 1, 0 --> PROFIdrive message class 18: error in the parameterization/configuration/ commissioning sequence
- Bits 20, 19, 18, 17, 16 = 1, 0, 0, 1, 1 --> PROFIdrive message class 19: general drive fault
- Bits 20, 19, 18, 17, 16 = 0, 1, 1, 0, 0 --> PROFIdrive message class 20: auxiliary unit faulted

r3123[0...63].0...20 Diagnostic attribute alarm

Data type: Unsigned32 **Visible in:** Extended display
Read permission: Read drive data or acknowledge messages
Write permission: Edit device configuration or drive applications
Parameter group: Faults / alarms
Unit: -

Description: Displays the diagnostic attribute of the alarm which has occurred.

Bit array:	Bit	Signal name	1 signal	0 signal
	00	Hardware replacement recommended	Yes	No
	11	Alarm class bit 0	High	Low
	12	Alarm class bit 1	High	Low
	13	Maintenance required	Yes	No
	14	Maintenance urgently required	Yes	No
	15	Message has gone	Yes	No
	16	PROFIdrive fault class bit 0	High	Low
	17	PROFIdrive fault class bit 1	High	Low
	18	PROFIdrive fault class bit 2	High	Low
	19	PROFIdrive fault class bit 3	High	Low
	20	PROFIdrive fault class bit 4	High	Low

Dependency: See also: r2122, r2123, r2124, r2125, r2134, r2145, r2146

Note

The buffer parameters are cyclically updated in the background (refer to status signal in r2139).

The structure of the alarm buffer and the assignment of the indices is shown in r2122.

For bit 12, 11:

These status bits are used for the classification of internal alarm classes and are intended for diagnostic purposes only on certain automation systems with integrated SINAMICS functionality.

For bits 20 ... 16:

Bits 20, 19, 18, 17, 16 = 0, 0, 0, 0, 0 --> PROFIdrive message class 0: not assigned

Bits 20, 19, 18, 17, 16 = 0, 0, 0, 0, 1 --> PROFIdrive message class 1: hardware fault/software error

Bits 20, 19, 18, 17, 16 = 0, 0, 0, 1, 0 --> PROFIdrive message class 2: line fault

Bits 20, 19, 18, 17, 16 = 0, 0, 0, 1, 1 --> PROFIdrive message class 3: supply voltage fault

Bits 20, 19, 18, 17, 16 = 0, 0, 1, 0, 0 --> PROFIdrive message class 4: DC link fault

Bits 20, 19, 18, 17, 16 = 0, 0, 1, 0, 1 --> PROFIdrive message class 5: power electronics faulted

Bits 20, 19, 18, 17, 16 = 0, 0, 1, 1, 0 --> PROFIdrive message class 6: overtemperature electronic components

Bits 20, 19, 18, 17, 16 = 0, 0, 1, 1, 1 --> PROFIdrive message class 7: ground fault/phase fault detected

Bits 20, 19, 18, 17, 16 = 0, 1, 0, 0, 0 --> PROFIdrive message class 8: motor overload

Bits 20, 19, 18, 17, 16 = 0, 1, 0, 0, 1 --> PROFIdrive message class 9: communication error to the higher-level control

Bits 20, 19, 18, 17, 16 = 0, 1, 0, 1, 0 --> PROFIdrive message class 10: safe monitoring channel has identified an error

Bits 20, 19, 18, 17, 16 = 0, 1, 0, 1, 1 --> PROFIdrive message class 11: incorrect position actual value/speed actual value or not available

Bits 20, 19, 18, 17, 16 = 0, 1, 1, 0, 0 --> PROFIdrive message class 12: internal (DRIVE-CLiQ) communication error

Bits 20, 19, 18, 17, 16 = 0, 1, 1, 0, 1 --> PROFIdrive message class 13: infeed unit faulted

Bits 20, 19, 18, 17, 16 = 0, 1, 1, 1, 0 --> PROFIdrive message class 14: braking controller/Braking Module faulted

Bits 20, 19, 18, 17, 16 = 0, 1, 1, 1, 1 --> PROFIdrive message class 15: line filter faulted

Bits 20, 19, 18, 17, 16 = 1, 0, 0, 0, 0 --> PROFIdrive message class 16: external measured value/signal state outside the permissible range

Bits 20, 19, 18, 17, 16 = 1, 0, 0, 0, 1 --> PROFIdrive message class 17: application/technology function faulted

Bits 20, 19, 18, 17, 16 = 1, 0, 0, 1, 0 --> PROFIdrive message class 18: error in the parameterization/configuration/commissioning sequence

Bits 20, 19, 18, 17, 16 = 1, 0, 0, 1, 1 --> PROFIdrive message class 19: general drive fault

Bits 20, 19, 18, 17, 16 = 0, 1, 1, 0, 0 --> PROFIdrive message class 20: auxiliary unit faulted

p3234**Delay line voltage failure detection**

Data type: Unsigned16

Visible in: Extended display

Read permission:

Read drive data or acknowledge messages

Write permission:

Edit device configuration or drive applications

Can be changed in the operating state: Operation

Parameter group:

Load torque monitoring

Unit: ms

Min:

0 [ms]

Max:

100 [ms]

Factory setting:

10 [ms]

Description:

Sets the time delay for detecting the line voltage failure.
The function must be activated via p2149.16.

Dependency:

See also: p2149
See also: F30265

r3988**Final boot state**

Data type: Integer16

Visible in: Extended display

Read permission:

Read drive data or acknowledge messages

Write permission:

Edit device configuration or drive applications

Parameter group:

System identification

Unit: -

Description: Displays the final boot states.
 001 - Software error
 200 - Carry out first commissioning
 250 - Topology error (check the connected hardware)
 800 - Ready
 The following options are available to reach the "Ready" state:
 - Check the project and load again.
 - Restore factory setting.
 - Check the hardware.
 - Carry out a POWER ON (switch-off/switch-on).

p4405 **PTO maximum output frequency**
 S200 PN **Data type:** FloatingPoint32 **Visible in:** Standard display
Read permission: Read drive data or acknowledge messages
Write permission: Edit device configuration or drive applications
Can be changed in the operating state: Commissioning
Parameter group: Pulse encoder emulation
Unit: kHz
Min: **Max:** **Factory setting:**
 1 [kHz] 4000 [kHz] 1000 [kHz]

Description: Sets the maximum output frequency for encoder emulation.

p4408 **PTO pulse number**
 S200 PN **Data type:** Unsigned32 **Visible in:** Standard display
Read permission: Read drive data or acknowledge messages
Write permission: Edit device configuration or drive applications
Can be changed in the operating state: Commissioning
Parameter group: Pulse encoder emulation
Unit: -
Min: **Max:** **Factory setting:**
 0 16777216 1024

Description: Sets the pulse number output from the PTO.

p4409 **Gearbox encoder (motor)/PTO denominator (Control Unit)**
 S200 PN **Data type:** Unsigned32 **Visible in:** Standard display
Read permission: Read drive data or acknowledge messages
Write permission: Edit device configuration or drive applications
Can be changed in the operating state: Commissioning
Parameter group:
Unit: -
Min: **Max:** **Factory setting:**
 1 2147000000 1

Description: Sets the denominator for the gearbox between the encoder and PTO.

Note
 This parameter is only of significance for p4408 = 0.
 A change only becomes effective after a POWER ON.

p4410	Gearbox encoder (motor)/PTO numerator (Control Unit)		
S200 PN	Data type: Unsigned32	Visible in: Standard display	
	Read permission:	Read drive data or acknowledge messages	
	Write permission:	Edit device configuration or drive applications	
	Can be changed in the operating state:	Commissioning	
	Parameter group:		
	Unit: -		
	Min:	Max:	Factory setting:
	1	2147000000	1
Description:	Sets the numerator for the gearbox between the encoder and PTO.		
	Note		
	This parameter is only of significance for p4408 = 0. A change only becomes effective after a POWER ON.		
r4419	PTO diagnostics position setpoint		
S200 PN	Data type: Integer32	Visible in: Standard display	
	Read permission:	Read drive data or acknowledge messages	
	Write permission:	Edit device configuration or drive applications	
	Parameter group:	Pulse encoder emulation	
	Unit: -		
Description:	Displays the position setpoint after taking into account the step up / step down.		
c4420	PTO position setpoint		
S200 PN	Data type: Unsigned32	Visible in: Standard display	
	Read permission:	Read drive data or acknowledge messages	
	Write permission:	Edit device configuration or drive applications	
	Parameter group:	Pulse encoder emulation	
	Unit: -		
Description:	Signal for the incremental encoder emulation position setpoint.		
Recommendation:	The position actual value of the leading encoder in the current controller clock cycle is available in r0479.		
p4422.0	PTO configuration		
S200 PN	Data type: Unsigned16	Visible in: Standard display	
	Read permission:	Read drive data or acknowledge messages	
	Write permission:	Edit device configuration or drive applications	
	Can be changed in the operating state:	Commissioning	
	Parameter group:	Pulse encoder emulation	
	Unit: -		
	Min:	Max:	Factory setting:
	-	-	0000 bin
Description:	Settings for Pulse Train Output (PTO).		
Bit array:	Bit	Signal name	1 signal 0 signal
	00	PTO position actual value	Inverted Not inverted
Dependency:	See also: c4420		

p4426	PTO zero mark offset		
S200 PN	Data type: Unsigned32	Visible in: Standard display	
	Read permission:	Read drive data or acknowledge messages	
	Write permission:	Edit device configuration or drive applications	
	Can be changed in the operating state:	Commissioning	
	Parameter group:	Pulse encoder emulation	
	Unit: -		
	Min:	Max:	Factory setting:
	0	16777215	0
Description:	Sets a zero mark offset to shift the zero mark within one mechanical revolution. Example: p0408 = 2048 (encoder pulses) p4426 = 512 (zero mark offset in pulses) --> Positive direction: The zero mark is output offset by 512 pulses. --> Negative direction: The zero mark is output offset by 1536 pulses.		
Dependency:	See also: p0408		
	Note The setting for the zero mark offset (p4426) must be less than the encoder pulse number (p4408).		

r4479	PTO diagnostics position actual value		
	Data type: Integer32	Visible in: Standard display	
	Read permission:	Read drive data or acknowledge messages	
	Write permission:	Edit device configuration or drive applications	
	Parameter group:	Pulse encoder emulation	
	Unit: -		
Description:	Display and numerical signal source for the PTO position actual value.		

r4705[0...1]	Trace status		
S200 Basic PN	Data type: Integer16	Visible in: Extended display	
	Read permission:	Read drive data or acknowledge messages	
	Write permission:	Edit device configuration or drive applications	
	Parameter group:	Trace	
	Unit: -		
Description:	Displays the actual status of the trace.		
Value:	0:	Trace inactive	
	1:	Trace is recording presamples	
	2:	Trace is waiting for trigger event	
	3:	Trace is recording	
	4:	Recording (trace) ended	
	5:	Trace inactive with permissible configuration data	
	6:	Trace inactive with inadmissible configuration data	
Index:	[0] =	Trace 0	
	[1] =	Trace 1	

p5271[0].0...7	Online / One Button Tuning configuration		
	Data type: Unsigned16	Visible in: Extended display	
	Read permission:	Read drive data or acknowledge messages	
	Write permission:	Edit device configuration or drive applications	
	Can be changed in the operating state:	Ready for operation	
	Parameter group:		
	Unit: -		
	Min:	Max:	Factory setting:
	-	-	0000 1100 bin
Description:	Sets the configuration for online tuning / One Button Tuning.		
Bit array:	Bit	Signal name	1 signal 0 signal
	00	PD controller for large load moments of inertia	Yes No
	01	Reduce gain at low speeds	Yes No
	02	Load adaptation Kp	Yes No
	03	Setting the speed precontrol	Yes No
	04	Setting the torque precontrol	Yes No
	05	Setting the maximum acceleration for the basic positioner	Yes No
	06	Do not change Kp	Yes No
	07	Setting the voltage precontrol	Yes No
Dependency:	See also: p5272, r5274, p5275		

Note

For bit 00:

For significant differences between the motor moment of inertia and load moment of inertia - or for a low controller dynamic response - the P controller in the position control loop is transformed into a PD controller. As a consequence, the dynamic performance of the position controller is increased.

This function should only be set when the speed precontrol (bit 3 = 1) or the torque precontrol (bit 4 = 1) is active.

For bit 01:

At low speeds, the controller gain factors are automatically reduced in order to avoid noise and oscillation at standstill.

For bit 02:

The estimated load moment of inertia is taken into account for the speed controller gain.

For bit 03:

Activates the speed precontrol for the basic positioner (EPOS).

For bit 04:

Activation of the torque precontrol for the basic positioner (EPOS); if this is not active, then the internal drive speed/ torque precontrol is parameterized.

For bit 05:

The maximum acceleration (p2572) and maximum deceleration (p2573) for the basic positioner (EPOS) are determined using the estimated moment of inertia. This is only realized once by setting the bit.

Prerequisite:

The drive pulses are inhibited and the moment of inertia was previously determined.

For bit 06:

The speed controller gain set in p1460 is not changed when calculating the controller data.

For bit 07:

Activation of the voltage precontrol.

p5272[0]	<p>Online tuning dynamic factor</p> <p>Data type: FloatingPoint32 Visible in: Extended display</p> <p>Read permission: Read drive data or acknowledge messages</p> <p>Write permission: Edit device configuration or drive applications</p> <p>Can be changed in the operating state: Operation</p> <p>Parameter group:</p> <p>Unit: %</p> <table border="0"> <tr> <td>Min:</td> <td>Max:</td> <td>Factory setting:</td> </tr> <tr> <td>5.0 [%]</td> <td>1000.0 [%]</td> <td>100.0 [%]</td> </tr> </table>	Min:	Max:	Factory setting:	5.0 [%]	1000.0 [%]	100.0 [%]
Min:	Max:	Factory setting:					
5.0 [%]	1000.0 [%]	100.0 [%]					
Description:	Sets the dynamic factor for the proportional gain of the speed controller for online tuning.						
Dependency:	See also: p5271, r5274, p5275						
	<p>NOTICE</p> <p>The speed control can become unstable for excessively high values.</p>						
	<p>Note</p> <p>The stiffer the mechanical load coupling, the higher the dynamic factor can be set.</p>						

r5274	<p>Online / One Button Tuning dynamic response estimated</p> <p>Data type: FloatingPoint32 Visible in: Standard display</p> <p>Read permission: Read drive data or acknowledge messages</p> <p>Write permission: Edit device configuration or drive applications</p> <p>Parameter group:</p> <p>Unit: ms</p>
Description:	Display and signal source for the estimated dynamic response of the speed control loop as PT1 time constant for online tuning/One Button Tuning. This position controller setting is required if the closed-loop position control is in an external control system.
Dependency:	See also: p5271, p5272, p5275

p5275[0]	<p>Online / One Button Tuning dynamic response time constant</p> <p>Data type: FloatingPoint32 Visible in: Extended display</p> <p>Read permission: Read drive data or acknowledge messages</p> <p>Write permission: Edit device configuration or drive applications</p> <p>Can be changed in the operating state: Operation</p> <p>Parameter group:</p> <p>Unit: ms</p> <table border="0"> <tr> <td>Min:</td> <td>Max:</td> <td>Factory setting:</td> </tr> <tr> <td>0.0 [ms]</td> <td>60.0 [ms]</td> <td>7.5 [ms]</td> </tr> </table>	Min:	Max:	Factory setting:	0.0 [ms]	60.0 [ms]	7.5 [ms]
Min:	Max:	Factory setting:					
0.0 [ms]	60.0 [ms]	7.5 [ms]					
Description:	Sets the time constant for the precontrol symmetrization for online tuning / One Button Tuning. As a consequence, the drive is allocated a defined, dynamic response via its precontrol. For axes, which must interpolate with one another, the same value must be entered. Examples: 0 ms = travel without following error (Kv factor is infinity) 5 ms = settling behavior as for PT1 with 5 ms (Kv factor = 12 [1000/min])						
Dependency:	See also: p5271, p5272, r5274						
	<p>Note</p> <p>This time constant is only effective if p5302.7 is set = 1. Otherwise, the precontrol symmetrization is adapted to the estimated dynamic response, therefore setting positioning without any overshoot.</p>						

r5276[0] Online / One Button Tuning maximum Kv factor estimated

Data type: FloatingPoint32 **Visible in:** Standard display
Read permission: Read drive data or acknowledge messages
Write permission: Edit device configuration or drive applications

Parameter group:**Unit:** 1000 rpm**Description:** Displays the estimated maximum position controller gain for online tuning/One Button Tuning.**Dependency:** See also: p5271, p5272, p5275**WARNING**

The calculation assumes that the DSC is activated in the drive and is controlled on the motor measuring system.

If this is not the case, then excessively high values are displayed.

The value that is displayed does not take into account low-frequency resonance effects in the drive train. If necessary, the value must be significantly reduced.

Note

The value for the closed-loop position control is required by a higher-level control system.

r5277[0] Online/One Button Tuning precontrol symmetrizing time estimated

Data type: FloatingPoint32 **Visible in:** Standard display
Read permission: Read drive data or acknowledge messages
Write permission: Edit device configuration or drive applications

Parameter group:**Unit:** ms**Description:** Displays the estimated time constant for symmetrization of the speed precontrol.

This is required to symmetrize the position controller for online tuning / One Button Tuning if the position control is realized in an external control system.

Dependency: See also: p5271, p5272, p5275**WARNING**

The calculation assumes that the DSC is activated in the drive and is controlled on the motor measuring system.

If this is not the case, then the time is not correctly calculated.

p5291.0...16 FFT tuning configuration

Data type: Unsigned32 **Visible in:** Standard display
Read permission: Read drive data or acknowledge messages
Write permission: Edit device configuration or drive applications

Can be changed in the operating state: Operation**Parameter group:****Unit:** -**Min:**

-

Max:

-

Factory setting:0000 0000 0000 0000 0000 0000 0011
1001 bin**Description:** Sets the configuration for the "FFT tuning" function.
This function is used for One Button Tuning (p5300 = 1).

Bit	Signal name	1 signal	0 signal
00	Noise excitation after pulse enable	Yes	No
01	Set current setpoint filter (HF)	Yes	No
02	Set speed controller gain (HF)	Yes	No
03	Length of FFT window bit 0 (LF, HF)	Yes	No
04	Length of FFT window bit 1 (LF, HF)	Yes	No

05	Windowing the time signals using a Hamming window (LF, HF)	Yes	No
06	Measure current controller	Yes	No
07	Bandwidth bit 0 (LF)	Yes	No
08	Bandwidth bit 1 (LF)	Yes	No
09	Bandwidth bit 2 (LF)	Yes	No
10	Measuring periods bit 0	Yes	No
11	Measuring periods bit 1	Yes	No
12	Inject noise onto speed setpoint	Yes	No
13	Do not reduce Kp for measurement	Yes	No
14	Set the current setpoint filter with loop compensation	Yes	No
16	Torque in front of the current setpoint filter	Yes	No

Dependency: See also: r5293, p5296

Note

HF: high frequency

LF: low frequency

For bit 00:

A PRBS signal (pseudo random binary signal) is superimposed on the current setpoint to be able to better identify the mechanical controlled system.

For bit 01:

The identified mechanical resonance points are suppressed using current setpoint filters.

For bit 02:

The maximum speed controller gain is determined from the identified mechanical controlled system.

For bits 03, 04:

The measured value buffer length is set using these bits:

Bit 04 = 0 and bit 03 = 0 -> buffer length = 256

Bit 04 = 0 and bit 03 = 1 -> buffer length = 512

Bit 04 = 1 and bit 03 = 0 -> buffer length = 1024

Bit 04 = 1 and bit 03 = 1 -> buffer length = 2048

For bit 05:

A Hamming window is used to filter the measured time signals.

For bit 06:

The measurement checks the current controller frequency response and this is taken into account in the speed controller loop.

For bits 07, 08, 09:

The measurement bandwidth is set using these bits:

Bit 09 = 0, bit 08 = 0, bit 07 = 0 -> bandwidth = 50 Hz

Bit 09 = 0, bit 08 = 0, bit 07 = 1 -> bandwidth = 100 Hz

Bit 09 = 0, bit 08 = 1, bit 07 = 0 -> bandwidth = 200 Hz

Bit 09 = 0, bit 08 = 1, bit 07 = 1 -> bandwidth = 400 Hz

Bit 09 = 1, bit 08 = 0, bit 07 = 0 -> bandwidth = 800 Hz

Bit 09 = 1, bit 08 = 0, bit 07 = 1 -> bandwidth = 1600 Hz

For bits 10, 11:

Number of measuring periods.

Bit 11 = 0 and bit 10 = 0 -> number of measurements = 1

Bit 11 = 0 and bit 10 = 1 -> number of measurements = 2

Bit 11 = 1 and bit 10 = 0 -> number of measurements = 4

Bit 11 = 1 and bit 10 = 1 -> number of measurements = 8

For bit 12:

The PRBS signal is switched to the speed setpoint (in front of the filter).

For bit 13:

The input signal for the torque actual value is taken from in front of the current setpoints filters.

For bit 14:

When the bit is set, a current setpoint filter is used to partially compensate the mechanical system.

This is recommended for the following machine attributes:

- The load moment of inertia is significantly higher than the motor moment of inertia (e.g. > 6x).
- The coupling between the machine elements has almost no backlash (no play).
- The stiffness of the mechanical transmission elements does not change significantly in the traversing range.

p5292**FFT tuning dynamic factor**

Data type: FloatingPoint32

Visible in: Standard display

Read permission:

Read drive data or acknowledge messages

Write permission:

Edit device configuration or drive applications

Can be changed in the operating state: Operation

Parameter group:

Unit: %

	Min: 25.0 [%]	Max: 125.0 [%]	Factory setting: 80.0 [%]
Description:	Sets the dynamic factor for the proportional gain of the speed controller for FFT tuning. This function is used for One Button Tuning (p5300 = 1).		
Dependency:	See also: p5291		

r5293 **FFT tuning speed controller P gain identified**

	Data type: FloatingPoint32	Visible in: Standard display	
	Read permission:	Read drive data or acknowledge messages	
	Write permission:	Edit device configuration or drive applications	
	Parameter group:		
	Unit: Nms/rad		
Description:	Displays the determined proportional gain Kp of the speed controller before FFT tuning. This function is used for One Button Tuning (p5300 = 1).		
Dependency:	See also: p5291		

p5296[0...2] **Controller optimization noise amplitude**

	Data type: FloatingPoint32	Visible in: Standard display	
	Read permission:	Read drive data or acknowledge messages	
	Write permission:	Edit device configuration or drive applications	
	Can be changed in the operating state: Operation		
	Parameter group:		
	Unit: %		
	Min: 1.0 [%]	Max: 300.0 [%]	Factory setting: [0] 10.0 [%] [1] 30.0 [%] [2] 5.0 [%]
Description:	The drive determines the noise amplitude for One Button Tuning and writes the value to p5296.		
Dependency:	See also: p5291		

p5300[0] **Autotuning selection**

	Data type: Integer16	Visible in: Standard display	
	Read permission:	Read drive data or acknowledge messages	
	Write permission:	Edit device configuration or drive applications	
	Can be changed in the operating state: Ready for operation		
	Parameter group:		
	Unit: -		
	Min: -1	Max: 2	Factory setting: 0
Description:	Setting to activate/deactivate the One Button Tuning function. For p5300 = 1: Function One Button Tuning is configured using p5271 and p5301. If p5300 = 2: The "Online tuning" function is configured using p5302.		
Value:	-1: Reset controller parameters 0: Inactive 1: One Button Tuning 2: Online tuning		

Dependency: The motor must have already been commissioned so that One Button Tuning functions perfectly.
 The One Button Tuning function is configured using p5271 and p5301. The required dynamic performance of the control loop is set in p5292. The traversing path for the test signal is parameterized in p5308.
 Online tuning:
 p5302 configures the "Online tuning" function.
 p5272 if the required dynamic response of the control loops is set.
 Other relevant parameters: p5271, p5275, r5274
 See also: p5271, p5272, r5274, p5275, p5292, r5293, p5296, p5301, p5302, p5308, p5309

CAUTION
 For some drive trains, the "online tuning" function can result in unstable settings (motor makes a whistling sound). This is especially the case for high load moments of inertia, which are coupled to the motor through a low-frequency connection/coupling. In this case, the value in parameter p5272 must be reduced.

Note
 For p5300 = -1:
 Autotuning is deactivated, and p5300 is automatically set to 0. In addition, the default setting values for the speed and position controller are restored.
 For p5300 = 0:
 Online tuning is inactive.
 To permanently save the values determined for the speed and position controllers, the parameters must be saved in a non-volatile manner (p0977 = 1 or "copy RAM to ROM").
 For p5300 = 1:
 One Button Tuning is active.
 The moment of inertia is determined once using a test signal. The controller parameters and current setpoint filters are additionally determined once using a noise signal as excitation source. The steps to be executed can be configured using p5301.
 If p5300 = 2:
 Online tuning is active.
 The moment of inertia is estimated. The controller parameters are recalculated if the moment of inertia noticeably changes. The steps to be executed can be configured using p5302.

p5301[0].0...8

One Button Tuning configuration 2

Data type: Unsigned32 **Visible in:** Standard display
Read permission: Read drive data or acknowledge messages
Write permission: Edit device configuration or drive applications
Can be changed in the operating state: Operation
Parameter group:
Unit: -
Min: - **Max:** - **Factory setting:** 0000 0000 0000 0111 bin

Description: Setting the functions for One Button Tuning (p5300 = 1).
 A test signal is required for some functions. To do this, observe parameters p5308 and p5309.

Bit	Signal name	1 signal	0 signal
00	Setting the proportional gain Kp	Yes	No
01	Setting current setpoint filter	Yes	No
02	Estimate moment of inertia	Yes	No
08	Moment of inertia determination from frequency response	Yes	No

Dependency: It is only possible to change the configuration if One Button Tuning is not active (p5300 = 0).
 See also: p5292, r5293, p5296, p5300, p5308, p5309

Note

For bit 00:
The speed controller gain is determined and set using a noise signal.

For bit 01:
Possibly required current setpoint filters are determined and set using a noise signal.
As a consequence, a higher dynamic performance can be achieved in the speed control loop.

For bit 02:
Using this bit, the moment of inertia is determined using a test signal. If this bit is not set, then the load moment of inertia must be manually set using parameter p1498. The test signal must have been previously set using parameters p5308 and p5309.

For bit 08:
Using this bit, the moment of inertia is determined from the frequency characteristic using a test signal, and is transferred to p1498. The traversing path must first be set using parameter p5308.

p5302[0].2...8

Online tuning configuration

Data type: Unsigned32 **Visible in:** Extended display
Read permission: Read drive data or acknowledge messages
Write permission: Edit device configuration or drive applications
Can be changed in the operating state: Operation
Parameter group:
Unit: -
Min: **Max:** **Factory setting:**
- - 0000 0000 0000 1100 bin

Description: Setting the functions for online tuning (p5300 = 2).

Bit	Signal name	1 signal	0 signal
02	Estimate moment of inertia	Yes	No
03	Configuring the moment of inertia estimator	Cyclic	Once
06	Activating the current setpoint filter adaptation	Yes	No
07	Activating synchronized axes	Yes	No
08	Moment of inertia determination from frequency response	Yes	No

Dependency: It is only possible to change the configuration if autotuning is not active (p5300 = 0).
See also: p5271, p5272, r5274, p5275, p5300

 **CAUTION**

Please note the general conditions for the moment of inertia estimator, online tuning as well as adaptive resonance filter in the following reference:
SINAMICS S120 Function Manual Drive Functions

Note

For bit 02:

When the bit is set, the moment of inertia is determined while traversing (moment of inertia estimator). If this bit is not set, then the load moment of inertia must be manually set using parameter p1498.

For bit 03:

If p5302.3 = 0, "Once" applies:

After having successfully determined the moment of inertia (p1498), the moment of inertia estimator is deactivated.

If p5302.3 = 1, "Cyclic" applies:

The moment of inertia is continually determined and the control parameters adapted. After the moment of inertia has been successfully determined, it is recommended that the parameters are saved in a non-volatile fashion. As a consequence, the controllers do not have to restabilize after the next switch on.

For bit 06:

The adaptation of a current setpoint filter is activated.

This adaptation may be necessary if a mechanical resonance frequency changes in operation. It can also be used to dampen a fixed resonance frequency. Once the control loop has stabilized, this bit should be deactivated and the determined parameters saved in a non-volatile fashion.

For bit 07:

When the function is activated, these axes are adapted to the dynamic response set in p5275. This is necessary for interpolating axes. The time in p5275 should be set according to the axis with the lowest dynamic response.

r5306[0].0...14 Autotuning status

Data type: Unsigned16

Visible in: Standard display

Read permission:

Read drive data or acknowledge messages

Write permission:

Edit device configuration or drive applications

Parameter group:

Unit: -

Description:

Displays the status of the auto tuning functions performed - "Online tuning" and "One Button Tuning".

The functions can be activated via p5300.

Bit array:

Bit	Signal name	1 signal	0 signal
00	Proportional gain Kp set	Yes	No
01	Current setpoint filter set	Yes	No
02	Moment of inertia estimation carried out	Yes	No
04	Load vibration detection performed	Yes	No
05	Detected load oscillation set	Yes	No
06	Current setpoint filter adaptation active	Yes	No
07	EPOS set	Yes	No
12	Online tuning active	Yes	No
13	One Button Tuning successfully completed	Yes	No
14	Controller parameters reset due to fault	Yes	No

Dependency:

See also: p5300, p5301, p5302

Note

For bit 00 = 1: The speed controller gain was set using One Button Tuning.

For bit 01 = 1: The current setpoint filter was set using One Button Tuning

For bit 02 = 1: The moment of inertia was determined.

For bit 04 = 1: Load oscillation detection was performed using One Button Tuning

For bit 05 = 1: Detected load oscillation suppression was set using One Button Tuning.

For bit 06 = 1: Adaptive resonance filters of the online tuning are active.

For bit 12 = 1: Online tuning is active and modifies the controller.

p5308[0]	One Button Tuning distance limiting		
	Data type: Integer32	Visible in: Standard display	
	Read permission:	Read drive data or acknowledge messages	
	Write permission:	Edit device configuration or drive applications	
	Can be changed in the operating state:	Ready for operation	
	Parameter group:		
	Unit: °		
	Min: -30000 [°]	Max: 30000 [°]	Factory setting: 0 [°]
Description:	Setting the distance limiting (permissible traversing range of the motor). The traversing range is limited in the positive and negative directions.		
	Note A value of 360 degrees corresponds to one motor revolution. The position before the pulse enable is used as zero point.		

p5309[0]	One Button Tuning test signal duration		
	Data type: Unsigned32	Visible in: Standard display	
	Read permission:	Read drive data or acknowledge messages	
	Write permission:	Edit device configuration or drive applications	
	Can be changed in the operating state:	Ready for operation	
	Parameter group:		
	Unit: ms		
	Min: 0 [ms]	Max: 5000 [ms]	Factory setting: 2000 [ms]
Description:	Sets the test signal sequence duration (several acceleration operations). This function is used for One Button Tuning (p5300 = 1) to identify the total moment of inertia of the drive train.		
Dependency:	See also: F07093		

p5375[0].0...1	Additional motor overload protection configuration		
	Data type: Unsigned16	Visible in: Extended display	
	Read permission:	Read drive data or acknowledge messages	
	Write permission:	Edit device configuration or drive applications	
	Can be changed in the operating state:	Operation	
	Parameter group: Motor temperature		
	Unit: -		
	Min: -	Max: -	Factory setting: 0000 bin
Description:	Sets the configuration for additional motor overload protection.		
Bit array:	Bit	Signal name	1 signal 0 signal
	00	Activation of monitoring	Yes No
	01	Activation of speed dependency	Yes No

Note

To comply with standard UL 61800-5-1 Ed. 2, bit 0 and bit 1 must be set.

These bits activate electronic motor overload protection according to IEC 61800-5-1 Ed. 3 / UL 61800-5-1 Ed. 2, with the emulation of an electronic overload relay, Class 20 and the speed sensitivity.

For bit 00:

This bit activates electronic motor overload protection with emulation of an electronic overload relay, Class 20.

For bit 01:

This bit activates the speed dependency of the electronic motor overload protection. Not active, if bit 00 is also set.

r8400[0...2]**Date**

Data type: Unsigned16

Visible in: Standard display

Read permission:

Read drive data or acknowledge messages

Write permission:

Edit device configuration or drive applications

Parameter group:

Diagnostics general

Unit: -

Description:

Displays the actual date in year, month and day.

Index:

[0] = Year (YYYY)

[1] = Month (1 ... 12)

[2] = Day (1 ... 31)

Note

The time in r8400 and r8401 is used to display the fault and alarm times.

Possible date/time setting:

- Web server (manually)

- NTP (Network Time Protocol)

When the converter is switched off, date/time are not updated. After power on the instant of the previous power off is valid.

r8401[0...2]**Time**

Data type: Unsigned16

Visible in: Standard display

Read permission:

Read drive data or acknowledge messages

Write permission:

Edit device configuration or drive applications

Parameter group:

Diagnostics general

Unit: -

Description:

Displays the current time in hours, minutes and seconds.

Index:

[0] = Hour (0 ... 23)

[1] = Minute (0 ... 59)

[2] = Second (0 ... 59)

Note

The time in r8400 and r8401 is used to display the fault and alarm times.

The time is displayed in the 24-hour format.

Possible date/time setting:

- Web server (manually)

- NTP (Network Time Protocol)

When the converter is switched off, date/time are not updated. After power on the instant of the previous power off is valid.

r8600[0...20]	<p>PROFIdrive PZD receive Float32</p> <p>Data type: FloatingPoint32 Visible in: Standard display</p> <p>Read permission: Read drive data or acknowledge messages</p> <p>Write permission: Edit device configuration or drive applications</p> <p>Parameter group: Configuration</p> <p>Unit: -</p>
Description:	Displays the PZD (setpoints) in the Float32 format received from the fieldbus controller.
Index:	<p>[0] = PZD 1 + 2</p> <p>[1] = PZD 2 + 3</p> <p>[2] = PZD 3 + 4</p> <p>[3] = PZD 4 + 5</p> <p>[4] = PZD 5 + 6</p> <p>[5] = PZD 6 + 7</p> <p>[6] = PZD 7 + 8</p> <p>[7] = PZD 8 + 9</p> <p>[8] = PZD 9 + 10</p> <p>[9] = PZD 10 + 11</p> <p>[10] = PZD 11 + 12</p> <p>[11] = PZD 12 + 13</p> <p>[12] = PZD 13 + 14</p> <p>[13] = PZD 14 + 15</p> <p>[14] = PZD 15 + 16</p> <p>[15] = PZD 16 + 17</p> <p>[16] = PZD 17 + 18</p> <p>[17] = PZD 18 + 19</p> <p>[18] = PZD 19 + 20</p> <p>[19] = PZD 20 + 21</p> <p>[20] = PZD 21 + 22</p>

c8601[0...26]	<p>PROFIdrive PZD send Float32</p> <p>Data type: FloatingPoint32 Visible in: Standard display</p> <p>Read permission: Read drive data or acknowledge messages</p> <p>Write permission: Edit device configuration or drive applications</p> <p>Parameter group: Configuration</p> <p>Unit: -</p>
Description:	Displays the PZD (actual values) in the Float32 format that are sent to the fieldbus controller.

Index:	[0] = PZD 1 + 2
	[1] = PZD 2 + 3
	[2] = PZD 3 + 4
	[3] = PZD 4 + 5
	[4] = PZD 5 + 6
	[5] = PZD 6 + 7
	[6] = PZD 7 + 8
	[7] = PZD 8 + 9
	[8] = PZD 9 + 10
	[9] = PZD 10 + 11
	[10] = PZD 11 + 12
	[11] = PZD 12 + 13
	[12] = PZD 13 + 14
	[13] = PZD 14 + 15
	[14] = PZD 15 + 16
	[15] = PZD 16 + 17
	[16] = PZD 17 + 18
	[17] = PZD 18 + 19
	[18] = PZD 19 + 20
	[19] = PZD 20 + 21
	[20] = PZD 21 + 22
	[21] = PZD 22 + 23
	[22] = PZD 23 + 24
	[23] = PZD 24 + 25
	[24] = PZD 25 + 26
	[25] = PZD 26 + 27
	[26] = PZD 27 + 28

r8936[0...1]	PN cyclic connection state
	Data type: Integer16
	Visible in: Extended display
	Read permission: Read drive data or acknowledge messages
	Write permission: Edit device configuration or drive applications
	Parameter group:
	Unit: -
Description:	Displays the status of the cyclic PROFINET connection.
Value:	0: Canceled
	1: Not connected
	2: Connection starts to be established
	3: Module information expected
	4: Module information received
	5: Module address expected
	6: Module address received
	7: Parameterization data expected
	8: Parameterization data received
	9: Evaluate parameterization data
	10: Connection being established completion expected
	12: Configured controller STOP
	13: Configured controller RUN
Index:	[0] = Controller 1
	[1] = Reserved

Dependency: See also: r8961

Note

For value = 10:

If the connection remains in this state, then when using PROFINET IRT the following can apply:

- topology error (incorrect port assignment).

- Synchronization missing.

r8937[0...5] PN cyclic connection diagnostics

Data type: Unsigned32

Visible in: Extended display

Read permission:

Read drive data or acknowledge messages

Write permission:

Edit device configuration or drive applications

Parameter group:

Unit: -

Description: Display to diagnose the cyclic PROFINET connection.

Index:

[0] = Number of cyclic connections

[1] = Number of send subslots of all connections

[2] = Number of send net data (bytes) of all connections

[3] = Number of receive subslots of all connections

[4] = Number of receive net data (bytes) of all connections

[5] = Connection type (RT, IRT)

Note

The parameter is active when the "PROFINET Device" protocol is selected.

For index [5]:

Bit 0 = 1: there is at least one RT connection.

Bit 1 = 1: there is an IRT connection.

r8961[0...3] PN controller IP address

Data type: Unsigned8

Visible in: Extended display

Read permission:

Read drive data or acknowledge messages

Write permission:

Edit device configuration or drive applications

Parameter group:

Configuration

Unit: -

Description: Displays the IP address of the PROFINET controller.

c8995[0...3] Ethernet X127 enable

Data type: Unsigned8

Visible in: Extended display

Read permission:

Read drive data or acknowledge messages

Write permission:

Edit device configuration or drive applications

Parameter group:

Configuration

Unit: -

Description: Signal to enable the Ethernet interface X127 for applications.

Index:

[0] = Secure S7 Protocol Startdrive

[1] = Web server HTTPS

[2] = S7 protocol PCS7

[3] = Web server HTTP

Note

The parameter influences the access from applications.

1 signal:

Ethernet interface X127 is enabled for access.

0 signal:

Ethernet interface X127 is blocked and cannot be accessed.

The signal is not influenced by setting the factory setting.

c8997[0...2]**PROFINET X150 enable**

Data type: Unsigned8

Visible in: Extended display

Read permission:

Read drive data or acknowledge messages

Write permission:

Edit device configuration or drive applications

Parameter group:

Configuration

Unit: -

Description:

Signal to enable PROFINET interface X150 for applications.

Index:

[0] = Secure S7 Protocol Startdrive

[1] = Web server HTTPS

[2] = S7 protocol PCS7

Note

The parameter influences the access from applications.

1 signal:

PROFINET interface X150 is enabled for access.

0 signal:

PROFINET interface X150 is inhibited for access.

The signal is not influenced by setting the factory setting.

p9603.0**SI control**

S200 PN

Data type: Unsigned32

Visible in: Standard display

Read permission:

Read drive data or acknowledge messages

Write permission:

Edit Safety Integrated application

Can be changed in the operating state: Commissioning (Safety Integrated)

Parameter group:

Safety Integrated

Unit: -

Min:

-

Max:

-

Factory setting:

0001 bin

Description:

Sets the type of control for the safety functions integrated in the drive.

Bit array:

Bit **Signal name**

00 Control via F-DI

1 signal

Enable

0 signal

Inhibit

Note

When online safety commissioning has been completed, a change results in an automatic restart.

p9604.0**SI enable**

S200 PN

Data type: Unsigned32

Visible in: Standard display

Read permission:

Read drive data or acknowledge messages

Write permission:

Edit Safety Integrated application

Can be changed in the operating state: Commissioning (Safety Integrated)

Parameter group:

Safety Integrated

Unit: -

	Min:	Max:	Factory setting:	
	-	-	0001 bin	
Description:	Sets the enable signal for the safety functions integrated in the drive.			
Bit array:	Bit	Signal name	1 signal	0 signal
	00	Enable STO	Enable	Inhibit

p9699 SI configuration alarm filtering

S200 PN	Data type: Integer16	Visible in: Extended display
	Read permission:	Read drive data or acknowledge messages
	Write permission:	Edit device configuration or drive applications
	Can be changed in the operating state:	Ready for operation
	Parameter group:	Basic functions
	Unit: -	

Min:	Max:	Factory setting:
0	1	1

Description: Sets the enable for the "Alarm filtering" function.

Value:	0:	Deactivate alarm filtering
	1:	Activate alarm filtering

Note

Parameter is active after a POWER ON

r9720.0...7 SI control word

S200 PN	Data type: Unsigned32	Visible in: Standard display
	Read permission:	Read drive data or acknowledge messages
	Write permission:	Edit device configuration or drive applications
	Parameter group:	Extended functions
	Unit: -	

Description: Control signals for safety functions integrated in the drive.

Bit array:	Bit	Signal name	1 signal	0 signal
	00	Deselect STO	Yes	No
	07	Acknowledgment	Signal edge active	No

r9722.0...7 SI status signals

S200 PN	Data type: Unsigned32	Visible in: Standard display
	Read permission:	Read drive data or acknowledge messages
	Write permission:	Edit device configuration or drive applications
	Parameter group:	Extended functions
	Unit: -	

Description: Display and signal source for the status signals for the safety functions (synchronized signal).

Bit array:	Bit	Signal name	1 signal	0 signal
	00	STO or safe pulse cancellation active	Yes	No
	07	Internal event	No	Yes

NOTICE

For bit 07:
An internal event is displayed if STO is active.

r9725[0...2]	SI diagnostics data cross-check		
S200 PN	Data type: Unsigned32	Visible in: Extended display	
	Read permission:	Read drive data or acknowledge messages	
	Write permission:	Edit device configuration or drive applications	
	Parameter group:	Extended functions	
	Unit: -		
Description:	Displays the diagnostics of the data cross-check. For index [0] Number of the data, which, for the data cross-check between the two monitoring channels, led to the SCF (Safety Channel Failure) on the drive. For index [1]: Displays the value from channel A for a KDV error. For index [2]: Displays the value from channel B for a KDV error.		
Index:	[0] = Message value for KDV [1] = KDV actual value channel A [2] = KDV actual value channel B		
	Note KDV: Data cross-check		

r9728	SI actual checksum configuration of the safety functions		
S200 PN	Data type: Unsigned32	Visible in: Extended display	
	Read permission:	Read drive data or acknowledge messages	
	Write permission:	Edit device configuration or drive applications	
	Parameter group:	Extended functions	
	Unit: -		
Description:	Displays the checksum over the checked parameters used to configure safety functions (actual checksum).		
Dependency:	See also: p9729		

p9729	SI reference checksum configuration of the safety functions		
S200 PN	Data type: Unsigned32	Visible in: Extended display	
	Read permission:	Read drive data or acknowledge messages	
	Write permission:	Edit Safety Integrated application	
	Can be changed in the operating state:	Commissioning (Safety Integrated)	
	Parameter group:	Extended functions	
	Unit: -		
	Min: 0000 hex	Max: FFFF FFFF hex	Factory setting: A1A1 A1A1 hex
Description:	Sets the checksum over the checked parameters used to configure safety functions (reference checksum).		
Dependency:	See also: r9728		

r9750[0...63].0...20	SI diagnostic attributes		
	Data type: Unsigned32	Visible in: Extended display	
	Read permission:	Read drive data or acknowledge messages	
	Write permission:	Edit device configuration or drive applications	
	Parameter group:	Extended functions	
	Unit: -		
Description:	Displays the diagnostic attributes of the safety messages that have occurred.		

Bit array:	Bit	Signal name	1 signal	0 signal
	00	Hardware replacement recommended	Yes	No
	15	Message has gone	Yes	No
	16	PROFIdrive fault class bit 0	High	Low
	17	PROFIdrive fault class bit 1	High	Low
	18	PROFIdrive fault class bit 2	High	Low
	19	PROFIdrive fault class bit 3	High	Low
	20	PROFIdrive fault class bit 4	High	Low

Note

The buffer parameters are cyclically updated in the background (refer to status signal in r2139).

The structure of the safety message buffer and the assignment of the indices is shown in r60045.

For bits 20 ... 16:

Bits 20, 19, 18, 17, 16 = 0, 0, 0, 0, 0 --> PROFIdrive message class 0: not assigned

Bit 20, 19, 18, 17, 16 = 0, 0, 0, 0, 1 --> PROFIdrive message class 1: hardware fault/software error

Bits 20, 19, 18, 17, 16 = 0, 0, 0, 1, 0 --> PROFIdrive message class 2: line fault

Bits 20, 19, 18, 17, 16 = 0, 0, 0, 1, 1 --> PROFIdrive message class 3: supply voltage fault

Bits 20, 19, 18, 17, 16 = 0, 0, 1, 0, 0 --> PROFIdrive message class 4: DC link fault

Bits 20, 19, 18, 17, 16 = 0, 0, 1, 0, 1 --> PROFIdrive message class 5: power electronics faulted

Bits 20, 19, 18, 17, 16 = 0, 0, 1, 1, 0 --> PROFIdrive message class 6: overtemperature electronic components

Bits 20, 19, 18, 17, 16 = 0, 0, 1, 1, 1 --> PROFIdrive message class 7: ground fault/phase fault detected

Bits 20, 19, 18, 17, 16 = 0, 1, 0, 0, 0 --> PROFIdrive message class 8: motor overload

Bits 20, 19, 18, 17, 16 = 0, 1, 0, 0, 1 --> PROFIdrive message class 9: communication error to the higher-level control

Bits 20, 19, 18, 17, 16 = 0, 1, 0, 1, 0 --> PROFIdrive message class 10: safe monitoring channel has identified an error

Bits 20, 19, 18, 17, 16 = 0, 1, 0, 1, 1 --> PROFIdrive message class 11: incorrect position actual value/speed actual value or not available

Bits 20, 19, 18, 17, 16 = 0, 1, 1, 0, 0 --> PROFIdrive message class 12: internal (DRIVE-CLiQ) communication error

Bits 20, 19, 18, 17, 16 = 0, 1, 1, 0, 1 --> PROFIdrive message class 13: infeed unit faulted

Bits 20, 19, 18, 17, 16 = 0, 1, 1, 1, 0 --> PROFIdrive message class 14: braking controller/Braking Module faulted

Bits 20, 19, 18, 17, 16 = 0, 1, 1, 1, 1 --> PROFIdrive message class 15: line filter faulted

Bits 20, 19, 18, 17, 16 = 1, 0, 0, 0, 0 --> PROFIdrive message class 16: external measured value/signal state outside the permissible range

Bits 20, 19, 18, 17, 16 = 1, 0, 0, 0, 1 --> PROFIdrive message class 17: application/technology function faulted

Bits 20, 19, 18, 17, 16 = 1, 0, 0, 1, 0 --> PROFIdrive message class 18: error in the parameterization/configuration/commissioning sequence

Bits 20, 19, 18, 17, 16 = 1, 0, 0, 1, 1 --> PROFIdrive message class 19: general drive fault

Bits 20, 19, 18, 17, 16 = 0, 1, 1, 0, 0 --> PROFIdrive message class 20: auxiliary unit faulted

r9753[0...63]**SI message value for float values**

S200 PN

Data type: FloatingPoint32**Visible in:** Extended display**Read permission:**

Read drive data or acknowledge messages

Write permission:

Edit device configuration or drive applications

Parameter group:

Extended functions

Unit: -**Description:**

Displays additional information about the safety message that has occurred for float values.

Dependency:

See also: r9754, r9755, r9756, r60044, r60045, r60048, r60049, p60052

r9754[0...63]**SI message time received in days**

S200 PN

Data type: Unsigned16**Visible in:** Extended display**Read permission:**

Read drive data or acknowledge messages

Write permission:

Edit device configuration or drive applications

Parameter group:

Extended functions

Unit: -

Description: Displays the relative system runtime in days when the safety message occurred.

Dependency: See also: r9753, r9755, r9756, r60044, r60045, r60048, r60049, p60052

r9755[0...63] SI message time removed in milliseconds

S200 PN

Data type: Unsigned32

Visible in: Extended display

Read permission:

Read drive data or acknowledge messages

Write permission:

Edit device configuration or drive applications

Parameter group:

Extended functions

Unit: ms

Description: Displays the relative system runtime in milliseconds when the safety message was removed.

Dependency: See also: r9753, r9754, r9756, r60044, r60045, r60048, r60049, p60052

r9756[0...63] SI message time removed in days

S200 PN

Data type: Unsigned16

Visible in: Extended display

Read permission:

Read drive data or acknowledge messages

Write permission:

Edit device configuration or drive applications

Parameter group:

Extended functions

Unit: -

Description: Displays the relative system runtime in days when the safety message was removed.

Dependency: See also: r9753, r9754, r9756, r60044, r60045, r60048, r60049, p60052

r9776.0...4 SI diagnostics

S200 PN

Data type: Unsigned32

Visible in: Standard display

Read permission:

Read drive data or acknowledge messages

Write permission:

Edit device configuration or drive applications

Parameter group:

Safety Integrated

Unit: -

Description: Displays the operating state, referred to the safety functions. The parameter is used for diagnostics.

Bit array:

Bit	Signal name	1 signal	0 signal
00	Safety parameter changed	Yes	No
01	Safety functions enabled	Yes	No
02	Safety component replaced and data save required	Yes	No
04	Safety commissioning mode active	Yes	No

Note

For bit 00 = 1:

At least one safety parameter was changed. The change only becomes effective after a restart, which is automatically performed after exiting safety commissioning.

For bit 01 = 1:

Safety functions have been enabled and are active.

For bit 02 = 1:

A safety-relevant component has been replaced. Retentively save (save all parameters, p0977 = 1)

For bit 04 = 1:

The safety commissioning mode is selected.

r9780[0...1]	SI checksum to check changes	
S200 PN	Data type: Unsigned32	Visible in: Standard display
	Read permission:	Read drive data or acknowledge messages
	Write permission:	Edit device configuration or drive applications
	Parameter group:	Safety Integrated
	Unit: -	
Description:	Displays the checksum to track changes for Safety Integrated. These are additional checksums that are created to track changes (fingerprint for the "safety logbook" functionality) to safety parameters (that are relevant for checksums).	
Index:	[0] = SI checksum to track functional changes [1] = SI checksum to track hardware-specific changes	
Dependency:	See also: p9729	

r9781[0...1]	SI change control time stamp days	
S200 PN	Data type: Unsigned16	Visible in: Standard display
	Read permission:	Read drive data or acknowledge messages
	Write permission:	Edit device configuration or drive applications
	Parameter group:	Safety Integrated
	Unit: -	
Description:	Displays the time stamps for the checksums for tracking changes for Safety Integrated. The time stamps for the checksums for tracking changes (fingerprint for the "safety logbook" functionality) made to safety parameters are saved in parameters r9780[0] and r9780[1].	
Index:	[0] = SI time stamp for checksum to track functional changes [1] = SI time stamp for checksum to track hardware-specific changes	
Dependency:	See also: p9729, p9799	

NOTICE
The time comprises r9781 (days) and r9782 (milliseconds).

r9782[0...1]	SI change control time stamp milliseconds	
S200 PN	Data type: Unsigned32	Visible in: Standard display
	Read permission:	Read drive data or acknowledge messages
	Write permission:	Edit device configuration or drive applications
	Parameter group:	Safety Integrated
	Unit: ms	
Description:	Displays the time stamps for the checksums for tracking changes for Safety Integrated. The time stamps for the checksums for tracking changes (fingerprint for the "safety logbook" functionality) made to safety parameters are saved in parameters r9780[0] and r9780[1].	
Index:	[0] = SI time stamp for checksum to track functional changes [1] = SI time stamp for checksum to track hardware-specific changes	
Dependency:	See also: p9729, p9799	

NOTICE
The time comprises r9781 (days) and r9782 (milliseconds).

r9794	SI actual checksum safety enable	
S200 PN	Data type: Unsigned32	Visible in: Extended display
	Read permission:	Read drive data or acknowledge messages
	Write permission:	Edit device configuration or drive applications
	Parameter group:	Basic functions
	Unit: -	

Description: Displays the checksum over the parameters to enable the safety functions (actual checksum).

Dependency: See also: p9795

p9795**SI reference checksum safety enable**

S200 PN

Data type: Unsigned32**Visible in:** Extended display**Read permission:**

Read drive data or acknowledge messages

Write permission:

Edit Safety Integrated application

Can be changed in the operating state: Commissioning (Safety Integrated)**Parameter group:**

Basic functions

Unit: -**Min:**

0000 hex

Max:

FFFF FFFF hex

Factory setting:

A1A1 A1A1 hex

Description:

Displays the checksum over the parameters to enable the safety functions (reference checksum).

Dependency:

See also: r9794

r9798**SI actual checksum over the drive configuration**

S200 PN

Data type: Unsigned32**Visible in:** Extended display**Read permission:**

Read drive data or acknowledge messages

Write permission:

Edit device configuration or drive applications

Parameter group:

Basic functions

Unit: -**Description:**

Displays the checksum over the checksum-checked parameters to configure the drive (actual checksum).

Dependency:

See also: p9799

p9799**SI reference checksum over the configuration of the drive**

S200 PN

Data type: Unsigned32**Visible in:** Extended display**Read permission:**

Read drive data or acknowledge messages

Write permission:

Edit Safety Integrated application

Can be changed in the operating state: Commissioning (Safety Integrated)**Parameter group:**

Basic functions

Unit: -**Min:**

0000 hex

Max:

FFFF FFFF hex

Factory setting:

A1A1 A1A1 hex

Description:

Sets the checksum over the checksum-checked parameters to configure the drive (reference checksum).

Dependency:

See also: r9798

r9828**SI actual checksum configuration of safety functions channel B**

S200 PN

Data type: Unsigned32**Visible in:** Extended display**Read permission:**

Read drive data or acknowledge messages

Write permission:

Edit device configuration or drive applications

Parameter group:

Extended functions

Unit: -**Description:**

Displays the checksum over the checksum-checked parameters to configure safety functions (actual checksum) channel B.

Dependency:

See also: p9829

p9829 **SI reference checksum configuration of safety functions chan. B**
 S200 PN **Data type:** Unsigned32 **Visible in:** Extended display
Read permission: Read drive data or acknowledge messages
Write permission: Edit Safety Integrated application
Can be changed in the operating state: Commissioning (Safety Integrated)
Parameter group: Extended functions
Unit: -
Min: **Max:** **Factory setting:**
 0000 hex FFFF FFFF hex B2B2 B2B2 hex

Description: Sets the checksum over the checked parameters used to configure safety functions (reference checksum).
Dependency: See also: r9828

r9894 **SI actual checksum safety enable channel B**
 S200 PN **Data type:** Unsigned32 **Visible in:** Extended display
Read permission: Read drive data or acknowledge messages
Write permission: Edit device configuration or drive applications
Parameter group:
Unit: -

Description: Displays the checksum over the parameters to enable the safety functions (actual checksum) channel B.
Dependency: See also: p9895

p9895 **SI reference checksum safety enable channel B**
 S200 PN **Data type:** Unsigned32 **Visible in:** Extended display
Read permission: Read drive data or acknowledge messages
Write permission: Edit Safety Integrated application
Can be changed in the operating state: Commissioning (Safety Integrated)
Parameter group:
Unit: -
Min: **Max:** **Factory setting:**
 0000 hex FFFF FFFF hex B2B2 B2B2 hex

Description: Displays the checksum over the parameters to enable the safety functions (reference checksum) channel B.
Dependency: See also: r9894

r9898 **SI actual checksum configuration of the drive, channel B**
 S200 PN **Data type:** Unsigned32 **Visible in:** Extended display
Read permission: Read drive data or acknowledge messages
Write permission: Edit device configuration or drive applications
Parameter group: Basic functions
Unit: -

Description: Displays the checksum over the checksum-checked parameters to configure the drive (actual checksum) channel B.
Dependency: See also: p9899

p9899	SI reference checksum over the drive configuration, channel B		
S200 PN	Data type: Unsigned32	Visible in: Extended display	
	Read permission:	Read drive data or acknowledge messages	
	Write permission:	Edit Safety Integrated application	
	Can be changed in the operating state:	Commissioning (Safety Integrated)	
	Parameter group:	Basic functions	
	Unit: -		
	Min: 0000 hex	Max: FFFF FFFF hex	Factory setting: B2B2 B2B2 hex
Description:	Sets the checksum over the checksum-checked parameters to configure the drive (reference checksum) channel B.		
Dependency:	See also: r9898		
p10000.0	SI F-DI enable		
S200 PN	Data type: Unsigned8	Visible in: Standard display	
	Read permission:	Read drive data or acknowledge messages	
	Write permission:	Edit Safety Integrated application	
	Can be changed in the operating state:	Commissioning (Safety Integrated)	
	Parameter group:	Safety Integrated	
	Unit: -		
	Min: -	Max: -	Factory setting: 0001 bin
Description:	Sets the enable signal for the failsafe digital inputs.		
Bit array:	Bit	Signal name	1 signal 0 signal
	00	F-DI 0 (X131.1/2, X131.5/6)	Enabled Not enabled
	Note		
	F-DI that have been enabled are monitored in a safety-relevant way. It is neither permissible that the associated DI are set to simulation nor used as non-safety-related functions, as they can be subject to test pulses.		
p10002	SI F-DI changeover discrepancy time		
S200 PN	Data type: FloatingPoint32	Visible in: Standard display	
	Read permission:	Read drive data or acknowledge messages	
	Write permission:	Edit Safety Integrated application	
	Can be changed in the operating state:	Commissioning (Safety Integrated)	
	Parameter group:	Safety Integrated	
	Unit: ms		
	Min: 1.00 [ms]	Max: 2000.00 [ms]	Factory setting: 500.00 [ms]
Description:	Sets the discrepancy time for digital inputs. The signal states at the two associated digital inputs (F-DI) must assume the same state within this discrepancy time.		
	Note		
	The time must be set longer than the SI monitoring clock cycle.		

p10017[0...2]	SI digital inputs input filter		
S200 PN	Data type: FloatingPoint32	Visible in: Standard display	
	Read permission:	Read drive data or acknowledge messages	
	Write permission:	Edit Safety Integrated application	
	Can be changed in the operating state:	Commissioning (Safety Integrated)	
	Parameter group:	Safety Integrated	
	Unit: ms		
	Min:	Max:	Factory setting:
	1.00 [ms]	100.00 [ms]	4.00 [ms]
Description:	<p>Setting of the input filter for the digital inputs. The input filter is rounded off to whole milliseconds and accepted. The input filter acts on the following digital inputs: - Failsafe digital inputs (F-DI).</p> <p>Example: Input filter = 1 ms: Fault pulses of 1 ms are filtered; only pulses longer than 2 ms are processed. Input filter = 3 ms: Fault pulses of 3 ms are filtered; only pulses longer than 4 ms are processed. The input filtering result can be read in r10051 and r10151. The set input filter impacts the response time of the safety function.</p>		
Index:	<p>[0] = F-DI 0 [1] = Reserved [2] = Reserved</p>		
	<p>Note If the self test is enabled using externally specified dark pulses (p10041 = 3) for at least one F-DI, then p10017 must be set longer than the maximum duration of the dark pulses + 2 ms. If the test pulses are specified using the switchable power supply (p10041 = 1), then this means p10017 > p10018 + 2 ms.</p>		
p10018	SI F-DI self test length dark pulses VS+		
S200 PN	Data type: FloatingPoint32	Visible in: Standard display	
	Read permission:	Read drive data or acknowledge messages	
	Write permission:	Edit Safety Integrated application	
	Can be changed in the operating state:	Commissioning (Safety Integrated)	
	Parameter group:	Safety Integrated	
	Unit: ms		
	Min:	Max:	Factory setting:
	0 [ms]	50 [ms]	0 [ms]
Description:	<p>Sets the dark pulse length of the switchable power supply for the self test using specified dark pulses (p10041) of the F-DI. Value = 0: switchable power supply, permanently switched on. Value > 0: dark pulse length for the switchable power supply. The test cycle is fixed at 5 s.</p>		
	<p>Note The dark pulses of the switchable power supply are only enabled for the self test using specified dark pulses (p10041 = 1). The switchable power supply is continuously switched on if another self test was set</p>		

p10019	SI F-DI self test external dark pulses wait time		
S200 PN	Data type: FloatingPoint32	Visible in: Standard display	
	Read permission:	Read drive data or acknowledge messages	
	Write permission:	Edit Safety Integrated application	
	Can be changed in the operating state:	Commissioning (Safety Integrated)	
	Parameter group:	Safety Integrated	
	Unit: s		
	Min:	Max:	Factory setting:
	10 [s]	3600 [s]	1020 [s]
Description:	Sets the maximum wait time for the dark pulses for the F-DI self test using an externally specified test pulses.		
	Note		
	This parameter is only active for F-DIs that are tested using external test pulses (p10041[x] = 3).		

c10022	SI STO input terminal		
S200 PN	Data type: Unsigned8	Visible in: Standard display	
	Read permission:	Read drive data or acknowledge messages	
	Write permission:	Edit Safety Integrated application	
	Parameter group:	Safety Integrated	
	Unit: -		
Description:	Signal for the axis-specific selection of function "STO (Safe Torque Off)" (control via F-DI).		
	Note		
	F-DI: Failsafe Digital Input		

p10040.0	SI F-DI input mode		
S200 PN	Data type: Unsigned8	Visible in: Standard display	
	Read permission:	Read drive data or acknowledge messages	
	Write permission:	Edit Safety Integrated application	
	Can be changed in the operating state:	Commissioning (Safety Integrated)	
	Parameter group:	Safety Integrated	
	Unit: -		
	Min:	Max:	Factory setting:
	-	-	0000 bin
Description:	Sets the input mode for the safety digital inputs (F-DI).		
Bit array:	Bit	Signal name	1 signal 0 signal
	00	F-DI 0, DI 11 (X131.5/6)	NO contact NC contact

p10041[0...2]	SI F-DI self test mode selection		
S200 PN	Data type: Integer16	Visible in: Standard display	
	Read permission:	Read drive data or acknowledge messages	
	Write permission:	Edit Safety Integrated application	
	Can be changed in the operating state:	Commissioning (Safety Integrated)	
	Parameter group:	Safety Integrated	
	Unit: -		
	Min:	Max:	Factory setting:
	0	3	0
Description:	Enable for the F-DI self test.		

Value: 0: Self test using internal test signals
 1: Self test using specified dark pulses (VS+)
 3: Self test using externally specified dark pulses

Index: [0] = F-DI 0
 [1] = Reserved
 [2] = Reserved

Note

Mode 1:

A check is made whether p10017 is > p10018 + 2 ms and whether p10018 is set > 0.

r10051.0

SI digital inputs status channel A

S200 PN

Data type: Unsigned8

Visible in: Standard display

Read permission:

Read drive data or acknowledge messages

Write permission:

Edit device configuration or drive applications

Parameter group:

Safety Integrated

Unit: -

Description:

Display and signal source for the single-channel, logical and debounced status of the failsafe digital inputs of channel A.

Bit array:

Bit	Signal name	1 signal	0 signal
00	Status of the DI 10 (X131.1/2)	Logical 1	Logical 0

Dependency:

See also: p10017

Note

The relationship between the logic level and the external voltage level at the input is intended for the use of a safety function:

With 24 V at the input, NC contacts have a logical "1" level, for 0 V at the input, a logical "0" level.

This means that an NC/NC contact parameterization for 0 V at both inputs of the F-DI leads to a status of the F-DI equal to "0" (safety function selected), for 24 V at both inputs of the F-DI, to a status of the F-DI equal to "1" (safety function deselected).

F-DI: Failsafe Digital Input

NC contact:

24V at the input -> logical "1"

0V at the input -> logical "0"

r10071.0

SI F-DI status

S200 PN

Data type: Unsigned8

Visible in: Standard display

Read permission:

Read drive data or acknowledge messages

Write permission:

Edit device configuration or drive applications

Parameter group:

Safety Integrated

Unit: -

Description:

Display for the status of the failsafe digital inputs.

Bit array:

Bit	Signal name	1 signal	0 signal
00	Status of the F-DI 0	Logical 1	Logical 0

Note

The following applies:

- Logical "0": Safety function is selected

- Logical "1": safety function is deselected

F-DI: Failsafe Digital Input

r10080.0...7**SI status signals channel A**

S200 PN

Data type: Unsigned32**Visible in:** Extended display**Read permission:**

Read drive data or acknowledge messages

Write permission:

Edit device configuration or drive applications

Parameter group:**Unit:** -**Description:**

Status signals (channel A) for safety-relevant motion monitoring functions integrated in the drive.

Bit array:

Bit	Signal name	1 signal	0 signal
00	STO or safe pulse cancellation active	Yes	No
07	Internal event	No	Yes

NOTICE

For bit 07:

An internal event is displayed if STO is active.

Note

Only the status signals of the available and enabled functions (see p9604) are updated. All others are 0 across the board.

r10098**SI actual checksum across device-specific parameters**

S200 PN

Data type: Unsigned32**Visible in:** Extended display**Read permission:**

Read drive data or acknowledge messages

Write permission:

Edit device configuration or drive applications

Parameter group:

Basic functions

Unit: -**Description:**

Displays the checksum over the checksum-checked parameters for the device-specific parameters of the drive system (actual checksum).

Dependency:

See also: p10099

p10099**SI reference checksum across device-specific parameters**

S200 PN

Data type: Unsigned32**Visible in:** Extended display**Read permission:**

Read drive data or acknowledge messages

Write permission:

Edit Safety Integrated application

Can be changed in the operating state: Commissioning (Safety Integrated)**Parameter group:**

Basic functions

Unit: -**Min:**

0000 hex

Max:

FFFF FFFF hex

Factory setting:

A1A1 A1A1 hex

Description:

Displays the checksum over the checksum-checked parameters for the device-specific parameters of the drive system (reference checksum).

Dependency:

See also: r10098

r10151.0**SI digital inputs status channel B**

S200 PN

Data type: Unsigned8**Visible in:** Standard display**Read permission:**

Read drive data or acknowledge messages

Write permission:

Edit device configuration or drive applications

Parameter group:**Unit:** -**Description:**

Display for the single-channel, logical and debounced status of the failsafe digital inputs of channel B.

Bit array:

Bit	Signal name	1 signal	0 signal
00	Status of the DI 11 (X131.5/6)	Logical 1	Logical 0

Dependency: See also: p10017, p10040

Note

The relationship between the logic level and the external voltage level at the input depends on the parameterization (see p10040) of the input as NC contact or NO contact, and is aligned to the use of a safety function:

With 24 V at the input, NC contacts have a logical "1" level, for 0 V at the input, a logical "0" level.

This means that an NC/NC contact parameterization of 0 V at both inputs of the F-DI leads to a status of the F-DI equal to "0" (safety function selected), for 24 V at both inputs of the F-DI, to a status of the F-DI equal to "1" (safety function deselected).

With 24 V at the input, NO contacts have a logical "0" level, for 0 V at the input, a logical "1" level. This means that for an NC/NO contact parameterization, the level 0 V/24 V leads to a status of the F-DI equal to "0" (safety function selected), the level 24 V/0 V leads to status of the F-DI equal to "1" (safety function deselected).

F-DI: Failsafe Digital Input

r10171.0

SI F-DI status channel B

S200 PN

Data type: Unsigned8

Visible in: Extended display

Read permission:

Read drive data or acknowledge messages

Write permission:

Edit device configuration or drive applications

Parameter group:

Safety Integrated

Unit: -

Description:

Display for the status of the failsafe digital inputs.

Bit array:

Bit	Signal name	1 signal	0 signal
00	Status of the F-DI 0	Logical 1	Logical 0

Note

If a safety function (e.g. via c10022) is controlled via an F-DI, then the following applies:

- Logical "0": Safety function is selected

- Logical "1": safety function is deselected

F-DI: Failsafe Digital Input

r10180.0...7

SI status signals channel B

S200 PN

Data type: Unsigned32

Visible in: Extended display

Read permission:

Read drive data or acknowledge messages

Write permission:

Edit device configuration or drive applications

Parameter group:

Unit: -

Description:

Status signals (channel B) for safety-relevant motion monitoring functions integrated in the drive.

Bit array:

Bit	Signal name	1 signal	0 signal
00	STO or safe pulse cancellation active	Yes	No
07	Internal event	No	Yes

NOTICE

For bit 07:

An internal event is displayed if STO is active.

Note

Only the function status signals of the available and enabled functions (see p9604) are updated. All others are 0 across the board.

r10198	SI actual checksum across device-specific parameters channel B		
S200 PN	Data type: Unsigned32	Visible in: Extended display	
	Read permission:	Read drive data or acknowledge messages	
	Write permission:	Edit device configuration or drive applications	
	Parameter group:	Basic functions	
	Unit: -		
Description:	Displays the checksum over the checksum-checked parameters for the device-specific parameters of the drive system (actual checksum) channel B.		
Dependency:	See also: p10199		

p10199	SI reference checksum across device-specific parameters chan B		
S200 PN	Data type: Unsigned32	Visible in: Extended display	
	Read permission:	Read drive data or acknowledge messages	
	Write permission:	Edit Safety Integrated application	
	Can be changed in the operating state:	Commissioning (Safety Integrated)	
	Parameter group:	Basic functions	
	Unit: -		
	Min: 0000 hex	Max: FFFF FFFF hex	Factory setting: B2B2 B2B2 hex
Description:	Displays the checksum over the checksum-checked parameters for the device-specific parameters of the drive system (reference checksum) channel B.		
Dependency:	See also: r10198		

r10352.0...15	SI STO select cause			
S200 PN	Data type: Unsigned32	Visible in: Standard display		
	Read permission:	Read drive data or acknowledge messages		
	Write permission:	Edit device configuration or drive applications		
	Parameter group:	Safety Integrated		
	Unit: -			
Description:	Reason that STO (Safe Torque Off) function was selected.			
Bit array:	Bit	Signal name	1 signal	0 signal
	00	Selection via F-DI	High	Low
	04	Safety commissioning mode active	High	Low
	12	Stop response	High	Low
	14	Response to parameterizing error	High	Low
	15	Response to internal software error	High	Low

r10452.0...15	SI STO select cause channel B			
S200 PN	Data type: Unsigned32	Visible in: Extended display		
	Read permission:	Read drive data or acknowledge messages		
	Write permission:	Edit device configuration or drive applications		
	Parameter group:	Safety Integrated		
	Unit: -			
Description:	Reason for the selection of function STO (Safe Torque Off) on channel B.			
Bit array:	Bit	Signal name	1 signal	0 signal
	00	Selection via F-DI	High	Low
	04	Safety commissioning mode active	High	Low
	12	Stop response	High	Low

14	Response to parameterizing error	High	Low
15	Response to internal software error	High	Low

c11500[0...3] LR initiate absolute encoder adjustment

Data type: Unsigned8 **Visible in:** Standard display
Read permission: Read drive data or acknowledge messages
Write permission: Edit device configuration or drive applications
Parameter group: Position control
Unit: -

Description: Initiate adjustment for absolute encoder
A 0/1 signal starts the absolute encoder adjustment.

Index: [0] = Position control
[1] = Motor encoder
[2] = Encoder 2
[3] = Encoder 3

Dependency: See also: p2507, r2526, c2598, p2599

⚠ CAUTION

For rotating absolute encoders, when adjusting, a range is set up symmetrically around zero with half of the encoder range, within which the position must be re-established after switch-off/switch-on. In this range, it is only permissible that the encoder overflows.

After the adjustment has been completed, it must be guaranteed that the range is not exited. The reason for this is that outside the range, there is no clear reference any longer between the encoder actual value and mechanical system. If the home position (c2598) lies in this range, then the position actual value is set when adjusting to the home position. Otherwise, adjustment is canceled with F07443.

There is no overflow for linear absolute encoders. This means that after the adjustment, the position can be re-established in the complete traversing range after switch-off/switch-on. When adjusting, the position actual value is set to the home position.

Note

The status of the absolute encoder adjustment is indicated via p2507 and in status word r2526. To permanently accept the determined position offset, it must be retentively saved (p0977). This adjustment can only be initiated for an absolute encoder.

p11550 EPOS active homing reference cam selection

Data type: Integer16 **Visible in:** Standard display
Read permission: Read drive data or acknowledge messages
Write permission: Edit device configuration or drive applications
Can be changed in the operating state: Ready for operation
Parameter group: Homing
Unit: -

Min:	Max:	Factory setting:
0	1	0

Description: Signal to evaluate "Active homing reference cam".

Value: 0: Reference cam selection 1
1: Reference cam selection 2

Dependency: See also: p2607, c2612

c11560	EPOS direct setpoint input/MDI acceleration setpoint
Data type: FloatingPoint32	Visible in: Standard display
Read permission:	Read drive data or acknowledge messages
Write permission:	Edit device configuration or drive applications
Parameter group:	Direct setpoint input (MDI)
Unit: 1000 LU/s ²	
Description:	Signal for the acceleration setpoint in mode "direct setpoint input/MDI".
Dependency:	See also: c2649, c2650

NOTICE

The parameter may be protected as a result of r0922 and cannot be changed.

Note

Depending on c2649, the acceleration setpoint is either transferred continuously or edge-triggered.

c11560	EPOS direct setpoint input/MDI acceleration setpoint
S200 Basic PN (EPOS load side, rotating), S200 PN (EPOS load side, rotating)	Data type: FloatingPoint32
	Visible in: Standard display
	Read permission:
	Read drive data or acknowledge messages
	Write permission:
	Edit device configuration or drive applications
	Parameter group:
	Direct setpoint input (MDI)
	Unit: 1000 LU/s ²
Description:	Signal for the acceleration setpoint in mode "direct setpoint input/MDI".
Dependency:	See also: c2649, c2650

NOTICE

The parameter may be protected as a result of r0922 and cannot be changed.

Note

Depending on c2649, the acceleration setpoint is either transferred continuously or edge-triggered.

c11561	EPOS direct setpoint input/MDI deceleration setpoint
	Data type: FloatingPoint32
	Visible in: Standard display
	Read permission:
	Read drive data or acknowledge messages
	Write permission:
	Edit device configuration or drive applications
	Parameter group:
	Traversing blocks
	Unit: 1000 LU/s ²
Description:	Signal for the deceleration setpoint in mode "direct setpoint input/MDI".
Dependency:	See also: c2649, c2650

NOTICE

If, when calculating the traversing profile, it is identified that the target position with the programmed deceleration setpoint cannot be reached without reversing the direction, then when accepting the dynamic response values, the higher deceleration setpoint is accepted and becomes effective.

The parameter may be protected as a result of r0922 and cannot be changed.

Note

Depending on c2649, the deceleration setpoint is either transferred continuously or edge-triggered.

c11561	EPOS direct setpoint input/MDI deceleration setpoint	
S200 Basic PN (EPOS load side, rotating), S200 PN (EPOS load side, rotating)	Data type: FloatingPoint32	Visible in: Standard display
	Read permission:	Read drive data or acknowledge messages
	Write permission:	Edit device configuration or drive applications
	Parameter group:	Traversing blocks
	Unit: 1000 LU/s ²	
Description:	Signal for the deceleration setpoint in mode "direct setpoint input/MDI".	
Dependency:	See also: c2649, c2650	

<p>NOTICE</p> <p>If, when calculating the traversing profile, it is identified that the target position with the programmed deceleration setpoint cannot be reached without reversing the direction, then when accepting the dynamic response values, the higher deceleration setpoint is accepted and becomes effective.</p> <p>The parameter may be protected as a result of r0922 and cannot be changed.</p>
--

Note
Depending on c2649, the deceleration setpoint is either transferred continuously or edge-triggered.

r11570	EPOS actual acceleration	
	Data type: FloatingPoint32	Visible in: Standard display
	Read permission:	Read drive data or acknowledge messages
	Write permission:	Edit device configuration or drive applications
	Parameter group:	Jog, Traversing blocks, Direct setpoint input (MDI)
	Unit: 1000 LU/s ²	
Description:	Displays the acceleration value currently being processed.	
Dependency:	See also: p2572	

Note
The maximum acceleration from p2572 is active in operating mode "Jog" and "Home position approach".

r11570	EPOS actual acceleration	
S200 Basic PN (EPOS load side, rotating), S200 PN (EPOS load side, rotating)	Data type: FloatingPoint32	Visible in: Standard display
	Read permission:	Read drive data or acknowledge messages
	Write permission:	Edit device configuration or drive applications
	Parameter group:	Jog, Traversing blocks, Direct setpoint input (MDI)
	Unit: 1000 LU/s ²	
Description:	Displays the acceleration value currently being processed.	
Dependency:	See also: p2572	

Note
The maximum acceleration from p2572 is active in operating mode "Jog" and "Home position approach".

r11571	EPOS actual deceleration	
	Data type: FloatingPoint32	Visible in: Standard display
	Read permission:	Read drive data or acknowledge messages
	Write permission:	Edit device configuration or drive applications
	Parameter group:	Jog, Traversing blocks, Direct setpoint input (MDI)
	Unit: 1000 LU/s ²	
Description:	Displays the deceleration value currently being processed.	
Dependency:	See also: p2573	

Note
The maximum deceleration from p2573 is active in operating mode "Jog" and "Home position approach".

r11571	EPOS actual deceleration		
S200 Basic PN (EPOS load side, rotating), S200 PN (EPOS load side, rotating)	Data type: FloatingPoint32	Visible in: Standard display	
	Read permission:	Read drive data or acknowledge messages	
	Write permission:	Edit device configuration or drive applications	
	Parameter group:	Jog, Traversing blocks, Direct setpoint input (MDI)	
	Unit: 1000 LU/s ²		
Description:	Displays the deceleration value currently being processed.		
Dependency:	See also: p2573		
	Note		
	The maximum deceleration from p2573 is active in operating mode "Jog" and "Home position approach".		
c29048	Torque limit selection bit 0		
	Data type: Unsigned8	Visible in: Standard display	
	Read permission:	Read drive data or acknowledge messages	
	Write permission:	Edit device configuration or drive applications	
	Parameter group:	Technology Extensions	
	Unit: -		
Description:	Signal of bit 0 for the torque limit.		
c29049	Torque limit selection bit 1		
	Data type: Unsigned8	Visible in: Standard display	
	Read permission:	Read drive data or acknowledge messages	
	Write permission:	Edit device configuration or drive applications	
	Parameter group:	Technology Extensions	
	Unit: -		
Description:	Signal of bit 1 for the torque limit.		
p29050[0...3]	Upper torque limit		
	Data type: FloatingPoint32	Visible in: Standard display	
	Read permission:	Read drive data or acknowledge messages	
	Write permission:	Edit device configuration or drive applications	
	Can be changed in the operating state:	Ready for operation	
	Parameter group:	Technology Extensions	
	Unit: %		
	Min:	Max:	Factory setting:
	-150 [%]	350 [%]	350 [%]
Description:	Sets the upper torque limit. Three internal torque limits in total are available. With the combination of the digital input signals Torque limit selection bit 0 and Torque limit selection bit 1, you can select one of the three internal torque limits as the source of the upper torque limit.		
Index:	[0] = Upper torque limit 0 [1] = Upper torque limit 1 [2] = Upper torque limit 2 [3] = Upper torque limit 3		

p29051[0...3]	Lower torque limit		
	Data type: FloatingPoint32	Visible in: Standard display	
	Read permission:	Read drive data or acknowledge messages	
	Write permission:	Edit device configuration or drive applications	
	Can be changed in the operating state:	Ready for operation	
	Parameter group:	Technology Extensions	
	Unit: %		
	Min: -350 [%]	Max: 150 [%]	Factory setting: -350 [%]
Description:	Sets the lower torque limit. Three internal torque limits in total are available. With the combination of the digital input signals Torque limit selection bit 0 and Torque limit selection bit 1, you can select one of the three internal torque limits as the source of the lower torque limit.		
Index:	[0] = Lower torque limit 0 [1] = Lower torque limit 1 [2] = Lower torque limit 2 [3] = Lower torque limit 3		

c29063	Speed limit selection bit 0		
	Data type: Unsigned8	Visible in: Standard display	
	Read permission:	Read drive data or acknowledge messages	
	Write permission:	Edit device configuration or drive applications	
	Parameter group:	Technology Extensions	
	Unit: -		
Description:	Signal of bit 0 for the speed limit.		

c29064	Speed limit selection bit 1		
	Data type: Unsigned8	Visible in: Standard display	
	Read permission:	Read drive data or acknowledge messages	
	Write permission:	Edit device configuration or drive applications	
	Parameter group:	Technology Extensions	
	Unit: -		
Description:	Signal of bit 1 for the speed limit.		

p29070[0...3]	Speed limit in positive direction of rotation		
	Data type: FloatingPoint32	Visible in: Standard display	
	Read permission:	Read drive data or acknowledge messages	
	Write permission:	Edit device configuration or drive applications	
	Can be changed in the operating state:	Ready for operation	
	Parameter group:	Technology Extensions	
	Unit: rpm		
	Min: 0 [rpm]	Max: 210000 [rpm]	Factory setting: 210000 [rpm]
Description:	Sets the maximum speed for the positive direction. Three internal speed limits in total are available. With the combination of the digital input signals Speed limit selection bit 0 and Speed limit selection bit 1, you can select one of the three internal speed limits as the source of the speed limit.		

Index: [0] = Speed limit for positive direction 0
 [1] = Speed limit for positive direction 1
 [2] = Speed limit for positive direction 2
 [3] = Speed limit for positive direction 3

Dependency: The default value depends on the maximum motor speed.

p29071[0...3] Speed limit in negative direction of rotation

Data type: FloatingPoint32 **Visible in:** Standard display
Read permission: Read drive data or acknowledge messages
Write permission: Edit device configuration or drive applications
Can be changed in the operating state: Ready for operation
Parameter group: Technology Extensions
Unit: rpm
Min: -210000 [rpm] **Max:** 0 [rpm] **Factory setting:** -210000 [rpm]

Description: Sets the maximum speed for the negative direction.
 Three internal speed limits in total are available.
 With the combination of the digital input signals Speed limit selection bit 0 and Speed limit selection bit 1, you can select one of the three internal speed limits as the source of the speed limit.

Index: [0] = Speed limit for negative direction 0
 [1] = Speed limit for negative direction 1
 [2] = Speed limit for negative direction 2
 [3] = Speed limit for negative direction 3

Dependency: The default value depends on the maximum motor speed.

r29404.0...5 DO status word

Data type: Unsigned32 **Visible in:** Standard display
Read permission: Read drive data or acknowledge messages
Write permission: Edit device configuration or drive applications
Parameter group: Technology Extensions
Unit: -

Description: Displays the status word of the digital outputs.

Bit array:	Bit	Signal name	1 signal	0 signal
	00	ready for servo on		
	01	current control mode		
	02	overload level reached		
	03	speed reached		
	04	warning1		
	05	warning2		

r60000 PROFIdrive reference speed

Data type: FloatingPoint32 **Visible in:** Extended display
Read permission: Read drive data or acknowledge messages
Write permission: Edit device configuration or drive applications
Parameter group:
Unit: rpm

Description: Sets the reference quantity for the speed values.
 All speeds specified as relative values refer to this reference quantity.
 The reference quantity corresponds to 100% or 4000 hex (word) or 4000 0000 hex (double word).

Dependency: See also: p2000

Note

Parameter r60000 is an image of parameter p2000 in conformance with PROFIdrive.

r60044 **SI message buffer counter changes**

S200 PN **Data type:** Unsigned16 **Visible in:** Extended display
Read permission: Read drive data or acknowledge messages
Write permission: Edit device configuration or drive applications
Parameter group: Extended functions
Unit: -

Description: Displays the changes of the safety message buffer.
This counter is incremented every time that the safety message buffer changes.

Recommendation: This is used to check whether the safety message buffer has been read out consistently.

Dependency: See also: r9753, r9754, r9755, r9756, r60045, r60048, r60049, p60052

r60045[0...63] **SI message code**

S200 PN **Data type:** Unsigned16 **Visible in:** Extended display
Read permission: Read drive data or acknowledge messages
Write permission: Edit device configuration or drive applications
Parameter group: Extended functions
Unit: -

Description: Displays the numbers of safety messages that have occurred.

Dependency: See also: r9753, r9754, r9755, r9756, r60044, r60048, r60049, p60052

Note

The messages type "safety message" (Cxxxxx) are entered in the message fault buffer.

Message buffer structure (principle):

r60045[0], r60048[0], r60049[0], r9753[0], r9754[0], r9755[0], r9756[0] --> safety message 1 (oldest active message) of the actual message case.

...

r60045[7], r60048[7], r60049[7], r9753[7], r9754[7], r9755[7], r9756[7] --> safety message 8 (latest active message) of the actual message case,

Safety messages that have gone are automatically acknowledged.

History of acknowledged messages:

r60045[8], r60048[8], r60049[8], r9753[8], r9754[8], r9755[8], r9756[8] --> safety message 1 of the 1st acknowledged message case,

...

r60045[16], r60048[16], r60049[16], r9753[16], r9754[16], r9755[16], r9756[16] --> safety message 1 of the 2nd acknowledged message case,

...

r60045[56], r60048[56], r60049[56], r9753[56], r9754[56], r9755[56], r9756[56] --> safety message 1 of the 7th acknowledged message case,

...

r60045[63], r60048[63], r60049[63], r9753[63], r9754[63], r9755[63], r9756[63] --> safety message 8 (oldest gone message) of the 7th acknowledged message case,

r60047[0...63]	SI message number	
S200 PN	Data type: Unsigned16	Visible in: Extended display
	Read permission:	Read drive data or acknowledge messages
	Write permission:	Edit device configuration or drive applications
	Parameter group:	Extended functions
	Unit: -	
Description:	Displays the numbers of safety messages that have occurred.	
Dependency:	See also: r9753, r9754, r9755, r9756, r60044, r60048, r60049, p60052	
	Note	
	The messages type "safety message" (Cxxxxx) are entered in the message fault buffer.	
	Message buffer structure (principle):	
	r60045[0], r60048[0], r60049[0], r9753[0], r9754[0], r9755[0], r9756[0] --> safety message 1 (oldest active message) of the actual message case.	
	...	
	r60045[7], r60048[7], r60049[7], r9753[7], r9754[7], r9755[7], r9756[7] --> safety message 8 (latest active message) of the actual message case,	
	Safety messages that have gone are automatically acknowledged.	
	History of acknowledged messages:	
	r60045[8], r60048[8], r60049[8], r9753[8], r9754[8], r9755[8], r9756[8] --> safety message 1 of the 1st acknowledged message case,	
	...	
	r60045[16], r60048[16], r60049[16], r9753[16], r9754[16], r9755[16], r9756[16] --> safety message 1 of the 2nd acknowledged message case,	
	...	
	r60045[56], r60048[56], r60049[56], r9753[56], r9754[56], r9755[56], r9756[56] --> safety message 1 of the 7th acknowledged message case,	
	...	
	r60045[63], r60048[63], r60049[63], r9753[63], r9754[63], r9755[63], r9756[63] --> safety message 8 (oldest gone message) of the 7th acknowledged message case,	
r60048[0...63]	SI message time received in milliseconds	
S200 PN	Data type: Unsigned32	Visible in: Extended display
	Read permission:	Read drive data or acknowledge messages
	Write permission:	Edit device configuration or drive applications
	Parameter group:	Extended functions
	Unit: ms	
Description:	Displays the relative system runtime in milliseconds when the safety message occurred.	
Dependency:	See also: r9753, r9754, r9755, r9756, r60044, r60045, r60049, p60052	
r60049[0...63]	SI message value	
S200 PN	Data type: Integer32	Visible in: Extended display
	Read permission:	Read drive data or acknowledge messages
	Write permission:	Edit device configuration or drive applications
	Parameter group:	Extended functions
	Unit: -	
Description:	Displays the additional information about the safety message that occurred (as integer number).	
Dependency:	See also: r9753, r9754, r9755, r9756, r60044, r60045, r60048, p60052	

p60052	SI message cases counter		
S200 PN	Data type: Unsigned16	Visible in: Extended display	
	Read permission:	Read drive data or acknowledge messages	
	Write permission:	Edit device configuration or drive applications	
	Can be changed in the operating state:	Operation	
	Parameter group:	Extended functions	
	Unit: -		
	Min:	Max:	Factory setting:
	0	65535	0
Description:	Number of safety message cases that have occurred since the last reset.		
Dependency:	The safety message buffer is cleared by resetting the parameter to 0. See also: r9753, r9754, r9755, r9756, r60044, r60045, r60048, r60049		

r6100[0...4]	PROFIdrive telegram display total		
	Data type: Unsigned16	Visible in: Extended display	
	Read permission:	Read drive data or acknowledge messages	
	Write permission:	Edit device configuration or drive applications	
	Parameter group:	Configuration	
	Unit: -		
Description:	Displays the send and receive telegrams.		
Index:	[0] = Subslot 1: MAP [1] = Subslot 2: PROFIsafe [2] = Subslot 3: standard/SIEMENS [3] = Subslot 4: supplementary telegram [4] = Subslot 5: supplementary telegram		
Dependency:	See also: r0922		

Note
Value = 65534: No telegram
Value = 65535: MAP "Module Access Point"

r61000[0...239]	PROFINET Name of Station		
	Data type: Unsigned8	Visible in: Extended display	
	Read permission:	Read drive data or acknowledge messages	
	Write permission:	Edit device configuration or drive applications	
	Parameter group:	Configuration	
	Unit: -		
Description:	Displays PROFINET Name of Station.		

r61001[0...3]	PROFINET IP of Station		
	Data type: Unsigned8	Visible in: Extended display	
	Read permission:	Read drive data or acknowledge messages	
	Write permission:	Edit device configuration or drive applications	
	Parameter group:	Configuration	
	Unit: -		
Description:	Displays PROFINET IP of Station.		

A.4 Assembling cables

A.4.1 General notes

Description

Cables are important components of a servo drive system. They are essential to the stable and reliable operation of the system.

Siemens recommends that you use Siemens cable assemblies and connectors. All Siemens cable assemblies and connectors are tested and compliant with CE standards and EMC requirements. If you use non-Siemens cable assemblies, for example, cables made by yourself or third-party cables, Siemens does not guarantee that the servo drive system meets CE standards. In this case, if the drive system is required to be operated in a CE-compliant environment, you should reapply for the certification.

Siemens does not provide any guarantee or warranty regarding the functionality, reliability or quality of non-Siemens cables used with the S200 servo drive system, and is not responsible for device (e.g. motor and converter) damages due to use with non-Siemens cables.

Siemens allows you to assemble your own cables in case that, for example, cables of special length are needed; therefore, Siemens provides instructions for assembling cables and connectors. Siemens does not guarantee that your cables meet CE standards and EMC requirements.

When assembling the cables, observe the following instructions:

- The assembly must be performed by qualified personnel.
- Prepare appropriate tools, raw cables, and Siemens connectors.
- To avoid splaying or fraying of the strands, strip the wires squarely and evenly.

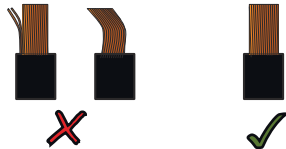

- To avoid short-circuiting between wires and unused pins on the connector, cover the unused pins with heat-shrinkable tubes.

More information

For more information about Siemens cables and connectors, see Section "Cables and connectors (Page 130)".

A.4.2 Assembling connectors on the converter side

A.4.2.1 Assembling the cable lugs

Overview

This section offers general assembly instructions for cable lugs and is applicable to the following cables:

- Mains supply cable
- 24 V DC power supply cable
- Motor holding brake cable
- Motor power cable
- External braking resistor cable
- STO connection cable

Requirement

You have prepared appropriate tools, raw cables, and cable lugs.

Procedure

1. Remove the outer sheath of the cable.
2. Remove the insulation from the conductor. For more information about stripping length, see Section "Cables and connectors (Page 130)".

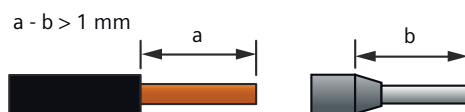

3. Insert the stripped end into the cable end sleeve.



4. Crimp the cable end sleeve.



A.4.2.2 Assembling the encoder connector

Overview

The Siemens IX-C connector is used for encoder connection to the converter. It consists of the following components:

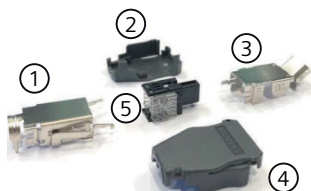

- | | | | |
|---|-------------|---|--|
| ① | Shielding A | ④ | Front cover |
| ② | Back cover | ⑤ | Insulation-displacement contact (IDC) terminal |
| ③ | Shielding B | | |

Figure A-1 IX-C connector

Requirement

You have prepared appropriate tools, a raw cable, and the Siemens IX-C connector.

Procedure

1. Prepare the cable.
 - Remove the outer sheath of the cable by 17 mm.
 - Remove the cable shield by 12 mm.
 - Fold the remaining cable shield backward over the cable sheath, and wrap the folded cable shield with copper tape.

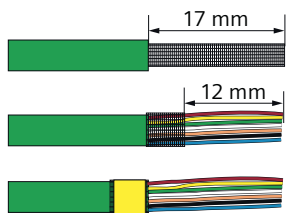

2. Arrange the conductors as shown below.



3. Insert the conductors into the connector with the correct order, pushing through until the conductor ends reach the end of the connector.

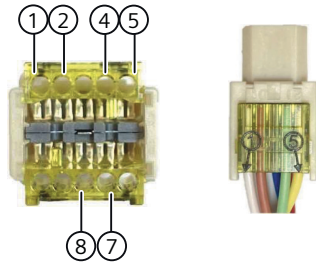

Pin	Conductor color	Pin	Conductor color
1	White	5	Yellow
2	Red	7	Pink
4	Green	8	Blue

4. Insert the connector into the IDC slot in the crimping tool and crimp the connector. Make sure that red, yellow, and green conductors face up.

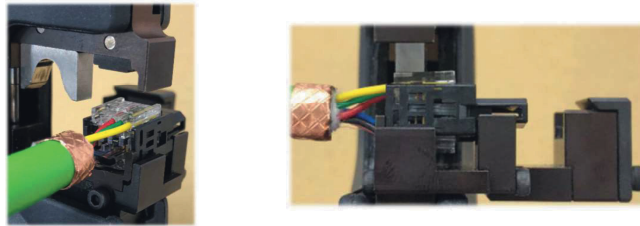

5. Assemble the shielding A.

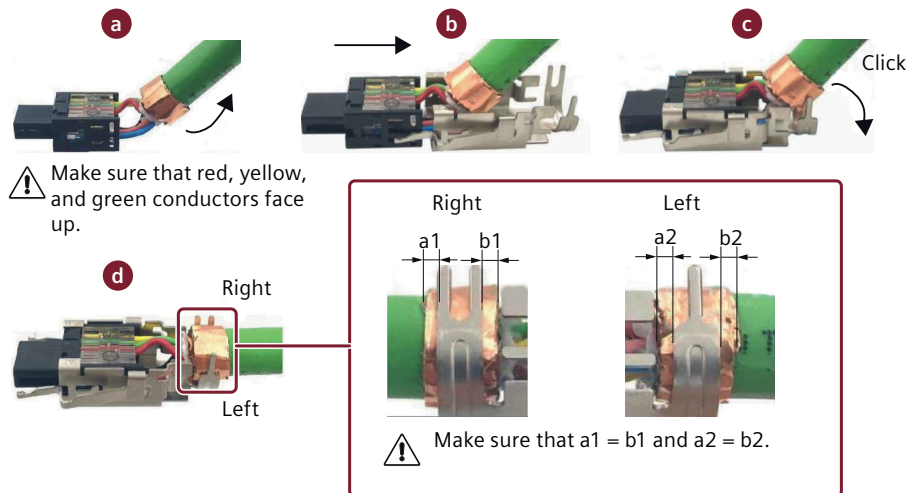

6. Assemble the shielding B.

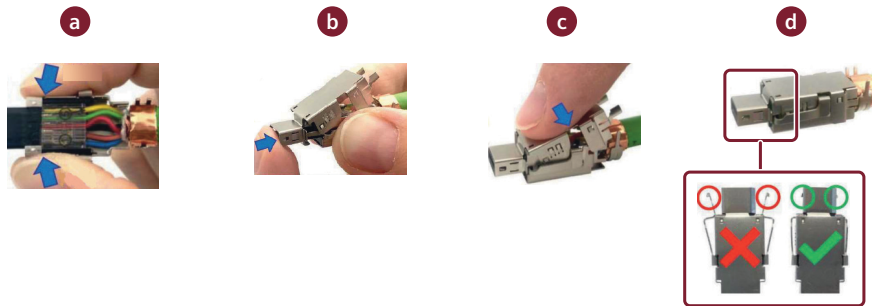

Make sure that the installed shielding B is level. If it tilts upward, adjust as follows.

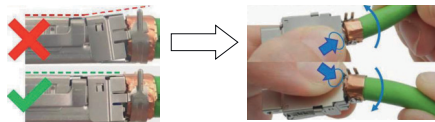

7. Insert the connector into the cable crimp slot in the crimping tool and crimp the cable shield.

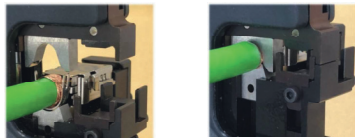

8. Install the housing.

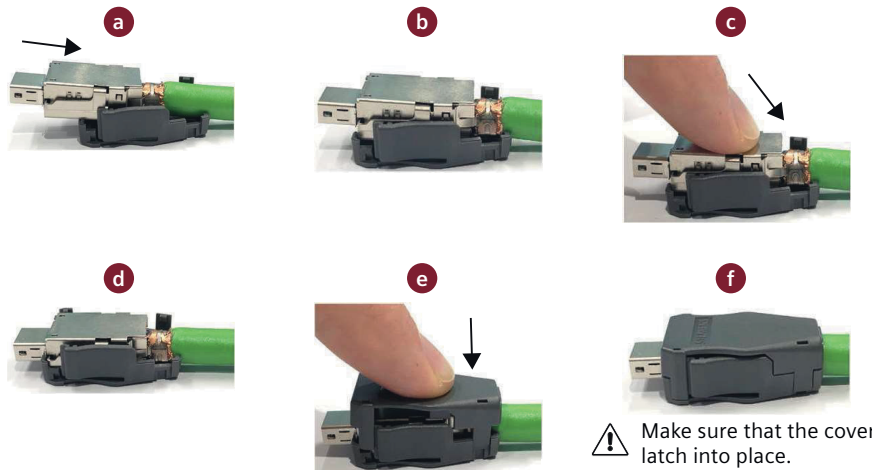

A.4.2.3 Assembling the I/O connector

Requirement

You have prepared appropriate tools, raw cables, and the Siemens 20-pin MDR connector.

Procedure

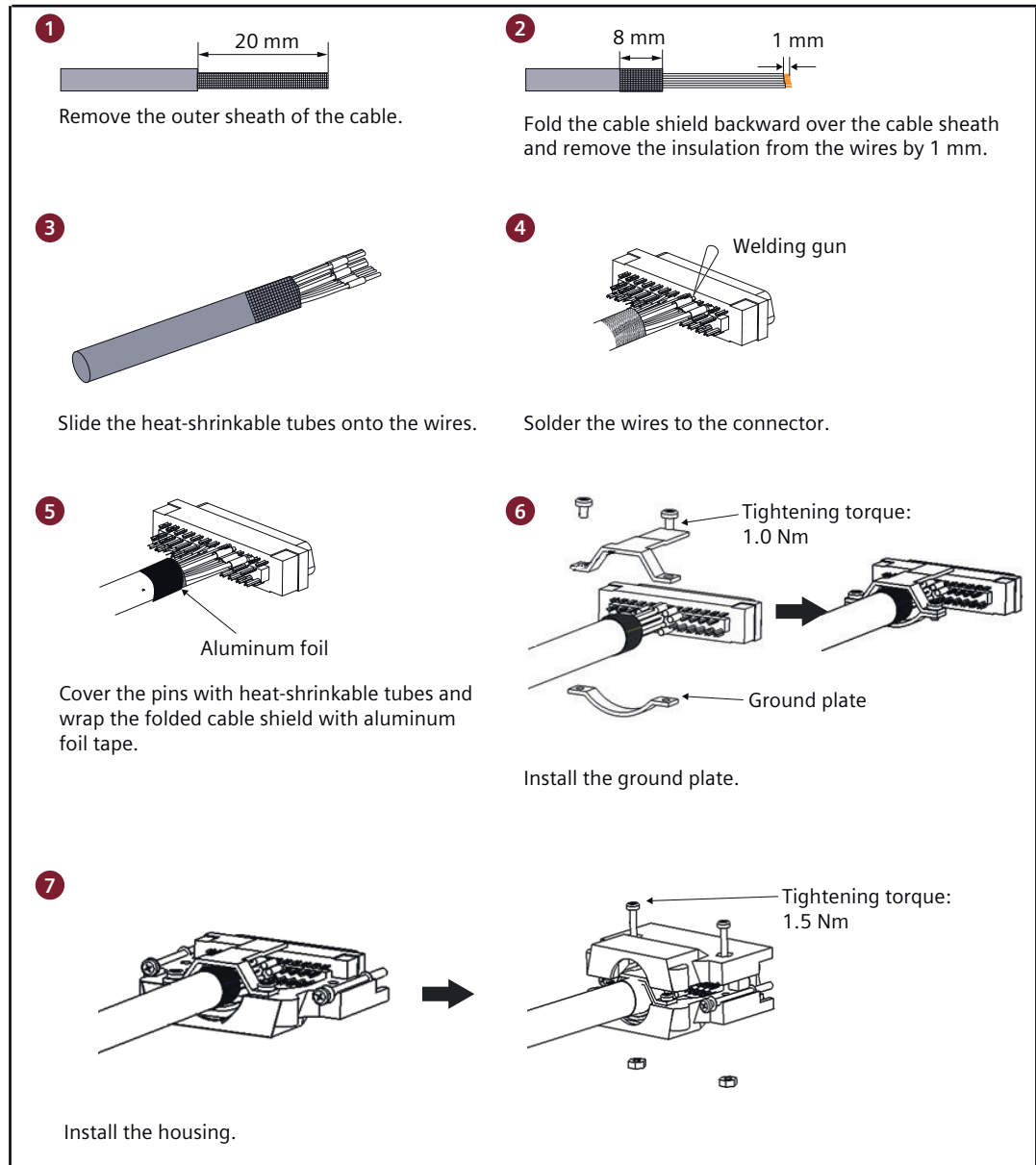

Figure A-2 Assembling the I/O cable

A.4.3 Assembling connectors on the motor side

A.4.3.1 Assembling the hybrid plug for 1FL2 motors, shaft heights 20, 30, and 40

Overview

The Siemens hybrid plug is used for connecting the converter to the motor and the encoder in the motor. It consists of the following components:

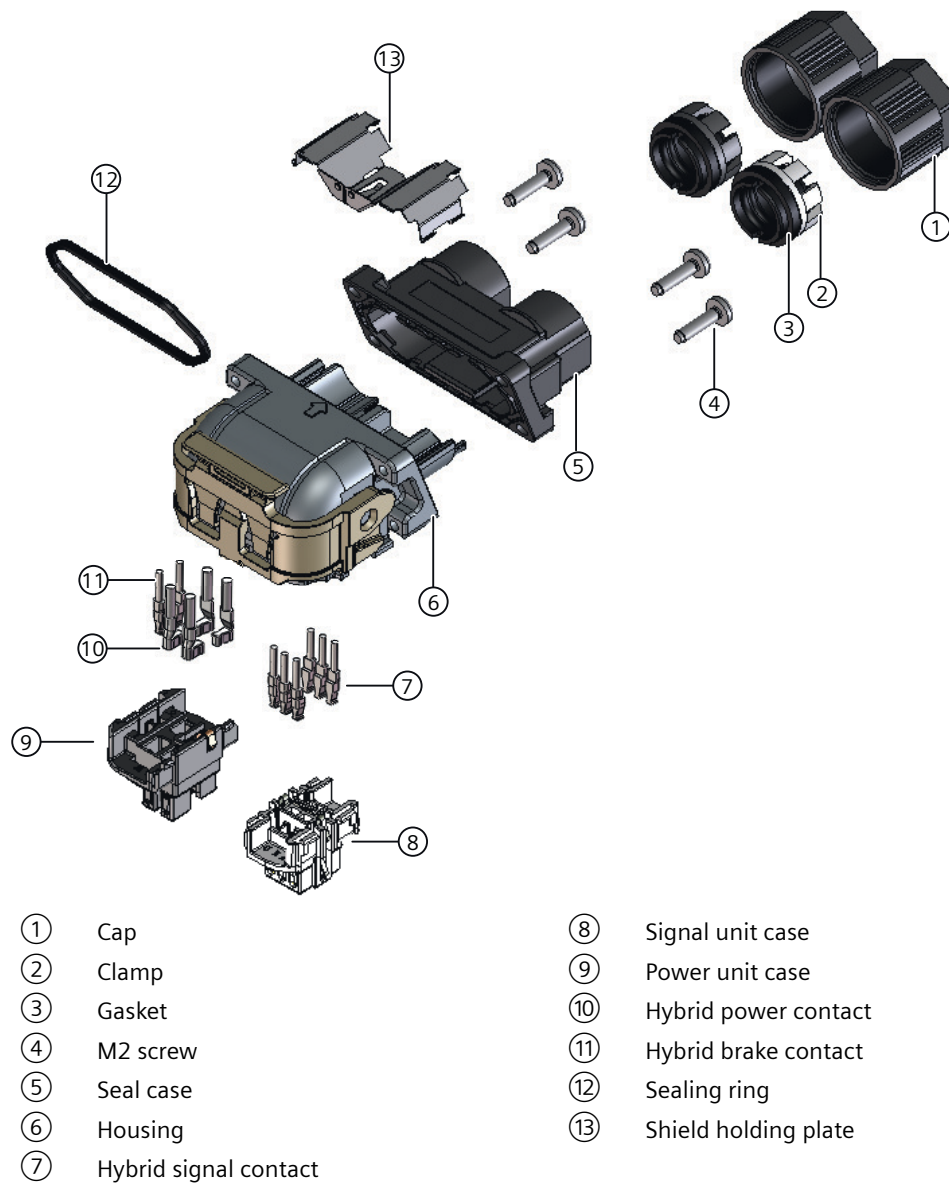

- | | | | |
|---|-----------------------|---|----------------------|
| ① | Cap | ⑧ | Signal unit case |
| ② | Clamp | ⑨ | Power unit case |
| ③ | Gasket | ⑩ | Hybrid power contact |
| ④ | M2 screw | ⑪ | Hybrid brake contact |
| ⑤ | Seal case | ⑫ | Sealing ring |
| ⑥ | Housing | ⑬ | Shield holding plate |
| ⑦ | Hybrid signal contact | | |

Figure A-3 Hybrid plug overview

Requirement

You have prepared the following items:

- Raw cables
Reserve 58 mm at the ends of the cables for termination into the hybrid connector.

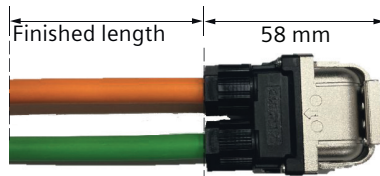

- Siemens hybrid plug
- Copper tapes
- Scissor
- Screwdriver
- Crimping tool

Procedure

1. Prepare the power cable.
 - Slide the cap, the clamp, and the gasket onto the power cable.
 - Remove the outer sheath of the cables by $25\text{ mm} \pm 1\text{ mm}$.
 - Loosen the braided shield of the cable and fold the shield backward over the cable sheath.
 - Remove the foil shield. If the power cable is integrated with the brake conductors, additionally loosen the braided shield of the brake cable and fold its shield backward over the cable sheath.
 - Cut the folded shield to make sure that the length of the folded shield is $8\text{ mm} \pm 1\text{ mm}$. Remove the debris to ensure cable insulation.
 - Wrap around the shield 1.5 to 2 times with copper tapes.

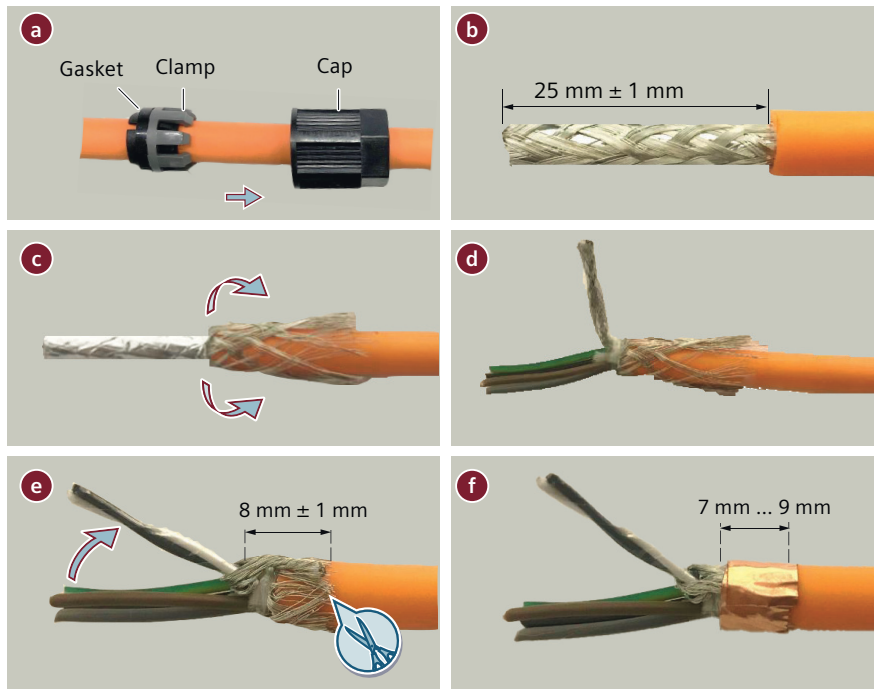

2. Prepare the encoder cable.
 - Slide the cap, the clamp, and the gasket onto the encoder cable.
 - Remove the outer sheath of the cables by $25\text{ mm} \pm 1\text{ mm}$.
 - Loosen the braided shield of the cable and fold the shield backward over the cable sheath. Cut the folded shield to make sure that the length of the folded shield is $8\text{ mm} \pm 1\text{ mm}$. Remove the debris to ensure cable insulation.
 - Wrap around the shield 1.5 to 2 times with copper tapes.
 - Remove the foil shield.

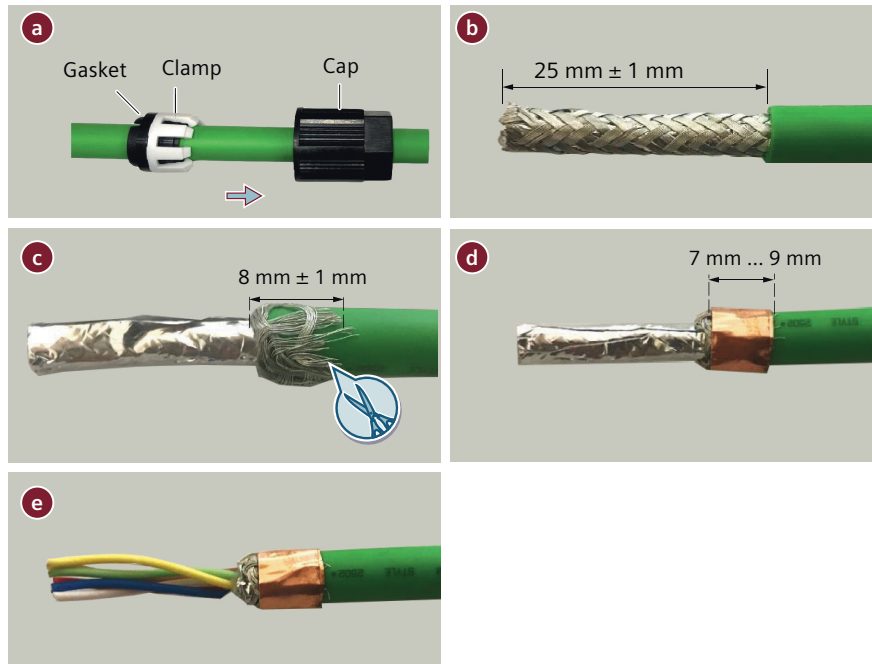

3. Arrange and cut the conductors.

The conductor length required for termination into the hybrid plug varies depending on the variant of the hybrid plug and the contacts. Conductors that are close to the cable outlet should be cut 3 mm more.

Conductor	Conductor length requirement (mm)	
	Drive-end variant	Non-drive end variant
Power conductor U	25 ± 1	22 ± 1
Power conductor V	22 ± 1	25 ± 1
Power conductor W	25 ± 1	22 ± 1
PE conductor	22 ± 1	25 ± 1
Brake conductor +	25 ± 1	25 ± 1
Brake conductor -	25 ± 1	25 ± 1
Signal conductors A, B, and C	22 ± 1	25 ± 1
Signal conductors D, E, and F	25 ± 1	22 ± 1

The following images show the conductor length requirement of the drive-end hybrid plug.

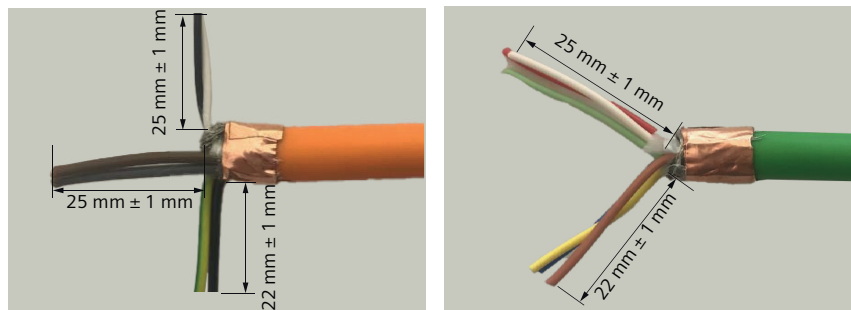

4. Strip the power and PE conductors by 2.4 mm ± 0.5 mm, and encoder and brake conductors by 2.2 mm ± 0.5 mm.

5. Crimp the contacts onto the conductors. Make sure that the lance side of the contacts face outwards.

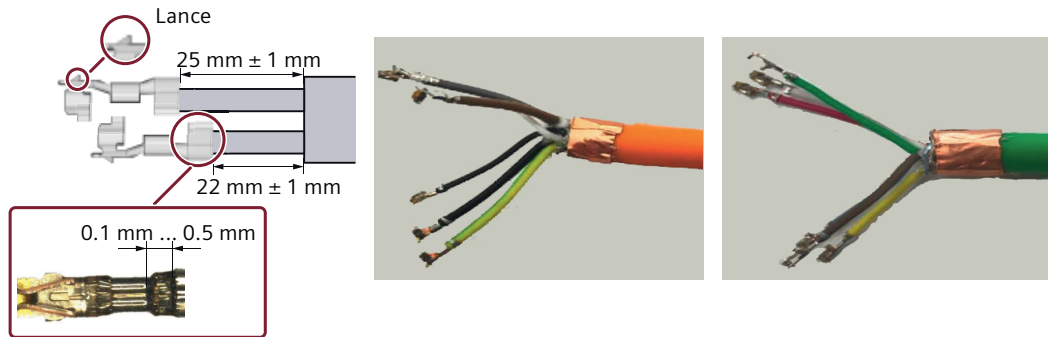

6. Slide the power and signal cables through the seal case and the housing. Avoid deforming the contact tips. Siemens recommends that you protect the conductors with a tape during the process.

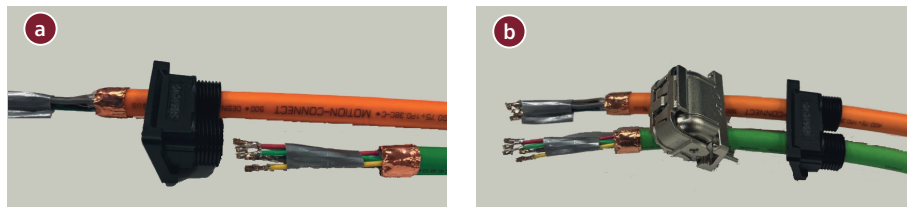

7. Insert the power and brake contacts into the power unit case and adjust the conductors to make sure that the cable does not rise up.

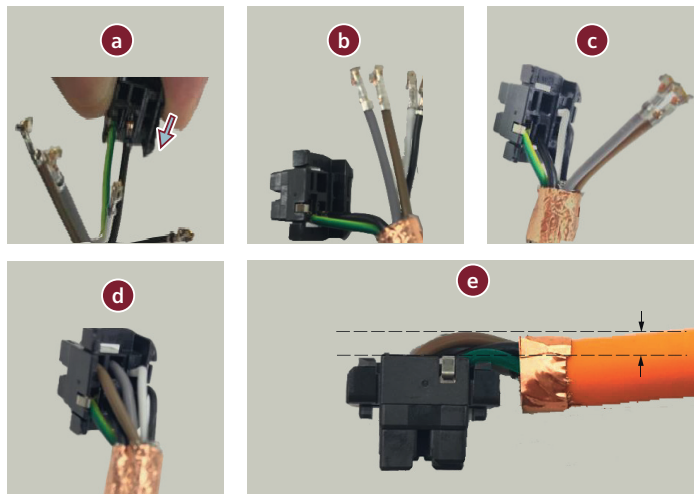

8. Insert the signal contacts into the signal unit case and adjust the conductors to make sure that the cable does not rise up.

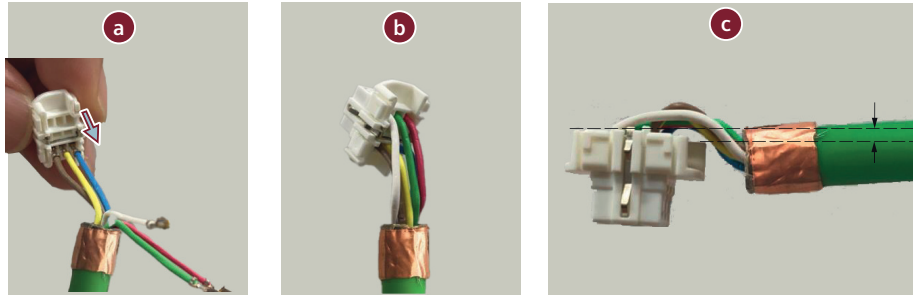

9. Insert the signal and the power unit cases into the housing by pulling the cables back. Make sure that the signal and the power unit cases are latched to the housing.

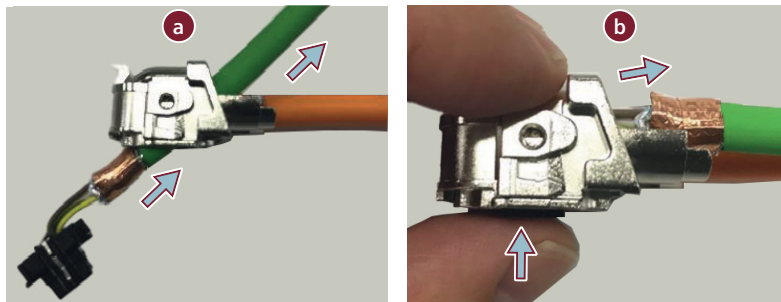

10. Insert the shield holding plate into the housing.

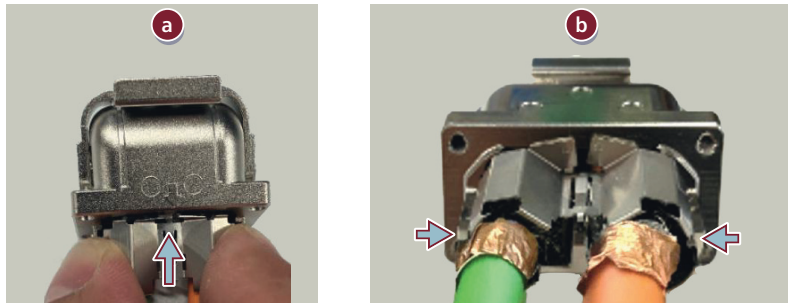

11. Assemble the housing and the seal case.

- Hold the shield holding plate and slide the seal case to the housing.
- Tighten the M2 screws with a tightening torque of $0.18 \text{ Nm} \pm 0.01 \text{ Nm}$.

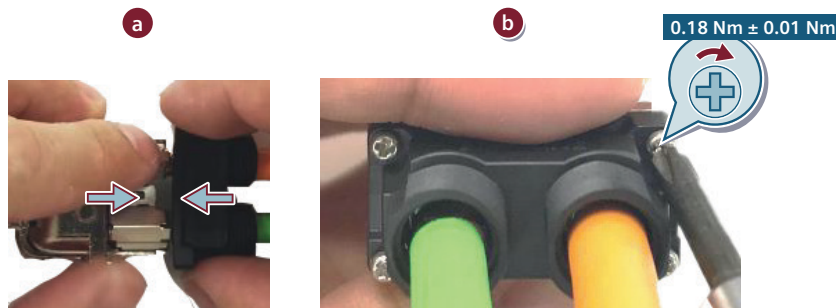

12. Insert the gaskets and the clamps to the seal case.

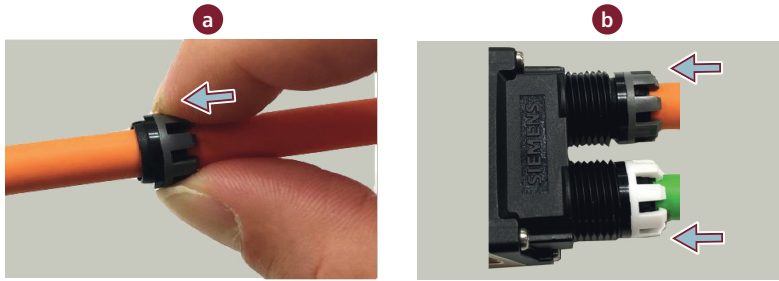

13. Tighten the caps.

- Rotate the caps in the counterclockwise direction to match the threads of the seal case and the caps.
- Rotate the caps in the clockwise direction.
- Tighten the caps by wrench with a tightening torque of $1.5 \text{ Nm} \pm 0.01 \text{ Nm}$.

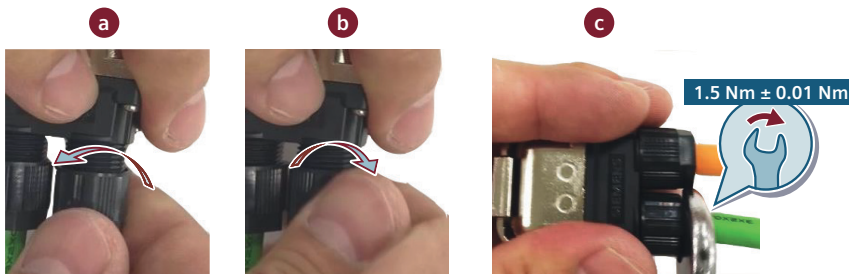

More information

For more information about connecting the converter and the motor, see Section "Connecting the motor (Page 135)".

A.4.3.2 Assembling connectors for 1FL2 motors, shaft heights 48 and 52

Overview

This section offers assembly instructions for power and encoder cables of the 1FL2 motors shaft heights 48 and 52.

Requirement

You have prepared appropriate tools, raw cables, and the Siemens M17 connector.

Procedure

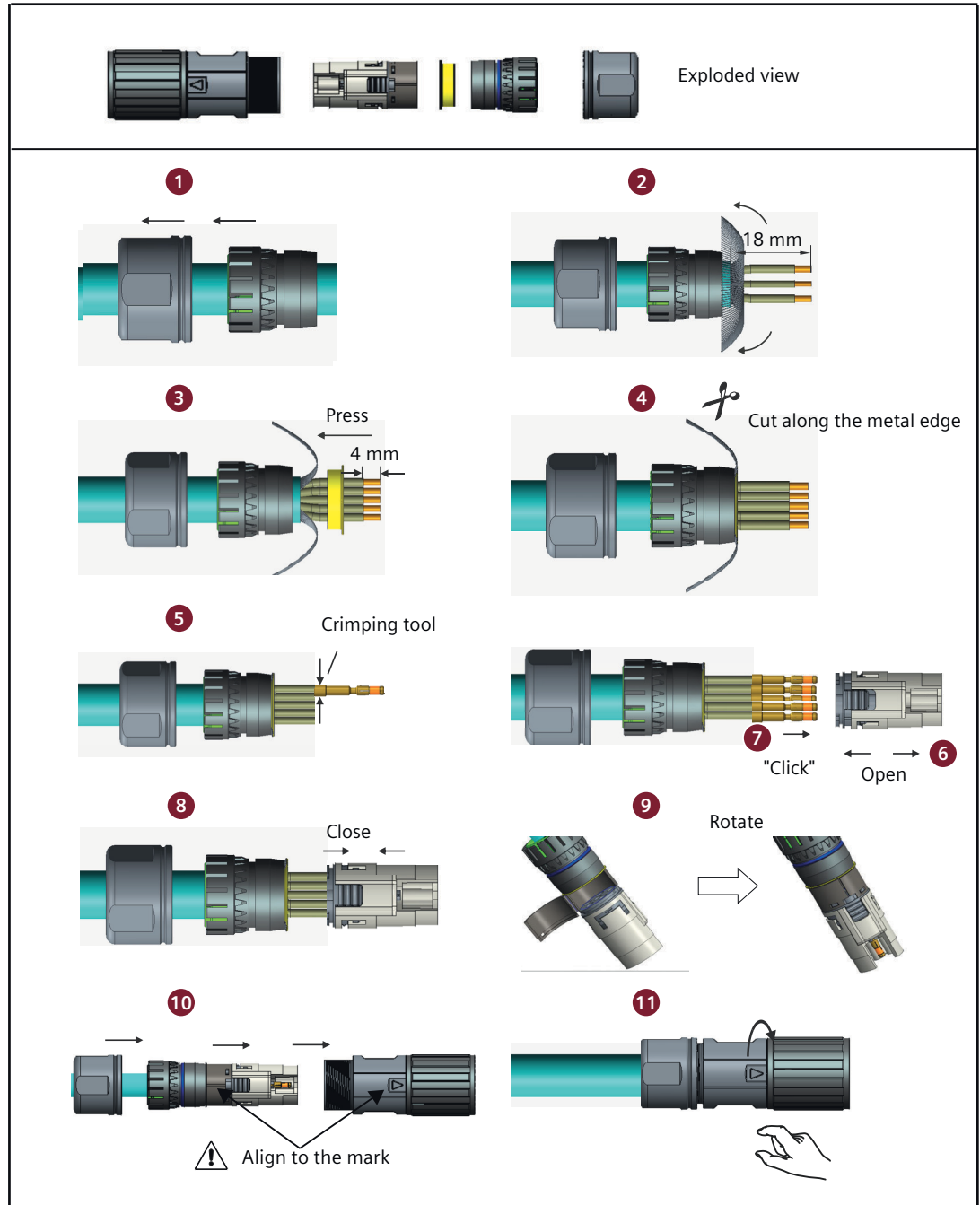

Figure A-4 Assembling the power or encoder cable of the 1FL2 motor shaft height 48 or 52

More information

For more information about connecting the converter and the motor, see Section "Connecting the motor (Page 135)".

A.4.3.3 Assembling connectors for 1FL2 motors, shaft heights 45, 65 and 90

Assembling the power connector

Requirement

You have prepared appropriate tools, raw cables, and the Siemens M23 connector.

Procedure

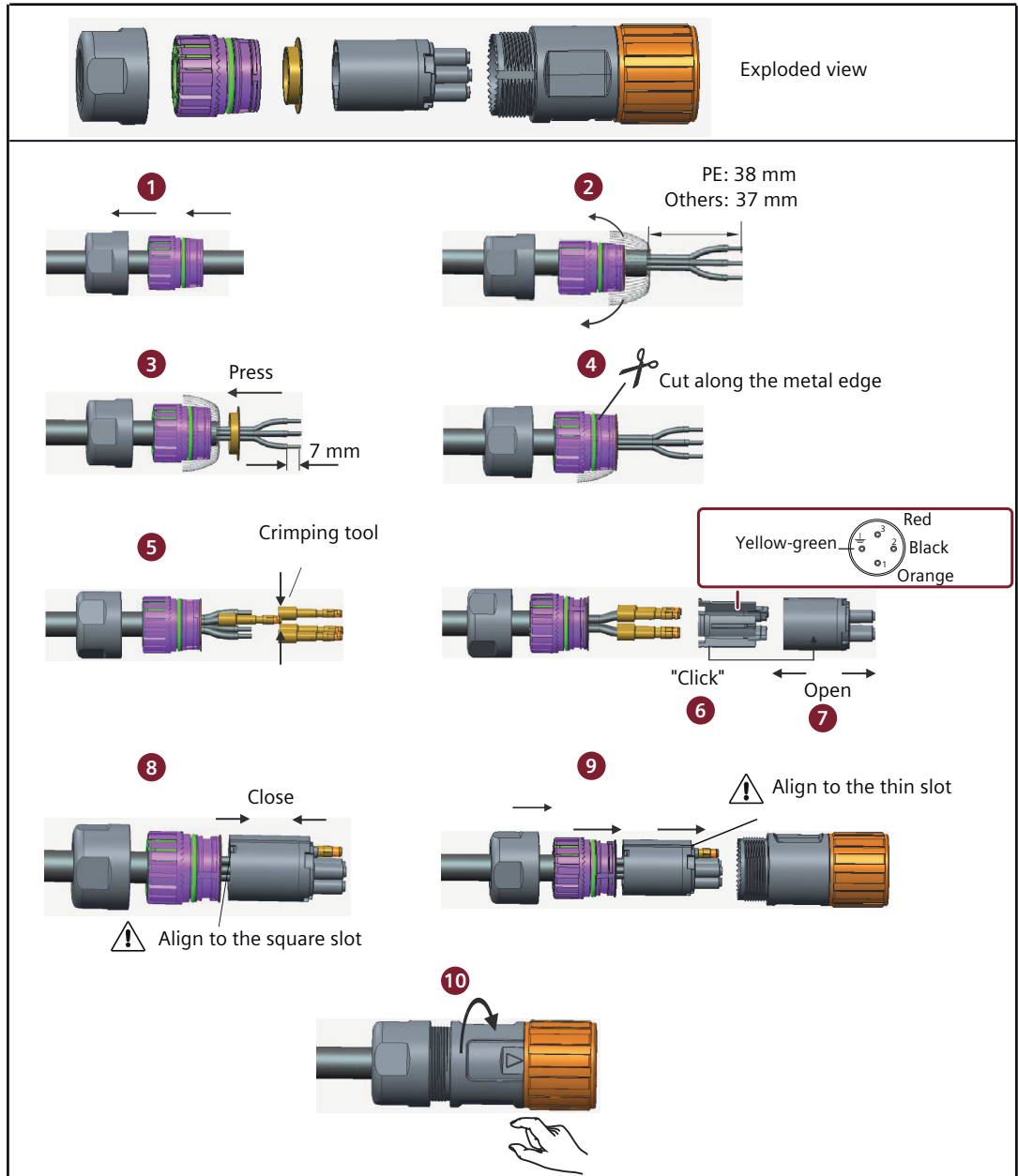

Figure A-5 Assembling the power cable of the 1FL2 motor shaft height 45, 65, or 90

More information

For more information about connecting the converter and the motor, see Section "Connecting the motor (Page 135)".

Assembling the encoder connector

Requirement

You have prepared appropriate tools, raw cables, and the Siemens M17 connector.

Procedure

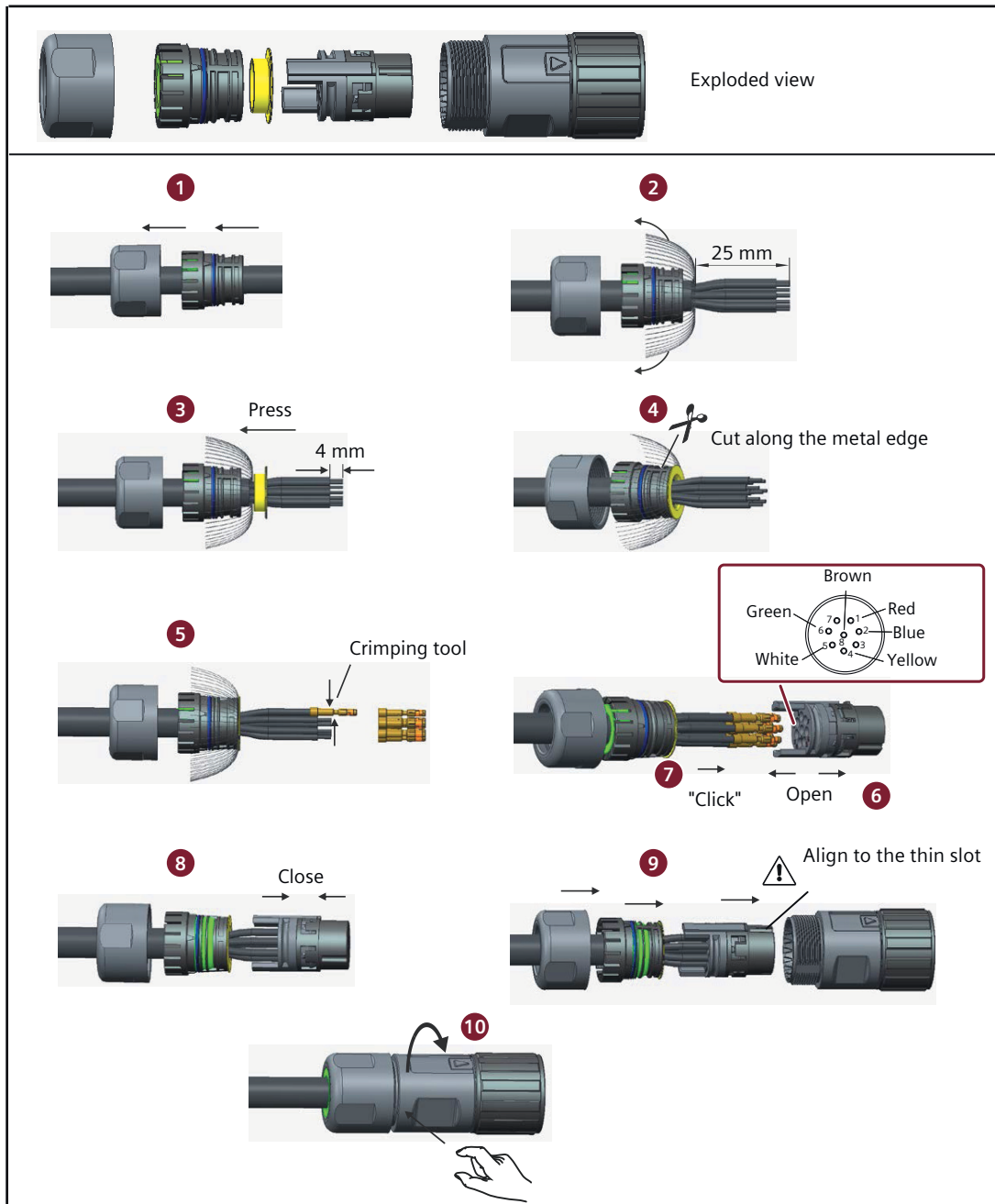

Figure A-6 Assembling the encoder cable of the 1FL2 motor shaft height 45, 65, or 90

More information

For more information about connecting the converter and the motor, see Section "Connecting the motor (Page 135)".

Assembling the motor holding brake connector

Requirement

You have prepared appropriate tools, raw cables, and the Siemens M17 connector.

Procedure

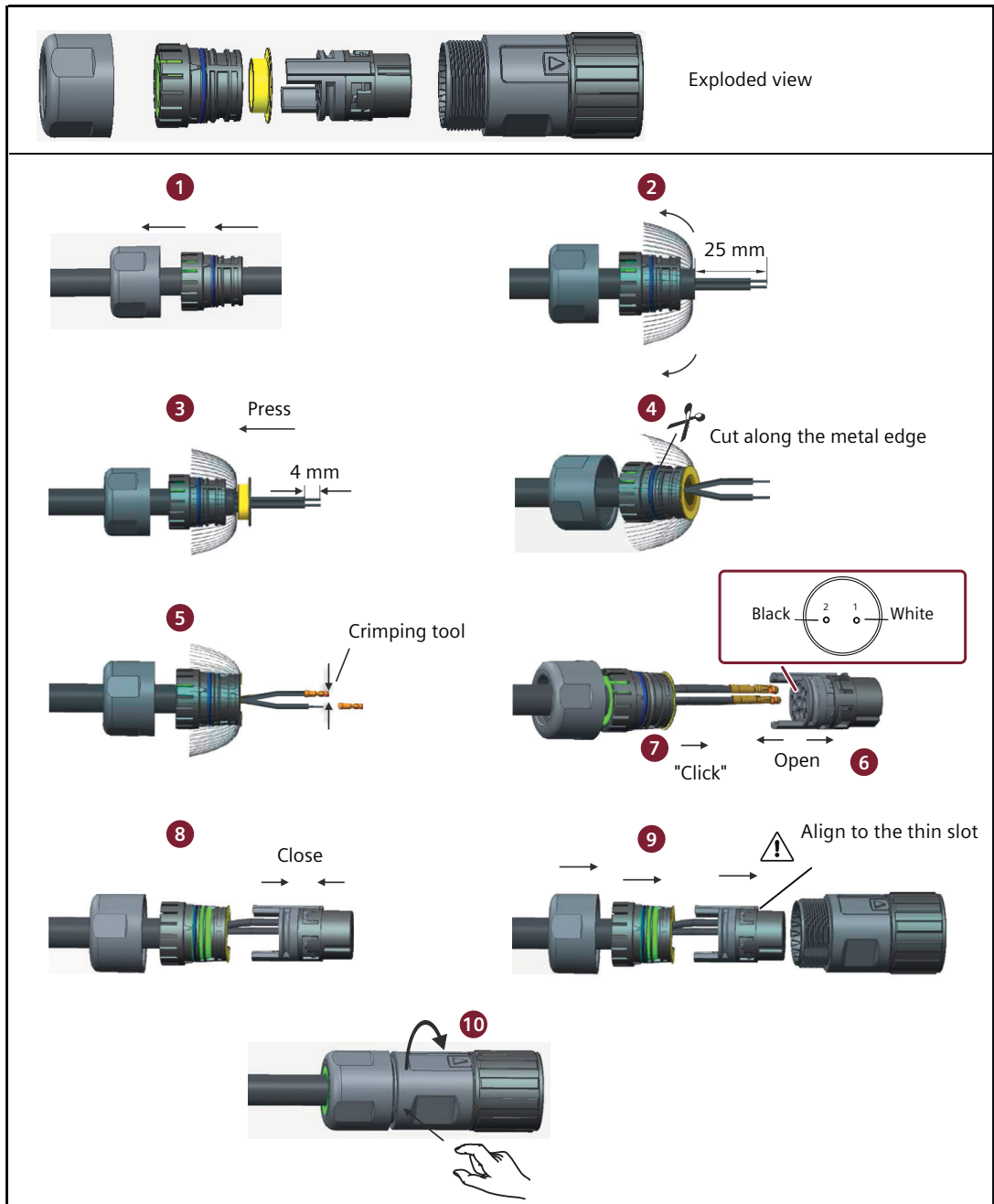

Figure A-7 Assembling the holding brake cable the 1FL2 motor shaft height 45, 65, or 90

More information

For more information about connecting the converter and the motor, see Section "Connecting the motor (Page 135)".

A.5 Motor selection

A.5.1 Selection procedure

Overview

The following section shows the principal steps for selecting a suitable motor. Then you can calculate the moment of inertia of your system and the braking energy accordingly.

Requirement

None

Procedure

Proceed as follows to select a motor:

1. Determine the mechanism type as well as the detailed data of the related mechanical parts, such as ball screw lead, diameter, lead, and gear diameter. Three mechanism types are shown below:

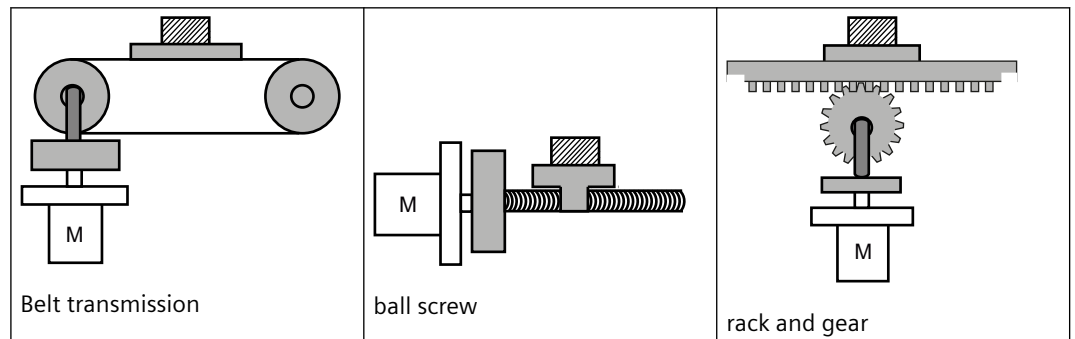

2. Determine the operation pattern including such parameters as acceleration time (t_a), constant motion time (t_u), deceleration time (t_d), stopping time (t_s), cycle time (t_c), and travel distance (L).
3. Calculate load inertia and inertia ratio.
The inertia ratio can be obtained by dividing the load inertia by the rotor inertia of the selected motor. The unit of inertia is $\times 10^{-4} \text{ kg}\cdot\text{m}^2$.
4. Calculate the speed.
Calculate the speed according to the travel distance, acceleration time, deceleration time, and constant motion time.
5. Calculate the torque.
Calculate the torque according to the load inertia, acceleration time, deceleration time, and constant motion time.
6. Select the motor.
Select the motor that matches the data in step 3 to step 5.

Typical load inertia equations

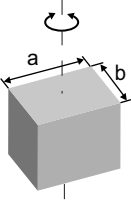
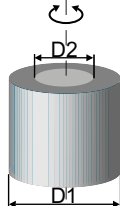
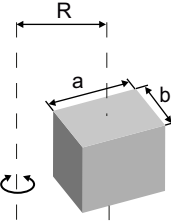
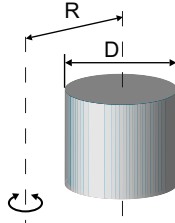
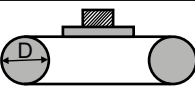
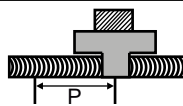
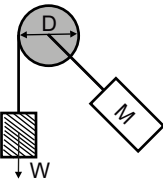
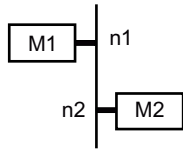
Mechanism	Equation	Mechanism	Equation
 <p>Axis of rotation on center</p>	$J = \frac{W}{12} (a^2 + b^2)$ <p>W: Mass (kg) a: Length (m) b: Width (m)</p>	 <p>Axis of rotation on center</p>	$J = \frac{W}{8} (D_1^2 + D_2^2)$ <p>W: Mass (kg) D₁: External diameter (m) D₂: Internal diameter (m)</p>
 <p>Axis of rotation off center</p>	$J = W \cdot \left(\frac{a^2 + b^2}{3} + R^2 \right)$ <p>W: Mass (kg) a: Length (m) b: Width (m) R: Rotational diameter (m)</p>	 <p>Axis of rotation off center</p>	$J = \frac{W}{8} (D^2 + 8R^2)$ <p>W: Mass (kg) D: Workpiece diameter (m) R: Rotational diameter (m)</p>
 <p>Conveyor</p>	$J = \frac{W \cdot D^2}{4}$ <p>W: Mass (kg) D: Pulley wheel diameter (m)</p>	 <p>Ball screw</p>	$J = \frac{W \cdot P^2}{4\pi^2} + J_b$ <p>W: Mass (kg) P: Lead (m) J_b: Ball screw inertia (kg·m²)</p>
 <p>Object hung with pulley</p>	$J = W \cdot \left(\frac{D}{2} \right)^2 + J_p$ <p>W: Mass (kg) D: Pulley wheel diameter (m) J_p: Pulley inertia (kg·m²)</p>	 <p>Reducer</p>	$J = J_1 \cdot \frac{n_1^2}{n_2^2} \cdot J_2$ <p>W: Mass (kg) n₁/n₂: Speed of each motor (rpm) J₁/J₂: Inertia of each motor (kg·m²)</p>

A.5.2 Selection examples

Description

This section uses a ball screw mechanism as an example to illustrate the motor selection procedure.

Exemplary data

The following table lists the data related to the ball screw mechanism and operation pattern.

Workpiece weight	W	40 kg
Material density of the ball screw	ρ	7.9 × 10 ³ kg/m ³

Ball screw length	B_l	2 m
Ball screw diameter	B_d	0.04 m
Ball screw pitch	B_p	0.04 m
Mechanical efficiency	B_η	0.9
Coupler inertia (refer to the supplier's product catalog)	J_c	$20 \times 10^{-6} \text{ kgm}^2$
Acceleration time	t_a	0.15 s
Constant motion time	t_u	0.7 s
Deceleration time	t_d	0.15 s
Cycle time	t_c	2 s
Travel distance	L	0.5 m
Gravitational acceleration	g	9.81 m/s^2
Frictional coefficient	μ	0.025

Calculating velocity

Maximum traveling velocity:

$$V_{\max} = \frac{2 \cdot L}{t_a + 2 \cdot t_u + t_d} = \frac{2 \times 0.5}{0.15 + 2 \times 0.7 + 0.15} = 0.588 \text{ m/s}$$

Calculating forces, pitch angle and friction angle

Frictional force:

$$F_R = \mu \cdot W \cdot g = 0.025 \times 40 \times 9.81 = 9.81 \text{ N}$$

Accelerating force/decelerating force:

$$F_a = F_d = W \cdot \frac{V_{\max}}{t_a} = 40 \times \frac{0.588}{0.15} = 156.8 \text{ N}$$

Pitch angle of the ball screw:

$$\alpha_B = \arctan \frac{B_p}{\pi \cdot B_d} = \arctan \frac{0.04}{3.14 \times 0.04} = 0.308 \text{ rad}$$

Friction angle of the ball screw:

$$\beta = \arctan \frac{B_p}{\pi \cdot B_d \cdot B_\eta} - \alpha_B = \arctan \frac{0.04}{3.14 \times 0.04 \times 0.9} - 0.308 = 0.0321 \text{ rad}$$

Calculating torques for the ball screw and the coupling when accelerating and decelerating

Angular velocity of the ball screw at V_{\max} :

$$\omega_{\max B} = \frac{2 \cdot \pi \cdot V_{\max}}{B_p} = \frac{2 \times 3.14 \times 0.588}{0.04} = 92.316 \text{ s}^{-1}$$

Maximum rotating velocity:

$$n_{motor\ max} = \frac{\omega_{max\ B} \cdot 60}{2 \cdot \pi} = \frac{92.316 \times 60}{2 \times 3.14} = 882\ rpm$$

Angular acceleration of the ball screw:

$$\alpha_{aB} = \frac{\omega_{max\ B}}{t_a} = \frac{92.316}{0.15} = 615.44\ s^{-2}$$

Ball screw weight:

$$B_W = \rho \cdot \pi \cdot \left(\frac{B_d}{2}\right)^2 \cdot B_l = 7.9 \times 10^3 \times 3.14 \times \left(\frac{0.04}{2}\right)^2 \times 2 = 19.84\ kg$$

Moment of inertia of the ball screw:

$$J_B = \frac{B_W}{8} \cdot B_d^2 = \frac{19.84}{8} \times 0.04^2 = 0.00397\ kgm^2$$

Moment of inertia of the ball screw + coupling:

$$J_{B+c} = J_B + J_c = 0.00397 + 0.00002 = 0.00399\ kgm^2$$

Accelerating torque and decelerating torque for the ball screw + coupling:

$$M_{aB+c} = M_{dB+c} = J_{B+c} \cdot \alpha_{aB} = 0.00399 \times 615.44 = 2.46\ Nm$$

Preselecting the motor

Based on the calculated torques, if we select the 1FL2306-2AC motor:

$$n_n = 2000\ rpm, M_n = 4.78\ Nm, J_{motor} = 1.326 \times 10^{-3}\ kgm^2$$

Then the inertia ratio:

$$\frac{J_{load}}{J_{motor}} = \frac{J_{B+c} + J_W}{J_{motor}} = \frac{0.00399 + 0.0016}{1.326 \times 10^{-3}} = 4.22$$

Wherein, J_W is the moment of inertia of the workpiece:

$$J_W = W \cdot \frac{B_p^2}{4 \cdot \pi^2} = 40 \times \frac{0.04^2}{4 \times 3.14^2} = 0.0016\ kgm^2$$

Calculating the motor torques during the constant motion phase

$$M_{motor} = F_R \cdot \frac{B_d}{2} \cdot \tan(\alpha_B + \beta) = 9.81 \times \frac{0.04}{2} \times \tan(0.308 + 0.0318) = 0.069\ Nm$$

Calculating the motor torques when accelerating and decelerating

Accelerating torque and decelerating torque for the motor:

$$M_{amotor} = M_{dmotor} = J_{motor} \cdot \alpha_{aB} = 1.326 \times 10^{-3} \times 615.44 = 0.82 Nm$$

Motor torque when accelerating:

$$\begin{aligned} M_{motor} &= M_{amotor} + M_{aB+c} + (F_a + F_R) \cdot \frac{B_d}{2} \cdot \tan(\alpha_B + \beta) \\ &= 0.82 + 2.46 + (156.8 + 9.81) \times \frac{0.04}{2} \times \tan(0.308 + 0.0318) = 4.458 Nm \end{aligned}$$

Motor torque when decelerating:

$$\begin{aligned} M_{motor} &= -M_{dmotor} - M_{aB+c} + (-F_a + F_R)^* \cdot \frac{B_d}{2} \cdot \tan(\alpha_B + \beta \cdot \text{sign}(+)^*) \\ &= -0.82 - 2.46 + (-156.8 + 9.81) \times \frac{0.04}{2} \times \tan(0.308 - 0.0318) = -4.113 Nm \end{aligned}$$

* If the expression in brackets has a negative sign, the sign of β changes to minus.

Final selection

According to the above calculated speed, torque, and inertia ratio, 1FL2306-2AC motor is suitable.

Further information

SINAMICS:
www.siemens.com/sinamics

SIMOTICS:
www.siemens.com/simotics

Siemens AG
Digital Industries
Motion Control
P.O. Box 3180
91050 Erlangen
Germany

Scan the QR code
for additional
information about
the product.

