

Panasonic

High-grade Model
CO₂ Laser Marker

LP-400 SERIES

FDA

Conforming to
FDA regulations
(LP-400-A only)

CE

Conforming to Low Voltage
and EMC Directive
(LP-400-C only)

UL US

Listing
(LP-400-A only)



Exceptional performance.
Advanced functionality. Flawless quality.
The CO₂ Laser Marker High-grade Model.

LP-400_{SERIES}



Standard model



Tower head model

Enhanced lineup is easier to use than ever.

Select the features that are right for your application.

30 W

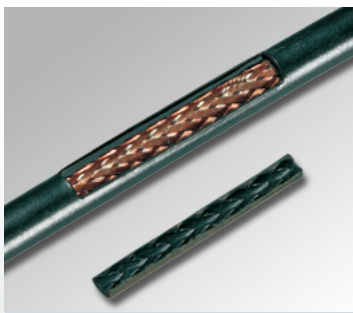

Removing cable insulation

20 W(short wavelength)



Marking PET bottles

10 W



Marking pouch packaging

Performance. Functionality. Quality. Operability.
The high-grade LP-400 CO₂ Laser Marker delivers,
meeting needs ranging from marking to processing.

High-performance galvanoscanner

Improved productivity

High-speed marking over 700 cps*

Improved productivity means dramatically reduced tact time
and compatibility with high-speed production lines.

High-stability laser

Support for a wide range of applications

Laser output stability of within $\pm 3\%$ (typ.)*
ensures consistent marking and high-quality
processing over the full output range.

Extensive lineup

Freedom of installation

The proprietary rotating head found on standard models and
the additional freedom of installation provided by a selection of
tower head models provide the performance to meet a variety of needs.

Choose the model that is right for your application

Convenient operation

In keeping with Panasonic Industrial Devices SUNX's stubborn commitment
to exceptional ease of use and operability, the LP-400 can be controlled from
a computer with the Laser Marker NAVI application or by using a simple
touch panel console.

* Excluding 10 W type

High-speed marking at 700 cps*

Three times the productivity means less time and equipment.

Capable of marking at speeds of 700 cps, the LP-400 can deliver more than three times the productivity of previous models thanks to its shorter tact time. Enjoy dramatically reduced equipment costs since a single laser marker can now handle applications that previously required multiple units.

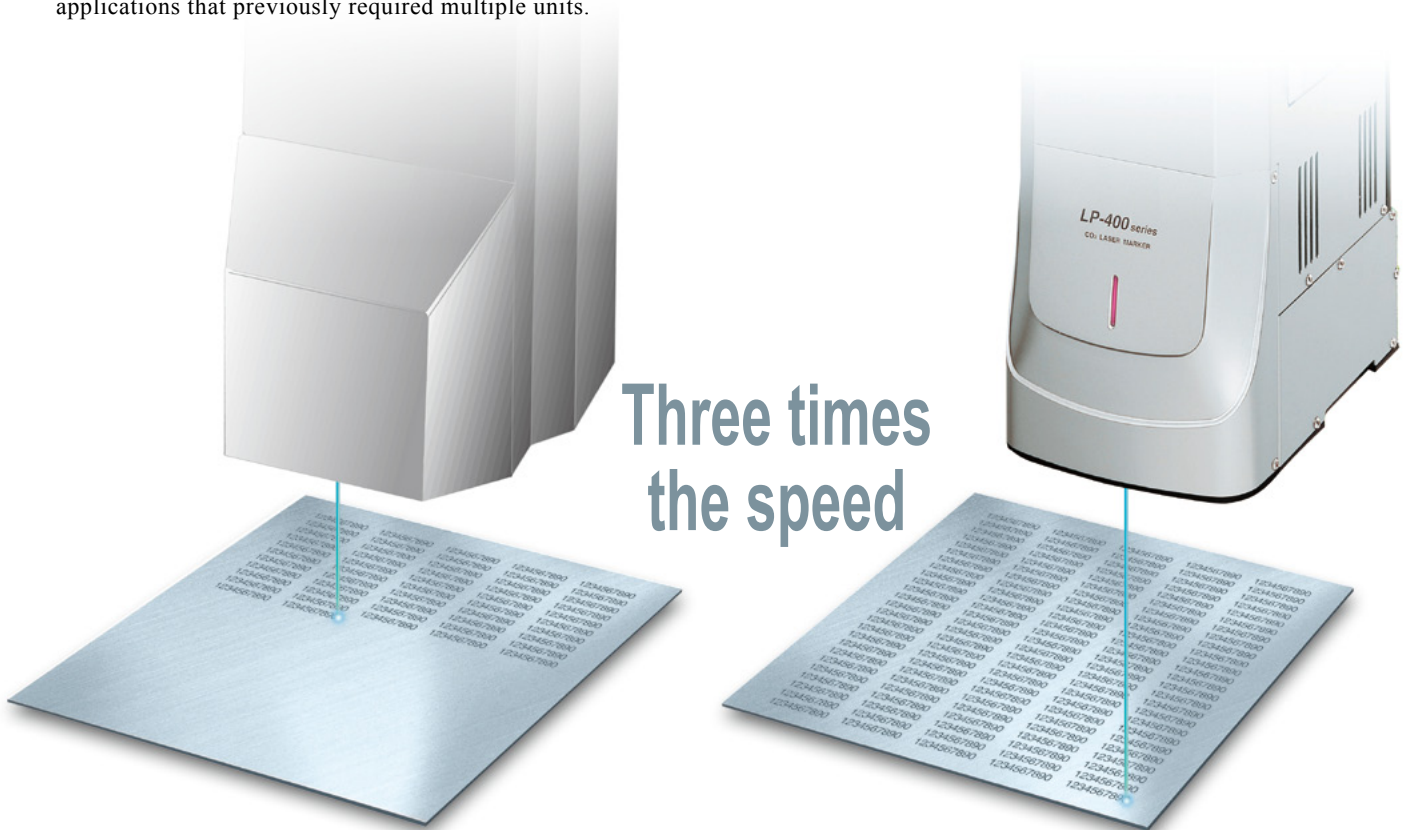

Previous models
200 cps



LP-400
700 cps*

* Excluding 10 W type

Helping drive increased productivity

The high-speed marking capabilities of the LP-400 series dramatically improve productivity by reducing tact time. Thanks to the high-performance galvanoscanner and other advanced technology, series models can mark on objects moving at high speed.



LP-400 SERIES

Reduced marking tact time

The LP-400 series features a high-performance galvanoscanner whose acceleration, deceleration, and response speeds exceed those of previous models by at least 200 %, delivering dramatically shorter marking tact time.

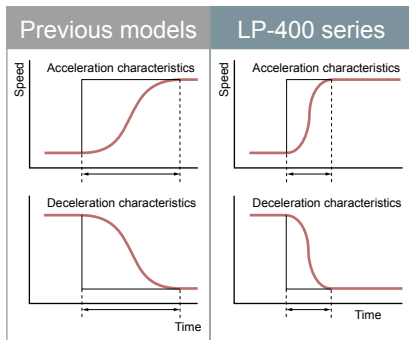

Simulated Characteristics of High-performance Galvanoscanner

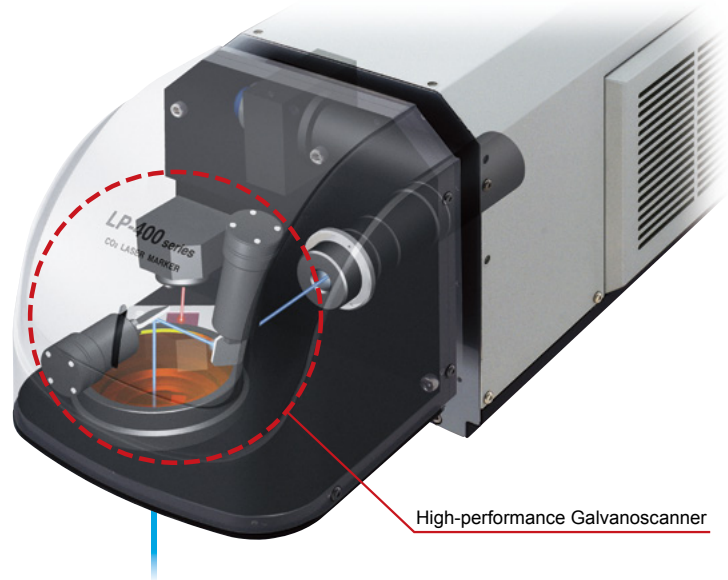

High-performance Galvanoscanner

Accurate marking at high speed

Panasonic Industrial Devices SUNX's proprietary galvanoscanner control technology keeps marking accurate and aligned, even at high speed.

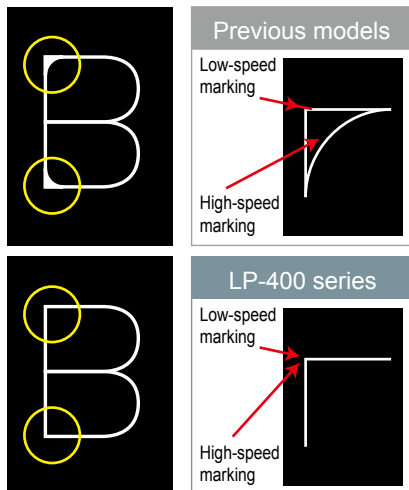

Improved marking resolution

Proprietary servo technology delivers marking resolutions of $1\mu\text{m}$ **0.039 mil***, enabling more accurate marking - a key capability when outputting super-small characters.

* Small-spot type

Step and Repeat feature

Step and Repeat provides high-speed batch marking for printed circuit boards and plastic packaging such as trays and lead frames, helping increase speeds on semiconductor and electronic component production lines where short tact times of 0.1 seconds are imperative.

Step and Repeat example

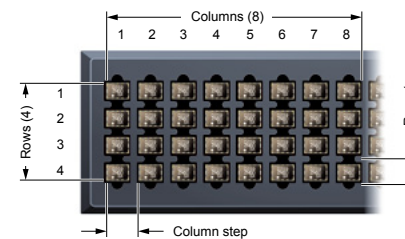

Serial data marking feature

With previous models, data such as characters and 2D codes had to be sent from the control computer separately. Thanks to revamped software, the LP-400 series supports batch transfers of data to the laser marker, simplifying complex code transfer procedures and preventing marking mistakes caused by data mix-ups.

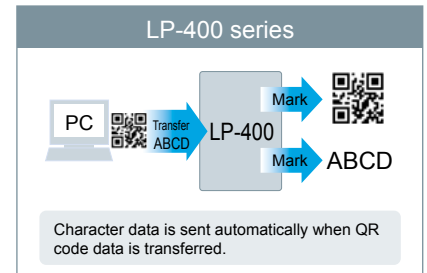
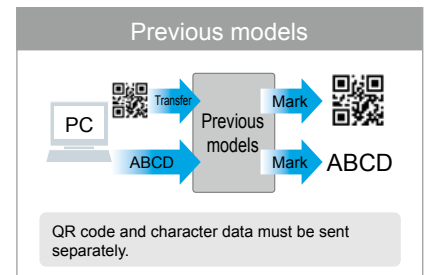

Marking order optimization feature

The LP-400 series automatically determines the most efficient marking order, further reducing tact times.

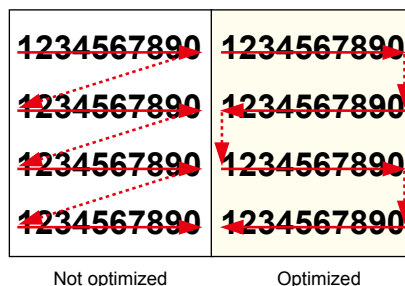

Laser output and wavelength options accommodate more applications.

Three available laser output levels: 10 W, 20 W, 30 W

Two available laser wavelengths: 10.6 μm 0.417 mil, 9.3 μm 0.366 mil



Marking product packaging

10.6 μm 0.417 mil fundamental wavelength laser for flexible marking

Crisp output and high-quality processing

With a laser output stability of within $\pm 3\%$ (typ.)*, 10.6 μm 0.417 mil wavelength models work well in applications ranging from marking thin films and other tricky substrates to processing tasks such as removing insulation from cables.

* Excluding 10 W type



Marking pouch packaging

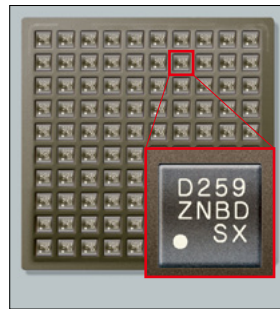

Marking low-profile electronic components



Removing cable insulation

Long-term output consistency

The oscillator has a soft seal design whose effectiveness has been well established. Large gas volume mechanism keeps marking output consistent over the long term.

RSS (GS1 DataBar) code support

The LP-400 series supports RSS (GS1 DataBar) and Composite codes, allowing product codes and other information to be output in a space-efficient manner on small medical products such as ampoules and vials. Both normal and reversed (white on a black background) marking modes are supported.

RSS (GS1 DataBar)

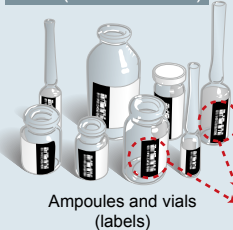

Ampoules and vials (labels)



RSS-14 (GS1 DataBar) Stacked

Composite



Medical product cases (packaging)



RSS (GS1 DataBar) Limited CC-A

* In addition to the above, the LP-400 series supports JIS-defined Barcodes (8) and 2D codes (QR, Data Matrix, etc.).

LP-400 SERIES

9.3 μm 0.366 mil short-wavelength laser for marking PET and PC plastics

Well-matched to the heat absorption characteristics of plastics, the 9.3 μm 0.366 mil wavelength laser allows marking on plastic surfaces by melting the surface layer without creating excessively deep marking and limiting damage to the substrate. This capability rectifies issues with the previous models where deep marking would create pinholes or otherwise make marking output difficult to read.

- PET plastic absorption characteristics (representative example)

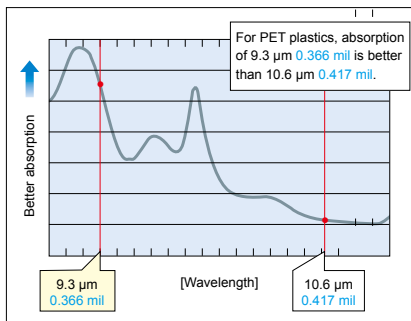

- PC plastic absorption characteristics (representative example)

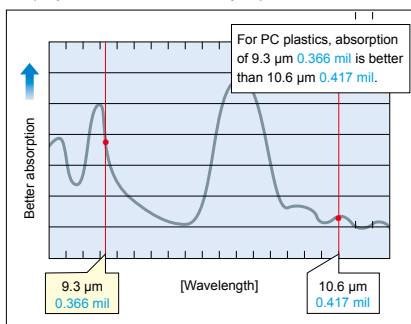

High-quality processing

Short-wavelength laser radiation is readily absorbed by plastics, allowing the creation of sharp edges and increasing dimensional accuracy.

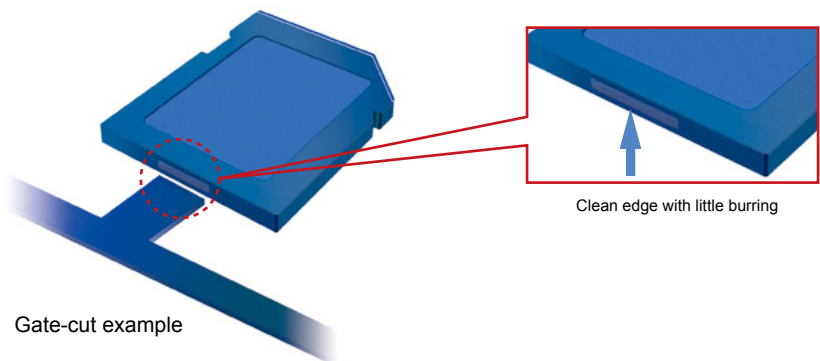

Technologies behind high-quality marking

The LP-400 series leverages a number of new technologies to create crisp, high-quality marking.

Intersection correction

Advanced control functionality prevents excessively deep marking where lines intersect, eliminating the tendency of overlapping lines to distort the shape of output characters in previous models.

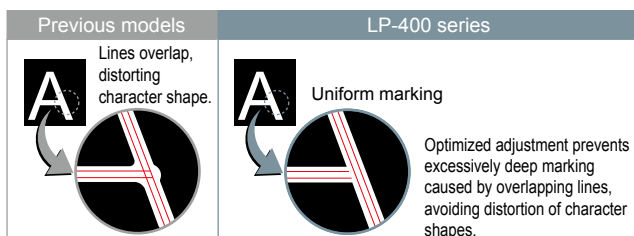

Depth control

The LP-400 series automatically adjusts marking strength at locations susceptible to deep marking such as the beginning and ends of lines and areas where straight and curved lines intersect. The result is beautiful output with uniform line depth.

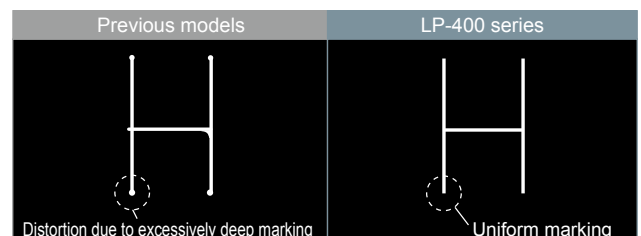

Flexible support for all production lines Select the installation/marketing orientation and marking area that is right for your application.

Two available head types: Vertical, Horizontal
Three available marking areas: 55 mm **2.2 in**, 110 mm **4.3 in**,
160 mm **6.3 in** square

Panasonic Industrial Devices SUNX has met the needs of diversifying production lines with an extensive lineup of models with both tower and standard heads as well as three available marking areas ranging from 55 mm × 55 mm **2.2 in × 2.2 in** to 160 mm × 160 mm **6.3 in × 6.3 in**.

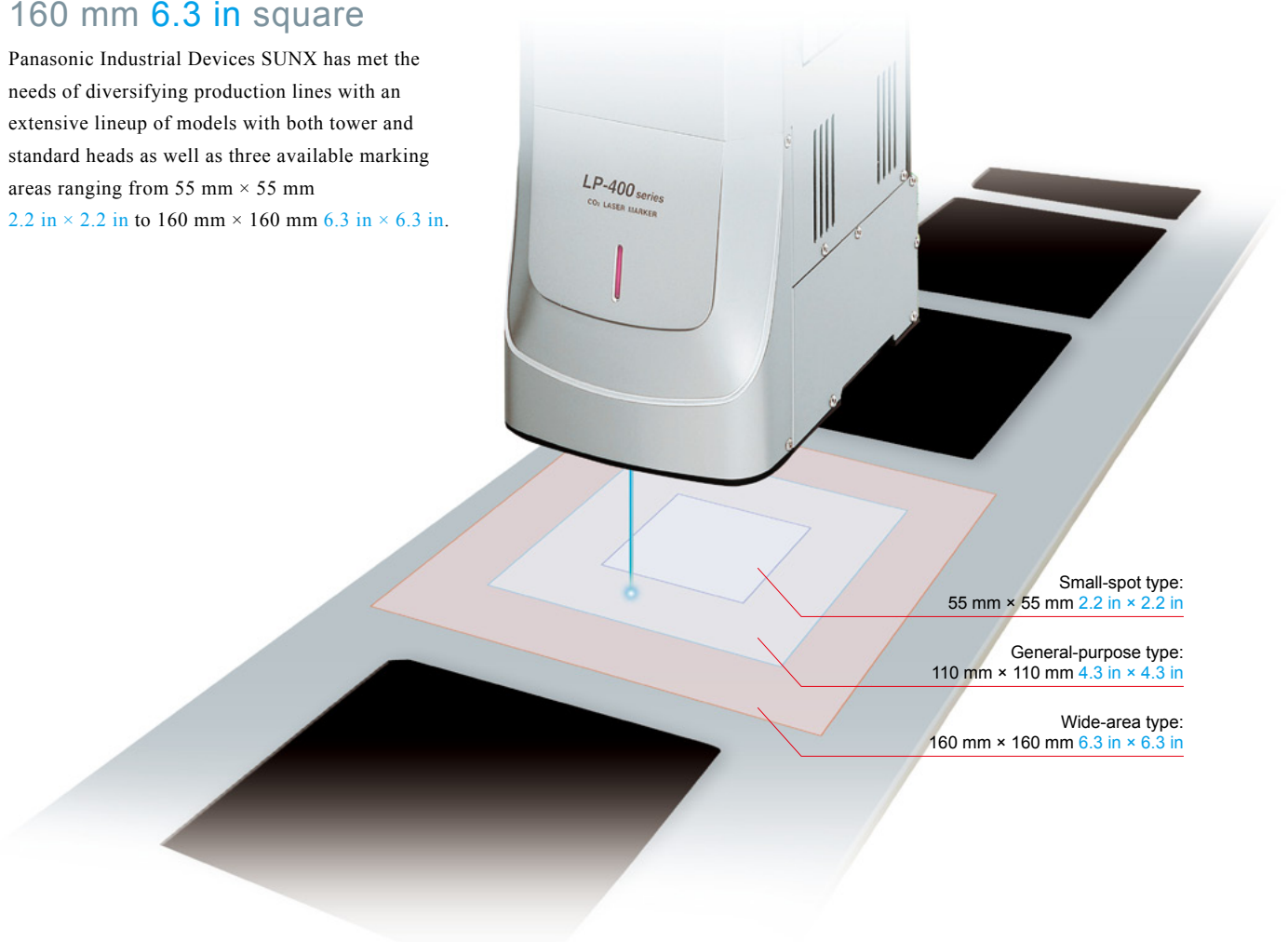

Small-spot type:
55 mm × 55 mm **2.2 in × 2.2 in**
General-purpose type:
110 mm × 110 mm **4.3 in × 4.3 in**
Wide-area type:
160 mm × 160 mm **6.3 in × 6.3 in**

Effective for use with large target objects and multi-unit layouts

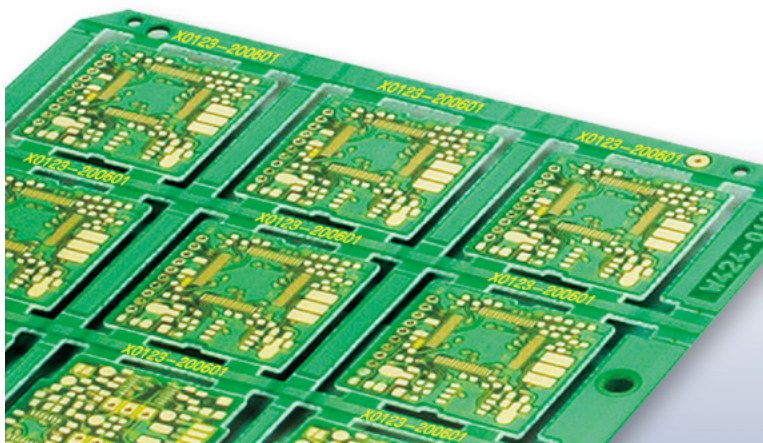

Batch marking of multi-unit layouts

The LP-400 series includes wide-area 160 mm × 160 mm **6.3 in × 6.3 in** models for use with applications that require a large marking area.

Advantages of wide-area models

- Support for batch marking of multi-unit layouts
- No setup changes
- Fewer units required
- Support for marking of large target objects

LP-400_{SERIES}

Rotating head design (standard models)

A unique head design that rotates freely through 350° allows the laser marker to be installed even in a vertical orientation. Flexible installation options make it easy to fit the system into a variety of production environments.

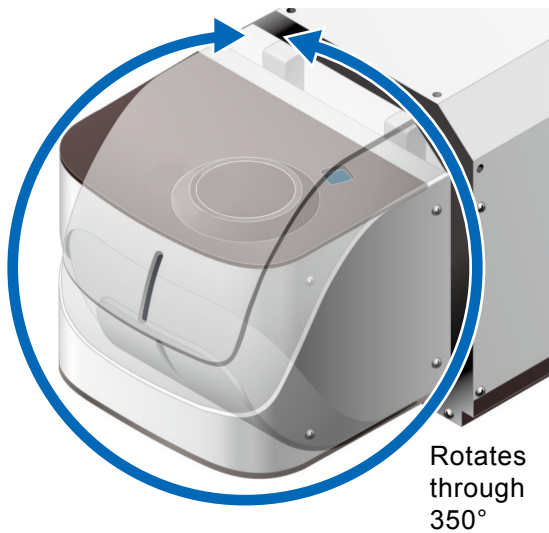

Facing down Facing left or right

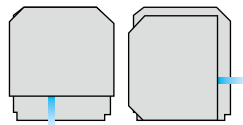

Facing up Facing diagonally

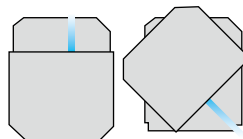

Space-saving design (tower head models)

At 175 mm × 230 mm 6.9 in × 9.1 in, the tower head is smaller than a B5 sheet of paper. Tower head models require less space for installation and can be integrated into existing production line space.



Dust-proof design

To compensate for its extreme susceptibility to even small pieces of dirt and dust, the galvanoscanner is protected by an effective dust-proof design. This feature guarantees output consistency over the long term.

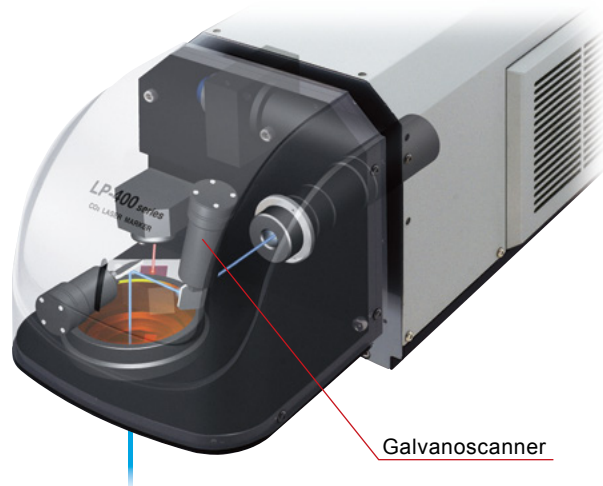
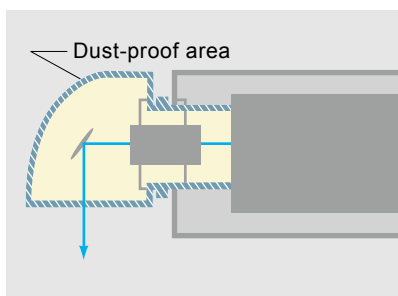

Focus adjustment feature

In simplifying calibration at the time of installation, a newly developed focus adjustment feature makes it easy to adjust the laser marker's focus without moving the head or fixture when the height of the target object has changed or when you want to create thicker marking lines.

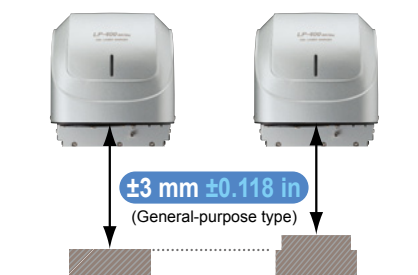
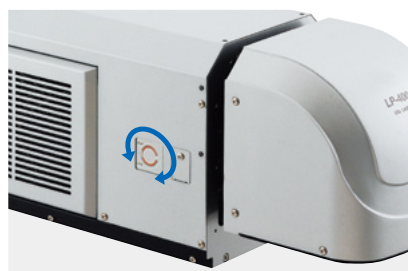

Convenience means selecting the mode of operation that is right for your application.

Control multiple laser markers with the new Laser Marker NAVI application. The LP-400 series comes standard with application software for easily configuring marking data.

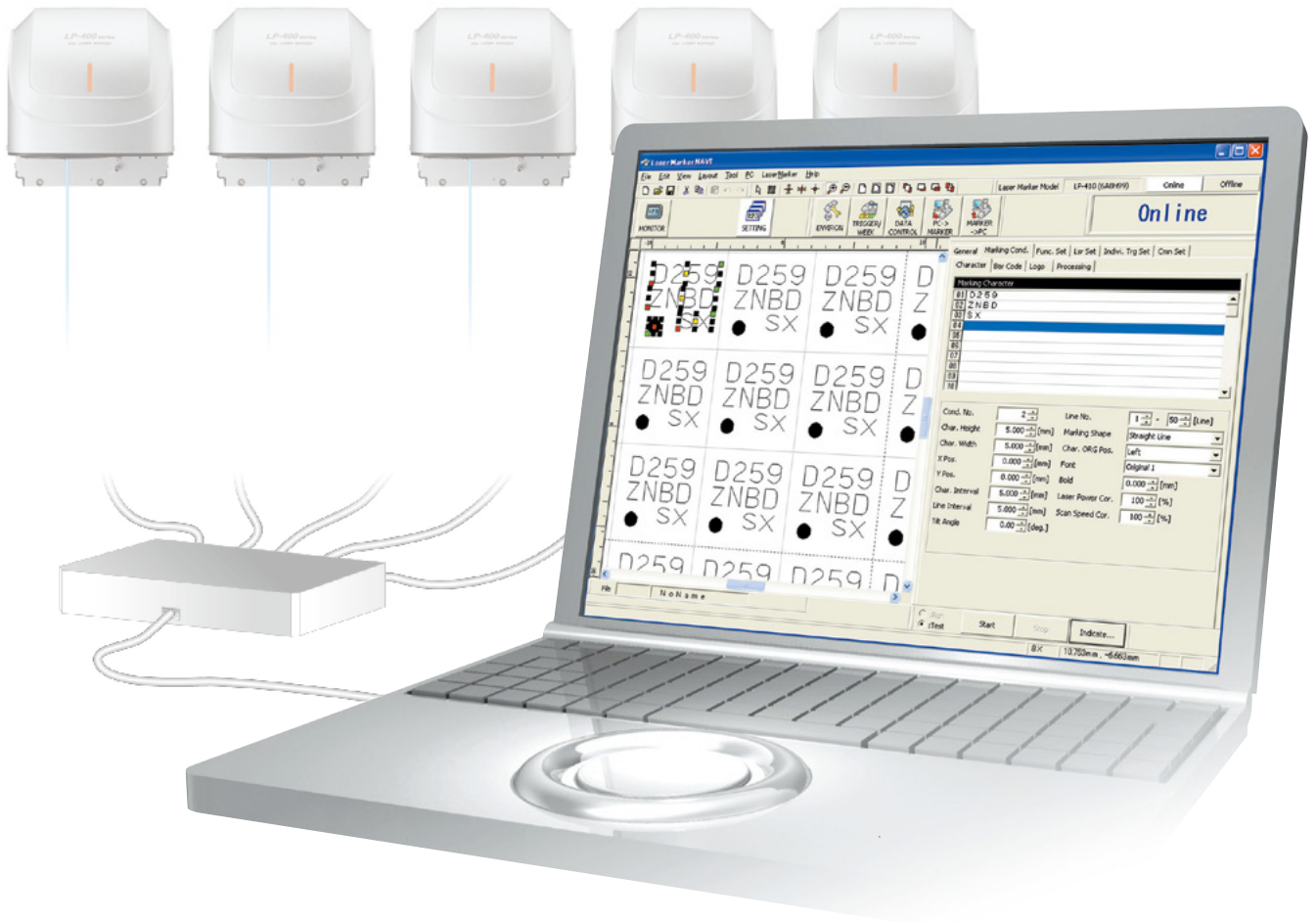

Batch laser marker management

Now you can connect multiple laser markers to a single computer for centralized management of all connected markers and associated configuration data. Easy, straightforward monitoring of settings and operational status rounds out the application's management capabilities, ensuring that advanced our technology will pave the way for dramatically improved work efficiency.

* A USB hub is required separately.

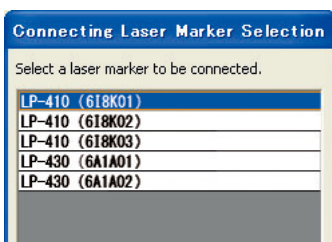

Intuitive interface

Laser Marker NAVI's simple, intuitive mouse-driven interface makes it easy to configure marking conditions and positions in setting files, allowing you to easily create marking layouts according to plan. The application also allows your computer to monitor system operation, and you can check error logs and the I/O monitor at the same time.

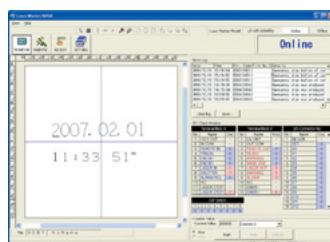

System operation monitor screen

Offline configuration

Now you can create and save data at a remote location such as an office and later transfer it to the laser marker on-site for marking. Alternatively, you can avoid the need for an on-site computer entirely by using a USB memory stick and console to save data to the laser marker for marking*.

* You can also operate the laser marker using a monitor and mouse.

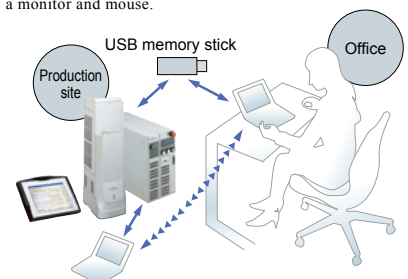

LP-400 SERIES

The touch panel console is ready for immediate use at production sites.

A color LCD touch panel console (optional) provides unmatched ease of use.

Laser Marker NAVI included softwares

Logo data conversion software

Output logos and other graphical marks from DXF, BMP, or JPEG data and read marks using a scanner with Laser Marker NAVI.

* DXF is a data format developed by Autodesk, Inc. to facilitate the exchange of data between CAD applications.

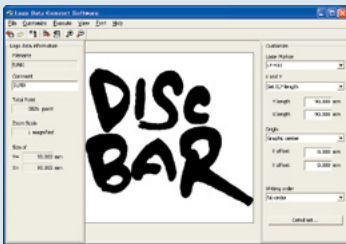

Logo data editing software

Create and edit logo files without using commercial CAD software.

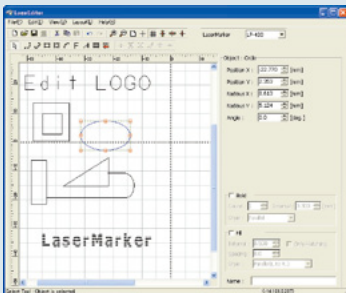

Font maker software

Create original fonts.

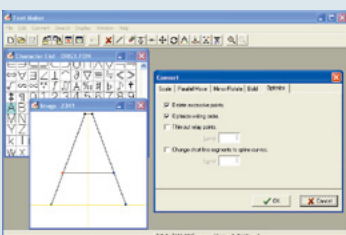

* Simulated screen image.

Intuitive operation

The console uses an intuitive, easy-to-understand hierarchical interface. The ability to generate a test mark or check data being output from all screens facilitates quick operational response. Combine features such as changing the display magnification, displaying target object images, and configuring device offsets for even greater convenience.

Quick review

A color touch panel designed for maximum ease of use and viewing provides stress-free operation by displaying marking data and settings immediately. An ergonomic design makes it equally easy to use in both handheld and equipment-mounted configurations.

Control with off-the-shelf monitor and mouse

* Customers are encouraged to verify proper operation of system components in advance when using off-the-shelf hardware.



LP-400 series laser markers can also be used with a standard computer monitor and mouse.

Convenient features meet a variety of needs.

USB connectors

The ability to store system settings on standard USB memory sticks lets you backup marking settings or copy the same set of settings to multiple laser markers, delivering improved ease of use compared to the floppy disk drive used by previous models. (The system also supports USB-connected floppy disk drives.)

* Customers are encouraged to verify proper operation of system components in advance when using off-the-shelf hardware.



Dual pointers

LP-400 series laser markers incorporate dual pointers created by a red guide light to make it easier to check and adjust the marking position and focus distance. This feature also enables you to easily fine-tune the focus distance.

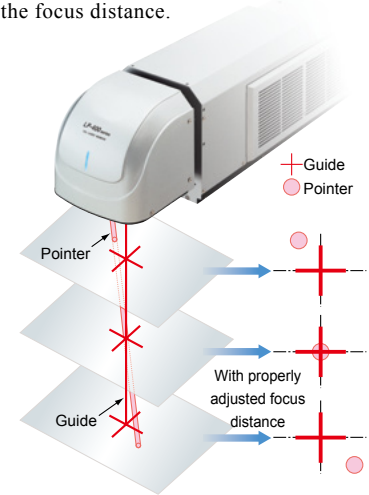

Easy marking of Adobe® Illustrator® data

Data created by Adobe® Illustrator® can be converted into marking data by "ExportVec", which is a standard-included software. Logos or marks can be easily marked while staying true to the original Adobe® Illustrator® graphic images.

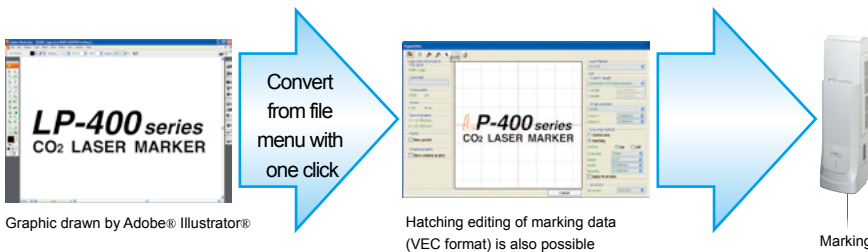

* Adobe® Illustrator® is a registered trademark of Adobe Systems Incorporated in the United States and other countries.

Guide laser feature for checking marking position

LP-400 series laser markers use an easily visible red guide laser to trace out the set marking data and the marking position, allowing you to visually check the marking position before actual marking begins.



Terminal block monitor and error log display features

An I/O monitor provides on-screen confirmation of terminal block status, allowing you to easily simulate equipment tests. An error log display feature saves information about system errors for later viewing.

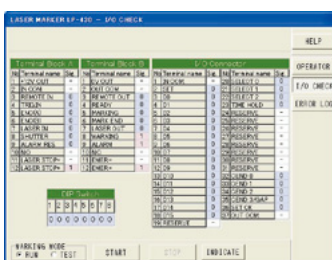

● I/O confirmation monitor feature

Password feature

A password feature dramatically improves safety and security by restricting users' ability to input certain information and protecting system settings, enabling safe and convenient use of the system for design, technical support, facilities, and production workers.

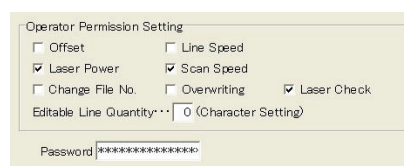

Help feature

LP-400 series laser markers include a help feature so that even first-time users are able to operate the system smoothly. Detailed messages inform users of potential configuration mistakes, reflecting Panasonic Industrial Devices SUNX's belief that a responsive and intuitive interface is an important aspect of system performance.

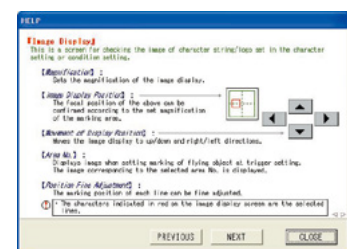

● Marking Samples

■ Character size (typical)	ABCDEFGHI JKLMN abcdefghijklmn 1234567890-. : ? ABCDEFGHI JKLMNOPQRSTUVWXYZ abcdefghijklmnopqrstuvwxyz 1234567890-. : ? !"#\$%&*#@□◇	■ 2D code	■ Logos
0123456789 ABCDEFGHI JKLMNOPQRSTU abcdefghijklmnopqrstuvwxyz 0123456789 ABCDEFGHI JKLMNOPQRSTU abcdefghijklmnopqrstuvwxyz		QR 	
■ Arced and angled marking	■ Japanese kanji characters	Micro QR code 	■ Barcode
	製造日 賞味期限 型式名 品番 警告 注意 危険 管理外 単位 日本製 入力 出力 電源 機種	Data Matrix 	
			■ Composite code

● Marking and Processing Examples

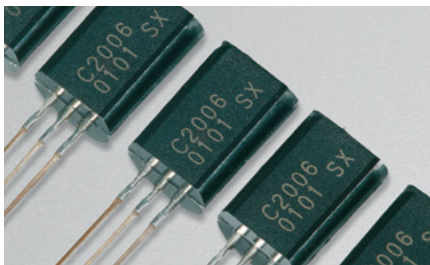

● Transistors

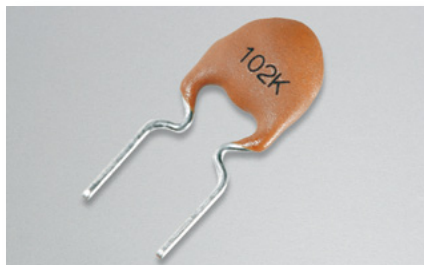

● Ceramic capacitors

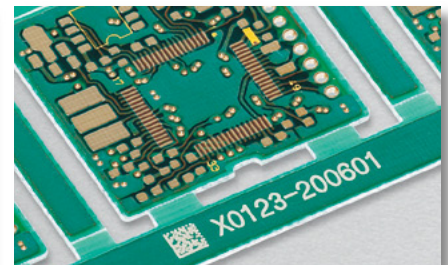

● Printed circuit boards



● Ceramic circuit boards

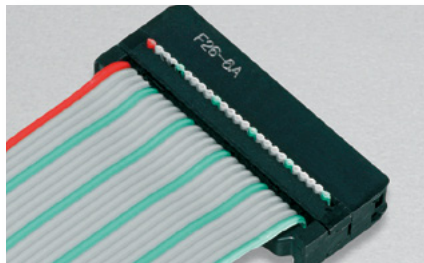

● Bus connectors



● Coaxial cable



● CD·DVD



● Silicone tubing



● Product packaging



● Retortable pouches



● Rubber gaskets (processing)

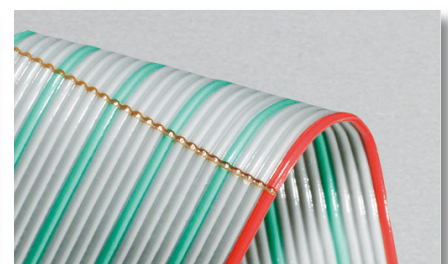

● Removal of ribbon cable insulation (processing)

Specifications

Item	Model No.	Type	General-purpose type			Small-spot type			Wide-area type		
		Standard models	LP-430U	LP-420S9U	LP-410U	LP-431U	LP-421S9U	LP-411U	LP-435U	LP-425S9U	
		Tower head models	LP-430TU	LP-420S9TU	LP-410TU	LP-431TU	LP-421S9TU	LP-411TU	LP-435TU	LP-425S9TU	
Marking laser		Class 4 CO ₂ laser									
	Average output (Note 1)		30 W	20 W	10 W	30 W	20 W	10 W	30 W	20 W	
	Wavelength		10.6 μm 0.417 mil	9.3 μm 0.366 mil	10.6 μm 0.417 mil	10.6 μm 0.417 mil	9.3 μm 0.366 mil	10.6 μm 0.417 mil	10.6 μm 0.417 mil	9.3 μm 0.366 mil	
Guide laser/pointer		Class 2 semiconductor laser; wavelength: 655 nm 0.026 mil									
Marking field			110 mm × 110 mm 4.3 in × 4.3 in			55 mm × 55 mm 2.2 in × 2.2 in			160 mm × 160 mm 6.3 in × 6.3 in		
Work distance (Note 2)			185 mm 7.3 in			111 mm 4.4 in			262 mm 10.3 in		
Scanning speed			Max. 12,000 mm/s			Max. 6,000 mm/s			Max. 12,000 mm/s		
Line speed (Note 3)			240 m/min or less		170 m/min or less	120 m/min or less		85 m/min or less	240 m/min or less		
Character height / width			0.2 to 110 mm 0.008 to 4.3 in (variable in 0.001 mm 0.00004 in steps)			0.2 to 55 mm 0.008 to 2.2 in (variable in 0.001 mm 0.00004 in steps)			0.2 to 160 mm 0.008 to 6.3 in (variable in 0.001 mm 0.00004 in steps)		
Marking spacing (character spacing, line pitch)			0 to 110 mm 0 to 4.3 in (variable in 0.001 mm 0.00004 in steps) Arched output: -180° to +180° (variable in 0.01° steps)			0 to 55 mm 0 to 2.2 in (variable in 0.001 mm 0.00004 in steps) Arched output: -180° to +180° (variable in 0.01° steps)			0 to 160 mm 0 to 6.3 in (variable in 0.001 mm 0.00004 in steps) Arched output: -180° to +180° (variable in 0.01° steps)		
Marking shape			Straight Line, Arc, Proportional, Justify								
Character types			English uppercase letters, English lowercase letters, numerals, katakana, hiragana, kanji (JIS No. 1 and No. 2 standards), symbols, user-registered characters (up to 50)								
Barcodes			Code 39, Code 128, ITF, NW-7, JAN (EAN) / UPC, RSS-14 (GS1 DataBar), RSS (GS1 DataBar) Limited, RSS (GS1 DataBar) Expanded								
2D codes			QR Code, Micro QR Code, Data Matrix, GS1 Data Matrix								
Composite codes			RSS-14 (GS1 DataBar) CC-A, RSS-14 (GS1 DataBar) Stacked CC-A, RSS (GS1 DataBar) Limited CC-A, etc.								
I/O			Input terminal, Output terminal, I/O connector								
Interface			RS-232C, Ethernet								
Logos / Shape			VEC (Note 4), BMP, DXF, HPGL, JPEG, AI (Note 5), EPS (Note 5)								
Cooling method			Forced air cooling								
Power voltage			90 to 132 V AC, or 180 to 264 V AC (automatic switching), 50/60 Hz								
Power consumption	100 V AC		1,000 VA or less		670 VA or less	1,000 VA or less		670 VA or less	1,000 VA or less		
	200 V AC		1,200 VA or less		700 VA or less	1,200 VA or less		700 VA or less	1,200 VA or less		
Inputs			Remote, trigger, encoder (A), encoder (B), shutter control, laser excitation, alarm reset, emergency stop, laser stop, etc.								
Outputs			Power supply (+12 V), remote, marking ready, marking, marking complete, laser excitation, warning, alarm, configuration complete, counter complete								
Marking condition			Static, On the fly								
Functions			<ul style="list-style-type: none"> ● Marking order optimization ● Lot marking ● System offset ● Overlapping marking ● Proportional marking ● Rank marking ● I/O simulation ● Power and speed configuration by row or logo file ● Intersection correction ● Logo data marking ● Shared character settings ● Backup ● Marking image display ● Offset marking ● Error log display ● Counter marking ● Font creation and editing ● Guide laser ● Marking on long moving objects ● Marking time measurement ● Time hold ● Serial data marking ● Current date marking ● Monospaced alignment ● Dual pointers ● Font selection ● Target object image display ● Step and repeat ● Deadline date marking ● Updating of operating screen display ● Focus adjustment ● Bold marking ● Operator adjustment ● I/O check monitor 								
Emergency stop switch			Located on controller								
Ambient temperature			0 to +40 °C +32 to +104 °F (Storage: -10 to +60 °C +14 to +140 °F) (No dew condensation or icing allowed)								
Ambient humidity			35 to 85 % RH (No dew condensation or icing allowed)								
Weight	Standard head / Tower head		20 kg	16 kg	20 kg	16 kg	20 kg	16 kg	20 kg	20 kg	
	Controller		12 kg	11 kg	12 kg	11 kg	12 kg	11 kg	12 kg	12 kg	
Laser Marker Driver & Utility OS (Note 6)			Microsoft Windows® 7 Professional (32 bit / 64 bit) / Vista Business (32 bit) / XP Professional (32 bit)								

Notes: 1) Independent output of oscillator. 2) Work distance varies by approx. ±2 mm ±0.079 in from model to model. 3) Varies by target object.
 4) VEC is a usable format of logo file for laser maker. 5) The PC installed Adobe® Illustrator® 9.x to CS5 (Windows) is necessary.
 6) Please contact our sales office for details of the software. Windows® 7 Professional, Vista Business and, XP Professional are trademarks or registered trademarks of Microsoft Corporation in the United States and other countries.

FDA and CE marking compliant Model No. List

Type	Japanese model	FDA regulations conforming type	CE marking conforming type
General-purpose type	Standard model	LP-430U	LP-430U-C
		LP-420S9U	LP-420S9U-C
		LP-410U	LP-410U-C
	Tower head model	LP-430TU	LP-430TU-C
		LP-420S9TU	LP-420S9TU-C
		LP-410TU	LP-410TU-C
Small-spot type	Standard model	LP-431U	LP-431U-C
		LP-421S9U	LP-421S9U-C
		LP-411U	LP-411U-C
	Tower head model	LP-431TU	LP-431TU-C
		LP-421S9TU	LP-421S9TU-C
		LP-411TU	LP-411TU-C
Wide-area type	Standard model	LP-435U	LP-435U-C
		LP-425S9U	LP-425S9U-C
	Tower head model	LP-435TU	LP-435TU-C
		LP-425S9TU	LP-425S9TU-C

● Precautions for Proper Use

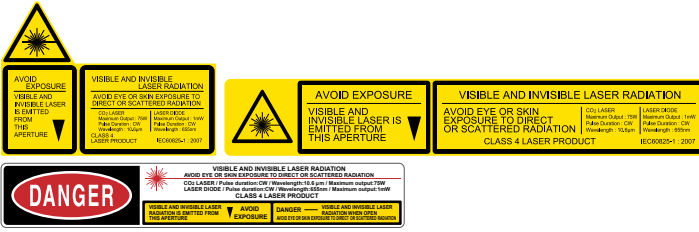

Laser safety

- This product is classified as a Class 4 Laser Product in IEC / JIS standards and in FDA regulations 21 CFR 1040.10 and 1040.11. Never look at or touch the direct laser beam and its reflection.
- The laser used by this product generates infrared light that is invisible to the human eye. Use particular caution when the laser is operating.
- The following labels are attached to this product. Handle the product according to the instruction given on the warning labels. (Warning labels are not shown in the product photographs in this catalog.)

Recommended use of a dust collector

- Depending on the object being marked, harmful gasses or smoke that have a detrimental effect on the human body or the laser marker may be generating during marking. If your application falls under this description, use a dust collector.
- *For more information, contact your sales representative.

● Dimensions (Unit: mm in)

Controller

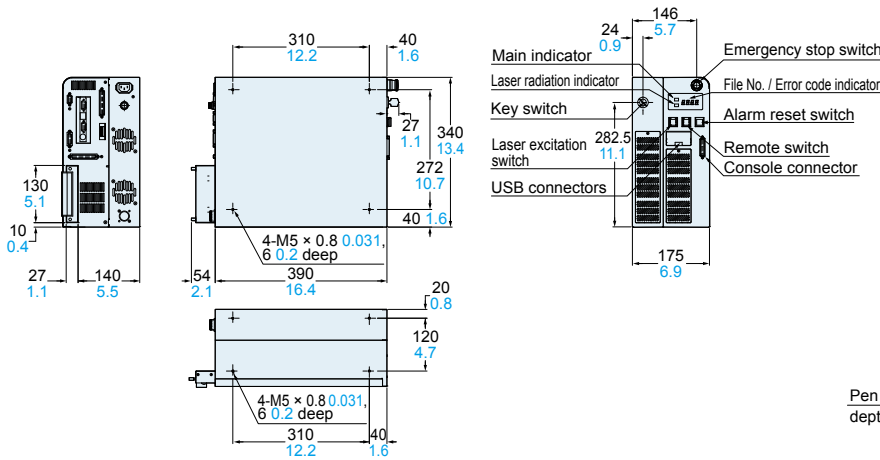

Console LP-ADP40 (Sold separately)

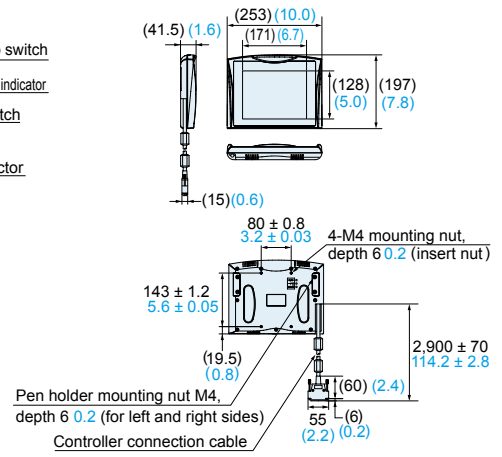

Head: Standard models (LP-430U, LP-431U, LP-435U, LP-420S9U, LP-421S9U, LP-425S9U)

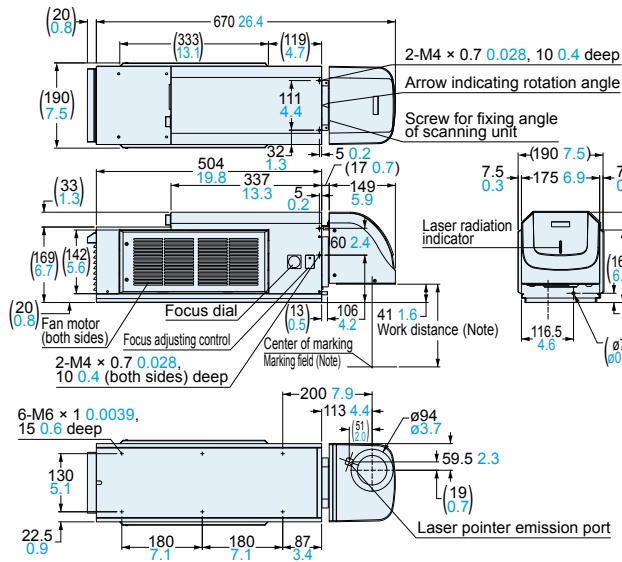

Head: Tower head models (LP-430TU, LP-431TU, LP-435TU, LP-420S9TU, LP-421S9TU, LP-425S9TU)

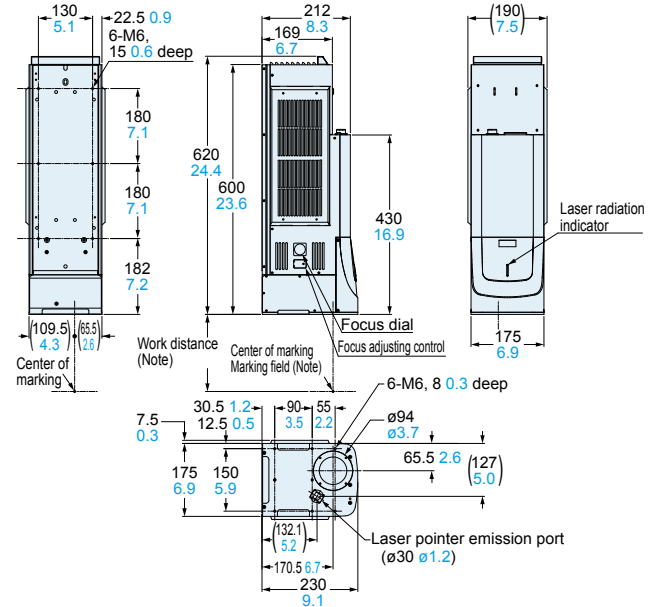

(Note)

Model No.	LP-430U LP-420S9U	LP-431U LP-421S9U	LP-435U LP-425S9U
Item			
Work distance	185 7.3	111 4.4	262 10.3
Marking field	110 × 110 4.3 × 4.3	55 × 55 2.2 × 2.2	160 × 160 6.3 × 6.3

(Note)

Model No.	LP-430TU LP-420S9TU	LP-431TU LP-421S9TU	LP-435TU LP-425S9TU
Item			
Work distance	185 7.3	111 4.4	262 10.3
Marking field	110 × 110 4.3 × 4.3	55 × 55 2.2 × 2.2	160 × 160 6.3 × 6.3

● Dimensions (Unit: mm in)

Head: Standard models
(LP-410U, LP-411U)

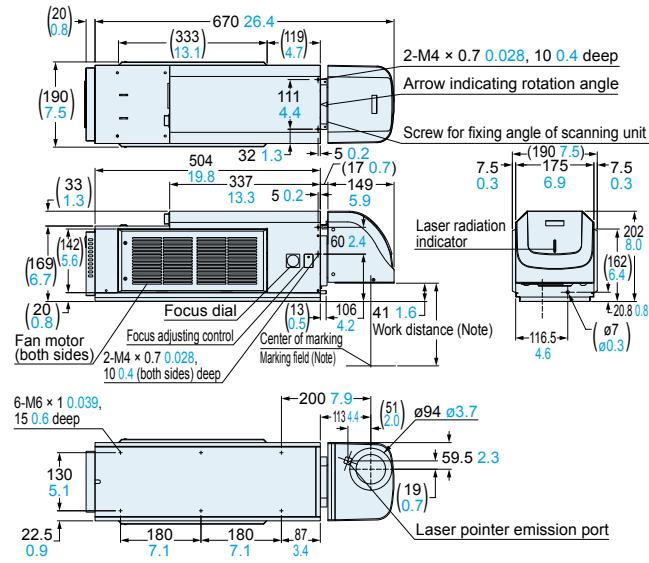

(Note)

Model No.	LP-410U	LP-411U
Work distance	185 7.3	111 4.4
Marking field	110 × 110 4.3 × 4.3	55 × 55 2.2 × 2.2

Head: Tower head models
(LP-410TU, LP-411TU)

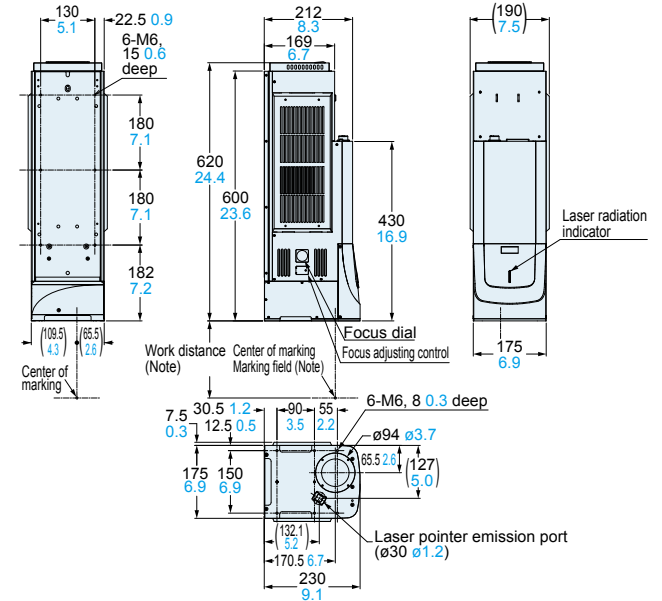

(Note)

Model No.	LP-410TU	LP-411TU
Work distance	185 7.3	111 4.4
Marking field	110 × 110 4.3 × 4.3	55 × 55 2.2 × 2.2

Please contact :

Panasonic Industrial Devices SUNX Co., Ltd.

2431-1 Ushiyama-cho, Kasugai-shi, Aichi, 486-0901, Japan

Global Sales Department

■ Telephone: +81-568-33-7861 ■ Facsimile: +81-568-33-8591

panasonic.net/id/pidsx/global

All Rights Reserved ©Panasonic Industrial Devices SUNX Co., Ltd. 2015