

Amplifier Built-in / DC 3-wire Type

Cylindrical Inductive Proximity Sensor

GX-300 SERIES



Recognition
(Small-diameter type
only. Excluding bending-
resistant cable type.)



CERTIFIED
Listing
(Excluding small-diameter type)

Standard Type Cylindrical Inductive Proximity Sensors with Improved Basic Performance



IO-Link compatible Sensor Models in Lineup

**M8 / M12 / M18 / M30 Threaded Type
PNP Output, Normally Open Type**

* Switchable to Normally Closed Type

Standard type cylindrical inductive proximity sensors with improved basic performance GX-300 series

Improved basic performance

Response frequency of 5 kHz* allows the use of high-speed application

* In the case of GX-303S

The GX-303S boasts a response frequency of 5 kHz and realizes high speed response. The response frequency of other sensor models has been also improved by up to 4 times as compared to our conventional models.

Since the GX-300 series responds quickly to sensor ON/OFF judgement, it works well with a high-speed application and contributes to the reduction of equipment cycle time.

Typical examples (Shielded type)

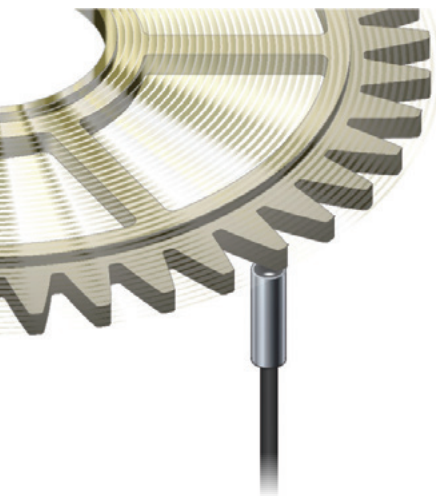

| Type | Response frequency of our conventional model | Significant improvement over conventional models! | Response frequency of GX-300 standard sensing range type |
|---|--|---|--|
| ø3 mm ø0.118 in | — | | 5 kHz (GX-303S) |
| ø4 mm ø0.157 in <small>* Conventional model: ø3.8 / ø4.4 mm ø0.150 / ø0.173 in</small> | 1 kHz | 4 times | 4 kHz (GX-304S) |
| ø5.4 mm ø0.213 in | 1.5 kHz | 2.7 times | 4 kHz (GX-305S) |
| M5 threaded | 1 kHz | 4 times | 4 kHz (GX-305M) |
| M8 threaded | 1 kHz | 2 times | 2 kHz (GX-308M) |
| M12 threaded | 450 Hz | 3.3 times | 1,500 Hz (GX-312M) |
| M18 threaded | 300 Hz | 2 times | 600 Hz (GX-318M) |

What is response frequency?

A rotating plate having the standard sensing object pasted at constant intervals is placed in front of the proximity sensor. The plate is rotated while observing the sensing output. The maximum number of times per second at which sensing can be done, for which the corresponding sensing output can be obtained, is the maximum response frequency.

In other words, the larger the numeric value of the response frequency is, the faster the response is.

Example) Conversion of response frequency to response speed
1 kHz → 1-ms cycle 5 kHz → 0.2-ms cycle

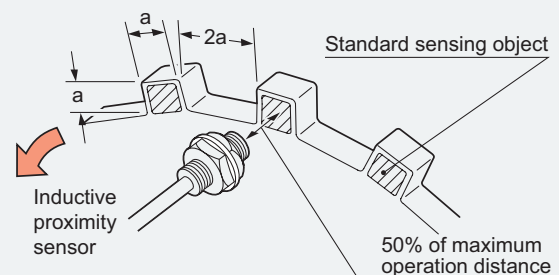

a: Side length of standard sensing object

Enhanced a degree of the detection margin

Sensing over long distance

The M8 / M12 / M18 / M30 threaded type sensors are available in standard sensing range type or long sensing range type ("K" at the end of model No.).
The long sensing range means reliable detection with plenty of performance margin to spare.

Sensing range comparison

M30 threaded type, shielded type

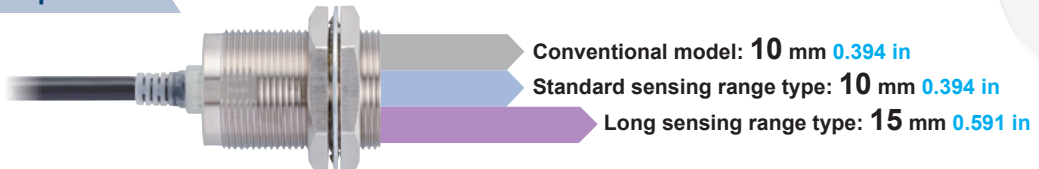

M30 threaded type, non-shielded type



Minimum risk of collision or sensing error even if the distance to the sensing object changes due to equipment vibration

If the distance to the sensing object changes due to equipment vibration or time-related degradation, the sensor may generate sensing errors including sensing failure in some cases.

If the sensor is set up very close to the sensing object for the purpose of preventing detecting failures, the sensor may contact the sensing object and cause damage.

The long sensing range models facilitate the sensor setup for reliable sensing since they detect the sensing object at a long distance.

Positioning processing equipment

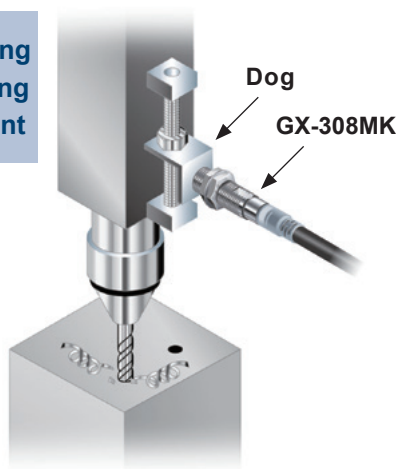

Conventional model

The distance to the dog becomes longer due to equipment vibration and the sensor may fail to detect the sensing object.

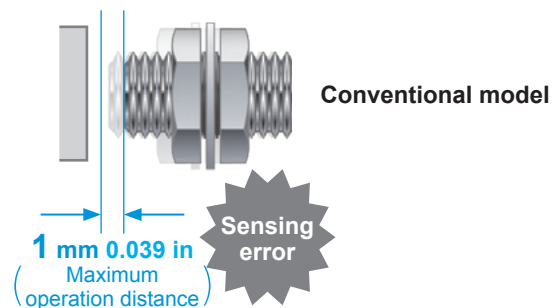

GX-300

The long sensing range model can perform sensing over long distance to ensure stable detection.

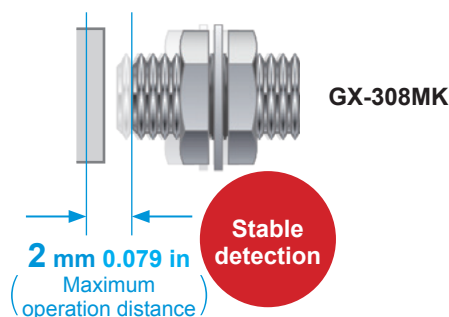

Reduced variation in maximum operation distance

With the GX-300 series, variation in maximum operation distance is kept within $\pm 10\%$
* $\pm 15\%$ in the case of the previous GX series.

Variation in the maximum operation distance of the $\varnothing 3 / \varnothing 4 / \varnothing 5.4$ mm $\varnothing 0.118 / \varnothing 0.157 / \varnothing 0.213$ in, M5 / M8 threaded type models has been also reduced as compared to the conventional models.

Improved usability

Indicator with significantly improved visibility

The bright and highly visible indicator is convenient for checking the setup and operation.

Conventional model

If the operation indicator position is adjusted to make the indicator visible, the sensor distance changes.



GX series



GX-N series

GX-300

In the small-diameter type sensors, the indicator light is visible at 4 locations. In the M8 and larger threaded type sensors, the high-brightness indicator and the resin containing dispersing agent provide clear and highly visible light to facilitate the cumbersome adjustment of installation position.

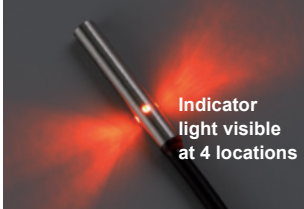

Small-diameter type



M8 / M12 / M18 / M30 threaded type

- * The indicator light may appear differently depending on ambient environments and brightness.
- * On the M8 and larger threaded type sensors, the indicator light is visible at 2 locations on one side.
- * The operation indicators of the M8 and larger threaded type sensors flash in green during IO-Link communication.

Further reduction of the size of small-diameter type sensors for easier embedment

The small-diameter type sensors are 25.1 mm **0.988 in** in depth while the conventional models measured 30 mm **1.181 in**. (GX-303S measures 27.1 mm **1.067 in** in depth.) The reduced unit size enables the installation of the sensor in a smaller space.

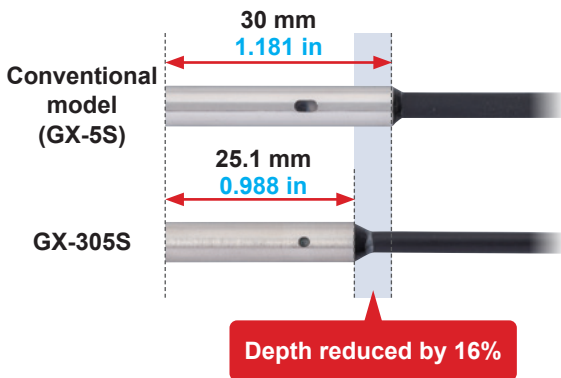

Comparison of depth dimensions of small-diameter type sensors

| Type | Our conventional model | GX-300 |
|-------------------|--|--|
| ø3.0 mm ø0.118 in | – | 27.1 mm 1.067 in |
| ø3.8 mm ø0.150 in | 30 mm 1.181 in | – |
| ø4.0 mm ø0.157 in | – | 25.1 mm 0.988 in |
| ø4.4 mm ø0.173 in | 30 mm 1.181 in | – |
| ø5.4 mm ø0.213 in | 30 mm 1.181 in | 25.1 mm 0.988 in |
| M5 thread | 30 mm 1.181 in Threaded section: 18 mm 0.709 in | 25.1 mm 0.988 in Threaded section: 15.1 mm 0.594 in |

Extensive model lineup

The GX-300 series includes 310 different sensor models. We offer various types of sensor models such as the cable type (cable length: 2 m **6.562 ft** or 5 m **16.404 ft**), connector type and pigtailed type. Furthermore, we can supply bending-resistant cable type models (cable length: 2 m **6.562 ft** or 5 m **16.404 ft**), which are suitable for installation on moving parts. (For the detail of our model lineup, see page 6 and following pages.)



Suitable for IoT applications

IO-Link compatibility

Evolution from ON/OFF judgment sensors to sensors capable of transmitting the detection level and sensor status information

* Only the M8 / M12 / M18 / M30 threaded type, PNP output, normally open type models are compatible with IO-Link.

◆ IO-Link compatible sensors can also be used as ordinary sensors (PNP output type).

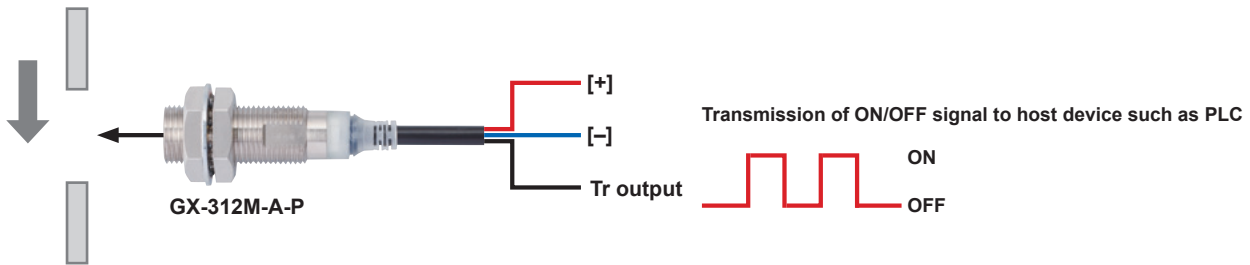

◆ When IO-Link compatible sensors are connected to the IO-Link master, they can transmit not only ON/OFF signal but also sensor level information and operation mode switching information in both ways. So, the sensors can be utilized for the visualization of manufacturing operations or for the incorporation of IoT technology.

■ Typical field network



*CC-Link IE Field and CC-Link are trademarks of Mitsubishi Electric Corporation, and are controlled by the CC-Link Partner Association. DeviceNet and EtherNet/IP are registered trademarks of ODVA (Open DeviceNet Vender Association, Inc.). EtherCAT is a registered trademark of Beckhoff Automation GmbH. Modbus is a registered trademark of Schneider Automation, Inc.

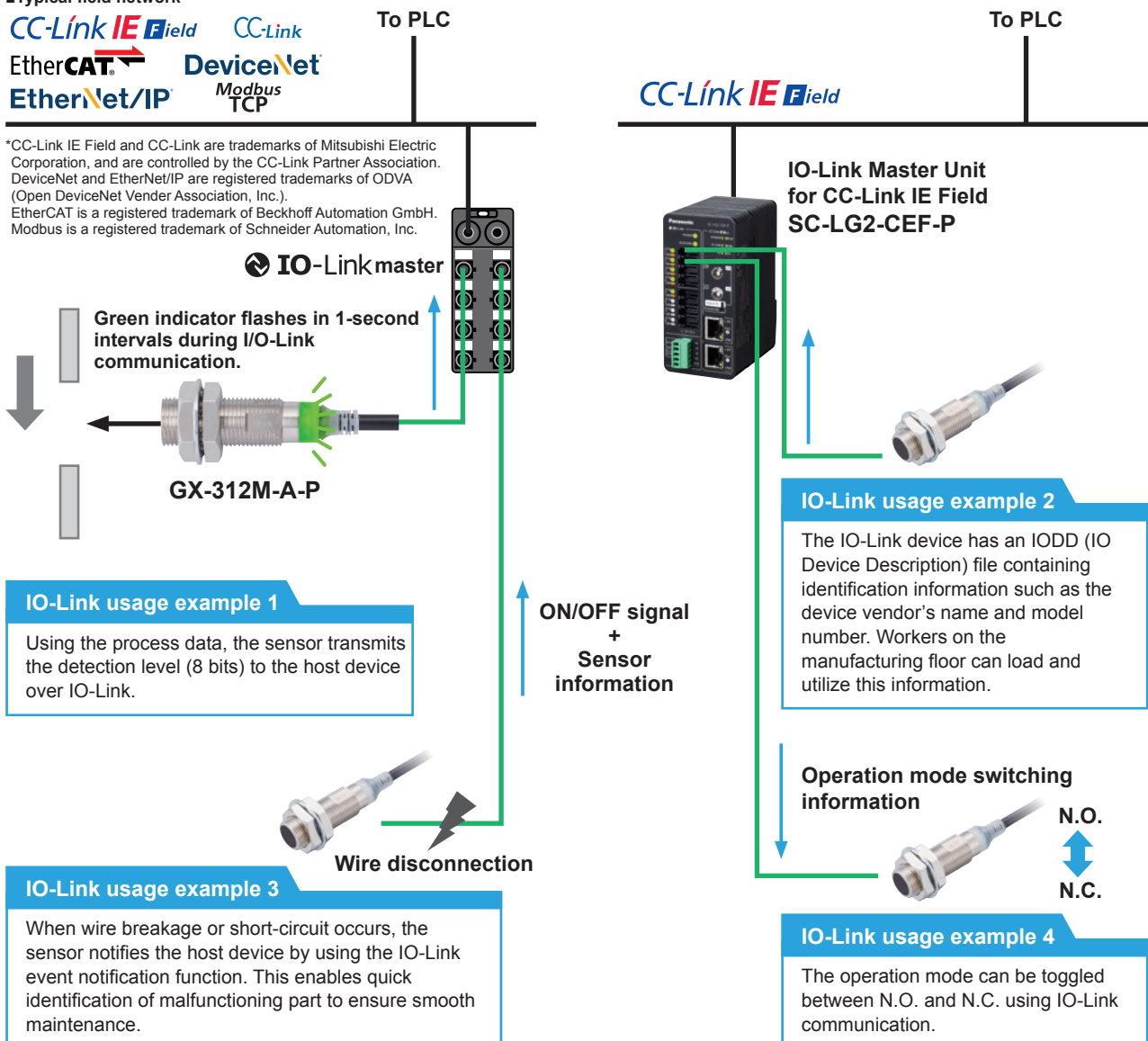

What is "IO-Link"?



IO-Link is an open communication technology according to IEC 61131-9 for the 1:1 bidirectional communication between the IO-Link device (sensor or actuator) and the IO-Link master.

IO-Link usage example 1

Using the process data, the sensor transmits the detection level (8 bits) to the host device over IO-Link.

IO-Link usage example 3

When wire breakage or short-circuit occurs, the sensor notifies the host device by using the IO-Link event notification function. This enables quick identification of malfunctioning part to ensure smooth maintenance.

IO-Link usage example 2

The IO-Link device has an IODD (IO Device Description) file containing identification information such as the device vendor's name and model number. Workers on the manufacturing floor can load and utilize this information.

Operation mode switching information



IO-Link usage example 4

The operation mode can be toggled between N.O. and N.C. using IO-Link communication.

ORDER GUIDE

Model No.

GX-3 08 M L K - A - N -C5

Size

03: $\varnothing 3.0$ mm $\varnothing 0.118$ in **04:** $\varnothing 4.0$ mm $\varnothing 0.157$ in
05: $\varnothing 5.4$ mm $\varnothing 0.213$ in / M5
08: M8 **12:** M12
18: M18 **30:** M30

Shape

S: Non-threaded type **M:** Threaded type

Shielded / Non-shielded

None: Shielded **L:** Non-shielded type

Sensing range

None: Standard sensing range **K:** Long sensing range

Connecting method

None: Standard 2 m 6.562 ft cable
-C5: Standard 5 m 16.404 ft cable
-R: Bending-resistant 2 m 6.562 ft cable
-R5: Bending-resistant 5 m 16.404 ft cable
-J: Pigtailed type
-Z: Connector type

Output

N: NPN output
P: PNP output

Operating mode

A: Normally open
B: Normally closed

DC 3-wire type (Small-diameter, shielded type)

| Type | Appearance (mm in) | Sensing range (Note) | Model No. | Output | Output operation |
|-------------------------------|---|--|--------------------|-------------------------------|------------------|
| Small-diameter, shielded type | <p>$\varnothing 3$ $\varnothing 0.118$ 27.1 1.067</p> | 0.8 mm 0.031 in ← Max. operation distance (0 to 0.56 mm 0 to 0.022 in) ← Stable sensing range | GX-303S-A-N | NPN open-collector transistor | Normally open |
| | | | GX-303S-B-N | | Normally closed |
| | | | GX-303S-A-P | PNP open-collector transistor | Normally open |
| | | | GX-303S-B-P | | Normally closed |
| | <p>$\varnothing 4$ $\varnothing 0.157$ 25.1 0.988</p> | 1.2 mm 0.047 in (0 to 0.84 mm 0 to 0.033 in) | GX-304S-A-N | NPN open-collector transistor | Normally open |
| | | | GX-304S-B-N | | Normally closed |
| | | | GX-304S-A-P | PNP open-collector transistor | Normally open |
| | | | GX-304S-B-P | | Normally closed |
| | <p>$\varnothing 5.4$ $\varnothing 0.213$ 25.1 0.988</p> | 1 mm 0.039 in (0 to 0.7 mm 0 to 0.028 in) | GX-305S-A-N | NPN open-collector transistor | Normally open |
| | | | GX-305S-B-N | | Normally closed |
| | | | GX-305S-A-P | PNP open-collector transistor | Normally open |
| | | | GX-305S-B-P | | Normally closed |
| Threaded type | <p>M5 25.1 0.988</p> | 1.2 mm 0.047 in (0 to 0.84 mm 0 to 0.033 in) | GX-305M-A-N | NPN open-collector transistor | Normally open |
| | | | GX-305M-B-N | | Normally closed |
| | | | GX-305M-A-P | PNP open-collector transistor | Normally open |
| | | | GX-305M-B-P | | Normally closed |

Note: The maximum operation distance stands for the maximum distance for which the sensor can detect the standard sensing object.
 The stable sensing range stands for the sensing range for which the sensor can stably detect the standard sensing object even if there is an ambient temperature drift and/or supply voltage fluctuation.

ORDER GUIDE

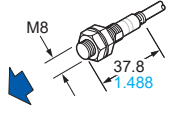
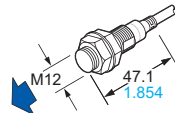
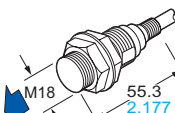
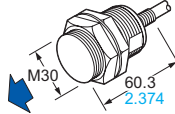
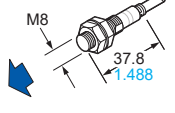
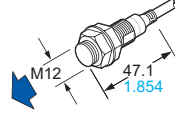
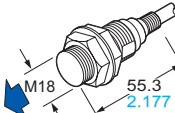
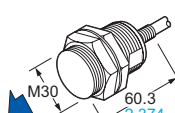
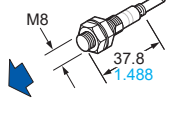
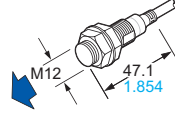
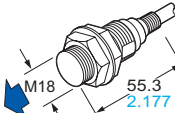
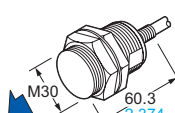
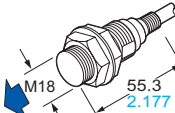
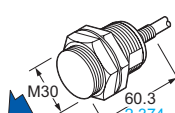
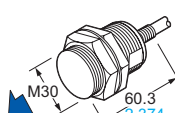
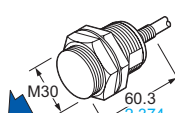

DC 3-wire type (Shielded type)

| Type | Appearance (mm in) | Sensing range (Note 1) | Model No. (Note 2) | Output | Output operation | | | |
|---|--|---|---|--|--|-------------------------------|-------------------------------|-----------------|
| Shielded type Threaded type |  <p>M8 37.8 1.488</p> | 1.5 mm 0.059 in ← Max. operation distance (0 to 1.2 mm 0 to 0.047 in) ← Stable sensing range | GX-308M-A-N | NPN open-collector transistor | Normally open | | | |
| | | | GX-308M-B-N | | Normally closed | | | |
| | |  <p>M12 47.1 1.854</p> | 2 mm 0.079 in (0 to 1.6 mm 0 to 0.063 in) | GX-308M-A-P | PNP open-collector transistor | Normally open | | |
| | | | | GX-308M-B-P | | Normally closed | | |
| | |  <p>M18 55.3 2.177</p> | | 5 mm 0.197 in (0 to 4 mm 0 to 0.157 in) | GX-312M-A-N | NPN open-collector transistor | Normally open | |
| | | | | | GX-312M-B-N | | Normally closed | |
| | |  <p>M30 60.3 2.374</p> | 10 mm 0.394 in (0 to 8 mm 0 to 0.315 in) | | GX-312M-A-P | PNP open-collector transistor | Normally open | |
| | | | | | GX-312M-B-P | | Normally closed | |
| |  <p>M8 37.8 1.488</p> | 2 mm 0.079 in (0 to 1.6 mm 0 to 0.063 in) | | GX-318M-A-N | NPN open-collector transistor | Normally open | | |
| | | | | GX-318M-B-N | | Normally closed | | |
| | | |  <p>M12 47.1 1.854</p> | 4 mm 0.157 in (0 to 3.2 mm 0 to 0.126 in) | GX-318M-A-P | PNP open-collector transistor | Normally open | |
| | | | | | GX-318M-B-P | | Normally closed | |
| | |  <p>M18 55.3 2.177</p> | | | 8 mm 0.315 in (0 to 6.4 mm 0 to 0.252 in) | GX-330M-A-N | NPN open-collector transistor | Normally open |
| | | | | | | GX-330M-B-N | | Normally closed |
| | | |  <p>M30 60.3 2.374</p> | 15 mm 0.591 in (0 to 12 mm 0 to 0.472 in) | | GX-330M-A-P | PNP open-collector transistor | Normally open |
| | | | | | | GX-330M-B-P | | Normally closed |
| |  <p>M8 37.8 1.488</p> | 2 mm 0.079 in (0 to 1.6 mm 0 to 0.063 in) | | | GX-308MK-A-N | NPN open-collector transistor | Normally open | |
| | | | | | GX-308MK-B-N | | Normally closed | |
| | | |  <p>M12 47.1 1.854</p> | 4 mm 0.157 in (0 to 3.2 mm 0 to 0.126 in) | GX-308MK-A-P | PNP open-collector transistor | Normally open | |
| | | | | | GX-308MK-B-P | | Normally closed | |
|  <p>M18 55.3 2.177</p> | | 8 mm 0.315 in (0 to 6.4 mm 0 to 0.252 in) | | | GX-312MK-A-N | NPN open-collector transistor | Normally open | |
| | | | | | GX-312MK-B-N | | Normally closed | |
| | | |  <p>M30 60.3 2.374</p> | 15 mm 0.591 in (0 to 12 mm 0 to 0.472 in) | GX-312MK-A-P | PNP open-collector transistor | Normally open | |
| | | | | | GX-312MK-B-P | | Normally closed | |
|  <p>M18 55.3 2.177</p> | 8 mm 0.315 in (0 to 6.4 mm 0 to 0.252 in) | GX-318MK-A-N | | | NPN open-collector transistor | Normally open | | |
| | | GX-318MK-B-N | | | | Normally closed | | |
| | |  <p>M30 60.3 2.374</p> | 15 mm 0.591 in (0 to 12 mm 0 to 0.472 in) | GX-318MK-A-P | PNP open-collector transistor | Normally open | | |
| | | | | GX-318MK-B-P | | Normally closed | | |
|  <p>M30 60.3 2.374</p> | 15 mm 0.591 in (0 to 12 mm 0 to 0.472 in) | | | GX-330MK-A-N | NPN open-collector transistor | Normally open | | |
| | | | | GX-330MK-B-N | | Normally closed | | |
| | |  <p>M30 60.3 2.374</p> | 15 mm 0.591 in (0 to 12 mm 0 to 0.472 in) | GX-330MK-A-P | PNP open-collector transistor | Normally open | | |
| | | | | GX-330MK-B-P | | Normally closed | | |

- Notes: 1) The maximum operation distance stands for the maximum distance for which the sensor can detect the standard sensing object.
The stable sensing range stands for the sensing range for which the sensor can stably detect the standard sensing object even if there is an ambient temperature drift and/or supply voltage fluctuation.
- 2) The PNP output, normally open type models [GX-3□M(K)-A-P(-□)] are compatible with IO-Link.
The PNP output, normally closed type models and all NPN output type models do not support IO-Link.

ORDER GUIDE

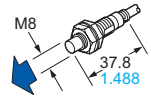
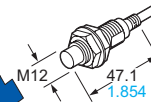
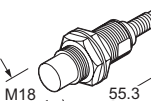
DC 3-wire type (Non-shielded type)

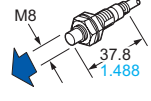
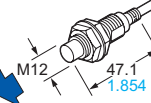
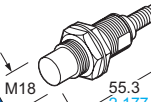
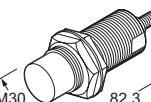
| Type | Appearance (mm in) | Sensing range (Note 1) | Model No. (Note 2) | Output | Output operation | |
|--|---|---|--|-------------------------------|-------------------------------|-----------------|
| Non-shielded type | Threaded type |  <p>2 mm 0.079 in ← Max. operation distance (0 to 1.6 mm 0 to 0.063 in) ← Stable sensing range</p> | GX-308ML-A-N | NPN open-collector transistor | Normally open | |
| | | | GX-308ML-B-N | | Normally closed | |
| | | | GX-308ML-A-P | PNP open-collector transistor | Normally open | |
| | | | GX-308ML-B-P | | Normally closed | |
| | | |  <p>5 mm 0.197 in (0 to 4 mm 0 to 0.157 in)</p> | GX-312ML-A-N | NPN open-collector transistor | Normally open |
| | | | | GX-312ML-B-N | | Normally closed |
| | | GX-312ML-A-P | | PNP open-collector transistor | Normally open | |
| | | GX-312ML-B-P | | | Normally closed | |
| | |  <p>10 mm 0.394 in (0 to 8 mm 0 to 0.315 in)</p> | | GX-318ML-A-N | NPN open-collector transistor | Normally open |
| | | | | GX-318ML-B-N | | Normally closed |
| | | | GX-318ML-A-P | PNP open-collector transistor | Normally open | |
| | | | GX-318ML-B-P | | Normally closed | |
| |  <p>18 mm 0.709 in (0 to 14.4 mm 0 to 0.567 in)</p> | | GX-330ML-A-N | NPN open-collector transistor | Normally open | |
| | | | GX-330ML-B-N | | Normally closed | |
| | | GX-330ML-A-P | PNP open-collector transistor | Normally open | | |
| | | GX-330ML-B-P | | Normally closed | | |
| | | Long sensing range type |  <p>4 mm 0.157 in (0 to 3.2 mm 0 to 0.126 in)</p> | GX-308MLK-A-N | NPN open-collector transistor | Normally open |
| | | | | GX-308MLK-B-N | | Normally closed |
| | GX-308MLK-A-P | | | PNP open-collector transistor | Normally open | |
| | GX-308MLK-B-P | | | | Normally closed | |
| |  <p>8 mm 0.315 in (0 to 6.4 mm 0 to 0.252 in)</p> | | | GX-312MLK-A-N | NPN open-collector transistor | Normally open |
| | | | | GX-312MLK-B-N | | Normally closed |
| | | | GX-312MLK-A-P | PNP open-collector transistor | Normally open | |
| | | | GX-312MLK-B-P | | Normally closed | |
|  <p>16 mm 0.630 in (0 to 12.8 mm 0 to 0.504 in)</p> | | | GX-318MLK-A-N | NPN open-collector transistor | Normally open | |
| | | | GX-318MLK-B-N | | Normally closed | |
| | GX-318MLK-A-P | | PNP open-collector transistor | Normally open | | |
| | GX-318MLK-B-P | | | Normally closed | | |
| |  <p>30 mm 1.181 in (0 to 24 mm 0 to 0.945 in)</p> | GX-330MLK-A-N | NPN open-collector transistor | Normally open | | |
| | | GX-330MLK-B-N | | Normally closed | | |
| GX-330MLK-A-P | | PNP open-collector transistor | Normally open | | | |
| GX-330MLK-B-P | | | Normally closed | | | |

- Notes: 1) The maximum operation distance stands for the maximum distance for which the sensor can detect the standard sensing object.
The stable sensing range stands for the sensing range for which the sensor can stably detect the standard sensing object even if there is an ambient temperature drift and/or supply voltage fluctuation.
- 2) The PNP output, normally open type models [GX-3□ML(K)-A-P(-□)] are compatible with IO-Link.
The PNP output, normally closed type models and all NPN output type models do not support IO-Link.

ORDER GUIDE

5 m 16.404 ft cable length type

5 m 16.404 ft cable length type (standard: 2 m 6.562 ft) is also available. When ordering this type, suffix “-C5” to the model No. (e.g.) 5 m 16.404 ft cable length type of **GX-303S-A-N** is “**GX-303S-A-N-C5**”.

Bending-resistant cable type (2 m 6.562 ft / 5 m 16.404 ft cable length)

The shielded, non-threaded type sensors (ø4 mm ø0.157 in / ø5.4 mm ø0.213 in) and threaded type sensors (M5 / M8) are available with a bending-resistant cable (cable length: 2 m 6.562 ft or 5 m 16.404 ft). (Note that the ø5.4 mm ø0.213 in size, normally closed type sensors are not available with a 5-m-long bending-resistant cable.)

When ordering bending-resistant 2 m 6.562 ft cable type, suffix “-R” to the model No. When ordering bending-resistant 5 m 16.404 ft cable type, suffix “-R5” to the model No.

(e.g.) Bending-resistant 2 m 6.562 ft cable type of **GX-304S-A-N** is “**GX-304S-A-N-R**”.
(e.g.) Bending-resistant 5 m 16.404 ft cable type of **GX-304S-A-N** is “**GX-304S-A-N-R5**”.

Pigtailed type

The threaded type sensors (M8 / M12 / M18 / M30) are available in the pigtailed type. (Connector: M12)

When ordering this type, suffix “-J” to the model No.

(e.g.) Pigtailed type of **GX-308M-A-N** is “**GX-308M-A-N-J**”.

Connector type

The threaded type sensors (M12 / M18 / M30) are available in the connector type. When ordering this type, suffix “-Z” to the model No.

(e.g.) Connector type of **GX-312M-A-N** is “**GX-312M-A-N-Z**”.

• List of connection systems

| Type | | 5 m 16.404 ft cable length (“-C5” at the end of model No.) | Bending-resistant 2 m 6.562 ft cable (“-R” at the end of model No.) | Bending-resistant 5 m 16.404 ft cable (“-R5” at the end of model No.) | Pigtailed type (“-J” at the end of model No.) (Note) | Connector type (“-Z” at the end of model No.) |
|-------------------------------|-------------------|--|---|---|--|---|
| Small-diameter, shielded type | ø3.0 mm ø0.118 in | Available | — | — | — | — |
| | ø4.0 mm ø0.157 in | Available | Available | Available | — | — |
| | ø5.4 mm ø0.213 in | Available | Available | Available *Excluding normally closed type | — | — |
| | M5 | Available | Available | Available | — | — |
| Shielded type | M8 | Available | Available | Available | Available | — |
| | M12 | Available | — | — | Available | Available |
| | M18 | Available | — | — | Available | Available |
| | M30 | Available | — | — | Available | Available |
| Non-shielded type | M8 | Available | — | — | Available | — |
| | M12 | Available | — | — | Available | Available |
| | M18 | Available | — | — | Available | Available |
| | M30 | Available | — | — | Available | Available |

Note: Please purchase mating cables separately when using pigtailed type models.

• Mating cable

| Model No. | Description | |
|------------------|-----------------------|--|
| CN-24S-C2 | Length: 2 m 6.562 ft | AWG20 4-core cable with M12 Smartclick connector on one end Cable outside diameter: ø6 mm ø0.236 in |
| CN-24S-C5 | Length: 5 m 16.404 ft | |

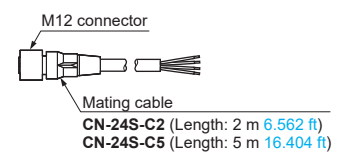

Note: Smartclick is a trademark of OMRON Corporation.



SPECIFICATIONS

DC 3-wire type (Small-diameter, shielded type)

| Type | | Small-diameter, shielded type | | | | |
|----------------------------------|-----------------------------|--|---|---|--|--------------------|
| | | Non-threaded type | | | Threaded type | |
| Item | Model No. (Note 2) | Normally open | GX-303S-A-□ | GX-304S-A-□ | GX-305S-A-□ | GX-305M-A-□ |
| | | Normally closed | GX-303S-B-□ | GX-304S-B-□ | GX-305S-B-□ | GX-305M-B-□ |
| Regulatory compliance | | CE Marking (EMC Directive, RoHS Directive), UKCA Marking (EMC Regulations, RoHS Regulations), UL Recognition Certification (excluding bending-resistant cable type) | | | | |
| Max. operation distance (Note 3) | | 0.8 mm 0.031 in ±10 % | 1.2 mm 0.047 in ±10 % | 1.0 mm 0.039 in ±10 % | 1.2 mm 0.047 in ±10 % | |
| Stable sensing range (Note 3) | | 0 to 0.56 mm 0 to 0.022 in | 0 to 0.84 mm 0 to 0.033 in | 0 to 0.7 mm 0 to 0.028 in | 0 to 0.84 mm 0 to 0.033 in | |
| Standard sensing object | | Iron sheet 3 × 3 × t 1 mm 0.118 × 0.118 × t 0.039 in | Iron sheet 4 × 4 × t 1 mm 0.157 × 0.157 × t 0.039 in | Iron sheet 5.4 × 5.4 × t 1 mm 0.213 × 0.213 × t 0.039 in | Iron sheet 4 × 4 × t 1 mm 0.157 × 0.157 × t 0.039 in | |
| Hysteresis | | 15 % or less of operation distance (with standard sensing object) | | | | |
| Supply voltage (Note 4) | | 10 to 30 V DC [including 10 % ripple (p-p)] | | | | |
| Current consumption | | 10 mA or less | | | | |
| Output (Note 5) | | <NPN output type> NPN open-collector transistor • Maximum sink current: 100 mA or less (50 mA or less for GX-303S) • Applied voltage: 30 V DC or less (between output to 0 V) • Residual voltage: 2 V or less (Note 6) (at max. sink current) | | <PNP output type> PNP open-collector transistor • Maximum source current: 100 mA or less (50 mA or less for GX-303S) • Applied voltage: 30 V DC or less (between output to +V) • Residual voltage: 2 V or less (Note 6) (at max. source current) | | |
| Short-circuit protection | | Incorporated | | | | |
| Response frequency (Note 7) | | 5 kHz | 4 kHz | | | |
| Operation indicator | | Orange LED (lights up when the output is ON) | | | | |
| Pollution degree | | 3 | | | | |
| Altitude | | 2,000 m 6561.68 ft or less | | | | |
| Environmental resistance | Protection | IP67 (IEC) | | | | |
| | Ambient temperature | -25 to +70 °C -13 to +158 °F , Storage: -25 to +70 °C -13 to +158 °F (No condensation or icing allowed) | | | | |
| | Ambient humidity | 35 to 95 % RH, Storage: 35 to 95 % RH (No condensation allowed) | | | | |
| | Voltage withstandability | 500 V AC for one min. between all supply terminals connected together and enclosure | | | | |
| | Insulation resistance | 50 MΩ or more, with 500 V DC megger between all supply terminals connected together and enclosure | | | | |
| | Vibration resistance | 10 to 55 Hz frequency, 1.5 mm 0.059 in double amplitude in X, Y and Z directions for two hours each | | | | |
| Shock resistance | | 500 m/s ² acceleration in X, Y and Z directions ten times each | | | | |
| Sensing range variation | Temperature characteristics | Within ±15 % of sensing range at +23 °C +73 °F in ambient temperature range | | | | |
| | Voltage characteristics | Within ±2.5 % for ±15 % fluctuation of the rated supply voltage | | | | |
| Material | | Enclosure: Stainless steel (SUS303) [Brass (Nickel plated) for GX-305S] Sensing part: Heat-resistant ABS, Cable: Polyvinyl chloride (PVC) | | | | |
| Mating cable | | 0.09 mm ² 3-core ø2.4 mm ø0.094 in cabtyre cable, 2 m 6.562 ft long | 0.14 mm ² 3-core ø2.9 mm ø0.114 in cabtyre cable, 2 m 6.562 ft long (Note 8) | | | |
| Weight (Note 6) | | Net weight: 20 g approx. Gross weight: 40 g approx. | Net weight: 25 g approx. Gross weight: 50 g approx. | Net weight: 30 g approx. Gross weight: 50 g approx. | | |
| Accessories | | — | | | Nut: 2 pcs., Toothed lock washer: 1 pc. | |

- Notes: 1) Where measurement conditions have not been specified precisely, the conditions used were an ambient temperature of +23 °C **+73 °F**.
 2) The sensors with "N" indicated instead of □ in their model Nos. are NPN output type. The sensors with "P" are PNP output type.
 3) The maximum operation distance stands for the maximum distance for which the sensor can detect the standard sensing object.
 The stable sensing range stands for the sensing range for which the sensor can stably detect the standard sensing object even if there is an ambient temperature drift and/or supply voltage fluctuation.
 4) When used at a power of 12 V, the product is less susceptible to the effects of internal self-heat generation and therefore a more stable repeat accuracy can be obtained.
 5) When the output is 20 mA or less, the product is less susceptible to the effects of internal self-heat generation and therefore a more stable repeat accuracy can be obtained.
 6) When the cable length is 2 m **6.562 ft**.
 7) The response frequency is an average value.
 8) The bending-resistant cable type models come with a 0.15 mm² 3-core bending-resistant ø2.9 mm **ø0.114 in** cabtyre cable.

SPECIFICATIONS

DC 3-wire type (Shielded type)

| Item | Model No. (Note 2) | Type | Shielded type | | | | | | | |
|----------------------------------|-----------------------------|------|--|--|--|--|---|--|--|--|
| | | | Standard sensing range | | | | Long sensing range | | | |
| | | | Normally open | Normally closed | Normally open | Normally closed | Normally open | Normally closed | Normally open | Normally closed |
| Regulatory compliance | | | CE Marking (EMC Directive, RoHS Directive), UKCA Marking (EMC Regulations, RoHS Regulations), UL/c-UL Listing Certification | | | | | | | |
| Max. operation distance (Note 3) | | | 1.5 mm 0.059 in ±10 % | 2 mm 0.079 in ±10 % | 5 mm 0.197 in ±10 % | 10 mm 0.394 in ±10 % | 2 mm 0.079 in ±10 % | 4 mm 0.157 in ±10 % | 8 mm 0.315 in ±10 % | 15 mm 0.591 in ±10 % |
| Stable sensing range (Note 3) | | | 0 to 1.2 mm 0 to 0.047 in | 0 to 1.6 mm 0 to 0.063 in | 0 to 4 mm 0 to 0.157 in | 0 to 8 mm 0 to 0.315 in | 0 to 1.6 mm 0 to 0.063 in | 0 to 3.2 mm 0 to 0.126 in | 0 to 6.4 mm 0 to 0.252 in | 0 to 12 mm 0 to 0.472 in |
| Standard sensing object | | | Iron sheet 8 × 8 × t 1 mm 0.315 × 0.315 × t 0.039 in | Iron sheet 12 × 12 × t 1 mm 0.472 × 0.472 × t 0.039 in | Iron sheet 18 × 18 × t 1 mm 0.709 × 0.709 × t 0.039 in | Iron sheet 30 × 30 × t 1 mm 1.181 × 1.181 × t 0.039 in | Iron sheet 8 × 8 × t 1 mm 0.315 × 0.315 × t 0.039 in | Iron sheet 12 × 12 × t 1 mm 0.472 × 0.472 × t 0.039 in | Iron sheet 24 × 24 × t 1 mm 0.945 × 0.945 × t 0.039 in | Iron sheet 45 × 45 × t 1 mm 1.772 × 1.772 × t 0.039 in |
| Hysteresis | | | 10 % or less of operation distance (with standard sensing object) | | | | 15 % or less of operation distance (with standard sensing object) | | | |
| Supply voltage | | | 10 to 30 V DC [including 10 % ripple (p-p)], Class 2 | | | | | | | |
| Current consumption | | | 16 mA or less | | | | | | | |
| Output (C/Q) (Note 4) | IO-Link communication | | IO-Link Specification Ver1.1 | | | | | | | |
| | Baud rate | | COM3 (230.4 kbps) | | | | | | | |
| | Process data | | PD size: 2 bytes, OD size: 1 byte (M-sequence type: TYPE2_2) | | | | | | | |
| | Minimum cycle time | | 0.4 ms | | | | | | | |
| | Vendor ID | | 834 (0x342) | | | | | | | |
| | Device ID | | GX-308□: 0x70000, GX-312□: 0x70001, GX-318□: 0x70002, GX-330□: 0x70003 | | | | | | | |
| Output | | | <NPN output type> NPN open-collector transistor • Maximum sink current: 200 mA or less [GX-308M(K)-□: 200 mA or less (-40 to +70 °C -40 to +158 °F), 100 mA or less (+70 to +85 °C +158 to +185 °F)] • Applied voltage: 30 V DC or less (between output to 0 V) • Residual voltage: 2 V or less (Note 5) (at sink current 200 mA or less) | | | | <PNP output type> PNP open-collector transistor • Maximum source current: 200 mA or less [GX-308M(K)-□: 200 mA or less (-40 to +70 °C -40 to +158 °F), 100 mA or less (+70 to +85 °C +158 to +185 °F)] • Applied voltage: 30 V DC or less (between output to +V) • Residual voltage: 2 V or less (Note 5) (at source current 200 mA or less) | | | |
| | Short-circuit protection | | Incorporated | | | | | | | |
| Response frequency (Note 6) | | | 2,000 Hz | 1,500 Hz | 600 Hz | 400 Hz | 1,500 Hz | 1,000 Hz | 500 Hz | 250 Hz |
| Operation indicator | | | Standard I/O mode (SIO mode): Operation indicator (orange, ON), Communication indicator (green, OFF) IO-LINK communication mode (COM mode): Operation indicator (orange, ON), Communication indicator [green, flashing (1-sec intervals)] | | | | | | | |
| Pollution degree | | | 3 | | | | | | | |
| Altitude | | | 2,000 m 6561.68 ft or less | | | | | | | |
| Environmental resistance | Protection | | IP67 (IEC), IP69K, IP67G [IP67 (IEC), IP69K for connector type] | | | | | | | |
| | Ambient temperature | | -40 to +85°C -40 to +185°F, Storage: -45 to +85°C -49 to +185°F (No condensation or icing allowed) (UL temperature rating for pigtailed type: -25 to +70 °C -13 to +158 °F) | | | | | | | |
| | Ambient humidity | | 35 to 95 % RH, Storage: 35 to 95 % RH (No condensation allowed) | | | | | | | |
| | Voltage withstandability | | 1,000 V AC for one min. between all supply terminals connected together and enclosure | | | | | | | |
| | Insulation resistance | | 50 MΩ or more, with 500 V DC megger between all supply terminals connected together and enclosure | | | | | | | |
| | Vibration resistance | | 10 to 55 Hz frequency, 1.5 mm 0.059 in double amplitude in X, Y and Z directions for two hours each | | | | | | | |
| Shock resistance | | | 1,000 m/s ² (GX-308M(K)-□: 500 m/s ²) acceleration in X, Y and Z directions ten times each | | | | | | | |
| Sensing range variation | Temperature characteristics | | Within ±15% of sensing range at +23 °C +73°F in ambient temperature range Within ±10% of sensing range at +23 °C +73°F in temperature range of -25 to +70 °C -13 to +158 °F | | | | | | | |
| | Voltage characteristics | | Within ±1% for ±15 % fluctuation of the rated supply voltage | | | | | | | |
| Material | | | Enclosure: Nickel-plated brass [stainless steel (SUS303) for GX-308M(K)-□], Sensing part: Polybutylene terephthalate (PBT), Cable: Polyvinyl chloride (PVC) | | | | | | | |
| Mating cable | | | 0.2 mm ² 3-core oil resistant ø4 mm ø0.157 in cabtyre cable, 2 m 6.562 ft long (Note 7) | 0.2 mm ² 3-core oil resistant ø6 mm ø0.236 in cabtyre cable, 2 m 6.562 ft long (Note 8) | 0.2 mm ² 3-core oil resistant ø4 mm ø0.157 in cabtyre cable, 2 m 6.562 ft long (Note 7) | 0.2 mm ² 3-core oil resistant ø6 mm ø0.236 in cabtyre cable, 2 m 6.562 ft long (Note 8) | 0.2 mm ² 3-core oil resistant ø4 mm ø0.157 in cabtyre cable, 2 m 6.562 ft long (Note 7) | 0.2 mm ² 3-core oil resistant ø6 mm ø0.236 in cabtyre cable, 2 m 6.562 ft long (Note 8) | 0.2 mm ² 3-core oil resistant ø4 mm ø0.157 in cabtyre cable, 2 m 6.562 ft long (Note 7) | 0.2 mm ² 3-core oil resistant ø6 mm ø0.236 in cabtyre cable, 2 m 6.562 ft long (Note 8) |
| Weight | Cable type (Note 5) | | Net weight: 55 g approx. Gross weight: 80 g approx. | Net weight: 70 g approx. Gross weight: 95 g approx. | Net weight: 140 g approx. Gross weight: 160 g approx. | Net weight: 210 g approx. Gross weight: 240 g approx. | Net weight: 55 g approx. Gross weight: 80 g approx. | Net weight: 70 g approx. Gross weight: 95 g approx. | Net weight: 140 g approx. Gross weight: 160 g approx. | Net weight: 210 g approx. Gross weight: 240 g approx. |
| | Pigtailed type | | Net weight: 25 g approx. Gross weight: 55 g approx. | Net weight: 40 g approx. Gross weight: 70 g approx. | Net weight: 70 g approx. Gross weight: 100 g approx. | Net weight: 140 g approx. Gross weight: 170 g approx. | Net weight: 25 g approx. Gross weight: 55 g approx. | Net weight: 40 g approx. Gross weight: 70 g approx. | Net weight: 70 g approx. Gross weight: 100 g approx. | Net weight: 140 g approx. Gross weight: 170 g approx. |
| | Connector type | | — | Net weight: 25 g approx. Gross weight: 55 g approx. | Net weight: 50 g approx. Gross weight: 75 g approx. | Net weight: 130 g approx. Gross weight: 150 g approx. | — | Net weight: 25 g approx. Gross weight: 55 g approx. | Net weight: 50 g approx. Gross weight: 75 g approx. | Net weight: 130 g approx. Gross weight: 150 g approx. |
| Accessories | | | Nut: 2 pcs., Toothed lock washer: 1 pc. | | | | | | | |

- Notes: 1) Where measurement conditions have not been specified precisely, the conditions used were an ambient temperature of +23°C +73 °F.
2) The sensors with "N" indicated instead of □ in their model No. are NPN output type. The sensors with "P" are PNP output type.
3) The maximum operation distance stands for the maximum distance for which the sensor can detect the standard sensing object.
The stable sensing range stands for the sensing range for which the sensor can stably detect the standard sensing object even if there is an ambient temperature drift and/or supply voltage fluctuation.
4) PNP output, normally closed type models and all NPN output models do not support IO-Link.
5) When the cable length is 2 m 6.562 ft.
6) The response frequency is an average value.
7) The bending-resistant cable type comes with a 0.2 mm² 3-core bending-resistant ø4 mm ø0.157 in cabtyre cable.
8) The bending-resistant cable type comes with a 0.2 mm² 3-core bending-resistant ø6 mm ø0.236 in cabtyre cable.

SPECIFICATIONS

DC 3-wire type (Non-shielded type)

| Item | Model No. (Note 2) | Type | Non-shielded type | | | | | | | |
|----------------------------------|-----------------------------|---|--|--|--|--|---|--|--|--|
| | | | Standard sensing range | | | | Long sensing range | | | |
| | | | Normally open | Normally closed | Normally open | Normally closed | Normally open | Normally closed | Normally open | Normally closed |
| Regulatory compliance | | | CE Marking (EMC Directive, RoHS Directive), UKCA Marking (EMC Regulations, RoHS Regulations), UL/c-UL Listing Certification | | | | | | | |
| Max. operation distance (Note 3) | | | 2 mm 0.079 in ±10 % | 5 mm 0.197 in ±10 % | 10 mm 0.394 in ±10 % | 18 mm 0.709 in ±10 % | 4 mm 0.157 in ±10 % | 8 mm 0.315 in ±10 % | 16 mm 0.630 in ±10 % | 30 mm 1.181 in ±10 % |
| Stable sensing range (Note 3) | | | 0 to 1.6 mm 0 to 0.063 in | 0 to 4 mm 0 to 0.157 in | 0 to 8 mm 0 to 0.315 in | 0 to 14.4 mm 0 to 0.567 in | 0 to 3.2 mm 0 to 0.126 in | 0 to 6.4 mm 0 to 0.252 in | 0 to 12.8 mm 0 to 0.504 in | 0 to 24 mm 0 to 0.945 in |
| Standard sensing object | | | Iron sheet 8 × 8 × t 1 mm 0.315 × 0.315 × t 0.039 in | Iron sheet 15 × 15 × t 1 mm 0.591 × 0.591 × t 0.039 in | Iron sheet 30 × 30 × t 1 mm 1.181 × 1.181 × t 0.039 in | Iron sheet 54 × 54 × t 1 mm 2.126 × 2.126 × t 0.039 in | Iron sheet 12 × 12 × t 1 mm 0.472 × 0.472 × t 0.039 in | Iron sheet 24 × 24 × t 1 mm 0.945 × 0.945 × t 0.039 in | Iron sheet 48 × 48 × t 1 mm 1.89 × 1.89 × t 0.039 in | Iron sheet 90 × 90 × t 1 mm 3.543 × 3.543 × t 0.039 in |
| Hysteresis | | | 10% or less of operation distance (with standard sensing object) | | | | 15 % or less of operation distance (with standard sensing object) | | | |
| Supply voltage | | | 10 to 30 V DC [including 10 % ripple (p-p)], Class 2 | | | | | | | |
| Current consumption | | | 16 mA or less | | | | | | | |
| Output (C/Q) (Note 4) | IO-Link communication | | IO-Link Specification Ver1.1 | | | | | | | |
| | Baud rate | | COM3 (230.4 kbps) | | | | | | | |
| | Process data | | PD size: 2 bytes, OD size: 1 byte (M-sequence type: TYPE2_2) | | | | | | | |
| | Minimum cycle time | | 0.4 ms | | | | | | | |
| | Vendor ID | | 834 (0x342) | | | | | | | |
| | Device ID | | GX-308□: 0x70000, GX-312□: 0x70001, GX-318□: 0x70002, GX-330□: 0x70003 | | | | | | | |
| Output | | | <NPN output type> NPN open-collector transistor • Maximum sink current: 200 mA or less [GX-308ML(K)□: 200 mA or less (-40 to +70 °C -40 to +158 °F), 100 mA or less (+70 to +85 °C +158 to +185 °F)] • Applied voltage: 30 V DC or less (between output to 0 V) • Residual voltage: 2 V or less (Note 5) (at sink current 200 mA or less) | | | | <PNP output type> PNP open-collector transistor • Maximum source current: 200 mA or less [GX-308ML(K)□: 200 mA or less (-40 to +70 °C -40 to +158 °F), 100 mA or less (+70 to +85 °C +158 to +185 °F)] • Applied voltage: 30 V DC or less (between output to +V) • Residual voltage: 2 V or less (Note 5) (at source current 200 mA or less) | | | |
| | Short-circuit protection | | Incorporated | | | | | | | |
| Response frequency (Note 6) | | | 1,000 Hz | 800 Hz | 400 Hz | 100 Hz | 1,000 Hz | 800 Hz | 400 Hz | 100 Hz |
| Operation indicator | | | Standard I/O mode (SIO mode): Operation indicator (orange, ON), Communication indicator (green, OFF) IO-LINK communication mode (COM mode): Operation indicator (orange, ON), Communication indicator [green, flashing (1-sec intervals)] | | | | | | | |
| Pollution degree | | | 3 | | | | | | | |
| Altitude | | | 2,000 m 6561.68 ft or less | | | | | | | |
| Environmental resistance | Protection | | IP67 (IEC), IP69K, IP67G [IP67 (IEC), IP69K for connector type] | | | | | | | |
| | Ambient temperature | | -40 to +85 °C -40 to +185 °F, Storage: -45 to +85 °C -49 to +185 °F (No condensation or icing allowed) (UL temperature rating for relay connector type: -25 to +70 °C -13 to +158 °F) | | | | | | | |
| | Ambient humidity | | 35 to 95 % RH, Storage: 35 to 95 % RH (No condensation allowed) | | | | | | | |
| | Voltage withstandability | | 1,000 V AC for one min. between all supply terminals connected together and enclosure | | | | | | | |
| | Insulation resistance | | 50 MΩ or more, with 500 V DC megger between all supply terminals connected together and enclosure | | | | | | | |
| | Vibration resistance | | 10 to 55 Hz frequency, 1.5 mm 0.059 in double amplitude in X, Y and Z directions for two hours each | | | | | | | |
| Shock resistance | | 1,000 m/s ² (GX-308ML(K)□: 500 m/s ²) acceleration in X, Y and Z directions ten times each | | | | | | | | |
| Sensing range variation | Temperature characteristics | | Within ±15% of sensing range at +23 °C +73°F in ambient temperature range Within ±10% of sensing range at +23 °C +73°F in temperature range of -25 to +70 °C -13 to +158 °F | | | | | | | |
| | Voltage characteristics | | Within ±1% for ±15 % fluctuation of the rated supply voltage | | | | | | | |
| Material | | | Enclosure: Nickel-plated brass [stainless steel (SUS303) for GX-308ML(K)□], Sensing part: Polybutylene terephthalate (PBT), Cable: Polyvinyl chloride (PVC) | | | | | | | |
| Mating cable | | | 0.2 mm ² 3-core oil resistant ø4 mm ø0.157 in cabtyre cable, 2 m 6.562 ft long (Note 7) | 0.2 mm ² 3-core oil resistant ø6 mm ø0.236 in cabtyre cable, 2 m 6.562 ft long (Note 8) | 0.2 mm ² 3-core oil resistant ø4 mm ø0.157 in cabtyre cable, 2 m 6.562 ft long (Note 7) | 0.2 mm ² 3-core oil resistant ø6 mm ø0.236 in cabtyre cable, 2 m 6.562 ft long (Note 8) | 0.2 mm ² 3-core oil resistant ø4 mm ø0.157 in cabtyre cable, 2 m 6.562 ft long (Note 7) | 0.2 mm ² 3-core oil resistant ø6 mm ø0.236 in cabtyre cable, 2 m 6.562 ft long (Note 8) | 0.2 mm ² 3-core oil resistant ø4 mm ø0.157 in cabtyre cable, 2 m 6.562 ft long (Note 7) | 0.2 mm ² 3-core oil resistant ø6 mm ø0.236 in cabtyre cable, 2 m 6.562 ft long (Note 8) |
| Weight | Cable type (Note 5) | | Net weight: 55 g approx. Gross weight: 80 g approx. | Net weight: 70 g approx. Gross weight: 95 g approx. | Net weight: 140 g approx. Gross weight: 170 g approx. | Net weight: 200 g approx. Gross weight: 230 g approx. | Net weight: 55 g approx. Gross weight: 80 g approx. | Net weight: 70 g approx. Gross weight: 95 g approx. | Net weight: 140 g approx. Gross weight: 170 g approx. | Net weight: 240 g approx. Gross weight: 280 g approx. |
| | Pigtailed type | | Net weight: 25 g approx. Gross weight: 55 g approx. | Net weight: 40 g approx. Gross weight: 65 g approx. | Net weight: 75 g approx. Gross weight: 100 g approx. | Net weight: 140 g approx. Gross weight: 160 g approx. | Net weight: 25 g approx. Gross weight: 55 g approx. | Net weight: 40 g approx. Gross weight: 65 g approx. | Net weight: 75 g approx. Gross weight: 100 g approx. | Net weight: 170 g approx. Gross weight: 220 g approx. |
| | Connector type | | — | Net weight: 25 g approx. Gross weight: 55 g approx. | Net weight: 55 g approx. Gross weight: 80 g approx. | Net weight: 120 g approx. Gross weight: 150 g approx. | — | Net weight: 25 g approx. Gross weight: 55 g approx. | Net weight: 55 g approx. Gross weight: 80 g approx. | Net weight: 160 g approx. Gross weight: 200 g approx. |
| Accessories | | | Nut: 2 pcs., Toothed lock washer: 1 pc. | | | | | | | |

Notes: 1) Where measurement conditions have not been specified precisely, the conditions used were an ambient temperature of +23°C +73 °F.

2) The sensors with "N" indicated instead of □ in their model No. are NPN output type. The sensors with "P" are PNP output type.

3) The maximum operation distance stands for the maximum distance for which the sensor can detect the standard sensing object.

The stable sensing range stands for the sensing range for which the sensor can stably detect the standard sensing object even if there is an ambient temperature drift and/or supply voltage fluctuation.

4) PNP output, normally closed type models and all NPN output models do not support IO-Link.

5) When the cable length is 2 m 6.562 ft.

6) The response frequency is an average value.

7) The bending-resistant cable type comes with a 0.2 mm² 3-core bending-resistant ø4 mm ø0.157 in cabtyre cable.

8) The bending-resistant cable type comes with a 0.2 mm² 3-core bending-resistant ø6 mm ø0.236 in cabtyre cable.

I/O CIRCUIT AND WIRING DIAGRAMS

GX-3□S-□-N GX-305M-□-N

NPN output type

I/O circuit diagram

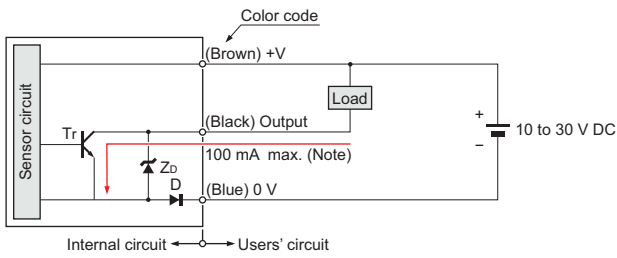

Wiring diagram

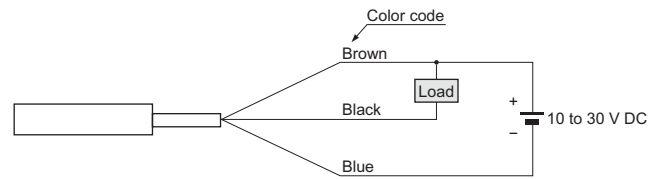

Note: Only GX-303S is 50 mA max.

Symbols... D: Reverse supply polarity protection diode
ZD: Surge absorption zener diode
Tr: NPN output transistor

GX-3□S-□-P GX-305M-□-P

PNP output type

I/O circuit diagram

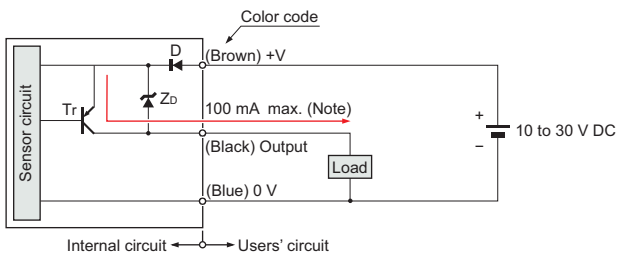

Wiring diagram

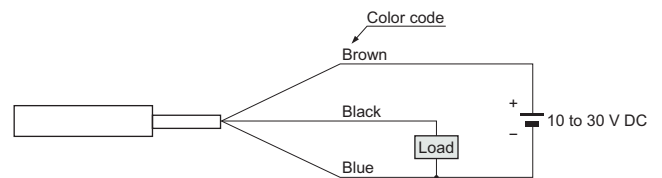

Note: Only GX-303S is 50 mA max.

Symbols... D: Reverse supply polarity protection diode
ZD: Surge absorption zener diode
Tr: PNP output transistor

GX-3□M(K)-A-N GX-3□ML(K)-A-N

* Excluding M5 threaded type NPN output, Normally open type

I/O circuit diagram

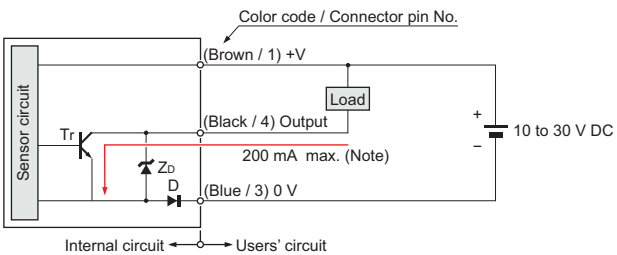

Wiring diagram

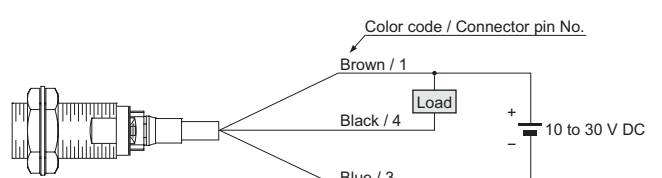

Note: In the case of the M8 threaded type:
200 mA max. (at -40 to +70 °C -40 to +158 °F),
100 mA max. (at +70 to +85 °C +158 to +185 °F)

Symbols... D: Reverse supply polarity protection diode
ZD: Surge absorption zener diode
Tr: NPN output transistor

Connector pin diagram

Pigtailed type
Connector type

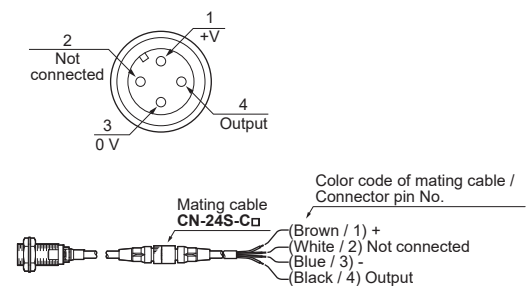

I/O CIRCUIT AND WIRING DIAGRAMS

GX-3□M(K)-B-N GX-3□ML(K)-B-N

* Excluding M5 threaded type **NPN output, Normally closed type**

I/O circuit diagram

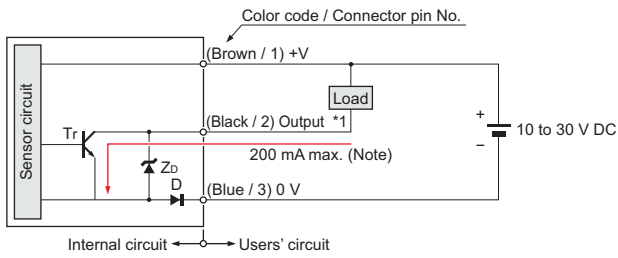

Note: In the case of the M8 threaded type:
200 mA max. (at -40 to +70 °C **-40 to +158 °F**),
100 mA max. (at +70 to +85 °C **+158 to +185 °F**)

Symbols... D: Reverse supply polarity protection diode
Zd: Surge absorption zener diode
Tr: NPN output transistor

*1: Note that the lead color of the sensor and that of the matting cable are different.

Wiring diagram

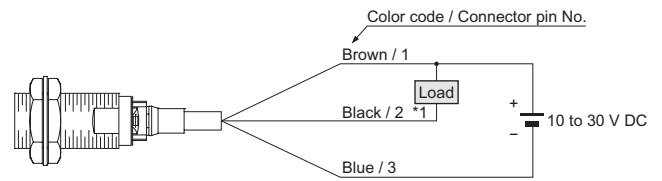

Connector pin diagram

Pigtailed type Connector type

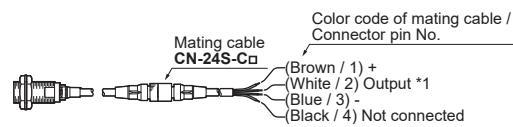
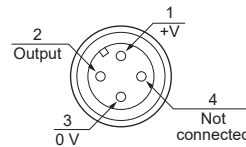

GX-3□M(K)-A-P GX-3□ML(K)-A-P

* Excluding M5 threaded type **PNP output, Normally open type**

I/O circuit diagram

<When used as ordinary sensor>

Standard I/O mode (SIO mode)

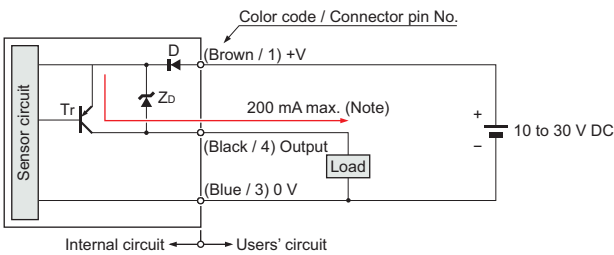

Note: In the case of the M8 threaded type:
200 mA max. (at -40 to +70 °C **-40 to +158 °F**),
100 mA max. (at +70 to +85 °C **+158 to +185 °F**)

Symbols... D: Reverse supply polarity protection diode
Zd: Surge absorption zener diode
Tr: PNP output transistor

<When connected to IO-Link master>

IO-Link communication mode (COM mode)

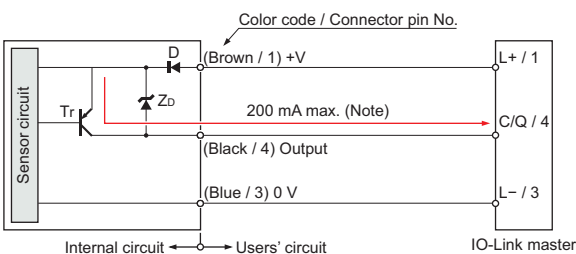

Notes: 1) In the case of the M8 threaded type:
200 mA max. (at -40 to +70 °C **-40 to +158 °F**),
100 mA max. (at +70 to +85 °C **+158 to +185 °F**)
2) In the IO-Link mode, the cable between the IO-Link master and sensor must have a length of 20 m **65.617 ft** or less.

Symbols... D: Reverse supply polarity protection diode
Zd: Surge absorption zener diode
Tr: PNP output transistor

Wiring diagram

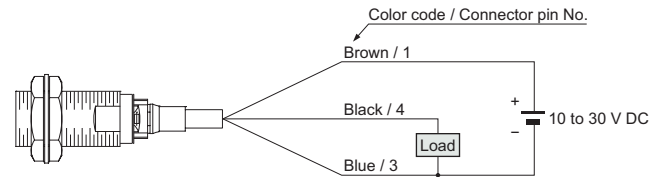

Connector pin diagram

Pigtailed type Connector type

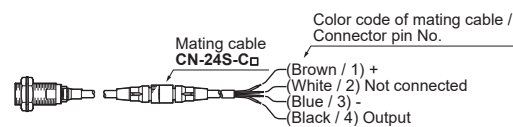
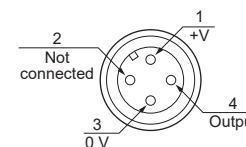

I/O CIRCUIT AND WIRING DIAGRAMS

GX-3□M(K)-B-P GX-3□ML(K)-B-P

* Excluding M5 threaded type PNP output, Normally closed type

I/O circuit diagram

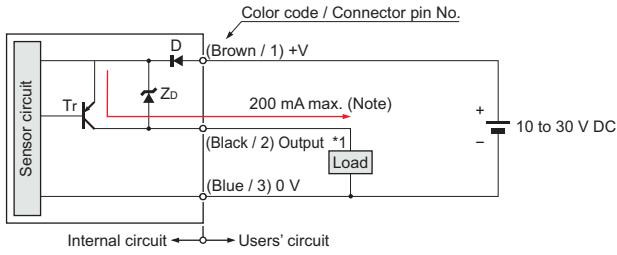

Note: In the case of the M8 threaded type:
 200 mA max. (at -40 to +70 °C -40 to +158 °F),
 100 mA max. (at +70 to +85 °C +158 to +185 °F)

Symbols... D: Reverse supply polarity protection diode
 ZD: Surge absorption zener diode
 Tr: PNP output transistor

*1: Note that the lead color of the sensor and that of the matting cable are different.

Wiring diagram

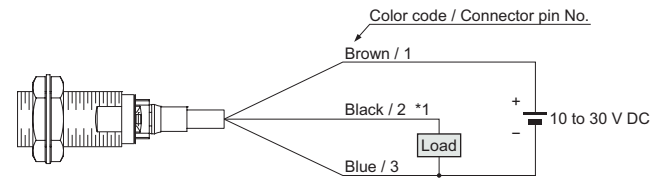

Connector pin diagram

Pigtailed type Connector type

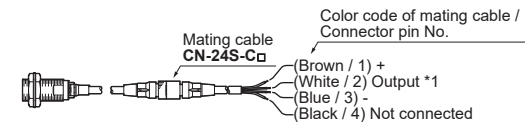
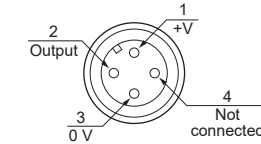

SENSING CHARACTERISTICS (TYPICAL)

All models

Sensing field

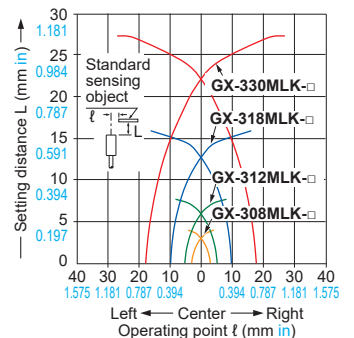
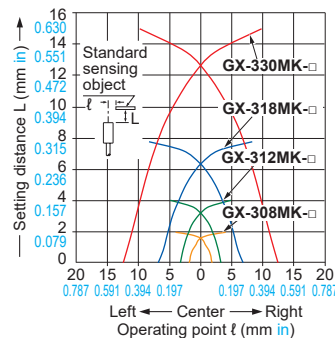
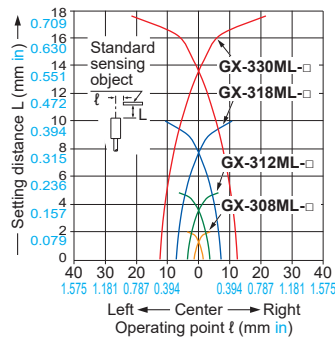
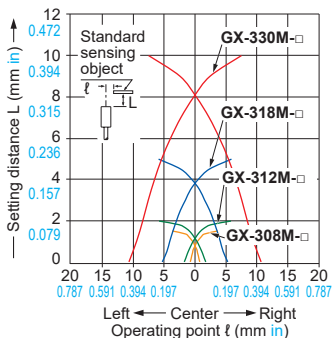
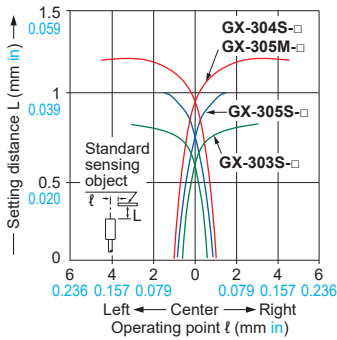

SENSING CHARACTERISTICS (TYPICAL)

GX-303S-□

Correlation between sensing object size and sensing range

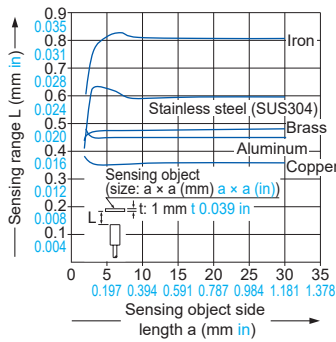

As the sensing object size becomes smaller than the standard size (iron sheet 3 × 3 × 1 mm 0.118 × 0.118 × t 0.039 in), the sensing range shortens as shown in the left figure.

Correlation between sensing range and repeatability

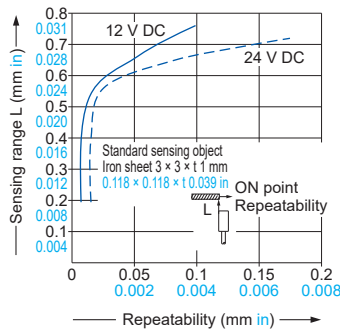

GX-304S-□ GX-305M-□

Correlation between sensing object size and sensing range

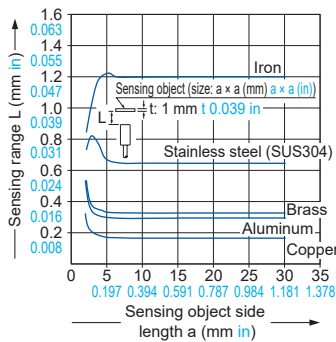

As the sensing object size becomes smaller than the standard size (iron sheet 4 × 4 × 1 mm 0.157 × 0.157 × t 0.039 in), the sensing range shortens as shown in the left figure.

Correlation between sensing range and repeatability

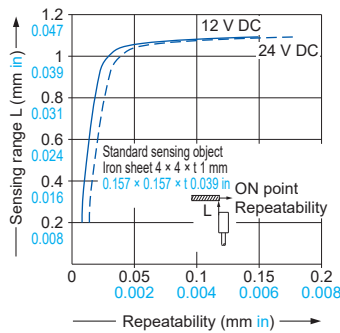

GX-305S-□

Correlation between sensing object size and sensing range

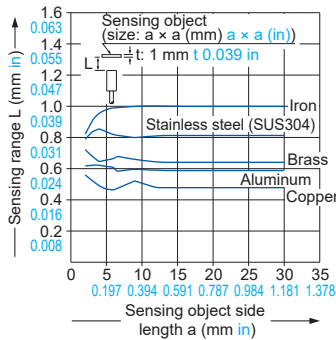

As the sensing object size becomes smaller than the standard size (iron sheet 5.4 × 5.4 × 1 mm 0.213 × 0.213 × t 0.039 in), the sensing range shortens as shown in the left figure.

Correlation between sensing range and repeatability

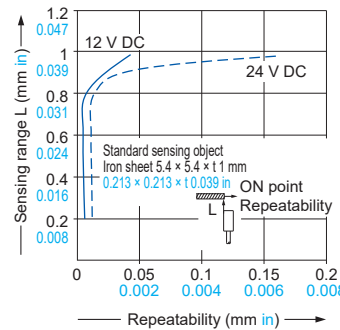

SENSING CHARACTERISTICS (TYPICAL)

GX-308M-□

Correlation between sensing object size and sensing range

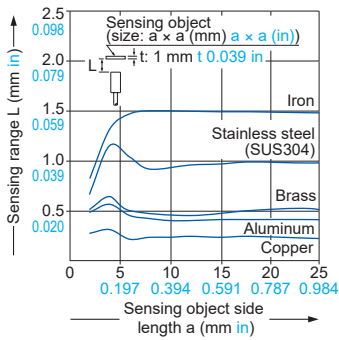

As the sensing object size becomes smaller than the standard size (iron sheet $8 \times 8 \times t$ 1 mm $0.315 \times 0.315 \times t$ 0.039 in), the sensing range shortens as shown in the left figure.

Correlation between monitor output and sensing range

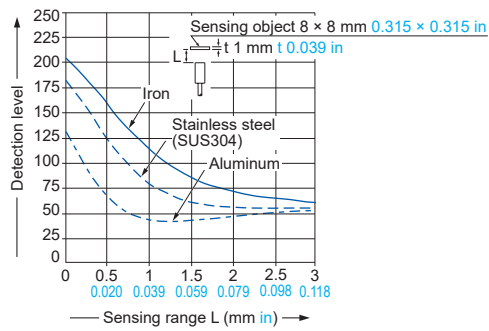

GX-312M-□

Correlation between sensing object size and sensing range

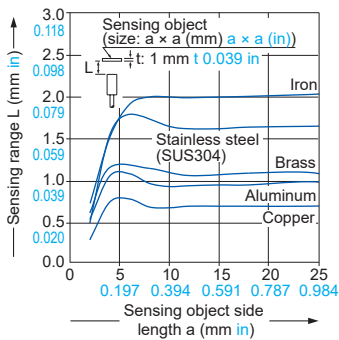

As the sensing object size becomes smaller than the standard size (iron sheet $12 \times 12 \times t$ 1 mm $0.472 \times 0.472 \times t$ 0.039 in), the sensing range shortens as shown in the left figure.

Correlation between monitor output and sensing range

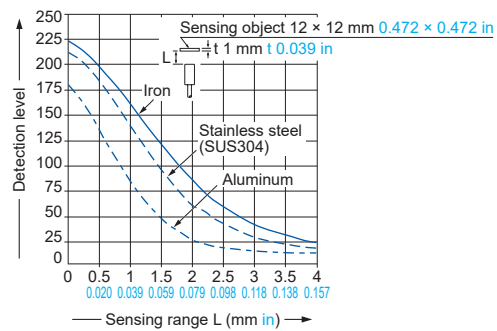

GX-318M-□

Correlation between sensing object size and sensing range

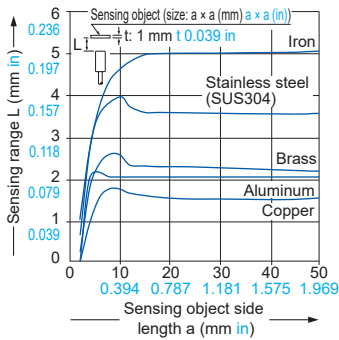

As the sensing object size becomes smaller than the standard size (iron sheet $18 \times 18 \times t$ 1 mm $0.709 \times 0.709 \times t$ 0.039 in), the sensing range shortens as shown in the left figure.

Correlation between monitor output and sensing range

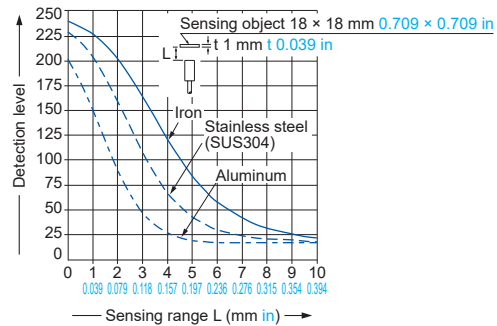

GX-330M-□

Correlation between sensing object size and sensing range

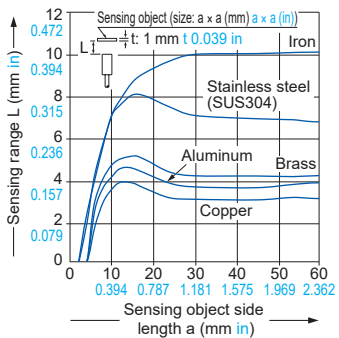

As the sensing object size becomes smaller than the standard size (iron sheet $30 \times 30 \times t$ 1 mm $1.181 \times 1.181 \times t$ 0.039 in), the sensing range shortens as shown in the left figure.

Correlation between monitor output and sensing range

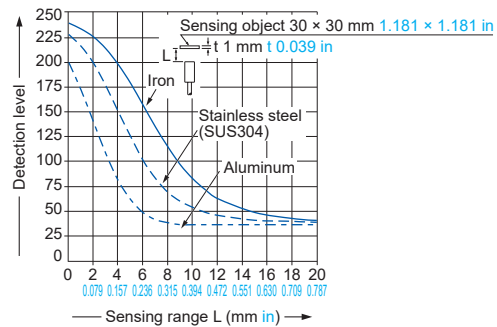

SENSING CHARACTERISTICS (TYPICAL)

GX-308MK-□

Correlation between sensing object size and sensing range

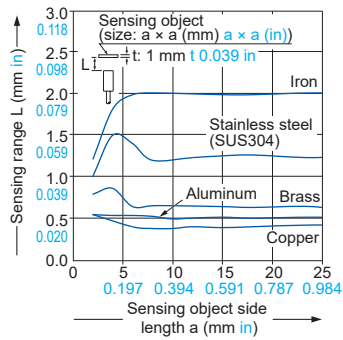

As the sensing object size becomes smaller than the standard size (iron sheet $8 \times 8 \times t 1 \text{ mm } 0.315 \times 0.315 \times t 0.039 \text{ in}$), the sensing range shortens as shown in the left figure.

Correlation between monitor output and sensing range

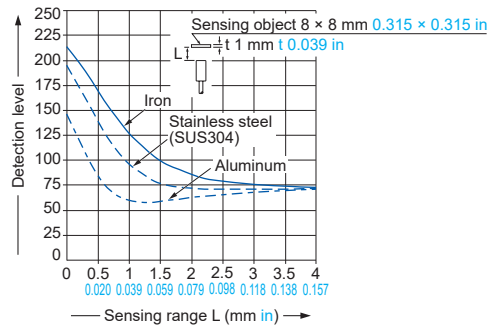

GX-312MK-□

Correlation between sensing object size and sensing range

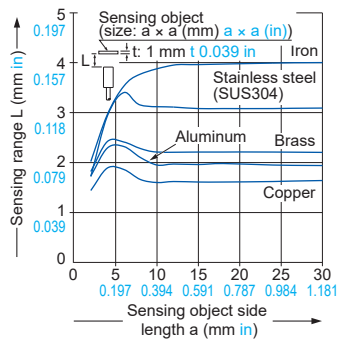

As the sensing object size becomes smaller than the standard size (iron sheet $12 \times 12 \times t 1 \text{ mm } 0.472 \times 0.472 \times t 0.039 \text{ in}$), the sensing range shortens as shown in the left figure.

Correlation between monitor output and sensing range

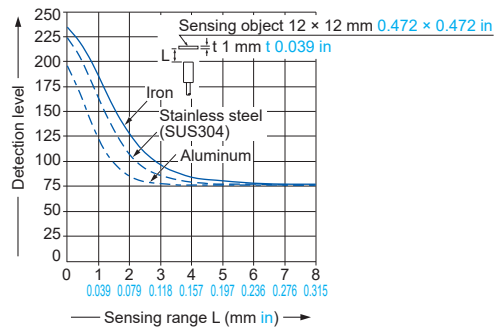

GX-318MK-□

Correlation between sensing object size and sensing range

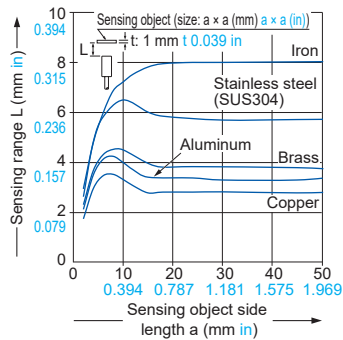

As the sensing object size becomes smaller than the standard size (iron sheet $24 \times 24 \times t 1 \text{ mm } 0.945 \times 0.945 \times t 0.039 \text{ in}$), the sensing range shortens as shown in the left figure.

Correlation between monitor output and sensing range

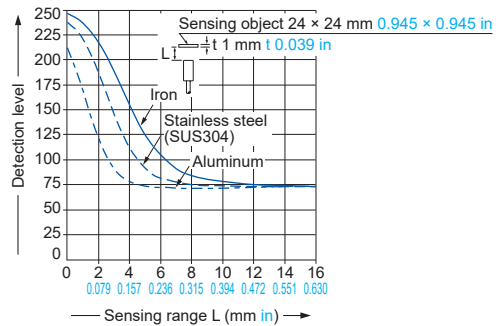

GX-330MK-□

Correlation between sensing object size and sensing range

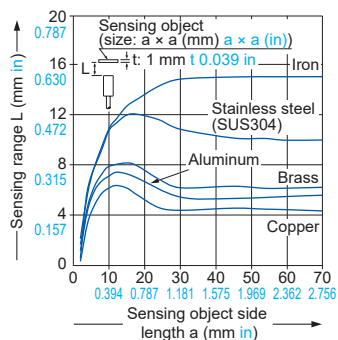

As the sensing object size becomes smaller than the standard size (iron sheet $45 \times 45 \times t 1 \text{ mm } 1.772 \times 1.772 \times t 0.039 \text{ in}$), the sensing range shortens as shown in the left figure.

Correlation between monitor output and sensing range

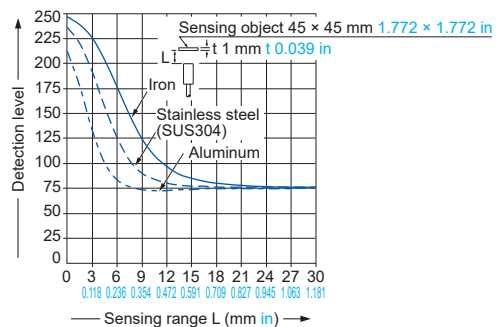

SENSING CHARACTERISTICS (TYPICAL)

GX-308ML-□

Correlation between sensing object size and sensing range

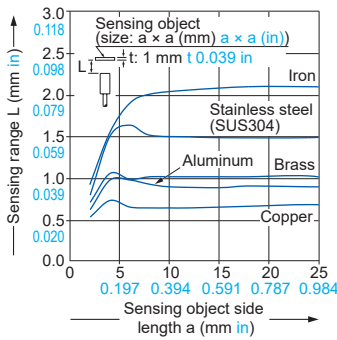

As the sensing object size becomes smaller than the standard size (iron sheet $8 \times 8 \times t$ 1 mm $0.315 \times 0.315 \times t$ 0.039 in), the sensing range shortens as shown in the left figure.

Correlation between monitor output and sensing range

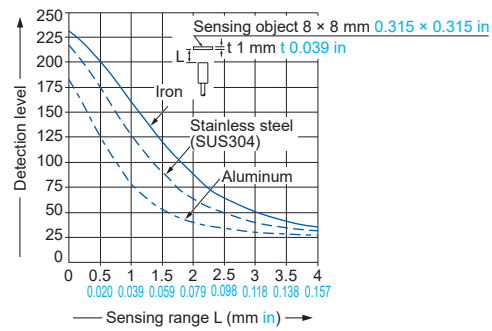

GX-312ML-□

Correlation between sensing object size and sensing range

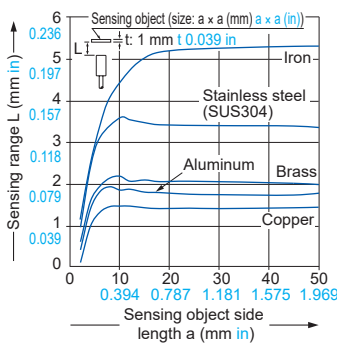

As the sensing object size becomes smaller than the standard size (iron sheet $15 \times 15 \times t$ 1 mm $0.591 \times 0.591 \times t$ 0.039 in), the sensing range shortens as shown in the left figure.

Correlation between monitor output and sensing range

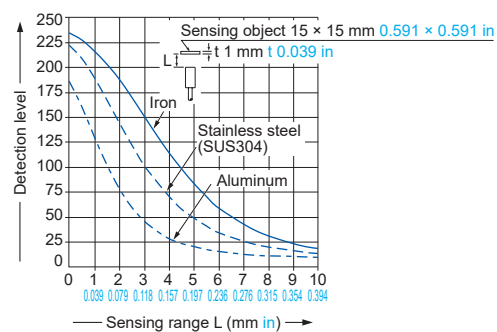

GX-318ML-□

Correlation between sensing object size and sensing range

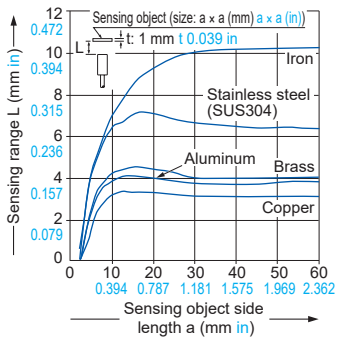

As the sensing object size becomes smaller than the standard size (iron sheet $30 \times 30 \times t$ 1 mm $1.181 \times 1.181 \times t$ 0.039 in), the sensing range shortens as shown in the left figure.

Correlation between monitor output and sensing range

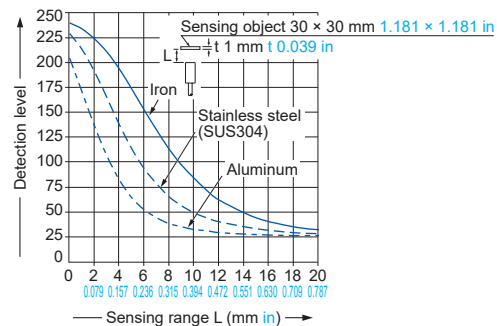

GX-330ML-□

Correlation between sensing object size and sensing range

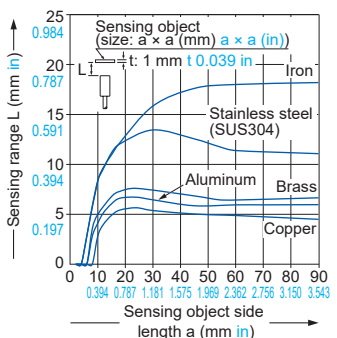

As the sensing object size becomes smaller than the standard size (iron sheet $54 \times 54 \times t$ 1 mm $2.126 \times 2.126 \times t$ 0.039 in), the sensing range shortens as shown in the left figure.

Correlation between monitor output and sensing range

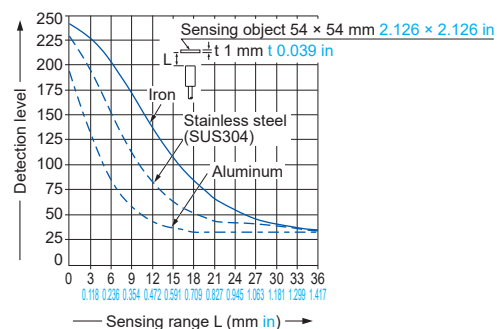

SENSING CHARACTERISTICS (TYPICAL)

GX-308MLK-□

Correlation between sensing object size and sensing range

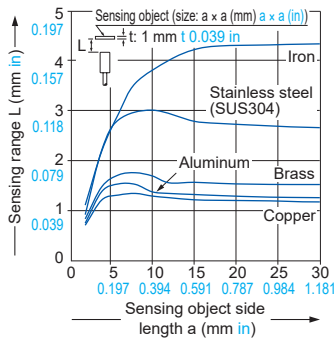

As the sensing object size becomes smaller than the standard size (iron sheet $12 \times 12 \times t$ mm $0.472 \times 0.472 \times t$ 0.039 in), the sensing range shortens as shown in the left figure.

Correlation between monitor output and sensing range

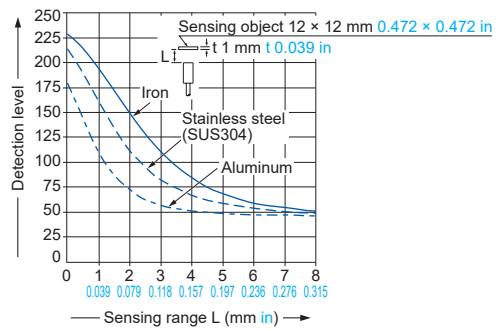

GX-312MLK-□

Correlation between sensing object size and sensing range

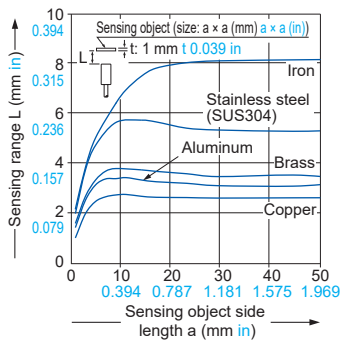

As the sensing object size becomes smaller than the standard size (iron sheet $24 \times 24 \times t$ mm $0.945 \times 0.945 \times t$ 0.039 in), the sensing range shortens as shown in the left figure.

Correlation between monitor output and sensing range

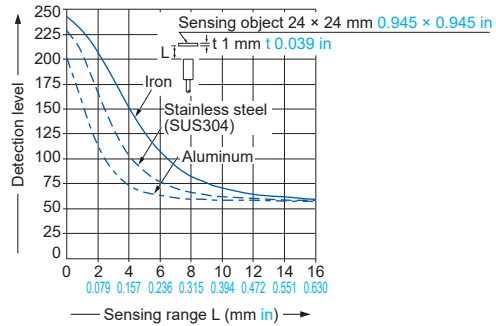

GX-318MLK-□

Correlation between sensing object size and sensing range

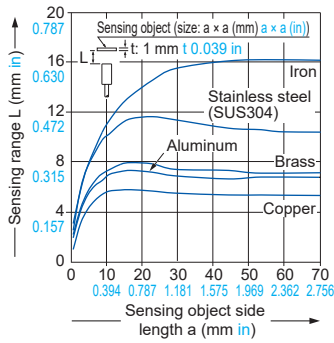

As the sensing object size becomes smaller than the standard size (iron sheet $48 \times 48 \times t$ mm $1.890 \times 1.890 \times t$ 0.039 in), the sensing range shortens as shown in the left figure.

Correlation between monitor output and sensing range

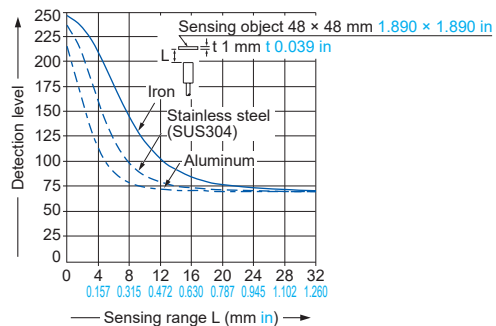

GX-330MLK-□

Correlation between sensing object size and sensing range

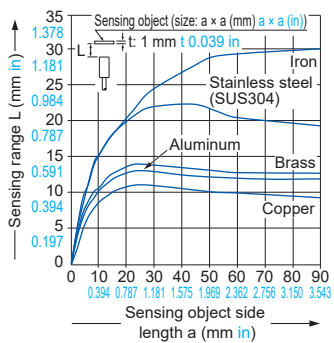

As the sensing object size becomes smaller than the standard size (iron sheet $90 \times 90 \times t$ mm $3.543 \times 3.543 \times t$ 0.039 in), the sensing range shortens as shown in the left figure.

Correlation between monitor output and sensing range

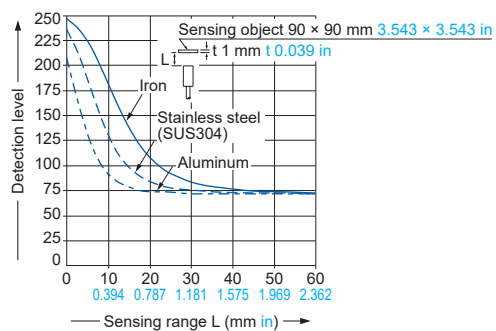

PRECAUTIONS FOR PROPER USE

- This catalog is a guide to select a suitable product. Be sure to read instruction manual attached to the product prior to its use.



- Never use this product as a sensing device for personnel protection.
- In case of using sensing devices for personnel protection, use products which meet laws and standards, such as OSHA, ANSI or IEC etc., for personnel protection applicable in each region or country.

Mounting

- The tightening torque should be under the value given below.

Installation using set screw

- Do not tighten the product mounting nuts with excessive force.

<Non-threaded type>

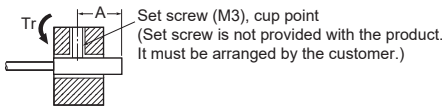

| Model No. | Tightening torque | Set screw location A (mm in) |
|-----------|-------------------|------------------------------|
| GX-303S | 0.2 N·m | 13 to 21 0.512 to 0.827 |
| GX-304S | | 8 to 21 0.315 to 0.827 |
| GX-305S | 0.4 N·m | |

Installation using nut

- Do not tighten the nut with excessive force. Be sure to install the toothed locked washer.
- In the case of the M8 threaded type, the allowable strength differs depending on the distance from the tip of the head. The following table shows the allowable tightening strengths for section B and section C shown in the diagram. (Section B starts from the tip of the head and its dimension is indicated in the table. Section C includes the nut on the head side. Therefore, if the nut extends into section B even slightly, the strength of section B is applicable.)
- The following allowable tightening strengths are applicable when the washer is installed.

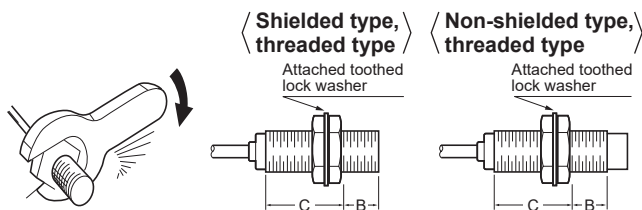

| Model No. (Shielded type) | B | | C |
|------------------------------|-------------------|-------------------|-------------------|
| | Dimension (mm in) | Tightening torque | Tightening torque |
| GX-305M | - | 1 N·m | |
| GX-308M(K) | 9 0.354 | 9 N·m | 12 N·m |
| GX-312M(K) | - | 30 N·m | |
| GX-318M(K) | - | 70 N·m | |
| GX-330M(K) | - | 180 N·m | |

| Model No. (Non-shielded type) | B | | C |
|----------------------------------|-------------------|-------------------|-------------------|
| | Dimension (mm in) | Tightening torque | Tightening torque |
| GX-308ML(K) | 3 0.118 | 9 N·m | 12 N·m |
| GX-312ML(K) | - | 30 N·m | |
| GX-318ML(K) | - | 70 N·m | |
| GX-330ML(K) | - | 180 N·m | |

Mounting hole and nut dimensions

Mounting hole



Nut dimensions



| Model No. | D (mm in) | E (mm in) |
|---------------------------|--|-----------|
| GX-303S | $\phi 3.3^{+0.5}_0$ $\phi 0.130^{+0.0197}_0$ | - |
| GX-304S | $\phi 4.2^{+0.5}_0$ $\phi 0.165^{+0.0197}_0$ | - |
| GX-305S | $\phi 5.7^{+0.5}_0$ $\phi 0.224^{+0.0197}_0$ | - |
| GX-305M | $\phi 5.5^{+0.5}_0$ $\phi 0.217^{+0.0197}_0$ | - |
| GX-308M(K) GX-308ML(K) | $\phi 8.5^{+0.5}_0$ $\phi 0.335^{+0.0197}_0$ | 13 0.512 |
| GX-312M(K) GX-312ML(K) | $\phi 12.5^{+0.5}_0$ $\phi 0.492^{+0.0197}_0$ | 17 0.669 |
| GX-318M(K) GX-318ML(K) | $\phi 18.5^{+0.5}_0$ $\phi 0.728^{+0.0197}_0$ | 24 0.945 |
| GX-330M(K) GX-330ML(K) | $\phi 30.5^{+0.5}_0$ $\phi 1.201^{+0.0197}_0$ | 36 1.417 |

Bending radius of lead-out cable section

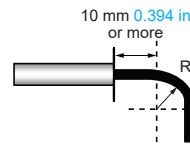

| Model No. | Bending radius R |
|-----------|-----------------------|
| GX-303S | 7 mm 0.276 in or more |
| GX-304S | 9 mm 0.354 in or more |
| GX-305S | |
| GX-305M | |

Installing small-diameter sensor

- Please use the sensor after confirming the installation distance by following (a) and (b) with an actual detection object when you install.
 - The detection distance receives the influence by the material of the detection object, thickness, shape, and the size. So, the detection object is brought close to the front side of the sensor and detection distance (S) is measured. For the effect of the material, see the graph, "Correlation between sensing object size and sensing range," (p.16).
 - Please decide installation distance (Sa) with $S \times 70\%$ or less after measuring sensing distance(S).
- Please install the sensor to come within the range of (Sa) when the detection object moves from vertical direction.
- Please install the sensor to pass within the range of (Sa) when the detection object moves from horizontal direction.
- When using the sensor, refer to the "Standard sensing object" specified in the specifications (p.10) and the graph, "Correlation between sensing object size and sensing range," (p.16).

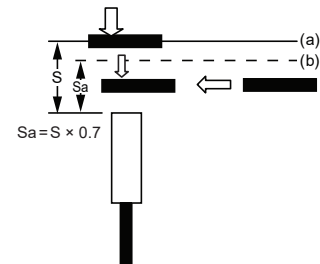

PRECAUTIONS FOR PROPER USE

Distance from surrounding metal

- As metal around the sensor may affect the sensing performance, pay attention to the following points.

Influence of surrounding metal

- The surrounding metal will affect the sensing performance. Keep the minimum distance specified in the table below.
- When mounting the sensor using a nut, use the nut and washer provided with the product.
- The type of the provided nut varies in different models. See the external dimensions diagrams (p.23~) for the detail of the shape.

Mounting method A (Using the provided nut)

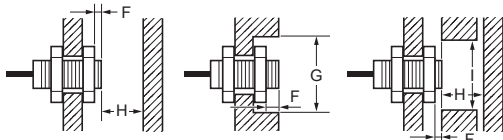

Mounting method B (Embedded in the metal)

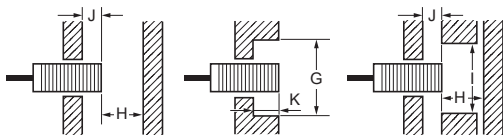

(Unit: mm in)

| Model No. (Shielded type) | Mounting method A | | | | Mounting method B | | | | |
|------------------------------|-------------------|---------------|--------------|-------------|-------------------|----------------|--------------|--------------|-------------|
| | F | G | H | I | J | G | K | H | I |
| GX-303S | - | - | - | - | 0 | ø3 ø0.118 | 0 | 3 0.118 | 8 0.315 |
| GX-304S | - | - | - | - | 0 | ø4 ø0.157 | 0 | 5 0.197 | 10 0.394 |
| GX-305S | - | - | - | - | 0 | ø5.4 ø0.213 | 0 | 3 0.118 | 8 0.315 |
| GX-305M | 0 | ø5 ø0.197 | 5 0.197 | 10 0.394 | 0 | ø5 ø0.197 | 0 | 5 0.197 | 10 0.394 |
| GX-308M | 0 | ø8 ø0.315 | 4.5 0.177 | 12 0.472 | 0 | ø8 ø0.315 | 0 | 4.5 0.177 | 12 0.472 |
| GX-312M | 0 | ø12 ø0.472 | 8 0.315 | 18 0.709 | 0 | ø12 ø0.472 | 0 | 8 0.315 | 18 0.709 |
| GX-318M | 0 | ø18 ø0.709 | 20 0.787 | 27 1.063 | 0 | ø18 ø0.709 | 0 | 20 0.787 | 27 1.063 |
| GX-330M | 0 | ø30 ø1.181 | 40 1.575 | 45 1.772 | 0 | ø30 ø1.181 | 0 | 40 1.575 | 45 1.772 |
| GX-308MK | 0 | ø8 ø0.315 | 4.5 0.177 | 12 0.472 | 0 | ø8 ø0.315 | 0 | 4.5 0.177 | 12 0.472 |
| GX-312MK | 0 | ø18 ø0.709 | 12 0.472 | 18 0.709 | 2.4 0.094 | ø18 ø0.709 | 2.4 0.094 | 12 0.472 | 18 0.709 |
| GX-318MK | 0 | ø27 ø1.063 | 24 0.945 | 27 1.063 | 3.6 0.142 | ø27 ø1.063 | 3.6 0.142 | 24 0.945 | 27 1.063 |
| GX-330MK | 0 | ø45 ø1.772 | 45 1.772 | 45 1.772 | 6 0.236 | ø45 ø1.772 | 6 0.236 | 45 1.772 | 45 1.772 |

| Model No. (Non-shielded type) | Mounting method A | | | | Mounting method B | | | | |
|----------------------------------|-------------------|----------------|-------------|--------------|-------------------|----------------|-------------|-------------|--------------|
| | F | G | H | I | J | G | K | H | I |
| GX-308ML | 6 0.236 | ø24 ø0.945 | 8 0.315 | 24 0.945 | 6 0.236 | ø24 ø0.945 | 6 0.236 | 8 0.315 | 24 0.945 |
| GX-312ML | 11 0.433 | ø40 ø1.575 | 20 0.787 | 36 1.417 | 15 0.591 | ø40 ø1.575 | 15 0.591 | 20 0.787 | 36 1.417 |
| GX-318ML | 18 0.709 | ø55 ø2.165 | 40 1.575 | 24 2.126 | 12 0.866 | ø55 ø2.165 | 12 0.866 | 40 1.575 | 24 2.126 |
| GX-330ML | 25 0.984 | ø90 ø3.543 | 70 2.756 | 90 3.543 | 30 1.181 | ø90 ø3.543 | 30 1.181 | 70 2.756 | 90 3.543 |
| GX-308MLK | 9 0.354 | ø24 ø0.945 | 8 0.315 | 24 0.945 | 6 0.236 | ø24 ø0.945 | 6 0.236 | 8 0.315 | 24 0.945 |
| GX-312MLK | 11 0.433 | ø40 ø1.575 | 20 0.787 | 36 1.417 | 15 0.591 | ø40 ø1.575 | 15 0.591 | 20 0.787 | 36 1.417 |
| GX-318MLK | 21 0.827 | ø70 ø2.756 | 48 1.890 | 70 2.756 | 25 0.984 | ø70 ø2.756 | 25 0.984 | 48 1.890 | 70 2.756 |
| GX-330MLK | 40 1.575 | ø120 ø4.724 | 90 3.543 | 120 4.724 | 45 1.772 | ø120 ø4.724 | 45 1.772 | 90 3.543 | 120 4.724 |

Mutual interference

- When two or more sensors are installed in parallel or face to face, keep the minimum separation distance specified below to avoid mutual interference

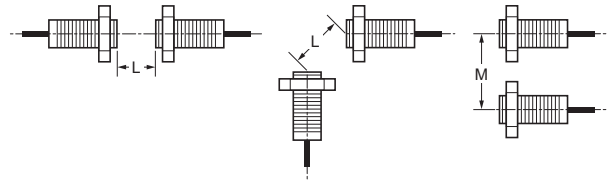

| Model No. (Shielded type) | L (mm in) | M (mm in) |
|------------------------------|-----------|-----------|
| GX-303S | 20 0.787 | 15 0.591 |
| GX-304S | 20 0.787 | 15 0.591 |
| GX-305S | 20 0.787 | 15 0.591 |
| GX-305M | 20 0.787 | 15 0.591 |
| GX-308M(K) | 20 0.787 | 15 0.591 |
| GX-312M(K) | 30 1.181 | 20 0.787 |
| GX-318M | 50 1.969 | 35 1.378 |
| GX-318MK | 60 2.362 | 35 1.378 |
| GX-330M | 100 3.937 | 70 2.756 |
| GX-330MK | 110 4.331 | 90 3.543 |

| Model No. (Non-shielded type) | L (mm in) | M (mm in) |
|----------------------------------|------------|------------|
| GX-308ML(K) | 80 3.150 | 60 2.362 |
| GX-312ML(K) | 120 4.724 | 100 3.937 |
| GX-318ML | 200 7.874 | 110 4.331 |
| GX-318MLK | 200 7.874 | 120 4.724 |
| GX-330ML | 300 11.811 | 200 7.874 |
| GX-330MLK | 350 13.780 | 300 11.811 |

Timing chart

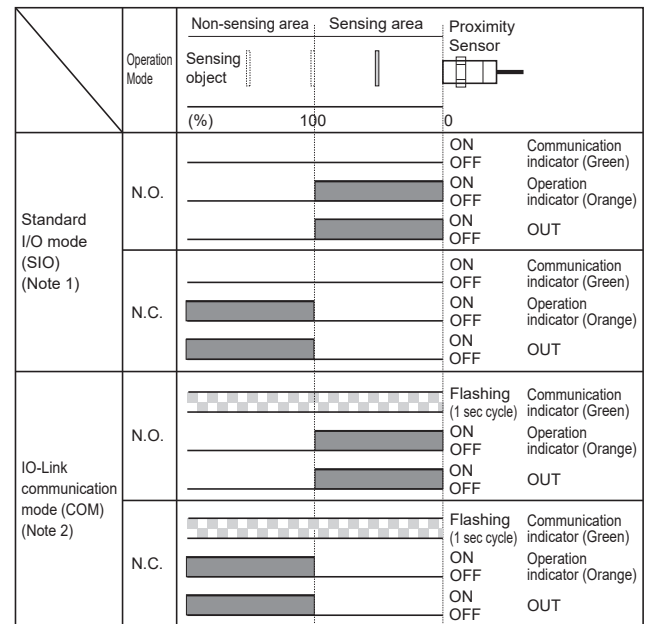

- Notes: 1) When sensors that are not compatible with IO-Link are used or when IO-Link compatible models are used as ordinary sensors, they operate in the standard I/O mode (SIO mode).
2) The operation mode can be changed by the IO-Link communications. The timer function of the output can be set up by the IO-Link communications.

PRECAUTIONS FOR PROPER USE

Others

- This product has been developed / produced for industrial use only.
- Do not install the product in the following locations. Doing so may result in product failure or malfunction.
 - Outdoor locations directly subject to sunlight, rain, snow, water droplets, or oil.
 - Locations subject to atmospheres with chemical vapors, in particular solvents and acids.
 - Locations subject to corrosive gases.
- The product may malfunction if used near ultrasonic cleaning equipment, high-frequency equipment, transceivers, cellular phones, inverters, or other devices that generate a high-frequency electric field.
- Laying the product wiring in the same conduit or duct as high-voltage wires or power lines may result in incorrect operation and damage due to induction. Wire the product using a separate conduit or independent conduit.
- The following conditions shall be observed if you use the product under an environment using cutting oil that may affect product's life and/or performance.
 - Usage in oil or water is prohibited.
- Impact on the product life may differ depending on the oil you use. Before using the cutting oil, make sure that it should not cause deterioration or degradation of sealing components.
- Never use thinner or other solvents. Otherwise, the product surface may be dissolved.
- When turning ON the power by influence of temperature environment, an output mis-pulse sometimes occurs. After the product has passed for 300 ms after turning ON, please use in the stable state. If the sensing object is located near the sensor's sensing surface, an output mis-pulse may be generated for 300 ms or longer at the time of power-on. Be sure to check the product for proper operation under actual operating condition before using.
- The product is adjusted with a high degree of accuracy, so do not use in the environment with sudden temperature change.
- Do not attempt to disassemble, repair, or modify the product.
- Do not use a voltage that exceeds the rated operating voltage range. Applying a voltage that is higher than the operating voltage range may result in damage or burnout.
- Be sure that the power supply polarity and other wiring is correct. Incorrect wiring may cause explosion or burnout.
- If the power supply is connected directly without a load, the internal elements may explode or burn. Be sure to insert a load when connecting the power supply.
- Please use gloves to protect yourself from injury caused by screw.
- For the connector type and pigtailed type, check the specifications of the connector cable to be used. Please do not use it under conditions that exceed the range of its specifications of both the product and the connector cable.
- Please make sure there is no foreign matter in connector part before connecting the connector cable to the connector type and pigtailed type.
- In the IO-Link mode, the cable between the IO-Link master and sensor must have a length of 20 m **65.617 ft** or less.

DIMENSIONS (Unit: mm in)

The CAD data can be downloaded from our website.

GX-303S-□

Sensor

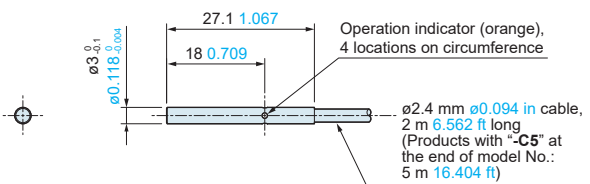

GX-304S-□

Sensor

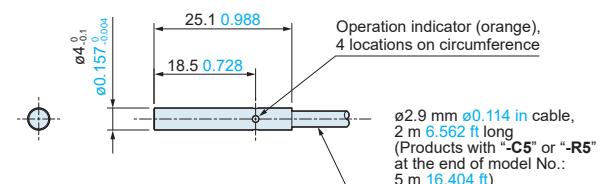

GX-305S-□

Sensor

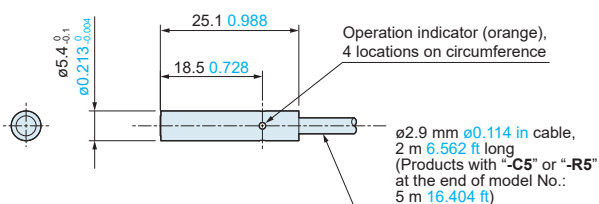

GX-305M-□

Sensor

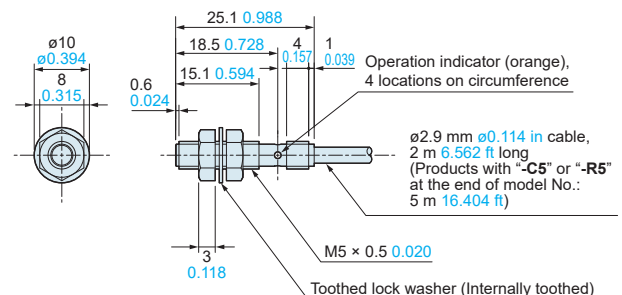

GX-308M(K)-□ GX-312M(K)-□ GX-318M(K)-□ GX-330M(K)-□
 GX-308ML(K)-□ GX-312ML(K)-□ GX-318ML(K)-□ GX-330ML(K)-□

Sensor

Cable type / Pigtailed type

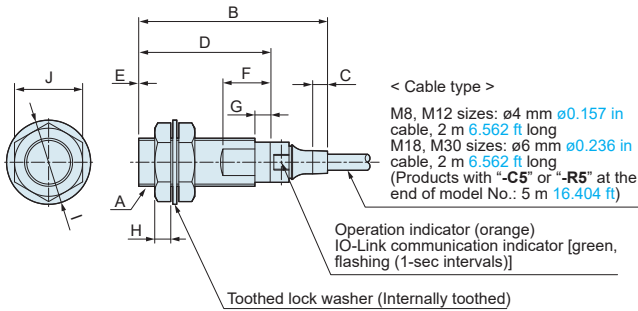

Connector type

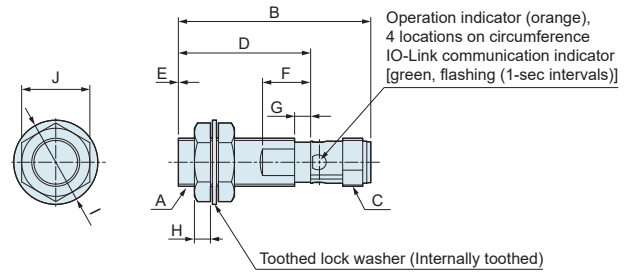

< Pigtailed type >

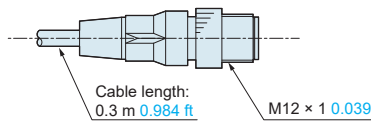

| Symbol Model No. | Shielded type | | | | | | | | | |
|---------------------|--------------------------|---------------|--------------|-------------|---|-------------|------------|------------|-------------|-------------|
| | A | B | C | D | E | F | G | H | I | J |
| GX-308M(K) | M8 x 1 M8 x 0.039 | 37.8 1.488 | 4.4 0.173 | 26 1.024 | - | 10 0.394 | 4 0.157 | 3 0.118 | 15 0.591 | 13 0.512 |
| GX-312M(K) | M12 x 1 M12 x 0.039 | 47.1 1.854 | 3.7 0.146 | 33 1.299 | - | 12 0.472 | 4 0.157 | 4 0.157 | 21 0.827 | 17 0.669 |
| GX-318M(K) | M18 x 1 M18 x 0.039 | 55.3 2.177 | 8.5 0.335 | 38 1.496 | - | 12 0.472 | 4 0.157 | 4 0.157 | 29 1.142 | 24 0.945 |
| GX-330M(K) | M30 x 1.5 M30 x 0.059 | 60.3 2.374 | 8.3 0.327 | 43 1.693 | - | 12 0.472 | 4 0.157 | 5 0.197 | 42 1.654 | 36 1.417 |

| Symbol Model No. | Shielded type | | | | | | | | | |
|---------------------|--------------------------|-------------|------------------------|-------------|---|-------------|------------|------------|-------------|-------------|
| | A | B | C | D | E | F | G | H | I | J |
| GX-312M(K) | M12 x 1 M12 x 0.039 | 48 1.890 | M12 x 1 M12 x 0.039 | 33 1.299 | - | 12 0.472 | 4 0.157 | 4 0.157 | 21 0.827 | 17 0.669 |
| GX-318M(K) | M18 x 1 M18 x 0.039 | 53 2.087 | M12 x 1 M12 x 0.039 | 38 1.496 | - | 12 0.472 | 4 0.157 | 4 0.157 | 29 1.142 | 24 0.945 |
| GX-330M(K) | M30 x 1.5 M30 x 0.059 | 58 2.283 | M12 x 1 M12 x 0.039 | 43 1.693 | - | 12 0.472 | 4 0.157 | 5 0.197 | 42 1.654 | 36 1.417 |

| Symbol Model No. | Non-shielded type | | | | | | | | | |
|---------------------|--------------------------|---------------|--------------|-------------|-------------|-------------|---|------------|-------------|-------------|
| | A | B | C | D | E | F | G | H | I | J |
| GX-308ML(K) | M8 x 1 M8 x 0.039 | 37.8 1.488 | 4.4 0.173 | 26 1.024 | 6 0.236 | 8 0.315 | - | 3 0.118 | 15 0.591 | 13 0.512 |
| GX-312ML(K) | M12 x 1 M12 x 0.039 | 47.1 1.854 | 3.7 0.146 | 33 1.299 | 7 0.276 | 10 0.394 | - | 4 0.157 | 21 0.827 | 17 0.669 |
| GX-318ML(K) | M18 x 1 M18 x 0.039 | 55.3 2.177 | 8.5 0.335 | 38 1.496 | 10 0.394 | 10 0.394 | - | 4 0.157 | 29 1.142 | 24 0.945 |
| GX-330ML | M30 x 1.5 M30 x 0.059 | 60.3 2.374 | 8.3 0.327 | 43 1.693 | 13 0.512 | 10 0.394 | - | 5 0.197 | 42 1.654 | 36 1.417 |
| GX-330MLK | M30 x 1.5 M30 x 0.059 | 82.3 3.240 | 8.3 0.327 | 65 2.559 | 15 0.591 | 10 0.394 | - | 5 0.197 | 42 1.654 | 36 1.417 |

| Symbol Model No. | Non-shielded type | | | | | | | | | |
|---------------------|--------------------------|-------------|------------------------|-------------|-------------|-------------|---|------------|-------------|-------------|
| | A | B | C | D | E | F | G | H | I | J |
| GX-312ML(K) | M12 x 1 M12 x 0.039 | 48 1.890 | M12 x 1 M12 x 0.039 | 33 1.299 | 7 0.276 | 10 0.394 | - | 4 0.157 | 21 0.827 | 17 0.669 |
| GX-318ML(K) | M18 x 1 M18 x 0.039 | 53 2.087 | M12 x 1 M12 x 0.039 | 38 1.496 | 10 0.394 | 10 0.394 | - | 4 0.157 | 29 1.142 | 24 0.945 |
| GX-330ML | M30 x 1.5 M30 x 0.059 | 58 2.283 | M12 x 1 M12 x 0.039 | 43 1.693 | 13 0.512 | 10 0.394 | - | 5 0.197 | 42 1.654 | 36 1.417 |
| GX-330MLK | M30 x 1.5 M30 x 0.059 | 80 3.150 | M12 x 1 M12 x 0.039 | 65 2.559 | 15 0.591 | 10 0.394 | - | 5 0.197 | 42 1.654 | 36 1.417 |

Note: M8 type models are not available in the connector type.

Disclaimer

The applications described in the catalog are all intended for examples only. The purchase of our products described in the catalog shall not be regarded as granting of a license to use our products in the described applications. We do NOT warrant that we have obtained some intellectual properties, such as patent rights, with respect to such applications, or that the described applications may not infringe any intellectual property rights, such as patent rights, of a third party.



Panasonic Industry Co., Ltd.

Industrial Device Business Division
 7-1-1, Morofuku, Daito-shi, Osaka 574-0044, Japan
industrial.panasonic.com/ac/e/