

Amplifier Built-in

Ultra-minute Photoelectric Sensor

EX-Z SERIES

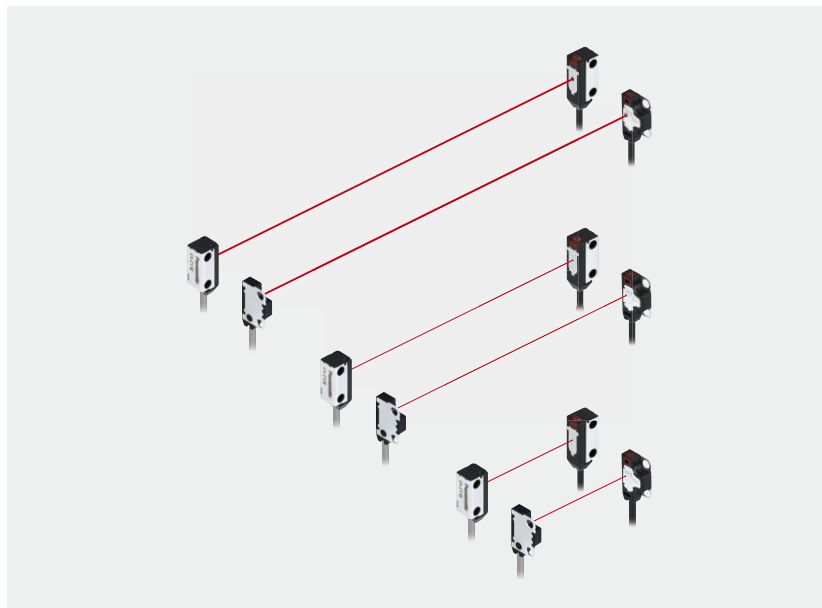

EX-Z SERIES

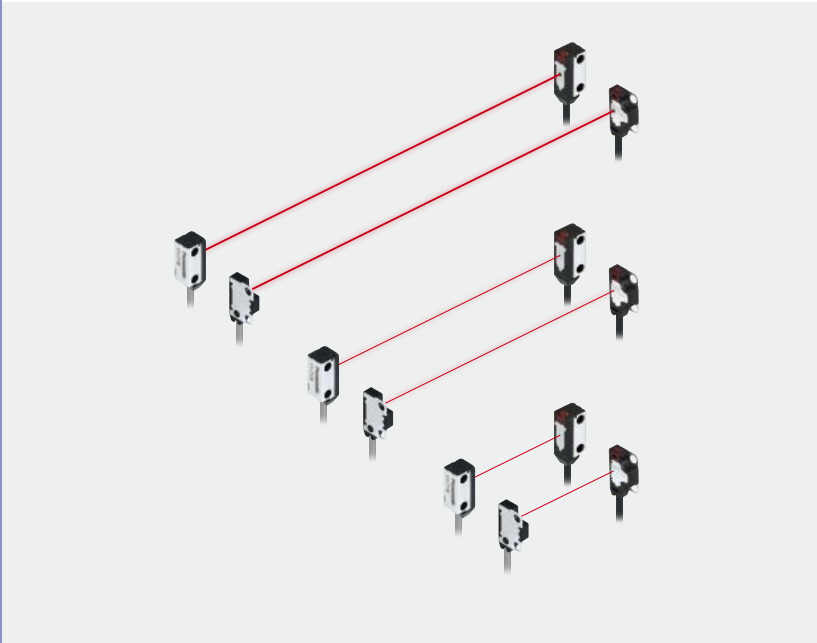

The World's No. 1* in Compactness



* Among photoelectric sensors with built-in amplifier, as of April 2017 in-company survey

Unit volume ratio reduced by about 50%* * As compared to EX-10 series

The world's thinnest* sensor dimension of 3 mm 0.118 in has been achieved by utilizing new semiconductor packaging technology that does not use wire bonding. The small unit size allows installation of sensors in a narrow space where only a conventional fiber sensor head could be installed before. The built-in amplifier also saves on installation space.

* Among photoelectric sensors with built-in amplifier, as of April 2017 in-company survey

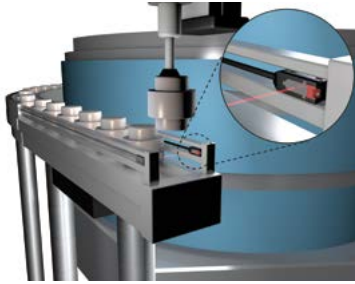
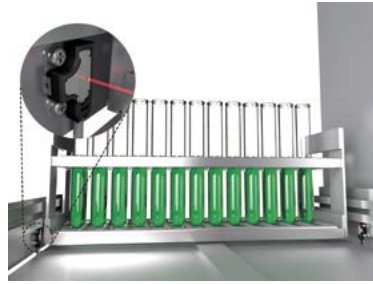

| Front sensing type | Side sensing type |
|--|--|
| <p>Approx. 50% smaller in volume ratio than EX-10</p>  | <p>Approx. 35% smaller in volume ratio than EX-10</p>  |
| <p>EX-Z1□F□ W8 × H14 × D3 mm W0.315 × H0.551 × D0.118 in</p> | <p>EX-Z1□ W5.5 × H15.9 × D6.5 mm W0.217 × H0.626 × D0.256 in</p> |

APPLICATIONS**Detection of parts in parts feeder****Detection of presence / absence of test tube tray****Detection of LED lead****Capable of sensing an extremely small $\varnothing 0.3$ mm $\varnothing 0.012$ in object without slit** **EX-Z11**

A slit is provided on the front side of the main sensor body. The sensor can detect a $\varnothing 0.3$ mm $\varnothing 0.012$ in object (the smallest-object sensing capability in the industry*) without using an optional slit.

* Among photoelectric sensors with built-in amplifier, as of April 2017 in-company survey

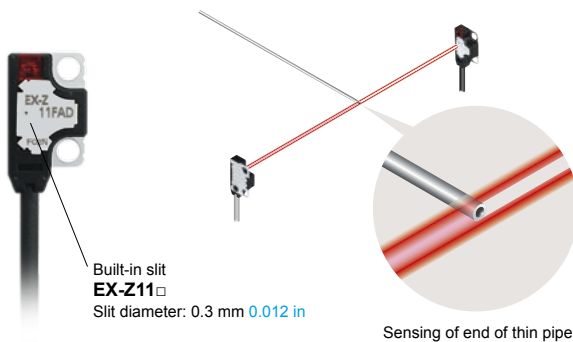
**Capability to sense a small $\varnothing 1.0$ mm $\varnothing 0.039$ in object over long distance** **EX-Z13**

The high-brightness 4-element red LED provides strong light emission stably over a long period of time. In spite of the extremely small size, both front sensing and side sensing units can sense a small $\varnothing 1.0$ mm $\varnothing 0.039$ in object from a long distance of 500 mm 19.685 in. Since the spotlight is clearly visible, the sensing position can be easily confirmed.

Clearly
visible
spotlight

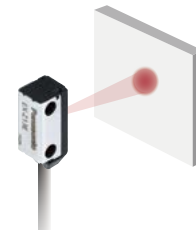
**ENVIRONMENTAL RESISTANCE****Bending-resistant cable type available for all models**

Bending-resistant cable type with improved flex resistance is available for all models. Select the model suitable for your specific application.

The standard type comes with lead wires with the same diameter as previous models, but the outside diameter of the cable is 2.0 mm 0.079 in and thinner than the cables of the **EX-10** series. This facilitates cable routing.

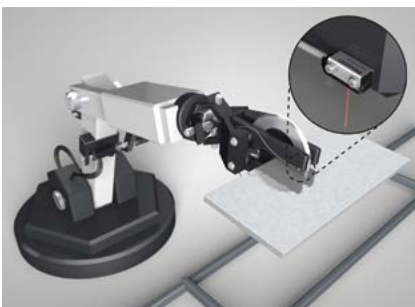
**Waterproof IP67**

The sensors features an IP67 rating to allow their use in process lines where water is used or splashed. Rust-resistant stainless steel sensor mounting brackets and screws are available.

Note: If water splashes on the sensor during sensing operation, it may sense water as an object.

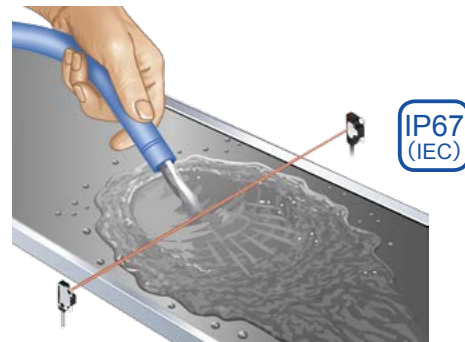

OPTIONS

A variety of mounting brackets are available!

A spacer for mounting at the back (1 type) for through-wall sensing and sensor mounting brackets (3 types) are available to meet a diversity of sensor installation needs.

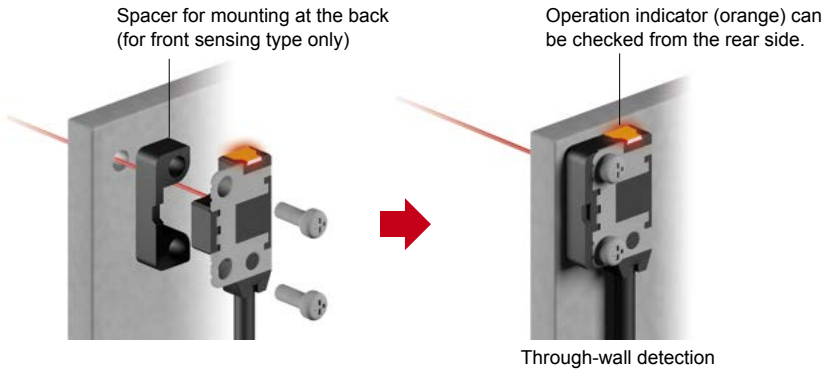

ORDER GUIDE

| Type | Appearance | Sensing range | Model No. (Note) | | Output operation |
|-----------------|--|------------------|------------------|--------------|------------------|
| | | | NPN output | PNP output | |
| Thru-beam | Front sensing Infection resistant cable | 50 mm 1.969 in | EX-Z11FA | EX-Z11FA-P | Light-ON |
| | | | EX-Z11FB | EX-Z11FB-P | Dark-ON |
| | | 200 mm 7.874 in | EX-Z12FA | EX-Z12FA-P | Light-ON |
| | | | EX-Z12FB | EX-Z12FB-P | Dark-ON |
| | | 500 mm 19.685 in | EX-Z13FA | EX-Z13FA-P | Light-ON |
| | | | EX-Z13FB | EX-Z13FB-P | Dark-ON |
| | | 50 mm 1.969 in | EX-Z11FA-R | EX-Z11FA-P-R | Light-ON |
| | | | EX-Z11FB-R | EX-Z11FB-P-R | Dark-ON |
| | | 200 mm 7.874 in | EX-Z12FA-R | EX-Z12FA-P-R | Light-ON |
| | | EX-Z12FB-R | EX-Z12FB-P-R | Dark-ON | |
| | | 500 mm 19.685 in | EX-Z13FA-R | EX-Z13FA-P-R | Light-ON |
| | | | EX-Z13FB-R | EX-Z13FB-P-R | Dark-ON |
| | Side sensing Infection resistant cable | 50 mm 1.969 in | EX-Z11A | EX-Z11A-P | Light-ON |
| | | | EX-Z11B | EX-Z11B-P | Dark-ON |
| | | 200 mm 7.874 in | EX-Z12A | EX-Z12A-P | Light-ON |
| | | | EX-Z12B | EX-Z12B-P | Dark-ON |
| | | 500 mm 19.685 in | EX-Z13A | EX-Z13A-P | Light-ON |
| | | | EX-Z13B | EX-Z13B-P | Dark-ON |
| 50 mm 1.969 in | | EX-Z11A-R | EX-Z11A-P-R | Light-ON | |
| | | EX-Z11B-R | EX-Z11B-P-R | Dark-ON | |
| 200 mm 7.874 in | | EX-Z12A-R | EX-Z12A-P-R | Light-ON | |
| | EX-Z12B-R | EX-Z12B-P-R | Dark-ON | | |
| | 500 mm 19.685 in | EX-Z13A-R | EX-Z13A-P-R | Light-ON | |
| | | EX-Z13B-R | EX-Z13B-P-R | Dark-ON | |

NOTE: Mounting bracket is not supplied with the sensor. Please select from the range of optional sensor mounting brackets (**MS-EXZ-□**).

Note: The model No. with "E" shown on the label affixed to the thru-beam type sensor is the emitter, "D" shown on the label is the receiver.

OPTIONS

| Designation | Model No. | Description |
|---------------------------------|-----------------|--|
| Sensor mounting bracket | MS-EXZ-1 | L-shaped mounting bracket (SUS304) for front sensing and side sensing types (2 sets are required) |
| | MS-EXZ-2 | Mounting bracket (SUS304) for front sensing type (2 sets are required) |
| | MS-EXZ-3 | Mounting bracket (SUS304) for side sensing type (2 sets are required) |
| Spacer for mounting at the back | MS-EXZ-4 | Spacer for mounting at the back (polyacetal) for front sensing type One set consists of 10 pcs. |

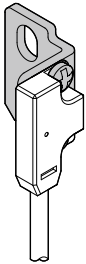
Sensor mounting bracket• **MS-EXZ-1**

Material: Stainless steel (SUS304)
Two M2 (length 4 mm 0.157 in) pan head screws and two M2 (length 8 mm 0.315 in) pan head screws are attached.

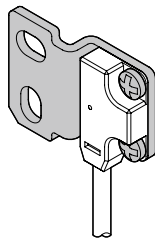
• **MS-EXZ-2**

Material: Stainless steel (SUS304)
Two M2 (length 4 mm 0.157 in) pan head screws are attached.

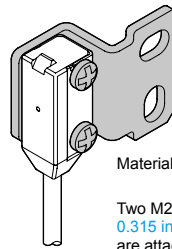
• **MS-EXZ-3**

Material: Stainless steel (SUS304)
Two M2 (length 8 mm 0.315 in) pan head screws are attached.

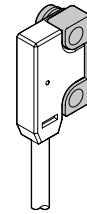
Spacer for mounting at the back• **MS-EXZ-4**

Material: Polyacetal
M2 (length: 10 mm 0.394 in) screws, nuts, spring washers and flat washers are attached. (20 pieces each)

PRECAUTIONS FOR PROPER USE

- Never use this product as a sensing device for personnel protection.
- In case of using sensing devices for personnel protection, use products which meet laws and standards, such as OSHA, ANSI or IEC etc., for personnel protection applicable in each region or country.

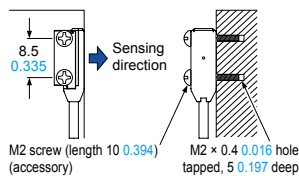
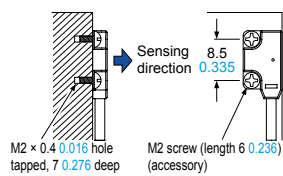
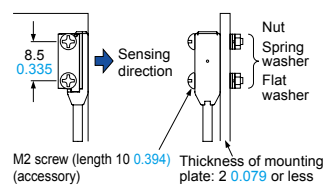
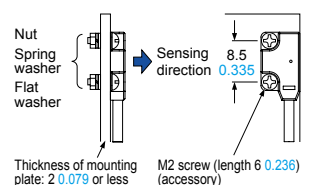
Mounting• **In case of mounting on tapped holes (Unit: mm in)****Side sensing****Front sensing**• **In case of using attached screws and nuts (Unit: mm in)****Side sensing****Front sensing**

The tightening torque should be 0.2 N·m or less.

The tightening torque should be 0.2 N·m or less.

Other

- Do not use during the initial transient time (0.5 sec. approx.) after the power supply is switched on.

SPECIFICATIONS

| Item | Type | | Thru-beam | | | | | |
|--|--------------------------|----------|---|------------------------|--|--|--|------------------------|
| | Model No. (Note 2) | Light-ON | Front sensing | Side sensing | Front sensing | Side sensing | Front sensing | Side sensing |
| | | Dark-ON | EX-Z11FA(-P)(-R) | EX-Z11A(-P)(-R) | EX-Z12FA(-P)(-R) | EX-Z12A(-P)(-R) | EX-Z13FA(-P)(-R) | EX-Z13A(-P)(-R) |
| | | | EX-Z11FB(-P)(-R) | EX-Z11B(-P)(-R) | EX-Z12FB(-P)(-R) | EX-Z12B(-P)(-R) | EX-Z13FB(-P)(-R) | EX-Z13B(-P)(-R) |
| CE marking directive compliance | | | EMC Directive, RoHS Directive | | | | | |
| Sensing distance | | | 50 mm 1.969 in | | 200 mm 7.874 in | | 500 mm 19.685 in | |
| Minimum sensing object | | | ø0.3 mm ø0.012 in opaque object (Completely beam interrupted object) (Setting distance between emitter and receiver: 50 mm 1.969 in) | | ø0.5 mm ø0.02 in opaque object (Completely beam interrupted object) (Setting distance between emitter and receiver: 200 mm 7.874 in) | | ø1.0 mm ø0.039 in opaque object (Completely beam interrupted object) (Setting distance between emitter and receiver: 500 mm 19.685 in) | |
| Hysteresis | | | — | | | | | |
| Repeatability (Perpendicular to sensing axis) | | | 0.02 mm 0.001 in or less | | 0.03 mm 0.001 in or less | | 0.05 mm 0.002 in or less | |
| Supply voltage | | | 12 to 24 V DC ±10 % Ripple P-P 10 % or less | | | | | |
| Current consumption | | | Emitter: 10 mA or less, Receiver: 10 mA or less | | | | | |
| Output | | | <NPN output type> NPN open-collector transistor • Maximum sink current: 20 mA • Applied voltage: 30 V DC or less (between output and 0 V) • Residual voltage: 1.5 V or less (at 20 mA sink current) | | | <PNP output type> PNP open-collector transistor • Maximum source current: 20 mA • Applied voltage: 30 V DC or less (between output and +V) • Residual voltage: 1.5 V or less (at 20 mA source current) | | |
| Short-circuit protection | | | Incorporated | | | | | |
| Response time | | | 0.5 ms or less | | | | | |
| Operation indicator | | | Orange LED (Lights up when the sensing output is ON) | | | | | |
| Stability indicator | | | Green LED (Lights up under the stable light received condition or the stable dark condition) | | | | | |
| Environment resistance | Protection | | IP67 (IEC) | | | | | |
| | Ambient temperature | | -10 to +55 °C 14 to +131 °F (No dew condensation or icing allowed), Storage: -30 to +70 °C -22 to +158 °F | | | | | |
| | Ambient humidity | | 35 to 85 % RH, Storage: 35 to 85 % RH | | | | | |
| | Ambient illuminance | | Incandescent light: 5,000 lx or less at the light-receiving face | | | | | |
| | Voltage withstandability | | 1,000 V AC for one min. between all supply terminals connected together and enclosure | | | | | |
| | Insulation resistance | | 20 MΩ or more, with 250 V DC megger between all supply terminals connected together and enclosure | | | | | |
| | Vibration resistance | | 10 to 500 Hz frequency, 3 mm 0.118 in double amplitude in X, Y and Z directions for two hours each | | | | | |
| | Shock resistance | | 500 m/s ² acceleration (50 G approx.) in X, Y and Z directions three times each | | | | | |
| Light emitting element | | | Red LED (Peak emission wavelength: 650 nm 0.026 mil , modulated) | | | | | |
| Grounding | | | Floating | | | | | |
| Material | | | Enclosure: PBT, Lens: Polycarbonate, Metallic part: Stainless steel (SUS304) (SUS301 for rear side of front sensing type) | | | | | |
| Cable (Note 3) | | | 0.1 mm ² 3-core (emitter: 2-core) cabtyre cable, 2 m 6.562 ft long | | | | | |
| Cable extension | | | Extension up to total 50 m 164 ft is possible with 0.3 mm ² , or more, cable (both emitter and receiver). | | | | | |
| Weight | | | Net weight (each emitter and receiver): 15 g approx., Gross weight: 35 g approx. | | | | | |
| Accessories | | | M2 mounting screws [Stainless steel (SUS304)]: 1 set (front sensing type: 6 mm 0.236 in in length; side sensing type: 10 mm 0.394 in in length) | | | | | |

Notes: 1) Where measurement conditions have not been specified precisely, the conditions used were an ambient temperature of +23°C 73°F.

2) Model Nos. having the "-P" are PNP output type and model Nos. having the "-R" are bending-resistant cable type.

3) The bending-resistant cable type has a 0.1 mm² 3-core (thru-beam type emitter: 2-core) bending-resistant cabtyre cable, 2 m **6.562 ft** long.

I/O CIRCUIT DIAGRAMS

NPN output type

I/O circuit diagram

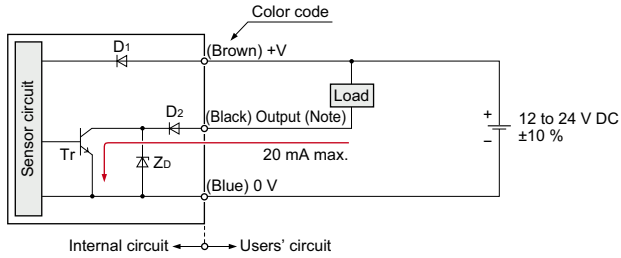

Note: The emitter does not incorporate the output.

Symbols ... D1: Reverse supply polarity protection diode
 D2: Reverse output polarity protection diode
 ZD: Surge absorption zener diode
 Tr: NPN output transistor

PNP output type

I/O circuit diagram

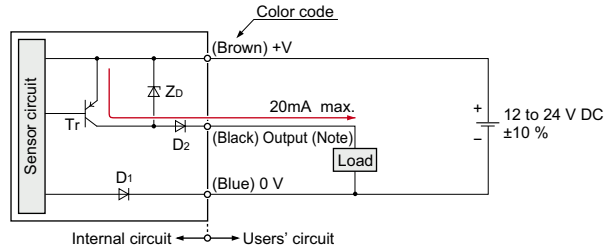

Note: The emitter does not incorporate the output.

Symbols ... D1: Reverse supply polarity protection diode
 D2: Reverse output polarity protection diode
 ZD: Surge absorption zener diode
 Tr: PNP output transistor

SENSING CHARACTERISTICS (TYPICAL)

EX-Z11F □ EX-Z11 □

Thru-beam type

Parallel deviation

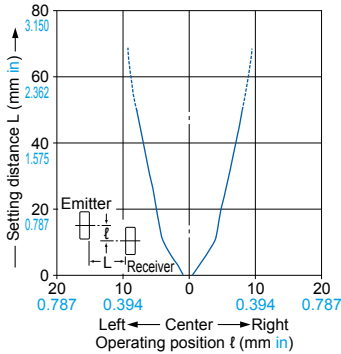

Angular deviation

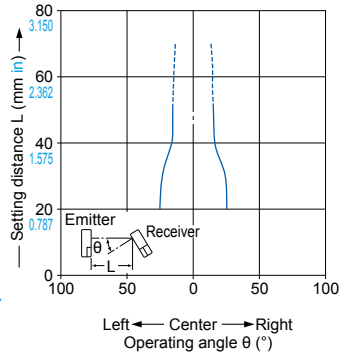

EX-Z12F □ EX-Z12 □

Thru-beam type

Parallel deviation

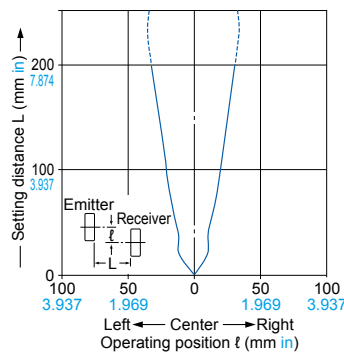

Angular deviation

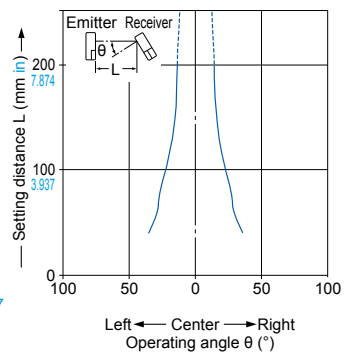

EX-Z13F □ EX-Z13 □

Thru-beam type

Parallel deviation

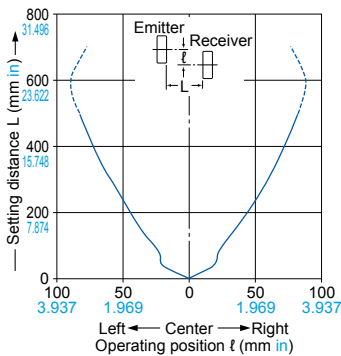

Angular deviation

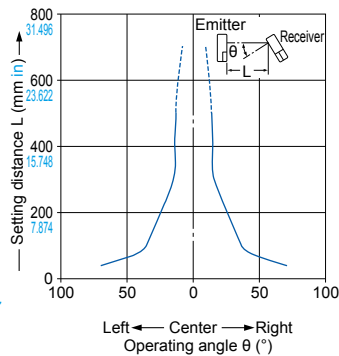

DIMENSIONS (Unit: mm in)

The CAD data can be downloaded from the website.

EX-Z11F **EX-Z12F** **EX-Z13F**

Sensor

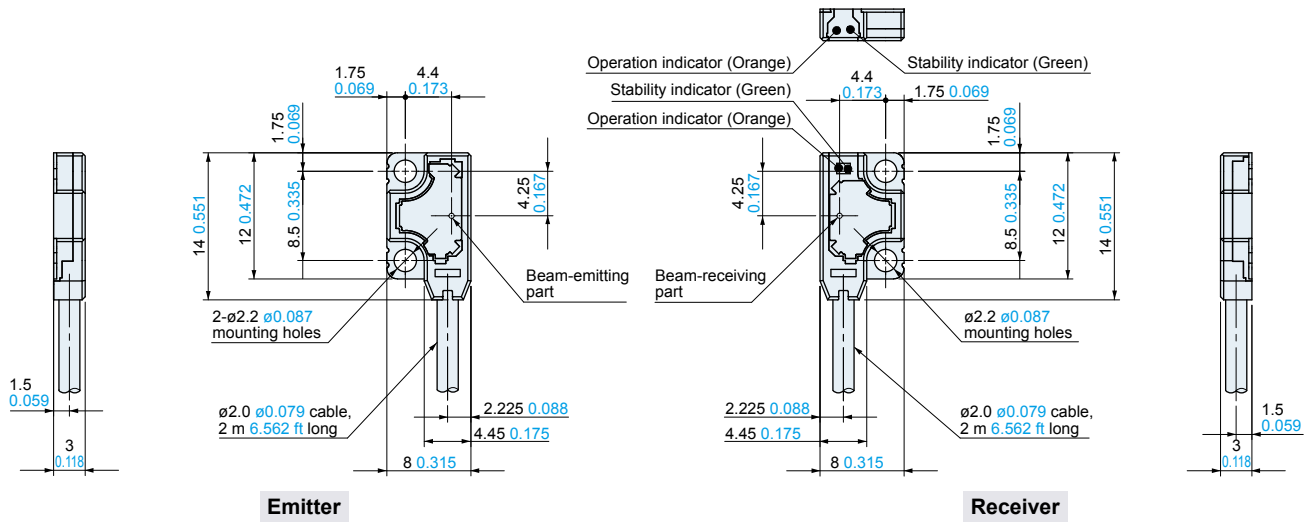
**EX-Z11** **EX-Z12** **EX-Z13**

Sensor

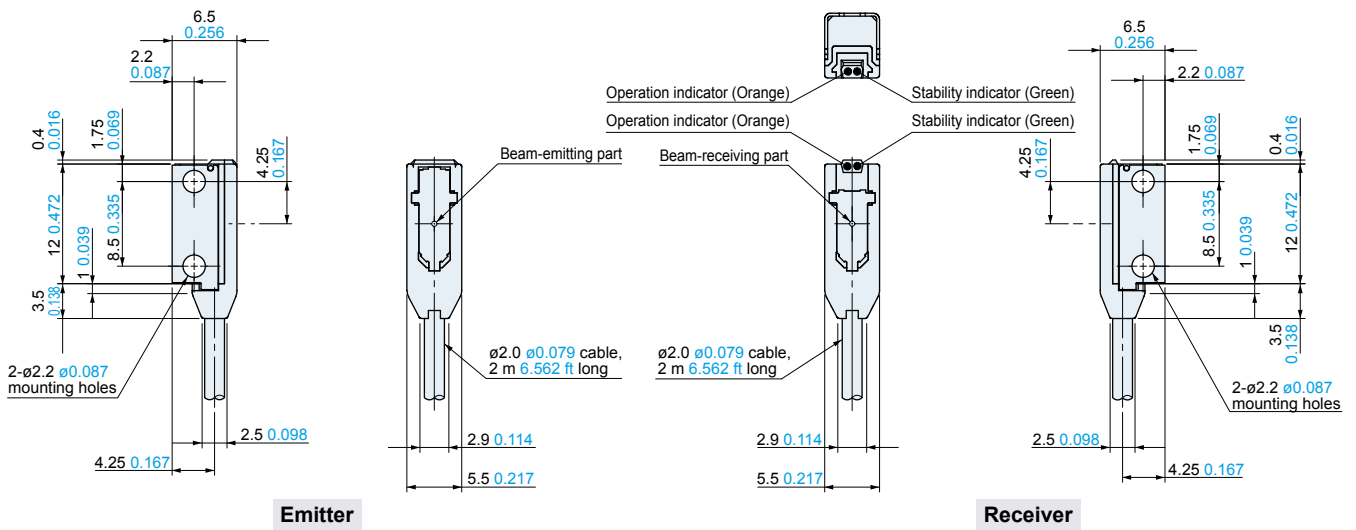
**MS-EXZ-1**

Sensor mounting bracket (Optional)

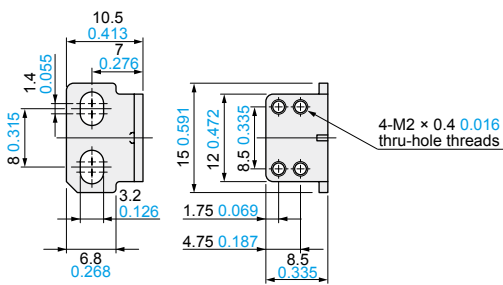

Material: Stainless steel (SUS304)

Two M2 (length 4 mm 0.157 in) pan head screws and two M2 (length 8 mm 0.315 in) pan head screws are attached.

MS-EXZ-2

Sensor mounting bracket (Optional)

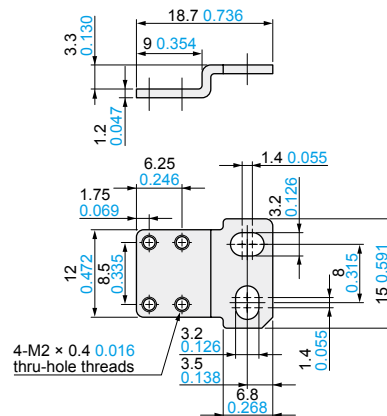

Material: Stainless steel (SUS304)

Two M2 (length 4 mm 0.157 in) pan head screws are attached.

DIMENSIONS (Unit: mm in)

The CAD data can be downloaded from the website.

MS-EXZ-3

Sensor mounting bracket (Optional)

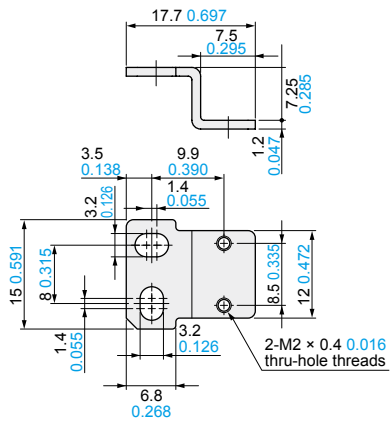

Material: Stainless steel (SUS304)

Two M2 (length 8 mm) pan head screws are attached.

MS-EXZ-4

Spacer for mounting at the back (Optional)

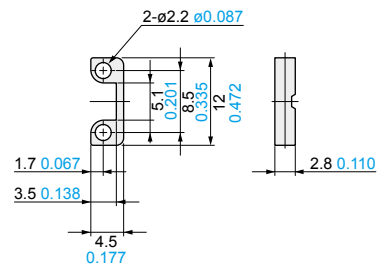

Material: Polyacetal

Set of 10 pieces

M2 (length: 10 mm) screws, nuts, spring washers and flat washers are attached. (20 pieces each)

Disclaimer

The applications described in the catalog are all intended for examples only. The purchase of our products described in the catalog shall not be regarded as granting of a license to use our products in the described applications. We do NOT warrant that we have obtained some intellectual properties, such as patent rights, with respect to such applications, or that the described applications may not infringe any intellectual property rights, such as patent rights, of a third party.

Panasonic
INDUSTRY

Panasonic Industry Co., Ltd.

Industrial Device Business Division

7-1-1, Morofuku, Daito-shi, Osaka 574-0044, Japan

industrial.panasonic.com/ac/e/