

Amplifier Built-in

Pipe-mountable
Liquid Level Detection Sensor
EX-F1

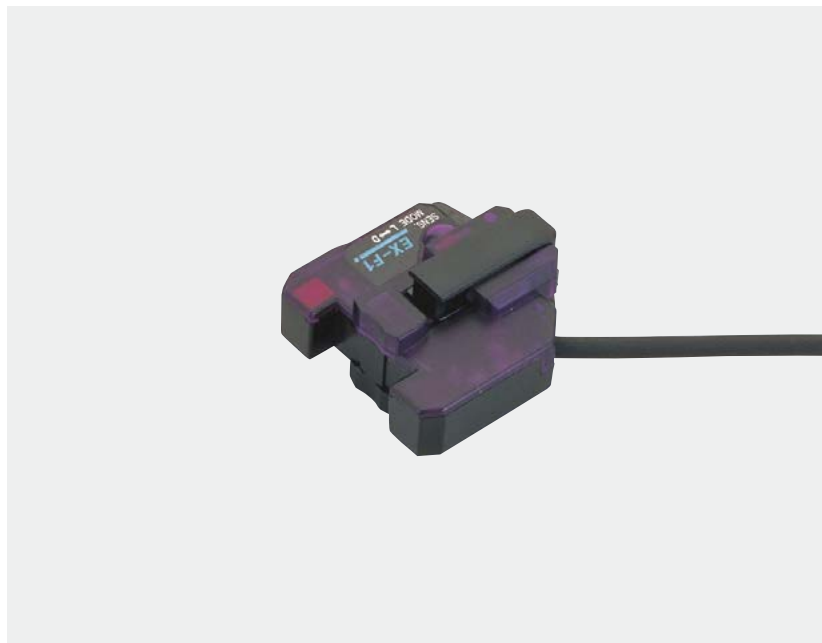

EX-F1

CE



Reliable liquid level detection with amplifier built-in low-priced sensor

Space-saving amplifier built-in type

EX-F1 amplifier built-in sensor saves space as there is no need to install a separate amplifier.

Low price

EX-F1 is very cost-effective.

Easy to check operation indicator

The operation can be checked at a glance from different directions.



Easily mountable and adjustable

Just attach it on a pipe with the tying bands. The position can be easily changed with the release lever even after mounting, so that there is no need to cut the tying bands.

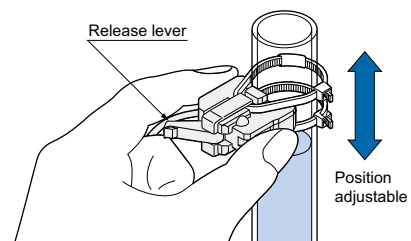

Operation mode switch

Either Light-ON or Dark-ON can be selected by a switch. This is useful to check the operation during installation because it forces the output to be turned ON or OFF even without the liquid being inside the pipe.

APPLICATIONS

Detecting liquid level in a tank

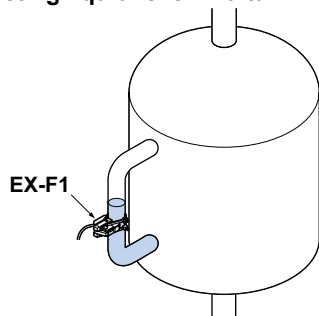

Principle of Detection

When the pipe is empty, the beam is reflected from the inner surface of the pipe wall and returns to the beam-receiving part, since the difference in the refractive indexes of the pipe and air is large. When there is liquid in the pipe, the beam enters the liquid through the wall and does not return to the beam-receiving part, since the difference in the refractive indexes of the pipe and the liquid is small.

<Empty pipe>

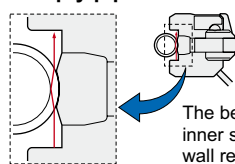

The beam reflected from the inner surface of the pipe wall returns to the beam-receiving part.

<Filled pipe>

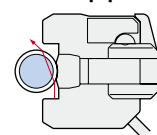

The beam passes through the wall into the liquid.

ORDER GUIDE

Type	Appearance	Sensing object	Applicable pipe diameter	Model No.
Amplifier built-in pipe-mountable 5m 16.404ft cable length type		Liquid (Note 1)	Outer dia. $\phi 6$ to $\phi 13$ mm $\phi 0.236$ to $\phi 0.512$ in transparent pipe [PFA (Fluorine resin) or equivalently transparent pipe, wall thickness 1 mm 0.039 in (Note 2)]	EX-F1 EX-F1-C5

Notes: 1) Unclear or highly viscous liquid may not be detected stably.
2) Do not use the sensor with pipes other than the above specified.

SPECIFICATIONS

Type		Amplifier built-in • Pipe-mountable
Item	Model No.	EX-F1
CE marking directive compliance		EMC Directive, RoHS Directive
Sensing object		Liquid (Note 2)
Applicable pipe diameter		Outer dia. $\phi 6$ to $\phi 13$ mm $\phi 0.236$ to $\phi 0.512$ in transparent resin pipe [PFA (Fluorine resin) or equivalently transparent pipe, wall thickness 1 mm 0.039 in] (Note 3)
Supply voltage / Current consumption		12 to 24 V DC $\pm 10\%$ Ripple P-P 10 % or less / 30 mA or less
Output		NPN open-collector transistor <ul style="list-style-type: none"> • Maximum sink current: 100 mA • Applied voltage: 30 V DC or less (between output and 0 V) • Residual voltage: 1 V or less (at 100 mA sink current) 0.4 V or less (at 16 mA sink current)
Utilization category		DC-12 or DC-13
Output operation		Switchable either Light-ON (Liquid-absent-ON) or Dark-ON (Liquid-present-ON)
Short-circuit protection		Incorporated
Response time		2 ms or less
Operation indicator		Red LED (lights up when the output is ON)
Environmental resistance	Pollution degree	3 (Industrial environment)
	Ambient temperature (Note 4)	-10 to $+55$ °C $+14$ to $+131$ °F (No dew condensation or icing allowed), Storage: -20 to $+70$ °C -4 to $+158$ °F
	Ambient humidity / Ambient illuminance	35 to 85 % RH, Storage: 35 to 85 % RH / Incandescent light: 3,000 lx or less at the light-receiving face
	Voltage withstandability	1,000 V AC for one min. between all supply terminals connected together and enclosure
	Insulation resistance	20 M Ω , or more, with 250 V DC megger between all supply terminals connected together and enclosure
	Vibration resistance	10 to 150 Hz frequency, 0.75 mm 0.030 in double amplitude in X, Y and Z directions for two hours each
Shock resistance	100 m/s ² acceleration (10 G approx.) in X, Y and Z directions three times each	
Emitting element		Infrared LED (modulated)
Material		Enclosure: Polycarbonate, Tying band: Nylon, Anti-slip tube: Silicone
Cable		0.1 mm ² 3-core cabtyre cable, 1 m 3.281 ft long
Cable extension		Extension up to total 50 m 164.042 ft is possible with 0.3 mm ² , or more, cable.
Weight		Net weight: 15 g approx., Gross weight: 60 g approx.
Accessories		Tying band: 2 pcs., Anti-slip tube: 2 pcs.

Notes: 1) Where measurement conditions have not been specified precisely, the conditions used were an ambient temperature of $+20$ °C $+68$ °F.
2) Unclear or highly viscous liquid may not be detected stably.
3) Do not use the sensor with pipes other than the above specified.
4) Liquid being detected should also be kept within the rated ambient temperature range.

I/O CIRCUIT AND WIRING DIAGRAMS

I/O circuit diagram

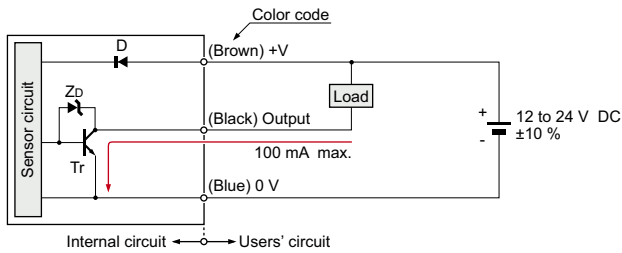

Symbols ... D : Reverse supply polarity protection diode
 ZD: Surge absorption zener diode
 Tr : NPN output transistor

Wiring diagram

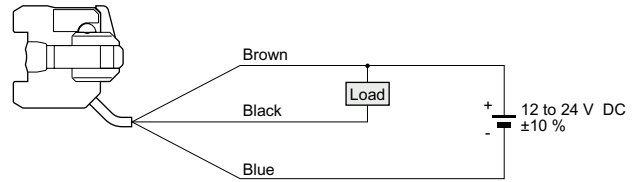

PRECAUTIONS FOR PROPER USE



- Never use this product as a sensing device for personnel protection.
- In case of using sensing devices for personnel protection, use products which meet laws and standards, such as OSHA, ANSI or IEC etc., for personnel protection applicable in each region or country.

Mounting

- Mount the sensor on a pipe with the attached tying bands and anti-slip tubes as shown in the figure below. Make sure that the release lever is retracted (position as in the figure) before mounting. Fasten two tying bands, as shown, and cut off the excess portions.

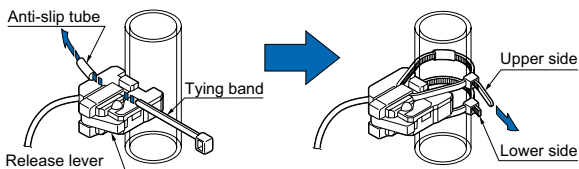

- If other tying bands are to be used, the dimension \textcircled{A} shown in the figure below should be 2.5 mm **0.098 in** or less.

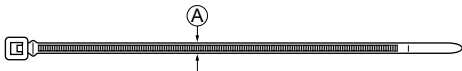

Selecting output operation

- Either Light-ON (Liquid-absent-ON) or Dark-ON (Liquid-present-ON) can be selected with the operation mode switch according to your application.

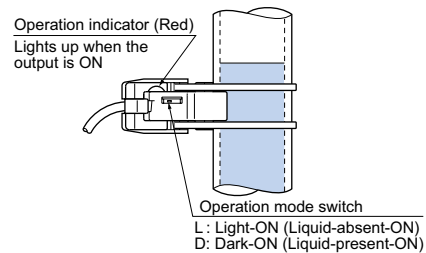

- The indicator operation and the output operation are different with the setting of the operation mode switch as given in the table below.

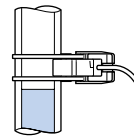

Liquid-absent

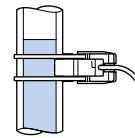

Liquid-present

☀: Lights up ●: Lights off

MODE	Sensing condition	Operation indicator	Output operation
Light-ON (Liquid-absent-ON)	Liquid-present	●	OFF
	Liquid-absent	☀	ON
Dark-ON (Liquid-present-ON)	Liquid-present	☀	ON
	Liquid-absent	●	OFF

PRECAUTIONS FOR PROPER USE

Others

- Do not use during the initial transient time (50 ms) after the power supply is switched on.
- Do not use this sensor with a pipe which is not transparent.
- Unclear or highly viscous liquid may not be detected.
- Fit the sensor to the pipe securely, otherwise the operation may be erroneous.
- Take care that no dew condenses on the pipe's sensing surface or the pipe's inside wall and that no bubble attaches on the pipe's inside wall, since it can affect the operation.
If a liquid drop flows down across the sensing point or an air bubble sticks on the wall at the sensing point, the operation may be erroneous. Make sure that no bubble arises in the liquid, and that no dew or liquid drop is present on either surface of the pipe wall.
- **EX-F1** is not water-proof or chemical-resistant. Installation should be avoided at any place where it could come in direct contact with water or chemicals.

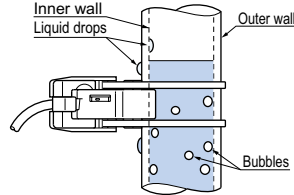

DIMENSIONS (Unit: mm in)

The CAD data can be downloaded from our website.

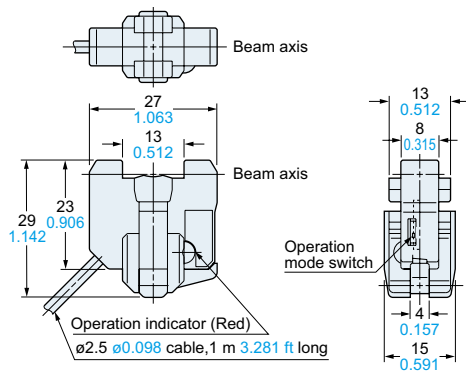

Disclaimer

The applications described in the catalog are all intended for examples only. The purchase of our products described in the catalog shall not be regarded as granting of a license to use our products in the described applications. We do NOT warrant that we have obtained some intellectual properties, such as patent rights, with respect to such applications, or that the described applications may not infringe any intellectual property rights, such as patent rights, of a third party.

Panasonic
INDUSTRY

Panasonic Industry Co., Ltd.

Industrial Device Business Division

7-1-1, Morofuku, Daito-shi, Osaka 574-0044, Japan

industrial.panasonic.com/ac/e/